

# Electronic Design

THE MAGAZINE OF ESSENTIAL NEWS, PRODUCTS AND TECHNOLOGY

VOL. 14, NO.

# 4

FEB 15, 1966

**Vidicon on a wafer** is on its way. Researchers unveil its details at the 1966 Solid State Circuits Conference. They have evaporated a 180-line image

sensor with 32,400 photodiodes on a wafer  $3/8 \times 3/8$  square. This and other new developments from the sessions of the SSCC are presented starting on p 17.



# CLIFTON

## steps in to the Stepper Motor field

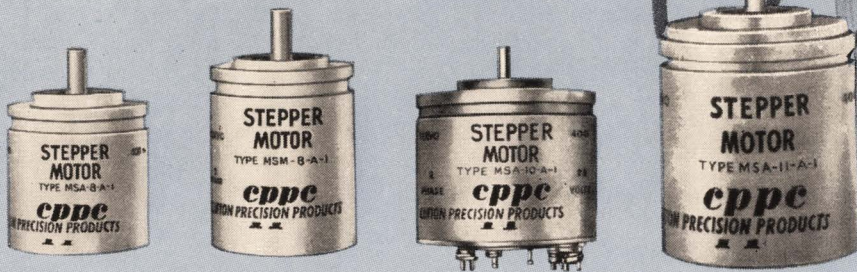

### CLIFTON STEPPER MOTORS

SIZE	8	8	10	10	11	11	8	8	8	11
LENGTH (M.F.)	0.770	0.770	0.770	0.770	1.215	1.215	1.062	1.112	0.770	1.215
WEIGHT (OZ.)	1.0	1.0	1.6	1.6	3.2	3.2	1.5	1.5	1.0	3.2
INERTIA (GM-CM <sup>2</sup> )	0.19	0.19	0.19	0.19	0.77	0.37	0.18	0.45	0.19	0.77
INDEX ANGLE	90° ±3°	90° ±3°	90° ±3°	90° ±3°	90° ±3°	15° ±1°	90° ±3°	90° ±3°	45° ±2°	45° ±2°
TYPE	PM 2∅	PM 2∅	PM 2∅	PM 2∅	PM 2∅	VR 3∅	PM 2∅	PM 2∅	PM 2∅	PM 2∅
RATED D.C. VOLT.	28V	28V	28V	28V	28V	28V	28V	28V	28V	28V
RESISTANCE (OHMS/PHASE)	460	300	300	300	300	150	300	300	135 per PHASE	130 per PHASE
NO LOAD RESPONSE RATE PULSE/SEC	250	320	350	330	220	600	360	280	600	440
NO LOAD SLEW RATE PULSE/SEC	510	930	700	610	265	1600	375	650	2700	1200
HOLDING TORQUE OZ-IN ONE PHASE	0.37	0.35	0.50	0.53	1.1	0.60	0.80	0.58	0.60	1.5
DETENT, OZ-IN ZERO INPUT	0.12	0.05	0.05	0.13	0.24	—	0.17	0.10	0.05	0.12
TYPE NUMBER	MSA-8-A-1	MSA-8-A-2	MSA-10-A-1	MSA-10-A-2	MSA-11-A-1	RSA-11-A-1	MSM-8-A-1	MSL-8-A-1	MSA-8-A-3	MSA-11-A-2

EXCITATION MODE: TWO PHASES PARALLELED ALTERNATELY.

After careful testing and having already had units in end-use equipment in the field, we are now ready to announce a full line of size 8, 10 & 11 stepper motors and the controllers that go with them.

Steppers are gaining popularity rapidly in digital systems because of their quick response, high resolution, and many other distinct advantages over the con-

ventional servo motor.

We'd like to step in to your stepper motor picture with Clifton Precision quality, reliability and application knowledge.

Clifton Precision Products, Division of Litton Industries, Clifton Heights, Pa., Colorado Springs, Colo. Area 215 622-1000; TWX 215 623-6068.

**cppe** **CLIFTON** PRECISION PRODUCTS  
DIVISION OF LITTON INDUSTRIES



ON READER-SERVICE CARD CIRCLE 234

Speed Inquiry to Advertiser via Collect Night Letter

# With this Analog Frequency Meter you can:



Measure directly  
from 3 c/s to 1.5 Mc/s

Monitor changes in frequency  
with easy-to-follow analog meter

Measure fm deviation  
and incidental fm

Record directly  
from the 1- to 5-mA output

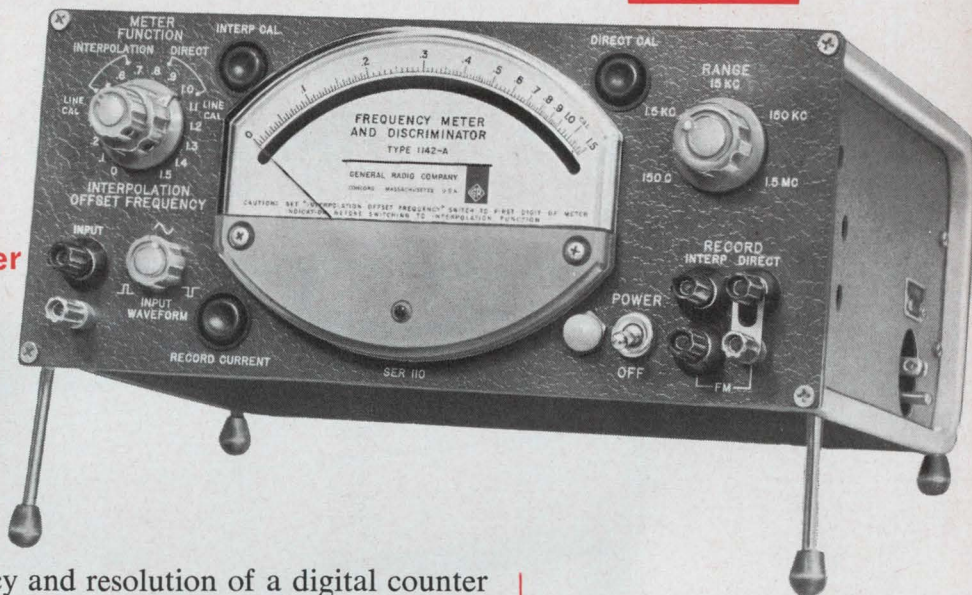

Do you always need the accuracy and resolution of a digital counter to make your frequency measurements? Many measurements require only a small fraction of a counter's capability, and can be made as well, if not better, with an analog instrument. A GR Type 1142-A Frequency Meter and Discriminator for these measurements can save you hundreds of dollars in primary and accessory equipment costs.

The Type 1142-A is an analog instrument with  $\pm 0.2\%$  accuracy. Its large, logarithmic meter and dc recorder output (1- to 5-mA) make it particularly useful for monitoring frequency changes and stability; drift measurements at 100 Mc/s can be made to a resolution of one part in  $10^9$  with heterodyne techniques, for example. Accurate measurements are possible with input signals of only 20 mV, thanks to this instrument's high sensitivity.

This instrument is also an extremely linear fm discriminator, with residual fm noise at least 100 dB below full output. It can be used with an ac voltmeter to measure fm deviation, or with a wave analyzer to determine individual components of incidental fm in oscillators and multipliers.

## SPECIFICATIONS:

**Frequency Range** — 3 c/s to 1.5 Mc/s in five decade ranges.

**Input Sensitivity** — 20 mV from 20 c/s to 150 kc/s, rising to 200 mV at 3 c/s and 1.5 Mc/s. Impedance: 100 k $\Omega$ , dropping to a minimum of 5 k $\Omega$  above 500 kc/s.

**As a Frequency Meter** — Logarithmic meter maintains constant accuracy. Calibrated interpolator effectively expands meter scale by a factor of 10. Higher frequency measurements can be made by heterodyne techniques. Readings independent of waveform.

**As a Discriminator** — Output is 15V, full scale. Low noise; residual fm is down more than 100 dB below 1 Mc/s.

**Accuracy** — In the "direct" mode, 1% of reading. In the "interpolate" mode, 0.2% of full scale.

**Recorder Outputs** — Adjustable from 1 mA to 5 mA; current proportional to input frequency. Interpolator output for high-Z recorders; voltage is proportional to frequency deviation.

**Price** — \$595 in U.S.A.



## Measure Directly to 15 Mc/s

GR's new Type 1156-A Decade Scaler is a completely self-contained 10:1 divider of any input frequency up to 100 Mc/s. A five-position input attenuator provides sensitivities of 0.1, 0.2, 0.5, and 1 volt, peak-to-peak (35 mV to 0.35 V, rms), at 50 ohms;

and 1 volt, peak-to-peak (0.35 V rms), at 500 ohms. Output is a 20-mA square wave that delivers 1 volt into a 50-ohm load, sufficient to operate most frequency meters without amplification. \$490 in U.S.A.

## GENERAL RADIO COMPANY

WEST CONCORD, MASSACHUSETTS

IN CANADA: Toronto 247-2171, Montreal (Mt. Royal) 737-3673  
IN EUROPE: Zurich, Switzerland — London, England

BOSTON (W. Concord) 646-0550    NEW YORK, N. Y. (Ridgefield, N. J.) 943-3140    CHICAGO (Oak Park) 848-9400    PHILADELPHIA (Ft. Washington) 646-8030    WASHINGTON, D.C. (Rockville, Md.) 946-1600    SYRACUSE 454-9323    DALLAS ME 7-2240    SAN FRANCISCO (Los Altos) 948-8233    LOS ANGELES 469-6201    ORLANDO, FLA. 425-4671    CLEVELAND 886-0150

ON READER-SERVICE CARD CIRCLE 212

# From REDCOR's Original Modular Systems Component Concept, evolves the 663 series\* "TOTAL SYSTEM IN A BOX."

\*Digital Monolithic and Linear Hybrid Integrated Circuit All Silicon Construction.



## FEATURES

- SYSTEM REPEATABILITY AND RESOLUTION —  $\pm 0.01\%$   $\pm \frac{1}{2}$  L.S.B., 3 sigma error distribution (15 bit binary or 17 bit BCD).
  - SYSTEM THROUGHPUT RATES — 43 kc at 13 bits and 36 kc at 15 bits.
  - DIFFERENTIAL SAMPLE AND HOLD — Aperture time less than 100 nanosecs; 5  $\mu$ secs settling time. (0.01%)
  - HIGH INPUT IMPEDANCE — 100 megohms for both differential and common mode signals (selected or unselected channels).
  - ANALOG-DIGITAL GROUND ISOLATION is obtained by differential amplifiers with high common mode rejection maintaining a system accuracy of 0.01%.
  - OVERLOAD RECOVERY — Each input is clamped so that the system will recover from a 100 V overload in one channel time.
  - "NO COST" OPTIONS include true and false digital outputs, positive or negative logic levels from 6 V to 12 V, Absolute Value and Sign or complement output coding, internal-external bit clock, and internal-external reference.
  - AUTOMATIC — sequential or random access multiplexer address, internal-external bit clock. MANUAL by front panel multiplexer advance and A-D start.
  - EXTRA CARD SLOTS for expansion of the basic system using compatible REDCOR modules to meet specific customer total data acquisition systems requirements.
  - MULTIPLEXER EXPANDABLE from 1 to 256 channels in 1 channel increments (1 plug-in microelement per channel).
  - INTEGRATED CIRCUIT DESIGN AND ALL SILICON DESIGN increases system reliability and overall performance; reduces physical size; lowers system power consumption.
  - MTBF — Calculated per MIL handbook 217 — 3500 hours. Actual experience in excess of 36 machine months operation with no failures.
  - TOTAL PLUG-IN FEATURES including power supply and front panel assembly provides unique ease of maintenance.
  - PLUG-IN MICROELEMENTS allow inexpensive spares provisioning and minimizes total troubleshooting costs.
  - BUILT-IN FILTER AND ATTENUATOR — No reduction in number of channels necessary.
  - EXTERNAL REFERENCE — The A-D Converter can be slaved to an external reference voltage if desired.
  - PATCHABLE number of sequence positions or channels.
  - TEST POINTS on the integrated circuit modules eliminates the necessity of back-plane probing.
  - COMPLETE FUNCTIONS are contained on individual 8"x12" modules for ease of maintenance. The system consists of only 5 different types of modules including power supply.
- For complete specifications, write for Brochure 663.

**REDCOR**

*complete systems compatibility*

7800 DEERING AVE., P.O. BOX 1031, CANOGA PARK, CALIFORNIA 91304

Phone: (213) 348-5892 • TWX 213-348-2573

*An Equal Opportunity Employer*

Speed Inquiry to Advertiser via Collect Night Letter  
ON READER-SERVICE CARD CIRCLE 1

---

## NEWS

- 13 News Report
- 17 **Novelty abounds at solid-state conference**  
Technical papers with subjects ranging from a solid-state vidicon to new ICs, hybrid microwave and memory devices are discussed in this survey.
- 22 National role for reliability                      31 Washington Report
- 24 Cryogenic dc transformer                      34 Electronics at Boat Show
- 28 Parametric amplifier                      36 Letters
- 28 \$1000 Idea-of-the-Year award
- 47 **Editorial:** Dispersal—one answer to civil defense

---

## TECHNOLOGY

- 50 **Receiving unwanted signals?** Then shore up the port-to-port isolation of your phase detector via complementary transistors in a beta-multiplier circuit.
- 56 **Try IC gate-ring counters!** Not only are they feasible, but they offer certain advantages over other types of microelectronic counters.
- 62 **Testing coaxial cables** involves more than meets the eye. Cables respond differently for cw and for pulsed signals, and tests must check out both domains.
- 70 **Guarantee circuit performance!** Use this current-mode technique for worst-case design. It's simple, quick and reliable.
- 78 **A/D converter goes adaptive** and features many advantages over conventional converters. This one uses level sensing and current switching.
- 84 **Find the received signal level** through a quick graphical technique. The graph evaluates the loss factors and establishes the received signal strength.
- 104 **Build a tone-burst generator** for \$50.00. If your transient-testing needs are conventional, extensive costly digital circuitry is not a must.
- 88 **Ideas for design**

---

## PRODUCTS

- 110 **Systems:** Miniature 14-bit A-D converter gives 2 microsecs per bit
- 114 **Semiconductors:** 200 MW at 2 GHz from this microwave oscillator
- 120 **Test Equipment:** Voltage and phase-angle measurements, 1 MHz-1 GHz
- 124 **Components:** Differential op-amp has Schmitt trigger applications
- 118 Power equipment
- 138 Materials
- 140 Microwaves
- 142 Production

---

## Departments

- 156 Advertisers Index
- 152 Application Notes
- 154 Designer's Datebook
- 144 New Literature

# DESIGNER'S

P. R. MALLORY & CO. INC., INDIANAPOLIS, INDIANA 46206

## New miniature tantalum capacitor for microcircuits

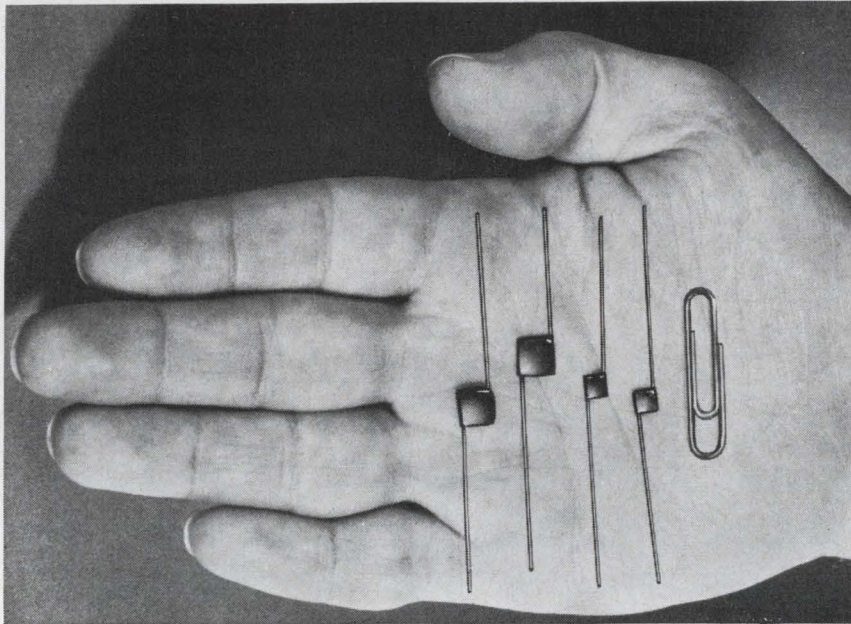

The Mallory TUR is a miniature solid electrolyte tantalum capacitor designed for use with integrated circuits, thin film and other micro-electronic circuits. It is supplied un-encapsulated to provide extremely small size per rating. It is intended for use with microcircuits where it will be encapsulated after assembly.

The TUR has a new configuration which provides maximum capacity per unit volume. It's a square chip, only .225" to .325" square, and .04" to .170" thick depending on rating. It is supplied with an electrically insulating coating on the positive side of the case, so it can be stacked or placed directly on the circuit chip or board prior to encapsulation. When properly pre-dried and encapsulated, it withstands MIL environments.

CV (capacity x voltage) product is extremely high. Ratings range from

47 mfd., 6 VDC to 15 mfd., 50 VDC. Temperature rating is  $-55^{\circ}\text{C}$  to  $+85^{\circ}\text{C}$ , de-rated linearly to  $\frac{2}{3}$  voltage at  $125^{\circ}\text{C}$ . DC leakage is low. Three configurations keyed to lead position are available. Standard units are polarized; non-polarized units on special order. Leads are gold-plated ribbons, can be welded or soldered.

### DIMENSIONS

Case Size	A Max.	B Max.	C Max.
A	.225	.225	.040
B	.225	.225	.050
C	.225	.225	.060
D	.225	.275	.075
E	.225	.225	.110
F	.325	.325	.060
G	.325	.325	.075
H	.325	.325	.110
J	.325	.325	.125
K	.325	.325	.170

CIRCLE 105 ON READER SERVICE CARD

## Reducing costs with Mallory packaged rectifier circuits

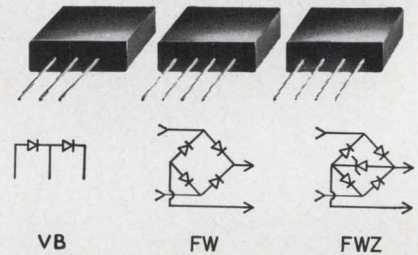

You can save both on component costs and on assembly costs, with Mallory rectifier packages. Each of these factory-connected circuits costs less than what you would pay for an equivalent number of separate rectifiers. The four-rectifier bridge package costs less than four separate rectifiers, and the full-wave and doubler packages cost less than a pair of rectifiers.

Savings in assembly come from reduction in number of soldered connections which you need to make . . . one less on a doubler or full-wave circuit, two less on a bridge. You can figure it out for your own conditions, but here's a typical analysis. At a labor rate of \$1.60 per hour, the saving is about \$300 per 25,000 doubler packages, or \$600 per 25,000 bridge packages. Extra reliability due to fewer solder joints is a plus value.

Cold-case encapsulated circuits include Type FW full wave bridge, Type VB voltage doubler, Type CT full-wave center tap with either positive or negative polarity . . . all rated for  $100^{\circ}\text{C}$ , in PRV values from 50 to 600 volts. Bridge circuits, Type FWZ, are also supplied with an integral, factory-connected zener diode across DC output terminals; all standard zener voltage ratings are available in this configuration.

CIRCLE 106 ON READER SERVICE CARD

## Improved heavy-duty performance now provided by Mallory Alkaline Batteries

Recent refinements in Mallory Alkaline Batteries increase their ability to deliver long life at higher values of current drain, and further improve their advantage over conventional zinc-carbon batteries both in service dependability and cost per hour.

This added capability is the result of new internal construction which increases the effective anode area in relation to cell volume. Internal impedance of the cell is reduced, particularly at low temperatures. At 70°F ambient, the Mallory alkaline system delivers up to 7 times more hours of service on continuous heavy drain than ordinary batteries (see chart). At 32°F, the improvement in performance is even better.

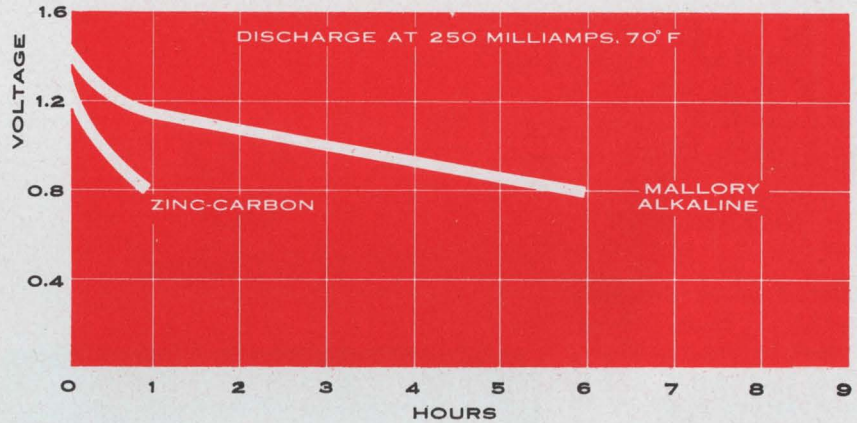

Added refinements in case and seal construction have also been made to insure reliability of the seal under even the most severe vibration.

Mallory Alkaline Batteries with the new construction are available in a broad range of standard cell configurations.

CIRCLE 107 ON READER SERVICE CARD

## Circuit breaker-switch now available on Mallory controls

The OCB breaker-switch eliminates the need for a separate circuit breaker by combining overload protection and line switch into a single, compact unit. It's an extra convenience idea for television and stereo equipment, for instruments and any products which require overload breakers under 5 amperes.

To reset the breaker after it trips, you simply turn the switch back to OFF, then to ON. You cannot hold the breaker closed against an overload.

Holding current is factory-set to your specifications; standard range is 1.25 to 1.9 amperes, with special models available up to 5 amperes.

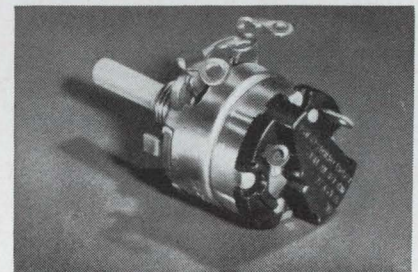

OCB breaker switch attached to volume control.

Break current is 50% higher than holding current. The OCB switch will withstand a 10% overload for 4 hours at 65°C ambient. It will take a 50 ampere surge, peaking in 1.6 millisecond and decaying to normal in 3 millisecond, without opening or being damaged.

The OCB is supplied attached to standard Mallory volume controls as a rotary on-off switch, or can be supplied as a separate breaker switch. As a combination control-switch-breaker, it offers savings in total component and assembly cost.

CIRCLE 108 ON READER SERVICE CARD

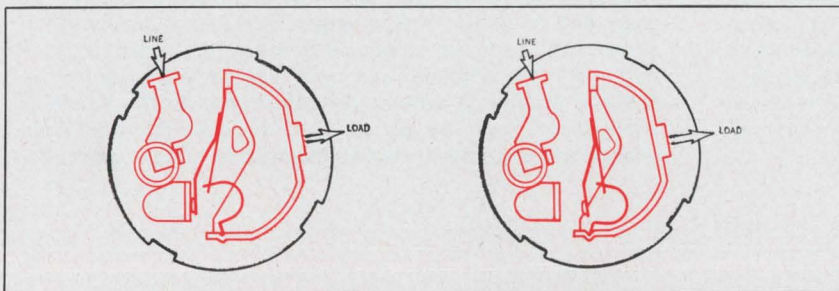

Diagrams show operation of breaker mechanism: at left, in MAKE position; at right, in BREAK position.

ON READER-SERVICE CARD CIRCLE 105 thru 108

# AIRPAX Signal Conditioning Amplifier

The Airpax MAS50 Signal Conditioning Amplifier is a dc-to-dc amplifier. It converts a transducer signal (current or voltage) to a standard output range of 0 to +5 vdc. Input is differential and floating. • Voltage gain, 0 to 100 with a stability of  $\pm 0.01\%$  per degree C. • Linearity is within 0.1% of full scale. • Zero null stability of 0.5 microvolts per degree C. • Common mode rejection at 60 CPS is 120 db minimum.

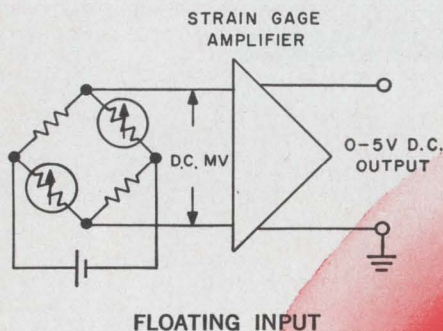

**Strain-Gage Amplifier:** Extremely high rejection of common mode interference by the MAS50 enables it to operate with a floating input circuit, as in strain gage applications. The signal, after conditioning by the amplifier, can be multiplexed with other conditioned signals because any number of MAS50's can share a common ground at their outputs.

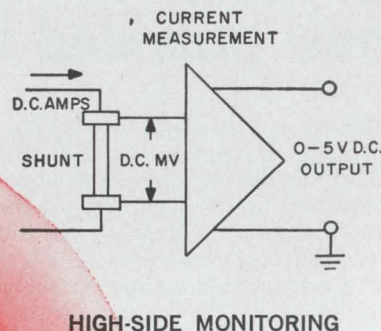

**Current Measurement:** Having its input well insulated, the MAS50 can be connected across a shunt in the high side of a line if necessary. For example, measurement of the plate or screen current of a power tube operating at high voltages can be done with the case of the MAS50 grounded.



**\$157**  
EACH  
(1 to 6 pieces)

TYPE MAS50

Delivery  
from stock

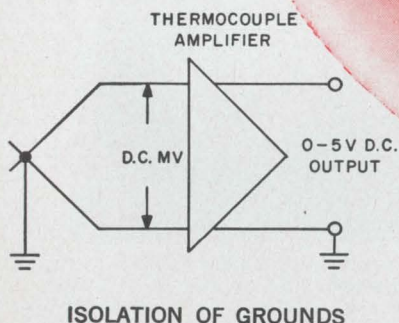

**Thermocouple Amplifier:** In applications such as amplification of a thermocouple output, the MAS50 combines inherently stable high gain with negligible drift in zero offset. Because input and output are electrically isolated from each other, the input can be either grounded or ungrounded while the output has one side grounded. Calibration of thermocouple lead length is unnecessary in normal-length runs because amplifier input resistance is much higher than thermocouple resistance.

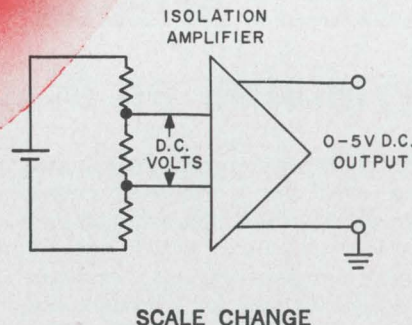

**Isolation Amplifier.** Basically the MAS50 is an active 4-terminal device that produces 0 to +5 vdc output from a 0 to 50 microampere input. The amplifier provides a change of scale and of zero in several ways: by using a resistance in series with the input, by choice of a voltage gain of 1 or of 100 within the amplifier and by a bias current through the auxiliary winding. A screwdriver adjustment on the amplifier changes the gain by about 20% to calibrate the scale change and to compensate for tolerance in metering circuits.

**AIRPAX ELECTRONICS** Incorporated Seminole Division, Fort Lauderdale, Florida

PHONE 305 587-1100 • TWX 305 587-1000

ON READER-SERVICE CARD CIRCLE 2



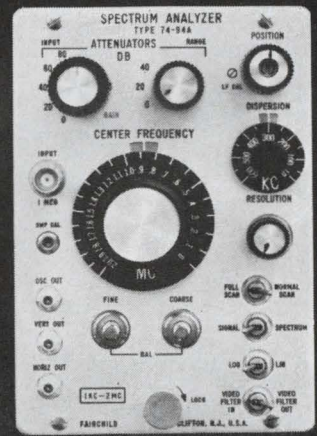
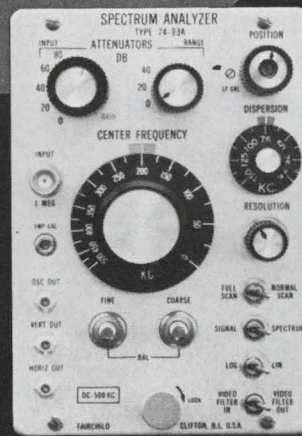
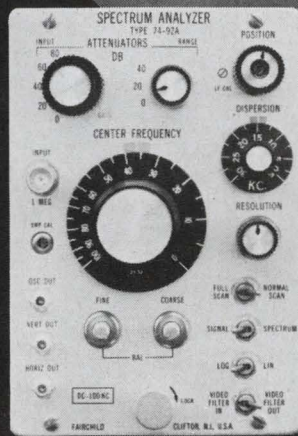
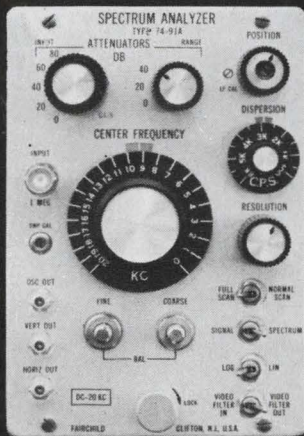
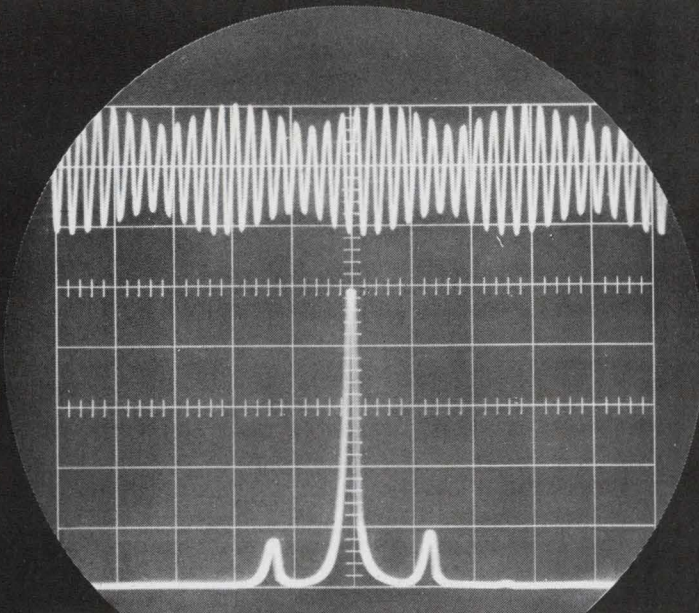

## These new plug-ins make your Fairchild scope a versatile spectrum analyzer

Four new spectrum analyzer plug-ins for Series 765H oscilloscopes give you unique measurement capabilities. These range from low frequency vibration analysis through noise density measurements to telemetry analysis, either on a swept or manually tuned basis. Manual tuning allows frequency measurement to an accuracy as high as three parts in  $10^9$ . Other applications include percentage modulation and deviation; oscillator analysis; distortion and spectral density measurement; sonar; VLF transmitter design and alignment. Specifically, these four plug-ins provide bandwidths from DC to 20, 100 and 500 kc, and from 1 kc to 2 mc. Prices range from \$820 to \$950. Available soon: additional units with bandwidth capability into the microwave region.

For additional versatility two analyzers in a Fairchild 777 dual beam scope permit two simultaneous displays on the same tube. Thus, in telemetry subcarrier oscillator analysis you can observe the complete subcarrier band together with any desired section of it. Or, with proper

choice of plugs-ins, both frequency domain (spectral display) and time domain (standard scope display) are presented simultaneously on the single CRT. No other spectrum analyzer offers these features. For informative Application Note No. 108 and specification, write Fairchild Instrumentation, 750 Bloomfield Avenue, Clifton, N.J.

**FAIRCHILD**  
INSTRUMENTATION

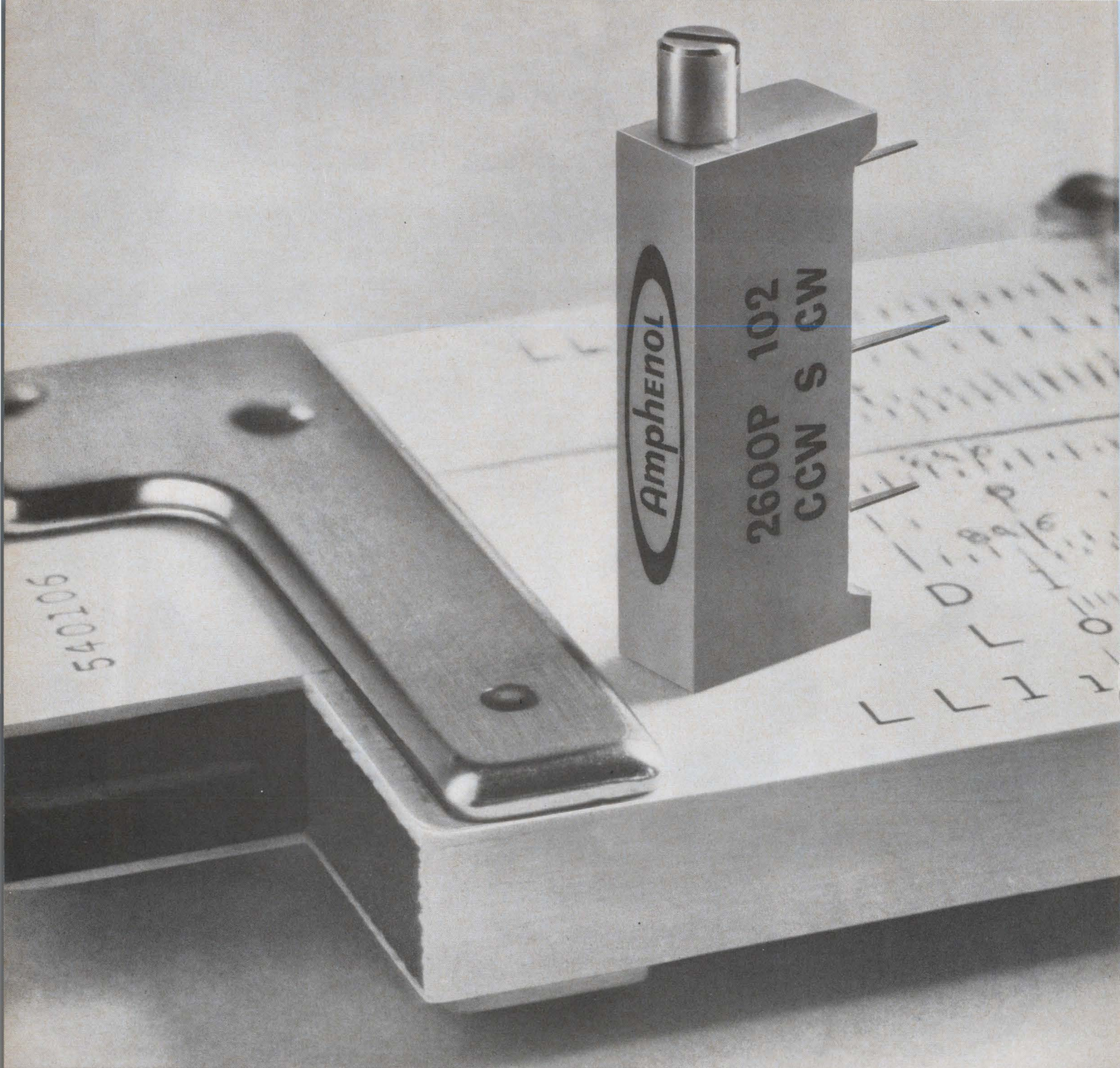

***17 ways to design circuits  
better with this tiny  
\$1.46 commercial trimmer***

Check the list at right. This Amphenol 2600 trimmer rates 17 ways better than the next best commercial trimmer. All for less cost.

**SIMPLIFIED DESIGN.** Just  $\frac{3}{4}$ " long and .04 ounce, the 2600 has only seven parts. By eliminating interconnecting parts, assembly is easy. We mass-produce the 2600—over 1 million this



ACTUAL SIZE

Speed Inquiry to Advertiser via Collect Night Letter  
ON READER-SERVICE CARD CIRCLE 214



year—with big savings for you. (Even Amphenol's \$2 humidity-proof 2610 costs only one-fifth as much as similar trimmers.)

**53% BETTER RESOLUTION.** Simplified design has eliminated mounting holes, so the mandrel runs the full length of the trimmer. Result: you get resolution from .22% to 1.78%—up to 53% better than competitive trimmers.

And you get Amphenol quality.

Like silver-brazed terminations. Gold-plated external metal parts. A low-mass wiper that can't shift under shock or vibration. Self-lock lead-screw. And the exclusive ratcheting clutch that prevents end-turn damage.

**OFF-THE-SHELF DELIVERY.** You can get 2600's or 2610's right away from your local Amphenol Industrial Distributor's shelf stocks. Or call your Amphenol Sales Engineer. Or write us in Janesville, Wis.

Feature	Amphenol 2600	*Brand B 1 inch
Power rating	1 watt at 40°C	.5 watt at 25°C
Temp. range °C	-65° to +125°	-55° to +85°
No. of turns	20 Full turns	Only 15 turns
Humidity	MIL-STD-202A	No
Weight	.04 oz.	.10 oz. (approx.)
End settings	to 1.0%	to 2.0%
Dielectric strength	1000 vac	500 vac
Noise	100 ENR Max.	
Insulation resistance	100 Meg. Min.	
Shock	50 g's	
Vibration	20 g's	
Acceleration	50 g's	
Sand & dust	MIL-E-5272C	
Fungus	Non-nutrient	
Load Life	2000 hours	
Mechanical life	200 cycles	
Price (25-49)	\$1.46 each	\$1.54 each

\*Sources dated 3/65, 5/63



**AMPHENOL CONTROLS DIVISION**  
AMPHENOL CORPORATION

Specify Amphenol . . . the leading name in cable, connectors, assemblies, RF switches, potentiometers, motors, microelectronics

# Did you know Sprague makes...?

## UNICIRCUIT® RCTL INTEGRATED CIRCUITS

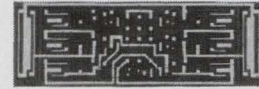

(8x actual size)

Sprague Series US-0100 . . . a complete line of monolithic digital building blocks featuring low power consumption (2 mW typ.)

ON READER-SERVICE CARD CIRCLE 820

## UNICIRCUIT® RTL INTEGRATED CIRCUITS



TO-5 CASE

Types US-0708 through US-0721 . . . Fully interchangeable mW digital building blocks featuring power consumption of 4 mW/node and propagation delay of 40 nanoseconds.

ON READER-SERVICE CARD CIRCLE 821

## DIFFERENTIAL AMPLIFIER TRANSISTOR PAIRS

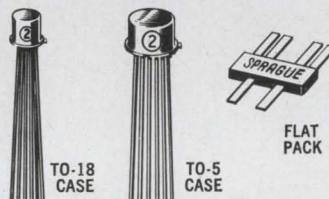

NPN or PNP • Matched characteristics.  
 $h_{FE} = 10-20\%$ .  $\Delta V_{BE} = 5-20$  mV.  
 $\Delta V_{BE}/Temp = 5-20$   $\mu V/^{\circ}C$ .

ON READER-SERVICE CARD CIRCLE 822

## MULTIPLE TRANSISTORS (NPN-PNP PAIRS/QUADS)

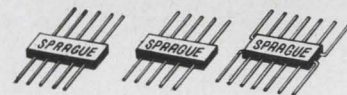

AMPLIFIERS SWITCHES CHOPPERS

Pairs		Quads	
2 NPN	2 PNP	4 NPN	4 PNP
1 NPN—1 PNP		2 NPN—2 PNP	

ON READER-SERVICE CARD CIRCLE 823

## UNICIRCUIT® CUSTOM HYBRID CIRCUITS

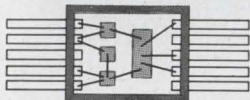

Combine monolithic silicon circuits with Ni-Cr alloy resistors. Close resistance tolerances, low temperature coefficient,  $\pm 2\%$  resistor matching.

ON READER-SERVICE CARD CIRCLE 824

## LOW-COST HERMETICALLY- SEALED PLANAR TRANSISTORS

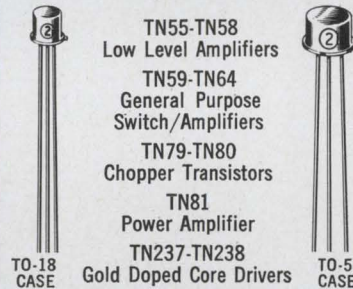

TO-18 CASE TO-5 CASE

TN55-TN58 Low Level Amplifiers  
 TN59-TN64 General Purpose Switch/Amplifiers  
 TN79-TN80 Chopper Transistors  
 TN81 Power Amplifier  
 TN237-TN238 Gold Doped Core Drivers

ON READER-SERVICE CARD CIRCLE 825

## SILICON ALLOY REPLACEMENT TRANSISTORS

### FULL PLANAR RELIABILITY

2N327A	2N945	2N1026
2N328A	2N946	2N1469
2N329A	2N1025	2N1917

Sprague makes 82 standard high-emitter-voltage full planar silicon alloy replacement types.

ON READER-SERVICE CARD CIRCLE 826

## DUET\* HIGH-VOLTAGE DUAL-EMITTER TRANSISTORS

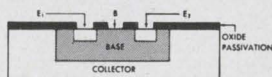

New Type 3N123 low-cost transistor with 25-volt rating now available.

Sprague makes more dual-emitter chopper transistors than any other source.

★Trademark

ON READER-SERVICE CARD CIRCLE 827

## TWIN DUET\* DUAL-EMITTER TRANSISTORS IN FLAT PACKS

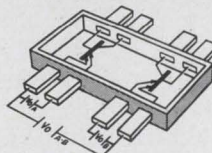

Sprague leads again with two dual-emitter chopper transistors in one flat-pack case, with tight  $V_{OFF}$  matching of both devices.

★Trademark

ON READER-SERVICE CARD CIRCLE 828

For complete technical data on any of these products, write to Technical Literature Service, Sprague Electric Company, 347 Marshall Street, North Adams, Massachusetts 01248.

455-5152

# SPRAGUE®

THE MARK OF RELIABILITY

\*Sprague' and '®' are registered trademarks of the Sprague Electric Co.

# ED News

Novelty abounds at solid-state conference PAGE 17

A national role for reliability is explored PAGE 22

Cryogenic thin-films transform dc voltages PAGE 24

Small-boat electronics makes a splash PAGE 34

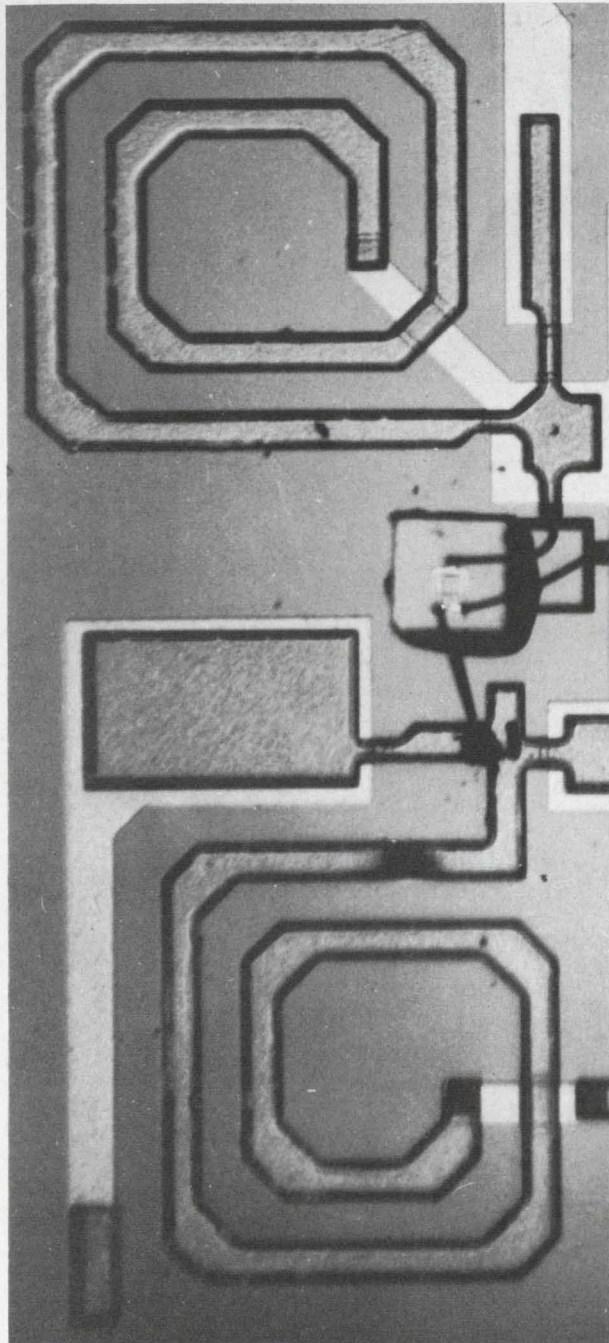

Solid-state microwaves, photodetectors, et al . . . 17

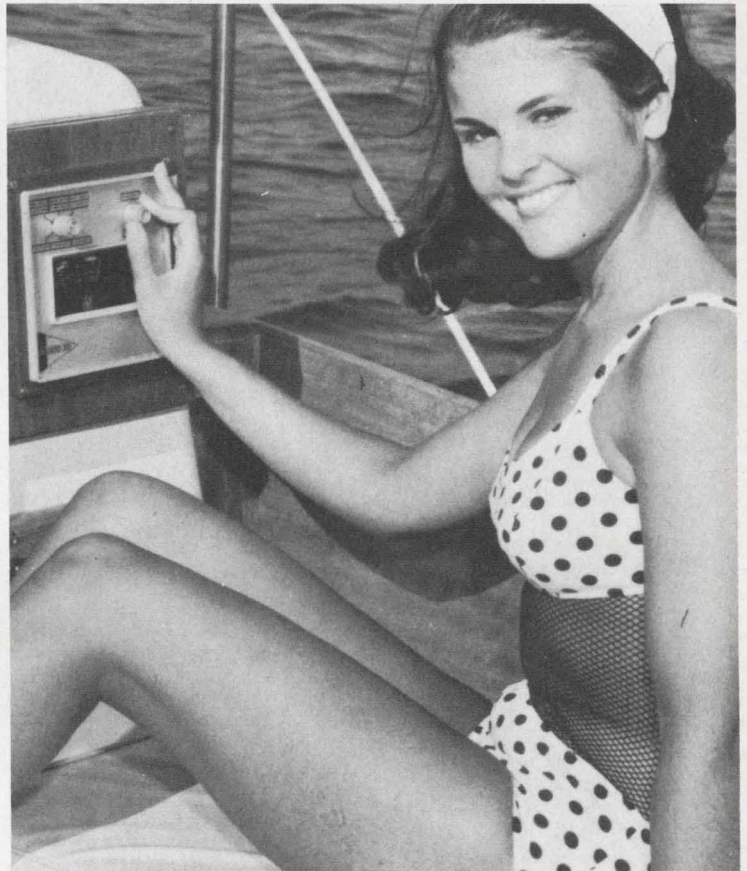

Electronics (?) at the boat show . . . 34

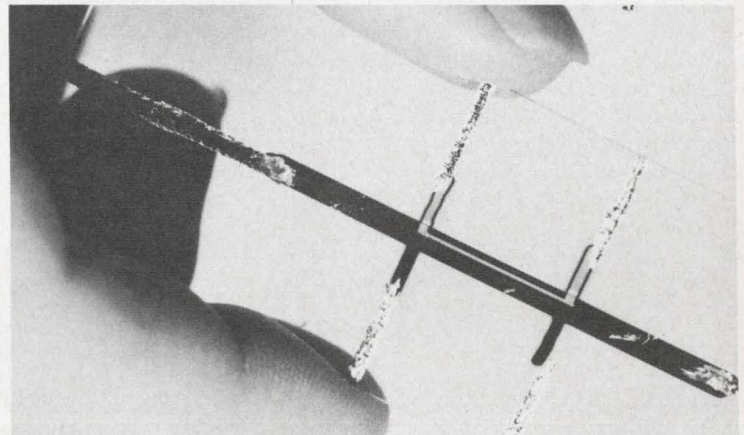

A dc transformer?? . . . 24



signal in

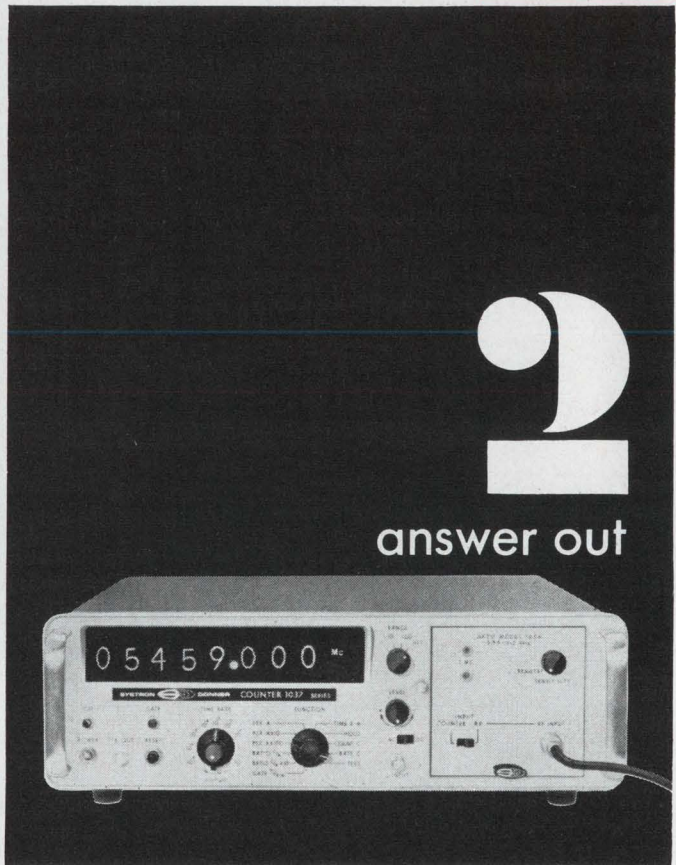

answer out

# yes, it's that simple to measure microwave frequencies directly

## (and with counter accuracy!)

Just connect the input signal and read the answer! Syston-Donner's new frequency measuring system is completely automatic. No calculations, no manipulations of any kind. This great new tool for the lab and production testing will prove to be as necessary as a digital voltmeter.

S-D can deliver this automatic system now for measurements between 3.95

and 8.2 GHz. Soon we'll offer coverage over the rest of the microwave spectrum. The system shown here illustrates the basic concept—a combination of the S-D 50 Mc Model 1037 Counter and the S-D Model 1254 Automatic Computing Transfer Oscillator. Other plug-ins will cover L, S and X bands.

FOR MAXIMUM STABILITY—Syston-Donner exclusively offers a high stabil-

ity oscillator with an aging rate of 1 part in  $10^9$  per 24 hours. That's a three-fold increase in stability over the best previous oscillators!

Prices: Model 1037 Counter, \$2,550. Model 1254 ACTO Plug-in, \$1,950. To learn more about automatic GHz counting, please write to us in Concord or contact your nearest S-D sales engineer (listed in EEM).

**SYSTRON  DONNER**  
CORPORATION

888 Galindo Street • Concord, California  
Speed Inquiry to Advertiser via Collect Night Letter  
ON READER-SERVICE CARD CIRCLE 3

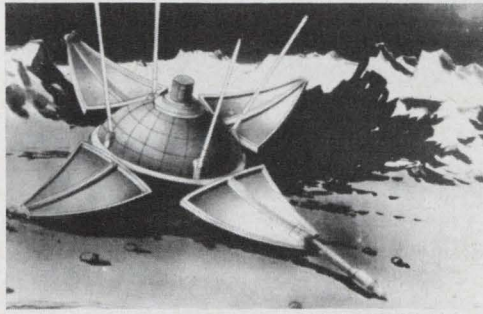

Wide World Photo

## Soviet scores with Luna 9

So far, the soft-landing of Russia's Luna 9 on the moon has had no announced effect on this country's lunar-mission plans or equipment. Some observers hope, however, that Congress may call for loosening of the purse strings on NASA's budget, now scheduled for \$5.019 billion.

Neither NASA nor companies involved in designing vehicles for Surveyor, lunar-orbit or Apollo missions have indicated any changes in schedule or design based on the sketchy information thus far released about Luna 9. A spokesman for Grumman Aircraft, designer of the American LEM vehicle, noted that the moon "crawler" could adapt to either a hard or soft surface.

No detailed information on the instrumentation aboard Luna 9 has been released. The Russians indicated that battery power, with no solar-cell recharge capability, was used to transmit the TV pictures to earth. This would indicate that its planned mission was to be relatively short-lived.

The U.S. Surveyor soft-landing mission is still scheduled for around April 1, but a new postponement would not surprise observers. It is to be followed by five lunar-orbit photo flights.

## Motorola slashes germanium prices

Sweeping price reductions on its germanium transistor line have been announced by Motorola Semiconductor Products. The price cuts range from 14 to 91 per cent, with the across-the-board average at 49 per cent. Affected by the new price structure are 29 transistor types, ranging from commonly used units to advanced state-of-the-art-types.

According to Motorola, the price slash is the result of a new manufacturing technique, known as Selective Metal Etch. With this new technique a masked photographic process similar to that used in silicon transistor and integrated-circuit manufacturer can be applied to the batch fabrication of germanium transistors. The Selective Metal Etch Technique is

# News Report

a result of the recent development of etching solutions capable of selectively removing gold and aluminum.

In announcing the price cuts, Motorola officials voiced optimism about the future of the germanium transistor. Their optimism runs counter to the contention of many in transistor circles that silicon transistors are rapidly tolling the death knell of their germanium counterparts. Significantly, though, Motorola is willing to put its money where its optimism is, as indicated by the company's announcement that it is well on the way toward increasing its germanium production by 30 per cent.

## Western electronics sees new growth

The electronics industry in the western part of the nation expects to continue to grow at a steady, high rate. This is what the president of the Western Electronic Manufacturers Association, Dr. Wendell B. Sell, told 50 members of Congress from 13 states at a recent association luncheon in Washington.

Dr. Sell, who also is president of the Packard Bell Electronics Corp., based his optimistic report on a survey just completed by the manufacturers' association. It showed that total sales of electronics in the West increased 11% to \$4.3 billion in 1965. A similar gain is forecast for the current year.

The comparable figures on a national level indicate a 1965 increase of 5.5% to \$17 billion, with a similar gain expected for 1966. Dr. Sell stated that the \$4.74 billion in sales forecast by western companies for 1966 amounted to nearly 26% of the nation's total electronics forecast for the year.

He added that this boost could result in 20,000 new electronics jobs during the year. Electronics employment in the West at the end of 1965 was at 267,300 jobs, up 24,200 from the year before.

In giving his report, Dr. Sell pointed out that the sales and employment upswing had been caused primarily by commercial and other non-defense business. (over)

"The step-up in military buying is boosting sales for some companies, particularly those in micro-waves and other segments of the industry affected adversely by Government cutbacks two years ago," Dr. Sell said.

"However, new technology and rapidly expanding use of electronics in consumer and industrial applications are the major forces behind the present industry expansion."

This fact is reflected particularly in the 31% sales and 45% employment increases reported in Arizona during 1965. According to the association survey, these gains resulted almost entirely from nonmilitary business.

### Audio ICs to debut in TV line

Integrated circuits will continue a cautious entry into nonmilitary/space fields with a debut into television sets this fall.

The Radio Corp. of America, according to reports, has designed a new integrated audio circuit, to be used in some models of its fall TV line. Company officials would not elaborate, but they said that the device was not currently available or made by RCA.

The circuits will be housed in a 14-lead flatpack. The company said that it planned to include integrated circuits in other home-entertainment products "in the future", but it declined to elaborate on the plans.

### 200-GeV accelerator future uncertain

The Atomic Energy Commission's plans for a 200-billion-electron-volt accelerator, as yet unlocated and unbudgeted, may be in trouble, many observers feel. Conspicuously absent from the President's budget request was any mention of the project, except for a statement in the analysis section that "design funds for the . . . machine will be requested once a site has been selected and the design has been authorized."

The price of the facility has also been increasing with each new study, the latest estimate being \$375 million.

Congressman Chet Holifield (D., Calif.), chairman of the Joint Committee on Atomic Energy, reported recently that the site-selection committee had visited the more than 100 proposed sites and expected to make its report in the next few weeks to the National Academy

of Science. The AEC will then study the academy's recommendations and make a selection.

### Upsurge expected in WESCON attendance

Attendance at this year's Western Electronic Show and Convention, to be held in Los Angeles, Aug. 23-26, is expected to exceed 45,000—reversing the downward trend of recent years. In fact, according to a WESCON spokesman, attendance at the show may go substantially beyond this figure, due to expected improved business in 1966. Applications for 1100 display booths, representing more than 700 organizations, have already been received.

The four-day technical program will generally follow the successful format introduced last year, in which it is organized into session units.

---

**The acquisition of the Hallicrafters Corp.** by Northrop Corp., for around \$20 million, is being considered by the directors of both companies.

**Semiconductors for the hobbyist-experimenter** is a new marketing approach for Motorola Semiconductor Products, Inc. A wide line of transistors, diodes, SCRs, etc., at less than MIL-SPEC ratings will be available through radio-parts stores. Solid-state project handbooks will explain various popular experiments. The HEP (for hobbyist experimenter-professional) components will reportedly be available for 25-50% less than their MIL-SPEC counterparts.

**Prof. H. W. Farris**, chairman of the University of Michigan's EE Dept., has been elected president of the Chicago-based National Electronics Conference, to be held Oct. 3-5.

**An eighth anniversary for Explorer I**, the first U.S. satellite, was marked on January 31.

**An interest in merging** with other organizations has reportedly been expressed by the Annual Symposium on Reliability, held recently in San Francisco. An increase in better papers and fewer meetings were given as reasons for the desired move. Possible merger candidates given were AIAA, ASME and SAE.

**A home color video recorder** has been shown by Sony Corp. but is not expected to go into production until next year. With a price tag of "under \$2000," the unit uses the same tape as Sony's \$995 black-and-white recorder.



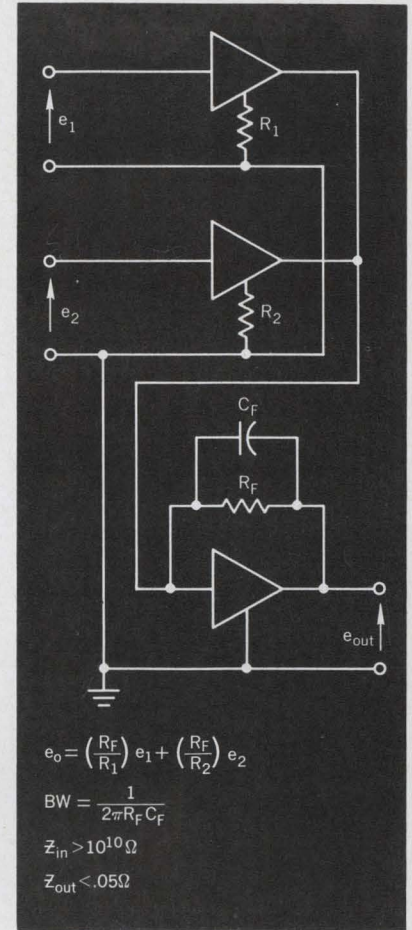
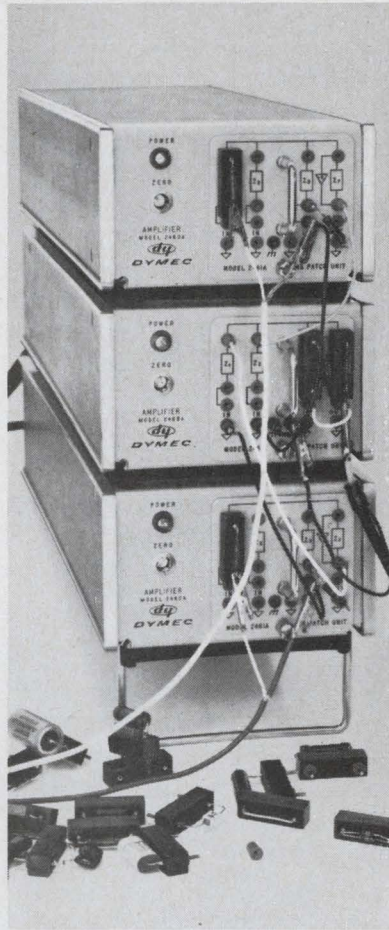
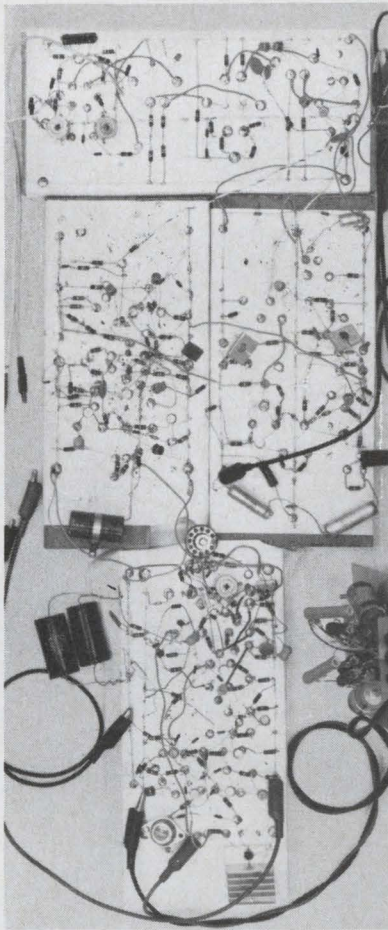

## THIS OR THIS DOES THIS

**Why not do it the quicker, more reliable way, at less cost ...with the Dymec solid-state DY-2460A Amplifier?**

Of course, you can design and build the amplifier element of your newly designed circuit yourself. But, how long will you work on it...rather than on the original designs of your circuit? And, can you do it for \$445—the low cost of the DY-2460A?

Will your amplifier have high performance and reliability, with versatility to permit you to multiply, amplify, add, integrate, differentiate, isolate and invert? The general purpose DY-2460A is ready-made to perform these functions, complete with built-in power supply. Simply insert the appropriate plug-in unit into the front panel. The DY-2460A will supply an output of  $\pm 10$  v peak at 10 ma. Zero drift is less than 1  $\mu$ v per week, and noise less than 4  $\mu$ v peak to peak.

How about reliability? The DY-2460A utilizes a

photo-conductive chopper and all solid-state circuitry for maximum reliability. The photo chopper is inherently a long-life device, unaffected by mounting position and vibration. It is non-synchronous for elimination of all effects of ac pick-up. Production instrumentation is by far your most reliable choice.

We think the DY-2460A makes more sense. Ask your Dymec/Hewlett-Packard field engineer for details on how the DY-2460A can make your breadboarding more reliable and easier at less cost. Or write Dymec Division, 395 Page Mill Road, Palo Alto, California 94306. Phone (415) 326-1755, TWX 910-373-1296.

Price: DY-2460A Amplifier, \$445; DY-2461A-M1 Data Systems Plug-in, \$85; DY-2461A-M2 Bench-use Plug-in, \$125; DY-2461A-M3 Patch Unit Plug-in, \$75; DY-2461A-M4 Plus-one Gain Plug-in, \$35.

*Data subject to change without notice. Prices f.o.b. factory.*

**HEWLETT  
PACKARD**  **DYMEC  
DIVISION**

ON READER-SERVICE CARD CIRCLE 4

**1/2 to 1/3 the size and  
less than 1/2 the weight  
of conventional units . . .**

# Sorensen ACR Voltage Regulators give up to 95% efficiency, too!

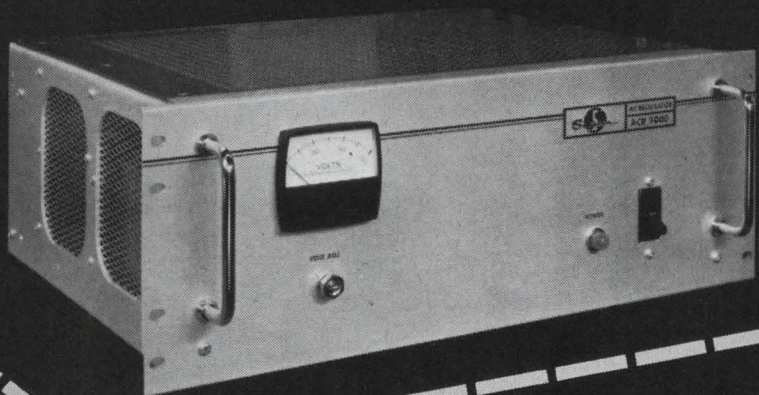

In these new Sorensen silicon controlled rectifier AC regulators, you get the best combination of power, performance, and packaging you've ever seen. The unit is reduced to the size of the transformer and control circuitry. Ideal for motor starting, lamp loads, tube filaments, X-ray applications, etc., ACR Series regulators are designed to control the RMS voltage to a variety of loads requiring precise regulation, fast response time, and low distortion.

- |  |   |  |
|--|---|--|
| 1. 8 MODELS AVAILABLE (500, 1000, 2000, 3000, 5000, 7500, 10000, 15000 VA) | 4. UP TO 95% efficiency                                     | 7. LOW DISTORTION (3% max.)                                |
| 2. LOW PRICES (starting at \$290)  | 5. INPUT VOLTAGE RANGE 95-130 VAC; OUTPUT RANGE 110-120 VAC | 8. STABILITY (.05% / 8 hours, after a 30-minute warm-up)   |
| 3. SMALL SIZE AND WEIGHT   | 6. FAST RESPONSE to line or load changes (30 ms)            | 9. REGULATION $\pm 0.1\%$ RMS                              |
|  |   | 10. PROGRAMMABLE   |
|  |   | 11. REMOTE SENSING   |
|  |   | 12. CONVECTION COOLED                                      |
|  |   | 13. EASY MAINTENANCE (removable "plug-in" printed circuit) |

For complete data on the ACR Series and other Sorensen products, send for the "Controlled Power Catalog and Handbook." Write: Sorensen, A Unit of Raytheon Co., Richards Ave., South Norwalk, Conn. 06856. Or use reader service card number 200.

## ACR ELECTRICAL AND MECHANICAL SPECIFICATIONS

MODEL NUMBER	OUTPUT VA RANGE	REGULATION ACCURACY		EFFICIENCY (FULL VA)	TYPICAL POWER FACTOR	TEMPERATURE AMBIENT COEFFICIENT		DIMENSIONS (INCHES)			PRICE**	
		LINE	LOAD			(°C)	(°C)	WIDTH	HEIGHT	DEPTH		RACK HEIGHT
ACR 500	0-500	$\pm 0.1\%$	$\pm 0.1\%$	88%	75%	0-50	.03%	15*	5	9	5 1/4	\$ 290
ACR 1000	0-1000	$\pm 0.1\%$	$\pm 0.1\%$	90%	75%	0-50	.03%	19	5 1/4	11	5 1/4	340
ACR 2000	0-2000	$\pm 0.1\%$	$\pm 0.1\%$	92%	75%	0-50	.03%	19	5 1/4	15	5 1/4	435
ACR 3000	0-3000	$\pm 0.1\%$	$\pm 0.1\%$	95%	75%	0-50	.03%	19	7	15	7	555
ACR 5000	0-5000	$\pm 0.15\%$	$\pm 0.15\%$	95%	75%	0-50	.03%	19	7	20	7	715
ACR 7500	0-7500	$\pm 0.15\%$	$\pm 0.15\%$	95%	75%	0-50	.03%	19	12 1/2	20	12 1/2	850
ACR 10000	0-10000	$\pm 0.15\%$	$\pm 0.15\%$	95%	75%	0-50	.03%	19	12 1/2	20	12 1/2	1,200
ACR 15000	0-15000	$\pm 0.15\%$	$\pm 0.15\%$	95%	75%	0-50	.03%	19	17 1/2	20	17 1/2	1,500

\*A 19 inch adapter (rack) panel is available.

\*\*Optional Meter \$22.



# Novelty abounds at solid-state conference

**High-speed ICs, an inch-square image scanner, hybrid and integrated microwave devices, and memories that compete with IC technology lead the parade.**

Here is a fast look at some of the outstanding developments described at the annual International Solid State Circuits Conference, held last week in Philadelphia. In the March 15 issue, we'll provide in-depth coverage of the many panel discussion sessions.

For a complete digest of technical papers, send \$6 to H. G. Sparks, Moore School of Electrical Engineering, University of Pennsylvania, Philadelphia.

## A new switch in fast ICs

A new technique that hinges on a simple cross-coupling resistor adds improved dimensions to threshold control in feedback current-switches. It gives these high-speed, monolithic switching circuits better speed, noise and stability characteristics.

The novel approach was reported by T. S. Jen of IBM Corp., Hopewell Junction, N. Y., at the High-Speed Integrated Circuits session of the conference (Session 1.3). In addition to the cross-coupling resistor and the standard feedback-current-switch elements, the technique

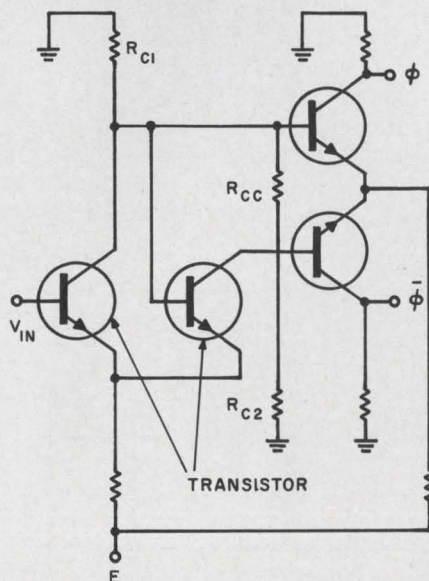

involved a differential amplifier stage.

By referring to the circuit diagram, we see that cross-coupling resistor  $R_{cc}$  adjusts the threshold. The resulting  $V_o - I_o$  characteristic curve does not change, but the load line is no longer fixed. This load-line shift enables the threshold to be designed closer to the dc input level by the proper choice of the  $R_{c1}$ ,  $R_{c2}$  and  $R_{cc}$  combinations. The net effect is a reduction of hysteresis, with its attendant improvement in ac and dc noise tolerances.

The proximity of the threshold to the input dc level also results in faster speed. Switching occurs more rapidly because the threshold is reached sooner. Moreover the configuration itself is less sensitive to fan-in effects, because the load-line is not as dominated by  $I_{E1}$  influences on the  $V_o - I_o$  curve.

Observe that the differential amplifier section raises the circuit's gain and driving capability, thus providing for greater versatility. Note that some sacrifice in speed accompanies this (because of the amplifier delay), but that it is minor in comparison with the other speeds involved.

Jen also pointed out some additional benefits of the new design. He cited the negative dc feedback role of  $R_{cc}$  as contributing to overall stability. The circuit is less sensitive to variations in both components and temperature because of it, according to Jen.

## Charge-control speeds logic

Two new means for removing excess bias charge in saturated logic gates give the integrated circuits incorporating them the promise of switching speed figures comparable to nonsaturated devices. The accompanying noise margins are superior to those obtained with the nonsaturated type and equal to the results experienced with slower, standard

diode-transistor logic NAND gates.

L. D. Hirsch of Westinghouse Electric Corp., Baltimore, reported on these high-speed monolithic developments (Session 1.4). One approach features a "stoppered diode," used as the offset-determining component; the other technique entails the use of a transistor operating in a beta-enhancement mode.

Each method overcomes the switching-speed limitations caused by the DTL circuit series diodes. According to Hirsch, these diodes, "which establish the desired threshold levels, exhibit relatively high series impedances or store insufficient charge." These shortcomings show up in the inverter transistor and must be overcome by an excess-charge (unbalance) removal technique.

The stoppered-diode approach is depicted in the accompanying illustration, where it ( $D_2$ ) is used to reduce the turn-off delay caused by the charge imbalance between  $Q_1$  and  $Q_2$ . When used as the integrated offset diode, this component shows:

- Minimized series bulk resistance, because of a high concentration and a wide base region.
- Greater stored charge than emitter-base diode counterparts.
- Additional offset voltage (because of the higher concentration) which reduces temperature sensitivity and raises noise immunity.
- Lower parasitic capacitance per unit of stored charge.

The net effect is a halving of the

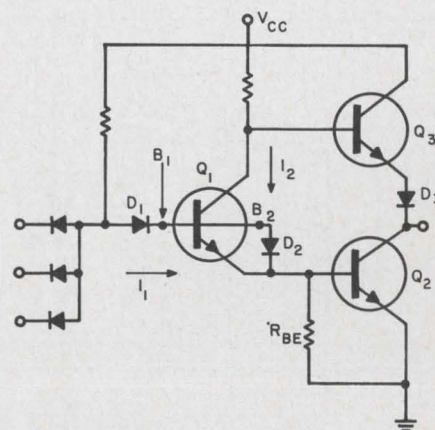

**(solid-state, continued)**

switching speed with average propagation-delay times of the order of 8.0 ns and a noise margin improvement of 200 mV.

In the second method charge removal is accomplished by the beta-enhancement of charge stored in the transistor's collector-to-base junction. In essence, a low-impedance path is provided during the turnoff transition, to deplete the excess base charges. This circuit arrangement also features a bi-directional output capability. Hirsch emphasized that the resulting switching speeds were "very fast, with delay times typically well below 10 nanoseconds."

**Memories bank on MOSs**

Another step towards the computer-on-a-chip reality has been taken. In line with the mushrooming trend towards systems making use of arrays, a complete integrated-circuit memory system has been developed using complementary, enhancement-type MOS-FETs.

The circuit provides an excellent storage cell capability as well as the necessary driving, decoding and other logic functions surrounding the storage process. These characteristics were revealed and discussed by J. R. Burns, RCA Laboratories, Princeton, N. J., in an ISSCC conference session devoted to digital applications of field-effect transistors (Session 11.2).

The memory system is well suited for small capacity, integrated high-speed scratch pad applications and large systems requiring multifunction logic combined with high-capacity

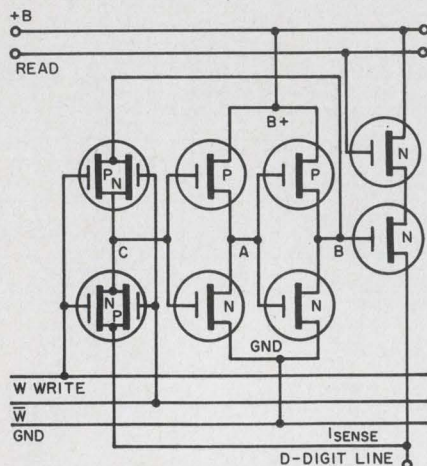

capacity variable and/or fixed storage. The benefits of the complementary approach, as outlined by Burns, include "negligible standby power, low dynamic power, high speed, good noise immunity and non-stringent tolerance requirements."

Representative of the capability of these MOS-FET circuits is a basic storage cell (see illustration) subsystem which uses ten of the devices, some of which are complementary pairs. Burns stated that "the storage cell could be written into by means of two MOS transmission gates. One is for opening the feedback loop from B to C and the other is used to enter information from the digit line into the cell at C."

The loop is closed by bringing the WRITE line down to ground potential, thereby leaving the information permanently stored in the flip-flop portion. The high-speed capability is demonstrated by the low 16.0 ns pair delay time expanded for the equalization of the potential voltage at B and C.

**Vidicon on a wafer?**

The incoming tide of integrated circuitry has finally brought in a solid-state vidicon on a glass wafer. This wafer is only one inch square

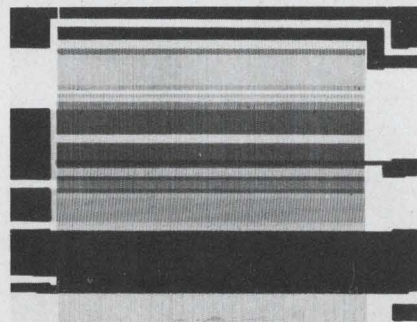

and 1/8 inch thick.

The photosensitive panel—the solid-state vidicon's working surface—measures 3/8 inch square and contains 32,400 photoconductive elements and an equal number of diodes. These 64,800 elements are arranged in a square matrix of 180 rows and columns. The solid-state vidicon was described by Drs. P. K. Weimer, G. Sadasiv, H. Borkan, L. Meray-Horvath, J. Meyer Jr. and F. V. Shallcross, all of RCA Laboratories, Princeton, N. J. (Session 11.4).

To recreate a visual image that falls on the panel, the elements

must be examined in order. This is done by two pulse-scanning generators, according to Dr. Weiman. Last year this team made two thin-film pulse scanners for this purpose, using integrated circuit techniques.

Each sensor is made of cadmium sulphide with contacts of aluminum and tellurium. The diodes are the contact between the cadmium sulphide and the tellurium. The aluminum and tellurium are used to make the horizontal and vertical address strips (dark areas in photo). The sensors must have a very high gain; then their persistence of excitation gives the effect of partially integrating the light that falls from the first time a sensor is read to the next time it is read.

Compared with the 400 to 500 lines of resolution in commercial telecasts, the 180 lines of the new glass-wafer vidicon produce a coarse image. True, the wafer can simply be made much larger, but the RCA researchers are planning instead to reduce the space occupied by each element. Their goal is to produce a vidicon that resolves 500 lines and contains the light sensitive panel and the two 500-stage pulse-scanning generators all on a one-inch-square wafer.

Once this glass wafer is available in final form, the user will have only to add a lens to take television pictures. The entire camera might fit easily into a cigarette pack.

**Amplifier has built-in heater**

Significant improvements in the thermal stability of integrated-circuit amplifiers—in many respects to the point where they will compete with chopper-stabilized units—have been achieved with recent improved understanding of thermal-electrical interactions. These advances have yielded a variety of monolithic, direct-coupled silicon amplifiers with equivalent differential input drifts of  $0.1 \mu\text{V}/^\circ\text{C}$ .

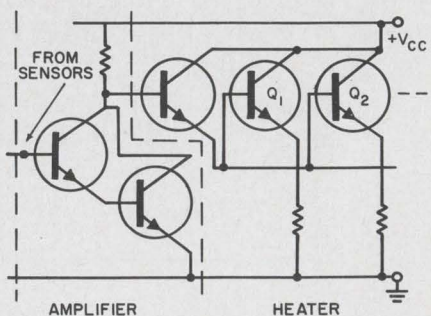

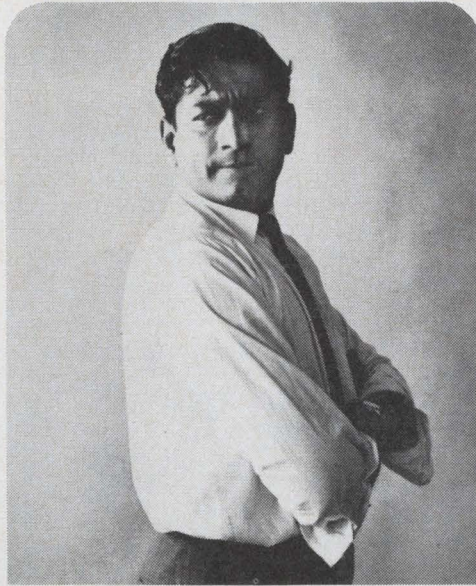

## Looking for rugged 3 amp transistors?

### Prabodh Shah speaks your language.

Prabodh Shah is one of our applications engineers. We call him Pete. Customers call him just plain great, because he's made available *both* 3 amp germanium DAP and alloy power PNP transistors. Over 60 types in all. All competitively priced. Available in TO-5, TO-37, stud nut MT-27 and hexagonal nut MT-28 packages.

You can use our DAP® (Diffused Alloy Power) transistors for audio amplifiers, pulse amplifiers, relay drivers and switching. Featured are switching times in microseconds without worry of secondary breakdown; high collector-to-base voltage  $V_{CBO}$  to  $-200$  V; high DC current gain:  $h_{FE}=30$  to  $90$  at  $V_{CE} = -1$  V,  $I_C = -0.5$  A; low collector cutoff current:  $I_{CBO} = -3$  mA maximum at  $+85^\circ\text{C}$ ; low saturation voltage:  $V_{CE(s)} = -0.2$  V typical with  $I_C = -1$  A,  $I_B = -0.5$  mA; excellent frequency response:  $f_{\alpha b} \geq 2.5$  MHz. All are SOAR (Safe Operating Area) specified.

Use our Alloy power transistors for solenoid drivers, small power supplies (inverter/converter), audio amplifiers and control circuits. They feature  $V_{CBO}$  to  $-100$  V,  $V_{CEO}$  to  $-60$  V,  $I_C = -3$  to  $-3.5$  A,  $V_{CE(s)} = -0.25$  V maximum with  $I_C = -1$  A,  $I_B = -0.1$  A; high DC current gain:  $h_{FE}=20$  to  $60$  at  $-3$  A;  $f_T \geq 0.25$  MHz. All Bendix 3 amp Alloy transistors are SOAR specified.

Ten types are now available meeting military specifications. In addition, our commercial DAP and Alloy lines offer packages that meet MIL-S-19500, MIL-STD-750 and MIL-STD-202 environmental and mechanical requirements.

More information? Just phone or write our nearest sales office. If it's a particularly tough application, we'll have Prabodh Shah translate it into easy terms for you.

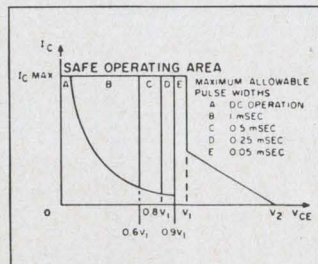
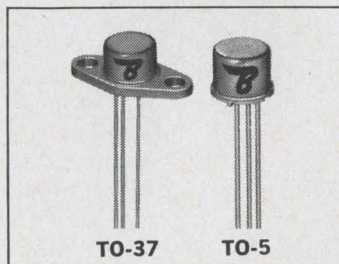

TYPE NUMBER	Ic Amps	V1 Volts	V2 Volts
<b>DAPS</b>			
2N2282—2N2284	3	30 to	70 to
2N2467—2N2469		70	110
<b>ALLOYS</b>			
2N1038—2N1045	3 to	30 to	60 to
2N2552—2N2567	3.5	60	90

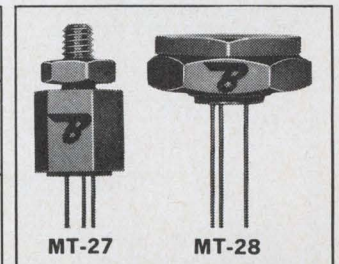

**Bendix Semiconductor Division**  
HOLMDEL, NEW JERSEY



Baltimore, Md.—(301) 828-6877; Chicago—(312) 637-6929; Dallas—(214) 357-1972; Detroit—(313) JO 6-1420; Holmdel, N. J.—(201) 747-5400; Los Angeles—(213) 776-4100; Miami—(305) 887-5521; Minneapolis—(612) 926-4633; Redwood City, Calif.—James S. Heaton Co., (415) 369-4671; Seattle—Ray Johnston Co., Inc., (206) LA 4-5170; Syracuse, N. Y.—(315) 474-7531; Waltham, Mass.—(617) 899-0770; Export—(212) 973-2121; Cable: "Bendixint," 605 Third Ave., N. Y.; Ottawa, Ont.—Computing Devices of Canada, P.O. Box 508—(613) TA 8-2711.

ON READER-SERVICE CARD CIRCLE 5

Did you  
know  
Sprague  
makes...?

### TRIGGER TRANSFORMERS FOR SCR CIRCUITS



A better, less-expensive way to trigger SCRs. Will accommodate large SCR gate impedance differences. 3-winding or 2-winding designs for full-wave or half-wave applications.

ASK FOR BULLETIN 40,225.2

ON READER-SERVICE CARD CIRCLE 791

### SILICONTROL® SCR GATE DRIVES

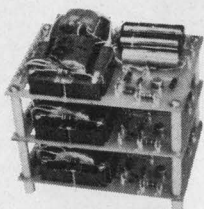

For balanced SCR firing in 3-phase a-c or d-c power control. Pulse rise time of 1 to 3 microseconds to meet requirements of high-current-rated SCRs.

ASK FOR BULLETIN 85,520A

ON READER-SERVICE CARD CIRCLE 792

### VOLTAGE-SENSITIVE SWITCHES

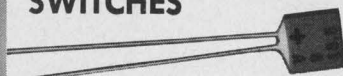

Unique semiconductor device which remains in the "open" state until a specified actuating voltage is reached. When "breakdown" voltage is applied, switch closes almost instantaneously, providing a low-impedance conductive path between terminals. Breakdown voltages from 7 to 200 V.

ASK FOR BULLETIN 93,000

ON READER-SERVICE CARD CIRCLE 793

### DYNACOR® BOBBIN CORES

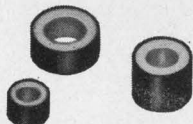

Logical flux values in popular physical sizes are stocked in production quantities for fast delivery. Value engineered for quality with economy.

ASK FOR BULLETIN SERIES 50,000

ON READER-SERVICE CARD CIRCLE 794

### INDISTOR® R-L DELAY NETWORKS



Save space by replacing separate inductors and resistors. Guaranteed L/R ratio. Available in fully molded or epoxy-dipped cases.

ASK FOR BULLETIN SERIES 45,000

ON READER-SERVICE CARD CIRCLE 795

### MOLDED-CASE SHIELDED R-F INDUCTORS

Fully shielded, ultra-tiny, yet performance is comparable to that of larger units. Inductance values from 0.1 to 12,000  $\mu$ H. Molded for positive protection against humidity and handling. Meet requirements of MIL-C-15305.

ASK FOR BULLETIN SERIES 41,800

ON READER-SERVICE CARD CIRCLE 796

For complete technical data on any of these products, write for applicable Engineering Bulletin(s) to Technical Literature Service, Sprague Electric Company, 347 Marshall Street, North Adams, Massachusetts 01248.

455C-4161

**SPRAGUE®**  
THE MARK OF RELIABILITY

\*Sprague' and '®' are registered trademarks of the Sprague Electric Co.

## NEWS

(solid-state, continued)

A new approach described by S. P. Emmons and H. W. Spence of Texas Instruments (Session 10.1) involves diffusing within the same substrate an electrically separate temperature control circuit to maintain a nearly constant temperature in the wafer. The circuit is a feedback system composed of temperature-sensing diodes, a dc amplifier that drives a heater, and a thermal-feedback path, whose characteristics are determined by the thermal properties of the physical structure used. The heater itself was formed by several parallel-connected transistors, which introduce heat uniformly across one end of the structure (see illustration).

The circuit in the accompanying figure is typical of several that are intended for lowdrift preamplifiers, with sufficient gain to eliminate drift contributions from subsequent stages. Typical characteristics for the circuit (at 25°C) include:

- Differential dc input offset: 1.5 mV; 100 nA.
- Differential dc input drift ( $-25^{\circ}\text{C}$  to  $100^{\circ}\text{C}$ ):  $0.15 \mu\text{V}/^{\circ}\text{C}$ .
- Ac voltage gain (Differential, input 2 mV at 1 kHz): 1000.
- Input impedance: 50 k $\Omega$ .
- Common-mode rejection: 60 dB
- Input common-mode voltage swing: 5 V.
- Output impedance differential: 20 k $\Omega$ .
- Power drain: (+12 V): 20 mA, (-12 V): 0.7 mA.

### Microwave ICs at hybrid stage

Integration is becoming the byword of microwave design engineers.

A balanced mixer, using Schottky-barrier diodes directly deposited on silicon substrate, was introduced by W. M. Portnoy of Texas Instruments, Inc., Dallas (Session 2.3). The diodes, formed on epitaxial material, are shown in cross-section in the drawing. In brief, their series resistance and capacitance are higher than they are in axially formed diodes. Both parameters depend on the definition of the center finger and can be controlled with careful manufacturing techniques, Portnoy said.

The balanced mixer includes a 3-dB coupled section, two mixer

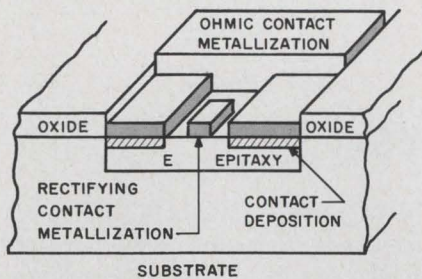

diodes and reactive lines for matching and filtering. About 200 of these circuits will be formed on a single slice of silicon, Portnoy reported.

Another example of a microwave integrated circuit—a 500 MHz IF amplifier—was introduced by G. D. Johnson, also from Texas Instruments (Session 2.5). Although silicon models with transistors diffused into the substrate have not yet been made, preliminary results are encouraging, Johnson said. Now the circuits are deposited on silicon and ceramic substrates, and chip transistors are bonded to the circuit. The following typical data were measured on silicon amplifiers:  $f_o = 550$  MHz, bandwidth = 85 MHz,  $P_o = 18$  dB. The noise figure was relatively high (around 10 dB), but optimization of input impedance can improve it, according to Johnson.

### Strip-line adjusts signal

Time-varying transmission lines can be used to speed, amplify or slow propagating signals. The technique involves matched pairs of varactors in a split-line configuration that controls the capacitance of the line, according to a report by Brian J. Elliott of the Watson Research Center, Yorktown Heights, N. Y. (Session 2.2).

The varactor control voltage changes the propagation velocity of the line by changing its parameters. For example, a sudden drop in the line's capacitance increases its propagation velocity. The effects of this change on the propagating signal depend on the time the control voltage is applied.

If the signal pulse is applied before the beginning of the control voltages, the output pulse is compressed and amplified, and a reflected reversed pulse appears. The cause of this reversed pulse has not yet been determined, according to Elliott.

If the control voltage is applied first and then the signal—and the voltage is reduced to zero while the pulse is still on the line—the control voltage will be stretched by as much as a factor of two, Elliott explained.

Experiments proved that the control voltage might be much slower than the signal. The rise time of the control voltage was 10 times greater than that of the output pulse in one case.

The results point to widespread applications, including an increase in the speed of pulse generators and the possibility of viewing 1-ns pulses with CROs that have 70-ns sampling times. The only difficulty is in developing varactors that have the required bandwidth. For example, to extend usefully the time resolution of the best time-sampling oscilloscope (70 ns), a bandwidth of 10 GHz would be needed. This is not impossible, since varactors that operate up to 40 GHz do exist. For a pulse compressor that would improve the fastest tunnel-diode pulse generator (50 ns), a bandwidth of 15 GHz is necessary, Elliott concluded.

### Duplexer uses pin diodes

All-diode duplexers that handle 2-mW peak power with 1  $\mu$ s pulses at 0.001 duty cycle are being developed at Microwave Associates, Burlington, Mass., according to P. Basken (Session 5.4). The device uses *pin* diodes exclusively.

A balanced phase-shifter duplexer configuration, with iterative sections, was selected because it maximizes power-handling capability. The duplexer includes the phase shifter, two 3-dB hybrids, a matching phase section and a diode receiver protector. The phase shifter consists of a 72-*pin*-diode array, constructed in a quarter-height WR-187 waveguide (See illustration below).

A duplexer has already been built

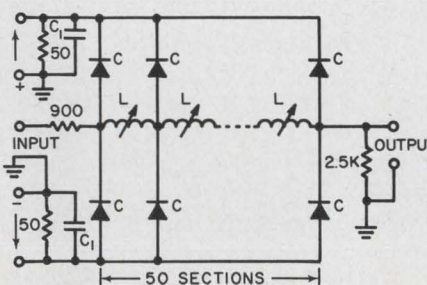

with a 1-mW peak power capability and a switching time of less than 10  $\mu$ s. Its insertion loss over a 10% band in C-band was 1 dB under forward bias (transmitting stage) and 2dB under reverse bias (receiving state). The phase shift of 180° remained flat over this bandwidth. The balanced mixer introduces about a 20-dB isolation between the transmitting and receiver arms, Basken said.

### Ferrite vs IC memories

Some of the more significant developments in memory techniques disclosed at the conference indicate that ferrite memories are holding their own in the face of newer thin-film and IC types.

A monolithic ferrite memory with an integrated storage-diode word selection matrix was described by M. M. Kaufman and R. L. Pryor of RCA, Camden, N. J. (Session 9.2). The 256-word, 64-bit memory is word organized and uses only one diode per word. The elements incorporated in this system have the potential for a maximum-storage-density, high-speed, word-organized memory that is competitive over the full range of random access memory needs that individual cores have met in the past. This particular project was initially conceived as aiming toward a scratch-pad application, but since the storage diodes available for use at the time had a somewhat longer storage time than is optimum for the highest operating speed possible with the monolithic stack, no attempt was made to push the operating speed to its limit. Stress was placed first on proving the storage diode in the integrated package as an element of an unusual and economical selection matrix, and, second, on testing the monolithic platelets of the memory stack for uniformity of signal. Toward this end an exerciser was built and used to test in detail all of the 256 words of the memory. Although only four-digit bits were energized and sensed at a time, a mapping of the entire memory stack was made by moving the connector along in steps. Due primarily to associated circuit speed limitations, the cycle time achieved was 500 ns. The minimum fully disturbed sense signal was 6mV, despite a very slow (100 ns) rise time of the read pulse. ■ ■

# A national role for reliability explored

**San Francisco symposium calls for expansion of goals beyond defense and space applications. Approaches to integrated-circuit reliability are considered.**

**Peer Fossen**  
West Coast Editor

A new dimension in the field of reliability—its impact on the economic growth and future prosperity of the nation—was in the spotlight at the 1966 Annual Reliability Symposium in San Francisco. Rallying on the theme "Reliability and Economic Progress," conferees were told in a keynote address:

"Reliability should be given a wider focus than defense and space. Applications to our full economic life are readily identifiable."

The keynoter, D. J. Haughton, president of the Lockheed Aircraft Corporation, predicted that as the nation became wealthier, it would be willing to spend more for reliability. As it learns of the high reliability achieved in space and missile programs, he continued, it will demand more of it in daily life.

## Panel debates economics

Expanding on the theme, a panel of leading executives from industry and Government analyzed some aspects of the relationship between economics and reliability. This discussion was moderated by Dr. E. T. Ferraro, vice president of General Precision, Inc. The participants were Dr. J. E. Goldman, director, Scientific Laboratory, Ford Motor Co.; J. E. Condon, director, Office of Reliability, NASA; C. I. Johnson, director of reliability and quality assurance, International Business Machines; Dr. J. A. Morton, vice president, Bell Telephone Laboratories, and R. L. Wells, vice president, Westinghouse Electric Corp.

A note of warning was sounded by Wells. Discussing specific instances of achieving economic progress through reliability, he said: "There are some limits here. Industrial organizations exist to supply goods and services that their customers need and want, but to do these things at a profit. The customer may not—in fact, often is not—

ready to pay for this maximum attention to functional performance or product reliability for all possible risks."

## IC reliability methods surveyed

William R. Rodrigues de Miranda of Honeywell, Inc., analyzed the results of a survey he conducted among 11 integrated-circuit manufacturers. The aim was to emphasize the need for reliable microcircuitry. Rodrigues noted that he had once considered the failure rates, stress levels and temperature relationships for transistors in MIL-Handbook 217 as applicable to ICs. The assumption was based on the fact that both devices use the same manufacturing processes and materials. However, he had some preliminary doubts about the validity of these data for ICs. Comparison with available data from several manufacturers resulted in a disturbing diversity of interpretations for the failure rate/temperature relationship. "Thus," Rodrigues said, "the applicability of these data were questioned, both for transistors and integrated circuits."

Rodrigues went on to say that when IC reliability data were made available, they were confusing. Different manufacturers used different test parameters and devices, making data interpretation and correlation difficult. "Furthermore," he said, "with the introduction of integrated circuits, the reliability engineer was confronted with a device that fitted neither the technical description of a component nor that of a discrete circuit. Available reliability experience in these two areas seemed inadequate, and a new knowledge was needed. Therefore, in addition to the need for failure rates and temperature relationship data, questions pertaining to physics and failure, stress definitions, packaging, etc., required answering."

Analyzing the answers by the 11

participating manufacturers to 66 questions that the survey posed, Rodrigues pointed out these highlights, among others:

- In spite of considerable test data, it was not possible to assign "a failure rate" to an integrated circuit. The data merely summarize the results of tests performed under a great variety of conditions and a great many different devices.

- Standardization of test methods and conditions is necessary to establish a generally accepted failure rate for one or more types of circuits.

- The survey did not provide adequate answers to the questions of "effects of electrical stress." The problem is apparently one faced by the circuit consumer rather than the producer.

- All but one manufacturer listed bond failures among the three most prevalent, with several listing it as the top one.

- Most manufacturers predicted continuing fast decline of failure rates in ICs, followed by gradual leveling-off after three years. Estimates of failure rates three years from now ranged from 0.004% to 0.0002% per 1000 hours at 55°C.

## Two IC reliability philosophies

A third paper of the session, discussing "Proving Integrated Circuits Reliability," was given by Phil Holden of Texas Instruments, Inc. It gave the pros and cons of the two philosophies currently used in IC reliability test programs: the failure-rate school and the failure-mechanism school. He pointed out that while both philosophies were legitimate reliability concepts, neither appeared to be a panacea. Holden said: "To take the middle-of-the-road approach may seem conservative and like fence-riding, but the forthcoming school of thought is the merging of the best from these two philosophies. This newest group of reliability people believes that it is wise not to put all of your eggs in one basket. Their philosophy is: You must prove the reliability and improve it." ■ ■



# GLASS-K

New CORNING® Glass-K Capacitor:  
100,000 pf in this case size

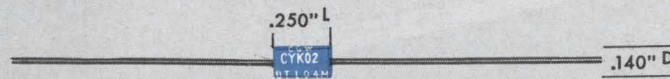

Glass-K has rewritten the definition for size and stability with life\* of CK-type capacitors.

CAPACITANCE—PF	STYLE CYK	SIZE		LIFE $\Delta C$
		L Max.	D Max.	% (Max.)
1000 - 10,000	01	.250	.100	2%
12,000 - 20,000	01	.250	.100	2%
	02	.250	.140	
22,000 - 39,000	01	.250	.100	10%
	02	.250	.140	2%
47,000 - 51,000	01	.250	.100	10%
56,000 - 100,000	02	.250	.140	10%

The GLASS-K is a miniature stable capacitor that exhibits a high capacitance-to-volume ratio. It offers the size advantages of ceramic capacitors and the consistent performance associated with glass dielectrics made possible by development of a new dielectric material.

### ADVANTAGES

- Smaller Size • Three Stability Characteristics • Repeatability (part to part) • Small  $\Delta C$  with Life • Minimal Voltage Coefficient (AC & DC) • Good Frequency Characteristics • Automatically Insertable

\*Method 108 mil std 202C. 200% rated voltage at 125°C for 1,000 hours.

Send for complete data to Corning Glass Works, 3901 Electronics Dr., Raleigh, N. C.

**CORNING**  
ELECTRONICS

Speed Inquiry to Advertiser via Collect Night Letter  
ON READER-SERVICE CARD CIRCLE 6

# Cryogenic thin films transform dc voltages

**Lab-model dc transformer, developed by discoverer of 'tunneling' and described to physicists, exhibits new supercooled boundary effects.**

**Roger Kenneth Field**  
News Editor

No, you won't wake up tomorrow to find a dc transformer on every telephone pole. And your house current will still alternate as usual. The electronics industry will hardly be revolutionized by the dc transformer that was revealed at the annual meeting of the American Physical Society in New York. But this transformer, along with the cryotron (superconducting switch), is clearly destined to become a basic device in the slowly emerging field of cryogenic electronics.

It has long been known that a changing magnetic flux is needed to induce current in a conductor. Conversely, the magnetic flux surrounding a conductor can be changed if the current is varied. In the past an unvarying magnetic field has always been associated with direct current.

But Dr. Ivar Giaever, the physicist who discovered "tunneling" and demonstrated "negative resistance," looked closely at the superconduction of dc. He observed variations in the magnetic flux immediately surrounding the surface of a superconducting thin film of tin, even when it carries direct current. And this changing flux can induce a direct current in another superconducting thin metal film, when it lies within one-millionth of an inch of the primary film. By plating two secondary films over the primary and connecting them in series, the output voltage can be doubled. Secondary films can be added almost as easily as secondary turns to an ac transformer, and the added voltage is accompanied by a corresponding drop in secondary current. Of course, the temperature of all the films must be within a few degrees of absolute zero.

## No commercial applications yet

Oddly enough, Dr. Giaever is not

optimistic about finding applications for the new dc transformer. "It would be invaluable in the design of a cryogenic computer," he said, "but no one seems to have any plans to make one. I guess the cryotron hasn't yet demonstrated enough speed to interest the computer designers." The physicist pointed out that there has been no commercial use of any cryogenic device as yet, probably because it is difficult to store helium. He feels that for the present, at least, the dc transformer, like the other cryogen-

ic devices, will remain in the laboratory.

Dr. Giaever did his work at General Electric's Research and Development Center in Schenectady, N. Y.

## Extremely low power

The working model of the new transformer (see Fig. 2) operates in the milliamp and millivolt range. It will probably never be able to handle much power. Another fault is the theoretical limit on its efficiency.

"This is a resistive coupling device, unlike an ac transformer, which is an inductive coupling device," Dr. Giaever said. "That places a definite upper limit on

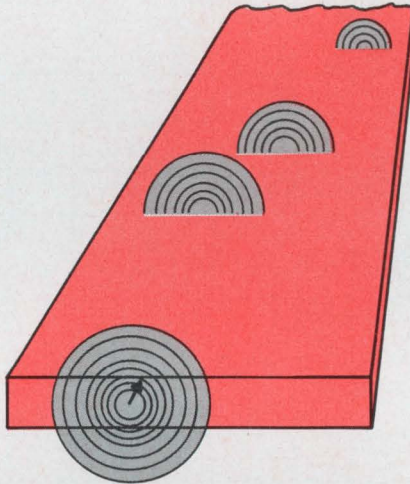

1. Magnetic flux due to moving electrons is perpendicular to the film surface.

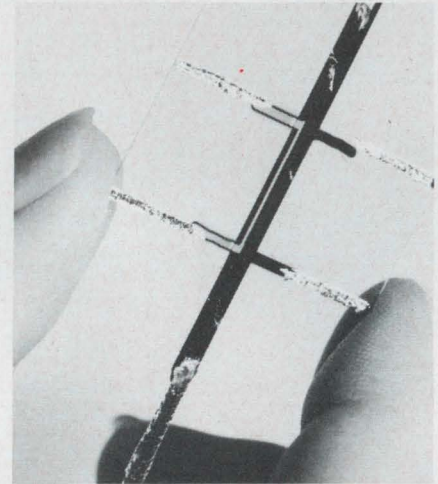

2. Dc transformer working model is limited in use due to cryogenic problems.

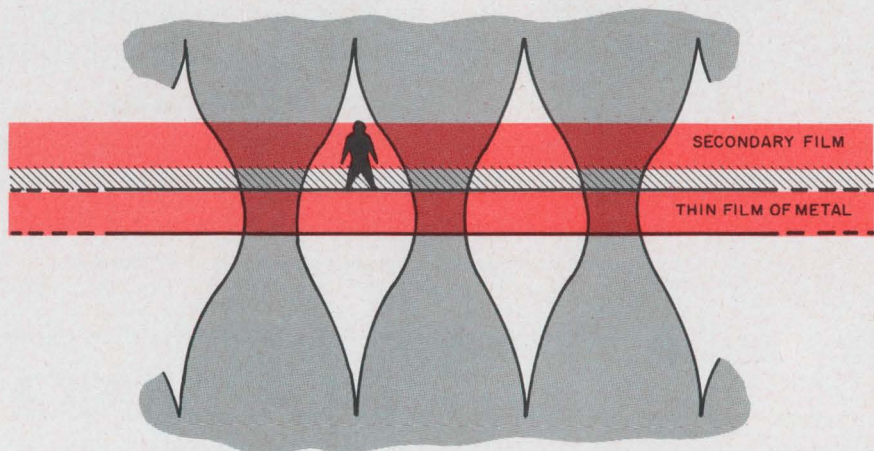

3. Resistive coupling of dc in two superconducting films of tin is observed by "little man," if the films are within a micro-inch of each other.

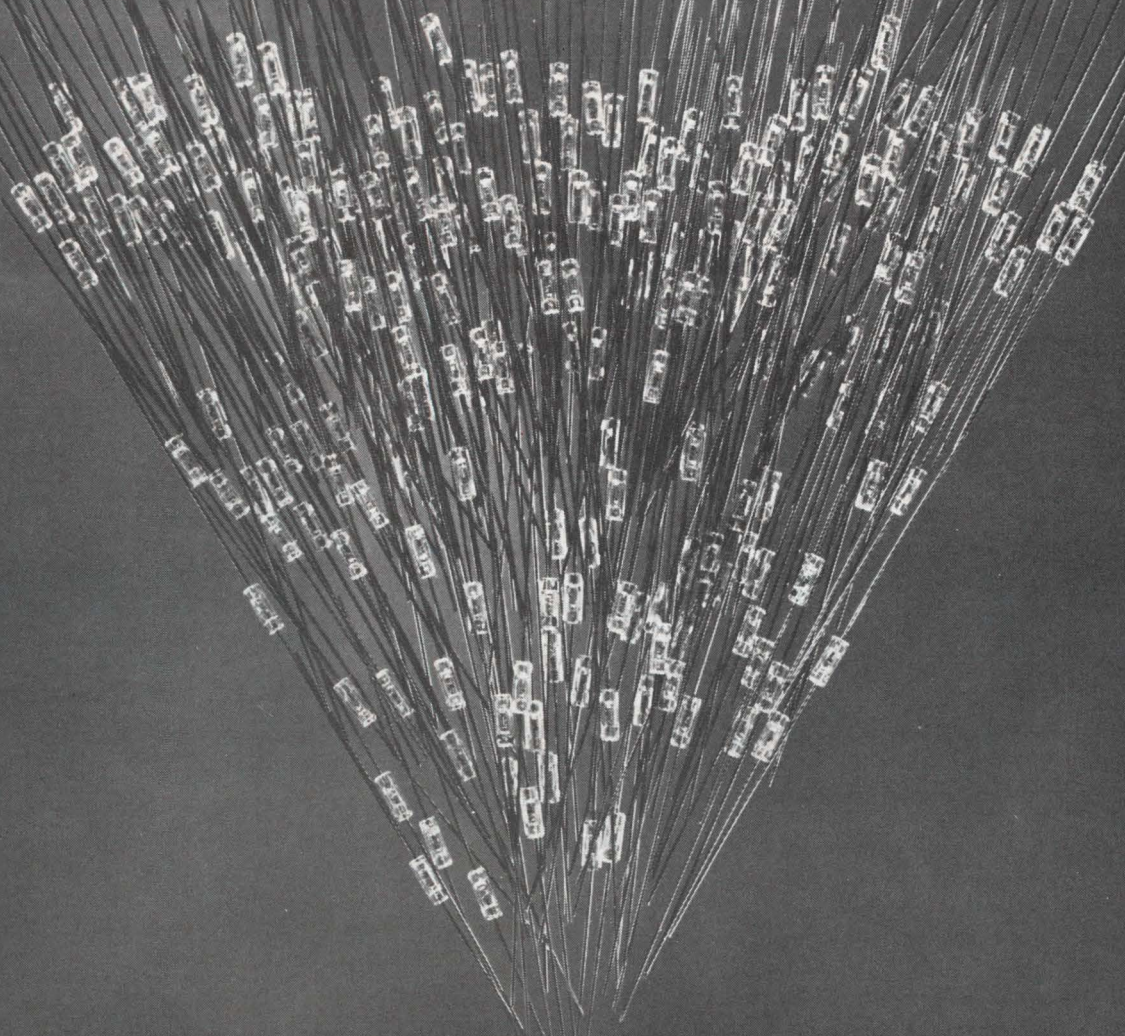

15  15

## Monolithic Diode Matrix

**Now available in any configuration from 5x5 to 15x15.** Another microelectronics breakthrough from Radiation Incorporated. New matrix, pictured actual size, is equivalent to 225 general-purpose planar diodes.



**RADIATION  
INCORPORATED**

For data sheets, price and delivery information, write: Radiation Incorporated, Physical Electronics Division, Dept. ED-02, Melbourne, Florida 32902. Phone: (305) 723-1511. Sales offices: 650 North Sepulveda Blvd., Suite 622, El Segundo, Cal., (213) 772-6371 • 600 Old Country Road, Suite 438, Garden City, N.Y., (516) 747-3730

See this and other Radiation products at Booths 2B34-36, IEEE Show

Speed Inquiry to Advertiser via Collect Night Letter

ON READER-SERVICE CARD CIRCLE 7

**(dc transformer, continued)**

efficiency. That limit could be anywhere from 20% to 100%; we don't know yet."

But even discounting the commercial potentials of the transformer, we still have a fascinating, yet simple device that transforms dc by virtue only of its fluctuating magnetic field and its use of rather unusual boundary properties. To understand how a steady current can cause this fluctuating field, the engineer must know a few facts of cryogenic life.

**Three cryogenic materials**

The materials of the cryogenic world are divided into three types: superconductors, materials that contain (perhaps considerable) resistance, and intermediate materials that exhibit superconduction in some regions and resistance in other regions. It is this last group that interests Dr. Giaever.

Like the electrical field inside an ordinary conductor, the magnetic field inside a superconductor is normally zero. But in both cases an object's resistance to an internal field can be overcome if the imposed field is strong enough. When a magnetic field penetrates a superconductor, its resistance suddenly becomes appreciable, and hence it is no longer a superconductor. It has been found that certain configurations of certain metals allow only partial penetration of an external magnetic field in irregular regions. In these regions, where the outside field continues into the metal, current encounters resistance. But between these regions there is no internal magnetic field, and the metal remains superconductive. This, then,

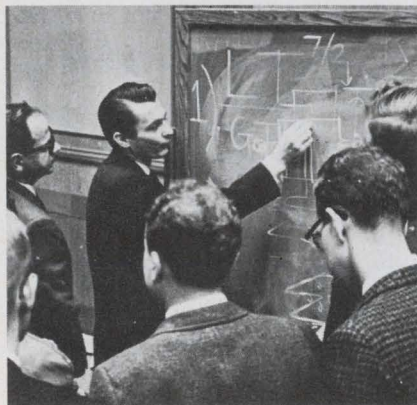

Dr. Ivar Giaever assures physicists he hasn't repealed Maxwell's equations.

is the case in which the metal is in the intermediate state. Cryophysicists refer to this state as "Type II" superconduction.

**Current causes 'Type II'**

Most metal thin films can be made to enter this Type II state simply by passing a sufficient current through them. (Fig. 1 will help visualize the field created by an electron flow in a thin film. Note that the flux due to the movement of each charge is perpendicular to the wide surfaces of the film.) When the current exceeds a certain value—around a few mils for very thin tin—its own flux becomes strong enough to pierce the film. At that moment the superconductor becomes Type II, and the flux at its surface becomes discontinuous (see Fig. 3).

Assume a "little man" stands on the surface of the primary film in Fig. 3. The regions of flux move along with the current flow past the man. He seems to be in a changing magnetic flux. The crucial point here is this: The man must be within a few millionths of an inch of the surface of a superconducting thin film *and* the film must be carrying sufficient current to convert itself to a Type II material in order for him to "see" this magnetic flux variation due to direct current.

**Dc induction in secondary film**

As already indicated, the secondary films are insulated from the primary film by a layer—in this case, silicon dioxide—one-millionth of an inch thick. If the flux due to the primary current is dense enough to change the primary film to Type II, it also pierces the secondary film and converts that, too, to Type II. As flux transverses the length of film, it carries along the free electrons of the secondary film in the superconducting pockets in front of and behind it. And that is the secondary current.

Dr. Giaever gave his presentation at the annual meeting of the American Physical Society, which took place late last month in New York.

As soon as Dr. Giaever had finished presenting his paper, he was surrounded by curious physicists, who asked him if his dc transformer has invalidated Maxwell's equations (see photo). He calmly assured them that it hadn't. ■ ■

**MOSFET KITS are now available at your authorized GI distributor.**

- ALABAMA**  
BIRMINGHAM—M.G. Electronics, (205) FA 8-4525  
HUNTSVILLE—M.G. Electronics, (205) 837-0350
- ARIZONA—PHOENIX**  
R.V. Weatherford Co., (602) 272-7144
- CALIFORNIA—NORTHERN**  
MOUNTAIN VIEW—Avnet Corp., (415) 961-7700  
Kierulff Electronics, Inc., (415) 968-6292  
OAKLAND—Elmar Electronics, (415) 834-3311  
PALO ALTO—Pencor Electronics, (415) DA 6-3366
- CALIFORNIA—SOUTHERN**  
CULVER CITY—Avnet, (213) 870-6140  
INGLEWOOD—Liberty Electronics, Inc., (213) OR 8-8111  
LOS ANGELES—Kierulff Electronics, Inc., (213) 685-5511
- SAN DIEGO**—Milo of California, Inc., (714) BE 2-8951
- COLORADO—DENVER**  
Industrial Electronic Sales Co., (303) 757-1261
- FLORIDA**  
MELBOURNE—Electronic Wholesalers, Inc., (305) PA 3-1441  
MIAMI—Electronic Wholesalers, Inc., (305) OX 6-1620
- GEORGIA—ATLANTA**  
Southeastern Radio Parts Co., (401) JA 4-7536
- ILLINOIS**  
CHICAGO—Newark Electronics Corp., (312) ST 2-2944  
FRANKLIN PARK—Avnet, (312) 678-8160  
SCHILLER PARK—Pace Electronic Supplies Inc., (312) 678-6310
- INDIANA—INDIANAPOLIS**  
Graham Electronic Supply, Inc., (317) ME 4-8486
- IOWA—CEDAR RAPIDS**  
Deeco, Inc., (319) EM 5-7551
- LOUISIANA—NEW ORLEANS**  
Southern Radio Supply Co., (504) 524-2345
- MARYLAND—WASHINGTON, D. C.**  
BALTIMORE—Radio Electric Service Co. of Baltimore, Inc., (301) LE 9-3835  
BETHESDA—Empire Electronics Supply Co., (301) OL 6-3300  
HYATTSVILLE—Milgray Washington, Inc., (301) UN 4-6330
- MASSACHUSETTS**  
BURLINGTON—Avnet Corp., (617) 272-3060  
CAMBRIDGE—R & D Electronics Supply Co., Inc., (617) UN 8-6644  
NEWTON—The Greene-Shaw Co., (617) WO 9-8900
- MICHIGAN—KALAMAZOO**  
Electronic Supply Corp., (616) WO 5-1241
- MINNESOTA—ST. PAUL**  
Gopher Electronics, (612) 645-0241
- MISSOURI**  
KANSAS CITY—Walters Radio Supply Co., Inc., (816) VA 1-7015  
UNIVERSITY CITY—Olive Industrial Electronics, Inc., (314) VO 3-4051
- NEW JERSEY—CAMDEN**  
General Radio, (609) 964-8560
- NEW MEXICO—ALBUQUERQUE**  
Electronic Parts Co., Inc., Albuquerque, (505) AL 6-0946
- NEW YORK (METROPOLITAN AREA)**  
YONKERS—Delburn Electronics, (914) 423-2800  
NEW YORK—Milgray Electronics, Inc., (212) YU 9-1600  
Terminal Hudson Electronics, Inc., (212) CH 3-5200
- NEW YORK STATE**  
BINGHAMTON—Stack Industrial Electronics, (607) RA 3-6326  
BUFFALO—Summit Distributors, (716) TT 4-3450
- OHIO—CINCINNATI**  
The Mytronic Co., (513) 961-4600
- OKLAHOMA**  
OKLAHOMA CITY—Trice Wholesalers, (405) JA 4-4411  
TULSA—Radio, Inc., (918) LU 7-9124
- PENNSYLVANIA—SOUTH JERSEY**  
PHILADELPHIA—Herbach & Rademan, Inc., (215) LO 7-4309  
Milgray Delaware Valley, Inc., (215) BA 8-2000
- TENNESSEE**  
KNOXVILLE—McClung Appliances, (615) 524-1811  
NASHVILLE—Electra Distributing Co., (615) AL 5-8444
- TEXAS**  
ARLINGTON—Beta Electronics, Inc., (214) TA 1-1120  
DALLAS—Contact Electronics, Inc., (214) ME 1-9530  
Solid State Electronics, (214) 352-2601  
EL PASO—McNicol, Inc., (915) 566-2936  
FT. WORTH—Scooters Radio Supply Co., (817) ED 6-7448  
HOUSTON—Busacker Electronic Equipment Co., (713) JA 6-4661
- UTAH—SALT LAKE CITY**  
Kimball Electronics, Inc., (810) 328-2075
- VIRGINIA**  
CHARLOTTESVILLE—Virginia Radio Supply Co., Inc., (703) 296-4184  
NORFOLK—Priest Electronics, Inc., (703) 855-0141
- WASHINGTON—OREGON—SEATTLE**  
Seattle Radio Supply, Inc., (206) MA 4-2341
- WISCONSIN—MILWAUKEE**  
Electronic Expeditors, Inc., (414) UP 1-3000

# Can You Top This ?

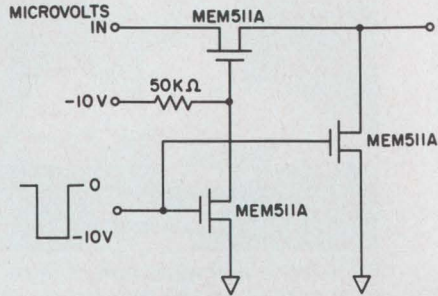

SERIES SHUNT CHOPPER CIRCUIT

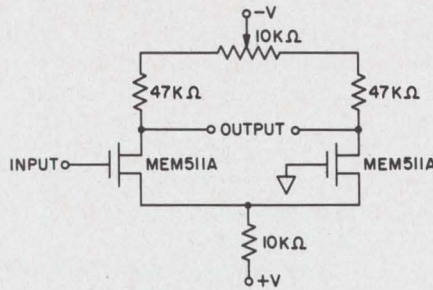

DIFFERENTIAL AMPLIFIER CIRCUIT

Here are just two ways MOS field effect transistors provide unique advantages like these: high input impedance, high on-to-off resistance, and isolation of gate drive. Care to try your hand at a few more? We have an attractive prize for the six best circuit ideas.

## If you can, you may win a handsome 15-volume McGraw-Hill Encyclopedia of Science and Technology

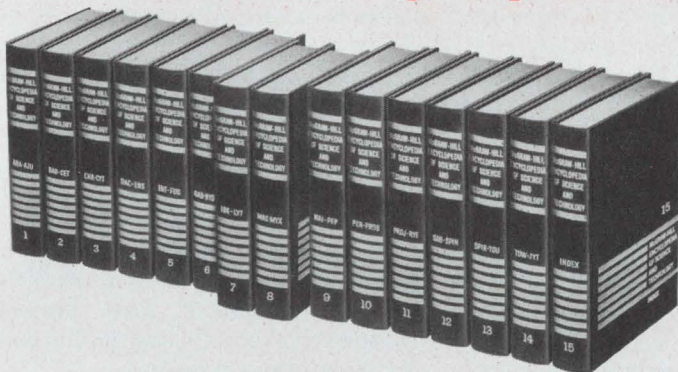

Return the coupon below for an official contest Entry Form and helpful design data on General Instrument's MEM 511A MOSFET. The contest begins immediately and ends March 31, 1966. Six winners will be chosen. You may enter as many circuits as you wish, covering any function in any field of electronics . . . but the MEM 511A must be central to your design.

### MEM 511A offers:

- P-channel, enhancement mode operation, plus . . .
- Protective diode in the gate to prevent electrostatic destruction
- High input impedance ( $10^{10}\Omega$  Typ.)
- Interdigitated geometry

### YOU DON'T NEED THIS KIT TO ENTER THE CONTEST (BUT YOU'RE APT TO WANT IT ANYWAY!)

YOU NEEDN'T buy this kit — or anything else — to be eligible for the big GI MOSFET CIRCUIT DESIGN CONTEST . . .

But it's such a bargain (and limited to the duration of the contest) that it's hard to see how you can resist. Here's what you get:

- 25 Type MEM 511A MOSFETS (normally priced at \$10. each).
- MOS CIRCUIT DIGEST, with full information on designing with MOSFETS . . . 12 circuit diagrams . . . and complete specs on GI MOS Devices. Contains all you've wanted to know about MOS, and maybe a bit more.

This unit is ideal for you or your staff to test experimental MOS circuits; or merely to put GI MOSFETS through their paces to see how much they'll take. Please order through your authorized GI Distributor — and remember: this offer expires with the contest on March 31, 1966.

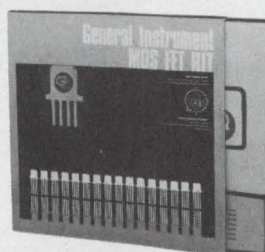

**Special**  
**MOSFET CIRCUIT  
DESIGNER'S KIT**  
**\$250. VALUE**  
**Only 79.50**

### MAIL THIS COUPON NOW

General Instrument Corporation • Technical Service Center  
600 West John Street, Hicksville, New York 11802

Please rush me my Entry Blank, Contest Rules, and MEM 511A Data Sheet for the General Instrument MOSFET CIRCUIT DESIGN CONTEST.

NAME \_\_\_\_\_ TITLE \_\_\_\_\_  
COMPANY \_\_\_\_\_  
ADDRESS \_\_\_\_\_  
\_\_\_\_\_  
\_\_\_\_\_

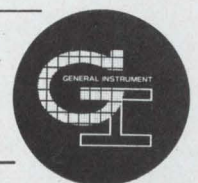

**GENERAL INSTRUMENT CORPORATION / SEMICONDUCTOR PRODUCTS GROUP**

600 West John Street, Hicksville, New York

## Parametric multiplier saves space and cost in S-band transmitter

A low-power 2.4 GHz transmitter achieves unusually small volume and low cost by use of a patented "parametric transistor multiplier."

The circuit, for which Richard Moss of Sylvania Electronic Systems, Buffalo, N. Y., has received a patent, both amplifies and multiplies the 150 MHz crystal output to 600 MHz. He reports that the capacitive reactance of the transistor's base-to-collector junction is utilized as a varactor multiplier.

The 2.4 GHz output of the transmitter tops 1 mW at a 2 MHz bandwidth, but can be increased to approach 100 mW with higher battery power. The current model includes a 12-volt battery, and is designed for beacons, local oscillators or other low-power applications. Addition of a few components in the same package will add frequency modulation capability to the unit.

The transmitter is tunable over a 5-10% range by changing the crystal and retuning. Stability of the unit is one part in  $10^5$  over a temperature range of  $-10^\circ$  to  $+60^\circ\text{C}$ , Moss reported.

The company said that the unit may be producible for under \$100 in quantity. The 3.5 ounce transmitter measures 3 x 1 x 0.5 inches. ■ ■



Parametric multiplier circuit in miniature S-band transmitter is tuned by Dick Moss, engineer at Sylvania Electronic Systems Div.

## E D's \$1000 'Idea of the Year' award to TI engineer



Jack K. Hickman, electronic systems engineer in the Apparatus Division of Texas Instruments, Inc., of Dallas, is the winner of ELECTRONIC DESIGN's annual \$1000 "Idea of the Year" award. Hickman's idea, "Complementary Diode Feedback Produces Nonlinear Gain," was adjudged by the magazine's editorial board to be the most interesting and useful published last year in the Ideas for Design department.

The winning entry, which appeared in the June 7, 1965 issue, was derived from an infrared systems project, in which Hickman was responsible for the video portion. The concept is applicable to

general amplifying and feedback networks and is of particular use in electronic and optical systems. Hickman has filed a patent disclosure for the design.

The TI engineer's entry was his first contribution to ELECTRONIC DESIGN. He has since placed a number of other Ideas for Design. In addition the award is the second in a row to go to an engineer in the Dallas area. Robert T. Hart, project engineer for the Collins Radio Co., was last year's winner.

Hickman's idea, and those of the two preceding annual award winners, are available in a free reprint. To obtain a copy, circle 739 on the Reader Service Card. ■ ■

## Ultra-thin solar cells

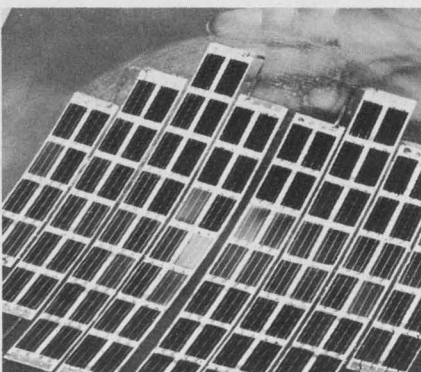

Silicon solar cells mounted in a polyimide film panel are only 4 mils thick and weigh 60 milligrams each. This compares with conventional silicon cell thicknesses of about 13 mils and weights in excess of 170 milligrams. Developed by Electro-Optical Systems of Pasadena, Calif., the units were fabricated from diffused single-crystal silicon having silver titanium contacts. Two of the panels, each containing 100 cells, will be used to generate power for high-altitude meteorological balloons.

## Battery pulses 25 MW

A rechargeable nickel-cadmium battery designed to deliver pulsed power of 25 megawatts has been developed for a laser power supply.

The size of a telephone booth, the giant battery will utilize a bipolar plate concept that has not been used commercially heretofore, according to Dr. Robert Shair of Gulton Industries, which developed the battery. Instead of separate nickel and cadmium plates, the unit has a single sheet clad with the two metals.

# This is the **reliable** film/foil polycarbonate capacitor



First, we designed PAKTRON® epoxy coated polycarbonate capacitors for greater temperature stability, higher insulation resistance and a lower dissipation factor. In fact, we provided a virtually flat T.C. over the entire temperature range. We made them highly resistant to moisture, shock, vibration and contamination to meet rigid specs. We tested them until they surpassed many of the toughest environmental requirements. Our engineers made dimensions precise, broadened capacitance ranges to 1.0 mfd. and established exacting tolerances. Then, we answered your packaging engineer's dream . . . we put all of this know-how into a small size. Hot or cold, minus 65°C to plus 105°C, the inherent stability of PAKTRON epoxy coated polycarbonate capacitors will provide you with consistent *reliability* over the entire temperature range. Best of all, we added a sensible price tag. See for yourself, ask for full details and *free* samples—no obligation. The graphs below provide typical examples of performance.

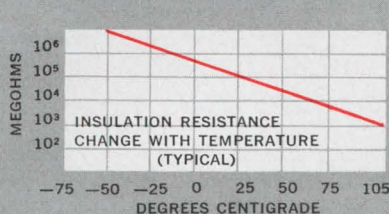

**INSULATION RESISTANCE.** 10<sup>6</sup> megohms, minimum, at 25°C; 10<sup>2</sup> megohms at 105°C when measured at rated DC voltage, with an electrification time before measuring of 2 minutes.

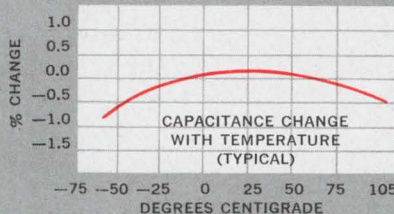

**TEMPERATURE STABILITY.** Maximum capacitance change from 25°C value will be +1% -5% at 105°C. Maximum change at -65°C will be +0% -1%.

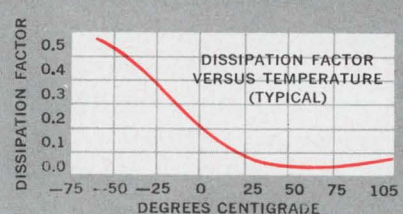

**DISSIPATION FACTOR.** Will not exceed .1% when measured at 1 K.C. ± 20 cps and 25°C ± 5%.

"Remember, you're never more than a few feet away from a product of ITW"



## PAKTRON

DIVISION ILLINOIS TOOL WORKS INC.  
1321 LESLIE AVENUE • ALEXANDRIA, VIRGINIA 22301

# ONLY 3C OFFERS

## TOTAL INTEGRATED CIRCUIT CAPABILITY: $\mu$ -PACS, MEMORIES, AND COMPUTERS

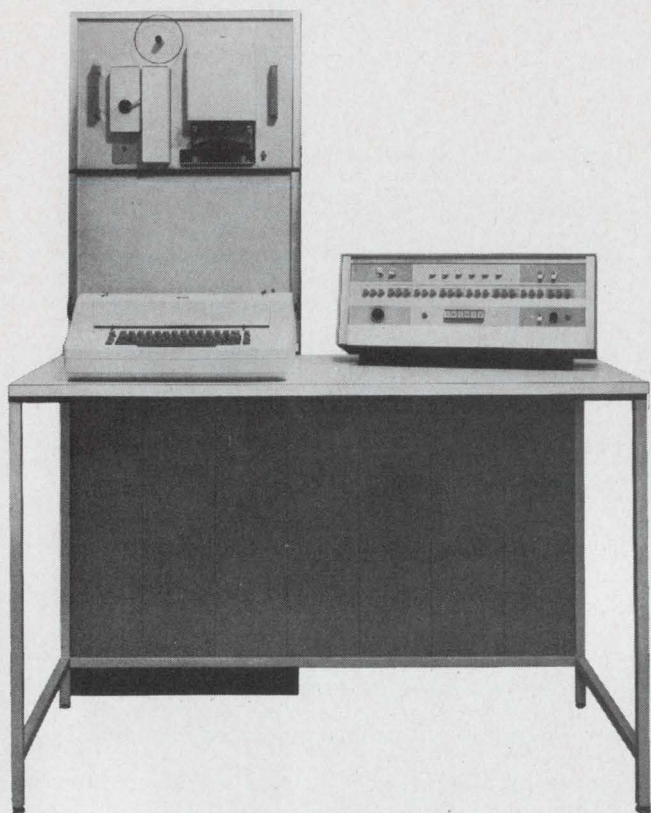

### MICROCIRCUIT DDP-124

24-bit word DDP-124 features monolithic integrated circuit  $\mu$ -PAC<sup>tm</sup> construction; fast, reliable, and flexible logic configuration — binary, parallel, sign/magnitude, single address with indexing, powerful command structure. Over 285,000 computations per second. MEMORY: 8192 words (expandable to 32,768) directly addressable; cycle time 1.75  $\mu$ secs. INPUT-OUTPUT: Typewriter, paper tape reader and punch. (Strong optional I/O capability and broad range of peripheral equipment.) SOFTWARE: FORTRAN II and IV, assembler, executive, utility and service routines. Fully program compatible with DDP-24 and DDP-224 general purpose computers.



### INTEGRATED CIRCUIT 1 $\mu$ SEC CORE MEMORY

New ICM-40 microcircuit, coincident current, random access core memories feature full cycle operation in 1  $\mu$ SEC (less than 500 nsec access time). ICM-40's feature price, size and reliability advantages of integrated circuit  $\mu$ -PAC<sup>tm</sup> logic. Word capacities to 16,384 in a 5 $\frac{1}{4}$ " high unit for mounting in a standard relay rack. Design permits pull out front rack access. Operating temperatures from 0°C to +50°C, with broad margins. Clear/Write, Read/Restore and Read/Modify/Write are standard modes of operation. ICM-40 interfaces comfortably with both discrete component and integrated circuit systems. Low power dissipation.

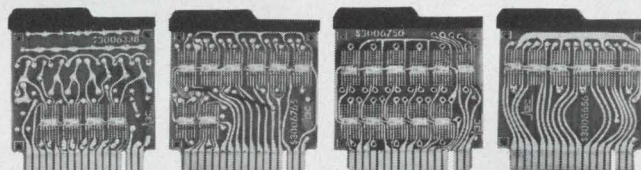

### $\mu$ -PAC LOGIC MODULES

3C is the world's largest supplier of digital logic modules. With several years of in-house funded research and design, 3C has developed a broad line of standard, fully integrated, monolithic, 5mc circuit modules with the flexibility of 3C's long established discrete package lines. This has been achieved while retaining advantages inherent in the integrated circuit — price, size, reliability.



3C SALES OFFICES: NEEDHAM, MASS.; FOREST HILLS, N.Y.; LEVITTOWN, PA.; SYRACUSE, N.Y.; SILVER SPRING, MD.; HOUSTON, TEXAS; HUNTSVILLE, ALA.; COCOA BEACH, FLA.; DES PLAINES, ILL.; DETROIT, MICH.; WEST CARROLLTON, OHIO; LOS ANGELES, CALIF.; KENT, WASH.; ALBUQUERQUE, N.M.

**COMPUTER CONTROL COMPANY, INC.**  
OLD CONNECTICUT PATH, FRAMINGHAM, MASSACHUSETTS 01702

Speed Inquiry to Advertiser via Collect Night Letter  
ON READER-SERVICE CARD CIRCLE 10



The 'Cubmarine', deep-sea diver

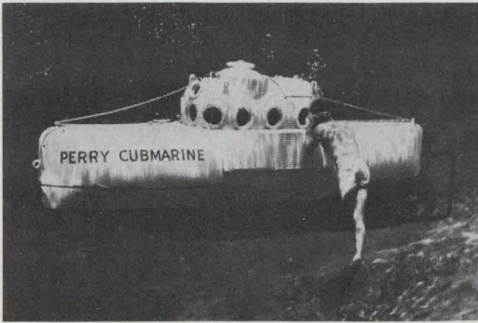

### Definitive report in oceanography issued

The U.S. has officially identified what it considers to be the "undersea vehicles for oceanography." The identification has been made in a report issued by the Interagency Committee on Oceanography (ICO) and the Federal Council for Science and Technology.

The document (ICO Pamphlet No. 18, "Undersea Vehicles for Oceanography," U.S. Government Printing Office, 65 cents) clarifies a lot of muddled waters. Until ICO declared in effect, "this craft is an undersea research craft and that craft is not," there was wide variance in unofficial lists. Some included almost anybody's basement craft with a garden-hose air supply, and others excluded all but the Navy's Trieste and the Navy-supported Alvin. The variations were important, since the lists were often used to delineate the ocean engineering market, evaluate efforts and opportunities in this field, and even lay the groundwork for Government programs, including support grants.

The ICO list names 21 U.S. Government and non-Government craft, including Trieste, Alvin, Aluminaut, the Deepstars and Cubmarines. And it identifies six foreign craft. In releasing the list, ICO also pointed out some of the problems holding back design and production of more advanced undersea research craft. Many of the snags are electronic. One is power supply—not only a reliable, virtually unlimited source for propulsion, but also one for instruments. Another is the need for improved ocean-bottom navigation systems and instruments. Even after these two basic areas are under control, the craft is severely limited as a research tool, until it can be equipped with superior manipulators to obtain samples and perform tasks.

However, before companies and institutions think ahead to advanced undersea research craft, ICO apparently is urging them to gain more experience with operating the 27 existing vehicles. Not only is the committee working behind the scenes to develop more such experience—possibly to provide the basis for licensing—but it is also urging operators to evaluate their craft as research tools.

Observers point out that since there is little

# Washington Report

S. DAVID PURSGLOVE,  
WASHINGTON EDITOR

likelihood that ICO would disparage the value of undersea craft, its request probably is designed to build a case file to aid in securing further Federal design and development funds.

### 'Wet NASA' proposals revived

Proposals to gather all of the Government's oceanography and ocean-engineering activities under one NASA-like roof were revived early in the second session of the 89th Congress. Many variations have been offered, but the one most likely to see action comes from Rep. Joseph Karth (D., Minn.) third ranking member of the House Committee on Science and Astronautics. At present the Interagency Committee on Oceanography acts as a clearinghouse for the ocean activities of 22 agencies. Some proposals would increase the committee's scope and give it authority to make and police decisions on an oceanographic "division of labor." Others would set up a national oceanographic council similar to the National Space Council. But Karth and members of a subcommittee that he heads want a new, independent agency.

With Congress increasing the allocations for ocean sciences, it wants not only a coordinated effort, which most Congressmen view as more efficient and less expensive, but it also wants a single agency to be responsible to Congress.

### AEC plans its biggest reactor year

Atomic Energy Commission officials are uncrossing their fingers now that they have studied the budget for Fiscal 1967. They know that despite heavy cuts in some programs, they will have the funds to work with industry in what likely will be the biggest year yet for commercial atomic power. It follows a year already officially on the books as the biggest. During 1965 utilities placed orders for eight nuclear units with a total capacity of almost 5000 MW. When 1965 ended, seven plants were under construction in seven states. The AEC's reactor development and technology director, Milton Shaw, says firm commitments are being made for more reactors, and 1966 "appears even more promising" than 1965.

Although the commission's total budget will be down \$103 million in fiscal 1967 (to just under

# Washington Report

CONTINUED

\$2.3 billion), the heavy cuts were in raw materials and weapons. Reactor development funds are up slightly. The following activities concerned with civilian central station power generation show rises: civilian power reactors, cooperative power-reactor demonstration program, general reactor technology and nuclear safety. Advanced systems R&D funds are down slightly. Other areas that have been reduced are the Army's power reactor program, which has been cut to almost nothing; Pluto, which had already been scratched, and SNAP programs, which have been pared slightly.

In the civilian program, emphasis is clearly increasing in the fast breeder reactor area. In the coming year increased effort should be seen in fast breeder reactor physics and in fuel development for these reactors.

Challenges are forming in Vice Adm. Hyman G. Rickover's naval reactors program, and the AEC has been promised the money to meet them. The biggest push was prompted by the Administration's agreement to allocate funds for a new, two-reactor aircraft carrier. Funds for development of these D1W-type reactors will jump from \$13.8 million to \$20.2 million. An area that promises to repeat the urgency and challenges of early submarine-reactor development is the NR-1 program. Here, Rickover is developing the power plant for the Navy's deep-diving research vehicle (see E/D, Feb. 1, p 21). The entire deep-submergence program, of which the NR-1 is a major part, has recently been reoriented by the Navy as a high-priority project.

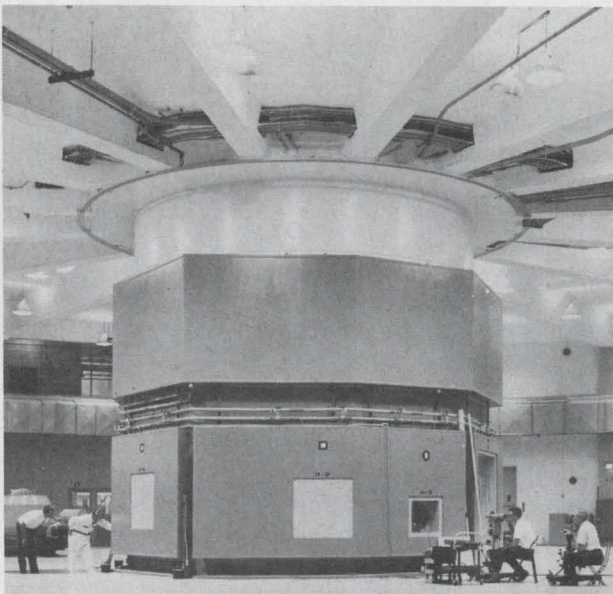

A high-flux beam reactor is undergoing final alignment at Brookhaven National Laboratory. Men at right take readings through beam port.

Many observers here believe that the Deep Submergence Systems Project will gradually take over the military submarine program, with the majority of the future fleet consisting of ultra-deep-diving craft, designed along the lines being developed in the NR-1 program. AEC power plant money alone has risen from \$2.8 million to \$3 million in Fiscal 1967. In 1965 the total was only \$200,000.

## Auto safety agency in the offing

Electronic designers may soon have a central agency to work with in the now helter-skelter programs to adapt computers to traffic safety and to develop automobile safety devices. President Johnson's State of the Union Message promised a "highway safety act." He gave no details, but many Administration officials believe it will provide an agency for central research into auto accidents. Such an agency would seek and test new safety equipment, much of it electronic (see E/D, Aug. 30, p 6).

Many Congressmen already have their own ideas about such an agency. Rep. James A. Mackay (D., Ga.), member of the House Interstate and Foreign Commerce Committee, which would have responsibility on the House side of the Capitol, sums up much of the thinking. The agency, as he sees it, would be headed by an administrator with status comparable to that of the Federal Aviation Administrator. The organization itself would be set up along lines similar to the Federal Aviation Agency. The agency would promote a strong program of research, design and testing. It would also have the authority to set auto-design standards and highway regulations, based on its research.

A complaint voiced in the electronics industry is that each of the 16 Federal agencies and 45 private groups engaged in traffic safety work has its own theories, standards and operating practices. Government officials agree that the industry has developed several practical devices for use on cars and highways and even more devices that have proved to be valuable tools in education, research, testing and data handling. However, no one of the existing agencies can set the nationwide criteria needed to make production and marketing worthwhile. Rectification of this situation, says Representative Mackay, is high on the list of reasons why the present Congress is anxious to centralize Federal traffic-safety activities.

## Date Set for First Apollo Flight

The nation's \$21-billion moon race with the Soviet Union is scheduled to take to the skies on George Washington's birthday—Feb. 22. NASA plans the first unmanned launching of the Apollo spacecraft—a 39-minute, sub-orbital hop to a South Atlantic recovery spot.



*"the rumor was true, Boris...  
Guardian has added **QUICK-CONNECT**  
terminals to their 98¢ relay"*

If Boris could have waited we would have given him all the details! Engineers have been asking for a 3/16" quick-connect version of the famous Guardian 98¢ Relay for some time now. It's here at last. The ideal unit for any applications where maintenance and down-time are critical. This relay snaps

in place quickly, ends costly soldering and maintenance expense. A quality unit, made in the U.S.A., it outperforms relays costing far more. Simplified design enables 8 parts to do the work of 22! One-piece field and core. New capsulated coil with cover. Contacts: DPDT with rating of 10 amps at

110VAC resistive load. Coil: Voltages 24, 115, 230VAC or 6, 12, 24VDC. This new 910 "quick connect" Series Relay is available right now from stock—minimum order, 200 pieces. (Or, it is available from your Guardian authorized Distributor in quantities up to 199 units.) Write for further information.

**GUARDIAN**  **ELECTRIC**

Guardian® Electric Manufacturing Co.

• Dept. ES62, 1550 West Carroll Avenue

• Chicago, Illinois 60607

ON READER-SERVICE CARD CIRCLE 217

# Small-boat electronics makes a splash



**Solid-state meter** displays several readings. It can be set up with a choice of plug-in PC modules.

## Roger Kenneth Field News Editor

Electronic solutions for three nautical problems were put to sea recently at New York's annual boat show:

- A small, solid-state meter tells a skipper the boat's speed, the depth of the water and the amount of charge in the battery. It can even indicate wind speed, fume level in the bilge or the proximity of a passing school of fish.

- A compact computer automatically tunes the boat's radiophone antenna to match any output frequency between 2 and 3 MHz.

- A portable communications unit enables skin divers to talk to each other underwater or to the boat crew.

### Multi-purpose meter

The solid-state meter that offers the boat enthusiast several navigational readings is the new Unipas 300, sold by College Hill Industries of East Providence, R. I. When the boat owner buys the meter, he selects any three of six available plug-

in PC modules. Each module is furnished with an appropriate sensor.

Its large, clean face has only two scales—1 to 10, and 1 to 25. The boatsman selects either the high or the low scale of any module in the meter by turning a single switch. He then simply supplies (mentally) the obvious units: Knots for wind or boat speed, feet for water depth, and volts for the battery check. The meter consumes less than 150 mA.

Prices for the meter, with three modules and sensors, start at \$355. Though the cost (with a nautical mileage indicator) may go as high as \$629, it is still cheaper than providing separate units for each reading.

### Computer-tuned antenna

For loud, clear communications to shore, Au-tenna Systems Co. of New Canaan, Conn., offers an automatic marine antenna system. A small, solid-state computer checks the phase angle between the output voltage and current of the boat's radiophone and then tunes the antenna to the best signal level.

A small dc motor changes the resonant point of the antenna by moving its internal ferrite slug. The computer checks the phase angle, directs the motor to move the slug, stops the motor when the antenna is tuned, and signals the operator to speak. All of this is done in a fraction of a second each time the operator presses the "talk" button. Prices for this system start at \$296.

### Underwater communications

Another communications problem occurs below the rudder: Divers have always been able to talk underwater; unfortunately they couldn't be heard. With the new Raytheon Yack/Yack strapped around his stomach, a diver can now exchange pleasantries underwater with any man, fish or mermaid within 50 feet.

No equipment is needed to hear the diver. His voice feeds through a small dynamic microphone in his

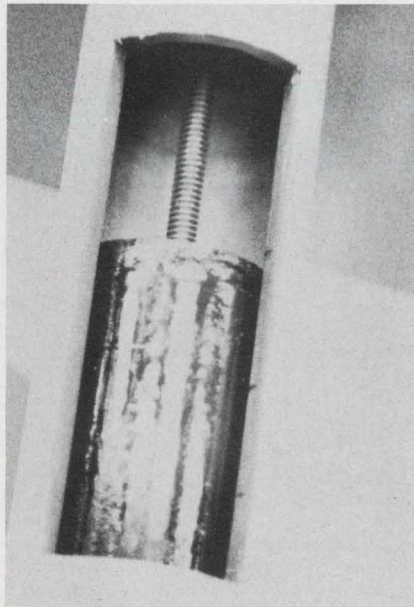
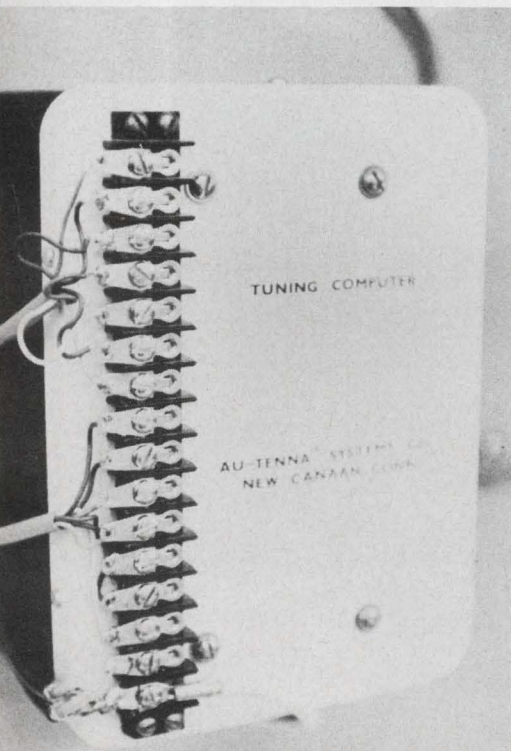

**Solid-state computer** (left) tunes ferrite slug inside radiophone's antenna (above). The computer tunes to obtain the strongest signal for each channel and antenna angle.

# DATA COMMUNICATIONS

equipment for on-line,  
real-time processing

## there's more than that to a page printer!

Is most of your data coded in numbers? Need a page printer that will print in 2-colors? Neither is difficult in data communications, because Teletype page printers offer a wide variety of print-out capabilities.

The Teletype numeric keyboard has keys similar to an office adding machine to provide fast, efficient collection, integration, and transmission of numerically coded data. It can be used by branches to record and transmit numeric data to processing or distribution centers to simplify ordering and inventory control, as well as speed shipping. Though this Teletype set transmits numeric data only, it will receive and print-out all alphanumeric characters.

### TWO-COLOR PRINTING

There are many applications of 2-color printing, including tie-ins with business machines. Accounting and statistical departments can use Teletype machines to transmit data in 2-colors to the home office or a centralized data processing center. For instance, the red can be used to indicate

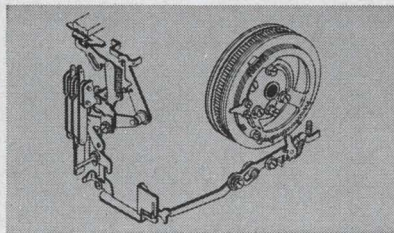

HORIZONTAL TABULATOR

"loss" figures and the black to indicate "profit" figures. Page printers can also be used to report plant operations, using black for normal conditions and red for abnormal conditions.

### AIDS TO DATA COMMUNICATIONS

There are many additional Teletype page printer features that further improve your data communications capabilities. These include: vertical and horizontal tabulators; a variety of type styles and sizes; and sprocket feed platens that enable you to type on multicopy business forms.

There are also a variety of platen widths to accommodate most standard size forms. Another important feature is the automatic forms feed-out. With one key stroke, you can advance a business form, bringing the next one to the starting position automatically.

### KEEPS MANAGEMENT UP-TO-DATE

The capabilities of Teletype page printers have found wide application in both business and industry. For

example, a large aircraft plant uses nearly 50 Teletype Model 35 page printers throughout the plant to report production information to two real-time computers. In this way, management is provided with instant information on the status of plant operations. This system has helped management to tighten control over in-plant functions, shorten production time, and reduce overall manufacturing costs.

And there's more to Teletype equipment than just page printing—such as automatic and keyboard send-receive sets, and a variety of paper tape punches and readers to name only a

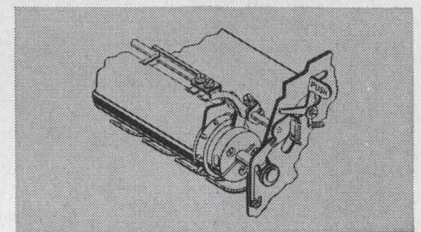

SPROCKET FEED PLATEN

few. That's why these Teletype machines are made for the Bell System and others who need dependable communications at the lowest possible cost. A brochure on the applications of Teletype equipment is available by writing: Teletype Corporation, Dept. 89B, 5555 Touhy Avenue, Skokie, Illinois 60078.

*machines that make data move*



ON READER-SERVICE CARD CIRCLE 11

# TWO WAY DELAY

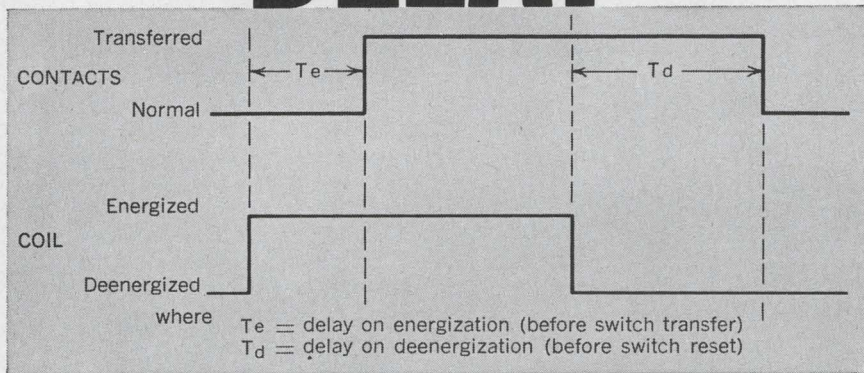
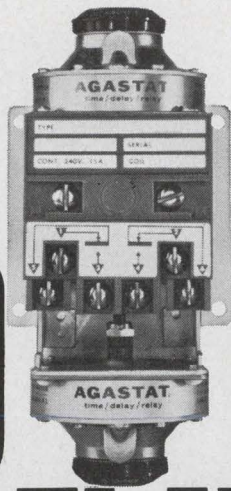

You get "on-delay" and "off-delay" operation in sequence in the same unit with the new AGASTAT® Double Head time/delay/relay. Each delay can be independently set on the unit's time-calibrated dials, in any of eight ranges covering a total span from .01 second to a full thirty minutes. Thus, the unit can take the place of two conventional timers, with substantial savings in panel space and installation time.

This new model of the 2400 Series is supplied for operation on all standard ac and dc voltages. Pneumatic timing offers high repeat accuracy, not affected by normal voltage and temperature fluctuations. DPDT switches handle loads up to 20 amps.

Want more complete data? Write the leader in time/delay instrumentation since 1931. Department A33-42.

**AGASTAT TIMING INSTRUMENTS**  
 ELASTIC STOP NUT CORPORATION OF AMERICA  
 ELIZABETH DIVISION • ELIZABETH, NEW JERSEY  
 IN CANADA: ESNA LIMITED, 271 PROGRESS AVENUE, SCARBOROUGH, ONTARIO  
 Speed Inquiry to Advertiser via Collect Night Letter  
 ON READER-SERVICE CARD CIRCLE 12

## NEWS

(boat show, continued)

mask to a waterproof orange unit that amplifies it. The amplifier's output is coupled to the water by a liquid-filled transducer designed for this purpose. Raytheon will not disclose details of the transducer, which has been hermetically sealed to keep out both the water and the competition.

Two divers equipped with Yack/Yacks can converse with each other. And a special unit is available for communications from the ship above to the diver below. When the unit is lowered underwater on a cable, the ship's crew can talk to any divers within range and hear any who use their own individual Yack/Yacks.

The diver's unit uses about 0.5 watt—but only when he talks. When he doesn't talk, no power is consumed. Raytheon says its battery will last an entire season.

In emergencies the diver presses a switch on the side and the unit emits a continuous emergency signal.

Yack/Yack is priced at \$118. ■ ■



Sealed underwater unit amplifies a diver's voice. The microphone (in model's right hand) is installed under the face mask. The signal is coupled to the water by a transducer.

# DATA COMMUNICATIONS

equipment for on-line,  
real-time processing

## how modular can you get?

Teletype machines are modular by design, as are all the special purpose control and operating functions. As a result, Teletype equipment provides many more opportunities for you to improve on your capability to communicate data. This is also why Teletype sets are the best equipped to prepare data for transmission, as well as to transmit and receive it.

### FRICION OR SPROCKET FEED?

Teletype sets can be equipped with either a friction feed platen that prints on single or multiple copy paper, or a sprocket feed platen that positions multi-copy business forms for printing. Projecting pins engage perforations in the business form to provide for continuous, accurate multi-copy alignment.

Also, horizontal and vertical tabulators can be provided on Teletype Model 35 equipment to speed typing and improve efficiency. Teletype sets can be equipped with a form-out feature that with one key stroke will advance a business form, bringing the next one to the starting position.

*machines that make data move*

### NON-PRINTING FUNCTIONS

The stunt box can control many non-printing functions that add to the versatility of Teletype sets. Among these functions are carriage return and line feed, plus the ability to activate other apparatus including paper tape punches, paper tape readers, and business machines.

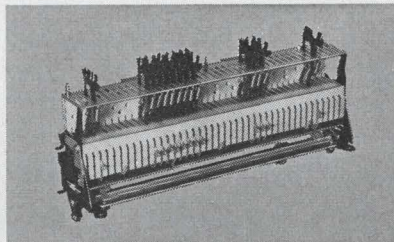

STUNT BOX

### OTHER CONTROL FUNCTIONS

Control circuits for operating auxiliary input and output devices can be utilized, such as on the Teletype Model 35 ACS (Automated Communications Set). This is basically an automatic send-receive set with an additional tape reader for internal programing capabilities.

The auxiliary devices include: push button addresser that automatically calls in a preselected remote receiver, a push button generator that automatically types in repetitive stored data to further simplify the filling-out of business forms, and an auxiliary page printer and tape punch.

### ADDITIONAL TIMESAVERS

To further aid the operator in preparing business forms, Teletype machines are equipped with a copyholder to hold papers for easy, convenient reading and handling. Also, there is a form supply box for storing unused and completed business forms.

We have indicated only a few of the features that are or can be incorporated into Teletype sets. This versatility is one of the reasons why they are made for the Bell System and others who require dependable communications at the lowest possible cost. The new Model 35 ACS is described in an 8-page brochure, which you can obtain by writing: Teletype Corporation, Dept. 89B, 5555 Touhy Avenue, Skokie, Illinois 60078.



MODEL 35 AUTOMATED COMMUNICATIONS SET



ON READER-SERVICE CARD CIRCLE 13

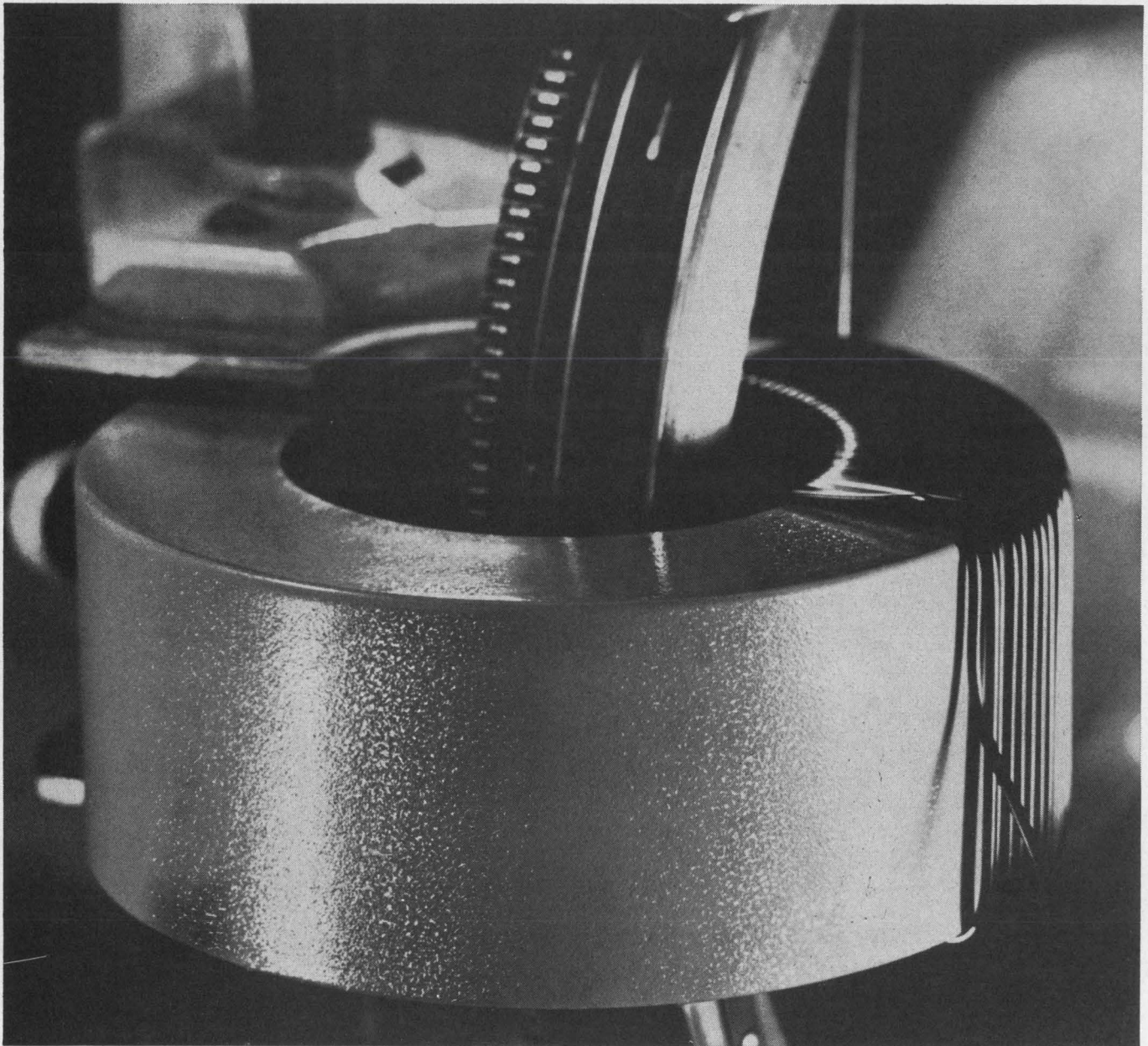

## ROUGH WITH A REASON

### Unique GVB finish cuts core winding costs

GVB encased cores mean fewer production delays because GVB does much more than seal the core box against potting material. Its matte finish provides a resilient, non-slip base for winding, and the tough epoxy skin prevents the wire from cutting through to the core box. Guaranteed not to fail, even when wound with heavy #6 wire, GVB surface also eliminates abraded wire problems. No prior taping of the core is required, so another winding operation is wiped out.

Magnetics doubles the normal guarantee on core box finishes by expressing it in this unique way: The guaranteed voltage breakdown (GVB) finish seals the box

and is capable of withstanding at least 1,000 volts at 60 cycles *between a bare winding and the aluminum case*. Quality control monitors the application and curing of GVB to assure dimensional and voltage breakdown fidelity. Performance characteristics are maintained between -65 and 200 degrees C.

To reduce production costs on your winding operations, try Magnetics' tape wound cores with GVB. Eight material types, in a wide range of sizes from 0.375" to 4.0" inside diameter, are stocked for immediate delivery. More information? Write *Magnetics Inc., Dept. ED-27, Butler, Pa.*



Speed Inquiry to Advertiser via Collect Night Letter  
ON READER-SERVICE CARD CIRCLE 14



# DATA COMMUNICATIONS

equipment for on-line  
real-time processing

## there are keyboards...and there are keyboards

Data communications vary, requiring a variety of different keys and even different keyboards. This is why there are Teletype sets available with 3-row keyboards, 4-row keyboards, and numeric keyboards, having a variety of special purpose keys.

The 3-row keyboard operates on the 5-level Baudot code. The new 4-row keyboard is similar to the standard office typewriter, and operates on an 8-level code that's compatible with the American Standard Code for Information Interchange. It can communicate directly with computers and other business machines in data processing systems. The numeric keyboard consists of 25 keys that are used primarily to speed transmission of coded numeric data such as used to control inventory and delivery in warehouses, supermarkets, etc. Though this Teletype set can send only numeric data, it is capable of receiving and printing all alphanumeric characters.

### WHAT ARE THE "KEY" DIFFERENCES?

There are many different special purpose keys on Teletype keyboards. The most commonly used are the function or non-printing keys. On the 3-row keyboard, depressing the LTRS key transmits the letter characters shown on the lower keytops while depressing the FIGS key transmits the figure characters on the upper keytops.

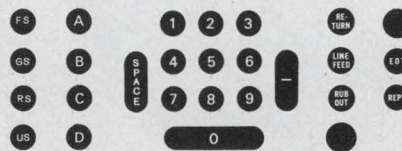

NUMERIC KEYBOARD

On the 4-row keyboard, both the letters and figures are shown on the lower part of the keytops. Thus, the SHIFT key enables the code combinations to be generated for the printing characters shown on the upper keytops, such as "&" and "%". A CONTROL key is used to generate the code combination for the function characters shown on the upper keytops, such as "WRU" (who are you?) and "EOT" (end of transmission).

### ERROR DETECTION AID

The 4-row keyboard can generate an "even parity" which is used to aid in error detection. Even parity provides for adding a marking pulse whenever the number of marking pulses in a code combination is odd. Thus, if a code having an odd number of marking pulses is received, it indicates an error. The eighth level is used for providing even parity.

*machines that make data move*

On friction feed typing units, depressing the LINE FEED key causes the paper to advance one line. Sprocket-feed typing units are equipped with both LINE FEED and FORM-OUT keys that cause the platen to advance a printed business form either one line or a sufficient distance to bring the next form to the starting position.

### SELF-CONTAINED KEYBOARDS

Self-contained 4-row keyboards are available to provide direct parallel-wire entry of variable data into computers and business machines.

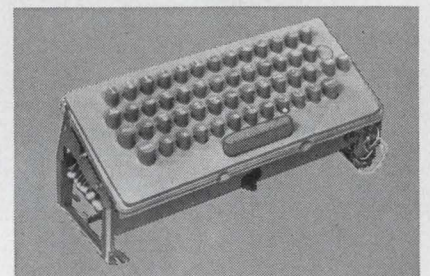

ALPHANUMERIC KEYBOARD

The versatility of Teletype keyboards is another reason why they are made for the Bell System and others who demand reliable communications at the lowest possible cost. If you wish further information on Teletype equipment write: Teletype Corporation, Dept. 89B, 5555 Touhy Avenue, Skokie, Illinois 60078.





At the NCR Electronics Division, you build your career on hardware—not hope. Advanced developments like CRAM and the NCR 315 RMC Rod Memory Computer—the first commercially available computer with an all-thin-film main memory—are a marketplace reality. (And bear in mind that the NCR marketplace consists of more than 120 countries!) If you want to combine career stability with go-ahead, on-line opportunity...if you want to earn a good living while enjoying the good Southern California life... look into the opportunities listed here.

## BUILD YOUR IN WORLD-WIDE BUSINESS AUTOMATION AT NCR, LOS ANGELES

### MAGNETIC RECORDING

Senior and intermediate positions for men with experience in advanced magnetic recording techniques. Knowledge of media, circuitry and magnetic head design necessary. Requires BS in engineering or physics.

### MEMORY DESIGN

Positions are available to perform memory design. Requires a BS in EE and previous experience with high speed applications of magnetic cores or thin films to memories. Must also be familiar with computer systems logic and hardware.

### PACKAGING

#### GROUP LEADER

To provide technical and administrative direction for electronic packaging of digital computers, including processors, memories, and peripherals. Requires a minimum of 6 years'

experience in electronic packaging and some previous supervisory experience. Must be knowledgeable of heat transfer and advanced manufacturing techniques. BS in engineering required.

### ADVANCED LEVEL

To perform advanced packaging of computer systems, including processors, memories and peripherals. Requires BS in engineering and thorough knowledge of packaging concepts as related to digital computers.

### INTERMEDIATE LEVEL

These positions entail layout and design of packaging for computer systems. Applicants must have previous experience with electronic computers or electromechanical devices. Background in miniaturization utilizing thin films and integrated circuits is desirable but not required. BS in engineering desirable.

### LOGIC DESIGN

For design of advanced integrated circuit computers. Requires BSEE and 2 to 5 years' experience in logic design; experience on processor and float-point design desirable.

### QUALITY ENGINEERS

Assignments will entail mechanical and electrical analyses with responsibilities for project testing and inspection specifications, including processes for automatic wirewrapping, cabling and electrical and mechanical assemblies. Requires BSEE or BSME and 3 years' related experience.

### PROGRAMMERS

#### SOFTWARE

Positions entail development of software for various computer input/output routines, operation systems and monitors. Applicants must

have previous programming experience with machine language on a large file computer.

### DESIGN AUTOMATION

Positions require 2 years' previous experience in programming. Good understanding of engineering and hardware problems desirable, BS degree in math, engineering or related field required.

### DIAGNOSTIC

Position entails the writing of diagnostic programs for checkout, acceptance test and field maintenance of EDP systems. Requires previous programming experience; college degree desirable.

### ADVANCED MECHANISMS SPECIALIST

For analysis and design of complex computer mechanisms. Must have knowledge of applied mechanics and high-level mathematical ability. PhD required.

### PROJECT ENGINEERING

#### COMPUTING SYSTEMS

Assignment will entail technical and administrative leadership of engineers involved in advanced digital computer system and logic design. Requires BSEE and 5 years' experience in logic design of digital computers. Must have system design capability and knowledge of peripheral equipment operation and interfacing. Previous team leader experience desirable.

## PERIPHERAL EQUIPMENT

To direct engineers in the development of electromechanical magnetic files for digital computers. Requires BSEE and a minimum of 6 years' experience in electromechanical peripheral development, logical design and machine organization. Must have recent experience entailing project responsibility.

## SYSTEMS FORMULATION

Positions available at all levels to study and formulate systems for commercial and industrial on-line computer applications, with emphasis on communications interface. Requires a minimum of two years' experience in specifying or programming real-time systems for banks, airlines or industry. A degree in engineering, business administration or related field is required.

## CIRCUIT DESIGN

Intermediate- to senior-level positions are available for circuit designers who are experienced in analog or digital circuit design. Experience in power supply design, memory design, and micro-electronics desirable. BSEE required.

## ELECTRONIC PRODUCT ENGINEERING

Assignments will entail design, checkout, documentation and liaison for digital computer systems. Requires BSEE and previous experience in these areas.

## RELIABILITY ENGINEERS

Positions are available on an intermediate level in both mechanical and electrical reliability engineering to perform evaluation of electrical components, sub-assemblies and systems, as well as complex mechanical and electromechanical mechanisms. Also will be responsible for design reviews of new and existing

# FUTURE

EDP equipment. Requires BSEE and/or BSME with minimum of 2 years' experience in design or reliability engineering.

## ARRANGE NOW FOR AN INTERVIEW IN YOUR AREA

Confidential interviews will be held soon in various parts of the country. Openings above are in Los Angeles. Additional openings in Dayton, Ohio, for mechanical, electrical and chemical engineers, physicists, chemists (MS or PhD level). Send resume immediately to Bill Holloway, Technical Placement, or call collect.

The National Cash Register Company



ELECTRONICS DIVISION  
2817 W. El Segundo Blvd., Hawthorne, Calif.  
Telephone: Area Code (213) 757-5111

An equal-opportunity employer

ON READER-SERVICE CARD CIRCLE 890

# Letters

## Is a rectifier diode an RFI source? Author says it's a switch

Sir:

Re: "Capacitor Cuts Nuisance RFI In A Power Supply," (E/D, Dec. 20, p 42) the author has touched on an important source of RFI. His solution is correct—a capacitor across the transformer secondary. However, I feel that the analysis is either incomplete or incorrect.

If the diode is considered to be an RF generator, it sees a circuit that includes some rather high inductive reactance, and some lower valued radiation resistance, before the capacitor is added. The diode will radiate!

The added capacitor bypasses the inductance (and the radiation resistance), and allows the RF energy to be dissipated in the load along with the lower frequencies.

R. Cameron Barritt  
Washington, D. C.

## The author's reply

Sir:

In answer to Mr. Barritt, the rectifier diode is not considered a source of RFI, per se. It is viewed as a switch which interrupts a sinusoidal current pulse. The rate of the current-change, when interrupted, depends mainly on the size of the filter capacitor.

The transformer's leakage inductance, combined with the rapid rate of the current-change as the rectifier diode opens, produces an excitation of the circuit, as shown in Fig. 2b of the article. The result is a damped, oscillatory current. In the time domain, the impulse interference occurs after the rectifier diode has opened. There is no interference generated from the oscillatory current transient, discussed in the article, prior to the end of rectifier conduction.

The discussion presented in the article assumes that there is no coupling between any circuitry which follows the rectifier and the power supply transformer. Only conducted interference is being considered. Consequently, radiation and its

effects on circuits following the rectifier did not exist. In practical situations, particularly with active regulators following the rectifier and filter, the discussed oscillatory transient can cause unwanted spurious response in the regulator. This is another reason why the oscillatory transient should be shifted down in frequency.

William J. Mattox  
Supervisory Engineer  
Electro International, Inc.  
Annapolis, Md.

## Alert reader catches error in Idea

Sir:

With reference to your "Ideas for Design" section, I would like to call your attention to an error in the schematic for the SCR pulse follower circuit (#114 in the December 20th issue). The line connecting the positive sides of the two relay coils should not exist. Also one minor misprint, the third paragraph states: "Resistor  $R_2$  is chosen so that it can not supply sufficient holding current for the SCR. Thus, the SCT will shut off," etc. SCT should be SCR.

John S. Poole  
Systems Engineer  
U. S. Naval Research Laboratory  
Washington, D. C.

## Focus '66: credit where it's due

Sir:

On page 20 of your January 4, 1966 issue you published a table entitled "Computer Equipment Shipments—U.S. (\$ million)." The format and figures in this table are identical to those released in our special research report presented. . . . during the recent Fall Joint Computer Conference.

I could find no indication of the source of the figures published. The impression is created that they are part of the EIA's figures printed be-

Seconds from now,  
these cables will be

- R.F.I. SHIELDED
- PROTECTED FROM ABRASION
- GROUNDED
- —AND HAVE EXTREME FLEXIBILITY!

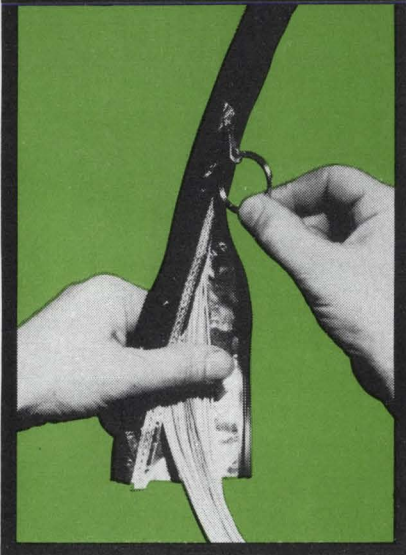

ALL THIS BECAUSE OF

## SHN-3 Zippertubing®

You could do the same for your wiring or cables — in a single zip-quick operation — by specifying SHN-3 Zippertubing®. SHN-3 is a lamination of vinyl impregnated Nylon cloth and aluminum foil, with tinned copper braid attached to the inside of the overlap.

Like to know more about Zipper-tubing®? Write or call:



THE Zippertubing® CO.

Main Office and Plant:  
13000 S. Broadway, Los Angeles 61, Cal. • FA 1-3901  
Eastern Office and Warehouse:  
480 U. S. Hwy. 46, S. Hackensack, N. J. • HU 7-6261

Speed Inquiry to Advertiser via  
Collect Night Letter

ON READER-SERVICE CARD CIRCLE 16

## LETTERS

### (EAI figures, continued)

low or else independently arrived at by your magazine.

Any figures projecting industry shipments to 1975, of course, have to be based upon careful judgment and analysis. Our figures were produced under a sponsored contract with major computer manufacturers (amounting to over \$100,000), to study the current computer market and related sectors of the computer industry.

Patrick McGovern  
President, International Data Corp.  
Newtonville, Mass.

### International code: yes—siemens: no

Sir:

With regard to the action that you have taken: To convert to International Standards for abbreviations —well done!!!

Your reluctance to use the "siemens" in place of the "mho" for the unit of conductance is well justified at this time, because even some of the German companies (other than Siemens & Halske A. G.) are reluctant to adopt the siemens. They apparently feel that it does not pay them to promote a competitor's name in their published data. Furthermore, in the proposed ASA/IEEE Standard on Letter Symbols for Quantities Used in Electrical Science and Engineering, now out on Letter Ballot, the mho is being retained.

Keep up the good work!

Howard L. Cook  
Cedar Grove, New Jersey

### Reader comes up with a better idea

Sir:

Regarding the transmission-gate circuit for processing video signals (E|D, Ideas For Design, Jan. 4, 1966, p 128), I believe that the same function can be accomplished by the circuit shown below.

In the absence of gate pulses,  $Q_1$  is cut off and the signal passes without attenuation. The positive gate pulses turn  $Q_1$  on, pulling  $Q_2$ 's base to ground. Consequently  $Q_2$  will be cut off and no signal appears at the

output, which can be taken either from the emitter or the collector of  $Q_2$ .

Les Toth

Project Engineer  
Diamond Electronics  
Lancaster, Ohio.

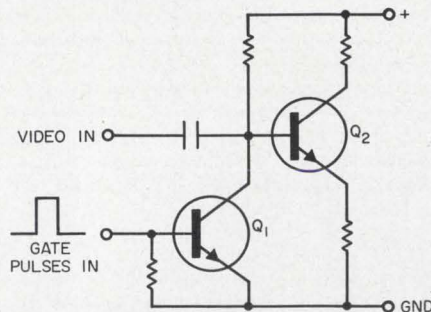

### Auto group clarifies its stand on EMC

Sir:

Thank you for the Jan. 4, 1966 news report on the activities of the AE-4 Committee of the Society of Automotive Engineers concerning electromagnetic compatibility (EMC).

To preclude possible misinterpretation of the news report, the SAE standards under development are intended to complement, and not to replace, present military specifications, so industry may better understand and undertake the responsibilities required by MIL-I-61810, MIL-E-6051C and MIL standard 826.

Thank you for your interest in Committee AE-4.

Walter McKerchar  
Secretary,  
AE-4 Committee  
McDonnell Aircraft Corp.  
St. Louis, Mo.

### Accuracy is our policy

The photograph captioned "350,000,000 mile mariner . . ." on page 76 of the January 4 issue is actually a shot of the Topside Sounder Satellite. Our apologies to all concerned, particularly to Cutler-Hammer, AIL Division, who supplied the photograph.

The following was omitted from "Switch high power with diodes . . ." by R. H. Brunton (E|D, January 4, 1966, p. 118):

"This work was sponsored by the Navy Department, Bureau of Ships, under Contracts NOBSR-89462 and 89463."

# HOW CAN JUST 200 RECTIFIERS REPLACE OVER 1000?

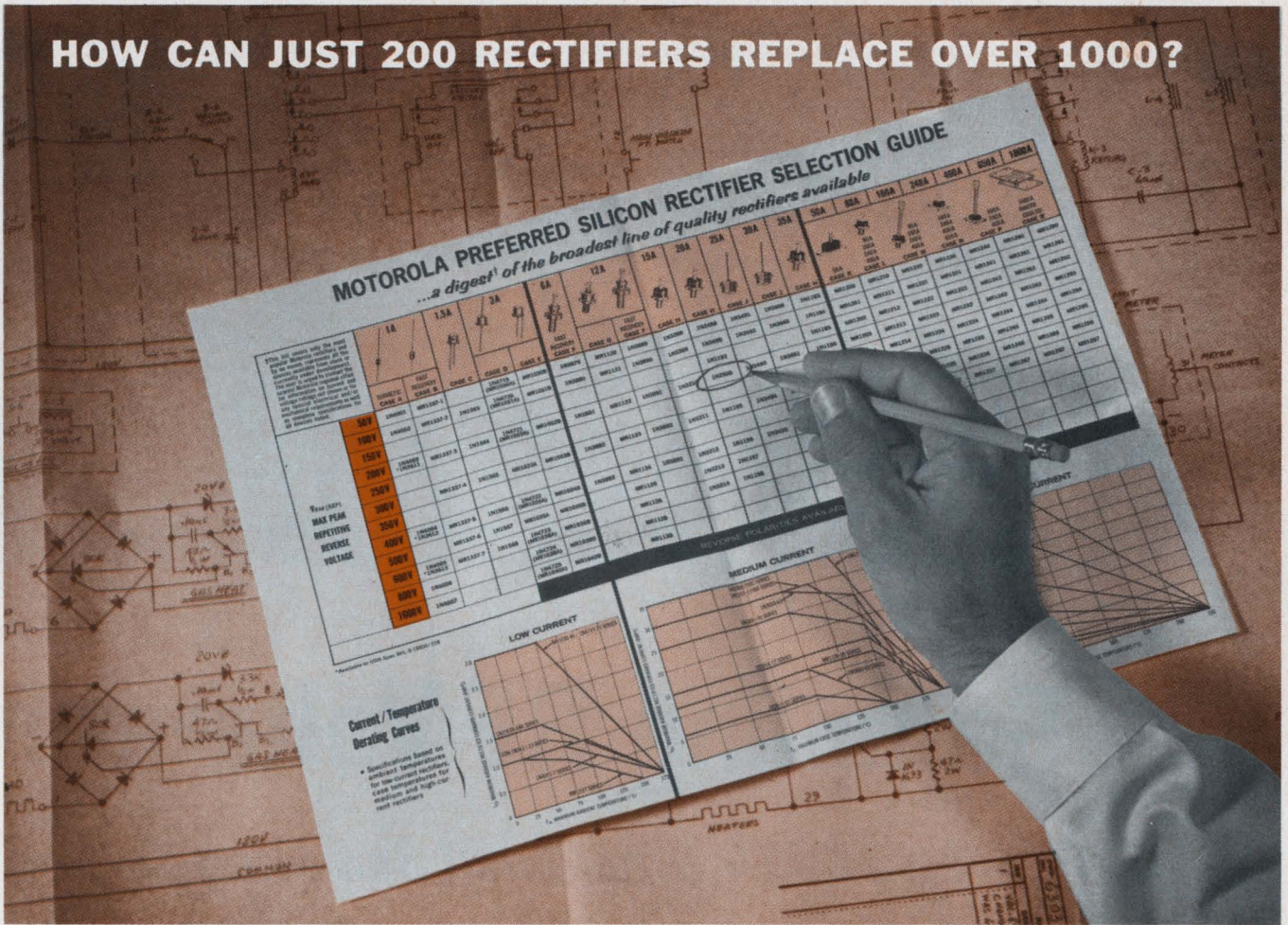

You'll find out by using Motorola's new Silicon Rectifier Selection Guide . . . a comprehensive profile of the most versatile rectifier line in the industry . . . 200 types that cover the complete spectrum of power requirements from 1 to 1000 Amps — 50 to 1000 Volts.

## A RECTIFIER FOR EVERY APPLICATION ... EVERY POCKETBOOK!

Starting from the ■ Low Cost 1 Amp Surmetics\* (1N4001 Series)—which have become the industry standards . . . featuring a full 1 Amp at 75°C, ambient ■ 3 Amp lead-mount types — with surge current ratings up to 300 Amps. ■ 12 Amp “universal” stud-mount series — so economically priced that they virtually replace *all* conventional “stud” types rated up to 12 Amps. ■ 15, 20, 25, 30 and 35 Amps units — featuring the world famous Motorola “press-fit” case design (25 and 30 Amp types) . . . *All the way up to* ■ High-current Multi-cells† from 50 to 1000 Amps!

No matter what your needs, you can now select the “just right” Motorola rectifier that most economically fits your particular current and voltage requirements.

## SIMPLIFY PROCUREMENT TOO . . .

That “just right” rectifier you specify is from a standard, large volume line (the world's largest), built to satisfy your specific application as well as a broad scope of similar requirements.

*Ask Your Distributor About Motorola Rectifiers!*

\*Trademark of Motorola Inc. †Patents Pending

Speed Inquiry to Advertiser via Collect Night Letter  
ON READER-SERVICE CARD CIRCLE 17

## Have your own miniature prototyping warehouse...

Order a Motorola Rectifier “Handylab” Kit\*— a wide assortment of popular usage rectifiers and molded-bridges covering current ratings from 1 to 35 Amps, 200-3000V (84 units in kit).

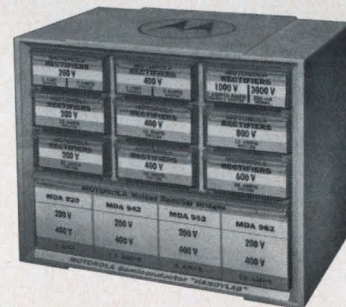

Total Value \$236.10 (incl. cabinet)

You Pay  
ONLY **\$94<sup>50</sup>**  
Save — \$141.60

**In Stock Now!**  
At Your Franchised  
Motorola Distributor  
... CALL HIM TODAY  
FOR DETAILS!



**MOTOROLA**  
Semiconductor  
Products Inc.

BOX 955 • PHOENIX, ARIZONA 85001

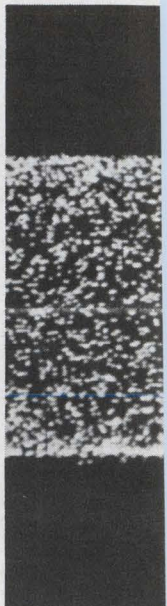
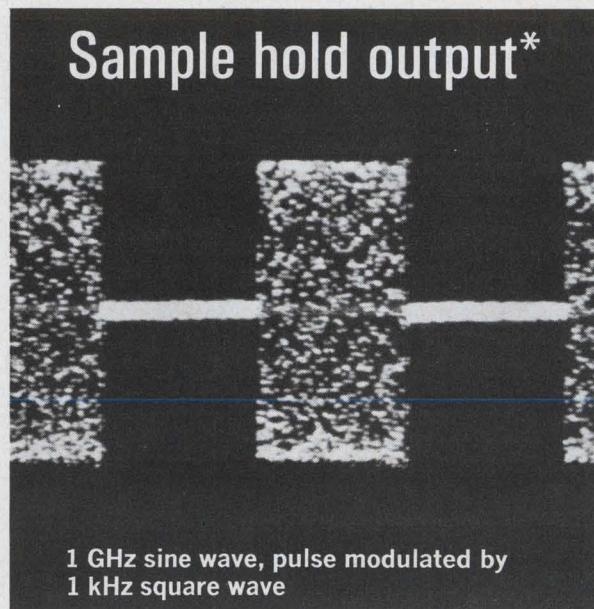
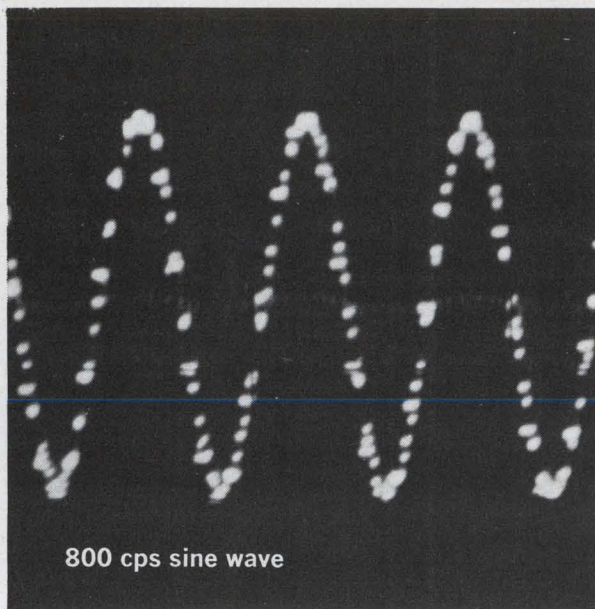

# Sampling RF Voltmeter!

## *hp 3406A Broadband Sampling Voltmeter*

Unique sampling technique has been applied to an analog meter to permit economical, broadband measurements.

The 3406A is an average-responding voltmeter that provides more accuracy and sensitivity than is presently available from any other type.

Peak and true rms measurements can be made using the "sample hold" output. Many other uses include retrieval of AM carrier envelopes, power and noise measurements.

Extra features, such as the front-panel calibrator and the pushbutton probe (which allows retention of a reading), are among some of the many reasons why you should call your Hewlett-Packard field engineer. Or write for full specifications and a description of this state-of-the-art sampling technique to Hewlett-Packard, Palo Alto, Calif. 94304. Tel. (415) 326-7000; Europe: 54 Route des Acacias, Geneva.

\*Measured with a low-frequency scope.

*Complete accessories available*

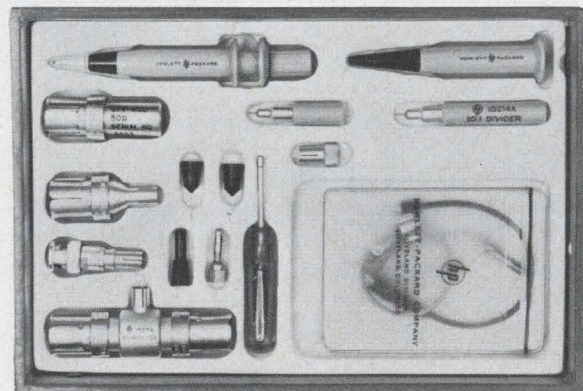

**HEWLETT**  **PACKARD**  
An extra measure of quality

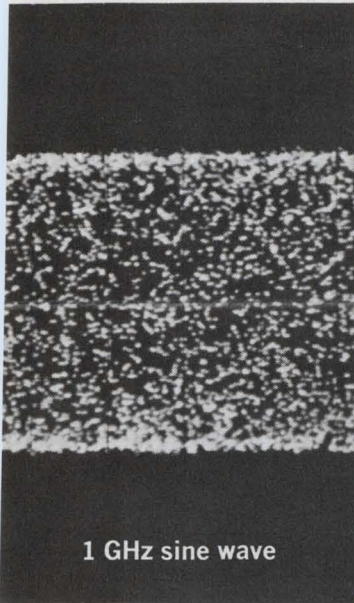

1 GHz sine wave

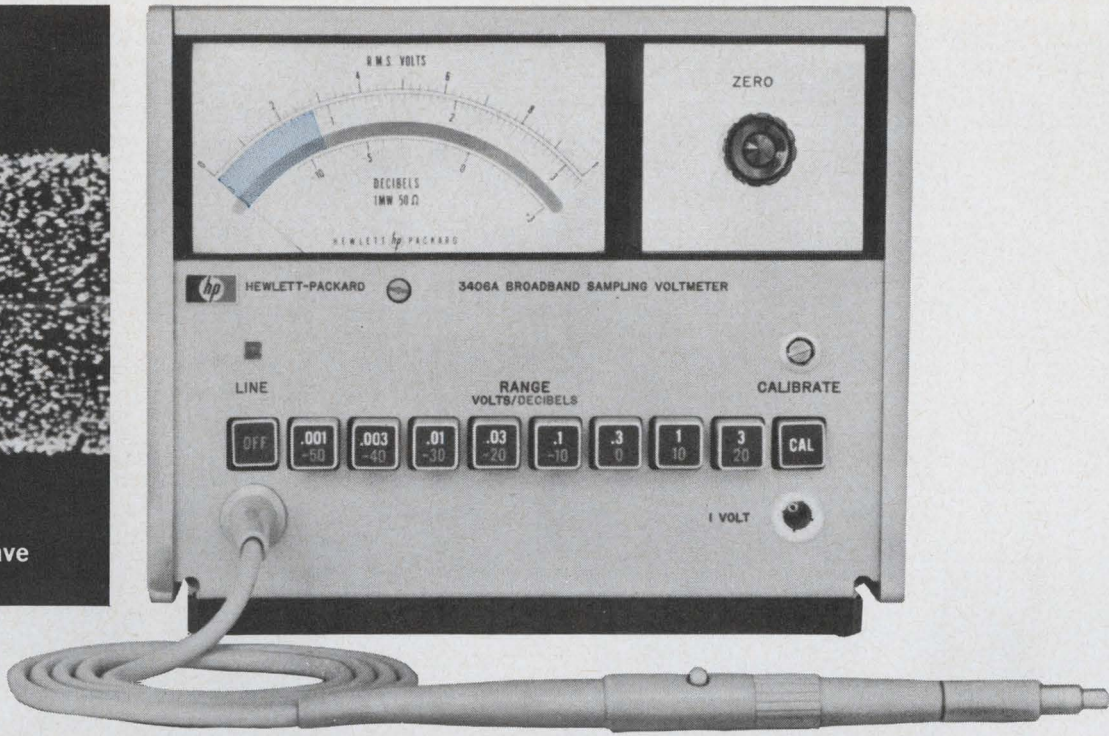

## measure **1 MV to 3 V,** **10 kHz to 1 GHz!**

### The first rf voltmeter to give:

- 50  $\mu$ V readings with 20  $\mu$ V resolution
- $\pm 5\%$  measurements at 700 MHz (usable to 2 GHz)
- Linear scale on all ranges
- Recorder and sample hold outputs \*
- Probe with measurement retention
- Price—only \$650

### Specifications, hp 3406A

- Voltage range:** 1 mv to 3 v full scale, 8 ranges; db -50 to +20 dbm (0 dbm=1 mw in 50 ohms); absolute average-reading instrument calibrated to rms of sine wave
- Frequency range:** 10 kHz to 1 GHz, useful sensitivity 1000 Hz to beyond 2 GHz
- Full-scale accuracy:**  $\pm 3\%$ , 10 kHz to 100 MHz;  $\pm 5\%$ , 100 MHz to 700 MHz;  $\pm 8\%$ , 700 MHz to 1 GHz
- Input impedance:** 100,000 ohms at 100 kHz, capacity approximately 2 pf (input capacity and resistance depend on accessory tip used)
- Outputs:** dc recorder, 1.2 ma into 1 K ohms at full scale, proportional to meter deflection; ac, sample-hold output—ac signal statistically equivalent to measured signal (on ranges 0.01 v and above)

- Meter scales:** linear voltage, 0 to 1 and 0 to 3; db, -12 to +3; individually calibrated taut-band meter
- Dimensions:** 6½" high, 8⅞" wide, 11½" deep (165 x 225 x 292 mm); 8 lbs
- Accessory furnished:** 11072A Isolator Tip
- Accessories available:** 11064A Basic Probe Kit (\$100)—  
11063A 50 Ohm "T"  
10214A 10:1 Divider Tip  
10218A BNC Adapter  
(0950-0090) 50 Ohm Termination  
11071A Probe Kit (\$185) consists of above, plus—  
11073A Pen Type Probe  
10219A Type 874A Adapter  
10220A Microdot Adapter  
11035A Probe Tip Kit

Data subject to change without notice. Prices f.o.b. factory.

ON READER-SERVICE CARD CIRCLE 18

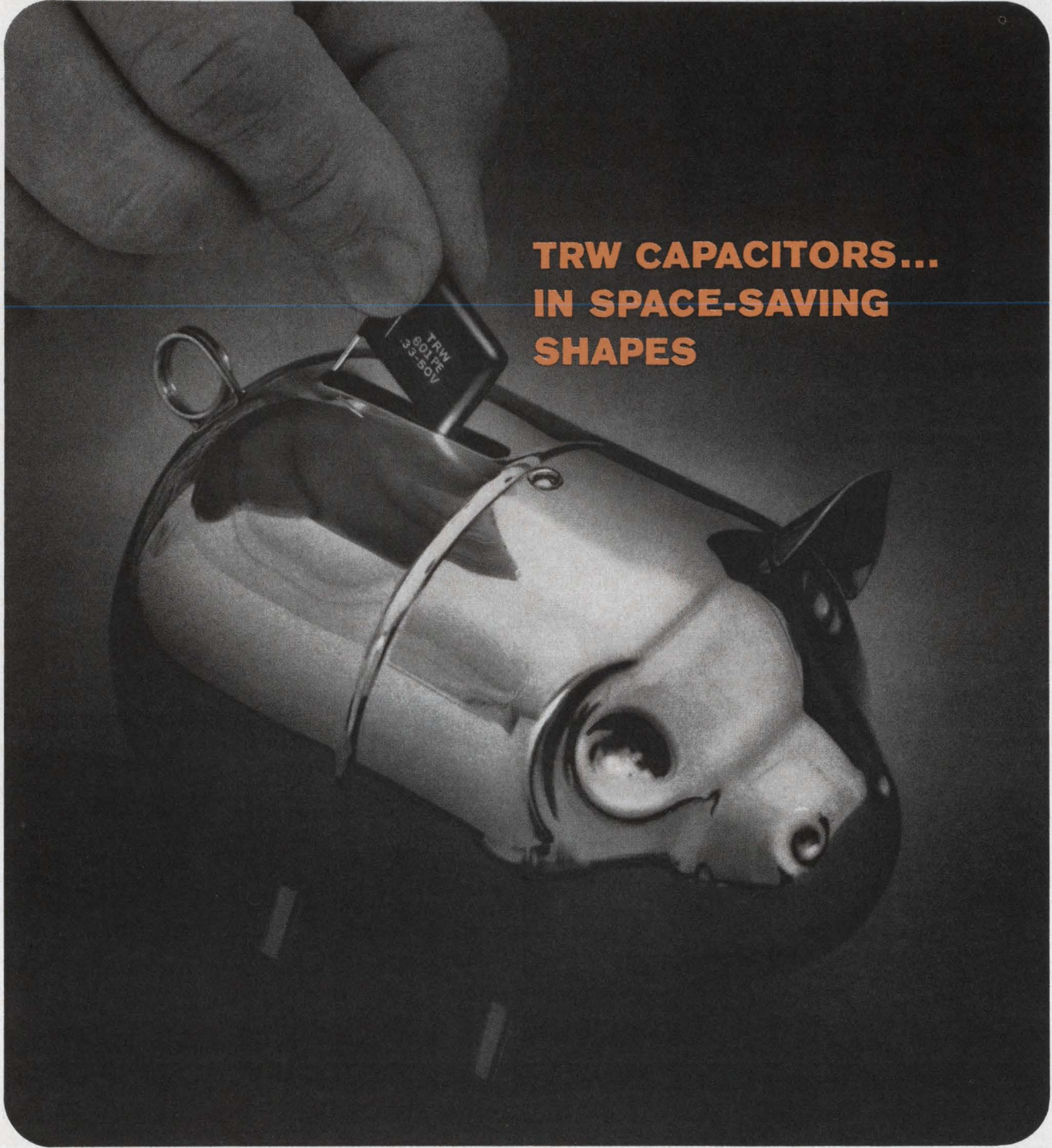

**TRW CAPACITORS...  
IN SPACE-SAVING  
SHAPES**

14-60

**The 601 PE... a particular shape for a particular need.**

Design with Mylar reliability in the size and shape of a disc! The slim, compact type 601 PE is tailored for printed circuits in military or industrial applications.

In all you will find more than 200 design variations of reliable TRW Capacitors. Round or oval cross-sections. Axial

or radial leads. Dipped, tape-wrapped, or metal enclosed cases. Essentially all these constructions are available in film-foil, in metalized Mylar\* and polycarbonate dielectric.

In a tight spot? There's a TRW Capacitor to help you. Contact TRW Capacitors, Box 1000, Ogallala, Nebraska.

\*Du Pont Trademark

**TRW CAPACITORS**

ON READER-SERVICE CARD CIRCLE 19



**Co-Publishers**

James S. Mulholland, Jr.  
Robert E. Ahrensorf

**Editorial Director**

Edward E. Grazda

**Editor**

Howard Bierman

**Managing Editor**

Robert C. Haavind

**Technical Editors**

Maria Dekany  
Frank Egan  
Mark B. Leeds  
Rene Colen  
Joseph J. Casazza

**News Editors**

Roger K. Field  
Richard Harnar  
Alfred Rosenblatt

**West Coast Editors**

Ralph Dobriner  
Peer Fossen

**New Products Editors**

Ronald A. McGee  
Patrick Cook

**Washington Editor**

S. David Pursglove

**Editorial Production**

Dollie S. Viebig  
Anne T. Lombardi

**Art Director**

Clifford M. Gardiner

**Art Assistant**

William Kelley

**Technical Illustrators**

Lewis D. Hill  
Cheh Nam Low  
Leonard P. Levenson

**Production Manager**

Thomas V. Sedita

**Asst. Production Manager**

Helen De Polo

**Production Assistants**

Bernard Wolinsky  
Carl Merkin

**Circulation Manager**

Nancy L. Merritt

**Reader Service**

Diane Pellechi

## E|D EDITORIAL



## Dispersal—one answer to civil defense

Nuclear warfare isn't pleasant to think about, but unfortunately there isn't much choice. The possibility exists, and it can't be tucked out of mind with hopes that it will soon go away.

How much better to think about it—but constructively: How can we make it unprofitable for an enemy to mount an atomic attack? How can we minimize the damage if an attack should occur?

One way is by population dispersal. And the country would reap more benefits thereby than extra peace of mind.

It isn't hard to visualize some Siberian mountain range hiding silos that contain H-bomb-tipped missiles, with targets such as New York, Washington, Chicago, Los Angeles, Pittsburgh, Boston, Philadelphia and a few other large industrial centers, stamped on them. How conveniently we have arranged things for any potential attacker! We have crammed most of our industrial might and population into dense clusters, conveniently lowering production and housing costs but raising the potential effectiveness of any missile attack on us.

Building deep underground shelters under cities, with power plants, food centers and other essential services at the intersections in a matrix of tunnels, doesn't appeal to us. This approach was recently suggested by a group of scientists who grappled with the question of survival in a nuclear holocaust.

We'd rather take our chances above ground with population dispersal, even with some risk of radioactivity. The added benefit of this approach would be alleviation of many of the miserable conditions in our major cities today. Housing, transportation and other facilities in the big urban centers have been taxed to the point of saturation for years.

To achieve such dispersal requires a planned program. Already the electronics industry has, in a few cases, pointed the way. Plants have been built in rural areas, in order to offer such attractions as seacoast, a dry climate or skiing country. Some states have mounted successful campaigns to attract industry. Similar campaigns to cite the advantages of rural settings could be started. Tax advantages could be offered to manufacturers who shifted out of densely packed areas.

The Government is already sponsoring retraining programs for areas like Appalachia, where workers are available but whole industries have disappeared. These workers could be trained for jobs in plants that moved away from central city areas.

Cities would suffer to a certain extent because of the loss of tax revenue from industry and workers. But city costs would shrink if overcrowded conditions were relieved. Many costly social problems would be alleviated.

We think that the dispersal concept deserves attention. Seventenths of the U.S. population now lives in urban clusters, and the situation is getting worse.

ROBERT HAAVIND

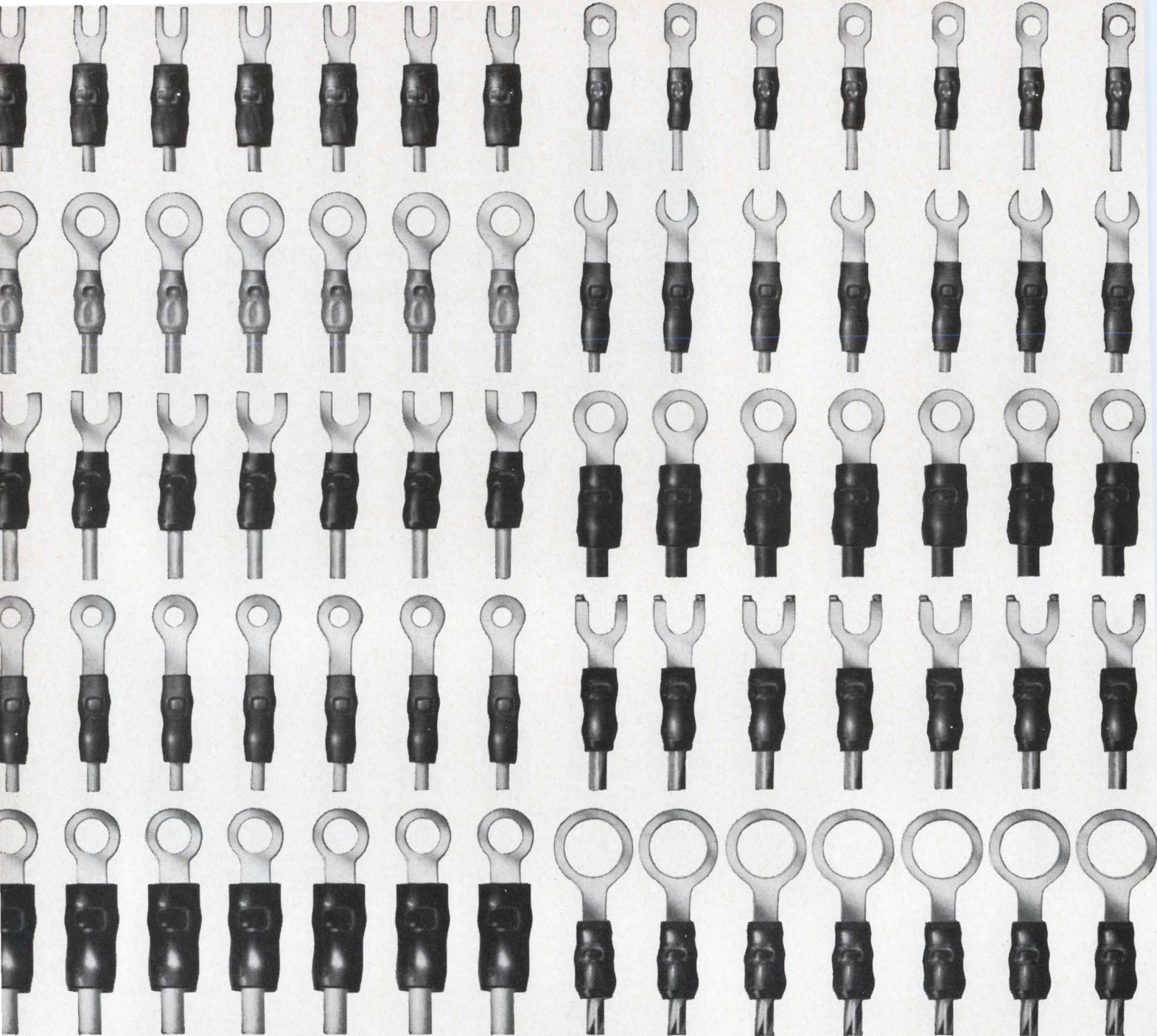

## Bandolug reels off 1,500 perfect terminations an hour

Do you insist on highest quality? Do you want highest speed? Burndy Bandolug satisfies the most demanding engineers on both counts.

A change from one stud to another takes 10 seconds. From one wire size to another no more than 90 seconds. And Bandolug crimps a wide range on wire sizes #10 thru #26.

The machine automatically rejects inadequately stripped wires, delivers uni-

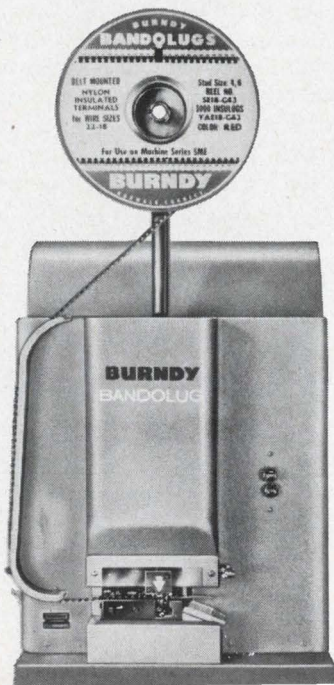

## and it's a quick-change artist.

formly perfect results—no sheared or unplated edges. You can count on dependable performance year after year with noiseless operation and assured safety reducing operator fatigue to minimum.

So go ahead—be demanding. Demand top quality, top speed and lowest installation costs. Demand Bandolug®.

# BURNDY

Norwalk  Connecticut

# ED Technology

How to reduce reception of unwanted signals PAGE 50

Gate-ring counters suitable for IC applications PAGE 56

The right way to test coaxial cables PAGE 62

Current-mode technique simplifies worst-case design PAGE 70

Adaptive A/D converter offers high speed PAGE 78

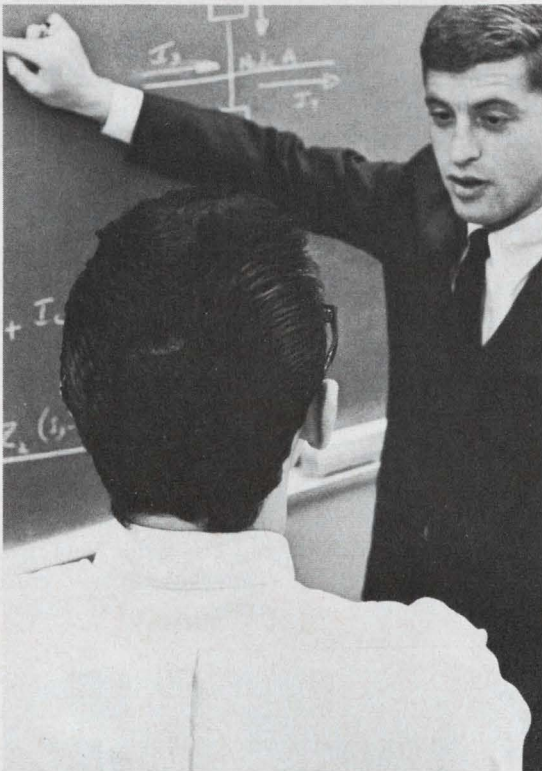

Never fear the worst . . . 70

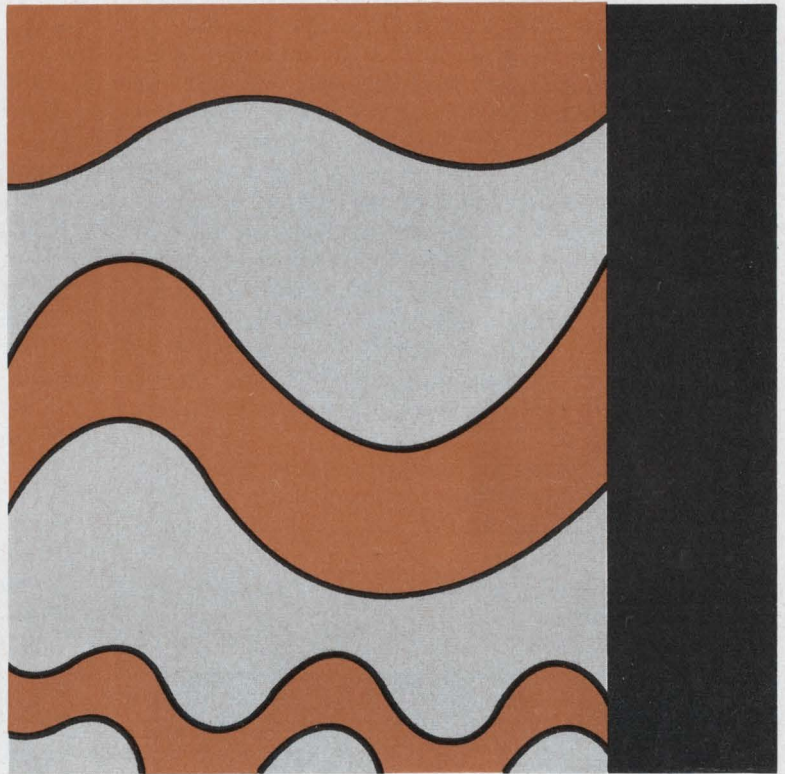

Scuttle unwanted signals . . . 50

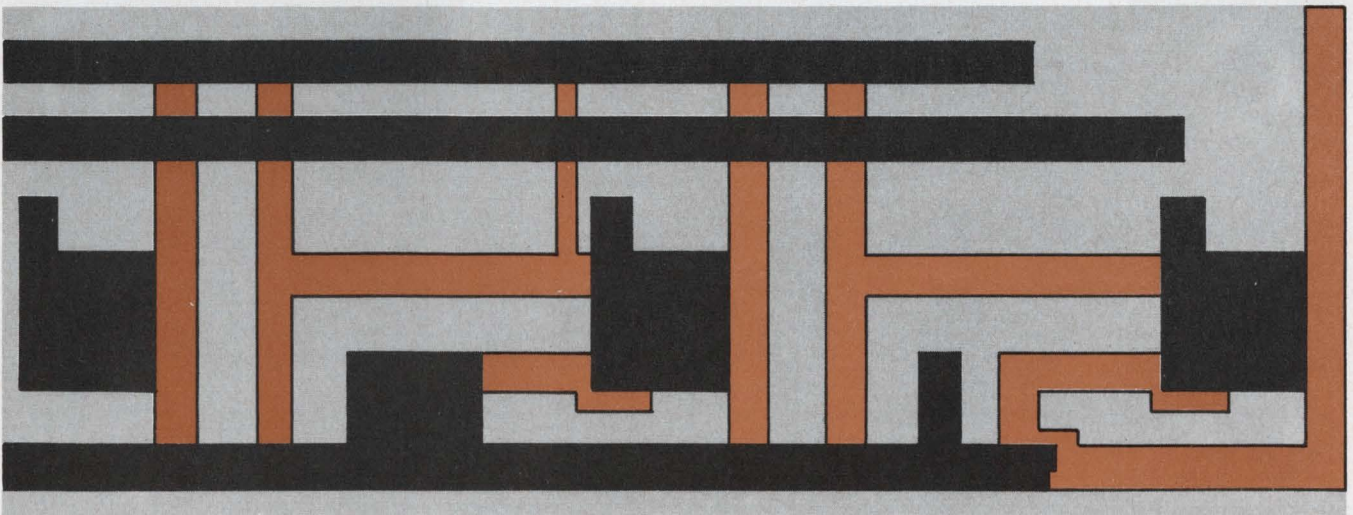

Gate-ring counters are ready for ICing . . . 56

# Receiving unwanted signals? Then shore up the port-to-port isolation of your phase detector via complementary transistors in a beta-multiplier circuit.

It is hardly uncommon to find an unwanted signal in every port of your receiver. These signals can play havoc with system operation unless the port-to-port isolation is sufficiently high to block them. This "shield" may easily be formed by using *npn* and *pnp* transistor complements and inverting the output stage.

The complementary pair forms a beta-multiplying stage which closely resembles a Darlington configuration. In the reverse direction, the inverted output stage thus serves as an attenuator to substantially decrease feed-through. Stated in other terms, the net result is a very large, negative gain (minus decibels) from load-to-port.

The complementary approach is also less complex than competing techniques which improve port-to-port isolation. Moreover, because of the *npn-pnp* arrangement, the  $V_{be}$  variations with temperature cancel each other out, thus improving the receiver's thermal stability. By developing the complementary design about a multi-channel phase detector (where unwanted signal feed-through may be severe), each of these advantages is easily realized.

In multi-channel receivers where the phases of various signals are compared, two-stage transistor circuits are commonly used for the phase

**Robert K. Walters**, Systems Engineer, LTV Electrosystems, Inc., Garland, Tex.

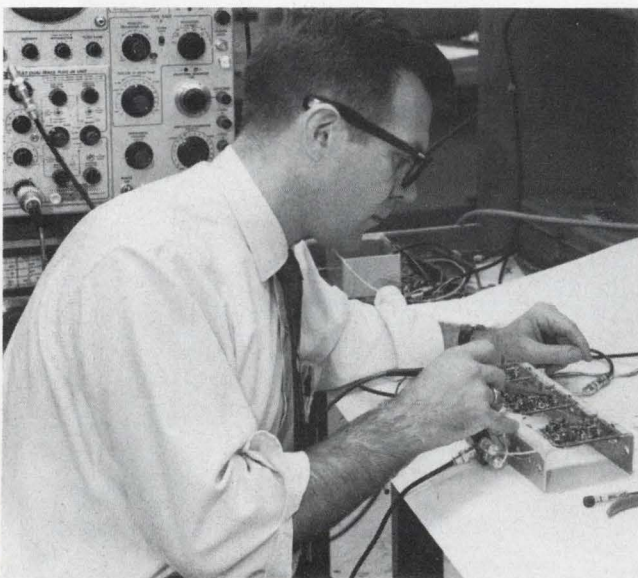

**Shore-up your receiver's isolation.** Author Walters measures the improved port-to-port isolation obtained by using *npn-pnp* complementary transistors in the phase-detector stages. A beta-multiplier circuit is thus formed to decrease unwanted signal feedthrough.

detection function. The isolation between the inputs of any one detector is critical, for if a wrong signal is detected, phasing errors are introduced. The well-known single-stage *y*-parameters are used to analyze the detector's operations, since they lend themselves to circuit analysis (more so than *h*, *z*, or other sets of transistor parameters).

## Deriving port-to-port gain

Two phase detectors (Fig. 1a) are viewed as a "black box" to derive the isolation requirement. If the  $\phi_1$  signal should appear (by coupling through detector #1) at the  $\phi_2$  input to detector #2, the output of detector #2 will be in error. This error will be in proportion to the magnitude of the unwanted signal. System specifications typically require that these undesirable signals be of the order of 40 to 60 dB down in transmission.

A complete, two-transistor phase detector, with inputs  $\phi_1$  and  $\phi_2$ , appears in Fig. 1b. The degree of isolation may easily be calculated if the circuit is broken down into two parts, each one the reflection of the other, and analyzed using two-port matrix theory. If each input is viewed as a port, the isolation for the common-collector phase detector is the forward-voltage gain from port #1 to load, multiplied by the reverse-voltage gain from load to port #2, all expressed in decibels.

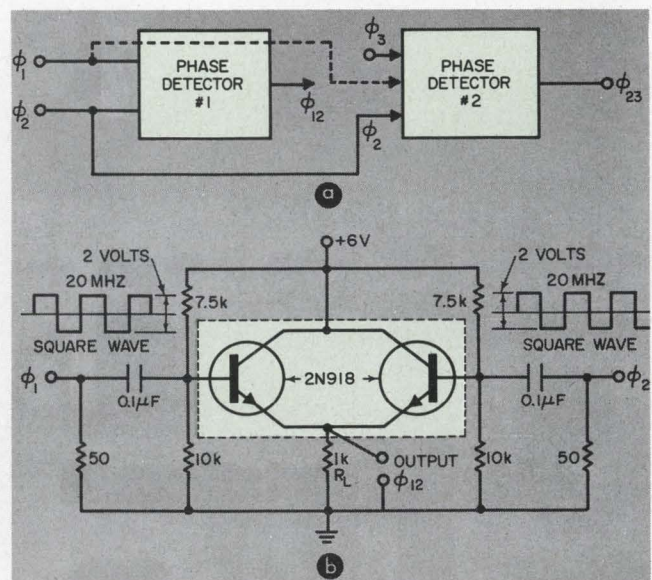

**1. Multiple-phase detectors (a)** are used to compare the phases of signals in a multi-channel receiver. Each detector stage consists of a two-transistor network (b) which provides 20-dB of isolation from port to port to prevent unwanted signal feed-through.

Thus, the port-to-port voltage gain,  $A_{Vpp}$ , is:

$$A_{Vpp} = A_{VF1} A_{VR2}, \quad (1)$$

where  $A_{VF1}$  is the common-collector forward voltage gain of stage #1, and  $A_{VR2}$  is the common-collector reverse-voltage gain of stage #2. In terms of  $y$ -parameters, the forward-voltage gain,  $E_2/E_1$ , of a common-collector stage is:

$$A_V = \frac{-y_{fc}}{y_{oc} + y_L} = \frac{-y_{21c}}{y_{22c} + y_L}, \quad (2)$$

where  $y_L$  is the load admittance and  $y_{fc}$  and  $y_{oc}$  are the transistor's admittance parameters. Converting to common-emitter parameters (which usually appear on the transistor data sheet), Eq. 2 becomes:

$$A_V = \frac{(y_{11e} + y_{22e})}{y_{11e} + y_{12e} + y_{21e} + y_{22e} + y_L} \quad (3)$$

$$= \frac{y_{ie} + y_{oe}}{y_{ie} + y_{re} y_{fe} + y_{oe} + y_L}$$

For the 2N918 at 25 MHz, the values of these parameters are:

$y_{ie} = 2 \times 10^{-3}$  mho,  $y_{re} = 0.03 \times 10^{-3}$  mho,  
 $y_{fe} = 60 \times 10^{-3}$  mho and  $y_{oe} = 0.2 \times 10^{-3}$  mho.  
 For a 500-ohm load,  $y_L = 1/500 = 2 \times 10^{-3}$  mho.

Thus,  $A_V = A_{VF1} = 0.966$

#### Attenuation need: load-to-part

The reverse-voltage-gain expression will be derived from the black-box representation of the detector (Fig. 2).

The general  $y$ -parameter equations are:

$$I_1 = y_{11} E_1 + y_{12} E_2 \quad (4a)$$

and

$$I_2 = y_{21} E_1 + y_{22} E_2 \quad (4b)$$

The values  $I_1 = -E_1/R_g$  and  $I_2 = -(E_2 - e_g)/R_L$  are substituted into Eq. 4, and  $E_1$  and  $E_2$  are solved for by the determinant method. Obtaining  $E_1$  and  $E_2$ , the ratio  $E_1/E_2$ , which is the reverse-voltage gain, becomes:

$$\frac{E_1}{E_2} = \frac{-y_{12} e_g y_L}{(y_{11} + y_g)(e_g y_L)}, \quad (5)$$

where  $y_L = 1/R_L$  and  $y_g = 1/R_g$ . This becomes:

$$\frac{E_1}{E_2} = \frac{-y_{12}}{y_{11} + y_g} = \frac{-y_{rc}}{y_{ic} + y_g} = \frac{y_{ie} + y_{re}}{y_{ie} + y_g}. \quad (6)$$

Substituting the common-emitter  $y$ -values and using  $y_g = 1/50$ :

$$A_{VR} = \frac{E_1}{E_2} = \frac{(2+0.03)10^{-3}}{(2+20)10^{-3}} = 0.0923 \quad (7)$$

Thus, from load to port, the isolation is:

$$20 \log_{10} 0.0923 = -20.72 \text{ dB} \quad (8)$$

This analysis did not, however, take into account the shunting effect of the bias resistors at the input. These resistors (7.5k and 10k in parallel) are equivalent to 4.27k. This resistance,  $R_b$ , placed in parallel with the input, modifies the  $I_1$  terms of Eq. 4 as follows:

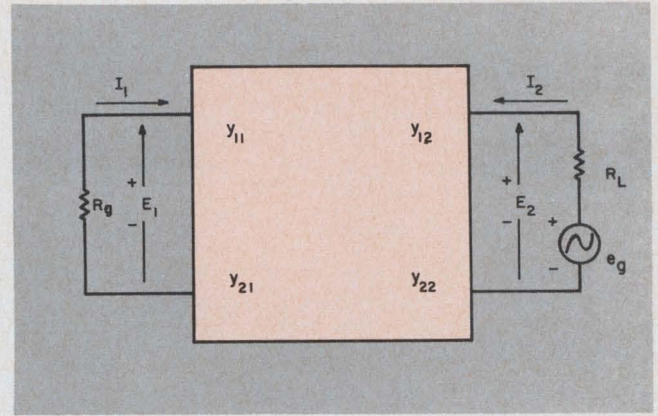

2. Reverse-voltage gain of the phase detector is computed by using the equivalent black-box circuit representation and  $y$ -parameter analysis.

$$I_1' = y_{11} E_1 + E_1/R_b + y_{12} E_2 = y_{11}' E_1 + y_{12} E_2 \quad (9)$$

Substituting  $y_{11}' = 2.234$  into Eqs. 6 and 7 yields:

$$A_{VR}' = \frac{(2.234+0.03)10^{-3}}{(2.234+20)10^{-3}} = 0.102 \quad (10)$$

The corrected load-to-port isolation is then  $20 \log_{10} (0.102)$ , or  $-18.4$  dB.

The effect of bias-resistor loading is thus a 2.32 dB reduction in load-to-port isolation. The total port-to-port voltage gain is the product of  $A_{VF1}$  and  $A_{VR2}$ , or  $(0.966)(0.102) = 0.0985$ , for a port-to-port isolation of  $20 \log_{10} (0.0985) = -20.1$  dB.

#### Providing greater isolation

Note that the conventional phase-detector isolation figure is only 50% of what many specifications call for. To meet the need for greater isolation, the four-transistor complementary phase detector was developed (Fig. 3a). If this circuit is split down the middle, each half is a reflection of the other. The split section may be analyzed as a black box in cascade with the other half. Note that the load is common to both halves and must be converted into  $2R_L$  when the half-circuit analysis is made.

The left half of Fig. 3a is redrawn in Fig. 3b to show how the entire circuit is split and analyzed. Each transistor is then shown as a black box with  $a$ -parameter representation (Fig. 3c). Observe that  $a$ -parameters are used here because they lend themselves to cascaded matrix analysis (better than  $y$ -parameters).

Figure 3c may be used to find the total port-to-port isolation by first finding its reverse-voltage gain and then computing the forward-voltage gain. The generator in series with  $R_L$  is included to derive the reverse-voltage-gain expression.

Assuming that the corresponding  $a$ -parameters of each box are equal, the equation for two boxes in cascade are:

$$E_1 = (a_{11}^2 + a_{12} a_{21}) E_2' - (a_{11} a_{12} + a_{12} a_{22}) I_2' \quad (11)$$

and

$$I_1 = (a_{21} a_{11} + a_{22} a_{21}) E_2' - (a_{21} a_{12} + a_{22}^2) I_2'. \quad (12)$$

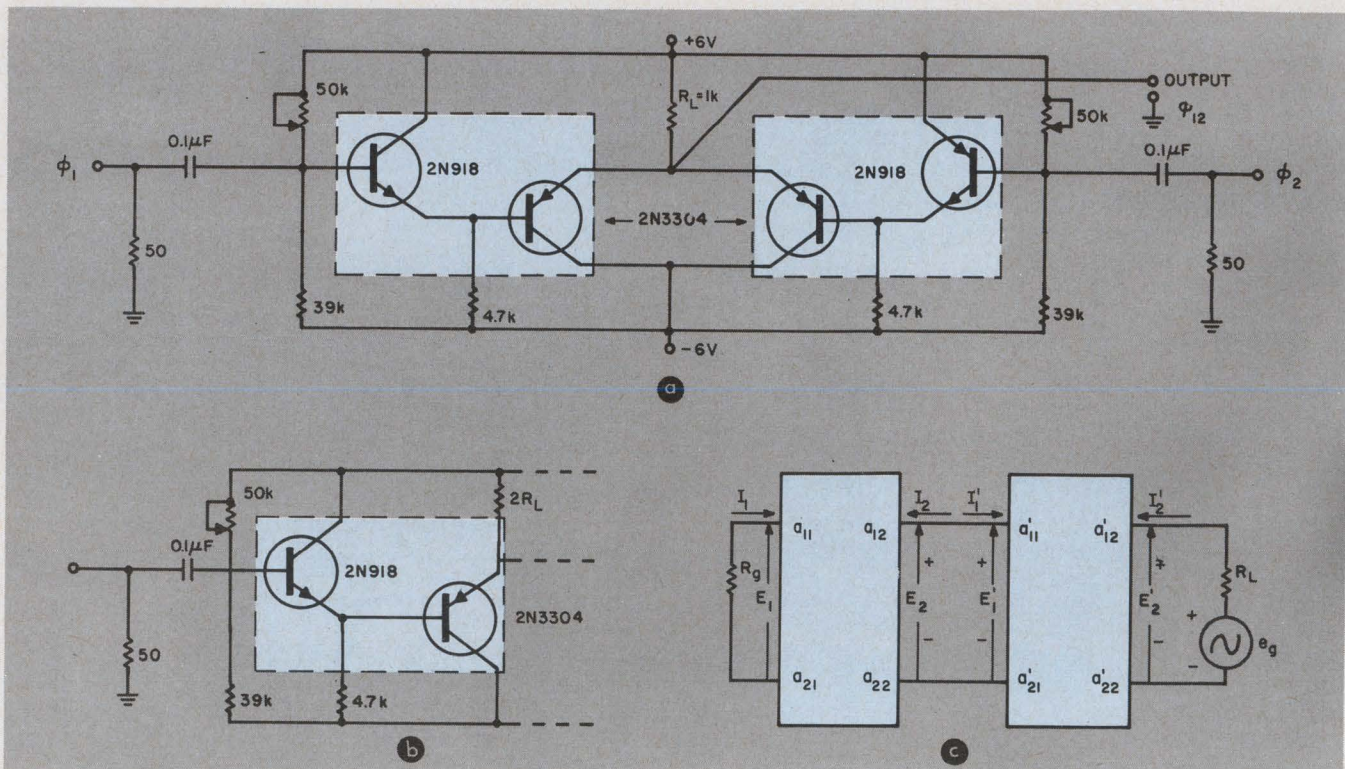

3. When complementary pairs are used in the phase detector (a), the port-to-port isolation figure exceeds 48-dB. By splitting the circuit in half (b), a mirror image is formed. This permits an analysis to be easily made by using *a*-parameters for the cascaded equivalents (c). Anal-

yses of cascaded matrixes favor *a*-parameters over *y*-parameters. The total port-to-port isolation is obtained by using this circuit. Both the forward voltage gain and reverse voltage gains are derived, and then multiplied to yield the isolation figure.

This may be simplified to:

$$E_1 = a E_2' - b I_2' \quad (13)$$

and

$$I_1 = c E_2' - d I_2', \quad (14)$$

where  $a = a_{11}^2 + a_{12} a_{21}$ ,  $b = a_{11} a_{12} + a_{22} a_{12}$ ,  $c = a_{21} a_{11} + a_{22} a_{21}$  and  $d = a_{21} a_{12} + a_{22}^2$ .

Note that the *a*-parameters for the 2N918 and 2N3304 complements are not exactly equal. However, the *y*-parameters from which they are derived, as they appear on the respective transistor specification sheets, are closely matched. Therefore the approximation (assumed) is accurate. Substituting  $I_2' = -(E_2' - e_g) / R_L$  and  $I_1 = -E_1 / R_g$  into Eqs. 13 and 14, and solving for the reverse-voltage gain ( $E_1/E_2$ ), one obtains:

$$\frac{E_1}{E_2} = \frac{R_g [(ad/b) - c]}{1 + dR_g/b} \quad (15)$$

#### Gain increased by 150%

Using the values previously calculated for the *a*-parameters (from the common-emitter *y*-parameters):

- $a = a_{11}^2 + a_{12} a_{21} = 1.0096$
- $b = a_{11} a_{12} + a_{12} a_{22} = 16.67$
- $c = a_{11} a_{21} + a_{21} a_{22} = -0.025 \times 10^{-3}$
- $d = a_{12} a_{21} + a_{22}^2 = 0.655 \times 10^{-3}$
- $R_g = 50$  ohms

$$\text{Thus, } E_1/E_2 = \frac{50 \times 10^{-3} (0.065)}{1.002} = 3.24 \times 10^{-3}, \text{ or}$$

$$20 \log_{10} (3.24 \times 10^{-3}) = -49.8 \text{ dB load-to-port.}$$

The forward-voltage gain for this circuit is simply the gain of each transistor cascaded. Since each transistor stage is identical to the stage of the two-transistor network discussed earlier (the non-complementary circuit in Fig. 1b), the forward gain here is:

$$(0.966) \times (0.966) = (0.966)^2 \quad (16)$$

The port-to-port voltage gain is thus:

$$(0.966)^2 \times 3.24 \times 10^{-3} = 3.02 \times 10^{-3}.$$

Expressed in decibels, it is  $20 \log_{10} (3.02 \times 10^{-3}) = -50.4$ .

Note that isolation using common-collector stages is obtained almost entirely from the voltage gain from load to port; the gain from port-to-load is nearly unity. When the effect of bias resistors is included, the above figure can be expected to decrease by about 2.0 dB (as in the two-transistor case). The net port-to-port isolation is -48 dB, which is a considerable improvement over the -20 dB figure of the two-transistor circuit.

#### Complements yield extra benefits

Although the complementary circuit was designed primarily to obtain a higher degree of port-to-port isolation, other benefits are derived from it. For example, contrast it with a Darlington-

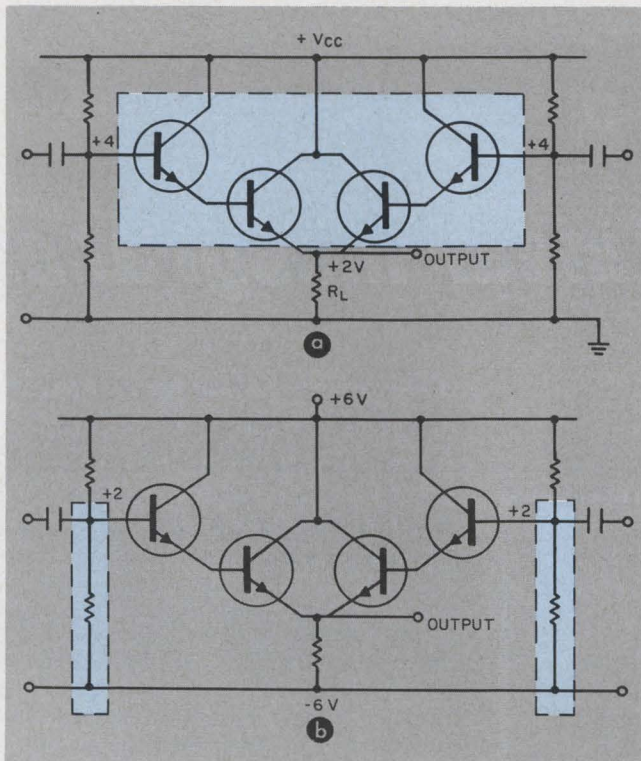

4. A Darlington phase detector (a) will provide the same isolation as the complementary network, but it exhibits clipping, stability and input signal restrictions. With two power supplies (b), clipping is eliminated, but the input bases are referenced above ground.

type connection (Fig. 4a) that yields about the same gain and isolation. In that circuit, however, the output is zeroed to some positive potential other than ground. Moreover, the input signal must swing about a higher level. If a nominal 6-volt supply is used, the input bases are biased at about +4 volts and the output at +2. Clipping will result for an input swing greater than 2 volts. If all resistors are returned to a negative 6-volt supply (Fig. 4b), the output may be biased to zero (ground) and the clipping problem largely eliminated. However, the input bases will still be above ground (by the sum of two base-to-emitter drops) and will vary with temperature. In addition, the input swing will remain restricted.

The complementary design in Fig. 3 also uses two supplies. But its complementary transistors (both input and output) can be biased to ground because the respective  $V_{be}$  drops cancel out each other. Moreover, the input can swing an equal amount (both positive and negative) before clipping occurs. It uses fewer components, does not contain severe input- and output signal-swing restrictions and is more stable with temperature changes. ■ ■

**References:**

1. Engineering Staff of Texas Instruments Inc., *Transistor Circuit Design* (New York: McGraw-Hill Book Co., 1963) pp 96-101.
2. Albert A. Sorenson, *Semiconductor Electronics*, Reprint available from Electro-Technology, Copyright 1961, pp 19-21.
3. L. E. Getgen, "Applications of Matrix Algebra to Circuit Design," *Electro-Technology*, February, 1963.

**IF THIS  
HIGH VALUE METAL  
FILM RESISTOR  
DOESN'T CHANGE YOUR  
design ideas**

*...try one of these*

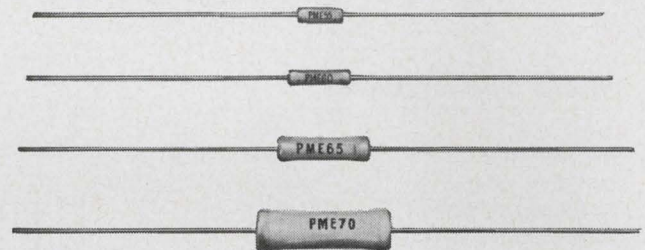

Part No.	Power	Ohms	Tol.	Temp. Coef.
PME 50	1/20 W	10Ω to 500K	±1% to .1%	T-0, T-2, T-9
PME 55	1/10 W	10Ω to 2M	±1% to .1%	T-0, T-2, T-9
PME 60	1/8 W	49Ω to 3.5M	±1% to .1%	T-0, T-2, T-9
PME 65	1/4 W	49Ω to 8M	±1% to .1%	T-0, T-2, T-9
PME 70	1/2 W	24Ω to 15M	±1% to .1%	T-0, T-2, T-9
PME 75	1 W	49Ω to 25M	±1% to .1%	T-0, T-2, T-9

The stability and accuracy of Pyrofilm's PME metal film resistors makes their use ideal in applications where before only wire wound resistors could be used. These resistors are virtually unaffected by environmental conditions and withstand constant exposure to high moisture conditions without change in specifications. PME resistors meet or surpass all requirements of MIL-R-10509F.

Send for fact-filled literature sheet!

**PYROFILM RESISTOR  
COMPANY, INC.**  
3 SADDLE ROAD • CEDAR KNOLLS, NEW JERSEY • 201-539-7110



# TI Adds Linear Integrated

**Two general-purpose amplifiers and a sense amplifier have been added to 39 digital units in TI's line of economy integrated circuits for industrial applications.**

SN723 and SN724 integrated circuits from Texas Instruments are limited-temperature versions of linear circuits first offered for high-reliability military applications. Temperature range  $-0^{\circ}\text{C}$  to  $70^{\circ}\text{C}$  is adequate for industrial environments, yet makes possible prices competitive with discrete-component amplifiers of equivalent performance.

Applications include buffer amplifiers, comparators, differential amplifiers, differentiators, integrators, level detectors, multi-vibrators, summing amplifiers, and voltage regulators.

**1** The SN723 features both differential inputs and differential emitter-follower outputs, providing considerable design flexibility. The amplifier is designed with a resistance network in the emitters of the input stage, allowing gain to be adjusted over a wide range (40 to 70 dB) simply by shorting various lead combinations. Frequency response is typically dc to 150 kHz.

**2** The SN724 features an unusually high input impedance, resulting from the Darlington-type connection of the input transistors. It has a large dynamic output range providing an input common-mode voltage range of  $\pm 5$  volts, which permits a high degree of flexibility in circuit design. In addition to the standard flat pack, the SN724 is available in a TO-78 package (modified TO-5).

**3** The SN7500 is a complete sense amplifier, including strobe gate and pulse-shaping output circuits. It detects bi-polar differential input signals from a magnetic-core memory and provides a one-shot output interface between the memory and logic circuitry. It can be used for other applications requiring signal-level detection with an extremely sharp threshold.

## 39 Digital Industrial Circuits

**4** TI's expanding line of IC's also includes 39 digital circuits. Typical gate characteristics

**1** **SN723 General-purpose Differential Amplifier**

TYPICAL CHARACTERISTICS	
Voltage gain (Differential)	2500
Input impedance	10 k $\Omega$
Input offset voltage	2 mV
D-c drift referred to input	5 $\mu\text{V}/^{\circ}\text{C}$
Output signal swing, single-ended	$\pm 6.5$ V
Common-mode rejection	90 dB
Temperature range	$0^{\circ}$ to $+70^{\circ}\text{C}$

**2** **SN724 General-purpose Operational Amplifier**

TYPICAL CHARACTERISTICS	
Voltage gain	1200
Input impedance	1 M $\Omega$
Input offset voltage	12 mV
D-c drift referred to input	20 $\mu\text{V}/^{\circ}\text{C}$
Output signal swing, single-ended	$\pm 7.5$ V
Common-mode rejection	55 dB
Temperature range	$0^{\circ}$ to $+70^{\circ}\text{C}$

**3** **SN7500 Magnetic-core Sense Amplifier**

TYPICAL CHARACTERISTICS	
Input threshold voltage level	17 mV
"Off" output level	3.2 V
"On" output level	0.3 V
Common-mode rejection	2 V
Propagation delay	70 nsec
Temperature range	$0^{\circ}$ to $+70^{\circ}\text{C}$



# Circuits to Industrial Line

for each of the five logic families are listed in the table at right.

5 Types of circuits available are also listed at right. All these circuits, except Series 70, are reduced-temperature (0° to +70°C) versions of established military integrated circuit lines. They feature the same high performance, same high reliability, and same multi-function economies.

By fabricating two, three and four circuits simultaneously in a single silicon bar, the cost-per-circuit-function is drastically reduced. Reductions are also obtained in the number of circuit packages, interconnections, and circuit boards—and in inventories, testing, and handling.

## New Plug-in Industrial Flat Package

6 TI's new 16-pin plug-in flat package (shown right) has been developed to reduce handling and assembly costs for industrial applications. The two rows of sturdy plug-in pins with 100-mil spacing facilitate automatic handling, assembly, and flow soldering to industrial-type PC boards. The hermetic package is designed for excellent reliability as well as for handling convenience and economy.

The new package is available at no additional cost for Series 74, 74 930, 1580, and most units in Series 73. Standard package for all series is the five-year-proved 1/4" x 1/8" flat pack.

## New Integrated Circuits Designer's Kits Available

7 Now, you can get everything you need for a headstart in modern logic design. TI Designer's Kits include a useful selection of integrated circuits, breadboarding sockets, applications guide, and performance data for Series 73 or Series 74 digital or Series 72 linear circuits.

Demonstrate for yourself the many economies and the high performance inherent in integrated-circuit design. Start now to design and breadboard integrated-circuit assemblies. Order your designer's kit today from the TI distributor in your area.

4

Parameter	Series 73	Series 74	Series 74 930	Series 70	Series 1580
Propagation delay, nsec	30	13	13	5	25
Power dissipation, mW	10	10	10	40+	5
Fan-out	10	10	10	N/A	8
Noise immunity, mV	300	1000	1000	250	750
Supply voltage, V	3 to 4	4.75 to 5.25	4.75 to 5.25	+1.25, -3.5	4.5 to 5.5
Temperature range, °C	0° to +70°	0° to +70°	0° to +70°	0° to +70°	0° to +70°

5

	Series 73 Modified-DTL NAND/NOR	Series 74 TTL NAND	Series 74930 TTL (Replaces 930 DTL)	Series 70 ECL OR/NOR	Series 1580 DTL NAND
J-K Flip-flop	SN7300 SN7301	SN7470	SN74 948		SN1590 SN1591 SN1593
Dual J-K Flip-flop	SN7302 SN7304				
Quad gate	SN7360	SN7400	SN74 946		SN1583
Triple gate	SN7331	SN7410	SN74 962		
Dual gate	SN7311 SN7330	SN7420 SN7440	SN74 930 SN74 932	SN7000 SN7001	SN1581 SN1584
Single gate	SN7310	SN7430	SN74 965		
Dual EXCLUSIVE-OR	SN7370	SN7450/51	SN74 966		
Expander	SN7320	SN7460			SN1580
Inverter, Buffer	SN7350				SN1582
"One Shot"	SN7380				

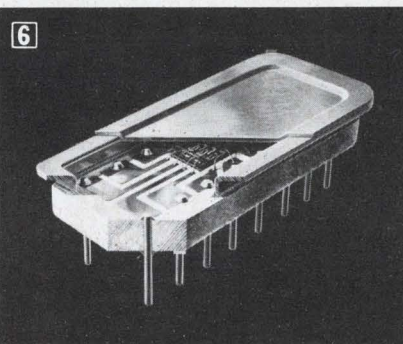

Cut-away view of TI's new 16-pin plug-in package, optional for all 39 digital industrial circuits.



TI Designer's Kit for integrated circuits. Three different kits are offered by TI distributors.



**TEXAS INSTRUMENTS**  
INCORPORATED  
13500 N. CENTRAL EXPRESSWAY  
P. O. BOX 5012 • DALLAS 22, TEXAS

SEMICONDUCTOR PLANTS IN BEDFORD, ENGLAND • NICE, FRANCE • DALLAS, TEXAS

21676

ON READER-SERVICE CARD CIRCLE 21

# Try IC gate-ring counters!

Not only are they feasible, but they offer certain advantages over other types of microelectronic counters.

Counters used in integrated circuits are usually of the flip-flop variety, despite the fact that other types of counters are inherently superior in terms of flexibility and power dissipation. The reason for this seeming anomaly is the present limitations of integrated-circuit fabrication techniques.

One type of counter that appears realizable as an integrated circuit and which offers capabilities not available with ring and cascade flip-flop counters is the gate-ring counter.

This first part of a two-part article describes gate-ring counters that can be built in integrated-circuit form. The second part will compare the characteristics of gate-ring counters with those of flip-flop types.

## NOR or NAND gates can be used

Gate-ring counters can be simply realized by using NAND gates if all gates are OFF except one, or by using NOR gates if all gates are ON except one.

Consider first a gate-ring counter in which all gates are OFF except one. The state table for such a counter employing five gates is shown in Fig. 1a. Positive logic is assumed, where  $V_{cc} = "1"$ ,  $V_{sat} = "0"$ .

For this array of gates to be able to hold the

required states, the setting functions for the gates must be:

$$f(A) = \overline{BCDE}$$

$$f(B) = \overline{ACDE}$$

$$f(C) = \overline{ABDE}$$

$$f(D) = \overline{ABCE}$$

$$f(E) = \overline{ABCD}$$

From these logical expressions, it is evident that a counter of this type can be realized using NAND gates. The layout of such a NAND gate-ring counter is shown in Fig. 1b. Two NAND gates that can be fabricated in integrated-circuit form to build such a counter are shown in Fig. 2.

The state table for a five-gate counter of the second type (all ON but one) is shown in Fig. 3a. To satisfy the state table, the setting functions for the gates must be:

$$f(A) = \overline{BCDE} = \overline{B+C+D+E}$$

$$f(B) = \overline{ACDE} = \overline{A+C+D+E}$$

$$f(C) = \overline{ABDE} = \overline{A+B+D+E}$$

$$f(D) = \overline{ABCE} = \overline{A+B+C+E}$$

$$f(E) = \overline{ABCD} = \overline{A+B+C+D}$$

From these expressions, the designer can see that a counter of this type can be realized by means of NOR gates. Fig. 3b shows the layout of a NOR gate-ring counter. An integrated-circuit NOR gate that can be used to build such a counter is

**George J. Veth**, Applied Physics Laboratory, Johns Hopkins University, Baltimore, Md.

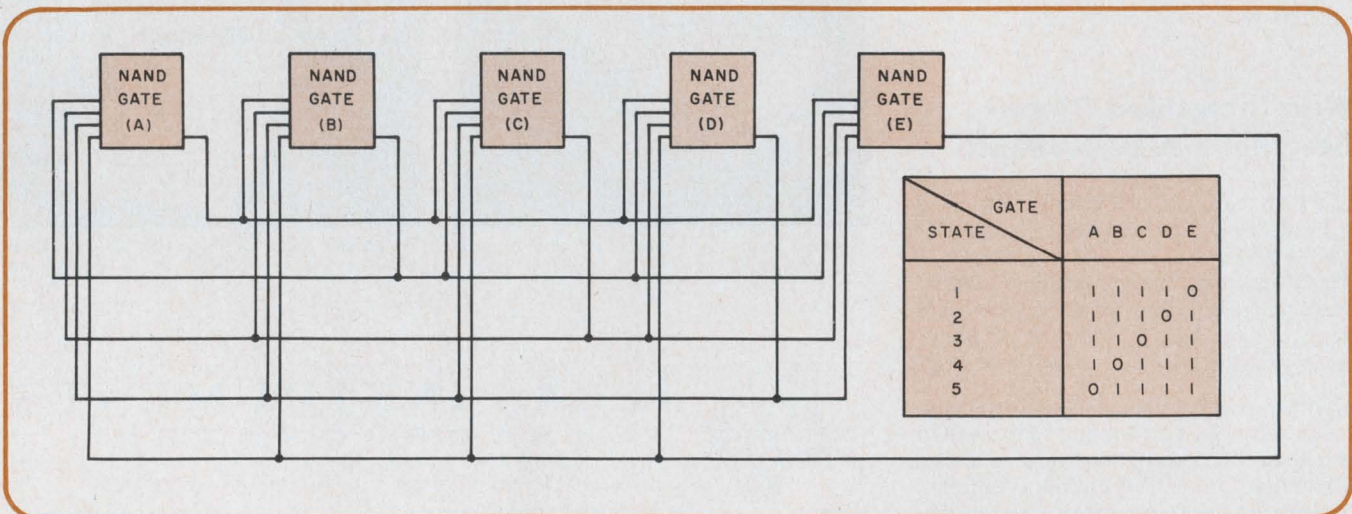

1. NAND gate-ring counter state table (a) can be implemented by NAND gates interconnected as in (b).

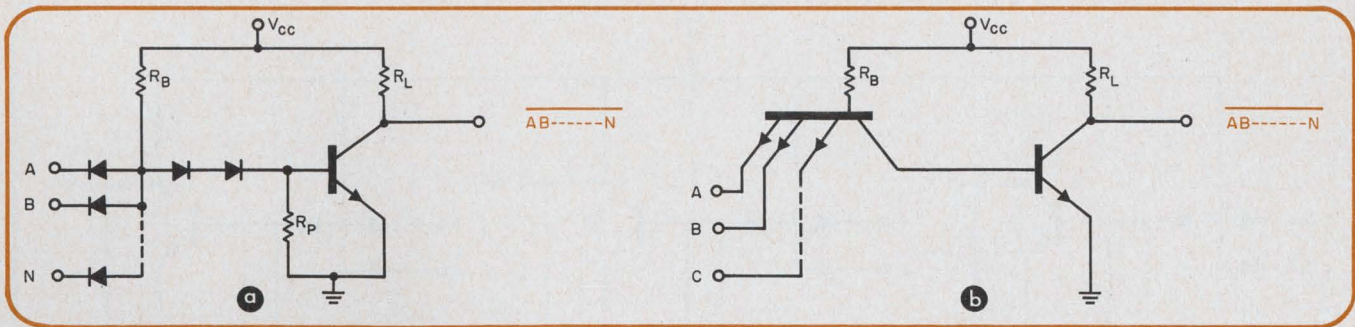

2. Two NAND gates easily realizable in integrated-circuit form are the DTL type (a) and the TTL type (b).

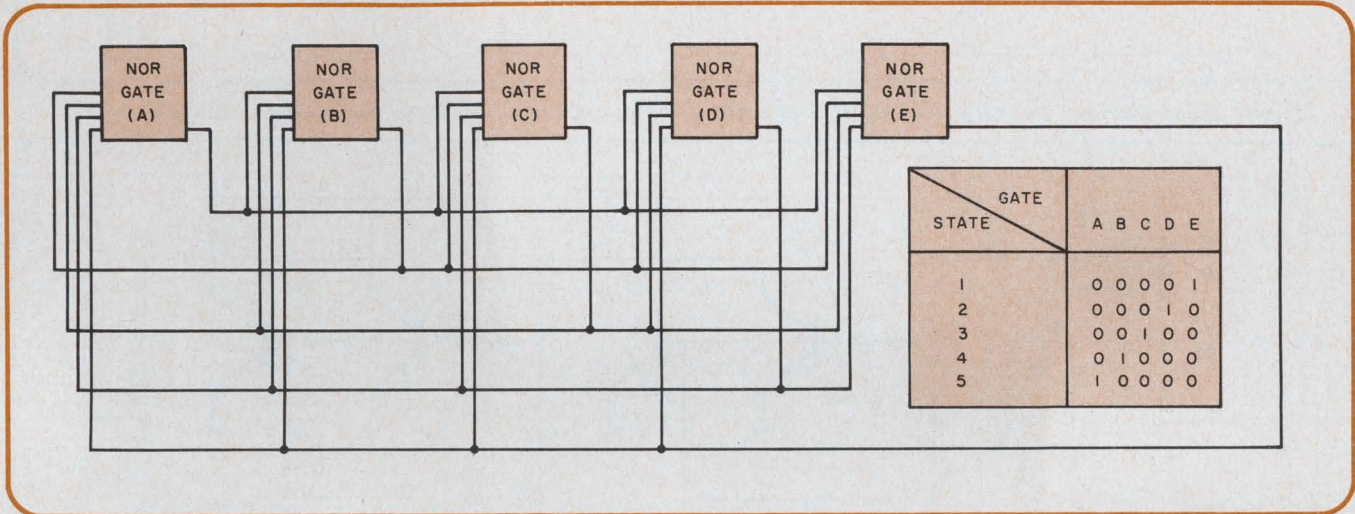

3. NOR gate-ring counter state table (a) can be implemented by NOR gates interconnected as in (b).

shown in Fig. 4.

Because of their logical structure, gate-ring counters can be constructed so as to divide by any whole number. In practice, however, there is a limit on the number of gates that can be placed in a single counter, since the required gate fan-in and fan-out increases with increasing number of gates, and the circuit stability decreases.

#### Simple pulse-steering network possible

For the ON or OFF gate of a gate-ring counter to progress around the ring upon application of a pulse train, a pulse-steering network must be added to the ring. One type of simple steering network for integrated-circuit counters is shown in Figs. 5 and 6. The operation of the network can be explained by referring to points *K* on the figures.

With the input at ground, each point *K* assumes the potential of the transistor collector it is tied to via the steering-network resistor. As the input changes from ground to a positive potential, no change occurs at those points which are tied via the resistor to the collector of an OFF transistor. This assumes that the input magnitude does not exceed  $V_{cc}$  and that ideal diodes are used. Those points that are tied to an ON collector rise with the input pulse and inject base current into the transistor connected to this point via the steering network capacitor. For the NAND gate-ring counter (Fig. 5), this happens to one transistor

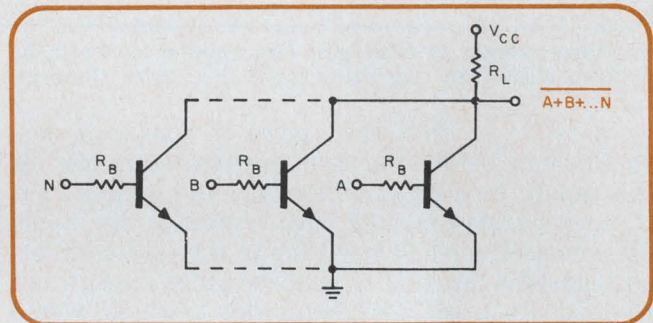

4. RTL-type NOR gate is easily realizable in integrated-circuit form with present fabrication techniques.

each positive transition of the input. Turning this NAND gate ON forces the gate which was ON to its OFF state, since the interconnection of the gates insures that only one gate will be ON in any of the counter states.

For the NOR gate-ring counter, charge is injected into all but one transistor base during each positive transition of the input. Turning all but one NOR gate ON forces the gate not turned on to its OFF state, since the interconnection of the gates insures that only one gate will be OFF in any of the counter states.

The maximum speed at which this steering network can switch the counter from one state to another is dependent on the time constant of the steering-network resistor and capacitor. For maximum speed, the  $RC$  product must be as small

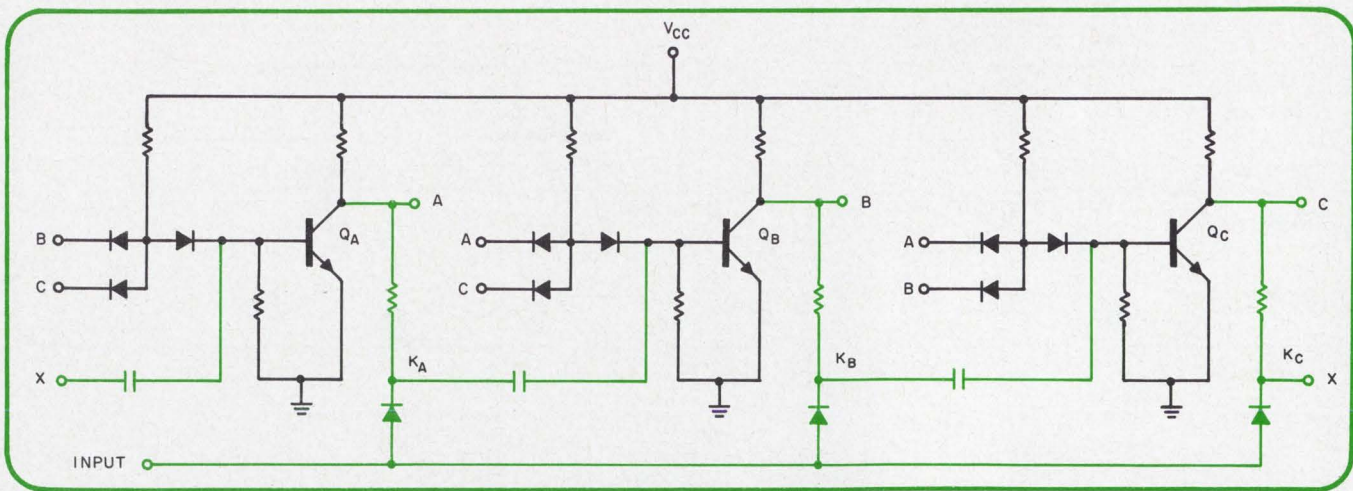

5. Simple pulse-steering network for NAND gate-ring counter requires only three components per gate.

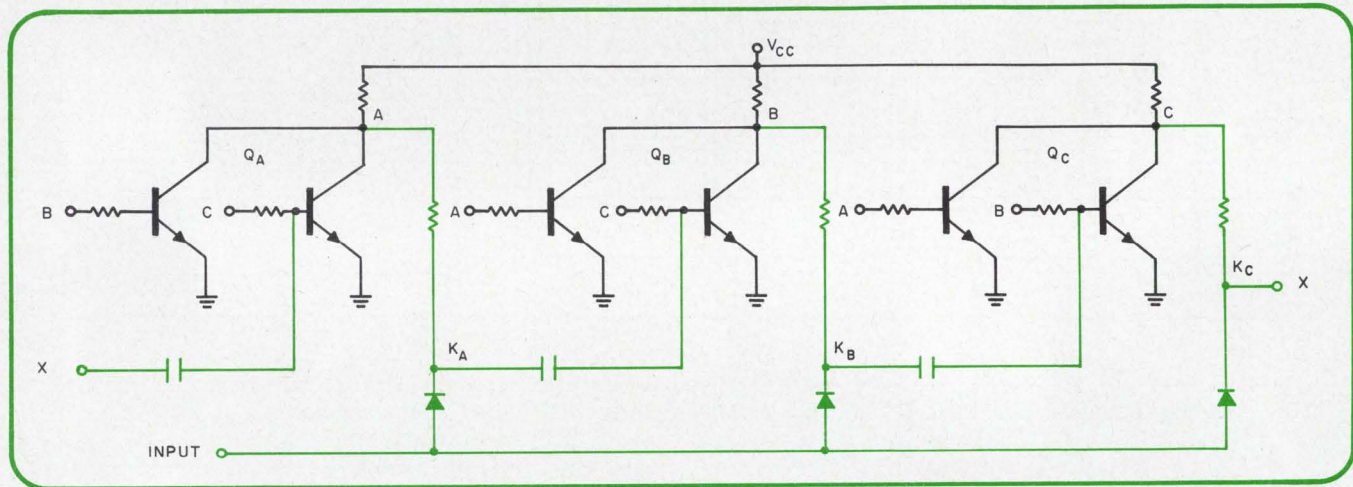

6. Pulse-steering of NOR gate-ring counter can also be accomplished with few components per gate. However,

because of the simplicity of the steering network, only limited operating speeds can be realized.

as possible so that each point  $K$  can approach equilibrium before the next positive transition of the input. In addition, however, the capacitance,  $C$ , must be large enough with respect to the input-pulse magnitude and rise time to turn its associated transistor on, and  $R$  must be large enough not to load its associated transistor (which would increase circuit power dissipation) or to divert drive current from the transistor bases.

each NOR-gate input. Naturally, because of the increased number of capacitors required, this approach is not too practical if the counter is to be in integrated-circuit form. If TRL-type NOR gates are used, only one capacitor per gate is required. However, TRL gates themselves are not practical in integrated-circuit form.

For the NAND gate-ring counter (Fig. 5), change of state can be activated on the negative transition of the input by reversing the direction of the steering-network diodes. This changes the circuit operation. Current is now diverted from all the transistor bases connected to points  $K$  that are initially at a positive potential at the onset of the negative transition of the input. The transistor whose base is connected via the capacitor to the one  $K$  point near ground potential is then forced ON due to the interconnection of the gates. When using this type of steering network with the diodes reversed, counter operation has been found to be critical with respect to the input-voltage magnitude.

#### Additional components add speed

For the NOR ring counter (Fig. 6), reversing the steering-network diodes will not initiate a change of state on the negative transition of the input, unless additional capacitors are added to

Although the steering network in Figs. 5 and 6 is simple, it has a limited speed of operation. Faster counter speed can be realized with a more complex steering network, like that shown in Figs. 7 and 8. As in the previous network, points  $K$  in Figs. 7 and 8 charge to the potential of the transistor collector they are tied to via the steering-network resistor. When the input changes from ground to a positive potential, the potential of these points does not essentially change, due to the clamping action of the diode paralleling the steering-network resistor. When the input changes from a positive potential to ground, the  $K$  points that are at a positive potential follow the input to ground and then charge to the potential of their associated transistor collectors. However, those  $K$  points that are near ground potential are forced below ground, forward biasing those steering-

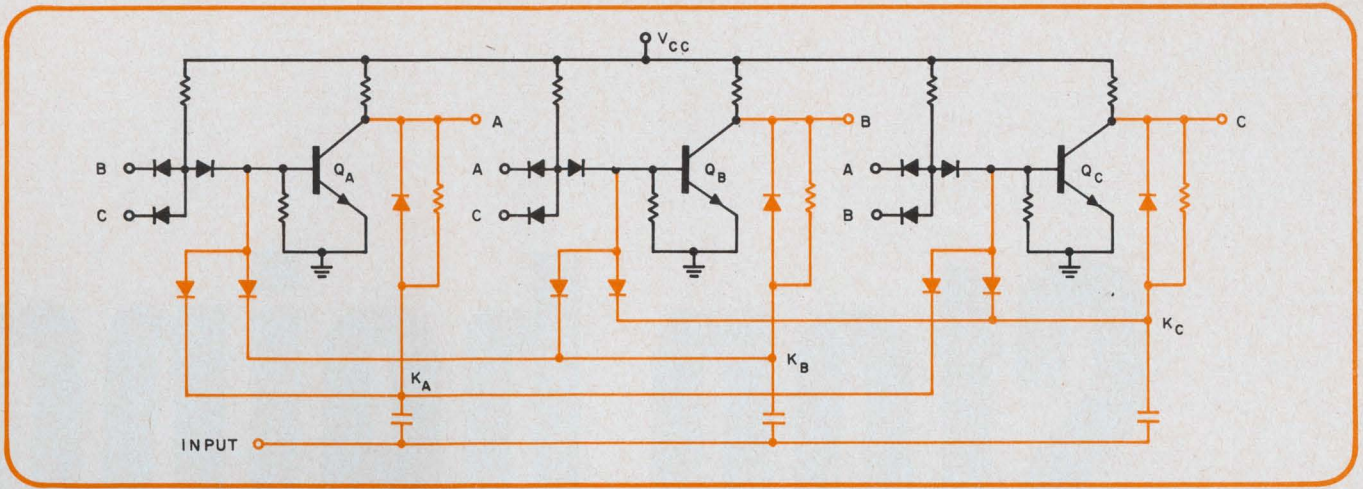

7. More complex pulse-steering network increases the maximum operating speed of the NAND counter.

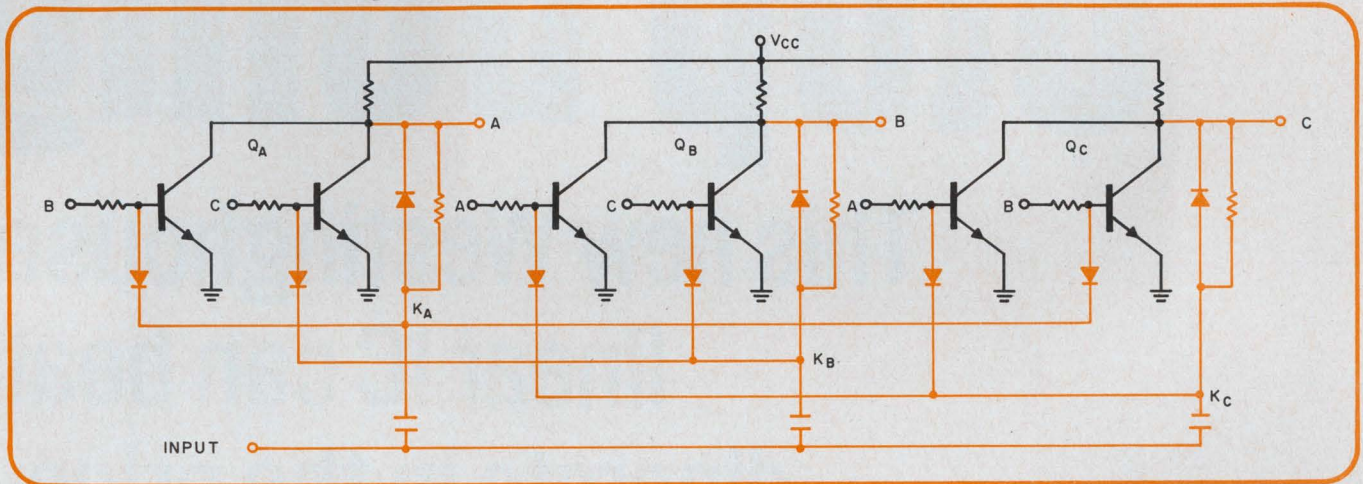

8. Increased operating speed of this NOR counter is made possible by the clamping diodes in parallel with

the steering-network resistors. The same is true for the NAND counter of Fig. 7.

network diodes connected between points  $K$  and the transistor bases. This diverts transistor base current from these transistors, turning them off.

For the NAND gate-ring counter (Fig. 7), this steering network diverts base current from all the gate transistors but one, thus forcing that gate ON. This network works over a range of input magnitudes much wider than that of the previous steering network when current starving is employed (diodes reversed).

For the NOR gate-ring counter (Fig. 8), reversing the diodes will result in the negative transition of the input pulse cutting off only one gate, thus forcing the others ON due to the interconnection of the gates.

The speed of operation of this type of steering network is greater than that of the simple networks because of the reduction in the steering-network time constant caused by the clamping diodes paralleling the steering-network resistors.

It is interesting to note that if only two gates are employed in the counters of Fig. 7 and 8, the circuits reduce in concept to the familiar Signetics (SE124) and Texas Instruments (SN510) integrated flip-flops with pulse steering networks.

#### Simple rules allow network extension

The extension of the simple steering network to

more than three gates is evident. But extension of the networks in Figs. 7 and 8 may not be as evident; therefore, simple rules for their implementation to counters of any length are given.

For a NAND gate-ring counter whose ON gate advances from  $A$  to  $B$  to  $C$ , etc., each  $K$  point is designated  $K_X$ , where  $X$  corresponds to the transistor collector to which the  $K$  point is connected via the steering-network resistor.  $K_X$  is connected through a diode to all the transistor bases except that of the transistor designated by the next letter. For example,  $K_B$  is connected via a diode to all transistor bases except that of  $Q_C$ .

For a similar NOR gate-ring counter, the point  $K_X$  is connected via a diode to all the transistor bases whose inputs are tied to collectors of the following letter. Here,  $X$  is the letter corresponding to the gate output point to which  $K$  is connected via the steering-network resistor. For example,  $K_B$  is connected via a diode to all the transistor bases whose inputs are connected to the output of  $Q_C$ . ■ ■

#### Acknowledgement:

Interest in these counters was stimulated by work in progress at NASA-Goddard Space Flight Center with counters similar to those of Fig. 5. The work reported herein was supported by RREN-4 of the Bureau of Naval Weapons.

# Stop being

**This new Westinghouse  
linear IC can beat  
discrete in the price-  
performance tradeoff**

# so discrete:

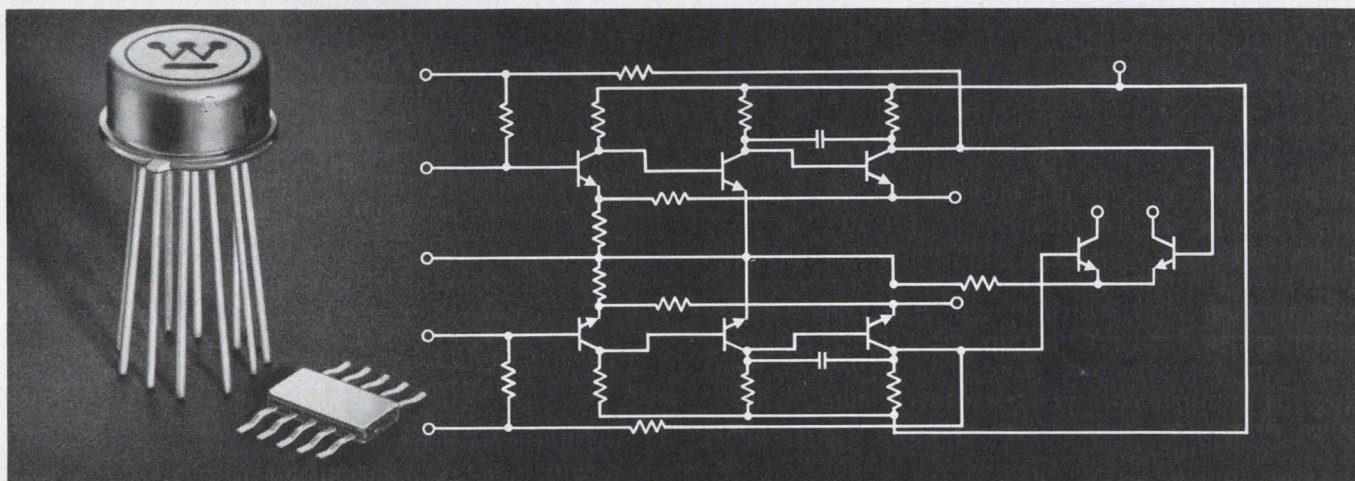

## New Class B amp gives 94 db gain at 4.5 Vcc, has over 50% efficiency

Here's the best commercially available Class B audio amplifier in silicon! It's the new Westinghouse WC 183. This universal low-level IC audio amplifier gives high gain throughout the Vcc range from 1.5 to 9. Minimum gain with a single battery cell is 60 db.

And here's a stopper...you can buy the WC 183 in TO can or flat package for only \$7.50 in quantities of 50! How does Westinghouse do it? We start the circuit with a three stage Class A preamplifier. There's your high gain. We follow it with a Class B output stage. That gives high efficiency. The entire 8-transistor balanced circuit with internal DC feedback draws only 5 ma. at a minimum output power of 3 mw.

The quiescent current is extremely low too. It's only 0.9 ma. at 1.5 Vcc. This means vastly extended battery

life in most applications. It also makes possible a broad range of new battery-powered IC applications.

You'll find the WC 183 ideal for hearing aids, paging systems, dictating equipment, phone amplifiers, and dozens of other voice communication applications. You can also put it to work in phonographs, tape recorders, and other uses where you want flat frequency response extending beyond the audio range.

Reliability? Every chip undergoes storage bake at 150°C, 20,000 G centrifuge, and hermeticity tests. Life tests indicate less than 0.01% failure rate per 1000 hrs.

Send for the specs. You'll think of at least a dozen great ways to use the remarkable WC 183. Write Westinghouse Electric Corporation, Molecular Electronics Division, Box 7377, Elkridge, Maryland 21227. J-09125

You can be sure if it's Westinghouse



# Testing coaxial cables

involves more than meets the eye. Cables respond differently for cw and for pulsed signals, and tests must check out both domains.

In testing a coaxial cable, the engineer must take into account the type of signal it will propagate. The cable responds differently for cw and for pulsed signals. To bring these differences to light, we examine experimentally both the frequency and time domain responses.

In both domains the tests must find the input and transfer characteristics of the cable. While a mathematical relationship exists between these two domains, it is simpler and more accurate to measure both responses directly. It is also possible

Allen M. Kushner, Engineering Manager, David E. Korman, Staff Engineer, David A. Peterson, Quality Assurance Manager, Times Wire and Cable, Wallingford, Conn.

to calculate the cable's response from data supplied by the manufacturer. However, experience has proved that theoretically computed characteristics usually do not conform to measured ones. Manufacturing process and other factors alter the characteristics.

## Frequency domain: sweep the range

In the frequency domain four characteristics determine the cable's response: input impedance, attenuation, phase shift and cross-talk.

Since radical changes can occur in these with a 1% change in frequency, it is advisable to sweep slowly through the frequency range of interest.

## Input impedance

There are many ways to express and to measure the input impedance. For example, with the reflection coefficient or with the return-loss figure. The RF bridge in Fig. 1 measures the mismatch between ports 2 and 3; it appears as an output voltage at port 4. This output is then calibrated by loads of known vswr.

The connectors and the cable-to-connector junction can affect the impedance of the cable greatly. Both of these should be checked carefully to establish the best match.

Short cables (less than 10 wavelengths) have cyclically varying responses. Their vswr's may be as high as 1.5 above 500 MHz. With a slight increase in cost, this value can be reduced to 1.10 at frequencies up to 10 GHz. Over narrow band-

widths the vswr can be reduced to 1.03 to 1.05.

Long cables usually have high vswr's over narrow frequency ranges. These result from periodic and random impedance variations (Fig. 2). The cable used by the authors for the test met the impedance requirements of MIL-C-17D of 50 ohms  $\pm 2$  ohms. Typical vswr values could be as high as 4.0 up to 10 GHz. Over narrow bandwidths, the vswr can be reduced to 1.10 to 1.05.

Longitudinal nonuniformities in the supporting dielectric can cause high vswr spikes at certain frequencies. Since these are more serious in long cables, such cables should be checked for spikes. The nonuniformities can also change the cable's characteristics when the cable is reversed or cut. Hence test long cables from both ends.

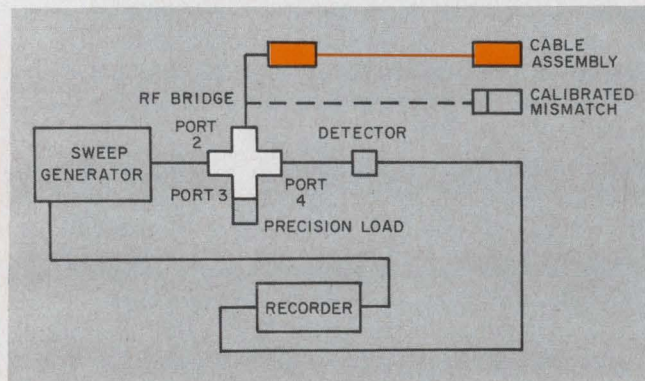

1. Hybrid instrumentation measures input impedance of a coaxial cable propagating a cw signal. The voltage at port 4 indicates the mismatch between ports 2 and 3. This is calibrated by loads with known vswr's.

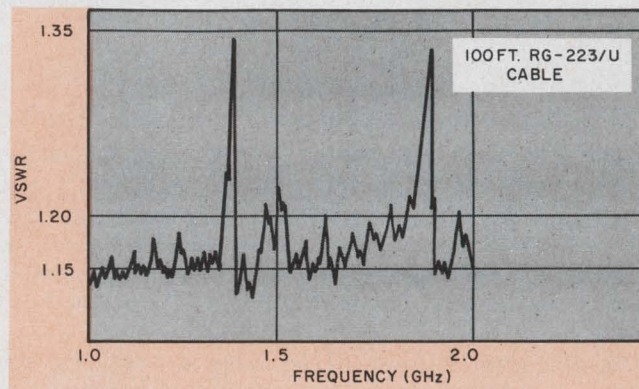

2. Electrically long cables exhibit both periodic and random impedance variations that appear as high vswr's with narrow bandwidths. The cable used to plot this curve met the requirements of MIL-C-17D.



## Attenuation

The attenuation is normally expressed in dB/100 ft and can be measured at single frequencies with an accuracy of 0.1 dB without much difficulty.

The characteristic of particular interest is the unusual change in attenuation, occurring over narrow bands and mostly in long cables. The loss can decrease sharply, as shown in Fig. 3. (The cable tested by the authors met the requirements of MIL-C-17D.) This sharp change happens at the frequency where variations in the input impedance would occur.

A standard cable, manufactured under controlled conditions, usually exhibits less than 1.5% variation without significant increase in cost.

The nominal attenuation of flexible coaxial cables has been reduced by recent improvements. For example, if the outer conductor is made from flat strips of copper, instead of round wires, the loss decreases above 1 GHz (Fig. 4).

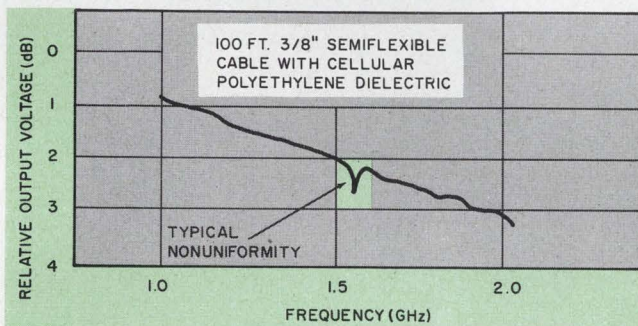

3. The output voltage of the cable has a typical non-uniformity that appears as a sharp dip over a narrow band. This change occurs at the frequency where large input impedance variations would be detected.

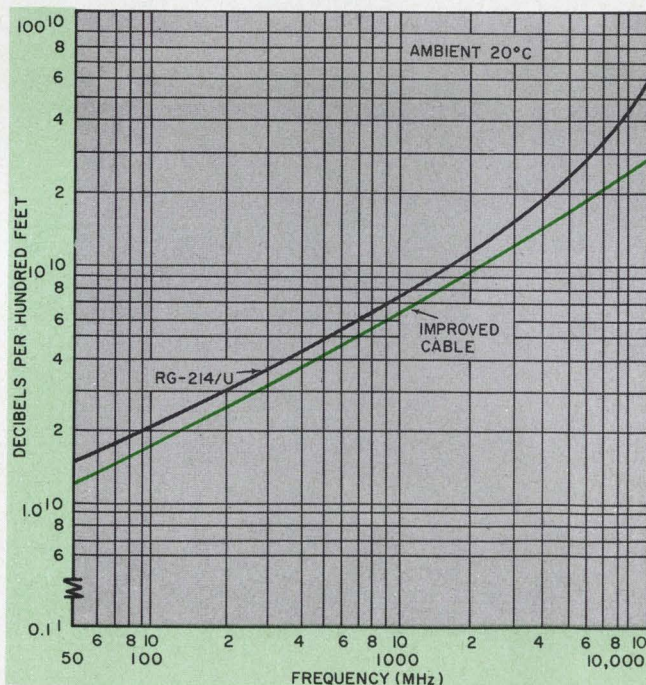

4. Braided flat strips, as outer conductors, offer lower attenuation than roundwire. This improvement is more noticeable above 1 GHz.

## Phase shift

The electrical length of the cable changes the phase of the signal. The electrical length—and hence the phase shift—varies with the frequency and with the velocity of propagation.

The variation in the velocity of propagation is too small to measure accurately with present techniques. The theoretically calculated values for a 75-ohm, flexible solid polyethylene coaxial cable (RG-164-U) is tabulated as follows:

Frequency (MHz)	1	10	200	0.02
Error (%)	1.0	0.3	0.08	0.02

The error increases significantly as the electrical size of the cable decreases (lower frequency). An additional phase error of  $\pm 0.5^\circ$  has been measured from the normal curve; it can be attributed to non-uniformities (reflections) within the cable.

No known, commercially available cable has reduced the errors caused by the velocity of propagation. However, an analysis of cable parameters indicates that, for specific bands, some improvement can be achieved with special designs. Phase variations as small as  $\pm 0.2^\circ$ , caused by non-uniformities, appear to be quite practical.

Phase-shift errors due to non-uniformities in the cable can be evaluated by resonating several identical lengths of cables at various frequencies and determining the phase shift from the difference in resonant frequencies. This method, while not very accurate, indicates at least the magnitude of the error. Most commonly, changes in electrical length caused by changes in frequency are compared with a selected standard. On a comparative basis, variations less than  $0.1^\circ$  can be resolved.

## Cross-talk

It is difficult to measure in the laboratory the cross-talk induced in a coaxial cable in actual operations. As a result, cross-talk measurements are made on a relative basis, where the energy emanating from the cable is monitored in an identical manner for various cable constructions. A relative shielding efficiency figure is then determined, and it indicates the expected improvements over the reference cable.

The most common technique is to build a closed chamber, which forms a coaxial cable with the outer conductor of the cable. Probes are then used to sample the energy within the outer coaxial field.

A second technique is to form a triaxial cable by using an outer tube, shorted at one end. The energy is propagated to the opposite end in the coaxial line and measured there. That end is formed by the outer conductor and the tube.

The tabulation of the shielding figures (Table 1) indicates that they remain fairly constant over a frequency range of from 50 to 200 MHz. The results are valid for cables whose dielectric configuration is similar to the RG-214/U.

(continued on p 64)

(continued from p 63)

The shielding efficiency decreases as the frequency increases. It reaches about 50% of its low-frequency value at 10 GHz. The improvement between single- and double-shielded cables also appears to be reduced by 50%.

Strip-wire braids have poorer shielding efficiency below 50 MHz than round-wire braids. This is a result of the thinness of the strip, which is usually about 50% of the round wire's diameter. Aging (corrosion of the braids) also lowers the shielding efficiency.

**Table 1. Shielding figures for coaxial cables**

Outer conductor design	Average shielding figure (dB)	Improvement over single shielded bare copper (dB)
<b>Round wire braid</b>		
Single shield, bare copper	34	0
Double shield, bare copper	62	28
Triaxial, bare copper	76	42
Single shield, silver plate	40	6
Double shield, silver plate	69	35
<b>Strip wire braid</b>		
Single shield, bare copper	53	19
Double shield, bare copper	72	38
Triaxial, bare copper	79	45
Double shield, silver-plated copper	72	38

Now let's consider the cable's response in the time domain.

### Time-domain response depends on input pulse

In the time domain the characteristics under scrutiny are:

- Pulse reflection.
- Pulse distortion.
- Pulse amplitude.
- Time delay.
- Cross-talk.

The first one defines the cable's input characteristic; the rest are pertinent to its transfer properties. All properties may be some function of the input pulse's rise time and width. In the evaluations that follow we assume an input pulse with a rise time of less than 0.75 ns and a width of less than 100 ns. Also, the pulse width is considerably shorter than the cable under consideration.

## Pulse reflection

Both the input pulse and the pulse reflection may be recorded with the setup in Fig. 5.

When checking the reflections, keep in mind that any reflection is attenuated by a distance  $2L$ , where  $L$  is the distance from the input to the origin of the reflection.

The reflected pulse-amplitude is calibrated as a percentage of the input pulse. The sampling oscilloscope has an input rise time of less than 0.5 ns.

The reflections in Fig. 6 are caused by non-uniformities within a long cable.

Reflections of less than 1% can be produced by special designs and controlled manufacturing conditions. Further improvements, down to 0.5%, are possible without substantial cost increase. However, small reflections do not guarantee good frequency-domain response.

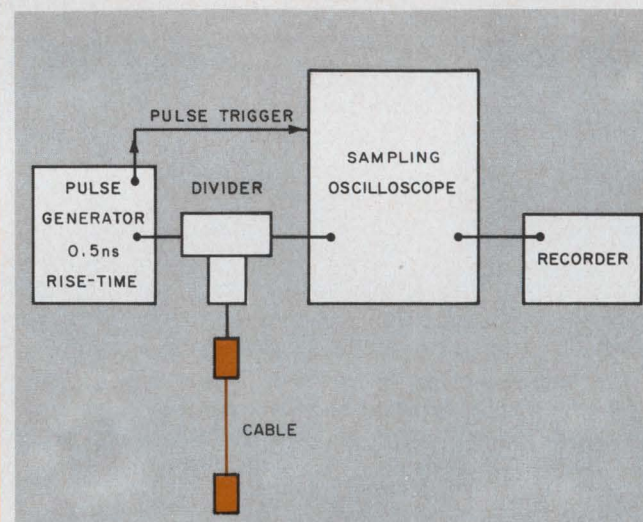

**5. Test setup measures the input pulse and determines the reflected pulse as a percentage of the input pulse. The cable's response depends on the input pulse width and rise time.**

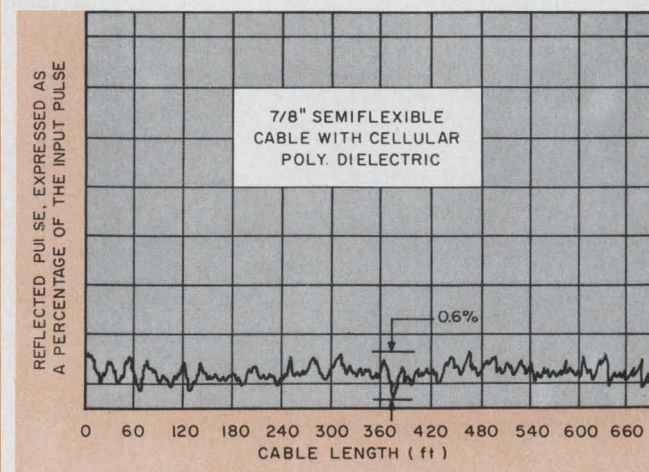

**6. Non-uniformities in a long cable produce reflections. These usually amount to less than 1% of the input pulse's amplitude.**

## Pulse distortion

Pulse-distortion information is lacking on all sizes and types of cables, because the majority of cables are normally evaluated for frequency-domain responses. However, sufficient information is available to note the effects of length and cable size, which are related to the attenuation response in the frequency domain.

The test setup in Fig. 5 indicates the distortion by measuring the rise time and pulse width of the output. By comparing these with the input's rise time and width, one can easily determine the distortion.

The change in rise time is definitely a function

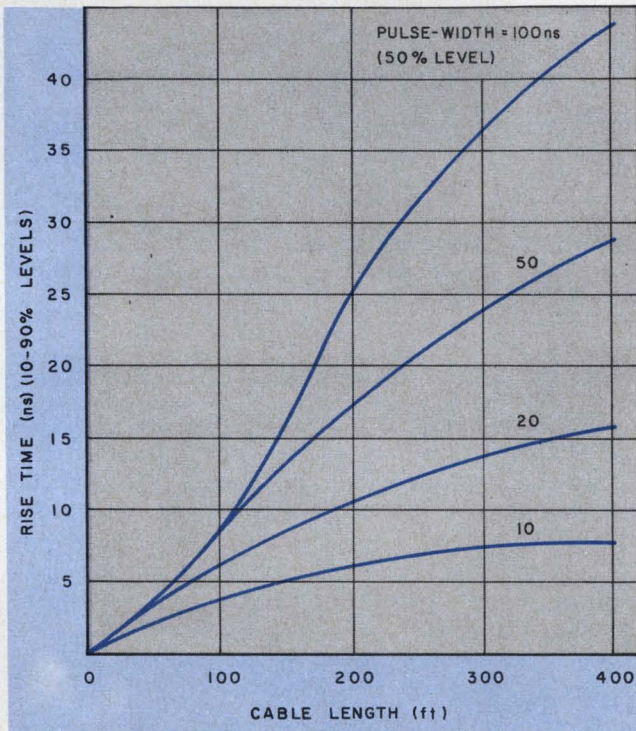

7. The change in the rise time of the output pulse depends on the cable length and the pulse width. These curves are based upon an input pulse having a 0.75 ns rise time. An increase in pulse width brings about a similar increase in the rise time.

of the pulse width (Fig. 7). It is also affected by the length of the cable (RG-223/U). The responses of various cables to an input pulse of 0.75 ns rise time are shown in Table 2.

The response of two dielectric configurations to a step having a rise time of 0.3 ns is in Fig. 8.

The pulse distortion in coaxial cables is related to the frequency-domain attenuation response in a linear manner: the lower the attenuation, the less the pulse-distortion.

Special designs to reduce pulse distortion are being investigated, but practical constructions are not yet available commercially.

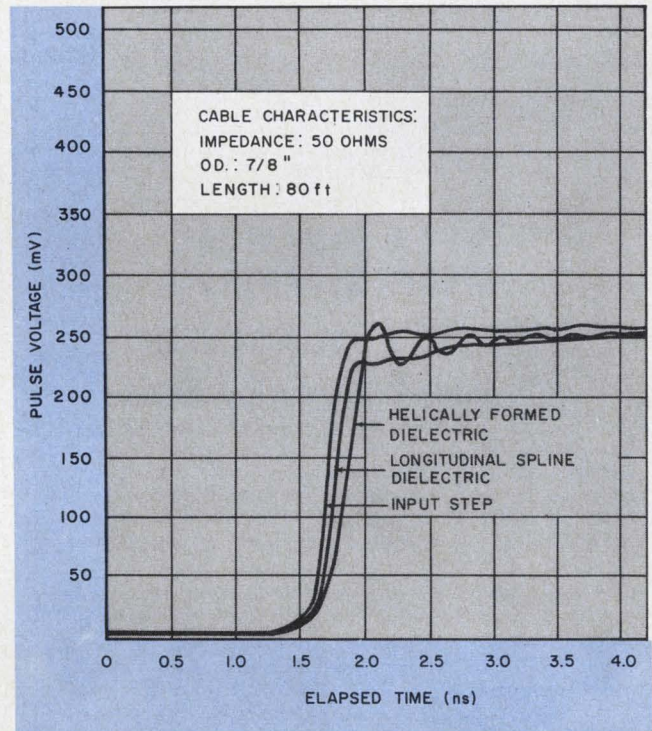

8. Response of a semiflex cable to a step input depends on its dielectric configuration. Longitudinal construction results in no overshoot. The rise time of the input is 0.3 ns. Pulse distortion can be reduced by special designs, but practical constructions are not yet available.

Table 2. Rise time of cables

Cable type	Dielectric	Pulse width (50%)	Cable length (ft)	Output rise time (ns)
1/2" Semiflex	Foam 50 ohms	150 ns	1000	100
1/2" Semiflex	Foam 100 ohms	For 100% output no voltage rise	1000	200
7/8" Semiflex	Foam 50 ohms	50 ns	1000	36

Where pennies are important  
**ECC**  
 saves you dimes and quarters

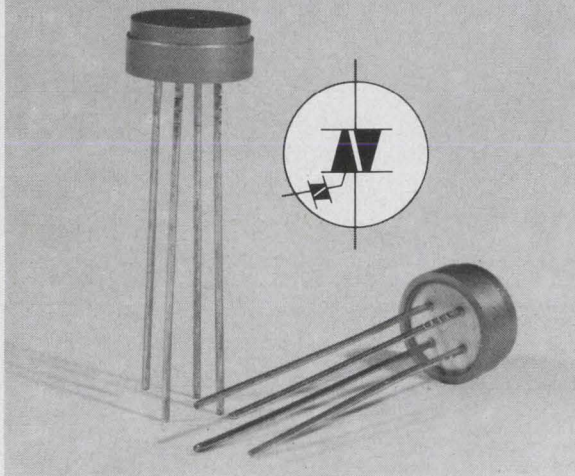

## QUADRAC<sup>®</sup>

Integrated AC semiconductor  
 with built-in triggering diode

QUADRAC does the work of two SCR's connected in inverse parallel — plus, QUADRAC contains its own built-in triggering diode (optional). This reduces the number of components needed in most AC circuits and substantially lowers component and circuit assembly costs while increasing circuit reliability.

QUADRAC, with built-in triggering diode, even costs up to 47¢ less than comparable bi-directional triode semiconductors without the trigger.

Further, QUADRAC is passivated and completely protected against high voltage transients, assuring long life and circuit reliability. QUADRAC's case is electrically isolated, eliminating the need to isolate when mounting. Think of the savings!

Many manufacturers are already using QUADRAC in AC applications such as motor speed controls, lighting controls, blower and fan speed controls, solid-state switches, static relays and temperature modulation controls. Other applications are virtually unlimited — ranging from air conditioning and heating equipment to business machines, large and small household appliances, and industrial control equipment. Wherever AC current is being switched, modulated or controlled, QUADRAC can substantially reduce package size, lower component and assembly costs and, at the same time, increase circuit reliability.

NOW AVAILABLE FROM STOCK: The complete line of QUADRAC's rated up to  $\pm 400$  volts  $V_{bo}$  — 3 to 15 amps.

®QUADRAC is a registered trademark of  
 Electronic Control Corporation

For complete details, write or call:

***ECC***

**Electronic Control Corporation**

P. O. Box J • Euless, Texas • 214 — AN 4-2429



ON READER-SERVICE CARD CIRCLE 23

### Pulse amplitude

The output pulse's amplitude is expressed in dB below the input pulse's amplitude.

The peak amplitude decreases with longer lengths and narrower pulse amplitude for RG-223/U. Note that the peak amplitude does not vary linearly with pulse width (Fig. 9).

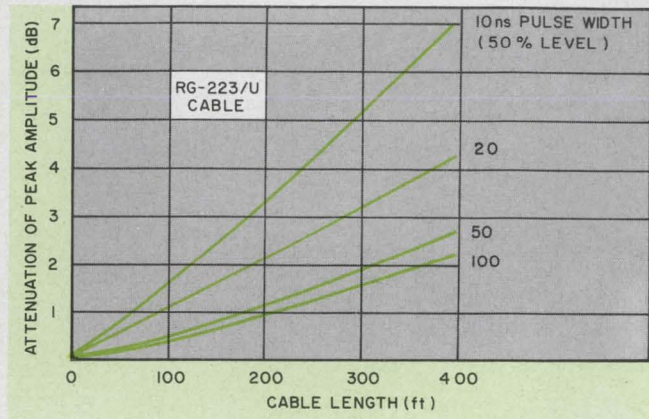

9. The peak amplitude of the output decreases with longer cable lengths. It can also be effected by the input pulse width.

### Time delay

Time delay may be measured through the calibrated time base of an oscilloscope. The accuracy of such a measurement is about 5%. Special oscillator-counter devices have been developed with accuracies of 0.1%.

The time delay can also be approached quite accurately by using the equivalent electrical length at a specific frequency on an absolute basis. Absolute length can be cut at hf frequencies with rated accuracies of  $\pm 0.2^\circ$ .

The uniformity of delay per unit length from cable to cable of the same construction is a very significant factor. Measurements of flexible cables indicate that variations of +1.5% to -0.5% can be encountered for a given length. In foam dielectric cables  $\pm 2.0\%$  can be expected, while in some airspace cables  $\pm 1.0\%$  can be expected. The nominal delay per foot obtainable with various cable constructions is shown in Table 3. ■ ■

Table 3. Delay of cable types

Cable dielectric	Delay (ns/ft)
Solid polyethylene	1.55
Air-space, polyethylene	1.21
Solid TFE	1.47
Air-space TFE, flexible	1.21
Foam polyethylene	1.27
Air-space polyethylene or TFE semiflexible	1.12

# HERE IT IS!

The new low-priced DIGITAL VOLTMETER and RATIO METER

- **COMPACT**
- **LIGHTWEIGHT**
- **VERSATILE**
- **ACCURATE**
- **RELIABLE**

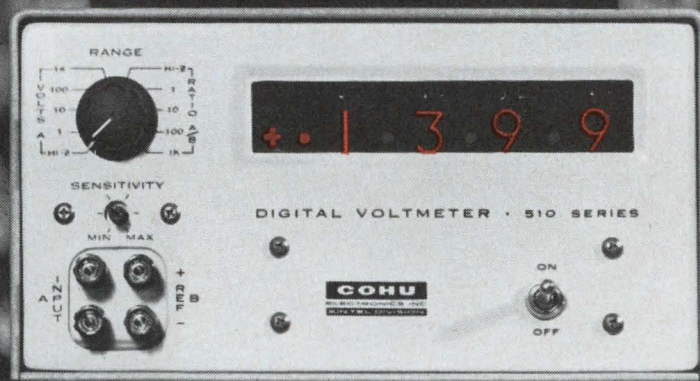

developed by COHU ELECTRONICS and designated the model 511

## CHECK THESE ABBREVIATED SPECIFICATIONS:

- 0.01% ACCURACY,  $\pm 1$  DIGIT
- 4 DIGITS RESOLUTION ON ALL RANGES
- AUTOMATIC POLARITY INDICATION
- 10 MANUAL RANGES, 1V TO 1000V, 1:1 TO 1000:1 RATIOS
- HIGH INPUT RESISTANCE
- SOLID-STATE REFERENCE AND CIRCUITRY
- BI-DIRECTIONAL, TRACKING LOGIC
- PRICE: \$995.00 F.O.B. San Diego. Additional export charge

Box 623, San Diego, California 92112 Phone 714-277-6700



for detailed specifications contact your nearest representative

KODAK SAFETY FILM



→ 8A

→ 9

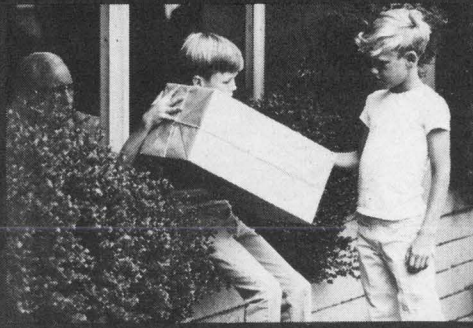

→ 9A

→ 10

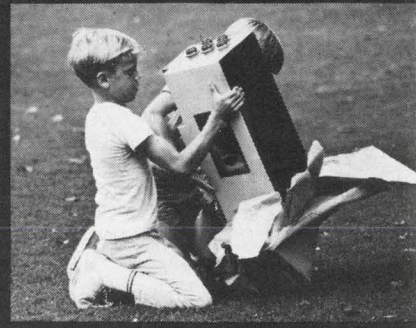

→ 10A



→ 11A

→ 14



→ 14A

→ 15

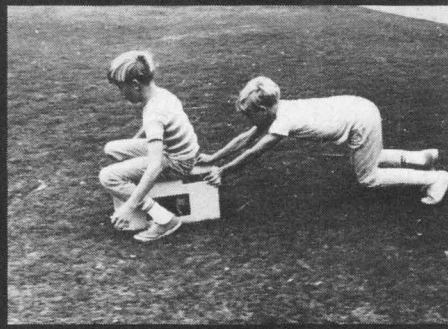

→ 15A



→ 18A

→ 19

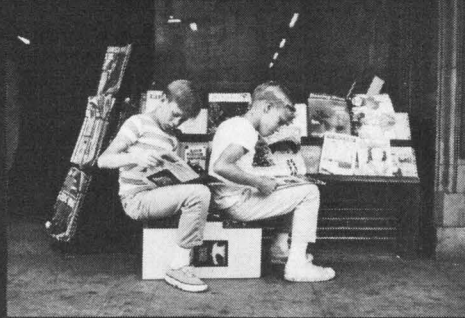

→ 19A

→ 20



→ 20A



→ 23A

→ 24



K

J

H

→ 25



→ 25A



→ 11A →



→ 16A →



→ 21A →

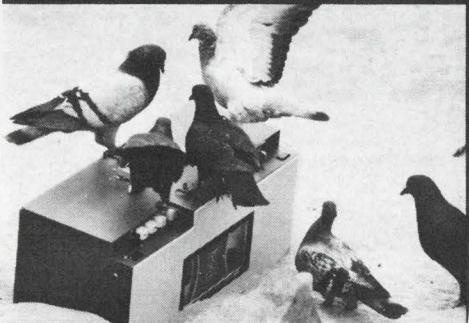

→ 26A →

## Tough Recorder Environments: Kid Stuff!

Try leaving a couple of kids alone for ten minutes with a brand new toy. Result: the kind of chaotic environment Leach recorders thrive on. Like in-flight testing, automotive torture tests, hydrofoil recordings, etc. . . . if you can keep a transducer on it, we'll monitor the output.

Take the MTR-3200 for example. For a modest power input of as little as 50 watts at 28VDC, this compact 44 pound package records, stores and reproduces data under the toughest conditions. Conditions like 10g shock with less than a 3% peak to peak flutter. 10g vibration with less than a 6% peak to peak flutter. 25g acceleration. -40° to 71° c operating temperatures. 95% humidity. 150,000 foot altitude. Check these specs against any other recorder/reproducer and see if they'll operate through conditions like that.

And the MTR-3200 is versatile, too. Plug in electronic modules provide up to 14 analog and FM or 16 digital channels usable in any combination. Six tape speeds are selectable in speed pairs. Even data bandwidths are extended beyond IRIG standards, and the entire unit is compatible with IRIG standard data reduction equipment. For those special applications, Leach offers a wide range of little luxuries such as analog to digital, serial to parallel and parallel to serial conversion equipment.

If these specs meet your immediate requirements, or if you have a highly improbable environmental situation to be challenged and accommodated, write us. No one knows more about high environmental tape recorders than Leach Corporation, Controls

**LEACH** Division, 717 North Coney Avenue,  
Azusa, California Phone: (213) 334-8211.  
Export: Leach International, s.a.

ON READER-SERVICE CARD CIRCLE 25

# Guarantee circuit performance!

Use this current-mode technique for worst-case design. It's simple, quick, reliable and applicable to any electronics network.

Reliability, more than any other consideration, is most often the determining factor in circuit performance. One of the surest ways of providing reliability entails a worst-case design analysis. But unless the worst-case technique itself can be relied on, circuit performance and even operating life remain a hit-or-miss affair.

Here is a worst-case analysis method that is free of uncertainties. Based upon a current, rather than a voltage, technique, it is rapid, simple to use and applicable to any electronic circuit. The method is performed with:

- All parameters simultaneously set at their worst-case purchase tolerance.

- The most critical parameter taken at its worst-case, end-of-life tolerance. (This insures that a specified condition will always be realized, regardless of component variations.)

- A more reliable estimate of the direction of worst-case situations. (The user has less difficulty deciding upon the direction in which to worst-case the parameters involved.)

The technique itself specifically guarantees the presence of a maximum or minimum voltage (as desired) at a particular node. It establishes that this voltage will be greater or less than a specified level.

Because a voltage analysis is not used, the engineer is freed from having to both solve node equations and then set up inequalities. Once a proficiency with the technique is obtained, the user need merely examine the circuit diagram and immediately write a final design equation. The derivation of the technique and a few examples based upon its use bear this out.

## For a better worst-case analysis

The main objection to conventional methods of worst-case design hinges on the direction estimate cited above. This problem occurs when trying to guarantee a maximum or minimum voltage level at a particular node. An example is in the design

of transistor switching circuits. There, the base-to-emitter potential must be maintained at a value greater or less than a given quantity to ensure that the transistor will not conduct under the worst possible conditions. But the specified voltage level is a function of the transistor itself. It varies from unit to unit and within the unit as well. The definition of the maximum or minimum values then becomes an uncertainty, and the worst-case criterion is not valid for all cases.

Figure 1 shows a simple, hypothetical circuit that will be used to explain this current-mode method. The symbols used in the illustration and elsewhere in the text are defined as  $V$  = voltage at node A,  $I_{in}$  = total current entering node A,  $I_{out}$  = total current leaving node A, and  $Z$  = general impedance. By elementary electronics theory, it can be shown that:

$$I_1 = \frac{V_1 - V}{Z_1} = \sum_{s=1}^b \frac{V_s - V}{Z_s}, \quad (1)$$

where  $b$  = the number of impedance branches

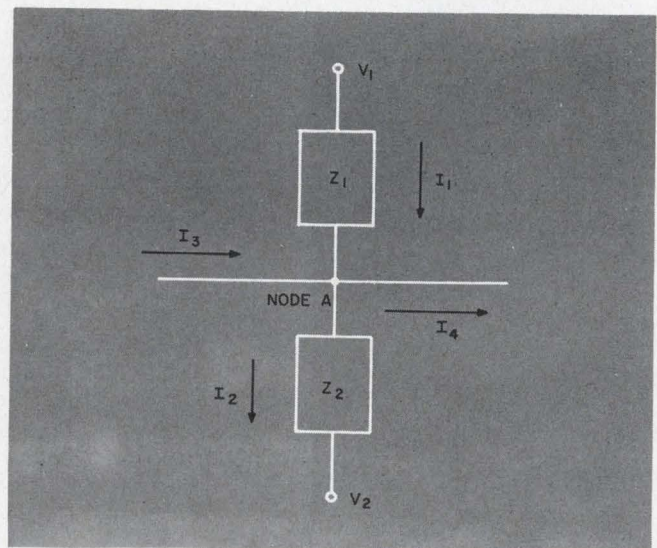

1. Current mode method for worst-case design is applicable to any electronic circuit. In essence, it guarantees the presence of a voltage at a particular node that is either greater or less than (as desired) a specified level.



where current flows into node A. Similarly,

$$I_2 = (V - V_2)/Z_2 = \sum_{p=1}^t \frac{V - V_p}{Z_1}, \quad (2)$$

$$I_3 = \sum_{j=1}^n I'_{in(j)}, \quad (3)$$

$$I_4 = \sum_{k=1}^m I'_{out(k)}, \quad (4)$$

where  $t$  = the number of impedance branches in which current flows from node A,  $n$  = the number of current sources into node A, and  $m$  = the number of current sources from node A.

The essence of the current technique is that it guarantees a voltage that is either greater or less than a specified level. Thus, two requirements can be satisfied. The first, ensures that the voltage at node A (in Fig. 1) will always be greater than some specified voltage,  $V_o$ . The second requirement is to guarantee that the voltage at node A will always be less than  $V_o$ .

The first condition may be met by hypothetically making the total current entering the node greater than the total current leaving the node when  $V$  equals  $V_o$ . Observe that this is an unstable condition. Then, when node A reaches equilibrium ( $I_{in} = I_{out}$ ),  $V$  will always be greater than  $V_o$ .

#### Intuitive approach validates method

Initially, an intuitive approach can be used to provide a convincing argument for the validity of the first case. Assume that the nominal value of the current entering the node is greater than or equal to the current leaving the node (under the condition that  $V = V_o$ ). This naturally violates Kirchhoff's Law, which states that the algebraic sum of the currents at a node must be zero, and that the node is therefore in an unstable state.

Before the node can assume a stable configuration,  $I_{in}$  must decrease and  $I_{out}$  must

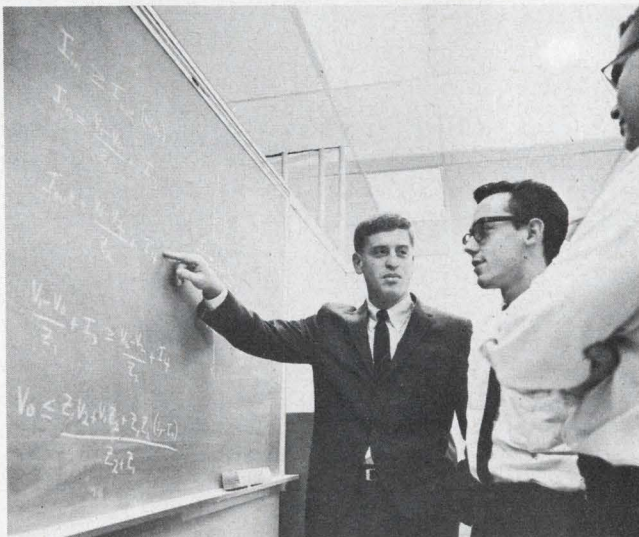

**Chalk up a better worst-case analysis . . .** Author Smith demonstrates his current-mode worst-case design technique to circuit designer colleagues. The method is applicable to any electronics circuit.

increase until the two are equal. As a result of this shift in current levels, the voltage at node A must become more positive than it was in the unstable state. Consequently,  $V$  (voltage in the stable state) must always be greater than or equal to  $V_o$  (voltage in the unstable state).

Up to this point, the analysis has not taken into account the circuit parameter variations. This can easily be done if the variations are assumed to be in such a direction that the current entering the node is at a minimum and the current leaving the node is at a maximum. This will force the minimum current entering the node to be greater than the maximum current leaving the node. This establishes that  $V$  will be greater than  $V_o$  under the worst possible conditions. Note that this assumption is logical and perfectly consistent with electronic behavior.

The case may be proved by analytical means to strengthen the intuitive reasoning. In the unstable state, the following relationships hold:

$$I_{in} \geq I_{out} \quad (\text{when } V = V_o) \quad (5)$$

$$I_{in} = \frac{V_1 - V_o}{Z_1} + I_3 \quad (6)$$

$$I_{out} = \frac{V_o - V_2}{Z_2} + I_4 \quad (7)$$

Substituting Eqs. 2 and 3 into Eq. 1 and solving the resulting inequality for  $V_o$  yields

$$V_o \leq \frac{Z_1 V_2 + V_1 Z_2 + Z_1 Z_2 (I_3 - I_4)}{Z_2 + Z_1}. \quad (8)$$

The stable condition may be expressed as:

$$I_{in} = I_{out} \quad (\text{voltage at node A} = V), \quad (9)$$

but

$$I_{in} = \frac{V_1 - V}{Z_1} + I_3 \quad (10)$$

and

$$I_{out} = \frac{V - V_2}{Z_2} + I_4. \quad (11)$$

Substituting Eqs. 10 and 11 into Eq. 9 and solving for  $V$  produces:

$$V = \frac{Z_1 V_2 + V_1 Z_2 + Z_1 Z_2 (I_3 - I_4)}{Z_1 + Z_2}. \quad (12)$$

#### Stable-state simplifies solution

The right side of Eq. 8 and 12 are identical. Therefore,  $V$  may be substituted for the right side of Eq. 8. Doing this, the following equation is obtained:

$$V \geq V_o. \quad (13)$$

Thus, in the stable condition,  $V$  is always greater than or equal to  $V_o$ .

Turning to the solution of the second case, we can ensure that the voltage at node A will be less than some specified voltage  $V_o$ . This can be achieved by hypothetically making the total current leaving the node greater than the total current entering the node when  $V$  equals  $V_o$ .

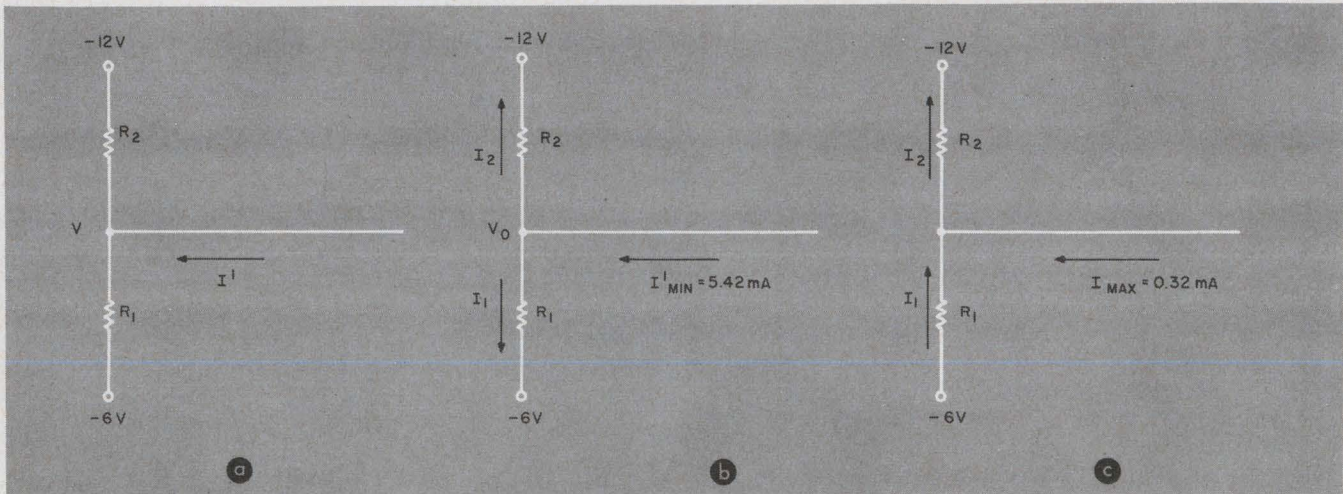

2. **Simple resistive network** is used to demonstrate the worst-case design technique (a). The task is to specify minimum and maximum values for  $V$ . The values of re-

sistors  $R_1$  and  $R_2$  are established by inequalities set up for the minimum (b) and maximum (c) current levels. The method is simple and rapid in application.

(unstable condition). Then, when node A reaches equilibrium ( $I_{out} = I_{in}$ ),  $V$  will always be less than  $V_o$ .

The deductive and analytical proofs here are very much similar to those given for the first case. Note that in the second case we assume that the nominal value of the current leaving the node is greater than or equal to the current entering the node (under the condition that  $V = V_o$ ). Once again, this violates Kirchhoff's Law and the node is in an unstable state.

Before the node can assume a stable configuration,  $I_{out}$  must decrease and  $I_{in}$  must increase until the two currents are equal. As a result of this shift in current levels, the voltage at node A must become more negative than it was in the unstable state. Consequently,  $V$  is always less than or equal to  $V_o$ . Again, we specify the minimum current leaving the node and the maximum current entering the node because it is desirable that  $I_{out} \geq I_{in}$  under the worst conditions.

These general rules can now be restated in a simple form:

**Case A**—If  $I_{in} (min) \geq I_{out} (max)$  when  $V = V_o$ , then when equilibrium is reached ( $I_{in} = I_{out}$ ),  $V \geq V_o$ .

**Case B**—If  $I_{out} (min) \geq I_{in} (max)$  when  $V = V_o$ , then when equilibrium is reached ( $I_{in} = I_{out}$ ),  $V \leq V_o$ .

### Practical examples demonstrate use

The presentation of a simple resistive network will illustrate the procedure outlined in Cases A and B. Let the network shown in Fig. 2a represent the output of a current-switching circuit. The current  $I'$  represents the load current from a succeeding stage and varies with the change in voltage level,  $V$ . In addition, assume that the voltage-supply tolerance is  $\pm 4\%$  and that the resistance tolerance is  $\pm 5\%$ . The problem is to guarantee that  $V \geq 5.6$  volts when the minimum load current ( $I'_{min}$ ) is 5.42 mA. We must also

guarantee that  $V \leq -6.4$  volts when the maximum load current ( $I'_{max}$ ) is 0.32 mA.

Referring to Fig. 2b, we first want to guarantee that when  $I = I'_{min} = 5.4$  mA,  $V$  will be  $> -5.6$  volts ( $V_o$ ).

Let us apply case A, which states that  $V \geq V_o$  (stable state) if  $I_{in} (min) \geq I_{out} (max)$  when  $V = V_o$ . This is expressed by:

$$I_{in(min)} = 5.42 \text{ mA}$$

$$I_{out(max)} = I_{1max} + I_{2max}$$

$$I_{1(max)} = \frac{-5.6 + 6(1 + 0.04)}{R_1(1 - 0.05)}$$

$$I_{2(max)} = \frac{-5.6 + 12(1 + 0.04)}{R_2(1 - 0.05)}$$

Using the method of substitution, a single equation is obtained that relates  $R_1$  and  $R_2$  to the given values:

$$5.42 \times 10^{-3} \geq \frac{-5.6 + 6(1.04)}{R_1(0.95)} + \frac{-5.6 + 12(1.04)}{R_2(0.95)} \quad (14)$$

Referring to Fig. 2c, we now want to guarantee that when  $I = I'_{max} = 0.32$  mA,  $V$  will be less than  $-6.4$  volts ( $V_o$ ).

Let us now apply case B, which states that  $V \leq V_o$  (stable state) if  $I_{out(min)} \geq I_{in(max)}$  when  $V = V_o$ .

Thus:

$$I_{in(max)} = 0.32 \times 10^{-3} + I_{1(max)}$$

$$I_{out(min)} = I_{2(min)}$$

$$I_{1(max)} = \frac{-6(1 + 0.04) + 6.4}{R_1(1 - 0.05)}$$

$$I_{2(min)} = \frac{-6.4 + 12(1 - 0.04)}{R_2(1 + 0.05)}$$

Substitution is again used to produce the second

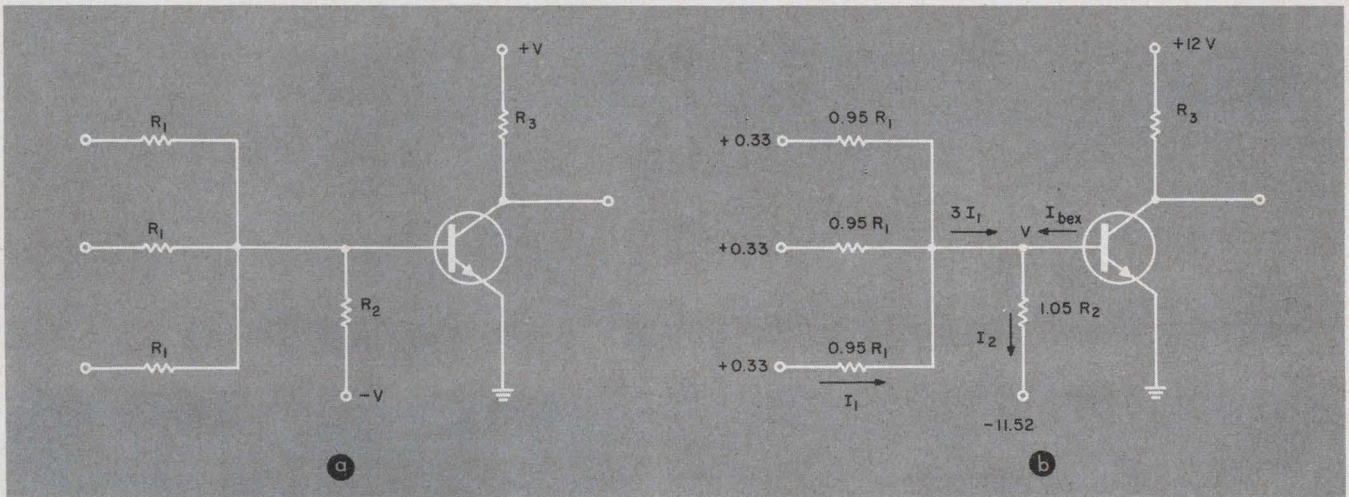

3. Transistor switching network, often a problem for conventional worst-case design analyses, is easily accommodated by the current-mode technique (a). Worst-case

purchase and end-of-life tolerances for resistors, power supplies and transistor parameters are used to set up the design equations (b).

expression for  $R_1$  and  $R_2$ . Thus:

$$\frac{-6.4 + 12(0.96)}{R_2(1.05)} \geq \frac{0.32}{10^3} + \frac{-6(1.04) + 6.4}{R_1(0.95)} \quad (15)$$

Equations 14 and 15 are two inequalities that satisfy the restrictions placed on the circuit. The next step is to solve them and obtain a suitable range of values for  $R_1$  and  $R_2$ . Rewriting the inequalities and solving for  $R_1$ , we see that  $R_1 \geq 275$  ohms to fulfill the design requirements. Settling on a standard resistor value, we choose  $R_1 = 390$  ohms. Now  $R_2$  is solved for by substituting 390 for  $R_1$  in the equations. This yields  $R_2 \leq 2.38k$  and  $R_2 \geq 1.95k$ . In accordance with standard-value components, we choose  $R_2 = 2.0k$ .

Thus, if  $R_1$  is 390 ohms and  $R_2$  is 2.0k, the specified voltage levels will be guaranteed under the worst possible conditions in the circuit. Note that if there is no common solution to the inequalities satisfying the conditions imposed on the circuit, this indicates that the circuit is not realizable under these conditions.

#### Applying method to logic circuits

The design of transistor switching circuits can also be achieved with this worst-case technique. Fig. 3a shows a simple NOR circuit that uses positive logic. A logical "one" is represented by an up level (defined as any potential between 5.76 volts and 12.48 volts). A logical "zero" is represented by a down level (any potential between 0 volt and 0.33 volt).

The circuit is to be designed so that a logical "one" appearing at any one of the input resistors will cause the transistor to saturate and a logical "zero" to appear at the output. The transistor will be turned off only when logical zeros have been applied to all of the input resistors. This condition will cause a logical "one" to appear at the output.

The design of the complete circuit may be divided into two parts. The first is the "ON design," and it may be stated as follows: When any

or all inputs are at the up level, the transistor must be guaranteed to be ON. Moreover, the output level must lie between 0 volts and +0.33 volt in this state. The second part is classified as the "OFF design." Here, when all the inputs are at the down level, the transistor must be guaranteed to be OFF and have a leakage ( $I_{bex}$  and  $I_{cex}$ ) of less than  $30\mu A$ . The output level must lie between 5.76 volts and 12.48 volts in this condition. The following specifications are available to the designer:

**Resistor purchase tolerance** =  $\pm 5\%$ ; end-of-life tolerance =  $\pm 10\%$ .

**Supply tolerance** =  $\pm 4\%$ .

**Transistor specifications** (based upon purchase and end-of-life tolerances):

- (a)  $V_{CE(sat)} \leq 0.33$  volt at  $I_c = 36$  mA.
- (b)  $V_{BE(sat)} \leq 0.60$  volt at  $I_c = 36$  mA.
- (c)  $\beta$  (dc gain)  $\geq 40$  at  $I_c = 36$  mA.
- (d)  $I_{bex} = I_{cex} \leq 20 \mu A$  at  $V_{BE} \leq -0.1$  volt (purchase tolerance only).
- (e)  $I_{bex} = I_{cex} \leq 30 \mu A$  at  $V_{BE} \leq -0.1$  volt (end-of-life tolerance only).

In illustrating the use of the principle, we will only concern ourselves with guaranteeing that the OFF conditions are satisfied. Fig. 3b shows the worst-case OFF condition.

To guarantee that the leakage current will be less than  $30 \mu A$ , we must ensure that  $V_{BE}$  is more negative than  $-0.1$  volt. Mathematically, this may criteria, this means that when  $V = V_o = -0.1$  volt,  $I_{out(min)}$  must be greater than or equal to  $I_{in(max)}$ . If this condition is satisfied when the currents reach equilibrium,  $V$  will always be more negative than  $-0.1$  volt. Mathematically, this may be expressed by:

$$I_{in(max)} = 3 I_{1(max)} + I_{bex(max)} \quad (16)$$

$$I_{out(min)} = I_{2(min)} \quad (17)$$

$$3 I_{1(max)} = 3 \left( \frac{0.33 + 0.1}{0.95 R_1} \right) \text{ at } V = -0.1 \text{ volt} \quad (18)$$

# MASKS

for integrated circuitry  
thin film devices  
semiconductors

## PHOTOMASKS

NEW Perma-Chrome (metal film on glass).

High resolution photo emulsion.

## EVAPORATION MASKS

Electroformed nickel.

Etched molybdenum and stainless steel.

Bimetal (electroformed nickel and copper).

Prompt quotations and deliveries.



**TOWNE LABORATORIES, INC.**

Somerville, N. J. • Tel. 201 - 722-9500

See us at IEEE Booth 4A37  
ON READER-SERVICE CARD CIRCLE 26

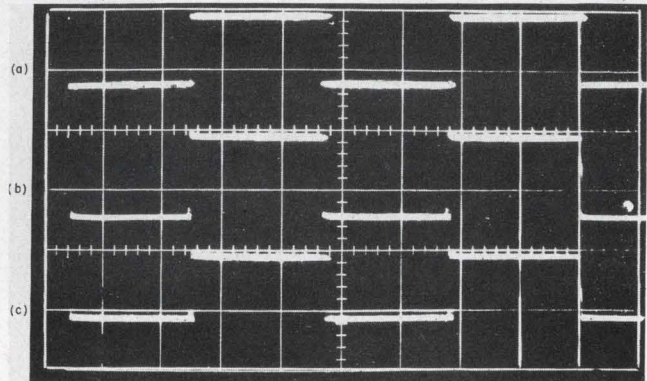
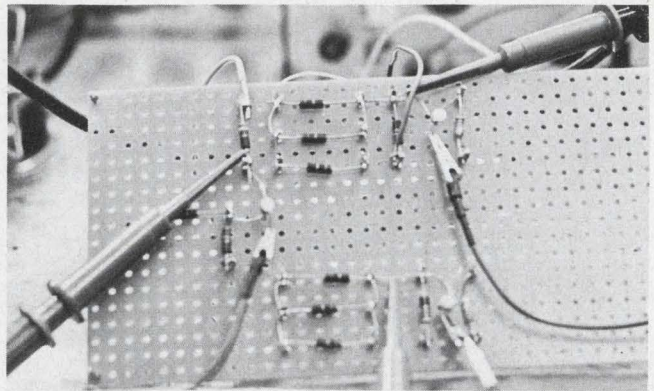

A black-and-white example of improved worst-case design. Breadboard (upper photo) contains two switching networks. Upper network was designed using current-mode worst-case technique. Lower circuit has component values obtained by an unreliable worst-case design method. Note that transistor switch (left-hand portion of board) is common to both. Waveform of input to each circuit (a) and CRO traces of base-emitter voltage of output stage in each network show proper performance in current-mode circuit (b) and inadequate performance in other circuit (c). The latter is not firmly cutoff in the OFF case and is more susceptible to leakage current turn-on.

$$I_{ber(max)} = 30 \times 10^{-6} \text{ A} \quad (19)$$

$$I_{2(min)} = \frac{-0.1 + 11.52}{1.05 R_2} \text{ at } V = -0.1 \text{ volt} \quad (20)$$

It should be noted at this point that  $I_{ber}$  is considered to be the most critical parameter and was taken at its end-of-life tolerance. All other parameters were taken at their worst-case purchase tolerances. Rearranging terms, the following equation is obtained:

$$\frac{-0.1 + 11.52}{1.05 R_2} \geq 3 \left( \frac{0.33 + 0.1}{0.95 R_1} \right) + 30 \times 10^{-6} \quad (21)$$

This fulfills the requirement that  $I_{out} (min) \geq I_{in} (max)$  when  $V = 0.1$  volt.

Equation 21 shows a relationship between  $R_1$  and  $R_2$  that satisfies the OFF condition requirements. A second equation must also be determined to satisfy the ON conditions. The two equations will then completely specify the range of values for  $R_1$  and  $R_2$ . ■ ■

### Reference:

1. K. M. Trampel, "The Design and Application of the Transistor NOR Circuit," IBM Technical Note TN 00.08000.429, March 22, 1960.



## ARNOLD / TOROIDAL COIL WINDER

sets up quickly...easy to operate...  
takes wide range of wire sizes

### SPECIFICATIONS:

- Min. finished hole size: .18 in.
- Max. finished toroid O.D.: 4.0 in.
- Winding speed: 1500 turns/min.
- Wire range: AWG 44 to AWG 26
- Dual, self-checking turns counting system
- Loading (wire length) counter
- Core range: 9/32" I.D. to 4" O.D. to 1 1/2" high

### LABORATORY USE

- Change wire and core size in 45 sec.

### PRODUCTION USE

- 1500 turns per minute
- Insert core and load in 20 sec.

**\$890.00** includes all rings, counters and accessories

immediate delivery. literature on request

### ARNOLD MAGNETICS CORP.

6050 W. Jefferson Blvd., Los Angeles, Calif. 90016  
(213) 870-6284

ON READER-SERVICE CARD CIRCLE 27





**Model 11** \* diameter 1"  
 \* number of turns 11  
 \* protrusion from panel  $\frac{7}{8}$ "  
 \* numbers snap into the window as each turn is completed \* base price in 1-9 quantities, \$7.75.

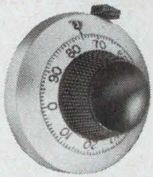

**Model 30** \* diameter  $1\frac{3}{16}$ "  
 \* number of turns 10  
 \* protrusion from panel 1"  
 \* numbers snap into the window as each turn is completed \* base price in 1-9 quantities, \$5.75.

# Read to 1/1000 Turn Accuracy

With New Spectrol Dials for  
Potentiometers and Other Rotating Devices

**Model 25** A new turns-counting dial with DIGITAL readout for multi-turn applications \* 3-digit dial reads to 1099 (11 turns) \* 4-digit dial reads to 9999 (100 turns) \* fine calibrations allow setting to 1/1000 of a shaft turn \* 2 to 1 gear ratio between setting knob and device shaft allows extremely fine settings \* diameter  $1\frac{3}{16}$ " \* standard 11-turn, 3-digit dial price, 1-9 quantities, \$14.25 \* standard 100-turn, 4-digit dial price, 1-9 quantities, \$19.75.

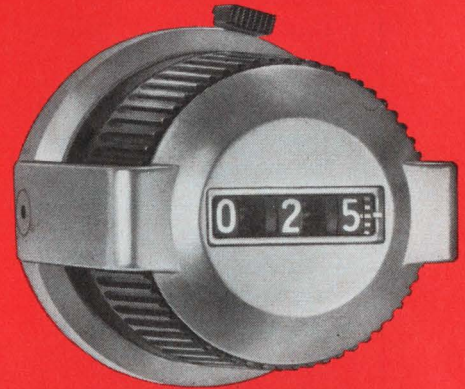

Spectrol Multidial® turns-counting dials offer these unique features: **Finely marked scale graduations** enable the operator to read settings with high accuracy. **Easy installation.** No disassembly, extra panel drilling or mounting hardware required. **Easy locking** with a finger touch that grips or releases without disturbing the setting. Settings are unaffected by vibration or shock. **Universal application** to any type of multi-turn potentiometer or other device. **Attractive satin chrome finish** with black plastic turning knob. Available for  $\frac{1}{4}$ ",  $\frac{3}{16}$ " and  $\frac{1}{8}$ " diameter shafts.

Call your nearest Spectrol distributor for immediate off-the-shelf delivery at factory prices, or write for complete specifications.

50

## spectrol

**SPECTROL ELECTRONICS CORPORATION**  
 17070 E. Gale Ave., City of Industry, Calif. 91745  
 Adams Court, Plainview, L. I., New York, 11803

# A design advance

**Broadest line of standard silicon modular power supplies for fixed voltage applications**

**UP TO 60 VDC • UP TO 90 AMPS**

## Features and Data

Meet Mil. Environment Specs.

RFI—MIL-I-16910

Vibration: MIL-T-4807A

Shock: MIL-E-4970A • Proc 1 & 2

Humidity: MIL-STD-810 • Meth. 507

Temp. Shock: MIL-E-5272C • (ASG) Proc. 1

Altitude: MIL-E-4970A • (ASG) Proc. 1

Marking: MIL-STD-130

Quality: MIL-Q-9858

Convection cooled—no heat sinking or forced air required

Wide input voltage and frequency range—105-132 VAC, 45-440 cps

Regulation (line) 0.05% plus 4MV  
(load) 0.03% plus 3MV

Ripple and Noise—1MV rms, 3MV p to p

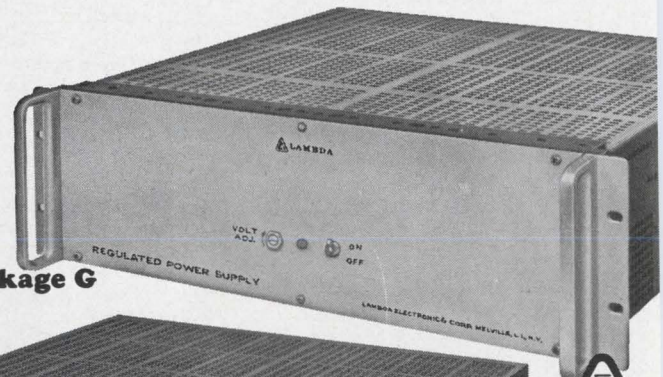

**Package G**



**Package F**

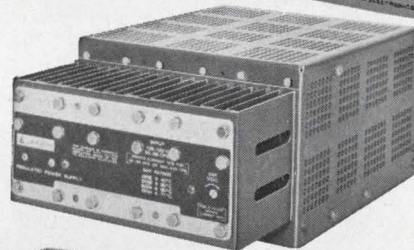

**Package E**

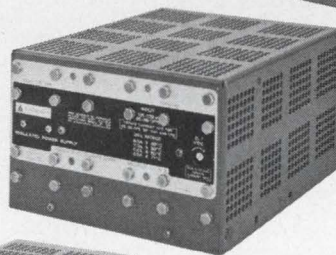

**Package D**

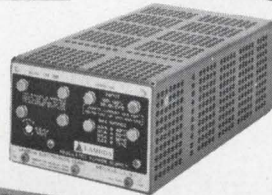

**Package C**

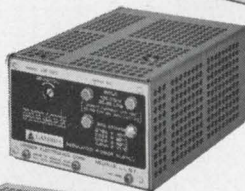

**Package B**

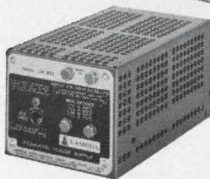

**Package A**



## RACK ADAPTERS

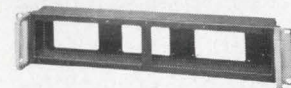

LRA-5—3½" height by 2⅞" depth.  
Mounts up to 4 A package sizes;  
3 B or C package sizes; or 2 A and 1 B or  
C package sizes. Price \$35.00

LRA-4—3½" height by 14" depth.  
(For use with chassis slides)  
Mounts up to 4 A package sizes; 3 B or C  
package sizes; or 2 A and 1 B or C  
package sizes. Price \$55.00

LRA-3—5¼" height by 2⅞" depth.  
Mounts up to 4 A, B or C package sizes;  
2 D or 2 E packages sizes; or 2 A, B or C  
and 1 D or 1 E package sizes. Price \$35.00

LRA-6—5¼" height by 14" depth.  
(For use with chassis slides)  
Mounts up to 4 A, B or C package sizes;  
2 D or 2 E packages sizes; or 2 A, B or C  
and 1 D or 1 E package sizes. Price \$60.00

PATENTS PENDING

ON READER-SERVICE CARD CIRCLE NO. 228



**LAMBDA ELECTRONICS CORP.**

515 BROAD HOLLOW ROAD • MELVILLE, L. I., NEW YORK • 516 MYRTLE 4-4200

# from Lambda

## Ordering Information

METERS—3½" Metered panel MP-3 is used with rack adapters LRA-4, LRA-5 and packages A, B and C.

5¼" Metered panel MP-5 is used with rack adapters LRA-6, LRA-3 and packages A, B, C, D and E.

To order these accessory metered panels, specify panel number which MUST BE FOLLOWED BY the MODEL NUMBER of the power supply with which it will be used.

Examples For Lambda Panel Model No.  
Metered Panels Model and Price  
MP-3 LM-B2 MP-3-LM-B2 \$40  
MP-5 LM-B2 MP-5-LM-B2 \$40

Note—F and G LM Packages are full rack power supplies available metered or non-metered. For metered

OVERVOLTAGE PROTECTION—Externally mounted adjustable crowbar type overvoltage protection accessory for use with A, B, C and D packages—\$25.

E, F and G packages available with built-in overvoltage protection. To order crowbar type overvoltage protection for E, F and G packages, add suffix OV to the model no. and \$60 to the E package price and \$90 to the F and G package price.

FIXED VOLTAGES—In addition to the fixed voltages listed, any fixed voltage is available up to 65 VDC at moderate surcharge.

models, add suffix M to the Model No. and \$30 to the non-metered price.

**Package A** 3½" x 3¼" x 6½"

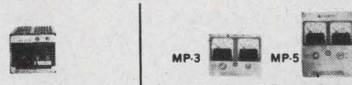

Accessory Metered Panels: \$40.00

Model	ADJ. VOLT. RANGE VDC	I MAX. AMPS <sup>1</sup>				Price
		40°C	50°C	60°C	71°C	
LM-201	0-7	0.85	0.75	0.70	0.55	\$ 79
LM-202	0-7	1.7	1.5	1.4	1.1	99
LM-203	0-14	0.45	0.40	0.38	0.28	79
LM-204	0-14	0.90	0.80	0.75	0.55	99
LM-205	0-32	0.25	0.23	0.20	0.15	79
LM-206	0-32	0.50	0.45	0.40	0.30	99
LM-207	0-60	0.13	0.12	0.11	0.08	89
LM-208	0-60	0.25	0.23	0.21	0.16	109

**Package B** 3½" x 4¼" x 6½"

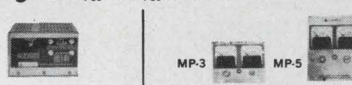

Accessory Metered Panels: \$40.00

Model	ADJ. VOLT. RANGE VDC	I MAX. AMPS <sup>1</sup>				Price
		40°C	50°C	60°C	71°C	
LM-217	8.5-14	2.1	1.9	1.7	1.3	\$119
LM-218	13-23	1.5	1.3	1.2	1.0	119
LM-219	22-32	1.2	1.1	1.0	0.80	119
LM-220	30-60	0.70	0.65	0.60	0.45	129
LM-B2	2 ±5%	3.4	3.0	2.3	1.4	119
LM-B3	3 ±5%	3.4	3.0	2.3	1.4	119
LM-B4	4 ±5%	3.4	3.0	2.3	1.4	119
LM-B4P5	4.5±5%	3.3	2.9	2.2	1.4	119
LM-B5	5 ±5%	3.3	2.9	2.2	1.4	119
LM-B6	6 ±5%	3.2	2.8	2.2	1.3	119
LM-B8	8 ±5%	3.0	2.7	2.2	1.3	119
LM-B9	9 ±5%	2.7	2.5	2.1	1.3	119
LM-B10	10 ±5%	2.6	2.4	2.1	1.3	119
LM-B12	12 ±5%	2.4	2.3	2.1	1.3	119
LM-B15	15 ±5%	2.1	1.9	1.7	1.2	119
LM-B18	18 ±5%	1.8	1.6	1.5	1.2	119
LM-B20	20 ±5%	1.6	1.4	1.3	1.1	119
LM-B24	24 ±5%	1.3	1.2	1.1	1.0	119
LM-B28	28 ±5%	1.2	1.1	1.0	0.90	119
LM-B36	36 ±5%	1.1	1.0	0.90	0.85	129
LM-B48	48 ±5%	0.90	0.85	0.80	0.75	129

**Package C** 3½" x 4¼" x 9"

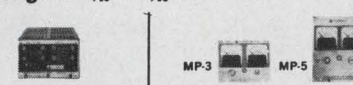

Accessory Metered Panels: \$40.00

Model	ADJ. VOLT. RANGE VDC	I MAX. AMPS <sup>1</sup>				Price
		40°C	50°C	60°C	71°C	
LM-225	0-7	4.0	3.6	3.0	2.4	\$139
LM-226	8.5-14	3.3	3.0	2.5	2.0	139
LM-227	13-23	2.3	2.1	1.7	1.4	139
LM-228	22-32	2.0	1.8	1.5	1.2	139
LM-229	30-60	1.1	1.0	0.80	0.60	149
LM-C2	2 ±5%	4.9	4.2	3.5	2.4	139
LM-C3	3 ±5%	4.9	4.2	3.5	2.4	139
LM-C4	4 ±5%	4.9	4.2	3.5	2.4	139
LM-C4P5	4.5±5%	4.9	4.2	3.4	2.4	139
LM-C5	5 ±5%	4.8	4.1	3.3	2.4	139
LM-C6	6 ±5%	4.6	4.0	3.1	2.4	139
LM-C8	8 ±5%	4.4	3.8	3.0	2.0	139
LM-C9	9 ±5%	4.2	3.6	3.0	2.0	139
LM-C10	10 ±5%	4.0	3.5	2.9	2.0	139
LM-C12	12 ±5%	3.8	3.3	2.8	2.0	139
LM-C15	15 ±5%	3.4	3.2	2.7	1.8	139
LM-C18	18 ±5%	3.0	2.8	2.5	1.7	139
LM-C20	20 ±5%	2.9	2.7	2.4	1.7	139
LM-C24	24 ±5%	2.5	2.4	2.2	1.5	139
LM-C28	28 ±5%	2.3	2.1	2.0	1.4	139
LM-C36	36 ±5%	2.0	1.8	1.7	1.3	149
LM-C48	48 ±5%	1.6	1.4	1.3	1.0	149

**Package D** 4¼" x 7¼" x 9"



Accessory Metered Panels: \$40.00

Model	ADJ. VOLT. RANGE VDC	I MAX. AMPS <sup>1</sup>				Price
		40°C	50°C	60°C	71°C	
LM-234	0-7	8.3	7.3	6.5	5.5	\$199
LM-235	8.5-14	7.7	6.8	6.0	4.8	199
LM-236	13-23	5.8	5.1	4.5	3.6	209
LM-237	22-32	5.0	4.4	3.9	3.1	219
LM-238	30-60	2.6	2.3	2.0	1.6	239
LM-D2	2 ±5%	13.1	11.3	9.2	6.2	199
LM-D3	3 ±5%	13.1	11.3	9.2	6.2	199
LM-D4	4 ±5%	13.1	11.3	9.2	6.2	199
LM-D4P5	4.5±5%	13.1	11.3	9.2	6.2	199
LM-D5	5 ±5%	12.6	10.8	9.2	6.1	199
LM-D6	6 ±5%	12.4	10.6	8.9	6.0	199
LM-D8	8 ±5%	12.2	10.3	8.8	5.9	199
LM-D9	9 ±5%	11.3	10.0	8.6	5.7	199
LM-D10	10 ±5%	10.8	9.7	8.5	5.7	199
LM-D12	12 ±5%	10.0	9.2	8.3	5.7	199
LM-D15	15 ±5%	9.0	8.4	7.9	5.3	209
LM-D18	18 ±5%	7.9	7.4	6.9	5.0	209
LM-D20	20 ±5%	7.4	6.9	6.5	4.9	209
LM-D24	24 ±5%	6.7	6.3	5.8	4.8	219
LM-D28	28 ±5%	6.0	5.6	5.2	4.7	219
LM-D36	36 ±5%	5.4	5.0	4.7	4.3	239
LM-D48	48 ±5%	4.1	3.9	3.6	3.1	239

**Package E** 4¼" x 7¼" x 11½"

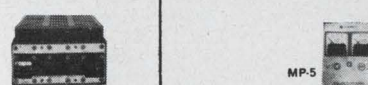

Accessory Metered Panels: \$40.00

Model	ADJ. VOLT. RANGE VDC	I MAX. AMPS <sup>1</sup>				Price
		40°C	50°C	60°C	71°C	
LM-E2	2 ±5%	18.0	16.0	15.0	10.0	\$269
LM-E3	3 ±5%	18.0	16.0	15.0	10.0	269
LM-E4	4 ±5%	17.0	16.0	15.0	10.0	269
LM-E4P5	4.5±5%	16.0	15.0	14.0	10.0	269
LM-E5	5 ±5%	16.0	15.0	13.0	10.0	269
LM-E6	6 ±5%	15.0	14.0	12.0	10.0	269
LM-E8	8 ±5%	14.0	13.0	12.0	9.5	269
LM-E9	9 ±5%	13.5	12.5	11.0	9.5	269
LM-E10	10 ±5%	13.0	12.0	10.0	9.2	269
LM-E12	12 ±5%	12.0	11.0	9.5	9.0	269
LM-E15	15 ±5%	11.0	10.0	9.0	8.5	269
LM-E18	18 ±5%	10.5	9.5	8.5	8.1	269
LM-E20	20 ±5%	10.0	9.0	8.3	7.7	269
LM-E24	24 ±5%	9.0	8.5	7.7	7.0	269
LM-E28	28 ±5%	8.5	8.0	7.3	6.6	269
LM-E36	36 ±5%	6.8	6.3	5.9	5.2	279
LM-E48	48 ±5%	5.0	4.6	4.3	3.9	299

**Package F** 3¼" x 19" x 16½"



For metered models, add suffix (M) to model number and \$30.00 to the price below.

Model	ADJ. VOLT. RANGE VDC	I MAX. AMPS <sup>1</sup>				Price
		40°C	50°C	60°C	71°C	
LM-F2	2 ±5%	44.0	39.0	32.0	24.0	\$425
LM-F3	3 ±5%	44.0	39.0	32.0	24.0	425
LM-F4	4 ±5%	44.0	39.0	32.0	24.0	425
LM-F4P5	4.5±5%	44.0	39.0	32.0	24.0	425
LM-F5	5 ±5%	44.0	38.0	31.0	24.0	425
LM-F6	6 ±5%	43.0	37.0	30.0	23.0	425
LM-F8	8 ±5%	40.0	34.0	28.0	22.0	425
LM-F9	9 ±5%	38.0	32.0	26.0	21.0	425
LM-F10	10 ±5%	36.0	31.0	25.0	20.0	425
LM-F12	12 ±5%	30.0	26.0	21.0	16.0	425
LM-F15	15 ±5%	25.0	22.0	18.0	15.0	425
LM-F18	18 ±5%	23.0	20.0	17.0	13.0	395
LM-F20	20 ±5%	21.0	19.0	16.0	12.0	395
LM-F24	24 ±5%	18.0	16.0	13.0	10.0	380
LM-F28	28 ±5%	17.0	15.0	13.0	9.5	380
LM-F36	36 ±5%	13.0	11.0	10.0	7.5	395
LM-F48	48 ±5%	10.0	9.0	7.5	6.0	425

**Package G** 5¼" x 19" x 16½"



For metered models, add suffix (M) to model number and \$30.00 to the price below.

Model	ADJ. VOLT. RANGE VDC	I MAX. AMPS <sup>1</sup>				Price
		40°C	50°C	60°C	71°C	
LM-G2	2 ±5%	90.0	83.0	62.0	43.0	\$575
LM-G3	3 ±5%	85.0	80.0	62.0	43.0	575
LM-G4	4 ±5%	77.0	71.0	61.0	43.0	575
LM-G4P5	4.5±5%	72.0	68.0	60.0	43.0	575
LM-G5	5 ±5%	68.0	64.0	59.0	43.0	575
LM-G6	6 ±5%	60.0	55.0	52.0	43.0	525
LM-G8	8 ±5%	59.0	54.0	48.0	39.0	525
LM-G9	9 ±5%	58.0	53.0	47.0	37.0	525
LM-G10	10 ±5%	56.0	52.0	44.0	35.0	525
LM-G12	12 ±5%	48.0	44.0	37.0	29.0	525
LM-G15	15 ±5%	39.0	37.0	31.0	24.0	525
LM-G18	18 ±5%	32.0	30.0	27.0	21.0	525
LM-G20	20 ±5%	30.0	28.0	25.0	20.0	525
LM-G24	24 ±5%	27.0	25.0	20.0	16.0	480
LM-G28	28 ±5%	25.0	23.0	19.0	15.0	480
LM-G36	36 ±5%	22.0	20.0	16.0	13.0	525
LM-G48	48 ±5%	17.0	14.0	12.0	9.0	575

<sup>1</sup> Current rating is from zero to I max.

Current rating applies over entire output voltage range.

Current rating applies for input voltage 105-132 VAC 55-65 cps.

For operation at 45-55 cps and 360-440 cps derate current rating 10%.

# A/D converter goes adaptive and features many advantages over conventional converters. This one uses level sensing and current switching.

An adaptive analog-to-digital converter has a digital output that is a continuously varying function of the input voltage. Such a converter has the advantage of not requiring external gating, timing or clocking functions. Its digital output changes automatically and virtually instantaneously with changes in input voltage. Furthermore, voltage comparators *per se* are eliminated, as well as the need for complex successive approximations and staircase or ramp generators.

An adaptive converter of this sort\* yields a seven-bit binary representation of the analog input in a conversion time of 100 ns. With the same techniques, but using faster components, it is expected that this conversion time could be reduced considerably.

In fulfilling the adaptive nature of the converter, certain design criteria were initially established. These provided that:

1. Given an unknown analog input voltage, the converter will deliver a binary output that is a continuously varying function of the input.
2. The inputs will be weighted to threshold-sensitive elements so that only the most significant

digits, or bits, are of consequence.

3. Feedback from the most significant bits to those of lesser significance will provide the required configuration of ON and OFF elements.

4. The analog input voltage to the converter is positive. The feedback between elements will therefore have to be negative.

Since one of the most important features of the converter was to be high speed, current-switching and current-sensing techniques were used. The element selected as the current-sensing device was the tunnel diode.

## Converter delivers straight binary

While not a prerequisite, the converter operates on straight binary notation, such that:

$$N = \sum_{n=0}^j a_n 2^n$$

where,  $a_n$  is 0 or 1, and  $N$  is the absolute analog voltage to be encoded. As shown in the flow diagram (Fig. 1), the converter consists of various elements for each of its seven bit positions, with appropriate feedback between the elements.

The symbolic elements in Fig. 1 are shown in schematic form in Fig. 2. Elements 1 through 64 each consists of a tunnel diode and a corresponding *pnp* transistor. Elements *a* through *f* are feed-

\*Patent applied for

Carl A. Budde, Technical Staff, Electronic Warfare Division, Electronic Specialty Co., Los Angeles, Calif.

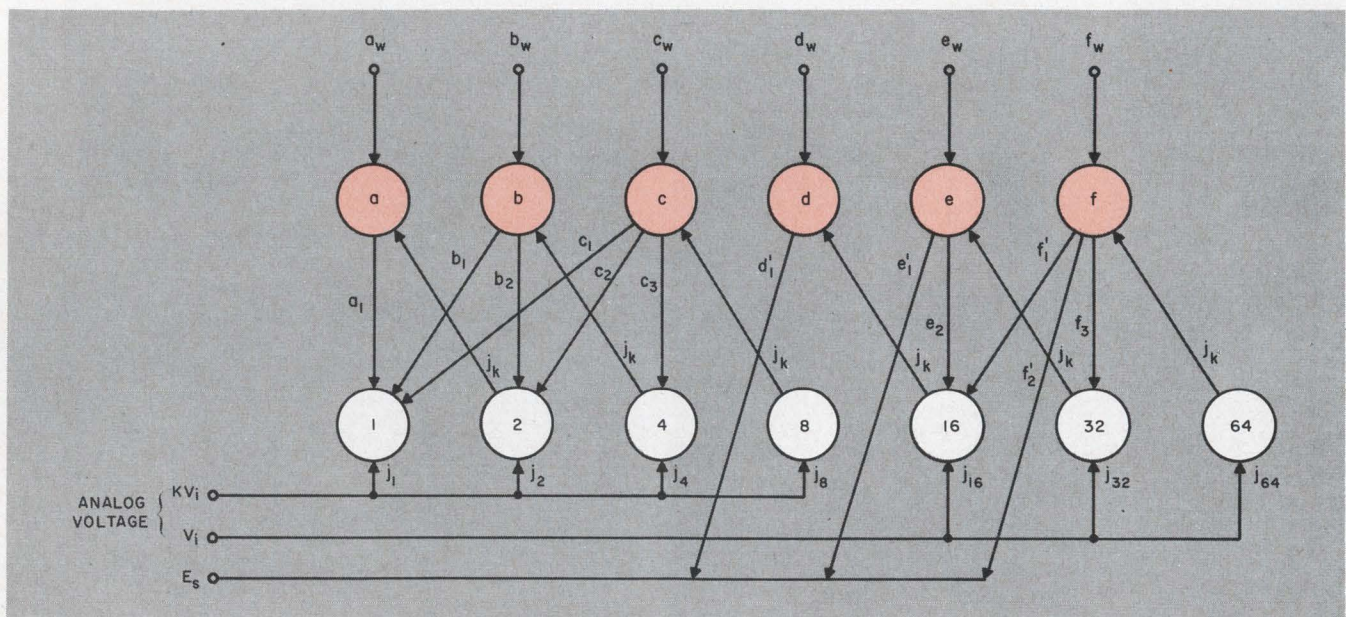

1. Threshold-sensitive elements with weighted inputs are used in each position of the converter. Negative feedback

between positions is used to provide the required configuration of ON and OFF elements.



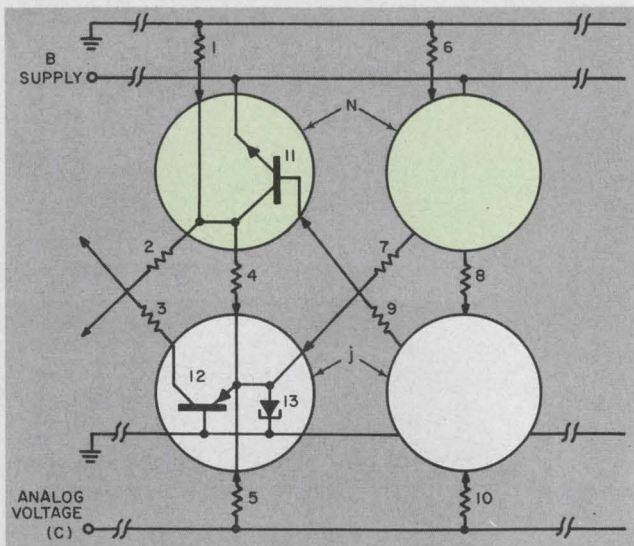

2. Each *j* element consists of a tunnel diode and a common-base transistor stage. Each *N* element is a feedback transistor stage.

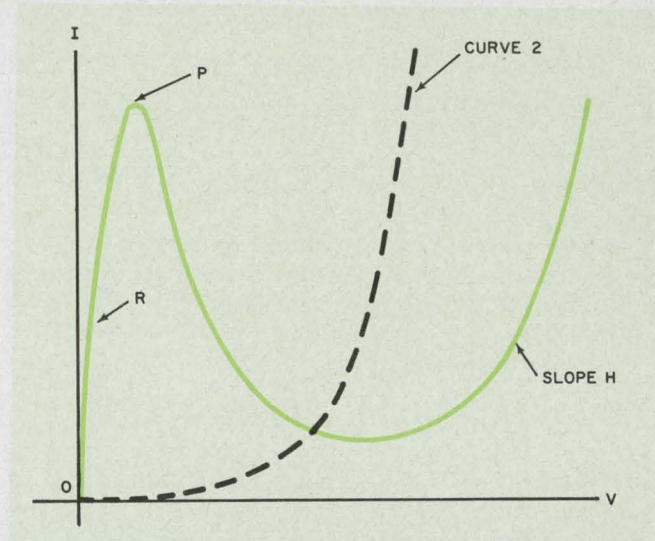

3. Negative-resistance characteristic of the tunnel diode makes it suitable for threshold detection. (solid curve) The broken curve is for the associated transistor stage.

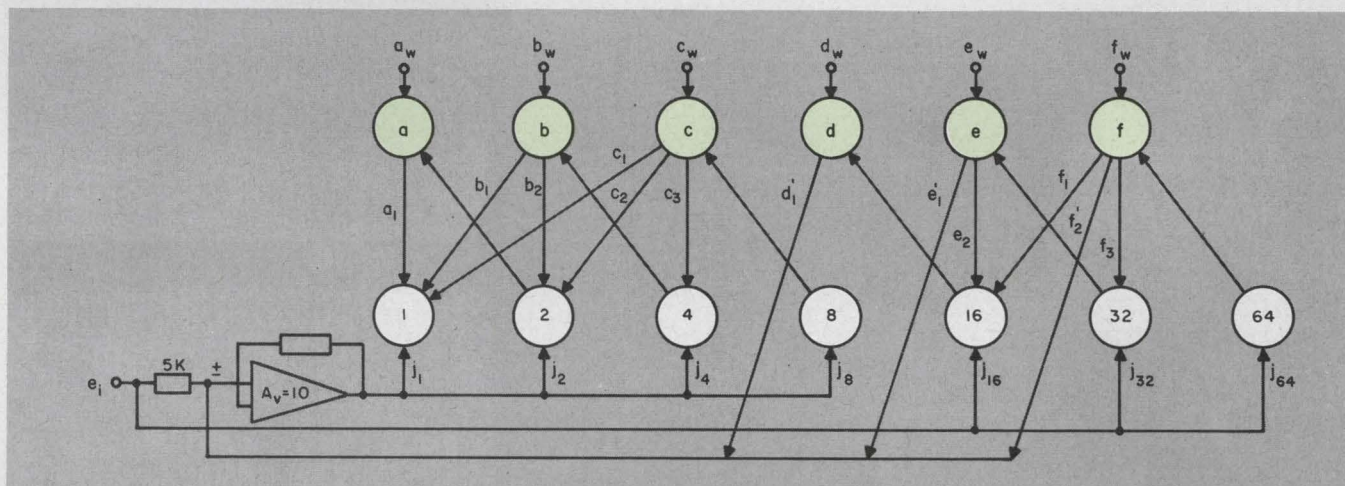

4. Broadband differential amplifier is used in the input line to the four lowest order positions. It reduces the feed-

back requirements from positions 16, 32 and 64 and improves conversion accuracy for fractional voltages.

back *npn* generating transistors. The various resistors have values weighted to the bit position of the particular element. The relative weights are such that the bit positions have operating parameters based on the powers of two.

The threshold-sensing operation of the tunnel-diode/transistor combination in each of positions 1 through 64 can be understood by considering the voltage-current curves shown in Fig. 3 and the circuit in Fig. 2. The analog voltage applied to line *C* (Fig. 2) produces a corresponding change in the current through resistor 5, increasing the current through the tunnel diode (13). This current increase is characterized by a current-voltage increase (slope *R* in Fig. 3) approaching the peak, *P*. When the peak is reached, the tunnel diode switches to the high state, slope *H*. However, with the common-base transistor stage present, this forward voltage will assume the emitter-base potential of the transistor, which will be somewhere on curve 2. In this way, each tunnel-diode and common-base-transistor combination is weighted to sense a discrete value of the analog

input and, when it does, to switch on the preceding *N* transistor (*a* through *f*, Fig. 1) by means of current flow through the  $j_k$  resistor.

When a transistor in an *N*th position is switched on, a current is fed back to all preceding tunnel diodes via the  $N_j$  resistors ( $a_1$  through  $f_3$ ). This current is of such a magnitude as to reduce the current flowing in those tunnel diodes to zero.

The function of the  $N_w$  weights ( $a_w$  through  $f_w$ ) is to assure that an equal value of current is switched in each *N* position.

A simple, broadband operational amplifier, shown in Fig. 4, is used with the converter. Its purpose is to reduce the amount of current fed back from the elements for bits 16, 32 and 64 and to increase the accuracy of conversion for fractional-voltage levels.

As an example of converter operation, consider an input voltage having a level corresponding to a binary output of 16 (Fig. 4). The tunnel diodes in positions 1 through 16 switch to the high state. However, since 16 is the most significant bit, it will be the main controlling element, switching

### How to determine weighted resistor values

1. The input resistors,  $j_1$  through  $j_{64}$ , are found by:

$$j_n = \frac{V_i}{I_p},$$

where  $V_i$  is the input voltage and may be either  $V_i$  or  $KV_i$  of Fig. 1;  $I_p$  is the peak current of the tunnel diodes used in the  $j$ th position.

2. The  $N_j$  weighted values,  $a_1$ ,  $b_1$  through  $f_3$ , are determined from:

$$N_j = \frac{V_b - V_{CE \text{ sat}}}{V_i j_n},$$

where  $V_b$  is the B- voltage (Fig. 2), and again,  $V_i$  is either  $V_i$  or  $KV_i$  of Fig. 1.

3. The  $j_k$  values are found by:

$$j_k = \frac{V_B - V_{BE}}{\left[ V_B - V_{CE \text{ sat}} \left/ \frac{1}{\sum_{j=1}^n \frac{1}{N_j} + \frac{1}{N_w}} \right. \right] + \beta_N \text{ min.}},$$

where  $N_w$  is resistors 1, 6, etc., in Fig. 2. The term:

$$\frac{V_B - V_{CE \text{ sat}}}{1/\frac{1}{N_j} + \frac{1}{N_w}} + \beta_N \text{ min.}$$

is the collector current in the  $N$ th position. The simplest way to determine the  $N_j$  values is to completely ignore the slight loading effects that will be present at the input due to parallel connections and to assume that a negative output is required (instead of a positive one) of the same magnitude as the input to either the 16, 32 or 64 position.

transistor  $d$  on. Transistor  $d$  supplies a negative voltage via  $d_i'$  to the summing point of the operational amplifier, driving its output to zero. Now positions 1 through 8 are in the low state, and since 32 and 64 never received a sufficient amount of current to switch to the high state, they remain in the low state.

If the analog voltage were equivalent to a binary value of 18, the negative feedback from transistor  $d$  would not drive the operational amplifier output to zero. It would instead reduce the amplifier output to the point where positions 4 and 8 switch to the low state. Feedback from position 2 would then cut off position 1, leaving only positions 2 and 16 in the high state.

### Waveforms show operation

Fig. 5 shows the waveforms produced by bit positions 1, 2 and 3 for three values of input voltage to the converter. The scale of the input waveform is 2 V/cm and that of the output waveforms, 0.5 V/cm. Sweep time was 100 ns/cm.

The input voltage in Fig. 5a causes only bit position 1 to be driven to its high state. The larger input voltage in Fig. 5b drives both positions 1

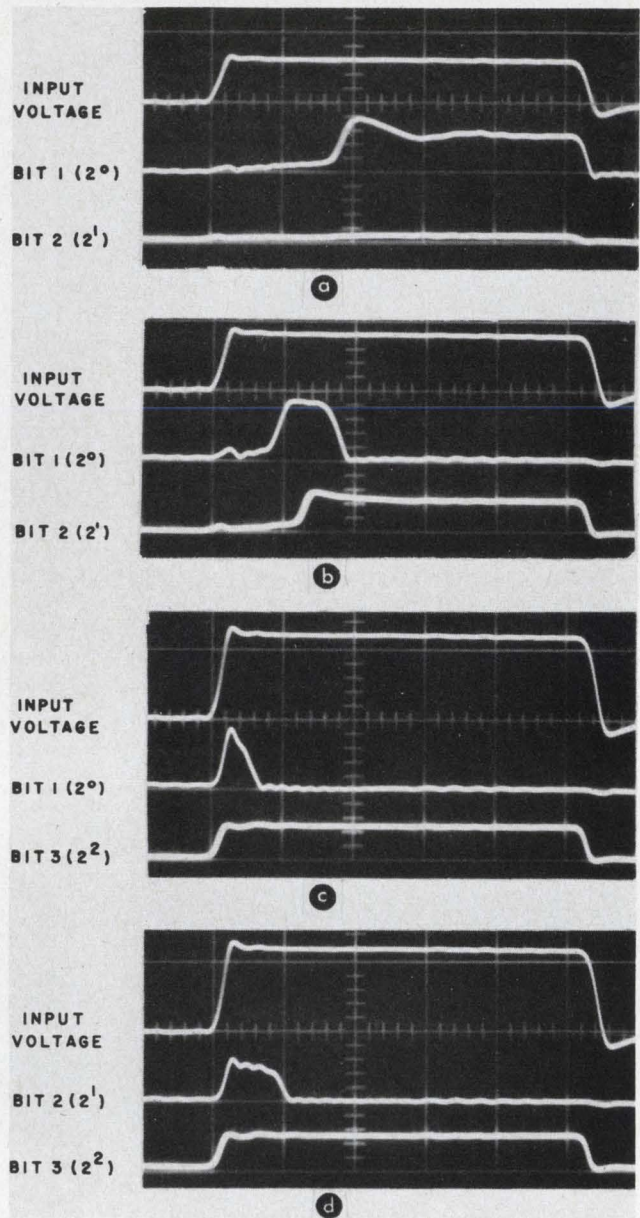

5. Controlling action of the most significant bit position is shown by the output waveforms. In (a), only position 1 is activated. In (b), bit 2 is the controlling position and in (c) and (d), bit 3 is the controlling position.

and 2 to their high states. However, feedback from position 2 cuts off position 1, leaving only 2 high. The still larger input voltage in Fig. 5c drives positions 1, 2 and 3 high, but only position 3 remains high, since it quickly cuts off 1 and 2.

The basic design technique used for the converter offers a wide range of flexibility. While the counter is designed to yield a binary digital output, this does not represent a limitation. It should be possible with appropriate weighting to implement the technique with any code, so long as corresponding modifications in design philosophy do not impose stringent requirements on component tolerances.

Negative input voltages can also be accommodated by substituting  $nnp$  transistors for  $pnp$  transistors and vice-versa, and inverting the tunnel diodes. In addition, other devices besides tunnel diodes may be used as level detectors. ■ ■

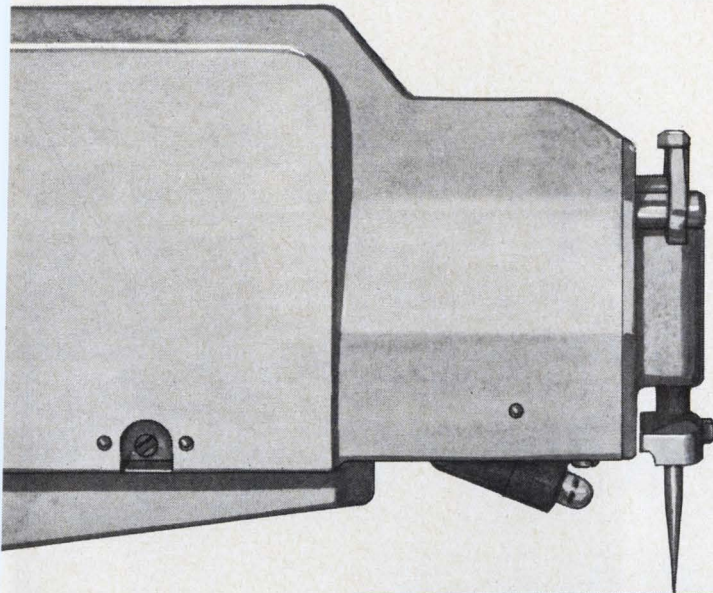

# CHALLENGE US!

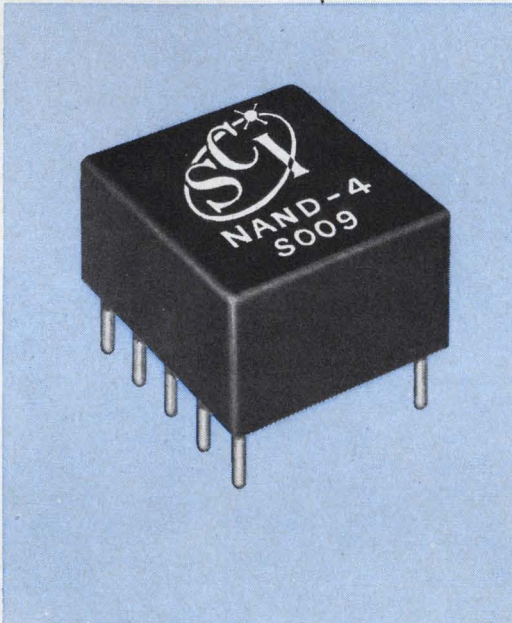

## SPACE CRAFT, INC.

8620 SO. MEMORIAL PARKWAY  
HUNTSVILLE, ALABAMA 35802

Gentlemen:

Consider yourselves challenged. Send me your short form specification sheet for custom-welded modules. I'll fill it out. Then you quote a price and give me whatever suggestions you may have for improving the module.

Name \_\_\_\_\_

Title \_\_\_\_\_

Company \_\_\_\_\_

Address \_\_\_\_\_

City \_\_\_\_\_ State \_\_\_\_\_ Zip \_\_\_\_\_

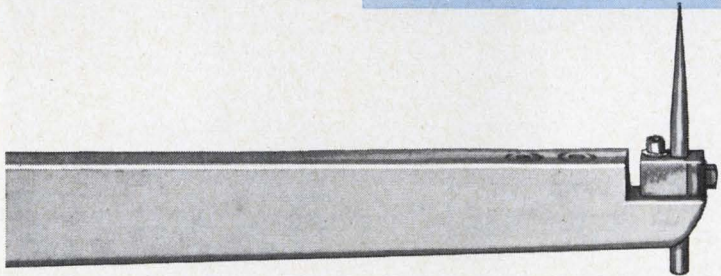

If you would like your system to have the reliability and size reduction advantages of custom welded modules but think you can't afford it, challenge us! Whether you need to design an all-new circuit, to adapt an existing design to welded packaging or to locate a qualified vendor for production quantities of your circuits, Space Craft will perform for you at surprisingly low cost. To call our hand, just use the coupon above.

## SPACE CRAFT, INC.

8620 SO. MEMORIAL PARKWAY / HUNTSVILLE, ALABAMA 35802  
TELEPHONE: (205) 881-1611 TWX: (510) 579-2234



ON READER-SERVICE CARD CIRCLE 220

# COMPONENT PART ENGINEERS

## Application – Standards – Reliability – Design – Evaluation

The Components and Materials Laboratory of Hughes Aircraft Company in Southern California has immediate needs for engineers to fill permanent positions in the following fields:

### COMPONENT APPLICATION ENGINEERS

Provide technical consultation and liaison to design activities, assist in selection and application of component parts, participate in design reviews.

### MICROELECTRONIC ENGINEERS

Evaluate integrated and thin film devices, analyze failure modes, investigate effects of environments and materials on device characteristics, determine application criteria.

### TEST ENGINEERS

Define evaluation and qualification programs, determine test methods and procedures, direct performance of tests.

### COMPONENT STANDARDS ENGINEERS

Coordinate component-equipment requirements, provide technical consultation, select vendors, determine evaluation programs, initiate procurement documentation.

### RELIABILITY ENGINEERS

Coordinate reliability programs, con-

duct component failure analyses, define and direct experiments, establish mathematical models, investigate component performance.

### INTERCONNECTION APPLICATION ENGINEERS

Provide technical consultation and liaison to design activities and prime customers in the selection and design of wire, cable and flat flexible harnesses.

### COMPONENT DEVELOPMENT ENGINEERS

Develop components using advanced techniques, investigate new design concepts, study component phenomena, direct experiments and design evaluations.

### TECHNICAL WRITERS

Write and edit technical proposals and handbooks, develop component procurement specifications and standards, prepare technical reports.

### PACKAGING ENGINEERS

Develop new concepts of interconnecting electronic assemblies. Design interconnection systems and components using advanced techniques of packaging.

### SUPERVISORS

In addition to requirements for both junior and senior engineers for these

positions, several supervisory openings are available.

### Requirements:

BS, MS or PhD in Electrical or Mechanical Engineering or in Physics. Openings are also available for non-degree engineering personnel.

Positions are available in the following and associated technical fields:

Potentiometers	Electron Tubes
Microwave	Connectors
Crystals	Capacitors
Resolvers	Relays
Microelectronics	Crystal Filters
Instruments	Mechanical
Cable	Motors
Semiconductors	Resistors
Magnetics	Wire
Hardware	Switches

U.S. CITIZENSHIP IS REQUIRED

For immediate consideration, please airmail resume to:

**Mr. Robert A. Martin**  
Head of Employment  
Hughes Aerospace Divisions



11940 W. Jefferson Blvd.  
Culver City 86, California

An equal opportunity employer

The heart of any data system is the DVM

## Only E-I gives you a choice of DVM logics ...lets you pick the one that best meets your system needs!

Your data measuring and recording systems are tailored to specific applications. So are signal measuring methods used in digital voltmeters. Why tailor most of your system and then be limited to *one* method of voltage determination?

Of all DVM manufacturers E-I offers the widest pick of logics, permitting you to choose the one which best measures *your* signal levels under *your* conditions:

**1. Successive Approximation** (EI-85 Series) 5 digits, 10  $\mu\text{V}$  resolution, normal mode rejection using 3-pole active Bessel filter, to 25 measurements per sec., DC and ratio. From \$9,100.

**2. Integrating logic** (630 Series) 5 digits plus overrange, 1  $\mu\text{V}$  resolution, normal mode noise rejection through integration, to 6 measurements per sec.,

DC, frequency and time interval. From \$8,400.

E-I premium line systems also give  $\pm 0.01\%$  accuracy, 300,000 to 1 common mode interference rejection, high normal mode noise rejection, and resolution down to 1  $\mu\text{V}$  (with pre-amp, except 630 series). Ask your E-I sales engineer for a complete system capability brochure, or write direct.

### 1. Successive Approximation



### 2. Integrating logic

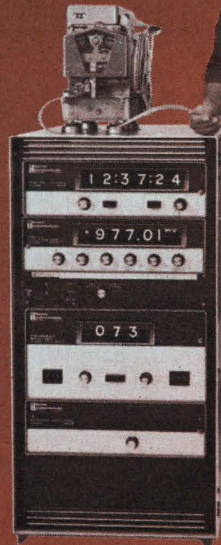

"Extensions" extend systems capabilities. In addition to a choice of logics, E-I systems offer a variety of extensions including AC voltage, resistance, pre-amp, transducer signal conditioning, thermocouple reference junctions, strain

gauge power supplies, scale factoring, linearizing, digital clocks and timers, patchboard or tape programmers, digital comparators, printers, typewriters, tape perforators, IBM 526 card punch and digital magnetic tape.

### New Compact 620 System!

A premium, low cost system complete with 40 point scanner, E-I 620 integrating dvm, and E-I digital printer—all for only \$4,300, approx.



 **Electro Instruments, Inc.**

8611 Balboa Avenue, San Diego, California 92112

41 Emmastraat, Meerveldhoven, Holland

ON READER-SERVICE CARD CIRCLE 28

# Find the received signal level through a quick graphical technique. The graph evaluates the loss factors and establishes the received signal strength.

**T**HE FIELD STRENGTH, or power, of a transmitted signal at the receiver can be quickly calculated with the graphs shown below.

$$E = K + P_r - 10 \log_{10} f - 10 \log_{10} [6400 \sin 6400/d] - \alpha d/1000.$$

where:

- $E$  = electric field in decibels above  $1 \mu\text{V/m}$ .
- $K$  = a constant, 97.5 for day and 94.8 for night.
- $P_r$  = power radiated in decibels related to 1 kW.
- $f$  = frequency in kHz
- $d$  = distance in km ( $d \geq 2000$  km).
- $\alpha$  = attenuation rate in decibels per 1000 km.

The determination of  $\alpha$  is of prime importance. It varies with frequency, ground conductivity, ionospheric conditions with the direction of propagation.

The curves give the expected values of the attenuation rate,  $\alpha$ , in dB/1000 km, from 10 to 30 kHz for sea, land and permafrost paths.

To use the nomogram, simply lay the straight edge from the expected value of  $\alpha$  through the distance line to the reference line. The straight edge is then shifted to pass through the operating frequency and that same point on the reference line. The expected field strength for either day or night operation is then read from the left-hand line. Field strength is given in decibels above  $1 \mu\text{V/m}$  for 1 kW radiated. For higher powers radiated, the field strength is merely raised by the corresponding number of decibels related to 1 kW. ■ ■

**Robert A. Hunting**, Senior Electronic Engineer, **Edward J. Salley**, Electronic Engineer, General Electric Co., Oklahoma City, Okla.

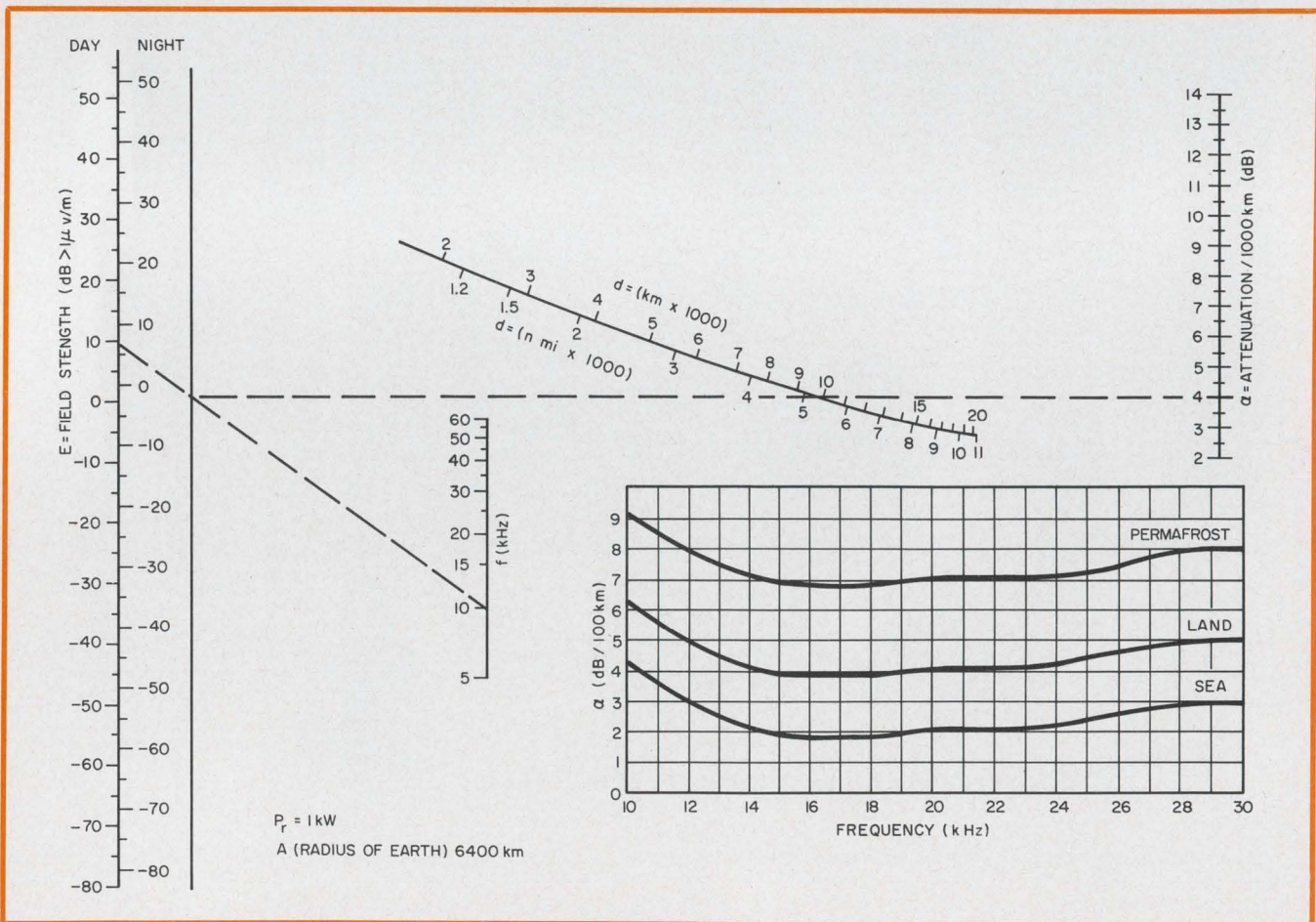

# Con Avionics' new silicon power supply has an M.T.B.F. of 100,000 hours and a 5 year guarantee. It costs \$65.

These dc regulated power supplies are available in nearly 200 different voltage-current combinations. Silicon transistors are used throughout and the units operate in ambients as high as 75°C, with a small external heat sink.

The Mean Time Between Failure of the modules is 100,000 hours, calculated according to Mil Handbook 217. They are certified to meet the environmental tests of Mil-E-5272, and most of the requirements of three other mil specs. In addition, they meet the RFI requirements of Mil-I-6181.

Prices start at \$65. Every time you specify one of these supplies, instead of a comparable germanium unit, you save considerable money. If you're using commercial supplies, typical savings-per-unit are about \$40. For military supplies it's much more.

The fastest way to get complete technical information and prices is to write, call, TWX or wire Gerry Albers at Con Avionics.

	SPECIFICATIONS		
	STANDARD MODEL	"A" MODEL	ALL MODELS
Total Regulation (Line and Load)	±0.5%	±0.05% or 2 mv	Input 105-125 v ac, 47 to 440 cps
Ripple (rms. max.)	10 mv	1 mv or .003%	Temperature 75°C ambient max. 95°C base plate max.
Temperature Coefficient	0.07%/°C	0.015%/°C	Response Time 10 microseconds
			Military Specifications Certified to meet the environmental requirements of MIL-E-5272 and the RFI requirements of MIL-I-6181

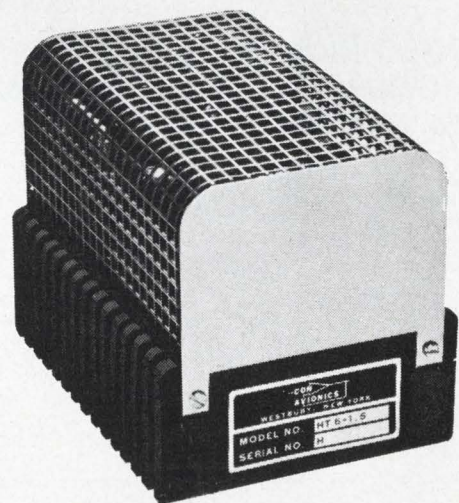

**CONSOLIDATED AVIONICS**

A DIVISION OF **CONDEC** CORPORATION

800 Shames Drive • Westbury, L. I., New York • (516) ED 4-8400

Speed Inquiry to Advertiser via Collect Night Letter  
ON READER-SERVICE CARD CIRCLE 29

# ON YOUR MARK...



Kay 154: 50 KHz to 100 MHz

Kay 159: 1 MHz to 300 MHz

**PM 7650 Plug-in:  
Pulse Markers  
0.5 to 100 MHz**

**PM 7660 Plug-in:  
Harmonic & CW Markers  
1 to 300 MHz**

These solid-state sweep and marker generators cover the range in a single sweep; provide a continuously-variable narrow sweep. Performance characteristics include line-lock, cw, manual and variable sweep rates, and external input.

PM 7650 and PM 7660 plug-in marker heads offer up to eight optional, individually-switched crystal plug-in markers per head.

A variable birdie marker provision is standard. All plug-in marker heads may be changed or added as required.

External modulation from dc up to more than 15 KHz, a built-in detector and switched attenuator are standard features. Sweep high-to-low or low-to-high.

*For literature and prices write:*

**KAY ELECTRIC COMPANY**

Pine Brook, Morris County, New Jersey • (201) 227-2000

## Wide-Sweep Generator

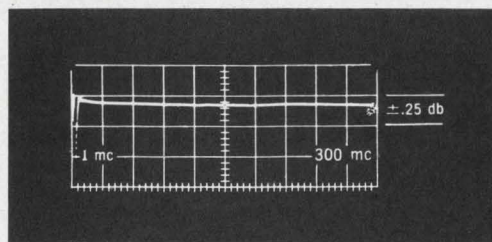

Full 300 MHz Wide Video Sweep

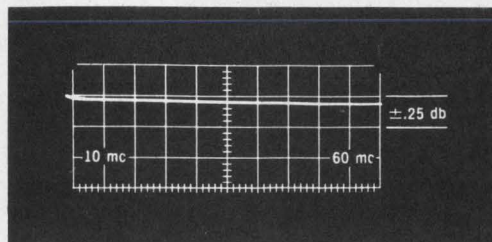

Programmable, Voltage Controlled Oscillator

## Marker Generator

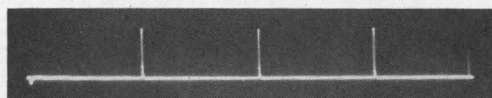

Pulse-Type Markers



Harmonic (or Comb) Birdie Markers

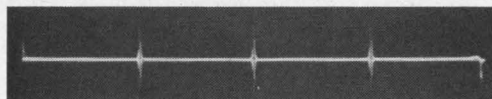

Single-Freq. Type Birdie Markers

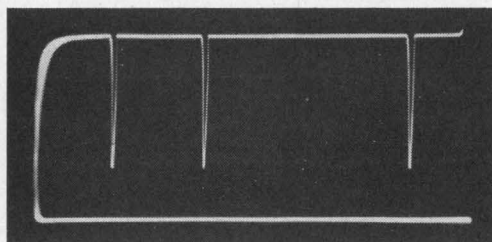

Detected Turn-Off Markers

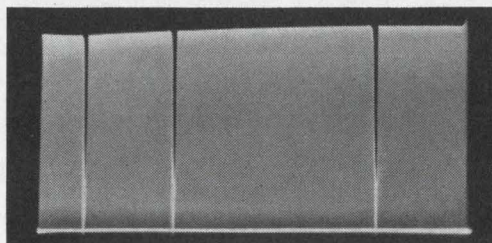

Undetected Turn-Off Markers

Visit Kay at the IEEE Show, Booths 3C11 - 3C17

ON READER-SERVICE CARD CIRCLE 30



# *Photocircuits' fully-militarized* **500 RM TAPE READER**

*is the only reader to pass the tests for:*

**HEAT, COLD, VIBRATION,  
EXPLOSION, SHOCK, ALTITUDE,  
RFI, SALT, SAND AND DUST!**

*(as required by MIL-E-16400 Class 3 and MIL-T-21200 Class 2)*

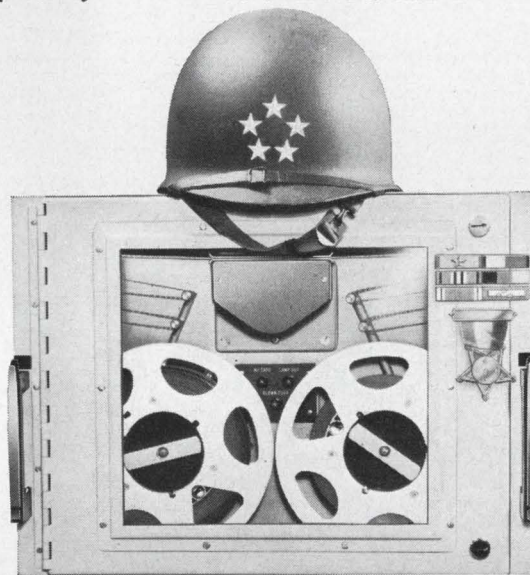

## **Still...the top military performer**

*Users of the 500 RM fully-militarized Tape Reader will not be surprised that it passed successfully a complete "campaign" of military environmental tests. Its speed, accuracy and reliability provide a performance that meets all the worst case conditions of the above MIL specs.*

*Specifically designed as a military unit, the 500 RM is a high-speed photoelectric reader providing speeds to 1,000 char/sec. — with 8" reels to give you maximum data-storage. Its smooth power comes from a unique printed-motor, direct-capstan drive. This means that all tape-reading modes are electronically controlled. The 500 RM has none of the clutch, pulley, brake or pinch-roller*

*problems inherent in conventional or hybrid tape readers, since all of this high-maintenance hardware has been eliminated.*

*If your department or agency requirements demand top performance with MIL spec reliability — find out about the 500 RM Tape Reader today. Simply write or phone: Photocircuits Corporation, Tape Reader Division, Glen Cove, New York. Telephone: (516) ORiole 6-8000.*



**Photocircuits**  
CORPORATION  
**TAPE READER DIVISION**  
GLEN COVE, NEW YORK

# Complementary monostable circuit has low-standby current drain

For digital applications, monostable circuits with low-standby current drains can be designed easily with complementary transistors. Because of the complementary circuit arrangement, well-defined pulse periods result.

Microminiaturization techniques aim at allowing a high component packing density. However, in obtaining a volume reduction, we must pay attention to decreasing the power supply requirements. This is necessary to keep semiconductor junc-

tion temperatures at low values. Furthermore, it is desirable that standby current drains be small, so that the power unit is compatible in size with the equipment it supplies. Here is how these problems are solved.

Circuit operation is as follows (Fig. 1a): In the absence of an input trigger pulse, both  $Q_1$  and  $Q_2$  are cut-off. Since  $Q_1$  is cut-off, its collector voltage is set by  $D_2$ ,  $E_2$ ,  $E_3$  and  $R_4$ . This reverse-biases the base-emitter junction of  $Q_2$ , the collector of which is clamped to ground by diode  $D_3$ .  $Q_3$  is held in a low conduction state because resistance  $R_6$  is of a low value. Thus the emitter of  $Q_3$  is approximately at zero potential, and the initial voltage across  $C$  is nearly zero.

When a negative trigger pulse is applied at the base of  $Q_1$ ,  $Q_1$  conducts and its collector voltage rises. This forces  $Q_2$  into conduction. As a result, the collector of  $Q_2$  unclamps and  $D_4$  starts to conduct. When this occurs,  $Q_3$  is prevented from passing current. Since the charge on  $C$  cannot change instantaneously, the anode of  $D_1$  falls, and this causes an increased base current in  $Q_1$ . A cumulative switching action follows, and this results in  $Q_1$  and  $Q_2$  becoming heavily bottomed.  $Q_1$  and  $Q_2$  stay bottomed for as long as the charging current in  $C$  supplies sufficient current to the base of  $Q_1$ .

A simplified equivalent circuit for determining the pulse period  $T$  is shown in Fig. 1b. Here  $D$  simulates the forward-biased emitter-base diode of  $Q_1$ . Two assumptions are necessary. One, that the voltage drops across  $D$  and  $Q_2$  (when the latter is saturated) are both much less than  $E_3$ . The second premise is that the dynamic resistances of  $D$  and  $Q_2$  during the pulse period are also much less than  $R_2$ .

The circuit will revert to its initial condition when the base current of  $Q_2$  is insufficient to support saturation in  $Q_1$ . Let this occur at a value denoted by  $i_x$ .

The pulse duration  $T$  is then

$$T = CR_2 \left[ \log_e \left( \frac{E_2}{R_2} \right) - \log_e \left( \frac{E_1}{R_1} + i_x \right) \right] \quad (1)$$

Note that  $i_x$  will not be precisely known because of the parameter spreads of  $Q_1$ . But an average value for it will still give fairly accurate results if it is assumed that  $i_x \ll E_1/R_1$ . With this,

$$T = CR_2 \log_e \left( \frac{E_2}{R_2} \right) \left( \frac{E_1}{R_1} \right) \quad (2)$$

If further,  $E_1 = E_2$  and  $R_1 = 2R_2$ , then

**IDEAS FOR DESIGN:** Submit your Idea for Design describing a new or important circuit or design technique, the clever use of a new component, or a cost-saving design tip to our Ideas for Design editor. If your idea is published, you will receive \$20 and become eligible for an additional \$30 (awarded for the Best of Issue Idea) and the grand prize of \$1000 for the Idea of the Year.

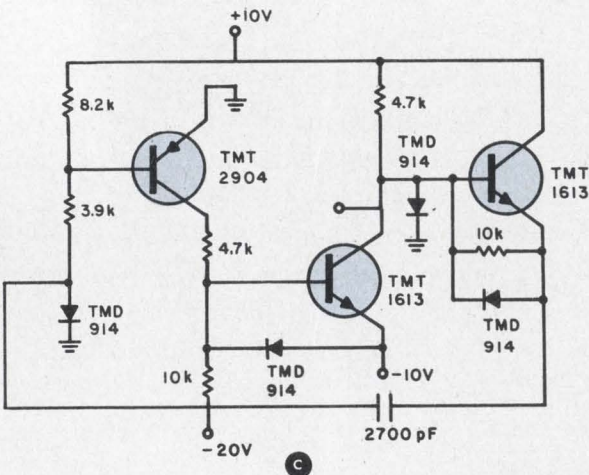
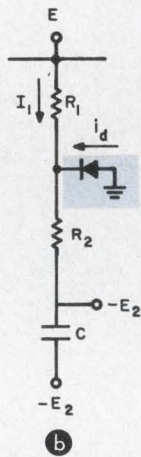
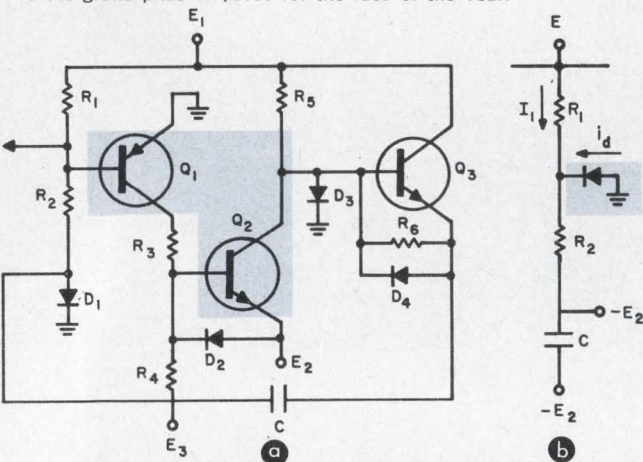

**Complementary transistors used** in monostable multivibrator circuit (a) yield low-standby current drain. Pulse period is determined by using equivalent circuit of  $Q_1$  (b), in which  $D$  simulates the emitter base diode of  $Q_1$ . Complete circuit (c) produces 10-volt output pulse at the collector of  $Q_2$  with a rise time of less than  $0.1 \mu s$ .

$$T \approx 0.7 R_2 C \quad (3)$$

After the pulse has expired, the fall in collector current in  $Q_1$  causes first  $Q_1$ , and then  $Q_2$ , to come out of saturation. The rising collector voltage of  $Q_2$  cuts off  $D_4$  and causes  $Q_3$  to be driven hard into conduction.  $D_1$ 's anode rises, and the base current of  $Q_1$  decreases. A regenerative action causes  $Q_1$  and  $Q_2$  to switch off. Note that  $Q_1$  comes out of bottoming before  $Q_2$  does.  $C$  is rapidly discharged by  $Q_3$ . Collector current flows in  $Q_3$  only on the trailing edge of  $Q_2$ 's output waveform. Hence, the collector of  $Q_3$  can (if desired) be connected directly to the base of the next stage to trigger it.  $R_5$  and  $D_3$  cause a more rapid rise of the collector voltage of  $Q_2$  when the latter is cut off and provide for a more rapid recharging of  $C$  through  $Q_3$ .

A circuit variation omits  $R_6$  and uses a *pn*p transistor in place of  $D_4$ . This entails a complementary emitter-follower driving  $C$ . It has the virtue of slightly speeding up the switching on of  $Q_1$ . A further improvement in the change-over time may be obtained by shunting  $R_3$  with a small capacitor. It must not be too large, or else the fall time at  $Q_2$ 's collector will be degraded.

This circuit may alternatively be triggered by applying a positive pulse at the base of  $Q_2$ . Figure 1c shows a complete circuit that produces a 10 V amplitude pulse at  $Q_2$ 's collector. The pulse has a leading edge  $< 0.1 \mu\text{s}$  and a trailing edge  $< 0.2 \mu\text{s}$ . Measured pulse duration at half amplitude  $\approx 7.4 \mu\text{s}$ .

*B. L. Hart, Senior Lecturer, West Ham College of Technology, Stratford, London (U.K.).*

VOTE FOR 110

## Current-mode detector is inexpensive and precise

An inexpensive amplitude detector independent of nonlinear loading effects can be designed easily. Even though it doesn't contain a feedback loop, it is superior to single peak-detecting systems.

In sine wave oscillators, agc circuits for amplitude stabilization are sometimes preferred to temperature-dependent resistor techniques. But the agc methods require a means of detecting ac amplitudes and converting them to proportional dc control signals.

One obvious example of the latter technique is the peak voltage rectifier circuit used in power

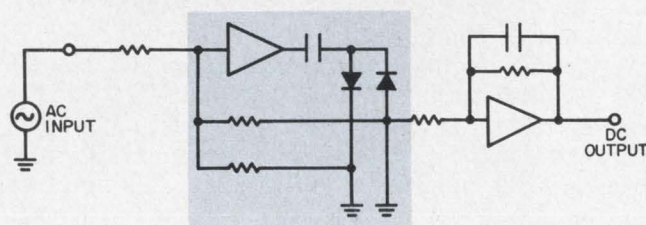

1. High-accuracy amplitude detectors (a) usually feature ac-to-dc converters.

supply rectification and AM radio detection. This circuit works particularly well, because accuracy over a wide band of frequencies is not a problem. When used over a wide range of frequencies however, errors caused by ripple effects are a problem. Another problem is the upper frequency limit resulting from the small current conduction angle when the capacitor element is being peak-charged.

If the ripple is made quite small, then the conduction angle is also quite small and the diode reverse-recovery time limits the high-frequency performance. Nonlinear loading effects on the sine wave source also reduce the accuracy of the system. These problems may be overcome by higher impedance circuitry or by decade-switching the capacitor to smaller values as the frequency is switched to higher ranges.

When accuracy is critical, these ac-to-dc conversion problems are usually solved by using a rectifier scheme. In these cases the rectifying diode conducts for an entire half cycle, and the average dc value, rather than the peak of the sine wave, is detected. This is commonly used in ac VTVM circuits. In a typical ac-to-dc converter of this type (Fig. 1), an amplifier drives the rectifier diodes, and a signal proportional to the sum of diode current is fed back to the input. This produces a feedback-stabilized relationship between the rectified output and the ac input. However, this technique is often too elaborate and too expensive for most oscillator amplitude controls.

By turning to a simple, relatively inexpensive circuit that possesses one of the major advantages of the amplifier feedback rectifier system shown in Fig. 1, a better solution arises. In it, the diodes conduct over intervals of 1/2 cycle to produce a dc output proportional to the average value of the applied ac signal. The circuit has a high input impedance, to free it of nonlinear loading effects on the ac source. Because it does not use feedback around the diodes, the circuit does not measure up to the potentialities of the system of Fig. 1, with respect to frequency response and linearity. However, its performance as a detector for oscillator amplitude systems is in many ways superior to that of the simple peak detector.

The simple current-mode amplitude detector is shown in Fig. 2a. It consists of an amplifier that transforms the sinusoidal input voltage into two output currents of opposite phase. It has a diode rectifier circuit for each phase. The output of the rectifier circuit is terminated in a current summing node at the input of an operational amplifier. Since this summing node is maintained at ground potential by the operational amplifier, the diode rectifiers present a load to the driving amplifier ( $Q_1$  &  $Q_2$ ) that behaves as if the diodes were connected back-to-back to ground.

The signal voltage at the collectors of  $Q_1$  and  $Q_2$  is a square wave whose peak-to-peak voltage is twice the forward drop of one diode (about 1.2 volts). This signal excursion at the collector allows the dc bias at the collectors to be set at 4 volts, with most of the 45 volts supply being dropped across the load resistors. This yields an output impedance of

39 k for a 1.0 mA bias in  $Q_1$  and  $Q_2$ .

The coupling capacitor values are determined by this 39 k impedance. The  $g_m$  of the amplifier is established by  $R_e$ , which swamps out the transistor  $r_e$  value and changes in  $r_e$ .  $Q_3$  is a 2.0 mA emitter-biasing source, and it insures that  $R_e$  determines the emitter signal current. Resistor  $R_e$  and its dc voltage drop swamp out the  $V_{be}$  varia-

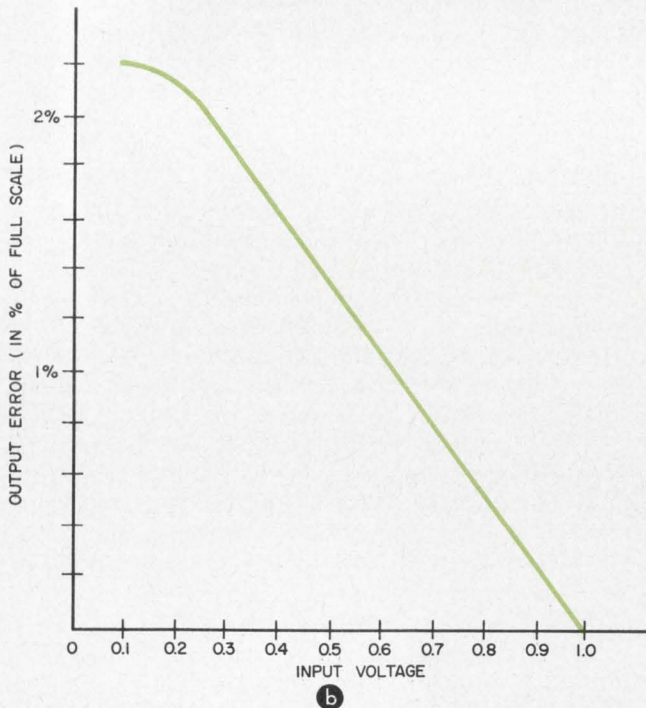
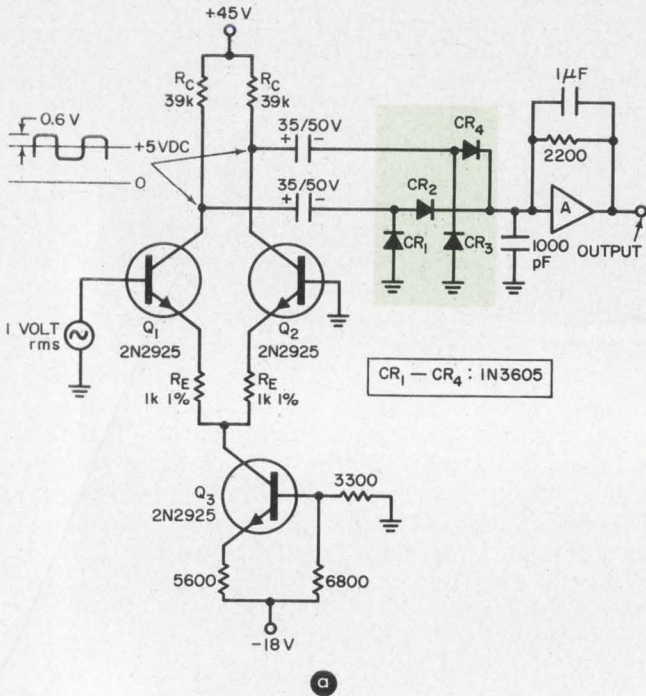

2. A simpler, less expensive approach uses a current-mode technique to achieve precise amplitude detection (a). Here the diodes produce a dc output proportional to the average value of the ac input signal. Note the linearity of the output (b).

tions of  $Q_1$  and  $Q_2$  to provide equal biasing currents for  $Q_1$  and  $Q_2$ .

The circuit was designed for an input of 1 volt rms. It produces a collector signal current of 0.5 mA rms, delivered into the back-to-back diodes shunted by the 39 k resistor. Taking the Thevenin equivalent of the current source seen by the diodes suggests a 19.5 volt rms source (27.3 volts peak), compared with a diode threshold of approximately 0.6 volts. These figures indicate the magnitude of the diode crossover problem. Except for this crossover, half sine waves of current are delivered alternately by  $CR_2$  and  $CR_1$  to the current node. Amplifier A provides most of the required ripple filtering, because it is connected as an integrator. At the higher frequencies where the integrator becomes imperfect because of bandwidth limitations in amplifier A, additional filtering is supplied by the small bypass capacitor connected from the node to ground.

The frequency response of the amplitude detector is flat to within 0.1% from the 10 Hz to 100 kHz. The influence of temperature on response is most severe for frequencies above 100 kHz, because of the storage effect in the diodes. Observing the linearity of the detector (Fig. 2b), note that the error indicated is mainly a zero offset type engendered by the threshold imposed by the diodes. From 20% to 100% of full scale, a potential linearity of 0.1% is exhibited. The input impedance of the detector is between 200 and 600 k. The forward transmittance of the rectifier circuit is 0.45 mA dc/volt rms.

Sidney G. Freshour, Engineer, Vidar Corp., Mountain View, Calif.

VOTE FOR 111

## Dual 2-input gate forms free-running clock

A self-starting, free-running multivibrator, when implemented by a dual two-input gate, can function as a variable-frequency clock source. The addition of a few resistors, capacitors and diodes to a standard micro-logic element (the gate) extends the multivibrator's frequency range and provides for the self-starting property.

A conventional method used to implement a clock circuit by the use of micro-logic elements is shown in Fig. 1a. The free-running multivibrator is attractive for frequencies less than 2 MHz. Above 2 MHz, the conventional clock fails to oscillate because of recovery and charging problems that crop up.

This disadvantage has been overcome by use of the modified circuit (Fig. 1b). This multivibrator has an upper frequency limit in excess of 6 MHz. In addition, the circuit is self-starting because of the  $D_1$  diode network. The rise and fall times of the square-wave output are less than 100 ns, independent of the frequency of operation. This is due to the  $D_2$  diodes.

(continued on p 94)



## SERENDIPITY IS A \$985 INTEGRATING DIGITAL VOLTMETER

What makes the VIDAR 500 a rare and worthwhile find is not its price alone. It is the combination of low price and performance features that include:

Five full-scale ranges from  $\pm 100$  mv to  $\pm 1000$  volts

Three significant digit display (over-ranging adds a fourth from one to three times full scale)

Accuracy better than  $\pm 0.05\%$  of reading  $\pm 1$  digit

Up to nine readings per second

Variety of plug-in options

Built in voltage-to-frequency converter produces pulses at a rate precisely proportional to the input voltage. A precision electronic counter counts the pulses over a fixed time interval and displays an integral or average value. This technique virtually eliminates errors caused by noise superimposed on the data signal.

Used as a frequency counter, the

VIDAR 500 ranges from 10 cps to 200 kc with a four digit display and selectable gate times of 0.1 and 1.0 seconds.

You can own a VIDAR 500 Integrating Digital Voltmeter for \$985! Send today for the complete performance data. Your copy awaits you at: 77 Ortega Ave., Mountain View, Calif.

**VIDAR**  
CORPORATION

ON READER-SERVICE CARD CIRCLE 98

A  
LICON  
EXCLUSIVE



Butterfly<sup>®</sup>  
double-break  
switches

# LII

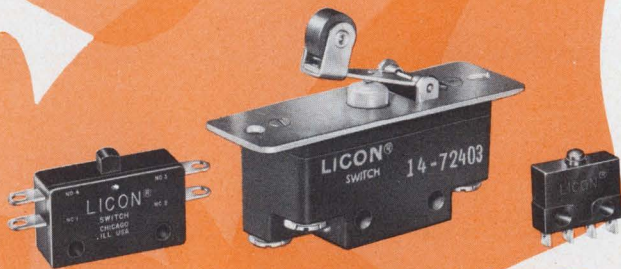

DOUBLE-BREAKS

WRITE FOR LATEST LICON SWITCH CATALOG

IF YOU USE BASIC SWITCHES, LOOK INTO

# LICON<sup>®</sup>

## SWITCHES



SINGLE-BREAKS

LIGHTED

SEALED

INDUSTRIALS

**it** LICON  
**w**

DIVISION ILLINOIS TOOL WORKS INC.  
6615 W. IRVING PARK ROAD • CHICAGO, ILLINOIS 60634

*"Remember, you're never more than a few feet away from a product of ITW" <sup>®</sup>*

(continued from p 90)

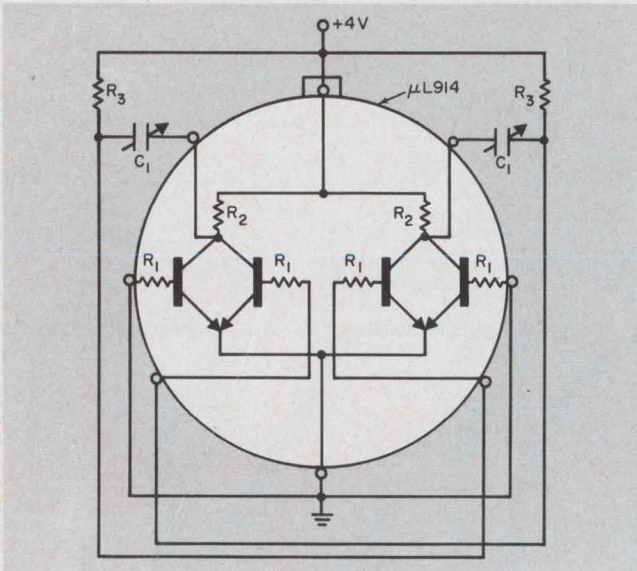

(a)

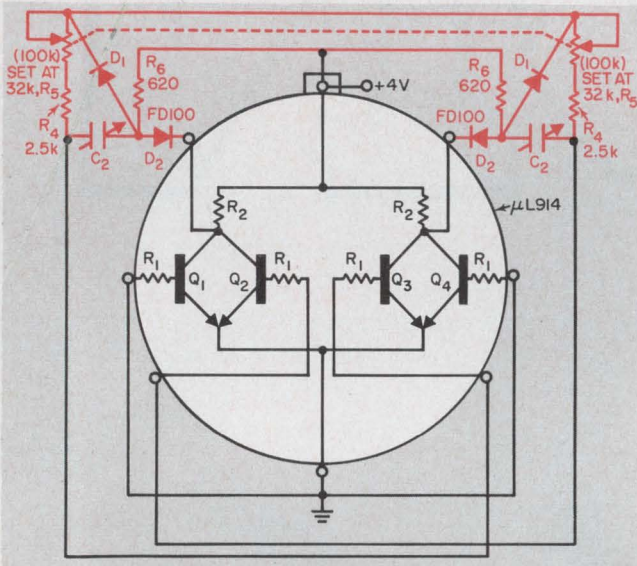

(b)

**Free-running multivibrator** may be formed by using a dual two-input gate micro-logic element (a). By adding an RC-diode network (b), the circuit's frequency range is extended, and it exhibits a self-starting capability.

The value of the timing capacitor  $C$  can be varied between 20 pF and 2.0  $\mu$ F to produce output frequencies between 10 Hz and 6 MHz. The value of the ganged potentiometer (32k) was chosen to produce a frequency range of 10:1. Note that only a single input of the gate is used, the extra gate terminal being grounded. This inhibits the input permanently, for it backbiases transistors  $Q_1$  and  $Q_4$ .

The free-running multivibrator may be used wherever a low-precision clock is required, such as in timers, counters, dividers, BCD to binary converters and shift registers. Note also that one of the spare-gate inputs may be used to control the

astable mode of operation by means of the level-input control.

The circuit may be implemented using any  $\mu$ L914 element. However, the frequency output may vary between individual elements (because of the tolerance of the  $R_1$  resistors) by approximately 10%. For this reason, the circuit should be considered a low-precision clock.

*K. D. Smith, Instrumentation Engineer, Atomic Energy Div., Phillips Petroleum Co., Idaho Falls, Ida.*

VOTE FOR 112

## Simple splash-proof guard protects printed circuits

A simple, inexpensive splash guard makes ordinary edge-on, printed-circuit connectors drip-proof. Moreover it permits direct access to the board and does not require much space.

Military requirements normally specify that electronic equipment must operate under conditions of humidity and temperature that cause condensation. To prevent the moisture from shorting the contacts of printed-circuit connectors, two solutions have been employed. One is the application of special drip-proof connectors. The second is the use of mounting connectors on a vertical surface, which are plugged into the printed circuit boards with "horizontal" motion.

But the use of drip-proof connectors consumes a fair amount of printed-circuit board space, thereby decreasing the packing density. And the cost of a pair of mating drip-proof connectors is about 4 times that of an edge-on connector. Moreover it is usually more convenient, especially in test-equip-

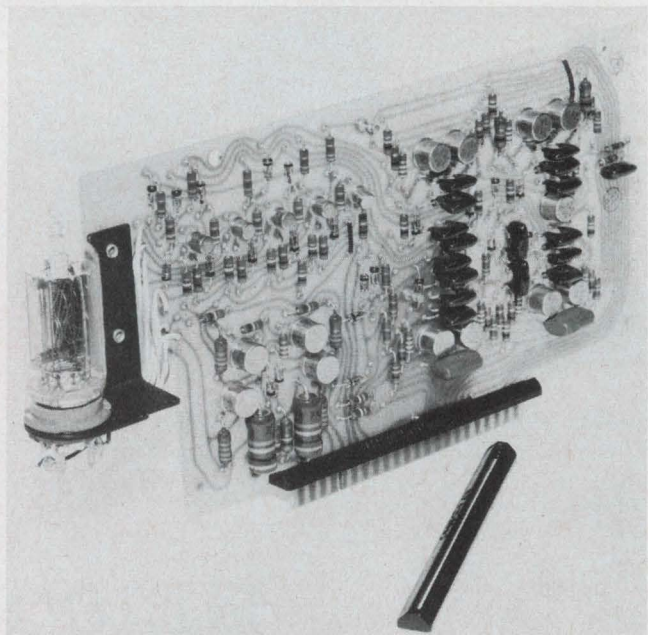

**Inexpensive splash-proof guard** (lower right) protects printed circuit connectors from shorting caused by condensation. Direct access to the board is also permitted by the small-sized guard.

(continued on p 98)



Accuracy  $\pm 0.0025\%$ . Maximum meter resolution, 0.1 ppm. Fourteen pounds later you have the new solid-state Fluke 885 DC Differential Voltmeter, the first truly portable laboratory standard. Peak-to-peak reference stability is 15 ppm for 60 days. Use the Fluke 885 as an isolation amplifier. Grounded recorder output is so well isolated that a short-circuit at the output produces no voltmeter reading error. Ground loops are completely eliminated when the battery powered Model 885AB is used.

Other Specifications: Range, 0 to 1100 Volts. Null sensitivity, 100 microvolts full scale. Line regulation better than 2 ppm.

No zener oven, less than 30 seconds warm-up time.

Cabinets can be half rack or full rack mounted with optional mounting kits.

Price of the Model 885A line cord version is \$1,195.

The battery powered Model 885AB is \$1,325.



**FLUKE • Box 7428 • Seattle, Washington 98133 • Phone: (206) PR 6-1171 • TWX: (910) 449-2850**

Model 885A reading precise voltage from Model 332A Voltage Calibrator on 10V range



From the expanding line of Sigma relays . . .

# Now there are 3 low-cost relays for switching up to 2 amps.

Order them off-the-shelf.

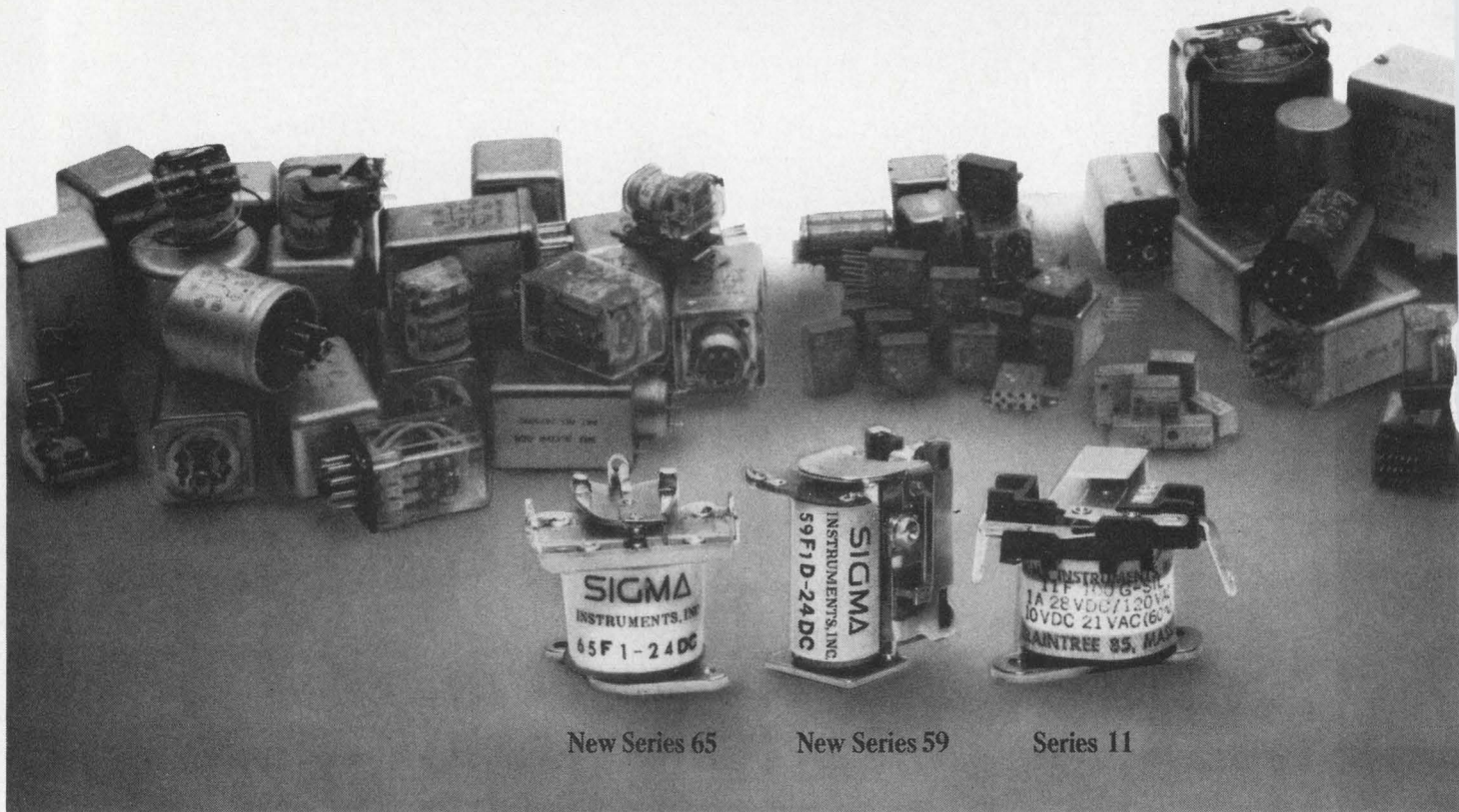

New Series 65

New Series 59

Series 11

**Match these specifications against your requirements.  
Then contact Sigma or your distributor.**

<b>Series 11:</b>	Contact rating 1 ampere. Unenclosed, screw mounted, solder or printed-circuit terminals, all UL-listed (E28610 Yellow Card). Choice of 3 physical types, 11 coil resistances, 2 adjustments, 3 DC or 2 AC coil voltages.
<b>Series 59:</b>	Contact rating 2 amperes. Unenclosed, screw mounted, solder terminals; or metal dust cover, 8-pin plug. Choice of 3 DC coil voltages.
<b>Series 65:</b>	Contact rating 1 ampere. Unenclosed, screw mounted, solder terminals, or terminals for printed circuit mounting. Choice of 3 DC coil voltages.

New Sigma Series 59 and 65 relays now join the popular Series 11 to provide a broader range of low-cost SPDT relays for general purpose switching. Each of these small, one-ounce relays provides optimum operation for controlling light industrial and commercial loads. All are immediately available from stock at low prices.

How low in cost? Take the new Series 65. These DC relays are available in quantity at less than a dollar. They are specifically designed for simple, reliable on-off switching.

New Sigma Series 59 relays are built for gradually changing signals as well as on-off operation. This is made possible by the unique construction of these DC relays which use a snap-switch instead of conventional contacts.

Sigma Series 11 relays are available in both AC and DC versions. They are UL-listed and combine low price and high sensitivity with the ability to respond to gradually changing and on-off DC.

The new Sigma Series 59 and 65 relays and the Series 11 are suitable for applications ranging from vending machines and alarm systems to industrial controls. Use them wherever there is need for small, low-cost, highly dependable relays.

**FREE CATALOG:** Send today for the new Sigma Preferred Standard and Stock Relay Catalog and up-to-date stock list. They will help you select the relay types immediately available in quantity from your distributor or Sigma direct.

**SIGMA DIVISION**  **SIGMA INSTRUMENTS INC**  
*Assured Reliability With Advanced Design / Braintree, Mass. 02185*

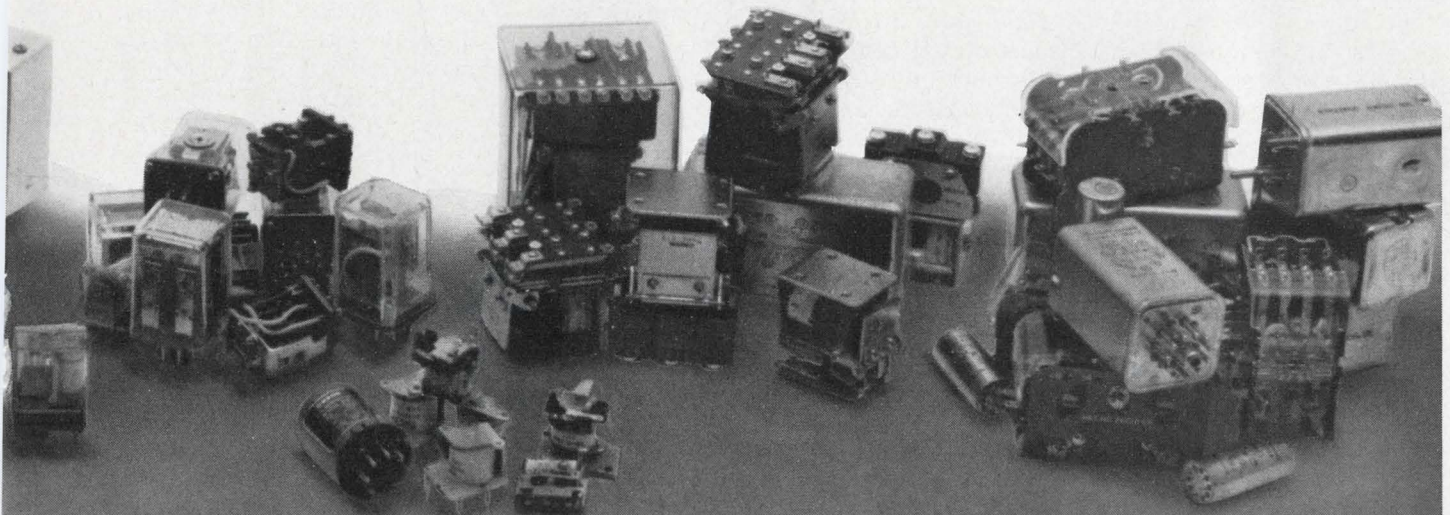

Sigma's line of over 100,000 relays includes (from left to right) Sensitive, High Performance, Pulse and Telegraph, General Purpose, Power, and Special Purpose types.

(continued from p 94)

ment applications, to have access to the printed-circuit boards from the top of the equipment.

These problems have been overcome by the use of a simple, molded splash guard, which is epoxied to the finished printed-circuit assembly. The plastic guard costs pennies. When a printed-circuit card, with the attached guard, is plugged into the standard edge-on connector, any accumulated moisture running off the board is diverted over the edges of the connector. The moisture can be dissipated through weep holes in the equipment chassis, thus leaving the electrical connections completely dry.

*James Marine, Designer Engineer, Computer Measurements Corp., San Fernando, Calif.*

VOTE FOR 113

## Logic-circuit multi yields precise pulse-delay periods

A very precise synchronized pulse delay is often required from the output of a timing device or logic circuit. A simple way to achieve it is by using microelectronic logic elements. They provide a long, variable delay period that can be used to trigger SCRs.

Referring to the schematic (see illustration), we see that the input pulse of 2 volts amplitude is fed through  $C_1$  to Fairchild logic block 91429. The logic block has been cross-coupled to form a bistable multivibrator.

The voltage on pin 7 goes negative, thus preventing  $Q_1$  from conducting. This causes the voltage on its collector to rise from zero to 10 volts. The 10-volt level is held constant by zener diode  $D_1$ . Capacitor  $C_2$  charges through  $R_5$  and  $R_6$  until the threshold voltage of the unijunction transistor is reached. Then the 2N2646 conducts.

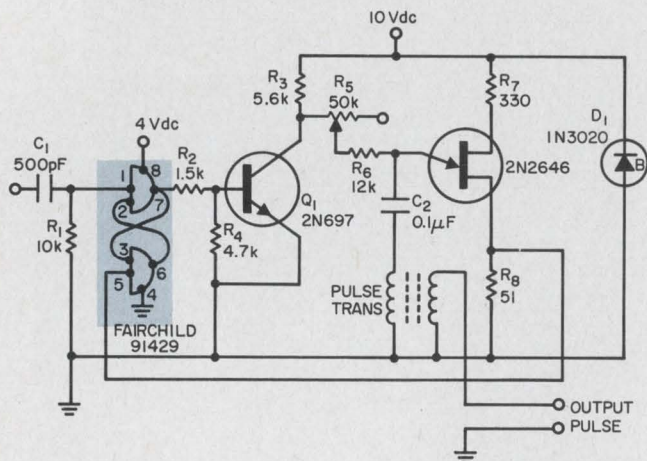

Microelectronic logic elements are cross-coupled to form bistable multivibrator. Flip-flop is then used with UJT to form a precise, synchronized pulse delay.

The delayed output pulse appears at the output of the pulse transformer. A pulse produced across  $R_8$  causes the multivibrator to be reset. The delay itself is determined by the combination of  $R_5$ ,  $R_6$  and  $C_2$ . This product may be changed to secure delay variations from less than 1 ms to several minutes or more.

*Robert J. Lamere, R&D Engineer, Richard D. Brew Co., Concord, N. H.*

VOTE FOR 114

## Slide-rule procedure directly yields equivalent resistances

Slide-rule calculations of parallel resistance are normally inconvenient because of the arithmetic addition. Here is a rapid and extremely accurate method of computation requiring only the "C" and "D" scales. Moreover, it is applicable to any number of resistances in parallel.

The familiar expression of two resistances in parallel may be rewritten as:

$$R_p = \frac{R}{R/r + 1}, \quad (1)$$

where  $R \geq r$ , by designation.

By mentally adding one (unity) to the ratio of  $R/r$ , the entire operation may be performed directly on the slide rule.

Consider the example of  $R_p = 1.87$  ohms in parallel with 4.75 ohms. First set the index opposite 1.87 on the "D" scale; then move the hairline to 4.75 on the same scale. Read 2.54 (the  $R/r$  ratio) under the hairline on the "C" scale. Now mentally add one to obtain 3.54. Next, move 3.54 on the "C" scale under the hairline and the answer is read at the index on the "D" scale as 1.341.

For more than two resistances in parallel, repeat the operation in sequence. Always start with the lowest value for convenience. Continuing the first example with  $R_p = 1.87 // 4.75 // 8.25$ , move the hairline to 8.25 on the "D" scale. Read the new  $R/r$  ratio of 6.15 under the hairline on the "C" scale; mentally add one to obtain 7.15. Next move 7.15 on the "C" scale under the hairline and the answer is again at the index on the "D" scale as 1.153. Since the answer always appears at the index, the "CF" and "DF" scales may be used conveniently for off-scale computations. Each additional calculation, then, requires only two new settings.

Conversely, if  $R_p$  and one other resistance is known, the remaining one may be similarly determined by the relationship:

$$r = \frac{R}{R/R_p - 1}, \quad (2)$$

where one is subtracted from the ratio. Note that a significant figure (precision) is lost in the subtraction process.

*Andrew Chao, Design Engineer, The Bendix Corp., North Hollywood, Calif.*

VOTE FOR 115  
(continued on p 100)

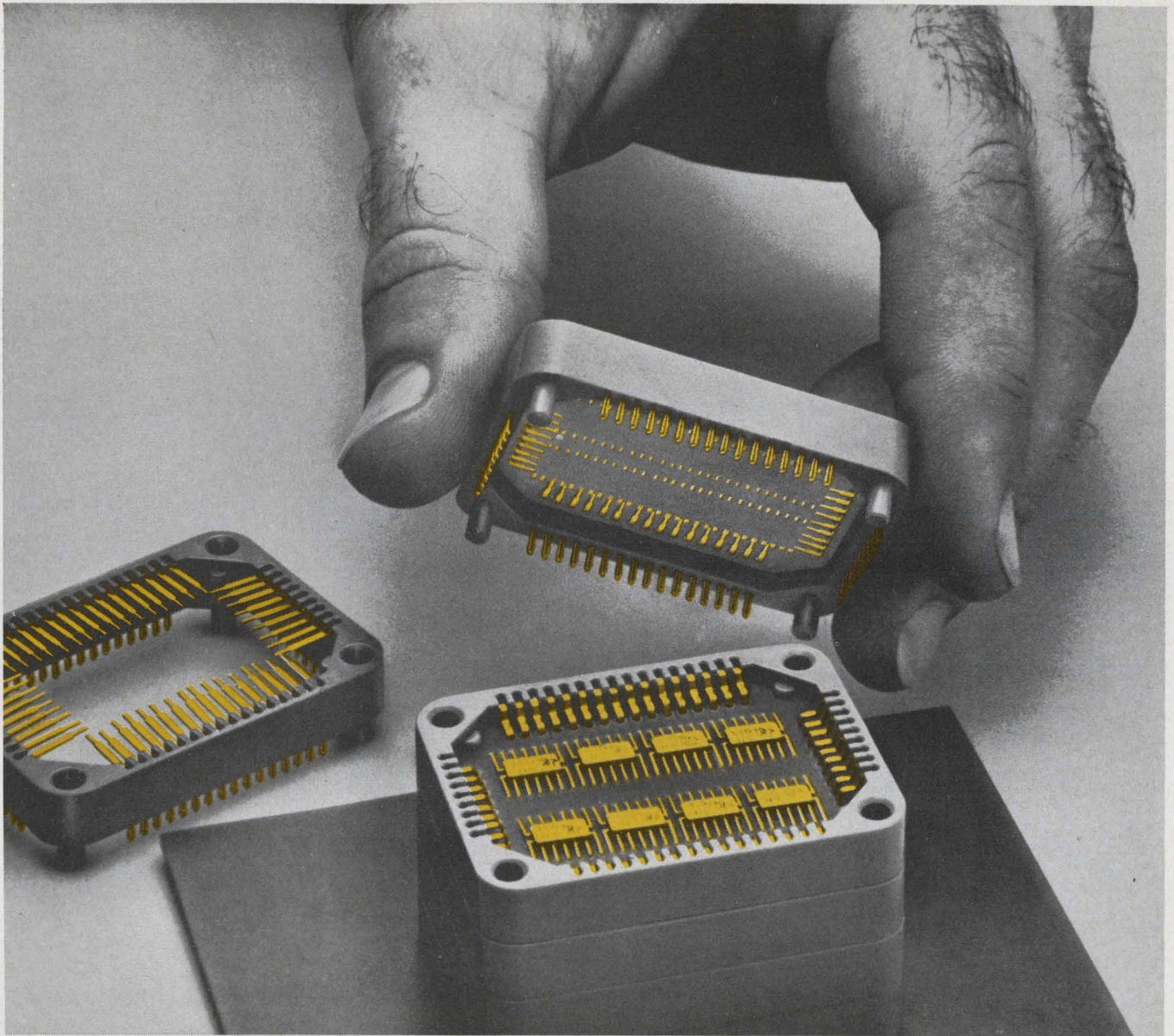

## Heads up microcircuitry

Microcircuitry itself is presently available in many forms with units packaged principally in flat packs, transistor cans or cubical cases. Innumerable variations are available in each of these package types. And for each type of package AMP has a connector, including this new active pin stacking connector.

The A-MP★ Stacking Connector is capable of housing eight flat packs or other types of pre-wired microcircuitry, and is presently available in a 50-position contact size. The one-piece active pin contacts are plug-gable to plated holes in a board. They can be flow soldered, if desired, after the circuit test and burn-in phases have been completed. Additional connectors can be stacked on the first. Interconnections through the stack is accomplished by the active pin contacts. These interconnections are easily programmable. A typical application variation of this basic connector is a special receptacle with crimp-on, snap-in contacts used to interconnect the stack instead of a circuit board.

Each A-MP Active Pin Stacking Connector features:

- 50 active pin contacts on .075" centers
- AMP's exclusive gold over nickel contact plating
- Tough, heat-resistant LEXAN® housings
- Polarized housings

- Integral heat vents
- Housing occupies a maximum of three square inches
- Each connector accommodates eight flat packs or will accept other pre-wired microcircuits
- Maximum top-of-the-board, multi-level circuit flexibility at low installed cost.

Each system for packaging microcircuits is different. The A-MP Active Pin Stacking Connector is only one of many special connecting systems designed by AMP to satisfy a variety of requirements.

For the complete story on the head start AMP has on microcircuit packaging write for the informative booklet "Connectors for Microminiature Circuits".

© Trademark of General Electric Co., Inc.

★ Trademark of AMP INCORPORATED



A-MP★ products and engineering assistance are available through subsidiary companies in: Australia • Canada • England • France • Holland • Italy • Japan • Mexico • Spain • West Germany

Speed Inquiry to Advertiser via Collect Night Letter  
ON READER-SERVICE CARD CIRCLE 33

(continued from p 98)

## Inexpensive transistor functions as low-TC reference diode

The collector-to-emitter junction of a transistor can serve as a low-cost zener regulator element. Temperature coefficients (TC) as low as 0.01% per degree C or better can be realized in this operating mode.

A circuit that uses the base-emitter junction of the 2N3638 silicon *pnp* "economy" transistor as a breakdown diode (Fig. 1a) is an illustration of the more conventional way of using the transistor as a zener. The transistor has a sharp and uniform base-emitter zener knee and is therefore suited for use as a low-cost zener diode. Since the base-emitter diode of the transistor consists of a single, silicon junction, the circuit has a typical voltage-temperature coefficient of 0.02 to 0.05%/°C. This classifies it as a uncompensated regulator.

This performance can be substantially improved when the transistor is used as a zener, as shown in the circuit of Fig. 1b, where the entire transistor now functions as a temperature-compensated zener reference diode. It displays a temperature coefficient that is typically below 0.01%/°C. This places the circuit in the class of compensated reference zeners and is suitable for use whenever a low impedance, temperature-stable voltage source is required.

Here is how temperature compensation in the circuit is achieved: Operating current for the zener (transistor),  $I_z$ , flows into the collector of the transistor. It forward-biases the collector-base junction, and since the two transistor junctions are in series, it adds 0.53 V to the base-emitter

zener voltage level (6.5 V) for an output voltage of 7.03 V. The base-emitter junction voltage change with temperature has a positive coefficient and is given by

$$V_{be} = (0.03\%/^{\circ}\text{C})(6.5\text{ V}) = 1.95\text{ mV}/^{\circ}\text{C}. \quad (1)$$

The forward-biased collector-base diode on the other hand, has a negative voltage coefficient of about  $-2.0\text{ mV}/^{\circ}\text{C}$ , which is typical of silicon diodes. These two voltage changes nearly cancel each other out, so that the circuit output voltage is practically independent of temperature.

Several units were measured in the circuit of Fig. 1b for  $R_L = \infty$  and  $I_z = 5\text{ mA}$ . Unit 1 had a TC of less than  $0.001\%/^{\circ}\text{C}$ , and unit 2 measured  $0.0056\%/^{\circ}\text{C}$ . This compares favorably with the "standard" value of  $0.01\%/^{\circ}\text{C}$  for reference zeners costing many times the 31 cents paid for this transistor. Higher voltages are easily obtained by stacking units in series.

Allan G. Lloyd, Project Engineer, ACF Industries Inc., Paramus, N. J.

NOTE FOR 116

## Independent astable multi uses adjustable current sources

The addition of adjustable current sources to the base sections of an astable multivibrator produces two independent operating modes. The multivibrator rate may then be varied without any accompanying change in duty cycle, or its duty cycle may be modified without any effect on the rate of operation.

An astable multivibrator together with a one-shot can maintain the desired duty cycle (constant) when the rate is varied, but this technique requires the simultaneous adjustment of the duty-cycle control and rate control. The addition of adjustable current sources to the base circuit of the astable multivibrator solved this problem of dual adjustment.

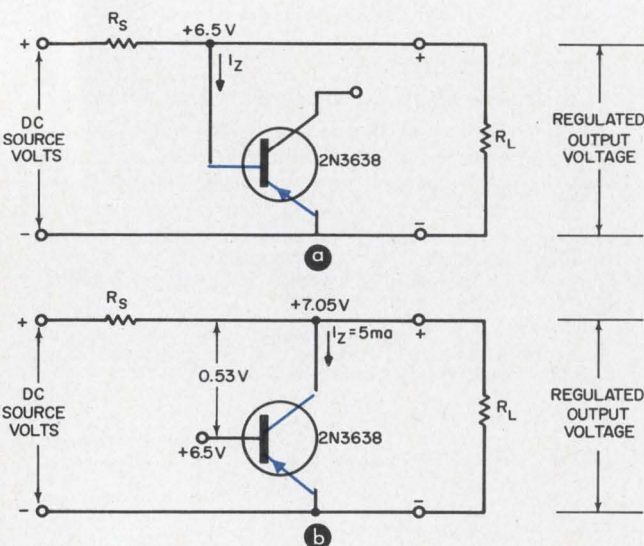

Reference element behavior can be obtained from a transistor when the base-emitter junction is operated in a zener manner (a). A lower temperature coefficient is realized when the collector-emitter junction of an inexpensive silicon *pnp* type is utilized instead (b).

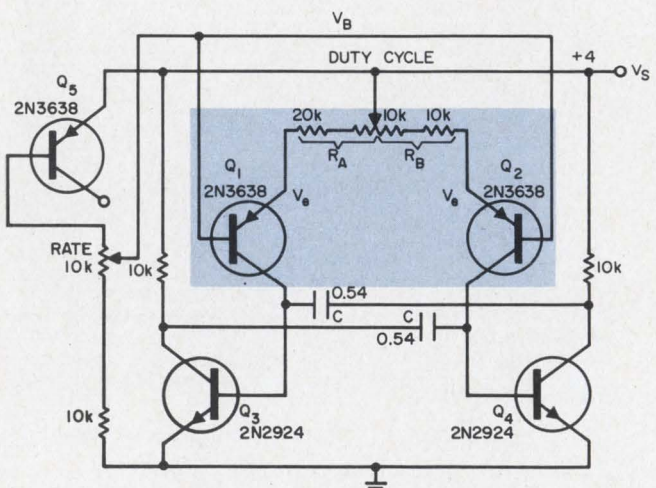

Adjustable current sources  $Q_1$  and  $Q_2$  render the rate of the astable multivibrators,  $Q_3 - Q_4$ , independent of duty cycle and vice-versa.

(continued on p 102)

Helipot's side-adjust  
Helitrim® cermet  
trimmer-world's  
smallest-costs as little  
as \$1.50 in quantity.



Helipot's side-adjust  
Helitrim® cermet  
trimmer-world's  
smallest-costs as little  
as \$1.50 in quantity.

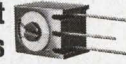

Helipot's side-adjust  
Helitrim® cermet  
trimmer-world's  
smallest-costs as little  
as \$1.50 in quantity.

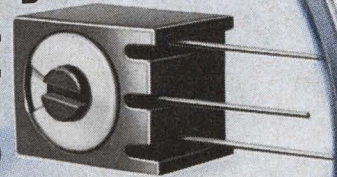

Helipot's side-adjust  
Helitrim® cermet  
trimmer-world's  
smallest-costs as little  
as \$1.50 in quantity.



The Model 62PA side-adjust is a new easy-access cermet trimmer with these quality features: virtually infinite resolution; excellent high frequency characteristics; and standard resistance from 10 ohms to 1 megohm. Its rugged cermet resistance element gives you long, trouble-free life and freedom from sudden failure. Inside its plastic case is a sealed metal housing identical to the popular 1/4" top-adjust Model 62P.

Focus in on delivery advantages, too... immediate stock availability. Call your Helipot sales rep for full specs.



INSTRUMENTS, INC.  
HELIPOT DIVISION  
FULLERTON, CALIFORNIA • 92634

INTERNATIONAL SUBSIDIARIES: GENEVA; MUNICH; GLENROTHES, SCOTLAND; TOKYO; PARIS; CAPETOWN; LONDON

Speed Inquiry to Advertiser via Collect Night Letter  
ON READER-SERVICE CARD CIRCLE 34

(continued from p 100)

The off-time of each half of the astable circuit (see illustration) depends on the output swing,  $V_o$ , and the rate at which the timing capacitor,  $C$ , is charged. Transistor  $Q_1$  is used as an adjustable current source for  $Q_3$ ; the current is approximately  $(V_s - V_e)/R_A$ . Thus the off-time of  $Q_3$  is  $CV_o R_A / (V_s - V_e)$ .

The off-time of  $Q_4$  is  $CV_o R_B / (V_s - V_e)$ . The total period is the sum of the off-times, or  $CV_o (R_A + R_B) / (V_s - V_e)$ . The duty cycle of  $Q_3$  is  $R_A / (R_A + R_B)$ , which is independent of period or rate. Since  $R_A$  and  $R_B$  are constant, the rate may be adjusted independently of the duty cycle by changing  $V_e$ . By changing the value of  $V_B$ ,  $V_e$  is effectively varied.

With the component values shown, it is possible to vary the duty cycle between 26% and 51%, while the period remains constant within 2%. On the other hand, the rate is adjustable between 66 and 238 Hz while the duty cycle remains constant within 2%.

Gerald Vurek, *Electronics Engineer, National Heart Institute, Bethesda, Md.*

VOTE FOR 117

## Peak-following amplifier provides two outputs

A simple amplifier arrangement both discriminates and forms pulses when used as a detector. In addition to handling input signals that possess large dc components and feature asymmetrical periods, the circuit produces dual-output reference pulses.

In the circuit (Fig. 1a), output 1 provides a positive pulse whenever the slope of the input signal changes from minus to plus. Output 2 provides a positive pulse whenever the slope of the signal changes from plus to minus. Figure 1b shows the waveform of output 1 as a function of the input signal.

The key to circuit functioning hinges on the storage effect of capacitors  $C_2$  and  $C_3$ . The voltage on the capacitors follows the input to transistors  $Q_2$  and  $Q_3$ . When the signal slope changes positively,  $Q_2$  starts conducting and yields a positive-going output.  $Q_3$  is reverse biased by this input-signal slope. Thus, it yields no change in output. The reverse operation occurs for a slope that changes from positive to negative.

The circuit is useful for control instrumentation systems, such as photoelectric sensing. Generally, it is applied where individual events or items must be counted against a high and changing ambient background.

Also note its simplicity: The discrimination and pulse-forming circuit normally required in these applications would consist of an amplifier stage, an active filter stage and an inverter-steering

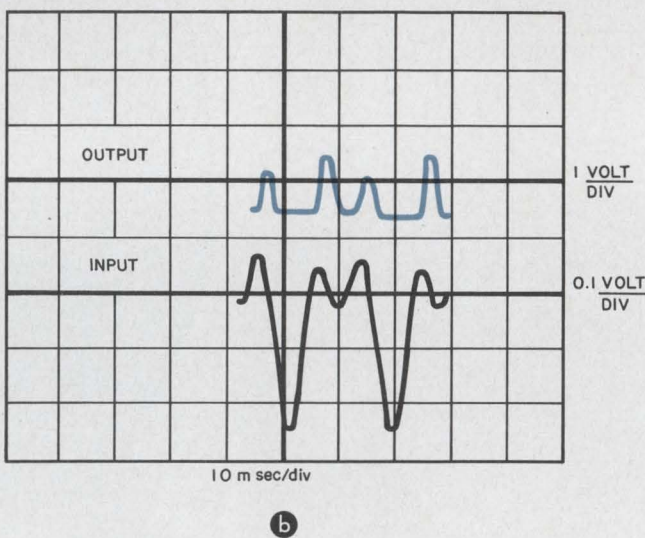
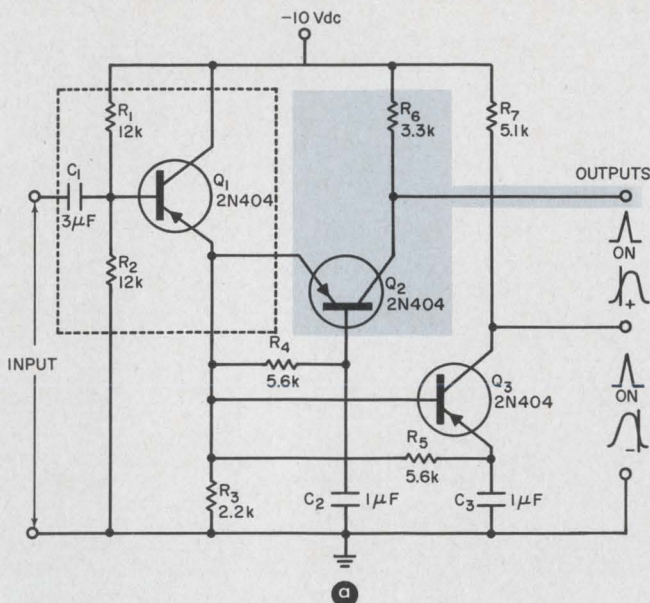

**Peak following amplifier** (a) detects the polarity of slope of an input signal. Two outputs are provided to accommodate positive- and negative-going slope changes. The pulse waveform at the collector of  $Q_2$  (b) yields a positive output when the input slope goes from minus to plus.

stage. The described circuit does all this in one stage, consisting of only a transistor, two resistors and a capacitor.

In addition, the provision for two follower circuits—one for positive slopes and one for negative slopes—provides outputs that are a function of the time rate of change of input voltage and is relatively independent of absolute level.

Herman Levin, *Research Engineer, Bell & Howell Co., Chicago, Ill.*

VOTE FOR 118

## IFD Winner for Nov. 8, 1965

John F. Cleary and Dwight V. Jones, Applications Engineers, General Electric Co., Semiconductor Products Dept., Syracuse, N. Y.

Their idea, "Cascaded UJT oscillators form stable frequency divider," has been voted the \$50.00 Most Valuable of Issue Award.

Cast Your Vote for the Best Idea in this Issue.



# This is our Miniature 4-Pole Relay *but* we magnified it 2½ times to show you the kind of quality you can buy for \$4.10.

The Series JA is in all respects a high quality miniature 4 PDT relay for AC or DC operation. This is borne out by the fact that our customers have reported 40,000,000 mechanical operations without a single failure. The JA is excellent for computer, logic system and data processing applications. We could write an essay about its virtues but prefer to let the features and specifications speak for themselves.

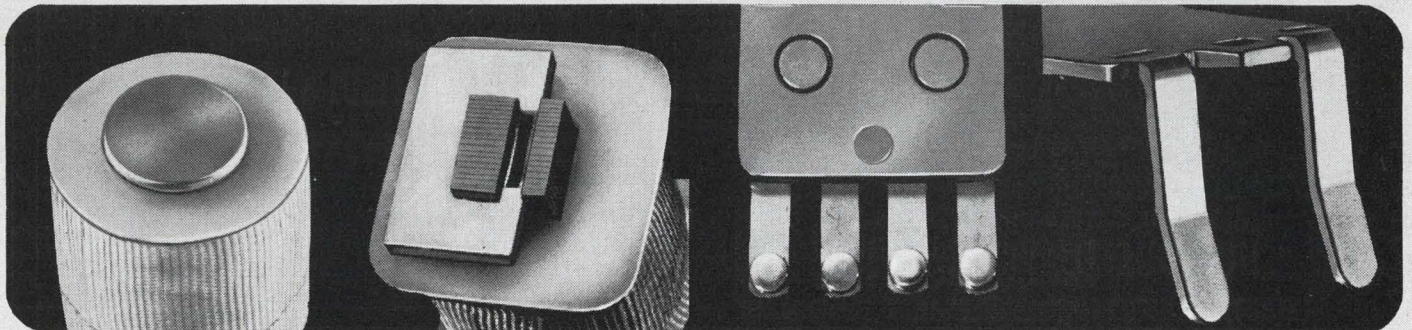
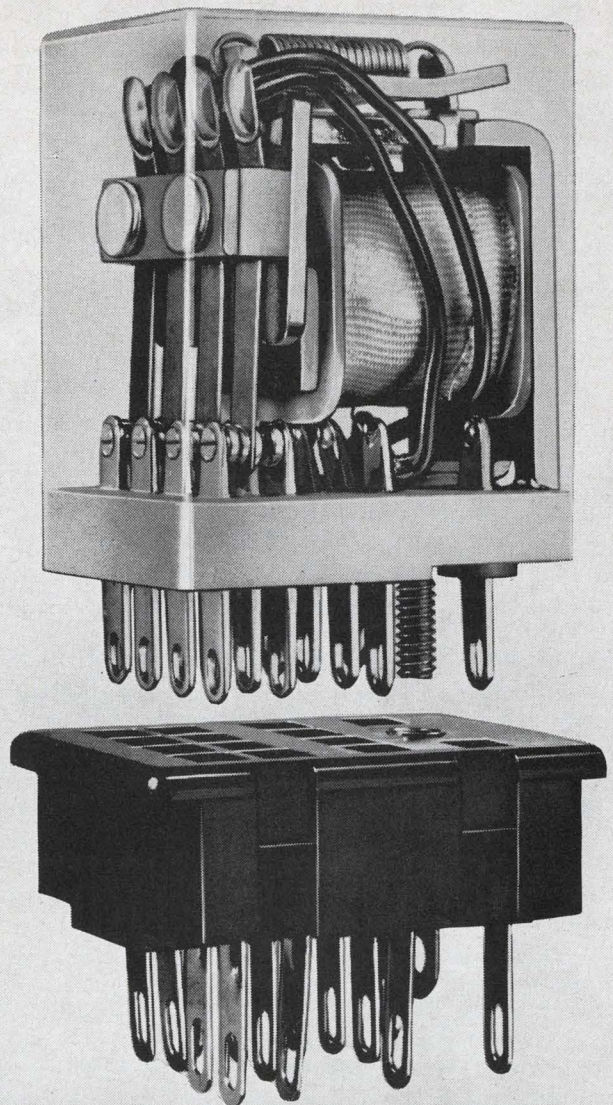

On DC relays solid mushroom head pole piece increases the magnetic flux to assure faster response and release.

On AC relays 15 laminations in pole construction intensifies the magnetic field for faster contacting and increased sensitivity.

A freeze pin in the armature plate prevents it from sticking after the coil current cuts off, thereby assuring instant release.

Two armature balance stems provide greater resistance to vibration and shock for smoother operation under variable conditions.

CONTACTS: 4 PDT rated at 3 amps (6-115 VAC and 6-110 VDC) available in (1) Gold flashed fine silver (2) Silver-Cadmium Oxide (3) 3% Palladium Alloy (4) Gold diffused (5) Gold alloy. ENCLOSURES: Available with Nylon Covers in (1) Clear (2) Translucent (3) 5 colors. MOUNTINGS: (1) Side mounting bracket (2) Top mounting bracket. COIL RESISTANCES: 40 to 10,000 Ω DC. (800 MW) 10.5 to 3,900 Ω AC. (1.1 VA). TERMINALS: (1) Printed circuit (2) Solder lug (3) Taper Tab. SOCKETS: (1) Solder lug (#92-79) (2) Printed circuit (#92-80). DIMENSIONS: 1" x ¾" x 1 1/16" (open)

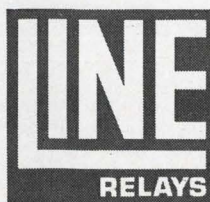

	Voltage	Resistance	Nominal Power	Price
DC	6 VDC	40 OHMS	800 MW	\$4.10
	12 VDC	160 OHMS	800 MW	4.10
	24 VDC	650 OHMS	800 MW	4.10
	48 VDC	2500 OHMS	800 MW	4.10
	90 VDC	10000 OHMS	800 MW	4.90
	110 VDC	10000 OHMS	800 MW	4.90
AC	6 VAC	10.5 OHMS	1.1 VA	\$4.40
	12 VAC	43 OHMS	1.1 VA	4.40
	24 VAC	160 OHMS	1.1 VA	4.40
	115 VAC	3900 OHMS	1.1 VA	4.90

LINE ELECTRIC COMPANY/DIV. OF INDUSTRIAL TIMER CORPORATION  
205 River Street, Orange, New Jersey  
In Canada: Sperry Gyroscope Ottawa Ltd., Ont.

## Build a tone-burst generator for \$50. If your transient-testing needs are conventional, extensive, costly digital circuitry is not a must.

Before you spend large sums for a tone-burst generator, see if you can build your own instead. Your transient-testing, signal simulation and wave-shape-study needs may be met by a simple generator designed with a parts cost of less than \$50.

The complexity and cost criteria hinge on the amount of digital circuitry required. If an oscilloscope can be requisitioned to provide the cycling function (ON and OFF times), then you can get away with this low-cost, laboratory-built unit.

It dispenses with the need for purchasing a commercial unit that costs hundreds of dollars or for building an elaborate system that uses large numbers of costly digital timing stages. The generator circuitry then boils down to a few gates, two time-delay units, simple generating and amplifying elements, and a flip-flop. The key to performance lies in the use of two feedback paths to provide stability and a broad operating range.

Operation of the circuit (Fig. 1) is quite simple. Assume that the transmission gate is closed and that a sinusoidal signal is connected to the input. The trigger generator produces one pulse for each input cycle. By an adjustment of the trigger-level control, these pulses may occur at any point on the negative slope portion of the input wave.

The first of these pulses passes through gates 1 & 2 and triggers the transmission gate control flip-flop. This opens the transmission gate, thus providing for an output. The trigger pulse also starts Time Delay 1, causing gate 2 to close. This prevents trigger pulses from reaching the flip-flop.

After Time Delay 1 has returned to its initial state, Gate 2 opens, and the next pulse from the trigger generator passes to the flip-flop, causing it to close the transmission gate. The closing control-voltage also starts Time Delay 2, thereby closing Gate 1. Until Time Delay 2 has returned to its initial state, no trigger pulses get beyond Gate 1. When Time Delay 2 returns to its initial state, the cycle repeats itself. Figure 2 shows the gating and time delay relationship.

### Time-delays key duty cycle

From the foregoing it can be seen that Time Delay 1 controls the ON time (transmission gate open) and the the OFF (closed) time is controlled by Time Delay 2. The circuit used to accomplish this is shown in Fig. 3a. The choice of semiconductor components was dictated by an available

surplus and is not considered optimum.

Switching transients appearing in the output are reduced by a factor of about 5 by  $R_1$ .  $C_1$  compensates for the various time delays inherent in the circuit. It allows the input to be swept from 20 Hz to 10 KHz without adjusting the trigger level control (to maintain the same triggering point at all frequencies). Photographs of the output appear in Fig. 3b. Operation of the unit indicates that a maximum ratio of OFF to ON time exists. This "multiple pulsing" is due to duty-cycle limitations in Time Delay 2. If Time Delay 2 is set for an ON time less than  $T$ , the closing of the transmission gate will not start Time Delay 2, and another pulse will be passed to the flip-flop. This results in another output burst.

This instrument was designed and used for loud-speaker transient testing but has since been put to several other uses. Some of these are the simulation of cutting-tool vibrations, a study of acoustical defects in an auditorium, a demonstration of the speed of sound, and the generation of strange sound-effects for a theater production. ■ ■

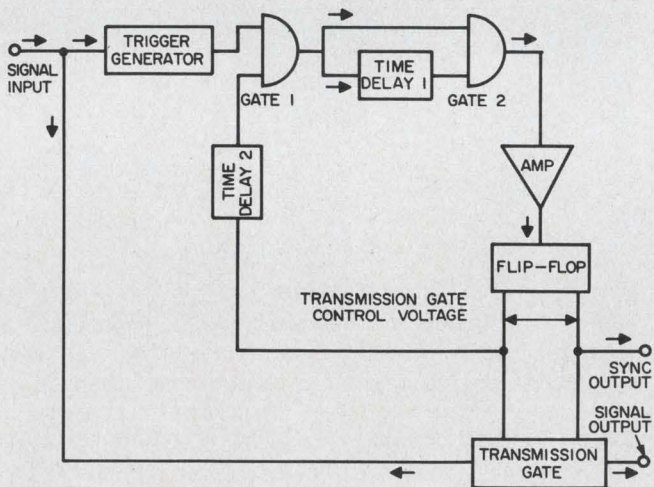

1. Simple tone-burst generator can be used for signal simulation and transient testing. ON time and OFF time are controlled by the time-delay stages.

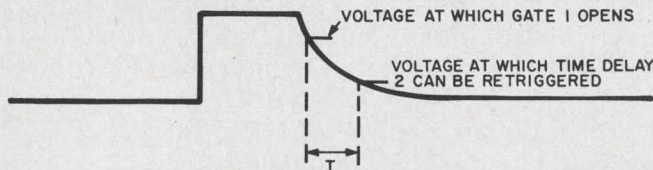

2. Maximum ratio of OFF time to ON time is determined by the transition period  $T$ .

Richard W. Cummings, Principal Engineer, University of California, Berkeley, Calif.

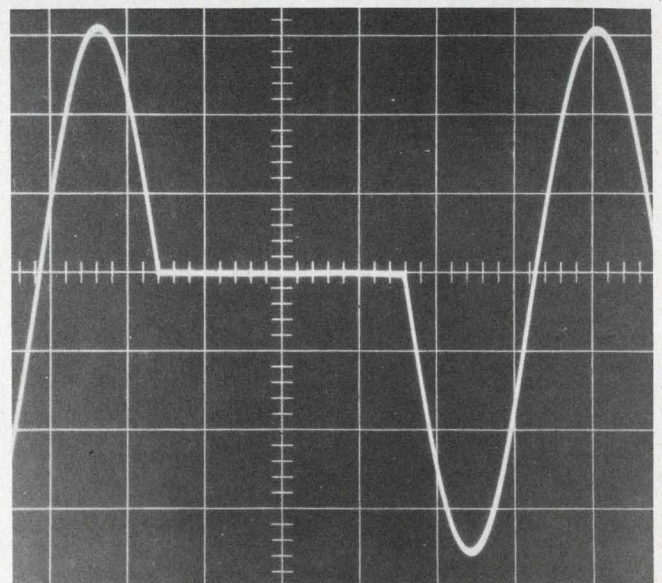
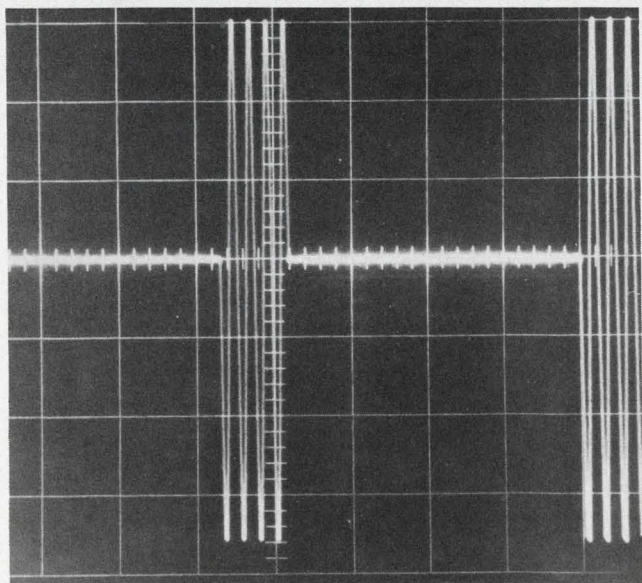
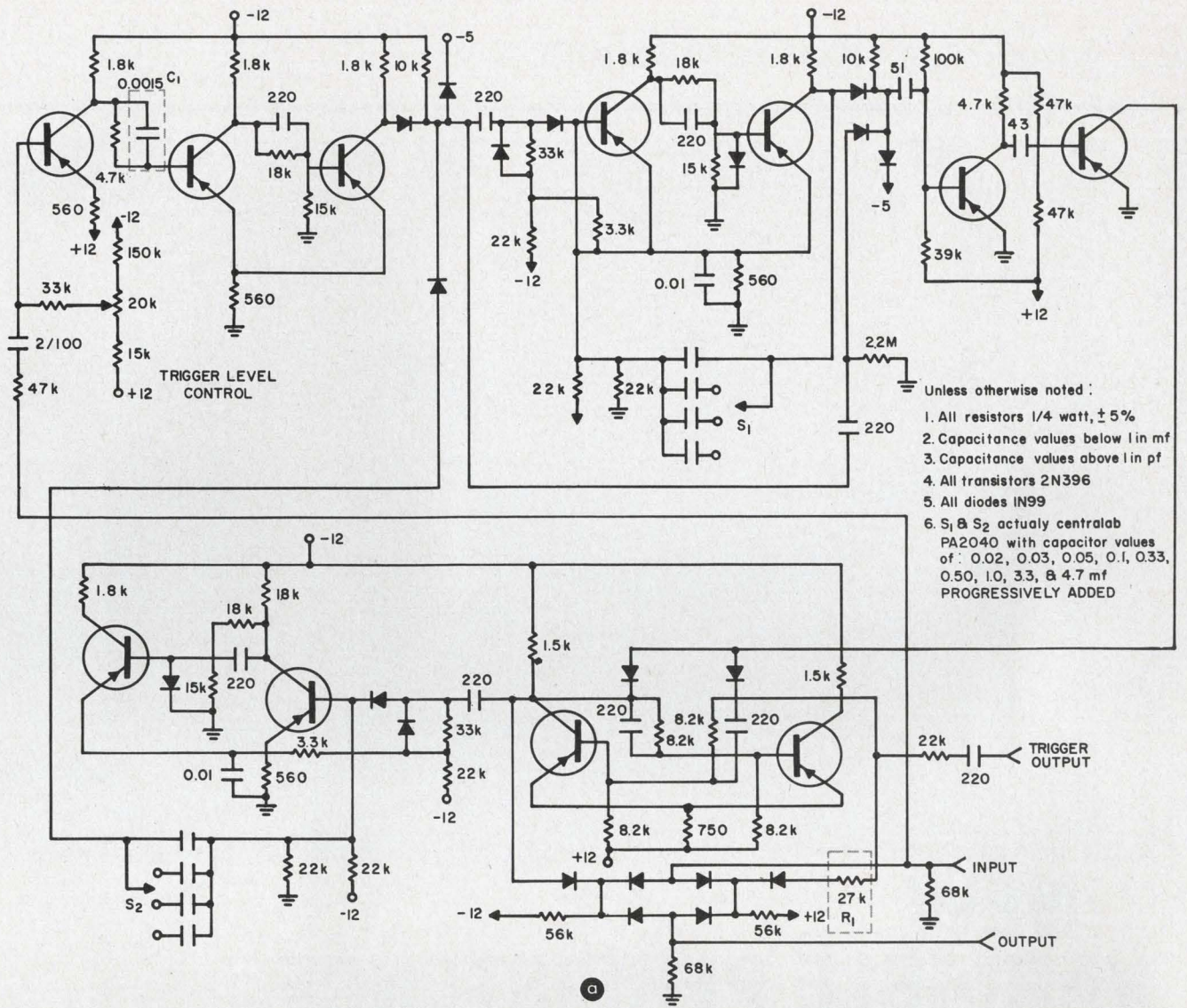

3. Complete design of generator entails use of surplus laboratory semiconductor components (a). Critical elements  $R_1$  and  $C_1$  reduce switching transients and compen-

sate for various time delays, respectively. Typical outputs appear in the photographs (b). Vertical scale is 1.0 volt/div, and horizontal scale 5.0 msec/div.

*new measure of scope performance:*

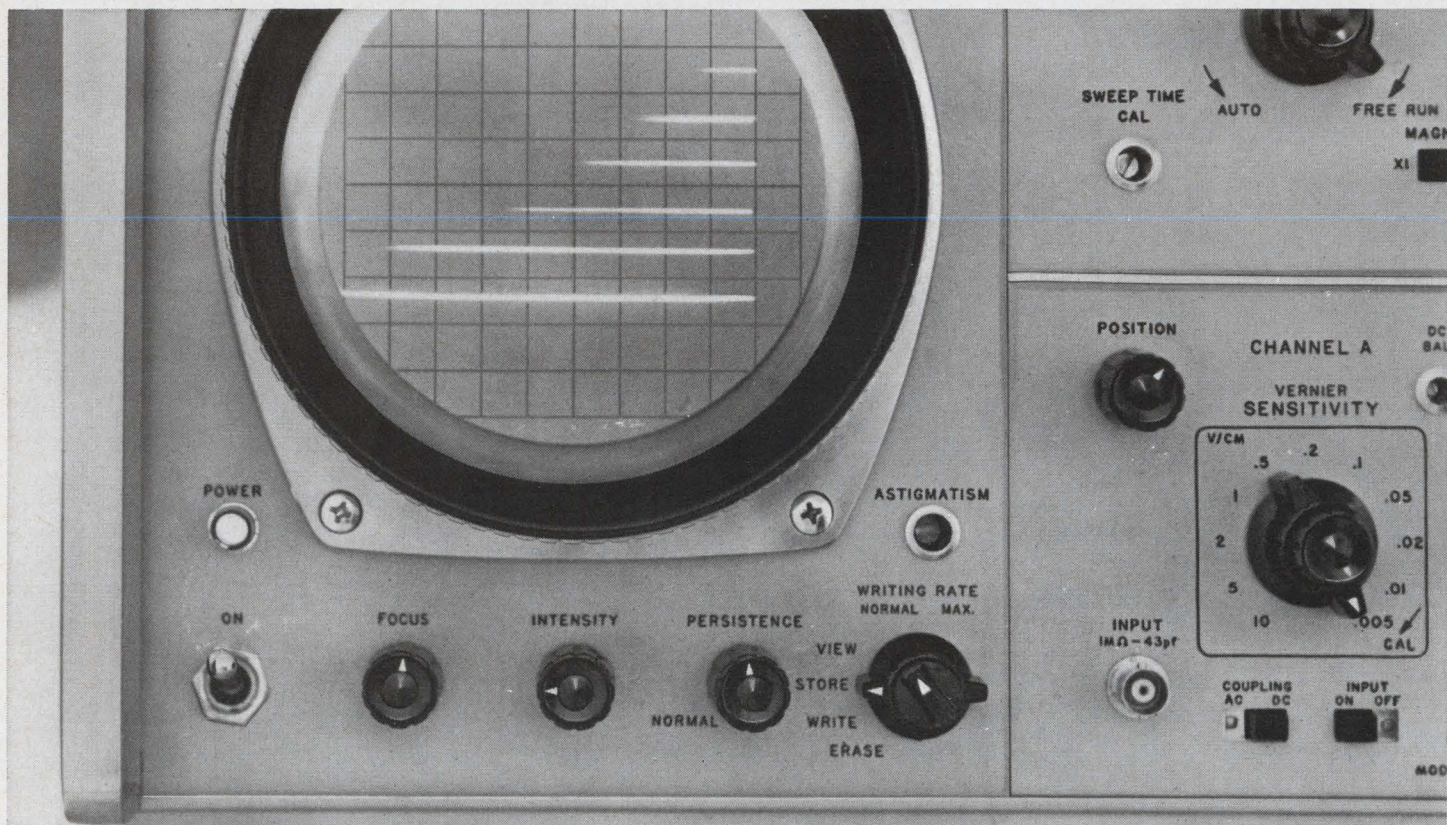

# **NEW** **VARIABLE PERSISTENCE** **for EASY, FLICKER-FREE VIEWING** **OF ALL WAVEFORMS** ■■■ *on the new*

*Hewlett-Packard 141A, also offering storage capability and all the versatility of a conventional, high-performance plug-in scope!*

- variable persistence, 1/5 sec. to 1 min., to eliminate flicker for easy viewing of all types of waveforms
- trace storage up to an hour, giving you time to study signals, make better camera set-ups (or even avoid photography altogether); fast erase, fast 1 cm/ $\mu$ sec writing rate
- versatile conventional scope operation with plug-ins to match your need, each one value-priced
- all this, plus high-contrast picture, full year crt warranty on specs, no-parallax internal graticule, full 10 cm x 10 cm viewing area!

## Variable persistence

Front-panel controls on the 141A scope permit continuous adjustment of persistence from 1/5 sec. to 1 min., eliminating annoying flicker on slow sweeps and fast signals with low rep rates. Easy viewing, too, for slowly moving waveforms, such as those from biochemical or medical phenomena. Just adjust so that the entire signal is on the screen, yet fades fast enough to avoid interference with the next signal.

Also, display several successive traces simultaneously, merely by adjusting the persistence control, superimposed or separated vertically.

Variable persistence also improves the resolution of signals viewed with the 1415A Time Domain Reflectometer Plug-in, for testing cables, connectors, strip lines, etc., where slow sweep speeds provide the best resolution, and with the 1416A Swept-Frequency Indicator Plug-in, where reflections and insertion losses are best resolved with slow sweeps.

## Storage scope

Traces can be stored for up to an hour at diminished intensity, viewed at any time at full intensity with storage switch in View position, and even stored for days with the scope turned off. Study waveforms at your convenience, without using a camera. Even fast single-shot signals can be captured with fast 1 cm/ $\mu$ sec writing rate.

Storage also permits automatic integration of repetitive signals... lets you build up a dim trace until it is comfortable to view, easy to photograph or study.

Long life of your storage crt is guaranteed, too... a year's warranty at full specification with no degradation of performance.

## Conventional Scope

Five vertical amplifier and two time base plug-ins, plus the two double-size special-purpose plug-ins, make the 141A as versatile as the popular hp 140A Plug-in Scope. The 141A with dual-channel 20 MHz bandwidth and time base with sweep delay, for example, costs only \$2450. A 100  $\mu$ V/cm 500 kHz system costs only \$1810.

The hp 141A Variable Persistence Storage Scope, without plug-ins, costs \$1275, price f.o.b. factory.

And every combination of scope and plug-ins gives

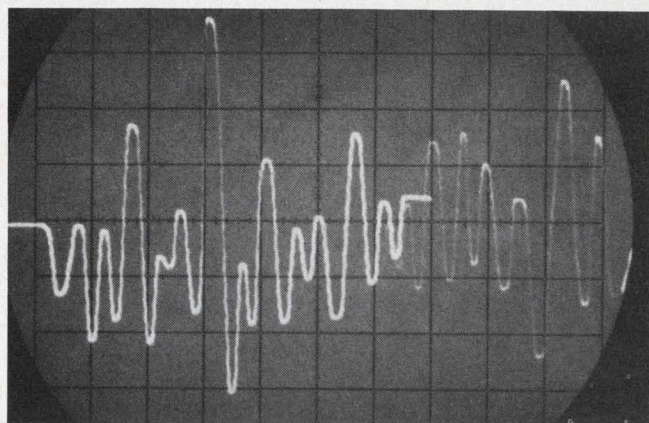

*Here, the tail of the previous signal is fading as the succeeding signal advances across the crt, left to right.*

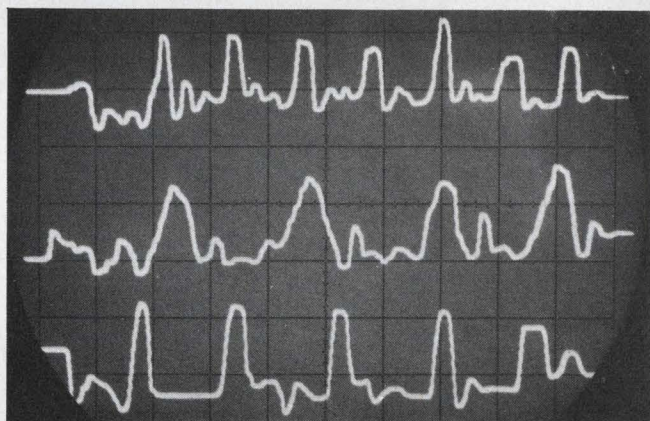

*Three single-shot signals are stored here, will remain for an hour for study without the use of a camera.*

you Hewlett-Packard design and manufacturing quality. Backed up, too, by your Hewlett-Packard field engineer, who can help solve your measurement problem with a scope or with other tools from the broad line of high-quality instrumentation he offers. Give him a call for complete information on the 141A. Or write for complete data: Hewlett-Packard, Palo Alto, California 94304, Tel. (415) 326-7000; Europe: 54 Route des Acacias, Geneva.

**HEWLETT**  **PACKARD**  
An extra measure of quality

# Count Down ...or Up

Low-cost, low-power precision counting. Frequency division, programming, timing, memory storage, pulse delay and pulse shaping. These are only some of the assignments designers can call on the INCREMAG Series QC-10 to perform in industrial applications.

And look what you get, too! Greater simplicity, reliability and flexibility compared with standard binary componentry, as one benefit. You need only 8 transistors instead of 20 for a count ratio of 1,000:1. You use fewer associated components, much less power. Plan for continuous information storage without a power supply. The higher the count ratio, the more you can save.

More benefits—HAYDON performance. HAYDON dependability. HAYDON application assistance. For details on INCREMAG Series QC-10 write HAYDON Products, Industrial Controls Division, General Time Corporation, Thomaston, Connecticut.

## Outstanding Features

- Magnetic counting/dividing circuit delivers output pulse after receiving pre-set number of inputs
- No delay; automatic reset during delivery
- Handles odd or even numbers
- All solid state circuitry—two transistors per stage
- Low voltage—6VDC  $\pm$  15% @ 380 ma maximum
- Count memory—no loss of prior count even with power failure
- Not limited to binary logic—any count from 1 to 12, multi-staged units for counts over 12
- Cascaded single stages give composite count equal to product of fixed count stage. Counting rate from 10,000 cps to repetitive pulse one/day or lower. Plug-in to fit standard octal socket for rapid assembly
- 1.60 cubic inches per stage permits smaller end product design. Long life, high reliability, low cost.

Need additional flexibility? Investigate HAYDON'S adjustable count module QC-20 which provides expanded capabilities for many industrial applications. Block diagram below shows logic of the QC-20 adjustable count INCREMAG.

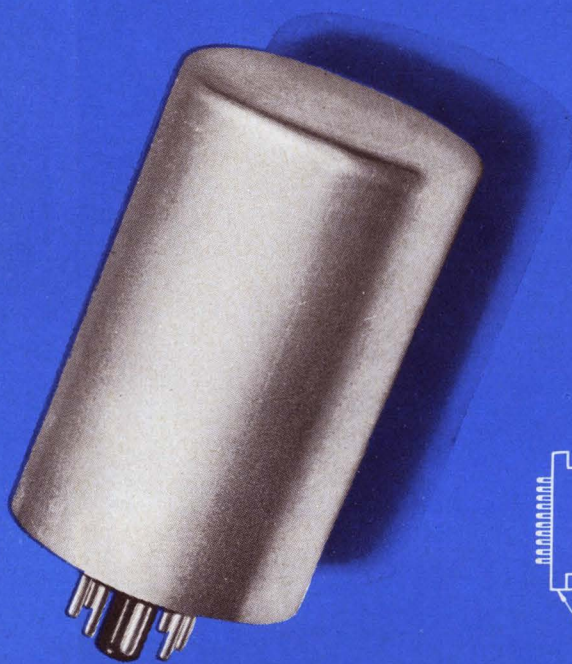

Adjustable count INCREMAG<sup>®</sup> module.  
Dimensional details

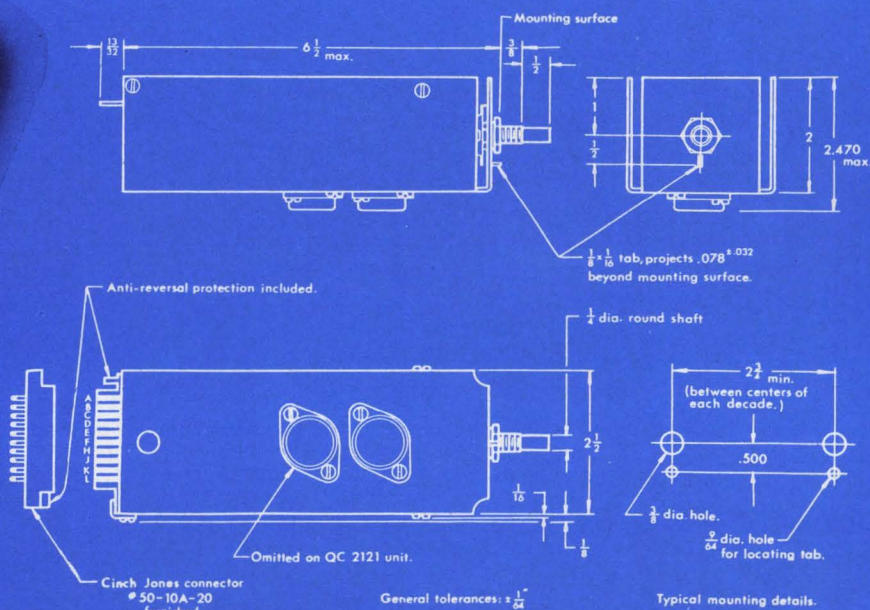

### BINARY CHAIN USED AS A 1000/1 FREQUENCY DIVIDER

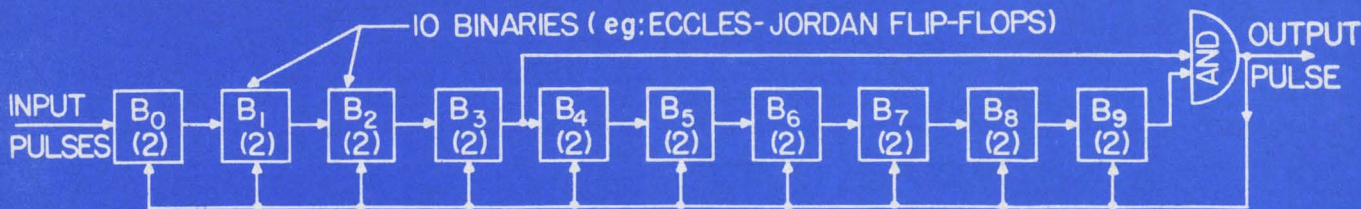

### INCREMAG MAGNETIC DECADE COUNTERS USED AS 1000/1 FREQUENCY DIVIDER



# ED Products

Miniature 14-bit A-D converter PAGE 110

Matrix programming boards have up to 6 decks PAGE 110

Differential op-amp has 100 dB gain PAGE 124

Coax microwave transistor gives 200 MW at 2 GHz PAGE 114

New high in SCR power PAGE 114

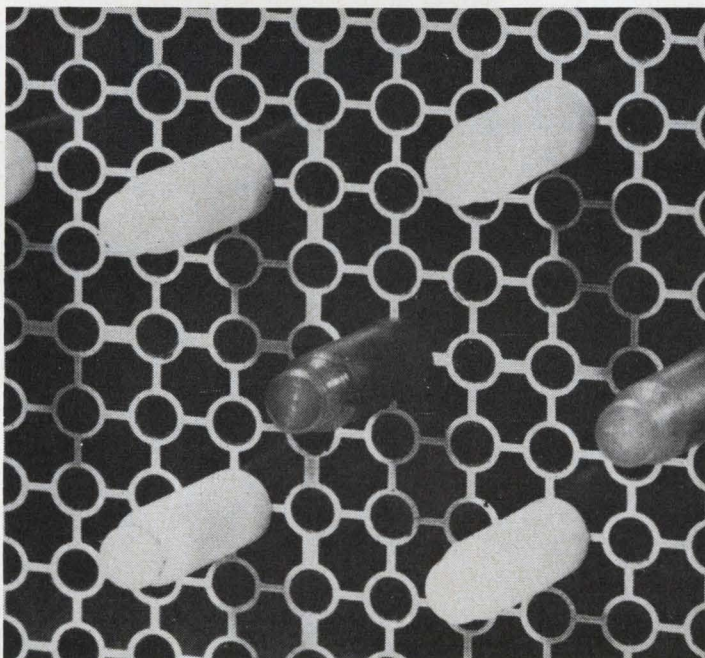

Matrix pinboards use rigid pins. . . 110

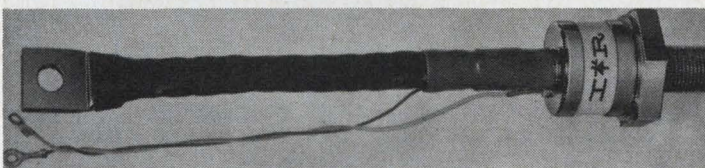

SCRs give up to 550A<sub>rms</sub> with conventional cooling. . . 114

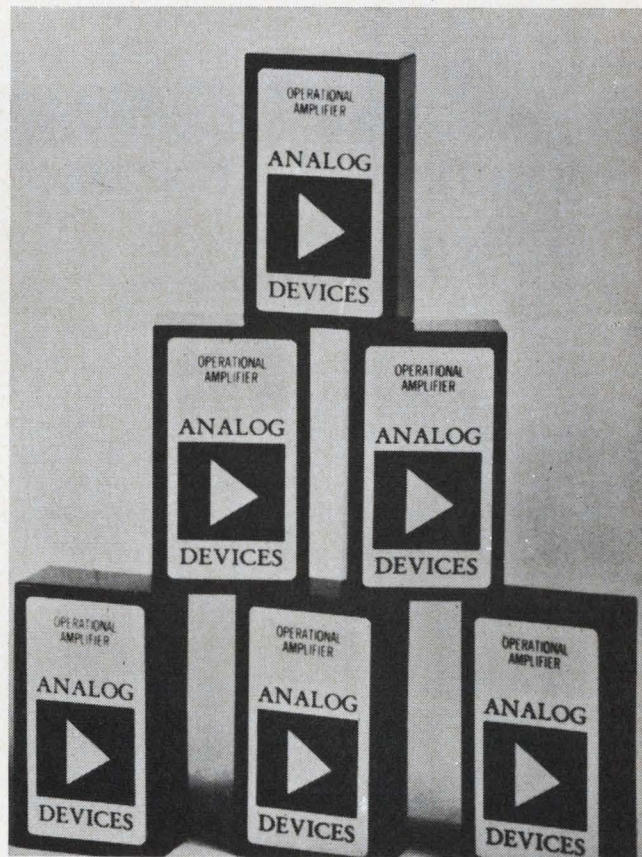

Building block for switching circuits. . . 124

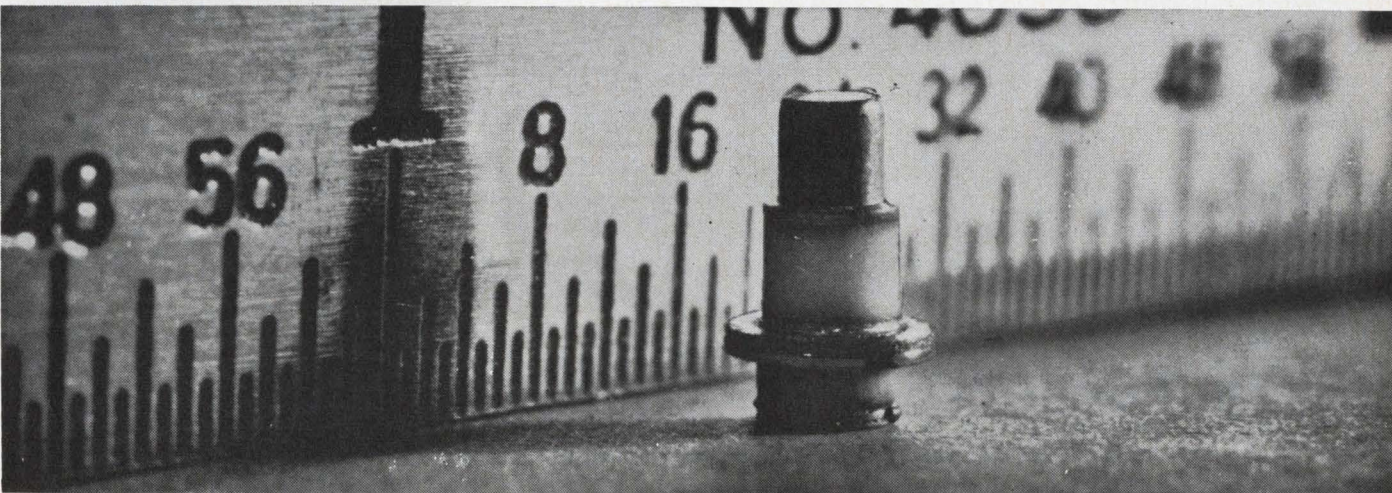

Coax transistor oscillates or amplifies microwaves. . . 114





# Now—Bourns Gives You a Complete Choice Of 7/8" Precision Potentiometers

Take your pick from the industry's finest, most extensive 7/8"-diameter precision potentiometer line:

BUSHING MOUNT	SERVO MOUNT
Model 3500, 10-turn	Model 3550, 10-turn
Model 3507, commercial 10-turn	Model 3560, 3-turn
Model 3510, 3-turn	Model 3570, 5-turn
Model 3520, 5-turn	Model 3580, single-turn*
Model 3530, single-turn	

\*Meets all requirements of MIL-R-12934C; can be ordered by Bourns model number or by MIL-Spec designation RR09.

In quantity and quality, this line is unmatched. Exclusive

SILVERWELD® multi-wire termination eliminates the chief cause of potentiometer failure. All-sealed construction insures MIL-Spec humidity performance (cycling and steady state). One hundred per cent inspection and the double-check follow-through of the Bourns Reliability Assurance Program are your final quality guarantees.

No matter what your requirements in precision potentiometers, you will find the answer at Bourns—the complete source. Write for technical data on our entire line of bushing- and servo-mount models, KNOBPOT® potentiometers, and turns-counting dials.

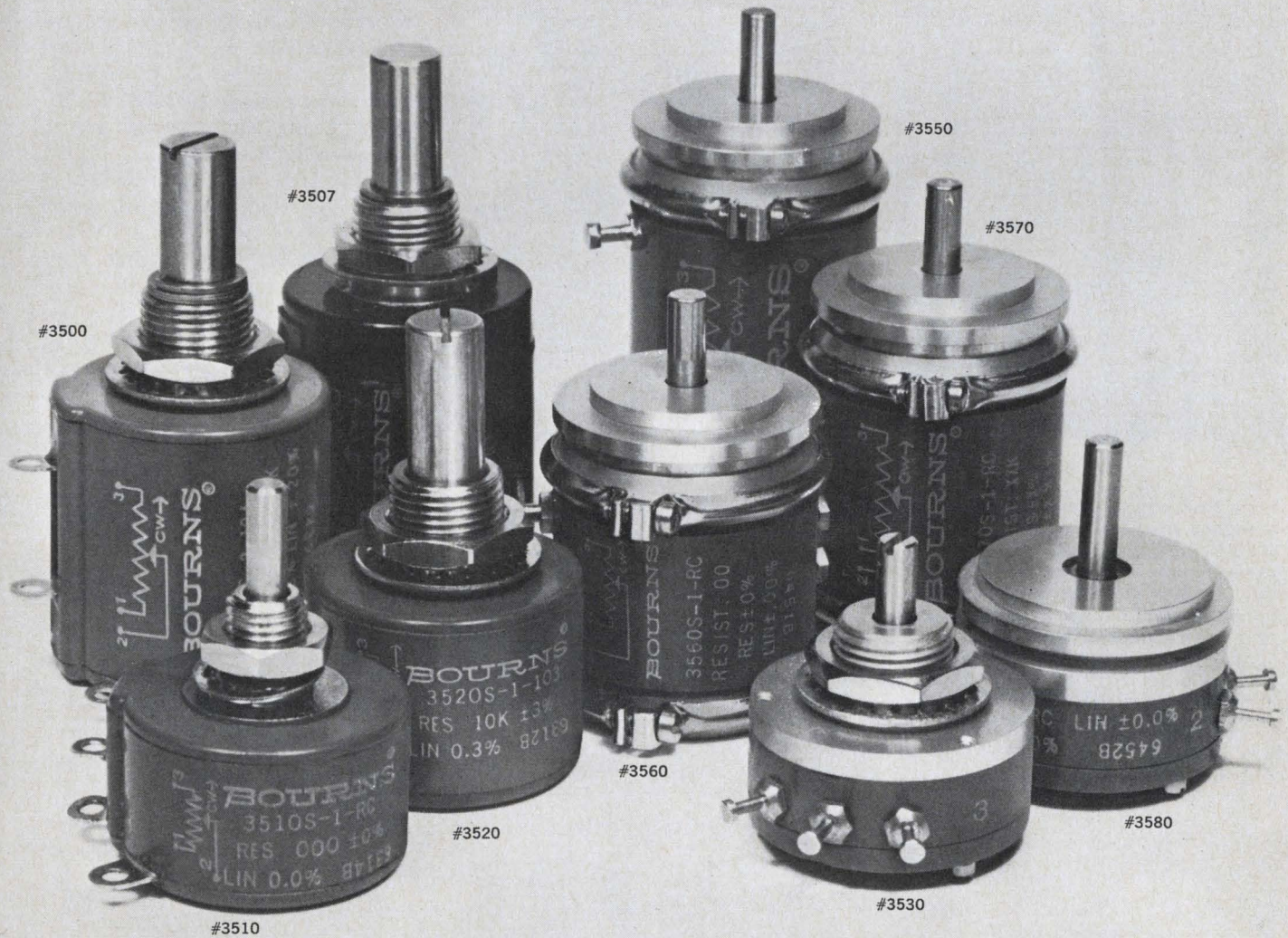

BOURNS, INC., TRIMPOT DIVISION  
1200 COLUMBIA AVE., RIVERSIDE, CALIF.  
PHONE 684-1700 • TWX: 714-682 9582  
CABLE: BOURNSINC.

New Member  
of the  
**QUALITY  
QUORUM**



**Bliley**  
TYPE  
**BK2 CRYSTALS**

Type BK2 was designed primarily for compact precision at 1 mc in high stability applications. A Koldweld sealed holder eliminates contamination due to heat and flux to assure optimum crystal performance. Typical parameters include:

- ▶ Maximum aging  $3 \times 10^{-8}$  per week
- ▶ Short term stability  $1 \times 10^{-8}$  per day
- ▶ Average Q 500,000

Type BK2 is also available on special order in range 900-1000 kc.

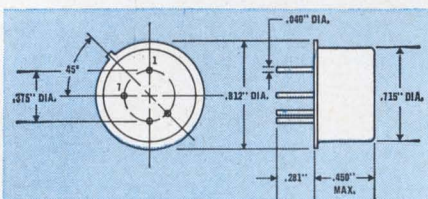

Request Bulletin 527B-S for complete information.

**Bliley** If you buy quality

**BLILEY ELECTRIC COMPANY**  
Union Station Bldg.  
Erie, Pennsylvania

ON READER-SERVICE CARD CIRCLE 121

## SYSTEMS

### Core memory system

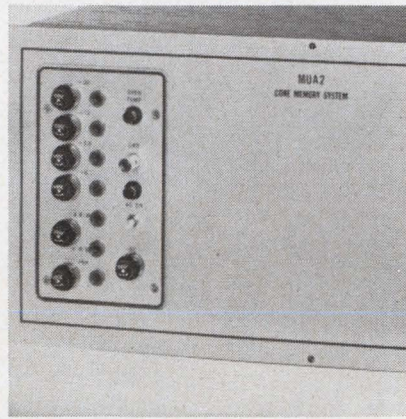

A full-cycle time of  $2 \mu\text{s}$  is the leading feature of the series MUA integrated circuit core memory system. The MUA is supplied in any of four access modes: random; sequential; random/sequential and sequential/interlaced.

The user can also select from a variety of interface circuits. Word capacities range from 64 to 4,096 with two to 30 bits per word.

Fabri-Tek, Inc., Amery, Wis.  
Phone: (715) 292-0900.

Circle No. 383

### Tape recorders

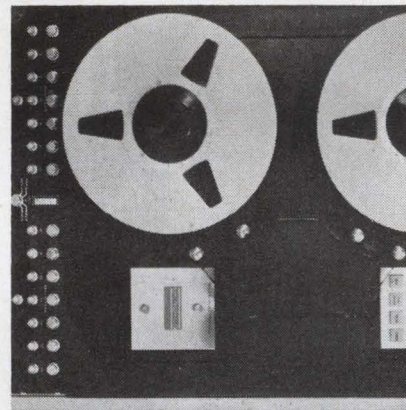

The W-7000 series of tape recorders are based on a concept in which two separate magnetic circuits are used for separation of the bias and record signals. This is said to eliminate the circuitry associated with record heads and provide for a sharper magnetic gradient on the tape. The IRIG systems provide harmonic distortion below 55 dB on all tracks of a 14-track tape.

Fairchild, Winston Research, 6711 S. Sepulveda, Los Angeles, Calif.  
Phone: (213) 670-3305.

Circle No. 384

### Buffer storage

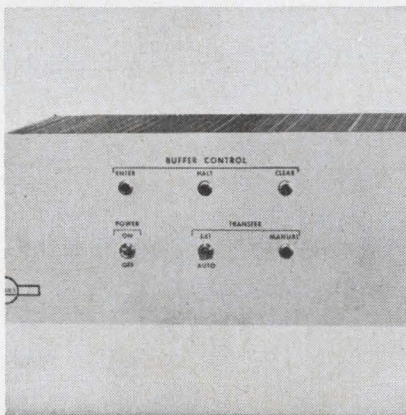

A modular storage approach allows the conversion of line-at-a-time punched tape information into parallel block outputs. The unit can be expanded to as many as four blocks. All circuitry required for control of the reader is included in the buffer. The unit is self contained and designed for relay-rack mounting compatible with several of the same manufacturer's tape readers.

Ex-Cell-O Corp, RemexDiv., Detroit, Mich. Phone: (313) 868-3900.

Circle No. 385

### Digital strip-printer

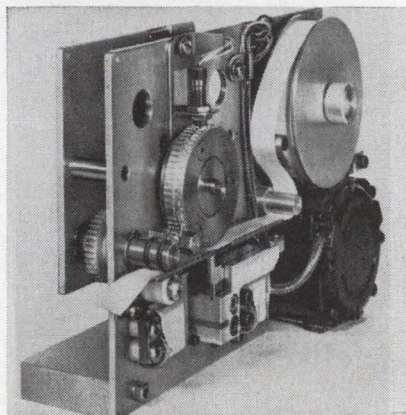

Model 120 digital strip-printer runs through its 63 characters at the rate of 20 per second. Printout is one-line (a la ticker-tape) on 1/2 in. paper tape. Character printing requires a 26 V pulse of 3.5 A for 1.3 ms. Input is 105-125 Vac. Dimensions of the unit are 3 x 6-1/4 x 8-5/8-in.

Price: \$200-\$300, depending on options and quantities. Franklin Electronics, Div. Anelex Corp., Bridgeport, Pa. Phone: (215) 272-4800.

Circle No. 386

# Simpson

## STOCK PANEL METERS

OVER 1325 STOCK  
SIZES AND TYPES



*The Original Wide-Vue design  
by Simpson*

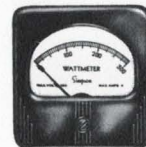
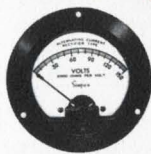
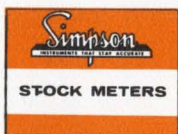

© COPYRIGHT SIMPSON ELECTRIC CO. 1965



**SIMPSON ELECTRIC COMPANY**

5200 WEST KINZIE STREET, CHICAGO, ILLINOIS 60644 · AREA CODE 312, 379-1121

INDEX	SIZE	PAGE
Wide Vue Style	1½" - 4½" - 8"	2-5
Taut Band Meters	1½" - 4½"	3-7
Standard Round & Rectangular Styles	2½" - 4½"	6-10
Special Rectangular Style	6"	11
Elapsed Time Meters	3½"	11
Segmental Voltmeters	2½", 3½", 4½", 4"x6"	12-13
Edgewise	1½", 2½"	14-15
Meter Relays	4½"	16-17
Rugged Seal	3¼", 4½", 4"x6"	18
Accessories		19
260 VOM's and other test equipment		20-23

# 1½", 2½", 3½", 4½", 8" WIDE-VUE PANEL METERS

## CASE STYLES



1½" Models

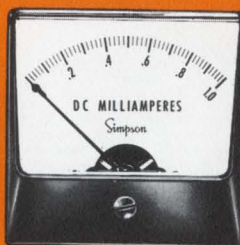

2½" Models

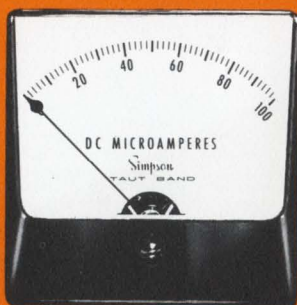

3½" Models

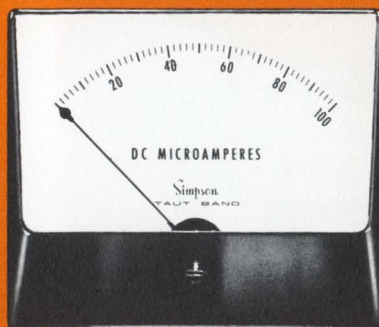

4½" Models

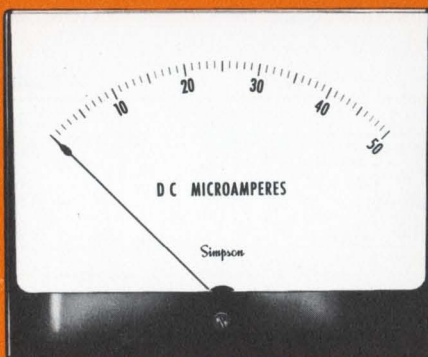

8" Models

# "INSTRUMENTS THAT STAY ACCURATE"

## STOCK PANEL METER RANGES AND PRICES

CALIBRATION AND DIALS—All DC Wide-Vue meters listed below have the Simpson self-shielded movement (Calibration not affected by stray magnetic fields or magnetic mounting). All AC Wide-Vue meters have the Simpson Iron-vane type movement. AC Milliammeters and Ammeters are calibrated for use on 25 through 800 cps. All AC Voltmeters are calibrated for use on 25 through 125 cps. Calibration at frequencies up to 800 cps can be made. Contact your local Distributor for prices.

APPROX. RANGE	RESISTANCE (ohms)	1½"		2½"		3½"		4½"	
		CASE STYLE CAT. NO.	PRICE	CASE STYLE CAT. NO.	PRICE	CASE STYLE CAT. NO.	PRICE	CASE STYLE CAT. NO.	PRICE
<b>DC VOLTMETERS</b>									
Self Shielding Meter Movement									
		<b>MODEL 1212</b>		<b>MODEL 1227</b>		<b>MODEL 1327</b>		<b>MODEL 1329</b>	
0-5	1000 ohms per volt	9540	\$14.10	9550	\$15.30	9720	\$15.75	9870	\$17.40
0-8		Note <sup>1</sup>	Note <sup>1</sup>	Note <sup>1</sup>	Note <sup>1</sup>	9730	15.75	9880	17.40
0-10		9541	14.10	9560	15.30	9740	15.75	9890	17.40
0-15		9542	14.10	9570	15.30	9750	15.75	9900	17.40
0-25		9543	14.10	9580	15.30	9760	15.75	9910	17.40
0-30		9544	14.10	9590	15.30	9770	15.75	9920	17.40
0-50		9545	14.10	9600	15.30	9780	15.75	9930	17.40
0-100		9546	14.10	9610	15.30	9790	15.75	9940	17.40
0-150		9547	14.10	9620	15.30	9800	15.75	9950	17.40
0-200		Note <sup>1</sup>	Note <sup>1</sup>	9622	15.30	9810	15.75	9960	17.40
0-250	Note <sup>1</sup>	Note <sup>1</sup>	9623	15.30	9820	15.75	9970	17.40	
0-300	Note <sup>1</sup>	Note <sup>1</sup>	9630	15.30	9830	15.75	9980	17.40	
0-300	2000 ohms per volt	9548	14.10	Note <sup>1</sup>	Note <sup>1</sup>	Note <sup>1</sup>	Note <sup>1</sup>	Note <sup>1</sup>	Note <sup>1</sup>
0-500		9549*	17.70	9640	15.75	9840	16.50	9990	17.85
0-750		Note <sup>1</sup>	Note <sup>1</sup>	9650	19.35	9850	16.50	10000	17.85
0-1000		Note <sup>1</sup>	Note <sup>1</sup>	9660*	19.65	9860*	20.55	10010*	21.90
<b>DC AMMETERS</b>									
Self Shielding Meter Movement									
		<b>MODEL 1212</b>		<b>MODEL 1227</b>		<b>MODEL 1327</b>		<b>MODEL 1329</b>	
0-1	.050	2431	\$14.10	2440	\$14.40	2640	\$15.15	2820	\$16.50
0-1.5	.033	Note <sup>1</sup>	Note <sup>1</sup>	2450	14.40	2650	15.15	2830	16.50
0-2	.025	2432	14.10	2460	14.40	2660	15.15	2840	16.50
0-3	.0166	2433	14.10	2470	14.40	2670	15.15	2850	16.50
0-5	.010	2434	14.10	2480	14.40	2680	15.15	2860	16.50
0-10	.005	2435	14.10	2490	14.40	2690	15.15	2870	16.50
0-15	.0033	2436†	14.10	2500	14.40	2700	15.15	2880	16.50
0-25	.0020	2437	14.10	2510	14.40	2710	15.15	2890	16.50
0-30	.0017	Note <sup>1</sup>	Note <sup>1</sup>	2520	14.40	2720	15.15	2900	16.50
0-50	.001	2438†	14.10	2530	14.40	2730†	15.15	2910†	16.50
0-100	10.0	Note <sup>1</sup>	Note <sup>1</sup>	2540†	14.40	2740†	15.15	2920†	16.50
0-150	10.0	Note <sup>1</sup>	Note <sup>1</sup>	2550	14.40	2750†	15.15	2930†	16.50
0-200	10.0	Note <sup>1</sup>	Note <sup>1</sup>	2552†	14.40	2760†	15.15	2940†	16.50
0-300	10.0	Note <sup>1</sup>	Note <sup>1</sup>	2554†	14.40	2770†	15.15	2950†	16.50
0-500	10.0	Note <sup>1</sup>	Note <sup>1</sup>	Note <sup>1</sup>	Note <sup>1</sup>	2780†	15.15	2960†	16.50
15-0-15	.0033	Note <sup>1</sup>	Note <sup>1</sup>	Note <sup>1</sup>	Note <sup>1</sup>	2790	16.05	Note <sup>1</sup>	Note <sup>1</sup>
30-0-30	.0017	Note <sup>1</sup>	Note <sup>1</sup>	Note <sup>1</sup>	Note <sup>1</sup>	2800	16.05	Note <sup>1</sup>	Note <sup>1</sup>
50-0-50	.001	Note <sup>1</sup>	Note <sup>1</sup>	Note <sup>1</sup>	Note <sup>1</sup>	2810	16.05	Note <sup>1</sup>	Note <sup>1</sup>

Note<sup>1</sup> Not normally carried in stock. Distributor delivery 2-3 weeks. Prices on request.

\*External Multipliers, Model 183, are furnished on 1½" DC meters 500 volts or higher; on 2½" DC meters 750 volts or higher; and on 3½" and 4½" DC meters 1000 volts or higher. All others are self-contained.

†1½" DC Ammeters are self-contained through 10 amps. 15 amps and higher are supplied as 50 MV meters to be used with external shunts. 2½", 3½" and 4½" DC ammeters are self-contained through 50 amps. Higher range DC ammeters are 50 MV meters to be used with external shunts. Shunt listings are on page 17.

## NEW 3½" and 4½" BEHIND PANEL BEZELS

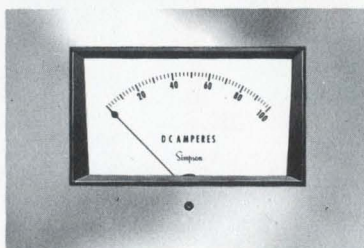

### NEW 3½" and 4½" WIDE VUE BEHIND THE PANEL MOUNTING BEZEL KITS

Modern, streamlined appearance, interchangeable with most popular recess and flush mount types. See pages 16 and 17 for complete specifications.

# SPECIFICATIONS

SIZE	MODEL NO.	ACCURACY	SCALE LENGTH
1 1/2"	1212T	± 2% of full scale	1.5" (38.1 mm)
	1214	± 3% F. S. @ 25° C. & 60 cy. Sine Wave	
2 1/2"	1227T, 1257	± 2% of full scale	2.5" (63.8 mm)
	1247	± 3% F. S. @ 25° C. & 60 cy. Sine Wave	
3 1/2"	1327T, 1337, 1357	± 2% of full scale	3.14" (79.7 mm)
	1347	± 3% F. S. @ 25° C. & 60 cy. Sine Wave	
4 1/2"	1329T, 1339, 1359	± 2% of full scale	3.93" (100 mm)
	1349	± 3% F. S. @ 25° C. & 60 cy. Sine Wave	
8"	728T	± 2% of full scale	6.9" (174.2 mm)

RANGE	RESISTANCE (ohms)	1 1/2" CASE STYLE		2 1/2" CASE STYLE		3 1/2" CASE STYLE		4 1/2" CASE STYLE	
		CAT. NO.	PRICE	CAT. NO.	PRICE	CAT. NO.	PRICE	CAT. NO.	PRICE
<b>DC MILLIAMMETERS</b>									
Self Shielding Meter Movement									
		<b>MODEL 1212</b>		<b>MODEL 1227</b>		<b>MODEL 1327</b>		<b>MODEL 1329</b>	
0-1 1/2	43	6163	\$13.65	6175	\$14.25	6310	\$14.85	6470	\$15.75
0-3	2.0	Note <sup>1</sup>	Note <sup>1</sup>	6180	14.25	6320	14.85	6480	15.75
0-5	2.0	6164	13.65	6190	14.25	6330	14.85	6490	15.75
0-10	10.0	6165	13.65	6200	14.25	6340	14.85	6495	15.75
0-15	6.6	6166	13.65	6210	14.25	6350	14.85	6502	15.75
0-20	5.0	Note <sup>1</sup>	Note <sup>1</sup>	6215	14.25	6360	14.85	6524	15.75
0-25	4.0	6167	14.10	6220	14.55	6370	15.30	6530	16.50
0-50	2.0	6168	14.10	6230	14.55	6380	15.30	6540	16.50
0-100	1.0	6169	14.10	6240	14.55	6390	15.30	6550	16.50
0-150	.66	6170	14.10	6250	14.55	6400	15.30	6560	16.50
0-200	.5	6171	14.10	6260	14.55	6410	15.30	6570	16.50
0-250	.4	6172	14.10	6270	14.55	6420	15.30	6580	16.50
0-300	.33	6173	14.10	6280	14.55	6430	15.30	6590	16.50
0-500	.2	6174	14.25	6290	14.55	6440	15.30	6600	16.50
0-750	.13	Note <sup>1</sup>	Note <sup>1</sup>	Note <sup>1</sup>	Note <sup>1</sup>	6450	15.30	6610	16.50
0-1000	.05	Note <sup>1</sup>	Note <sup>1</sup>	6292	14.55	6460	15.30	6620	16.50

RANGE	RESISTANCE (ohms)	1 1/2" CASE STYLE		2 1/2" CASE STYLE		3 1/2" CASE STYLE		4 1/2" CASE STYLE	
		CAT. NO.	PRICE	CAT. NO.	PRICE	CAT. NO.	PRICE	CAT. NO.	PRICE
<b>DC MICROAMMETERS</b>									
Self Shielding Meter Movement									
		<b>MODEL 1212</b>		<b>MODEL 1227</b>		<b>MODEL 1327</b>		<b>MODEL 1329</b>	
0-50†	1800	4294	\$17.85	4310	\$18.45	4380	\$18.90	4480	\$20.40
0-100	1800	4295	15.90	4320	16.50	4390	17.25	4490	19.20
0-200	1100	4296	14.40	4330	15.75	4400	15.75	4500	17.40
0-500	90	4297	14.10	4340	14.85	4410	15.45	4510	16.80
25-0-25	1800	4298	18.00	Note <sup>1</sup>	Note <sup>1</sup>	4420	19.05	4520	20.55
50-0-50†	1800	4302	16.05	4350	16.80	4430	17.40	4530	19.35
100-0-100	1100	4300	14.55	4351	15.30	4440	15.90	4540	17.55
500-0-500	43	4301	13.80	4352	14.40	4450	15.15	4550	15.90

RANGE	RESISTANCE (ohms)	1 1/2" CASE STYLE		2 1/2" CASE STYLE		3 1/2" CASE STYLE		4 1/2" CASE STYLE		8" CASE STYLE	
		CAT. NO.	PRICE	CAT. NO.	PRICE	CAT. NO.	PRICE	CAT. NO.	PRICE	CAT. NO.	PRICE
<b>TAUT BAND DC MICROAMMETERS</b>											
Self Shielding Meter Movement											
		<b>MODEL 1212T</b>		<b>MODEL 1227T</b>		<b>MODEL 1327T</b>		<b>MODEL 1329T</b>		<b>MODEL 728T</b>	
0-5	5750	—	—	—	—	4358†	\$33.60	4458†	\$35.85	—	—
0-10	4900	—	—	4303	\$28.50	4359	29.70	4459	32.10	—	—
0-15	1960	4601•	\$25.50	4304	25.50	4361	26.40	4461	28.80	—	—
0-25	1960	4602•	22.35	4306	22.80	4371	23.85	4471	26.10	11200•	\$33.60
0-50	1100	4603•	19.50	4311	20.10	4381	20.55	4481	22.05	11201•	29.55
0-100	500	4604•	17.55	4321	18.15	4391	18.90	4491	20.85	11203•	28.50
0-200	234	4605•	16.20	4331	17.10	4401	17.70	4501	19.50	Note <sup>1</sup>	Note <sup>1</sup>

†Resistance of 0-50 Mic Meter in Model 1212 is 5500 ohms.  
 †Resistance of 0-500 Mic Meter in Model 1212 is 190 ohms.  
 †High flux annular taut band meter movement.

•New Panel Meter Addition.  
 ‡Available in 8" size: Model 728—Catalog No. 11210... \$26.10.

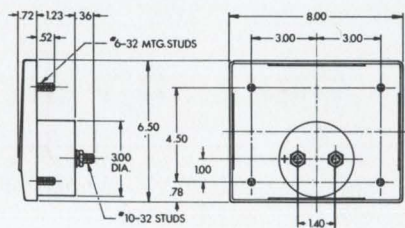

8" Model 728T

# DIMENSIONS

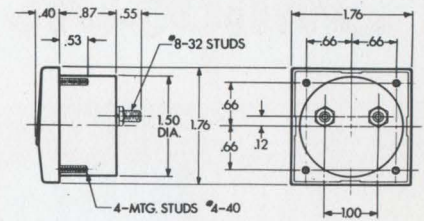

1 1/2" Models 1212, 1214

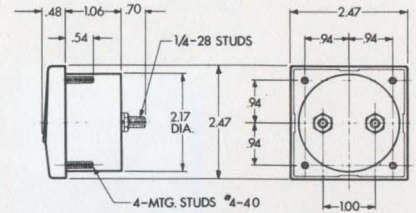

2 1/2" Models 1227, 1247, 1257

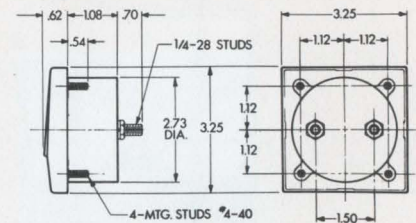

3 1/2" Models 1327, 1337, 1347, 1357

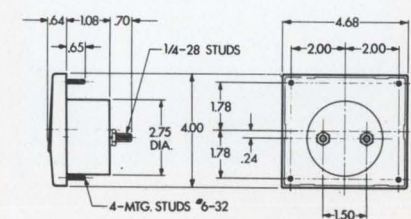

4 1/2" Models 1329, 1339, 1349, 1359

SIMPSON PANEL METERS ARE CARRIED IN STOCK BY ELECTRONIC DISTRIBUTORS EVERYWHERE.

# Simpson

## 1½", 2½", 3½", 4½" WIDE-VUE PANEL METERS

### CASE STYLES



1½" Models



2½" Models



3½" Models

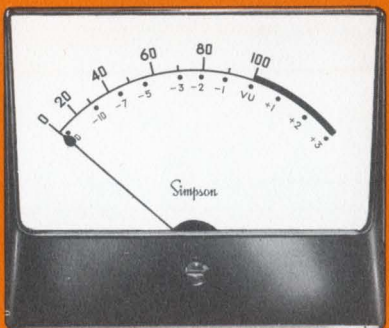

4½" Models

## SIMPSON STOCK METER RANGES AND PRICES

**CALIBRATION AND DIALS**—All DC Wide-Vue meters listed below have the Simpson self-shielded movement (Calibration not affected by stray magnetic fields or magnetic mounting). All AC Wide-Vue meters have the Simpson Iron-vane type movement. AC Milliammeters and Ammeters are calibrated for use on 25 through 800 cps. All AC Voltmeters are calibrated for use on 25 through 125 cps. Calibration at frequencies up to 800 cps can be made. Contact your local Distributor for prices.

### SPECIFICATIONS

SIZE	MODEL NO.	ACCURACY	SCALE LENGTH
1½"	1212	±2% of full scale	1.5" (38.1 mm)
	1214	±3% F. S. @ 25° C. & 60 cy. Sine Wave	
2½"	1227, 1237, 1257, 1277	±2% of full scale	2.5" (63.8 mm)
	1247	±3% F. S. @ 25° C. & 60 cy. Sine Wave	
3½"	1327, 1337, 1357, 1377	±2% of full scale	3.14" (79.7 mm)
	1347	±3% F. S. @ 25° C. & 60 cy. Sine Wave	
4½"	1329, 1339, 1359, 1379*	±2% of full scale*	3.93" (100 mm)
	1349	±3% F. S. @ 25° C. & 60 cy. Sine Wave	

\*Compensated Wattmeters ±3%.

RANGE	APPROX. RESISTANCE (ohms)	1½" CASE STYLES CAT. NO. PRICE	2½" CASE STYLES CAT. NO. PRICE	3½" CASE STYLES CAT. NO. PRICE	4½" CASE STYLES CAT. NO. PRICE	
<b>DC MILLIVOLTMETER</b> Self Shielding Meter Movement						
		MODEL 1212	MODEL 1227	MODEL 1327	MODEL 1329	
0-50	10	7005 \$14.10	7010 \$14.40	7020 \$15.15	7030 \$16.50	
50-0-50	20	— —	— —	7021 15.15	7031 16.50	
<b>RF AMMETERS</b> Self Shielding Meter Movement						
				MODEL 1337	MODEL 1339	
0-1	.343	— —	— —	2970 \$17.55	3050 \$20.10	
0-1.5	.200	— —	— —	2980 17.55	3060 20.10	
0-2	.120	— —	— —	2990 17.55	3070 20.10	
0-2.5	.10	— —	— —	3000 17.55	3080 20.10	
0-3	.08	— —	— —	3010 17.55	3090 20.10	
0-5	.045	— —	— —	3020 17.55	3100 20.10	
0-8	.031	— —	— —	3030 17.55	3110 20.10	
0-10	.023	— —	— —	3040 17.55	3120 20.10	
<b>RF MILLIAMMETERS</b> Self Shielding Meter Movement						
0-500	.63	— —	— —	5362 \$20.70	5364 \$23.40	
<b>AC VOLTMETERS RECTIFIER TYPE</b> Self Shielding Meter Movement						
		MODEL 1214	MODEL 1247	MODEL 1347	MODEL 1349	
0-5	2000 OHMS PER VOLT	10011 \$19.50	10015 \$18.15	10020 \$20.25	10090 \$22.20	
0-10		10012 19.50	10016 18.15	10030 20.25	10100 22.20	
0-15		Note <sup>1</sup> Note <sup>1</sup>	Note <sup>1</sup> Note <sup>1</sup>	10040 20.25	10110 22.20	
0-50		Note <sup>1</sup> Note <sup>1</sup>	Note <sup>1</sup> Note <sup>1</sup>	10050 20.25	10120 22.20	
0-150		10013 19.50	10017 18.15	10060 20.25	10130 22.20	
0-300		10014 19.50	10018 18.15	10070 20.25	10140 22.20	
<b>VOLUME LEVEL INDICATORS DECIBEL METERS</b> Self Shielding Meter Movement						
	RANGE		MODEL 1247	MODEL 1347	MODEL 1349	
	Zero Power Level—6 MW. 500 Ohm Line					
<b>General-Purpose 5000 ohms</b>		— —	3483 \$20.40	3485 \$21.60	3487 \$22.35	
<b>VOLUME LEVEL INDICATORS V. U. METERS†</b> Self Shielding Meter Movement						
	Reference Level—1 MW. 600 Ohm Line		MODEL 1214	MODEL 1247	MODEL 1347	MODEL 1349
	A—Scale	10472 \$21.90	10474 \$24.15	10480 \$24.75	10490 \$26.10	
	B—Scale	Note <sup>1</sup> Note <sup>1</sup>	Note <sup>1</sup> Note <sup>1</sup>	10550 24.75	10560 26.10	
<b>DC GALVANOMETERS</b> Self Shielding Meter Movement						
	SENSITIVITY RESISTANCE		MODEL 1212	MODEL 1227	MODEL 1327	MODEL 1329
	RANGE AMPERES (ohms)					
50-0-50	500-0-500	43	3692 13.80	3700 \$14.25	3730 \$15.15	3732 \$15.90
50-0-50	75-0-75	1800	3694 \$14.55	3710 15.45	3720 16.80	3734 18.45

Note<sup>1</sup> Not normally carried in stock. Distributor delivery 2-3 weeks. Prices on request.

†Simpson VU meters meet all the Electrical and Ballistic specifications established by Bell Laboratories and American Standards Association as required by broadcasting, communication and sound engineers. They are available with either type A or B scales. Type A scale stresses the level in VU for monitoring wire lines. Type B scale stresses per cent use of transmitter output and is the standard for broadcast service.

## DIMENSIONS

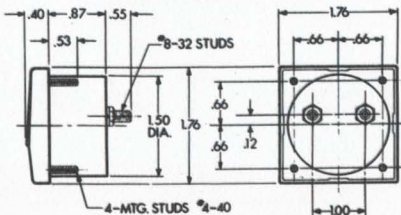

1 1/2" Models 1212, 1214

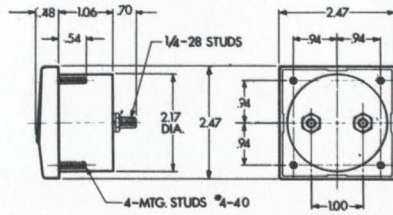

2 1/2" Models, 1227, 1237, 1247

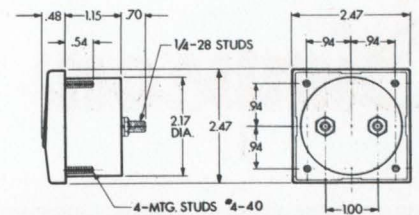

2 1/2" Models 1257

## WIDE-VUE PANEL METERS

RANGE	APPROX. RESISTANCE (ohms)	2 1/2" CASE STYLE CAT. NO.	2 1/2" PRICE	3 1/2" CASE STYLE CAT. NO.	3 1/2" PRICE	4 1/2" CASE STYLE CAT. NO.	4 1/2" PRICE
<b>AC VOLTMETERS</b> Iron Vane Type Movement							
		<b>MODEL 1257</b>		<b>MODEL 1357</b>		<b>MODEL 1359</b>	
0-5	33	—	—	10160	\$13.95	10260	\$15.90
0-10	133	9670	\$13.65	10170	13.95	10270	15.90
0-15	300	9675	13.65	10180	13.95	10280	15.90
0-25	833	9680	13.80	10190	14.40	10290	16.05
0-50	3,333	9690	13.80	10200	14.40	10300	16.05
0-100	16,666	9695	14.10	10210	15.15	10310	16.20
0-150	25,000	9700	14.40	10220	15.45	10320	16.50
0-250	41,166	9705	14.40	10230	15.45	10330	16.50
0-300	50,000	9710	14.40	10240	15.45	10340	16.50
0-500*	83,333	9715	18.45	10250	19.65	10350	21.00
<b>AC AMMETERS</b> Iron Vane Type Movement							
		<b>MODEL 1257</b>		<b>MODEL 1357</b>		<b>MODEL 1359</b>	
0-1	.287	2560	\$12.90	3130	\$13.80	3260	\$16.05
0-1.5	.185	2570	12.90	3140	13.80	3270	16.05
0-2	.115	—	—	3150	13.80	3280	16.05
0-3	.027	2575	12.90	3160	13.80	3290	16.05
0-5	.012	2580	12.90	3170	13.80	3300	16.05
0-10	.0031	2590	12.90	3180	13.80	3310	16.05
0-15	.0022	2599	12.90	3190	13.80	3320	16.05
0-25	.0003	2609	13.65	3200	14.25	3330	16.50
0-30	.0003	2615	13.65	3205	14.25	3335	16.50
0-50	.0006	2619	13.65	3210	14.25	3340	16.50
0-75	.0005	—	—	3215	15.45	3345	17.70
0-100	.012	2622†	12.90	3220†	13.80	3350†	16.05
0-150	.012	2624†	12.90	3230†	13.80	3360†	16.05
0-200	.012	2626†	12.90	3240†	13.80	3370†	16.05
0-300	.012	2627†	12.90	3250†	13.80	3380†	16.05
<b>AC MILLIAMMETERS</b> Iron Vane Type Movement							
		<b>MODEL 1257</b>		<b>MODEL 1357</b>		<b>MODEL 1359</b>	
0-10	2,000	6294	\$12.90	6625	\$13.80	6665	\$16.05
0-50	80	6295	12.90	6630	13.80	6670	16.05
0-100	20	6296	12.90	6640	13.80	6680	16.05
0-250	5	6297	12.90	6650	13.80	6690	16.05
0-500	.9	6300	12.90	6660	13.80	6699	16.05
<b>WATTMETERS</b> DYNAMOMETER TYPE Single Phase							
RANGE WATTS	RANGE VOLTS	MAX. AMPS	Wattmeters calibrated for either magnetic or non-magnetic panels and for a frequency range of 25-125 cycles.		MODEL 1379		
0-75	150	1.0	—	—	—	—	10960• \$38.55
0-150	150	2.0	—	—	—	—	10970• 38.55
0-300	150	4.0	—	—	—	—	10975• 38.55
0-750	150	10.0	—	—	—	—	10990• 38.55
0-600	300	4.0	—	—	—	—	10980• 41.25
0-1500	300	10.0	—	—	—	—	11000• 41.25
0-3000	300	20.0	—	—	—	—	11010• 41.25
<b>COMPENSATED WATTMETERS</b> ACCURACY ±3% F.S. MODEL 1379							
0-10	300	.175	—	—	—	—	10930• 51.45
0-20	300	.400	—	—	—	—	10940• 51.45
0-30	300	.650	—	—	—	—	10950• 51.45

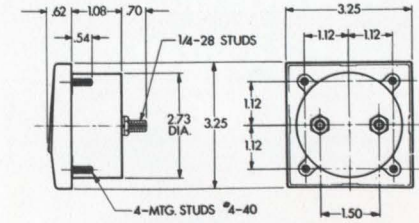

3 1/2" Models 1327, 1337, 1347

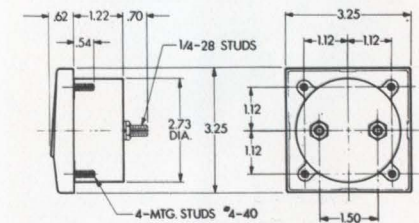

3 1/2" Model 1357

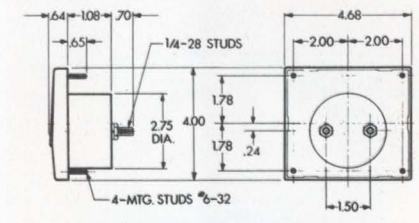

4 1/2" Models 1329, 1339, 1349

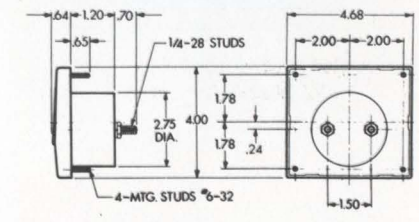

4 1/2" Model 1359

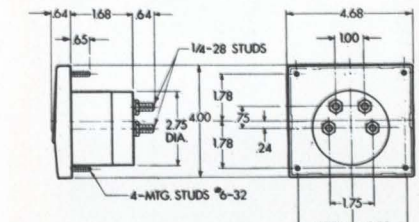

4 1/2" Model 1379

\*External Multipliers, Model 183, (Featured on page 17) are furnished on AC meters having a range of 500 volts or higher. All others are self-contained.

†2 1/2" AC ammeters are self-contained through 50 amps. 3 1/2" and 4 1/2" AC ammeters self-contained through 75 amps. Higher range AC ammeters are 5 amp meters to be used with external current transformer. See page 17 for current transformer listings.

•New Model Additions.

# Simpson

## INSTRUMENTS THAT

2½", 3½", 4½"

- ROUND and
- RECTANGULAR STOCK METERS



2½" Models 127, 157  
3½" Models 27, 57



2½" Models 125, 155  
3½" Models 25, 55

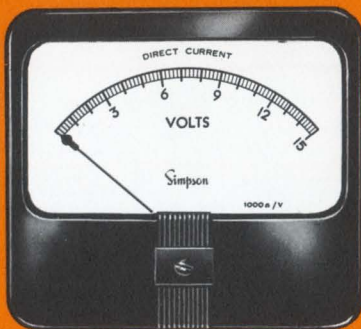

4½" Model 29

### SIMPSON STOCK METER RANGES AND PRICES

CALIBRATION AND DIALS—All DC meters listed below have the Simpson self-shielded movement (Calibration not affected by stray magnetic fields or magnetic mounting).

RANGE	APPROX. RESISTANCE (Ohms)	2½"		3½"		4½"				
		CASE STYLES CATALOG NOS.	PRICE	CASE STYLES CATALOG NOS.	PRICE	CASE STYLES CAT. NO.	PRICE			
<b>DC VOLTMETERS</b> Self Shielding Meter Movement		<b>MODELS 125 127</b>		<b>MODELS 25 27</b>		<b>MODEL 29</b>				
0-1.5	1000 ohms per volt	8850	9020	\$14.40	Note <sup>1</sup>	7290	\$14.85	7620	\$16.35	
0-3		8860	9030	14.40	7070	7300	14.85	7630	16.35	
0-5		8870	9040	14.40	7080	7310	14.85	7640	16.35	
0-8		8880	9050	14.40	Note <sup>1</sup>	7320	14.85	7650	16.35	
0-10		8890	9060	14.40	7100	7330	14.85	7660	16.35	
0-15		8900	9080	14.40	7110	7350	14.85	7670	16.35	
0-25		8910	9090	14.40	7120	7360	14.85	7680	16.35	
0-30		8920	9100	14.40	7130	7370	14.85	7690	16.35	
0-50		8930	9110	14.40	7140	7380	14.85	7700	16.35	
0-100		8940	9130	14.40	7150	7400	14.85	7710	16.35	
0-150		8950	9140	14.40	7160	7410	14.85	7720	16.35	
0-200		8960	9160	14.40	7170	7430	14.85	7730	16.35	
0-250		8970	9170	14.40	7180	7440	14.85	7740	16.35	
0-300		Note <sup>1</sup>	9180	14.40	7190	7450	14.85	7750	16.35	
0-500		Note <sup>1</sup>	9200	15.25	7200	7470	15.60	7760	16.95	
0-750	2000 ohms per volt	Note <sup>1</sup>	Note <sup>1</sup>	Note <sup>1</sup>	7210	7490	15.60	7770	16.95	
0-1000		Note <sup>1</sup>	Note <sup>1</sup>	Note <sup>1</sup>	7220†	7495†	19.35	7780†	21.15	
0-1500		Note <sup>1</sup>	Note <sup>1</sup>	Note <sup>1</sup>	7230†	7520†	19.65	7790†	21.45	
0-2000		Note <sup>1</sup>	9225†	19.35	7240†	7530†	20.10	7800†	21.90	
0-2500		Note <sup>1</sup>	Note <sup>1</sup>	Note <sup>1</sup>	Note <sup>1</sup>	7550†	20.40	7810†	22.20	
0-3000		Note <sup>1</sup>	Note <sup>1</sup>	Note <sup>1</sup>	7260†	7560†	20.70	7820†	22.50	
0-4000		Note <sup>1</sup>	Note <sup>1</sup>	Note <sup>1</sup>	Note <sup>1</sup>	Note <sup>1</sup>	—	7830†	22.80	
0-5000		Note <sup>1</sup>	Note <sup>1</sup>	Note <sup>1</sup>	7280†	7600†	21.30	7840†	23.10	
<b>DC AMMETERS</b> Self Shielding Meter Movement		<b>MODELS 125 127</b>		<b>MODELS 25 27</b>		<b>MODEL 29</b>				
0-1		.050	1460	1680	\$14.25	0005	0230	\$14.70	0450	\$16.20
0-1.5		.033	1470	1690	14.25	0020	0240	14.70	0460	16.20
0-2		.025	Note <sup>1</sup>	1709	14.25	0030	0250	14.70	0470	16.20
0-3		.0166	1490	1710	14.25	0040	0260	14.70	0480	16.20
0-5		.010	1500	1720	14.25	0050	0270	14.70	0490	16.20
0-10		.005	1510	1730	14.25	0060	0280	14.70	0500	16.20
0-15	.0033	1520	1740	14.25	0070	0290	14.70	0512	16.20	
0-25	.0020	1530	1750	14.25	0080	0300	14.70	0520	16.20	
0-30	.0017	1540	1760	14.25	0090	0310	14.70	0530	16.20	
0-50	.001	1550	1770	14.25	0099	0320	14.70	0540	16.20	
0-75	10.0	1560†	1780†	13.80	0110†	0330†	14.25	0550†	15.90	
0-100	10.0	1570†	1790†	13.80	0120†	0340†	14.25	0560†	15.90	
0-150	10.0	1580†	1800†	13.80	0130†	0350†	14.25	0570†	15.90	
0-200	10.0	1590†	1810†	13.80	0140†	0360†	14.25	0580†	15.90	
0-250	10.0	Note <sup>1</sup>	Note <sup>1</sup>	13.80	0150†	Note <sup>1</sup>	14.25	0590†	15.90	
0-300	10.0	1610†	Note <sup>1</sup>	13.80	0160†	0380†	14.25	0600†	15.90	
0-500	10.0	1620†	Note <sup>1</sup>	13.80	0170†	0390†	14.25	0610†	15.90	
0-750	10.0	Note <sup>1</sup>	Note <sup>1</sup>	Note <sup>1</sup>	0177†	0400†	14.25	0620†	15.90	
0-1000	10.0	Note <sup>1</sup>	Note <sup>1</sup>	Note <sup>1</sup>	0188†	0410†	14.25	0630†	15.90	
15-0-15	.0033	Note <sup>1</sup>	Note <sup>1</sup>	Note <sup>1</sup>	0200	Note <sup>1</sup>	15.15	0640	16.80	
30-0-30	.0017	1660	1880	14.55	0210	0430	15.15	0650	16.80	
50-0-50	.001	1670	1890	14.55	0220	0440	15.15	0660	16.80	

†External Multipliers, Model 183, are furnished on 2½" DC meters 750 volts or higher; and on 3½" and 4½" DC meters 1000 volts and higher. All others are self-contained.

‡DC ammeters are self-contained for ranges up to and including 50 amperes. Higher range DC ammeters (50MV) listed above are calibrated for 5 ft. leads and require external shunts. See page 19 for complete listings.

Note<sup>1</sup> Not normally carried in stock. Distributor delivery 2-3 weeks. Prices on request.

**SEE YOUR ELECTRONIC DISTRIBUTOR FOR YOUR PANEL METER AND TEST EQUIPMENT REQUIREMENTS.**



# STAY ACCURATE

## SPECIFICATIONS

SIZE	MODEL NUMBER	ACCURACY	SCALE LENGTH
2½"	125, 127	±2% of full scale	1.8" (45.7 mm)
3½"	25, 27		2.5" (63.7 mm)
4½"	29		3.9" (99.0 mm)

RANGE	APPROX. RESISTANCE (Ohms)	2½"		3½"		4½"			
		CASE STYLES CATALOG NOS.	PRICE	CASE STYLES CATALOG NOS.	PRICE	CASE STYLES CAT. NO.	PRICE		
<b>DC MILLIVOLTMETERS</b> Self Shielding Meter Movement		<b>MODELS 125 127</b>		<b>MODELS 25 27</b>		<b>MODEL 29</b>			
0-50	10	6970	6990	\$13.80	6910	6930	\$14.25	6950	\$15.60
0-100	20	Note <sup>1</sup>	Note <sup>1</sup>	—	Note <sup>1</sup>	6940	14.25	6960	15.60
<b>DC MILLIAMMETERS</b> Self Shielding Meter Movement		<b>MODELS 125 127</b>		<b>MODELS 25 27</b>		<b>MODEL 29</b>			
0-1	43	5580	5760	\$13.50	4610	4790	\$14.10	5070	\$15.45
0-1.5	2.0	5590	5780	13.50	4620	4810	14.10	5080	15.45
0-3	2.0	Note <sup>1</sup>	5790	13.50	4630	4820	14.10	5090	15.45
0-5	2.0	5610	5800	13.50	4640	4830	14.10	5100	15.45
0-10	10.0	5620	5810	13.50	4650	4840	14.10	5110	15.45
0-15	6.6	5630	5830	13.50	4660	4860	14.10	5120	15.45
0-20	5.0	Note <sup>1</sup>	Note <sup>1</sup>	—	4670	4880	14.10	5130	15.45
0-25	4.0	5650	5860	14.25	4680	4890	14.70	5140	16.35
0-50	2.0	5660	5880	14.25	4690	4910	14.70	5150	16.35
0-75	1.3	5670	Note <sup>1</sup>	—	Note <sup>1</sup>	4930	14.70	5160	16.35
0-100	1.0	5680	5910	14.25	4710	4940	14.70	5170	16.35
0-150	.66	5690	5930	14.25	4720	4960	14.70	5180	16.35
0-200	.5	5700	5940	14.25	4730	4980	14.70	5190	16.35
0-250	.4	5710	5960	14.25	4740	5000	14.70	5200	16.35
0-300	.33	5720	5970	14.25	4750	5010	14.70	5210	16.35
0-500	.2	5730	5990	14.25	4760	5030	14.70	5220	16.35
0-750	.13	Note <sup>1</sup>	Note <sup>1</sup>	—	Note <sup>1</sup>	5050	14.70	5230	16.35
0-1000	.05	Note <sup>1</sup>	6020	14.25	4780	5060	14.70	5240	16.35
<b>DC MICROAMMETERS</b> Self Shielding Meter Movement		<b>MODELS 125 127</b>		<b>MODELS 25 27</b>		<b>MODEL 29</b>			
0-50	1800	4210	4260	\$18.90	3760	3860	\$19.35	3960	\$20.85
0-100	1800	4220	4270	16.35	3770	3870	17.10	3970	19.05
0-200	1100	4230	4280	14.55	3780	3880	15.45	3980	17.10
0-500	90	4240	4281	14.10	3790	3890	15.45	3990	16.35
25-0-25	1800	4192	4243	19.20	3800	3900	19.50	4000	21.00
50-0-50	1800	4194	4245	16.50	3810	3910	17.25	4010	19.20
100-0-100	1100	4196	4247	14.25	3820	3920	15.60	4020	17.40
500-0-500	43	Note <sup>1</sup>	4249	13.65	3830	3930	14.25	4030	15.60
<b>TAUT BAND DC MICROAMMETERS</b> Self Shielding Meter Movement		<b>MODELS 125T 127T</b>		<b>MODELS 25T 27T</b>		<b>MODEL 29T</b>			
0-5	5750	—	—	—	3738*	03838*	\$34.05	3938*	\$36.30
0-10	4900	4197*	04246*	\$30.30	3739*	03839*	30.30	3939*	32.55
0-15	1960	4199*	04248*	30.30	3741*	03841*	27.00	3941*	29.25
0-25	1960	4201*	04251*	23.40	3751*	03851*	24.30	3951*	26.70
0-50	1100	4211*	04261*	20.55	3761*	03861*	21.00	3961*	22.50
0-100	500	4221*	04271*	18.00	3771*	03871*	18.75	3971*	20.70

\*New Panel Meter Addition.

Note<sup>1</sup> Not normally carried in stock. Distributor delivery 2-3 weeks.

## DIMENSIONS

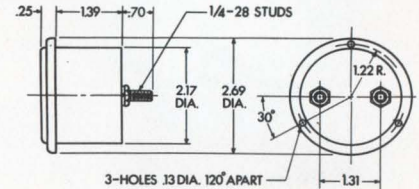

2½" Model 125, 125T

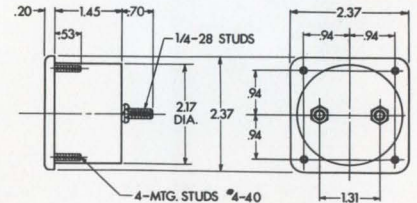

2½" Model 127, 127T

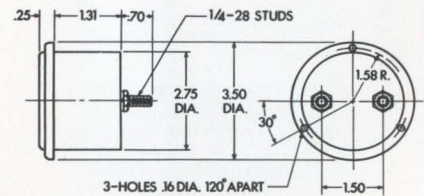

3½" Model 25, 25T

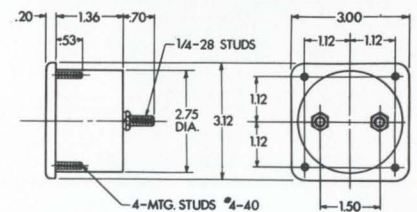

3½" Model 27, 27T

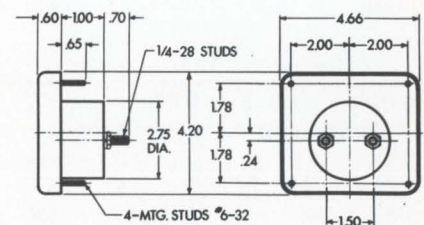

4½" Model 29, 29T



# SPECIFICATIONS

SIZE	MODEL NUMBER	ACCURACY	SCALE LENGTH
2½"	125, 127, 135, 137	±2% of full scale  (Compensated wattmeters ±3%)	1.8" (45.7 mm)
	175, 177		1.6" (41.1 mm)
	155, 157		2.5" (63.7 mm)
3½"	25, 27, 35, 27		2.3" (57.4 mm)
	75, 77		3.8" (97 mm)
4½"	55, 57		3.5" (89.0 mm)
	29, 39		
	59		
	79		

RANGE	APPROX. IMPEDANCE (Ohms) @ 60 cps	2½"		3½"		4½"	
		CASE STYLES	PRICE	CASE STYLES	PRICE	CASE STYLES	PRICE
<b>AC VOLTMETERS</b> Iron Vane Type Meter Movement		<b>MODELS</b>		<b>MODELS</b>		<b>MODEL</b>	
		155	157	55	57	59	
0-1.5	3	Note <sup>1</sup>	Note <sup>1</sup>	Note <sup>1</sup>	Note <sup>1</sup>	Note <sup>1</sup>	8710 \$15.60
0-3	12	Note <sup>1</sup>	Note <sup>1</sup>	Note <sup>1</sup>	Note <sup>1</sup>	Note <sup>1</sup>	8540 \$13.80
0-5	33	Note <sup>1</sup>	Note <sup>1</sup>	Note <sup>1</sup>	Note <sup>1</sup>	Note <sup>1</sup>	8550 \$13.80
0-10	133	9260	9400	8420	8566	8740	13.60 \$13.60
0-15	300	9270	9420	8430	8580	8750	13.80 \$15.60
0-25	833	9280	9440	8440	8599	8760	14.10 \$15.75
0-50	3,333	9290	9450	8450	8610	8770	14.10 \$15.75
0-100	16,666	Note <sup>1</sup>	9460	8460	8620	8780	15.30 \$16.20
0-150	25,000	9310	9470	8470	8630	8790	15.15 \$16.35
0-250	41,166	9320	9490	8480	8650	8800	15.15 \$16.35
0-300	50,000	9330	9500	8490	8660	8810	15.15 \$16.35
0-500	83,333	9340	9520	8500	8680	8820	19.50 \$20.25
0-750	125,000	Note <sup>1</sup>	Note <sup>1</sup>	Note <sup>1</sup>	8510	8690	21.30 \$22.20
0-1000	166,666	Note <sup>1</sup>	Note <sup>1</sup>	Note <sup>1</sup>	8520	8700	22.95 \$24.00

RANGE	APPROX. IMPEDANCE (Ohms) @ 60 cps	2½"		3½"		4½"	
		CASE STYLES	PRICE	CASE STYLES	PRICE	CASE STYLES	PRICE
<b>AC AMMETERS</b> Iron Vane Type Meter Movement		<b>MODELS</b>		<b>MODELS</b>		<b>MODEL</b>	
		155	157	55	57	59	
0-1	.287	2100	2270	950	1120	1290	\$15.90
0-1.5	.185	Note <sup>1</sup>	Note <sup>1</sup>	Note <sup>1</sup>	960	1130	1302 \$15.90
0-2	.115	2120	2290	12.75	970	1140	13.50 \$13.50
0-3	.027	2130	2300	12.75	980	1145	13.50 \$13.20
0-5	.012	2140	2310	12.75	990	1160	13.50 \$13.30
0-10	.003	2150	2320	12.75	1001	1170	13.50 \$13.40
0-15	.0022	2160	2330	12.75	1010	1180	13.50 \$13.50
0-25	.0003	2170	2340	13.05	1020	1190	13.80 \$13.60
0-30	.0003	2180	2350	13.05	1030	1200	13.80 \$13.70
0-50	.0006	2190	2360	13.05	1040	1210	13.80 \$13.80
0-75	.0005	Note <sup>1</sup>	Note <sup>1</sup>	Note <sup>1</sup>	3432	3434	14.55 \$3436
0-75	.012	2200	2370	12.75	1050	1220	13.50 \$13.90
0-100	.012	2210	2380	12.75	1060	1230	13.50 \$14.00
0-150	.012	2220	2390	12.75	1070	1240	13.50 \$14.10
0-200	.012	Note <sup>1</sup>	Note <sup>1</sup>	Note <sup>1</sup>	1080	1250	13.50 \$14.20
0-250	.012	2240	2410	12.75	1090	1260	13.50 \$14.30
0-300	.012	Note <sup>1</sup>	2420	12.75	1100	1270	13.50 \$14.40
0-500	.012	2260	2422	12.75	1110	1280	13.50 \$14.50

RANGE	APPROX. IMPEDANCE (Ohms) @ 60 cps	2½"		3½"		4½"	
		CASE STYLES	PRICE	CASE STYLES	PRICE	CASE STYLES	PRICE
<b>AC MILLIAMMETERS</b> Iron Vane Type Meter Movement		<b>MODELS</b>		<b>MODELS</b>		<b>MODEL</b>	
		155	157	55	57	59	
0-10	2,000	6030	6100	\$12.75	Note <sup>1</sup>	5440	\$13.50
0-15	875	Note <sup>1</sup>	Note <sup>1</sup>	Note <sup>1</sup>	Note <sup>1</sup>	5380	5499 \$13.50
0-25	390	Note <sup>1</sup>	Note <sup>1</sup>	Note <sup>1</sup>	Note <sup>1</sup>	5460	13.50 \$5530
0-50	80	6060	6130	12.75	5400	5470	13.50 \$5540
0-100	20	6070	6140	12.75	5410	5480	13.50 \$5550
0-250	5	6080	6150	12.75	5420	5490	13.50 \$5560
0-500	.9	6090	6152	12.75	5430	5500	13.50 \$5570

Note<sup>1</sup> Not normally carried in stock. Distributor delivery 2-3 weeks.

†External Multipliers, Model 183, (Featured on page 17) are furnished AC on meters having a range of 500 volts or higher; on 2½" DC meters 750 volts or higher; and on 3½" and 4½" DC meters 1000 volts and higher. All others are self-contained.

‡These meters are 5 amp meters with scales as indicated and require external current transformers. See listings on page 19.

# DIMENSIONS

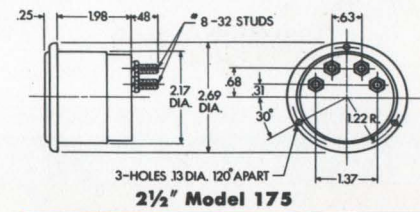

2½" Model 175

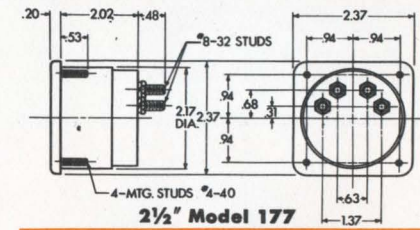

2½" Model 177

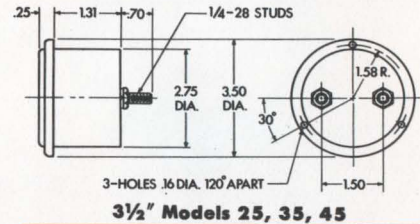

3½" Models 25, 35, 45

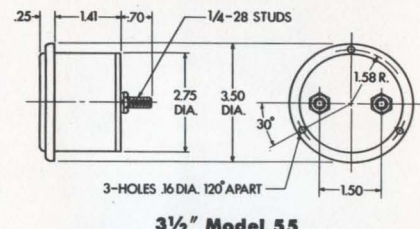

3½" Model 55

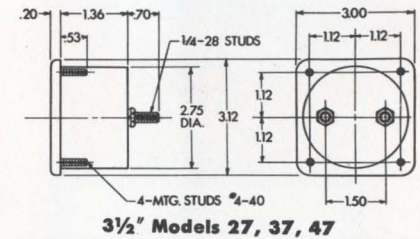

3½" Models 27, 37, 47

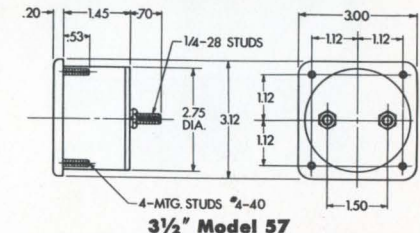

3½" Model 57

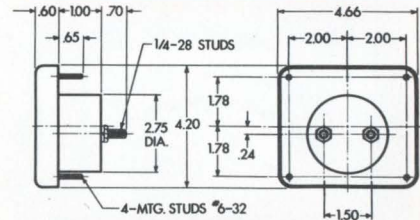

4½" Models 29, 39, 49

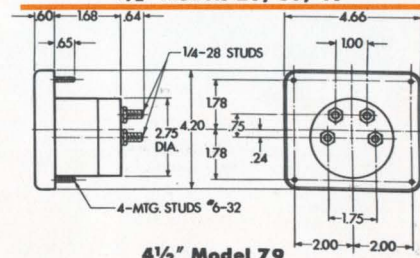

4½" Model 79

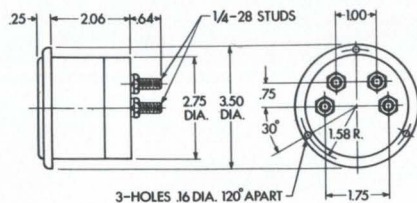

3½" Model 75

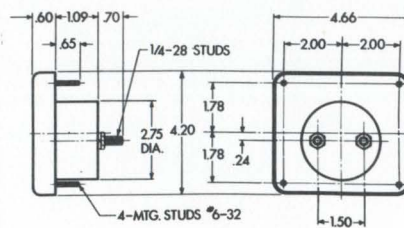

4½" Model 59

# Simpson

INSTRUMENTS THAT STAY ACCURATE

2½", 3½", 4½", 6"

• ROUND and  
• RECTANGULAR  
STOCK METERS

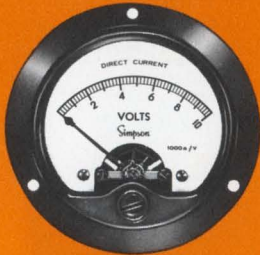

2½" Model 145  
3½" Model 45



2½" Model 147  
3½" Model 47

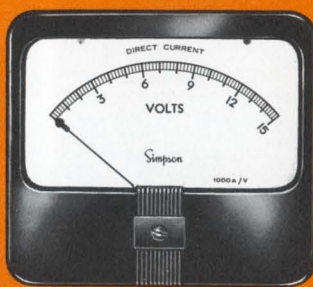

4½" Model 49

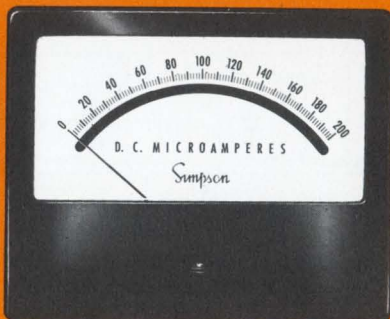

6" Model 1150-1  
1% Meter supplied  
with Mirror Scale

## SIMPSON STOCK METER RANGES AND PRICES

CALIBRATION AND DIALS—All meters have the Simpson self-shielding movement and may be used on either magnetic or non-magnetic panels.

### SPECIFICATIONS

SIZE	MODEL NO.	ACCURACY	SCALE LENGTH
2½"	145, 147	DB and Rectifier type meters ±3% of full scale @ 25°C. and 60 cycle sine wave	1.8" (45.7 mm)
3½"	45, 47		2.5" (63.7 mm)
4½"	49, 142		3.8" (97 mm)
6"	1150,	±2% of full scale	4.6" (114.8 mm)
	1150-1	±1% of full scale, mirrored scale	

RANGE	Approx. RESISTANCE (Ohms)	2½" CASE STYLES		3½" CASE STYLES		4½" CASE STYLE			
		CATALOG NOS.	PRICE	CATALOG NOS.	PRICE	CAT. NO.	PRICE		
<b>AC VOLTMETERS</b> Rectifier Type Self Shielding Meter Movement				<b>MODELS</b> 45 47		<b>MODEL</b> 49			
0-1	2000 ohms per volt	—	—	Note <sup>1</sup>	8120	\$20.70	8300	\$22.65	
0-3		—	—	Note <sup>1</sup>	8130	20.70	8310	22.65	
0-5		—	—	7960	8140	20.70	8320	22.65	
0-10		—	—	7970	8150	20.70	8330	22.65	
0-15		—	—	7980	8160	20.70	8340	22.65	
0-50		—	—	Note <sup>1</sup>	8170	20.70	8350	22.65	
0-100		—	—	Note <sup>1</sup>	8180	20.70	8360	22.65	
0-150		—	—	8010	8190	20.70	8370	22.65	
0-300		—	—	8020	8200	20.70	8371	22.65	
<b>AC MILLIAMMETERS</b> Rectifier Type Self Shielding Meter Movement				<b>MODELS</b> 45 47		<b>MODEL</b> 49			
0-1	600	—	—	6820	6850	\$19.80	6880	\$21.45	
0-2	400	—	—	Note <sup>1</sup>	6860	19.80	6890	21.45	
0-5	200	—	—	6840	6870	19.80	6900	21.45	
<b>AC MICROAMMETERS</b> Rectifier Type Self Shielding Meter Movement				<b>MODELS</b> 45 47		<b>MODEL</b> 49			
0-100	3400	—	—	4080	4120	\$22.65	4160	\$24.30	
0-200	2400	—	—	Note <sup>1</sup>	Note <sup>1</sup>	Note <sup>1</sup>	4170	21.90	
0-300	1800	—	—	Note <sup>1</sup>	4140	19.80	4180	21.45	
0-500	1200	—	—	Note <sup>1</sup>	4150	19.50	4190	21.15	
Volume Level Indicators <b>DECIBEL METERS</b> Zero Power Level 6 MW 500 Ohm Line Self Shielding Meter Movement		<b>MODELS</b> 145 147		<b>MODELS</b> 45 47		<b>MODEL</b> 49			
<b>GENERAL PURPOSE TYPE</b> -10 to +6 db 5000 ohms		3470	3480	\$20.25	Note <sup>1</sup>	3450	\$20.40	3460	\$22.20
Volume Level Indicators <b>VU METERS</b> † Reference Level 1 MW 600 Ohm Line Self Shielding Meter Movement				<b>MODELS</b> 45 47		<b>MODEL</b> 142			
"A" SCALE; Not Illuminated		—	—	—	10440	10450	\$24.60	10460	\$26.70
"B" SCALE; Not Illuminated		—	—	—	Note <sup>1</sup>	10520	24.60	10530	26.70
"A" SCALE; Illuminated		—	—	—	Note <sup>1</sup>	Note <sup>1</sup>	Note <sup>1</sup>	10470	29.40
"B" SCALE; Illuminated		—	—	—	Note <sup>1</sup>	Note <sup>1</sup>	Note <sup>1</sup>	10540	29.40

Note<sup>1</sup> Not normally carried in stock. Distributor delivery 2-3 weeks. Prices on request.

†Simpson VU meters meet all the Electrical and Ballistic specifications established by Bell Laboratories and American Standards Association as required by broadcasting, communication and sound engineers. They are available with either type A or B scales. Type A scale stresses the level in VU for monitoring wire lines. Type B scale stresses per cent use of transmitter output and is the standard for broadcast service. Impedance is 3900 Ω at "0" V.U. deflection.

# DIMENSIONS

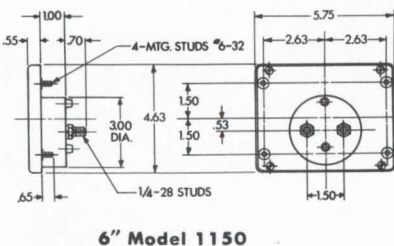
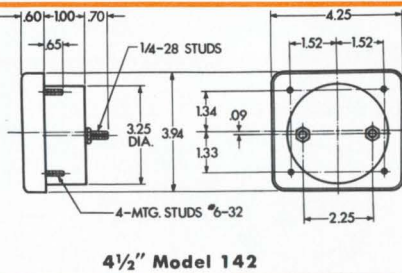
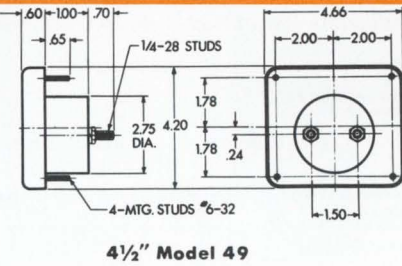
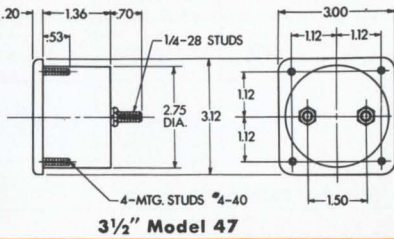
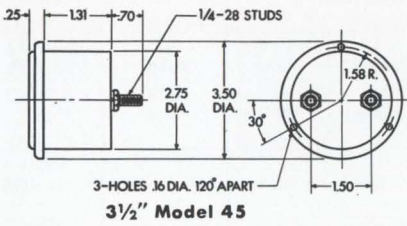
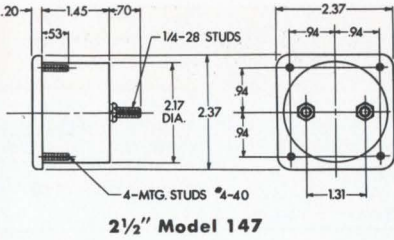
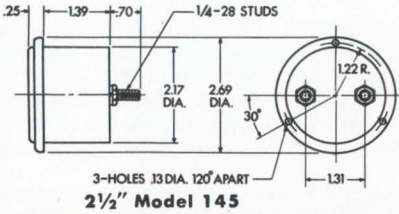

## 1% and 2% Tolerance 6" RECTANGULAR CASE STYLE—MODELS 1150 Self Shielding Meter Movement

RANGE	RESISTANCE APPROX. (Ohms)	CAT. NO.	PRICE	RANGE	RESISTANCE APPROX. (Ohms)	CAT. NO.	PRICE
<b>DC VOLTMETERS</b> 2%				<b>DC MILLIAMMETERS</b> 2%			
<b>MODEL 1150</b>				<b>MODEL 1150</b>			
0-10		9533	\$20.85	0-1	43	6153	\$20.85
0-25	1000	9534	20.85	0-10	10	6154	20.85
0-50	OHMS	9535	20.85	0-50	2.0	6155	20.85
0-100	PER	9536	20.85	0-100	1.0	6156	20.85
0-150	VOLT	9537	20.85	0-500	.2	6157	20.85
0-300		9538	20.85	<b>DC MILLIAMMETERS</b> 1% Mirrored Scale <b>MODEL 1150-1</b>			
0-500	2000 Ω/V	9539	21.45	0-1	43	6158	\$26.25
<b>DC MILLIVOLTMETERS</b> 2%				<b>DC MICROAMMETERS</b> 2%			
<b>MODEL 1150</b>				<b>MODEL 1150</b>			
0-50	10	7003	\$21.75	0-15	5500	4282	\$33.00
<b>DC AMMETERS</b> 2%				<b>DC MICROAMMETERS</b> 1% Mirrored Scale <b>MODEL 1150-1</b>			
<b>MODEL 1150</b>				<b>MODEL 1150-1</b>			
0-1	.050	2424	\$21.75	0-25	5500	4283	29.55
0-5	.010	2425	21.75	0-50	5200	4284	27.00
0-10	.005	2426	21.75	0-100	2100	4285	25.80
0-15	.0033	2427	21.75	0-200	1100	4286	22.50
0-25	.0020	2428	21.75	0-500	90	4287	21.90
0-30	.0016	2429	21.75	<b>DC MICROAMMETERS</b> 1% Mirrored Scale <b>MODEL 1150-1</b>			
0-50	.001	2430	21.75	0-50	5200	4290	\$32.40
				0-100	2100	4291	31.20
				0-200	1100	4292	27.90
				0-500	90	4293	27.30

## 3 1/2" ELAPSED TIME PANEL METERS

Widely used by research labs, manufacturing plants, broadcasting stations . . . to keep life and performance records based on operating time. These meters use self-starting synchronous clock motors. They indicate up to 9999.9, then recycle and begin again at 0000.0.

Molded bakelite case similar to the Simpson 3 1/2" rectangular and round meters. Case depth—2 3/16".

RANGE	MODEL 55ET	MODEL 57ET		
	CAT. NO.	PRICE	CAT. NO.	PRICE
120V-60 cps	3580	\$20.85	3590	\$20.85
240V-60 cps	3600	21.15	3610	21.15



3 1/2" Model 55ET



3 1/2" Model 57ET

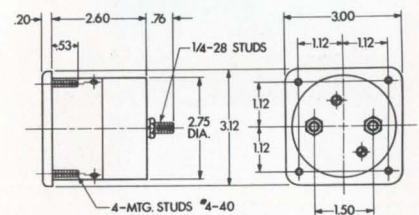
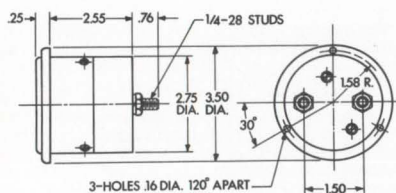

# RUGGED-SEAL SEGMENTAL STOCK METERS



2 1/2", 3 1/2", 4 1/2" Models

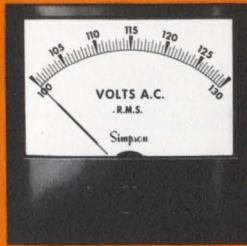

3 1/2", 4 1/2" Models

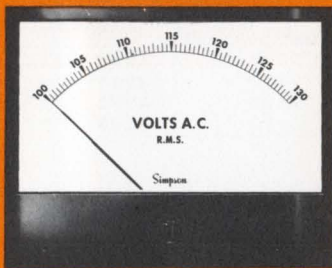

4" x 6" Models

## WIDE-VUE AND BAKELITE SEGMENTAL VOLTMETERS Single, Multi-Range



3 1/2" Model 1347

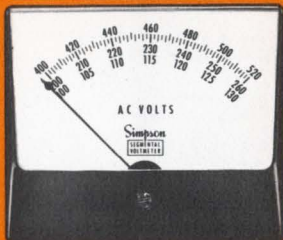

MULTI-RANGE 4 1/2" Model 1349

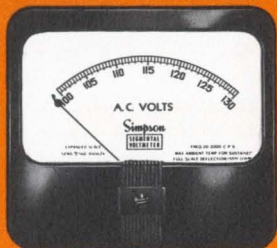

4 1/2" Model 49

## SIMPSON AVERAGE SENSING, TRUE RMS & DC SEGMENTAL INSTRUMENTS

Segmental Voltmeters and frequency meters make it possible to measure very small changes in input conditions. The significant portion of the overall voltage or frequency range is expanded to occupy the full scale length. Thus, only that segment of the range that is important appears. In addition to the standard expansions and accuracies shown, special segmental voltmeters can be built on order. Write the factory for a quotation.

The A.C. segmental voltmeters are available in either average sensing or true R.M.S. sensing units. When working with sine wave currents or when other measurements will be made with average sensing equipment, the average sensing meters are preferred.

When working with distorted waveforms, as would be encountered in constant voltage transformers, S.C.R. circuits, D.C. to A.C. solid state inverters or similar equipment, the true R.M.S. sensing meter would probably be preferred.

GENERAL SPECIFICATIONS WIDE-VUE and BAKELITE CASE STYLES			RUGGED-SEAL and RUGGEDIZED METAL CASE STYLES				
RANGE	AVERAGE SENSING AC SEGMENTAL VOLTMETERS		RMS SENSING AC SEGMENTAL VOLTMETERS			DC SEGMENTAL VOLTMETERS	FREQUENCY METERS
	SINGLE RANGE	MULTI-RANGE*	100-130 AC Volts	105-125 AC Volts	110-120 AC Volts		
AC	100-130	100-130 200-260 400-520	100-130	105-125	110-120	—	—
ACCURACY (% OF CENTER SCALE VALUE)	±.5%	100-130 ±.5% 200-260 ±.75% 400-520 ±.75%	±1.0%	±.5%	±.3%	±.5%	±.25%
FREQUENCY RANGE	20-2000 CPS	50-1000 CPS	55-550 CPS			—	—
CENTER SCALE VALUE	115 Volts	115/230/460 Volts	115 Volts	115 Volts	115 Volts	27 Volts	60 CPS 400 CPS
SENSITIVITY OR POWER CONSUMPTION	.6 to 1.3 VA (Sensitivity decreases as input voltage increases)		50 OPV	65 OPV	80 OPV	100 OPV	3 VA Max.
MAX. INPUT VOLTAGE (10 SECONDS)	150 Volts RMS	150/300/600 Volts RMS	150 Volts RMS			40 Volts	140 Volts RMS
SQUARE WAVE WAVEFORM INFLUENCE	11%		2.5%	2.0%	1.0%	—	.1%
TRIANGULAR WAVE INFLUENCE	5%		1.2%	.6%	.3%	—	.1%
VOLTAGE INFLUENCE 105-125 Volts	—		—	—	—	—	.25%
MOVEMENT TYPE	Self Shielding		Shielded External Magnet				

\*Supplied with external potential transformer

External Potential Transformer  
Supplied with Multi-Range Segmental Panel Meter.

## DIMENSIONS

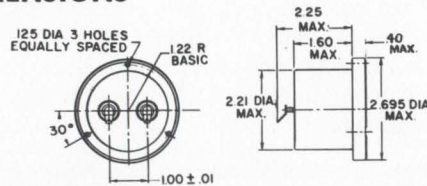

2 1/2" Model 3222

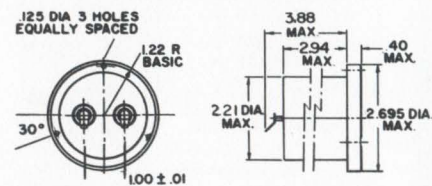

2 1/2" Model 3282

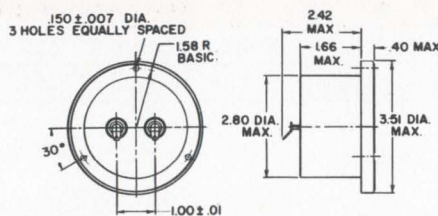

3 1/2" Model 3223

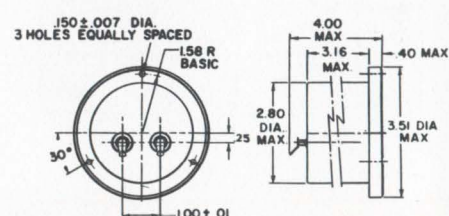

3 1/2" Model 3283

## WIDE-VUE and BAKELITE

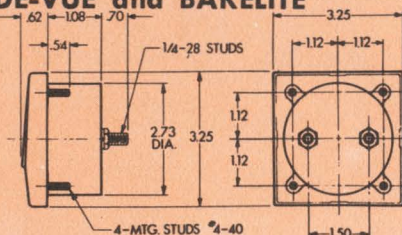

3 1/2" Model 1347

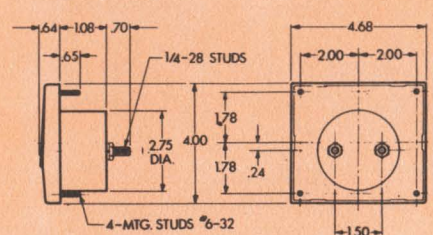

4 1/2" Model 1349



# EDGEWISE PANEL METERS BARREL TYPE CONSTRUCTION 1½", 2½"



Where your panel designs call for making every square inch count, or where saving weight is important, Simpson edgewise meters solve many design problems. These meters are supplied with complete hardware which includes the bezel and two nuts. Mounting is fast and easy.

## SPECIFICATIONS

Models	1½" 1521, 1541	2½" 1522, 1542
Accuracy	DC ± 2% of full scale; AC rectifier type ± 3% of full scale @ 25° and 60 cycle sine wave	
Movement Type	Self Shielding Meter Movement	
Scale Length	1¾"	1¾"
Pointer	Lance	
Case Construction	Dustproof, molded acrylic	
Terminals	Solder (ammeters—stud type)	
Net Weight	5 ounces	

RANGE	APPROX. RESISTANCE (Ohms)	1½" CASE STYLE		2½" CASE STYLE	
		CAT. NO.	PRICE	CAT. NO.	PRICE
<b>DC VOLTMETERS</b> Self-Shielding Meter Movement					
		<b>MODEL 1521</b>		<b>MODEL 1522</b>	
0-10	1000 Ω/volt	10354	\$15.45	10360	\$16.50
0-15	1000 Ω/volt	10355	15.45	10370	16.50
0-25	1000 Ω/volt	10356	15.45	10375	16.50
0-50	1000 Ω/volt	10357	15.45	10380	16.50
0-150	1000 Ω/volt	10358	15.45	10390	16.50
0-500	2000 Ω/volt	10359	15.60	10410	16.80
<b>DC MILLIAMMETERS</b> Self-Shielding Meter Movement					
		<b>MODEL 1521</b>		<b>MODEL 1522</b>	
0-1	20	6811	\$15.30	6710	\$16.35
0-5	2.5	6812	15.30	6720	16.35
0-10	13.5	6813	15.30	6730	16.35
0-25	5.4	6815	15.90	6740	17.10
0-50	2.7	6816	15.90	6750	17.10
0-100	1.35	6817	15.90	6760	17.10
0-500	.27	6819	15.90	6810	17.10
<b>DC AMMETERS</b> Self-Shielding Meter Movement					
		<b>MODEL 1521</b>		<b>MODEL 1522</b>	
0-5	.010	—	—	3390	\$17.40
0-25	.002	—	—	3420	17.40
RANGE	APPROX. RESISTANCE (Ohms)	1½" CASE STYLE		2½" CASE STYLE	
		CAT. NO.	PRICE	CAT. NO.	PRICE
<b>DC MILLIVOLTMETERS</b> Self-Shielding Meter Movement					
		<b>MODEL 1521</b>		<b>MODEL 1522</b>	
0-50	10 Ω	0713	\$16.20	07011	\$17.40
<b>DC MICROAMMETERS</b> Self-Shielding Meter Movement					
		<b>MODEL 1521</b>		<b>MODEL 1522</b>	
0-25	3150	4552†	\$23.40	4560	\$24.45
0-50	1800	4553	20.40	4570	21.45
0-100	1100	4554	18.00	4580	19.20
0-200	290	4555	16.20	4590	17.40
0-500	90	4556	15.75	4600	16.95
<b>VOLUME LEVEL INDICATORS</b> VU METERS Self-Shielding Meter Movement					
		<b>MODEL 1541</b>		<b>MODEL 1542</b>	
"A" SCALE		—	—	10500	\$27.30
"B" SCALE		—	—	10570	27.30
<b>AC VOLTMETERS</b> Rectifier Type Self-Shielding Meter Movement					
		<b>MODEL 1541</b>		<b>MODEL 1542</b>	
0-150	1000 Ω/volt	10415	\$20.10	10420	\$21.15
0-300	1000 Ω/volt	—	—	10430	21.15

†Resistance of Model 1521 0-25 Mics is 5500 Ω.

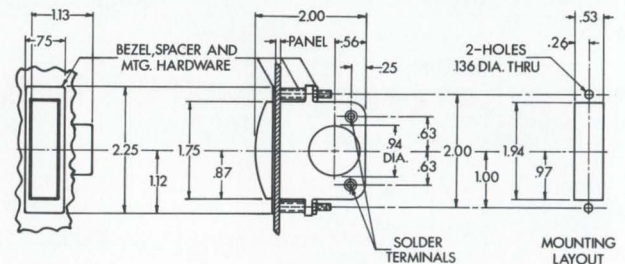
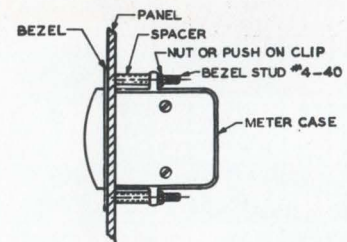

1½" Models 1521, 1541

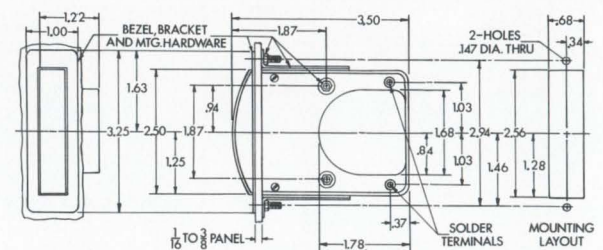

2½" Models 1522, 1542





# EDGEWISE PANEL METERS STACKS Horizontally or Vertically 1 1/2", 2 1/2"

Simpson's new miniature edgewise panel meter has a unique Self-Shielding core magnet movement\* that eliminates the need for the protruding barrel that is prevalent in other edgewise meter designs. It lends itself to a design that is sharp, modern, extremely compact and with a meter scale that extends nearly to the full width and height of the meter. An optimum scale display area allows for the use of large, easy-to-read numerals on a horizontal plane.

\*Patent Pending

## SPECIFICATIONS

Models	1 1/2" 1921, 1941	2 1/2" 1622, 1642
Accuracy	± 2% of full scale	
Movement Type	Self Shielding Core Magnet Movement	
Scale Length	1.370 inches	1.85 inches
Pointer	Lance	
Case Construction	Steel Housing with rustproof finish; plastic window; insulated terminals; dustproof construction.	
Terminals	Solder Type	8-32 studs
Dielectric	1500 Volts RMS	
Panel Cut Out	.525" x 1.718"	.562 x 2.312
Hardware	Removable brackets with clamping screws.	Bezel, bracket, lockwashers & nuts.
Net Weight	3 1/2 ounces	4 1/2 ounces
Shipping Weight	5 1/2 ounces	6 1/2 ounces

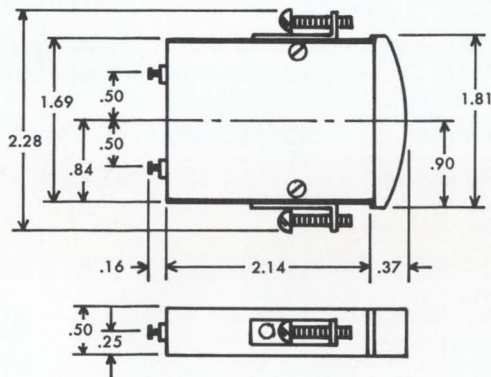

1 1/2" Model 1921

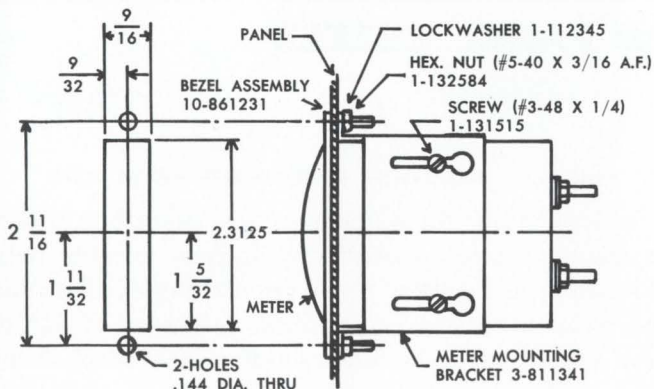

2 1/2" Model 1622

RANGE	APPROX. RESISTANCE (Ohms)	1 1/2" CASE STYLE		2 1/2" CASE STYLE	
		CAT. NO.	PRICE	CAT. NO.	PRICE
<b>DC VOLTMETERS</b> Self-Shielding Meter Movement		<b>MODEL 1921</b>		<b>MODEL 1622</b>	
0-10	5000 Ω/volt	18000•	\$18.45	18006•	\$19.50
0-15	5000 Ω/volt	18001•	18.45	18007•	19.50
0-25	5000 Ω/volt	18002•	18.45	18008•	19.50
0-50	5000 Ω/volt	18003•	18.45	18009•	19.50
0-150	5000 Ω/volt	18004•	18.45	18010•	19.50
0-500	—	—	—	18011•	19.65
<b>DC MILLIAMMETERS</b> Self-Shielding Meter Movement		<b>MODEL 1921</b>		<b>MODEL 1622</b>	
0-1	18	18012•	\$18.15	18019•	\$19.35
0-5	2	18013•	18.15	18020•	19.35
0-10	5	18014•	18.15	18021•	19.35
0-25	2	18015•	18.90	18022•	20.10
0-50	1	18016•	18.90	18023•	20.10
0-100	.5	18017•	18.90	18024•	20.10
0-500	.1	18018•	18.90	18025•	20.10
<b>DC MILLIVOLTMETERS</b> Self-Shielding Meter Movement		<b>MODEL 1921</b>		<b>MODEL 1622</b>	
0-50	400 Ω/volt	18028•	\$19.20	18029•	\$20.40
<b>DC MICROAMMETERS</b> Self-Shielding Meter Movement		<b>MODEL 1921</b>		<b>MODEL 1622</b>	
0-25	7760	18030•	\$26.25	18035•	\$24.75
0-50	2020	18031•	23.40	18036•	24.45
0-100	1060	18032•	21.00	18037•	22.20
0-200	310	18033•	19.20	18038•	20.40]
0-500	63	18034•	18.75	18039•	19.80
<b>AC VOLTMETERS</b> Rectifier Type Self-Shielding Meter Movement		<b>MODEL 1941</b>		<b>MODEL 1642</b>	
0-150	5000 Ω/volt	18042•	\$22.95	18043•	\$24.15

# METER RELAYS contactless 4½"

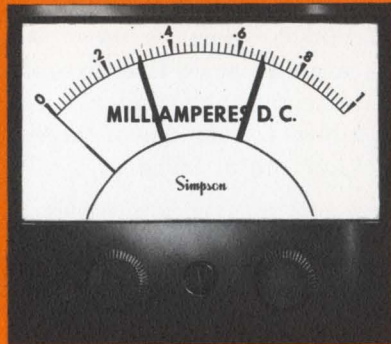

Contactless Type  
4½" Model 3324XA

## CONTACTLESS TYPE—MODEL 3324XA

Contactless types are intended for those applications in which utmost reliability of operation on small differential or small power is desired. Set points are adjusted thru external, front adjusted gear drive. Set point is indicated by separate lance pointers. Sensing is accomplished thru an infinite life lamp and photo-conductors. A solid state switching circuit and D.P.D.T. slave relay are provided (internally) for each control point. Slave relays will switch 10 amperes @ 115 Volts A.C.

## Single or Dual Control

### Model 3324XA

for alarm control or limit applications  
on equipment designed for unattended applications

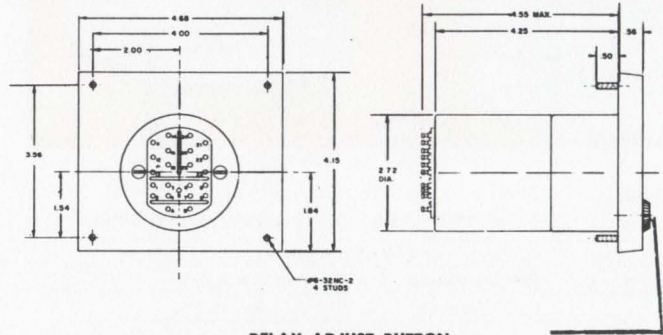

RELAY ADJUST BUTTON

.75 DIA. PROTRUDING .18 ABOVE BEZEL, LOCATED .97 BELOW METER CENTER LINE, AND .98 LEFT AND /OR RIGHT OF THE METER CENTER LINE AS APPLICABLE.

## SPECIFICATIONS

**CALIBRATION ACCURACY:** ± 2% of Full Scale.

**CONTROL POINT ADJUSTMENT:** Control points are externally adjustable over 95% of the scale arc. Control point indication is within 2% of actual switching.

**CONTROL POINT DIFFERENTIAL:** Difference between "on" and "off" is within .5% of Full Scale.

**POWER REQUIREMENTS:** 115 Volts A.C. 50-500 CPS. D.C. power required for sensing and switching is provided by the external power module furnished with the relay.

**OUTPUT:** D.P.D.T. relay contacts for each control point. Contacts rated @ 10 amperes, 115 A.C. resistive.

**METER INDICATION:** Continuous, unaffected by control point setting.

**CONTROL CIRCUITRY:** Fail-safe. Both slave relays "open" in event of power failure.

## RANGES AND PRICES

## CONTACTLESS TYPE—MODEL 3324XA

RANGE	SINGLE CONTROL		DOUBLE CONTROL		
	Resist. Approx. Ohms	Cat. No.	Price	Cat. No.	Price
<b>DC MICROAMMETERS</b>					
0-50	3000	16451	\$99.00	16470	\$136.35
0-100	1300	16452	96.15	16471	133.65
0-200	570	16453	96.15	16472	133.50
0-500	220	16454	96.15	16473	133.50
<b>DC MILLIAMMETER</b>					
0-1	80	16455	95.10	16474	132.45
<b>DC MILLIVOLTMETER</b>					
0-50	10	16460	95.40	16480	137.25

## NEW 3½" and 4½" BEHIND PANEL BEZELS

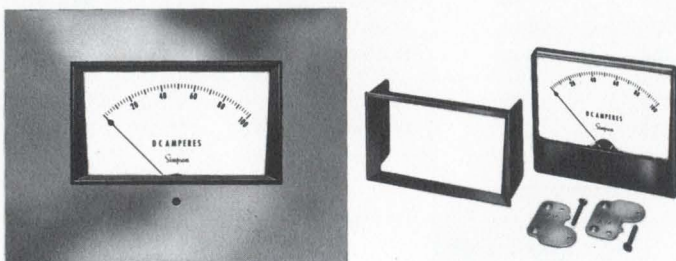

## NEW 3½" and 4½" WIDE-VUE MOUNTING BEZEL KITS

For that modern, streamlined appearance—Mounting Bezels, made for wide-vue panel meters and interchangeable with flush and recess type meters of many popular styles. Designed for behind panel mounting on material thickness of 1/8" to 3/16". Groove and flange style construction. Each bezel of die cast metal has an attractive black enamel satin finish and is supplied with mounting hardware and template.

Bezel Mount Kit consists of bezel brackets and screws and installation instructions.

# METER RELAYS contact type 4 1/2"

## Dual Control

### Model 29XA

for alarm control or limit applications  
on equipment designed for unattended applications

#### CONTACT TYPE—MODEL 29XA

Contact making types are well suited to most general purpose applications in which cost and reasonable reliability are primary considerations. The contacts are the non-locking type and may be positioned along the scale arc by an external, front adjusted gear drive. Styling and mounting dimensions are designated as the Model 29XA.

#### SPECIFICATIONS

**GENERAL:** Model 29XA Relays are of the D'Arsonval Type. Externally adjusted limit setting contacts are non-locking and intended for circuits with external locking provisions or for light duty non-locking applications.

**CALIBRATION:** Accuracies  $\pm 2\%$  of full scale.

**CONTACTS:** Gold Alloy. For use @ 15 volts DC, 10 milliamperes maximum, on resistive or diode protected inductive loads.

**CONTACT ADJUSTMENT:** Contacts are externally adjustable over  $95^\circ$  of  $100^\circ$  scale arc, and within  $5^\circ$  of each other. The pointer will indicate the contact make position within  $2^\circ$  of actual contact intercept.

**CONTACT DIFFERENTIAL:** Normally, contacts will close within  $2\%$  of full scale value and break within  $10\%$  of full scale value.

**INSULATION:** Breakdown 300 volts AC from Relay contacts to meter circuit. 3 KV AC from Relay terminals to mounting panel. (All Tests at 60 cycles.)



Contact Type  
4 1/2" Model 29XA

#### RANGES AND PRICES CONTACT TYPE—MODEL 29XA

RANGE	DUAL CONTROL		
	Resist. Approx. Ohms	Cat. No.	Price
<b>DC MICROAMMETERS</b>			
0-50	5200	7032	\$48.60
0-100	1800	7034	46.50
0-200	1000	7036	43.65
0-500	280	7038	42.90
<b>DC MILLIAMMETER</b>			
0-1	140	7040	42.00
<b>DC MILLIVOLTMETER</b>			
0-50	10	7050	42.15

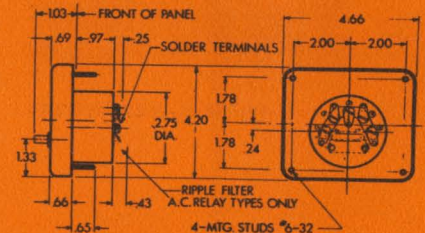

4 1/2" Model 29XA

#### 3 1/2" BEZEL KIT

Part No.	For Models	Price
1253	1327, 1347, 1357	\$1.65

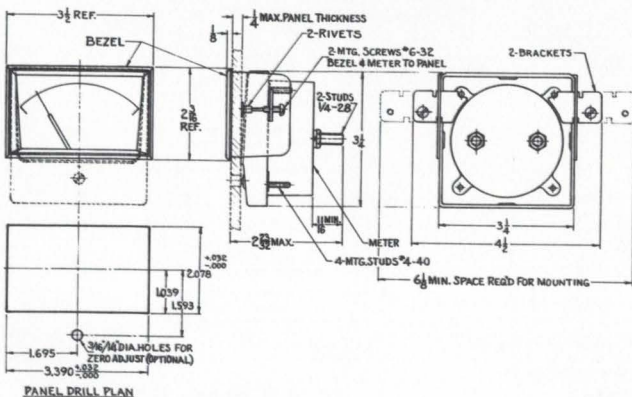

3 1/2" Wide-Vue, Behind Panel Meter Mounting, with Bezel

#### 4 1/2" BEZEL KIT

Part No.	For Models	Price
1123	1329, 1339, 1349, 1359, 1379	\$1.65

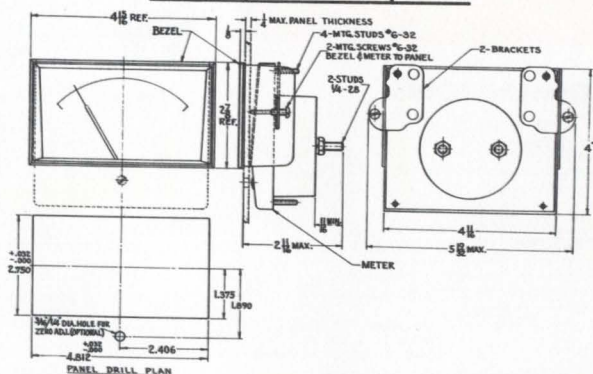

4 1/2" Wide-Vue, Behind Panel Meter Mounting, with Bezel 17

# "RUGGED SEAL"

## 3 1/2", 4 1/2", 4" x 6"

- SQUARE
  - RECTANGULAR
- ### STOCK METERS

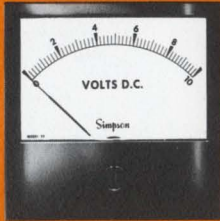

3 1/2" Models 3323, 3383

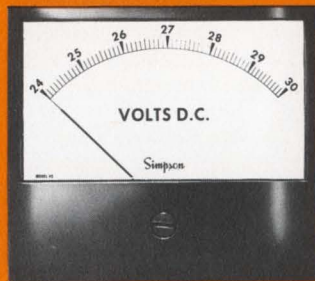

4 1/2" Models 3324, 3384

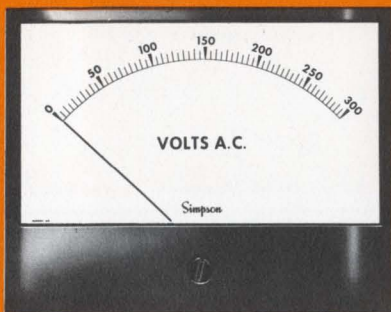

4" x 6" Models 3326, 3386

## NEW SIMPSON "RUGGED SEAL" PANEL METERS

This new line of metal cased panel instruments is ideal for use in field test equipment or wherever rigorous environmental conditions are encountered. They are completely sealed, commercially ruggedized, glass window, metal cased and shielded, not affected by steel panel mounting.

### SPECIFICATIONS

SIZE	MODEL NO.	ACCURACY	SCALE LENGTH
3 1/2"	3323, 3343*	DC METERS: ±2% F. S. AC METERS: ±3% F. S. @ 25°C. and 60 cy. Sine Wave	2.9" (74 mm)
4 1/2"	3324, 3344*		3.9" (101 mm)
4" x 6"	3326, 3346*		4.7" (120 mm)

\*All AC Meters are rectifier type. AC Voltmeters, Milliammeters and Microammeters maintain their rated accuracy over a range of 25 through 2500 cps. AC Ammeters maintain their accuracy over a range of 55 through 125 cps.

RANGE	APPROX. RESISTANCE (Ohms)	3 1/2"		4 1/2"		4" x 6"	
		CASE STYLE CAT. NO.	PRICE	CASE STYLE CAT. NO.	PRICE	CASE STYLE CAT. NO.	PRICE
<b>DC VOLTMETERS</b> Shielded Case not affected by magnetic Mounting							
		MODEL 3323		MODEL 3324		MODEL 3326	
0-1.5	1000 OHMS	16000	\$18.90	16095	\$20.55	16190	\$22.50
0-10		16005	18.90	16100	20.55	16195	22.50
0-15		16010	18.90	16105	20.55	16200	22.50
0-25	PER VOLT	16015	18.90	16110	20.55	16205	22.50
0-50		16020	18.90	16115	20.55	16210	22.50
0-100		16025	18.90	16120	20.55	16215	22.50
0-500		16030	18.90	16125	20.55	16220	22.50
<b>DC AMMETERS</b> Shielded Case not affected by magnetic Mounting							
		MODEL 3323		MODEL 3324		MODEL 3326	
0-5	INTERNAL SHUNT 75 MV MAX.	16035	\$19.20	16130	\$20.85	16225	\$23.10
0-10		16040	19.20	16135	20.85	16230	23.10
<b>DC MILLIAMMETERS</b> Shielded Case not affected by magnetic Mounting							
		MODEL 3323		MODEL 3324		MODEL 3326	
0-1	80 Ω	16045	\$18.15	16140	\$19.80	16235	\$22.05
0-100	.5 Ω	16050	19.50	16145	20.85	16240	23.10
<b>DC MICROAMMETERS</b> Shielded Case not affected by magnetic Mounting							
		MODEL 3323		MODEL 3324		MODEL 3326	
0-50	3000 Ω	16055	\$24.45	16150	\$26.10	16245	\$28.65
0-100	1300 Ω	16060	22.20	16155	23.85	16250	26.40
<b>AC VOLTMETERS (Rectifier Type)</b> Shielded Case not affected by magnetic Mounting							
		MODEL 3343		MODEL 3344		MODEL 3346	
0-150	1000 OHMS	16065	\$22.80	16160	\$24.15	16255	\$26.40
0-300	PER VOLT	16070	22.80	16165	24.15	16260	26.40
<b>AC AMMETERS (Rectifier Type)</b> Shielded Case not affected by magnetic Mounting							
		MODEL 3343		MODEL 3344		MODEL 3344	
0-1	Internal Transformer Burden	16075	\$28.50	16170	\$29.70	16265	\$32.10
0-5	0.5 VA Maximum	16080	28.50	16175	29.70	16270	32.10
<b>AC MILLIAMMETERS (Rectifier Type)</b> Shielded Case not affected by magnetic Mounting							
		MODEL 3343		MODEL 3344		MODEL 3346	
0-1	600 Ω	16085	\$22.50	16180	\$23.85	16275	\$25.80
<b>AC MICROAMMETERS (Rectifier Type)</b> Shielded Case not affected by magnetic Mounting							
		MODEL 3343		MODEL 3344		MODEL 3346	
0-100	4000 Ω	16090	\$23.85	16185	\$24.75	16280	\$27.15

### DIMENSIONS

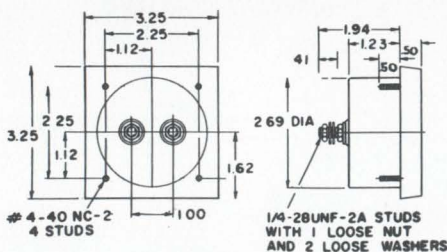

•New addition to catalog.

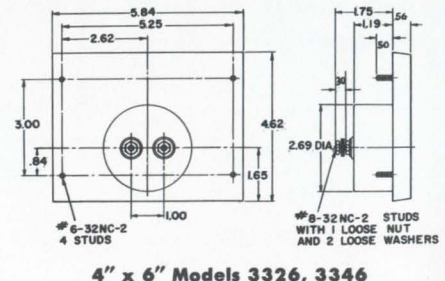
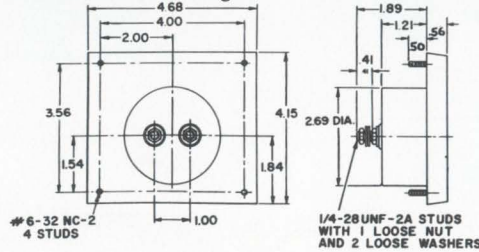



# Shunts • Current Transformers • External Multipliers

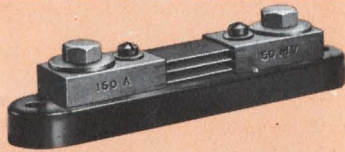

BAKELITE BASE IS SUPPLIED UP TO 200 AMPERES

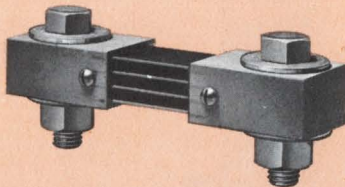

SWITCHBOARD TYPE 100 THROUGH 7000 AMPS

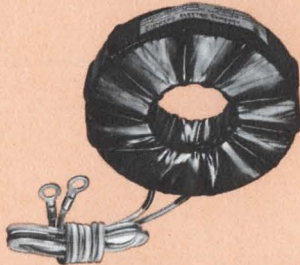

CURRENT TRANSFORMER



EXTERNAL MULTIPLIER MODEL 183 For Usage See Voltmeter Footnotes

## EXTERNAL PORTABLE AND SWITCHBOARD SHUNTS—

### FOR USE WITH DC AMMETERS

These shunts are adjusted for a 50 millivolt drop for use with switchboard and panel ammeters where external shunts are required. Portable shunts are bakelite base and supplied up to 200 amperes. (Prices shown include 5' leads.) Accuracy = 1%.

### PORTABLE SHUNTS

Amps.	Part No.	Price
1	6700	\$7.90
5	6703	7.90
10	6704	7.90
15	6705	7.90
25	6707	7.90
30	6708	7.90
50	6709	7.90
75	6711	7.90
100	6713	7.90
150	6714	7.90
200	6715	7.90

### SWITCHBOARD SHUNTS

Amps.	Part No.	Price
100	6500	\$7.90
150	6503	8.35
200	6504	8.35
250	6505	8.35
300	6506	8.35
400	6507	10.30
500	6508	12.25
600	6509	14.50
750	6510	18.65
800	6511	19.70
1000	6512	23.90
1200	6513	28.55
1500	6514	35.70
2000	6515	40.20
2500	6516	50.25
3000	6517	59.70
3500	6518	83.35
4000	6519	100.15
4500	6520	109.75
5000	6521	123.40
6000	6522	136.15
7000	6523	163.60

## CURRENT TRANSFORMERS— FOR USE WITH AC AMMETERS

These current transformers are of the inserted one turn primary type for use with switchboard and panel ammeters where external transformers are required.

AMPERE RANGES Primary	Secondary	Part No.	Price
50	5	1293	\$18.40
75	5	1306	13.60
100	5	1297	11.20
150	5	1298	10.00
200	5	1299	10.00
250	5	1313	11.20
300	5	1300	11.20
400	5	1305	12.40
500	5	1301	13.60
600	5	2303	13.60
750	5	2459	16.00
1000	5	2304	17.20

## MODEL 183 MULTIPLIER SERIES

Simpson External Multipliers are available for immediate delivery from your local distributor in the ranges listed below. Other intermediate ranges are available on special order: DC Volts to 5000; AC Volts to 1000. Send your specifications for a quotation.

### AC VOLTS—166 Ohms/Volt

Range	Multiplier		Meter		Part No.	Price
	Resistance Ohms	Volt. Drop	Volt. Drop			
0-500	58,333	350	150	8562	\$6.10	
0-600	75,000	450	150	8563	7.00	
0-750	100,000	600	150	8564	7.75	
0-1000	141,666	850	150	8565	9.25	

### DC VOLTS—2000 Ohms/Volt

Range	Multiplier Resistance Megohms	Meter Sensitivity DC UA	Part No.	Price
0-500	1	500	8552	\$5.05
0-750	1.5	500	8553	5.35
0-1000	2	500	8554	5.35
0-1250	2.5	500	8555	5.35
0-1500	3	500	8556	5.65
0-2000	4	500	8557	5.65
0-2500	5	500	8558	5.80
0-3000	6	500	8559	5.80
0-4000	8	500	8560	6.25
0-5000	10	500	8561	6.85

## SIMPSON TEST EQUIPMENT

Add-a-tester Adapters Expands the famous 260 or 270 VOM as the need arises.



Handscope Model 466



+



=



100,000 ohms per volt AC-DC Volt-Ohm-Microammeter Model 269

WORLD'S LARGEST MANUFACTURER OF ELECTRONIC TEST EQUIPMENT

Write for bulletin 2072



5200 W. Kinzie St.  
Chicago, Illinois 60644  
Phone: EStebrook 9-1121  
(Area Code 312)

WESTERN DIVISION:  
Simpson Instruments  
1130 Simpson Way (P.O. Box 488)  
Escondido, California 92026  
Phone: 714-745-8202

Export Dept.:  
400 West Madison St.  
Chicago, Illinois 60606  
Cable: Amergaco

In Canada:  
Bach-Simpson Ltd.  
London, Ont.



ELGIN PLANT



LAC DU FLAMBEAU PLANT



KINZIE ST. PLANT



AURORA PLANT



MERCER PLANT

# Simpson 260<sup>®</sup> The World's Best Selling VOM Family of Instruments



260-5.....\$52.95



260-5M.....\$54.95



Model 261..... \$62.95



260-5P.....\$79.95



270-3.....\$67.95

## CARRYING CASES



Roll Top VOMs  
 260-5RT.....\$58.95  
 260-5MRT.....\$60.95  
 260-5PRT.....\$85.95  
 261-RT.....\$68.95  
 270-3RT.....\$73.95



Ever-Redy Vinyl  
 Carrying Case Only  
 No. 0805....\$9.95



Utility Case  
 Cat. No. 0549  
 \$15.95



Probe Case  
 Cat. No. 0574  
 \$3.95

## WORLD FAMOUS 260<sup>®</sup>\* AC/DC Volt-Ohm-Milliammeter

**NEW IMPROVED 260<sup>®</sup>\* VOLT-OHM-MILLIAMMETER** continues as the World's largest selling VOM. Over a million instruments have been sold. Known for its reliability and ruggedness, the 260 has been continually improved to meet changing market conditions. Among the many built-in features of the 260 are:

- Movement Overload Protection.
- Self shielded Meter Movement.
- Increased linearity and stability.
- Greater repeatability.
- Input protected with an internal 1 amp fuse.
- Individual 260 instruments with special features and accuracies (Identified as 250, 255, 260-5, 5M, 261 and 270).

Complete with test leads No. 7500 and operator's manual.

260-5.....\$52.95  
 260-5M (Mirror Scale).....\$54.95

### ROLLTOP VOMs

260-5RT.....\$58.95  
 260-5MRT.....\$60.95

## NEW PROTECTED 260-5P\* AC/DC VOLT-OHM-MILLIAMMETER

This Simpson Instrument has built-in Meter and Tester protection approaching 100% which virtually makes this VOM GOOF PROOF. The 260-5P will be of particular value in situations where the instrument may be used by inexperienced people; students, apprentices, and new employees. Technicians, too, will find the instrument ideal for exploring unfamiliar equipment, especially when lack of a schematic diagram poses the hazard of encountering unexpected high voltages when making tests.

### Combined protection not found in any other VOM.

1. Reset button pops out to indicate overload.
2. You cannot reset circuits while overload is present.
3. Protective circuit does not require massive overloads which can cause hidden damage to the instrument.
4. All ranges are protected except those not feasible in a portable instrument —1000 and 5000 volts DC and AC; 10 Amps DC.

The 260-5P has the same ranges and takes the same accessories as the Simpson 260-5 VOM.

Complete with test leads 7500 and operator's manual.

260-5P Protected (GOOF PROOF).....\$79.95  
 260-5PRT Protected Roll Top.....\$85.95

## HIGH ACCURACY 261\* and 270\*-3 AC/DC VOLT-OHM-MILLIAMMETERS

For those test VOM applications requiring higher accuracies, Simpson has combined the latest in VOM design with strict manufacturing controls to produce two popular VOM's of the 260 family, 261 and 270 Series 3.

These features include:

1. A new self-shielded annular meter movement.
2. Special calibration circuit that increases accuracy.
3. Diode overload protection. (Prevents movement burnout even on 200,000% overload.
4. Mirror scale with knife edge pointer.
5. Input protected with an internal 1 amp fuse.

Complete with test leads 7500 and operator's manual

Model 261.....\$62.95  
 270-3.....\$67.95

### ROLL TOP VOMs

Model 261-RT.....\$68.95  
 270-3RT.....\$73.95

# Designed to Meet Today's Changing Test Equipment Requirements



Cat. No. 0531  
....\$29.95

Model 255.....\$89.95

## SIMPSON'S ELECTRICAL & TEMPERATURE TESTER MODEL 255\* WITH AC AMMETER CLAMP-ON ADAPTER FACILITY

Model 255 is well suited for the servicemen in many fields, such as: gas appliance servicing and installation, electrical utilities, and heating service and installation. By using the AC clamp-on adapter, AC currents through 250 amperes can be checked without disconnecting the leads or otherwise opening the circuit. This tester includes the important VOM functions of the 260 as well as providing a temperature range of +100°F to +1050°F. A low millivolt drop is provided on the direct current ranges.

Complete with test leads with prods (Cat. No. 0115), 5 Ft. thermocouple lead (0163), and operator's manual.

Model 255.....\$89.95 AC Clamp-on Adapter, Cat. No. 0531.....\$29.95  
10,000 VAC High Voltage Probe, Cat. No. 0161.....\$11.75



Model 250.....\$59.95

## NEW... 50 MILLIVOLT DROP VOM... MODEL 250\*

This is Simpson's answer to transistor circuitry testing requiring a VOM with a low millivolt drop on current ranges. Model 250 contains all of the built-in features of the World's Largest Selling VOM, the 260, together with modified range coverage designed for solid state testing, plus the provision for using the add-a-tester adapters, the 260 high voltage probes and other accessories.

Complete with test leads and operator's manual.

Model 250.....\$59.95

### VOLT-OHM-MILLIAMMETER SPECIFICATIONS—20,000 Ω/V DC; 5,000 Ω/V AC

RANGES	250	255	260-5	260-5M	260-5P	261	270-3
DC VOLTS	0-0.050; 0-0.250; 0-2.5; 0-10; 0-50; 0-250; 0-500; 0-1000	0-0.050; 0-0.250; 0-1; 0-2.5; 0-10; 0-50; 0-250; 0-1000					0-0.25; 0-2.5; 0-10; 0-50; 0-250; 0-1000; 0-5000
AC VOLTS	0-2.5; 0-10; 0-50; 0-250; 0-500; 0-1000	0-2.5; 0-10; 0-50; 0-250; 0-1000					0-2.5; 0-10; 0-50; 0-250; 0-1000; 0-5000
DC MICROAMPERES	0-50 (Both 50 and 250 MV Drop)				0-50 (250 MV Drop)		
DC MILLIAMPERES	0-1; 0-10; 0-100; 0-500 (50 MV Drop)				0-1; 0-10; 0-100; 0-500		
DC AMPERES	0-10 (50 MV Drop)	NONE			0-10 (250 MV Drop)		
AC AMPERES	NONE	0-5, 0-25, 0-100, 0-250			NONE		
DB SCALE (1MW-600Ω)	-20 to +10; -8 to +22; +6 to +36; +20 to +50	NONE			-20 to +10; -8 to +22; +6 to +36; +20 to +50		
OUTPUT RANGES	NONE	NONE			0.1 mfd capacitor in series with all AC voltage ranges through 250 volts.		
RESISTANCE RANGES	R X 1 0-2000Ω (12Ω center)		R X 100	0-200KΩ (1200Ω center)		R X 10K	0-20 megΩ (120KΩ center)
TEMPERATURE RANGE	NONE	+100° F. to +1050° F.				NONE	
ACCURACIES:							
0-50 MV; 0-250 MV; 0-2.5 to 0-1000 V DC	±2% F.S.	±2% F.S.			±2% F.S.	±1.5% F.S.	±1.25% F.S.
0-5000 V DC	—	—			±3% F.S.	±2.5% F.S.	±2.25% F.S.
0-50 MICROAMPERES	±1% F.S.	±1% F.S.			±1.5% F.S.	±1.0% F.S.	±.75% F.S.
0-1 MA to 0-10 A DC	±2% F.S.	±2% F.S.			±2% F.S.	±1.5% F.S.	±1.25% F.S.
R X 1 R X 100, R X 10,000	±2.5° of Arc ±2.0° of Arc	±2.5° of Arc ±2.0° of Arc			±2.5° of Arc ±2.0° of Arc	±2.0° of Arc ±1.5° of Arc	±1.5° of Arc ±1.0° of Arc
0-2.5 to 0-1000 V AC	±3% F.S.	±3% F.S.			±3% F.S.	±3% F.S.	±2.0% F.S.
0-5000	—	—			±4% F.S.	±4% F.S.	±3% F.S.
MOVEMENT TYPE	Self Shielding Annular—Taut Band		Self Shielding Annular—Pivot and Jewel				Self Shielding Annular Taut Band
TEMPERATURE COMPENSATED	NO	NO	NO	NO	NO	NO	YES
METER MOVEMENT PROTECTION	YES	YES	YES	YES	YES	YES	YES
RESETABLE TESTER CIRCUIT PROTECTION	NO†	NO†	NO†	NO†	YES	NO†	NO†
MIRROR SCALE	NO	NO	NO	YES	NO	YES	YES
SCALE LENGTH	4.2 Inches						
DIMENSIONS	5¼" x 7" x 3½"						
NET WEIGHT	3½ lbs.						
PRICE	\$59.95	\$89.95	\$52.95	\$54.95	\$79.95	\$62.95	\$67.95

#### ACCESSORIES For 250, 255, 260-5/5M/261/270

	Cat. No.	Price		Cat. No.	Price		Cat. No.	Price
10,000v DC High voltage probe...	0507	\$10.20	10,000v AC High voltage probe...	0161	\$11.75	Roll top safety case only.....	0249	\$ 9.95
25,000v DC High voltage probe...	0508	11.50	Banana plugs and alligator clip...	7500	2.10	Utility Carrying Case, Vinyl.....	0549	15.95
50,000v DC High voltage probe...	0509	12.50	Banana plugs and test prods....	7538	2.50	Probe Case.....	0574	3.95
Clamp-on AC Ammeter adapter (For Model 255 only).....	0531	29.95	Leather Carrying Case.....	1818	8.95	Thermocouple lead (5 ft.) (Model 255 only).....	0163	3.95
			Ever-Redy Carrying Case.....	0805	9.95			

†1 amp fuse limits maximum current.

\*EXCLUSIVE SIMPSON ADJUST-A-VUE HANDLE

# SIMPSON MODEL 604

VOLT-AMP-MILLIAMP-MICROAMP

# MULTICORDER®

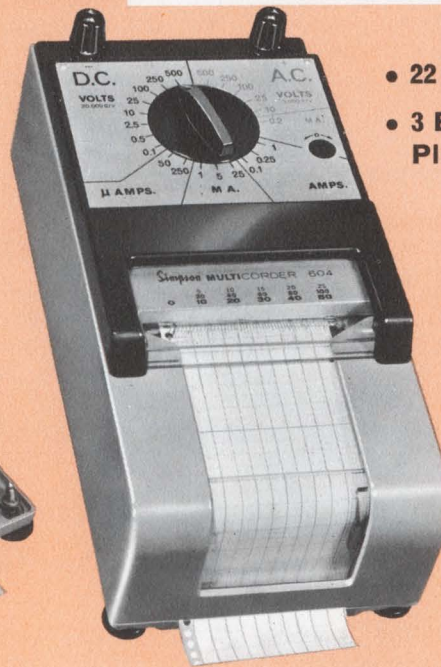
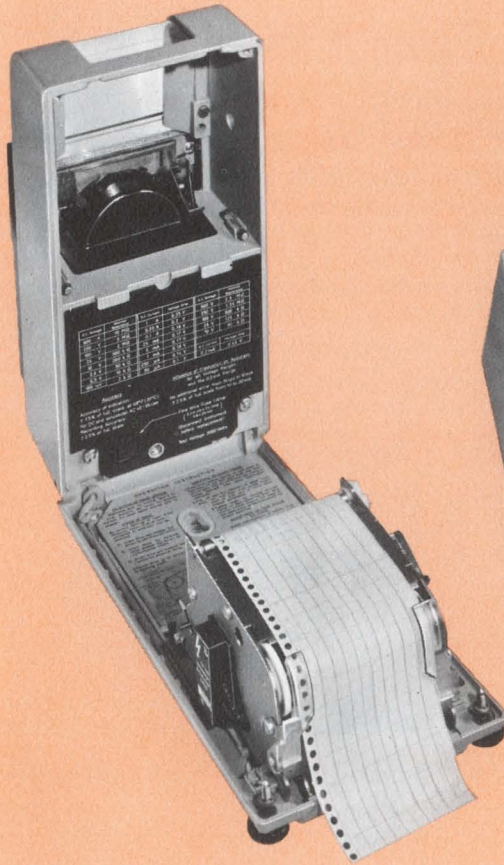

- 22 Built-in Ranges . . . AC & DC
- 3 Built-in Speeds . . . 1/3/12 in./hr.  
Plus external drive



Ever-Redy  
Vinyl  
Carrying  
Case

Catalog No. 02611  
\$24.95 ea.

## FEATURES:

- A permanent record of both range and measured value.
- Inkless recording via fast sequential impressions on pressure sensitive strip chart paper (no pen and ink maintenance problems).
- A high torque meter movement, with a shock-proof taut band suspension moving coil system.

SIMPSON MULTICORDER Model 604 contains a unique range marking system that indicates the range being used as the value is being recorded. Compact, rugged design, easy-to-operate and accurate, the Multicorder is an indicating instrument with a wide band of ranges and functions for measurements that eliminates the need for a separate recorder for each of the functions and ranges. You get visual readout in addition to the recording action that offers three chart speeds: 1"/3"/12" per hour. This Simpson Multicorder is the only multi-function recorder available for less than \$200.00.

## RANGES:

D. C. Volts: 0-.1/.5/2.5/10/25/100/250/500 @ 20,000 ohms per volt.

A. C. Volts: 0-10/25/100/250/500 @ 5,000 ohms per volt.

Direct Current: 0-50/250 Mics, 1/5/25 Milliamps, .1/.25/1.0 Amps.

350 MV Drop maximum.

Alternating Current: 0-.2 Milliamps. 450 MV drop.

Complete with test leads (#7500) and two rolls of Chart Paper

Model 604 Multicorder..... \$199.95

Additional Chart Paper #02612..... \$ 2.50 ea.  
(Box of 10) \$19.50

Special Gear Unit 30/60/90 in/hr.  
Cat. #0683..... \$29.95

Ever-Redy Vinyl Carrying Case Cat. #02611.. \$24.95

## SPECIFICATIONS

### ACCURACY OF INDICATION:

DC	±1.5% F.S.
AC (45 to 65 cps Sine Wave)	±1.5% F.S.
Accuracy of Recording:	±2.5% F.S.

### TEMPERATURE INFLUENCE:

DC—for 10°C change (18°F) 1 max  
(% of true value)

AC—for 10°C change (18°F) 1 max  
(Influence is positive from 20°C to 0,  
(68°F to 32) and negative from 20 to  
50°C, (68 to 122°F). (% of true value)

### FREQUENCY INFLUENCE:

Flat from 15 to 10,000 cps.  
2.5% of full scale from 10,000 to  
20,000 cps.

### Recorder:

Chart paper and chopper bar action can be driven either by the self-contained synchronous motor or by external driving means.

### Motor Drive:

Self-starting synchronous motor, 115 volts, 60 cps, contained in recorder. Grounded line cord is provided with recorder.

### Chart Speed:

1/3/12 inch/hour  
Chart impressions are made every two seconds.

### Chart Paper:

Type—Pressure sensitive paper.  
Width of recording—2.3 inches.  
Length of paper on roll—50 feet approximately.  
Divisions—50.

Size: 9¾" x 4¾" x 4". Net Weight: 5½ lbs.

NOT AVAILABLE OUTSIDE OF THE UNITED STATES OF AMERICA



# Simpson TEMPERATURE MEASURING INSTRUMENTS



**Model 385-3L...\$35.95**  
For Three Probes



**Model 388-3L...\$69.95**  
For Three Probes

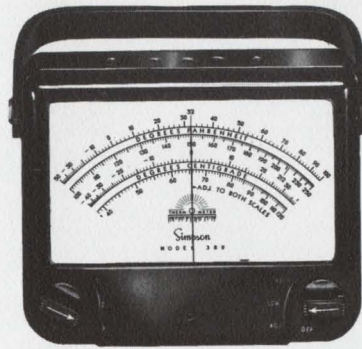

**Model 389-3L...\$64.95**  
For Three Probes



**Model 387...\$29.95**  
Appliance Tester

## MODEL 385-3L TEMPERATURE METER

Model 385-3L is ideal for those fast, accurate temperature checks from  $-50^{\circ}\text{F}$  to  $+70^{\circ}\text{F}$ . Light weight, portable, fits easily in your hand. Three lead model. Takes temperature readings in three different locations with a simple flick of the selector knob. Standard Model has Fahrenheit scale. Supplied with one No. 0010, 15 ft. thermistor lead and operator's manual.

**Size:** 3" x 5 $\frac{1}{8}$ " x 2 $\frac{1}{2}$ ". **Weight:** 1 $\frac{1}{2}$  lbs. ....\$35.95

## MODEL 388-3L THERM-O-METER®

Simpson's popular wide range Therm-O-Meter tester measures the temperature of practically anything within  $-50^{\circ}\text{F}$  to  $+1000^{\circ}\text{F}$ . Standard model has combination  $^{\circ}\text{C}$  and  $^{\circ}\text{F}$  scale. Sensing Element: Thermocouple (Iron-Constantan). Supplied with internal battery and one 8' general purpose probe No. 0190 and operator's manual. Order additional probes as required.

**Size:** 7-15/16" x 6" x 2-15/16" **Weight:** 4 lbs.  
**Model 388-3L** for three probes.....\$69.95

## MODEL 389-3L DUAL RANGE THERM-O-METER®

Model 389-3L temperature tester, using three leads, makes temperature readings in three different locations at the same time; i.e., in a refrigerator, one lead could be connected to the evaporator plate, another to the wall of the food compartment and the third in the center of the food compartment. Readings are made quickly in 15 to 30 seconds depending on the medium being checked. Supplied with  $^{\circ}\text{C}$  and  $^{\circ}\text{F}$  scale.

Supplied with one general purpose thermistor lead No. 0010 and operator's manual. Order additional leads as required.

**Size:** 7-15/16" x 6" x 2-15/16". **Weight:** 4 lbs. ....\$64.95

## APPLIANCE TESTER

### MODEL 387 MILLIVOLTMETER

Make gas unit servicing faster, more accurate. Use Simpson's Millivoltmeter. Simply place the probe across the thermocouple terminals and test for the correct value. Checks Safety Thermocouples on Gas-Fired Units.

- Furnaces
- Hot Water Heaters
- Boilers
- Dryers
- Heaters
- Refrigerators

**Size:** 3" x 5 $\frac{1}{8}$ " x 2 $\frac{1}{2}$ ". **Weight:** 1 $\frac{1}{2}$  lbs. ....\$29.95

RANGE & ACCURACY	PROBES, LEADS AND CARRYING CASES																											
$-50^{\circ}\text{F}$ . to $+70^{\circ}\text{F}$ . $\pm 1^{\circ}\text{F}$ . @ Center Scale $\pm 2^{\circ}\text{F}$ . @ Either End	<table border="1"> <thead> <tr> <th>Description</th> <th>Cat. No.</th> <th>Price</th> </tr> </thead> <tbody> <tr> <td>Surface Temperature Probe.....</td> <td>0790</td> <td>\$ 5.95</td> </tr> <tr> <td>Free Air Temperature Probe.....</td> <td>0789</td> <td>7.45</td> </tr> <tr> <td>Additional Thermistor Lead.....</td> <td>0010</td> <td>5.50</td> </tr> <tr> <td>30 Ft. Thermistor Lead.....</td> <td>0216</td> <td>6.45</td> </tr> <tr> <td>50 Ft. Thermistor Lead.....</td> <td>0415</td> <td>7.60</td> </tr> <tr> <td>100 Ft. Thermistor Lead.....</td> <td>0416</td> <td>10.40</td> </tr> <tr> <td>150 Ft. Thermistor Lead.....</td> <td>0417</td> <td>12.90</td> </tr> <tr> <td>Ever-Redy Leather Carrying Case.....</td> <td>8073</td> <td>8.75</td> </tr> </tbody> </table>	Description	Cat. No.	Price	Surface Temperature Probe.....	0790	\$ 5.95	Free Air Temperature Probe.....	0789	7.45	Additional Thermistor Lead.....	0010	5.50	30 Ft. Thermistor Lead.....	0216	6.45	50 Ft. Thermistor Lead.....	0415	7.60	100 Ft. Thermistor Lead.....	0416	10.40	150 Ft. Thermistor Lead.....	0417	12.90	Ever-Redy Leather Carrying Case.....	8073	8.75
	Description	Cat. No.	Price																									
	Surface Temperature Probe.....	0790	\$ 5.95																									
	Free Air Temperature Probe.....	0789	7.45																									
	Additional Thermistor Lead.....	0010	5.50																									
	30 Ft. Thermistor Lead.....	0216	6.45																									
	50 Ft. Thermistor Lead.....	0415	7.60																									
	100 Ft. Thermistor Lead.....	0416	10.40																									
	150 Ft. Thermistor Lead.....	0417	12.90																									
	Ever-Redy Leather Carrying Case.....	8073	8.75																									
$-50^{\circ}\text{F}$ . to $+1000^{\circ}\text{F}$ . $\pm 1\frac{1}{2}$ Scale Divisions	<table border="1"> <tbody> <tr> <td>General Purpose Type.....</td> <td>0190</td> <td>\$ 4.95</td> </tr> <tr> <td>Surface Temperature Probe Type (1000° F. Max.).....</td> <td>0187</td> <td>8.90</td> </tr> <tr> <td>Rugged Service Lead (8 ft.).....</td> <td>0496</td> <td>6.95</td> </tr> <tr> <td>Ever-Redy Vinyl Carrying Case.....</td> <td>5262</td> <td>9.95</td> </tr> </tbody> </table>	General Purpose Type.....	0190	\$ 4.95	Surface Temperature Probe Type (1000° F. Max.).....	0187	8.90	Rugged Service Lead (8 ft.).....	0496	6.95	Ever-Redy Vinyl Carrying Case.....	5262	9.95															
	General Purpose Type.....	0190	\$ 4.95																									
	Surface Temperature Probe Type (1000° F. Max.).....	0187	8.90																									
	Rugged Service Lead (8 ft.).....	0496	6.95																									
Ever-Redy Vinyl Carrying Case.....	5262	9.95																										
$- 50^{\circ}\text{F}$ . to $+100^{\circ}\text{F}$ . $+100^{\circ}\text{F}$ . to $+250^{\circ}\text{F}$ . Within $\pm 2^{\circ}\text{F}$ .	<table border="1"> <tbody> <tr> <td>Surface Temperature Probe.....</td> <td>0790</td> <td>\$ 5.95</td> </tr> <tr> <td>Free Air Temperature Probe.....</td> <td>0789</td> <td>7.45</td> </tr> <tr> <td>Additional Thermistor Lead.....</td> <td>0010</td> <td>5.50</td> </tr> <tr> <td>30 Ft. Thermistor Lead.....</td> <td>0216</td> <td>6.45</td> </tr> <tr> <td>50 Ft. Thermistor Lead.....</td> <td>0415</td> <td>7.60</td> </tr> <tr> <td>100 Ft. Thermistor Lead.....</td> <td>0416</td> <td>10.40</td> </tr> <tr> <td>150 Ft. Thermistor Lead.....</td> <td>0417</td> <td>12.90</td> </tr> <tr> <td>Ever-Redy Vinyl Carrying Case.....</td> <td>5262</td> <td>9.95</td> </tr> </tbody> </table>	Surface Temperature Probe.....	0790	\$ 5.95	Free Air Temperature Probe.....	0789	7.45	Additional Thermistor Lead.....	0010	5.50	30 Ft. Thermistor Lead.....	0216	6.45	50 Ft. Thermistor Lead.....	0415	7.60	100 Ft. Thermistor Lead.....	0416	10.40	150 Ft. Thermistor Lead.....	0417	12.90	Ever-Redy Vinyl Carrying Case.....	5262	9.95			
	Surface Temperature Probe.....	0790	\$ 5.95																									
	Free Air Temperature Probe.....	0789	7.45																									
	Additional Thermistor Lead.....	0010	5.50																									
	30 Ft. Thermistor Lead.....	0216	6.45																									
	50 Ft. Thermistor Lead.....	0415	7.60																									
	100 Ft. Thermistor Lead.....	0416	10.40																									
150 Ft. Thermistor Lead.....	0417	12.90																										
Ever-Redy Vinyl Carrying Case.....	5262	9.95																										
0-10, 0-30, 0-100, 0-300, 0-1000 Millivolts $\pm 3\%$ of Full Scale	<table border="1"> <tbody> <tr> <td>Test Prods and Spade Terminals.....</td> <td>8379</td> <td>\$ 2.50</td> </tr> <tr> <td>Alligator Clips and Spade Terminals.....</td> <td>8376</td> <td>1.75</td> </tr> <tr> <td>Ever-Redy Vinyl Carrying Case.....</td> <td>8073</td> <td>8.75</td> </tr> </tbody> </table>	Test Prods and Spade Terminals.....	8379	\$ 2.50	Alligator Clips and Spade Terminals.....	8376	1.75	Ever-Redy Vinyl Carrying Case.....	8073	8.75																		
	Test Prods and Spade Terminals.....	8379	\$ 2.50																									
	Alligator Clips and Spade Terminals.....	8376	1.75																									
	Ever-Redy Vinyl Carrying Case.....	8073	8.75																									

# GOOF- PROOF

# VOM



Here's the most foolproof volt-ohm-milliammeter ever made. Protection approaches 100%. It's the VOM you will want to have on hand where inexperienced people are running tests . . . or will reach for yourself on those days when you're all thumbs. The 260-5P will save you all kinds of headaches from burned out meters and resistors, bent pointers, and inaccuracies caused by overheating.

#### Combined Protection You Won't Find In Any Other VOM

1. Reset button pops out to indicate overload.
2. You cannot reset circuits while overload is present.
3. Protective circuit does *not* require massive overloads which can cause hidden damage to the instrument.
4. All ranges are protected except those not feasible in a portable instrument—1000 and 5000 volts DC and AC; 10 amp DC.

## SIMPSON 260-5P

ONLY \$79.95

**Ranges**—The 260-5P has the same ranges and takes the same accessories as Simpson's famous 260-5 VOM.

# Simpson

Representatives in Principal Cities  
...See Telephone Yellow Pages



DIVISION

#### SIMPSON ELECTRIC COMPANY

5202 W. Kinzie Street, Chicago, Ill. 60644 • Phone: (312) ESTebrook 9-1121

Export Dept.: 400 W. Madison Street, Chicago, Ill. 60606 Cable, Amergaco

California: Simpson Instruments, Inc., P.O. Box 488, 1130 Simpson Way, Escondido, Calif. • Phone: (714) SH 5-8202

In Canada: Bach-Simpson Ltd., London, Ontario

In India: Ruttonsha-Simpson Private Ltd., International House, Bombay-Agra Road, Vikbrali, Bombay

WORLD'S LARGEST MANUFACTURER OF ELECTRONIC TEST EQUIPMENT

## D/A converter

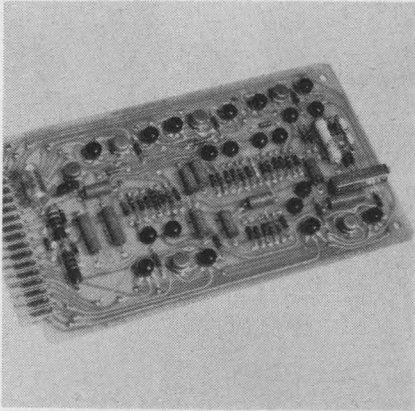

The TD-810-206 digital to analog converter uses a 10-bit integrated storage register. The converter uses eleven input lines, one per register and a lock line. Several channels can be multiplexed serially by connecting each channel's input to a digital source. Accuracy is  $0.1\% \pm 1/2$  LSB,  $0-45^{\circ}\text{C}$ .

P&A: \$275; stock to 30 days. Epsco, Inc., 411 Providence Highway, Westwood, Mass. Phone: (617) 329-1500. TWX: (617) 326-9200.

Circle No. 389

## Servo control unit

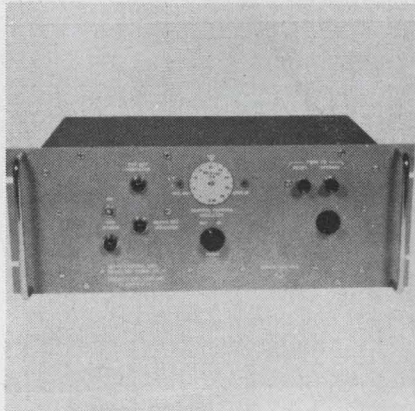

Control of current and voltage levels during high power admittance or impedance measurement is possible through a new servo control unit that allows accuracies to  $\pm 2\%$ . Designated model 501, the control is used for dc and for cw sinusoidal signals in the 100 Hz to 100 kHz range as well as for pulsed cw when provided with an external peak detector.

Dranetz Engineering Labs., 11 Washington Ave., Plainfield, N. J. Phone: (201) 755-7080.

Circle No. 390

## 0.47 to 1 GHz synthesizer

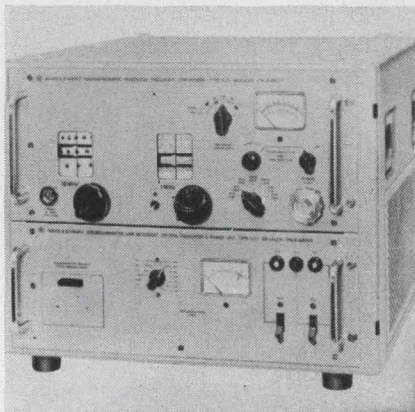

Designated type XUC, a solid-state frequency synthesizer generates 470-1000 MHz directly. The frequency is made up of two components; one is taken from a crystal frequency standard and the other is derived from a tunable interpolation oscillator. Resolution is 5 kHz or 0.5 Hz with an external standard. Output voltage is variable from  $250 \mu\text{V}$  to 1.5 V.

P&A: \$7700; April. Rohde & Schwarz, 111 Lexington Ave., Passaic, N. J. Phone: (201) 773-8010.

Circle No. 391

## Lab thermometer

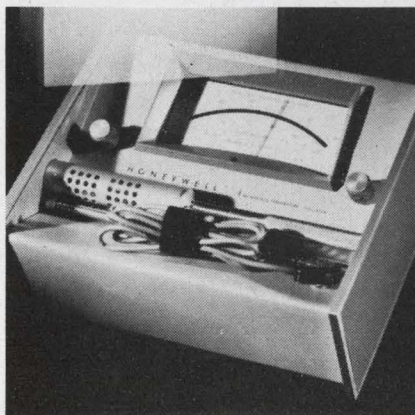

Full portability is the leading feature of a laboratory-grade thermometer called Thermidicator. Readings are instantaneous, accurate to  $1^{\circ}\text{F}$  from  $20^{\circ}$  to  $120^{\circ}\text{F}$  and humidities are accurate to 2% from 7-95%, automatically temperature compensated. A built-in battery with trickle-charger supplies power and recharge.

Price: \$425 complete. Honeywell Inc., 2727 South Fourth Ave., Minneapolis, Minn. Phone: (612) 332-5225.

Circle No. 392

DID  
SOMEONE  
ALREADY  
TAKE  
THE  
NEW  
*Simpson*  
STOCK  
CATALOG  
BOUND IN  
AT LEFT?



if so,  
**CIRCLE  
NO. 248**  
on the reader  
service card  
at the back  
of this magazine  
...or write  
*Simpson*

**ELECTRIC COMPANY**  
5202 W. Kinzie Street  
Chicago, Illinois 60644  
Phone: (312) ESTebrook 9-1121

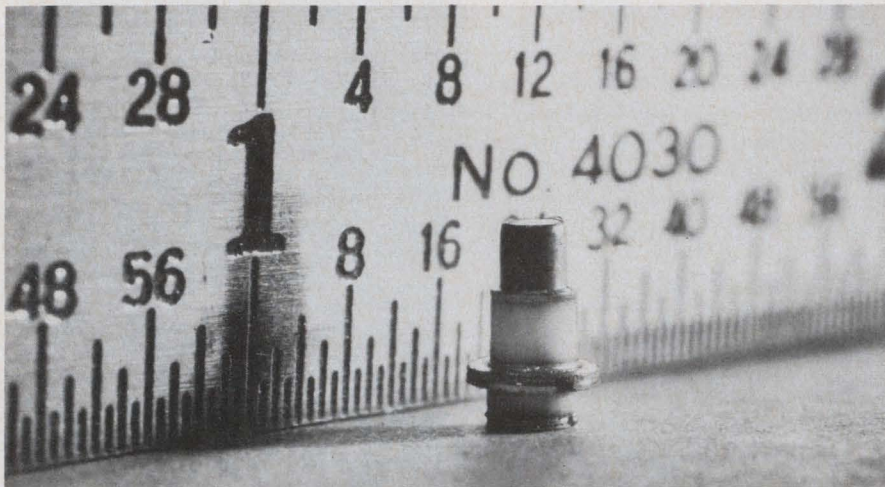

## Coaxial microwave transistor gives 200 MW at 2 GHz

A coax microwave transistor for oscillator applications in the 2 GHz and up area is called MT1050.

The npn silicon planar epitaxial device offers an output capacitance of 4 pF, and emitter transition capacitance of 8 pF. Total dissipation is 2 watts at 70°C case temperature. Maximum operating junction temperature is 175°C.

The coaxial packaging gives low

interelectrode capacitance and lead inductance as inherent characteristics. This yields stability in uhf-vhf amplifier operations and increases oscillator efficiency.

P&A: \$350. Distributor stock. Fairchild Semiconductor Div. Fairchild Camera and Instrument, 313 Fairchild Dr., Mountain View, Calif. Phone: (415) 962-2530.

Circle No. 393

## High-power SCR series

A family of silicon-controlled rectifiers has ratings up to 550 A<sub>rms</sub> with conventional cooling methods.

These four epitaxial flexible-lead SCRs include a model with 400 A<sub>rms</sub>/250A<sub>AV</sub>, two models at 470 A<sub>rms</sub>/300A<sub>AV</sub> (fast-switching and standard), and a device with a rating of 550 A<sub>rms</sub> or 350 average dc amp. All four units range up to 1200 V repetitive, 1300 V transient.

The 300 amp fast switching unit has 40 μs typical turn-off time. The 250 amp rectifier is rated 400A<sub>rms</sub>/250A<sub>AV</sub>, while the 300 amp models have 470A<sub>rms</sub>/300A<sub>AV</sub>.

Stud-mounted configurations have a maximum across-the-flats dimension of 1.690-in. and a max height to top of housing of 1.639-in.

P&A: \$128-\$629 each; 6-8 weeks. International Rectifier, 233 Kansas St., El Segundo, Calif. Phone: (213) 678-6281.

Circle No. 394

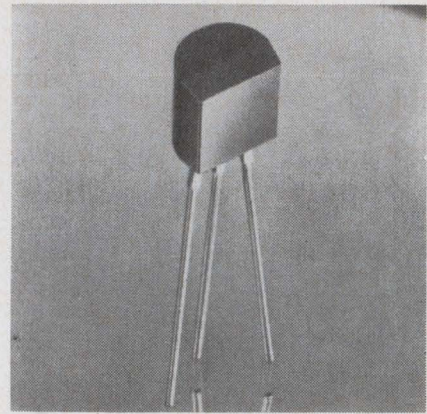
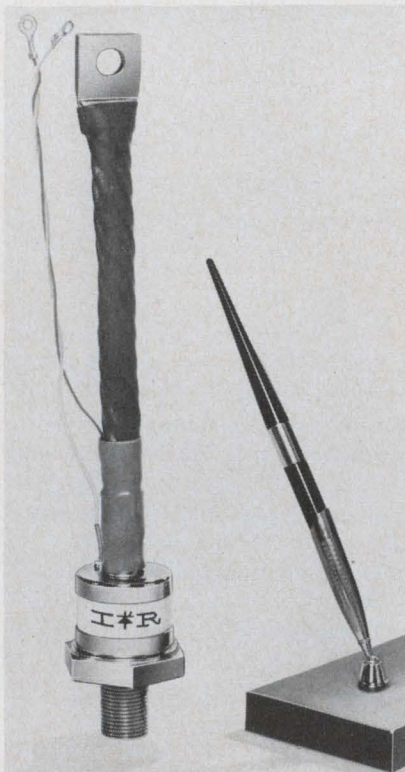

## Dual switching diodes

A single-piece transfer-molded plastic form contains closely matched dual-switching diodes. The package lies flat for easy printed-circuit mounting. Each diode has a breakdown voltage of 100 volts, min. Capacitance is 1.5 pf max with a reverse voltage of zero. Reverse recovery time is 4 ns max at 10 milliamps, in this common-cathode device.

Price: \$.75 each, 100-199. Motorola Semiconductor, Box 995, Phoenix, Ariz. Phone: (602) 273-6900. TWX: (602) 255-0590.

Circle No. 395

## P-channel FETs

Three new FETs feature high gm, low capacitance, and low leakage. Noise figure at 1 kHz is less than 1.5 db with 1 meg source impedance.

Minimum gm for the units is 1,000 μmhos with an I<sub>D</sub> of 1 mA for the 2N4088, 800 μmhos, (I<sub>D</sub> at 0.5 mA) for the 2N4089, and 500 μmhos (I<sub>D</sub> of 0.2 mA), for the 2N4090. Maximum V<sub>p</sub> is 8.0, 5.0, and 3.0 volt respectively.

Amelco Semiconductor Div. of Teledyne, Inc., 1300 Terra Bella Ave., Mountain View, Calif. Phone: (415) 968-9241.

Circle No. 396

## Silicon stacks

Standard and fast recovery silicon stacks in tubular packages have controlled avalanche characteristics. Ratings vary from 1200 PIV at 1000 mA to 20,000 PIV at 80 mA. Fast recovery versions have a max recovery time of 500 ns.

Unitrode, 580 Pleasant, Watertown, Mass. Phone: (617) 926-0404.

Circle No. 397

# Why specify Mallory wet slug tantalum capacitors?

## Four reasons:

- most microfarad-volts per unit volume
- lowest DC leakage
- maximum freedom from catastrophic failure
- highest voltage and temperature ratings

ACTUAL SIZE

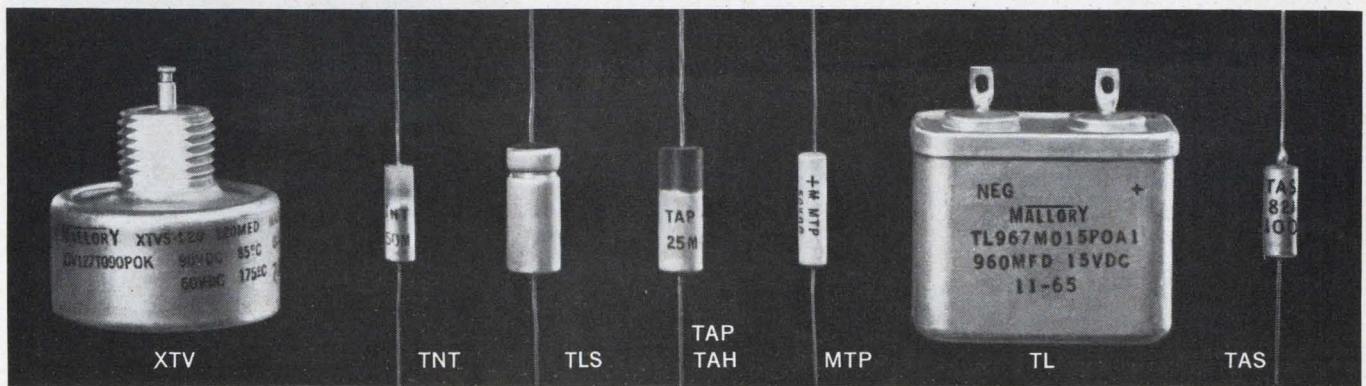

Compare these characteristics:

Mallory Wet Slug Types

Solid Electrolyte

	Mallory XTV	Mallory TNT	Mallory TLS	Mallory TAP/TAH	Mallory MTP	Mallory TL	Mallory TAS
Mfd-volts/in <sup>3</sup>	42,600	52,200	62,500	83,900	178,000	25,600	37,200
Max. DC Wkg. Voltage, 85°C	630V	50V	125V	90V	60V	150V	100V
Max. DC Leakage at highest mfd and voltage, ua/CV	.0052	.0050	.00064	.0026	.00071	.00026	.010
Failure mode	-----Degradational-----						Catastrophic
Temp. range	-55°C +200°C	-55°C +85°C	-55°C +125°C	-55°C +85°C/ +125°C	-55°C +85°C	-55°C +125°C	-55°C +125°C
Weight: grams/mfd-volt	.0018	.0021	.0015	.0012	.00067	.0024	.0024

Next time you need a capacitor for high-reliability applications, consider Mallory wet-slug tantalum capacitors. We'll recommend the best type for you: we make them all—wet

slug, solid and foil—and can recommend without bias. Write or call Mallory Capacitor Company, a division of P. R. Mallory & Co. Inc., Indianapolis, Indiana 46206.



Speed Inquiry to Advertiser via Collect Night Letter  
ON READER-SERVICE CARD CIRCLE 37

## Power transistors

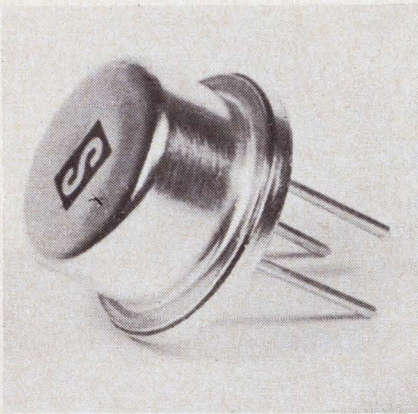

Two families of npn silicon power transistors in the TO-8 package include 5-amp and 10-amp series.

Both have frequencies of 20 MHz, three gain ranges (20-40, 40-120, and 100 min) at 40-80V ( $BV_{CEO}$ ).

Saturation voltages are 0.5 V at  $I_C$  of 1-amp for the 5-amp MHT4611-4619, and 0.5V at  $I_C$  of 5-amperes for the 10-amp MHT7511-7519.

P&A: 5-amp, \$12-\$30; 10-amp, \$16-\$32, each at 100; factory stock. Solitron Devices, 1177 Blue Heron Blvd., Riviera Beach, Fla. Phone: (305) 848-4311.

Circle No. 398

## Chip tunnel-diode

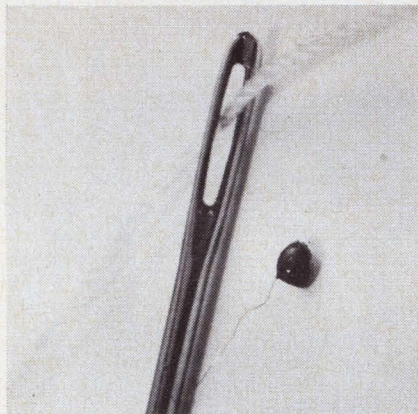

A microminiature chip tunnel-diode switches in five ns, and measures 0.04-in. square. Operating in the 60-700 mV range, with peak currents of 0.47 through 10 mA, the CTD 100-400 series chip is suited to computer use in avionics. Its low rate of environmental degradation suits it to use under extremes of shock and vibration. Leads are thermal compression bonded.

Hoffman Semiconductor Div., 4501 North Arden Drive, El Monte, Calif. Phone: (213) 686-0123.

Circle No. 399

## Dual annular transistors

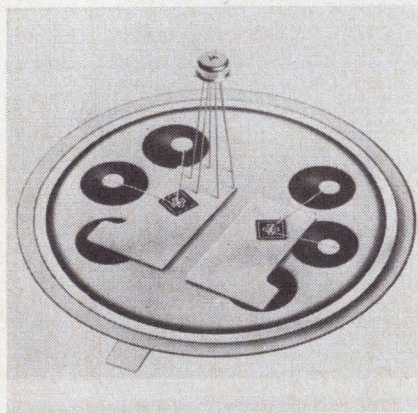

Three series of dual-device silicon annular transistors are the MD2218, MD2904, and the MD3250. Each number is matched to its 2N single-device counterpart. Characteristics also are closely matched, with two devices (MD3250A and MD3251A) having a  $\beta$  match as close as 0.9 to 1, and a base-voltage differential of 3 mV max at 100  $\mu$ A<sub>dc</sub>.

These devices are applicable as differential amplifiers, dc-vhf amplifiers, and high-speed switches.

Motorola Semiconductor, Box 995, Phoenix, Ariz. Phone: (602) 273-6900. TWX: (602) 255-0590.

Circle No. 700

## Power transistors

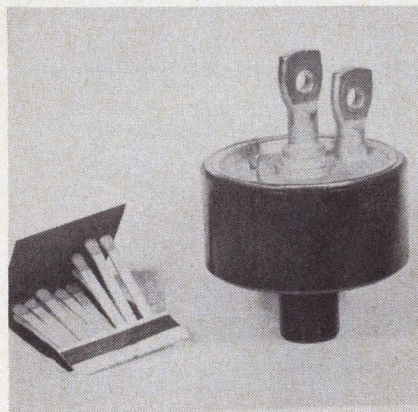

A family of low saturation germanium transistors has collector currents ranging from 150-200 amps. These units are furnished in double-end configuration (MHT 2150 to 2112), and single-ended (MHT 2150 to 2152). Collector saturation voltage is 70 mV, with high gain and low input resistance.

P&A: \$190 to \$280 in 100 quantities; Factory stock. Solitron Devices, Inc., 1177 Blue Heron Blvd., Riviera Beach, Fla. Phone: (305) 848-4311.

Circle No. 701

**Come  
to where  
the  
"Action"  
is on...  
Delco  
Radio**

**EASTERN  
RADIO CORP.**

312 CLIFTON AVENUE  
CLIFTON, NEW JERSEY 07015

**N.J. 201-471-6600  
N.Y. 212-244-8930**

(DIRECT N.Y. LINE)

Delco Radio's new 400V silicon power transistors will change your thinking about high voltage circuitry. You can reduce current, operate directly from rectified line voltage, and use fewer components. Our standard TO-3 package stays cool (junction to heat sink 1.0°C per watt). And price is low—less than 3c a volt even in sample quantities—for wide ranging applications. Vertical and horizontal wide-screen TV out-

# The heat's off high energy circuits

puts, high voltage, high efficiency regulators and converters. Your Delco Radio Semiconductor distributor keeps them on ice. Call him today for data sheets, prices and delivery.

RATINGS	DTS 413	DTS 423
<b>VOLTAGE</b>		
V <sub>CEO</sub>	400 V	400 V
V <sub>CEO</sub> (Sus)	325 V (Min)	325 V (Min)
V <sub>CE</sub> (Sat)	0.8 (Max)	0.8 (Max)
	0.3 (Typ)	0.3 (Typ)
<b>CURRENT</b>		
I <sub>c</sub> (Cont)	2.0A (Max)	3.5A (Max)
I <sub>c</sub> (Peak)	5.0A (Max)	10.0A (Max)
I <sub>B</sub> (Cont)	1.0A (Max)	2.0A (Max)
<b>POWER</b>	75 W (Max)	100 W (Max)
<b>FREQUENCY RESPONSE</b>		
f <sub>t</sub>	6 MC (Typ)	5 MC (Typ)

#### FIELD SALES OFFICES

UNION, NEW JERSEY\*  
Box 1018 Chestnut Station  
(201) 637-3770

SYRACUSE, NEW YORK  
1054 James Street  
(315) 472-2668

DETROIT, MICHIGAN  
57 Harper Avenue  
(313) 873-6560

CHICAGO, ILLINOIS\*  
5151 N. Harlem Avenue  
(312) 775-5411

SANTA MONICA, CALIF.\*  
726 Santa Monica Blvd.  
(213) 870-8807

General Sales Office:  
700 E. Firmin, Kokomo, Ind.  
(317) 457-8451—Ext. 2175

\*Office includes field lab and resident engineer for application assistance.

## DELCO RADIO

Division of General Motors, Kokomo, Indiana



ON READER-SERVICE CARD CIRCLE 39

POWER EQUIPMENT  
Regulated supply

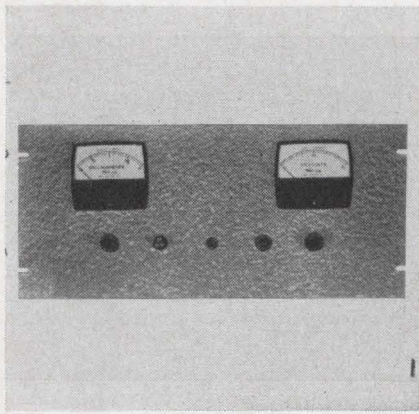

The model TR-135 is continuously variable from 3 to 32 kV with regulated focus voltage tap for 4 to 9 kV. Ripple of the supply is less than 0.5% and regulation against line and load is better than 0.05% at 1 mA. It is furnished complete with voltage and current meters and is housed in a case measuring 19 x 8-3/4 x 15-in.

P&A: \$575; 2 weeks. Spellman High Voltage Co., Inc., 1930 Adee Ave., Bronx, N. Y. Phone: (212) 547-0306.

Circle No. 702

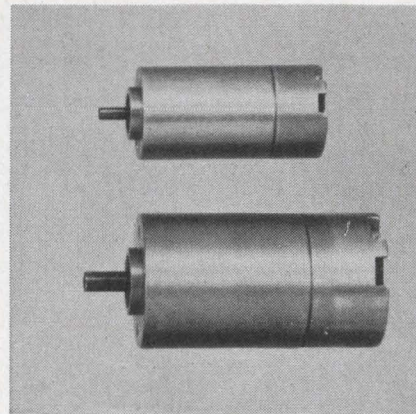

Fractional hp motors

A modular approach to precision fractional horsepower motors is provided by a series of custom-designed standardized parts. This approach is said to eliminate the need for special testing and machine shop set-up time for both large and small users. The motors can be used for tuners, actuators, blowers, tape recorders and chart drives.

Indiana General Corp., 405 Elm St., Valparaiso, Ind. Phone: (219) 462-3131.

Circle No. 704

Regulated power supply

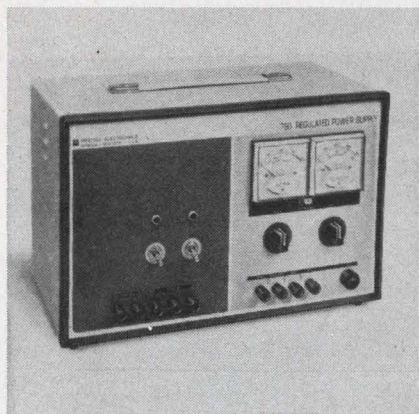

Variable regulated dc plate, bias and ac heater voltages are provided by the model 780 power supply. Voltage output is continuously variable from 0 to 400 V, current from 0 to 150 mA (between 200 and 400 V) with regulation of 0.33% or 0.3 V from no-load to 100 ma. Meters read dc voltage and dc current. Input power is 117 V at 50/60 Hz. Enclosures of model 780 supplies are human-engineered for readability.

Designatronics Inc., Precise Electronics Div., 76 East Second St., Mineola, N. Y. Phone: (516) 741-7070.

Circle No. 703

**IN STOCK**

... standard **RBM** enclosed relays with all the advantages of "specials"

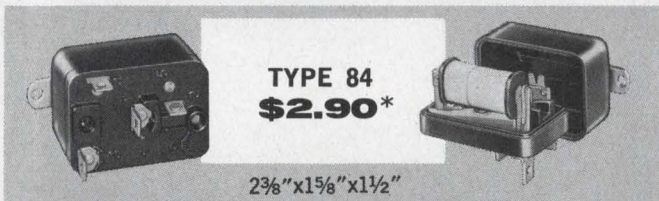

**TYPE 84**  
**\$2.90\***

2 3/8" x 1 5/8" x 1 1/2"

millions in use—time tested and field proven under exacting operating conditions

**TYPE 84** 8 AMP (Inductive)  
SPNO or SPDT

**RBM TOTALLY ENCLOSED AC RELAYS... AT OPEN TYPE PRICES**



**TYPE 129**  
**\$3.94\***

2 3/8" x 1 7/8" x 1 7/8"

\*SPNO—24 Volt 50/60 Cycle—Lots 1 to 24

**TYPE 129** 18 AMP (Inductive)  
SPNO or SPDT

**AUTHORIZED STOCKING DISTRIBUTORS**

ALLIED  
BLUFF CITY  
LEW BONN  
BURSTEIN-APPLEBY  
CRAMER  
DIXIE RADIO  
ELECTRONIC EQPT.  
ELECTRO TECH

FEDERATED  
FISHER SWITCHES  
GRAHAM  
HAMMOND  
INTERSTATE  
LOU JOHNSON  
KIERULFF  
NEWARK

PIONEER/SREPCO  
POWELL  
RISSI  
RADIO PARTS  
SPECIALTY  
STACK  
TEXAS INSTRUMENTS SUPPLY  
WESTERN ELECTRONICS



WRITE FOR 1966 STANDARD CONTROLS CATALOG

SOLD NATIONALLY THROUGH ELECTRONIC DISTRIBUTORS BY  
**ELECTRONIC MARKETING DIVISION**

3501 W. Addison Street • Chicago, Illinois 60618

ON READER-SERVICE CARD CIRCLE 40





# RECORD

Visit the Moseley Division  
of Hewlett-Packard at IEEE  
3rd floor New York Coliseum,  
March 21-24

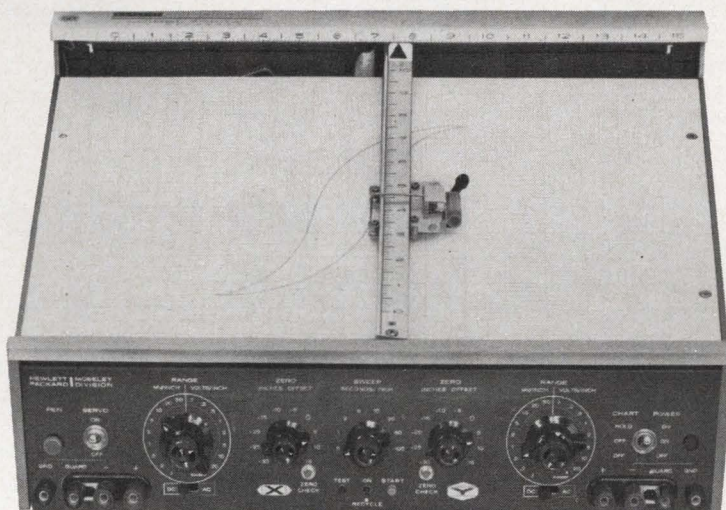

## low-level ac low-level dc

### ON THIS SOLID-STATE 11" x 17" X-Y RECORDER

100  $\mu$ v/inch dc sensitivity  
5 mv/inch ac sensitivity  
1-megohm input resistance  
high common mode rejection

The Moseley Division 7000A Recorder accepts dc or ac signals on either or both axes, offers dc cmr of 140 db, ac cmr of 120 db. Potentiometric input available on six most sensitive ranges; accepts roll chart and other accessories for maximum versatility. Internal time base switchable to either axis, featuring automatic reset, adjustable sweep length, automatic recycling.

Other features of the 7000A include extended zero offset with calibrated steps,

maintenance-free AUTOGRIP\* electric paper holddown, sturdy, compact construction. Also available from current production is the Model 7001A, identical to the 7000A except for the omission of ac input ranges. Metric and rack mount models available, as well. Price, 7000A, \$2495; 7001A, \$2175.

\*Trade Mark Pat. pend.

Data subject to change without notice.  
Prices f.o.b. factory.

948

**HEWLETT  
PACKARD**  **MOSELEY  
DIVISION**

ON READER-SERVICE CARD CIRCLE 41

# Life before the PVB



**"Before the PVB, we would have needed many expensive instruments to do the same jobs!"**

Sam Yoshikawa wanted a resistance bridge for the Instrumentation and Calibration Lab he supervises for Signetics Corporation of Sunnyvale, California. We asked him why he chose our Model 300 PVB (Portametric Voltmeter Bridge).

His answer: "The PVB gives us a lot more measuring capability than we bargained for. We use it principally as a high-accuracy resistance bridge, to calibrate decade boxes in the lab, and for other resistance measurements.

"But it also packs eight other measurement functions into one compact, portable case. So the boys in the Electronic Maintenance Department often take it over there to calibrate their test equipment. And the instrumentation group use it as a design tool in the development of our automatic test equipment.

"In fact, the PVB is so versatile we can hardly keep it in the lab. We sure got a lot of test and calibration equipment in this one \$750 instrument."

*ESI, 13900 NW Science Park Drive, Portland, Oregon (97229)*

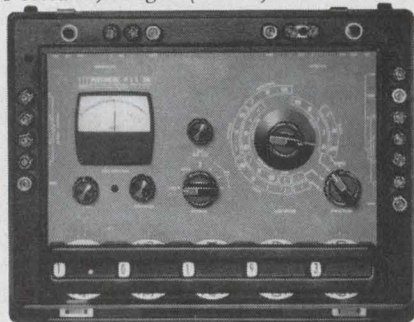

In a single battery-operated unit, the PVB combines the functions of a potentiometric voltmeter, voltage source, ammeter, guarded Kelvin double bridge, resistance comparison bridge, ratiometer and electronic null detector. Accuracy:  $\pm 0.02\%$  of reading or 1 switch step on virtually all ranges.

**esi**<sup>®</sup>

**Electro Scientific Industries**

ON READER-SERVICE CARD CIRCLE 42

## TEST EQUIPMENT



## RF voltmeter reads phase-angle too from 1 MHz to 1 GHz

Model 8405A Vector Voltmeter is a dual-channel wideband RF millivoltmeter and phase-meter. It has a frequency range of 1 MHz to 1 GHz, maximum sensitivity of 100  $\mu\text{V}$  full-scale, and  $\pm 180^\circ$  phase measurement with resolution to  $0.1^\circ$ .

One channel (A) reads voltage through a high-impedance probe. The second channel (B) is used to probe another sector of the circuit under test, giving phase-angle relative to the first. This channel B may also be switched to read voltage, giving gain or loss between two points. A coherent sampling technique finds and phase locks to the fundamental frequency within 10 ms, with channel A amplitude as low as 300  $\mu\text{V}_{\text{rms}}$  (5 MHz-500 MHz), 500  $\mu\text{V}_{\text{rms}}$  (500 MHz-1 GHz).

The 8405A uses a design concept new to voltmeters, though used by this manufacturer in oscilloscopes. A calibrated superheterodyne circuit uses harmonic mixers with high-order feedback stabilization. RF waveforms can be analyzed at the intermediate frequency. Self-tuning is accomplished over 21 overlapping octave-wide frequency ranges by a phase-lock loop system with a search oscillator. Frequency response is flat over the entire range, and phase-readings are independent of voltage. This, of course, requires decoupling. Interchannel

isolation is better than 100 dB to 100 MHz, more than 75 dB at 1 GHz. Modular printed-circuit boards are vertically arranged and removable with built-in levers.

As a voltmeter, each channel has 100  $\mu\text{V}$  full-scale sensitivity with 10 V max input, with other ranges to 1 V, or 10 V with a voltage divider. Gains and losses of 100 dB can be measured.

The phasemeter, on its  $180^\circ$  scale, pinpoints the sector wherein the final phase reading will lie. The phase offset control, with  $10^\circ$  steps, can then be employed to give a maximum sensitivity reading. The  $\pm 6^\circ$  end-scale reading may easily be resolved within  $0.1^\circ$ .

The 20 KHz intermediate frequency is available for monitoring, and recorder outputs are provided.

P&A: \$2500; April. Hewlett-Packard, 1501 Page Mill Rd., Palo Alto, Calif. Phone: (415) 326-7000. TWX: (910) 373-1267.

Circle No. 705

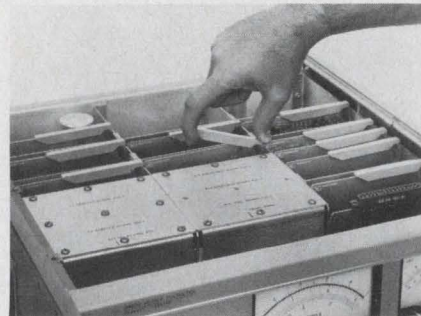

Levers extract printed circuits.

If you could get a commutator that has  $\pm 0.1\%$  accuracy, weighs less than 10 ounces, measures less than 10.5 cu. in., has rates of 0 to 10,000 pps, accepts internal or random external clocking, includes isolation power supply, is extremely reliable, and costs no more than a lot of commutators that are not as good, wouldn't you use it?

Well, Vector has it in stock.

It's the Vector SC Series Subminiature Electronic Commutator, part of Vector's full line of FM, digital, and RF telemetry equipment. For more information write or call Vector, Division of United Aircraft Corporation, Southampton, Pennsylvania.

**Vector** DIVISION OF UNITED AIRCRAFT CORPORATION  
SOUTHAMPTON, PENNSYLVANIA

U  
A

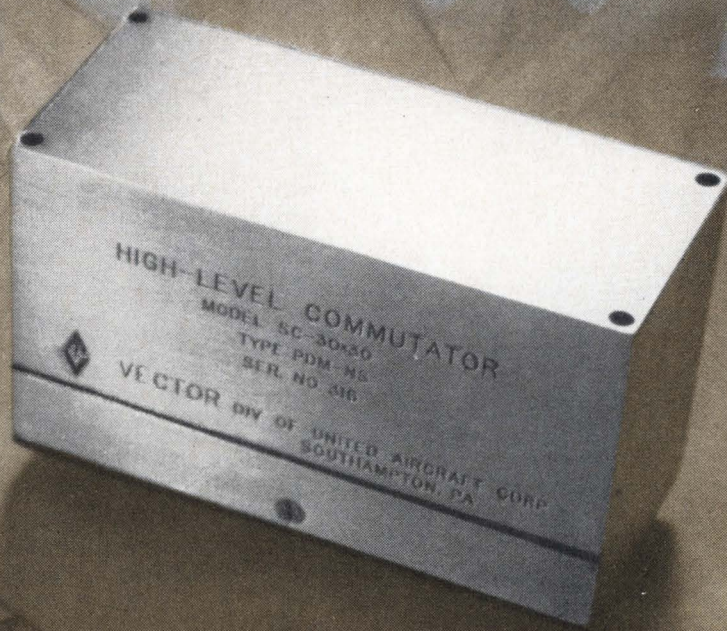

TEST EQUIPMENT

**Microwave power meter**



The new model 540 power meter is used in conjunction with a thermal converter mount to provide indications of microwave power. An unusual feature of this instrument is its use of a standard 60 Hz ac line for calibration. The thermal converter mount has a vswr below 1.5 from 8.2 to 12.4 GHz and the mount efficiency is better than 98%.

P&A: \$95; 30 days. MSI Electronics Inc., 116-06 Myrtle Ave., Richmond Hill, N. Y. Phone: (212) 441-6420.

Circle No. 706

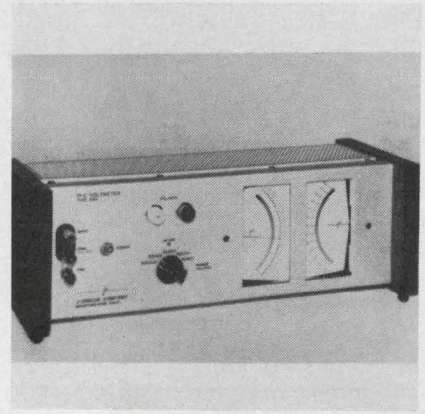

**Hybrid dc voltmeter**

Combining digital and analog circuitry, the Type 21BV volt-meter is capable of measuring voltages over a broad range, from the low millivolts region to 3,200 volts. After initial range selection operation is fully automatic.

About 90% of an input value is presented in true digital form, the remainder as analog vernier.

P&A: \$650.00; 2 to 3 weeks. J-Omega Company, 2278 Mora Drive, Mountain View, California. Phone: (415) 961-2000.

Circle No. 708

**Moisture gage**



A solid-state instrument provides direct readings of moisture content with a basic accuracy of  $\pm 2\%$  at 70°F. The unit, Model 101-A, is supplied with a prong-type electrode, a carrying strap and a battery charger. Unit size is 6-3/4 x 5-1/4 x 2-3/8-in. Calibrations for special materials are made at the factory at no additional cost.

P&A: \$149.50; stock. Henry Francis Parks Laboratory, Box 1665, Seattle, Wash. Phone: (206) 534-4832.

Circle No. 707

**perfect fit** ON ANY SIZE OR SHAPE OPENING!

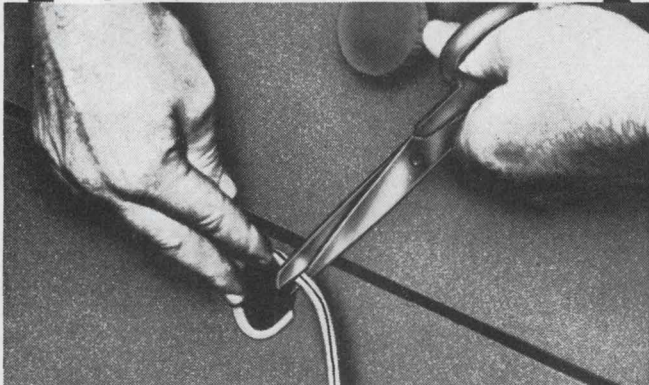

**GROMMET STRIP**  
with the "snip-n-fit" feature

Why carry a stock of different grommets for every size or shape hole? Just five sizes of GROMMET STRIP meet nearly all job requirements. Just "snip-n-fit." The natural polyethylene fits tight and is impervious to almost anything—atmospheric gases, ozone, dampness, acids, and oils, to name a few. And it does the job for pennies. You've got to try it to believe it! Send for a free sample today.

Sold Coast-to-Coast through Authorized Distributors.

**ELECTROVERT INC.**  
86 Hartford Avenue, Mt. Vernon, N.Y.  
Burbank, California • San Francisco, California

ON READER-SERVICE CARD CIRCLE 43

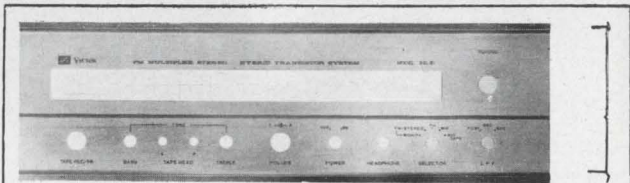

**UMENAME**

.....Manufacturers of Embossed, Etched, Lithographed, Engraved, Litho-Embossed and Printed Name Plates, Data Plates, Dials, Escutcheons, Speaker Grilles and Extruded Aluminum Control Panels.

**UMENAME** products can be found in every home and industry, domestic or abroad, intrinsic to articles of everyday use such as appliances, cameras, radios, televisions, hifi amplifiers/tuners, watches/clocks; electronic control panels, measuring instruments, communication receivers/transmitters, transformers and motors, locomotives and other rolling stocks, vessels and other marine products, etc.

*Inquire for samples and details.*

*Largest Nameplate Manufacturer in the East.*

**Umeda Nameplate Seisakusho (Mfg.) Co., Ltd.**

12-4 chome, Momoi, Suginami-ku, Tokyo, Japan.  
Phone: 399-1111 Cable: UMENAME TOKYO

ON READER-SERVICE CARD CIRCLE 44



# new portable 50 MHz oscilloscope

- **DUAL-TRACE DISPLAYS**  
20 mV/div through 10 V/div, dc-to- > 50 MHz.  
10 mV/div, dc-to- > 45 MHz.  
5 mV/div, dc-to- > 40 MHz.
- **SINGLE-TRACE DISPLAYS**  
1 mV/div, dc-to- > 25 MHz (channels cascaded).
- **X-Y OPERATION**  
5 mV/div through 10 V/div, dc-to- > 5 MHz.
- **OPERATING MODES**  
Channel 1 only; Channel 2 only (normal or inverted); Added Algebraically ( $\geq 20:1$  CMRR up to 20 MHz, linear dynamic range  $\geq 20X$  indicated sensitivity); Alternate; Chopped (500 kHz  $\pm 20\%$  chopping rate).
- **SWEEP RATES**  
5 sec/div to 0.1  $\mu$ sec/div (Time Base A), 0.5 sec/div to 0.1  $\mu$ sec/div (Time Base B), with 10X magnifier extending fastest sweep rates to 10 nsec/div.
- **SINGLE SWEEP**  
Time Base A.
- **PRECISION SWEEP DELAY**  
50 sec to 1  $\mu$ sec.
- **DISPLAY FEATURES**  
4-inch rectangular tube; 6 x 10 div display area (1 div/0.8 cm); internal, illuminated graticule; 10 kV accelerating potential; P31 phosphor.
- **TRIGGER SYSTEM**  
To 50 MHz, from Channel 1 or combined signals (both sweeps). Trigger modes include AC, AC LF REJ, AC HF REJ, DC, AUTO. Trigger sources include INT, LINE, EXT, EXT  $\div 10$ .
- **POWER REQUIREMENTS**  
96-127, 103-137, 192-254, or 206-274 V ac ( $\approx 100$  W) 45 to 440 Hz.
- **MECHANICAL FEATURES**  
Net weight is  $\approx 28$  lbs. including panel cover; shipping weight is  $\approx 36$  lbs. Overall height including feet is 7 $\frac{1}{4}$ " ; overall width including handle is 12 $\frac{1}{2}$ " ; overall length including rear feet and front cover is 20 $\frac{1}{2}$ " , including rear feet and extended carrying handle is 22 $\frac{1}{8}$ " . Carrying handle may be set in any one of a number of positions for viewing convenience. Feet on rear provide for vertical operation.
- **ENVIRONMENTAL FEATURES**  
Ruggedly designed to operate reliably under environmental conditions encountered in portable use.

Type 453 Oscilloscope . . . \$1950  
 Rack Mount Type R453 . . . \$2035  
 U.S. Sales Prices F.o.b. Beaverton, Oregon



A compact, high-performance oscilloscope, the Type 453 operates almost anywhere, and under severe environmental conditions—giving sharp bright displays. The Type 453 offers dual-trace and sweep-delay for accurate and reliable measurements over the dc-to-50 MHz range.

For a demonstration,  
 call your Tektronix field engineer.  
**Tektronix, Inc.**

# Differential op-amp reverses with minute input changes

The model 104 dc differential operational amplifier is modular for printed circuit applications. It provides sub-millivolt discrimination between adjustable reference and variable input signals, enabling uses such as zero-crossing detectors, voltage-time converters, pulse-height discriminators, and voltage/current comparators.

The virtues of this unit lie in its highly non-linear operation. While conventional amplifiers increase output with input, this amplifier functions as a switch: nothing happens until the input exceeds the preset level. For instance, as a voltage comparator, the 104 develops full +11 Vdc until the input signal overcomes the reference voltage level. When the input is 100  $\mu$ V above the reference, the 104 switches, producing -11 Vdc.

In Schmitt trigger applications the 104's full open-loop gain makes it more accurate and less prone to drift than a conventional Schmitt circuit. With appropriate connections, the op-amp can also produce relaxation oscillations.

Sensitivity of the 104 is dependent on the open-loop gain of 100,000. Accuracy is dependent on de-drift characteristics, which refute sensitivity by changing the reference point. The amplifier's drift specifications, power supply coupling and long-term stability determine its minimum signal-resolving capability. For example, although only 100  $\mu$ V input is needed for full 11 V out-

put, temperature induced dc drift referred to the input is 5  $\mu$ V/ $^{\circ}$ C in one model. This means that a 20 $^{\circ}$ C temperature rise produces the equivalent of 100  $\mu$ V input signal, requiring the actual input to change an additional 100  $\mu$ V before the signal changes. By taking into account worst-case errors over a  $\pm$ 50 $^{\circ}$ C temperature range and  $\pm$ 1% supply voltage regulation, this unit will still resolve 500  $\mu$ V.

Thus if a voltage comparator uses a -10 V reference, output will switch for inputs greater than +10.0005 V under all conditions.

The wide bandwidth of the unit, coupled with a fast slewing rate enables quick reaction to changing inputs over a wide frequency range. Slewing rate is a measure of the amplifier's switching speed from full positive to full negative, or vice-versa. The high differential input impedance minimizes loading of the input signal source, and allows use of summing resistors with values to 100 K. With a  $\pm$ 10 V common-mode input voltage, and the common-mode impedance of 2,000 Megs, the amplifier can remain accurate while resolving millivolt signals that float at  $\pm$ 10V.

Specifications of the 104 include an operating temperature range of -25 $^{\circ}$  to +85 $^{\circ}$ C, a differential input impedance of 4 Megs, common-mode impedance of 2,000 Megs, slewing rate of 2 V/ $\mu$ s, overload recovery time of 50  $\mu$ s, and noise level within 3  $\mu$ V from dc to 50 KHz. Open-loop dc gain is 100 dB (100,000), bandwidth is 10 MHz, and max V drift is 20, 10, and 5  $\mu$ V/ $^{\circ}$ C in three models labeled A, B, and C. Max current drift is 0.2nA/ $^{\circ}$ C; long-term stability is within 10  $\mu$ V per day, and supply-voltage coupling is 15  $\mu$ V/1%. The unit is enclosed in a 2 x 5/8 x 1.2-in. box.

P&A: \$68, \$78, and \$98, models A, B, and C respectively; Samples, stock. 3 weeks, production. Analog Devices, 221 5th St., Cambridge, Mass. Phone: (617) 491-1650.

Circle No. 719

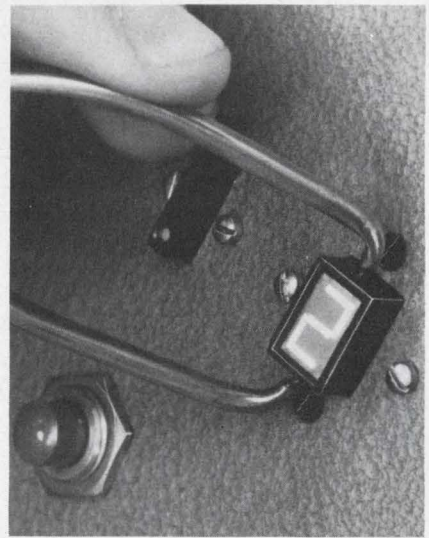

## Plug-in digit lights

A family of self-illuminated incandescent miniature displays is called "Opticator II." These second-generation readouts were designed for vehicle-borne computers. The 1 x 0.35 x 5-in. deep units have plug-in connectors, enabling exchange within five seconds.

Three intensity levels, 200, 400, and 800 foot-Lamberts are available. Numerals, letters, symbols, and decimal points are on 7-bar matrix fields. Figures are 0.34-in high, and light segments are essentially in contact, eliminating dark areas. All units operate at 4 Vdc.

Interfacing equipment: memory circuits, power supplies, and 10 digit converters are available.

Bowmar-Ft. Wayne Div., 800 Bluffton Rd., Fort Wayne, Ind. Phone: (219) 747-3121.

Circle No. 720

## Relay driver

A new solid-state voltage-sensing relay driver offers complete isolation between input and output.

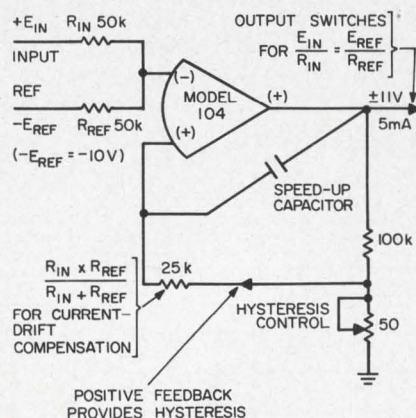
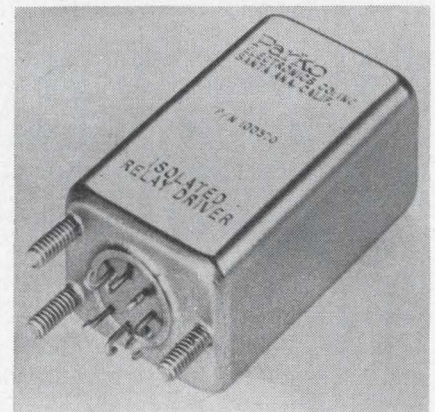

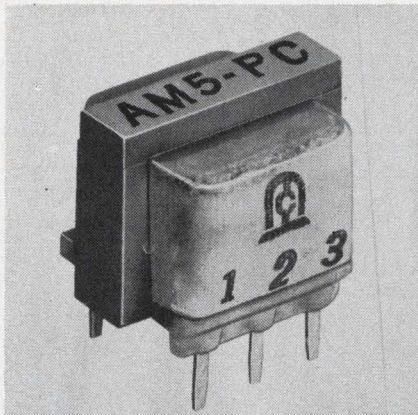

## Miniature transformers

A complete catalog line of miniature transformers for military and industrial applications features plug-in design.

Twenty impedance ranges from 3.4 ohms to 100,000 ohms are offered in the Deci-Miniature series. They meet MIL-T-27B grade 6, and are vacuum varnish impregnated. Terminal lugs are molded into the bobbin to provide for plug-in printed-circuit mounting. These transformers measure 13/32-in. high by 25/32-in. long, and 11/16-in. across the coil. They weigh approximately 1/2 ounce. The unit is self-mounted by means of its terminal lugs, and is suitable to many industrial and commercial, as well as military applications.

P&A: from \$2 to \$3 in hundred piece quantities, depending on electrical ratings. Microtran Co., 145 East Mineola Ave., Valley Stream, L. I., N. Y. Phone: (516) 561-6050. TWX: (516) 593-2685.

Circle No. 721

Minimum isolation between input-sensing circuit and the output and power supply circuitry is 1,000 Megs at 100 Vdc.

The fully-transistorized driver has a pull-in voltage from 5-100 Vdc. Input impedance is at least 100 K, accuracy is within  $\pm 2\%$ , dropout differential is 2% max, temperature coefficient is  $\pm 0.06\%$  per  $^{\circ}\text{C}$ , and the unit switches up to 100 mA at 28 Vdc. It may drive an electromechanical relay, or be used as an spno solid-state relay.

P&A: \$172.50 each 1 to 9, lower prices for quantity orders; 6 to 8 weeks. Parko Electronics Co., Inc., 1320 East Wakeham Ave., Santa Ana, Calif. Phone: (714) 547-0184.

Circle No. 722

A helical bourdon-tube pressure gauge has only 0.56-in. diameter. Designed for the Mariner spacecraft, it is also applicable in laboratory, and industrial programs.

The unit meets all applicable MIL specs for temperature, altitude, vibration and shock. The dial reads 0-300 PSI with other ranges and modifications available at the user's option.

Delivery: 3-6 weeks. American-Standard, Monrovia Instruments, 1401 South Shamrock Ave., Monrovia, Calif.

Circle No. 723

## Miniature pressure gage

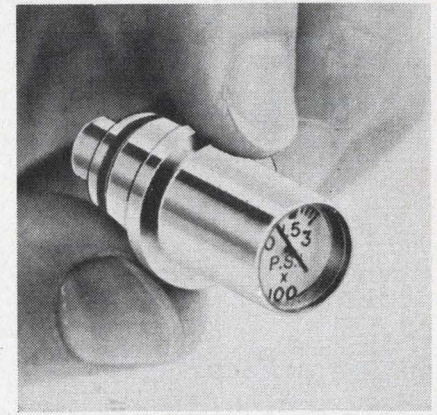

## Subminiature jack

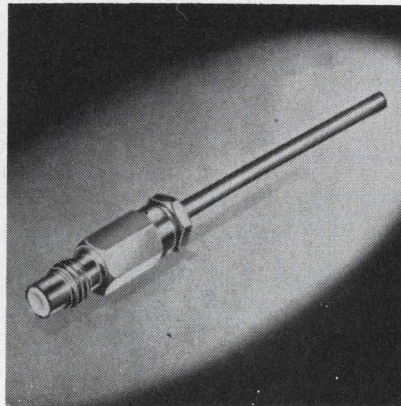

A subminiature RF cable-jack is intended for use with semi-rigid coax. Designated #50-008-3702, the jack features a collet-type clamping action which can be finger-tightened sufficiently to prevent the cable from pulling out. Soldering operations other than center conductor contact are thus eliminated.

The 50 ohm semi-rigid coax is similar to 188/U cable, except that it has a solid copper shield and a teflon dielectric.

Sealectro, 225 Hoyt, Mamaroneck, N. Y. Phone: (914) 698-5600.

Circle No. 724

A dual-purpose device is a precision wirewound resistor and a fuse. Controlled characteristics and operating reliability allow precise control of fusing point and time-lag.

At low power these units are precision wirewounds; above design limits they open within a specified time. Blow-time can be under 100  $\mu\text{s}$ , operating temperature is  $-55^{\circ}$  to  $+125^{\circ}\text{C}$ , and standard temperature coefficient is  $+20$  ppm/ $^{\circ}\text{C}$ .

RCL Electronics, 1 Hixon Pl.,

Circle No. 725

## Fuse-resistor

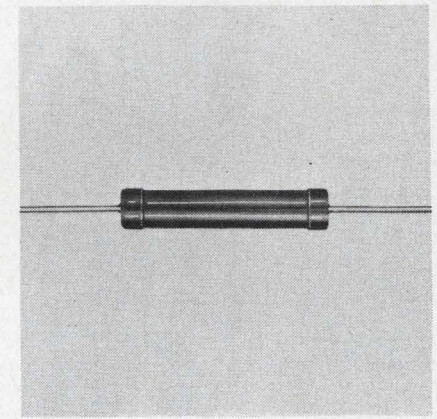

## Rugged potentiometer

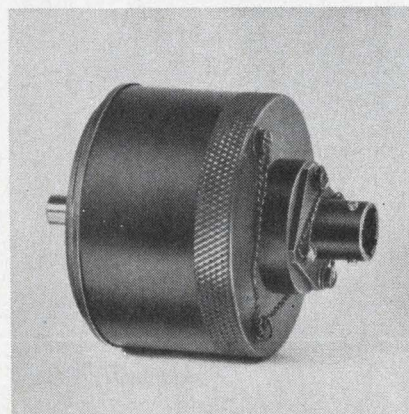

A precision potentiometer is ruggedized for severe environmental conditions. Model 205 is a single turn, infinite resolution pot, encapsulated in silastic. The unit was designed for subjection to water splashing, ice, sand and dust.

Model 205 is available with linear or non-linear output voltage ratios. Life is 5-50 million resolutions, and resistance rating is 500 ohms to 2 Megs.

Computer Instruments Corp., 92 Madison Ave., Hempstead, L. I., N. Y. Phone: (516) 483-8200.

Circle No. 726

# MAKE YOUR OWN MAGNETIC SHIELDS

To Your Specs

*Cut Quickly—  
Wrap Easily*



With ordinary scissors, cut flexible Co-Netic and Netic foil to any size or outline. Your component is quickly wrapped and protected—within seconds. Component performance is dramatically enhanced. Co-Netic and Netic foils stop degradation from unpredictable magnetic fields. When grounded, they also shield electrostatically. Foils are not significantly affected by dropping, vibration or shock, and do not require periodic annealing. Available in thicknesses from .002" in rolls 4", 15", and 19-3/8" wide. High attenuation to weight ratio possibilities. Widely used in experimental evaluation and production line operations for military, commercial and industrial applications.

## MAGNETIC SHIELD DIVISION

Perfection Mica Company

1322 N. ELSTON AVENUE, CHICAGO 22, ILLINOIS

ORIGINATORS OF PERMANENTLY EFFECTIVE NETIC CO-NETIC MAGNETIC SHIELDING

ON READER-SERVICE CARD CIRCLE 46

## Digital D. C. Voltmeters

0.1%  
full  
scale  
accuracy

9 Standard Single  
and Multi-Range  
Models with  
F.S. Ranges From  
10 MV to 1000 VDC

from \$315

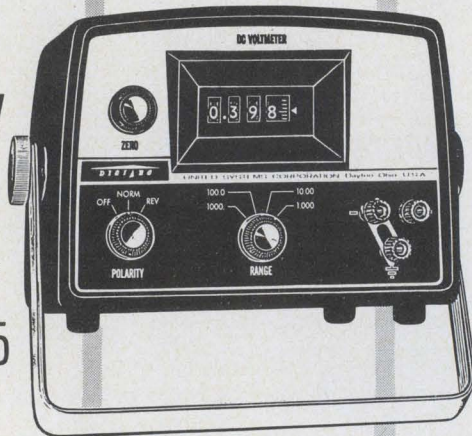

**Model 201 (Shown)**  
1-10-100 and 1000 VDC Ranges  
0.1% F.S. Accuracy  
0.05% F.S. Linearity  
2% Calibrated Over Range  
2.2 Megohm Input Impedance  
Portable, 5 1/2" x 8" x 7",  
Wt. 8 lbs.

#### Available Options Include

- BCD Output
- Retransmitting Pot
- Auto-Polarity
- Min. or Max. Reading Retention
- Rack Panel Adaptor Kits
- Modular Units for OEM

#### All Instruments

- Certified Accurate
- Floating or Grounded Input
- Reading Retention
- Wide Viewing Angle
- Bright Glowing Readout
- Solid State Amplifier

Send for complete Catalog D-65

DIGITEC

by UNITED SYSTEMS CORPORATION

918 Woodley Road, Dayton 3, Ohio (513) 254-3567

Stocking representatives  
throughout the world

ON READER-SERVICE CARD CIRCLE 47

## COMPONENTS

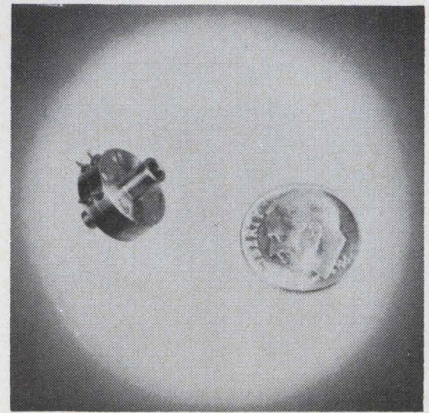

### Pressure transducer

This low-range pressure transducer is said to be the smallest unit of this type, measuring 0.500-in. diameter, and 0.567-in. over-all length.

This transducer is available in ranges of  $\pm 1/2$  psid to +15 psid. It features high-output for use in hot-shot, shock, and hypervelocity wind-tunnel applications.

Availability: stock to 3 wks. Hydne Instr. & Engrg., 217 Big Springs Ave., Tullahoma, Tennessee. Phone: (615) 455-9810.

Circle No. 709

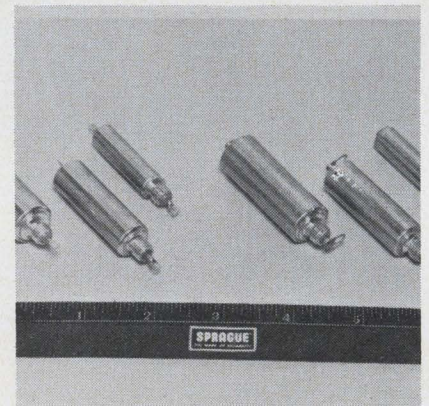

### Feed-through capacitors

Small feed-through capacitors for use in electromagnetic interference control use metallized paper dielectrics. Type 104JX series capacitors are designed to carry a 10 amp feed-through current. Insertion loss meets MIL-C-11693. Most of the environmental characteristics of the same MIL spec, characteristic K, are met.

Standard capacitance values are available at ratings of 200, 400 and 600 Vdc.

Sprague Electric Co., 347 Marshall St., North Adams, Mass.

Circle No. 710



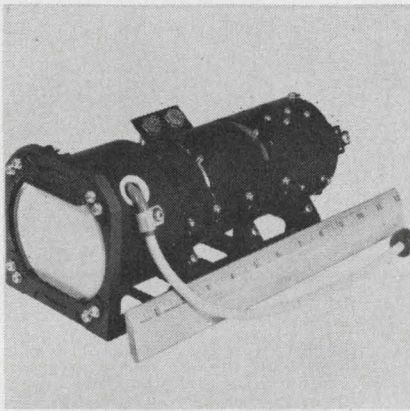

### High-resolution CRT

A new cathode ray tube focuses a 0.5-mil spot over a 2.75-inch diameter quality circle. The three-inch CRT (4XP-11) weighs 5.75 pounds including magnetic deflection and focus yokes, magnetic shield, and support casting. It was designed for aerial photographs, line and frame scan. It has been environmentally tested to meet applicable MIL-specs.

Aeronutronic Div., Philco Corp., Ford Road, Newport Beach, Calif. Phone: (215) 675-1234.

Circle No. 711



### Mercury-wetted relays

A line of mercury-wetted relays for printed circuit applications is designated series BW5. They are designed to meet the high-speed switching needs of computer, control and data processing systems.

Switch times are as short as 1 ms with power as low as 1.2 mW. Operating temperatures are  $-37^{\circ}\text{C}$  to  $+107^{\circ}\text{C}$ .

Babcock Relays Div. Babcock Electronics, 3501 Harbor Blvd., Costa Mesa, Calif. Phone: (714) 546-2711. TWX: (714) 546-0445.

Circle No. 712



This is their connector...



This is ours.  
(TIMATCH® for metal sheathed coaxial cables.)

Who needs a kit when you have everything you need in Times one-piece Timatch Connector with its exclusive built-in CoilGrip® Cable Clamp?

To install, just slip the connector on the cable in a simple one-step operation. Absolutely no assembling required. You can use the Timatch Connector over and over again—it disconnects just as easily—without impairing either the RF or physical characteristics of connector or cable.

Timatch offers uniform mechanical and electrical characteristics and long-term reliability... *matching the life of the cable itself*. It's a major advance in the connector field that virtually makes all other connectors and kits obsolete. So why do it the hard way when Timatch makes it so easy?

Write for full data on Timatch connectors to TIMES WIRE & CABLE,

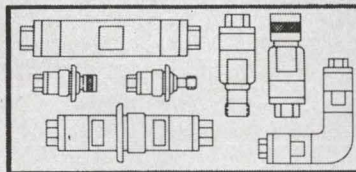

**TIMES**  
**WIRE & CABLE**  
DIVISION OF THE INTERNATIONAL SILVER CO.  
Wallington, Conn.

ON READER-SERVICE CARD CIRCLE 48

## Foil thermocouples

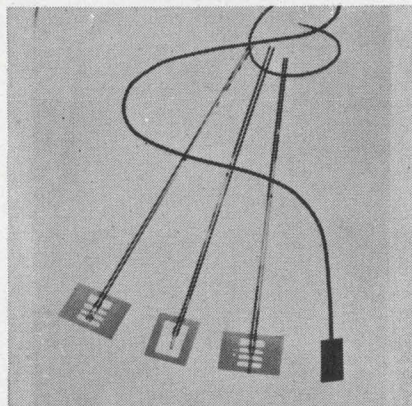

Foil thermocouples for surface temperature measurement are of the free-filament and matrix types.

Ungrounded units show 10 ms for 63% response to step change. Grounded junctions are in the 1 to 5 ms range. The polymer used in the matrix types allows extended use at 500°F, and short-time use at 700°F. Several types are available, others can be made to specifications.

RdF Corporation, Hudson, N. H.  
Phone: (603) 882-5195. TWX:  
(603) 882-6752.

Circle No. 713

## Octave bandwidth amps

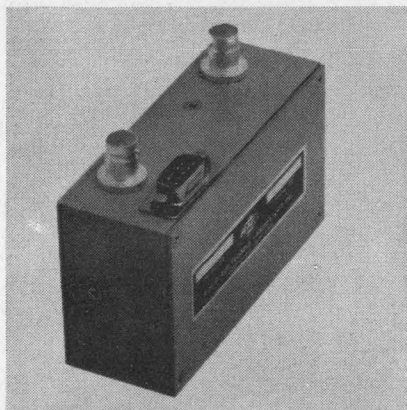

A series of octave bandwidth amplifiers covers the frequency range from 2 to 1000 MHz. Each of the nine B500 amplifiers features solid-state reliability, noise figures to 2.5 dB, low input and output vswr, RFI and weatherproof housings, and each is available with or without power supply.

As an example, model 508 has a frequency range of 300-600 MHz and a min gain of 20 dB. Price of the 508 is \$675.

RHG Electronics Lab, Inc., 94 Milbar Rd., Farmingdale, L. I., N. Y. Phone: (516) 694-3100.

Circle No. 714

## Test-point connector

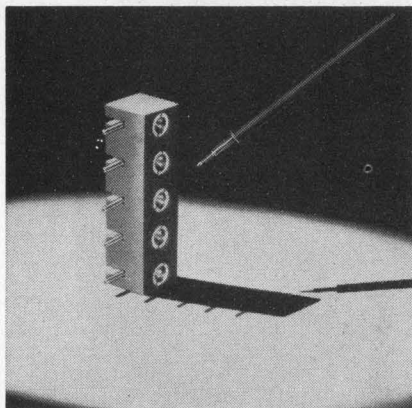

Type UTP-55 printed circuit test-point contact connector module is built to withstand 1800 Vac rms between contacts.

Five button-contacts on a 0.150 center-to-center spacing have a five-amp current rating. The connector is built to operate between -65°C and +125°C. It meets all provisions of MIL-C-21097B. The flame resistant short-glass-fibre filled diallyl phthalate body is type SDG-F per MIL-M-14F.

U.S. Components, Inc., 1320 Zeraga Ave., Bronx, N. Y. Phone: (212) 824-1600.

Circle No. 715

## Low-cost trimmer

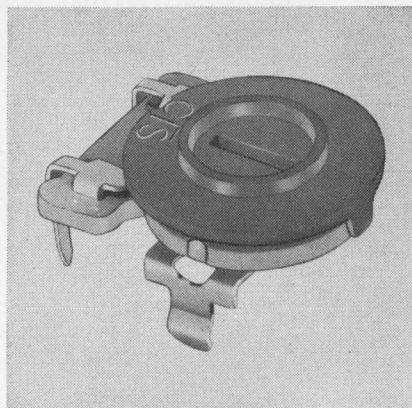

Press-fit terminals and a smooth edged knob are the leading features of the Series X-201, 1/4-watt low-cost potentiometer. This device uses terminal lugs that peg directly into the printed-circuit board instead of being angled. The smooth edged knob is said to reduce accidental misaligning while other components are being serviced.

Price: \$0.112 each in 1000 lots. CTS Corp., Elkhart, Ind. Phone: (219) 523-0219.

Circle No. 716

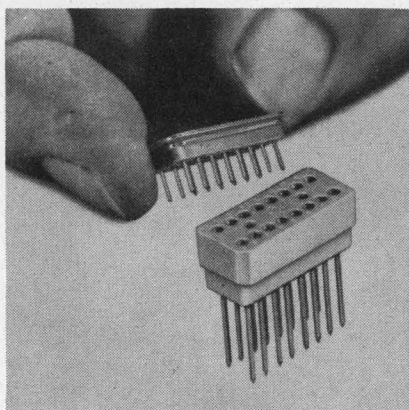

## Plug-in connector

A microelectronic connector, MPC4, allows connection of in-line or plug-in flatpack integrated circuits.

Sixteen sockets, 0.1-in. between centers, are in two rows, spaced 0.2-in. apart. One corner is chamfered for indexing, and sockets are numbered both top and bottom. Gold-plated beryllium copper spring contacts are housed in gold-plated brass for reliability.

Texas Instruments, Metals and Controls Div., 34 Forest, Attleboro, Mass. Phone: (617) 222-2800.

Circle No. 717

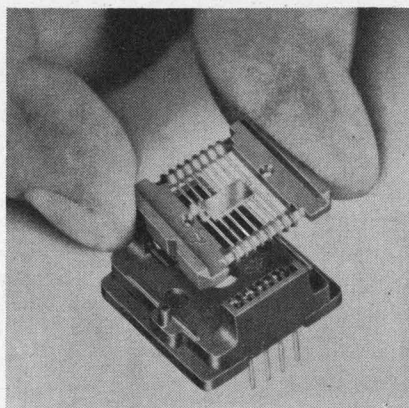

## High-temp connector

A high-temperature microelectronic connector enables testing and operating integrated circuits at temperatures up to 200°C. Hard gold-plated contact springs of a special alloy are set in the glass-filled diallyl phthalate body. Operating temperature is -65° to +200°C. Dimensions are 0.95 x 0.95 x 0.4-in. Contacts are on 0.1-in. centers.

Texas Instruments, Metals and Controls Div, 34 Forest, Attleboro, Mass. Phone: (617) 222-2800. TWX: (617) 222-1259.

Circle No. 718

ON READER-SERVICE CARD CIRCLE 246 ➤

## Watch those "HIDDEN" COSTS in an economy line of resistors

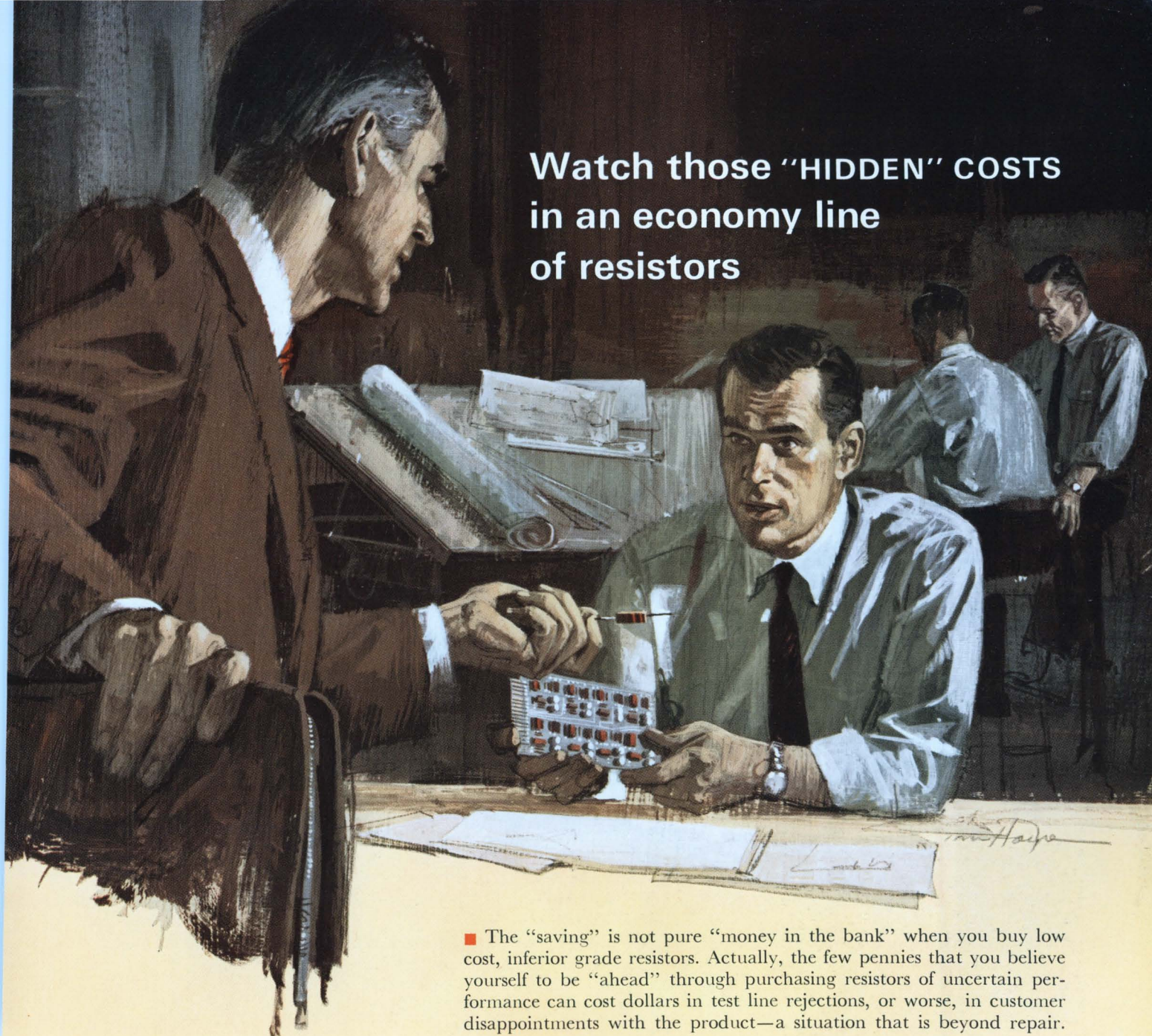

■ The "saving" is not pure "money in the bank" when you buy low cost, inferior grade resistors. Actually, the few pennies that you believe yourself to be "ahead" through purchasing resistors of uncertain performance can cost dollars in test line rejections, or worse, in customer disappointments with the product—a situation that is beyond repair.

How can you protect yourself against such accidents? Easy—standardize on Allen-Bradley resistors!

Allen-Bradley makes *only* one quality of resistors—a premium quality. The many manufacturers who have standardized on Allen-Bradley resistors find these resistors function also as an endorsement of the quality of the instrument in which they are used. Being produced by a unique hot molding process on highly specialized automatic equipment—designed and used only by Allen-Bradley—the resultant uniformity of characteristics from resistor to resistor—from one billion to the next—is not even approached by other resistor manufacturers. In fact, long term resistor performance is accurately predictable. And no user of Allen-Bradley resistors has ever encountered a catastrophic failure in service.

You'll be more fair with your customers when you permit your resistor dollar to buy for you the ultimate in dependability, performance, and uniformity of Allen-Bradley hot molded resistors. Allen-Bradley Co., 222 W. Greenfield Ave., Milwaukee, Wisconsin 53204. Export Office: 630 Third Ave., New York, N.Y., U.S.A. 10017.

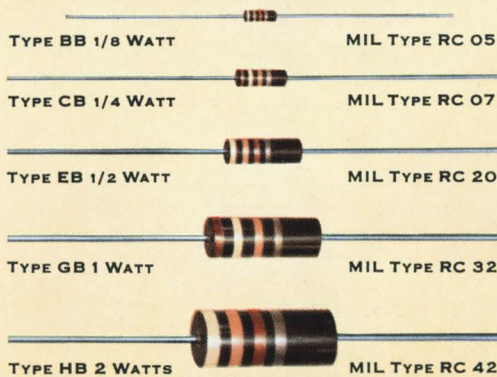

**HOT MOLDED FIXED RESISTORS** are available in all standard EIA and MIL-R-11 resistance values and tolerances, plus values above and below standard limits. Shown actual size.



# ALLEN - BRADLEY

QUALITY ELECTRONIC COMPONENTS

here are the resistors  
you've been looking for  
*to use in your miniaturized circuits*

ALLEN-BRADLEY Type BB 1/8-watt and  
Type CB 1/4-watt hot molded resistors  
shown approximately 4 times actual size

■ Here are two resistors that are ideally suited for your miniaturized circuits—the Allen-Bradley Type BB 1/8-watt and the Type CB 1/4-watt units. While extremely small, both have integrally molded insulated bodies and are full-fledged members of the Allen-Bradley hot molded resistor family.

This is made possible by employing the same exclusive hot molding process as used for the higher ratings of A-B resistors. The use of special automatic machines removes the element of human error, assuring complete uniformity of physical and electrical properties from one resistor to the next—from one billion to the next. And catastrophic failures are absolutely unheard of with Allen-Bradley hot molded resistors.

Be sure you have full specifications on both of these A-B hot molded resistors on hand. Please send for Technical Bulletin 5050 on the Type CB and Technical

Bulletin B5005 on the Type BB: Allen-Bradley Co., 222 W. Greenfield Ave., Milwaukee, Wis. 53204. Export Office: 630 Third Avenue, New York, New York, U.S.A. 10017.

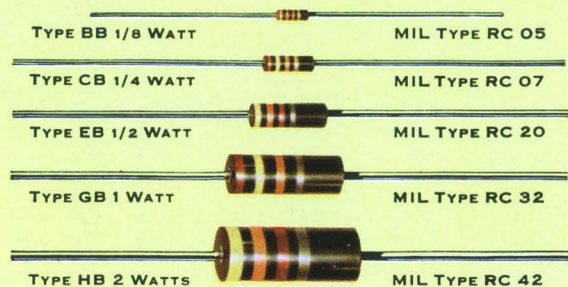

HOT MOLDED FIXED RESISTORS are available in all standard EIA and MIL-R-11 resistance values and tolerances, plus values above and below standard limits. Shown actual size.



**ALLEN-BRADLEY**  
QUALITY ELECTRONIC COMPONENTS

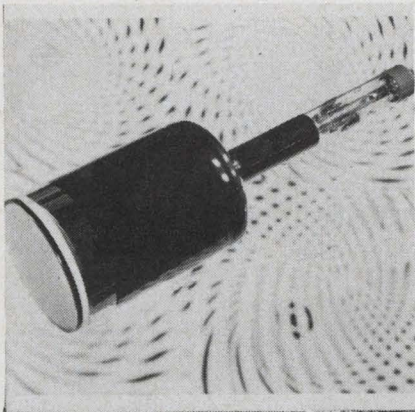

## High resolution CRT

A high-resolution cathode-ray tube, KC 2515 gives 0.0015 line resolution by coupling special focusing techniques with fine-grain phosphor screens. Features include a 26° deflection angle, a flat faceplate ground to 0.005 mil, and three different phosphors. Aluminized screen backing increases light output and prevents spurious-charge effects. A fibre-optic faceplate aids in direct photographing of single traces.

Electron Tubes Div., Fairchild Camera and Instrument Corp., 750 Bloomfield Ave., Clifton, N. J. Phone: (201) 773-2000.

Circle No. 251

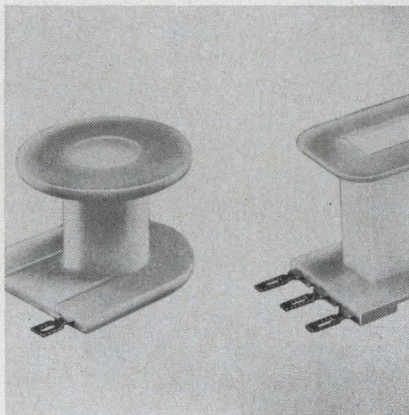

## Nylon bobbins

Nylon bobbins are now available with terminals already inserted. This service is said to save several man-hours in the process of winding coils.

The full line includes square, rectangular, round, cup-core and reed switch bobbins. In all, over 1000 standard sizes and shapes are included in line.

Cosmo Plastics Co., 3239 West 14th St., Cleveland, Ohio. Phone: (216) 861-5596. TWX: (216) 574-9284.

Circle No. 252

February 15, 1966



# TECHNO

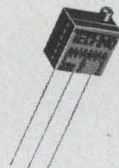

MODEL 12  
ACTUAL SIZE

**techno**  
**1/4" trimmer**  
**solves the**  
**space race!**

The small size advantage of a multiturn (25:1) trimming potentiometer that measures only 1/4" square and an equally valuable power rating of 0.5 watt at 50° C, that's what you'll get when you use Techno's Series 10 precision trimmers. Series 10, wire-wound trimmers, are available in resistance ranges from 100 ohms to 25K ohms with a standard ±5% tolerance. The standard TC is 50 PPM/°C throughout the operating temperature range of -65° to 175°C. Meets applicable MIL-SPECS, too!

Models are available with top or side screw adjustment and in bottom pin styles with printed circuit board standoffs or for flush mounting. All styles have standard printed circuit pin spacing of .100" center-to-center.

You'll find that Techno's exclusive "two-half" case construction signifies 100% inspection before and after assembly. This means the assurance of the highest trimming potentiometer quality and reliability for you. Can you use the advantage of a 1/4" trimmer from Techno? For full details, call or write:



## TECHNO-COMPONENTS CORP. TECHNO

7803 LEMONA AVENUE · VAN NUYS, CALIFORNIA 91405 · (213) 781-1642

ON READER-SERVICE CARD CIRCLE 49

129

## Automatic, High speed, Dual or single limit Capacitance tests at 1 Mc/s

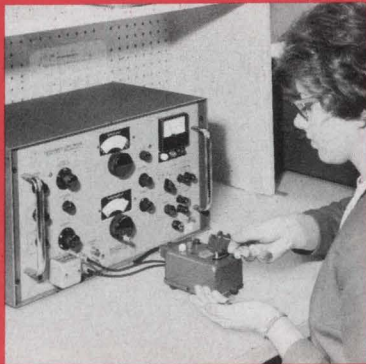

Model 77B Automatic Capacitance Limit Bridge

The Model 77B brings the precision and resolution of meticulous bridge measurements to automatic, high-speed, dual or single limit capacitance testing.

With low level 1 Mc/s test signal, dc bias, and the ability to test devices having Q's as low as 0.1, the Model 77B is particularly valuable for semiconductors.

- Automatic capacitance test range: 0.001 pF to 1000 pF; basic accuracy, 0.25%
- Tolerance limits continuously adjustable from  $\pm 0.0005$  pF to  $\pm 200$  pF
- 50 millisecond test time
- Limit tests insensitive to the loss of the specimen
- Visual and electrical test decision outputs
- Internally supplied 1 Mc/s test signal; \* limit tests with adjustable test level as low as 15 mV
- Internal dc bias continuously adjustable from -6 to +150 V; external bias to  $\pm 400$  V
- Three-terminal arrangement permits remote testing
- Also operable in "manual" mode for conventional capacitance/loss measurements
- Limit tests or manual measurements of inductance from 25  $\mu$ H to  $\infty$
- Price: \$2000

\* 100 Kc/s Version, Model 77B-S1, also available.

**BOONTON  
ELECTRONICS**  
CORPORATION

ROUTE 287 AT SMITH RD, PARSIPPANY, N. J.  
TELEPHONE: 201-887-5110 TWX: 510-235-6747

Speed Inquiry to Advertiser  
via Collect Night Letter

ON READER-SERVICE CARD CIRCLE 50

## COMPONENTS

### On-delay relay

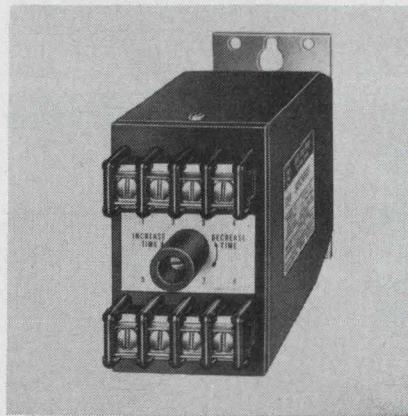

An adjustable time-delay range of 0.1 to 120 seconds is provided by the On-Delay solid state relay. The unit was designed for industrial service and is rated to carry 2 amps continuous at 120 Vac. It can handle motors up to size four. Repeatability is rated to within  $\pm 1\%$  of setting and live span is predicted at several billion operations at rated load.

Westinghouse Electric Corp., Standard Control Div., Beaver, Pa. Phone: (412) 7755-2000.

Circle No. 253

### Rotary switches

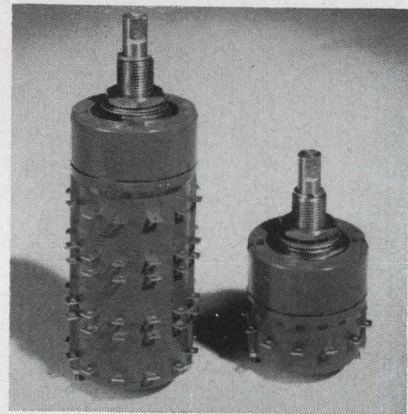

New 01-series rotary switches meet or exceed MIL-S-3768B. The silver-contact switches feature low and stable contact resistance, long life and low thermal emf.

Offered in configurations of from one to six poles, this 12-position switch functions over a temperature span of  $-65^\circ$  to  $+125^\circ$  C. Factory lubrication assures continuous performance.

Leeds & Northrup, Components Div., North Wales, Pa. Phone: (215) 329-4900. TWX: (215) 725-7360.

Circle No. 254

### Submin coax adapters

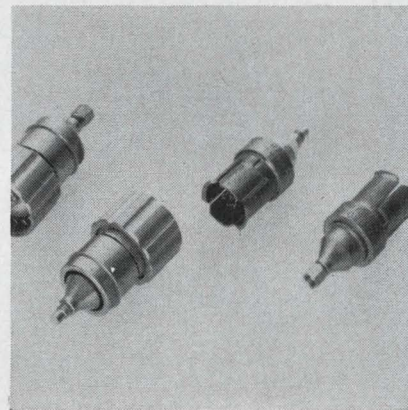

A group of coaxial adapters are designed to mate the General Radio 900 and 874 series connectors with the manufacturer's 50-ohm connectors. The adapters are designed with plugs or jacks in the screw-on, snap-on or slide-on mounting configurations. They are said to make possible the testing of any MIL-C-22557 connector using the GR900 or 874 as its output terminal.

Sealectro Corp., 225 Hoyt St., Mamaroneck, N. Y. Phone: (914) 698-5600. TWX: (710) 566-1110.

Circle No. 255

### Differential amplifier



The model 4009 differential amplifier uses planar silicon transistors and cermet resistors in a hybrid construction. The unit is encased in a low-silhouette TO-5 case.

It features a  $\pm 20$  V common mode range with  $\pm 20$  V output. Unity-gain bandwidth is greater than 10 MHz. Power supply voltages from  $\pm 6$  V to  $\pm 36$  V are applicable. It is usable in dc servo systems, and as an operational amp.

P&A. \$22.00; stock. Opamp Labs, 172 S. Buena Vista, Los Angeles, Calif. Phone: (213) 934-3566.

Circle No. 256

ACTUAL SIZE

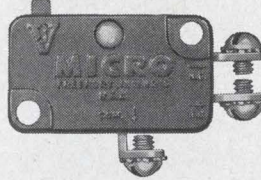

# See what the V3 switch can do for you now

The V3 switch, developed by MICRO SWITCH over 20 years ago, was the first precision snap-action switch to combine miniature size and high electrical capacity.

Through the years there have been many improvements and many new variations designed to satisfy specific customer requirements. Today there are over 500 standard designs available—offering you complete design freedom for a broad variety of applications. The adaptability of this switch to your requirement and its proven reliability over years of user acceptance make it a vital component in your equipment.

**CHOOSE FROM THESE OPTIONS:**

- Electrical ratings: UL and CSA listed for 10 or 15 amps, 125-250 vac; and gold contact designs for dry circuit use.
- Circuitry: SPDT, SPNO, SPNC.
- Operating Force: From 15 grams to 14 ounces.
- Differential Travel: .002 inch to .008 inch.
- Temperature Maximums: +185°, 400° and 600° F.
- Actuators: Auxiliary and Integral as shown below.
- Terminals: Variations as shown below.

For information on V3 switches and application assistance, contact a Branch Office or Distributor (see Yellow Pages, "Switches, Electric"). Or write for Catalog 50.

**AUXILIARY ACTUATORS**



**INTEGRAL ACTUATORS**

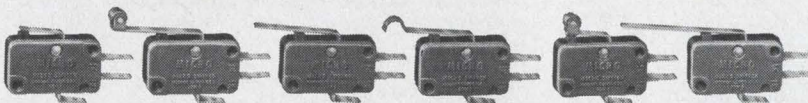

**TERMINAL VARIATIONS**



**MICRO SWITCH**  
FREEPORT, ILLINOIS 61032  
A DIVISION OF HONEYWELL

## Pulse transformers

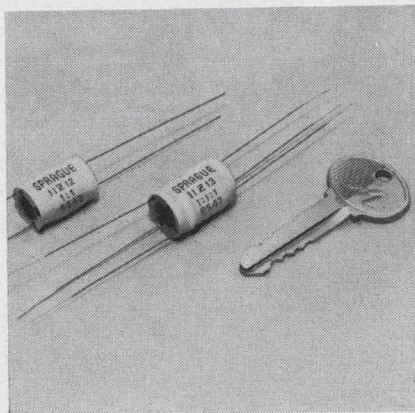

A series of pulse transformers has been designed for commercial and industrial triggering applications.

Among the features of this line are balanced pulse characteristics and energy transfer, minimum saturation effect, fast rise time, increased current capability, and increased energy transfer efficiency.

They are designed for stable operation over the temperature range  $-10^{\circ}$  to  $+70^{\circ}\text{C}$ .

Sprague Electric Co., 347 Marshall St., North Adams, Mass.

Circle No. 257

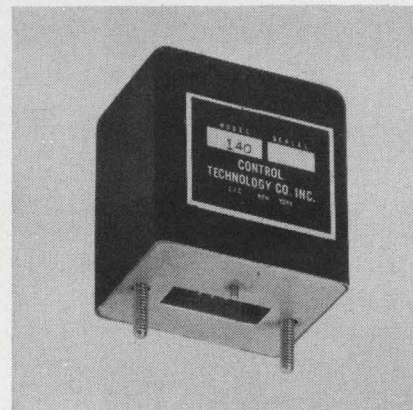

## Servo amplifier

The model 140 transistorized servo amplifier will drive 6 watt servo motors from low-level 400 Hz signals. Gain of the amplifier is 1000, controllable by an external resistor. An important feature of the 140 is its 50-ohm output impedance. This feature is said to allow quick servo response without danger of oscillation. The requirements of MIL-E-5272 are met by the transistorized module.

Control Technology Co., Inc., 4116 29th St., Long Island City, N. Y. Phone: (212) 361-2133.

Circle No. 259

## Jacks and plugs

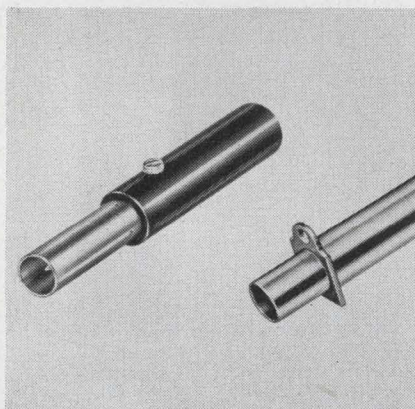

Designed to meet the needs of RF and wide-band video circuits, a new line of CV jacks and plugs provides low-impedance terminating and connecting. The units included in the new line provide such features as Teflon insulation, gold and fine silver plating, molded black plastic handles and precision-machined interconnection faces.

Prices: from \$4.25 to \$10.00. Switchcraft, Inc., 5555 N. Elston Ave., Chicago, Ill. Phone: (312) 774-1515.

Circle No. 258

# NEW! RED SHIELD LINE

## of Subminiature Shielded Inductors

- Unsurpassed "Q" to "L" ratio
- Exceptional "L" to size ratio
- High Self-Resonance
- Designed to MIL-C-15305C
- Maximum Coupling—3%—units side by side
- Stock—73 predesigned values
- Non-Flammable Envelope
- Operating Temperature  $-55^{\circ}$  to  $125^{\circ}\text{C}$ .

### MICRO-RED

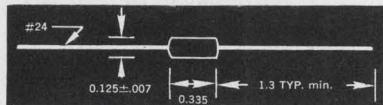

The "Micro-Red" is a shielded inductor that offers the largest inductance range 0.10 to 10,000 $\mu\text{h}$  in its size. "Q" to "L" ratio unsurpassed with excellent distributed capacity. Inductance tolerance  $\pm 10\%$  measured per MIL-C-15305C. Stocked in 61 predesigned values.

### MINI-RED

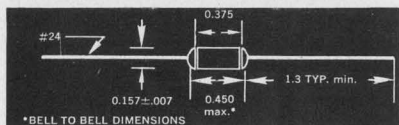

The "Mini-Red" offers the highest "Q" to "L" ratio available over inductance range 0.10 to 100,000 $\mu\text{h}$  in a shielded inductor this size. Inductance tolerance  $\pm 10\%$  measured per MIL-C-15305C. Stocked in 73 predesigned values.



Data Sheets: Write or Phone  
**LENOX-FUGLE ELECTRONICS, INC.**  
 475 Watchung Ave., Watchung, New Jersey 07060  
 Telephone code 201-756-1164-1165

ON READER-SERVICE CARD CIRCLE 52

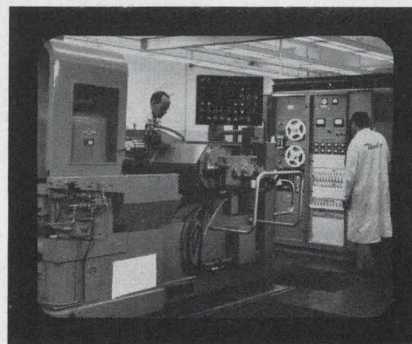

## To electronic engineers with a sense of timing: BENDIX IS ON THE MOVE!

(KANSAS CITY DIV.)

This is a highly opportune moment to send us your résumé. Bendix, prime contractor for the AEC, has enjoyed an enviable, orderly expansion for 16 years, but right now we are entering a unique developmental phase which opens new fields of activity in microminiaturization, microwave and logic circuitry. This situation adds up to a ground-floor opportunity in an already well-established engineering corporation. Let us hear from you promptly so we may spell out more clearly the many professional advantages we can offer you.

Please mail résumé to:

MR. E. C. MCGURREN  
 Tech. Personnel Rep.  
 BENDIX CORPORATION  
 Box 303-CF  
 Kansas City, Mo. 64141

An Equal Opportunity Employer



ON READER-SERVICE CARD CIRCLE 895

ELECTRONIC DESIGN



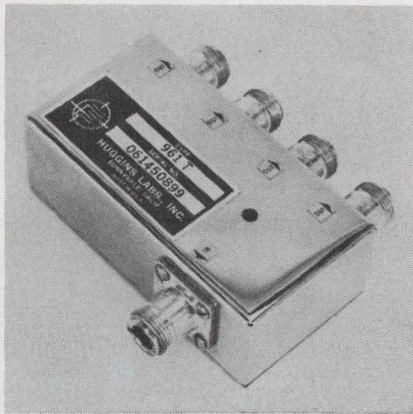

### High-level splitter

A high voltage splitting transformer, the Model 961T allows parallel drive of four 50-ohm lines from a single source. It is rated for input voltages as high as 4 kV, delivering half the current and half the voltage at each of its outputs. Measurements are 4 x 2-1/4 x 1-1/2-in. exclusive of connectors. Type-N female coax connectors are used for both input and output.

P&A: \$75; 30 days. Huggins Labs., 999 E. Arques Ave., Sunnyvale, Calif. Phone: (408) 736-9330. TWX: (408) 737-9992.

Circle No. 260

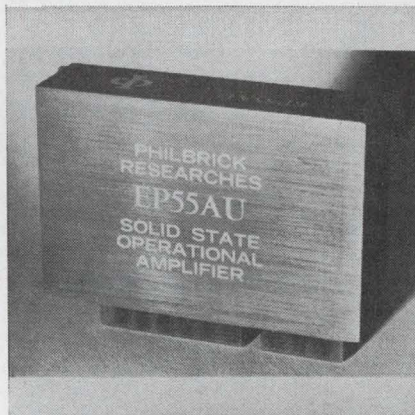

### \$20 operational amp

The EP55AU all-silicon plug-in operational amplifier has voltage gains of 20,000 with 5 k output load, and 40,000 with 100 k load. Output is  $\pm 11$  V min,  $\pm 2.2$  mA.

The use of silicon transistors in silicone plastic, rather than hermetically sealed cases, gives the unit the same performance in the range 0-60°C as the higher-priced predecessor lines by the same maker.

Price: \$20 ea, lower in quantity. Philbrick Researches, Allied Dr. at Rte. 128, Dedham Mass. Phone: (617) 329-1600.

Circle No. 261

# BIG POWER SMALL PACKAGE CERMET STABILITY UNDER \$2.00 each

(in production quan.)

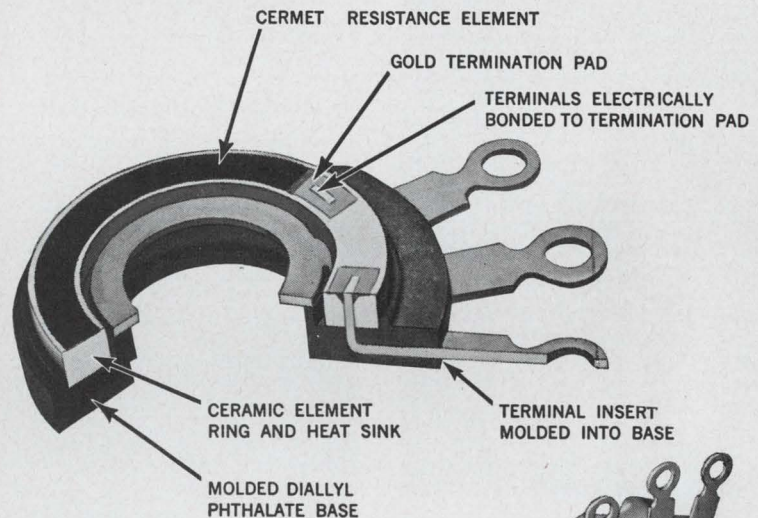

Series 550 has long life—  
no catastrophic failures



## New 2-watt, 3/4" diameter CERMET Variable Resistor

Applications: computers, instruments, medical electronics, communications equipment, electronic machine controls, electronic processing equipment, aerospace electronics, microwave transmission, etc.

### Outstanding features:

- Closed construction*—Cover entirely protects against dust and dirt. Exceeds MIL-R-23285 (Navy) metal film, Cermet; also far exceeds MIL-R-94B.
- Extreme stability* under severe environmental conditions.
- Resistance range*—50 ohms through 1 Megohm.
- Infinite resolution.*
- Low noise and long life.*
- Excellent high frequency characteristics.*



Founded 1896

Request data sheet 3550.

**CTS OF BERNE, INC.**  
**BERNE, INDIANA**

a subsidiary of

**CTS** Corporation, Elkhart, Indiana

# INSULTITE

## heat-shrinkable tubing

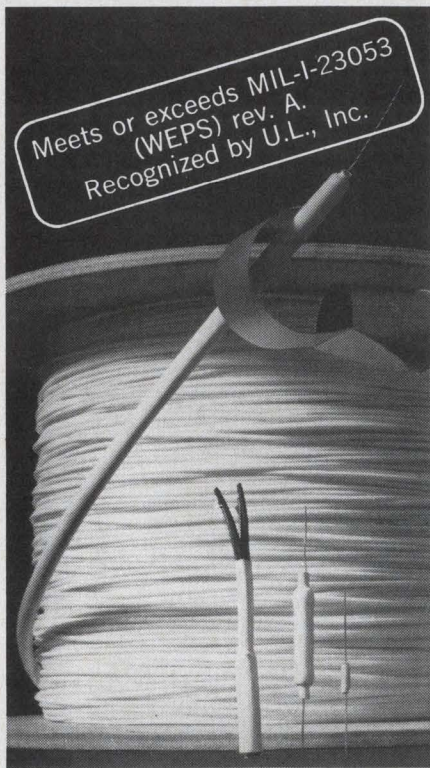

### first of the INSULRAD family of irradiated polyolefins from E.C.C.

Now there's an important new source of heat-shrinkable tubing—INSULTITE from Electronized Chemicals Corporation.

INSULTITE meets competitive heat-shrinkable tubing requirements spec for spec—outperforms other shrinkables in volume resistivity, longitudinal change, water absorption, and resistance to solvents.

INSULTITE is the answer wherever skin-tight packaging or encapsulating covers are needed. Apply heat: INSULTITE molds itself around smooth or irregular shapes to form a tight protective jacket.

INSULTITE is available in standard colors and sizes and is supplied in four-foot or specified lengths . . . all competitively priced and available now. For more information on this new product, write, wire or call Electronized Chemicals Corporation, Burlington, Mass. Tel. 617-272-2850. Dealer inquiries are invited.



**ELECTRONIZED  
CHEMICALS  
CORPORATION**  
*a subsidiary of*

**HIGH VOLTAGE ENGINEERING**

ON READER-SERVICE CARD CIRCLE 55

## COMPONENTS

### 100,000 cycle-life switch

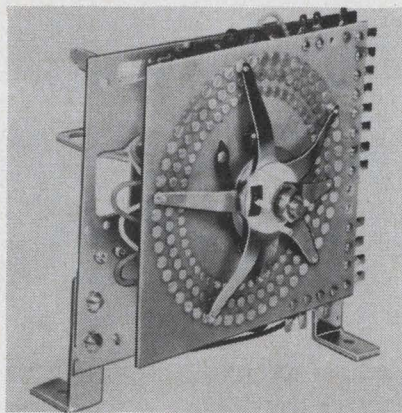

A self-cycling, 50-position, rotary stepping switch is designed for a life of 100,000 cycles. Coin-silver contacts on phosphor-bronze arms wipe silver-plated brass contacts.

Solenoid operating voltages are 12V through 115 ac/dc pulsing. Pulsing rate is 350-400 counts per minute, and contact rating is 5 A at 115 Vac, 60 Hz.

P&A: \$7.50, Immediate. Chicago Dynamic Ind., Precision Prods. Div., 1725 Diversey Blvd., Chicago, Ill. Phone: (312) 935-4600.

Circle No. 262

### Miniature capacitor

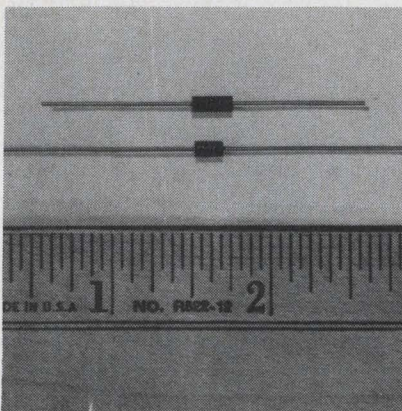

Model EPC19X neolythic ceramic capacitor, for ultra-miniature cordwood applications, measures 0.2-in. length by 0.1-in. diameter. Capacitance ranges from 10 pF through 0.012  $\mu$ F. Standard 10% tolerance or 5% on request.

Temperature range is  $-55^{\circ}$  to  $+125^{\circ}$ C, and capacity variance is less than  $\pm 10\%$ . Leads are gold-plated nickel, and the unit meets or exceeds MIL-C-11015.

Marshall Industries Capacitor Div., 1960 Walker Ave., Monrovia, Calif. Phone: (213) 681-3292.

Circle No. 263

### Precision potentiometer

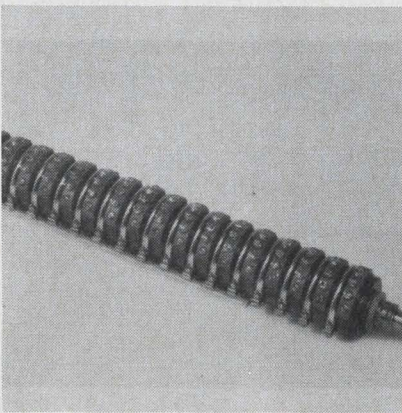

Resistance values of 0-100 K are available in a line of gangable potentiometers. The 7/8-in. diameter units provide 0.5 linearity and 1% tracking with center tap available. Other features include fork-type terminals, stainless steel shaft and provisions for field-phasing of each unit in the field. A ganged group of 25 units and their mounting measures 8.5-in. in length.

Voltronics, Inc., 7746 West Addison St., Chicago, Ill. Phone: (312) 625-1779.

Circle No. 264

### Panel meters

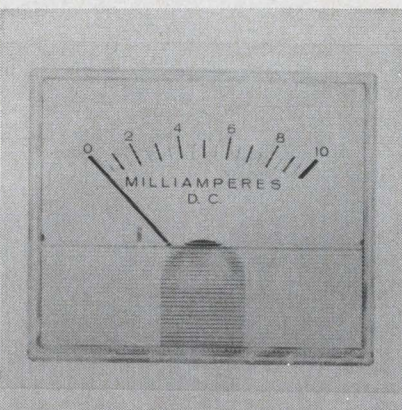

Meters in the model 795 line are 5% moving-magnet types designed for mounting either on or behind the panel. Full-length, flattened arc scales and knife-edge pointers are standard features and the polystyrene case front is treated with an anti-static finish. Specially damped movements are available with sensitivities as low as 0-1 mA.

Hoyt Electrical Instrument Works, Burton-Rogers Div., 42 Carleton St., Cambridge, Mass. Phone: (617) 491-7400.

Circle No. 265

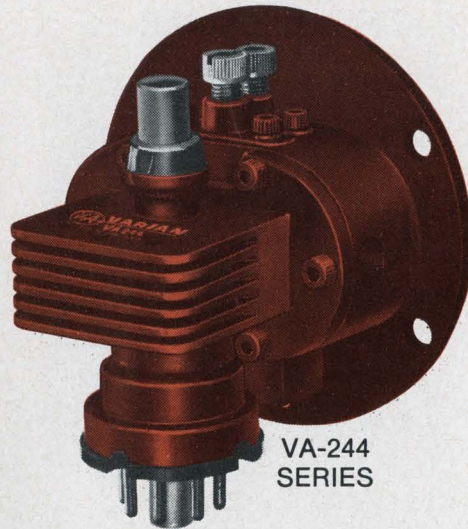

VA-244  
SERIES

## WARRANTY TRIPLED TO 15,000 HOURS

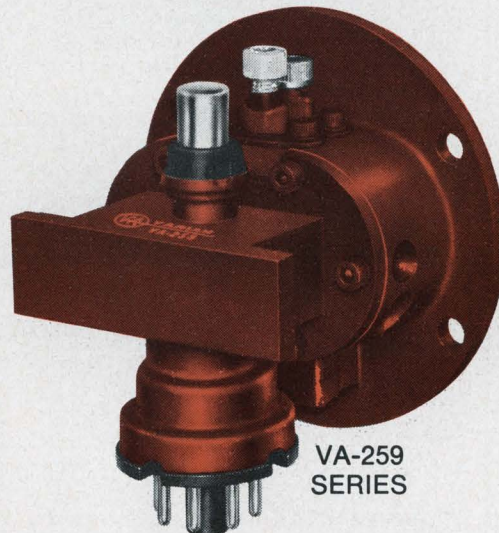

VA-259  
SERIES

### Two Varian klystrons in the 4.4 to 8.5 Gc range cut your warranty cost-per-operating-hour by a full *two-thirds*.

Originally warranted for 5,000 hours, the VA-244 and VA-259 klystrons have demonstrated a remarkably long life-expectancy. In the past two years, reports from users around the world, as well as results from our own laboratory Life Tests, indicate that the operating life of these tubes is far in excess of 15,000 hours. Therefore, we have tripled the warranty to

15,000 hours on both the VA-244 and VA-259 reflex klystrons.

For more complete information, write Palo Alto Tube Division, Executive Offices, 611 Hansen Way, Palo Alto, California. In Europe, write Varian A.G., Zug, Switzerland.



Speed Inquiry to Advertiser via Collect Night Letter  
ON READER-SERVICE CARD CIRCLE 56

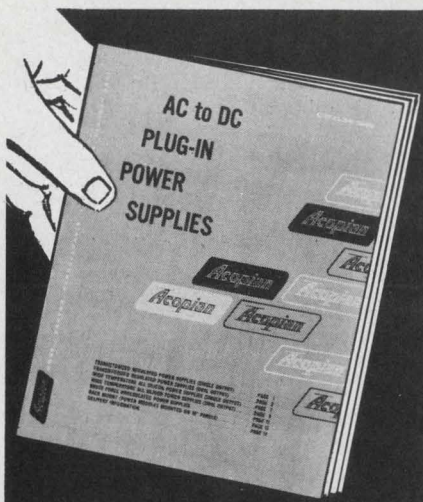

with this catalog  
you can  
choose  
from  
62,000  
different  
power supplies...



Write for  
your copy today to  
Acopian Corp.  
Easton, Pennsylvania  
or telephone  
(215) 258-6149.



ON READER-SERVICE CARD CIRCLE 57

## COMPONENTS

### Radial-lead capacitors

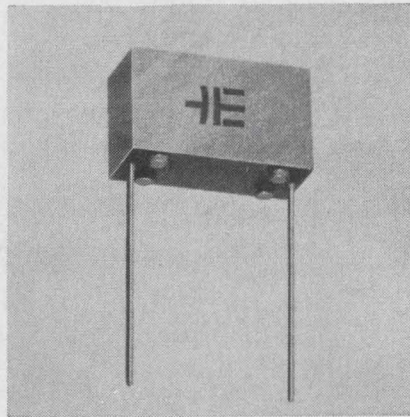

Rectangular radial-lead capacitors are designated "R" case style. They are offered in a variety of series: metallized polycarbonate, metallized mylar (thin-film and extended foil), and metallized paper (solid, polyester, and microcrystalline wax impregnants). Available with ratings from .0001 to 15 $\mu$ f, 50 to 600 Vdc, they have operating temperature ranges from -55° to +125°C.

Elpac, 4270 Artesia, Fullerton, Calif. Phone: (714) 521-8754.

Circle No. 266

### Pressure transducer

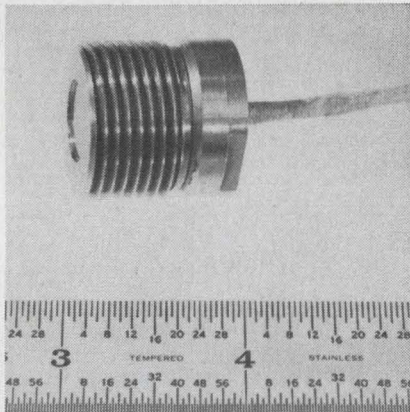

The GT10 pressure transducer combines a bonded strain-gage sensing element with a flush-diaphragm, providing a 50 kHz natural frequency.

Operating characteristics include sensitivity of 3.0 mV/V nominal, hysteresis of 0.5% full-scale, non-linearity of  $\pm 0.5\%$  full-scale, and temperature range of cryogenic to +300°F.

P&A: \$350; 4 wks. General Transducer, 3551 Thomas Rd., Santa Clara, Calif. Phone: (408) 248-2075.

Circle No. 267

### Submin VCXO

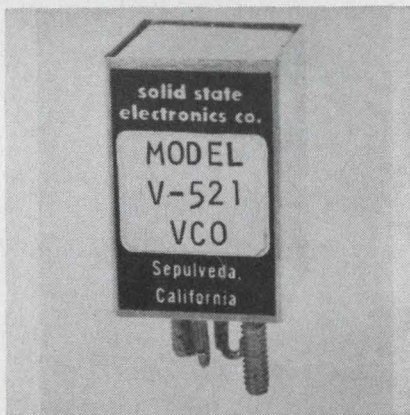

The Model V-521 voltage controlled oscillator provides conversion of a varying analog dc voltage to a linearly proportional square-wave. Frequency deviation is 4700 to 5200 Hz with input voltage of 0 to 5 V. Output is a square-wave 2 V signal into 10 K. Short-term stability is 0.5% of band for eight hours at 25°C  $\pm 5^\circ$ .

\$265; 1 week. Solid State Electronics Corp., 15321 Rayen St., Sepulveda, Calif. Phone: (213) 894-2271.

Circle No. 268

### Miniature blower

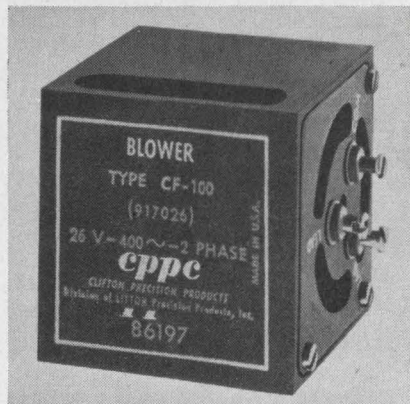

A 1-inch cube houses a blower delivering 2-ft<sup>3</sup>/min. Self-generated vibration is only 2G max, and the unit has a design life of 1000 hrs under MIL-B-23071.

The CF-100 is a radial bladed, centrifugal blower weighing less than 37 grams. It has a 2 $\theta$ , 2 pole hysteresis motor operating at 26 V, 400 Hz. Operating temperature is -55°C to +125°C.

Clifton Precision Div. Litton, 5050 State Rd., Drexel Hill, Pa. Phone: (215) 6222-1000.

Circle No. 269



*The Leader* IN MAGNETIC MATERIALS AND SPECIALTY RESISTORS

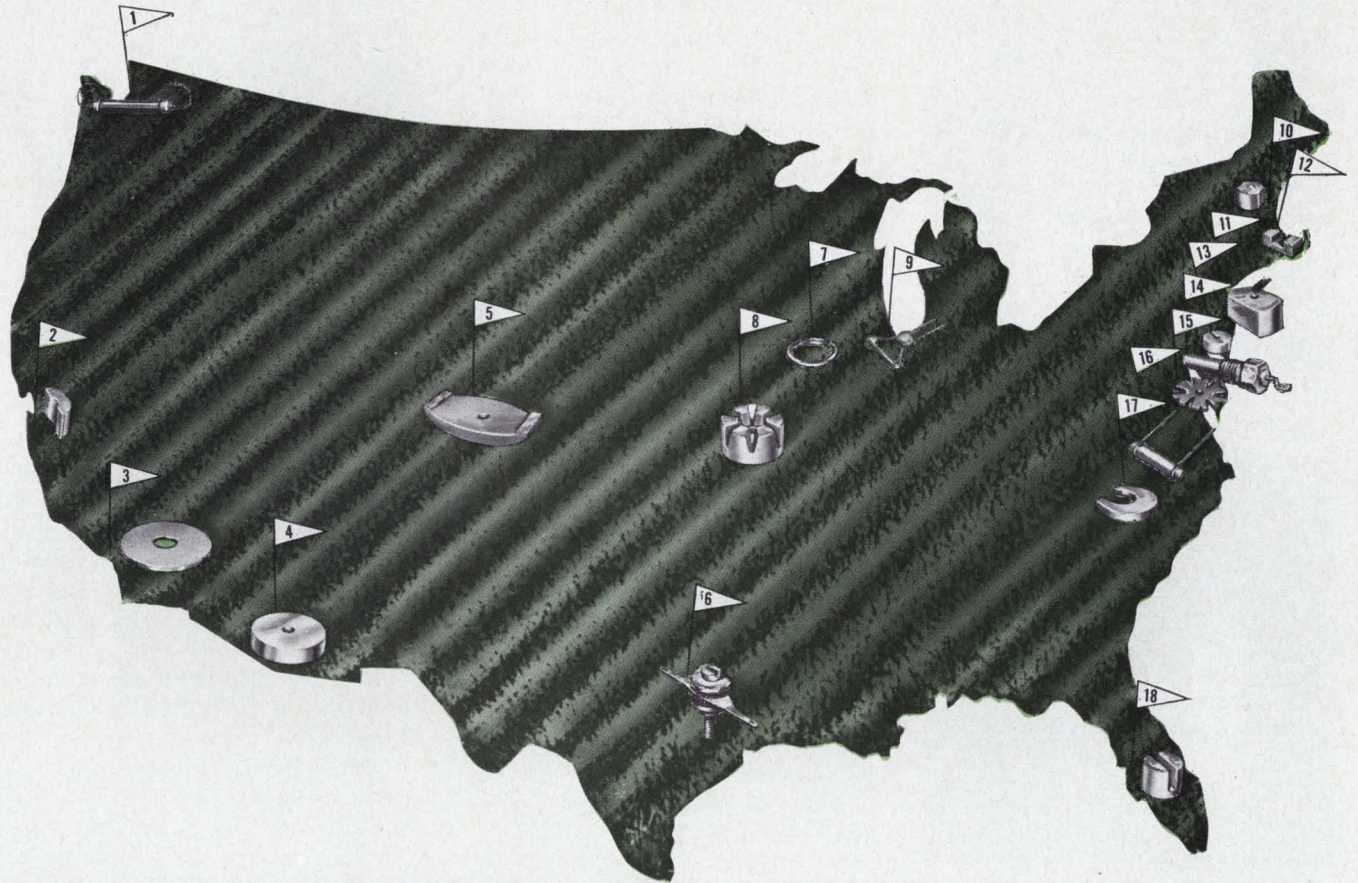

# now coast-to-coast

General Electric can meet your permanent magnet, thermistor and Thyrite® Varistor needs.

We've redrawn our sales map. General Electric now has magnetic material and specialty resistor sales assistance in 18 offices from coast-to-coast . . . one is near you.

G-E Alnico and Lodex® permanent magnet materials, thermistors, and Thyrite® Varistor materials are already at work in dozens of industries helping to solve sticky and critical design problems. They can help you, too.

Just give us a call today and we'll send a man with technical assistance your way fast. Let us show you why General Electric is the industry leader in magnetic materials and specialty resistors. **MAGNETIC MATERIALS SECTION, (Telephone 517-427-5151), Edmore, Michigan 48829.**

731-08

® Registered Trademark of General Electric Co.

*Progress Is Our Most Important Product*

**GENERAL  ELECTRIC**

## G-E MAGNETIC MATERIALS SALES AND SERVICE OFFICES

- |   |   |    |   |
|---|---|----|---|
| 1 | Seattle, Washington<br>220 S. Dawson Street<br>206-725-6804               | 10 | Rochester, New York<br>39 Jefferson Road<br>716-436-2800          |
| 2 | Redwood City, California<br>555 Veterans Blvd.<br>415-369-7151            | 11 | Clifton, New Jersey<br>200 Main Avenue<br>201-757-3673            |
| 3 | Los Angeles, California<br>11840 W. Olympic Blvd.<br>213-479-7763         | 12 | Wellesley, Massachusetts<br>468 Washington Street<br>617-235-5521 |
| 4 | Phoenix, Arizona<br>Suite 712, Guaranty Bank<br>Bldg.<br>602-264-1751     | 13 | Philadelphia, Pennsylvania<br>3 Penn Center Plaza<br>215-568-1800 |
| 5 | Denver, Colorado<br>201 University Avenue<br>303-388-5771                 | 14 | Baltimore, Maryland<br>1 N. Charles Street<br>301-685-6500        |
| 6 | Dallas, Texas<br>4447 N. Central Expressway<br>214-521-1931               | 15 | Washington, D. C.<br>777-14th Street NW<br>202-393-3600           |
| 7 | Cedar Rapids, Iowa<br>210 Second Street SE<br>319-364-9149                | 16 | Lynchburg, Virginia<br>Carroll Avenue<br>703-846-7311             |
| 8 | Kansas City, Missouri<br>106 W. 14th Street, Room<br>2500<br>816-221-4033 | 17 | Charlotte, North Carolina<br>129 W. Trade Street<br>704-375-5571  |
| 9 | Chicago, Illinois<br>3800 N. Milwaukee Avenue<br>312-777-1600             | 18 | Tampa, Florida<br>2106 South Lois Avenue<br>813-877-8311          |

ON READER-SERVICE CARD CIRCLE 58

MATERIALS

**Powdered epoxy resin**

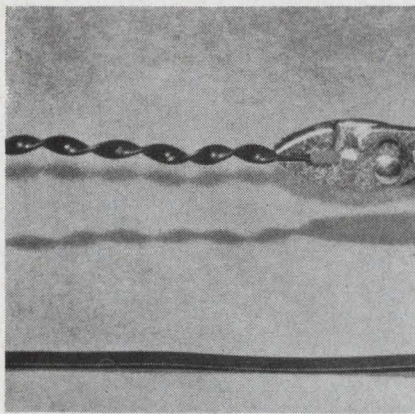

A one-part, fully flexible, powdered epoxy is offered for a wide variety of applications. Called XR-5079, the coating can be applied by spraying or aerated bed coating. Tests of the material show that it will not crack when bent around a 1/4-in. mandrel and that it will withstand forward and reverse impact of 160 in./lb without adhesive failure.

P&A: \$2.48-\$4.00 per pound; stock. 3M Company, 2501 Hudson Rd, St. Paul. Phone: (612) 733-4033.

Circle No. 270

**Solder masking**

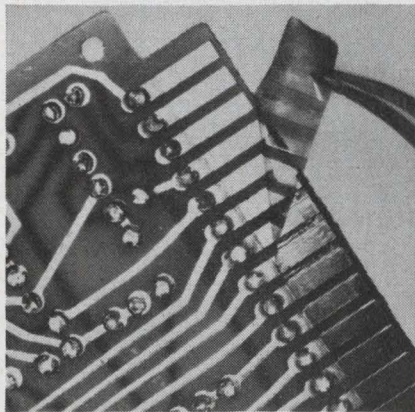

A fast-drying, one-component masking material resists soldering temperatures and strips off easily upon drying.

Stripcoat 931 can be used over gold-plated contact surfaces, for masking of board holes, or for selective, partial soldering of metallic surfaces and leads. Brush, dip or flow 931 over any surface; dry 10-20 minutes, then cure it at 150-200°F for 10-15 minutes. To remove 931, lift one corner and strip it off.

Alpha Metals, 56 Water St., Jersey City, N. J. (201) 434-6778.

Circle No. 271

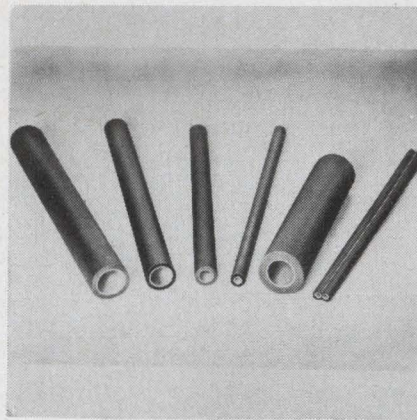

**Teflon-lined tubing**

Teflon-lined neoprene tubing withstands a continuous service temperature of 200°F or higher temperatures for short times. It has applications as a transmittal tube for chemicals, petroleum, paint, food and dairy products, waste, pharmaceuticals, and electrical and electronic cabling.

It is available in 1/8-through 1/2-in. ID and in lengths to customer specifications.

Pennsylvania Fluorocarbon Co., Clifton Heights, Pa. Phone: (215) 622-2300. TWX: (215) 623-1577.

Circle No. 272

**Performance Proves:**

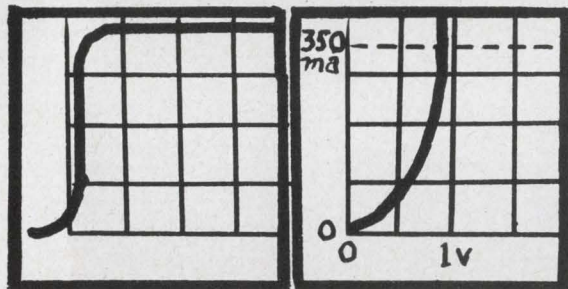

**Fastest Switching Diode With High Forward Current**

Test waveforms show that International Diode Corp.'s ID3-050T alloy junction diode has a reverse recovery time (left) in the picosecond range, with a 200-to-400 milliamper forward conductance (right). IDC can provide more than 100 types to solve your design problems, including Q6-100, Q5-100, ID3-050, 1N3146. Price as low as 45 cents in quantities; delivery mostly from stock. Write or phone for details.

**INTERNATIONAL DIODE CORP.**

90 Forrest Street, Jersey City, N. J. 07304  
201 - 432-7151

ON READER-SERVICE CARD CIRCLE 59

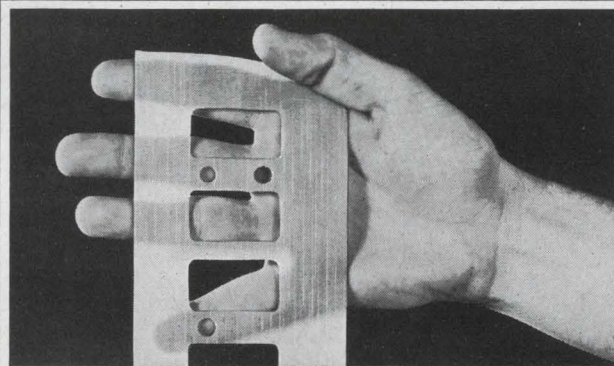

U.S. Patent No. 3,126,440

**POLASHEET II**

**first truly effective pressure & RFI seal for connectors!**

Polasheet II is oriented rubber sheets just .062" thick. Yields overall system attenuation of 125-135 db ... with sealing pressures up to 30 psi. Can be die

cut into resilient, flexible gaskets of any shape. Compressible, too, so machined surfaces are not needed. About 12¢ per sq. in. Write for Free Samples, prices, literature!

**METEX Corporation**

Walnut Ave., Clark, N. J. • (201) FU 1-7272 • TWX RAH 1232  
West Coast: 5057 W. Washington Blvd., Los Angeles



ON READER-SERVICE CARD CIRCLE 54

**WHEN YOU  
NEED  
ULTRA-FAST  
TURN ON  
AND**

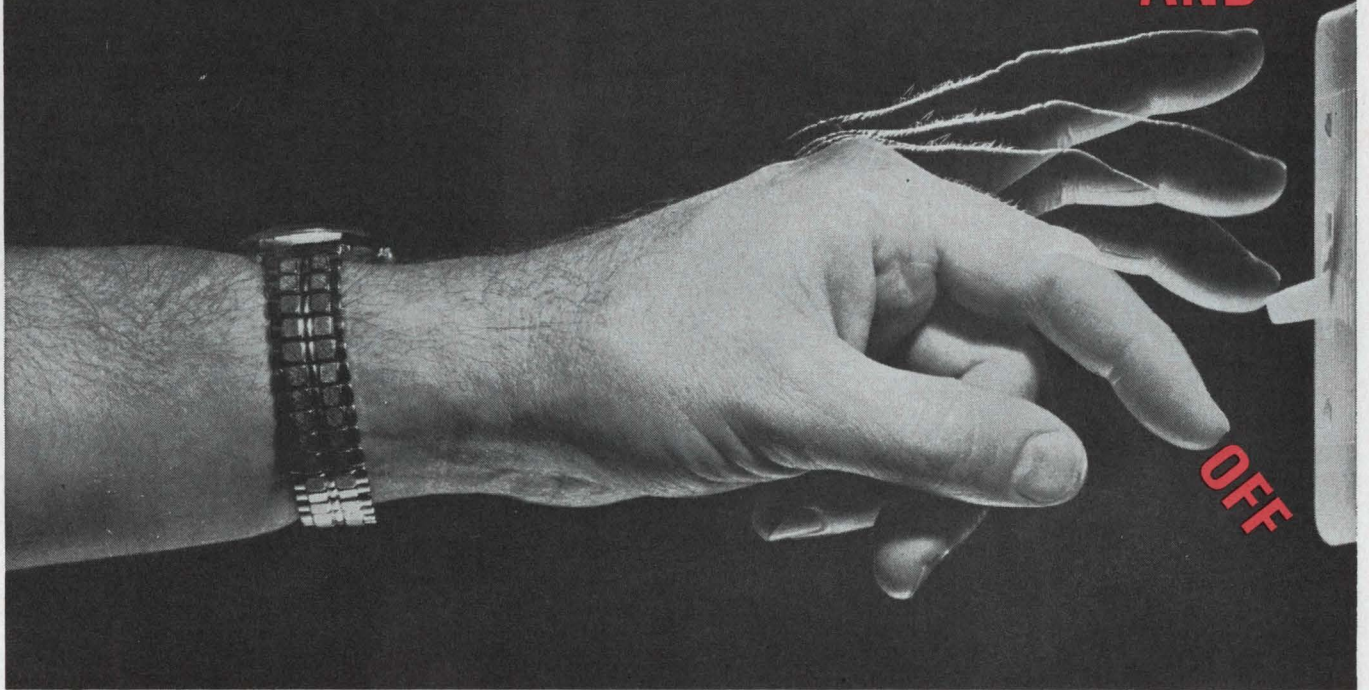

**...specify  
hot carrier diodes  
by hpa**

Whether your high-speed switching requirements are for ultra-fast computers, sampling circuits, test equipment, or UHF and VHF mixers and detectors, it will pay you to investigate the new low-noise, high-reliability 2300 Series Hot Carrier Diodes from hp associates. All devices in this series have minority carrier lifetimes of less than 100 picoseconds! Incorporating the latest advances in metal-silicon technology, these devices offer increased forward current and higher breakdown voltage. Operating and storage temperature range extends from  $-60^{\circ}\text{C}$  to  $+125^{\circ}\text{C}$ . Power dissipation at  $25^{\circ}$  is rated at 125 mw. Peak pulse power rating is 5 ergs. They also meet the requirements of Mil-S-19500C.

Write today for application information and complete data, including life test data.

**TYPICAL DEVICE SPECIFICATIONS**

Device	Forward Current $I_{F1}$	Forward Voltage $I_{F2}$	Breakdown Voltage $BV_R$	Leakage Current $I_R$	Capacitance $C_O$	Effective Minority Carrier Lifetime <sup>o</sup> $\tau$	Price 1 to 99 100 to 999
hpa 2301 Min. Max.	50 ma	1 ma	30 v	300 na	1 pf	100 ps	\$9.60 ea. 6.40 ea.
hpa 2302 Min. Max.	35 ma	1 ma	30 v	300 na	1 pf	100 ps	8.70 ea. 5.80 ea.
hpa 2303 Min. Max.	35 ma	1 ma	20 v	500 na	1.2 pf	100 ps	8.00 ea. 5.35 ea.
Test Conditions	$V_F = 1\text{ v}$	$V_F = 0.4\text{ v}$	$I_R = 10\ \mu\text{a}$	$V_R = 15\text{ v}$	$V_R = 0$		

<sup>o</sup>These diodes are too fast to measure in conventional circuits utilizing standard reverse recovery time measurements. Therefore, the effective minority carrier lifetime is specified as  $\tau$  instead of  $\text{Trr}$ . Devices are hermetically sealed in a miniature glass package 0.160" long, 0.070" in diameter, color coded.

12674

**hp associates** 620 PAGE MILL ROAD,  
PALO ALTO, CALIF. 94304, (415) 321-8510  
An Affiliate of Hewlett-Packard Company

ON READER-SERVICE CARD CIRCLE 60

HAVING  
**FREQUENCY**  
PROBLEMS?



GET IN  
TUNE  
WITH THE  
**60KC**

**PHASE COMPARATOR  
RECEIVER**

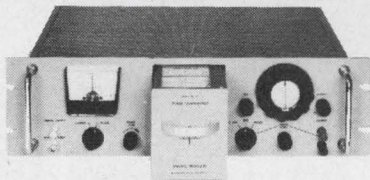

**Low Cost • Easy to Operate • Accurate**

The Model SR-60 is the first low cost VLF Phase Comparison Receiver designed to permit phase comparison measurements between a local oscillator and the National Bureau of Standards transmitted 60 Kc/s from WWVB, Fort Collins, Colorado. The receiver is a straight-forward Tuned Radio Frequency receiver and can be used in any location in the United States with highly satisfactory results.

The SR-60 permits accuracy measurements to parts in  $10^6$  with relative short measurements. Phase difference is displayed on a front panel meter or on a strip chart when more precise measurements are made over a long period of time.

Antenna input through a specially designed antenna coupler is made from the rear chassis. The antenna coupler allows the use of a high impedance antenna. Provisions are made to tune the coupler for any antenna. Connections are also available for scope monitoring the incoming signal (output of RF Amplifiers) the multiplied RF carrier signal and the multiplied (or divided) local oscillator signal.

**PRICE: \$850.00**

**Write, wire or phone for  
complete catalog information.**

*Specialists in Frequency Management*

**SPECIFIC  
PRODUCTS**



P.O. BOX 425  
21051 COSTANSO STREET  
WOODLAND HILLS, CALIFORNIA  
AREA CODE: 213 340-3131



ON READER-SERVICE CARD CIRCLE 61

**MICROWAVES**

**Backward-wave oscillator**

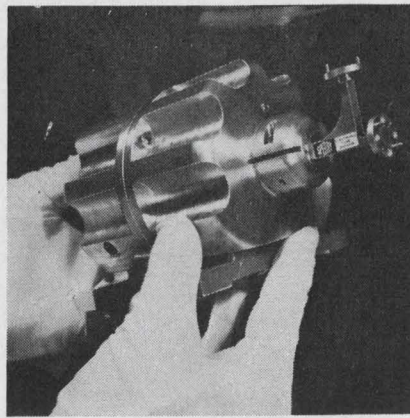

Type SBF-4221 backward-wave oscillator has capabilities to 100 GHz. It provides 20 mW over the 93 to 98 GHz region.

Developed as a BWO signal source in the 94 GHz atmospheric window, it can be applied to space communication systems. It has permanent magnet focusing, with single-knob tuning and improved circuitry for size, weight and convenience.

Sperry Electronic Tube Division, Sperry Rand Corp., Gainesville, Fla. Phone: (305) 372-0411.

*Circle No. 273*

**Diode laser pulser**

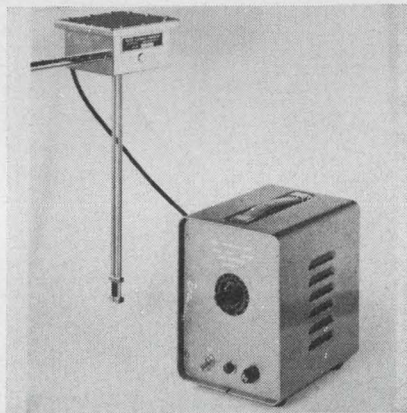

Peak currents in excess of 2000 amps with a 40 ns pulse width are within the capabilities of the Model H diode laser pulser. These short-duration, high-level pulses are said to allow large output power from a diode laser without damage to the semiconductor element.

Applications are said to include optical ranging, nonlinear effects, radar and lab experiments.

Seed Electronics Corp., 258 East St., Lexington, Mass. Phone: (617) 862-8090.

*Circle No. 274*

**Traveling-wave tube**

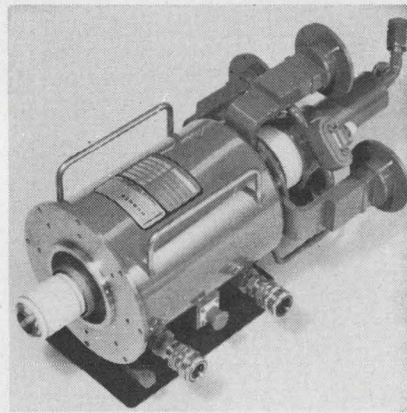

Model 614H covers the entire 5.925 to 6.425 GHz communications band without mechanical or electrical adjustments. It is capable of more than 10kW CW operation, and attains 30% efficiency using a depressed collector. Solenoid focusing and a coupled-cavity interaction structure insure long-life stability.

Hughes Microwave Tube Division, Hughes Aircraft Co., 11105 South La Cienega Boulevard, Los Angeles, Calif. Phone: (213) 670-1515.

*Circle No. 275*

**Tunnel-diode amplifier**

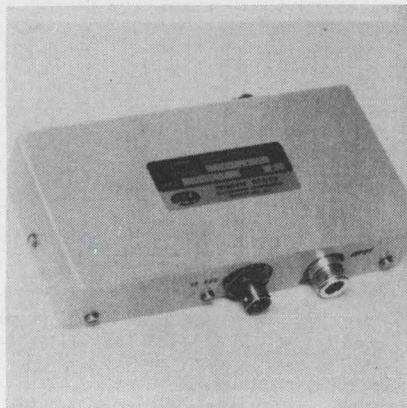

The compact tunnel-diode amplifier CN-5607 measures 6 x 3 x 1-in. It operates between 5.4 and 5.9 MHz in the X-band with a gain of 15 dB and a noise figure of 5 dB.

Its size, weight and operating characteristics make it suited to retrofit installations in airborne responders and radar equipment.

Delivery is 45-60 days. Micro State Electronics Corp., Raytheon Subsidiary, 152 Floral Ave., Murray Hill, N. J. Phone: (201) 464-2000.

*Circle No. 276*



# Small and stable -capacitors for a filter man's thinking

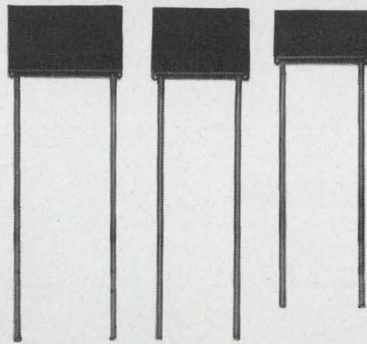

ACTUAL SIZE

**KEMET Flat-Kap: Parylene dielectric extended-foil capacitors with excellent stability in a very small plug-in conformal design. Available with tight tolerances.**

Typical retrace stability is 0.1% from cycling, use, or storage, over the full operating range from  $-55^{\circ}$  to  $+125^{\circ}\text{C}$ , with nominal T.C.  $-200$  ppm/  $^{\circ}\text{C}$ . They are available in any value from 0.001 to 0.100  $\mu\text{F}$ , 50 VDC, with tolerances as tight as  $\pm 1\%$ . Insulation resistance is 1,000,000 megohms, minimum, at  $25^{\circ}\text{C}$ . Flat-Kap capacitors are up to 95%

smaller than glass, mica, porcelain or polystyrene.

The reason: A remarkable new dielectric from Union Carbide research called Parylene. Vacuum-vapor-deposited in micron-range thickness on aluminum foil, Parylene offers, in minimum capacitor volume, the very stable characteristics demanded by today's precision circuitry.

Even if you're not a filter designer, you'll probably think of circuit problems the Flat-Kap capacitor can solve. For technical details, mail the coupon.

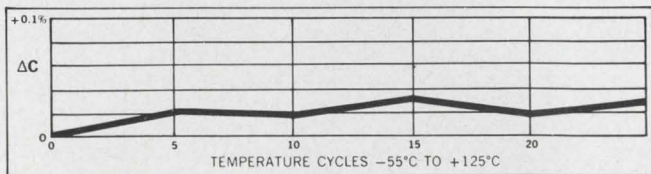

Superior capacitance stability of Flat-Kap capacitors.

#### Regional Sales Offices

East Coast: J. G. Egan, 1341 Hamburg Turnpike, Wayne, New Jersey 07472. Phone: 201-696-2710 / Mid-Atlantic: R. H. Robecki, 1341 Hamburg Turnpike, Wayne, New Jersey 07472. Phone: 201-696-2710 / Mid-West and South: K. S. Collart, P. O. Box 6087, Cleveland, Ohio 44101. Phone: 216-221-0600 / West Coast: B. G. Bryant, 701 East Whittier Blvd., Whittier, California 90605. Phone: 213-698-8077.

KEMET is a registered trade mark of Union Carbide Corporation.

Speed Inquiry to Advertiser via Collect Night Letter  
ON READER-SERVICE CARD CIRCLE 62

Clip, fill in name and title, attach to letterhead

Union Carbide Corporation  
Linde Division, Dept. ED-23  
270 Park Avenue, New York 10017

Please send Engineering Bulletin #22, on  
KEMET Flat-Kap film-foil capacitors

Name \_\_\_\_\_

Title \_\_\_\_\_



## Lead cleaner

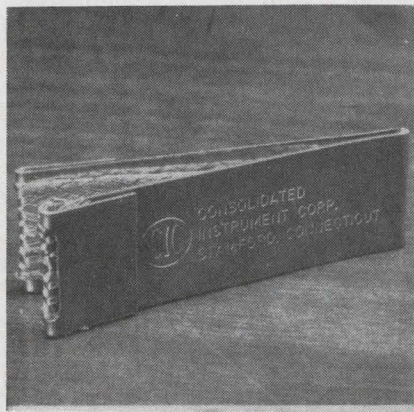

A new hand-held tool, lead-cleaner #W-14, removes the oxide layer from pretinned component leads to assure better quality soldered connections.

The method is to abrade the oxide coating with the cross-weave of a flat wire braid, doubled inside a hand-grip. The unit is designed to comply with NASA NPC 200-4 soldering techniques.

Price: \$1.49 each, substantial quantity discounts. Consolidated Instruments Corp., Box 1030, Stamford, Conn. Phone: (203) 322-7222.

Circle No. 277

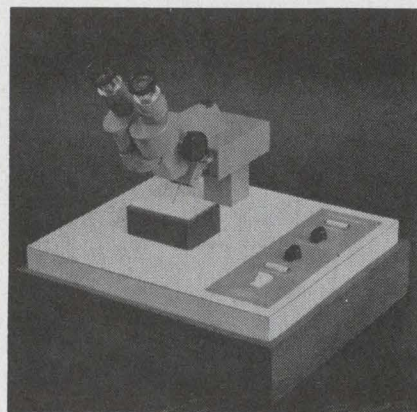

## Micro-soldering

Microbond II is a micro-soldering console for foot-pedal soldering of micro circuitry. Resistance heating is repeatable, minimizing operator error and inconsistency. Solder temperatures up to 1000°F are attainable. Resistance probes feature controlled pressure. 10x optics and a high intensity light are coupled with solid-state circuitry contained in the base for space conservation.

Browne Eng., 2003 State, Santa Barbara, Calif. Phone: (805) 965-9600.

Circle No. 279

## Thin film sources

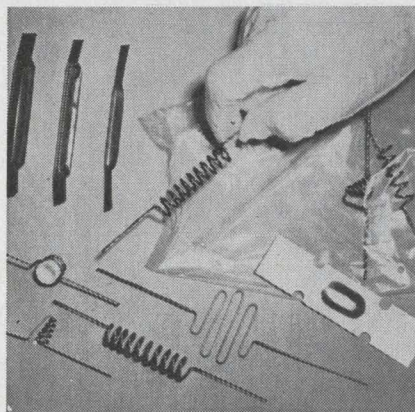

A line of ultra-clean film sources is processed to eliminate contaminants. Spectrographic analysis data are provided, and the units are polyethylene packed for complete isolation. The units are shipped with sterile gloves for handling during installation. These TFE series units are used in semiconductor and optical fields.

P&A: \$.50 to \$25; stock. Evaporation Apparatus Inc., 2202 S. Wright, Santa Ana, Calif. Phone: (714) 546-3640.

Circle No. 278

# Circuit Design Is an Art

Our client wants the engineer who takes pride in his work and seeks out complex problems laden with challenge.

Sure he works hard! He likes it that way. He gets paid well . . . both in salary and satisfaction.

If you consider yourself above average and want to practice your art in some of its most interesting and rewarding aspects, contact me today for details. Send resume or phone. Ask for me, Arnold Goldberger.

Salaries range from \$9-24,000 and our client pays all expenses.

**CCC CROSS COUNTRY CONSULTANTS**  
RECRUITERS FOR INDUSTRY

Suite 200 ■ 16 W. 25 St. ■ Baltimore, Md. 21218 ■ Area code 301-889-2994

## DISCOVER

THIS  
FASTER,  
MORE  
ACCURATE,  
DISTORTION-FREE

"PRESS and PEEL"

METHOD  
for making  
printed circuit  
master  
drawings

## BY-BUK

## "TAPE-LIFT"

PRINTED CIRCUIT DRAFTING AIDS in flat 8" strips packaged in handy slip-pack boxes. Featuring our NEW Black Matte Finish, Clear Adhesive Centerless Donuts, Teardrops and Oval Pads in many new stock sizes, also Tees, Elbows, Fillets, Adapters, Register Marks, Drafting Film and Grids, Conductor line tapes in Matte or Creped finish in widths from 1/64" up.

Write for our NEW CROSS-REFERENCE DRAFTING AIDS GUIDE & PRICE LIST NO. P-41 - FREE SAMPLES.

## BY-BUK COMPANY

4326 W. Pico Blvd., Los Angeles, Calif. 90019 • (213) 937-3511

Speed Inquiry to Advertiser via Collect Night Letter

ON READER-SERVICE CARD CIRCLE 63

ON READER-SERVICE CARD CIRCLE 896

# Dial "X" for convenience

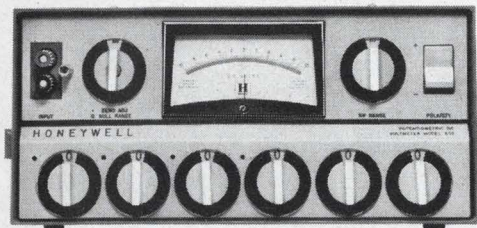

## Get 7-dial resolution in this 6-dial, solid-state Honeywell 852 Guarded Potentiometric Voltmeter

By simply dialing "X" on the 852's last dial and reading it as 10.00000, the instrument advances from 9.99999 to 10 volts. Just like that.

You get the same convenience on all 6 dials, and at 1, 100, and 1000 volts, too. All told, the Honeywell 852 permits *infinite impedance* measurements from 0 through 1,111.110 volts in four overlapping ranges, with one ppm resolution.

Completely solid-state, the 852 features an ultra-stable 1,111.110 volt DC reference, a sensitive, high-impedance null detector, and a precision 6-dial Kelvin-Varley divider. And, you get the handsome, functional styling that's so evident in our illustration. Best of all, the 852 is competitively priced. Shouldn't one be in your lab?

### 1K100 Primary DC Reference Standard

This versatile Honeywell instrument is used for precision calibrations of digital, differential, and potentiometric voltmeters, shunts and current measuring devices, volt boxes, potentiometers, and voltage dividers.

Also featuring the convenience of 7-dial resolution, the 6-dial 1K100 provides voltages from one microvolt to 1,111.110 volts DC in four overlapping ranges, with one ppm resolution.

With its high current output, 100 ma with variable current limiting, the 1K100 permits calibrations once impossible or impractical. Accuracy:  $\pm 0.01\%$ ; twice

the stability of any other reference: 0.001% per day, non-cumulative; 0.01% for 1000 hours of operation. The price? Competitive!

For more information on the 1K100 or the 852, contact your Honeywell representative or mail the coupon below for comprehensive literature.

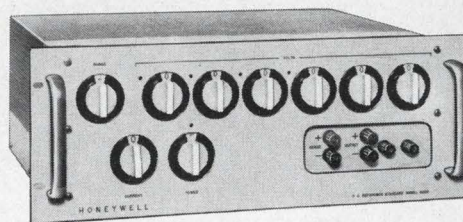

The highly versatile 1K100 Reference Standard

Carl Boyer  
Honeywell, Denver Division  
Mail Station 414  
Denver, Colorado 80217

Please send 852 and 1K100 literature to:

Name \_\_\_\_\_

Company \_\_\_\_\_

Address \_\_\_\_\_

City \_\_\_\_\_ State \_\_\_\_\_ Zip \_\_\_\_\_

DATA HANDLING SYSTEMS

# Honeywell

HONEYWELL IS WORLDWIDE • Sales and service offices in all principal cities of the world. Manufacturing in Brazil, Canada, France, Germany, Japan, Mexico, Netherlands, United Kingdom, United States.

ON READER-SERVICE CARD CIRCLE 64

## THE DESIGNER OF THIS STATIC AC SWITCH\*

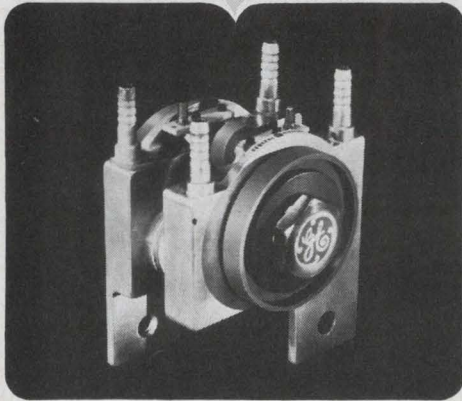

*selected*  
**MYCALEX® 410**  
glass-bonded mica  
FOR  
HIGH TEMPERATURE,  
ARC RESISTANCE  
AND  
COMPRESSION STRENGTH

These and other advantages are inherent in MYCALEX® glass-bonded mica and SUPRAMICA® ceramoplastics:

- High dielectric strength
- Thermal expansion close to that of stainless steel
- Total dimensional stability
- Moldable with metal inserts
- Machinable to close tolerances
- Inorganic formulation

Solve your design problems with the world's most nearly perfect insulation materials.

\*GENERAL ELECTRIC COMPANY SEMICONDUCTOR PRODUCTS DEPARTMENT



## MYCALEX

CORPORATION OF AMERICA

A comprehensive 36 page catalog provides complete technical and design information.  
Write or call for your copy.

125 Clifton Boulevard, Clifton, N.J.

ON READER-SERVICE CARD CIRCLE 65

## New Literature

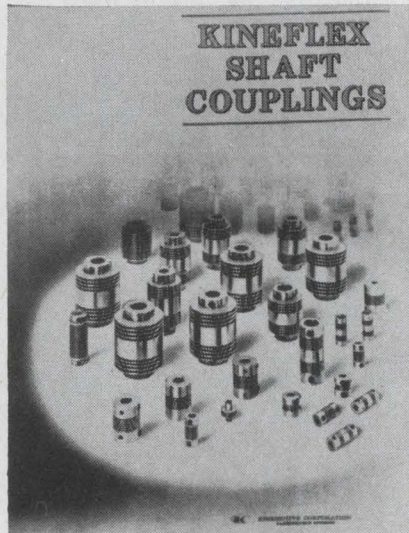

### Flexible coupling catalog

A catalog describes over 120 standard couplings for the convenience of design engineers. Performance data and equations for dynamic and loading specifications are given. Kinemotive.

Circle No. 280

### Waveguide catalog

A 12-page catalog covers application and design data, as well as specifications and ordering information on the manufacturer's Flexaguide and Twistaguide waveguide series. Airtron Div., Litton.

Circle No. 281

### Recording system

An eight-page brochure describes the EECO 755 magnetic tape recording system. Up to 200 analog inputs can be accepted, and operation is at up to 500 characters per second. Output is binary or BCD computer format. Electronic Engineering Corp.

Circle No. 282

### Proximitors catalog

A catalog describes the 3000 series proximitors. The non-contacting proximitors operate by induction, and are capable of measuring from 10<sup>-9</sup> to 0.2 in. Bently Nevada.

Circle No. 283

### Rubber catalog

Military, ASTM, and industrial spec sheet, strip, gasket, and adhesives are covered in a new 52 page catalog. Engineering guides, listings of solids, shapes, coated fabrics, and die-cut information are included, in addition to price data. MINOR Rubber Co.

Circle No. 284

### Dilatometer catalog

A 12-page catalog gives details, specifications, and options for the manufacturer's automatic recording dilatometer. The instrument permits rapid interchange of standard and high-vacuum measuring systems. Brinkman Instruments.

Circle No. 285

### Instrument catalog

A 24-page short-form catalog describes solid-state and electron tube counters, transducers, digital printers and double pulse generators. The catalog includes specs and purchasing data. Berkeley Div., Beckman Instruments.

Circle No. 286

### Impulse counters

Bulletin 201 contains 6 pages of specifications, operating characteristics, electrical and mechanical data, dimensions and typical installation diagrams for small impulse printing counters. Landis & Gyr.

Circle No. 287

### Regulated power supplies

Data on a line of regulated power supplies is given in this brochure. Specifications and price are covered. Lambda.

Circle No. 288

### Log periodic antennas

Seven log-periodic antennas are covered in this brochure. Operating specifications and applications checklists are included. Litton Industries.

Circle No. 289

# Progress Report

# ALSiPAK CERAMIC PACKAGES

## Four New Preferred Styles

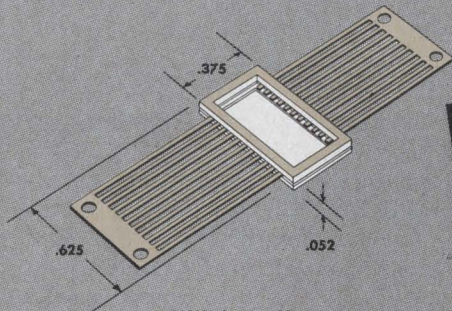

ALSiPak No. AP-66788  
22 Leads

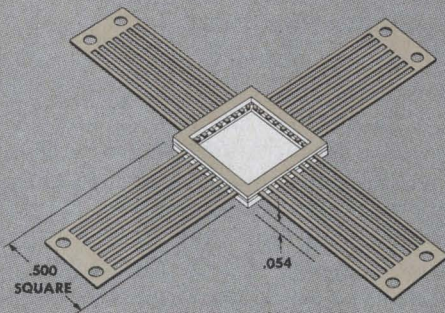

ALSiPak No. AP-66903  
16 or 32 Leads

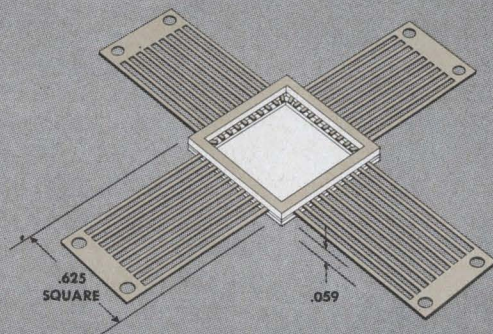

ALSiPak No. AP-66907  
20 or 40 Leads

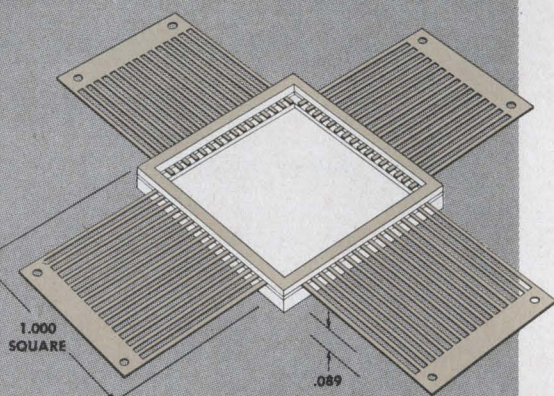

ALSiPak No. AP-66911  
32 or 64 Leads

The **RELIABILITY** of ALSiPak CERAMIC PACKAGES for electronic circuits is thoroughly proven. The use of these ceramic packages has grown rapidly and continues to rise.

As a service to the electronic industry, American Lava Corporation introduced seven "preferred style" packages early in 1965. They involve no tooling charges, are more promptly available and permit several low cost or no charge options on leads, inside depth, pads, etc., to readily adapt these preferred styles to an individual need.

As new requirements in volume are established, American Lava moves promptly to meet them. Shown are four new ALSiPak packages which have been added to the original Preferred Style packages introduced in American Lava Bulletin No. 655. We believe this bulletin is the most inclusive technical publication presently available on ceramic packages.

**CUSTOM PACKAGES.** ALSiPak ceramic packages can be custom made for your specific requirements. Our technical people with special experience on package design will make suggestions if you request them.

**NEW CHIP MOUNTING PAD PACKAGES.** Recent advances on chip mounting pad package designs now permit ALSiPak packages with nickel-iron-cobalt pad brought directly off one lead down onto the floor of the package.

Bulletin No. 655 Available on Request

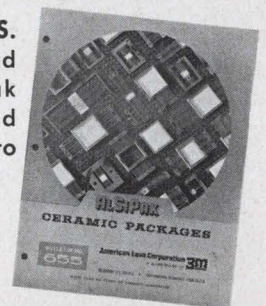

**American Lava Corporation** **3M**  
A SUBSIDIARY OF COMPANY

PHONE 615 265-3411, CHATTANOOGA, TENN. 37405

For service, contact American Lava representatives in Offices of Minnesota Mining and Manufacturing Co. in these cities (see your local telephone directory): Birmingham, Michigan • Boston: Needham Heights, Mass. • Chicago: Bedford Park, Illinois • Cleveland, Ohio • Laurens, S. C. • Los Angeles, Calif. • Minneapolis, Minn. • Metropolitan New York: Ridgefield, N. J. • Up-State New York: Phelps, N. Y. • Philadelphia, Penn. • Dallas, Texas • Roanoke, Va. • South San Francisco, Calif. All export except Canada: Minnesota Mining and Manufacturing Co., International Division, 700 Grand Ave., Ridgefield, N. J.

64th  
YEAR  
OF  
CERAMIC  
LEADERSHIP

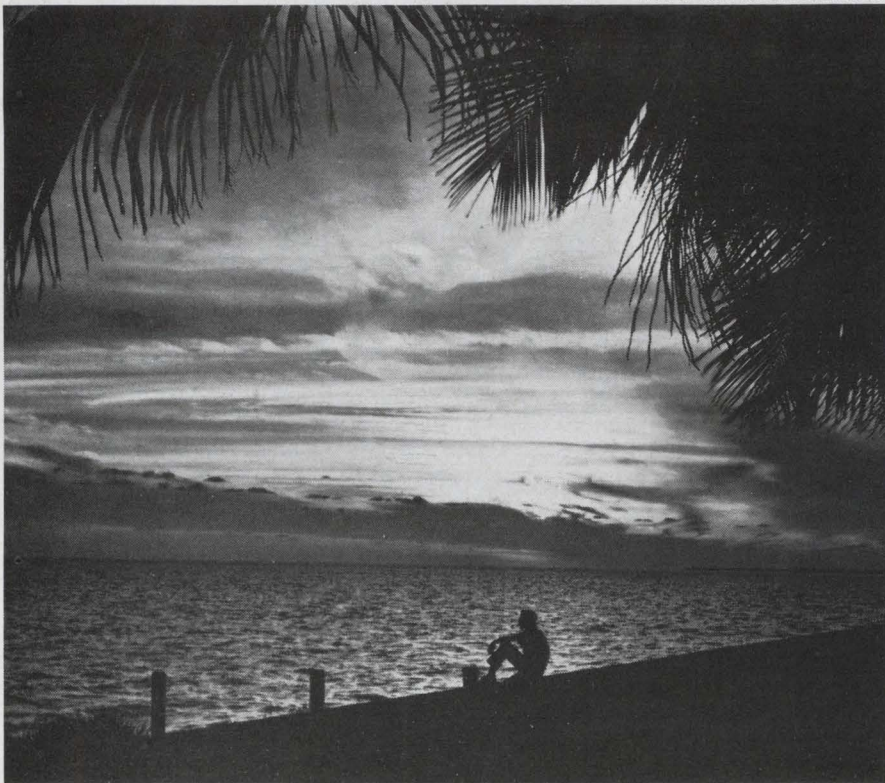

## How Does He Manage It?

By having guts, technical savvy, and the ability to be boss.

On the job, he's a hard-hitting organizer, managing the entire instrumentation complex on his down-range island (whether it be Eleuthera, Grand Bahama Island, Ascension, or one of the other 9 major stations on the Eastern Test Range). Each multimillion dollar space launch depends on his judgment and split-second decision-making.

As Base Operations Manager, he takes full responsibility for directing the real-time monitoring of vehicle performance in flight...using the latest in pulse and CW radar, telemetry, optics, infrared, timing, command/control, data encoding and transmission equipment, and digital computers. Soon he'll be working in support of MOL, Apollo and additional Gemini flights.

He earns his time on the beach.

If you have a strong technical background in these many areas of electronics... if you have engineering management ability and can make the right decision under pressure... if you want broad exposure to the whole world of range technology, a springboard to even more important positions at the Cape, write in confidence to Manager, Professional Employment, Dept. 30B-3.



## GUIDED MISSILES RANGE DIVISION

PAN AMERICAN WORLD AIRWAYS, INC.  
750 S. ORLANDO AVENUE, COCOA BEACH, FLORIDA

An Equal Opportunity Employer M/F

ON READER-SERVICE CARD CIRCLE 897

## NEW LITERATURE

### Small motors

Catalog 2820 lists design and construction features, specifications, applications, and prices for motors rated 1/20 to 5 hp with NEMA 48 and 56 frames. Included are split-phase, capacitor-start and poly-phase units. Westinghouse Electric Corporation.

Circle No. 296

### Multiplexer brochure

Bulletin 50802 provides technical information on series 970 solid-state multiplexers. The bulletin describes three high-speed multiplexers with improved FET switching, high input impedance, 8 to 128 channel expandability, and selectable stepping rates from 0-20,000 channels per second. Astrodata Inc.

Circle No. 297

### Instrument catalog

An 8-page illustrated catalog covers solid-state amplifiers, data systems, digital voltmeters and semiconductor test systems. Fairchild Instrumentation.

Circle No. 298

### Feed-thru capacitors

Bulletin No. 3525A gives standard ratings, performance characteristics and application guide for lug-terminal capacitors Type 180D. The family of capacitors, used for RFI suppression, is now available in 50 and 75 volt ratings. Sprague Electric.

Circle No. 299

### Silicon power modules

The "A" series of silicon power modules is described in Bulletin 103B. The bulletin lists changed ratings and additional information on the 261 standard models which cover voltage ratings from 1.5 to 264 and currents up to 37 amperes. Deltron, Inc.

Circle No. 351

### Relay catalog

A 28-page catalog describes the manufacturer's line of solid-state and reed relays for industrial and military applications. Solid State Electronics.

Circle No. 352

## Test equipment data

A series of data sheets and applications information covers ultrasonic, vhf, and uhf test equipment. Emphasis is placed on a high-power pulsed oscillator in the 5-90 MHz range and associated amplifiers and preamps. Arenberg Ultrasonic Labs.

Circle No. 290

## Industrial silver

Three schedules for industry list new prices for fine silver and standard silver alloy sheet, wire, grain and strip, and manufacturing charges for anodes, salts and silver plating. Engelhard Industries.

Circle No. 291

## Copper-metals lexicon

The third edition of "Copper and Copper Alloy Metalexicon" includes terminology and definitions of products supplied by mills. Photographs and drawings illustrate products and processes involved. Anaconda American Brass Co.

Circle No. 292

## Automatic testing

"Automatic Test Instruments for Electronic Components" is the title of this 32-page booklet. It discusses testing techniques, component classification and computer-operated test systems. Over 50 instruments for testing resistors, diodes, transistors and zener diodes are cataloged. Teradyne.

Circle No. 293

## Connector catalog

A condensed catalog covers a line of standard and special purpose connectors. Printed circuit connectors, right angle plugs, micro-miniature connectors and other types are included. Transitron.

Circle No. 294

## Light dimmers

Specifications on a full line of solid-state light dimmers are given in an 8-page catalog. Electrical and mechanical details and installation instructions are provided. Lutron Electronics Co.

Circle No. 295

CAM Corporation

Box 10325

Greensboro, N.C.

Gentlemen:

Please send me your complete catalog of patchcord programming systems.

Please send me specific details on a \_\_\_\_\_ contact system for application on \_\_\_\_\_

Name \_\_\_\_\_ Title \_\_\_\_\_

Company \_\_\_\_\_

City \_\_\_\_\_ State \_\_\_\_\_ Zip \_\_\_\_\_

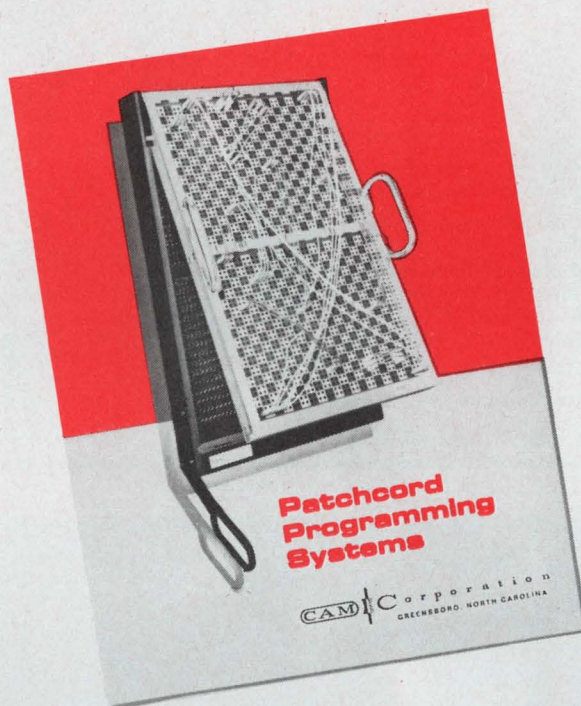

## Learn how patchcord systems are improved for 1966-67

This new catalog will give you a comprehensive look at CAM Corporation's patchcord programming line... the newest, ruggedest, most versatile equipment available anywhere. The book contains specifications on rear-frame and spring assemblies, removable boards and non-removable panels from 240 to 5120 contacts. It also has descriptive material on an extensive line of manual and semi-permanent patchcords in lengths from 3 to 45 inches. CAM's capability for custom boards and cords is also described.

GET UP TO DATE ON PATCHCORD PROGRAMMING EQUIPMENT. ORDER YOUR FREE COPY OF CAM'S NEW CATALOG TODAY!

**CAM** | **C** o r p o r a t i o n

BOX 10325/GREENSBORO, N.C. 27410

ON READER-SERVICE CARD CIRCLE 66

# AUGAT

**LEAD SOCKETS**  
Wide Range of Sizes  
Easy to Assemble

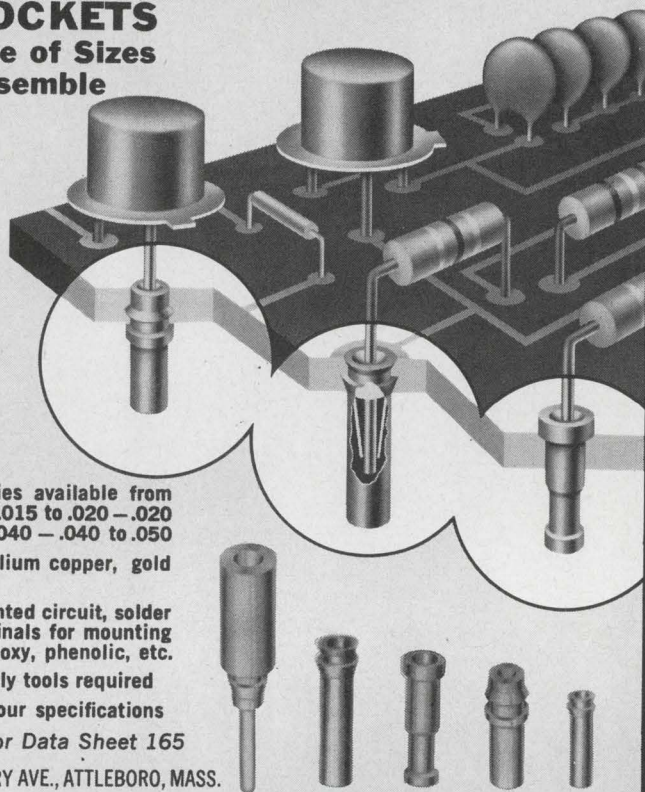

- Standard assemblies available from stock. Size ranges .015 to .020 — .020 to .030 — .030 to .040 — .040 to .050
- Closed-entry beryllium copper, gold plated contacts
- Self-anchoring printed circuit, solder pot or turret terminals for mounting in teflon, glass epoxy, phenolic, etc.
- No special assembly tools required
- Modifications to your specifications

For details write for Data Sheet 165

**AUGAT INC.** PERRY AVE., ATTLEBORO, MASS.

ON READER-SERVICE CARD CIRCLE 67

## GET ALL 5

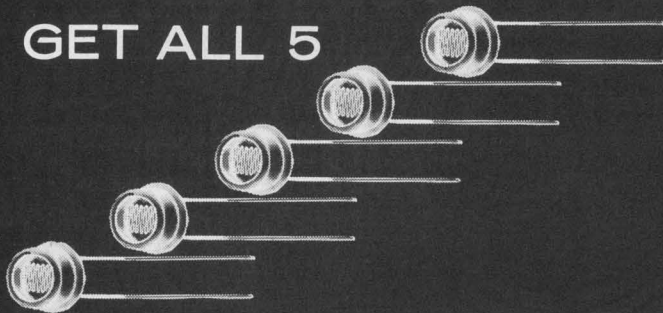

## IN 1 NEW PHOTOCELL...

Now, the 5 best characteristics of CdSe and CdS are combined in 1 new Clairex CdS photosensitive material, the type "5H".

1. High speed (1-2 millisecond response)
2. Low temperature coefficient (0.5%/°C)
3. Low memory (15 X lower than CdSe)
4. High linearity (slope of 0.9 from 0.1 to 100 FC)
5. Uniform color temperature response (100% - 106%, 2854°K-6700°K)

Detailed information on type "5H" photocells plus the new Clairex 16 page Designers' Manual free on request.

# CLAIREX

"The LIGHT Touch in Automation and Control"

1239 Broadway, New York, N.Y. 10001, 212 MU 4-0940

ON READER-SERVICE CARD CIRCLE 68

## NEW LITERATURE

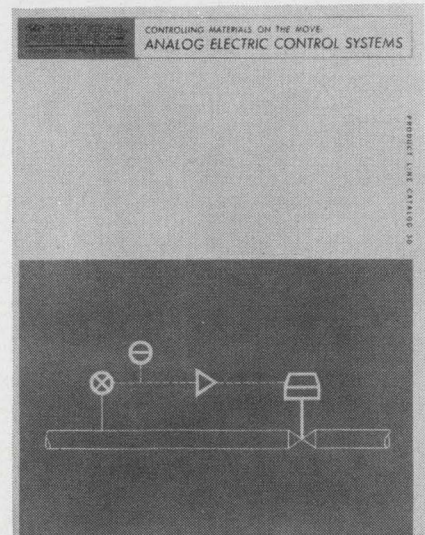

### Analog control systems

"Analog Electric Control Systems" is a presentation of operations principles and schematics of processing systems. The applications feature the manufacturer's line of sensors, transmitters, controllers and actuators. General Precision.

Circle No. 353

### FET amplifier

A 5-page note shows how to take advantage of junction FETs in high impedance circuits. A compensation method results in input impedance greater than  $200 \times 10^9$  ohms, input current less than  $0.10 \times 10^{-12}$  amps, zero input capacitance, gains above 100, and compensation for external currents and temperature. Crystalonics Div. Teledyne, Inc.

Circle No. 354

### Function module catalog

A six-page catalog gives specifications for a broad line of analog function modules, analog-to-digital interface modules, instrumentation amplifiers, power supplies, and accessories. Burr-Brown Research.

Circle No. 355

### Thermocouple catalog

A 10 page brochure, No. 332, contains information on thermocouples and extension wires produced by the manufacturer. Included are insulation breakdown tables, wire capacity information, and weights and dimensions. Thermo-Electric Co.

Circle No. 356



## Phenolic molding

A 16-page two-color bulletin covers the wear and molding characteristics of phenolic compounds. A technical article on TFE-teflon lubricated phenolics serves to introduce specifications, characteristics, and design parameters for the manufacturer's line. Whitford Chemical Corp.

*Circle No. 357*

## Instrumental rental

A new catalog lists tape recorders, ac-dc amps, power supplies, oscilloscopes, freq. counters, etc. for rent. It gives manufacturers specifications and term rental rates. Datacraft.

*Circle No. 358*

## Low-level switching

Data sheet 1251-B details five relay types minimizing noise and thermal voltage problems in low-level switching. The sheet includes characteristics and specs for modular and can types encompassing varied speeds and duty cycles. C. P. Clare & Co.

*Circle No. 359*

## RFI filter catalog

A brochure gives electrical and physical characteristics for a group of radio frequency interference filters. Tubular and bathtub styles are included. Gudeman Co. of Calif.

*Circle No. 360*

## Stack switch catalog

An eight-page catalog lists stack switches for prototype, production and pre-production assembly. Detailed electrical and mechanical specifications are given with design suggestions. Switchcraft.

*Circle No. 361*

## Capacitor catalog

A 53-page catalog lists capacitors and resistors for industrial applications. Electrolytics, paper, film, metallized film, subminiatures, MIL types, ceramics and micas are among the capacitors shown. Decade boxes, filters and resistors are also included. Aerovox.

*Circle No. 362*

**Applied Technology, Inc. announces a substantial reduction in price for its premium line of SP series solid-state, octave bandwidth preamplifiers—100 mc to 1 Gc.**

**You are also cordially invited to investigate ATI's new line of high power output, solid-state preamplifiers.**

**Guaranteed Specifications, SP-215:**

**Frequency . . . . 150-300 mc**  
**Noise Figure. . . . . 6 db**  
**(5 db typical)**

**Linear Power Output +16 dbm**  
**(+20 dbm typical)**

**Other frequency ranges available.**

**For complete details, contact**

## **APPLIED TECHNOLOGY INCORPORATED**

3410 Hillview Avenue  
Stanford Industrial Park  
Palo Alto, California • 94304  
Telephone (415) 321-5135  
TWX (415) 492-9370



ON READER-SERVICE CARD CIRCLE 69

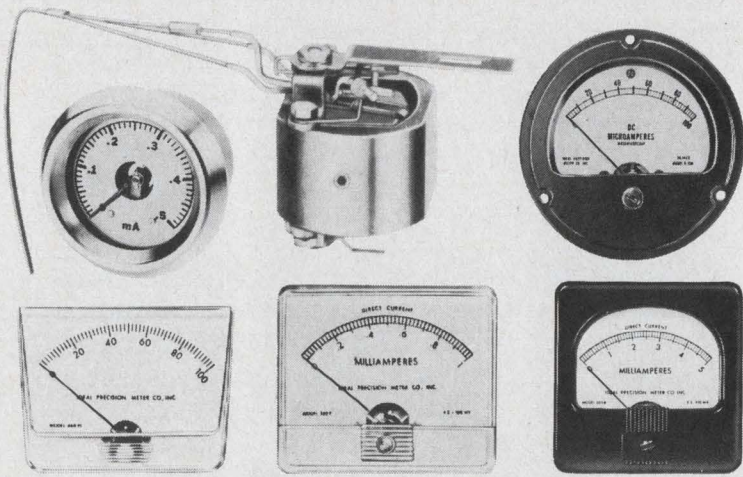

You name the shape, we have it—or we'll make it for you:

## For everything in meters you can count on Ideal.

BRAND

Ideal is a specialist's specialist—a complete facility with 100% concentration on meter development and design exclusively. Ideal meters are used by every branch of the Military and by leaders in defense and industry. Whatever you need in meters—ruggedized or commercial, custom and stock, 1/2" to 7"—call Ideal, the proven leader.

Write for free 52-pg. handbook and catalog. Ideal Precision Meter Co., Inc., 218 Franklin St., Brooklyn, N.Y. 11222. (212) EVergreen 3-6904.



ON READER-SERVICE CARD CIRCLE 70

### Smallest 3-Phase Electronic Frequency Converters Ever Made!



Now, from CML, comes a series of the smallest 3-phase Electronic Frequency Converters ever made... featuring fixed or adjustable plug-in oscillators at frequencies ranging from 45 to 6,000 cycles. Write today for details on Models T500A through T2500A!

Model	3 $\phi$ Output VA	Dimensions (For standard 19" relay rack mounting)
T500A	500	8 3/4" h x 21" d
T750A	750	14" h x 21" d
T1200A	1200	14" h x 21" d
T1750A	1750	14" h x 21" d
T2500A	2500	14" h x 21" d



**CML, Inc.**

A Subsidiary of Tenney Engineering, Inc.  
350 Leland Avenue • Plainfield, New Jersey  
Telephone (201) 754-5502 • TWX: 201-756-2064

ON READER-SERVICE CARD CIRCLE 71

## NEW LITERATURE

### Power supplies

Silicon modular power supplies are described in a six-page brochure. Chassis and rack mounting are featured in 32 models with dc voltages up to 120 Vdc, nine amps. Lambda Electronics.

Circle No. 363

### Power transistors

A series of specification sheets on a line of vhf-uhf silicon npn power transistors features results of electrical testing. Vector Div., United Aircraft.

Circle No. 364

### Induction motors

Small, lightweight induction motors are featured in an eight-page bulletin. Power from 15 mhp to 1/2 hp is available in 3, 3-7/8, and 4-7/8 in. diameter frames. Applications, specifications, rating charts, performance curves and dimension and connection diagrams are given. General Electric.

Circle No. 365

### Hot carrier diodes

Articles on detection and mixing with hot carrier diodes are featured in precis form in Hewlett-Packard Journal Vol. 17, No. 4. The complete papers are available on request. Hewlett-Packard.

Circle No. 366

### Servo recorder catalog

A 24-page catalog describes and gives specifications for five new servo recorders and a multiple input, non-indicating controller. Esterline Angus.

Circle No. 367

### Thermistor brochure

Bulletin SB53-1 covers a diversified line of thermistors, thermistor probes and varistors, together with publications and reprints pertaining to these and allied products. Victory Engineering.

Circle No. 368

## Additional Relay Data

The following information is an addendum to ELECTRONIC DESIGN's 1965 Relay Directory (Nov. 29 issue). It refers to the manufacturers' literature offering (p 6) and their product lines (p 64).

Advanced Electronics, Inc.  
1765 Silas Deane Highway  
Rocky Hill, Conn. 06067  
Electronic and Vibration-Sensitive Relays  
Data Sheets, Catalog available.  
(Circle Reader Service No. 780 for information)

F. A. Scherma  
Co., Inc.  
424 Broome Street  
New York, N. Y. 10013  
Midget Telephone-type, Antenna-switching, Coaxial, General-purpose, Multiple-arm, Plug-in, Sealed and Dust-covered relays. Catalog sheets available.  
(Circle Reader Service No. 781 for information)

Square D. Co.  
P. O. Box 472  
Milwaukee, Wis. 53201  
General-purpose, High-voltage, Miniature, Armature, Overload, Polarized, Power, Sensitive, Subminiature, Time-delay, Clapper, Electronic, Electromechanical, Explosion-proof, Plug-in, Solenoid-actuated, Solid-state and Thermal relays.  
Data Sheets, Catalog available.  
(Circle Reader Service No. 782 for information)

Stevens-Arnold, Inc.  
7 Elkins Street  
South Boston, Mass.  
Electromechanical reed type (Ultra-high speed, Chopper/Modulator and Frequency-selective) relays.  
Catalogs available.  
(Circle Reader Service No. 783 for information)

### Accuracy is Our Policy

The battery that feeds the two windings of Relay B was omitted from the drawing of the rotary switch in the Relay Issue (November 29, 1965, p 75).



## IMAGINATION: is yours being used?

HAVE YOU CONSIDERED EMR AS A CAREER EMPLOYER? YOU SHOULD! EXPERIENCED ENGINEERS WITH EXCEPTIONAL ABILITY AND IMAGINATION ARE INVITED TO EXPLORE THESE OPPORTUNITIES: RELIABILITY, QUALITY CONTROL, MECHANICAL, LOGIC DESIGN, PRODUCT DEVELOPMENT, RF, CIRCUIT DESIGN, ELECTRONIC SYSTEMS, APPLICATIONS, ELECTRONIC PACKAGING. SEND RESUME TO J. B. APPLIEDORN, PROFESSIONAL STAFFING, BOX 3041, SARASOTA, FLORIDA. **ELECTRO-MECHANICAL RESEARCH, INC.** **EMR**

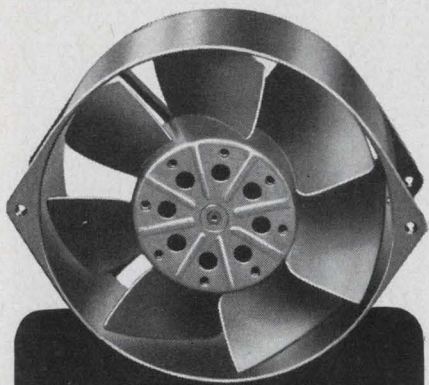

**New**

**5 1/2"**

**SHADED-POLE**

**Model 6500**

**PAMOTOR**

**Axial Fans**

- Free air delivery in excess of 300 cfm at 3000 rpm
- Over 20,000 operational hours without maintenance
- Outstanding performance at moderate cost (under \$30.00 for single units)
- Only 2" deep
- 110 v or 220 v operation
- Stocked for immediate delivery

Write for technical data on the Model 6500 and other PAMOTOR axial fans to:

**PAMOTOR, INC.**

312 SEVENTH STREET • SAN FRANCISCO, CALIF.

ON READER-SERVICE CARD CIRCLE 73

## Application Notes

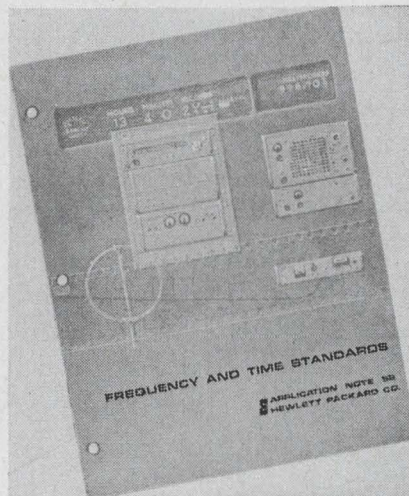

### Frequency and time text

A newly revised 108-page text on frequency, time and laboratory standards for them is called "Frequency and Time Standards," Application Note #52.

It contains fundamentals as well as the latest schedules on U.S. and international time standards. The atomic second (cesium beam) is covered, as well as all other systems of time measure (Ephemeris, Universal, Sidereal, Lunar, Solar, etc.).

An introduction is followed by a section on system operation of frequency and time standards, methods of comparison of standards, time determination data and a section on spectral purity in frequency standards. Hewlett Packard.

*Circle No. 369*

### Memory drum applications

A 26-page application note covers a series of random access storage drums vis-a-vis conventional drums and discs.

Redundancy capabilities, rapid-access, reliability and write/read access are segments featured. The manufacturer uses two models from his own line as comparisons. Characteristics, specifications and interface details are covered. Bryant Computer Prods. div. of Ex-Cell-O Corp.

*Circle No. 370*

### Gearmotor designs

A four-page technical brochure, B-2732 provides design data on the complete range of the type FC motors with integral planetary gearheads. The information provided includes extensive tables of ratios and performance in both even and odd ratios. Globe Industries.

*Circle No. 371*

### Synchro/resolver test

Precision synchro and resolver test instruments plus theory and applications are covered in the third edition of the manufacturer's catalog #11.

Each section includes complete specs on a particular type of instrument and separate sections are provided on special applications and operational theory. Gertsch Products.

*Circle No. 372*

### Copper-clad laminates

A new, up-dated brochure on metal-clad laminated plastics for printed circuits has been issued. The brochure lists properties of Synthane grades most used with metal foils, and describes quality control methods employed in testing finished metal-clad sheets. Synthane Corp.

*Circle No. 373*

### Polarized readout

The brochure, "Polaroid Circular Polarizer for Contrast Improvement," describes in detail how polarizing filters work with readout devices such as Burroughs' Nixie indicator tubes. Because of the circular polarizers' ability to absorb back reflection, the readability of Nixie-type displays is said to be improved. Polaroid Corp.

*Circle No. 374*

GLOBE

# Globe A. C. Centrifugals COOL with slingshot force

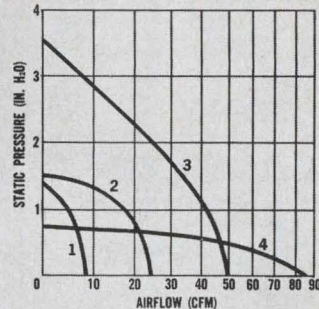
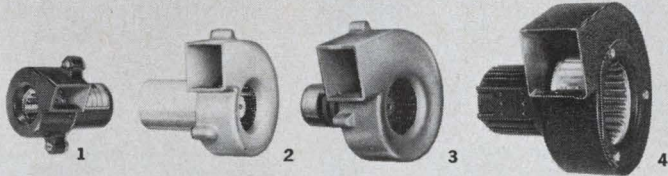

For economical cooling and pressurization, obtain a Globe proposal the next time you need standard or special centrifugal blowers. Globe makes single and double styles, for military or commercial applications. We also make a.c. and d.c. vaneaxial, tubeaxial, and multistage blowers and fans. Request Bulletin CB. **Globe Industries, Inc., 2275 Stanley Ave., Dayton, Ohio, 45404, U.S.A., Tel.: 513 222-3741.**

### PERFORMANCE

- 1 1" wheel. 115 v.a.c., 400 cps. Overall length 2.48". Weight 4 oz. Part Number 19A565.
- 2 1½" wheel. 115 v.a.c., 400 cps. Overall length 3.30". Weight 16¼ oz. Part Number 19A690.
- 3 2" wheel. 115 v.a.c., 400 cps. Overall length 3.77". Weight 18¾ oz. Part Number 19A694.
- 4 3" wheel. 115 or 208 v.a.c., 50 or 60 cps. Overall length 6" max. Weight 3½ lb. Part No. 19A1540.

ON READER-SERVICE CARD CIRCLE 74

## MITSUMI COMPONENTS

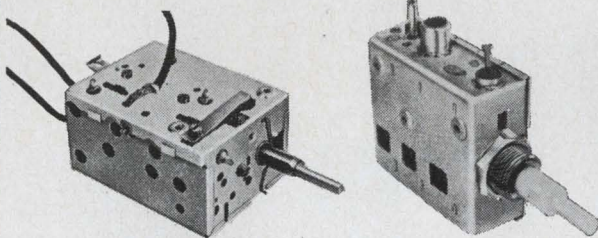

VHF V-AS11

UHF U-AS11

### NEW TRANSISTOR TV TUNER

The characteristics of Mitsumi transistor TV tuner are high sensitivity, small spurious radiation and high durability.

The tuner is available for both VHF and UHF. It has a unique fine adjustment mechanism and is superior in humidity characteristics and temperature characteristics.

#### Main Products

Polyvaricon · IFT · Oscillator coil · Antenna coil · Composite coil · Special coil · Micro motor · Synchronous motor · Variable resistor · Trimming potentiometer · FM tuner TV tuner · Various sockets · CdS photoconductive cell.



### MITSUMI ELECTRIC CO., LTD.

New York office: 11 Broadway, New York, N.Y. 10004, U.S.A. Phone: HA-5-3085, 3086  
Main office: 1056, Koadachi, Komae-machi, Kitatama-gun, Tokyo, Japan. Phone: Tokyo 415-6211/23

ON READER-SERVICE CARD CIRCLE 75

February 15, 1966

# FORK CONTACTS

Radiused Mating Surfaces Provide Smoother Positive Mating. Assure Repeated Low Resistance Contact. Available in Bulk Or In Permanent Dielectric. Connectors Available With 15 to 47 Contacts. All Popular Termination Styles.

### IMMEDIATE DELIVERY

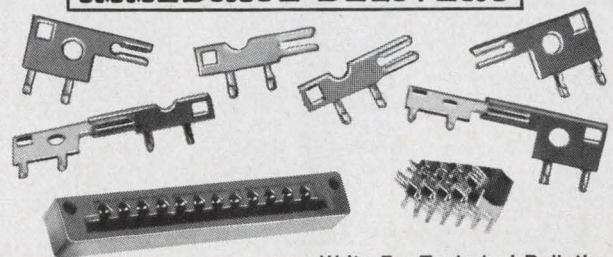

Write For Technical Bulletin



### Methode Electronics, Inc.

7447 W. Wilson Ave. · Chicago, Illinois 60656  
Underhill 7-9600  
Licensed under Elco patents.

ON READER-SERVICE CARD CIRCLE 76

# Available Now NEW DESIGNERS CATALOG ON RELAYS

BY

**BRANSON**

Including:

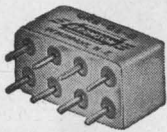

- Solid State Time Delay Relays

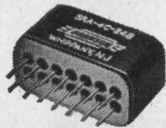

- 2 & 4 pole 1/2 size crystal can relays

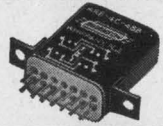

- 2 & 4 pole crystal can relays

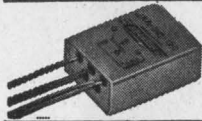

- Transistor Size Relays

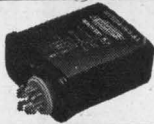

- Time Delay Relays

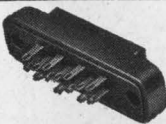

- Relay Sockets

- Custom Designed Relays

This new designers catalog, by Branson, is complete with: application data, diagrams, photos, type numbers, environmental, mechanical and electrical specifications.



Relays...  
Our Only Business

Write for your FREE copy now

**BRANSON CORP.**

VANDERHOOF AVENUE  
DENVER, NEW JERSEY  
(201) 625-0600

ON READER-SERVICE CARD CIRCLE 77

## Design Aids

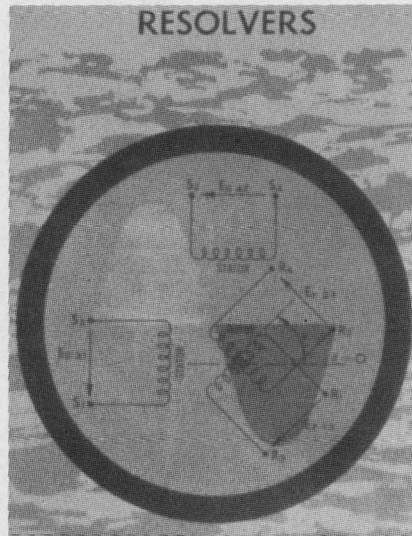

### Resolver manual

A manual covers theory, definitions, electrical characteristics, applications and performance of resolvers. Charts, illustrations and photographs are included in this 22-page design manual. A discussion of special models and an appendix of terminology are followed by a page of sample specs from the manufacturer's lines. American Electronics, Inc.

Circle No. 375

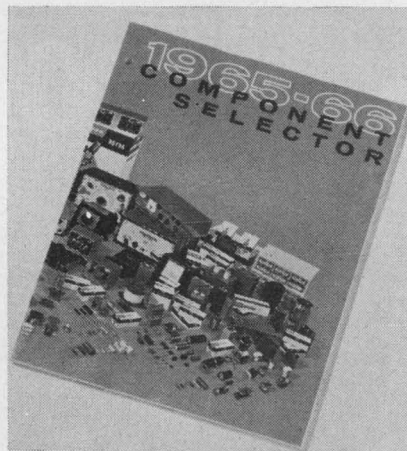

### Component and stock data

Two books cover selection of components with application charts, type selector charts and standard rating guides. The 128-page Component Selector covers technical considerations of most components, while the pocket-size Rating Selector acts as a guide to purchasing and applications of the manufacturer's line. Cornell-Dubilier Div. of Federal Pacific.

Circle No. 376

### Transmission-line data

"Useful Tables and Graphs for Determining Transmission Line Relationships" is a 12-page information booklet. Tables cover "DB return loss vs reflection coefficient" and "universal ratio function 'U'." Graphs are "return loss (dB) vs. vswr." PRD Electronics.

Circle No. 377

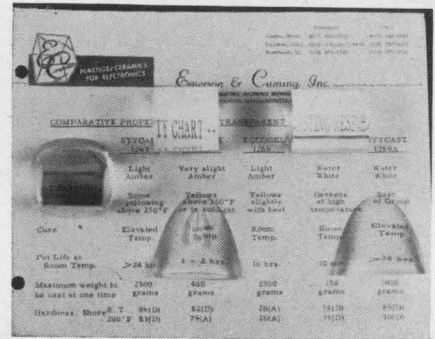

### Epoxy comparisons

A quick comparison chart for properties and handling characteristics of Stycast epoxies 1263, 1264, 1266, 1269A and Eccogel 1265 lists color, cure temperature, pot life, and max weight for one casting pour, as well as hardness and maximum use temperature. Emerson and Cuming.

Circle No. 378

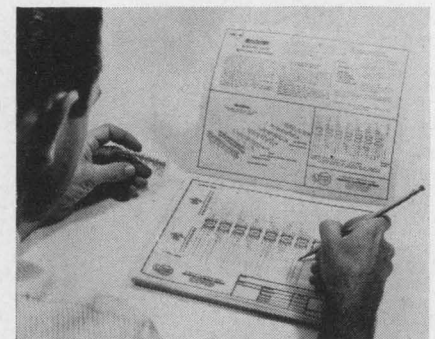

### Flat-pack connection aid

A preprinted vellum pad greatly simplifies design of interconnections for flat-pack integrated circuits. Designer's Aid Pads give a practical method for connecting groups of two to ten or more. The resulting "stick" can be soldered or welded to a circuit board. Engineered Electronics Co.

Circle No. 379



Motorola's New  
Complementary Annular  
Transistors are in Demand  
by BOTH Switching and  
Amplifier Designers!  
**WHY?**

"We used them because they were available in complementary pairs."

"Even with high  $f_t$ , beta, and voltage . . . they were very reasonably priced!"

"The complete h-parameter specs told us what we needed in our amplifier design."

"We selected them for the switching parameters —  $t_d$ ,  $t_r$ ,  $t_s$ , and  $t_f$  — given in the spec."

"The combination of high voltage and low  $C_{ob}$  is just what we needed."



Because these key Motorola transistors (PNP type 2N3250/51 and NPN 2N3946/47) are more completely specified for *both* switching *and* amplifier performance than any other types!

For example, if you're working with amplifiers, the complete h-parameter specs ( $h_{fe}$ ,  $h_{re}$ ,  $h_{ie}$ ,  $h_{oe}$ ), the 40-volt ( $V_{CE0}$ ) breakdown voltage, the 250 MHz (min) frequency response, the noise figure spec, and low capacitance values — would be just the measurements you needed for calculating circuit performance.

Or, if you're working with switching designs, the complete switching time specs ( $t_r$ ,  $t_d$ ,  $t_s$ ,  $t_f$ ), low saturation voltage ( $V_{CE(SAT)} = 0.25$  volts max.), low  $r'_b C_c$  value, and low input and output capacitances would be ideal design values to know.

In short, we think you'll find these well-specified Motorola PNP and NPN silicon annular transistors

are the "most usable" complementary devices for general purpose switching and amplifier applications available anywhere!

They are available *now* from your local franchised Motorola semiconductor distributor in quantities to 999 or in production lots from your Motorola field representative. Call your Motorola man. He'll be happy to give you samples for evaluation. For complete technical details on PNP types 2N3250-51 or NPN types 2N3946-47, write the Technical Information Center, Motorola Semiconductor Products Inc., Box 955, Phoenix, Arizona 85001.



**MOTOROLA**  
**Semiconductors**

Speed Inquiry to Advertiser via Collect Night Letter  
ON READER-SERVICE CARD CIRCLE 78

*Now...*

**PRECISION APPLICATION OF CONDUCTIVE  
CIRCUITS (AND INSULATING COATINGS)  
ON GEOMETRIC SHAPES**

Custom formulated to meet specifications. Insulation applied to metal shapes is brittle or flexible, with high bond strength and heat resistance. Motson circuitry techniques provide electrical characteristics to the most exacting standards for use in radar antennae, missile nose cone fusing, capacitance probes in jet plane fuel gauge systems, etc.

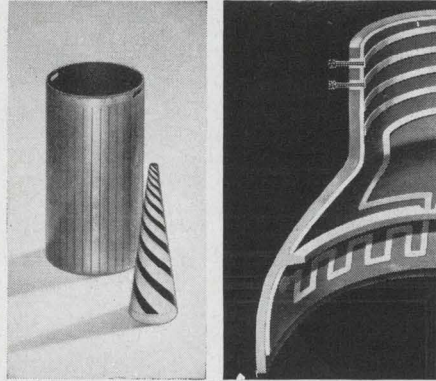

● Write today for literature on Motson applied circuits... or send details and prints of possible application to

J. Frank Motson Company  
Flourtown, Pa. • Tel: (215) Chestnut Hill 7-1900.



**APPLIED CIRCUITRY**  
ON READER-SERVICE CARD CIRCLE 79

INNOVATION  
INNOVATION  
INNOVATION  
INNOVATION



**In  
Electrical  
Electronics  
Engineering**

- 80 Technical sessions, 300 papers — all at the New York Hilton
- 4 floors of exhibits — all at the New York Coliseum. Four days only — Monday - Thursday
- Gala IEEE Banquet—Wednesday, 7:15 p.m., New York Hilton Grand Ballroom — \$15.00
- Free shuttle busses between the Hilton and the Coliseum — every few minutes
- Registration — Members \$2.00 — Non-members \$5.00. Ladies \$1.00. Good for all days — Technical Sessions and Exhibits. In and out privileges.

**EXHIBITS (4 days only)**

Monday through Thursday  
11:30 a.m. - 9:30 p.m.

**NEW YORK COLISEUM**

**TECHNICAL SESSIONS**

Monday through Friday

**NEW YORK HILTON**

**MARCH 21-25, 1966**

Students (over 14) accompanied by adult will be admitted to Exhibits Thursday only. \$2.00. (Not more than 3 per adult)



**IEEE EXHIBITION**

ON READER-SERVICE CARD CIRCLE 80

**Advertisers'  
Index**

**\*PARTICIPANTS IN  
NIGHT LETTER PROGRAM**

Advertiser	Page
*AMP, Incorporated	99
Acopian Corporation	136
*Agastat Timing Instruments, Elastic Stop Nut Corporation of America	36
Airpax Electronics, Incorporated	6
Seminole Division	128AA
Allen-Bradley Co.	145
American Lava Corporation	8, 9
*Amphenol Controls Division, Amphenol Corporation	149
Applied Technology Incorporated	74
Arnold Magnetics Corp.	148
Augat, Inc.	101
*Beckman Instruments, Inc., Helipot Division	19
Bendix Corporation, The, Semiconductor Division	112
Bliley Electric Co.	130
Boonton Electronics Corporation	111
*Bourns, Inc.	154
Branson Corp.	48
Burdny Corporation	142
By-Buk Company	147
CAM Corporation	150
CML, Inc.	133
C T S of Berne, Inc.	157
California Resistor Corporation	148
Clairex Corporation	Cover II
*Clifton Precision Products, Division of Litton Industries	67
Cohu Electronics, Inc., KinTel Division	30
*Computer Control Company, Inc.	85
*Consolidated Avionics, A Division of Condec Corporation	23
*Corning Glass Works, Electronics	158
Curtis Development & Mfg. Co.	Cover III
*Dale Electronics, Inc., Delco Radio, Division of General Motors	117
ESI/Electro Scientific Industries	120
Eastern Radio Corp.	116
Electro Instruments, Inc.	83
Electronic Control Corporation	66
Electronized Chemicals Corporation	134
Electrovert, Inc.	122
Essex Wire Corporation, Electronic Marketing Division	118
Fairchild Instrumentation, A Division of Fairchild Camera and Instrument Corporation	7
*Fluke Mfg. Co., Inc., John	95
General Electric Company, Magnetic Materials Section	137
General Instrument Corporation	26, 27
General Radio Company	1
Globe Industries, Inc.	153
Guardian Electric Manufacturing Co.	33
H P Associates	139
Hayden Publishing Company, Inc.	159
Haydon Products, Industrial Controls Division	108
Hewlett-Packard	44, 45, 106, 107
Hewlett-Packard, Dymec Division	15
Hewlett-Packard, Moseley Division	119
Honeywell Denver Division	143
Hughes Aircraft Company, Aerospace Divisions	82
Hyperion Industries Corporation	160
IEEE Exhibition	156
Ideal Precision Meter Co. Inc.	150
International Diode Corp.	138

Kay Electric Company 86



**Advertiser**

**Page**

Lambda Electronics Corp. ....	78, 79
*Leach Corporation .....	68, 69
Lenox Fugel Electronics, Inc. ....	132
Licon, Division Illinois Tool Works Inc. ....	92, 93
Line Electric Company Div. of Industrial Timer Corporation ..	103
*Magnetics, Inc. ....	38
*Mallory & Co., Inc., P. R. ....	4, 5, 115
Metex Corporation .....	138
Methode Electronics, Inc. ....	153
*MicroSwitch, A Division of Honeywell, ..	131
Mitsumi Electric Co., Inc. ....	153
*Motorola Semiconductor Products, Inc. 43,	155
Motson Company, J. Frank .....	156
Mycalex Corporation of America .....	144

Paktron Division, Illinois Tool Works, Inc	29
Pamotor, Inc. ....	152
Perfection Mica Company .....	126
Photocircuits Corporation .....	87
Power-Tronics Systems, Inc. ....	159
Pyrofilm Resistor Co., Inc. ....	53

RCA Electronic Components and Devices .....	Cover IV
*Radiation, Incorporated .....	25
*Redcor Corporation .....	2

Sigma Instruments, Inc. ....	96, 97
Simpson Electric Company .....	112A-X, 113
Solid State Electronics Corporation .....	159
Sorensen, A Unit of Raytheon Company	16
Space Craft, Inc. ....	81
Specific Products .....	140
*Spectrol Electronics Corporation .....	75
Sprague Electric Company .....	10, 20
*Systron-Donner Corporation .....	12

TRW Capacitors .....	46
Techno-Components Corp. ....	129
Tektronix, Inc., Oscilloscopes .....	123
Teletype Corporation .....	35, 37, 39
Texas Instruments Incorporated, Semiconductors-Components Division	54, 55
Thermosen, Inc. ....	158
Times Wire and Cable, Division of The International Silver Company .....	127
Town Laboratories, Inc. ....	74

Umeda Nameplate Seisakusho Co., Ltd. ..	122
Union Carbide Corporation, Linde Division	141
United Systems Corporation .....	126
Universal Instruments Corporation .....	158

Vactec Inc. ....	157
*Varian, Palo Alto Tube Division .....	135
Vector Division of United Aircraft .....	121
Vidar Corporation .....	91

Westinghouse Electric Corporation, Molecular Electronics Division .....	60, 61
--	--------

\*Zippertubing Corp., The ..... 42

**Regional Advertising**

*Arnold Engineering Company, The .....	128A
*Brush Instrument Division of Clevite ..	128B
*JFD Electronics Corporation .....	128D
*Leach Corporation .....	128C

**Career Advertising**

Bendix Corporation, The .....	132
Cross Country Consultants .....	142
Electro Mechanical Research, Inc. ....	149
National Cash Register Company, The 40,	41
Pan American World Airways, Inc. ....	146



**VACTEC PHOTOCELLS**

*Vital Components in the Electronic Scoreboard that Electrifies Sports Fans in Houston's Fabled\*Astrodome*

Do they go to the Astrodome to see the game, or to enjoy the scoreboard? This \$2,000,000 electronic marvel puts on a show that really turns a crowd on. And Vactec is proud to be selected as supplier of approximately 11,000 matched cadmium sulfide photoelectric cells that are an integral part of the picture transmission system.

Specifically, the varying sensitivities of the Vactec cells control the brightness of the individual lamps

that transmit images on the scoreboard's huge center TV screen. Another example of Vactec's versatility and skill in the design and production of precise photosensitive devices.

Vactec provides a complete line of Se photovoltaic cells as well as CdS and CdSe photoconductive cells. Or Vactec will custom-design a unit for your application.

\* Used by permission of Houston Sports Assn., Inc.

**VACTEC INC.** 2423 Northline Industrial Blvd. Maryland Heights, Mo. 63045  
Area Code 314, HE 2-4200

ON READER-SERVICE CARD CIRCLE 81

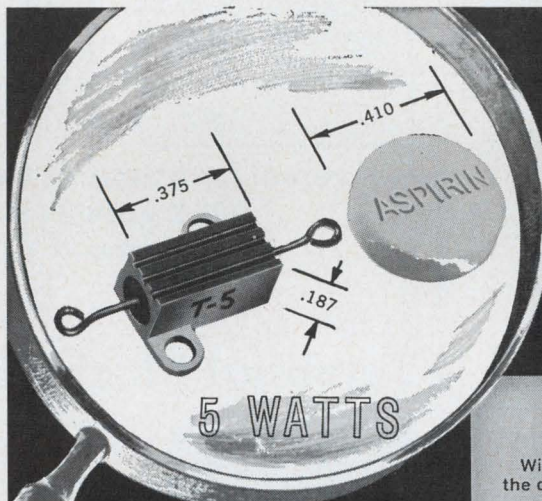

**NEW YEAR ARRIVAL**

from **CAL-R**

If power in small size is a headache... Specify CAL-R T Series chassis mount resistors

**MIRACLE IN MINIATURIZATION**

Will dissipate 5 watts plus on the chassis size of an aspirin can

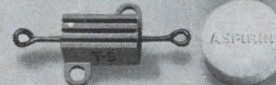

ACTUAL SIZE

**COMPARE THESE OUTSTANDING FEATURES FROM CAL-R**

- 5 watts to 3KΩ inductive-tolerance to .05
- 3 watts to 400KΩ non-inductive-tolerance to .01
- Meet or exceed MIL-R-18546D requirements on 2½" x 4½" x 1" chassis
- Completely welded construction terminal to terminal
- High density extruded aluminum housing
- Gold anodic coating for maximum resistance to extreme environmental conditions
- Leads — straight or eyelet-weldable if desired

**WRITE FOR COMPLETE DATA**

Better Power Resistors In Smallest Packages



**CALIFORNIA RESISTOR CORPORATION**  
1631 Colorado Ave., Santa Monica, Calif. 90404  
393-9861 • 870-6897 • Area Code 213

ON READER-SERVICE CARD CIRCLE 82

## Reprints Available

The following reprints are available free and in limited quantities. To obtain single copies, circle the number of the article you want on the Reader-Service Card.

*Basic Thin Film Techniques* (No. 740)

*Circuit Marriages Add Flexibility to Logic Design* (No. 741)

*A New Tool for Easier Network Synthesis* (No. 742)

*Binary Quinary Logic Improves Decade Counters* (No. 743)

*Simple IC Tester Handles Prototype Quantities* (No. 744)

*Trouble Spots in Circuits* (No. 745)

*Hall Effect Multiplier Simplifies Polar Displays* (No. 746)

*Designers Challenge* (No. 747)

*Reliability Terminology* (No. 748)

*Collector Tap Improves Logic Gating* (No. 749)

*Digital Computers* (No. 750)

*Thick Films—How and When to Use Them* (No. 751)

*Harmonic Generators—Is the Step Recovery Diode Best?* (No. 752)

*Keeping A CRT's Spot in Focus* (No. 753)

*Improving the Stability Measurement of Precision Oscillators* (No. 754)

*Slotted Antenna Arrays Can Be Smaller* (No. 755)

*Inside the Company Library* (No. 756)

## Subscription Policy

ELECTRONIC DESIGN is circulated free of charge to qualified design engineers in the U.S., Western free Europe and England. To establish your qualifications, send ELECTRONIC DESIGN the following information on your company's letterhead: Your name, engineering title, description of your design duties and a list of your company's major products. The letter must be signed by you personally.

Subscription rates for nonqualified subscribers—\$25.00 per year in U.S.A., \$35.00 in all other countries. Single copy, \$1.50.

## Change of Address

An address change for a subscriber requires a restatement of his qualifications. To expedite the change, and to avoid missing any issues, send along a label from a back copy.

Microfilm copies of all 1961, 1962, 1963 and 1964 issues of ELECTRONIC DESIGN are available through University Microfilms, Inc., 313 N. First Street, Ann Arbor, Mich.

# Design Data from

## The Multireed Relay



This highly explicit pamphlet provides full technical data on Thermosen's Multireed Relay. The Multireed Type A has 4 to 8 contact groups controlled by a single coil; Type B has up to 3 independent DPDT relays; and Type C has up to 5 SPDT relays. True Form C switching and individual contact adjustment make this unit adaptable in a wide variety of applications. For further information write:

**Thermosen, Inc.**  
375 Fairfield Avenue  
Stamford, Conn.

**171**

## High Speed Printed Circuit Assembly

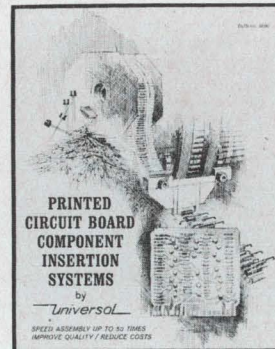

New 16-page brochure reviews latest automatic systems . . . including numerically controlled . . . for high speed insertion of components into printed circuit boards. Will insert sequenced axial lead components at up to 5,500/hr. per head. Transistor and other multiple lead component insertion developments, as well as component sequencing systems, also described. 50 photos and schematics show equipment operation and sub-assemblies. Important educational reference for design and assembly engineers.

**Universal Instruments Corporation**  
139 E. Frederick St.  
Binghamton, N. Y.

**173**

## Terminal Block Selector

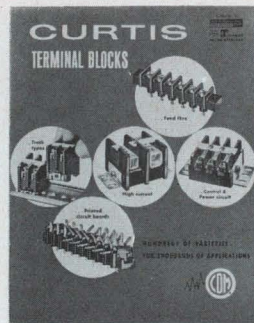

A new 24-page, completely illustrated catalog contains photos, descriptions, ratings, engineering drawings, and prices of the complete line of Curtis terminal blocks. Included are printed circuit, insulated feed-thru, quick disconnect, track type, and high current terminal blocks. Handy selection chart quickly locates the perfect block for your particular requirements. Send today for your free copy.

**Curtis Development & Mfg. Co.**  
3236 North 33rd Street  
Milwaukee, Wisconsin 53216

**175**

# Manufacturers

Advertisements of booklets, brochures, catalogs and data sheets. To order use Reader-Service Card.

## Flight Simulation and Tracking Systems

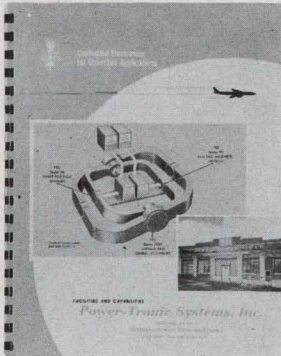

A complete review of multiple axis tracking mounts, flight simulation and inertial test equipment, tracking systems, stabilization platforms and other advanced data and devices. A very helpful catalog for those interested in static and dynamic control of optical, inertial and RF systems.

**Power-Tronic Systems, Inc.**  
Subsidiary, Hydra-Power Corporation  
10 Pine Court, New Rochelle, N.Y.

# 172

## New Solid State Module Catalog

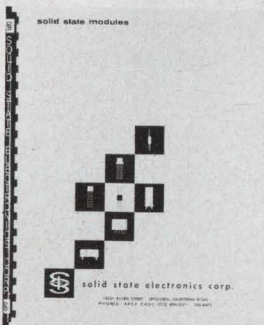

A new 140 page catalog is available which describes Solid State Choppers (30 types), Signal Isolators, Relays, DC Amplifiers, Frequency-to-DC Converters, Frequency Sensitive Relays, Phasemeters, LC, Crystal & Tuning Fork Oscillators, Voltage Controlled Oscillators, A-D Converter, Transducers, FM Telemeters, Light Controlled Resistors, Discriminators, Transformers. Each data sheet gives a complete description of the product which includes electronic data, mechanical data and typical applications. These solid state modules are designed for aerospace, military, industrial, and ground support applications.

**Solid State Electronics Corporation**  
15321 Rayen Street  
Sepulveda, California 91343

# 174

## Test Equipment Reference Data

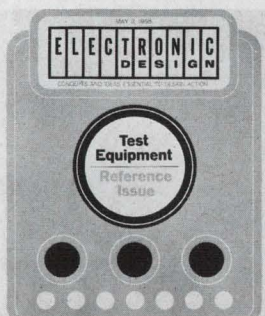

ELECTRONIC DESIGN'S Test Equipment Reference Issue covers 12 important classes of test instruments. Included are complete up-to-date specifications for approximately 2500 off-the-shelf test instruments, arranged for quick and easy reference and comparison, and cross indexed by product category and manufacturer's name. Technical data prepared from the Directory of Technical Specification/Electronic Test Instruments, by Technical Information Corporation. Twelve application-oriented articles by industry experts complete the package. Price \$5; check or money order must accompany order.

**Hayden Publishing Company, Inc.**  
850 Third Avenue  
New York, New York 10022

# Electronic Design

## Advertising Representatives

New York 10022  
Robert W. Gascoigne  
Thomas P. Barth  
George W. Fleck  
John F. Gilbert, Jr.  
Rick Brough  
850 Third Avenue  
(212) PLaza 1-5530  
TWX: 867-7866

Philadelphia 19066  
Fred L. Mowlds, Jr.  
P. O. Box 206  
Merion Station, Pa.  
(215) MO 4-1073

Marblehead 01945  
Richard Parker  
7 Redstone Lane  
(617) 742-0252

Chicago 60611  
Thomas P. Kavooras  
Berry Conner, Jr.  
720 N. Michigan  
(312) 337-0588

Cleveland 44107  
Robert W. Patrick  
8410 Treetower Drive  
Chagrin Falls, Ohio  
(216) 247-7870

Los Angeles 90005  
Stanley I. Ehrenclou  
Terrence D. Buckley  
W. James Bischof  
3275 Wilshire Blvd.  
(213) DUnkirk 2-7337

San Francisco 94306  
Ashley P. Hartman  
541 Del Medio  
Suite #301  
Mountain View, Calif.  
(415) 327-6536

Southwestern 75235  
Tommy L. Wilson  
6200 North Central Expressway  
Dallas, Tex. 75206  
(214) EMerson 1-2311

London W. 1  
Brayton C. Nichols  
44 Conduit Street

Tokyo  
Yoshihiro Takemura  
International Planning  
Service, Inc.  
Room No. 512 Nikkoh  
Mita Building  
1, Nishidaimachi, Shiba-  
Takanawa  
Minato-ku, Tokyo



# Designer's Datebook

MARCH						
S	M	T	W	T	F	S
		1	2	3	4	5
6	7	8	9	10	11	12
13	14	15	16	17	18	19
20	21	22	23	24	25	26
27	28	29	30	31		

APRIL						
S	M	T	W	T	F	S
					1	2
3	4	5	6	7	8	9
10	11	12	13	14	15	16
17	18	19	20	21	22	23
24	25	26	27	28	29	30

## Mar. 2-4

**Scintillation & Semiconductors Counter Symposium** (Washington, D.C.) Sponsor: IEEE, G-NS; W. A. Higinbotham, Brookhaven Nat'l Labs, Upton, N. Y.

## Mar. 21-25

**IEEE International Convention** (New York) Sponsor: IEEE 345 East 47th St., New York, N. Y.

## Apr. 6-8

**Electron Beam & Laser Technology Annual Symposium** (Ann Arbor, Mich.) Sponsor: IEEE, G-ED, PMP; Univ of Mich.; Prof. G. I. Haddad, Univ. of Mich., Ann Arbor, Mich.

## Apr. 12-14

**Quantum Electronics Conference** (Phoenix, Ariz.) Sponsor: IEEE et al; Lewis Winner, 152 W. 42nd St., New York, N. Y.

## Apr. 20-22

**Southwestern IEEE Conference & Exhibit** (Dallas, Tex.) Sponsor: IEEE Region 5; Dr. Robert Carrel, Collins Radio Co., Dallas, Texas

## Apr. 26-27

**National Relay Conference** (Stillwater, Okla.) Sponsor: Nat'l Assn. of Relay Mfrs., Okla. State Univ.; Dr. D. D. Lingelbach, School of E. E., Okla. State Univ., Stillwater, Okla.

## Apr. 26-28

**Spring Joint Computer Conference** (Boston) Sponsors: AFIPS, IEEE, ACM; Dr. Harlan Anderson, Digital Equip. Corp., Maynard, Mass.

## Apr. 20-22

**1966 Intermag** (International Conf. on Magnetics) (Stuttgart, Germany) Sponsor: IEEE, G-Mag; Dr. E. W. Pugh, IBM Corp., 1000 Westchester Ave., White Plains, N. Y.

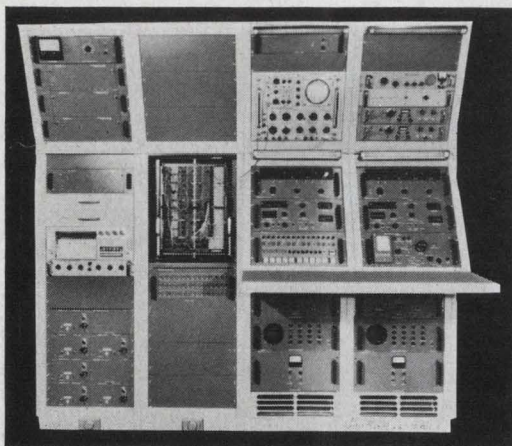

U. S. Navy (AUTEC) Master Timing System

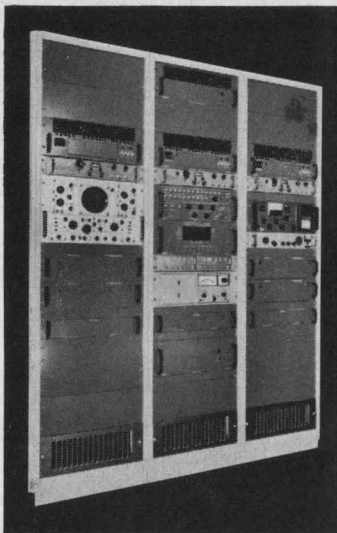

NASA Mississippi Test Facility (MTF) Master Timing System

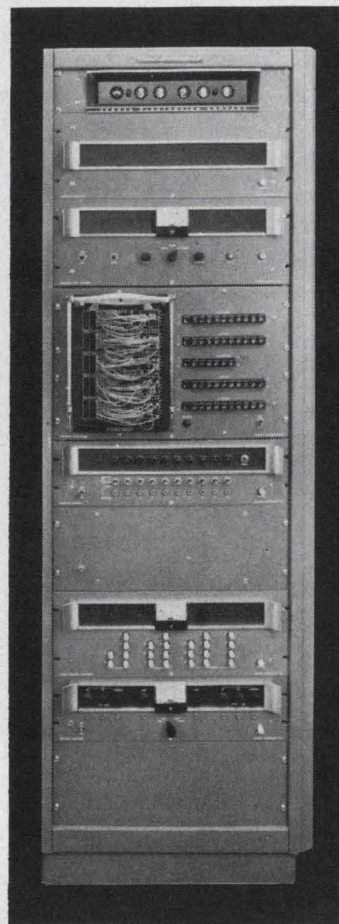

NASA Wallops Island Terminal Time Systems

# Hyperion

## the name for Precision Time Indexing and Automatic Search Equipment and Systems

Hyperion's Timing Equipments are being used on many major Range Facilities including NASA, Mississippi Test Facility (MTF), U. S. Navy Underwater Range (AUTEC), NASA, Wallops Island, etc. Hyperion's Technical Staff represents 100-man years of technical experience in the field of Precision Timing and a broad background in the field of Ultra-Stable Oscillators, Automatic Time Synchronization with LORAN-C, VLF, and WWV Time Transmission Equipment, Precision Time Equipment includes Precision Time Code Generators and Countdown Clocks, and Fully Automatic Tape Search Equipments for Ground and Airborne environments.

Write or call Hyperion for your precision range time indexing and search requirements

## Hyperion

INDUSTRIES CORPORATION

DIGITAL PRODUCTS DIVISION

134 COOLIDGE AVENUE, WATERTOWN, MASSACHUSETTS 02172  
TWXN: 617-924-9272 TEL: 617-WA6-0140

ON READER-SERVICE CARD CIRCLE 83

# 4

**DALE**

**BONUS FEATURES! New G & HG resistors offer more versatility than any other wirewounds!**

## 1. MORE POWER in MIL SPEC SIZE

G SERIES\*

DALE TYPE	MIL-R-26C TYPE	MIL-R-23379 TYPE	POWER RATING (WATTS)		RESISTANCE RANGE (OHMS)	
			Dale	Mil.	.05%, .1%, .25%	.5%, 1%, 3%
G-1	—	—	1.0	—	10 to 950	1 to 3.4K
G-3	RW-70	RWP-18	2.25	1	1 to 2.7K	.1 to 10.4K
G-5C	RW-69	RWP-20	5	3	1 to 8.6K	.1 to 32.3K
G-15	RW-68	RWP-23	15	10	.5 to 73.4K	.1 to 273K

HG SERIES

DALE TYPE	MIL-R-18546C TYPE	POWER RATING (WATTS)		RESISTANCE RANGE (OHMS)	
		Dale	Mil.	.05%, .1%, .25%	.5%, 1%, 3%
HG-5	None	15	—	1 to 6.5K	1 to 24.5K
HG-10	RE-65	20	10	1 to 12.7K	.1 to 47.1K
HG-25	RE-70	35	15	.5 to 25.7K	.1 to 95.2K
HG-50	RE-75	50	20	.5 to 73.4K	.1 to 273K

**Major Environmental Specifications:** LOAD LIFE: 1% Max. ΔR in 1000 hours at full power. OVERLOAD: .5% Max. ΔR at 3, 5, or 10 times momentary overload per applicable Mil. Spec. OPERATING TEMPERATURE: -55°C to +275°C

\*G Series models are typical: 10 resistors in complete line.

## 2. THE SAME POWER in LESS SPACE

### 1 Watt Silicone Coated Resistor

Conventional MIL-R-26C and MIL-R-23379



### 15 Watt Mil. Rated Housed Power Resistor

Conventional MIL-R-18546C Size

DALE HG-5

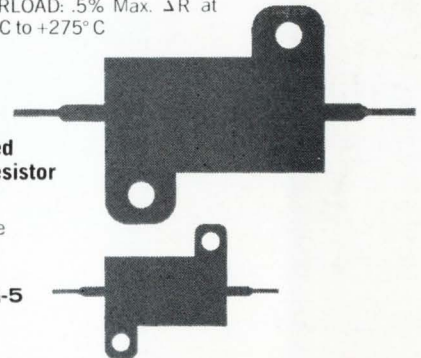

## 3. EXCEPTIONAL STABILITY at CONVENTIONAL RATINGS

Two RW-69, MIL-R-26C resistors (Dale G-5C and conventional silicone-coated wirewound) operated at Mil power levels.

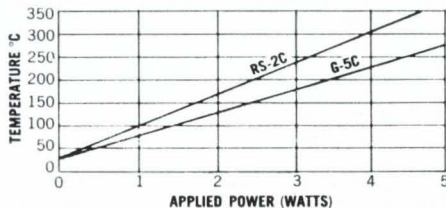

Two RE-65, MIL-R-18546C resistors (Dale HG-10 and conventional housed power wirewound, RH-10) operated at Mil power levels.

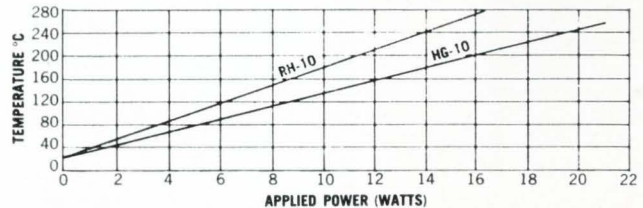

## 4. IMPROVED THERMAL EFFICIENCY

The chart at right shows the outstanding heat dissipation advantages which the beryllium oxide cores used in Dale G and HG resistors have over conventional core materials. To complement this advantage, Dale uses a special high temperature silicone coating on the G Series and a new extruded aluminum housing for the HG Series.

Core Conductivity at 275° C	BTU-Ft / Ft <sup>2</sup> -Hr.°F
ALUMINUM-130	~1.5
BERYLLIUM OXIDE (BeO)-64	~1.5
STEEL-33	~0.5
ALUMINUM OXIDE-8	~0.5
STEATITE-1.5	~0.5

FOR COMPLETE INFORMATION  
WRITE FOR CATALOG A



**DALE ELECTRONICS, INC.**

1328 28th Avenue, Columbus, Nebraska

Also Sold by Dale Electronics Canada, Ltd., Toronto, Ontario, Canada

**DALE**

Speed Inquiry to Advertiser via Collect Night Letter  
ON READER-SERVICE CARD CIRCLE 235

## CERMOLOX® design means power...

Here's an RCA family of ruggedly constructed tubes for use from DC through UHF. There is a tube for virtually every type of electronic application: Communications • Control • UHF-TV • Radar • Phased Array • ECM • Industrial Processing.

These compact RCA ceramic-metal Beam Power Tubes offer long life and high reliability. They feature precision-aligned grids for outstanding efficiency, and coaxial electrode construction designed for use in coaxial-cavity as well as parallel-line and lumped-constant circuits. They are designed for power levels from watts to megawatts.

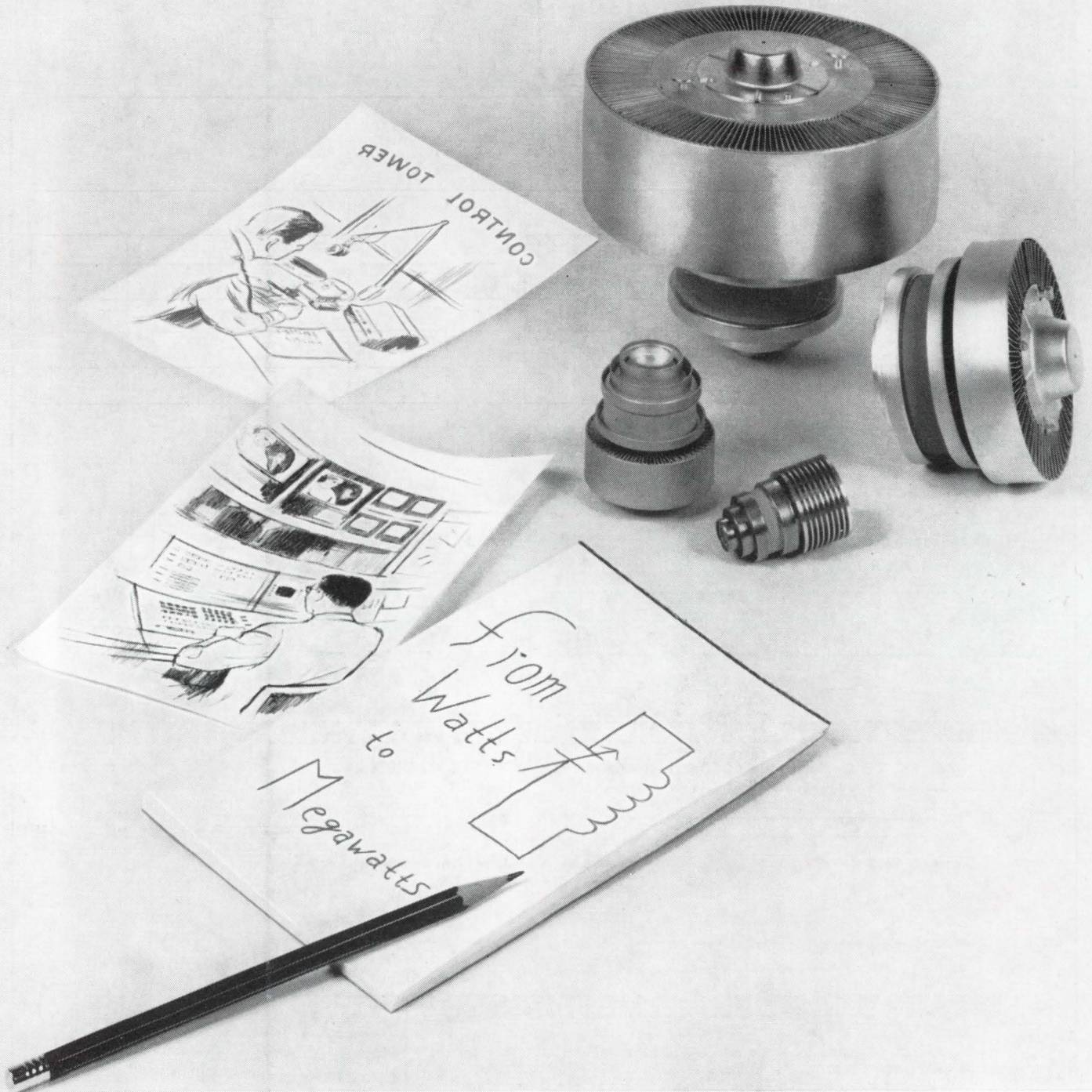

RCA ELECTRONIC COMPONENTS AND DEVICES

**The Most Trusted Name in Electronics**

To meet the increasing demand for dependable power sources, choose one of the more than 25 types in the RCA Cermlorox line of forced-air-, liquid-, or conduction-cooled types. Check into this RCA concept in Beam Power Tube technology with your RCA Representative. For technical data on specific types, write: RCA Commercial Engineering, Section B18Q-3, Harrison, New Jersey.

**ALSO AVAILABLE FROM YOUR RCA INDUSTRIAL TUBE DISTRIBUTOR**