

# EDN<sup>®</sup>

THE DESIGN MAGAZINE OF THE ELECTRONICS INDUSTRY

July 7, 1994

Special Report  
**Power ICs: weighing  
the benefits of  
integration** pg 68

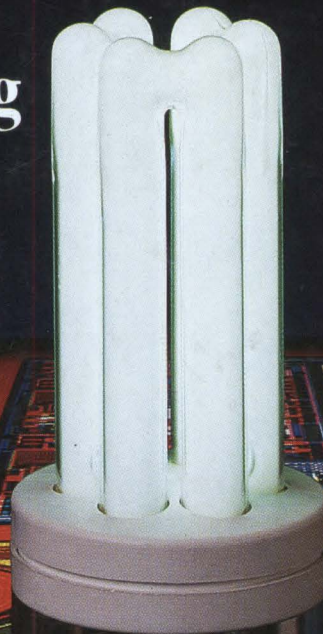

## TECHNOLOGY UPDATES

Low-power ASICs save board space and time to market pg 41

Isolated innovation marks movement toward miniature magnetics pg 59

## DESIGN FEATURES

Break the performance bottlenecks in today's multi-processor designs pg 113

To see spectrum-analysis detail fast, match sweep time to measurement pg 125

Weigh the benefits of fuzzy-logic vs classical control in a disk-drive spindle pg 137

Design Ideas pg 93

How is DAC '94 like a Grateful Dead concert? pg 201

# Get Interactive!

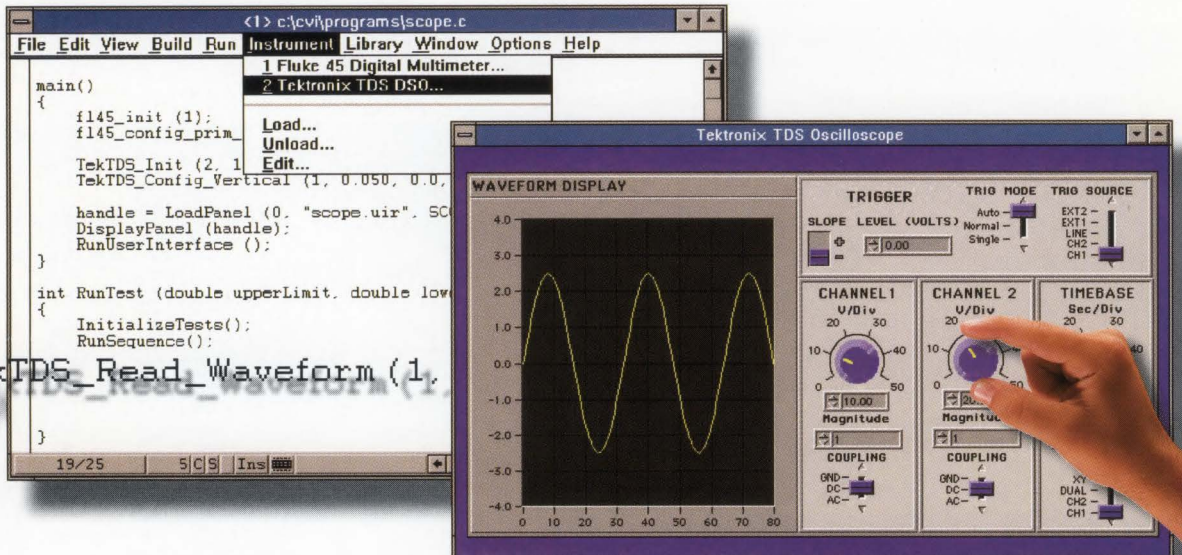

## LabWindows®/CVI The Programming Power of C, the Development Ease of BASIC

Discover a new approach to C programming for instrumentation – the interactive approach. With LabWindows/CVI, you harness the power and flexibility of ANSI C through easy-to-use interactive code-generation tools. LabWindows/CVI is an ANSI C programming environment with GUI objects, instrumentation libraries, data analysis functions, and utilities specifically designed for data acquisition and instrument control systems.

### Interactive Development

As an instrumentation system developer, you need quick results. With LabWindows/CVI function panels, you can interactively acquire data from plug-in boards, or control GPIB, VXI, and RS-232 instruments without writing a single line of code. Then, use function panels to generate code automatically and jump start your programming efforts.

### C Programming Flexibility

LabWindows/CVI is more than just interactive tools to make programming easier. With LabWindows/CVI, you have the power and flexibility of ANSI C at your fingertips, so you can be assured that it is fast enough, powerful enough, and flexible enough to get your job done. Plus, the integrated LabWindows/CVI environment has the advanced editing, compiling, and debugging tools you expect. Combining the power of ANSI C with an interactive, BASIC-like development environment results in true programming productivity.

You don't have to sacrifice ease of use when you program in a standard language anymore.



Call for a FREE  
LabWindows/CVI  
demo disk  
(800) 433-3488  
(U.S. and Canada)



6504 Bridge Point Parkway • Austin, TX 78730-5039 • Tel: (512) 794-0100 • 95 (800) 010 0793 (Mexico) • Fax: (512) 794-8411

Branch Offices: Australia 03 879 9422 • Austria 0662 435986 • Belgium 02 757 00 20 • Canada 519 622 9310 • Denmark 45 76 26 00 • Finland 90 527 2321 • France 1 48 14 24 24 • Germany 089 741 31 30  
Italy 02 48301892 • Japan 03 3788 1921 • Netherlands 03480 33466 • Norway 32 848400 • Spain 91 640 0085 • Sweden 08 730 49 70 • Switzerland 056 27 00 20 • U.K. 0635 523545

© Copyright 1994 National Instruments Corporation. All rights reserved. Product and company names listed are trademarks or trade names of their respective companies.

CIRCLE NO. 36

# When Time Is Money...

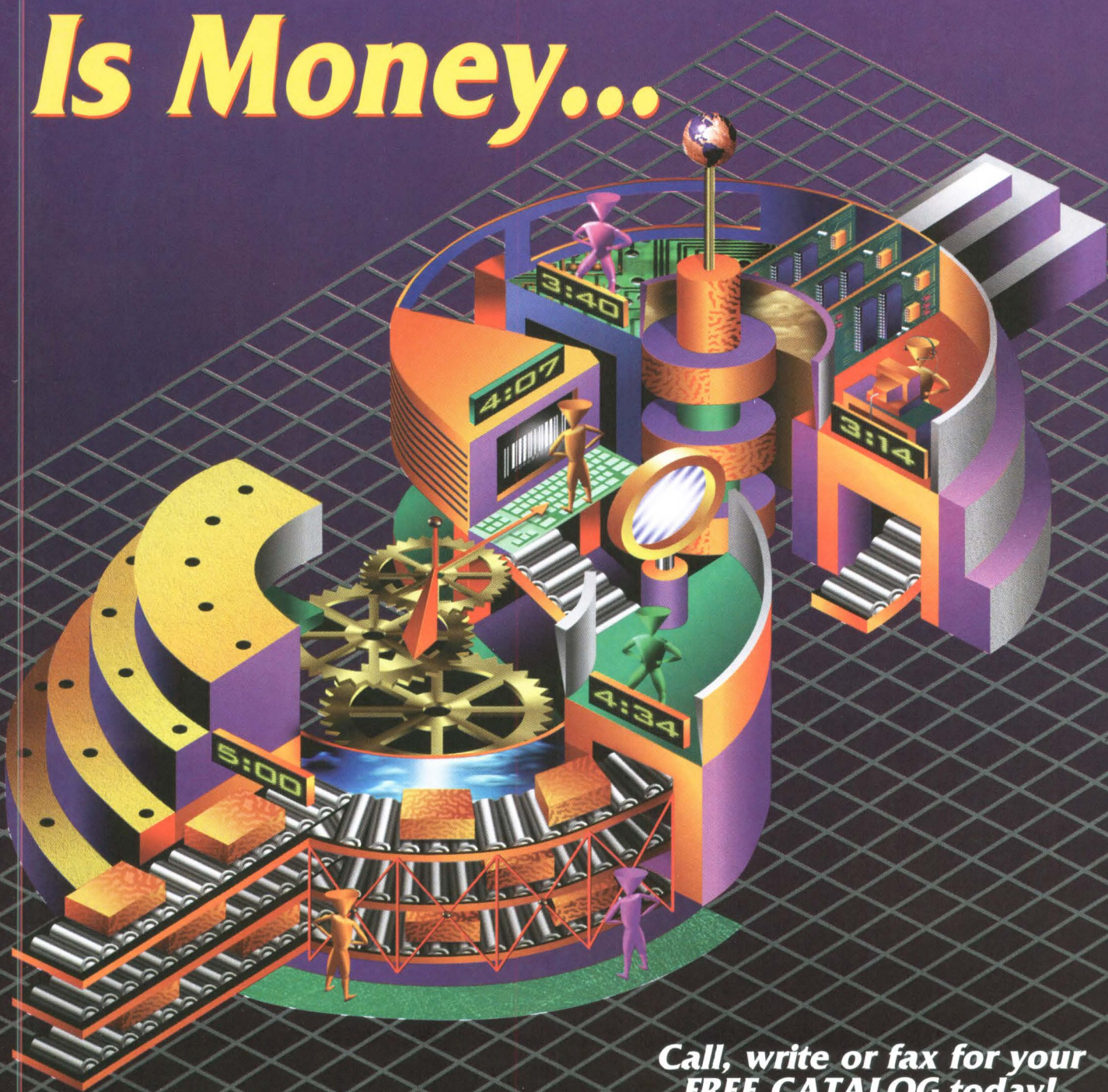

**Rated #1 for . . .**

- **Availability of Product!**
- **On-Time Delivery!**
- **Overall Performance!**

Call, write or fax for your  
**FREE CATALOG today!**

**Digi-Key**<sup>®</sup>  
CORPORATION

Quality Electronic Components, Superior Service

**1-800-344-4539**

701 Brooks Ave. South, Thief River Falls, MN 56701

Fax: 218-681-3380

CIRCLE NO. 1



**NEW [TDS 310]**  
2 Chan/50 MHz



**NEW [TDS 410]**  
2 Chan/150 MHz

**the TDS 500 series**

Precision, extended record length and waveform analysis



**[TDS 544A]**  
4 Chan/500 MHz



**[TDS 644A]**  
4 Chan/500 MHz

**the TDS 300 series**

Our most affordable family of DSOs



**[TDS 420]**  
4 Chan/150 MHz



**[TDS 520A]**  
2 Chan/500 MHz



**[TDS 620A]**  
2 Chan/500 MHz

**the TDS 800 series**

Highest resolution and bandwidth



**[TDS 320]**  
2 Chan/100 MHz



**[TDS 460]**  
4 Chan/350 MHz



**[TDS 524A]**  
2 Chan/500 MHz

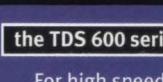

**the TDS 600 series**

For high speed digital/analog applications



**NEW [TDS 684A]**  
4 Chan/1 GHz



**NEW [TDS 350]**  
2 Chan/200 MHz

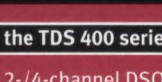

**the TDS 400 series**

2-/4-channel DSOs for bench and field applications



**[TDS 540A]**  
4 Chan/500 MHz



**[TDS 640A]**  
4 Chan/500 MHz



**[TDS 820]**  
2 Chan/6 GHz

# The Scope of Choice. No Matter Which One You Choose.

It should come as no surprise that Tektronix sells more high performance oscilloscopes than all other companies combined. Because, across the board, the Tektronix TDS family delivers superior performance and usability at every price point. And superior price at every performance point. ■ From the new \$2,300 TDS 310 to our 5 GS/s 1 GHz TDS 684A, every TDS scope has the same highly intuitive graphical user interface. Learn one TDS scope and you've learned to use them all. So it's easy to move from scope to scope. And from project to project ■ Our exclusive NuColor™ technology gives you the

New TDS 684A:  
4 channels of  
1 GHz real-time  
acquisition, powerful triggering  
and advanced  
probing solutions.

industry's best full-color display, for about the same price as competitive monochrome scopes.

■ Using our new ultra small FET probes you can access today's highest density devices safely and accurately. TDS scopes even streamline documentation by saving screens in popular

desktop publishing formats. ■ Of course the only way to get the full story is to contact your

nearest Tektronix representative today. Or call 800-426-2200, ext 284. Make your next scope the scope of choice.



**Tektronix**



Copyright 1994 Tektronix, Inc. All rights reserved. Tektronix, Tek and NuColor are trademarks.

03W-284512

CIRCLE NO. 154

# AMPLIFIERS

## 0.5 to 2000MHz

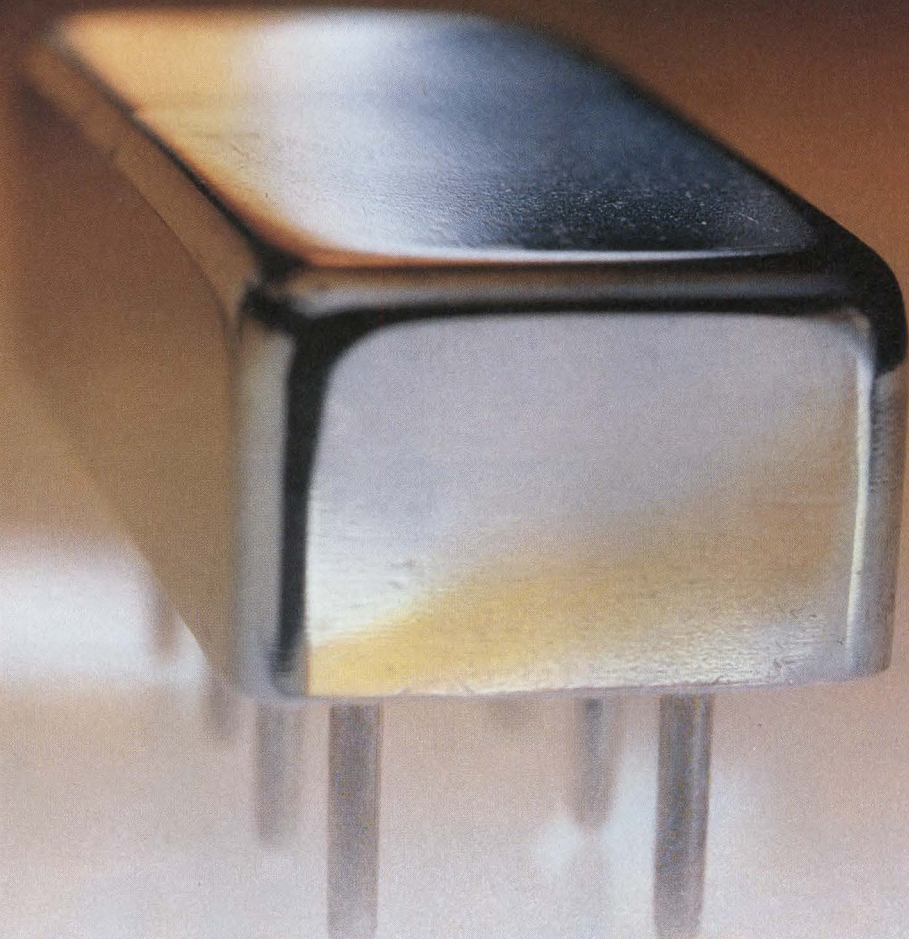

**High Power, up to +15dBm Rugged, Plug-in Package** from **\$13<sup>95</sup>** (10-24qty.)

Both inside and out, the high level of performance you've been looking for in a broadband, plug-in amplifier is right here in Mini-Circuits value priced MAN series...featuring gain to 28dB, reverse gain greater than 40dB and power output as high as +15dBm! These unconditionally stable units are built incredibly tough to meet full MIL-specs and packaged in miniature 0.4"x0.8"x0.25" hermetically sealed metal casings. Inside,

the MAN amplifiers consist of 2 stages including coupling capacitors and can withstand operational temperatures from a frigid -55°C to a scorching +100°C! MAN amplifiers are available from stock starting at the small price of just \$13.95. But, don't just read about this impressive list of features...call Mini-Circuits and put the power of MAN amplifiers to work for you today!

**Mini-Circuits...we're redefining what VALUE is all about!**

CIRCLE NO. 196

Model	Freq. Range $f_L$ to $f_U$ (MHz)	Gain		Max. Output		NF typ. (dB)	Isol. typ. (dB)	DC PWR (V/mA)	Price \$ ea. (10-24)
		min. (dB)	flatness* (+/-dB)	PWR** (dBm)					
MAN-1	0.5-500	28	1.4	8.0	4.5	41	12/60	13.95	
MAN-2	0.5-1000	18	1.5	7.0	6.0	37	12/85	15.95	
MAN-1LN	0.5-500	28	1.4	8.0	2.8	42	12/60	15.95	
^MAN-1HLN	10-500	10	0.8	15.0	3.7	16	12/70	15.95	
MAN-1AD	5-500	16	1.0	6.0	7.2	50	12/85	24.95	
MAN-2AD	2-1000	9	0.7	-2.0	6.5	33	15/22	22.50	
MAN-11AD	2-2000	8	1.5	-3.5	6.5	27	15/22	29.95	

\* Midband  $10f_L$  to  $f_U/2$ , +/- 0.5 dB    \*\* At 1dB compression point    ^ Case height 0.3 inch



Actual Size

# Mini-Circuits

P.O. Box 350166, Brooklyn, New York 11235-0003 (718) 934-4500 Fax (718)332-4661

For detailed specs on all Mini-Circuits products refer to • THOMAS REGISTER Vol. 23 • MICROWAVES PRODUCTS DIRECTORY • EEM • MINI-CIRCUITS' 740- pg. HANDBOOK.

**CUSTOM PRODUCT NEEDS...Let Our Experience Work For You.**

F 175 Rev Orig

# LITTLE FOOT, Big Selection.

<p>Si9925DY Dual N-Channel</p>  <p>20 V, 50 mΩ</p>	<p>Si9940DY Dual N-Channel</p>  <p>50 V, 50 mΩ</p>	<p>Si9958DY Complementary N-&amp;P-Ch</p>  <p>N-Ch: 20V, 100 mΩ P-Ch: -20V, 100 mΩ</p>	<p>Si9410DY Single N-Channel</p>  <p>30 V, 30 mΩ</p>	<p>Si9928DY Complementary N-&amp;P-Ch</p>  <p>N-Ch: 20V, 50 mΩ P-Ch: -20V, 110 mΩ</p>
<p>Si9952DY Complementary N-&amp;P-Ch</p>  <p>N-Ch: 25 V, 100 mΩ P-Ch: -25 V, 250 mΩ</p>	<p>Si9959DY Dual N-Channel</p>  <p>50V, 300 mΩ</p>	<p>Si9400DY Single P-Channel</p>  <p>-20V, 250 mΩ</p>	<p>Si9433DY Single P-Channel</p>  <p>20V, 65 mΩ</p>	<p>Si9956DY Dual N-Channel</p>  <p>20V, 100 mΩ</p>
<p>Si9948DY Dual P-Channel</p>  <p>-60 V, 280 mΩ</p>	<p>Si9430DY Single P-Channel</p>  <p>-20 V, 50 mΩ</p>	<p>Si9407DY Single P-Channel</p>  <p>-60V, 150 mΩ</p>	<p>Si9936DY Dual N-Channel</p>  <p>30V, 50 mΩ</p>	<p>Si9939DY Complementary N-&amp;P-Ch</p>  <p>N-Ch: 30V, 50 mΩ P-Ch: -30V, 100 mΩ</p>
<p>Si9953DY Dual P-Channel</p>  <p>-20V, 250 mΩ</p>	<p>Si9947DY Dual P-Channel</p>  <p>-20V, 100 mΩ</p>	<p>Si9435DY Single P-Channel</p>  <p>-30V, 55 mΩ</p>	<p>Si9405DY Single P-Channel</p>  <p>-20V, 100 mΩ</p>	<p>Si9955DY Dual N-Channel</p>  <p>50V, 130 mΩ</p>
<p>Si9943DY Complementary N-&amp;P-Ch</p>  <p>N-Ch: 20V, 125 mΩ P-Ch: -20V, 160 mΩ</p>	<p>Si9945DY Dual N-Channel</p>  <p>60 V, 100 mΩ</p>	<p>Si9942DY Complementary N-&amp;P-Ch</p>  <p>N-Ch: 20V, 125 mΩ P-Ch: -20V, 200 mΩ</p>	<p>Si9933DY Dual P-Channel</p>  <p>-20V, 110 mΩ</p>	<p>Si9434DY Single P-Channel</p>  <p>-12V, 40 mΩ</p>

Try these specs on for size. Nothing fits your design for low on-resistance load switching, power conversion, and motor control like the original LITTLE FOOT® power MOSFETs.

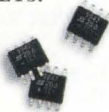

Lower on-resistance and more choice than ever.

Whether your system runs at 2.7, 3.3, 5 V, or more, there's a LITTLE FOOT product that can help it run cooler and more efficiently. You'll notice the difference Siliconix proprietary technologies make, like p-channel devices with a maximum 40-mΩ on-resistance – even at 4.5 V!

Walk a mile in our shoes.

You can't beat experience when it comes to quality and service. We've shipped over 150 million devices in three years with less than 1 ppm AOC.

If the shoe fits, contact your local TEMIC sales office. Or call 1-800-554-5565, ext. 928, for more information.

**Siliconix**  
A Member of the TEMIC Group

FREE INFO, FREE POSTAGE  
Use our postage-paid reader service card  
to get information on this issue's products.

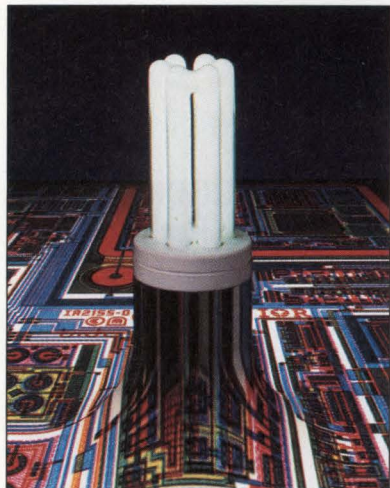

**On the cover:** With the advent of process technologies that can integrate virtually everything but the load itself, the capabilities of ICs for power actuation and switching seems almost limitless. See our Special Report, beginning on **pg 68**. (Photo courtesy International Rectifier; concept and computer graphics, Jon Walker, The Dartford Group)

## THE DESIGN MAGAZINE OF THE ELECTRONICS INDUSTRY

### Power ICs: weighing the benefits of integration

SPECIAL REPORT

68

The business of power ICs is full of stories of technological achievements, but market success of highly complex ICs has not come so easily.—*Anne Watson Swager, Technical Editor*

### Break the performance bottlenecks in today's multiprocessor designs

DESIGN FEATURES

113

Operating-system and device-driver software for symmetric multiprocessing hardware make interrupt distribution the least important hardware-design consideration. You achieve better performance by developing an efficient bus protocol.—*Brian Bennett, AST Research*

### To see spectrum-analysis detail fast, match sweep time to measurement

125

In spectrum analysis, slower sweep speeds provide improved detail.—*Morris Engelson, Tektronix Inc*

### Weigh the benefits of fuzzy-logic vs classical control in a disk-drive spindle

137

You can apply fuzzy- and classical-control techniques to any servo-control loop. Which technique you use depends heavily on the nonlinearities in a system.—*Brian P Tremaine, Seagate Technology*

#### DESIGN IDEAS

Biasing corrects position-sensing photodiode	93
Clean switcher powers 16-bit A/D converters	93
DMM measures frequency	94
Single resistor betters inexpensive buffer	96
12-bit converter upgrades $\mu$ C's ADC	96
Sawtooth generator spans a 70-dB range	98
10-octave audio generator speeds tests	100
Envelope tracker quells jitter	102
IC diodes help deduce junction temperature	102
Low-power interrupt updates real-time clock	106

*Continued on page 7*

EDN® (ISSN 0012-7515, GST Reg. #123397457, IPM #0280844) is published 38 times per year, bi-weekly with one additional issue per month, by Cahners Publishing Company, A Division of Reed Publishing USA, 275 Washington Street, Newton, MA 02158-1630. Robert L. Krakoff, Chairman and Chief Executive Officer; Timothy C. O'Brien, Executive Vice President/Finance and Administration; Michael Wisner, Senior Vice President/General Manager, Boston Division; Michael Wisner, Vice President/Publishing Director. Circulation records are maintained at Cahners Publishing Company, 8773 South Ridgeline Blvd., Highlands Ranch, CO 80126-2329. Telephone (303) 470-4445. Second-class postage paid at Highlands Ranch, CO 80126-2329 and additional mailing offices. **POSTMASTER: Send address changes to EDN®, PO Box 7500, Highlands Ranch, CO 80126-7500.** EDN® copyright 1994 by Reed Publishing USA. Rates for non-qualified subscriptions, including all issues: US, \$140.00 one year, \$238.00 two year; Canada, \$209.00 one year, \$355.00 two year (includes 7% GST, GST# 123397457); Mexico, \$195.00 one year, \$332.00 two year; Foreign surface \$245.00 one year, \$417.00 two year; Foreign air expedited surcharge add \$152.00 one year, \$304.00 two year. Except for special issues where price changes are indicated, single copies are available for \$10.00 US and \$15.00 foreign. Please address all subscription mail to EDN®, 8773 South Ridgeline Blvd., Highlands Ranch, CO 80126-2329. EDN® is a registered trademark of Reed Properties Inc., used under license. (Printed in USA)

## What Is The #1 Reason To Choose Us For Optoelectronics?

### #1 In Surface Mount Performance And Selection.

We offer an unbeatable variety of surface mount products, including TOP-LED's, SIDE-LED's and BOTTOM-LED's, as well as our unique MULTI-LED's which let you electrically change the display color. All feature an industry-standard footprint, SMT soldering compatibility, and pick-and-place ease of handling. *Call and ask for Lit. SKU #OPT009.*

**CIRCLE NO. 131**

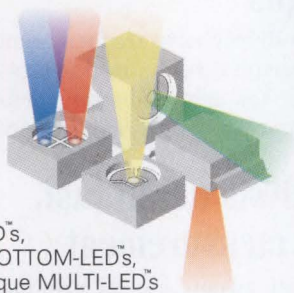

### #1 Provider Of The Industry's Highest Board Density Optocouplers.

Nobody offers more innovative optocouplers than Siemens. We're first in DIP packages for Dual and Quads. First in SO-8 packages for single, dual and PCMCIA-compatible packages. And the first with a 2-channel (dual) surface mount in one package (SO-8), which doubles your board density and saves significant board space. *Call and ask for Lit. SKU #OPT007.*

**CIRCLE NO. 132**

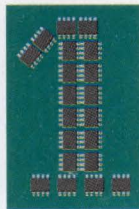

### #1 Linear Optocoupler.

Our commitment to R&D has resulted in innovations like the IL300 family, as well as SIDE-LED™ right-angle SMT emitters and detectors for office automation and consumer applications. *Call and ask for Lit. SKU #OPT007.*

**CIRCLE NO. 133**

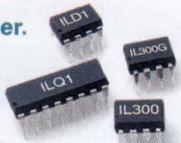

### MOST Flexible Optoelectronics Solutions In The World.

Our *Application Specific Intelligent Displays®* let you create your own semicustom display. And we'll deliver it in about 14 weeks, for about what you'd pay for a standard part. One example is our SCDV 554X, the first multicharacter 5x5 dot matrix vertical format display. *Call and ask for Lit. SKU #OPT005.*

**CIRCLE NO. 134**

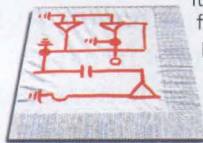

## Announcing Our Latest Reason.

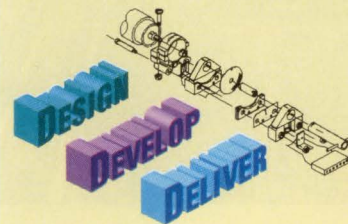

### #1 In Custom Design Flexibility And Affordability.

If your application calls for a unique product design or specific performance requirements, Siemens Custom Optoelectronics Products offers the Custom Engineering Support, Packaging Capabilities and Hybrid Module Expertise to help you develop exactly the right part for the job.

Our engineers are experts in evaluating customer requirements and proposing solutions which can reduce the size and costs of your designs. We can even fabricate products from a variety of hybrid modules, for unequalled flexibility in your design. And we back all our products with on-site field support for added convenience and security. *Call and ask for Lit. SKU #OPT008.*

**CIRCLE NO. 135**

## You Decide.

From simple standard designs to complex custom applications, the most advanced Optoelectronics solutions begin with Siemens.

We've become one of the world's largest suppliers of optoelectronics by helping our customers develop the right product, then get their

product to market fast. With the flexibility to create your own unique solution, or choose from a large variety of standard products.

And we continue to offer the package selection, Just-In-Time delivery, and ease-of-design you need to succeed.

Whatever your #1 reason might be for choosing an Optoelectronics supplier, Siemens is the #1 company to call.

**1-800-77-SIEMENS**

**Call Today, And Ask For Extension 3.**



**Home Office**

275 Washington St, Newton, MA 02158  
 EDN Bulletin Board: (617) 558-4241  
 MCI: EDNBOS; fax (617) 558-4470  
 Phone (617) 558-plus 4-digit extension below  
 To send a message to an EDN editor via Internet,  
 add "@MCIMAIL.COM" to the MCI address.

**Publisher**

Jeffrey Patterson -4454

**Editor-in-Chief**

Steven H Leibson -4214

**Managing Editor**

Joan Morrow Lynch -4215

Gary Legg, *Senior Technical Editor* -4404

Charles Small, *Senior Technical Editor* -4556

MCI: EDNSMALL

Dan Strassberg, *Senior Technical Editor* -4205

MCI: EDNSTRASSBERG

John A Gallant, *Technical Editor* -4666

Frances T Granville, *Senior Associate Editor* -4344

James P Leonard, *Senior Associate Editor* -4324

Anne Coyle, *Associate Editor* -4333

Gillian A Caulfield,

*Manager of Editorial and Art Production* -4263

Patricia Shaughnessy, *Production Editor* -4206

Ken Racicot, *Senior Art Director* -4708

Chinsoo Chung, *Associate Art Director* -4446

Brian Kerridge, *Senior Technical Editor*

22 Mill Rd, Loddon

Norwich, NR14 6DR, UK

(508) 528435; fax (508) 528430

MCI: EDNKERRIDGE

Doug Conner, *Technical Editor*

Atascadero, CA: (805) 461-9669

fax: (805) 461-9640; MCI: EDNDCONNER

Markus Levy, *Technical Editor*

Citrus Heights, CA: (916) 725-4485

MCI: EDNLEVY

Richard A Quinell, *Technical Editor*

Aptos, CA: (408) 685-8028

MCI: EDNQUINNELL

David Shear, *Technical Editor*

Corvallis, OR: (503) 754-9310

MCI: EDNSHEAR

Anne Watson Swager, *Technical Editor*

Wynnewood, PA: (215) 645-0544

MCI: EDNSWAGER

EDN Asia, Mike Markowitz, *Editor*

Cahners Asia Ltd

19th Floor, Centre Point

181-185 Gloucester Rd, Wanchai, Hong Kong

Phone (852) 838-2666; fax (852) 575-1690

**Contributing Technical Editors**

Robert Pease, Don Powers, Bill Travis,

Jack Ganssle, David Brubaker

**Assistant to Editor-in-Chief**

Kathy Leonard -4405

**Editorial Services**

Helen Benedict, *Senior Secretary* -4681

**Marketing & Business Director**

Deborah Virtue -4779

**Marketing Communications**

Jean Graham, *Promotion Specialist* -4698

**Director of Creative Services**

Norm Graf, -4293

**Production**

Andrew Jantz, *Group Manager* -4372

Karen Banks, *Production Manager* -4441

Alice Dorsey, *Production Associate* -4601

**EDN Products**

301 Gibraltar Dr, Box 650

Morris Plains, NJ 07950

Phone (201) 292-5100; fax (201) 292-0783

**Group Publisher**

Terry McCoy, Jr

**Associate Publisher**

Steven P Wirth, (201) 292-5100, ext 380

**Editorial Director**

Richard Cunningham, (702) 648-2470

**Editor-in-Chief**

Bruce Bennett, (201) 292-5100, ext 390

**Managing Editor**

Jen Brinkman, (201) 292-5100, ext 330

**Production Manager**

Sheila Rodgers, (201) 292-5100, ext 287

**Customer Service Manager**

Tara Poli, (201) 292-5100, ext 318

**Design Director**, John M Angelini**Art Director**, Beverly Blake

July 7, 1994

Continued from page 5

**TECHNOLOGY UPDATES**

**Low-power ASICs save board space and time to market**

41

The relentless demand for low power has driven vendors to offer ASICs with reduced power consumption. Some of these devices have such large densities that even a full-blown version must offer thermal management.—*John Gallant, Technical Editor*

**Surface-mount power magnetics: Isolated innovation marks movement toward miniature magnetics**

59

Hampered by fundamental physical limits and manufacturing constraints, the magnetics industry is slowly joining the trend toward surface-mount designs. Standardization, however, remains a distant dream.—*Richard A Quinell, Technical Editor*

**EDITORIAL**

**Don't take it any more—act!**

33

Gripping and whining don't solve problems. Actions do.

—*Steven H Leibson, Editor-in-Chief*

**COLUMNIST**

**DAC '94 and the Grateful Dead**

201

The picks and the pans of the Design Automation Conference.

—*John Cooley, EDA consumer advocate*

**NEW PRODUCTS**

Computers & Peripherals .....	151
Electronic Design Automation .....	156
Test & Measurement .....	162
Integrated Circuits .....	174
Power Sources .....	180

**DEPARTMENTS**

News Breaks .....	13
Signals & Noise .....	27
Literature .....	185
Career Opportunities .....	195
Business Staff .....	196
EDN's International Advertisers Index .....	198



# Squeeze the most out of your design cycle.

You know time is money. And at Texas Instruments, we can help you speed your product to market. Meaning you are free to do what you do best – create the next breakthrough products.

**Be first to market with leading-edge designs.** From notebooks and PDAs to wireless communications and multimedia, you can harness the power of TI's DSP solutions, low-power 486 microprocessors and mixed-signal devices to design unique products fast. Our industry-leading TMS320 DSP family offers a road map with the flexibility of software-programmable solutions that can migrate into highly integrated, custom DSPs that deliver cost-effective high performance. And compatible logic families and memory devices also help you move your designs easily from 5 V to 3 V.

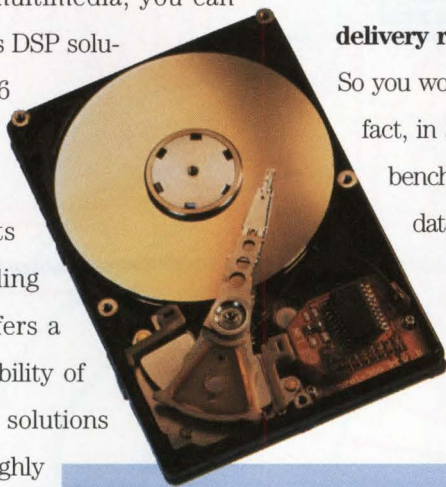

#### **Total Integration in action.**

*Seagate Technology put the power of Total Integration to work when creating their hard disk drives. In addition to combining TI's high-performance DSP cores and application-specific logic with memory and analog cells, TI had the tools and service to help Seagate produce a highly differentiated product. And TI's on-time delivery made a difference. TI provides high-volume, quick-ramp manufacturing capability to meet Seagate's needs as an industry leader.*

**Technical support that gets you up to speed, fast.** Move quickly from selection to prototype with clear, concise technical information and real-world application notes. And C compilers, emulators, development tools, behavioral models and SPICE rules can help you create DSP solutions in record time.

**Setting the benchmark: A 94% on-time delivery record.** At TI, we deliver what we promise. So you won't be left waiting for your ICs to arrive. In fact, in an expanding market, we set an industry benchmark by having a 94% on-time-to-commit-date delivery record.

**Win the race to market.** Getting to market faster with a better product. That's what business is all about. And with TI, you'll find a unique blend of silicon,

support and service. We call it Total Integration.<sup>™</sup> You'll call it your competitive edge. To find out more and receive a free subscription to *Integration*, simply call **1-800-477-8924, ext. 3922.**

EXTENDING YOUR REACH<sup>™</sup>

 **TEXAS  
INSTRUMENTS**

# Avoid future shock: Transvidiate\* with XTK™

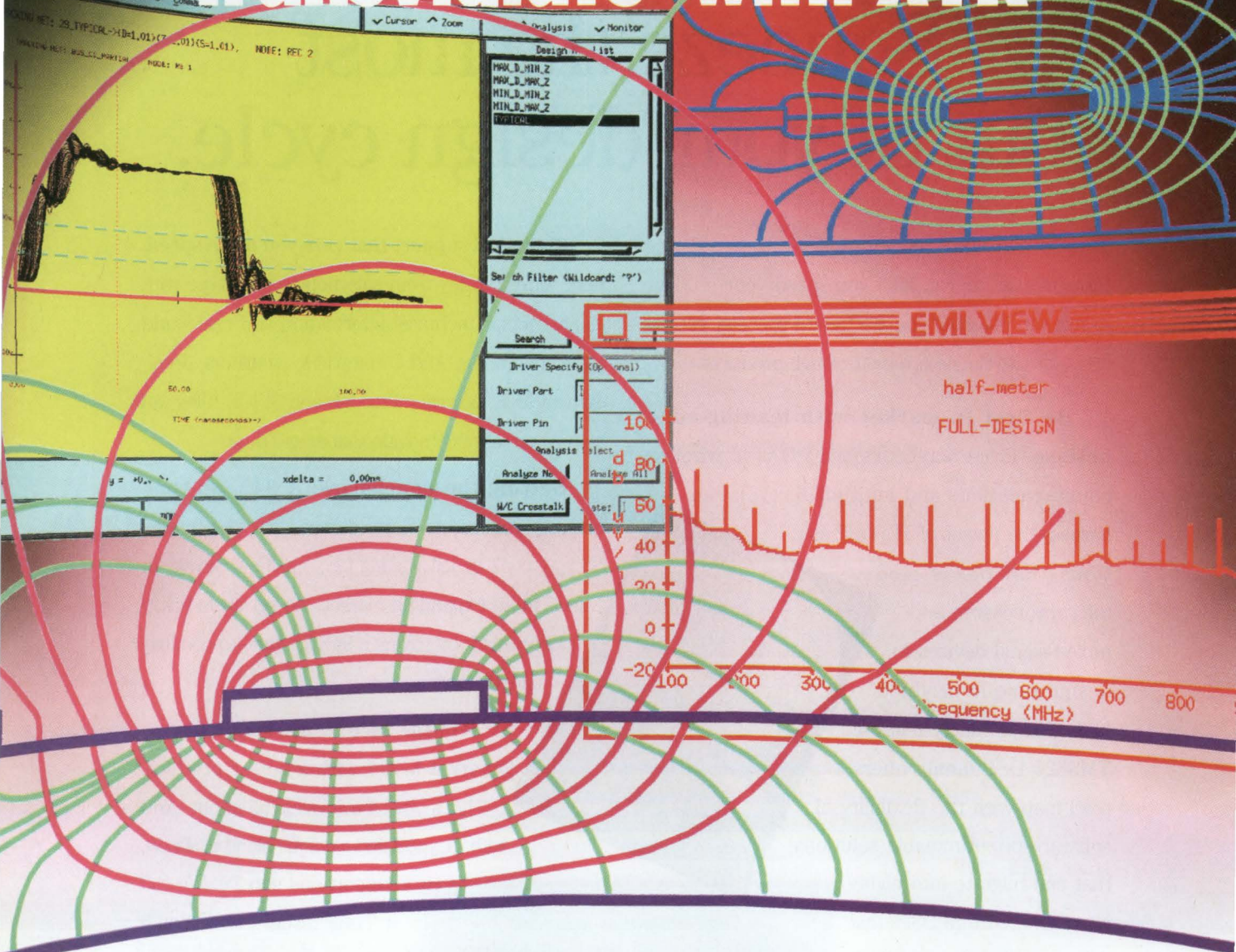

## **I**dentify signal distortions before they occur.

If the rigors of high performance design have you caught up in repetitive prototyping, break away with XTK (Crosstalk Tool Kit) from Quad Design. Simply stated, XTK is the most powerful and comprehensive signal integrity tool money can buy. It speeds your design cycle by pinpointing signal quality problems and predicting the effects of signal distortions prior to prototyping.

XTK automatically extracts topology and electrical parameters from PCB and MCM layout systems, allowing rapid and accurate simulation of lossy transmission line and crosstalk effects for entire digital systems. This, in addition to its speed and accuracy, makes XTK an essential element in increasing the quality of your high performance designs while decreasing product debug time.

For an even greater impact on your design cycle, XTK will soon be augmented by QUIET™, the industry's first integrated EMI tool kit. QUIET will not-so-quietly predict radiated noise from PCBs.

Avoid future shock by transvidiating with XTK. Call Quad Design at (805) 988-8250 and we'll send you a brochure on our whole fleet of predictive tools. 1385 Del Norte Road, Camarillo, California 93010... FAX (805) 988-8259.

CIRCLE NO. 222

**QUAD  
DESIGN**  
A Viewlogic Company



\* *transvidiate* (trans vid'è àt') vt. -a ted, -a ting [TRANS (L. across, over) + VID (L. videre, to see) + -IATE)] **1.** to bridge the present and future by knowing all signal distortion effects of your digital circuit design before they happen **2.** to avoid future design mistakes while the design is still a vision **3.** to exist in the future presently — *trans-vid'i-a'tion* n.

RELIABILITY YOU CAN DEPEND ON!

# RUGGED DC-DC CONVERTERS

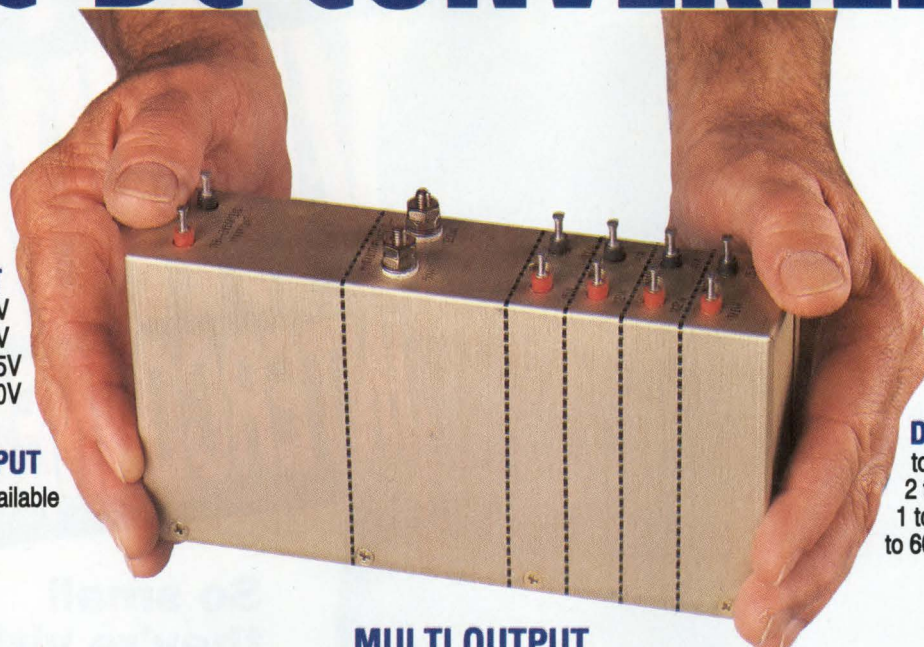

**DC INPUT**  
28V  
48V  
155V  
270V

**AC INPUT**  
Also Available

**DC OUTPUT**  
to 110A  
2 to 300V  
1 to 8 outputs  
to 600 watts

**MULTI OUTPUT  
EL2000 SERIES**

## WE PUT IT ALL TOGETHER

**SAVE MONEY & SPACE - NO EXTRA PARTS TO ASSEMBLE**

- Surge and spike protection to input requirements of Mil-Std-1275A and Mil-Std-704D.

- Operation to Mil-Std-810D environments.

- High density designs.

- Efficiencies to 80%+.

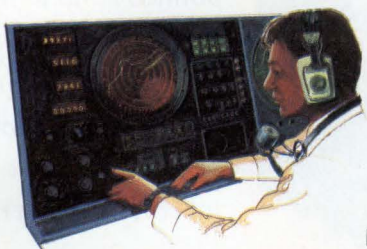

Mil-Std-1275A

- Extended MTBF to >500,000 hours.
- Low EMI/RFI options available.

- Meets applicable requirements of Mil-E-5400T,

Mil-E-16400,  
Mil-E-4158E and  
Mil-Std-454J.

- Design and derating to NAVMAT P4855-1.



Mil-Std-704D

- Mil-I-45208A facilities and systems.
- Standard products for custom applications without NRE.
- Short lead times...deliveries in weeks not months.

AC input with power factor correction available.

For complete brochure or applications assistance please call Toll Free 1-800-421-8181 (in CA 805/484-4221)

**ARNOLD MAGNETICS**

### ARNOLD MAGNETICS CORPORATION

4000 Via Pescador, Camarillo, California 93012 • Phone: (805) 484-4221 • FAX: (805) 484-4113

CIRCLE NO. 65

EDN July 7, 1994 • 11

# SAMTEC VIRTUAL INTERCONNECTS

(actual size)

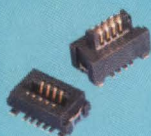

**So small  
they're virtually  
invisible.**

Samtec 1mm and .050" pitch surface mount and micro interconnects provide high-speed, low-impedance connections in minimal space. In fact, if you couldn't see them, you would hardly know they were there. Just the way interconnects should be.



**.050"  
FOUR ROW**

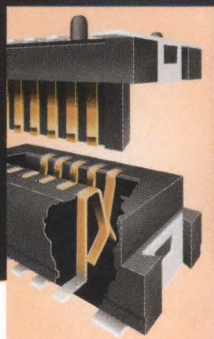

**1mm  
SURFACE MOUNT**



**.050"  
SURFACE MOUNT**



**.050"  
SKYSCRAPER**

Get the big story on Samtec's Full-Line of small interconnects. Call 1-800-SAMTEC-9

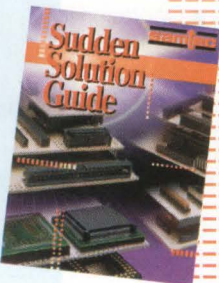

**samtec**



**IS SUDDEN SOLUTIONS**

New Albany, Indiana USA • Cumbernauld, Scotland UK • Singapore  
SAMTEC, INC. • P.O. Box 1147 • New Albany, IN 47151-1147 USA • Phone 812-944-6733 • Fax 812-948-5047

EDITED BY FRAN GRANVILLE

## Data-acquisition board houses eight delta-sigma ADCs

Delta-sigma ADC technology results in admirably low noise, good immunity from aliasing, and exceptional differential linearity—traits that data-acquisition designers seek avidly. But unlike successive-approximation ADCs, which have dominated data acquisition for two decades, delta-sigma converters don't lend themselves to multiplexed operation. When you use delta-sigma ADCs, unless you can tolerate very low conversion rates, you need an ADC for each channel. On the other hand, even though their outputs correspond to voltages that appeared at their analog inputs milliseconds earlier, delta-sigma ADCs can track signals that change quite rapidly: Units are available that convert audio-bandwidth signals with 16-bit resolution.

Now, Data Translation has introduced an ISA bus board, the DT3818, that contains eight delta-sigma ADCs driven from a common clock, which you can set to over 10,000 frequencies. The ADCs and everything else on the board run under the control of a Texas Instruments (TI) TMS320C40 DSP. Each ADC can make 1000 to 52,000 16-bit conversions/sec. Inherent in the delta-sigma architecture is a "brick-wall" filter whose passband and stopband track the conversion rate. At 48,000 conversions/sec, the ADCs' -3-dB frequency is 24 kHz; noise and artifacts above 26 kHz are attenuated by at least 80 dB. The phase shift through the ADCs matches within  $\pm 0.1^\circ$ .

Each channel's full-scale range is  $\pm 10V$ . The inputs are differential with an input impedance of 100 M $\Omega$  in parallel with 100 pF and a CMRR of more than 80 dB. Also on the board are two 16-bit delta-sigma DACs, 24 digital I/O lines, three

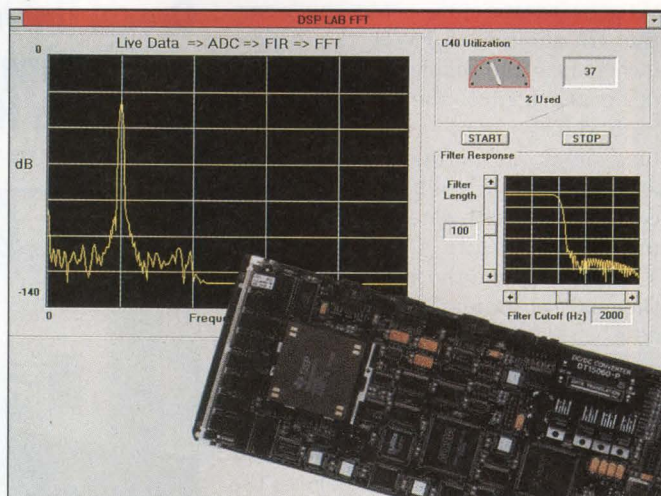

Eight delta-sigma ADCs under the control of a C40 DSP give Data Translation's DT3818 data-acquisition board, a member of the company's Fulcrum series, exceptionally low noise and excellent differential linearity.

counter timers, and channel-gain-list hardware. The DT3818 costs \$4995. The DT3814, which contains two delta sigma ADCs and no DACs but is otherwise identical, costs \$1995. The DSP Lab developers kit, which includes Spectron Microsystems' Spox V1.4 DSP operating system, TI's DSP development tools, diagnostic routines, and sample programs with source code, costs \$2995 (\$1995 without the TI compiler).

—by Dan Strassberg

Data Translation Inc, Marlboro, MA, (508) 481-3700.

Circle No. 548

## 3V RS-232C IC architecture reduces supply current

To provide both low power and  $\pm 5V$  RS-232C performance from a 3V supply, Maxim Integrated Products' MAX3241 uses a proprietary low-dropout output stage that comprises a voltage doubler instead of a more power-hungry voltage tripler. The IC's maximum supply current of 1 mA is 20 times less than that of ICs based on voltage triplers. In addition to its lower supply current, the three drivers/five receivers serial port requires only four small, inexpensive 0.1- $\mu F$  external capacitors, and the company guarantees the device to run at data rates up to 120 kbps while maintaining  $\pm 5V$  RS-232C output levels.

The company uses voltage doublers in its standard 5V RS-232C products, but 3V operation requires a different output stage. To use the lower power

voltage doubler, designers came up with a patent-pending low-dropout stage that enables the doubler to operate from a 3V supply. The voltage drop from the output of the doubler to the output of the transmitters is only about 50 mV. The new output stage also improved signal skews, allowing operation at data rates far above the guaranteed 120-kbps data rate.

The IC has two extra outputs for the fourth and fifth receivers that are active in the shutdown mode but that draw only 1  $\mu A$  of current when transmitting. You can use these extra receivers to monitor external devices, such as a modem, without forward-biasing the protection diodes in circuitry that's disconnected from  $V_{CC}$ .

The MAX3241 operates with input voltages from 3 to 5.5V and comes in 28-pin SSOPs and SOICs (\$3.16). Future ICs that will use the doubling architecture include the 3232 and 3222 (\$1.85 each), which have two drivers and two

receivers. The 3222 also has two active receivers in shutdown. Another future device, the 3242 (\$3.16), has the same number of drivers and receivers as the 3241 but requires 1- $\mu F$  capacitors and has a lower maximum supply current of 500  $\mu A$ .—by Anne Watson Swager

Maxim Integrated Products, Sunnyvale, CA, (408) 737-7600. Circle No. 549

## Power switchers fit in 3-pin packages

In just 3-pin TO-220 or D-pack power-transistor packages, Power Integrations' TOPSwitch family implements all the functions for a switching power supply. For off-line flyback, forward, and boost-PFC power-supply applications, the ICs combine a high-voltage N-channel MOSFET with a voltage-mode switching power-supply controller. These generic PWM power switches offer a duty cycle proportion-

al to the inverse of the control pin's current. In addition to PWM, the devices incorporate the following functions to drive and control the power stage: a high-voltage bias-current source, a bias-shunt regulator/error amplifier, an oscillator, a bandgap reference, a controlled turn-on gate driver, and self-protection circuits. Controlled MOSFET turn-on and the source-connected thermal tab minimize EMI and filter cost.

To fit all of these functions into one package, the company designed four patented circuits: a temperature-compensated trimmable current source for the oscillator; a circuit that derives the start-up bias current from the drain pin to avoid having to make a separate connection to the rectified line input; the use of the MOSFET's on-resistance as the sense resistor for the current-limit function; and a circuit that combines the feedback-input, compensation, and bias-supply pins.

The resultant design provides the control pin with seven functions: a bias-supply current input; an internal-supply bypass pin to provide the instantaneous peak currents for the gate drive; a feedback-signal input; compensation node; a 5.7V voltage-reference output; an externally triggered shutdown/reset pin; and an auto-restart time-capacitor node (the same capacitor as the one for compensation). The first milliamp into the control pin provides the supply current necessary to run the IC continuously. Any additional current becomes the feedback current for duty-cycle control. Between 1.2 and 2.5 mA, the duty cycle stays at the maximum value of 70% and then decreases linearly to the minimum of approximately 1.5% at 6.5 mA.

The 10-part family comprises five PWR-TOP10X devices with breakdown voltages of 350V (for 100/110V-ac off-line operation) and 2 to 10Ω  $R_{DS(ON)}$ . The other five PWR-TOP20X devices have breakdown voltages of 700V (for 85 to 265V-ac off-line operation) and 3 to 18Ω  $R_{DS(ON)}$ . Some of each group of five are available now, and the others will be available in August. Prices range from \$1 (10,000) for the TOP100 to \$1.92 for the TOP204.

—by Anne Watson Swager

Power Integrations, Mountain View, CA, (415) 960-3572. **Circle No. 550**

## Drexel University engineering labs purchases HP equipment



**First-year Drexel University engineering students learn how to measure input impedance using an oscilloscope and function generator from HP.**

Hewlett-Packard Co has installed 150 of its test-and-measurement instruments in Drexel University's engineering labs. Drexel (Philadelphia) will use the equipment to teach students real-world problem-solving skills. Part of the project comes from a 5-year, \$2.1-million grant from the Engineering and Science Education Directorate of the National Science Foundation. The directorate designated Drexel the lead project in a 10-institution, \$4.5-million effort to improve undergraduate engineering education in the United States.

With the equipment, Drexel created 30 lab stations. Each station includes a computer, an HP 54600A digitizing oscilloscope with an FFT module, an HP 33120A function generator, an HP 34401A 6½-digit multimeter, and an HP 53131A universal counter.

—by Fran Granville

Hewlett-Packard Co, Palo Alto, CA, (800) 452-4844. **Circle No. 551**

## DC/DC converter topology quiets output

Boosting single-cell voltages to 3 or 5V is one design challenge, but providing a quality, regulated output is another. To

meet both, Micro Linear's ML4890 combines a high-efficiency (85%) switching boost circuit with a low-dropout linear regulator. The switching circuit raises the low input to an intermediate voltage that activates the linear regulator, which lowers and smoothes the output. The result is a converter that boosts a battery voltage as low as 0.9V to 5, 3.3, or 3V with output ripple of 2 mV p-p. A 2 to 5.5V adjustable version is also available.

Placing the low-dropout regulator on the same IC as the switching regulator allows the device to use a patent-pending feedback technique that maintains a minimal voltage across the low-dropout regulator's pass transistor. This technique produces high efficiency over a wide range of load demands and allows for maximum ripple rejection over the operational frequency of the switcher.

The ML4890 delivers up to 100 mA and holds its output to within 5% of the desired voltage. Maximum quiescent and shutdown current are 100 and 8 μA, respectively. The device requires three external components—one inductor and two capacitors. Samples are available now; production quantities will be available in September. In 8-pin SOICs, the converter costs \$2.95 (1000).—by Anne Watson Swager

Micro Linear Corp, San Jose, CA, (408) 433-5200. **Circle No. 552**

## ATM terminal-controller ICs handle 25 to 155 Mbps

Fujitsu Microelectronics has introduced terminal-controller ICs to suit asynchronous-transfer-mode (ATM) network-interface cards for PCs, high-end workstations, and server applications.

The ITC-25 controller IC targets 25-Mbps PC add-in cards, and the ITC-51/155 suits high-bandwidth applications using 155-Mbps synchronous-optical-network (SONET) STS-3c and synchronous-digital-hierarchy (SDH) STM-1, and 51-Mbps SONET STS-1 interfaces.

Both ICs provide as many as 4096 user-definable virtual channels, on-chip support for ATM adaptation layer 5, and 64 levels of traffic shaping covering



# Optimize for Peak Performance!



When making the ascent to a finely-tuned circuit design, you need something better than trial-and-error methods. To design for peak performance, you need Paragon!

Paragon optimizes the performance of analog designs while providing you with complete control over performance goals and constraints. Part of the **Design Center** family of products, Paragon iteratively simulates your schematic-based circuit design using PSpice or PSpice A/D. Design parameter values are adjusted until the solution is found that best meets your specified goals subject to the constraints.

Unlike most analog circuit optimizers, Paragon implements both unconstrained *and* constrained minimization algorithms. In fact,

Paragon is the only analog optimizer in the industry that can tackle *nonlinear* constraint problems! Efficient algorithms mean fewer simulations are required to obtain results.

Featuring a highly interactive user interface, Paragon provides you with immediate graphical feedback so that you can quickly observe circuit performance and investigate tradeoffs between different design parameter values, goals, and constraints. Whether you choose to use Paragon to automatically optimize your circuit design or to manually explore design tradeoffs, you're assured of the most technically sophisticated, easy-to-use, and affordable analog optimizer available on the market today for PC and Sun platforms! Please call for more information.



**MicroSim Corporation**

*The Desktop EDA Company*

20 FAIRBANKS • IRVINE, CA 92718 • USA • (714) 770-3022  
(800) 245-3022 • FAX: (714) 455-0554 • BBS: (714) 830-1550

Design Center and PSpice are registered trademarks of MicroSim Corporation. All other trademarks are the property of their respective owners.

• Circle No. 150 for PC • Circle No. 152 for Workstation

EDN July 7, 1994 • 15

peak and sustainable cell rates. In addition, both ICs include interfaces to serial EEPROM for configuration storage, and to EPROM or flash memory for diskless workstations and remote downloading.

A key architectural feature of both controllers is the decoupling of bus and network activity. Local buffer memory—DRAM for the ITC-25 and SRAM for the ITC-51/155—achieves this decoupling, and each chip includes an appropriate interface.

The ITC-25 features physical-level framing compatible with IBM's 25.5-Mbps PHY specification, and a multiplexed ISA/PCMCIA-compliant 8/16-bit slave interface. The ITC-51/155 version incorporates a PCI-compliant 32-bit master/slave interface.

The company expects prices to be less than \$30 (10,000) for the ITC-25 and less than \$60 for the ITC-51/155. Samples are due in September.

Fujitsu has also announced plans for a range of transceiver ICs (MB580/2/3) that will interface directly with these communication controllers and with the company's network-termination controllers. Samples are due in the fourth quarter.—by Brian Kerridge

Fujitsu Microelectronics, Maidenhead, UK, (628) 76100. **Circle No. 553**

## IEEE P1394 working group selects Inmos technology

The IEEE P1394 working group for a serial-bus interface standard has adopted the Inmos DS-Link bit-level encoding mechanism. (Inmos is a member of the SGS-Thomson Microelectronics group.) The serial bus supports isochronous real-time transmission of data required by multimedia applications. The DS-Link serial technology operates at 100 to 200 Mbps and allows the encoding of clock and data signals to provide a high skew tolerance and reliable asynchronous transmission. DS-Links also allows you to multiplex any number of software, or virtual, channels between any number of devices.

SGS-Thomson Microelectronics, Lincoln, MA, (617) 259-0300.

**Circle No. 554**

## AT&T rings up first DSP chip with built-in flash

Flash memory translates into quick code updates, which is the intention behind AT&T's FlashDSP 1616. This device has replaced the DSP1616-x30's 12k-word ROM with the equivalent amount of flash memory. System-design prototyping time can be reduced considerably, because instead of waiting eight weeks for AT&T to turn the ROM version, the flash memory can be updated in seconds.

From a technology standpoint, the difficulty of integrating flash memory into a DSP chip is related to being able to obtain an access time fast enough to keep up with the DSP engine. When designing a flash-memory cell, trade-offs can be made between high-performance reads or writes. AT&T opted to tweak the cell's design to obtain 10-nsec access times, which is adequately fast to feed the DSP.

For \$20,000, AT&T supplies a hardware-development system, a demo board, software tools, and three FlashDSP 1616 devices. The software tools include the algorithms you'll need to program and erase the on-chip flash memory. To modify the flash memory, the chip's IEEE-standardized JTAG port delivers the actual commands.

—by Markus Levy

AT&T Microelectronics Customer Response Center, Allentown, PA, (800) 372-2447, fax (610) 778-4106.

**Circle No. 555**

## Flash gets smart via voltage requirements

Using 0.6- $\mu$ m technology, Intel's new flash-memory device provides system designers with flexibility to choose a variety of supply voltages. The 16-Mbit 28F016SV (SV signifies SmartVoltage technology) dynamically adapts to 5 or 12V for program and erase operations and 3.3 or 5V for reads.

Special input-voltage-sensing circuitry for both  $V_{CC}$  and  $V_{PP}$  detects the system supply and internally switches the device's voltage source. Although the 28F016SV still maintains a separate program/erase voltage pin, the

device can operate from a single 5V supply. In this mode, similar to all single-supply flash devices, the 28F016SV utilizes an on-chip charge pump. The system designer has the option of providing 12V on this pin, essentially doubling program and erase performance. The separate pin provides additional merit for data security, which prevents accidental erase or program. This gives the system control for switching off the supply, either 5 or 12V, when not performing program or erase operations.

To accommodate low-power systems, the device performs 120-nsec reads at 3.3V. However, if faster reads are a priority, the 28F016SV can perform 5V reads at 70 nsec. The 56-lead TSOP chip costs \$69 (10,000).—by Markus Levy  
Intel Corp, Santa Clara, CA, (800) 468-8118.

**Circle No. 556**

## PCI bus controller chip makes debut

Designers trying to create add-in cards for the PCI local bus can now use a single-chip, general-purpose PCI bus interface controller. The chip, the S5933, is the first in a planned family of such devices from Applied Micro Circuits Corp. Future family members will have interface options that reduce the 160-pin package size of the parent part.

The device provides bus-master or -slave operation and passes data to and from the PCI bus in three ways. It offers a pass-through mode that allows direct access to the bus and peripheral hardware resources. Data can also pass through 32-byte FIFO buffers, allowing burst transfers. The third option allows the use of mailboxes for exchanging information such as status and control commands.

To provide a user's device ID and BIOS memory, the device offers two interfaces to nonvolatile memory. One interface is a byte-wide port for flash or ROM, and the other is a serial port for EEPROM. The chip allows the use of serial devices as large as 2048 bytes; byte-wide devices can be as large as 64 kbytes.

Samples of the S5933 will be available in July, and production is scheduled for late in the year. The part costs \$39.95 (1000).—by Richard A Quinnell

Applied Micro Circuits Corp, San Diego, CA, (800) 755-2622. **Circle No. 557**

The system engineer says

he wants a single power supply.

Too bad he didn't tell you

where to find the op amps.

## THE LEADER IN PRECISION OP AMPS IS ALSO THE LEADER IN SINGLE-SUPPLY OP AMPS. (NOW YOU KNOW WHO TO CALL.)

If you're looking for a single-supply op amp, it makes sense to check Analog Devices first.

Not only do we offer you more single-supply amplifiers — nearly twice as many as our closest competitor — we also offer the



best performance in every category.

### MORE AMPS...MORE CHOICES

So finding the exact single-supply amp you need has never been easier.

Choose from low power amps with rail-to-rail I/O. Precision amps with the lowest noise and drift. High-speed amps featuring 5 MHz

from +3 to +36V. General-purpose, low cost amps. Amps with FET input. And many more are on the way.

### CALL FOR A FREE SAMPLE

Why settle for anything less than the specifications you want. Just match your requirements to the amplifier specs in our handy guide. Then call **1-800-ANALOG-D** (262-5643), and we'll rush you a free sample and data sheet. Or fax your request to

617-821-4273.

CIRCLE NO. 93

 **ANALOG DEVICES**  
Analog. Digital. Solutions.

SINGLE-SUPPLY AMPLIFIER GUIDE (A PARTIAL LISTING)														
Part Number			3 V	5 V	12 V	±15 V	Rail-to-Rail		V <sub>os</sub>	e noise	I Out	I Sup	GBP	Key Feature
Single	Dual	Quad					Input	Output	( $\mu$ V)	(nV/√Hz)	(mA)	(mA)	(MHz)	
OP	113	213	413						75	4.7	±40	1.75	3.4	Lowest noise and drift
OP	183	283		•	•	•			1000	10	±25	1.5	5	5 MHz from +3 to +36V
OP	90	290	490	1.6	•	•			150	60	+13/-7	0.015	0.02	Precision micro power
OP		291	491		•	•	•	•	700	21	±10	0.35	3	Low power R-R I/O
OP		292	492		•	•			800	15	±8	1.4	4.5	Low cost
OP		295	495		•	•	•	•	300	45	±18	0.15	0.075	Accuracy and output drive
AD	820	822		•	•	•	•	•	400	16	±30	0.8	1.9	FET Input
SSM		2135			•	•			1000	4.7	±40	1.75	3.5	Excellent for audio
AMP04					•	•			150	25	±15	0.7	0.3	Easy-to-use +5V inst. amp
AD626				•	•	•		>	250	250	15	0.23	0.1	Low cost diff. amp

## Zuken and Racal-Redac merge

Zuken, a major Asian supplier of pc-board, multichip modules (MCM), and CAD/CAM tools, has acquired Racal-Redac, a major European supplier of pc-board and MCM-design software. According to the new company, the merger will have a combined annual sales of \$150 million, making the company the world leader in pc-board and MCM-design tools. Outside Japan, the company will operate under the name Zuken-Redac.—by Doug Conner

Zuken-Redac, Mahwah, NJ, (201) 934-8700. **Circle No. 558**

## Teledyne Brown to demonstrate laser-diode correctors

Teledyne Brown Engineering will demonstrate its laser-diode corrector assemblies at the Optical Engineering Instrumentation show on July 24 through 29 in San Diego.

The laser-diode-beam corrector captures 85% of the diode output and converts it into a 0.7-mm-diameter circular beam with diffraction-limited performance. With these correctors, laser-diode performance exceeds that of helium neon lasers in a more compact and economical package, according to the company. In addition, laser diodes use 20 to 30 times less power than helium neon lasers. Applications for the laser diodes include point-of-sale and inventory-control scanners, laser-disk read-and-write subsystems, fiber optics, and traditional optical-metrology functions.—by Fran Granville

Teledyne Brown, Huntsville, AL, (800) 933-2091, ext 2402. **Circle No. 559**

## Report analyzes power-distribution trends

The Darnell Group market-research company has published *Trends in Power Distribution*, a report quantifying market sizes and product needs for the distributed-power-architecture market. The 120-pg, \$2500 publication includes 60 tables and 30 graphs. It

provides 5-year growth estimates for high-density dc/dc converters, power-factor-corrected ac/dc front ends, and other types of power electronics for building a distributed-power architecture. The report also quantifies the use of central, in-shelf, per-function, and on-board power distribution.

—by Fran Granville

The Darnell Group, Norco, CA, (909) 279-6684. **Circle No. 560**

## California begins trial of Racom's contactless smart cards

Three California cities—Gardena, Los Angeles, and Torrance—have begun field tests of an automatic-fare-collection system on public buses. The trials are using contactless smart cards from Racom Systems Inc. The cards, called In-Charge cards, automatically debit bus fares while a user boards a bus; the user simply waves the card in front of the fare-collection terminal.

The credit-card-sized, batteryless cards act as 2-way radios that respond to commands from the bus-fare-collection system. The test will later involve automatic vehicle location, transfer and receipt printing, voice annunciation of stops, and passenger data collection. The system will ultimately be able to monitor vehicle performance, videotape security problems, and integrate onboard electronics.

—by Fran Granville

Racom Systems Inc, Englewood, CO, (303) 771-2077. **Circle No. 561**

## GenRad spin off specializes in design-automation products

GenRad Inc recently spun off a design-automation products group called Veda design automation (VEDA). The new company, based in Fareham, UK, will focus on providing high-performance VHDL simulation to the electronic-design-automation market. VEDA's strategic focus will include concentrating on the supply of VHDL design and simulation products for top-down electronics system design. VEDA will also address system behavior and ASIC and pc-board design. VEDA

launched its Vital VHDL simulator in January.—by Anne Coyle

Veda Design Automation, Fareham, UK, +44 (0329) 822240. **Circle No. 562**

## Natural MicroSystems forms global group

Natural MicroSystems has formed a not-for-profit entity called the Global Organization for Multi-Vendor Integration Protocol Inc (GO-MVIP). MVIP vendors include Brooktrout, Lindon, Mitel, Natural MicroSystems, Rhetorex, and Scott Instruments. Aculab Ltd sponsored the group's first conference in London on March 24. The group's goal is to provide a "single, local venue at which to meet and exchange ideas and information," according to Alan Pound of Aculab. The companies are making plans for a fourth annual developers' conference, which will take place on October 18 through 20 in Toronto.—by Fran Granville

Natural MicroSystems, Natick, MA, (508) 650-1365. **Circle No. 563**

## Video-game chip employs system-on-a-chip technology

Sony Computer Entertainment recently unveiled a CPU chip that will power the company's CD-based home video-game station, the PlayStation. Sony plans to introduce the PlayStation system in 1995. LSI Logic Corp, which uses 0.5- $\mu$ m technology to develop systems-on-a-chip for customers, developed the PlayStation CPU. The chip contains a 32-bit Mips RISC  $\mu$ P, 3D geometric graphics, and high-resolution video from its JPEG decompression subsystem.

The chip generates 3D images as fast as 360,000 polygons/sec and moves as many as 4000 2D images in a field. The result is high-speed simultaneous movement of characters and high-quality backgrounds generated at 60 fields/sec, which is equivalent to TV transmission. LSI Logic has also employed system-on-chip technology to develop a laser-printer controller and an asynchronous-transfer-mode chip.

—by John Gallant

LSI Logic Corp, Milpitas, CA, (408) 433-8000. **Circle No. 564**

# With TI and 1394, a single, real-time I/O is close at hand.

An unprecedented universal I/O solution connects portables, desktops, peripherals and consumer devices as never before. It's the proposed IEEE 1394 High-Performance Serial Bus. And it offers real-time data transfer for multimedia capabilities via low-cost interface. In fact, *Byte* magazine named 1394 "the most significant new technology" of the fall COMDEX '93 show.

## Now available, the first fully compliant 1394 chipset from TI.

We're providing breakthrough silicon in this emerging interface standard. And we are the first to offer a physical-layer chip (TSB11C01) and a link-layer chip (TSB12C01). Combined, they give you a full-chipset solution.

### 1394 Serial Bus Features

- Real-time data transfer for video and audio applications
- 100 Mbits/s data rates today; 200 and 400 Mbits/s in future
- Live insertion and "plug and play" ability
- Branch and daisy-chain support
- No need for active termination
- Allows for bandwidth allocation
- Single connector for all applications
- Compliant with proposed 1394 standard

### Fewer ports, faster data rates.

This leading-edge technology allows you to eliminate current I/O solutions such as SCSI, IDE and RS-232. With TI's complete 1394 chipset, you have the capability of designing in one common interface for all applications, such as HDD and CD-ROM, digital cameras and printers.

**Inventing the future: You, Texas Instruments and 1394.** New possibilities are what the 1394 standard is all about. For complete information, simply return the reply card or call **1-800-477-8924, ext. 3474.**

EXTENDING YOUR REACH  
WITH TOTAL INTEGRATION™

 **TEXAS  
INSTRUMENTS**

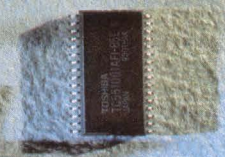
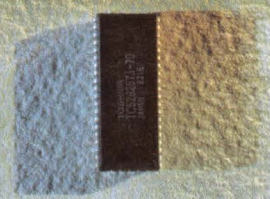
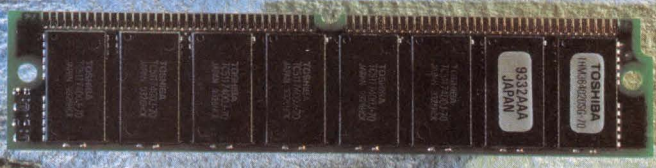

When it comes to

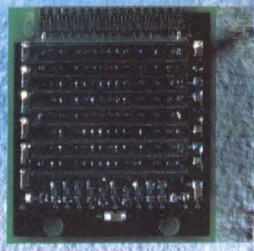

At Toshiba, we've sold more memory products than anyone else in the world.

Anyone.

An achievement we're justifiably proud of.

And why no matter where you look, you'll find our DRAM, SRAM, Non-Volatile products and Memory Cards in more places than anyone else.

Naturally, we're in all types of computers, from PCs to workstations, minis to mainframes, Personal Digital Assistants to supercomputers.

But our influence extends much further.

To laser, dot matrix and color thermal printers.

National Semiconductor, Samsung and others, we're helping take technology to places never before dreamed possible — while standardizing it for everyone's use.

All of which translates into more than just the industry's most expansive line

of memory products.

It means consistent supply, due to huge manufacturing capabilities. Performance advantages, from a long history of

technological innovation and product quality. Reliable alternate sourcing. And the kind of customer service, financial strength and overall stability you'd expect from one of the world's largest corporations.

That's why companies the world over depend

on Toshiba for memory. And why they've put us in the most important place of all — first.

memory, we're in all the right places.

Modems and digital switches. Handheld instruments. Consumer products like mobile phones, faxes and copiers. Even automobiles and electric vehicles.

And thanks to strategic partnerships with companies like IBM, Motorola, Siemens, Rambus,

For more information, or a free product guide, just call 1-800-879-4963.

Then follow the lead of systems manufacturers worldwide.

And commit our name to memory.

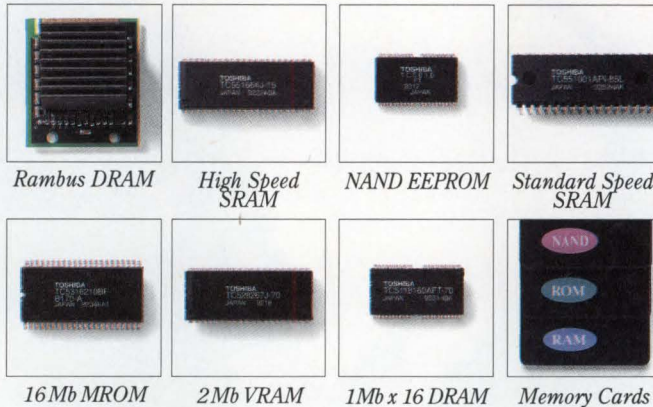

In Touch with Tomorrow  
**TOSHIBA**

TOSHIBA AMERICA ELECTRONIC COMPONENTS, INC.

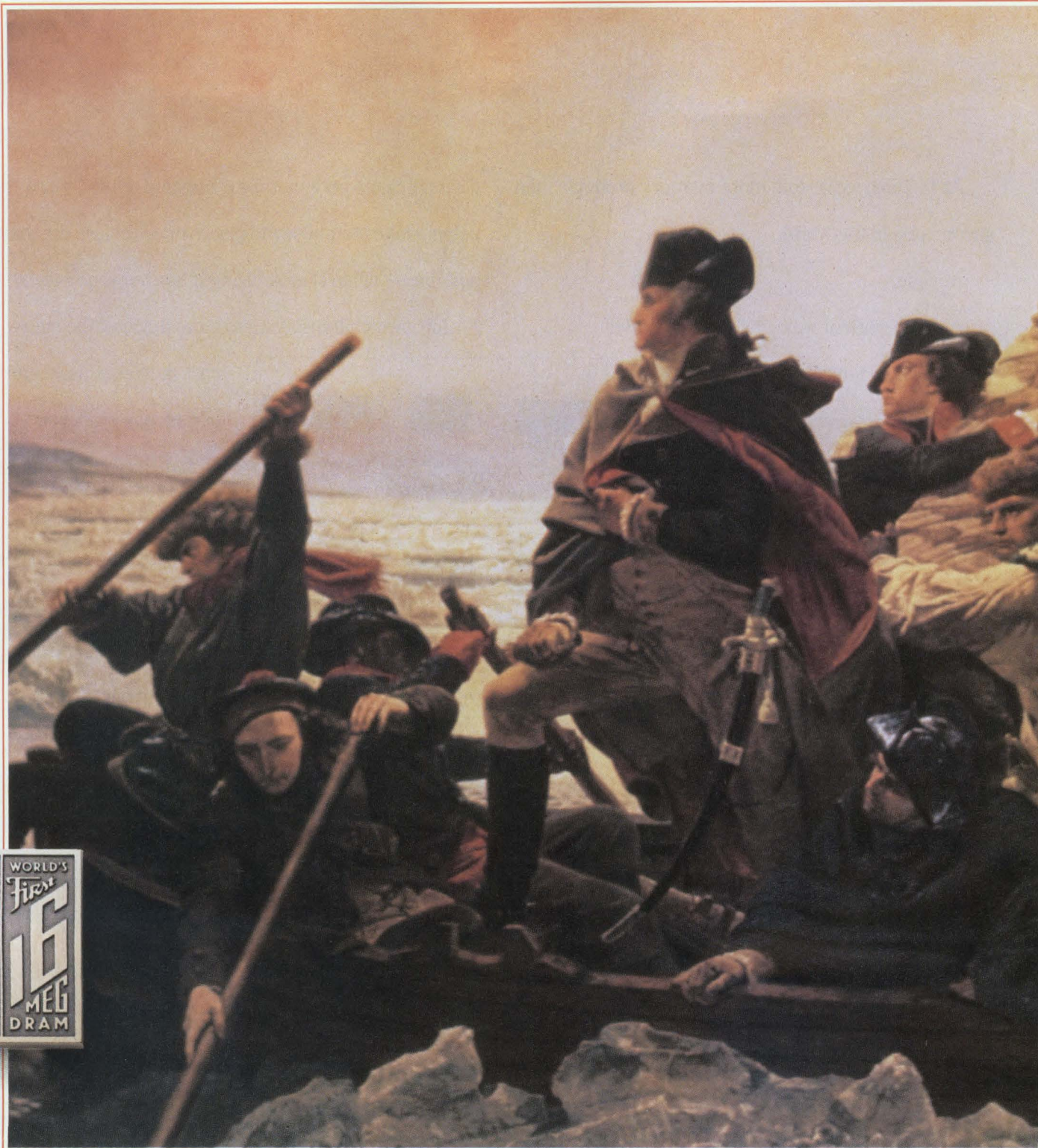

You're designing a Pentium- or Power PC-based system and you know it needs synchronous SRAM cache to generate the performance it ought to have.

But synchronous SRAM cache is so expensive that using it is prohibitive.

That's exactly the problem these

new Samsung SRAMs solve. We've used an innovative pipelined burst design to produce a part we can sell for about half the cost of conventional burst SRAMs. But which gives you approximately 99% of the performance that they do.

As you can see, we consider it

heady stuff—we look on it as a revolutionary development.

And because it actually does make performance affordable—and makes synchronous cache available to designers of even highly cost-constrained systems—we think you'll probably agree.



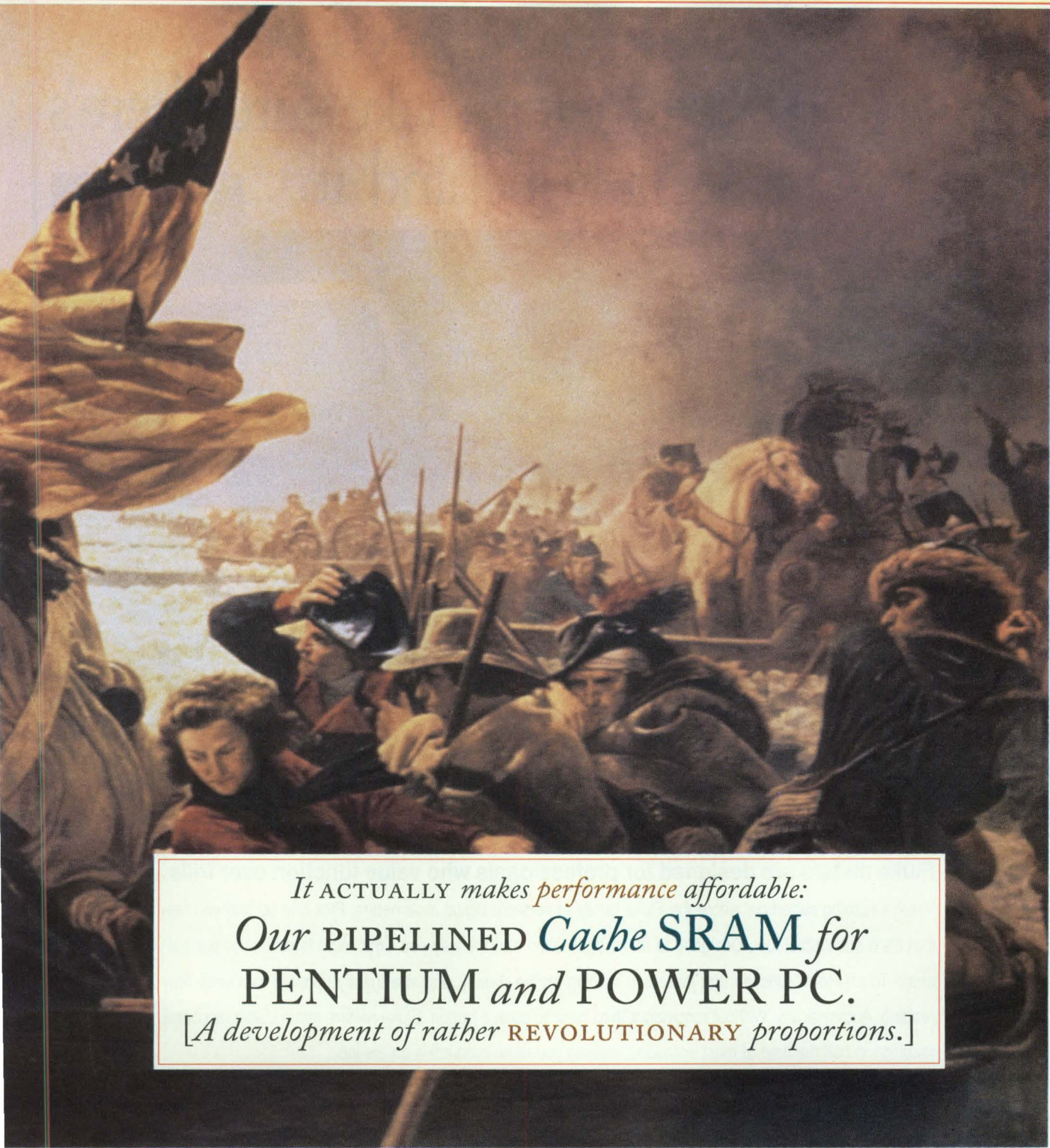

*It ACTUALLY makes performance affordable:*  
**Our PIPELINED Cache SRAM for  
PENTIUM and POWER PC.**  
*[A development of rather REVOLUTIONARY proportions.]*

This revolutionary design was developed collaboratively with major systems developers. It has already met with wide acclaim throughout the industry, and is second-sourced. It will support 3.3 volt systems up to 75 MHz, and is available in speeds of 7, 8, and 9ns.

For Samsung, the pipelined burst cache SRAM is just one of many notable achievements in memory—in a program that sails forward with remarkable success.

For information on designing it in, please call 1-800-446-2760 or 408-954-7229 today. Or write to

SRAM Marketing, Samsung Semiconductor Inc., 3655 North First Street, San Jose, CA 95134.



SEMICONDUCTOR

*A Generation AHEAD.*

Before you get turned on  
by the front of a meter, make sure there's  
something behind it.

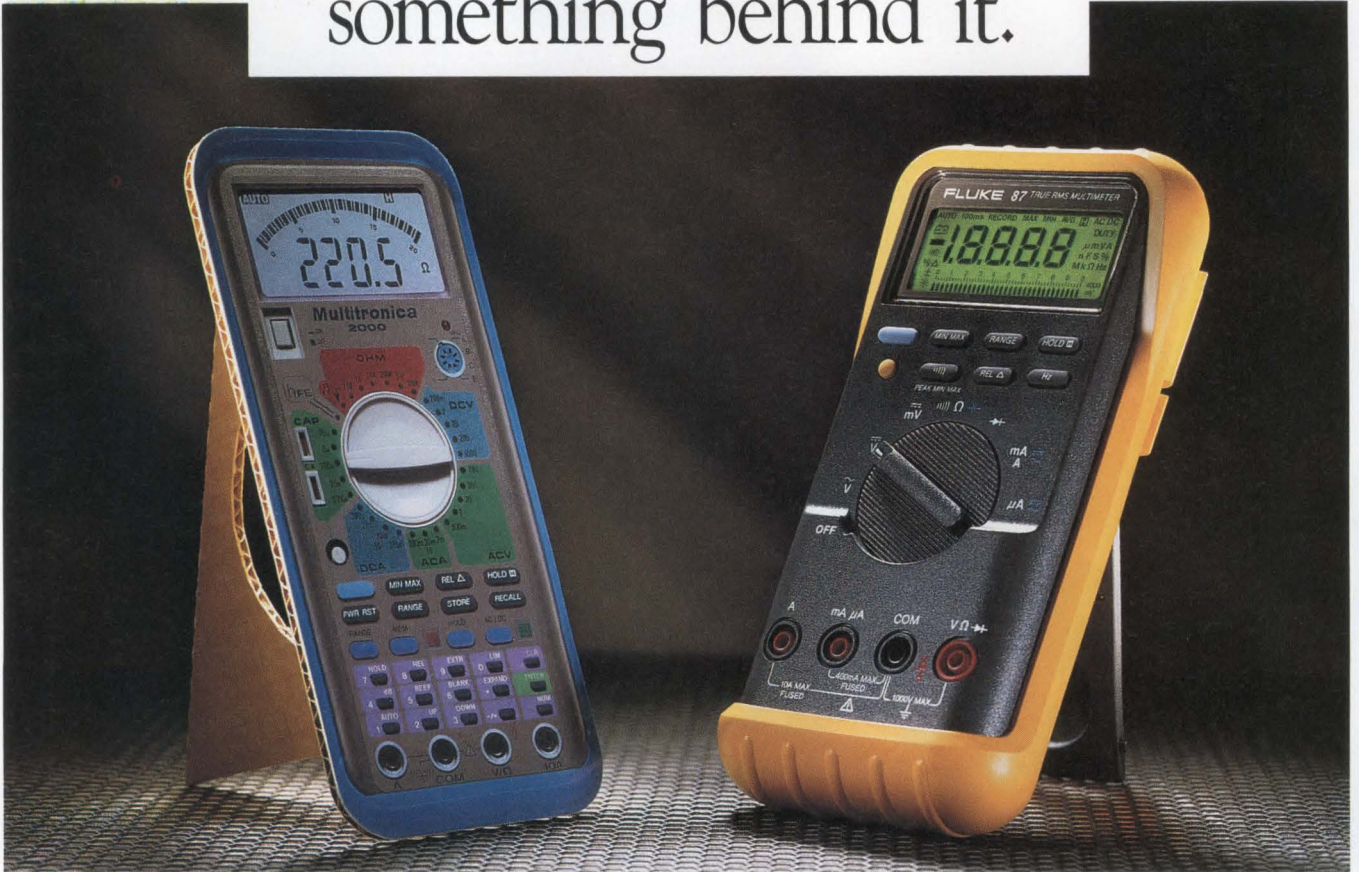

**Fluke meters are designed for professionals who value function over frills.**

There's nothing superficial about the Fluke family of versatile digital multimeters. Pick one up and you feel that it's a substantial tool. Designed to fit the application and the way you work. With features like our patented Touch Hold® function that freezes a reading on the display, and intelligently updates with each new reading. Automatically. Without requiring a third hand to push a button. Fluke meters attain stable, accurate readings in half the time of most imitations, making you more productive on the job.



Other meters are merely "designed to meet" certain guidelines; Fluke designs and builds a full line of meters that actually achieve UL, VDE and TÜV safety certification. Fluke's guarantee goes beyond manufacturing defects to include meter specifications for an entire year, so you can trust the readings. And Fluke backs you with toll-free customer assistance numbers, and a world-wide service organization. Discover why more professionals around the world say, "Hand me the Fluke." See your local distributor, or call **1-800-87-FLUKE** for a catalog and the name of the distributor nearest you.

© 1994 Fluke Corporation. P.O. Box 9090, M/S 250E, Everett, WA, USA 98206-9090. U.S. (206) 356-5400. Canada (905) 890-7600. Europe (31 40) 644200. Other Countries (206) 356-5500. All rights reserved. Ad No. 00567

Serious Tools for Serious Work

**FLUKE®**

## Tools of the trade

In a letter in the May 26 issue of *EDN*, Ed Sutter wonders, "How do so many emulator vendors stay in business?" Well, as a profitable emulator vendor, I'm delighted to report that bugs are still rampant in embedded systems, and engineers will (quite rightly) buy whatever tool is needed to cure their products' ills as efficiently as possible.

No tool is really essential. I can pound in nails with the heel of my shoe if I choose not to invest in a hammer. Watch engineers working in a lab. How often do you see one remove insulation with his teeth because strippers aren't close at hand? Even Sutter's logic analyzer is not really needed for debugging embedded systems—why not use a scope and tediously move the probe across the data bus to determine what the program is doing?

Emulators offer some critical debugging assets that no other tool provides. Some are obvious, like extensive breakpoint capability—stop the code when exactly this event occurs. Real-time trace is much like the display on Sutter's logic analyzer, but emulators are typically far more closely coupled to a source-level debugger, giving a perfect correlation between source code and what's in the trace buffer. Emulation memory, tied so tightly to the source debugger, makes downloading code a breeze while preserving the debugging links to the source.

While all emulator vendors like to tout how "nonintrusive" their products are, intrusive emulation is a critical feature. Suppose the code doesn't work. Patch it! What's the value of that I/O port when we hit the breakpoint? Read it! Will altering the queue pointers fix the circular buffer code? Try it! Emulators are the only tools that combine nonintrusive program execution with the ability to make changes at will.

One of my personal frustrations is that emulators are more and more regarded as software-development tools only, when in fact there is no easier way to fix a prototype computer board than with an ICE. If the board doesn't work, plug in an emulator and ask it to display ROM repeatedly. Then use a scope to check for chip selects and the like. I/O broken? Use the ICE to read ports and construct scope loops. Is the A/D linear? Without writing a sin-

# Measure It All!

## The DMM/LCR Meter/ Frequency Counter. All in One.

**T**roubleshoot down to the component level — any component! Verify poorly marked parts, test for tolerances and damage. Wavetek's new DM27XT is not only a full-function DMM, but also includes complete inductance, capacitance, and frequency measurement capabilities.

- **Wide LCR range:**  
10  $\Omega$  to 2000 M $\Omega$   
10 pF to 2000  $\mu$ F  
100  $\mu$ H to 20 H
- **Autorangeing frequency meter** 10 Hz to 20 MHz
- **Ac and dc current to 20 A**
- **Logic test, diode test, max reading hold, continuity beeper, input warning beeper, fused input protection, battery saver**

Consolidate your test bench with one meter that does it all — Wavetek's high-performing, full-function XT Series DMM. It's all in one compact, rugged, field-ready package with a big 0.7-inch, 3 1/2-digit display. Insulated probes and alligator clip leads are included, and there is a huge selection of accessories, including current, rf and HV probes, temperature converters, holsters, and cases. Ask for Wavetek DMMs. They're the meters to pick when you have things to fix.



# \$119<sup>95</sup>

Other XT Series DMMs from \$89.95

U.S.A.: (619)279-2200  
Europe: (44/243) 531323  
Asia Pacific: (852)865-1903

©1993 Wavetek Corporation



# WAVETEK

CIRCLE NO. 185

# Get To The Source...

## FOR AC/DC SWITCHING POWER SUPPLIES.

- 15 to 650 Watts
- 1 to 8 Outputs
- Universal Input
- UL/CSA/TUV Approval
- Chassis Mount, L-Bracket, Open Frame
- Over 1000 Off-The-Shelf Power Supply Solutions

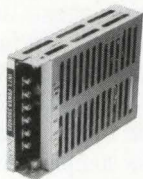
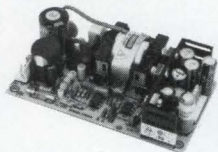

Solve Your Power Supply Problems With Standard, Off-The-Shelf Solutions. Or Talk To Our Engineers About Modifications Or A Complete Custom Solution.



International Power Sources, Inc.

**FAX TOLL-FREE FOR OUR LATEST 64 PAGE CATALOG.**



200 Butterfield Drive, Ashland, MA 01721  
Tel: (508) 881-7434 ■ Fax: (800) 226-2100

CIRCLE NO. 33

# 45 watt power supply in a small 3"x5" size

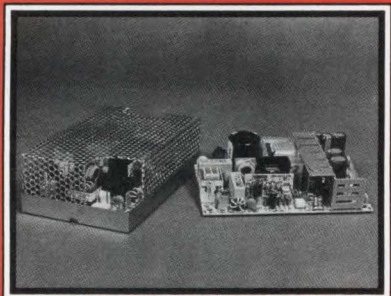

### Zenith's Model ZPS-45

- Universal Input
- Triple Output — +12V or +15V
- 90-265 VAC, 120-364 VDC
- UL 1950, CSA 22.2, IEC 950, FCC Part 15J, Class B, VDE 0871/B, VDE EN60950, BABT 340 and BS 6301; Also available with UL 544
- No minimum load required
- Standard off-the-shelf delivery
- 500,000 hours MTBF & backed by 1 year warranty

*Optional Safety Cover*

Zenith Model	Maximum Output Power (Watts)	Main Output		2nd Output		3rd Output	
		Volts DC (Nominal)	Amps (Min/Max)	Volts DC (Nominal)	Amps (Min/Max)	Volts DC (Nominal)	Amps (Min/Max)
ZPS-45	45	+5.0	0.0/5.0 PK 7.0	+12.0	0.0/2.0 PK 3.0	-12.0	0.0/0.7
ZPS-45-15	45	+5.0	0.0/5.0 PK 7.0	+15.0	0.0/1.5 PK 2.0	-15.0	0.0/0.7

Call for a free brochure:  
**800-827-8720**

Fax: (708) 391-7238

1000 Milwaukee Avenue, Glenview, IL 60025-2493



power supplies

by Oryx Power Products  
— a division of Oryx Technology Corp.  
Independent of and not affiliated with Zenith Electronics Corp.

CIRCLE NO. 197

gle line of code, use the ICE to read and display the converter as you ramp its input.

A logic analyzer, scope, or any other tool only lets you watch the system crash and maybe (perhaps if you burn enough incense...if the gods are smiling...if the you paid your taxes) figure out why the system is dead. An emulator lets you run controlled, repeating tests to quickly isolate problems to a specific component.

Yes, we emulator vendors benefit from our customers' mistakes and miseries. It's a synergistic relationship, though: Our tools reduce their angst and ultimately increase both our profits and their profits.

*Jack Ganssle, President  
Softaid  
Columbia, MD*

### One more

I want to congratulate you on the March 3 *EDN* article "User-interface prototypes help you design products real people can operate" (pg 51). It was quite interesting and educational at the same time...only one thing was missing—us. Virtual Prototypes Inc is a leading supplier of software tools for developing real-time graphical human/machine interfaces (HMIs). VPI's tools are designed to make the development and deployment of graphical HMIs a straightforward task. Our technology, called "virtual prototyping," addresses three basic HMI design needs: rapid prototyping, automatic code generation and retargeting for operation and embedded systems, and real-time simulation and training.

*Claire Champeau  
Marketing and Communications  
Coordinator  
Virtual Prototyping Inc  
Montreal, Quebec, Canada*

### Sound off

Send your letters to Signals and Noise Editor, *EDN*, 275 Washington St, Newton, MA 02158. Or fax us at (617) 558-4470. *EDN* reserves the right to edit letters for clarity and length.

# 100 watts per cubic inch is meaningless if it's a big job to cool it.

Have you ever looked into using a board mounted power module (miniature DC/DC converter) with an advertised power density of 100 watts/cubic inch ...only to find out you need exotic cooling techniques to reach full rated output power?

Not so with AT&T's next generation of board mounted power modules.



## 150 Useable Watts in a 50 Watt Package

They deliver up to 150 useable watts in a small 2.4 x 2.28 x 0.5 inch package. Their high efficiency (>84%) design provides 150 watts of

5 volt output power with an allowable base-plate temperature of 100° C. They provide power levels from 50 to 150 watts, output voltages from 2.0 to 24 volts, and



wide 2:1 input voltage ranges (18/36V and 36/72V).

So while others talk high density, AT&T delivers.

As always, with AT&T power modules, you're assured very competitive prices, plus the broadest offering: 0.5 to

200 watt products.

Give us a call at 1 800 526-7819

before you make your next power decision. From technical support to creative power solutions, we'll give you real reasons to make AT&T your power resource.

## AT&T Power Systems. The power to do more.

For other AT&T power literature or power information, call 1 800 372-2447, ext. 910.



# NOT THE SAME

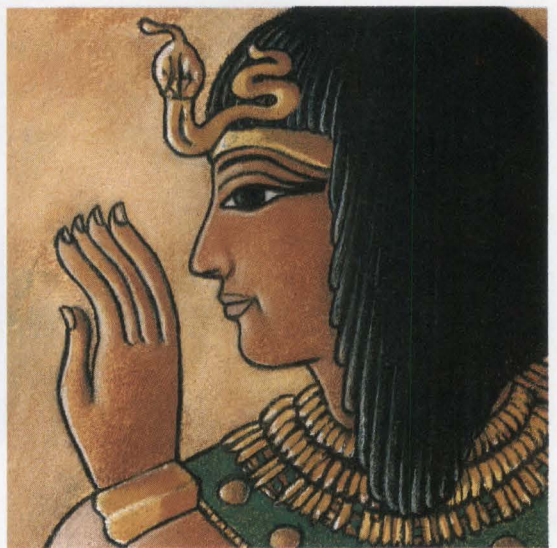

**The LMC7101** ~ Combines high-performance and low-voltage operation in the tiniest possible packaging (SOT23-5) ~ Provides maximum dynamic

range with rail-to-rail input and output ~ Low voltage (3V to 15V) and low power operation (500 $\mu$ A supply current) ~ Low offset of 3mV ~ 1MHz GBW @ 3V ~

© 1994 National Semiconductor Corporation. NORTH AMERICA: P.O. Box 7643, Mt. Prospect, IL 60056-7643 (Tel: 1-800-628-7364, Ext. 307 Fax: 1-800-888-5113). All rights reserved.

OLD WAVE



The world's  
**tiniest**  
rail-to-rail  
**OP-AMP**

~ 1/3 the surface area of an SO-8 ~

Guaranteed over the industrial temperature range (-40°C to +85°C) ~ For ordering information and a free product sample kit, call 1-800-NAT-SEMI, Ext. 307.



*National Semiconductor*



# *FAST* Track to *FAST* SCSI

**90's Challenges.** The 90's demand higher levels of performance and faster delivery than ever. Time-to-market, technological demands, and changing user needs make fast, simple SCSI seem as elusive as the horizon. To stay ahead in these challenging times, you need products you can count on, with proven ability to deliver the quality and reliability your customers require.

**90's Products.** After over a decade of industry leadership, NCR is still working hard to meet your needs and the challenges of the 90's. The NCR 53C90 family of SCSI Controllers is constantly evolving, implementing and offering state-of-the-art products. For example, the NCR 53C90 family supports multiple bus architectures, advanced SCSI-2 commands, fast SCSI data transfers and provides our exclusive TolerANT® SCSI driver and receiver technology, for reliable data transfers in every SCSI system.

**90's Solutions.** The SCSI challenges of the 90's can't be solved with silicon alone. NCR quality and service provide you with the competitive edge that can make your industry leading designs a reality. Whether you require SCSI-1 or fast SCSI-2, in any system architecture, NCR has the product to meet your needs today. You can count on us to keep you on the fast track with the right technology, at the right price, at the right time for all your SCSI requirements.

## The NCR 53C90 Family

*Proven Performance  
for the 90's and  
Beyond*

CIRCLE NO. 218



***NCR SCSI: Real Products, Real Solutions, Real Fast!***

SCSI	FAST SCSI*	
<b>53C90A</b>	<b>53CF90A</b>	<i>Single-bus architecture; SCSI sequences controlled by hardware state machine to minimize host intervention</i>
<b>53C90B</b>	<b>53CF90B</b>	<i>Adds pass-through parity for increased system reliability</i>
<b>53C94</b>	<b>53CF94</b>	<i>Adds split-bus architecture for more flexibility</i>
<b>53C96</b>	<b>53CF96</b>	<i>Adds support for differential transfers</i>

***For more information about  
NCR SCSI products  
and a free poster,  
call 1-800-334-5454.***





# Don't take it any more—act!

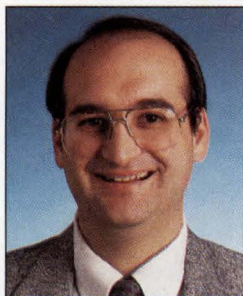

EDN's readers often tell me about problems they've had with suppliers. Sometimes EDN can help, and sometimes we can't. Recently, Creigh Shank, a principal consultant at Cox and Associates, contacted me regarding problems his company was experiencing with a PC component vendor over a 3-month period. It seems that several of the motherboards and graphics controllers supplied by this vendor had failed, and Shank was getting nowhere fast with his appeals to the vendor for help. Shank's solution was to send 67 letters to various electronics and computer magazines explaining his problems in detail. He also sent a copy of his letter to the vendor along with a list of the magazines he'd contacted.

Shank's gambit worked. Apparently, the vendor is now paying a lot of attention to the problems and is solving them to Shank's "full satisfaction," as he stated in a follow-up letter.

This story, one that repeats often in our industry, is a prime example of how you can be effective in achieving your personal and corporate goals. You do that simply by taking matters into your own hands and acting.

All relationships have problems. You should expect them and not be put off by

them. When problems do occur, the real test of the relationship is what you do in response to the problem. If the problems are sufficiently large, you may choose to terminate the relationship. However, that choice discards the investment you've made in the relationship, which may be very large indeed.

You may try to work the problems out. This was Shank's first move. In his case, this approach seemed not to work, though many times it does.

Finally, Shank used what I call the "two-by-four approach." When you can't get the other party's attention, you must sometimes resort to using the figurative equivalent of a big piece of wood (a two-by-four) to whack the other person on the head and get his or her attention. Note that I'm not advocating physical violence here, nor am I advocating overreacting. I am advocating assertive action to solve problems.

Take a look at the problems plaguing you at the moment. Write them down. Then write down some actions you can take to creatively and assertively attack each of these problems. Gripping and whining don't solve problems. Actions do.

Steven H Leibson  
Editor-in-Chief



Jesse H. Neal  
Editorial Achievement Award  
1990 Certificate, Best Editorial  
1990 Certificate, Best Series  
1987, 1981 (2), 1978 (2),  
1977, 1976, 1975

American Society of  
Business Press Editors Award  
1991, 1990, 1988, 1983, 1981

Send me your comments via fax at (617) 558-4470, or on the EDN Bulletin Board System at (617) 558-4241, 300/1200/2400 8,N,1. From the Main System Menu, enter ss/soapbox and select W to write us a letter.



**A DESIGN CYCLE THAT COMPRESSES WEEKLY.**

**A BUDGET THAT SHRINKS DAILY.**

**A BOSS THAT INQUIRES HOURLY.**

**IT'S NOT JUST A/D AND D/A ANYMORE.**

**NOBODY DOES CONVERTERS LIKE ANALOG DEVICES.**

You've got a problem that goes way beyond simple data conversion. So you think of Analog Devices first. Which is natural because we're the world leader in converters. But also because we go way beyond simple data conversion. Many of our converters include on-board references and sample/hold amplifiers that offer highly integrated solutions for all your data acquisition needs. We combine advanced mixed-signal techniques with our proven expertise in data conversion. So we can provide ADCs with features like self-calibration. And sigma-delta converters for a variety of specific applications in process con-

 *The 12-bit AD7892, with a 500 ksps conversion rate and a power dissipation of just 60mW, features unique voltage protection on the analog input and the flexibility of both serial and parallel interfaces.*

control, computers, medical instrumentation and communications.

Our converters span resolutions from 6 to 24 bits and speed from dc to hundreds of megasamples per second. Advanced functionality is built-in. So leading companies look

to us for converter leadership. Sony™ chose our AD875 10-bit, 15 MHz ADC converter because it gave them the low power, high performance and low cost they needed for their digital camcorder. We supply five of the top seven GSM manufacturers with baseband and voiceband converters. And in a joint venture with IBM®, we developed a 1 GHz, SiGe

*To make the best workstations, you need the best displays. That's why SUN Microsystems Inc. chose our ADV7152 video RAM-DAC, with 220 MHz 24-bit (effective 30-bit) resolution and gamma correction RAM.*



DAC that, as one trade journal put it, threatens to upend the wireless communications market.

Put all of this together with our world-class operations, on time delivery, responsiveness, applications support and competitive pricing and what have you got? The world leader in converters. And a good reason to call 1-800-ANALOGD.



Analog. Digital. Solutions.

**CIRCLE NO. 26**

 4-Mbit  
VRAM



# When you want fully compatible 4-Mbit VRAMs, TI delivers.

To meet the competitive demands of today's graphics market, TI delivers the only commercially available solution — our full family of 4-Mbit VRAMs. And puts you on the path to a higher level of graphics performance than 1- or 2-Mbit VRAMs can provide.

**Compatibility means flexibility.** The first to introduce the 4-Mbit VRAM, TI is also the first to meet the JEDEC 4-Mbit VRAM standard, including a 256-bit Serial Access Memory (SAM). So when you start your next-generation high-resolution graphics designs with TI, you get maximum future design flexibility. Something not all 4-Mbit VRAM manufacturers can deliver.

**The right devices, right now.** We deliver what we promise. Our family of 4-Mbit VRAMs has been in volume production

more than a year, so you can get the devices you need in full production quantity.

**Higher integration, lower cost.** The higher density of 4-Mbit VRAMs reduces chip count for more efficient use of board space and increased system reliability. The dual asynchronous data ports simplify the CPU interface and greatly reduce the memory bandwidth bottleneck. Add that to our Total Integration™ philosophy and it equals cost-effective designs.

**Available today.** TI offers you unprecedented service and support, along with timely information, when and where you need it. Just call **1-800-477-8924, ext. 3611.** We'll get the facts on TI's fully compatible family of 4-Mbit VRAMs delivered to you right away.



#### Available Features

- EDO page mode
- 18/22-ns serial cycle time
- 60/70-ns access speeds
- Programmable split register stop point
- 256K x 16 DRAM organization
- 256 x 16 SAM
- Write per bit
- (4 x 4) x 4 block write
- 2 WE      • 2 CAS
- CAS before RAS refresh

EXTENDING YOUR REACH  
WITH TOTAL INTEGRATION™

 **TEXAS  
INSTRUMENTS**

# 3pF SCSI Gives Your Bus a Lift

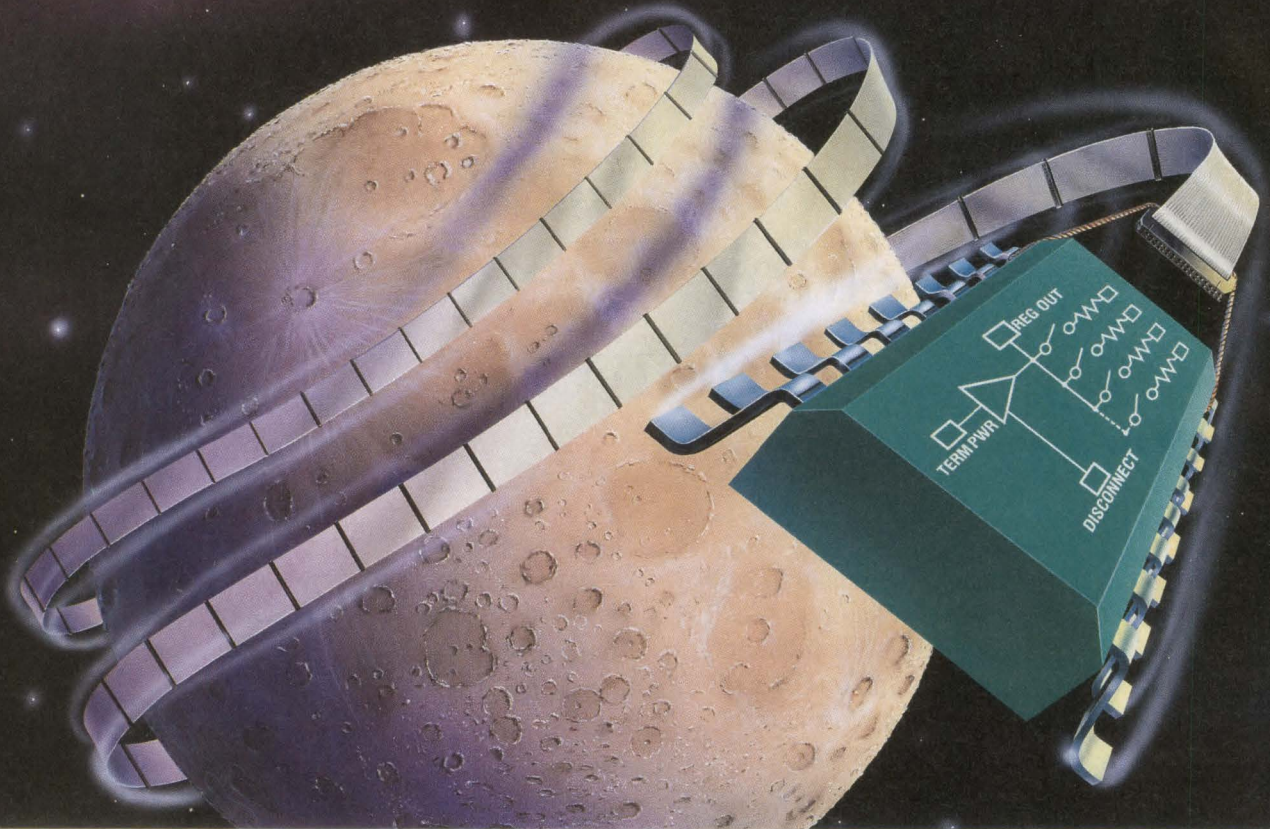

Lighten your bus and take your designs to a new level of speed with Unitrode's UC5613 nine line SCSI active terminator. With the lowest capacitance available today, your designs will have hotswap ability, and a high transfer rate. The UC5613 will launch your CD Rom and computer peripheral designs with confidence and greater speed.

Call, FAX, or write us today for free samples and application information.

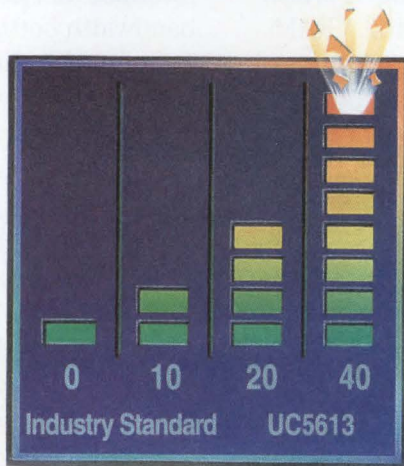

**Megatransfer Rate**

## The UC5613 Advantages

- ◆ 3pF Channel capacitance during disconnect
- ◆ Meets SCSI hot plugging capability
- ◆ +400mA Sinking current for active negation
- ◆ Custom power packages are utilized to allow normal operation at full power (1.2 watts)
- ◆ 0.7V Dropout voltage regulator
- ◆ Logic command disconnects all termination lines
- ◆ 100µA Supply current in disconnect mode



**TEL: (603) 429-8610**

FAX: (603) 424-3460

7 Continental Boulevard, Merrimack, NH 03054

CIRCLE NO. 164



LSI/ISO 9001/EN 29001

# Low-power ASICs save board space and time to market

JOHN GALLANT, Technical Editor

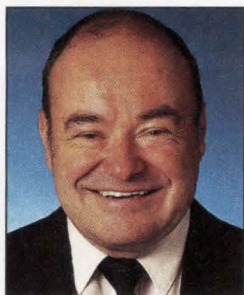

**The relentless demand for low power has driven vendors to offer ASICs with reduced power consumption. Some of these devices have such large densities that even a full-blown version must offer thermal management.**

It seems like everyone is demanding low-power consumption from their ICs these days. The reasons are manifold. Battery-operated devices, such as laptop and palm-top computers and personal digital assistants, require low current drain to increase time between battery charges. Cellular and cordless phones also demand power-conserving features to preserve battery life.

In addition, ASIC density, which formerly ranged from 25,000 to 50,000 gate equivalents, has grown in recent years to 500,000 to 1 million gate equivalents. The high gate counts can stress an ASIC's thermal properties. Therefore, thermal management has become another critical reason for demanding low power consumption from an ASIC. Dense designs using high clock frequencies place severe demands on the thermal-dissipation capabilities of a package.

The most widely used method for achieving low power from an ASIC is to lower the supply voltage from 5 to 3.3V. All things being equal, the voltage reduction can achieve approximately 60% in power savings. The lower voltage, however, means an approximately 50% lower operating speed. The lower speeds help reduce EMI because the lower voltage produces longer rise and fall times for I/O logic levels than those produced in higher-voltage devices. In addition, an ASIC operating from a 3V supply can use a much

less expensive package for thermal considerations.

### Three flavors of ASIC

Low-voltage ASICs come in three varieties: gate arrays, embedded gate arrays, and standard cells. Gate arrays employ a sea-of-gates architecture in which the gates are prediffused to achieve turnaround in a few weeks for large quantities. Standard cells employ gates that are not prediffused, which allows them to include large macrocells, such as RAM, ROM, and  $\mu$ P cells. Because standard cells require more masking procedures to manufacture, their turnarounds are longer than those of standard gate arrays. An embedded array, a compromise between a gate array and a standard cell, allows embedding of some large

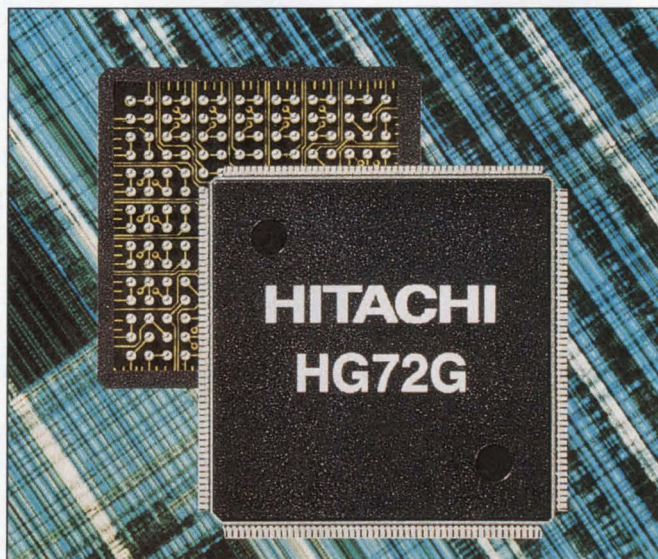

**Gate arrays in 0.5- $\mu$ m geometries can feature high gate count and high speed. Hitachi's HG72G/E arrays operate faster than 100 MHz with as many as 667,000 gates that require high-performance packaging.**

## LOW-POWER ASICs

macrocells into a standard gate array.

Some vendors, such as American Microsystems Inc (AMI) and NCR, offer a 3V characterization for their basic 5V ASIC families. AMI's base gate arrays, the AMI8GxS family, use a 0.8- $\mu$ m CMOS process employing a sea-of-gates architecture. The arrays use double or triple metallization and are available in 5 or 3V. NCR offers the VS500 standard-cell family, which employs a 0.75- $\mu$ m technology. The family allows 5 and 3.3V I/O and core cells for mixed-voltage applications. The family has more than 700 digital core cells.

### How to estimate power

How do you estimate the power consumption of an ASIC? Many vendors quote a power factor for a single gate's power dissipation. For CMOS processes, the power factor depends on the

operating frequency, so vendors measure it in microwatts per megahertz per gate ( $\mu$ W/MHz/gate). In bipolar processes, the power dissipation is constant with frequency, so the vendors measure it the power factor in microwatts per gate ( $\mu$ W/gate). The power factor is different for core cells and I/O buffers, so you must take a weighted average of the total power factors a data sheet provides to achieve an average value.

If you employ CMOS devices, you can break your design into blocks of logic based on switching frequency once you achieve a weighted average for the power factor. You can calculate the dynamic power consump-

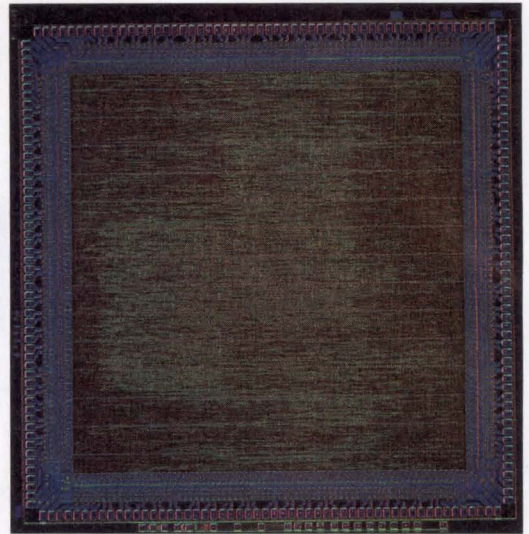

**Motorola's H4CPLUS 3V metal CMOS gate arrays suit mixed 3 and 5V applications. A unique interface design permits chip-to-chip communications at 200 MHz with low power dissipation.**

## MANUFACTURERS OF LOW-POWER ASICs

For free information on the low-power ASIC products discussed in this article, circle the appropriate numbers on the postage-paid Information Retrieval Service card or use EDN's Express Request service. When you contact any of the following manufacturers directly, please let them know you read about their products in EDN.

**American Microsystems Inc**  
Pocatello, ID  
(208) 233-4690  
Circle No. 307

**AT&T Microelectronics**  
Allentown, PA  
(800) 372-2447  
Circle No. 326

**Cadence Design Systems Inc**  
San Jose, CA  
(408) 943-1234  
Circle No. 308

**Cascade Design Automation**  
Bellevue, WA  
(800) 258-8574  
Circle No. 309

**Fujitsu Microelectronics Inc**  
San Jose, CA  
(800) 642-7616  
Circle No. 310

**Hitachi America Ltd**  
Brisbane, CA  
(800) 285-1601, ext 31  
Circle No. 311

**IBM Microelectronics**  
Burlington, VT  
(802) 769-0111  
Circle No. 312

**LSI Logic**  
Milpitas, CA  
(408) 433-8000  
Circle No. 313

**Mentor Graphics**  
Wilsonville, OR  
(503) 685-7000  
Circle No. 314

**Mitsubishi Electronic Device Group**  
Sunnyvale, CA  
(408) 730-5900  
Circle No. 327

**Motorola Inc**  
Chandler AZ  
(602) 821-4418  
Circle No. 315

**NCR Corp**  
Fort Collins, CO  
(303) 226-9500  
Circle No. 316

**NEC Electronics Inc**  
Mountain View, CA  
(800) 366-9782  
Circle No. 317

**Oki Semiconductor**  
Sunnyvale, CA  
(408) 720-1900  
Circle No. 318

**SMOS Systems**  
San Jose, CA  
(408) 922-0200  
Circle No. 319

**Synergy Semiconductor Corp**  
Santa Clara, CA  
(408) 730-1313  
Circle No. 320

**Synopsys Inc**  
Mountain View, CA  
(415) 962-5000  
Circle No. 321

**Texas Instruments Inc**  
Dallas, TX  
(214) 995-6611, ext 3990  
Circle No. 322

**Toshiba America Electronic Components Inc**  
Irvine, CA  
(714) 455-2000  
Circle No. 323

**VLSI Technology Inc**  
San Jose, CA  
(408) 434-3000  
Circle No. 324

### VOTE . . .

Please also use the Information Retrieval Service card to rate this article (circle one):

**High Interest 589**  
**Medium Interest 590**  
**Low Interest 591**

### Super Circle Number

For more information on low-power ASIC products available from all of the vendors listed in this box, you need only circle one number on the postage-paid reader service card.

**Circle No. 325**

tion by multiplying each block of gates or cells by the power factor and then by the operating frequency. You then sum the power for each block to achieve the total power consumption.

Unfortunately, this method gives you only a ballpark figure because actual power consumption depends on other factors, such as the output pads' load capacitance and frequency. You must also weigh a device's static power consumption. To achieve a more accurate estimate of power consumption, you must develop a netlist for your design and let a simulator give you a power estimate based on test vectors. Tools from electronic-design-automation vendors, such as Cadence, Cascade, Mentor Graphics, and Synopsys, can estimate power consumption. If the test vectors are complete, the power estimates are usually conservative; actual prototypes should yield lower power levels.

### Mixed-voltage I/O is popular

Most low-voltage ASICs have mixed-voltage I/O pads and fixed 3 or 5V cores. Mixed-voltage I/Os allow the device to communicate with inexpensive 5V devices, such as DRAMs. Motorola's 0.6- $\mu$ m H4CPlus series of gate arrays features current-mode transceiver-logic buffers, which provide a self-terminating I/O method and CMOS chip-to-chip interface speeds exceeding 200 MHz. The arrays have dual  $V_{DD}$  rails to power the





Arm your VME system for industrial control with A-D and servo-motor control modules.

A-D conversion ready in an instant.

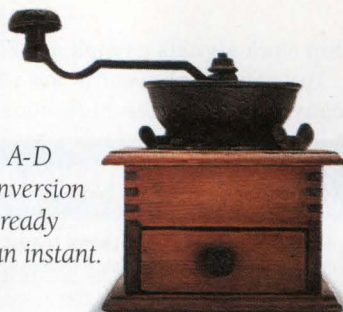

Need network connections such as Ethernet, Serial, X.25 or SNA? We'll hook you up with all you need.



Satisfy any taste in VME modules by choosing from over 120 IndustryPack modules on the market.



We offer you a wide spectrum of O/S software choices.

# Think Of This As A VME Smörgasboard.

The Motorola VME product line is like a gourmet buffet. You take what you like, and you'll like what you take.

## Make The Call, Not The Board.

Motorola VME boards offer you more choices. More ways to get the features you need, at a price you can afford. When you select your board from Motorola, you'll save a lot more than time. Add networking options (such as Ethernet, Serial, X.25, SNA), memory, motor control, A-D

conversion, graphics capabilities with either IndustryPack™ or VME modules™.

With more than 120 IndustryPack modules and over 3,000 VME modules available industry-wide, your options are unlimited, and your finished product will be dependable.

## Flexible Performance, Inflexible Commitment.

Depend on Motorola VME modules for a variety of design needs. One of our boards can perform multiple

tasks, saving you slots, cash, and hassle. And as your needs change, just add modules to your existing board.

While we serve up a huge menu of VME selections, there's one thing we won't consider changing: our Five-Year Warranty. Call Motorola and you'll get your just desserts.

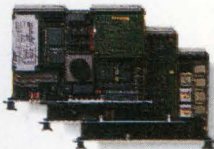

Motorola VME modules let you select the features you need, at a price you can afford.

1-800-759-1107 Ext. EDN



© Copyright 1994 Motorola, Inc. Motorola and the Motorola logo are registered trademarks of Motorola, Inc. "Because The Game Has Changed" and VME module are trademarks of Motorola, Inc. All other products mentioned are trademarks or registered trademarks of their respective holders.



**MOTOROLA**  
Computer Group  
Because The Game Has Changed™

## LOW-POWER ASICs

output buffers for 3.3 or 5V or mixed-voltage levels. You can embed analog PLLs in two corners of the die for on-

chip clock signals as high as 125 MHz. To achieve high speed at low voltages, many vendors offer high-density 3V

families with 0.5- $\mu$ m processes. Hitachi, IBM, LSI, NEC, Toshiba, and VLSI all provide ASICs in 0.5- $\mu$ m

### TABLE 1—LOW-POWER ASICs

Company	Model	Maximum usable gates	Power dissipation ( $\mu$ W/MHz/gate)	Internal gate delay (psec)	Supply voltage (V)	Price	Features
American Microsystems Inc Circle No. 307	AM18Gx (0.8 $\mu$ m)	432,180 and 324,526	3.2 at 5V	200	2.7 to 5.5	Not specified	2- and 3-level metallization; automatic test-pattern generation, includes scan macroshifters; 3 to 5 and 5 to 3V level shifters; selectable 1- to 16-mA output-current drivers, synchronous single-port RAMs to 1k $\times$ 32 bits; maximum of 528 bond pads
AT&T Microelectronics Circle No. 326	HL400C (0.5 $\mu$ m)	500,000	2	330	2.7 to 3.6	Not specified	Standard cell library has 400 kbits of RAM, 80C196 $\mu$ C, UART, and DMA controller; supports 5V, LVTTTL, GTL, and PECL I/O ports; system clock speeds greater than 120 MHz; IEEE 1149.1 boundary-scan macrocell; 3-layer metallization
Fujitsu Circle No. 310	CG51, CE51 (0.5 $\mu$ m)	490,000	1.2	210	3.3	NRE starts at \$65,000	3-layer metallization; maximum, system clock speed=100 MHz; automatic test-pattern generation, JTAG IEEE 1149.1 boundary scan; internal PLL clocks and embedded RAM or ROM
Hitachi Circle No. 311	HG72G/E (0.5 $\mu$ m)	39,000 to 500,000	1.2	200	3.3	NRE starts at \$70,000	System clock speed >100 MHz; ball-grid array with 672 I/O pins; on-chip PLL clocks and maximum metallized memory of 256 kbits
IBM Microelectronics Circle No. 312	CMOS 5L	1.2 million	1 to 1.5	Not specified	3.3	\$200,000 NRE (includes place and route)	4-layer metallization; >100 MHz operation; logic-sensitive scan design generates test vectors; 625-pin ball-grid array; 25 embedded arrays, including RAM
LSI Logic Circle No. 313	LCB500K (0.5 $\mu$ m)	1.5 million	Not specified	065 at 3.3V	3.3 and 2.4	NRE starts at \$30,000	System clock speeds >200 MHz; cell- and gate-array-based; 4-layer metallization; 160 kbits of RAM and 350 cells; PECL, GTL, and PCI interfaces
Mitsubishi Circle No. 327	0.5- $\mu$ m CMOS ASIC	1 million	1.3	170	3.3	Not specified	2- or 3-layer metallization; programmable-current output buffers; 256-kbit RAM with 3.7-nsec access time
Motorola Circle No. 315	H4CPLUS (0.6 $\mu$ m)	13,000 to 295,000	3 at 5V, 1 at 3V	28 at 5V, 42 at 3V	3.3 and 5	NRE ranges from \$35,000 to \$200,000	Current-mode logic-transceiver logic buffers permit CMOS chip-to-chip interfaces >200 MHz; customer-defined array allows large diffused blocks, such as RAMs; 3-layer metallization
NCR Corp Circle No. 316	VS500 (0.75 $\mu$ m)	200,000 (180 core-cell functions)	3.55 at 5V, 1.45 at 3.3V	280	3 and 5	Not specified	Global clock tree synthesis to minimize skew; output slew-rate control; IEEE 1149.1 JTAG boundary-scan functions, including test-access-port controller; power simulation provides early identification of thermal characteristics

Table continued on pg 46

# *There may be only one power source more reliable than our switchers.*



**Condor's Global Performance<sup>®</sup> power supplies offer continuous range input, full agency approvals and more.**

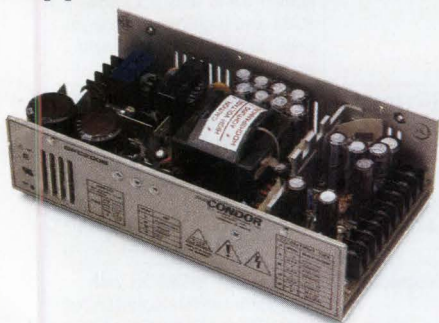

Our Global Performance switchers give you reliability, performance and full agency approvals, including UL1950 without D3 deviation, CSA22.2 No. 234 Level 3, IEC950, EN60950, VDE0805 Class B EMI and VDE0871 Level B EMI. Medical versions are approved to UL544, IEC601-1, CSA234 Level 3 and VDE0750.

Features include:

- 71 models (single- and multi-output)
- Industry-standard packages
- Custom designs available
- 8 power levels (40 to 225W)
- Continuous-input voltage (85-264VAC)
- OVP on all 5V outputs and single-output units

- MTBF 100,000+ hours per Mil Hndbk 217E
- 8-hour burn-in with cycling (24 hours on medical versions)
- Computerized testing (data sheets furnished)
- 2-year warranty
- 30-day FREE evaluation (call for samples)

If you want top performance and reliability with quick turnaround and competitive pricing, try Condor's Global Performance switchers. The only approval they're missing is yours!

**WORLD CLASS RELIABILITY**  
**CONDOR**

Condor D.C. Power Supplies, Inc. • 2311 Statham Parkway, Oxnard, CA 93033 • (805) 486-4565 • 1-800-235-5929 (outside CA)  
FAX (805) 487-8911 • Send for our catalog, or see us in EEM.

CIRCLE NO. 84

EDN July 7, 1994 • 45

## LOW-POWER ASICs

geometries. LSI's LCB500K cell-based technology can achieve I/O frequencies from 100 to 500 MHz having as many as 1.5 million gates. The large densities require packages with large pin counts and many power and ground pins to

prevent ground bounce when many outputs switch simultaneously.

### Automatic test makes life easy

Traditional test methodologies become impractical at such large den-

sities. LSI Logic has developed an automatic JTAG builder that generates IEEE 1149.1 test vectors. The automatic-test capabilities can insert a boundary-scan/test-access-port controller, generate tests for boundary-

### TABLE 1—LOW-POWER ASICs (CONT)

Company	Model	Maximum usable gates	Power dissipation ( $\mu\text{W}/\text{MHz}/\text{gate}$ )	Internal gate delay (psec)	Supply voltage (V)	Price	Features
NEC Electronics Inc Circle No. 317	CB-C8 (0.5 $\mu\text{m}$ )	600,000	0.8	130	3.3	208-pin PQFP with 64 kbits of RAM: \$50 (10,000)	64 kbits of RAM and 256 kbits of ROM; 300 macro functions include analog components and data-path-compiled macros; GTL-bus interface and on-chip PLL; 440 I/O pads having 124- $\mu\text{m}$ -pitch; 5V-tolerant I/O pins
	ECL-8 (0.5 $\mu\text{m}$ )	23,000 and 68,000	1.5 mW/gate	050	-3.3 and -5.2	68,000 gates in a 364-pin ceramic QFP: \$770 (5000)	Supports an output frequency as fast as 1.2 GHz; embedded self-timed RAM; cell structure=10 npn transistors, 16 resistors, one capacitor; 4-GHz toggling frequency; supported by Synopsys and Cadence design software
	BiCMOS-8CL (0.5 $\mu\text{m}$ )	165,000	3.3	180	3.3	\$441 (3000) for 447-pin plastic PGA	Operates at 150-MHz I/O frequency; 10KH ECL, 100K ECL; low-voltage TTL and GTL interfaces; 8-nsec 256 $\times$ 8-bit BiCMOS RAM; on-chip PLL; 3- or 4-layer metallization
Oki Semiconductor Circle No. 318	MSM33S-0000 (0.8 $\mu\text{m}$ )	6.5 to 135,168	Not specified	250	3 and 5	NRE starts at \$33,000	Automatic test-vector generation using scan macros; clock-skew management guarantee <1-nsec skew; slew-rate-controlled outputs; megacells, such as UARTs, SCSI controller, and JTAG boundary scan
	MSM10R-0000 (0.5 $\mu\text{m}$ )	12,230 to 541,632	Not specified	110	3.3	NRE starts at \$98,000	624 I/O pins having a 100- $\mu\text{m}$ pitch; 3-layer metallization; megacells include RAM, ROM, UARTs, and SCSI controller; clock-skew management of 0.5 nsec; IEEE 1149.1 JTAG boundary scan
SMOS Circle No. 319	SLA2-0000 (0.65 $\mu\text{m}$ )	10,700 to 100,000	1.6 at 3V	280 at 5V, 45 at 3V	3 and 5	NRE starts at \$15,000	System clock speeds >100 MHz; I/O-level shifting to handle mixed-voltage supplies; 128 to 368 I/O pads; RAM and high-density megacells, including UARTs and embedded Z80 $\mu\text{P}$
	SLA100L (2 $\mu\text{m}$ )	6400	0.3	8.5 nsec at 1.5V	0.9 to 3	NRE ranges from \$15,000 to \$25,000	2-layer metallization; 178 I/O pads; 4- and 8-mA output current at 5V
	SLA100X (2 $\mu\text{m}$ )	1224 to 6200	0.3 at 1.5V	8.5 nsec at 1.5V	0.9 to 3	NRE ranges from \$15,000 to \$25,000	On-chip level shifters from 1.5 to 3 and from 3 to 5V; 2-layer metallization; 24- or 48-mA output drive current at 5V
Synergy Circle No. 320	System Elements family (1.2 $\mu\text{m}$ )	500 to 3500 cells (70,000 gate equivalents)	Programmable at 350 to 1200 $\mu\text{W}/\text{cell}$	70	5	Not specified	Bipolar and BiCMOS with transistor trench isolation for $f_t=17$ GHz, mixed-signal designs with more than 20 analog blocks, including PLLs and DACs; 2-level ECL structures

Table continued on pg 48

# The World's Most Accurate A/D for Low Level Signals

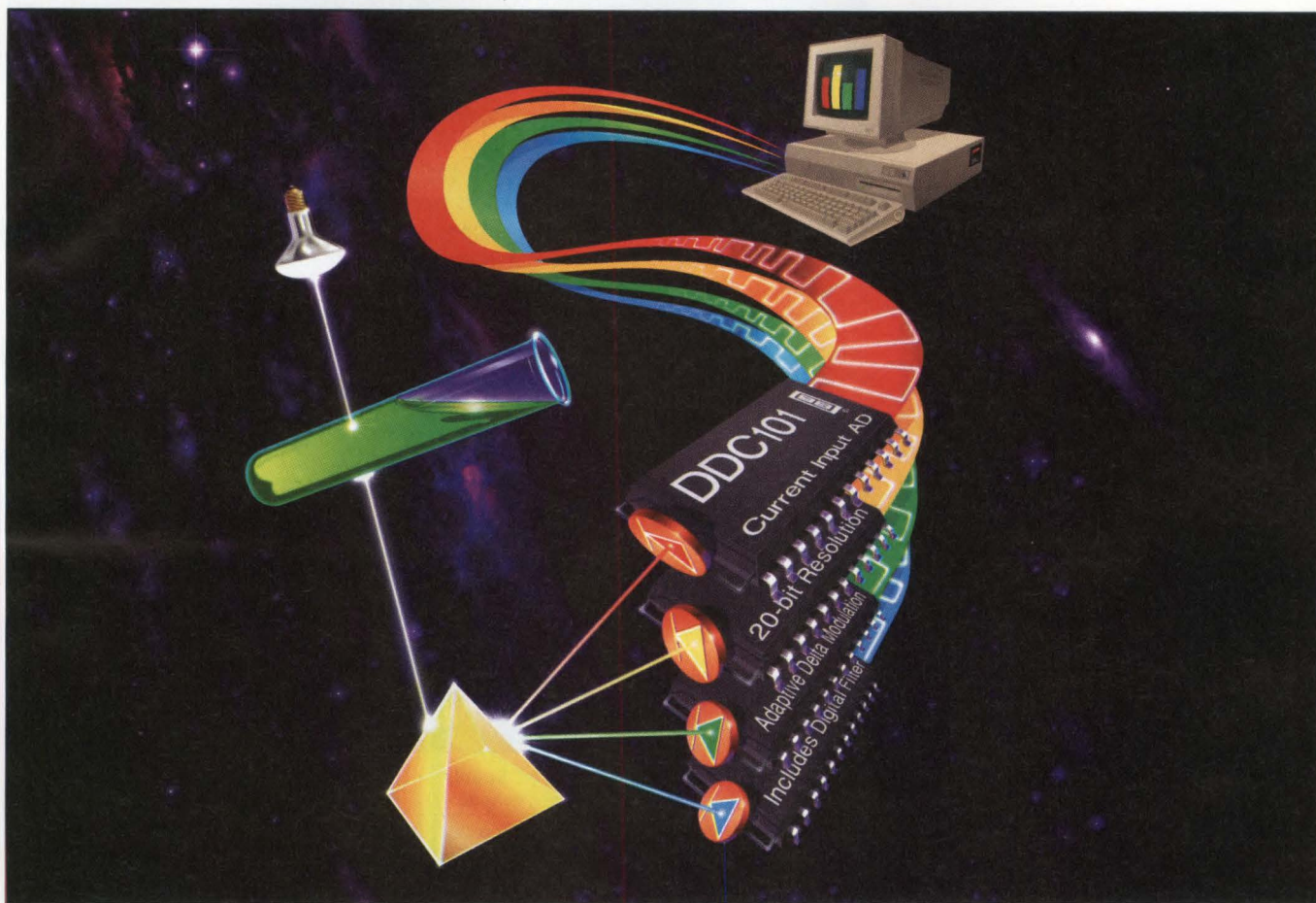

## 20-Bit Photo Sensor A/D

**DDC101** is a 20-bit, current input A/D converter designed for direct connection to photodiodes and other low level current output devices. It replaces an amplifier circuit, programmable-gain amplifier, and high resolution A/D converter—all on a single, monolithic chip. Use **DDC101** for photosensor digitization, medical analyzers, data acquisition systems, chemical analyzers, and infrared pyrometry. It's the closest thing to digitized light!

## Light Years Ahead Architecture

**DDC101's** patented delta modulation architecture accurately digitizes a current signal. Using digital integration, oversampling, digital filters, and DSP, it improves noise and linearity as the input level decreases. Or, as the input signal gets smaller and smaller, **DDC101** gets better and better—with an input signal of 0.1% full scale the maximum linearity error is only 0.00028% FSR! Its conversion rate is up to 15kHz. It is the world's most accurate A/D for low level signals!

## DDC101 Key Specifications

- Resolution.....20-bit
- Noise.....1.6ppm, rms
- Conversion rate .....up to 15kHz
- Accuracy at low level .....2.5ppm of FSR, (max)
- Power dissipation.....170mW
- Digital error correction.....CDS
- Packages.....28-pin DIP and 24-pin SOIC
- Demo Board with part (\$350.00)
- From **\$18.50** in 1000s

## See the Light...FREE Samples!

Try the light years ahead solution! Get your **FREE** sample and detailed data sheet by calling **1-800-548-6132**. Or, contact your local sales rep for more information.



CIRCLE NO. 79



Burr-Brown Corp. • P.O. Box 11400 • Tucson, AZ 85734

EDN July 7, 1994 • 47

## LOW-POWER ASICs

scan logic, and automatically generate boundary-scan description logic. The builder uses the JTAG cells in the ASIC libraries. The 500,000-gate, 3.3V library includes RAM, ROM, FIFO buffers, delay-line memories, PLAs, and content-addressable memory. The library is also available in a 2.4V version for internal and I/O macrocells.

VLSI's 0.5- $\mu$ m FlexArray and cell-based designs have both SRAM and ROM compilers for as much as 128 kbits of memory. Cell-based designs can use a functional-system-block library that comprises embedded processors, serial communications controllers, SCSI controllers, and host interfaces. A typical 2-input NAND gate operating at 3V with a fan-out of 2 has a 190-psec propagation delay and a 1.1- $\mu$ W/MHz/gate power factor.

## LOOKING AHEAD

Vendors are relentlessly pushing to lower process geometries to achieve higher gate densities and lower feature levels. Attendant with this push is the drive to maintain low-voltage power supplies and, consequently, lower power consumption. But changing a fabrication facility to achieve lower geometries is a pure financial decision. It costs about \$500 million to put a new fabrication facility in place. Therefore, many vendors want to reap some benefits from existing facilities before investing in a new one.

Nevertheless, companies are going forth with fabrication investments. For example, American Microsystems Inc will bring a 0.6- $\mu$ m facility on-line by the fourth quarter to produce a family of 3V-only gate arrays. IBM has already approved a 0.25- $\mu$ m fabrication facility for higher-density arrays operating at 2.5V. The new family will feature five layers of metallization, shallow trench isolation, and stacked vias. These low voltage ASICs are increasingly interfacing to low-level interfaces, such as Gunning transceiver logic, low-voltage TTL, and PCI.

The packaging issue for these high-density, low-voltage gate arrays has gotten out of hand. Ball-grid arrays seem to be popular, but ceramic pin-grid arrays, plastic flat packages, ceramic flat packages, tape automated bonding, and plastic leaded chip carriers all come with myriad pin counts and are vying for position. Your choice depends on cost and thermal demands (Ref 1).

### TABLE 1—LOW-POWER ASICs (CONT)

Company	Model	Maximum usable gates	Power dissipation ( $\mu$ W/MHz/gate)	Internal gate delay (psec)	Supply voltage (V)	Price	Features
Texas Instruments Circle No. 322	TGC1000 at 5V, TGC1000LV at 3V (0.7 $\mu$ m)	16,000 to 455,000	0.8 at 3V	270 at 5V, 360 at 3V	5 or 3.3	NRE starts at \$20,000 for the TGC1000 series	2- or 3-layer metallization; sea-of-gates architecture with digital PLL operating as fast as 100 MHz at 5V and 60 MHz at 3V; CMOS base cell operates as low as 2.7V; supports mixed-voltage I/O levels; automatic test-pattern generation using level-sensitive scan design
Toshiba Circle No. 323	TC180 Series (0.5 $\mu$ m)	30,000 to 315,000 (TC183G)	2.2	230	3.3 and 5	NRE: \$114,600	Gate array (TC183G), embedded array (TC183E), standard cell (TC183C); 3.3 and 5V I/Os; 2- or 3-layer metallization; embedded blocks include RAM and multipliers; 628 I/O pads
	TC170 series (0.7 $\mu$ m)	22,000 to 194,000 (TC170G)	4.4	270	5	\$15 for 45,000 gates	2-layer metallization, less power than previous 0.8- $\mu$ m, 5V ASICs; gate array (TC170G), standard cell (TC170C), libraries compatible with TC180 series
VLSI Circle No. 324	FlexArray (0.5 $\mu$ m)	800,000	1.1	190	3.3	Not specified	2- and 3-layer metallization, cell-based libraries contain large functional-system blocks; supports system-clock rate as fast as 200 MHz; 672 pins on a taped ball-grid array; GTL- and PCI-compliant I/O interfaces; IEEE 1149.1 boundary scan

Super Circle  
Number



For more information on low-power ASIC products available from all of the vendors listed in this box, you need only circle one number on the postage-paid reader service card. **Circle No. 325**

# Which gets your data faster and easier?

TEXT BASED LANGUAGE

DT VEE FOR WINDOWS

Fred Molinari,  
President

## DT VEE for Windows: the Obvious Choice!

**Half Price!**  
All VEE Products  
Limited Time Offer.  
Call Today!

### GET DATA FAST AND EASY!

A complete application  
in three simple steps



- Quick to learn, easy to use
- Powerful data analysis and display
- 100% Windows: simplified interface, DDE
- Flexible application development and maintenance
- No time-consuming compiling—ready to run

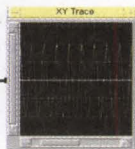

Speed your application development with DT VEE™ for Windows.™ DT VEE is a complete graphical programming approach that lets you create sophisticated data acquisition applications without ever writing code.

With DT VEE, you easily create, debug, and document. Program development is intuitive—simply connect function-specific objects in a logical sequence and run. It's that easy.

With more than 180 analysis functions, comprehensive display capabilities, and full hardware support, DT VEE has everything you need for data acquisition. DT VEE is based on HP VEE for Windows,™ and is backed by the Hewlett-Packard and Data Translation commitment to quality.

**Call 1-800-525-8528 today (In USA and Canada).  
FREE DT VEE evaluation version available.**



**DATA TRANSLATION**

World Headquarters: (508) 481-3700, UK Headquarters: (0734) 793838, Germany Headquarters: (07142) 95 31-0, Italy Headquarters: (030) 2425696. Sales Offices: Argentina (1) 322-3791; Australia 2699-8300; Austria (222) 367660; Belgium (02) 466.81.99; Brazil 011-564-6024; Canada (800) 525-8528, (800) 268-0427; China (1)-8318811-5223; Denmark 42 27 45 11; Finland (0) 3511800; France (1) 69.07.78.02; Greece (1) 361-4300; Hong Kong 515-0018; India 22-2831040; Israel 09-545685; Japan (03) 5379-1971, (03) 5489-3871, or (03) 5689-8000; Korea (2) 718-9521; Malaysia (3) 248-6786; Mexico 575-6091; Netherlands (70) 399-6360; New Zealand (9) 415-8362; Norway (22) 43 41 50; Portugal (1) 7934834; Singapore 773 4300; South Africa (12) 803-7680/93; Spain (1) 555-5112; Sweden 08-765 02 80; Switzerland (1) 908-1360; Taiwan (2) 3039836; Thailand (02) 281-9596; Turkey (212) 288-6213 4/27/94

# Get SMART<sup>™</sup> REGULATORS

Enable...Reset...Watchdog

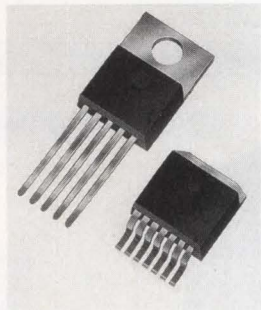

Cherry Semiconductor SMART Regulators, give you clean, tightly-regulated supply lines, sophisticated micro-processor monitoring & control, and energy conservation capabilities all in one IC!

Available in a range of efficient power packages, simply select the best combination of logic functions for your application:

- **Get ENABLE** to control your system actuators as needed.
- **Get RESET** for your micro-processor during low voltage conditions.
- **Get WATCHDOG** protection against microprocessor misexecutions.

Call 1-800-272-3601 for your FREE Smart Regulator<sup>™</sup> Selection Guide!

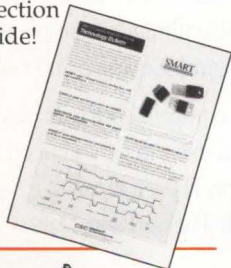

## CHERRY SEMICONDUCTOR

Cherry Semiconductor Corporation  
2000 South County Trail, East Greenwich, RI  
401 885-3600

CIRCLE NO. 75

## EDN-TECHNOLOGY UPDATE

### LOW-POWER ASICs

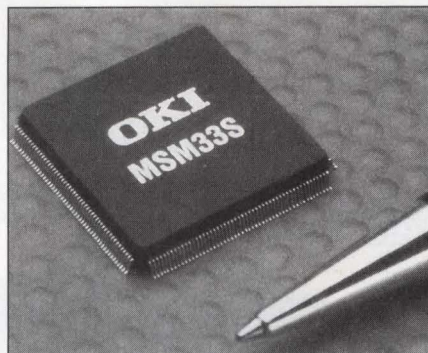

Oki Semiconductor's 0.8- $\mu$ m MSM33s0000 sea-of-gates architecture features slew-rate-controlled outputs, which can be configured as 3 or 5V, TTL, or 3-state having a 2- to 24-mA driver.

Hitachi recently introduced a 0.5- $\mu$ m CMOS gate and embedded array having raw gate counts ranging from 52,000 to 667,000. The HG72G/E family operates faster than 100 MHz and has 500,000 usable gates and as many as 500 I/O pins. Despite advances in low-power operation, such ASICs can dissipate 15 to 20W. Hitachi has developed a ball-grid-array package with as many as 672 I/O pins to handle these high-density applications. The HG72G/E family offers on-chip PLL clocks and a maximum metallized memory storing 256 kbits.

**Table 1** highlights some representative low-power ASICs. Although the gate densities are high, many of today's EDA tools and package technologies limit the practical density of designs. Many times you can achieve a power savings by breaking up a design into multiple ASICs and using more than one less expensive package. **EDN**

### Reference

1. Pivin, David P, "Pick the right package for your next ASIC design," *EDN*, February 3, 1994, pg 91.

You can reach Technical Editor John Gallant at (617) 558-4666; fax (617) 558-4470.

### VOTE

Please use the Information Retrieval Service card to rate this article (circle one):

High Interest 589	Medium Interest 590	Low Interest 591
----------------------	------------------------	---------------------

# PICO

Free 136 pg. catalog

SURFACE MOUNT  
& PLUG-IN  
TRANSFORMERS  
& INDUCTORS

## DC-DC CONVERTERS

- Surface Mount • PC Board Mount
- Low Profile • Single and Dual Output
- Isolated • Industrial to Military
- up to 1000 Volts

## AC-DC POWER SUPPLIES

- Linear • Switchers • Open Frame
- Low Profile • Up to 200 Watts

## New HIGH POWER DC-DC CONVERTERS

- New Isolated **DUAL** Outputs
- Wide Input Voltage Range
- Regulated 100 Watts



See EEM or send direct for Free PICO Catalog.  
Call toll free **800-431-1064**  
in NY call **914-699-5514**  
FAX **914-699-5565**

**PICO Electronics, Inc.**

453 N. MacQuesten Pkwy., Mt. Vernon, N.Y. 10552

CIRCLE NO. 123



# Power Tools



Highlight critical paths across windows

QuickBoolean entry embedded in schematic symbol

Simulation results dynamically displayed on schematic

Path timing met via timing driven placement

## The Fastest Tools for the World's Fastest FPGAs

The fastest **time-to-market** is attained when designers use productivity Power Tools for QuickLogic's *WildCat*™ Series — the world's fastest FPGAs.

QuickLogic toolkit owners find instant productivity with the intuitive interfaces of both our Windows and Sun packages. These tools feature 100% automatic place and route using advanced timing-driven placement that eliminates time-consuming intervention with hand tools.

### Great Power Tools Drive Great FPGAs

Our pASIC® family's low cost *WildCat* Series provides a wealth of interconnect resources for an environment where design iterations have no effect on pin-out and minimal effect on timing. Even the use of all I/O and flip-flops will consume only 5% of the available interconnect. And your designs will *always* route, even with all pads fixed.

At the heart of QuickLogic's software is a tool called SpDE™ (Speedy), and it lives up to its name by running 1K usable-gate designs in under 2.5 minutes. And our toolkit also includes a powerful Technology Mapper, which improves *any* synthesized

result, including VHDL and Verilog, with up to 60% reduction in silicon and a performance increase of 25%.

If you need more convincing that QuickLogic delivers a superior time-to-market design solution, just fax us your business card. Be one of the first 100 faxes and receive a **FREE** Evaluation Kit, complete with all the tools you need to enter, simulate and analyze your design.

To learn more about our Power Tools, fax us at **408-987-2012** or call **1-800-842-FPGA (3742)** for a QUICK response.



**1-800-842-FPGA(3742) • European Fax: +49 (89) 857 77 16**

©1994 QuickLogic Corporation. pASIC is a registered trademark and SpDE and *WildCat* are trademarks of QuickLogic Corporation. All other trademarks are the property of their respective companies.

# Clip and Save!



No.	Product	Series	Type	Samples	Typical Circuit
1	Solid Chip Suppressor	NZ	1608		
			2012		
			3216		
			4516		
2	Inductor	NW	5750		
			2520		
3	Common Mode Choke	M	520		
			530		
			540		
		CZ	5745		
			TZ	5745	
4	Leadless Power Inductor	P•I-Z	9x7x5		
			12x10x6		
		P•I-L	9x7x5		
			12x10x6		
5	3-Terminal Noise Suppressor	E-T	4525		
6	3-Terminal Chip Capacitor	E-C	3216		

Project  
1000  
Tu

Ca  
re

Whether you're working with camcorders, cellular phones or electronics notebooks, signal lines or power lines, normal mode or common mode, TOKIN EMC components provide exceptional functionality that can boost your PC boards to a powerful new performance level!

**TOKIN**

**Tokin Corporation**

International Sales Department  
Sumitomo Seimei Sendai Chuo Bldg., 4-6-1, Chuo, Aoba-ku,  
Sendai 980, Japan  
Phone: 022-211-1281 Fax: 022-211-0975  
Korea Representative Office  
#602, Champs-Elysees Bldg., 889-5, Daechi-Dong, Kangnam-gu,  
Seoul, Korea  
Phone: (2) 569-2582 ~ 5 Fax: (2) 544-7087

**Tokin America Inc.**

155 Nicholson Lane, San Jose, California 95134, U.S.A.  
Phone: 408-432-8020 Fax: 408-434-0375  
Chicago Branch  
9935 Capitol Drive, Wheeling, Illinois 60090, U.S.A.  
Phone: 708-215-8802 Fax: 708-215-8804

**Tokin Electronics (HK) Ltd.**

Unit 705-707, Chiwan Tower, Park Lane Square, 1 Kimberly Rd.,  
Tsimshatsui, Kowloon, Hong Kong  
Phone: 730-0028 Fax: 375-2508  
Taiwan Liaison Office  
Phone: (02) 7728852 Fax: (02) 7714260  
Singapore Branch  
Phone: 2237076 Fax: 2236093, 2278772  
Shanghai Liaison Office  
Phone: 21-433-4488 Ext. 80809 Fax: 21-433-3265 Ext. 80809

**Tokin Europe GmbH**

Knorrstr. 142, 80937 München, Germany  
Phone: 089-311 10 66 Fax: 089-311 35 84

# Some Delays Can't Be Avoided.

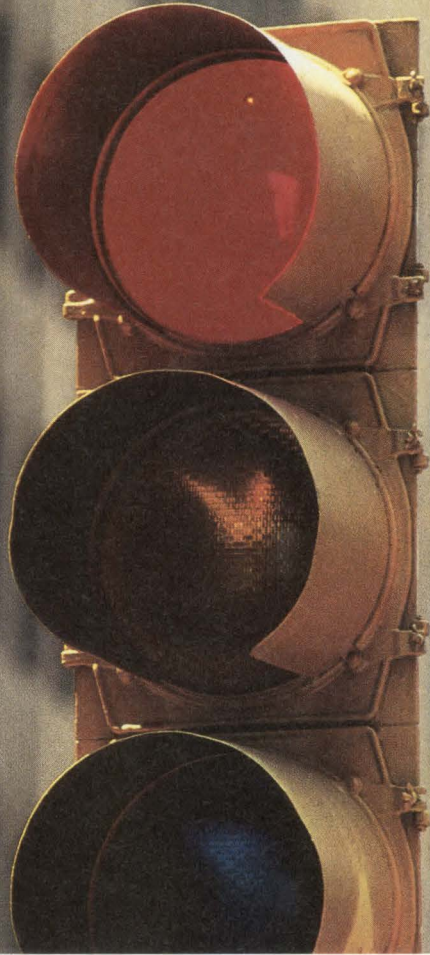

## Some Can.



No one likes delays. System engineers especially. That's why we invented a logic switch so fast it 'disappears' in your system. Its 250 ps propagation delay is *at least* 10 times faster than standard logic devices. So you can say good-bye to logic-induced performance penalties for good.

This high-end technology has swiftly grown into our QuickSwitch® product family. Offering pin-for-pin replacements for bus switches, high-speed buffers and transceivers, and mux/demux devices.

QuickSwitch products deliver delay-free 5V-to-3V signal conversion making them ideal for emerging

Pentium-based PCs as well as laptops and PDAs. They also have the hot-plug (live insertion) capability plus a low 5-ohm "On" resistance. They add no power dissipation, no ground bounce, and require no directional control.

QuickSwitch devices come in SOIC, QSOP, and now QVSOP™ as well as standard DIP packages. Call today for the popular *QuickSwitch Product Handbook* chock full of innovative, customer-inspired applications. 1-800-609-3669. Or Fax 408/496-0773.

Avoid delay. We did.



Quality Semiconductor, Inc.

QuickSwitch is a registered trademark of Quality Semiconductor, Inc. Q and QVSOP are trademarks of Quality Semiconductor, Inc.

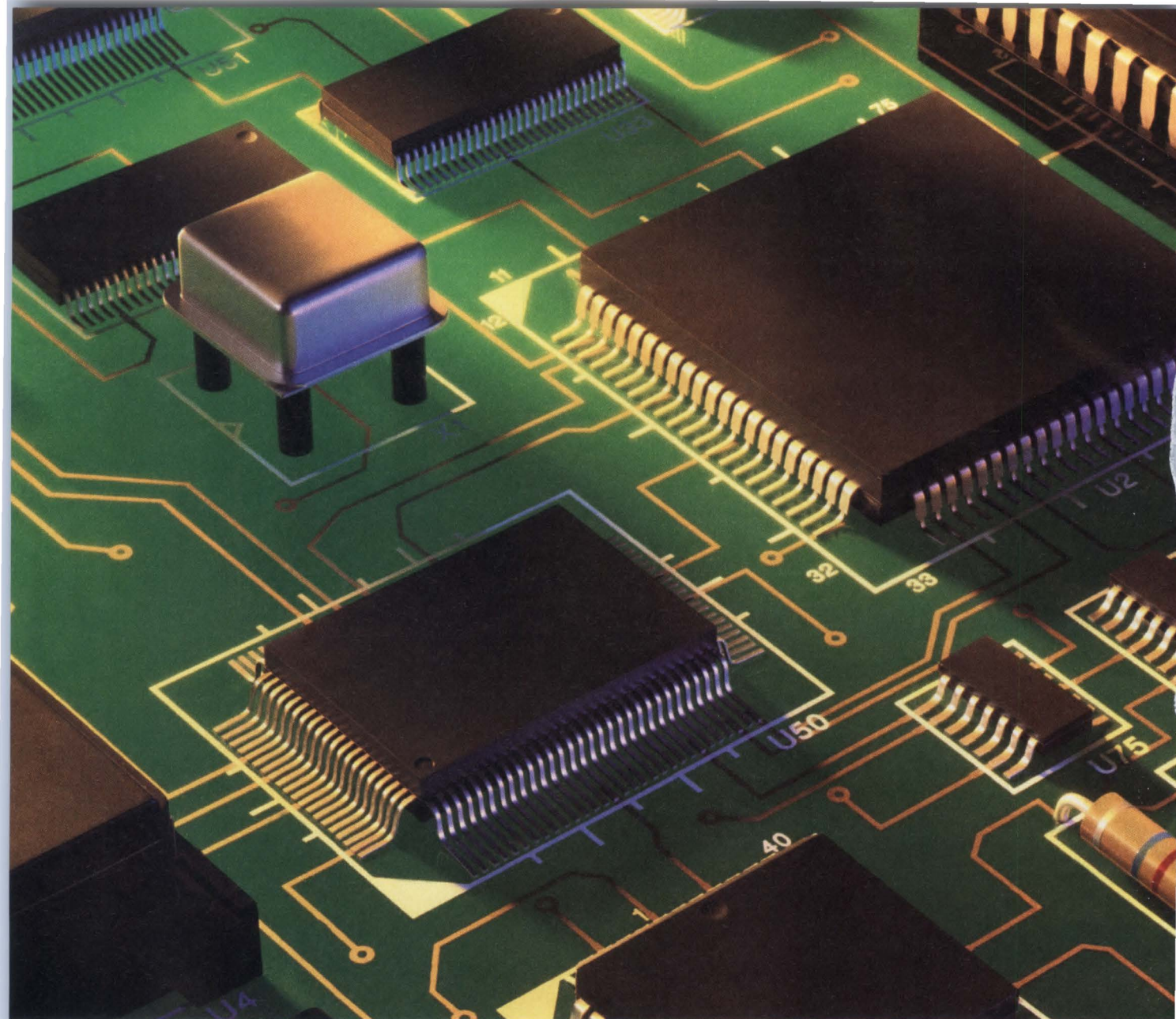

# For the industry's most wake up to



With FPGAs, it's always something. Sacrifice speed to get density. Give up low power consumption for speed. If you're tired of living with compromise, you'll love what Intel is serving up.

Intel's FLEXlogic family of devices offers the best combination of performance, predictability and advanced features, with low risk and fast time to market. Here's a taste of what we offer:

With FLEXlogic devices, your pin-to-pin  $t_{PD}$

is 10ns. Period. No matter what path you choose or how you route the device. That makes them the fastest FPGAs at comparable densities, without design surprises.

FLEXlogic chips are extremely flexible, too.

Intel FLEXlogic Family				
DEVICE	MACROCELLS	$t_{PD}$	I/O	$I_{CC}$
iFX8160	160	10ns	168	2.5mA/MHz
iFX780	80	10ns	102	1.5mA/MHz
iFX760	60	10ns	60	1.5mA/MHz
iFX740	40	10ns	50	1mA/MHz
iFX730	30	10ns	30	1mA/MHz

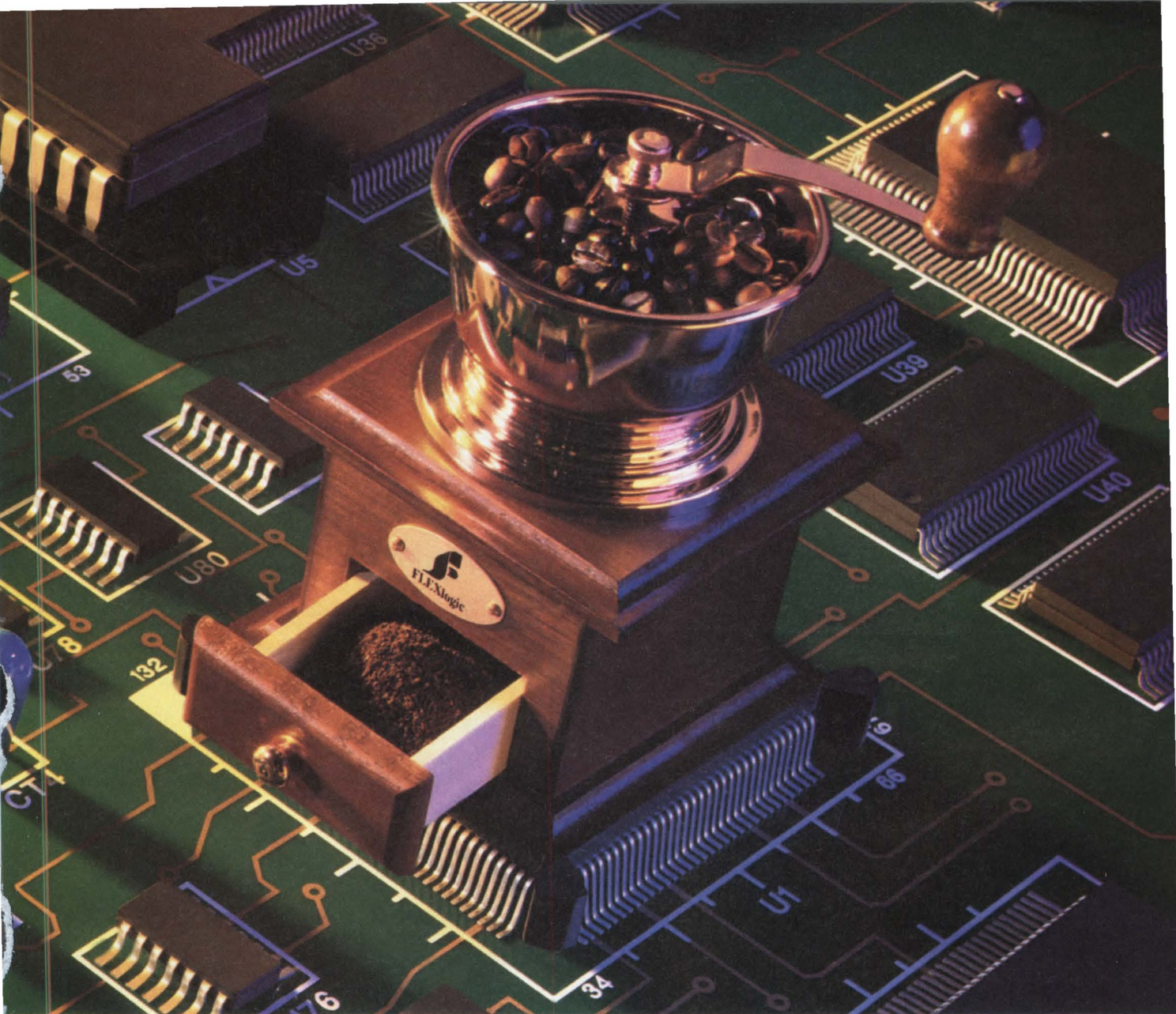

# select blend of features, Intel FLEXlogic.

Their configurable function blocks can be programmed as either 24V10 logic or SRAM. They also have a high number of I/O pins, which you can program for either 5V or 3.3V operations.

And FLEXlogic devices reduce design hassles. For example, they fully support JTAG Boundary Scan IEEE 1149.1 and in-system reconfiguration. And the new iFX8160 has on-chip Flash for in-system reprogramming.

To further simplify the design process, Intel FLEXlogic devices are supported by Intel PLDshell

Plus software, available for free, as well as advanced design support on industry-standard CAE tools.

A new day is dawning for logic devices. Call 1-800-879-4683, ext. 138 for complete FLEXlogic specs, or dial FaxBack\* at 1-800-628-2283, doc. #2725. Because when it comes to logic innovation, Intel definitely has something brewing.

**intel**®

# Power-One

One power supplier for all reasons.



## LINEARS

Produced in an ISO 9000 certified facility and agency certified to EN60950, Power-One linears continue to set the standards for performance.



## MAP SERIES™

40 to 130 watts - This robust low-power switcher product line features autoranging, high power densities and superior regulation.

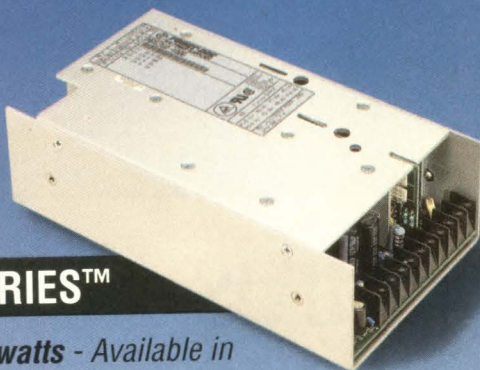

## NRG SERIES™

250 to 550 watts - Available in modular configurations with up to seven outputs or four-output non-modular OEM configurations.



## HIGH POWER

500 to 2500 watts - These modular products provide up to 21 outputs. Options include power factor correction.



# Power-One™

## POWER SUPPLIES

"Dedicated Supplier For Over 20 Years"

740 Calle Plano • Camarillo, CA 93012 • [800] 693-0212 • FAX [805] 388-0476

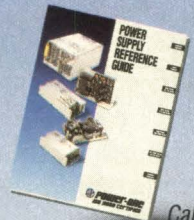

Call For Our Catalog Today!



Power-One logo, NRG Series, MAP Series and ISO 9000 logo are trademarks of Power-One, Inc.

## SURFACE-MOUNT POWER MAGNETICS

# Isolated innovation marks movement toward miniature magnetics

RICHARD A QUINNELL, Technical Editor



**Hampered by fundamental physical limits and manufacturing constraints, the magnetics industry is slowly joining the trend toward surface-mount designs. Standardization, however, remains a distant dream.**

Nearly every segment of the electronics industry has struggled to adapt to surface-mount technology. One of the last holdouts, the magnetic component used in power conversion, is finally adapting, and innovative products are beginning to appear. Surface-mount power magnetics form an immature technology, however, and designers should proceed carefully when selecting components. They should also keep their expectations modest.

Compared with the progress that other electronic components have made toward surface mount, magnetics are only now emerging from the dark ages. Offerings are limited, standardization is nonexistent, and components are still relatively bulky. But such a comparison is a bit unfair, because magnetic components suffer from some fundamental limitations that other components don't face.

Consider, for example, the component's bulk. Before surface-mount technology became widespread, devices such as resistors, capacitors, and semiconductors were a given size, mainly based on packaging. The functional portion of the component could be as low as 20% of the package's total volume. The ubiquitous  $\frac{1}{4}$ W resistor, for example, was widely used because it was inexpensive, not because designs needed the power rating. As circuits

shrank, reducing the resistor's size was relatively easy. Even ICs have seen much of their size decrease because of packaging innovations, not die shrinks.

As a result of the relative ease with which other components shrank, designers have come to expect similar strides in magnetic components. They have been disappointed. Yet there are a number of significant reasons as to why progress has been slow. These reasons include both manufacturing and physical limitations.

Most magnetic component manufacturers are small to midsized companies with tools

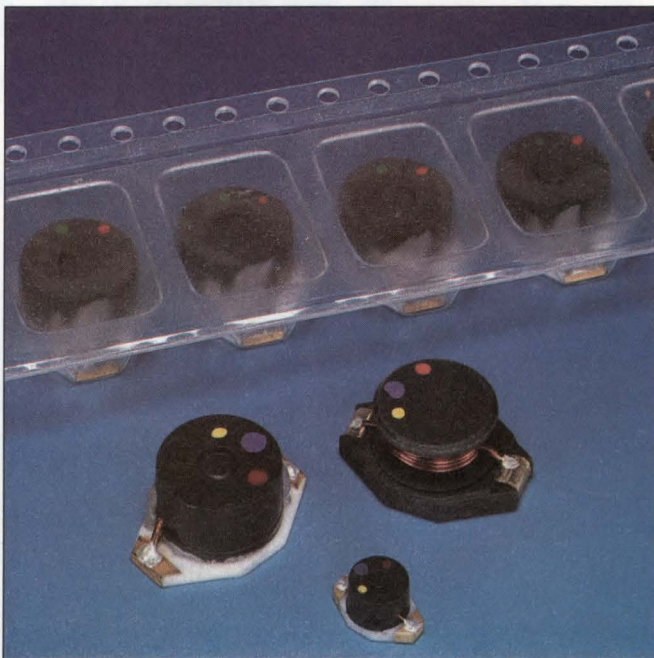

**Surface-mount power magnetics such as the DT and DO series from Coilcraft, shown here, are making some strides toward compactness. Ultimately, however, such devices are limited in how small they can become by their core dimensions.**

## SURFACE-MOUNT POWER MAGNETICS

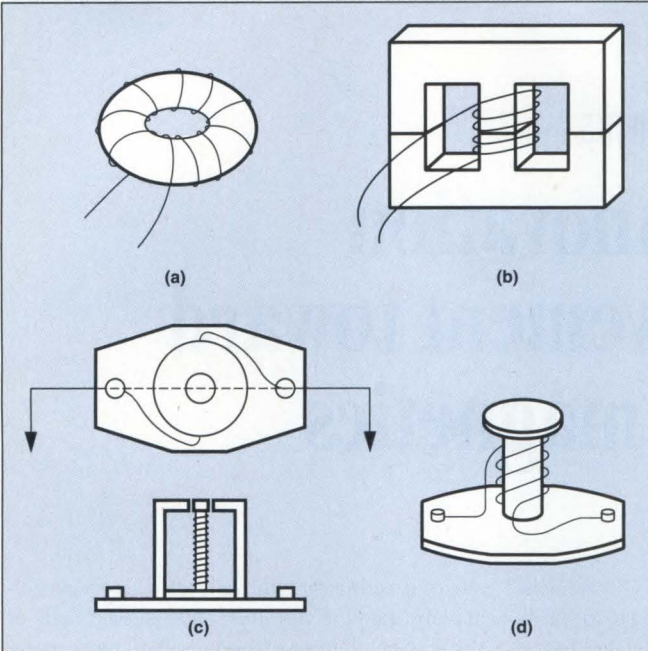

Fig 1—Surface-mount inductors can have an open- or a closed-core design. The toroid (a), double-E (b), and pot (c) cores form closed magnetic paths, reducing the generation of EMI. The open-core design (d) can handle more current but can interfere with sensitive components.

designed for producing traditional component sizes. Most equipment for producing magnetic cores, for example, has an absolute machining tolerance of 0.1 mm to 0.5 mm (0.005 to 0.020 in.). That tolerance is fine for components that are larger than 10 mm (0.4 in.). It represents an intolerable variability when creating a product that must be shorter than 1.2 mm (0.05 in.) to fit inside a PCMCIA card. But the smaller companies remain reluctant to retool because

the resulting capital expenditure represents a significant portion of their resources.

Such problems are readily solved, however, if there is enough money waiting for those that take the risk. The market is not yet at that point. The emergence of a substantial, uniform market for small magnetic components or the assistance of a large customer is needed to change the manufacturing situation. What will not change so readily are the physical limits that keep magnetic components relatively large.

### Physics prevents small magnetics

The physical limits stem from the energy-storage capacity of magnetic devices. The energy ( $W$ ) stored in a component with inductance ( $L$ ) carrying an instantaneous current ( $I$ ) is:

$$W = \frac{1}{2}LI^2$$

If the inductor is a solenoid of height ( $h$ ) and core cross-sectional area ( $A$ ),

**ORDER NOW**

# 90MHz PENTIUM™ PRO

## Passive Backplane Single Board Computer

Optional Fan Power

IDE Connector

Floppy Connector

Parallel Port

Industry Standard Auxiliary Ports

512Kb External Secondary WriteBack Cache

Up to 128Mb DRAM Onboard

**90MHz PENTIUM™ PROCESSOR**  
3.3 VOLT





its inductance value is approximately:

$$L = \mu N^2 A / h, \quad (1)$$

where  $\mu$  = the core inductance and  $N$  = the number of turns of wire around the core. The magnetic field strength ( $B$ ) inside the core is:

$$B = \mu NI / h. \quad (2)$$

Magnetic cores have an upper limit on the field strength they can contain that, in turn, limits the energy the inductor can store. Solving Eq 2 for  $I$  and combining with Eq 1, you can calculate the energy storage as:

$$W = B^2 Ah / 2\mu.$$

The volume ( $A \times h$ ) of core material used, therefore, sets an upper limit on the energy an inductor can store.

The energy-storage needs of power-converter circuits, then, determine the minimum size surface-mount magnetic components can achieve. You have some

flexibility in that you can trade increased core area for decreased height, thus shrinking the magnetic component's profile. There must be enough height to accommodate the wire turns, however, so even this tradeoff has its limits.

## LOOKING AHEAD

Designers' major complaint about surface-mount power magnetics, their lack of standards, is unlikely to be corrected anytime soon. For many magnetics suppliers, their competitive edge is the uniqueness of their products. Once their products are designed in, the manufacturers are ensured of a customer. A move toward standardization threatens their existence.

That situation could change if the market demands standardized products. There are some indications that such demands are growing, but the market remains small. The most likely candidate for growing the small standard-magnetic-component market is the PCMCIA card. It has the potential of forming a large demand for low-cost, widely available magnetics; that is, standardized products.

The designer's other complaint, size, is more likely to see industry activity, although that activity will remain sporadic without a concurrent move toward standardization. Magnetics manufacturers are interested in finding new designs and methods; they just can't afford to take too much risk on their own. With the help of large customers, however, they will continue to create options in small magnetic components. Progress will be slow, that's all.

### Increase $f$ , lower $L$

Another option is to raise the switching frequency ( $f$ ) in your power-conversion circuit. The size inductor you need is inversely proportional to the switching frequency. Increasing switching frequency has its drawbacks, however.

# CESSOR puter Architecture

**3.3 VOLT  
LOW HEAT**

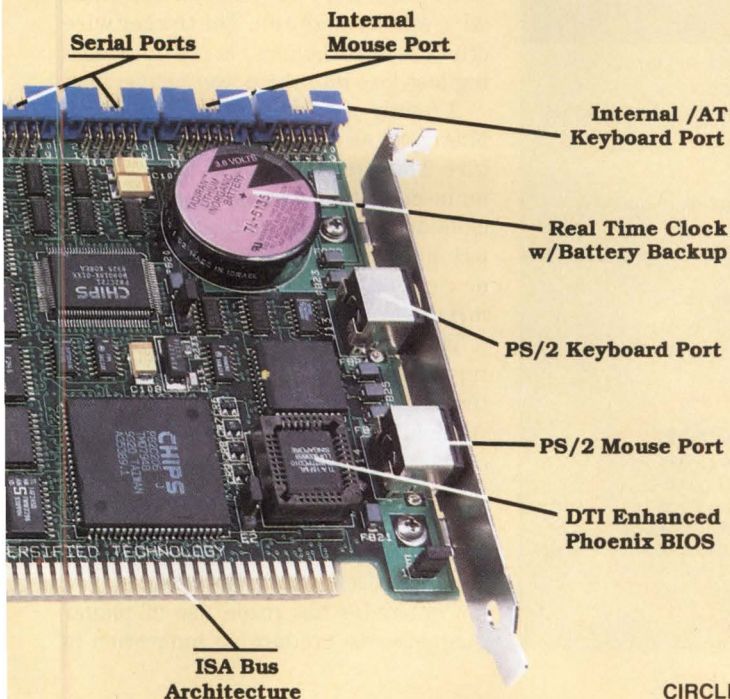

SPECIFICATIONS	CAT3010 Pentium™ Processor	CAT3001 Pentium™ Processor	CAT1070 i486™ Processor	CAT1012 i486™ Processor
90MHz PENTIUM™ 3.3 VOLT	✓			
60/66MHz PENTIUM™ 5 VOLT		✓		
50MHz 486DX & 50/66MHz 486DX2			✓	✓
33MHz 486DX/SX			✓	✓
VGA True Color w/BitBlit			✓	
Up to 512Kb PROM/FLASH Disk			✓	
16Kb Internal Pipelined Cache	✓	✓		
512Kb WriteBack 2nd Cache	✓	✓		
64Kb/256Kb WriteBack 2nd Cache			✓	✓
8Kb Internal Cache			✓	✓
Up to 128Mb DRAM Onboard	✓	✓		
Up to 64Mb DRAM Onboard			✓	✓
2 Serial Ports / 1 Parallel Port	✓	✓	✓	✓
IDE/Floppy Interface	✓	✓	✓	✓
PS/2 Mouse Support	✓	✓	✓	✓
/AT-PS/2 Keyboard Support	✓	✓	✓	✓
Manufactured In-House(USA)	✓	✓	✓	✓
Powermeter 1.2 MIPS 90MHz Pentium	72.1			
Powermeter 1.2 MIPS 66MHz Pentium		44.8		
Powermeter 1.2 MIPS-60MHz Pentium		40.2		
Powermeter 1.2 MIPS-66MHz 486 DX2			28.8	26.6

**Diversified  
Technology®**  
An Ergon Co.

Call us toll free for orders and information.

**1-800-443-2667**

U.S.A. - (601) 856-4121 Fax (601) 856-2888  
Outside U.S.A. - (201) 891-8718/Fax (201) 891-9629

Product names are trademarks or registered trademarks of their respective companies. 386, 486 & PENTIUM are trademarks of Intel Corp.

CIRCLE NO. 28

## SURFACE-MOUNT POWER MAGNETICS

In addition to generating additional EMI, higher frequencies increase ac losses in the inductor. These losses come from two effects: eddy currents and skin effects.

Eddy currents are electrical currents induced in the magnetic core material by the changing fields within the core. The currents circulate around the magnetic field path, dissipating energy as heat within the core material. The size of the currents depends on the changing magnetic field's frequency and the core material's conductivity. Proper selection of core material will limit eddy-current losses.

The skin effect refers to the tendency of high-frequency currents to remain near the surface of conductors. Because the current occupies only a portion of a wire's cross section, the wire's effective resistance increases with frequency. The solution is to use stranded wire when winding the coil, thus increasing the conductor's surface area for the same total volume. Winding small coils with fine stranded wire, however, can prove to be a costly alternative.

If you can't change your design to reduce your inductor needs, you're stuck with the core-volume limit. This limit is the major reason why surface-mount power magnetics have lagged behind other components in size reduction. All is not lost, however. There have

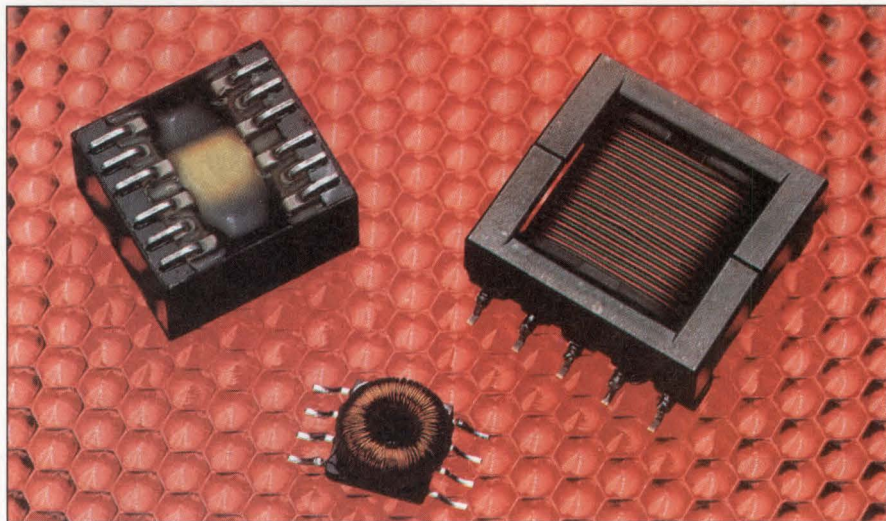

**A number of different core types are available in surface-mount form. Not all have the flat surfaces needed for automatic pick-and-place assembly, however. (Photo courtesy of GFS Manufacturing)**

been innovations in the industry, and several manufacturers have developed unique structures to reduce component size.

Two of the most common configurations for power magnetic components are the toroid and the double-E core (**Fig 1a** and **b**). Both are available in surface-mount versions from a variety of manufacturers. More recently, structures such as pot core (**Fig 1c**) have become available in products such as the Coilcraft DT series. Coilcraft has also created an open-core product (**Fig**

**1d**), the DO series, to provide increased current-handling capability.

### Open-core structures are smaller

The open-core structure of the DO series provides several attributes that allow for a greater energy-storage capability than do the more common structures. Because the magnetic field path passes through air, which does not saturate, the device can carry more current before saturating. In addition, the structure allows the use of thicker wire than is feasible with shapes like the toroid or double-E core, which have windows in the core material that thick wire would rapidly fill. The thicker wire offers less resistance, hence introducing less loss into the power conversion.

A family of axial inductors from GFS Magnetics also uses the open-core structure. These inductor blocks are intended for in-line filters in power conversion circuits and offer low dc-resistance. A 10  $\mu$ H inductor can handle as much as 4A-dc current, and inductors as large as 1 mH are available.

The drawback of the open-core structure these two devices use is a greater tendency to generate EMI. By allowing the field to pass through the open air, the open-core structure runs the risk of having the field interact with other parts on the circuit board. Closed cores constrain the inductor's magnetic field to reside almost entirely within the core.

Coiltronics has made use of planar magnetics to produce an innovation in

## FOR FREE INFORMATION...

For free information on the power-magnetic components discussed in this article, circle the appropriate numbers on the postage-paid Information Retrieval Service card or use EDN's Express Request service. When you contact any of the following manufacturers directly, please let them know you read about their products in EDN.

**Coilcraft Inc**  
Cary, IL  
(708) 639-6400  
**Circle No. 301**

**Coiltronics Inc**  
Boca Raton, FL  
(407) 241-7876  
**Circle No. 302**

**GFS Manufacturing Co Inc**  
Dover, NH  
(603) 742-4375  
**Circle No. 303**

**Pico Electronics Inc**  
Mt Vernon, NY  
(914) 699-5514  
**Circle No. 304**

**Premier Magnetics Inc**  
Aliso Viejo, CA  
(714) 362-4211  
**Circle No. 305**

### VOTE . . .

Please also use the Information Retrieval Service card to rate this article (circle one):

**High Interest 598**  
**Medium Interest 599**  
**Low Interest 600**

### Super Circle Number

For more information on power magnetic components available from all of the vendors listed in this box, you need only circle one number on the postage-paid reader service card.  
**Circle No. 306**

# How dense can you get?



← 1/2" →

## These remarkable new ultraminiature inductors can shrink your DC-DC converters to the bare minimum.

Coilcraft's DT Series inductors represent a significant breakthrough in size, performance and price.

Thanks to our exclusive L-tra™ magnetics enhancement technology, you get exceptionally high inductance and current capability in a small footprint part.

### "Swinging" inductance

Unlike other DC-DC converter inductors, these parts provide very high L at

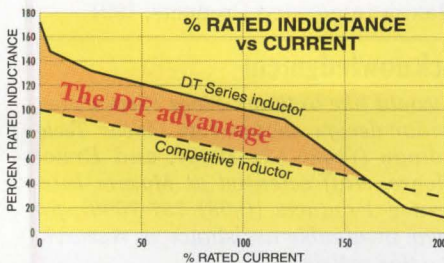

zero or low current. This "swinging" inductance characteristic is especially desirable in converters that have varying load currents. It eliminates the need to

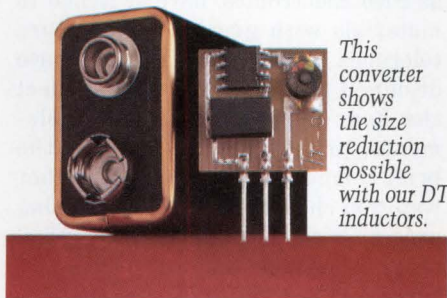

This converter shows the size reduction possible with our DT inductors.

use an excessively large inductor to accommodate small or no load conditions.

### Excellent power handling

Our DT inductors solve thermal management problems. As you can see from the graph, even at 150% of rated current the temperature rise is less than 15°. You can use them at much higher currents because their construction provides a natural heat sink.

### True surface mount design

All materials used in these inductors are optimized for surface mounting. There are no structural plastics or potting materials to be damaged by reflow soldering or cleaning oper-

ations. Their flat top and standard tape and reel packaging permit easy auto insertion. And self-shielding characteristics are on a par with toroid designs.

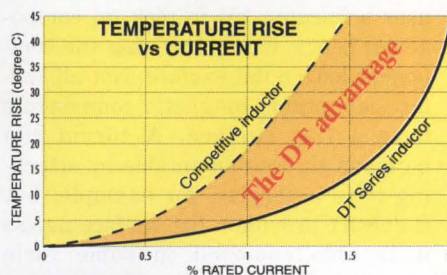

ations. Their flat top and standard tape and reel packaging permit easy auto insertion. And self-shielding characteristics are on a par with toroid designs.

### Free evaluation samples

Check out the size and performance advantages of these new DT Series inductors for yourself. Order our \$95 Designer's Kit No. C104 with 3 each of 38 different parts. Or call 800/322-2645 for free samples of two values.

Coilcraft

eem/electronic engineers master See our catalog in Vol. A, Section 1800

1102 Silver Lake Rd., Cary IL 60013 800/322-2645 Fax 708/639-1469

CIRCLE NO. 77

EDN July 7, 1994 ■ 63

## SURFACE-MOUNT POWER MAGNETICS

closed-core design. The company offers a 10- $\mu$ H double-E core inductor capable of handling 600 mA (peak) yet only 1.19 mm high. The device uses the traces on a multilayer pc board in place of wire for the coil, increasing the coil density. The device, dubbed Micro-Power, is the first in a family of low-profile parts that the company will slowly develop as standard products.

### Manufacturing challenges remain

Even though the industry is producing some small components, surface-mount magnetics are far from a mature product. You still have some factors to consider that may affect your design's manufacturability. Also, surface-mount power magnetics present some significant manufacturing challenges.

One challenge involves the pick-and-place equipment that automatically positions components on a circuit board for soldering. Such equipment typically uses a vacuum tip to pick up components; hence, it requires that the component have a flat surface. Not all surface-mountable magnetic components have a flat surface. A toroid can be made surface-mountable by attaching it to a carrier, for example, but it doesn't provide a flat surface unless it is also enclosed in some form of case. Yet many surface-mount magnetic components are not enclosed.

This forces the board manufacturer to place these components by hand, increasing your design's manufacturing cost.

Another challenge lies in the soldering meth-

**Electrical and mechanical compatibility is all but unknown among magnetic components from different suppliers. One exception is the Octa-Pac series from Coilcraft. GFS Manufacturing offers the Power-Pac series, a compatible part, shown here.**

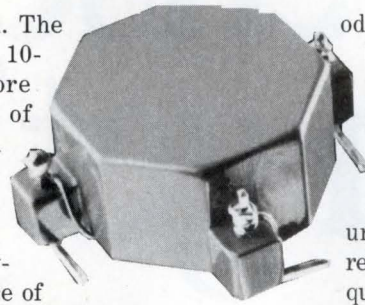

ods for surface-mount circuit boards. The most common method uses a heated chamber or IR radiation to melt solder attached to both the board and the components, causing the two solder volumes to flow together. This reflow-soldering technique requires heating the assembly to 220 to 250°C for approximately 30 sec.

The problem is, most magnetic components are made of materials that are rated only at 130 to 150°C continuous exposure. The brief excursion to higher temperatures risks damaging such things as the enamel insulation used in coil windings. The high temperature also risks deforming the plastics used in the cases, potentially causing the component to lift from the pc board during soldering.

To combat this problem, some magnetic-component manufacturers, such as Pico Electronics, have switched to materials with greater temperature tolerance. Other manufacturers have designed their components to deflect the heat away from sensitive elements, providing resistance to the brief temperature excursion. Either way, you should check your soldering process with the magnetics manufacturer to ensure that the parts will survive.

A final manufacturing challenge comes from the limited selection of surface-mount magnetic components available. You may be forced to go with a custom design in order to meet your circuit's needs, with the attendant development cost. Even if you can use a stock value, you still face one of the custom component's drawbacks: a sole-source supplier. Magnetic-component suppliers each have their own techniques and product styles. Rarely do two manufacturers offer devices that are both electrically and mechanically similar.

### Limited standardization

One exception is the Octa-Pac series from Coilcraft. This design has been popular enough that other manufacturers have begun to copy it. GFS Magnetics, for example, has introduced its Power-Pac series, a pin-compatible equivalent to the Octa-Pac.

Such exceptions are rare, however. Many magnetics manufacturers attract and retain their customers by offering unique capabilities. Changing from their unique designs to industry-standard products would force them to invest in equipment and tooling without the guarantee of customers. There is little internal motivation to follow that approach, nor are there any magnetics-industry groups that can impose standards. Only a large customer or great demand for uniform products will drive them to standardization.

As a result, innovation in surface-mount power magnetics continues to occur on a sporadic and disjointed basis. So, if the devices that are available don't meet your needs, don't expect the industry to offer alternatives soon. Change comes slowly on its own. Your best bet is to work with a supplier to develop the product you need. Magnetics manufacturers are glad to help find innovative answers to your surface-mount magnetics needs, if they're not in it alone.



EDN

## References

1. Nelson, Carl, "LT1070 Design Manual," *Application Note 19*, Linear Technology, June 1986.
2. "Careful inductor selection optimizes low-power dc/dc converters," *Maxim Engineering Journal*, V4, Maxim Integrated Products, 1991.

## Acknowledgment

*I would like to thank Steve Pietkiewicz, senior design engineer at Linear Technology ((408) 432-1900), and Bruce Moore, staff scientist at Maxim Integrated Products ((408) 737-7600), for their invaluable assistance in researching this article.*

*Technical Editor Richard A Quinnell can be reached at (408) 685-0504, fax (408) 685-0504\*.*

## VOTE

Please use the Information Retrieval Service card to rate this article (circle one):

High  
Interest  
598

Medium  
Interest  
599

Low  
Interest  
600

From PBX circuitry to advanced fault tolerance, VMEmodules are the talk of the telecommunications industry.

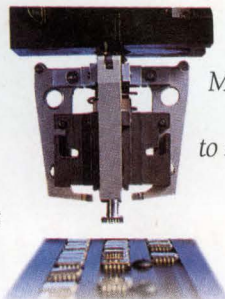
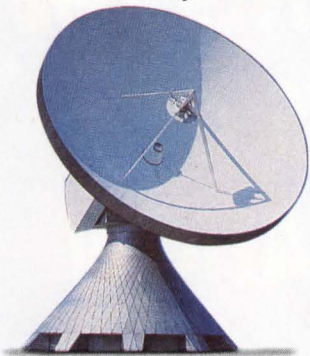

Motorola VMEmodules are an automatic choice to streamline a wide range of manufacturing control applications.

Motorola VMEmodules process the commands that make aircraft simulators fly.



Motorola VMEmodules are helping make high-tech, high-quality medical imaging picture perfect.



Motorola VMEmodules keep systems on cruise ships sailing.



Our VMEmodules are used in electronic prepress to keep it fast, cost-effective, and letter-perfect.

# What Would You Like Your VME Board To Be Today?

The Motorola VME family of products are incredibly versatile. In fact, one of our VMEmodules can fulfill an array of functions, yet it fills only one VME slot. VMEmodules give you more functionality per square inch, and more functions per module. For less overall cost than modules you could build yourself.

## We Work For You.

Typical VMEmodule™ functions include a basic compute engine, network interface, mass storage interface, parallel port interface, serial device interface, VMEbus interface, non-volatile data storage, and various timers.



And that's just one module.

We want to be your VME partners, and offer you exacting standards, fast turn-around times, and a wide range of options. The options you choose will be delivered to you in modules that snap onto your board or VME backplane. These modules are compatible with thousands of ready-to-use software programs. Start with the functions you need now, and add modules as needed later.

## How Much Is Quality Worth?

When you buy your VME-modules from Motorola, you

know you're buying quality, but you'll be surprised how affordable quality can be. We test our modules to exacting tolerances, and we back our boards with the industry's first Five-Year Warranty. Give us a call and let us know what you need your VME board to be today. We'll show you why ours will be a better value, day in and day out.

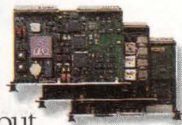

Motorola VMEmodules give you more functionality per square inch, and are compatible with thousands of software programs.

1-800-759-1107 Ext. EDN

© Copyright 1994 Motorola, Inc. Motorola and the Motorola logo are registered trademarks of Motorola, Inc. "Because The Game Has Changed" and VMEmodule are trademarks of Motorola, Inc. All other products mentioned are trademarks or registered trademarks of their respective holders.



**MOTOROLA**  
**Computer Group**  
*Because The Game Has Changed™*

# POWER ICs

## WEIGHING THE BENEFITS OF INTEGRATION

The business of power ICs—specifically those for power switching and motion control—is full of stories of technological achievements, but market success of highly complex ICs has not come so easily. After a decade of thinking the sky's the limit, vendors and designers are now seeking the right scale of integration from a wide range of possibilities.

ANNE WATSON SWAGER, TECHNICAL EDITOR

**W**ith the advent of process technologies that can integrate virtually everything but the load itself, the current capabilities of ICs for power actuation and switching seem almost limitless. The potentially integrated functions include logic and control, sometimes implemented by a fully functional microcontroller ( $\mu$ C); protection; diagnostic feedback; and, finally, a power-output stage. Whether you call it “smart” or “intelligent” power, the technical feasibility of combining these functions into one IC using some mixture of bipolar, CMOS, and DMOS (double-diffused MOS) structures is proven. (See **box**, “Combining power with memory and a  $\mu$ C.”)

However, once manufacturers started reaching this technological peak, some of them also started backing down the hill. While the concept of a complex IC that can perform every necessary function is allur-

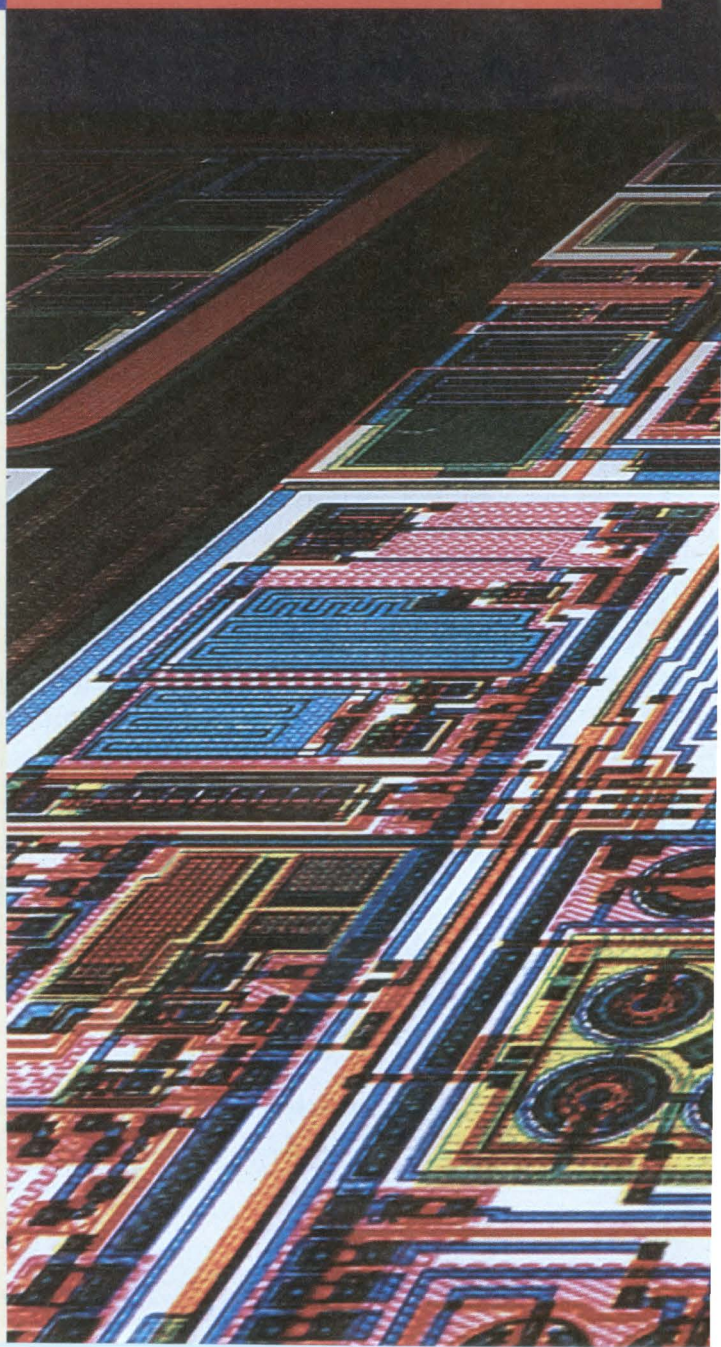



PHOTO COURTESY INTERNATIONAL RECTIFIER

## POWER ICs

ing, the cost and complexity of these ICs greatly narrow their applications. As a result of some disappointing sales, some vendors have backpedaled, now mainly offering custom devices and few if any standard products. Others have concentrated on improving their process technology and have forged ahead producing even more highly integrated devices, again mainly on a custom basis. These companies have lowered costs by carefully targeting their products and services for high-volume markets and by working closely with customers to deliver specific high-performance ICs.

Still other vendors, even those that have the bipolar, CMOS, and DMOS (BCD) technology to produce high levels of integration, are trying an intermediate approach. (See **box**, "Taking the middle ground.") The overall result is a power-IC business that involves both custom products and a diverse category of standard products for specific markets and

for the general industrial market. Because of this diversity, many of these products are proprietary, although a few compatible sources, particularly of simple driver ICs, do exist. Spice models also become more rare as ICs increase in complexity.

### Tackling the definition

Just what constitutes a "power IC" varies from manufacturer to manufacturer, depending on their product portfolios and points of view; that is, whether they approach the market from a discrete-transistor or an IC perspective. Some define power ICs by their functions—whether the IC actually includes the power transistor itself—others, by the ICs' voltage and current levels, and still others by the ICs' general involvement in controlling power. Even the nomenclature of power ICs is mind-boggling: There are Smart SIP-MOS, SmartMOS, and PowerPlus, to name a few.

The result is confusion. To eliminate further confusion, avoid trying to define a power IC explicitly, and instead think of how semiconductors involved with controlling power fit into a general framework (**Fig 1**). The

**figure** shows two independent paths of

devices, beginning with discrete power transistors and driver ICs. As integration increases, each device adds functions until the transistor and driver combine into one. **Fig 1** focuses not on what manufacturers label these parts but on the parts' internal functions. That's because names can be extremely misleading; a simplistic name like "switch," for example, can obscure the part's sophistication.

While **Fig 1** puts the products and nomenclature into perspective, the **boxes** describe some devices that constitute this framework and some emerging applications. However, before jumping too quickly into the details, take a general look at the power-IC business in which strong market forces affect vendors' approaches and thus the products available. Also, consider one key design decision: to use discrete transistors and drivers or to use an IC that combines the two.

Vendors offer a wide range of products, but several manufacturers carefully tune those products to high-volume markets. Because of the trend in the 1980s for vendors to produce ICs with higher and higher levels of integration, many vendors have focused their power-product portfolios on two market segments: automotive and computer peripheral. The most successful of these ICs

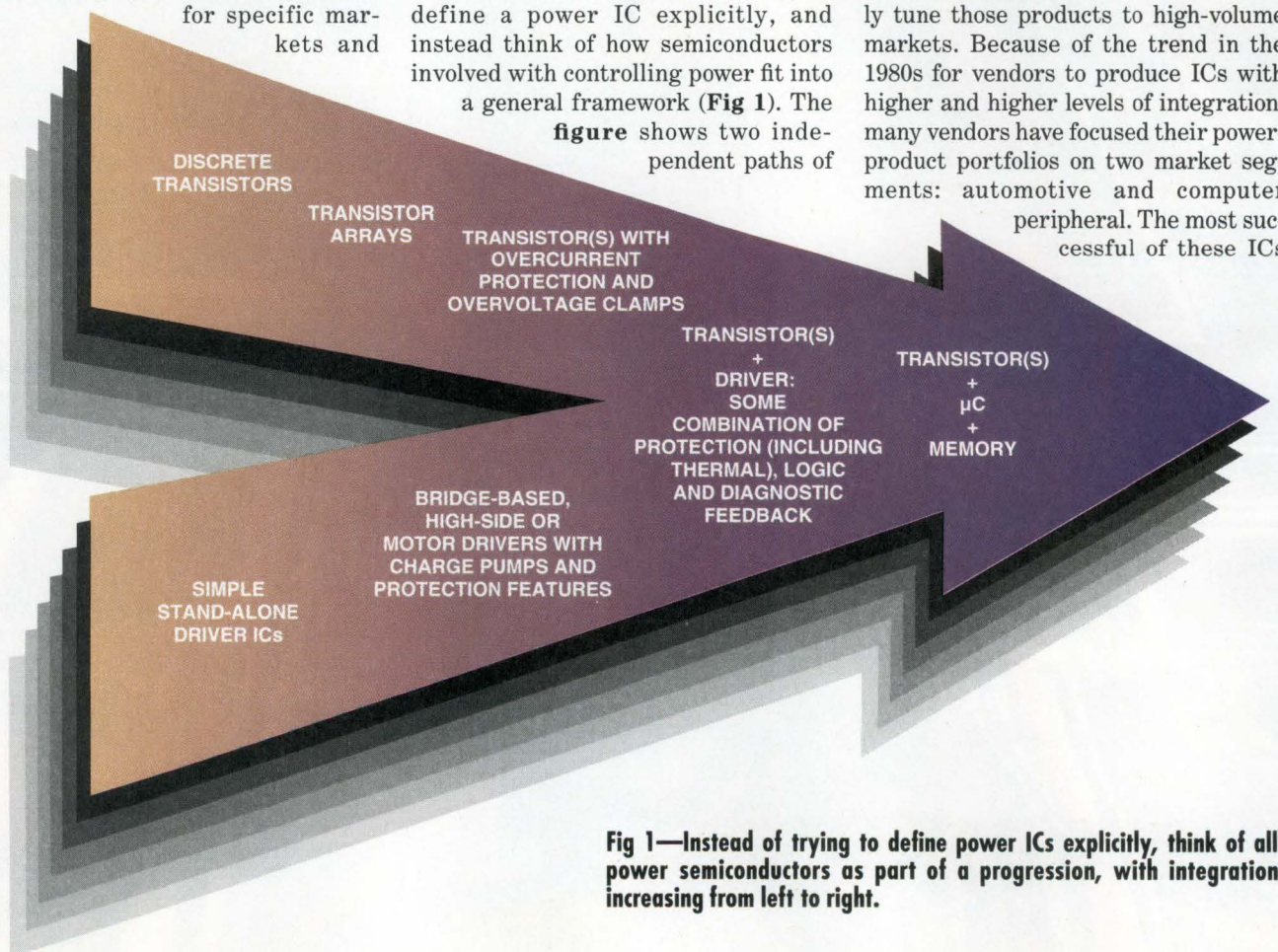

**Fig 1**—Instead of trying to define power ICs explicitly, think of all power semiconductors as part of a progression, with integration increasing from left to right.



## COMBINING POWER WITH MEMORY AND A $\mu\text{C}$

Combining power devices with a microcontroller ( $\mu\text{C}$ ) and memory currently represents the highest level of integration. To date, a number of manufacturers, including Motorola, Philips, SGS Thomson, and Texas Instruments, have demonstrated this capability, as the material in **Ref 1** shows. In 1990, Motorola integrated its 8-bit 68HC05 core with 96 bytes of RAM and 2064 bytes of user ROM and 240 bytes of ROM for test functions.

More recently, SGS Thomson unveiled its third-generation BCD3 process with which the company can combine an ST6 8-bit  $\mu\text{C}$  with a DMOS H-bridge power stage, driver and interface functions, a charge pump, and thermal protection. Using BCD3, the company can also integrate EEPROM, making the IC configurable by hardware and software. This "programmable power device," or "power PLD," contradicts the notion that "high integration means narrow application." With the SGS Thomson technology, you can potentially use a highly integrated device for a variety of applications.

TI's Prism process technology physically joins DMOS power switches with  $\mu\text{C}$  cores, memories, and analog. Prism tackles this joining through a modular design methodology that minimizes the number of mask steps to only those required for each IC; a power-only device takes six to eight mask steps, for example, and a fully featured product takes 16 to 18. Harris Semiconductor also uses a semicustom cell-based approach to build power ASICs.

While this technology is extremely impressive, taking advantage of it requires a close working relationship with the vendor, so that the vendor is essentially providing a custom IC. SGS Thomson provides demonstration ICs to show what users can accomplish with the BCD3 process.

Detractors of this approach, including other vendors who've been unsuccessful selling many of the massive ICs they've built, always cite cost as the limiting factor.

Samples of SGS Thomson's H081 demonstration IC cost \$10 each. Other devices with similar performance to this IC should cost around \$5 to \$6 each in OEM quantities.

## TAKING THE MIDDLE GROUND

With the Power+Logic family, Texas Instruments attempts to strike a balance between power elements, logic functions, and protection features. The company uses the same 60V Prism process to produce these ICs as it does to produce its highly integrated ICs. (See **box**, "Combining power with memory and a  $\mu\text{C}$ .") The Power+Logic family suits power-switching applications that require multiple power channels and onboard logic but do not require the advanced fault detection and reporting of highly integrated, intelligent-power ICs.

The first three logic devices in the family—the TPIC6259 8-bit addressable latch, the 6273 octal D-type latch, and the 6595 8-bit shift register—emerged two years ago in standard DIP and SOIC packages. The parts feature multiple independent DMOS power transistors with typical on resistances of  $1.3\ \Omega$  and avalanche energy of 75 mJ. Continuous output current is 250 mA, pulsed output current is 1.5A, and typical quiescent current is  $15\ \mu\text{A}$ . The devices include 45 or 50V output-voltage clamps for inductive load switching.

TI is now releasing the second round of family members, which offer the same three logic functions with their currents scaled down to drive arrays of lamps and LEDs. Typical specifications for the 6B259, 6B273, and 6B595 are  $5\ \Omega$   $r_{\text{DS(ON)}}$ , 30-mJ avalanche energy, 150-mA continuous current, and 500-mA current limit. Prices for all of the devices in the Power+Plus logic family range from \$0.77 to \$1.89 (1000).

The company also uses its Prism process and methodology to produce the Power+Arrays family, ICs that combine two to seven multiple-DMOS power transistors. Current ratings range from 1 to 7.5A of continuous current;  $r_{\text{DS(ON)}}$  ranges from  $0.5\ \Omega$  to  $90\ \text{m}\Omega$ . The newest low-current arrays come in standard SOIC packages. Prices range from \$1.12 to \$2.42 (1000).

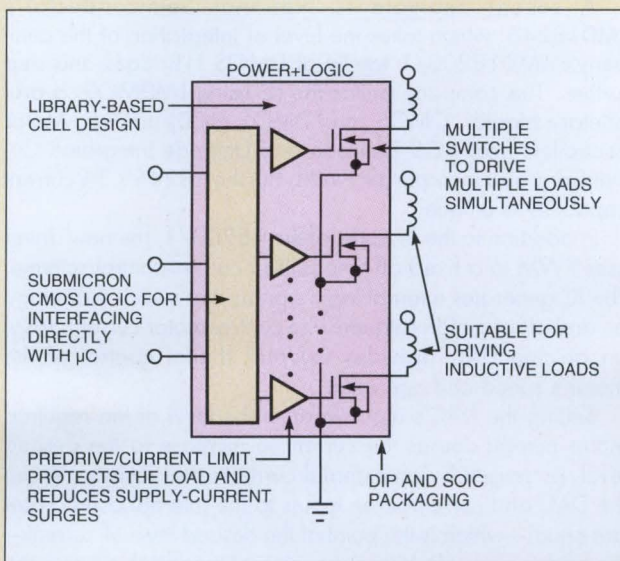

## POWER ICs

implemented precise functions for specific needs. One such example is the "combo" disk-drive IC, which combines the spindle and voice-coil motor drives, making smaller drives possible. Many of these specialized products, particularly automotive ones, with typical 60V and 4A ratings, have spilled over into the general industrial market, starting out as custom ICs and eventually becoming standard offerings.

Although the automotive and disk-drive markets are huge, numerous other products target the more fragmented industrial markets. (See **box**, "Fully integrated H-bridges combine PWM.") Also, emerging high-volume markets are pushing the development of power ICs with high voltage and current requirements. The foremost example is the integration of high-voltage structures—generally greater than 100V—with logic-level circuitry. (See **box**, "High-voltage power ICs surge.") Many vendors of these ICs are targeting the

market for electronic ballasts for fluorescent bulbs because of its potential volume in commercial applications.

In addition to these strong market influences on IC development, the **box**, "MOSFET drivers enable Class D audio amplifiers," provides a notable example of integrated ICs' effect on a previously unwieldy application.

Regardless of the end use of a power circuit, one principle is common: Users of power components must choose between relatively simple and flexible functions performed well on the one hand and complex—but *conceptually* simple—ICs on the other. The magic of simple functions is that you can quickly and easily configure them in the real world and make any necessary future design changes. The allure of a complex IC is its design simplicity: One IC can do everything.

No one would dispute that drivers and discrete power transistors can produce the most flexible designs. Two developments contribute to this flexibility: the wide availability of discrete transistors,

particularly power MOSFETs, and the increasing numbers and types of drivers, particularly MOSFET drivers. Regardless of the driver you select, you can independently select a MOSFET based on the design's speed and efficiency. Vendors of these MOSFETs also continue to make dramatic improvements in the devices' efficiency. The on-resistance ( $r_{DS(ON)}$ ) of state-of-the-art TO-220-packaged N-channel MOSFETs is less than 10 m $\Omega$  at 60V. A similarly packaged, state-of-the-art P-channel device has an on-resistance of around 45 m $\Omega$ .

Integrated power transistors just can't compete with discrete transistors on the basis of  $r_{DS(ON)}$  alone. There is a tradeoff between specific on-impedance—a measure of  $r_{DS(ON)}$  vs die area—of discrete transistors and ICs. Most power ICs have higher specific on-impedances than do discrete devices, simply because of fabrication differences that result in the ICs' larger power structures.

Just as discrete transistors' on-resistance has come down, so has that of inte-

## FULLY INTEGRATED H-BRIDGES COMBINE PWM

Although it seems that most highly integrated power ICs are geared toward the automotive industry, vendors do develop many ICs—specialized motor controllers and drivers, in particular—for many computer-peripheral and industrial applications. Some of these drivers now integrate PWM to drive bidirectional stepper and dc motors.

A recent example is National Semiconductor's LMD18245, which takes the level of integration of the company's LMD18200/1 family of DMOS H-Bridges one step further. The company builds the IC using LMDMOS, a proprietary bipolar, CMOS, and DMOS (BCD) process. Motor controllers from SGS Thomson and Unitrode Integrated Circuit Corp also incorporate PWM, but the 18245's 3A current capability is unique.

In addition to the features of the 18200/1, the new driver uses PWM in a fixed off-time pulsed current-control scheme. The IC generates internal logic signals that switch the bridge on and off at a high frequency to control motor current. Also, an on-chip DAC provides external digital control of the motor's speed and operation.

Setting the DAC's input word to the level of the required motor current causes the current to increase to the desired level, as sensed by an external current-sense resistor. When the DAC and current-sense inputs to the internal comparator are equal—which is the point of the desired level of current—the bridge shuts off. When the internal monostable times out, the bridge turns back on, and the current again begins to

increase to the selected trigger point. Using this high-frequency chopping action, the IC maintains the DAC-selected current level in the motor.

Other features include typical  $r_{DS(ON)}$ /switch of 0.3 $\Omega$ , high-impedance current sensing, thermal shutdown, current limiting, and undervoltage lockout. In a 15-lead TO-220 package, the IC costs \$8.45 (1000).

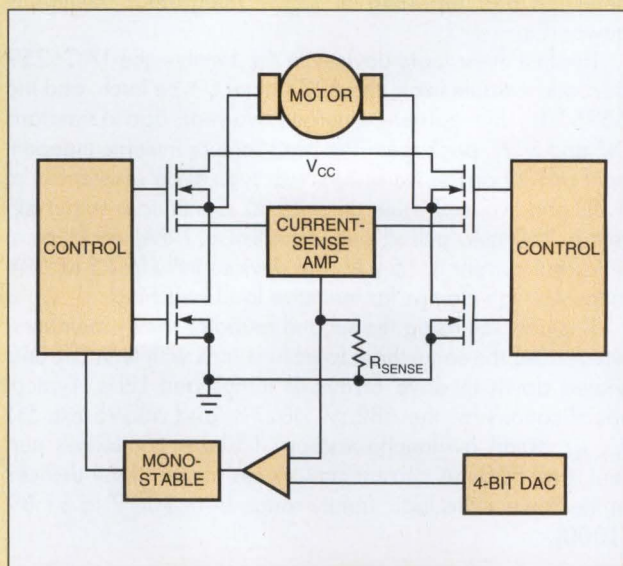

# SINGLE-DEVICE **5V TO 3.3V** POWER

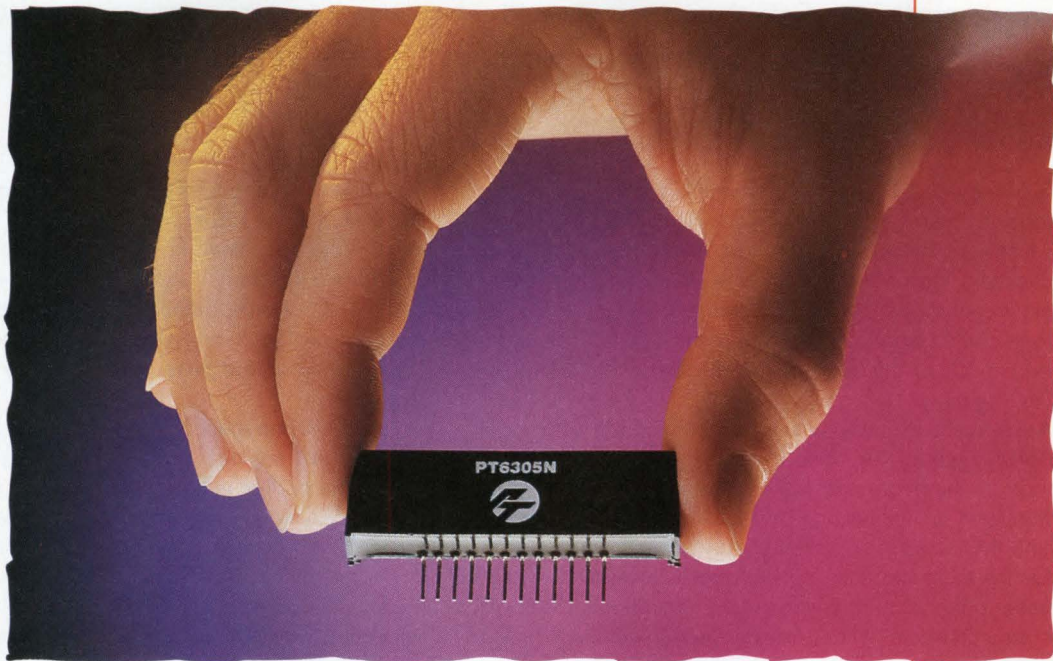

## ...THAT PLUGS RIGHT IN.



Now, from the innovator in integrated switching regulators, comes a new series of high-performance 5V to 3.3V, 3 Amp, 12-Pin, single in-line products. The new Power Trends PT6305 family lets you easily solve the problem of integrating low power 3.3V logic integrated circuits into existing 5V systems, *without redesigning the power supply.*

And, because the PT6305 Series has an extremely low profile of .36" x 2.00" x .60" (H),

it's ready to meet your needs *and* conserve board space. Vertical, horizontal and surface mount versions are available.

The PT6305 features a high operating frequency of 650KHz, for state-of-the-art power density and 85% efficiency. The device supports a wide input range of 4.5 to 10V with good line and load regulation. Over-temperature and short circuit protection are built in.

If you're ready for a space-saving on-board power converter that you can plug right in, *call Power Trends for a sample today!*  
**1-800-531-5782.**



**POWER TRENDS®**

1101 North Raddant Road, Batavia, IL 60510 • (708) 406-0900 • Fax (708) 406-0901

CIRCLE NO. 137

EDN July 7, 1994 • 73

## POWER ICs

grated transistors. However, until vendors develop processes that allow for using the same compact DMOS structures in integrated devices that they use in discrete transistors, the two devices' on-

resistance numbers will never match because of economic reasons. An IC requires two to four times more die area than does a discrete transistor to achieve the same on-resistance; such a large die area makes ICs too expensive to produce. The on-resistance numbers

also depend on vendors' proprietary processes and voltages.

Using discrete transistors also provides two other advantages: reduced size and increased protection. Discrete transistors are undergoing a dramatic shrinkage. For example, Sil-

## HIGH-VOLTAGE POWER ICs SURGE

One of the newest abilities of power ICs is integrating high-voltage structures with logic-level circuitry. Some 20 semiconductor companies worldwide, including AT&T Microelectronics, Harris Semiconductor, International Rectifier, Power Integrations, and SGS Thomson, are pursuing high-voltage control applications. One of the high-volume markets driving much of this work is the electronic ballast for fluorescent lighting.

Applying IC technology to electronic ballasts is hot for two reasons: a worldwide drive for energy efficiency is causing a boom in the fluorescent-lighting industry, and real money, in the form of utility-company subsidies to consumers, is behind the increased-efficient-energy effort.

On the technical side, high-voltage IC technology has progressed to the point at which vendors can build low-cost ICs that can compete with existing electronic-ballast designs. These designs typically use a pulse transformer and discrete transistors. Using an IC eliminates the need for a transformer, thus easing the design, increasing efficiency, and reducing the design's size.

A recent example of a low-cost approach for this application is International Rectifier's IR2155 (see "High-voltage ICs displace magnetic components for electronic ballasts," *EDN*, March 31, 1994, pg 73). The IC costs \$0.098 (50,000).

In addition to its high-voltage floating section, the IC

integrates a number of other useful features. First, the IC self-oscillates at a frequency set by an external R and C, similar to a 555 timer. The IC also has internal circuitry that provides a nominal 1- $\mu$ sec dead time between alternating high- and low-side output for driving half-bridges. Finally, the IC operates directly from the ac line using an on-chip shunt regulator that generates 15V via a low-watt dropping resistor.

In addition to electronic-ballast applications, high-voltage technologies are also propelling the design of ICs that can work from ac line voltages for all types of applications. For example, a new family of switching-power-supply ICs from Power Integrations shows a significant level of integration and cost reduction. In 3-pin TO-220 packages, devices in the TOP-Switch family integrate a high-voltage N-channel MOSFET with a CMOS PWM controller, including a 100-kHz oscillator and various protection circuits. The off-line ICs work from 85 to 265V-ac voltages and produce regulated dc outputs. Prices are as low as \$1 (10,000).

Still other developments include SGS Thomson's BCD-Offline, which extends the company's line of BCD processes to higher voltages by incorporating grounded-source lateral DMOS transistors and insulated-gate bipolar transistors that operate at 500 to 700V. Products undergoing qualification or under development include a full-custom fluorescent-lamp driver and half-bridge driver for appliance motors.

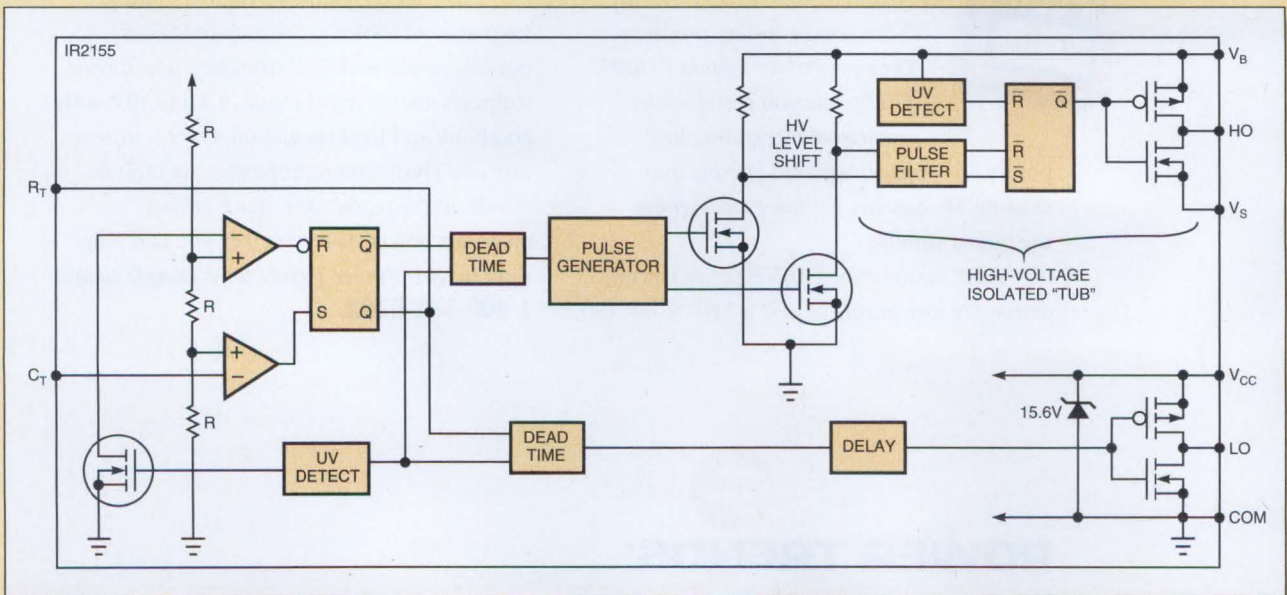

# WE'VE TEAMED UP...

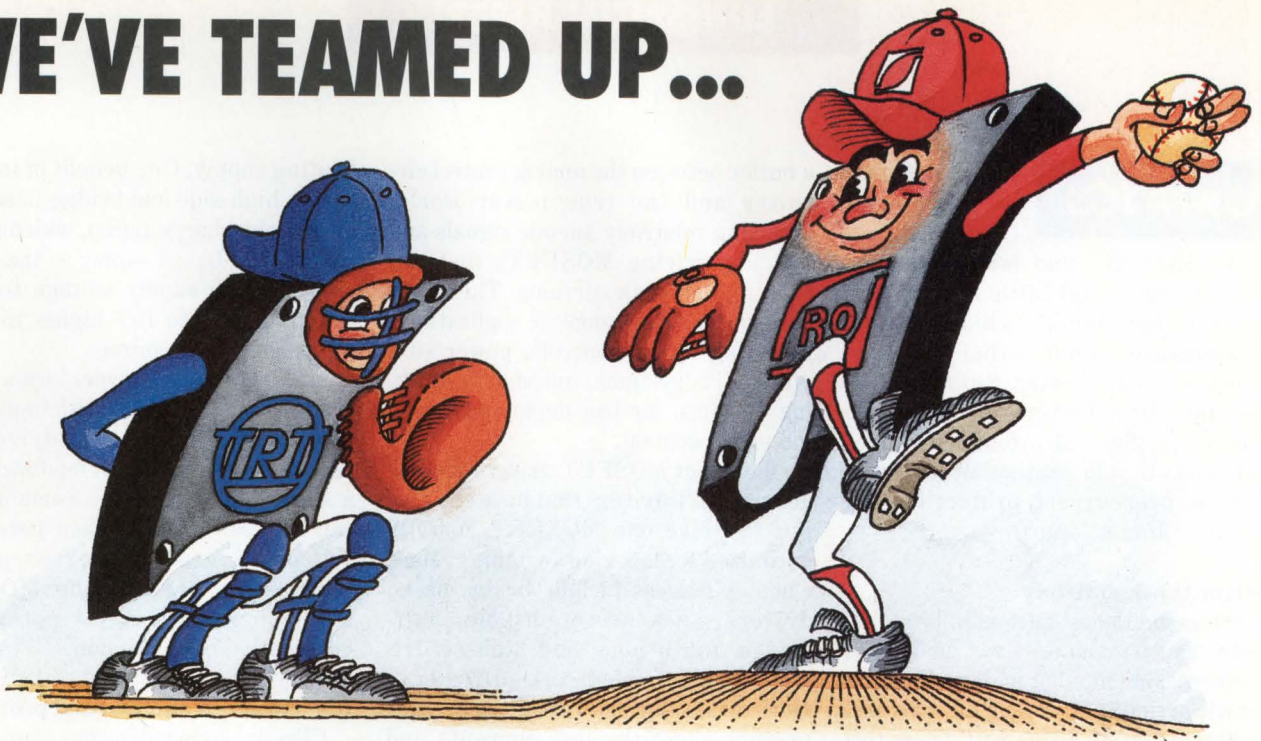

## FOR A WHOLE NEW BALL GAME IN DC-DC CONVERTERS.

### WORLD'S MOST ADVANCED DC-DC CONVERTERS.

- Miniature Size – Up to 58 W/in.<sup>3</sup>
- Up to 250 Watts Per Module
- 12/24/28/48/270/300 VDC Inputs
- Single and Triple Outputs
- Parallelable with Current Sharing
- FAULT-SAFE™ Power
- N+M Redundancy - No Single Point of Failure
- Hot Plug-in Capability
- 2nd Sourcing - Independent Manufacturers
- >1 Million Hours MTBF per MIL-HNBK-217E
- Non-Shutdown OVP
- Constant Frequency Operation
- Output Good Signal
- Optional Synchronization

### NEW AUTOMATED PRODUCTION FACILITIES DELIVER HIGH VOLUME AT LOW PRICES.

RO has a new automated production line in Sunnyvale, CA. TOHRITSU's fully automated production facilities can deliver 100's of thousands of units per month. **All units are full-featured – No stripped down economy models.** Customers are invited to visit both facilities.

### WE'LL DELIVER ONE OR ONE MILLION

Deliveries of low and medium quantities will be made by RO and higher volume requirements by TOHRITSU. The transition can be as transparent as desired.

**LET'S PLAY BALL.  
CALL TODAY FOR A QUOTE.  
800-443-1450**



RO ASSOCIATES  
SINCE 1963



TOHRITSU CO.  
SINCE 1952

246 Caspian Dr., P.O. Box 61419  
Sunnyvale, CA 94088  
Tel: 408/744-1450  
Fax: 408/744-1521  
CIRCLE NO. 38

## POWER ICs

iconix recently announced Lite Foot, a power MOSFET that is even smaller than the successful Little Foot family. The Lite Foot family, which features performance similar to that of its predecessor, comes in an 8-pin TSSOP package. Manufacturers of discrete transistors have also found inexpensive ways to add protection features, such as overcurrent protection and output-voltage clamps.

### Driver types multiply

The second boost to flexibility of discrete-transistor-and-driver designs is the increasing number and types of drivers, particularly MOSFET drivers. The term "MOSFET driver" refers to a wide range of devices. They all provide

a buffer between the analog control circuitry and the true power world, inputting relatively anemic signals and actually driving MOSFETs that can require high peak currents. These drivers suit a wide range of applications, including motor controls, power supplies, UPS systems, automobile braking systems, air-bag deployment, and industrial control.

Classes of MOSFET drivers include generic FET drivers that have one output to drive one MOSFET, usually optimized for low-side switching. More complex devices include bridge-based drivers, such as totem-pole, half-bridge, full-bridge, and 3-phase drivers. These bridges are difficult to work with and require designs that prevent shoot-through currents and maintain the refresh on the upper

floating supply. One benefit of integration in high-side and bridge-based drivers is the charge pump, which pumps the ground-based supply to the necessary floating-supply voltage to drive the gate at 10 to 15V higher than the upper MOSFET source.

Although these drivers lack a power transistor, they can still implement protection. A separate driver can sense overcurrent with feedback from a series shunt resistor. Some drivers can also sense insufficient gate-drive voltage—a form of undervoltage protection—to prevent the MOSFET from operating in its potentially destructive linear region.

### ICs add speed and thermal protection

Clearly, using discrete transistors with many of the available driver ICs

## MOSFET DRIVERS ENABLE CLASS D AUDIO AMPLIFIERS

Using a MOSFET driver IC to implement a Class D audio amplifier may seem unusual, but higher integration and faster switching speeds are blending the two. Instead of a motor, the driver's load becomes a speaker and a lowpass filter, and an audio input replaces the motor's control signal. In essence, the same PWM scheme that controls a motor or a switching power supply instead drives a speaker. Harris Semiconductor is championing this idea using its HIP4080 MOSFET driver (\$3.50 (1000)).

The HIP4080 H-bridge driver handles 80V at 2.5A while switching into a 1000-pF load at 1 MHz. Typical rise and fall times are 10 nsec. Propagation delays are typically in the 50-nsec range. Other features include a 95V-dc bootstrap-supply maximum voltage, and an integrated charge pump/bootstrap to maintain the upper switch-bias supply.

The driver's speed and propagation delays are the biggest factors driving its application in Class D amplifiers. The 1-MHz speed eases the design of the filter, and the 50-nsec propagation delays—difficult to achieve using discretely—reduce factors that cause audio distortion. Miniaturization, efficiency, and a simpler design are also key benefits of the Class D approach. The design is less cumbersome than that of discretely because a bridge-based scheme requires an upper drive, which is difficult to implement with discretely.

Any Class D amplifier requires a control block to perform PWM of the control signal. The performance of the amplifier

in the **figure** is analogous to that of a switching power supply. The circuit first modulates the control signal to some high-frequency level and uses this PWM signal to drive the bridge. The filter then strips the PWM carrier from the bridge's output, leaving only the audio signal.

During a 1993 power-application seminar, Harris demonstrated the use of the 4080 in a 70W audio amplifier that fit in a 5.25×3.5-in. pc board. The design required only small heat sinks. The amplifier's efficiency was around 90%.

A promising application of Class D amplifiers is noise cancellation. Harris and Noise Cancellation Technologies (Stamford, CT) are working jointly on ICs similar to the 4080 to implement active-noise-cancellation products for automotive and industrial applications.

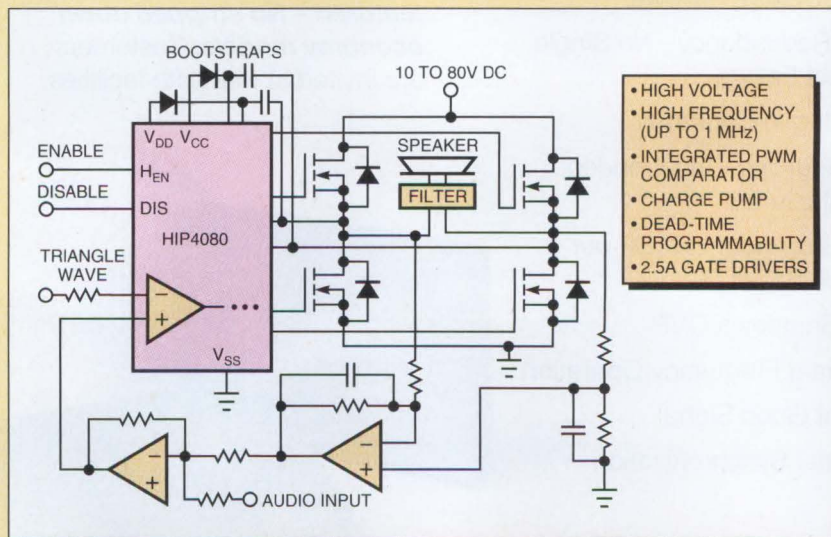

# THE DAWNING OF LOW COST SURFACE MOUNT TECHNOLOGY

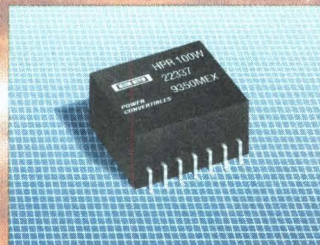
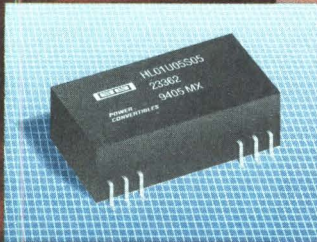

Power Convertibles had a brilliant idea. To provide you with a superior quality, surface mountable DC/DC converter at a very low cost. The new HL and HPR1XX Series offers an extensive selection of input and output voltage combinations to choose from and features internal filtering, low output noise and short circuit protection.

If that sounds like the dawn of a great beginning, call us today and we'll shed more light on the subject.

**POWER  
CONVERTIBLES™**

A BURR-BROWN COMPANY

3450 S. Broadmont Drive ■ Suite 128 ■ Tucson, Arizona 85713  
602-628-8292 ■ FAX 602-770-9369

CIRCLE NO. 83

**ISO9001  
CERTIFIED**

## POWER ICs

presents formidable competition to the all-in-one IC approach. However, the advantages of ICs involve more than just combining circuitry into less space. Integrated power and driver ICs can do things that drivers and discrete transistors often cannot. For example, ICs that integrate the driver and power transistor or transistors can boast all the protection features of

discrete transistors, including thermal protection, which discrete transistors can't easily implement. (See **box**, "Integrating temperature sensing and serial communication.")

Thermally protecting a discrete transistor is possible, but it requires additional components. For example, Siemens accomplishes this task with the TempFET line by including a sensor along with the FET in a TO-220 or -218 package. To the user, this extra

component is transparent. But, aside from this exception, ICs can add thermal protection without additional components. Implementing these protection features in an IC results in lower circuit overhead and power losses, particularly when the IC is sensing over-current conditions.

The ability to indicate to other systems via diagnostic feedback that a fault condition exists is another advantage of ICs. According to Siemens, a

## INTEGRATING TEMPERATURE SENSING AND SERIAL COMMUNICATION

One of the biggest advantages of integrating a power switch with control and logic circuitry is that it eases a design's ability to sense temperature and implement a fast shutdown. Although thermistors can sense a power transistor's temperature, integrated ICs offer much shorter delays and can more quickly shut off the overtemperature transistor.

Motorola's MC33298 octal serial switch (OSS) demonstrates this capability along with a high level of integration, including multiple output drivers and a serial interface. This integrated lowside switch also serves as an example of a device that a company conceived, specified, designed, and developed for the automotive industry but that's now available as a standard part.

A key aspect of the IC is that it can sense the temperature and independently implement shutdown of each of the eight

channels. Other fault-detection features include open-load detection, overvoltage detection and shutdown, and short-circuit detection and shutdown with one automatic retry per write cycle.

The serial interface exemplifies the diagnostic features available in complex ICs and allows the IC to communicate directly with a microcontroller ( $\mu\text{C}$ ). You can also daisy-chain four of these switches and use the same four serial lines from the  $\mu\text{C}$  to control all 32 outputs.

Key specifications of the device include typical  $r_{\text{DS(ON)}}$  of 35 m $\Omega$  at 25°C and power-supply voltage of 13V. Sleep-mode supply current drops to a maximum of 50  $\mu\text{A}$  (when  $V_{\text{DD}} < 2\text{V}$ ).

The IC can control inductive loads (with output voltages clamped to 60V) and incandescent loads (with 3 to 6A output currents). The MC33298 costs \$5.74 (1500+). It comes in 20-pin DIP and 24-pin SOIC packages.

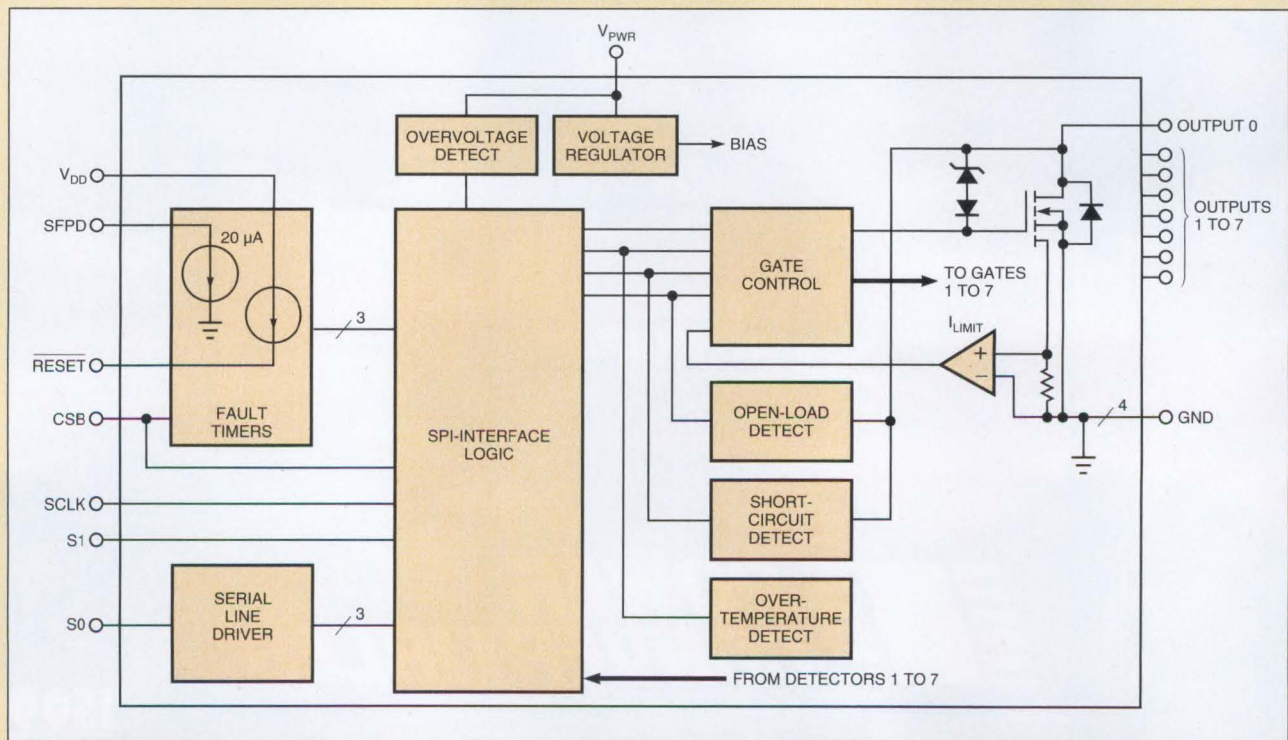



# There are many areas where our function generator will surpass your expectations.

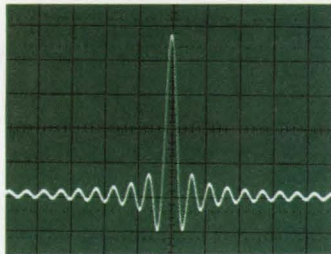

A built-in 12-bit, 40 MSample/sec, 16K deep arbitrary waveform generator easily handles your custom waveform needs.

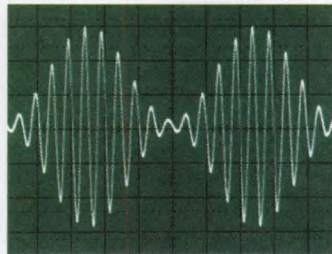

Internal AM, FM, FSK and burst modulation eliminate your need for a second modulation source.

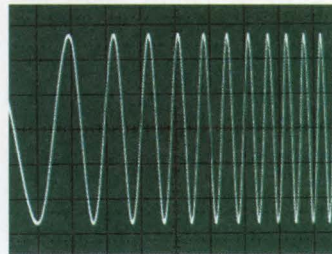

Both linear and log sweeps are built in, making filter and amplifier testing quick and easy.

## And one where it falls short.



© 1993 Hewlett-Packard Co. TMFPM085EDN

### The HP 33120A 15 MHz synthesized function/arbitrary generator: Within budget, without compromise.

In the world of function generators, price and performance have always been synonymous. So it's understandable you'd expect to pay more for the measure of confidence you get with a synthesized signal source that delivers stable, accurate signals test after test. Or, for the flexibility to generate complex waveforms with arbitrary waveform capability.

You'd probably also expect to pay a premium for the convenience of built-in sweep and modulation functions. And to have both HP-IB and RS-232 interfaces standard.

Fact is, you can always get high performance with the high price to

match. Or, order the HP 33120A fully loaded function/arbitrary generator and get something totally unexpected. A price you can afford.

**Call HP DIRECT at 1-800-452-4844\*, Ext. 7819 to talk to an HP engineer about your function generator needs.**

Want to speak to someone about the HP 33120A function/arbitrary generator features, its complementary BenchLink/Arb software, or your application needs? Calling HP DIRECT is the fast, easy way to get all your questions answered — with no obligation to order.

You see, HP DIRECT is your direct line to information and solutions for HP basic test instruments. With one simple call, you can get product

specifications or any technical literature you need to make the right decision. Or, for one-on-one technical support, you can speak to an engineer who has

first-hand experience with HP products.

And, of course,

if you're ready to order, we can help you do that, too.

So give us a call. And discover how much more you get from HP today.

\* In Canada, call 1-800-387-3867, Dept. 476

**There is a better way.**



**POWER ICs**

truly "smart" IC, such as those in the company's ProFET family, must be able to indicate its status, including short-circuit, undervoltage, and overvoltage conditions. The ProFET family of high-side switches, which now includes 2-channel devices that sell for around \$2 (10,000) each, includes diagnostic feedback; CMOS- and TTL-compatible inputs and status outputs; and ESD, overtemperature, overcurrent, and short-circuit protection.

An IC also has a speed advantage because it lacks the parasitics associated with the drive and packaging of

discrete transistors. Higher speed benefits not only the device's general performance but also its ability to perform fast shutdown after sensing an overcurrent or overtemperature fault condition.

Ultimately, integrated power devices brush up against limits to usable output power. Handling too much power in an IC becomes uneconomical because of package constraints and excessive dissipation. Just as with the debate of integration itself, packing too much power into an IC eventually gets too expensive because of the larger die sizes such an IC requires. According to some esti-

mates, power greater than 100W begins to stretch the economic practicality of an IC.

**Sorting through the costs**

Ultimately, determining the appropriate design approach requires emphasizing total system costs and any indirect savings an integrated design may produce. For example, by increasing switching frequencies, ICs can reduce the size and cost of other components. Reducing the number of discrete components may increase a design's reliability and decrease its size and component count. Eventually, you have to compare the cost of the exact

**MANUFACTURERS OF POWER ICs**

For free information on the power ICs for motion control and switching applications such as those described in this article, circle the appropriate numbers on the postage-paid Information Retrieval Service card or use EDN's Express Request service. When you contact any of the following manufacturers directly, please let them know you read about their products in EDN.

**Allegro Microsystems Inc**

Worcester, MA  
(508) 853-5000  
Full-bridge PWM motor drivers,  
lamp and relay drivers  
**Circle No. 339**

**AT&T Microelectronics**

Allentown, PA  
(800) 372-2447 ext 882  
High-voltage technology,  
high-side gate drivers  
**Circle No. 340**

**Cirrus Logic Inc**

Fremont, CA  
(510) 226-2001  
Disk-drive motion controllers,  
power drivers  
**Circle No. 341**

**Harris Semiconductor**

Melbourne, FL  
(800) 442-7747, ext 7127  
MOSFET drivers, power ASICs  
**Circle No. 342**

**Hitachi America LTD**

Brisbane, CA  
(415) 589-8300  
Custom ICs (including logic, control,  
diagnostic features, and power out-  
put) for disk-drive and automotive  
applications  
**Circle No. 343**

**International Rectifier**

El Segundo, CA  
(310) 322-3331  
High-voltage MOSFET drivers  
**Circle No. 344**

**Linear Technology**

Milpitas, CA  
(408) 432-1900  
MOSFET switches and drivers  
**Circle No. 345**

**Micrel Semiconductor**

San Jose, CA  
(408) 435-3408  
MOSFET drivers  
**Circle No. 346**

**Micro Linear**

San Jose, CA  
(408) 433-5200  
Lamp drivers, motor controllers,  
electronic-ballast controllers  
**Circle No. 347**

**Motorola Inc**

Phoenix, AZ  
(602) 897-3840  
Low- and high-voltage  
BCD technology  
**Circle No. 348**

**National Semiconductor**

Santa Clara, CA  
(408) 721-6937  
BCD technology, motor drivers  
**Circle No. 349**

**Philips Semiconductor**

Sunnyvale, CA  
(800) 447-1500, ext 3000  
BCD technology, motor drivers,  
and controllers  
**Circle No. 350**

**Power Integrations**

Mountain View, CA  
(408) 960-3572  
High-voltage technology,  
half-bridge drivers  
**Circle No. 351**

**Semtech Corp**

Newbury Park, CA  
(805) 498-2111  
Interface drivers  
**Circle No. 352**

**SGS Thomson**

Lincoln, MA  
(617) 259-0300  
BCD technology  
**Circle No. 353**

**Siemens Components Inc**

Cupertino, CA  
(408) 777-4500  
Protected FETs and ICs  
**Circle No. 354**

**Silicon Systems**

Tustin, CA  
(714) 573-6200  
Disk-drive motor controllers  
**Circle No. 355**

**Siliconix**

Santa Clara, CA  
(408) 988-8000  
Switches, motor controllers,  
BCD technology  
**Circle No. 356**

**Supertex Inc**

Sunnyvale, CA  
(408) 744-0100  
High-voltage ICs  
**Circle No. 357**

**Telcom Semiconductor**

Mountain View, CA  
(415) 968-9241  
MOSFET drivers  
**Circle No. 358**

**Texas Instruments**

Dallas, TX  
(214) 995-6611  
BCD technology, transistor  
arrays, power logic  
**Circle No. 359**

**Toko America Inc**

Colorado Springs, CO  
(719) 528-2200  
MOSFET/IGBT drivers  
**Circle No. 360**

**Toshiba America Electronics Components Inc**

Irvine, CA  
(714) 455-2000  
Motor drivers and controllers  
**Circle No. 361**

**Unitrode Integrated Circuits Corp**

Merrimack, NH  
(603) 424-2410  
Drivers and motor controllers  
**Circle No. 362**

**VOTE . . .**

Please also use the Information Retrieval Service card to rate this article (circle one):

**High Interest 583**  
**Medium Interest 584**  
**Low Interest 585**

**Super Circle Number**

For more information on the power ICs available from all of the vendors listed in this box, you need only circle one number on the postage-paid reader service card.

**Circle No. 363**

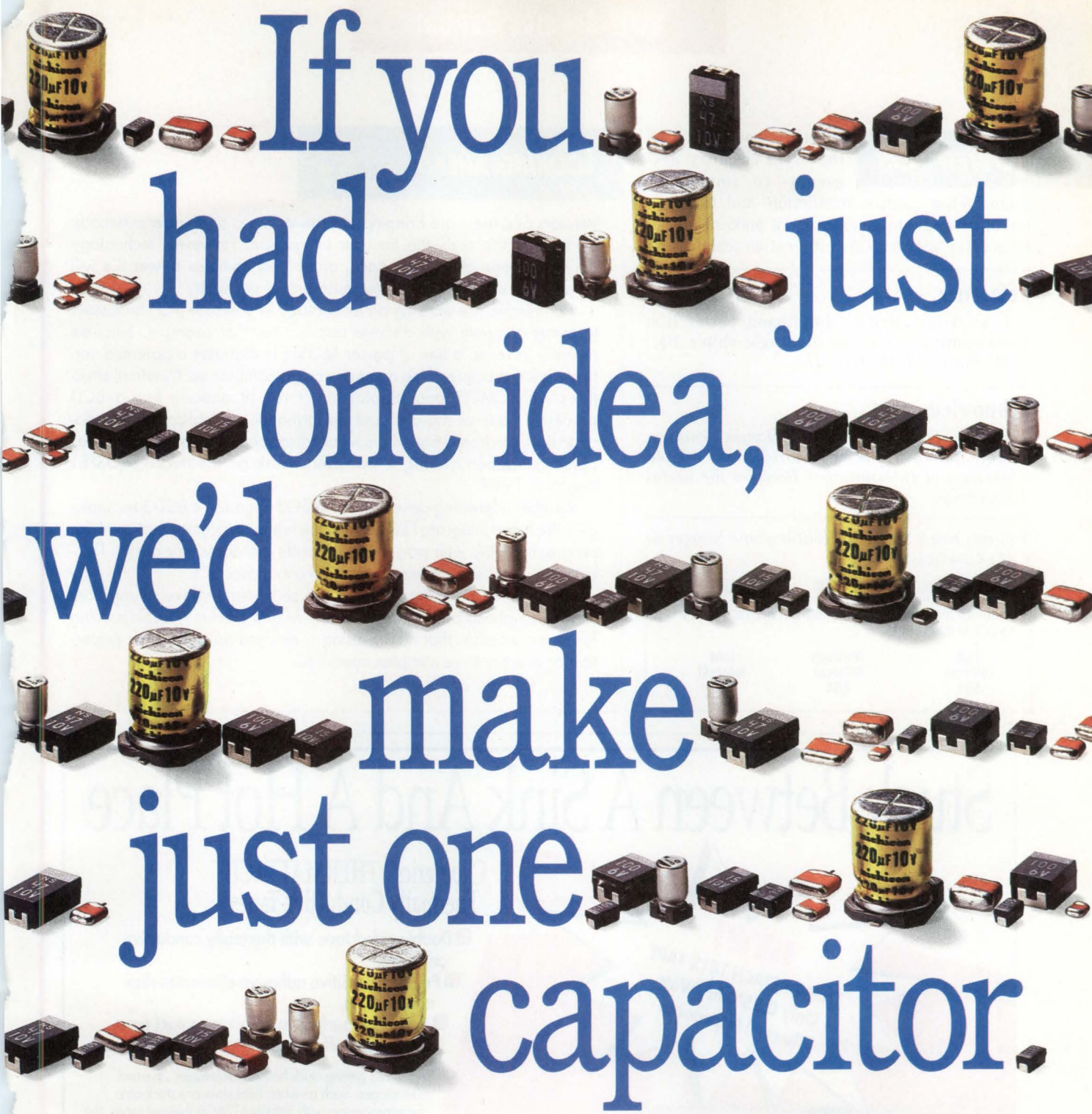

# If you had just one idea, we'd make just one capacitor.

On the surface, nobody gives you a wider or more reliable choice of surface mount aluminum electrolytic and tantalum chip capacitors than Nichicon.

Fifteen series, designed to help you cut costs and speed assembly time. Each, designed to help you match the operating performance and delivery dates you want to your product needs.

Call your Nichicon representative or distributor for your free Product Catalog. It's an idea you can live with.

**AN ISO 9000 CERTIFIED COMPANY**  
**SURFACE MOUNT CAPACITORS from**

**nichicon**<sup>®</sup>  
**The capacitor choice.**  
(708) 843-7500. FAX (708) 843-2798.

## POWER ICs

functions you need with the extra circuitry necessary to implement

them. When control, protection, and feedback circuitry costs start mounting, it makes sense to take a step or two up the integration scale. **EDN**

### Reference

1. Kerridge, Brian, "Intelligent power ICs: Auto applications drive up single chip's IQ," *EDN*, March 17, 1994, pg 27.

### Acknowledgment

*Thanks to Dean Henderson of Harris Semiconductor, Randy Frank of Motorola, and Arnold Alderman of International Rectifier for useful discussions.*

You can reach Technical Editor Anne Swager at (215) 645-0544.

### VOTE

Please use the Information Retrieval Service card to rate this article (circle one):

High  
Interest  
583

Medium  
Interest  
584

Low  
Interest  
585

## LOOKING AHEAD

Vendors and users are bringing designs down to earth after a decade of thinking the sky's the limit on integration. However, technology doesn't change at an even pace, and highly complex power ICs will no doubt find their way into more and more products.

Companies are working on technology to combine BCD processes to better compete with discrete approaches. For example, Siliconix recently unveiled a line of power MOSFETs that uses a patented vertical-trench structure. If the company could combine such vertical structures with CMOS and bipolar structures (it already has a BCD process), many of the cost and performance tradeoffs between discrete and integrated transistors would disappear. None of these developments happen overnight, however. Work on the trench MOSFET began in 1987.

Another interesting development is SGS Thomson's BCD3 technology, which can integrate EEPROM. In the future, processes that combine programmability with power may provide the necessary design flexibility to tip the scale toward more complex power ICs.

For now, most of the action seems to be in medium-level integration, with an emphasis on keeping costs down and efficiently implementing functions, whether that means using a discrete transistor with protection or using a more complex control IC.

# Stuck Between A Sink And A Hot Place

**NEW!**

**THERMATTACH T412 TAPE**  
Only 0.25°C-in<sup>2</sup>/Watt  
Thermal Impedance

## Chomerics® THERMATTACH® Thermally Conductive Tapes

- Double-sided tape with thermally conductive adhesive.
- Pressure sensitive adhesive eliminates clips and epoxies.
- Embossed surface maximizes contact area.
- Eliminates off-line curing of liquid adhesives.

Sometimes getting stuck has its advantages...thermal advantages. Such as when heat sinks are stuck onto microprocessors with THERMATTACH thermal tapes, the hot new product in the CHO-THERM® family of thermal interface materials. Extensive testing by leading component manufacturers and Chomerics clearly demonstrates the thermal and mechanical advantages of tape over other attachment methods. And THERMATTACH tapes do it at a lower installed cost.

*See for yourself. Call or fax for more information.*

## CHOMERICS

Chomerics, Inc.  
77 Dragon Court  
Woburn, MA 01888  
Tel: 617-935-4850  
Fax: 617-933-4318

Chomerics (UK) Ltd.  
Parkway, Globe Park  
Marlow, Bucks England SL7 1YB  
Tel: (0628) 486030  
Fax: (0628) 476303

# AMPLIFIERS

**NOBODY DOES AMPLIFIERS LIKE ANALOG DEVICES**

## IN THIS ISSUE

Whatever your application, ADI has the ideal amplifier for you. And they're available from national distributors and local sales offices nearby. In this issue you'll find our newest amplifiers, with performance and prices to meet the most demanding applications.

### High-Speed

High-speed amplifiers for video, high-definition imaging and graphics, office equipment, communications systems, and test and measurement instrumentation.

### Precision

From the inventors of the OP-07 come new circuits that combine superior ac/dc specifications, high common-mode rejection, and low gain error.

### Single-Supply

If you're designing 3 V or 5 V systems, you need amplifiers specifically designed and tested for low-voltage applications. Choose from the industry's largest selection of true single-supply amplifiers.

### Low-Noise

For medical imaging systems or advanced audio equipment, ADI has a low-noise, low-distortion amplifier to fit your needs, at a price you can afford.

### Instrumentation Amps

Why build your own instrumentation amplifier when ADI has a full selection ready to go, all with high accuracy and prices to beat discrete designs.

### Free Spice Disk

The industry's best SPICE models covering over 392 devices are yours for the asking. The diskette includes macro-models of amplifiers, references, multipliers, analog switches, and more.

### Applications Information

Our team is on your team. For assistance call on our factory or field applications engineers. With over twenty-five years of analog experience, we're here to help. 1-800-ANALOG-D.

## LEADERS IN HIGH SPEED

### FASTEST AMP ON 50 mW

Introducing the industry's fastest op amp on 50 mW. The new AD8001 800-MHz unity-gain monolithic amplifier uses just 5 mA of supply current. It can process high-speed video signals in HDTV equipment, professional cameras and graphics workstations. Video-specific parameters include 0.1 dB gain flatness to 100 MHz, 0.01% differential gain, 0.025° differential phase ( $G = +2$ ,  $R_L = 150 \Omega$ ).

Other specifications include 1,200 V/ $\mu$ s slew rate and 10 ns settling of 2 V steps to within 0.1%. A single AD8001 can provide 70 mA of output current and drive up to six back-terminated (75  $\Omega$  load) cable lines. Full power bandwidth is 125 MHz with 5 V p-p signal swings. The AD8001's worst harmonic component at 20 MHz is -60 dB, and voltage noise

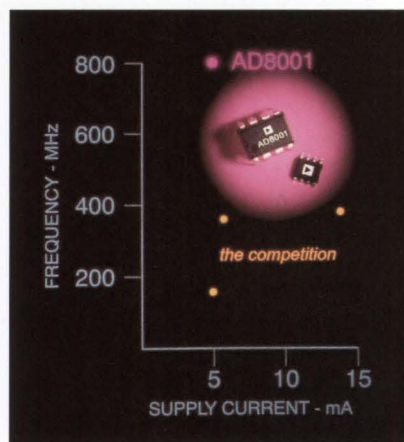

at 10 kHz is only 2 nV/ $\sqrt{\text{Hz}}$ .

The AD8001 is packaged in an 8-pin plastic DIP or SO-8 and operates from -40°C to +85°C. Military grades will be available with operation from -55°C to +125°C. Prices begin at \$2.75 in 1,000s.

**CIRCLE 1**

### LOW-POWER 110-MHz BUFFER RUNS COOL

The 110-MHz BUF04 slews at 3,000 V/ $\mu$ s and consumes only 6.9 mA. At  $\pm 5$  V, you can reduce power to one-third with full  $\pm 15$  V performance. Closed-loop design provides low offset and great gain accuracy, and  $\pm 10$  V signals settle to within 0.1% in 60 ns. Best of all, the BUF04 is packaged in low-profile SO-8 and 8-pin DIPs.

Applications include a/d converter buffering, video cable driving, pulse detection, pro-audio d/a converters, and more. The BUF04 operates from

### BUF04 KEY SPECS

Parameter	Min	Typ	Max	Units
GBW		110		MHz
Slew Rate	2,000	3,000		V/ $\mu$ s
Supply Current		6.9	8.5	mA
Voltage Noise Density		4		nV/ $\sqrt{\text{Hz}}$
Offset Voltage		0.3	1	mV
Gain Linearity		0.005		%

Prices, from \$3.71 in 1,000s.

1 Specifications with  $\pm 15$  V supply operation

$\pm 5$  V to  $\pm 15$  V supplies over temperatures from -40°C to +125°C.

**CIRCLE 2**

## WIDE BAND OP AMPS FOR VIDEO, IMAGING, AND COMMUNICATIONS

These new high-speed op amps provide optimal price/performance in a wide range of video-speed applications. They excel at driving heavy capacitive loads. Some are specified for operation on single +3 V to +5 V supplies, others use common  $\pm 5$  V and  $\pm 15$  V dual supplies.

### AMPS WITH LOW $\Delta G/\Delta \theta$

If you need high output drive, try the AD811. It's a high-performance video amplifier with superb video specs to preserve signal fidelity in high-definition TV systems. The AD811 delivers high output drive of 100 mA for efficient line driving. It's specified over a wide power supply range of  $\pm 4.5$  V to  $\pm 18$  V and uses just 16.5 mA of power supply current.

Other family members include the AD810 and AD812, ideal for broadcast-quality applications. The AD810 is a low-power version that consumes just 6.8 mA in normal mode, while a DISABLE feature further reduces power to only 2.1 mA. The versatile and low-cost dual AD812, runs on a single +3 V or +5 V supply, or from  $\pm 5$  V or  $\pm 15$  V supplies. Package options include 8-pin plastic DIPs, 16- and 20-pin SOICs, 8-pin Cerdip, or 20-pin LCCs.

**CIRCLE 3**

### TRIPLE VIDEO AMP WITH FAST DISABLE

The triple AD813 packs three current-feedback op amps, each with its own independent 80 ns disable function. It offers unprecedented gain flatness for high-quality computer video and broadcast video gear. Operation is from either single +3 V to +5 V, or  $\pm 5$  V to  $\pm 15$  V supplies. Supply current is a low 3.5 mA (+3 V) and it delivers 100 MHz of unity gain ( $-3$  dB) bandwidth.

For video muxing, CCD-based equipment, and RGB line driver applications, nothing matches the AD813. It operates from  $-40^\circ\text{C}$  to  $+85^\circ\text{C}$  and comes in small 14-pin DIP or narrow body SOIC packages.

**CIRCLE 4**

### LOW-COST, GENERAL-PURPOSE AMPLIFIERS

The AD817 is optimized for applications that require unity-gain stable operation. Its counterpart, the AD818 is tailored for gains of magnitude equal to or greater than +2 or  $-1$ . The AD818, with low differential phase and gain errors, is great for video cameras and pro video equipment. As an ADC buffer or line driver, the AD817 excels with its combination of high output current and unlimited capacitive load drive.

**CIRCLE 5**

### HIGH-SPEED FET-INPUT

The AD843 and AD845 FET-input op amps combine excellent ac and dc performance with low power consumption. The dc performance of these unity-gain stable op amps is perfect for high-speed data acquisition systems. Their low input bias current and offset voltage can reduce errors in high-speed active filters, integrators, peak detectors, and current-to-voltage converter circuits.

Dynamic performance is equally impressive. They have low total harmonic distortion for high-speed sample/hold circuits, ADCs, and DSP front-end circuits. They also have industry-standard pinouts and can upgrade system performance. Both op amps operate from  $\pm 15$  volt supplies with five performance grades specified over commercial, extended, and military temperature ranges.

**CIRCLE 6**

### VIDEO LINE DRIVING MADE EASIER

The figure below depicts a video line driver circuit and provides a list of recommended products with associated resistor values. When using a current feedback op amp for U1, closed-loop bandwidth largely depends on the value of the feedback resistor  $R_F$ .

Attenuation of the circuit's open-loop response, especially when driving a load value  $< 250 \Omega$ , will also affect its bandwidth. Gain resistance ( $R_G$ ) is typically set for stable operation at  $G = 2$ . Low values of  $R_G$  and  $R_F$  will minimize the circuit's feedback time constant and nonlinear behavior. The use of 1% metal-film resistors ensures the widest possible 0.1 dB bandwidth. To achieve even wider bandwidths, you can reduce the magnitude of  $R_F$ , but you run the risk of increasing signal peaking. Use maximum supply voltages and limit amplifier loads to minimize signal distortion.

With the exception of the AD8001, which operates from  $\pm 5$  V supplies, the products in the chart below are characterized with  $\pm 15$  V supplies. Bandwidth is a measure of gain flatness at 0.1 dB.

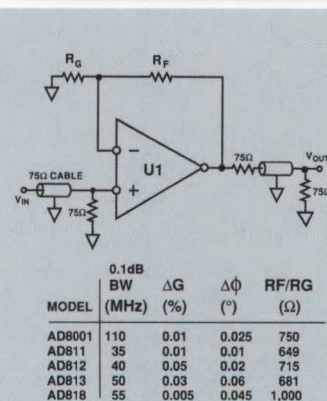

**F O R I N F O R M A T I O N**

## HIGH SPEED QUAD WITH PRECISION

The OP467, with four fast op amps in one package, has the fastest slew rate (170 V/ $\mu$ s) and settling time ( $\leq 200$  ns to 0.01%) among quads. In multi-channel systems, it can save space, reduce power and cost, and increase reliability. It's unity-gain stable and can drive high-capacitance loads up to 1,600 pF.

Besides its speed, it offers a low 200  $\mu$ V offset. Use the OP467 in high-speed instrumentation and test equipment, high-speed detectors, laser scanners, sonar arrays, and other applications that need speed, accuracy, and a wide  $\pm 5$  to  $\pm 15$  V operating range. It's housed in 14-pin plastic DIP, cerdip, 16-lead SOL, and 20-contact LCC surface-mount packages.

**CIRCLE 7**

## IMPROVED EL2020

The ADEL2020, a superior second source, will improve performance with less power drain and lower cost. Low differential gain and phase errors make it ideal for low-power video applications. The ADEL2020 is available in either plastic DIP or SOIC packages specified over the  $-40^{\circ}\text{C}$  to  $+85^{\circ}\text{C}$  industrial temperature range.

**CIRCLE 8**

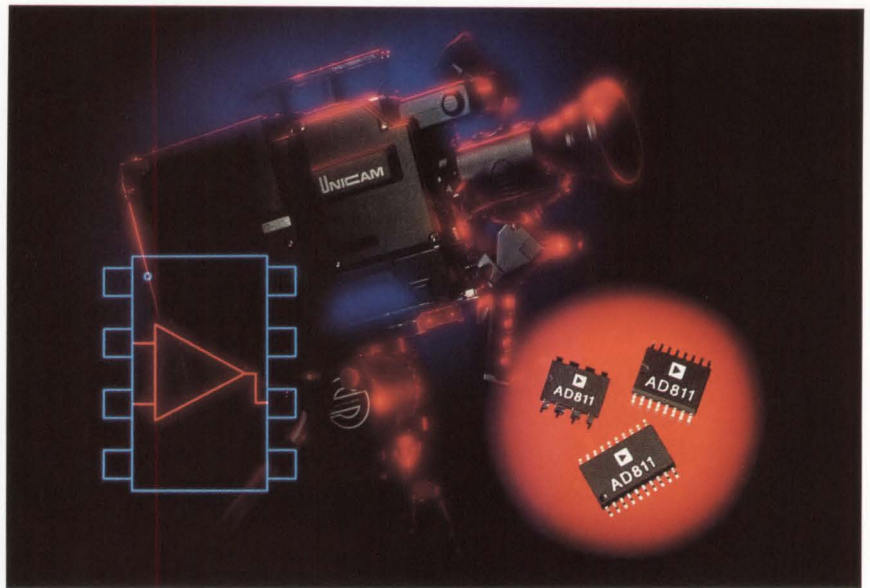

## AN AMPLIFIER WITH A DIFFERENCE

The AD830 wideband amplifier rejects high-frequency common-mode voltage noise in differential line receiver applications. It handles differential signals, system grounds, and low-distortion high-frequency amplification. With  $> \pm 50$  mA full-output-current drive, it's useful for driving heavy loads. And its output clamping is great for driving ADCs.

Other benefits include balanced impedance inputs, symmetrical circuit behavior for gain of either +1 or -1, and low sensitivity to source resistance.

The AD830 uses  $\pm 15$  V and  $\pm 5$  V supplies, but its special offsetting capability allows it to perform with single supplies from +10 to +30 V. Packages include 8-pin plastic miniDIP, cerdip, and SOIC. **CIRCLE 9**

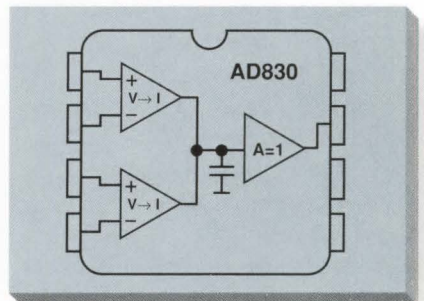

MODEL	AD810	AD811	AD812	AD813	AD817	AD818	AD843	AD845	OP467	AD830	UNITS
Channels	Single	Single	Dual	Triple	Single	Single	Single	Single	Quad	Single	
Supply Voltages	$\pm 5, \pm 15$	$\pm 5, \pm 15$	+3 to $\pm 15$	+3 to $\pm 15$	+5 to $\pm 15$	+5 to $\pm 15$	$\pm 15$	$\pm 15$	$\pm 5, \pm 15$	$\pm 5, \pm 15$	Volts
Feedback	Current	Current	Current	Current	Voltage	Voltage	Voltage	Voltage	Voltage	Voltage	
BW, 0.1 dB (G=+2)	30	35	40	50	16	55	—	—	—	15	MHz
BW, -3 dB (G=+1)	80	140	145	125	50	130 (+2)	34	16	28	100	MHz
Slew Rate	1,000	2,500	1,600	450	350	500	250	100	170	530	V/ $\mu$ s
Settling Time (0.01%)	125	65	40 (0.1%)	40 (0.1%)	70	80	135	350	200	35 (0.1%)	ns
$\Delta$ Gain Error	0.02	0.01	0.02	0.03	0.04	0.005	0.025	0.04	—	0.05	%
$\Delta$ Phase Error	0.04	0.01	0.02	0.06	0.08	0.045	0.025	0.02	—	0.08	$^{\circ}$
$V_n$ (10 kHz)	2.9 (1 kHz)	1.9 (1 kHz)	3.5	3.5	15	10	19	18	6 (1 kHz)	27	nV/ $\sqrt{\text{Hz}}$
Max $V_{OS}$	6	3	5	5	2	2	2	1.5	0.5	$\pm 3$	mV
Min Output Current	40	100 (typ)	40	50	50	50	50	50 (typ)	50 (typ)	$\pm 50$	mA
Max Supply Current	8	18	5.5	5.5	7.5	7.5	13	12	10	14.5	mA
Prices in 1,000s	\$2.08	\$2.85	\$2.48	\$3.74	\$1.52	\$1.69	\$3.70	\$2.76	\$4.86	\$2.42	USD
	CIRCLE 3	CIRCLE 3	CIRCLE 3	CIRCLE 4	CIRCLE 5	CIRCLE 5	CIRCLE 6	CIRCLE 6	CIRCLE 7	CIRCLE 9	

1 . 8 0 0 . 2 6 2 . 5 6 4 3

**LOW-POWER PRECISION FAMILY**

When your design demands precision and low power, nothing beats the OP97 family. The OP97 (single) OP297 (dual) and OP497 (quad) are great for designs that need very low bias currents.

The OP97 family is ideal for sample-and-hold circuits, peak detectors, and logarithmic amplifier designs that exhibit low leakage current. Thermocouples, strain gages and other industrial equipment need the OP97's accuracy over wide temperature ranges. Unlike conventional FET-input op amps, these ICs use a unique current cancellation circuit to keep bias current low over the entire temperature range.

The family combines low power consumption with guaranteed accuracy. Maximum voltage offset at 25°C is only 50 µV (with only 0.5 µV/°C drift) and bias current is 100 pA. Minimum open-loop gain is 2 kV/mV. Combined, these specs can eliminate the need for offset trims and additional gain stages.

Battery and low-powered systems will benefit from the OP97 family's low supply current: 625 µA (max) per channel. Wide supply voltages range from ±2 V to ±20 V. Packaging options include 8- and 14-pin DIPs and cerdips, 8- and 16-pin SOICs, and 20-contact LCCs.

**CIRCLE 10**

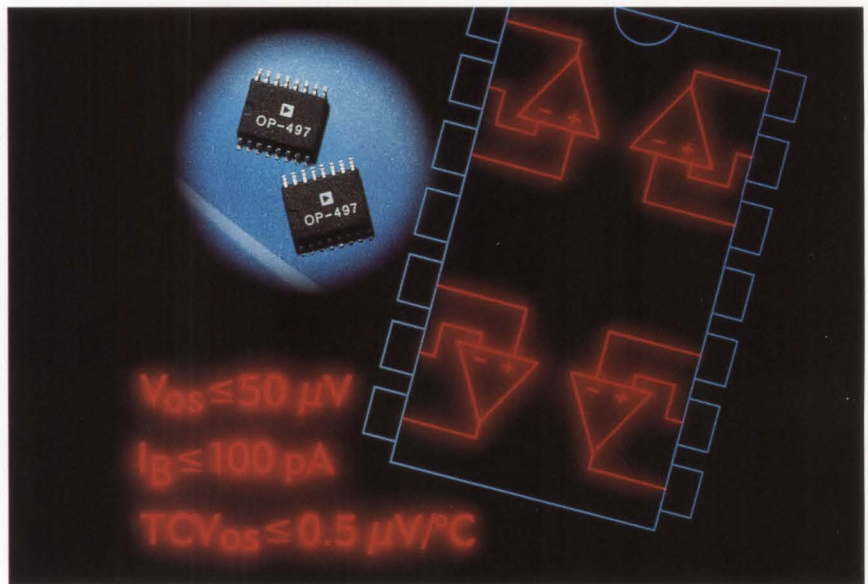

**WHAT'S BETTER THAN THE OP-07?**

The OP177 is today's industry standard for ultrahigh precision. Maximum offset voltage is only 10 µV, with less than 0.1 µV/°C V<sub>OS</sub> drift, eliminating external V<sub>OS</sub> trimming and increasing system accuracy over temperature. Other guaranteed specifications include minimum 130 dB CMRR and 120 dB PSRR.

This low-noise, bipolar-input op amp is a good alternative to chopper-stabilized amplifiers. The OP177 provides chopper-type performance without high noise, low frequency chopper spikes, external capacitors, and limiting common-mode input voltage

range. The OP177 is available in 8-pin plastic, cerdip and SO-8 packages. Cerdip and 20-lead LCC devices are guaranteed over extended and military temperature ranges.

**CIRCLE 11**

**DUALS AND QUADS TOO**

The dual OP200 and quad OP400 offer great performance over temperature and use very little power. For example, the OP200's input offset voltage is typically 25 µV with only 0.2 µV/°C drift from -55°C to +125°C. Its supply current (per amplifier) is a scant 570 µA. Industry standard DIP, SOL and LCC packages are available.

**CIRCLE 12**

MODEL	OP97	OP297	OP497	OP177	OP200	OP400	UNITS
Channels	Single	Dual	Quad	Single	Dual	Quad	
Offset Voltage (V <sub>OS</sub> )	25	50	50	10	75	150	µV, max
V <sub>OS</sub> Drift	0.6	0.6	0.5	0.1	0.5	1.2	µV/°C, max
Offset Current (I <sub>OS</sub> )	0.1	0.1	0.1	1	1	1	nA, max
Input Bias Current	±0.1	±0.1	0.1	1.5	2	3	nA, max
Voltage Noise @ 1kHz	14	17	15	(118)	11	18	nV/√Hz (nV <sub>RMS</sub> )
Current Noise	20	20	20	(8)	400	600	fA/√Hz (pA <sub>RMS</sub> )
CMRR	132	120	120	130	120	120	dB, min
PSRR	132	120	120	120	-	-	dB, min
Input Voltage Range	±14	±14	±14	±13.5	±13	±13	V
Bandwidth (G=+1)	900	500	500	600	500	500	kHz
Supply Current	600	625	625	2,000	725	725	µA, max
Prices in 1,000s	\$1.00	\$2.50	\$4.04	\$0.95	\$2.48	\$4.50°	USD
	CIRCLE 10	CIRCLE 10	CIRCLE 10	CIRCLE 11	CIRCLE 12	CIRCLE 12	



## SINGLE-SUPPLY AMPLIFIERS DELIVER TOP PERFORMANCE AT LOW COST. INDUSTRY'S BROADEST PRODUCT LINE

Nobody has a broader product portfolio of single-supply amplifiers for low-power and battery-powered gear. These are just a few of the products we've recently introduced.

### LOW-COST DUALS AND QUADS OUTPERFORM CMOS AMPS

The dual OP292 and quad OP492 single-supply op amps are low in cost and outperform comparably priced CMOS devices. These 4 MHz, 4 V/ $\mu$ s amplifiers combine the qualities of complementary bipolar—low noise, precision and output drive capability—with the low cost of CMOS devices. With +5 V supplies, the OP292 guarantees 2.4 mV maximum (500  $\mu$ V typ) offset over our new HOT temperature range (-40°C to +125°C), at no additional cost.

Unlike competitive ICs, the inputs of these amplifiers can swing well below ground with output swings to ground. The OP292 and OP492 draw less than 1.4 mA per channel, excellent for multichannel battery-powered applications. Both amps feature low voltage and current noise: 15 nV/ $\sqrt{\text{Hz}}$  and 0.7 pA/ $\sqrt{\text{Hz}}$ , and channel separation (at 1 kHz) is 100 dB.

Applications that can take advantage of the OP292 and OP492 include disk drives, mobile phones, multichannel industrial and servo control systems, modems, fax machines, pagers, and power supply monitoring circuits. Packaging options include 8- and 14-pin plastic DIPs or surface-mount narrow-body SOICs. USD prices for the OP292 and OP492 start at \$1.32 and \$2.16, respectively.

**CIRCLE 13**

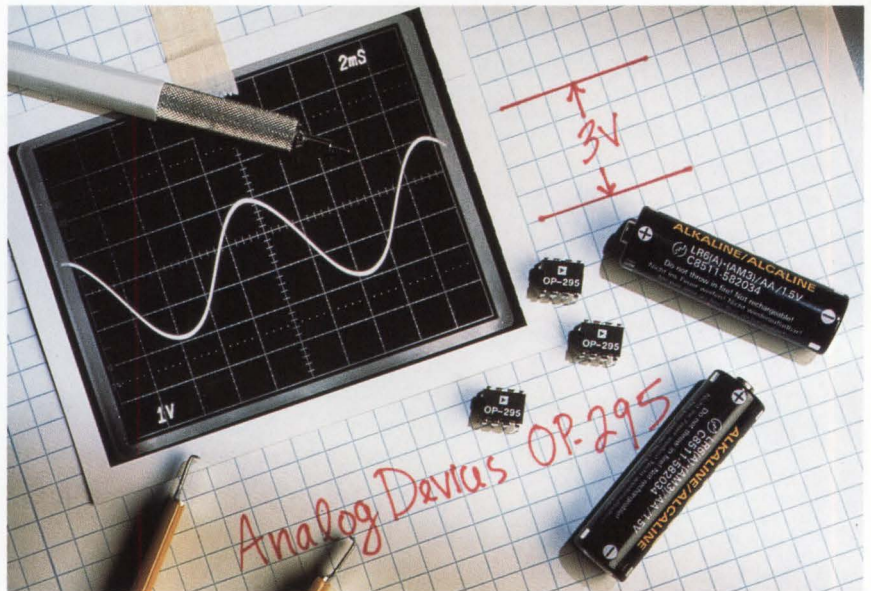

### 3-V TO 30-V RAIL-TO-RAIL

The dual OP295 and quad OP495 3-V single-supply op amps are the industry's highest accuracy, lowest power true rail-to-rail amplifiers. Their low 30  $\mu$ V offset, combined with a high gain of 1,000 V/mV, makes them ideal for portable instrumentation. On a 3 V supply, they drive a 10 k $\Omega$  load from 2.90 V to within only 2 mV of ground—perfect for process and motor control circuitry.

For driving coax cable, large FETs, or other capacitive loads, the OP295 and OP495 offer stability with loads up to 300 pF. They can supply over  $\pm 25$  mA to the load on  $\pm 15$ V supplies ( $\pm 18$  mA at +5 V), with a typical gain-bandwidth product of 75 kHz.

The OP295 uses less power than CMOS chips, gives exceptionally low voltage offset drift (typically 1  $\mu$ V/°C), and requires only 50% of the quiescent current of the closest competitive product.

The OP295 and OP495 are specified from -40°C to +125°C and packaged in plastic DIPs and SOICs. Die are also available. USD prices in 1,000s begin at \$1.98 and \$3.56, respectively.

**CIRCLE 14**

### HIGH PRECISION AT +5 V

The OP113, OP213 and OP413 are single, dual and quad single-supply precision amplifiers. Operating from +5 V to  $\pm 15$  V, these op amps feature low noise (4.7 nV/ $\sqrt{\text{Hz}}$ ), 3.5 MHz bandwidth, 75  $\mu$ V offset voltage, and drift of just 0.2  $\mu$ V/°C. Applications include automotive, process control, portable instruments, and pressure/strain gages. Packaging options range from 8-lead SOIC and plastic DIP to 16-lead SOL packages. USD prices in 1,000s begin at \$1.47 (single), \$2.21 (dual) and \$4.92 (quad).

**CIRCLE 15**

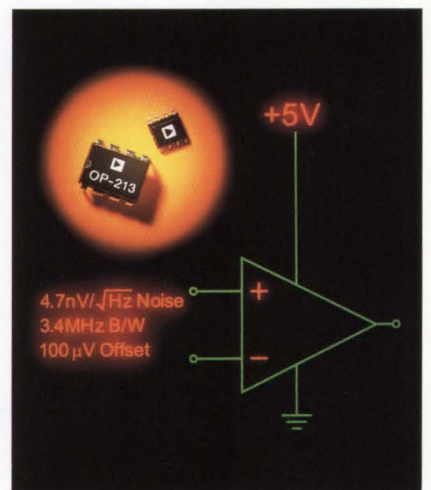

1 . 8 0 0 . 2 6 2 . 5 6 4 3

**SINGLE-SUPPLY FET**

The AD820 (single) and AD822 (dual) are precision, low-power, FET-input op amps that operate from a single +3 to +36 V range, or with dual supplies from ±1.5 to ±18 V. Their outputs swing from rail to rail (within 10 mV) and their inputs can swing 0.2 V below ground. The JFET input stage maintains low bias current ( $\leq 10$  pA at 25°C, B grade), with offsets as low as 900  $\mu$ V max over temperature (-40°C to +85°C) and 25 nV/ $\sqrt{\text{Hz}}$  noise at 10 Hz.

Though the quiescent current drain is only 620  $\mu$ A, both the AD820 and AD822 will drive loads of up to 15 mA and 350 pF. They both have a unity gain bandwidth of 1.8 MHz and 3 V/ $\mu$ s slew rate. A 3-volt version is optimized for low-power operation from -40°C to +85°C at no extra cost. The AD820 and AD822 are available in 8-pin plastic DIPs and SOICs.

**CIRCLE 16**

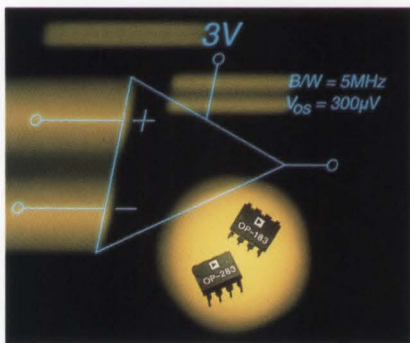

**INDUSTRY'S FASTEST 3 V SINGLE-SUPPLY AMP**

If your 3 V system needs a gain bandwidth product greater than 1 MHz, select the OP183 or OP283. They combine 5 MHz bandwidth with low noise for use in low voltage applications, such as ADC buffering, filtering, servo control and audio for portable computers.

These two amps are thoroughly specified for +3 V, +5 V and ±15 V supply operation. Unlike competing

3 V devices that specify only typical performance characteristics, the OP183 and OP283 guarantee low offset, high gain, and input and output ranges that include ground. Noise is typically a low 10 nV/ $\sqrt{\text{Hz}}$ , and both amplifiers can sink and source 25 mA—even with a 3 V supply.

Both devices are specified from -40°C to +85°C and are available in 8-lead plastic DIPs and SO-8 packages. Prices for the OP183 and OP283 (in 1,000s): \$1.42 and \$2.15, respectively.

**CIRCLE 17**

**SINGLE-SUPPLY INSTRUMENTATION AMPLIFIERS FEATURE SINGLE-SUPPLY, HIGH ACCURACY, LOW COST**

When accuracy, space and cost are your concern, one of these three in-amps will provide the lowest cost solution—especially when compared with the time to design and implement an equivalent circuit.

**SINGLE SUPPLY IN-AMP**

Specified for operation from +5 to ±15 volts, the AMP04 precision in-amp packs accuracy in a small SO-8 footprint for those difficult single-supply designs. The AMP04 can eliminate the need for a separate gain stage to isolate low-level differential signals from high-level common-mode signals. Gain is easily programmable from 1 to 1,000 with a single resistor.

The AMP04 has an input offset current of 1 nA for direct connection to strain gages and high-impedance transducers. Guaranteed max specs include 3  $\mu$ V/°C offset drift, 150  $\mu$ V offset voltage, and 0.005% gain non-

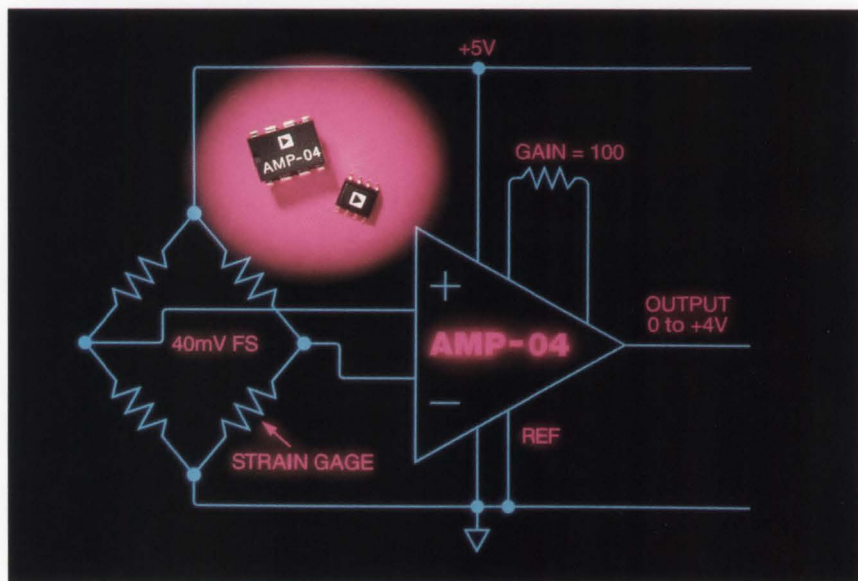

linearity, while requiring only 700  $\mu$ A of supply current. A unique feature of the AMP04 is that it doesn't exhibit common-mode swing limiting at high gain, unlike "triple-amp" designs (see sidebar).

The AMP04 precision in-amp is specified for operation from -40°C to +85°C. Package options include an 8-pin plastic DIP, 8-pin SOIC, or 8-pin cerdip. USD prices (in 1,000s) begin at \$4.55. **CIRCLE 18**

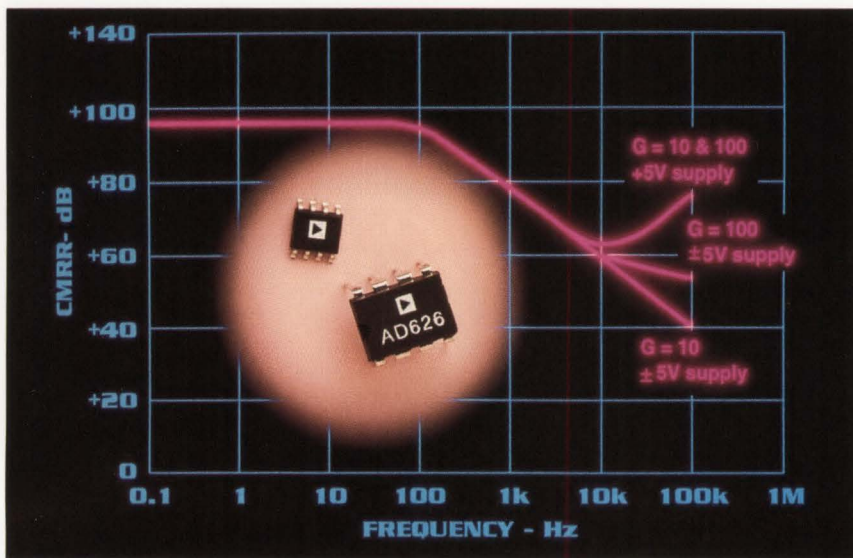

### LOW-COST IN-AMP REPLACES DISCRETE DESIGNS

The AD620 high-accuracy in-amp replaces discrete designs with less overall error, lower power use, and reduced board space. It allows for gains from 1 to 1,000 set by a single external resistor. Noise is low (0.28  $\mu\text{V}$  p-p, 0.1 to 10 Hz and 9 nV/ $\sqrt{\text{Hz}}$  at 1 kHz); bandwidth is 120 kHz ( $G = 100$ ). With guaranteed-maximum 50  $\mu\text{V}$  voltage offset, 0.6  $\mu\text{V}/^\circ\text{C}$  drift, 1 nA input bias current, and 40 ppm nonlinearity—and minimum 93 dB CMR ( $G = 10$ )—it's ideal for weigh scales, transducer interfaces and ECG circuits. The supply range is a wide  $\pm 2.3$  V to  $\pm 18$  V, at 1.3 mA (maximum). Prices in 1,000s begin at \$3.27 USD.

**CIRCLE 19**

### SINGLE-SUPPLY DIFFERENTIAL AMP

The AD626 is a single-supply, low-power differential amplifier with on-chip gains of 10 and 100 V/V (externally set). Its supply range is +2.4 to +10 V single,  $\pm 1.2$  to  $\pm 6$  V dual, drawing less than 290  $\mu\text{A}$  of current. Uses include current sensing and sensor interfacing, especially in battery and portable applications. Its common mode range,  $6 (V_S - 1 \text{ V})$ , exceeds the supply; for +5 volt supply, CMR = 90 dB and the output range is +30 V to +4.7 V (minimum). Its inputs are overload protected (50 V continuous), and the internal attenuation network includes RFI filters. Prices (1,000s) start at \$2.85 USD.

**CIRCLE 20**

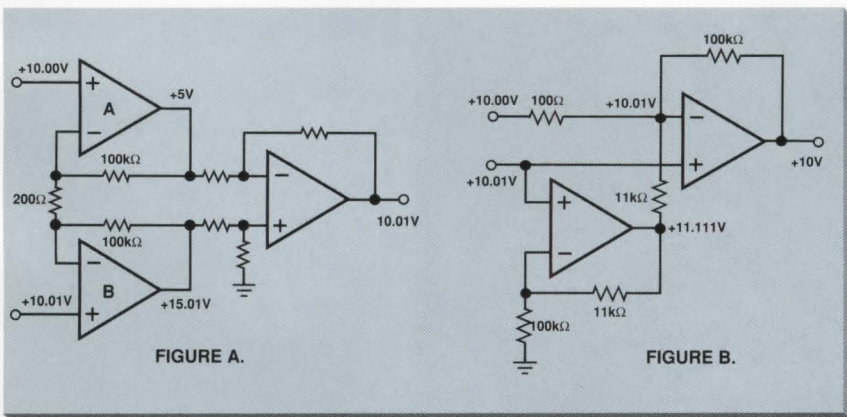

### EXTEND COMMON-MODE SWING LIMITATIONS AT HIGH GAIN

In traditional three op amp in-amp designs, common-mode voltage (CMV) range is limited at high gain. For example, the in-amp circuit below (Figure A) is designed for a gain of 1001 with a CMV of 10 volts, but there's a problem. Amplifier B must swing to 15.01 volts in order for the circuit's output to swing to 10.01 volts. Operating from a +15 V supply, an op amp cannot handle this swing range. The output will saturate before reaching the supply rails.

The single-chip AMP04 in Figure B, operating at the same common-mode conditions, does not exhibit this limitation. None of its internal nodes reach signal levels that are high enough to cause amplifier saturation. In addition, the AMP04 maintains a gain accuracy of 0.5%, provides high input impedance ( $4 \times 10^9$ ), and features 105 dB of CMRR at a gain of 1,000.

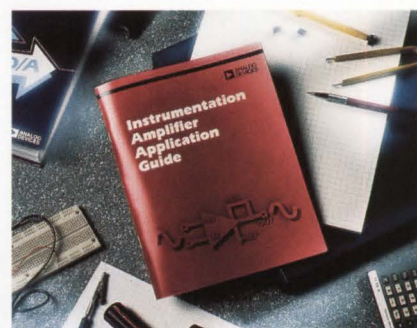

*Instrumentation Amplifier Guide*

**CIRCLE 21**

## LOWEST NOISE & DISTORTION AMPS

The AD797 features the industry's lowest voltage noise and distortion. It's an excellent choice for use in audio pre-amplifiers, FFT and spectrum analyzers, and IR and ultrasound imaging:  $V_n = 0.9 \text{ nV}/\sqrt{\text{Hz}}$  and remains flat over the full 8 MHz bandwidth (Gain = 10) at 1 kHz. Total harmonic distortion is -120 dB at 20 kHz. Settling time is 800 ns to 16-bit accuracy.

Many dc specifications are guaranteed, including a maximum 60  $\mu\text{V}$  voltage offset with 0.6  $\mu\text{V}/^\circ\text{C}$  drift, 300 nA (200 nA typical) input offset current, and 2  $\mu\text{A}$  input bias current. The AD797 features a fast 20 V/ $\mu\text{s}$  slew rate and a gain-bandwidth product of 110 MHz (Gain = 1,000). Full-power bandwidth is 280 kHz at 20 Vp-p. Output current drive is typically 50 mA, permitting the use of low-value gain-setting resistors to curb resistor noise.

AD797 operates from  $\pm 5$  to  $\pm 15$  V supplies over the  $-40^\circ\text{C}$  to  $+85^\circ\text{C}$  industrial and  $-55^\circ\text{C}$  to  $+125^\circ\text{C}$  military temperature ranges. Packages include 8-pin plastic DIP, SOIC and cerdip. Prices start at \$3.36 (1,000s).

**CIRCLE 22**

### LOW-POWER AUDIO AMPS COMBINE ADVANTAGES OF JFET & BIPOLAR CHIPS

The single OP176 and dual OP275 op amps feature a patented input circuit (combining both JFET and bipolar technologies) that offers new levels of performance to audio, instrumentation and consumer applications. The result is an op amp that offers the traditional benefits of bipolar amps (low

distortion and voltage noise) with the advantages of JFETs (high slew rates, and wide dynamic range) at one third the power of the NE5532.

The OP275 features 0.0006% total harmonic distortion plus noise and 6  $\text{nV}/\sqrt{\text{Hz}}$  voltage noise density. Input offset voltage is guaranteed at  $<1 \text{ mV}$  allowing the OP275 to be used in dc coupled or summing applications without adding noisy offset adjustment circuitry. Dynamic characteristics include 22 V/ $\mu\text{s}$  slew rate and 9 MHz gain-bandwidth product. In addition, the OP275 uses less than 5 mA of supply current, even with  $\pm 22$  volt supplies.

For professional audio console designs, the small SO-8 package combined with the low power can save many square inches of board space and many watts of power, resulting in cooler operation and greater density.

Its companion, the OP176 has the same attributes with greater output swing and output short-circuit protection, at much lower power than NE5534, plus it's stable at unity gain.

Both the OP176 and OP275 are specified over the  $-40^\circ\text{C}$  to  $+85^\circ\text{C}$  extended industrial temperature range and are available in 8-pin plastic DIP or SOIC packages. The SOIC package is offered in 2,500 piece spools for high volume handling. Prices for the OP176 and OP275 begin at \$.88 and \$1.08, respectively in 1,000s.

**CIRCLE 23**



### FREE SPICE DISK CONTAINS OVER 350 MODELS

ADSpice puts the power to predict amplifier behavior in your PC. This free disk contains the most innovative and comprehensive library of SPICE models ever. It contains over 350 complete models, including hundreds of high-speed and precision op amps, CMOS analog switches, variable-gain amplifiers, and video-difference amplifiers.

This valuable tool uncovers design problems before you breadboard by simulating real-world transient and ac electrical conditions. Critical performance models such as noise, bandwidth, and phase response are included. Don't miss this free offer, available on either 3-1/2" or 5-1/4" IBM PC-compatible disks.

**Circle 24 (3-1/2")**

**Circle 25 (5-1/4")**

MODEL	AD797	OP176	OP275	Units
Channels	Single	Single	Dual	
GBW	110	10	9	MHz
Slew Rate	20	25	22	V/ $\mu\text{s}$
Supply Current	10.5	2.5	5	mA, max
THD + N	(98)	0.001	0.0006	(dB) %
Offset Voltage	0.8	1	1	mV, max
$V_{\text{OUT}}$ Swing	$\pm 13$	$\pm 13.5$	$\pm 13.5$	V
Price in 1,000s	\$3.36	\$0.88	\$1.08	USD

CIRCLE 22

CIRCLE 23

CIRCLE 23

### WORLDWIDE HEADQUARTERS

Analog Devices, Inc.  
P.O. Box 9106  
Norwood, MA 02062-9106, U.S.A  
Tel: (800) 262-5643  
Fax: (617) 326-8703

Printed in U.S.A.

 **ANALOG  
DEVICES**

## What do a Cape Canaveral missile, a 486X computer and a child's train set have in common?



They're all powered by Zenith standard switching power supplies--the switchers that accommodate an almost endless range of applications.

Miniature in size with a 3"x5" footprint, but a giant in performance, the *Low Power Series* includes both a 30 and 45 watt with single, dual or triple outputs. They also feature universal input with no minimum load requirements. The full featured quad output *Mid Power Series*, ranging from 150-400 watts, offers complete system protection and user-adjustable voltage output settings as standard.

All are designed to meet rigid international safety and EMI standards: CSA, IEC, FCC, and BS 6301, as well as UL 544, and IEC 601 for medical equipment.

And these competitively priced switching power supplies are tough and reliable--with up to 500,000 hour MTBF rating for durable performance, and are backed by one or two year warranty coverage.



Best of all, they're designed by Zenith. For over 70 years, we've been a leader in quality through design, engineering and world class manufacturing. With our worldwide distribution network and off-the-shelf delivery, we've earned a reputation for responsiveness to customer needs.

From the minds of scientists to the hearts of youngsters, Zenith switchers provide the power to make your applications come to life.

**Call today for more information:  
1-800-827-8720**

**ZENITH** | power supplies

by Oryx Power Products

— a division of Oryx Technology Corp.

Independent of and not affiliated with Zenith Electronics Corp.

1000 Milwaukee Avenue Glenview, IL 60025-2493 Fax: (708) 391-8569

# Some of Our Competitors Are Really Big in ADCs.

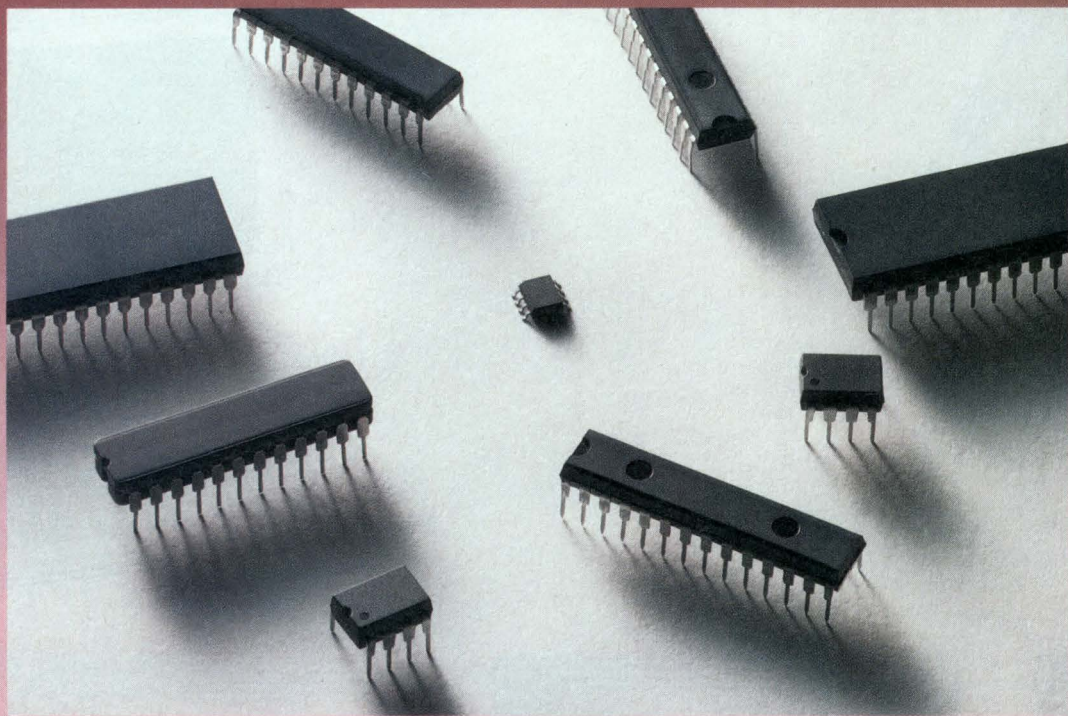

**But we put a 12-bit micropower ADC into an SO-8 package. For less than \$5.**

With the demand for small, low-cost, battery-powered electronic products accelerating, you face some tough design challenges. Until now, most ADCs were too big, too expensive, and consumed too much power.

You can solve these problems with the industry's smallest, lowest cost, lowest power 12-bit micropower ADCs, the LTC1286 and the LTC1298. Both devices include a sample-and-hold, serial I/Os, 1- or 2-channel MUX,  $\pm 3/4$  LSB maximum DNL, and operate on a single 5V supply.

Battery operation is extended since the LTC1286 draws only 250 $\mu$ A at 12.5ksps, while the

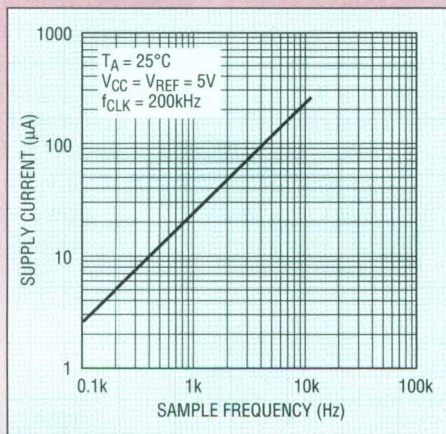

LTC1298 draws 340 $\mu$ A at 11.1ksps. Power drain drops even more in auto-shutdown to 20 $\mu$ A at 1ksps, and at idle it plunges to 1 nanoamp!

The best news is the price. The LTC1286 and LTC1298 are priced at just \$4.98 for the SO-8 package and \$4.65 for the DIP in 1000 piece quantities.

And for 3V systems, our new LTC1285 and LTC1288 offer the same great features as their 5V counterparts, at even lower power.

For more details, contact Linear Technology Corporation, 1630 McCarthy Boulevard, Milpitas, California, 95035/ 408-432-1900. For literature only, call 1-800-4-LINEAR.



FROM YOUR MIND TO YOUR MARKET  
AND EVERYTHING IN BETWEEN.

## Biasing corrects position-sensing photodiode

Yishay Netzer, Consultant, Yuvalim, Israel

..An integrator powers the light source in **Fig 1**'s position-sensing circuit, eliminating errors arising from variations in the source's intensity. This circuit's accuracy is essentially that of the sensor itself, beating designs that use a more complex analog divider.

Amplifiers IC<sub>1A</sub> and IC<sub>1B</sub> convert the two detector currents from D<sub>1</sub>, a photosensitive strip, into voltages in the conventional manner. IC<sub>2B</sub> subtracts these two voltages to derive the output signal V<sub>O</sub>. V<sub>O</sub> is proportional to the position of the spot cast by the light source upon D<sub>1</sub>.

IC<sub>2A</sub> integrates these two voltages along with a current from a regulated 5V source, driving the light source via Q<sub>1</sub>. This closed-loop scheme supplies illumination proportional to the sum of the two input currents, providing a fixed-scale factor for the signals supplied to the difference amplifier, IC<sub>2B</sub>. Using a monolithic resistor network for all the 10-kΩ resistors in the circuit enhances temperature stability. (DI #1452)

EDN

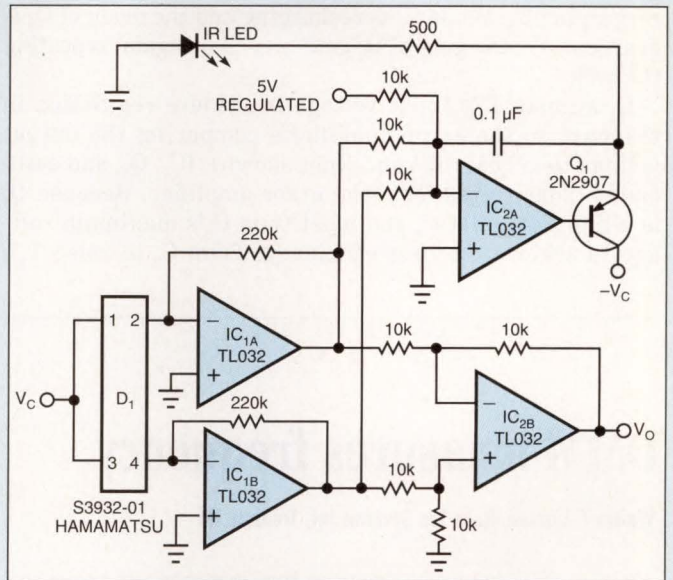

**Fig 1**—A closed-loop integrator powers the light source of this position-sensing circuit, providing a fixed-scale factor for the signals supplied to the circuit's difference amplifier.

To Vote For This Design, Circle No. 328

## Clean switcher powers 16-bit A/D converters

Patrick Kevin Garner, Advanced Technology Systems, McLean, VA

The low-noise switcher in **Fig 1** works much like a TV's horizontal-deflection circuit to provide clean power for a 16-bit A/D converter.

In operation, Q<sub>3</sub> is a logic-level gate-drive MOSFET driven

by the same 100-kHz square wave that clocks the A/D converter. When Q<sub>3</sub> turns off, the primary of T<sub>1</sub> resonates with C<sub>3</sub> and flies back to 25V. Energy then transfers to the transformer's secondary. When the flyback voltage attempts to go

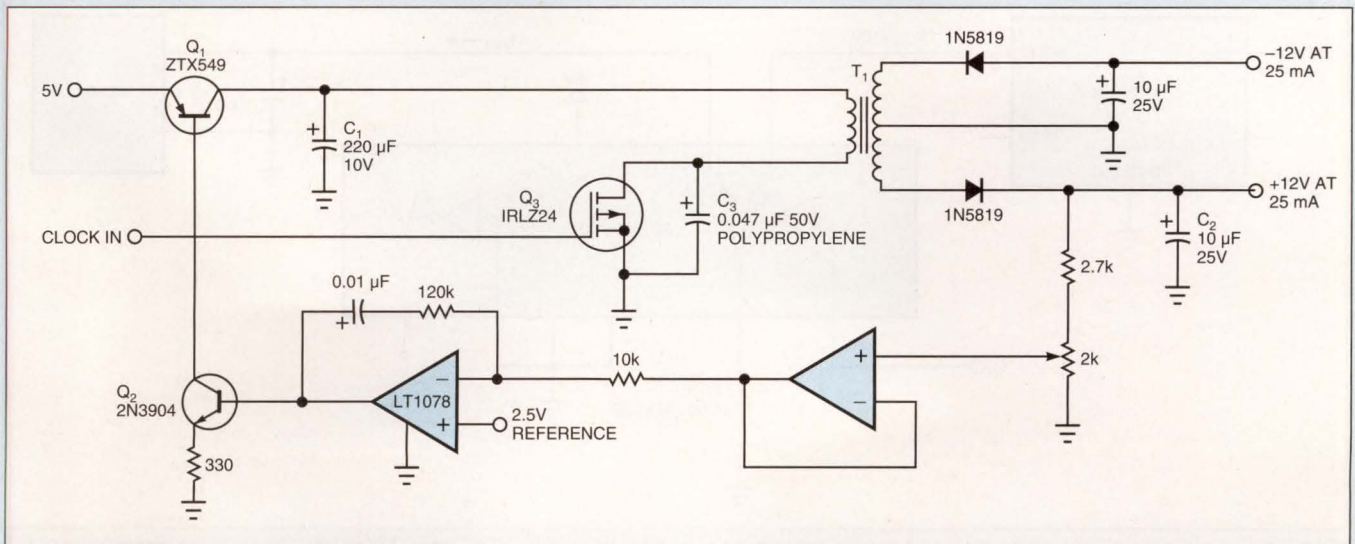

**Fig 1**—This resonant switcher provides clean power for high-resolution A/D converters.

below ground, the integral body diode of the power MOSFET  $Q_3$  clamps the flyback voltage, causing excess resonant energy in the transformer to flow back through its primary, recharging  $C_1$ . While  $C_1$  is recharging and the drain of  $Q_3$  is nearly at 0V, the gate of  $Q_3$  gets turned on again, repeating the cycle.

$Q_1$  adjusts  $T_1$ 's input voltage to achieve regulation in response to the error amplifier's comparing the output voltage to a 2.5V reference (not shown).  $IC_1$ ,  $Q_2$ , and associated components form the error amplifier. Because  $Q_1$  is a linear regulator, you must trim  $C_3$ 's maximum voltage to achieve the best efficiency. Trim  $C_3$  to raise  $T_1$ 's

input voltage to above 4V. At 4.5V, 70% efficiency is possible.

$T_1$ 's construction is not critical. The primary consists of seven turns of 24 AWG, and the secondary has 12 turns of 24 AWG with the ground tap at six turns. The core is a Philips E187 3C85, and the gap in the outer legs of the core measures 2 mils. The primary's inductance should be around 12  $\mu$ H.  $C_3$  must be a high-quality, low-inductance electrolytic, suitable for switching supplies. (DI #1451) EDN

**To Vote For This Design, Circle No. 329**

## DMM measures frequency

Walter P Sjursen, Base Ten Systems Inc, Trenton, NJ

The circuit in **Fig 1** uses two ICs, a few passive components, and a standard DMM to measure frequency. In the circuit, a switched-capacitor network, analog switch  $IC_2$  and capacitor  $C_1$ , simulates a frequency-dependent resistor.

The network's resistance is the inverse of the input frequency,  $f_{IN}$ , multiplied by  $C_1$ 's value. If the circuit applies a constant voltage ( $V_{REF}$ ) across the frequency-depend-

ent resistor, then the current through the resistor is directly proportional to the frequency.

$IC_1$  supplies this 10V reference voltage. Capacitor  $C_2$  is a lowpass filter and should be much larger than  $C_1$ . **Table 1** contains values for  $C_1$  that provide convenient scale factors. (DI #1448) EDN

**TABLE 1—CONVENIENT  $C_1$  VALUES**

Frequency range (kHz)	$C_1$ ( $\mu$ F)
0 to 0.1	1
0 to 1	0.1
0 to 10	0.01
0 to 100	0.001

**To Vote For This Design, Circle No. 330**

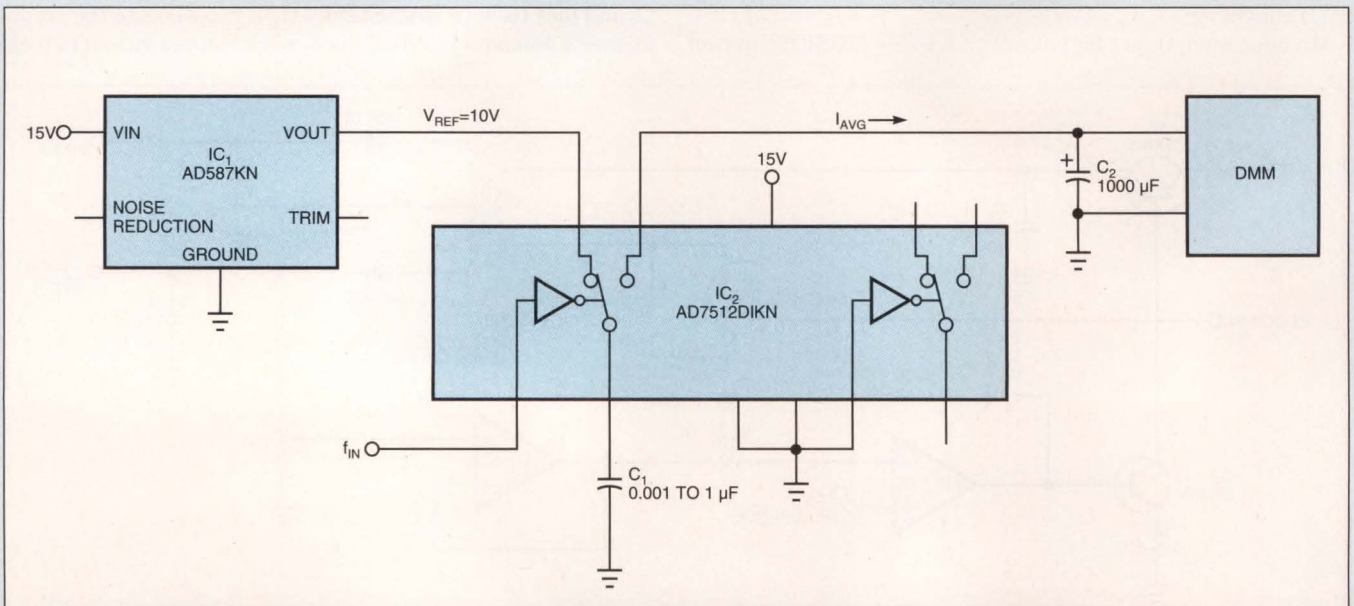

**Fig 1—Because a switched-capacitor network can simulate a frequency-dependent resistor, this circuit allows a common DMM to measure frequency.**



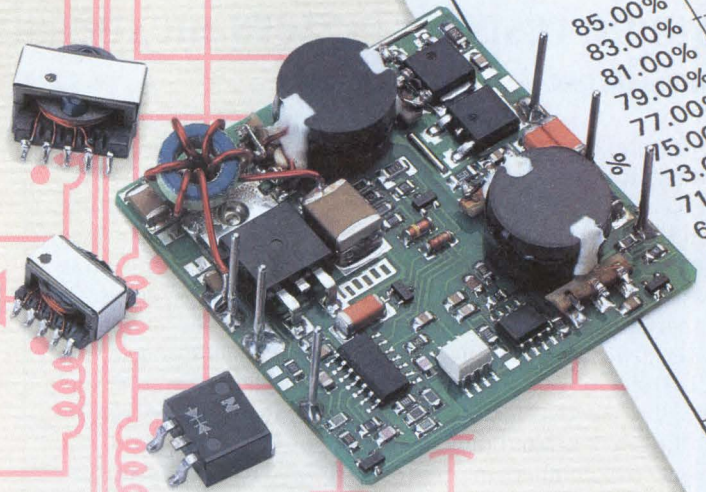
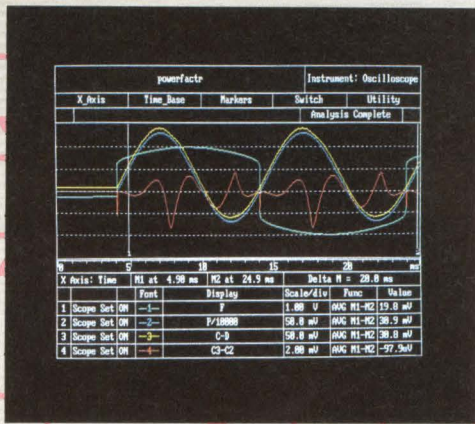

# Custom DC/DC Designs for OEM Applications

High Reliability Power Converters ... On Time and On Budget!

The unique cost/performance/size objectives of your new high-density power distribution system may require unique DC/DC converters. DATEL's world-class design, development and manufacturing team stands ready to define, design and assemble the exact power solution you need.

DATEL has compiled a large library of DC/DC designs that are currently used in a variety of telecommunication, medical, computer, railway, aerospace and industrial applications. We may already have the converter you need.

When reliability, delivery and cost are crucial, look to the leader ... DATEL.

- Narrow or Ultra-Wide Input Ranges
- Single or Multiple Outputs
- High or Low-Voltage (<2V) Outputs
- Output Power to 100 Watts
- Isolated and Non-Isolated Designs
- Smart Load Sharing
- Extended Temperature Ranges
- High-Speed, Automatic SMT Assembly
- Calculated and Demonstrated MTBF's
- Burn-in / HALT / HASS
- Environmental Screening; EMI Testing

DATEL, Inc., 11 Cabot Boulevard, Mansfield, MA 02048 Tel: (508) 339-3000  
FAX: (508) 339-6356. For immediate assistance 800-233-2765.

**DATEL**  
INNOVATION and EXCELLENCE

CIRCLE NO. 78

EDN July 7, 1994 • 95

## Single resistor betters inexpensive buffer

Jim Riphahn, Comlinear Corp, Fort Collins, CO

Differential gain and phase are important video characteristics, and video-equipment manufacturers welcome any low-cost method of improving these parameters. **Fig 1** shows one simple method using a low-power, low-cost, closed-loop buffer with a total circuit cost of around \$1.60, including resistors and bypass capacitors. Because output-stage drive capabilities affect differential gain and phase, low power often translates into degraded numbers. For example, the CLC109's typical differential gain and phase are 0.7% and 0.03°, respectively, while driving a 150Ω load. However, by adding a 1-kΩ pull-down resistor on the output pin, the respective numbers improve to 0.05% and 0.01°, respectively. Thus, the cost of a single resistor brings an order-of-magnitude improvement and makes the differential gain and phase of the buffer comparable to much more expensive devices. However, if low power is a sensitive issue, you should carefully consider this method. Adding the resistor increases **Fig 1**'s typical supply current from 3.5 to 7.5 mA. This idea works equally well with video op amps. (DI #1553)

EDN

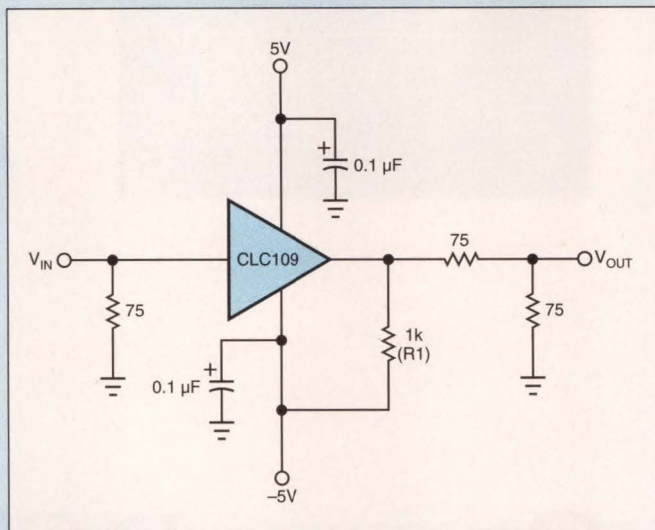

**Fig 1**—Adding a 1-kΩ pull-down resistor to an inexpensive, low-power buffer's output decreases typical differential gain and phase errors from 0.7% and 0.03° to 0.05% and 0.01°, respectively.

To Vote For This Design, Circle No. 331

## 12-bit converter upgrades μC's ADC

John Wettroth, Maxim Integrated Products, Sunnyvale, CA



The simple circuit in **Fig 1** and an accompanying software routine let you easily substitute a multi-channel 12-bit ADC for the 8-bit ADC internal to the 87C752 μC. A single assembly can then implement both

the low- and high-performance version of a system. A socket lets you plug in the external ADC when you need it; otherwise, you plug in the network of 10 100Ω resistors. At power-up, the μC executes a routine that looks for the external con-

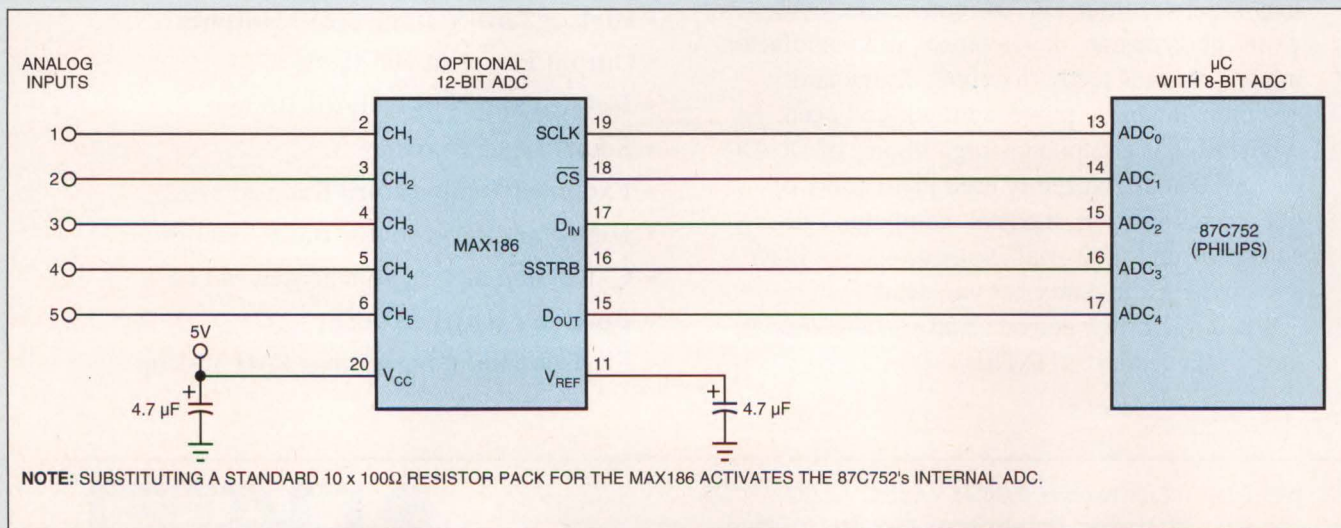

**Fig 1**—This circuit and corresponding software allow you to switch easily between using a μC's internal 8-bit ADC and using a more accurate 12-bit ADC.

# SMD Power.

Or where to find the widest  
selection of power SMDs  
at the lowest cost/amp.

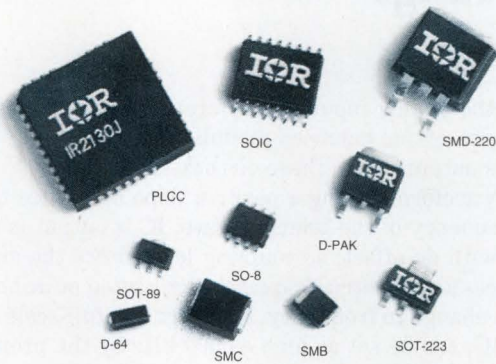

Small as they are, our power SMDs save you more than just board space. They save you time. And money. With the best price-performance ratio from the widest choice of SMDs available.

All off the shelf. All under one roof. And value-priced at the lowest cost/amp. From HEXFET® power MOSFETs and IGBTs to their drivers, the IR2100 Series. And, of course, Schottkys.

You'll find no other power SMDs so closely matched in features and capabilities. But don't take our word for it. Send for our "SMD Power Pak" by fax. Or call. 310-322-3331, ext. 2529.

You'll be surprised at what you save.

*Available now at key IR distributors.*

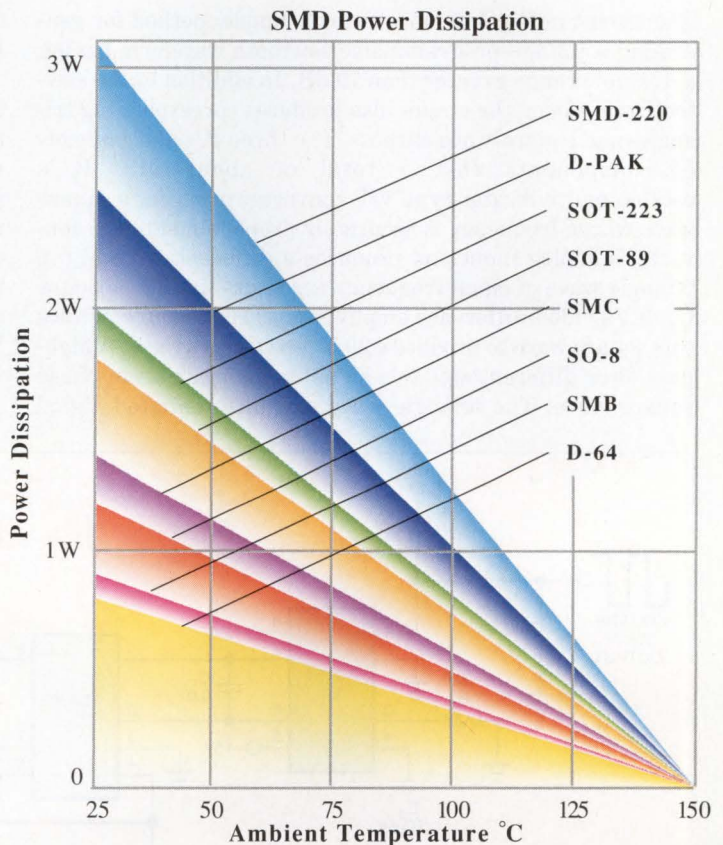

## International Rectifier

WORLD HEADQUARTERS: 233 KANSAS ST., EL SEGUNDO, CA 90245, USA 310-322-3331, FAX 310-322-3332, TELEX 66-4464. EUROPEAN HEADQUARTERS: HURST GREEN, OXTEY, SURREY RH8 9BB, ENGLAND, (0883) 713215, FAX (0883) 714234

CIRCLE NO. 109

EDN July 7, 1994 • 97

verter. If the converter is present, the  $\mu\text{C}$  uses the external ADC. If the converter is absent, the 8-bit ADC takes over. The  $\mu\text{C}$  internally handles all conversion results as 12-bit values.

This idea relies on the fact that the 87C752's five ADC input pins can also serve as the bidirectional pins of an 8051 port (Port 1). The resistor network connects the internal ADC directly to the applied analog inputs. Alternatively, replacing the network with the external ADC connects those inputs to corresponding channels on that converter, and the  $\mu\text{C}$ 's ADC input pins (now acting as a bidirectional port) serve as a digital interface to the converter.

The assembly-language software routine attached to **EDN BBS/DI\_SIG #1554** determines the presence of an external converter by triggering a conversion and noting whether the

converter's busy flag (SSTRB) goes low. If it does, the  $\mu\text{C}$  sets an internal global flag (AD12) that tells it to use the external-converter routines for each subsequent conversion. This action is transparent to the calling routine. The conversion result, returned as bytes ADHI and ADLO, has the same format in either an internal- or external-ADC case, except the four LSBs are 0 for 8-bit converter data.

The  $\mu\text{C}$ 's full-scale range is 5V, but the MAX186 ADC sets its full-scale input range with an internal reference of 4.096V. Software resolves the incompatibility in this example, but you can also use a different ADC, such as the MAX188, with an external 5V reference. (DI #1554) **EDN**

To Vote For This Design, Circle No. 332

## Sawtooth generator spans a 70-dB range

Paul Hendricks, Analog Devices, Wilmington, MA

The circuit in **Fig 1** demonstrates a simple method for generating a voltage-programmable sawtooth waveform having a dynamic range greater than 70 dB. In addition to the sawtooth waveform, the circuit also produces corresponding triangle- and square-wave outputs. The three ICs and associated components cost a total of about \$13. IC<sub>1</sub>'s astable-multivibrator-type V/F converter produces a square wave whose frequency is accurately proportional to the converter's analog input and produces a differential 1.8 V p-p triangle wave of equal frequency across its timing capacitor C<sub>T</sub>. IC<sub>2</sub>'s video-difference amplifier level shifts and amplifies this square wave to produce a 20 V p-p triangle wave. A high-pass filter differentiates this signal to generate an in-phase square wave. The triangle wave and differentiated signal

drive the analog input and reference-comparator inputs of IC<sub>3</sub>'s gain-of-one balanced modulator.

IC<sub>3</sub>'s output under these circumstances is a 20 V p-p sawtooth waveform having a positive slope and twice the original frequency of the triangle wave. IC<sub>1</sub>'s output is a square wave with dc offset; ac coupling level-shifts the signal and produces a symmetrical square wave having no dc level shifts with a change in frequency. Although the full-scale frequency of IC<sub>1</sub> can be set as high as 500 kHz by the proper selection of R<sub>S</sub> and C<sub>T</sub>, the sawtooth waveform output begins to degrade above 50 kHz due to the bandwidth limitations of IC<sub>3</sub>. (DI #1557) **EDN**

To Vote For This Design, Circle No. 333

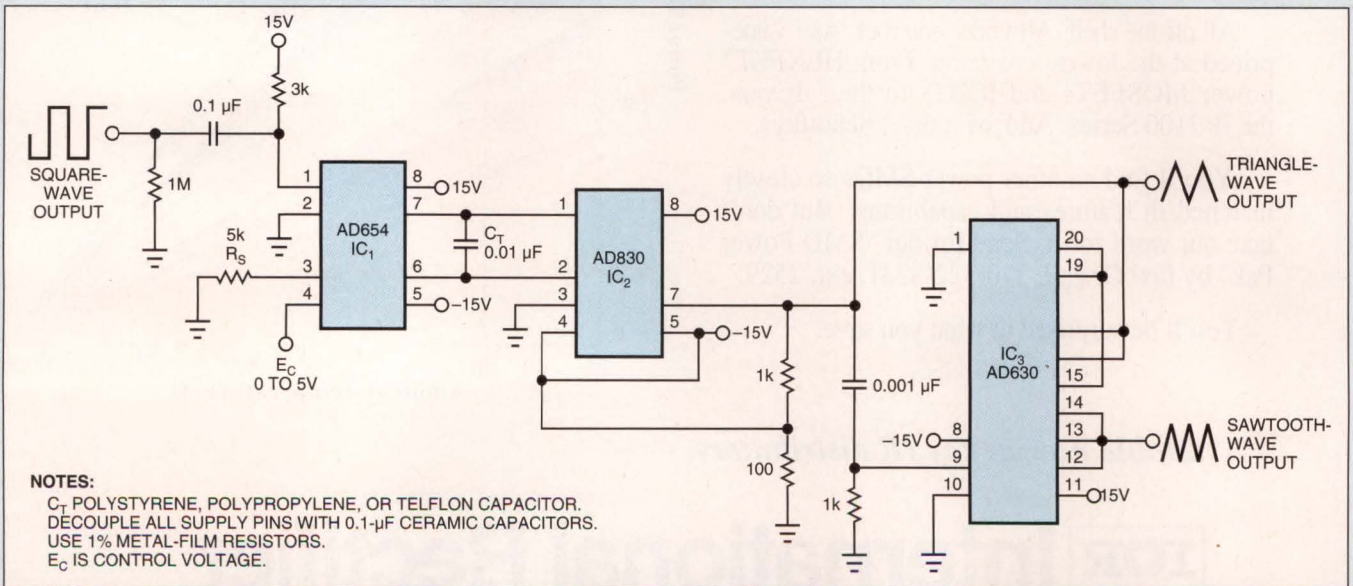

**Fig 1—Three ICs and accompanying components produce a programmable sawtooth waveform with a 70-dB dynamic range and produce corresponding square and triangle waves.**

# Power-full tiny inverter.

Or how to shrink a 1hp, 3-phase motor control inverter to fit your pocket...book.

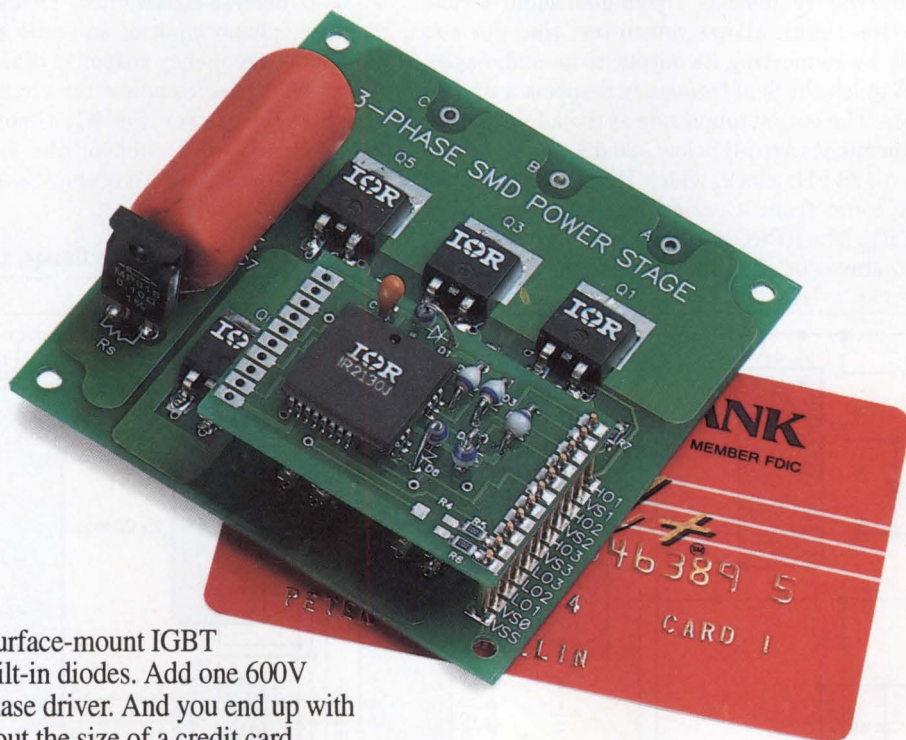

Take six IR surface-mount IGBT CoPacks with built-in diodes. Add one 600V IR2130J three-phase driver. And you end up with a 1hp inverter about the size of a credit card.

The lower part count, size and weight reductions bring added value to your end product. Your customers benefit from the pass-along savings. And you gain the competitive edge.

Thanks to the most compatible line of power devices ever. Value-priced to save you money. In stock to save you delivery time. Send for our data "Shrink Pak." Quicker yet, call. 1-800-245-5549.

You'll see how small your inverters can get.

*This motor control inverter is 3" x 3" sq. and features six SMD-220 surface-mount CoPack UltraFast IGBTs driven by a single 600-volt, 3-phase driver (IR2130J) with current-sensing.*

*Available now at key IR distributors.*

**IR** International Rectifier

WORLD HEADQUARTERS: 233 KANSAS ST., EL SEGUNDO, CA 90245, USA 310-322-3331, FAX 310-322-3332, TELEX 66-4464. EUROPEAN HEADQUARTERS: HURST GREEN, OXTED, SURREY RH8 9BB, ENGLAND, (0883) 713215, FAX (0883) 714234

CIRCLE NO. 110

EDN July 7, 1994 • 99

# 10-octave audio generator speeds tests

Wayne Sward, Consultant, Bountiful, UT

**BBS** Testing the frequency response of an audio device typically requires a sine-wave oscillator, an ac voltmeter or an oscilloscope, and an operator to record the response of the device at several frequencies across the audio band. Complicating this test is the inability of many audio oscillators to maintain a constant output level as the frequency varies, particularly when switching between frequency ranges.

To speed testing, the circuit in **Fig 1** generates a composite audio signal comprising 10 sine waves of 10 different equal-amplitude frequencies across the audio band. Values stored in EPROM determine the frequencies. Driving an audio device-under-test with this circuit allows you to test that device's responses quickly by connecting its output to an audio-spectrum analyzer. A quick check of frequency response requires only a few seconds. The output amplitude at the LINE output is 1V rms, and harmonics are all below -20 dB.

IC<sub>1</sub> generates a 128-kHz clock, which R<sub>1</sub> adjusts, to drive counter IC<sub>2</sub>. The count from IC<sub>2</sub> addresses successive locations in EPROM IC<sub>3</sub>. The EPROM contains the data values to generate the 10 octaves of equal-amplitude sine waves (see

listing in **EDN BBS /DI\_SIG #1559**). In this case, the frequencies are 1 octave apart from 31.3 Hz to 16 kHz. IC<sub>4</sub> and IC<sub>5</sub> latch the 8-bit data from IC<sub>3</sub>. The latched values drive IC<sub>6</sub>, an 8-bit DAC.

The first amplifier of IC<sub>7</sub>, a quad op amp, converts the current output of IC<sub>6</sub> to a voltage. The next two amplifiers filter the resulting signal, removing all frequencies above 20 kHz. The signal then goes through a level control and pad resistors to permit connection to the line or microphone inputs of the audio device. The signal also goes through the last section of IC<sub>7</sub> to an inverse RIAA filter. This filter compensates for the magnetic phono input of an audio amplifier, resulting in an overall flat frequency response of the test setup.

Two 9V batteries power the circuit. Voltage regulator IC<sub>8</sub> provides 5V power for IC<sub>1</sub> through IC<sub>5</sub>. The resistors between -9V and each of the LM324 outputs prevent crossover distortion. All of the ICs are low-power to increase battery life. (DI #1559)

EDN

To Vote For This Design, Circle No. 334

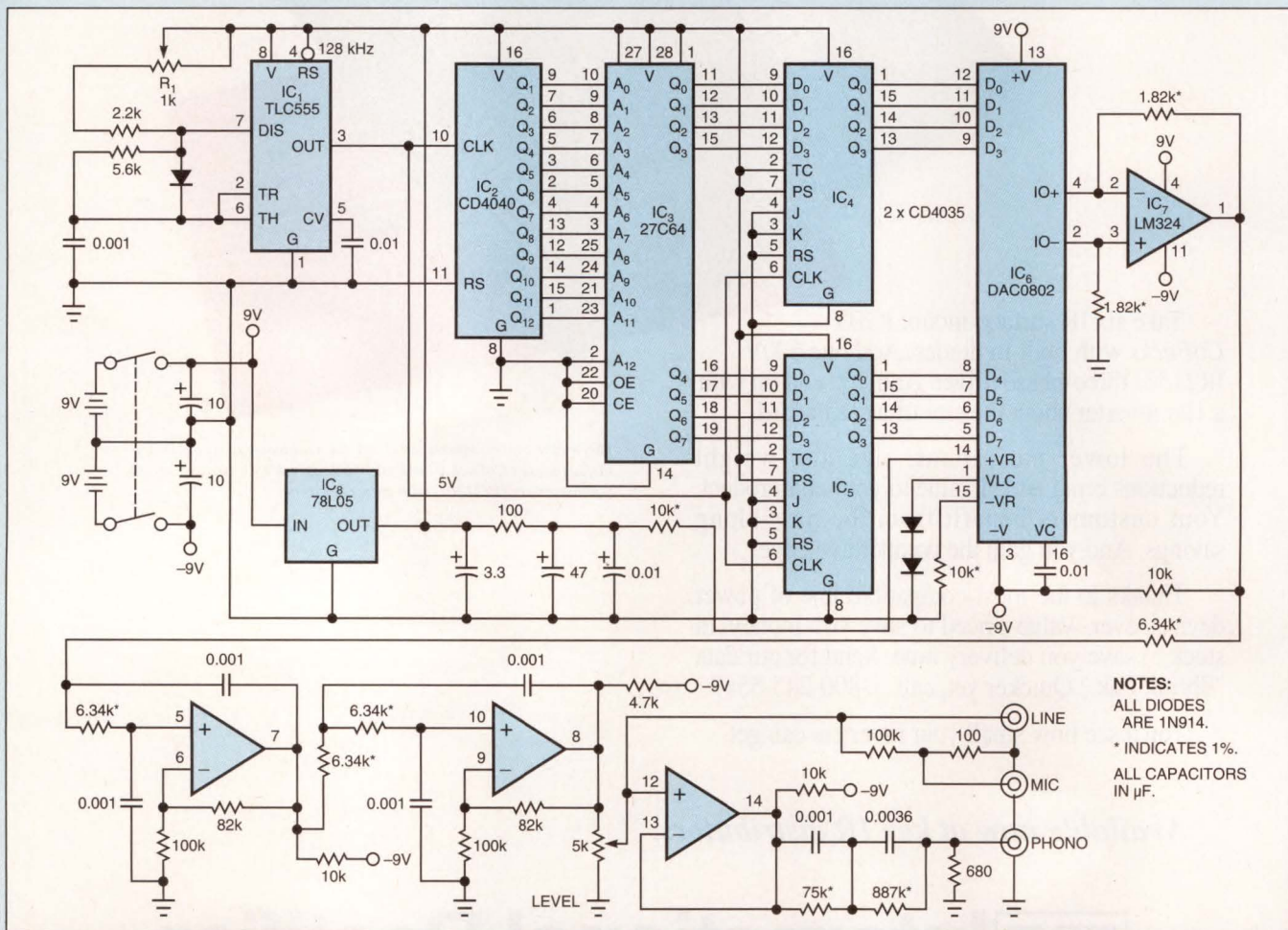

**NOTES:**  
ALL DIODES ARE 1N914.  
\* INDICATES 1%.  
ALL CAPACITORS IN μF.

**Fig 1**—To speed testing of audio equipment, this circuit generates a composite audio signal comprising 10 frequencies of equal amplitude that span 10 octaves from 31.3 Hz to 16 kHz.

# Motor control savings.

Or how to design noise-free inverters that switch faster for less money.  
The 1200V IGBT *CoPack*.

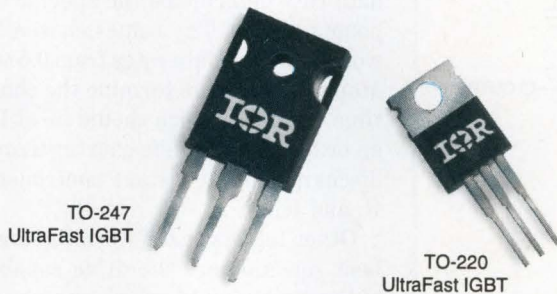

Now you can design simpler, more efficient motor control inverters. That switch at 20kHz. Quietly. Without snubbers. All it takes is our UltraFast 1200V *CoPack* with built-in diode.

You cut system costs with less parts. Get the lowest conduction loss. Fastest switching speed. Short circuit withstand. And super-soft recovery. All from more than 200 IGBT part numbers.

Rated from a few amps up to 50 amps. And value-priced to save you money. Delivery? Right from stock. Call for data on today's most cost effective IGBT line. 310-322-3331, ext. 2529.

You'll save more than you think.

*Available now at key IR distributors.*

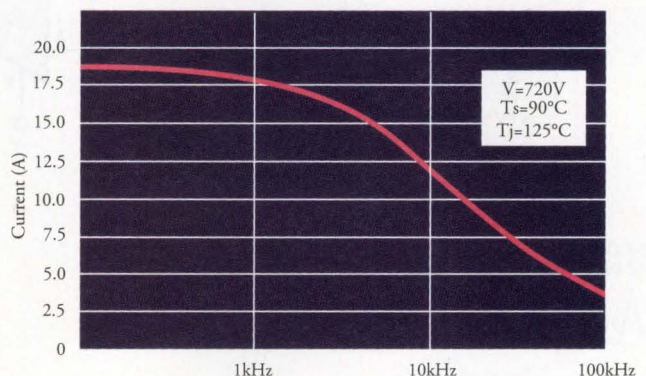

Output current vs frequency for two IRGPH50KD2 in half-bridge, 50% duty cycle.

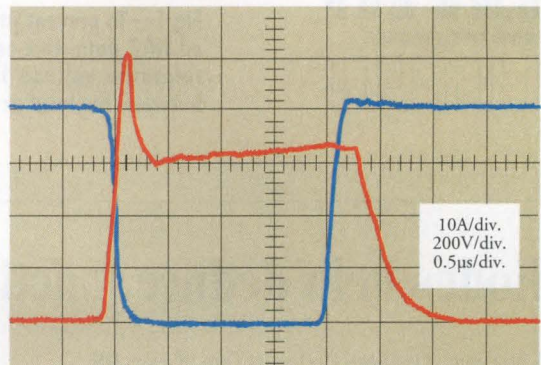

Switching waveforms of the IRGPH50KD2 in a clamped inductive load at  $T_j = 90^\circ\text{C}$ .

## **IR** International Rectifier

WORLD HEADQUARTERS: 233 KANSAS ST., EL SEGUNDO, CA 90245, USA 310-322-3331, FAX 310-322-3332, TELE 66-4464. EUROPEAN HEADQUARTERS: HURST GREEN, OXTEY, SURREY RH8 9BB, ENGLAND (0883) 713215, FAX (0883) 714234

HEXFET Power MOSFETs • IGBTs • Schottkys • Power ICs • SMDs • Modules • Rectifiers • SCRs • Bridges

CIRCLE NO. 34

EDN July 7, 1994 • 101

## Envelope tracker quells jitter

Roger C Whipple, Hazeltine Corp, Braintree, MA

**Fig 1's** envelope tracking circuit solves the problem of receiving ac-coupled NRZ data over a coaxial data link. Because the spectral content of the NRZ data approaches dc (even with alternate frame inversion), the signal tends to integrate in any ac-coupled stage preceding the zero-crossing detector, despite the low cutoff frequencies. Thus, the dc level of the received data wanders, changing the relative switching point at the comparator.

The system input determines the data pattern, which can have frequencies that beat with the data frame rate, causing the data's envelope to have large excursions. After passing through a transmission medium, the signal is band-limited

and has slow edges. Since the zero-crossing detector on the receiving end switches as the data crosses the reference-signal input, the apparent switching point moves if the reference is fixed but the data isn't. This movement can add a considerable amount of jitter to the output signal.

The envelope tracking circuit compensates for this problem by creating a reference voltage that is always centered between the local excursions of the data. The circuit uses the filtered average of positive and negative peak detectors as the reference voltage. The circuit itself is simple;  $C_1$  charges on positive peaks through  $R_1$  and  $D_1$ , and  $C_2$  charges on negative peaks through  $R_2$  and  $D_2$ .  $R_3$  and  $R_4$  determine the time constant of the discharge and provide the mean value to the reference pin.  $C_3$  provides some noise immunity and should be near the comparator pin. The data rate determines the specific component values. The values chosen here work well with data rates from 0.5 to 1.5 Mbps.  $R_1$  and  $R_2$  determine the charge-time constant, which should be at least an order of magnitude shorter than the discharge-time constant controlled by  $R_3$  and  $R_4$ .

Other factors that determine component selection are the drive capability of the input source, which must be able to charge the capacitors through the 390 $\Omega$  resistors, and the amplitude of the input signal, which must be greater than two diode drops. **Fig 1's** values are optimum for a signal of about 3V p-p biased at about 2.5V. You may have to reverse the polarity of  $C_2$  if the input is not biased above ground. Circuit performance is not sensitive to any of the component values. (DI #1558) **EDN**

To Vote For This Design, Circle No. 335

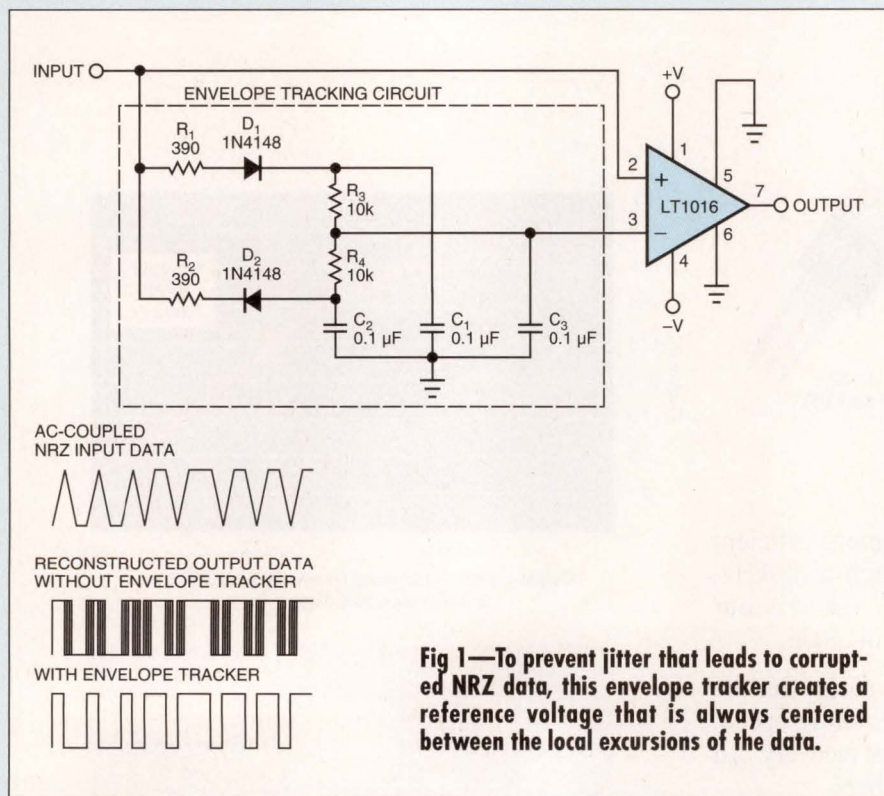

**Fig 1**—To prevent jitter that leads to corrupted NRZ data, this envelope tracker creates a reference voltage that is always centered between the local excursions of the data.

## IC diodes help deduce junction temperature

Edward S Brinkman, Cincinnati Electronics Corp, Mason, OH

A simple method for directly measuring an IC's temperature uses the device's input-protection diodes as temperature sensors. Static-discharge protection diodes are common features in many modern IC input structures, and their location on the IC makes them ideal as noninvasive temperature sensors.

**Fig 1** shows the typical input structure for a CMOS IC and the measurement setup. One protection diode is forward-biased with a current source and suitable supply voltage

greater than  $V_{DD}$ . The device under test can be fully operational if the selected input is normally tied to logic HIGH. For a logic LOW input, substitute a current sink and find a voltage supply less than  $V_{SS}$ . Other IC process technologies may also have accessible diode structure.

The ideal diode equation

$$V = (nKT/q) * (I/I_0 + 1)$$



# Power Supply savings.

Or how to get the lowest cost-per-amp fast, simple and easy.

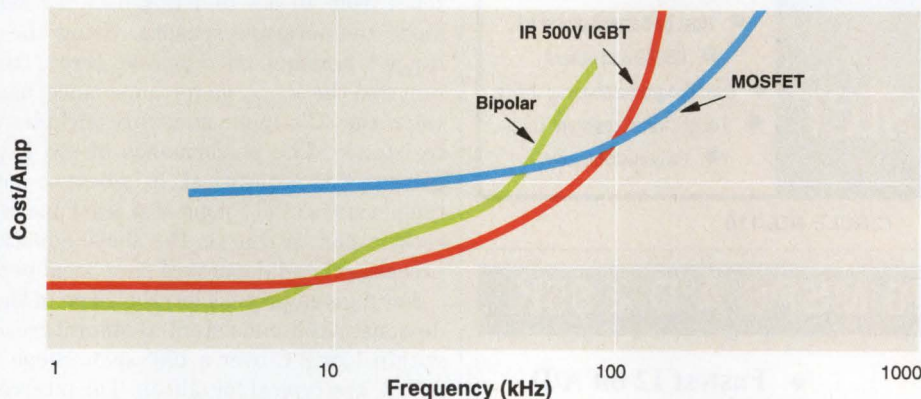

Just plug in IR's UltraFast 500V IGBT. And you instantly improve the efficiency and cost-per-amp of your single-ended off-line switch-mode power supplies. Without redesigning.

Our IGBTs also come paired with IR super-soft recovery diodes in *CoPacks* for half-bridge supplies. All give you the lowest conduction losses ever. And fast switching speeds.

Available from the most cost-effective IGBT line today. Value priced to save you money. In stock to save you delivery time. Send for our IGBT data pack. Or call. 310-322-3331, ext 2529.

You'll easily save more for your converters.

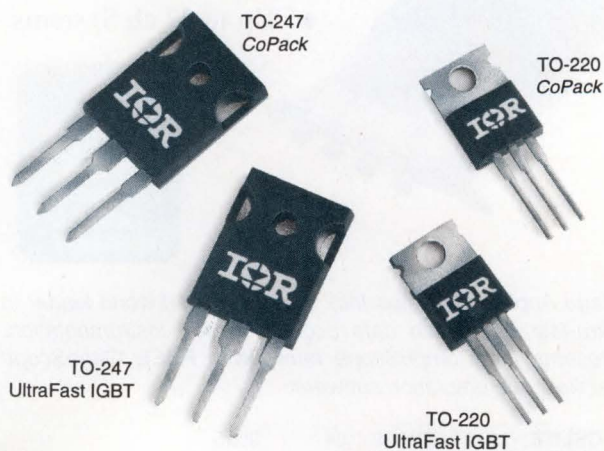

*Available now at key IR distributors.*

**IR International Rectifier**

WORLD HEADQUARTERS: 233 KANSAS ST., EL SEGUNDO, CA 90245, USA 310-322-3331, FAX 310-322-3332, TELEX 66-4464. EUROPEAN HEADQUARTERS: HURST GREEN, OXTED, SURREY RH8 9BB, ENGLAND, (0883) 713215, FAX (0883) 714234

CIRCLE NO. 111

EDN July 7, 1994 • 103



## HAND-HELD TERMINALS

# GET IN TOUCH WITH OYSTER

HAND-HELD TERMINAL HOTLINE

# 714 361 2038

Oyster can take care of any OPERATOR INTERFACE requirement

- 2 to 8 line LCD's.
- Membrane or button keys.
- Host or battery powered.
- RS232 and others.
- User-programmable capability.
- Tough, water-resistant cases.
- Fully customizable.

# Oyster

CIRCLE NO. 116

## 12 BIT, 20 MSPS A/D < \$5K

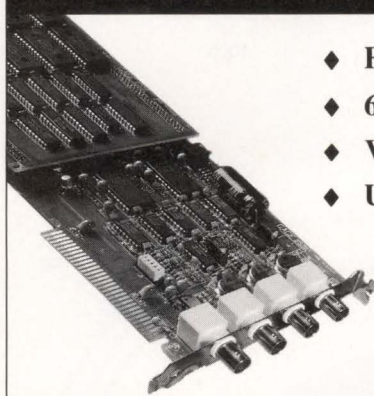

- ◆ Fastest 12 bit A/D
- ◆ 65 dB SNR
- ◆ Very Deep Buffers
- ◆ Up to 32 ch Systems

Drivers in  
C, Pascal,  
BASIC,  
Windows DLL,  
LabVIEW,  
LabWindows,  
DasyLab,  
HyperSignal ...

Gage Applied Sciences Inc., the recognized world leader in ultra-fast PC based data acquisition and instrumentation, presents the CompuScope family with **FREE** GageScope oscilloscope emulation software.

CSLITE	8 bit / 40 MSPS / 16K	\$595
CS220	8 bit / 40 MSPS / 256K	\$1,995
CS250	8 bit / 100 MSPS / 32K	\$3,500
CS1012	12 bit / 20 MSPS / 512K	\$4,995

**CALL 1-800-567-GAGE**

Inquire about our D/A cards

Gage Applied Sciences Inc.

5465 Vanden Abeele, Montreal, Quebec, Canada H4S 1S1  
From outside North America, call +1-514-337-6893  
Fax: (514) 337-8411, BBS: (514) 337-4317

# GaGe

CIRCLE NO. 31

## EDN-DESIGN IDEAS

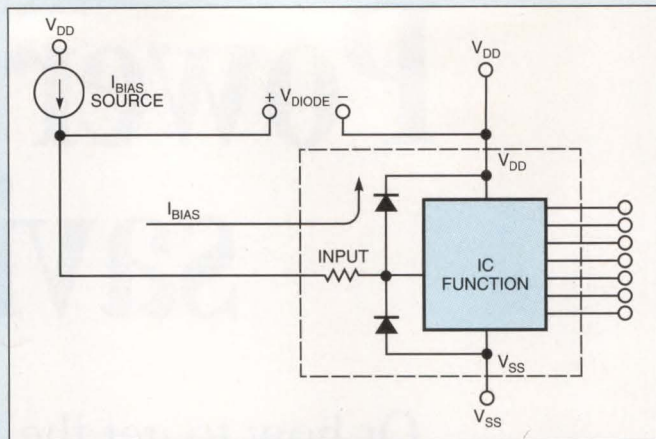

**Fig 1—Using one of an IC's input-protection diodes as a sensor allows you to directly determine the junction temperature.**

indicates the diode's temperature dependence. In practice, the voltage-temperature relationship is not quite linear, particularly over a large temperature range. Forward-bias currents from 10  $\mu$ A to 1 mA have worked successfully with diode temperature sensors. Using the higher end of this range is recommended to avoid errors from device input current and the  $V_{DIODE}$  meter impedance; use lower bias current when the IC's input structure includes a significant series resistance. The performance of the  $I_{BIAS}$  constant-current generator is not critical. It is best to measure the volts-vs-temperature (V-T) slope of at least one representative device rather than relying on the above equation alone because of process-related departure from ideal behavior.

For a given process lot, the slope of the diode's V-T curve demonstrated consistent temperature-rise measurements within 1 or 2°C over a 100° span. Slope values of -2 to -2.4 mV/°C are typical for silicon. The intercept point on the V-T curve is less repeatable among devices, so if only lot sample data is available, a second measurement at a known temperature is recommended (ie, room temperature with the device's power off).

A word of caution: older CMOS ICs suffer from parasitic SCR latch-up when the input-protection diodes are driven into conduction. The results of this condition can be catastrophic. Modern CMOS designs are free from latch-up, with input diodes conducting tens of milliamps or more.

Also beware of problems due to noise, crosstalk from adjacent pins, and ground bounce. Also, the hottest spot on the chip may not necessarily be near the bond pad, and temperatures could be higher elsewhere. (DI #1555) EDN

**To Vote For This Design, Circle No. 336**

### How to use our bulletin board



This icon identifies those Design Ideas that have computer-readable material posted on EDN's bulletin-board system (BBS). Call our free BBS at (617) 558-4241 (300/1200/2400 8,N,1). Not every Design Idea has downloadable material, but each one does have a BBS number printed at the end of it. If you'd like to comment on any Design Idea, include the number in the subject field of your message.

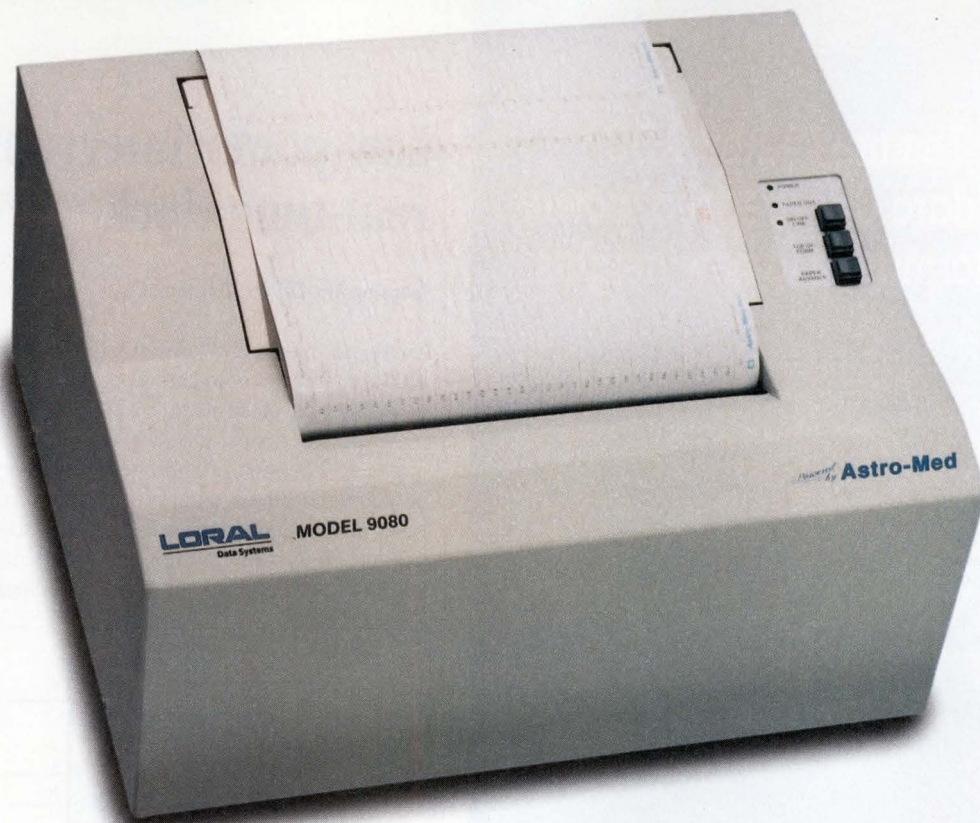

## Loral Makes a Replacement for the Versatec V80™ That Uses No Liquid Chemicals.

### NEW FROM LORAL

The Loral 9080 is a plug-compatible, exact replacement for the Versatec V80. It gives you everything you want and need in a high speed printer/plotter. With the 9080, you get clean, crisp copies every time using an environmentally-friendly dry process. No chemical inks or toners.

### EASY TO INSTALL AND USE

Installation couldn't be easier. Simply unplug the V80 and plug in the 9080. The 9080 is designed to work with all existing Versatec V80 software and hardware interfaces.

Powered by the Astro-Med Print Engine, the 9080 prints high-resolution documents at 200 dpi on fanfold or roll paper. Print Speed is 15 pages per minute. Plot speed is one inch per second. Price is under \$12,000.

To order the Model 9080, call (813) 378-6984. For more information write: Loral Data Systems, P.O. Box 3041 M/S41, Sarasota, FL 34230 or call our hotline (813) 377-5590.

**LORAL**  
Data Systems

Versatec and V80 are trademarks of Versatec, Inc.

CIRCLE NO. 113

EDN July 7, 1994 • 105

The next 12-bit ADC standard drives speed/power performance to new heights.



IT'S ACCURATE.  
IT'S CRYSTAL.

THE CS5032 DELIVERS  
500kHz FOR ONLY 55mW

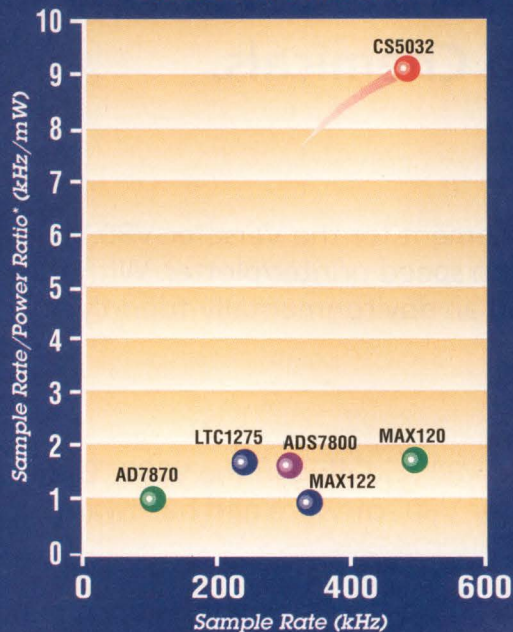

\*Datasheet specifications for -55°C/125°C

**CRISTAL**  
SEMICONDUCTOR CORPORATION

1-800-550-5030

## Low-power interrupt updates real-time clock

Yongping Xia, EBT Inc, Torrance, CA

Some  $\mu$ P-based systems need a real-time clock. The  $\mu$ P's built-in timer can do the work, but it usually requires several milliamps of current to keep the timer running. If the main power drops, the clock requires a backup battery to operate. The size of the backup battery depends mainly on how long the clock must run without main power supply and how much current the  $\mu$ P draws. Usually, during the main power supply's dropping period, the only task the  $\mu$ P should perform is to update the real-time clock.

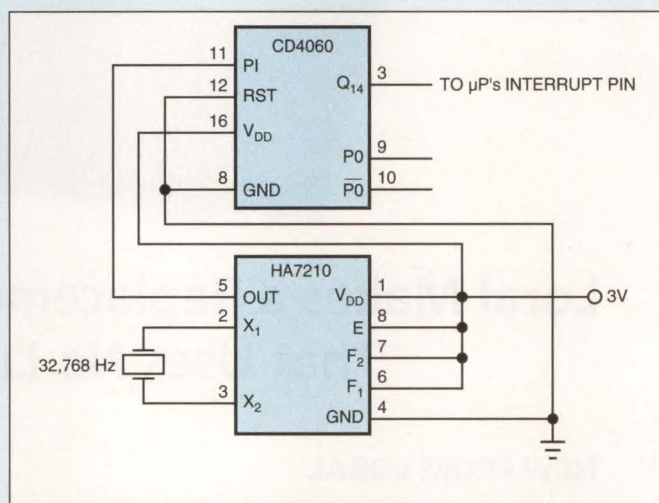

**Fig 1**—A further way to conserve power during main power-down conditions, is to generate a low-power interrupt that awakens the  $\mu$ P from sleep mode to update its real-time clock quickly.

However, there is an alternative way to run the real-time clock. Most CMOS-based  $\mu$ P's have stop or sleep modes in which the  $\mu$ P consumes only a few microamps of current. Instead of running all the time, the  $\mu$ P goes into stop or sleep mode if it detects a main power drop. Under these conditions, you can use an external interrupt source to awaken the  $\mu$ P and cause it to update the real-time clock and then return to sleep mode. Because the real-time-clock update takes only a short time, the  $\mu$ P still spends most of its time in sleep mode.

**Fig 1's** circuit provides an interrupt every 0.5 sec. The HA7210 (Harris Semiconductor, Melbourne, FL) low-current crystal oscillator consumes about 4  $\mu$ A with a 32,768-Hz crystal. The CD4060 14-stage binary counter divides the output signal from the HA7210 down to a 0.5-sec square wave and consumes 7  $\mu$ A more. You can set the  $\mu$ P to positive- or negative-edge-trigger interrupt mode. If the average  $\mu$ P current is 9  $\mu$ A, the total current with the interrupt circuit is around 20  $\mu$ A. (DI #1556)

EDN

To Vote For This Design, Circle No. 337

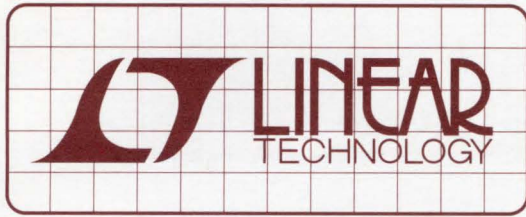

# DESIGN NOTES

## Source Resistance Induced Distortion in Op Amps

Design Note 84

William H. Gross

### Introduction

Almost all op amp data sheets have Typical Characteristic Curves that show amplifier total harmonic distortion (THD) as a function of frequency. These curves usually show various gains and output levels but almost always the input source resistance is low, typically  $50\Omega$ . In some applications, such as active filters, the source impedance will be much larger. If the input impedance of the op amp is nonlinear with voltage, the resulting distortion will be significantly higher than the values indicated in the data sheet.

### Test Circuit

It is quite easy to evaluate source resistance induced distortion. Connect the amplifier as a unity-gain buffer operating on  $\pm 15V$  supplies. Feed a low distortion  $20V_{p-p}$  signal to the noninverting input through a source resistor and measure the output signal distortion. The setup is shown in Figure 1. The readings at 1kHz and 10kHz were recorded for various values of source resistance from  $100\Omega$  to  $100k$ . The measured results for several op amps are plotted in Figures 2 and 3.

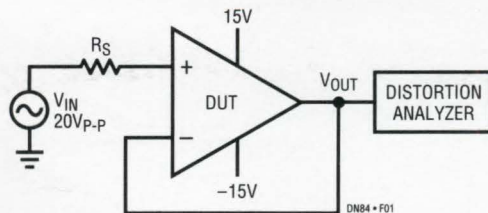
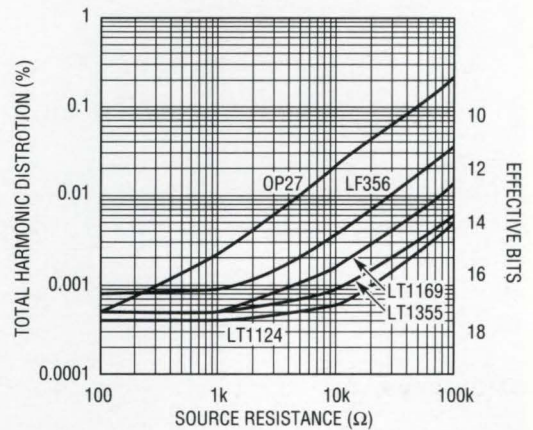

Figure 1

### Results

Unfortunately there is no easy way to predict which amplifiers will have the lowest source resistance induced distortion from the data sheets. There are two main causes of the distortion: nonlinear input resistance and nonlinear input capacitance. At first thought, one would not expect the small input capacitance of an



DN84 • F02

Figure 2. 1kHz Distortion vs Source Resistance

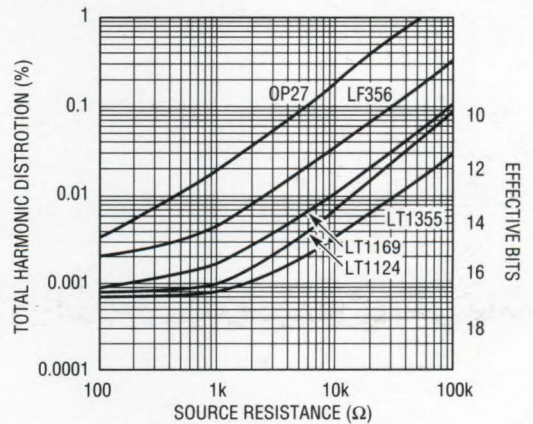

DN84 • F03

Figure 3. 10kHz Distortion vs Source Resistance

op amp to cause distortion at a few kHz. But a 10k source is loaded 0.01% by 1pF at 1.6kHz! Therefore a change in input capacitance of 1pF will cause measurable distortion at 1kHz. For lowest distortion we want an amplifier with low input capacitance as well as very high (and constant) input resistance.

FET input op amps have the highest input resistance but they also have a significant nonlinear input capacitance. The LF356 is a typical FET input op amp; the distortion is 5 to 20 times worse with a 10k source compared with a low source resistance. The LT1169 is a new dual FET input op amp with very low input capacitance (1.5pF) and therefore has about three times lower distortion than the LF356.

The OP27 is a popular high speed precision op amp that has very low distortion when driven from a 50Ω source. Unfortunately the input bias current cancellation circuit works well only at very low frequencies; at 1kHz the input resistance is very nonlinear. The distortion from the OP27 is 50 times worse with a 10k source than with a 100Ω source. The LT1124 is a dual low noise precision op amp that uses a different input bias current cancellation circuit. The LT1124 has the least source resistance induced distortion at 1kHz of any of the op amps tested. The LT1355 is a member of a new family of low power, high slew rate op amps that have outstanding high frequency performance. The LT1355 has the least source resistance induced distortion at 10kHz of any op amp tested.

Figure 4 shows a 20kHz Butterworth active filter as might be used for anti-aliasing or band limiting in a data acquisition system. Figure 5 shows the frequency re-

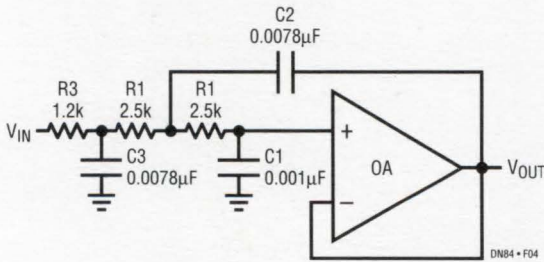

Figure 4

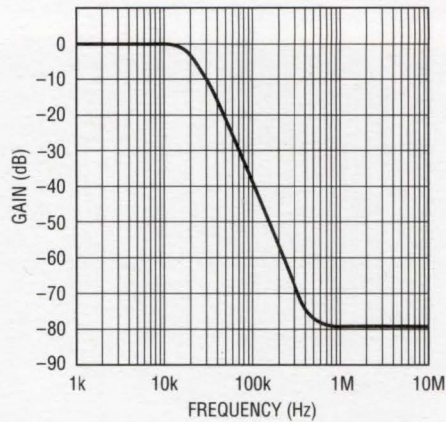

Figure 5. Filter Frequency Response

sponse of the circuit. Note that for signals well below the cutoff frequency, the capacitors have no effect and the op amp sees a 6.2k source resistance. Distortion was measured with several op amps in the circuit to confirm the data shown in Figures 2 and 3. Table 1 shows the results of the best op amps.

Table 1. Filter Distortion

Amplifier	100Hz	1kHz	2kHz	5kHz	10kHz
LT1124	0.0004%	0.0005%	0.0008%	0.0021%	0.0090%
LT1355	0.0005%	0.0006%	0.0010%	0.0035%	0.0052%
LT1169	0.0005%	0.0012%	0.0024%	0.0080%	0.0100%

Source resistance induced distortion usually limits the dynamic range of unity-gain RC active filters. An interesting high performance alternative is the LTC1063 and LTC1065. These fifth order, switched-capacitor low-pass filters are not only smaller and easier to use, their distortion is less than 0.01% even with 10k source resistance.

For literature on our Operational Amplifiers, call 1-800-4-LINEAR. For applications help, call (408) 432-1900, Ext. 456

# GaAs SWITCHES

DC-2GHz Immediate Delivery from **\$2<sup>30</sup>**  
(1000 qty.)

Finally! A line of SPDT absorptive, reflective and transfer switches that appeals to your technical side, and business side as well! It's

Mini-Circuits GaAs switches...providing outstanding performance features such as very high isolation (up to 60dB), superfast 3nsec switching speed and excellent compatibility with surface mount soldering techniques. Additionally, the entire series is built extremely tough and is immediately available from stock with a 1 week shipment guarantee. At only \$2.95 (qty.10), this top-of-the-line value is priced with your bottom line in mind!

To order, call or Fax Mini-Circuits with your requirements today.

**Mini-Circuits...we're redefining what VALUE is all about!**

Model No.	Freq. (GHz)	Insertion Loss ① dB (max.)	1dB Comp. ① dBm (typ.)	In-Out Iso. ① dB (typ.)	Price \$ea. (qty.10)
MSW-2-20 (Reflective)	DC-2.0	1.0	+24	34	2.95
MSWA-2-20 (Absorptive)	DC-2.0	1.3	+27	40	3.45
MSWT-4-20 (Transfer)	DC-2.0	1.8 TX ② 2.0 RX ③	+28 TX ② +27 RX ③	30	3.95

① Midband, 500-1000MHz ② Transmit ③ Receive

All Units: SOIC 8pin Package

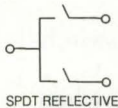
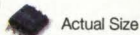

SPDT REFLECTIVE

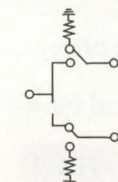

SPDT ABSORPTIVE

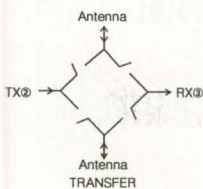

Antenna TRANSFER



**Mini-Circuits®**

P.O. Box 350166, Brooklyn, New York 11235-0003 (718) 934-4500 Fax (718)332-4661

For detailed specs on all Mini-Circuits products refer to • THOMAS REGISTER Vol. 23 • MICROWAVES PRODUCTS DIRECTORY • EEM • MINI-CIRCUITS' 740- pg. HANDBOOK.

**CUSTOM PRODUCT NEEDS...Let Our Experience Work For You.**

F 174 Rev Orig

CIRCLE NO. 202

EDN July 7, 1994 • 109

# THE HIGH PERFORMANCE GIGAHERTZ RELAY

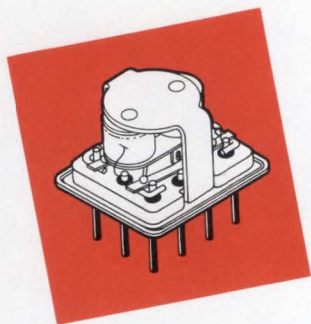

- RF Switching up to 4 GHz
- Magnetic latching cuts power drain
- Convenient Centigrid® package
- Aerospace and commercial versions

**T**he TO-5 family of relays are great performers in RF switching applications. They are inherently that way. Low inter-contact capacitance. Low insertion loss. Up through 500 MHz. No problem.

But then you wanted them for even higher frequencies. You wanted gigahertz performance, and not just 1 GHz, but 3 or 4. That took some serious doing. But our combination of experience and innovation was equal

to the task. We married over three decades of TO-5 and Centigrid® technology with some new techniques we developed to enhance the RF characteristics. The results? The gigahertz Centigrid® relay (RF 170). We were able to extend the relay's performance from the MHz range to the GHz range. And handle RF switching functions all the way up to 4 GHz. The RF 170 has higher isolation across contacts and across poles over the frequency range.

The high performance gigahertz Centigrid® relay (RF 170) will handle your toughest switching assignments, especially when power drain is critical. For price, delivery, and more technical information, call **1-800-284-7007** or Fax us at 1-213-779-9161.



**TELEDYNE RELAYS**  
Innovations In Switching Technology

**Home Office:** 12525 Daphne Avenue, Hawthorne, CA 90250 • Telephone: 213-777-0077 • Fax: 213-779-9161

**Overseas:** GERMANY, (0611) 7636-143; ENGLAND, (081) 571-9596, BELGIUM, (02) 717-52-52; JAPAN, (03) 3797-6956



# Simple As 1, 2, 3! Configure Your Own Modular Power Supply

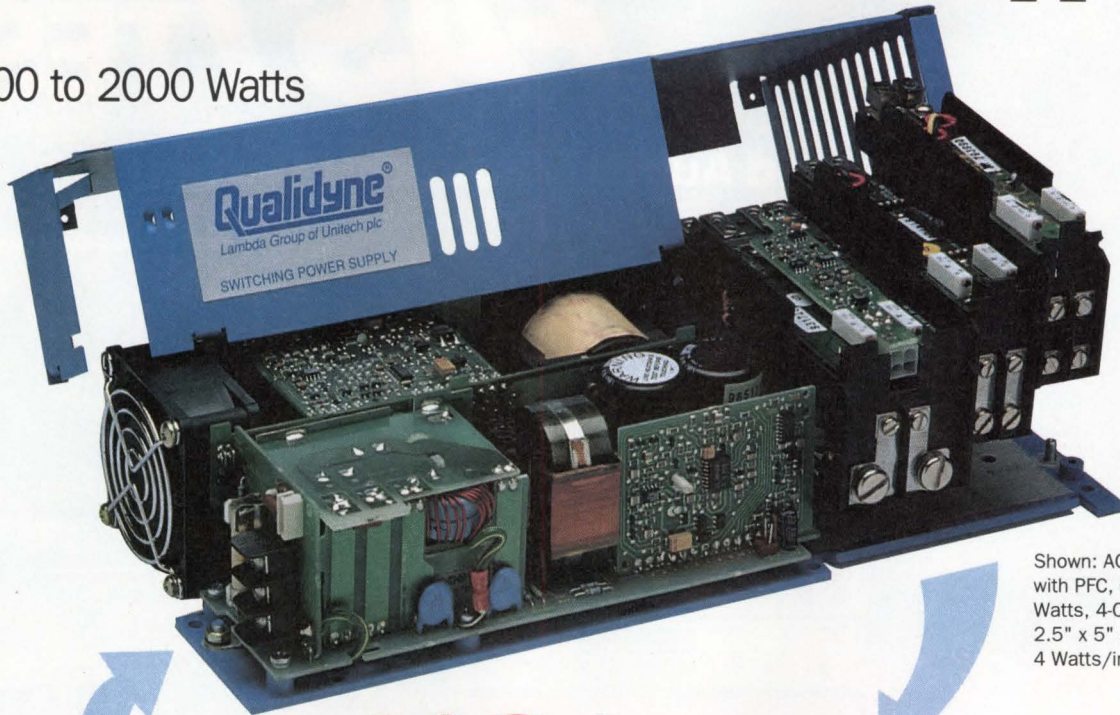

200 to 2000 Watts



Shown: AC input with PFC, 600 Watts, 4-Outputs, 2.5" x 5" x 11" 4 Watts/in<sup>3</sup>

1.



SELECT INPUT VOLTAGE (CHECK ONE)	
	AC 115/230 VAC (Auto Select optional)
	AC with PFC 85-264 VAC (Meets IEC 555-2)
	DC (48 VDC)

2.

SELECT DC OUTPUTS			
Volts	Amps	Module	Quantity Needed
2-6V	25A	B	
2-6V	60A	A	
2-6V	100A	L	
5-15V	12A	C	
5-15V	24A	F	
5-15V(x2)	6A max*	E	
12-28V(x2)	3.5A max*	H	
12-28V	7A	D	
12-28V	15A	G	
25-60V	10A	J	

Select up to 8 DC output modules. \*Total current from dual output module.

3.

**CALL (619) 575-1100 . . . OR FAX (619) 575-7185**

Now configuring your own power supply is as easy as filling in the blanks. Just tell us which input and which DC outputs you need and we'll put the modules in place. What could be simpler?

- Up to 16 outputs in the voltage/current combinations of your choice

- Parallel/Current-Share (optional)
- 200 to 2000 Watts
- 2.5 to 5 inches high
- Power Factor Correction (IEC 555-2)

Call for your free catalog:  
(619) 575-1100.



**LAMBDA**  
Qualidyne Inc. 

ISO 9001  
Certified  
Manufacturer

3055 Del Sol Blvd. • San Diego, CA 92154 • Tel: (619) 575-1100 • Fax: (619) 575-7185

Circle No. 121 For U.S. & Canada Responses

Circle No. 122 For International Responses

111

# FAST FASTER FASTTEST

## High Speed Audio Frequency Testing



### Audio Precision offers a Full Range of Audio Test Sets...

#### FAST

**ATS-1** is a competitively priced audio test set featuring front panel and GPIB programmable operation as well as higher performance and speed than the typical audio testers it replaces. Both Audio Precision and HP 8903B GPIB command sets are supported. A sample suite of 43 measurements<sup>1</sup> takes only 33 seconds. The dual channel ATS-1 is at home in production floor environments thanks to its rugged fan-cooled enclosure and front or rear mount modular connector panels.

#### FASTER

**System One** automated integrated audio test sets measure distortion, frequency phase, wideband or selective noise, and crosstalk in production test environments benefiting from high speed and performance. System One can make a sample suite of 43 measurements<sup>1</sup> in 21 seconds. Optional spectrum analysis and digital domain signal generation and analysis capabilities make it the one-stop audio test system. Available both in GPIB and PC controlled versions, System One is today's recognized standard in audio testing.

#### FASTTEST

**System One DSP** versions test any audio channel in the *fastest* possible time. With DSP power, **FASTTEST** completes the 43 measurement<sup>2</sup> example above in 2 seconds! System One **FASTTEST** technology generates and analyzes special multi-sinewave test signals. These wideband signals provide complete frequency response, distortion and noise measurements from a single stimulus acquisition.

**Audio  
precision**

P.O. Box 2209  
Beaverton, OR 97075-3070  
(503) 627-0832 (800) 231-7350  
FAX: (503) 641-8906

<sup>1</sup>Sample suite of GPIB programmed audio measurements included 1) noise measurement (20Hz-22kHz bandpass).

<sup>2</sup>31 point single tone frequency response sweep over 20Hz-22kHz range, and 3) 11 point distortion sweep over 20Hz-22kHz range.

<sup>3</sup>FASTTEST uses multi-tone stimulus and analysis to make the same measurements listed above.

INTERNATIONAL DISTRIBUTORS: **Australia:** IRT Electronics Pty. Ltd., Tel: 2 439 3744 **Austria:** ELSINCO GmbH, Tel: (222) 815 04 00 **Belgium:** Trans European Music NV, Tel: 2/466 5010 **Brazil:** INTERWAVE LTDA, Tel: (21) 325-9221 **Bulgaria:** ELSINCO, h.e. Strelbishte, Tel: 92 581 698 **Canada:** GERRAUDIO Distribution, Tel: (416) 698-2779 **China, Hong Kong:** A C E (Int'l) Co. Ltd., Tel: 424-0387 **Czech Republic:** ELSINCO Praha spol. s r.o., Tel: (2) 4702 I. 451, 452 **Denmark:** npp Elektronik aps, Tel: 86 57 15 11 **Finland:** Genelec OY, Tel: 77 13311 **France:** ETS Mesureur, Tel: (1) 45 83 66 41 **Germany:** RTW GmbH, Tel: 221 70913-0 **Greece:** KEM Electronics O.E., Tel: 01-6478514/5 **Hungary:** ELSINCO KFT, Tel: (1) 112 4854 **India:** HINDITRON Services PVY, Tel: 22 836-4560 **Israel:** Dan-El Technologies, Ltd., Tel: 3-544-1466 **Italy:** Audio Link s.n.c., Tel: 0521/648723 **Japan:** TOYO Corporation, Tel: 3 (5688) 6800 **Korea:** B&P International Co., Ltd., Tel: 2 546-1457 **Malaysia:** Test Measurement & Engineering Sdn. Bhd., Tel: 3 734 1017 **Netherlands:** TM Audio B.V., Tel: (0) 30 414070 **New Zealand:** Audio & Video Wholesalers, Tel: 7 847-3414 **Norway:** Lydcosult, Tel: 9 19 03 81 **Poland:** ELSINCO Polska sp. z o.o., Tel: (22) 39 69 79 **Portugal:** Acutron Electroacustica LDA, Tel: 1 9414087 / 9420862 **Singapore:** TME Systems Pte Ltd., Tel: 298-2608 **Slovakia:** ELSINCO Bratislava spol. s r.o., Tel: (7) 784 165 **South Africa:** SOUNDFUSION, Tel: 11 477-1315 **Spain:** Telco Electronics, S. A., Tel: 1 531-7101 **Sweden:** Tal & Ton Elektronik AB, Tel: 31 80 36 20 **Switzerland:** Dr. W.A. Gunther AG, Tel: 1 910 41 41 **Taiwan:** ACESONIC Intl Co., Ltd., Tel: 2 719 2388 **United Kingdom:** SSE Marketing Ltd., Tel: 71 387-1262

# Break the performance bottlenecks in today's multiprocessor designs

Brian Bennett, AST Research Inc

*New operating-system and device-driver software for symmetric multiprocessing hardware make interrupt distribution the least important hardware-design consideration. You achieve better performance by developing an efficient bus protocol and increasing concurrency.*

Early efforts to supply additional processing power by adding CPUs to a common bus resulted in a simple master-slave relationship between CPUs, called "asymmetrical multiprocessing." Though this architecture was simple, it soon reached a "premature" bottleneck because of poor task distribution among processors. The architectural limitations occur in both software and hardware. Early operating-system (OS) software neither could run in multiprocessor systems nor could take full advantage of the increased processing power.

Additionally, most I/O drivers were "single-threaded," which limited their execution to a single dedicated I/O processor. Initially, this was not a major problem because "asymmetrical hardware" typically did not allow all processors access to all system resources. In general, asymmetric hardware dedicates a single processor to I/O functions. The performance of this single I/O processor can, and often does, become the system bottleneck as it reaches its performance limits. Both the asymmetric hardware and single-threaded software pose barriers to system performance. Thus, asymmetric machines exhibit limited scalability because adding processors does not benefit a system that is limited by the performance of one of its processors.

The solution to this bottleneck was to redesign both the hardware and the software, which led to today's symmetric multiprocessors (SMPs) coupled with multithreaded software. An "SMP" is a system in which all processors are identical and all resources—specifically, all the memory and I/O

space and interrupts—are equally accessible. While the symmetrical nature of SMP hardware eliminates any architectural barriers, the software must still efficiently divide the tasks among processors.

SMPs have been slow to catch on because they require software to provide a performance advantage over asymmetrical multiprocessing architectures. That is, without "symmetric" software, SMP hardware performs at the same level as an asymmetrical multiprocessor.

## Fixed vs dynamic interrupt allocation

In an asymmetrical multiprocessor system, one processor typically performs all the I/O and, hence, fields all the I/O interrupts, performs the low-level I/O functions, and passes interrupts to the processor elements as needed. One of the most controversial issues in an SMP design is how to distribute the interrupts to the system processors. Generally, you can use one of two implementations: fixed or dynamic (lowest priority) distribution.

From a strictly hardware perspective, fixed distribution—the (programmable) assignment of interrupts to specific processors—offers the advantage of simplicity. Furthermore, by repeatedly assigning a specific interrupt to a given processor, that processor is more likely to have the interrupt-service routine (ISR) in its cache. In this scenario, a CPU (say, CPU A), which has just serviced the interrupt can more quickly and more efficiently handle the interrupt while using less precious system-bus bandwidth than some other CPU (say, CPU B). However, if enough time passes, newer data and instructions may overwrite the contents of CPU A's cache, thus destroying the benefit of sending the interrupt to the same processor. The downside to this approach is that CPU B may be "less busy" and better able to service the interrupt.

Dynamic distribution relies on interrupt-control hardware to route the interrupt to the lowest priority processor. The hardware does this in the hope of assigning the additional workload of the ISR to the least busy processor (the one executing the lowest priority task). This assignment

## SYMMETRIC MULTIPROCESSORS

increases a system's scalability by more evenly distributing the workload.

To ascertain the performance impact of interrupt distribution, ask a more fundamental question: What does the OS do within an ISR when the ISR processes an interrupt? Today's ISRs are small routines that identify the source of an interrupt (when multiple devices share an interrupt), perform any housekeeping necessary to re-enable the interrupt, and pass a deferred-procedure call (DPC) to the system via a system-process queue. (Fig 1). The next available processor that takes a job from the process queue also handles the interrupt.

In light of this information, coupled with the relative infrequency of interrupts as a percentage of bus-cycle time, you can deduce that the interrupt-distribution method is relatively benign as far as system performance goes. In fact, an asymmetrical interrupt distribution in which one processor services all interrupts is technically acceptable. The asymmetric architecture might, however, make a product difficult to sell. Today's interrupt-handling solutions are based more around cost factors and software support than around the performance merits of the hardware mechanisms that distribute the interrupts.

### System-bus bandwidth

An architecturally superior SMP machine can eliminate the previous system bottleneck, but three new bottlenecks

appear: software scalability; limitations of the backbone, or common multiprocessor bus; and limitations of the I/O subsystem. These design tradeoffs are not specific to SMP design, but they become more prominent as you add processors.

Designers generally ask two questions when evaluating a backbone bus for SMP systems:

- 1) What is the clock speed?
- 2) What is the data-bus width?

However, the answers to these questions may not be the best measure of relative performance and usable bandwidth. The overall best number to evaluate a multiprocessor bus is the sustainable bandwidth because it reflects not only the bus speed and data-bus width, but also the bus-protocol efficiency. Although a high number is generally better, it comes with a cost and other tradeoffs.

Designers should expend no more cost than necessary to provide a design that balances system- and I/O-bus requirements. What good is a 400-Mbyte/sec sustained throughput on a system bus if an application requires an I/O data rate of 40 Mbytes/sec, and the I/O bus operates at only 33 Mbytes/sec? In this example, a user would pay extra for system-bus bandwidth without realizing the benefit. Unfortunately, the variety of applications, each with differing I/O-bandwidth requirements, makes this tradeoff more of an art than a science.

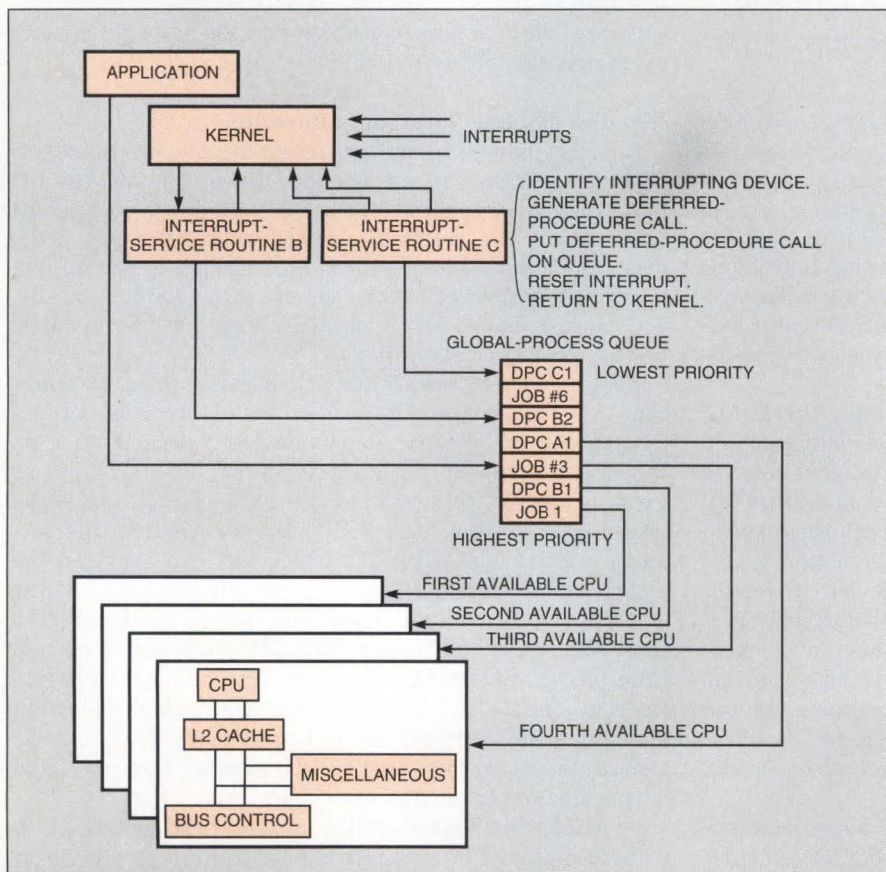

Fig 1—Windows NT keeps interrupt-service routines (ISRs) small by performing only minimal processing at the ISR level. Instead, the ISR generates a deferred-procedure call (DPC), which the system queue manages.

### Benefits of improving protocol

Aside from increasing the bus speed and data width, a more efficient use of system-bus bandwidth can yield significant gains. For a fixed memory-access time, increasing the bus speed may provide little gain: Instead of waiting five clocks at 25 MHz, you can wait 10 clocks at 50 MHz. For systems with separate address and data buses, you can pipeline accesses on the bus so that CPUs can simultaneously access multiple memory banks.

Interleaving memory boards on cache-line boundaries allows concurrent memory accesses. Pipelining increases sustainable throughput for a 33-MHz, 267-Mbyte/sec bus from 107 to 214 Mbytes/sec (Fig 2). Because of the probabilistic nature of cache-line interleaving, you may realize on an average only half of this gain. Thus, you can achieve a 50% increase in bus throughput with little added complexity—the ability of the memory to register two addresses plus some minor control logic.

Memory pipelining improves bus efficiency but requires a simpler memory design than does a split-transaction protocol. Because  $\mu$ Ps can pipeline the address bus, pipelining becomes a natur-

## KEYS TO SUCCESS

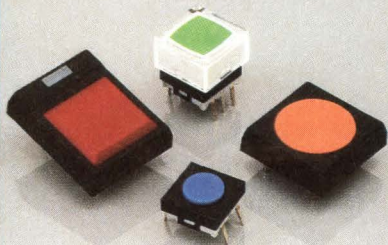

Dome contact, low profile keypad switches. Lighted & non-lighted, round & square. Sub-surface mounting types. Up to 5 million actuations.

## FLAWLESS LOGIC



Real or complement coded, decimal or hexadecimal dip rotaries. Screwdriver, shaft or dial actuation. Washable.

## WASH AND GO

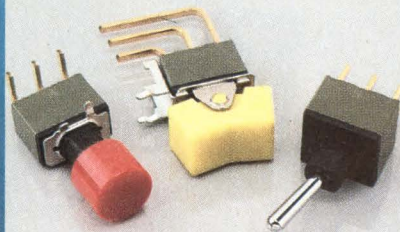

NKK washables lead the way with the industry's widest range of circuits, actuators, terminals & accessories. Micro thru std. sizes.

## LITTLE GIANTS

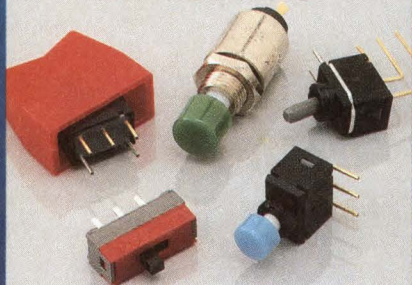

NKK pioneered the smallest. Toggles, rocker, pushbutton, slides. Washables, SMDs, anti-static & STC contacts available.

## FREE DESIGN TOOL

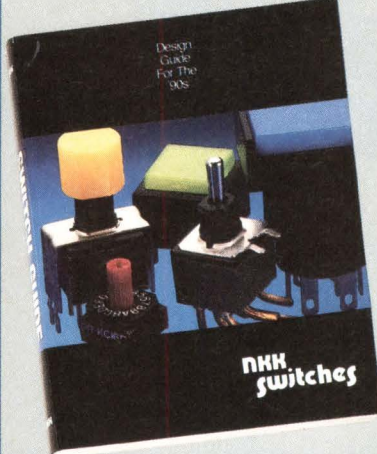

## LIGHT FANTASTICS



Tiny, but bright. Low-profile snap-in or panel mounting. Numerous actuators, circuits, ratings, terminals and colors.

## WAYS TO GLOW

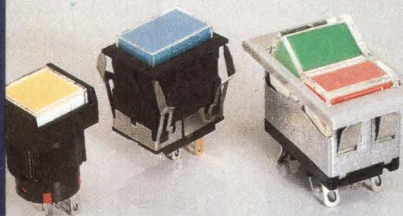

Round, square, rectangle shapes. In all popular colors. Wide choice of terminals, circuits, lamp types & accessories.

## POINTS OF LIGHT

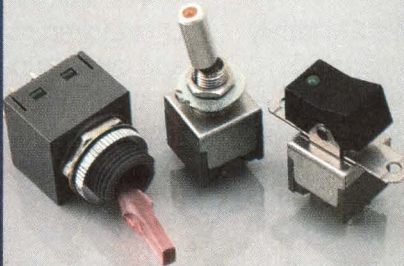

Lighted toggle and paddle tips add style and function to designs. Several actuator and circuit options.

## STAY ON TOP



The latest surface mount technology. Washable, vapor phase solderable toggles, pushbuttons and dip rotaries. Gull-winged terminals.

# DESIGN PARTNERS

We have exactly what every design engineer needs — over one million switch options and more than 40 years of switch know-how. Before you start your design-in, call for our 456-page Design Guide, then call on our experience. Make sure your design-ins go flawlessly. Make NKK your design partner right from the start. Call NKK Switches, (602) 991-0942, 7850 E. Gelding Dr., Scottsdale, AZ 85260, FAX (602) 998-1435.

**NKK**<sup>®</sup>  
**switches**



# SPARKS OF GENIUS.

Small wonders, you could call them. Abbott's SM family of surface mount DC to DC converters are the most reliable very high density power supplies available today. Guaranteed to operate without derating over the full-Mil temperature range from -55° to 100°C. And delivering up to 280 Watts at better than 50 Watts per cubic inch, in an industry standard footprint.

Rugged durability is just the beginning. Inside their tough exteriors is a constant frequency topology that minimizes ripple and makes filtering a breeze. The exclusive use of commercially available, fully derated components eliminates the risk of underperforming on specs —

or stretched out or missed deliveries. Plus full overvoltage and over temperature protection with (n + 1) paralleling for designing in redundancy and backup. Even a companion filter module and an input transient suppressor, to make your designs simpler and more compact.

For all this ingenuity, delivery is quite predictable. Get the whole family off-the-shelf. With 50, 100 or 200 Watt outputs. Single or dual output configuration. For inputs ranging from 28 to 270 VDC.

Talent recognizes genius, they say. In that case, call Abbott to try out the SM family. And prepare to be impressed.

MODEL	SM100S	SMH50	SM100D	SMF200	SM1275
SPEC	SM200S	SMH100	SM200D		
PRODUCT DESCRIPTION	SINGLE OUTPUT	HALF-SIZE SINGLE OUTPUT	DUAL OUTPUT	HALF-SIZED EMI FILTER	HALF-SIZED TRANSIENT SUPPRESSOR
PEAK POWER IN WATTS	100 / 280	50 / 100	100 / 200	375	300
INPUT VOLTAGE (VDC)	16-50 and 200-400				MIL-STD-1275A MIL-STD-704A
OUTPUT VOLTAGE (VDC)	2, 3.3, 5, 5.2, 12, 15, 24, 28		±5, ±12, ±15	—	—

**abbott**  
when reliability is imperative®

CIRCLE NO. 48

## SYMMETRIC MULTIPROCESSORS

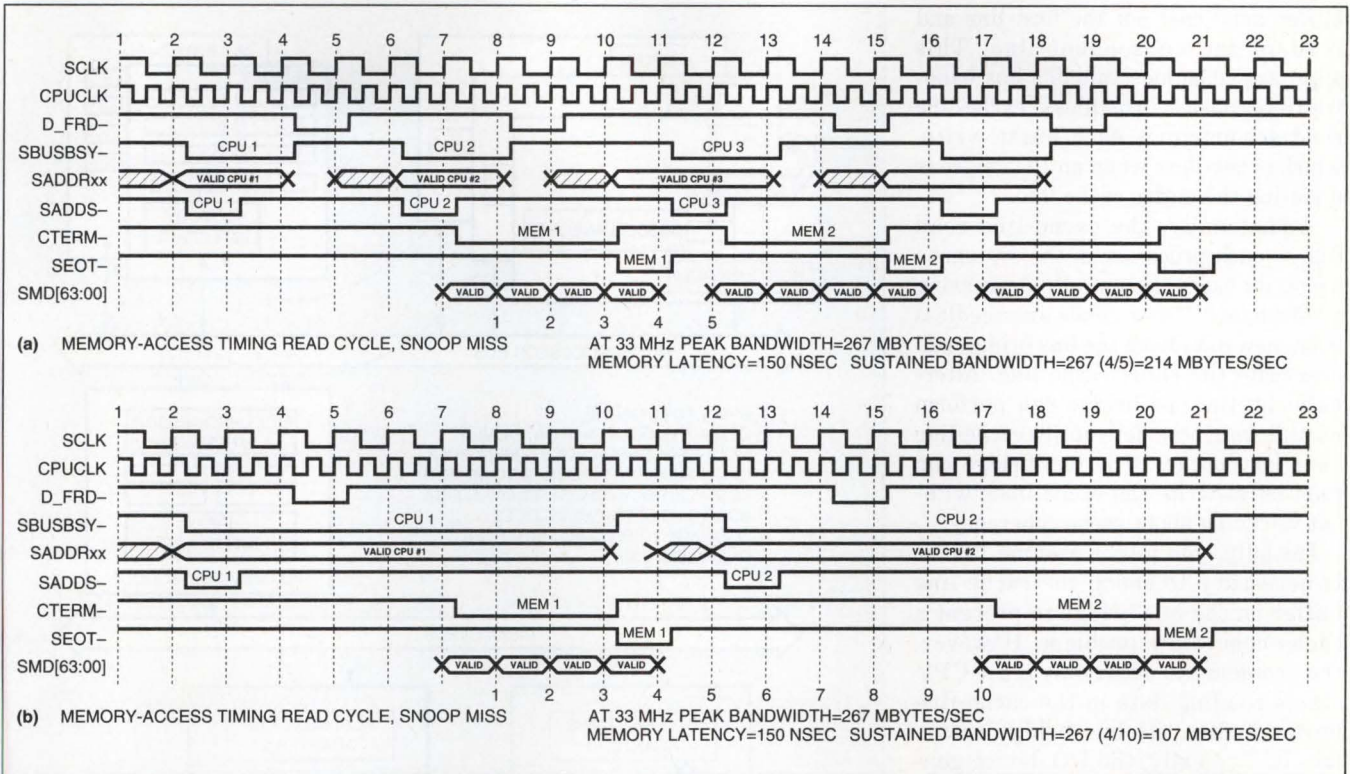

**Fig 2—A pipelined system bus (a) achieves a significant increase in throughput over a nonpipelined system (b).**

al extension from the CPU to the system bus in SMP systems.

Another way to address long-latency accesses is to use a split-transaction-protocol bus that can reconnect and transfer data. Though you can also use the split-transaction mechanism to access multiple memory modules, the relative speed of memory response usually does not warrant adding such complexity to the memory boards.

A split transaction typically provides the most benefit for long-latency accesses such as those that occur when the processor accesses an I/O controller through an I/O bridge. When the processor writes to such I/O devices, a posted-write buffer usually can eliminate any write latency, but read operations can still take a long time. In general, an I/O-bus bridge contains the logic to be a system bus master. To add the split-transaction capability, you need only to add control logic.

Although many designers recognize the need for split transactions to minimize the bus use on long-latency I/O-bus cycles, many do not see a need to support the split transactions to main memory. The memory references are fast enough to justify this decision, but this unnecessary bus limitation may preclude the bus architecture from supporting future directory-based cache architectures with a scalable-coherent-interface (SCI) topology. A bus that implements SCI correctly has no performance penalty compared with a non-split-transaction bus. Memory boards need only monitor the signal D\_FRD to know that they are not responding to the current access (Fig 2). Memory actions are then similar to the actions the memory takes when responding to a snoop-hit-dirty condition.

### I/O-subsystem bus bridge

Several multiprocessor systems offer dual-bus bridges to provide multiple paths to I/O resources. Whether or not you choose a multiple-I/O-bridge architecture, you must optimize this interface. When speaking of performance and I/O buses, the magic word is "concurrency." Concurrency can take many forms in any multiprocessor. For example, an SMP can have several concurrent events occurring in the system (Fig 3).

To obtain the highest performance possible from the bus bridge, it must have cache-line buffers to enable it to transfer data to or from the I/O bus *concurrent* with activity on the multiprocessor bus. Cache-line buffers offer many performance benefits. First, they allow concurrent operations; the system and the I/O bus operate simultaneously. Second, cache-line buffers package the I/O bus' (usually) smaller data width into the full data-bus width and thus consume fewer system-bus cycles. Third, cache-line buffers allow the bus bridge to burst an entire cache line, eliminating any idle time between burst data as the faster multiprocessor bus waits for the next data from the I/O bus.

Cache-line buffers allow transfer of a full cache line over the bus bridge, which raises two issues: What if the I/O device needs to transfer only a few bytes of data, and what if the transfer starts or ends in the middle of a cache line? You solve these problems in one of two ways: Some architectures allow only full cache-line transfers. In this case, you have no choice except to let the bus bridge perform a read-for-ownership cycle and then write the new data into the cache line. When the I/O device proceeds to the next cache line, the

## SYMMETRIC MULTIPROCESSORS

buffer must cast out the first line and read in the subsequent line. This approach consumes valuable bus bandwidth because a "worthless" cache-line read accompanies each burst write, which is needless when an I/O device is updating the entire cache line.

Additionally, the cache-line read causes each processor in the system to snoop its cache, potentially decreasing performance. These reads are needless when new data from the bus bridge will overwrite the *entire* cache line. Alternatively, the bus bridge can perform partial-word transfers until a cache-line boundary occurs. The bus bridge can then burst-write the cache lines without worrying about cache coherency.

Initially, you might assume that it is necessary to snoop the cache-line buffer on the bus bridge to prevent a cache-coherency problem. However, the problem can occur only if the CPU starts reading data in the cache-line buffer before the bus bridge transfers it. Typically, the I/O device generates an interrupt to the system when the I/O operation is complete. If the CPU starts to read data before this interrupt, the data might be stale whether or not it is buffered in a bus bridge. However, if the interrupt has a separate path from the data, the interrupt can "bypass" the data in the bus bridge (Fig 4).

Separate interrupt and data paths open a small "window" that can be a major problem (and would then require snooping of the bus bridge). If the CPU attempts to use I/O data before the bus bridge transfers the last byte and if the bus bridge lacks a snoop feature, the CPU gets stale data. You can prevent this problem by forcing the bus bridge to empty the data buffers before transferring the interrupt vector. Thus, it is not necessary to snoop the bus bridge.

When the bus bridge is transferring a new cache line to memory, the CPU cache could hold the same cache line as "modified" data. Because this data is "old," a mechanism should tell the CPU to snoop and invalidate without write-back. This scheme eliminates the need for the bus bridge to wait for the snoop results and the write-back of any modified data from the CPUs.

### Avoiding deadlock

A system employing bus bridges for concurrent operation must avoid deadlock. Deadlock occurs when a CPU attempts to access the I/O bus at the same time that an I/O device attempts to access the system bus, such as for main-memory access. One of these bus masters needs to back off, but which one? A system employing a standard PC I/O bus, such as EISA, may not have a choice: There is no graceful back-off mechanism.

For single-CPU systems, implementing a single back-off

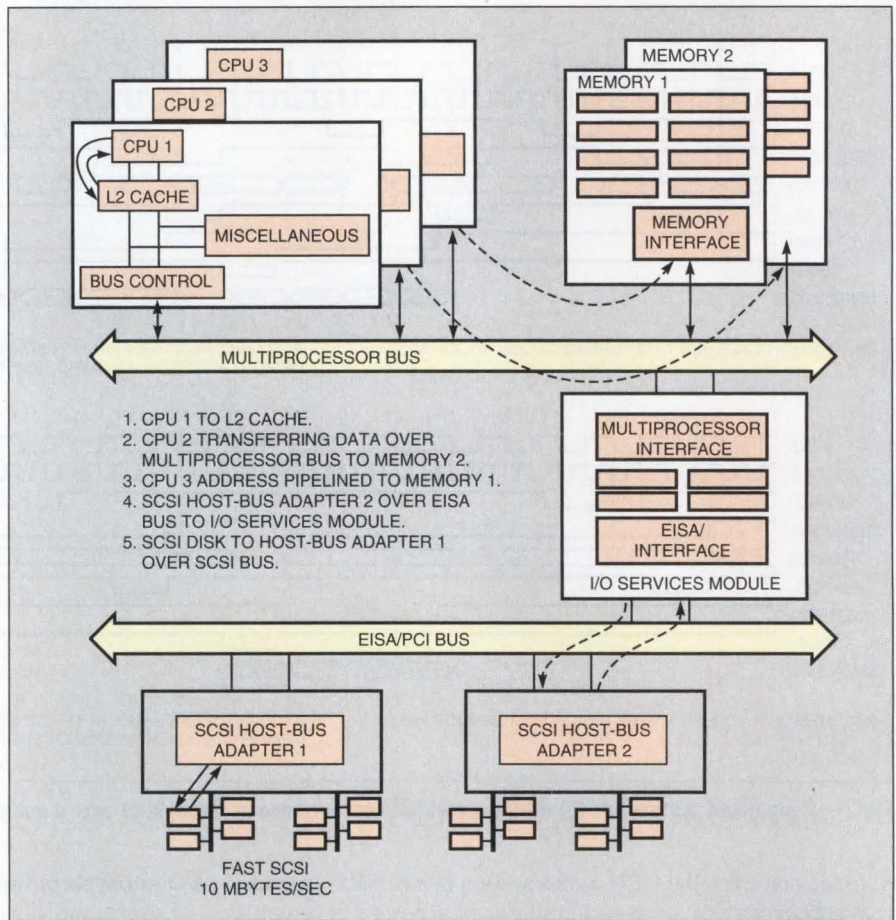

Fig 3—Increasing system concurrency is one key to maximizing performance.

signal would work fine. However, multiple CPUs complicate the situation. To avoid stopping all processors, each needs a separate back-off signal. Using one signal line is better because the bus bridge tends to be a pin-limited board. Using a deferred response is undesirable because it requires the bus bridge to store several requests while filling the cache-line buffers from the I/O device. Such a scheme is possible but costly and provides little performance gain.

A preferable design is to have processors that are requesting access to the bus bridge monitor the signal line IOBUSBSY. The bus bridge asserts this signal before it grants the bus to the I/O device, thus allowing one possible simultaneous write to access the I/O bus before granting the I/O bus to the I/O device. To accomplish this, when initiating an operation, each CPU must first decode its own address and monitor IOBUSBSY. This technique keeps unnecessary back-off cycles off the system bus.

### Partial vs full cache-line transfers

Some designs simplify the memory interface and the bus protocol by allowing only full cache-line transfers. This approach eliminates the need for logic to perform the read-merge-write operations for writing partial words to memory. (The read-merge-write is needed to generate correct ECC bits for a 32-bit word.) Because most transactions are cache-line operations, this approach may at



# We made our High Power Transformers smaller, lighter and ready to travel.

## Signal's new High Power International Transformers, 200VA to 3.5kVA, they're your passport to worldwide acceptance.

Our new MPI and HPI transformers share the same high performance and volumetric efficiency. Our unique insulating and construction techniques provide high isolation (4000V RMS Hipot), low leakage, and compliance with international safety standards. Here are other features that deserve a closer look:

- ★ Regulation: 7.5% or better (dependant on VA rating)
- ★ Low leakage current for medical applications
- ★ 5 mils thick copper Faraday shield reduces common mode noise
- ★ Shield terminated to handle high currents
- ★ MPI's—incorporate Faston/screw type shock proof terminals
- ★ HPI's—incorporate Euro style screw terminals
- ★ MPI's—operate at: 100V, 115V, 200V, 215V, 230V - 50/60 Hz
- ★ HPI's—operate at: 100V, 115V, 215V, 230V - 50/60 Hz
- ★ MPI's—approvals pending: UL 506, CSA 22.2 # 66 and VDE 0805 (IEC 950)
- ★ HPI's—approved to UL 506, CSA 22.2 # 66, and VDE 0550. Approval pending: TUV IEC 950
- ★ MPI's—constructed with Class B materials (130°C)
- ★ HPI's—constructed with Class H materials (180°C)

### ORDERING EXAMPLE:

MPI - 400 - 24

MULTI-PURPOSE INT'L SERIES

VA SIZE (400VA)

OUTPUT VOLTAGE (SERIES CONNECTED)

AVAILABLE IN STANDARD VOLTAGES:

10V, 12V, 16V, 20V, 24V, 28V, 36V, 40V, 48V, 230V

FOR CUSTOM VARIATIONS CALL OUR ENGINEERING DEPARTMENT

Part No.	VA	Secondary		1-9 Pcs Price
		Series	Parallel	
MPI-200-10 THROUGH	200	10Vct. @ 20.0A	5V @ 40.0A	\$ 85.00
MPI-200-230	200	230Vct. @ 0.87A	115V @ 1.74A	
MPI-250-10 THROUGH	250	10Vct. @ 25.0A	5V @ 50.0A	90.00
MPI-250-230	250	230Vct. @ 1.1A	115V @ 2.2A	
MPI-300-10 THROUGH	300	10Vct. @ 30.0A	5V @ 60.0A	96.00
MPI-300-230	300	230Vct. @ 1.3A	115V @ 2.6A	
MPI-400-10 THROUGH	400	10Vct. @ 40.0A	5V @ 80.0A	111.00
MPI-400-230	400	230Vct. @ 1.74A	115V @ 3.48A	
MPI-650-10 THROUGH	650	10Vct. @ 65.0A	5V @ 130.0A	145.00
MPI-650-230	650	230Vct. @ 2.8A	115V @ 5.6A	
MPI-900-10 THROUGH	900	10Vct. @ 90.0A	5V @ 180.0A	162.00
MPI-900-230	900	230Vct. @ 3.9A	115V @ 7.8A	

### Mechanical Dimensions

Size	L	W	H	ML (mtg)*	MW (mtg)*	WGT
200VA	3.750" 95.3 mm	4.203" 106.6 mm	3.720" 94.5 mm	3.250" 82.6 mm	2.800" 71.1 mm	6.22 lbs 2.82 kg
250VA	4.125" 104.8 mm	3.898" 99.0 mm	4.000" 101.6 mm	3.625" 92.1 mm	2.601" 66.1 mm	6.76 lbs 3.07 kg
300VA	4.125" 104.8 mm	4.223" 107.3 mm	4.000" 101.6 mm	3.625" 92.1 mm	2.915" 74.0 mm	7.80 lbs 3.54 kg
400VA	4.125" 104.8 mm	4.805" 122.0 mm	4.000" 101.6 mm	3.625" 92.1 mm	3.505" 89.0 mm	9.82 lbs 4.46 kg
650VA	5.250" 133.3 mm	4.430" 112.5 mm	4.800" 121.9 mm	4.500" 114.3 mm	3.415" 86.7 mm	14.83 lbs 6.73 kg
900VA	5.250" 133.3 mm	5.197" 132.0 mm	4.800" 121.9 mm	4.500" 114.3 mm	4.205" 106.8 mm	19.84 lbs 9.01 kg

### HPI SERIES

Part No.	VA	Secondary		1-9 Pcs Price
		Series	Parallel	
HPI-20	2000	230V @ 8.7A	115V @ 17.4A	\$ 368.00
HPI-27	2750	230V @ 12.0A	115V @ 24.0A	398.00
HPI-35	3500	230V @ 15.2A	115V @ 30.4A	450.00

### Mechanical Dimensions

Size	L	W	H	ML (mtg)*	MW (mtg)*	WGT
2000VA	7.500" 190.5 mm	5.600" 142.2 mm	6.560" 166.6 mm	5.750" 146.1 mm	4.350" 110.5 mm	41.3 lbs 18.71 kg
2750VA	7.500" 190.5 mm	6.230" 158.2 mm	6.560" 166.6 mm	5.750" 146.1 mm	4.980" 126.5 mm	48.0 lbs 21.77 kg
3500VA	7.500" 190.5 mm	7.330" 186.2 mm	6.560" 166.6 mm	5.750" 146.1 mm	6.080" 154.4 mm	62.4 lbs 28.30 kg

**signal**  
TRANSFORMER  
The American  
Original.™

BUY DIRECT: (516) 239-5777 ★ Fax: (516) 239-7208

Signal Transformer, 500 Bayview Ave., Inwood, NY 11696

\*For dimensional drawings, schematics, or any other additional questions you might have, please contact our Engineering Dept.

## SYMMETRIC MULTIPROCESSORS

first glance appear optimal. But this approach can limit performance when interfacing to a bus bridge. Unless you can guarantee that all I/O-subsystem read operations will begin and end on cache-line boundaries *and* will contain only full cache-line operations, the bus bridge will need to perform a "read-for-ownership" cycle to acquire the cache line before writing the data from the I/O device. Once the I/O device writes new data into the cache line, the bus bridge must then write the cache line back to main memory. Thus, the bus bridge consumes *twice* the I/O-bus bandwidth on the system bus. (That is, when transferring data from the I/O bus at 33 Mbytes/sec, the bus bridge needs 33 Mbytes/sec of "read-for-ownership" cycles and 33 Mbytes/sec of cache-line write cycles.)

This design may lose additional performance because it requires two cache snoops: one when the bus bridge reads the cache line and one when it writes the cache line back. However, you could eliminate snooping on cache-line write-back operations.

### Software is the key to scalability

Contention for common resources, such as system memory and I/O, cause delays that degrade processor performance, which, in turn, limits hardware scalability. Improved bus throughput, faster memory, and larger caches help mitigate the impact of bus contention, but the software also plays a significant role. The software's scalability lies in its ability to break tasks into subtasks, or "threads," which can execute independently.

Threads differ from traditional "processes" in that they carry less machine context and, therefore, do not overburden a system with context saving and restoring. Building the OS kernel from these threads spreads the work of the OS across several processors. "Single-threaded" software, on the other hand, executes whole tasks on one processor. Early I/O drivers, for instance, executed almost entirely at the ISR level and as single, whole tasks. Thus, they required a major OS rewrite to define threads that could execute in parallel. The finer these threads, the more benefit a design derives from multiple processors.

The point of diminishing returns sets in when the time spent in task synchronization offsets the benefit of smaller threads and when more semaphore accesses cause increased bus use and, in turn, decreased performance. EDN

## References

1. Marrin, Ken, "Multithreading support grows among

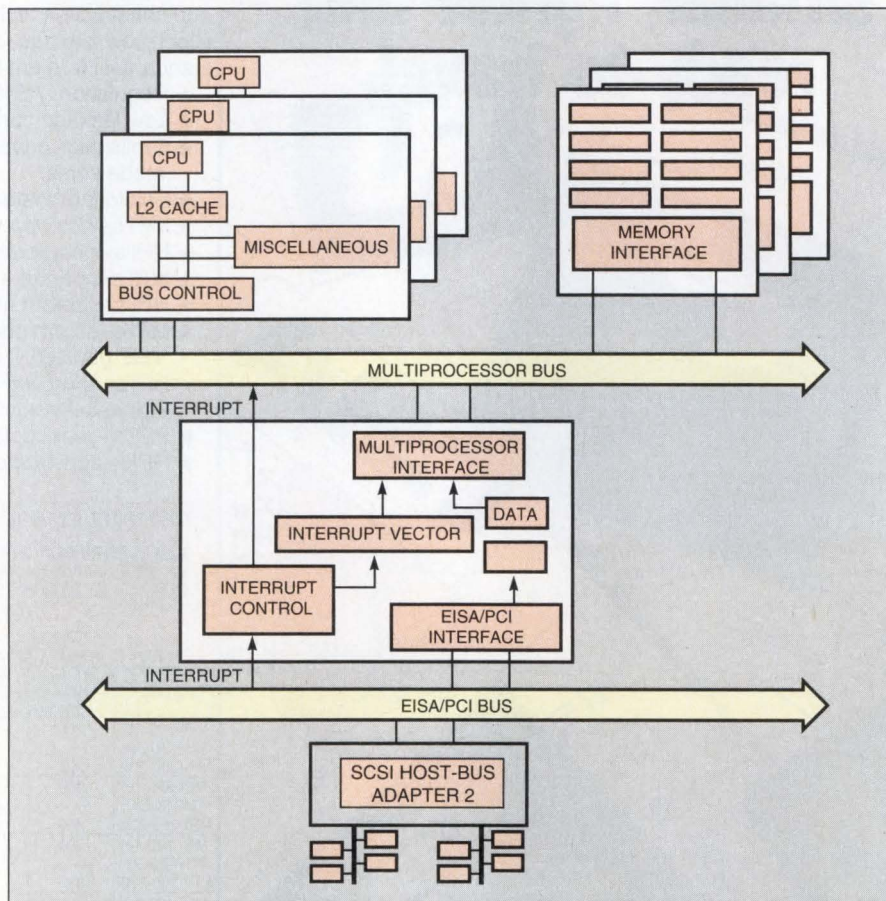

**Fig 4—Snooping into a bus bridge that contains cache-line buffers is unnecessary if your design ensures that the device interrupt cannot "bypass" the device data.**

real-time operating systems," *Computer Design*, March 1993.

2. "AP-474 An APIC-Based Symmetric Multiprocessor System Design," Intel Corp, 1993.

3. NT Driver Design Guide, Microsoft Corp, 1992.

## Author's biography

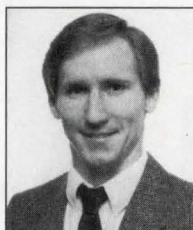

Brian Bennett is a senior engineer in the Server Systems group at AST Research Inc, Irvine, CA, where he has worked for three years. Brian earned a BSEE from California Polytechnic State University (San Luis Obispo), and an MSEE from the University of Southern California (Los Angeles) in 1981 and 1991, respectively. He is working on an MBA at Pepperdine University (Malibu, CA). In his spare time, he enjoys skydiving, rock climbing, and bronco riding.

## VOTE

Please use the Information Retrieval Service card to rate this article (circle one):

High Interest  
592

Medium Interest  
593

Low Interest  
594

# High-speed hard metric system. A performance step beyond Futurebus+.

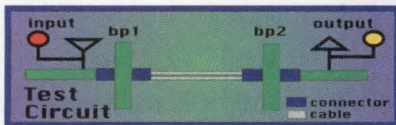
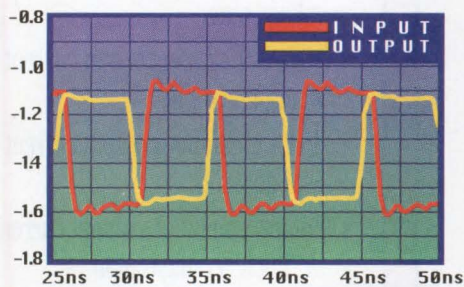
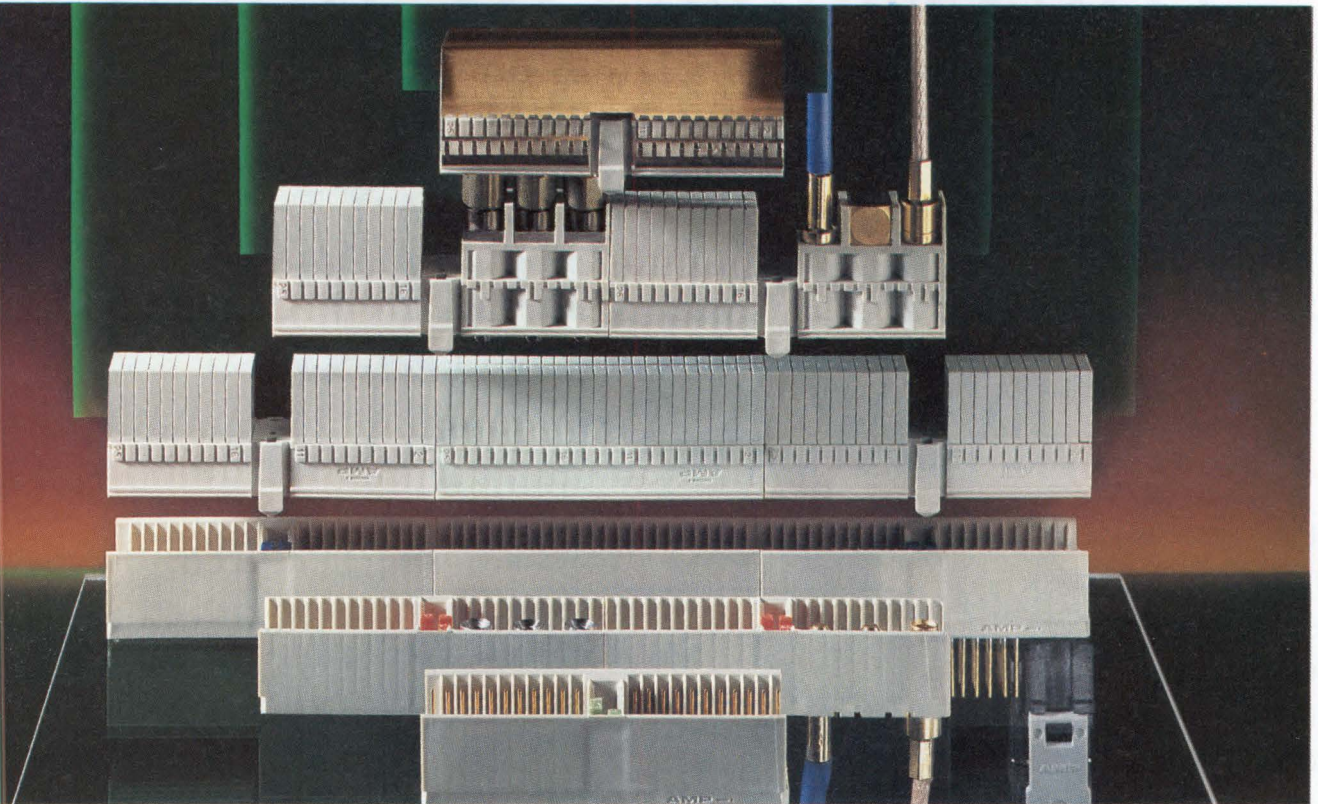

*ECLiPS ECL differential circuit performance of Z-Pack 2mm HM system ( $t_p \approx 250$ ps). Multiline models and full simulation services available to simplify development.*

The AMP Z-Pack 2mm HM interconnection system offers the modularity and performance scalability you need for critical high-speed, high-density applications. The 2mm hard metric interface (fully compliant with IEC 917) is ideally suited for global system design.

Stackable 25 and 50mm modules provide full board-to-board and cable-to-board capabilities, with provision for high-current, coax, and fiber optic contacts. Header pins — in three mating levels — can extend through the backplane for “midplane”, cross-connect, or cable-to-backplane arrangements.

The basic 5-row AMP 2mm HM system offers 12.5 signal lines/cm for single-ended signals with edge rates to 500ps. Enhanced versions (7-row, with ground shield) provide 20 signal lines/cm for differential signals to 500ps. Enhanced versions with integral crosstalk shielding maintain 20 signal lines/cm and offer even greater performance — to 250ps. All this while maintaining  $\leq 5\%$  multiline crosstalk.

If you need performance beyond our standard Futurebus+ line, you'll love how fast the fast Z-Pack 2mm HM system from AMP will come through for you.

ECLiPS is a trademark of Motorola Corp. AMP and Z-Pack are trademarks.

If you would like more information about our Z-Pack 2mm HM interconnection system, call our Product Information Center at 1-800-522-6752 (fax 717-986-7575). AMP, Harrisburg, PA 17105-3608. In Canada, call 905-475-6222.

# THE HARRIS HIP5600: WORLD'S MOST INTERNATIONAL HIGH VOLTAGE LINEAR REGULATOR.

With the industry's widest available AC and DC input voltage ranges, this single-chip regulator tames line currents from Azerbaijan to Zimbabwe – without a transformer. And the HIP5600 packs a lot of features for such a light traveler: a big 650V maximum input voltage plus built-in overcurrent protection and thermal shutdown. All in a TO-220 package that easily heat sinks for even more output range. Use it – or our HV2405E, or one of our other high-performance regulators – to replace discretes and bulky transformers in all kinds of non-isolated off-line applications. And let it take your next design wherever you want it to go.

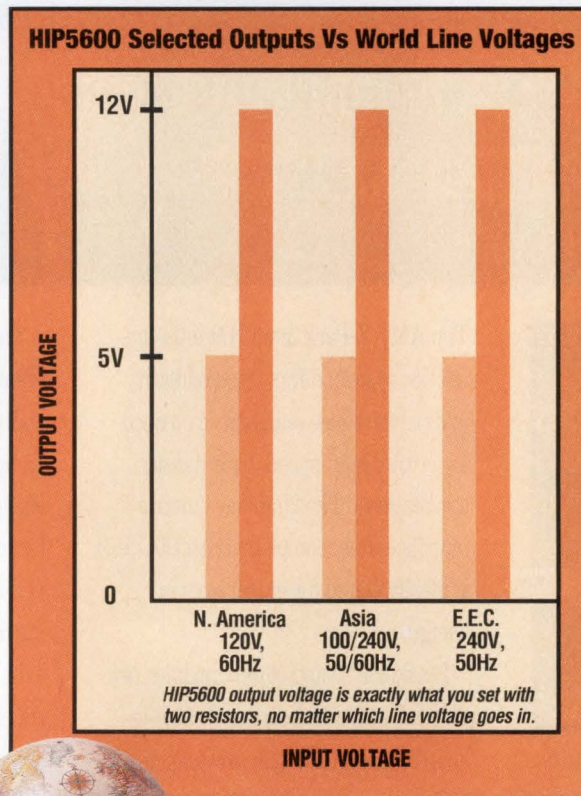

## Features

- Direct off-line AC or DC operation
- 650V maximum input voltage
- 80V - 280V AC input
- 50V - 400V DC input
- 1.2V to 320V ( $V_{peak}$ ) output voltage range
- 10mA continuous output current without heat sink
- 35mA continuous output current with heat sink
- 250mA continuous output current in "buck" configuration
- Evaluation boards available
- 3-lead TO-220 package
- 8-lead SOIC available later this year
- Just \$1.34/thousand (OEM)
- Underwriters Laboratory recognized

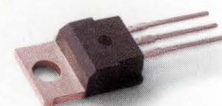
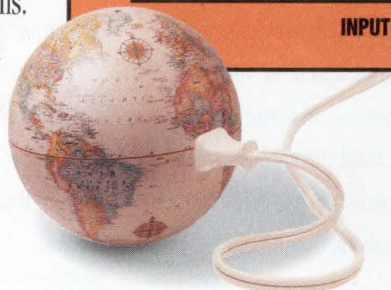

The HIP5600. It's welcome anywhere in the world.



Try our AnswerFAX service!

Call 407-724-3818 and request document #7004.

Or call 1-800-4-HARRIS, ext. 7244.



**HARRIS**  
SEMICONDUCTOR

# To see spectrum-analysis detail fast, match sweep time to measurement

Morris Engelson, Tektronix Inc

*In spectrum analysis, slower sweep speeds provide improved detail. If you understand some basics, however, you can choose a sweep speed that provides needed detail without wasting time.*

A spectrum analyzer's sweep time (T) depends on the frequency span to be displayed (S), the resolution bandwidth (B), the video-filter bandwidth (V), the signal-intercept or detector function (D), and the vertical-display setting (VD). (Some secondary factors that also affect the sweep time, such as the digital-storage sample rate, are not discussed here.) The sweep time increases directly with the span and inversely with the video-filter bandwidth and the square of the resolution bandwidth. The peak-detector function in the 10-dB/div logarithmic vertical mode usually provides the fastest sweep and the minimum measurement time. In addition, you can achieve faster sweep times by accepting reduced measurement accuracy or by using accessory items such as a preamplifier.

The abbreviated block diagram of Fig 1 relates spectrum-analyzer operating functions to circuits. The frequency-sweep width of the first local oscillator determines the span. The swept mixed signal is translated after the bandpass filter that determines the resolution, or signal separation. After the resulting spectrum is detected, it is amplified in a lowpass "video-filter" amplifier prior to display on the CRT. The two most critical functions are the predetection resolution-filter bandwidth (B) and the postdetection video-filter bandwidth (V).

The relationships among the key parameters are well understood and

have been discussed in literature. However, the discussion is spread out over many publications and sometimes appears as a footnote to a different main topic. This article provides a complete picture of accuracy/sweep-time tradeoffs by summarizing and integrating the scattered information.

## Span, time, and bandwidth

Ref 1 shows that for spectrum analyzers whose bandwidth is specified at the -3-dB points (for example, those made by Hewlett-Packard) the span (S), resolution bandwidth (B), and sweep time (T) are related by the formula  $S/TB^2=0.5$ . For spectrum analyzers that specify resolution bandwidth at the -6-dB points (those made by Tektronix,

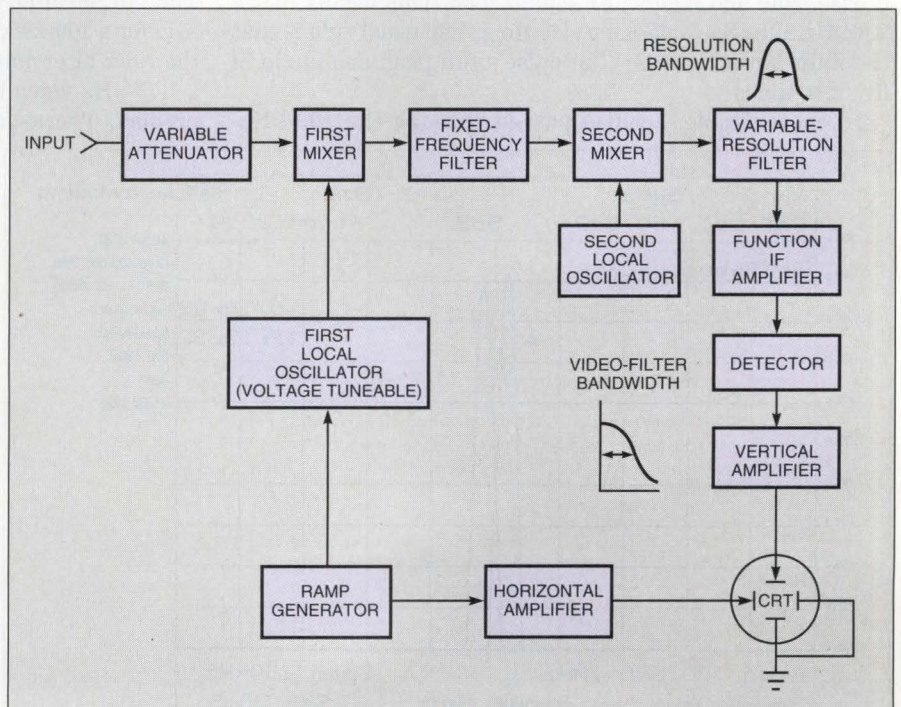

Fig 1—In the spectrum-analyzer block diagram, the two blocks that have the most influence on the bandwidth (and indirectly on the sweep time) are the variable-resolution filter at the upper right, and the vertical amplifier, at the lower right, which includes the video filter.

## SPECTRUM ANALYSIS

for example), the relationship is  $S/TB^2=0.22$ . The two formulas are identical when you consider that the resolution bandwidth defined at the  $-6$ -dB points,  $B_{-6dB}=1.5B_{-3dB}$  (the resolution bandwidth defined at the  $-3$ -dB points), and  $0.5/0.22=1.5^2$ . This relationship holds for the normal spectrum-analyzer default setting where the video-filter bandwidth is equal to or greater than the resolution bandwidth. Real spectrum analyzers sweep about 25% slower than the theory predicts. Thus, for the Tektronix 2784 spectrum analyzer at a 100-MHz span and 100-kHz resolution, the actual time is 57 msec, whereas the computed sweep time is 45 msec. Similar results will be found for other settings and other spectrum analyzers.

The above is based on the assumption that amplitude must be measured accurately. Sweep time can be significantly reduced when amplitude-measurement accuracy is not critical. As Refs 1 and 2) show, a slight degradation in amplitude accuracy permits a sweep-time improvement of up to 5 times; if you can accept an amplitude-accuracy loss of about 3 dB, a 10-times sweep-time reduction is frequently possible.

The spectrum-analyzer circuit following the detector is known as the video filter. The video filter's bandwidth—when it is wider than the resolution bandwidth that precedes the detector—is not a factor in determining the sweep time. A relatively narrow video bandwidth, however, does affect sweep time, because the video filter must faithfully reproduce the amplitude of a pulse of duration  $t=BT/S$  (Ref 2).

In the previous example,  $S=100$  MHz,  $B=100$  kHz, and  $T=45$  msec, so  $t=45$   $\mu$ sec. To determine the bandwidth of a lowpass filter that will faithfully reproduce the amplitude of this pulse, remember that for a simple RC filter, the product of rise time and bandwidth equals 0.35. This means that a 7.8-kHz filter has a 45- $\mu$ sec rise time. The usual rule is that the filter output reaches the pulse's full peak amplitude in five rise times.

In the example, a pulse passed through the 100-kHz-

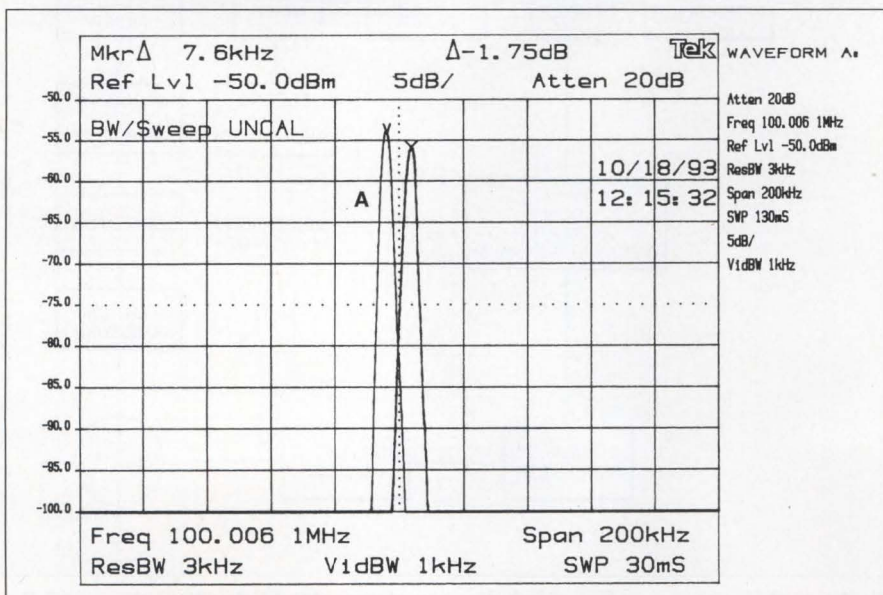

**Fig 2—Reducing the sweep time from a theoretically correct 130 msec (left trace) to 30 msec (too fast a sweep to yield good amplitude accuracy) produces a response 1.75 dB too low (right trace), but speeds the sweep by a factor of 4.3.**

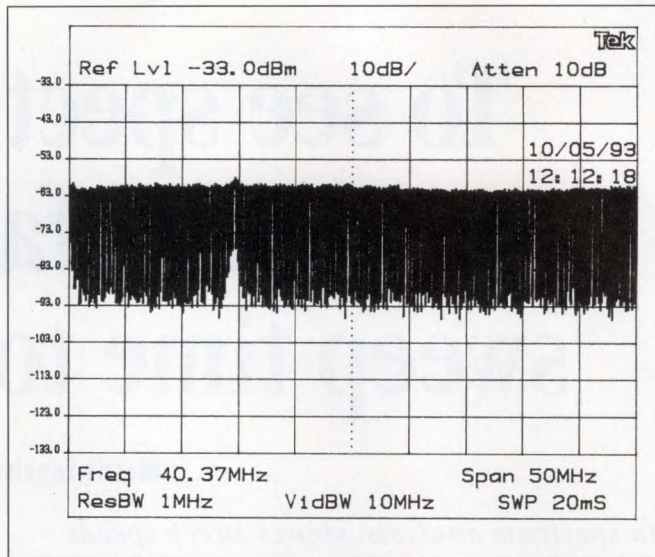

**Fig 3—Mixing a sine wave with pulses yields a spectrum in which the presence of the sine wave is barely discernible.**

bandwidth filter has more than 10 rise times to reach its final value. Thus, a 100-kHz video-filter bandwidth is more than sufficient to reproduce the output of a 100-kHz resolution filter without need for a change in sweep time. This is not the case for a much narrower video-filter bandwidth, such as 10 kHz.

### Automatic settings emphasize accuracy

The sweep time on the Tektronix 2782 spectrum analyzer slows to 200 msec when the video bandwidth is reduced to 10 kHz for a 100-kHz resolution and 100-MHz span. At  $t=BT/S$ , the video filter must reproduce a 200- $\mu$ sec pulse, which yields a 1.75-kHz video bandwidth for one time constant at a 0.35 product. The usual convention is that you need about five time constants to reproduce a pulse shape properly. A 10-kHz video-filter bandwidth fits this profile at  $10/1.75=5.7$  time constants.

Sweep time (T), span (S), resolution bandwidth (B), and video-filter bandwidth (V) are changed in steps rather than continuously. Also, different instruments may use different filter types or numbers of sections. Therefore, actual spectrum-analyzer settings may differ from each other or from theoretically calculated values. Actual settings approximate those shown in Table 1. Note that the 3- and 6-dB bandwidth relationships are the same when you take into account that the 6- and 3-dB bandwidths differ by a factor of 1.5.

These are the default values that the spectrum analyzer is preset to follow. Ref 1 shows that a sweep-time reduction of up to 10 times compared with default settings is sometimes possible

# The Low-Voltage Solution for High-End Telecom

## OKI'S ADVANCED CODECS

<i>OKI Part No.</i>	<i>Voltage</i>	<i>Coding</i>	<i>Package</i>
MSM7533	5 Volt	PCM	SOP
MSM7541	3 Volt	PCM	TSOP
MSM7543	5 Volt	PCM	TSOP
MSM7566	3 Volt	PCM	TSOP
MSM7560	5 Volt	ADPCM	SOP
MSM7570/90	5 Volt	ADPCM	TSOP
MSM7570L/90L	3 Volt	ADPCM	TSOP



## Introducing OKI's Advanced CODECS

**ALL ROADS LEAD TO OKI** when it comes to CODECS. Our cost-effective, feature-rich telecom family delivers state-of-the-art solutions: Single-rail, low-power 3V and 5V products. Popular industry standards, including  $\mu$ -law and A-law, G.711-726 for PCM and ADPCM applications. Space-saving TSOPs. Plus immediate delivery. **COMPREHENSIVE CAPABILITIES.**

Why settle for middle-of-the-road? With OKI, you choose from a broad range of top-of-the-line CODECS—designed to meet the most advanced wireless requirements. **FAST TO MARKET.** Take the easy street to design success with OKI's full line of telecom ICs. To get OKI's CODEC white paper, call **1-800-OKI-6388** and ask for Pkg No. 021.



**OKI**  
Semiconductor

785 North Mary Avenue  
Sunnyvale, CA 94086-2909  
Phone: 408-720-1900  
Fax: 408-720-1918

*People-to-People Technology*

## SPECTRUM ANALYSIS

with only a minor loss in amplitude-measurement accuracy. You can achieve good accuracy at higher sweep speeds by manually setting T, B, and V independently of each other, although the instrument will show an error message when you violate the preset relationships in this way.

Fig 2 illustrates some of this discussion. A span of 200 kHz with 3-kHz resolution bandwidth and 1-kHz video-filter bandwidth provides a spectrum display of a 100-MHz sine wave at a 130-msec sweep time. The sweep time computed from the formula for 6-dB-bandwidth-based spectrum analyzers is in good agreement at 133 msec. The second trace, showing a lower-amplitude display, was obtained at a 30-msec sweep time. The 2782 spectrum analyzer is no longer amplitude-calibrated, as indicated by the UNCAL error message near the upper left corner of the screen. An amplitude comparison shows that the absolute amplitude level is in error by 1.75 dB, which would be unacceptable in many applications. Note, however, that if you don't need to measure the amplitude accurately, these settings reduce the measurement time by a factor of 130/30=4.3.

### Detector function

Sweep-time limitations discussed so far are determined by how fast a signal can be swept through a filter. The filter bandwidth is the dominant sweep-speed factor when the instrument is set to respond to the peak level of the signal. This is not the case for quasi-peak (QP) and average-signal measurements.

The QP detector, used for EMI measurements, is extremely slow. There are two ways to reduce the measurement time

**Table 1—How spectrum-analyzer sweep time varies with bandwidth**

Bandwidth definition	6 dB	3 dB
$V \geq B$	$T=S/0.22B^2$	$T=S/0.50B^2$
$V < B$	$T=S/0.50BV$	$T=S/0.33BV$

**Note:** These formulas are approximate. A different type of derivation shows a 3-dB bandwidth relationship of  $S/TBV=0.55$  (Ref 5). Whatever the assumptions, however, the results are similar.

for such measurements. One way is to use the much faster peak detector instead of the QP detector. This is perfectly legal because peak-detector results always show a level at least as high as QP results. Hence, a device that fails interference-acceptance limits in QP also fails in peak-detection mode. The incentive for using the QP mode is that some devices fail acceptance testing in peak but are perfectly all right in QP. Therefore, when measurement time is important, it is a good idea to use peak

as the primary measurement mode and retest in QP when a peak measurement is out of spec (Refs 3 and 4).

Sometimes, the signal characteristics are such that the QP detector can be swept much faster than normal with very little degradation in amplitude accuracy. As discussed in Ref 3, by avoiding QP whenever possible and by using a faster-than-normal sweep for some signals, you can achieve speed increases of 10 times or more in most measurements that require the use of QP.

Averaging, no matter how it is done, requires a certain amount of time. You cannot perform averaging measurements as fast as peak measurements. However, you can save much time by choosing an optimum averaging technique based on the application and accuracy requirements. Several procedures discussed in Refs 4, 5, and 6 are summarized below.

### To speed averaging, try a log display

A common averaging procedure is to set the spectrum analyzer for a narrow video-filter bandwidth. However, sweep time is inversely proportional to video bandwidth. Consequently, the greater the degree of averaging, the longer the sweep takes. In theory, to obtain a correct average value, the averaging should be performed in the linear

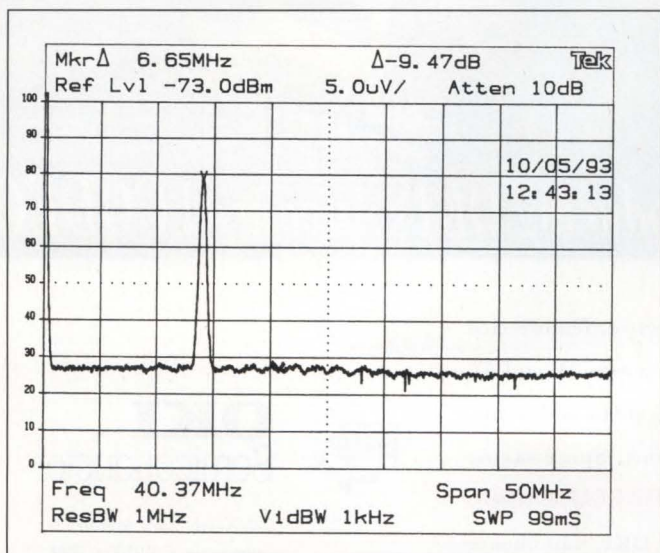

**Fig 4—Reducing the video-filter bandwidth to 1 kHz reduces the amplitude of the pulse spectrum by averaging, and the sine wave shows at 9.47 dB above the averaged pulse-spectrum level. The sweep time increased to 99 msec compared with Fig 3's 20 msec, however.**

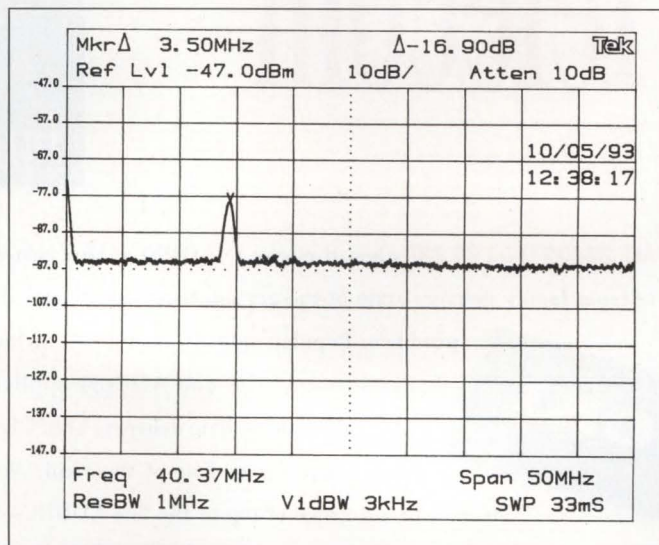

**Fig 5—This trace, which was taken at 10 dB/div in log mode, shows an improved signal ratio of 16.9 dB. This was obtained at a video-filter bandwidth of 3 kHz and a sweep time of 33 msec.**



# Don't Let EMI Be A Drag On Your Design



If you design microprocessor-based boards, or systems, you know that high emissions—EMI—can eat you alive. Your designs could be affected. Or even rejected. And redesigns for clock schemes take time. And cost money.

#### Don't Lose Another Knight Redesigning Your Boards

AMCC clock and timing products are famous for their low emissions. They'll shield you from certification problems. And, your designs will use fewer components, cost less, and run faster.

#### You Can Live Happily Ever After

Our SC3500 family of clock drivers provide:

- ◆ Patented low-noise outputs. To eliminate ringing and ground bounce. Fast edges rates without EMI-generating noise.
- ◆ On-chip termination eliminates extra components.

- ◆ Low skew. As low as 250 ps.
- ◆ High speed. Up to 80 MHz for your Power PC, Pentium, Alpha, and other RISC-based applications.
- ◆ The SC3300 family provide a \$3.3V I/O-compatible solution.

#### Contact AMCC Today

We won't tell you a fairy tale. Ask for a copy of our new Computer Products Databook. FAX us at (619) 450-9885. Or write to us: MarCom, AMCC, 6195 Lusk Blvd., San Diego, CA 92121-2793.

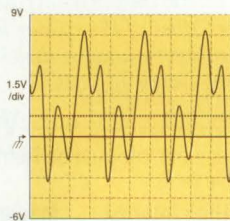

Theirs Unterminated

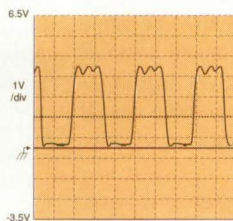

Ours Unterminated

Call (800) 755-2622

CIRCLE NO. 64



EDN July 7, 1994 • 129

## SPECTRUM ANALYSIS

vertical mode. Nevertheless, averaging a logarithmically compressed signal is almost as accurate as linear processing, and the video bandwidth can be five or more times as wide (Refs 4 and 5). Log-mode averaging, therefore, significantly reduces measurement time at a small cost in accuracy.

The plots in Figs 3 and 4 illustrate the improvement in averaging by using a logarithmic display. Fig 3 shows a combination of pulsed and continuous-wave signal spectra. The sine wave is barely discernible within the pulse-spectrum distribution. In Fig 4, reducing the video-filter bandwidth to 1 kHz reduces the amplitude of the pulse spectrum by averaging, and the sine wave shows at 9.47 dB above the averaged pulse-spectrum level. The sweep time increases to 99 msec compared with Fig 3's 20 msec. Fig 5, which was taken at 10 dB/div in log mode, shows an improved signal ratio of 16.9 dB. This was obtained at a video-filter bandwidth of 3 kHz and a sweep time of 33 msec. Thus, a 10-dB/div log display produces better averaging than does the linear mode (16.9 vs 9.47 dB), yet the video bandwidth is wider and the sweep time is less by a factor of three.

Although video-filter averaging is the usual procedure, most spectrum analyzers also provide various means of averaging spectra digitally. Sometimes the digital processing is more effective or faster than the analog technique of using a narrow video filter. One way to save measurement time is to use digital and analog video-filter averaging simultaneously. For the Tektronix 2794 spectrum analyzer, for example, 100 msec of digital averaging is equivalent to using a 5-kHz-wide video filter (Ref 6). Thus, at a 50-MHz span, 100-kHz resolution bandwidth, and 10-kHz video-filter bandwidth, the sweep time is 100 msec, as computed from  $S/TBV=0.5$ . Simultaneously performing digital and video-filter averaging to achieve the equivalent of a 5-kHz video bandwidth takes no extra time. The combination of 10-kHz video and 5-kHz digital filtering provides a bandwidth of less than 4 kHz without increasing the measurement time.

## Additional factors

As noted previously, a logarithmic display permits faster signal averaging than is possible in the linear vertical mode. Indeed, the logarithmic vertical mode permits a faster sweep than a linear display even at wide video bandwidth, because the width and rise time of the previously discussed  $t=BT/S$  pulse increase as the spectrum is compressed in the logarithmic display. Note in Fig 6 how the same sine-wave signal spectrum appears wider in the (outer) logarithmic-mode display than in the (inner) linear display.

Finally, note an important relationship between measurement sweep time and signal-detection sensitivity. Pulling a small sine-wave signal out of noise requires a very narrow res-

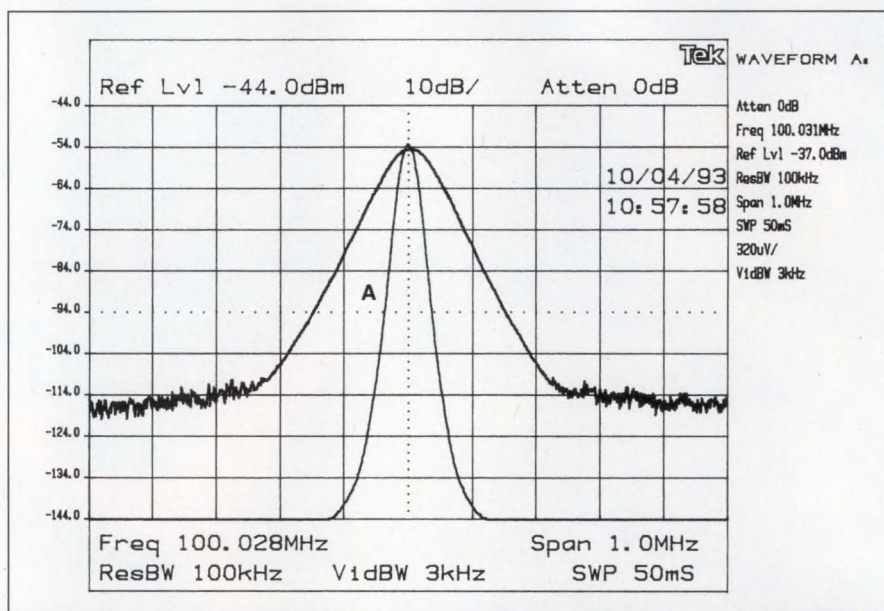

Fig 6—The same sine-wave signal spectrum appears wider in the (outer) logarithmic-mode display than in the (inner) linear display.

olution bandwidth, which results in a long sweep time. An input-signal preamplifier increases the signal level so that a wider bandwidth and less measurement time do the job (Ref 7). EDN

## References

1. "Sweep-time results in spectrum analysis," Tektronix Inc, Publication No. 2EW-8710-0.
2. Engelson, Morris, *Modern Spectrum Analyzer Theory and Applications*, JMS, Portland, OR.
3. Engelson, Morris, "EMI applications using the Tektronix 2712 spectrum analyzer," Tektronix Inc, Publication No. 2EW-8888-0.
4. Linkwitz, "Measurement of narrowband and broadband emissions using peak and average detection," Transactions of IEEE EMC symposium, 1989.
5. Linkwitz, "Average measurements using a spectrum analyzer," *EMC Test and Design*, May/June 1991.
6. "Selective level-display averaging in spectrum analysis," Tektronix Inc, Publication No. 2EW-9016-0.
7. "Using an input amplifier to enhance spectrum-analyzer measurements," Tektronix Inc, Publication No. 2EW-8331-0.

## Author's biography

Morris Engelson is a fellow of the IEEE. He is a consultant with JMS in Portland, OR, and is affiliated with Tektronix Inc in nearby Beaverton. Engelson holds bachelor's and master's degrees in EE and is a certified electromagnetic-compatibility engineer. Most of his career has been spent in designing spectrum analyzers and in developing techniques for measuring radio-frequency signals.

## VOTE

Please use the Information Retrieval Service card to rate this article (circle one):

High Interest  
595

Medium Interest  
596

Low Interest  
597

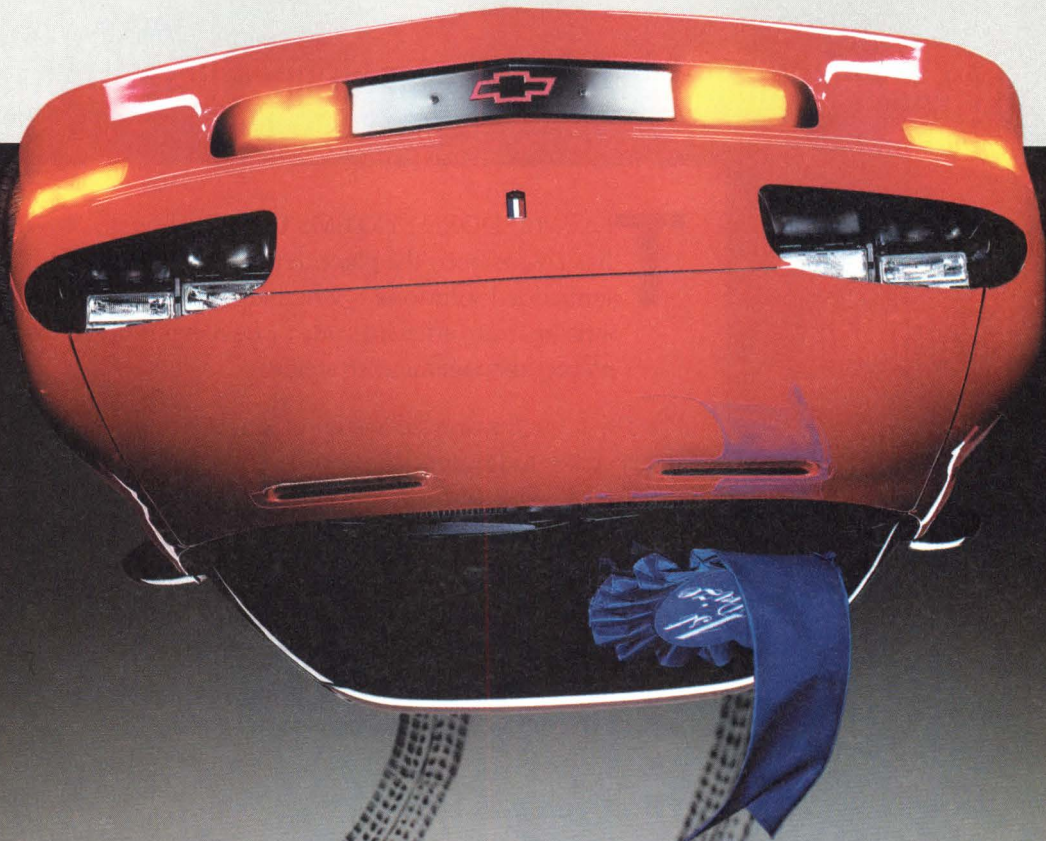

## A DESIGN CONTEST FOR ENGINEERS WHO SEE THINGS DIFFERENTLY.

If conventional thinking drives you up the wall,  
order the Philips DS-750 development tool kit.

It helps you dream up great designs using our  
8-bit 8XC750 microcontroller. Including the  
design that could win you a hot new Camaro!

For the low price of just **\$4750** (plus  
shipping), the Philips DS-750 gives you all the  
hardware, software and documentation  
needed to quickly build, emulate and  
debug 8-bit designs using our 8XC750.

The 8XC750 is our powerful, low-cost  
entry into the full family of Philips 80C51  
microcontrollers.

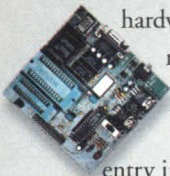

© Philips Electronics North America Corporation, 1994

Together, they give you winning designs.

Which is why you  
should be sure to

enter the exciting Philips  
Dream Machine Design Contest. Just submit  
a design to us using the 8XC750 or any  
Philips 80C51 microcontroller derivatives by  
September 30, 1994. If it turns our judges on  
their heads, you could win the Camaro or a  
color or monochrome laptop computer.

So turn it up. Use your credit card to order  
the DS-750 today. We'll also send you more infor-  
mation on this incredible design contest:

**1-800-447-1500, ext. 1120 DN**



Co-sponsored by EDN

# The World's Largest Embedded Systems Conference Just Got Larger

## The Sixth Annual Embedded Systems Conference



September 20-23, 1994

Santa Clara Convention Center

Santa Clara, CA

**T**he EMBEDDED SYSTEMS CONFERENCE has always been the place developers go for total embedded solutions -- whether its improving design, writing more efficient code or devising more effective project management strategies.

For 1994, the Embedded Systems Conference has been expanded to also cater to the specialized needs of single board computer developers. Our technical program will now offer not only programming tips, but even more hardware-related workshops, lectures, and tutorials on topics like these:

- Control and DSP applications
- High-performance and multi-processor applications
- Fuzzy logic
- Bus interfacing issues
- And more!

### What you will learn:

- New techniques to help you write tighter code and get your projects out the door
- Programming tips for writing faster code
- Faster debugging through reusability
- Resolutions to systems integrations issues
- Maximizing your use of hardware platforms
- Tailoring software for specific hardware platforms

### Witness First-Hand As Vendors Unveil Their Newest Products

See the largest dedicated exhibition of embedded development tools and utilities and meet face-to-face with representatives from more than 150 leading companies.

**Send me the details on the Embedded Systems Conference!**

**I'm interested!**

FAX: (415) 905-2220

September 20-23, 1994

PHONE: (415) 905-2354

Santa Clara Convention Center • Santa Clara, CA

I'm interested in:

Attending

Exhibiting

Name

Title

Company

Address

City

State/Province

Zip Code

Phone

Fax

EN4P

CIRCUIT BREAKERS FOR EQUIPMENT

# PERFECTLY *on board*

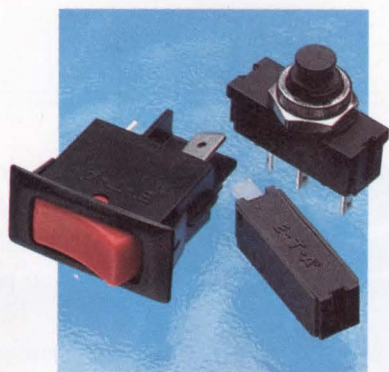
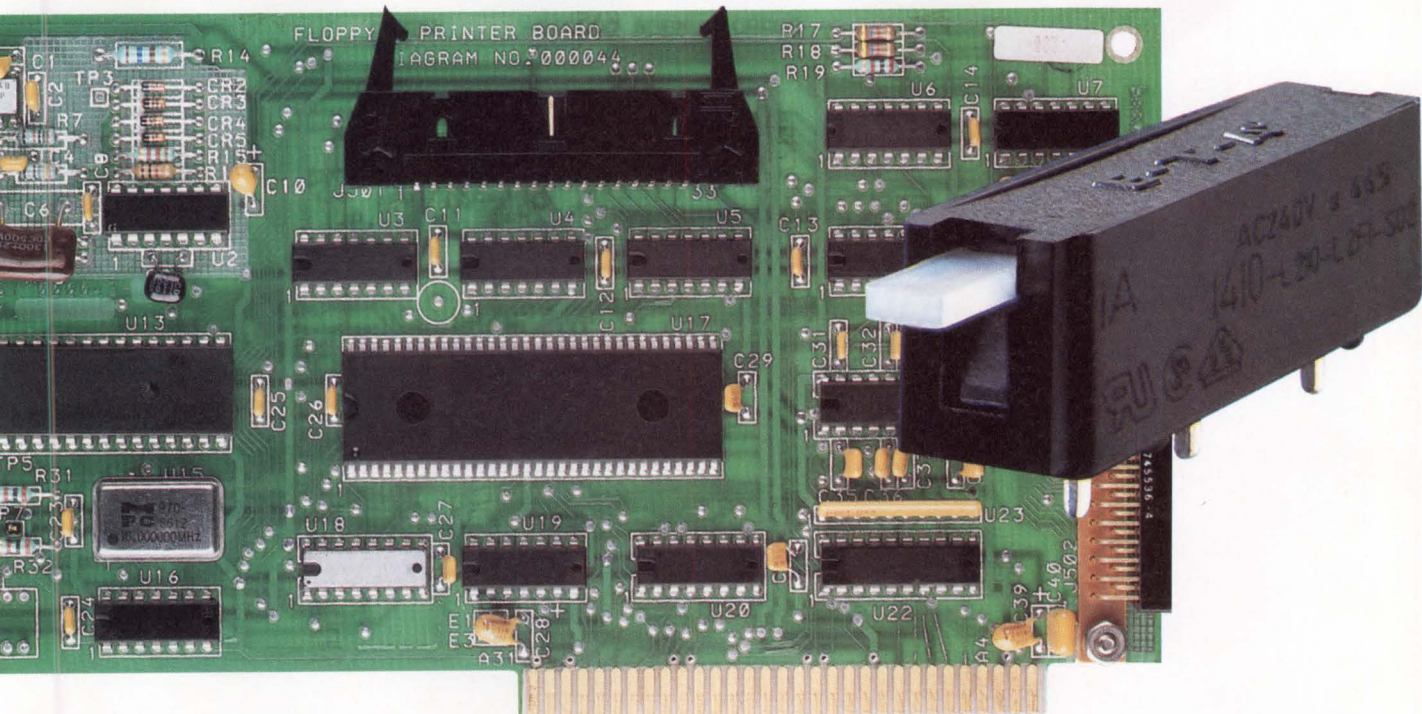

E-T-A Series 1410 Circuit Breakers for Equipment are specially designed to protect printed circuit boards.

The tiny, fast acting 1410 CBE deals with short circuits or current overload quickly and cost-effectively. Because, in the competitive world of electronics manufacturing, extended downtime is unacceptable.

At E-T-A, we believe that protecting circuits allows no compromise. That's why all

our products fit precise application and performance specs. Perfectly.

So, next time you need to protect a PCB, get on board with perfection, choose E-T-A.

- ▶ Direct PCB or remote mounting
- ▶ Push-button manual reset
- ▶ Solder pin or blade terminal connections
- ▶ Current ratings from 0.63 to 8.0 A



Call or fax for Your free E-T-A Circuit Protection Brochure.

7400 N. Croname Rd.,  
Niles IL 60714-3982  
(708) 647-8303  
FAX (708) 647-7494

E-T-A Circuit Breakers  
236 Hood Rd., Markham,  
Ontario L3R 3K8  
(905) 475-5886  
FAX (905) 475-5889



CIRCLE NO. 95

**WE PROTECT CIRCUITS TO PERFECTION**



10,000 gates/\$79.00

7,500 gates/\$62.00

6,000 gates/\$37.00

©1994, Xilinx, Inc. 2100 Logic Drive, San Jose, CA 95124. Europe, 44(932)549401; Japan, 81(5)297-9191; Asia, 852(5)721-0900. Xilinx is a trademark, and The Programmable Logic Company is a service mark of Xilinx, Inc. All other trademarks or registered trademarks are the property of their respective

# WE JUST REDUCED THE PRICE OF YOUR PRODUCT.

You're welcome. And really, it was no trouble at all. We simply reduced the price of *our* product—Xilinx™ FPGAs.

Now you can afford to equip your products with the best logic solution available.

You see, thanks to the best research, development and manufacturing in the business, our FPGAs now feature even smaller geometries.

So naturally, they feature even smaller prices, too.

But the impact doesn't stop with your product. What we've done, in effect, is serve

4,000 gates/\$20.00

3,000 gates/\$14.00

1,200 gates/\$4.00

holders. All product pricing is representative of a 5000 or higher quantity order.

notice on the gate array market. To whom we say the following: objects in mirror are closer than they appear.

Quite literally, we're going as far and as fast as the laws of physics will allow.

Which means you can expect Xilinx FPGAs to keep getting faster and denser.

And our prices to keep getting smaller and smaller.

But let's talk about the present. For instance, over the past year, we've made possible as much as a 70% savings on our high density

XC4000 and up to a 50% reduction on our high performance XC3100A line.

These reductions have even reached our lower end XC2000 and XC3000 lines —as well as our XC7000 series EPLDs, now available for as little as \$4 each.

At these prices, you really can't afford not to use Xilinx. But not just because they'll save you money.

Because they'll also save you time.

You know that being first out of the gate is an often

staggering advantage.

Well, Xilinx FPGAs get you to market faster than conventional gate arrays — months faster.

Xilinx FPGAs can also save you headaches.

Because a Xilinx FPGA isn't finished until you say it is, you're not stuck with what the gate array foundry turns out. You can reprogram it—even in the system —until you get it just right.

And with more than 500 device/package types, we have one that's right for you.

Want to know more?

Just call 1-800-231-3386 and we'll send you a detailed information package.

Or contact your local Xilinx representative.

Then use Xilinx FPGAs for your next project and cut your costs.

We suggest you hurry. After all, your competitors know how to read, too.

 **XILINX**<sup>®</sup>  
The Programmable  
Logic Company.™



# Turn Your Ideas Into Reality

Think Partnership.

Think Technology Leadership.

Think Competitive Edge.

Now think about calling Philips. And gaining access to some of the world's most-advanced technology — and the production facilities to go with it.

Our array of advanced key technologies will help you develop better, more-competitive products. Or we'll work with you to create a customized solution.

No matter which path you choose, you'll be in partnership with the company that invented the CD, CD-I, the audio cassette and the DCC. Philips also holds over 90,000 patents, and spends \$2 billion annually on R&D.

Philips has what you need to succeed. And now it's available to you.

Simply call Philips Key Modules at 1-800-235-7373.

It's time to turn your wildest product ideas into competitive realities.



## PHILIPS



# Weigh the benefits of fuzzy-logic vs classical control in a disk-drive spindle

Brian P Tremaine, Seagate Technology

***You can apply fuzzy- and classical-control techniques to any servo-control loop. Which technique you use depends heavily on the nonlinearities in a system.***

A furor is raging over whether you should use fuzzy-logic or classical-control tools to analyze a complex servo-control system. Fuzzy-logic advocates claim it eliminates the need for a mathematical system description, while classical-control advocates claim fuzzy logic's lack of analysis tools makes it undesirable. To observe these extreme views, compare the classical- and fuzzy-control analysis of a disk-drive dc spindle motor. The comparison uses a C program, which simulates the plant and classical feedback-control signal.

The FIDE (fuzzy inference-development) program from Apronix Inc compiles the plant program to simulate a fuzzy controller. The spindle-motor example shows that even a basic system can have nonlinearities, which preclude linear analysis. However, knowledge of the system equations can aid the design of a fuzzy controller.

The dc spindle motor, driver electronics, and digital transducers comprise the system's plant and are inherently nonlinear. The driver develops only positive torque, which is a common practice in disk-drive applications. Therefore, the motor depends only on coulomb friction to decelerate. The plant's nonlinearities include saturation of the error signal, torque control in only one quadrant, and quantization of the transducer signals from the output control voltage. Therefore, linear-analysis methods do not apply for either the classical or fuzzy set of control tools. This analysis compares the differences between a classical proportional plus integral (PI) controller and a fuzzy controller.

The plant model (Fig 1) is a dc 3-phase, 12-pole spindle motor along with the driver electronics. The output circuitry comprises three half-bridge drivers with current-sense feedback. The input to the driver is an analog voltage, which generates the spindle motor current through a current amplifier having a gain of gm (amps/volt). When the input voltage equals some reference voltage, the current command is zero, and the output stages are off. During this time, coulomb friction decelerates the motor. Maximum current drive occurs when the input voltage is at 0V. The motor resistance, supply voltage, and the back EMF from the motor limit the maximum current drive to the motor.

## Simulator doesn't model current control

The current-control loop around the motor and the current amplifier typically have a bandwidth several orders of magnitude greater than the motor's velocity bandwidth. There-

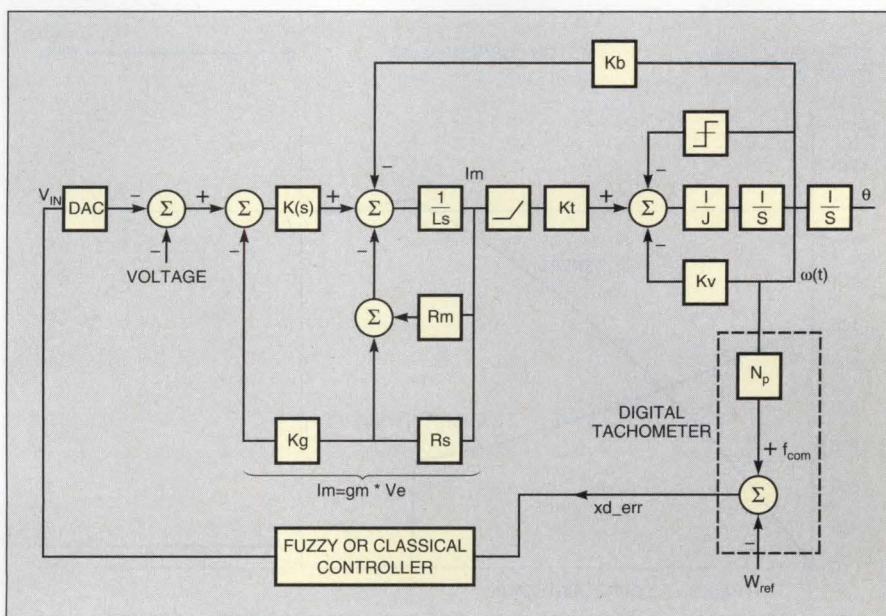

**Fig 1**—The block diagram of the plant for a 3-phase, 12-pole spindle motor comprises a current amplifier driving the motor and half-bridge output drivers with current-sensing feedback.

## FUZZY AND CLASSICAL CONTROL

fore, the plant simulation doesn't include the dynamics of the current-control loop in **Fig 1**. Instead, the plant model calculates the maximum available current and drives the motor using a current source, which is equal to either the commanded current or the maximum available current, whichever is smaller.

The classical-control analysis applies linearization to the nonlinear plant to design a proportional PI controller. The linear model does not predict the correct simulated transient response. The simulated plant model calculates motor speed in rad/sec, position in rad, and a digital encoder pulse, called  $f_{com}$ . A digital tachometer and digital phase detector use the  $f_{com}$  signal, which occurs nine times/revolution of the motor ( $N_p=9$ ). The linearized transfer function of the motor and current driver in continuous time is:

$$H(s)=(gm \cdot Kt/Jm)/(s+Kv/Jm), \text{ rad/sec} \cdot V, \quad (1)$$

where  $gm=0.5 \text{ A/V}$ , transconductance;  $Kt=1.05 \text{ oz-in./A}$ , torque constant;  $Kv=0.001 \text{ oz-in./sec}$ , viscous constant; and  $Jm=752E-6 \text{ oz-in.-sec}^2$ , inertia.

The equation represents the transfer function from the input voltage to the motor's radial velocity output. Because the tachometer's outputs are discrete, the continuous-time representation is converted to discrete time using the z-transform. The transform involves an approximation because the sample interval is at a fixed motor rotation ( $2\pi/N_p$ ) and not at a fixed sample time. As a practical matter, the discrete system is often analyzed assuming  $T$  is a fixed sample time. Although we make this approximation, linearizing the system and assuming a fixed sample time completely ignores the real system's nonlinearity. Stability of the linearized system does not ensure global stability of the real system. An appropriate

Lyapunov function could determine a nonlinear system's degree of stability. Finding such a Lyapunov function is difficult, however.

You can derive a difference equation directly from **Eq 1** by assuming a small time increment, as follows:

$$(\omega(t+dt))=(1-dt \cdot (Kv/Jm)) \cdot \omega(t)+(gm \cdot Kt \cdot dt/Jm) \cdot v(t). \quad (2)$$

If  $dt=T$  and  $t=kT$ , then **Eq 2** becomes

$$(\omega(kT+T)=(1-T \cdot (Kv/Jm)) \cdot \omega(kT)+(gm \cdot Kt \cdot T/Jm) \cdot v(kT).$$

Noting that the z-transform of  $\omega(kT+T)$  is  $\omega(z) \cdot z$ , the overall transfer function is

$$H(z)=gm \cdot Kt \cdot T/Jm/(z-(1-T \cdot Kv/Jm)), \text{ rad/sec} \cdot V. \quad (4)$$

### Digital tachometer provides feedback

Regardless of whether the controller is classical or fuzzy, you must measure the spindle speed for feedback control. **Fig 1** includes a block diagram labeled "digital tachometer" showing the measurement of the spindle speed,  $\omega(t)$ . The output of this block is  $xd\_err$ , a digital word representing speed error.

The digital tachometer counts the period of the  $f_{com}$  pulse with 1- $\mu\text{sec}$  resolution ( $t_i$ ). You subtract the final count from a reference count of 1880. The tachometer then truncates the count to fall within -128 to +127 counts to generate the  $xd\_err$  signal. If the time interval is  $T_t$  and the average velocity over an  $f_{com}$  period is  $w_{avg}$ , then  $w_{avg}(T_t)$  is the average velocity over the time interval:

$$\omega_{avg}(T_t)=2 \cdot \pi/(N_p \cdot T_t). \quad (5)$$

This equation is nonlinear in the variable  $T_t$ . To linearize the equation, you can write a Taylor series around the reference velocity  $\omega_{ref}$  and the reference period  $T_t$ . You linearize a function using a Taylor series about an equilibrium point. If you linearize  $f(x,t)$  about the point  $x_0$ , then the first two terms of the Taylor series are

$$f(x,t)=f(x_0,t)+f'(x_0,t)(x-x_0),$$

where  $f'$  denotes the derivative with respect to  $x$ . Applying this to **Eq 5** yields

$$\omega_{avg}(T_t)=\omega_{ref}-(\omega_{ref}/T_{ref}) \cdot (T_t-T_{ref}). \quad (7)$$

Because  $\omega_{avg}(T_t)$  is the average velocity over the period  $T_t$ , you can express the equation in terms of the velocity at the beginning and the end of the period, as follows:

$$\omega_{avg}(k)=(1/2) \cdot (\omega(k)+\omega(k-1)). \quad (8)$$

Combining **Eqs 7** and **8** yields

$$(\omega(k)-\omega_{ref}+(\omega(k-1)-\omega_{ref}))/2=(\omega_{ref}/T_{ref}) \cdot (t_t-T_{ref}). \quad (9)$$

Denoting the difference between  $w$  and  $\omega_{ref}$  as  $\omega_e$  and measuring the time interval in terms of  $t_i$  reduces **Eq 9** to

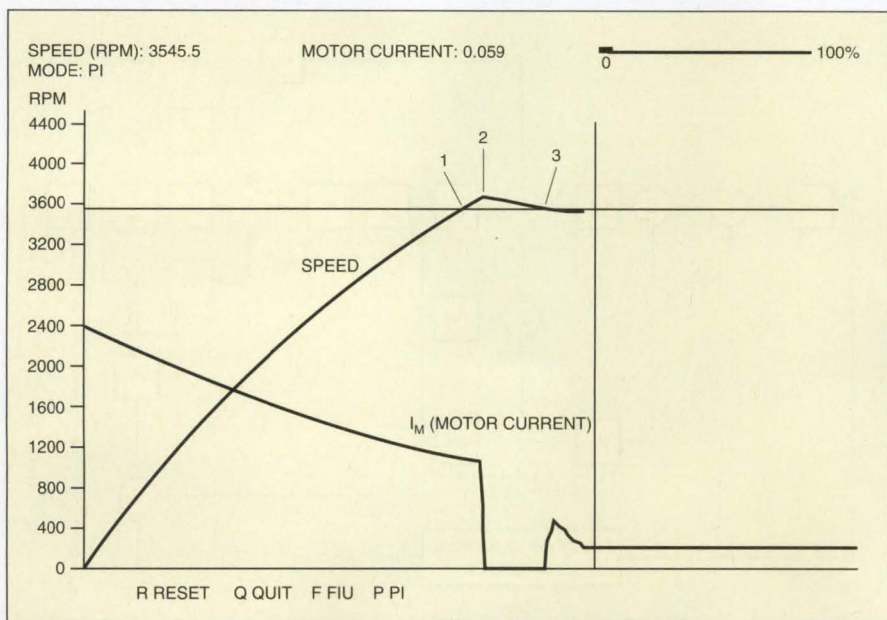

**Fig 2—Driving a spindle motor from a dead stop to a final spindle speed using a classical proportional integral (PI) controller shows a severe target overshoot. The integrator shuts off the motor current at Point 2 to allow the motor to settle using coulomb friction.**

### 2 CHANNEL VIDEO MIXER/FADER

#### GT4123A

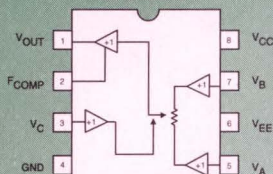

$$V_{OUT} = V_C \times V_A + (1 - V_C) \times V_B$$

- Excellent Video & Control Performance
- 25 MHz 0.1dB BW; 75 dB Isolation @ 5MHz; 0.02% dg, 0.02° dp
- 4 ns Control Delay; 1% Control Linearity
- \$5.55 in 100 unit quantities

### UNITY GAIN VIDEO BUFFER WITH POWER-DOWN

#### GB4600

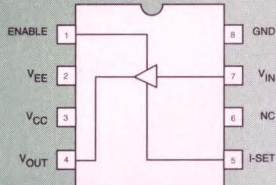

- 100 MHz 0.1 dB BW Driving 27 pF
- 0.02% dg, 0.02° dp
- Disabled Power Only 160 μW
- \$2.42 in 100 unit quantities

### DC RESTORED VIDEO AMPLIFIER

#### GB4551

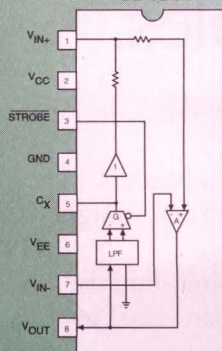

- ±1 mV DC Restore Uses Integration For Accuracy
- 0.03% dg, 0.03° dp, 30 MHz BW
- Space-Saving SIP Needs Only 2 External Capacitors
- \$5.13 in 100 unit quantities

### NOISE-TOLERANT VIDEO SYNC SEPARATORS

#### GS1881

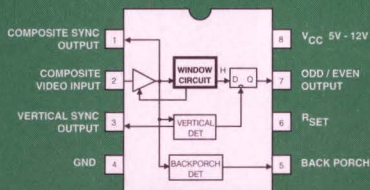

- Window Circuit For Noise Immunity, Fast Recovery
- Excellent Specs & Temperature Stability (±1 ns)
- Replaces LM1881 With Improved Performance
- Industrial Temperature Range Available
- \$2.35 in 100 unit quantities

#### GS4881

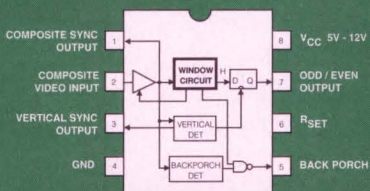

- All the Features of the GS1881 Plus
- Constant Rate, Noise Immune Back Porch Pulse
- Replaces LM1881 For New Designs
- Industrial Temperature Range Available
- \$2.50 in 100 unit quantities

#### GS4981

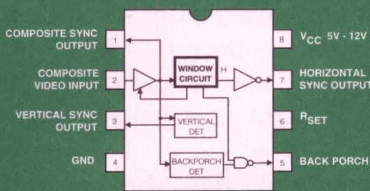

- All the Features of the GS4881 Plus
- Horizontal Sync Output in Place of ODD/EVEN
- H-Sync Output has Superior Noise Immunity
- Industrial Temperature Range Available
- \$2.60 in 100 unit quantities

### FULLY BUFFERED SUB-10ns SWITCH

#### GY4102A

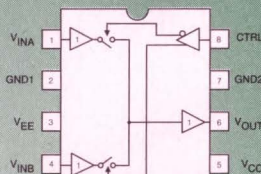

$$V_{OUT} = CTRL \times V_{INA} + \overline{CTRL} \times V_{INB}$$

- Sub 10ns Switching @ 100 MHz 0.1 dB BW
- Ultra Low Switching Transients (25mV/3ns)
- Outstanding Video Specs (0.02% dg, 0.01° dp)
- \$5.23 in 100 unit quantities

### 4 x 1 VIDEO MUX

#### GX4314L

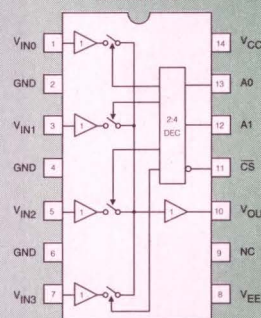

- Low Offset (±7 mV) Buffered Signal Path
- Excellent Video Specifications (0.01% dg, 0.01° dp)
- 80 dB Isolation @ 100 MHz; 100 MHz - 1.0 dB BW
- \$6.24 in 100 unit quantities

### VIDEO AMPLIFIER WITH SYNC TIP CLAMP

#### GB4550A

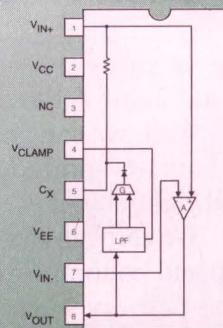

- Restores Sync Tip to V\_CLAMP ±7 mV
- 0.03% dg, 0.03° dp, 30 MHz BW
- \$4.60 in 100 unit quantities

For Literature or Samples call (800) 263-9353\* ext. 282  
Get instant Fax literature at (905) 940-5515 access code 1212

\* In Canada call (905) 632-2999 ext. 282.

GENNUM CORPORATION P.O. Box 489, Stn. A, Burlington, Ontario, Canada L7R 3Y3

Tel (905) 632-2996 Fax (905) 632-2055

# 3M boardmount connectors come in all shapes, sizes and applications.



## Naturally, we're giving samples.

We've always been known for our high-quality wiremount connectors. Shouldn't the world know about our *boardmount* connectors, too?

Well, we can get you a complete line of boardmount products: shrouded headers, in both low-profile and latch-eject models; shunts; pin strips. Polarized sockets, straight and right-angled.

We can get you high-temperature bodies, true surface-mounts and through-boards, top and bottom. Choose your pin length. Choose your plating. Great for board-stacking. Plus delivery when promised.

We're out to make your life much simpler when it comes to boardmounts. A call to 800-328-0016, ext. 100, will get you our new Boardmount Engineering Guide—it's free. And qualify you for samples of 3M boardmount connectors at the same time.

**3M** Electronics/Electrical

©1993, 3M

## FUZZY AND CLASSICAL CONTROL

$$\omega e(k) + \omega e(k-1) = -2 \cdot (\omega_{ref}/T_{ref}) \cdot t_i \cdot d(k), \quad (10)$$

where  $d(k)$  is the digital count of the time interval.

The z-transform for **Eq 10** is the transfer function of the digital tachometer, as follows:

$$\begin{aligned} \omega e(z) + \omega e(z)/z &= -2 \cdot (\omega_{ref}/T_{ref}) \cdot (T_t - t_i) \cdot d(z) \\ D(z) = d(z)/\omega e(z) &= -T_{ref} / (2 \cdot \omega_{ref} \cdot t_i) \cdot (1+z)/z \end{aligned}$$

If the motor velocity is significantly different from the reference frequency ( $\omega_{ref}$ ), the Taylor series expansion is no longer accurate. In addition, if the velocity is low, the sample time is long, and the phase delay of  $D(z)$  is long.

The plant-transfer function in **Eq 1** has a maximum phase delay of  $90^\circ$ . Even when you represent **Eq 1** in discrete form (**Eq 4**), the closed-loop bandwidth is sufficiently below the Nyquist frequency,  $1/T$ , that the phase delay caused by sampling is small. Therefore, you can stabilize the plant using only proportional feedback from the tachometer. However, the speed error is not exactly zero. Offsets in the driver stage and motor running torque relative to the driver input requires a speed error to counteract the offsets.

To force the speed error to zero, classical feedback-control systems sum the speed error and the time integral of the speed error (PI) to generate the feedback-control law. The control-law calculation for a discrete time system follows:

$$Vint(k) = Vint(k-1) + k_i \cdot xd\_err(k); \quad (13)$$

$$Vout(k) = k_p \cdot xd\_err(k) + Vint(k), \quad (14)$$

where  $xd\_err$  is the digital word representing speed error. **Eq 13** is the difference equation for the digital integrator, and **Eq 14** is the linear sum of the speed error and time integral of the speed error. You can combine **Eqs 13** and **14** into a transfer function in the z-domain for the equivalent digital controller,  $C(z)$ , as follows:

$$C(z) = Vout(z)/xd\_err(z) = kp + ki \cdot z/(z-1).$$

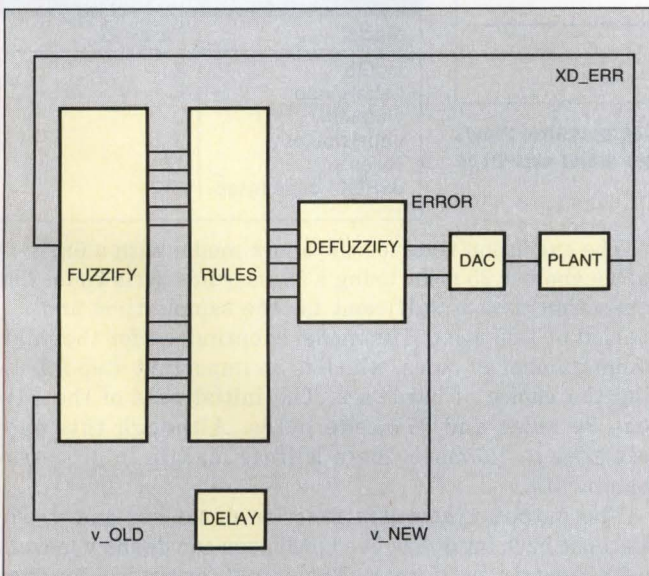

**Fig 3**—The fuzzy integral-control block diagram uses a fuzzy-inference unit, which is analogous to the proportional plus integral control of classical methods.

The open-loop gain of the linearized system is

$$H(z) \cdot C(z) \cdot D(z), \quad \text{Gol}(z) = D(z) \cdot ((k_p + k_i) \cdot gm \cdot K_t \cdot T/J_m) \cdot (z - k_p)/(k_p + k_i) / [z \cdot (1 - T \cdot K_v/J_m) \cdot (z - 1)]. \quad (17)$$

Substituting some of the system parameters into **Eq 17** yields open-loop poles as  $z_1=1$ , and  $z_2=0.99$ . The digital tachometer produces a pole at  $z=0$  and a zero at  $z=-1$ . The ratio of the integral gain to proportional gain determines the zero at  $z=1/(1+k_i/k_p)$ .

The linearized model predicts closed-loop poles that are well-damped for small  $k_i/k_p$  and under-damped for large  $k_i/k_p$ . This result is in contrast to the simulation results (**Fig 2**) and highlights the fact that nonlinearities in a system can invalidate the use of linear methods.

**Fig 2** shows a plot of the simulated spindle speed using a

```
$ SPINDLE disk drive spindle PI control
$brian tremaine 6 July 1993, revised 1 Jan. 1994
fiu tvfi (min max);
```

```
>xd_err "bits":-128()127 [
  Neg_Large (@-128,255, @-64,0),
  Neg_Med (@-128,0, @-64,255, @0,0),
  Zero (@-64,0, @0,255, @64,0),
  Pos_Med (@0,0, @64,255, @127,0),
  Pos_Large (@64,0, @127,255)];

>v_old "bits":0()255 [
  Neg_Large (@0,255, @64,0),
  Neg_Med (@0,0, @64,255, @128,0),
  Zero (@64,0, @128,255, @192,0),
  Pos_Med (@128,0, @192,255, @255,0),
  Pos_Large (@192,0, @255,255)];

<error "bits": 0()255* (
  Neg_Large = 0.0,
  Neg_Med = 8,
  Zero = 128,
  Pos_Small = 248,
  Pos_Large = 255);

<v_new "bits": 0()255* (
  Neg_Large = 0.0,
  Neg_Med = 64,
  Zero = 128,
  Pos_Med = 192,
  Pos_Large = 255);

$
if xd_err is Neg_Large then v_new is Neg_Large;
if xd_err is Neg_Med then v_new is Neg_Large;
if xd_err is Zero and v_old is Pos_Large then v_new is Pos_Large;
if xd_err is Zero and v_old is Pos_Med then v_new is Pos_Med;
if xd_err is Zero and v_old is Zero then v_new is Zero;
if xd_err is Zero and v_old is Neg_Med then v_new is Neg_Med;
if xd_err is Zero and v_old is Neg_Large then v_new is Neg_Large;
if xd_err is Pos_Med and v_old is Pos_Med then v_new is Pos_Med;
if xd_err is Pos_Med and v_old is Zero then v_new is Pos_Med;
if xd_err is Pos_Med and v_old is Neg_Med then v_new is Zero;
if xd_err is Pos_Med and v_old is Neg_Large then v_new is Neg_Med;
if xd_err is Pos_Large then v_new is Pos_Large;

$
if xd_err is Neg_Large then error is Neg_Large;
if xd_err is Neg_Med then error is Neg_Med;
if xd_err is Zero then error is Zero;
if xd_err is Pos_Med then error is Pos_Small;
if xd_err is Pos_Large then error is Pos_Large;
end
```

**Fig 4**—The listing for the fuzzy controller of the spindle disk drive is compiled with Apronix's FIDE (fuzzy inference development) program.

## FUZZY AND CLASSICAL CONTROL

		V_OLD				
		NEG_LARGE	NEG_MED	ZERO	POS_MED	POS_LARGE
XD_ERR	NEG_LARGE	NL/NL	NL/NL	NL/NL	NL/NL	NL/NL
	NEG_MED	NL/NM	NL/NM	NL/NM	NL/NM	NL/NM
	ZERO	NL/ZR	NM/ZR	ZR/ZR	PM/ZR	PL/ZR
	POS_MED	NM/PM	ZR/PM	PM/PM	PL/PM	/PM
	POS_LARGE	PL/PL	PL/PL	PL/PL	PL/PL	PL/PL

OUTPUT LEGEND: v\_new/error  
 NL = NEG\_LARGE  
 NM = NEG\_MED  
 ZR = ZERO  
 PM = POS\_MED  
 PL = POS\_LARGE

**Fig 5**—The rule table for the fuzzy integral controller contains redundant rows of rules that can be condensed into fewer rules for the fuzzy-inference unit to follow.

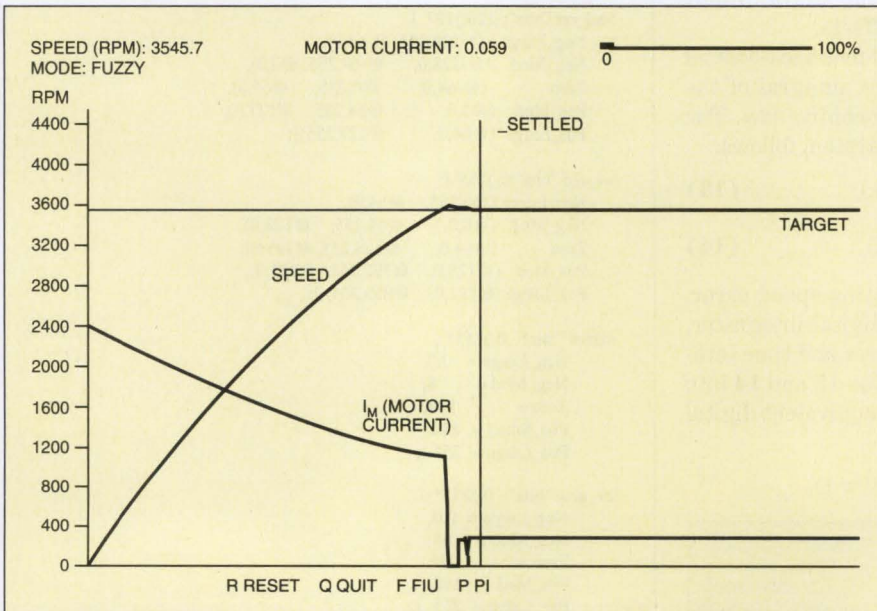

**Fig 6**—The spin-up of the spindle motor from a dead stop using fuzzy integral control shows less overshoot than with a classical PI controller. The integrator reduces motor current to zero when the system is over speed to cause deceleration.

classical PI controller with a nonlinear plant. In Eqs 13 and 14,  $k_i=3/2048$ , and  $k_p=48/2048$ . The speed overshoots the target and slowly decays with a linear ramp to the target speed value. From time  $t=0$  until Point 1, the speed error is negative, and the integrator continues to accumulate until it saturates. Not until the speed error begins to go positive does the integrator begin to come out of saturation. At Point 2 the integrator has recovered enough to allow the control voltage to command zero current. From Point 2 until Point 3 the only deceleration is due to coulomb friction. Beyond Point 3, the system settles to a steady state value.

### Fuzzy control uses different control blocks

Fuzzy integral control analyzes the spindle motor using a fuzzy-inference unit (FIU) (Fig 3). This analysis block is

analogous to the proportional plus integral control block of the classical method. Because an FIU has no memory, fuzzy control accomplishes the integral function by using the feedback from the FIU's output to its input. The FIU has the FIDE listing shown in Fig 4. The inputs to the FIU are the speed error ( $xd\_err$ ) and previous output integral count ( $V\_old$ ). The outputs of the FIU are proportional count (error) and integral count ( $V\_new$ ). Fig 5 shows a table representation of the FIU rules. The control law is a summation of both outputs

$$V_{out} = 16 \cdot (\text{error} - 128) / 255 + 3 \\ + (v_{new} - 128) / 255 + 3.$$

Fig 6 shows a plot of motor speed and current for spin-up from a dead stop. The steady state speed nearly equals the commanded speed, as in the integral controller. However, the fuzzy method improves transient response, decreases overshoot, and provides faster settling. A classical PI system involves a tradeoff between overshoot and settling time. The fuzzy-system rules and membership functions effectively implement "anti-windup" integral control. When  $xd\_err$  is positive, (over speed) the integral term ( $v\_new$ ) is forced positive to zero the spindle-motor current immediately to cause deceleration.

Table 1 details the fuzzy model:

Table 1—The fuzzy model	
Model	Fuzzy PI
Inputs	2
Labels/input	5
Outputs	2
Labels/output	5
Rules	17
68HC11 code bytes	717

The execution time for the above model with a 68HC11  $\mu P$  is about 1.25 msec using a 50-nsec bus cycle time. The execution time is sufficient for the sample time and  $f_{com}$  period of 1.88 msec. The model is optimized for the minimum number of rules, which is an important step affecting the choice of hardware. The initial pass of the FIU has 30 rules and 877 code bytes. Although this pass executes in 1.6 msec, there is little margin in processor bandwidth.

The output  $v\_new$  is a function of  $xd\_err$  and  $v\_old$ . Because each input has five labels, you can define  $v\_new$  as a  $5 \times 5$  matrix, or 25 rules. The output, error, is a function of  $xd\_err$  only. Because  $xd\_err$  has five labels, five rules can define the output, error. Therefore, there are 30 rules for the the first pass. In the last row of Fig 5, when  $xd\_err$



*UPS Standard*



*UPS Expedited*



*UPS Express*

## How small a continent do you want to make it?

UPS just made doing business in North America more manageable than ever before. Because depending on your schedule and budget, you can now choose between three levels of door-to-door service from the United States to either Canada or Mexico: from Standard to Expedited to overnight Express. All of which offer tracking, customs clearance and shipment pricing.

Just tell us when your packages need to get there and we'll be happy to adjust the size of the continent accordingly. For more information on how we can tailor North America for you, simply call us at 1-800-PICK-UPS. **The package delivery company more companies count on.™**



## FUZZY AND CLASSICAL CONTROL

is Pos\_Large, V\_new is Pos\_Large, regardless of v\_old. This condition lets you replace five rules with one rule: "If xd\_err is Pos\_Large, then v\_new is Pos\_Large." Modifications such as these can reduce the number of rules from 30 to 17.

In comparing a classical PI servo-control loop with a fuzzy-control loop for a dc spindle motor, the plant and the tachometer have inherent nonlinearities that preclude applying linear stability theory, regardless of the control method. Knowledge of classical PI servo-control principles helps with the design of a fuzzy controller. The performance in terms of the spin-up settling time and the transient response is superior using the fuzzy system compared with the classical PI controller when there are severe nonlinearities.

The C source code for both the FIDE fuzzy modules and the plant model is available from the author. In addition to the PI controller, you can also use the Apronix bulletin-board system to access source and executable simulation code for proportional control, PLL control, and dual-phase and tachometer loops for classical and fuzzy control. **EDN**

## References

1. Kosko, B, *Neural Networks and Fuzzy Systems: A Dynamical Systems Approach to Machine Intelligence*, Prentice Hall, 1992.

2. Franklin, G, D Powel, and M Workman, *Digital Control of Dynamic Systems*, Second Edition, Addison Wesley, 1990.

## Author's biography

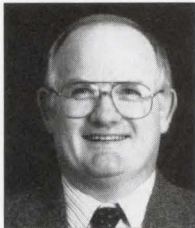

Brian P Tremaine is a senior engineering director for Seagate Technology in Scotts Valley, CA. His job includes managing a group that is responsible for control-system design of actuator and spindle servos on 2.5- and 1.8-in. disk files. In his nine years with Seagate, he has helped to develop a host of disk-file products. Tremaine has BSEE and MSEE degrees from San Jose State University, San Jose, and an MBA from Golden Gate University, San Francisco. He is a registered professional engineer in California, and he is completing an engineer degree at Stanford University, Stanford, CA, this year. Tremaine is married and has two children.

## VOTE

Please use the Information Retrieval Service card to rate this article (circle one):

High Interest  
586

Medium Interest  
587

Low Interest  
588

## THE NEW TCXO SOLUTIONS FROM RALTRON.

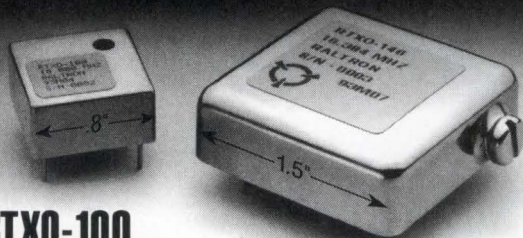

### RTX0-100 RTX0-146

- Small size
- Wide temperature range
- +5 VDC, +12 VDC
- Wide frequency range
- Voltage control option
- Custom options
- Lower cost

#### FREQUENCY STABILITY:

100: -30°C to +70°C: ±1ppm

146: -40°C to +85°C: ±1ppm

#### DIMENSIONS: 100 146

Length	.8"	1.5"
Width	.8"	1.5"
Height	.4"	.5"

Call or fax your specs to Sandy Cohen.

## RALTRON

### ELECTRONICS CORP.

2315 NW 107 AVENUE  
MIAMI, FLORIDA 33172 U.S.A.

FAX (305) 594-3973  
TELEX 441588 RALSEN  
(305) 593-6033

### ONLY RALTRON HAS IT ALL

Crystals / Crystal Oscillators  
Crystal Filters / Ceramic Resonators

CIRCLE NO. 145

## Buyer in Trouble #56

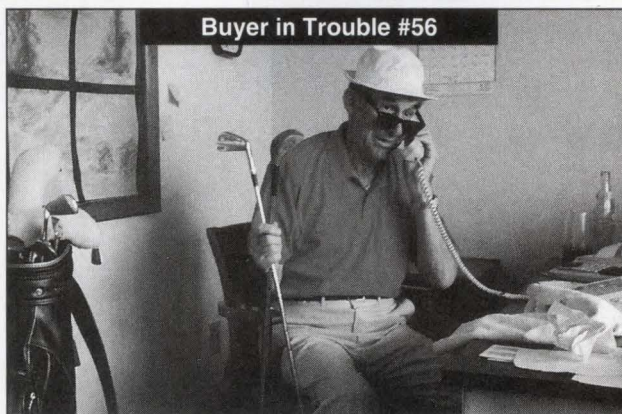

## Teeing Off the Engineers

"What do you mean they don't work? Well, you shoulda said something about volts before this. I know Prem custom designs power transformers, but the other guys had a sale on 15 volt units. (CLICK!) Hello...Hello...Picky engineers!"

I really shoulda called Prem.

You oughta call Prem!"



# PREM®

Where Quality Really Counts!

For Prem's new catalog or additional product information, call or write  
Prem Magnetics, Inc.  
3521 North Chapel Hill Road, McHenry, IL 60050.  
Phone: 815-385-2700. FAX: 815-385-8578.

CIRCLE NO. 138



# If You Think You Can't Get Both High Speed And High Capacity In An FPGA...



## Think Again. Think Actel. The Industry's Fastest, High Capacity FPGAs.

Do you have a need for both high performance and high capacity? Now you don't need to choose between speed and capacity. Actel's ACT™ 3 family of FPGAs – with performance to meet your 75 MHz system requirements and capacity needs up to 10,000 gates – *in the same device*.

### Think Performance and Predictability

Based on PREP™ benchmarks, Actel's ACT 3 devices offer an exceptional speed and capacity combination with the flexibility and predictability Actel has become famous for.

Covering a range of 1,500 to 10,000 gates, ACT 3 devices run up to 167 MHz for counter and datapath designs and offer up to 228 user I/Os. Fast I/Os provide clock-to-out speeds of 7.5 nanoseconds.

software, fully automatic placement and routing, and links to all popular CAE and PLD design tools, including Mentor Graphics®, Data I/O®, Synopsys™, Cadence™, OrCad™, and Viewlogic®. Our Designer Series of development tools start at \$995 and support 386 and 486 PCs, HP®, and Sun® workstations.

	Average PREP Performance*			Clock-to-Out (Pad-to-Pad)
	Fastest	Slowest	Predictability	
ACT 3	80 MHz	71 MHz	89%	7.5 ns
FLEX 8000	54 MHz	46 MHz	78%	10.5 ns
XC4000	41 MHz	27 MHz	60%	13.0 ns

ACT 3 - highest PERFORMANCE and Most PREDICTABLE High Capacity Solution

### Think Service and Support

You get all this, plus extensive service and support. Actel's technical HOTLINE and Action FACTS system provides you with automatic access to technical documents, design tips, and experienced engineering support to help you meet your time-to-market goals.

### Think About The Possibilities

Actel is the best choice – whatever your need may be. For applications ranging from bus interfaces, networking, and communications to high speed graphics and processor interfaces. We offer more than 200 combinations of device, package, speed, and testing options. So for both high speed and high capacity – Think Actel. For more information, call us today at **1-800-228-3532**. You'll receive our new 1994 full line Data Book. Also ask us about our 1200 gate FPGAs for under \$10!

**Call 1-800-228-3532**  
**Outside U.S. 908-225-0700**

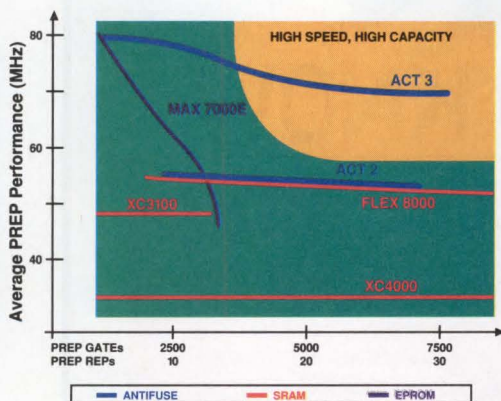

### Think Fast, Flexible Design

Actel's Designer Series of highly automated FPGA development systems feature powerful logic synthesis and device fitting



CIRCLE NO. 49

Actel Corporation, 955 E. Arques Avenue, Sunnyvale, CA 94086 Actel Europe Ltd. Intec 2, Wade Road, Basingstoke, Hants RG24 ONE U.K.

1. Usable PREP Gates assumes 250 gates per average instance.
2. Average PREP Performance calculated by averaging internal mean frequencies.
3. Performance Projections based on certified and uncertified PREP Co. data.
4. ACT 3 calculated from A1425A-2 projected and A1460A-2 submitted data. FLEX 8000 calculated from EPF81188-2, EPF8820-2, EPF8452-2 and EPF8282-2 certified data. XC4000 calculated from XC4010-5 certified data. ACT and the Actel logo are trademarks of Actel Corporation. PREP is a trademark of the Programmable Electronics Performance Corporation. All other brand or products names are property of their respective holders.

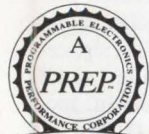

COMPANY  
TM

Presentations use or include the most recent PREP PLD Benchmark data which is measured according to Benchmark Suite #1, Version 1.2. Any analysis is not endorsed by PREP.

## Sockets



Harwin, Inc. offers a variety of solder, wire-wrap, DIL and SIL sockets. Along with reeled and loose pc board sub miniature sockets, headers, PLCC and PGA sockets. These high reliability sockets are designed to meet severe environmental conditions of high shock, vibration, bump, etc. — ideal choice for those applications where space is limited. Harwin, Inc. (812) 285-0055 FAX (812) 285-0056.

CIRCLE NO. 224

## Pin Headers and Shunts on 2MM Centers

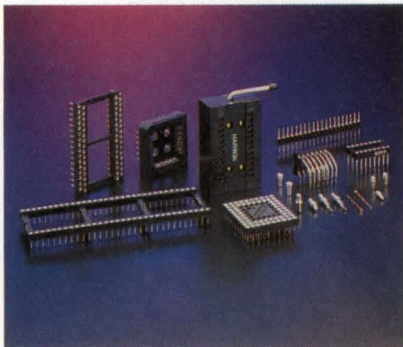

Pin headers are available from Harwin, Inc., in single and double row, 2 to 32 position lengths in both vertical and horizontal styles. A "small footprint" horizontal style is available for use where PCB space is at a premium. All versions are stocked in both gold and tin finishes. The 2mm shunts are designed with a low initial point of contact to eliminate the possibility of intermittent contact. The body is end stackable with tapered entry for easy pin header insertion. The contacts offer low insertion force, high retention and are open top for test probe access. Both gold and tin finishes are available. Harwin, Inc. (812) 285-0055 FAX (812) 285-0056.

CIRCLE NO. 225

## 2mm High Density Connectors Available in 3 Row Versions

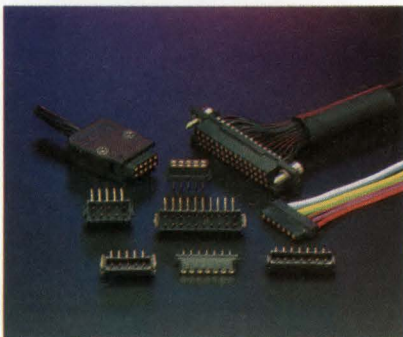

Harwin, Inc. announces the availability of a 3 row version of its popular connectors on 2mm centers. These "Datamate" connectors are designed for use in applications such as mobile communications, data processing, medical and military equipment where miniaturization and absolute contact integrity is required. The high temperature moldings are produced in 27 to 63 contact versions and the range is doubled by the option of including two power contacts in each size. Additional features include polarization, shrouded contacts, selective plating, replaceable contacts, jackscrew options, small footprint and low profile. Harwin, Inc. (812) 285-0055 FAX (812) 285-0056.

CIRCLE NO. 226

ISO 9001  
CERTIFIED

# DID YOU KNOW

If you have a need for top-quality circuit board connectors and associated hardware, it's time you met Harwin.

Harwin is recognized as a world-wide leader in providing high-quality interconnection devices and hardware to O.E.M. customers in the computer, aerospace and telecommunications industries, as well as supplying the military.

Harwin brings the highest credentials, with expertise in engineering, design, marketing, manufacturing and quality control. Harwin has earned these internationally recognized and audited approvals: DESC, EN 29002, BS 5750 Part 2, C.E.C.C., BS 9000, A.Q.A.P. 9(MOD) and ISO 9001.

1410 New Albany/Charlestown Pike  
Jeffersonville, IN 47130 USA  
Telephone: (812) 285-0055 • Facsimile: (812) 285-0056

# HARWIN

CIRCLE NO. 214

**EDI Memory  
Data Book '94  
Now Available!**

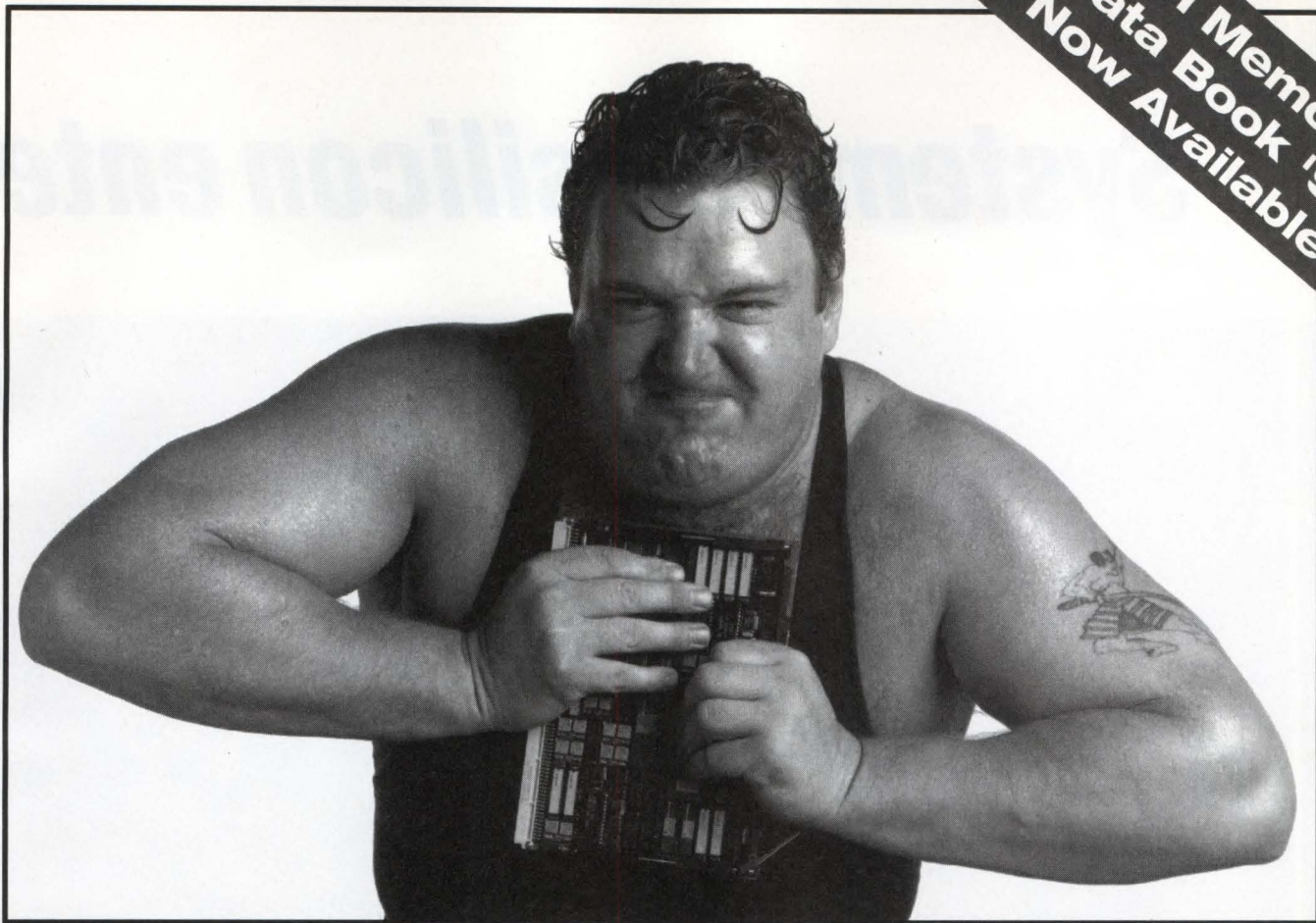

## NOW THERE'S AN EASIER WAY TO SQUEEZE MORE MEMORY ON TO YOUR BOARD

EDI's new range of wide memory devices provide a more practical way to add muscle to microprocessor system performance, while reducing size and weight.

Packing a powerful punch, high speed (down to 12ns) Static RAMs benefit from ultra high density vertical ZIP and SIMM packaging and wide data widths, up to 32 bits.

There's no need to wrestle with tough decisions either, because they are available in plastic packaging for commercial and industrial use.

### Commercial and Industrial Grade SRAM Modules

#### High Density Vertical Package Styles

Organization	Part No.	Speed (ns)	Package Style
64Kx32	EDI8F3265C*	12	64 pin ZIP/SIMM
128Kx32	EDI8F32128C*	12	64 pin ZIP/SIMM
256Kx32	EDI8F32256C*	12	64 pin ZIP/SIMM
256Kx32	EDI8F32257C*	17	64 pin ZIP
32Kx24	EDI8F2432C	15	56 pin ZIP
64Kx24	EDI8F2464C	15	56 pin ZIP
128Kx24	EDI8F24128C	20	60 pin ZIP

#### Surface Mount Package Styles

Organization	Part No.	Speed (ns)	Package Style
256Kx8	EDI8F8257C*	70	32 pin SOIC
2x512Kx8	EDI9F81025C	55	36 pin SOIC

\*JEDEC Pinout

## HIGH PERFORMANCE MEMORY MODULES

**1-800-800-SRAM (XT.219)**

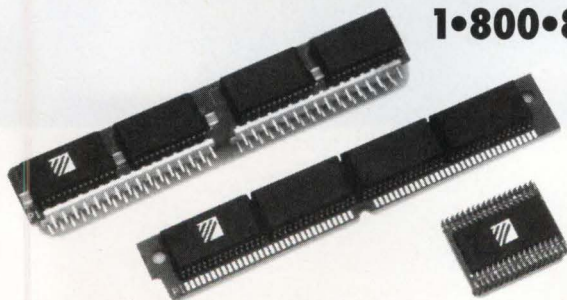

ELECTRONIC DESIGNS INC.

One Research Drive • Westborough, MA 01581 USA  
Tel: 508-366-5151 • Fax: 508-836-4850  
Tech Hot Line: 800-400-3349

Electronic Designs Europe Ltd.

Shelley House, The Avenue • Lightwater, Surrey GU18 5RF  
United Kingdom • 0276 472637 • FAX: 0276 473748

CIRCLE NO. 97

EDN July 7, 1994 • 147

# ***Systems on silicon enter***



# the 3V era.

## New 0.5-micron, Cell-Based ASICs run 50% faster, consume 70% less power.

Systems on silicon have reached a higher level of performance and a lower level of power consumption with the introduction of NEC's 0.5-micron, Cell-Based ASICs. Optimized for true 3V operation, our CB-C8 family offers exciting new possibilities for designers of telecom, personal computer and consumer systems.

CB-C8 ASICs give you a loaded speed of 220 picoseconds\*, power dissipation of only  $0.8\mu\text{W}/\text{MHz}/\text{cell}$  and high integration of up to 600,000 gates. Compared to our previous generation of 0.8-micron ASICs, the new family offers a 50% boost in speed and a 70% drop in power consumption. \*F/0=2, L=2mm, power gate

Since speed to market counts almost as much as internal system speed, we offer a comprehensive cell library to facilitate your development of 3V systems on silicon. Macros include:

- V30MX CPU (33MHz, 8086-compatible)
- PLL, GTL, PCI\* and RAMBUS\*\*
- A/D and D/A converters\* \* under development

Our OpenCAD® Design System also helps to shorten the development cycle. A unified front-to-back-end design package, OpenCAD allows you to mix and match our tools with those of the industry's most popular vendors.

Fast enough to match speeds with the industry's foremost microprocessors, yet featuring exceptionally low power dissipation, our CB-C8 ASICs offer a no-compromise solution to your design needs. For more information on how the CB-C8 family can improve performance for your cellular phone, personal digital assistant, multimedia platform, graphics system, PC or workstation, call NEC today.

All registered trademarks are property of their respective holders.

CIRCLE NO. 114

# Tomorrow's Technology... Today

"When we developed our new PCMCIA fax/modem card series, we needed a semiconductor vendor who understood the design challenges of packing high-speed modem capabilities into our three RediCARD™ models... And that company is Zilog.

By migrating our existing Z80® software code to Zilog's feature-rich next generation Z182 microprocessor, we easily converted our proven custom modem technology into a PCMCIA design to meet the emerging market demands.

Strategic relationships with companies like Zilog help us to provide innovative products in the shortest possible time to meet the production requirements for some of the worlds largest portable PC manufacturers."



Les Staples,  
Chief Technical Officer  
- DATA RACE



Contact your nearest Zilog sales office or authorized distributor for more information.



210 E. Hacienda Avenue  
Campbell, CA 95008-6600  
(800) 662-9826 – within the U.S.  
(408) 370-8000  
FAX (408) 370-8056

Zilog and Z80 are registered trademarks of Zilog, Inc.  
RediCARD is a trademark of DATA RACE.  
All rights reserved. © 1993 Zilog, Inc.

## A bevy of new workstations offers price/performance options

No fewer than four workstation makers have announced new models or new configurations of already-released models. The new offerings come from Hewlett-Packard, IBM, Sun, and Tatung. The basic packages range in price from under \$5000 to over \$30,000, with most in the \$10,000 to \$20,000 range.

IBM and HP have the more powerful workstations. IBM's RS/6000 3BT, with

optional 1-Mbyte Level 2 cache, achieves a SPECfp92 rating of 205.3. Sun and Tatung, with similar units based on the microSPARC II, offer better prices. Tatung quotes a base price of \$4570, but Sun's prices (around \$10,000) include more hardware options.

Consult **Table 1** for more details, but bear in mind that the listings show ranges of specifications for several basic



**New workstations offer powerful processing at ever lower prices. Shown here is Hewlett-Packard's HP 9000 Series 700 Model 715.**

**TABLE 1—WORKSTATIONS**

Manufacturer	HP	IBM	Sun	Tatung
<b>Models</b>	HP 9000 Series 700	RS/6000 41T, 41W,	SPARCstation 5 715, 725	COMPstation II-385 3AT, 3BT
<b>Processor</b>	PA-RISC 7100LC Power2	80-MHz 601, microSPARC II	70-MHz, 85-MHz microSPARC II	85 MHz
<b>SPECint92</b>	66.6 to 100.1	88.1 to 114.3	57 to 64	64
<b>SPECfp92</b>	96.5 to 137	98.7 to 205.3	47.3 to 54.6	54.6
<b>Memory (Mbytes)</b>	32	16 to 32	32	16
<b>Maximum memory (Mbytes)</b>	256 to 512	256 to 512	256	256
<b>Cache (kbytes)</b>	256	512 to 1024	24	NA
<b>Disk (Mbytes)</b>	525	540	535 to 1050	520
<b>Color monitor</b>	17 in.	17 in.	17 in.	14 in.
<b>Price</b>	\$9995 to \$19,005	\$12,100 to \$32,300	\$9595 to \$11,595	\$4570

configurations. Other configurations and options are also available.—**Gary Legg**

*Hewlett-Packard Co, Palo Alto, CA. (800) 637-7740. Circle No. 401*

*International Business Machines Corp, Somers, NY. (800) 426-3333. Circle No. 402*

*Sun Microsystems Computer Corp, Mountain View, CA. (800) 872-4786. Circle No. 403*

*Tatung Science and Technology Inc, Milpitas, CA. (800) 659-5902. Circle No. 404*

### PC flash disk emulates hard disk.

The PC Flash Disk, a half-size flash-memory card for the ISA or EISA bus, is essentially a hard disk without moving parts. The disk replaces the disk and controller and does not require cabling. An onboard expansion BIOS eliminates the need for special software. The board also allows for cold boots and provides full magnetic hard-disk emulation. It's available in capacities from 1 to 32 Mbytes. 1-Mbyte version, \$180 (100). **M-Systems**, Fremont, CA. (510) 505-9081. **Circle No. 405**

### FREE INFO, FREE POSTAGE

Use our postage-paid reader-service cards to get more information on any of these products.

requests, store additional requests in a "mailbox" and force the OS to wait. The VL-bus-based board comes with SCSI ribbon cable, installation software, and Corel SCSI Version 2 drivers and utilities. \$379. **AdvanSys**, San Jose, CA. (408) 383-9400. **Circle No. 406**

### RAID controller works with PC operating systems.

The LDP Cache IV RAID 1 controller provides RAID Level 1 (mirroring) capabilities for PC-bus systems. It controls SCSI drives but appears as an IDE controller to the system, allowing use of standard OS drivers. The controller supports as much as 16 Mbytes of cache memory. It provides data-trans-

fer rates of 5 Mbytes/sec, with bursts to 10 Mbytes/sec. \$795 without cache memory. **Lomas Data Products Inc**, Marlboro, MA. (508) 460-0333. **Circle No. 407**

### DSP board works on PCI bus.

The Eagle-56, a DSP board based on Motorola's DSP56002, operates on the PCI local bus. A 40-MHz version offers 20 MIPS performance, and a 66-MHz version boosts performance to 33 MIPS. Each board has a high-speed parallel host interface and four banks of 64k×24-bit zero-wait-state SRAM. 40-MHz version, \$2695; 66-MHz version, \$3695. **Momentum Data Systems Inc**, Costa Mesa, CA. (714) 557-6884. **Circle No. 408**

**PCI and VL graphics cards provide true color.** The VideoBlitz II graphics accelerators, available for the PCI and the VL bus, display true (24-bit) color.

### SCSI adapter boosts I/O rate.

By simultaneously processing up to 255 read or write requests, the ABP842 SCSI host adapter doubles the speed at which disk drives and other peripherals deliver data. Its high-speed memory stores all I/O requests from the operating system as opposed to most adapters, which, after receiving four

# EDN-NEW PRODUCTS

## COMPUTERS & PERIPHERALS

The PCI version, based on the Weitek P9100 accelerator chip, produces a 1280×1024 true-color display; the VL version makes an 800×600 24-bit display. Both versions have 2 Mbytes of VRAM; the PCI version is expandable to 4 Mbytes. PCI version, \$589; VL version, \$549. **Genoa Systems Corp**, San Jose, CA. (408) 432-9090, ext 262. **Circle No. 409**

**PCI and VL graphics cards allow video playback.** The Viper Pro

graphics accelerators, available for the PCI and VL buses, allow 30-frames/sec video playback with the optional Video Power chip from Weitek. The graphics processor is Weitek's P9100, which provides 1280×1024 true-color (24-bit) displays. The boards are available with 4 Mbytes of VRAM or with 2 Mbytes, upgradable to 4 Mbytes. 2-Mbyte version, \$479; 4-Mbyte version, \$699. **Diamond Computer Systems Inc**, Sunnyvale, CA. (408) 736-2000. **Circle No. 410**

**Computer cards embed PC architecture.** Two new 16-bit single-board computers enable use of the PC architecture in embedded systems. The SAT-486SLC-33, based on a 33-MHz 486SLC processor, and the SAT-386SX-25, based on a 25-MHz 80386SX, are 4.5×7.1-in. boards that operate at temperatures from -40 to +85°C. The 486 version is also available with clock-doubled parts for clock speeds to 66 MHz. A 16-bit PC/104 connector allows expansion with additional functions. SAT-486SLC-25-1M (with 1 Mbyte of onboard parity-checked DRAM), \$995; SAT-386SX-25-1M, \$895. **WinSystems**, Arlington, TX. (817) 274-7553. **Circle No. 411**

**Pentium and PCI work on passive backplane.** The SB586 single-board CPU is based on the Pentium processor and contains a PCI local bus extension. It's available with a choice of two PCI-bus passive backplanes from the manufacturer. The board includes IDE and SCSI-2 controllers. CPU, \$3525; backplanes, \$379 to \$529. **Industrial Computer Source**, San Diego, CA. (800) 523-2320. **Circle No. 412**

# ABSOLUTE VALUE.

SRS DEMO DIRECT  
2 Day Delivery, No Obligation  
CALL (408)744-9040



## High performance LCR meters from SRS. Absolutely lowest price. Starting at \$995

For passive component measurement, the new standards in value are the SR720/715 LCR meters from SRS.

Meters that offer significant advantages in performance and price. Performance like .05% basic accuracy, 100 kHz test frequency, and fast measurement rates up to 20 per second. Features like a built in Kelvin fixture, averaging, binning and limits, stored setups, and quick calibration. With the standard RS232 and optional GPIB and Handler interfaces, the SR720/715 solves your incoming inspection and automated test needs. All for a price well below what you'd expect.

Call (408)744-9040 today for more information.

**SR720** **\$1995**

- 0.05% basic accuracy
- 100 Hz to 100 kHz measurement frequency
- Two 5 digit displays for simultaneous readout of major and minor parameters.
- Auto, R+Q, L+Q, C+D, C+R, Series and Parallel measurement modes
- 100 mV to 1.0 V test signals
- Internal and External Bias
- Binning and Limits for production testing and component inspection.
- RS232 interface
- GPIB and Handler interface (optional)

**SR715** **\$995**

- Same as SR720 except:
- 0.2% basic accuracy
- 100 Hz to 10 kHz measurement frequency



**STANFORD RESEARCH SYSTEMS**

1290 D Reamwood Avenue, Sunnyvale, CA 94089  
TEL (408)744-9040 FAX 4087449049

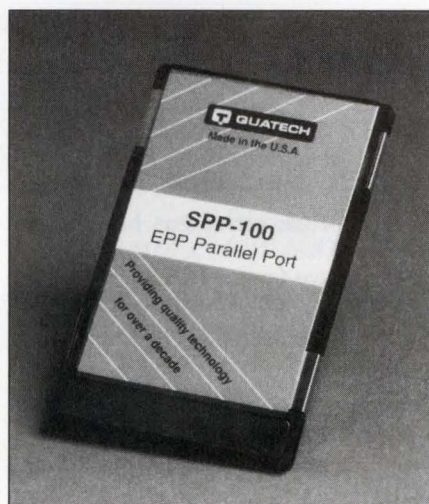

**PCMCIA card adds enhanced parallel port.** The SPP-100, a Type II PCMCIA card, is configurable either as a standard parallel port or as an enhanced parallel port (EPP), as defined by the IEEE 1284 specification. A DOS client driver, compatible with PCMCIA Card Services Specification 2.1, configures the card. A separate enabler program allows use without Card Services and Socket Services installed. A cable provides a D-25 connection. \$195. **Quatech Inc**, Akron, OH. (216) 434-3154. **Circle No. 413**



# "When I Call Allied, There's More On The Line Than Parts."

At Allied Electronics, every time our phone rings, we know there's more riding on that call than just parts. That caller is putting his project on the line. Or his reputation. Or, if it's a start-up company, he may be putting the company's future on the line.

They call Allied because we understand what's at stake. They call because they expect results.  
**And we deliver.**

## ALLIED IS DIFFERENT

For over 65 years, we've earned the confidence of engineers by being more than simply the best catalog in the industry. Our special Allied brand of personal service means our customers get what they've come to expect and more. Like the engineer who wasn't sure what kind of connector he needed to finish his prototype. The local Allied sales office and our product manager figured it out and the next morning the connector was on the engineer's desk. Our customers know that we become a part of their team. And with more than 80 local Allied offices,

***we're there when our customers need us because we realize there's a person at the end of the line.***

Same day  
shipment

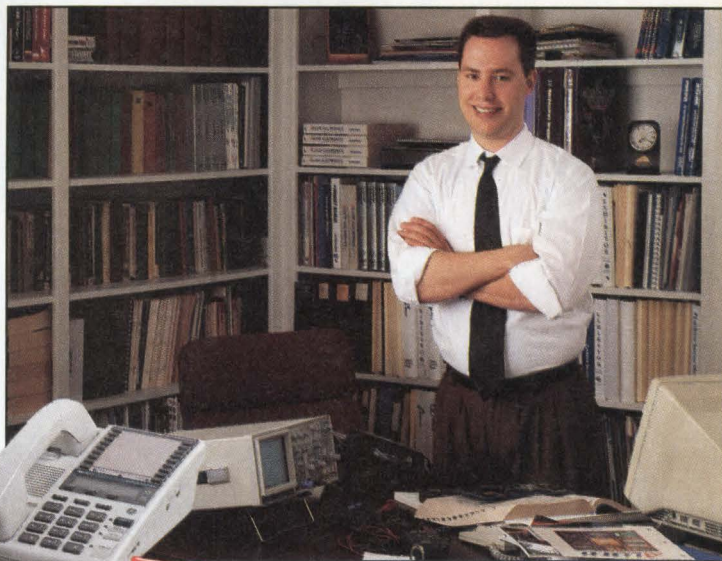

**NEW!**

The Allied Electronics  
Engineering Manual  
& Purchasing Guide

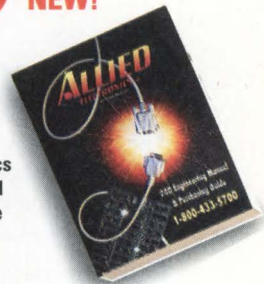

## MORE THAN A CATALOG

Our catalog is called an Engineering Manual and Purchasing Guide for a reason. The drawings, specifications and tables give more useful information to working engineers than just lists of part names and numbers that you see in other catalogs. And beyond the limits of the printed page, each of our service representatives has on-line access to our own and Avnet warehouses with inventory worth hundreds of millions of dollars.

***Expect the best.  
Call today for your free  
Engineering Manual  
& Purchasing Guide.***

Convenient ordering on  
accounts, credit cards or COD



More than 80 local offices

**ALLIED ELECTRONICS INC.**  
AN AVNET COMPANY

**Going by the book...And beyond!  
1-800-433-5700**

# The **Century** Series

## A New Era in VF Displays

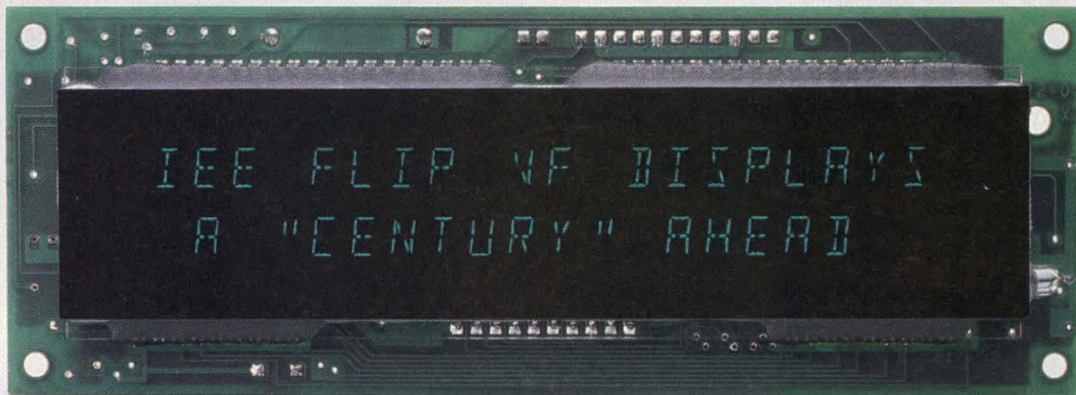

Actual Size

### Versatile, Compact, High-Performance... Value Priced!

For nearly fifteen years IEE has been a premier supplier of Vacuum Fluorescent Display modules. We have manufactured nearly one million FLIP displays for hundreds of customers, filling virtually every conceivable industrial application.

Now, IEE introduces the new FLIP "Century Series" line of low-cost segmented VF displays. Utilizing a 14-segment "star-burst" font, these modules display standard 64-character ASCII upper case alphanumeric with the light-emitting readability and quality of far more costly displays.

The new "Century Series" modules are the most versatile ever. They offer a unique jumper-selectable multiple processor interface, requiring no external circuitry accommodations. All "Century Series" modules interface to Intel or Motorola host processors.

Choose your data interface – both 8 bit parallel and EIA-232C serial at baud rates up to 19.2Kb are included. Hardware and software reset features, plus an extensive self-test routine are standard in all models.

Software controls include vertical and horizontal scroll modes, multiple level dimming control, multiple blink rates/fields, and

a unique, selectable "screen-saver" dimming or full display blanking feature for increased tube life in "constant-on" applications.

Very low power 5VDC operation is standard (1.5 watts typical), along with a wide industrial-duty -20 to +70°C operating temperature range (-40/+85 extended range, and conformal coating are standard factory options).

State-of-the-art low-profile surface mount technology yields super-compact packages to solve your most demanding space problems. These high-performance displays are also the answer to your most cost-sensitive applications and can effectively replace LCD modules to enhance the appearance and functionality of your product.

The six models listed below will cover application needs from arms-length instrument use to jumbo annunciators. The FLIP "Century Series" sets a new industry standard for low-cost segmented vacuum fluorescent displays.

IEE provides solutions for all your front panel needs: displays, keyboards, integrated panels and more. Contact us today for a problem-free tomorrow.

IEE is a sustaining member of **SID**

Model	Display Format	Character Height	Package Size:		
			Length	Width	Depth
03702-020-05220	2x20	5mm	5.65"	1.98"	0.82"
03702-021-08110	1x10	8mm	5.00"	1.60"	0.90"
03702-022-13112	1x12	13mm	7.20"	2.40"	0.90"
03702-024-09116	1x16	9mm	6.70"	2.30"	0.90"
03702-026-09120	1x20	9mm	8.30"	2.35"	0.95"
03702-029-13120	1x20	13mm	10.20"	1.93"	0.96"



**DISPLAYS**  
**KEYBOARDS**  
**INTEGRATED PANELS**

**INDUSTRIAL ELECTRONIC ENGINEERS, INC.**  
7740 Lemona Avenue  
Van Nuys, California 91409-9234  
Tel 818-787-0311 ext. 418 • Fax 818-901-9046  
Immediate Response Circle 103

## COMPUTERS & PERIPHERALS

### DRAM cards hold 2 to 32 Mbytes.

The new Type I, 88-pin DRAM cards, each about the size of three credit cards stacked, are JEDEC/JEIDA compliant and hold 2, 4, or 8 Mbytes of data. Versions to be available later this year will hold 16 and 32 Mbytes. The cards are available with 16- and 18-bit memory, with and without parity, respectively. Memory-access time is 60 nsec. Prices range from \$107 (2 Mbytes, no parity) to \$370 (8 Mbytes with parity). **Motorola Inc.**, Austin, TX. (512) 933-6700.

Circle No. 414

### Computer board combines Pentium and PCI bus.

The LBC4500 connects a Pentium processor with the PCI local bus in a single-board computer for a passive backplane. The card is designed for use with the manufacturer's LBP14 passive backplane, which provides four PCI slots and eight ISA slots. From \$3295. **Diversified Technology**, Jackson, MS. (800) 443-2667.

Circle No. 415



### Disk drives increase capacity and performance.

Models 425, 850, and 1275 in the Filepro Advantage disk-drive family offer formatted capacities of 425, 850, and 1275 Mbytes, respectively. All models are available with either an Enhanced IDE or SCSI-2 interface. The drives support PIO Mode 4, the IDE specification for transferring data at 16.7 Mbytes/sec, and also DMA Modes 1 and 2, for transfer rates of 13.1 and 16.7 Mbytes/sec, respectively. Model 425, \$255; Model 850, \$399; Model 1275, \$599. **Conner Peripherals Inc.**, San Jose, CA. (408) 456-4500.

Circle No. 416

### Computer board has 100-MHz 486.

The Little Board/486 DX4 puts a 100-MHz 486 and other functions of a PC/AT motherboard into the profile of a

5.25-in. disk drive. With three or four expansion cards, the total space consumed equals a half-height drive. The board accepts PC/104 modules for onboard expansion. \$1950 (100). **Ampro Computers Inc.**, Sunnyvale, CA. (408) 522-2100.

Circle No. 417

### PCI and VL cards combine graphics and video.

The Imascan boards, available for the PCI and VL buses, combine with an attachable Chroma

module to graphics acceleration, video frame grabbing, and video-in-a-window display. The boards use the Tseng ET4000/W32P graphics processor for 800×600 displays of 24-bit color; a single frame buffer holds both graphics and video display data. Video input via the Chroma module can be RS-170, NTSC, PAL, or SECAM in 16- or 24-bit color or monochrome. Imascan with Chroma module, \$1195. **Imagraph Corp.**, Chelmsford, MA. (508) 256-4624.

Circle No. 418

# VME PERSPECTIVE

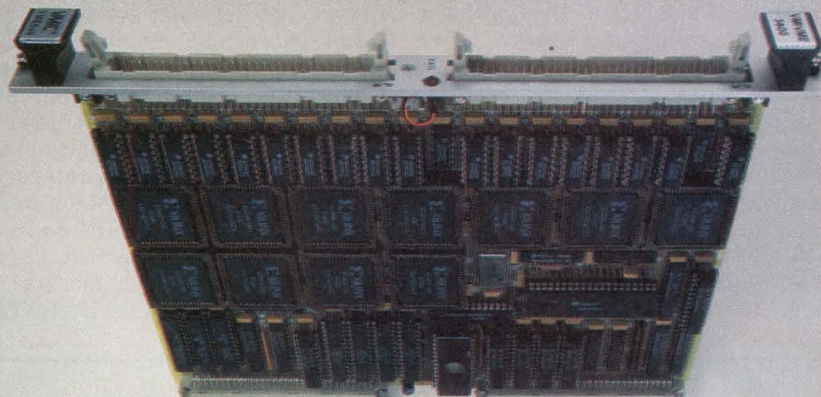

VMIC offers over 100 VMEbus products with a two year warranty, 24 hour technical support and immediate delivery. Our perspective on VME is unsurpassable, just like the people at VMIC.

PC/AT CPU'S • Host Computer Interfaces & Adapters • Reflective Memory • VME-to-VME Links • VMEbus Repeater Links • Digital, Analog & Serial I/O Boards • Synchro/Resolver Boards • Global Resource Boards • Intelligent & Universal I/O Controllers

Applications include Factory Automation, Process Control, Simulation and Training, Data Acquisition, Control and Plant Monitoring.

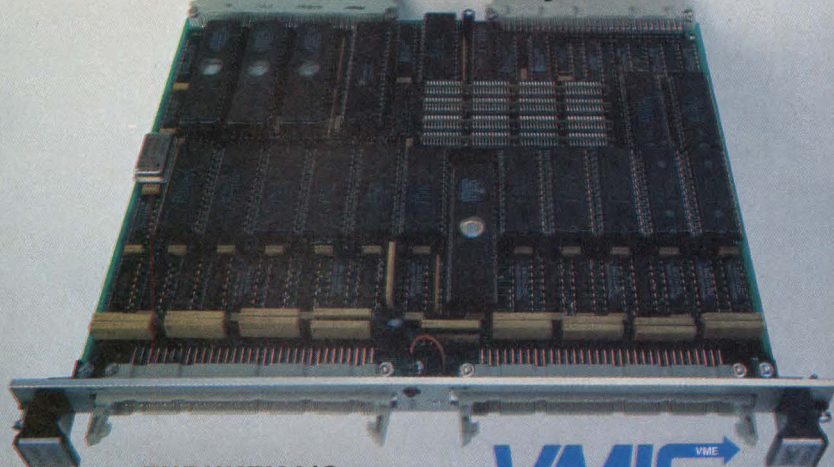

TURNKEY I/O  
SUBSYSTEM  
SOLUTIONS

**VMIC** VME  
VME Microsystems  
International Corporation

**TWO YEAR WARRANTY**

**1-800-322-3616**

12090 South Memorial Parkway • Huntsville, AL 35803-3308 • (205) 880-0444 • FAX (205) 882-0859  
VMIC products are internationally represented by distributors throughout the world. Call or fax VMIC for complete information.

# EDN-NEW PRODUCTS

## ELECTRONIC DESIGN AUTOMATION

**Software lets you simulate and test ATM network designs.** ATM Modeler is a software protocol analyzer for testing circuit designs developed for asynchronous transfer mode (ATM) networks. Used with the company's Optium simulation environment, the tool provides a customizable test environment capable of simulating ATM networks with up to 4000 end systems and a variety of network traffic. \$35,000. **Vantage Analysis Systems Inc.**, Fremont, CA. (510) 659-0901.

Circle No. 500

**Graphical system design tool provides tighter integration with simulators.** Version 1.2 of DesignVision now has the ability to interact directly with VHDL and Verilog simulators from third parties. Not only can you describe behavioral models graphically, you can also set simulation breakpoints in the graphical diagram, display the current simulation state in the diagram, and step through simulation while displaying the simulation changes graphically. A debugging panel lets you step forward or back-

### FREE INFO, FREE POSTAGE

Use our postage-paid reader-service cards to get more information on any of these products.

ward through simulation time. The workstation-based software costs \$10,000, but, until October 31, 1994, your company can purchase its first copy for \$3000. **Vista Technologies Inc.**, Schaumburg, IL. (780) 706-9300.

Circle No. 501

**Spice simulator provides graphical results while the simulation is running.** The ICAP/4 Virtual Circuit Design Lab lets you avoid the traditional batch-mode simulation of Spice simulators and see graphical waveforms as the simulation progresses. While the simulator is running, you can alter circuit values and observe the effects instantly. An interactive stimulus mode lets you sweep component or model parameters and compare the changing circuit performance. A cross-probing tool lets you see node voltages and device currents

directly on the schematic. The software lets you use simulation breakpoints to stop simulation when a voltage, current, or computed device parameter satisfies a condition you set. Although the simulator directly accepts Spice netlists from all major schematic design tools, the included

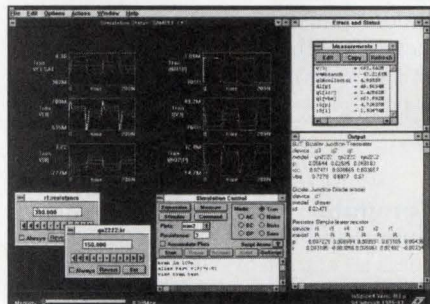

SpiceNet schematic design tool can drive the entire simulation process, including graphical circuit editing, Spice netlist generation, simulation control, circuit measurement, and waveform display. ICAP/4 costs \$2595 and runs under Windows, Windows NT, and on Macintosh systems. **Intusoft**, San Pedro, CA. (310) 833-0710.

Circle No. 502

**NEW**

# Power Manager

Low Value Chip Resistor  
.01 Ohms, 1% Tolerance

Dale's new WSL-2512 gives you the best combination of performance, size and cost available in a low value chip resistor. This new metal-strip surface mount resistor fits a standard EIA 2512 footprint and combines non-inductive construction with low noise and excellent high frequency performance.

Because it provides extremely low resistance values plus excellent stability, the WSL is ideal for efficient current sensing in power supply controller circuits and other power-saving circuitry including battery-operated PC's, "green" desktop PC's, handheld mobiles, low voltage lighting and many other applications. For complete information contact your Dale Representative or phone (402) 563-6506.

#### WSL-2512 SPECIFICATIONS

Power Rating	1 watt @ 70°C
Ohmic Range	.01 ohm to 1 ohm
Tolerance	±1%, tighter tolerances available
Temp. Coefficient	±75PPM/°C, lower TC's available
Inductance	.5nH to 5nH
Dimensions	.250" L x .125" W x .020" H [6.35] [3.18] [0.51]

DALE ELECTRONICS, INC., 1122 23rd Street, Columbus, NE 68601-3647  
For Literature only, FAX 1-800-835-4272

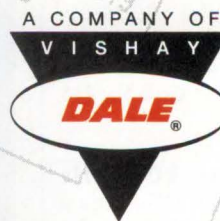
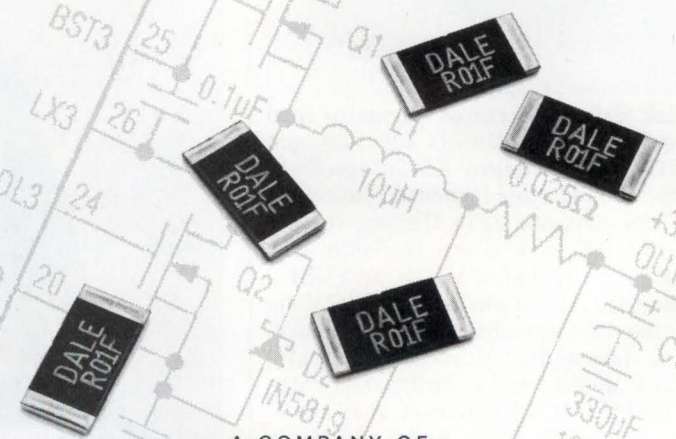

VISHAY ELECTRONIC COMPONENTS, U.S.: DALE®, ROEDERSTEIN, SPRAGUE®, VISHAY RESISTIVE SYSTEMS

# CACHE PROBLEM SOLVED.

50MHz Cache

Cache RAM tAA = 40ns - 12ns - 5ns - 3ns - 9ns = 16ns tAA

2 cycles clock to address latch delay derating 486 setup

50 SHEETS  
100 SHEETS  
22-141  
22-142  
100 SHEETS  
22-144  
ANALOG

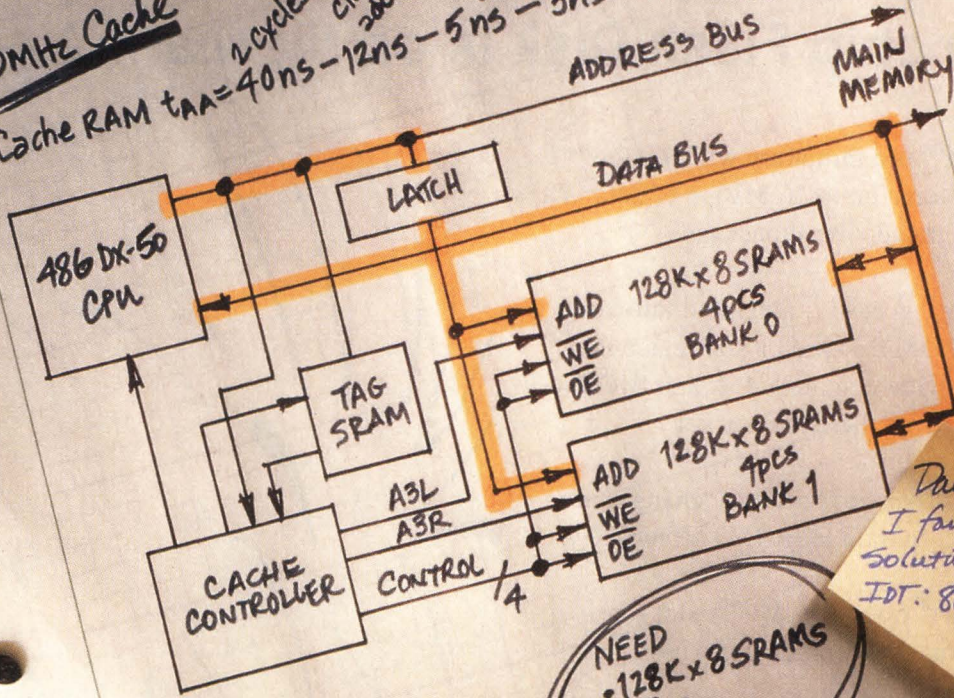

WANT  
• 1MB Cache size  
• Zero-wait-state performance  
• Minimal board space

NEED  
• 128Kx8 SRAMs  
• 15ns  
• 300mil SOJ

Dave  
I found the  
solution! Call  
IDT: 800 345-7015  
Mike.

## We'll provide the 15ns 128K x 8 300mil SOJ SRAMs for your first board!

IDT is the only 1Mb SRAM vendor to offer 15ns, 300mil SOJ SRAMs in volume, now. IDT's leading CMOS technology provides the performance and manufacturability to make the IDT71024 the ideal 1Mb SRAM for your design. Available in 300mil SOJ and 400mil SOJ/DIP packages, our 128K x 8 SRAM is the ideal solution for both high-density board designs and performance upgrades of existing systems. Interested? Call us or FAX in the coupon today to get technical data, application briefs, and details on our free 300mil SOJ 1Mb SRAM offer.

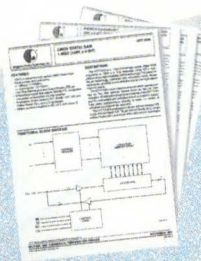

NAME \_\_\_\_\_

TITLE \_\_\_\_\_

COMPANY \_\_\_\_\_

ADDRESS \_\_\_\_\_

CITY \_\_\_\_\_ STATE \_\_\_\_\_ ZIP \_\_\_\_\_

PHONE (\_\_\_\_) \_\_\_\_\_

FAX (\_\_\_\_) \_\_\_\_\_

E-MAIL \_\_\_\_\_

**(800) 345-7015**  
**FAX: 408-492-8674**  
**ASK FOR KIT CODE 8101**



**Integrated Device  
Technology, Inc.**

# Honey *I shrunk the disk!*

Make *Flash* happen *today* with DiskOnChip™ !  
Single chip Flash Disk is *on the market now* !

DiskOnChip™ is a miniature with a large capacity. It stores up to 16 MByte of data in a standard integrated circuit package.

DiskOnChip™ is easily integrated into your system. EUROM designed it to replace the BIOS and provide complete disk and BIOS functionality from the BIOS socket.

No software drivers or hardware changes are needed to incorporate EUROM's technology.

DiskOnChip™ frees a PCMCIA slot for essential communication cards.

- 100% DOS compatible and fully bootable
- Pin to pin compatible replacement for system BIOS chip
- Embedded Flash File System software
- Single chip solution for space and weight savings
- Single 5 volt supply
- Low power consumption
- Non-volatile storage

Call or fax:



- **Headquarters: EUROM FlashWare Solutions Ltd.**  
Atidim Industrial Park Bldg. 1, P.O.B 58032, Tel Aviv 61580, Israel  
Tel: +972-3-490 920 Fax: +972-3-490 922
- **USA Office: EUROM FlashWare Solutions Inc.**  
4655 Old Ironsides Drive, Suite 200, Santa Clara, CA 95054  
Tel: 408-748-9995 Fax: 408-748-8408

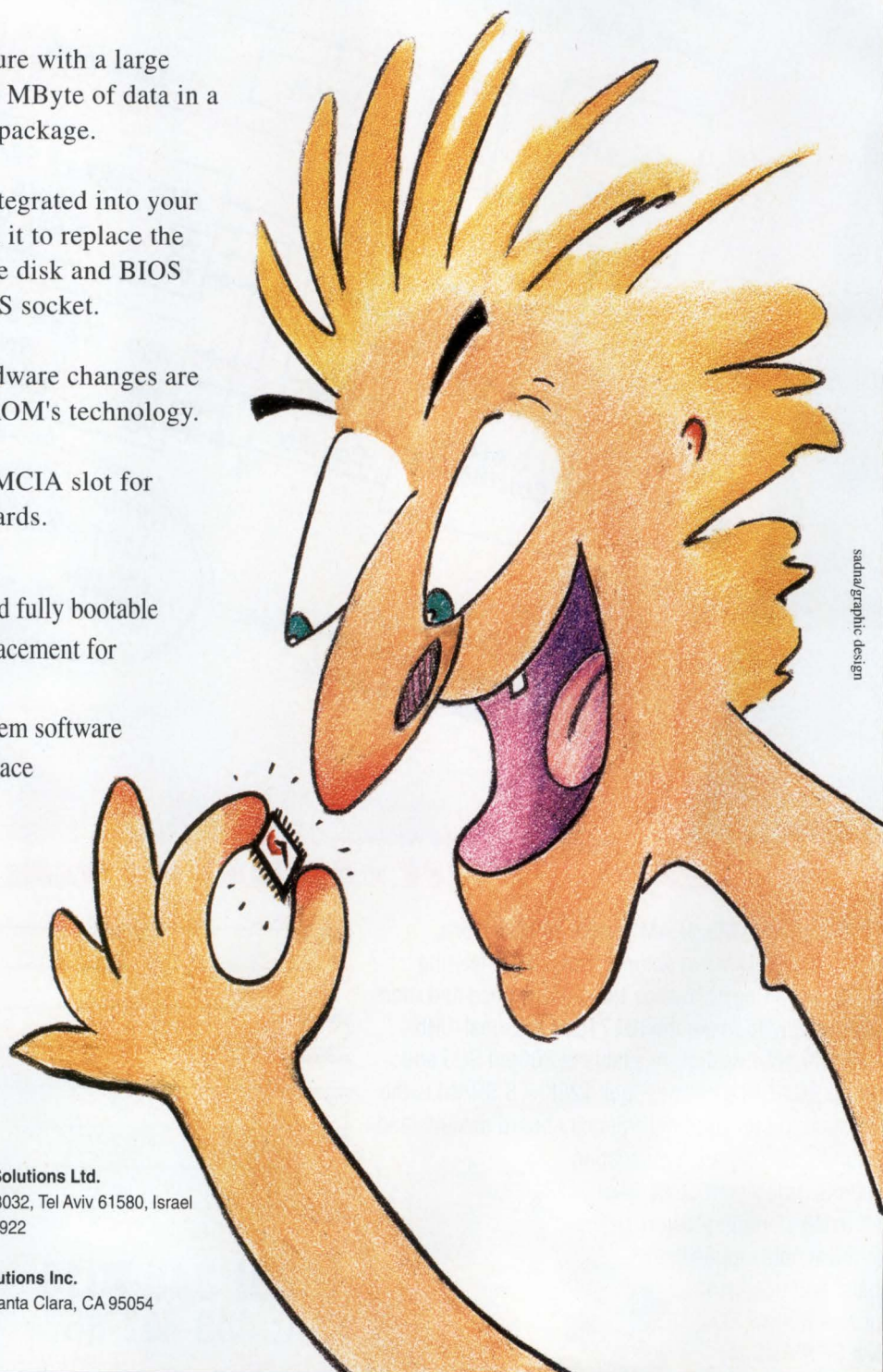

sadna/graphic design

**Timing-driven layout tool for ASICs improves performance and reduces die area.** The ChipBench product from IBM provides a complete top-down, timing-driven, physical-design tool for ASICs. The company claims the tool reduces design-cycle time, improves performance through shorter wiring delays, and reduces chip area. The workstation-based tool starts at \$246,000. **Altium Inc.**, San Jose, CA. (408) 534-4140. **Circle No. 503**

custom prototype hardware. The Paradigm RP turnkey prototyping system handles designs with up to 250,000 gates and starts at \$60,000. Concept Silicon costs \$28,000. **Zycad Corp.**, Fremont, CA. (510) 623-4400. **Circle No. 506**

models and parameters for submicron designs. The software will be available in the third quarter and starts at \$50,000. **Meta-Software Inc.**, Campbell, CA. (408) 369-5400. **Circle No. 507**

**Spice modeling tool for geometries below 0.5  $\mu\text{m}$ .** The Device Model Builder is a modeling and characterization tool to help you develop

**Automatic place and route tool speeds physical layout of ICs.** The PathFinder multilayer router features a window-routing architecture and a topology manager that lets you place

**Software tool lets you design and simulate communication systems using graphical blocks.** The Advanced Communication Link Analysis and Design Environment (Acolade) lets you model communication systems by stringing together models for each system block such as channel, transmitter, receiver, encoder, and decoder. The tool includes a wide variety of models that may be interconnected to describe virtually any conceivable system topology. Acolade for PCs costs \$8000; for Sun Sparc systems, the cost is \$12,000. **Amber Technologies Inc.**, Concord, MA. (508) 369-0515. **Circle No. 504**

## Great Things . . . Small Packages!

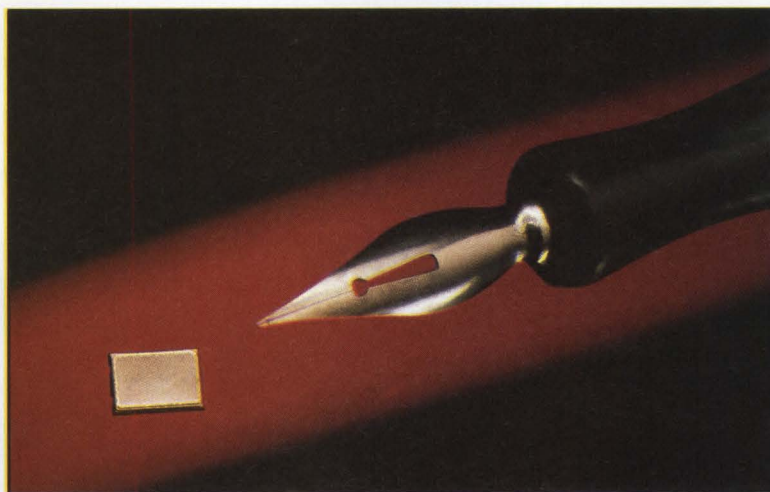

### Ecliptek Introduces the ECCM1 1.3 MM Ceramic SMT Crystal for PCMCIA

- Designed For All PCMCIA Applications
- Lowest Profile Industry Standard Package
- Gold Sealed For Optimum Performance
- Common Chipset Specifications In Stock
- Frequency Range From 11.0592MHz to 150.000MHz
- Tape And Reel Standard For Automatic Insertion

**Crystals • Clock Oscillators • Inductors**

*For Further Information, Contact:*



**ECLIPTEK**  
CORPORATION

3545 Cadillac Ave. • Costa Mesa, CA 92626  
Fax: (714) 433-1234

**1-800-ECLIPTEK**

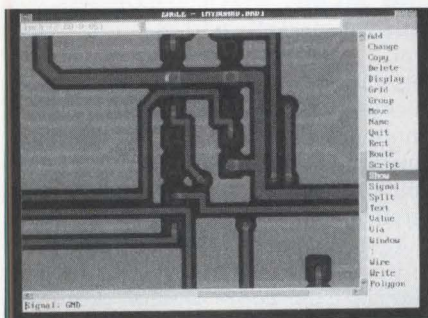

**Schematic capture and pc-board layout software takes advantage of 32-bit system.** Running on 386 or higher PCs under DOS, Eagle 3.0 runs in the 32-bit protected mode and is able to use the entire system RAM. The software includes schematic entry, a layout editor, and an autorouter. \$1897. **CadSoft Computer Inc.**, Delray Beach, FL. (407) 274-8355. **Circle No. 505**

**Partition large designs into multiple FPGAs for rapid prototyping.** The Concept Silicon partitioning software is aimed at the developers of real-time and DSP ASICs and systems. The software provides a complete set of graphical tools for mapping a design onto either the company's Paradigm RP configurable hardware architecture or

# PICO

## ULTRA-MINIATURE Surface Mount Audio Transformers

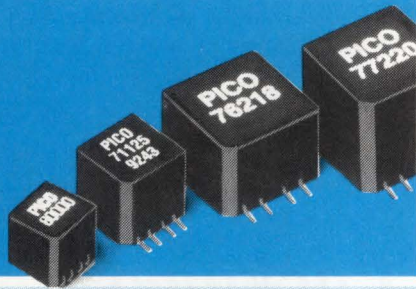

Low Profile  
.2" Ht.

- Manufactured and tested to MIL-T-27
- Frequency range 20 Hz to 250 KHz
- Available from 100 milliwatts to 3 watts
- Impedance from 20 ohms to 100 K ohms
- Operating temperature -55°C to +130°C
- Low profile .2" ht.

PICO surface mount units utilize materials and methods to withstand extreme temperature (220°C) of vapor phase, I.R., and other reflow procedures without degradation of electrical or mechanical characteristics.

Delivery—  
stock to one week

See EEM  
or send direct  
for Free PICO Catalog.

Call toll free **800-431-1064**  
in NY call **914-699-5514**  
FAX **914-699-5565**

**PICO Electronics, Inc.**

453 N. MacQuesten Pkwy., Mt. Vernon, N.Y. 10552  
CIRCLE NO. 123

160 • EDN July 7, 1994

## EDN-NEW PRODUCTS

### ELECTRONIC DESIGN AUTOMATION

and route complex ICs up to four times faster than previous tools from the company with density improvements of 20 to 30%. The tool uses global routing information to generate chip layout topologies early in the design cycle that will meet timing requirements and reduce layout iterations. PathFinder for gate and embedded arrays is available now, and versions for cell-based designs will be available in the fourth quarter. From \$200,000. **Compass Design Automation**, San Jose, CA. (408) 433-4880. **Circle No. 508**

**Signal-integrity tool includes new IBIS modeling specifications.** The I/O Buffer Information Specification (IBIS) 1.1 includes capabilities for simulating open-drain and open-collector driver ICs. Because the models are tailored specifically for signal-integrity simulation, they offer Spice-level accuracy while simulating faster. LineSim Pro V3.2 includes the new IBIS features and costs \$1295. **HyperLynx Inc.**, Redmond, WA. (206) 869-2320. **Circle No. 509**

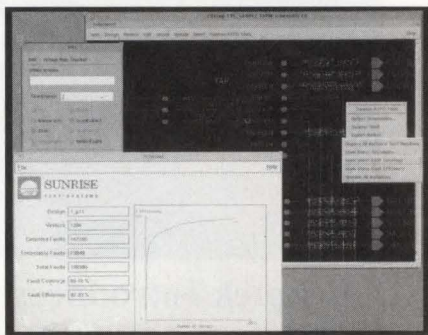

**Automatic test-pattern-generation software offers test logic synthesis.** The 2.0 version of TestGen offers improvements in full scan performance, IEEE 1149.1 JTAG support, and test logic synthesis. The tool can automatically select and implement the most effective test methodology for each portion of a complex circuit design in a single pass. The tool may insert full scan, partial scan, or use nonscan design for test techniques where scan cannot be inserted. TestGen 2.0 starts at \$75,000; the test-synthesis option costs \$25,000. **Sunrise Test Systems Inc.**, Santa Clara, CA. (408) 980-7600. **Circle No. 510**

**Create reprogrammable prototype for ASICs.** The Logic Animator lets you create reprogrammable proto-

types of ASICs containing as many as 50,000 gates. The software for creating the prototypes costs \$60,000 and the FPGA-based reprogrammable hardware costs \$30,000 per unit. Volume production is scheduled for the third quarter. **Quickturn Design Systems**, Mountain View, CA. (415) 967-3300. **Circle No. 511**

**Device modeling and characterization tool adds submicron MOS-FET model capability.** The BSIM3 model was developed specifically for modeling submicron MOSFETs. The model accurately represents short-channel effects and can predict scaling effects on output characteristics in advance of your process capability. BSIM3 is part of the Success device modeling and characterization tool that interfaces to the company's analog simulator and to analog simulators from other companies. The complete Success system costs \$25,000. **Anacad EES**, Milpitas, CA. (408) 954-0600. **Circle No. 512**

**Design tool lets you explore a variety of tradeoffs in pc-board and MCMs.** EDNavigator lets you work concurrently with electrical, thermal, routability, partitioning, packaging, and component-placement issues to arrive at an optimum design with a minimum of iterations. The tool is available with a variety of modules that let you configure a system to suit your requirements. EDNavigator runs on workstations and is priced from \$10,500 to \$45,000, depending on configuration. **Harris Electronic Design Automation Inc.**, Fishers, NY. (716) 924-9303. **Circle No. 513**

## SHORTS

VCS 2.1 now provides back annotation of delays and other functions, enabling the Verilog simulator to be used as a sign-off simulator. The simulator costs \$40,000. **Chronologic Simulation**, (415) 965-3312. **Circle No. 514**

The Aida II automatic test-pattern-generation software now includes a partial scan test capability. \$49,000. **Crosscheck Technology Inc.**, (408) 432-9200. **Circle No. 515**



# WITH TDK YOU'LL ALWAYS HAVE THE WINNING HAND.



CERAMIC CAPACITORS, INDUCTORS, TRANSFORMERS, EMI FILTERS, MAGNETS AND MORE - any combination of TDK products will always give you a royal flush.

TDK offers the most complete selection of advanced electronic components, specially suited for your strictest surface mount technology requirements.

We're your one-stop shop for passive electronic components used in applications for: automotives, consumer electronics, computers, telecommunications and more.

Play your cards right, and with TDK you can create systems that work as effectively and reliably as possible.

Whatever your electronic component needs, you can bet TDK has the answer.

**ELECTRONIC COMPONENTS DIVISION**

- DIRECT/OEM
- DISTRIBUTION
- FACTORY AUTOMATION



SEE US AT THE ELECTRO SHOW  
BOOTH # 4534

TDK CORPORATION OF AMERICA 1600 Feehanville Drive, Mount Prospect, IL 60056, USA Phone: 708-803-6100 INDIANAPOLIS Phone: 317-872-0370 NEW YORK Phone: 908-494-0100 SAN FRANCISCO Phone: 408-437-9585 LOS ANGELES Phone: 310-539-6631 DETROIT Phone: 313-462-1210 BOSTON Phone: 508-624-4262 HUNTSVILLE Phone: 205-464-0222 GREENSBORO Phone: 910-292-0012 DALLAS Phone: 214-506-9800  
CEL, TDK's Component Engineering Laboratory in Torrance, CA, can custom design and test manufacture TDK EMI/RFI suppression components to meet your specific requirements. For more information, call (213)530-9397. TDK CORPORATION Tokyo, Japan



**5 1/2-digit DVM attaches to PC's parallel port.** Unlike classical handheld meters, the 1.41×3.75×6.3-in. Intelligent DVM includes no display; it uses your PC to present its readings. The \$299.95 autoranging unit (1-range version: \$239.95) offers an error of ±0.01% of full-scale-range (FSR) and a ±0.015% FSR/°C temperature coefficient. A \$339.95 unit reduces errors by 40% and is 1/10 as sensitive to temperature. On the most sensitive range, the units resolve 100 nV; the least sensitive FSR is ±200V. A differential multiplexer scans eight inputs; there are two digital outputs. Conversion speed is 13

## FREE INFO, FREE POSTAGE

Use our postage-paid reader-service cards to get more information on any of these products.

readings/sec. Windows-based software provides full control; it converts readings to engineering units and displays data as numbers or graphs. **Delta Quest**, San Jose, CA. (408) 997-8644.

Circle No. 420

## ISA bus DSO boards use sequential sampling to capture 300-MHz repetitive signals.

The single-channel PCI-425 (\$1695) and the 2-channel PCI-435 (\$2695) have 50Ω inputs. Although they do not acquire single-shot transients, their bandwidth rivals that of many high-speed benchtop scopes. The BenchCom software that accompanies each unit lets you set up the boards and integrate them into your system. A \$495 package called BenchTop lets you store and recall setups and waveforms. Delivery, 6 weeks ARO. **PC Instruments Inc.**, Twinsburg, OH. (216) 963-0800.

Circle No. 421

## Software tool lets you program DSP applications in Visual Basic.

WinSpox enables users of Visual Basic for Windows to control compute- or I/O-intensive operations with a minimum of programming effort. The package works with PCs equipped with fixed- or floating-point DSPs manufactured by TI and Analog Devices. WinSpox doesn't care whether the target resides on the PC motherboard or on an ISA bus add-in card; it does require that the target be running Spox V2.0, the vendor's DSP operating system. WinSpox includes a VBX (Visual Basic Extension) that permits interaction with the Windows Resource-Management Interface (RMI). \$3000. **Spectron Microsystems**, Goleta, CA. (805) 968-5100.

Circle No. 422

## ISA bus board captures analog signals at 60M samples/sec.

The 30-MHz-bandwidth CompuScope 6012 resolves 12 bits. It can capture two channels simultaneously at 30M samples/sec, or one channel at 60M samples/sec. The board, which includes 512k samples of capture memory, can address 8M samples. Signal-to-noise

# Few words can describe the

Need to know more?  
Phone or fax Grayhill.  
Ask for Engineering  
Catalog No. 1 and  
information about the  
1/2" diameter Series 26,  
binary coded or Gray  
coded rotary switch. It's  
the last word in  
reliability!

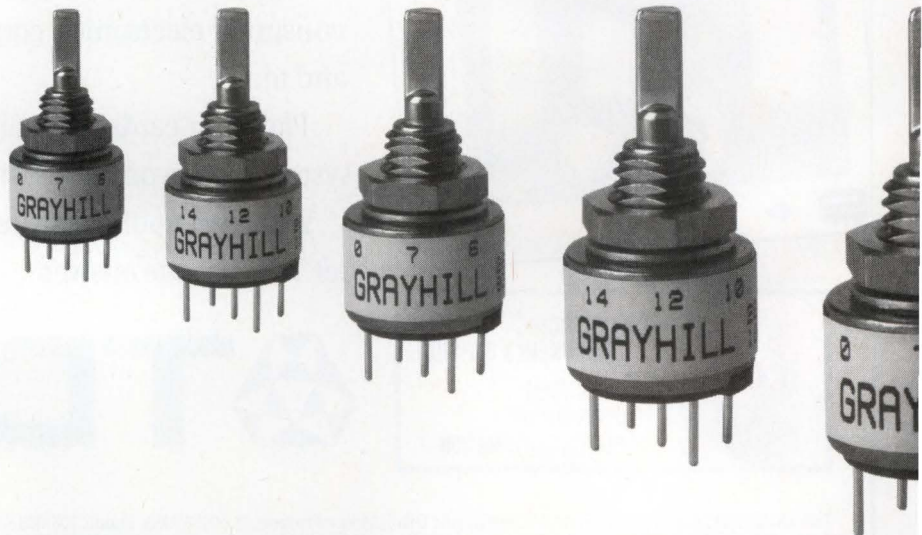

## TEST & MEASUREMENT

ratio is 62 dB at the maximum sampling rate. Real-time software calibration reduces the offset and gain temperature coefficients to 20 ppm/°C. Software drivers permit transferring data to a 486 PC's extended memory at 1.5M words/sec. \$6995. (Upgrade from the vendor's CompuScope 1012: \$2500.) **Gage Applied Sciences Inc**, Montreal PQ, Canada. (514) 337-6893.

Circle No. 423

### Data-acquisition boards offer "hands-off" setup and calibration for under \$1000.

The \$995 DT31-EZ and the \$895 DT34-EZ, which lacks D/A outputs, take up to 330k 12-bit samples/sec. Except for address settings, the units are completely free of analog trims and digital jumper or switch settings. Data-transfer modes include 1- and 2-channel DMA, programmed I/O, and fast transfers (330k samples/sec on 486-based PCs) using the REPINSW (repeat instring word) instruction. A 512-point channel-gain memory lets you select different gains for each channel. You can connect 16 single-ended or eight differential signals, and you can select gains of 1, 2, 4,

or 8 under software control. The inputs, which tolerate  $\pm 35V$  continuously with power on ( $\pm 20V$  with power off), withstand electrostatic discharges of 1.5 kV. Each board includes eight TTL I/O lines and complies with FCC Class-A electromagnetic-interference standards. **Data Translation Inc**, Marlboro, MA. (508) 481-3700. **Circle No. 424**

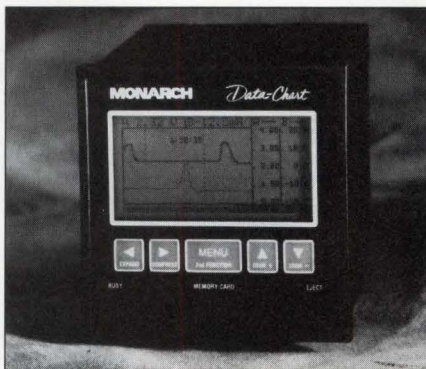

**Paperless recorder captures data for over 9½ years.** The ¼-DIN-size, panel-mounted, line- or dc-powered Data-Chart has one or two channels. The unit can record as fast as 100 sam-

ples/sec or as slowly as 1 sample/10 min. It stores from 64k to 512k 8-bit samples in a nonvolatile PCMCIA card; an internal 16k-sample memory holds new data while you change cards. A back-lit 2.9×1.5-in. 160×80-pixel LCD presents the latest data or lets you look at previously acquired signals. You can equip the unit with several types of signal conditioning, including linearization and cold-junction compensation for three types of thermocouples. From \$670. **Monarch Instrument**, Amherst, NH. (603) 883-3390. **Circle No. 425**

### VMEbus plug-in triggers on anomalies and does 96-channel, 200-MHz timing analysis.

The Timbat-PB plugs onto the vendor's VBT-325, a VMEbus analyzer that occupies a single VMEbus slot. The resulting product performs state and timing analysis, automatically detects timing violations, and creates a cycle-by-cycle screen display of bus addresses and data. The 200-MHz timing analyzer can trigger on any combination of 1, 0, and don't-care signals qualified by pattern duration. \$5995. **VMetro Inc**, Houston, TX. (713) 584-0728. **Circle No. 426**

# reliability of our new switch.

MEETS  
VI SIGMA  
STANDARD



**Grayhill**  
INC.

An ISO-9001 Company

561 Hillgrove Avenue  
P. O. Box 10373  
LaGrange, Illinois 60525-0373 USA  
Phone: 708/354-1040  
Fax: 708/354-2820

CIRCLE NO. 87

## EDN-NEW PRODUCTS

### TEST & MEASUREMENT

#### 1M-sample/sec ISA bus ADC boards offer simultaneous sampling and a differential programmable-gain amplifier per channel.

The Win-30PGSH (gains of 1, 2, 4, and 8) and the Win-30PGSL (gains of 1, 10, 100, and 1000) accept eight differential signals. Each channel has its own sample-and-hold circuit and differential-input programmable-gain amplifier. This configuration eliminates delays associated with settling of an amplifier shared by multiple channels. The 12-bit

ADC converts a single input 750,000 times/sec, but its speed rises as it scans more channels. When it scans four or more channels, it makes a total of 1M conversions/sec. \$2250. **United Electronic Industries**, Watertown, MA. (617) 924-1155. **Circle No. 427**

**16-bit ISA bus data-acquisition board costs \$995.** The LDAS-16-AC takes 50,000 samples/sec and provides 16 TTL I/O lines. The board itself

accepts 16 single-ended or eight differential inputs. An expansion multiplexer allows up to 256 analog inputs. C-language libraries cost \$295. **Analogic Corp**, Peabody, MA. (508) 977-3000.

**Circle No. 428**



#### Handheld device programmer also functions as ROM emulator.

The \$795, battery-powered Orbit 32 programs EPROMs to 8 Mbits, EEPROMs, and flash devices as well as some CMOS PROMs and serial EEPROMs. It accepts DIPs with up to 32 pins in rows whose center-to-center spacing ranges from 0.3 to 0.6 in. The unit, which operates in 8-, 16-, and 32-bit modes and also functions as a ROM emulator, has a user interface that is based on a splash-proof membrane keypad and a 4-line x 20-character alphanumeric display. In many cases, the unit allows you to edit a device's contents while emulation is in process. **Stag Microsystems Inc**, Santa Clara, CA. (408) 988-1118.

**Circle No. 429**

#### Units convert 8- and 16-bit SCSI bus from single-ended to differential and back and extend bus up to 56m.

These SCSI bus converters and extenders let you mix single-ended and differential units on the bus. Operation is automatic and does not require programming. Versions are available for SCSI-1 and -2, and for SCSI-2 Fast and SCSI-2 Wide. Packaging options include open boards for OEM use and fully encased units with power supplies. Some configurations even include cables. Prices range from \$300 to \$1550. **Ancot Corp**, Menlo Park, CA. (415) 322-5322.

**Circle No. 430**

#### 2-channel frequency synthesizer covers 100 kHz to 310 MHz with 0.1-Hz resolution.

The PTS 310 contains two independent synthesizers. Phase noise is -115 dBc/Hz at a 1-kHz offset from the carrier, spurious out-

# HANSEN

## THE BEST THING GOING.

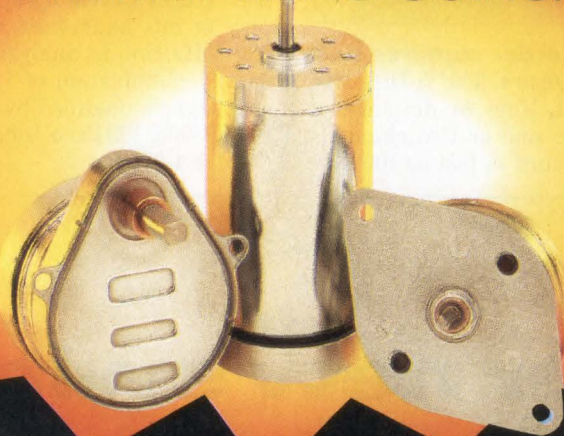

Hansen's precision motors have a reputation for efficient and productive service...even under the most demanding conditions.

**DC Motors.** High performance, long life and reasonable costs are characteristic of Hansen's DC motors, ideally suited for a number of applications.

**Stepper Motors.** Generate precision motion control with a Hansen stepper motor. A wide range of sizes (from 14 through 28) are utilized by our customers in the computer, office machine, medical equipment and automotive industries.

**Synchronous Motors.** Hansen is a leader in synchronous motor technology and proudly supplies millions of synchronous motors annually for a variety of applications. Hansen's built-in quality and on-time delivery are supported by our customer service.

We will work with you to custom design the motor for your specific needs and match your application with the correct power source.

Tomorrow's ideas for today's technology...that's what Hansen is all about. Our motors are simply the best things going.



## Hansen Corporation

Hansen Corporation  
A Minebea Group Company  
P.O. Box 23 • Princeton, IN 47670-0023  
Phone: 812-385-3415 • Fax: 812-385-3013

**CIRCLE NO. 193**

Very Small, Very Fast, Very Smart

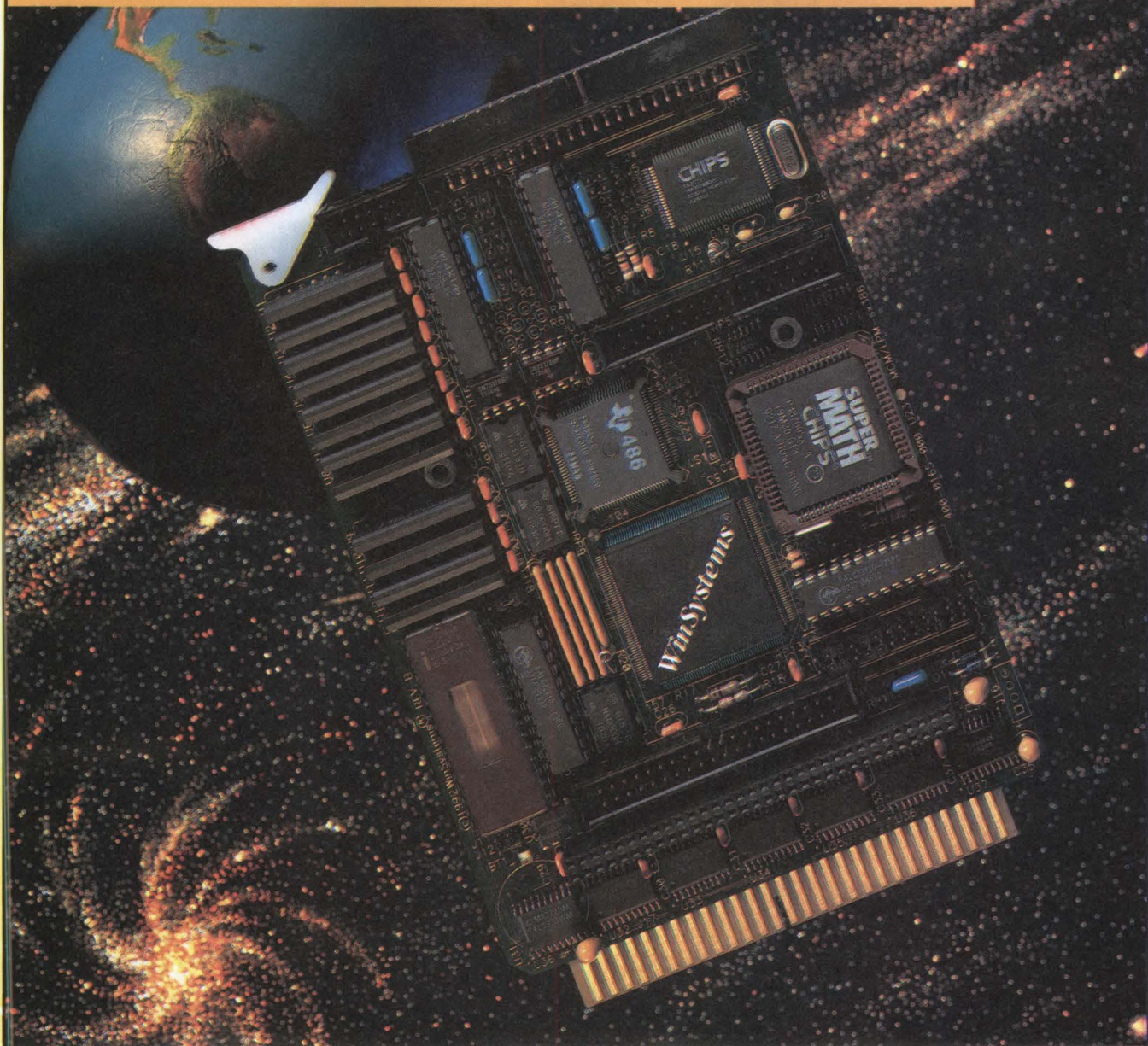

The Universe of high-performance, affordable, embedded system design expands with WinSystem's SBCs. Select 386/486 CPUs for standalone use. Or expand with the STD or PC/104 Bus. Unparalleled flexibility for space and budget-limited applications requiring PC performance and compatibility in harsh or remote environments.

Call or write for a *free* Catalog and Poster.

**WinSystems®**

**THE EMBEDDED AUTHORITY™**

715 Stadium Drive • Arlington, Texas 76011 • Phone 817/274-7553 • FAX 817/548-1358

# Your clock has the jitters? We can help!



AKM's Stereo DACs don't mind a little jitter. Or even a lot! Up to 100ns is no problem. AKM's unique architecture provides high tolerance to clock jitter, ideal monotonicity and low distortion—all without trimming. Choose AKM's low cost, easy-to-use DAC products for any application—digital CATVs, satellite receivers, digital audio systems, digital music keyboards, digital sound recording systems, CD players, etc. AKM delivers—price, performance, quality.

DAC Product Family

Device	# of bits	DR	S/N	THD + N	Special Features	Voltage
<b>New</b> AK4310	16	92dB	92dB	0.005%	<ul style="list-style-type: none"> <li>• High tolerance to clock jitter</li> <li>• On chip buffer</li> </ul>	3 ~ 5.5V
AK4316	16	90dB	90dB	0.01%	<ul style="list-style-type: none"> <li>• High tolerance to clock jitter</li> </ul>	+5V
AK4318	18	97dB	97dB	0.0025%	<ul style="list-style-type: none"> <li>• High tolerance to clock jitter</li> <li>• De-emphasis control circuit</li> <li>• Soft mute function</li> </ul>	+5V
AK4313	18	93dB	93dB	0.004%	<ul style="list-style-type: none"> <li>• High tolerance to clock jitter</li> <li>• De-emphasis control circuit</li> <li>• Soft mute function</li> <li>• Low voltage</li> </ul>	2.7 ~ 4.0V

For more information, please contact:

USA ——— 2055 Gateway Place, Suite 415, San Jose, CA 95110 Phone: (408) 436-8580/Fax: (408) 436-7591  
EUROPE — Avenue Louise 326, Bte 056, 1050 Brussels, Belgium Phone: (32) 2-649-7831 /Fax: (32) 2-640-1809



**Asahi Kasei Microsystems**

TS Bldg., 24-10, Yoyogi 1-chome, Shibuya-ku, Tokyo 151, Japan

CIRCLE NO. 66

# EDN-NEW PRODUCTS

## TEST & MEASUREMENT

puts are below  $-70$  dBc, frequency switching takes place in under  $20 \mu\text{sec}$ , and output power is  $+13$  dBm. Each channel has its own 50-pin parallel interface. A unit with an oven-controlled oscillator stable to  $\pm 10$  parts/billion from  $0$  to  $50^\circ\text{C}$  and  $1$  ppm/year costs  $\$8225$ . **Programmed Test Sources Inc**, Littleton, MA. (508) 486-3008. **Circle No. 431**

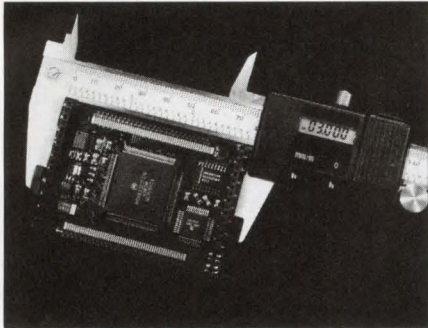

**1-oz, \$495 data logger teams 68332 and PIC16C64**  $\mu\text{Ps}$ . The  $2 \times 3 \times 0.5$ -in. Tattletale Model 8 accepts eight analog inputs, which it digitizes to 12 bits at up to 100k samples/sec. It includes 256 kbytes to 1 Mbyte of RAM, 128 kbytes to 1 Mbyte of flash EEPROM, two RS-232C ports, a real-time clock, and 25 digital I/O lines. For data-intensive applications, you can add a PCMCIA adapter. Support includes C and Basic libraries, technical notes, documentation, tools, and sample programs. Two mezzanine prototyping boards let you connect signal conditioning, communications, I/O, and memory circuits. **Onset Computer Corp**, Pocasset, MA. (508) 563-9000. **Circle No. 432**

**ISA bus boards expand digitizer's memory to 1 Gbyte, accept 200 Mbytes/sec.** The MEM500 board stores 32, 64, 128, or 256 Mbytes. It makes 32- and 64-bit data transfers via an auxiliary bus at speeds to 200 Mbytes/sec. The board was designed for use with the vendor's DA500 500M-sample/sec 350-MHz digitizer—you can connect up to four MEM500s to a DA500—but it is also available separately. Power required is 5V at 2.4A max.  $\$6950$  to  $\$34,900$ . **Signatec Inc**, Corona, CA. (909) 734-3001. **Circle No. 433**

**Add-in for 1-2-3 and Excel brings FFT capabilities to Windows spreadsheets.** FFTtools V2.0 is a DLL that calculates mixed-radix FFTs. It preprocesses data sets to remove the mean, pad the data with

zeros, truncate the data to speed calculations, or window the data with any of 17 taper functions. It also post-processes FFTs to center them at dc or make them single-sided, logarithmically compress their amplitude, scale them into physical units, compute power, or compute the phase of noisy data.  $\$99$ . Users' guide,  $\$25$ . Upgrade from FFTtools V1.0,  $\$39$  ( $\$29$  for registered users). **Integrated Scientific Resources**, Santa Monica, CA. (310) 453-6809. **Circle No. 434**

**PCMCIA data-acquisition card captures eight channels at 25k samples/sec.** The  $\$299$  PCM-DAS08 plugs into type II and III PCMCIA slots. Its 12-bit ADC converts at 25k, 12.5k, 6.25k, or 3.125k samples/sec. The standard input range is  $\pm 5\text{V}$ , but ranges of  $\pm 0.5\text{V}$  and  $\pm 0.05\text{V}$  are also available. The card has three CMOS digital outputs and two digital inputs. One of the inputs can act as a rising-edge trigger for the ADC. A  $\$49$  software package includes card and socket services, a uni-



### EAGLE-PICHER LITHIUM BATTERIES

# We've Been The Shape Of Things To Come For Over 150 Years!

No other battery can fit your application or maximize your circuit board space like Eagle-Picher's Keeper II Lithium series. For additional information about how we can fit all of your power supply needs, call an Eagle-Picher representative right now.

## EAGLE PICHER

COMMERCIAL PRODUCTS DEPARTMENT  
PO Box 180 • Seneca, MO 64865 • PH 417-776-2256 • FAX 417-776-2257



CIRCLE NO. 201

# EDN-NEW PRODUCTS

## TEST & MEASUREMENT

versal data-acquisition library, and calibration routines. **Computer Boards Inc.**, Mansfield, MA. (508) 261-1123.

Circle No. 435

### Data-acquisition software graphs to 110k points/sec in real time.

Snap-Master V3.0 can create real-time graphs of much of the data gathered by data-acquisition boards. Most competitive packages plot at speeds no faster than 15k points/sec, so they often must plot graphs from previously acquired data. Snap-Master achieves the 110k-point/sec speed using a 25/50-MHz 486DX2 PC with a graphics accelerator; plotting speed is 80k points/sec without the accelerator. New displays include dials, bar graphs, simulated LEDs, and digital meters. \$995 to \$2480. **HEM Data Corp.**, Southfield, MI. (313) 559-5607.

Circle No. 436

**Units test PCMCIA sockets.** PCCTest 350 series testers verify that PCMCIA sockets are working correctly. The  $\mu$ P-based units, which are PCMCIA cards themselves, verify all data, and address and control signals on sock-

ets that comply with V2.x of the PCMCIA standard. An on-board ADC measures the supply voltages. The accompanying software works with socket controller ICs from Intel, Vadim, and Cirrus Logic. An optional RS-232C interface permits connection of a terminal for interactive debugging. \$495 to \$795. **Sycard Technology**, Sunnyvale, CA. (408) 247-0730.

Circle No. 437

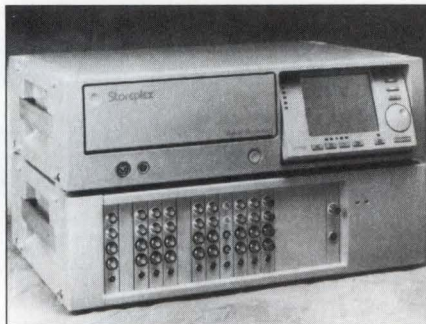

**Portable cassette-tape instrumentation recorder acquires digital as well as analog data.** The Storeplex Portable Instrumentation Recorder now accepts a digital record/replay

module that acquires data from sensors that have digital outputs. You can now also replace the unit's 2-channel analog record/playback modules with 4-channel record-only modules, thus doubling the channel capacity. A single S-VHS cartridge can store 69 Gbytes. From \$35,000. **Racal Recorders Inc.**, Irvine, CA. (714) 727-3444.

Circle No. 438

### 2-channel, 8-pole active filter tunes from 0.03 Hz to 1 MHz.

Both of the Model 3988's channels can operate as highpass or lowpass filters or voltage amplifiers with up to 70 dB of gain and a 7-MHz bandwidth. In the highpass mode, the maximum corner frequency is 300 kHz. Minimum high- and low-pass corner frequencies of 0.003 Hz are optional. You can pick Butterworth or Bessel characteristics with 48 dB/octave slope, and you can connect the two channels as one band-pass or band-reject filter. The inputs accept single-ended or differential signals at levels to  $\pm 10$ V. Prefilter gain adjusts in 10-dB steps; postfilter gain adjusts in 0.1-dB steps. \$2995. **Krohn-Hite Corp.**, Avon, MA. (508) 580-1660.

Circle No. 439

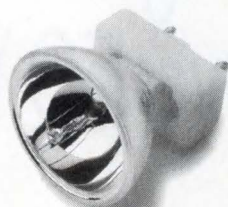

IT'S NEW...  
IT'S SMALL...  
IT'S BRIGHT...  
IT'S EFFICIENT.

**WA**<sup>®</sup>  
**Welch Allyn**

Lighting Products Division  
4619 Jordan Road, P.O. Box 187  
Skaneateles Falls, NY 13153-0187  
Phone: 315-685-4347  
Fax: 315-685-2854

IF YOU USE LAMPS,  
IT'S FOR YOU.

**FIND OUT.**

CIRCLE NO. 46

## HIGH POWER FACTOR

Custom Switching Power Supplies

- for ● Engineering work stations
- Computer main frames
- Computer peripheral equipment
- Business equipment
- Telecommunications
- etc.



- High power factor 0.99
- Design, manufacturing in Japan
- Repair center in U.S.A.

FDK also specializes in DC-DC converters, hybrid ICs, memory cards, ferrite cores, lithium batteries, stepper motors, optical isolators, etc.

**FDK** Your Best Strategic Partner  
**FDK AMERICA, INC.**

A Division of Fuji Electrochemical Co., Ltd.  
San Jose Office: 3099 North First Street, San Jose, CA 95134, U.S.A.  
TEL: 408-432-8331 FAX: 408-435-7478

Dallas TEL: 214-650-7742 FAX: 214-650-7792  
Boston TEL: 617-487-3198 FAX: 617-487-3199

CIRCLE NO. 203



# THE UNIVERSAL DEVICE PROGRAMMER FOR ALL PACKAGE TYPES.

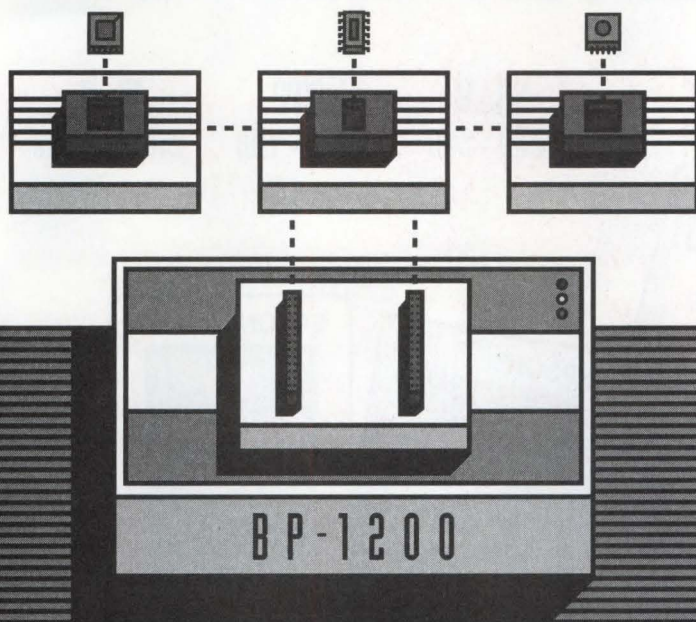

The BP-1200 universal device programmer leads the industry in devices supported, programming speed, ease of use and reliability. With prices starting at \$2495, **free software updates**, and a three year limited warranty,\* the BP-1200 is simply the best choice for those seeking the biggest bang for the buck!

The BP-1200's ability to program virtually every programmable device, including the fastest and largest PLDs, microcontrollers and memories, gives you the freedom to choose the ideal parts for your next design. The BP-1200 also supports all package types. Our full line of interchangeable programming sockets supports DIP, LCC, PGA, PLCC, QFP, SOIC and TSOP devices directly.

The BP-1200 is the first programmer that programs and vector tests devices with up to 240 pins. If you don't need 240 pin support yet, you can start with as little as 32 pin DIP support and upgrade in the field (to 40, 48, 84, 144 or 240 pins) when you need to do so.

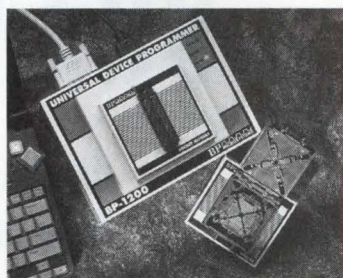

The BP-1200 is the fastest universal programmer on the market. Since the BP-1200 connects directly to your PC's printer port, you can program parts in seconds, not minutes. The BP-1200 reads files directly from your hard disk or network, so you won't waste time copying files to a floppy disk or waiting on a serial download.

The BP-1200's high speed, high yields and optional Advanced Feature Software make it ideal for production use, whether you are doing medium volume manual programming or very high volume autohandler production.

Call today for more information about the BP-1200 and a free demonstration disk!

#### DEVICE SUPPORT INCLUDES:

- Altera 7000 series
- AMD MACH parts
- Intel 32M bit flash EPROM
- Intel FX740 and FX780 FPGAs
- Lattice pLSI and ispLSI devices
- Microchip PIC microcontrollers
- Motorola 68HC705 and 68HC711 families
- over 3400 devices from over 66 manufacturers

**BP MICROSYSTEMS**  
BP Microsystems, Inc. • Houston, TX

1-800-225-2105

\*Only on BP-1200s purchased in the U.S. after September 15, 1993. Some restrictions and exclusions apply. Features and specifications subject to change without notice. Call for details.

# EPSON®

## OEM MEMORY CARDS

SRAM	OTP	Flash	ATA Flash	MROM
64KB - 2MB	64KB - 1MB	256KB - 16MB	2.5MB - 40MB	256KB - 16MB



**BRANDED PC CARDS**

HIGH PERFORMANCE  
 MOST COMPATIBLE  
 HIGH SPEED  
 LOW POWER CONSUMPTION

**RETAIL READY PRODUCTS  
FOR OEM BUNDLING**



**EPSON®** EPSON AMERICA, INC.  
Component Sales Department Telephone: 310/787-6300

Call your sales rep today.

EPSON Sales Representatives: AL-GA-TN Concord Components 205/772-8883 • AZ-NM Fred Board Assoc. 602/994-9388 • CA-No. Costar 408/446-9339 • CA-So. Bager Electronics 714/957-3367 • CO-UT Wn. Region Mktg. 303/428-8088 • FL Dyne-A-Mark 407/660-1861 • IL-WI LTD Technologies 708/773-2900 • KS-MO-IA Microtronics 913/262-1444 • MA-NH-CT Rosen Assoc. 617/449-4700 • MD-VA Tech Sales Assoc. 301/461-7802 • MI-IN-KY C C Electro 317/921-5000 • MN Electromark 612/944-5850 • NC-SC Envision 919/231/9939 • NJ JMR Sales 908/525-8000 • NY Elcom Sales 716/385-1400 • METRO-NY Niktronix 516/929-4671 • OH J.D. Babb Assoc. 216/934-4454 • OR-WA Matrex 503/245-8080 • PA Omega Sales 215/244-4000 • TX-OK Component Tech. 214/783-8831 • CANADA Dynasty Components, Inc. 613/596-9800

Call for  
New Low Pricing  
on SMD models.



# Interpoint's MIL-STD-883 dc-dc converters: Recognized for outstanding performance.

On Space Station Freedom, the Patriot Missile, European Fighter Aircraft and thousands of critical applications, Interpoint dc-dc converters are the ones designers choose first. However you measure performance, Interpoint commands the field.

Interpoint is recognized for broadest selection. From fully qualified SMD parts to low-cost solutions, from 5 to 285 watts. Interpoint has a solution for almost every power need.

Interpoint is recognized for innovation. Our 20-year history of breakthroughs includes the first 70 W/in<sup>2</sup> board-mountable dc-dc converters.

Interpoint is recognized for reliability. Our power supplies have logged more than 1,000,000 field hours per failure.

Our new, fully compliant MSA Series offers 5 watts of power in a case just 0.27" high. The MSA also meets MIL-STD-704A input voltages (up to 80V surges) with 5, 12, and 15 Vdc outputs.

For your **FREE HI-REL DESIGN FIELD KIT**, with Guides to selecting and using dc-dc converters in HI-REL systems, call:

**NEW!**  
The 30-watt  
MTR Series  
now meets  
MIL-STD-883

**1-800-822-8782**

In Europe, call:  
Interpoint U.K. (0252) 815511  
Interpoint France (1) 34-28-54-55

#### HI-REL DC-DC Converters for Every Power Level

Series	V in	V out	Outputs	Power
MSA	16 to 40	5,12,15	1 or 2	5 W
MHF+	16 to 40	5,12,15	1 or 2	15 W
MTR	16 to 40	5,12,15	1, 2, or 3	30 W
MFL	16 to 40 80 to 160 160 to 400	5,12,15,28	1 or 2	65 W*
MFLHP	19 to 40	5,12,15	1 or 2*	100 W*

\*Multiple units current share

**interpoint**

**8-bit ADCs shut down power to 0.5 mW.** The 20-MHz MP8786 and MP8776 typically dissipate 110 mW. Both converters include output-enable control logic to produce 3-state outputs that can directly interface with a bus or a  $\mu$ P. Pin-for-pin replacements of the company's MP8775 and MP8785, the 8776 (\$5.28 (1000)) and 8786 (\$5.42) come in 24- and 20-pin, packages, respectively. **Micro Power Systems**, Santa Clara, CA. (408) 727-5350.

Circle No. 440

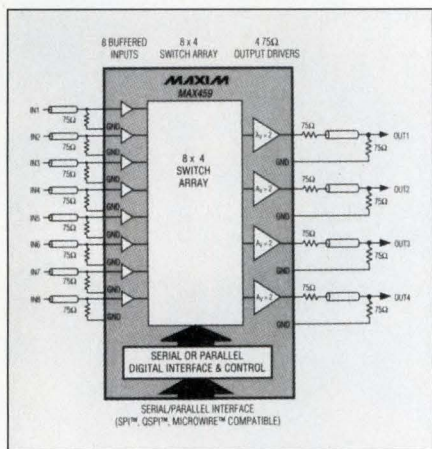

**100-MHz crosspoint switches drive 75Ω cable.** The MAX458/459 8×4 video crosspoint switches replace multiple switches, amplifiers, and logic. The 458 includes four digitally controlled, 100-MHz unity-gain-stable output buffers (gain of +1) and has a differential phase and gain error of 0.05° and 0.01%, respectively. The 459 includes four 90-MHz, 300V/ $\mu$ sec amplifiers with a fixed gain of +2 for directly driving 150Ω back-terminated cable without external feedback resistors. To parallel multiple switches, a digitally controlled disable mode turns off each output amplifier and puts each into a high impedance state. The devices come in 40-pin DIPs, and prices start at \$24 (1000). **Maxim Integrated Products**, Sunnyvale, CA. (408) 737-7600.

Circle No. 441

**Genlock IC produces eight standard NTSC and PAL frequencies.**

The EL4584 generates a master clock that is phase-locked to an external horizontal sync reference. The IC includes eight preset frequencies; you can also use an external divider to generate nonstandard frequencies. When you use the IC with the company's EL4583 sync separator, the IC generates H-sync phase-locked clocks. The internal PLL includes a phase-frequency detec-

### FREE INFO, FREE POSTAGE

Use our postage-paid reader-service cards to get more information on any of these products.

tor, which preempts locking to a harmonic, and a coast feature, which disables the loop without disturbing the VCO. An external varactor and LC-tuned circuit or crystal oscillator controls the VCO's frequency, which can go up to 35 MHz. In 16-pin DIPs and SOICs, the chip costs \$4.71 (1000). **Élantec Inc**, Milpitas, CA. (408) 945-1323.

Circle No. 442

**Photosensor ADC has 20-bit resolution.** The DDC101 current-input ADC directly connects to low-level sensors, such as photodiodes and other current-output devices. The IC uses a patented delta-modulation topology—slightly different from delta-sigma and integrating converters—that accurately digitizes the low-current levels. Using digital integration, oversampling, correlated double sampling, and digital filtering, the IC improves noise and linearity as input level decreases. With an input signal of 0.1% full-scale, the maximum linearity error is 0.0003% FSR. The conversion rate is 15 kHz. The ADC comes in 24-pin SOICs and 28-pin DIPs; prices start at \$22.95 (1000). **Burr-Brown Corp**, Tucson, AZ. (800) 548-6132.

Circle No. 443

**Electronic circuit breaker integrates fast fault protection and control.** The UCC3912 IC integrates a 0.15Ω power MOSFET and operates from 3 to 8V. Other features include digitally programmable current limit from 0 to 3A, a programmable on-time, and a programmable start delay. When disabled, the IC draws 1  $\mu$ A. During extended faults, the IC automatically opens the circuit and resets it at a 3% duty cycle to limit power dissipation. Other than supply bypass, the IC requires only a single external capacitor for fault timing. \$2.50 (1000). **Unitrode Integrated Circuits Corp**, Merrimack, NH. (603) 424-2410.

Circle No. 444

**Dual op amps top  $\pm$ 5V video specs.** The HA5022 and HA5023 specify typical 0.07-dB gain flatness to 20 MHz, 0.03% and 0.03° respective differential gain and phase, and 0.8-mV input offset when running from a  $\pm$ 5V supply. These ICs are dual versions of the company's HA5020. The 5022 features a

per-output enable/disable, which allows video multiplexing without a separate multiplexer. When configured for a gain of +1, the amplifiers provide a 125-MHz, 3-dB bandwidth, a 28-MHz full-power bandwidth, and a 350V/ $\mu$ sec slew rate. At gains of +2, the same specs are 95, MHz, 26 MHz, and 475V/ $\mu$ sec, respectively. A 16-pin DIP or SOIC HA5022 costs \$3.30 (100). The 8-pin 5023 costs \$3.20. **Harris Semiconductor**, Melbourne, FL. (800) 442-7747, ext 7224.

Circle No. 445

**16-bit DAC integrates fast interface.** The DAC712 comes with a precision  $\pm$ 10V temperature-compensated reference, a  $\pm$ 10V output amplifier, and a 16-bit port-bus interface. The digital interface has 60-nsec min write-pulse widths, is double buffered, and has a clear function that resets the analog output to bipolar zero. Double buffering permits simultaneous updating of several DACs. The output swings  $\pm$ 10V using  $\pm$ 12 to  $\pm$ 15V supplies. Maximum power dissipation is 600 mW. In 28-pin DIPs and wide SOICs, 13- and 14-bit linearity grades are available starting at \$13 (100). **Burr-Brown Corp**, Tucson, AZ. (800) 548-6132.

Circle No. 446

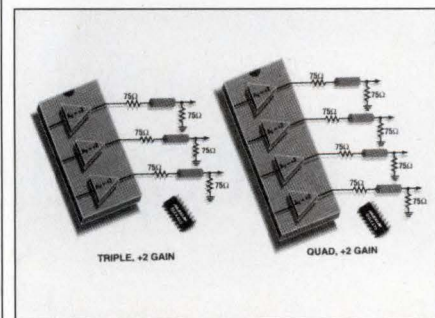

**Triple and quad video buffers eliminate drive amplifiers.** The MAX467 through 470 have closed-loop gains of +1 or +2 for driving 50 or 75Ω back-terminated coaxial cables with low differential gain and phase error of 0.01% and 0.03°, respectively. Specified for  $\pm$ 5V operation, the buffers guarantee an output drive of  $\pm$ 2.5V into a 150Ω load. The buffers also feature 100-MHz unity-gain bandwidths and 300V/ $\mu$ sec slew rates. Prices for the 16-pin DIPs and SOICs start at \$3.70 (1000). **Maxim Integrated Products**, Sunnyvale, CA. (408) 737-7600.

Circle No. 447

**Video DACs feature true color and gamma correction.** Each IC in the ADV15x series combines three 10-bit

# CMOS SWITCHES DELIVER 2Ω CHANNEL MATCHING AND 3Ω RON FLATNESS

## Unrivalled Precision—0.012% CMRR without trimming

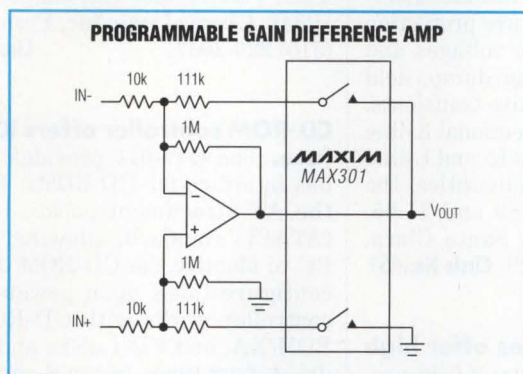

Maxim's new precision analog switches guarantee 3Ω on-resistance flatness and 2Ω channel matching. These ground-breaking specifications assure lower distortion, improved linearity and accuracy, and freedom from trimming for attenuators, tuned filters, and programmable-gain amplifiers. The circuit shown, for example, allows CMRR as low as 0.012% without trimming. All switches operate from single supplies of 10V to 30V, or dual supplies of ±4.5V to ±20V.

### Choose the right switch for your design!

PART	FUNCTION	RON (Ω)	MATCH (Ω)	FLATNESS (Ω)	CHARGE INJECTION (PC)	V <sub>LOGIC</sub>	*COST (\$)
MAX301	dual SPST	30	2	3	15	✓	1.23
MAX303	dual SPST	30	2	3	15	✓	2.57
MAX305	dual SPST	30	2	3	15	✓	2.57
MAX317	SPST	30	N/A	3	10	✓	1.05
MAX318	SPST	30	N/A	3	10	✓	1.05
MAX319	SPST	30	2	3	10	✓	1.41
MAX333A	quad SPST	30	2	3	10	N/A	3.60
MAX351	quad SPST	30	2	3	10	✓	1.76
MAX352	quad SPST	30	2	3	10	✓	1.76
MAX353	quad SPST	30	2	3	10	✓	1.76
MAX361	quad SPST	85	2	9	10	✓	1.29
MAX362	quad SPST	85	2	9	10	✓	1.29
MAX364	quad SPST	85	2	9	10	N/A	1.14
MAX365	quad SPST	85	2	9	10	N/A	1.14

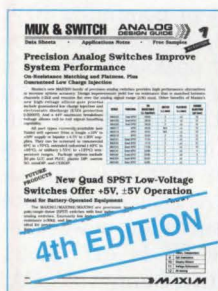

**FREE Mux & Switch Design Guide—Sent Within 24 Hours!**  
Includes: Data Sheets and Cards for Free Samples

CALL TOLL FREE 1-800-998-8800  
For a Design Guide or Free Sample

MasterCard® and Visa® are accepted for Evaluation Kits or small quantity orders.

# MAXIM



Distributed by Arrow, Bell, Digi-Key, Elmo, Hamilton Hallmark, and Nu Horizons. Authorized Maxim Representatives: AL, M-Squared, Inc. AZ, Techni Source Inc. CA, Mesa, Pro Associates, Inc., Infinity Sales, Inc. CO, Component Sales CT, Comp Rep Associates DE, TAI Corporation FL, Sales Engineering Concepts GA, M-Squared, Inc. ID, E.S. Chase IL, Heartland Technical Marketing Inc. IN, Technology Marketing Group IA, JR Sales Engineering, Inc. KS, Delltron LA, BP Sales MD, Micro-Comp, Inc. MA, Comp Rep Associates MI, Micro Tech Sales MN, Mel Foster Technical Sales, Inc. MS, M-Squared, Inc. MO, Delltron MT, E.S. Chase NE, Delltron NV (Reno, Tahoe area only) Pro Associates, Inc. NH, Comp Rep Associates NJ, Parallax, TAI Corporation NM, Techni Source Inc. NY, Parallax, Reagan/Compar NC, M-Squared, Inc. OH, Lyons Corporation OK, BP Sales OR, E.S. Chase PA (Pittsburgh area) Lyons Corporation, (Philadelphia area) TAI Corporation SC, M-Squared, Inc. TN, M-Squared, Inc. TX, BP Sales UT, Luscombe Engineering Co. VA, Micro-Comp, Inc. WA, E.S. Chase WI, Heartland Technical Marketing, Inc.

Distributed in Canada by Arrow. Authorized Maxim Representative in Canada: Tech Trek.

Austria, Allmos Electronics Belgium, Master Chips Denmark, Exatec A/S Finland, Yleiselektronikka Oy, France, Maxim France, France/Distributors: Maxim France, ASAP Germany, Maxim GmbH Germany/Distributors: Maxim GmbH, Spezial Electronic KG Ireland, FMG Electronics Italy, Consystem S.r.l., Italy/Distributor: Esco Italiana Electronics Supply Netherlands, Koning En Hartman Norway, Odin Electronics A/S Poland, Uniproduct, Ltd. Portugal, ADM Electronics, S.A. Spain, ADM Electronics S.A. Sweden, Egevo AB Switzerland, Laser & Electronic Equip. Turkey, Interex (U.S.A.) U.K. Maxim Integrated Products (U.K.), Ltd., U.K./Distributors, Maxim Integrated Products (U.K.), Ltd., 2001 Electronic Components, HB Electronic

Maxim is a registered trademark of Maxim Integrated Products. © 1994 Maxim Integrated Products

# EDN-NEW PRODUCTS

## INTEGRATED CIRCUITS

video DACs and associated color-palette RAM in one package. The DACs can deliver 24-bit true-color performance at rates up to 220 MHz. Four other family members operate at 170, 135, 110, and 85 MHz. The ADV7150 and 7152 feature three 8-bit control inputs that provide  $256^3$  addressable colors. Their companion, the pseudo-color 7151, displays images of equal resolution but with a choice of 256 colors/frame. The 7151's three  $256 \times 10$ -pixel color look-up table enables on-chip linearization, including gamma correction and monitor calibration. Prices range from \$69 to \$71 for the 85-MHz versions to \$121 to \$167 for the 220-MHz grades. **Analog Devices**, Wilmington, MA. (617) 937-1428. **Circle No. 448**

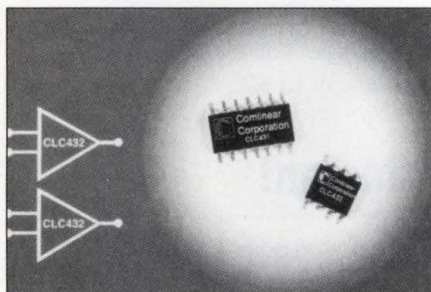

**Dual wideband op amps save board space.** The CLC431 and CLC432 current-feedback amplifiers feature typical dc-coupled small-signal bandwidths of 62 MHz at gains of +2 and typical slew rates of  $2000V/\mu\text{sec}$ . The amplifiers operate from single 10 to 36V and dual  $\pm 5$  to  $\pm 18V$  supplies. Typical supply current is 7.1 mA/channel ( $R_L = \text{infinity}$ ). The dual amplifiers have closely matched dc and ac electrical characteristics, and channel isolation is 70 dB at 10 MHz. The 14-pin 431 (\$2.99 (1000)) includes a disable feature that operates single-ended or differentially to accommodate a wide range of logic families. The 432 (\$2.49 (1000)) comes in an 8-pin package. Both are available in DIPs and SOICs. **Comlinear Corp**, Fort Collins, CO. (303) 226-0500.

**Circle No. 449**

**Video preamps meet XGA-monitor requirements.** The LM1207 and LM1208 video preamplifiers have bandwidths of 85 and 130 MHz, respectively. Both feature 0 to 4V-dc controls for interfacing with  $\mu\text{Cs}$ , on-chip video blanking requiring only six external components, and dc restoration. The 1208 also features a 40-dB drive-control range. The outputs are stable, and output rise and fall times are symmetrical. The devices come in 28-pin DIPs, and

prices begins at \$2.20 (1000) and \$2.50, respectively. **National Semiconductor**, Santa Clara, CA. (408) 721-5240.

**Circle No. 450**

**Small bus drivers meet auto standards.** The Si9241EY and Si9243EY narrow-body SOICs meet the ISO9141 standard for communication between automotive computers and diagnostic equipment. The devices include short-circuit and overtemperature protection and can handle the high voltages and stresses imposed by load dump, field decay, and other automotive transients. The 9241 features a bidirectional K-line pinout. The 9243 provides K- and L-line pinouts. In large OEM quantities, the 9241 and 9243 cost \$0.89 and \$1.05, respectively. **Siliconix**, Santa Clara, CA. (800) 554-5565, ext 29. **Circle No. 451**

**Interconnection devices offer high I/O densities.** The IQ line of field-programmable interconnect devices (FPIDs) offers I/O densities from 96 to 320 ports. The devices operate as fast as 100 MHz and have pin-to-pin delays of 10 nsec. The heart of the devices' architecture is a nonblocking globally connected switch matrix, which allows flexible routing signals. You can program each I/O port as an input, an output, or a bidirectional port. The devices offer programmed switch-matrix connections and I/O port attributes that are configured with data stored in internal SRAM cells and registers. Prices range from \$0.20 to \$0.30/port (10,000). **I-Cube Inc**, Santa Clara, CA. (408) 986-1077.

**Circle No. 452**

**Serial memory interfaces with  $\mu\text{P}$ .** The X84041 provides 4 kbits of EEPROM organized as 512 bytes. The 5V nonvolatile-memory device adapts serial-memory functions to a  $\mu\text{P}$ . The architecture incorporates write-, output-, and chip-enable signals, which exist on wide bus systems, eliminating the need for latches and I/O ports. The devices replace low-density byte-wide devices in applications with low package size and height. The device comes in 8-pin SOICs (\$1.64) and DIPs (\$1.45) (10,000). **Xicor Inc**, Milpitas, CA. (408) 432-8888.

**Circle No. 453**

**V.32bis chip sets have small form factor.** The CL-MD1414UN and its PCMCIA version, CL-MD1414UNP, are data, fax, and voice modem chip sets that offer external controller code that

supports international communication standards. By moving this code to external ROM, EPROM, RAM, or flash memory, you can design internationally compliant data, fax, and voice modems. A mixed-signal design makes it possible to integrate analog and digital functions on two CMOS chips. Standards supported include CCITT V.23, V.21, V.32, V.32bis, V.22, Bell 212A, and Bell 103 for data and CCITT V.17, V.29, V.27ter, and V.21 ch2 for fax. \$50 (1000). **Cirrus Logic Inc**, Fremont, CA. (510) 226-2037. **Circle No. 454**

**CD-ROM controller offers IDE interface.** The OTI-011 provides an IDE-bus interface for CD-ROMs. It follows the AT attachment-packet interface (ATAPI) standard, allowing the host PC to identify the CD-ROM drive and configure itself upon power-up. The controller works with CD-ROM, CD-ROM/XA, and CD-I disks and handles drives four times faster than the standard CD-ROM speed. The device comes with ATAPI drivers and costs \$8.95 (10,000). **Oak Technology Inc**, Sunnyvale, CA. (408) 737-0888. **Circle No. 455**

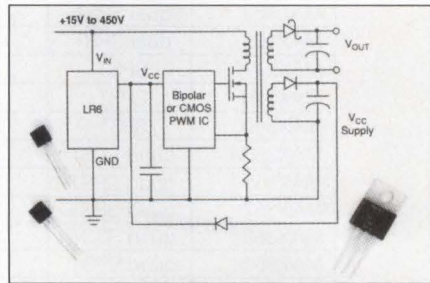

**Start-up regulator runs off 15 to 450V-dc inputs.** The LR645 3-terminal, high-input voltage regulator provides a fixed output of nominally 10V. Available in TO-92, TO-220, and surface-mount SOT-89 packages, the ICs can output 3 mA of continuous and 30 mA of peak current. Typical line regulation is 0.1 mV/V, and load regulation is 50 mV/mA. Supply current is typically 50  $\mu\text{A}$ . A 100-nA typical off-state leakage current ensures low power dissipation when the IC is off. \$0.21 (50,000). **Supertex Inc**, Sunnyvale, CA. (408) 744-0100. **Circle No. 456**

**Digital video mixer handles 12-bit data.** The HSP48212 accepts two 12-bit digital video signals and provides a weighted average proportioned according to a 12-bit mix ratio. The 13-bit output value is automatically rounded to

# A COMPLETE 20MHz FUNCTION GENERATOR IN ONE IC!

## No Design Needed to Produce Sine, Square, and Triangle Waveforms

Designing 20MHz function generators just got easy with the new MAX038. The MAX038 produces modulated and unmodulated Sine, Square, and Triangle waveforms from 1Hz to 20MHz.

**ALL THIS**

**IN THIS!**

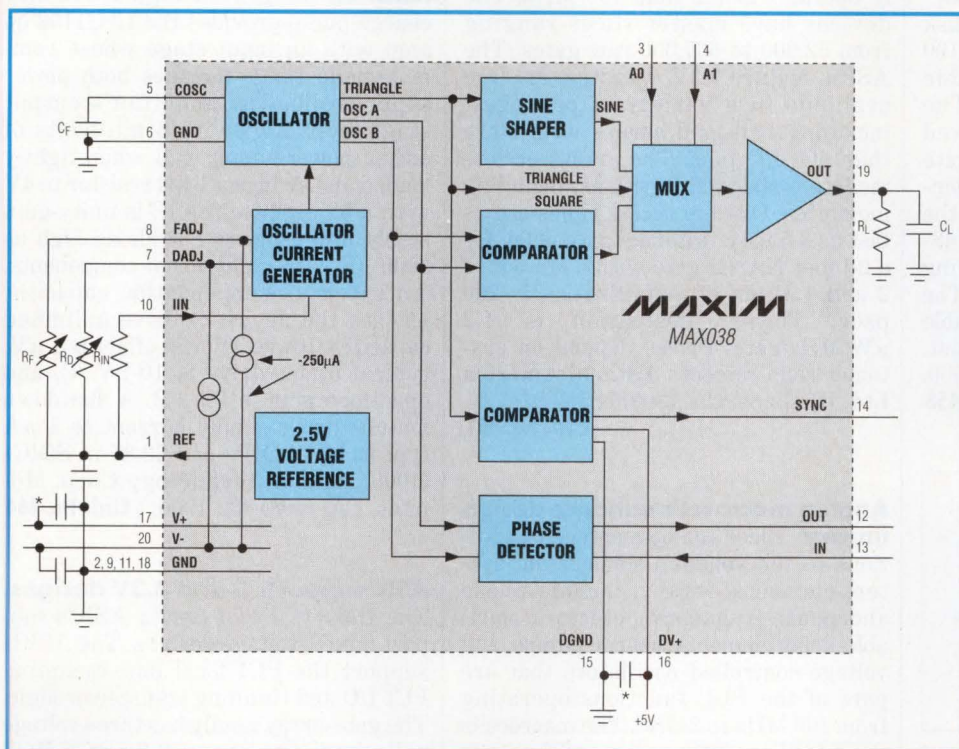

**SINE-WAVE OUTPUT (20MHz)**

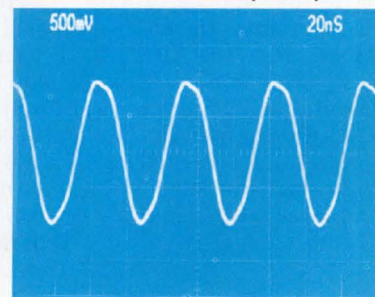

**FREQUENCY MODULATION**

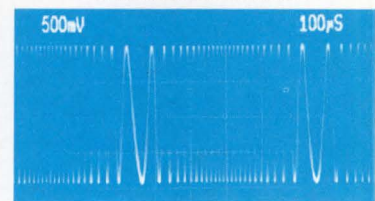

- 1Hz to 20MHz Operation
- Sine, Square and Triangle Waveforms
- 1% Distortion
- ±5V Supply Operation
- 350 to 1 Frequency Sweep Range
- Independent Frequency & Duty Cycle Adjustment

**CALL TOLL FREE 1-800-998-8800 For Free Samples**

MasterCard® and Visa® are accepted for Evaluation Kits or small quantity orders.



Distributed by Arrow, Bell, Digi-Key, Elmo, Hamilton Hallmark, and Nu Horizons. Authorized Maxim Representatives: AL, M-Squared, Inc. AZ, Techni Source Inc. CA, Mesa, Pro Associates, Inc., Infinity Sales, Inc. CO, Component Sales CT, Comp Rep Associates DE, TAI Corporation FL, Sales Engineering Concepts GA, M-Squared, Inc. ID, E.S. Chase IL, Heartland Technical Marketing Inc. IN, Technology Marketing Group IA, JR Sales Engineering, Inc. KS, Delltron LA, BP Sales MD, Micro-Comp, Inc. MA, Comp Rep Associates MI, Micro Tech Sales MN, Mel Foster Technical Sales, Inc. MS, M-Squared, Inc. MO, Delltron MT, E.S. Chase NE, Delltron NV (Reno, Tahoe area only) Pro Associates, Inc. NH, Comp Rep Associates NJ, Parallax, TAI Corporation NM, Techni Source Inc. NY, Parallax, Reagan/Compar NC, M-Squared, Inc. OH, Lyons Corporation OK, BP Sales OR, E.S. Chase PA (Pittsburgh area) Lyons Corporation, (Philadelphia area) TAI Corporation SC, M-Squared, Inc. TN, M-Squared, Inc. TX, BP Sales UT, Luscombe Engineering Co. VA, Micro-Comp, Inc. WA, E.S. Chase WI, Heartland Technical Marketing, Inc. Distributed in Canada by Arrow. Authorized Maxim Representative in Canada: Tech Trek.

Austria, Allmos Electronics Belgium, Master Chips Denmark, Exatec A/S Finland, Yleiselektronikka Oy, France, Maxim France, France/Distributors: Maxim France, ASAP Germany, Maxim GmbH Germany/Distributors: Maxim GmbH, Spezial Electronic KG Ireland, FMG Electronics Italy, Consystem S.r.l., Italy/Distributor: Esco Italiana Electronics Supply Netherlands, Koning En Hartman Norway, Odin Electronics A/S Poland, Unipro, Ltd. Portugal, ADM Electronics, S.A. Spain, ADM Electronics S.A. Sweden, Gevego AB Switzerland, Laser & Electronic Equip. Turkey, Interec (U.S.A.) U.K. Maxim Integrated Products (U.K.), Ltd., U.K./Distributors, Maxim Integrated Products (U.K.), Ltd., 2001 Electronic Components, HB Electronic

Maxim is a registered trademark of Maxim Integrated Products. © 1994 Maxim Integrated Products

# EDN-NEW PRODUCTS

## INTEGRATED CIRCUITS

12, 10, or 8 bits to match system needs. The device accepts video at clock rates to 40 MHz and delays each input signal by as many as seven clock cycles to help synchronize video sources. It is available in 68-pin PLCC (\$14.32 (1000)) or 64-pin PQFP (\$18.46) packages. **Harris Semiconductor**, Melbourne, FL. (800) 442-7747, x7200. **Circle No. 457**

**Disk controllers include error correction.** The AIC-8300 family of disk controllers handle data as fast as 100 Mbps and provide programmable error-correction coding (ECC). The ECC is a 297-bit, 3-way interleaved code that applies to data. A separate ECC protects the disk's data-field identifiers. Both the AIC-8370 IDE and the AIC-8320 SCSI devices include a 48-Mbyte/sec buffer interface for storing data flowing between host and disk. The parts cost \$20 each; the 8370 is available now, and the 8329 is due in August. **Adaptec**, Milpitas, CA. (408) 945-8600. **Circle No. 458**

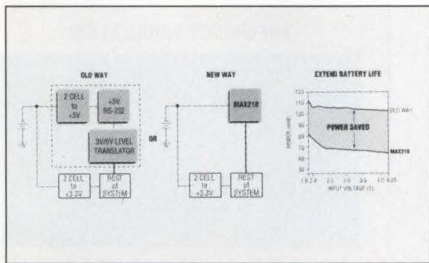

**Two cells produce RS-232C output levels.** The MAX218 dual transceiver operates from input voltages of 1.8 to 4.25V and maintains true RS-232C and EIA/TIA-562 voltage levels. The IC guarantees data rates up to 120 kbps. The two receivers remain active in 1- $\mu$ A shutdown mode to monitor external devices that can wake up the IC when data needs to be transferred. The ICs come in 20-pin SSOPs, DIPs, and wide SOICs, and prices start at \$2.10 (1000). **Maxim Integrated Products**, Sunnyvale, CA. (408) 737-7600. **Circle No. 459**

**$\mu$ C supervisor has programmable watchdog timer.** The X25043 microcontroller ( $\mu$ C) supervisor combines 4 kbits of EEPROM with a complex reset controller and a watchdog timer with programmable intervals. The device has a high-speed serial peripheral interface and software protocol, which allows rapid access to data on a 3-wire bus. The reset controller generates a reset signal to the  $\mu$ C during power-up, power-down, and brown-out situations.

The watchdog timer begins running once the reset signal is released. Two EEPROM bits of a configuration register, which selects one of four options, control the watchdog timer. 8-pin DIP, \$1.50 (10,000). **Xicor Inc**, Milpitas, CA. (408) 432-8888. **Circle No. 460**

**0.5- $\mu$ m gate array has high gate count.** The HG72G/E gate-array family operates faster than 100 MHz. The devices have master slices ranging from 52,000 to 667,000 raw gates. The ASICs feature 3.3V operation and are available in a variety of packages, including ball-grid arrays with more than 600 I/O pins. The arrays accommodate embedded functions, including memories. On-chip access times are as fast as 3.5 nsec. Internal gate delay for a 2-input NAND gate with a fan-out of 2 and 1.4 mm of metallization is 200 psec. Power dissipation is 1.2  $\mu$ W/MHz/gate. Prices depend on customer requirements. **Hitachi America Ltd**, Brisbane, CA. (800) 285-1601. **Circle No. 461**

**Analog macrocells enhance design library.** These analog macrocells, additions to the vendor's semicustom system-elements library, include phase and phase-frequency detectors, variable-delay elements, charge pumps, and voltage-controlled oscillators that are part of the PLL functions operating from 100 MHz to 2 GHz. The macrocells provide phase jitter as low as 6.5 psec at 622 MHz. The library also includes DACs having 3-, 4-, 5-, 6-, and 8-bit resolutions at speeds as high as 500 MHz. An 8-bit video DAC with 4-nsec RAM macrocells offers 1- and 3-channel graphics. NRE charges, \$40,000. **Synergy Semiconductor**, Santa Clara, CA. (408) 773-3643. **Circle No. 462**

**0.7- $\mu$ m ASICs feature low power.** The TC170 series of ASICs are fabricated in a 0.7- $\mu$ m process and come as gate arrays or standard cells. Typical gate delays are 270 psec; the devices operate from 5V. The arrays employ two layers of metallization and typically dissipate 4.4  $\mu$ W/MHz/gate. Gate complexity ranges from 22,000 to 194,000 for the TC170G gate array and 5000 to 219,000 for the TC170C standard cell. The design libraries are compatible with the company's 3V T180/183 series. Volume pricing is \$15 for a 45,000-gate product. **Toshiba America Electronic Components Inc**, Irvine, CA. (800) 879-4963. **Circle No. 463**

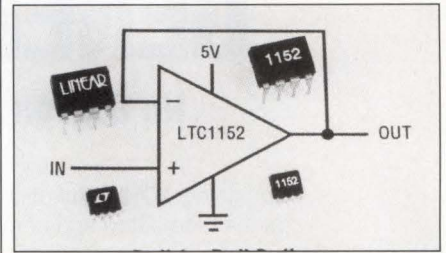

**Zero-drift op amp swings rail to rail.** An integrated high-frequency charge pump provides the LTC1152 op amp with an input stage whose common-mode range includes both power supply rails. The amplifier's output stage swings to within millivolts of either power-supply rail when lightly loaded and swings a 1-k $\Omega$  resistor to 4V with a 5V supply. The IC is unity-gain stable into capacitive loads as high as 2000 pF with no external components. An external compensation capacitor enables the device to drive unlimited capacitive loads. Typical offset is 1  $\mu$ V, typical offset drive is 10 nV/ $^{\circ}$ C, and open-loop gain is 130 dB. A shutdown feature drops supply current to 1  $\mu$ A typ. \$3.12 in DIPs and \$3.37 in SOICs (1000). **Linear Technology Corp**, Milpitas, CA. (408) 432-1900. **Circle No. 464**

**ASIC supports 5 and 3.3V designs.** The Universal PCI Series ASICs support mixed-voltage designs. The ASICs support the PCI local bus, including PCI I/O and Gunning transceiver logic. The gate-array family has three voltage rails and employs a 0.6- $\mu$ m CMOS process including as many as 223,000 gates. Other features include a 290-nsec propagation delay for a 2-input NAND gate, a 2.7- $\mu$ W/MHz/gate power dissipation, a 2- or 3-layer metallization, and 160- to 304-pin plastic quad flat packaging. Special macros include PLL, clock-tree synthesis, and RAM and ROM. \$6 to \$60 (10,000). **NEC Electronics Inc**, Mountain View, CA. (800) 366-9782. **Circle No. 465**

**ASIC family offers high-reliability plastic package.** This ASIC family is available in plastic packaging that the vendor claims rivals ceramic packaging's reliability. The packaging suits avionics and military applications and enables ASICs to withstand 1000 temperature cycles over a -65 $^{\circ}$  to +150 $^{\circ}$ C temperature range. The temperature testing exceeds the reliability requirements of ceramic-packaged MIL-STD-883 products. \$299; same device in ceramic, \$399. **American Microsystems Inc**, Pocatello, ID. (208) 234-4690. **Circle No. 466**



# ISOLATED RS-485 IN ONE PACKAGE FOR UNDER \$10!

## Complete 28-Pin Solution Includes DC-DC Converter

Why waste time designing and debugging a discrete isolated RS-485 solution when you can plug in the MAX1480 for under \$10? The MAX1480 includes the optocouplers, transformer, DC-DC converter, and diodes necessary to provide a complete 500VRMS isolated RS-485 transceiver in one 28-pin package.

## Save Design Time, Board Space, and Cost

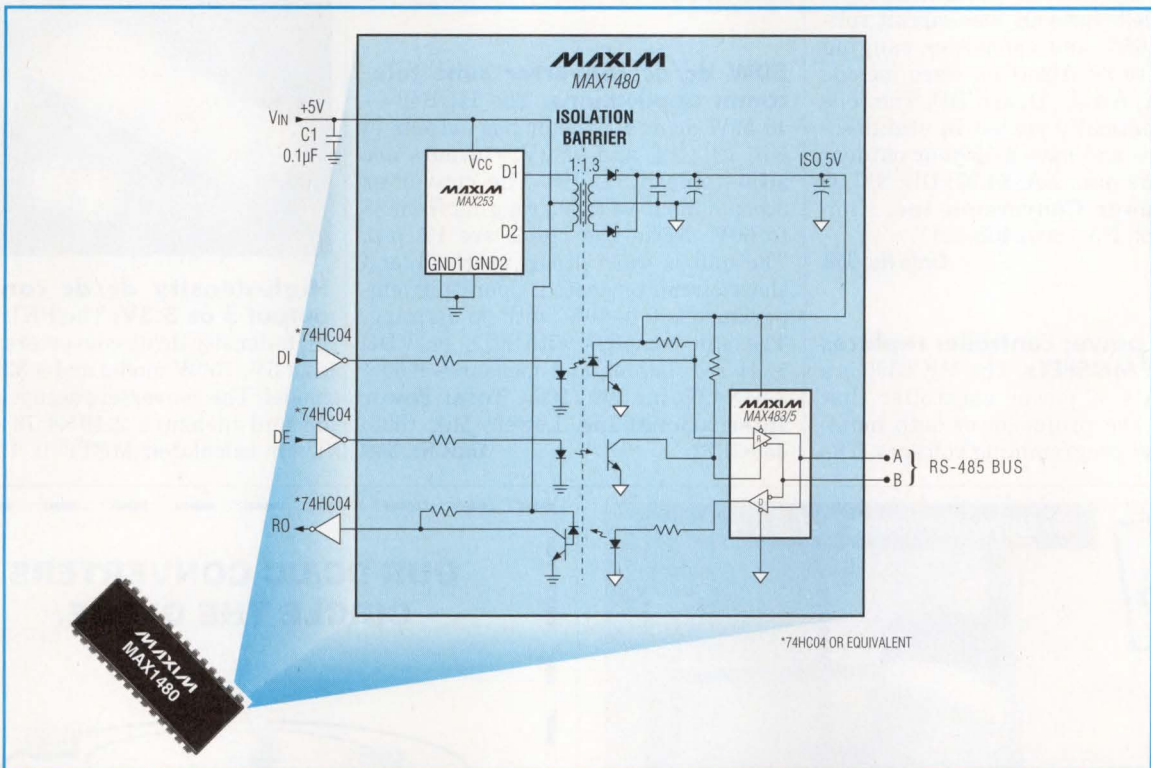

◆ 2.5Mbps Data Rate Guaranteed (MAX1480A)

◆ Slew-Rate Limiting Reduces EMI and Reflections (MAX1480B)



**FREE Interface Design Guide—Sent Within 24 Hours!**  
Includes: Data Sheets and Cards for Free Samples

CALL TOLL FREE 1-800-998-8800  
For a Design Guide or Free Sample

MasterCard® and Visa® are accepted for Evaluation Kits or small quantity orders.

# MAXIM



Distributed by Arrow, Bell, Digi-Key, Elmo, Hamilton Hallmark, and Nu Horizons. Authorized Maxim Representatives: AL, M-Squared, Inc. AZ, Techni Source Inc. CA, Mesa, Pro Associates, Inc., Infinity Sales, Inc. CO, Component Sales CT, Comp Rep Associates DE, TAI Corporation FL, Sales Engineering Concepts GA, M-Squared, Inc. ID, E.S. Chase IL, Heartland Technical Marketing Inc. IN, Technology Marketing Group IA, JR Sales Engineering, Inc. KS, Delltron LA, BP Sales MD, Micro-Comp, Inc. MA, Comp Rep Associates MI, Micro Tech Sales MN, Mel Foster Technical Sales, Inc. MS, M-Squared, Inc. MO, Delltron MT, E.S. Chase NE, Delltron NV (Reno, Tahoe area only) Pro Associates, Inc. NH, Comp Rep Associates NJ, Parallax, TAI Corporation NM, Techni Source Inc. NY, Parallax, Reagan/Compar NC, M-Squared, Inc. OH, Lyons Corporation OK, BP Sales OR, E.S. Chase PA (Pittsburgh area) Lyons Corporation, (Philadelphia area) TAI Corporation SC, M-Squared, Inc. TN, M-Squared, Inc. TX, BP Sales UT, Luscombe Engineering Co. VA, Micro-Comp, Inc. WA, E.S. Chase WI, Heartland Technical Marketing, Inc.

Distributed in Canada by Arrow. Authorized Maxim Representative in Canada: Tech Trek.

Austria, Allmos Electronics Belgium, Master Chips Denmark, Exatec A/S Finland, Yleiselektronikka Oy, France, Maxim France, France/Distributors: Maxim Franice, ASAP Germany, Maxim GmbH Germany/Distributors: Maxim GmbH, Spezial Electronic KG Ireland, FMG Electronics Italy, Consystem S.r.l., Italy/Distributor: Esco Italiana Electronics Supply Netherlands, Koning En Hartman Norway, Odin Electronics A/S Poland, Unipro, Ltd. Portugal, ADM Electronics, S.A. Spain, ADM Electronics S.A. Sweden, Egevo AB Switzerland, Laser & Electronic Equip. Turkey, Interex (U.S.A.) U.K. Maxim Integrated Products (U.K.), Ltd., U.K./Distributors, Maxim Integrated Products (U.K.), Ltd., 2001 Electronic Components, HB Electronic

Maxim is a registered trademark of Maxim Integrated Products. © 1994 Maxim Integrated Products

## POWER SOURCES



**Lithium thionyl-chloride cells run for 15 years continuously outdoors.** Eternacell lithium thionyl-chloride cells have an open-circuit voltage of 3.65V and capacities ranging from 0.9 to 30 Ahr. Cell sizes include  $\frac{1}{8}$ A,  $\frac{1}{2}$ AA, AA, C, D, and DD. The cells are hermetically sealed in stainless-steel cases and have a 15-year outdoor service life min.  $\frac{1}{8}$ A, \$4.97; DD, \$17.95 (1000) **Power Conversion Inc**, Elmwood Park, NJ. (800) 452-1211.

Circle No. 364

**PCMCIA power controller replaces forest of MOSFETs.** The MIC2560 is a PCMCIA-slot power controller that manages the profusion of both main-supply and programming voltages. The

### FREE INFO, FREE POSTAGE

Use our postage-paid reader-service cards to get more information on any of these products.

controller's 16-pin surface-mount package fits between a PCMCIA controller and a PCMCIA socket, replacing 6 to 10 MOSFETs and associated glue logic. The device's outputs are short-circuit and overvoltage protected. \$2.96 (1000). **Micrel Semiconductor**, San Jose, CA. (408) 944-0800. **Circle No. 365**

**50W dc/dc converter suits telecom applications.** The HDB49-C-40 50W dc/dc converter has outputs of 5.6, 12, -12, and -5.2V. Outputs are adjustable by  $\pm 10\%$ . The converter accepts input voltages ranging from 35 to 60V. Noise and ripple are 1% p-p. The unit is overvoltage, overload, and short-circuit protected. Operating temperature is 0 to 50°C with no derating. The unit complies with FCC or VDE EMI regulations and measures 6.60 x 3.94 x 1.95 in. \$99 (100). **Total Power International Inc**, Lowell, MA. (508) 453-7272. **Circle No. 366**

**Supplies energize ultraminiature ultraviolet lamps.** The 44 series and PS-5 series power supplies accept 5, 12, and 24V dc and measure 3 x 3.3 x 1.5 in. The supplies power Pen-Ray and CP series ultraviolet lamps. The lamps are low-pressure, cold-cathode, mercury gaseous-discharge lamps made of double-bore quartz whose lighted length ranges from 0.75 to 90 in. \$40 to \$240. **UVP Inc**, Upland, CA. (800) 452-6788, ext 210. **Circle No. 367**



**High-density dc/dc converters output 5 or 3.3V.** The PKU series of high-density dc/dc converters comprises a 5V, 150W model and a 3.3V, 100W model. The converters accept 36 to 72V dc and measure 2.19 x 4.79 x 0.66 in. Their calculated MBTF is 1.2 million

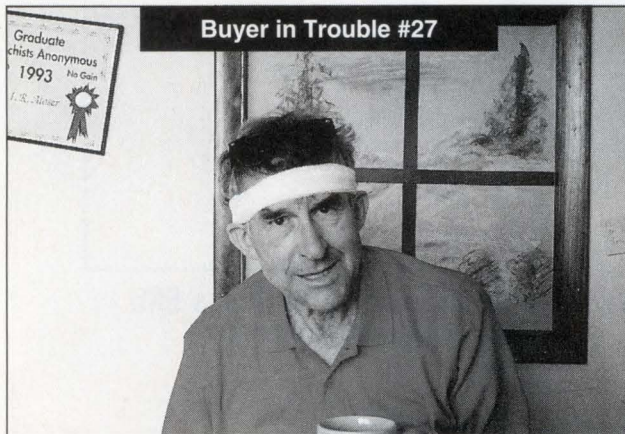

Buyer in Trouble #27

## My Anxiety is Mounting

"I thought all transformers were mounted on the surface. What do they mean I shoulda called Prem for genuine surface mount transformers?"

I really shoulda called Prem.

You oughta call Prem!"



# PREM®

Where Quality Really Counts!

For Prem's new catalog or additional product information, call or write Prem Magnetics, Inc. 3521 North Chapel Hill Road, McHenry, IL 60050. Phone: 815-385-2700. FAX: 815-385-8578.

## OUR DC/DC CONVERTERS CIRCLE THE GLOBE.

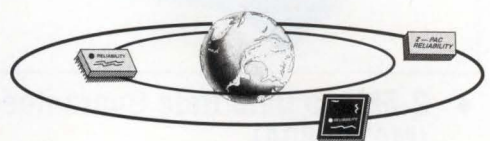

At Reliability, our commitment to worldwide manufacturing of zero-defect DC-DC converters assures our customers of receiving the highest quality products possible. Our products are available in 1 to 25 watts with efficiencies up to 90%. All our products carry a three year warranty. Contact us today for a copy of our catalog.

**Reliability®**  
Quality is Reliability  
A Zero-Defects Company

Call: 713.492.0550 Fax: 713.492.0615

# 1-CELL (1.1V) INPUT STEP-UP GUARANTEES 5V, 30mA OUTPUT

## Internal Synchronous Rectifier Assures Complete 20 $\mu$ A Shutdown

The MAX777/MAX778/MAX779 step-up dc-dc converters deliver more power from a single battery cell (1.1V) than any other IC solution available. An internal active rectifier diode increases efficiency and provides true 20 $\mu$ A shutdown. Only 2 capacitors and a small 22 $\mu$ H inductor are needed, saving space and cost. Guaranteed start-up is 1V (10mA load). In shutdown, the internal switched rectifier opens the DC path from the input to the output, stopping current drain associated with conventional step-up converters. Also, the Active Rectifier™ allows these regulators to act as buck/boost converters, providing regulation for input voltages above and below the output voltage. Order the complete surface-mount evaluation kit (MAX778EVKIT-SO) to speed your design.

- ◆ 5V @ 30mA or 3.3V @ 60mA from 1.1V Inputs, Guaranteed
- ◆ Internal Synchronous Rectifier
- ◆ True 20 $\mu$ A Shutdown Supply Current
- ◆ 3.3V or 5V Regulated Output from 1V to 6.2V Input
- ◆ 8-Lead DIP or SOIC Package
- ◆ MAX777: 5V Output  
MAX778: 3.3V/3V Output  
MAX779: Adjustable Output (2.7V to 6V)
- ◆ Evaluation Kit Available

HIGH OUTPUT CURRENT vs. LOW INPUT VOLTAGE

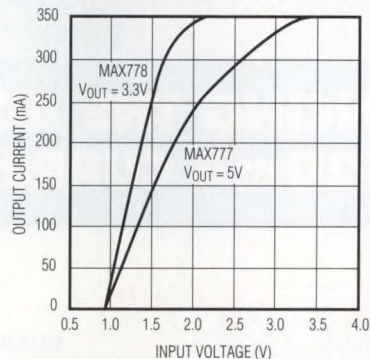

1V INPUT STEP-UP CONVERTER  
USES ONLY 3 COMPONENTS

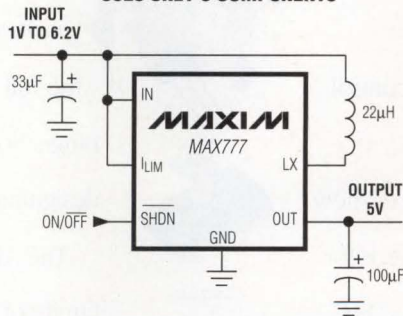

**FREE Power Supply Design Guide—Sent Within 24 Hours!**  
**Includes: Data Sheets and Cards for Free Samples**

**CALL TOLL FREE 1-800-998-8800**  
**For a Design Guide or Free Sample**

MasterCard® and Visa® are accepted for Evaluation Kits or small quantity orders.

# MAXIM



**Distributed by Arrow, Bell, Digi-Key, Elmo, Hamilton Hallmark, and Nu Horizons.** Authorized Maxim Representatives: **AL**, M-Squared, Inc. **AZ**, Techni Source Inc. **CA**, Mesa, Pro Associates, Inc., Infinity Sales, Inc. **CO**, Component Sales **CT**, Comp Rep Associates **DE**, TAI Corporation **FL**, Sales Engineering Concepts **GA**, M-Squared, Inc. **ID**, E.S. Chase **IL**, Heartland Technical Marketing Inc. **IN**, Technology Marketing Group **IA**, JR Sales Engineering, Inc. **KS**, Delltron **LA**, BP Sales **MD**, Micro-Comp, Inc. **MA**, Comp Rep Associates **MI**, Micro Tech Sales **MN**, Mel Foster Technical Sales, Inc. **MS**, M-Squared, Inc. **MO**, Delltron **MT**, E.S. Chase **NE**, Delltron **NV** (Reno, Tahoe area only) Pro Associates, Inc. **NH**, Comp Rep Associates **NJ**, Parallax, TAI Corporation **NM**, Techni Source Inc. **NY**, Parallax, Reagan/Compar **NC**, M-Squared, Inc. **OH**, Lyons Corporation **OK**, BP Sales **OR**, E.S. Chase **PA** (Pittsburgh area) Lyons Corporation, (Philadelphia area) TAI Corporation **SC**, M-Squared, Inc. **TN**, M-Squared, Inc. **TX**, BP Sales **UT**, Luscombe Engineering Co. **VA**, Micro-Comp, Inc. **WA**, E.S. Chase **WI**, Heartland Technical Marketing, Inc.

**Distributed in Canada by Arrow. Authorized Maxim Representative in Canada: Tech Trek.**

**Austria**, Allmos Electronics **Belgium**, Master Chips **Denmark**, Exatec A/S **Finland**, Yleiselektroniikka Oy, **France**, Maxim France, *France/Distributors*: Maxim France, ASAP **Germany**, Maxim GmbH *Germany/Distributors*: Maxim GmbH, Spezial Electronic KG **Ireland**, FMG Electronics **Italy**, Consystem S.r.l., *Italy/Distributor*: Esco Italiana Electronics Supply **Netherlands**, Koning En Hartman **Norway**, Odin Electronics A/S **Poland**, Unipro, Ltd. **Portugal**, ADM Electronics, S.A. **Spain**, ADM Electronics S.A. **Sweden**, Egevo AB **Switzerland**, Laser & Electronic Equip. **Turkey**, Intorex (U.S.A.) **U.K.**, Maxim Integrated Products (U.K.), Ltd., *U.K./Distributors*, Maxim Integrated Products (U.K.), Ltd., 2001 Electronic Components, HB Electronic

Maxim is a registered trademark of Maxim Integrated Products. © 1994 Maxim Integrated Products

Seems you're spending more time

designing the I/O than the control

system. Wouldn't you love a

drop-in solution right about now?

## ANNOUNCING THE AD420, THE FIRST SINGLE CHIP 4-20mA CURRENT-LOOP OUTPUT DAC.

**W**hy spend valuable time and money designing 4-20mA driver circuits for your industrial control system?

Analog Devices' new AD420 DAC does it for you. It's the *only* DAC that takes serial information directly from your controller and converts it into a 4-20mA or 0-20mA output.

And since the AD420 is a single chip solution, you can reduce your I/O footprint or add more channels in the same board space.

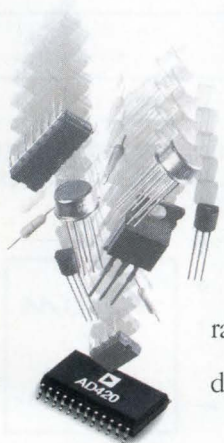

*Complete single chip solution provides lowest total cost per output channel.*

### GUARANTEED PERFORMANCE

Our new AD420 provides you with complete functionality plus *guaranteed* performance over the full industrial temperature range. So you can spend time designing systems, not circuits.

The AD420 is the first in a new family of industrial DACs from Analog Devices. Its advanced sigma-delta technology actually delivers 16-bit monotonicity for *30% less* than you'd pay for 12-bit accuracy.

- Complete 4-20mA output channel
- SPI® and MicroWire® compatible serial interface
- Loop-fault detection capability
- 16-bit monotonicity
- \$10 in 1000s†



*Small footprint SOIC minimizes board space per channel.*

### CALL NOW FOR A SAMPLE

Get the full story. Call today and we'll rush you a sample and complete technical information. Just dial **1-800-ANALOG-D** (262-5643). Or fax your request to 617-821-4273.

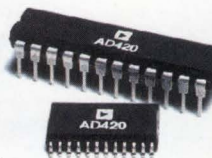

*Fully tested, guaranteed performance over the full industrial temperature range. Available in 24-pin SOIC and PDIP.*

**ANALOG DEVICES**

Analog. Digital. Solutions.

Analog Devices, Inc., One Technology Way, P.O. Box 9106, Norwood, MA 02062-9106. Distribution, offices and application support available worldwide. All trademarks and registered trademarks are property of their respective holders. †USD, 1,000-Up, Recommended Resale, FOB USA

# EDN-NEW PRODUCTS

## POWER SOURCES

hours at 25°C ambient. Below 60°C, the converters require no heat sinks if airflow is 300 lfm. \$145 (1000). **Ericsson Components Inc**, Richardson, TX. (214) 997-6561. **Circle No. 368**

**Lithium primary batteries are thin enough to fit in PCMCIA cards.** Powerdex lithium primary batteries furnish 3 or 6V outputs yet measure 0.7 mm thick. Units come in 6.6×9.4-, 4.6×7.4-, and 3×3.9-cm sizes. Capacities are 50 to 1400 mAh. You can solder the batteries' coplanar side tabs directly to a pc board. **Gould Electronics Inc**, Eastlake, OH. (800) 722-7890. **Circle No. 369**

**25W dc/dc converters accept wide-ranging inputs.** The TA series 25W dc/dc converter is available with single, dual, or triple outputs. The inputs accept voltages ranging from either 9 to 36V or 20 to 72V. The units measure 2.50×3×0.83 in. \$58 to \$69 (500). **Semiconductor Circuits Inc**, Windham, NH. (603) 893-2330. **Circle No. 370**



**Miniature 0.5 and 1W dc/dc converters target distributed applications.** The PM600 series 0.5 and 1W dc/dc converters measure 1.25×0.8×0.4 in. and exhibit 50% efficiency. The converters operate from either 5 or 12V ±10%. The converters come with an internal input filter. \$15 (OEM quantities). **Computer Products**, South Boston, MA. (617) 464-6656. **Circle No. 371**

**Rechargeable-battery snap bollixes 9V primary batteries.** A battery snap for 7.2 or 8.4V NiCd rechargeable batteries has a third contact that precludes users' connecting conventional 9V primary batteries. The third contact strikes a plate found only on rechargeable batteries. \$0.40 (1000). **Memory Protection Devices Inc**, Farmingdale, NY. (516) 293-5891. **Circle No. 372**

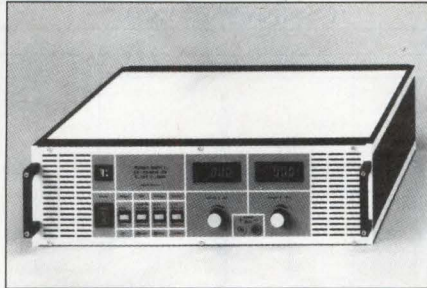

**Lab supplies deliver prodigious currents.** The EA-9000 laboratory

power supplies come in three voltage/current combinations: 0 to 18V at 300A, 0 to 36V at 180A, and 0 to 72V at 90A. The power-factor-corrected units require 3-phase input power. The supplies feature automatic remote sensing, 0.15% stability, programmability, and analog or LCD meters. Rack mounting and an IEEE-488 interface are optional. \$3000 (2 kW); \$8000 (6 kW). **Electro Automatic Corp**, Lawrence, MA. (508) 687-6411. **Circle No. 373**

The new operator interface

...that's BIG on visibility and computing power,

and small on size

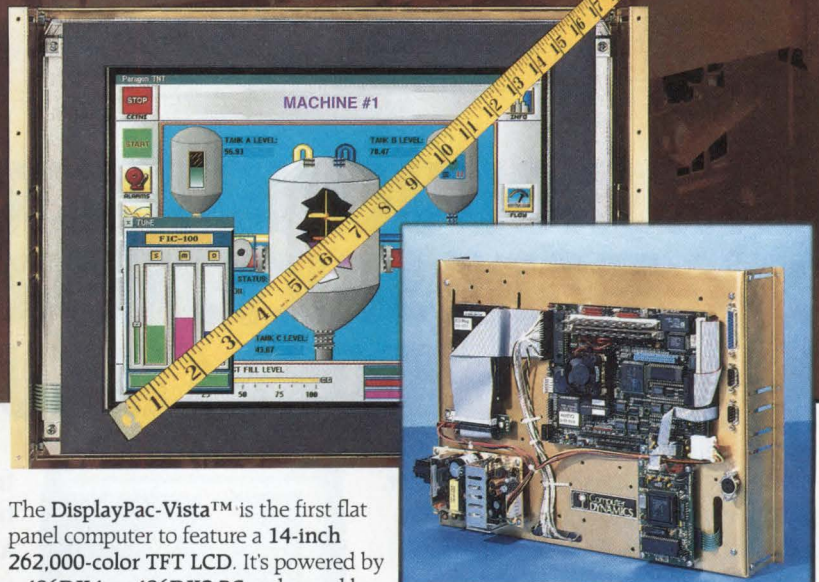

The DisplayPac-Vista™ is the first flat panel computer to feature a 14-inch 262,000-color TFT LCD. It's powered by a 486DX4 or 486DX2 PC, enhanced by a resistive touchscreen, and housed in a compact 11.7" x 16.6" x 4.5" metal OEM frame (or optional 19" rackmount).

#### See it clearly.

The impressive 14" VGA LCD displays 262,000 brilliant colors -- perfect for machine control environments where operator information must be highly visible.

#### Workstation power

- 486DX4 at 100 MHz or 486DX2 to 66 MHz with local bus video & Windows accelerators
- Up to 32M DRAM and 1.5M semiconductor disk
- 65W switching power supply included
- Disk drive options: 1.44M 3.5" floppy, or 2.5" hard disk drive up to 500M

#### Expansion possibilities

- One or two slot PCMCIA credit card drive
- SBX interface on board the single board computer
- Up to six rear-mounted PC bus expansion slots

DisplayPacs come in many sizes, in all price ranges. Call for our NEW CATALOG, and ask a Computer Dynamics Applications Engineer for information on our wide variety of flat panel solutions.

"The Flat Panel Experts"™



**Computer DYNAMICS**

107 SOUTH MAIN STREET, GREER, SC 29650  
(803) 877-8700 • FAX (803) 879-2030

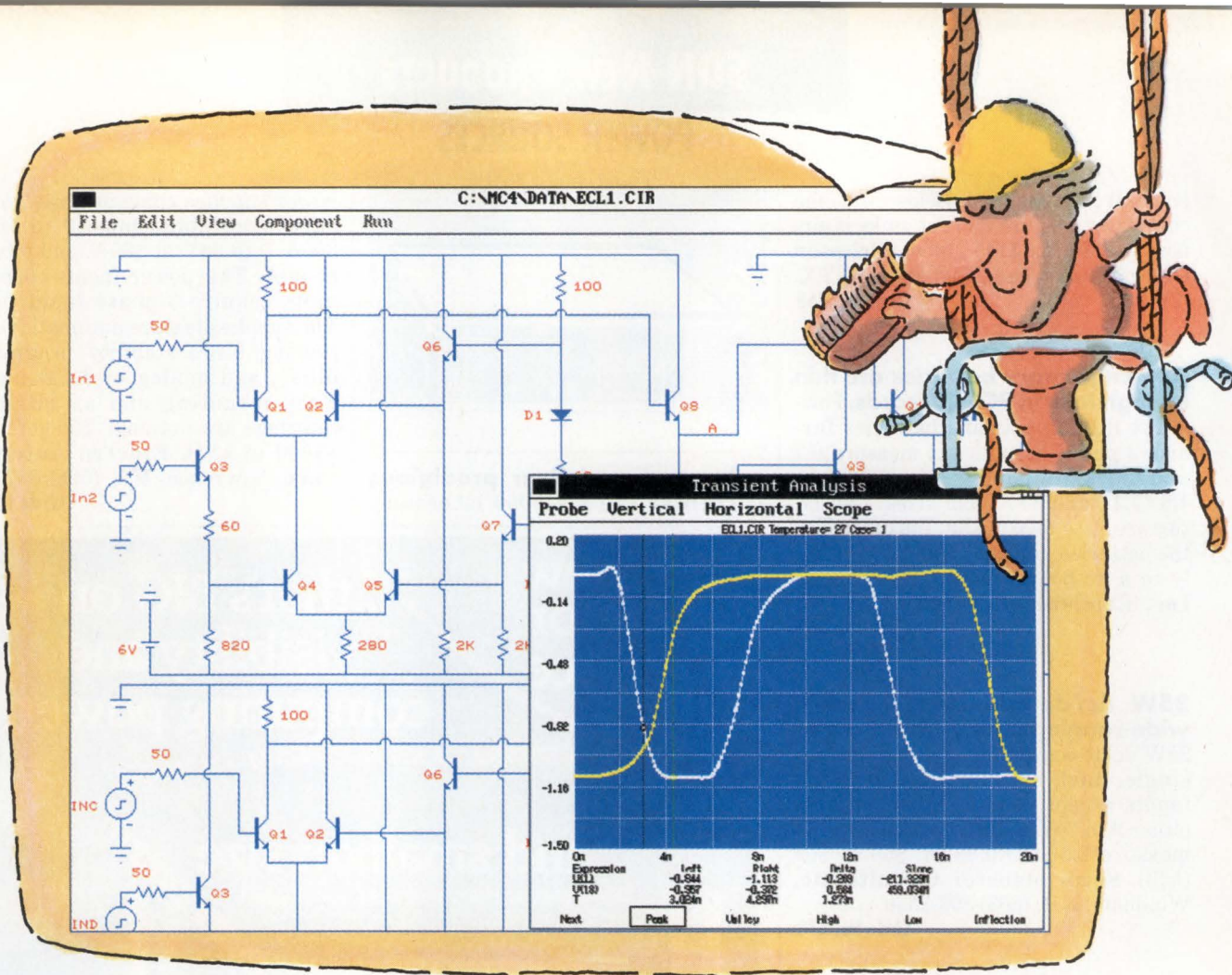

# INTRODUCING MICRO-CAP IV.<sup>TM</sup> MORE SPICE. MORE SPEED. MORE CIRCUIT.

PC-based circuit analysis just became faster. More powerful. And a lot easier. Because MICRO-CAP IV is here. And it continues a 12-year tradition of setting CAE price/performance standards.

Put our 386/486 MICRO-CAP IV to work, and you'll quickly streamline circuit creation, simulation and edit-simulate cycles — on circuits as large as 10,000 nodes. In fact, even our 286 version delivers a quantum leap upward in speed. Because, for one thing, MICRO-CAP IV ends SPICE-file-related slowdowns; it reads, writes and analyzes SPICE text files and MC4 schematic files. It also features fully integrated schematic and text editors. Plus an interactive graphical interface — windows, pull-down menus, mouse support, on-line HELP and documentation — that boosts speed even higher.

Now sample MICRO-CAP IV power. It comes, for example,

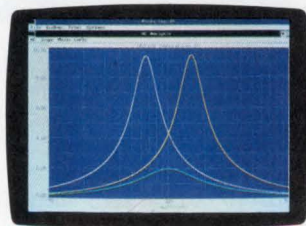

AC Analysis

from SPICE 2G.6 models plus extensions. Comprehensive analog behavioral modeling capabilities. A massive model library. Instant feedback plotting from real-time waveform displays. Direct schematic waveform probing. Support for both Super and Extended VGA.

And the best is still less. At \$2495, MICRO-CAP outperforms comparable PC-based analog simulators — even those \$5000+ packages — with power to spare. Further, it's available for Macintosh as well as for IBM PCs. Write or call for a brochure and demo disk. And experience firsthand added SPICE and higher speed — on larger circuits.

**spectrum**

1021 S. Wolfe Road  
Sunnyvale, CA 94086  
(408) 738-4387 FAX (408) 738-4702

**Catalog of Xilinx products.** Digi-Key is the first catalog distributor to carry Xilinx products; this catalog covers the full range, including field-programmable gate arrays, erasable programmable logic devices (EPLDs), serial configuration PROMs for FPGAs, and the Viewlogic base development system. **Digi-Key Corp.**, Thief River Falls, MN. **Circle No. 516**

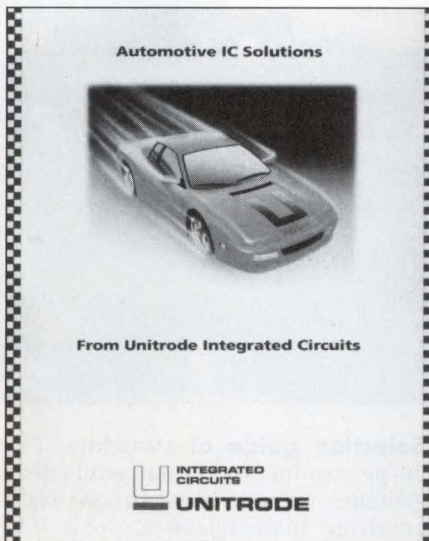

**Brochure features ICs for automotive applications.** This 12-pg brochure includes both text and diagrams pertaining to motor-control ICs, driver/special-function ICs, and power-management ICs. The brochure also highlights typical applications, including multiplex wiring, automatic suspension control, air-bag activation systems, and ignition control. **Unitrode Integrated Circuits Corp.**, Merrimack, NH. **Circle No. 517**

**Technical note covers DSO applications.** *Digital Oscilloscope Applications in High Speed Electronics* explains how scope bandwidth and sample rate affect the measurement of both repetitive and single-shot signals. The publication also addresses problems making measurements in the presence of noise; cross-channel timing measurements; crosstalk;  $\mu$ P crashes; timing problems due to clock skew; metastability; probes; and using long memory to gain higher effective bandwidth. **LeCroy**, Chestnut Ridge, NY. **Circle No. 518**

**Free configuration tool for data-acquisition systems.** This free tool allows designers to reduce the complex-

ity and time to configure a PC-based-data acquisition system for PC/XT/AT/EISA and Micro Channel-based computers, including laptops and notebooks. **National Instruments**, Austin, TX. **Circle No. 519**

**Catalog details technical supplies.** This illustrated buying guide provides information on electronic tools, test equipment, and technical supplies for assembling, testing, and repairing electronic products. The catalog also covers precision hand tools, test instruments, datacomm/telecomm equipment, tool kits, soldering/desoldering systems, lamps, magnifiers, and static-control products. **HMC**, Canton, MA. **Circle No. 520**

**Guide to test-and-measurement instruments.** This 96-pg guide contains information and specifications on a line of hand and stationary tachometers, frequency meters, running time meters, insulation testers, stroboscopes, controllers, and static eliminators. In addition, the catalog presents information on multimeters and test instruments. **Herman H Sticht Co.**, Brooklyn, NY. **Circle No. 521**

**Book teaches graphical programming language.** *Cutting Your Test Development Time with HP VEE* provides a detailed tutorial on HP VEE, a graphical programming language. The book features numerous programming examples along with additional exercises for advanced users. \$38. **Hewlett-Packard**, Palo Alto, CA. **Circle No. 522**

**Catalog describes new electronic test-and-calibration instrumentation.** This 98-pg catalog describes a line of signal sources, including waveform, function, and pulse generators; precision calibrators and multimeters; and RF signal/sweep generators. It also covers a line of high-performance VXI signal sources, options, and accessories. **Wavetek Corp.**, San Diego, CA. **Circle No. 523**

**Catalog describes line of pc-board pin headers and receptacles.** A 50-pg catalog provides information on and product drawings for standard and custom interconnections for pc boards. **Specialty Electronics Inc.**, Landrum, SC. **Circle No. 524**

**Brochure highlights books and journals for instrumentation, measurement, and sensors.** This catalog details a range of books, journals, and reference works for instrumentation, measurement, and sensors. Sample copies of journals mentioned in the brochure are available. **Institute of Physics Publishing Inc.**, Philadelphia, PA. **Circle No. 525**

**Guide for comm products, ASICs, and cache controllers.** *The 1994 Vitesse Product Selection Guide* contains general information on all Vitesse standard products and ASICs. Products include 1-Gbps Fibre Channel-compatible data-communications devices, 2.5-GHz SONET-compatible ICs, and cache controllers for Pentium and P54C CPUs. **Vitesse Semiconductor Corp.**, Camarillo, CA. **Circle No. 526**

**Test-accessory catalog.** A 36-pg catalog lists over 100 products, including logic-analyzer test accessories, IEC1010-safe probes, and banana jacks. Other products include boxes, test strips, and laboratory power supplies. **ITT Pomona Electronics**, Pomona, CA. **Circle No. 527**

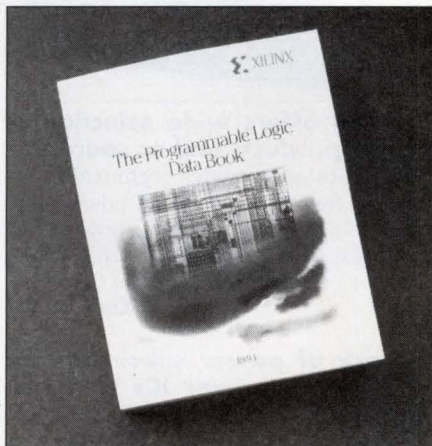

**Data book for programmable-logic products.** This 600-pg data book offers detailed information on field-programmable gate arrays, erasable programmable-logic devices, and serial PROMs. Electrical and timing parameters for all subfamilies are provided. The book offers 160 pgs on applications, ranging from general design hints to documented subsystem examples. Also included is *The Best of XCELL*, a collection of newsletters filled with hints for programmable-logic users. **Xilinx Inc.**, San Jose, CA. **Circle No. 528**

**Heat sinks for cooling  $\mu$ Ps detailed.** This 36-pg catalog covers a broad range of heat sinks, attachment methods, interface materials, and other thermal-management products. A heat sink/ $\mu$ P selector guide and an applications form are also included. **Aavid Engineering Inc**, Laconia, NH.

Circle No. 529

**Data book on DSP products.** This data book contains detailed technical information on a variety of DSP products, including video imaging products, enhanced speed grades of existing products, and data sheets of 41 DSP products. **Logic Devices Inc**, Sunnyvale, CA.

Circle No. 530

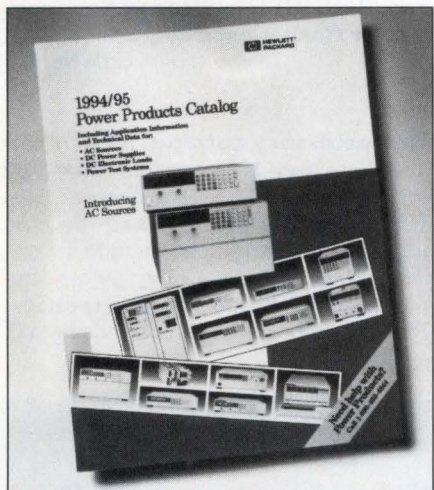

**Catalog offers wide selection of power products and ac sources.** A 66-pg catalog provides technical information for ac sources, dc power supplies, dc electronic loads, power test systems, and solar-array simulators. **Hewlett-Packard**, Palo Alto, CA.

Circle No. 531

**Library of power subcircuits for developing power ICs and systems.** *Circuit Simulation of Switching Regulators Using HSpice* is a collection of papers and subcircuit models that allows you to convert power building blocks, such as switching regulators, pulse-width modulators, and inverters, to board or IC designs. The library comprises power subcircuits for simulating switching-regulator power systems in continuous- or discontinuous-conduction modes. All the library subcircuits come as HSpice files on a floppy disks or as standard Spice files. To download the files, call DOM Engineering Services at (512) 477-0756, EDN at (617) 558-4231, or the Intusoft

BBS on Compuserve. The library and technical-reserach packet costs \$50. **Meta-Software**, Campbell, CA.

Circle No. 532

**RF/wireless handbook provides applications and design information.** This 1100-pg handbook incorporates application information and design short cuts for engineers. The handbook highlights amplifiers, comparers, IF systems, front-end systems, baseband processors, frequency synthesizers, and transmitters. **Philips Semiconductors**, Sunnyvale, CA.

Circle No. 533

**Catalog features discontinued semiconductor products.** This 106-pg guide details the selection of devices available to be built to various screening levels and in various packages. **Rochester Electronics Inc**, Newburyport, MA.

Circle No. 534

**Catalog features optoelectronic products.** This 88-pg short-form guide details optoelectronic products, including military high-reliability displays, optocouplers, LED lamps, infrared and fiber-optic emitters, and custom products. **Siemens Components Inc**, Cupertino, CA.

Circle No. 535

**Application guide for low-temperature infrared sensors.** This 16-pg guide is for users with little or no experience with low-temperature infrared sensors. Topics include infrared energy and how an infrared sensor works. The brochure also includes charts, graphs, and a list of applications. **Watlow Electric**, St Louis, MO.

Circle No. 536

**Literature on interconnection applications.** This 8-pg brochure highlights interconnection technologies for improving pc-board building efficiency and reliability. It also describes additional interconnection products designed to meet electronic production needs. **Zierick Manufacturing Corp**, Mt Kisco, NY.

Circle No. 537

**Paper evaluates high-performance, VME-based embedded computer systems.** *The SKYchannel Technical White Paper* reviews circuit-switched architectures, quick-ring architectures, and packet-bus architectures for communications on and

between VME accelerator boards. **SKY Computers Inc**, Chelmsford, MA.

Circle No. 538

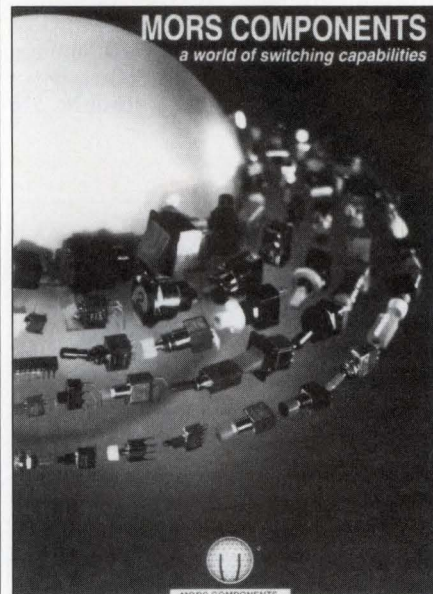

**Selection guide of switches.** This 50-pg product-selection guide lists switches manufactured in ISO 9002-certified facilities in Europe. The guide specifies washable and miniature toggle, rocker, and pushbutton switches and power toggle switches. In addition, the guide covers switch hardware and switch-sealing boots. **MORS/ASC**, Wakefield, MA.

Circle No. 539

**Guide highlights full-service testing.** This 10-pg illustrated guide details the testing, procurement, and assembly of high-reliability electronic components. Four pages describe state-of-the-art testing services for discrete and high-complexity circuits. Two other pages cover the parts-management program, which combines procurement, testing, and just-in-time delivery of microcircuits and semiconductors. **Solid State Testing Inc**, Burlington, MA.

Circle No. 540

**Brochure provides application data for environmental test chambers.** This 20-pg, color brochure details application, operational, and dimensional specifications for a line of environmental test chambers. The brochure also details controls, instrumentation, and chamber-design characteristics that help achieve specific environments. **Blue M Electric**, Blue Island, IL.

Circle No. 541



# Our Power Module is Dual... theirs is only single output!

## Now—75, 100 and 200 Watt Models

- **Low Cost DC-DC Converters**  
*Single Outputs \$104 / Dual Outputs \$149*
- **Dual Isolated Outputs**  
*28 Standard Models / Special Voltages Available*
- **Wide Input Voltage**  
*Four Series / 18-380 VDC Input*
- **Parallel Operation**  
*Fixed Frequency 100kHz  
True Redundancy Operation*

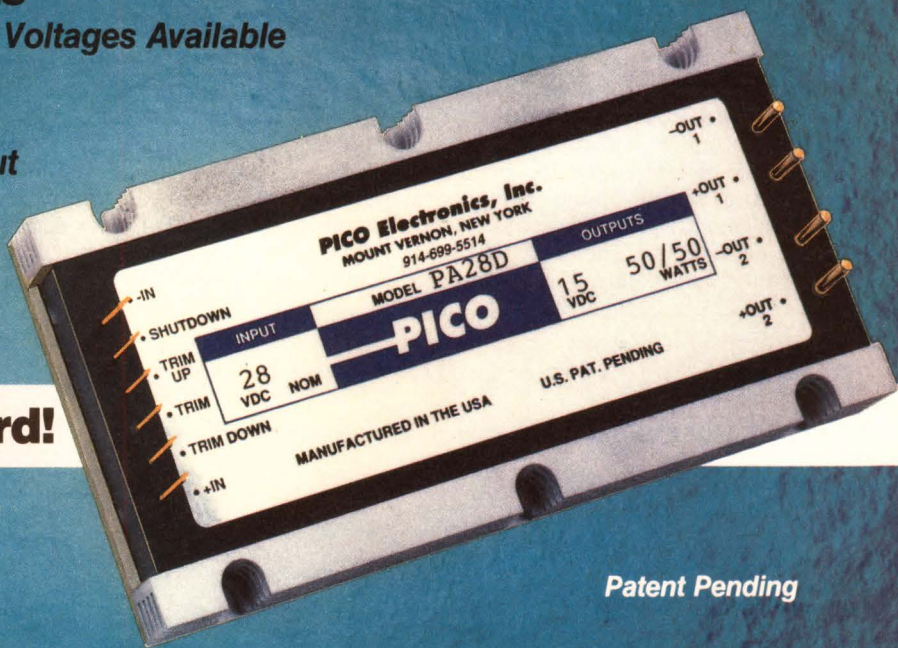

**100 VDC Output, standard!**

*Patent Pending*

The availability of DUAL ISOLATED OUTPUTS creates cost and space savings in many applications.

Fully safeguarded for over voltage, over temperature and continuous short circuit protection, these FIXED Hi-Frequency units minimize technical problems.

With output voltages from 3.3VDC to 100VDC, four distinct input ranges and the choice of single or dual outputs plus the capability of Parallel Operation, as standard features, your circuit designs can be optimized.

Assembled in the U.S.A. with PICO quality components, these hi density units allow the most stringent mechanical, electrical and environmental requirements.

FAX or call today for immediate engineering assistance, product information or FREE catalog.

# PICO Electronics, Inc.

453 N. MacQuesten Pkwy., Mt. Vernon, N.Y. 10552

Call Toll Free

# 800-431-1064

in New York Phone 914-699-5514

FAX 914-699-5565

**Catalog describes 4-channel portable recorder.** A 10-pg, 4-color brochure describes the Dash IV 4-channel field and lab recorder. The brochure contains specifications and a variety of full-size unretouched chart samples. **Astro-Med Inc**, West Warwick, RI.

Circle No. 542

**Handbook on distributed power architectures.** This free comprehensive design guide covers the benefits of distributed power and details physical, electrical, and mechanical issues related to decentralized power architectures. It also describes component mechanical integrity and how each element in a distributed system affects reliability. **Ericsson Components AB**, Stockholm, Sweden.

Circle No. 543

**Brochure describing expandable, embedded PCs and modules.** This 16-pg, 4-color catalog offers an overview of embedded-PC products, including single-board computers, PC/104 modules, and software tools. Also featured is a line of PC/104 modules, including analog-I/O, digital-I/O,

VGA, and flat-panel controllers; communications; networking; solid-state-disk; and a Sound-Blaster-compatible audio card. **WinSystems Inc**, Arlington, TX.

Circle No. 544

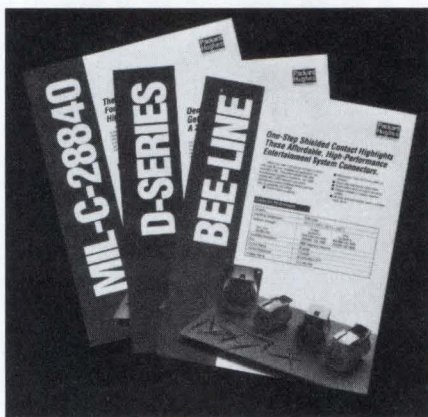

**Connector data sheets.** These data sheets describe three families of 20-gauge electrical connectors for high-performance and rugged field applications. The families include the Bee-Line connectors for airborne applications, the D-Series connectors for the most rugged environments, and the MIL-C-28840 connectors for

shipboard applications. **Packard-Hughes Interconnect**, Irvine, CA.

Circle No. 545

**Brochure on electromagnetic shielding.** *The Unseen Force* details a new diagnostic service that performs an on-site analysis of electromagnetic levels, provides an evaluation, and designs and installs a shielding solution. Free. **Lindgren R F Enclosures Inc**, Glendale Heights, IL.

Circle No. 546

**Brochure describes Visual Engineering Environment.** This 12-pg, color brochure (Literature 5962-9239E) describes Hewlett-Packard's Visual Engineering Environment (VEE). The brochure focuses on VEE's graphical programming language, its benefits over traditional methods of generating code, and its impact on areas of automated test. Examples illustrate how VEE can be applied in jet-engine component testing, design verification for mobile phones, life testing for consumer appliances, and functional test for transponders. **Hewlett-Packard**, Palo Alto, CA.

Circle No. 547

## Non Contact Measurement? Low Cost Sensor? Thermopiles TPS 424 and TPS 434 will meet your requirements.

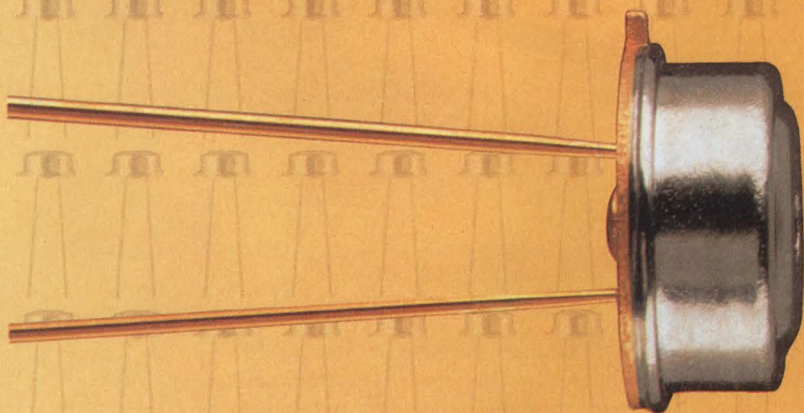

**New series of thermopile sensors in TO-5 package with very low temperature coefficients enable monitoring of temperature from a distance.**

**Produced by latest Silicon Micro Machined technologies.**

**Options available including temperature reference thermistor and special narrow band optical filters.**

**Our experience in sensor mass production stands for high quality and consistent parameters. Try this new device - the performance will convince you.**



**EG&G HEIMANN**  
Optoelectronics

Within the EG&G Group Heimann Optoelectronics specializes in Pyroelectric IR-Sensors, Thermopile Sensors, Photoconductive Cells, Image Tubes, Flash Tubes and Trigger Coils. Contact our US office today under 1-800-995-0602 or by Fax 215-368-4790 to obtain more details from our specialists. EG&G Optoelectronics group: EG&G Canada, EG&G Electrooptics, EG&G Heimann Optoelectronics, EG&G Judson, EG&G Reticon, EG&G Vactec.



## **Our EMI filters help keep your briefcase from becoming a battleground.**

If business is war, this is where the fight gets serious. Cellular phones, notebook computers, pagers and soon, PCS devices – the potential for interference among them is surpassed only by the potential for interference inside them. Fortunately, our EMI/RFI filters are superb peace-keepers. We offer the widest selection of EMI/RFI filters in the industry, in unsurpassed ranges of inductance and capacitance values, temperature ratings, frequencies and current ratings. Products like our unique high-frequency L-Chip Inductor, with its precision tolerance of

$\pm 2\%$ , are made possible by our exclusive thin-film technology. And our ability to combine high current ratings with lower DC resistance means you don't have to compromise one for the other in your designs. So as you're designing the newest weapon for the corporate wars, let us be a small part in your success and help you avoid internal strife. For more information and our EMI Filter catalog, call **1-800-831-9172, ext. 129.**



**A small part  
in your success**

# Noritake

Need a display with only characters?

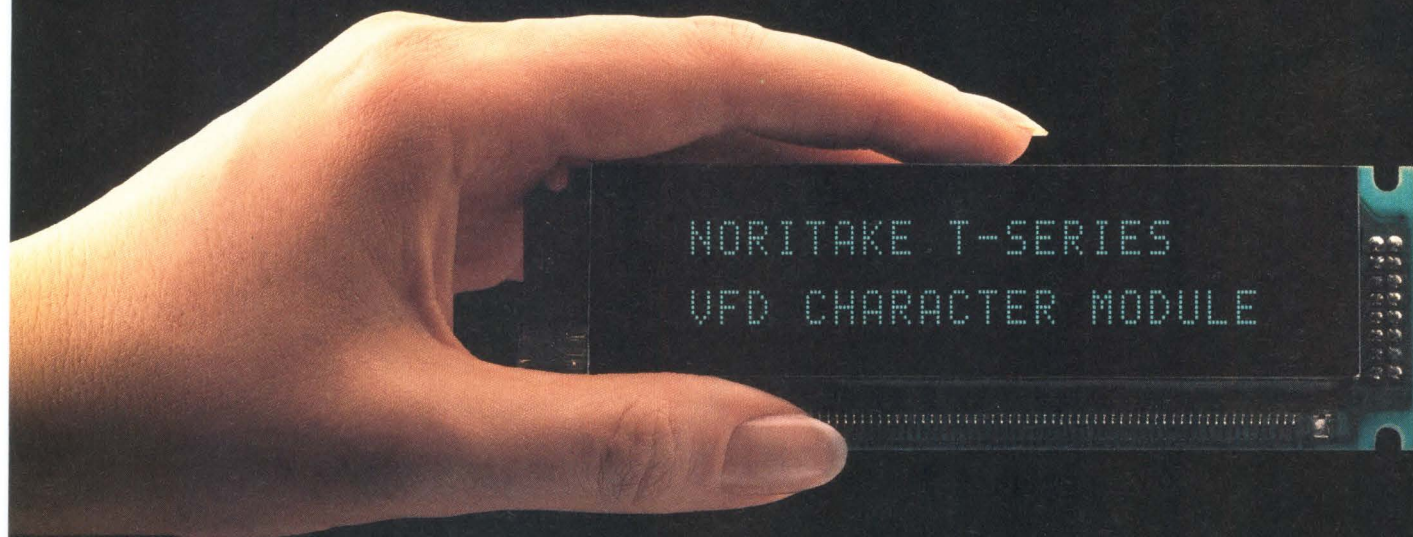

Or a display that will express your character?



Noritake has whatever kind of Vacuum Fluorescent Display that will fit your particular needs, including a wide range of character modules and graphic modules.

- Low cost
- Easy user interface
- Flexible control data
- High visibility
- High brightness
- SMT
- Character Modules - over 20 models
- Graphic Modules - over 10 models

**Call TOLL FREE 800-837-4727**

or contact your local Noritake office:

#### Chicago

2635 Clearbrook Drive  
Arlington Heights, IL 60005  
Tel. 708-439-9020  
Fax 708-593-2285

#### Boston

945 Concord Street, Ste. 118  
Framingham, MA 01701  
Tel. 508-626-0811  
Fax 508-626-0429

#### Dallas

2454 Dallas Trade Mart  
Dallas, TX 75207  
Tel. 214-742-9389  
Fax 214-747-5065

#### Los Angeles

2050 E. Vista Bella Way  
Compton, CA 90220  
Tel. 310-603-9770  
Fax 310-603-9810

#### New Jersey

75 Seaview Drive  
Secaucus, NJ 07094  
Tel. 201-319-0800  
Fax 201-319-1962

#### Canada

Noritake Canada Ltd.  
90 Nugget Avenue  
Agincoourt, Ontario M1S 3A7  
Tel. 416-291-2946  
Fax 416-292-0239

#### Europe

Noritake Europa GmbH.  
Frankfurter Strasse 97-99  
W-6096 Raunheim, Germany  
Tel. 06142-43095/96/97  
Fax 06142-22799

# EDN

## PRODUCT MART

This advertising is for new and current products.

Please circle Reader Service number for additional information from manufacturers.

### EXPRESS

**Best Value in the World**  
for  
**POLYIMIDE & FR4**  
**1 to 5 DAY TURN**  
1 to 12 Layers

PRINTED CIRCUIT PROTOTYPES

2 PIECE PRICES FOR FR4 .062 Th.

LAYERS	1	2	3&4	5&6	7&8
15	\$233	\$292	\$639	\$787	\$935
30	264	330	724	891	1059
60	311	389	853	1049	1137
90	358	448	980	1207	1434
120	385	486	1044	1311	1559

5 PIECES x 1.34    5 DAY PRICES ABOVE  
10 PIECES x 1.67    UL LISTED

EXTRAS	CAPABILITIES	DISCOUNTS
<ul style="list-style-type: none"> <li>Photo Plotting</li> <li>Testing</li> <li>Gold Contacts - \$50</li> <li>25% - Below 8 Mil Hole</li> <li>Below 15 Mil Hole</li> <li>SMOBC &amp; LPI - \$50</li> </ul>	<ul style="list-style-type: none"> <li>Buried &amp; Blind Vias</li> <li>Polyimide Multilayer</li> <li>Full Body Gold</li> <li>Carbon Paste</li> <li>Tin nickel burn-in boards</li> <li>SMT-SMOBC</li> <li>Up to 22 layers</li> <li>Impedance control boards</li> </ul>	<ul style="list-style-type: none"> <li>5%</li> <li>10%</li> </ul>

FOR MORE INFORMATION CALL OR FAX

Ken Bahi ■ 1108 W. Evelyn Ave., Sunnyvale, CA 94086  
Phone (408) 735-7137 FAX (408) 735-1408 Modem (408) 735-9842

CIRCLE NO. 242

**In-Circuit Emulators For**

## 8051

## 683XX

## 68HC11

## 68HC16

## 80C196

See EEM 93/94 Pgs. D1304-1309

- Rental and 10-day trials available.
- Full Source-level Debugger with complete C-variable support.
- Supports virtually all members of the 8051, 80C196, 68HC11, 68HC16 and 68300 families.

CALL OR WRITE FOR FREE DEMO DISK!

**NOHAU CORPORATION**

51 E. Campbell Ave.  
Campbell, CA 95008  
FAX (408) 378-7869  
TEL (408) 866-1820

Call 408-378-2912  
Nohau's 24-hour information center to receive info via your FAX

CIRCLE NO. 250

## Little Star™

**NEW** 30 I/O lines  
Only \$195

Newest in Z-world's line of C-programmable miniature controllers, the Little Star™ has 16 protected digital inputs, 14 high-current driver outputs, RS232/RS485, battery-backed RAM and real-time clock, programmable timers, watchdog, and more. The Little Star is also available with enclosure and LCD/keypad, expansion cards for additional I/O, and optional 18 MHz clock. Our easy-to-use, yet powerful Dynamic C™ development system (\$195) integrates an editor, compiler, debugger, and dozens of software libraries all in source code. The Little Star is ideal for OEM control applications, manufacturing automation, test and data acquisition.

24-Hour AutoFAX 1724 Picasso Ave.  
916.753.0618. Call Davis, CA 95616  
from your FAX. 916.757.3737  
Request catalog 18. 916.753.5141 FAX

**ZWORLD ENGINEERING**

CIRCLE NO. 247

## ROM-IT

EPROM EMULATION SYSTEM

The Most Flexible EPROM Emulator You Can Get Today

- Emulates up to eight 4-Megabit EPROMs through one standard serial port.
- Downloads 2-Megabit programs in less than 23 seconds
- Examine and modify individual bytes or blocks.
- Accepts Intel Hex, Motorola S-Record and Binary files.
- Software available for IBM PC and compatibles.
- Base 27256 EPROM System \$395.00. Other configurations available.

**Incredible Technologies, Inc.**  
Visa, Mastercard and American Express Accepted

Order Now - It's Easy  
Call (708) 870-7027 Or Fax (708) 870-0120  
For More Information

CIRCLE NO. 237

## UNIVERSAL/GANG PROGRAMMERS

**FLEX-700**  
32 pin from \$645  
40 pin from \$845  
48 pin from \$945

**ALL-03A \$595**

IC Manufacturer approved & under \$1000

- Supports Altera 7xxx, MACH 435, Xilinx, Intel FX7xx, nearly all FPGA/CPLD/PLD...
- Support EPROM, 28/29F FLASH, Serial PROM, PSD4XX/5XX, Intel/Motorola/TI/NEC/Hitachi MPU/DSP devices.
- Test 74/40/45 series, DRAM(SIP/SIMM), and SRAM.
- Parallel port connection to PC option.
- Free software updates via BBS.

**Tribal Microsystems Inc.**  
44388 S. GRIMMER BLVD., FREMONT, CA 94538  
Tel: (510) 623-8859  
Fax: (510) 623-9925

CIRCLE NO. 252

## Advin

PILOT-U84 Universal Programmer

**#1 in New Device Support & Expandability**

Altera 7064,7128,7160,7192 in 84-, 100- and 160-pin packages  
Xilinx 1765D,17128 etc Intel FLEX, 87C196 K.C.KD.JR.MC etc.  
Moto 68HC711, 68HC705, WSI PSD-3XX-4XX-5XX.PAC.SAM  
Atmel 29C040, ATF22V10 etc. AMD MACH435, 29F040, etc  
Lattice pLSI-1000,2000-,3000. Microchip PIC micros  
All packages to 256-pin: PLCC,PGA,QFP,TQFP,TSOP,SOIC  
800-627-2456 FAX:(408) 736-2503, Sunnyvale, CA.

CIRCLE NO. 230

## ANALYZER-EMULATOR



### UniLab 8620

- ❑ PC Based, Zero-Wait-State Operation
- ❑ Non-Stop Analysis: Define & Refine Triggers & View Multiple Traces On-The-Fly
- ❑ Source Level & Symbolic Debug
- ❑ Built-In EPROM Programmer
- ❑ Same Base Unit Supports Most 8-bit  $\mu$ Cs &  $\mu$ Ps, including 8051, 68HC05, 68HC11, Z80, 80C196, 6502, 8085, etc.

**1-800-729-7700**

Tel: 415-327-8800  
Fax: 415-327-9881

**ORION**  
INSTRUMENTS

180 Independence Dr., Menlo Park, CA 94025 U.S.A.

CIRCLE NO. 248

## Gang/Set E/EPROM Programming

stag  
microsystems

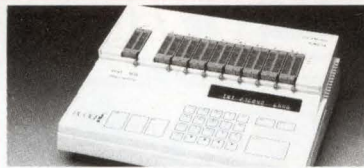

- ★ PP42 - the total solution for Gang/Set programming of EPROMs and EEPROMs
- ★ 8, 16 or 32-bit programming of device sets in a single operation (24 to 32 pins)
- ★ Option modules for ganging Micros, MROM EPROMs, 40-pin DIP/16-bit or 32-PLCC
- ★ 4 Mbits RAM standard - expands to 64M
- ★ Stand-alone or PC operation
- ★ Serial and Parallel ports

Stag Microsystems, Inc  
Tel: 408 988-1118 Fax: 408 988-1232



CIRCLE NO. 251

## MICROPROCESSOR EMULATORS

Zax provides a comprehensive series of real-time emulation support for Motorola, Intel, NEC, Zilog, and Hitachi microprocessors. Some of the highlighted features include source-level debug, real-time trace, and performance analysis.

Call now for more information:

(800) 421-0982  
(714) 474-1170 (Inside CA)  
(714) 474-0159 (Fax)

**ZAXTEK**

42 Corporate Park Irvine, CA 92714

CIRCLE NO. 246

## Real-Time Development At a Realistic Price

### SIGNUM IN-CIRCUIT EMULATORS

80196 • 8051 • 80186 • Z8  
DSP • HPC • 8085 • Z380



REAL-TIME IN-CIRCUIT  
DEBUGGING & DEVELOPMENT

ON-THE-FLY ACCESS TO  
PROGRAM AND  
DATA MEMORY

REAL-TIME  
TRACE  
FILTERING

**FREE!  
10-DAY  
TRIAL  
TRY BEFORE  
YOU BUY**

WINDOWS & MOUSE USER INTERFACE

FREE USER SUPPORT

EXTERNAL UNIT WITH NO PLUG-IN CARDS

**SIGNUM** FOR MORE INFO OR TO ARRANGE  
YOUR 10 DAY FREE TRIAL, CALL:  
**SYSTEMS 1-800-838-8012**

CIRCLE NO. 243

## Fast & Friendly

The handheld programmer/emulator for demanding engineers.



S4 programs EPROMs, EEPROMs, FLASH, PICs,  
8751 micros. It emulates RAM and ROM too!

To get S4 on your desk tomorrow, or to simply request literature, call:

**800-328-2336 or 407-649-3335**  
Fax: 407-649-3310 BBS: 407-649-3159

**Dataman**  
Dataman Programmers Inc.

Dataman Programmers Inc.,  
22 Lake Beauty Drive,  
Suite 101, Orlando,  
FL 32806, USA.

15 years of innovative solutions in the palm of your hand.

CIRCLE NO. 254

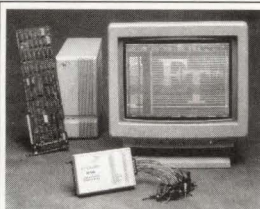

*Rated #1  
for  
Ease-of-use  
by OEMs  
& end users*

### Expandable Logic Analyzer plus

- ✓ 50 MHz and 25 MHz state and timing
- ✓ 32K sample depth, up to 192 channels
- ✓ Professional features in PC-based product
- ✓ Easy-to-use, windows-like interface
- ✓ PC-based desktop and ISA bus versions
- ✓ Digital/analog pattern generator option



EMULATION TECHNOLOGY, INC.  
**800.995.4381**

CIRCLE NO. 225

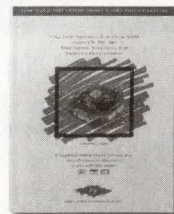

*#1 in  
Adapter  
Solutions  
for over  
10 years*

### FREE 1994 Interconnect Solutions Catalog

- ✓ Over 3,500 devices for one-stop-shopping
- ✓ 120 "Off-the-shelf" items available for overnight delivery
- ✓ Unlimited application consulting
- ✓ Time saving solutions for product development
- ✓ Ask about our custom designs
- ✓ Leading edge technology -- over 500 PQFP solutions



EMULATION TECHNOLOGY, INC.  
**800.995.4381**

CIRCLE NO. 226

## THINK EMBEDDED THINK MCSI

"The Embedded PC Specialists"

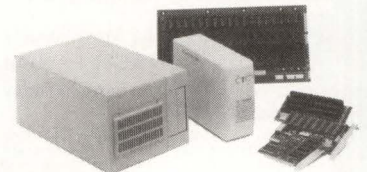

- PROMDISK® disk emulator boards support Flash, EPROM, and SRAM, up to 4M-bytes.
- Full line of ISA and EISA CPU boards to 66MHz
- 3 to 20 slot ISA and EISA passive backplanes
- 3 to 14 Slot Embedded and Rack Mount Chassis
- Custom Products, Engineering, and Licensing

Call now for our Special "Get Embedded Offer"

**MCSI** 2598 fortune way  
vista, ca 92083  
**619/598-2177**  
fax 619/598-2450

CIRCLE NO. 240

## PLCC LoClip – PLCC Probe

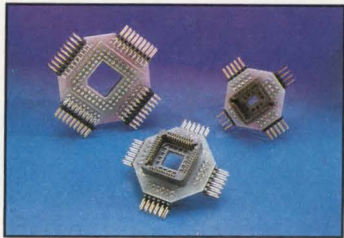

### Probe in Place

- Probe surface mounted PLCC chips
- Lowest profile Clip (.45" – .75")
- Instrument VME bds. etc with no extender
- PLCC sizes from 20-84 pins
- Annotations available
- Mechanically and electrically reliable connection
- Ask about custom solutions

**IRONWOOD ELECTRONICS**  
P.O. BOX 21151, ST. PAUL, MN 55121  
(612) 431-7025; FAX (612) 432-8616

CIRCLE NO. 238

You Don't Have  
To Burn Your  
Devices Like This!



## LOGICAL



Has a Full  
Range of  
High Quality  
Universal & Gang  
(EEPROMs, FLASH, PLD,  
& MICRO CONTROLLER)  
Programmers

**LOGICAL**  
DEVICES, INC. **digelec**  
TEL: (305) 428-6868  
FAX: (305) 428-1811

1 800 331-7766 Ext: 103

CIRCLE NO. 239



### NEED MORE SPEED.... DON'T WANT TO REDESIGN

#### MOTOROLA® CPU "ACCELERATOR ADAPTERS™

- Δ Replaces original CPU with next generation technology.
- Δ Extends the life of your current system.
- Δ Avoids the high cost of redesign.
- Δ Add 32-bit RAM and math coprocessor.
- Δ Custom design and manufacturing services.

Interested in speeding up your system?

**Computer System Associates**  
7564 Trade Street Phone: (619) 566-3911  
San Diego, CA 92121 FAX (619) 566-0581

CIRCLE NO. 234

## TINY 2400 bps MODEM

\$ 29.95 / 1,000 pcs.  
OEM Quantities

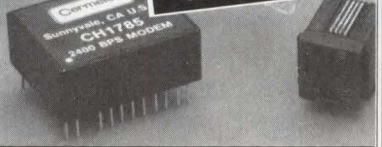

### CHI785, A Complete Modem

- V.22 bis, V.22, 212A, 103
- FCC Part 68 Approved
- AT Commands
- 5V, Low Power
- 1.25" x 1.00" x 0.50"

Your Source for Modem Components



Tel: 408-752-5000  
Fax: 408-752-5004

Cermetek Microelectronics, Inc.  
1308 Borregas Ave. • Sunnyvale, CA 94089

CIRCLE NO. 233

## Smart TekMeter from Tektronix



The new TekMeter integrates the usability of a digital multimeter with the waveform display of an oscilloscope in a compact, easy-to-use, two pound battery-operated package. TekMeter has 25Ms/sec digitizer(s) automatic setup, spike detect and cursors. Prices for TekMeters range from \$859 to \$1,259. For more information, call Tektronix at 800-426-2200 or your local distributor.

CIRCLE NO. 245

## LITTELFUSE ANNOUNCES NANO<sup>2</sup> SURFACE MOUNT CIRCUIT PROTECTION SYSTEM

Littelfuse, Inc. recently introduced a complete surface mount circuit protection system that meets all PC board layout, circuit and maintenance needs.

With this system, the manufacturer has the freedom to choose the NANO<sup>2</sup>™ Fast-Acting or Slo-Blo® SMF fuses for direct mount applications, or either fuse pre-installed in the SMF Omni-Blok® surface mount fuse block that permits easy fuse replacement if frequent replacements may be required.

Littelfuse, Inc.  
(708) 824-0400



CIRCLE NO. 258



Melts  
the Price  
of 8051  
ICE



### iceMASTER-PE In-Circuit Emulators from \$851

New AET (patented) emulator architecture delivers incredible value!

- Up to 42 MHz Operation
- 128K Code/XDATA Memory
- 128K Hardware Breakpoints
- Optional 16K Transparent Trace (View Trace While Executing)
- Real Time & Nonintrusive
- Symbolic & Source-Level Debug
- Windowed User Interface
- Serial Link to Any PC
- 8031/8032/8X51/8X52
- 8XC51FX/87L51FB
- 8XC751/752
- DS80C320

Call today for  
FREE DEMO DISK!

(800) 638-2423

MetaLink Corporation  
Phone: (602) 926-0797 FAX: (602) 926-1198

CIRCLE NO. 249

## This DSP System will help get your new product to market fast.

Blazing-fast, PC-based Turbo C30-II Real-Time DSP Development Board gives you the tools (like TI TMS320C30 32-bit DSP; up to 2MB Dual Access, 0 wait state memory; 4.2MB/sec data transfer; TI & Tartan C/C++ software; and more)—and

industry-leading engineering services provide support—for quick product design.



Turbo C30-II  
& Prototyping Boards

Call  
800-550-7302  
for details.

**WINTRISS**  
ENGINEERING  
CORPORATION

CIRCLE NO. 253

## HAND HELD TERMINALS & COMPUTERS

Industry Proven Reliability

- RS-232, RS-422, RS-485
- 5 VDC, Extended 8-24 VDC or Battery Powered
- 4x20 or 8x24, 16x32 Supertwist Liquid Crystal Displays
- Rugged Ergonomic Housing
- Full Range of Models Available
- Off The Shelf or Quickly Customized To Suit Your Needs



**Two Technologies**  
419 Sargon Way  
Horsham, PA 19044  
Tel: (215) 441-5305  
Fax: (215) 441-0423

CIRCLE NO. 257

## RELIABILITY PREDICTION SOFTWARE

### ARE YOUR PRODUCTS RELIABLE?

The RelCalc 2 Software Package automates the reliability prediction procedure of MIL-HDBK-217, or Bellcore, allowing quick and easy reliability analysis of electronic products on your PC. Say goodbye to tedious, time consuming, and error prone manual methods!

- NEW UPDATE! VERSION 3.1 now available.
- User friendly: pop-up menus, hypertext help.
- Very easy to learn and use; quick data entry.
- Part library for rapid recall of part data.
- Global editing functions for what-if? trials.
- Reports which clearly organize results.
- Save time & money as you design for quality.
- Try our Demo Package today for \$25.

T-Cubed Systems, 31220 La Baya Drive,  
Suite 110, Westlake Village, CA 91362  
CALL: (818) 991-0057 FAX: (818) 991-1281

CIRCLE NO. 244

## IMAGINE IF YOUR PRODUCT COULD TALK!

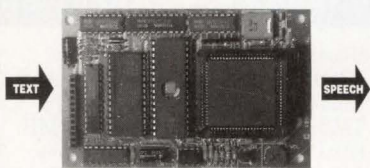

V8600 text-to-speech synthesizer

- Converts plain ASCII text into speech ("talking printer")
- Requires only a single 5V supply and speaker
- Unlimited vocabulary—no custom recording necessary
- Programmable pitch, rate, tone, volume, etc.
- Text, character, phonetic, tone and PCM modes
- Microprocessor, serial and printer interfaces
- Use in telecom, robotics, monitoring systems, etc.
- Less than \$100 in OEM quantities
- ISA, PC/104 and stand-alone versions available

**FREE V8600 DATA BOOK**  
USA Ph: 206 355-3800 Fax: 355-1098  
UK/Europe Ph: 4481 539 0285

**RC SYSTEMS**  
INCORPORATED

RC Systems, Inc. • 1609 England Avenue • Everett, WA 98203 USA

CIRCLE NO. 255

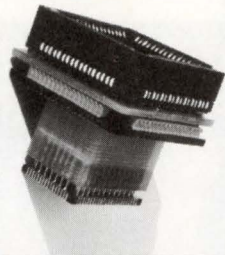

## QFP and SOIC SMT Adaptors for Emulators and Logic Analyzers

- Two part modular construction
  - 62 mil high generic base replaces the chip variety of tops can be purchased separately, e.g. emulator, logic analyzer, ZIF socket, cable, etc. tops
- Easy to solder
  - 160 leads under 1 minute
  - no special equipment or experience required
- Rugged construction, minimum size, short traces
- Vertical extensions available
- Deliveries from stock to 3 days on most products

EDI Corp., PO Box 366, Patterson, CA 95363,  
Tel.: 209/892-3270, Fax: 209/892-3610

CIRCLE NO. 261

## A Complete Line of Development Boards, Programmers and In-Circuit Emulators

NEW...NEW...NEW...NEW...

DS-186 – In-Circuit Emulator for  
80C186/8/XL/EA/EB/EC, V40/50  
8086/8 and other  $\mu$ Cs

\*\*\* NEW ADDRESS IN THE USA \*\*\*

Call today for your  
free demo and  
software update

Toll Free: 1-800-833-4084

**CEIBO** 7 EDGESTONE CT.  
FLORISSANT, MO 63033  
TEL: 314-830-4084  
FAX: 314-830-4083

CIRCLE NO. 232

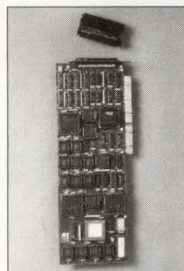

## PC-EISA TO ENCORE HSD DATA LINK/EMULATION

Using our PCEHSD® card and file transfer software, files can be moved between a PC EISA bus computer and an Encore computer HSDII board. The PCEHSD also emulates the HSDII; therefore, the PCEHSD can drive a HSDII compatible peripheral device. Transfer rates in excess of 10Mbytes/second. DOS I/O routines and interactive test program, and UNIX driver available. This product is an excellent tool for hi-speed data acquisition, monitoring or product test fixture.

**APPLIED DATA SCIENCES, INC.**  
P.O. Box 814209, Dallas TX 75381-4209  
(214) 243-0113 • FAX (214) 243-0217

CIRCLE NO. 231

Combine your  
Product Mart ads in  
EDN Magazine and  
Products Editions  
for  
*higher impact*  
and a  
*lower rate!*

CIRCLE NO. 259

## REMOVE HARDWARE LOCKS

**PROTECT YOUR INVESTMENT!  
MAINTAIN PRODUCTIVITY!**  
Software utility that allows for  
the removal of hardware locks.

Available for most major  
CAD/CAM and PCB  
software programs

*Easy - Simple - Guaranteed*

Programs start at \$99.00 U.S.

Visa and Mastercard Welcome  
Call or Fax for more information

SafeSoft Systems Inc.  
201-1111 Munroe Ave. Phone (204) 669-4639  
Winnipeg, Mb. R2K 3Z5 FAX (204) 668-3566  
Canada

CIRCLE NO. 241

Find out how you  
can break through  
the clutter to get big  
results for a small  
price, by placing a  
4-color ad in  
EDN Product Mart.  
Call Joanne Dorian  
at (212) 463-6415  
for details.

CIRCLE NO. 260



# EDN-CAREER OPPORTUNITIES

**Software Engineer** to be member of small development team; Participate in the development of software products and documentation to allow personal computers and laser printers to print checks and other negotiable documents as well as design, strategy and planning of product. Must be able to write applications for Microsoft windows using C or C++. Require: BA, BS, BE in computer science or engineering with 1 yr 6 mths exp. in job offered. Salary: \$42,000/yr; M-F 8am -5pm; 40 hrs wk; Located in Jacksonville, FL  
Send resume to: Job Service of Florida, 2810 Sharer Rd., Suite 30B, Sugar Creek Plaza, Tallahassee FL 32312. Job No. FL-1037984.

Company needs an Electrical Engineer to design electrical power distribution systems, generation systems, lighting systems and control systems for commercial and industrial use, to develop graphics software, computer aided design software and electrical circuit simulation software to evaluate the accuracy and behavior of AC and DC circuit models; and to perform hands-on work as well as doing theoretical calculations. Applicant must have M.S.E.E. and one year experience in power distribution systems and computer aided design systems and must know how to use PsPice and Matlab simulators for analyzing electrical circuit. 40 hrs /week, \$27,650/year. Submit your proof of qualification and resume to John F. Scott, Missouri Division of Employment Security, 421 East Dunklin Street, Post Office Box 59, Jefferson City, Missouri 65104-0059, re: Job #127233.

## DESIGN/FIELD SERVICE ENGINEER

New England independent repair co. Requires electrical and mechanical experience with proven hands-on ability to install, repair, retrofit & maintain industrial, utility, government and commercial. Circuit breakers, transformers, switchgear, ac/dc drives, etc. Send resume in confidence to: Fredrick A. Farrar, Inc. 15 Avon St. Keene, N.H. 03431. 603/352-4316

A SMALL AD HERE COULD ATTRACT A LOT OF ATTENTION

## IOWA MIDWEST RF/TELECOM WIRELESS

### IOWA-MINNESOTA-ILLINOIS

I have immediate openings for Design Engineers and Technical Project Managers with BS/MS plus 3 to 10 years RF/Radio design experience in any of the following areas: RF circuit design (100 MHz to 3.0 GHz), Receivers, Transmitter Exciters, Low-noise Frequency Synthesizers, Power Amplifiers, Spread Spectrum Modulation, Digital Radio DSP. These positions are all with top non-defense companies in good Upper-Midwest locations

### DON GALLAGHER, MSEE

Gallagher & Brei Associates

1145 Linn Ridge Rd., Mount Vernon, IA 52314  
(319) 895-8042 • Fax (319) 895-6455

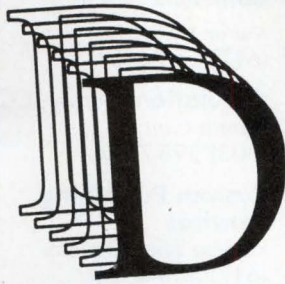
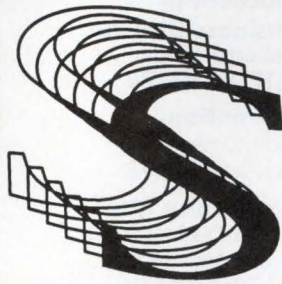
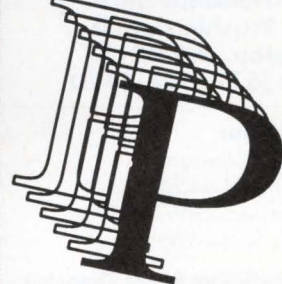
# Without Tears™

Learn DSP and put your knowledge to work IMMEDIATELY!

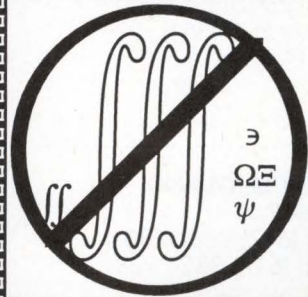

COMING TO A CITY NEAR YOU

Atlanta San Jose  
Salt Lake City  
Washington D.C.  
Toronto Austin  
Scottsdale, AZ

Call Z Domain Technologies, Inc.

800-967-5034

404-587-4812

Hours 9-5 EST.

Ask for a brochure.

Our 2-Day Advanced Course is ready. Call for more info.

By taking this 3-Day Course you will really learn DSP. Guaranteed!

If you want to reach over 163,000 engineering professionals, in over 52,000 locations, EDN Career Opportunities is the best place to advertise your company's positions.

Get the attention of 100% qualified engineers and managers involved in designing or developing electronic products, who look to EDN Magazine's Classified section for career opportunities.

Only EDN can guarantee you're reaching the key design engineers in the Electronic Original Equipment Manufacturer market.

For more information on advertising, contact:

**JACKIE DANIELS**

**Tel: 1-800-603-4859 Fax: 1-617-630-3925**

**EDN Headquarters**  
**275 Washington St**  
**Newton, MA 02158**  
**Fax: (617) 558-4470**

**Publisher**

Jeffrey Patterson  
 (617) 558-4454  
 Maria McGrath, Assistant  
 (617) 558-4346

**Advertising Sales Director**

Paul Rothkopf  
 (617) 558-4651

**Marketing/  
 Business Director**  
 Deborah Virtue  
 (617) 558-4779

**Promotion**  
 Jean Graham  
 (617) 558-4698

**Production Staff**  
 Andrew A Jantz,  
 Group Manager  
 (617) 558-4372

Karen Banks, Manager  
 (617) 558-4441  
 Alice Dorsey, Associate  
 (617) 558-4601

**Contracts**

Muriel Murphy,  
 (617) 558-4451

**Circulation:** Denver, CO  
 Denise Garcia,  
 (303) 398-7694

**Custom Publishing  
 Services**

Patricia Tyler, Director  
 (617) 558-4526  
 fax: (617) 558-4470

**Reprints of EDN arti-  
 cles are available on a  
 custom printing basis  
 at reasonable prices in  
 quantities of 500 or  
 more. For a quote,  
 phone Ellen Sandram,  
 Cahners Reprint Service  
 at (708) 390-2773.**

**NEW ENGLAND**

Chris Platt  
 Tel: (617) 964-3730  
 Fax: (617) 332-7128

**NEW YORK/NEW JERSEY  
 AND MID/SOUTH  
 ATLANTIC**

Diane Driscoll  
 Tel: (203) 326-5161  
 Fax: (203) 326-5160

**IL, IN, KY, OH,  
 TN, TX, OK, FL, SC**

JoAnn Cannon  
 Tel: (708) 635-8800  
 Fax: (708) 635-0929

**IL, MI, MN, NE, IA, KS,  
 ND, SD, WI, MO, AL, AR,  
 GA, MS, CANADA**

Jack Johnson  
 Tel: (708) 635-8800  
 Fax: (708) 390-2815

**ARIZONA**

Donnie Jones Adams  
 Tel: (408) 243-8838  
 Fax: (408) 243-2144

**ORANGE/RIVERSIDE/  
 SAN DIEGO COUNTIES  
 LOS ANGELES/  
 SOUTHERN CA, NV**

Susan N Green  
 Tel: (714) 851-9422  
 Fax: (714) 752-6867

**NORTHERN CA/  
 SILICON VALLEY**

Donnie Jones Adams  
 Bettina McGowan  
 Tel: (408) 243-8838  
 Fax: (408) 243-2144

**EUROPEAN  
 OPERATIONS**

Tully Giacomazzi,  
 Managing Director  
 Tel: 49 89 769 02 391  
 Fax: 49 89 769 02 144

**UK**

John Waddell  
 Tel: 44-81-312-4696  
 Fax: 44-81-312-1078

**NORWAY, SWEDEN,  
 FINLAND**

Roland Nihlmar,  
 Lars Grunberger  
 Tel: 46 8616 0760  
 Fax: 46 8616 0777

**DENMARK**

Aase Kisborg  
 Tel: 45 33 14 9888  
 Fax: 4533149288

**GERMANY-NIELSEN 4/  
 BAVARIA**

Margarethe Munchmeier  
 Tel: (49-89) 22 20 15  
 Fax: (49-89) 299 160

**SPAIN**

Luis S Giner  
 Tel: 343-894-43-26  
 Fax: 343-894-88-37

**AUSTRIA**

Sven Kollensperger  
 Tel: 43-732-79-34-55  
 Fax: 43-732-79-34-58

**ISRAEL**

Asa Talbar  
 Tel: 972-35-223-621  
 Fax: 972-3-524-2177

**ITALY**

Roberto Laureri  
 Tel: 39-2-236-2500  
 Fax: 39-2-236-4411

**SWITZERLAND**

Roswitha N Briand  
 Tel: 41-1-261-4690  
 Fax: 41-1-251-45-42

**NETHERLANDS/  
 BELGIUM/NORTHWEST  
 GERMANY (NIELSEN 1, 2,  
 5, 6, 7)**

Albert Ticheler  
 Tel: 31-40-41-37-27  
 Fax: 31-40-42-04-30

**CENTRAL/  
 SOUTHWEST GERMANY  
 (NIELSEN 3A, 3B)**

Renate Munk  
 Tel: (49) (6272) 2345  
 Fax: (49) (6272) 2167

**FRANCE**

Alain Faure  
 Tel: 33-1-4629-4629  
 Fax: 33-1-4093-0337

**HONG KONG**

Adonis Mak  
 Tel: 852-838-2666  
 Fax: 852 575 1690/  
 852 575 1967

**JAPAN**

Kaoru Hara  
 Tel: (81-3) 3389-1822  
 Fax: (81-3) 3389-1761

**KOREA**

Jeong-gwon Seo  
 Tel: 82-2-752-4392  
 Fax: 82-2-752-4394

**SINGAPORE/  
 MALAYSIA**

Hoo Siew Sai  
 Tel: 65-738-0122  
 Fax: 65-738-2108

**AUSTRALIA**

Alexandra Harris-Pearson  
 Tel: 61-2-299-5677  
 Fax: 61-2-299-6178

**TAIWAN**

Parson Lee, John Shih  
 Tel: 886-2-7114833  
 Fax: 886-2-7415110

**PRODUCT MART**

Joanne Dorian  
 Tel: (212) 463-6415  
 Fax: (212) 463-6404

**INFO CARDS/  
 LITERATURE LINK**

Melissa Bachman  
 Tel: (617) 558-4282  
 Fax: (617) 558-4328

**RECRUITMENT**

Jacqueline Daniels  
 Tel: (617) 558-4488  
 Fax: (617) 630-3925

Direct Mail Service:  
 (708) 390-2361

**Cahners  
 Magazine Division**

Robert Krakoff,  
 President, CEO,  
 Cahners Publishing

Michael Wisner,  
 Senior VP/General Mgr,  
 Boston Div

Tom Dellamaria,  
 Senior VP/Production &  
 Manufacturing

# Play with Our Video Building Blocks!

## EL4581C Video Sync Separator

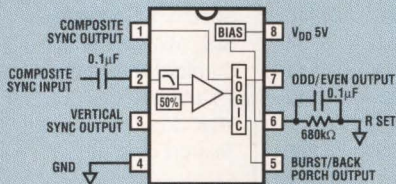

- Precision 50% Slicing
- Low Power CMOS (1.5 mA Max)
- \$2.67 in 1,000's P-DIP

## EL4083C Current Mode 4-Quadrant Multiplier

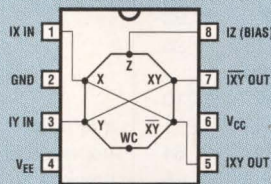

- 200 MHz Bandwidth
- THD < 0.1% @ 10 MHz
- \$6.90 in 1,000's P-DIP

## EL4583C Video Sync Separator

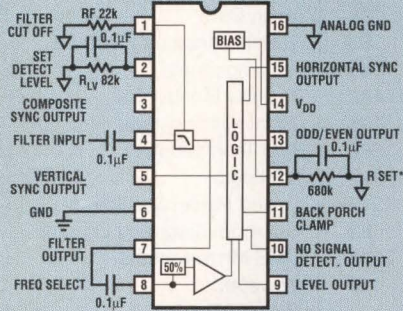

- Adjustable Filter & H-sync Output
- Precision 50% Slicing
- \$3.76 in 1,000's P-DIP

## EL4441/EL4442 Multiplexed-Input Video Amps

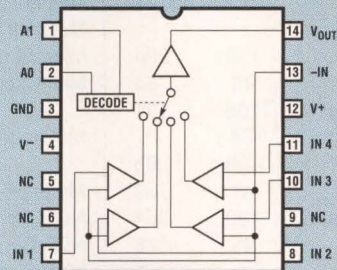

- 8 ns Switching Time
- 0.02%/0.02° Diff Gain/Phase
- \$4.71 in 1,000's P-DIP

## EL4584 Genlock

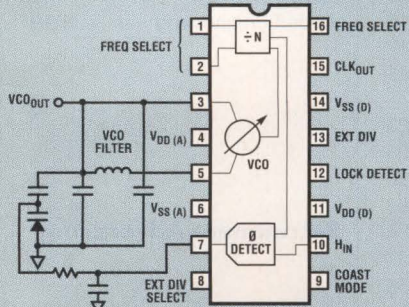

- Selectable 8-Pre-set Frequencies
- Precision Phase-Locked Loop
- \$4.71 in 1,000's P-DIP

## EL4451C Wideband Variable-Gain Amp

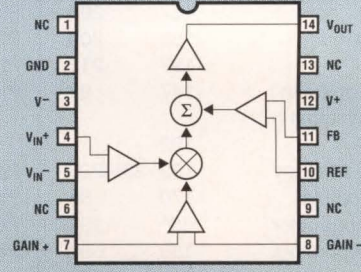

- 80 MHz Bandwidth
- Calibrated Linear Gain Control
- \$3.33 in 1,000's P-DIP

**élantec**  
ANALOG INTEGRATED CIRCUITS

FOR SAMPLES CALL (800) 333-6314 ext 311  
For Literature Only - ext 234

ELANTEC, INC. ■ 1996 Tarob Court ■ Milpitas, CA 95035 ■ (408) 945-1323 ■ (800) 333-6314 ■ FAX (408) 945-9305

Authorized Distributors: Marshall Industries ■ Nu Horizons ■ Insight Electronics

CIRCLE NO. 212

# EDN-INTERNATIONAL ADVERTISERS INDEX

Company	Page	Circle	Company	Page	Circle	Company	Page	Circle
AMP Inc	121-123	47	Incredible Technology	191	237	Siemens AG	10-11*	89
AT&T	29	209	Integrated Device Technology Inc	157		Siemens Components	6	131-135
Abbott Electronics Inc	116	48	Intel Corp	54-57	108	Sierra Circuits	191	242
Actel Corp	145	49	International Power Sources	28	33	Signal Transformer	119	148
Advin Systems	191	230	International Rectifier	97	109	Signum Systems	192	243
Allied Electronics Inc	153	192		99	110	Siliconix	4	
Analog Devices Inc	17	93		101	34	Spectrum Software	184	149
	34-35	26		103	111	Stag Microsystems	192	251
	83-90			C3	112	Stanford Research	152	199
	182	210	Interpoint	171-173		T-Cubed	194	244
Applied Data Sciences	194	231	Ironwood Electronics	193	238	TDK Corp	161	153
Applied Micro Circuits Corp	129	64	Lambda Qualidyne Inc	111	121-122	Tektronix Inc	2	154
Arnold Magnetics Corp	11	65	Linear Technology	92	190		193	245
Asahi Kasei				107-108		Teledyne Relays	110	155
Microsystems Co Ltd	166	66	Littlefuse	193	258	Texas Instruments	8-9	107
Audio Precision	112	94	Logical Devices	193	239		19-21	157
BP Microsystems	169	211	Loral Data Systems	105	113		27-38	
Burr-Brown Corp	47	79	MCSI	192	240		36-39	
CEIBO	194	232	Maxim Integrated Products	175	205	Texas Instruments Europe	127*	158
Cermetek	193	233		177	206		129*	159
Cherry Semiconductor	50	75		179	207		131*	160
Chomerics Inc	82	76		181	208	3M	140	92
Coilcraft	63	77	Melcher AG	6*	88	Tokin Corp	52	161
Computer Dynamics	183	27	Metalink Corp	193	249	Toshiba America Electronic Components	22-23	98-99
Computer System Associates	193	234	MicroSim Corp	15	150-152	Toshiba Electronics	104-105*	162
Condor Inc	45	84	Mini-Circuits	3	196	Tribal Microsystems	191	252
Crystal Semiconductor	106	191	Motorola Computer Systems	43	217	Two Technologies	194	257
Cypress Semiconductor	C4			65-67	215	US Logic	192	256
Dale Electronics	156	85	Murata Electronics	189	82	United Parcel Service	143	163
Data Translation	49	189	NCR Corp	32	218	Unirode Integrated Circuits	40	164
Dataman Programmers LTD	192	254	NEC Corp	148-149	114	VME Microsystems	155	91
Datel Inc	95	78	NKK Switches	115		Wavetek	27	185
Digi-Key Corp	1	1	National Instruments	C2	36	Welch Allen Inc	168	46
Diversified Technology	60-61	28	National Semiconductor	30-31		WinSystems	165	186
E-T-A Circuit Breakers	133	95	Nichicon	81	194	Wintriss Engineering	193	253
EDI Corporation	194		Nohau Corp	191	250	Xilinx	134-135	187
EG&G Heiman			Noritake	190	220	Zaxtek	192	246
Optoelectronics Inc	188	29	Oki Semiconductor	127	115	Zenith Power Supplies	91	223
ESL	200	96	Orion Instruments	192	248		28	197
EUROM Flash Ware Solutions Ltd	158	105	Oyster Terminals	104	116	Zilog	150	188
Eagle-Picher	167	201	Payton Industries	82*	117	Zworld Engineering	191	247
Ecliptek Corp	159	200	Philips Key Modules	136	221			
Elantec	197	212	Philips Semiconductor	131				
Electronic Designs Inc	147	97	Pico Electronics	50	123			
Embedded Systems Conference	132			160	123			
Emulation Technology	192	235-236		187	136			
Epson America Inc	170	86	Power Convertibles Corp	77	83			
Epson Semiconductor	63*	198	Power One	58	124			
Ericsson Components	199	80	Power Trends	73	137			
FDK Corp	168	203	Prem Magnetics	144	138			
Fluke Corp	26	30		180	139			
Gage Applied Sciences Inc	104	31	Quad Design	10	222			
Gennum Corp	139	213	Quality Semiconductor Inc	53	125			
Grayhill Inc	162-163	87	Quicklogic	51	144			
Hansen Corp	164	193	RC Systems	194	255			
Harris Semiconductor	124	32	RO Associates Inc	75	38			
Harwin Inc	146	214	Raltron Electronics	144	145			
Hewlett-Packard	79	106	Reliability Inc	180	37			
Hirose Electric USA	203		Safe Soft Systems	194	241			
IEE	154	103-104	Samsung Semiconductor Inc	24-25	146			
			Samtec Inc	12	147			

**Recruitment Advertising 195**

\*Advertiser in European edition

This index is provided as an additional service. The publisher does not assume any liability for errors or omissions.

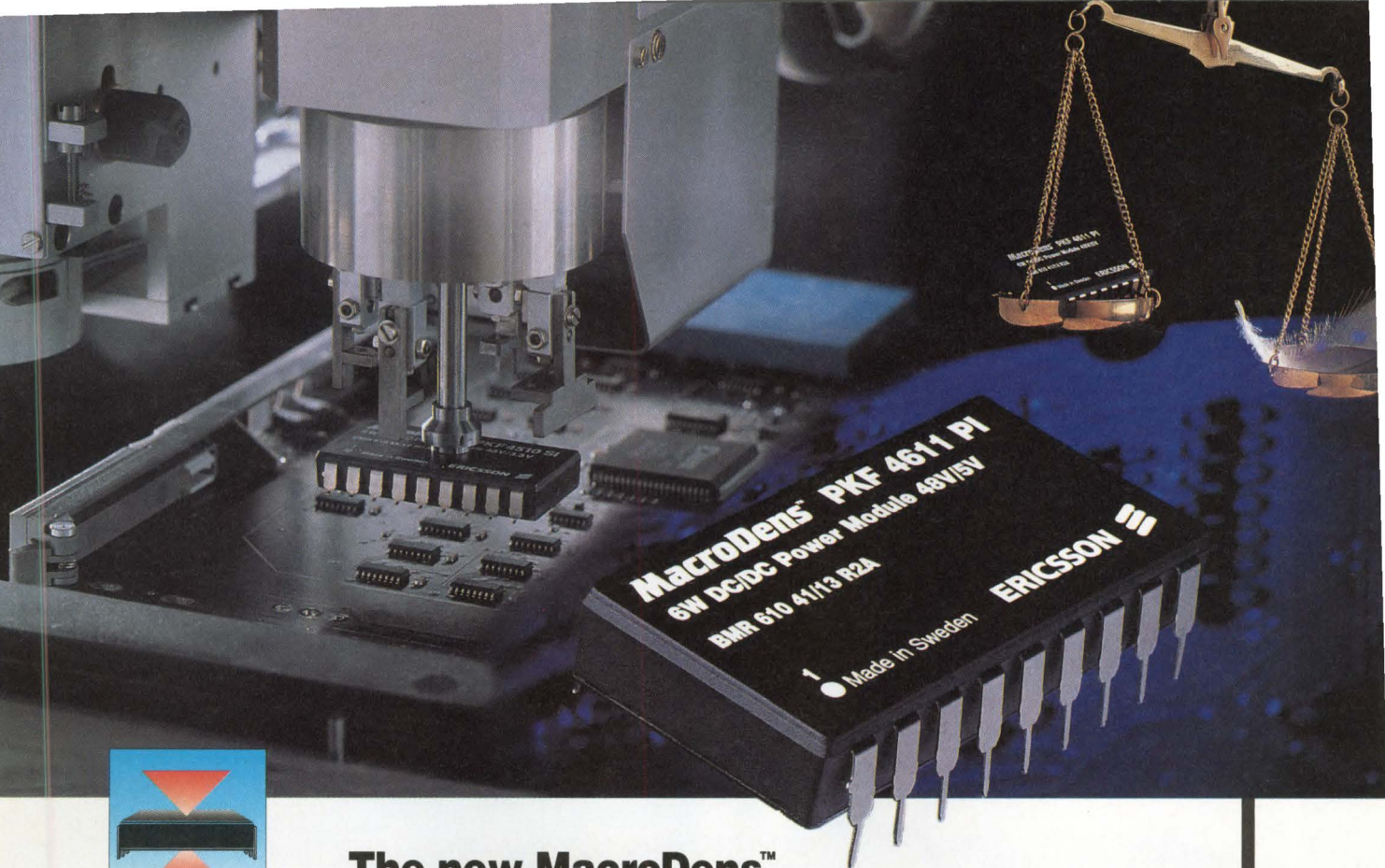

## The new MacroDens™ DC/DC converter. So small it's bound to make a big impression.

The latest in a long line of DC/DC converter innovations for distributed power from Ericsson, the MacroDens™ is unlike any other 3-7 watt device on the market. In a remarkably small 18-pin DIL package measuring just 48mm x 24mm x 8mm (1.89" x 0.94" x 0.31"), the different versions weigh only 15-20 grams (0.52 - 0.71oz). This makes it the first device of its type suitable for automatic placement. And there's a choice of through-hole or surface mount versions.

The size of the MacroDens™ does not limit its specification: 38 to 72 Vdc input range; a choice of 2, 3.3, 5 or 12 V outputs; and 1,500 Vdc isolation. And thanks to its optimized flyback circuitry, smart power chip, and highly integrated design, the MTBF is more than 400 years!

If you need more power, simply parallel MacroDens™ converters together. You don't even need load sharing components.

In short, the MacroDens™ is certainly the world's most advanced miniature DC/DC converter, so it's bound to make a big impression. Call us for the full specification.



8mm (0.31")



15g (0.52oz)



Low Cost



1,500 V dc  
Isolation



Safety Approvals

Sweden	Stockholm, Tel: +46-8-721 6356 Fax: +46-8-721 7001
Denmark	København, Tel: +45-33 88 31 00 Fax: +45-33 88 31 05
Finland	Helsinki, Tel: +358-0-299 4189 Fax: +358-0-299 4188
France	Guyancourt, Tel: +33-1-30 64 85 00 Fax: +33-1-30 64 11 46
Germany	Nue-Iseburg, Tel: +49-211 534 0 Fax: +49-211 534 1514
Great Britain	Swindon, Tel: +44-793-48 83 00 Fax: +44-793-48 83 01
Hong Kong	Hong Kong, Tel: +852-950 2388 Fax: +852-590 7152
Italy	Milano, Tel: +39-2-55 21 26 16 Fax: +39-2-55 21 30 36
Norway	Billingstad, Tel: +47-66 84 18 10 Fax: +47-66 84 19 09
United States	Richardson, TX, Tel: +1-214-997-6561 Fax: +1-214-680-1059

ERICSSON 

CIRCLE NO. 80

EDN July 7, 1994 • 199



# Proof?

# Positive!

**W**hy fret over development test? Think positive. Prove your results beyond the shadow of a doubt with the TRW VP8000 Wideband Signal and Test System.

The key is deep memory. The TRW VP8000 has up to 64 megabytes of it. With high-speed capture and generation in both analog and digital. This lets you soak up more real-world signal. In more detail. In less time. With less retesting.

This assures that you catch problems in the lab. Not in production.

The TRW VP8000 proves to be a positive in other ways, too. A single workstation-based system, it replaces stacks of test and measurement devices. Integrating the accessibility of computers with the power of instrumentation. Delivering such doubtless benefits as fast test set-up... a smooth upgrade path... portability... and affordability.

So, don't just prove results the usual way – improve. Give us a call at **1-800-354-6195.**

And let us prove how the TRW VP8000 will erase all your doubts about development test.

The TRW VP8000 – there's no doubt about it.





**JOHN COOLEY, EDA  
CONSUMER ADVOCATE  
& FOUNDER OF ESNUG**

# Awards

## DAC '94 and The Grateful Dead

The parallels between going to a Grateful Dead concert and attending the Design Automation Convention (DAC) are uncanny. Both events typically last for four or five days with a main floor show and lots of more interesting things happening off the floor. At night, you can partake in all sorts of fun in the parking lot if you're at the Dead show, or at an EDA vendor-sponsored dinner party if you're at DAC. Sign that unwritten, unspoken social contract not to tell anyone what you're about to see and do, and they'll let you into that tent/bus/van for extra special "fun" only hinted at on the Dead concert floor. Sign that lawyer-written, carefully

worded nondisclosure agreement from EDA vendors and they'll let you into their demo suites to see their extra special upcoming software only hinted at on the DAC show-room floor.

Just like there are sets of songs that get the Dead audience all rocking and sets that put everyone to sleep, there are DAC panels that have everyone talking and others that people walk out on. And, just like there are lightweight, occasional recreational drug users next to hard-core junkies in the Dead concert, there are occasional PC-based schematic-capture FPGA designers next to hard-core Unix-workstation-pumping, Ver-



ilog/Synthesis/ATPG, 200-MHz, 350k-gate GaAs ASIC designers at DAC. Both worlds employ "pushers" (salesmen) to provide the controlled substances (or controlled software) to the users for a hefty cut of the price.

Both subcultures wear special attire (tie-dyes or suits), trade bootleg material (concert tapes or EDA benchmarks), and converse in special words that have meaning only to members of that particular subculture ("electric Kool Aid," "ganja," "tripping" vs "ESDA," "PLI," and "regressions"). Just as there are unique personalities known in the Dead world (Timothy Leary, Bill Graham, Jack Kerouac, Tom Wolfe, Ken Kesey, and Hunter S Thompson), unique personalities also exist in the DAC world (Aart De Geus, Ron Collett, Bill Fuchs, Richard Goering, John Sanguinetti, and Joe Costello). But enough cultural anthropology, on with the awards!

**WORST OVERALL SURPRISE AT DAC:** An awful lot of attendees at DAC were caught off guard when the DAC exhibit hall closed a day early. Yes, technically it was buried in the schedule, but who reads schedules until the day of the event? (As a consequence, on Thursday, I found myself in a 2½-hour lunch/interrogation about industry trends with Ron Collett, a market researcher.) Also, DACnet had technical problems the first day that made it very difficult to log in and use. This meant many people were hard to contact because they blew off retrying the healthy DACnet on subsequent days. (A good DACnet note: they added telnet and ftp capability this year—great!)

**MOST ANXIOUS EDA VENDOR(S):** Virtually all of the non-Cadence- and non-ViewLogic-affiliated Verilog vendors were acting like debutantes at their first ball. Because Synopsys tipped its hand in the Verilog/VHDL wars in its failed bid for Chronologic, and Mentor is openly stating it needs a Verilog solution, the remaining independent Verilog vendors are terrified at



**Every time an interesting exchange started, the moderator would actively step in and stop it.**

the prospect of not being asked to dance.

**WHAT EDA USERS THOUGHT WAS HOT:** Because submicron and low-power design seems to be of interest to quite a few people these days, one of the hottest talked-about companies at DAC this year was Epic Design Technology. Its PathMill is an advanced static analysis tool, PowerMill is the leading dynamic power analysis tool, and TimeMill is the Spice-like accelerated analysis tool—all for submicron design.

The second hot topic was Chrysalis' Design Insight and Design Verifier, two of the first commercial tools to take the formal verification approach to check for your design flaws. Because these products take a mathematical approach, Chrysalis claims that formal verification beats dynamic simulations by orders of magnitude in overnight regressions.

The third topic people were discussing was Synopsys' Behavioral Compiler, a tool that can take algorithmically written Verilog or VHDL and convert it to gates. Unlike regular synthesis that pretty much translates from the original structure in the source HDL, Behavioral Compiler literally juggles around things like registers, multiplexers, and adders to best fit the designer's scheduling goals.

The Redwood/Comdisco demo and the recent purchase of Redwood by Cadence were also on people's minds.

(The big question is how many of the original Redwood R&D engineers are going to stick around?) Cadence's Verilog and VHDL co-simulation products were also hot. (Mix and match Verilog/VHDL source/libraries at will!)

ArcSys is targeting Cadence in the place and route business, and Integrated Silicon Systems (ISS) also seems to be attacking Cadence on the mask-verification front (Dracula). Everyone goes after the big company.

**BEST DAC PANEL:** Tie between the EE Times/DEC/ViewLogic-sponsored DAC Forum and the DAC-sponsored Four CEO panel.

What people liked about the DAC Forum was that they could "vote" electronically for what a particular panelist was saying at the moment, making it very audience interactive in a grand way. (Only users—no vendors—were given the handheld voting machines.) What the audience liked about the Four CEO Panel was a rare look at how these industry bigwigs see the world.

**WORST DAC PANEL:** The EE Times Benchmarking Summit. Lots of people on the panel and in the audience came prepared to discuss issues like the Actel Proposal, how Prep works, benchmarking clauses in nondisclosure agreements, and benchmarkers who blackmail EDA vendors. Instead, the moderator (a non-EDA-knowledgeable person) had everyone spend 2 hours partaking in a UN conflict-resolution exercise where we had to argue the opposing side's point of view. (Someone would say something and the moderator would then have everyone determine, "What should I write in the 'ASSUMPTION' column and in the 'WANTS' column on that statement?") Every time an interesting exchange started, the moderator would actively step in and stop it. As a result, all we could do was lightly touch some of the politics of benchmarking.

**BEST AFTER-HOURS PARTY:** Quickturn Emulation's Tuesday night bash. The company had a sit-down dinner after which the Temptations per-



## 2mm PITCH CONNECTORS FOR STACKING

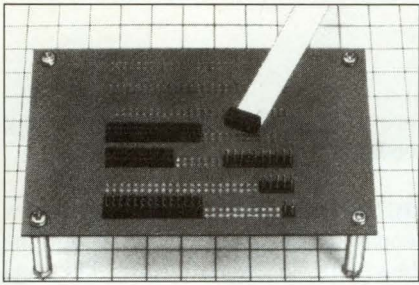

High densification in assembly is now possible with Hirose's A3C-A3D series of ultra compact 2mm pitch connectors for board-to-board stacking. When combining with other receptacles in the A3 family, a number of diverse lightweight applications are possible. Pin assortments on the receptacles are 2 through 20, plus 24, 26, 28, 32, and 50. Pin headers are available from 2 to 28. Ideal for HDD, FDD, VTR and mobile telephone production. When used board-to-board, the spacing between boards can be either 6mm or 5.1mm. For information, contact

**Hirose Electric (U.S.A.), Inc.**  
2688 Westhills Court, Simi Valley, CA 93065-6235. (805) 522-7958 or FAX (805) 522-3217. For instant fax catalog information: 1-800-879-8071. Ask for number 5006.

**CIRCLE NO. 70**

**Great Designs Are A Snap With Hirose Circular Connectors!**



The uncomplicated design of the HR10A Snap-Lok™ circular connector series assures rugged dependability and enables rapid, error-free mating and unmating—even under the most adverse situations.

Three shell sizes are available (7mm, 10mm and 13mm) with insert arrangements from 4 to 20 contacts; in-line receptacle jacks are also available with crimp or solder contacts.

The handsome, high-tech design and sturdy construction of Snap-Lok™ connectors ensure engineering integrity. That's why so many leading manufacturers worldwide insist on only Hirose HR10A series connectors.

For further information, contact the sales department, **Hirose Electric (U.S.A.), Inc.**, 2688 Westhills Court, Simi Valley, CA 93065-6235. (805) 522-7958 or FAX (805) 522-3217. For instant fax catalog information: 1-800-879-8071. Ask for #1001.

**CIRCLE NO. 71**

## High Density Board-to-Board Connector Proves Ideal for Downsizing PC's.

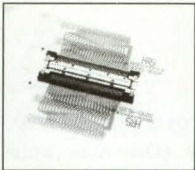

Developed for downsizing personal computers and workstations, Hirose is providing its 3200 series of high-density interface connectors (board-to-board) with 0.8mm contact spacing and 152 positions. The new 3200 series connector offers two rows of contacts with 0.8mm contact pitch. Its low profile is only 5.5mm from the PCB with a reliable two point contact pin; each pin is protected by an insulator wall against deformation caused by severe handling, such as twisting.

For further information, contact **Hirose Electric (U.S.A.), Inc.**, 2688 Westhills Court, Simi Valley, CA 93065-6235. (805) 522-7958 or FAX (805) 522-3217. For catalog information by fax: 1-800-879-8071, ask for # 8004.

**CIRCLE NO. 72**

## Hirose Shielded Modular Connectors

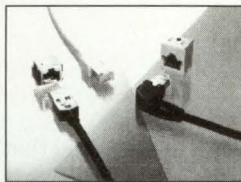

Hirose Electric has announced the TM11 Series of shielded modular connectors for computers, office automation equipment, and telecom. The TM11 series offers the only connectors specifically designed and

compatible with industry standards to provide RFI/EMI shielding and protect against ESD discharge. The low profile TM11 has eight signal lines and a grounded shield. 6-8 positions currently available.

For further information, contact the sales department, **Hirose Electric (U.S.A.), Inc.**, 2688 Westhills Court, Simi Valley, CA 93065-6235. (805) 522-7958 or FAX (805) 522-3217. For instant fax catalog information: 1-800-879-8071, ask for # 3002.

**CIRCLE NO. 73**

# HIROSE HOLDS THE KEY TO SMT CONNECTORS!

The H.F.L. the world's smallest SMT co-axial connector, has a mated height of only 3mm. At DC-3000 MHz. It is ideal for ultra-compact mobile communications devices. Fax catalog #4002.

The innovative ICB is a low-profile, dual-slot SMT-to-board PC card connector. Meets PCMCIA and JEIDA requirements for types I, II and III cards. Its unique two-piece construction allows full access to the SMT leads. Fax catalog #8009.

SX1 is a double density socket connector for 72-position dual in line memory module (DIMM) standardized by JEDEC. The SX1 sockets are about half the size of conventional SIMM sockets. Fax catalog #5017.

The FH12 flip-lock, SMT/ZIF type flexible printed circuit connector, has a low 2mm mounting height and is available with 10 to 50 positions. The pitch is a compact 0.5mm. Fax catalog #5018.

FX6 series high density 0.8mm pitch SMT stacking connectors offer variable stacking heights and lighter weight for electronic equipment in compact to 100 pins available. Fax catalog #5013.

From the birth of the SMT revolution, Hirose engineers have been a step ahead of the pack. They have been applying their creativity and experience to develop and manufacture what OEM's need for cutting-edge, miniature, SMT designs.

If you like working with a company that cares about the smallest details, let Hirose engineers work with you on your next SMT project.

- Board-to-board or cable
- I/O connectors • Flex circuit ZIF connectors • RF coaxial connectors • Telephone modular jacks • DIMM memory module sockets • PCMCIA connectors

© 1994 Hirose

**CIRCLE NO. 74**

**HRS**

**Hirose Electric (U.S.A.), Inc.**  
2688 Westhills Court, Simi Valley, CA 93065-6235  
(805) 522-7958 • FAX (805) 522-3217 • For catalog information by fax: 1-800-879-8071, ask for #9001.

**EDN July 7, 1994 • 203**

formed. Although it had appeared that ViewLogic was going to win this award with a ferry ride to a sit-down dinner on Harbor Island and comedian (everyone was schmoozing like crazy to get tickets before this event), the comedian turned out to be a flop in many people's opinion. (He was more caustic than funny: Attendees were stuck laughing nervously to be polite.) It was rumored that LSI gave 100 of its "most favored customers" a regatta in San Diego bay with six people per sailboat. It sounded like fun, but was too limited a party to qualify for an award.

#### **BEST USE OF DAC TERRAIN FOR A PARTY:**

Synopsys' wild night at the zoo. The moment you got off the bus, there was a table full of beers with helpers saying "Take two! The tour's 45 minutes," as they shooed you onto the double-decker open-air tour bus to go around the zoo. (Harvey Jones, Synopsys' chairman, who was sitting two seats behind me, commented on how excited I was when we saw the sheep exhibits.) Stumbling off the bus, we got more beer and great predinner munchies at a party where we could pet six different animals. Then we had a choice of a swordfish or chicken dinner in an open-air Gilligan's Island setting. Afterwards, all 300 of us were given Irish coffee as we walked to the firedrummer's performance. (In contrast, Collett reports that Cadence also had a dinner at the San Diego Zoo for about 65 people with no tour and three petting animals brought in after dinner. Mentor did something of similar ilk and size at the San Diego Aquarium.)

**BEST RARE DAC FREEBIE:** Summit Design's denim jackets. They were well made with a small, tasteful "Summit" patch on the left shoulder. Total number given away: 175 (120 went to its Pacific Rim distributor, 25 on the show-room floor, and 30 for schmoozers).

**BEST COMMON DAC FREEBIE:** The Official DAC gym bag. It's sturdy, use-

ful and has a tasteful royal purple, teal, and black color scheme. (One user wondered if IBM was "in" on the bag's color scheme because all the IBM shirts matched it *exactly*.) Runners Up: a tie between the ViewLogic soccer ball and the Epic Design Technology sports radio. (ViewLogic consciously chooses a high-quality freebie that's a pain to carry back on the plane so everyone can see you carrying it in the airport. They did it last year with the baseball bat and this year with the soccer ball. The message I get with this type of freebie is

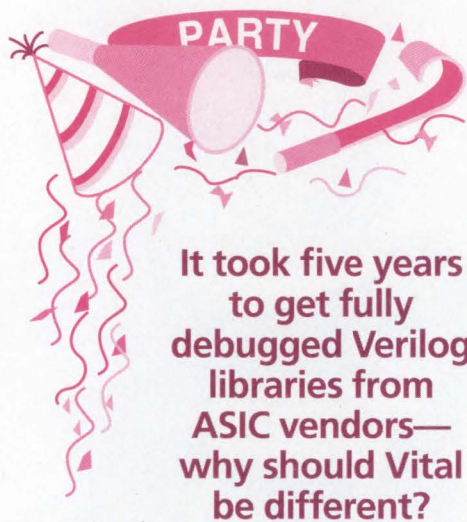

"we're hard to work with.") The Epic Design Technology sports radio is great (batteries included!) but *nowhere* near the quality of a Sony.

**MOST UNEXPECTED DAC FREEBIE:** Quad Design's hammers. (Racal-Redac and Analogy gave out tape measures. Are their marketing managers a little confused about what the hardware-design industry is?) Runner Up: Aptyx's coconuts. Huh?

**MOST CONTENT-FREE VENDOR PRESENTATION:** Synopsys' talk on submicron design. I'm told it was 40 minutes and only two things were said: design is headed toward the submicron level, and there's going to be more transistors on chips in the future. A close second was Cadence's re-engineering talk where the company spent 20 minutes vaguely discussing customer successes and stating that, "Cadence is

here to help with your re-engineering needs."

**BIGGEST VENDOR LIE:** Quite a few people told me about going through the ViewLogic Soccer Ball Quest. They had to sit through a "VHDL is better than Verilog" talk by a ViewLogic salesman. The salesman confidently said that "Vital is just around the corner! VHDL handles concurrent processes better!" These statements surprised the experienced simulation users because they've always described Verilog as "just like C but with wires, registers, and constructs to handle concurrent processes." Plus, it took five years to get fully debugged Verilog libraries from ASIC vendors—why should Vital be different? Ready for a discussion on these topics, they asked the salesman to explain his reasoning. The salesman replied, "Well, that's what I've been told."

**WHAT DO YOU MEAN "WHAT'S NEW?":** A long-time customer asked people in the Mentor booth: "What do you have new this year?" They were unable to answer with anything other than a simple design manager tool.

**MOST PERSONALLY GRATIFYING DAC PANEL:** The HDL Summit. Ron Collett moderated six panelists ranging from Verilog bigots to people using both to VHDL bigots. As usual, Collett tried to conclude the panel with his spin that VHDL was where everyone was going, etc. Just to annoy him, I pointed out how, years ago, a researcher at Dataquest had made a now-embarrassing prediction that VHDL users would outnumber Verilog in early '92—a prediction that turned out to be greatly exaggerated. That Dataquest researcher was Ron Collett.

*John Cooley, an EDA consumer advocate and founder of the outlaw E-mail Synopsys Users Group (ESNUG), lives on the Holliston Poor Farm in Massachusetts. He raises sheep and is an EDA- and ASIC-design instructor and project-in-crisis consultant. He can be reached at "jcooley@world.std.com" or at (508) 429-4357.*

# SmartFET.™

Or how to protect your power switch, your budget and your competitive edge.

IRSF3010

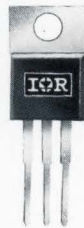

SmartFET

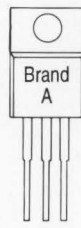

Two chips



One chip

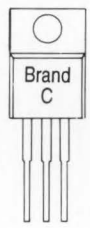

One chip

Our new IRSF3010 single-chip, 50V SmartFET device is today's lowest cost way to upgrade power switching protection. With 11A overcurrent shutdown. And full turnoff at 165°C.

Plus 55V overvoltage protection with a guaranteed clamped energy rating of 400mJ. The IRSF3010 SmartFET power switch easily handles more than 4,000 volts of ESD, too.

It's SmartFET performance like this that protects your end product and competitive edge. Delivery? Off-the-shelf. Write for data and price. Quicker yet, call. 1-800-245-5549.

You'll save a lot more than you think.

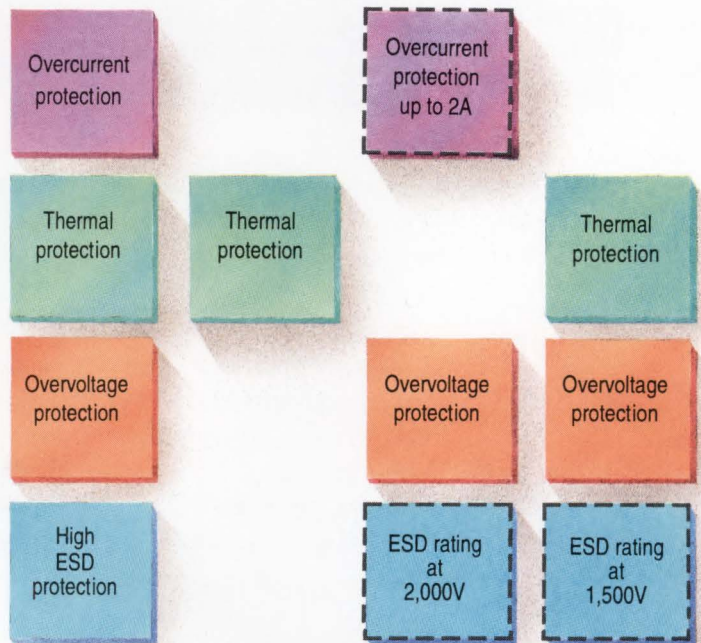

*Available now at key IR distributors.*

**IR International Rectifier**

WORLD HEADQUARTERS: 233 KANSAS ST., EL SEGUNDO, CA 90245, USA 310-322-3331. FAX 310-322-3332. TELEX 66-4464. EUROPEAN HEADQUARTERS: HURST GREEN, OXTED, SURREY RH8 9BB, ENGLAND (0883) 713215. FAX (0883) 714234

# DELICIOUS ATM, WITHOUT THE JITTERS.

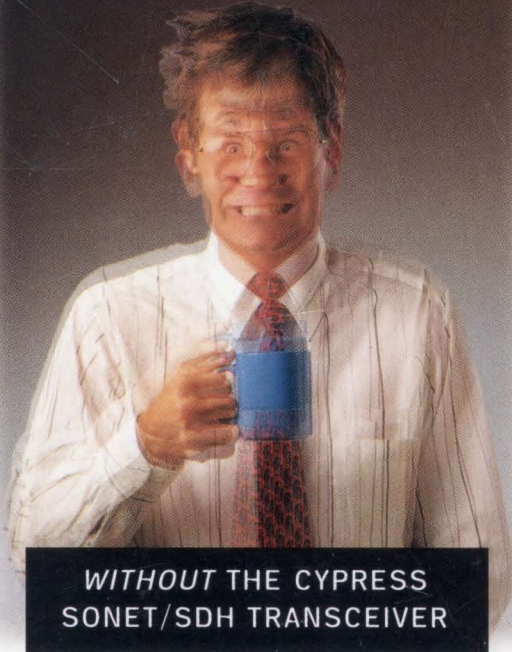

**WITHOUT THE CYPRESS  
SONET/SDH TRANSCEIVER**

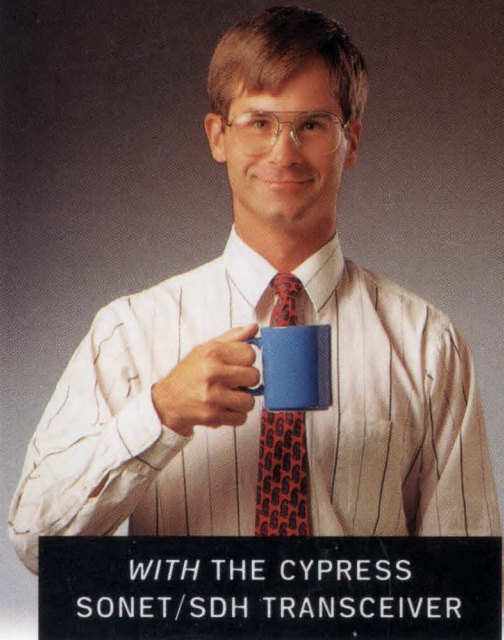

**WITH THE CYPRESS  
SONET/SDH TRANSCEIVER**

Here's a wake-up call for anyone designing-in ATM functionality: the CY7B951 SST™ (SONET Serial Transceiver) clock recovery chip from

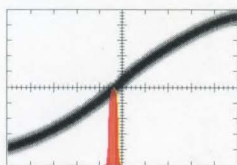

*Industry's Lowest Jitter*

Cypress. With its miniscule jitter of just 10 ps, the SST is as close as you can get to guaranteed flawless performance in your ATM environment.

In fact, it is the only solution to support both major ATM application frequencies (51.8 OC-1 and 155.52 MHz OC-3.)

Thanks to its integrated transmit and receive phase lock loops, the SST lets you use a low-cost 19.44 MHz

oscillator. The SST also performs wonders for board space by eliminating the need for external filter components.

By using advanced BiCMOS technology, the SST consumes a miserly 50 mA, for power savings of up to 50% over competitive devices. And its loop-back testing capabilities enable in-system diagnostics.

So don't let the stringent jitter requirements of ATM get on your nerves. Start off your next design day with the SST from Cypress, the high-speed leader.

It'll open your eyes.

**For your free sample certificate and design kit. Call 1-800-858-1810, Dept. C413**

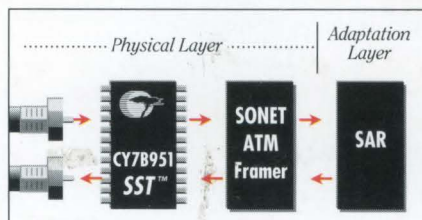

\*In Europe, fax requests to the above Dept. at (32) 2-652-1504 or call (32) 2-652-0270. In Asia, fax to the above Dept. at 1 (415) 940-4337. © 1994 Cypress Semiconductor, 3901 North First Street, San Jose, CA 95134 Phone 1-408-943-2600.

