

EDN[®]

A CAHNERS PUBLICATION

October 1, 1992

ELECTRONIC TECHNOLOGY FOR ENGINEERS AND ENGINEERING MANAGERS WORLDWIDE



Special Report:
**EMC tools predict
formal test results**
pg 78

SPECIAL ISSUE

Test and
Measurement

SPECIAL REPORT

EMC bench tools
pg 78

DESIGN FEATURES



**Design It
Right Part 1:**
A tale of three
digital multimeters
pg 60

Designer's guide
to sampling A/D
converters—Part 2
pg 97

TECHNOLOGY UPDATES

Ignoring real-
world data
invalidates
simulations
pg 39

Superconductivity
moves into the
land of reality
pg 49

Ask EDN
pg 29

Design Ideas
pg 115

Announcing the Economic Recovery Plan from Hewlett-Packard. Trade up to the new test equipment you need. And recover 20%.

Although technology is growing by leaps and bounds, chances are your budget isn't.

So, how can you get the new test equipment it takes to keep up, without breaking the bank?

With the Economic Recovery Plan from Hewlett-Packard — that's how. It's the best way to get the new-generation HP test equipment you need. At a substantial savings.

Just trade in your present high-performance oscilloscope, portable logic analyzer, or spectrum analyzer*, any time before January 31, 1993. And we'll give you a 20% credit toward an upgrade to one of HP's new state-of-the-art instruments.

If you'd like more information about our new test products — or if you're ready to trade up — call 1-800-452-4844 Ext. 7046 or your local field engineer.

But don't wait. If you miss this opportunity to save 20% on HP test equipment, you might never recover.

There is a better way.



*Certain restrictions apply.

Trade in your old equipment and save 20% on the latest models from HP.

HP 54700 family of high-performance, modular oscilloscopes lets you capture your most elusive problems.

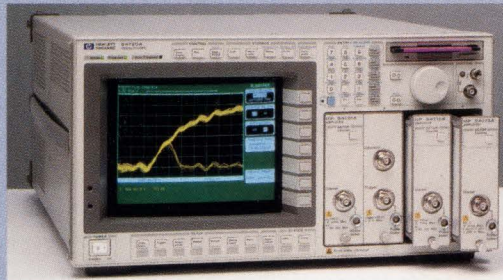

- 1 GHz single shot bandwidth (4 GSa/s)
- Accurate waveform reproduction with non-intrusive probing
- Modular system adapts to your changing needs

HP 1660 family of portable logic analyzers gives you the confidence to solve your toughest digital problems.



- 100 MHz state and 500 MHz timing
- 34, 68, 102, and 136-channel models
- Intuitive mouse, keypad, and keyboard interface

HP 8560 and 8590 E-Series of portable spectrum analyzers offer the highest performance for the price.

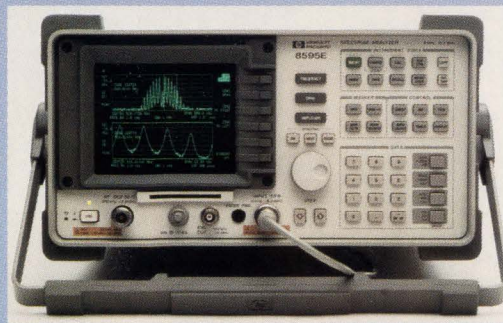

- Improved phase noise and narrower resolution bandwidth
- Many application-specific, one-button measurement functions
- User-friendly interface

© 1992 Hewlett-Packard Co. ADTMCOL252

990,000 CYCLES FREE IN EVERY SERIAL EEPROM.



Available in DIP and SO packages.

Guaranteed minimum 1,000,000 erase/write cycles for the price of 10k.

Superior reliability and high quality don't have to cost extra. SGS-THOMSON's 1,000,000 erase/write cycle serial EEPROMs offer convincing proof. They're priced the same as a 10k cycle device, yet they deliver an additional 990,000 cycles at no extra cost.

Fully compatible 4k, 8k and 16k I²C bus[®] serial EEPROMs include write protection circuitry and low

2.5 to 5.5 volt operation. Non-write protected 1k and 2k devices are also available. Plus, SGS-THOMSON offers low voltage, 1k to 4k-bit MICROWIRE[®] bus parts. Choose 8-pin DIP or SO packages in commercial, industrial and automotive temperature ranges.

Specify maximum endurance SGS-THOMSON serial EEPROMs and get the best insurance money can buy — 990,000 extra erase/write cycles — absolutely free. Or buy their low-endurance 10k devices and risk buying trouble.

Return the coupon, write or

call (602) 867-6259 for a memory selector guide: SGS-THOMSON Microelectronics, 1000 E. Bell Road, Phoenix, Arizona 85022. For fast response, FAX your request to (602) 867-6102.

For literature or samples, mail or FAX this coupon to SGS-THOMSON Microelectronics, 1000 E. Bell Road, Phoenix, AZ 85022. FAX (602) 867-6102. The following information is required:

Name _____

Company _____

Address _____

City _____

State _____ ZIP _____

Phone (____) _____

FAX (____) _____

 **SGS-THOMSON**
MICROELECTRONICS
access to technology

MICROWIRE is a registered trademark of National Semiconductor. I²C bus is a registered trademark of Philips Semiconductors.

© 1992 SGS-THOMSON Microelectronics. All rights reserved.

Circle No. 1

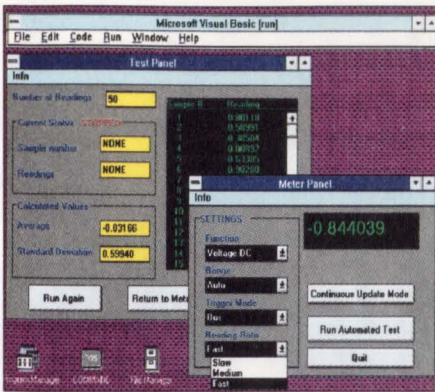

NI-488.2™ software for Windows and DOS

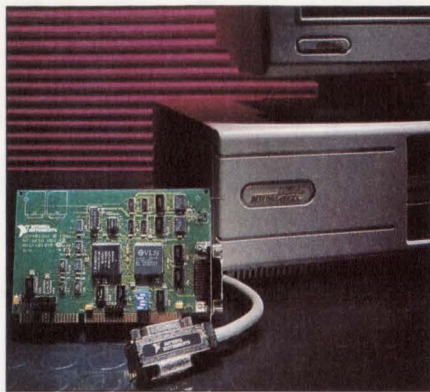

IEEE 488.2 interfaces for PC/XT/AT/EISA, PS/2, and Macintosh

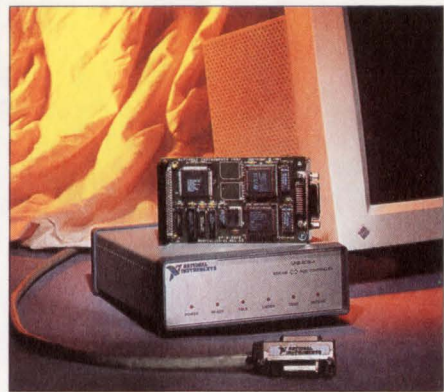

IEEE 488 interfaces for desktop workstations



Bus extenders and expander/isolator

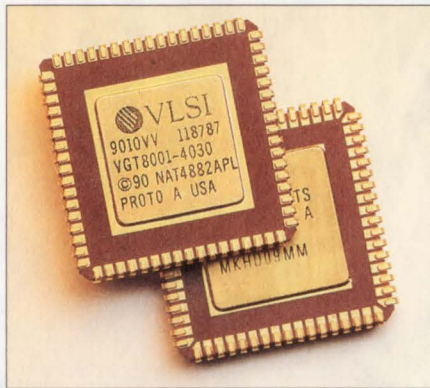

Custom GPIB chips – NAT4882™ and Turbo488®

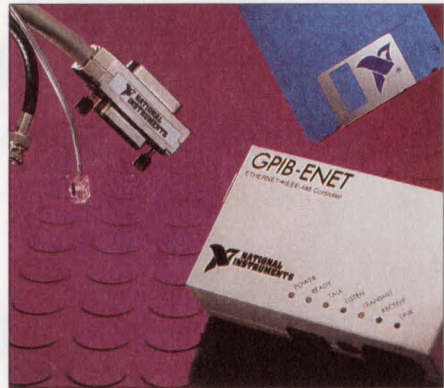

Ethernet-to-GPIB Controller for the Sun SPARCstation



Bus analyzer



Embedded VXI controllers

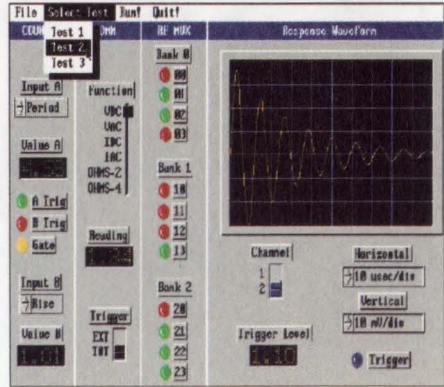

LabWindows® and LabVIEW® software

A Sound Investment in IEEE 488.2 Control

Are you considering an investment in IEEE 488.2? If so, look to the company that has invested extensively in IEEE 488 for over 16 years – National Instruments.

Whether your system requires a plug-in IEEE 488.2 interface, an external Ethernet-to-GPIB Controller, a compact bus extender, a versatile bus analyzer, a GPIB-to-VXI translator or application software, our products are right on the money for your test system needs.

Get the most from your IEEE 488.2 investment with our custom NAT4882 ASIC. The NAT4882 not only provides full IEEE 488.2 compatibility, it also drastically reduces software overhead for higher throughput.

Test programs written with our industry-standard NI-488 software are portable between platforms and operating systems, even Windows, so your programming investment is preserved. Simplify your programming with our application software.

To find out more about making a wise IEEE 488.2 investment, call for a FREE catalog.
(512) 794-0100
(800) 433-3488 (U.S. and Canada)



6504 Bridge Point Parkway
Austin, TX 78730-5039
Fax: (512) 794-8411

Branch Offices: AUSTRALIA 03 879 9422 • BELGIUM 02 757 00 20 • CANADA 519 622 9310 • DENMARK 45 76 73 22 • FRANCE 1 48 65 33 70 • GERMANY 089 714 50 93
ITALY 02 48301892 • JAPAN 03 3788 1921 • NETHERLANDS 01720 45761 • NORWAY 03 846866 • SPAIN 91 896 0675 • SWEDEN 08 98 49 70 • SWITZERLAND 056 27 00 20 • U.K. 0635 523545
© Copyright 1992 National Instruments Corporation. All rights reserved. Product and company names listed are trademarks or trade names of their respective companies.

Circle No. 2

"See us at DSPx, booth 311"

FEATURING ZIF TECHNOLOGY,

It
ITT CANNON'S DL CONNECTORS
looks
ARE GUARANTEED TO PROVIDE
like
AT LEAST 10,000 MATING
a
CYCLES. THE DL IS IDEAL FOR
waffle
APPLICATIONS REQUIRING THE
iron

HIGHEST DURABILITY AND GREATEST NUMBER OF CIRCUITS. ITT CANNON'S DL PRODUCTS
but it's a lot
ARE AVAILABLE WITH UP TO 2,496 PINS, AND ARE THE ONLY ZIF CONNECTORS THAT EMPLOY
easier to use.

A CAM-ACTUATED HANDLE TO MATE WITH A SIMPLE TWIST.

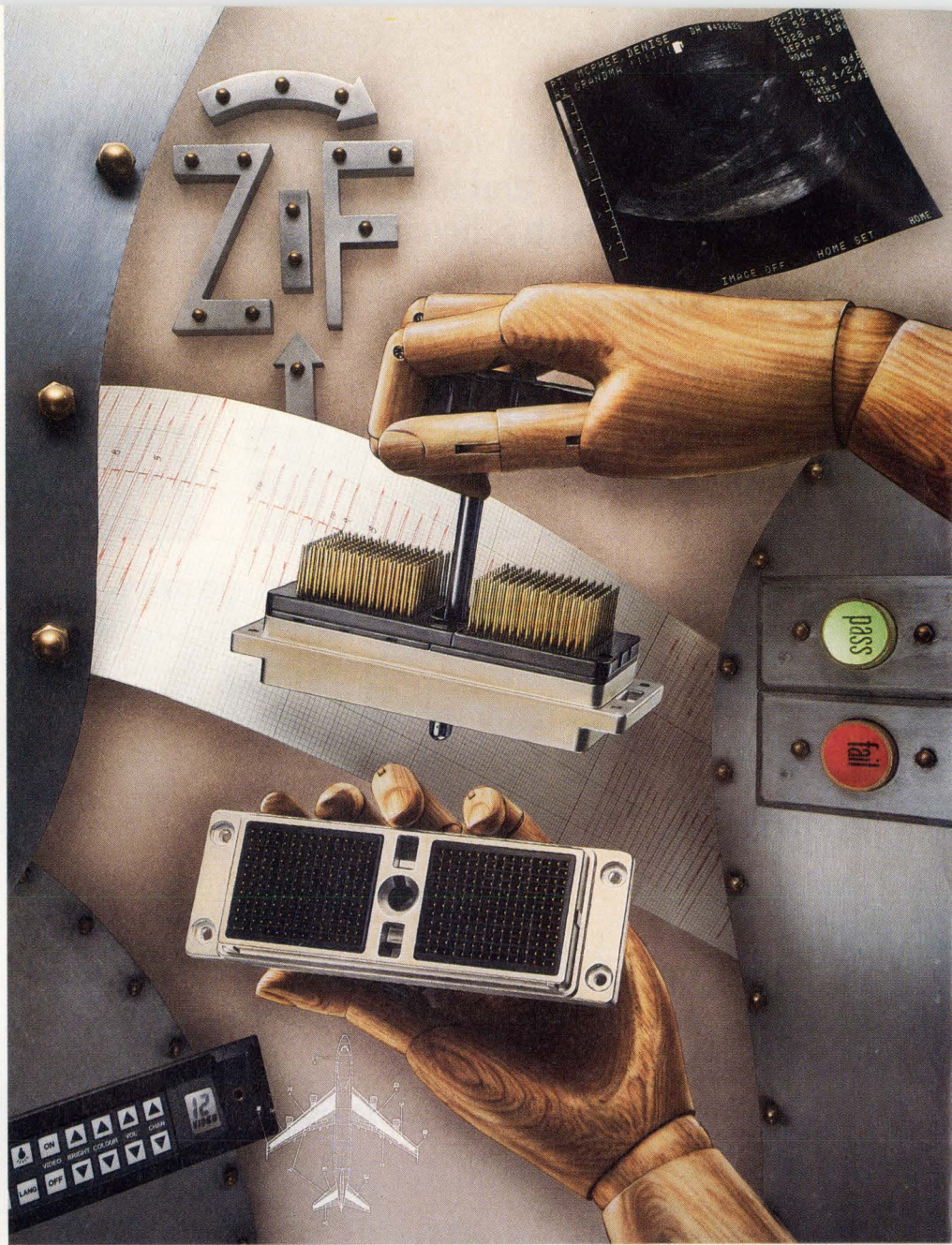

ITT Cannon

1851 E. DEERE AVE.
SANTA ANA, CA 92705
(714) 261-5300
FAX (714) 757-8301

What do designers of notebook computers
and other battery-powered systems
get with Siliconix' new power conversion chip set?

MORE BANG FOR YOUR BUCK.



That means higher power conversion efficiency, smaller system size, both 3.3-V and 5-V compatibility and longer battery life. DC/DC conversion at 94% measured efficiency.

This high-efficiency produced by our new power conversion chip set, the Si9150DY Synchronous Buck Converter and the Si9942DY LITTLE FOOT™ MOSFET allows your DC/DC converter to run cooler and adds about 10% to battery life during normal operation. And in sleep mode it only consumes 100 μ A, to extend battery life by 1000%.

FOOT SO-8 to achieve the most compact converter design possible. Our Si9150 design manual includes complete instructions for building your DC/DC converter. The bottom line result ... your product gets to market faster!

Operating voltage options.

Many "next-generation" designs are employing lower, and sometimes multiple operating voltages. That's why our Si9150DY/Si9942DY buck converter takes unregulated battery voltage and converts it into 5.0 V or 3.3 V.

Get more bang for your buck converter!

For OEM quantities, prices of this 94% efficient power conversion chip set can be yours for less than \$3.00.

More power efficiency, more compact design, and more voltage options are as close as your local Siliconix sales office. Or call toll-free hot line now! **(0635) 30905, ext. 970.** Ask for the "More Bang for your Buck" Design Manual.

Siliconix

Weir House, Overbridge Square, Hambridge Lane, Newbury, Berks RG14 5UX

Synchronous Buck Converter

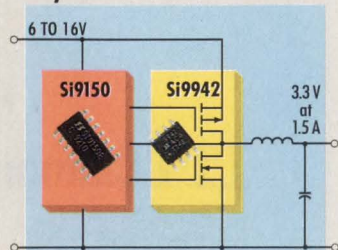

© Copyright 1992 Siliconix, Inc.

The smallest and simplest high-efficiency solution available.

The controller, in a tiny SO-14 package, is highly integrated and requires few external parts. Team it with our LITTLE

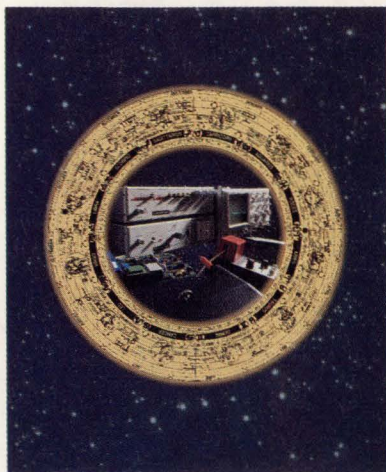

On the cover: With the proliferation of electromagnetic transmissions in our environment, you can't rely on mythical sources to predict EMC problems.

EDN's Special Report examines the precompliance EMC tools that enable you to predict in-house the outcome of a formal test house EMC check. (Photo courtesy of Schaffner EMC Ltd) **PAGE 78**

Foldout Contents

Turn to the last information-retrieval service card in the back of this magazine and you'll find a foldout table of contents. Now, instead of flipping back and forth from this table of contents to the articles you want to read, you can have the convenient foldout open at all times while you're reading EDN. Use the foldout contents to mark off articles you'd like your colleagues to read or to remind yourself to copy stories for your files.

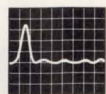

TEST & MEASUREMENT SPECIAL ISSUE

EMC bench tools

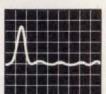

Tools for measuring electromagnetic compatibility (EMC) allow you to pinpoint and fix problems before formal compliance checks. Revised FCC regulations and Europe's EMC Law now demand your attention to this previously ignored aspect of design.

—*Brian Kerridge, Technical Editor*

SPECIAL REPORT

78

Design It Right—Part 1



EDN begins a 4-part look at the passions and pitfalls of product development. The first installment: "A tale of three digital multimeters." —*Dan Strassberg, Senior Technical Editor*

DESIGN FEATURES

60

Designer's guide to sampling A/D converters—Part 2

Part 2 of this 3-part series examines the four peripheral circuits that are vital to maximum performance. Part 3 will discuss ADC interface circuits and filtering requirements. —*Walt Kester, Analog Devices*

97

Continued on page 7

EDN® (ISSN 0012-7515, GST Reg. #123397457) is published 48 times a year (twice monthly with 2 additional issues a month, except for March and October, which have 3 additional issues and July and December which have 1 additional issue) by Cahners Publishing Company, A Division of Reed Publishing USA, 275 Washington Street, Newton, MA 02158-1630. Terrence M McDermott, President/Chief Operating Officer; Frank Sibley, Executive Vice President; Jerry D Neth, Senior Vice President/Publishing Operations; J J Walsh, Senior Vice President/Finance; Thomas J Dellamaria, Senior Vice President/Production and Manufacturing; Ralph Knupp, Vice President/Human Resources. EDN® is a registered trademark of Reed Properties Inc., used under license. Circulation records are maintained at Cahners Publishing Company, 44 Cook Street, Denver, CO 80206-5800. Telephone: (303) 388-4511. Second-class postage paid at Denver, CO 80206-5800 and additional mailing offices. **POSTMASTER: Send address changes to EDN®, PO Box 173377, Denver, CO 80217-3377.** EDN® copyright 1992 by Reed Publishing USA; Robert L Krakoff, President and Chief Executive Officer. Rates for nonqualified subscriptions: EDN Magazine and EDN News combined (48 issues) U.S. \$154.95/year; EDN Magazine only (26 issues) U.S. \$119.95 year; EDN News only (22 issues) U.S. \$74.95/year. Subscription rates higher outside U.S. Please inquire at Denver office for rates. Telephone (303) 388-4511. Except for special issues where price changes are indicated, single copies are available for \$20 U.S. and \$25 foreign. Please address all subscription mail to Ellen Porter, 44 Cook Street, Denver, CO 80206-5800.

FLUKE®



PHILIPS

Introducing SCOPEMETER.™

There's More Than One Reason to Reach for It.

In fact, there's *every* reason to reach for ScopeMeter.™ Because only ScopeMeter combines the expertise of Fluke and Philips to bring you a dual-channel digital scope along with everything you've come to expect from Fluke digital multimeters.

The result: an integrated scope-and-multimeter that lets you see a waveform and digital meter display at the same time from the same input. Or switch between dedicated high-performance Scope and Meter functions with the touch of a key. That makes it faster and easier than ever to capture, store and analyze precisely what you're looking for. At a price that looks good, too.

To get your hands on a ScopeMeter, contact your Fluke sales office or your nearest Fluke distributor. For more product information, call **1-800-44-FLUKE**.

SCOPEMETER. Now there's only one to reach for.



Built to Take It.

- Completely sealed against water, dust and contaminants.
- EMI protected and measures up to 600 volts rms.
- Rugged construction with shock-resistant holster.
- Three-year warranty from Fluke.

Simply Easy.

- Intuitive front panel layout for simple, straightforward operation.
- Pop-up menus and five function keys for easy control.
- Autotest automatically sets voltage, time and trigger functions.
- Safety-designed BNC connectors and probes simplify floating measurements.

Double Duty.

- 50 MHz digital storage scope and 3000-count digital multimeter in one handheld package.
- Precision Min Max Record and 40 ns Glitch Capture make it easy to troubleshoot intermittent failures.
- Simultaneous waveform and digital display on a backlit screen you can read across the room.

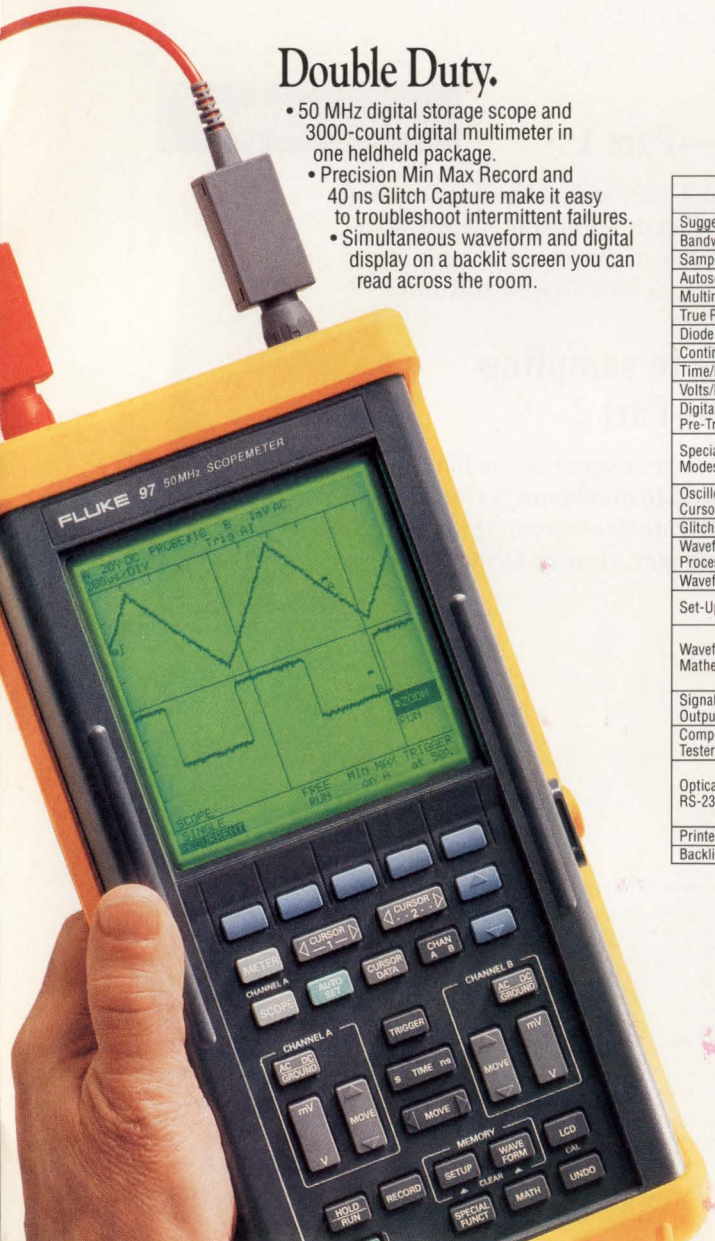

FLUKE 90 SERIES SCOPEMETER SELECTION GUIDE			
	FLUKE 97	FLUKE 95	FLUKE 93
Suggested List Price	\$1795	\$1495	\$1195
Bandwidth	50 MHz Dual Channel		
Sample Rate	25 Megasamples/second		
Autoset	Automatically sets Voltage, Time and Trigger		
Multimeter Display	3 ¹ / ₂ digits (>3000 Counts)		
True RMS Volts	AC or AC+DC up to 600V (1700V Pk-Pk)		
Diode Test	Up to 2.8V		
Continuity Beeper	Yes		
Time/Division	10 ns/div to 60 sec/div		
Volts/Division	1 mV/div to 100V/div	5 mV/div to 100V/div	
Digital Delay or Pre-Trigger	By Number of Cycles, Events, Time, or Zoom Mode	By Time	
Special Multimeter Modes	Min Max Average Record, Relative (zero), dBm, dBV, dBW, Audio Watts, % Scale, Frequency, Smoothing™ Change Alert™	Frequency, Smoothing™ Change Alert™	
Oscilloscope Cursors	12 Measurements, Display 5 Simultaneously		
Glitch Capture	≥40 ns		
Waveform Processing	Average, Variable Persistence, Min Max Record		
Waveform Memory	Store and Recall 8 Waveforms		
Set-Up Memory	Store and Recall 10 Front Panel Set-Ups		
Waveform Mathematics	Add, Subtract, Multiply, Invert, Filter or Integrate Waveforms		
Signal Generator Output	Sinewave or Squarewave		
Component Tester Output	Voltage or Current Ramp		
Optically Isolated RS-232-C Interface	Full Operation by Remote Control via optional PM 9080 cable		
Printer Output	Serial		
Backlit Display	Electroluminescent		



Goes Wherever You Go.

- Runs on rechargeable NiCad Batteries, standard C-cells or the included line voltage adapter/battery charger.
- Adjustable tilt-stand/hanger.
- Compatible with a wide range of Fluke multimeter accessories.

©1992 John Fluke Mfg. Co., Inc. Ad No. 00224.

FLUKE®

CIRCLE NO. 5

Home Office
275 Washington St, Newton, MA 02158
EDN Bulletin Board: (617) 558-4241
MCI: EDNBOS; (617) 558-extension

VP/Publishing Director
Peter D Coley -4673
VP/Publisher
Roy Forsberg -4367

VP/Editor/Editorial Director
Jonathan Titus -4573
Executive Editor
Steven H Leibson -4214

Managing Editor
Joan Morrow Lynch -4215

Assistant Managing Editor
Anne Gallagher -4653
Gary Legg, *Senior Technical Editor* -4404
Tom Ormond, *Senior Technical Editor* -4414
Charles Small, *Senior Technical Editor* -4556
MCI: EDNSMALL; Compuserve: 70324, 3270
Dan Strassberg, *Senior Technical Editor* -4205
John A Gallant, *Technical Editor* -4666
John C Napier, *Technical Editor* -4690
Julie Schofield, *Senior Associate Editor* -4619
Carl Quesnel, *Associate Editor* -4484
Susan Rose, *Associate Editor* -4738
Helen McElwee, *Senior Copy Editor* -4311
James P Leonard, *Copy Editor* -4324
Gillian A Caulfield, *Production Editor* -4263
Erin Heffernan, *Production Editor* -4333

Editorial Field Offices
Doug Conner, *Technical Editor*
Atascadero, CA: (805) 461-9669
MCI: EDNDCONNER
J D Mosley, *Technical Editor*
Arlington, TX: (817) 465-4961
MCI: EDNMOSLEY

Richard A Quinell, *Technical Editor*
Aptos, CA: (408) 685-8028
MCI: EDNQUINNELL
David Shear, *Technical Editor*
Corvallis, OR: (503) 754-9310
MCI: EDNSHEAR

Anne Watson Swager, *Technical Editor*
Wynnewood, PA: (215) 645-0544
MCI: EDNSWAGER

Ray Weiss, *Technical Editor*
Woodland Hills, CA: (818) 704-9454
MCI: EDNWEISS
Brian Kerridge, *Technical Editor*
22 Mill Rd, Loddon
Norwich, NR14 6DR, UK
(508) 28435
MCI: EDNKERRIDGE

EDN Asia, Mike Markowitz, *Editor*
Cahners Asia Limited
19th Floor, Centre Point
181-185 Gloucester Rd, Wanchai, Hong Kong
Phone (852) 838-2666; fax (852) 575-1690

Contributing Technical Editors
Robert Pease, Don Powers, Dave Pryce,
Bill Travis

Editorial Coordinator
Kathy Leonard -4405
Editorial Services
Helen Benedict -4681

Art Staff
Robert L Fernandez, *Art Department Director*
Ken Racicot, *Senior Art Director* -4708
Chinsoo Chung, *Associate Art Director* -4446
Cathy Madigan, *Associate Art Director* -4599
Marketing & Business Director
Deborah Virtue -4779
Marketing Communications
Kathy Calderini, *Manager* -4526
Pam Winch, *Promotion Specialist* -4660

TECHNOLOGY UPDATES

Data acquisition and modeling: Ignoring real-world data invalidates simulations

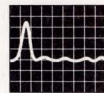

Circuit simulation is becoming a must for most analog engineers. But no rigorous, coherent, comprehensive approach exists to correlate simulated and real-world performance.

—Charles H Small, *Senior Technical Editor*

39

Superconductivity moves from the land of theory into the land of reality

The successful development of reliable, compatible, low-cost superconducting circuits could benefit every application involving microelectronics and ICs.

—Tom Ormond, *Senior Technical Editor*

49

NEW PRODUCTS

Integrated Circuits.	123
Computers & Peripherals.	127
Components & Power Supplies.	133
Test & Measurement Instruments.	139
CAE & Software Development Tools.	143

DEPARTMENTS

Inside EDN.	9
News Breaks.	17
Ask EDN.	29
Calendar.	31
Editorial.	33
Design Ideas.	115
Career Opportunities.	157
EDN's International Advertisers Index.	161
Hands On!.	162
Editorial Questionnaire.	163

Twice the Logic in Half the Space



DOUBLE-DENSITY™ FROM IDT

46% BOARD SAVINGS

IDT's new 16-, 18-, and 20-bit Double-Density FCT-T Logic family offers the performance of two octal logic devices in one flow-through 48- or 56-pin high-density, JEDEC-standard, shrink small outline package (SSOP) or Cerpack, for twice the functionality in half the board space.

A WIDEBUS™ UPGRADE

IDT's Double-Density logic family is more than twice as fast as ACT, uses 35% less power than ABT, and it's form-, fit-, and function-compatible with both

of TI's Widebus families. The Double-Density family also offers typical pin-to-pin skew of 250ps and quiescent supply current at 0.05mA (typ.).

3 APPLICATION CHOICES

5V High Output Drive

Ideal for low-impedance bus and backplane applications.

5V Balanced Drive (Low Noise)

Contains on-chip, source-terminating resistors to minimize signal noise. These devices are ideal for driving point-to-point transmission lines and highly capacitive loads, such as a bank of DRAMs or SRAMs.

3.3V Low-Power Logic

Designed for regulated or unregulated 3.3V power supplies, these devices use less power than 5V parts, without sacrificing high speed. 5V-to-3.3V unidirectional and bidirectional translators are also available.

FREE SAMPLES

Call today for free samples and a copy of the new **High-Performance Logic Data Book** and start your Double-Density logic design today!



DOUBLE-DENSITY CONFIGURATION*	I _{OH}	I _{OL}	t _{PD} (Max.)	I _{CCQ} (Typ.)	PIN-TO-PIN SKEW (Typ.)	GND BOUNCE (Typ.)
High Drive	-32 mA	+64 mA	4.1 ns	0.05 mA	250 ps	< 1.0 V
Balanced Drive	-24 mA	+24 mA	4.1 ns	0.05 mA	250 ps	< 0.6 V
3.3V	-8 mA	+24 mA	4.8 ns	0.05 mA	250 ps	< 0.3 V

*Specs are for '244 device

Double-Density is a trademark of IDT. All others are trademarks of their respective manufacturer.

(800) 345-7015 • FAX: 408-492-8674
ASK FOR KIT CODE 3071

CIRCLE NO. 7



Integrated
Device Technology, Inc.

A summary and analysis of articles in this issue

In 1995, the European Community's EMC Law is slated to take effect, and instrument vendors around the world are responding with a variety of instruments to meet these laws. If you'd like to **locate and fix your EMC problems yourself**, read this issue's Special Report. Our European Technical Editor Brian Kerridge lists the benchtop tools that can help you make the right precompliance EMC measurements.

These tools are best used, says Kerridge, to find potential problem areas. Although they cannot replace formal emissions tests, tools that measure conducted and radiated emissions can make the test-house check a rubberstamping procedure, saving you time, money, and lots of frustration. Kerridge explains where to look for more information, and he'll also explain the terminology for engineers who may be unfamiliar with EMC lingo.

The melding of designer with design is part and parcel of the process of good product design, as Senior Technical Editor Dan Strassberg stresses in the first part of his 4-part **Design It Right** series. Strassberg starts off the series with "A tale of three multimeters," comparing the strategies, not the products, of three companies that deliver high-quality test-and-measurement products.

Using the development of Hewlett-Packard's 34401A digital multimeter as an example, he explains how a management technique called quality-function deployment helped HP's designers focus on the most effective features for their new product. Keithley's 2001 multimeter was developed by a design team dedicated to viewing its product the way its customers would. Fluke's approach to its DMM series was to develop high-quality products that could be manufactured in the US in large quantities for low cost. Sound impossible? All of these goals have largely been met, explains

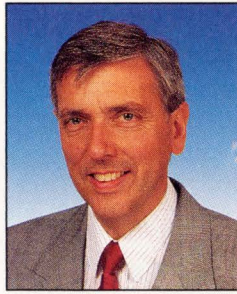

European Technical Editor Brian Kerridge

Strassberg, by following the "Do's and Don'ts" in each company's write-up. The comparisons tell why these methods worked so well; you decide which methods can work for you.

Superconductivity does have a place in the real world, explains Senior Technical Editor Tom Ormond in his Technology Update. "Superconductivity has entered the real world—it's still not as simple as buying or using a flip-flop, but it is now common enough that Nova won't be offering an introductory series on it."

Okay, so superconductors are not a new technology, but research on them has expanded, especially in the field of high-temperature superconductors (HTS), materials that remain conductive above 30°K. Ormond explains that the HTS materials are the easiest to use in electronic applications, and they make good economic sense.

Senior Technical Editor Charles H Small notes that **analog-circuit simulation** is a must for most engineers, yet engineers are without a coherent means of simulating real-world performance. For Small, creating your own device models—characterizing, designing, and then simulating them—is where it really gets fun. He shows you the analog road less traveled, the nooks to look in for special-purpose equipment and software, and how to combine the hardware and software to exact a purposeful simulation.

Anne J Gallagher
Assistant Managing Editor

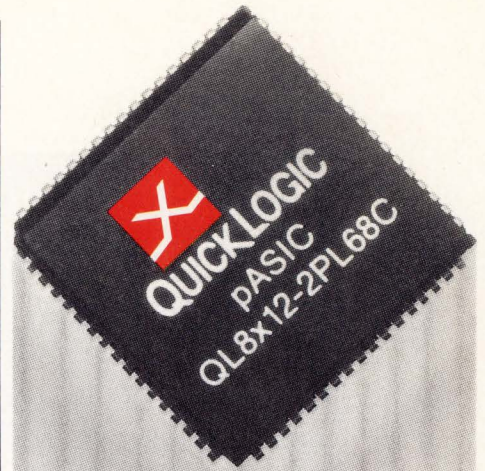

You Need the World's Fastest* FPGAs!

- To support high speed-RISC and CISC CPUs
- To integrate fast PAL, TTL and FCT logic
- To operate in the data path at 33 to 66 MHz

*QuickLogic FPGAs are two to three times faster than Actel and Xilinx in most applications....offer fast, fully automatic place and route on designs using 100% of the logic cells....and will be second sourced by Cypress Semiconductor.

QuickLogic Corporation, 2933 Bunker Hill Lane, Santa Clara, CA 95054

FOR QUICK RESPONSE

Fax: 408-987-2012
Phone: 408-987-2000

Please send the Very High-Speed FPGA Data Book

Name _____

Company _____

Address _____

City _____

State _____ Zip _____

Phone _____ Fax _____

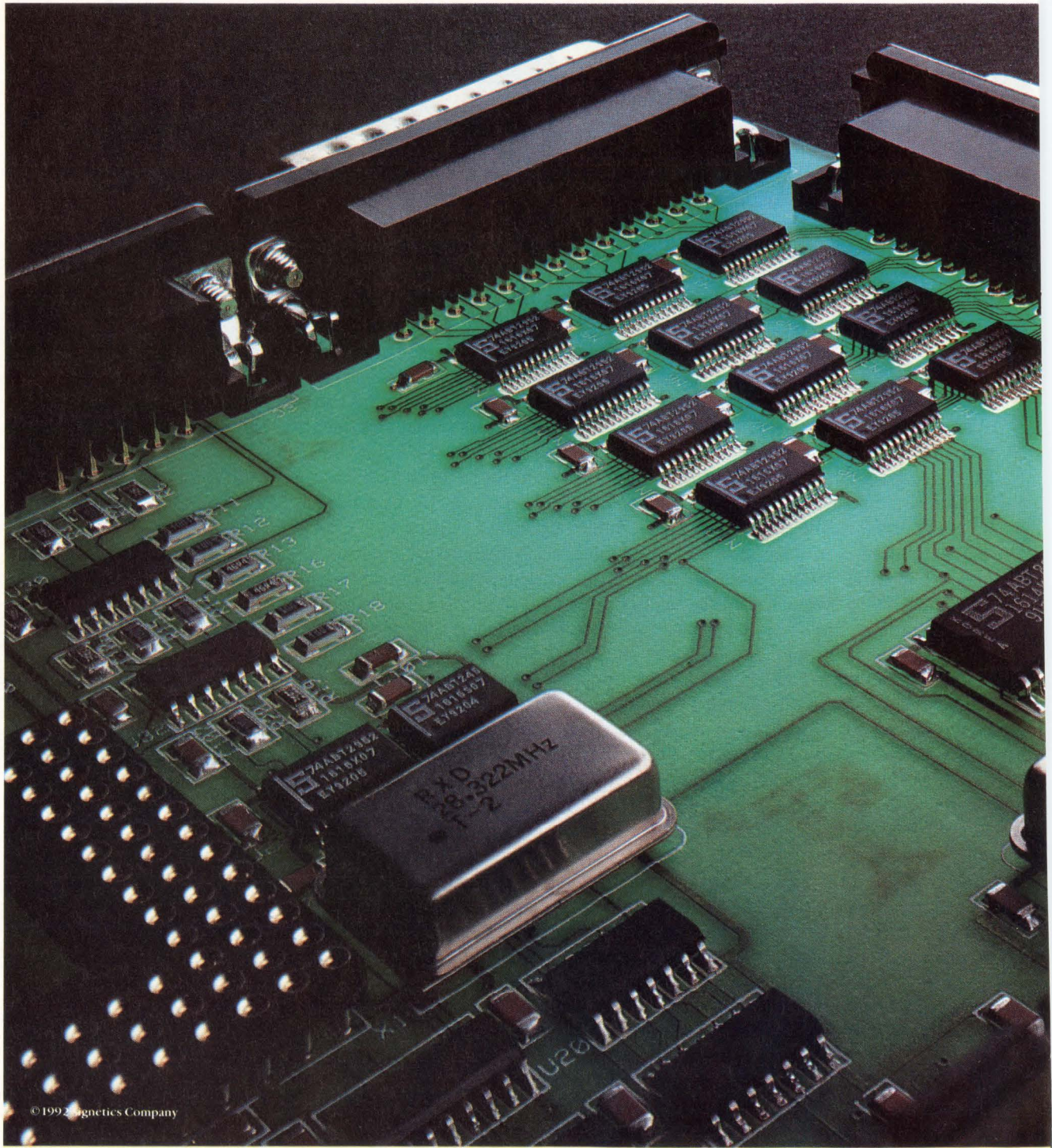

© 1992 Magnetics Company

Philips Semiconductors

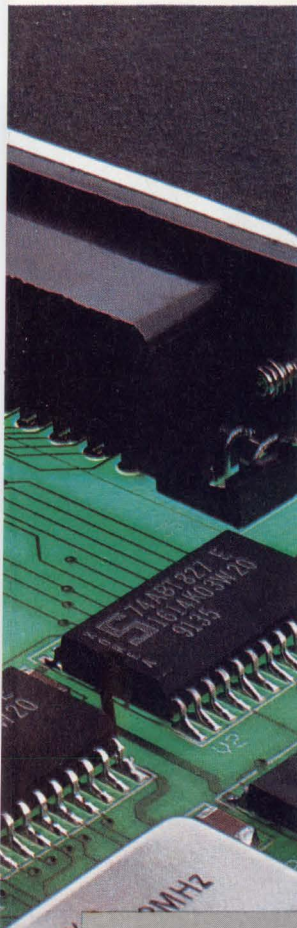

When you need extra room for improved functionality and smaller designs, simply replace your old bus interface logic with the new SSOP version of our popular ABT devices.

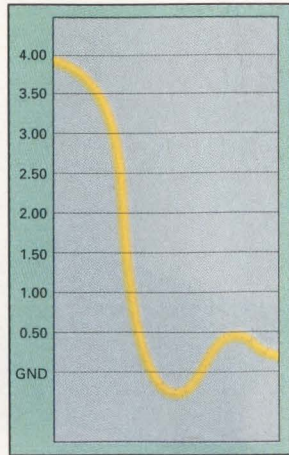

ABT in SSOP offers the highest performance while improving noise characteristics.

As well as offering you the significant space savings of an SSOP package, each also delivers all the performance you've come to expect from ABT.

Like the highest usable speed available. The lowest possible noise. And 64mA output drive. All of which let you design products that run faster and sell faster.

Also, thanks to our QUBiC BiCMOS process, you dissipate the lowest power. That's perfect for today's power-critical applications. Plus it simplifies thermal management.

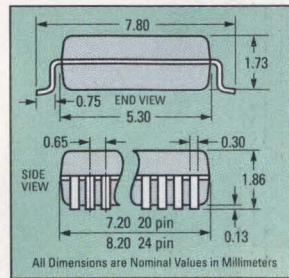

And with more than 40 ABT products — and a contracted second source — you're always assured of the right devices at the right time.

OUR ABT LOGIC IN THE NEW SSOP PACKAGE LEAVES YOU PLENTY OF ROOM FOR IMPROVEMENT.

To learn more, or to receive your ABT BiCMOS bus interface logic SSOP sample package, call us today at 800-227-1817, ext. 755D.

See how things improve when you apply a little logic.

Signetics

Extending the Dimensions of Performance



PHILIPS



The Official Flag Of The

AMD Delivers The World's Fastest 386s.

The great 386 race is over. And the clear winner is the Am386 microprocessor family.

The fact is, no other 386 microprocessors available today can rival the sheer speed and performance of the Am386 microprocessors. The Am386DXL-40 CPU brings 40MHz,

full 32-bit 386 performance to the desktop. The Am386SXL-33 CPU makes 33MHz the standard for 386SX machines both at the desktop and for battery powered applications.

In either case, they're over 20% faster than those run-of-the-mill 386s.



The 40MHz DXL-40 and the 33MHz SXL-33 are available in low-cost PQFP packaging.



Am386 Microprocessors.

And of course, they're proven-compatible with the IBM® standard.

Best of all, they're available now, available in quantity, and available at surprisingly low prices.

So don't just keep up with the competition with ordinary 386 systems. Blow them away with the world's fastest 386 systems—built around the Am386 microprocessors from Advanced

Micro Devices. Call **1-800-222-9323** for more information.



Advanced Micro Devices

"We're Not Your Competition."™

is a trademark of Advanced Micro Devices, Inc. All brand or product names mentioned are trademarks or registered trademarks of their respective holders.

CIRCLE NO. 16

EDN October 1, 1992 • 13

This is your chance to get the full power of embedded

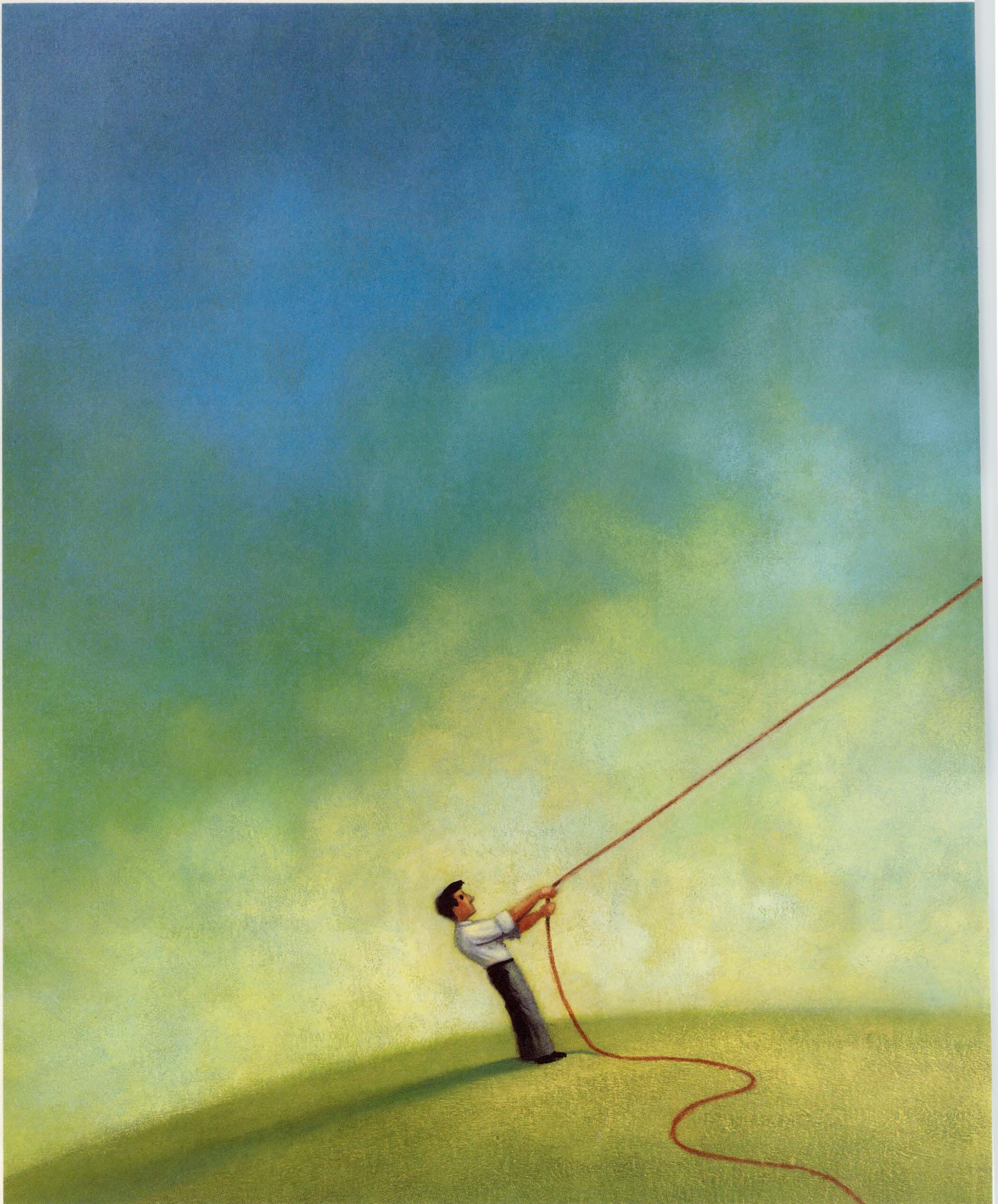

FORCE Computers, Inc., 3165 Winchester Blvd., Campbell, CA 95008-6557, Prof.-Messerschmitt-Str. 1, W-8014 Neubiberg/München. All brands or products are trademarks of their respective holders. ©1992. FORCE Computers, Inc.

SPARC. Don't let it slip away.

This is one of those times when you just have to seize the day. Because opportunities like this are rare indeed.



You see, FORCE is the only company licensed by Sun to put SPARC[™] station 2 technology on VME.

Choose from a range of systems, for a highly integrated solution.

So we're the only ones who can give you validated hardware and software compatibility. Allowing you to run SunOS[™] with any of your SPARCstation 2 applications and peripherals. Without a hitch.

We also have a whole new family of SPARC 2 products. With everything from our CPU-2CE (6U) board to the *microforce* single-slot system.



Our CPU-2CE features a 40MHz SPARC RISC micro-processor, delivering 28.5 MIPS.

We even have 20-slot systems that allow you to customize I/O. Giving you the perfect combination of real-time and UNIX.

And our SPARC products provide the broadest software offering of any RISC architecture. Including SunOS, real-time operating systems and a host of application software.

So if you want a better grasp of embedded SPARC, call for a free brochure. 800-237-8863, ext.5. Or in Europe, 49.89.608-14-0.

Because there's no reason to let all this power slip through your fingers.



Last year several hundred Pulse Generator users dumped the one line display and the High Price.

Here's why.



Sophisticated Signal Sources from LeCroy

To receive a complete package of
technical information:

1-800-4-LeCroy

(1-800-453-2769)

LeCroy 9210 300 MHz Programmable Pulse Generator

	with 9211 Module	with 9212 Module	with 9213 Module
TRANSITION SPEED	1 ns - 10 ns	300 ps - 1 ns	6.5 ns - 95 ns
MAX. REP RATE	250 MHz	300 MHz	50 MHz
OUTPUT LEVEL	5V p-p (50Ω)	5V p-p (50Ω)	16V p-p (50Ω)
VARIABLE EDGES	Yes	Yes	Yes
TIMING ACCURACY	±(0.5% + 0.2 ns)	±(0.5% + 0.2 ns)	±(0.5% + 0.2 ns)

LeCroy

Innovators in Instrumentation

CIRCLE NO. 18

Exposition in San Jose highlights DSP applications

For a 3-day intensive look at digital-signal processing, check out the first DSP^x Exposition and Symposium, October 14 to 16 at the San Jose Convention Center. DSP^x starts with a 1-day symposium that includes an introduction to DSP, a session of new DSP product introductions, a keynote address by the well-known MIT Media Lab director and technological gadfly Nicholas P Negroponte, and an overview of DSP market trends and technology. Admission to the 1-day symposium is \$295.

The following two days of DSP^x provide you with workshops in 14 sessions that cover enabling silicon and software technology and key DSP applications in the communications, computers, consumer, automotive, industrial, medical, military, and aerospace arenas. Admission to all three days, including the symposium and the applications workshops, is \$645. An exhibit floor with more than 60 exhibiting companies complements the symposium and the applications workshops. Exhibitors will be showing the latest DSP hardware and software products. The exhibits will be open to attendees for all three days. Reed Exhibition Companies, Cahners Exposition Group, Stamford, CT, (203) 964-0000, FAX (203) 964-0176.

Embed your application on a SPARC-based system

Now you can move applications software running on a Sun SPARCstation II directly into an embedded system without modification or recompiling. Furthermore, any peripheral, SBus module, or system enhancement for the SPARCstation II will work in Force Computers' SPARC-based systems. The company's CPU-2CE VMEbus board is the heart of the system; it has a 40-MHz SPARC μ P that delivers 28.5 MIPS and a double-

precision floating-point unit that delivers 4.2 Mflops. The board is available individually with 16-Mbyte RAM (expandable to 64 Mbytes) for \$7995.

The minimum system configuration is the Microforce system (\$9950), which includes the CPU-2CE with a 3.5-in. floppy-disk drive, a 420-Mbyte SCSI hard drive, and two SBus slots. A Mini-force system (\$11,990) is similar but adds four free VME slots for expansion. The Teraforce system (\$19,500) provides 19 free VMEbus slots for a maximum of 20 processor boards in the system and adds a 320-Mbyte streaming-tape drive to the standard equipment

list. All systems come with SunOS 4.1.2 (Solaris 1.0.1) system software and two right-to-use licenses. Force Computers Inc, Campbell, CA, (408) 370-6300, FAX (408) 374-1146.

Modem chip sets add FAX and voicemail to PC add-in cards

The next wave of PC modem add-in cards will merge voice and data communications, according to IC vendors Phylon and Sierra Semiconductor. Recently, the two companies introduced modem chip sets that offer fax and modem data rates to 14,400 bps (V.32bis and V.17). They also incorporate a DTMF (dual-tone multifrequency) receiver, ADPCM (adaptive pulse-code modulation) pass-through voice compression and decompression, and a caller ID receiver. The chip sets are DSP-based, so designers can upgrade to new communications standards with software changes.

Phylon is offering two such chip sets, the PHY1001 and PHY1002, that work with an external controller. Both sets offer identical capabilities but have different packaging and power options. The PHY1001 comes as two 68-lead plastic leaded chip carriers (PLCCs) for \$40 (1000). The PHY1002 (\$50) is a smaller, lower-

power (450-mW) version that comes in 64- and 80-lead quad flatpacks.

Sierra's 4-chip set, the SQ3214, includes a controller and I/O interface device. In addition to the capabilities it has in common with the Phylon chip sets, the SQ3214 offers a 12-bit A/D converter for digitizing incoming voice messages. The set can handle sampling rates of 9600, 8000, or 4800 samples/sec and includes a FIFO buffer to simplify use of a PC's hard disk for message recording. The set costs \$93 (10,000) and comes in PLCCs or plastic quad flatpacks. Sierra is offering a dial-up bulletin board, (408) 263-8294, to provide customer support. Phylon, Fremont, CA, (510) 656-2606, FAX (510) 656-0902. Sierra Semiconductor, San Jose, CA, (408) 263-9300, FAX (408) 263-3337.

Guide describes all VXI products on the market

A 56-page guide lists all products for the VXI modular-instrumentation bus—nearly 600 hardware and software products in 27 categories from 65 vendors. Copies were mailed to VXIbus Newsletter subscribers in August; now, individual copies are available for \$20. Bode Enterprises, 8380 Hercules Dr, Suite P3, La Mesa, CA 91942, (619) 697-8790, FAX (619) 697-5955.

Low-cost 32-bit emulator eliminates ROM monitors

For \$9995 you can achieve real-time emulation of Motorola's 68300 and 68HC16 μ Cs with the Powerpack in-circuit emulator. The basic package includes eight complex hardware triggers, two event counters, one timer, an external trigger I/O, and a 4-level trigger sequencer. You can use each of these features to control trace collection and breakpoints. Complex breakpoint definitions accommodate any combination of address, data, and processor status.

The standard trace buffer is 128k frames deep and 96 bits wide. You can subdivide it into as many as 256 unique buffers. The debugger collects a trace frame on every target clock cycle. Thus, at the binary level, Powerpack behaves as a 96-channel state analyzer for 128k frames per channel. You can also use this unit to perform qualified trace collection or to encapsulate the collection process when multiple code modules are writing to the same location.

A \$1995 optional transparent software debugger eliminates the resource demands extracted by traditional ROM monitors. The debugger's hardware enables and communicates with the target μ C via a background mode. And, unlike typical ROM monitors, its operation does not depend upon a valid stack or uncorrupted operational RAM. The tool will continue to operate if the application software crashes.

Powerpack and Powerscope use a Windows 3.1-based interface called Powerviews, which provides network compatibility and combats stack-overflow problems. The minimum host configuration is an 80386SX-based ISA computer with 4 Mbytes of RAM and a VGA monitor. Microtek International, Hillsboro, OR, (800) 886-7333, (503) 645-7333, FAX (503) 629-8460.

Analog scopes' menus mimic DSOs'

Tektronix's new 2-channel analog scopes, the \$1540 60-MHz TAS 455 and the \$2195 100-MHz TAS 465, appear to be as simple to use as scopes can be. Some of the convenience

features include a ground trace that appears on the screen for a few seconds any time you touch a channel's position control and a trigger-level trace that appears superimposed on the trigger waveform whenever you adjust the trigger level. The scopes boast a menu structure that is identical to that of the DSOs in Tek's TDS series for all functions

the two series have in common. The result is that an engineer who uses a TDS scope can use his technician's TAS unit without needing to figure out how the controls work.

Through the use of VLSI, the design has been dramatically simplified: The new boards are $\frac{1}{4}$ the size of those in the predecessor product. Moreover, unlike the earlier boards, these boards have only two layers and are uncluttered. As a result, the prices are relatively modest, and greater reliability lets the vendor offer an unusual 3-year warranty for defects in materials or workmanship. Tektronix Inc, Beaverton, OR, (800) 426-2200.

3V analog surges ahead

To meet the anticipated demand of 3V components for portable equipment, analog-IC manufacturers continue to do their part. A dual, rail-to-rail op amp and ADCs are the latest analog additions. When operating from a 3V supply, Analog Devices' OP-295 (\$1.98 (1000)) dual op amp has a maximum offset voltage of 500 μ V, maximum supply current of 300 μ A, and a minimum output swing of 2.9V to within 2 mV of ground when driving a 10-k Ω load. The op amp is stable with loads up to 300 pF and has a typical gain-

bandwidth product of 75 kHz. The company specifies the device, which comes in an 8-pin plastic DIP or SOIC, over a -40 to +85°C temperature range. Analog Devices Inc, Wilmington, MA, (617) 937-1428, FAX (617) 821-4273.

Linear Technology Corp's three new data-acquisition-system components are the 10-bit LTC1283 (\$11.40), the 12-bit LTC1289 (\$18.35), and the 12-bit LTC1287 (\$16.70) (100 qty for C electrical-grade versions). All three devices are pin compatible with the company's existing converters (the '1090, '1290, and '1292). The company designed these existing converters to be compatible with future low-voltage processes and used the same mask set on a 3V process to manufacture the new devices. The minimum guaranteed supply voltage of the '1283 is 3V, and for the other two devices, 2.7V. Operating at 3V, the devices' typical supply currents are 150 μ A, 1.5 mA, and 1.5 mA respectively. Similar to their existing pin-compatible counterparts, these converters contain a successive-approximation ADC, S/H amplifier, and serial I/O. The first two devices also include 8-channel multiplexers. The '1287 fits in an 8-pin mini DIP, and the '1283 and '1289 come in 20-pin DIPs. Linear Technology Corp, Milpitas, CA, (800) 637-5545.

Desktop CAE and the Design Center!™

Your Path to

- ✓ Effective Engineering
- ✓ High Productivity
- ✓ Good Business

Desktop CAE means every engineer has his or her own design station, providing a comprehensive workspace for conceiving and designing the product to fulfill an engineering task. All of the engineer's design needs are at his or her fingertips.

The Design Center provides just this! As a universal circuit design environment, analog and digital circuits can be created using a schematic editor, then directly simulated and graphically analyzed for correct behavior. Whether you're operating on a Sun workstation running OpenWindows, or on an IBM-PC running Microsoft Windows, all of this is achieved from a single system designed for user friendliness. This is Desktop CAE.

The **Design Center** is a self-sufficient system, easily maintained and used by the engineer to whom it belongs. Easy installation, intuitive user interface, and comprehensive documentation are characteristic of the **Design Center**. Everything you need to get the job done is on your desktop. This is Desktop CAE.

MicroSim Corporation is proud to provide you with the **Design Center** for Desktop CAE. We believe the **Design Center** stands on its own. But if you ever need assistance, our development and application engineers are always available through our free technical support program.

The **Design Center** is synonymous with Desktop CAE. Consider the **Design Center** for your engineering business, and make it the most effective and productive business that it can be. For more information on the **Design Center**, please call us toll free at (800) 245-3022 or FAX at (714) 455-0554.

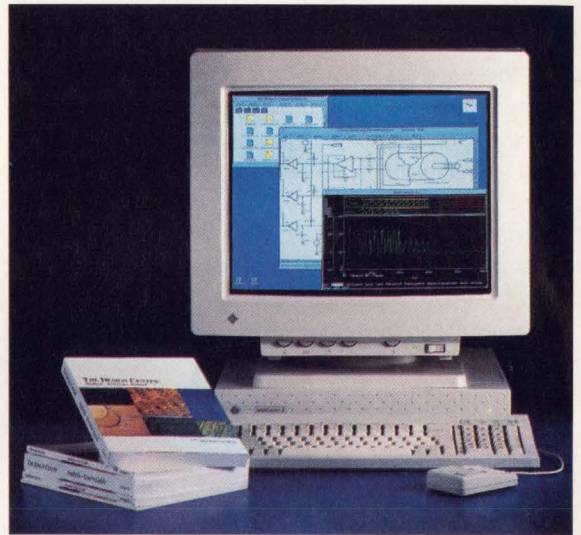

The Design Center under Sun OpenWindows



The Design Center under Microsoft Windows



MicroSim Corporation

The Standard for Circuit Design
20 Fairbanks • Irvine, CA 92718

THE MAKERS OF PSpICE

PSpice is a registered trademark of MicroSim Corporation

For More Information on IBM PC Circle #150 On Macintosh Circle #151 On SPARCstation Circle #152

Boundary-scan tools work with PCs or logic analyzers

Fluke and Philips want you to know that you can debug boundary-scan pc boards more quickly than you can debug boards that use classical design approaches. Moreover, the vendors insist that, contrary to widely held opinion, as scannable ICs become available in increasing numbers, the incremental cost of scannable hardware is heading rapidly toward zero. Those who want to be shown before they make a significant investment can find out by purchasing the PM 3705/E. This \$695 package consists of a hardware tool called the Boundary Scan Explorer, a demo board, PC-based software, and reference material on boundary-scan design. The demo board includes switches through which you can introduce faults that you can then diagnose with the aid of the software.

This boundary-scan test package is just one of several hardware and software tools being offered by the vendors. All of the tools work with MS-DOS PCs—even notebook PCs. In some cases, in place of a PC, you can use a logic analyzer from the PM 3580 series. The Explorer with software that you can use on any board—not just on the demo board—is available as the PM 3705 for \$4950. The PM 3770, a PC-based boundary-scan test-generation software package, costs \$14,900; a diagnostic package, the PM 3790, also costs \$14,900. You can buy the PM 3705, the PM 3770, and the PM 3790 together as the PM 3705/L for \$24,900. Delivery for all items is six weeks ARO. John Fluke Mfg Co Inc, Everett, WA, (800) 443-5853; In Europe, Philips Test and Measurement, Eindhoven, the Netherlands.

EPROMs evolve to meet specific application needs

Cypress Semiconductor has begun offering EPROMs tailored to match the needs of specific applications better. Two recently released products target state-machine designs and high-performance μ P memory systems. Both products combine EPROM arrays

with glue logic to reduce parts count and increase overall speed in applicable designs.

The CY7C259 state-machine EPROM starts with a 2k \times 16-bit EPROM array, then adds input- and output-signal latches, input-signal multiplexers, and an internal feedback path from 11 output signals to the input multiplexer. The internal logic has a smaller delay than a design made with discrete devices, letting the

resulting state machine handle clock rates as fast as 83 MHz.

The CY7C270 adds latches, registers, programmable chip selects, and burst counters to a 16k \times 16-bit EPROM array to simplify the device's interface to high-performance μ Ps. Because the additional logic is user configurable, you can program the device to match a variety of processors, including the 80386, 80486, R2000, R3000, 68040, 88000, 29000, and SPARC. The PROM's access time is 14 nsec for burst reads and 28 nsec for single reads—fast enough to keep pace with 25- and some 33-MHz μ Ps.

Both devices are available in production quantities. The CY7C259 state-machine EPROM costs \$72.70 (100) in 44-pin LCCs and CLCCs (ceramic leadless chip carriers). A 28-pin version, the CY7C258, provides output pins for only eight of the PROM's 16 bits and costs \$29.05. The CY7C270 processor-tailored EPROM costs \$56.05 and comes in plastic leaded chip carriers. Contact Cypress Semiconductor, San Jose, (408) 943-2600.

14-bit ADC converts at 5 MHz and costs \$495

High resolution and speed in the megahertz range are a tough combination for ADCs. Edge Technology's

Model 14651 is a \$495 (100) true 14-bit, 5-MHz tracking ADC. The company also has a 3-MHz version, the 14631 (\$265 (100)). According to the company, these devices provide 2 \times the performance of other devices at $\frac{2}{3}$ the price.

The word *true* applies to these converters because, as opposed to some so-called 14-bit converters, these devices' integral and differential nonlinearities are a maximum of 1 and 0.75 LSB, and typically both are 0.5 LSB. The devices feature no missing codes, an S/N ratio of 82 dB, a spurious-free dynamic range of -88 dB, and low noise < 1 LSB.

Both devices are self-contained subsystems and contain an internal high-speed broadband track-and-hold amplifier (hence, a tracking converter), precision voltage reference, and 14-bit quantizer. Latched TTL outputs and timing- and error-correcting circuitry mean that only a convert clock, analog input, and power supplies are necessary for operation. The 4 \times 3-in. pc board comes enclosed in a metal case that requires no heat sink and provides electromagnetic and electrostatic shielding. Typical power dissipation of the industrial grades is 3W. Premium grades with typical power specs of 1.8W cost \$795 and \$375, respectively, for the 5- and 3-MHz versions. Delivery for small qty is from stock; 12 weeks for OEM qty. Edge Technology, Lynnfield, MA, (617) 334-3330.

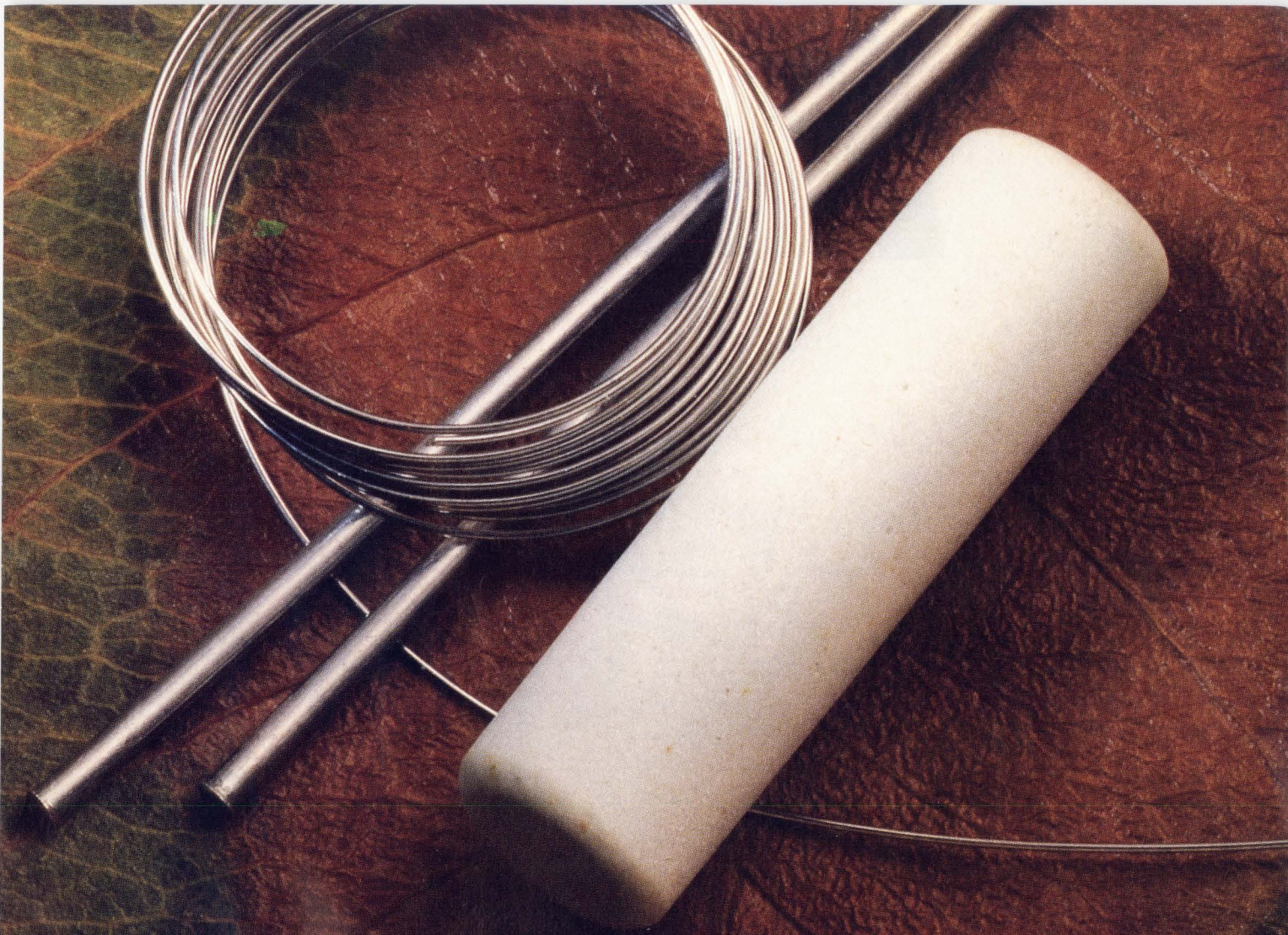

2 grams of ceramic and 18 inches of wire can't make you more competitive.

There's only one real reason to specify Dale® wirewound resistors: We'll work harder turning something common into something uncommonly valuable. Up front, that means saving you selection time by producing every standard shape and size in the book. Plus, we give you immediate access to design assistance and a wide range of proven special products.

It means factory and distributor stocking programs that can be quickly fine-tuned to your Just-In-Time delivery programs.

And, it means making reliability

Dale® Can.



the least of your worries with well-established Statistical Process Control and Quality Assurance systems to give you ship-to-stock capability.

Dale wirewound resistors.

CIRCLE NO. 19

They're not commodities — they're the power you need to help make your products more competitive. Contact your Dale Representative or Distributor, or phone: 402-563-6506. Dale Electronics, Inc., 1122 23rd Street, Columbus, NE 68601-3647.

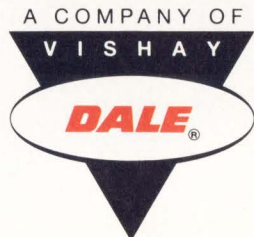

FILTERS



dc to 3GHz from \$1145

lowpass, highpass, bandpass

- less than 1dB insertion loss • greater than 40dB stopband rejection • surface-mount • BNC, Type N, SMA available
- 5-section, 30dB/octave rolloff • VSWR less than 1.7 (typ) • rugged hermetically-sealed pin models • constant phase
- meets MIL-STD-202 tests • over 100 off-the-shelf models • immediate delivery

low pass, Plug-in, dc to 1200MHz

Model No.	Passband MHz loss < 1dB	Stopband, MHz loss > 20dB	loss > 40dB	Model No.	Passband MHz loss < 1dB	Stopband, MHz loss > 20dB	loss > 40dB
PLP-5	DC-5	8-10	10-200	PLP-250	DC-225	320-400	400-1200
PLP-10.7	DC-11	19-24	24-200	PLP-300	DC-270	410-550	550-1200
PLP-21.4	DC-22	32-41	41-200	PLP-450	DC-400	580-750	750-1800
PLP-30	DC-32	47-61	61-200	PLP-550	DC-520	750-920	920-2000
PLP-50	DC-48	70-90	90-200	PLP-600	DC-680	840-1120	1120-2000
PLP-70	DC-60	90-117	117-300	PLP-750	DC-700	1000-1300	1300-2000
PLP-90	DC-81	121-137	167-400	PLP-800	DC-720	1080-1400	1400-2000
PLP-100	DC-98	146-189	189-400	PLP-850	DC-760	1100-1400	1400-2000
PLP-150	DC-140	210-300	300-600	PLP-1000	DC-900	1340-1750	1750-2000
PLP-200	DC-190	290-390	390-800	PLP-1200	DC-1000	1620-2100	2100-2500

Price, (1-9 qty), all models: plug-in \$14.95, BNC \$32.95, SMA \$34.95, Type N \$35.95

Surface-mount, dc to 570MHz

Model No.	Passband MHz loss < 1dB	Stopband, MHz loss > 20dB	loss > 40dB	Model No.	Passband MHz loss < 1dB	Stopband, MHz loss > 20dB	loss > 40dB
SCLF-21.4	DC-22	32-41	41-200	SCLF-190	DC-190	290-390	390-800
SCLF-30	DC-30	47-61	61-200	SCLF-380	DC-380	580-750	750-1800
SCLF-45	DC-45	70-90	90-200	SCLF-420	DC-420	750-920	920-2000
SCLF-135	DC-135	210-300	300-600				

Price, (1-9 qty), all models: \$11.45

Flat Time Delay, dc to 1870MHz

Model No.	Passband MHz loss < 1.2dB	Stopband MHz loss > 10dB	loss > 20dB	VSWR Freq. Range, DC thru	0.6fco X	Group Delay Variations, ns Freq. Range, DC thru	fco X	2fco X	2.67fco X
PBPL-39	DC-23	78-117	117	1.3:1	2.3:1	0.7	4.0	5.0	
PBPL-117	DC-65	234-312	312	1.3:1	2.4:1	0.35	1.4	1.9	
PBPL-156	DC-94	312-416	416	0.3:1	1.1:1	0.3	1.1	1.5	
PBPL-200	DC-120	400-534	534	1.6:1	1.9:1	0.4	1.3	1.6	
PBPL-300	DC-180	600-801	801	1.25:1	2.2:1	0.2	0.6	0.8	
PBPL-467	DC-280	934-1246	1246	1.25:1	2.2:1	0.15	0.4	0.55	
▲BPL-933	DC-560	1866-2490	2490	1.3:1	2.2:1	0.09	0.2	0.28	
▲BPL-1870	DC-850	3740-6000	5000	1.45:1	2.9:1	0.05	0.1	0.15	

Price, (1-9 qty), all models: plug-in \$19.95, BNC \$36.95, SMA \$38.95, Type N \$39.95

NOTE: ▲ -933 and -1870 only with connectors, at additional \$2 above other connector models.

high pass, Plug-in, 27.5 to 2200MHz

Model No.	Stopband MHz loss < 40dB	loss < 20dB	Passband MHz loss < 1dB	VSWR Pass-band Typ.	Model No.	Stopband MHz loss < 40dB	loss < 20dB	Passband MHz loss < 1dB	VSWR Pass-band Typ.
PHP-25	DC-13	13-19	27.5-200	1.8:1	PHP-400	DC-210	210-290	395-1600	1.7:1
PHP-50	DC-20	20-26	41-200	1.5:1	PHP-500	DC-280	280-365	500-1600	1.8:1
PHP-100	DC-40	40-55	90-400	1.8:1	PHP-600	DC-350	350-440	600-1600	2.0:1
PHP-150	DC-70	70-95	133-600	1.8:1	PHP-700	DC-400	400-520	700-1800	1.6:1
PHP-175	DC-70	70-105	160-800	1.5:1	PHP-800	DC-445	445-570	780-2000	2.1:1
PHP-200	DC-90	90-116	185-800	1.6:1	PHP-900	DC-520	520-660	910-2100	1.8:1
PHP-250	DC-100	100-150	225-1200	1.3:1	PHP-1000	DC-550	550-720	1000-2200	1.9:1
PHP-300	DC-145	145-170	290-1200	1.7:1					

Price, (1-9 qty), all models: plug-in \$14.95, BNC \$36.95, SMA \$38.95, Type N \$39.95

bandpass, Elliptic Response, 10.7 to 70MHz

Model No.	Center Freq. (MHz)	Passband I.L. 1.5 dB Max. (MHz)	3 dB Bandwidth Typ. (MHz)	Stopbands I.L. > 20dB at MHz	I.L. > 35dB at MHz
PBP-10.7	10.7	9.6-11.5	8.9-12.7	7.5 & 15	0.6 & 50-1000
PBP-21.4	21.4	19.2-23.6	17.9-25.3	15.5 & 29	3.0 & 80-1000
PBP-30	30.0	27.0-33.0	25-35	22 & 40	3.2 & 99-1000
PBP-60	60.0	55.0-67.0	49.5-70.5	44 & 79	4.6 & 190-1000
PBP-70	70.0	63.0-77.0	68.0-82.0	51 & 94	6.0 & 193-1000

Price, (1-9 qty), all models: plug-in \$18.95, BNC \$40.95, SMA \$42.95, Type N \$43.95

Constant Impedance, 21.4 to 70MHz

Model No.	Center Freq. MHz	Passband MHz loss < 1dB	Stopband loss > 20dB at MHz	VSWR 1.3:1 Total Band MHz
PIF-21.4	21.4	18-25	1.3 & 150	DC-220
PIF-30	30	25-35	1.9 & 210	DC-330
PIF-40	42	35-49	2.6 & 300	DC-400
PIF-50	50	41-58	3.1 & 350	DC-440
PIF-60	60	50-70	3.8 & 400	DC-500
PIF-70	70	58-82	4.4 & 490	DC-550

Price, (1-9 qty), all models: plug-in \$14.95, BNC \$36.95, SMA \$38.95, Type N \$39.95

CIRCLE NO. 20

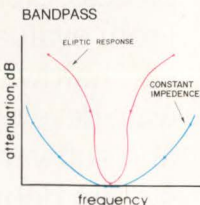
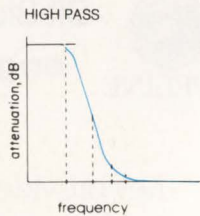
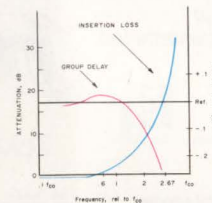
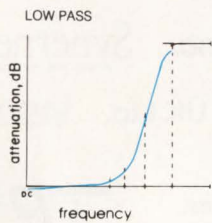

For connector revisions, where applicable, replace model prefix (P) with B, N, or S as required.

finding new ways ...
setting higher standards

Mini-CircuitsTM

WE ACCEPT AMERICAN EXPRESS AND VISA

P.O. Box 350166, Brooklyn, New York 11235-0003 (718) 934-4500 Fax (718) 332-4661

Distribution Centers/NORTH AMERICA 800-654-7949 • 417-335-5935 Fax 417-335-5945

EUROPE 44-252-835094 Fax 44-252-837010

F132 REV.B

Put These G And Take So



Think of it as peer pressure at its finest. All these companies want you to take some time off: Time off your design cycle, and your time to market. They're the Fusion29K™ Partners, and their support helps make the 29K™ Family of embedded RISC processors so fast and easy to use.

Fusion29K Partners include over 100 reputable companies with more than 200 different support products. Together,

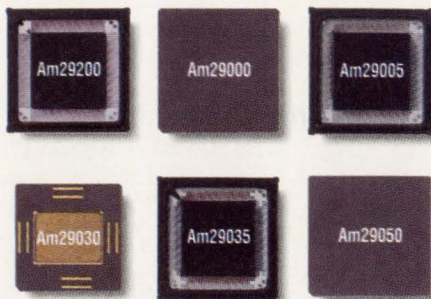

The 29K Family includes parts for every conceivable application—from the brand new low cost, easy-to-use Am29200™ to the top-of-the-line Am29050™ with on-chip floating point coprocessor.

they provide everything you need to speed up the design process, every step of the way. From evaluation, to system and hardware design, software development, hardware and software integration, system debug—all the way to production.

The Fusion29K Partners have a whole arsenal of time and labor saving devices. You'll find emulators, simu-

Ways To Work me Time Off.



5M Consulting



TeleSoft International, Inc.

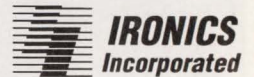

MICRO-PROCESSOR SERVICES, INC.

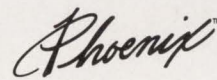

Schneider & Koch



Research



Graphics Resource Group

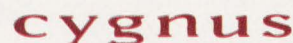

Epsilon Industries

telenetworks
SOFTWARE FOR DATA AND TELECOMMUNICATIONS A LHM COMPANY



Capricorn Systems International

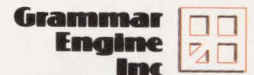

PEERLESS



Gibbons & Associates

Augat

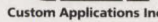

GSI Techsi



LOGIC MODELING



Information & Communications Mgmt.



XDI



IBM



lators, CASE and CAE tools, C compilers, machine and source level debuggers, logic analyzers, and manufacturing support of all kinds. All of the highest quality and performance standards.

And it won't take a lot of time to get acquainted with these development tools, since they include most of the hardware and software products you already know.

For more information on the 29K Family of embedded RISC processors and Fusion29K support, call AMD today: **1-800-292-9263 Ext. 3.**

With this much support, you may be able to take some time off for yourself.



Advanced Micro Devices

901 Thompson Place, P.O. Box 3453, Sunnyvale, CA 94088. © 1992 Advanced Micro Devices, Inc. 29K is a trademark and Fusion29K is a servicemark of Advanced Micro Devices. All other brand or product names are trademarks or registered trademarks of their respective holders.

An Object Less For Absolutely Pr



The MACH™ Family From AMD: The Fastest, Most Predictable High Density PLDs Available Today.

Oops! You're a couple of nanoseconds shy this time, and it's going to hurt. Perhaps next time you'll choose a more predictable vehicle. And the most predictable high speed, high-density PLDs available are the MACH family from AMD.

Only the MACH Family offers you worst case delays of 15ns* or

less. Because MACH parts are essentially PAL® devices, just like the kind you already know. Not some hybrid

PLD/FPGA, where you don't know how it performs — until it's too late. So you don't have to guess your delays or clock speeds, you just read them right off our datasheet.

But they're not just ordinary

Model Number	Equiv. Gates	Macro Cells	Max. Delay	System Speed	I/O Pins	Hard-Wired Option
MACH 110	900	32	12ns	66.7 MHz	44	MASC 110
MACH 210	1800	64	12ns	66.7 MHz	44	MASC 210
MACH 120	1200	48	15ns	50 MHz	68	MASC 120
MACH 220	2400	96	15ns	50 MHz	68	MASC 220
MACH 130	1800	64	15ns	50 MHz	84	MASC 130
MACH 230	3600	128	15ns	50 MHz	84	MASC 230

*In applications with a full 16 product terms. Every MACH part is specified using real-life conditions with all outputs switching.

on In The Need edictable Speed.



PAL devices. They're bigger and better, with densities ranging from 900 to 3600 gates, all in our submicron CMOS technology.

Nor will you face unpredictable delays when you order. Because the entire MACH family is now shipping in volume.

Working with them is equally predictable. You don't have to learn any new techniques, just use the software and test equipment you already know. Like ABEL, CUPL, OrCad, and others. Not to mention the software and support from over 20 FusionPLD vendors — all prepared to bring your products to market on time.

And each MACH part can migrate easily to a pin-

compatible, hard-wired MASC™ counterpart for high volume. So you can get the volume you need, without redesign, NRE, or unforeseen delays.

So call AMD today at **1-800-222-9323**. And let the MACH family make your design cycle a whole heck of a lot safer.



Advanced Micro Devices

© 1992 Advanced Micro Devices, Inc. 901 Thompson Place, P.O. Box 3453, Sunnyvale, CA 94088. PAL is a registered trademark, and MACH and MASC are trademarks of Advanced Micro Devices, Inc. All brand or product names mentioned are trademarks or registered trademarks of their respective holders.

CIRCLE NO. 23

50% higher discharge capacity 25% less space



Advanced Cylindrical Sealed Rechargeable Nickel Cadmium Batteries

NOW is the time to upgrade your battery packages

Sanyo's new compact, lightweight Cadnica® Slim batteries maximize volumetric energy to deliver a discharge capacity that's 50% higher than standard cylindrical NiCd batteries - plus, the low profile, rectangular shape facilitates stacking to eliminate dead space.

The KF Series batteries feature superior gas absorption and a voltage of 1.2V per cell. They can be "quick charged" in 1.5 hours and possess superior shock and vibration resistance due to laser welding technology and strong steel cans.

These features plus high reliability and long life make these Sanyo batteries ideal for your most demanding design concepts like portable electronic products.

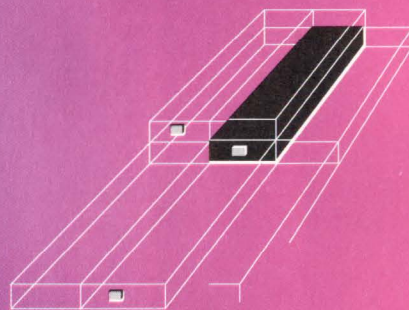

AVAILABLE NOW

Sanyo's Cadnica® Slim series, which had been available on a limited basis, are now available to the entire OEM design community. Call today.

In Florida: (904) 376-6711
 In Illinois: (708) 285-0333
 In New Jersey: (201) 641-2333
 In Georgia: (404) 279-7377
 In Dallas: (214) 480-8345
 In San Diego: (619) 661-6620

Model	Nominal Voltage (V)	Capacity (mAh) at 0.2C rate	Standard Charge		External Dimensions (including tube)			Weight (approx.g)
			Charging Current (mA)	Time (Hrs.)	L (mm)	W (mm)	T (mm)	
KF-A600	1.2	600	60	14-16	67.0	17.0	6.1	23
KF-A900	1.2	900	90	14-16	67.0	17.0	8.1	30
KF-A1200	1.2	1200	120	14-16	67.0	17.0	10.3	38
KF-B600	1.2	600	60	14-16	48.0	17.0	8.1	21
KF-B400	1.2	400	40	14-16	48.0	17.0	6.1	16

SANYO

SANYO Energy (U.S.A.) Corporation
 2001 Sanyo Avenue
 San Diego, CA 92173

There's more than one way to convert programs to BasicA

Over the years, I have used several PLL, Microstrip, and Stripline Basic design programs developed on the Tektronix 4052 or the Apple II computers. These programs use quite a bit of Basic graphics in either Tektronix Basic or Apple II Basic.

The problem is the fact that these two computers are obsolete by today's standards and usually unavailable. I have found the design programs to be extremely difficult to translate into PC BasicA because of the differences in graphic commands and display modes for complex plotting, such as a Bode plot.

Does anybody know an easy way to translate these programs into PC BasicA?

John H Renault
Consulting Engineer
Indianapolis, IN

For information on the Apple II part of your question, we asked Dennis Doms of Resource Central, which publishes *A2-Central*, a monthly newsletter for Apple II owners (subscriptions cost \$34/year). Among its other activities, Resource Central operates the Apple II special-interest groups (SIGs) that subscribers to the Genie information service can access via modem. (You can contact Resource Central directly at Box 11250, Overland Park, KS 66207. Phone (913) 469-6502. FAX (913) 469-6507. To learn how to subscribe to Genie, call (800) 638-9636 on an old-fashioned (voice) telephone.)

Dennis, who insists that reports of the Apple II's death are greatly exaggerated, offered two possibilities. The first involves installing a coprocessor board that emulates an Apple II in one of a PC's ISA bus I/O slots. The only such boards that EDN or Resource Central know about are Diamond Computer Systems' Trackstars. They use a full-length slot and emulate an Apple IIe with 128 kbytes of RAM. The company's address is 532 Mercury Dr, Sunnyvale, CA 94086. Phone (408) 736-2000. FAX (408) 730-5750. According to Trackstar Product Manager Brian Burke, the version that Mr Renault wants is the Trackstar Plus (list price \$445). Although Diamond introduced the line back in 1986, the Trackstar Plus will work in modern PCs, even ones

that use i486 μ Ps and have VGA graphics adapters (640 \times 480-pixel or better resolution). To load your Apple II software, you'll have to plug one of your Apple's 5 $\frac{1}{4}$ -in. disk drives into the Trackstar. You can copy files from Apple disks onto PC floppy disks (3 $\frac{1}{2}$ or 5 $\frac{1}{4}$ in., any density) or onto the PC's hard drive.

Another approach is to translate the program from the Apple II's Applesoft Basic to a proprietary Basic dialect called ZBasic. ZBasic is a compiled language. There are versions for the Apple II, for MS-DOS machines, and for other computers, including the Macintosh. The \$69.95 Apple II version and the Macintosh version are published by Zedcor, whose address is 4500 E Speedway, Suite 22, Tucson, AZ 85712. Phone (800) 482-4567 (orders only); (602) 881-8101. The Apple II package includes an Applesoft-to-ZBasic translator that runs on Apple IIs and will do about 95% of the work of converting a program to the new language. Once your ZBasic program compiles and runs on an Apple II, you can move the source code, which is pure ASCII text, to MS-DOS. After slight modifications relating to operating-system calls, you can recompile the program to run on MS-DOS PCs; the compiler will produce versions compatible with just about any PC ever made. You will also need ZBasic/PC (\$149.95) from 32-Bit Software (3232 McKinney, Suite 865, Dallas, TX 75204. Phone (800) 322-4879; (214) 720-2053. FAX (214) 855-0677).

If you contact suppliers of IBM PC public-domain or shareware programs or browse bulletin-board systems (BBSs) that contain such programs, you might be able to find an Apple II emulator that runs on MS-DOS PCs. Apparently, several such programs exist, and their capabilities vary. We cannot recommend this approach, however, because at least one such program allegedly infringes on Apple Computer's copyrights for the Apple II firmware. You won't find this software on the EDN BBS; Sysop (system operator) Charles H Small makes sure that we can legally distribute the software we make available for downloading. Nor will you find software of dubious pedigree on Genie's Apple II SIGs.

We had limited success getting information on the Tektronix 4052. The product has been out of production for a number of years, but the Customer Support Center at Tektronix's Network Display Div (Phone (800) 547-8949) can still provide some support. According

to the person we spoke with at Tektronix, the Support Center would be interested in quoting a price for converting your software to GW-Basic for an MS-DOS PC. (BasicA, available only on PCs manufactured by IBM Corp, is the partially ROM-resident version of disk-based GW-Basic. Both the GW-Basic and BasicA interpreters can run the same programs.)

Company specializes in discontinued transistors

We have been looking for transistors that are no longer manufactured by RCA or Motorola. We discovered that General Transistor Corp is making all these older-type devices as well as current devices. They will also make special devices to a specification control drawing. The specifications are in the company's semiconductors catalog, which is available on request.

General Transistor Corp
216 W Florence Ave
Inglewood, CA 90301
(310) 673-8422
FAX (310) 672-2905

Dan Lee
Purchasing Manager
DI Design Services
Culver City, CA

Manual is free for the copying

We'd like to thank the three readers who answered Robert E Bober's request for a Prompt 48 manual in the June 4, 1992, issue. Richard Cullman of Magnetic Analysis (Mount Vernon, NY), Tom Paden of Trimble Navigation (Sunnyvale, CA), and Ron Vrana of Ocean & Atmospheric Science Inc (Dobbs Ferry, NY) all volunteered to lend Mr Bober their manuals for copying.

Ask EDN solves nagging design problems and answers difficult questions. Address your letters to Ask EDN, 275 Washington St, Newton, MA 02158. FAX (617) 558-4470; MCI: EDNBOS. Or send us a letter on EDN's bulletin-board system at (617) 558-4241: From the Main System Menu, enter SS/ASK_EDN and select W to write us a letter.

FAST FLASH 22V10

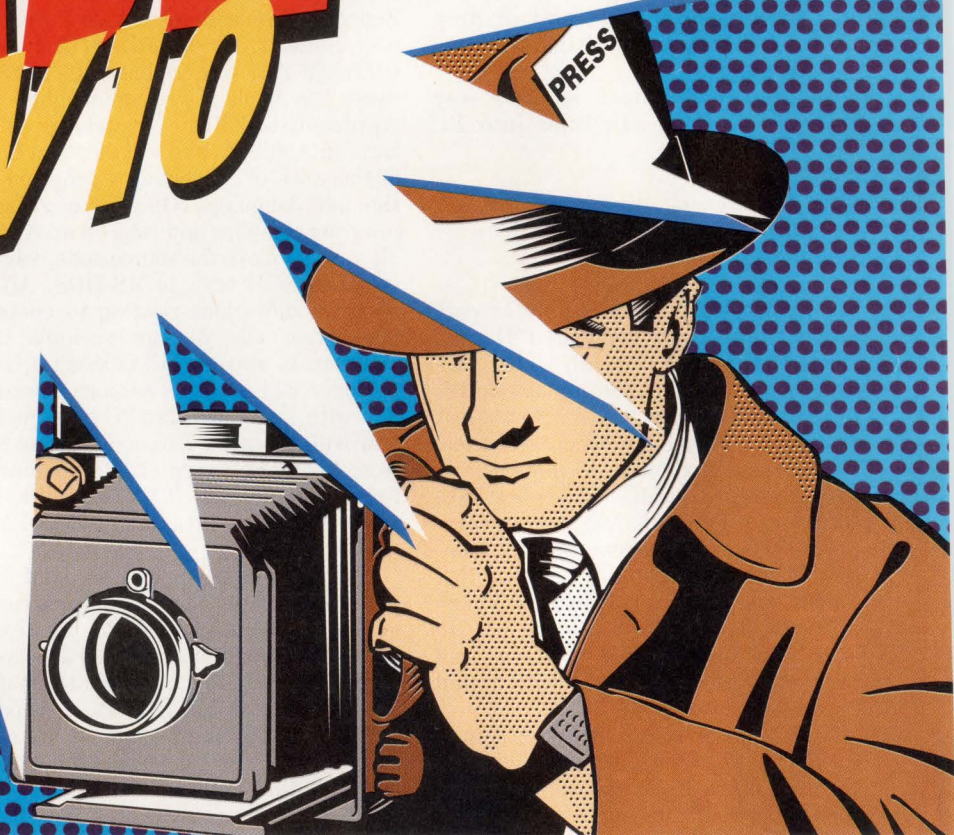

EXTRA! CYPRESS STUNS WORLD WITH FIRST FLASH PLD.

Stop the presses! Once again, Cypress has the lead story in PLD technology for high-performance systems. Cypress is first on the world scene with 10 ns, Flash 22V10 devices. Electrically alterable 22V10s are your fastest route to risk-free inventory and ease of design. Cypress scoops the competition again!

Also newsworthy: This 22V10 is CMOS, needing just 90 mA max (commercial) and 100 mA (military applications), so it stays cool for reliable operation. Choose from DIP, PLCC and LCC packaging options.

Cypress's Flash 22V10 is the latest member in a complete family of landmark PLD products with the widest variety of speeds, densities and architectures to suit your application. Read all about it—call the Cypress hotline for your free Flash sample certificate and data sheet today.

FREE FLASH SAMPLE HOTLINE: 1-800-858-1810*
Ask for dept C47.

*In Europe, fax your request to the above dept. at (32) 2-652-1504 or call (32) 2-652-0270. In Asia, fax to the above dept. at 1 (415) 961-4201.
© 1992 Cypress Semiconductor, 3901 North First Street, San Jose, CA 95134. Phone 1 (408) 943-2600, Telex: 8211032 CYPRESS SNJ UD, TWX: 910-997-0753.



Radar 92 International Conference, Brighton, England. Conference Services, IEE, Savoy Pl, London WC2R OBL, UK. Phone (071) 240-1871, ext 222. FAX (071) 240-7735. TLX 261176. October 12 to 13.

Networld Dallas, Dallas, TX. Bruno Blenheim Inc, Fort Lee Executive Park, 1 Executive Dr, Fort Lee, NJ 07024. Phone (800) 829-3976, ext 143; (201) 346-1400. FAX (201) 346-1602. October 13 to 15.

Open Bus Systems 92, Zürich, Switzerland. Karyne Nguyen, VITA Europe, Box 192, NL-5300 AD Zaltbommel, The Netherlands. Phone (31) 4180-14661. FAX (31) 4180-15115. October 13 to 15.

Microprocessor Forum, Burlingame, CA. Microprocessor Forum, 874 Gravenstein Hwy S, Suite 14, Sebastopol, CA 95472. Phone (707) 823-4004. FAX (707) 823-0504. October 14 to 15.

DSPx: International Conference and Exposition on DSP Applications and Technology, San Jose, CA. Reed Exhibition Co, Box 3833, Stamford, CT 06905. Phone (203) 352-8367. FAX (203) 964-0176. October 14 to 16.

Fuzzy Logic Conference, Duke University, Durham, NC. Monte Basgall, Duke University News Service, 615 Chapel Dr, Durham, NC 27706. Phone (919) 681-8057; (919) 684-2823. October 14 to 16.

Successfully Simulating Circuits with Spice (short course), Houston, TX. RCG Research Inc, Box 509009, Indianapolis, IN 46250. Phone (800) 442-8272; (317) 877-2244. October 14 to 16.

International Symposium on Microelectronics, San Francisco, CA. ISHM 92 Registration, Box 2698, Reston, VA 22090. Phone (800) 525-4746; (703) 471-0066. FAX (703) 471-1937. October 19 to 21.

NEW!

Guarded-measurement Capability in a Low-cost MDA

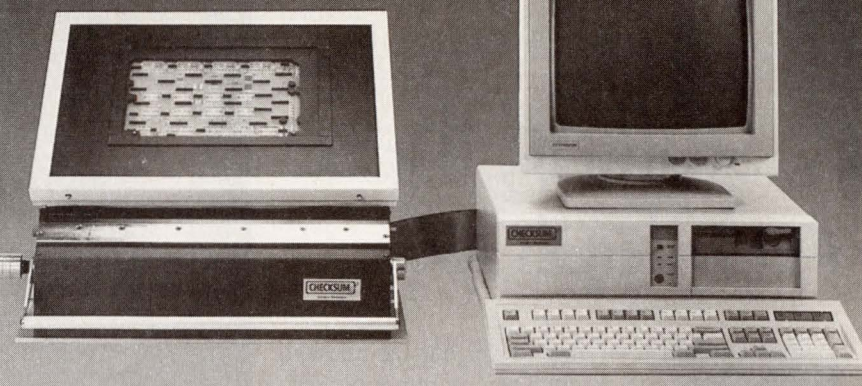

Powerful New Features!

- AC and DC measurements of up to 1600 points; each with 6 guard points
- Test capacitors, inductors, resistors, semiconductors, opens and shorts
- Complete 400-point systems with fixture and PC for \$9995. (200-point core systems starting at \$4495.)

The most cost-effective way to find manufacturing faults!

Call (206) 653-4861



8416 134th St. N.E., Arlington, WA 98223

CIRCLE NO. 26

The best way to a man's stomach...NordicTrack®.

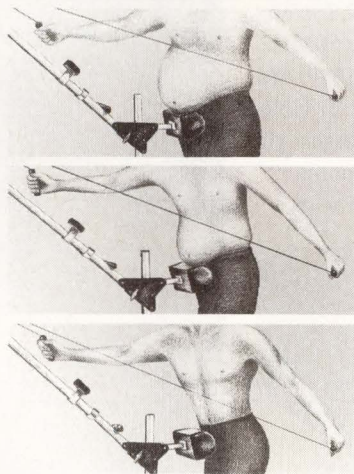

"The World's Best Aerobic Exerciser."TM

NordicTrack duplicates the motion of cross-country skiing, which most experts agree is the most efficient and effective aerobic exercise.

It burns more calories in less time than many other exercise machines. Up to 1,100 calories per hour, according to fitness experts.

NordicTrack
A CML Company

Models priced from \$299.⁹⁵ to \$1,299.⁹⁵

Besides burning calories, it strengthens the heart, tones the muscles and improves stamina. And it's much less stressful on the body than running and high-impact sports. Working out on NordicTrack also boosts creativity and productivity and lowers stress, making you feel as good as you look.

It's time to change your spare tire.

Unlike most in-home exercisers, NordicTrack works all the major muscle groups of the body including the arms, legs, buttocks, shoulders and, yes, even stomach.

So what are you waiting for? Call NordicTrack today.

30 day in-home trial!



Call or Write for a **FREEVIDEO & Brochure**

1-800-328-5888 Ext. 144J2
 Please send me a free brochure
 Also a free video VHS Beta
 Name _____
 Street _____
 City _____ State _____ Zip _____
 Phone () _____
 NordicTrack, Dept #144J2,
 141 Jonathan Blvd. N., Chaska, MN 55318

©1992 NordicTrack, Inc. A CML Company. All rights reserved. NordicTrack reserves the right to change prices and specifications without prior notice.

CIRCLE NO. 27

Try stuffing these into a laptop.



Laptops have their place, but for mission-critical applications requiring serious expansion, workstation power, CRT-quality screens or toolbox ruggedness, get a P.A.C.™ (Portable Add-In Computer).

■ **MASSIVE EXPANSION.** Nobody gives you more expansion possibilities than Dolch. In an 18 pound package a Dolch P.A.C. has room for up to five full-size EISA/ISA add-in cards. You can add up to 32 MB RAM, 1 GB HDD, and any combination of drives, CD-ROM, removable HD, streaming tape, and more. ■ **EXTREME POWER.** Dolch P.A.C. systems have been rated "the fastest portables on the market" since 1987, and have won more Editor's Choice awards than any other product in its category. *Computer Reseller News* calls the 486-50E "a dream machine . . . one of the most powerful PCs of any kind." P.A.C. systems are based on 386SX and DX, and 486 CPUs up to 50MHz, delivering as much as 22 MIPs. ■ **DAZZLING DISPLAYS.** "Breathtaking . . . Dolch's heart-stopping TFT Color Display produces vibrant colors and sharp images virtually on par with those seen on desktop VGA monitors," reports *PC Computing*. ■ **MIL RUGGEDNESS.** Every P.A.C. is as tough as it is powerful. Certified under MIL Std. 810C Dolch provides true mission critical reliability. ". . . it simply outclasses its competitors and it is sturdy and solid . . ." says *PC Magazine*. ■ **GET THE FULL STORY.** Call 1.800.995.7581. In Canada 1.800.561.4527.



CIRCLE NO. 28



POWER PORTABLE ADD-VANTAGE
DOLCH COMPUTER SYSTEMS · 372 TURQUOISE STREET · MILPITAS · CALIFORNIA 95035 · USA

32 • EDN October 1, 1992



1989



1989



1990



1990



1991



1991



1992

Designing it wrong: the fax machine from hell



EDN is haunted by a machine we call "the fax from hell." We used to have a machine that had few bells or whistles on it. The beauty of it was that anyone could walk up to it and, in less than 15 seconds, figure out how to send a fax.

Then somebody in the front office decided that we could do better. One morning we found that our faithful old machine had been replaced by a marvelous new one. The new machine has every feature most people want in a fax. The problem is that we can't figure out how to use it. Lots of us depend on the machine, and we know that sending faxes is no big deal. So imagine our exquisite frustration when we discovered that, with the aid of improved technology, sending faxes had suddenly become nearly impossible.

I decided that I could conquer the problem by reading the manual. Silly me—imagine expecting help from the manual. Though nicely printed, profusely illustrated, grammatical, and indexed, it's useless. The organization is abysmal, and the index is worse; you can rack your brain for 10 minutes thinking of every conceivable synonym for what you're trying to find and still not hit on the right word.

When this marvelous machine scans a document, it doesn't send it right away. Instead, it places the document's image in memory. Then, on its LCD screen, the machine flashes an identification number. If you don't have your eyes fixed on the screen for the 100 milliseconds or so during which this number appears, or if you forget the number, you can't find out whether the fax was successfully sent. When the machine does transmit your fax (and none of us can figure out how it decides when to transmit), it prints out a little slip showing the identification number. Usually, the people who clear the machine discard these little slips, so you aren't likely to

find out whether your document was sent successfully—even if you can remember its number.

If these problems sound bad, listen to what happens when a fax arrives. Even if the machine isn't in the midst of printing a document received earlier, it doesn't always print out the incoming fax right away; sometimes it places the document in memory and prints it out later. I've received faxes as many as 19 hours after they were sent. At other times, the machine seems to print out incoming faxes when it receives them. We can't figure out why the machine stores some faxes and prints others, or how it decides when to print a stored fax.

The main reason for faxing a document is immediacy. Clearly, the designers of a machine that holds incoming faxes for 19 hours forgot why people buy their product. Another major reason for fax machines' growth in popularity over the last few years is simple operation. When you realize that in adding features to create a new model, a design team could completely disregard immediacy and simplicity, you have to ask what's wrong with the way companies define and develop products.

This machine comes from a large and venerable Japanese firm that has an impeccable reputation for quality; indeed, nobody faults the machine's construction or reliability. What we do fault is the thinking that preceded the formal design effort. In this issue, EDN begins a series of articles called "Design it Right." We want to make clear that unless you start with a good concept, you can't have a good product. As with Humpty Dumpty, if the idea is broken, no amount of ingenuity or care in execution can put the design "back together again."

Dan Strassberg
Senior Technical Editor



Jesse H. Neal
Editorial Achievement Awards
1990 Certificate, Best Editorial
1990 Certificate, Best Series
1987, 1981 (2), 1978 (2),
1977, 1976, 1975

American Society of
Business Press Editors Award
1988, 1983, 1981

Send me your comments via FAX at (617) 558-4470 (I'll get them eventually), or address E-mail to EDNSTRAS on the EDN Bulletin Board System at (617) 558-4241 300/1200/2400/9600 8,N,1.

So many switch choices.

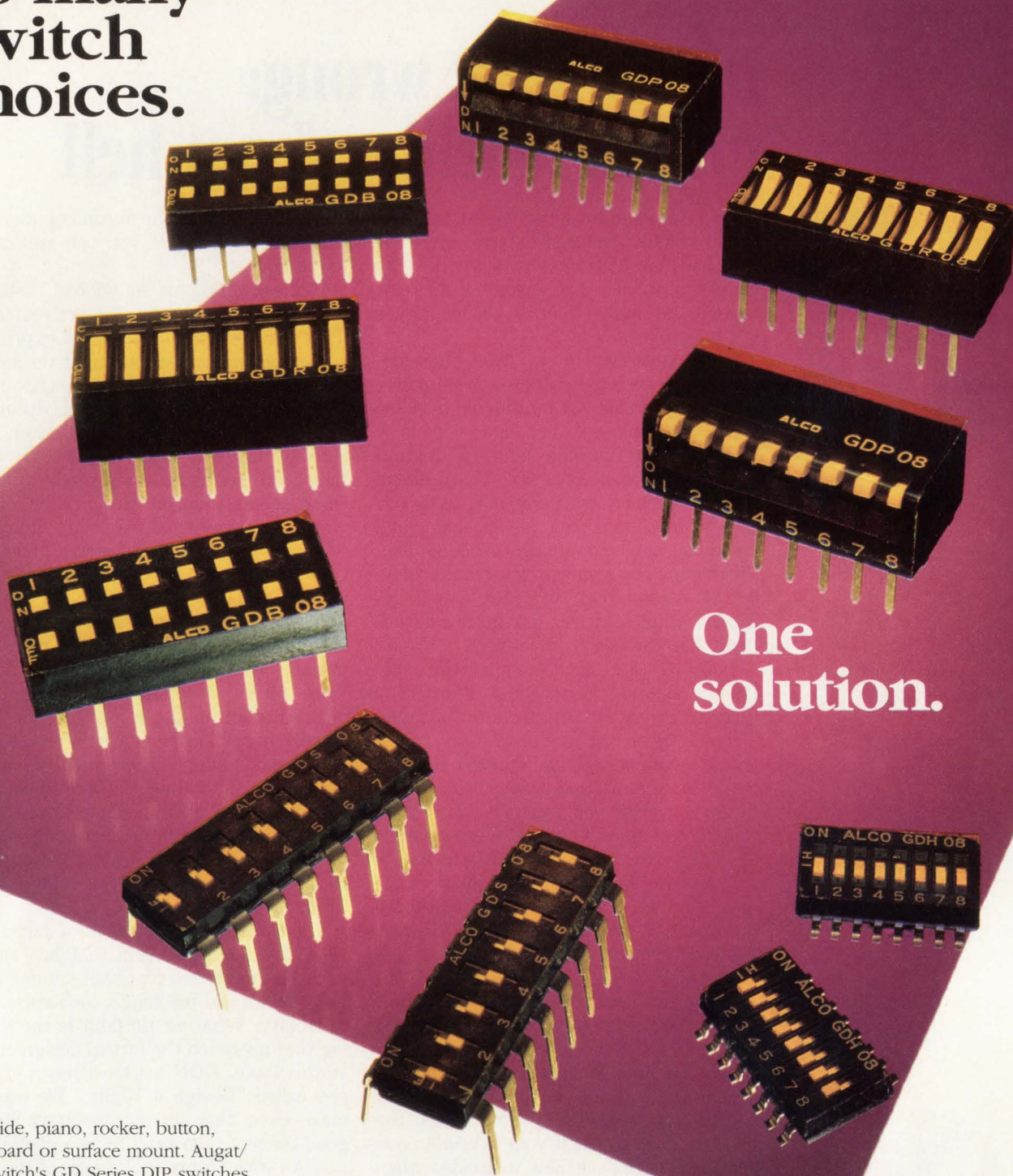

One solution.

Slide, piano, rocker, button, thru board or surface mount. Augat/Alcoswitch's GD Series DIP switches offer you one solution.

The end stackable GDS model is up to 26% smaller than other low profile dip switches. This space saving design lets you reduce the size of your PCB or place more components on it. Also, laying out your board now becomes easier. All holes are on a .100 x .300 grid regardless of how many switches you stack.

For surface mount boards the GDH half pitch DIP is only .244" W x .444" L for the 8 position version. All GD series DIPs are molded in high temperature polymer

which withstands 260°C reflow soldering temperatures.

No cumbersome tape tab to interfere with component placement equipment. Our unique corner notch allows easy tape removal.

We encourage you to get complete technical and delivery information on these or any other Augat interconnection components you require.

AUGAT[®] *Quality
and Innovation*

INTERCONNECTION PRODUCTS DIVISION

452 John Dietsch Boulevard
Attleboro Falls, MA 02763 USA
Tel: (508) 699-9800 FAX: (508) 699-6717

DAC ATTACK

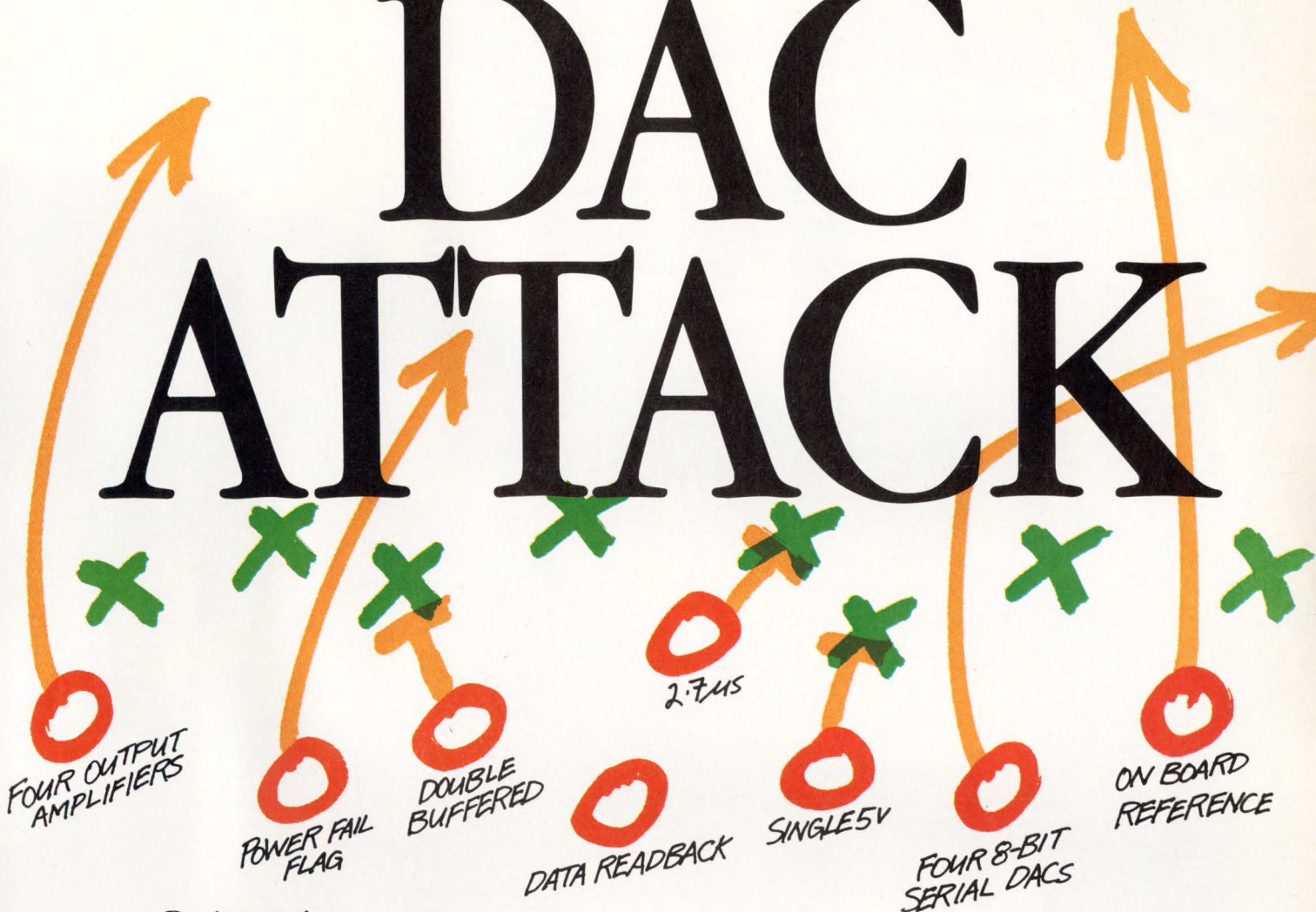

Design a winner with our new quad 8-bit serial DAC.

With National's DAC0854, you'll tackle your next design with the advantages of higher speed,

higher integration and on-chip diagnostic capabilities.

That's the lineup that puts excess wiring, wasted board space, and rising test costs on the defensive. With the DAC0854,

more efficient designs are part of every game plan.

Play to win.

To get that competitive edge, call us for a free sample at 1-800-NAT-SEMI, ext. DAC. Or, fax: 1-800-888-5113.

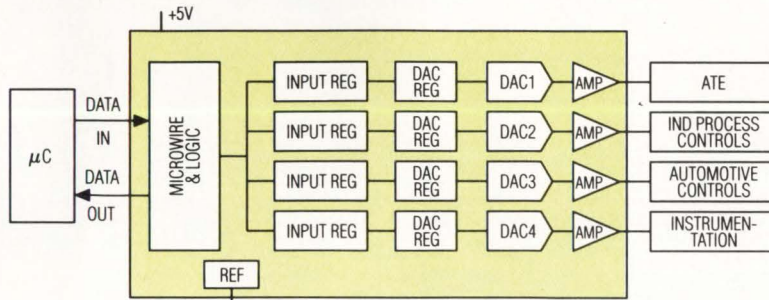

DAC0854 System Block Diagram



SONY

SONY MAKES THE CHIP. SUN MAKES THE HISTORY.

Sun Microsystems' new SPARCstation™ 10 is fast making history running at speeds to 400 MIPS and beyond. Inside is SuperCache™, a Sony-designed, 20 ns, one-meg, self-timed static RAM that's optimized for SPARC® processors. The CXK77910J-20.

This synchronous "STRAM" gives Sun's power users three times more fast cache than any other workstation. You, too, can make history with Sony SRAMs and other breakthrough ICs. Call 800-288-SONY. Or FAX your current requirements

to 714-229-4333 in U.S.A., 416-499-8290 in Canada.

Sony is a trademark of Sony. Sun, Sun Microsystems, and SuperCache are trademarks or registered trademarks of Sun Microsystems, Inc. All SPARC trademarks are trademarks or registered trademarks of SPARC International, Inc. SPARCstation is licensed exclusively to Sun Microsystems, Inc.

CIRCLE NO. 25

DATA ACQUISITION AND MODELING

Ignoring real-world data invalidates simulations

CHARLES H SMALL, Senior Editor

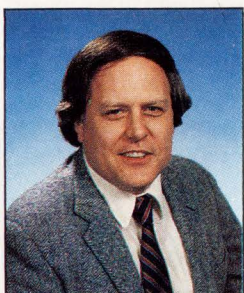

Circuit simulation is becoming a must for most analog engineers. But no rigorous, coherent, comprehensive approach exists to correlate simulated and real-world performance.

As powerful PCs and workstations proliferate, more and more engineers are taking advantage of all this computing power to simulate their analog circuits before prototyping them. Indeed, many companies *require* a simulation prior to signing a design off. Before simulating a circuit, engineers must find or create models for all the components in their circuits. And after building a circuit, engineers must verify that the circuit's performance matches the simulation's predictions. Software and hardware exist for doing each of these jobs individually, but no coherent, comprehensive approach exists that unites the two.

For starters, the reservoir of available component models is far too shallow. Device manufacturers model only some of their more popular devices (or at least the devices they want you to buy). According to Charles Hymowitz, vice president of Intusoft, right now manufacturers supply models for 80 to 90% of op amps, none of their discrete devices, and almost none of their complex analog devices such as multipliers. Although no digital models are currently available, Signetics (Sunnyvale, CA) may soon have digital-gate IC models.

Do-it-yourself analog models

Because of this dearth, engineers often have to cook up their own device models. Cooking up a model of a device involves three steps: characterizing the device's parameters, designing the model, and verifying that the resultant

model's simulated performance matches the real device's performance. In many cases, engineers cannot rely solely on manufacturers' data sheets to provide parameters for device models. Instead they must characterize the devices themselves—or have someone characterize the devices for them (Ref 1).

Characterizing a device means far more than measuring the performance of just a few examples of the device. Characterization involves statistically significant samples of devices, expensive test equipment, and lots of engi-

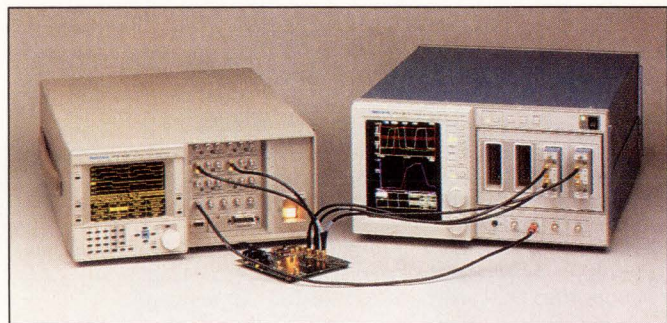

If you are going to treat a component as a "black box," then a network analyzer such as Tektronix's CSA 803 can acquire the raw input you'll need for the transfer-function approach.

neering time. Until now, design engineers have preferred to have an outside firm, or some poor drudge in the components-engineering department, do characterizations for them. However, using outside firms is not cheap; costs run about \$1000 to \$2000 per device.

Verifying a circuit's performance involves applying the proper stimulus to the circuit, measuring its output, and analyzing the measurements. To correlate a circuit simulation and a test, the simulated stimulus must match the real stimulus, and some objective, mathematical means should determine how

AND THEN THERE BE DRAGONS!



Where Standard DSP Tools End, Hypersignal™-Macro EX Begins.

Is your DSP project taking you into unknown territory? Standard development tools such as assemblers, compilers, and even those old reliables, the hardware debugger and software simulator, can only take you so far. They can help you implement your algorithms and your product, but they can't help you with design. Even DSP design programs with "tool boxes" and "modules" can come up short, leaving you with limited functionality for a high price. Hypersignal™-Macro EX contains a full range of *integrated* simulation and real-time tools for algorithm design and development, and supports over 40 DSP/Acquisition boards and 8 DSP chips with built-in device drivers and

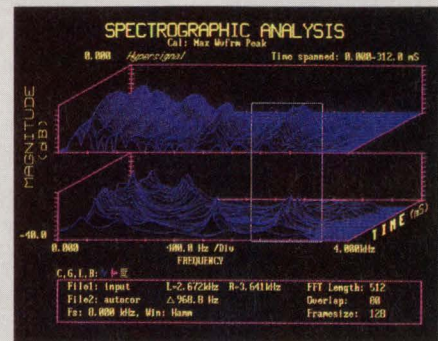
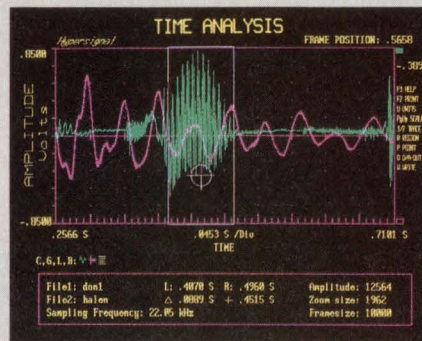
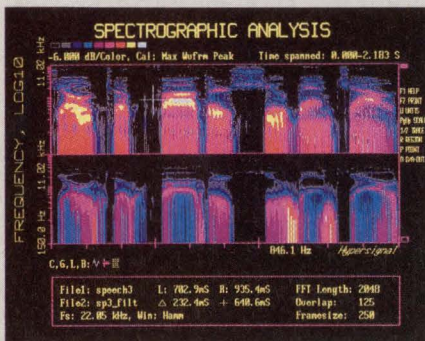

downloaders. Hypersignal-Macro EX has what it takes to slay DSP dragons: time and frequency domain waveform displays, real-time instruments, including Spectrum Analyzer and Digital Oscilloscope, DSP and math functions, filter design, difference equations, and DSP source code interfaces.

ALGORITHM DESIGN and SIMULATION

- DSP Functions: FFT, convolution, correlation, linear predictive coding, power spectra, transfer function, etc.
- Difference Equations: signal arithmetic/trig/calculus, feedback, function and noise generation
- IIR and FIR classical and arbitrary filter design, file-based and "snap-in" real-time usage, graphical editor, code generation
- Supported DSP boards can be used as "Accelerators"

INTERACTIVE WAVEFORM DISPLAY and EDITING

- Time domain, frequency domain contour, waterfall, unwrapped phase, and group-delay; publication-quality hardcopy

REAL-TIME INSTRUMENTATION, MEASUREMENT

- Dual- or overlaid-trace linear/log magnitude, transfer function, impulse response, time, and phase display; mixed file and analog input, triggering, capture, print, cursor read-out
- Continuous signal acquisition/generation to/from disk
- Stimulus & Response measurement

REAL-TIME ALGORITHM IMPLEMENTATION

- Over 40 DSP/Acquisition boards supported
- DSP Source Code Interfaces: Analog Devices ADSP-210x, AT&T DSP32C, DSP3210, Motorola DSP56001, DSP96002, NEC 77220, Texas Instruments TMS320C25, TMS320C30

One integrated environment, one low price. Menu-driven and interactive for ease-of-use, yet programmable for flexibility. A high-level macro language provides problem-solving and "what-if" capability for your project's future, and ready-to-execute functions such as sampling rate conversion, frequency zoom, and stimulus & response for the present. "Record-playback" is also available for your repetitive tasks. Ask us for a list of board drivers, a free demo diskette, and information about our upcoming, Windows-based DSPower™ block-diagram program that generates 'C' and macro language output. Explore your new DSP territory quickly and accurately with Hypersignal-Macro EX!

SIGNALLOGIC™

Signalogic
9704 Skillman #111
Dallas, TX 75243
tel: 214-343-0069
fax: 214-343-0163

For your DSP answers, call 1-800-DSPower™

Australia: Boston Technology, 9-321-2899, or DSP Engineering, 7-207-2267 • Denmark: Assentoft Electronics, 86-16-29-26 • France: dipsi INDUSTRIE, (1) 47 90 2111 • Germany: Electronic Tools, 02102-88010 • Japan: MTT Instrumentation, 03-5379-1971 (PC-980x の 7- 7 に つ い て 詳 し く 是 記) • Korea: I.D.S. System Corp. 02-444-3593 • South Africa: Peralex, 021-723-871 • United Kingdom: Bores Signal Processing, 0483-740138, or Loughborough Sound Images, 0509-231843

Hypersignal is a registered trademark of Hyperception, Inc. SIGNALogic and DSPower are trademarks of Signalogic, Inc.

DATA ACQUISITION AND MODELING

closely the real output matches the simulated output.

Thus, simulating analog circuits—which at first blush seems to be a purely theoretical activity—really involves acquiring real-world data as well. Ron Kieldowski of RCG Research Inc has set up in-house, device-modeling labs for several firms. He notes that although some firms want a push-button Spice-model lab that a technician can operate, others want more-flexible equipment for experienced engineers to use. If this demand continues to grow, design engineers will find themselves characterizing more devices and circuits in house.

At home in two worlds

This idea that theory and practice must agree is nothing new. Engineers have always moved easily, back and forth, from the real to the ideal. For example, engineers can measure a physical system's per-

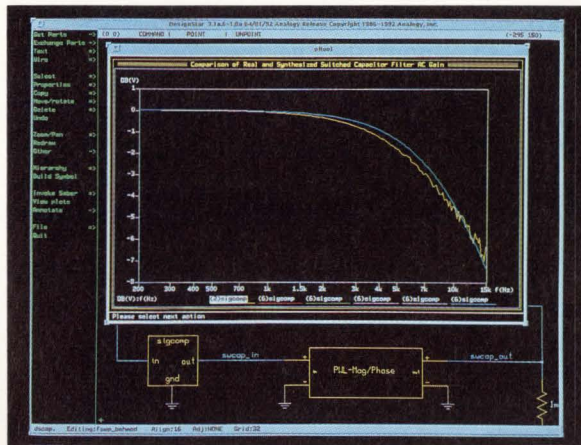

Comparing the frequency response of a switched-capacitor filter and the response of a synthesized model shows close correlation over the entire operating frequency range. (Analogy Inc)

formance, extracting a pole-zero plot. They can then move the poles and zeros around to achieve better performance and, finally, synthesize component values for a new system that will exhibit the improved performance. Using data-acquisition hardware and software to characterize devices, then simulating a circuit using another program, and lastly returning to the real world

to measure a prototype's performance is merely another bi-directional path for engineers to tread.

The path not taken

Curiously, although all the stepping stones for this path are in place, they remain isolated, unconnected, and not well traveled.

Numerous versions of Spice and other analog simulators are avail-

For more information . . .

For more information on the data-acquisition and -modeling products discussed in this article, circle the appropriate numbers on the Information Retrieval Service card or use EDN's Express Request service. When you contact any of the following manufacturers directly, please let them know you read about their products in EDN.

Analog and RF Models

6987 N Oracle Rd
Tucson, AZ 85704
(602) 575-5323
FAX (602) 297-5160

Circle No. 710

Analogy Inc

Box 1669
Beaverton, OR 97075
(503) 626-9600
FAX (503) 643-3361

Circle No. 711

Data Translation

100 Locke Dr
Marlboro, MA 01752
(508) 481-3700
FAX (508) 481-8620
TLX 951646

Circle No. 712

Electrical Engineering Software Inc

4675 Stevens Creek Blvd
Suite 200
Santa Clara, CA 95051
(408) 296-8151
FAX (408) 296-7563
TLX 171201

Circle No. 713

HEM Data Corp

17336 12 Miles Rd
Suite 200
Southfield, MI 48076
(313) 559-5607
FAX (313) 559-8008

Circle No. 714

Hewlett-Packard Co

Box 58059, MS 51L-SJ
Santa Clara, CA 95051
(800) 452-4844

Circle No. 715

Intusoft

Box 710
San Pedro, CA 90733
(310) 833-0710
FAX (310) 833-9658

Circle No. 716

Laboratory Technologies Corp

400 Research Dr
Wilmington, MA 01887
(508) 657-5400
FAX (508) 658-9972

Circle No. 717

Microsim Corp

20 Fairbanks
Irvine, CA 92718
(800) 245-3022
FAX (714) 455-0544

Circle No. 718

National Instruments

6504 Bridge Point Pkwy
Austin, TX 78730
(512) 338-9119
FAX (512) 794-8411

Circle No. 719

RCG Research Inc

Box 509009
Indianapolis, IN 46250
(800) 442-8272;
(317) 877-2244

Circle No. 720

Tektronix Inc

Test and Measurement Group
Box 1520
Pittsfield, MA 01202
(800) 426-2200

Circle No. 721

Tesoft Inc

205 Crossing Creek Ct
Roswell, GA 30076
(404) 751-9785
FAX (404) 664-5817

Circle No. 722

Zeelan Technology

8305-D SW Creekside Pl
Beaverton, OR 97005
(503) 520-1000
FAX (503) 520-1001

Circle No. 723

VOTE . . .

Please also use the Information Retrieval Service card to rate this article (circle one):

High Interest 482 Medium Interest 483 Low Interest 484

DATA ACQUISITION AND MODELING

able that allow engineers to enter spec-sheet parameters, transfer functions, or HDL (hardware-description language) specifications to model devices. However, there's more to modeling a device than typing in spec-sheet values. Given device manufacturers' abilities to skillfully concoct "high-performance" spec sheets, persnickety engineers will check any model generated from a spec sheet against some real devices.

If a device's spec sheet is incomplete, inappropriate, or inadequate, computer-controlled, special-purpose test equipment such as Tektronix's model 372 (\$24,950) or Hewlett-Packard's model HP 4145B (\$27,500) can measure a device's parameters. Ordinary PC data-acquisition boards lack the precision needed to make subtle semiconductor measurements.

If you are going to treat the component as a "black box," then a network analyzer can acquire the raw input for the transfer-function approach. Analogy Inc, for example, can supply application notes describing how the firm linked various test instruments to a Sun workstation to acquire data for the firm's component-model synthesizer. (The physical link between the workstation and instrument, in this case, was a SCSI-to-IEEE 488 converter.) Similarly, literature from Tesoft describes how its Tesla block-diagram, communications simulator accepts digitized, real-world waveforms.

Combining transfer functions and device models can allow you to simulate oddball circuits such as a neural net and its associated electronics. The transfer-function approach is not without its draw-

backs, however. Because you are just doing math and not simulating a physical device, your model will not include any of the side effects that the real device exhibits. Using transfer functions can also lead to convergence problems during a simulation run. Therefore, you should attempt first to assemble a model from the simulation program's built-in components. Only if this approach doesn't work should you turn to transfer functions.

Welter of ways

For characterizing a circuit, engineers have an embarrassment of riches. Most analog circuits' inputs and outputs are within the range of PC-based hardware. Data-acquisition and waveform-generation boards for PCs, such as Data Translation's DT3801 (\$7195 to \$7595; development kit, \$2995), have built-

Benchmarks at
107MHz!
Landmark V2.0 at 33MHz

Cyrix™ 486DLC

Passive Backplane - Single

486DLC 33MHz
"Engine Only"

IDE Interface

SCSI Interface

Floppy Interface

Up to 32Mb of
DRAM Onboard

Up to 128Kb 2-Way
Set Associative CACHE

High Performance
Cyrix Cx486DLC

83D87 Cyrix
Math Co-Processor

CAT985DLC

COPYRIGHT 1991

Product names are trademarks or registered trademarks of their respective companies.

in, real-time-analysis capabilities as well as companion PC programs for further analysis. But these boards and software are not the only tools engineers can bring to bear on their analog circuits. Third-party data-acquisition/analysis programs can also supervise waveform-generation and data-acquisition boards as well as laboratory instruments. Furthermore, analog-simulation programs' "post processors" can analyze data from a simulated circuit or a real circuit—if the real circuit's data is in the proper form. In other words, you can skin this particular cat many ways. Yet, beyond exchanging ASCII files of data, none of these systems work together.

A somewhat simplistic way to juxtapose the ideal and the real on a PC would be to obtain Windows 3.X versions of Spice and data-

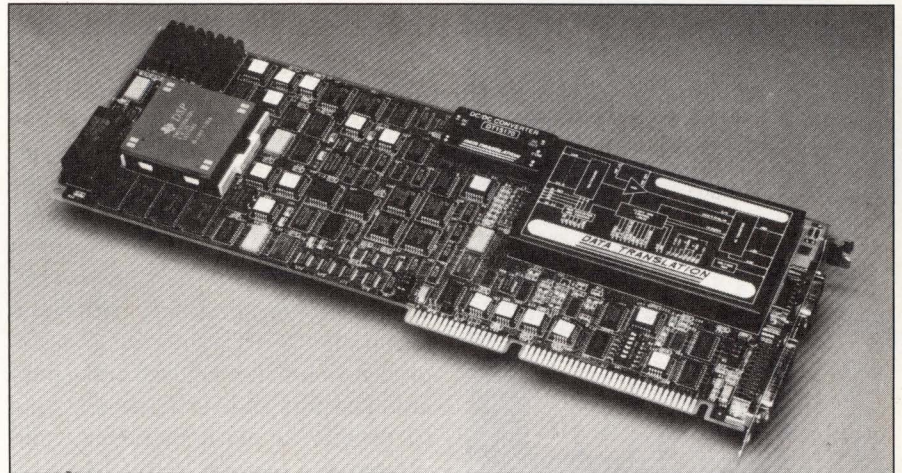

Data-acquisition and -analysis pc boards, such as this Data Translation DT3801, which has its own digital-signal-processing μ P, allow design engineers to apply a stimulus to a prototype circuit, record the circuit's output, and analyze the results.

acquisition/analysis software and place their windows side by side. Microsim has a Windows 3.X version of its version of Spice (\$8200). Data-acquisition/-analysis programs

such as Laboratory Technologies' Notebook (\$1495), National Instruments' Labview (\$995 to \$1995), and HEM Data Corp's Snap-Master (\$995 to \$1985) are also available

33MHz Board Computer

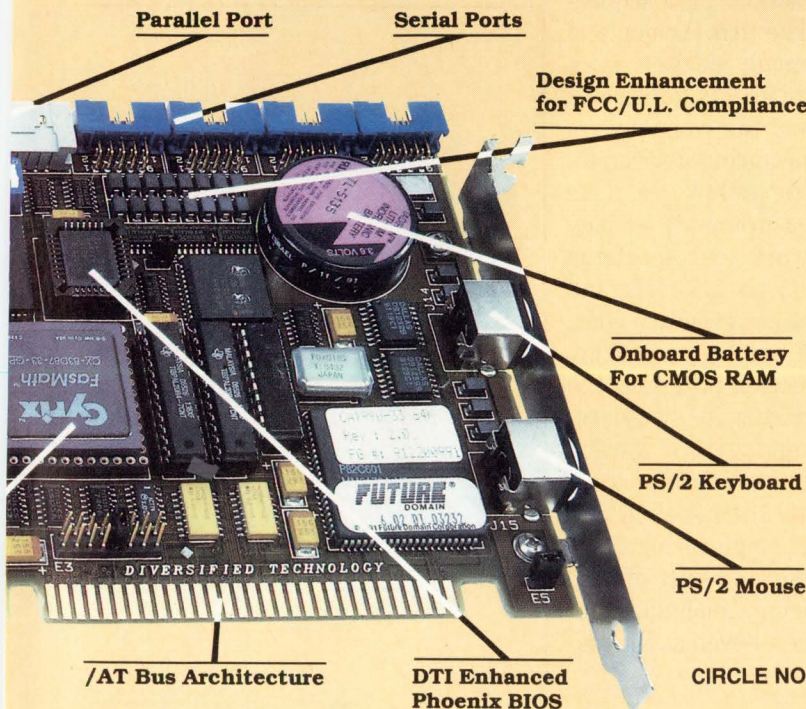

386 FUNCTIONS	CAT990 Fully Integrated		CAT985 Engine Only	
	without DLC	with DLC	without DLC	with DLC
25/33MHz 386	✓			
33MHz Cyrix 486DLC		✓		✓
25MHz 386			✓	
Internal Cache		✓		✓
64Kb-128Kb Optional Cache	✓	✓		
Up to 1 Mb PROM/FLASH Disk			✓	✓
Up to 32Mb DRAM Onboard	✓	✓	✓	✓
2 Serial Ports / 1 Parallel Port	✓	✓		
SCSI/IDE/Floppy Interface	✓	✓		
Noise Reduction Circuitry For FCC Class B	✓	✓	✓	✓
PS/2 Mouse Support	✓	✓	✓	✓
/AT-PS/2 Keyboard Support	✓	✓	✓	✓
Double-Sided Surface Mount Technology	✓	✓		
Manufactured In-House (USA)	✓	✓	✓	✓
Landmark V2.0 at 33MHz	50			
Landmark V2.0 at 25MHz			36	
Landmark V2.0 at 33MHz with Cyrix 486DLC		107		107

Diversified Technology
An Ergon Co.

Call us toll free for orders and information.

1-800-443-2667

U.S.A. - (601) 856-4121 Fax (601) 856-2888
Outside U.S.A. - (201) 891-8718/Fax (201) 891-9629

CIRCLE NO. 31

DATA ACQUISITION AND MODELING

in Windows 3.X versions. Equipped with both kinds of programs, you could simulate your circuit in one window, record its actual behavior in another window, and eyeball the two results to see if they matched.

A rigorous, coherent approach would, on the other hand, use exactly the same stimuli for both simulation and verification. Such an approach would also analyze both simulation results and verification results to provide a mathematically valid comparison instead of relying on an engineer's uncalibrated eyeball.

Yet few analog engineers or companies have bothered to combine existing software and hardware into a coherent approach. EDN informally polled Spice vendors and data-acquisition hardware and software vendors. The Spice vendors reported that their customers are clamoring for some way to inject real-world data into Spice simulations. Yet the data-acquisition vendors had never encountered anyone acquiring real-world data for Spice simulations.

Unmet desires

The few companies that are modeling devices from acquired data are not using commercial data-acquisition software. The firm Analog and RF Models normally devises Spice models from data sheets for its customers. However, the company recently began measuring devices instead of relying solely on data sheets. The measurements employ IEEE-488 network and spectrum analysis from dc to 1.5 GHz and yield models that are good to 5 GHz. Yet rather than employ an off-the-shelf data-acquisition program, the company has written its own data-acquisition and analysis software.

Only a few companies offer a coherent approach to modeling devices. Electrical Engineering Software has an integrated suite of software for measuring, modeling, and simulating devices—even at the wa-

fer level. The characterization software ranges from \$9500 to \$25,000, depending on semiconductor technologies handled. Simulation software costs \$19,500 for a single workstation or \$30,000 for a network version plus \$4000 per network node. Zeelan Technology's Modelstation (\$48,000) combines instruments and software. The unit can characterize an op amp, developing a Boyle op-amp Spice model at the press of a button. These op-amp models can be accurate enough to best the free models from op-amp makers, especially if the conditions for your application differ from the conditions the op-amp maker assumed. The unit can also measure the impulse response of a device and extract its transfer function. **EDN**

Reference

1. Conner, Doug, "Parameter analyzers give you a closer look at dc-circuit performance," *EDN*, February 17, 1992.

Article Interest Quotient
(Circle One)

High 482 Medium 483 Low 484

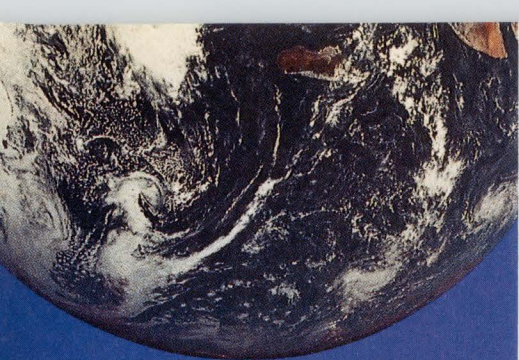

A WORLD OF IEEE 488 CHOICES

FREE DOS-installable driver
included with Ziatech's
PC/AT and PS/2 interfaces.

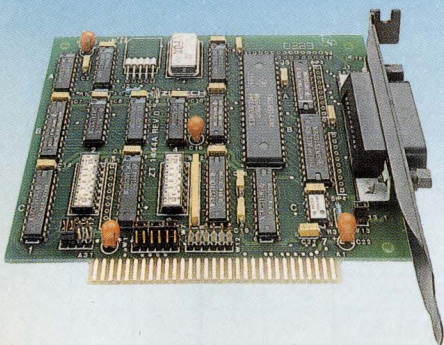

- IEEE 488 interfaces for PC/AT, PS/2, STD Bus and MULTIBUS
- Popular language support built in
- Discount pricing for OEM purchases

FREE BROCHURE
805/541-0488

ZIATECH
CORPORATION

3433 Roberto Court
San Luis Obispo, California 93401 USA

FAX (805) 541-5088

Telephone (805) 541-0488

CIRCLE NO. 32

POWER To Configure

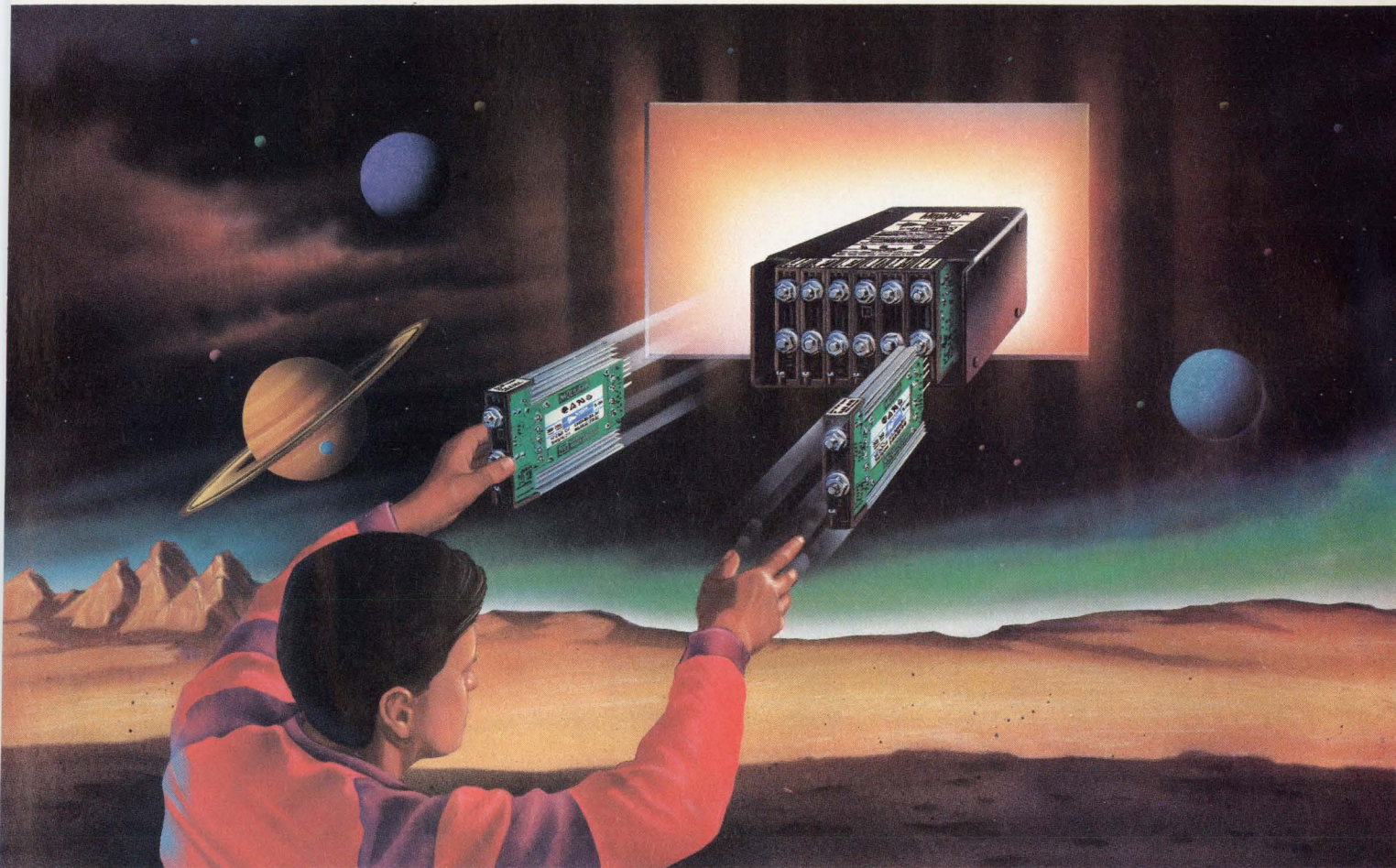

MegaPAC™

Power: Up to 1200 Watts

Input: 110/220 VAC, strappable; 300 VDC

Outputs: 1 to 8 isolated and fully regulated,
2 to 95 VDC

Size: 11.8"L x 6.0"W x 3.4"H



Plug into *instant power supply configurability* with the new MegaPAC switcher from our Westcor division. MegaPAC outputs can be configured in virtually an infinite number of voltage and power combinations using up to 8 slide-in

ModuPAC™ assemblies. Want to change a voltage or power level at your factory or at a customer site? No problem. . .shut down input power, slide out the ModuPAC you want to replace and slide in the new one. It's that simple.

MegaPAC's instant configurability takes Westcor's popular StakPAC to the next level of customization and flexibility. And its improved manufacturability means a substantial price reduction too! At the heart of each plug-in ModuPAC is a standard Vicor VI-26X series DC-DC converter module. . .over 1 million are operating reliably in systems world-wide. With potential applications around the globe, MegaPAC is designed to meet stringent UL, CSA, and IEC safety standards (approvals in process).

So take the risk out of specifying your system power supply. Contact us today and request ordering information. . .then sit back and relax. . . your custom-tailored MegaPAC will be delivered within four weeks.

Call VICOR EXPRESS (800) 735-6200 for information and be sure to ask for a MegaPAC data sheet. Or call WESTCOR (division of Vicor) at (408) 395-7050. Fax us at (508) 475-6715 or (408) 395-1518.



VICOR Corporation
23 Frontage Road, Andover, MA 01810

Component Solutions For Your Power System

Cable assemblies for your toughest applications. Or your tenderest.

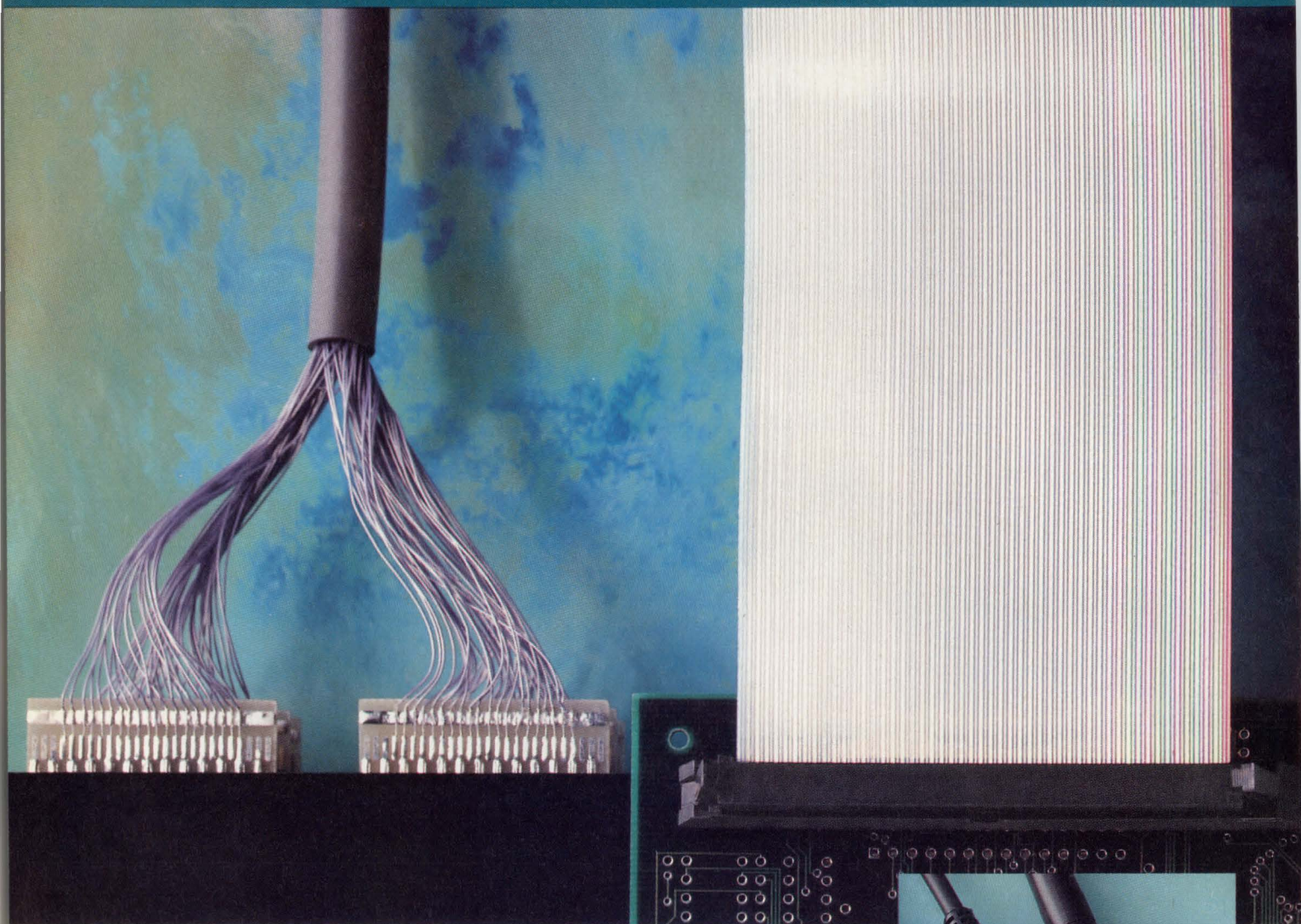

Your need may be defined by signal requirements: the speed demands of today's 'hot' designs. Or your need may derive from the environment a signal passes through, or even the signal's source. High-performance cable assemblies from AMP come in just as many types as you have needs. With the level of reliability – and support – you require.

Microminiature cable assemblies for the medical field serve in environments where space, weight, and maneuverability

are critical, and 'friendliness' isn't a nicety, but a necessity. We design and manufacture assemblies to meet your most demanding requirements. They offer outstanding signal fidelity. They're rugged enough for heavy use. Yet they're astonishingly small, flexible, and easy to handle.

Our cable assemblies for high-speed data applications answer to a different challenge: moving your signals transparently. Fast data streams require coaxial or transmission-line assemblies for

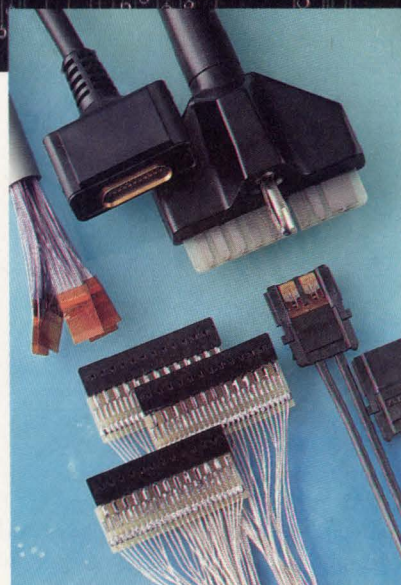



effective signal management. We custom-engineer around your performance requirements—matching cable, connector, and termination technology to the critical impedance/risetime needs of your design. And meeting your critical business needs for a cost-effective, time-effective solution.

The know-how we bring to your high-performance interconnect needs can be extended as much as you need, too: we offer services that pick up from your

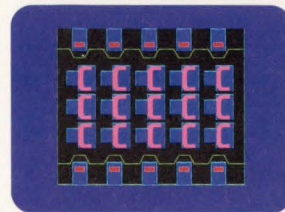
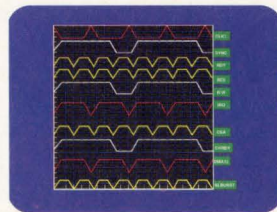
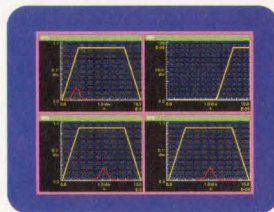

initial design concept and take you all the way to production. Starting with in-depth analysis and verification, we can provide board layout and routing, full software simulation of and proof of first article, thermal and electrical analysis,

package design, and fabrication.

For more information, contact our Product Information Center at 1-800-522-6752 (fax 717-986-7575). AMP Incorporated, Harrisburg, PA 17105-3608. In Canada call 416-475-6222.

Heard the news about Keithley's new switching system?



It's on all 80 channels.

Introducing the Keithley Model 7001
High-Density Switching System.

Now, get up to 80 channels of two-wire
switching from just one half-rack mainframe
and two high-density cards.

Monitor all channels at once, too.
The unique vacuum fluorescent display
shows the open/close status of *all*
channels simultaneously. Program, modify,
or debug your test systems with
remarkable ease.

Plus, have the capability to switch a
variety of signals. From femtoamps to
amps. Nanovolts to kilovolts. And DC
to 500MHz. It's the kind of measurement
integrity that has made Keithley
switches a preferred choice for nearly
two decades.

Call 1-800-348-3735. Or return the card. An
applications engineer will provide
details, arrange a demonstration, even help
you design your test system.

Contact Keithley today. We'll be watching
for your reply.

KEITHLEY INSTRUMENTS

Superconductivity moves from the land of theory into the land of reality

TOM ORMOND, Senior Technical Editor

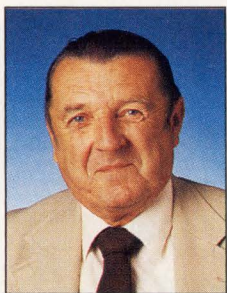

The successful development of reliable, compatible, low-cost superconducting circuits could benefit every application involving microelectronics and ICs.

In 1986, the discovery of a new class of oxide materials opened up a broad range of applications in conventional electronics. These materials, known as high-temperature superconductors, have critical temperatures in the 77°K range. As a result, liquid nitrogen—a far more viable coolant—can cool these oxides.

Today, there are two camps of superconductor research and development—high-temperature superconductors (HTSs) and low-temperature superconductors (LTSs). HTS materials are those that remain superconductive above 30°K; LTS materials remain superconductive below 30°K.

Within both camps, there are several known materials that can achieve superconductivity. Thallium is the highest temperature material used for HTS material; YBCO (yttrium barium copper oxide) has a somewhat lower operating temperature, but is more common. Niobium is the most common material used for LTS materials. Because of the difficulties associated with cooling, LTS materials have found only restricted use. LTS applications are primarily found in the medical area, where they are used for magnets in large MRI (magnetic resonance imaging) diagnostic machines and in scientific equipment.

HTS materials will find

wide usage in a range of electronic and electrical applications. The reasons are quite simple—they are easy to use and they are commercially viable. Thallium-based HTS materials have demonstrated several strong points. YBCO has several disadvantages when compared with thallium. The major limitations associated with YBCO are lower operating temperature and instability at convenient temperatures. It is also difficult to fabricate uniform high-quality YBCO on two sides of a substrate. High-quality thallium films are generally thicker than YBCO films and have consistently outperformed YBCO in microwave and RF applications.

A number of companies are actively investigating superconductivity today (Table 1). These investigations break



A coplanar delay that superconducts at 77°K is the key component in the FMCW radar unit from Superconductor Technologies.



Pick up the number one real-time operating system.



And run with it.

In today's competitive market, it's important to run with the best. And when it comes to real time, the iRMX® operating system is the clear favorite.

You see, iRMX has a 13-year track record for proven reliability. In fact, only DOS runs on more X86 systems. Now, iRMX for Windows provides the first real-time operating system with guaranteed response time that runs DOS and standard-mode Windows on the i386™ and i486™ architecture. That's right, true real time on a PC.†

iRMX for Windows brings more than just

affordable hardware to real time. It also gives you a head start on development with access to the huge installed base of DOS applications and tools. In fact, you even have the option to run Windows†† (including Windows 3.1).

So take the first step, call (800) GET-iRMX (800-438-4769)* and ask for Lit. Pack. #2D. And start running real time with your favorite DOS and Windows software.

intel®

*Outside the U.S.A and Canada, FAX (503) 696-4633. © 1992 Intel Corporation. iRMX is a registered trademark and i386 and i486 are trademarks of Intel Corporation.

†iRMX runs on IBM and Compaq compatible i386 and i486 based PCs. ††All other products shown or mentioned are trademarks or registered trademarks of their respective owners.

SUPERCONDUCTIVE MATERIALS

down into two areas—active circuits and passive circuits. For the most part, all the active-device work being done today is being done with LTS materials. One ex-

ception is the Squid (superconducting quantum interference device), which has been fabricated in both LTS and HTS materials (see box “The Squid’s a key ingredi-

ent”). Current investigations have led to the development of a number of working electronic devices—both active and passive. For the most part, the active devices are not your

A look at the power picture

Superconductivity Inc and American Superconductor have concentrated their investigations in the power rather than electronic area. The superconducting storage device (SSD) from Superconductivity stores enough electrical energy to provide megawatts of ride-through power during voltage sags and momentary power losses lasting several seconds. The SSD design uses a coil that is submerged in liquid helium contained in a vacuum-insulated cryostat (Fig A). Energy is stored in the magnet by the flow of dc in a coil made of superconducting material.

In standby mode, the current stored in the magnet circulates through the normally closed switch of the regulator and back to the magnet. The power supply provides a small trickle charge to replace the power lost in the nonsuperconducting part of the circuit. When the voltage drops on the capacitor-bank side of the inverter drops during a sag or outage, the switch in the regulator opens and current from the magnet immediately flows across the capacitor bank. When the voltage across the capacitor bank reaches a preset level, the switch in the regulator closes. This cycle then repeats until the voltage from the utility is restored.

SSD’s are available with capacities ranging from 460 to 2500 kVA. Stored energy available to support the load ranges from 500 to 2500 kW-sec. There are two versions of the SSD—a motor-driven unit and a shunt-connected unit. You can link the motor-driven device directly to the power supplies of industrial motors, and the shunt-connected system shields critical processes at the plant’s utility-feeder source. Both units recharge within minutes and can repeat the charge-discharge sequence thousands of times without any magnet degradation.

American Superconductor produces ceramic superconducting wires by deformation processing techniques, which are closely analogous to those in the existing metal-wire industry. The process uses a metal tube or billet (typically silver) which is packed with a precursor powder. The billet is then deformed into a wire shape using a variety of deformation processes—extrusion, wire-drawing, rolling, or pressing. Finally, the wire undergoes a heat treatment to transform the precursor powder inside the wire into HTS material.

American Superconductor takes two basic approaches to the deformation processing of the silver-sheathed wires. One is the oxide-powder-in-tube (OPIT) method, which involves the use of oxide powders. In the second approach, the metallic precursor (MP) method, metallic powders are packed in the billet. The metallic precursor used in the MP method is easier to form than the ceramic precursor used in the OPIT method, so the MP scheme might lend itself to more cost-effective manufacturing.

At the present time, American Superconductor is able to fabricate lengths of flexible wire 30 meters at a time. The wire is fully superconducting at 77°K and can carry 7000 A/cm². The wire has been wound around a metal core to form a coil that stands just three inches high. This superconducting coil is a key component in a working motor under development at Reliance Electric (Cleveland, OH). Initial versions of the motor produced 25W of power with a current of 0.5A in the superconducting field coil.

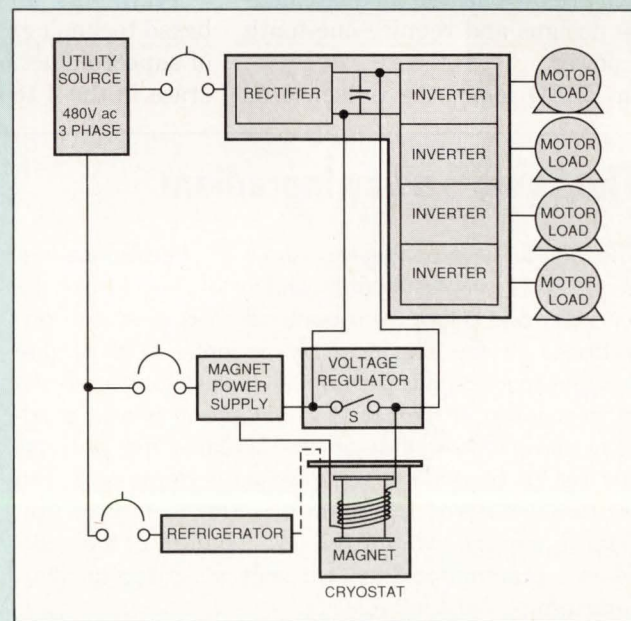

Fig A—A superconducting coil submerged in helium is the key component in the SSD superconducting storage devices from Superconductivity Inc. The unit can release megawatts of power within 2 msec to replace a sudden loss in line power.

SUPERCONDUCTIVE MATERIALS

typical off-the-shelf type of component—they have been fabricated to prove a concept. However, a look at some of these proof-of-concept devices illustrates the performance capabilities available with superconductors.

LTS is not dead yet

Although the HTS materials are garnering a significant share of the press, not all design work has stopped in the LTS area. Hypres has developed a toggle flip-flop that operates at 144 GHz, as well as 4- and 32-bit shift registers that operate at 60 and 45 GHz, respectively. Power dissipation for the flip-flop is only 1.6 μ W, and the total dissipation for the 32-bit register is a mere 100 μ W. The circuits are implemented with Niobium-based technology using 3.5- μ m geometries and operated at 4.2°K.

These circuits are implemented using rapid single-flux quantum (RSFQ) superconducting digital logic. RSFQ logic is based on nonlatching Josephson junctions, which are 30 \times faster than latching-type designs and require one-tenth the power.

In RSFQ logic, the presence or

Table 1—Summary of superconductor activity

Company	Low-temperature superconductors	High-temperature superconductors	Circuitry	
			Active	Passive
Conductus Inc	X	X	X	X
DuPont Superconductivity	X	X	X	X
Hypres Inc	X	X	X	X
Microelectronics and Computer Technology Corp	X	X	X	
Superconductor Technologies Inc		X		X
TRW Inc	X	X	X	X
Westinghouse Electric Corp	X	X	X	

absence of a quantized magnetic fluxon represents ones and zeros, respectively. As a fluxon moves through a Josephson junction, it generates a small, fast pulse. The integrated energy in this pulse equals 2 mV/psec. The logic readily generates, transmits, and combines these pulses in the nonlatching Josephson junctions. Hypres has also fabricated nonlatching Josephson junctions using HTS materials, so the RSFQ logic family is compatible with available HTS junctions.

TRW has also used niobium-based technology to develop a range of superconducting devices that operate in the 4 to 5°K range. One of

the devices is a low-noise microwave parametric amplifier. A conventional parametric amplifier consists of a low-noise microwave diode, with an input coupler, a pump, and an output coupler. The pump is a microwave signal that is normally twice the frequency of the signal to be amplified. A reactance (from a varactor diode) is varied at the pump frequency. Amplification takes place through the nonlinear process of mixing the signal frequency and the pump frequency.

In TRW's superconducting parametric amplifier, a single-junction Squid provides the variable reactance. The amplifier consists of a

The Squid's a key ingredient

The Squid (superconducting quantum interference device), in its simplest form, consists of two Josephson junctions and a loop of superconducting wire. Any disturbance in the electrical or magnetic field at one Josephson junction is immediately communicated to the other junction. If the two junctions are in phase, maximum current flows through the Squid; if the junctions are out of phase, the supercurrent is depressed. The resulting interference pattern is similar to that of light passing through two parallel slits. Because of the interference pattern, the Squid is sometimes called an interferometer.

The periodicity of the Squid corresponds to the quantity of magnetic flux equivalent to that contained in a hydrogen atom with one electron. A 1-cm² Squid loop has a magnetic field periodicity of 10⁷ gauss; a mag-

netic field that approximates the size of the field generated by the action of the human heart.

There is also a single-junction version of the Squid. Usually called an RF Squid, this device consists of one Josephson junction and a superconducting loop. The name stems from the fact you have to use RF or microwave techniques to measure the actions of the Squid.

The use of Squids in RF circuits overcomes certain limitations of the basic Josephson junction, which suffers from instabilities and low impedance. A Squid tunes out the junction capacitance and controls the instabilities by efficiently converting the junction energy into a current circulating in the Squid's inductance. This in turn allows efficient coupling of junction energy to any external circuitry.

BUY A TEKTRONIX SCOPE FROM ONE OF THESE GUYS.

Allied Electronics, TEXAS, (800) 433-5700
Brownell Electro, NEW JERSEY, (800) 828-1552
Carlton-Bates, ARKANSAS, (800) 482-9313
Contact East, MASSACHUSETTS, (508) 682-2000
Dow Electronics, GEORGIA, (404) 448-4004
Electronic Parts, NEW MEXICO, (505) 293-6164
Electronics Supply, KANSAS, (800) 669-3752
EMSCO Division/Hammond Electronics, FLORIDA, (800) 275-3554
EnTest, TEXAS, (800) 955-0077
Frigid North, ALASKA, (907) 561-4633
HARCO Electronics, MARYLAND, (800) 638-7616
ITC Electronics, CALIFORNIA, (800) 225-5482
Inotek Technologies, TEXAS, (800) 492-6767
Instrument Engineers, CALIFORNIA, (800) 444-6106
Jensen Tools, ARIZONA, (800) 426-1194
Joseph Electronics, ILLINOIS, (800) 323-5925
Kendall/Great Lakes Electronics, MICHIGAN, (800) 321-8434
Klaus Radio Supply, ILLINOIS, (800) 545-5287
Marshall Industries, CALIFORNIA, (800) 522-0084
Metermaster, ARIZONA, (602) 431-9304
R.A.G. Electronics, CALIFORNIA, (800) 732-3457
R.S. Electronics, MICHIGAN, (800) 366-7750
Resource Electronics/Dixie Division, SOUTH CAROLINA, (800) 854-1002
NW Test & Measurement, OREGON, (503) 645-9000
Olive Electronics, MISSOURI, (314) 997-7709
Radar Electric, WASHINGTON, (206) 282-2511
Stark Electronics, MINNESOTA, (800) 752-4215
Sunshine Instruments, PENNSYLVANIA, (800) 343-1199
TESSCO, MARYLAND, (800) 638-7666
Transcat, NEW YORK, (800) 828-1470
Zack Electronics, CALIFORNIA, (408) 942-5432
Zorn Industries, MASSACHUSETTS, (603) 894-4950

AND WE'LL KNOCK 1/2 OFF ONE OF THESE GUYS.

OFFER GOOD! (on selected Tektronix oscilloscopes purchased between July 6 and December 31, 1992.) OFFER GOOD!
(only on scopes purchased through an authorized Tek distributor.) OFFER GOOD! (in U.S. only.) OFFER GOOD! (trust us.)



Tektronix
Test and Measurement

VIW-283134 Copyright © 1992, Tektronix, Inc.

CIRCLE NO. 37

EDN October 1, 1992 • 55

SUPERCONDUCTIVE MATERIALS

monolithic impedance-matching network, a thin-film single-junction Squid, and a cooled circulator operating at X-band frequency (8.3 GHz). It has the lowest noise temperature (6°K) of any microwave amplifier except the maser. Gain is about 120 dB and the bandwidth is 150 MHz.

Finally, scientists at Westinghouse's Science and Technology Center have successfully fabricated a high-resolution superconducting A/D converter. Known as a counting converter, the 1-cm² chip promises an unprecedented combination of high resolution and low power consumption. The 12-bit circuit, fabricated using LTS devices, has a resolution of one part in 4000.

The A/D converter consists of an input quantizer followed by a flip-flop counter. The quantizer is a dc Squid with a 50-turn primary coil and a single-turn secondary coil. The counter, which has successfully

operated at 116 GHz, is composed of a series of 2-junction Squids. The converter is fabricated using a 10-level process. A combination of etching processes serves to define the niobium junctions. The device has a monotonic conversion characteristic and it is linear to 1 LSB with a sensitivity of 13 μ A per count. Total power dissipation during operation is approximately 100 μ W.

It's not room temperature

Although most active-device modeling today involves the use of LTSs, some work is being done with HTSs. Under a DARPA (Defense Advanced Research Projects Agency) contract requiring the development of HTS microwave materials and components, Superconductor Technologies has developed a completely self-contained microwave assembly—a frequency-modulated continuous-wave (FMCW) radar demonstration unit complete

with integral cooler. The FMCW unit incorporates an HTS microwave device, a permanently sealed dewar, a closed-cycle Stirling cooler, and all the necessary microwave output circuitry. The unit is available with a basic, low-cost 110V ac power supply.

The heart of the FMCW radar unit is a coplanar delay line fabricated from thin-film T1BaCaCO material that becomes superconducting below 100°K. The 0.4-in. square X-band delay line weighs 0.33g—50% less than similar delay lines made of RG141 coaxial cable and with 90% less volume.

The dewar/microwave package provides a long-life vacuum, low thermal mass, wide bandwidth, and low insertion loss. The design uses a hermetically sealed vacuum dewar for the necessary thermal insulation. The dewar utilizes several getters to absorb water and outgassing constituents that may

For more information . . .

For more information on the superconductor materials and products discussed in this article, circle the appropriate numbers on the Information Retrieval Service card or use EDN's Express Request service. When you contact any of the following manufacturers directly, please let them know you read about their products in EDN.

American Superconductor Corp
149 Grove St
Watertown, MA 02172
(617) 923-1122
FAX (617) 923-0020
Circle No. 700

Conductus Inc
969 W Maude Ave
Sunnyvale, CA 94086
(408) 737-6700
FAX (408) 737-6699
Circle No. 701

DuPont Superconductivity
Experimental Station 304/C116
Wilmington, DE 19880
(800) 873-4872
FAX (302) 695-2721
Circle No. 702

Hypres Inc
175 Clearbrook Rd
Elmsford, NY 10523
(914) 592-1190
FAX (914) 347-2239
Circle No. 703

Microelectronics & Computer Technology Corp
3500 W Balcones Center Dr
Austin, TX 78759
(512) 338-3512
FAX (512) 338-3892
Circle No. 704

National Institute of Standards and Technology
Electromagnetic Technology Div
Boulder, CO 80303
(303) 497-3000
Circle No. 705

Superconductivity Inc
Box 56074
Madison, WI 53705
(608) 831-5773
FAX (608) 831-5793
Circle No. 706

Superconductor Technologies Inc
460 Ward Dr, Suite F
Santa Barbara, CA 93111
(805) 683-7646
FAX (805) 683-8527
Circle No. 707

TRW Inc
Superconducting Products
Applied Technology Div
1 Space Park
Redondo Beach, CA 90278
(310) 812-0052
FAX (310) 813-4873
Circle No. 708

Westinghouse Electric Corp
Science & Technology Center
1310 Beulah Rd
Pittsburgh, PA 15235
(412) 256-1888
FAX (412) 256-1310
Circle No. 709

VOTE . . .

Please also use the Information Retrieval Service card to rate this article (circle one):

High Interest 476 Medium Interest 477 Low Interest 478



Within budget. Without compromise.

The value of this 100 MHz digital scope is easy to see.

Take a close look at the HP 54600 oscilloscope, and you can't help but notice certain things.

It looks and feels like an analog scope, with dedicated knobs and a display that responds instantly to your control changes. Yet it has all the digital power that analog can't give you—high accuracy, automatic measurements, hard copy output and programmability. And superior viewing of virtually any waveform, even at low rep rates and slow sweep speeds.

But what really stands out is that the HP 54600 gives you this performance for just **\$2,895** (4-channel) and **\$2,495** (2-channel version)*. And that's a value worth looking into.

☎ For more information, or same-day shipment, call **HP DIRECT, 1-800-452-4844****. Ask for Ext. T505. And we'll send you a data sheet.

HP 54600 Digital Oscilloscope	
No. of channels	2 or 4
Bandwidth	100 MHz
Timebase accuracy	±0.01%
Vertical accuracy	±1.5%

* U.S. list price

** In Canada call 1-800-387-3867, Dept. 435

There is a better way.

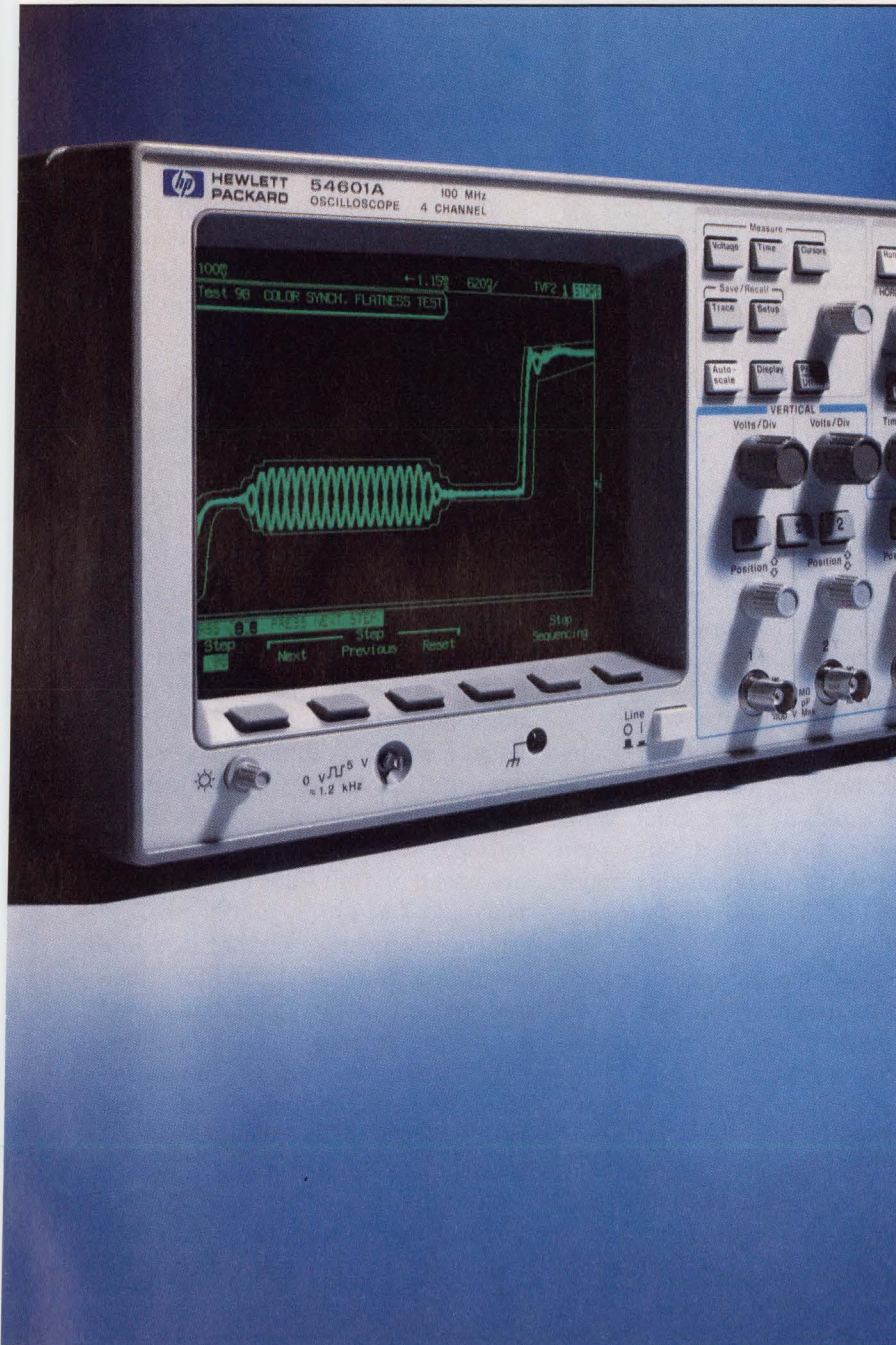

© 1992 Hewlett-Packard Co. TMCOL139/B/EDN

SUPERCONDUCTIVE MATERIALS

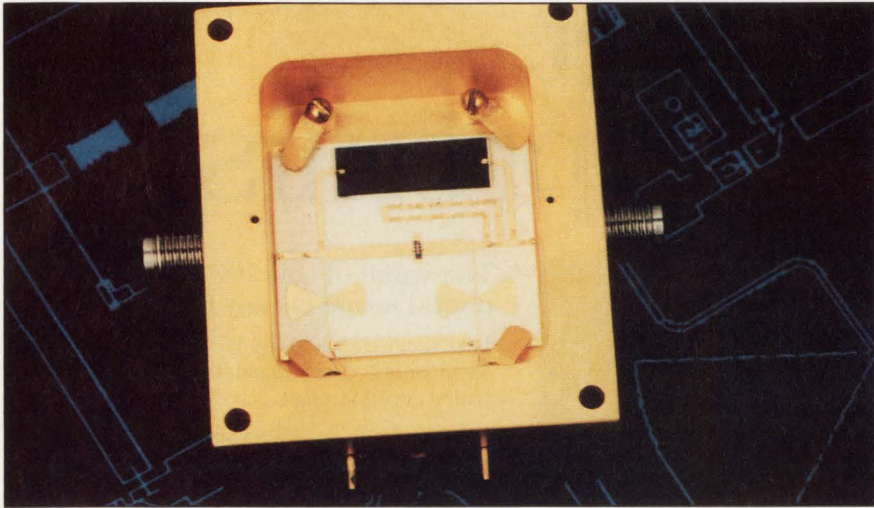

Based on hybrid semiconductor/superconductor circuitry, local oscillators from DuPont operate over a 2-to 12-GHz range and have stability figures of 0.001%.

come from the microwave hardware over the assembly lifetime. With the HTS operating at 77°K, the outside of the package is not noticeably cool.

A Hughes Model 7050H Split Stirling Cryocooler, originally developed to cool infrared detectors, cools the FMCW assembly. The cooler has a 0.65W cooling capacity at 77°K.

DuPont Superconductivity also offers a number of passive devices that use HTS materials. Among them are a line of splitter/combiners, which provide exceptionally low-loss multisection in-phase splitting or combine in compact (1.5×0.92×0.5-in.) hermetic packages. The components yield pass bandwidth of 0.5 to 5 GHz with seven or more sections per stage, return loss of greater than 20 dB at all ports, and port-to-port isolation of more than 20 dB.

Phase noise between ports is essentially zero. If fabricated in thin-film copper or gold, such a compact device would have an excess insertion loss of greater than 3 dB, making such a component useless. With the 0.4 dB/stage excess loss provided by HTS material, multiple-stage splitting or combining in the same compact package becomes a

practical option. For example, a component of seven section stages would provide a 1:8 splitting/combining ratio with total excess loss of less than 1.5 dB. You can fabricate these HTS splitters/combiners on thallium or YBCO films deposited on lanthanum aluminate substrates to meet the operating temperature requirements.

Taking a hybrid approach

The Microelectronics and Computer Technology Corp (MCC) has received a patent for a small, very-low power, high-speed, high-gain amplifier that could eliminate major obstacles in the use of superconducting materials in electronic circuits. The device amplifies superconductor devices' voltage levels (on the order of several mV) to voltage levels of hundreds of mV—levels compatible with semiconductor devices. Unlike previous hybrid circuits, this device will let manufacturers integrate both types of material onto a single chip.

The MCC hybrid combines SFETs (superconducting FETs) with CMOS transistors to form an amplifier circuit. Since SFETs have no channel resistance in the superconducting state, transmission paths will have zero attenuation.

The CMOS amplifiers can provide the appropriate gate voltages required to control the SFET pass gates. With proper partitioning, the amplifier lends itself to some very useful circuits. MCC researchers have operated the CMOS amplifiers at temperatures of 4 to 10°K. They have also demonstrated ideal CMOS amplifier behavior by slightly modifying conventional CMOS devices.

Keeping things in order

The National Institute of Standards and Technology (NIST) has maintained a program in superconductivity for more than two decades. In line with their primary mission, part of the NIST program involves the development of superconducting devices for measurement systems. The objective here is to develop the next generation of techniques, instrumentation, and physical standards for a variety of electrical and magnetic measurements.

NIST maintains a fabrication facility for superconducting microcircuits that has produced Squid magnetic detectors, an A/D converter, a fast counter, millimeter wave mixers, and a voltage measurement system that incorporates the basic national standard. All these devices are based on thin films of LTS materials and Josephson junctions. Present work includes further development of a power standard for infrared and microwave radiation based on a kinetic inductance bolometer. NIST is also working on the fabrication of microcircuits using HTS materials. This work includes the establishment of processes to fabricate high-quality thin films, to perform lithography, and to fabricate multilayer circuits and reproducible Josephson junctions. NCE

Article Interest Quotient
(Circle One)

High 476 Medium 477 Low 478



WIDE FORMAT COLOR
EARTH TONES

Nothing brings out earth tones quite like our electrostatic color plotters.

For presentation-quality color, one line of electrostatic plotters can make a world of difference: The 8900 series.

The 8900 series gives you a range of options. It produces specular color plots in 24, 36 or 44-inch widths. It does it fast—up to 2 inches per second. And with less media waste between plots. You also get automatic trimming capabilities with our



The 8900 series delivers unmatched presentation-quality color plots.

Plot data courtesy of TenTen.

new ACS option for standard cut sheet sizes. And finishing capabilities like automatic cutting and rolling. Which means you'll save time and eliminate the cost of a dedicated operator.

And the 8900 series helps bring people in your world together. With our ServeWare LAN software, multiple users can access each plotter. And finally, the 8900 series comes with a special feature that

no one else can offer—the Xerox Total Satisfaction Guarantee program. For more information, call Xerox Engineering Systems at 800-538-6477. And find out how to get plots with earth shattering color.



The engineering document company.

Xerox Engineering Systems

5853 Rue Ferrari, P.O. Box 210061, San Jose, CA 95151-0061
Xerox is a trademark of Xerox Corporation. © 1992 XES, Inc.

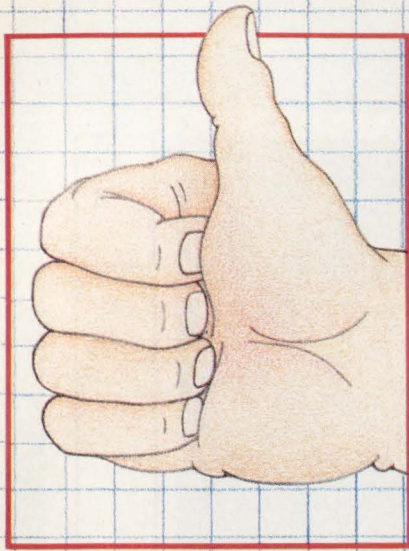

DESIGN IT

DAN STRASSBERG, Senior Technical Editor

Product development is more than a vocation; if you're in the field, you know. At some point in a program, the line between you and your product becomes blurred; the product turns into an expression of yourself, an extension of yourself, a reflection of your likes, your dislikes . . . your passions. As the program progresses and your involvement grows, this thing you're working on becomes inseparable from you—becomes indistinguishable from you. It *is* you. You can't shut off your thoughts of it when you leave work. The project occupies more than your normal working hours; it consumes all of your *waking* hours, and maybe even more time when you ought to be asleep.

Unhealthy? Maybe. Exhilarating? You bet. Despite its cold, logical, rational side, without this obsessive, compulsive side, without the pride of authorship, without the coalescence of designer and design, product development would hold little fascination or romance for legions of engineers.

In this issue and the next three, we're going to tell the stories of a dozen or so product-development programs. Our object isn't simply to provide interesting

PART 1

OCTOBER 1

A tale of three digital multimeters.

PART 2

OCTOBER 15

The story behind the design of three computer products.

PART 3

OCTOBER 29

Leverage: unconventional approaches lead to bigger, faster pay-offs.

PART 4

NOVEMBER 12

Giving another company or division responsibility for a major part of a product.

RIGHT

reading. Every program holds lessons; we've asked each company whose story we're telling to summarize the key lessons they learned from their experiences. Those lessons appear in do's and don'ts boxes. If you study the boxes closely, you'll discover that they sometimes contradict each other: what worked for one company was a disaster for another. You'll find some common threads, though—techniques that several companies, working independently, developed on their own. It's up to you to decide which techniques might work for you.

Outwardly, engineers are an unemotional lot. Many of them won't admit that they can become so totally absorbed in a project or so completely captivated by something inanimate that they can no longer view it objectively. After all, engineers are rational beings. This kind of preoccupation is . . . well . . . *irrational*. But it's also the stuff of which great products are made. By telling these stories, we hope to create a tribute to, and a celebration of, design engineering, the painful, wonderful process that transforms ideas into reality—*mass-produced* reality.

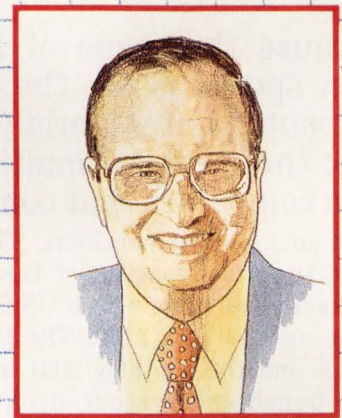

Author's biography

Senior Technical Editor Dan Strassberg covers test-and-measurement topics from EDN's home offices in Newton, MA. He has done so since joining the magazine in August 1987.

Dan holds a BSEE from Rensselaer Polytechnic Institute, Troy, NY, and an MSEE from Massachusetts Institute of Technology, Cambridge, MA. He is a registered professional engineer in Massachusetts. Until he joined EDN, his entire career had been devoted to developing and managing the development of electronic test-and-measurement products, from circuit modules to multimillion-dollar automatic test systems. He has also managed test-engineering and manufacturing-engineering groups.

Dan's career in electrical engineering spans more than three decades. He has worked at MIT, Hewlett-Packard, Honeywell, Becton-Dickinson, Analog Devices, and Teradyne. He is a member of the IEEE, the NSPE (National Society of Professional Engineers), and honor societies Tau Beta Pi, Eta Kappa Nu, and Sigma Xi.

Dan can be reached at (617) 558-4205; FAX (617) 558-4470.

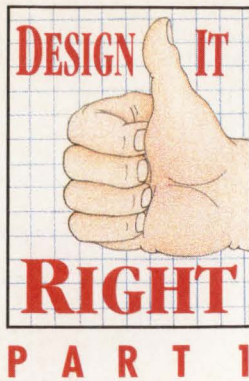

A tale of three multimeters

Because this issue of EDN is a test-and-measurement special issue, the first part of Design It Right is about quintessential test-and-measurement products: three digital multimeters. Although they come from companies that compete fiercely, these products aren't in direct competition. The Fluke 10 series consists of three handheld units, all of whose US list prices are less than \$100. The HP 34401A and the Keithley 2001 are both bench-and-system instruments; the 34401A is a 6½-digit unit whose list price is \$995, whereas the 2001 provides 7½-digit resolution and sells for \$2695. Though you may be tempted to compare these two units, you shouldn't; 6½- and 7½-digit DMMs really don't compete.

In any event, this article is not about comparing meters; we'll leave that for EDN's Technology Up-

dates and Special Reports. Instead, it's about developing products. Multimeters are a good place for EDN to start exploring product development: All EDN readers have used multimeters and understand them—at least from a user's perspective. Moreover, most readers have opinions about the instruments.

You should not be surprised that in developing these products, all three manufacturers used a team approach. In every case, the interdisciplinary teams included representatives from design engineering, manufacturing engineering, test engineering, and marketing. Nor

should you be astonished to find that the three firms devoted a substantial part of their development efforts to defining and refining the meters' user interfaces. In fact, both of the vendors of benchtop DMMs used computer simulation to let users "test drive" the instruments before prototypes existed.

Unlike the developers of the "Fax machine from Hell" described in this issue's editorial (see pg 33), the designers of these meters understand a basic precept of usability: Customers who have been conditioned to expect that products of a certain type will be easy to use won't tolerate a product of that type whose basic functions are hard to use. Furthermore, users' expectations of simple operation are unaffected by the number of extra features included in a new unit.

Hewlett-Packard, Loveland—34401A DMM

Get it right with quality-function deployment

When HP's Loveland (CO) Instrument Div began to think about what eventually became the 34401A 6½-digit multimeter, people at the division had been attending courses on a management technique called quality-function deployment (QFD).

One objective of QFD is to help designers decide what features a new product really ought to have and what features—though possibly nice—would have little effect on the product's success.

Needless to say, there were skept-

tics, but Mark Bailey, the program manager for the new meter, was willing to give QFD a try. The 34401A was to be a popularly priced unit (HP ultimately set the selling price at \$995), which meant that the market was large and highly com-

petitive, and the stakes were high: With sales over its life expected to number in the tens of thousands of units, the product might, in time, generate total revenues of \$100 million. Bailey recognized, however, that before QFD could begin formally, his team needed more information.

The division's traditional method of determining new-product features seemed to be based on giant leaps from problem statements to proposed solutions, rather than on true assessments of customer needs. Both the design and manufacturing people at Loveland are heavy users of the division's instruments. Because of this experience, they sometimes had trouble imagining that they might not know all they needed to about product shortcomings and ways to overcome them. Bailey figured that listening to real, live customers might be an eye opener.

The first step was to set up focus groups. For each group session, a market-research firm assembles a dozen or so customers or potential customers in a room equipped with a 1-way mirror and videotape equipment. A facilitator introduces discussion topics, draws out reticent group members, and downplays more verbal members' efforts to dominate the discussion. Typical sessions last about two hours. Participants usually don't learn the sponsor's identity before, during, or after a session; with HP's focus groups, that was the case. Nevertheless, HP representatives watched and listened from behind the mirror and took home the tapes so that co-workers could observe too.

HP followed the focus groups with more than a dozen in-depth interviews. In these, the firm revealed its identity at the outset. None of the interviewees had participated in the focus groups; several were major purchasers of HP instruments who, nevertheless,

bought their DMMs from competitors. After these interviews, ten members of the project team—two from marketing, two from manufacturing, and six from R&D, including the industrial designer—conducted a series of telephone interviews. Each team member called between five and eight users of existing HP meters. Although the interviewers did not use a script, they tried to stick to an outline.

All of this emphasis on customers proved revealing indeed. Much to the surprise of several team members, not all of the customers were ecstatic about their HP meters. As a result, the team's orientation shifted from product features to customer needs—an appropriate frame of mind for beginning QFD in earnest.

In QFD, you construct a matrix

in which each customer need is assigned a row. The 34401A team ranked the needs from 1 (least important) to 5 (most important). In the 34401A matrix, the columns represented product features. Team members placed dots at each row-column intersection where a feature addressed a need. (For example, users demanded a display that was readable over a wide angle. The vacuum-fluorescent (VF) display met that need, so there was a dot at the intersection of the VF-display column and the wide-angle-viewability row. But where the same row intersected the 6½-digit-resolution column there was no dot; viewing angle and resolution aren't related.)

The 34401A matrix started with about 25 rows and 20 columns. The object was to eliminate columns

Ideas to sweeten your developments



Stick with your plan to "do it right." Up-front market research and QFD take time, and they won't get your product to market sooner. In the case of the 34401A, though, they greatly improved both the product and the manufacturing process.



Don't shortcut market research and QFD in an attempt to provide the appearance of progress. If you do, your product will not be responsive to customers' real needs.



Get management to understand and buy into your approach. The buy-in will make the pressure more bearable when tangible results are slow in coming during the project's early stages.



Don't surrender to others' can't-do attitudes. There will always be plenty of

nay sayers who will explain in exquisite detail why something can't be done. Listen to them with an open mind; they might have something to say. But unless you have very strong reasons, don't back down from your determination to achieve your objectives.



Don't reject off-the-wall ideas out of hand. Although they may not be achievable—or worth achieving—they will often lead to something worthwhile that you can accomplish.



Set some "stretch" goals and go after them. Although the 34401A team didn't meet every stretch goal it set for itself, it met most of them—more than many team members at first thought possible. Had there been no such goals, the product would not have succeeded to the degree it did.

VOTE! Please also use the Information Retrieval Service card to rate this article (circle one):
High Interest 470 Medium Interest 471 Low Interest 472

DESIGN IT RIGHT

A TALE OF THREE MULTIMETERS

that had no dots (features that didn't address needs) and to minimize the number of columns that had few dots, except when the dots corresponded to features that customers considered very important. One very important feature was the less-than-\$1000 price; the product would have exceeded it had it included certain marginal features. Those features were eliminated, but others were added.

Bailey observes that it's really easy to cheat in a QFD exercise. First you decide what features the product will have, and then you list the supposed user needs that these features address. With this approach, you can spend just a few hours performing a task that took the 34401A team about six months (and, even though the division has now become skilled at doing it, still would probably take three or four months). The difference is that by cheating you will have defined a product that meets *your perception* of customer needs, not one that meets real customer needs.

Finally, the spec

When the QFD matrix was in final form, the team prepared the formal product specification. Bailey says that the final product conforms to those specs amazingly closely. Although some ideas that weren't part of the original spec found their way into the final product, there were few such instances. The team members became quite adept at critiquing their own ideas and testing them against the needs ranked on the QFD matrix. The exercise paid off by removing temptations to add nonessential features. (When such additions occur repeatedly during a project, the phenomenon is called "creeping elegance.")

The next step was defining the user interface. The 34401A incorporates three μ Ps and offers a host of features. Without a well-thought-out user interface, operating the

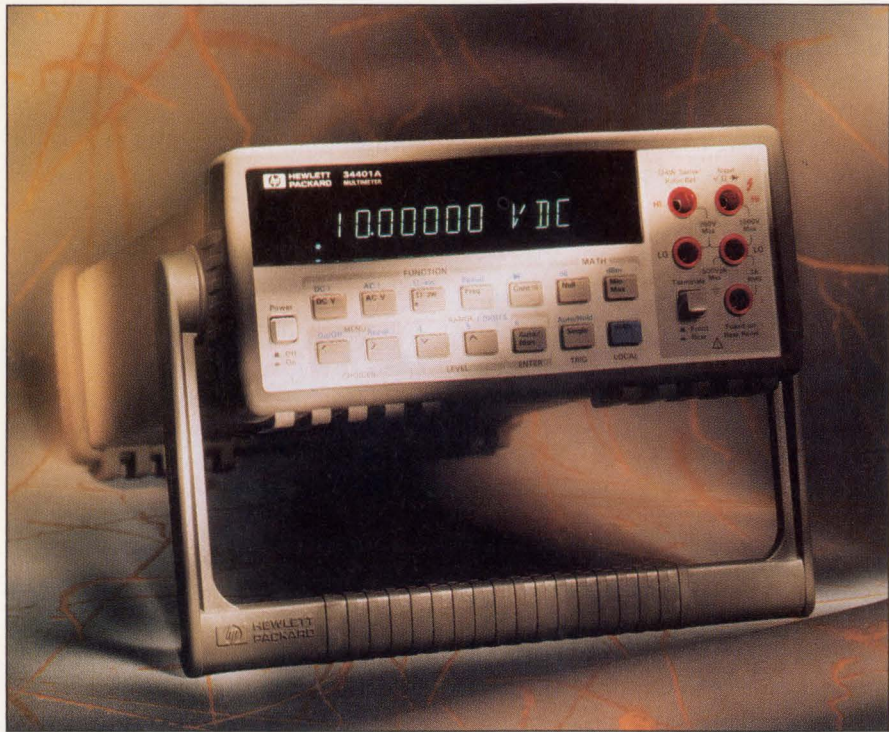

When you glance at the 34401A's reassuringly straightforward front panel, it isn't immediately obvious that the two menu buttons at the lower left provide access to a 3-layer menu structure. The menus are so intuitive that most users, after just minutes of practice, can navigate to any function without consulting the reference card.

meter could have been a nightmare. DMMs are not a new class of instrument, so users are accustomed to having little trouble operating them. A DMM that defies those expectations is guaranteed to fail in the marketplace. The interface *had* to be right.

A few team members found that simulating the meter's controls and displays on a Unix workstation held the key to solving the problem. They carried the workstation to users; at each location, they'd set up for a day and spend 1½ to 2 hours each with four or five users. After a day of testing, they would repair to Loveland to make changes. Just as the team members had hoped, after two or three such expeditions, the need for changes dropped off. The resulting 3-layer menu system is straightforward enough that most users can invoke any feature without consulting the reference card that HP furnishes. Users had

so little trouble that the team dropped plans to build in a pull-out card, which would have added cost.

Bailey cautions, though, that all of the market research and planning took its toll on his nerves. For him, the project's worst moment occurred when the team had little to show besides the QFD matrix, the product specification, and the simulated user interface. Division management, which had at first enthusiastically backed his structured approach, began to show concern over the lack of visible progress. However, Bailey didn't have long to wait for one of his best moments. The first prototypes came up and ran with few problems; colleagues told him the units looked so clean that they appeared ready to ship.

Hewlett-Packard Co
Box 58059, MS 51L-SJ
Santa Clara, CA 95051
(800) 452-4844

Circle No. 667

Keithley Instruments—2001 DMM

Freeze out creeping elegance but give innovation a warm reception

For an instrument that costs \$2695, the 7½-digit 2001 multimeter breaks a lot of ground. For Keithley, a company whose annual revenues are just over \$100 million, developing it was a very big deal: Based on the number of person-years invested, the development program that culminated in the 2001 announcement late last year was the largest in Keithley's 45-year history. So far, the company has had no reason to rethink its approach. Despite the recession, sales have gotten off to a brisk start. One reason is the meter's accuracy: Most units with equivalent accuracy cost several times as much; some of the specifications are unmatched at any price.

Before the 2001 program even got started, Keithley management had deliberated for a long time about how to get the firm's engineers to think about the company's products the way customers do. Part of the answer was a program that rotates design engineers into applications-engineering assignments lasting approximately six months. Answering dozens of phone calls each day about how to accomplish specific tasks using instruments you helped to design (and whose operation you probably thought was self evident), changes your perspective.

The engineering department's customer focus was only one of many design-related issues on the minds of Keithley management, though. As you might imagine, re-

ducing time to market and designing for more cost-effective manufacture were others. Management also wanted to reap the fruits of the company's ongoing investments in advancing fundamental measurement technology. Although many larger firms can afford to make such investments over long periods with no more than the hope of a payback, Keithley's spending on areas close to basic research is unusual for a medium-sized company.

Freezing without rigidity

On several different levels, Keithley's answer was "the freeze." When an engineering program such as the 2001 project needs a new ap-

proach, say for A/D conversion or analog signal switching, engineering management does not expect that the technology under investigation in one of the company's research programs will necessarily have reached its ultimate objectives. Rather, the question is "At its present stage of refinement, will the technology allow us to meet the product's performance and cost goals?" If the answer is affirmative, then for the purpose of the new product, the technology is frozen. What appears in the product is a "snapshot" of the technology as it existed at the time of the freeze.

Not all innovations come out of research programs, though; Keith-



Not only does the dot-matrix vacuum-fluorescent display provide high brightness and contrast and a wide viewing angle, it makes for eminently readable characters and lets the 2001 indicate the results of multiple measurements simultaneously.

DESIGN IT RIGHT

A TALE OF THREE MULTIMETERS

ley encourages all of its design engineers to propose new features for products in development. Clearly, however, the company must balance its efforts to foster creativity against its need to control creeping elegance. Without such controls, release dates would slip, and product costs would escalate. Here again the answer is the freeze. At key points in a program, no further design changes are allowed. Instrument Division Engineering Director Ken Reindel is purposely eva-

sive about the exact points, but he does say that they occur just before the firm commits significant additional funds (say, before proceeding with tooling).

According to Reindel, the details of the 2001 user interface affected so many decisions that the team had to freeze this aspect of the design very early on. So team members had users operate a computer simulation of the meter's front panel. The team members could easily modify the simulated panel

until they were satisfied with its operation. Only a few details—for example, the precise wording of messages—could change after the freeze. One such change replaced a "help" key with an "info" function; users turned out to be too proud to request help—even from an inanimate meter—but they weren't ashamed to ask for information.

Sometimes, work done to enhance one aspect of a product's design has beneficial effects in another area entirely. An approach that

Keithley's guidelines from the 2001 program



Use a long-term technology-development approach rather than simply a product-development approach. Often, new technologies will suit multiple products.



When you've developed a technology to the point where it's usable in a product, evaluate whether you can justify developing the technology further. Frequently you will decide that additional effort is likely to result in improvements that you can incorporate in subsequent products.



Go to extraordinary lengths to encourage team members to take risks.



Don't censure team members for taking risks.



Find ways to provide immediate feedback on team members' ideas and suggestions. Without quick feedback, members run open loop. Needless refinements can acquire a life of their own. When they do, redirecting effort away from such time-consuming diversions can sap team members' time, energy, and morale. Moreover, just waiting for feedback can produce anxiety and reduce productivity.



Make sure that all team members are involved in the team's communications from the get-go. Leaving out members whose substantive participation is several months away may seem like an efficient way to run a program. But for team members to make maximum contributions, they must share in the excitement that comes from a sense of ownership. If they feel isolated, they will lack this sense of ownership.



Locate the team members from various disciplines in one area. On the 2001 project, the predictive self-test function was a direct result of having manufacturing and design engineers seated at adjacent benches. A manufacturing engineer was working on the self-test capability; his neighbor, a design engineer, saw that the feature would be worthwhile for users and figured out how to make it accessible to them.



Adapt a multilevel freeze concept.



Be flexible enough to know when to unfreeze the design. For example, had Keithley been adamant about keeping the design frozen, the 2001 would not

have its nulling bar-graph display. It was fairly late in the project when the team figured out how to add this feature, which overcomes an inherent shortcoming of digital meters.



Don't ignore cultural differences between manufacturing and design. Manufacturing wants to do away with uncertainty; design thrives on creating and exploring it. A successful team leader understands these differences and even learns how to take advantage of them. For example, if you turn a design engineer loose on the problem of figuring out ways in which a product might fail, a manufacturing engineer can devise ways of testing for conditions that predict the failures. The result will be a more bullet-proof design and a better test process.



Don't call on management to solve problems. When management steps in, team members lose the vital sense of ownership and initiative.



Don't rely on outside consultants to bring reality to the scheduling of activities. A consultant may know how long an activity ought to take in a hypothetical situation, but you know more about your company and the people.

VOTE! Please also use the Information Retrieval Service card to rate this article (circle one):

High Interest 470 Medium Interest 471 Low Interest 472

Keithley's engineers developed to reduce the 2001's manufacturing cost led to a way of increasing user confidence. To aid the manufacturing test technicians who work on it, the DMM includes built-in self-test functions. Once these functions were present, making them accessi-

ble to users and test personnel wasn't hard. As a result, users can assure themselves—without the need of additional equipment—that their meters perform major functions correctly. Moreover, the test routines provide useful indications of possible impending trouble.

Keithley Instruments
28775 Aurora Rd
Cleveland, OH 44139
(800) 552-1115; (216) 248-0400
FAX (216) 248-6168
David Brock
Circle No. 668

John Fluke Mfg Co—Series 10 DMMs

High quality, large quantities, low cost—and made in the USA

Pick up a Fluke 10, 11, or 12 DMM, look at it, play with its few controls, and if you make any comment at all, you'll probably say "OK . . . looks like it can do what Fluke says. So what?" A handheld 4000-count multimeter is not what most EDN readers would call high tech. But the 10 series is deceptive; it embodies much more state-of-the-art technology than such a casual appraisal concedes. Within these meters are

- A fully custom analog IC for signal conditioning and A/D conversion. Fluke fabricates these ICs in a company-owned facility.
- A 4-bit processor with custom on-chip firmware.
- An in-house designed and fabricated resistor network that is responsible for much of the units' accuracy and stability. As part of the program to develop the meters, the manufacturer developed not only the network, but also the process for trimming it.

The three members of the family retail for \$69.95 to \$89.95. Even though all of them are made in the US, the vendor did not achieve the low prices by compromising quality, durability, or reliability. You are bound to be impressed with the meters' rugged feel, although such

subjective reactions don't really prove a lot. Moreover, during the instruments' production life, Fluke expects to sell several million. These facts demonstrate that, even



Although the three members of the 10 series of handheld DMMs look rather simple and perform functions most EEs take for granted, they embody high technology. The meters can be produced in the US at low cost and in high quantities only because of the attention to detail that went into their design and the design of the processes used in manufacturing them.

though the US no longer manufactures many consumer electronics products, America still possesses the technology to make complex, high-quality electronic assemblies in large quantities at low cost.

Fluke introduced and first shipped the meters less than a year ago. Developing them took approximately 30 months and required less than 7½ person-years. Approximately one-third of this effort was in hardware design (including IC design), 30% was in software design, one-third was in manufacturing engineering, and the remainder was in customer service. Many more people were involved than you might suspect from the 7½-person-year effort. The core team included a representative from each of the following disciplines: electrical design, IC development, software design, mechanical design, industrial design, marketing, manufacturing engineering, and test engineering.

Manager from manufacturing

Heading the team was a program manager whose background is in manufacturing engineering but who did not function as the manufacturing engineering representative. Lastly, the team included a project

DESIGN IT RIGHT

A TALE OF THREE MULTIMETERS

coordinator. This person has long experience dealing with vendors; in another company, this role might have been filled by someone from purchasing. This core team was the nucleus of a larger team that also included members from pc-board layout, publications, and production engineering. (At Fluke, production engineering and manufacturing engineering are separate. Manufacturing engineering designs new processes; production engineering keeps them running.)

A subset of the core team—the program manager and the design and marketing representatives—developed the product specifications.

As neat and formal as this structure sounds, the real reason that the process works is the attitudes of the team members. Recently, the

Series 10 team received an award for teamwork and team spirit. Competing for the award were the teams that worked on new-product programs that ran concurrently in all Fluke divisions.

As Bob Greenberg, a product planner at Fluke, points out, although the development process requires structure, that structure shouldn't enforce rigidity. For example, although every development program needs a specification, the team can't regard the spec as set in concrete. When a spec is written, nobody can foresee every good idea that will come up during the program. To avoid creeping elegance, what developers need is a way to decide whether a new idea is worth pursuing. The program manager should be able to determine whether

a new feature will bring in enough profit to justify adding, say, 30 days to the schedule and \$2 to the product cost. The specification's financial and market goals should form the basis for such decisions.

John Fluke Mfg Co Inc
Box 9090
Everett, WA 98206
(800) 873-5853

Circle No. 669

Philips Test and Measurement
Bldg TQIII-4
5600MD Eindhoven
The Netherlands
Phone local office

Circle No. 670

Note: Philips Test and Measurement distributes Fluke products in Europe; Fluke distributes Philips products in North America.

Article continued on pg 70

Key lessons the Series 10 program taught Fluke



Identify *all* of the team members early on and include every member in group communications from the outset.



Don't forget to make members of organizations normally thought of as peripheral to a development program (publications and customer service, for example) feel that they are part of the team. Team spirit is vital to the success of your program. Each team member must appreciate where the other members are coming from. Once that understanding exists, members will be able to build the essential feeling of common purpose and relate the company's goals for the project to their personal goals.



Use consistent project-management tools throughout all phases of the program. Changing the rules in the middle of the game confuses the team members and lowers productivity and morale.



Don't be too proud to seek help from outside the project team. You may have to request help from senior members of the technical staff elsewhere in your company or from consultants.



Don't select as consultants (whether from your company or outside) people whose hidden agenda is to feed their egos by impressing you with their brilliance. Such people are more likely to create dissension and doubts among the team members than to provide any real help.



Don't allow intermediaries—manufacturers' representatives, for example—to muddy communications with important contributors, such as vendors supplying critical parts. This advice applies even when the "vendor" is another division of your own firm.



Find a contact at the vendor organization who is personally responsible for parts like yours. Establish a strong working relationship with this person.



Have a post-release follow-up meeting to evaluate the program. In fact, you may want to hold more than one such meeting. When design engineering is ready to hand off the primary responsibility to manufacturing, the chances are that design hasn't yet dotted all of the i's or crossed all of the t's. The purpose of the meeting is to clearly identify what remains to be done, how the design people expect it to be done, who is responsible for getting it done, and when they are expected to have it done. Without this step, there is little chance that the product will meet the factory cost and yield objectives used in the profit projections that justified the program.

VOTE! Please also use the Information Retrieval Service card to rate this article (circle one):
High Interest 470 Medium Interest 471 Low Interest 472

It's a First!

GRAYHILL SERIES 50/51 MINIATURE ROTARY SWITCH

Signed — Qualified to MIL-S-3786

Sealed — Contact System Sealed to Withstand Assembly Contamination

Delivered! — From Grayhill or Local Distributors

- ▶ Application-proven 1/2" diameter, single deck rotary switches
- ▶ Process-sealed to eliminate special handling
- ▶ Your least-cost way to land rotary switches on your PC board

Industry has been happily using these highly reliable Grayhill 1/2 inch single-deck rotaries for years. Now they've been redesigned for manufacturability, process-sealed to withstand contamination during PC board assembly and cleaning. The result: your best value and least cost to land and/or assemble switches to your board. The proof: they're the first and only miniature rotaries that are qualified

to the MIL-S-3786 spec for process sealing.

Series 50/51 switches are available in 30°, 36°, 45°, 60°, or 90° angle of throw, with PC or solder lug terminations; rated 200mA for 25,000 cycles; and have up to 4 poles on the single deck and up to 12 positions.

Your quality assurance bonus: they're manufactured by Grayhill, Inc., first switch manufacturer to have its U.S. facilities certified to ISO 9001.

Your convenience bonus: they're available locally from your authorized Grayhill distributor.

Grayhill manufactures a wide range of rotary switch sizes and types, along with miniature pushbuttons, DIPs, and keypads. If the Series 50/51 is not your answer, there's sure to be another Grayhill switch that fits your needs. Ask today for your FREE copy of the 256 page Grayhill Engineering Catalog #1.

Grayhill
INC.
An ISO-9001 Company

561 Hillgrove Avenue, P.O. Box 10373
LaGrange, Illinois 60525-0373 USA
Phone: (708) 354-1040 Fax: (708) 354-2820
TLX OR TWX: 190254 GRAYHILL LAGE

CIRCLE NO. 40

SIGNED ○ SEALED ○ AND ○ DELIVERED

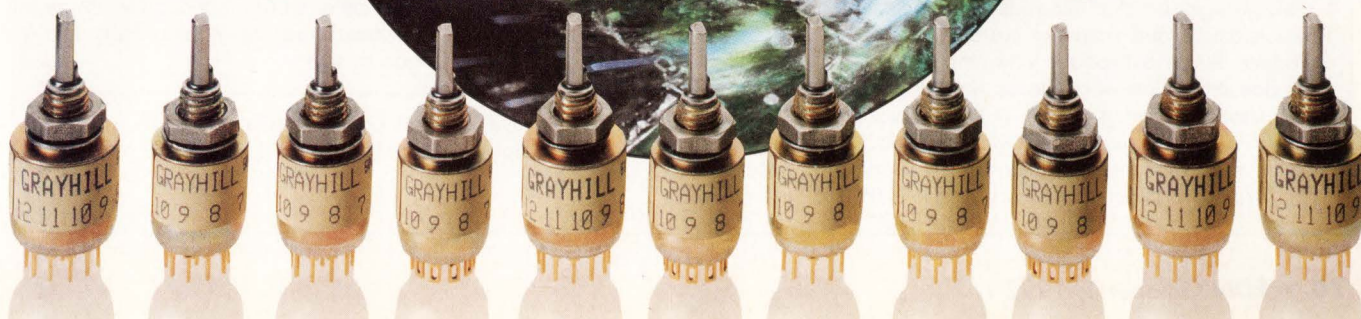

EDITOR'S ANALYSIS

Concurrent engineering helps, but it isn't the whole answer

Within the last few years, engineers who develop electronic products have become much more productive. Among the reasons: concurrent engineering and a back-to-basics approach have helped to shorten development cycles, despite dramatic increases in product complexity. Although the name "concurrent engineering" is new, the idea of involving manufacturing and test early in the design process is not. Companies throughout the industry have recognized the value of this approach for decades. But until concurrent-engineering tools became available, more firms were talking about paralleling design, manufacturing, and test than were doing it.

Although concurrent engineering may shorten development cycles and reduce the possibility of costly errors, it is not a panacea or a substitute for a sound product concept. If concurrent engineering turns product development into a routine, formulaic activity, it may well destroy the notion that there are still opportunities to create great products—the kinds of products that transform lives and give rise to new industries. That's why, when I hear the often-repeated comment that hardware is a commodity, I shudder. Plenty of hardware products are a long way from commodity status. If you need proof, this series will provide it.

Engineers who design assembled electronic products must execute many elements in a competent and timely manner. These elements include circuit design (which today often includes ASIC design), thermal management and packaging, pc-board layout, firmware design, component selection, and consideration of the needs of manufacturing and test. Failure to do a any of these jobs well can doom a product.

Though concurrent engineering can help to ensure the accurate, timely execution of these elements, if the initial idea is faulty, or if it focuses too much on the details and loses sight of the big picture, the product can't succeed. No amount of competence—or even brilliance—in the classic design disciplines can rescue it. (See this issue's editorial on pg 33.)

Range of elements makes for success

If you feel that concurrent engineering, by itself, will guarantee your product's success, you're sadly mistaken. Concurrent engineering normally disregards a whole constellation of elements that can be crucial to success. For example, an area of product design whose importance eludes many engineers is the user interface. Just because the design-team members have no trouble making the product do what they expect it to doesn't mean that the average user will be as fortunate. Too often, engineers' desire to show off their cleverness results in adding "free" features—usually ones embedded in firmware—that become the downfall of usability. (Happily, the user interface was a key consideration in many of the products in this series. It was particularly important in the HP and Keithley DMMs featured in this installment.)

Most engineers don't consider the documentation received by customers and potential customers to be a part of the product. But in a broader view, the product includes all of this documentation—presale as well as postsale: brochures, data sheets, ordering guides, price lists, installation manuals, operating instructions, and service manuals. In a sense, even the advertising is part of the product. Every such document can affect a product's success because it affects customers'

opinions of the product's suitability for an application and customers' perceptions of how well the product does its job.

Lastly, there is serviceability. Usually, the companies that pay attention to this aspect of product design are ones that have customer-service groups. Service is almost always a profit center, and service personnel learn very quickly what a product's designers did or forgot to do that affects their organization's profitability. What is more difficult is for a service department to pinpoint potential serviceability problems in a product under development. And more difficult still is for service personnel to prevail upon the design team to make changes to improve serviceability.

Nearly every part of the company helps

Nearly every part of the company is responsible for some activities that affect a product's success. At this point, unless you work in a very small company, you are probably protesting that, as an engineer, there are only so many activities that you can get your arms around, and an even smaller number that management actually holds you accountable for. You're right! Moreover, if you try to meddle in activities very far from your primary responsibilities, you are likely to make yourself quite unpopular and to invite criticism that you are trying to do everybody's job but your own.

So in a series on good product design meant to be read by design engineers, why bring up activities that design engineers can't control? The answer is that even if you can't control these activities, you can learn about them. If you learn what customer service, order entry, material control, and the various groups that produce documentation need to do their jobs more successfully, you can think about these requirements as you perform tasks that clearly are your responsibility. In some cases, you'll find new ways of doing your job or structuring the product that will improve the chances of success for the whole enterprise of producing and marketing the product.

For certain, it makes no sense to give too many groups a direct voice in the product concept. Although 20 departments may influence a product's success, involving too many of them too soon is an invitation to chaos. If more than a handful of people take part in defining the product and fleshing out the specifications, you'll find that you can't make progress. Conceptualization is a lonely task. Moreover, if you make a large group "responsible," nobody feels ownership or responsibility.

But for the very reason that many departments can't participate in product definition, the people who do participate must understand the concerns of groups that won't be involved until later. As a design engineer, you may never look at serviceability the way a customer service manager does, but you should hear and appreciate the manager's concerns and factor them into your thinking during conceptualization. If you succeed, you'll save a lot of grief, recrimination, and expensive backtracking later on. In other words, although you may not own the business, you should treat developing a product as if the company belonged to you.

Article Interest Quotient (Circle One)
High 470 Medium 471 Low 472

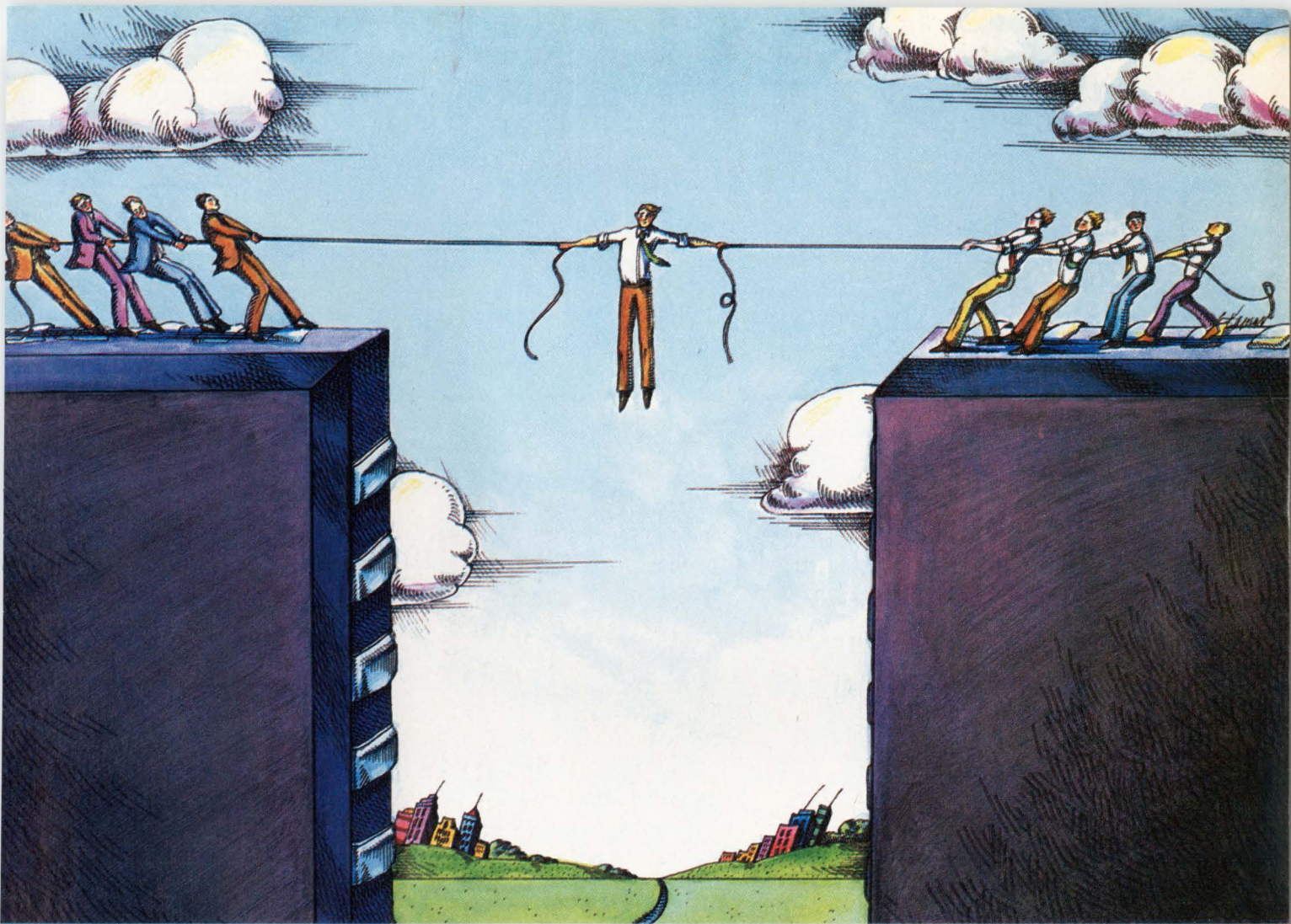

TI's 7.5-ns '22V10. For those times you're torn between profit and performance.

Trying to get the best performance on a tight budget can create a few hang-ups. Texas Instruments has a simple solution. Introducing the TIBPAL22V10-7. TI's newest high-performance programmable logic device that's designed to fit the bottom line as easily as it meets your design specs.

High performance, low price
While competitive pricing is one of our '22V10's most outstanding features (less than \$17 when you purchase 5,000 or more), you'll be even more impressed by its performance.

At an incredibly fast 7.5 ns, our '22V10 supports system speeds up to 50 MHz with a variable term distribution that gives you more design freedom with complex functions. It's an excellent choice for high-end systems

using the latest microprocessors. And since all this is achieved using our proven bipolar process, the '22V10 provides a universal architecture that's easy to work with using familiar design tools.

Accurate, dependable and available today

Speed and ease of use mean nothing if difficult programming keeps your product from getting to market on time. That's why our '22V10 is designed for quick, dependable programming with your present tools. In fact, we're running at a 99.4% first-time programming success rate.

Best of all, our 7.5-ns '22V10 is available in volume *today* with just-in-time and ship-to-stock delivery programs tailored to meet your needs. You'll also have the backing of our

global support network to help keep things running smoothly.



Hang in there —
a free sample is on the way
Simply return the attached reply card or call 214-995-6611, ext. 3717, for one free TIBPAL22V10-7.

 **TEXAS
INSTRUMENTS**

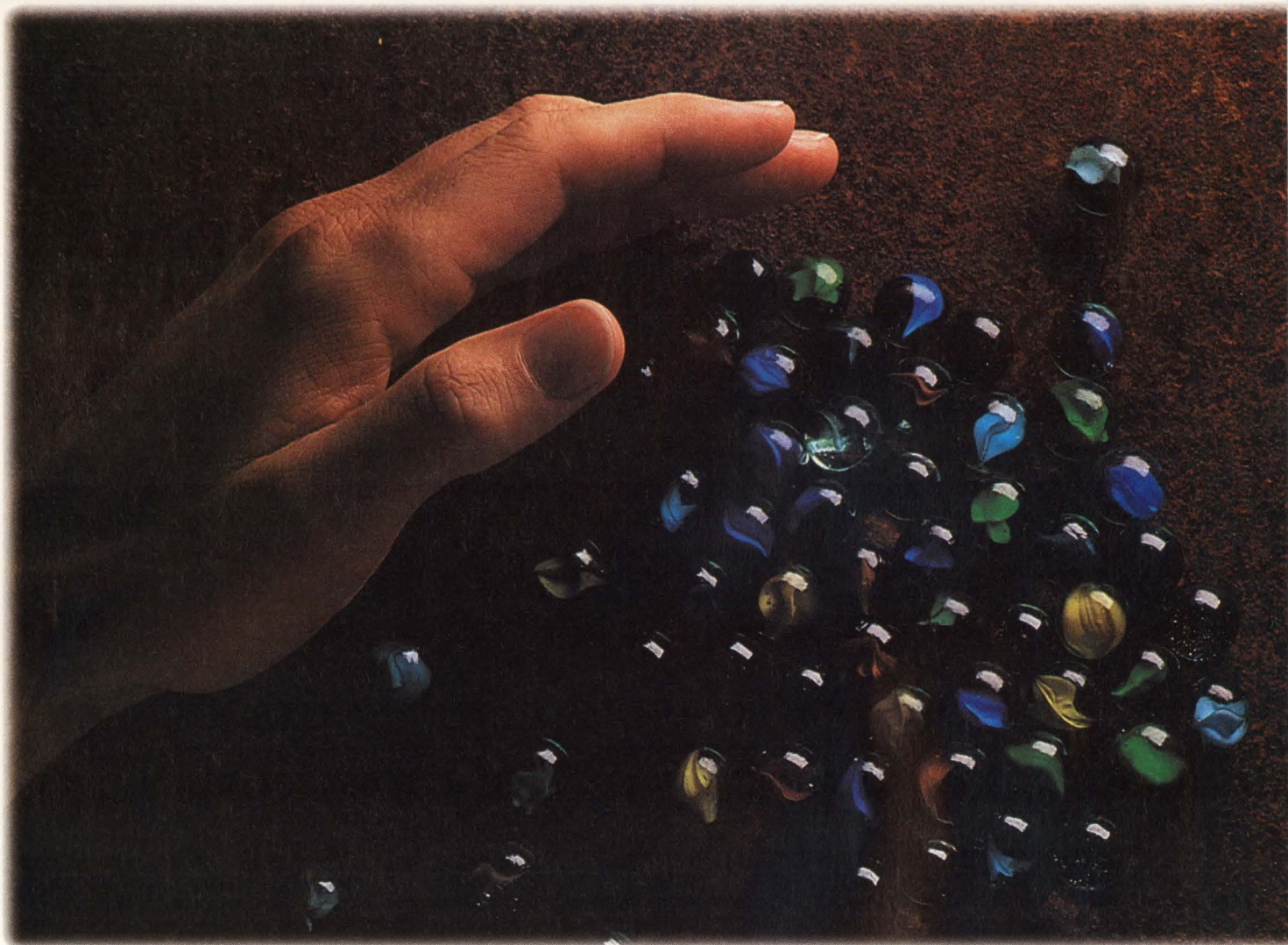

The value of timely market entry is no longer incalculable.

Research shows that a six-month delay in getting to market reduces a product's profitability by a third over its life cycle.

And consider this.

Rapidly evolving technologies reward quick product development, but accelerate obsolescence. So how do you achieve the first without getting bumped off by the second?

**GET TO MARKET FIRST,
THEN STAY THERE.**

The old saying is, "the view only changes for the lead dog"

Well, when you put your logic on a Xilinx device, here's what

the leader's view looks like.

First, no one can help you roll out a product faster than we can. Our hardware and software were designed for just that purpose.

Once you're out there, the fun starts.

You can respond to changing market conditions and customers' needs almost

as soon as you hear about them, just by modifying your design.



Our PLDs are standard parts that arrive at your shipping dock fully tested, and dropping in price. What a sweet deal.

A task our software makes virtually automatic.

Just as an example, since our FPGAs are reprogrammable in the system, you can produce a new generation of products, with new features and new capabilities, simply by reloading new logic via EPROM, disk, or modem.

**OUR IMPROVEMENTS,
YOUR INNOVATIONS.**

We're always pushing to deliver denser, faster, smaller, more highly integrated devices, at lower costs. Likewise, our software

HOW MUCH IS IT WORTH TO GET TO MARKET FIRST?

is easier to use, and gives you more efficient device utilization, resulting in better performance.

Together they let you build new systems that are smaller, lighter, faster, more reliable, and yet pack more features than previous models. And yet still hold the line on costs.

When you have all that going for you, you won't just get to market. You'll *be* the market.

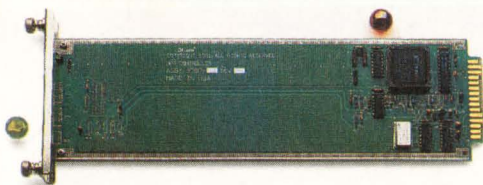

Before Xilinx, this board was crawling with chips. We reduced chip count by 80%, power consumption by 75%, and cut out two board layers. That's what we call a good shrink.

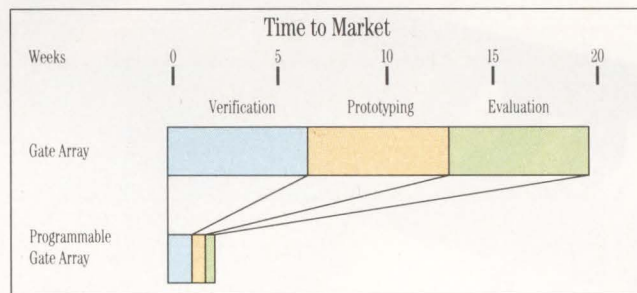

You can't buy time, but you can do the next best thing. Buy Xilinx and save time. Nearly four months, compared to a conventional gate array.

GO WITH SOMEONE WHO'LL GET YOU THERE.

Because no one has a broader product line, you can get the right part, at the right time, build the right design, and refine it without risk.

What's more, you'll find our prices will continue to drop as our volume continues to increase. Which it does every day, as more and more

companies discover the benefits of our approach.

An approach that promises substantial rewards. So call our 24-hour literature hotline at 800-231-3386 for

our latest product information and the name of the Xilinx representative nearest you. Now.



The Programmable Logic Company.™

© 1992 Xilinx, Inc., 2100 Logic Drive, San Jose, CA 95124. Europe, 44 (932) 349401; Japan, 81 (3) 297-9191; Asia, 852 (3) 721-0900. Xilinx is a trademark, and The Programmable Logic Company is a service mark of Xilinx, Inc. All other trademarks or registered trademarks are the property of their respective holders.

Synchronous 4Mb At 100MHz,

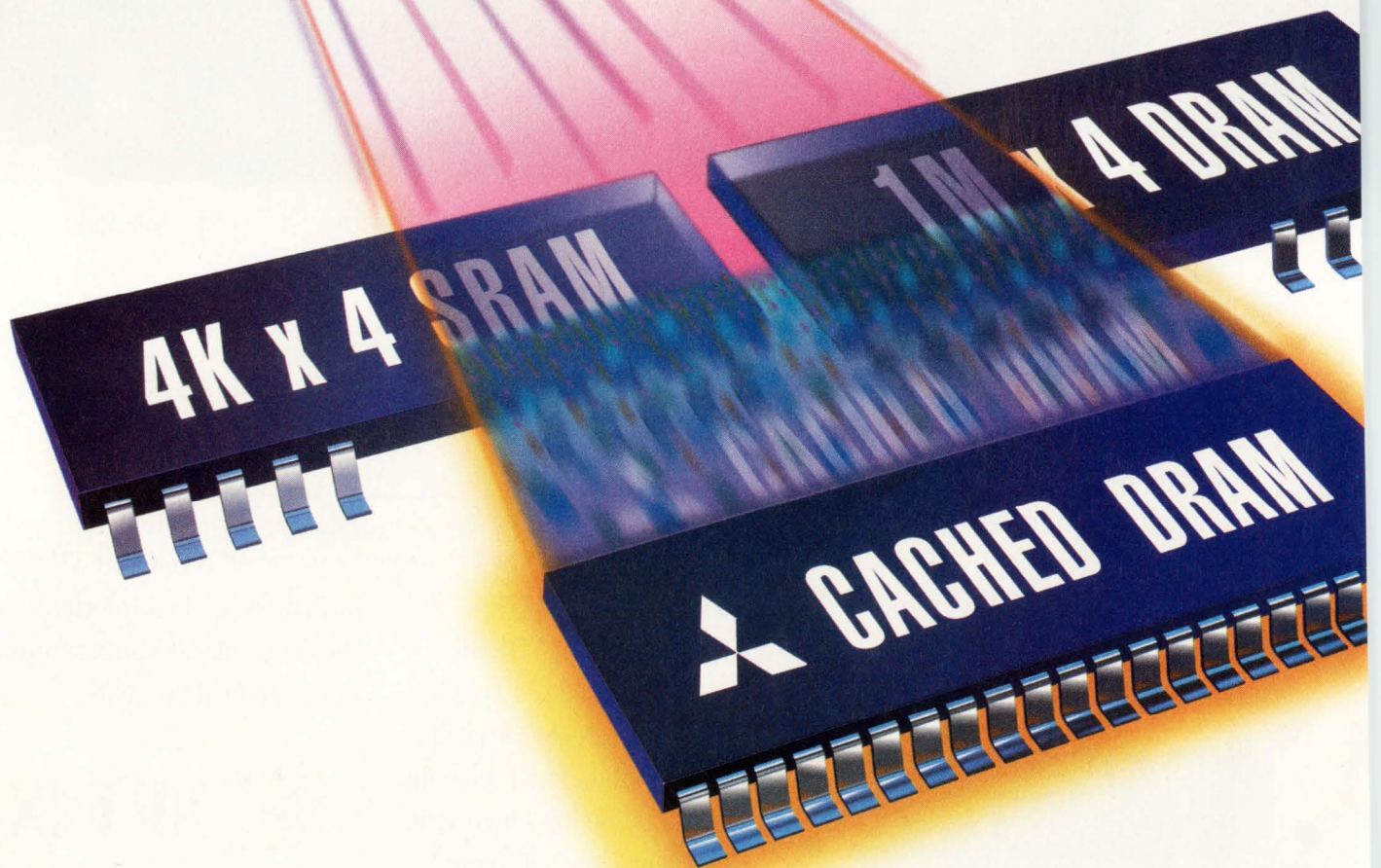

Cached DRAM. It Screams!

Matching low-cost DRAM technology with today's high-speed CPUs can be a design engineer's nightmare. Until now. **Introducing the 100MHz 4Mb Cached DRAM from Mitsubishi.**

FIRST SYNCHRONOUS DRAM

Mitsubishi combined a fast, 4K x 4 SRAM and a 1M x 4 DRAM with a wide, 16 x 4 bit internal bus and a synchronous clock design, all into one tiny TSOP IC. The result is the industry's first synchronous DRAM with on-board cache.

100MHz OPERATION

The Cached DRAM's large, 16 x 4 bit internal data path can transfer a 16-line data block in just one cycle, allowing the small on-chip cache to perform like a much larger external cache. The result is fast, 100MHz performance at a much lower cost than separate cache configurations. Plus, the Cached DRAM's fast copy-back scheme significantly reduces the miss cycle penalty time.

COST-EFFICIENT, SMALL SIZE

The Cached DRAM die and package are only 7% larger than those of a standard 1M x 4 DRAM. And, since they are manufactured with the same process and on the same production line as Mitsubishi's standard 4Mb DRAMs, Cached DRAMs are highly cost-efficient to manufacture.

LOW POWER OPERATION

With a clock that can be stopped to reduce power consumption to as low as 1mW, the Cached DRAM is ideal for portable and highly integrated applications where low power consumption, compact size and fast operation are essential.

MITSUBISHI'S CACHED DRAM PERFORMANCE

Part Number	Cache Hit Access/Cycle	Cache Miss Access/Cycle	Direct Array Access/Cycle	Package
M5M44409TP-10	10ns/10ns	70ns/280ns*	70ns/140ns	TSOP**
M5M44409TP-15	15ns/15ns	75ns/300ns*	75ns/150ns	TSOP**
M5M44409TP-20	20ns/20ns	80ns/320ns*	80ns/160ns	TSOP**

*Cache hit cycles can resume after one miss access time, while the copy-back completes in the background.

**TSOP Type II. Also available in reverse pin-out TSOP.

Not your ordinary next-generation DRAM, Mitsubishi's 4Mb synchronous

Cached DRAM sets a totally new standard for cost-effective, high performance memory. For more information and technical specifications, please call (408) 730-5900, ext. 2106 or 2226.

Standard 4Mb DRAM.

Actual size.

4Mb Cached DRAM is only 7% larger than a standard 4Mb DRAM.



Samples Available June 1992

 **MITSUBISHI**
ELECTRONIC DEVICE GROUP

EMC Bench Tools

Tools for measuring electromagnetic compatibility (EMC) allow you to pinpoint and fix problems before formal compliance checks. Revised FCC regulations and Europe's EMC Law now demand your attention to this previously ignored aspect of design.

Motivated mainly by the scope of Europe's impending EMC Law (Ref 1), instrument vendors are offering a growing range of tools with the principal aim of enabling you to make meaningful precompliance EMC measurements. What's more, you can make the measurements on your premises, and definitely without the need of an electromagnetically shielded and damped room.

Using EMC tools, you can measure all near-field radiated- and conducted-emissions signals on your development bench. Far-field radiated-emissions measurements will require more space to achieve consistent results, so you may find yourself trekking out to your company's car park to make those types of measurements. (The box, "EMC basics," explains the meaning of near-field, far-field, and other EMC terms.)

Although the foregoing broad and bold claims may cause EMC purists to shudder, remember the objective of using these tools is simply to provide you a rough-and-ready early warning of potential problem areas.

The tools are no substitute for formal emissions tests by specialist operators using certified measuring instruments in a prepared environment. What the tools can do is provide you with enough confidence so that a subsequent test-house check becomes effectively a rubber-stamping or final-auditing exercise.

Don't expect to make highly accurate measurements with the majority of these tools. At the lower-cost end, accuracy is either crudely specified or so wide that you can't be certain whether your product passes or fails official compliance limits. The only exceptions are when you measure with certified transducers and test receivers. (These combinations will cost you over \$30,000 and so hardly qualify as everyday bench tools.)

If you're resourceful, you can find ways around the uncertain accuracy of lower-cost EMC tools. For example, you can carefully measure emissions from a particular product with your uncalibrated tools before and after a formal check at a test house. You can then retain that product

Brian Kerridge, Technical Editor



with its test-house results, and your own measurements, as a quasi transfer-standard to impart some degree of integrity to your tools. Alternatively, for a tool with a wide accuracy figure, you can continue designing until emissions reach a comfortable margin (20 dB) below official limits, if that's possible.

In case you think that none of this in-house precompliance testing is really necessary, consider the alternative of simply submitting an unchecked product to a test house only to learn the product fails to comply. Your marketing colleagues will soon cast shadows over your bench and be eager to know: Can you fix things in time for those critical beta-site demos? Will it affect the newly printed brochure that already states compliance? And what about the press-launch photos that show the product proudly sporting the highly regarded CE stickers?

Now you're in a tight spot. All you'll have back from the test house is a plot of the emissions spectrum and a bill for around \$2500. With luck, knowledge of the design could

lead you to the offending section of circuit (for example a processor clock), but what do you do next? Even if you can put together a quick fix, are you ready to gamble away more company funds on a retest?

At this stage, you may consider using an EMC design consultant. You may be too late. According to Tim Williams, EMC design consultant with Elmac Services, it's best to employ a consultant or address EMC problems yourself in the early stages of any design. Williams says companies rarely follow this advice and frequently only call in outside help or investigate a problem when it's so acute that sales are endangered. He says it's common for companies to launch a new product without thinking about its EMC performance. A customer is often the first to report back an EMC problem with a product. For example, maybe that the product's microprocessor locks up when a motor starts next door, or a display blanks out when a portable phone operates nearby.

Williams says that by the time you reach this stage, any fix you imple-

Use EMC bench tools as an early-warning system for potential problems. (Photo courtesy Rohde & Schwarz)

EMC

Bench Tools

ment is expensive, unwieldy, and inefficient. A late fix always requires a disproportionate amount of effort in terms of engineering changes, and sometimes severely affects a product's profitability. If a manufacturer has committed the product to the market, it will have little option but to expend whatever it costs trying to cure the problem. (The box, "Designing-in EMC," suggests some techniques to adopt in the

early stages of your design cycle.)

There's no doubt some companies with EMI-benign products will adopt the gambling route and continue to ignore the foregoing advice. As long as test-house reports remain favorable, nothing's lost by this approach. But you don't need many unfavorable reports before you can justify purchasing at least some of the lower-cost EMC tools.

Table 1 shows an assortment of

tools you can employ for gaining confidence that your product is ready for a formal EMC checkup. The products shown represent the lowest cost combination of tools each vendor can supply.

Formal EMC testing is complex by nature—different standards exist for different categories of products, in different environments, and in different countries. Some of this complexity tracks into the range of

Table 1—Representative EMC bench tools¹

Vendor	Transducer				Intermediate Instrument		
	Type	Model	Frequency range	Price	Type	Model	Price
Advantest	LISN	KNW-242C	100 kHz to 30 MHz	\$4000	Preselector	R3551A	See Comments
	Half-wave dipole antenna	TR1722	25 MHz to 1 GHz	\$2200	Preselector	R3551A	See Comments
	Log-periodic antenna	TR17204	200 MHz to 1 GHz	\$5300	Preselector	R3551A	See Comments
Chase EMC	Interference tracer	CIT 9600	50 Hz to 500 MHz	\$795	Not required	NA ²	NA
	LISN ⁴	CLN 2060	9 kHz to 30 MHz	\$1597	EMI signature scope	ESS 7500	\$4299
	Probe set	NFPS1	9 kHz to 1 GHz	\$3350	EMI signature scope	ESS 7500	\$4299
Farnell	LISN	LSN30	150 kHz to 30 MHz	£280	Not required	NA	NA
	Probe set	7405	9 kHz to 1 GHz	£840	Not required	NA	NA
	Antenna and tripod	S30280	30 MHz to 1 GHz	£1495	Not required	NA	NA
Hewlett-Packard	LISN	HP 11967C	9 kHz to 30 MHz	\$2880	Transient limiter	HP 11947A	\$510
	Probe set	HP 11945A	9 kHz to 1 GHz	\$1215	Preamplifier	HP 8447F	\$2790
	Magnetic loop antenna	HP 11966A	9 kHz to 30 MHz	\$2535	Preamplifier	HP 8447F	\$2790
	Biconical antenna	HP 11966C	30 MHz to 300 MHz	\$1650	Preamplifier	HP 8447F	\$2790
	Log-periodic antenna	HP 11966D	200 MHz to 1 GHz	\$1920	Preamplifier	HP 8447F	\$2790
Laplace	Probe set	RF100	9 kHz to 1 GHz	£180	Spectrum analyzer converter	SA450A	£995
	Spectrum probe	VOS105	1 MHz to 100 MHz	£345	Not required	NA	NA
	Spectrum probe	VOS255	30 kHz to 2.5 MHz	£345	Not required	NA	NA
Rohde & Schwarz	LISN	ESH 3-Z5	9 kHz to 30 MHz	DM 4780	Transient limiter	ESH 3-Z2	DM 800
	Biconical antenna	HK 116	20 MHz to 300 MHz	DM 3250	Not required	NA	NA
	Log-periodic antenna	HL 223	200 MHz to 1.3 GHz	DM 3630	Not required	NA	NA
Schaffner	LISN	LSN 2006	9 kHz to 30 MHz	£850	Spectrum imager	ESI 2000	£1995
	Magnetic field probe	MSP 2000	9 kHz to 30 MHz	£475	Spectrum imager	ESI 2000	£1995
	Electric field probe	ESP 2000	9 kHz to 1 GHz	£295	Spectrum imager	ESI 2000	£1995
	Magnetic loop antenna	MLA 2000	9 kHz to 30 MHz	£1782	Spectrum imager	ESI 2000	£1995
Tektronix	LISN	119-4147-00	10 kHz to 100 MHz	\$2395	Stepping RF preselector	2706	\$4450
	RF probe set	119-4146-00	9 kHz to 1.8 GHz	\$520	Stepping RF preselector	2706	\$4450
	Magnetic loop antenna	119-4144-00	9 to 30 kHz	\$2495	Stepping RF preselector	2706	\$4450
	Adjustable dipole	119-4145-00	28 MHz to 1 GHz	\$2695	Stepping RF preselector	2706	\$4450
	Biconical antenna	119-4148-00	30 to 300 MHz	\$1295	Stepping RF preselector	2706	\$4450
	Log-periodic antenna	119-4142-00	200 MHz to 1 GHz	\$1550	Stepping RF preselector	2706	\$4450

Notes:

1. Lowest-cost combination (transducers, intermediate instrument, measuring instrument) of tools shown for each vendor.
2. NA = Not applicable.
3. CISPR (International Special Committee on Radio Interference, from its name in French) quasi-peak bandwidths 9 kHz and 120 kHz.
4. LISN = Line-impedance-stabilizing network.
5. Any general-purpose oscilloscope that has X and Y inputs.
6. As note 3, X input not required.

tools available for checking EMC. But ignoring the various standards in detail for a moment, you cannot go far wrong if you select tools for making measurements in the two following areas:

Conducted emissions (150 kHz to 30 MHz)

Radiated emissions (30 MHz to 1 GHz)

These two areas of measurement show up as a common thread in several standards. If your tools help you to track down and minimize emissions in these areas, they're certain to assist compliance with a wide range of emissions standards, and likely to aid compliance with immunity standards as well.

The table shows tools under the main headings of transducers, intermediate instruments, and meas-

urement instruments. For all tests you must have at least a transducer and a measuring instrument. In some cases, your existing oscilloscope or spectrum analyzer will suffice, but it may require a front-end, or intermediate instrument, to adapt it to display EMC measurements. To perform a meaningful conducted-emissions check, you need to spend a minimum of about \$6000, which buys a transducer and

Measurement instrument recommended by vendor			Comments
Type	Model	Price	
Spectrum analyzer	R3261A	\$12,900	R3261A: 9 kHz to 2.6 GHz; quasi-pk detector ³ ; AM and FM detector with audio output; 50-point transducer factor memory. Option 15 (\$1950) adds IEEE-488 controller function. R3551A: 7-bands from 9 kHz to 1 GHz; gain 30 dB \pm 1.5 dB. Preselector only operates with R3261/3361 series spectrum analyzer. (System R2531 includes R3261A and R3551A and costs \$28,900.) Ten versions of system control software cost from \$550 to \$2000, to suit conducted/radiated, FCC, VDE, CISPR, etc. tests.
Spectrum analyzer	R3261A	\$12,900	
Spectrum analyzer	R3261A	\$12,900	
Not required	NA	NA	Handheld, battery-powered unit; selectable LF/HF bands; sensitivity control; average or pk detector; loudspeaker and meter. ESS 7500: converts oscilloscope to spectrum-analyzer display; 3-kHz to 30-MHz ranges; 3-, 30-, 300-kHz, 300-MHz frequency markers; limit-line display; \pm 4-dB amplitude accuracy; 100-dB μ V RF input; pk, quasi-pk, and average detectors; audio alarm.
Oscilloscope	[5]	NA	
Oscilloscope	[5]	NA	
Spectrum analyzer	SSA 1000A	£5250	SSA 1000A: 150 kHz to 1 GHz; CISPR detectors ³ ; 4-color printer; cursor control with direct amplitude and frequency readout. Turnkey Easy 1 system adds Easy 1 and Windows 3 software; IEEE-488 PC interface; cables; costs £8950.
Spectrum analyzer	SSA 1000A	£5250	
Spectrum analyzer	SSA 1000A	£5250	
Spectrum analyzer	HP 8591E	\$11,500	HP 8591E: 9 kHz to 1.8 GHz; CISPR quasi-pk detectors ³ ; HP 85712B EMC personality card adds stored compliance limit lines and transducer factors. HP 84100B turnkey EMC design system (8591, 85712, and 11945) \$22,500. HP 84110B turnkey EMC preproduction system (8591, 85712, LISN, and antennas) \$27,145.
Spectrum analyzer	HP 8591E	\$11,500	
Spectrum analyzer	HP 8591E	\$11,500	
Spectrum analyzer	HP 8591E	\$11,500	
Spectrum analyzer	HP 8591E	\$11,500	
Spectrum analyzer	HP 8591E	\$11,500	
Oscilloscope	[5]	NA	SA 450A: 2 to 450 MHz; 50-dB dynamic range; center scan frequency display; audio output; scan widths 1 kHz/cm to 50 MHz/cm. VOS 105 and VOS 255: 50-dB dynamic range; 180-kHz bandwidth; sweep rate 6 msec/100 MHz.
Oscilloscope	[6]	NA	
Oscilloscope	[6]	NA	
Test receiver	ESHS 10	DM 35,000	ESHS 10: 9 kHz to 30 MHz; 10-Hz frequency resolution; -36 dB to +137 dB μ V; amplitude accuracy <1 dB; CISPR detectors ³ . ESVS 10: 20 MHz to 1 GHz; 100-Hz frequency resolution; -14 dB to +137 dB μ V; amplitude accuracy <1 dB; CISPR detectors ³ .
Test receiver	ESVS 10	DM 43,000	
Test receiver	ESVS 10	DM 43,000	
Oscilloscope	[5]	NA	ESI 2000: converts oscilloscope to spectrum-analyzer display; 3-kHz to 30-MHz ranges; 3-, 30-, 300-kHz, 300-MHz frequency markers; limit-line display; \pm 4-dB amplitude accuracy; 100-dB μ V RF input; pk, quasi-pk, and average detectors; audio alarm.
Oscilloscope	[5]	NA	
Oscilloscope	[5]	NA	
Oscilloscope	[5]	NA	
Spectrum analyzer	2712	\$11,950	2712: 9 to 1.8 kHz; stores five sets transducer factors; direct dB microvolts/m field strength readout; optional CISPR detectors ³ . 2706: insertion loss -2 dB max; eight bands from 9 kHz to 1.8 GHz; bandpass flatness 1.5 dB max. S26EM12 EMI software package (\$495) allows you to make measurements automatically under control of a PC via an IEEE-488 interface.
Spectrum analyzer	2712	\$11,950	
Spectrum analyzer	2712	\$11,950	
Spectrum analyzer	2712	\$11,950	
Spectrum analyzer	2712	\$11,950	
Spectrum analyzer	2712	\$11,950	

EMC

Bench Tools

one of the scope-adaptor product.

For radiated-emissions work, you need more transducers (antennae) and a spectrum analyzer or dedicated EMC test receiver. A setup using a spectrum analyzer is likely to cost you around \$20,000. This figure jumps to at least \$30,000 if you want an EMC test receiver instead of a spectrum analyzer. Of course, you can also use either of these measuring instruments for conducted-emissions checks and get more accurate results. Several vendors of radiated-emissions setups offer bundled systems that include PC software that can make measurements automatically. Since just one complete radiated-emissions check can mean taking around a thousand measurements, automatic control is essential.

Probes pinpoint problem parts

The EMC transducers you need fall into three distinct areas of application. First, for tracing emissions close to your pc-board components, you can use probes. Most probe sets include two kinds of probes, one for detecting electric fields and another for sensing magnetic fields. In either case, readings you make so deep inside the near-field give you little guidance of emissions relative to levels quoted in standards. The great value of a probe is simply that it can serve as a diagnostic tool to pinpoint the precise component or circuit area that sources an offending signal.

The second category of transducers concerns only conducted-emissions measurements and specifically requires a device called a line-impedance-stabilizing network (LISN), (see **box**, "EMC basics"). You insert a LISN into the line supply of your product under test and connect your measuring instrument to the LISN signal output. Using this setup, you can perform a conducted-emissions measurement as

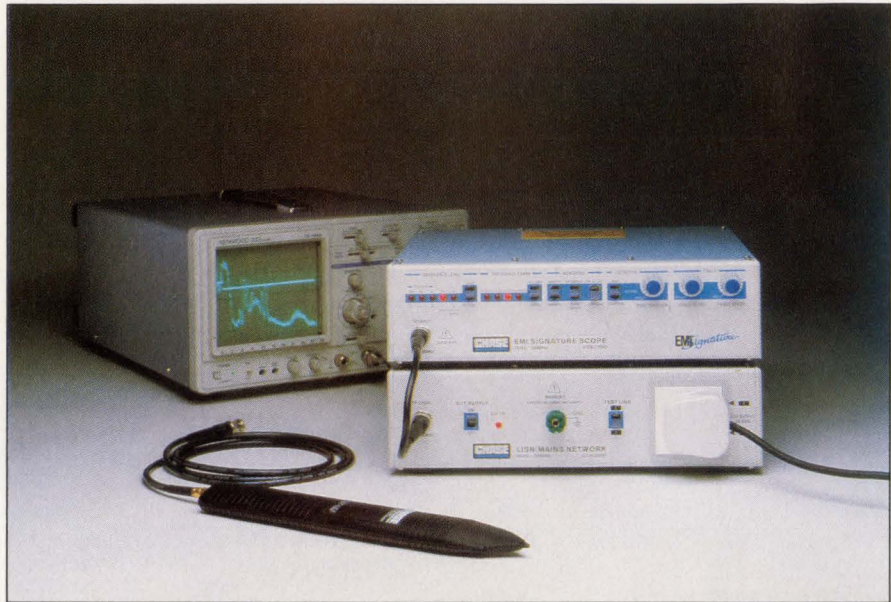

The EMI signature scope ESS 7500, and LISN CLN 2060 from Chase EMC combine with almost any oscilloscope to produce a low-cost measurement system for precompliance conducted-emissions tests from 3 kHz to 30 MHz.

well as any test house, right on your development bench. The only provisos are that your measuring instrument have sufficient accuracy, and that you take a little care with the layout of the setup (**Ref 2**).

The third and last category of transducers includes antennae for making radiated-emissions tests. Generally, you need two antennae to cover the 30-MHz to 1-GHz range: a biconical for the low end and a log-periodic for the high end. Radiation-emissions tests are not so straightforward because they require an open space. Generally, an area 20 x 10m, and clear of obstructions likely to cause reflections, is all you need.

The choice of measuring instrument is one of the most important you will make when selecting an EMC tools setup. If you're satisfied making only conducted-emissions measurements, then a general-purpose oscilloscope with an intermediate instrument such as Chase's signature scope, or Schaffner's spectrum imager, is perfectly adequate.

You can also use a spectrum ana-

lyzer to measure the output from a LISN, but you'll probably want to insert a transient limiter in the signal cable. This device protects the input of your analyzer from transients that the LISN's filters may develop when you connect your product under test to the LISN.

Preselector prevents compression

Depending on the nature of the emissions source in your product, you may also need a preselector in the signal path to your spectrum analyzer. According to John Dearing, EMC specialist with Chase EMC, without a preselector, large broadband emissions from your test product can drive the spectrum analyzer input into saturation (compression), causing erroneous readings. Even the most experienced spectrum analyzer user usually doesn't recognize this phenomenon. A similar effect can occur when you make radiated-emissions measurements, if there's a large ambient source present at your test site, such as a local broadcast station. A preselector effectively narrows

EMC basics

You need to become familiar with a few basic terms before you put your EMC tools to work. The following list includes the terms you will encounter most frequently.

Near-field and far-field

As signals radiate from components on your circuit, the nature of the signals depends on their distance from the source. Near the source, stray impedances in the immediate surroundings govern the nature of the signal. Far from the source, the characteristic impedance of free space (377Ω) determines the signal's nature. To form a common base for stating signal levels, most EMC standards documents assume you make measurements in the far-field, where the characteristic impedance is known. Measurements you make in the near-field simply give you a relative indication of signal levels close to your circuit components. You cannot sensibly relate measurements of signal levels in the near-field to signal levels in the far-field.

The distance from a source at which a near-field changes to a far-field depends on the frequency of the signal source. For the majority of sources, the relationship is as follows:

$$\text{distance} = \lambda \div 2\pi.$$

So, for example, the near- to far-field transition point occurs as follows:

Frequency	Distance
1 MHz	47.7m
10 MHz	4.8m
100 MHz	477 mm
1 GHz	48 mm

A few standards, notably VDE German standards, require you to measure radiation emissions for frequencies less than 30 MHz, and maybe as low as 9 kHz. In this case, you have no choice but to make near-field measurements because the far-field transition point is too distant. A magnetic loop antenna is the transducer for this application.

Conducted emissions

Conducted emissions describes signals conducted from your product back into the line supply. All information-technology, industrial, and scientific products require testing for these type of emissions. Most standards quote emission limits for frequencies from 150 kHz to 30 MHz.

LISNs

A line-impedance-stabilizing network (LISN) is a tool you need to compensate for variations in line supply impedance when you make conducted-emissions tests. The tool is simply a passive filter and is straightforward to construct. Design values appear in international specification CISPR 16. One effect to watch for when using LISNs is the transients that appear across the internal inductors. Most vendors offer transient limiters to protect inputs of measuring instruments, although some instruments already have internal protection to around 700V pk.

Radiated emissions

Radiated emissions describes signals transmitted from your product into free space; voltages and currents within your design develop signals that leak directly through apertures in a product's enclosure, or onto connecting cables, and thence into surrounding free space.

Quasi-peak detection

Quasipeak describes one setting of the response characteristics of a signal detector used in EMC-measuring instruments. Other settings display peak or average values. The reason for adding a quasi-peak response is to reduce detector sensitivity to impulse sources with pulse repetition rates below 1 kHz. EMC standard CISPR 16 specifies three quasi-peak responses, providing three sets of bandwidth, attack, and decay figures for different sections of the frequency spectrum.

Immunity

Immunity describes the ability of your product to maintain operation in the presence of external signal sources. The sources include electromagnetic radiation, conducted signals via external cables, and ESD. Although immunity requirements form part of European EMC Law, to date, standards for most product categories have yet to appear.

Another imponderable is the subjective method of determining if your product complies. According to UK draft regulations, in a borderline case someone will have to decide if "intermittent" and "significant impairment of function" is occurring.

EMC

Bench Tools

the wideband input of your spectrum analyzer to the frequency of interest for your measurements.

Compression often results with circuits that include a wideband source such as a square-wave clock, whereas low-level analog circuits are likely to be free of the problem. However, Dearing adds that it's easy to check if your signal analyzer is in compression. You simply introduce an external attenuator into the signal path and switch it in and out. If readings vary by the same value as the attenuation, then there's no compression; if readings vary by different values or not at all, then there is compression.



The 107 spectrum probe from Laplace Instruments produces a 100-MHz spectrum-analyzer display on any oscilloscope with a bandwidth of 100-MHz or more. The probe couples to your circuit via a 10-pF capacitor and has a dynamic range of 50 dB.

A spectrum analyzer is the best tool for designers to use for diagnostic work with emissions precompliance checks, according to Dearing. A spectrum analyzer provides a fast assessment of design changes across a frequency band, whereas a dedicated test receiver can only make measurements sequentially across a frequency range at a relatively slow scan rate. You may still need to add a preselector to narrow the input bandwidth and a preamplifier to lift readings 20 dB or so away from the analyzer's noise floor, however.

There's no doubt a test receiver provides more accuracy in both fre-

Designing-in EMC

The recommendations listed below form a good basis for "designing-in" EMC to your product. Observe that all the recommendations involve decisions you make in the early stages of designing. If you wait until the design is complete, it's either difficult or impossible to utilize these recommendations.

The list is no substitute for a proper course of training in EMC design techniques. Courses generally run for two to three days and cost around \$400/day. Chase EMC, Hewlett-Packard, Rohde & Schwarz, and Tektronix all operate this type of training.

Ref 7 shows results from two board layouts of the same digital circuit. One example closely adopts the recommendations listed here, while the other purposely disregards many of them to show a strikingly different result. The results include spectrum plots with and without a 1 m cable connected.

Layout of pc boards

Avoid long traces in general, and ensure that all high-frequency traces (>1 MHz) have an adjacent ground to minimize overall current loop area.

Especially consider clock and backplane data traces—these produce the highest emissions, and you should route these in first, by hand if necessary.

Thicken ground return traces, and ensure low-inductance joints with all external ground connections.

In multilayer boards, dedicate one layer for ground-plane return connections. If your clock frequency exceeds 30 MHz, or your logic transition times are <4 nsec, then consider a ground-plane layer as an essential part of your design.

Logic families

Select the slowest logic family that allows your design to operate properly; eg, choose 74HC devices in preference to 74A or 74F versions. Only use high-speed logic in those parts of the circuit where it is essential.

Decoupling

Position decoupling capacitors immediately adjacent to the points you intend to decouple. Equally important, keep the ground-return path short and, ideally, straight through the board into a ground plane.

I/O connections

Install filters on all analog, digital, and power connections to your design, to provide the minimum bandwidth necessary to properly pass the signal frequency.

Use properly terminated screened-connectors, ie, devices with 360° continuation of the screen through the backshell and onto the chassis of your product.

Do not use pigtail screen terminations, and do not terminate the screen to circuit OV traces.

Provide a separate low-inductance RF ground for screen and filter terminations if your product has no chassis.

Acknowledgment

Thanks go to Tim Williams, EMC design consultant with Elmac Services, for providing much of the information in this box.

quency and signal amplitude, and the receiver's peak, quasipeak, and average detectors allow you to measure strictly within CISPR (International Special Committee on Radio Interference) guidelines. But, as Dearing explains, making peak signal measurements (with a spectrum analyzer) conveniently assumes a worst-case situation. If your product passes the peak test, it will pass the other two.

Dearing adds that even in a test house you'll find engineers using a spectrum analyzer in favor of a test receiver most of the time. A spectrum analyzer provides a better overview of a setup when preparing

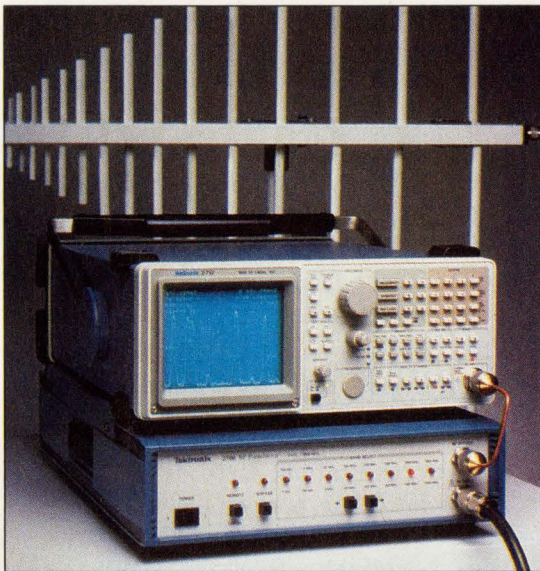

You must have an intermediate instrument, such as a Tektronix 2706 stepping preselector, if you use a general-purpose spectrum analyzer for making EMC measurements. The preselector limits the input spectrum width, so as to increase measurement dynamic range, and blocks large ambient signals that otherwise cause spurious responses within the analyzer.

Editor's analysis

Most designers are by now aware of impending European legislation requiring that electronic products sold in the European Community (EC) conform strictly to EMC standards.

Although awareness is rising, companies are showing few signs of making real preparations for designing-in EMC. This lethargy has several causes. For one, the new law is already late itself coming into effect, and it puts off the fateful day for mandatory conformance to December 31, 1995. Another reason is that companies are still feeling the recessionary blues, and now is not the time for thinking about extra design costs or pricey test equipment. But a significant reason for inaction, maybe the major reason, is that designers themselves are really not sure what all the words and numbers mean as far as their product is concerned. Designers generally view EMC as a mystery subject; measurements change each time you move, it's difficult to get the same result twice, and that sort of thing.

Fortunately, someone is trying to find remedies for this puzzlement. If the European EMC directive has done one good thing, it has focused the minds of EMC specialists to sort out the apparent mess for the rest of us.

Nowhere is this sorting out done better than in two recently published books (Refs 4 and 5), one by John Middleton, the other by Tim Williams. Both authors produce clear and presentable explanations of the whole business of designing-in and testing for EMC. They both devote a complete chapter to Europe's EMC Directive, its background, status, and requirements. The books cover EMC standards in general, and those particularly relevant to the Directive. But of most appeal to EDN

readers will be the extensive coverage given to design issues concerning EMC. Williams' book in particular covers design details of pc-board layout, grounding, interfaces, filtering, and shielding. Middleton's work contains useful revision chapters and appendices on RF field theory required for EMC work. The book includes both 5¼-in. and 3½-in. floppy disks with spreadsheet programs to support calculations used in the book. The book also contains superb diagrams throughout.

An earlier book you should also add to your library is by Henry Ott (Ref 6). This book concentrates on design techniques affecting noise reduction in all types of circuitry and, so, naturally incorporates valuable advice for designing-in EMC. The book is extremely readable and also makes liberal use of diagrams.

My advice is to purchase and study all three of these books straightaway. With them, you'll learn 80% of everything you need to know about EMC in 20% of the time it would take you to pore through individual specs and official guidance documents.

Certainly, this area of work is full of frustrations: trying to eliminate emissions that turn out to be a local broadcast station, loose screws on the enclosure allowing RF leakage, different power-cord position relative to the product giving quite different results, or just waiting for a fine Sunday to use the company car park. But take heart from the example of designers of switch-mode power supplies. They've proved that even the most "EMC-unfriendly" design can still meet the toughest EMC standards. Your task could work out to be much simpler.

EMC

Bench Tools

for a full test. When things look right on the spectrum analyzer, engineers use a test receiver for higher-resolution formal checks.

Whether you decide to use a spectrum analyzer, test receiver, or scope adapter for your measurement instrument, will largely determine your overall system accuracy. It's worth considering that the more system accuracy your tools provide, the closer you can design to specified limits and maintain confidence of formal compliance. The alternative, if you use low-accuracy tools, is you may waste time and effort needlessly improving a design's EMC simply because your tools don't have the resolution to tell you otherwise.

Homemade tool for consistent test

With a modest tool set and a resourceful attitude, most design labs should be able to produce meaningful precompliance test results. At Philips Semiconductors, Southampton, UK, for example, Mike Rose, EMC lab manager, relies on a basic tool set consisting of a LISN, antennae, a spectrum analyzer, and a pre-amplifier. In addition, he uses a

Philips in-house-designed tool called a workbench Faraday cage (Ref 3). The cage consists of a sealed metal enclosure, measuring approximately 30×18×9 in. You place your pc board under test inside the cage and take a signal from a selected point on the board's ground plane to your measurement instrument via a coupling network on the cage.

The cage is a simple EMC tool that enables consistent EMC testing throughout the company's organization. Rose says the tool is ideal for performing a quick comparative test on similar boards, or studying effects of small design changes such as one decoupling arrangement against another. The tool also works in reverse to measure the immunity response of your product—you excite a point on the ground plane of your pc board using an RF generator and monitor the board for malfunctions.

This Philips site set up its own in-house EMC test facility around 18 months ago, to carry out tests without having to use accredited EMC test facilities situated elsewhere in Philips. Although components and ICs are outside the scope

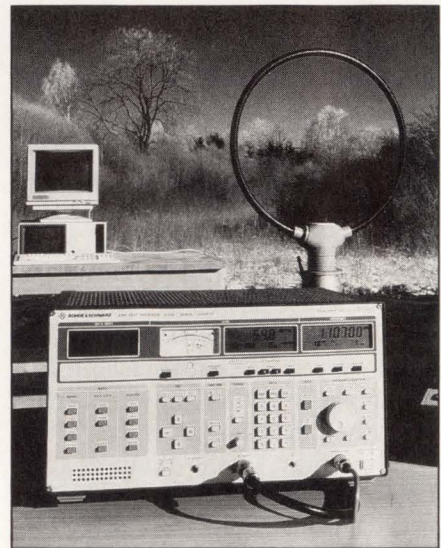

For precompliance radiated-emissions measurements, you may need to transport your measuring setup to a quiet corner of your company's car park.

of Europe's EMC directive, the company recognizes the importance its customers attach to using compliant parts. One of the objectives of Rose's work is to study EMC compliance prospects of Philips' ICs in typical applications. With this relatively basic tool set, used both on the bench and occasionally in the company car park, Rose expresses confidence that he can reasonably predict the outcome of a formal compliance test.

Immunity compliance

The European directive requires a product to be immune to EMI as well as to control its emissions. Although the directive as yet does not specify a particular immunity standard, it seems certain to be IEC 801. Tools for checking to IEC 801 largely require the use of a damped and shielded room, and are beyond the scope of this article. Clearly, it's not permissible to transmit signals in an open laboratory in order to subject your product to the energy levels specified in the standard. Companies with resident radio hams have been known to carry out unofficial radiation checks, but fre-



The Easy 1 turnkey emissions-assessment system from Farnell enables you to make conducted-, and radiated-emissions measurements for EMC precompliance. The kit includes one broadband antenna for covering 30 MHz to 1 GHz, LISN, an IEEE-488 PC interface card, and Easy 1 and Windows 3 software.

Within budget. Without compromise.

Get more of what you want in a 6½ digit DMM for just \$995.

The HP 34401A gives you more performance than any other DMM for the price. More resolution. Better accuracy. The highest reading speed. Fastest throughput. And widest AC bandwidth.

It has more standard features. Like HP-IB, RS-232 and built-in SCPI commands for more system flexibility. Plus ten extended functions including continuity, diode test, limit test, reading hold, dB and null to give you greater flexibility on the bench.

What more could you want? The HP 34401A also comes with a 3-year warranty, standard.

☎ For more information, or same-day shipment from HP DIRECT, call 1-800-452-4844**. Ask for Ext. T511. And we'll send you a data sheet.

HP 34401A Digital Multimeter	
DC Accuracy (1 year)	0.0035%
AC Accuracy (1 year)	0.06%
Maximum input	1000 Vdc
Reading speed	1000/sec
Resolution	100 nV, 10 nA, 100 μΩ

* U.S. list price

** In Canada call 1-800-387-3867, Dept. 434

There is a better way.

 HEWLETT
PACKARD



© 1992 Hewlett-Packard Co. TMLID135/B/EDN

CIRCLE NO. 47

EDN October 1, 1992 • 87

EMC Bench Tools

quencies allocated to hams limit parts of the spectrum where you can make tests.

The few tools you can use while you're designing for immunity include current probes for coupling signals into power and signal leads, and ESD guns for generating controlled discharges near your product.

Schaffner produces a portable current probe NSG 420 (£980) to couple interference into any connecting cable on your product. The frequency range extends up to 150 MHz and allows you to apply AM or FM. Rohde & Schwarz's version is a highly calibrated (and highly priced) version of the same thing but includes a model SMGL power generator (DM35,700) to drive an EZ17 current probe (DM1950).

Impulse (ESD) and transient interference testing are provinces of specialist companies such as Haefely and Keytek. But apart from ESD guns, there's nothing else you can use as an EMC bench tool for immunity testing. **EDN**

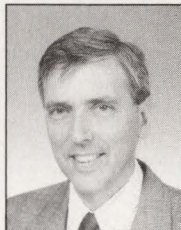

Brian Kerridge can be reached in the UK at (508) 28435; FAX (508) 28430.

Article Interest Quotient
(Circle One)

High 473 Medium 474 Low 475

References

1. Kerridge, Brian, "Europe lays down EMC Law," *EDN*, September 16, 1991, pg 57.
2. "Guide to EMC emission measurement," wall chart from Chase EMC.
3. "Workbench EMC evaluation method," Philips Semiconductors application note EIE/AN91001.
4. Middleton, John, "The engineer's EMC work book," Marconi Instruments Ltd, 1992.
5. Williams, Tim, "EMC for product designers," Butterworth-Heinemann, 1992.
6. Ott, Henry W, "Noise reduction techniques in electronic systems," John Wiley & Sons, 1988.
7. "EMC-92—Designing EMC into your product—Conference Proceedings," London, February 12 to 13, 1992, ERA report 92-0011, Leatherhead, UK.

Manufacturers of EMC bench tools

For more information on EMC bench tools such as those described in this article, circle the appropriate numbers on the Information Retrieval Service card or use EDN's Express Request service. When you contact any of the following manufacturers directly, please let them know you saw their products in EDN.

Advantest Inc

300 Knightsbridge Pkwy
Lincolnshire, IL 60069
(708) 634-2552
FAX (708) 634-2610

Circle No. 650

In UK:

Advantest Ltd

10th Floor, CI Tower
St George's Square, High St
New Malden KT3 4TL, UK
(81) 336-1606
FAX (81) 336-1657

Circle No. 651

Chase EMC Ltd

St Leonard's House
St Leonard's Rd
Mortlake, London SW14 7LY, UK
(81) 878-7747
FAX (81) 876-5928

Circle No. 652

In US:

Ibex Group Inc

5 Columbia Way
Somerville, NJ 08876
(908) 722-8085

Circle No. 653

Elmac Services

Unit A, Quarry Lane
Chichester PO19 2PQ, UK
(243) 533361
FAX (243) 780168

Circle No. 654

Farnell/Wayne Kerr

600 West Cummings Park
Woburn, MA 01810
(617) 938-8390
FAX (617) 933-9523

Circle No. 655

In UK:

Farnell Instruments

Sandbeck Way
Weiberby LS22 4DH, UK
(937) 581961
FAX (937) 587514

Circle No. 656

Haefely & Co Ltd

Lehenmattstrasse 353
CH-4028 Basel, Switzerland
(61) 3155111
FAX (61) 3112187

Circle No. 657

Hewlett-Packard Co

Signal Analysis Div
1212 Valley House Dr
Rohnert Park, CA 95405
(800) 452-4844

Circle No. 658

Keytek Instrument Corp

260 Fordham Rd
Wilmington, MA 01887
(508) 658-0880
FAX (508) 657-4803

Circle No. 659

Laplace Instruments Inc

119A Sandy Dr
Newark, DE 19713
(302) 456-5800
FAX (302) 456-0441

Circle No. 660

In UK:

Laplace Instruments Ltd

Tudor House
Grammar School Rd
North Walsham NR28 9JH, UK
(692) 500777
FAX (692) 406177

Circle No. 661

Marconi Instruments Inc

3 Pearl Ct
Allendale, NJ 07401
(210) 934-9050
FAX (210) 934-9229

Circle No. 662

In UK:

Marconi Instruments Ltd

Longacres
St Albans AL4 0JN, UK
(727) 59292
FAX (727) 839447

Circle No. 663

Rohde & Schwarz

Box 801469
Mühldorfstrasse 15
D-8000 München 80, Germany
(89) 4129-0
FAX (89) 4129-2164

Circle No. 664

Schaffner EMC Ltd

Ashville Way
Molly Millar's Lane
Wokingham RG11 2PL, UK
(734) 770070
FAX (734) 792969

Circle No. 665

Tektronix Inc

Box 1520
Pittsfield, MA 01202
(800) 426-2200

Circle No. 666

Which Analog DSP Interface uses 50% less power,
fewer components and only one supply?



The new Voice-band Audio Processor from TI.



Our new single-chip Voice-band Audio Processor integrates all the functions of a conventional codec, the amplification for speaker and microphone and more. As a result, you reduce component count and simplify your design.

Consuming about half the power of a codec, our TCM320AC36 operates from a single 5-V supply. And that takes care of your chief concerns with designing cellular and cordless telephones and other telecom and data-acquisition systems:

TCM320AC36 Highlights

- Single 5-V supply
- Low power: 40 mW (on), 1.2 mW (standby)
- Low noise: < 17 dB_{BrnC0}
- Pin-selectable 13-bit linear or 8-bit companding
- On-chip interface to speaker and microphone
- Direct interface to most DSPs
- Low cost: < \$4.50 (1,000s)

- **Size/Weight** — Eliminating the need for a negative supply and regulator reduces weight and design size. And small-outline surface-mount packaging is available for size-critical applications.

- **Talk time** — Lower power consumption of the 'AC36 allows longer talk time or the use of smaller batteries in your design.

For more information

On our TCM320AC36, send the reply card. For faster response, call (214) 995-6611, ext. 3432, your TI sales office or your TI distributor.

 **TEXAS
INSTRUMENTS**

Clean, dependable power.

AMPLIFIED

When you're powering high-current or sensitive industrial equipment, that power had better be clean and constant. But most important, strong.

Techron power amplifiers. They're the industry's heavy hitters when it comes to clean dependable high-current power. Techron power amplifiers reduce filtering requirements and give you a true power supply you can count on.

- ◆ Super-clean power from DC to 50 kHz.
- ◆ Total Harmonic Distortion: At 0.4% or better, one of the most distortion-free power sources in the industry.
- ◆ Inner Modulation Distortion: .001%
- ◆ Limiting: instantaneous with no flyback pulses, thumps or cutouts.
- ◆ Amplifier Output: Short-, mismatch- and open-circuit protected in voltage mode.
- ◆ Phase shift between input and output: from DC to 20 kHz less than -20 degrees.

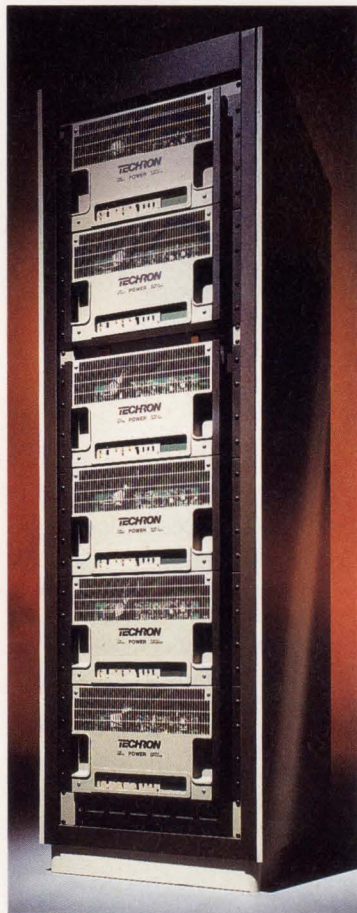

The right power

Different applications require specific solutions. That's how Techron came to be the power of choice for the gradient subsystem of one of modern medicine's most important diagnostic tools, the Magnetic Resonance Imaging systems. MRI manufacturers choose our power amplifiers which utilize advanced bi-level power supplies with clean, low-noise and linearity.

Tell us your application requirement. During development or in final application, Techron will back you up. With standard product or custom-configured amps. As a line voltage regulator and/or line voltage generator system. Working with you to solve power supply problems is what we do best.

That's what we mean by clean, dependable power. Amplified all the way down the line. Call Techron for more power than you've ever had before. **1-800-933-7956**

TECHRON

1718 W. Mishawaka Road, Elkhart, Indiana 46517



How to stay ahead in telecommunications design

When you need to keep at the leading edge of telecommunications technology, talk to Ericsson.

Our 100 years of experience in the industry could take months off your system development time and cut the cost and size of your final product. Whether it's a PCM repeater or a complete line card.

Ericsson offers the ultimate in integration for every application. Like customised or semi-standard Complete Line Interface Circuits which only need the addition of relays and line protection. Or regenerative PCM repeaters for 2.048 or 1.544 Mbit/s lines.

Then there's a comprehensive range of SLICs for PBX and DLC systems, complemented by Central Office versions with on chip regulators. In addition there is a range of Line Protection Circuits.

But Ericsson is more than just another component supplier. As a truly international telecommunications company, Ericsson has developed close partnerships with customers in many countries. So the design of our components reflects this by conformance to every major national and international specification. And quality is assured.

The telecommunications world constantly threatens to leave you one step behind. Ericsson can help you stay ahead. Simply call us for more information.

Ericsson Components Inc.

403 International Parkway Richardson TX 75081
Tel: 214-669-9900 Fax: 214-680-1059

Representatives: Alabama (205)880-8050. Arizona (602) 991-6300. California (408) 253-1960, (619) 292-1771, (714) 891-4621. Colorado (303) 758-4884. Connecticut (203) 243-9343. Florida (407) 352-3755. Georgia (404) 448-1215. Illinois (312) 968-0118. Indiana (317) 577-9950. Iowa (319) 354-8894. Massachusetts (508) 692-2500. New Jersey (201) 525-8000. New York (516) 929-5756, (716) 586-0777, (518) 383-2239. N.Carolina (919) 847-8800. S. Carolina (803) 233-4637. Texas (214) 553-1200, (512) 834-8374, (713) 370-8177. Washington (206) 882-0962, (206) 254-4572. Wisconsin (414) 781-1730.



Please send me your latest Telecom IC Shortform data

Name _____

Company _____

Job Title _____

Address _____

Telephone _____

Fax _____

**SEE US AT ELECTRONICA
STAND 25D07**

ERICSSON 

EDN October 1, 1992 • 93

NEW AT WESCON/92

**5 SHOWS UNDER
ONE ROOF**

**More Products, More
Opportunities to Increase Your
Technical Knowledge, More
Answers to Your Design Questions**

INTRODUCING

EC WORLD™
WESCON'S ELECTRONIC COMPONENT SHOW

EC WORLD, the world's largest electronic component event focusing on resistors, relays, capacitors, switches, cable, connectors, enclosures, and associated devices for the design engineer

ITM™
WESCON'S INTERNATIONAL TEST
& MEASUREMENT SHOW

ITM, an expanded world class event for test and measurement, featuring ATE, test and measurement equipment, instrumentation, data acquisition systems, calibration hardware, IEEE I/O devices, and similar products

ic expo™
WESCON'S SEMICONDUCTOR SHOW

IC EXPO, the show for manufacturers of ICs, Semiconductors, ASICs, ROMs, RAMs and similar products

COMPUTOOLS™
WESCON'S COMPUTER TOOLS FOR THE ENGINEERING ENVIRONMENT

COMPU-TOOLS, a computer show for engineers, encompassing hardware and software, EDA tools, workstations, PCs, boards, LANs, CAD/CAM and related products

EPEX™
WESCON'S ELECTRONIC
PRODUCTION EXPO

EPEX, the electronic production expo for worldwide contract manufacturers, surface mount, PCB suppliers, design houses, and products which service this market

**You can attend exhibits and technical
sessions at any Wescon/92 show with just
one admission ticket.**

**For Complimentary
Registration**

Call 1-800-877-2668



**November 17-19, 1992
Anaheim Convention Center, Anaheim, CA**

Transform Your World

EDN
Announces

DSP^x

Exposition & Symposium

...featuring the latest Digital Signal Processing applications and technology
San Jose Convention Center, October 14 - 16, 1992

The future of Digital Signal Processing is here. Improved technology has combined with decreasing manufacturing costs to produce a remarkably high rate of growth: DSP shipments grew a healthy 35% in 1991 versus 9% for integrated circuits.

Until now a current or prospective user could not turn to one source to learn more about DSP, its applications, and its benefits. Now there is DSP^x: Exposition & Symposium...featuring the latest Digital Signal Processing applications and technology.

DSP^x focuses on the needs of the commercial market. It offers an applications-oriented approach to DSP, providing both an introduc-

tion for those not familiar with the technology and detailed tutorials for those exploring new avenues of implementing DSP.

DSP^x promises to bring together top vendors of DSP devices, boards, software, and systems with current and prospective end-users in the computer, communications, automotive, consumer, medical, industrial, military, and aerospace industries.

It's no longer a question of whether DSP will be part of your product. It's only a question of when.

Managed and produced by



DSP^x

Exposition & Symposium

...featuring the latest Digital Signal Processing applications and technology

- Yes, I want to learn more about DSP^x: Exposition & Symposium...featuring the latest Digital Signal Processing applications and technology**
- Please send me information on attending the One-Day Introductory Course
- Please send me information on attending the Three-Day Conference Program
- Please send me information on exhibiting

Name: _____

Title: _____

Company: _____

Address: _____

City: _____

State: _____ Zip: _____

Telephone: _____

Fax: _____ XAS

**For more information, call: (203) 964-8287, or
Fax to: (203) 964-0176 or Mail to: DSP^x, P.O. Box 3833,
999 Summer Street, Stamford, CT 06905-0833**



WITH OMRON SWITCHES, YOUR MOUSE CAN NOW EXPECT TO RUN FIVE TIMES LONGER.

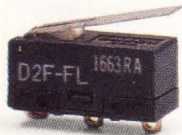

When computer mouse manufacturers needed a tiny, yet highly reliable snap action switch that could stand up to rough, high-frequency switching, they turned to Omron. To meet the challenge, Omron developed the model D2F subminiature switch. With its remarkably small size and incredible life of 5 million operations, the advanced switch really "clicked" with the industry. For advanced switching solutions for the office automation, computer peripheral, appliance and consumer electronics industries, Omron provides the performance you need in basic switches. Choose standard, micro, miniature and subminiature styles in a wide variety of contact configurations, amp ratings, terminal types or actuator styles. With highly automated production and 100% performance testing with zero defects. And with our switch you need — fast. So, if you're find the right switch, call Omron at

OMRON

WE HAVE THE FUTURE IN CONTROL.

CIRCLE NO. 52

you get consistently high quality large local inventories, you get the tired of running around in circles to 1-800-62-OMRON.

**Designer's guide to
sampling A/D converters
Part 2**

Peripheral circuits can make or break sampling-ADC systems

Walt Kester, Analog Devices

Part 1 of this 3-part series on sampling ADCs covered static and dynamic characteristics, minimizing switching transients, and protecting the analog input. Part 2 now examines the four peripheral circuits that are vital to maximum performance. Part 3 will discuss ADC interface circuits and filtering requirements.

Getting the maximum performance from a sampling A/D converter involves more than investigating the part's dc and ac characteristics. Because an ADC cannot stand alone, you need to examine the peripheral circuits that contribute to the device's performance. These circuits include the analog-input drive amplifier, antialiasing filter, reference-voltage circuit, and sampling-clock generator.

Selecting the appropriate drive amplifier for a sampling ADC involves several tradeoffs. Indeed, selecting the amplifier can be just as difficult as selecting the ADC in the first place. For this reason, you'll find it helpful to do some preliminary investigation. The following guidelines, coupled with information on the ADC's data sheet, should steer you in the right direction.

First, determine which ADC specifications—gain, offset, drift, S/N ratio, THD—are most important in your system. You might insist that all these specs are important, but at least try to prioritize them. In most real-time signal-processing applications that require a sampling ADC, you'll find that the dynamic specifications such as S/N ratio and THD are the most critical.

The ADC's characteristics should be compatible with these ac specifications.

Keeping these ac requirements in mind, you can start looking for a drive amplifier. Most sampling-ADC manufacturers recommend one or more drive amplifiers that are compatible with the ADC's performance and interface nicely to the device. These recommendations usually stem from device-characterization circuits, evaluation boards, or circuits for testing the ADC in production.

From this starting point, you can do a quick check of the op-amp data sheet to verify the device's ac performance and the noise and bandwidth compatibility between the op amp and the ADC. The next step is to do a quick dc error-budget calculation using the information on the op amp's data sheet. If the dc errors are within your error budget, you're ready to build a prototype. If not, then you must choose another amplifier with better dc characteristics. At this point, you may have to make some tradeoffs between ac and dc performance and perhaps noise.

Determining amplifier dc errors

The ADC drive amplifier acts as a signal-conditioning element to interface the input signal to the ADC. It is also a convenient point in the system for injecting signal gain or offset. However, be careful when using the op amp's offset-null terminals to inject offset voltages. The purpose of these pins is to null the offset voltage of the op amp, not to make large system-offset adjustments. If you use the offset-null pins for large system-offset corrections, you're likely to greatly in-

SAMPLING A/D CONVERTERS

crease the op amp's input-offset-voltage temperature coefficient. The proper way to introduce system offset voltages is to use a summing resistor connected to the inverting input of the op amp. Make the resistor as large as possible to minimize the resulting increase in circuit noise gain.

Once you have chosen the appropriate values for the feed-forward (R_1) and feedback (R_2) resistors and the noninverting source resistor (R_P), employ the following equation to calculate the total op-amp output offset-voltage error (V_0) using the data-sheet values for V_{OS} (input offset voltage), I_{B+} (noninverting-input bias current), and I_{B-} (inverting-input bias current):

$$V_0 = \pm V_{OS} \left(1 + \frac{R_2}{R_1} \right) \pm I_{B+} R_P \left(1 + \frac{R_2}{R_1} \right) \pm I_{B-} R_2.$$

Next, use the data-sheet temperature coefficients to determine the output-offset-voltage drift versus temperature. You may have to reduce the system's dynamic range slightly to allow enough headroom at the ADC input to prevent the offset-voltage shift from causing signal clipping. The alternative, of course, is to select an op amp having better dc characteristics. Note that when using bias-current-compensated op amps such as the ADOP-07, the optimal value for R_P is zero because the bias currents do not track each other.

In some applications, gain accuracy is required as well as low output-voltage drift. You can use the finite dc open-loop-gain specification (A_0) and the feedback factor (β) to calculate the closed-loop dc gain error (ϵ_{DC}) of a voltage-feedback amplifier from the approximation

$$\epsilon_{DC} = \frac{1}{|A_0\beta|},$$

$$\text{where } \frac{1}{\beta} = 1 + \frac{R_2}{R_1} = \text{noise gain},$$

$$\beta = R_1 / (R_1 + R_2) = 1 / \text{noise gain},$$

$$\text{and } |A_0\beta| = \text{loop gain at dc}.$$

This approximation assumes perfectly matched feed-forward and feedback resistors. For example, if you need 16-bit accuracy ($\epsilon_{DC} = 0.000015$) in a unity-gain inverter ($\beta = 0.5$), then the dc open-loop gain must be at least 133,333 (102.5 dB).

You can solve the previous equation for ϵ_{DC} and use it for a current-feedback amplifier, but you'll have to calculate A_0 and β first because these calculations are different from those for voltage-feedback amplifiers. Fig 1 shows a simplified diagram of a current-feedback

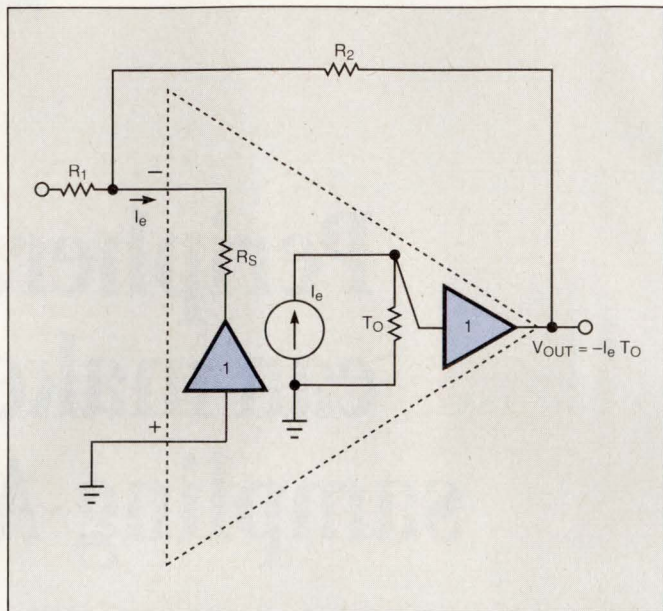

Fig 1—This dc model of a current-feedback amplifier lets you calculate the open-loop gain and the feedback factor. These calculations are different from those for a voltage-feedback amplifier. Note that the dc open-loop transimpedance gain, T_0 , is expressed in ohms.

amplifier. The dc open-loop transimpedance gain, T_0 , is expressed in ohms. The inverting-input voltage, I_E , multiplied by T_0 yields the output voltage. The inverting-input voltage is equal to $I_E R_S$. The dc open-loop voltage gain for the current-feedback amplifier is the output voltage divided by the input voltage:

$$A_0 = \frac{I_E T_0}{I_E R_S} = \frac{T_0}{R_S}.$$

The feedback factor, β , for the current-feedback amplifier is

$$\beta = \frac{R_S \parallel R_1}{(R_S \parallel R_1) + R_2}$$

Now that you know A_0 and β for the current-feedback architecture, you can calculate the corresponding value for dc loop gain:

$$\text{loop gain at dc} = A_0\beta = \frac{T_0 (R_S \parallel R_1)}{R_S [(R_S \parallel R_1) + R_2]}.$$

As in the case for the voltage-feedback amplifier, the dc closed-loop gain error is

$$\epsilon_{DC} \approx 1 / |\text{loop gain at dc}|.$$

In most cases, you can compensate for the absolute gain-accuracy error due to the finite open-loop op-amp gain by making an overall system-gain adjustment. Even so, a change in loop gain over temperature will produce a corresponding change in the closed-loop gain. The dc change in the closed-loop gain, $\Delta\epsilon_{DC}$, for a change in dc open-loop gain is

$$\Delta\epsilon_{DC} = \left| \frac{1}{A_{O1}\beta} - \frac{1}{A_{O2}\beta} \right|$$

where A_{O1} is the dc open-loop gain at temperature T_1 , and A_{O2} is the dc open-loop gain at temperature T_2 . This expression is valid for both voltage- and current-feedback amplifiers. If the variation in dc closed-loop gain over temperature is too great, you should use an amplifier with less change in dc open-loop gain over temperature or one with a higher initial dc open-loop gain. Obviously, you can also reduce the gain error by operating the op amp at a lower dc closed-loop noise gain.

Use signal ground-return pins for accuracy

Some precision ADCs such as the AD676 and AD7884 have a ground-return pin for the analog signal. You can use this pin to compensate for small voltage differences (<100 mV) between the analog-signal ground and the ADC analog ground, as **Fig 2** shows. The signal-ground-return pin can remotely sense the ground potential of the signal source and is especially useful if the circuit has to carry the signal some distance to the ADC. **Fig 2** also shows how to shield the signal wires in a noisy environment. Tie the analog- and digital-ground pins of the ADC together at the device and connect this point to the pc board's analog-ground plane. A 100-mV difference may not seem like much, but in a 16-bit, 10V system, it's about 650 LSB.

The gain-bandwidth product of an op amp is the

product of the closed-loop gain and the corresponding bandwidth at a specified frequency. For a voltage-feedback amplifier that has a single-pole response, this product is constant over a wide frequency range. If the op amp is stable at unity gain, the frequency at which the open-loop response crosses unity gain is the unity-gain-bandwidth frequency. Thus, you can use the gain-bandwidth specification to calculate the closed-loop bandwidth for various values of closed-loop gain.

A key point designers sometimes overlook when selecting voltage-feedback amplifiers based on bandwidth is that the closed-loop gain, A_{CL} , refers to the noise gain, not the signal gain. In the noninverting mode, the dc signal gain ($1 + (R_2/R_1)$) equals the dc noise gain. In the inverting mode, however, the noise gain is still $1 + (R_2/R_1)$, but the signal gain is $-R_2/R_1$. For example, if an op amp has a unity-gain-bandwidth product of 10 MHz, the closed-loop bandwidth for a noninverting unity-gain configuration is 10 MHz, and that of a unity-gain inverter is 5 MHz.

Unlike voltage-feedback amplifiers, current-feedback amplifiers have bandwidths that are relatively independent of gain, assuming that the value of the feedback resistor remains constant. Thus, referring to the gain-bandwidth product for this type of amplifier is inappropriate. You can determine the closed-loop bandwidth for a current-feedback amplifier at various gains from the amplifier's data sheet.

You can approximate the gain error (ϵ) for various input frequencies using the formula

$$\epsilon = \frac{1}{2} \left(\frac{f_{MAX}}{f_C} \right)^2$$

where f_C is the closed-loop signal bandwidth, and f_{MAX} is the maximum allowable frequency for a gain error less than ϵ . For example, for a signal to remain flat

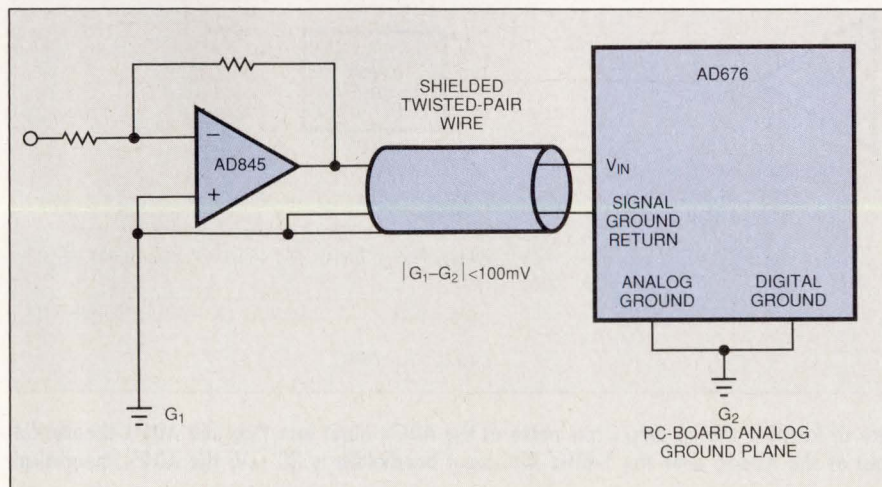

Fig 2—Some precision ADCs have a signal ground-return pin that you can use to compensate for small voltage differences between the signal ground and the ADC analog ground. A method for shielding the signal wires in a noisy environment is to tie the ADC's analog- and digital-ground pins together at the device and connect this point to the pc board's analog-ground plane.

SAMPLING A/D CONVERTERS

within 0.1 dB ($\epsilon < 0.01$) up to a frequency of 50 kHz (f_{MAX}), the amplifier requires a minimum closed-loop signal bandwidth of 353 kHz. Remember, however, that this approximation applies only to single-pole amplifiers. Additional poles may provide gain flatness up to higher frequencies for the same closed-loop signal bandwidth.

When selecting an ADC drive amplifier you should keep in mind that the harmonic distortion of the amplifier needs to be less than that of the ADC so the amplifier does not limit the system's dynamic range. To ensure that you select an appropriate amplifier, you should examine the device's distortion specifications in conjunction with its bandwidth specifications. Op-amp data sheets usually include information about distortion levels as a function of signal frequency and amplitude. Ideally, the data sheet will specify the amplifier's harmonic distortion under the same amplitude and loading conditions the ADC presents. If the data sheet doesn't have this information, connect the op amp to the ADC on a breadboard and measure the harmonic distortion of the op amp.

Another factor to consider is the op amp's settling time. This specification may not be critical in frequency-domain applications such as spectral analysis, but it's extremely important in time-domain applications such as pulse-height analysis where the circuit must accurately measure the amplitudes of fast-slewing pulses. Other applications requiring fast-settling op amps are multiplexer output buffering and CCD imaging.

Manufacturers usually specify op-amp noise in terms of input voltage-noise spectral density (V_N) and nonin-

verting- and inverting-input current-noise spectral density (I_{N+} and I_{N-}). The other source of noise in op-amp circuits is the thermal, or Johnson, noise the external resistors generate. For practical wideband op-amp circuits, you can usually neglect the resistor noise because of the low values ($< 10 \text{ k}\Omega$) of the feed-forward and feedback resistors typical of high-speed circuits.

An amplifier's total integrated output-voltage noise (V_{ON}) over the single-pole, closed-loop bandwidth (f_{CL}) is

$$V_{ON} = \sqrt{1.57 f_{CL}} \sqrt{V_N^2 \left(1 + \frac{R_2}{R_1}\right)^2 + I_{N-}^2 R_2^2 + I_{N+}^2 R_P^2 \left(1 + \frac{R_2}{R_1}\right)^2}$$

where R_1 is the feed-forward resistor, R_2 is the feedback resistor, and R_P is the noninverting-input resistor. The factor of 1.57 converts the single-pole bandwidth (f_{CL}) to the equivalent noise bandwidth.

Although voltage- and current-noise spectral densities are not constant across the frequency band, you can make reasonable estimates of the output noise voltage by assuming a nominal value across the entire frequency band of integration. In any case, the higher-frequency noise is usually the largest contributor to broadband noise.

The previous equation will work for both voltage- and current-feedback amplifiers. In the case of voltage-feedback op amps, $I_{N+} \approx I_{N-}$. For most current-feedback op amps, however, the inverting-input current noise is larger than the noninverting input current noise, so you should use the appropriate values in the equation.

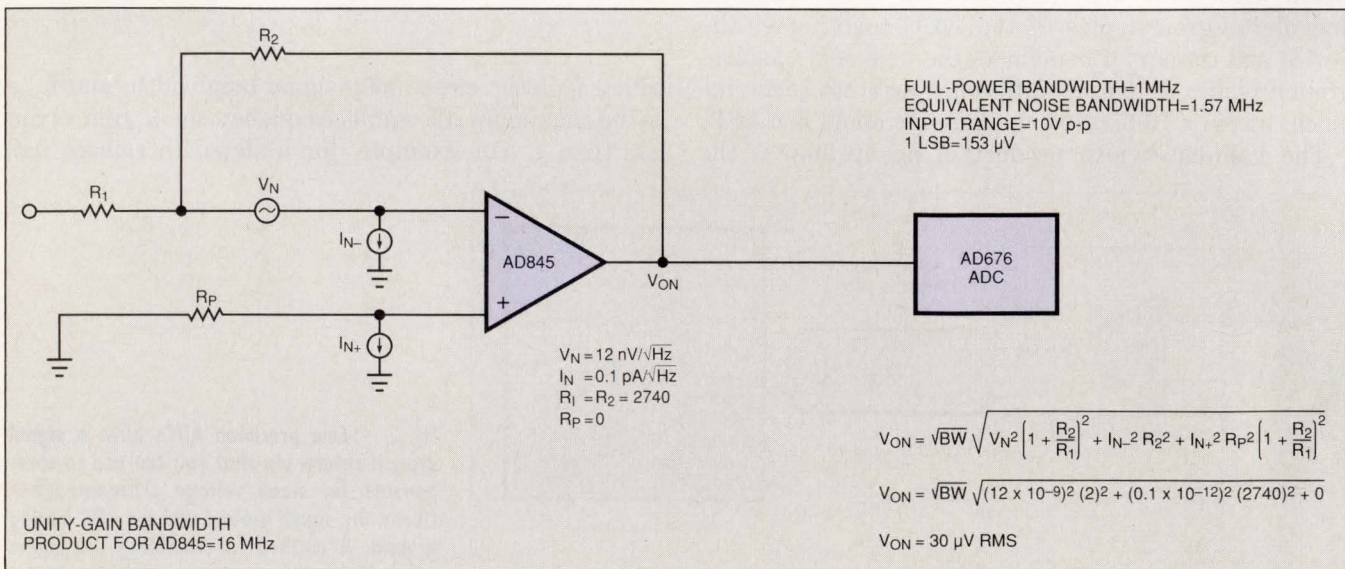

Fig 3—This noise model illustrates the importance of keeping the op amp's rms noise at the ADC's input less than the ADC's theoretical rms quantization noise. The total rms noise output of the AD845 over the 1-MHz ADC input bandwidth is 30 μV ; the ADC's theoretical 16-bit quantization noise is 44 μV .

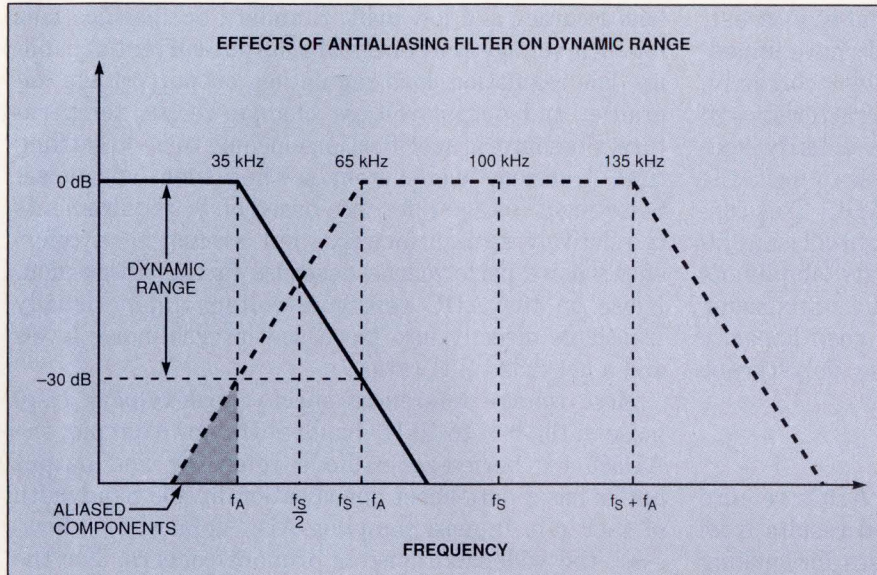

Fig 4—Many sampling-ADC applications require an antialiasing filter to eliminate unwanted signals. In this illustration, the signal has a maximum full-scale frequency content of $f_A = 35$ kHz; the ADC samples the signal at a rate of $f_s = 100$ ksamples/sec. The aliased components limit the system's dynamic range.

Most sampling ADCs have input bandwidths that exceed the Nyquist bandwidth, which is half the sampling rate. If the op amp directly drives the ADC, the ADC's front-end bandwidth becomes the integration bandwidth for the op amp's output-voltage-noise spectral density (assuming that the op amp's closed-loop bandwidth exceeds that of the ADC). The rms noise voltage you calculated for the ADC's input bandwidth must fall within the ADC's Nyquist bandwidth because the circuit aliases noise components greater than half the sampling rate.

Armed with this information and the previous equation for V_{ON} , you can calculate the equivalent rms voltage noise the op amp generates at the ADC input. Be sure to multiply the input bandwidth of the ADC, which data sheets usually list as the full-power bandwidth, by the correction factor of 1.57 to get the approximate integration bandwidth.

A good rule of thumb is to keep the op amp's rms noise at the ADC's input less than the theoretical rms quantization noise of the ADC. This quantization noise is $q/\sqrt{12}$, where q is the weight of the LSB. Fig 3 shows the AD845 precision low-noise op amp driving the AD676 16-bit, 100-ksample/sec ADC. The op amp's noise characteristics are $V_N = 12$ nV/ $\sqrt{\text{Hz}}$ and $I_{N+} = I_{N-} = 0.1$ pA/ $\sqrt{\text{Hz}}$. The ADC has a full-power bandwidth of 1 MHz. The total rms noise output of the AD845 over the 1-MHz ADC input bandwidth is 30 μV rms. The op amp's theoretical 16-bit quantization noise (10V full-scale range) is 44 μV rms. Fig 3 includes these calculations.

The drive amplifier is only the first peripheral circuit you'll have to contend with. Many sampling-ADC applications also require an antialiasing filter to eliminate unwanted signals. To specify the antialiasing filter

properly, you need to know the signal's spectral characteristics and the system's dynamic-range requirements. Consider the case of a signal that has a maximum full-scale frequency content of $f_A = 35$ kHz, sampled at $f_s = 100$ ksamples/sec. Assume the signal has the spectrum Fig 4 shows and that the circuit attenuates the signal by 30 dB at 65 kHz ($f_s - f_A$). Assume also that this attenuation is a natural part of the signal's spectral characteristic and is not due to any additional filtering. Observe that the aliased components limit the system's dynamic range to 30 dB at 35 kHz.

If the application requires additional dynamic range, you'll need an antialiasing filter to provide more attenuation at 65 kHz. If you want a dynamic range of 74 dB (12 bits) at 35 kHz, then the antialiasing filter's attenuation must go from 0 dB at 35 kHz to 44 dB at 65 kHz. This 44-dB attenuation over slightly less than one octave requires an 8-pole filter. Each filter pole provides approximately 6 dB of attenuation per octave. In addition to determining the filter's amplitude response, you must also determine the phase response before actually designing the filter.

Also consider the possibility that broadband noise may be present with the signal and alias within the bandwidth of interest. This possibility is especially strong for wideband op amps that have low distortion.

For lower-frequency antialiasing filters (200 kHz and less), active filters are an attractive alternative to traditional passive filters. The final stage of the active filter should be able to drive the ADC at the appropriate signal level and at acceptable noise and distortion levels. Remember that the output-noise spectral density of the final stage must be integrated over the entire front-end ADC bandwidth. In most cases, the ADC bandwidth is considerably greater

SAMPLING A/D CONVERTERS

than that of the highest-frequency signal of interest.

Higher-frequency passive filters usually have impedances of 50 to 100 Ω . To place these filters correctly, you must fully understand the input characteristics of the ADC. If the input of the ADC has a fairly high impedance and low capacitance, it's better to place the antialiasing filter directly ahead of the ADC. This configuration is advantageous because the antialiasing filter will limit the bandwidth of the drive amplifier's output noise. The type of capacitor the antialiasing filter uses is also important. To ensure good linearity and minimum dielectric absorption, use polystyrene or polypropylene capacitors.

ADC reference-voltage circuits

Most precision, monolithic, sampling ADCs require an external voltage reference. This need results from the fact that the IC fabrication processes for making precision sampling converters cannot usually create on-chip precision voltage-reference circuits. The reference voltage establishes the full-scale range of the ADC; the overall dc accuracy and stability of the ADC can be no better than that of the reference. Standard monolithic reference-voltage values are 2.5, 5, and 10V. Precision converters usually require either 5 or 10V. Converters that do have an internal reference voltage may let you supply an external reference for better accuracy.

Voltage-reference circuits are available as ICs that incorporate laser-trimmed, thin-film resistors for excel-

lent accuracy and low drift. Standard dc specifications for such voltage references are output-current capability, line regulation, load regulation, output-voltage tolerance, and output-voltage change versus temperature. Standard ac specifications include turn-on settling time, transient load-current settling time, and noise. Selecting a voltage reference based on dc requirements is relatively straightforward, but evaluating a reference's noise performance deserves further discussion. Noise on the ADC reference-voltage input usually translates directly into increased internal-noise levels and a degraded S/N ratio.

Most voltage references specify peak-to-peak (p-p) noise in the 0.1- to 10-Hz bandwidth. For example, the AD586 5V buried-zener-diode reference and output buffer has a data-sheet specification in this bandwidth of 4 μ V p-p. In most sampling-ADC applications, however, the wideband noise is of more concern. For the AD586, the unfiltered noise in a 1-MHz bandwidth is approximately 200 μ V p-p, which corresponds to $200/6 = 33$ μ V rms. This value is usually larger for bandgap voltage references such as the REF-02, which has 800- μ V p-p noise. Regardless of the type of reference you choose, proper external filtering can virtually eliminate the wideband noise.

Some voltage references, such as the AD586, have a noise-reduction pin. Connecting an external capacitor between this pin and ground forms a single-pole low-pass filter that has an internal 4000 Ω resistor. For

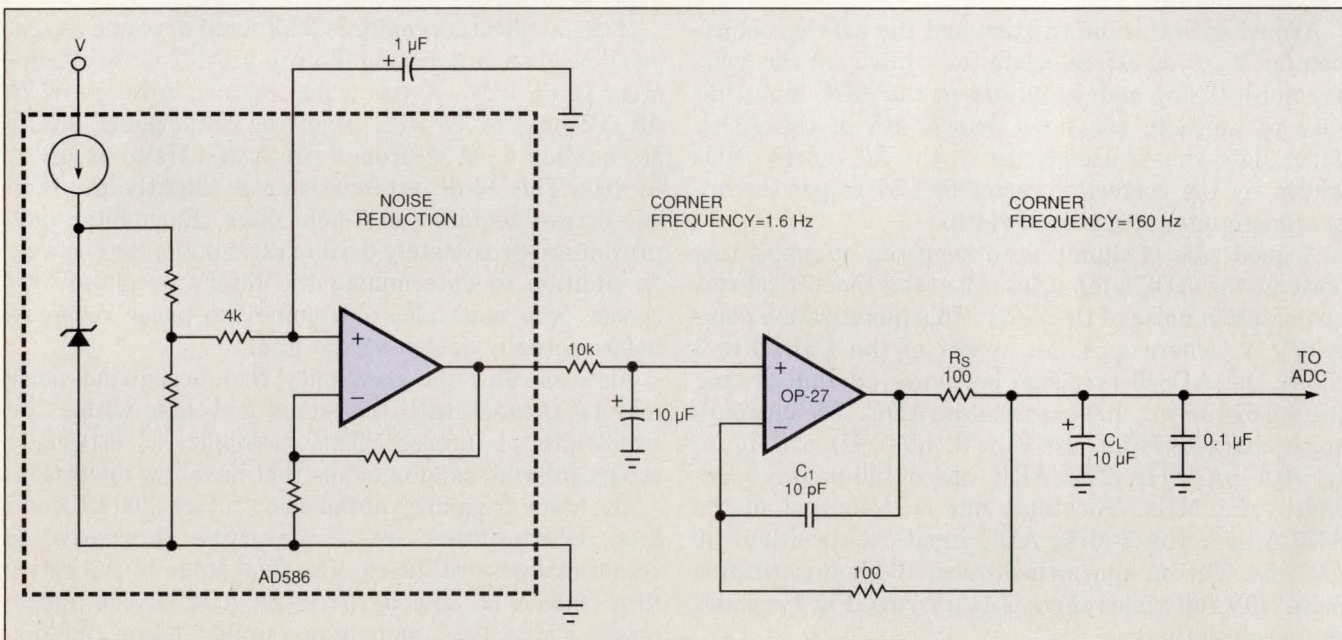

Fig 5—This near-ideal ADC voltage reference uses a 10-k Ω resistor and a 10- μ F capacitor to form a lowpass filter at the output of the AD586 reference. The filter's 1.6-Hz corner frequency reduces the noise to approximately 4 μ V p-p in the 0.1- to 10-Hz band. The low-noise OP-27 buffer amplifier uses a resistor R_S and capacitor C_1 to form a lowpass filter having a corner frequency of approximately 160 Hz. The combined filtering reduces the circuit's output voltage noise to a negligible value.

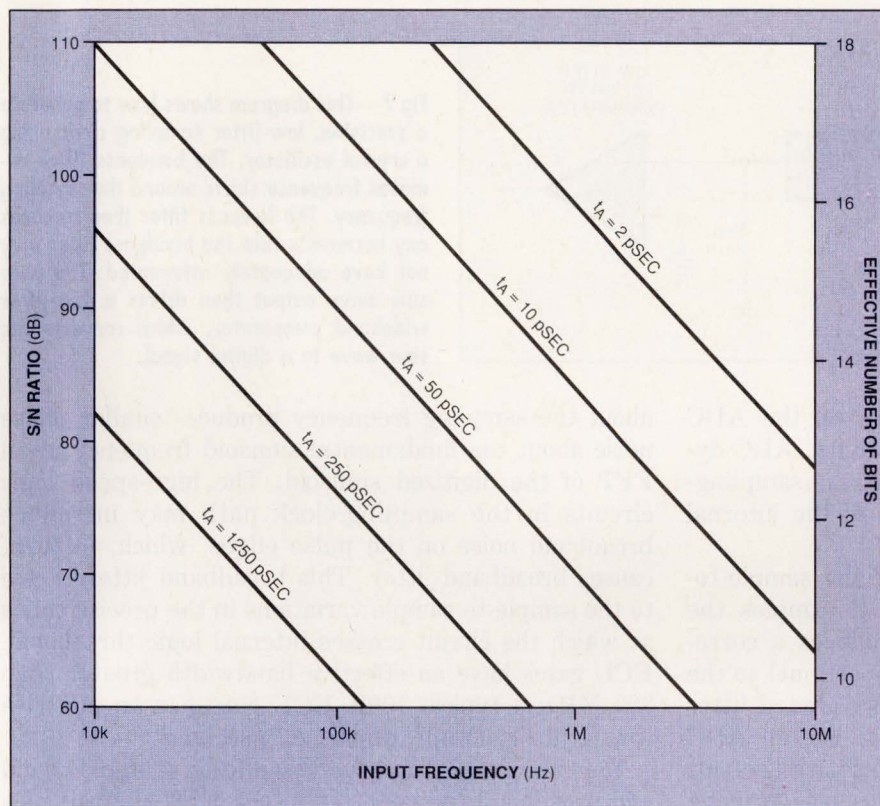

Fig 6—This plot of S/N ratio and the effective number of bits as a function of the full-scale-input frequency shows the effects of aperture jitter (t_A). For example, to achieve a 16-bit S/N ratio (98 dB) with a 50-kHz input sine wave, the aperture jitter can be no more than 40 psec.

example, an external 1- μF capacitor produces a single-pole corner frequency of approximately 40 Hz. This filter virtually eliminates the broadband noise from the buried zener diode, but the output buffer amplifier, which has a bandwidth of about 1 MHz, still produces approximately 160- μV p-p noise.

If the application requires still lower noise, you might think that adding a large capacitor (say, 10 μF) on the reference output would reduce the noise even further. However, this addition is not usually a good idea for two reasons. First, the op amp has a closed-loop output impedance of only a few ohms at low frequencies. The additional large capacitor does little to reduce this impedance. Second, loading the output of the internal op amp with a large capacitor may cause the op amp to become unstable and oscillate or ring under transient load conditions.

In precision applications, try using a filter such as the one in Fig 5 regardless of the type of voltage reference. The 10-k Ω resistor and the 10- μF capacitor form a single-pole passive filter that has a corner frequency of 1.6 Hz. This filter reduces the noise to approximately the value the ADC data sheet specifies for the 0.1- to 10-Hz frequency band. (The value is 4 μV p-p for the AD586.) Following this passive filter is a precision low-noise (3-nV/ $\sqrt{\text{Hz}}$) buffer amplifier such as the OP-27. The large load capacitor ($C_L = 10 \mu\text{F}$) serves two purposes. First, it forms a lowpass

filter with R_S to create a corner frequency of about 160 Hz. This filtering reduces the op amp's output-voltage noise to a negligible value. Second, the filter provides additional reference-voltage stability by acting as a charge reservoir to any transient load current.

The 10- μF capacitor is a heavy load on any op amp. The capacitor requires R_S and C_1 to compensate for the pole C_L introduces and the op amp's output resistance. This compensation scheme ensures that the buffer circuit recovers and settles from the output transient quickly and without the long settling tails that might produce conversion errors. The 0.1- μF capacitor in parallel with C_L keeps the output impedance low at high frequencies, where the 10- μF electrolytic capacitor becomes less effective. You can use the output-filtering circuit in Fig 5 with any voltage reference to eliminate the effects of wideband noise.

In applications that don't require voltage-reference-noise filtering, you can eliminate the decoupling capacitors on the ADC's voltage-reference input terminal. You rid the system of these capacitors by buffering the voltage-reference output with a precision low-noise high-bandwidth amplifier that has a sufficient transient-load settling time, such as the AD845. This approach minimizes the need for additional components but slightly sacrifices dc precision and noise.

Many designers who use precision sampling ADCs fail to understand the critical nature of the sampling-

SAMPLING A/D CONVERTERS

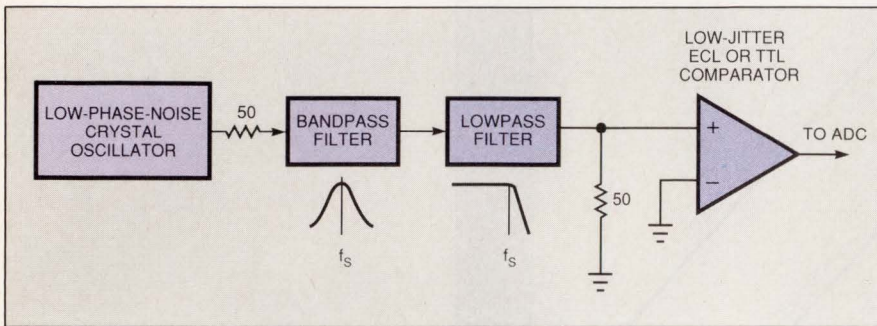

Fig 7—This diagram shows how to generate a precision, low-jitter sampling clock using a crystal oscillator. The bandpass filter removes frequency skirts around the sampling frequency. The lowpass filter then removes any harmonics that the bandpass filter may not have adequately attenuated. The pure sine-wave output then drives a low-jitter wideband comparator, which converts the sine wave to a digital signal.

clock signal. They tend to focus more on the ADC aperture-jitter specification when, in reality, ADC dynamic errors due to noise and jitter on the sampling-clock input may far exceed those due to the internal ADC aperture jitter.

Aperture jitter is the rms value of the sample-to-sample variation in the time the ADC samples the input signal. This rms time jitter produces a corresponding rms voltage error that is proportional to the slew rate of the ADC's input signal. Broadband jitter degrades the ADC's overall S/N ratio. For an ADC with infinite resolution, you can approximate the rms S/N ratio the broadband aperture jitter causes by using the formula

$$S/N \text{ ratio} = 20 \log_{10} \left(\frac{1}{2\pi f t_A} \right),$$

where t_A is the broadband aperture jitter (regardless of the source), and f is the full-scale input sine-wave frequency.

Aperture jitter for an ADC is usually attributed to the S/H amplifier. Unfortunately, the ADC aperture jitter is not the only possible source of error. In a practical ADC, unwanted external sources often modulate the phase or amplitude of the sampling clock. These sources can be wideband random noise, oscillator phase noise, power-line noise, or digital noise due to poor layout, bypassing, or grounding techniques. Consequently, phase jitter on the input sine wave can produce the same effect as jitter on the sampling clock.

Fig 6 shows the effects of even small amounts of timing jitter. The graph plots the S/N ratio and the effective number of bits as a function of the full-scale-input sine-wave frequency for various amounts of rms timing jitter. For example, to achieve a 16-bit S/N ratio (98 dB) using a 50-kHz full-scale-input sine wave, the rms aperture jitter can be no more than 40 psec.

The total rms timing jitter generally consists of narrowband and broadband frequency components. The sampling-clock oscillator will usually produce narrowband phase noise. Narrowband phase noise centered

about the sampling frequency produces similar phase noise about the fundamental sinusoid frequency in an FFT of the digitized sinusoid. The high-speed logic circuits in the sampling-clock path may introduce broadband noise on the pulse edges, which, in turn, causes broadband jitter. This broadband jitter is due to the sample-to-sample variations in the precise times at which the circuit crosses internal logic thresholds. ECL gates have an effective bandwidth greater than 300 MHz; a typical 100K ECL gate has an effective timing jitter of approximately 7 psec rms.

You can directly observe the effects of narrowband and broadband timing jitter in the FFT analysis of a sinusoid. Narrowband phase noise shows up as a widening of the main lobe of the fundamental sinusoid; the broadband jitter causes an overall increase in the noise floor.

The sampling clock must have low phase noise, which completely rules out the use of RC and relaxation oscillators. A crystal oscillator is a better choice. However, don't construct the crystal oscillator using logic gates, capacitors, and resistors. Instead, build the oscillator around discrete bipolar and FET devices recommended by the crystal manufacturer. Filter the output of the crystal oscillator as **Fig 7** shows. The bandpass filter following the crystal oscillator removes frequency skirts around the sampling frequency (f_s). The lowpass filter then removes any sampling-clock harmonics that the bandpass filter may not have adequately attenuated. The resulting pure sine-wave output then drives a low-jitter wideband comparator, which converts the sine wave to a digital signal. Use a TTL comparator such as the AD9696 if the ADC requires TTL inputs, and an ECL comparator such as the AD96685 if the ADC requires ECL inputs.

To the maximum extent possible, you should isolate the sampling-clock circuits from the digital portions of the system. For optimal results, you may need separate, decoupled power supplies. It is vital that you don't let the digital outputs of the ADC couple into the sampling-clock signal. Coupling will cause an increase in the harmonic distortion of the ADC by letting

WE'VE LOWERED
THE COST
OF HIGH
PERFORMANCE
FOR FRAMEMAKER.



THE PERSONAL
DECSTATION
STARTS AT \$3995.

Today's applications like FrameMaker® demand the balanced performance of a complete workstation and only the Personal DECstation™ gives it to you at such an affordable price.

Many of the features other low-priced workstations offer, such as an open bus, 8-plane graphics and color, are add-ons. With the Personal DECstation, they're standard. And it's built for the future with new CPU and graphics cards, multimedia

DIGITAL'S SPEED AND FLEXIBILITY ARE PERFECT FOR FRAMEMAKER.

FrameMaker and Digital combine to provide a complete document publishing system for creating business and technical documents. FrameMaker incorporates full-featured WYSIWYG word processing, graphics, page layout, tables, conditional text, equations editing, and structured document tools into a single, easy-to-use application.

FrameMaker supports the Motif® windowing environment and takes advantage of the innovative tools available with Digital, such as Display PostScript®. In addition, FrameMaker supports Digital's multimedia capabilities and allows you to seamlessly incorporate audio and video into your FrameMaker document. FrameMaker on the Digital platform is the complete solution for your document publishing needs.

For a trial version of FrameMaker, please call 1-800-U4-FRAME, EXT. 145.

technology, network interconnects and upgrades.

The Personal DECstation from Digital. The power of a workstation. The productivity of a workstation. The price of a PC.

digital™

© Digital Equipment Corporation 1991. The DIGITAL logo, DECsystem, DECstation, DECwindows and ULTRIX are trademarks of Digital Equipment Corporation. UNIX is a registered trademark of UNIX Systems Laboratories, Inc. in the USA and other countries. FRAME is a trademark and FrameMaker is a registered trademark of Frame Technology Corporation. Motif is a registered trademark of Open Software Foundation, Inc. PostScript is a registered trademark of Adobe Systems, Inc.

DIGITAL. THE OPEN ADVANTAGE.

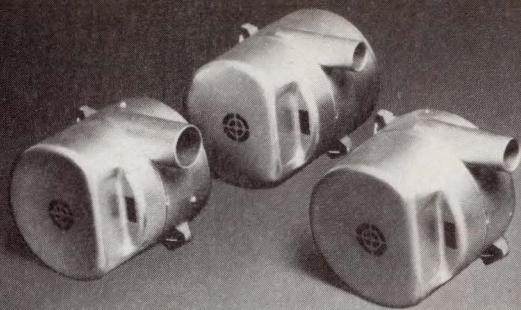

Compact motorized blowers provide high vacuum and pressure

Windjammer® centrifugal blowers, only 5.7" in diameter provide performance from 75" H₂O vacuum at 0 flow to 125 CFM at 0" H₂O. Designed for business machines, medical equipment and materials handling systems. Drive options include brushless DC motors with or without an integral controller, featuring manual or remote speed control. AMETEK, Technical Motor Division, 627 Lake Street, Kent, OH 44240.

Tel: 216-673-3452. Fax: 216-678-8227. In Europe, Friedrichstrasse 24, D6200 Wiesbaden, Germany. Tel: 0611-370031. Fax: 0611-370033.

AMETEK
TECHNICAL MOTOR DIVISION

CIRCLE NO. 53

Raltron manufactures its compact VC 7025 Voltage Controlled Crystal Oscillator to meet your Phase Locked Loop specifications, delivering deviation sensitivity or pullability of up to ± 100 PPM/V. Big performance in a small package. At a price you've been looking for.



VCXO WITH PULLABILITY

Raltron manufactures a complete line of the highest quality VCXO's to both standard and custom specifications. Send us your VCXO specifications today or call (305) 593-6033 for more information.

Raltron Electronics Corp.

2315 NW 107th Avenue,
Miami, Florida 33172 U.S.A.
FAX (305) 594-3973
TELEX 441588 RALSEN
(305) 593-6033

Telecommunications:

If you're into it, listen to this!

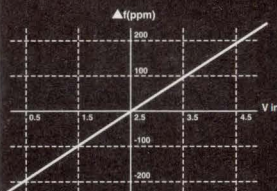

• Crystals • Crystal Oscillators
• Crystal Filters • Ceramic Resonators

RALTRON

Only Raltron has it all.

CIRCLE NO. 54

SAMPLING A/D CONVERTERS

signal-dependent digital transients get into the sampling clock. Conversely, because the sampling clock is itself a digital signal, it has the potential for causing noise in the analog portion of the system. Therefore, you should isolate the sampling clock from both the analog and digital portions of the system. **EDN**

References

1. Fredrickson, Thomas M, *Intuitive Operational Amplifiers*, McGraw-Hill Inc, New York, NY, 1988.
2. Gray, Paul R and Robert C Meyer, *Analysis and Design of Analog Integrated Circuits*, Second Edition, John Wiley & Sons Inc, New York, NY, 1984.
3. Jung, Walter G, *IC Op-Amp Cookbook*, Third Edition, SAMS (Division of Macmillan Publishing Co Inc), New York, NY, 1986.
4. *The Best of Analog Dialogue, 1967 to 1991*, Analog Devices Inc, Norwood, MA.
5. *High Speed Design Seminar*, Analog Devices Inc, Norwood, MA, 1990.
6. *Mixed Signal Design Seminar*, Analog Devices Inc, Norwood, MA, 1991.
7. Buxton, Joe, "Careful Design Tames High-Speed Op Amps," *Electronic Design*, April 11, 1991, pg 81.
8. Strassberg, Dan, "Avoid overspecifying antialiasing filters," *EDN*, July 18, 1991, pg 76.

Author's biography

Walt Kester is a corporate staff applications engineer with Analog Devices and has been with the company for 23 years. His principal responsibility is applications support for linear and converter products. A member of IEEE, Walt has a BSEE from North Carolina State University (Raleigh, NC) and a MSEE from Duke University (Durham, NC). In his leisure time, Walt enjoys travel and carpentry.

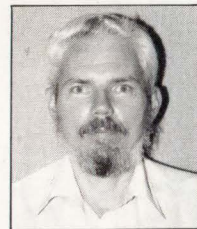

Article Interest Quotient (Circle One)

High 479 Medium 480 Low 481

What's Coming Up In EDN

Look for Part 3 of this series, "A designer's guide to A/D converters," in an upcoming issue of EDN Magazine. In Part 3, the author examines the problems of interfacing the ADC to the rest of the system and addresses the critical issues of grounding, layout, and filtering.

Series FPD



5 Watt Module, 20-56V Input



10 Watt Module, 20-56V Input



10 Watt Module, 36-72V Input



50 and 100 Watt Module

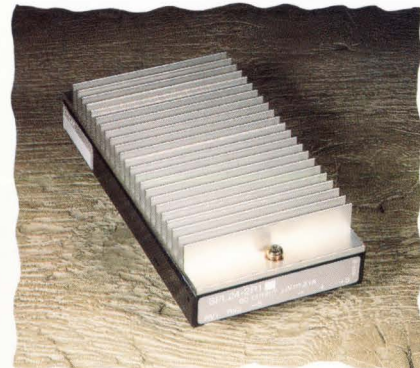

100 Watt Module shown with optional finned radiator

FPD INPUT CHARACTERISTICS

RANGE			
12V	9-18V	48V "W"	20-56V
24V	20-30V	48-60V	36-72V
48V	40-56V	150V	110-165V
EFFICIENCY			
VOLTS	POWER	EFFICIENCY	FREQUENCY
12	50W	78%typ	300KHz
24	50W	81%typ	450KHz
24	100W	80%typ	450KHz
48	50W	80%typ	550KHz
48	100W	80%typ	550KHz
48 "W" Wide-range input (20-56)	5W	75% at 24V 71% at 48V	700KHz
	10W	80% at 24V 76% at 48V	700KHz
60 "W" Wide-range input (36-72)	10W	80% at 5V	100KHz min
	10W	83% at 12, 15V	100KHz min
150	50W	80%typ	500KHz
150	100W	80%typ	500KHz

FPD OUTPUT CHARACTERISTICS

SPECIFICATION	TYP.	MAX.	CONDITION
Source effect	1%	2%	(min-max)
Load effect	1%	2%	(10%-100%)
Temperature effect	1%	2%	(0-71°C)
Combined effect	3%	6%	source, load, temp
Time effect	0.1%	0.2%	0.5-8hrs, 25°C

10 WATT (36-72V) INPUT MODELS

SINGLE OUTPUT

Source effect	0.05%	0.2%	(min-max)
Load effect	0.05%	0.2%	(10%-100%)
Temperature effect	0.3%	1.5%	(0-71°C)
Combined effect	0.4%	1.9%	source, load, temp
Time effect	0.1%	0.1%	0.5-8hrs, 25°C

DUAL OUTPUT

Combined effect	(± 12V) 10.8-13.2	(± 15V) 13.5-16.5
-----------------	-------------------	-------------------

RIPPLE

Volts	Switching Frequency mV p-p			Spike mV p-p	Output Volts	Switching Frequency mV p-p*
	5W	10W	50-100W			
5V	100	200	150	250	5V	70
12V	200	200	200	300	12V&15V	100
15V	200	200	200	300	± 12V & ± 15V	300
24V	300	300	200	400		

*5Hz to 20mHz



Flatpack d-c to d-c Converters from Kepco.

5W • 10W • 50W • 100W

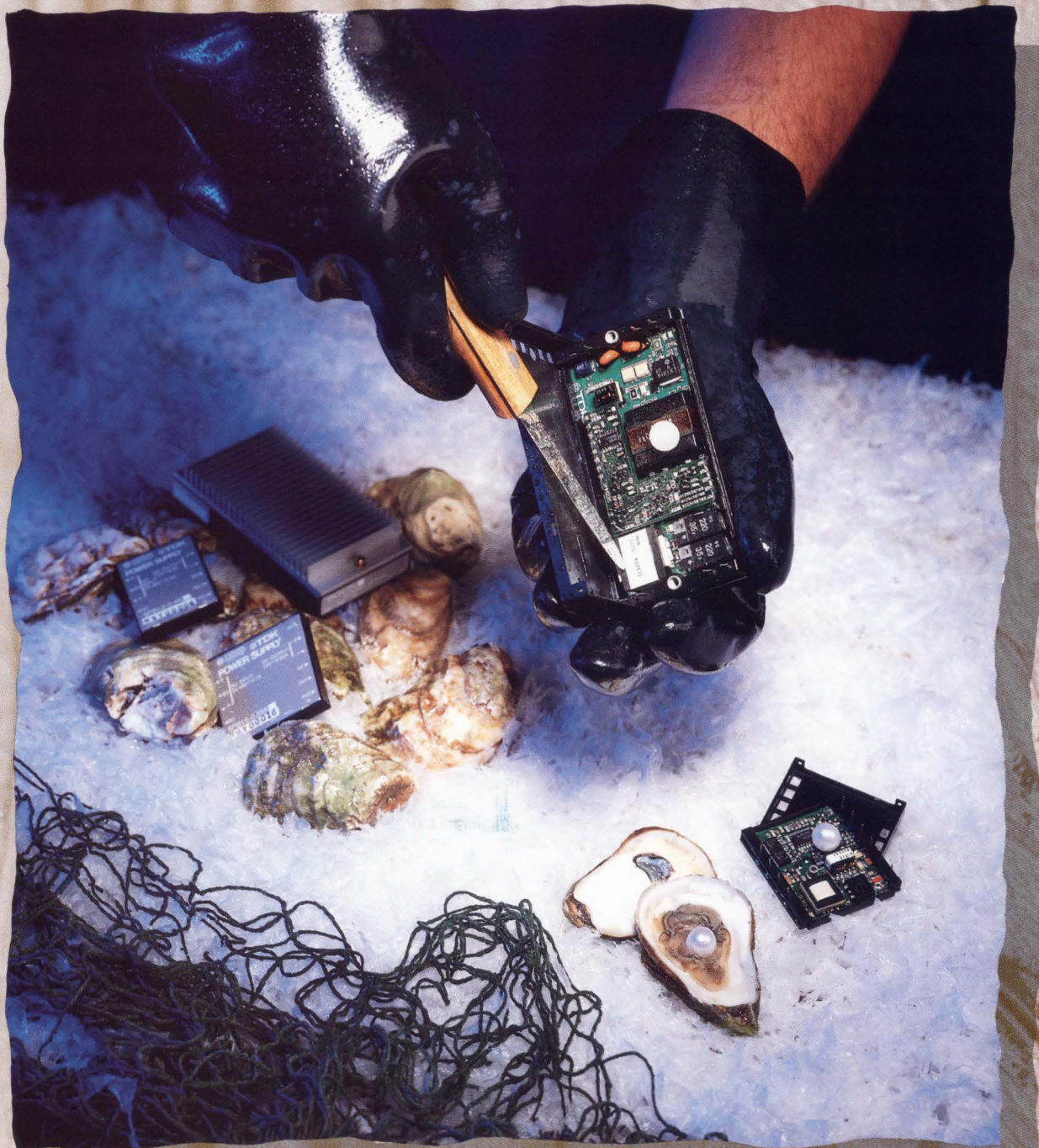

INPUT: 12V • 24V • 48V • 60V • 150V

Flatpack d-c to d-c Converters from Kepco.

You may not find a pearl in every one, you *will* find an aluminum base plate/PCB stuffed with surface-mount devices... even a surface-mount transformer, a 500KHz fixed-frequency forward converter (not resonant mode) and beautiful, surface mount construction.

TEAR ON DOTTED LINE TO REMOVE AND SAVE.

FPD MODEL TABLE

SPECIFICATION	OUTPUT VOLTS	OVP SETTING VOLTS	OUTPUT CURRENT AMPS	OVER CURRENT SETTING (2)	NOMINAL INPUT VOLTS
5 WATT MODELS⁽¹⁾, 20-56 VOLT INPUT					
FPD 5-1-48W	5	5.5- 6.9	1.0	1.20-2.0 FB	24-48
FPD 12-0.4-48W	12	13.2-15.7	0.4	0.48-0.8 FB	24-48
FPD 15-0.35-48W	15	16.5-19.0	0.35	0.42-0.7 FB	24-48
FPD 24-0.2-48W	24	26.4-31.5	0.2	0.24-0.4 FB	24-48
10 WATT MODELS⁽¹⁾, 20-56 VOLT INPUT					
FPD 5-2-48W	5	5.5- 6.9	2.0	2.4-4.0 FB	24-48
FPD 12-0.8-48W	12	13.2-15.7	0.8	1.0-1.6 FB	24.48
FPD 15-0.65-48W	15	16.5-19.0	0.65	0.8-1.3 FB	24-48
FPD 24-0.4-48W	24	26.4-31.5	0.4	0.5-0.8 FB	24-48
10 WATT MODELS⁽¹⁾, 36-72 VOLT INPUT					
SINGLE OUTPUT					
FPD 5-2-60W	5	5.4-7.0	2.0	3.0-5.2 SQ	48-60
FPD 12-0.8-60W	12	12.6-16.0	0.8	1.5-2.5 SQ	48-60
FPD 15-0.65-60W	15	15.75-19.0	0.65	1.25-2.4 SQ	48-60
DUAL OUTPUT					
FPD 2X12-60W	+12, -12	± 13.2-18.0	± 0.4	1.2-2.5 SQ	48-60
FPD 2X15-60W	+15, -15	± 16.5-21.0	± 0.32	1.1-2.4 SQ	48-60
50 WATT MODELS					
FPD 5-10-12	5	5.5- 6.9	10.0	10.3-13.5A SQ	12
FPD 12-4.2-12	12	13.2-15.7	4.2	4.3- 5.7A SQ	12
FPD 15-3.4-12	15	17.0-19.0	3.4	3.5- 4.5A SQ	12
FPD 24-2.1-12	24	27.0-30.5	2.1	2.2- 2.9A SQ	12
50 WATT MODELS					
FPD 5-10-24	5	5.5- 6.9	10.0	10.3-13.5A SQ	24
FPD 12-4.2-24	12	13.7-15.7	4.2	4.3- 5.7A SQ	24
FPD 15-3.4-24	15	17.0-19.0	3.4	3.5- 4.5A SQ	24
FPD 24-2.1-24	24	27.0-30.5	2.1	2.2- 2.9A SQ	24
50 WATT MODELS					
FPD 5-10-48	5	5.5- 6.9	10.0	10.3-13.5A SQ	48
FPD 12-4.2-48	12	13.7-15.7	4.2	4.3- 5.7A SQ	48
FPD 15-3.4-48	15	17.0-19.0	3.4	3.5- 4.5A SQ	48
FPD 24-2.1-48	24	27.0-30.5	2.1	2.2- 2.9A SQ	48
50 WATT MODELS					
FPD 5-10-150	5	5.5- 6.9	10.0	10.3-13.5A SQ	150
FPD 12-4.2-150	12	13.7-15.7	4.2	4.3- 5.7A SQ	150
FPD 15-3.4-150	15	17.0-19.0	3.4	3.5- 4.5A SQ	150
FPD 24-2.1-150	24	27.0-30.5	2.1	2.2- 2.9A SQ	150
100 WATT MODELS					
FPD 5-20-24	5	5.5- 6.9	20.0	20.6-27A SQ	24
FPD 12-8.3-24	12	13.7-15.7	8.3	8.5-11.2A SQ	24
FPD 15-6.6-24	15	17.0-19.0	6.6	6.8- 8.9A SQ	24
FPD 24-4.2-24	24	27.0-30.5	4.2	4.3- 5.7A SQ	24
100 WATT MODELS					
FPD 5-20-48	5	5.5- 6.9	20.0	20.6-27A SQ	48
FPD 12-8.3-48	12	13.7-15.7	8.3	8.5-11.2A SQ	48
FPD 15-6.6-48	15	17.0-19.0	6.6	6.8- 8.9A SQ	48
FPD 24-4.2-48	24	27.0-30.5	4.2	4.3- 5.7A SQ	48
100 WATT MODELS					
FPD 5-20-150	5	5.5- 6.9	20.0	20.6-27A SQ	150
FPD 12-8.3-150	12	13.7-15.7	8.3	8.5-11.2A SQ	150
FPD 15-6.6-150	15	17.0-19.0	6.6	6.8- 8.9A SQ	150
FPD 24-4.2-150	24	27.0-30.5	4.2	4.3- 5.7A SQ	150

(1) W = wide range input

(2) FB = fold back/winker type current limit, SQ = square-type current limit

SEE KEPKO SERIES KFD FOR 150 WATT HIGH DENSITY dc-dc CONVERTERS

Data subject to change without notice.
© 1992 KEPKO, Inc. Litho in USA

Flatpack d-c to d-c Converters from Kepco.

FPD GENERAL SPECIFICATIONS

SPECIFICATION	CONDITION	RATING/DESCRIPTION
Temperature	Operating	0-71°C (full power to 50°C)
	Storage	- 40 to + 75°C
	Baseplate	85°C, 100% load 95°C, 80% load (Overtemperature protection built-in) Finned radiators available for 50W and 100W
	5W and 10W	No finned radiator required 0-50°C, 100% load 60°C, 70% load 71°C, 40% load
Shock	50g, 3 axes	
Vibration	5g, 10-55Hz	
Isolation	Input-Output	100M Ω, 500V at 25°C, 65% RH
	Input Ground	100M Ω, 500V at 25°C, 65% RH
Humidity		5%-95% RH (non-condensing)
Enclosure	Plastic UL 94V-0 with aluminum base	

DIMENSIONS

5W inches — 2 x 1.57 x 0.3
(20-56V): mm — 50.8 x 39.8 x 8.5

10W inches — 2 x 2 x 0.3
(20-56V): mm — 50.8 x 50.8 x 8.5

10W inches — 1.6 x 2 x 0.50
(36-72V): mm — 40.6 x 50.8 x 12.7

50W inches — 2.28 x 4.53 x 0.52
(12, 24, 48, 150V): mm — 58 x 115 x 13.2

100W inches — 2.28 x 4.53 x 0.52
(24, 48V): mm — 58 x 115 x 13.2

100W inches — 2.28 x 5.12 x 0.52
(150V): mm — 58 x 130 x 13.2

NET WEIGHT

5W (20-56V): 1.0 oz, 30 gm

10W (20-56V): 1.4 oz, 40 gm

10W (36-72V): 1.6 oz, 45 gm

50W (12, 24, 48, 150V): 5.3 oz, 150 gm

100W (24, 48, 150V): 5.3 oz, 150 gm

OUTLINE DIMENSIONAL DRAWINGS

All dimensions are in millimeters. Tolerances: 0.03" (0.7 mm) unless otherwise noted.

**5 WATT
20-56V INPUT MODELS**

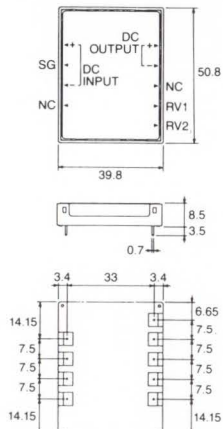

**10 WATT
20-56V INPUT MODELS**

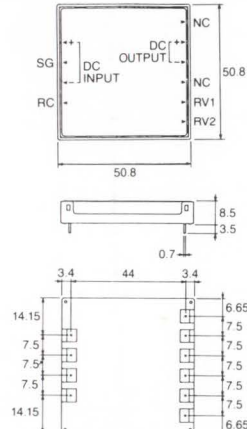

**10 WATT
36-72V INPUT MODELS**

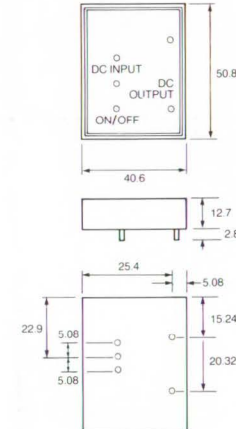

**50 WATT
12V, 24V, 48V, 150V
INPUT MODELS**

**100 WATT
24V, 48V, 150V INPUT MODELS**

MODEL	A	B
50W 12, 24, 48V	115	104
100W 24, 48V	115	104
50W 150V	115	104
100W 150V	130	119

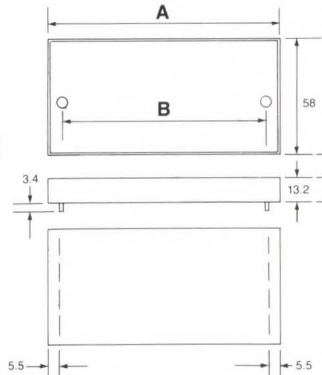

FINNED RADIATOR

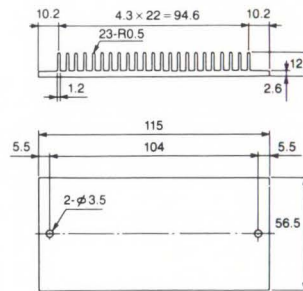

FIN 50:
for 50 and 100W models
with 12, 24 and 48V input

FIN 100:
130mm long
for 100W models
with 150V input





Looking for monumental embedded solutions? Let our SPARClite family lead the way.

Chip by chip, we've built a highly advanced family of processors which enables designers of embedded systems to scale greater heights than ever before.

The SPARClite™ family of RISC processors from Fujitsu Microelectronics gives you a wide range of bright solutions. From an inexpensive entry point into the world of SPARC® embedded computing, all the way up to clock speeds of 40 MHz. Providing 40 MIPs peak and 37 MIPs sustained performance. And soon, even higher speeds will be available.

Our SPARClite family of solutions can easily be designed into your embedded applications. Giving your designs much greater performance at very competitive prices. And to get you to market more

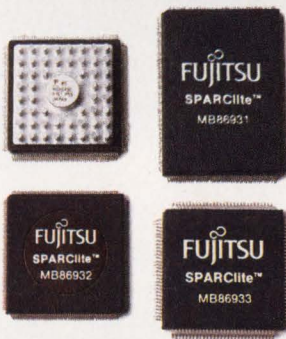

FUJITSU

Delivering the Creative Advantage.

quickly, they're complemented by a full range of multi-platform support tools. Like real-time operating systems, compilers, in-circuit emulators and evaluation boards. From the leading names in development systems.

What's more, as your computing needs grow, so does our SPARClite family. In fact, by the end of this year, two new SPARClite products will be added, bringing the family to four. Each and every one software compatible with the industry standard SPARC high-performance RISC architecture.

So call us at 1-800-642-7616. And discover our family of SPARClite processors. Built to lead the way—now and for the future.

FUJITSU MICROELECTRONICS, INC. 3545 N. First Street, San Jose, CA 95134-1804. Ph: 408-456-1161 Fax: 408-943-9293.
 FUJITSU MICROELECTRONICS ASIA PTE LTD. (Head Office, Singapore) Ph: 65-336-1600 Fax: 65-336-1609. HONG KONG SALES OFC Ph: 852-723-0393 Fax: 852-721-6555.
 TAIPEI SALES OFC Ph: 886-2-757-6548 Fax: 886-2-757-6571. JAPAN SALES OFC Ph: 81-3-3216-3211 Fax: 81-3-3216-9771. KML CORP. (Rep. Korea) Ph: 82-2-588-2011 Fax: 82-2-588-2017.
 PACIFIC MICROELECTRONICS, PTY. LTD. (Rep. Australia) Ph: 61-2-481-0065 Fax: 61-2-484-4460.
 FUJITSU MIKROELEKTRONIK GmbH (Dreieich-Buschlag, Germany) Ph: 06103-6900 Fax: 06103-690122.
 SPARClite is a trademark of SPARC International, Inc., licensed exclusively to Fujitsu Microelectronics, Inc. SPARC is a registered trademark of SPARC International, Inc. © 1992 Fujitsu Microelectronics, Inc.

You don't always get what you pay for.



With PTS synthesizers, you get more.

Because we're synthesizer specialists, we give you *more for your money* in more ways than one.

From our economy PTS x10, to our space-saving PTS 310, to our top-of-the-line PTS 1000, we have *more models* to cover your source needs from 100 KHz to 1 GHz.

And more options, including:

- OCXO, TCXO or external standard,
- choice of resolution from 100 KHz to 0.1 Hz,
- DDS with phase-continuous switching,
- digital phase rotation,
- BCD or GPIB remote control,

and almost a hundred others to let you specify a synthesizer so well-tailored to your requirements that it's like having one custom made for you.

Our priority in design and manufacturing is to make our synthesizers *more reliable*, and this has led to a demonstrated MTBF of 25,000 hours. That's why we can back them with our all-inclusive 2-year warranty, along with a flat-rate service charge for eight years following the warranty period.

But wait, there's less!

All of our synthesizers feature *low power consumption*, *low spurious output* (as low as -75 dBc), *low phase noise*, and *fast frequency switching* (as fast as 1 μ second).

And all of our models are available, at a lower price, in a remote-only OEM configuration for easy integration into your OEM system.

Our full catalog has all the information you need to specify the most synthesizer for your money.

Call or FAX us for your copy, or for immediate engineering assistance.



PTS

PROGRAMMED TEST SOURCES

P.O. Box 517 Littleton, MA 01460

508/486-3008 FAX 508/486-4495

Differential amplifier reduces parts count

Irwin Cohen, Hewlett-Packard, Waltham, MA

Whereas the most common differential amplifier has six resistors, the differential amplifier in Fig 1 has only four, suiting the circuit for designs that must have an absolutely minimal parts count.

In operation, IC₂ drives the noninverting input of IC₃ to a virtual ground. The closed-loop gain of the IC₂/IC₃ loop is less than -1, regardless of potentiometer R₂'s setting (use R₂ to null out common-mode signals from IC₁'s output). Ideally, R₂'s wiper will be ex-

actly in the center, feeding equal currents into the inverting inputs of IC₁ and IC₂ from the output of IC₃. The current flowing to IC₁'s inverting input cancels the common-mode signal at its noninverting input. Note that the inverting input of IC₁ is *not* at a virtual ground. EDN BBS /DL_SIG #1172 **EDN**

To Vote For This Design, Circle No. 748

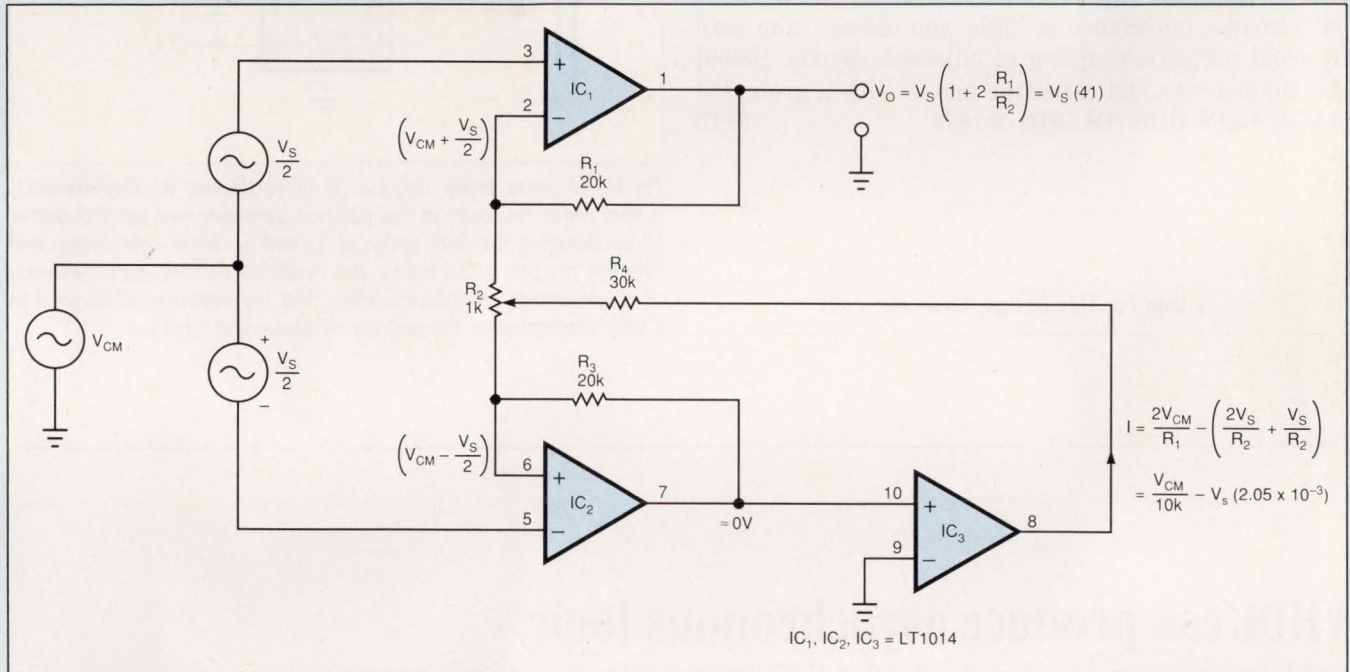

Fig 1—This differential amplifier uses two fewer resistors than a conventional design.

Dual timer senses position capacitively

Yishay Netzer, Yuvalim, Israel

Fig 1 shows a capacitive position sensor that is extremely flexible mechanically and requires only one IC and a few passive components. This sensor is appropriate for those applications that don't demand high accuracy. The sensing technique is based on a differential capacitor that you can shape to sense angular or rectilinear displacement. The technique uses a CMOS

dual timer for which the two timing capacitors are displacement dependent. Because a CMOS timer can use very large timing resistors, the timing capacitor can be quite small, and the plate dimensions can be only a few millimeters. The two capacitors share a common grounded plate, and their sum is essentially independent of the displacement.

The capacitance is given by $C = \epsilon_0 A/d$, where ϵ_0 is the air-dielectric constant, A is the effective plate area, and d is the separation. The amount of proportional or a reciprocal displacement determines the difference between the capacitors, depending on whether it is the gap area or gap separation that varies, respectively. In **Fig 1a**, the sum of the two effective areas is fixed. In **Fig 1b**, the sum of the plate separation is fixed.

The circuit in **Fig 1c** illustrates the fixed-area case. An external clock triggers the two timers, which generate two pulse trains with pulse durations of RC_1 and RC_2 . Subtracting and low-pass filtering the two pulse trains produces a dc output. This output will be proportional to $A_1 - A_2$. If you were to change the figure so that d varies, the output will depend on $d_1 - d_2$. Because the circuit's impedance is high, you should take care to avoid parasitic coupling of adjacent signals. Shield the components and capacitor plates with a grounded shield. EDN BBS /DL_SIG #1074

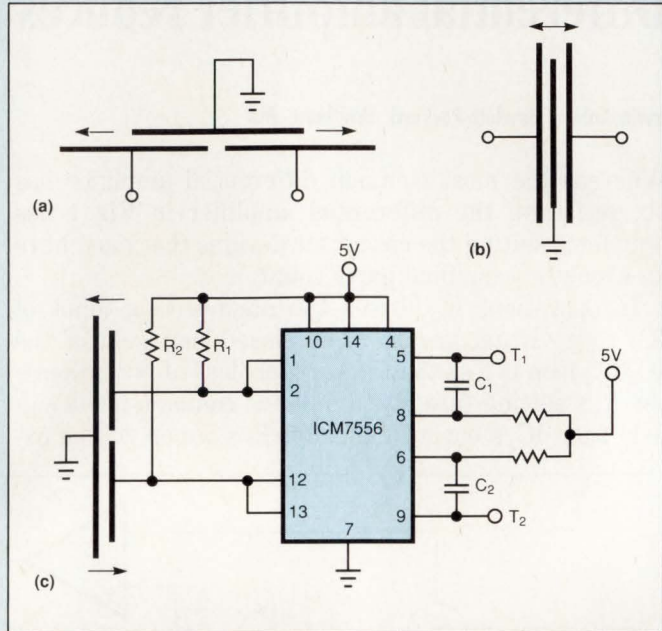

Fig 1—To sense either angular (a) or rectilinear (b) displacement, a dual timer responds to the position between two parallel plates (c) by changing the duty cycles of T_1 and T_2 . After subtracting and filtering the two pulse trains, the resultant dc level indicates area or displacement differences. (Note that the capacitor illustrated in c only demonstrates the angular-displacement case.)

To Vote For This Design, Circle No. 749

VHDL can produce asynchronous logic

Steve Carlson, Synopsys Inc, Mountain View, CA

Logic synthesizers that accept VHDL (VHSIC hardware-description language) presuppose that designs are mostly synchronous. You can, however, synthesize asynchronous logic if you accept a greater degree of responsibility for the correctness of your circuits.

One common way to produce asynchronous logic is to use gated clocks on latches or flip-flops. Although VHDL synthesizers support gated clocks, they cannot guarantee that the logic network generating the final clock signal is glitch free.

The listing shows a VHDL specification for a simple counter having an asynchronous reset. The counter also uses a gated clock. **Fig 1** shows the resulting counter. This counter will work if you make sure the proper timing relationships exist between the asyn-

Listing 1—VHDL counter

```
entity COUNT is
  port(RESET, ENABLE, CLK: BIT;
        Z: buffer INTEGER range 0 to 7);
end;

architecture ARCH of COUNT is
  signal GATED_CLK: BIT;
begin
  GATED_CLK <= CLK and ENABLE;

  process(RESET, ENABLE, GATED_CLK, Z)
  begin
    if(RESET = '1') then
      Z <= 0;
    elsif(GATED_CLK'event and GATED_CLK = '1') then
      if(Z = 7) then
        Z <= 0;
      else
        Z <= Z + 1;
      end if;
    end if;
  end process;
end;
```

RF TRANSFORMERS

Over 80 off-the-shelf models...

3KHz-1500MHz from \$1⁹⁵

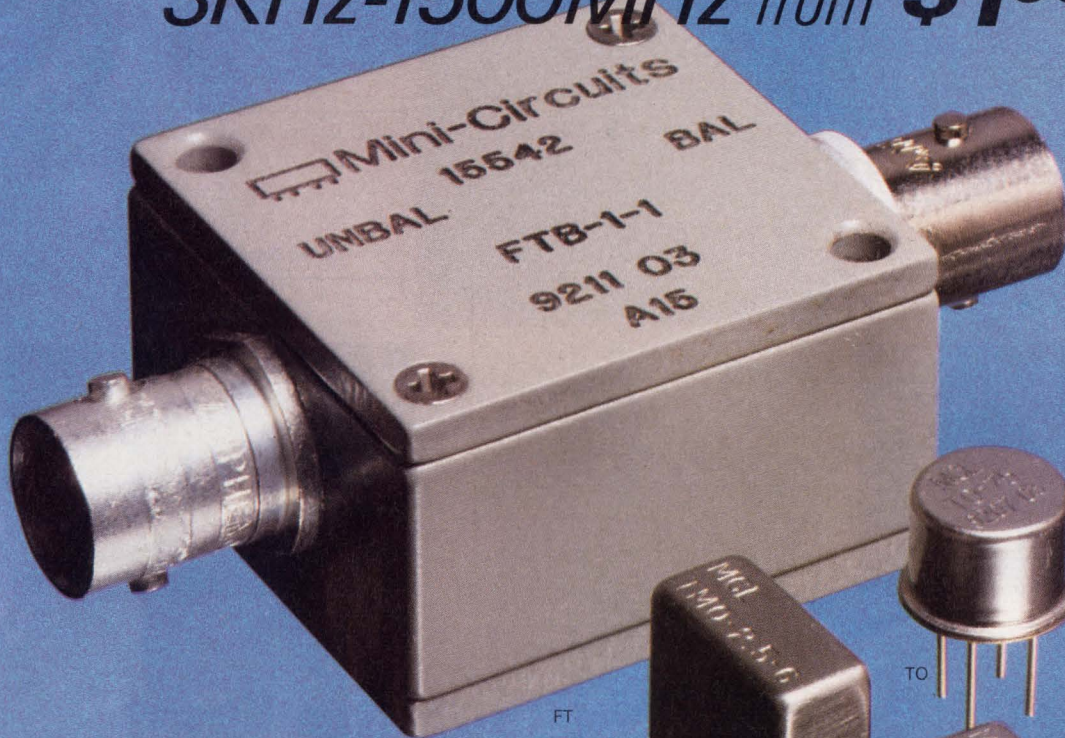

Having difficulty locating RF or pulse transformers with low droop, fast risetime or a particular impedance ratio over a specified frequency range?...Mini-Circuits offers a solution.

Choose impedance ratios from 1:1 to 36:1, in connector, TO-, flatpack, surface-mount, or pin versions (plastic or metal case built to meet MIL-T-21038 and MIL-T-55831 requirements*). Coaxial connector models are offered with 50 and 75 ohm impedance; BNC standard, other types on request.

Ultra-wideband response achieves low droop and fast risetime for pulse applications. Ratings up to 1000M ohms insulation resistance and up to 1000V dielectric voltage. For wide dynamic range applications involving up to 100mA primary current, use the T-H series. Fully detailed data appear in our 740-pg RF/IF Designer's Handbook.

Need units in a hurry?...all models are covered by our exclusive one-week shipment guarantee. Only from Mini-Circuits.

*units are not QPL listed.

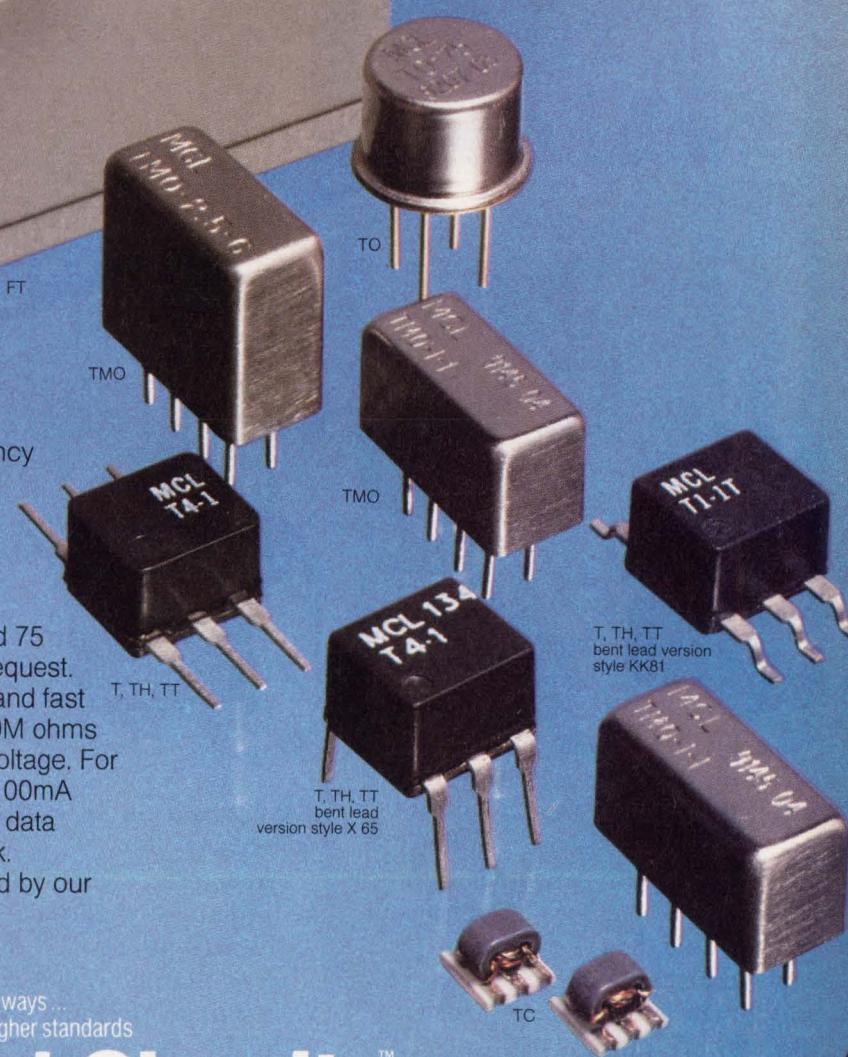

finding new ways...
setting higher standards

Mini-Circuits™

P.O. Box 350166, Brooklyn, New York 11235-0003 (718) 934-4500 Fax (718) 332-4661

Distribution Centers / NORTH AMERICA 800-654-7949 • 417-335-5935 Fax 417-335-5945 EUROPE 44-252-835094 Fax 44-252-837010

For detailed specs on all Mini-Circuits products refer to • THOMAS REGISTER Vol. 23 • MICROWAVES PRODUCT DIRECTORY • EEM • MINI-CIRCUITS' 740-pg HANDBOOK.

CIRCLE NO. 57

F 71 REV. D

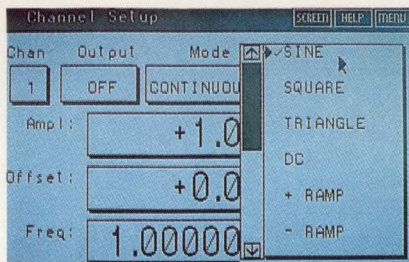

Standard Functions

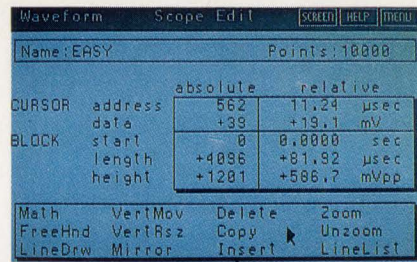

User-Defined Waveform

Summed Channels

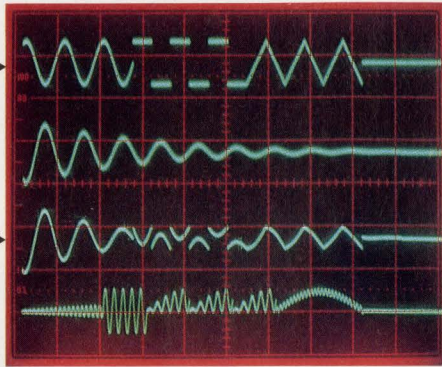

Linked Waveforms

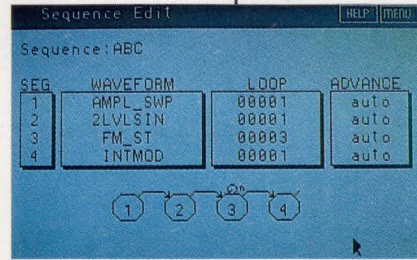
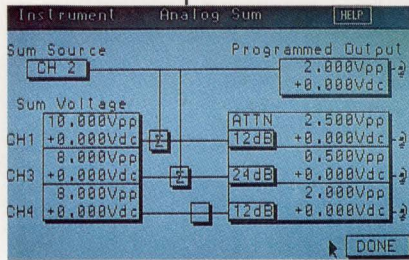

Just A Sample Of What The First 50 MHz Four-Channel Arb Can Do.

You're looking at the most versatile Arbitrary Waveform Generator you can buy. Speed, resolution and a choice of 1 to 4 synthesized channels mean that Wavetek's new Model 295 can take the place of multiple instruments in a wide variety of applications.

Model 295 is easy to use, too. For example, a handy mouse lets you quickly create waveforms on an oscilloscope. You can use the convenient front panel keyboard to enter math expressions or recall stored waveforms. A sophisticated graphic interface provides window-like pull-down menus with easy-to-follow steps to make waveform



creation and editing easier than ever before.

Waveforms created remotely can be loaded into the Model 295 via GPIB. An optional 3.5" disk drive allows unlimited waveform storage. Waveform looping and linking, along with inter-channel triggering, summing, and phase control, give you still more flexibility.

Each channel can operate like a

separate Arb with 50 MHz sampling frequency, exceptional 2 ppm accuracy, and 12 bit vertical resolution. In addition, channels can be synchronized.

It comes to this: Model 295 combines leading-edge performance with traditional Wavetek value and reliability to meet all your Arb requirements.

Call today for Model 295 product information.

(800) 223-9885

Europe: U.K. (603) 404824,
Germany (089) 9609490

Asia Pacific: Hong Kong (852) 86519402
©1992 Wavetek Corporation.

WAVETEK

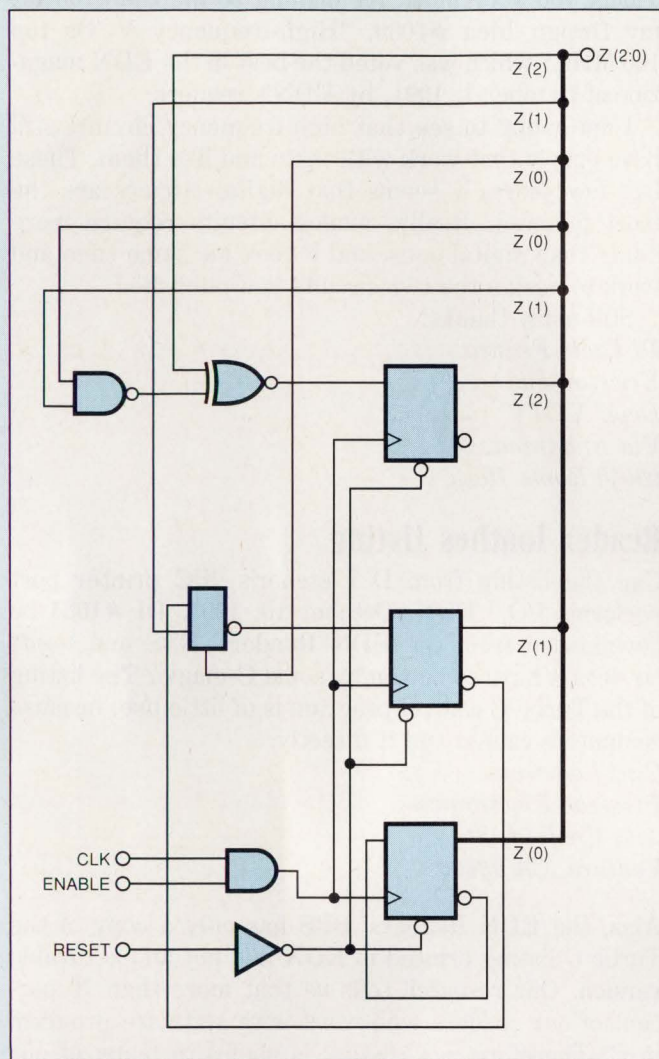

Fig 1—This counter, synthesized from the VHDL specification in Listing 1, has a gated clock and an asynchronous reset. These asynchronous elements are permissible under VHDL (which is normally synchronous), but VHDL puts the onus on you to ensure proper timing.

chronous control lines (ENABLE and RESET) and the clock (CLK). You must also ensure that both the clock and asynchronous control lines are glitch free.
EDN BBS /DL_SIG #1173 **EDN**

To Vote For This Design, Circle No. 750

LOOKING FOR A QUALITY BOARDHOUSE?

ALL YOUR CIRCUIT BOARD NEEDS UNDER ONE ROOF

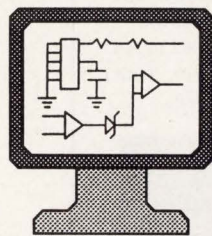

PCB MANUFACTURING

- 2 Day turn on multi-layers
- Prototype and production
- Gerber Data Review
- Database/Netlist test

PCB LAYOUTS

- Backplanes
- Impedance control
- Analog and ECL
- SMT both sides

TECHNICAL ASSISTANCE

- PCB layout tips
- Mfg cost cutting tips
- Artwork standards
- Gerber Data via modem, 24 hours (714) 970-5015

CALL FOR A QUOTE!

A MANUFACTURING, LAYOUT AND SUPPORT CENTER



MURRIETTA
CIRCUITS

4761 E. HUNTER AVE. ANAHEIM, CA. 92807
 TEL: (714) 970-2430 FAX: (714) 970-2406

CIRCLE NO. 60

POWER SUPPLY DESIGN TIPS

DISTRIBUTED POWER

- Use DC/DC Modules Locally
- Eliminate Bussing of Low Voltages
 - N + 1 Redundancy Increases Reliability
 - Hot Pluggability Maximizes Uptime

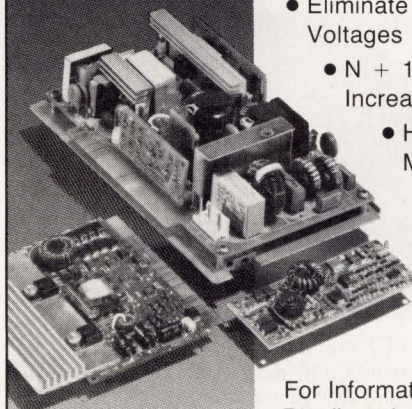

For Information on Standard Distributed and Custom Switching Power Supplies

CALL

1-407-831-2000



MicroENERGY INC

745 W. State Road 434 • Longwood, FL 32750-4909

PHONE: (407) 831-2000 • FAX (407) 831-1100

CIRCLE NO. 61

NEW PRODUCTS FOR NEW TIMES

We upgraded our full line of OCXOs, TCXOs & VCXOs to meet the requirements for improved accuracy, smaller packages, lower power, faster warm-up and lower prices.



TF 65037 brings 2×10^{-8} stability (-100 to +60°C) to under US \$ 100 oscillators. Mini package: 27x35x16 mm.



TF69100. Instant-on 0.3 ppm stability (-100 to +60°C) in a subminiature package: 20x20x10 mm.



TF68666 VHF oscillator, 100-200 MHz ECL output. Combines hi-stability (± 35 ppm/ -100 to +60°C) with wide (± 150 ppm) adjustment range, in a low profile DIP.

To learn more on how our new products can help you meet the challenge of new times, call TFL Marketing
TEL. +972-3-5574107 FAX. +972-3-5574114.



Time & Frequency Ltd.

P.O. Box 1792 Holon 58117, Israel

CIRCLE NO. 62

EDN-DESIGN IDEAS

Feedback & Amplification

Author is surprised at interest in high-frequency idea

Thank you very much for mailing to me the \$100 for my Design Idea #1030, "High-frequency VCOs top 100 MHz," which was voted the best in the EDN magazine of October 1, 1991, by EDN's readers.

I am happy to see that high-frequency circuits still have people that work with them and like them. These last few years, it seems that digital circuits are the most followed. Really, analog circuits require more study than digital ones, and it took me some time and work to design the two circuits you published.

Still many thanks!

Di Paolo Franco

Ericsson-Fatme

Dept: XT/TT

Via Anagnina, 203

00040 Rome Italy

Reader loathes listing

Can the listing from D Fletcher's "PC printer port performs I/O," EDN, October 10, 1991, DI #1034 be downloaded from the EDN Readers' BBS and used? Or does it have to be run by some C-magic? The listing of the Turbo C control program is of little use, because computers cannot run it directly.

Carl Lodstrom

Pressebo Electronics

7261 Coolidge St

Ventura, CA 93003

Alas, the EDN Readers' BBS has only a copy of the Turbo C listing printed in EDN and not an executable version. Our research tells us that more than 70 percent of our readers who work with software program in C. Therefore, a C listing is useful to many of our readers. Surely you do not expect that every reader will be able to use every Design Idea we print? In the case of DI #1034, the listing is only an example program that does a simple digital loopback, not a full-fledged application program. You would have to write your own program for your own application anyway, necessitating a C compiler.

How to use our bulletin board



This icon identifies those Design Ideas that have computer-readable material posted on EDN's bulletin-board system (BBS). Call our free BBS at (617) 558-4241 (300/1200/2400/9600 8,N,1). Not every Design Idea has downloadable material, but each one does have a BBS number printed at the end of it. Once you get into the system, you can use that number to find more information on a particular idea. If you'd like to comment on any Design Idea, include the number in the subject field of your message.

Precision Frequency & Time Instruments

Superior performance and reliability at an affordable price. That's the basic philosophy at Stanford Research Systems, a worldwide leader in signal recovery instrumentation for scientific research.

SRS offers a full line of precision electronic test and measurement equipment targeted for both R&D and production applications. SRS products have the features you want, the accuracy you need, the quality you demand, and the low prices which make them truly exceptional values.

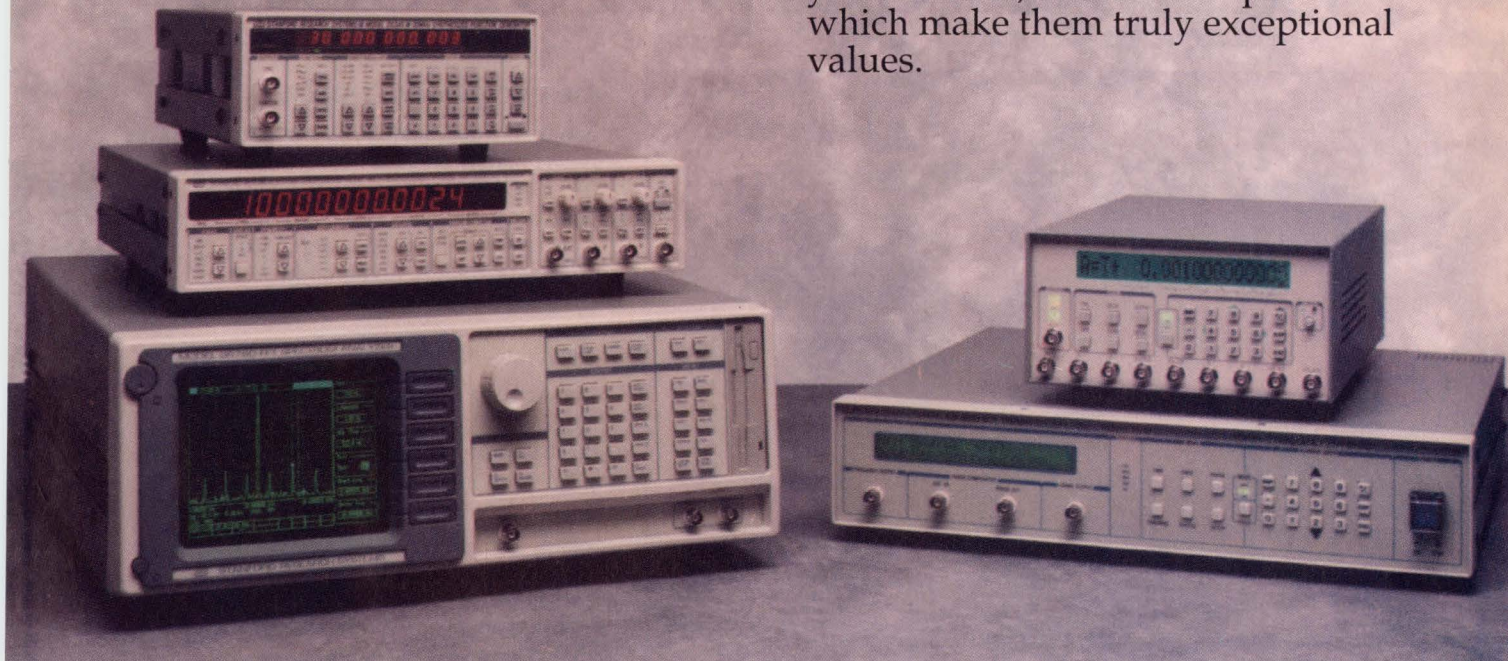

Synthesized Function Generators

- 3, 15 or 30 MHz range, all with 1 μ Hz resolution
- Sine, square, ramp, triangle, and arb waveforms
- Logarithmic / linear sweeps and modulation
- Optional GPIB, RS-232 interfaces

DS335 \$995

DS340 \$1595

DS345 \$2195

Time Interval / Frequency Counter

- 25 ps single shot resolution
- 1.3 GHz max. frequency, 11 digit resolution
- Statistics, Allan variance, histogram outputs
- GPIB, RS-232 and printer interfaces

SR620 \$4500

FFT Spectrum Analyzer

- 476 μ Hz to 100 kHz frequency range
- 90 dB dynamic range
- PSD, octave, THD, band, sideband analysis
- GPIB, RS-232, printer interfaces, 3.5" DOS drive

SR760 \$4750

Pulse / Digital Delay Generator

- 4 delay channels, delays to 1000 seconds
- 5 ps delay resolution with 50 ps rms jitter
- GPIB interface, internal or external timebases

DG535 \$3500

10 MHz Frequency Standard (LORAN-C)

- Cesium clock long term stability (10^{-12})
- Four 10 MHz outputs, adjustable TTL output
- Phase comparator with strip chart output
- GPIB interface, 8' antenna, 100' coax cable

FS700 \$4950



STANFORD RESEARCH SYSTEMS

1290 D Reamwood Ave., Sunnyvale, CA 94089, TEL: (408) 744-9040, FAX: 4087449049

Within budget. Without compromise.

In a dc power supply.

Now, put a dependable, 30-watt dc power supply on your bench for just **\$300***. You'll get the low noise your work demands (200 μ V rms). Constant-voltage or constant-current operation. And built-in reliability ensured by conservative design margins and rigorous environmental testing.

Outstanding value in a dc power supply. It's just one in a full line of basic instruments developed by HP to give you uncompromising performance at an affordable price.

 **To order, call HP DIRECT, 1-800-452-4844, † Ext. TB22.**

We'll ship your order the day it's received. Instruments come with a sixty-day, money-back guarantee.

All you need is a company purchase order or credit card.



HP 30-watt power supplies		E3610A	E3611A	E3612A
Output	Range 1	8V, 3A	20V, 1.50A	60V, 0.50A
	Range 2	15V, 2A	35V, 0.85A	120V, 0.25A
Load or line regulation	0.01% + 2 mV			
Ripple and noise (10 Hz-10 MHz)	200 μ V rms/2 mV p-p			

* U.S. list price.

† In Canada call 1-800-387-3867, Dept. 442.

There is a better way.

 **HEWLETT
PACKARD**



© 1992 Hewlett-Packard Co. TMNJ105/B/EDN

Integrated Circuits

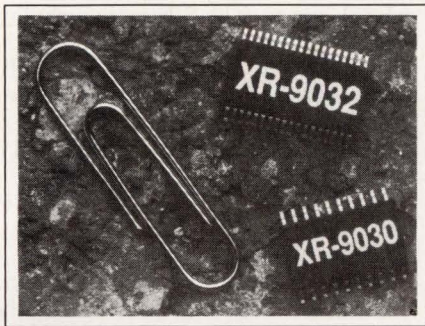

Read/write preamplifiers. The XR-9030 and XR-9032 are read/write preamplifiers for thin-film recording heads. The XR-9030 controls two or four channels, and the XR-9032 controls six or eight channels. Both devices dissipate less than 35 mW in idle mode and 145 mW in read mode. The read preamplifier has a 70-MHz bandwidth, a gain of 200V/V, and an equivalent input noise of $0.58 \text{ nV}/\sqrt{\text{Hz}}$. XR-9030, less than \$3; XR-9032, less than \$4. **Exar Corp**, Box 49007, San Jose, CA 95161. Phone (408) 434-6400. FAX (408) 943-8245.

Circle No. 351

Erasable PLDs. The fourth member of the MAX 7000 family of EPLDs contains 192 macrocells and 124 user I/O pins. The EPM7192 operates at clock rates greater than 70 MHz and has 3750 usable gates. The chip's Programmable Interconnect Array provides uniform signal delays between any two locations on the device. The 160-pin PGA package, \$198 (100). **Altera Corp**, 2610 Orchard Pkwy, San Jose, CA 95134. Phone (408) 894-7000.

Circle No. 352

Clock recovery chip. The AD802-155 recovers the clock and re-times 155.52-Mbps data in SONET/SDH (synchronous-optical-network)/(synchronous-digital-hierarchy) networks. A frequency/phase-locked loop tracks incoming data to produce 2.2° rms of clock jitter when there are data transitions at each clock period. The clock jitter is typically 3.3° rms when the input data is a $(2^{23} - 1)$ -bit pseudorandom code. \$56 (1000). **Analog Devices Inc**, 804 Woburn St, Wilmington, MA 01887. Phone (617) 937-2532. FAX (617) 937-2004.

Circle No. 353

PWM generators. Three pulse-width modulation (PWM) generators produce output frequencies as fast as 24 kHz. The MA818 is a 3-phase PWM generator, that uses an external ROM for waveform storage. The MA828-1 is

similar to the MA818 but includes waveform storage on chip. The MA838-1 is a single-phase PWM generator with waveform storage on chip. Two standard waveshapes include a sine wave and a sine wave plus third harmonic at one-sixth the fundamental amplitude. MA818, \$8.79; MA828-1, \$8.42; MA838-1, \$5.09 (1000). **GEC Plessey Semiconductors**, 1500 Green Hills Rd, Scotts Valley, CA 95067. Phone (408) 439-6077.

Circle No. 354

25-nsec, 1-Mbit PROMs. Three 1-Mbit PROMs, fabricated in the company's 0.8- μm BiFAMOS (BiCMOS Floating-Gate Avalanche MOS) process, achieve 25-nsec access times. The CY7B210 and CY7B201 are asynchronous PROMs having $64\text{k} \times 16$ -bit and $128\text{k} \times 8$ -bit organizations, respectively. The CYB211 is a registered PROM having a $64\text{k} \times 16$ -bit organization. The fast access times eliminate the need for a shadow RAM to keep pace with fast μP and DSP chips. CY7B210 in ceramic DIPs, \$68.50 (100). **Cypress Semiconductor**, 3901 N First St, San Jose, CA 95134. Phone (408) 943-2600.

Circle No. 355

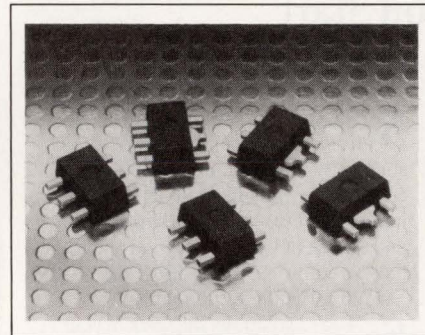

Step-up switching regulators. The S-8435XF and S-8436XF deliver 1.5, 3, or 5V outputs from a minimum input voltage of 0.9V. The voltage tolerance is $\pm 3\%$, and the maximum output current is 30 mA. The S-8435XF requires an external coil and capacitor, and the the S-8436XF has a provision for adding an external transistor for higher output current. \$1.03 (1000). Delivery, stock to 14 weeks ARO. **Seiko Instruments, Semiconductor Products Group**, 1150 Ringwood Ct, San Jose, CA 95131. Phone (408) 433-3208. FAX (408) 433-3201.

Circle No. 356

16-Mbit mask ROM. The LH5316501 16-Mbit mask ROM has a $1\text{M} \times 16$ -bit or $2\text{M} \times 8$ -bit organization. The single-word access time is 150 nsec. However

for successive read operations consisting of four 16-bit or eight 8-bit words, a page-mode feature provides 70-nsec access times. An internal address comparator provides fast sequential access times. \$13 (10,000). Delivery, six weeks ARO. **Sharp Electronics Corp**, 5700 NW Pacific Rim Blvd, MS20, Camas, WA 98607. Phone (800) 642-0261.

Circle No. 357

Quad comparator. The Bt684 quad comparator accepts +8V to -4V input voltages and provides a choice of CMOS, ECL, TTL, or custom-output logic levels. The chip tracks a 3V/nsec input rise time with a propagation delay of <300 psec. The input bias current is $<4 \mu\text{A}$. \$99. **Brooktree Corp**, 9950 Barnes Canyon Rd, San Diego, CA 92121. Phone (619) 452-7580. FAX (619) 452-1249.

Circle No. 358

Video scaling IC. The SAA7186 accepts real-time video data and scales the data to fit a randomly sized window. The IC accepts YUV 4:2:2 formatted data and converts the data to RGB format. The IC can resize 1023×1023 -pixel screens without changing the vertical refresh rate. \$40 (100). **Signetics Co**, Box 3409, Sunnyvale, CA 94088. Phone (408) 991-2000.

Circle No. 359

4-Mbit dynamic RAMs. The DM 22xx-series of 4-Mbit dynamic RAMs (DRAMs) consists of the $4\text{M} \times 1$ -bit DM 2200; the $1\text{M} \times 4$ -bit DM 2202; and the $1\text{M} \times 4$ -bit DM 2212 having write-per-bit capability. The DRAMs feature page-mode and static-column access. Each DRAM array has an on-chip static RAM row register. The DRAMs come in 15- and 20-nsec versions for cache access time and page-mode writes. 15-nsec version, \$21.78; 20-nsec version, \$18.67 (1000). **Ramtron International Corp**, 1850 Ramtron Dr, Colorado Springs, CO 80921. Phone (800) 545-3726; (719) 481-7000. FAX (719) 481-9170.

Circle No. 360

Switching regulator. The TK84819D switching regulator has a controlled power factor. It meets the IEC 555-2 power-line harmonic-distortion standard. The chip features ESD protection in excess of 2000V. Besides producing low power-line harmonics, the chip increases the maximum available power from an ac outlet by 50%. TK84819D (0 to 70°C) version, \$3.25; TK84819DA

EDN-NEW PRODUCTS

Integrated Circuits

(-40 to +85°C) version, \$3.90 (1000). **Toko America Inc**, 1510 Quail Lake Loop, Colorado Springs, CO 80906. Phone (719) 540-3800. FAX (719) 540-3970. **Circle No. 361**

12-bit hybrid A/D converter. The AD9007 ADC has a track and hold amplifier, a voltage reference, and timing circuitry. It operates at 10 Msamples/sec and accepts input signals in the

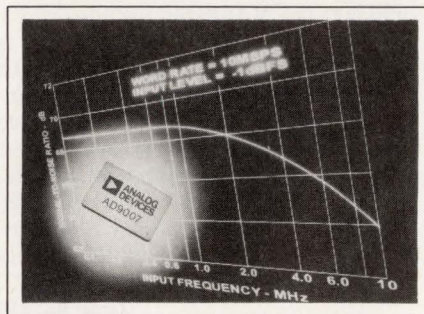

$\pm 1.25V$ range. The S/N ratio including harmonics is 65-dBc S/N ratio, and the total harmonic distortion is -75 dBc for a 4.3-MHz signal. \$420 (100). **Analog Devices Inc**, 181 Ballardvale St, Wilmington, MA 01887. Phone (617) 937-1428. FAX (617) 821-4273.

Circle No. 362

Media interface controller. The NCR85C266 chip is compatible with the ANSI FC-0 level standard for communicating on 62.5- μm cable at 133- and 266-Mbps rates. It consumes 800 mW of power when operating at 266 Mbps. The chip integrates both the transmitter and the receiver on a single chip. Its biphasic PLL performs serial-to-parallel data conversion and clock generation and recovery. \$35 (5000). **NCR Corp**, Microelectronic Products Div, 1700 S Patterson Blvd, Dayton, OH 45479. Phone (800) 334-5454; (303) 226-9550.

Circle No. 363

Cell-based arrays. The Hi-IQ family combines the fast design turnaround of gate arrays with the high density of standard cells. The family consists of five arrays ranging from 24,300 to 157,323 compute cells. The arrays feature as many as 284 signals I/O pins that are TTL/CMOS compatible. \$10 to \$300 (10,000). **Signetics Co**, Box 3409, Sunnyvale, CA 94088. Phone (408) 991-2000.

Circle No. 364

40-MHz Mbus chip set. The Sparkit-40/Mbus comprises a set of SPARC chips for building a 40-MHz SPARCstation 2-compatible color workstation. The chip set consists of seven units: the L64831 integrated integer and floating-point unit; the LM64815, a memory-management and cache controller; the L64850 dynamic-RAM controller; the L64851 Mbus-to-I/O port adapter; the L64852 Mbus-to-SBus adapter; the L64853 enhanced SBus DMA controller; and the L64855 SBus graphics controller. \$629 (100 kits/month). **LSI Logic Corp**, 1551 McCarthy Blvd, Milpitas, CA 95035. Phone (408) 433-7175.

Circle No. 365

i486 bus-to-ISA bus controller. The VL82C480 adapts the 32-bit i486 local bus to the ISA bus. It operates at 33 MHz, and when running with a 386DX μP , can operate at 40 MHz. The chip can access 64 Mbytes of system RAM in page mode and 2-way interleave con-

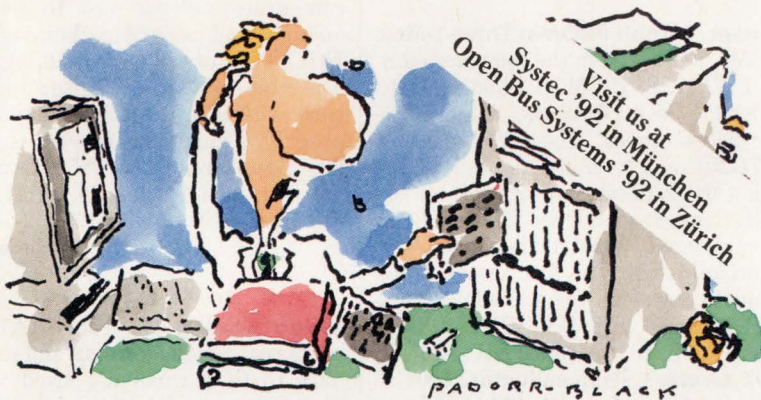

The Top 6 Reasons You Should Call MIZAR Before You Start Your Next Embedded Design.

- 1 You're smart. You want the solution that is best for your design.
- 2 You want to get your product to market as quickly as possible. Mizar's VMEbus solutions give you a proven hardware starting point to build on. And Mizar's variety of real-time software solutions enable you to get your system up and running in record time.
- 3 You want to minimize design risk for your product. With Mips-based R4000 or R3000 CPUs, SPARC on VME designs and a variety of 68K ('010 to '040, including '340) single board computers, Mizar can supply the technology that you need. Whatever processor you have chosen, Mizar has the solution.
- 4 You need maximum design flexibility. With Mizar's VME MXbus you can add custom I/O to a proven VME design and create a custom CPU card or a smart I/O card. Even if you need a custom product, Mizar has the solution.

- 5 You can get everything you need from Mizar including computer I/O such as SCSI, Ethernet or graphics controllers. And Mizar has all manner of industrial I/O as well, including digital and analog I/O, machine vision and motion control products. So if you need I/O, Mizar has the solution.
- 6 Mizar's solutions will work in your system to make you and your product star performers.

Whatever your reason, call Mizar today.



1-800-635-0200

MIZAR

Your Source for Solutions

2410 Luna Road
Carrollton, TX 75006
(214) 277-4600 (214) 277-4666 FAX

Mizar is a registered trademark of Mizar Digital Systems, Inc.
Other names are trademarks of their respective manufacturers. ©1992 Mizar Digital Systems, Inc.

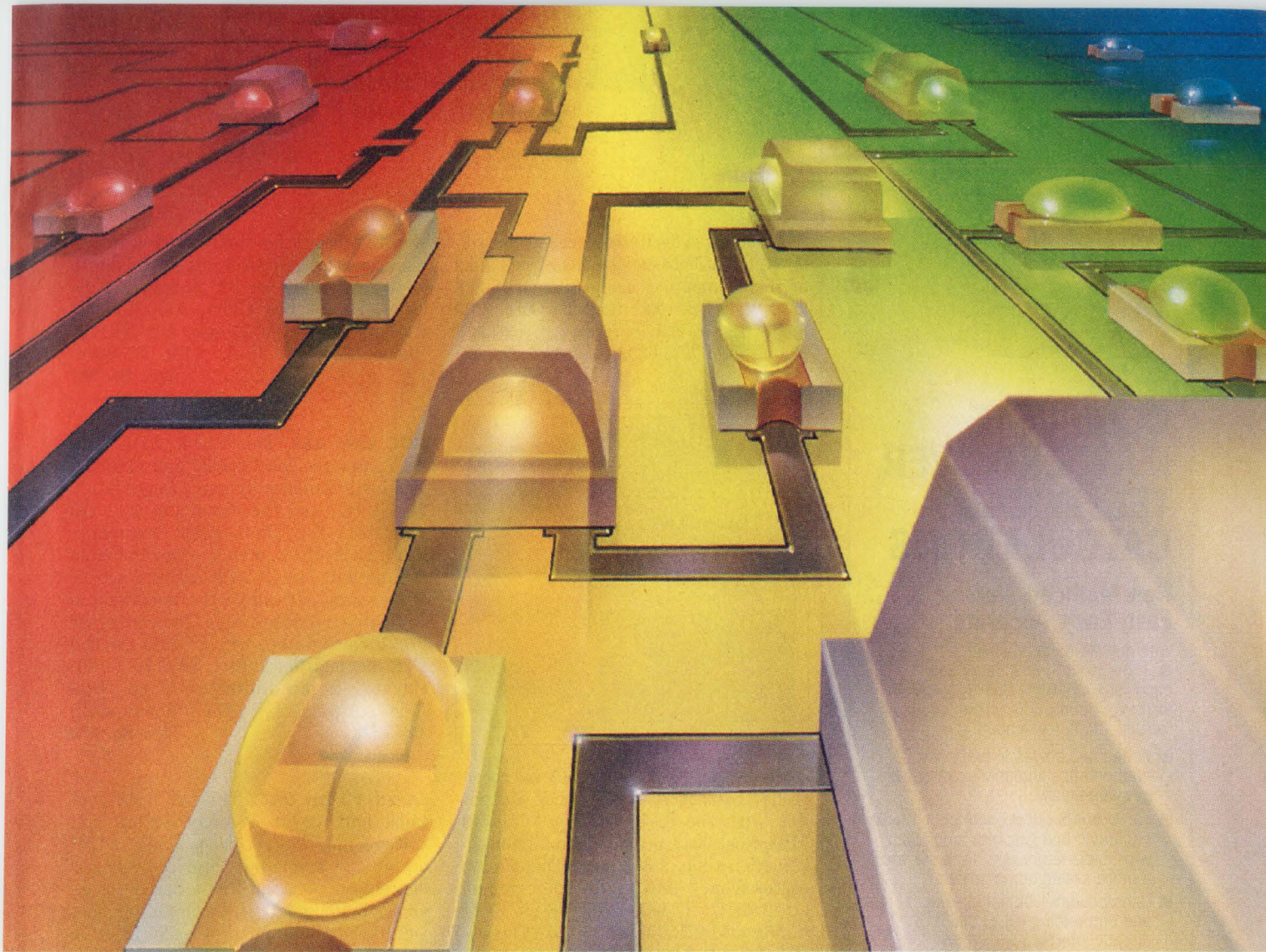

Dialight's microLED™ Series Covers Blue To Infrared.

Dialight's introduction of its microLED 597 Series brings to the market the most extensive line of surface mount LED components available from any source. The product line includes top view and right angle configurations and covers not only a broad spectrum of colors, from blue to infrared, but

We Went To Great Wavelengths To Cover The Full SMD LED Spectrum.

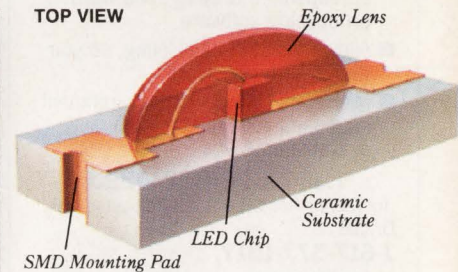

also offers excellent thermal conductivity characteristics. The microLED can be driven continuously at 75mA, or more than twice the current of other LEDs. The top view product, which is incredibly small, measures only 1.3 x 3.1 mm, making it the smallest LED commercially available, and features a 180° viewing angle.

For microLED literature and samples, contact: Dept. SMDM:

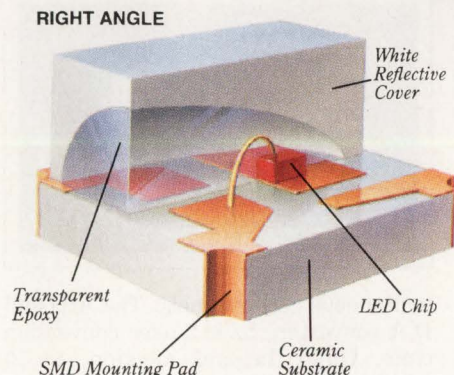

also includes photodetectors. To achieve the small size and high brightness, white ceramic was chosen as the base material. Not only does it provide excellent reflectivity, but it

ALL INDICATIONS ARE

DIALIGHT

Recipient, Motorola Supplier Award for Excellence

UNITED STATES
Tel: (908) 223-9400
Fax: (908) 223-8788

FRANCE
Tel: +33 1 64 30 55 55
Fax: +33 1 60 07 64 65

JAPAN
Tel: +03-3348-0611
Fax: +03-3348-0623

UNITED KINGDOM
Tel: +0638.665161
Fax: +0638.660718

EDN-NEW PRODUCTS

Integrated Circuits

$$A = \begin{bmatrix} 2 & -3 & 0 \\ 3 & 5 & \sin(3.0) \\ 4 & 7 & \ln(4.5) \end{bmatrix}$$

COMPLETE MASTERY OVER TECHNICAL CALCULATIONS

New Mathcad® Version 3.1... Fast, Easy, Accurate

With new Mathcad Version 3.1, you'll do more math, more easily and communicate more clearly. It literally turns your computer screen into a "smart" math scratchpad.

- Writes and solves virtually any mathematical equation, numerically or symbolically.
- Easily prints out presentation-quality equations and graphics along with your explanatory text, to make you a more skilled communicator.
- Uses powerful Object Linking and Embedding (OLE) Client to directly interface with your spreadsheet, drawing, and word processing software.
- Allows "what if" calculating, so you derive better answers.
- Microsoft® Windows™ environment increases ease of use. Also available for Macintosh and UNIX.

Call **1-800-628-4223**

for more information and a free demo disk. Or call

1-617-577-1017,

or fax the coupon below to

1-617-577-8829

YES! Tell me more about Mathcad 3.1

Please send my FREE Mathcad 3.1 Information Kit and Demo Disk to the address below.

Disk Size 3 1/2" 5 1/4"

Name _____

Title _____

Co./Inst. _____

Address _____

City/State/Zip _____

Phone (_____) _____

MathSoft Please mail this coupon to
MathSoft, Inc., 201 Broadway,
Cambridge MA 02139 USA

CIRCLE NO. 67

126 • EDN October 1, 1992

figurations. A write-back cache controller communicates with one or two banks of direct-mapped cache memory. \$28 (100). **VLSI Technology Inc.**, 200 Parkside Dr, San Fernando, CA 91340. Phone (602) 752-6202. **Circle No. 366**

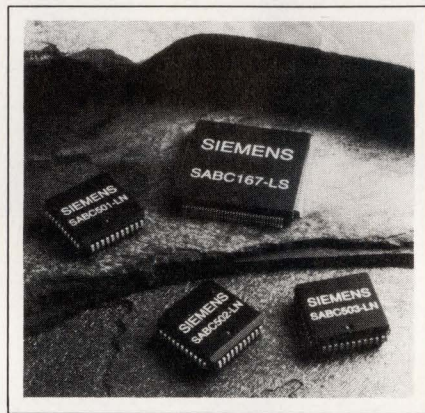

40-MHz μ C. The SAB-C501 microcontroller (μ C) is pin and opcode compatible with the SAB 80C52 μ C. Its 40-MHz clock rate provides a minimum instruction time of 300 nsec. The chip operates from 3 to 5.5V dc when running at 12 MHz. It has an 8k \times 8-bit ROM, a 256k \times 8-bit RAM, four 8-bit I/O ports, and three 16-bit timers. Idle and power-down modes reduce power. \$4.20 (10,000). **Siemens Corp.**, 2191 Laurelwood Rd, Santa Clara, CA 95054. Phone (408) 980-4518. **Circle No. 367**

Variable gain amplifier. The CLC522 dc-coupled 2-quadrant multiplier with differential inputs and a single-ended output. You can externally set the maximum gain from 2V/V to 100 V/V. The gain control input provides as much as 40 dB of attenuation from the maximum gain setting. Other features include a 165-MHz bandwidth; 0.15% differential gain; 0.08° differential phase; and a gain accuracy of $\pm 0.3\%$ at 10V/V gain setting. \$9.26. **Comlinear Corp.**, 4800 Wheaton Dr, Fort Collins, CO 80525. Phone (303) 226-0500. FAX (303) 226-0564. TLX 450881. **Circle No. 368**

CMYK-to-RGB converter. The Bt496 is a triple 9-bit RAMDAC that converts CMYK colors to RGB colors. It makes the color conversion on a pixel-by-pixel basis, which allows the display of CMYK color windows combined with RGB pixel data in the same frame. The triple DAC also provides gamma correc-

tion to correct for nonlinearities in the monitor or color processing. Pixel depth is 1, 2, 4, 8, 16, or 32 bits/pixel. \$261 (100). **Brooktree Corp.**, 9950 Barnes Canyon Rd, San Diego, CA 92121. Phone (800) 843-3642; (619) 535-3466. FAX (619) 452-1249. **Circle No. 369**

ADC chip set. This 24-bit ADC chip set comprises the CS5322 and CS5323. The instantaneous dynamic range is 120 at 411 Hz, and the distortion is -110 dB at 411 Hz. The CS5322 is a monolithic FIR filter having programmable decimation. The CS5323 contains a 1-bit delta-sigma A/D converter embedded in a negative feedback loop. The converter provides 256-kbps serial data to the FIR decimation filter. \$269.70 (100). **Crystal Semiconductor Corp.**, Box 17847, Austin, TX 78750. Phone (512) 445-7222. **Circle No. 370**

Quad 12-bit DAC. The DAC4813 contains four 12-bit D/A converters and voltage amplifiers that provide ± 10 V outputs. A single bus interface consists of a 12-bit port, an input buffer latch, and a holding latch. An input pin lets you reset the inputs of each DAC to zero. The device has a 6- μ sec settling time and $\pm 1/2$ LSB linearity specification. \$29.95 (100). **Burr-Brown Corp.**, Box 11400, Tucson, AZ 85734. Phone (800) 548-6132; (602) 746-1111. FAX (602) 889-1510. **Circle No. 371**

Analog peripheral chip. The ML2377 contains four analog functions on a single chip. The functions include a 10-bit A/D converter, two D/A converters having 10- and 8-bit resolution, a 6-channel input multiplexer, and two si-

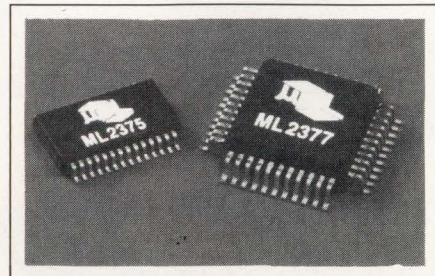

multaneous S/H channels. The A/D and D/A converters have 2- μ sec conversion time. Quad flatpack version, \$6.50 (1000). **Micro Linear Corp.**, 2092 Concourse Dr, San Jose, CA 95131. Phone (408) 433-5200. **Circle No. 372**

EDN-NEW PRODUCTS

Computers & Peripherals

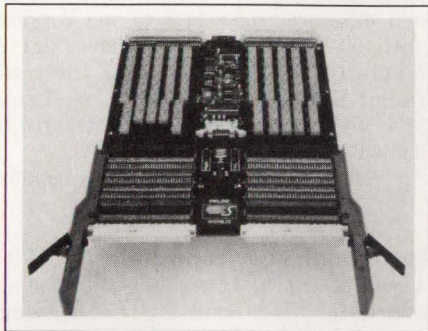

VMEbus extender board. A live-insertion VMEbus extender board, Pro-long, lets you install CPU, I/O, and memory modules in fully powered, on-line VME bus systems. Live insertion doesn't disrupt the bus-cycle operations on the P1 and P2 backplanes. You can use the extender board with any 6U VMEbus board. \$2590. **Vmetro Inc.**, 16010 Barker's Point Lane, Suite 575, Houston, TX 77079. Phone (713) 584-0728. **Circle No. 373**

Voice-recognition board. The VR/160p is a modular speaker-independent voice-recognition ISA bus board. It recognizes either isolated or connected words. The board employs the company's PCM Expansion Bus (PEB) to interface with the company's telephone network or voice-processing boards. The PEB communicates at either 1.544 Mbps or 2.048 Mbps for voice and data. From \$3995. **Dialogic Corp.**, 300 Littleton Rd, Parsippany, NJ 07054. Phone (201) 334-8450. **Circle No. 374**

Laser printers. The switching capability of the 13X09 and 13X16 laser printers allows the printer to simultaneously serve PC, mainframe, and midrange hosts. Both printers come with 0.5-Mbyte memory with 1-Mbyte upgrades available to a maximum of 4.5 Mbytes. The 13X09 prints 9 pages/minute and costs \$3000; the 13X16 prints 16 pages/minute and costs \$5600. **Idea**, 29 Dunham Road, Billerica, MA 01821. Phone (800) 257-5027; (508) 663-6878. FAX (508) 663-8851. **Circle No. 375**

32-bit color-graphics card. The #9GXITC ISA bus board employs a TMS34020 40-MHz graphics coprocessor for 32-bit color graphics. The card comes with the Hawkeye Feature Set, which includes Zoom for magnifying the screen by 2x, 4x, 8x, or 16x; Chame-

leon Cursor, which lets you change the cursor color; Virtual Screen, which lets you create a 2048x2048 pixel display; and Resolution Exchange to choose desired resolution and number of colors displayed. \$2295. **Number Nine Computer Corp.**, 18 Hartwell Ave, Lexington, MA 02173. Phone (617) 674-0009. FAX (617) 674-2919. **Circle No. 376**

Graphics accelerator. The Michaelangelo VRAM 1280 accelerates Windows applications by using S3's 86C911 graphics chip. The board generates 1280x1024-pixel graphics for noninterlaced monitors. Standard configuration with 1 Mbyte of video RAM, \$395. **IO-comm**, 12700 Yukon Ave, Hawthorne, CA 90250. Phone (310) 644-6100. FAX (310) 644-6068. **Circle No. 377**

Multiprotocol communications adapter. The MPI-600 ISA bus board features an Intel 82530 serial-communications controller for SDLC/HDLC (synchronous data-link control/high-level data-link control), BiSYNC, and asynchronous communications. The adapter employs a 16-MHz Intel 80C188 μ P and contains a 1-Mbyte dynamic RAM for program and data storage. \$995; communications software, \$300. **Quatech Inc.**, 662 Wolf Ledges Pkwy, Akron, OH 44311. Phone (216) 434-3154. FAX (216) 434-1409. **Circle No. 378**

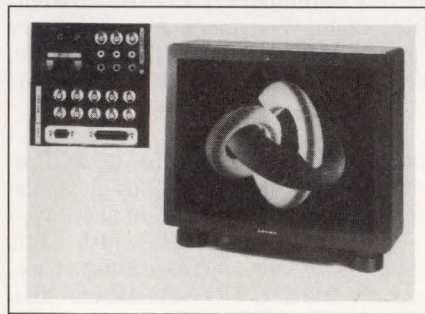

27-in. color monitor. The AM-2752A color monitor is compatible with SE-CAM, NTSC, and PAL video standards. It accepts horizontal scan rates of 15.5 to 39 kHz and vertical scan rates of 45 to 100 Hz. A dynamic beam-forming technique maintains the focus on the edges of the screen as well as the center. \$3700. **Mitsubishi Electronics America**, Professional Electronics Div, 800 Cottontail Lane, Somerset, NJ 08873. Phone (908) 302-2855. FAX (908) 563-0713. **Circle No. 379**

PICO DC-DC INDUSTRIAL CONVERTERS

**Economical
Wide Input Voltage
36-170V DC
Hi Reliability**

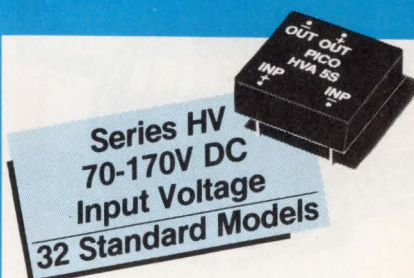

- Single and Dual Isolated Outputs
- Low Profile, .500" max. ht.
- Up to 15 Watts
- No External Components Required
- Fully Regulated
- Short Circuit Protection
- No Heat Sink or Electrical Derating Required
- -20°C to +70°C Operating Temp. Ambient

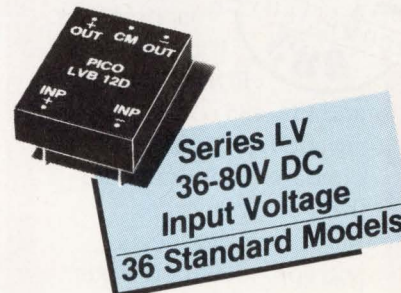

Delivery—
stock to one week

See EEM
or send direct for
FREE PICO Catalog

PICO Electronics, Inc.

453 N. MacQuesten Pkwy. Mt. Vernon, N.Y. 10552

Call Toll Free **800-431-1064**

IN NEW YORK CALL **914-699-5514**
FAX **914-699-5565**

MIL/AERO UPGRADE #2

AR629 Terminal Controller



THE ONLY DATA device fully compliant to ARINC 629.

AR629, our new communications protocol controller, is approved for the industry's next-generation commercial airliner.

Available in ceramic PGA and new surface-mount ruggedized plastic packaging,

AR629 ensures highly reliable bidirectional data transfers.

It also joins our FDDI, Ethernet, and EIA-485 solutions as yet another example of our ongoing commitment to the avionics market.

For free datasheets and app notes, here's our other number:

1-800-NAT-SEMI, Ext. 211.

Here today.
Backed tomorrow.

 **National**
Semiconductor

EDN-NEW PRODUCTS

Computers & Peripherals

SBus port module. The model PT-SBS540A offers a SCSI port, three serial I/O ports, and a parallel I/O port in one SBus slot. It provides a 10-Mbyte/sec SCSI-2 port for SPARCstations and SPARCstation clones. By using accompanying Adaptive Synchronous Negotiation software, the module adjusts the optimal SCSI transfer rate to the prevailing conditions. \$995. **Performance Technologies**, 315 Science Pkwy, Rochester, NY 14620. Phone (716) 256-0200. FAX (716) 256-0791.

Circle No. 380

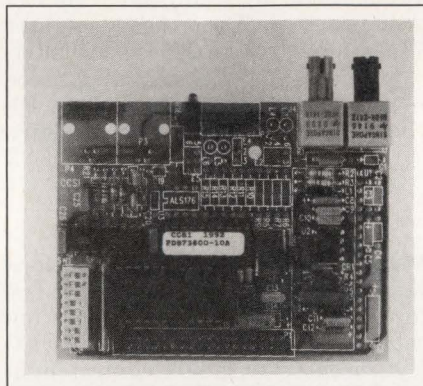

Arcnet interface board. The SBX20 Arcnet network interface module attaches to an iSBX expansion connector on single-board computers. It employs a 20020 Arcnet controller chip and connects to coaxial, fiber-optic, or RS-485 twisted-pair cable. The module measures 2.85 x 3.7 in. Coaxial or RS-485 cable versions, \$195; fiber-optic version, \$345. **Contemporary Control Systems Inc.**, 2500 Wisconsin Ave, Downers Grove, IL 60515. Phone (708) 963-7070. FAX (708) 963-0109.

Circle No. 381

Expansion subsystem for SBus. Providing three additional SBus slots, the SBus Expansion Subsystem allows you to use single- or double-width SBus cards. It provides increased disk space, accommodating two 424-Mbyte disk drives. The subsystem connects to the SBus-based SPARCstation IPX, SPARCstation 2, SPARCstation 10, and the SPARCserver 630 system. \$2495. **Sun Microsystems Computer Corp.**, 2550 Garcia Ave, Mountain View, CA 94043. Phone (415) 960-1300. FAX (415) 969-9131.

Circle No. 382

386SL-based notebook computer. The Freestyle/SL Notebook computer features a tilt and swivel screen. It employs a 25-MHz Intel i386SL μ P. A 9.5-

in. LCD provides 640 x 480 pixels. The portable computer weighs 5.6 pounds and measures 8.5 x 11.3 x 2 in. Version with 60-Mbyte hard-disk drive and 2 Mbytes of RAM, \$1895. **Zeos International Ltd.**, 530 5th Ave NW, St Paul, MN 55112. Phone (800) 423-5891; (612) 633-4591. FAX (612) 633-1325.

Circle No. 383

Flat-panel VGA controller. The Pit-Viper is an ISA bus, VGA controller board for flat-panel LCD, EL, and plasma displays. It allows 64 gray scales on a monochrome LCD or 256 colors in 640 x 480-pixel resolution. The controller has 512 kbytes of RAM and a dual-port RAM to track the mouse during quick movements. \$375. **Dolch Computer Systems**, 372 Turquoise St, Milpitas, CA 95035. Phone (408) 957-6575. FAX (408) 263-6305.

Circle No. 384

Expanded RISC/Unix line. The Personal DECstation 5000 Model 33 and the DECsystem 5000 Model 133 server add to the company's line of RISC/Unix computers based on the MIPS architecture. The Model 33 is rated at 25.3 SPECmarks (SPECmark 1989) and has a base price of \$6995. The Model 133 uses the 33-MHz CPU daughter card and has up to 128 Mbytes of memory. \$11,885, with 16 Mbytes of memory and 426-Mbyte hard-disk drive. **Digital Equipment Corp.**, 146 Main St, Maynard, MA 01754. Phone (800) 344-4825.

Circle No. 385

Disk-drive arrays. The Microarray offers 510 Mbytes of fault-tolerant storage using a RAID (redundant array of inexpensive disks) configuration. Five 2.5-in. storage modules provide a 6.5-Mbyte/sec data-transfer rate, a 32-kbyte cache buffer, and 17-msec access time. A Hot Plug feature lets you remove or install a module without turning off the power. You can also configure the arrays so that a computer communicates with as many as eight disk drives. \$6495. **Core International**, 7171 N Federal Hwy, Boca Raton, FL 33487. Phone (407) 997-6055. FAX (407) 997-6009. TLX 315809.

Circle No. 386

200-Mflops vector processor. The Supercard SC-3XL/VME VME64 board delivers 200 Mflops. The 6U board uses two i860 XP μ Ps and has as much as 64 Mbytes of RAM. The board's I/O services can transfer data as fast as 200

EDN-NEW PRODUCTS

Computers & Peripherals

Mbytes/sec. A lower performance model, the SC-3/VME, uses one i860 XP μ P and delivers 100 Mflops. From \$12,000. **CSPI Inc**, 40 Linnell Circle, Billerica, MA 01821. Phone (617) 272-6020. TWX 710 347-0176. **Circle No. 387**

VMEbus Ethernet controller. The VLAN-11 VMEbus Ethernet controller employs a 68HC000 CPU and a 256-kbyte dual-port RAM. The board communicates with TCP/IP, DECnet, OS-9/NET, DDCMP, SINEC AP 1.0, and the ISO/OSI network protocols. Drivers for OS-9, PSOS+, VRTX, and VxWorks operating systems are available. From \$1667 (OEM qty). **Dynatem Inc**, 15795 Rockfield Blvd, Suite G, Irvine, CA 92718. Phone (714) 855-3235. FAX (714) 770-3481. **Circle No. 388**

Network-repeater family. The MR120 family of dual-port repeaters contains internal power supplies. The MR121T links a 10Base-T segment to another segment via an AUI (attachment-unit-interface) port. The MR122T links a 10Base-T segment to a 10Base-2 segment. The MR123 links two network segments via two AUI ports. The MR124 links a 10Base-2 segment to another segment via an AUI port. The MR125 links two 10Base-2 segments. \$445 to \$995. **Allied Telesis Inc**, 575 E Middlefield Rd, Mountain View, CA 94043. Phone (415) 964-2994, ext 122. **Circle No. 389**

LCD controller. The CDS66841 controller board adapts standard RGB-video outputs to flat-panel LCDs. The board lets you replace a CRT with an LCD. The 5.25 x 7.75 x 0.75-in. board converts data to LCD screen sizes of 640 x 200, 640 x 400, and 640 x 480 pixels. The board converts RGB signals into eight gray-scale levels for the LCD. \$195 (100). Delivery, four to six weeks ARO. **Apollo Display Technologies Inc**, 194-22 Morris Ave, Holtsville, NY 11742. Phone (516) 654-1143. FAX (516) 654-1496. **Circle No. 390**

Laser-based bar-code scanners. The LT 1700 Lasertouch family of bar-code scanners combines bar-code technology with "touch" scanning. Applications include retail point-of-sale, workstation, or portable terminal-data entry. The design incorporates a moving-beam scanner with no internal moving parts. The patented harmonic-scan ele-

ment is similar in principle to a tuning fork. \$675 to \$749. **Symbol Technologies Inc**, 116 Wilbur Pl, Bohemia, NY 11716. Phone (516) 563-2400. FAX (516) 563-2831. **Circle No. 391**

50-MHz i486 single-board computer. The Apache Series of single-board computers for passive backplanes contain serial and parallel ports and an IDE controller. You can configure the board to have 32 Mbytes of system dynamic RAM and a 128-kbyte secondary write-back cache RAM. The module runs with either a 33- or 50-MHz 486DX μ P. \$2500. **Dolch Computer Systems**, 372 Turquoise St, Milpitas, CA 95035. Phone (408) 957-6575. FAX (408) 263-6305. **Circle No. 392**



3-D optical radar. The Dynasight sensor is a low-power optical radar for head-controlled pointing systems. A tiny target is placed on the viewer's forehead to track the position of the viewer's eyes. The measurement update rate is 33 Hz, and lateral spatial resolution is 0.1 mm. \$2995. Delivery, four to eight weeks ARO. **Origin Instruments Corp**, 854 Greenview Dr, Grand Prairie, TX 75050. Phone (214) 606-8740. FAX (214) 606-8741. **Circle No. 393**

Color monitor. Diamond Scan 16 features a compact enclosure, on-screen color calibration, and faster autoscanning-mode changes. The monitor has a 0.28-mm dot-pitch, 16-in. diagonal screen. The Diamond match color calibration system permits the control of colors on screen to match hard copy, Pantone colors, or other user-defined standards. \$1299. **Mitsubishi Electronics America**, 5665 Plaza Dr, Cypress, CA 90630. Phone (800) 843-2515; (714) 220-2500. **Circle No. 394**

MIL/AERO UPGRADE #1

Low-Dropout Regulator



LONGER BATTERY LIFE with ultralow dropout (<470mV) and quiescent current.

Introducing the LP2953, the world's most precise micropower low-dropout regulator.

It guarantees 250mA of output current and 0.2% load and line regulation over the full military temperature range. All of which reduces your error budget and external components.

Plus, it has shutdown and auxiliary comparator functions and an adjustable output of 1.23V to 29V.

For free samples, here's our other number: 1-800-NAT-SEMI, Ext. 211.

Here today.
Backed tomorrow.

 **National
Semiconductor**



New Lexan® 8B35F Film Smooths The Way To Greater Productivity

New Lexan 8B35F graphic film is specifically designed to help eliminate pinholes in demanding backlit applications, enabling screen printers to produce more high-quality, finished parts.

The next generation of our proven velvet/fine matte-grade polycarbonate film, Lexan 8B35F film offers the same excellent clarity, heat resistance and dimensional stability—with an even smoother surface. It assures top-quality second-surface graphics—the first time—in applications such as: LED overlays, dead-front automotive instrument panel clusters and a wide variety of nameplates.

Like all GE film products, Lexan 8B35F film is backed by the industry's most comprehensive technical service and customer support. For a virtually pinhole-free surface and maximum productivity on your toughest jobs, insist on Lexan 8B35F film from GE. For the name of your local distributor, technical data or information on obtaining a sample, call (800) 451-3147 today.



GE Plastics
Structured Products

® Registered Trademark of GE.

EDN-NEW PRODUCTS

Components & Power Supplies

Power supplies. E-100 100W supplies feature as many as four outputs. The board-style units operate from a universal input of 90 to 265V ac. Full-featured models can be configured with optional power-fail output and thermal shut-down. Standard features include input-line filtering and current limiting, transient-voltage protection, output-power and overvoltage protection, and 20-msec hold-up time. From \$50 (OEM qty). Delivery, stock to eight weeks ARO. **Tag Designs Inc**, 996 Lawrence Dr #101, Newbury Park, CA 91320. Phone (805) 376-2033. FAX (805) 376-3003. **Circle No. 409**

Chip capacitor. This multilayer chip capacitor comes in a 0603-size case, has a 0.1- μ F capacitance value, and features an X7R dielectric. Capacitance change over a -55 to $+125^\circ\text{C}$ range equals $\pm 15\%$. The unit comes with tolerances of ± 5 , ± 10 , ± 20 , and $+80/-20\%$ and with voltage ratings of 25, 50, and 100V dc. \$0.15 to \$0.25 (10,000). **AVX Corp**, 801 17th Ave S, Myrtle Beach, SC 29577. Phone (803) 946-0364. **Circle No. 410**

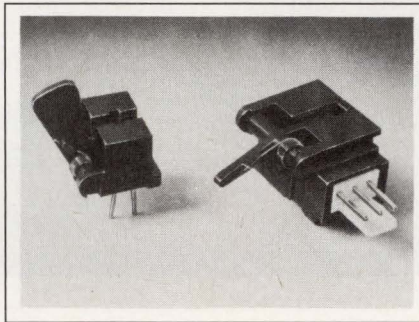

Optical flag switches. The OPB680 and OPB690 consist of an infrared LED and a phototransistor. A lever-arm-actuated flag interrupts the light beam switching the transistor between output states. The -680 features pc-board terminations, and the -690 features snap-in mounting with an integral connector. OPB680, \$1.65; OPB690, \$2.15 (1000). **Optek Technology Inc**, 1215 W Crosby Rd, Carrollton, TX 75006. Phone (214) 323-2200. **Circle No. 411**

Optical sensor. The EESPW-321/421 through-beam sensors have a 30-cm detection distance. The units are available

in dark-on (object present) or light-on (object not present) versions and feature a 1-msec response time. The sensors operate from a voltage of 12 to 24V, have an IEC IP64 protection rating, and have an operating range of -20 to $+55^\circ\text{C}$. From \$110. **Omron Electronics Inc**, 1 E Commerce Dr, Schaumburg, IL 60173. Phone (708) 843-7900. FAX (708) 843-7787. **Circle No. 412**

Graphic keyswitch. The DU848 features 48 graphic LCD switches. The unit will integrate easily into any RS-232C or -422 application. It has its own intelligent controller and power supply and is programmable using the Legend-Font Maker software. The keyswitch has red and green backlights and an 864-pixel display field. \$2950. **C Itoh Technology Inc**, Box 19657, Irvine, CA 92713. Phone (800) 347-2484, ext 4529. FAX (714) 757-4423. **Circle No. 413**

VME enclosure. The ENC 50 enclosure handles harsh environments. It accommodates a 15-slot VME backplane, power supply, fans, and hard drives in

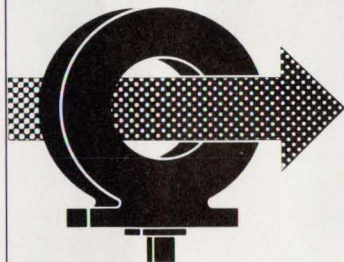

PEARSON Wide Band, Precision Current Monitor

With a Pearson current monitor and an oscilloscope you can make precise amplitude and waveshape measurement of ac and pulse currents from milliamperes to kiloamperes. Current can be measured in any conductor or beam of charged particles, including those at very high voltage levels.

A typical model gives an amplitude accuracy of $+1\%$, -0% , 20 nanosecond rise time, droop of 0.5% per millisecond, and a 3 db bandwidth of 1 Hz to 35 MHz.

Contact us and we will send you engineering data.

PEARSON ELECTRONICS, INC.

1860 Embarcadero Road
Palo Alto, Calif. 94303, U.S.A.
Telephone (415) 494-6444
Telex 171-412 • FAX (415) 494-6716

CIRCLE NO. 70

Performing in Perfect Time. SYNDAC™

- Flexible Clock Synthesizer & Palette
- VGA/SVGA, 8514/A
- Pixel Replicate™
- Loop Filters
- Sense



The SYNDAC combines a color lookup table, triple video DAC, and dual clock synthesizers in a single chip. Programmable clock frequencies eliminate multiple crystals and retain compatibility with any controller. Features include, on-chip reference, monitor sensing, and 50, 66, or 80 MHz pixel rates. Keep in sync with SYNDAC; contact MUSIC™ Semiconductors, The Specialty Memory Company.

For your FREE design kit call:
USA 1-800-788-MUSIC (6874),
Europe +31-45-467878, Asia 63-2-816-2477



CIRCLE NO. 71

Controlled Impedance Pin Probe Assemblies

Used for testing loaded circuit cards in high speed digital applications Meritec's new Pogo Pin Probe Subminiature Cable Assemblies are used in conjunction with automatic test equipment for testing loaded high speed digital circuit cards. The probes are terminated to subminiature shielded coax cable. Pins are connected to the signal conductors of the cables, while the probe barrels are connected to the cable shield. When used with plated through holes or solder contact pads in the PCB, the assemblies provide a continuous shield from the probes to the card under test.

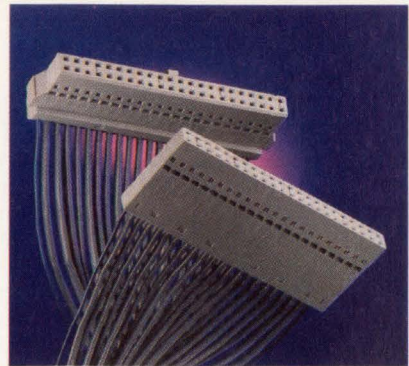
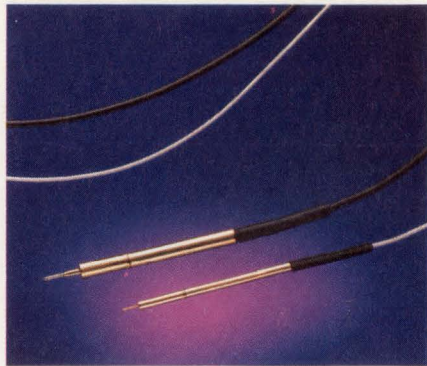

Impedance Matched Dual Row Twinax Cable Assemblies

Ground bus bar minimizes space while maximizing signal fidelity

An internal ground bus bar on Meritec's impedance matched Dual Row Twinax Cable Assembly allows subminiature twinax cable to be terminated to two row connectors with a common ground on standard .100"x100" square sockets. The bus bar in the assembly eliminates the need for an entire row of sockets, normally used to ground individual twinax lines. The assemblies are used for electrically sensitive applications using high speed CMOS, ECL or GaAs logic.

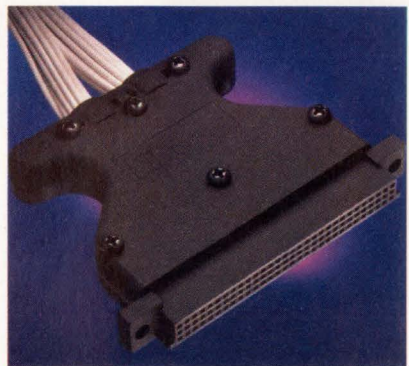

Strain Relief Handles for Subminiature Coaxial Carrier Systems

For high speed applications requiring frequent removal from the backplane

New Strain Relief Handles are available for Meritec Subminiature Coaxial Carrier Systems. The handles provide extra strain relief in applications where the carrier systems need to be frequently removed from the backplane. The handles feature an interior coax cable management retention system, which secures the cable to the inside of the handle. The handles are designed for use with Meritec Single Signal Carrier Systems, which consolidate their impedance matched 1x2 or 1x3 Single Signal Interconnects for grouped interfacing with headers.

Digital and analog interconnect systems that maximize board density and budget.

If you need speed and performance in a digital or analog interconnect system but have a limited budget, turn to Meritec. Meritec digital and analog interconnect systems are designed to meet the requirements of electrically sensitive applications using high speed CMOS, ECL or GaAs logic. Our systems are engineered to provide controlled impedance and propagation delay while minimizing crosstalk. You get ship to stock quality, backed up with technical service and applications support. All at a cost that's well in line with tight project budgets.

For more information and free literature on the complete line of Meritec digital and analog interconnect systems, call 216-354-3148.



1359 West Jackson Street
P.O. Box 8003
Painesville, Ohio 44077
Phone: 216-354-3148
FAX: 216-354-0509

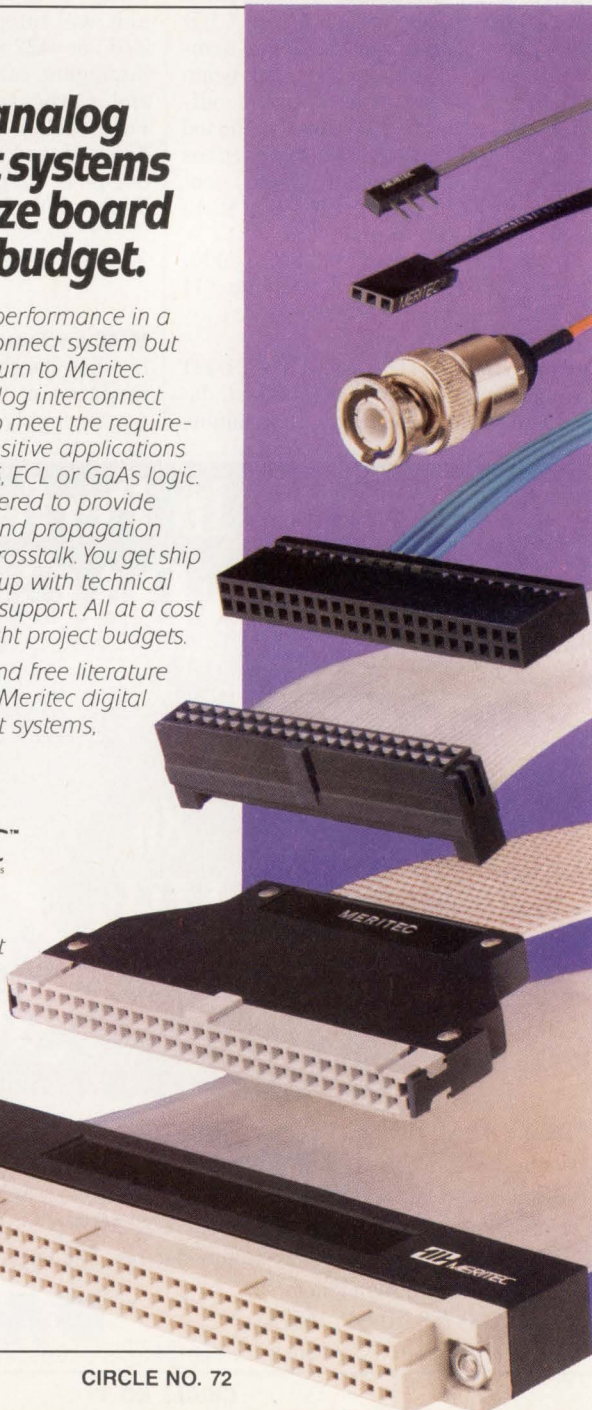

CIRCLE NO. 72

EDN-NEW PRODUCTS

Components & Power Supplies

an isolated subchassis. Six mounts provide shock and vibration isolation. For EMI shielding, all access panels have conductive gaskets, and filters cover the fan intake and exhaust areas. From \$7350. Delivery, six to eight weeks ARO. **Matrix Corp.**, 1203 New Hope Rd, Raleigh, NC 27610. Phone (800) 848-2330; (919) 231-8000. FAX (919) 231-8001. **Circle No. 414**

Audio switch. CLS Series switches suit the broadcast audio and video markets. The unit has sealed contacts to accommodate wave-soldering operations. The switches are available with gold or silver contacts and a choice of incandescent or LED illumination. From \$2.95 to \$4.50. Delivery, six to eight weeks ARO. **ITT Shadow Inc.**, 8081 Wallace Rd, Eden Prairie, MN 55344. Phone (800) 255-5896; (612) 934-4400. FAX (612) 934-9121. **Circle No. 415**

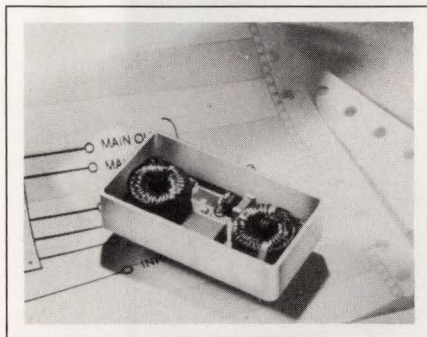

EMI filter. The EMI-82470 is a 60W filter designed to meet the requirements of MIL-STD-461B and MIL-STD-704. The unit has a nominal input voltage of 28V dc and an output current of 5A. Power dissipation measures 0.7W, and dc resistance equals 0.03Ω. The unit measures 2.09 × 1.11 × 0.495 in. and operates over -55 to +125°C. \$285. Delivery, stock to 90 days ARO. **ILC Data Device Corp.**, 105 Wilbur Pl, Bohemia, NY 11716. Phone (516) 567-5600, ext 7390. FAX (516) 567-7358.

Circle No. 416

Memory-card connectors. These units are available in 68-position header and receptacle assemblies that are compatible with PCMCIA release 2.0 and JEIDA release 4.1 standards. The 2-piece system features posted headers for the host equipment and a receptacle assembly for the memory/pc card. Mated pair, \$6 (1000). **AMP Inc.**, Box 3608, Harrisburg, PA 17105. Phone (800) 522-6752. **Circle No. 417**

Supporting Motorola's 68HC11, 68HC16 and many others ... Call for the complete list!

Bob Salitsky
Software Engineer

PENTICA SYSTEMS INC

IN-CIRCUIT EMULATORS

Pentica Systems, Inc.
19A Crosby Drive
Bedford, MA 01730
Tel: (617) 275-4419
Fax: (617) 275-6514

We love to solve puzzles!

#1. We stand by you.

"The right tools and support can save the whole day! With Pentica on your side, you can spend weekends at home, at the beach, or in your kayak..."

--Bob Salitsky
Software Engineer

CIRCLE NO. 76

FIFO, the trick chip, performs here

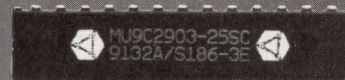

MUSIC's FIFOs offer from 512 through 4096 nine-bit words in pin-compatible packages and easily expand using minimal external logic with no degradation in performance. So whether your application is high-performance data buffers, LANs/WANs, data compression/decompression, or DSP, contact MUSIC Semiconductors, The Specialty Memory Company. For your FREE design kit call: USA 1-800-788-MUSIC (6874), Europe +31-45-467878, Asia 63-2-816-2477

MUSIC
SEMICONDUCTORS

CIRCLE NO. 77

HP's new 4 GSa/s scope helps you capture high-speed glitches.

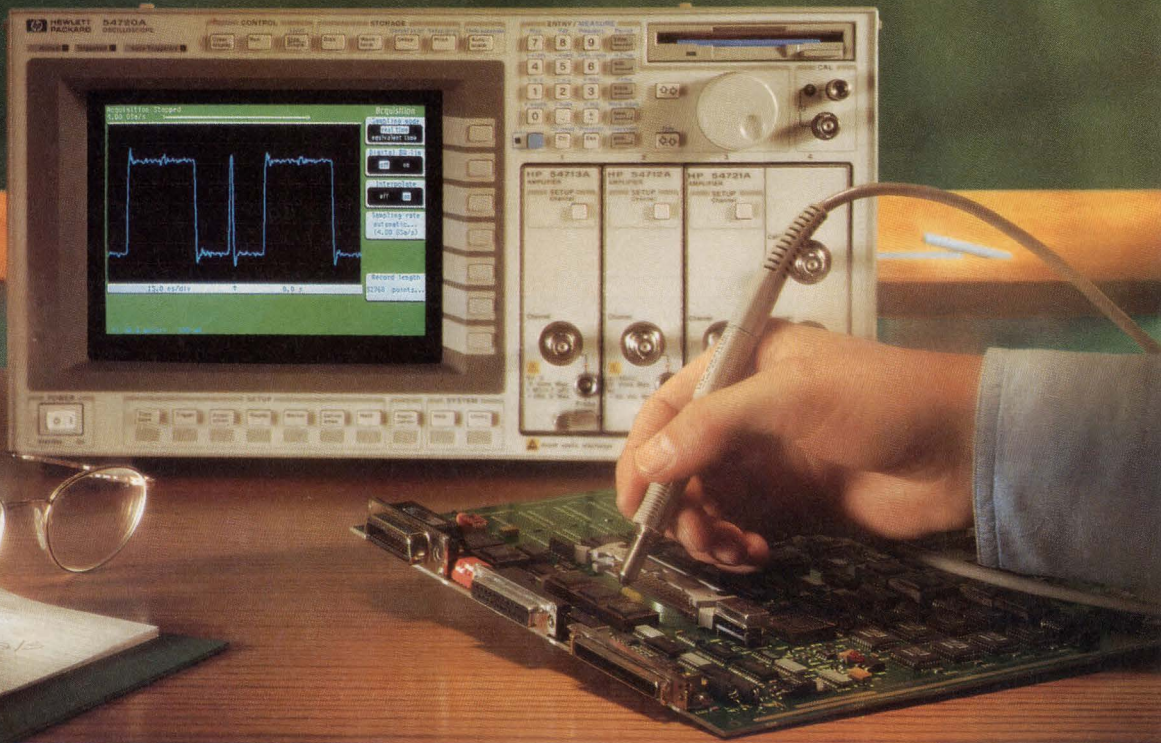
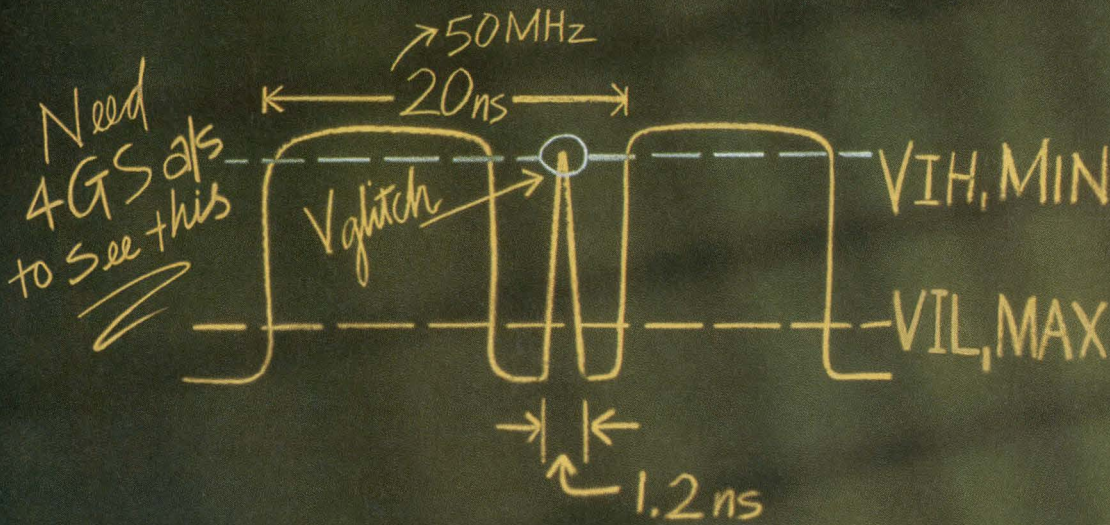

© 1992 Hewlett-Packard Co. TMCOL126/EDN

The new HP 54720A has the speed you need to solve intermittent problems.

When digital designs reach clock speeds above 33 MHz, you run into a new class of problems. That's when critical timing and noise margin analysis are crucial. And that's where the HP 54720A helps the most.

The HP 54720A has the highest sample rate available on multiple channels with exceptional real-time bandwidth—as well as low noise and jitter. So you get repeatable, high-fidelity waveform capture. And a clearer picture of the input signal.

To make sure the captured signal is reliable and distortion free, the HP 54720A has high vertical and horizontal accuracy. It teams up perfectly with the new non-intrusive HP 54701A active probe. And it's ideal for use with HP logic analyzers when you need maximum insight into digital system problems.

Plus, to make sure you have the information you need, HP offers educational programs, application notes, and seminars on solving high-speed digital design problems.

So, if intermittent problems are plaguing you, call 1-800-452-4844.*

Ask for Ext. 3079, and we'll send you a brochure and an application note that explain how the HP 54720A helps you get a clearer understanding of your high-speed digital designs.

There is a better way.

 **HEWLETT
PACKARD**

* In Canada call 1-800-387-3867, Dept. 453.

EDN-NEW PRODUCTS

Components & Power Supplies

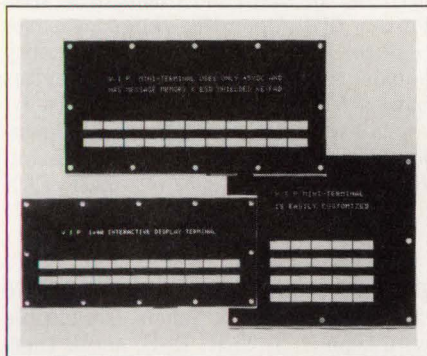

Interfaces. VIP Miniterminals feature an 11-kbit EPROM that can be used to display messages and switch output message strings. Each unit includes a vacuum-fluorescent (VF) display and a keypad, and they come with or without rear covers (Models 3900 and 3901, respectively). The units display the 96-character ASCII character set and European and scientific alternate characters. An onboard μ P provides display control. \$229 to \$306 (100). **IEE Inc.**, 7740 Leona Ave, Van Nuys, CA 91409. Phone (818) 787-0311, ext 418. FAX (818) 901-9046. **Circle No. 418**

DC/DC converters. The TPLD Series 7.5W converters develop single outputs of 5, 12, and 15V at currents ranging to 1.5A. Line and load regulation equal $\pm 0.5\%$, and efficiency figures range to 85%. All models have short-circuit and overvoltage protection, overvoltage shutdown, and undervoltage shutdown. \$72 (100). Delivery, four to six weeks ARO. **Total Power International Inc.**, 418 Bridge St, Lowell, MA 01850. Phone (508) 453-7272. FAX (508) 453-7395. **Circle No. 419**

Pressure transducer. The Eclipse pressure transducer is available in nine pressure ratings ranging from 100 to 7100 psis. The units have a 10^6 -cycle lifetime and feature an amplified 0.5 to 4.5V output with regulated 5V excitation. The combined effects of non-linearity, hysteresis, and repeatability are less than $\pm 1\%$ full scale, and worst-case total error equals $\pm 4\%$ max. \$49. **Data Instruments Inc.**, 100 Discovery Way, Acton, MA 01720. Phone (508) 264-9550. FAX (508) 263-0630. **Circle No. 420**

Crystal oscillators. Surface-mountable Model CO-2810/2910 oscillators feature a 2.65-mm profile. Operating frequencies range from 1.8432 to 50



With transfer rates up to 36 megabytes per minute and access times faster than 30 seconds, 3M $\frac{1}{4}$ -inch data cartridges give you a fast, practical, proven reliable choice for data backup. When you need to save the day in minutes, look to the fastest growing backup media—one that's growing to 10 gigabytes and beyond. Find out more. Call 1-800-888-1889, ext. 54.

Save the day.

In minutes.



3M Magnus 1.0 and 1.35 data cartridges require a compatible drive. Archive, Maynard, Sankyo, Tandberg, Tecmar and Wangtek have introduced gigabyte $\frac{1}{4}$ -inch drives. Magnus is a trademark of 3M. © 1992 3M

CIRCLE NO. 79

262,144 Colors Perform Here

- Pixel Replicate™
- Nibble Mode
- VGA/SVGA
- 8514/A
- XGA™

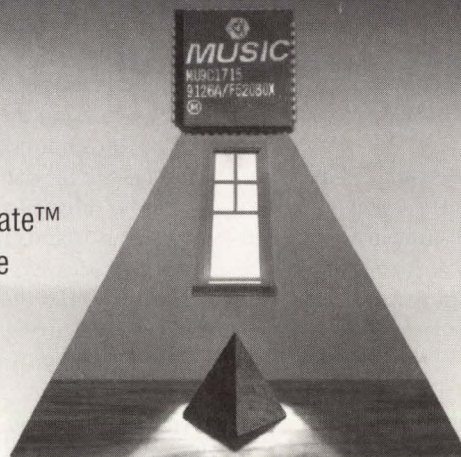

MUSIC's graphics color palettes are fine-tuned for your graphics subsystem applications. MUSIC gives you the sharpest graphics and truest colors available at the lowest cost. So whether you're designing desk-top computers, graphics add-in cards, low-power laptops or multi-media systems, contact MUSIC Semiconductors, The Specialty Memory Company. For your Free design kit call: USA 1-800-788-MUSIC (6874), Europe +31-45-467878, Asia 63-2-816-2477

CIRCLE NO. 80

First High-Speed IEEE 488.2 Controller for Notebook PCs



The 5.5" x 4" Personal488/NB enables 170 Kbyte/s IEEE control of up to 14 instruments

The **Personal488/NB** is a compact external IEEE 488.2 interface that enables 170 Kbyte/s IEEE 488.2 control of up to fourteen IEEE instruments from a notebook PC via its parallel port.

A virtual PC plug-in board in terms of speed and performance, the Personal488/NB is compatible with both IOtech's DLL driver for Microsoft Windows and with its DOS subroutine-style and device driver software. The Personal488/NB also supports third-party data acquisition software packages, such as DADiSP and Labtech Notebook.

The Personal488/NB uses FPGA (field programmable gate array) technology to permit simultaneous instrument-control and printer transactions via its connection to a notebook PC's parallel port. The unit can draw power from a notebook PC's keyboard port, a 7 to 15 VDC voltage source, or a standard A/C voltage source via an included power supply.

Portable and Remote Applications. As notebook PCs decrease in price and increase in functionality and power, many engineers are finding them practical, easily transportable alternatives to cumbersome desktop PCs. The Personal488/NB en-

ables engineers to use notebook PCs in IEEE instrument control and data acquisition. It is well suited for vehicle testing, such as aircraft and automobile testing, where physical space is at a premium, and is also ideal for users who require a portable computer, such as test-instrument sales engineers, who can now use notebook PCs to demonstrate IEEE 488 instruments on customer calls.

The Personal488/NB is also useful for engineers who need to analyze acquired data away from the test site because it enables the same notebook PC to be used both on-site for data acquisition, and in the lab for subsequent data analysis. This eliminates the time-consuming data transfer processes and cross-platform incompatibility problems sometimes associated with using one desktop PC for testing and another for analysis.

Pricing. The Personal488/NB is \$495, including the user's choice of IOtech's DLL driver for Microsoft Windows, its DOS device driver, or its DOS subroutine style driver. All items are available from stock. For more information, call **IOtech** at (216) 439-4091 or fax your request to (216) 439-4093.

Product names listed are trademarks of their respective manufacturers. Company names listed are trademarks or tradenames of their respective companies.

CIRCLE NO. 81

EDN-NEW PRODUCTS

Components & Power Supplies

MHz for the -2810 and 1.8432 to 80 MHz for the -2910. Operating range measures -10 to +70°C, and frequency stability equals ± 100 ppm max. Both devices have a 5V output. \$3.90 (1000). Delivery, 10 weeks ARO. **Raltron Electronics Corp.**, 2315 NW 107th Ave, Miami, FL 33172. Phone (305) 593-6033. FAX (305) 594-3973. **Circle No. 421**

Thermocouple amplifier. Model 470 thermocouple amplifier is compatible with type E, J, T, K, R, S, and B thermocouples. The unit is ac-line powered (115 or 220V), and the span can be adjusted over a gain range of 40 to 1500. Scale factors of 1 or 10 mV/°F are available. Common-mode rejection ratio equals 120 dB at 60 Hz. Cold junction compensation is provided. The amplifier has a ± 10 V output. \$180. **Calex Mfg Co Inc.**, 2401 Stanwell Dr, Concord, CA 94520. Phone (800) 542-3355. FAX (510) 687-3333. **Circle No. 422**

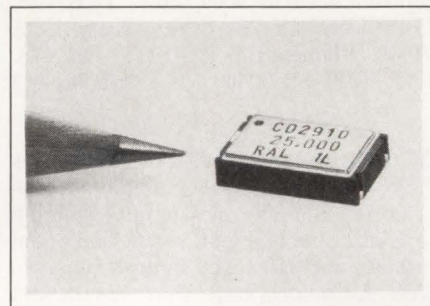

Crystal oscillator. Model 2920159 ovenized crystal oscillators cover a frequency range of 110 to 200 MHz. Typical single sideband phase noise at 120 MHz is -90 dBc/Hz at 10 Hz. Frequency stability equals $\pm 5 \times 10^{-8}$ over a temperature range of 0 to 60°C. The units operate from a 5V supply and measure $2 \times 2.5 \times 0.8$ in. \$500 to \$550 (OEM qty). **Piezo Crystal Co.**, 100 K St, Carlisle, PA 17013. Phone (717) 249-2151. FAX (717) 249-7861. TLX 510-650-2280. **Circle No. 423**

Photoelectric sensor. CP18 Series photoelectric sensors are 18-mm-diameter, self-contained devices. Through-scan models have a 30m sensing distance, and retroreflective units have a 4m sensing distance. The diffuse models are available with three scan ranges—100, 200, and 400 mm. All units have a 1-msec response time. The devices are available in either light- or dark-operate versions. \$33 (1000). **Micro Switch**, 11 W Spring St, Freeport, IL 61032. Phone (815) 235-6600. **Circle No. 424**

DATEL Turns your PC into a powerful, low cost ATE or Signal Processing Lab

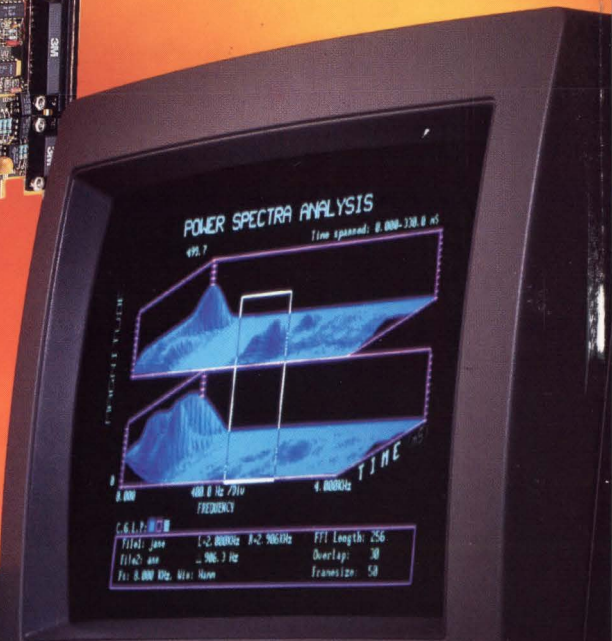
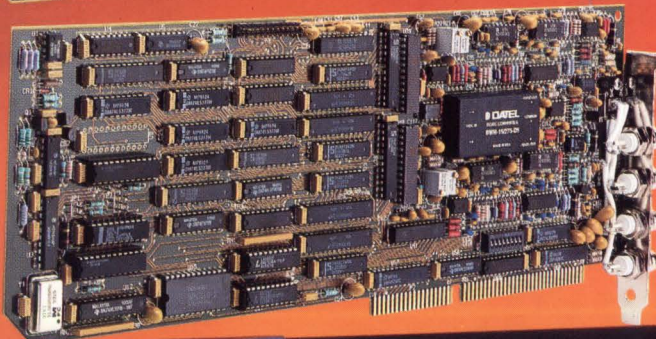
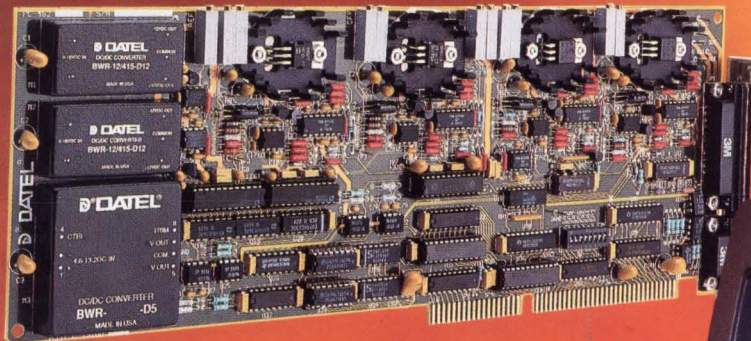
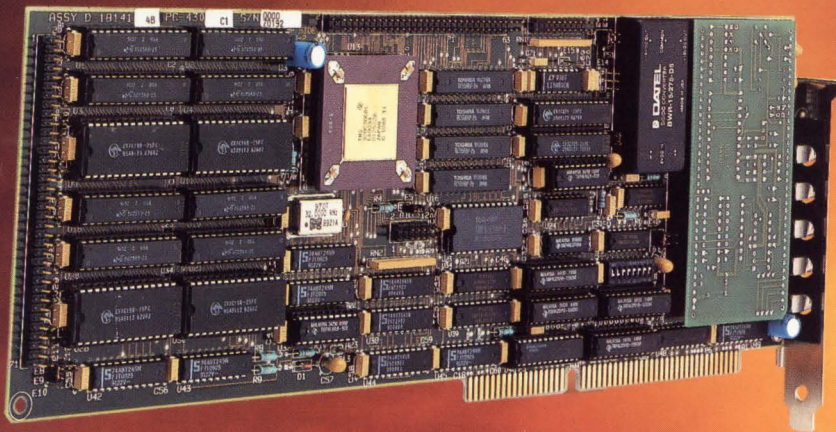

 **DATEL**
INNOVATION and EXCELLENCE

 MADE IN USA

Build a Spectrum Analyzer or Disk Data Recorder

An advanced

PC-420 Programmable Low-noise Arbitrary Waveform Generator

- Simultaneous two-channel outputs on a single PC/AT board
- Store waveform samples on disk for playback
- On-board waveform memory:
 - Store up to 32,768 samples per channel
 - Loop up to 256 times or forever
 - Repeat depth programmable 2 to 32K samples
- External clock and trigger gates
- Sample rate output up to 25 MHz per channel
- High signal quality, -72 dB THD
- Software programmable features:
 - Amplitude and offset per channel
 - Eight output filters
- "No programming" menued WINDOWS software
 - Graphic waveform editor
 - Signal waveform generator

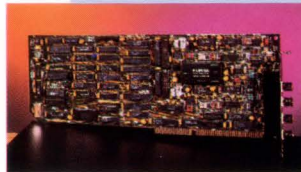
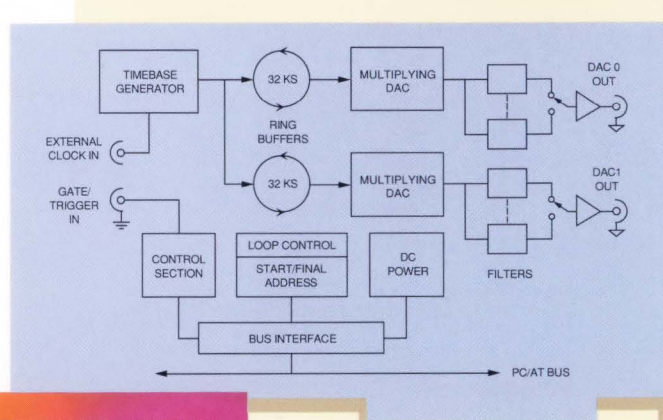

NEW

PC-462 Power your breadboards with an Isolated Programmable, Quad Output Power Supply Board

- 4 Independently programmable precision voltage/current outputs
 - 0 to +6.15 Vdc @ 1 Amp
 - 0 to -6.15 Vdc @ 1 Amp
 - 0 to +20.5 Vdc @ 250 mA
 - 0 to -20.5 Vdc @ 250 mA
- Remote sensing avoids load errors
- Fully isolated from PC/AT bus
- Realtime current and voltage monitors
- 4 General purpose analog inputs
- 2 Isolated digital inputs
- 2 Isolated relay driver outputs
- "No programming" menued WINDOWS software
- Free software driver library

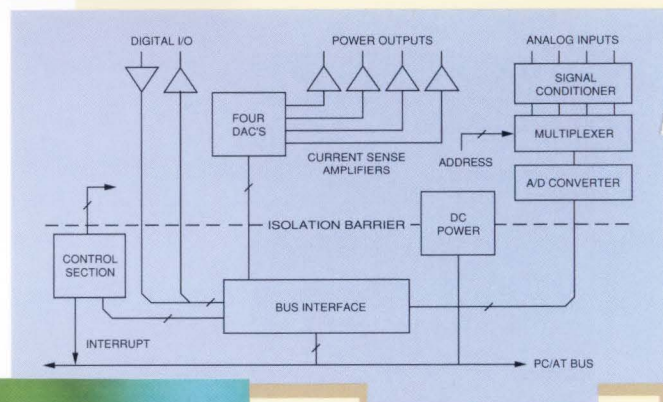

NEW

PC-422 Generate fast simultaneous, 16-channel analog outputs

- 8 or 16 Analog outputs
- Individually selectable output ranges per channel
- $\pm 0.025\%$ output linearity
- 330 KHz update rate with all channels in parallel
- Simultaneous output for phase tracking and skew elimination
- Trigger timer interrupt
- Internal precision update clock or external event synchronizing
- Discrete digital I/O (4-in, 4-out)

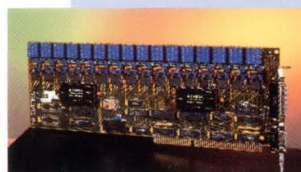
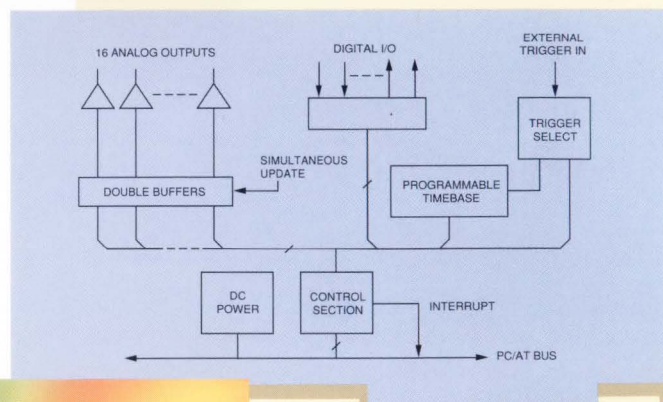

Simultaneous Update

ATE or DSP analog signal workbench

PC-420 Arbitrary Signal Generator

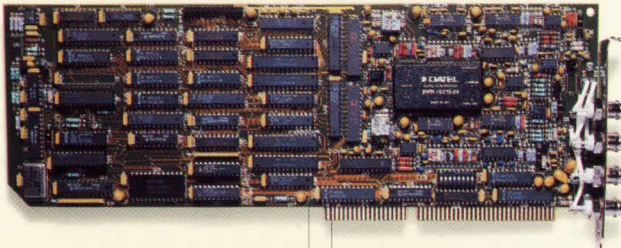

PC-420 "SET" Software



Test Signal Files

YOUR LINEAR CIRCUIT UNDER TEST

PC-411, 412, 414 or 430 Analog Boards

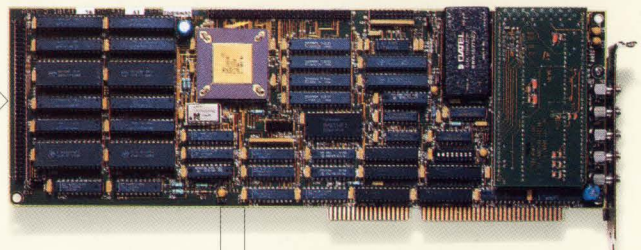

PC-462 Programmable Power Supply

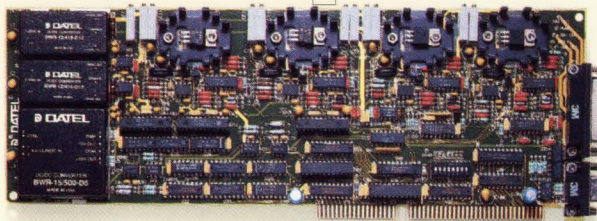

PC-462 "SET" Windows Software

"SET" Software



Signal Files

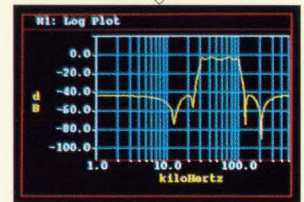

Spectrum Analyzer

PC-422 16-Channel Output Board

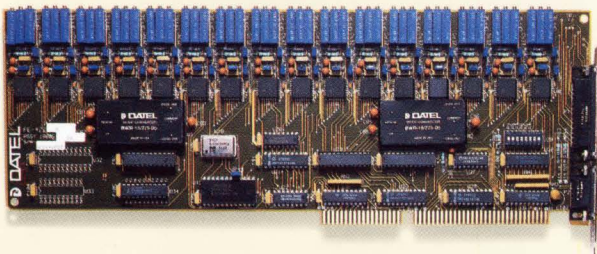

"SET" Software

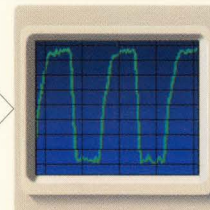

Control, Display, Recording, Simulation

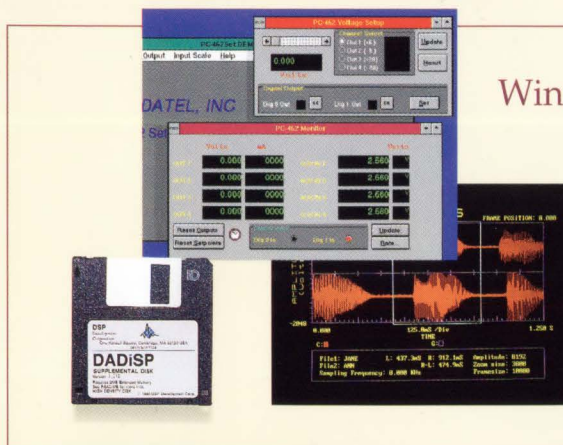

Windowed Lab, ATE or DSP Software

PC-430HYPER Real-time DSP graphics display software, Digital Oscilloscope and FFT Spectrum Analyzer for PC-430.

PC-DADISP File input A/D signal graphics, math macro, printer output, analysis worksheet software.

PC-"SET" Series "No programming," easy to use, windowed, setup-configuration signal file, save/playback software for PC-411, 412, 414, 422, 462, 420. "SRC" full source code.

DATEL is your Data Acquisition source

Fast A/D-DSP Coprocessor and Software

Model	A/D Channels	A/D Resolution	A/D Speed	Input Ranges	Simultaneous Sampling	Programmable Gain	Notes
PC-430A*	4S	12 bits	1.5 MHz	0 to +10V, , ±10V	4 channels	X1 or X10 (2 channels)	
PC-430B*	4S	14 bits	500 KHz	0 to +10V, , ±5V, ±10V	--	--	Choice of 1K or 4K
PC-430C*	4S	12 bits	1 MHz	0 to +10V, , ±5V, ±10V	--	--	FIFO memory
PC-430D*	1D	12 bits	4 MHz	±5V	--	--	programmable trigger/counter
PC-430E*	16S or 8D	12 bits	500 KHz	0 to +10V, , ±5V, ±10V	--	X1 to X100 (resistor)	
PC-430F*	2S	12 bits	2 MHz simul.	0 to +10V, , ±5V	2 channels	--	
MEM-30	1 Megabyte high-speed expansion memory for PC-430 (1.5 Megabytes total installed capacity)						
PC-430EXEC	"No programming" command language, DSP library software (executables)						
PC-430SRC	"No programming" command language, DSP library software (full source)						
PC-430HYPER	Hyperception integrated DSP display, data save software, digital oscilloscope, spectrum analyzer						
PC-430BUG	C Language debugger/monitor, single step, object file load/save software						

All PC-430's include:

- 32 MHz TI 320C30 DSP, 32-bit local data paths
- ½ Megabyte dual-ported memory

* A nearly identical product (DVME-630) is also available on VMEbus

Special Functions

Model	Description	Analog Channels	Notes
PC-462	Programmable Power Supply Board	4 isolated outputs: 0 to +6.15V @ 1A 0 to -6.15V @ 1A 0 to +20.5V @ 250mA 0 to -20.5V @ 250mA 4 isolated inputs (±5V)	4 isolated digital channels (2 in, 2 out), 12-bit A/D-D/A conversion, remote load sense
PC-462SET	Configuration, display/load software for WINDOWS (executables)		
PC-462SRC	Configuration, display/load software for WINDOWS (source code)		
PC-420	Arbitrary Waveform Generator	2 Simultaneous outputs: - Sample rate to 25 MHz - 12-bit D/A's - Programmable offset/attenuation	- 64K waveform RAM per channel - External trigger - 8 Selectable filters
PC-420SET	Configuration, waveform load/edit software for WINDOWS (executables)		
PC-420SRC	Configuration, waveform load/edit software for WINDOWS (source code)		

Windowed Lab, ATE or DSP Software

PC-430HYPER

- High-performance real-time data acquisition, graphics display, data file save/playback and DSP library for Datel's PC-430.
- Multi-channel digital oscilloscope, spectrum analyzer, FFT display, digital filtering, autocorrelation, code generation, many more!

PC-DADiSP

- High-quality, file input A/D data graphics display and analysis worksheet software.
- Use with any A/D signal file. Extensive math library, over 300 functions, FFT's, filters, 3D plotting, etc.
- Powerful macro math language, multi-Window displays, publication-quality graphics output.

PC-"SET" Series

- Low cost, easy to use setup, configuration, data save/load software for PC-411, 412, 414, 462, 422.
- Save data to disk or memory at over 1 MHz. Full source code available ("SRC" series).
- Windowed "no-programming" menu interface. File output to PC-DADiSP or spreadsheets.
- Batchable autorun mode.

Get the full story

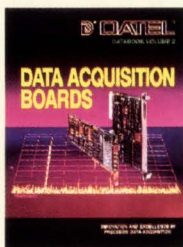

Send today for DATEL's free Data Acquisition Board catalog

Or complete catalogs on other DATEL products

- High performance Power Converters
- Digital Panel Instruments
- Data Acquisition Components

DATEL
INNOVATION and EXCELLENCE

11 Cabot Boulevard, Mansfield, MA 02048
Tel: (508) 339-3000 Fax: (508) 339-6356
For immediate assistance: All USA, EST business hours 1-800-233-2765

-- on your PC!

Choose from 3 advanced analog input boards

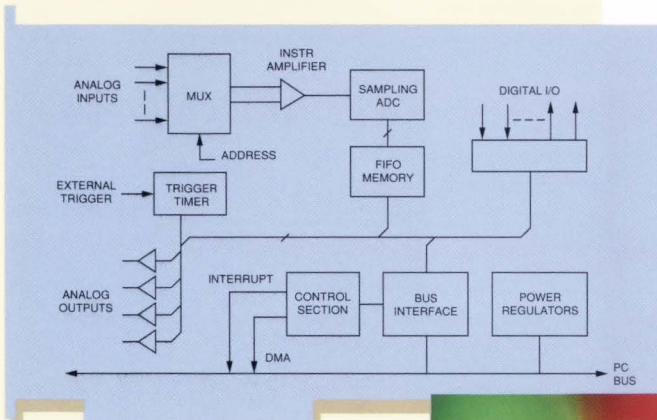

Low Cost

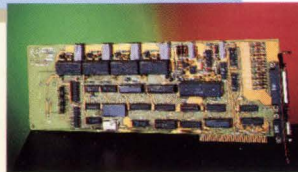

PC-411/PC-412

Combination analog-digital input/output at great prices

BOTH MODELS

- 16 Single-ended or 8 differential channels
- Choice of 12 or 14-bit A/D resolution
- FIFO memory, DMA and programmable interrupts for non-stop "streaming" data acquisition
- Ideal for fast disk data recording
- Programmable trigger clock
- Discrete digital I/O (8-in, 8-out)
- Programmable gain amplifier for direct sensor inputs

PC-412 ONLY

- 4 Analog outputs with simultaneous update
- Individually selectable output ranges

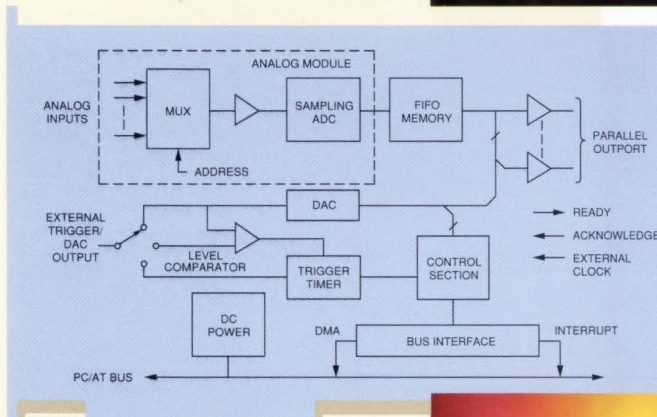

4 MHz Sampling

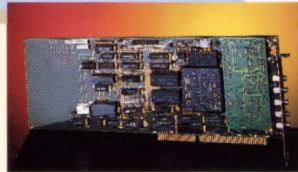

PC-414

Collect millions of high speed analog samples to memory, disk or parallel port

- 4 to 16 Analog input channels
- Up to 4 MHz A/D sampling
- 12 or 14-bit A/D resolution, wide choice of analog inputs
- Optional 4 Simultaneous Sample/Hold channels for signal phase deskewing
- On-board FIFO memory up to 16K samples for non-stop streaming to disk or memory
- Very low harmonic distortion. Ideal for DSP and FFT applications
- Excellent array or vector processor "front end"
- Parallel data port to avoid bus delays
- Analog input trigger comparator with programmable level threshold

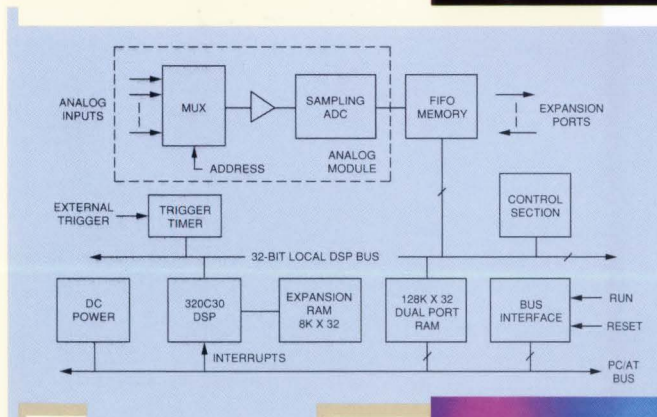

"No Programming" DSP Library

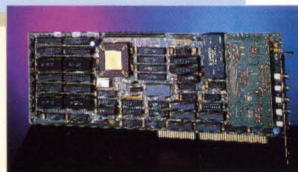

PC-430

High performance analog input plus an advanced DSP coprocessor

- TI 320C30 32 MHz Digital Signal Processor
- Up to 4 MHz A/D sample rate
- 2 or 4-Channel high-speed simultaneous sampling to deskew input phase
- Choice of 12 or 14-bit A/D resolution
- 512 Kilobyte dual ported RAM
- 8K x 32 parallel expansion RAM
- On-board DSP library - FFT's, filters, windowing, math package, etc.
- Fast, simple, powerful command Executive. No local programming
- Local FIFO, timers, external trigger
- RS-232 serial port, expansion ports
- 1 Megabyte high-speed memory expansion option (256K x 32)

The hottest line of high-performance Analog Boards in the world!

Combination Analog and Digital Input/Output

Model	A/D Channels	A/D Resolution	A/D Speed	Input Ranges	D/A Channels	D/A Resolution	Digital I/O	Notes
PC-411A1	16S or 8D*	12 bits	83 KHz	0 to +5V or ±5V*	None	--	8in, 8 out	FIFO memory, DMA,
PC-411B1	16S or 8D*	14 bits	59 KHz	0 to +5V or ±5V*	None	--	8in, 8 out	streaming design,
PC-412A1	16S or 8D*	12 bits	83 KHz	0 to +5V or ±5V*	4	12 bits	8 in, 8 out	programmable pacer timer,
PC-412B1	16S or 8D*	14 bits	59 KHz	0 to +5V or ±5V*	4	12 bits	8 in, 8 out	simultaneous D/A
PC-440	32S or 16D	A/D Channel Expander Slave Board		Up to 256 channels				
PC-411SET	Setup, configuration, data save software - executables only							
PC-411SRC	Setup, configuration, data save software - source files only							
PC-DADISP	Signal file data display, analysis worksheet software							
PC-490A,B	Screw termination and cables. 9-pin (490A) or 25-pin (490B)							

* These options are software selectable. Free BASIC disk on request.

High-Speed Analog Input Plus Memory

Model	A/D Channels	A/D Resolution	A/D Speed	Input Ranges	Programmable Gain	Simultaneous Sampling	Notes	
PC-414A*	4S	12 bits	1.5 MHz	0 to +10V, ±10V	X1 or X10 (2 channels)	4 channels	Programmable	
PC-414B*	4S	14 bits	500 KHz	0 to +10V, ±5V, ±10V	--	--	trigger/counter,	
PC-414C*	4S	12 bits	1 MHz	0 to +10V, ±5V, ±10V	--	--	A/D parallel port,	
PC-414D*	1 Diff.	12 bits	4 MHz	±5V	--	--	1 D/A channel,	
PC-414E*	16S or 8D	12 bits	500 KHz	0 to +10V, ±5V, ±10V	X1 to X100 (resistor)	--	analog comparator	
PC-414F*	2S	12 bits	2 MHz simul.	0 to +10V, ±5V	--	2 channels	trigger	
PC-414SET	Setup, configuration, data save software - executables only							
PC-414SRC	Setup, configuration, data save software - source files only							
PC-DADISP	Signal file data display, analysis worksheet software							

FIFO Memory for all models is up to 16K Samples

* A nearly identical product (DVME-614) is also available on VMEbus

Fast Simultaneous Analog Output

Model	D/A Channels	D/A Resolution	D/A Speed	Output Ranges	Digital I/O	Trigger Timer Interrupt	Notes	
PC-422A*	8 Simultaneous	12 bits	330 KHz	0 to +5V, 0 to +10V, ±2.5V, ±5V, ±10V	4 in, 4 out	537 sec to 500ns	Output ranges selectable per channel	
PC-422B*	16 Simultaneous	12 bits	330 KHz	0 to +5V, 0 to +10V, ±2.5V, ±5V, ±10V	4 in, 4 out	537 sec to 500ns	Output ranges selectable per channel	
PC-422SET	Setup, data load, file playback software (executables)							
PC-422SRC	Setup, data load, file playback software (source code)							

* A nearly identical product (DVME-622) is also available on VMEbus

EDN-NEW PRODUCTS

Test & Measurement Instruments

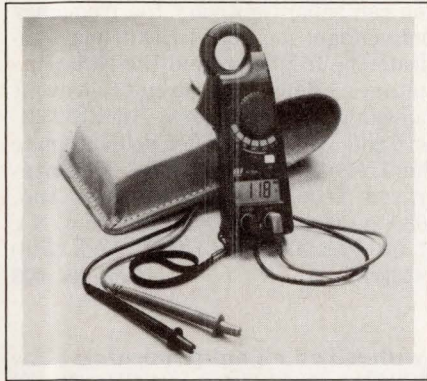

Pocket-sized DMM with clamp-on ac-current measurement capability.

The AC30A measures ac voltage to 600V and ac current to 400A. The clamp-on current transformer's jaws open to accommodate 1-in.-diameter cables. The meter's most sensitive current range is 20A full scale. The unit, which measures resistance to 2 k Ω and provides an audible continuity indication, shuts itself off automatically to preserve its batteries. A hold function retains readings in situations where you can't read the meter while holding probes on the circuit under test. \$110. **Beckman Industrial Corp.**, 3883 Ruffin Rd, San Diego, CA 92123. Phone (619) 495-3218. FAX (619) 268-0172. TLX 249031.

Circle No. 395

Manufacturing-defects analyzer.

The PC-based TR-4 uses mechanical force, rather than a vacuum, to press the pc board under test against spring-loaded contact probes. The unit uses guarded complex-impedance measurements to find short circuits, open circuits, missing components, and incorrectly inserted components. A 200-point system, \$6150. **Checksum Inc.**, 8416 134th St NE, Arlington, WA 98223. Phone (206) 653-4861. FAX (206) 653-1704.

Circle No. 396

8-channel ISA bus arbitrary-waveform generator.

The RC-128A generates eight analog waveforms and produces 4-bit-wide digital patterns. Each waveform can contain from 2 to 64k points stored with 12-bit resolution; for each analog sample, the board stores four bits of digital data. Unlike conventional DAC boards, the board will run indefinitely without the host-PC's intervention; it can produce outputs continuously or in bursts. Double buffering lets you download new data while the board produces waveforms stored earlier. Update rates range from 500 ksamples/sec

with two channels active to <1 point/hour. Analog outputs are deglitched, and each channel includes two software-selectable 4-pole filters. \$2895. **RC Electronics Inc.**, 6464 Hollister Ave, Goleta, CA 93117. Phone (805) 685-7770. FAX (805) 685-5853.

Circle No. 397

Calibrated light meter. Each hand-held Cal-light 400 has been calibrated using standards traceable to the National Institute of Standards and Technology (NIST). A single button controls the unit. Pressing the button briefly turns the meter on; a longer press holds a reading. The meter shuts off automatically after approximately one minute. The autoranging, cosine-corrected unit reads out to 400,000 fc or lux. \$345. **The Cooke Corp.**, Box 209, Buffalo, NY 14216. Phone (716) 833-8274. FAX (716) 836-2927.

Circle No. 398

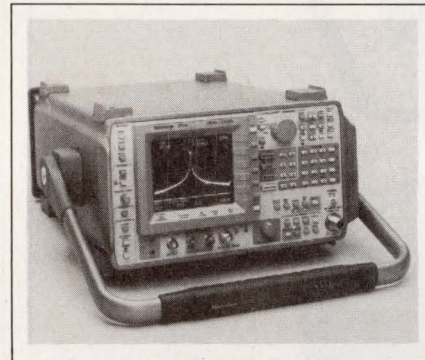

100-Hz to 325-GHz spectrum analyzers. The four units in the 2790 Series enhance spectrum-analyzer user friendliness. Although some analyzers have more Spartan panels, these units' ease of use comes from a combination of menus, soft controls, and dedicated controls. The 2792 covers 10 kHz to 21 GHz in coaxial cable; the use of external mixers extends the coverage to 26.5 GHz. The 2794 has similar coaxial coverage, but with external mixers its range extends to 325 GHz. The 2795 covers 100 Hz to 1.8 GHz; the 2797 extends the upper end of this range to 7.1 GHz. \$22,000 to \$33,000. Delivery, six weeks ARO. **Tektronix Inc.**, Box 1520, Pittsfield, MA 01202. Phone (800) 426-2200.

Circle No. 399

Unix-based dc-parametric test system. A single Sun Microsystems SPARCstation can control from one to four 400UX Series systems; each system can incorporate as many as 256 pins or instrument terminals. The systems

use dc source/measure technology in a 4-wire Kelvin configuration to measure voltage, current, resistance, and capacitance. By networking the measurement systems with both Sun and DEC VAX hosts, users can have access to all of the software tools available for semiconductor-parametric-data analysis. An average system costs from \$180,000 to \$200,000. **Keithley Instruments Inc.**, 28775 Aurora Rd, Cleveland, OH 44139. Phone (800) 552-1115; (216) 248-0400. FAX (216) 248-6168.

Circle No. 400

EPROM/EPLD/ μ P programmer. Solar programs 8-, 16-, and 32-bit devices in a single pass and offers gang and set modes. The unit, which has four sockets and 8 Mbytes of RAM, has both RS-232C and parallel interfaces. You can operate the programmer from a host PC or as a stand-alone unit. In the stand-alone mode, a built-in editor lets you modify data that you have read into memory from a master device. \$2195. **Stag Microsystems**, 1600 Wyatt Dr, Santa Clara, CA 95054. Phone (800) 227-8836; (408) 988-1118. FAX (408) 988-1232.

Circle No. 401

Electrostatic voltmeter. The 368 makes noncontacting voltage measurements to ± 2 kV dc or peak ac with errors of <0.1%. As many as four of the modular units mount side by side in a 5 $\frac{1}{4}$ -in.-high space in a 19-in.-wide equipment rack. Each meter provides a replica of its input voltage multiplied by $\frac{1}{200}$ or $\frac{1}{1000}$. Noise is <25 μ V rms; response time is <200 μ sec for a 1-kV step. \$2995. **Trek Inc.**, Box 728, Medina, NY 14103. Phone (716) 798-3140. FAX (716) 798-3106.

Circle No. 402

Tester/calibrator for 3 Φ UPSs and generators. The 8 \times 9 \times 13-in. VFMT-3000, which is enclosed in a water-tight

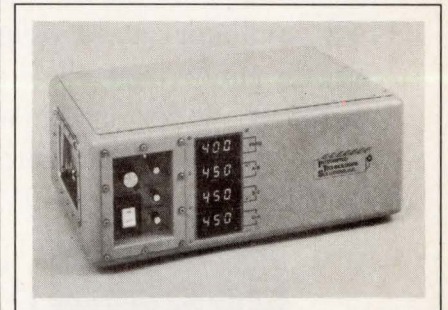

case, produces 3-phase ac voltages from 0 to 600V rms phase to phase, 60W per phase, at frequencies from 45 to 500 Hz.

One oscillator, any speed.



FROM 100 MHz THRU 160 MHz, ONE OF MF'S NEW PROGRAMMABLE ECL OSCILLATORS IS ALL YOU NEED.

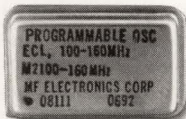

Forget about designing in a separate crystal oscillator for each frequency. One Model M2100 ECL oscillator can be programmed to any frequency over the entire range. Fine-tune a circuit *after* it's built. And stock one part instead of dozens. To find out more, contact: MF Electronics Corp., 10 Commerce Drive, New Rochelle, New York 10801. Phone: (914) 576-6570.

MF Electronics

COMPONENTS THAT SET THE PACE
SEE US AT WESCON BOOTH 1099

CIRCLE NO. 82

EDN-NEW PRODUCTS

Test & Measurement Instruments

You can separately vary the frequency and voltage; separate LED displays indicate the frequency and the three line voltages. Soft-start circuits prevent damaging voltage spikes. An RS-232C port and PC software let you automate the UPS-test process. \$8500. **Integrated Technologies Solutions Inc.**, 402 Chestnut Lane, East Meadow, NY 11554. Phone (516) 481-0857. FAX (516) 292-3115. **Circle No. 403**

Synthesized signal generators. The MG3631A (100 kHz to 1.04 GHz, \$9400) and the MG3632A (100 kHz to 2.08 GHz, \$13,600) produce outputs whose single-sideband noise is < -124 dBc/Hz at 1 GHz with a 10-kHz offset from the carrier frequency. Both units produce signals as large as 13 dBm (variable continuously over a 26-dB range as well as in steps) over the entire frequency range. They include 400-Hz and 1-kHz oscillators that can introduce amplitude or frequency modulation. An optional 20-Hz to 100-kHz oscillator allows simultaneous modulation by two sources. Each generator can store 100 front-panel setups. **Anritsu Wiltron Sales Co.**, 685 Jarvis Dr, Morgan Hill, CA 95037. Phone (408) 776-8300. FAX (408) 776-1744. **Circle No. 404**

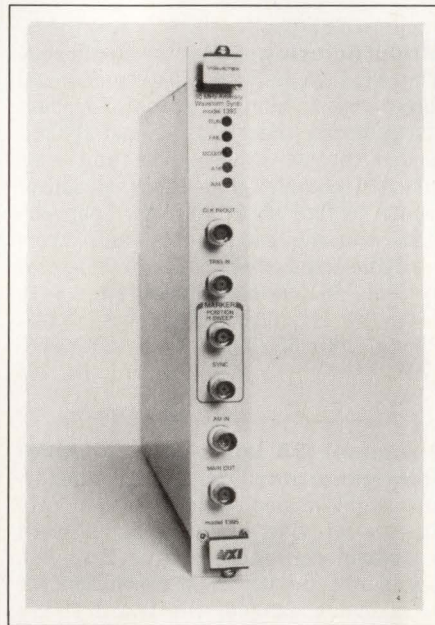

50M-sample/sec VXIbus arbitrary-waveform generator. In addition to 10 standard waveforms, the 1395 produces arbitrary waveforms defined by sequences of 5 to 32 12-bit ksamples (128 ksamples, \$995 extra). Linking and looping allow the creation of much

EDN-NEW PRODUCTS

Test & Measurement Instruments

longer sequences. Support for the VXI analog summing bus lets you combine the outputs of several generators. Standard waveforms include square waves to 25 MHz, sines and haversines to 20 MHz, and other waveforms to 2 MHz. The lowest frequency for all standard waves is 1 μ Hz. The generator operates in continuous, sweep, and burst modes. You can trigger sweeps and bursts and obtain logarithmic and linear sweeps. \$4895. Delivery, 60 days ARO. **Wave-tek Corp**, 9045 Balboa Ave, San Diego, CA 92123. Phone (619) 279-2200.

Circle No. 3105

8-channel, 16-bit-resolution, ISA bus ADC board. You can configure the ADC-16 to resolve 1 μ V. Full-scale ranges are ± 5 V and ± 3.2768 V. A programmable gain amplifier provides gains of 1, 10, and 100. A 256-location queue lets you specify channel sequences and gains. The board, which provides five TTL outputs and two CMOS inputs, also includes a pair of single-pole, double-throw relays. Included in the software support are drivers that can be called from several versions of Basic, a terminate-and-stay-resident program that displays a control panel, installation and calibration routines, and sample programs. A \$99 advanced software option includes drivers that can be called from C and Turbo Pascal, as well as a dynamic-link library for MS Windows V3.1. ADC-16, \$550. **Keithley Metrabyte**, 440 Myles Standish Blvd, Taunton, MA 02780. Phone (508) 880-3000. FAX (508) 880-0179.

Circle No. 406

VXIbus-based test and measurement systems. Geneva T&M Systems are an alternative to systems constructed of rack-and-stack instruments. The vendor provides the systems in two ways: as fully integrated turnkey "solutions," and as "open integration platforms." With the open-platform approach, you select the instrument modules and configure the software to suit the needs of your application. With either approach, you can use instruments from scores of firms that provide VXI products. From <\$100,000. **Gen-Rad Inc**, 300 Baker Ave, Concord, MA 01742. Phone (508) 369-4000, ext 2610.

Circle No. 407

Static-RAM tester. The Static RAM Tester automatically identifies, tests, and verifies the speed of 8-bit-wide de-

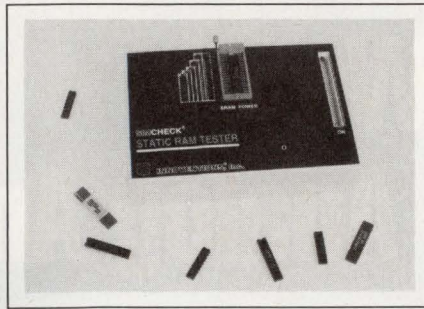

vices that store from 64 kbits to 4 Mbits, and of 1- and 4-bit-wide devices that store from 16 kbits to 1 Mbit. The unit can determine speeds from 5 to 151 nsec with a resolution of 2 to 4 nsec. The tester verifies the ICs' optional 2V data-retention mode and determines the lowest V_{CC} at which the device under test can continue to function. \$345. **Innoventions Inc**, 11000 Stancliff Rd, Suite 150, Houston, TX 77099. Phone (713) 879-6226. FAX (713) 879-6415. Circle No. 408

PUT A SUNTM WORKSTATION ON YOUR DESK FOR ABOUT A GRAND.



TOMORROW.

It's called the Leasametric Workstation Rental Program. And it means that as an Authorized Sun Rental Company, we can give you the latest Sun workstations as soon as you need them. Perform any maintenance and

repair while you've got them. And you can send them back as soon as you are done with them. All on a payment program that can save you thousands.



Leasametric

Isn't renting grand?

1-800-553-2255.

Sun, Sun Microsystems and the Sun logo are trademarks or registered trademarks of Sun Microsystems, Inc.

CIRCLE NO. 83

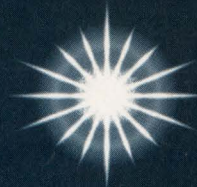

Leads the Way in High-Speed Analog Amps/Buffers

MONOCHROME & COLOR VIDEO AMPLIFIERS

- Cable Drivers
- Distribution Amps
- Gain Blocks

Singles/Duals/Triples/Quads
P-DIP, SO-8

CURRENT MODE FEEDBACK VIDEO AMPS

P/N	BW	\$ @ 100 pc.
EL2020	50 MHz	2.80
EL2232 dual	60 MHz	3.90
EL2099 Pwr	50 MHz	4.95
EL2130	85 MHz	3.25
EL2120	100 MHz	2.80
EL4393 triple	82 MHz	6.95
EL400/EL2070	200 MHz	4.95

NEW
NEW

VOLTAGE FEEDBACK VIDEO AMPS

P/N	GBW	\$ @ 100 pc.
EL2044	120 MHz	1.80
EL2244 dual	120 MHz	2.95
EL2444 quad	120 MHz	4.95
EL2045	100 MHz	1.80
EL2245 dual	100 MHz	2.95
EL2073	200 MHz	4.95
EL2074	400 MHz	5.25

NEW
NEW
NEW
NEW

VIDEO BUFFERS

P/N	BW	I/O	\$ @ 100 pc.
EL2001	70 MHz	±160 mA	2.45
EL2002	180 MHz	±160 mA	2.95
EL2003	100 MHz	±230 mA	3.45
EL2072	730 MHz	±70 mA	4.95
EL2008	55 MHz	±1.8A	6.79
EL2009	90 MHz	±1.8A	6.79

HIGH SPEED
HIGH POWER

GENERAL PURPOSE HIGH-SPEED AMPS/BUFFERS

- High-Speed Signal Processing
- Instrumentation
- Medical Instruments

D.C. RESTORATION AMPS

- Sync & Color Burst Processing
- Nulls D.C. Input Offset During Back Porch Period

FAST AMPLIFIERS

P/N	GBW	S/R*	\$ @ 100 pc.
EL2424 quad	60 MHz	200	6.95
EL2242 dual	30 MHz**	40	5.25
EL2243 dual	70 MHz**	90	5.25
EL2041	90 MHz	250	3.75
EL2006	60 MHz	450	22.59
EL2171	3 GHz	1200	4.95
EL2038	1 GHz	1000	3.90
EL2039	600 MHz	550	2.75

*V/μs **BW

FAST BUFFERS

P/N	BW	S/R*	\$ @ 100 pc.
EL2004	350 MHz	2500	21.00
EL2005	140 MHz	1500	20.15
EL2031	550 MHz	7000	40.00

*V/μs

P/N	BW	\$ @ 100 pc.
EL2090	100 MHz	6.75
EL4390 triple	82 MHz	9.95

NEW

LOW COST

THE EL2044 Single/EL2244 Dual 120 MHz VOLTAGE FEEDBACK OP AMPS

- ONLY 1.5¢/MHz
- 325 V/μs Slew Rate
- 120 MHz (-3 dB) BW @ Gain = 1
- Drives Unlimited Load Capacitance
- Single or Split Supplies as Low as 2.5V
- \$1.80 @ 100 pc. - P-DIP (\$1.90 - SO-8)
- Dual - \$2.95 @ 100 pc. - P-DIP

FOR INFORMATION — CALL (800)877-9839 — REF ELN 1

ELANTEC, INC. ■ 1996 Taroh Court ■ Milpitas, CA 95035 ■ (408) 945-1323 ■ (800) 333-6314 ■ FAX (408) 945-9305

CAE & Software Development Tools

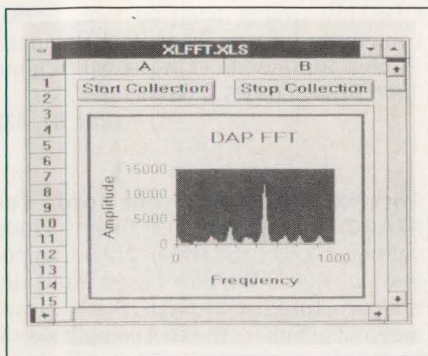

Data acquisition under MS-Windows. Windows Toolkit lets you measure and control real-time events at up to 235,000 samples per second. The toolkit works with a Data Acquisition Processor (DAP) that fits into a PC slot and includes on-board memory, processor, and multitasking software. The toolkit includes a Dynamic Link Library that communicates with the DAP. Windows Toolkit, \$95. Data Acquisition Processor, \$1195. **Microstar Laboratories Inc.**, 2265 116th Ave NE, Bellevue, WA 98004. Phone (206) 453-2345. FAX (206) 453-3199. **Circle No. 425**

Design tools for pc boards. EdtCAD LS includes schematic capture, interactive gridless layout and editing, shape-based autorouting, Gerber photoplot generation and verification, a design-rule checker (mechanical and electrical), automatic forward and backward annotation, and netlist importing from most other CAD systems. The LS system works with as many as 250 components having from 0 to 999 pins per component and 1000 nets. The Professional system handles 3000 components and 10,000 nets. EdtCAD LS, \$495; EdtCAD Professional, \$1995. **Electronic Design Tools Inc.**, 1219 Oak Meadows Dr, Dallas, TX 75232. Phone (214) 375-9848. FAX (214) 375-6303. **Circle No. 426**

Signal processing for PC Mathcad. Digital signal processing Function Pack is an add-on to PC Mathcad 3.1. It computes and plots 60 functions for DSP including transform analysis, spectral analysis, time series analysis, digital filtering, and filter design. The functions work in the same way as those in the base package, allowing you to write equations in typeset notation on-screen and get calculated results as numbers or graphics. \$249. **Mathsoft Inc.**, 201 Broadway St, Cambridge, MA 02139. Phone (617) 577-1017. FAX (617) 577-8829. **Circle No. 427**

Royalty-free kit for custom BIOS. Embedded BIOS Adaptation Kit lets embedded-system developers manufacture their own ROM BIOS and customize it to meet the needs of their embedded hardware. It includes complete source code in assembly language, 30 configuration options, ROM-building utilities, a ROM-disk BIOS extension module, remote-disk software, and the manufacturer's BIOS-aware debugger. The kit also works with the on-chip pe-

ripherals of the 80186 family and offers interrupt latency of <10 instructions. \$350. **General Software**, Box 2571, Redmond, WA 98073. Phone (206) 391-4285. FAX (206) 746-4655. **Circle No. 428**

Cross-development tools for the 386. VRTXvelocity DOS/386 runs on PCs and is upwardly compatible with earlier VRTXPC/386 and VRTX32-386 products. You use this tool to develop

Where you make the right contact.

Electronica is the world's largest trade fair for electronic components and assemblies. Here state-of-the-art technology is on display, and developments, trends, methods and solutions are showcased in a comprehensive, precise, clear and up-to-the-minute style.

Accompanying events at a glance

Congresses and lectures on the following subjects will take place during electronica 92:

- 6th International conference on power semiconductor and their applications
- Smart sensors - markets and state of the art
- Quality management within the scope of international standards
- Technical experience with the GSM mobile radio network

Further information can be obtained from:

Münchener Messe- und
Ausstellungsgesellschaft mbH
Postfach 12 10 09,
D-8000 München 12
Tel. + 49 89 / 51 07-0
Fax + 49 89 / 51 07-312

MESSE MÜNCHEN INTERNATIONAL

10 - 14 November

Munich



electronica 92

EDN-NEW PRODUCTS

CAE & Software Development Tools

applications that run the VRTX32 real-time kernel on a 386-based target system. This package includes development tools such as RTsource386, a multi-tasking C source-level debugger; Phar Lap 386/DOS extender; a reentrant C runtime library giving Unix-style access to standard I/O functions; and RTscope, a program that monitors and controls the target system. \$12,500. **Ready Systems Corp**, 470 Potrero Ave, Sunnyvale, CA 94086. Phone (408) 736-2600. FAX (408) 736-3400. **Circle No. 429**

Use CAD data in thermal analysis. Betasoft-R Version 4.2 for pc boards includes an Integrator that imports all the information available from any of 20 CAD systems for thermal analysis. PC version, \$3995. Workstation version, \$7995. **Dynamic Soft Analysis Inc**, 213 Guyasuta Rd, Pittsburgh, PA 15215. Phone (412) 781-3016. FAX (412) 781-3098. **Circle No. 430**

Parallel programming for SPARC 10. Circl software enables application developers to take advantage of the

multiprocessing SPARCstation 10. The program executes parallel applications on a stand-alone workstation or as part of a distributed network of other SPARC-based computers. The software also lets you use other networked computing resources that use SunOS and Unix System V, Release 4. **Circl Technology**, 5250 NE Elam Young Pkwy, Suite 200, Hillsboro, OR 97124. Phone (503) 681-8910. FAX (503) 640-5966. **Circle No. 431**

FPGA design software. The CDS2100 Development System is stand-alone software for designing with the CLi6000 Series FPGAs. The system combines Viewlogic design entry with the manufacturer's proprietary software. It includes complete design tools such as a macro library with 200 functions, Viewlogic Viewdraw schematic capture, automatic place and route, interactive layout editor, design-rule checking, layout-versus-schematic checking, plotting and system utilities, bit-stream generation, and a hardware prototyping kit with a sample device. In North America, \$3995. Optional CDS2120 circuit verification tool, \$4995. Optional

CDS2130 timing analysis tool, \$2995. **Concurrent Logic Inc**, 1290 Oakmead Pkwy, Sunnyvale, CA 94086. Phone (408) 522-8700. FAX (408) 732-2765.

Circle No. 432

Software development tools for SPARC. Native SPARC Tools include version 1.8.6 of the Green Hills Compilers and the X-Window-based Multi debugger. Integrated with Sun's native assembler/linker, the tool compiles code in four languages: C, C++, Fortran, and Pascal, each capable of calling the other. It also debugs simultaneously in these four languages and produces code for many processors including SPARC, Motorola 680x0 and 88000, and Intel 80386. Runs under Solaris 1.0. \$1550. **Oasys Inc**, One Cranberry Hill, Lexington, MA 02173. Phone (617) 862-2002. **Circle No. 433**

Analysis tool for C. The Ensemble modular tool suite automates software development, maintenance, and testing for C professionals. It gives you a common graphical user interface through

SPEED READING FOR

No one does megahertz so megafast. Because Harris monolithic devices give you -3 dB bandwidths up to 850 MHz. Plus excellent gain flatness of 0.14 dB to 100 MHz.

And unlike high-power discretes, Harris monolithic devices are low power. To drive your creativity. Not your power supply.

So for fast linear solutions, call this number. 1-800-4-HARRIS, ext. 7025. Fast.



THE OP AMPS WITH THE FASTEST EDGES

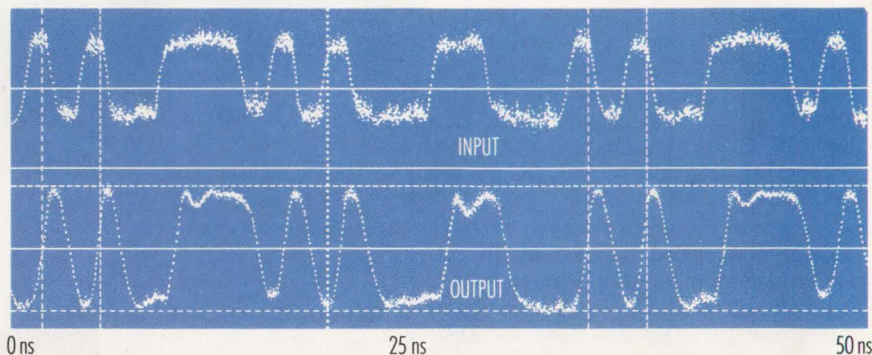

To give you an edge, Harris HFA1100 850 MHz op amps deliver the fastest edges around. The output signal matches the 220 MHz input signal with a delay measured at just 2 ns. And the HFA1130 has a programmable output clamp to boot.

U.S. DISTRIBUTORS Almac 206/643-9992 • Anthem 408/453-1200 • EMC 614/299-4161 • Falcon 203/878-5272 • Gerber 617/769-6000 • Hall-Mark 214/343-5000

U.S. SALES OFFICES Huntsville, AL 205/883-2791 • Costa Mesa, CA 714/433-0600 • Los Angeles, CA 213/649-4752 • San Jose, CA 408/922-0977 • Woodland Hills, CA 818/992-0686
Rahway, NJ 908/381-4210 • Durham, NC 919/361-1500 • Dallas, TX 214/733-0800

EDN-NEW PRODUCTS

CAE & Software Development Tools

which you access functions for understanding, constructing, testing, and documenting your code. The tools let you rebuild complete, original code, including comments, in original files at any stage of processing. You can also call one module from another, without exiting, through incremental links. The tool set is available now on Sun SPARC computers and includes six modules that you can purchase bundled for \$23,000 or separately for the following US list prices (per seat): System Understanding, \$5500; Function Understanding, \$3000; Construction, \$5000; Test Case Generation, \$6000; and Documentation, \$3000. **Cadre Technologies Inc.**, 222 Richmond St, Providence, RI 02903. Phone (401) 351-2273. FAX (401) 351-7380. **Circle No. 434**

Control multiple DOS processors under Windows. Starwindows gives you an MS-Windows interface to the manufacturer's Star System computer. The computer accommodates up to seven DOS-based processors, consolidating multiple industrial PCs into a single unit for real-time industrial control ap-

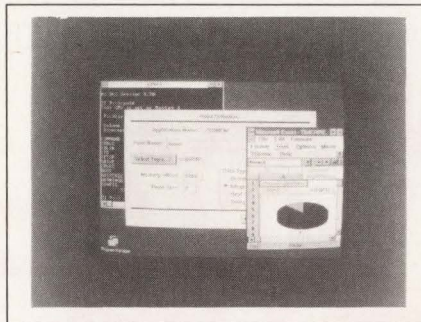

plications. The software includes a dynamic data exchange (DDE) server, a console function that lets an operator open a window into any processor in the system, and MS-Windows. \$295. **Ziatech Corp.**, 3433 Roberto Ct, San Luis Obispo, CA 93401. Phone (805) 541-0488. FAX (805) 541-5088. **Circle No. 435**

Software regression testing system. Ferret gives you tools to do window-based and real-time software testing as well as traditional capture, playback, and compare. A nonintrusive system, the product does not require that

you introduce internal hardware or software to the system under test. The product connects to the keyboard, pointing device, and graphics cables of the system under test. Currently available for Macintosh, Sun, SGI, DEC, PC, and IBM hardware. \$26,450. **Tiburon Systems Inc.**, 1290 Parkmoor Ave, San Jose, CA 95126. Phone (408) 293-4400. FAX (408) 293-9090. **Circle No. 436**

Native Ada compiler for Sun. The DACS SPARC/SunOS Ada compiler includes an Ada compiler, program library utility, program library, recom-compiler, linker, full-screen, window-oriented Ada symbolic debugger and disassembler, and a downloader for cross-compilers. The compiler passes the Ada Compiler Validation Capabilities 1.11 test suite. \$12,000. **DDC-I Inc.**, 410 N 44th St, Suite 320, Phoenix, AZ 85008. Phone (602) 275-7172. FAX (602) 275-7502. **Circle No. 437**

Low-cost DSP analysis software. Siglab is an interpretive DSP language for signals and systems analysis. You

ANALOG DESIGNERS.

THE PIN DRIVER WITH THE WORLD'S FASTEST DATA RATE

Product: HFA5250 Pin Driver
Data Rate 500 MHz
Rise and Fall Rate <1 ns
Minimum Pulse Width 1 ns
Slew Rate 2500 V/μsec
Output Range -2 Vdc to +7 Vdc

The HFA5250 ranks as the world's fastest pin driver for automatic test equipment. With a data rate of 500 megasamples/second, it's over twice as fast as the closest competitor.

WIDEBAND BUFFERS

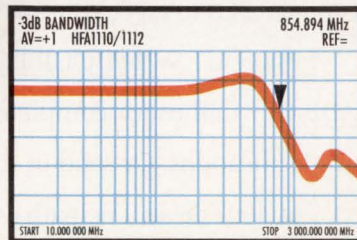

Our HFA1110/1112 buffer amps offer wide bandwidth and gain flatness of 0.14 dB to 100 MHz.

	HFA1110	HFA1112
-3 dB bandwidth	850 MHz	850 MHz
Selectable gain	unity	+2, ±1
Slew rate	1300 V/μsec	1700 V/μsec
Pinout	Std. buffer	Std. op amp
Price (100s)	\$5.95	\$5.95

TRANSISTOR ARRAYS

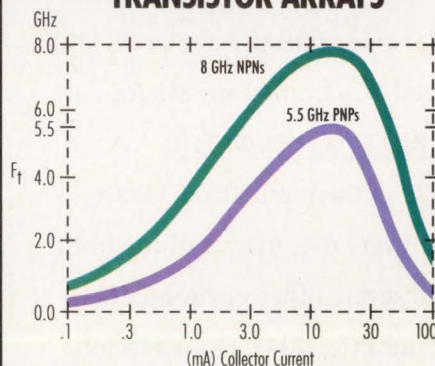

For extremely fast NPNs and PNPs on a single die, Harris transistor arrays are available as high-performance analog cells, enabling you to design your own differential amps, S/Hs, comparators, mixers and more.

APPLICATIONS

- High-Resolution Displays
- RF Transmitters/Receivers
- Medical Imaging Systems
- Radar Systems
- Flash A/D Drivers
- Video Switching and Routing/Line Drivers
- Fiber Optics
- ATE
- Wireless Communications

• Hamilton/Avnet 213/558-2000 • IIT 416/736-1144 • Newark 312/784-5100 • Arrow/Schweber 516/391-1300 • Wyle 408/727-2500

• Melbourne, FL 407/724-3576 • Indian Rocks Beach, FL 813/595-4030 • Carmel, IN 317/843-5180 • Burlington, MA 617/221-1850 • Southfield, MI 313/746-0800 • Mt. Laurel, NJ 609/727-1909

IN A HARSH ENVIRONMENT, AN ORDINARY PC IS A DEAD PC. A lot of PCs do well to survive a desk-top. But on the production floor or in the field, the dust, heat, vibration and traffic can finish an ordinary

tests, we shake, bake and beat them like there's no tomorrow. Because with an ordinary PC, there may be none.

OUR PCS ARE THE BEST BECAUSE THEY'RE BUILT FOR THE WORST. We design our 286, 386

If You Need A PC That Will Go Through Hell, Get One That's Been There.

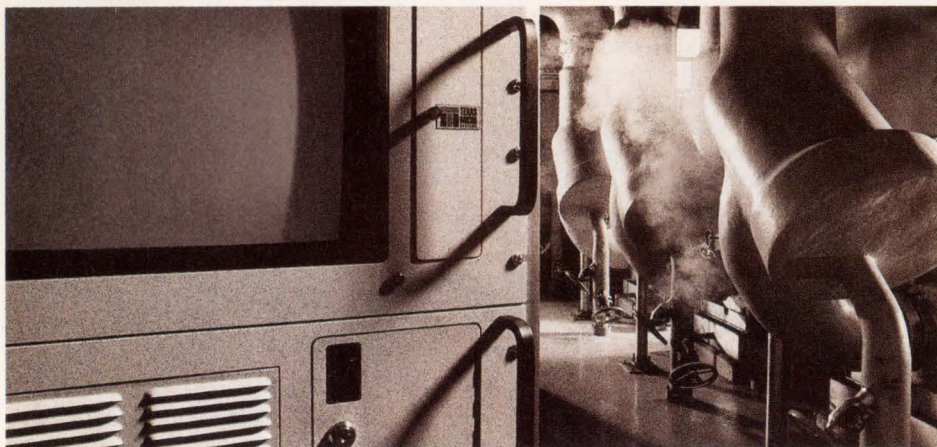

PC—and your operation—in a hurry. Even if your PC has to withstand hell, your business doesn't have to. As long as you're using ruggedized PCs from Texas Micro.

OUR PCS TAKE A BEATING FROM THE FORTUNE 100. In fact, 70 of them put Texas Micro PCs through the wringer every day, in everything from industrial applications to severe office environments.

And we don't spare our PCs, either. During factory

and 486 systems using rugged design techniques that give them up to three times the life expectancy of other PCs.

Our passive backplane, for example, gives you instant access to plug-in CPU cards and components, reducing Mean Time To Repair to under 10 minutes.

We shock-mount the drives within our nickel-plated, all-steel chassis to withstand vibration. We implement VLSI and PAL technology to increase component reliability. And we use positive airflow filtration to reduce contamination and system heat.

STRONG SUPPORT IS OUR STRONG SUIT. We provide toll-free technical assistance and a

regional network of field application engineers. We also customize PCs to meet your particular specifications.

FIND OUT WHAT OUR PCS ARE REALLY MADE OF. Call us for complete product information and specifications. Or send in the attached card.

But don't delay. The pathway to hell is paved with good intentions.



Ruggedized Rackmount

- 14 option slots, 3 drive bays
- Nickel-plated, steel chassis
- 100,000 hr. MTBF* power supply
- Complete front panel accessibility
- 14" VGA Multisync monitor



Ruggedized Workstation

- 9 option slots, 2 drive bays
- NEMA-4 compliant
- 100,000 hr. MTBF* power supply
- CRT/CPU in one unit
- VGA monitor



Ruggedized Benchtop

- 10 option slots, 2 drive bays
- Nickel-plated, steel chassis
- 100,000 hr. MTBF* power supply
- Extra small footprint

Ask A Few Tough Questions: 1-800-627-8700.†

All trade names referenced are the service mark, trademark or registered trademark of the respective manufacturer. *Mean Time Between Failure. † European inquiries call 31-36-536-5595. Other international inquiries call 1-713-933-8050.

CIRCLE NO. 87

EDN-NEW PRODUCTS

CAE & Software Development Tools

use it to generate test signals and system responses and display them using 2-D and 3-D custom graphics in multiple-graph windows that allow data location, zoom, and overlay. The software includes 140 built-in mathematical and systems operations used in DSP including FFT, phase and group delay, fixed-point support, matrix algebra, polynomial generation and evaluation, window generation, complex arithmetic, and signal operators (convolution, correlation). DOS version, \$99. **The Athena Group Inc.**, 3424 NW 31st St, Gainesville, FL 32605. Phone (904) 371-2567. FAX (904) 373-5182. **Circle No. 438**

Manage DOS TSRs. TSRs and More contains the system-oriented routines of Object Professional for Pascal, ported to C/C++. The package works with Borland C++ 2.0 or later, Turbo C++ 2.0 or later, and Microsoft C/C++ 7.0. Major features include swapping and nonswapping TSRs; a swapping Exec; keystroke recording and playback; automatic support for enhanced keyboards, EMS, XMS, and raw extended-memory management; huge arrays stored in EMS, XMS, disk, or normal RAM; and extended DOS and BIOS access. **Turbopower Software**, Box 49009, Colorado Springs, CO 80949. Phone (800) 333-4160; international orders, (719) 260-9136. FAX (719) 260-7151. **Circle No. 439**

Reliability prediction software. The 217 and Bellcore software packages calculate the reliability of electronic components per the MIL-HKKBK-217F and Bellcore reliability standards. The tools can analyze most types of components including integrated circuits, resistors, capacitors, and others. The software provides CAD interfaces, instant pi factors, graphics, user-definable defaults, deratings, and reports. For stand-alone PCs, \$1295. Also available for networked PCs. **Innovative Software Designs Inc.**, Two English Elm Ct, Baltimore, MD 21228. Phone (410) 788-9000. FAX (410) 788-9001. **Circle No. 440**

Numerical analysis under Motif. Xmath Version 1.1 for X-Window workstations combines interactive color graphics, a high-level scripting language, and extensive numeric functions. The scripting language lets you extend and customize the software to develop interactive engineering tools. You can create and manipulate objects

BEYOND EXPECTATION

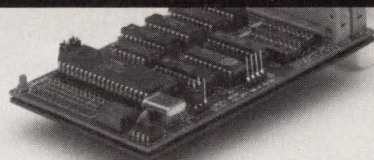

8051/52 • 8096/196

No two emulators run the same. The trick is to get the best functionality you can for your investment. With the SIGNUM 8051 family in-circuit emulator you get even more... you get:

- Outstanding price/performance
- Easy window interface & flash download
- Free user support
- C and PL/M debuggers
- Local variable support
- 512K Mappable emulation RAM with 256K H/W breakpoints
- Break on register ranges
- Program & external data access on the fly
- Bank switching

SIGNUM also has the Intel 8048, Zilog Z8 and Super-8, Texas Instruments DSP, the 8051/52 (from AMD, Siemens and Signetics), and more chips covered.

So, don't just look at in-circuit emulators. The only way to truly test an emulator is to use it. Call for your own free trial and demo disk.

You owe it to yourself to find how much emulator you can really get for your money.

10 DAY FREE TRIAL

SIGNUM SYSTEMS

171 East Thousand Oaks Blvd.
Thousand Oaks, CA 91360

Info. Tel: (415) 903-2220 FAX: (415) 903-2221

CIRCLE NO. 88



IEEE-488

You can control any IEEE-488 (HP-IB, GP-IB, 488.2) device with our cards, cables and software for the PC/AT/386, EISA, Micro Channel and Macintosh II. You get fast hardware and software support for all the popular languages, plus a software library of time saving utilities. Instrument control has never been easier.

FREE

Informative Catalog **800-234-4CEC**
Applications help **617-273-1818**

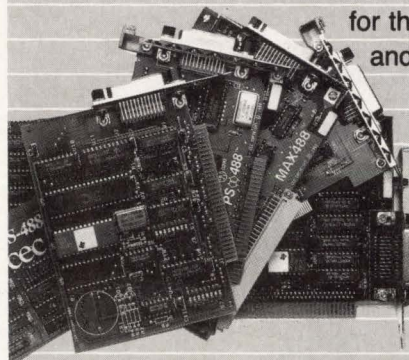

cec

Capital Equipment Corp.
Burlington, MA. 01803

Micro Channel is a trademark of IBM

CIRCLE NO. 89

ULTIMATE CONTROL

Testing Chambers From .37FT³ to 6.16FT³

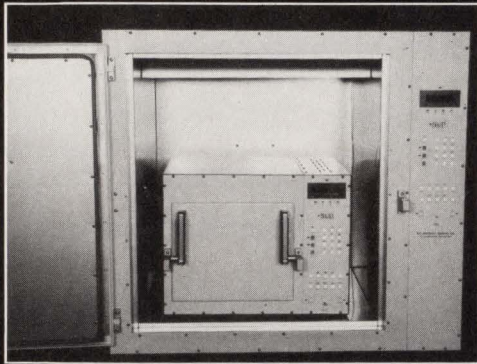

FREE 30 DAY TRIAL

- ▶ -184°C to +315°C
- ▶ GPIB & RS232/422
- ▶ Ramping
- ▶ User Probe
- ▶ PID Algorithms
- ▶ Chart Outputs
- ▶ Analog I/O
- ▶ Programmable
- ▶ 2 Year Warranty
- ▶ Fast Delivery



PROCESS CONTROLLER

- ▶ Single & Dual Channel Control
- ▶ T/C, RTD, Current & Voltage Inputs
- ▶ Dual Control Outputs per Channel
- ▶ 10 Programs in battery backed RAM
- ▶ 100+ segments, ramp/set point/soak



Sun Electronic Systems, Inc.

1601 NW 38th Ave, Ft. Lauderdale, FL 33311

305-587-5577 FAX 587-0450

CIRCLE NO. 90

Looking for a job doesn't have to be one.

EDN's Career Opportunities
section keeps you informed
of current job openings
from coast-to-coast

TURN TO
PAGE 157

EDN-NEW PRODUCTS

CAE & Software Development Tools

built from the Motif widget set without using C or C++. Extensions in this version include extended graphics to more fully utilize the X-Window System, linking with C and Fortran routines, expanded DSP functions, and calling from C and C++. For SPARC and DEC, \$2500. **Integrated Systems Inc.**, 3260 Jay St, Santa Clara, CA 95054. Phone (408) 980-1500. FAX (408) 980-0400. **Circle No. 441**

Escape icon overload in MS-Windows. EasyDOS for Windows Version 3.0 lets you dispense with icons and view all of your MS-Windows applications with verbal labels of your own choosing. The software also includes utilities such as a system-resource monitor, print screen, disk space and system information, and a task switcher. For MS-Windows 3.1, \$49.95. **Microseconds International Inc.**, Box 201, Rancho Santa Fe, CA 92067. Phone (619) 756-0765. FAX (619) 756-0855. **Circle No. 442**

Application accelerator for Unix. The Skyvec Release 3.0 software toolkit lets you develop multitasking applications to run on the Skystation and Skybolt application-accelerator products from the same manufacturer. This release also includes a Standard Math library that provides an interface between the maker's vector compiler and Quantitative Technologies' and Floating Point Systems' library calls, letting you port many existing programs without modification. **Sky Computers Inc.**, 27 Industrial Ave, Chelmsford, MA 01824. Phone (508) 250-1920. FAX (508) 250-0036. **Circle No. 443**

FPGA design kit for Quicklogic pASIC series. The design kit for Quicklogic pASIC Series FPGAs consists of a technology synthesis library, a pASIC-specific optimization algorithm, and a Quicklogic-specific netlist. The design kit requires the manufacturer's Complete Optimization/Retargeting Environment (CORE), at \$8000 per seat. For Unix and DOS. Design kit, \$2000. **Exemplar Logic Inc.**, 2550 Ninth St, Suite 102, Berkeley, CA 94710. Phone (510) 849-0937. FAX (510) 849-9935. **Circle No. 444**

EDN PRODUCT MART

This advertising is for new and current products.

Please circle Reader Service number for additional information from manufacturers.

ROM-IT™ EPROM EMULATION SYSTEM



The Most Flexible EPROM Emulator You Can Get Today!

- Emulates up to 8 4-Megabit EPROMS through one standard serial port.
- Downloads 2-Megabit programs in less than 23 seconds.
- Allows you to examine and modify individual bytes or blocks.
- Accepts Intel Hex, Motorola S-Record and Binary files.
- Software available for IBM PC and compatibles.
- Base 27256 EPROM System \$395.00. Other configurations available.

ORDER TODAY--IT'S EASY
CALL OR FAX FOR MORE INFORMATION



Incredible Technologies, Inc.
(708) 437-2433
(708) 437-2473 Fax
Visa and MasterCard accepted.

CIRCLE NO. 325

☆☆☆☆
"The Best 8051 Emulator"

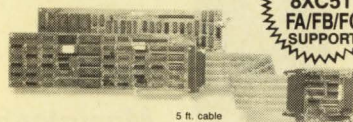

5 ft. cable

FULL
8XC51
FA/FB/FC
SUPPORT

8051

SEE EEM 91/92
Pages D 1300-1303

PC based emulators for the 8051 family

8031, 8032, 8051, 8052, 80C152/164/321/451/452/51FA/51GB/51S/517/53S/537/552/562/652/651, 80532, 83C451/552/652/751/752/851, 8344, 87C451/552/751/752, 8751, 8752, D55000 + CMOS ... more.

- PC plug-in boards or RS-232 box.
- Up to 33 MHz real-time emulation.
- Full Source-level Debugger w/complete C-variable support.
- 64 bit wide, 256K deep trace, with time stamp.
- Bond-out/hooks pods for 8051, 83C552, 83C451, 83C652, 83C751, 80C515/80C517, 83C752, 8XC51FA/FB/FC, and more.

CALL OR WRITE FOR FREE DEMO DISK!

Ask about our demo VIDEO



51 E. Campbell Avenue
Campbell, CA 95008
FAX (408) 378-7869
(408) 866-1820

Call 408-378-2912
Nohea's 24-hour
information center to
receive info via your FAX

CIRCLE NO. 326

NEW! Little PLC™ \$195

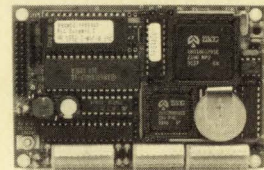

Program It In C

Our new Little PLC™ measures only 4.33 x 2.85 inches and can mount on standard DIN rail. This miniature controller costs only \$195, including 8 optically isolated inputs and 8 relay driver outputs. Low cost expansion cards allow you to add more inputs and outputs: digital and analog. It has dual RS-485 serial I/O, battery backed memory and time/date clock, programmable timers and a watchdog. Our easy to use and affordable Dynamic C™ integrated development system also costs \$195. You can write simple programs in an hour, or you can develop major applications with 20,000 lines of C language.

Z-World Engineering

1724 Picasso Ave., Davis, CA 95616
(916) 757-3737 Fax: (916) 753-5141
24 hr. Automatic Fax: (916) 753-0618
(Call from your fax, request catalog #18)

CIRCLE NO. 327

Natural Voice Playback Boards

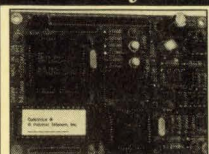

- Point of Sale Terminals
- Site Alarms
- Remote Telemetry
- Weather Stations
- ADA Requirements
- Repeater Identifiers
- Test Equipment
- Multiple Languages
- Emergency Messages

DataVoice DV-200

Add a high quality Recorded Natural Voice to your product. Up to 200 words or multiple phrases totalling 2 minutes can be stored in the non-volatile E-Prom memory. We'll record your words or message(s) in a male or female voice - or - you can record the library of words and phrases by using the optional SDS-1000 development system with an IBM or compatible computer. OEM designs are available.

Parallel / Serial word select 8 ohm audio output
500 ma. keyline output +9v to +14v supply
32 Kb sampling rate Size : 3.00" x 4.25"
Multiple modes Connectors included
Selectable timing Under \$ 90 (OEM qty)

Several different models available - Call for a demonstration
Palomar Telecom, Inc.
300 Enterprise St. Suite E - Escondido, Ca. 92029
(619) 746-7998 Fax (619) 746-1610

CIRCLE NO. 328

UNIVERSAL PROGRAMMER, EMULATOR & TESTER

TUP-400 \$745.00
TUP-300 \$575.00 NEW



- New improved hardware and software.
- The most complete PC-based Universal Programmer. Programs PLD (PAL, GAL, FPL, EPLD, PEEL, MAX, MACH...), E(E) PROM (up to 16 Mbit), Flash EPROM, BPROM, Special PROM, MPU (87XX, 68XX, Z8, PSD301, PIC16XX, TMS320EXX, UPD75PXXX, HD637XXX...).
- Covers DIP, PLCC, QFP, SOP, and PGA with 8 to 84 pins. Gang Programming adapters available also.
- EPROM EMULATION capability.
- Tests digital ICs and DRAMs (SIMM/SIP adapter available).
- Free software updates and new devices added upon request.
- IC Manufacturers' approval.
- 1 year warranty, 30 day money back guarantee.

Supports Motorola and PIC MICROS. WSI PSD 3XX, MAX and MACH. CALL TODAY FOR MORE INFORMATION. Distributors are welcome!



Tribal Microsystems Inc.
44388 S. GRIMMER BLVD, FREMONT, CA 94538
TEL: (510)623-8859
FAX: (510)623-9925

CIRCLE NO. 329

EXPRESS

Best Value in the World

for
5
DAY TURN
PRINTED CIRCUIT PROTOTYPES

LAYERS	2 PIECE PRICES				
	1	2	3&4	5&6	7&8
SQUARE INCH UP TO	15 \$212	\$265	\$581	\$715	\$850
TO	30 240	300	658	815	983
	60 283	354	775	954	1034
	90 325	407	891	1097	1304
	120 350	442	949	1092	1417

- 5 PIECES x 1.34
- 10 PIECES x 1.67

EXTRAS

- Photo Plotting
- Testing
- Gold Contacts - \$50
- 25% - Below 8 Mil

DISCOUNTS

10% **5%**
■ COD ■ NET 10
SALES CREDIT CARD SALES

FOR MORE INFORMATION CALL OR FAX

Ken Bahl
Sierra Circuits, Inc.
Phone (408) 735-7137 FAX (408) 735-1408 Modem (408) 735-9842

CIRCLE NO. 330

To advertise in Product Mart, call Joanne Dorian, 212/463-6415

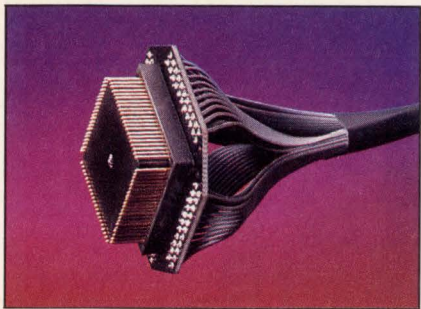

Easy Emulator Pods & Adapters

- Plug your PLCC and LCC packages into your PC board in minutes, with these easy-to-use adapters.
- Emulator/logic analyzer users: Adapt-a-Pod™ converts one package type to another (LCC, PLCC, PGA, and DIPs).
- Emulator pods and adapters are available in all standard pin counts, with ribbon or ribbon cable headers.
- Custom engineering services and do-it-yourself emulator pod converters. Free catalog.

Emulation Technology, Inc.
2344 Walsh Ave. Santa Clara, CA 95051
Phone: 408-982-0660 FAX: 408-982-0664



CIRCLE NO. 331

FREE DEMO DISKS



See why over 20,000 engineers rely on SCHEMA for their design needs.

- ✓ Schematic Capture
- ✓ PCB layout & routing
- ✓ Simulation
- ✓ PLD design

Call 800-553-9119



801 Presidential • Richardson, TX 75081
(214) 231-5167 • FAX (214) 783-9072

CIRCLE NO. 332

THE BEST PROGRAMMER VALUE AVAILABLE TODAY... and we'll prove it! For starters, let us send you a DEMODISK.



NEW SOCKET TECHNOLOGY SUPPORTS ALL PLCC SIZES!

- Universal PLCC & DIP ZIF Sockets
- Can support over 3,000 PLDs, E/EEPROMs, MICROS
- Up to 104 Programmable Pin Drivers
- Field Upgradable and Gang Module Options
- 24-Pin Entry Level Models start at \$995

B&C MICROSYSTEMS INC.
750 North Pastoria Avenue, Sunnyvale, CA 94086 USA
Tel: (408) 730-5511 Fax: (408) 730-5521

CIRCLE NO. 333

INTRODUCING PROTERM

FIRST IN A FAMILY OF LARGER DISPLAY OPERATOR INTERFACES

- 8 lines by 24 characters or 16 lines by 32 characters (selectable)
- VT-100 compatible (ANSI 3.64)
- User programmable keypad
- 30, or 45 key keypad
- Readily customized to suit your application
- RS-232 or RS-422 interface
- Two year warranty

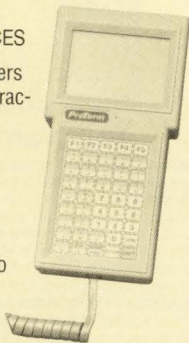

TWO TECHNOLOGIES, INC.
419 SARGON WAY
HORSHAM, PA 19044
(215) 441-5305 Fax (215) 441-0423

CIRCLE NO. 334



Schematic Capture for the Macintosh

NEW DesignWorks™ 3.0!

Introducing a new generation of design tools for the Apple Macintosh. **DesignWorks 3.0 Schematic Features** Unlimited hierarchy • multi-level Undo/Redo • auto-packaging • spreadsheet-style attribute browser and much more. **Optional Digital Simulation Module** 13-state event driven simulation, fully interactive even on hierarchical designs • New interactive test vector panel **Schematic Libraries** New expanded libraries with over 13,000 parts, including all 74xx families, 75xx, 4000, ECL, processors, memories, etc. **Interfaces** Netlist outputs for SPICE, Douglas, McCAD, Cadnetix, OrCad, Tango, Racal-Redac, etc. • Fully customizable reports

CALL (800) 444-9064 TODAY FOR YOUR FREE DEMONSTRATION KIT!
CAPILANO COMPUTING
(604) 522-6200 Fax (604) 522-3972

CIRCLE NO. 335

Combine Your Product Mart Ads

In EDN's Magazine and News Editions for higher impact and a lower rate.

FREE CATALOG



Affordable tools for programmable devices are just a phone call away.

- Unbeatable values on Data I/O® device programmers, software, updates, and accessories
- 30-day, money-back guarantee

Access to Data I/O's toll-free technical hotline and on-line bulletin board

To order your FREE catalog, call Data I/O Direct today.

1-800-3-DataIO
(1-800-332-8246)

DATA I/O

Save 50% on our memory programming system.



- Includes the 212 Multi Programmer with EPROM module, and PROMlink™ Ltd. PC Interface Software
- Supports more than 400 EPROMs up to 40 pins

- Full-hex keypad for extensive editing
- Optional logic and microcontroller modules
- Manufacturer-specified algorithms ensure accuracy

1-800-3-DataIO
(1-800-332-8246)

*U.S. list price only.

Call Data I/O® Direct today to order the 212 Memory System.

DATA I/O

CIRCLE NO. 337

CIRCLE NO. 338

Looking for a Quality Programmer?



SPRINT Universal Programmers

Call now and find out why Sprint is the fastest growing 84 pin programmer in North America.

Tel 800/722-4122 FAX 206/883-8601 for a free demo disk

SMS
North America Inc.

CIRCLE NO. 339

To advertise in Product Mart, call Joanne Dorian, 212/463-6415

Advin



ADVIN versus DATA I/O

- **Data I/O and Model 2900:** reputable company, dependable equipment, supports 40-pins. Software updates: fair amount.
- **Advin and PILOT-U40:** reputable company, dependable equipment, supports 40-pins. Software updates: free via electronic BBS.

ADVIN SYSTEMS INC.

Smaller Company. Better Service.

800-627-2456, 408-243-7000, Fax 408-736-2503

CIRCLE NO. 340

SOIC TO DIP

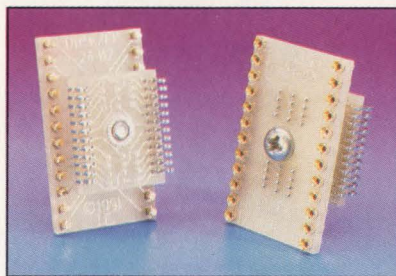

WITH DIP/SOIC PACKAGE CONVERTER

- Convert surface mounted SOIC pattern to DIP.
- Solder to SOIC Land Pattern.
- Then plug DIP IC into DIP socket.
- DIP pins are gold plated machined pins.
- Recessed screw/nut for added strength
- Multiple sizes available

IRONWOOD ELECTRONICS
P.O. BOX 21151, ST. PAUL, MN 55121
(612) 431-7025; FAX (612) 432-8616
CIRCLE NO. 341

TESLA

PC Block Diagram Simulator

Simulate Complete Analog/Digital ASICs and boards fast!

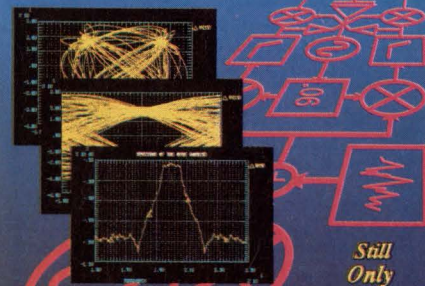

Still Only \$695!

Modems, HDTV, GPS, controls, synthesizers, DSP - any system!
Build up to 800-block systems. Hi-res graphics: time plots, spectrum analysis, XY plots. Do diagrams with OrCAD. Add new blocks with MODGEN option.
Call for demo disk 404-751-9785 fax404-6645817
TESOFT Inc, PO Box 305, Roswell, GA 30077

CIRCLE NO. 342

Now Networkable!

Facts about 750,000 ICs and Semiconductors at Your Fingertips

Cahners CAPS is the industry standard component search and selection tool for electronic design engineers.

- PC-driven, CD-ROM-based
- Includes unabridged manufacturers' technical documentation
- Represents more than 600 manufacturers worldwide

Call toll-free: 1-800-245-6696



275 Washington Street
Newton, MA 02158-1630
Telephone: 508-692-4148
Facsimile: 508-392-0603

CIRCLE NO. 343

Graphic Scientific Graphics

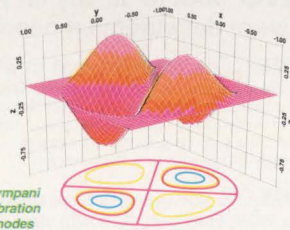

"All of the C language routines you need to write an impressive scientific graphing program of your own. Highly recommended."
PC Magazine 3/14/89

Windows © and DOS versions now available.
Licensed for personal use only.

Scientific Endeavors

508 N. Kentucky Street, Kingston, TN 37763
Orders: (800) 998-1571 FAX: (615) 376-1571

CIRCLE NO. 344

Tiny Embedded 386SX -40° to +85° C

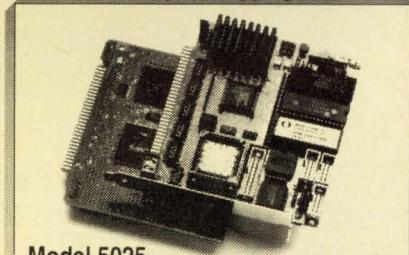

Model 5025

- ▶ 386SX, 25 MHz
- ▶ 4.5" x 4.9"
- ▶ 3 solid-state disks
- ▶ Low power CMOS
- ▶ Rugged, industrial quality
- ▶ Stand-alone or bus operation
- ▶ Flash memory programmer
- ▶ Coprocessor socket
- ▶ COM1, COM2, LPT1 ports
- ▶ 4 MB DRAM
- ▶ "Instant DOS" 3.31 in ROM
- ▶ Autorum operation
- ▶ 5V only operation
- ▶ Keyboard/speaker port
- ▶ Watchdog timer
- ▶ Calendar/clock

THE MICROWARE COMPANY

OCTAGON SYSTEMS
Tel: 303-430-1500, Fax: 303-426-8126

Call or Fax for full-line catalog

CIRCLE NO. 345

PCB and SCHEMATIC C.A.D.

EASY-PC \$195 EASY-PC

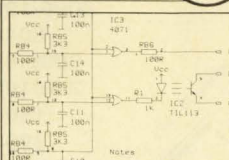

- Runs on PC/XT/AT/286/386 with Herc, CGA, EGA, VGA.
- Design Single sided, Double sided and Multilayer boards.
- Provides Surface Mount support.
- Standard output includes Dot Matrix / Laser / Inkjet Printer, Pen Plotter, Photo-plotter and N.C. Drill.
- Award Winning EASY-PC is now in use in over 12,000 Installations in 70 Countries World-wide.
- SUPERBLY EASY TO LEARN AND USE.
- Not Copy Protected.

Options:- 1000 piece symbol library \$75.00,
Surface Mount library \$112, Gerber Import facility \$195.00

For full info, write, fax, call or use Inquiry #
Number One Systems Ltd. 1
REF: EDN, HARDING WAY, ST. IVES, HUNTINGDON,
CAMBS., ENGLAND, PE17 4WR.

Telephone: USA: 011-44-480-61778. USA: 011-44-480-494042 AMEX, VISA,
Intrnl: +44-480-61778. Intrnl: +44-480-494042 MasterCard
UK :- 0480 61778 UK :- 0480 494042 Welcome

CIRCLE NO. 346

UNIVERSAL DATA ACQUISITION SYSTEM

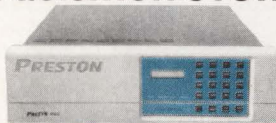

PRESYS 1000

New microprocessor-based system offers thousands of functional combinations for up to six concurrent users:

- 15 all-purpose card slots
- Analog and digital I/Os
- A/D & D/A conversion
- 13-16 bit resolution
- 300 KHz-1 MHz data rate
- 32 MB FIFO memory
- Multiple computer interfaces.

For full-color brochure contact



805 E. Cerritos Ave., Anaheim, CA 92805
(714) 776-6400, Fax (714) 776-3660

CIRCLE NO. 347

Telecom Solutions from Teltone

Central Office Grade DTMF Transceivers

Complete, single-chip DTMF transmitter/receivers with call progress detection, automatic tone burst mode, and adjustable guard time.

For paging systems, fax machines, interconnect dialers, PBX systems, computer systems, etc. CMOS, 5-volt power supply, 20-pin DIP.

- M-8880 features 6500/6800 microprocessor interface.
- M-8888 features 8051, 8086/88 microprocessor interface.

1-800-426-3926

Or: 206-487-1515 Fax: 206-487-2288



INNOVATING SOLUTIONS

In Telecom Interface Components

Teltone Corporation, 22121-20th Avenue SE, Bothell, WA 98021

CIRCLE NO. 348

MICROTIME Set up at 1984 for Development tools

Bice 8051 (Add-on Card ICE)

- 8051 adapter to emulate 8051/52, 8751/52
- 8031 adapter to emulate 8031/32
- Real-time breakpoint and Non real time trace
- Symbolic Debugger
- The others: 8048, Z8, 6805, T17000

MEMPET-256 (Memory emulator)

- To emulate EP (ROM) from 2K to 256K Bytes and SRAM from 8K to 128K Bytes
- To emulate byte, word, long word, expand up to 8 modules or 1 EPROM writer (4MBIT)
- Support Break, Range Break and external trigger function
- Support Line Assembler/Disassembler for each CPU (option)

AP-511 (Programmer)

- Can program 8751/52, 8748/49/50 family, and 27xxx up to 27020
- Support Line Assembler/Disassembler for each CPU

Stand-alone ICE and programmer

- ICEPET 8048, 8051, Z80, 5202, 8096, 188, Z8, 68000/10
- ICERET V (universal ICE) 80186/88, 80196 (8096), 87C75/1752, 64180(Z180) (Z80, 68000/10, 68020, 80286, 80386, 68HC11 will come out on 1992)



Distributor Welcome

MICROTIME COMPUTER INC.

10F, 196, SEC. 4, CHENG-TEH RD. TAIPEI, TAIWAN
R.O.C. TEL: 886-2-8811791 FAX: 886-2-8820836

CIRCLE NO. 349

INDUSTRIAL PC SINGLE BOARD COMPUTER & BACKPLANE B'D

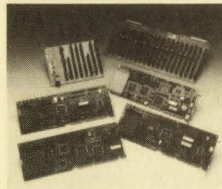

- Full surface mount technology.
- Single board is compatible with IBM and PC bus system. And all kind of industrial PC I/O board.
- 286C-12, 386SXC-16/20, 386DXC-33 CPU board.
- 6, 8, 12, 14, 18, 20 slot backplane board.
- Split backplane board is available.
- 19" rackmount PC enclosure is available.
- Centralized LAN station system (security)

COMTECH TECHNOLOGY

62 Bonaventura Dr.
San Jose, CA 95134

Tel. #: California: 408-456-0333
Nationwide: 800-875-0333
Fax #: 408-456-0366

CIRCLE NO. 350

MICROPROCESSOR EMULATORS

Zax provides a comprehensive series of real-time emulation support for Motorola, Intel, NEC, Zilog, and Hitachi microprocessors. Some of the highlighted features include source-level debug, real-time trace, and performance analysis.

Call now for more information:

(800) 421-0982
(714) 474-1170 (Inside CA)
(714) 474-0159 (Fax)

ZAXTEK

42 Corporate Park Irvine, CA 92714

CIRCLE NO. 751

Mixed Mode Simulation

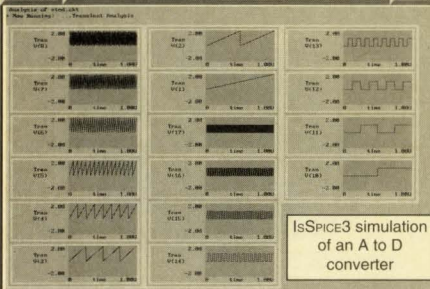

IsSPICE3 simulation of an A to D converter

FULLY INTEGRATED, EASY TO USE, ANALOG CIRCUIT SIMULATION ENVIRONMENT, FROM ONE VENDOR, FEATURING: A powerful SPICE simulator performing AC, DC, and Transient analyses, extensive model libraries, schematic entry, graphical waveform processing. Complete systems start at under \$1000.

Call Or Write For Your Free Demo and Information Kit
P.O. Box 710 San Pedro, CA 90733-0710
Tel. 310-833-0710 **intusoft** Fax 310-833-9658

CIRCLE NO. 752

FINALLY

One tool to satisfy all your firmware development needs

PROMICE is a universal system.

- Develops code for any microprocessor
- Complete, real time, source level debugging
- Host software for DOS, Unix, Mac, VMS
- Non intrusive on your target system
- Simply plugs into any ROM socket

PROMICE also supports Turbo Debugger, C_thru_ROM, FreeForm, GDB, and more.

PROMICE ...the affordable solution.



TEL: (614) 899-7878
West: (415) 750-0219
FAX: (614) 899-7888

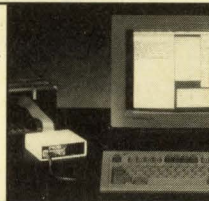

CIRCLE NO. 753

Communicate Weekly

to the electronics OEM through EDN's Magazine and News Editions Product Mart

TURBO 320 Realtime DSP Development System

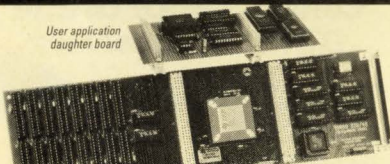

Digital Signal Processor development environment using TI's TMS320C30 40 MHz floating point DSP and the TI Compiler, Assembler, Linker and Debug software.

FEATURES

Optional daughter board interface • 8 Mb RAM 40 MHz speed • TI Software compatible



PO Box 230035, Encinitas, CA 92023
800-733-8089

CIRCLE NO. 755

EPROM PROGRAMMER

FOR THE PC \$139.95

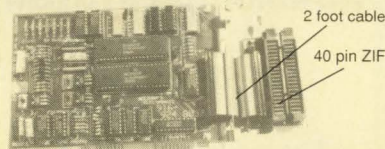

- 2716 to 4 Meg
- Programs 2764A in 10 seconds
- 16/32 bit split programming
- Menu driven software
- No personality modules required
- Adapter for 8748, 49, 51, 52, 55, TMS 7742, 27210, 57C1024, and memory cards
- 1 year warranty • 10 day money back guarantee
- Made in the U.S.A.

For more information, call (916) 924-8037
EMPDEMO.EXE available BBS (916) 972-8042

NEEDHAM'S ELECTRONICS

4539 Orange Grove Ave. • Sacramento, CA 95841
(Monday - Friday 8:00 a.m. - 5:00 p.m. PST)

CIRCLE NO. 756

CROSS-ASSEMBLERS

DOS COMPATIBLE

8051
8096/196
8048
8080/85
Z80/180
1800
9900
SPARC

Now honoring RELMS software licenses.

RELMS • LOGISOFT

PO BOX 61929 SUNNYVALE, CA 94088
CALL (408) 773-8465 FAX: (408) 773-8466

680X0
68HC11
6809
6805
6800
6502/65C02
6301

PROFESSIONAL TOOLS FOR ENGINEERING PROFESSIONALS

CROSS-DISASSEMBLERS

CIRCLE NO. 757

To advertise in Product Mart, call Joanne Dorian, 212/463-6415

DIODE - TRANSISTOR T_{RR}, T_T, T_L, T_R, T_F, T_S TESTS

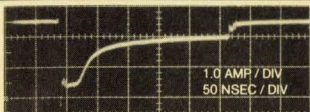

Avtech offers over 15 different fast high-power pulse generators ideal for performing switching time tests specified by diode and transistor manufacturers and by MIL-STD-750C and MIL-S-19500. See our free 80 page general catalog and Application Note No. 2 for:

- Transition times from 60 psec to 10 nsec
- Pulse widths from 1nsec to 20 usec
- Voltages from 5 to 100 volts
- Currents from 100 mA to 10 Amps
- Source impedance from 1 to 50 ohms
- 150 other nanosecond pulse generators, amplifiers, samplers, transformers and fast pulse accessories

AVTECH
ELECTROSYSTEMS

P.O. Box 265, Ogdensburg
New York 13669
(315) 472-5270

P.O. Box 5120, Station F
Ottawa, Canada K2C 3H4
(613) 226-5772
Fax: (613) 226-2802

CIRCLE NO. 758

16 MHz CPU
DRAM to 512K
20 MHz DSP
SRAM to 96K

DAPL™ Operating System
100+ standard commands
Custom commands in C

The
Intelligent
Solution
For
Data
Acquisition

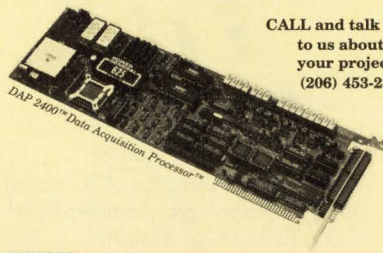

CALL and talk
to us about
your project.
(206) 453-2345

ANALOG I/O
DIGITAL I/O

Inputs to 235K samples per second
Outputs to 250K samples per second

Or call for
FREE demo diskette.

MICROSTAR
LABORATORIES
2265 116th Avenue NE
Bellevue, WA 98004
FAX (206) 453-3199

CIRCLE NO. 759

INTELLIGENT DATA ACQUISITION

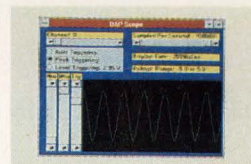

Now you can run high speed data acquisition under Windows™. A Data Acquisition Processor™ with on-board intelligence handles the critical part of an application: the tasks that run in real time. The DAP can be controlled from any Windows language or application that can make DLL calls. The one shown here is written in Visual Basic™ and uses only seven DLL functions.

Phone 206/453-2346, or fax
206/453-3199.

MICROSTAR
LABORATORIES

CIRCLE NO. 760

48 Channel 50MHz Logic Analyzer

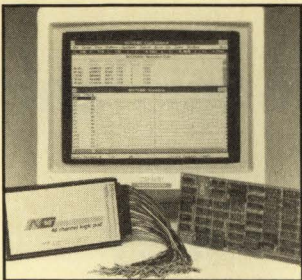

Complete System \$1895.00
New Windows 3.0 Compatible Software

- 48 Chnls @ 50 MHz x 4K words deep
- 16 Trigger Words/16Level Trigger Sequence
- Storage and recall of traces/setup to disk
- Disassemblers available for: 68000, 8088, 8086, 6801, 6811, Z80, 8085, 6502, 6809, 6303, 8031

NCI □ 6438 UNIVERSITY DRIVE,
HUNTSVILLE, AL 35806
(205) 837-6667 FAX (205) 837-5221

CIRCLE NO. 761

8051 68HC11 COP8 68HC05

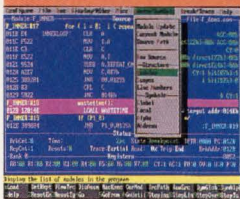

icEMASTER
Improved
User Interface
Features

- Easy to learn & use
- Windowed interface -- user configurable
- FAST! Download -- <3 sec. typ. at 115KB
- Source level debug

- A 4K frame trace buffer with advanced searching capabilities.
- icEMASTER connects easily to your PC, requires no disassembly or expansion slots. Works on any PC (DOS or OS/2), Micro Channel or EISA. Even laptops!
- Broad support of derivative devices.
- Rental and 10-day trials available.
- Now virtual memory and mouse support.
- Call today for free demo disk and ask about a free 8051 Macro Assembler! (800) 638-2423

MetaLink
Corporation

MetaLink Corporation P.O. Box 1329 Chandler, Az 85244-1329
Phone: (602) 926-0797 FAX: (602) 926-1198 TELE: 4998050110K

NEW
68HC05!

CIRCLE NO. 762

Tango

The Complete
Electronic Design Solution.



For FREE evaluation software
and product specs,

call 800 488-0680

Tango, the leader in
PC-based tools for:

- Schematic entry
- PCB layout and autorouting
- PLD design
- Simulation, timing verification and thermal reliability

ACCEL Technologies, Inc.
6825 Flanders Drive
San Diego, CA 92121-2986
Service 619 554-1000
Fax 619 554-1019

CIRCLE NO. 763

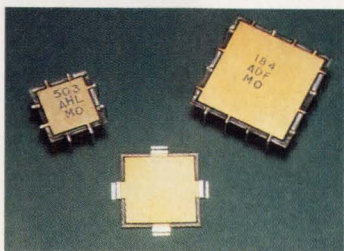

CUT PGA/PLCC NOISE

MICRO/Q® 3000 capacitors reduce noise associated with PGA and PLCC devices. Designed to be mounted under the device, take no extra board space. Can be used under MPUs, Gate Arrays, and ASICs. Choose from Z5V, X7R, and P3J dielectrics. Available in both thru-hole and surface mount versions. Several sizes available to fit all devices.

Circuit Components Inc.
2400 S. Roosevelt St., Tempe, AZ 85282
602/967-0624

CIRCLE NO. 764

400 MHz LOGIC ANALYZER

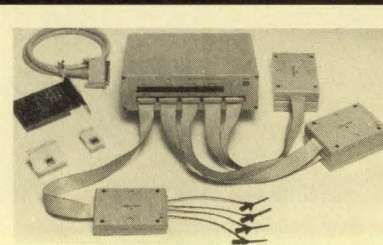

- up to 128 channels
- up to 400 MHz
- 16K samples/channel
- Variable threshold
- 8 External clocks
- 16 level triggering

\$799 - LA12100 (100 MHz, 24 Ch) Price is Complete
\$1299 - LA32200 (200 MHz, 32 Ch) Pads and Software
\$1899 - LA32400 (400 MHz, 32 Ch) included

Call (201) 808-8990
Link Computer Graphics, Inc.
369 Passaic Ave, Suite 100, Fairfield, NJ 07004 fax: 808-8786

CIRCLE NO. 765

UNIVERSAL PROGRAMMER

\$599
US Only

SUPERPRO[®]

- Programs PLD (PAL, GAL, FPL, EPDL, PEEL, MAX, MACH, ...) E(EP)ROM up to 8Mbit, Flash EPROM, BPROM, Micro-controllers (MOT, NSC, Zilgo, Hitachi, NEC, Microchip, Intel, ...) and 1700 other parts.

- Tests TTL/CMOS logic ICs & Dynamic/Static Memory.
- New parts added upon customer request and free updates on BBS (24 hrs)
- Online technical support and hardware warranty for 1 year.

ROM MASTER™: \$149

Universal E(EP)ROM programmer to 4Mbit

ROM MASTER/4: \$239

Universal E(EP)ROM programmer 4 Gang Version

XELTEK

757 N. Pastoria Avenue, Sunnyvale, CA 94086
TEL (408) 524-1929 FAX (408) 245-7084 BBS (408) 245-7082

CIRCLE NO. 766

To advertise in Product Mart, call Joanne Dorian, 212/463-6415

State Machine Design

For Complex & High Density PLDs



The most powerful PLD/FPGA CAE design software from \$495.00

CUPL™ 4.2

1-800-331-7766 **LOGICAL DEVICES, INC.**
1-305-428-6868

CIRCLE NO. 767

Device Programming

Certified by the Semiconductor Industry

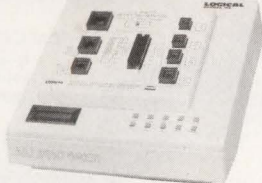

World's largest selection of PC based and stand-alone programmers from \$395.00 to \$10,000.

ALLPRO™ 88

1-800-331-7766 **LOGICAL DEVICES, INC.**
1-305-428-6868

CIRCLE NO. 768

Control Cross-C

Full ANSI Cross-C Compilers & Assemblers

- ◆ HD64180, HD647180X, Z80, Z180/1/2, Z280, 8085.
 - ◆ DOS based cross-compilers for ANSI and K&R C code.
 - ◆ C & assembler demos available on 24 hour BBS.
 - ◆ Completely automatic MMU support (no programming effort) for UP TO 1 MEG Z180 programs.
 - ◆ Includes HD64180/Z180 support library with source.
 - ◆ Comes with high-speed assembler, linker, and librarian.
 - ◆ Includes macros to interface C and assembly.
 - ◆ All ANSI .H files and libraries provided. Source available.
 - ◆ Generates inline port I/O. Char types are not promoted to int.
 - ◆ Allows in-line assembly with access to C variables.
 - ◆ All code is reentrant and ROMable.
 - ◆ Fast ANSI/IEEE 754/INTEL floating point support.
 - ◆ Supports C ISR's. Can compile to user defined segments.
 - ◆ 32 functions of real-time exec. (RTX) accessible from C.
 - ◆ RTX - 256 tasks, queues, & boxes w/ full interrupt support.
- ANSI C Compiler, Assembler, Linker - \$699
Assembler and Linker Only - \$279
32 Fn. Real-Time Executive incl. Source - \$399

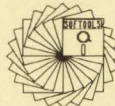

SOFTTOOLS, INC.

8770 Manahan Drive
Ellicott City, MD 21043
(410) 750-3733
FAX/BBS (410)750-2008

CIRCLE NO. 769

CHIP PAIR CORRECTS RANDOM AND BURST ERRORS

EASILY ADD FORWARD ERROR CORRECTION (FEC) TO ANY DATA CHANNEL.

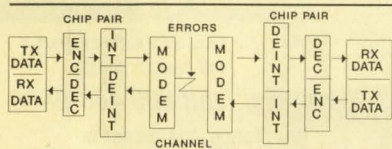

- Separate FEC and Interleaver chips.
- 1/2-rate FEC code chip alone corrects any 3-errors per 24-bit block.
- Programmable to correct error bursts from 9 to 12,285 bits!
- Completely transparent to user's data.
- Patented auto-sync scheme.
- Easy to use, low power CMOS.
- Only requires data and clock from user.



4950 FM 1960 WEST, SUITE C3190
HOUSTON, TX 77069
713-782-2244 713-875-1756 (FAX)

CIRCLE NO. 770

CP-1128 COMBINATION PROGRAMMER \$1295.00



- PROGRAMS ALL AMD MACH EPLDs
- PROGRAMS ALL 22V10 PALs including BiCMOS PLDs
- SUPPORTS E/EPROMs UP TO 28 PINS
- SUPPORTS bipolar PROMs UP TO 28 PINS
- CALL 1-800-225-2102 FOR A LITERATURE PACK AND DEMO DISK
- LIFETIME FREE SOFTWARE UPDATES
- MANUFACTURER APPROVED
- MADE IN THE USA

BP MICROSYSTEMS

The Engineer's Programmer™

Houston, Texas 77043-3239 • (713) 461-9430 • (713) 461-7413

1-800-225-2102

CIRCLE NO. 771

Consistency is key

to the power of EDN Product Mart

Speed THRILLS

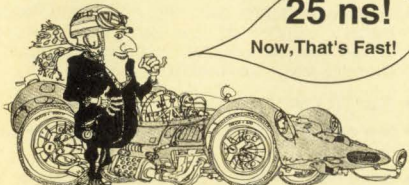

The Xicor X28TC256 is the World's Fastest E²PROM



Xicor, Inc., 1511 Buckeye Drive
Milpitas, CA 95035
(408) 432-8888 - FAX (408) 432-0640

CIRCLE NO. 773

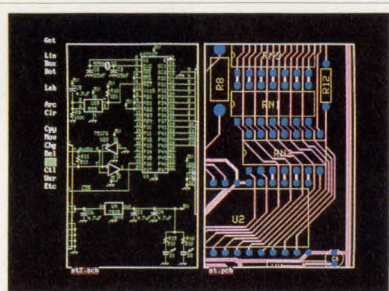

New Schematic and PCB Software

With support for extended and expanded memory, HiWIRE II can handle your most demanding schematic and PCB designs quickly and easily. The unique HiWIRE editor allows you to display and edit schematics and PCBs simultaneously, using the same commands for each. HiWIRE II is \$995, and is guaranteed.

Wintek Corporation

1801 South St., Lafayette, IN 47904
(800) 742-6809 or (317) 448-1903

CIRCLE NO. 774

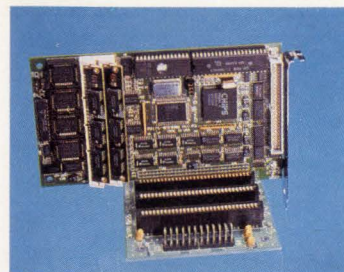

TURBO XT WITH SOLID STATE DISK

- PC Bus, 4.2" x 6.7", MS/DOS 2.0 - 5.0
- 2 Serial Ports, 1 Parallel Port
- Up to 2 FLASH SSDs, Bootable
- 1 Meg total FLASH storage, 2 Meg DRAM
- 10MHz Operation, WatchDog Timer
- Software Included / SSD, EMS Handling
- 6 Layer, CMOS, Wide Temp. Range
- Made in the U.S.A. / 1 Year Warranty
- \$295.00 qty. 1, Quantity **VMAX**® Pricing Available

TEMPUSTECH, INC.
TEL: (800) 634-0701 295 Airport Road
FAX: (813) 643-4981 Naples, FL 33942

CIRCLE NO. 775

To advertise in Product Mart, call Joanne Dorian, 212/463-6415

EDN-CAREER OPPORTUNITIES

1992 Recruitment Editorial Calendar

Issue	Issue Date	Ad Deadline	Editorial Emphasis
EDN Products & Careers	Oct. 8	Sept. 24	CAE • PC/Workstation Design • Engineering Management Special Series
EDN Magazine	Oct. 15	Sept. 24	Disk Drives • Portable-Computer Design • Switching Power Supplies • Design it Right Series—Part II
EDN Products & Careers	Oct. 22	Oct. 8	Data Storage Technology Communications Technology Regional Profile: Michigan, Illinois, Missouri
EDN Magazine	Oct. 29	Oct. 8	ELECTRONICA SHOW ISSUE • Object-oriented Programming • Chipsets for PCs Design it Right Series—Part III Wescon Preview Issue
EDN Products & Careers	Nov. 5	Oct. 22	COMDEX/WESCON SPECIAL ISSUE • Special Supplement: Design for Portability • Microprocessors • Wescon/Comdex Hot Products • CAE Software • Diversity Special Series
EDN Magazine	Nov. 12	Oct. 22	COMDEX/WESCON SPECIAL ISSUE • Integrated Circuits • Test & Measurement • Design it Right Series—Part IV
WESCON '92 SHOWGUIDE & PRODUCT SPOTLIGHT		Oct. 9	A free page available to all advertisers running a full page in 2 out of 3 Wescon issues.
EDN Products & Careers	Nov. 19	Nov. 5	CAE Software • EDN's "Innovation Crusade"—Winners Coverage • Communications Technology • Regional Profile: So. California, Nevada
EDN Magazine	Nov. 26	Nov. 5	19th Annual Microprocessor Directory • ASICs • Sensors • EDN's "Innovation Crusade"—Winners Coverage
EDN Products & Careers	Dec. 3	Nov. 19	ICs & Portable Computers • Power Sources • Laptops/Portables • Low-power Design • Regional Profile: Massachusetts, New Hampshire
EDN Magazine	Dec. 10	Nov. 19	INTERNATIONAL PRODUCT SHOWCASE—Vol. I • Power Sources • ICs & Semiconductors • Software • Hardware & Interconnect
EDN Magazine	Dec. 24	Dec. 3	INTERNATIONAL PRODUCT SHOWCASE—Vol. II • Computers & Peripherals • Components • Test & Measurement • CAE

Call today for information on Recruitment Advertising:

East Coast: Janet O. Penn (201) 228-8610
 West Coast: Judy Telander (310) 826-5818
 National: Roberta Renard (201) 228-8602

Explore Opportunities with CAE Leader!

Development Engineer

As a member of our R&D staff, you will participate in the creation of sophisticated CAE tools. Particular areas of involvement will include development of time- and frequency-domain simulation algorithms for high-frequency circuits and active/passive element models for inclusion in EEsosof's CAE products. Requires: MSEE (Ph.D. preferred); 2+ yrs. exp. in CAE as applied to linear/nonlinear circuit analysis in time- and frequency-domain, SPICE-type simulation algorithms, and high-frequency active/passive element models.

Senior Scientist

As part of our Product Marketing team, you will serve as a senior resource for RF systems theory and design. Will also provide technical liaison between customers, Marketing, and R&D on systems simulation tools. Requires: MSEE (Ph.D. preferred); 5+ yrs. exp. in system theory and design (with emphasis in digital communications); detailed theoretical understanding of communications, EW, and RADAR systems; and strong writing and presentation skills. System simulation experience highly desirable.

As the leading developer of high-frequency analog and microwave EDA tools, EEsosof offers competitive compensation and full benefits in a technically challenging environment. Explore opportunities by mailing or faxing your resume (principals only), in confidence, to: EEsosof, Attn: HR-EDN, 5601 Lindero Canyon Road, Westlake Village, CA 91362. FAX: 818-879-6212.

Equal Opportunity/Affirmative Action Employer

EEsosof Software Solutions for High-Frequency Analog Design

MICROELECTRONICS IN ARIZONA

Medtronic Micro-Rel, a strong Fortune-500 firm, is strategically placed in today's growth industries—Medical, Electronics and Semiconductor. We have grown consistently in sales, profitability and market share, in spite of the current recession. Among other products, we make implantable cardiac pacing devices that save lives. Medtronic Micro-Rel is located near Phoenix, an area that provides affordable housing, excellent schools and colleges, and an attractive life-style. Consider these opportunities:

PRINCIPAL MECHANICAL/PACKAGING ENGINEER

Responsible for managing IC/Hybrid assembly process engineering issues for start-up of new manufacturing line. Also includes selecting/implementing process controls, SPC and DOE; selecting/qualifying new equipment; and supervising Process Engineering team. Requires BSME or BS Material Science plus 10 years related experience in semiconductor manufacturing. (Back-end environment.)

SR. MANUFACTURING ENGINEER

Responsible for sustaining resistance seam sealing process for a MIL STD 1772 hybrid manufacturing line. A BSME, Chemical Engineering or Material Science degree with 3 years engineering experience within a microelectronics manufacturing, seam sealing/environmental testing setting required.

Please forward your resume in confidence to: Medtronic Micro-Rel, Dept. EDN101, 2343 W. 10th Place, Tempe, AZ 85281.

Medtronic  Micro-Rel

An Equal Opportunity Employer

We're looking for the perfect match.

Positions available in Austin, TX,
in the heart of the Texas Hill Country.



Opportunities to make an impact on future software/hardware for AIX/RISC System 6000 are now available for experienced engineers/programmers with a BSEE/CS or higher and a minimum of 3 years experience.

PROGRAMMERS

Unix, C, C++
TCP/IP-NFS-DCE
X-Windows-Graphics
Device Drivers-Kernel
Cluster
Multi-Processing
System Management
Performance Analysis

ELECTRICAL ENGINEERS

VLSI, Logic/Chip Design
Board/Card Design
Circuit Design
Simulation
Power System Design
Electronic Design Tools
I/O Design, DASD, Tape,
Communications
Experienced Chip/Board Layout

Please send resume in complete confidence, indicating area of interest, to:
Professional Recruiting, IBM Corporation, 11400 Burnet Road, Internal
Zip 1047, Austin, Texas 78758 or FAX resume to: (512)823-7891.



An equal opportunity employer.

AIX is a trademark of IBM
UNIX is a trademark of AT&T

Knock, Knock.

In EDN's
Magazine
and News
Editions,
opportunity
knocks all
the time.

EDN Magazine
Edition
News
Edition

Quality design and advanced technology. Because lives depend on it.

Siemens Pacesetter, Inc. makes implantable cardiac devices. Tiny enough to fit in your fist. Powerful enough to sustain life. Innovative enough to have made history. Incredible enough to last a decade or more. Perceptive enough to know when patients are exercising and when they're resting.

But at Siemens Pacesetter, Inc., together with our multi-billion dollar parent company Siemens, we are looking toward the future. We are developing implantable devices that can start a stopped heart. Pacemakers tiny enough to be implanted in premature babies with heart defects. Implantable technology that mimic the human heart down to the subtlest nuances.

The field of cardiac device therapy has come so far so fast, there's no telling where technology will take us in twenty years. If you need incredible challenges in a high-tech environment and the opportunity to do work that literally saves and changes lives, you'll find your opportunity to make a difference at Siemens Pacesetter, Inc. Future opportunities include:

AUTOMATED TEST ENGINEER

To perform analog and digital circuit design, SW development and test system integration. Requires BSEE and 3+ years ATE experience in the design/development of computer-based automatic production test equipment. **Respond to Dept. EDN/ATE.**

IC LAYOUT DESIGNER

Utilizing Sun SPARC workstations, will layout CMOS analog/digital circuits with standard cell and fully customized methodologies. Requires 2+ years layout experience and working knowledge of UNIX. **Respond to Dept. EDN/ICDE.**

PROCESS ENGINEER

Will handle machine design projects utilizing electro-pneumatic mechanisms/processes involving YAG laser welding. Requires BSME/EE with 5 years experience in CNC machine control, diagnostics, mechanical fixture design and repair of digital/analog circuits. **Respond to Dept. EDN/PE.**

SR. PROCESS ENGINEER

Will develop/implement new processes, equipment, components and manufacturing methods to support hybrid test and manufacturing. Emphasis will be on improving manufacturing yields, designing SPC systems and conducting hybrid material R&D. Requires BSEE/ME; 5 years hybrid experience preferred. **Respond to Dept. EDN/SPE.**

SOFTWARE QUALITY ENGINEER

Will develop/implement software test designs for validation/verification of product and manufacturing. Requires experience in software development for microprocessor-based products and software test design procedures. A BSCS or equivalent is desirable. **Respond to Dept. EDN/SQE.**

SR. COMPONENT RELIABILITY ENGINEER

Requires BSEE with 5 years experience in reliability engineering, failure analysis techniques and rate predictions. Knowledge of IC and hybrid design/evaluation/qualification techniques and CMOS is essential. **Respond to Dept. EDN/CRE.**

SR. ANALOG ELECTRONICS DESIGN ENGINEER

Duties include designing low power CMOS op amps and switched capacitor circuits and overseeing layout. Will also perform some system design, integration and scheduling. Requires BS/MS in Electronics, 10+ years analog design experience and 5+ years IC design experience. Thorough knowledge of SPICE and FET models a must. **Respond to Dept. EDN/AEDE.**

SR. ELECTRONIC PRODUCT ENGINEER

BSEE and 3-5 years experience in analog/digital design, CMOS/TTL devices and microprocessor-based systems essential. Ideal candidate will have knowledge of hybrid micro-electronics involved in the manufacture of high-reliability electronic devices. **Respond to Dept. EDN/EPE.**

SOFTWARE ENGINEER

Utilizing Assembly and C languages, will design/develop system and application SW for real-time embedded microprocessor-based device support products. Requires BSEE/CE or equivalent and 3+ years experience in embedded microprocessor and system-level SW design/development. **Respond to Dept. EDN/SE.**

In addition to our desirable Southern California location, we offer competitive compensation, paid relocation and complete benefits including employer-paid pension plan, 401(k) savings, tuition reimbursement, vision care and a choice of medical/dental plans. Send resume (NO PHONE CALLS, PLEASE!) to the appropriate department: **Greer A. Brooks, Employment Representative, Siemens Pacesetter, Inc., 15900 Valley View Court, P.O. Box 9221, Sylmar, CA 91392-9221. AA/EOE**

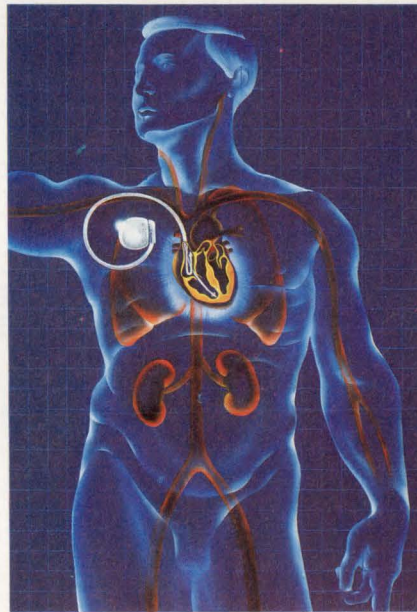

Siemens Pacesetter®



Excellence in Cardiac Pacing

INFINITE CHALLENGES

E-Systems ECI Division is in need of engineers with military satellite communication experience (ground, manpack/manportable, airborne, or spaceborne); a BSEE/BSCE; and at least 2 years' experience in one of the following areas:

SOFTWARE

- ADA, C
- 1750A, of 68020 Microprocessors
- VAX VMS, Sun UNIX
- Real-time, Embedded Microprocessor
- DOD-STD-2167A, CASE Tool

DIGITAL HARDWARE

- ACTEL FPGAs
- Microprocessor based systems
- 1553 bus interface

DIGITAL SIGNAL PROCESSING

- Discrete Fourier Transforms
- Control Loops
- PSK Demodulation

EMBEDDED CRYPTO

- Security Fault Analysis
- TEMPEST, Red/Black Isolation
- Related interface hardware

RF and MICROWAVE

- Synthesizer Design, Direct Digital
- Power amp and filter design
- MMIC design

ANTENNA DESIGN

- Parabolic Antenna Design
- Gimbal, Positioner
- 10 TO 60 GHz

SYSTEMS

- BSEE/MSEE, minimum 4 years' experience
- Strong communication background
- Requirements Analysis, Functional Analysis
- System Synthesis, System Analysis
- RF Link Budget Analysis
- System Integration/Test
- Customer Interface

Background: Hardware, Software Architecture Cryptographic; BIT/BITE; Antenna Pointing, Tracking, and Platform Stabilization; MIL-STD-1582; SI-1135, SI-2035, LL1005.

MILSTAR or other military satellite design experience a plus.

E-Systems offers very competitive salaries and an excellent benefits package which includes an Employee Stock Ownership Plan, 401 (k), and major medical and dental insurance. Qualified candidates should forward a resume and salary history to: Manager of Staffing, E-Systems, Inc., ECI Division, Post Office Box 12248, St. Petersburg, Florida 33733-2248.

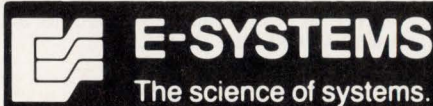

U.S. Citizenship Required.
An Equal Opportunity Employer, M/F, D,V.

Professional Profile

Announcing a new placement service for professional engineers!

To help you advance your career. Placement Services, Ltd. has formed the EDN Career News Databank. What is the Databank? It is a computerized system of matching qualified candidates with positions that meet the applicant's professional needs and desires. What are the advantages of this new service?

- It's absolutely free. There are no fees or charges.
- The computer never forgets. When your type of job comes up, it remembers you're qualified.
- Service is nationwide. You'll be considered for openings across the U.S. by PSL and its affiliated offices.

- Your identity is protected. Your resume is carefully screened to be sure it will not be sent to your company or parent organization.
- Your background and career objectives will periodically be reviewed with you by a PSL professional placement person.

We hope you're happy in your current position. At the same time, chances are there is an ideal job you'd prefer if you knew about it. That's why it makes sense for you to register with the EDN Career News Databank. To do so, just mail the completed form below, along with a copy of your resume, to: Placement Services, Ltd., Inc.

IDENTITY

Name _____

Home Address _____

City _____ State _____ Zip _____

Home Phone (include area code) _____

PRESENT OR MOST RECENT EMPLOYER

Parent Company _____

Your division or subsidiary _____

Location (City, State) _____

Business Phone if O.K. to use _____

EDUCATION

Degrees (List)	Major Field	GPA	Year Degree Earned	College or University

POSITION DESIRED EXPERIENCE

Present or Most Recent Position From To Title _____

Duties and Accomplishments Industry of Current Employer _____

Reason for Change _____

PREVIOUS POSITION

Job Title _____

Employer From To City _____

State Division Type of Industry _____

Salary Duties and Accomplishments: _____

COMPENSATION / PERSONAL INFORMATION * (optional)

Years Experience _____ Base Salary _____ Commission _____

Bonus _____ Total Compensation _____ Asking Compensation _____

Min. Compensation _____ Date Available _____

I own my home. How long? _____ I rent my home/ apt.

Employed Self-Employed Unemployed

Married Single Height _____ Weight _____

Level of Security Clearance _____ I Will Travel _____

U.S. Citizen Non-U.S. Citizen Light Moderate Heavy

WILL RELOCATE WILL NOT RELOCATE OTHER _____

My identity may be released to: Any employer

All but present employer

EDN Databank A DIVISION OF
265 S. Main Street, Akron, OH 44308 216/762-0279
PLACEMENT SERVICES LTD., INC.

EDN-INTERNATIONAL ADVERTISERS INDEX

ACCEL Technologies Inc	155
Advanced Micro Devices	12-13, 24-25, 26-27
Advin Systems Inc	153
Ametek	106
AMP	46-47
Augat	34
Avtech Electrosystems Ltd	155
BASF	10-11*
B&C Microsystems	152
BP Microsystems	156
Cahners CAPS	153
Capital Equipment Corp	149
Capilano Computer Systems Inc	152
Checksum	31
Circuit Components Inc	155
Comytech	154
Cypress Semiconductor	30
Dale Electronics	21
Data I/O Corp	152, C4
Datel	138A-F, 164C
Dialight Corp	125
Digital Equipment Corp	105
Diversified Technology	42-43
Dolch	32
DSP Development	95
Dynafer	73*
Elantec	142
Emulation Technology Inc	152
Ericsson Components	93
Escort Instruments Corp	73*
FELA Tee	72A-B*
Force Computers Inc	14-15
Fujitsu Microelectronics Inc	113
GE Plastics	132
Grammar Engine Inc	154
Grayhill Inc	69
Harris Semiconductor	144-145
Hewlett-Packard Co	C2, 57, 87, 122, 136
IDT	8
Incredible Tech	151
Intel	50
Intelligent Systems Inc*	153
International Rectifier	C3
Intusoft	154
IOtech Inc	138
Ironwood Electronics Inc	153
ITT Cannon	3
John Fluke Manufacturing Co Inc	6
Keithley Instruments	48
Kepeco Inc	107-112
Leasametric Inc	141
LeCroy Corp	16
Link Computer Graphics Inc	155
Logical Devices Inc	156
Logisoft	154
MathSoft Inc	126
Meritec	134
MetaLink Corp	155
MF Electronics	140
MicroENERGY Inc	119
Microstar Laboratories	155
MicroSim Corp	19
Microtime Computer Inc	154
Mini-Circuits Laboratories	22-23, 117, 164
Mitsubishi Electronics America Inc	76-77
Mizar Inc	124
Muncher Messegeseellschaft	143
Murrietta Circuits	119
Music Semiconductor	133, 135, 137
National Instruments	2
National Semiconductor Corp	35-37, 128-131
NCL	155
Needham Electronics	154
Nohau Corp	151
NordicTrack	31
Number One Systems Ltd	153
Octagon Systems	153

Omation Inc	152
Omron Electronics Inc	96
Palomar Telecom Inc	151
Pearson	133
Pentica Systems	135
Philips Test & Measurement	88A, B, C, D
Philips Industrial Elec Div	6*
Pico	127, 161
Preston Scientific	153
Programmed Test Sources	114
Quick Logic	9
Raltron	106
Sanyo	28
Scientific Endeavors	153
SGS Thomson	1
Sierra Circuits	151
Signalogic	40
Signetics Corp	10-11
Signum Systems	149
Siliconix Inc	4
SMS North American	152
Softools	156
Sony Semiconductor Div	38
Space Research Technology Inc	156
Stanford Research Systems Inc	121
Sun Electronic Systems Inc	150
Techron Industrial Power	92
Tektronix Inc	53-55
3M Data Storage	137
Teltone Corp	153
Tempustech Inc	156
Tesoft	153
Texas Instruments Inc	71-73, 89-91
Texas Microsystems Inc	146-148
Time & Frequency Ltd	120
Tribal Microsystems	151
Two Technologies	152
Versatec	59
Wavetek	118
Wescon	94
Westcor	45
Wintek Corp	156
Wintress Engineering	154
Xeltek	155
Xerox Engineering Systems/Versatec Products	59
Xicor Inc	156
Xilinx	74-75
Zaxtek	154
Ziatech Corp	44
Z-World	151

Recruitment Advertising

E-Systems ECI Div
Medtronic Micro-rel
Siemens Pacesetter

*Advertiser in European edition

This index is provided as an additional service. The publisher does not assume any liability for errors or omissions.

ULTRA-MINIATURE SURFACE MOUNT

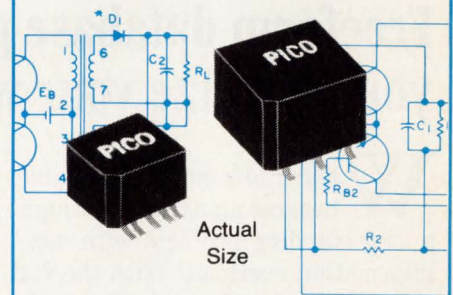

DC-DC Converter Transformers and Power Inductors

These units have gull wing construction which is compatible with tube fed automatic placement equipment or pick and place manufacturing techniques. Transformers can be used for self-saturating or linear switching applications. The Inductors are ideal for noise, spike and power filtering applications in Power Supplies, DC-DC Converters and Switching Regulators.

- Operation over ambient temperature range from -55°C to $+105^{\circ}\text{C}$
- All units are magnetically shielded
- All units exceed the requirements of MIL-T-27 ($+130^{\circ}\text{C}$)
- Transformers have input voltages of 5V, 12V, 24V and 48V. Output voltages to 300V.
- Transformers can be used for self-saturating or linear switching applications
- Schematics and parts list provided with transformers
- Inductors to 20mH with DC currents to 23 amps
- Inductors have split windings

Delivery—
stock to
one week

SEE EEM,
THOMAS REGISTER
OR SEND DIRECT FOR
FREE PICO CATALOG

PICO Electronics, Inc.

453 N. MacQuesten Pkwy. Mt. Vernon, N.Y. 10552

Call Toll Free 800-431-1064

IN NEW YORK CALL 914-699-5514

Freeform database package lets you organize your work and life *now*

When I left engineering and became an editor, I brought a long-standing problem with me: information overload. With the fast pace of the electronics business, I had a particularly tough time keeping track of people, their jobs, and their current employers. As an engineer, I tracked vendors, their local sales and support people, independent sales representatives, and interesting people who I met at conferences and seminars. As an editor, I have to keep track of people and their companies, their advertising agencies, and their PR agencies.

For years, I considered a variety of software database packages, but I knew that I could never create a structure that would meet all of my needs. I'm now using Info Select to solve this problem. It's a freeform database package, and it meets my needs perfectly with no programming. The software runs on DOS-based PCs and is available as a stand-alone package or a network version.

Info Select is simple to use. It employs a familiar model to hold your data: stacks of cards or, if you prefer, piles of notes. You can type anything you want into a card, and you can create as many stacks as you want. You give each stack a name, limited to eight characters because of DOS limitations. The product also has some pretty simple line-drawing commands, so you can even dress up the cards if you like.

So far, these attributes may appear to be like just about any other database package if you substitute the word "stack" for "file" and "card" for "record." The package's true power, however, is its ability to search every card in a stack for the occurrence of a character string. Because Info Select stores an entire

stack in memory (conventional or expanded), this search is very, very fast. In fact, when you execute a search command, the software matches each character you type to each of the cards in a stack as you type the character. Thus, by the time you've typed in your search string, the computer is ready to provide you with all matching cards. The program has one limitation: a stack must fit in memory. However, the specs list 10 Mbytes as a practical stack limit. And my current stack of almost 1200 business cards consumes only 162 kbytes.

Because there are no explicit fields in the program's database format, a match occurs if the search string appears anywhere on the card. So if I search using a key word such as "Xilinx," the cards for people working at Xilinx match, as do second-source vendors of Xilinx FPGAs (field-programmable gate arrays), companies offering Xilinto-ASIC conversion services, and consultants specializing in Xilinx FPGA design services. All of these cards match because I've typed the word "Xilinx" somewhere on each card. This characteristic allows me to pair companies and agencies as easily as it will allow you to pair vendors with their sales and application representatives.

Similarly, if I'm traveling to Hillsboro in Oregon, I can use "Hillsboro" as a search string, and every company in my stack that's located in Hillsboro appears. I also use key words such as "CAE" and "VHDL" (VHSIC Hardware Description Language) to help me group companies together. I've used part numbers, Zip Codes, telephone area codes, and even phone-number prefixes as search strings.

Because Info Select's cards are actually just text blocks, they're easy to edit. You can add key words at any time and at any place in a card. I've switched on an automatic-dating feature so that I know the entry date for each card. You can use Info Select simply as a text database, or you can take advantage of its other organizing features including a telephone dialer and a date tickler. The package includes some exotic features such as mail merge and hypertext links between cards, but I haven't yet become ambitious enough to experiment with those features.

The one major drawback to any database package, including Info Select, is that you must first enter all your data. To save some work, you can import ASCII files into Info Select—if you have them. However, in my case, the initial batch of information consisted of some 900 paper business cards. That massive data-entry job was one of the reasons I'd never transformed my business-card file into an electronic database. I finally bit the bullet, climbed into an easy chair with my laptop computer one Saturday morning, and had entered every card by Sunday night. I now use this electronic database several times a day, and I find that keeping the database current is pretty easy. Looking back, I can't believe that I procrastinated six years before hurdling just two days of work. Don't let this happen to you. Why not get organized now?

—Steven H Leibson

Info Select, \$149.95, Micro Logic, Box 70, Hackensack, NJ 07602. Phone (201) 342-6518. FAX (201) 342-0370.

HOW DO WE RATE?

During the past year, we've made some changes in EDN, and we'd like to know what you think about these enhancements. Please take a few minutes to answer the following questions. You can mail your answers to **The Editor, EDN Magazine, 275 Washington St, Newton, MA 02158**, or send them via fax to (617) 558-4470. Thanks for your help.

1. I read EDN

- 4 out of 4 issues
 3 out of 4 issues
 2 out of 4 issues

- 1 out of 4 issues
 Don't read EDN

2. Overall, how do you rate EDN's new look?

- Excellent
 Good
 Fair

- Poor
 Didn't notice any changes

3. How useful are the following new sections?

Very

Somewhat

Not at all

Don't recall seeing

Processor Update
Acronyms and abbreviations
Ask EDN
Inside EDN
Hands On!

4. How useful are these regular sections?

Very

Somewhat

Not at all

Don't recall seeing

Special Reports (cover article)
Contributed design articles
Technology Updates
Product Updates
Short Products
Design Ideas
Editorial
Professional Issues

5. EDN publishes a foldout table of contents on its last reader-service card in each issue. Have you used this table of contents?

Yes

No

If you answered yes to the above question, please give us your opinions on the foldout table of contents:

- It's easy to use
 It's difficult to find
 It helps me route articles to others
 It helps me scan an issue
 It lets me skip the table of contents in the front of EDN
 It's useless or of marginal value

If you answered no to the above questions, please give us your opinions about the foldout table of contents:

- I've seen it, but I don't use it
 It's so difficult to find that I don't use it
 I never knew it existed
 Now that I know it exists, I'll use it
 I'll never use it

6. Do you like EDN's new cover design, which lets us list more articles, departments, and page numbers than our old cover?

Yes

No

No opinion

7. Does the new color-bar coding on the cover, in the table of contents, and on the articles help make your reading easier?

Yes

No

No opinion

8. Are you familiar with EDN's Bulletin-Board Service (BBS)?

No

Yes, but I've never used it

Yes, I'd log on, but I don't have a computer or modem

Yes, I've logged on

9. If you have used the EDN BBS, do you have any comments about how the BBS works or what we could do to improve it?

10. What technical areas are we NOT covering that we should?

11. What technical topics are we covering too much?

12. Please give us any other comments about our level of technical detail, article selection, organization, etc. We would like your comments.

incredible!

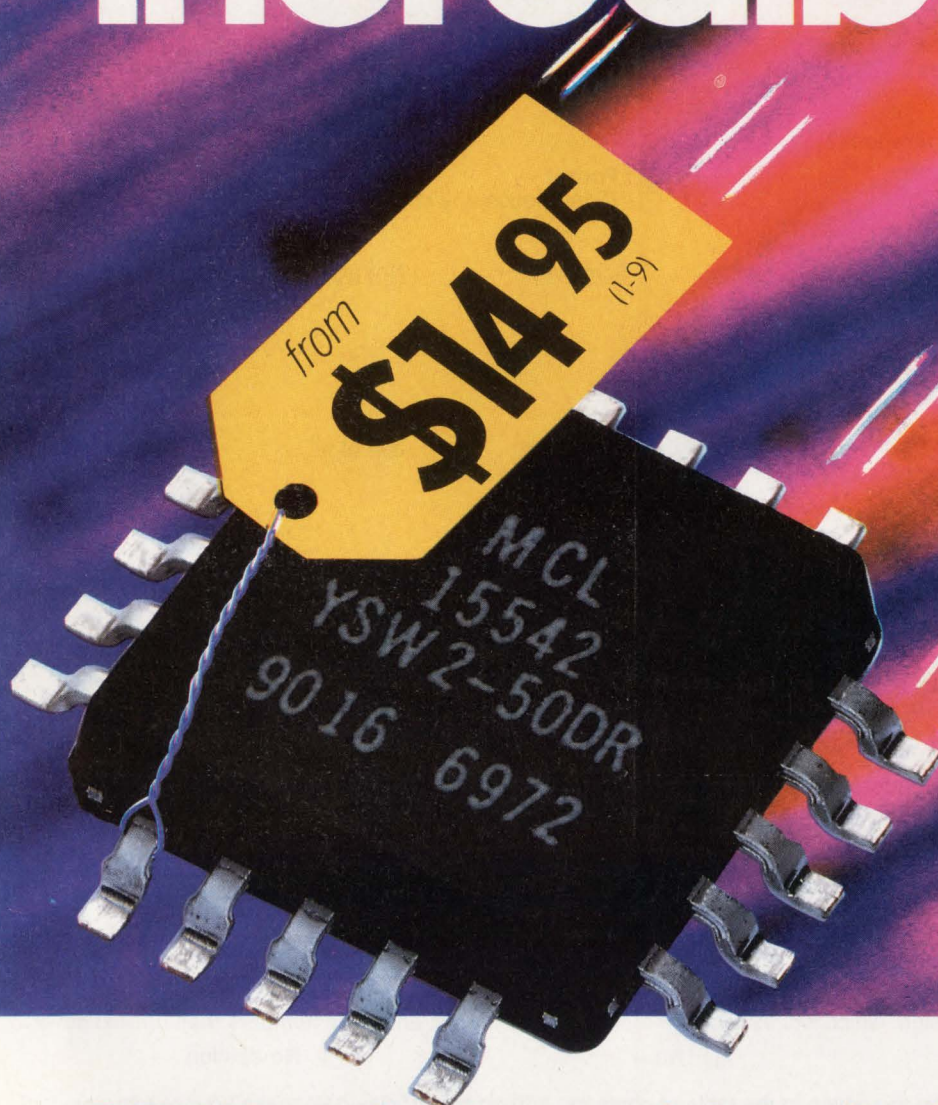

SPDT switches with built-in driver **ABSORPTIVE or REFLECTIVE dc to 5GHz**

Truly incredible...superfast 3nsec GaAs SPDT reflective or absorptive switches with built-in driver, available in pc plug-in or SMA connector models, from only \$14.95. So why bother designing and building a driver interface to further complicate your subsystem and take added space when you can specify Mini-Circuits' latest innovative integrated components?

Check the outstanding performance of these units...high isolation, excellent return loss (even in the "off" state for absorptive models) and 3-sigma guaranteed unit-to-unit repeatability for insertion loss. These rugged devices operate over a -55° to +100°C span. Plug-in models are housed in a tiny plastic case and are available in tape-and-reel format (1500 units max, 24mm). All models are available for immediate delivery with a one-year guarantee.

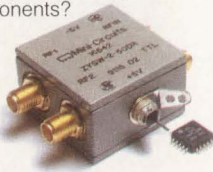

finding new ways...
 setting higher standards

SPECIFICATIONS (typ)

	Absorptive SPDT			Reflective SPDT		
	YSWA-2-50DR	ZYSA-2-50DR	ZYSW-2-50DR	YSW-2-50DR	ZYSW-2-50DR	ZYSW-2-50DR
Frequency (MHz)	dc-500	500-2000	2000-5000	dc-500	500-2000	2000-5000
Ins. Loss (dB)	1.1	1.4	1.9	0.9	1.3	1.4
Isolation (dB)	42	31	20	50	40	28
1dB Comp. (dBm)	18	20	22.5	20	20	24
RF Input (max dBm)	—	20	—	22	22	26
VSWR "on"	1.25	1.35	1.5	1.4	1.4	1.4
Video Bkthru (mV,p/p)	30	30	30	30	30	30
Sw. Spd. (nsec)	3	3	3	3	3	3
Price, \$ (1-9 qty)	YSWA-2-50DR (pin) 23.95 ZYSWA-2-50DR (SMA) 69.95			YSW-2-50DR (pin) \$14.95 ZYSW-2-50DR (SMA) 59.95		

Mini-Circuits™

WE ACCEPT AMERICAN EXPRESS AND VISA

P.O. Box 350166, Brooklyn, New York 11235-0003 (718) 934-4500 Fax (718) 332-4661

Distribution Centers / NORTH AMERICA 800-654-7949 • 417-335-5935 Fax 417-335-5945 EUROPE 44-252-835094 Fax 44-252-837010

For detailed specs on all Mini-Circuits products refer to • THOMAS REGISTER Vol. 23 • MICROWAVES PRODUCT DIRECTORY • EEM • MINI-CIRCUITS' 740-pg HANDBOOK

MORNING EDITION

TECHNOLOGY
INNOVATION
SECTION

AMPERE NEWS

IR 900 And 1200 Volt IGBTs Replace Bipolar.

Current Events.



It's now official. Bipolar is yesterday's news. IR announces 900v and 1200v IGBTs in TO-3P and TO-220 packages.

They're the more efficient, faster switching, easier-to-design alternative to bipolar.

They're also more rugged, take up less board space, and less budget space. And like their 600v predecessors, they're bound to set new performance standards wherever they're designed in.

For more information

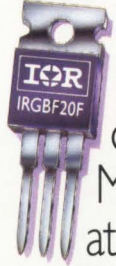
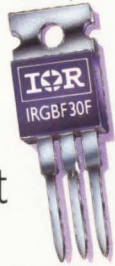

about the new 900v and 1200v TO-3P and TO-220 IGBTs, just phone your local IR rep, or the IR IGBT Marketing Group at 310/640-6534.

Or if you like your news delivered, we'll send you specs and samples.

IR International Rectifier

WORLD HEADQUARTERS: 233 KANSAS ST., EL SEGUNDO, CA 90245, U.S.A. (310) 322-3331. FAX (310) 322-3332. TELEX 472-0403. EUROPEAN HEADQUARTERS: HURST GREEN, OXTED, SURREY RH8 9BB, ENGLAND TELEPHONE (0883) 713215, TELEX 95219

Starting at
\$2995!

The 3900: The engineer's ultimate programmer.

Starting at just \$2995*, the 3900 family of device programmers gives you more for your money.

The 3900 programs more devices including leading-edge FPGAs, PLDs, memory devices, and microcontrollers up to 100 pins. And it uses semiconductor manufacturer-certified algorithms *exclusively* to ensure the most reliable programming.

The 3900 supports more packages such as TSOPs, QFPs over 100 pins,



PCMCIA cards, PLCCs, LCCs, JLCCs, SOICs, and PGAs.

Its flexible universal socketing technology not only accommodates today's package needs, but also tomorrow's.

The 3900 meets more standards, whether you're concerned about safety, noise, ESD, EMI, or reliability.

It has been approved by the world's toughest safety organizations including UL, CSA, and TUV, and complies with the strictest EMI and ESD standards.

To hear more reasons why the 3900 is the engineer's ultimate programmer, call today. We'll send you a FREE copy of our popular Wall Chart of Programmable Devices.



1-800-3-DataIO
(1-800-332-8246)

*U.S. list price only.

Data I/O Corporation 10525 Willows Road N.E., P.O. Box 97046, Redmond, WA 98073-9746, U.S.A. (206) 881-6444
1-800-3-DataIO (1-800-332-8246)

Data I/O Canada 6725 Airport Road, Suite 302, Mississauga, Ontario L4V 1V2 (416) 678-0761, in North America 1-800-3-DataIO (1-800-332-8246)

Data I/O Europe 660 Eskdale Road, Winnersh, Wokingham, Berkshire, United Kingdom RG11 5TS, 0734 448699

Data I/O GmbH Lochhamer Schlegel 5A, 8032 Graefelfing, Germany, +49 (0)89-858580

Data I/O Japan Sumitomo-seimei Higashishinbashi Bldg. 8F, 2-1-7, Higashi-Shinbashi, Minato-Ku, Tokyo 105, Japan
011-81-3-3432-6991

Data I/O Limited 660 Eskdale Road, Winnersh, Wokingham, Berkshire, United Kingdom RG11 5TS, 0734 440011

© 1992 Data I/O Corporation

CIRCLE NO. 97

DATA I/O