

EDN[®]

TEST & MEASUREMENT
SPECIAL ISSUE

VXIbus source guide pg 73

Comdex trends: Graphics boards, mass storage pg 97

The Jim Williams papers on analog design pg 163

ELECTRONIC TECHNOLOGY FOR ENGINEERS AND ENGINEERING MANAGERS

Special Report:
High-performance scopes zoom in on fleeting signals pg 146

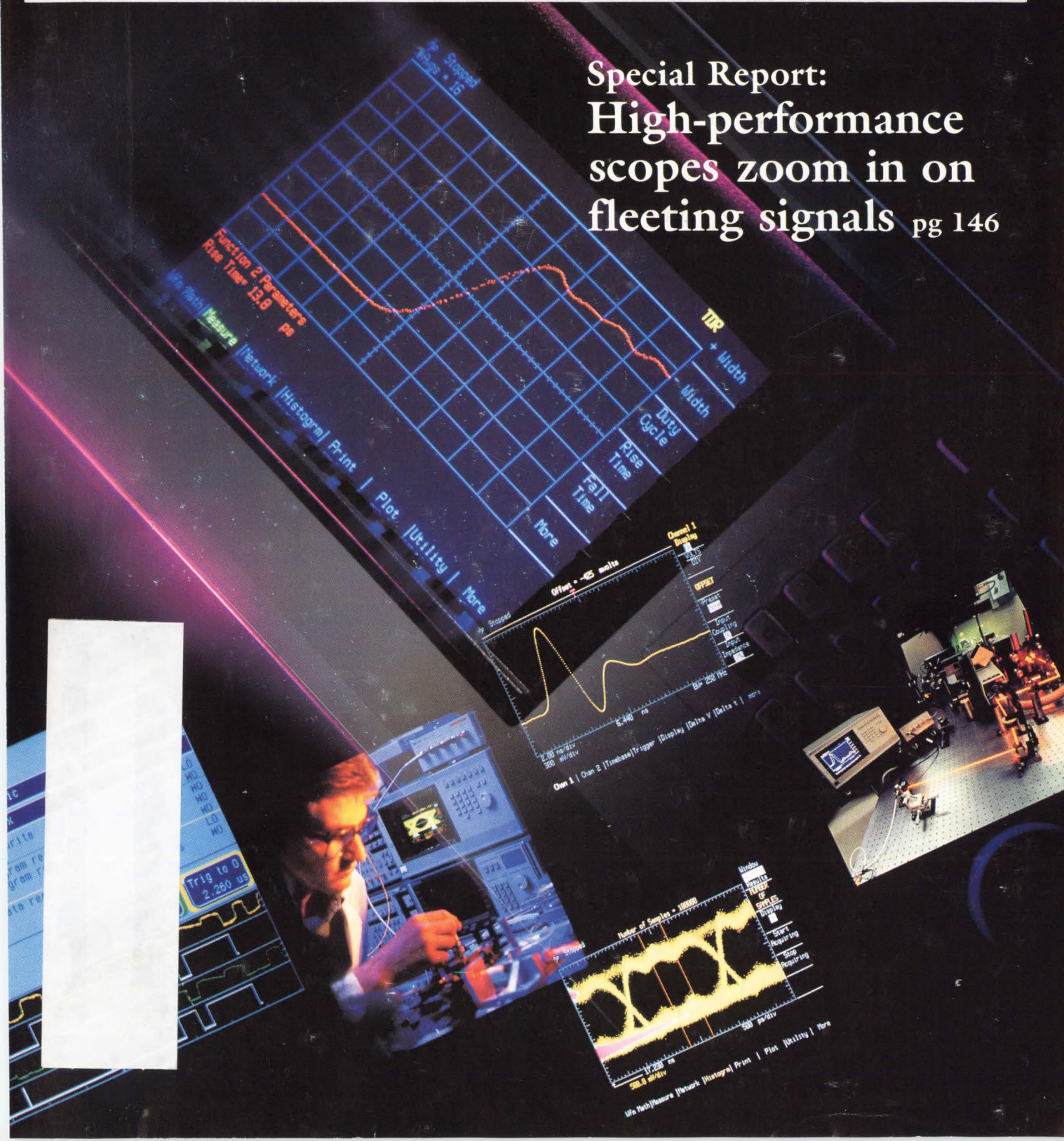

HMI development systems do it all!

HMI provides complete development systems—in-circuit emulator, window driven source level debugger and software performance analyzer—that address all aspects of the microprocessor system design cycle, from prototype to production:

HMI Emulators Feature:

- Run at real-time with no wait states.
- Complex events and sequences for break and trigger conditions.
- Two independent 4K deep trace buffers.
- 1 μ sec resolution interval timer.
- Logic analyzer capabilities built into the emulator.
- 16 External Trace bits.
- RS232 Interface up to 115.2K.
- Parallel Interface for high-speed downloading.
- Work with IBM PC family and UNIX based machines including SUN and Apollo.

EMULATORS

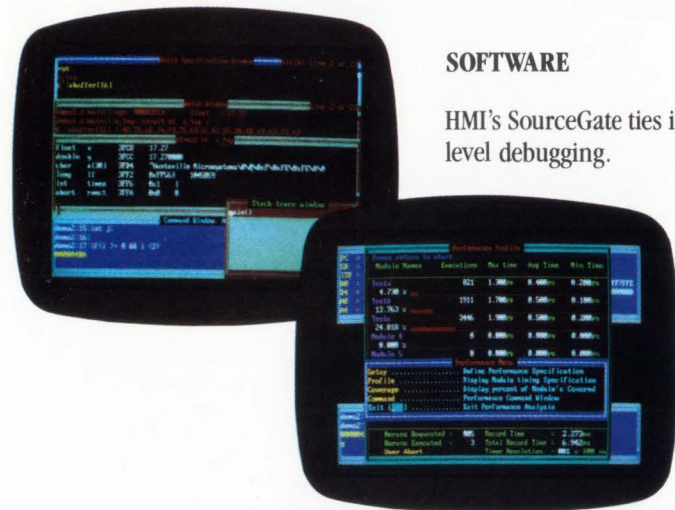

SOFTWARE

HMI's SourceGate ties it all together, so emulator features aren't sacrificed to gain source-level debugging.

HMI SourceGate® Features:

- Custom window configuration determined by user.
- Support for major C, PL/M, Pascal and ADA compilers.
- Source code in the trace buffers.
- C variable tracking.

Add our Performance Analysis Card to complete your development package.

Performance Analysis Features:

- Real-time hardware implemented software performance analyzer.
- 100 nsec resolution time-stamp in trace buffer.
- Setup trigger conditions to start and stop analysis.
- View covered and not covered pieces of code.

ANALYZERS



If you are looking for one development system that does it all, call (205) 881-6005, or write to Huntsville Microsystems Inc., 3322 South Memorial Parkway, Huntsville, AL 35801.

AVAILABLE EMULATORS

68000	68330/333	68HC001
68008	68331/332	8051 Family
68010	68340	DS5000
68020	6809/6809E	8096/80196 Family
68030	68EC020	8085
68302	68EC030	64180/Z180
68301/303	68HC11 including FI and D3	Z80

IBM is reg. T.M. International Business Machines, Inc. UNIX is reg. T.M., Bell Laboratories, Inc.



IMAGINE...



the resistor/capacitor or
custom networks you need.

Imagine the exact circuit you need. Then call Dale® and get dozens of ways to package resistors, capacitors and other components. Reliably. Faster. And in less space.

We're ready to deliver all types of general purpose R/C networks in molded DIP and conformal-coated SIP styles for ECL, line and Thevenin equivalent termination. In addition, we're an established producer of custom circuits which combine a variety of active and passive components in DIP, SIP or special packages.

Need extra precision? Our laser trimming methods can achieve

Then call Dale.®

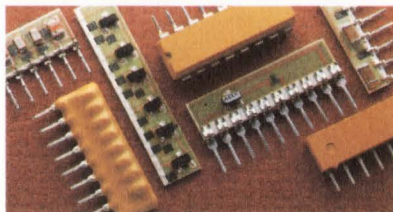

Resistor/Capacitor time constant matching of $\pm 1\%$. Special testing? Our capabilities include temperature cycling from -55°C to $+125^{\circ}\text{C}$ and power conditioning at room temperature, 70°C and 125°C .

Imagine how Dale networks can help you do a better job. Then call (402) 371-0080 for immediate assistance or write: Dale Electronics, Inc., 2300 Riverside Blvd., Norfolk, NE 68701-2242.

Remember, when it comes to delivering the networks you need — Dale Can.

A COMPANY OF
VISHAY



Circle No. 1

You'll like the feeling of our new digital troubleshooting scope.



Now there's a 100 MHz digital scope that handles just like analog.

Digital oscilloscopes have certain advantages that are hard to overlook. But for troubleshooting, many engineers still prefer analog scopes. Simply because they like the way they handle.

The HP 54600 changes that. It *looks* like a 100 MHz analog scope. All primary functions are controlled directly with dedicated knobs. And it *feels* like one.

* U.S. Prices only.
† In Canada, call 1-800-387-3867, Dept. 428.

The display responds instantly to the slightest control change.

But when it comes to troubleshooting, the HP 54600's digital performance leaves analog and hybrid scopes in the dust. At millisecond sweep speeds, the display doesn't even flicker. Low-rep-rate signals are easy to see without a hood. It has all the advantages that only a true digital scope can provide. Like storage, high-accuracy, pre-trigger viewing, hard copy output, and programming. And since it's one of HP's basic instruments, the HP 54600 gives you

all this performance at a very affordable price. Only \$2,395* for a 2-channel scope; \$2,895* for the 4-channel version.

So, if you need the power of a digital scope, but like the feel of analog, call 1-800-752-0900. Ask for Ext. 2286,† and find out how well the HP 54600 handles your troubleshooting needs.

There is a better way.



© 1991 Hewlett-Packard Co. TMCOL107/EDN

99¢

from

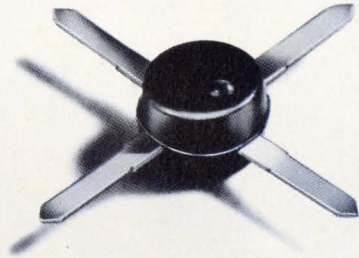

dc to 2000 MHz amplifier series

SPECIFICATIONS

MODEL	FREQ. MHz	GAIN, dB				• MAX. PWR. dBm	NF dB	PRICE \$ Ea.	Qty.
		100 MHz	1000 MHz	2000 MHz	Min. MHz (note)				
MAR-1	DC-1000	18.5	15.5	—	13.0	0	5.0	0.99	(100)
MAR-2	DC-2000	13	12.5	11	8.5	+3	6.5	1.50	(25)
MAR-3	DC-2000	13	12.5	10.5	8.0	+8□	6.0	1.70	(25)
MAR-4	DC-1000	8.2	8.0	—	7.0	+11	7.0	1.90	(25)
MAR-6	DC-2000	20	16	11	9	0	2.8	1.29	(25)
MAR-7	DC-2000	13.5	12.5	10.5	8.5	+3	5.0	1.90	(25)
MAR-8	DC-1000	33	23	—	19	+10	3.5	2.20	(25)

NOTE: Minimum gain at highest frequency point and over full temperature range.

- 1dB Gain Compression
- +4dBm 1 to 2 GHz

designers amplifier kit, DAK-2
5 of each model, total 35 amplifiers
only **\$59.95**

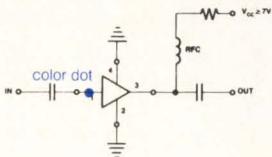

Unbelievable, until now... tiny monolithic wide-band amplifiers for as low as 99 cents. These rugged 0.085 in. diam., plastic-packaged units are 50ohm* input/output impedance, unconditionally stable regardless of load*, and easily cascadable. Models in the MAR-series offer up to 33 dB gain, 0 to +11 dBm output, noise figure as low as 2.8dB, and up to DC-2000MHz bandwidth.

*MAR-8, Input/Output Impedance is not 50ohms, see data sheet.
Stable for source/load impedance VSWR less than 3:1

Also, for your design convenience, Mini-Circuits offers chip coupling capacitors at 12 cents each.†

Size (mils)	Tolerance	Temperature Characteristic	Value
80 x 50	5%	NPO	10, 22, 47, 68, 100, 220, 470, 680, 1000 pf
80 x 50	10%	X7R	2200, 4700, 6800, 10,000 pf
120 x 60	10%	X7R	.022, .047, .068, .1µf

† Minimum Order 50 per Value
• Designers kit, kcap-1.50 pieces of each capacitor value, only \$99.95

finding new ways...
setting higher standards

Mini-Circuits

A Division of Scientific Components Corporation
P.O. Box 350166, Brooklyn, New York 11235-0003 (718) 934-4500
Fax (718) 332-4661 Domestic and International Telexes: 6852844 or 620156

K113-Rev. D

incredible!



SPDT switches with built-in driver

ABSORPTIVE or REFLECTIVE dc to 5GHz

Truly incredible...superfast 3nsec GaAs SPDT reflective or absorptive switches with built-in driver, available in pc plug-in or SMA connector models, from only \$19.95. So why bother designing and building a driver interface to further complicate your subsystem and take added space when you can specify Mini-Circuits' latest innovative integrated components?

Check the outstanding performance of these units...high isolation, excellent return loss (even in the "off" state for absorptive models) and 3-sigma guaranteed unit-to-unit repeatability for insertion loss. These rugged devices operate over a -55° to +100°C span. Plug-in models are housed in a tiny plastic case and are available in tape-and-reel format (1500 units max, 24mm). All models are available for immediate delivery with a one-year guarantee.



SPECIFICATIONS (typ)

	Absorptive SPDT			Reflective SPDT		
	YSWA-2-50DR	ZYSWA-2-50DR		YSW-2-50DR	ZYSW-2-50DR	
Frequency (MHz)	dc- 500	500- 2000	2000- 5000	dc- 500	500- 2000	2000- 5000
Ins. Loss (dB)	1.1	1.4	1.9	0.9	1.3	1.4
Isolation (dB)	42	31	20	50	40	28
1dB Comp. (dBm)	18	20	22.5	20	20	24
RF Input (max dBm)	20			22	22	26
VSWR "on"	1.25	1.35	1.5	1.4	1.4	1.4
Video Bkthru (mV,p/p)	30	30	30	30	30	30
Sw. Spd. (nsec)	3	3	3	3	3	3
Price, \$	YSWA-2-50DR (pin) 23.95			YSW-2-50DR (pin) 19.95		
(1-9 qty)	ZYSWA-2-50DR (SMA) 69.95			ZYSW-2-50DR (SMA) 59.95		

finding new ways ...
setting higher standards

Mini-Circuits

P.O. Box 350166, Brooklyn, New York 11235-0003 (718) 934-4500 Fax (718) 332-4661 Telexes: 6852844 or 620156

CIRCLE NO. 5

F141 REV. C

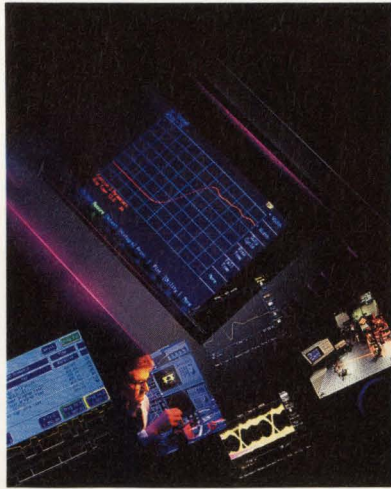

On the cover: By carefully examining your application's requirements, you can select a high-performance oscilloscope that best suits the case and, ultimately, saves you time, money, and frustration. See our Special Report on pg 146. (Photo courtesy Hewlett-Packard Co)

TEST AND MEASUREMENT SPECIAL ISSUE

SPECIAL REPORT

High-performance oscilloscopes 146

You need to choose an oscilloscope that can display the signals and make the measurements your application requires. Examining specs and features closely before choosing will pay off—using the right instrument will speed your work.—*Doug Conner, Regional Editor*

DESIGN FEATURES

The Jim Williams Papers 163

In this issue, EDN presents the first two in a group of articles on high-speed analog design.

The mysteries of probing 165

Unless you master the mysteries of probing and oscillography, you'll be doomed to measuring the errors in your setup and oscilloscope, not the errors in your circuit.

Correcting power-supply problems 181

To ensure proper operation of circuits that use high-speed op amps, you need to pay careful attention to power-supply bypassing. Of equal importance are layout techniques and the need to establish a proper ground plane.

TECHNOLOGY UPDATES

Analog simulation vs breadboarding: 55 Software clues balance bench-level intuition

Combining breadboarding and simulation lets you and your analog circuit benefit from the best of both worlds.

—*Anne Watson Swager, Regional Editor*

Continued on page 7

EDN[®] (ISSN 0012-7515, GST Reg. #123397457) is published 48 times a year (biweekly with 2 additional issues a month, except for February, which has 3 additional issues and July and December which have 1 additional issue) by Cahners Publishing Company, A Division of Reed Publishing USA, 275 Washington Street, Newton, MA 02158-1630. Terrence M McDermott, President; Frank Sibley, Executive Vice President; Jerry D Neth, Senior Vice President/Publishing Operations; J J Walsh, Senior Vice President/Finance; Thomas J Dellamaria, Senior Vice President/Production and Manufacturing; Ralph Knupp, Vice President/Human Resources. EDN[®] is a registered trademark of Reed Properties Inc., used under license. Circulation records are maintained at Cahners Publishing Company, 44 Cook Street, Denver, CO 80206-5800. Telephone: (303) 388-4511. Second-class postage paid at Denver, CO 80206-5800 and additional mailing offices. **POSTMASTER: Send address corrections to EDN[®], PO Box 173377, Denver, CO 80217-3377.** EDN[®] copyright 1991 by Reed Publishing USA; Ronald G Segel, Chairman and Chief Executive Officer; Robert L Krakoff, President and Chief Operating Officer; William M Platt, Senior Vice President. Annual subscription rates for nonqualified people: USA, \$119.95/year; Mexico, \$169.95/year; Canada, \$181.85/year; all other nations, \$209.95/year for surface mail and \$329.95/year for air mail. Single copies are available for \$15. Please address all subscription mail to Ellen Porter, 44 Cook Street, Denver, CO 80206-5800.

Check Out What Hamilton/Avnet Has in Storage for You.

Hamilton/Avnet now has, in stock, the industry's first 1 megabyte and 4 megabyte, PCMCIA-compatible flash memory cards to help you achieve higher functionality in portable and dedicated applications. In fact, when it comes to data acquisition and firmware updates, Hamilton/Avnet has the knowledge and expertise to help you design-in flash memory cards...today!

And for applications incorporating DOS, Intel offers a flash system developer's kit that enables you to check out how easy it is to design-in flash memory cards.

To order your flash system developer's kit, a \$499.95 value, simply call Hamilton/Avnet. For the branch nearest you, call toll free, 1 (800) 888-9236. Or, for further details, simply send in the coupon below.

I'd like additional information on Intel's Flash Memory Card offering.

Name _____

Title _____

Company _____

Address _____

City _____

State _____ Zip _____

Phone _____

Application _____

Hamilton/Avnet, Dept. 175
P.O. Box 9000
San Fernando, CA 91341-9981



CIRCLE NO. 6

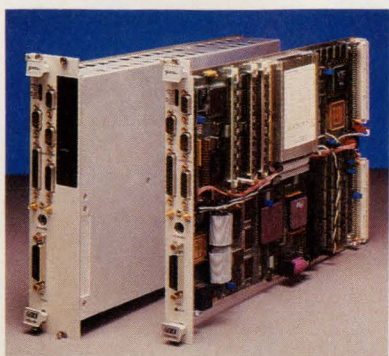

Those who take the time to learn about VXI (VME extensions for instrumentation) will be surprised and rewarded with the bus's cost savings, size, and fast operation. EDN's source guide presents VXI products from about 50 vendors (pg 73).

EDN magazine now offers Express Request, a convenient way to retrieve product information by phone. See the Reader Service Card in the front for details on how to use this free service.

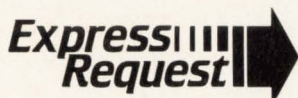

TECHNOLOGY UPDATES (CONTINUED)

VXI source guide: Costly technology can save you money 73

Picking the VXIbus for a test system might seem like making a conscious choice to start your project \$10,000 in the hole. But a closer look reveals a different picture.—*Dan Strassberg, Associate Editor*

COMDEX TRENDS

This time of year computer and electronic sleuths worldwide turn their attention to the Fall Comdex trade show, which produces the most important computer-related product announcements. As a prelude to the show, EDN examines industry trends in the areas of mass storage and graphics products and provides hints of some of the hottest new products.

PC graphics boards: Boards speed Windows and vie as standards 97

The emergence of Windows 3.0 as a de facto industry standard for PCs means that standard graphics hardware doesn't matter as much as it used to.—*Margery Conner, Contributing Editor*

Mass-storage devices: Price and size shrink while capacity grows 111

Every year manufacturers offer smaller mass-storage devices. The move toward smaller peripherals, however, has never been as dramatic as now—1.8-in. hard-disk drives are emerging, and some 3½-in. units can store 1 Gbyte.—*Maury Wright, Regional Editor*

EDITORS' CHOICE

x86-compatible family of μ Ps 126

PRODUCT UPDATES

VGA controller IC with RAMDAC	128
Switching mainframe	130
Signal-conditioning mainframe	132
ICE for 29000 μ P family	134
Variable-gain amplifier	136

Continued on page 9

Cahners Publishing Company, A Division of Reed Publishing USA Specialized Business Magazines for Building & Construction Research Technology Electronics Computing Printing Publishing Health Care Foodservice Packaging Environmental Engineering Manufacturing Entertainment Media Home Furnishings Interior Design and Lodging. Specialized Consumer Magazines for Child Care Boating and Wedding Planning.

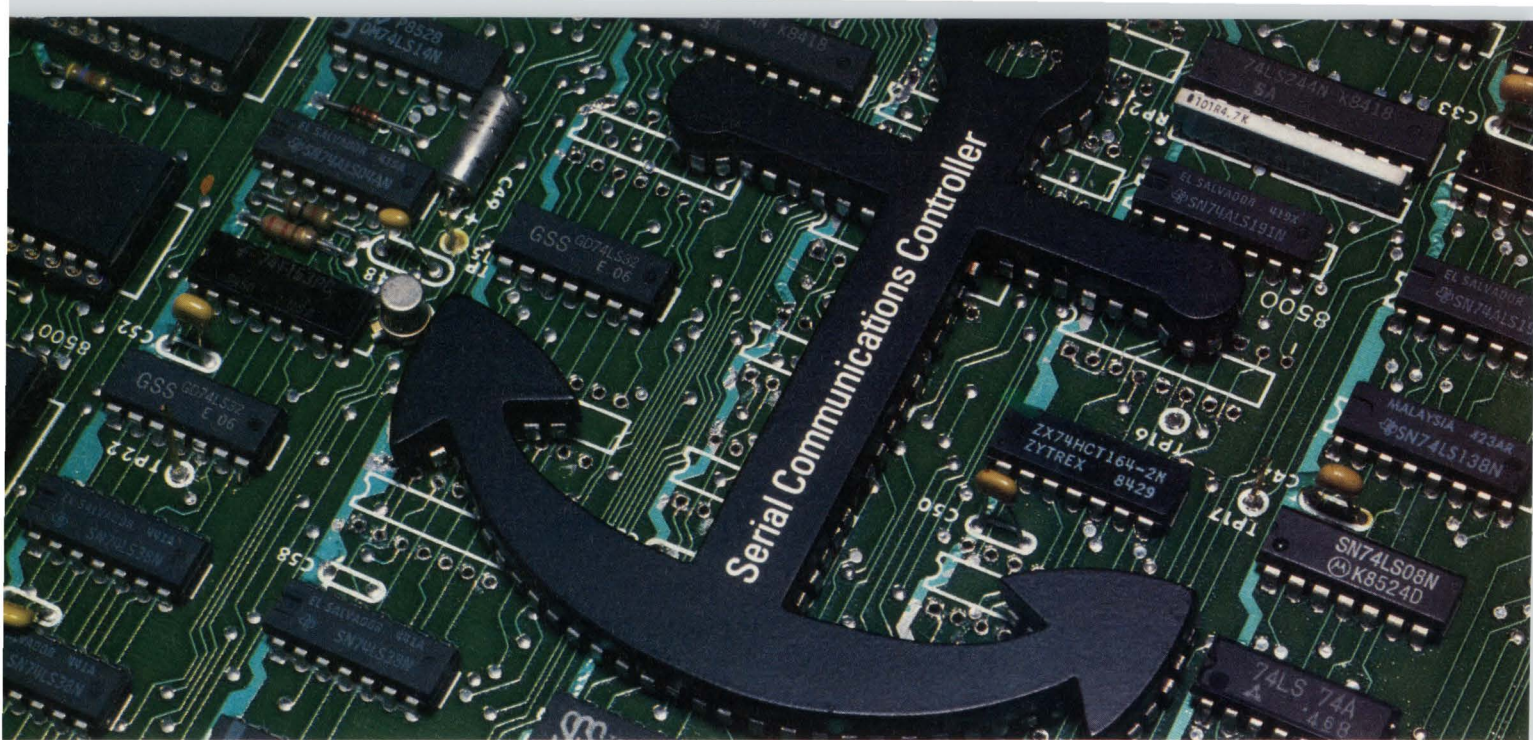

What other companies' datacom controllers look like to your CPU.

The CPU overhead imposed by standard datacom controllers can be a drag on your system performance, and on your development efforts.

Now there's a more intelligent solution. The Cirrus Logic CL-CD2400 single-chip datacom controller can send and receive complete packets with no host supervision. This gives you up to seven times more system performance than other serial communications controllers.

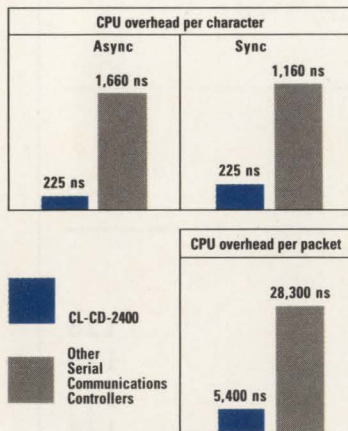

The CL-CD2400 has more intelligence for sophisticated error checking, special character matching, address recognition and automatic DMA management — with 1/7th the overhead*.

The CL-CD2400 even saves you development and debugging time, and lowers development expense. Our fast, flexible, double-buffered DMA makes buffer chaining and circular queues easy to implement. An append mode makes DMA efficient for async applications as well. Interrupt or DMA operation is selectable on a per-channel, per-direction basis. The CL-CD2400 even has much more flexible latency requirements than other controllers.

And you get all this with fewer parts. So you use less board space. At a much lower cost than you might expect.

Give your whole system and your development efforts a boost. Get the intelligent datacom controller that saves work for you and your CPU: The CL-CD2400 from Cirrus Logic.

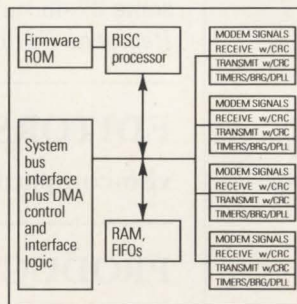

The next generation datacom controllers:

An on-chip RISC processor gives you the intelligence to achieve more performance. Four multi-protocol channels let you choose from all asynchronous and synchronous protocols. An integrated 32-bit-address DMA controller, integrated interrupt controller and on-chip FIFOs for each channel give fast I/O. Sophisticated character- and frame-processing features make this the most efficient controller on the market.

For free product information and technical comparison
Call 1-800-952-6300.
 Ask for dept. LD26.



©1991 Cirrus Logic, Inc., 3100 West Warren Avenue, Fremont, CA 94538 (415) 623-8300; Japan: (81) 462-76-0601; Singapore: (65) 3532122; Taiwan: (886) 2-719-4533; Germany: (49) 8152-2030; United Kingdom: (44) 344-780-782.
 *Overhead measured in an X.25 application. CPU overhead measured on PC-compatible. Cirrus Logic and the Cirrus Logic logo are trademarks of Cirrus Logic, Inc. All other trademarks are registered to their respective companies.

VP/Publisher
Peter D Coley

Associate Publisher
Mark Holdreith

VP/Editor/Editorial Director
Jonathan Titus

Executive Editor
Steven H Leibson

Managing Editor
Joan Morrow Lynch

Assistant Managing Editor
Christine McElvenny

Special Projects
Gary Legg

Home Office, Editorial Staff
275 Washington St, Newton, MA 02158
(617) 964-3030

Tom Ormond, *Senior Editor*
Charles Small, *Senior Editor*
Jay Fraser, *Associate Editor*
John A Gallant, *Associate Editor*
Michael C Markowitz, *Associate Editor*
Dave Pryce, *Associate Editor*
Carl Quesnel, *Associate Editor*
Susan Rose, *Associate Editor*
Julie Anne Schofield, *Associate Editor*
Dan Strassberg, *Associate Editor*
Chris Terry, *Associate Editor*
Helen McElwee, *Senior Copy Editor*
James P Leonard, *Copy Editor*
Brian J Tobey, *Production Editor*
Gillian A Caulfield, *Production Editor*

Editorial Field Offices

Doug Conner, *Regional Editor*
Atascadero, CA: (805) 461-9669

J D Mosley, *Regional Editor*
Arlington, TX: (817) 465-4961

Richard A Quinell, *Regional Editor*
Aptos, CA: (408) 685-8028

Anne Watson Swager, *Regional Editor*
Wynnewood, PA: (215) 645-0544

Ray Weiss, *Regional Editor*
Woodland Hills, CA: (818) 704-9454

Maury Wright, *Regional Editor*
San Diego, CA: (619) 748-6785

Brian Kerridge, *European Editor*
(508) 28435
22 Mill Rd, Loddon
Norwich, NR14 6DR, UK

Contributing Editors
Robert Pease, Don Powers,
David Shear, Bill Travis

Editorial Coordinator
Kathy Leonard

Editorial Services
Helen Benedict

Art Staff
Ken Racicot, *Senior Art Director*
Chinsoo Chung, *Associate Art Director*
Cathy Madigan, *Staff Artist*

Production/Manufacturing Staff
Andrew A Jantz, *Production Supervisor*
Sheilagh Hamill, *Production Manager*
Melissa Carman, *Production Assistant*
Diane Malone, *Composition*

Director of Art Department
Robert L Fernandez
Norman Graf, *Associate*

VP/Production/Manufacturing
Wayne Hulitzky

Director of Production/Manufacturing
John R Sanders

Business Director
Deborah Virtue

Marketing Communications
Kathy Calderini, *Manager*
Pam Winch, *Promotion Assistant*

DESIGN IDEAS

Filter quashes 60-Hz interference	195
Circuit selects transformer-input tap	196
Tube sinks constant current	198

EDITORIAL

FPGA manufacturers should be sharing complex design information, not hiding it in costly "macro libraries."

49

NEW PRODUCTS

Computers & Peripherals	200
Integrated Circuits	202
Components & Power Supplies	206
Test & Measurement Instruments	209
CAE & Software Development Tools	214

DEPARTMENTS

News Breaks	23
Signals & Noise	35
Ask EDN	43
Career Opportunities	232
Business/Corporate Staff	237
EDN's International Advertisers Index	239

EDN BBS Update

EDN continues to upgrade the Bulletin Board System (BBS) to make it easier for you to access the information you need, when you need it. The BBS ((617) 558-4241) now offers more than 1000 posted programs. Several readers are generously contributing their time and resources to make more programs available in the near future. You, too, can join reader-supported projects

- To develop a library of simple fuzzy-logic routines for ordinary microprocessors: /rsp_fuzz Special Interest Group.
- To develop a library of digital-signal-processing routines for ordinary microprocessors: /rsp_dsp Special Interest Group.
- To optimize Desqview, Windows3.0, and DOS5.0 as engineering environments on the PC. A massive documentation library for these operating environments is now available on EDN BBS: /eng_env Special Interest Group.

At \$60,000 each, only two of t

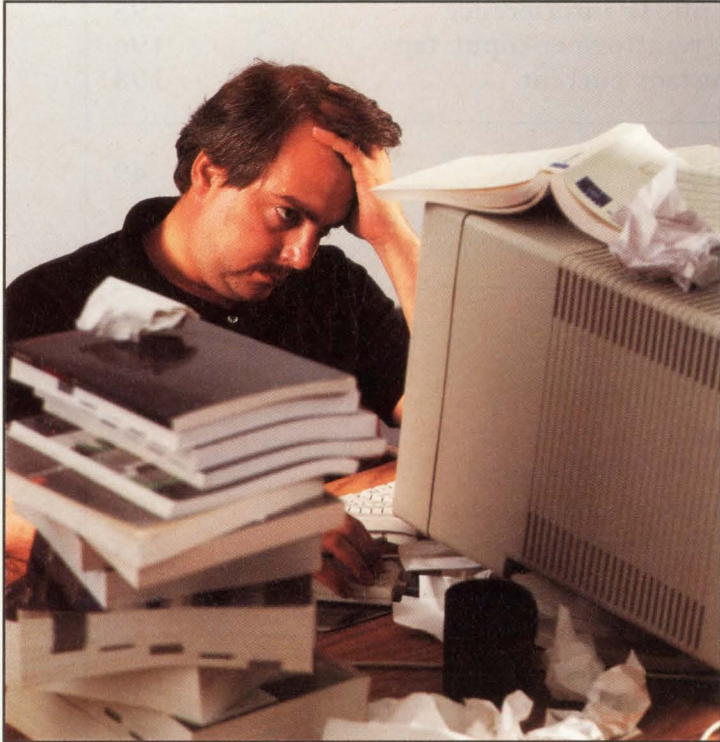

Option A Available from most EDA suppliers

The Conventional Workstation Package

There used to be only limited choices. For \$60,000 or so, you could get overpriced EDA software and a single PCB design environment. It also came with free, virtually endless levels of frustration, because these systems are hard to use and even more difficult to learn. Which made productivity look something like an inverted bell curve.



Option B Available only from OrCAD

The OrCAD Sun Productivity Package

Now, OrCAD brings you better options — OrCAD EDA tools and a high-performance UNIX® environment on the Sun SPARCstation™. Put OrCAD tools in the hands of an entire PCB design team for the same \$60,000 or so. Get four times as many workstations. And with OrCAD's intuitive, easy-to-learn tools, your designers will set a new precedent for productivity.

OrCAD®

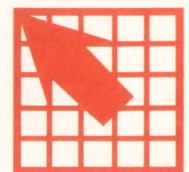

These EDA options make sense



Option C Available only from OrCAD **The OrCAD Sun Vacation Package**

Or with the same budget, you can set up one PCB designer with a truly inspiring, high-performance environment, including a hot car, a fast boat, and a view! With OrCAD EDA tools and a Sun SPARCstation, you'll have enough cash left over to requisition these extras. It's outrageous. But it is a feasible solution to creating exceptionally happy, motivated design engineers.

To find out how OrCAD can solve your PCB design challenges, call us today at (503) 690-9881 for the sales office nearest you.

More Designs From More Designers Than Anyone in the World

This Is How Am386™ CPUs Batter

Some might call it sleeping on the job. We call it true static operation—and that's how the low power Am386 microprocessors use a full 35% less power than the other so-called low power 386 at any sustained clock speed.

They're not only the most efficient 386s on the planet, they're also the fastest. Our Am386SXL-25 CPU clocks in at 25MHz,

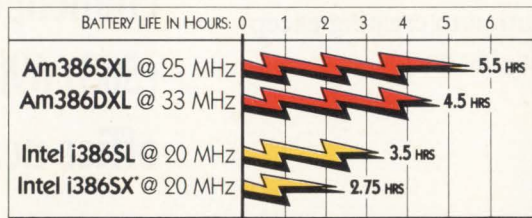

you can configure your system to literally stop the clock and save power when the processor is idle. Even between keystrokes.

Which means you get maximum battery life, with no performance compromise. Up to 2

25% faster than the i386SX-20, while our Am386DXL-40 CPU boasts a 40MHz clock speed.

Because Am386 microprocessors are truly static,

Now The You Extends Your Life.

hours and 45 minutes (100%) longer battery life than the i386SX-20. Or 2 hours (57%) longer than the i386SL-20.

The Am386SXL-25 and Am386DXL-33 microprocessors are available now in PQFP packages for the most compact notebook and palmtop designs ever. Our Am386DXL-40 CPU is available in standard PGA. Better still, they're now shipping in quantity.

So if you want longer battery life from your next design, it's time to retire that old 386.

Call **1-800-222-9323**. And rest easy with a low power Am386 microprocessor.



Advanced Micro Devices

"We're Not Your Competition."

901 Thompson Place, P.O. Box 3453, Sunnyvale, CA 94088. © 1991 Advanced Micro Devices, Inc. Am386 is a trademark of Advanced Micro Devices, Inc. All brand or product names mentioned are trademarks or registered trademarks of their respective holders. *Battery life for i386SX based on benchmarks provided by PC Magazine, March 12, 1991. All other comparisons based on engineering analysis emulating typical usage.

SAMSUNG
NOW

IN MEMORY MOD CROSSOVER HAS J

You've heard the old saying, "we'll cross that bridge when we come to it." Well, we have.

Cost crossover today makes 4-meg DRAMs more economical per bit than 1-meg DRAMs. And given all the benefits in reliability and board real estate, that's good news.

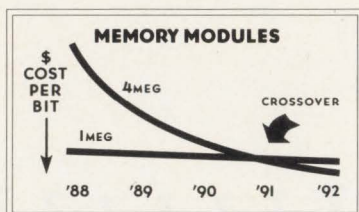

People are lining up to take advantage of it.

One specific advantage is in memory modules. Samsung 4-meg-based modules are actually more cost-effective today than their 1-meg-based counterparts.

All the modules listed here have reliability specs based on 600 temperature cycles (0-125°C) and 500 hours (85°C, 85% RH). Available features include 70, 80, and 100 ns access



ULES, COST-PER-BIT UST BEEN COMPLETED.



times, fast page mode, low-power versions, gold lead finish, and customer-specific labeling.

SAMSUNG MEMORY MODULES BASED ON 4-MEG DRAMs

<i>Megabytes</i>	<i>Part Number</i>	<i>Organization</i>
1	KMM581000AN	1M x 8
1	KMM591000AN	1M x 9
4	KMM584000A	4M x 8
4	KMM594000A	4M x 9
4	KMM5321000A	1M x 32
4	KMM5331000A	1M x 33
4	KMM5361000A	1M x 36
8	KMM5322000A	2M x 32
8	KMM5332000A	2M x 33
8	KMM5362000A	2M x 36

Samsung is one of the world's leading manufacturers of both DRAMs and memory modules. Our outstanding quality, reliability, and availability have helped us gain this leading position.

For data sheets on our 4-meg DRAMs and 4-meg-based modules, call 1-800-423-7364 or (408) 954-7229 today. Or write to Memory Module Marketing, Samsung Semiconductor, 3725 No. First St., San Jose, CA 95134.



Technology that works for life.

CIRCLE NO. 11

**Power
tool**



Power tools

KEPCO TEST/BENCHTOP POWER SUPPLIES

The correct tool makes any job easier. Kepco's Power Supplies for workbench, for burn-in, and float-charging batteries are just some of the tools at your disposal.

For your workbench choose a multi-out array that you configure for the application by plugging-in modules with adjustable outputs. You can combine one, two or three modules in convenient bench-top housings or put six of them together in a rack. Other experimentalist power includes a nice selection of 100W single output instruments (MSK), a triple output logic-analog model (MPS), and burn-in/float chargers (TBC) that range from 300 to 3000 Watts in all the popular voltages.

Custom power assemblies allow you to create your own toolkit with just the selection of voltage and power to fit your need.

Other power tools from Kepco include: *ac power* to 18KVA, precision *programmable dc* for test applications, *high voltage* models and four-quadrant *bipolar power*. For these, and our broad selection of *switching power* models, including *d-c to d-c converters*, please ask for one of the three catalogs illustrated below.

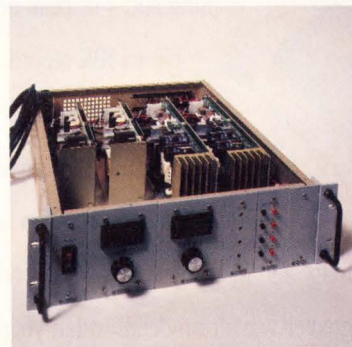
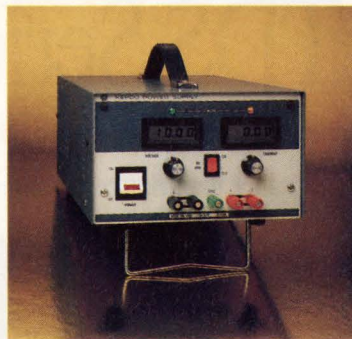
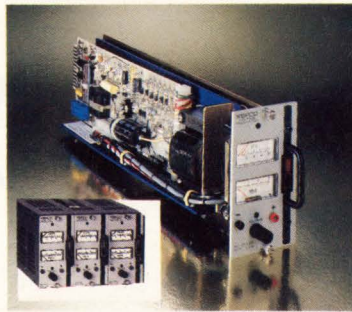

Plug-in power

- 20 Watt modules, either voltage stabilizers (series PCX-MAT) or current stabilizers (series CC).
- Sized to plug-in six abreast in a 19" rack or in bench-top housings for 1, 2 or 3 units.
- Mix or match.
- Select from six voltage ranges up to 100V.

Kepco Group PCX-MAT and CC Power Supplies

100 Watts of precision benchtop power.

- LCD meters to set the level accurately, a preview feature to check your setting before applying power to your load.
- Linear design for low-noise high stability.
- Ten-turn controls for good resolution.
- Five models offer outputs up to 125 Volts.

Kepco Group MSK Power Supplies

A triple output design for maximum convenience.

- 0-6V at 5A for logic and a tracked \pm 0-20V, 1A for analog.
- Each output current limited, the 0-6V output has an overvoltage protector.

Kepco Group MPS Power Supply

Battery/float-chargers.

- For telecommunications: maintain 12V, 24V and 48V batteries, built-in equalize timer.
- For burn-in: power up to 3000 Watts, current limited, over-voltage protected. Two output settings, remotely selectable for margining.

Kepco Group TBC Float Chargers/Power Supplies

Kepco Custom System Power Assemblies

We will stuff a 19" rack (5 $\frac{1}{4}$ " or 7") full of switchers to your requirement. With modules from 3 Watts to 3000 Watts, in a wide selection of voltage ranges, we can accommodate most needs.

- LCD output meters.
- Test points.
- Pilots, trimmers, circuit breakers. Convenient $\frac{1}{8}$ rack panel format allows multiple control and monitoring.

Kepco Power Assemblies.

CIRCLE NO. 12

SEE OUR PAGES IN VOLUME D **eem⁹¹₉₂**

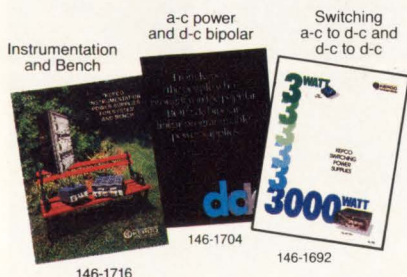

SEE US AT WESCON/91 KEPCO BOOTH 2135, 2137

Call/fax/write to Dept. LXT-12 for any of our three catalogs.

Kepco, Inc., 131-38 Sanford Avenue, Flushing, NY 11352 USA • Tel: (718) 461-7000 • Fax: (718) 767-1102 • Easylink (TWX): 710-582-2631

Eastern Region: 131-38 Sanford Avenue, Flushing, NY 11352 USA • Tel: (718) 461-7000 • Fax: (718) 767-1102 • Easylink (TWX): 710-582-2631

Western Region: 800 West Airport Freeway, Suite 320 LB 6018, Irving, TX 75062 USA • Tel: (214) 579-7746 • Fax: (214) 579-4608

Kepco Europe, Ltd., London, England: Salamander Quay West, Park Lane, Harefield, Middlesex UB9 6NZ • Tel: + 44 895 825046 • Fax: + 44 895 825045



You have to build a to build just

The new Tek TDS Series

More than a million Tektronix oscilloscopes have all been leading up to this: the most powerful, versatile, and intuitive instruments ever developed for the mainstream of test and measurement.

The new TDS 500 Series is the culmination of everything Tek has learned in the design, manufacture and use of digitizing oscilloscopes. It's an achievement made possible only by the unique integration of acquisition functions and combinational trigger logic onto a single board.

Only by the development of a milestone multiprocessor architecture.

Only by the addition of Tek's TriStar™ Digital Signal Processor (DSP).

Only by Tek's capacity for taking the hard work out of high performance.

The TDS Series performs, *live*, up-

dates and measurements that inhibit most other digitizing scopes. Its real-

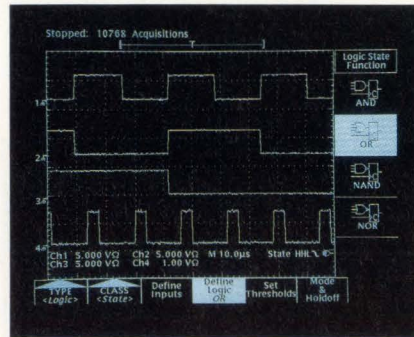

time DSP lets you perform single-shot averaging and extend resolution to 12 bits. The TDS Series arms you with up to

four full-featured channels. 500 MHz bandwidth. Up to 1 GS/s sam-

pling and 4 ns peak detect.

Up to 50K record lengths. Time interval,

2 ns glitch, runt, pattern and

state triggers. With acquisition sensitivity and fast overdrive recovery bringing greater waveform detail within your grasp.

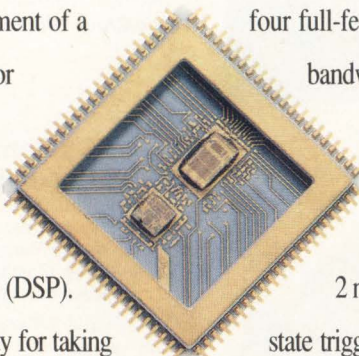

And if you think oscilloscopes aren't as easy to use and comprehend as they

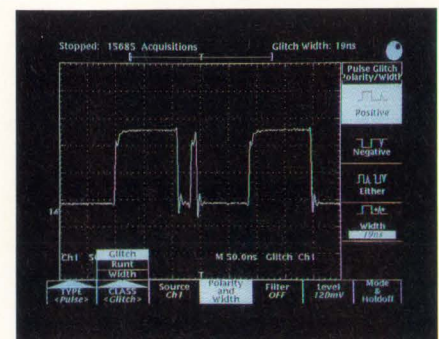

million oscilloscopes one like this.

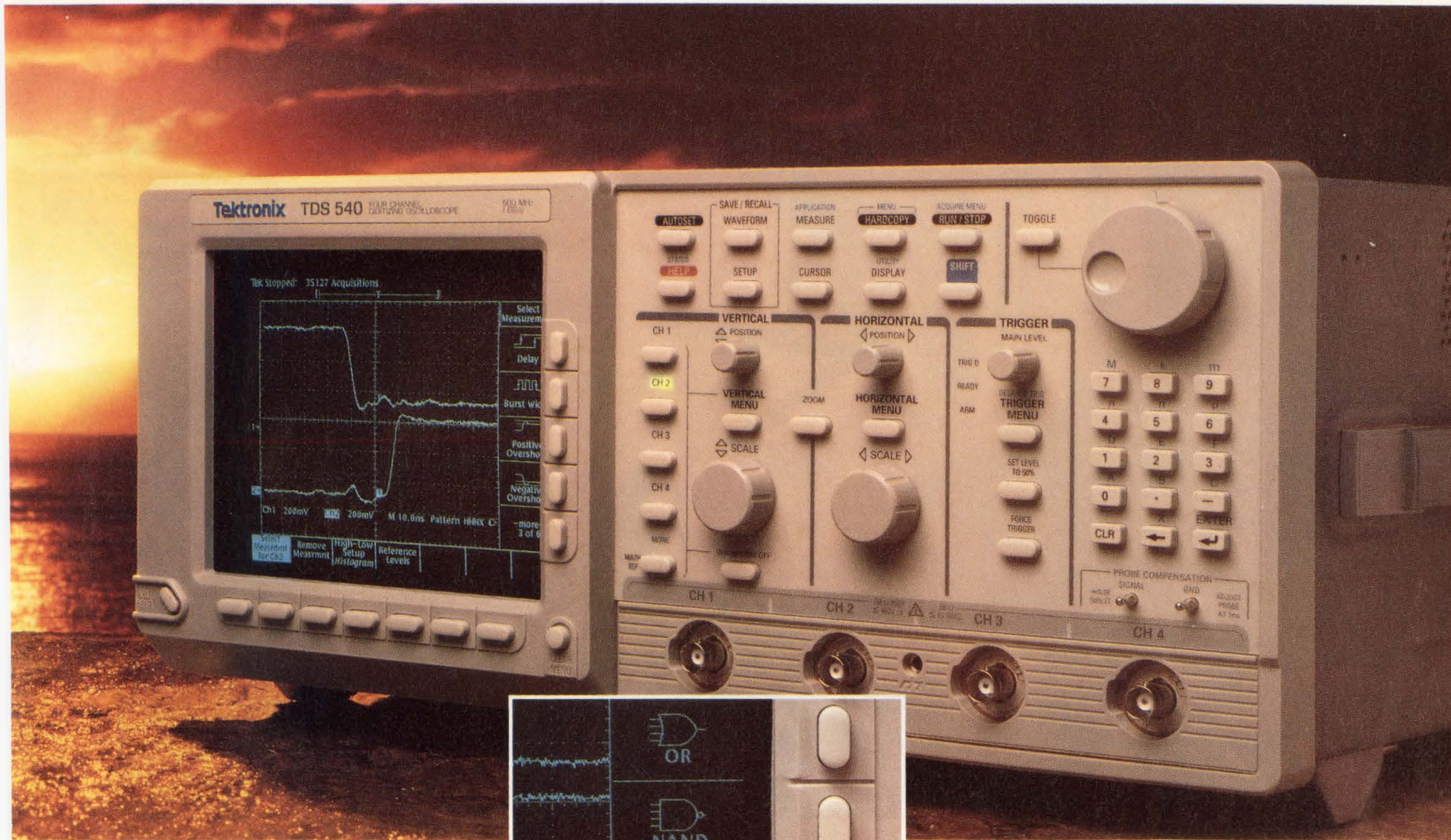

could be, you owe yourself a demo of the TDS. Its simplified front panel, VGA-quality display resolution, on-line help text, innovative icons that instantly differentiate menu functions — all add up to a scope that makes the user's manual more a formality than a necessity.

The TDS Series signals the start of a new generation of friendlier, more

powerful instruments from the world's leading supplier of digitizing and analog oscilloscopes. To get a first-hand feel for why performance like this only comes along about once in a million scopes, contact your Tek sales engineer or call **1-800-426-2200**.

One company measures up.

Tektronix
COMMITTED TO EXCELLENCE



Once again, HP has its name in lights.

Leave it to HP to premiere the very first SMT LED offering the brightness, clarity, and color choices of through-hole LEDs.

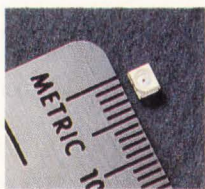

As one of the world's most experienced LED suppliers, HP wrote the book on high-performance LEDs. Now you can see the same star performance on tape, because our new LED is compatible with tape-fed automatic pick & place

equipment and SMT solder processes.

Its small footprint means you can pack more imprints per board. Yet it conforms to the EIA-535 BAAC standard specification for case size 3528 tantalum capacitors.

But we haven't let the bright lights go to our head. Our new SMT LED is competitively priced and multi-sourced.

A class production all the way, these new LEDs are designed to meet most quality and reliability

standards, eliminating the need for incoming inspection.

Once again, HP sets the stage for quality, reliability, and innovation. To get the star treatment from HP, call **1-800-752-0900, ext. 2367**, and ask for our FREE red & green SMT LED sample kit. And see what the biggest name in lights can do for you.

There is a better way.

 **HEWLETT
PACKARD**

NEWS BREAKS

EDITED BY SUSAN ROSE

8051 RAM UPPED TO 512 BYTES

Signetics' 8051-chip variants have increased on-chip RAM—two of the microcontrollers deliver 512 bytes of on-chip RAM, double the standard 256 bytes in many chips. One reason for adding memory was to increase on-chip stack space for C programs. These chips need increased memory, as engineers are increasingly turning to C for microcontroller-based embedded-systems applications. You can buy ROMless (80C528), 32-kbyte ROM (83C528), and 32-kbyte EPROM (87C528) versions. One-time-programmable versions are also available. The chips come in 16- or 20-MHz versions and run at speeds as low as 3.5 MHz. The 40-pin chips include four 8-bit I/O ports, two serial ports, three 16-bit timers, a watchdog timer, and an I²C serial interface. Prices for the 16-MHz chips start at \$7.50 (10,000). The chips are sampling now. Signetics, Sunnyvale, CA, (408) 991-2000.—Ray Weiss

DESIGN APPLICATION FLIES WITH FALCON

The Manufacturing Adviser/PCB is a design-for-manufacturability tool for pc-board design, built on the Mentor Falcon Framework's decision support system (DSS). The software references parts lists, ASCII netlists, or design information indirectly generated from the company's design-creation tools to component libraries that you either create or that come with the tool. These libraries contain mechanical, thermal, and manufacturing data for analysis. To perform the analysis, you provide a set of manufacturing rules and constraints, against which the software compares your design—at many levels of completion. As a result of the analysis, you can change component package types, use fewer or more board layers or a different board size, manufacture at another site, or adjust any parameter that impacts your ability to manufacture a board. The application, developed by Texas Instruments' Information Technology Group, features a component library of more than 800 component package styles. Although the first release only supports through-hole board technologies, the second release, slated for early 1992, will include surface-mount- and mixed-technology-board support. The software costs \$16,900 and is available on HP/Apollo workstations; Sun and HP Series 700-based software will be available in early 1992. Mentor Graphics, Wilsonville, OR, (503) 685-7000, (800) 547-3000.

—Michael C Markowitz

VIDEO WINDOW GENERATOR OFFERS CONTINUOUS SCALING

The Pixel Semiconductor subsidiary of Cirrus Logic has developed an IC that accepts digitized video and puts it in a window on your computer monitor. The Px007 video window generator handles interlaced or progressive-scan video in the luminance-chrominance color space used for broadcast video. You provide digitized data in 24-, 16-, or 12-bit formats at input sample rates as great as 15 MHz. The device then removes any gamma correction and converts the data into the RGB color space used by computer monitors. It hands the data to your computer's display memory and lets you program the output resolution to match your system's needs. You can select from 2 to 8 bits per color channel.

To help you fit the picture into an on-screen box, the device offers independent X and Y scaling and support for window clipping. It scales the video by using linear interpolation, not pixel dropping. You can, therefore, scale to single pixel resolution so as to fill arbitrarily sized boxes completely. To facilitate window clipping, the

NEWS BREAKS

device provides framing signals that mark the beginning of video fields and lines. The device comes in an 80-pin plastic quad flatpack. Samples are presently available for \$55 (1000), with volume production scheduled by the fourth quarter of 1991. Cirrus Logic, Fremont, CA, (510) 623-8300, FAX (510) 226-2160.—Richard A Quinnell

BUS BOARD HAS 32-BIT BIDIRECTIONAL COMMUNICATIONS

Designers that need a high-speed parallel-data link into VMEbus systems can use the DB-PCOMM board from Matrix. The VMEbus daughter card includes a front-panel connector that provides a 33-Mbyte/sec, 32-bit bidirectional data link to data acquisition systems, array processors, or other computers. The parallel-communications port uses EIA-485-compatible drivers and receivers. The board routes the data to and from the VSBbus or direct to the CPU local bus when used with the company's CPU boards. An auxiliary control port on the board's front panel provides 16 input and 16 output lines for status and control. The card costs \$2995 and is available now. Matrix Corp, Raleigh, NC, (919) 231-8000, FAX (919) 231-8001.—Maury Wright

DIGITAL-IC TESTER HITS 660 MHz

Hewlett-Packard Co believes its 83000 Model F660 is now the highest-speed digital-IC tester that any firm offers as a standard product. The tester, which is compatible with the firm's 82000-series IC-evaluation systems, is suited to device characterization as well as to production testing. It tests devices (including GaAs and ECL parts) that have as many as 512 pins at clock rates as high as 660 MHz, and does so without multiplexing (a technique that sacrifices channel capacity to improve speed). The system, which uses a "tester-per-pin" architecture and backs each pin with as much as 4 Mbits of memory, boasts pin-to-pin skew of 80 psec. Unlike most other high-performance testers, the system houses all of its test electronics in the unit to which you attach a device handler. The company calls this liquid-cooled unit a mainframe because of its size (although some companies would call it a test head). Additional cabinets house a heat exchanger and the system's power supply. The entire system occupies 28 ft². Other features include compressed-data storage and fiber-optic links between the controlling workstation and the mainframe. The tester costs \$1.6 million for 256 channels; additional channels are \$5500 each. Hewlett-Packard Co, Boeblingen, Germany, (800) 752-0900 (in the US). —Dan Strassberg

PROGRAM AND TEST PLDS ON BENCHTOP TESTER

The ETS200-PRO tester lets you program fuseable-link and electrically erasable PLDs and then test them. The 25-MHz tester is configurable with as many as 192 channels and 64-kword, test-vector memory. Split-cycle input/output operations on all pins let you test μ Ps and other devices with bidirectional buses. A fully configured 96-pin system with 16-kword-deep vector memory, programmable power sources, and a software interface to simulators costs less than \$32,000. Options include a dc parametric unit, additional power sources, and software utilities. Hilevel Technology, Irvine, CA, (714) 727-2100, FAX (714) 727-2101.—Doug Conner

VXIBUS-BASED TESTERS AIM TO LOWER DEVELOPMENT COSTS

Schlumberger Technologies has announced three pc-board test systems designed around the VXibus modular-instrumentation standard. The \$75,000 S760VXI is a core architecture. The \$150,000 S765VXI is based on the core architecture and adds a test-head interface, a control console, power supplies, IEEE-488 instruments, and custom-designed VXI modules for specific high-volume applications. The S790VXI

FULL SPEED AHEAD.

Faster circuits for faster systems: Here's the good book.

The 1991 Cypress Semiconductor Data Books are hot off the presses. Highlights include:

- **SPARC® RISC Microprocessors.** The fastest CMOS available. From embedded control to full chipsets.
- **Highest Speed PLDs.** Broad selection, from standards at rocket speeds to functionally specialized systems.
- **Static RAMs.** Biggest selection of high-speed devices, including our 10ns BiCMOS 64Ks.
- **VME Bus Controllers.** The space-saving solution for a broad range of processors.
- **CMOS PROMs.** The broadest line of

high-performance PROMs, to 512K densities. We'll fill your order fast.

- **Specialty Memories.** Including ultra-high-speed FIFOs.
- **Multichip Modules.** Including 32-bit space and time savers.
- **And much more.** All in our new Data Book.
- **Call for your copy today.**

**1991 Data Book Hotline:
1-800-952-6300*.** Ask for Dept. C4R

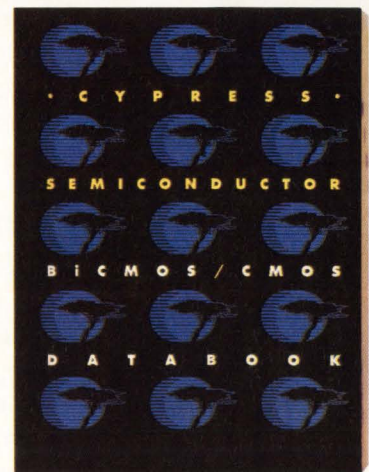

*1 (800) 387-7599 in Canada. (32) 2-652-0270 in Europe. ©1991 Cypress Semiconductor, 3901 North First Street, San Jose, CA 95134. Phone: 1 (408) 943-2600, Telex: 821032 CYPRESS SNJUD, TWX: 910-997-0753. SPARC is a registered trademark of SPARC International, Inc.



CYPRESS
SEMICONDUCTOR

NEWS BREAKS

is a high-performance mixed-signal tester that combines the company's universal digital-pin electronics with VXI instruments in a synchronized configuration built around a single high-speed backplane. Prices for the mixed-signal tester begin at \$275,000, with typical configurations expected to cost \$750,000. Deliveries range from 60 to 120 days ARO. All three systems use the firm's CATE (Computer-Aided Test Engineering) software, a framework for integrating CAE and test-development tools. The software holds down the cost of developing new products by providing a common interface for developers of R&D characterization tests, production tests, and diagnostic routines used for post-sale support and troubleshooting. Schlumberger Technologies, San Jose, CA, (408) 437-5129.—Dan Strassberg

IN-CIRCUIT EMULATOR SUITS 8XC751/2 MICROCONTROLLERS

The DS-752 real-time in-circuit emulator from Ceibo lets you develop systems using Philips 83C751/2 and 87C751/2 microcontrollers. The product avoids the need for bond-out chips by using proprietary code to access internal buses of a standard microcontroller part. A 5×6×1-in. package houses the emulator. A ribbon cable links to target hardware, and an RS-232C cable connects the unit to your PC. The emulator requires a 5V supply, or uses an optional ac adapter. The software-support package includes a source-level debugger for C and Programming Language for Microprocessors, on-line assembler and disassembler, conditional breakpoints, and a 32-kbyte trace buffer. An internal clock source lets you debug software in the absence of target hardware. The emulator costs \$960. Ceibo, Herzelia, Israel, (52) 555387, FAX (52) 553297. In US, (617) 863-9927, FAX (617) 863-9649.—Brian Kerridge

READ-CHANNEL IC INCORPORATES PROGRAMMABLE FILTER

GEC Plessey Semiconductors's PCA2400 read-channel IC shrinks the physical volume of components in hard-disk drives. The chip incorporates all of the analog electronics normally associated with a disk drive's read channel, such as the pulse detector, data separator, data encoder and decoder, and write-precompensation electronics. In addition, the device includes two functions that previously required additional chips: a programmable filter and a clock synthesizer for zone-bit recording. The chip handles data rates to 24 Mbits/sec. The chip also features eight power-down modes because small hard-disk drives, such as the 2.5- and 1.8-in. products, often run from batteries, and thus need the ability to draw only the amount of power appropriate to the immediate task at hand. Power dissipation for the 5V IC ranges from 15 mW in its shutdown mode to 1W in its full-write mode. Samples of the device will be available in November and production units will cost \$10 in OEM quantities. GEC Plessey Semiconductors Inc, Scotts Valley, CA, (408) 438-2900, FAX (408) 438-5576.—Steven H Leibson

EXPLORING C SOURCE CODE

Microtek Research's Xray Source Explorer lets programmers learn and re-engineer C source code. The \$695 tool builds graphical views of the source code—horizontal calling tree—that you can parse for special views. The software lets users navigate through the source code, moving down the calling tree and calling up source code as needed. The tool is compiler smart (the company builds cross development tools for a range of processors). Programmers can interactively check on which routines call a given function. You can break tasks down into multiple subtrees for ease of use, and trees can be selectively pruned of functions, library functions, or entire subtrees. The software is X-window Motif compatible and runs on Sun workstations. Microtek Research Inc, Santa Clara, CA, (408) 980-1300.—Ray Weiss

'040

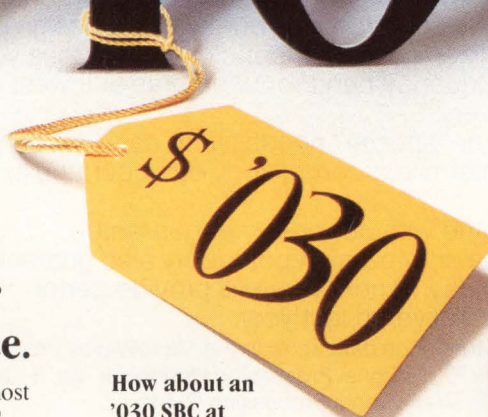

Synergy brings you the power of an '040 SBC at an '030 price.

It's true. For only \$2865*—less than the cost of most '030 boards—you can have a *full-featured* '040 SBC that gives your VME system vastly superior performance.

Synergy's new VME Workhorse VW40 is hardly a stripped-down SBC. There's SCSI and Ethernet on-board with 4 Mbytes of DRAM (2, 8 or 16 MB optional). There's a new multi-channel, intelligent DMA controller that handles both I/O and VME transfers—all concurrent with normal '040 operations.

Best of all, there's your choice of over a dozen EZ-bus modules with intelligent I/O—fully compatible with Synergy's entire line of '020, '030 and '040 SBCs. Compare that with any other manufacturer!

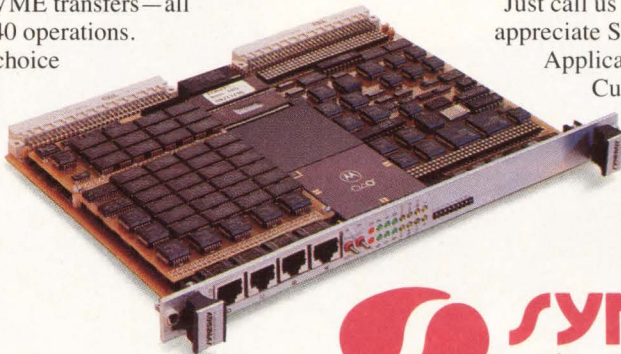

How about an '030 SBC at an '020 price?

Our new VW30 SBC can plug '030 power and capability into your '020-based system, and at \$1595* we'll keep your system price competitive.

Just call us and you'll appreciate Synergy's customer support: Application engineers that know VME. Custom I/O designs. Unbeatable documentation. Along with the very best price/performance in VME.

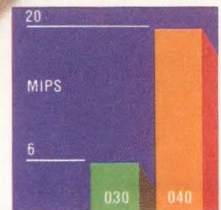

The '040 has 3× the performance of the '030: 20 vs 6 MIPS at 25 MHz.

*Price for qty. 100

 **SYNERGY**
microsystems

Synergy Microsystems, Inc.
179 Calle Magdalena, Encinitas, CA 92024
(619) 753-2191 FAX: 619-753-0903

POWER SPLITTERS/ COMBINERS

the world's largest selection
2KHz to 8GHz from \$4⁹⁵

With over 300 models, from 2-way to 48-way, 0°, 90° and 180°, a variety of pin and connector packages, 50 and 75 ohm, covering 2KHz to 8000MHz, Mini-Circuits offers the world's largest selection of off-the-shelf power splitter/combiners. So why compromise your systems design when you can select the power splitter/combiner that closely matches your specific package and frequency band requirements at lowest cost and with immediate delivery.

And we will handle your "special" needs, such as wider bandwidth, higher isolation, intermixed connectors, etc. courteously with rapid turnaround time.

Of course, all units come with our one-year guarantee. Unprecedented 4.5 sigma unit-to-unit repeatability also guaranteed, meaning units ordered today or next year will provide performance identical to those delivered last year.

For detailed specs and performance data, refer to the MicroWaves Product Directory, EEM or Mini-Circuits RF/IF Signal Processing Handbook, Vol. II. Or contact us for our free 68-page RF/IF Signal Processing Guide.

finding new ways ...
setting higher standards

 **Mini-Circuits**

A Division of Scientific Components Corporation
P.O. Box 350166, Brooklyn, New York 11235-0003 (718) 934-4500
Fax (718) 332-4661 Domestic and International Telexes: 6852844 or 620156

CIRCLE NO. 7

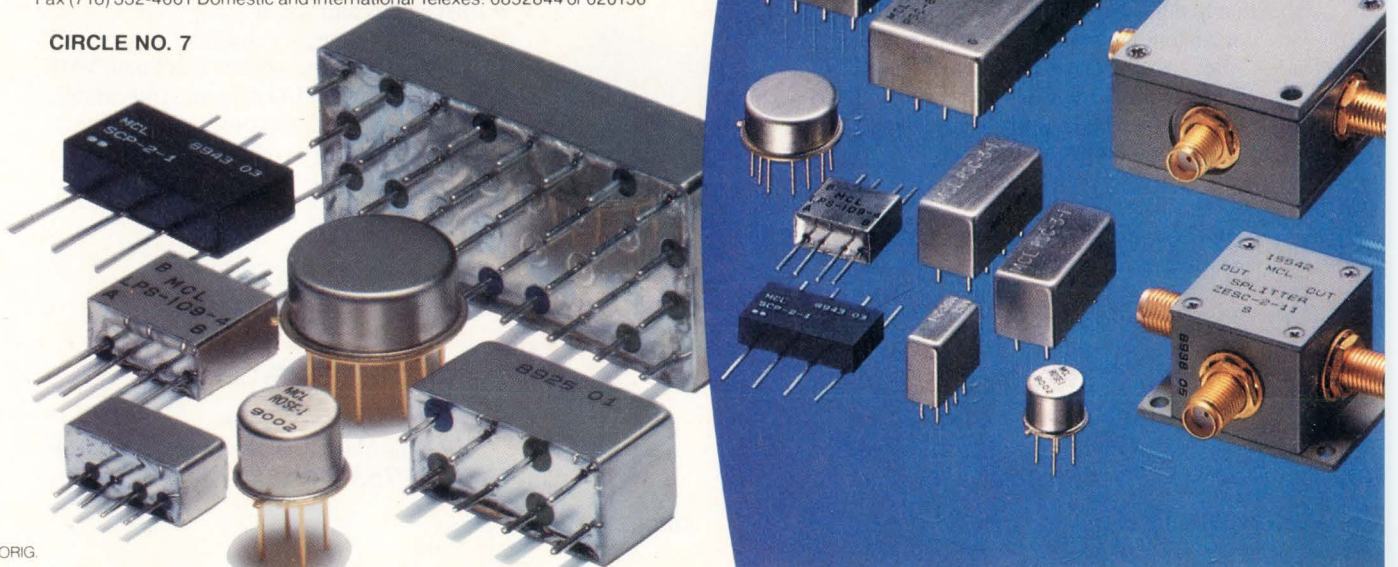

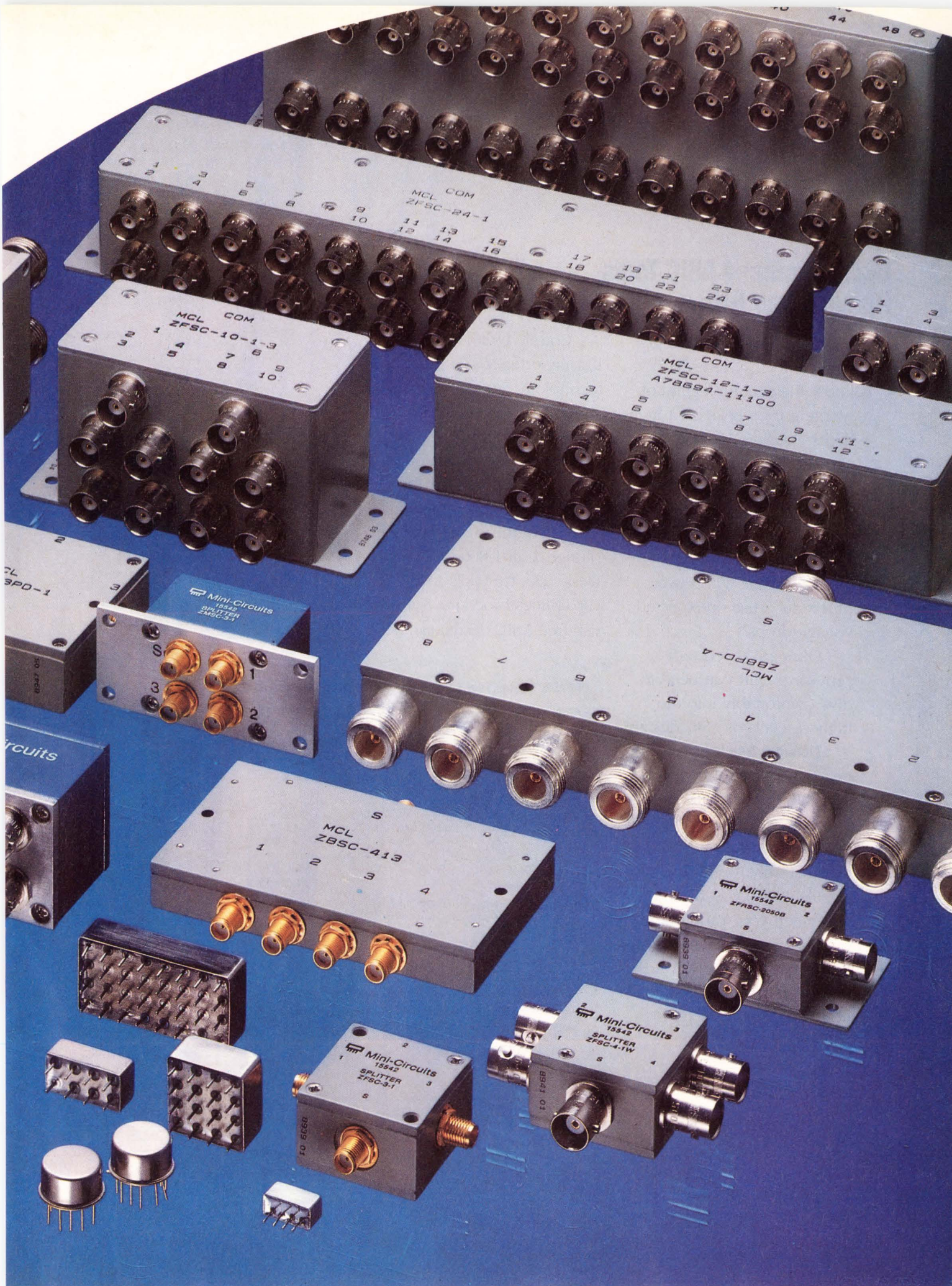

MCL COM
ZFSC-24-1

MCL COM
ZFSC-10-1-3

MCL COM
ZFSC-12-1-3
A78894-11100

Mini-Circuits
15542
SPLITER
ZFSC-3-1

MCL
ZBPPD-4

MCL
ZBSC-413

Mini-Circuits
15542
ZFSC-2050B

Mini-Circuits
15542
SPLITER
ZFSC-3-1

Mini-Circuits
15542
SPLITER
ZFSC-4-1W

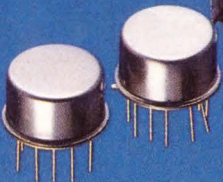

Oki's Advanced ASIC Tools Reduce Your Risk.

As an ASIC designer for high-performance systems, you know the sinking feeling of working for weeks on a high-density design—only to have it crash. You know the risks involved in designing with tools that offer no assurances—Will path delays meet spec? Will routed signals violate timing? Will power problems cause unexpected voltage drops?

Oki's advanced tools provide the lift you need to dive comfortably into the highest levels of ASIC design:

Timing-driven layout - enables control of critical net and path delays, better ensuring a design-to-silicon match.

Clock tree structures - automatically route logic signals where you want them and when you want them, optimizing clock distribution.

Power calculator - locates and corrects power distribution and dissipation problems, increasing overall system reliability.

Coupled with our 0.8 μ m leading-edge sea-of-gate technology and our high-level support—such as Verilog, Synopsys, and IKOS—these Oki software tools not only optimize ASIC performance but also optimize design time.

So go ahead and take the plunge. Call 1-800-OKI-6388, Dept. 050, for Oki's ASIC capabilities brochure. See how risk-free ASIC design can be.

Oki ASIC Design Tool Support for 0.8 μ m, 1.0 μ m, and 1.2 μ m

Vendor	Platform	Operating System/Rev	Description
Cadence	Sun/SPARC	Sun OS 4.1.1	Simulation
	Solbourne	Verilog 1.5C	Fault grading Design verification
IKOS		4.0 up	Simulation Fault grading
Mentor Graphics	HP/Apollo	DNIX 5.03, Sun OS 4.1.1	Capture
	DNx Series	Digital application 6.1	Simulation
		Digital application 6.3	Design check
	HP9000	Digital application 8.0 (in qualification)	Layout
	Sun/SPARC	Parade	Clock Structures
	Solbourne		
Synopsys	Sun/SPARC	Sun OS 4.1.1	Design synthesis
	Interface to Mentor, Valid, Viewlogic		Test synthesis
Valid	Sun/SPARC	Sun OS 4.1.1	Design capture
	Sun-3	GED, ValidSIM, RapidSIM	Simulation Design check
	DECstation 3100	ULTRIX, ValidSIM, GED	
	IBM RS6000	GED, ValidSIM, RapidSIM	
Viewlogic	Sun/SPARC	Sun OS 4.1.1	Design capture
		Workview 4.0	Simulation
	PC386	DOS 3.3, Workview 4.0	

TRANSFORMING TECHNOLOGY INTO CUSTOMER SOLUTIONS

WHEN YOU PLUNGE INTO ASIC DESIGN,
YOU WANT SUPPORT TOOLS THAT WORK.

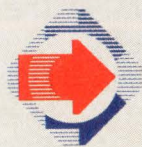

OKI
Semiconductor

785 North Mary Avenue
Sunnyvale, CA 94086-2909
1-800-OKI-6388, Dept. 050

CIRCLE NO. 18

How AMD Keep Up With



The Elegance Inside The HP LaserJet III^{Si}™ Printer: The 29K™ RISC Microprocessor Family.

29K

HP's customers were on the prowl. And Hewlett-Packard knew exactly what they were hunting for—a faster, PCL5 and PostScript® compatible, affordable desktop laser printer.

So they built the HP LaserJet III^{Si} printer. And naturally, they built it around the most versatile, high performance embedded RISC processor ever:

The 29K™ 32-bit microprocessor from AMD.

Only the 29K Family gives you the widest range of performance—thanks to its innovative register file and high-velocity memory interface. That's how HP achieves its blistering 17 page-per-minute throughput, even with complex PCL5 and PostScript documents.

Only the 29K Family keeps your system costs

Helps HP Its Customers.



low, while keeping performance high. Features like AMD's unique on-chip caches and burst mode give you maximum performance from less expensive memory.

Only the 29K Family helps bring your product to market so fast. You'll breeze through development with AMD's own tools, or the hardware and software tools provided by over 50 Fusion29KSM Partners. And the 29K Family continues to grow, with new members offering even higher performance and integration.

So make sure your customers are happy puppies, and start designing with the 29K Family from AMD. Call **1-800-292-9263 Ext. 3** for more information.



Advanced Micro Devices

901 Thompson Place, P.O. Box 3453, Sunnyvale, CA 94088. © 1991 Advanced Micro Devices, Inc.

29K is a trademark and Fusion29K is a servicemark of Advanced Micro Devices.
LaserJet III/II is a trademark of Hewlett-Packard Co. PostScript is a registered trademark of Adobe Systems, Inc. All other brand or product names are trademarks or registered trademarks of their respective holders.

In-hand solutions for small-enclosure needs.



Needing a small enclosure doesn't mean your needs are small. We offer a broad range of enclosures to meet your handheld measurement and control instrumentation requirements. Combining quality appearance with ergonomic design, our DataBoss series enclosures feature recessed surfaces for keypads, openings for displays and battery compartments. Internal mounting provisions make PCB installation easy. Offered in ABS, polystyrene, and glass-filled nylon.

Bopla has the solution at hand. Call us today to find out how we can put it in yours.

Tell me more about Bopla handheld enclosures.

Send me the Bopla enclosures catalog.

Name: _____

Phone: () _____ FAX: () _____

Company: _____

Address: _____

City: _____ State: _____ ZIP: _____

bopla[®]
Enclosure Systems

7330 Executive Way
Frederick, Maryland 21701

(301) 696-9300

FAX: (301) 696-9494

A PHOENIX MECANO COMPANY

CIRCLE NO. 27

See us at Wescon Booth #0017 and #0019

SIGNALS & NOISE

Two more shortcomings of engineering schools

I enjoyed reading Jay Fraser's article on engineering graduate schools (EDN, June 6, 1991, pg 244). In my opinion it touched on many of the shortcomings of today's higher education, but there are two that he missed: enforced boredom and lack of effective time management. As a professional with more than 14 years' experience, I have no interest in sitting through a class, required by whatever institution I might attend, rehashing what I already know.

I've looked into a number of schools over the years and find that I'm required to take courses I could teach. I have yet to find a "name" school (although they may exist) that allows seasoned professionals to use prior experience against required credits to get an advanced degree.

Seriously, with the pace of today's changing technology, most professionals find themselves reading more material in a year than when they were in college. When you add to this volume of reading the experience of having written five embedded operating systems, worked at the kernel level in three others, and written sensor-processing software, it's absurd to consider taking a course in operating systems theory, taught by an upper-level graduate student, where your final project is to write a simple or even moderately complex operating system.

Frankly, I've always wondered whether this attitude is about money (how can institutes charge for a degree if, after testing, all you need is one course to get a master's degree?) or we're viewed as corrupt. Our knowledge is somehow not true to the faith. We are "less"

than those who have remained pure.

*Paul Meyers
GTE Government Systems
Fort Hood, TX*

(Ed Note: Some schools may let you "test out" courses. You do have to pay the course fee at some of these schools, but passing a final exam gets you credit for the course.)

NEXT WEEK IN EDN

EDN News Edition's October 17 Comdex issue will feature a Product Watch on graphics boards and a special Comdex section that will cover products introduced at the show. Also look for a Career Opportunities article on artificial intelligence.

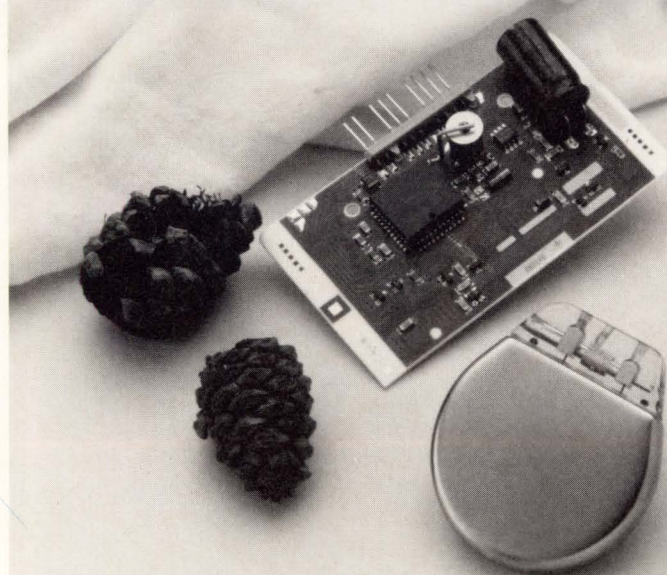

What do a heart pacer, an electronic circuit board, 40 million year old pine cones and an ancient burial shroud have in common?



They all benefit from the outstanding conformal protection of gas phase parylene polymer coating

Parylene conformal coating meets a myriad of protective and preservative challenges in electronics, medicine, science and artifactual conservation. This transparent material can be applied in an extremely thin layer (from $.5\mu$ to 250μ) to isolate surfaces from the damaging effects of moisture, vapor, chemicals and acids without stressing the underlying substrate. Unlike liquid coatings, parylene is deposited in a gas phase, and it polymerizes to form a pin-hole free barrier even in deep crevices and around sharp edges.

Parylene's stress-free coating performance is unmatched by any other process. Contact Nova Tran Corporation for an assessment of your difficult coating challenges.

 **NOVA TRAN**
Specialty Coating Systems, Inc.
 Subsidiary Of Union Carbide Corporation

5707 West Minnesota St.
Indianapolis, IN 46241
Telephone 800-356-8260
Fax 317-240-2073

**Before you buy CAE
from the ATE leader,
you'd better have
some damn good reasons.**

Some damn good reasons.

“We use Teradyne’s LASAR simulation religiously on the bipolar and BiCMOS designs we accept to do thorough race checking on both the circuit and the vectors. Before we started using LASAR, 9 out of 10 designs would require some intervention at test. LASAR guarantees us a stable design. That means we produce a higher quality part in less time.”

*Gary Oehrle,
Implementation Manager
AMCC*

“A Stardent 1000 system has more than 60 CMOS ASICs, a total of more than 2 million gates. Using AIDA, we were able to achieve virtually 100% fault coverage with the test vectors we generated for our ASIC supplier, LSI Logic. When we received first silicon, all the ASICs worked the first time. We had the whole system up and running in three days.”

*Bruce Schurmann,
Vice President of Hardware
Engineering
Stardent Computer, Inc.*

“Imagine you’re using a battery-powered laptop and suddenly your system shuts down. What’s happened is that as the battery’s power got lower, the parts on the laptop board began operating under worst-case conditions, causing the failure. At Western Digital, we want to design a quality product and eliminate these kinds of timing hazards. That’s why we’re believers in LASAR. It’s the only way you’re going to find timing hazards under worst-case conditions.”

*Bob Hutchins,
Manager, Design Automation
Western Digital*

“The MultiSim Interactive Designer is excellent – it’s the first CAE tool that works well with a top down design approach. It’s set up so you can build and simulate block by block, and its speed makes it easy to find your mistakes, make changes, and try again without a lot of time spent recompiling.”

*Steve DeLong,
Technical Team Leader
Jim Walsh,
Technical Staff Member
Rockwell International Corporation*

“We design and test complex boards for military and commercial satellites, and LASAR gives us two critical advantages: accuracy and reliability. LASAR’s ability to accurately predict timing hazards caused by IC lot variations and design errors gives us complete confidence in the manufacturability of the boards we design. And when we hand off a new board design to the test group, we’ve got a good head start because our test engineers also use LASAR and its testability analysis tools to develop the test program sets.”

*Ed Faller,
Senior Engineer
General Electric Company*



Design engineers are using Teradyne’s CAE tools for lots of good reasons. Interactive design analysis. Accurate design verification. Tight integration between design and test. With Teradyne CAE, you get greater speed, accuracy, and reliability than with other CAE systems. That adds up to higher product quality and faster time-to-market. And in today’s competitive environment, those are the best damn reasons of all.

To learn more, call Daryl Layzer today at 1-800-225-2699, ext. 3808, or FAX (408) 748-7761.

© 1991, Teradyne, Inc. AIDA, MultiSim, and Vanguard are trademarks of Teradyne, Inc. Frenchip is a product of Dassault Electronique.

TERADYNE

RF TRANS

Over 50 off-the-shelf models...

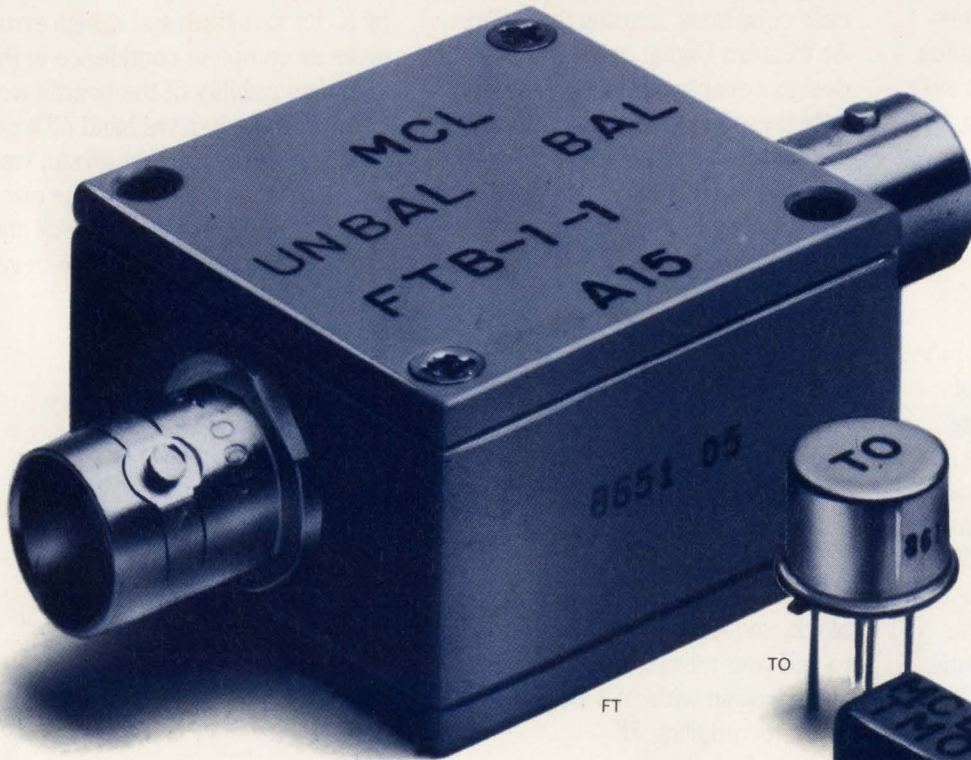

Having difficulty locating RF or pulse transformers with low droop, fast risetime or a particular impedance ratio over a specific frequency range? ... Mini-Circuits offers a solution.

Choose impedance ratios from 1:1 to 36:1, connector or pin versions (plastic or metal case built to meet MIL-T-21038 and MIL-T-55831 requirements*). Ultra-wideband response achieves low droop and fast risetime for pulse applications. Ratings up to 1000M ohms insulation resistance and up to 1000V dielectric voltage. For wide dynamic range applications involving up to 100 mA DC primary current, use the T-H series. Coaxial connector models are offered with 50 and 75 ohm impedance; BNC standard; request other types. Available for immediate delivery with one-year guarantee.

Call or write for 68-page catalog or see our catalog in EEM, or Microwaves Product Data Directory.

*units are not QPL listed

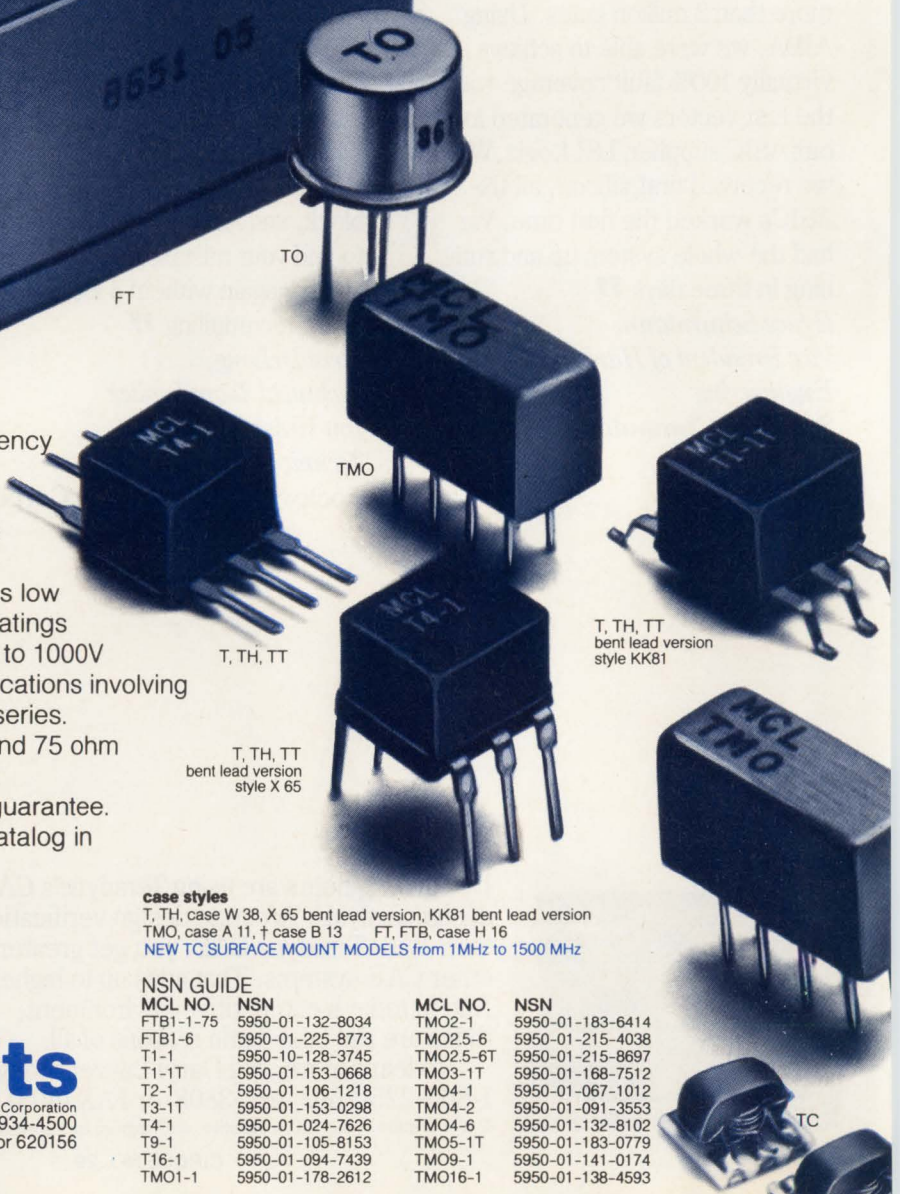

case styles

T, TH, case W 38, X 65 bent lead version, KK81 bent lead version
TMO, case A 11, † case B 13 FT, FTB, case H 16
NEW TC SURFACE MOUNT MODELS from 1MHz to 1500 MHz

NSN GUIDE

MCL NO.	NSN	MCL NO.	NSN
FTB1-1-75	5950-01-132-8034	TMO2-1	5950-01-183-6414
FTB1-6	5950-01-225-8773	TMO2.5-6	5950-01-215-4038
T1-1	5950-10-128-3745	TMO2.5-6T	5950-01-215-8697
T1-1T	5950-01-153-0668	TMO3-1T	5950-01-168-7512
T2-1	5950-01-106-1218	TMO4-1	5950-01-067-1012
T3-1T	5950-01-153-0298	TMO4-2	5950-01-091-3553
T4-1	5950-01-024-7626	TMO4-6	5950-01-132-8102
T9-1	5950-01-105-8153	TMO5-1T	5950-01-183-0779
T16-1	5950-01-094-7439	TMO9-1	5950-01-141-0174
TMO1-1	5950-01-178-2612	TMO16-1	5950-01-138-4593



finding new ways ...
setting higher standards

Mini-Circuits

A Division of Scientific Components Corporation
P.O. Box 350166, Brooklyn, New York 11235-0003 (718) 934-4500
Fax (718) 332-4661 Domestic and International Telexes: 6852844 or 620156

FORMERS

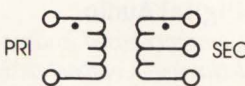
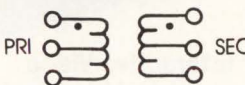
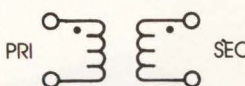
3KHz-800MHz from \$3²⁵

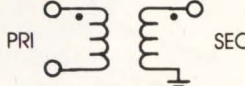
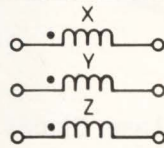
case style number see opposite page	MODEL NO.	Ω RATIO	FREQUENCY MHz	INSERTION LOSS			PRICE \$ Qty. (1-9)		
				3dB MHz	2dB MHz	1dB MHz			
A* 	T	T1-1T	1	.05-200	.05-200	.08-150	2-80	4.45	
		T1-6T	1	.003-300	.003-300	.01-150	.02-50	6.95	
		T2-1T	2	.07-200	.07-200	.1-100	5-50	4.95	
		T2.5-6T	2.5	.01-100	.01-100	.02-50	50-20	4.95	
		T3-1T	3	.05-250	.05-200	.1-200	5-70	4.95	
		T4-1	4	2-350	2-350	.35-300	2-100	3.25	
		T4-6T	4	.02-250	.02-250	.05-150	0.1-100	4.45	
		T5-1T	5	3-300	3-300	.6-200	5-100	4.95	
		T8-1T	8	.03-140	.03-140	.10-90	1-60	7.95	
		T13-1T	13	3-120	3-120	.7-80	5-20	4.95	
		T16-6T	16	.03-75	.03-75	.06-30	1-20	5.65	
		T4-1H	4	10-350	10-350	15-300	25-200	5.95	
		TH	TMO1-1T	1	.05-200	.05-200	.08-150	2-80	7.95
			TMO2-1T	2	.07-200	.07-200	.1-100	5-50	8.45
			†TMO2.5-6T	2.5	.01-100	.01-100	.02-50	0.5-20	8.45
			†TMO3-1T	3	.05-250	.05-250	.1-200	5-70	7.95
TMO4-1	4		2-350	2-350	.35-300	2-100	6.25		
TMO5-1T	5		3-300	3-300	.6-200	5-100	8.45		
TMO13-1T	13	3-120	3-120	.7-80	5-20	8.45			
B* 	TT	TT1-6	1	.004-500	.004-500	.02-200	1-50	6.95	
		TT1.5-1	1.5	.075-500	.075-500	2-100	1-50	5.95	
		TT2.5-6	2.5	.01-50	.01-50	.025-25	0.5-10	6.45	
		TT4-1	3	.05-200	.05-200	2-50	1-30	5.95	
		TT4-1A	3	0.1-300	0.1-300	0.2-250	0.3-180	6.95	
		TT25-1	25	.02-30	.02-30	.05-20	1-10	9.95	
		TTMO	TTMO25-1	25	.02-30	.02-30	.05-20	1-10	11.95
			TTMO1-1	1	.005-100	.005-100	.01-75	0.5-40	11.45
			TTMO4-1A	4	0.1-300	0.1-300	0.2-250	0.3-180	13.95
		C 	T	T1-1	1	.15-400	.15-400	.35-200	2-50
T1.18-3	1.18			0.01-250	0.01-250	0.02-200	0.03-50	5.65	
T1-6	1			.01-150	.01-150	.02-100	0.5-50	5.65	
T1.5-1	1.5			1-300	1-300	2-150	5-80	4.45	
T1.5-6	1.5			.02-100	.02-100	.05-50	0.1-25	5.65	
T2.5-6	2.5			.01-100	.01-100	.02-50	0.5-20	4.45	
T4-6	4			.02-200	.02-200	.05-150	1-100	4.45	
T9-1	9			.15-200	.15-200	3-150	2-40	3.95	
T16-1	16			3-120	3-120	7-80	5-20	4.45	
T36-1	36			.03-20	.03-20	.05-10	1-5	6.95	
TO	TO-75			1	10-500	—	10-500	40-250	6.95
	T1-1H			1	8-300	8-300	10-200	25-100	5.95
TH	T9-1H			9	2-90	2-90	3-75	6-50	6.45
	T16-H			16	7-85	7-85	10-65	15-40	6.45
TMO	TMO1-02			1	1-800	1-800	2-500	—	9.45
	TMO1-1			1	.15-400	.15-400	.35-200	2-50	6.25
	TMO1.5-1			1.5	1-300	1-300	2-150	5-8	8.45
	†TMO2.5-6			2.5	.01-100	.01-100	.02-50	0.5-20	7.95
	†TMO4-6	4	.02-200	.02-200	.05-150	1-100	7.95		
	TMO6-1	6	3-200	3-200	5-150	5-50	7.95		
	TMO9-1	9	.15-200	.15-200	3-150	2-40	7.95		
TMO16-1	16	3-120	3-120	7-80	5-20	7.95			
D 	T	T2-1	2	.050-600	.050-600	.1-400	5-200	3.95	
		T3-1	3	5-800	5-800	2-400	—	4.45	
		T4-2	4	2-600	2-600	5-500	2-250	3.95	
		T8-1	8	.15-250	.15-250	.25-200	2-100	3.95	
		T14-1	14	2-150	2-150	.5-100	2-50	4.95	
		TMO	TMO2-1	2	.050-600	.050-600	.1-400	5-200	7.95
	TMO3-1		3	5-800	5-800	2-400	—	8.45	
	TMO4-2		4	2-600	2-600	5-500	2-250	7.95	
	FT	TMO8-1	8	.15-250	.15-250	.25-200	2-100	7.95	
		TMO14-1	14	2-150	2-150	.5-100	2-50	8.45	
		FT1.22-1	1.22	.005-100	.005-100	.01-50	0.5-25	35.95	
	FT1.5-1	1.5	1-400	1-400	5-200	1-100	35.95		
E 	FTB	FTB-1	1	2-500	2-500	.5-300	1-100	36.95	
		FTB1-6	1	.01-125	.01-125	.05-50	1-25	36.95	
		■FTB-1-75	1	5-500	5-500	5-300	10-100	36.95	
F 	T	T-622	1	0.1-200	0.1-200	0.5-100	5-80	3.25	
		T626	1	0.01-10	0.01-10	0.2-5	0.4-2	3.95	

■ Denotes 75 ohm models

* FOR A AND B CONFIGURATIONS

Maximum Amplitude Unbalance
0.1 dB over 1 dB frequency range
0.5 dB over entire frequency range

Maximum Phase Unbalance
1.0° over 1 dB frequency range
5.0° over entire frequency range

CIRCLE NO. 30

C72-2 REV. B

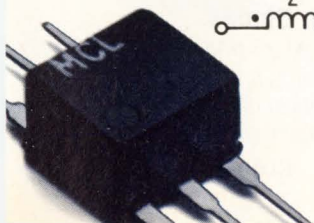

No guts.

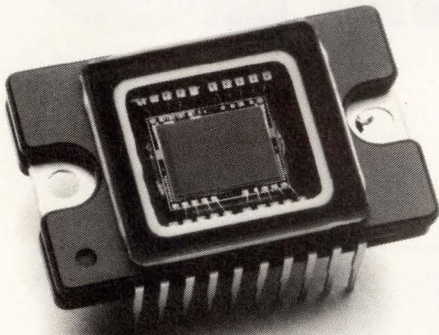

CCD Image Sensors

The CCD technology that led to Sony's leadership in color video cameras is now available to you.

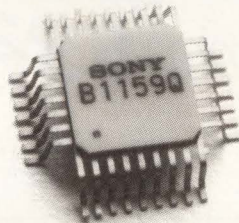

ECL Standard Logic

Wide range of high-speed, high-performance ECL logic devices. Low cost and design simplicity.

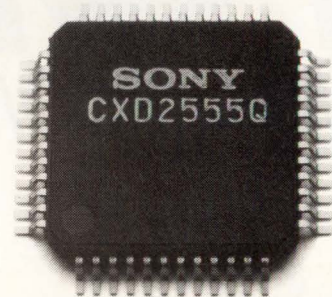

Digital Audio

Consumer-based leading-edge technology. Compact design. Small package. Capable of CD-ROM interface.



High Speed SRAMs

Broad family covers all your fast-processor cache-memory requirements.



ECL Gate Arrays

Super high-speed operation combined with low power consumption and extensive I/O interfaces.



Interactive Video

Sony's A/V IC leadership applies directly to new multimedia systems. Superior bipolar linear technology in encoder/decoder.



1-Meg SRAMs

Largest, most diverse family in the industry. The first products scheduled to come from our new San Antonio fab.



SRAM

High speed performance, self-timed RAM with register synchronous SRAM.

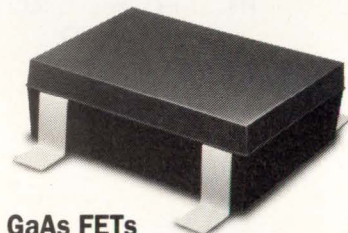

GaAs FETs

State-of-the-art performance, reliability and uniformity. Ideal when low noise is critical.



D/A Converters

High speeds to 500 MHz, low glitch energy, and low power consumption in very small packages.

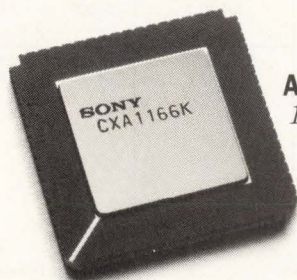

A/D Converters

18 models including the world's fastest. Fewer pins, smaller packages, low power consumption, and guaranteed low error rates.



Laser Diodes

Wide power range, high reliability, huge selection. Ideal for optical disk, laser printer and microsurgery designs.

No glory.

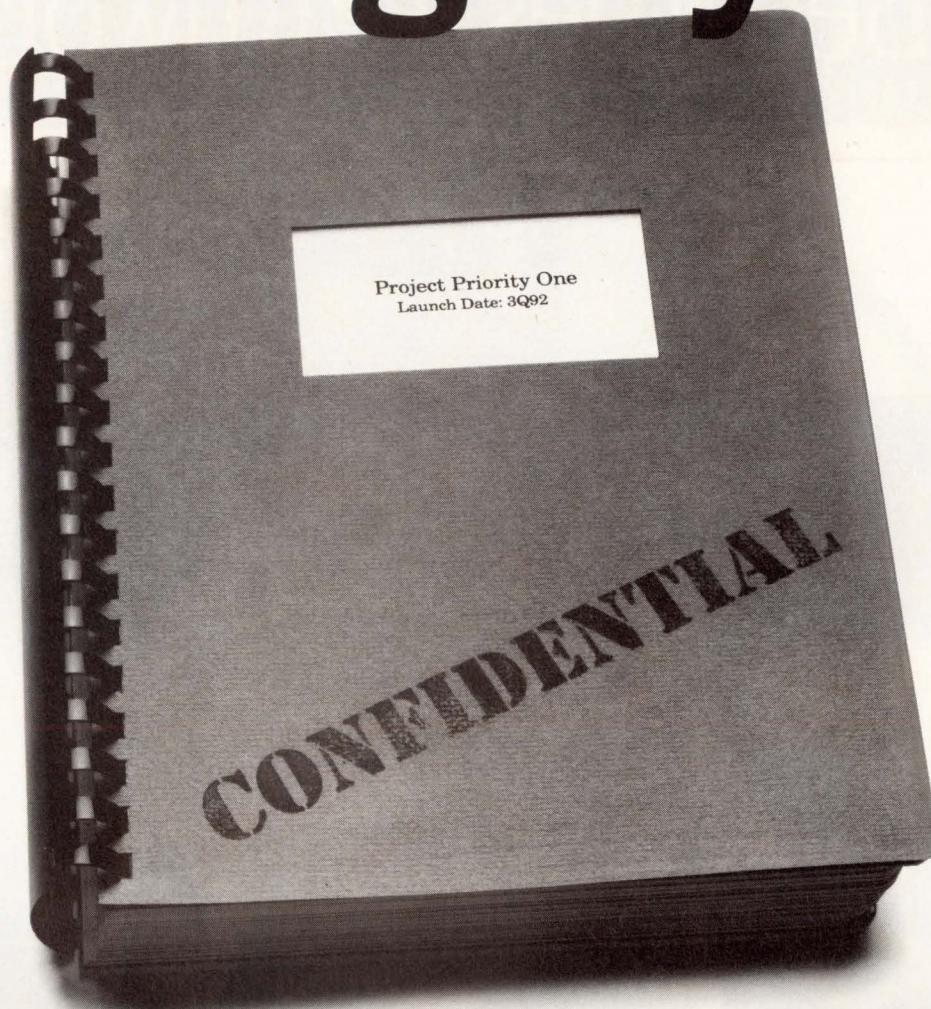

If you can't get the parts you need, you can't get your best designs out the door.

And that's where we can help. With cutting edge SRAMs—high and low speed. With high speed A/D and D/A converters. With high speed ECL logic chips. And with a long list of other components—the same components that have made Sony's consumer electronics so successful.

Perhaps more important, we're always here to help. With a design center to support your design engineers, in developing applications all the way through

production. With a service department to answer your questions and expedite your orders. And with world-class manufacturing, plus new facilities in San Antonio, Texas, to produce the technology you'll need next year.

To learn more about our custom design support, our competitive prices, and our full line of components, just call us today at (714) 229-4331 or (416) 499-1414 in Canada. You can even FAX us your current requirements at (714) 229-4285 or (416) 499-8290 in Canada.

SONY®

Sony Corporation of America, Component Products Company, 10833 Valley View Street, Cypress, CA 90630.
Sony Canada, 411 Gordon Baker Road, Willowdale, Ontario M2H 2S6.

How Design Work Becomes Teamwork.



The DAZIX Simultaneous Engineering Environment (SEE) turns design work into teamwork.

SEE allows your departments to coordinate efforts during every phase of the design process. This helps to improve product quality, lower production costs, and get products to market faster.

SEE delivers the integration you asked for. Common database management. Common user interface across applications. And a complete

toolset, including solutions for front-to-back electronics design, mechanical design, manufacturing, and document management.

What's more, with SEE, your entire team can benefit from an open-system framework. A framework that integrates DAZIX, Intergraph, and Sun products –

as well as leading third-party tools – in a single environment.

There's more you should know. Call us today at 800-239-4111 for a free copy of *Simultaneous Engineering*.

In Europe, call 33-1-4537-7100. In the Asia-Pacific area, call 852-8661966.

DAZIX[®]
An Intergraph Company

ASK EDN

EDITED BY JULIE ANNE SCHOFIELD

A chip for a song

I am looking for the manufacturer of melody-generator chips. These chips are the ones found in the musical birthday cards sold in any card shop.

Barry Cowen
Harvard Apparatus
South Natick, MA

The Cahners CAPS system, which is available from Cahners Technical Information Services, yielded the following manufacturer:

Samsung Semiconductor
3725 N First St
San Jose, CA 95134
(408) 434-5400
FAX (408) 434-5653

Samsung lists a variety of consumer electronic chips: radio chips, audio amplifiers, radio control, and so on. One is the KA223C 9-program music selector.

A faster way to test EPROMs

After burning programs in EPROMs, we verify the coded contents by addressing the PROM's ad-

dress/data digital readout. This time-consuming method works, but is there a quicker way of displaying the PROM's contents? Would modifying our computer terminal's hardware or software help speed things up?

Ralph Cruz
Engineering Manager
Scalar Industries
Elmhurst, IL

You didn't say whether you wanted to display or test the PROMs' contents. To test them, we suggest two routes. The first is to use a μ P to calculate a checksum and compare it to the checksum in the EPROM under test. The second route is to compare the new EPROM to a known-good one using the circuit in Fig 1.

Take care when measuring the human heart

I am a member of the Association for the Advancement of Medical Instrumentation (AAMI). I'm a voting member of the Cardiac Monitors Subcommittee, which develops and maintains the

American National Standard for cardiac monitors, heart-rate meters, and alarms. In the July 4 issue you printed a request by a reader who wished to work with very small signals, such as EKG heartbeats and recording-studio-quality signals (pg 37). Your reply was good, addressing some of the technical basics. But biomedical measurements involve safety issues that far overshadow those basics.

If one is measuring the ECG (an alternate spelling, which I prefer), one must address the issue of leakage currents. Excessive leakage currents through a human heart can kill. The heart is an electromechanical organ. It can be disrupted by a random noise current of sufficient magnitude and forced into ventricular fibrillation. This is the most lethal of all cardiac arrhythmias and can only be terminated by specially trained and equipped medical professionals. For this reason, the American National Standards Institute (ANSI), in conjunction with AAMI, has established the standard "Safe Current Limits for Electromedical Apparatus," document ES1. I strongly urge readers to consult this document before making electrical measurements of the human heart. It is available from AAMI at 3330 Washington Blvd, Suite 400, Arlington, VA 22201.

Noise rejection in electrocardiography is decidedly nontrivial, where typical body surface potentials are on the order of 1 mV p-p, with 60-Hz common-mode noise voltages due to capacitive coupling on the order of 170V p-p. I urge anyone interested in this or other related matters to contact AAMI at the above address.

Richard W Bowser
Lead Computer Systems Engineer
Creighton University
Cardiac Center
Omaha, NE

Thank you for your expert comments and suggestions.

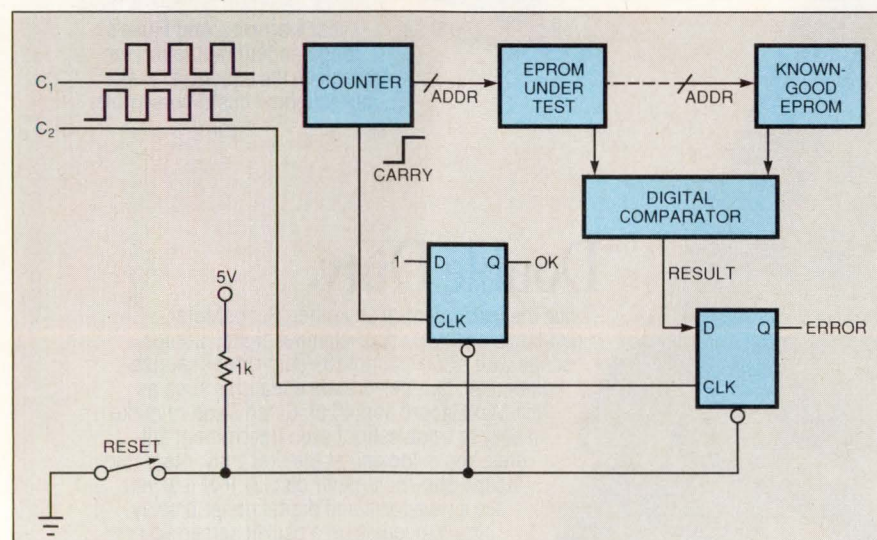

Fig 1—This circuit employs two D flip-flops, a counter, and a digital comparator to test a new EPROM by comparing it with a known-good device.

FLUKE®

Introducing

There's More Than One Reason to Reach for It.

In fact, there's *every* reason to reach for ScopeMeter™. Because only ScopeMeter combines the expertise of Fluke and Philips to bring you a dual-channel digital scope along with everything you've come to expect from Fluke digital multimeters.

The result: the first truly integrated scope-and-multimeter that lets you see a waveform and digital meter display at the same time from the same input. Or switch between dedicated high-performance Scope and Meter functions with the touch of a key. That makes it faster and easier than ever to capture, store and analyze precisely the information you're looking for.

What's more, ScopeMeter is compact, easy-to-use and built for the most demanding field conditions. In short, ScopeMeter has everything

it takes to be the *only* test equipment you take. Including the right price. To get your hands on a ScopeMeter, contact your Fluke sales office or your nearest Fluke distributor. For more product information, call **1-800-44-FLUKE.**



SCOPEMETER.

Now there's only one to reach for.

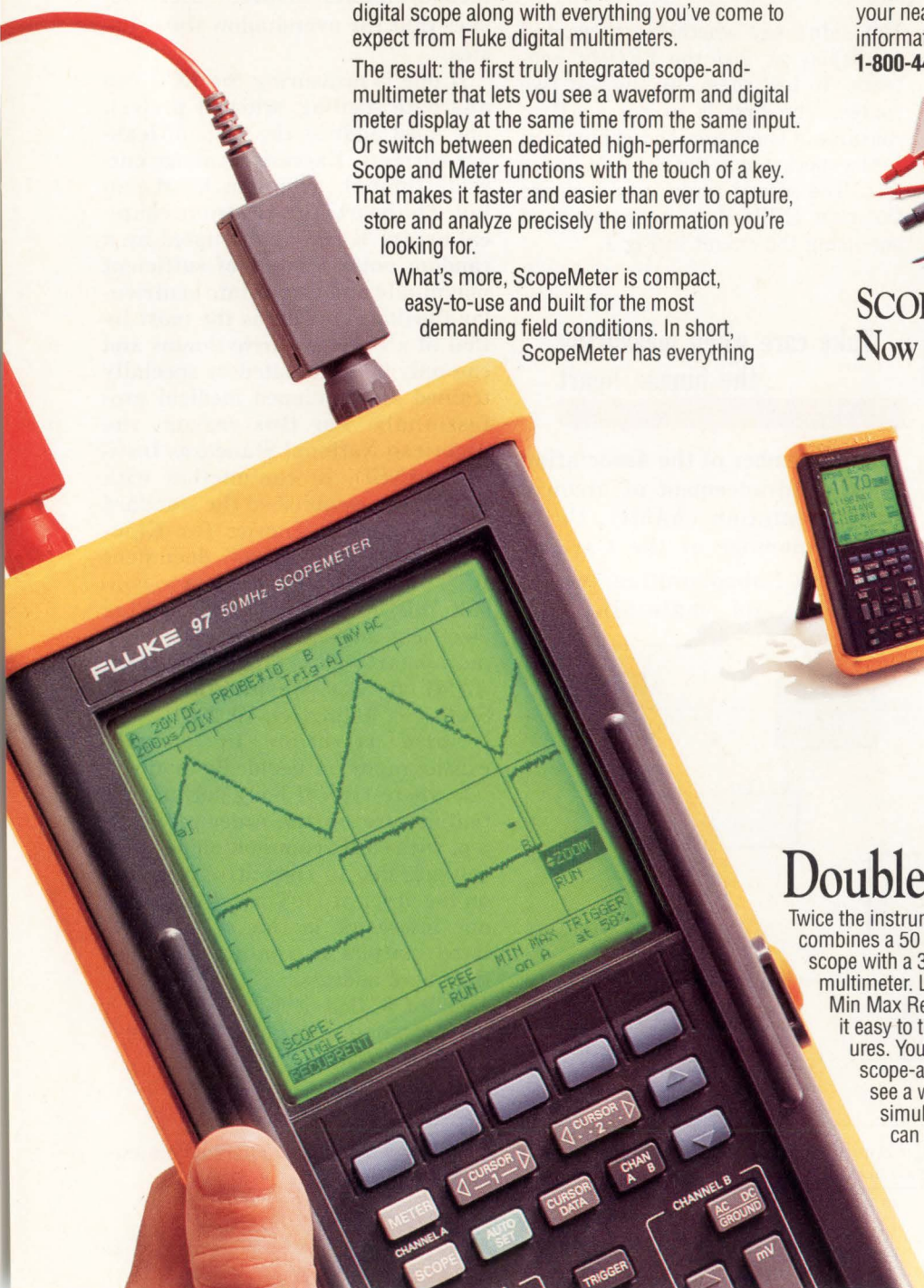

Built to Take It.

ScopeMeter's double-insulated case and rugged construction stand up to all kinds of abuse. ScopeMeter measures up to 600 volts, is completely sealed against water, dust and contaminants and shielded from EMI. It comes with a shock-resistant holster. A three-year warranty. And Fluke's longstanding reputation for reliability. It's enough to make our toughest customers smile.



Double Duty.

Twice the instrument of any other, ScopeMeter combines a 50 MHz dual-channel digital storage scope with a 3000-count (3²/₃ digit) full-featured multimeter. Lab-performance features such as Min Max Record and 40 ns Glitch Capture make it easy to troubleshoot even intermittent failures. You're looking at the first truly integrated scope-and-multimeter display that lets you see a waveform and digital meter display simultaneously on a backlit screen you can read across a room.



PHILIPS

SCOPEMETER™

FLUKE 90 SERIES SCOPEMETER SELECTION GUIDE			
	FLUKE 97	FLUKE 95	FLUKE 93
Suggested List Price	\$1795	\$1495	\$1195
Bandwidth	50 MHz Dual Channel		
Sample Rate	25 Megasamples/second		
Autoset	Automatically sets Voltage, Time and Trigger		
Multimeter Display	3 ^{2/3} digits (>3000 Counts)		
True RMS Volts	AC or AC+DC up to 600V (1700V Pk-Pk)		
Diode Test	Up to 2.8V		
Continuity Beeper	Yes		
Time/Division	10 ns/div to 60 sec/div		
Volts/Division	1 mV/div to 100V/div		5 mV/div to 100V/div
Digital Delay or Pre-Trigger	By Number of Cycles, Events, Time, or Zoom Mode		By Time
Special Multimeter Modes	Min Max Average Record, Relative (zero), dBm, dBV, dBW, Audio Watts, % Scale, Frequency, Smoothing™ Change Alert™		Frequency, Smoothing™ Change Alert™
Oscilloscope Cursors	12 Measurements, Display 5 Simultaneously		
Glitch Capture	≥40 ns		
Waveform Processing	Average, Variable Persistence, Min Max Record		
Waveform Memory	Store and Recall 8 Waveforms		
Set-Up Memory	Store and Recall 10 Front Panel Set-Ups		
Waveform Mathematics	Add, Subtract, Multiply, Invert, Filter or Integrate Waveforms		
Signal Generator Output	Sinewave or Squarewave		
Component Tester Output	Voltage or Current Ramp		
Optically Isolated RS-232-C Interface	Full Operation by Remote Control		
Printer Output	Serial		
Backlit Display	Electroluminescent		

Simply Easy.

ScopeMeter's intuitive front-panel layout is simple and straightforward to use. Pop-up menus and five function keys provide quick, visible control of all your options. With one touch of Autoset, ScopeMeter automatically sets voltage, timing and triggering control. And safety-designed BNC connectors and detachable probes simplify floating measurements.



Goes Wherever You Go.

ScopeMeter is a breakthrough in portable power. It slips easily into a briefcase, tool kit, or its own optional soft or hard case; and runs on rechargeable NiCad batteries, standard C-cells or the included line voltage adapter/battery charger. On the job, its adjustable tilt-stand is a strong, secure hanger, too. And ScopeMeter is compatible with a wide range of Fluke and Philips accessories.



FLUKE®

CIRCLE NO. 33

Universal Flexibility.

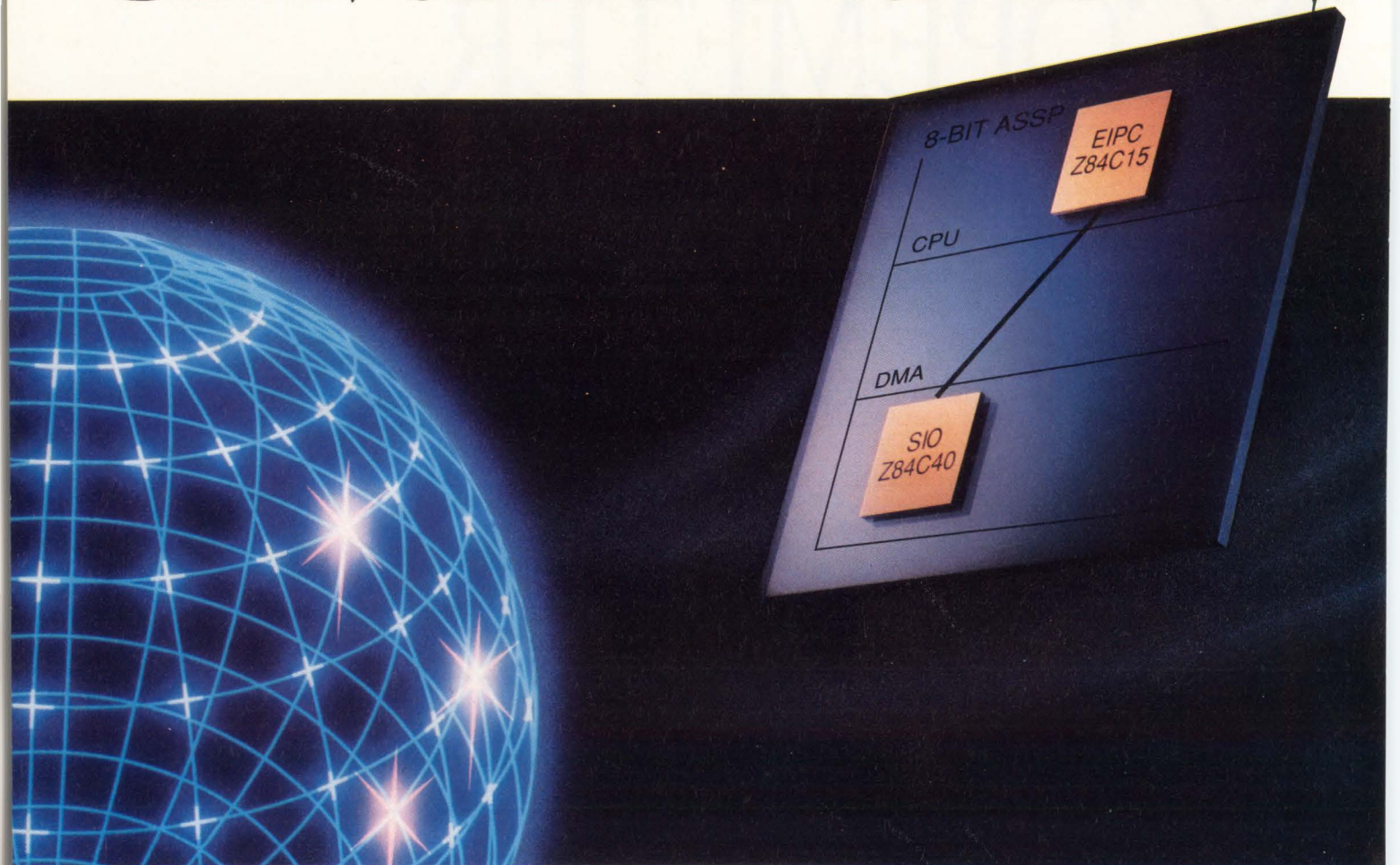

Zilog's SCC™ and USC™ datacom controller families give you a tremendous selection and the most flexibility in protocols, system interfaces and data transfer rates in the industry.

At Zilog, we understand our markets. We provide the devices that meet the needs of datacommunication designs right now, yet we always have an eye on the future. We offer serial communications controllers that ensure quick, easy and flexible interconnection of hosts and peripherals into LANs and WANs. And we provide flexibility in protocols allowing designers to build CPU-based boards with custom software, rather than hardware or firmware.

Our SCC and USC families of 8- and 16-bit SCC controllers range from Serial Input/Output controllers

Appletalk is a registered trademark of Apple Computer, Inc.
SCC, USC, SIO, ESCC, IUSC and Superintegration are trademarks of Zilog, Inc.
©1991, Zilog, Inc.

(SIO™ controller) and the versatile industry standard SCC controller that's used in all Appletalk® networks . . . to the Enhanced SCC (ESCC™ controller), which boosts performance up to 10 times. Plus our Integrated USC (IUSC™ controller), which provides sophisticated buffer management capability, is perfect for handling fast, packetized data across networks. And you get simplified, faster system operation with an on-board DMA. Since all these controllers offer code compatibility in their families, you're also assured a quick, easy migration path.

There's no question that ASSPs are the best option for a rapidly growing number of designs. At Zilog we've been producing ASSPs and refining Superintegration™ design methodology longer and better than anyone, which is why we provide the largest library of familiar

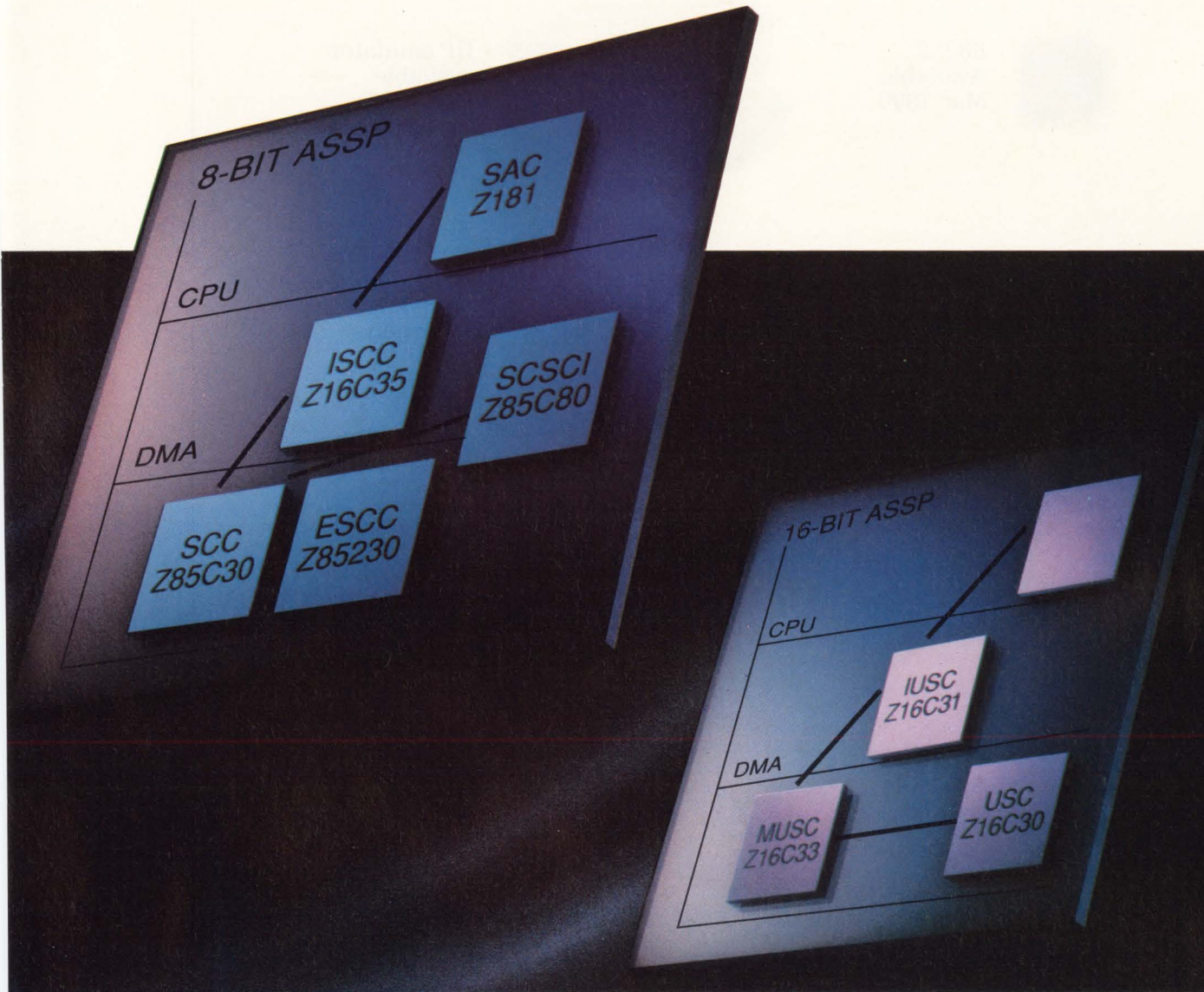

cores and cells in the industry. We're continually developing new members of Zilog's SCC and USC controller families, and, because we have the manufacturing control that comes from having our own fabrication facilities, you can rest assured that every exciting innovation will reflect the high standards of quality and reliability for which Zilog is known . . . and all the flexibility you need for today's complex designs.

To find out more about Zilog's Datacom families, or any of our rapidly growing Superintegration product families, contact your local Zilog sales office or your authorized distributor today. Zilog, Inc., 210 East Hacienda Ave., Campbell, CA 95008-6600, (408) 370-8000.

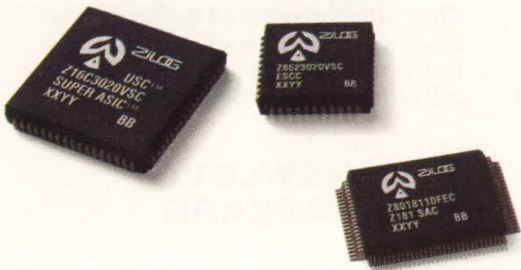



68332
Available
Mar. 1990



HP emulator
available
Dec. 1989
*(Got a little ahead
of ourselves.)*



68331
Available
Sept. 1990



HP emulator
available
Nov. 1990



68302
Available
Oct. 1989



HP emulator
available
Aug. 1990
*(We didn't start until
Feb. 1990, but we finished
it in 6 months.)*



68040
Available
Q4 1990



HP emulator
available
Q1 1991

Coincidence? We don't think so.

Nobody supports the Motorola line of microprocessors better than the Hewlett-Packard 64700 Series of emulators.

You see, HP has agreements with key chip manufacturers. Like Motorola. So while they're working on the next hottest chip design, we're simultaneously developing an emulator.

Our relationship with Motorola has allowed us to provide emulators this quickly for the new 68302, 68331 and 68332 processors.

As well as for the upcoming 68040. And, of course, we've always had broad support for the 68000, 68010, 68020 and 68030.

HP emulators also provide a complete solution. Logic and performance analysis tools and code coverage are all in the same box. They come with C cross compilers, simulators/debuggers and branch validators.

Even better, HP emulators work in real time without halting your target system. Which means you'll ensure a thorough analysis

of your design by executing it at full speed. Not by second-guessing.

All of this is accompanied by HP's renowned service and support. So call **1-800-752-0900, Ext. 1904** for a free demo disk or videotape. They'll demonstrate all the benefits of using an HP emulator. And by the way, if we answer your call quickly, it's no coincidence.



EDITORIAL

Make FPGA design easier

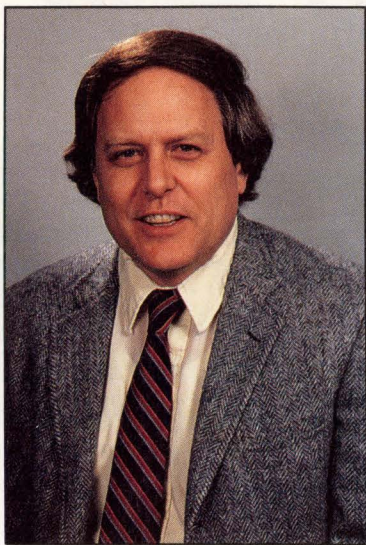

The FPGA (field-programmable gate array) industry is choking itself by trying to turn application support operations into profit centers. Engineers can get reams of priceless design ideas for every kind of IC except FPGAs. Engineers who want optimized design elements for FPGAs must pay for so-called "macro libraries." This shortsighted policy contrasts sharply with the tactics that the company MMI first used to woo digital designers from TTL to PAL devices.

MMI published a series of application notes explaining how to recast common TTL design elements into PAL devices. The company also gave away Palasm, a software tool that could compile the PAL-device designs into fuse maps acceptable to device programmers. MMI obviously had a clear idea of which business it was in: the IC business, not the software business.

Today's FPGA vendors lack this clear vision: They seem uncertain as to whether they are in the IC business or the software business. Right now, only a few talented, experienced designers produce designs that use virtually every gate in an FPGA and that run at rates in excess of 70 MHz. Most designers struggle to achieve a fraction of that performance from the very same devices. Yet it's those struggling designers facing their first few FPGA designs who will provide the big market for FPGA suppliers.

Instead of locking up the technology of FPGAs in expensive macro libraries, FPGA vendors should be working to extract the expertise of the talented, experienced few and disseminate that expertise as quickly, widely, and inexpensively as possible to all other designers.

A handwritten signature in black ink, appearing to read "Charles H. Small".

Charles H Small
Senior Editor



Jesse H. Neal
Editorial Achievement Awards
1990 Certificate, Best Editorial
1990 Certificate, Best Series
1987, 1981 (2), 1978 (2),
1977, 1976, 1975

American Society of
Business Press Editors Award
1988, 1983, 1981

Send me your comments via FAX at (617) 558-4470, or on the EDN Bulletin Board System at (617) 558-4241 300/1200/2400, 8, N, 1.

You Design Actel FPGAs You Do A PLD. But That's

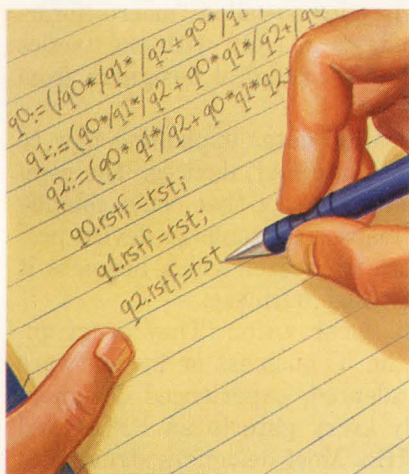

Use PLD Tools.

You design Actel FPGAs using the same tools as you would a PLD: ABEL™, CUPL™, LOG/iC™ and PGADesigner™. But that's where the similarity ends.

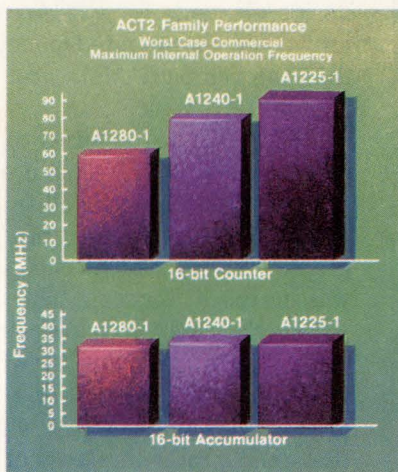

Fast. Fast. Fast.

Our FPGAs are real speed demons. Whatever application you may be working on, our parts will give you the kind of performance you're looking for.

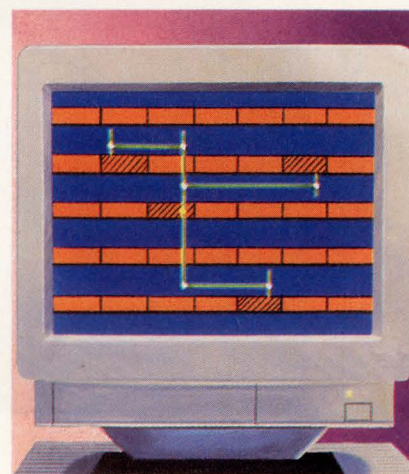

100% Automatic Place And Route.

Coupled with your PLD tools, Actel's Action Logic™ System (ALS) software lets you create your own FPGAs—using a 386 PC or workstation—right at your own desk. With Auto Place and Route that's proven in thousands of applications.

Announcing A Simple Way To Get From PLDs To FPGAs.

If you're a PLD designer with an interest in fast, flexible FPGAs, but you think you don't have time to learn new design techniques, we'd like to change your mind.

First of all, you don't have to give up your existing PLD design tools or Boolean equations. Actel's ALES™ 1 program translates the output of PLD

tools like CUPL™ and LOG/iC™ into logic optimized for our ACT™ devices. ABEL™ 4.0 includes optimization for Actel devices. Entire FPGA designs can be developed with PGADesigner™.

Actel devices offer everything you want in an FPGA. Like high I/O and flip-flop counts. And 100% automatic place

and route gets you to market fast.

Once your FPGA is designed, our Action Logic™ System (ALS) converts the captured design into a completed device in minutes. To give you true, high-density, field-programmable, channeled gate arrays.

Other FPGA manufacturers fall short on design verification. Our exclusive Actionprobe® diagnostic tools, give you 100%

observability of internal logic signals. So you don't have to give up testability for convenience.

It's never been easier to make your innovative designs a reality. We offer you a complete family of powerful FPGAs, like the A1010 and A1020, available in 44, 68 and 84 pin PLCC versions and implementing up to 273 flip-flops or up to 546 latches. And the first member of our ACT 2 family, the power-

FPGAs The Same Way The Similarity Ends There.

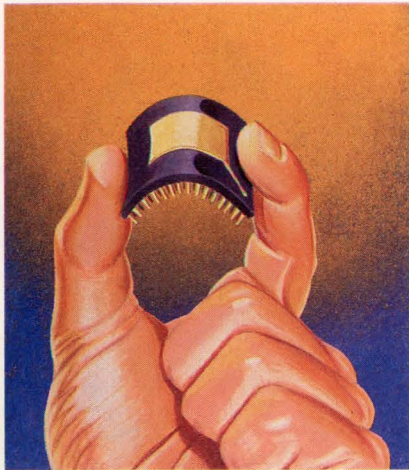

More Flexibility And Capacity.

Designing with Actel FPGAs gives you more freedom than you ever imagined. More gates. More flip-flops. More I/O. In fact, our new A1280 is the largest FPGA in the world.

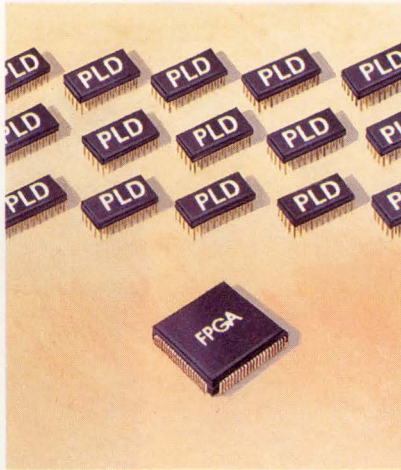

Small Footprint.

Actel FPGAs give you far more gates per square inch. As much as ten times as many as the densest PLDs. That can save a lot of real estate.

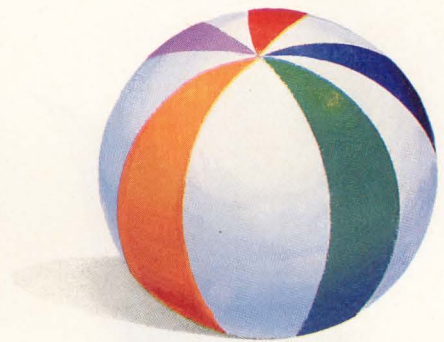

More Fun.

Designing Actel FPGAs is so simple that you'll have more time to do the things that made you want to become an engineer in the first place. Or just relaxing. You've earned it.

ful A1280. With 8,000 gates, up to 998 flip-flops, and 140 I/O pins, it's the highest capacity FPGA today. And our A1240-1 is the fastest. In the A1240-1, 16-bit counters run at 75 MHz, 16-bit accumulators at 33 MHz. Enough capacity and speed to handle almost any application.

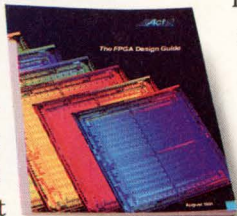

The FPGA Design Guide

The superior speed,

capacity, and auto place and route capabilities of our FPGAs are made possible by Actel's revolutionary PLICE® antifuse programming element. The advanced technology that makes our family of FPGAs an ideal way to unleash your engineering creativity.

Call 1-800-228-3532 for your free FPGA Design Guide.

Broad Family With High Capacity

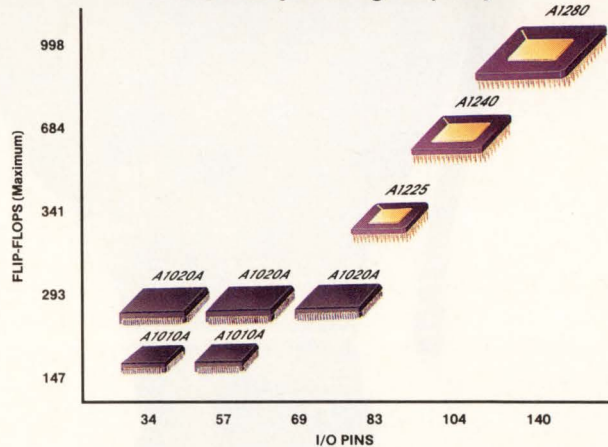

Actel
Risk-Free Logic Integration

Until Now, Density A Pretty Awkwa



And Speed Were rd Combination.

AMD Presents The MACH™ Family Of High Speed, High Density PLDs.

Nothing can squash an elegant, high density design faster than a slow, unpredictable and expensive PLD. That's why we've developed the MACH PLD family—for both density, and speed.

The MACH family gives you everything you need in a PLD on state-of-the-art CMOS: Densities up to 128 macrocells or 3600 equivalent gates. Clock speeds up to 66.7 MHz. And absolutely predictable, worst-case delays as low as 12ns per 16 product term macrocell.

And they work for peanuts. The MACH family can bring your costs down as low as a penny per gate—up to 40% less than other high density PLDs.

With the MACH family you'll get to market faster, too. Because it's supported by most popular design tools: Including ABEL™, CUPL™, LOG/iC™, MINC, OrCad®, and AMD's own PALASM® software. There's also

hardware and software support from over 20 additional FusionPLD partners.

Every MACH part migrates easily to a pin-compatible hard-wired MASC™ counterpart—for high volume orders with no redesign, no NRE, no performance glitches, no problems.

So don't horse around with slow, unpredictable, high density PLDs—start designing with the MACH family from AMD. Call **1-800-222-9323** for more information.

Model Number	Equiv. Gates	Macro Cells	Max. Delay	System Speed	I/O Pins	Hard-Wired Option
MACH 110	900	32	12ns	66.7 MHz	44	MASC 110
MACH 210	1800	64	12ns	66.7 MHz	44	MASC 210
MACH 120*	1200	48	15ns	50 MHz	68	MASC 120
MACH 220*	2400	96	15ns	50 MHz	68	MASC 220
MACH 130	1800	64	15ns	50 MHz	84	MASC 130
MACH 230*	3600	128	15ns	50 MHz	84	MASC 230

* Available Q4 1991.



Advanced Micro Devices

901 Thompson Place, P.O. Box 3453, Sunnyvale, CA 94088 © 1991 Advanced Micro Devices, Inc.
MACH and MASC are trademarks, and PALASM is a registered trademark of Advanced Micro Devices, Inc. All brand or product names mentioned are trademarks or registered trademarks of their respective holders.

CIRCLE NO. 42



*No Matter
What the
Application,
SBE Fits.*

Matching your high-speed data communications requirements with a quality supplier has never been easier. Whether you're a manufacturer of mini/superminicomputers, workstations or high-performance data communications products, *only* SBE provides a perfect fit.

Only SBE offers a complete line of intelligent high-performance communications controllers for all major interface technologies: FDDI, Token Ring, Ethernet and High Speed Serial. Only SBE adds premium features, without a premium cost, for the best price/performance in the industry.

Add integrated hardware/software solutions; availability in VMEbus, Multibus and SBus; plus legendary development assistance and continuing product support.

Discover how SBE's intelligent high-performance controllers can meet your LAN and WAN interface requirements. Turn to SBE today.

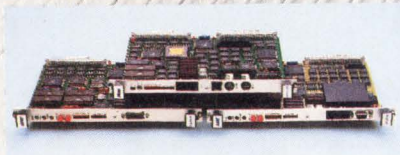

For fast action, call: 1-800-347-COMM

Germany: 0130-810588

United Kingdom: 0800-378-234

SBE, Inc., 2400 Bisso Lane, Concord, CA 94520

CIRCLE NO. 43

SBE
*Communications &
Real-time Solutions*

ANALOG SIMULATION VS BREADBOARDING

Software clues balance bench-level intuition

Combining breadboarding and simulation lets you and your analog circuit benefit from the best of both worlds.

*Anne Watson Swager,
Regional Editor*

If you're like many analog designers, you tend to be wary of simulation. But if you exclusively rely on traditional breadboarding techniques, you're overlooking simulation's potential to provide you with valuable design insight. Simulation can provide clues to a circuit's performance without your ever having to remove old parts or search for, procure, and install new ones. Simulation gives you a chance to prove design concepts, consider design tradeoffs, and glimpse those things that are hard to see—or dangerous to test—on the bench.

However, just as with a circuit's performance, a simulator is only as good as its design. Without a fair amount of knowledge and some feel for the performance of a particular simulation package, you can make erroneous assumptions. And without accurate and com-

prehensive models that can predict real behavior, simulation is a futile exercise.

Enter the age-old design tool, the breadboard. Breadboarding offers you a real-world look at your circuit and a chance to design out those unexpected but real-world phenomena. Troubleshooting breadboards forces you to become intimately familiar with parts of your design you may not have considered.

Unfortunately, the breadboard is not always a perfect tool either. Breadboards can sometimes be flukes—some chance combination of the best or worst performers of every component in your design. You may be able to build an astonishing breadboard, but never see a repeat performance in production. When you make breadboards using part samples from IC manufacturers, you have to keep in mind those devices' data-sheet tolerance spreads.

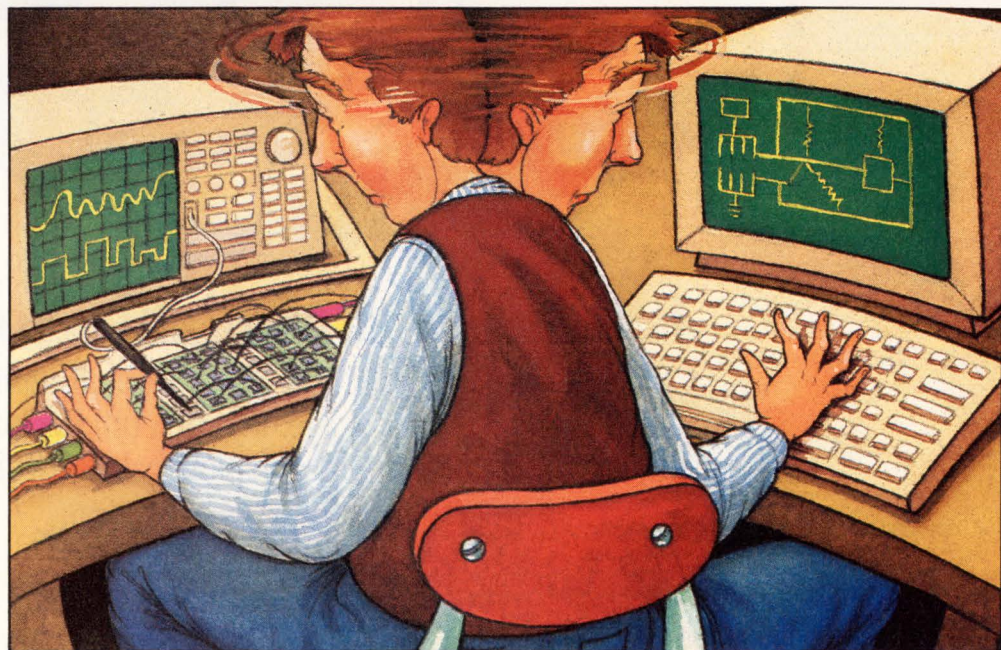

Michèle Noiset

At 1 Meg There's Simply No Faster SRAM.



1 Meg. 20ns. Available Now!

Order them in a 256K x 4 or 128K x 8 configuration.
In a high density plastic SOJ package. Part of a full line of fast SRAMs.
For samples, orders or more information, call 1-206-834-8959.

SHARP
FROM SHARP MINDS
COME SHARP PRODUCTS™

SRAMs • MROMs • FIFOs • PSRAMs • Core Micro • Displays • Opto • RF
Sharp Electronics Corporation Microelectronics Group 5700 N.W. Pacific Rim Blvd. Camas, WA 98607 (206)834-2500

TECHNOLOGY UPDATE

Analog simulation vs breadboarding

As pc boards become denser and more complex, they are increasingly difficult to build up quickly in the lab. High-frequency breadboards present the greatest design challenge. These breadboards can suffer from ground loops—a situation in which a computer simulation never finds itself. The layout of high-frequency breadboards is so critical that unless the breadboard exactly matches your production model, the test results of the two won't even come close to matching.

To be fair, simulation and breadboarding both have bugs. You can spend hours trying to find a crossed wire on your breadboard or the reason your Spice simulation generates a bizarre error message. These hours aren't spent analyzing your design, but debugging your design tool.

The best strategy is to combine the two techniques to arrive at a satisfactory design as quickly as possible. It's often difficult to know when to stop simulating or when to stop battling it out with a troublesome circuit on the bench. Clearly, deciding how much time and effort to spend simulating versus how much to spend breadboarding is a balancing act.

Charles Hymowitz, vice president of Intusoft, makers of IS Spice, outlines what he sees as the ideal simulation-and-breadboarding scenario. Try to simultaneously build a breadboard and write your simulation models and code. At some point, compare the simulation's results with the circuit's performance. Once you have some confidence in the simulation's match of the breadboard's characteristics, you can use simulation tools to their fullest. You can compare performance differences using different components and values, run sensitivity analyses, and use simulation to make subtle design tradeoffs.

This approach sounds like engi-

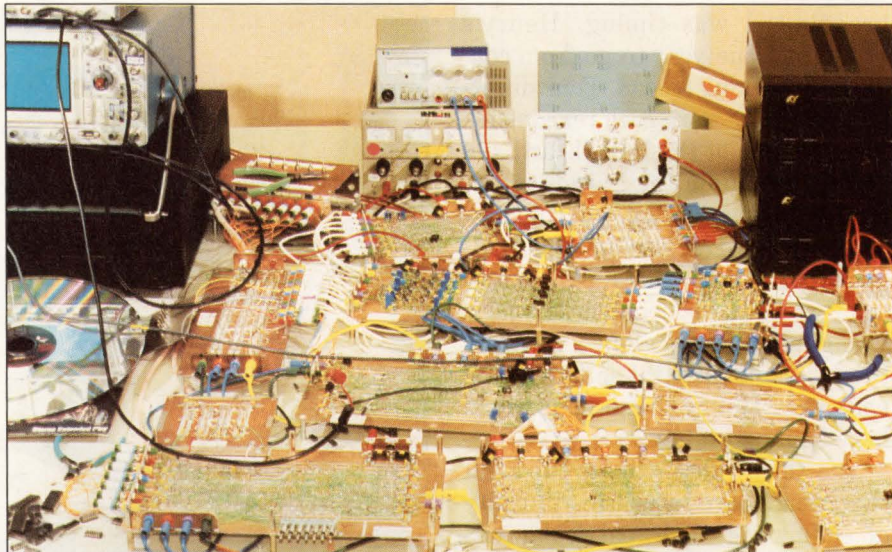

Breadboarding part or all of an IC is sometimes necessary. Engineers at Analog Devices' Precision Monolithics Div built this breadboard to help them design a consumer audio chip. By using simulation and breadboarding simultaneously, the designers completed the project sooner than if they had used either method exclusively.

neering heaven: an unlimited amount of time to figure out how well, and why, everything works the way it does. Unfortunately, real job pressures require you to limit the time you spend on each technique.

Steve Hageman, a designer of power-supply circuits and a frequent author on Spice subjects, relies mostly on his analytical design and breadboarding skills to test circuit designs. But when he's stumped, he turns to Spice. He uses Spice as a learning tool, not as something he banks on to prove the validity of a complete design.

The nature of your final product will help determine whether you should spend more time breadboarding or simulating. An obvious product comparison is the pc board versus the IC. In the case of the pc board, a breadboard that approximately matches the form factor and manufacturing materials of the final product is worthy of extensive bench time. For boards that are particularly dense, a few companies, such as Ariel Electronics, offer quick prototyping services. The

company's Circuitwriter Model 100 system is currently in beta-site testing. The system fabricates a fully functional multilayer board by extruding polymer thick films. The process generally takes less than a day.

If you think building a breadboard for a circuit that will eventually reside in one IC package is a waste of time, think again. Even semiconductor manufacturers do some breadboarding. For example, a project group at Analog Devices' Precision Monolithics Div (PMD) (Santa Clara, CA) built a breadboard for the SSM2125 Dolby prologic surround matrix decoder. The chip operates in home-theater applications.

Peter Henry, the project manager, explains that the group built the breadboard for several reasons. First, the chip is an audio device; it had to sound good. The designers wanted to actually listen to the results to judge the sound quality before committing to silicon. Computers just can't make such subjective judgments.

A second reason they built the

TECHNOLOGY UPDATE

Analog simulation vs breadboarding

breadboard was timing. Henry's group had one year to go from concept to working silicon. Four different designers were each responsible for a portion of the breadboard and the corresponding simulation. Henry postulates that if the project's designers had used breadboarding alone, the development time would have been three years. Using simulation alone, creating the IC would have taken two years, and, says Henry, "The chip would have sounded funny."

The third reason the group built the breadboard was the difficulty of simulating their particular circuit. Their audio design required transient ac-signal analysis—the type of analysis that requires the longest simulation time. The IC includes approximately 2000 analog-circuit components. Many of these components implement nonlinear functions, such as rectifiers and log amps. Spice-like simulators can have convergence problems when simulating nonlinear circuits.

The group didn't stop with Spice-level simulations but also used Analog's Saber behavioral simulator. The audio circuit was too big to simulate entirely using a full transistor-level simulation. As the designers ran behavioral simulations of various sections, they substituted transistor-level models for behavioral models. For Henry's group, even simulating at the behavioral level was an enormous task.

To build their giant breadboard, the IC designers used a combination of their own kit parts, commercially available logic, and scavenged cells. According to PMD's Henry, kit parts ideally have the same geometries as the final ICs. Usually the geometries differ somewhat, but kit parts come as close as you can get.

Extrapolating breadboard performance to an IC is tricky. In the



You can work in both the analog and digital realms using GEC Plessey Semiconductors' PDM prototype modeling design kit. The system lets you design, capture, simulate both digital and analog, and emulate a complete mixed-signal ASIC before committing it to silicon.

case of pure analog or mixed analog/digital ICs, breadboards can provide useful information, but definite differences exist between board-level and silicon-level performance. Most notably, parasitics on a pc board are quite different from those that exist on an IC. Parasitics can both help and hurt you: Circuits will run faster in an IC, but an IC version of a stable breadboard circuit may oscillate.

Nonetheless, many vendors of analog ASICs provide kit parts for designers who want to breadboard part or all of their circuits (Ref 1). In addition to kit parts, GEC Plessey sells the PDM design system, which lets you breadboard the analog portion of your IC while emulating the digital portion.

Another way to "breadboard" ICs is to get access to quick, inexpensive silicon. Orbit Semiconductor offers a prototyping service called Foresight. The Foresight service holds multiproject wafer runs every four weeks with a turnaround time of four weeks. You can

use the service to build low-volume, low-cost circuits using the company's fabrication processes.

Faith runs thin

Regardless of whether you're working at the board or IC level, balancing the time you spend breadboarding with the time you spend simulating depends on the amount of faith you have in the results of each method. The bottom line is that your simulation will lie to you if you ask it to. Part of any troubleshooting or debugging exercise is to recognize when your breadboard or simulation is producing deceptive results.

Take Spice as an example. Although Spice has existed for some 20 years now, a surprisingly large number of users don't know how Spice really works. "Too many people rely on Spice too much," says Intusoft's Hymowitz. For example, all versions of Spice are based on a small-signal model. "Small signal" implies that Spice takes a straightforward view of a transfer function.

With 546 different standard product configurations, our *Piezoresistive Silicon Pressure Sensors* meet almost anyone's spec. DIP and surface mount packages help cut your assembly costs, too. Which makes you more competitive—and more profitable. Find out why so many engineers are designing these sensors into their OEM applications. Circle the number below.

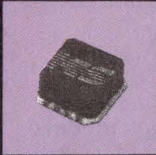

We'll send you product literature and data sheets.
Or call **800-767-1888**.

SENSORS

1701 McCarthy Blvd. Milpitas, CA 95035-7416

546 Different Silicon Pressure Sensors. One Phone Call.

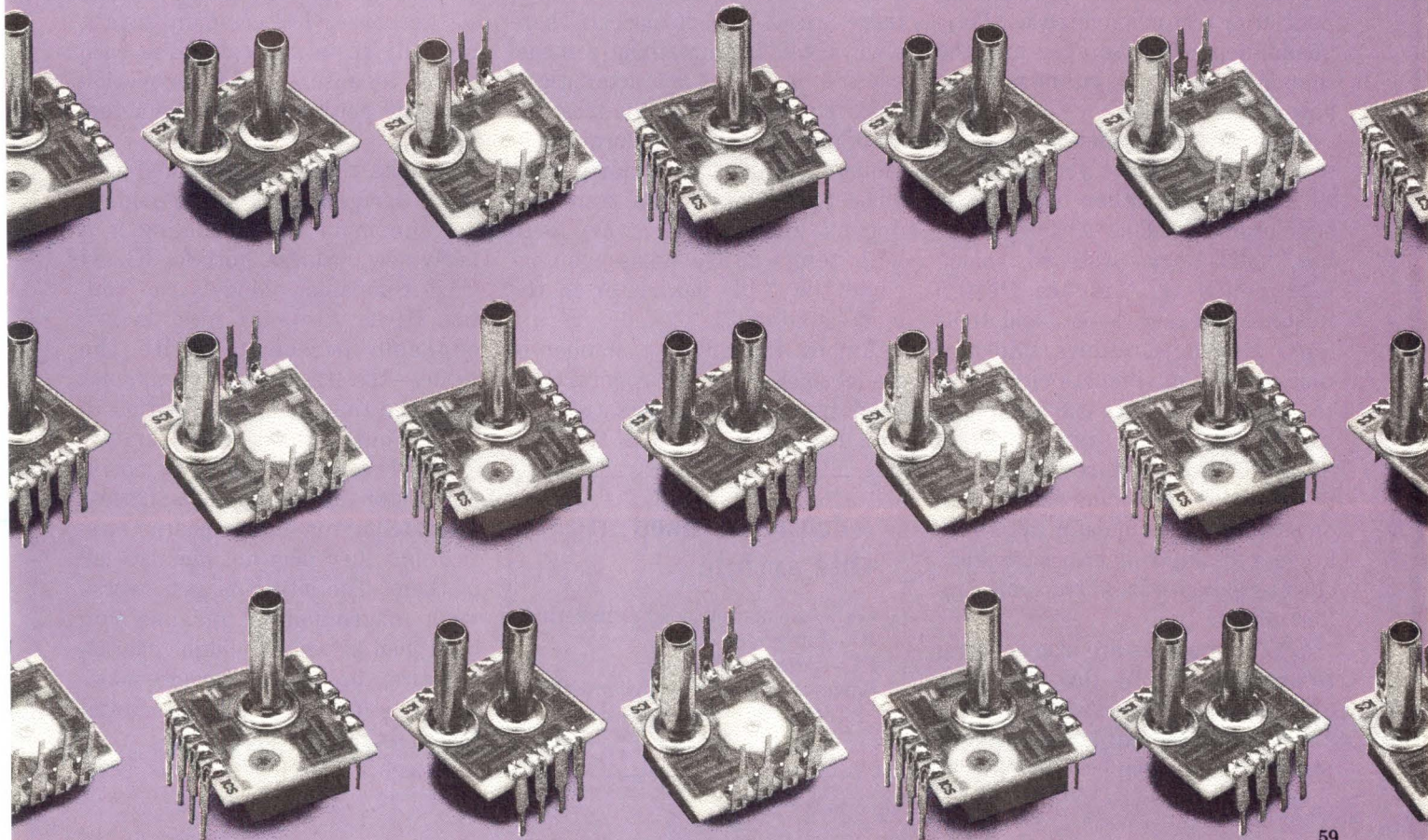

TECHNOLOGY UPDATE

Analog simulation vs breadboarding

To calculate the gain of an op amp, for example, Spice multiplies the input by the ratio of the feedback and input resistors. If you run an ac analysis with an op-amp model that has a gain of 10 and 10V inputs, Spice will tell you that the op amp's output will swing 100V. It's up to you—or the CAE vendor, who can add upgrades to basic versions of Spice—to recognize that no op amp can swing wider than its power-supply rails.

To make matters even more confusing, different versions of Spice have different model and analysis characteristics. Most commercial Spice packages are based on Berkeley's Spice2G.6, but a few, such as Contec Microelectronics' version of Spice, are based on Spice3. Spice3 does some things that the 2G.6 version can't, but at the price of not including some of the earlier version's features (Ref 2). For example, Spice3 has added pole-zero analysis but does not do Fourier or distortion analysis. Polynomial-dependent sources and the source-stepping algorithm are also absent from Spice3.

The type of information you need to know about Spice you also need to know about other higher-level simulators, such as Analog's Saber, Valid Logic Systems' Analog Workbench II, Cadence Design Systems' Analog Artist, and tools from Mentor Graphics. Most of these tools can simulate circuits at the Spice level; some can also simulate circuits at the system and behavioral levels. More simulation packages are including features to ensure that the simulator takes into account real-circuit characteristics, such as parasitics and transmission-line effects.

CAE companies are also working to produce software that takes into account a breadboard's physical layout. Although automatic layout tools are commonplace for digital

systems, few such tools exist for analog systems. One of the few analog-system tools is Valid Logic Systems' Analog Systems Lab. The software uses your design rules to keep certain interconnect distances short, specify net lengths to reduce stray capacitance or inductance, and specify rules regarding thermal or impedance considerations.

Learning more about your simulator and taking advantage of a simulator's ability to model real physical effects will ease many of your misgivings. However, the primary reason for simulation skepticism and inaccuracy is models. Ultimately, faith in your simulation comes from faith in your models' accuracy.

Simulation models can suffer from many limitations: They aren't accurate enough, they take up too much simulation time, or they don't emulate the behavior that's most critical or troublesome to your design. Intusoft's Hymowitz says there are no perfect models. There always will be something a model doesn't do, some characteristic it doesn't imitate. Often the most basic of models doesn't perform an obvious function. For example, the basic Spice model of a transistor doesn't automatically vary beta with temperature unless you include the XTB parameter in the model statement.

Among the growing number of model sources are IC vendors, CAE vendors, and consultants (Ref 3). Ron Kielkowski of RCG Research

is a consultant who develops models upon request. In addition, virtually all analog simulators come with some sort of model library. HSpice from Meta-Software has a standard device library that includes bipolar transistors, MOSFETs, op amps, ADCs, and DACs.

Sometimes, the models you want simply don't exist. Creating models takes great effort and can eat up chunks of time (Ref 4). Several vendors offer model-building software. For example, Microsim Corp's PSpice Parts option—\$450 to \$950, depending on the hardware type—lets you convert information from a component manufacturer's data sheet into parameter values for PSpice. Some vendors will also build models for you upon request.

Valid Logic Systems claims its Analog Workbench II has one of the largest analog-model libraries in the industry. The company provides data that compares manufacturers' device characteristics with the models' response. The company says it carefully tests and calibrates each model to ensure close correlation with the performance of the actual device.

Despite the availability and supposed performance of these models, keep in mind that modeling is a fairly new business, both for IC and CAE companies. Models can contain flaws. Also, the most knowledgeable person to write the model—the IC's designer—may not have the time or the inclination to do so. Thus, someone not as familiar with a design may create the model. Transistor models come the closest to modeling real-device characteristics, but they may not simulate all of them. The situation gets worse with macromodels because you can't nail down individual characteristics; the nature of macromodeling is to lump various characteristics together.

Intusoft's Hymowitz has seen

Acronyms used in this article

CAE—Computer-aided engineering
IC—Integrated circuit
PC—Personal computer
Spice—Simulation program with Integrated-circuit emphasis

Using silicon technology, our *Micromachined Accelerometers* deliver performance comparable to piezoelectric and strain gauge sensors—at *half the cost*. We offer eight standard acceleration ranges. Solid state reliability. And a variety of package styles to help make your job easier. Not familiar with piezoresistive sensors? If you measure vibration, acceleration, motion or shock, you should be. Circle the number below. We'll send product literature, data sheets, and a copy of *Understanding Accelerometer Technology*. Or call us at **800-767-1888**.

ICSENSORS

1701 McCarthy Blvd. Milpitas, CA 95035-7416

Imagine.

Accelerometers you can afford
to design into *your* products.

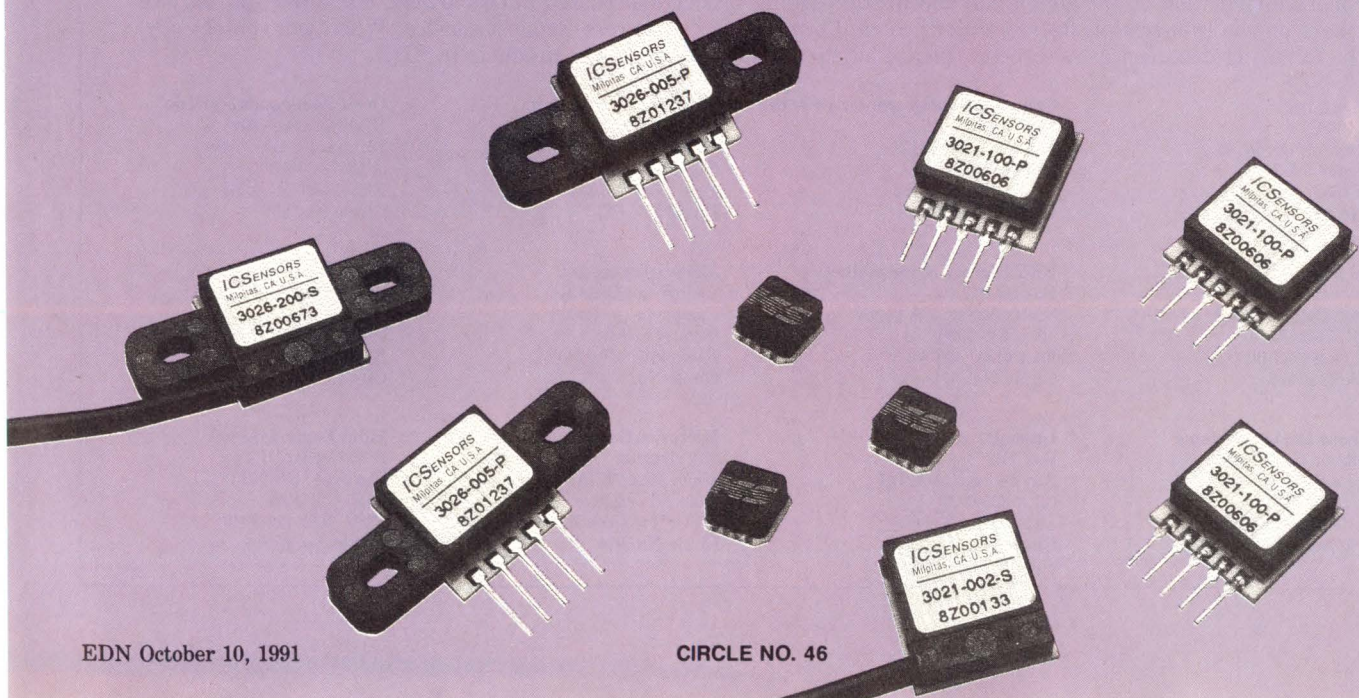

TECHNOLOGY UPDATE

Analog simulation vs breadboarding

bug-ridden models firsthand. He's had to reconfigure models from IC vendors to make them Spice compatible because the models included elements that Spice couldn't recognize, such as negative capacitors. He has also found errors in the models themselves. One notable case was a model for an LM111 comparator that used npn input transistors instead of the real device's pnps. When you run a simulation using the erroneous model, current flows the wrong way.

So before you use your models in a simulation, put them through their paces. Figuring out which characteristics models do and don't include can be difficult. Spend some time testing models and comparing IC and model performance. Once you have data in hand that proves the validity of these models, and perhaps more importantly, once you have models that include parameters critical to the performance of your company's final product, you can justify placing more faith in simulation.

Over time, the pitfalls of simula-

tors and the inaccuracies of models will diminish. But simulation problems are often the result of a user's assumptions. According to Hymowitz, "The people who have the most trouble are the ones who don't see the subtleties. There is no substitute for knowing what you're doing."

Many good simulation and modeling texts (Refs 5 and 6) and articles exist—many more than can be listed here. Both Intusoft and RCG Research offer Spice classes. Intusoft offers a 1-day course. RCG Research offers three 1-day courses that cover everything from syntax to dealing with time-step-control and convergence problems to how to write macromodels and behavioral models. Both novice and experienced users can benefit from the Spice insight these courses provide.

You might also want to beef up your breadboarding skills, which invariably boil down to troubleshooting skills. Bob Pease's book on analog troubleshooting (Ref 7) presents an armamentarium of tips for debugging both analog and digital

circuits. But ultimately, no amount of reading or course taking can substitute for hard-earned experience.

EDN

References

1. Swager, Anne Watson, "Semicutom Analog ASICs: Design methods resist generalization," *EDN*, February 4, 1991, pg 35.
2. *Inside Spice Newsletter*, Vol II, No. 3, RCG Research Inc, Indianapolis, IN, pg 3.
3. Kerridge, Brian, "Spice models enjoy multiple sources," *EDN*, September 3, 1990, pg 79.
4. Kerridge, Brian, "Accurate models mirror extremes of operation," *EDN*, May 9, 1991, pg 61.
5. Antognetti, P and G Massobrio, *Semiconductor Device Modeling with Spice*, McGraw-Hill, New York, NY, 1988.
6. Meares and Hymowitz, *Simulating with Spice*, Intusoft, San Pedro, CA, 1988.
7. Pease, Robert A, *Troubleshooting analog circuits*, Butterworth-Heinemann, Stoneham, MA, 1991.

Article Interest Quotient (Circle One)

High 509 Medium 510 Low 511

For more information . . .

For more information on the simulation and breadboarding products discussed in this article, circle the appropriate numbers on the Information Retrieval Service card or use EDN's Express Request service. When you contact any of the following manufacturers directly, please let them know you saw their products in EDN.

Analogy Inc

Box 1669
Beaverton, OR 97075
(503) 626-9700
FAX (503) 643-3361
Circle No. 667

Contec Microelectronics USA Inc

2188 Bering Dr
San Jose, CA 95131
(408) 434-6767
FAX (408) 434-6884
Circle No. 670

Mentor Graphics Corp

8005 SW Boeckman Rd
Wilsonville, OR 97070
(503) 685-7000
FAX (503) 685-1202
Circle No. 673

Orbit Semiconductor Inc

1230 Bordeaux Dr
Sunnyvale, CA 94089
(408) 744-1800
FAX (408) 747-1263
Circle No. 676

Ariel Electronics Inc

1285 Forgewood Ave
Sunnyvale, CA 94089
(408) 747-0200
FAX (408) 747-0899
Circle No. 668

GEC Plessey Semiconductors

Box 660017
Scotts Valley, CA 95067
(408) 438-2900
FAX (408) 438-5576
Circle No. 671

Meta-Software Inc

1300 White Oaks Rd
Campbell, CA 95008
(800) 346-5953
FAX (408) 371-5638
Circle No. 674

RCG Research Inc

Box 509009
Indianapolis, IN 46250
(800) 442-8272
FAX (317) 773-7706
Circle No. 677

Cadence Design Systems

555 River Oaks Pkwy
San Jose, CA 95134
(408) 943-1234
FAX (408) 943-0513
Circle No. 669

Intusoft

Box 710
San Pedro, CA 90731
(213) 833-0710
FAX (213) 833-9658
Circle No. 672

Microsim Corp

20 Fairbanks
Irvine, CA 92718
(800) 245-3022
FAX (714) 455-0554
Circle No. 675

Valid Logic Systems

2820 Orchard Pkwy
San Jose, CA 95134
(408) 432-9400
FAX (408) 432-9430
Circle No. 678

Who's Behind The Simulation Acceleration Movement?

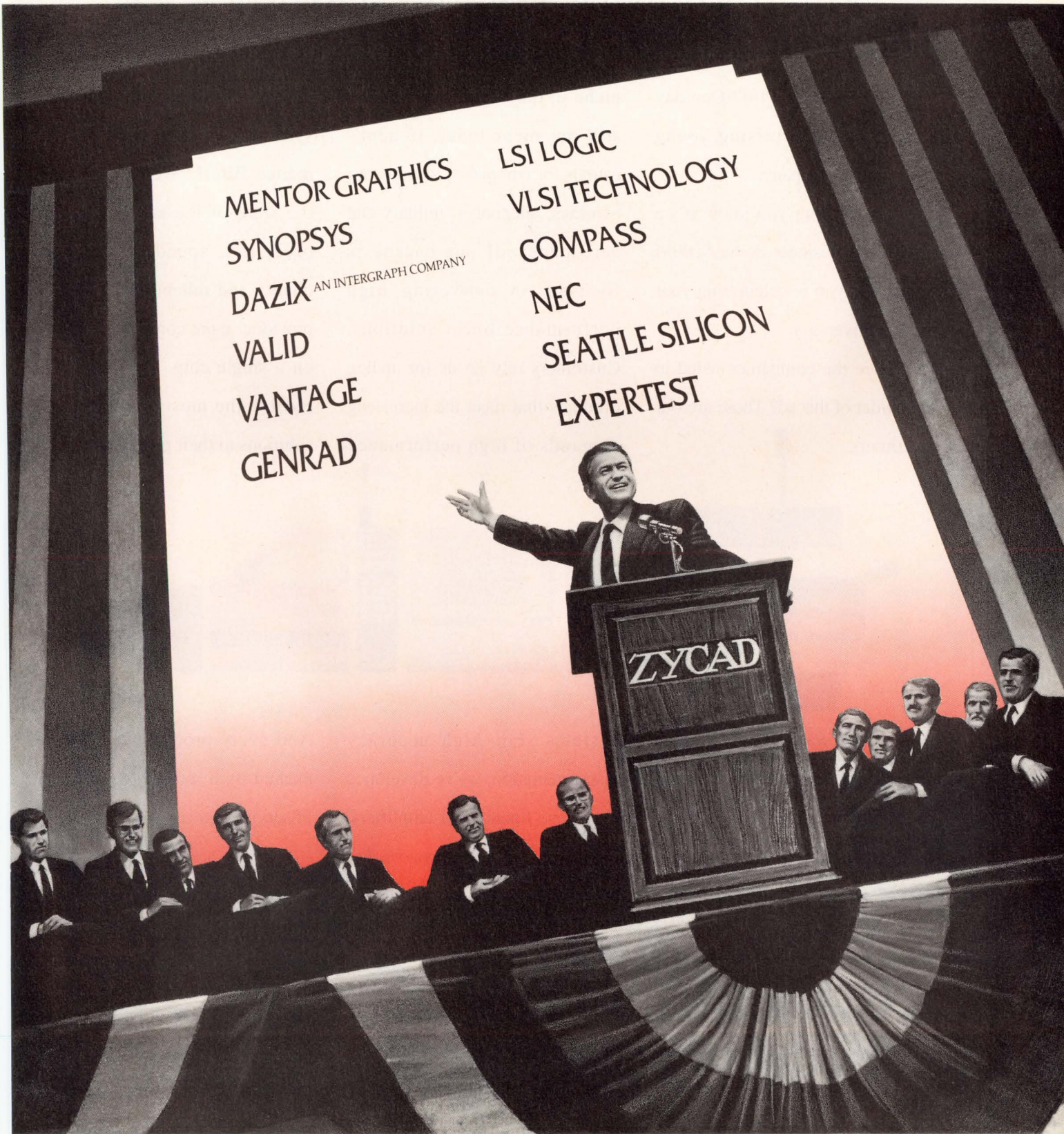

And Who's Leading It?

ZYCAD

THE HISTORY OF LINEAR TECHNOLOGY FOR THOSE OF YOU WHO LIKE DETAILS (AND PICTURES).

It's crazy, isn't it? One day a bunch of enterprising young turks start a company.

Next thing you know it's a worldwide business doing \$100M a year and you're celebrating your tenth anniversary.

See the companies listed in the border of this ad? Those are our customers.

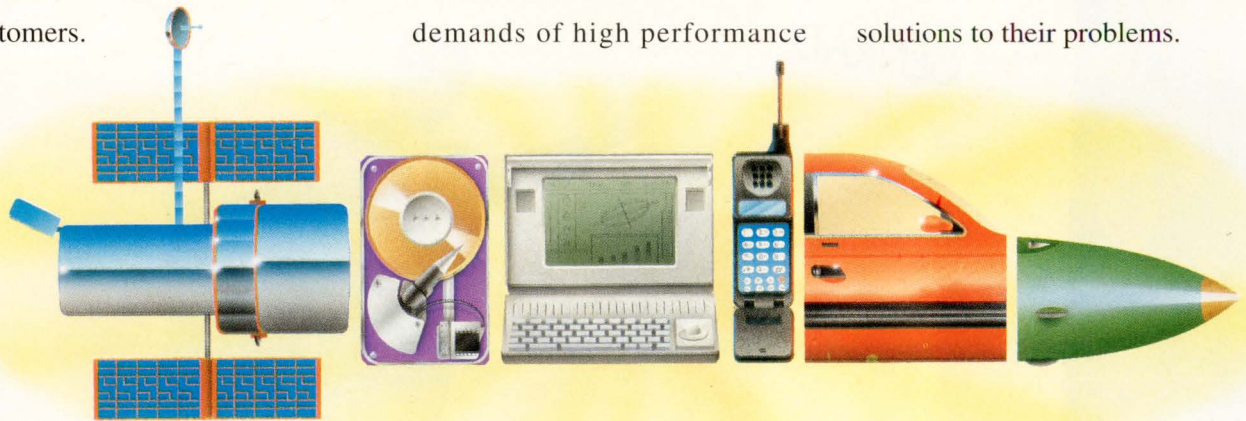

Regretfully, we couldn't list them all. But over the last ten years, all of them have given us problems. Problems that required a cost effective, high performance linear solution. Which is good because when we started this business we figured the best way to become successful was to become the best at solving high performance linear application problems.

You might say that was our

niche in the beginning. And it's still our niche today. In applications for computers, instruments, avionics, telephones, military and aerospace, all our energy is focused on delivering high performance linear solutions. Customers rely on us for analog products that meet the increasing demands of high performance

systems. For high accuracy instrumentation, we've developed low noise operational amplifiers, references, and comparators. For high performance systems we provide high efficiency power supply ICs. We've created high speed amplifiers, interface circuits and A/D converters for data acquisition. For battery powered applications, we supply a wide range of micropower

devices. And for communication systems, we offer high performance filters. We've advanced the state-of-the-art in areas of precision, speed, efficiency, quality and reliability as well as providing more complete solutions on a single chip. Our customers receive the most cost-effective solutions to their problems.

And every product we make is backed by a worldwide network of service and support.

How are we doing? So far, so good. Join the companies we've worked with over the last ten years — send us *your* problems. After all, that's what we're here for. And we've got a history of delivering the best high performance linear solution for the job. For more information please call 800-637-5545.

AND FOR THE REST OF YOU.

SO FAR,
10 Years \$100 M/Year
SO GOOD.

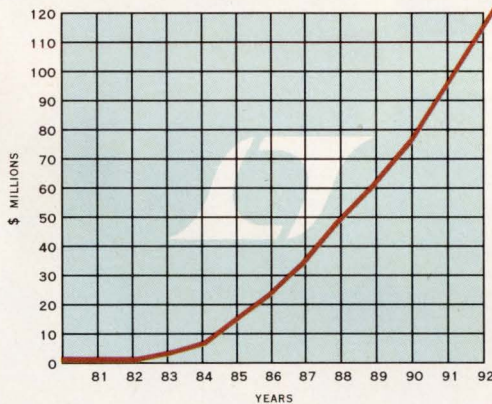

Thanks For Your Support.



Linear Technology Corporation, 1630 McCarthy Blvd., Milpitas, CA 95035

**ADDING PINPOINT
PRECISION TO
MANUFACTURING
SYSTEMS.**

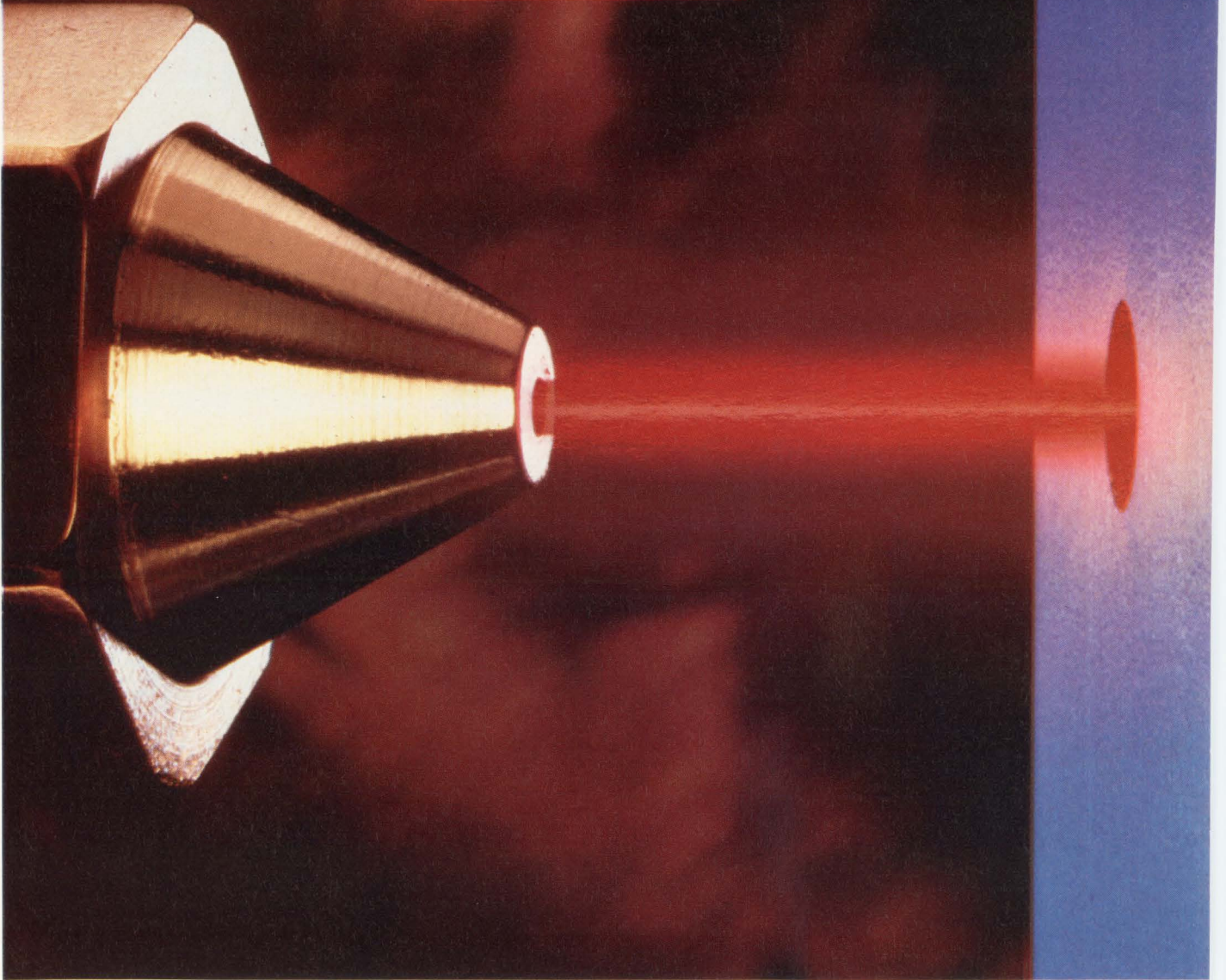

S I G N A L P R O C E S S I N G A N D



HARRIS
SEMICONDUCTOR

Flashing incandescent brilliance, an industrial laser cuts high-temperature alloy plate with uncanny accuracy and repeatability, thanks to signal processing and power control components from Harris Semiconductor. Signal processing and power control involves gathering real-world signals — like pressure, temperature and light — processing them, and driving devices that perform real-world tasks. And no one is better at making it happen than Harris, by combining the technologies of analog, mixed signal, DSP and power semiconductors. Precision manufacturing systems are just one example of how Harris supplies semiconductors that are right on target for signal processing and power control applications. So how can we help you? Call 1-800-4-HARRIS, Ext. 1122.

POWER CONTROL FROM HARRIS.

When it comes to microcontrollers... The Choice Is Not Always Plain.

Hitachi's new H8/300 Family of 8-Bit Microcontrollers is beefier, and includes all the extras: The best in price/performance. High-level language capability. ZTAT™ one-time user-programmable EPROM. The most on-chip peripherals.

Hitachi's new and growing H8/300 Family of Microcontrollers takes 8-bit beyond the ordinary, offering the right mix of ingredients to satisfy your embedded-control appetite. Hitachi's new H8/300 Series' recipe for success includes:

The best price-performance. Put more spice into your applications with the new CMOS H8/300 Family. These microcontrollers combine a modern, general-purpose register architecture with fast processor speeds, and include a CPU core with a maximum 10 MHz clock speed for minimum instruction cycle times of 200ns... 16-bit adds and subtracts in a mere 200ns... 8 x 8-bit multiplies or 16/8-bit divides in only 1.4μs...and up to 32 Kbytes of ROM.

High level language capability. Enjoy fast development and easy maintenance, without the slow program execution typical of old-fashioned software. Hitachi's H8/300 microcontrollers work with "C", Forth, and real-time operating systems, like Hitachi's μITRON. You can also use fuzzy logic compilers to put advanced capabilities, such as artificial intelligence, into embedded systems—quickly and easily.

ZTAT. Get to market *fast* with Hitachi's ZTAT (Zero Turn-Around Time) one-time user-programmable EPROM. With these low-cost plastic package devices, production can start the very same day you finish development—with no mask charges, lead times, or large quantity commitments. You have a choice for every phase of your product's life cycle: Ceramic windowed devices for development...ZTAT for quick, small-to-medium-scale production...mask ROM devices for lowest-cost large-scale production.

On-chip peripherals. Now you can reduce your whole embedded control system to a single chip, thanks to the H8/300 Family's right mix of on-chip peripherals. Choose from a variety of timers, interrupts, and I/O ports, 8-bit A/Ds, serial communications channels, PWM timers, EEPROM, and much more.

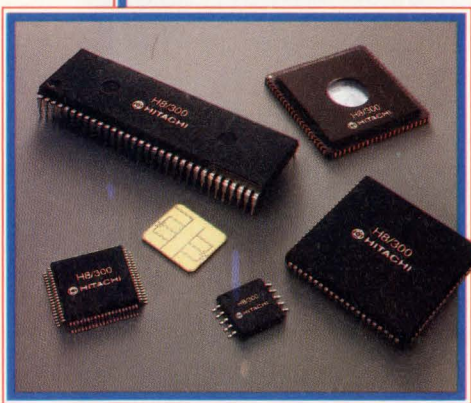

Description	H8/310 Smart-Card IC	H8/322 General-Purpose Real-Time Controller	H8/323 General-Purpose Real-Time Controller	H8/324 General-Purpose Real-Time Controller	H8/325 General-Purpose Real-Time Controller	H8/330 High-End Real-Time Controller	H8/350 Servo-Positioning Controller
ROM/RAM/EEPROM	10K/256/8K	8K/256/0	16K/512/0	24K/1K/0	32K/1K/0	16K/512/0	32K/512/0
Timers				3		5	10
Serial Channel				2		1	2
A/D Converter						8-Bit, 8 Channel	8-Bit, 16 Channel
Interrupts			4 External 16 Internal			9 External 19 Internal	9 External 47 Internal
I/O Ports	1-Bit I/O Common		47 I/O 4 Input Only			58 I/O 8 Input Only	50 I/O 16 Input Only
Other Features	Security Function		Parallel Handshake Port Programmable Pull-up for All I/O			15-Byte DPRAM, Prog. Pull-up for I/O	One 19-Bit Timer, Timer Network
Package	Die Form COB* SOP-10		DP-64S QFP-64 DC-64S w/Window			PLCC-84 QFP-80 LCC-84 w/Window	PLCC-84 QFP-80 LCC-84 w/Window

*Call your Hitachi representative for availability.

Serving it up... The H8/300 Family includes comprehensive development support: Documentation, easy-to-use cross-development tools, in-circuit emulators, and evaluation boards (with additional choices from third-party vendors).

The new Hitachi H8/300 Family of Microcontrollers. We've added all the right ingredients, so your next design can go beyond the ordinary. For more information, call or write today.

Literature Fast Action: For product literature only, CALL TOLL FREE, 1-800-285-1601; ask for literature number M21A001.



Hitachi America, Ltd.
Semiconductor & I.C. Division
Hitachi Plaza
2000 Sierra Point Parkway
Brisbane, CA 94005-1819



Our Standards Set Standards

CIRCLE NO. 50

For Literature Only Circle No. 174

To Have a Hitachi Representative Call Circle No. 175

SIEMENS



Globally Connected.

Siemens provides computer and peripheral manufacturers with a worldwide connection for state-of-the-art integrated circuits.

Siemens is building on a tradition of innovation with state-of-the-art technology in the workplace. And we back it with worldwide service and support, providing a global partner for all your system designs.

For applications such as laptop PCs, printers and disk drives, which require lower power consumption, we offer CMOS 8-bit microcontrollers based on the 8051 architecture. Like the SAB80C537, with advanced features



Innovative 8-bit microcontroller designs.

such as 16-bit hardware multiply/divide, and 8 data pointers.

We're also the only European DRAM manufacturer, providing high-quality 1-Mb and 4-Mb DRAMs. In fact, we're one of the world's leading suppliers, with DRAMs available worldwide, in volumes which have doubled since 1989. And we're continuing to advance this technology with our 16-Mb and 64-Mb DRAM programs.



Reliable 1-Mb and 4-Mb DRAMs.

Siemens has a wide range of ICs for PCs. Our powerful 80286 microprocessors include a super-fast 16 MHz design. And we provide the 82C206 and the NEAT™ chipset for optimized, low-cost solutions.



80286 and integrated peripherals.

Plus, Siemens offers an extensive line of CMOS ASIC devices.

For innovative solutions for computer and peripheral manufacturers, Siemens is the best connection you can make.

For details, call **(800) 456-9229**, or write:

Siemens Components, Inc.
2191 Laurelwood Road
Santa Clara, CA 95054-1514

Ask for literature package M14A013.

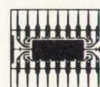

**Siemens
World Wise, Market Smart.**

VXI SOURCE GUIDE

Costly technology can save you money

Picking the VXIbus for a test system might seem like making a conscious choice to start your project \$10,000 in the hole. But a closer look reveals a different picture.

*Dan Strassberg,
Associate Editor*

You aren't necessarily an iconoclast if you conclude that the VXIbus (VME extensions for instrumentation) is a bad idea; that the engineers who thought up the modular-instrumentation standard four years ago should at least be fired and probably shot. Others have come to similar conclusions. But there are a couple of problems with that view: it's shortsighted and it comes from only the most superficial look at the technology. Shrinking staffs and shortened product-development cycles leave many engineers little time to research a subject adequately. But those who take the trouble to learn about VXI will find that the bus' value is much greater than it seems at first.

A good place to start looking into VXI is in **Table 1**, which lists approximately 50 vendors of VXI products. The **table** divides the products into 29 categories and shows which firms offer products in each category. To learn how to contact the vendors, consult the "For more information . . ." **box**. The **table** and **box** are shortened versions of a directory published in the August, 1991 issue of Bode Enterprises' *VXIbus Newsletter*; they appear here through the publisher's cooperation. The complete directory describes each product briefly and indicates its price. (In the US, news-

letter subscriptions cost \$195/year. See the **box** for Bode Enterprises' contact information.)

A cursory look at VXI quickly reveals most of the bus' cost shortcomings but none of its economic advantages: With VXI, your instruments don't have front panels, so if your system doesn't work, you can't do any debugging by exercising the components manually. And with VXI, before you can get even one instrument to do any more than sit on your bench and look kind of frumpy, you have to spend nearly \$10,000 on a main-frame (a card cage, backplane, and power supply). Every VXI system needs a controller, and controllers cost several thousand dollars. Moreover, some VXI instruments cost more than

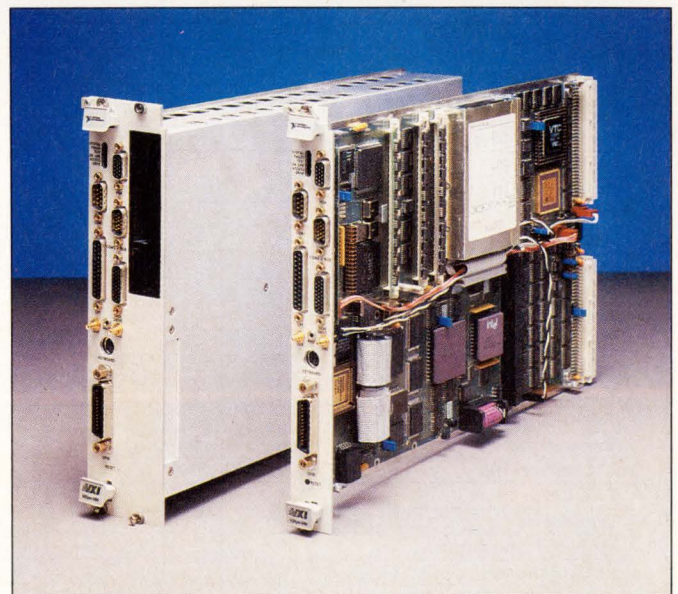

VXI modules' plain exteriors can hide impressive technology. C-size embedded controllers, such as these i386-based units from National Instruments, can include high-capacity hard disks. In addition, the double-width unit houses a floppy-disk drive. Pricing starts at \$7800.

TECHNOLOGY UPDATE

Table 1—VXI Source Directory

Vendor	Function and arbitrary-waveform generators	Pulse, pattern, and word generators	Attenuators and amplifiers	Synchro instruments	Digital voltmeters	Digital counters	Digitizers and DSOs	L-C-R and power meters, etc	A/D and D/A converters	Digital stimulus/response test units	Digital I/O	Signal processors	Scanners, switches, and multiplexers	Interconnect devices	VXI ICs	Power-supply controllers, programmable resistors	Frequency and voltage standards	MATE and MIL-STD modules
AD Data Systems																		
Analogic Corp									•		•		•					
Ascor Inc										•			•					
Augat Inc																		
Automated Technology																		
BICC-Vero Electronics																		
Blakell AQL																		
Bruel & Kjaer												•						
Cal-Av Labs Inc			•															
C&H Engineering Inc																		
Colorado Data Systems	See Tektronix/CDS																	
Dawn VME Products																		
Digital Technology																		•
EIP Microwave Inc	•					•												
Elgar Corp																	•	
Elma Electronics Inc																		
Genrad Inc																		
Giordano Associates										•	•							
Hewlett-Packard Co	•		•		•	•	•	•	•	•	•		•	•				
Hilevel Technology																		
ICS Electronics Corp																		
ILC Data Devices				•														
Intepro Systems																	•	
Interface Technology		•													•			
Interlogic Industries																		
LeCroy (Struck GmbH)											•					•		
Mac Panel Co														•				
Matrix Systems Corp													•					
Mupac Corp																		
National Instruments																		
NCR																		
NH Research																	•	
Nortek													•					
North Atlantic Ind's				•														
Proteus Corp																		
Racal-Dana Instrument	•					•				•	•		•	•			•	
Radisys Corp																		
Schlumberger						•												
Schroff Inc																		
Serendipity										•								
Talon Instruments										•								
Tasco Electronics Inc		•								•								•
Tektronix/CDS	•	•		•	•	•	•	•	•	•	•		•			•		•
Testniques																		
Tracewell Enclosures																		
Transmagnetics Inc				•														
TTI Testron Inc														•				
TYX Corp																		
Veretest Inc		•						•										
Virginia Panel Corp														•				
VXI Solutions																		
Wavetek San Diego Inc	•				•													
Westest										•								
Wind River Systems																		

TECHNOLOGY UPDATE



their rack-and-stack counterparts—as much as 25 or 30% more.

You have to do a little digging to learn that once you've paid the high up-front costs, the total cost of developing a VXI-based test system can be significantly lower than that of building a system based on conventional rack-and-stack instruments. The savings grow as you gain experience with VXI, and they're likely to grow further over time; for example, as vendors develop ASICs to interface with the bus. (Interface Technology is now selling such an IC.) Already, a few VXI instruments are priced dramatically lower than their rack-and-stack counterparts. For example, Racal-Dana offers a time-interval analyzer and a microwave counter that each cost about 40% less than competing conventional units.

VXI wins converts

Once you've built your first VXI system, you probably won't need inducements to use the bus again; your first experience may well turn you into a VXI convert. Although early on you undoubtedly will find aspects of VXI that don't please you, you're sure to discover that the bus offers some potent advantages. For example, nearly all test systems require some custom hardware, and VXI cuts the cost of building it. The basic packaging scheme provides the infrastructure to facilitate custom module designs: You don't have to select or design an enclosure or a power supply. Often, the bus provides all the connections a custom module needs, so you don't even have to choose connectors.

One large systems manufacturer estimates that the fully burdened cost of a test engineer is \$10,000/month, of which only about one-third is the engineer's salary. For

Software	Embedded computers and subsystems	Slot 0 and IEEE-488/VXI interfaces	Mainframes and backplanes, OEM	Mainframes, D-size	Mainframes, C-size	Mainframes, B-size	Development and starter systems	Prototype cards, adapters, and miscellaneous modules	System integration	Systems
•									•	•
•			•							
			•	•	•			•		•
								•	•	
									•	
			•	•						
			•	•	•	•				•
•	•	•			•	•	•	•	•	•
								•		
			•		•			•		•
•	•	•								
•										•
	•	•	•		•			•	•	
			•	•	•					•
•	•	•		•	•		•	•	•	
•			•	•	•					
									•	
•										•
•										

TECHNOLOGY UPDATE



this firm, VXI has more than paid for itself through a 2-month reduction in the average time engineers spend designing and debugging custom modules for each test system.

Good things in small packages

VXI's cost savings don't end with custom modules. VXI's most obvious improvement over rack-and-stack instruments is its small size. The size reduction, which can be crucial in flight-line test systems and military applications, may not seem to provide a very compelling incentive to use the bus on the factory floor. But reducing instrument size often allows you to build in one equipment rack a test system that previously required two racks or more. Though significant, the reduction in rack cost isn't the big item here. More important are the savings in cabling costs that result from the system's smaller size and from placing as many as a dozen instruments in a single chassis.

Lower cost isn't the only benefit that results from reducing the number and length of cables; performance improves too. If your system involves high-speed signals, triggering, or synchronization, a VXI embodiment will perform more predictably than an equivalent unit built from rack-and-stack instruments. In some cases, the improved performance can translate into higher throughput because you will no longer need to add waits to programs to compensate for poorly controlled cable delays.

In the microwave area, VXI systems now can include instrument modules in two forms. Two years ago, a battle of sorts erupted between advocates of competing technologies. A group led by Hewlett-Packard insisted that the correct way to integrate microwave capabilities into VXI was to use a sepa-

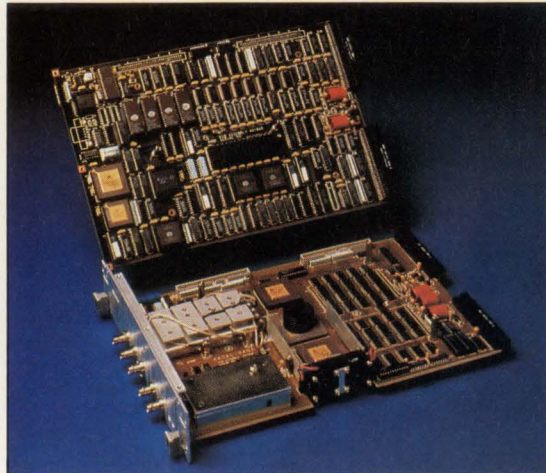

The technology inside VXI modules often is far from prosaic. But to realize this, you have to look under the cover and reckon the improvements VXI brings to throughput, performance, and total system cost. Racal-Dana's \$15,000 2351 Time-Interval Analyzer, a double-width C-size unit, costs about 40% less than some stand-alone instruments that perform similar functions.

rate, shielded chassis. To that end, HP released its MMS (Modular Measurement System) architecture to the public domain. MMS has been adopted by a group of vendors that has since set up a consortium of its own, now numbering nine members. Meanwhile, other vendors, led by Racal-Dana, demonstrated that they could successfully package microwave instruments as standard VXI modules. Several firms now offer such units.

Next to small size, faster operation than IEEE-488-based systems is VXI's most-talked-about advantage. Nevertheless, at the moment, most users are taking advantage of only a small fraction of VXI's speed potential.

Discussing VXIbus speed points out a truism: Ask an engineer what you think is a simple question, and you'll almost invariably find that the question isn't simple; it only appeared so because you didn't understand the problem. VXI's speed is a complex and controversial topic that has already been the subject of several technical papers and will doubtless elicit even more. Speed is closely tied to instrument architecture, to bus protocols, and to the design of the software used in VXIbus systems. The software is-

sues lead to discussions of debugging techniques and of tradeoffs between test-program development time and test-system throughput.

Communicate three ways

VXI offers three protocols for communicating with instruments: message based (word-serial), register based, and shared memory. With message based data transfers, you send commands to a module as strings of ASCII characters and the module returns data in the same form. The modules must have sufficient intelligence to recognize the commands. This mode of operation should be familiar to users of IEEE-488 instruments; communication via IEEE-488 is message based.

Indeed, some of the first VXI modules were little more than repackaged IEEE-488 instruments. If a company already builds a rack-and-stack instrument and wants to get an equivalent VXI unit to market in a hurry, repackaging the existing product as a message-based VXI module usually presents few challenges—especially if manufacturing cost is not a big concern.

Repackaging a rack-and-stack instrument has other advantages too: Potential users who are familiar with writing programs to control



**Any kind of
surface mount
in no time.
Flat.**

You already know General Instrument's reputation for quality, reliability and high volume production capacity.

You also know the advantages of surface mount rectifiers: How they withstand mechanical strain and thermal stress, facilitate high-speed pick and place and reduce board size by increasing surface density.

Now you can have all the advantages of General Instrument *plus* all the benefits of flat pack – because General Instrument has the industry's broadest range of chip technology in surface mount.

SMA, B and C. In standard, fast and ultrafast recovery. Schottky, Zener and TVS. And when reliability is most critical, only General Instrument has the flat pack *Superectifier*.™

Of course, cylindrical MELF-style surface mounts are still available, too.

The answer to every rectifier application has come to the surface – at General Instrument.

For more information, contact General Instrument, Power Semiconductor Division, 600 West John Street, Hicksville, NY 11802; (516) 933-3333.

**GENERAL
INSTRUMENT**
POWER SEMICONDUCTOR DIVISION

CIRCLE NO. 54

TECHNOLOGY UPDATE



IEEE-488 instruments will have little difficulty learning how to create programs to control the VXI unit. In fact, when test-system builders choose an external computer as a controller and interface it to a VXI mainframe via IEEE-488, they can program message-based VXI instruments housed in the mainframe exactly as if those units connected directly to the IEEE bus.

Therefore, if a message-based instrument has a reasonably good manual, an instrument vendor can ship the unit without software and be confident that most users will be able to make it work. A new command syntax called SCPI (standard commands for programmable instruments—pronounced skippy by some people; scuppy by others) will, as users gain familiarity with it, further simplify learning how to control message-based instruments. Already, significant numbers of VXI instruments support SCPI.

Some would skip SCPI

Not all producers of VXI instruments are enthusiastic about SCPI, however. Their argument is that you pay in performance for SCPI's flexibility and extensibility and for the high level of readability of SCPI code. SCPI's English-like syntax is relatively verbose. Parsing SCPI commands therefore requires more processing power—and time—than would parsing terse commands.

Tektronix/CDS (formerly Colorado Data Systems) feels that it has an answer to the speed penalty SCPI exacts; the firm calls its scheme Smart Registers. With Smart Registers, commands are terse and somewhat cryptic, but a fixed-program state machine in each instrument can interpret them at high speed. Because of this technique, Tek/CDS takes strenuous exception to a sentiment expressed

by several other VXI vendors—that message-based communication doesn't let you take full advantage of the VXIbus's potential for tight integration and high speed.

Note, however, that for many VXI modules, high speed is a bit of a red herring. If a module takes several seconds to make a measurement, as would, say, an 8½-digit multimeter, you should question whether it needs a fast communications protocol. Moreover, the register-based and shared-memory protocols require you to deal with the

intricacies of controlling the VXIbus. These protocols bring you into contact with VXIbus-control software and software modules called instrument drivers. With the register-based and shared-memory protocols, these drivers can be quite complex. If you stick with message-based instruments (Fig 1), you need not even be aware of such software.

For many types of instruments though (waveform digitizers, digital oscilloscopes, and arbitrary-waveform generators, to name a few),

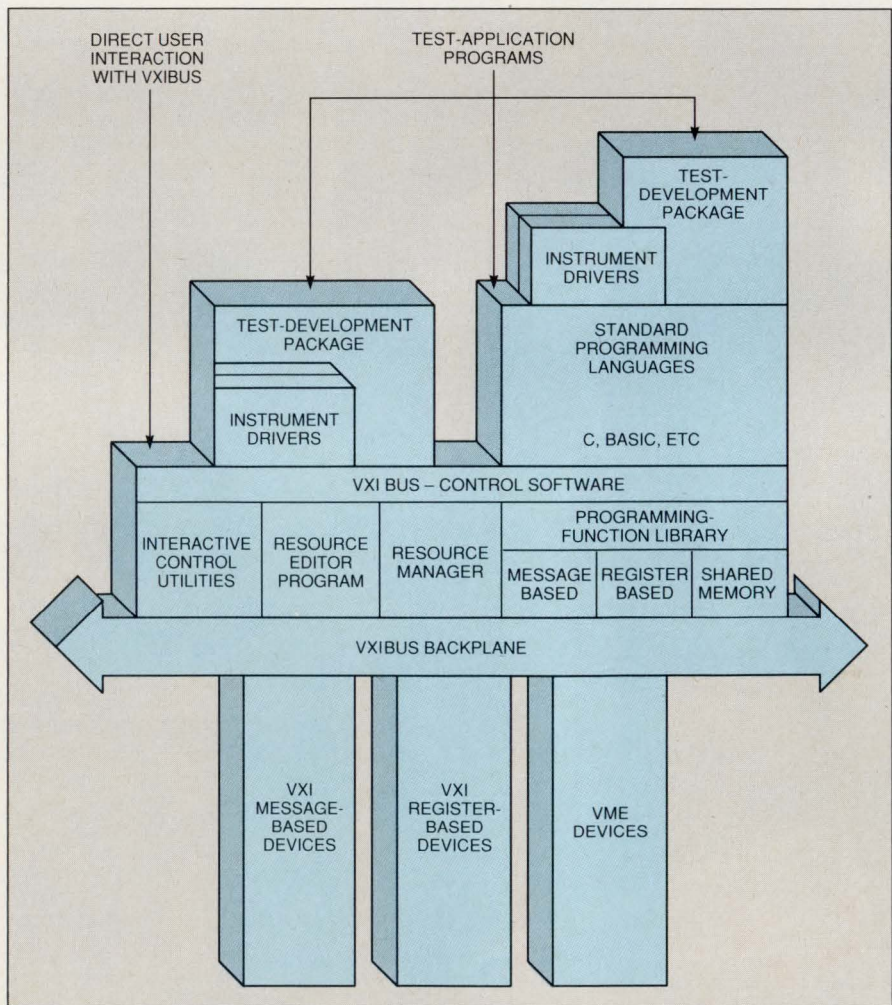

Fig 1—The architecture of software that controls VXI systems can be a bit daunting. If you use only the word-serial (message-based) protocol, however, your test application program can communicate with VXI instruments as if the instruments directly interfaced to the IEEE-488 bus.

NEWS

1553 DATA BUS
 SYNCHRO CONVERSION
 A/D & D/A CONVERSION
 POWER HYBRIDS
 SOLID-STATE POWER CONTROLLERS



ALL A BOARD FOR 1553B TEST AND SIMULATION

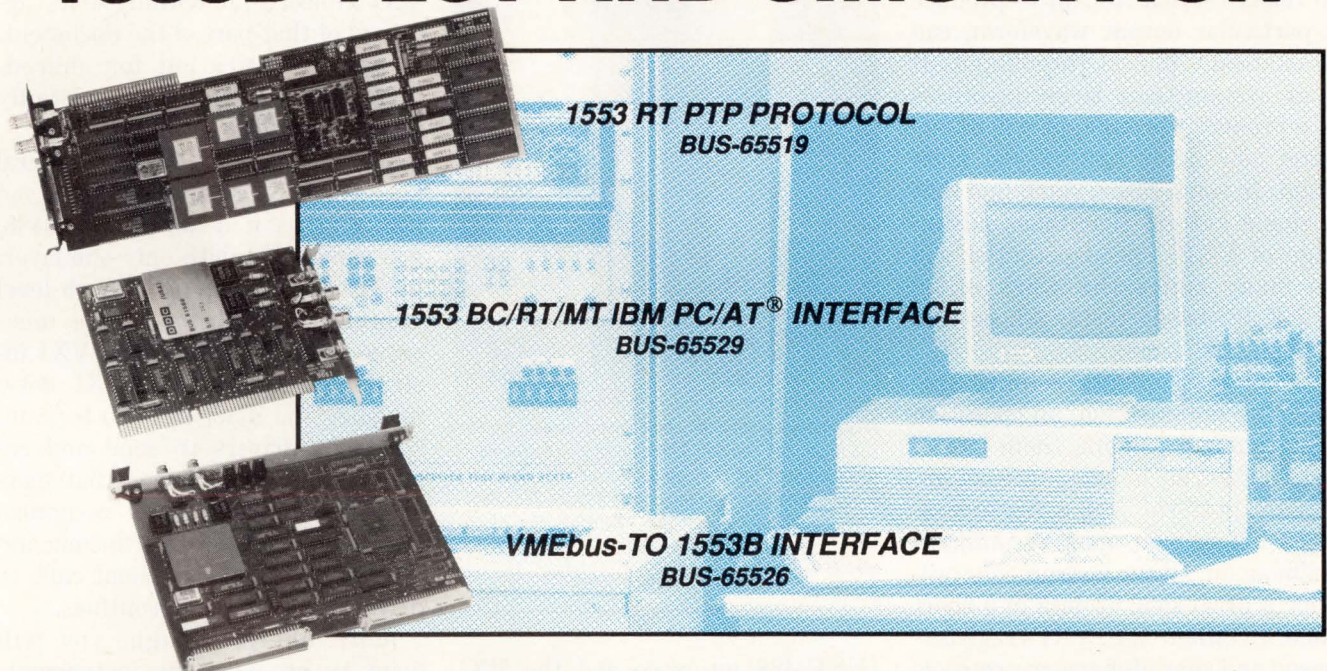

1553 RT PTP PROTOCOL
 BUS-65519

1553 BC/RT/MT IBM PC/AT[®] INTERFACE
 BUS-65529

VMEbus-TO 1553B INTERFACE
 BUS-65526

Do you need a MIL-STD-1553 single function communication card for PC or VME backplane? Or maybe just a MIL-STD-1553 tester/simulator card? DDC has a variety of board level products that will meet your needs.

The BUS-65529 and BUS-65526 are single function MIL-STD-1553 boards. The BUS-65529 is an IBM PC/AT[®] ISA standard board. The BUS-65526 is a VMEbus board. Both can be a BC/RT/MT. The boards comply with MIL-STD-1553B protocol and have dual redundant bus capabilities.

The boards are memory mapped, thus allowing the programmer to write software in any language. All register, memory locations, and bit maps are fully documented for user accessibility. DDC also supplies

FREE BUS-69052 & BUS-69054 "C" library software for these boards. These libraries allow the products to be controlled by high-level subroutine calls rather than by low-level bit and word operations. This dramatically reduces the time required to develop real-time software.

DDC's BUS-65519 is a tester/simulator card that can emulate BC, 31 RTs, and MT simultaneously. The BUS-65519 consists of an IBM PC MIL-STD-1553 interface card and a number of software packages. These packages include menu software for the RT Production Test Plan (PTP) protocol test, interactive menu software to control the 1553 BC/MT/RT modes, and two library packages to write real-time routines in Turbo Pascal or Microsoft "C". The

software package supports MIL-STD-1553 A and B protocol. With the BUS-65519, the test engineer characterizes the Unit Under Test (UUT) via the user friendly, menu driven software. The BUS-65519 can perform the ENTIRE protocol portion of the production test plan in under 20 seconds! The BUS-65519 reduces the time required to generate customized test software from an estimated 3 to 6 months, to less than 10 minutes!

In addition, the BUS-65519 board allows you to simulate your entire bus network for test, simulation, and demo applications.

For further product and applications information, please contact Fabio Stanzini at (516) 567-5600, extension 206. □

®IBM is a registered trademark of International Business Machines.



HEADQUARTERS AND MAIN PLANT: ILC Data Device Corporation, 105 Wilbur Place, Bohemia, NY 11716, (516) 567-5600, TLX: 310-685-2203, FAX: (516) 567-7358, (516) 563-5208
WEST COAST (CA): GARDEN GROVE, (714) 895-9777, FAX: (714) 895-4988;
 WOODLAND HILLS, (818) 992-1772, FAX: (818) 887-1372; SAN JOSE, (408) 236-3260, FAX: (408) 244-9787
WASHINGTON, D.C. AREA: (703) 450-7900, FAX: (703) 450-6610
NORTHERN NEW JERSEY: (201) 785-1734, FAX: (201) 785-4132
UNITED KINGDOM: 44 (635) 40158, FAX: 44 (635) 32264; **FRANCE:** 33 (1) 4333-5888, FAX: 33 (1) 4334-9762
GERMANY: 49 (8191) 3105, FAX: 49 (8191) 47433; **SWEDEN:** 46 (8) 920635, FAX: 46 (8) 353181
JAPAN: 81 (33) 814-7688, FAX: 81 (33) 814-7689; **IRELAND:** 353 (21) 341065, FAX: 353 (21) 341568

TECHNOLOGY UPDATE



high-speed data transfers are quite important. With these units, the time required to set up a measurement and retrieve the results, or to ready the instrument to produce a particular output waveform, can dramatically impact throughput. If your system tests large quantities of a product, throughput will determine how many testers you must build. In some cases, you'll find that a single system that takes advantage of VXI's speed potential will do many times the work of an IEEE-488-based tester whose cost is about the same.

Some instruments require frequent reconfiguration, an operation that requires sending them lots of data. Often, such units, once set up, rapidly perform just a few operations before you must reconfigure them again. Other instruments produce a great deal of data in a short time. In either case, VXI's register-based and shared-memory protocols can improve throughput significantly.

Making your point register

With register-based transfers, you write binary data to instrument registers and read measurement results from registers. VXI permits DMA (direct memory access), so an instrument can send large blocks of data to the memory of an appropriately designed embedded controller (or receive large blocks of data from the controller) without keeping the controller from simultaneously performing other tasks.

An embedded controller resides within a VXI cage or mainframe; external controllers reside outside. The most popular method of communicating between external controllers and VXI cages is the IEEE-488 bus. To communicate with a VXI cage via IEEE-488, an external controller must have an

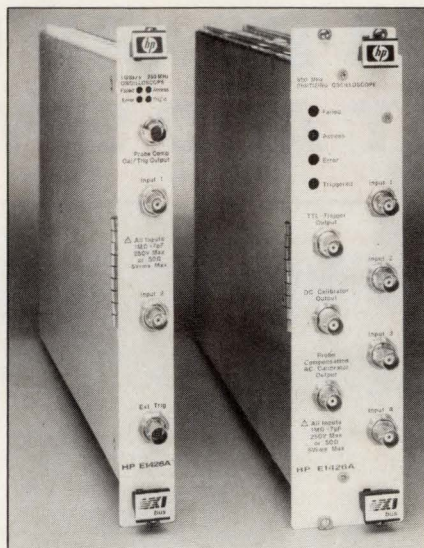

Digital storage scopes have come to the VXIbus. Of course, the display—if you need it—appears on the system controller's CRT. These C-size units come from Hewlett-Packard. The one on the left offers two channels that sample 250-MHz-bandwidth transients in real time at 1G sample/sec. It costs \$12,950.

IEEE-488 interface and the VXI cage's slot-0 module must connect to the IEEE bus. This arrangement supports only the message-based protocol. It does not allow the controller to closely manage VXIbus traffic the way most embedded controllers can.

An alternative to embedded controllers is the MXI Bus, pioneered and released to the public domain by National Instruments. MXI allows external controllers the same degree of VXIbus control as embedded ones.

Shared-memory operation is more flexible than register-based communication and is ideally suited to transferring very large blocks of data—for example, for downloading long waveforms to an arbitrary-waveform generator. In the shared-memory mode, an appropriately designed embedded controller can treat instrument memory as an extension of its own memory and in-

struments can treat portions of the controller's memory as their own. The original VXI spec covered shared-memory operation, but the VXI consortium withdrew its approval of that part of the document. A new specification for shared-memory operation is reportedly about to debut.

As Fig 1 shows, there are several layers of VXI software. When you use VXI as if it were IEEE-488, you can get by with only one layer: programs written in a high-level language that interchange messages with message-based VXI instruments by way of a VXI slot-0 module. You don't have to have instrument drivers to send and receive the ASCII strings that message-based instruments recognize and produce; you can transmit and receive the strings without calls to drivers or even to subroutines.

More likely, though, you will want to organize the instrument-interface functions into drivers. You can write message-based instrument drivers yourself. You can also purchase them as part of libraries that include drivers for popular instruments. Lastly, you can buy one of the several test-development packages that, among other things, contain tools to assist you in developing and debugging instrument drivers.

If you elect to use the register-based or shared-memory protocols, you change the situation: You now require VXIbus-control software. One way you can get this software is as a part of packages of lower-level support tools that also include instrument-driver libraries. (Examples are NI-VXI from National Instruments and EPConnect from Radisys.) Some test-development packages also include VXIbus-control software.

Although you can directly inter-

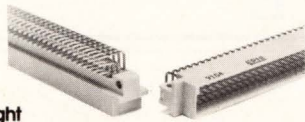

Right Angle Pressfit
 Cost-efficient ERNI Press pressfit connectors for the Eurocard sub-assembly:

- Type B & C male versions and Type Q & R female versions
- Universal press-in technique for thru hole or SMT board designs
- Gas tight connection withstands corrosion and vibration

ERNI

CIRCLE NO. 60

LDG Miniature Housing Enclosures

Multi-use, non-metallic, miniature, housing enclosures:

- Internal PCB mount terminal blocks
- Multiple connecting options (from 12 up to 70)
- DIN-rail mountable

ERNI

CIRCLE NO. 61



Application Specific DIN Connectors

PCB process compatibility and application specific options from ERNI:

- SMT DIN Connectors
- PCB hold-down clips
- Variable pin lengths for early-make-late-break connections for "Zap-proofing"

ERNI

CIRCLE NO. 62

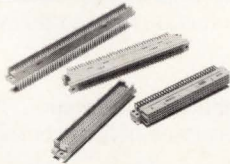

Extended DIN High I/O Connectors
 Extended DIN connectors including 120, 128, and 150 positions:

- Cost-efficient inverse (reverse) style two-piece DIN connectors
- 3 row (120 & 150) or 4 row (128) versions
- Solder, wirewrap, & pressfit options

ERNI

CIRCLE NO. 63



PCB Edgecard Connectors

ERNI Edgecard connectors featuring the latest configurations and options:

- Connectors for every bus type like STD, Multi(+ S-100), Q, Apple II, XT & AT, Microchannel, and more
- Complete range of high-density .050" types
- Extensive options in contact style, type of termination, mounting, and plating

ERNI

CIRCLE NO. 64



.050" SMC

Introducing ERNI's .050" SMC two-piece high-density connector system:

- Perpendicular (daughter to mother board), stacking (parallel or mezzanine), and side-to-side (edge-to-edge) mating configurations
- Anti-twist contact design assures longer life and reliability
- Built-in keying plug cavity for easy plug installation

ERNI

CIRCLE NO. 65

IN THE SPACE OF THIS 7"x10" AD YOU COULD MAKE 4,640 CONNECTIONS.

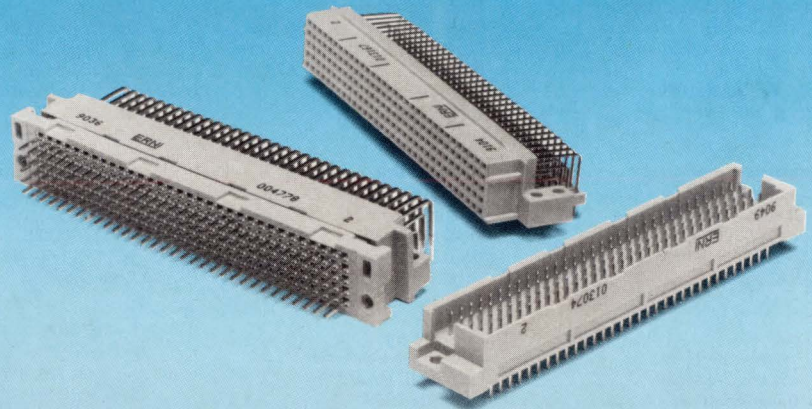

Introducing The New High-Density 160 Connector From ERNI.

An interesting addition to DIN 41612, the new Type E and TE 160 pin connectors meet today's design needs for high-density connectors. So pack it in: 160 connections in an array of 5 rows of 32 contacts in 3.740" x .618" — Type E160 external dimensions (Yes, 29 connectors could physically fit in this ad space!).

Spec it where miniaturization requires more contacts in less space. Take advantage of its flexibility through either standard (E) or inverse (TE) styles. Choose your connections: dip solder, wire wrap, or compliant press-fit. More choices: 3 quality grades with either gold- or tin-plated termination areas — providing design options to withstand up to 500 mat-

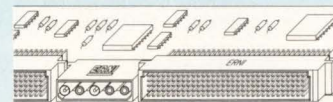

160 pins + Eurocard Center connectors = Increased I/O with power, coax, &/or fiberoptics

ing cycles. Add in ERNI's Eurocard Center connector and you have a multifunctional signal + coax + power + fiber optic system or 362 signal connections all possible on a double Eurocard. The selections list seems endless when you include backplane shrouds, coding strips, pressfit tooling, and more.

And with ERNI you get a world-class supplier manufacturing in 5 countries with offices in 20 others. With ERNI you get more than just a DIN supplier, you get a multi-product company.

So get with ERNI and get to know more about us and about all the possibilities and advantages of the 160 series. Phone or write to: ERNI Components;

520 Southlake Blvd.;
 Richmond, VA 23236;
 Phone (804) 794-6367;
 FAX (804) 379-2109.

CIRCLE NO. 67

ERNI

TECHNOLOGY UPDATE



face test programs to bus-control software, you may be able to simplify your job of writing and debugging programs for a specific applica-

tion by using a test-development software package. Among other things, most of the packages contain facilities for creating instru-

ment drivers. The best known test-development packages are Hewlett-Packard's ITG and ITG/DOS, National Instruments' Labwindows

For more information . . .

For more information on VXIbus products such as those discussed in this article, circle the appropriate numbers on the Information Retrieval Service card or use EDN's Express Request service. When you contact any of the following manufacturers directly, please let them know you read about them in EDN.

Note: This listing omits those VXI system integrators whose activities are concentrated in military electronics. The directory published in the VXIbus Newsletter (see article text and the listing for Bode Enterprises below) contains information on how to contact such firms.

AD Data Systems Corp
770 Basket Rd
Webster, NY 14580
(716) 265-1600
FAX (716) 265-1689
Circle No. 700

Bode Enterprises
8380 Hercules Dr, Suite P3
La Mesa, CA 92042
(619) 697-8790
FAX (619) 697-5955
Circle No. 707

Elgar
9250 Brown Deer Rd
San Diego, CA 92120
(619) 450-0085
FAX (619) 458-0267
Circle No. 714

ILC Data Device Corp
105 Wilbur Pl
Bohemia, NY 11716
(516) 567-5600
FAX (516) 567-7358
Circle No. 721

Analogic Corp
8 Centennial Dr
Peabody, MA 01961
(508) 977-3000
FAX (508) 532-6097
Circle No. 701

Bruel & Kjaer
185 Forest St
Marlborough, MA 01752
(508) 481-7000
FAX (508) 485-0519
Circle No. 708

Elma Electronics Inc
41440 Christy St
Fremont, CA 94538
(510) 656-3400
FAX (510) 656-3783
Circle No. 715

Intepro Systems Inc
6 Fortune Dr
Billerica, MA 01821
(508) 663-7555
FAX (508) 663-7558
Circle No. 722

Ascor
47790 Westinghouse Dr
Fremont, CA 94539
(510) 490-8819
FAX (510) 490-8493
Circle No. 702

Cal-Av Labs Inc
515B Westchester Dr
Campbell, CA 95008
(408) 371-0666
FAX (408) 371-0672
Circle No. 709

Genrad Inc
300 Baker Ave
Concord, MA 01742
(508) 369-4400
FAX (508) 369-6974
Circle No. 716

Interface Technology
2100 E Alosta Ave
Glendora, CA 91740
(818) 914-2741
FAX (818) 335-8346
Circle No. 723

Augat Inc
33 Perry Ave
Attleboro, MA 02073
(508) 222-2202
FAX (508) 222-0693
Circle No. 703

C&H Engineering Inc
8705 Shoal Creek, Suite 107
Austin, TX 78758
(512) 467-7444
FAX (512) 834-9165
Circle No. 710

Giordano Associates Inc
703 60th St Ct E
Bradenton, FL 34208
(813) 746-8753
FAX (813) 746-8501
Circle No. 717

Interlogic Industries
85 Marcus Dr
Melville, NY 11747
(516) 420-8111
FAX (516) 420-8007
Circle No. 724

Automated Technology Systems
27 Davids Drive
Hauppauge, NY 11788
(516) 231-7777
Circle No. 704

Dawn VME Products
47073 Warm Springs Blvd
Fremont, CA 94539
(510) 657-4444
FAX (510) 657-3274
Circle No. 711

Hewlett-Packard Co
19310 Pruneridge Ave
Cupertino, CA 95014
(800) 752-0900
Circle No. 718

LeCroy Corp
700 Chestnut Ridge Rd
Chestnut Ridge, NY 10977
(914) 425-2000
Circle No. 725
Note: LeCroy is the US representative for VXI products manufactured by Struck GmbH.

Bicc-Vero Electronics
1000 Sherman Ave
Hamden, CT 06514
(203) 288-8001
FAX (203) 287-0062
Circle No. 705

Digital Technology Inc
2300 Edwin C Moses Blvd
Dayton, OH 45408
(513) 443-0412
FAX (513) 226-0511
Circle No. 712

Hilevel Technology Inc
31 Technology Dr
Irvine, CA 92718
(800) 445-3835;
(714) 727-2100
FAX (714) 727-2101
Circle No. 719

Mac Panel Co
Box 7728
High Point, NC 27264
(919) 861-3100
FAX (919) 861-6280
Circle No. 726

Blakell AQL Systems Ltd
Blanford Heights
Blanford Forum DT11 7TE, UK
(258) 451353
FAX (258) 480183
Circle No. 706

EIP Microwave Inc
2731 N First St
San Jose, CA 95134
(408) 945-1477
FAX (408) 945-0977
Circle No. 713

ICS Electronics Inc
744 S Hillview Dr
Milpitas, CA 95035
(408) 263-5500
FAX (408) 263-5896
Circle No. 720

TECHNOLOGY UPDATE

and Labview, Tektronix's Tek/TMS, and Wavetek San Diego's Wavetest. ITG is for workstations from HP's 9000 series, Labview is

for the Apple Macintosh, and the others are for MS-DOS-based systems.

The test-development packages

fall into two groups: The majority interface directly with VXIbus-control software; some actually include the control software. Labwin-

Matrix Systems Corp
5177 N Douglas Fir Rd
Calabasas, CA 91302
(818) 992-6776
FAX (818) 992-8521
Circle No. 727

Mupac Corp
10 Mupac Drive
Brockton, MA 02401
(508) 588-6110
FAX (508) 588-0498
Circle No. 728

National Instruments Corp
6504 Bridge Point Pkwy
Austin, TX 78730
(800) 433-3488;
(512) 794-0100
FAX (512) 794-8411
Circle No. 729

NCR Corp
1700 S Patterson Blvd, SDC-4
Dayton, OH 45479
(800) 221-6287;
(513) 445-3758
FAX (513) 445-5494
Circle No. 730

NH Research Inc
16601 Hale Ave
Irvine, CA 92714
(714) 474-3900
FAX (714) 474-7062
Circle No. 731

Nortek
Box 2888
Winetka, CA 91306
(818) 700-9990
FAX (818) 700-8318
Circle No. 732

North Atlantic Industries Inc
60 Plant Ave
Hauppauge, NY 11788
(516) 582-6500
FAX (516) 582-8079
Circle No. 733

Proteus Corp
5827 Rapp St
Littleton, CO 80120
(303) 795-5944
FAX (303) 795-7225
Circle No. 734

Racal-Dana Instruments Inc
4 Goodyear St
Irvine, CA 92718
(714) 859-8999
FAX (714) 859-2505
Circle No. 735

Radisys Corp
19545 NW Von Neumann Dr
Beaverton, OR 97006
(800) 950-0044
FAX (503) 690-1228
Circle No. 736

Schlumberger Technologies
1601 Technology Dr
San Jose, CA 95110
(408) 453-0123
FAX (408) 453-0137
Circle No. 737

Schroff Inc
170 Commerce Dr
Warwick, RI 02886
(401) 732-3770
FAX (401) 738-7988
Circle No. 738

Serendipity Systems
5030 Allan Rd
Bethesda, MD 20816
(301) 229-5999
FAX (301) 229-6259
Circle No. 739

Talon Instruments
150 E Arrow Highway
San Dimas, CA 91773
(714) 599-0690
FAX (714) 599-6529
Circle No. 740

Tasco Electronics Inc
2121 W Crescent Ave
Anaheim, CA 92801
(714) 635-0550
FAX (714) 535-3458
Circle No. 741

Tektronix T&M Group
Box 1520
Pittsfield, MA 01201
(800) 835-4894
Circle No. 742

Tektronix/CDS
3301 W Hampden Ave, Unit C
Englewood, CO 80110
(800) 237-2831;
(303) 762-1640
FAX (303) 781-0253
Circle No. 743

Testniques
Box 27401
Minneapolis, MN 55427
(612) 533-4107
Circle No. 744

Tracewell Enclosures
567 Enterprise Dr
Columbus, OH 43081
(800) 848-4525
Circle No. 745

Transmagnetics Inc
210 Adams Blvd
Farmingdale, NY 11735
(516) 293-3100
FAX (516) 293-3793
Circle No. 746

TTI Testron
41 Century Dr
Woonsocket, RI 02895
(401) 766-9100
FAX (401) 766-9017
Circle No. 747

TYX Corp
1851 Alexander Graham Bell Dr
Suite 200
Reston, VA 22091
(703) 264-1080
Circle No. 748

VOTE...

Please also use the Information Retrieval Service card to rate this article (circle one):

High Interest 515 Medium Interest 516 Low Interest 517

Veretest Inc
45 E Main St
Southborough, MA 01772
(508) 485-5522
FAX (508) 485-8771
Circle No. 749

Virginia Panel Co
1400 New Hope Rd
Waynesboro, VA 22980
(703) 949-8376
FAX (703) 942-2856
Circle No. 750

VXI Solutions
1560-1 Newbury Rd
Suite 314
Newbury Park, CA 91319
(805) 371-1614
FAX (805) 498-8162
Circle No. 801

Wavetek San Diego Inc
9045 Balboa Ave
San Diego, CA 92123
(619) 450-9971
FAX (619) 450-0325
Circle No. 802

Westest Engineering Corp
1470 N Main St
Bountiful, UT 84010
(801) 298-7100
FAX (801) 292-7379
Circle No. 803

Wind River Systems
1010 Atlantic Ave
Alameda, CA 94501
(510) 748-4100
Circle No. 804

TECHNOLOGY UPDATE



dows, however, interfaces by way of standard programming languages: C and Basic. The vendor claims that the high-level-language interface produces significant benefits for users—in customizing instrument drivers and in debugging application programs, for example.

Limited options for change

Bear in mind that there is no standard for the interface to the bus-control software. If you pick a particular combination of embedded controller, operating system, and bus-control software, you will have little flexibility to make changes. Furthermore, selecting a test-development package will limit your choice of bus-control software. In most cases, changing the embedded controller or operating system will force you to change the bus-control software. That change will require you to modify your test programs and may very well force you to rethink your choice of a test-development package.

Such pitfalls, as well as the reluctance of a significant group of users to try register-based instruments, could be at the root of a situation that VXI vendors readily admit to. So far, most VXI users—perhaps 90% of them—are developing test programs without the aid of any test-development package. Most test engineers write test programs in high-level languages. C is, of course, a favorite, but in the test world, Basic remains popular.

Moreover, although most of the test-development packages provide tools that can simplify writing instrument drivers, the explicit support the packages provide—in the form of prepackaged drivers for individual VXI modules—is currently limited. That limitation creates yet another pitfall to trap unwary system designers. Once they select a

test-development package, they may find that if they choose new instrument modules from companies other than the one that provided the development package, they must either write instrument drivers themselves or turn to consultants.

Some VXI advocates expect to see a small industry develop for supplying instrument drivers. In this scenario, a system developer who needs an instrument driver to use with a specific combination of controller, operating system, VXIbus-control software, and language or test-development package would arrange for a consultant to write it. The consultant would charge approximately the cost, but would reserve the right to sell the driver to other system developers. The consultant's profit would come from the subsequent sales of the driver.

Getting into the driver's seat

Of course, there are instrument drivers and then there are instrument drivers. Some instruments are quite complex, and drivers that support all their functions and modes can occupy hundreds of kilobytes of controller memory. Few applications use all the capabilities of such complex instruments, however; drivers that support only the functions needed by a particular system can be much more compact and easier to develop. If you contract with a consultant to write an instrument driver, and the consultant wants the driver to become a product that he can sell on the open market, the development time can delay your project and you may wind up with a larger and more complex code module than you need.

In MS-DOS systems, large code modules can cause major problems

with DOS's 640-kbyte memory limit. Even with an 80386- or i486-based controller, you can't always sidestep such memory problems by placing the drivers in extended memory. If you risk running into a memory limitation, you may have to rule out a general-purpose driver or get your consultant to write the driver in modular form so that you can include only the parts of it your application actually uses.

Keep in mind too, you'll almost inevitably need to make changes. If you purchase instrument drivers from a consultant, make sure that you get the source code or that you have access to tools that let you make changes. (An example of such a tool is the test-development package the consultant used for driver development.) In the absence of the source code or the tools, you can become overly dependent on the consultant.

Sooner or later, VXI users and software vendors will work out streamlined methods to deal with such problems. When those methods exist, VXI will realize its potential for combining expeditious program development with high operating speed. One hardware-based solution has already appeared: Some recently introduced VXI instruments support the register-based protocol as well as message-based communication using SCPI commands. In the future, units will undoubtedly appear that support both message-based and shared-memory operation.

With such instruments, you can quickly get your system running using message-based communication to, say, check out a pilot production run. Then, as production volume and throughput demands increase, you can change critical portions of your program to the register-based or shared-memory modes. You

The Taming of the Slew

...TachoMod Handles Your Fastest Loads

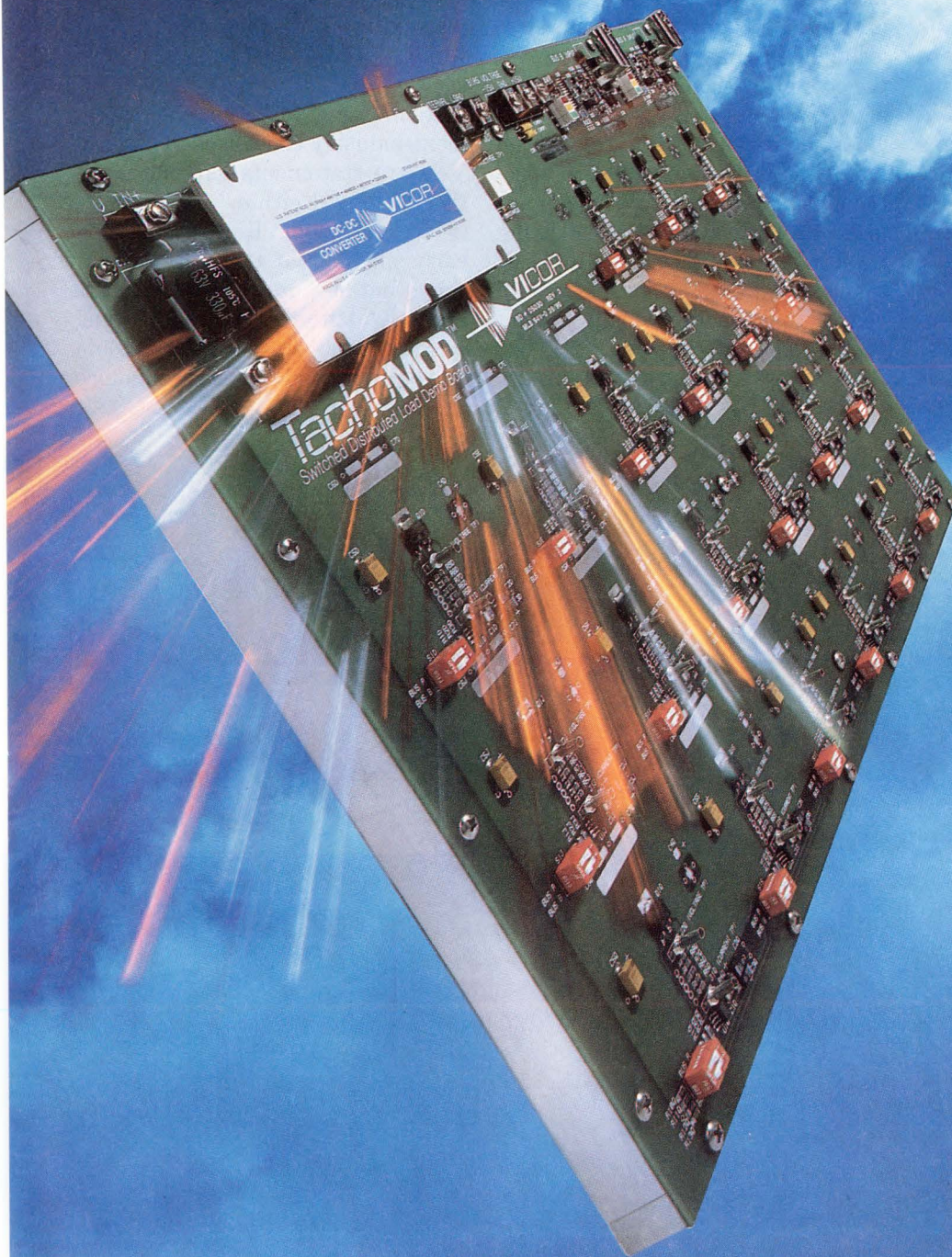

If you're pushing the limits on system speed, you know that fast slewing loads can create frustrating power distribution problems. The result...you add more and more bypass capacitors, wasting valuable board space, reducing system reliability and compromising overall system performance.

Now there's a better solution. Vicor's TachoMod can handle your fastest distributed loads... 10% to 90% load changes, at hundreds of Amps-per-microsecond... with a minimum of on-board bypass capacitance. And you get all of the benefits of Vicor's state-of-the-art VI-200 conversion technology... low profile standard packaging, small footprint, high efficiency, instant power expandability and low-noise FM control. And, we can supply TachoMods with input voltages ranging from 10 to 400 Volts, with outputs from 2 to 48 Volts, at power levels up to 200 Watts.

If you've been unsettled by the transient response of your power system, give us a call. We'll help you tame your slew...quickly and efficiently.



VICOR CORPORATION
23 Frontage Road, Andover, MA 01810
TEL: 1-800-735-6200 • FAX: 508-475-6715

TECHNOLOGY UPDATE



won't have to rewrite the whole program—only the parts that benefit from faster communication. Several influential VXI advocates see this mixed-mode capability as the way VXI instrument architectures will evolve.

System-level VXI products

Though widely held, the perception that VXI technology is intended for construction of one-of-a-kind or few-of-a-kind test systems is incorrect. Within the last year, three vendors of board-test systems, Genrad, Hewlett-Packard, and Schlumberger, have announced system-level product lines based on VXI technology. In the power-supply test field, several vendors, including Elgar, Intepro, and NH,

also have VXI-based system lines.

System vendors point out that, unlike in-house test-development groups that buy modules and put together unique VXI-based testers, customers who buy systems expect heavy-duty applications-development support tools. High on the list of such tools are application-program debugging aids. Happily for the system suppliers, the universe of instruments they offer is limited, whereas in-house test groups can integrate virtually the entire spectrum of VXIbus and VMEbus products into their systems. Restricting the list of module types that a system can contain permits a system vendor to focus on providing a comprehensive tool set.

Not everything that VXI has go-

ing for it is technical or economic in nature, though. Users are reassured by VXI's broad industry support and especially by the high level of commitment from the two largest test equipment firms, Hewlett-Packard and Tektronix. With HP and Tek behind VXI, users are convinced that their investment in VXI won't become obsolete any time soon.

Reinforcing the apparent instrument-industry consensus in favor of VXI are statements like one made recently by Keithley Instruments (Cleveland, OH). Keithley was an early member of the VXI consortium, but it publicly took a wait-and-see attitude toward the bus. Keithley now says that you should not be surprised to see it announce

DTI's
ESP2000.
The Leader
In EISA Technology

EISA '486' BREAK

DTI ESP2000/33MHz '486' Single Board Computer

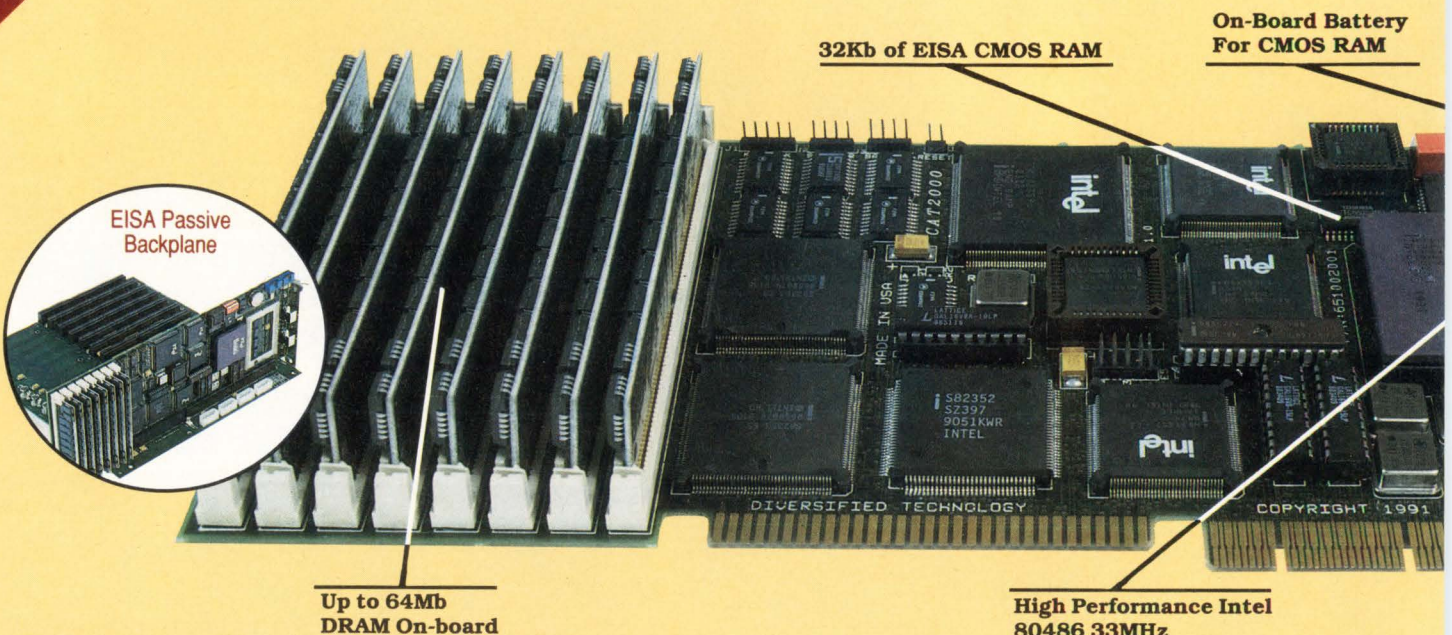

Product names are trademarks or registered trademarks of their respective companies.
386 & 486 are trademarks of Intel Corp. SLOTpro is a trademark of Diversified Technology Inc.

TECHNOLOGY UPDATE

VXI products before the end of 1992. The firm considers more than one of its product lines to be good candidates for the bus.

Broad-based support from well-capitalized companies is something lacking in lower cost alternatives to VXI. Instruments that plug into IBM PCs' ISA bus have been around a lot longer than VXI, and most of them cost considerably less. Although, in general, ISA-based instruments provide lower speed and accuracy than VXI units do, many offer remarkable value. An important difference between ISA-based instruments and VXI is that although vendors of the ISA-based units are more numerous than VXI vendors, most of the ISA-based-instrument companies have annual

sales in the tens of millions of dollars; a few have sales in the hundreds of millions and none have sales in the billions.

PCXI doesn't compete with VXI

A leading supplier of PC-based instruments, Rapid Systems (Seattle, WA), has been addressing the problem of making users feel secure in choosing PC-based units. Rapid Systems hit upon the idea of creating a consortium and developing a standard, just as the VXI consortium did. Rapid has dubbed the new standard PCXI (for personal computer extensions for instrumentation). By the time you read this, the PCXI consortium should have ratified a revision of the PCXI standard that encompasses the 32-bit

EISA Bus. Nevertheless, Rapid Systems steadfastly refuses to call PCXI an alternative to VXI. Instead, says General Manager Bo Ray, you should think of the two standards as complementary.

In sum, today's outlook for VXI is positive. If you expected that by this time VXI would have revolutionized the test equipment business, you're probably disappointed. But the VXI standard is just four years old. Significant numbers of VXI products have been available for only about two years. Four years into its life, IEEE-488 was no closer than VXI is today to becoming the universal standard it eventually became.

Although the pace of change in electronics is a good deal faster now

THROUGH! with Passive Backplane

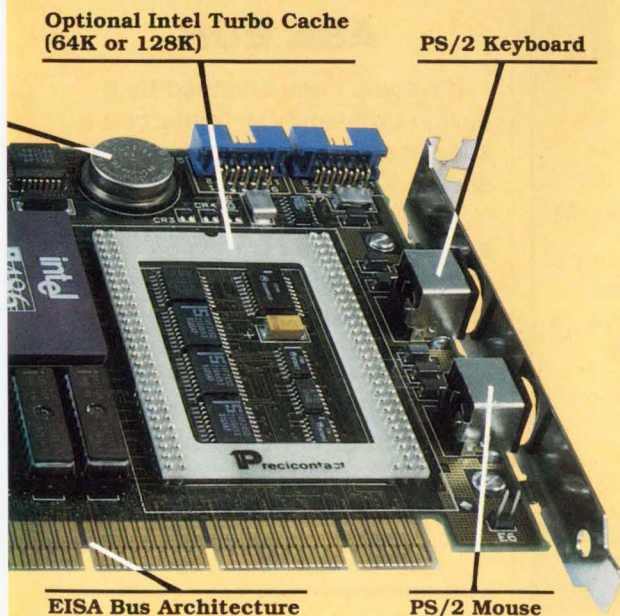

FUNCTION	DTI ESP2000 '486'
33 MHz - Shipping Now	✓
32Kb EISA CMOS RAM	✓
Up to 64Mb RAM Onboard	✓
Noise Reduction Circuitry For FCC Class B	✓
PS/2 Mouse Support	✓
PS/2 /AT Keyboard Support	✓
Optional Intel Turbo Cache	✓
On-Board Battery Real-Time Clock	✓
Double-Sided Surface Mount Technology	✓
Manufactured In-House(USA)	✓
Landmark V1.14 Speed at 33MHz	143.7

CIRCLE NO. 69

**Diversified
Technology**

An Ergon Co.

Call us toll free for orders and information.

1-800-443-2667

In MS - (601) 856-4121

MORE DTI SINGLE BOARD COMPUTERS

- '486' 33MHz EISA**
- '486' 25MHz - CAT1020**
Low Power / Speed Switching
(< 10 WATTS @ Low Speed)
Fully Integrated with:
- 2 Serial
 - 1 Parallel
 - Floppy
 - SCSI
 - IDE
- '486' 25/33MHz - CAT1010**
Fully Integrated with:
- 2 Serial
 - 1 Parallel
 - Floppy
 - SCSI
 - IDE
 - PROM Disk
- '486' 25/33MHz - CAT1000**
CPU & Memory Only
- '386' 25MHz - CAT985 - Low \$**
CPU & Memory Only with:
- PROM Disk
- '386' 25/33MHz - CAT990**
Fully Integrated with:
- 2 Serial
 - 1 Parallel
 - Floppy
 - SCSI
 - IDE
 - CACHE
- '386' 16/20/25MHz - CAT980**
CPU & Memory Only
- CACHE
- '386SX' 16/20MHz - CAT970**
Fully Integrated with:
- 2 Serial
 - 1 Parallel
 - Floppy
 - SCSI
 - IDE
 - VGA
- '386SX' 16/20MHz - CAT960**
CPU & Memory Only

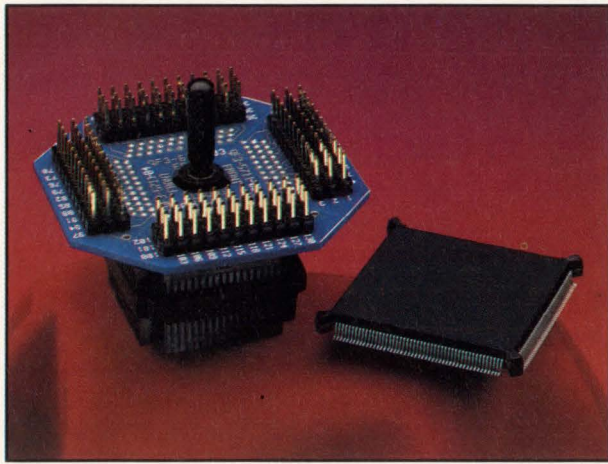

The PQFP Test Clip Solution...

... for hands-free testing of SMT PQFP packages.

- Clips directly onto your soldered-on PQFP device.
- Support for testing, logic analysis, and emulation.
- Converts JEDEC and EIAJ PQFP package footprints to standard test points .1" apart.
- Available in package sizes 80 pin--160 pin.
- Custom sizes also available!



Call for FREE Catalog and Quotation:

Emulation Technology Inc.
2344 Walsh Ave. Santa Clara, CA 95051
Phone: 408 982-0660 FAX: 408 982-0664

CIRCLE NO. 70

Call your Emulation
Technology Distributor:

AUSTRIA
222-603-1953
AUSTRALIA
613-764-5199
BELGIUM
15-212223
CANADA
613-725-2177
DENMARK
44-532244
ENGLAND
234-266455
FINLAND
0-334133
FRANCE
1-69412801
GERMANY
89-4602071
89-61208199
HONG KONG
3-460985
HUNGARY
361-116-2287
KOREA
2-516-1144
INDIA
11-6421114
ISRAEL
3-260-148
ITALY
2-353-8041
JAPAN
33-988-7534
33-791-6411
NETHERLANDS
10-450-1444
NORWAY
2-900900
SINGAPORE
281-7244
SOUTH AFRICA
11-789-1743
SPAIN
1-555-8112
SWEDEN
8-744-0300
SWITZERLAND
55-48-52-00
TAIWAN
2-507-9556
2-721-9533

UPDATE



than it was in the early eighties, when IEEE-488 was four years old, the parallel with VXI is not perfect. IEEE-488 filled a vacuum; before it appeared, there was no industry standard for communicating with instruments. The early adopters of IEEE-488 had few choices; if they didn't pick the then-new standard, their projects were in serious jeopardy. With the exception of people who absolutely must have VXI's speed, early adopters of VXI do have an alternative in IEEE-488.

What VXI offers to the pioneers who embrace it is a chance to build better systems—smaller, more economical systems with higher throughput and improved timing. You need a bit of courage to abandon a sure thing . . . to risk embarrassment or failure in the hope of making an improvement. But for engineers, that kind of risk taking is the name of the game. **EDN**

Article Interest Quotient
(Circle One)

High 515 Medium 516 Low 517

100% STD-AT™ Compatible Computer

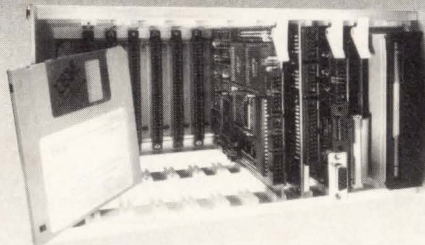

- 100% IBM-AT Compatible STD Bus Industrial Computer
- Fast 10, 12, 16 or 20 MHz 80286 CPU
- Phoenix Bios
- 20, 40, 100 Mbyte 27 mS Hard Disk
- VGA, EGA, CGA, MDA Color Graphics
- Industry Standard IEEE 961 STD Bus
- Compact, Rugged, Industrial Packaging

The STD-AT™ is the first 80286 IBM-AT compatible STD Bus computer offering over 18 times the performance over a standard XT. The compact 4.5" x 6.5" STD Bus card size makes it ideal for mounting in disguised and embedded controllers in a wide variety of industrial and commercial applications. The STD-AT is the blending of proven hardware and software standards to provide the most rugged, compatible, cost effective industrial solutions.

WRITE OR CALL FOR A FREE STD-AT BROCHURE

P.O. Box 121361, Arlington, TX 76012 Phone (817) 274-7553 Fax (817) 548-1358

WinSystems®

"THE STD BUS AUTHORITY"™

ASK EDN

Have you been stumped by a design problem? Can't interpret a spec sheet? Ask EDN. Our editors are ready to help you.

The Ask EDN column serves as a forum to solve nagging problems and answer difficult questions. Address your questions and answers to Ask EDN, 275 Washington St, Newton, MA 02158; FAX (617) 558-4470; MCI: EDNBOS. Or, send us a letter on EDN's bulletin-board system. You can reach us at (617) 558-4241 and leave a letter in the /ask_edn Special Interest Group.



See us at
Booth #2500

FDDI

AVAILABLE NOW!

**From Interphase,
of course.**

It's no bigger than this ad (6U VMEbus to be exact). It doesn't suck power like less efficient controllers. It's RISC-based for super performance. It connects single or dual attached stations from a single VME slot. It supports a variety of media, from fiber to twisted pair. It's ANSI X3T9 FDDI standard compliant. It's certified by the Advanced Networking Test Center™ and the University of New Hampshire Interoperability Lab (Interphase is a charter member of both).

And,

IT'S AVAILABLE...RIGHT NOW.

The Interphase V/FDDI 4211 Peregrine is at work **right now** in some of the industry's leading open systems networks. Put Interphase high performance expertise to work for you.

Call or FAX us today for information about Interphase FDDI solutions, including VME and Multibus controllers, the new fiberHUB FDDI Concentrator and the FDDI System Designer's Kit. We've also got proven Ethernet and Token-Ring products to tell you about.

(214) 919-9000

FAX: (214) 919-9200

In Europe:

(44) 869-321222 FAX: (44) 869-247720



INTERPHASE
CORPORATION



The basic idea behind our new

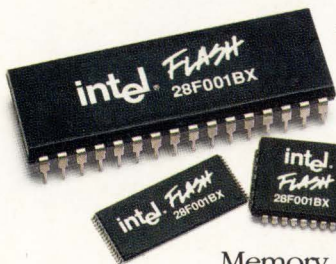

Updating your system code, to say the least, has been a pain. Well, erase those painful memories.

Introducing Intel Boot Block Flash Memory. The first blocked flash memory architecture that includes four separately erasable blocks with one "lockable" block for

critical boot code. A remarkable design that allows one 1Mb Boot Block Flash Memory chip to eliminate up to three memory chips.

It also allows you to reconfigure your system quickly and easily so you don't lose precious time getting to market. Also, future updates—whether it's for hardware or software—are easy. For instance, updating a PC BIOS is as easy and cheap as sending your customers a floppy disk. And all

Come see us at Comdex at the Sahara Hotel from 4:30-8:30 p.m.



block-erasable Flash Memory.

you need to change your embedded program code is a serial link. Life should be so simple.

Intel Boot Block Flash Memory has two configurations compatible with microprocessors and microcontrollers that boot from either high or low memory. Such as the i960™ microprocessor or the industry-standard Intel386™ and Intel486™ microprocessor families.

Now that you have the basic idea, we'd like

you to know more. So call (800)548-4725 and ask for Literature Packet #A6A38. And be the first on your block to make updating easy with Intel's new Boot Block Flash Memory.

intel®

The Computer Inside.™

THE BEST NAMES USE THE BEST



 **Seagate**



NEC



FUJITSU



olivetti



The best names in high-performance computer products all share something in common. They all rely on chips designed by the best name in SCSI.

Emulex.

Since 1985, our Micro Devices division has been designing and producing highly integrated, high-performance SCSI chip solutions for the disk,

workstation, PC, and SCSI peripherals marketplace. And they're so fast, reliable, and innovative, they're in virtually every high-end SCSI system sold today.

In fact, we're the designers of the renowned Emulex SCSI Processor (ESP) Series for SCSI-1 applications, which has sold worldwide to scores of

3545 Harbor Blvd., Costa Mesa, CA 92626

©1991 Emulex Corporation. This advertisement refers to various companies and products or registered trademarks

IN THE BUSINESS NAME IN SCSI.



MICROPOLIS

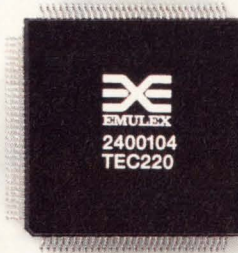

companies who buy and integrate our designs into their products.

We're also the originators of the Fast Architecture SCSI (FAS) Series for Fast and Wide SCSI-2 applications, as well as the Triple Embedded Controller (TEC) Series, an ideal single chip SCSI solution for disk applications—which includes a disk formatter, buffer

controller, and SCSI controller.

So when you're looking for the most effective solutions for your next design project, call Emulex's Micro Devices.

And let the best name in SCSI put you in the chips.



(800) 442-7563 or (714) 662-5600 in California

by their trade names. In most, if not all cases, these designations are claimed as trademarks by their respective companies.

THIS IS A
PLUG
FOR OUR
EIA-232
INTERFACE
FAMILY.



When it comes to CMOS EIA-232 driver/receiver options, we're more than just a lot of talk.

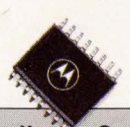

Part Number	Drivers X Receivers	Supply Voltage	Low-Power Standby	Pins
MC145406	3 X 3	+5, ±12 V		16
MC145407	3 X 3	+5 V		20
MC145403	3 X 5	+5, ±12 V		20
MC145404	4 X 4	+5, ±12 V		20
MC145405	5 X 3	+5, ±12 V		20
MC145408	5 X 5	+5, ±12 V		24
MC145705*	2 X 3	+5 V	√	20
MC145706*	3 X 2	+5 V	√	20
MC145707*	3 X 3	+5 V	√	24

It's no wonder we're proud of our EIA-232 interface family.

Ever since we created the industry-standard MC145406 single-chip driver/receiver, people have been hooking up with our rapidly-growing family of interface products.

Today, we're introducing even more innovative devices to accommodate emerging applications.

A variety of CMOS driver/receiver combinations are available with features like single power supply, low-power standby mode, and the latest in surface mount packaging. Now there's no easier way to make a connection.

For more information, call 1-800-521-6274, or mail in the coupon below

to receive your Free Interface Sample Kit.

We'll show you the interface family everyone's plugging.

FREE SAMPLE KIT! For sample parts and more information, return this coupon to:

Motorola, Inc.
P.O. Box 1466
Austin, Texas 78767

EDN 10/10/91

Application Requirements _____

Name _____

Title _____

Company _____

Address _____

City _____

State _____ Zip _____

Phone _____ Fax _____



Power Revelation



Our Westcor division's family of configurable AC or DC input fan cooled StakPAC switchers reveals a new world of power density and output flexibility to the system designer...whatever your power needs. Each StakPAC is built with field proven robotically manufactured Vicor VI-200 Series power components providing you the flexibility of a customized supply combined with the off-the-shelf availability of standard catalog products...“first article” StakPACS are typically delivered in 2 weeks.

Compact, up to 6W/in³, low profile StakPACs set the standard for “box” or open frame switchers. Besides meeting conducted EMI standards, custom configured StakPACs are pre-approved to UL, CSA, TÜV and VDE safety standards (DC Mini- in process).



MODEL	POWER	OUTPUTS	INPUT	DIMENSIONS (inches)
StakPAC	1,200W	up to 8	110/220 VAC	3.2 x 5.5 x 11.5
MINI	600W	up to 5	110/220 VAC	1.9 x 5.5 x 12.2
DC MINI	800W	up to 5	5 Ranges 18-76 VDC	2.5 x 4.3 x 12.2



Whether your application is OFF-LINE or DC INPUT, chances are we have a solution for you...we are designed into computer, telecom, and test measurement systems worldwide. Please call us to discuss your needs, then relax...bulky standards and risky long lead-time custom supplies belong to the past. Discover the new world of configurable supplies: StakPAC, MiniStakPAC and DC Mini.

Call VICOR EXPRESS for information and be sure to ask for a StakPAC or DC Mini Handbook: (800) 735-6200 or (508) 470-2900 at ext. 265. Or call Westcor (west coast) at (408) 395-7050.



Component Solutions For Your Power System

COMDEX TRENDS

PC GRAPHICS BOARDS

Boards speed Windows and vie as standards

The emergence of Windows 3.0 as a de facto industry standard for PCs means that standard graphics hardware doesn't matter as much as it used to.

*Margery Conner,
Contributing Editor*

Fall Comdex will showcase the newest trends and the latest confusion in IBM PC graphics. This year's show will be no exception, and the clear trend is the virtually unanimous acceptance of Windows 3.0 as the first de facto graphical-user-interface (GUI) standard for the PC. Because of the processing burden Windows lays on the system processor, Windows accelerator add-in cards will be among the most prevalent new graphics products at the show. Confusion will reign over the future of advanced graphics hardware for the PC, but graphics boards that don't make it as standards might succeed as Windows accelerators.

Windows's acceptance as a standard

GUI frees vendors from the tyranny of following standard IBM graphics hardware. In the past, graphics-board vendors had little reason to include enhancements such as hardware zoom and pan and bitblt (bit block transfer) because there was little chance that applications' software drivers would take advantage of the features. The boards were simply too numerous and the drivers too onerous for the application vendors to write.

Now, as long as your application runs under Windows 3.0 and your video board has a Windows driver, your board and the application will be compatible. What you have as a video board or graphics add-in board doesn't much mat-

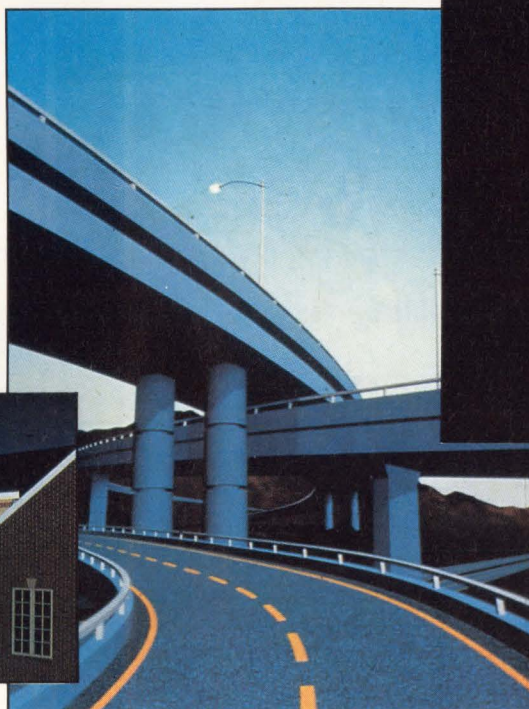

Contrast these photographs, which were generated on a Silicon Graphics imaging workstation, with the highest quality graphics you've seen from your PC. Chances are you'll agree that PC graphics still have a ways to go, but based on what you can see at Fall Comdex, the PC's graphics will get there sooner rather than later. (Photos courtesy Wavefront Technologies (Santa Barbara, CA))

Advanced Pressure Sensors

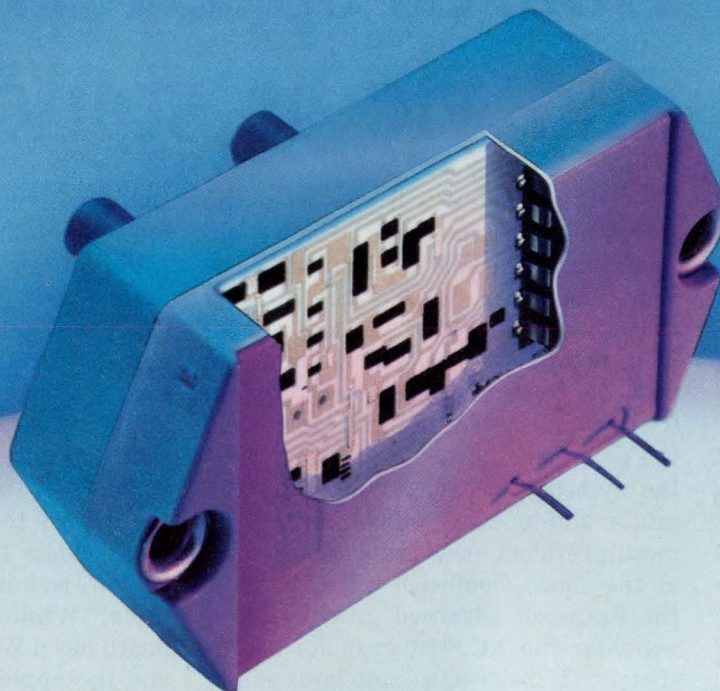

FOR: MEDICAL INDUSTRIAL HVAC

Sensym's 142/163 Series

Features Include:

- Guaranteed precision over temperature: $\pm 1\%$ Max (-18°C to $+63^{\circ}\text{C}$)!
- High level calibrated output: $1.0\text{V} \pm 50\text{mV}$ offset
 $5.0\text{V} \pm 50\text{mV}$ span
- Linearity: $<0.75\%$ FSO Max

These precision transducers are priced starting at **\$40 ea/100's. Stock delivery.**

Available parts:

163SC01D48 ... -20 to $+120\text{cmH}_2\text{O}$

142SC series .. 0 to 1psi up to 0 to 150psi



Free Handbook



Sensym's new 1990 Sensor Handbook gives complete product specifications plus over 200 pages of application notes and ideas.

Call or fax us today for your free Sensor Handbook.

CIRCLE NO. 76

1244 Reamwood Avenue ■ Sunnyvale, CA 94089 ■ Tel: (408) 744-1500 ■ Fax: (408) 734-0407

COMDEX TRENDS

PC graphics boards

ter as long as the board has a Windows driver. The board vendor optimizes the driver to take full advantage of the board's specific features. For this reason alone, the chances are good that you—if you aren't already—soon will be interested in running even your CAE programs under Windows.

Electronics engineers run a diverse collection of often esoteric programs that have unique and often demanding graphics needs. A standard VGA board is barely acceptable as the graphics adapter for even a low-end CAE workstation.

IBM introduced the VGA and 8514/A boards with its PS/2 line of personal computers. The VGA board enjoyed immediate acceptance. The board has no graphics coprocessing capability and offers little resolution increase compared with the previous EGA standard. But VGA chips were easy for IC companies to clone, so the VGA board quickly became a commodity-priced hardware graphics standard. (In addition, companies improved the resolution and increased the number of colors that VGA boards offered. Versions of these boards may vary from vendor to vendor, but the 1024 × 768-pixel, 256-color boards are called Super VGA.)

The 8514/A was the first IBM graphics board to have onboard graphics smarts, which made it less easy for the chip vendors to clone. Because the board has only a Micro Channel interface, it didn't work with the vast number of AT bus machines. And because the 8514/A board requires VGA hardware, it is not a stand-alone standard. However, the chip and board companies

Acronyms used in this article

bitblt—Bit block transfer
CAD—Computer-aided design
CAE—Computer-aided engineering
CPU—Central processing unit
DRAM—Dynamic RAM
EGA—Enhanced graphics adapter
GUI—Graphical user interface
I/O—Input/output
PC—Personal computer
RAM—Random-access memory
SuperVGA—Super video graphics array; 1024 × 768, 256 colors
VESA—Video Electronics Standards Association
VGA—Video graphics array; 640 × 480 pixels, 16 colors
WYSIWYG—What you see is what you get
XGA—Extended graphics adapter; 1024 × 768 pixels, 256 colors; 640 × 480 pixels, 65,536 colors
8514/A—1024 × 768 pixels, 256 colors

have adapted the 8514/A for the AT bus, combined it with an onboard VGA chip set, and offer the resulting board as another graphics hardware standard for \$500 to \$800.

The 8514/A's strengths, such as fast line draws, suited the board for its original purpose: an add-in board that improved graphics for CAD users. However, in IBM's original version, the board's memory-to-memory transfer speed—an important characteristic in any windowing environment—is slow. To overcome this weakness, many of the graphics chip and add-in board companies optimized their versions of the 8514/A board for memory-to-memory transfer and added other features such as hardware zoom.

Part of the uncertainty surrounding the 8514/A's future as a graphics hardware standard stems from concern over IBM's future plans for graphics. Shortly after the 8514/A's introduction, IBM came out with yet another graphics hardware interface, the XGA (extended graphics adapter). Doubt exists as to whether IBM will ever fully implement the 8514/A. However, the momentum of Windows 3.0 as a stan-

dard is so strong that most vendors of 8514/A boards are covering their bets by marketing their boards as Windows accelerators.

Jim Anderson, director of strategic marketing at Headland Technology (Fremont, CA), says a board needs three key features to speed Windows. The first is that the graphics hardware use video RAM for the onboard video memory. Because PC-based workstations use fast and powerful system CPUs, graphics processing is limited

by either the 8-MHz system I/O bus or the video-memory bandwidth. Using video RAM eliminates the video-memory bottleneck.

The second feature is a 32-bit-wide video-memory bus; the third is onboard hard-wired bitblt capability. Anderson points out that you can get the first two of the three features in high-performance Super VGA boards and claims that these boards cost less than dedicated Windows accelerator boards but speed Windows almost as effectively. Because video RAM costs more than the DRAM (dynamic RAM) used in standard VGA designs, you'll pay about \$400 for a video-RAM Super VGA board versus about \$150 for a name-brand Super VGA board. Prices for Windows accelerator boards, which have all three key features, start at about \$500.

(Keep in mind that these accelerator boards speed graphics displays for existing 386-based systems in which the VGA board is on the system I/O bus. Designers of future systems will be able to gain a speed advantage by putting the VGA board on the processor's

COMDEX TRENDS

PC graphics boards

local bus. For more information, see **box**, "Local-bus VGA boards: Faster for free.")

Windows acceleration encompasses more than just an efficient video-memory interface. Henry Quan, director of marketing at ATI (Ontario, Canada), says that for peak Windows performance, a graphics coprocessor is a must. He is equally emphatic that a hard-wired coprocessor—rather than a programmable processor, such as the Texas Instruments 340x0—is best: "Go with the hardware tailored for the application. As a comparison, would you rather take your car to the neighborhood garage, or to a shop that specializes in your car brand?" Hard-wired coprocessors can have a distinct speed advantage running Windows compared with the 340x0-based boards, but general-purpose coprocessors are often more powerful.

ATI's accelerator boards are based on chip sets that clone the IBM 8514/A board and its proprietary hard-wired graphics coprocessor.

Some vendors tailor their 8514/A boards to enhance specific applications such as desktop publishing. For example, some 8514/A-clone boards feature antialiasing font software, which is necessary for a

WYSIWYG display. A 1024-pixel, 14-in. monitor is capable of only 96 dpi; laser printers boast 300 dpi. Antialiasing software makes the screen fonts appear to have the same resolution as the hard copy. Also, Windows pushes the limits of 14-in. monitors in such specifications as refresh rate and resolution and typically runs on a white background, where flicker is most noticeable. You can expect to see 8514/A-based boards with refresh rates well over 70 Hz noninterlaced (the original 8514/A had a refresh rate of 87 Hz interlaced).

Quan, whose company makes 8514/A-type boards, considers the present confusion over the 8514/A's future as a standard to be temporary. "The 8514/A is here today, with a huge installed base of application software," says Quan. "If you wait for XGA, you'll be waiting for almost a year, paying twice as much, and not sure about software support." The 8514/A, he says confidently, will become the next graphics hardware standard for PCs.

Headland Technology's Anderson flatly states that the 8514/A will never make it as a standard. He predicts that the board's value in the short term will be strictly as a Windows accelerator and that by next summer, hardware clones of

the XGA board will be available. Anderson is speaking not only from his perspective at Headland, which has bet that video-RAM Super VGA boards will carry users over until the arrival of the XGA clones, but also from his vantage point as chairman of the Video Electronics Standards Association (VESA).

VESA is a consortium of PC-compatible chip and board manufacturers that has been developing a Super VGA standard. Super VGA boards will still not have any on-board processing, but the standard offers greater pixel resolution than does the VGA standard. VESA is also defining the requirements for an XGA standard. Anderson expects the consortium to finalize its XGA specification by this year's Comdex. The first hardware meeting the standard should be available next summer.

Proponents of 340x0-based graphics boards have been indifferent to the arguments over which hardware standard will gain acceptance because boards based on the programmable graphics engine can mimic any hardware standard. With the programmability comes some sacrifice of speed and a price premium: 340x0-based boards generally start at more than \$900. Because of their cost, 340x0-based

Local-bus VGA boards: Faster for free

Designers and, ultimately, purchasers of future systems will be able to take advantage of devices such as the HT216 chip from Headland Technologies, which accelerates all VGA graphics—not just the Windows environment—by interfacing the VGA board to the local CPU bus.

Conventional VGA chips—even those physically located on the mother board—interface to the CPU over the system's I/O bus. That bus's 8-MHz speed limits graphics data transfer. So in addition to the processor overhead that Windows adds, the sheer volume of graphical data being transferred makes

the I/O bus a prime bottleneck. By interfacing to the local bus, the HT216 can run at the processor's speed, which can be as fast as 33 MHz, and eliminate I/O-bus congestion. The chip's manufacturer claims local-bus VGA boards provide a minimum speed increase of 20% compared with today's fastest VGA boards. Typical speed increases are 200 to 300%.

Also, the chip's price is the same as that of existing VGA chips, so you'll be able to get the performance increase without increasing the cost of your system.

Experience 32-bit RISC Performance in Your 16-bit System at a Cost That'll Thrill You

Intel has given designers another exciting product breakthrough. This time it's Intel's i960™ SA/SB 32-bit embedded processors -- the products that let you design-in high performance in cost-sensitive applications.

With a full 32-bit internal architecture and a 16-bit data bus, the i960 SA/SB processors provide more performance than any other 16-bit embedded processor. And they're part of the complete i960 family, which spans 5 to 66 MIPS while preserving software compatibility.

Hamilton/Avnet has the i960 SA/SB processors and evaluation boards in stock, and the development tools to start your design now! From compilers and simulators, to debuggers and emulators, we offer the development tools you need to take full advantage of your design, while reducing time to market.

So get high performance, at a cost you'll be thrilled about with Intel's i960 SA/SB and development tools. For the Hamilton/Avnet branch nearest you or further information, call toll free, 1 (800) 442-6458.

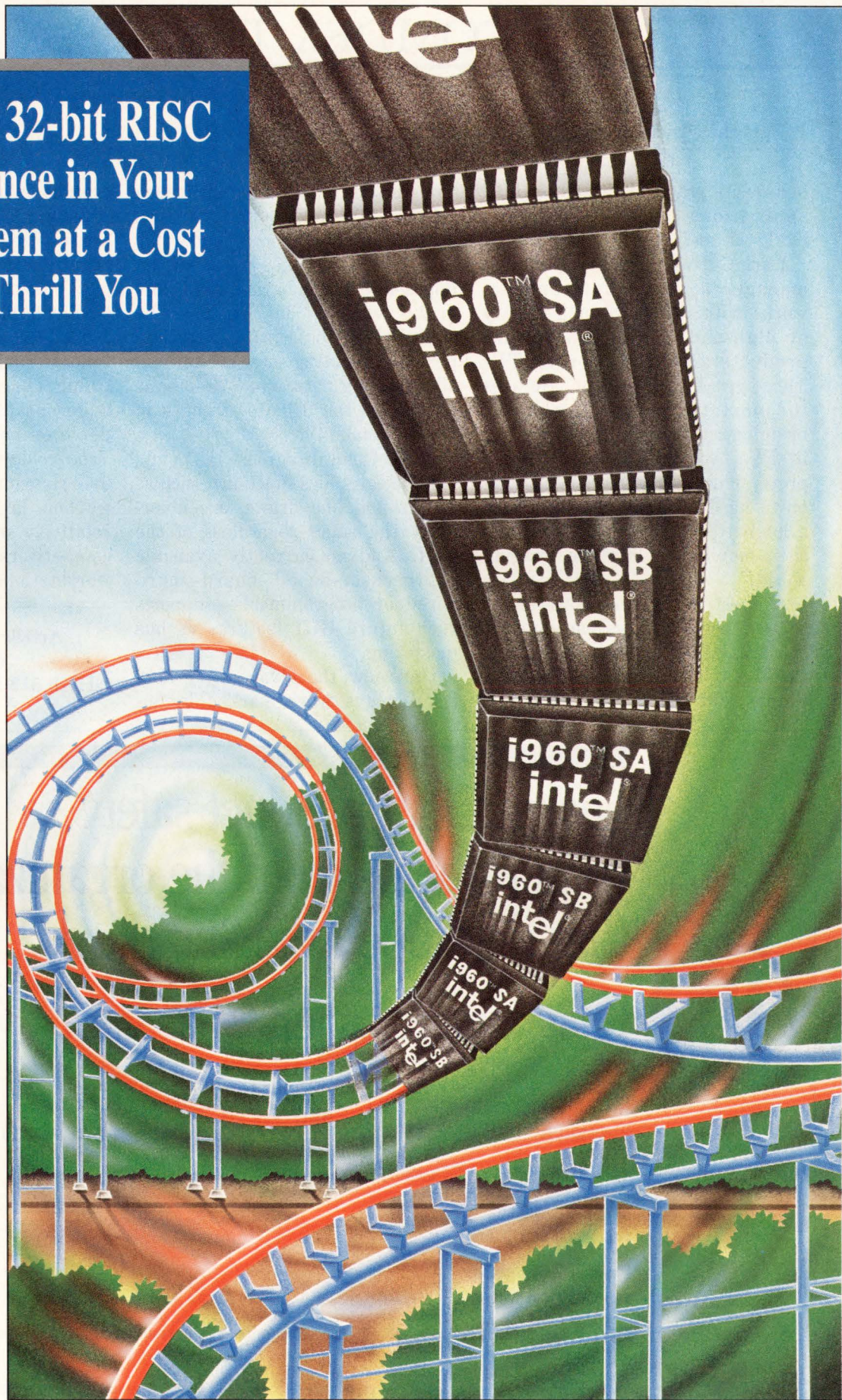

HAMILTON/AVNET

i960 is a trademark of the Intel Corporation.

COMDEX TRENDS

PC graphics boards

boards are practical for high-end PC applications, such as CAE/CAD workstations.

Karl Guttag, graphics strategy manager at Texas Instruments, works with designers of a variety of high-end graphics hardware products that incorporate TI's 340x0 graphics processor. He sees the next two to three years as bridging a gap "from what we had in PCs, which was really some pretty klunky graphics, to moving on to hardware that does graphics a lot better with more colors, and then moving on into the imaging world."

A question remains, however, as to whether Windows can support the transition to such a complex graphics environment. Guttag points out that Windows has

changed tremendously with each release, "There were pretty radical changes in going from Windows 2.0 to 3.0. For example, it was almost impossible to get beyond 256 colors in 2.0, while in 3.0 you have the ability to go to as many as 32 bits per pixel." Guttag sees this continually evolving nature of Windows as playing to the 340x0's strength in programmability.

ATI's Quan disagrees. He points out that graphics functions, such as bitblts and line draws, are inherently the same regardless of the GUI. And no currently available coprocessor-based board—hard wired or programmable—supports such future GUI features as bus mastering.

Until now, the advances in graphics displays were marked by in-

creases in resolution. Now, inexpensive monitors are reaching their screen-size limits while memory—a requirement for enhanced color—gets cheaper. Graphics PC resolution will likely top out at either 1024×768 or 1280×1024 pixels. Color resolution will soon be a defining characteristic of graphics add-in boards, with 24 bits of color per pixel being a common offering. True color may be the ace in the hole as manufacturers of PC graphics boards seek to position their relatively inexpensive systems as competitors to high-end imaging workstations. **EDN**

Article Interest Quotient
(Circle One)

High 512 Medium 513 Low 514

Learn about product safety requirements from the organization that developed the Standards



Underwriters Laboratories Inc.®

**"Information Technology
Equipment and UL 1950"**

AND

**"Plastics in Electronic
and Electrical Products"**

Attend both of UL's two-day seminars at one location for one reasonable price

**"Information Technology
Equipment and UL 1950"**

Tampa: November 19–20, 1991

**"Plastics in Electronic
and Electrical Products"**

Tampa: November 21–22, 1991

The "Information Technology" seminar will include analysis from an international safety expert from Germany's VDE testing authority.

For more information and registration fees, or to register for either or both seminars, call UL at (708) 272-8800, ext. 3444. Space is limited, so call today.



We offer the most complete line of debuggers, emulators and languages.



When you need development tools, Intel's selection runs the gamut. In fact, we offer the most extensive line available for Intel architectures—from i386,™ i486,™ i860,™ i960,™ and 186 microprocessors, to MCS®-51 and MCS-96 microcontrollers.

Because they're all from Intel, our tools work better together to help you get to market quickly. No other vendor can give you a better view of what's going on inside the processor. Plus, you save time by ordering tools from our catalog with a simple phone call.

What's more, Intel offers support from start to finish, including a 30-day, money-back guarantee, hotline assistance, training, field consulting, and support contracts. Which makes your purchase virtually risk free. So if your debugging needs can't be met by a shoe, call Intel at (800)874-6835 or fax (503)696-4633 for our free catalog. You'll find all the tools you need. And then some.

intel®

The Computer Inside.™

Our pulse generators will test what you have.



High Speed Bi-polar

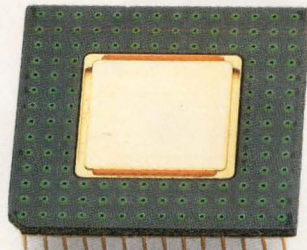

BICMOS



ECL

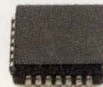

ECLips

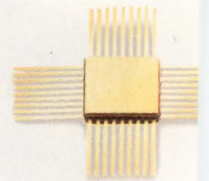

GaAs

That's a big statement. But these are powerful programmable pulse generators. Combined, they deliver top speed, high resolution and pulse-parameter flexibility. So you get accurate testing of your present and future high-speed designs, whether they're ICs, PCBs, or components.

Put the 500 MHz HP 8131A



HP 8130A Pulse Generator



HP 8131A Pulse Generator

to work on your hottest new devices. With a transition time of <math><200\text{ ps}</math>, plus pulse widths down to 500 ps with 10 ps timing resolution, you get the stimulus you've needed for accurate testing of your fastest designs.

For the most complete testing of your high-speed devices, choose the HP 8130A. It has

And what you have in mind.

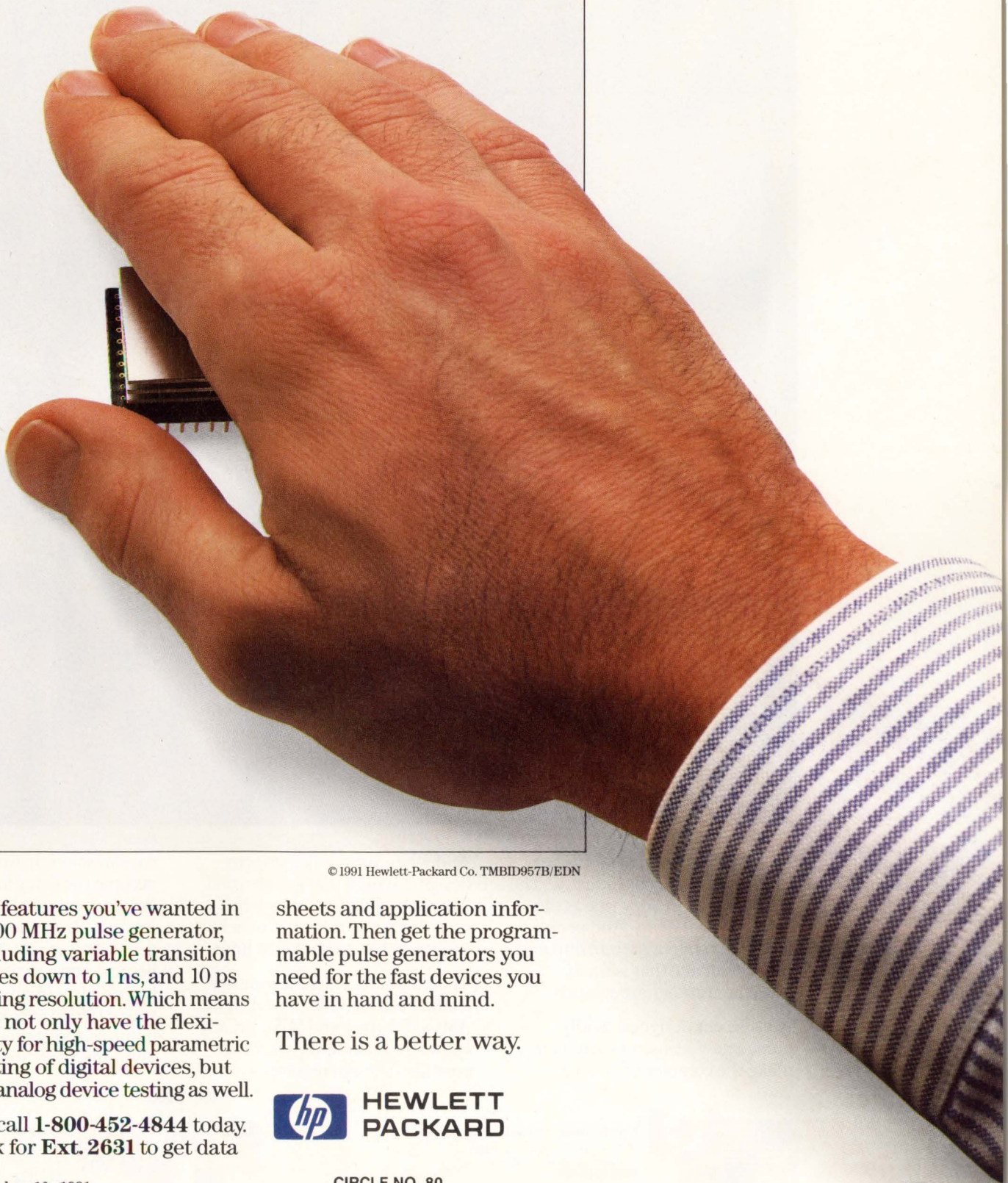

© 1991 Hewlett-Packard Co. TMBID957B/EDN

the features you've wanted in a 300 MHz pulse generator, including variable transition times down to 1 ns, and 10 ps timing resolution. Which means you not only have the flexibility for high-speed parametric testing of digital devices, but for analog device testing as well.

So call **1-800-452-4844** today. Ask for **Ext. 2631** to get data

sheets and application information. Then get the programmable pulse generators you need for the fast devices you have in hand and mind.

There is a better way.



**HEWLETT
PACKARD**

Challenging the limits of is the core of our success.



For NCR, it's defined by the very things that drive our industry. The changing technology that is the core of what we do. And people who join you in a partnership and provide service that actually exceeds customer expectation.

Because our designers avidly pursue new ideas, they can help make the complex a bit simpler.

And when your challenge is to design a system that goes beyond known boundaries – they will provide myriad resources to help you push that design to the limit.

Those resources include industry-leading products like mixed-signal ASICs, Ethernet and SCSI, already considered standards. Or, when your latest design requires a

custom solution, these products become the cores for unique devices – providing ever-increasing levels of integration in ever-decreasing space. Moreover, because you can design systems at higher levels of abstraction... you're free to explore a universe of limitless applications... and still save time, money and reduce the



North American Sales Headquarters
1731 Technology Drive, Suite 600
San Jose, California 95110
1-800-334-5454

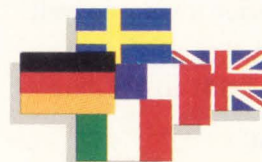

European Sales Headquarter
Gustav-Heinemann-Ring 133
8000 Munchen 83
Germany
49 89 632202

our universe

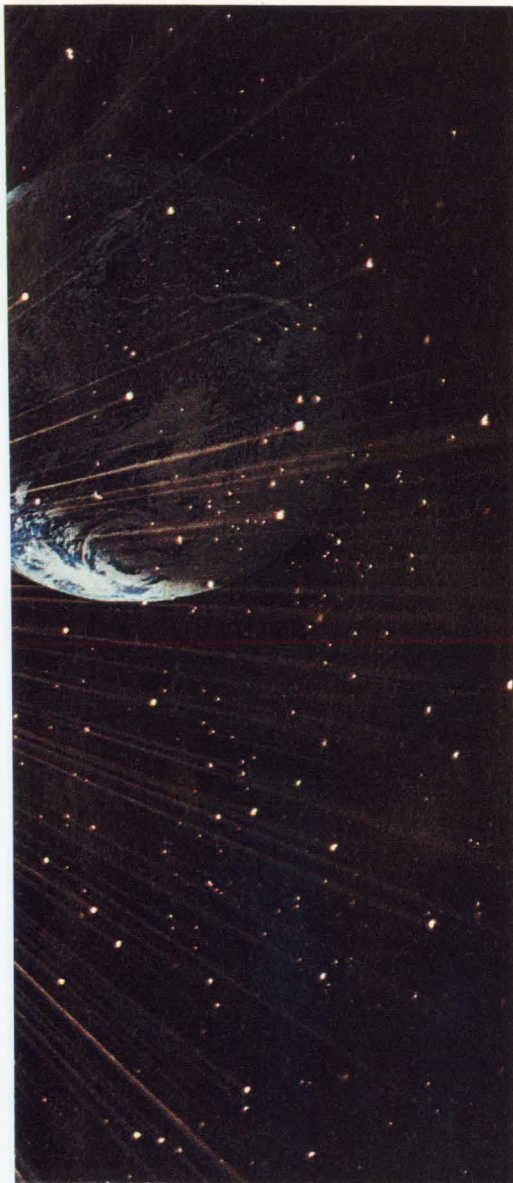

© Copyright NCR Corporation, 1991.



Semiconductors

risks associated with new product introductions.

and your design, when completed, will test and perform exactly as you intend. After all, your success, and yours... depends on it.

For more information, call
NCR Microelectronics Division:
800-334-5454.

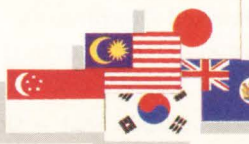

Asia/Pacific Sales Headquarters

35th Floor, Shun Tak Centre
200 Cannaught Road
Central Hong Kong
011-85-2-859-6044

CIRCLE NO. 81

REFLECTIONS OF QUALITY...

1.65 GB in a 5.25-inch Form Factor.

Available Now Is the New Hitachi DK516C-16 Winchester.

To back-up the famous Hitachi quality, the DK516 series drives are offered with a 150,000 hour MTBF and a 5-year warranty.

Edge-to-Edge Performance

The DK516C-16 uses Hitachi's advanced proprietary technology to deliver 1.65 GB of capacity and a fast 13.5 ms average access time.

Its SCSI interface provides a maximum data transfer rate of 5.0 Mbytes/sec (synchronous), with a 256 Kbyte data buffer and read look-ahead cache.

Or, if you have an ESDI application, look into Hitachi's new 1.54 GB DK516-15 with a 14 ms average seek time and a 2.75 MB/sec data transfer rate.

Edge-to-Edge Quality

Choose the DK516 and you get a drive backed by the quality and reliability of Hitachi—a \$44 billion company. Unlike other drive manufacturers, we design, build, and test all key components in-house.

If your new system design is leading the edge, then there's only one disk drive choice: the new DK516, from Hitachi.

For more information about the DK516, or any Hitachi disk drive, call 1-800-HITACHI.

Hitachi America, Ltd.
Computer Division, MS500
Hitachi Plaza
2000 Sierra Point Parkway
Brisbane, CA 94005-1819



HITACHI®

Our Standards Set Standards

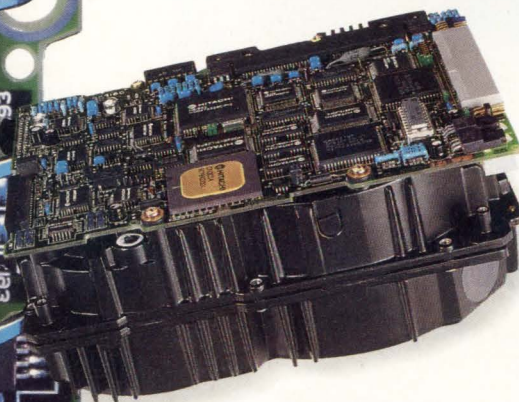

The Leading Edge of Capacity

CONSAN 612-949-0053
(LA, IL, IN, KS, KY, MI, MN, MO, ND,
NE, OH, Pittsburgh, PA, SD, WI)

GENTRY ASSOCIATES
800-877-2225 (AL, D.C., FL,
GA, LA, MD, MS, NC, SC, TN, VA)

R SQUARED 800-777-3478
(AZ, CA, CO, NM, OR, UT, WA, WY)

Authorized Distributors:

SIGNAL 800-228-8781
(CT, MA, ME, NH, RI, VT)

SPECIALIZED SYSTEMS
TECHNOLOGY 800-688-8993
(AR, LA, OK, TX)

See us at COMDEX FALL — Booth #1616

CIRCLE NO. 82

COMDEX TRENDS

MASS-STORAGE DEVICES

Price and size shrink while capacity grows

Every year, manufacturers offer smaller mass-storage devices. The move toward smaller peripherals, however, has never been as dramatic as now—1.8-in. hard-disk drives are emerging, and some 3½-in. units can store 1 Gbyte.

Maury Wright,
Regional Editor

As the Comdex Fall extravaganza quickly approaches, there's no question the hot topic of mass-storage devices will be shrinking peripherals. The downsizing theme may sound like same song, 20th verse, but this year you can find examples of smaller floppy-disk, hard-disk, tape, and optical drives. Smaller sizes don't mean less-capable drives though. New 3½-in. Winchester store more than 1 Gbyte. Helical-scan tape drives offer storage capacities starting at 2 Gbytes. And tiny, 1.8-in. hard-disk drives weigh in at less than 4 oz yet store as much as 40 Mbytes.

The emergence of portable computers as the fastest-growing segment of the industry provides plenty of motivation for producing smaller peripherals. Customers for portable systems now demand the same levels of capacity, performance, and reliability for portables as they do for their desktop systems. Furthermore, customers have demanded more-compact desktop systems, and slimline desktop-computer design benefits from small drives.

New applications for storage devices also demand smaller peripherals. For example, expect to see on-board navigation systems for automobiles that require one or more types of mass storage, most likely hard-disk drives. And the 2½-in. and smaller disk

drives will serve print-spooling and font-storage applications inside laser printers as well. The move to smaller drives makes way for new "stars" in the industry and can breathe second life into some struggling companies while leaving others gasping for air.

Floppy stands ½-in. high

You need not look far to find smaller peripherals. Teac America (Montebello, CA) now offers 3½-in. floppy-disk drives in a 0.5-in.-high package. The company expects to charge about a 15% premium for the low-profile drives compared with its 1-in.-high standard product line. The drives target notebook-computer applications, where system manufacturers are striving to design systems as thin as possible.

However, don't expect to see a move to floppy media smaller than 3½ in. The industry is already struggling with the



Weighing in at only 3.35 oz, the Mustang 1820 disk drive from Integral Peripherals stores 20 Mbytes in a 1.8-in. form factor.

Get on board NEC's 3-MIPS V53

On-board peripherals, that is

Our V53 microprocessor has some very important passengers, right on the chip. Like a 71071- and 8237-compatible 4-channel DMA controller that delivers eight megabytes per second data throughput. And three 8254-compatible timer/counters, a 16-bit refresh counter, an 8259-compatible interrupt controller, and 8251-compatible serial I/O port. All on-board, and all software compatible with industry standard devices.

Wicked fast

But if you think the weight of all this on-board cargo slows anything down, think again. Our 16 MHz microprocessor screams along at a minimum instruction execution speed of 125 nanoseconds and can

address up to 16 megabytes of memory. And on-board hardware allows memory implementation of a LIM 4.0 specification. Of course, the V53 is instruction-set-compatible with the entire V-series family of microprocessors and can serve as your embedded DOS engine. Don't settle for less than *both* thrilling speed and on-chip peripherals.

Smooth ride

And since you want a ride that's smooth as well as a fast, we offer you the development tools you need. And whether you choose the 132-pin PGA or 120-pin QFP, you'll save time, money and board space when

you specify NEC's V53 16-bit microprocessor, with on-board peripherals.

Free Data Book

For your free copy of NEC's 16-bit V-Series Microprocessor Data Book, call 1-800-632-3531. Ask for Info Pack #100.

NEC Electronics Inc.
401 Ellis St.
P.O. Box 7241
Mountain View, CA 94039-7241
1-800-632-3531/1-415-965-6158

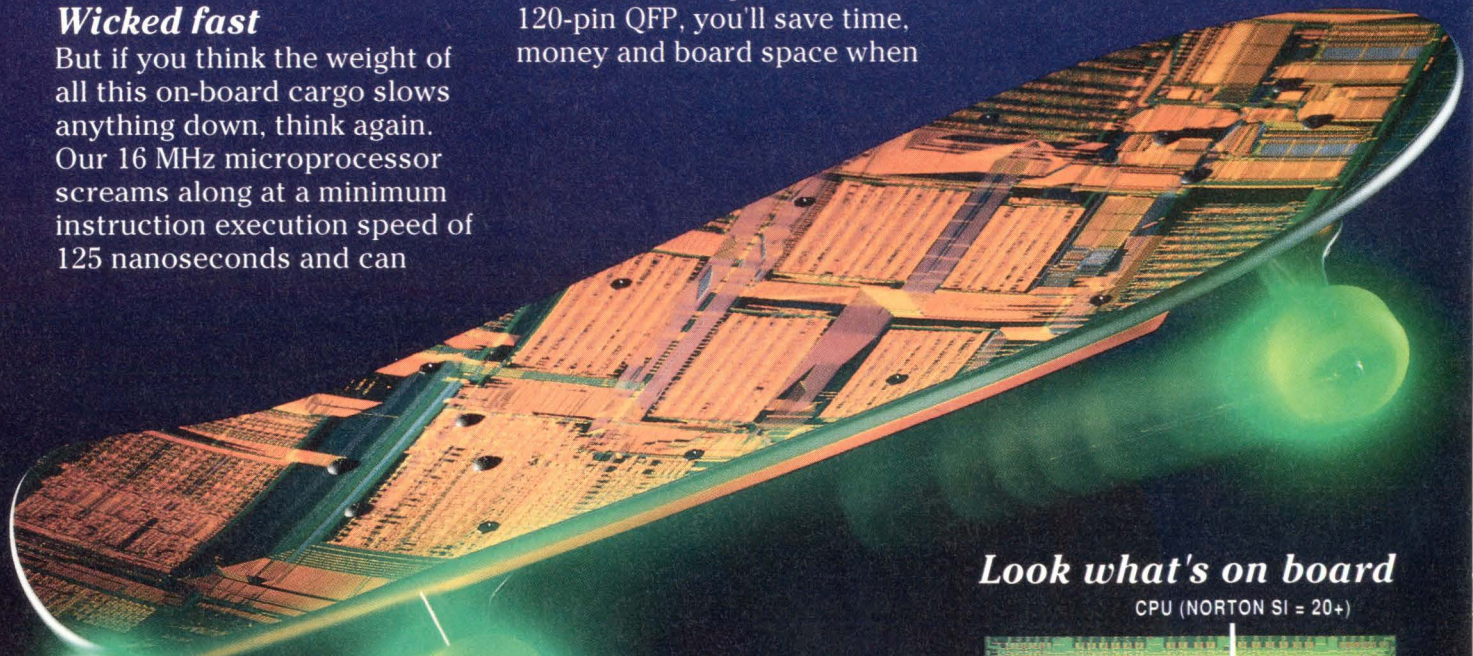

Look what's on board

CPU (NORTON SI = 20+)

4-CHANNEL
DMA CONTROLLER
PROGRAMMABLE
CHIP SELECT
BUS INTERFACE
BUS ARBITRATION
INTERRUPT CONTROLLER
REFRESH
TIMER COUNTER
WAIT CONTROLLER

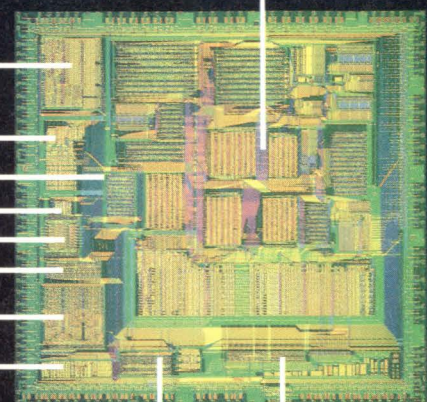

SERIAL I/O CLOCK GENERATOR

Free Data Book
Call 1-800-632-3531
FAX 1-800-729-9288

NEC

COMDEX TRENDS

Mass-storage devices

multiple sizes and formats of available floppy drives. System designers that can't live with the 3½-in. floppy will have to do without or use IC-based memory cards for removable storage.

The trend to smaller drives may even mean another chance for optical-drive manufacturers to establish their peripherals in mainstream computing applications. Several factors have hampered the growth of optical drives. The drives don't offer the performance of Winchester drives for primary-storage applications. The drives and media have been 2 to 10 times too expensive for use on the average system. You can partially attribute the high prices of optical drives to the "chicken and the egg" syndrome. Customers won't buy the product until prices drop, and manufacturers can't lower prices until sales volume increases.

Optical products simply come in too many variations of types and sizes. You have to choose between rewritable drives using numerous technologies, WORM (write once, read many) drives, and CD-ROMs. Furthermore, the drives come in

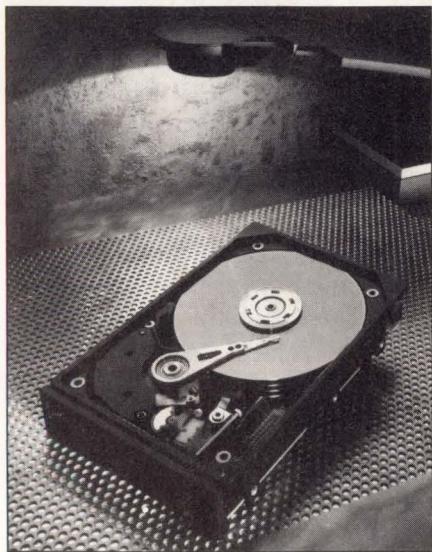

New 3½-in. form factor, 1-in.-high disk drives from Seagate Technology offer capacities ranging from 245 to 525 Mbytes.

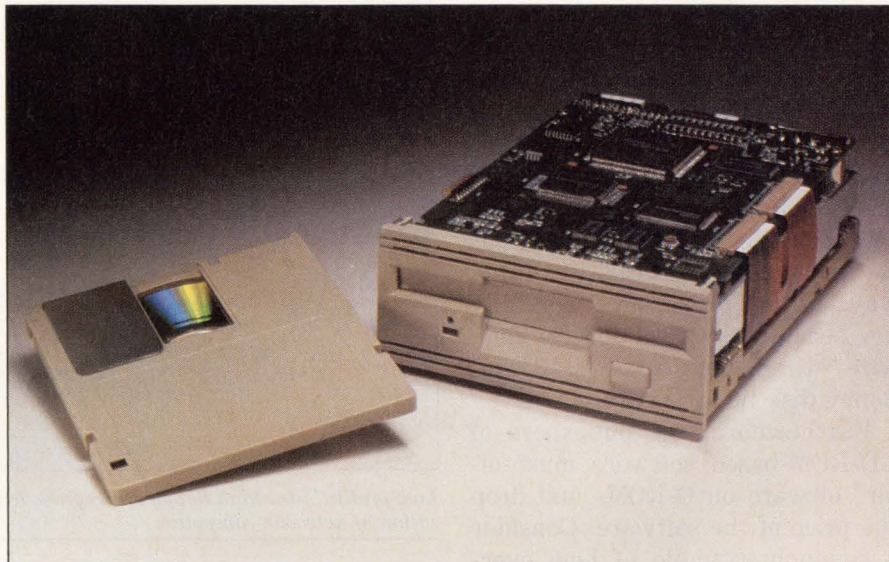

Compatibility with MO and O-ROM media allows the OD-3000 3½-in. optical drive from Teac America to serve applications ranging from desktop publishing to software distribution.

form factors ranging from 3½ to 14 in. and comply with a number of different standards for recording formats. Simply put, most of the available optical drives fill niche roles and have high prices associated with niche products.

Last year, 5¼-in. multifunction drives emerged that could work with different types of optical media—for example, drives that can read CD-ROMs and read/write on rewritable media. But manufacturers offer too many different types of drives in the 5¼-in. form factor for a multifunction drive to cover all of the bases.

Small drives focus market

Recently, a number of manufacturers have introduced multifunction drives that use 3½-in. media. The drives use MO (magneto-optical) rewritable technology and store 128 Mbytes on a hard-cased disk that looks similar to a 3½-in. floppy disk. The drives can also read 122-Mbyte O-ROM (optical ROM) disks that perform a function similar to CD-ROMs. Software publishers can produce O-ROM disks cheaply using a stamping process—just like CD-

ROM disks. But the O-ROM disks offer an order of magnitude faster seek times than CD-ROMs. The drives can also work with partial-ROM media that combines MO rewritable and O-ROM technology on a single disk.

Late last year, Most Inc (Cypress, CA) introduced the first of these drives, but its entry required a 5¼-in. mounting slot. Over the last three months, Teac America Inc (Montebello, CA), Sony Corp (San Jose, CA), and IBM (Armonk, NY) have introduced drives that fit in the 3½-in. form factor. You can expect to see several more drives introduced this fall.

The drives all include SCSI-2 (Small Computer System Interface) controllers. Performance specs on the products differ. However, the drives typically feature average seek times in the 40- to 50-msec range, and read-channel data rates of about 0.5 Mbytes/sec—about the performance of a Winchester five years ago.

Currently, the price of the 3½-in. optical drives remains well above \$1000 for the end user, and MO disks cost \$60. Tetsuo Oikawa, man-

COMDEX TRENDS

Mass-storage devices

ager of Teac's data-storage division, believes that the drives might drop to \$500 and the media to \$25 in 18 months.

Several variables will determine if vendors of 3½-in. products will make 1992 or 1993 "the year of optical." Prices certainly must drop for the technology to succeed in a big way. Media prices are especially key because users will forever compare MO media to the \$1 3½-in. floppy disk lying next to it.

Furthermore, the publishers of CD-ROM-based software must offer software on O-ROMs and drop the price of the software. Consider a common example of how overpriced CD-ROM software can be. You can buy a copy of the *Oxford English Dictionary* for less than \$500 at your local bookstore. CD-ROM publishers charge upwards of \$1000 for the dictionary even though it cost less to manufacture the CD-ROM version. The cost of audio compact discs—less than \$20—gives a good indication of manufacturing cost.

Manufacturers of 3½-in. optical drives have one key advantage that vendors of most new removable storage media don't. Older optical technology has been such an underwhelming success that most customers won't be concerned with moving to a new type of media. Relative to the potential market for 3½-in. optical drives, few users rely on an optical disk drive today.

Tape-drive vendors and customers face the exact opposite situation. For years, tape drives that

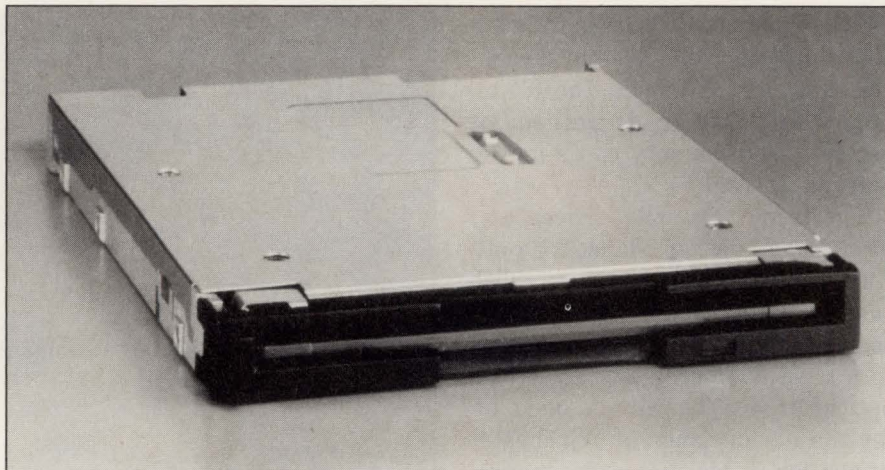

Low-profile 1/2-in.-high floppy drives from Teac will play a key role in the further miniaturization of notebook computers.

use the DC-600-style QIC (quarter-inch cartridge) have been the backup devices of choice for systems ranging from high-end PCs to low-end mainframes. But drives that use the DC-600-size cartridge will never fit the 3½-in. form factor. Furthermore, helical-scan drives based on 8-mm video-tape cartridges or 4-mm DAT (digital audio-tape) cartridges exceed the raw capacity QIC drives offer.

System designers and customers alike prefer to buy removable-storage drives that, at a minimum, can read the media produced by the previous year's drives. The customers always want smaller computers and therefore smaller peripherals—especially when the size reduction won't mean decreased capacity. But a move to smaller products often means new, smaller removable media and no compatibility with older products.

Designers that can still use 5¼-in. peripherals have several recently unveiled choices. Archive Technology Inc (Costa Mesa, CA) now offers the Anaconda 2800 family of half-height products that stores 2.1 Gbytes—with no data compression—on a DC-600-size cartridge. The company plans to offer data compression based on compression ICs from Stac Corp (Carlsbad, CA). Typically, data compression doubles tape-drive capacity.

Expect several other QIC vendors to announce drives late this year or early next year. Expect widespread availability next year and a OEM price less than \$1000.

Exabyte Corp (Boulder, CO) has finally added a half-height product to its 8200 family of 5¼-in. 8-mm-tape drives. The 8205 features 2.5 Gbytes of raw capacity and includes data compression as a standard feature. The company developed its

Acronyms used in this article

CD-ROM—Compact-disc read-only memory

DAT—Digital audio tape

EPROM—Electrically programmable read-only memory

HDA—Heads and disks assembly

IDE—Integrated drive electronics

LCD—Liquid crystal display

MO—Magneto optical

OEM—Original equipment manufacturer

O-ROM—Optical read-only memory

QIC—Quarter-inch cartridge

SCSI—Small Computer System Interface

VGA—Video graphics array

WORM—Write once, read many

True portables are totally off the wall.

No outlets. No rechargers. No reliance on AC whatsoever. That's true portability. It's what the world is coming to. And it runs on easy-to-replace primary batteries. The next generation promises even smaller, lighter weight, more convenient portables. That depends on you, and you can depend on us.

Duracell is the primary source for primary power. We offer you a world of technical expertise and marketing experience in developing powerful solutions for computers, cellular phones and more. Let us help you

select a primary battery system from our broad line that includes alkaline and high power lithium manganese dioxide batteries.

Call us for application-specific data, design-in assistance, or just more information. Our OEM hotline number is (800) 544-5454, Ext. 3281. Or fax us at (203) 791-3273.

True portability is the cutting edge. And it's in your power.

DURACELL®
PORTABILITY IS PRIMARY

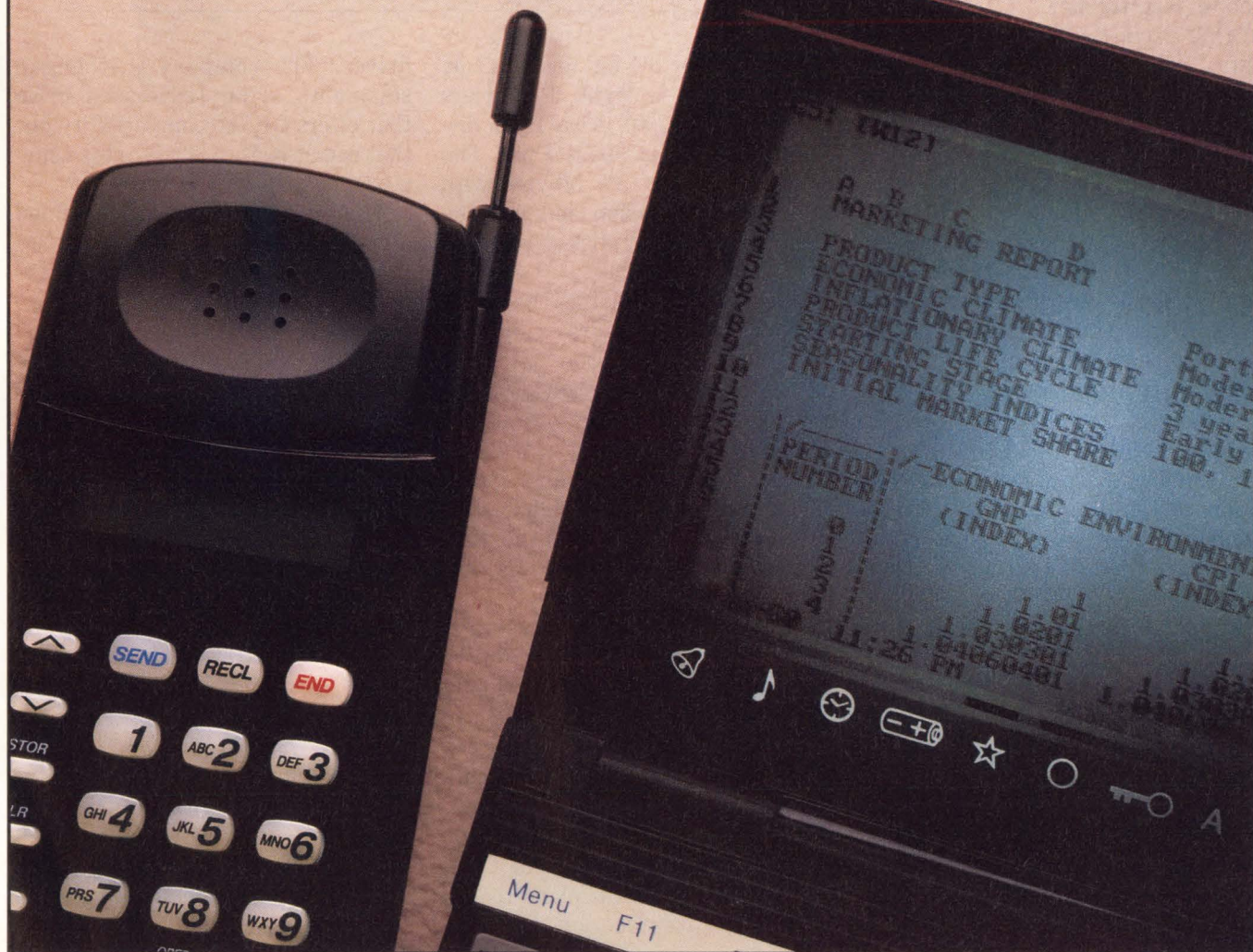

COMDEX TRENDS

Mass-storage devices

own compression IC based on the IDRC (improved-data-recording-capability) algorithm licensed from IBM. Drive samples will be available in the first quarter of 1992 and will cost less than \$2000 in OEM quantities. The company has also added data compression to its 8500 family of products. These drives feature a raw capacity of 5 Gbytes, but they require a full-height mounting slot. Exabyte believes, however, that it can migrate its tape technology to the 3½-in. size in the next two to three years.

An increasing number of system vendors will change to the 3½-in. form factor this year, however. Already, DAT drives and QIC DC-2000-style minicartridge drives currently dominate the small-form-factor tape market.

DAT products that store 2 Gbytes with no compression have been available in the smaller size for a year now. Companies that offer such products include Ardat Inc (Costa Mesa, CA), Hewlett-Packard CO (Cupertino, CA), R-Byte Inc (San Jose, CA), Sony Corp, WangDAT Inc (Irvine, CA), and Wangtek Inc (Simi Valley, CA). DAT drives should be the fastest growing segment of the tape industry over the next year.

Loader handles DAT cartridge

Cartridge loader mechanisms will soon be dominating DAT news. WangDAT, for example, has demonstrated a loader that holds a DAT drive and four DAT cartridges, yet fits in the standard 5¼-in. full-height form factor. Expect similar products from the other drive manufacturers. And look for DAT drives with 5-Gbyte raw capacity by the Fall of 1992.

Meanwhile, minicartridge drives have become the tape drive of choice in single-user PCs, although less than 10% of such PCs include tape drives. The minicartridge



The 85-Mbyte capacity of Quantum's 2½-in. Go-Drive allows users to equip their portable with the storage of a typical desktop.

drives fit the 3½-in. form factor, and the price is right. End users can buy a QIC-80 drive from discount houses for about \$300. The drives can store 120 Mbytes with no data compression and use the computer's floppy-disk-drive controller as an interface.

The QIC committee that sets standards for such drives has defined two new upgrade paths for minicartridge drives. QIC-385 defines a drive that uses a choice of the floppy interface or the IDE (integrated-drive-electronics) interface now popular on hard drives for PCs. Drives that meet the new standard will store 385 Mbytes with no data compression.

Expect Colorado Memory Systems (Loveland, CO) and Ardat to offer QIC-385 drives with floppy interfaces. Ed Harper, president of Colorado Memory Systems, believes the company will ship such a product in the first half of 1992. Summit Memory Systems Inc (Scotts Valley, CA), the old OEM division of Mountain, plans to use the IDE interface on QIC-385

drives. The company just began shipments of an IDE-based drive that offers QIC-80 compatibility but that can also store 305 Mbytes using a proprietary format.

The QIC committee also defined a QIC-410 class of drives that uses the SCSI interface and stores 410 Mbytes. QIC-410 drives use more expensive heads than do QIC-385 products and therefore won't be price competitive. But the QIC-410 products will transfer data faster and feature a more-sophisticated error-correction scheme. Expect the QIC-410 drives to find applications in file servers and workstations that already include SCSI.

Teac America appears to be the leading advocate of QIC-410. The company has a 155-Mbyte drive, the MT-01, available now with a SCSI interface. Teac has proposed that the QIC committee adopt the format used in the MT-01 as downward-compatible with the QIC-410. Teac also plans to build QIC-410 drives. The MT-01 offers yet another feature—the 3½-in. drive stands only 1-in. high. The drive is

Absolutely watertight

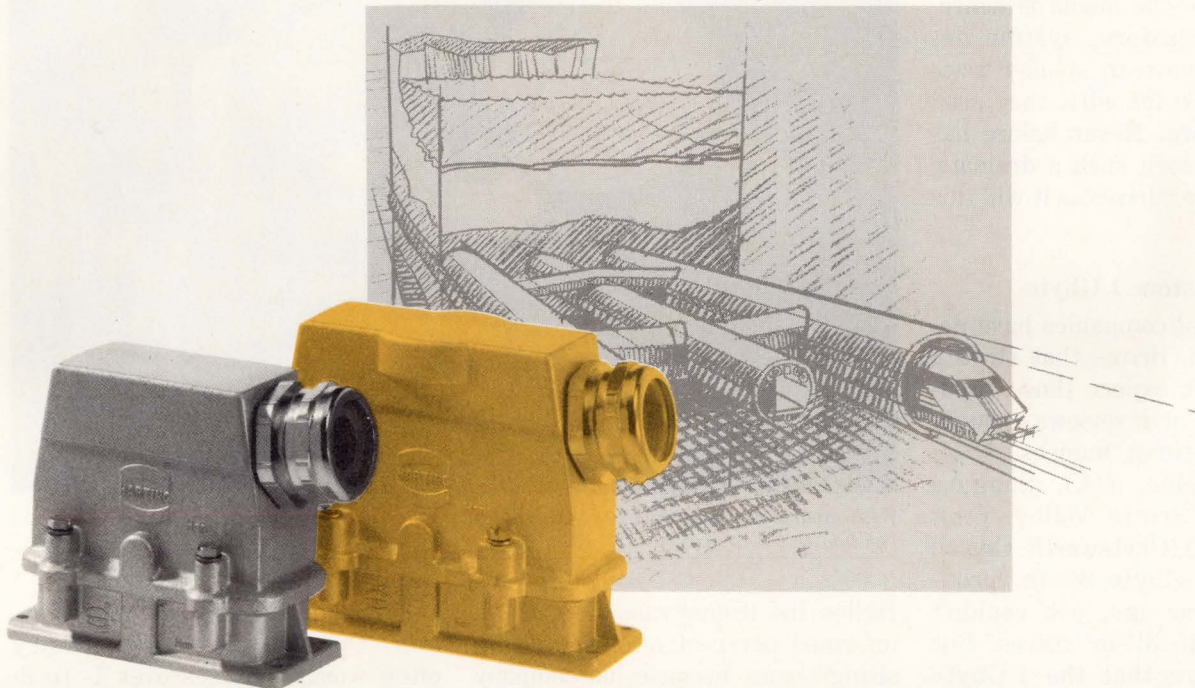

The reputation of all HARTING products is based on maximum quality and reliability – for example, in energy control rooms, washing installations, rail and road vehicles or in the food industry. Wherever the highest standards are required in terms of watertightness and resistance to corrosion in wet areas, including under-water situations, it is the Han®HP hoods and housings from HARTING which prove how superior they really are. They are extremely robust and absolutely watertight, even under very high pressure (checked by Hanover Technical Control Board).

Depending on requirements, the connectors offer the user a wide range of numbers of contacts for various voltages and currents.

Han® HP hoods and housings from HARTING – technological perfection to meet the highest requirements.

Connectors from HARTING – the quality connection



COMDEX TRENDS

Mass-storage devices

the first tape product to match the low-profile size that is increasingly popular in disk drives.

Manufacturers of Winchester disk drives have a huge advantage compared with the other types of mass storage—the media is nonremovable. Therefore, system designers can move to smaller sizes with no regard for what they used the year before. Never before has the industry seen such a dramatic move to smaller drives as it will this year.

Small drives store 1 Gbyte

A number of companies have developed 5¼-in. drives that store 2 Gbytes. Don't expect those products to draw rave reviews though. In the past three months, IBM, Toshiba (Irvine, CA), Seagate Technology (Scotts Valley, CA), and Micropolis (Chatsworth, CA) all introduced 1-Gbyte 3½-in. products. One year ago, you couldn't buy 400-Mbyte 3½-in. drives. But indications are that the 1-Gbyte units will be available in volume just after the first of the year.

Seagate followed with announcements of 1-in.-high 3½-in. drives in unprecedented capacities. The company now offers the ST3283 (245 Mbytes), the ST3500 (426 Mbytes), and the ST3600 (525 Mbytes) in the low-profile package. Prices range from \$700 to \$1795 for evaluation drives available now. Expect production quantities to be available around the end of the year. You can expect to see competing products from Quantum Corp (Milpitas, CA), Conner Peripherals (San Jose, CA), and Western Digital (Irvine, CA).

Except in mainframe and some server applications, 3½-in. drives have replaced 5¼-in. units as the drive of choice. The question remains whether 3½-in. drives will be relegated to a niche as capacity ramps up in 2½-in. drives.

Richard Freedland, president of



With models ranging from 20 to 85 Mbytes, Conner Peripherals holds a dominant market position in 2½-in. drives.

Helios Inc (Sunnyvale, CA), has a informed perspective on the downsizing issues because his company builds servo writers for disk-drive manufacturers. Freedland reports that the moves from 14- to 8- to 5¼- to 3½-in. form factors provided drive designers with as many advantages as it did new challenges. For example, smaller platters meant less mass and therefore simpler, lower-power motors.

Freedland believes two key areas will make it tough for 2½-in. drives to achieve the reliability and price-per-Mbyte levels that 3½-in. drives offer. Freedland points out that the castings used as the HDA (heads-and-disks-assembly) enclosure on 2½-in. drives will be less structurally sound. In fact, companies are using more plastics to lower HDA weight. Furthermore, Freedland believes that imperfections in ball bearings result in bearing runout specs that are a significant percentage of the innermost track diameter in 2½-in. and smaller drives.

Freedland readily admits, however, that the disk-drive industry often works miracles over 1- to 2-year periods, and that anything is possible. The 3½-in. size does seem to suit system vendors for desktop applications however. Maurice Webb, global commodity manager at Sun Microsystems (Mountain View, CA), reports that Sun's primary interest is lower prices for 3½-in. and smaller drives, not smaller size. Webb points out that each succeeding smaller form factor has produced lower cost drives in the same capacities than did the preceding larger form factor.

Leading 2½-in. drive vendor Conner Peripherals simply claims it will supply the drives the customer demands. The company also has a strong presence in 3½-in. drives. Other companies that seek to build market share in the 2½-in. arena include Areal Technology Inc (San Jose, CA), JVC (Huntington Beach, CA), Quantum, Seagate, Toshiba, and Western Digital. All of the com-

EPSON® IC MEMORY CARDS

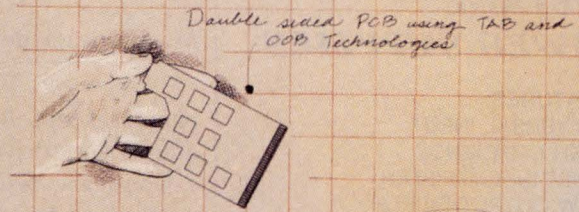

SRAM - replaceable battery

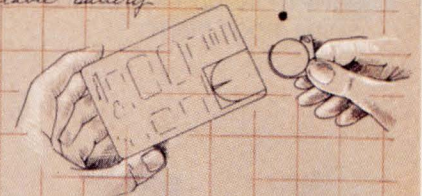

90 Pin and Socket (JEIDA)

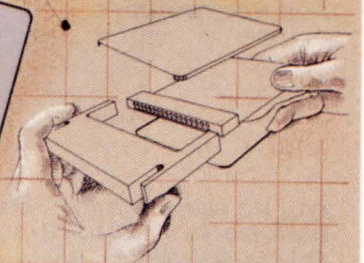

Card Edge - Protective shutter mechanism

JEIDA/PCMCIA

Storage and Software

SRAM	64kB to 2M
OTP EPROM	64kB to 2M
Flash EEPROM	64kB to 1M
Mask ROM	256kB to 8M
EEPROM	16kB to 32kB



CARD EDGE

SRAM	8kB to 1M
OTP EPROM	32kB to 1M
Flash EEPROM	128kB to 1M
Mask ROM	128kB to 4M
EEPROM	8kB to 32kB

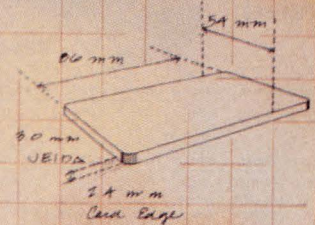

Musical Sound Cards

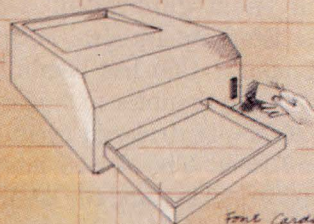
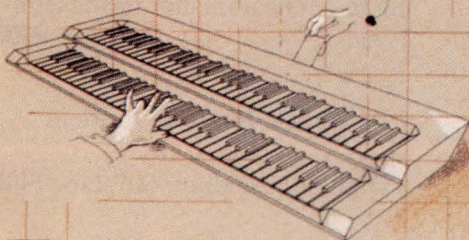

Font Cards



Programs and memory

EPSON® EPSON AMERICA, INC.
Component Sales Department Telephone: 213/787-6300

EPSON Sales Representatives: AL-GA-TN-NC Concord Components 205/772-8883 AZ-NM Fred Board Assoc. 602/994-9388 CA-No. Costar 408/446-9339
CA-So. Bager Electronics 714/957-3367 CO-UT Wn. Region Mktg. 303/428-8088 FL Dyrne-A-Mark 305/771-6501 IL-WI LTD Technologies 708/773-2900
IN-KY C C Electro 317/921-5000 KS-MO-IA Microtronics 913/262-1444 MA-NH-CT Rosen Assoc. 617/449-4700 MD-VA Tech Sales Assoc. 301/461-7802
MN Electro Mark 612/944-5850 NJ JMP Sales 201/525-8000 NY Elcom Sales 716/385-1400 METRO-NY Niktranix 516/929-4671 OH-MI J.D. Babb Assoc. 216/934-4454 OR-WA Matrex 503/245-8080 PA Omega Sales 215/244-4000 TX-OK Component Tech. 214/783-8831

Call your sales rep today.

See you at COMDEX Booth 1328



UNIVERSAL VOLTAGE POWER SUPPLIES

FEATURES:

- UNIVERSAL INPUT
- HIGH EFFICIENCY
- BUILT-IN EMI FILTER
- LOW OUTPUT RIPPLE
- OVER VOLTAGE AND SHORT CIRCUIT PROTECTION
- SMALL FOOT PRINT

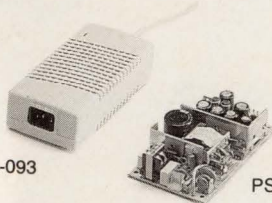

PSA-093

PSA-4031

FOR NOTEBOOK PC

WATTS	MODEL	O/P1	O/P2	O/P3	O/P4	DIMENSION
30W	PSA-093	9.5V/3A				149×75×45H
	PSA-161	16.5V/1.8A				
	PSA-181	18V/1.65A				
(7 MODELS)						
40W	PSA-4641	18V/1.4A	CHARGER 1A			166×80×45
(3 MODELS)						
50W	PSA-124	12V/4.2				166×80×54
	PSA-242	24V/2.2A				
(7 MODELS)						

FOR PC, HARD DISK & FLOPPY DISK DRIVES, INDUSTRIAL, TELECOMMUNICATION

WATTS	MODEL	O/P1	O/P2	O/P3	O/P4	DIMENSION
40W	PSA-4031	5V/6A	12V/2A	-12V/0.5A		127×76×30
	PSA-4005	5V/6A				
(8 MODELS)						
50W	PSA-5031	5V/5A	12V/2.5A	-12V/0.5A		160×100×45
(3 MODELS)						

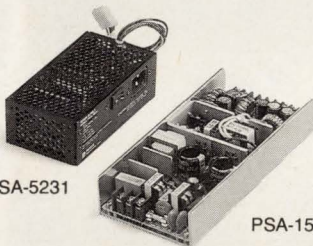

PSA-5231

PSA-1500U

WATTS	MODEL	O/P1	O/P2	O/P3	O/P4	DIMENSION
50W	PSA-5231	5V/4A	12V/2A	-12V/0.5A		144×80×48

WATTS	MODEL	O/P1	O/P2	O/P3	O/P4	DIMENSION
150W	PSA-1500U	5V/15A	-5V/1A	12V/1A	12V/5A	198×97×38
	PSA-1503U	5V/30A				
	PSA-1509U	5V/15A	-5V/1A	-12V/1A	12V/5A	
(10 MODELS)						
200W	PSA-2041U	5V/25A	-5V/2.5A	-12V/2.5A	12V/5A	203×114×51
(3 MODELS)						

SAFETY:

- * ALL APPROVED BY UL/CSA/TUV (PSA-2041 IS IN PROCESS)
- * PSA-40XX AND PSA-50XX APPROVED BY UL/CSA/TUV/VDE



PHIHONG ENTERPRISE CO., LTD.

TAIWAN:

16, LANE 530, CHUNG CHENG NORTH ROAD,
SAN CHUNG CITY TAIPEI, TAIWAN, R.O.C.
FAX: 886-2-9817086 & 886-2-9833222
TEL: 886-2-9882126 & 886-2-9805255

EUROPE:

HN ELEKTRONIK
POSTFACH 1113 D-6456
LANGENSELBOLD W. GERMANY
TEL: 06184-2872 FAX: 06184-62316

CIRCLE NO. 88

COMDEX TRENDS

Mass-storage devices

panies except Areal and JVC also offer 3½-in. drives.

Conner's 85-Mbyte drives currently lead the pack in terms of capacity. Areal, however, just announced a 120-Mbyte drive. You can also expect Maxtor (San Jose, CA) to introduce a 2½-in. drive with leading-edge capacity shortly.

In all likelihood, not all of the companies with 2½-in. drives will succeed unless the small drives can compete with 3½-in. drives' prices and reliability. Thus far, the vendors shipping drives find eager customers because of the demand for notebook computers. Furthermore, the price of notebook systems allows drive vendors to make a nice profit margin on the drives. Once enough vendors ramp-up production, selling drives will become more of a challenge.

One 2½-in. drive specialist has already fallen. Prairietek (Longmont, CO) was the first to announce and ship drives. In fact, the company had the market for 20-Mbyte 2½-in. drives to itself for a year. But problems with higher-capacity versions and price pressures recently lead the company to file for bankruptcy with the intention of dissolving.

Drives hit 1.8-in.

Just as 2½-in. drives celebrate a second birthday, you can buy one of the next-generation 1.8-in. drives. Start-up Integral Peripherals (Boulder, CO) has begun shipping 20-Mbyte units and plans to have 40-Mbyte drives in production by mid-1992. The drives measure 2×3.03×0.59 in., and the 20-Mbyte 1820 weighs 3.35 oz. You also get state-of-the-art performance with the drives—a less than 20-msec average seek time and a 32-kbyte buffer.

Steven Volk, president of Integral, believes that the drives will be a key enabling technology for a

new class of small computers called subnotebooks. Volk believes you will see 80386-based subnotebooks introduced shortly that use the 1.8-in. drives, include a full keyboard and a VGA LCD display, and weigh 2 to 3 lbs. Volk also believes the drives can be used in palmtop and pen-based systems. The 1820 drive requires 3.5W of power to spin up, only 2W during read/write operations, and only 0.015W in sleep mode. Therefore, you could power the drive with disposable batteries.

Some prognosticators have mentioned flash EPROM or battery-backed RAM as competition for the 1.8-in. drives. Volk points out that the disk drive will have a substantial cost advantage. He believes that Integral's disk drives will sell for \$10 to \$11 per Mbyte by next summer. But he sees flash EPROM costing at least \$45 per Mbyte in the same time frame. Finally, Volk believes that Integral will ship a 100-Mbyte 2½-in. drive within two to three years.

Integral will have company in the market shortly. Another startup, Ministor (San Jose, CA), has a drive ready for introduction. Also, industry stalwarts such as Conner, IBM, Quantum, and Western Digital all belong to an industry organization that set the size and mounting-hole standards for the 1.8-in. drives. And yes, the organization is looking to define a smaller form factor—1¼-in. **EDN**

Article Interest Quotient (Circle One)

High 506 Medium 507 Low 508

Searching... For A R3000 VME Hardware/Software Solution?

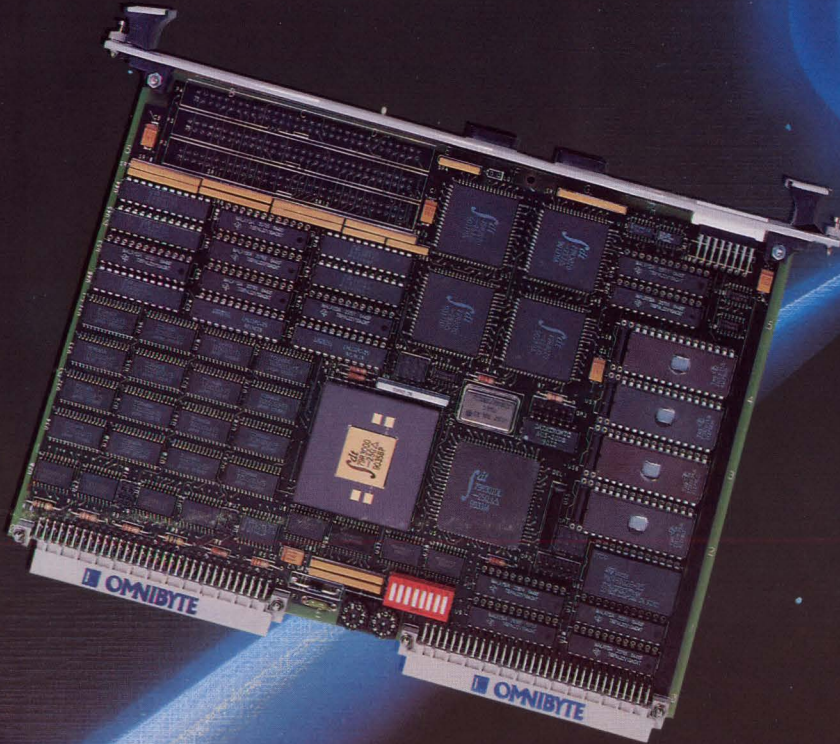

Omnibyte has the most complete line of MIPS R3000 VME hardware, software and systems for your project. In fact you may select from 72 distinct VME configurations.

You can get the fast and powerful Pulsar 3000tm, shown above, featuring:

- 25MHz R3000A RISC CPU
- 25MHz R3010A Floating-Point Coprocessor (opt.)
- (4) R3020 Write Buffers
- 128KB (or 32KB) I-cache
- 128KB (or 32KB) D-cache
- 32, 16, 8 or 4MB DRAM
- High speed SCSI port (opt.)
- Ethernet interface (opt.)
- (4) serial ports
- (4) ROM sockets (up to 4MB)
- Real time calendar clock w/battery

- 2KB NV RAM
- VIC068 VME Interface (slot 1) Controller

And the Pulsar is available with the following software:

Title	Type
SPP/e ¹	PROM monitor debugger & I/O library
SPP ¹	SPP/e with architecture & cache simulator
IDT/c ²	IBM/SUN X-compiler
C EXECUTIVE ³	Real time monitor
ADA ⁴	ADA compiler
VxWorks ⁵	Real time o.s.
RISC/os ¹	UNIX ⁶

In addition to our boards and software, we can also provide you with a complete line of MIPS development systems.

For further information, give Larry Snow a call today at **800-638-5022**, (708-231-6880 in IL).



OMNIBYTE CORPORATION
245 W. Roosevelt Rd.
West Chicago IL 60185

Trademarks: 1-MIPS Computer Systems Inc. (available in binary or source), 2-Integrated Device Technology, Inc., 3-JMI Software Consultants Inc., 4-DOD, 5-Wind River Systems (available for MIPS and DEC workstations), 6-AT&T

NEW! R3000 VME Hardware, Software and Systems. Look to OMNIBYTE for the complete line!

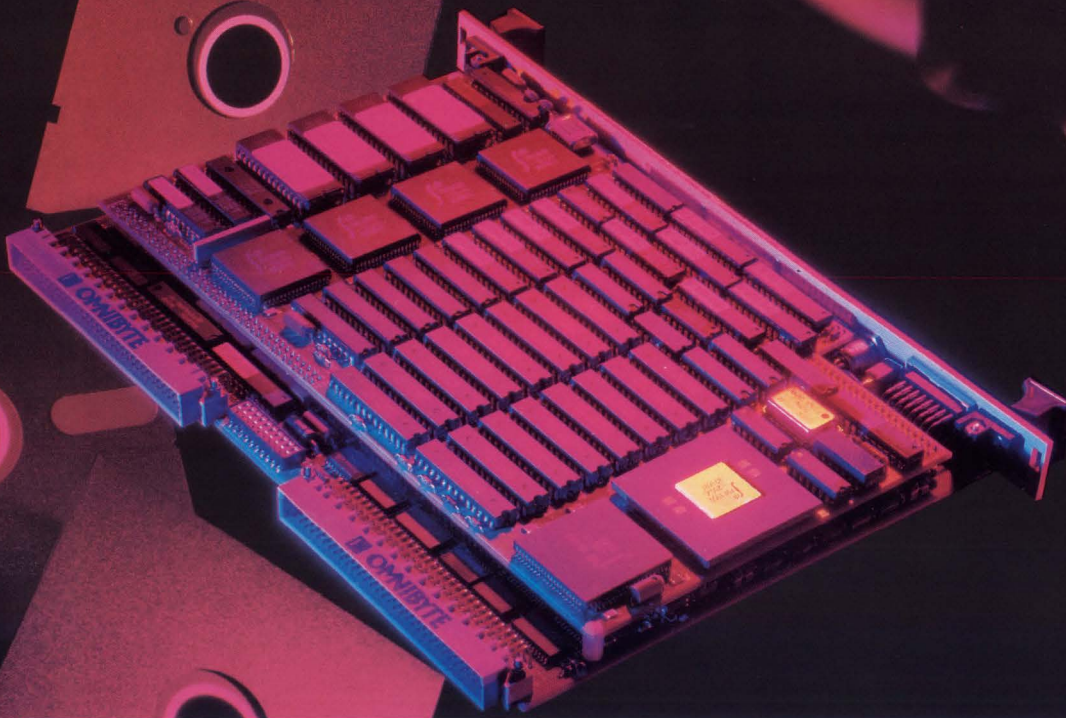

Omnibyte supports your total effort with a complete line of MIPS R3000 VME hardware, software and systems. With Omnibyte, you will get the most appropriate VME board for your application. That's because VME is our business and we have 72 distinct configurations to meet your needs. You can obtain the software and software support directly from us. And you can get full R3000 systems to help you develop your application.

Just look at the features on our high speed OB/ACP-VR3000tm shown above:

- 25MHz R3000A RISC CPU
- 25MHz 3010A Floating-Point Coprocessor (opt.)
- (4) R3020 Write Buffers
- 128KB (or 32KB) of I-cache

- 128KB (or 32KB) of D-cache
- 32, 16, 8 or 4MB of DRAM
- (1) RS232C serial port
- (4) ROM sockets (256KB max.)

And you can get the following software with the VR3000:

Title	Type
SPP/e ¹	PROM monitor & debugger
SPP ¹	SPP/e plus architecture & cache simulator
IDT/c ²	IBM/SUN X-compiler
C EXECUTIVE ³	Real time monitor
ADA ⁴	ADA compiler
VxWorks ⁵	Real Time o.s.
RISC/os ¹	UNIX ⁶

You also have this same selection of software for our PULSAR 3000tm which is shown on the opposite side of this page.

For more information on our line of R3000 VME boards, software or systems, call Larry Snow today at **800-638-5022**, (708-231-6880 in IL)



OMNIBYTE CORPORATION
245 W. Roosevelt Rd.
West Chicago IL 60185

Trademarks: 1-MIPS Computer Systems Inc. (available in binary or source), 2-Integrated Device Technology, Inc., 3-JMI Software Consultants Inc., 4-DOD, 5-Wind River Systems (available for MIPS and DEC workstations), 6-AT&T

Announcing a night to recognize greatness

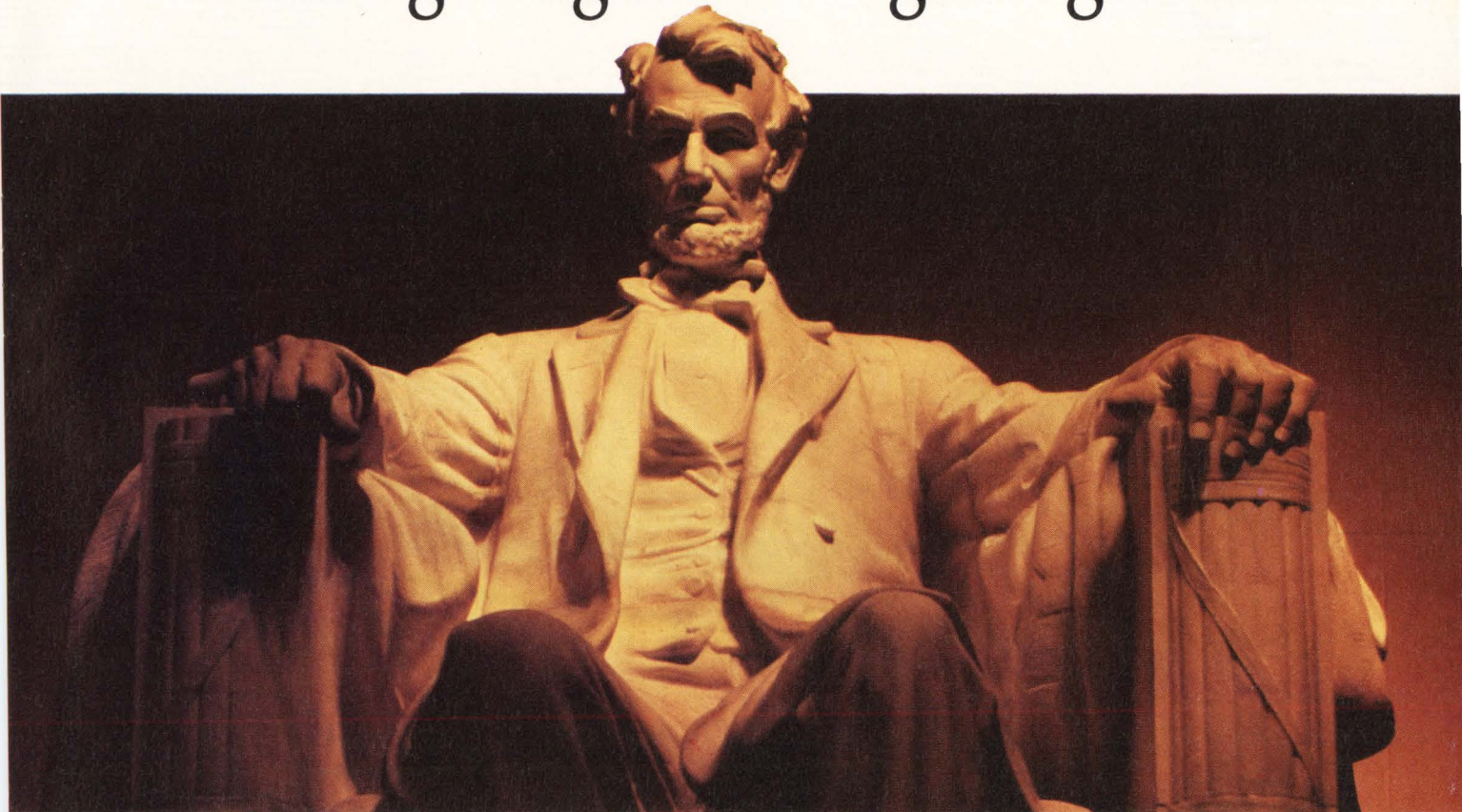

EDN's Innovation and Innovator of the Year Awards Ceremony

On the night of November 19 during Wescon, EDN will present the 1991 Innovation and Innovator of the Year awards at the Mark Hopkins Hotel in San Francisco. You are invited to show the finalists that you support greatness in innovation by attending the awards ceremony that is the culmination of their hard work. Through its Innovation Crusade, EDN hopes to inspire

engineering professionals within the electronics field to reach for higher plateaus of inspiration and creativity.

The dedication and involvement of EDN readers, like yourself, have made the Innovation Crusade and awards ceremony a reality. By taking the time to nominate your peers and, in

fact, select the winners, you show commitment to quality and creativity in electronics and are driving this crusade. But don't stop there ... order your ticket to the industry event of the year and show these innovators that greatness does not go unrecognized. All proceeds of the dinner will be donated to the EDN Scholarship Fund.

To receive a reservation order form to the EDN 1991 Innovation Dinner and Awards Ceremony, fax Pam Winch at (617) 558-4470.



EDN Magazine Edition News Edition.

To receive an Innovation Ceremony Reservation form, please circle no. 59



OUR GROWING 68HC11 FAMILY IS YIELDING A VARIETY OF HIGH PERFORMANCE SOLUTIONS.

You'll cover a lot of ground with Motorola's 68HC11 Family. With over 30 microcontrollers, this family is producing an abundance of cost/performance solutions. Starting at under \$3 in volume.

Our bumper crop features on-chip peripherals like fast math coprocessors, powerful timers, A/D, and virtually every memory option under the sun.

ENROUTE TO MARKET? OUR ONE-TIME PROGRAMMABLE MCUs TAKE YOU THERE IN NO TIME.

To help you get to market faster, we offer a full line of 68HC11 One-Time Programmable microcontrollers. These OTPs are ideal for prototyping or production when code changes for model variations are necessary.

Our 68HC11 Family is constantly growing to meet our customer specifications, and many new versions are currently in design.



Should your performance requirements continue to multiply, you can reap the benefits of the HC11's upward source code compatibility with our 16-bit architecture.

For demanding 8-bit applications, Motorola's 68HC11 microcontrollers provide economical, high-performance solutions. And a variety you can grow with.



For more information and a copy of Motorola's 68HC11 Roadmap, please complete the coupon below and send it to:

EDN10/10/91

Motorola, Inc.
P.O. Box 1466
Austin, Texas 78767

Name _____
Title _____
Company _____
Address _____
City _____
State _____
Zip _____
Phone _____

THE PATHWAY TO PERFORMANCE.



MOTOROLA

 and Motorola are registered trademarks of Motorola, Inc. © 1991 Motorola, Inc.

x86-compatible CPUs' supervisory layer lets you customize PC designs

One problem that plagues PC manufacturers is differentiating their computers based on something other than price. Although previously not a supplier of CPUs, Chips and Technologies has developed the x86-

compatible family of μ Ps. This family includes a hardware and software layer, operating between the CPU hardware and the system BIOS, which allows you to customize your PC designs. Called Superstate, this OEM-programmed layer

can intercept I/O and interrupts, perform power management functions, and arbitrate between two incompatible operating systems running on the same CPU.

Superstate is available embedded within the company's 8680,

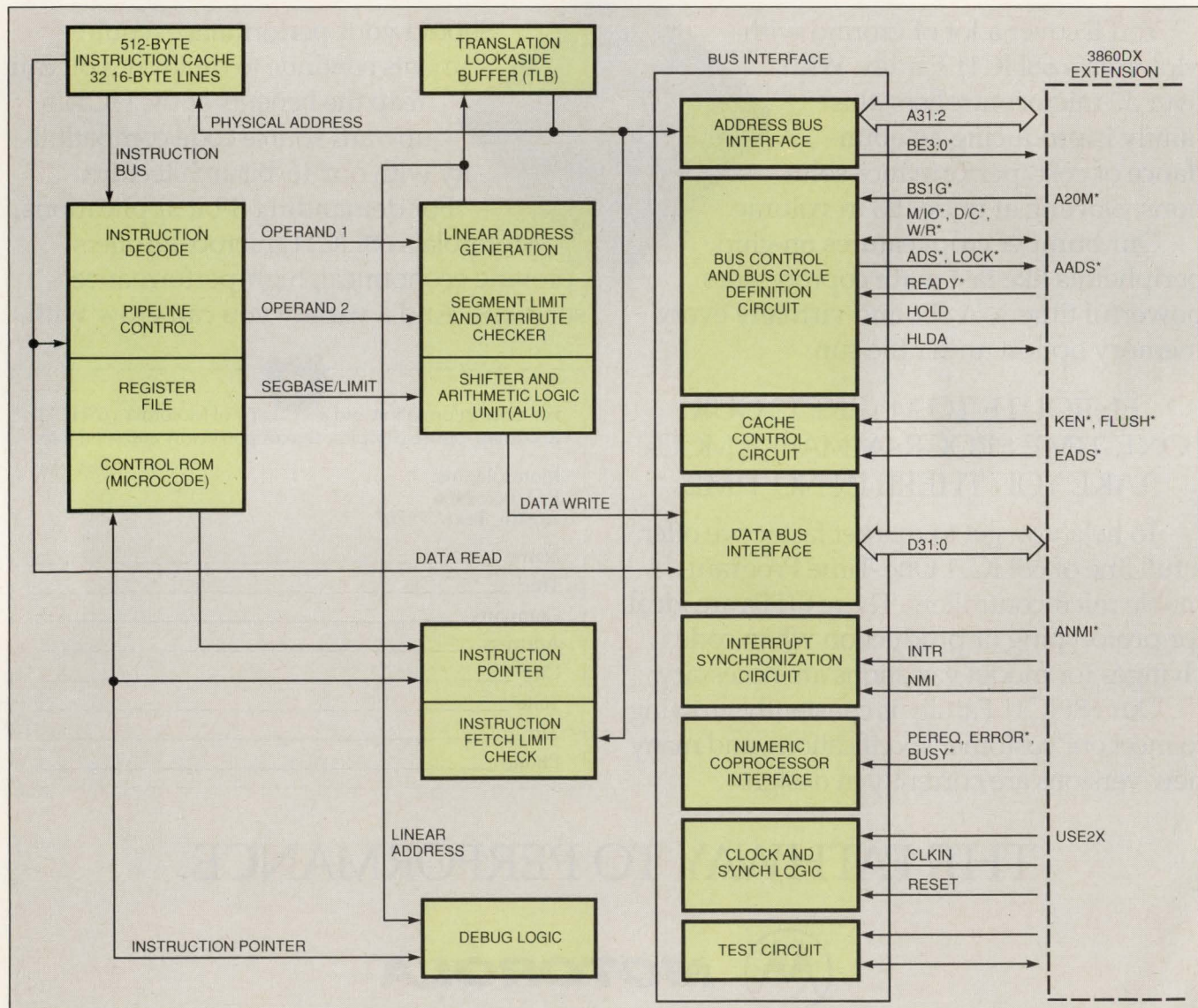

Acting as a layer between the system hardware and BIOS, Superstate can intercept interrupts and I/O calls.

38605SX, and 38605DX μ Ps. The \$35 (10,000) 8680 is source-code compatible to the Intel 8086 in a 160-pin plastic flatpack. The chip adds a CGA-compatible flat-panel and CRT controller, keyboard interface, direct IC-card interface, 16C450-compatible UART, PC-XT-system peripheral logic, and a serial port to the core CPU. This single-chip XT offers a 64-Mbyte memory map as a result of its 26-bit address. A 4-stage pipeline improves system throughput by reducing instruction latency.

In addition to the Superstate capability, the 132-pin 38605SX (\$110 (1000) for the 25-MHz device) and the 144-pin 38605DX (\$215 (1000) for the 40-MHz device) contain a 512-byte direct-mapped instruction cache as an enhancement to Intel's 80386SX and 80386DX. Adding these capabilities costs these devices pin compatibility with the existing μ Ps; the \$90 (1000) 38600SX and \$180 (1000) 38600DX retain pin-compatibility at the expense of Superstate and the internal cache. A 176-pin socket accommodates any of the four μ Ps, attaining maximum design flexibility and lowest inventory cost. Even though all implementations contain a 5-stage pipeline to improve performance, the I-cache on the 605 chip is better at keeping the pipe full.

Operating transparently to the user and the application, Superstate can monitor and trap hardware and software interrupts before TSRs (terminate-stay-resident) or interrupt handlers see the input. Trapped, Superstate's micro-coded software can cause register-

value substitution or interrupt-handler emulation. Such capability allows the system to translate data from incompatible peripherals or to operate with "virtual" peripherals.

You can also program the Superstate hardware—via control registers protected from application-generated I/O and memory instructions—to monitor system activity. Global monitoring allows the hardware and software layer to power-down peripheral devices if they aren't used by the system for a programmable amount of time. Furthermore, since the hardware shadows the port, Superstate can intercept operating-system monitoring routines and make the peripheral appear to be on.

Additional features within Superstate allow a trace-buffer capability that enables programmers to trace back breakpoint bugs. One function of this capability is to indicate when an instruction's execution has been completed—ensuring that marketing engineers can provide accurate instructions-per-cycle benchmark data.—**Michael C Markowitz**

Chips and Technologies Inc, 3050 Zanker Rd, San Jose, CA 95134. Phone (408) 434-0600. FAX (408) 943-9315.

Circle No. 697

Staying power.



Reliable solid-state power. When we designed our new 300-watt Model 300A100 rf amplifier, we knew it would answer the needs of many kinds of people.

People seeking a stable, economical way to drive an antenna to deliver at least 50 volts per meter for susceptibility testing. People who *must* trust an amplifier's ability to keep operating into a severe load mismatch—even shorted or open output terminals—without damage, oscillation, or fold-back. People who expect the full bandwidth—10 kHz to 100 MHz—to be there instantly for sweep testing, with no need for tuning or bandswitching. People who have to monitor both forward and reflected power. People who want automatic leveling. People who regularly perform both pulsed and cw procedures. People who demand remote-control interfacing.

The 300A100 is the latest all-solid-state member of a family of AR amplifiers covering a power range from one watt up to 10 kilowatts, and the rf range from 10 kHz up to 1 GHz. Their staying power is rated very conservatively—output stated as minimum, not nominal or peak. Chat with one of our applications engineers, who'll pick up the phone himself when you call, toll-free, 1-800-933-8181.

AR **AMPLIFIER RESEARCH**

160 School House Road
Souderton, PA 18964-9990 USA
215-723-8181 • Fax 215-723-5688

For engineering assistance and service throughout Europe, call

EMV GmbH • Munich • 89-612-8054
EMV Ltd. • London • 908-566-556
EMV S.A.R.L. • Paris • 1-64-61-63-29

CIRCLE NO. 90

1998

VGA controller IC provides RAMDAC and bus interface on chip

The CL-GD5410 VGA controller IC integrates RAMDAC and bus-interface circuits and supports color and monochrome display applications. In fact, you can build a minimally configured 3-chip graphics card using the VGA IC and two dynamic RAMs (DRAMs). The high level of integration makes the IC ideal for use on low-cost VGA cards or in mother-board VGA applications. The IC also provides super VGA resolutions, such as 1024×768 pixels.

Fig 1 depicts the VGA IC used in a typical VGA application. Designs only require video memory, a BIOS, and a crystal (not shown) in addition to the VGA IC to implement a complete controller. You can also combine the VGA BIOS with the system BIOS to further reduce chip count.

The IC has a dual-frequency synthesizer that provides separate clock signals to handle CRT and memory timing. The video-memory circuitry can handle your choice of 256k×4-, 256k×16-, and 512k×8-bit DRAMs. Furthermore, the memory-control circuitry can work with as much as 1 Mbyte of memory with no jumpers or switches. You can use page-mode DRAMs with the chip to lower memory cost without affecting performance.

The RAMDAC supports the VGA-industry-standard 256 colors. Designs can bypass the RAMDAC's on-chip color look-up table and use 15- or 16-bit-per-pixel true-color mode to display 32k or 64k simultaneous colors. You can use the IC with an external RAMDAC to produce even more colors.

VGA designs that use the IC of-

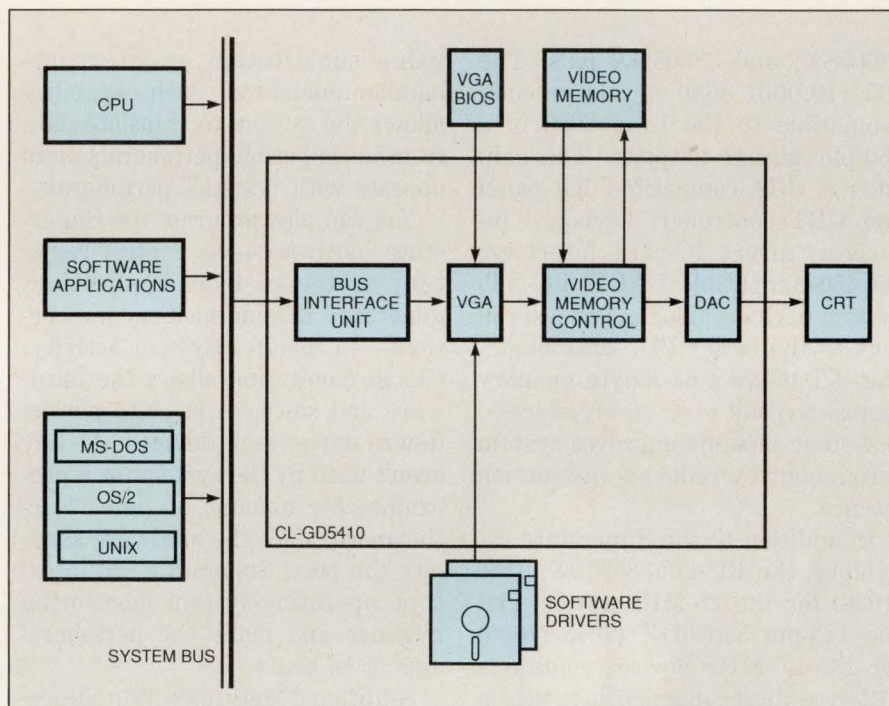

Two DRAMs and the VGA chip can implement a complete VGA controller in mother-board applications that use the CL-GD5410 VGA IC with an integrated RAMDAC and bus interface.

fer standard 640×480-pixel resolution. The IC can also drive a display with 800×600-pixel resolution and support 64k colors. Finally, the controller can handle 1024×768-pixel displays in interlaced and noninterlaced mode and display as many as 256 colors. The IC also has on-chip support for a VGA pass-through connector.

The bus interface circuits in the VGA chip can connect directly to ISA, EISA, and Micro Channel Architecture system buses. You can use the IC with an 8- or 16-bit host bus. The bus interface can operate at speeds as fast as 12.5 MHz.

Samples of the \$25 (1000) IC are available. Expect production quantities in the first quarter of 1992.

The company also plans to offer a demonstration kit that includes a working board as an example of how to use the IC. The kit also has evaluation software drivers and BIOS. —**Maury Wright**

Cirrus Logic Inc, 3100 W Warren Ave, Fremont, CA 94538. Phone (415) 623-8300. FAX (415) 226-2240.

Circle No. 698

REAL TIME CONSTRUCTION SET

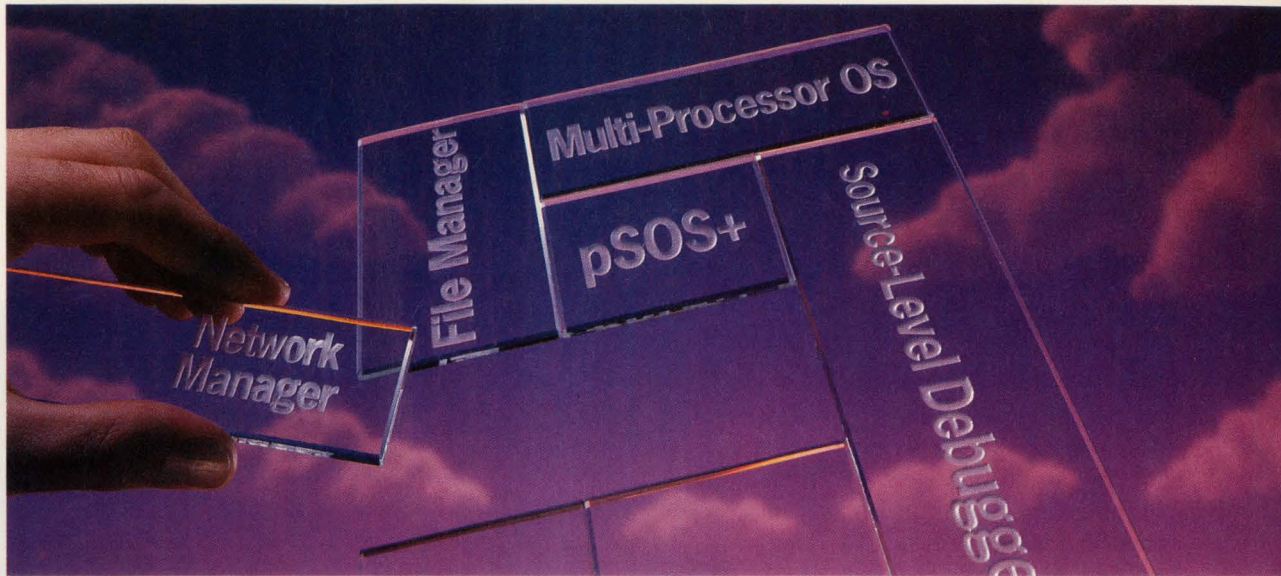

All the pieces you need, including peace of mind

You already know about our reliability.

Now we'd like you to know about the breadth of our product line. Because we not only market pSOS⁺, *the* real-time kernel for bullet-proof embedded systems in mission-critical applications. We also provide everything else you need.

Everything.

That includes seamless, efficient support for both loosely and tightly coupled multi-processor architectures... NFS, RPCs and other TCP/IP network facilities... a DOS- or UNIX-friendly development environment ... fully integrated source- and task-level debugging across a serial line or network... and a lot more.

Like more host/target combinations than anybody else.

Most important of all, we supply more peace of mind. Roughly \$5 billion worth of electronic equipment worldwide depends on pSOS every day - and no failure has ever been attributed to pSOS.

So if you're planning a real-time project, call our 800 number right now. There's no better way to get the whole story.

To receive a free copy of our new white paper on real time systems, call 1-800-458-PSOS.

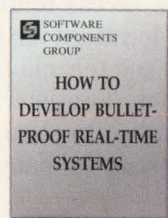

SOFTWARE COMPONENTS GROUP

1731 Technology Drive, San Jose, CA 95110 Tel. 408-437-0700 Fax. 408-437-0711

CIRCLE NO. 91

Switching mainframe minimizes wiring and ensures signal integrity

According to the vendor, the Model 7001 mainframe provides the highest density switching of any half-rack mainframe in the test and measurement market. It can handle as many as 80 channels of 2-pole switching, and it simplifies system setup. The mainframe has two slots that can accommodate any of 33 cards for switching capabilities from 30 nV to 1.3 kV, 10 fA to 5A, and dc to 500 MHz.

A vacuum-fluorescent, front-panel status display lets you simultaneously observe the open/closed positions of every channel in your system. Three switching cards provide the mainframe with configuration data. By allowing you to check card configuration and channel status at a glance, the mainframe simplifies system programming, modifying, and debugging. The display also provides error messages, help, setup, and configuration prompts.

You can program and control switching via the mainframe's IEEE-488 bus, or you can eliminate the computer and control channel spacing, scan spacing, and the number of scans directly by using push-buttons located on the front panel. You have access to 100 nonvolatile memory locations for storing switch patterns and ten additional nonvolatile memory locations for storing instrument setup data. This device can also scan as many as 200 channels/sec.

A built-in Trigger-Link provides six trigger lines that you can access via a rear-panel DIN connector. Each line is programmable from either the front panel or the IEEE-488 bus. This feature lets you recon-



Using a vacuum-fluorescent front-panel display that shows the status of all channels simultaneously, the Model 7001 2-slot switching mainframe handles as many as 80 channels of 2-pole switching.

figure the trigger interaction between instruments without having to switch cable positions. The Trigger-Link also minimizes the trigger latency and jitter problems that can complicate trigger timing. As a result, you can program precise, repeatable triggering of multiple instruments with higher throughput than is possible over the IEEE-488 bus.

The mainframe contains an analog backplane that automatically makes intercard connections inside the chassis. For most applications, this backplane eliminates any need for card-to-card wiring.

Two interconnect options let you tailor the mainframe for frequent wiring modifications or relatively stable configurations. By using a detachable, screw-terminal connection board, you can easily make changes and combine different types of wire on the same card. For

production-test applications in which the system setup is unlikely to change, a multipin connector lets you disconnect cards quickly without removing the connector from the mainframe.

The Model 7001 mainframe sells for \$1795. Three plug-in cards designed specifically for use in the mainframe are also available for \$995 each: the Model 7011 40-channel multiplexer card; the Model 7012 4 × 10-channel matrix card; and the Model 7013 20-channel independent-switch card.—**JD Mosley**

Keithley Instruments Inc, 28775 Aurora Rd, Cleveland, OH 44139. Phone (800) 552-1115; (216) 248-0400. FAX (216) 248-6168.

Circle No. 695

Power Solutions



Highest Power Density
AC/DC and DC/DC to KiloWatts
UL, CSA, VDE and TÜV
Worldwide Support

VI-200™

- Inputs: 10 to 400 VDC
- Outputs: 2 to 95 VDC
- 50 to 200 Watts
- Booster expansion to kiloWatts
- Size: 4.6"L x 2.4"W x 0.5"H



Worldwide Applications Support.

MiniMod™

- Inputs: 10 to 400 VDC
- Outputs: 2 to 95 VDC
- 25 to 100 Watts
- Size: 2.28"L x 2.4"W x 0.5"H



AC Input Front Ends

- Converter interface for worldwide AC lines: 85 to 264 VAC
- Single and three-phase: 250 Watts to 5 kiloWatts and over
- PCB and Chassis mount
- Power status signals
- Transient protection and filtering

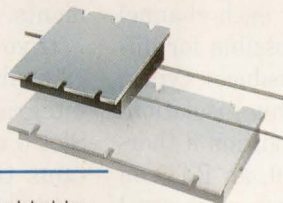

ComPAC™

- Inputs: 24, 48, and 300 VDC
- 1, 2 or 3 user-definable outputs
- Any output: 2 to 95 VDC
- Up to 600 Watts
- Transient protection and filtering for Telecom and Industrial
- Low profile: 0.99"



FlatPAC™

- Worldwide AC Input
- 1, 2 or 3 user-definable outputs
- Any output: 2 to 95 VDC
- Up to 600 Watts
- Transient protection and filtering to VDE/FCC Class A
- Low profile: 1.37"

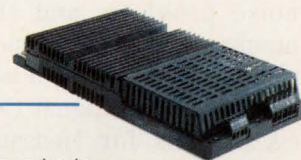

StakPAC™

- Worldwide AC or DC Input
- Up to 8 user-definable outputs
- Any output: 2 to 95 VDC
- Up to 1200 Watts
- Transient protection and noise filtering
- High density packaging
- Fan cooled



PowerCage™

- Choice of single ϕ and three ϕ inputs
- 1 to 36 isolated outputs at up to 7200 Watts
- Size: 19"L x 10.5"W x 11.25"H
- Designed to meet UL, CSA and TÜV

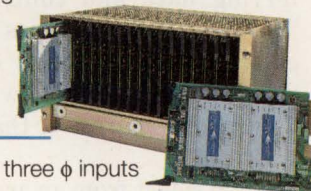

Call for further information.

Vicor Corporation

23 Frontage Road, Andover, MA 01810
 TEL: (800) 735-6200 • FAX: (508) 475-6715

Call for our complete catalog, including information on all products, applications and accessories.

Mainframe provides signal conditioning for as many as 384 instrument channels

If you have tried to use your PC to perform signal conditioning for hundreds of channels of data, you've probably been frustrated by noise problems and the limited number of expansion slots in your computer. However, a new product line called the Signal Conditioning eXtensions for Instrumentation (SCXI) provides mainframes, modules, and terminal blocks that can simplify and improve your signal-conditioning efforts. SCXI adds an instrumentation front end to your PC-based data-acquisition system.

Begin with either the SCXI-1000 mainframe that conditions as many as 128 channels by accepting four 32-channel modules, or the SCXI-1001 mainframe, which accepts 12 modules, for 384-channel-max conditioning. Each has Slot 0 capabilities, a power supply, and separate analog and digital buses for transferring data and control signals. The larger unit occupies 7 in. vertically in a 19-in.-wide equipment rack; the smaller unit, which is also 7 in. high, is narrower than full-rack width.

Then select from an array of plug-in modules, such as a 32-channel multiplexer amplifier, an 8-channel isolation amp, and an 8-channel S/H amp. To simplify cabling, the SCXI-1180 feedthrough panel lets you route all signals to the front of the SCXI mainframe. Terminal blocks and adapters simplify connections to the modules and route signals from the mainframe to different types of data-acquisition boards. The SCXI-1181 general-purpose breadboard lets you design custom SCXI modules.

An independent configuration for each multichannel module is possible for different signal types, in-

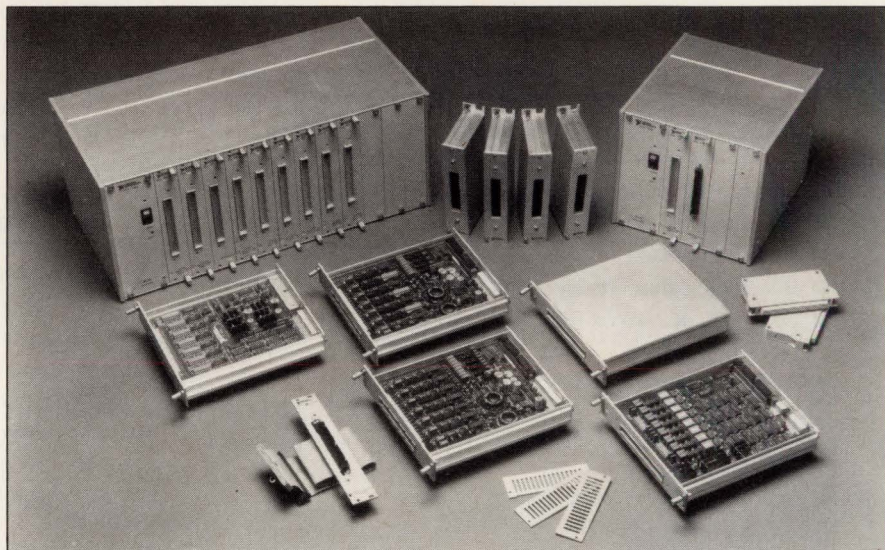

The SCXI has been developed to condition hundreds of signals, while maintaining greater than 12-bit accuracy. The product line, including a choice of mainframes and an array of modules, amplifiers, and terminal blocks, provides a cost-effective way to link general-purpose computers with the latest plug-in data-acquisition boards.

cluding thermocouples, strain gauges, resistance temperature detectors (RTDs), thermistors, microvolt, millivolt, volt, 4 to 20 mA, and 0- to 10-mA sources. SCXI creates a low-noise shielded environment outside the noisy PC chassis.

A configuration for each channel in a module is also possible for different signals or transducer types. For example, a 4-channel isolation-amp module could condition a thermocouple on channel 0, an RTD on channel 1, a strain gauge on channel 2, and a current on channel 3. In addition, a reconfiguration is possible for gain and bandwidth in each module.

Because your plug-in data-acquisition boards receive only high-level signals, SCXI maintains a high S/N ratio. Furthermore, you won't encounter the bottleneck problems that are prevalent in IEEE-488 and RS-232C systems.

SCXI devices have guarded ana-

log buses for signal routing and calibration, trigger buses for timing coordination, and shielded power supplies. A serial bus for controlling and interrogating modules has a quiet mode that halts all digital activity during sensitive measurements.

If you need to connect more than 12 modules to your system, you can integrate multiple mainframes. The Slot 0 module in each chassis maintains the channel order of all the modules in the chassis.

The manufacturer's latest versions of Labview, Labwindows, and Labdriver will have new function calls for configuration and calibration of the SCXI system. Prices for mainframes and modules range from \$75 to \$1495.—**JD Mosley**
National Instruments Corp, 6504 Bridge Point Pkwy, Austin, TX 78730. Phone (800) 433-3488; (512) 794-0100. FAX (512) 794-8411.

Circle No. 696

Gourmet Capacitors at Fast-Food Prices

High-performance mini-capacitors from TOKIN



There's no question that TOKIN's new chip-type high-capacitance multilayer ceramic capacitors are earning a loyal following. Suddenly, one can find them in the fanciest equipment and devices in town, and with good reason. One explanation is their large permittivity (capacitance). Another is size—only 1/5 that of conventional products.

And to clinch the ideal, they can be had for a very competitive price.

The story doesn't end there, though, because these

gourmet capacitors are ideal for surface mounting and offer outstanding reliability.

TOKIN was able to accomplish all this by firing two special materials with different temperature characteristics at a low temperature (less than 1,000°C), thereby

increasing capacitance while cutting costs. A dramatic breakthrough in capacitor technology.



What's more, you can put these devices to work in a wide range of application including EMI/EMC filters

and bypass capacitors.

Compact and high performance at budget prices, who could refuse?

Call us today.

New Multilayer Ceramic Capacitor

	25V10 μ F		25V22 μ F	
	Dimensions (mm)	Case Code	Dimensions (mm)	Case Code
NEW  Y5U (Z5U)	2.7x5.7x 2.5	C205M ^{*1} C205F	5.0x5.7x 2.5	C505F
CONVENTIONAL  Y5V	6.5x10.0x 3.0	C610F	—	—
Y5V 	4.0x8.0x 2.5	C408F	6.3x10x 3.0	C610F

^{*1}New product. C205M: Nickel/Tin Plate Termination

Ceramic Capacitor End Termination

Nickel/Tin Plate Termination ^{*1}	1E106ZY5U-SD
Fired-on End Termination	All Case Code

^{*1}The product is the experimental stage

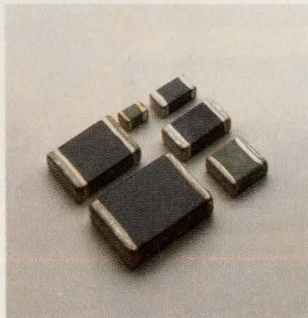

Stability at Low and High Temperatures

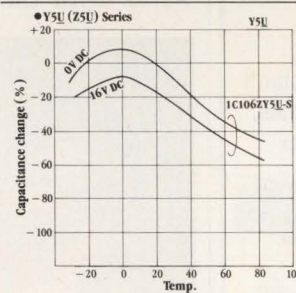

Frequency Characteristics

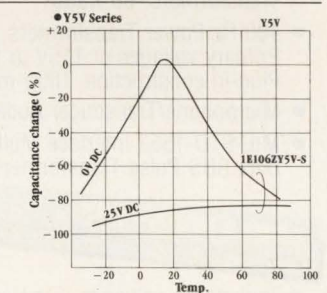
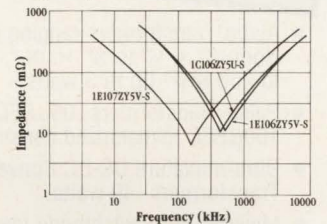

Characteristics

	Temp. Characteristics Y5U (Z5U)			Temp. Characteristics Y5V		
	25V	50V	75V	25V	50V	75V
10μF	1E106ZY5U-C205M 1E106ZY5U-C205F	1H106ZY5U-C505F	1N106ZY5U-C610F	10μF	1E106ZY5V-C408F 1H106ZY5V-C610F	1N106ZY5V-C812F
22μF	1E226ZY5U-C505F	1H226ZY5U-G10F	—	22μF	1E226ZY5V-C610F 1H226ZY5V-C812F	—
33μF	1E336ZY5U-C610F	1H335ZY5U-C812F ^{*1}	—	33μF	1E336ZY5V-C610F	—
47μF	1E476ZY5U-C812F ^{*1}	—	—	100μF	1E107ZY5V-C812F	—

^{*1}C812F (8x12.5x3mm). The product is in the experimental stage.

TOKIN

Tokin Corporation

Hazama Bldg., 5-8, Kita-Aoyama 2-chome, Minato-ku, Tokyo 107, Japan
Phone: 03-3402-6166 Fax: 03-3497-9756

Tokin America Inc.

155 Nicholson Lane, San Jose, California 95134, U.S.A.

Phone: 408-432-8020 Fax: 408-434-0375

Chicago Branch

9935 Capitol Drive, Wheeling, Illinois 60090, U.S.A.

Phone: 708-215-8802 Fax: 708-215-8804

Boston Branch

945 Concord Street, Framingham, Massachusetts 01701, U.S.A.

Phone: 508-875-0389 Fax: 508-875-1479

CIRCLE NO. 170

PICO Transformers & Inductors

**PLUG-IN
SURFACE MOUNT
AXIAL INDUCTORS
TOROIDAL
INSULATED LEADS**

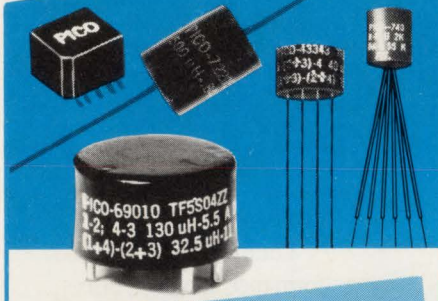

TRANSFORMERS

QPL standards available
MIL-T-27/103-1 thru 16, MIL-T-27/172-1 thru 50,
MIL-T-27/357-1 thru 114, MIL-T-27/358-1 thru 123,
MIL-T-27/359-1 thru 147

- Audio Transformers ranging in size from 1/4" x 1/4" to 3/4" x 1 1/2". 20 Hz to 250 KHz. Up to 3 watts.
- Pulse Transformers .05μSEC to 100μSEC miniaturized construction.
- Ultra-miniature DC-DC Converter Transformers. 40 watts.
- Miniaturized Switchmode Inverter Transformers. 60 watts.
- 400 Hz Power Transformers. Primary voltages of 115V or 26V. Plug-in construction. Ultra-miniature
- Microphone/Transducer Audio Input.
- MIL-STD-1553 Interface Multiplex Data BUS Pulse Transformers.

POWER INDUCTORS

QPL standards available MIL-T-27/356-1 thru 63

- Inductance values to 20mH with DC currents to 23 amps

COMMON MODE INDUCTORS

HIGH "Q" INDUCTORS

See EEM
or send direct for
FREE PICO Catalog

**PICO
Electronics, Inc.**

453 N. MacQuesten Pkwy. Mt. Vernon, N.Y. 10552

Call Toll Free **800-431-1064**

IN NEW YORK CALL **914-699-5514**

FAX **914-699-5565**

PRODUCT UPDATE

ICE handles three members of 29000 μP family

The Eclipse 29K in-circuit emulator (ICE) substitutes for the AMD 29000, 29030, and 29050 μPs. The emulator operates at 40-MHz clock speeds (max) and sports a 1-Mbyte, zero-wait-state emulation memory. The instrument's multilevel triggering and multiway branching permit store control, position counts, time tags, and pass counts at each trigger level.

The emulator has a 32-ksample x 256-bit trace buffer and 63 event recognizers. Thirty-two bits of the trace buffer are available for user-defined inputs; the others are dedicated to the μP. You can program all the event recognizers to trigger over a range of events, not just on a single, specific event.

The instrument's control software can run under Windows 3.0. The bundled high-level debugger is a 29000 version of XRay, which works with the company's compil-

ers. The system's integrated debugging facility provides a windowed interface for debugger and emulator functions. This integration links hardware triggers and trace buffers and performance analysis with the debugger's monitoring capabilities, software breakpoints, and source-level symbolic references.

Software-performance analysis tools include code coverage, execution statistics, and timing. Emulation statistics include interrupt latency and instruction-cache efficiency.

The software runs on MS-DOS computers and uses the PC's parallel port for downloads. A fully loaded system costs \$41,000.

—Charles H Small

Step Engineering, 661 E Arques Ave, Sunnyvale, CA 94088. Phone (800) 538-1750; (408) 733-7837. FAX (408) 773-1073. TWX 910-339-9506.

Circle No. 694

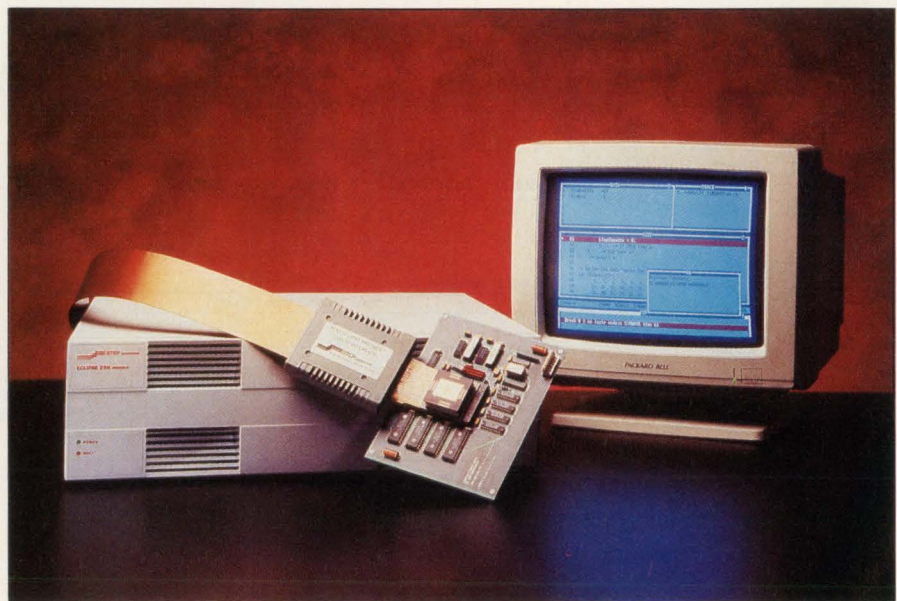

The Eclipse 29K in-circuit emulator substitutes for the AMD 29000, 29030, and 29050 μPs.



It's an 8-channel MUX, a track-and-hold amp, and a 10-bit A/D converter in one.

Presenting the world's most complete sampling system on a single chip. The Harris HI-7153.

Channels:	8
Data Output:	10 bits
Conversion Time:	5 μ sec
Resolution:	0.1%
Accuracy:	0.2%
Power Requirements:	150 mW

The 7153 combines speed, precision and low cost in one easy-to-use package. It can sample eight different signals up to 200,000 times per second. And its built-in sample and hold amplifier allows you to digitize 20 KHz signals to better than nine effective bits.

We even buffered the on-chip

MUX, so you don't need to add an external op amp. And it's microprocessor compatible.

So for a complete sampling system on a single chip, there's one single number to call. 1-800-4-HARRIS, ext. 1153.



HARRIS
SEMICONDUCTOR

Variable-gain amplifier lowers noise and distortion but keeps bandwidth at 35 MHz

Most voltage-controlled amplifiers use some sort of nonlinear circuit element directly in the signal path. These nonlinear elements increase distortion and noise and often force bandwidth tradeoffs as you vary the gain. The internal architecture of the AD600 and AD602 prevents you from having to make this tradeoff and also provides low input noise of $1.4 \text{ nV}/\sqrt{\text{Hz}}$, and low-distortion performance of -60 dBc at outputs of $\pm 1\text{V}$. The amplifiers' typical 3-dB bandwidth is 35 MHz and is essentially independent of the gain setting. The dual-channel AD600 and AD602 provide gain ranges of 0 to 40 dB and -10 to $+30 \text{ dB}$, respectively.

A 2-stage design enables the amplifiers to achieve their specs. The first stage is a variable attenuator comprising an R-2R, binary-weighted ladder network. This network is made from seven sections of fixed resistors, and it attenuates the input by 6.02 dB in each section. A proprietary circuit technique interpolates between these tap points and provides for continuous attenuation.

The second stage is a fixed-gain amplifier that provides a gain range of either 41 or 31 dB. This 2-stage design provides the amplifier with many advantages. First, the fixed amplifier can have negative feedback, which increases gain accu-

racy. Also, since the fixed amplifier never has to handle large input signals, its design can be optimized for low distortion and noise. The main advantage is that both the input attenuator and fixed amplifier are linear, and as such, introduce very little distortion.

This architecture ultimately results in a precise decibel-scaled gain law that stems directly from the recursive nature of the ladder network. For control voltages between -0.625 and $+0.625\text{V}$, the amplifiers provide a linear—in terms of dB—output between their respective gain-range extremes. The instantaneous S/N ratio for 1V rms outputs and a 1-MHz noise band-

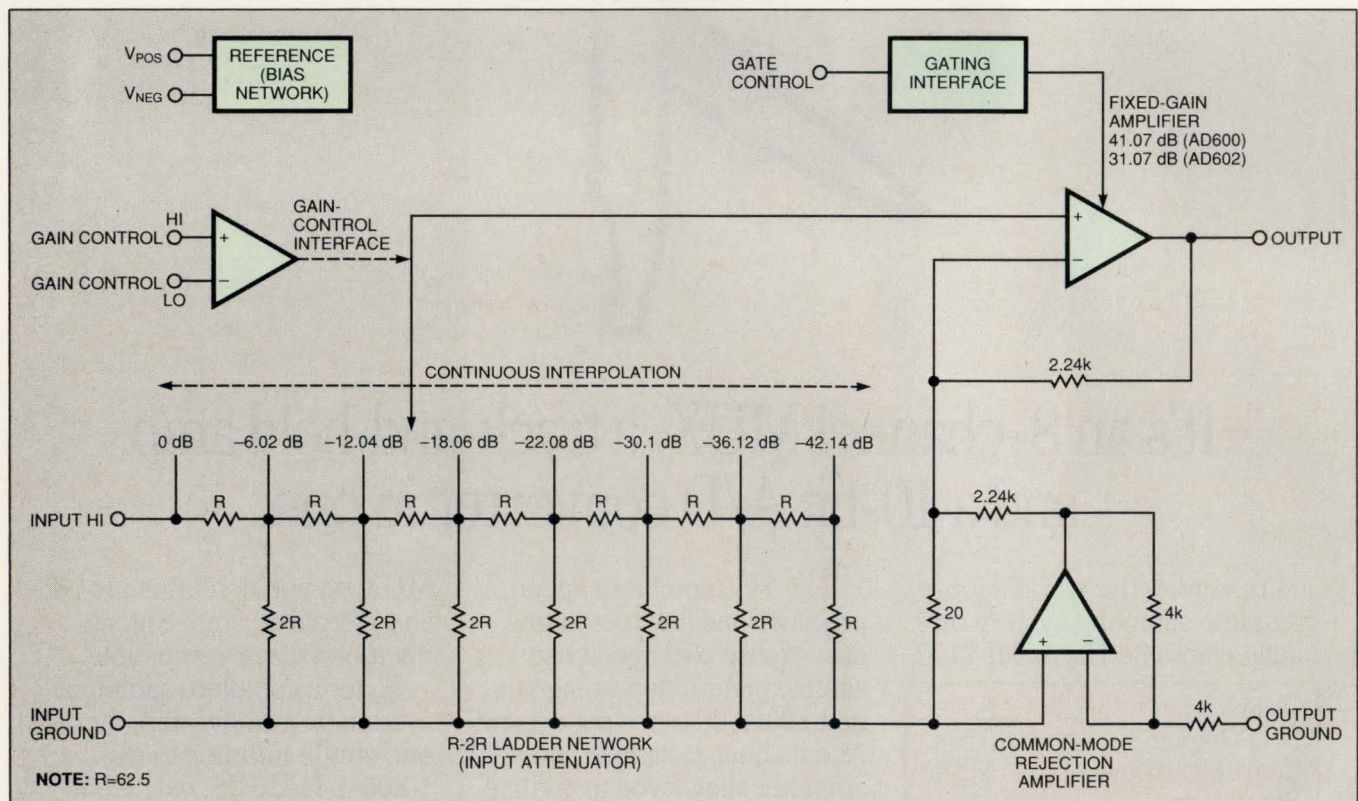

A 7-section ladder network followed by a fixed-gain amplifier implement a variable-gain architecture that provides each channel of the AD600 (one channel shown) and AD602 with low noise, low distortion, and a bandwidth that's independent of gain.

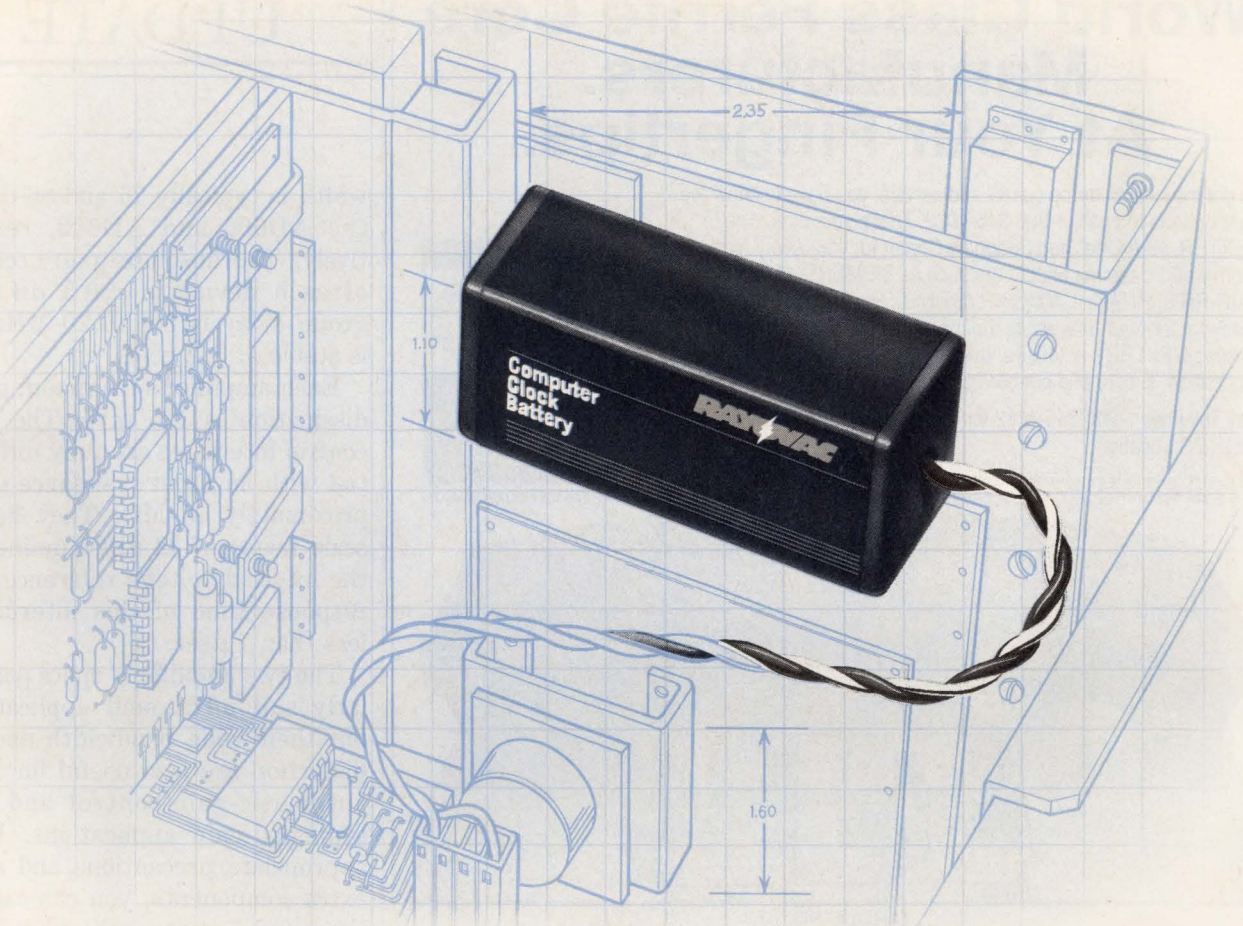

WHY MORE COMPANIES ARE PLUGGING US INTO THEIR DESIGNS.

Today the Rayovac 844 computer clock battery is specified by 23 system architects worldwide. Its proven reliability safeguards the configuration file memory in 286/386/486 personal computer products, especially in power-down situations.

Maintaining voltage is just one way the Rayovac 844 delivers superior reliability. It also offers long life, a 3-5 year span, plus safety no lithium battery can match.

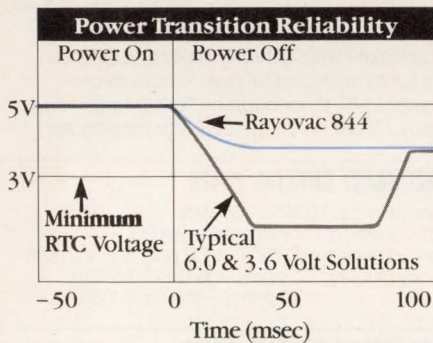

The 844 ensures IC voltage above the critical 3.0V level maintaining clock stability and configuration file memory.

The 844 is compatible with industry standard chip sets: Chips & Technology; VLSI Technology; Western Digital; Zymos and Intel. And it's made in the U.S.A., with on-time delivery available around the world.

So plug added reliability and service into your design. Specify a Rayovac 844. Call Rayovac's Technical Sales & Marketing Department for complete information and battery specifications at 608-275-4694. Fax: 608-275-4994.

In Europe contact:
Rayovac Europe B.V.
Tel: 31-1892-17855
Fax: 31-1892-17138

RAYOVAC[®]
When performance really counts.

World Class Ferrite Core Manufacturers. At Your Fingertips.

To get the best in ferrite quality and service, you have to know the right buttons to push. 1-800-345-4082. That's your direct line to DEXTER, your One Stop Shopping Center for your every ferrite need. From world class manufacturers such as SIEMENS, MAGNETICS, FAIR-RITE, HITACHI, MMG/KRYSTINEL. From standard stock items, ready for 24-hour delivery, to the most intricate custom designs utilizing DEXTER's extensive value-added services, like precision fabrication, E-core and pot-core gapping and testing, and more.

Call Toll Free 1-800-345-4082 for Free Catalog and Nearest DEXTER Location.

ATLANTA • BOSTON • CHICAGO • DALLAS • LOS ANGELES • MINNEAPOLIS/ST. PAUL • NEW YORK • SAN FRANCISCO • TOLEDO/DETROIT • ENGLAND • GERMANY



CIRCLE NO. 97

UPDATE

width is typically 76 and 86 dB for the AD600 and AD602, respectively. The absolute gain accuracy of each device is ± 0.5 dB. The group delay is flat to 10 MHz and is stable at ± 2 nsec.

Each amplifier's maximum power dissipation is 125 mW. The gain-control interfaces are fully differential with an input resistance of approximately 15 M Ω . They have a scale factor of 32 dB/V defined by the internal voltage reference. The response time of this interface is less than 1 μ sec.

The two amplifiers' specs particularly suit ultrasound applications, but their wide bandwidth and low distortion are also useful for other automatic-gain-control and programmed-gain applications. Using appropriate precautions and a few extra components, you can cascade the amplifiers to achieve a gain-control range of 80 dB. The devices are available in either 16-pin DIPs or SOICs and operate over the commercial temperature range of 0 to 70°C. They cost \$15 (100).

—Anne Watson Swager

Analog Devices Inc, 181 Ballardvale St, Wilmington, MA 01887. Phone (617) 937-1428. FAX (617) 821-4273.

Circle No. 699

- Crystals
- Crystal Oscillators
- Crystal Filters
- Ceramic Resonators

RALTRON

WHEN IT COMES TO HIGH ACCURACY CRYSTAL UNITS, ONLY RALTRON HAS IT ALL.

RALTRON manufactures one of the industry's most complete lines of high quality crystal units. Call us for all your crystal needs from micro-processor to AT strip to tuning fork to high accuracy. Or call us for our 28 page catalogue.

HIGH ACCURACY CRYSTAL UNITS

- Frequency Range: 1.0 MHz-360 MHz
- Mode of Oscillation: Fundamental to 9th O.T.
- Frequency Tolerance: @ 25°C: ± 2.5 ppm to ± 100 ppm
- Frequency Stability: ± 3 ppm (–10°C to +60°C) to ± 50 ppm (–55°C to +105°C)

SURFACE MOUNT CRYSTAL UNITS HC-45/U SMD, TT SMD, HC-49S SMD

- Frequency Range: 3.5 MHz-360 MHz
- Mode of Oscillation: Fundamental to 9th O.T.
- Frequency Tolerance: @ 25°C: ± 2.5 ppm to ± 100 ppm
- Frequency Stability: ± 3 ppm (–10°C to +60°C) to ± 100 ppm (–10°C to +70°C)

The Products. The Prices. The People. Only RALTRON has it all.

RALTRON ELECTRONICS CORP.

2315 NW 107th Avenue, Miami, Florida 33172
FAX (305) 594-3973 TELEX 441588 RALSENUJ
(305) 593-6033

CIRCLE NO. 98

IT'S HERE

Turn to page 163 in this issue to introduce yourself to Jim Williams and his study of high-speed analog design. Jim will inform and entertain you in our October 24, 1991, edition of EDN Magazine with articles on common problems with op amps and amplifiers with low offset and drift. Stay tuned for more.

Heard the news about Keithley's new switching system?



It's on all 80 channels.

Introducing the Keithley Model 7001
High-Density Switching System.

Now, get up to 80 channels of two-wire
switching from just one half-rack mainframe
and two high-density cards.

Monitor all channels at once, too.
The unique vacuum fluorescent display
shows the open/close status of *all*
channels simultaneously. Program, modify,
or debug your test systems with
remarkable ease.

Plus, have the capability to switch a
variety of signals. From femtoamps to
amps. Nanovolts to kilovolts. And DC
to 500MHz. It's the kind of measurement
integrity that has made Keithley
switches a preferred choice for nearly
two decades.

Call 1-800-348-3735. Or return the card. An
applications engineer will provide
details, arrange a demonstration, even help
you design your test system.

Contact Keithley today. We'll be watching
for your reply.

KEITHLEY INSTRUMENTS



Make all these disappear.

Poof, they're gone. Bulky battery packs, slow hard disks and more. You see, where memory cards make sense, the new Intel 4MB Flash Memory Card provides a high-density, read/write, truly nonvolatile portable storage solution.

The real trick, of course, is that it allows you to store large amounts of code or accumulate data in a small, rugged card that uses less power than traditional memory technologies. So now you can design products that are faster, lighter, tougher and more energy efficient.

Not tomorrow, but today. Thanks to our System Developer's Kit. A DOS-compatible package that includes a 1MB Flash Memory Card, an add-in board as well as design information. In addition, it includes an evaluation copy of Microsoft's Flash File System software. All the stuff to get you started—now!

Plus, Intel's Flash Memory Card is the first to comply with the 68-pin PCMCIA/JEIDA standard. This allows the card and its data to be interchangeable between a host of

Come see us at Comdex
Booth #1916 and at the
Sahara Hotel from 4:30-8:30 p.m.

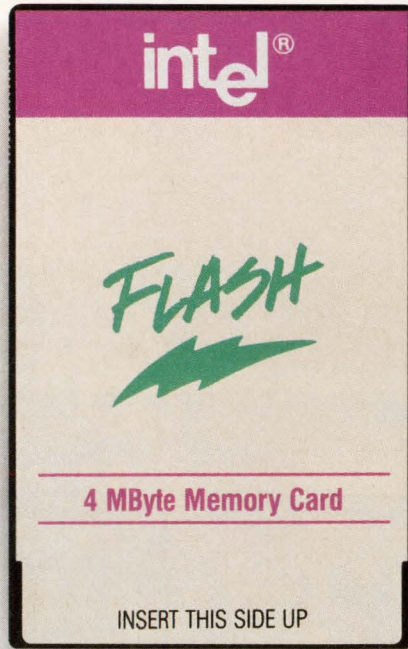

Actual Size.

With this simple card trick.

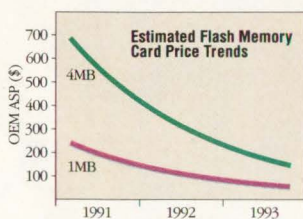

A technology so successful that volume continues to rise and prices continue to drop.

systems—from PCs to fax machines to bar-code readers.

The secret of the card's magic is Intel's ETOX™II Flash technology—combining RAM, ROM and mass storage capabilities onto a solid-state, energy-

efficient medium. Want to know more about the secrets of this amazing technology? Then call (800) 548-4725 today and ask for Literature Packet #C8A01. And start performing your own disappearing tricks.

intel
The Computer Inside.™

Bring the Modulation Domain designing on a higher level.



to your lab and start



These days, designers face problems that require a level of understanding beyond the scope of conventional measurement techniques. The Modulation Domain can give you that level of understanding. With a new dimension in signal measurement that makes it possible to analyze frequency, time-interval, and phase over continuous time. And now, HP brings the Modulation Domain to your lab with high-performance analyzers that give you insight into your designs you've never had before.

The HP 53310A streamlines Modulation Domain analysis with a simplified user interface, one-button signal acquisition and real-time measurements for fine-tuning your designs. It gives you continuous frequency and time-interval measurements for analyzing modulations in RF and microwave signals. Characterizing VCOs, phase-locked loops, and electro-mechanical devices. Locating sources of jitter. And much more.

The HP 5372A is ideal for gathering in-depth Modulation Domain information in single-shot events. In addition to frequency and time-interval measurements, it also displays phase over continuous time. And analyzes even the most complex signals with incredible detail.

Find out how to take your design skills to new heights. Call **1-800-752-0900*** Ask for Ext. 1852, and we will send you a *Visitor's Guide to the Modulation Domain* on floppy disk. That way, you'll be up on all the latest developments.



There is a better way.



*In Canada call 1-800-387-3867, Dept. 420.

© 1990, Hewlett-Packard Co. TMSCD057/EDN

EDN SPECIAL REPORT

HIGH-PERFORMANCE
OSCILLOSCOPES

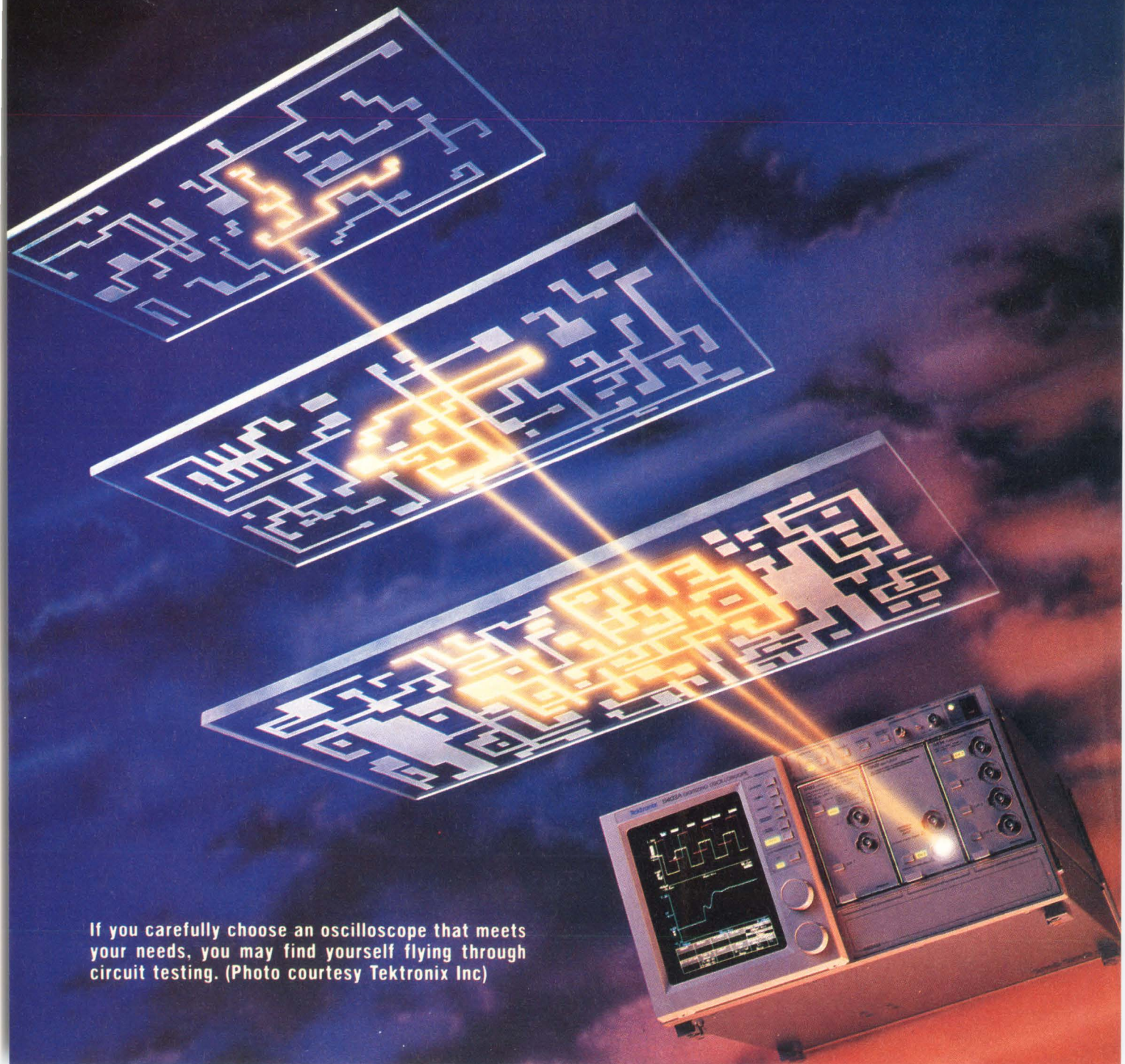

If you carefully choose an oscilloscope that meets your needs, you may find yourself flying through circuit testing. (Photo courtesy Tektronix Inc)

Using the right oscilloscope for your application will make your work easier, save you time, and, in the long run, save you money. To select the right scope, you need to analyze your application and determine what features and specs will meet your requirements. You need to be sure you can acquire the necessary signals and observe and measure them accurately.

The bandwidth of an oscilloscope is such an important specification that it's usually the scope's principal identifier. For digital circuits, however, the rise time is often a more pertinent specification than bandwidth. The two are approximately related by the equation:

$$\text{bandwidth} = 0.35/\text{rise time.}$$

A 100-MHz scope has an approximately 3.5-nsec rise time. A 1-GHz scope has a 350-psec rise time.

You don't want to use a 100-MHz scope to look at a 100-MHz waveform or a signal with a 3.5-nsec rise time. If you do, the rise time of the signal and the scope will rms together to give you a rise-time measurement of about 4.9 nsec, a 40% error. The general rule of thumb is to select a scope with a bandwidth that is three to five times the bandwidth of the signals you will be observing. If you follow that rule, you will keep rise-time measurement errors between roughly 2 and 5.5%.

Although the products covered here all have bandwidths of 200 MHz or higher, the considerations apply equally well to lower-bandwidth oscilloscopes.

Consider signal repetition rate

The next most important consideration of the acquisition system is the signal repetition rate. When all oscilloscopes were analog, you only had to determine whether you could observe the signal with a nonstorage analog scope. If the signal was single shot or so infrequent that viewing even with a hood was impossible, then you could only choose between using a storage scope or using a nonstorage scope and photography.

When dealing with digital scopes, the signal-repetition-rate considerations change. All digital scopes are storage scopes. And digital scopes don't

suffer from dim viewing problems—whatever data the scope acquires, you can view. The signal-repetition-rate consideration for digital scopes is whether you can wait for enough triggers to acquire sufficient data with repetitive acquisitions or if you need real-time acquisition to acquire all the data around one trigger event.

Digital scopes use one or more of three basic types of sampling methods: real time, random repetitive, and sequential. Many digital scopes offer both real-time and random repetitive sampling.

The maximum speed of the A/D converters in a scope usually limits the real-time sample rate. Currently, 2 Gsamples/sec is the maximum available sample rate on digital scopes. Some digital scopes achieve high sample rates by circumventing their slow converters. These scopes use CCDs to sample and hold the analog values at a high rate, then the A/D converters convert the values at a lower rate.

The usable bandwidth for real-time data acquisition ranges from about one-tenth the sample rate to about four-tenths of the sample rate (if you can accept considerable distortion). On some of its scopes, Hewlett-Packard combines predigitizing analog filters and digital reconstruction filters to obtain an undistorted real-time bandwidth of one-quarter the sample rate. However, one-tenth is the usual rule of thumb and the best number to use when the scope doesn't have advanced interpolation methods to help reconstruct a close approximation of the original waveform.

When operating at the maximum sampling rate, many scopes interleave digitizers, leaving only one channel available. For example, Tektronix's TDS540 is a 4-channel scope with four independent 250-Msample/sec digitizers. You can operate four channels at 250 Msamples/sec, two channels at 500 Msamples/sec, or one channel at 1 Gsample/sec.

The highest performance digital oscilloscopes have a maximum usable real-time bandwidth in the 200- to 800-MHz range, with 500 MHz being a more practical limit. For higher single-shot bandwidths, you need to use analog scopes. Tektronix's 7104 offers a 1-GHz bandwidth for real-time events. The company's image-intensifying microchannel plate technology permits

You need to choose an oscilloscope that can display the signals and make the measurements your application requires. Examining specs and features closely before choosing will pay off—using the right instrument will speed your work.

Currently, 2 Gsamples/sec is the maximum available sample rate on digital scopes.

viewing or photographing a single acquisition at the 1-GHz bandwidth. An optional digitizing camera lets you store real-time waveforms.

If you need to acquire a repetitive signal, a digital scope can acquire a waveform over a period and provide bandwidths as high as 50 GHz. Digital scopes use random-repetitive or sequential sampling modes to acquire repetitive signals.

Sequential sampling provides high bandwidth

Sequential sampling takes a single data point after each trigger event, incrementing the delay between trigger event and sample acquisition after each trigger. This sample-and-hold (S/H) approach allows high resolution of both voltage and time on high-bandwidth signals. Sequential-sampling scopes can achieve 8- to 16-bit voltage resolution and timing resolution to a fraction of a picosecond. Because sequential sampling only takes a single data point after each trigger, acquiring a full record of data will require 500 to several thousand trigger events, depending on the record length of the particular scope.

Sequential-sampling scopes offer the highest bandwidths for repetitive signals, but they have two drawbacks when compared with general-purpose digital scopes. First, the S/H circuitry is typically up front before any amplifiers, and protection circuitry is out of the question if you plan to acquire high-bandwidth signals. So you must be careful to keep the scope inputs away from damaging voltages including static dis-



A 2-GHz bandwidth for less than \$20,000 is available in the digital sequential sampling PM3340 from Philips.

charge. Second, sequential sampling does not provide the pretrigger capability found on random-repetitive-sampling scopes.

Digital scopes that use random repetitive sampling have their sampling systems running continuously, filling up memory and then overwriting it. Thus, you can set up the scope for a complete pretrigger acquisition, so that when a trigger event occurs, the scope can stop acquisition and save data that it collected up until the trigger. You can also set your digital scope for long post-trigger acquisitions or any combination of pre- and post-trigger. The scope places each sample point in the correct time location in memory relative to the trigger. By collecting data points around many trigger events, the time resolution for random-repetitive-sampling scopes goes as low as 10 psec. In addition, Tectronix's 11A81 plug-in has recently pushed the maximum bandwidth for random-repetitive-sampling scopes from 1 to 3 GHz.

When considering a digital scope's acquisition system, you commonly think of maximum sample rate and vertical resolution as the key specifications, but if you don't also consider the record length, you may be expecting better timing resolution than you can achieve.

At maximum sweep speeds, you'll get the advertised timing resolution of the scope, but as you reduce sweep speeds, the scope's timing resolution will eventually drop. The record length determines the sweep speed or time window size when a digital scope will lose resolution. The equation is

$$\text{time resolution} = \text{time window} / \text{record length}.$$

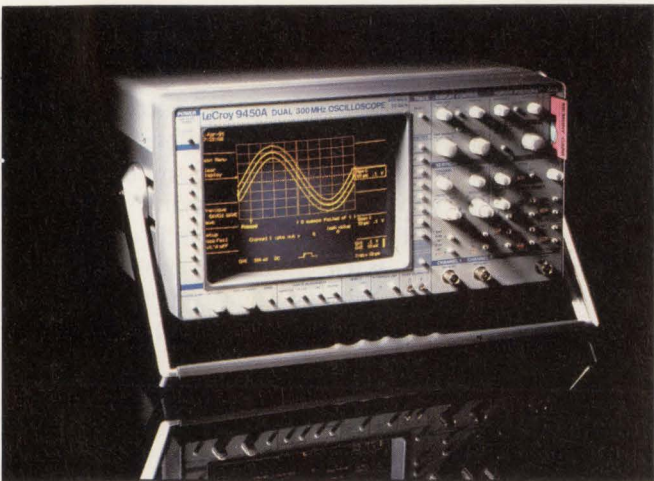

The 4k x 4k display resolution of LeCroy's 9450A is far superior to any other digital scope. A removable memory card and 50,000-point record lengths are other outstanding features of this 300-MHz digital oscilloscope.

For example, consider a 10-psec time resolution and a 1k record length. If you solve for time window, you get 10 nsec, or one typical 10-div display at 1 nsec/div. If you slow down the time window beyond 10 nsec (1 nsec/div in our example), you'll start dropping resolution. If you want maximum timing resolution for pulse-width or rise-time measurements, you have to keep the time window short. If the waveform characteristic you are measuring is longer than 10 nsec—or whatever the maximum time window is—the scope must operate at lower resolution.

If you use a scope with a 50k-point record length you can keep the 10-psec resolution for a 500-nsec time window or 50 nsec/div. Using an oscilloscope that has long records, you can acquire longer stretches of a waveform and still make full-resolution measurements. Longer record lengths are also a benefit when making single-shot acquisitions. The longer record makes it more likely you'll capture all of the data you need and, because of the short time period, do so with high resolution.

Another concern with digital scopes that relates to horizontal resolution and record length is glitch capture. As you reduce the sweep speed, the time-resolution steps become relatively large, especially with short record lengths. Your waveform could be riddled with large glitches that the scope could miss or that could show up only occasionally.

If you use the timing resolution equation above, you'll see the potential for missing glitches. For example, at 10 μ sec/div (100 μ sec full window size across 10 div), a digital scope with a 1k record length would have timing resolution of 100 nsec. A 20-nsec pulse could easily slip through undetected, especially on a single-shot acquisition.

To overcome the glitch problem, some scopes offer a glitch capture mode. Glitch capture modes typically acquire and display both the highest and lowest ampli-

tude measured in each time interval. If a glitch is present, these two amplitudes will show it.

Instead of, or in addition to, a glitch capture mode, some oscilloscopes provide triggering on glitches. The triggering system uses a trigger level in combination with a time qualifier.

For example, you can look for any pulse that is greater than 2V that lasts for less than 100 nsec. Depending on the scope, you may be able to bracket times. For example, you could look for a signal that lasts for more than 5 nsec but less than 20 nsec.

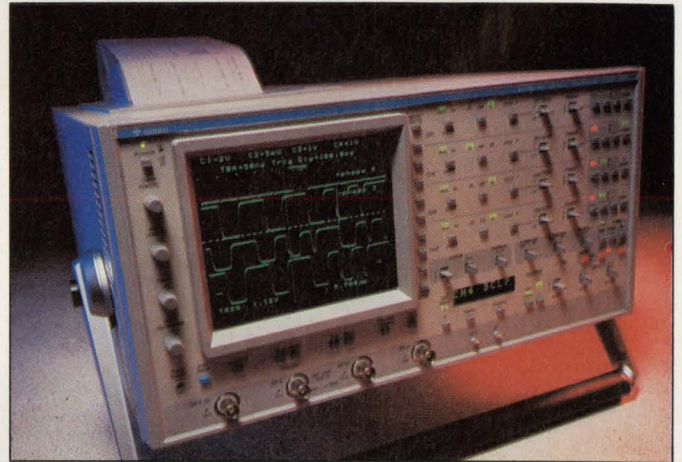

Two 800-Msample/sec digitizers give the 4094 digital scope from Gould a 200-MHz bandwidth for single-shot or repetitive signals. An internal plotter provides hardcopy output.

Tektronix's TDS 520 and 540 series digital scopes can trigger on signals that cross one level but fail to cross a second level before returning across the first. The "runt triggering capability," as Tektronix refers to it, allows you to trigger on problem signals that might otherwise be difficult to find. By using levels of 0.8V and 2.0V, you can trigger on pulses that go above the maximum TTL logic low but never reach the minimum logic high level before returning low.

Another aid in triggering on just the event you want is logic triggering. Typically limited to four channels, logic triggering lets you select high and low patterns or patterns plus a clock for triggering on a specific state.

While tracking down or solving a problem you'll often want to examine a waveform closely. For zeroing in on a detailed view of a waveform, several approaches are available. Analog oscilloscopes usually offer a delayed sweep or second timebase so you can delay for

Acronyms used in this article

CCD—Charge-coupled device
CRT—Cathode-ray tube
FFT—Fast Fourier transform
IEEE-488—Institute of Electrical and Electronics Engineers bus standard 488
rms—Root mean square
RS-232C—Recommended standard 232C
TTL—Transistor-transistor logic

One of the charms of analog scopes is the simplicity of their acquisition systems.

some period after the initial trigger and then be able to display a portion of the signal with an expanded time scale.

A few digital scopes also offer dual timebases. Other digital scopes provide detailed viewing using two other

methods. The first is simply a windowing function that lets you change the timebase on a second display window to look at the waveform expanded by some factor. Typically the maximum window expansion factors of scopes are limited to 20 to 1000 times. The windowing

Table 1—Representative high-performance oscilloscopes having bandwidths of 200 MHz or higher

Manufacturer	Model	Type (D=digital, A=analog, S=sequential sampling)	Bandwidth (input)	Number of channels (T=trigger)	Channels at maximum sample rate, Msamples/sec	Maximum record length (points)	Vertical resolution (bits)	Dual timebase	Interfaces		Weight (lbs)
									IEEE-488	RS-232C	
Analogic	6100/640-1	D, S	1 GHz	4	NA	32k	16	✓	O	O	40
Gould	4090	D	200 MHz	2	1 × 800	2k	8	✓	✓	✓	25
	4092	D	200 MHz	2	2 × 800	2k	8	✓	✓	✓	25
	4094	D	200 MHz	4	2 × 800	2k	8	✓	✓	✓	25
Hewlett-Packard	54100A	D	1 GHz	2+2T	2 × 40	1k	7		✓		42
	54100D	D	1 GHz	2+2T	2 × 40	1k	7		✓		42
	54110D	D	1 GHz	2+2T	2 × 40	1k	7		✓		59
	54111D	D	500 MHz	2+2T	2 × 1000, 1 × 2000 O	16k	6 to 8		✓		59
	54121T	D, S	20 GHz	4	NA	1k	12		✓		52
	54122T	D, S	12.4 GHz	4	NA	1k	12		✓		55
	54123T	D, S	34 GHz	4	NA	1k	12		✓		52
	54124T	D, S	50 GHz	4	NA	1k	12		✓		52
	54502A	D	400 MHz	2	2 × 400	2k	6	windows	✓		22
	54503A	D	500 MHz	4	2 × 20	1k	8	windows	✓		22
	54504A	D	400 MHz	2	2 × 200	2k	8	windows	✓		22
54510A	D	250 MHz	2	2 × 1000	8k	8		✓		22	
LeCroy	7200/7242	D	500 MHz	2 to 4	1 × 2000, 2 × 2000 O	50k	8	O	✓	✓	57
	9450A	D	300 MHz	2	2 × 400	50k	8	✓	✓	✓	33
Phillips	3092	A	200 MHz	2+2	NA	NA	NA	✓	✓	✓	18
	3094	A	200 MHz	4	NA	NA	NA	✓	✓	✓	18
	3323	D	300 MHz	2	2 × 500	4k	10		✓	✓	39
	3340	D, S	2 GHz	2	NA	4k	10		✓	✓	39
Tektronix	TDS520	D	500 MHz	2	1 × 500	5k, 50k O	8	✓	✓		27
	TDS540	D	500 MHz	4	1 × 1000	5k, 50k O	8	✓	✓		27
	2440	D	300 MHz	2	2 × 500	1k	8		✓		24
	2465B	A	400 MHz	4	NA	NA	NA	✓	✓		21
	2467B	A	400 MHz	4	NA	NA	NA	✓	✓		21
	11402A	D	3 GHz	2 to 12	1 × 20	10k	10	✓	✓	✓	42
	11403A	D	3 GHz	2 to 12	1 × 20	10k	10	✓	✓	✓	42
	11801A	D, S	50 GHz	1 to 136	NA	5k	8	✓	✓	✓	49
	CSA404	D	3 GHz	2 to 12	1 × 20	10k	10	✓	✓	✓	42
	CSA803	D, S	50 GHz	1 to 4	NA	5k	8	✓	✓	✓	49
	DSA601A	D	1 GHz	2 to 12	1 × 1000	20k	8	✓	✓	✓	67
DSA602A	D	1 GHz	2 to 12	1 × 2000	32k	8	✓	✓	✓	71	
7104	A	1 GHz	2	NA	NA	NA	NA	✓	✓	45	

Notes:

1. NA = not applicable
2. O = optional

approach lets you view both the original timebase and the expanded display, so you can scroll along the signal and see where the window display is in relation to the trigger.

The second approach is to use just a digital delay

from the trigger. You can scroll along the signal from trigger point to the delay limits of the scope by changing the delay value. You can scroll forward in time using pretrigger. Although the expanded display information is equivalent to that of a dual-timebase scope, you don't have the ability to see the big picture that shows where the expanded window you are looking at is in relation to the trigger.

Trigger features such as "delay by event" may make the lack of dual timebases less of a problem for some applications. If the reason you need the big picture of the waveform is so you can count over to the fifteenth pulse, you can let the scope do the counting by using a delay-by-event triggering mode. You enter the number of events to delay and the scope starts the display on the next edge.

Digital scopes excel in measurements

The goals behind triggering on and acquiring a waveform are to observe it and often to make measurements. Every high-performance digital scope offers a variety of pulse-parameter measurements such as rise and fall times, pulse width, and amplitude.

Digital scopes' timing accuracy of 0.1% or better is typically far superior to that of an analog scope, and their vertical accuracy of 1 to 2% is also better. Not only are their measurements more accurate than analog measurements, digital scopes make them automatically, saving time and eliminating any concerns about the subjective judgment or the skill level of the person operating the oscilloscope. Of course, some scope makers have reduced these concerns by adding A/D conversion circuitry to their analog scopes to allow automatic measurements.

Some digital scopes push waveform processing much further than others. In addition to the standard waveform measurements, you can find features such as measurement statistics, waveform arithmetic, integration, differentiation, FFTs, and inverse FFTs. These features can save you much time and energy in addition to providing valuable information. For example, mean and standard-deviation values give you a better understanding of circuit noise and jitter.

If you want to determine the slew rate of a signal, you could measure the voltages at two points on the waveform and the time between the points and calculate the slew rate. But waveform differentiation gives you an instant display of slew rate vs time.

Using waveform arithmetic, if you want to measure the current through a resistor vs time, you can display the voltage difference divided by the resistor value

Display (M=mono- chrome, C=color)	Controls (D=dedicated, K=menu keys, T=touch screen)	Price (\$)	Comments
M	D, K	15,390	
M	D, K	8950	
M	D, K	9950	
M	D, K	10,950	
M	K	16,900	Price for full-functional scope including plug-ins.
M	K	21,900	
C	K	23,900	
C	K	29,900	
C	K	30,400	
C	K	32,400	
C	K	36,400	
C	K	44,400	
M	K	7450	
M	K	5950	
M	K	6750	
M	K	10,950	
M	D, K	36,900	Price with 2 channels.
M	D, K	13,990	
M	D	2990	
M	D	3390	
M	D, K	9250	
M	D, K	19,500	
M	D, K	9490	
M	D, K	13,900	
M	D, K	7990	
M	D	6460	
M	D	12,950	
M	D, K, T	15,700	+ ~ \$9000 for plug-ins.
C	D, K, T	16,950	+ ~ \$9000 for plug-ins.
C	D, K, T	27,500	+ ~ \$11,000 for sampling head.
C	D, K, T	22,000	+ ~ \$9000 for plug-ins.
C	D, K, T	25,150	+ \$11,000 for sampling head.
C	D, K, T	24,745	+ ~ \$9000 for plug-ins.
C	D, K, T	32,635	+ ~ \$9000 for plug-ins.
M	D	31,500	+ plug-ins.

High-performance oscilloscopes

vs time. If the scope you're using doesn't support math functions, you either have to take the data manually and convert it or interface the scope with a computer using IEEE-488 or another interface.

Tektronix's DSA family of scopes can perform FFT computations. These scopes can rapidly convert time-domain information to amplitude vs frequency. If you'd like to see the data filtered, you can perform basic filtering on the frequency-domain data using lowpass, highpass, bandpass, band reject, or combinations of these filters. You can see the effects of the filtering in the time domain by using the invert FFT function on the filtered signal.

Scopes that offer FFT capabilities place special demands on the acquisition system for voltage and timing accuracy. If you're looking into scopes that perform FFTs, you might want to try them out on pure sine waves—or other cases where you know what to expect—to see how well they perform.

Histograms show data distributions

Some high-performance oscilloscopes generate histograms so you can see not only the mean and standard deviation of measurements but also the data distribution. Some of the scopes that generate histograms use a 2-D histogram database. As the scope acquires data, it puts each new acquisition in the correct histogram location. Tektronix's CSA 404 and CSA 803 use a 3-D database and generate the histogram from the database. The scope counts the number of times it activates each display pixel and stores the count in a $512 \times 256 \times 16$ -bit data array. It then generates a color-



The 500-MHz bandwidth and optional record length of 50,000 points are key specifications of the TDS 500 family from Tektronix. The TDS 520 has two channels and two 250-Msample/sec digitizers. The TDS 540 has four channels and four 250-Msample/sec digitizers.

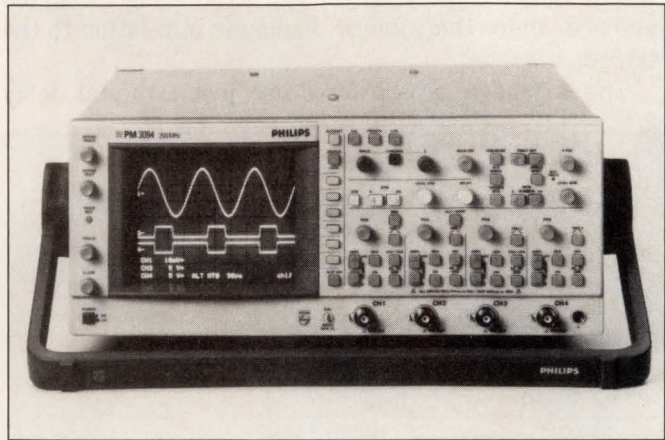

Four 200-MHz channels for less than \$3400 make analog scopes such as the PM 3094 from Philips an economical alternative.

graded display and a histogram showing the distribution. You can select and display new histogram parameters without reacquiring data, the scope just extracts the needed information from the database.

When considering a high-performance digital oscilloscope for extensive waveform processing work, keep in mind that the computer power can either be integral with the scope or external and linked through an interface such as IEEE-488 or RS-232C.

The advantages to having all the processing done in the scope are speed and convenience. Functions performed by the scope are typically faster than downloading the data and processing by computer. The advantages to having your computer do the processing are that you can perform as much processing as you like and a scope with less internal processing power will cost you less. However, some waveform processing functions are integral to the acquisition system of the scope and you cannot move them through an interface to a computer.

Improving resolution of single-shot data

Performing digital signal processing on LeCroy's 7200 and Tektronix's TDS 500 family to increase the effective resolution on single-shot acquisitions at low sweep speeds is an example of waveform processing that you can't download to a separate computer. All high-performance digital scopes allow you to average data on repetitive waveforms to increase effective resolution. Averaging typically allows the equivalent of two to four bits of increased resolution for repetitive signals.

A digital scope can use the same approach on a sin-

The next step in oscilloscope technology.

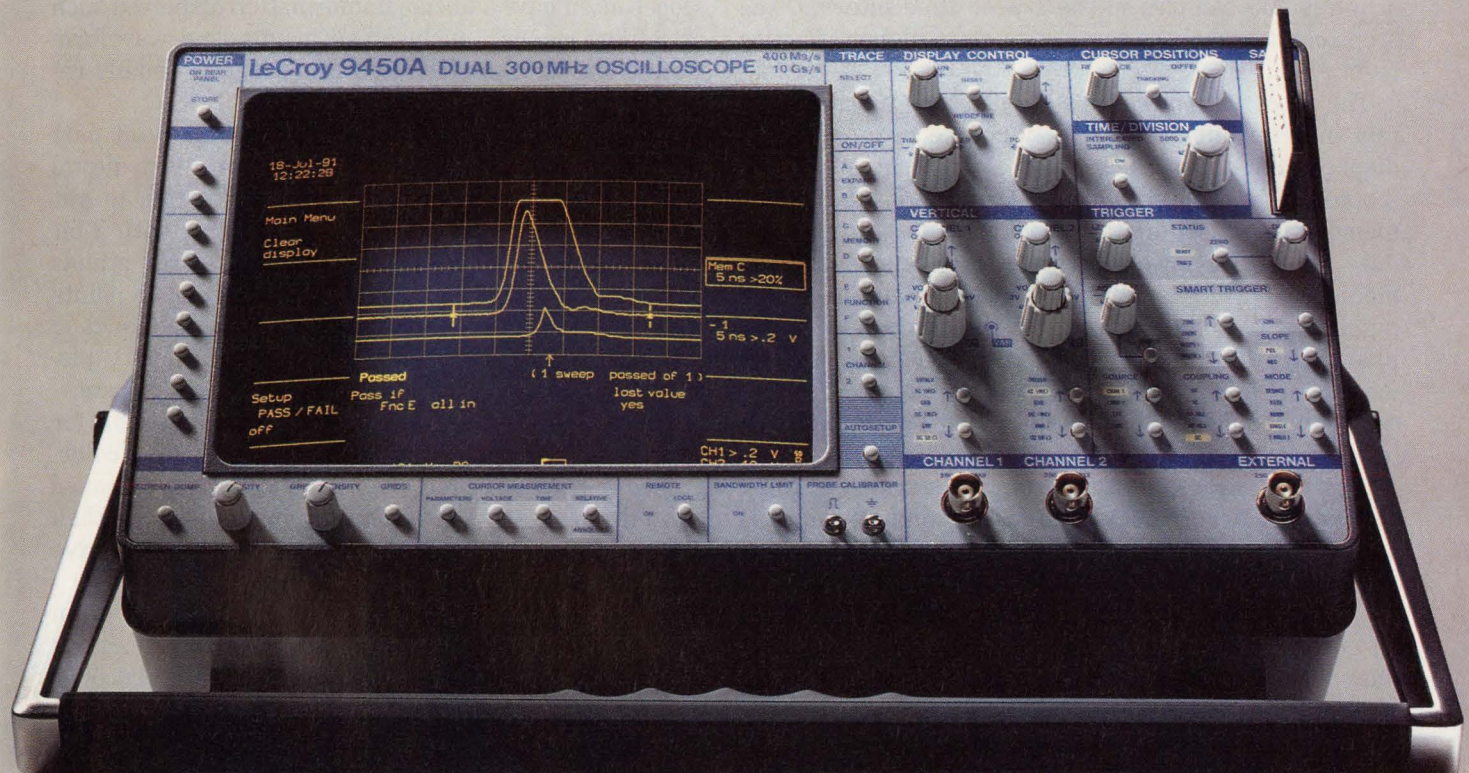

Spend a few minutes with LeCroy's new dual-channel 9450A and you'll see why nothing even comes close in decision-making power.

It's the first oscilloscope to offer next-generation performance. With a DOS-compatible memory card system. And automatic PASS/FAIL testing.

In fact, the PASS/FAIL feature combines two types of testing. You can set tolerances for up to four different measurements on one channel. And on the second channel, simultaneously compare another waveform to a specified template. If a test fails, the 9450A will act as instructed. (Such as print the waveform and continue or store on the memory card.)

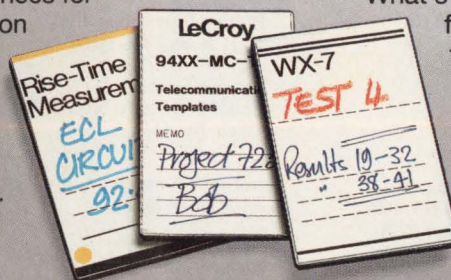

The 9450A's memory card system is another first. (It's been built into other LeCroy oscilloscopes, too.) The cards give you full read and write capabilities on DOS-compatible PCs. You can also automatically save waveforms after each acquisition. Transfer speed is up to 10 times faster than with a hard disk.

What's more, memory cards are available for various applications, so you can tailor the 9450A to your specific needs.

Now, the next step is up to you. Simply write or call your nearest LeCroy office for further information or a demonstration.

LeCroy Corporation
700 Chestnut Ridge Road - Chestnut Ridge, NY 10977-6499
Phone: 1-800-5 LeCroy- (914) 425-2000 Fax: (914) 425-8967

LeCroy

CIRCLE NO. 102

Innovators in Instrumentation

High-performance oscilloscopes

gle-shot acquisition when operating at slow timebase settings. A digitizer that is converting at the rate of 250 Msamples/sec may only need a data point every μsec to fill in the display record. Because the digitizer acquires 250 samples in the $1\text{-}\mu\text{sec}$ time interval, the scope can average the samples to get a higher effective resolution.

The processing power of a digital scope is also important in determining the display update rate. Although display refresh rates are not a problem on digital scopes, processing new data and getting it into display memory is. A few digital scopes have fast display update rates. Because the many different operating modes can greatly affect the display update, as do the number and type of automatic measurements, scope manufacturers have a difficult time specifying the update rate. Display update rate is one important reason why you should see a scope operating before purchasing it.

Another display spec to consider is re-arm dead time. The re-arm dead time of the fastest digital scopes is still several orders of magnitude slower than that of an analog scope. An analog scope just has to re-arm the trigger and slew the beam back for the next trace. In contrast, a digital scope typically needs to move data from acquisition memory into display memory, perform measurement computations, and operate the display.

The display quality is important because that's how you'll get most of the information from a scope, and in many cases the display is important to scope control

too. The key specifications of a scope display are size, resolution, and whether the display is color or monochrome. The size is important for easy viewing. A standard analog scope has a $10\times 8\text{-cm}$ display. Digital scopes often have additional information displayed such as softkey menus, touch-screen menus, and waveform parameter readouts. The extra information usually requires additional display area.

The display resolution also plays an important part in getting all the information on screen. Most digital scopes don't have sufficient vertical resolution to put up a split-screen display of two waveforms with 8-bit display resolution on each waveform. LeCroy stands out on display resolution with between 2k and 4k points of vertical resolution depending on the scope model.

Color displays show much more than a pretty picture. The color quickly establishes which measurements belong to which signal. Color is also useful for comparing overlapping waveforms and showing color-graded displays of time or voltage variation. Because color displays are considerably more expensive than monochrome, you'll only find them on expensive scopes.

After a scope acquires and displays data, you often need to store the data for future use. Most analog scopes still depend on photography. All digital scopes provide digital-waveform storage. Some scopes use nonvolatile memory for all or part of the waveform memory. In addition, most digital scopes provide direct connection to printers for generating hardcopy records.

A few digital scopes provide removable memory

Manufacturers of high-performance oscilloscopes

For more information on high-performance oscilloscopes such as those described in this article, circle the appropriate numbers on the Information Retrieval Service card or use EDN's Express Request service. When you contact any of the following manufacturers directly, please let them know you saw their products in EDN.

Analogic Corp
8 Centennial Dr
Peabody, MA 01960
(508) 977-3000
FAX (508) 531-1266
Dave Madsen
Circle No. 650

Gould Inc, Test & Measurement Group
8333 Rockside Rd
Valley View, OH 44125
(216) 328-7313
FAX (216) 328-7800
Doug MacLennan
Circle No. 651

Hewlett-Packard Co
19310 Pruneridge Ave
Cupertino, CA 95014
(800) 752-0900
Circle No. 652

LeCroy Corp
700 Chestnut Ridge Rd
Chestnut Ridge, NY 10977
(914) 425-2000, ext 2218
FAX (914) 578-5991
Lisa Honan
Circle No. 653

Philips International BV
T&M Dept, Bldg TQIII-4
5600 MD Eindhoven
The Netherlands
TLX 35000 PHTC NL/NLFEVSI
Circle No. 654

In North America:
John Fluke Mfg Co
Box 9090
Everett, WA 98206
(206) 347-6100
FAX (206) 356-5116
Circle No. 655

Tektronix
Box 500
Beaverton, OR 97077
(800) 835-9433
Circle No. 656

VOTE . . .

Please also use the Information Retrieval Service card to rate this article (circle one):

High Interest 497
Medium Interest 498
Low Interest 499

Design better **PCBs** faster and cheaper with **CAM-Bridge™ CAD/CAM software for PCs and UNIX workstations.** **And save a couple of trees in the process.**

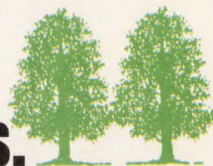

CAM-Bridge™ software from ALS DESIGN makes the transition from DOS to UNIX easy as it provides you with a complete set of affordable, high-performance CAM tools! Our software supports (better than anyone else's) a variety of computer platforms including **SUN SPARCstation, IBM 6000, MIPS MAGNUM, HP 9000, DG AViiON, and 286, 386 and 486 PCs.** Plus we offer **FREE** professional assistance in Gerber artwork verification and preparation. And **FREE** telephone technical support if or when you need it. And best of all, because we help reduce the need for paper and film, we can also save a few trees as well.

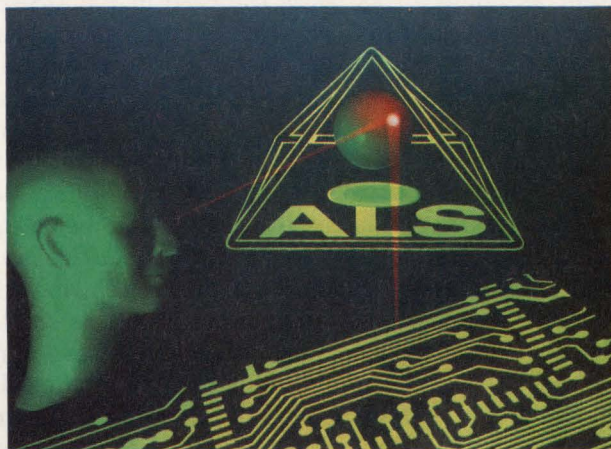

For a whole new way to look at PCB design and fabrication, call us at 1-800-825-7051 today!

For CAD/CAM products priced from \$295 to \$14,995, here's your window of opportunity:

A - TO GET YOU ON YOUR WAY...

ALS-VIEW II ELP @ \$295

GERBER VIEWER

- Fast graphics with Auto Panning
- View & Print positive/negative composites with imbedded traces
- Measure features and clearances
- Variable scale printing

ALS-DRC @ \$495

GERBER DESIGN RULE CHECKER

- Graphical view of violations • Checks Arc, Pad & Track clearances • Reports abutting & imbedded features • Netlist extraction

ALS-VPLOT @ \$495

FILE FORMAT CONVERTER AND PLOTTER DRIVER

- INPUTS: DXF, GERBER, HPGL, EXCELLON • OUTPUTS: DXF, GERBER, HPGL, EXCELLON, POSTSCRIPT

ALS-VIEW III @ \$795

GERBER

VIEWER/EDITOR/PANELIZER

- Edit multi-layer, single features or by window. • Gerber & apertures 1/10,000
- Panelization • Plus features in ALS-VIEW II ELP

FREE GERBER VIEWER

(value: \$295.00)
with purchase of
ALS-DRC or ALS-VPLOT

B - MOVE WITH 3rd PARTY PRODUCTS...

PHASE III LOGIC

SCHEMATIC CAPTURE

- DOS or UNIX • EDIF 2.00 xlators • Open ASCII Database

DYNAMIC SOFT ANALYSIS

THERMAL & RELIABILITY ANALYSIS

- DOS or UNIX • Temperature Map • Failure Rate Map

CADWARE

NETLIST & CAD DATABASE XLATORS

- Netlist to Netlist • CAD database to CAD database • PCAD-<>PADS • PADS <> REDAC

COMPUTERS:

SUN SPARCstations, SPARC and PC 286, 386 & 486 compatibles available. Worldwide service. Call for pricing!

Are we barking up the right tree?

Find out why IBM, AT&T, Honeywell, NASA, Compaq, Hitachi and many others are already successfully utilizing ALS DESIGN products!

Call 1-800-825-7051

to place an order or FAX your special request to 1-617-577-1209.



C - TO THE ULTIMATE CAM PACKAGES!

CAM-Bridge™ @ \$2,495

FULL CAM PACKAGE FOR PC s

- Includes ALS-VIEW, ALS-DRC & ALS-VPLOT • Plus Multi-layer Panelization • Plus 1/10,000 Resolution • Plus Auto Venting

CAM-Bridge™ Workstation @ \$7,495

FULL CAM PACKAGE FOR UNIX WORKSTATIONS

- SUN SPARCstation, IBM 6000, MIPS MAGNUM, HP 9000, DG AViiON • View & Edit DXF, GERBER & HPGL • Multi-layer Editing • Multi-layer DRC • 1/10,000 Resolution



Complete system including hardware and software @ \$14,995.



ALS DESIGN CORPORATION

USA Headquarters
One Kendall Square - #2200
Cambridge, MA 02139
TEL: (617) 621-7101
FAX: (617) 577-1209

Europe Headquarters
38 Rue Fessart
92100 Boulogne, FR
TEL: (33) 1-46-04-30-47
FAX: (33) 1-48-25-93-60

All trademarks are the property of their respective manufacturers.

High-performance oscilloscopes

either as floppy disks, as is the case in the DSA600 family from Tektronix, or as memory cards, as used by LeCroy. The removable memory offers some conveniences such as being able to store waveforms while working and then downloading them through a computer later for hardcopy or for on-computer documentation. You can also save instrument setups on the storage medium so you can recall customized scope setups.

Scope controls are a secondary but competitive issue. Control of analog oscilloscopes typically remains with dedicated knobs and keys. Dedicated controls are the best choice for instruments because they save time. However, they are impractical on many digital oscilloscopes due to the large number of control and measurement functions available. Most digital scopes use a combination of dedicated keys for frequently used functions and softkeys with menus for less commonly used functions.

One of the charms of analog scopes is the simplicity of their acquisition systems. Analog scopes route the input signals through amplifiers and use the resulting outputs to control where they spray electrons in a CRT. Analog scopes have displays that are easy to interpret and show no artifacts of digitizing. If you don't know what you're doing with a digital scope, you might find yourself looking at a stored signal when you think you are probing a circuit. Analog scopes give you undigested data, and they give it to you rapidly.

If your primary use for a scope is to observe signals rather than take measurements, analog scopes are fine,

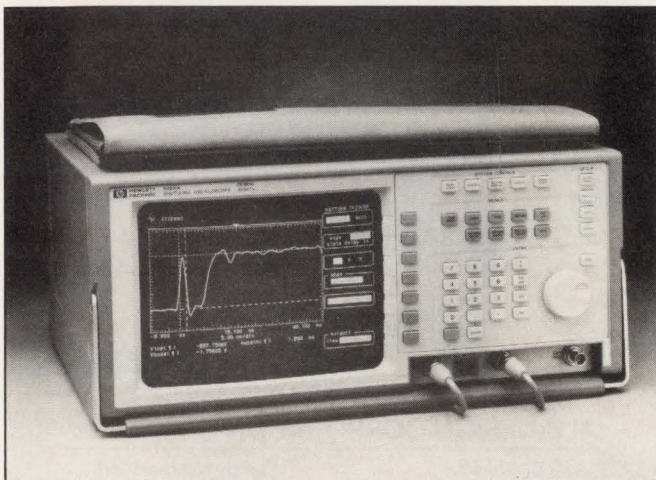

Two independent 1000-Msample/sec channels on the 54510A from Hewlett-Packard offer single-shot waveform capture of 250-MHz signals for less than \$11,000.

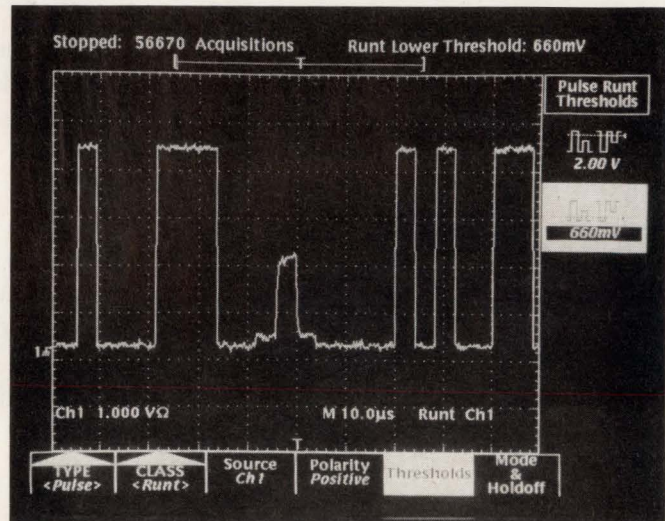

Advanced trigger features can help you zero in on a problem that's normally difficult to capture. The photo shows the runt triggering capability on Tektronix's TDS scopes. A signal that has crossed the logic low threshold but not the logic high threshold causes the scope to trigger when the signal drops low again.

and their fast, simple operation is an advantage. Of course, digital technology is creeping in everywhere, so many analog scopes can make automatic measurements and offer automatic setup—features found on all high-performance digital scopes.

As analog scopes become more digital, it becomes more obvious that the future of high-performance oscilloscopes favors digital technology. Although analog scopes are efficient instruments for some circuit situations, particularly analog, digital scopes are usually superior for making accurate, repeatable measurements and for working with digital circuits. At the lower bandwidths, analog scopes continue to offer attractive prices. In digital scopes, the trend is toward faster sampling speeds, faster display updates, and greater display processing.

Reference

1. Conner, Doug, "High-bandwidth DSOs push beyond 20 GHz," *EDN*, Jan 4, 1990, pg 61.

Article Interest Quotient (Circle One)
High 497 Medium 498 Low 499

Master Designer 5.0, the shortest distance from concept to reality.

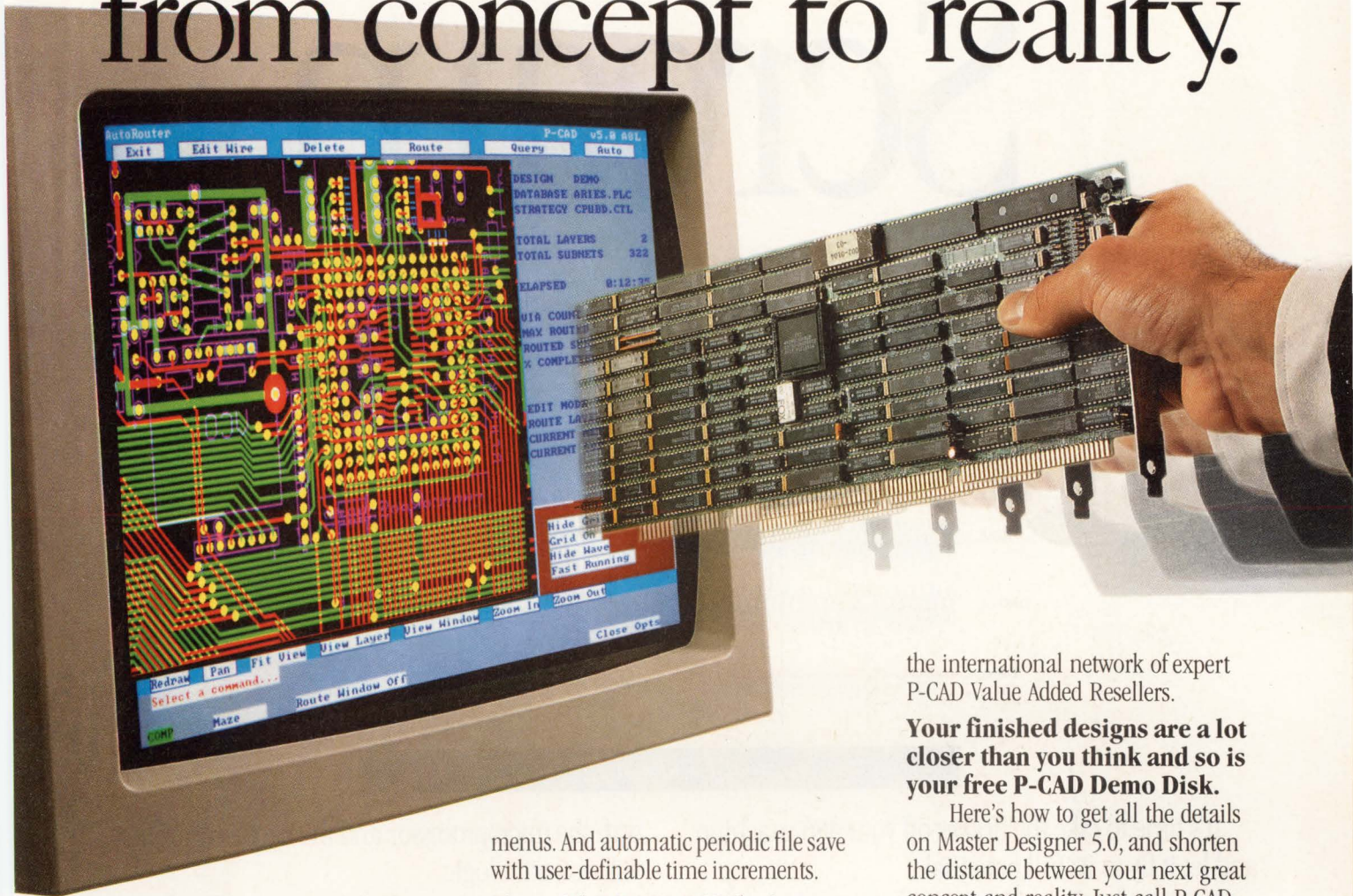

Master Designer™ 5.0 is the shortest distance from PCB design concept to reality. And the fastest, most productive and reliable way to get your designs to market using an IBM® or compatible PC.

And now Master Designer 5.0 has been enhanced with more than 100 new features, requested by PCB master design engineers like you.

New features, more productivity.

Master Designer 5.0 shortens the entire design cycle with new features like extended memory for 4-times larger designs. Automatic real-time on-line design rule checking. User configurable

menus. And automatic periodic file save with user-definable time increments.

First with 19,000 PCB designers.

You can rely on Master Designer 5.0 for the quality and dependability that has made it the choice of more than 19,000 PCB designers worldwide.

Master Designer 5.0 gives you the interactive support of Master Layout™ to handle surface mount, analog, and digital technology. The flexibility of Master Schematic™, fully automated optional Rip-n-Route, and our optional Master Placer™. Not to mention the plus of a consistent menu-driven interface.

With Master Designer 5.0, you're backed by CADAM, the world's leading CAD/CAM/CAE software supplier, and

the international network of expert P-CAD Value Added Resellers.

Your finished designs are a lot closer than you think and so is your free P-CAD Demo Disk.

Here's how to get all the details on Master Designer 5.0, and shorten the distance between your next great concept and reality. Just call P-CAD toll-free today and we'll send your free Master Designer 5.0 Demo Disk absolutely free.

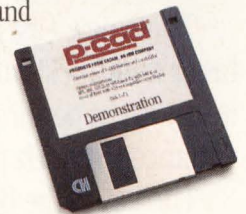

1-800-255-5710

World Class PCB CAD Productivity

p-cad®

PRODUCTS FROM CADAM, AN IBM COMPANY

IBM is a registered trademark of International Business Machines Corp. P-CAD is a registered trademark and Master Designer, Master Layout, Master Schematic, and Master Placer are trademarks of Personal CAD Systems, Inc. P-CAD/CADAM, 1935 N. Buena Vista St., Burbank, CA 91504. ©1991 CADAM INC.

Go ahead. Scream.

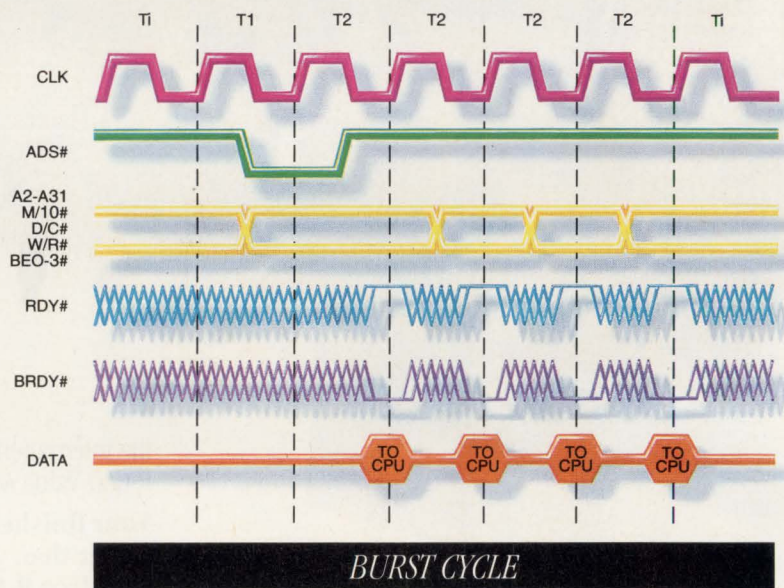

It's time to take the brakes off your 486 machine and let it fly to its full potential.

How? With a BurstRAM™ from Motorola.

These new Fast Static devices run at cycle times faster than most microprocessors. Stretching the limits of system performance to the peak for which enhanced 50 MHz processors are designed.

The key to the BurstRAM is our burst cycle protocol and the timely way it transfers several consecutive words in quick succession. The on-chip burst counter and specific logic let the BurstRAM interface directly

with the microprocessor and the cache controller without extra logic.

Once again, Motorola delivers just what it takes to enhance system performance. Like precocious design solutions. Preeminent technology. Relentless product support. And a very broad portfolio of Fast Statics. Not to mention a complete line of FSRAM and DRAM modules.

Want to read all about it? Send in the coupon on the opposite page and we'll show you just how far Motorola can take you. In no time at all.

If you like what's new, wait 'til you see what's next.



EDN INFO CARDS

THE 2¢ SOLUTION

to your marketing budget blues — the EDN Info Card Pack. At 2¢ per name, the EDN Info Card Pack can reach over 123,000 engineering specifiers affordably.

Call Heather McElkenny
at (617) 558-4282 for details.

EDN Magazine
Edition
News
Edition

A Partnership in Power and Prestige Worldwide

Read between the lines.



What's new in Motorola's Fast Static lineup? This chart gives you but a glimpse. Mail in the coupon below for our complete quarterly update of new Memory products. We think you'll like our line of thinking.

MOTOROLA FAST STATIC RAMS		
256K x 4	MCM6229	25ns
128K x 8	MCM6226	25ns
256K x 1	MCM6207	15/20/25ns
64K x 4	MCM6708●■	10/12ns
	MCM6709●■ (OE)	10/12ns
	MCM6208	15/20/25ns
	MCM6209 (OE)	15/20/25ns
32K x 8	MCM6706●■	10/12ns
	MCM6206	15/17/20/25ns*
32K x 9	MCM6205	15/17/20/25ns*
16K x 4	MCM6288	10■/12/15/20/25ns*
	MCM6290 (OE)	10■/12/15/20/25ns*
64K x 1	MCM6287	12/15/20/25ns*
8K x 8	MCM6264	12▲/15/20/25ns*
8K x 9	MCM6265	12▲/15/20/25ns*
4K x 4	MCM6268	20/25/35ns*
	MCM6269 (CS)	20/25/35ns
	MCM6270 (OE)	20/25/35ns
Synchronous Fast Static RAMs		
64K x 4	MCM62982♦	12/15ns
4 x 64K x 1	MCM62983♦	12/15ns
64K x 4	MCM62980	15/20ns
4 x 64K x 1	MCM62981	15/20ns
32K x 9	MCM62950	20/25ns
	MCM62960	17/20ns
	MCM62110	15/20ns
16K x 16	MCM62990	12▲/15▲/20ns
16K x 4	MCM6294	20/25ns
	MCM6295	25/30ns
4K x 10	MCM62963	18/25ns
4K x 12	MCM62973/4	18/25ns
	MCM62975	25/30ns
BurstRAMs™		
32K x 9	MCM62940	19/24ns
32K x 9	MCM62486	14/19ns
DSPRAM™		
8K x 24	MCM56824	20▲/25/35ns
Latched Fast Static RAMs		
16K x 16	MCM62995	12▲/17/20ns
8K x 20	MCM62820	17▲/23ns
Cache Tag RAM Comparators		
4K x 4	MCM4180	18/20ns
4K x 4	MCM62351	20/25ns
Fast Static RAM Modules		
256K x 32	MCM32257Z	20/25ns
256K x 8	MCM8256Z	15/20ns
64K x 32	MCM3264Z	15/20ns
2 x 32K x 36	MCM3632Z	15/20ns

● Fabricated in BICMOS technology ♦ Also available in slower speed
■ Production scheduled July 1991 ▲ Production scheduled 3Q91
● Registered outputs for two-stage pipeline

Return this coupon to Motorola, Inc. 496 EDN 10/91
P.O. Box 1466, Austin, Texas 78767

Application Requirements _____
Name _____
Title _____
Company _____
Address _____
City _____ State _____ Zip _____
Phone _____



MOTOROLA

We call it a FET Array.



She'd call it a Miracle.

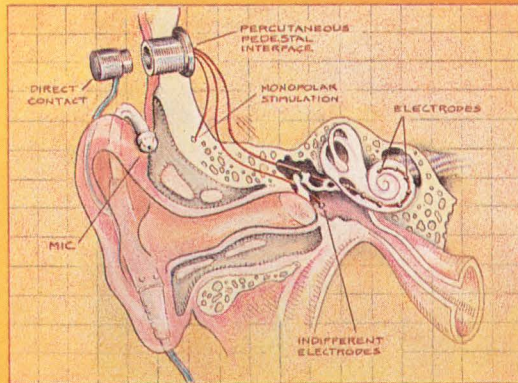

Hammer. Anvil. Stirrup. Drum.
Simple names for the complex natural "hardware" that allows us to hear. If it's injured—or congenitally defective—the deafness that occurs can't always be helped by conventional hearing aid.

A cochlear implant bypasses the damage, delivering filtered and processed analog signals directly to electrodes implanted deep in the inner ear. These signals stimulate the audio nerves in a natural way, allowing—in most cases—the deaf to hear.

The variety of applications for our new *RFA120* never ceases to amaze us. But then, a linear array that combines *both* bipolar *and* JFET gain blocks can provide some pretty versatile characteristics:

RFA120 FET Array
Operating Range: $\pm 5V$ to $\pm 15V$
Input Offset Voltage: 5 mV typ.
Input Bias Current: 30 pA typ.
Gain Bandwidth Product: 3.0 MHz typ.
Slew Rate (Gain = +1): 8 Vμs

The RFA120 is a low power device that's ideal for signal conditioning applications. One of our favorites also takes advantage of its small size.

It's a *cochlear implant system* that bypasses injured or congenitally defective "hardware" in the ear canal. The system converts audio signals to analog signals, routing them deep into the inner ear to stimulate the natural audio nerves that are "hardwired" to the brain.

We're committed to analog technology.

And we're committed to helping you develop creative, cost effective solutions.

Our *Win-Win* program is a good example. It lets you get to market quickly with a semicustom array, then shift to full custom as sales increase. It's fast, flexible and makes good business sense because it eliminates the risk of going full custom before you're really ready.

If you'd like more information on our analog arrays, give us a call at 1-800-722-7074. We'll send you our new brochure.

Raytheon Company. Semiconductor Division.
350 Ellis St. Mountain View, CA 94039.

Raytheon

Where quality starts with fundamentals

Annie Oakley/The Bettman Archive Inc.



One of the precise hand-held instruments that didn't need one of our cable assemblies.

Annie never missed. Well, almost never. As long as she was ahead of second best, the room for error was there.

Not so in the critical engineering of micro-miniature cable and connector solutions at Precision Interconnect. Tolerances are getting tighter, desired sizes smaller, and development time shorter.

Working with exact electrical requirements, plus challenging mechanical parameters,

we design and produce extremely reliable, long flex-life cable, with conductors terminated to standard connectors or active devices, and with protective flex-strain reliefs. These complete interconnect systems, usually using 30 AWG and smaller conductors, provide the critical link in hand-held applications on test and measurement equipment and medical diagnostic devices.

Our expertise, increasing with each unique problem we solve, ensures that reliability is designed in, built in, and tested. So we're right on target. Every time.



**PRECISION
INTERCONNECT**

16640 S.W. 72nd Avenue, Portland, OR 97224
(503) 620-9400

Offices in San Francisco, Boston,
Wilmington and Düsseldorf

High frequency probe provides matched impedance and matched time delay for a Tektronix logic analyzer.

CIRCLE NO. 171

T H E

JIM WILLIAMS

P A P E R S



MOST ENGINEERS THINK designing analog circuits for high-frequency and high-speed applications is a black art known only to a few wizards. If you are among that majority, prepare to enter the sorcerers' inner circle. Jim Williams has pried loose the secrets of practical, high-speed analog design. By codifying his observations, he has moved high-

speed analog design away from the art realm and toward the engineering domain.

Williams presents his discoveries in the articles that follow. Each article is self-contained, so you won't have to read the first article to understand the second. He delves into the mysteries of power-supply bypassing, parasitic coupling, and compensation. He discusses ways to prevent amplifiers from oscillating, how to keep oscillators stable, and how to couple high-speed analog circuits to the digital world. He even discusses the problems you'll face when your analog circuits outperform your test equipment. In short, he tells you how to obtain full performance from your high-speed analog silicon.

Regarding this undertaking, Williams writes

Even the most veteran designers sometimes feel that nature is conspiring against them. In some measure this is true. Like all engineering endeavors, high-speed circuits can work only if you negotiate compromises with nature. Ignorance of or contempt for physical law is a direct route to frustration. Mother Nature laughs at dilettantes and dabblers. She crushes arrogance unknowingly.

Over the past 15 years, the name Jim Williams has become synonymous with analog design in EDN. He published his first article in EDN on May 5, 1975, while teaching and conducting research at the Massachusetts Institute of Technology. In 1979, he started a 3-year stint as a linear designer at National Semiconductor Corp. Williams joined Linear Technology Corp (Milpitas, CA) in 1982 and continued to write innumerable articles about his designs, which today cover almost every analog function you can name.

Williams' devotion to the art of analog design drives his successful and unconventional career. Although he has no formal degree in engineering—Williams describes his experience with formal education as an incredible impedance mismatch—Williams was designing circuits, or in his words, "bumbling around circuits," long before he'd heard of calculus. Williams now describes himself as a floater. He spends about half of his time as a staff scientist doing what he's done for the last 15 years: designing circuits and writing about them. The rest of the time he's either acting as a mentor for engineers at his company or designing circuits for specific customers.

Despite working in the competitive business of selling semiconductors, Williams manages to balance the commercial aspirations of his employer while designing and writing about circuits that often include a competitor's device. You are about to read his latest opus—the product of one year's effort. These secrets didn't pry loose easily, and Williams has a mountain of breadboards for proof. EDN is proud of its longstanding relationship with Jim Williams and is proud to present a work of this caliber.

Illustration by John Schreck

If you had this...

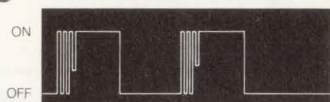

and we gave you this...



think what you could do!

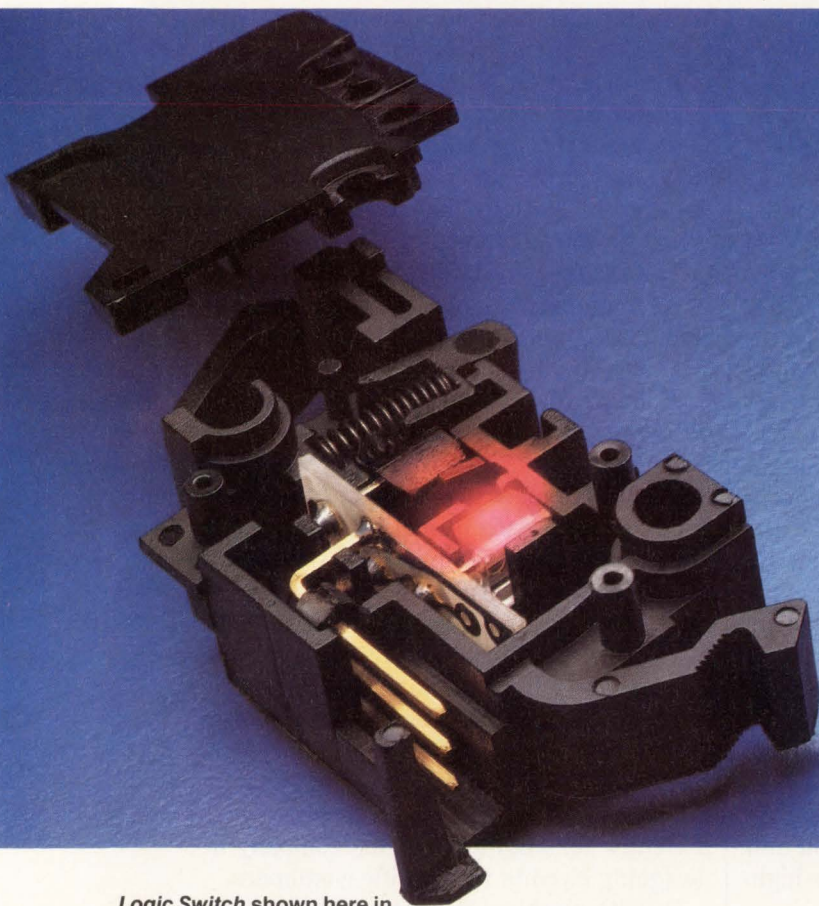

Logic Switch shown here in our Terminator® quick-connect, fast-mount configuration.

Introducing the *Logic Switch*™

Imagine! Noise-free, logic-level switching from an electromechanical package! We're calling it the *Logic Switch* because this alternative to mechanical contact switches gives you discrete, noise-free signal through optoelectronics. Solid-state and designed for long life and reliability. Think of the possibilities!

Here's How It Works.

The *Logic Switch* uses an infrared emitter and phototransistor sensor combination. An internal "flag" interrupts a beam of infrared light from emitter to sensor, thus changing the switch's output when activated.

The infrared light transmission reduces dust problems associated with visible light transmission, and the solid-state life-span is estimated at 50 million cycles.

What Can You Do With It?

The *Logic Switch* is so new, we wouldn't presume to guess at all its uses. Instead, we invite you to examine it firsthand and try it out on *your* ideas. Call Cherry at 708-360-3500, and we'll send qualified engineers a free *Logic Switch* and a specifications sheet.

The *Logic Switch* is ideal for any application in which logic-level switching is necessary and traditional snap-action switches are problematic.

But perhaps you have some different ideas.

Why not call us today and put those ideas to the test right in your own laboratory—for FREE. All you've got to lose is signal noise.

The *Logic Switch*: an electronic device in an electrical package.

**Comdex
Booth #H8418**

CHERRY 
THE CHERRY CORPORATION

Cherry Electrical Products
3600 Sunset Avenue
Waukegan, IL 60087
Phone: 708-360-3500
Facsimile: 708-360-3566

Circle #7 For immediate need

Circle #8 For Future need



The mysteries of probing

Unless you master the mysteries of probing and oscillography, you'll be doomed to measuring the errors in your setup and oscilloscope, not the errors in your circuit.

Jim Williams, *Linear Technology Corp*

Measuring a high-speed linear circuit is a classic problem in observability. The problem is twofold: Stimulating and probing the circuit without disturbing its behavior and ensuring that the waveforms on your oscilloscope's screen are valid representations of your circuit's behavior. Problems can start before you apply power to your prototype.

Even something as simple as cabling requires thought. All coaxial cable is not the same. Always route high-speed signals to and from your circuit board with good-quality coaxial cable. Use cable appropriate to your system's characteristic impedance.

Poorly chosen cable materials or construction methods can introduce odd effects at very high speeds, resulting in distorted waveforms. A poor cable choice can adversely affect 0.01% settling in the 100- to 200-nsec region. Similarly, poor-quality cable can spoil even the cleanest pulse generator's 1-nsec rise time or purity. All too typically, inappropriate cable can introduce tailing, rise-time degradation, aberrations following transitions, nonlinear impedance, and other undesirable effects.

Other potential cabling problems begin at your circuit's input. The driven end of an input cable is usually an instrument (such as a pulse or signal generator), presumably endowed with proper characteristics by its manufacturer. The cable and its termination, selected by the experimenter, often cause problems.

Fig 1a shows severe ringing on the pulse edges at the output of an unterminated pulse-generator cable. Reflections cause this ringing and you can eliminate it by terminating the cable. Always terminate the source with its characteristic impedance when driving cable or long printed-circuit traces. In the high-speed

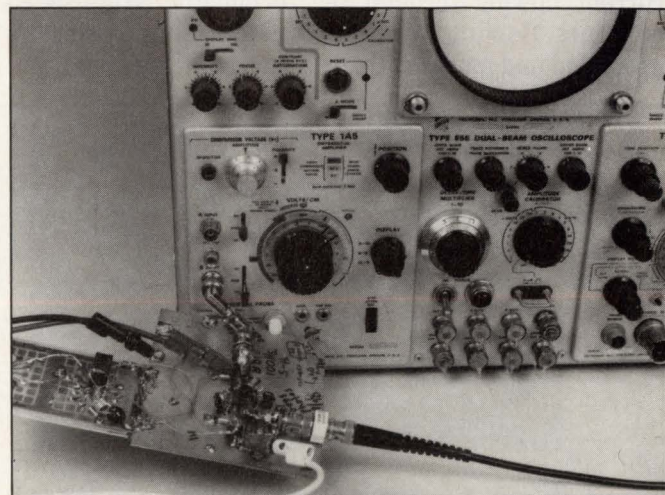

One of the secrets of probing is that sometimes the best probe is no probe. Oscilloscopes are so well designed that a 25-year-old scope suffices for 90% of today's applications.

THE
JIM WILLIAMS
P A P E R S

linear domain, any conductor longer than one inch is suspect.

In **Fig 1b** the cable is terminated, but ripple and aberration are still present following the high-speed edges. In this instance the terminating resistors' leads are lengthy ($\sim 3/4$ in.), sabotaging the wideband termination. The best terminating resistors for 50Ω cable are the BNC coaxial type. Their impedance vs frequency is flat into the GHz range. Although these terminators are practical on the test bench, they are rarely board-level components.

These coaxial terminators should not simply be resistors in an enclosure. Good grade, 50Ω terminators maintain true coaxial form. They use a carefully designed 50Ω resistor. The terminators' designers devoted significant effort to the connections to the actual resistive element. In particular, the terminators have the largest possible connection-surface area to minimize high-speed losses.

Termination resistors

The best termination resistors for pc-boards are carbon or metal-film types having the shortest possible lead lengths. These resistors' "end-cap" connections provide better high-speed characteristics than the rod-connected composition types' connections. Wirewound resistors, because of their inherent, pronounced inductance, are completely unsuitable for high-speed work. This prohibition includes noninductive types of resistors.

Another termination consideration is disposing of the current flowing through the terminator. High-speed currents flowing from the terminating resistor's grounded end must not disrupt your circuit's operation.

For example, returning terminator current to ground near the grounded positive input of an inverting op-amp would be unwise. The high-speed, high-density current flow could cause serious corruption of the op-amp's reference. For example, 5V pulses through a 50Ω termination generate 100-mA current spikes.

This possible corruption is another reason why, for bench testing, the coaxial BNC terminators are preferable to discrete, breadboard-mounted resistors. In the coaxial types, the termination current returns directly to the source generator and never flows in the breadboard. Select terminations carefully, and evaluate the effects of their placement in your test setup.

Figs 2a and **2b** illustrate these terminators' performance nicely. In **Fig 2a**, a 1-GHz sampling scope (Tektronix 556 with 1S1 sampling plug-in and P6032 probe) monitors a 1-nsec pulse with 350-psec rise and fall times. The waveform is clean, with only a slight hint of ring after the falling edge. The setup used in **Fig 2a** is a high-grade BNC coaxial terminator. The setup in **Fig 2b** does not share these attributes. Rather, a 50Ω carbon-composition resistor with lead lengths of about $1/8$ in. terminate the generator. The waveform rings and tails badly on turn-off before finally settling. Note that the sweep speed required a $2.5\times$ reduction to capture these unwanted events.

Connectors, such as BNC barrel extensions and tee-type adapters, represent a discontinuity in the cable and can introduce small but undesirable effects. In general, you should use them as close as possible to a terminated point in the system. Using them in the middle of a cable run provides only minimal absorption of their mismatch and reflections.

The worst offenders among connectors are adapters.

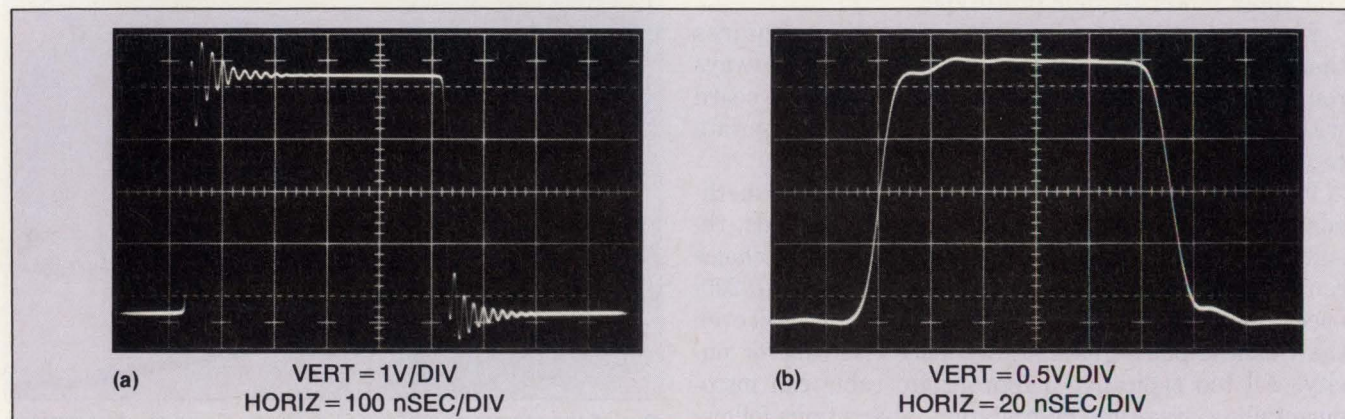

Fig 1—In scope photo **a**, an unterminated cable causes severe ringing. In **b**, improperly spec'ed termination resistors reduce, but do not eliminate, ringing.

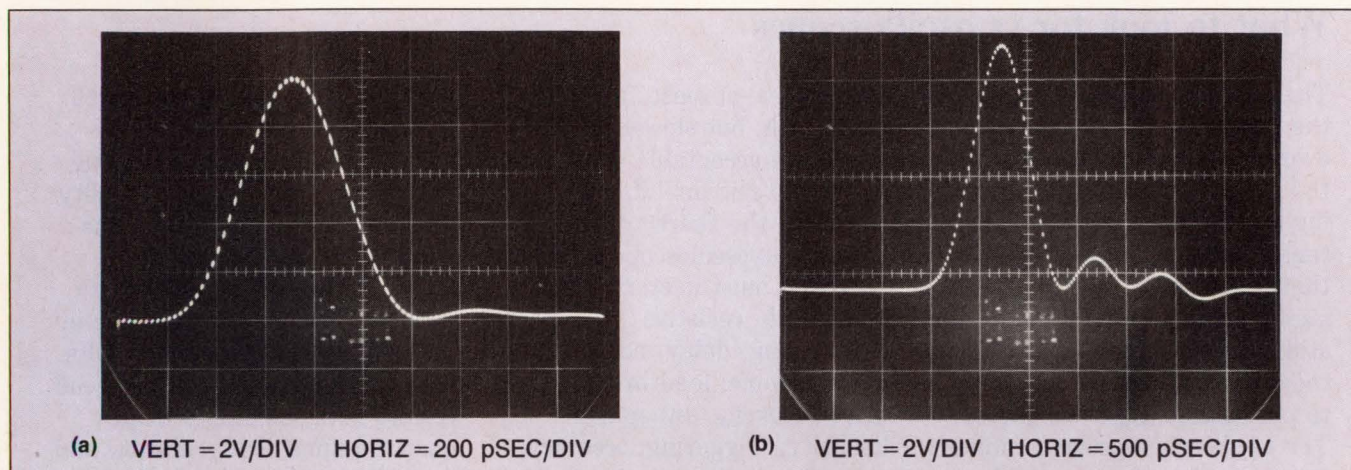

Fig 2—Coaxial-termination resistors (a) are superior in performance to carbon-composition resistors (b).

The lack of standard connectors among wideband instrumentation makes this situation unfortunate. The mismatch caused by a BNC-to-GR874 adapter at the input of a wideband sampling scope is small, but clearly discernible on an oscilloscope. Similarly, you can readily measure mismatches in almost all adapters on a high-frequency network analyzer, such as the Hewlett-Packard 4195A—even in theoretically identical adapters of different manufacture. (For additional wisdom and terror along these lines, see **Ref 1**.)

BNC connections are easily the most common, but not necessarily the most desirable, wideband connectors. The ingenious GR874 connector has notably superior high-frequency characteristics, as does the type N. Unfortunately, it's a BNC world out there.

Choosing the proper probe

After you find the type of connector that is best for your needs, you must choose a probe. Your oscilloscope's probe becomes an integral part of the circuit under test. Therefore, choosing which oscilloscope probe to use for a measurement is absolutely crucial.

Sometimes, however, the best probe is no probe at all. In some circumstances, connecting critical breadboard points directly to the oscilloscope is not only possible, but preferable. Connecting directly to critical breadboard points provides the highest possible grounding integrity, eliminates probe attenuation, and maintains bandwidth. In most cases, however, the direct connection is mechanically inconvenient, and often the oscilloscope's electrical characteristics (particularly input capacitance) will not permit it.

Of course, this mechanical inconvenience is why

equipment makers developed oscilloscope probes in the first place, and why they have put so much effort into their probes' development. (**Ref 2** is an excellent reference for the designing of probes.)

Probes are the most overlooked source of oscillographic mismeasurement. The most obvious culprit is probes' input resistance, but input capacitance usually dominates in a high-speed measurement. You can lose much time chasing phantom circuit events that are actually caused by improperly selected or applied probes. Pay particular attention to the probe's input capacitance. Standard 10-M Ω , 10 \times probes typically have 8 to 10 pF of input capacitance, with 1 \times types having much higher input capacitance.

Text continued on pg 170

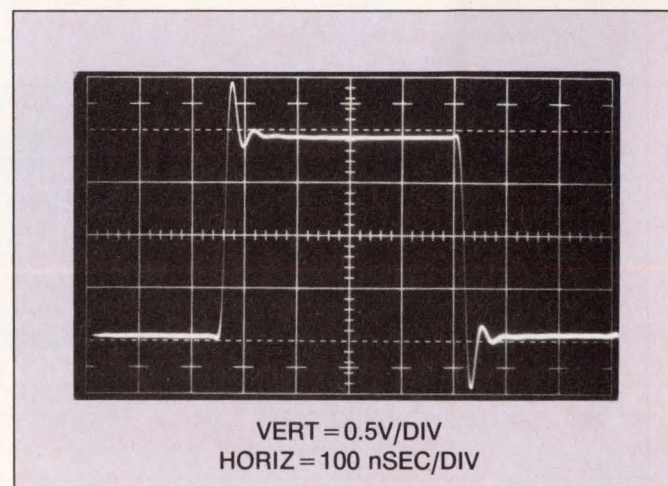

Fig 3—The capacitance of a probe clipped to another node in the circuit distorts this amplifier's response.

What to look for in oscilloscopes

The modern oscilloscope is one of the most remarkable instruments ever constructed. Perhaps only the zealotry devoted to timekeeping equals the protracted and intense development devoted to these machines. That instruments manufactured 25 years ago still suffice for more than 90% of today's measurements is a tribute to past oscilloscope designers. The oscilloscope-probe combination you select for your high-speed work is the most important equipment decision you can make.

Ideally, your oscilloscope

should have at least 150-MHz bandwidth, but slower instruments are acceptable if you understand their limitations. Be certain of the characteristics of your probe-oscilloscope combination. You must keep rise time, bandwidth, resistive and capacitive loading, delay, noise, channel-to-channel feedthrough, overdrive recovery, sweep non-linearity, triggering, accuracy, and other limitations in mind. High-speed linear circuitry demands a great deal from test equipment, and you can save yourself countless hours by

knowing your instruments well.

Engineers have wasted obscene amounts of time pursuing "circuit problems" that in reality arose from misunderstood, misapplied, or out-of-spec equipment. Intimate familiarity with your oscilloscope is invaluable in getting the best possible results with it. In fact, you can get good results with seemingly inadequate equipment if you know and respect the equipment's limitations.

Familiarity with equipment and thoughtful measurement technique permit useful measure-

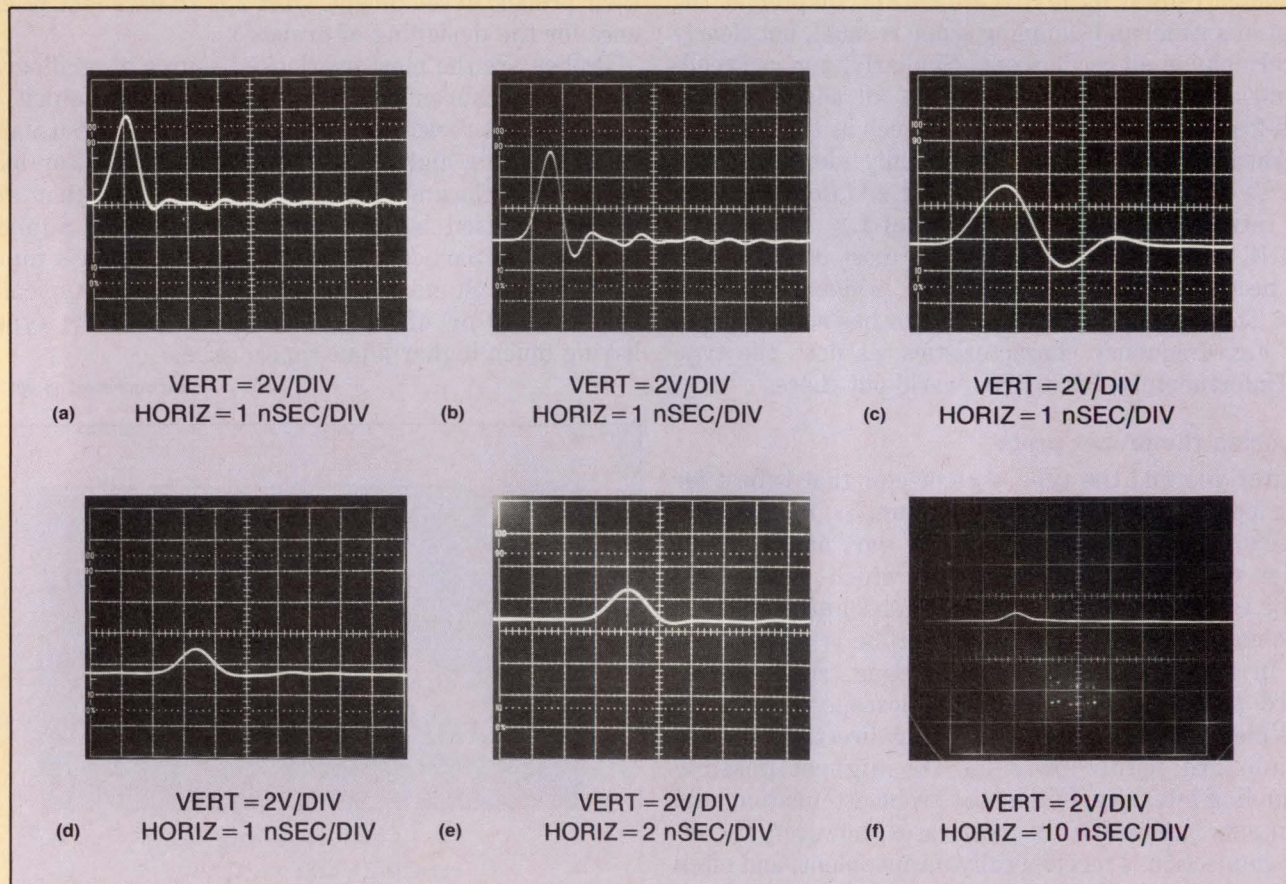

Fig A—This series of photos shows what the fast pulse in Fig 2a (pg 167) looks like on a variety of oscilloscopes.

ments seemingly beyond instrument specifications. A 50-MHz oscilloscope cannot track a 5-nsec rise-time pulse, but it can measure a 2-nsec delay between two such events. Using such techniques, you can often deduce the desired information. In some situations no amount of cleverness will work and you must use the right equipment (for example, a faster oscilloscope).

Sometimes "reality checking" a limited-bandwidth instrument with a higher-bandwidth oscilloscope is all that you need to do. For high-speed work, brute-force bandwidth is indispensable when needed, and no amount of features or computational sophistication will substitute. Most high-speed circuitry does not require more than two traces to get where you are going. Versatility

and many channels are desirable, but if your budget is limited, spend for bandwidth.

Probe-oscilloscope combinations of varying bandwidths produce dramatic differences in their displays. The series of scope photos in this box shows what a fast pulse looks like on various oscilloscopes. **Fig 2a** (pg 167) in the main text shows the output of a very fast pulse (**Ref 3**) monitored with a 1-GHz sampling scope (Tektronix 556 with 1S1 sampling plug-in). At this bandwidth the 10V amplitude appears clean, with just a hint of ringing after the falling edge. The rise and fall times of 350 psec are suspicious, as the sampling oscilloscope's rise time is also 350 psec.

Fig Aa shows the same pulse observed on a 350-MHz instrument with a direct connection to

the input (Tektronix 485/50 Ω input). Indicated rise time balloons to 1 nsec, while displayed amplitude shrinks to 6V, reflecting this instrument's lesser bandwidth. Poor grounding technique (1½ in. of ground lead to the ground plane) creates the prolonged rippling after the pulse fall.

Fig Ab shows results from the same 350-MHz oscilloscope with a 3-GHz, 10 \times probe (Tektronix P6056, 50 Ω input). Displayed results are nearly identical, because the probe's high bandwidth contributes no degradation. Again, deliberate poor grounding causes overshoot and rippling on the pulse's falling edge.

Fig Ac equates the same oscilloscope with a 10 \times probe specified at a 290-MHz bandwidth (Tektronix P-6047). Additionally,

Text continued on pg 170

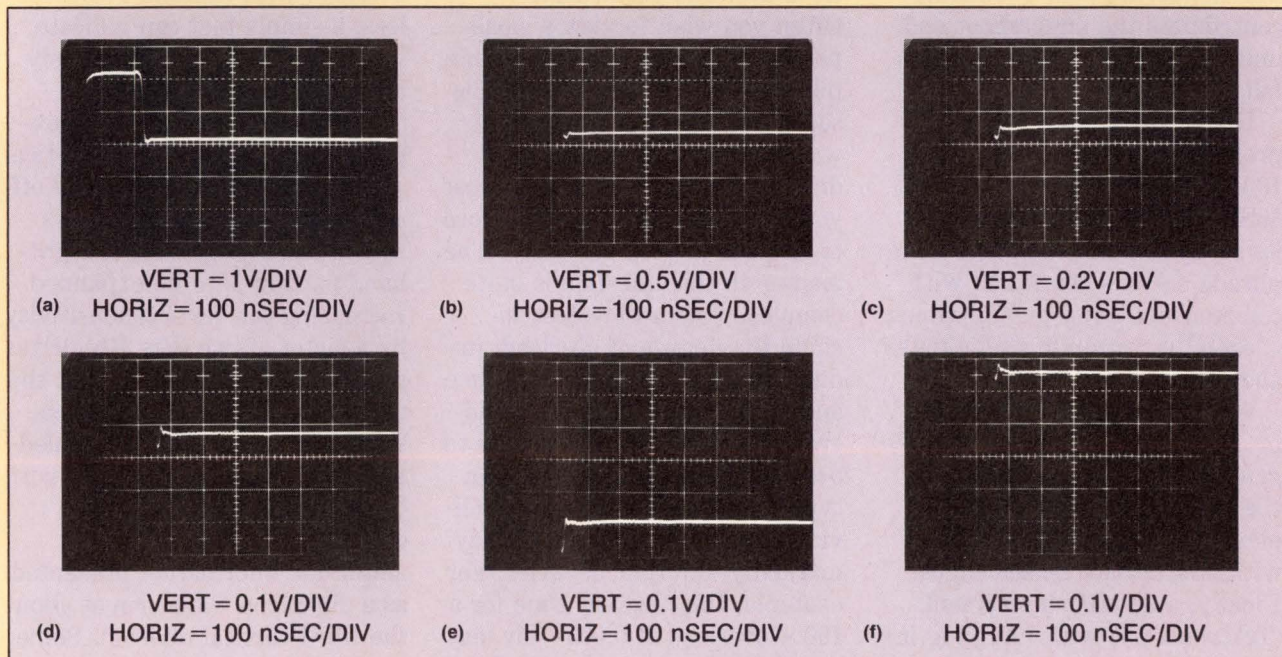
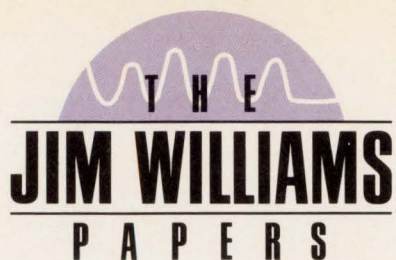

Fig B—Your particular oscilloscope may perform peculiarly when overloaded, as this series of scope photos demonstrates.



THE
JIM WILLIAMS
PAPERS

The probe-caused problem in **Fig 3** shows up as output peaking and ringing. In other respects the display is acceptable. A second $10\times$ probe connected to the amplifier's summing junction causes this output peaking. Because the summing point is so central to analyzing op-amp operation, it often has a probe attached. At high speeds, the probe's 10-pF input capacitance causes a significant lag in feedback action, forcing the amplifier to overshoot and hunt as it seeks the null point. Minimizing this effect calls for probes having the lowest possible input capacitance, mandating FET types or special passive probes. Account for the effects of probe capacitance, which often dominate the probe's impedance at high-speeds. A standard 10-pF $10\times$ probe, combined with a 1-k Ω source resistance, forms a 10-nsec lag.

But, by far, improper grounding is the greatest

source of error in probe use. Poor probe grounding can cause ripples and discontinuities in the observed waveform. In some cases the choice and placement of a probe's ground strap will affect waveforms on another channel. In the worst case, connecting the probe's ground wire will virtually disable the circuit being measured. The cause of these problems is the parasitic inductance in the probe's ground connection.

Fig 4 shows an amplifier output that rings and distorts badly after rapid voltage excursions. Here, the circuit is not at fault; the probe's ground lead is too long. For general-purpose work, most probes come with ground leads about six inches long. At low frequencies this length is fine. At high-speed, the long ground lead looks inductive, causing the ringing shown.

Fast probes always come with a variety of spring clips and accessories designed to aid in making the

What to look for in oscilloscopes (*continued*)

the oscilloscope was in its 1-M Ω input mode, reducing bandwidth to a specified 250 MHz. Amplitude degrades to less than 4V, and edge times similarly increase. The deliberate poor grounding contributes the undershoot and underdamped recovery on pulse fall.

In **Fig Ad** a 100-MHz, $10\times$ probe (Hewlett-Packard Model 10040A) substitutes for the 290-MHz unit. The oscilloscope and its setup remains the same. Amplitude shrinks below 2V, with commensurate rise and fall times. Cleaned up grounding eliminates aberrations.

A Tektronix 454A (150 MHz) produced **Fig Ae's** trace. A pulse generator connected directly to the oscilloscope's input. Displayed amplitude is about 2V, with appropriate 2-nsec edges. Finally, a 50-MHz instrument (Tektronix 556 with 1A4 plug-in) just barely grunts in response to the pulse (**Fig Af**). Indicated am-

plitude is 0.5V, with edges reading about 7 nsec. This last display is a long way from the 10V and 350 psec that's really there.

A final oscilloscope characteristic is overload performance. Often you wish to view a small portion of a large waveform's amplitude. In many cases the oscilloscope must supply an accurate waveform after the display is driven off screen. How long must you wait after an overload before taking the display seriously? The answer to this question is quite complex. Factors involved include the degree of overload, its duty cycle, its magnitude in time and amplitude and other considerations. Oscilloscope response to overload varies widely between types. Among a given type, individual instruments often display markedly different behavior. For example, the recovery time for a $100\times$ overload at 0.005V/div may be very different than at 0.1V/div. The recovery may also vary with

waveform shape, dc content, and repetition rate.

With so many variables, clearly you must approach measurements involving oscilloscope overload with caution. Nevertheless, a simple test can indicate when overdrive is deleteriously affecting an oscilloscope.

Place the waveform to be expanded on the screen at a vertical sensitivity that eliminates all off-screen activity. **Fig Ba** shows such a display. The lower right-hand portion is to be expanded. Increasing the vertical sensitivity by a factor of two (**Fig Bb**) drives the waveform off-screen, but the remaining display appears reasonable. Amplitude has doubled and waveshape is consistent with the original display. Looking carefully, you can see small-amplitude information presented as a dip in the waveform at about the third vertical division. Some small disturbances are also visible. This observed expansion of

lowest possible inductive connection to ground. Most of these attachments assume that your circuit has a ground plane—which it should have. Always try to make the shortest possible connection to ground; anything longer than one inch may cause trouble. The ideal probe-ground connection is purely coaxial. Probes mated directly to board-mounted coaxial connectors give the best results.

Sometimes determining if probe grounding is the cause of observed waveform aberrations is difficult. One good test is to disturb the grounding setup and see if changes occur. Touching the ground plane or jiggling probe-ground connectors or wires should have no effect. If you are using a ground-strap wire, try changing its orientation or simply squeezing it together to change and minimize its loop area. If any waveform change occurs, your probe grounding is unacceptable.

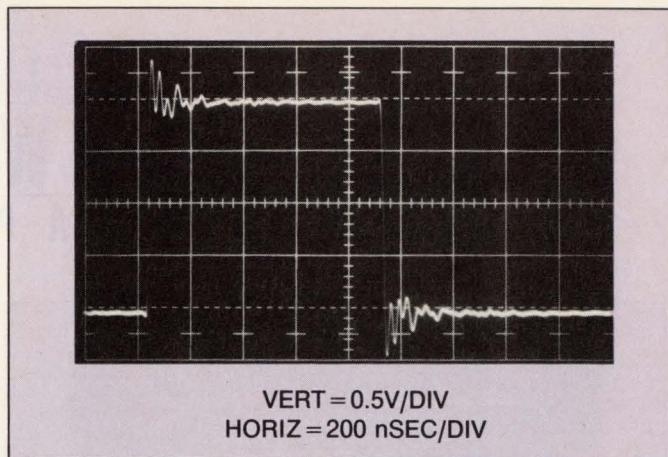

Fig 4—Probe capacitance isn't the only fly in the ointment; here, an overly long ground lead induces ringing.

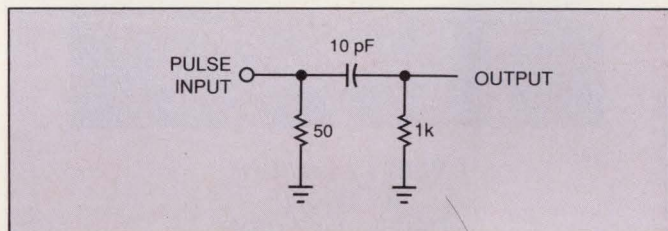

Fig 5—Monitoring this simple circuit's response to a pulse illustrates several potential probing problems.

the original waveform is believable.

In **Fig Bc's** display, gain is higher, and all the features of the **Fig Bb** example are amplified accordingly. The basic waveshape appears clearer, and the dip and small disturbances are also easier to see. No new waveform characteristics appear. The **Fig Bd** photo brings some unpleasant surprises. This increase in gain causes definite distortion. The initial negative-going peak, although larger, has a different shape. Its bottom appears less broad than in **Fig Bc**. Additionally, the peak's positive recovery is shaped slightly differently. A new rippling disturbance is visible in the center of the screen. This kind of change indicates that the oscilloscope is having trouble.

A further test can confirm that overloading is influencing this waveform. In **Fig Be's** photo, the gain remains the same but the vertical position knob has reposi-

tioned the display at the screen's bottom. This shifts the oscilloscope's dc operating point which, under normal circumstances, should not affect the displayed waveform. Instead, a marked shift in waveform amplitude and outline occurs. Repositioning the waveform to the screen's top produces a differently distorted waveform (**Fig Bf**). Obviously, for this particular waveform, you cannot obtain accurate results at this gain.

Differential plug-ins can address some of the issues associated with excessive overdrive, although they cannot solve all problems. Two differential plug-in types merit special mention. At low levels, a high-sensitivity differential plug-in is indispensable. The Tektronix 1A7 and 7A22 feature 10- μ V sensitivity, although bandwidth is limited to 1 MHz. The units also have selectable highpass and lowpass filters and good high-frequency, common-

mode rejection. Tektronix type 1A5, W, and 7A13 are differential comparators. They have calibrated dc nulling ("sideback") sources, letting you observe both small, slowly moving events on top of common mode dc or fast events riding on a waveform.

A special case is the sampling oscilloscope. Because of its nature of operation, a sampling scope in proper working order is inherently immune to input overload, providing essentially instantaneous recovery between samples (**Ref 4**).

The best approach to measuring small portions of large waveforms, however, is to eliminate the large signal swing seen by the oscilloscope. The **box**, "Measuring amplifier settling time," in the article "Subduing high-speed op-amp problems" (scheduled for the October 24 issue of EDN), shows ways to do this when measuring DAC/amplifier settling time to very high accuracy at high speed.

THE
JIM WILLIAMS
 P A P E R S

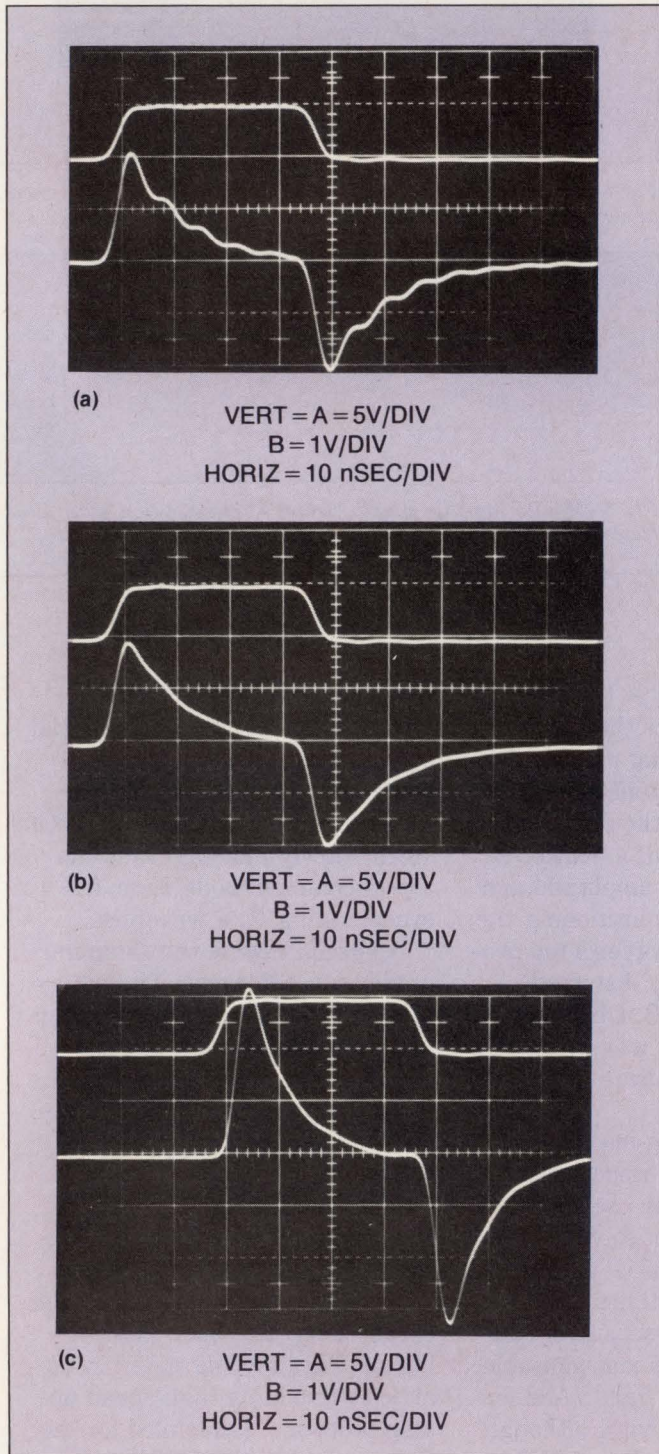

Fig 6—A probe's capacitance and ground-lead inductance add ringing and distortion to the output (a). Substituting a spring clip for the ground lead cleans up the output trace somewhat (b). Substituting an FET probe for the ground lead (c) reveals a 50% amplitude distortion in b.

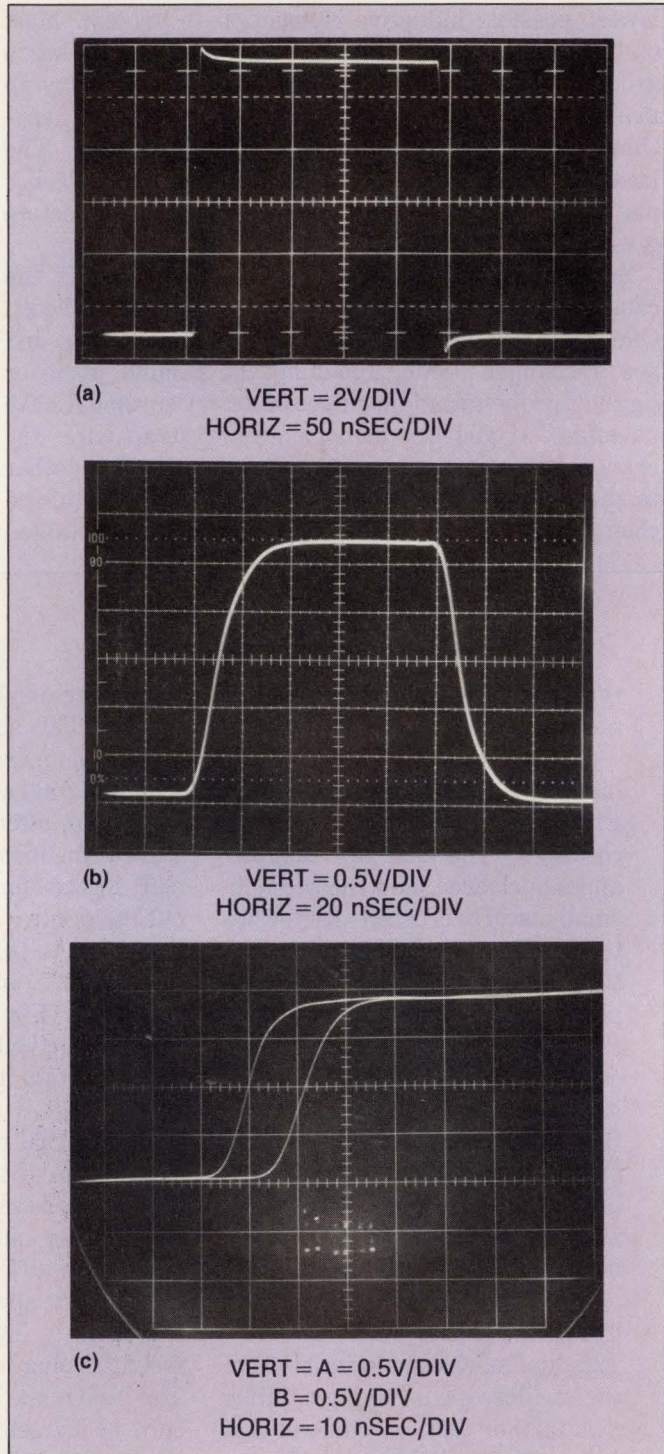

Fig 7—In a, a grossly miscompensated or improperly selected oscilloscope probe causes an op amp to appear to be delivering an 11V output from a 5V supply. In b, a probe having insufficient bandwidth rounds off the edges of this waveform. Probes can also add significant delay to observed waveforms (c).

The simple network of the circuit in Fig 5 shows just how easily poorly chosen or used probes cause bad results. A 9-pF input-capacitance probe with a 4-in. ground strap monitors the output (Fig 6a). Although the pulse input is clean, the output contains ringing. Using the same probe with a 1/4-in. spring-tip ground-connection accessory seemingly cleans up everything (Fig 6b). However, substituting a 1-pF FET probe (Fig 6c) reveals a 50% output-amplitude error in Fig 6b's measurement. The FET probe's low-input capacitance allows a more accurate version of the circuit's action. The FET probe does, however, contribute its own form of error. Note that the probe's response is tardy by 5 nsec because of delay in its active circuitry. Hence, you must make separate measurements with each probe to determine amplitude and timing characteristics of the output.

Poorly compensated probe

In Fig 7a, the probe is properly grounded, but a new problem pops up. This photo shows an amplifier output excursion of 11V—quite a trick from an amplifier running from $\pm 5V$ rails. Engineers commonly report this confusing problem when they work on high-speed circuits. The problem arises not because of a suspension of natural law, but from a grossly mismatched or improperly selected oscilloscope probe. Use probes that match your oscilloscope's inputs and compensate them properly.

Fig 7b illustrates another probe-induced problem. Here the waveform's amplitude seems correct, but the amplifier appears slow, developing pronounced edge rounding. Here, the probe used is too heavily compen-

sated or slow for the oscilloscope. Never use $1\times$ or "straight" probes. Their bandwidth is 20 MHz or less and their capacitive loading is high. Check probe bandwidth to ensure it is adequate for the measurement. Similarly, use an oscilloscope that has adequate bandwidth.

Mismatched probes account for the apparent excessive amplifier delay in Fig 7c's amplifier. The display shows delay of almost 12 nsec for an amplifier that specs 6 nsec. Always keep in mind that various types of probes have different signal-transit delay times. At high-sweep speeds this effect shows up in multitrace displays as time skew between individual channels. Using similar probes will eliminate this problem, but measurement requirements often dictate dissimilar probes. In such cases you should measure the differential delays and then mentally factor them in to reduce error when interpreting the display. Note that active probes, such as FET and current probes, have signal transit times as long as 25 nsec. A fast $10\times$ - or 50Ω -probe's delay can be inside 3 nsec. Account for probe delays in interpreting oscilloscope displays.

Fig 8a depicts a wildly distorted amplifier output. The output slews quickly, but the pulse's top and bottom recovery have lengthy, tailing responses. Additionally, the amplifier's output seems to clip well below its nominal-rated output swing. A common oversight is responsible for these conditions—An FET probe monitors the amplifier's output in this example. The probe's common-mode input range has been exceeded, causing the probe to overload, clip, and distort badly.

The rising pulse drives the probe deeply into saturation, forcing its internal circuitry away from normal

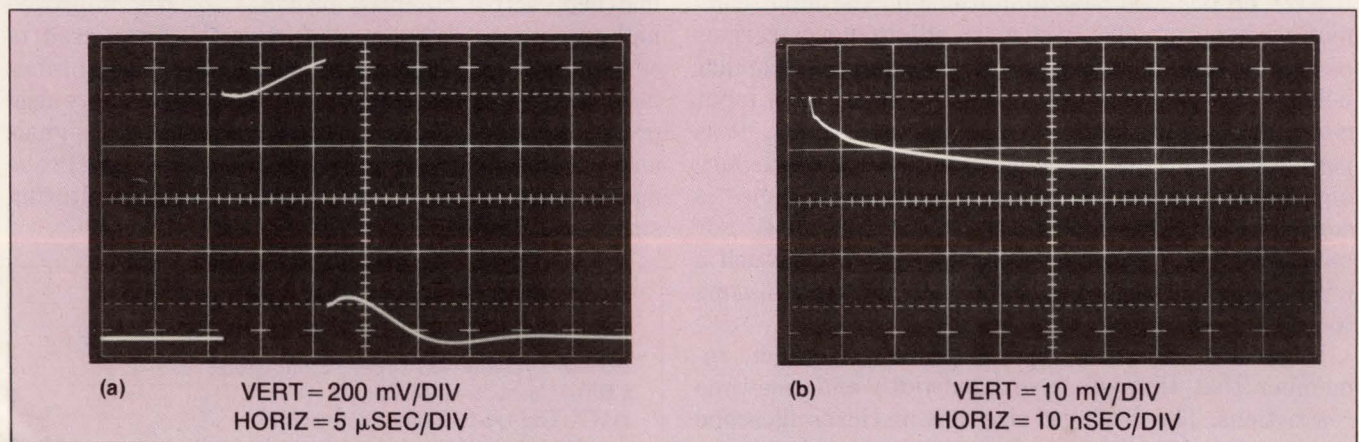

Fig 8—Section a shows the result of overdriving an FET probe's internal circuitry, and b illustrates the inadvisability of attaching bargain-basement probes to a high-speed circuit.

operating points. Under these conditions the displayed pulse top is invalid. When the circuit's output falls, the probe's overload recovery is lengthy and uneven, causing the tailing. More subtle forms of FET probe overdrive may show up as extended delays, but there is no obvious signal distortion. Avoid saturation effects arising from an FET probe's common-mode input limitations (typically $\pm 1V$) by using $10\times$ and $100\times$ attenuator heads when required.

A peaked, tailing response is the characteristic depicted in Fig 8b. The photo shows the final 40 mV of a 2.5V amplifier excursion. Instead of a sharp corner that settles cleanly, peaking occurs, followed by a lengthy tailing decay. An inexpensive "off-brand" $10\times$ probe picked off this waveform. Such probes are often poorly designed, and constructed from materials inappropriate for high-speed work. Selecting and integrating materials for wideband probes is a specialized and difficult art. Probe designers must expend substantial design effort to get good fidelity at high speeds. Never use probes unless their manufacturer specifies them for wideband operation. Obtain probes from a vendor you trust.

When choosing your probe, also keep in mind that you cannot use all $10\times$ probes with all oscilloscopes indiscriminately; the probe's compensation range must match the oscilloscope's input capacitance. Low impedance probes, designed for 50Ω inputs, (with 500Ω to $1k\Omega$ resistance) usually have input capacitance of 1 or 2 pF. They are a very good choice if you can stand the low resistance. FET probes maintain high-input resistance and keep capacitance at the 1-pF level, but have substantially more delay than passive probes.

FET probes also have limitations on the input common-mode range that you must adhere to or serious measurement errors will result. Contrary to popular belief, FET probes do not have extremely high input resistance—some types are as low as $100k\Omega$. It is possible to construct a wideband FET probe with very high input impedance, although input capacitance is somewhat higher than standard FET probes. For measurements requiring these characteristics, such a probe is useful (see box, "Build your own oscilloscope tools").

Regardless of which type of probe you select, remember that they all have bandwidth and rise-time restrictions. The displayed rise time on the oscilloscope is the vector sum of source, probe, and scope rise times,

$$T_{RISE} = \sqrt{(T_{RISE\ SOURCE})^2 + (T_{RISE\ PROBE})^2 + (T_{RISE\ OSCILLOSCOPE})^2}$$

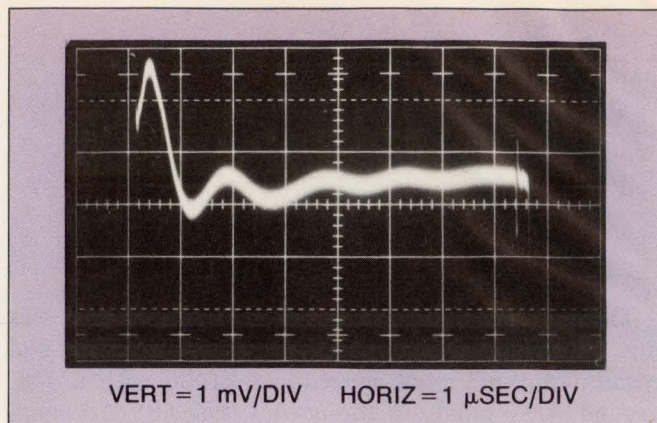

Fig 9—What appears to be a circuit's ringing is actually the oscilloscope recovering from overdrive arising from an off-screen excursion.

This equation warns that some rise-time degradation must occur in a cascaded system. In particular, if the probe and oscilloscope have the same rise time, the system's response will be slower than either.

Current probes are useful and convenient. The passive transformer types are fast and have less delay than the Hall-effect versions. The Hall types, however, respond at dc and low frequency, while the transformer types typically roll off somewhere below 1 kHz to 100 Hz. Both types have saturation limitations which, when exceeded, cause odd results on the CRT that will confuse the unwary. The Tektronix CT-1 current probe, albeit not nearly as versatile as the clip-on probes, bears mention. Although the CT-1 is not a clip-on device, it may be the least electrically intrusive way of extracting wideband signal information. Rated at a 1-GHz bandwidth, the CT-1 produces 5-mV/mA output with only 0.6-pF loading. The decay time-constant of this ac-current probe is $\sim 1\%/50$ nsec, resulting in a low-frequency limit of 35 kHz.

A very special probe is the differential probe. You may think of a differential probe as two matched FET probes contained within a common probe housing. This probe literally brings the advantage of a differential-input oscilloscope to the circuit board. The probes' matched, active circuitry provides greatly improved high-frequency, common-mode rejection compared to single-ended probing or even matched, passive probes used with a differential amplifier. The differential probe's resultant ability to reject common-mode signals and "ground noise" at high frequency lets this probe deliver exceptionally clean results when monitoring small, fast signals.

Acronyms used in this article

- BNC—BNC coax connector. A twist-lock connector for various types of RG-type coaxial cables.
- CRT—Cathode-ray tube
- DAC—Digital-to-analog converter
- dc—Direct current
- FET—Field-effect transistor
- IC—Integrated circuit

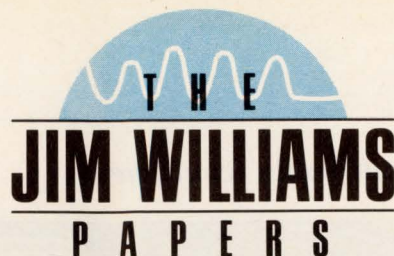

 THE
JIM WILLIAMS
 P A P E R S

A final form of probe is the human finger. Probing the circuit with a finger can accentuate desired or undesired effects, giving clues that may be useful. The finger can introduce stray capacitance to a suspected circuit node while you observe the results on the CRT. Two fingers, lightly moistened, can provide an experimental resistance path. Some engineers are particularly adept at these techniques and can estimate the capacitive and resistive effects created with surprising accuracy.

You can mount a miniature coaxial connector on your circuit board and mate whichever type of probe you choose to it. This technique provides the lowest possible parasitic inductance in the ground path and is especially recommended. If you use a current probe, a ground connection is not usually required. However, at high speeds, a ground connection may result in a cleaner CRT presentation. Because no current flows in the ground lead of current probes, a long strap is usually permissible.

Even an ideal probe connection does not guarantee an accurate scope display. **Fig 9** shows the final movements of an amplifier output excursion. Setting the scope at only 1-mV per division, the objective is to view the settling residue at high resolution. Multiple time constants, nonlinear recovery, and tailing characterize this response. Note also the high-speed event just before the waveform begins its negative going-transition. What you are actually seeing is the oscillo-

scope recovering from excessive overdrive. You should approach any observation that requires off-screen positioning of parts of the waveform with the greatest caution. Oscilloscopes vary widely in their response to overdrive, bringing displayed results into question. Approach all oscilloscope measurements that require off-screen activity with caution. Know your instrument's capabilities and limitations. **EDN**

References

1. Orwiler, Bob, "Oscilloscope Vertical Amplifiers," Tektronix Inc, Concept Series, 1969.
2. Weber, Joe, "Oscilloscope Probe Circuits," Tektronix Inc, Concept Series, 1969.
3. Williams, Jim, "Pulse generator wrings out scopes," EDN March 28, 1991, pg 162.
4. Mulvey, J, "Sampling Oscilloscope Circuits," Tektronix Inc, Concept Series, 1970.
5. "The ABC's of Probes," Tektronix Inc.

Author's biography

For more information on this article's author, see pg 163

Article Interest Quotient (Circle One)
 High 491 Medium 492 Low 493

Build your own oscilloscope tools

Under most circumstances the 1- to 2-pF input capacitance and 10-M Ω resistance of FET probes is more than adequate for difficult probing situations. Occasionally,

however, you may need very high input resistance along with high speed. At some sacrifice in speed and input capacitance, compared with commercial probes, you

can construct such a probe.

Fig A shows schematic details. IC₁, a 350-MHz hybrid FET buffer, forms the electrical core

Text continued on pg 176

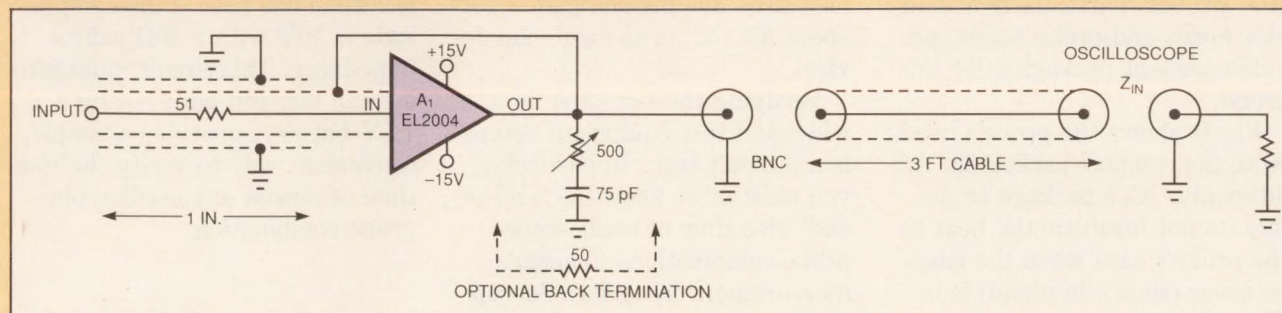

Fig A—Using this circuit, you can build your own high-performance FET oscilloscope probe.

Build your own oscilloscope tools (continued)

of the probe. This device is a low input-capacitance, wideband-FET source follower driving a fast bipolar output stage. The input of the probe goes to this device via a 51Ω resistor, reducing the possibility of oscillations in the follower's input stage when the probe sees low ac impedance. IC₁'s output drives a guard shield around the probe's input line, reducing effective input capacitance to about 4 pF. A ground-referred shield encircles the guard shield, reducing pickup and making high-quality ground connections to the circuit under test easy.

IC₁ drives the output BNC cable to feed the oscilloscope. Normally, back-terminating the cable at IC₁ is undesirable because the oscilloscope sees only half of IC₁'s output. Although a back termination provides the best signal dynamics, the resulting attenuation is a heavy penalty. You can trim the RC damper for best edge response while still maintaining an unattenuated output.

What you can't see in the schematic is the probe's physical construction. You must build the probe very carefully to maintain low input capacitance, low bias current, and wide bandwidth. The probe's head is particularly critical. Make every effort to minimize the length of wire between IC₁'s input and the probe's tip. In our lab, we have found that discarded pieces of broken $10\times$ probes, particularly attenuator boxes and probe heads, provide excellent packaging for this probe.

Fig B shows the probe's head. Note the compact packaging. Additionally, IC₁'s package transfers its not-insubstantial heat to the probe's case when the snap-on cover (shown in photo) is in place. This reduces IC₁'s sub-

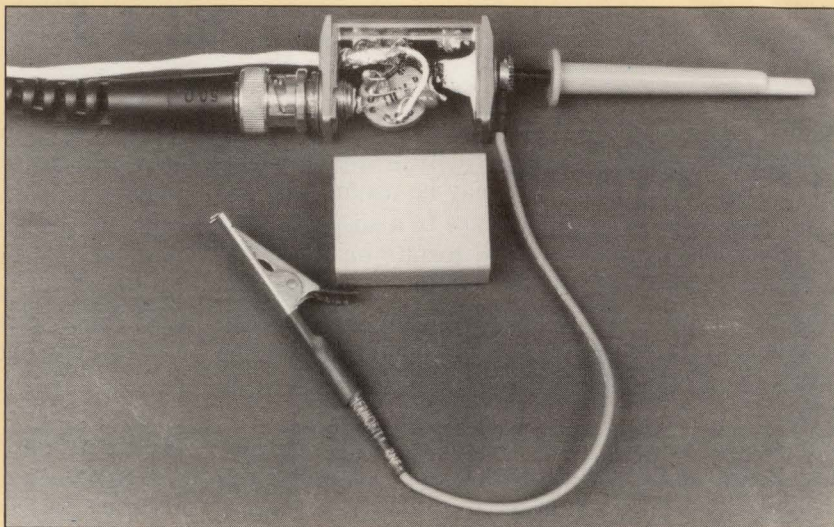

Fig B—The components in Fig A fit nicely into a salvaged commercial probe.

strate temperature, keeping bias current down. IC₁'s input connects directly to the probe's head to minimize parasitic capacitance. The power supply for IC₁, located in a separate enclosure, feeds in through separate wires. IC₁'s output goes to the oscilloscope via conventional BNC hardware.

Fig C shows the probe's output responding to an input as monitored on a 350-MHz oscilloscope (Tektronix 485). Measured specifications for Linear Technology's version of this probe include a rise time of 6 nsec, 6-nsec delay, and 350-MHz bandwidth. The delay time splits evenly between the amplifier and cable. Input capacitance is about 4 pF without the probe-hook tip and 7 pF with the hook tip. Input bias current measured 400 pA and gain error about 5% (IC₁ is an open-loop device).

Verifying the rise-time limit of wideband test equipment setups is a difficult task. In particular, you must often know the "end-to-end" rise time of oscilloscope-probe combinations to ensure measurement integrity. Conceptually, a pulse generator with rise

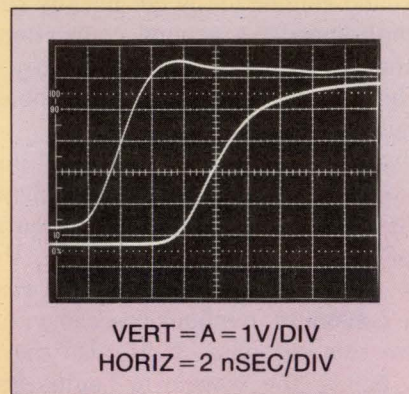

Fig C—This scope photo shows the homemade probe's output responding to an input.

times substantially faster than the oscilloscope-probe combination can provide this information. The circuit described in Ref 1 does this, providing a 1-nsec pulse having rise and fall times less than 350 psec. Pulse amplitude is 10V with a 50Ω source impedance. This circuit, built into a small box and powered by a 1.5V battery, provides a simple, convenient way to verify the rise time of almost any oscilloscope-probe combination.

• Chicago • Minneapolis • New York • Philadelphia • Phoenix • San Diego • San Francisco • Seattle

Chicago • Minneapolis • Denver • Dallas • Chicago • Seattle • San Francisco • San Diego • Phoenix • Philadelphia • New York • Minneapolis • Denver • Dallas • Chicago

Chicago • Dallas • Denver • Minneapolis • New York • Philadelphia • Phoenix • San Diego • San Francisco • Seattle



The NEPCON College Of Manufacturing

In-Depth Knowledge Is Power!

Chicago • Dallas • Denver • Minneapolis • New York • Philadelphia
Phoenix • San Diego • San Francisco • Seattle



- The hottest topics in electronics manufacturing presented in an **intensive three-day conference format** you will find nowhere else!
- **Comprehensive, in-depth study** of exciting technologies including: Multi-Chip Modules, SMT Soldering & Cleaning, Fine Pitch Technology, Board Test Strategies and Concurrent Engineering!
- **One-on-one problem solving** with today's leading technology experts to give you "customized" answers to your electronics manufacturing questions!

You need real answers, not just theory. Where can you find these practical applications of today's electronics manufacturing technology,...the "hands-on" experience that will give you the power to implement real change into your manufacturing operations? - The NEPCON College Of Manufacturing!

The newest member of the 30 year old family of National Electronic Packaging and Production Conferences (NEPCON), The NEPCON College Of Manufacturing, fills your need for in-depth study of the technology area you are most interested in,-a unique opportunity to study one technology topic extensively and completely.

And that's not all! The best part is **we're bringing this one-of-a-kind educational opportunity right to your doorstep!** The NEPCON College Of Manufacturing will visit 10 different cities over the next 12 months, one of them near you!

You won't find this expanded study of the technology applications you need anywhere else! Clip and return the coupon **TODAY** for your complete NEPCON College Of Manufacturing Program, and registration materials for the city nearest you!

Clip and mail to:
NEPCON College of Manufacturing Cahners Exposition Group
 1350 East Touhy Ave., P.O.Box 5060, Des Plaines, IL 60017-5060
YES! I need in-depth knowledge! Send me more information on the NEPCON College Of Manufacturing!

Name _____
 Title _____
 Company _____
 Address _____
 City _____ State _____ ZIP _____
 Phone _____ FAX _____
 I'm interested in attending the NEPCON College Of Manufacturing being held in _____
 For more information contact Michael Critser, Director Of NEPCON Conferences at (708) 299-9311.



©Reed Publishing (U.S.A.) Inc., 1991

• Chicago • Dallas • Denver • Minneapolis • New York •

Circle No.107 For Exhibitor Information

Circle No. 108 For Attendee Information

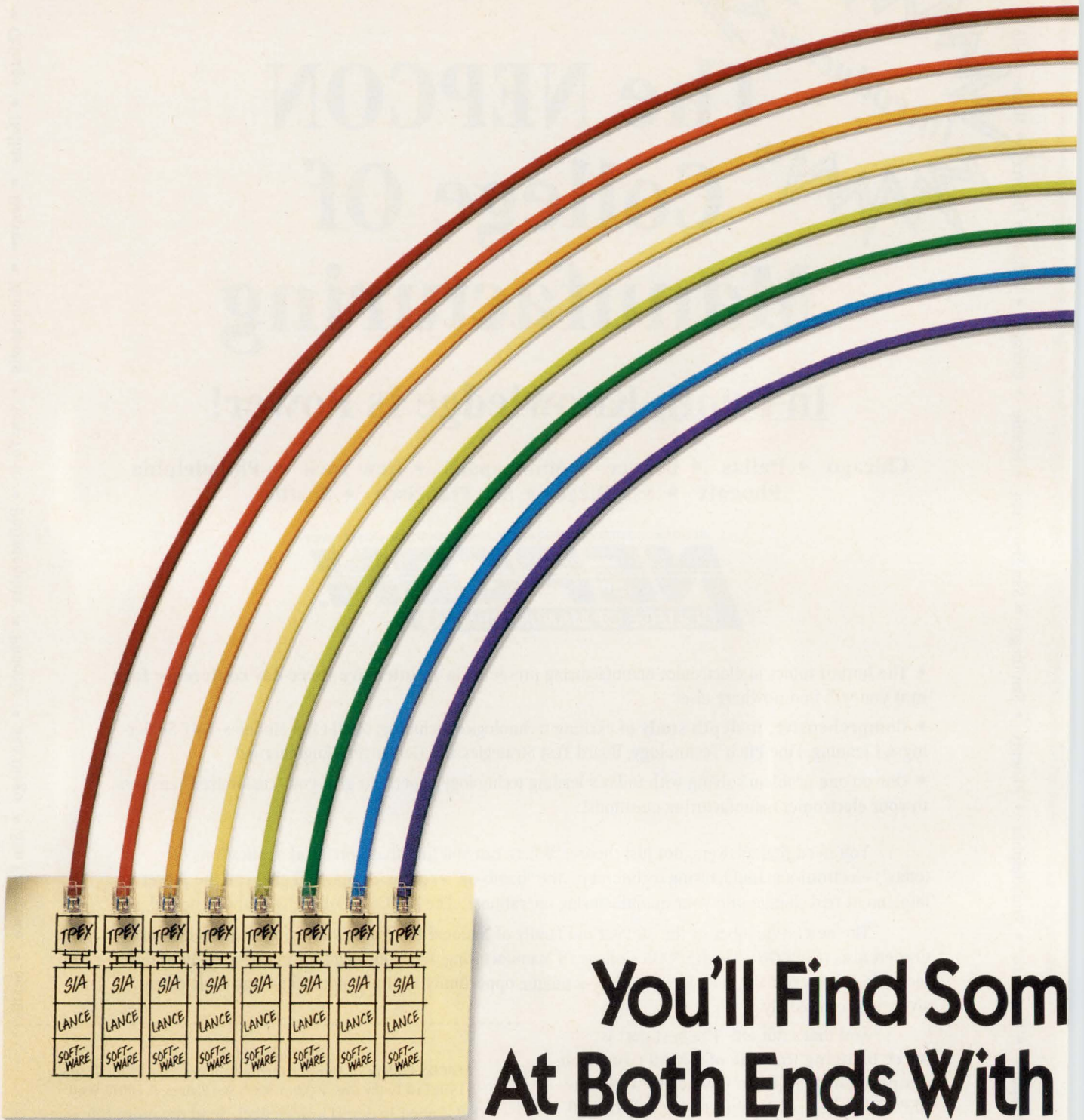

You'll Find Som At Both Ends With

We've all seen the light regarding Ethernet on twisted-pair. Now we'd like to show you the full spectrum in 10BASE-T— with the most complete selection of silicon for both ends of the LAN.

At the terminal end, the TPEX™ (twisted-pair Ethernet transceiver) provides the physical layer connection for add-in cards, motherboards and stand-alone MAUs. At the hub end, the IMR™ (Integrated Multiport Repeater) integrates eight

transceivers and an expansion port on one chip, and replaces over a dozen ICs. And that brings down your per-port cost.



Am79C98JC



Am79C980JC

So you can quickly design and assemble everything from compact Velcro® hubs that hang virtually anywhere, to larger intelligent hubs using multiple IMRs.

And you won't find the design

Something Great AMD's 10BASE-T.

risks you normally face. We'll lead you to market faster, supplying you with complete board level solutions. And we're behind you all the way with 10 years experience in Ethernet, including strategic partnerships with SynOptics and HP — co-developers of our TPEX and IMR, respectively.

And of course, all our 10BASE-T products comply with current IEEE specs.

So call AMD today at **1-800-222-9323**

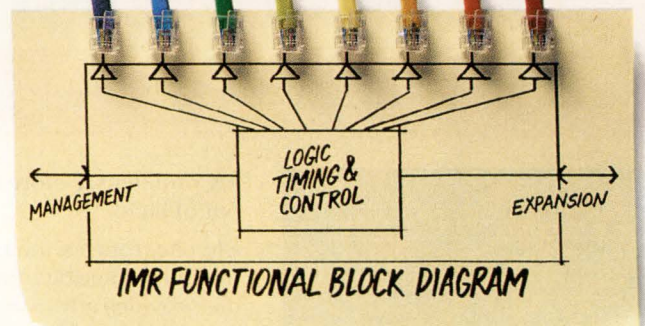

for a free information package. And give your next 10BASE-T design a truly brilliant ending.



Advanced Micro Devices

© 1991 Advanced Micro Devices, Inc. 901 Thompson Place, P.O. Box 3453, Sunnyvale, CA 94088. TPEX and IMR are trademarks of Advanced Micro Devices, Inc. Velcro is a registered trademark of Velcro Industries B.V. (Netherlands Corporation), Amsterdam, Netherlands.

Now catch the bugs that defy logic.



LOCK UP

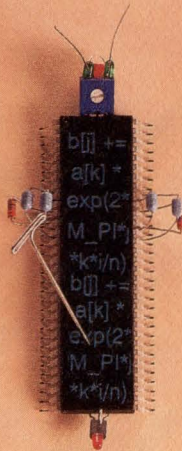

INCORRECT REGISTER VALUE

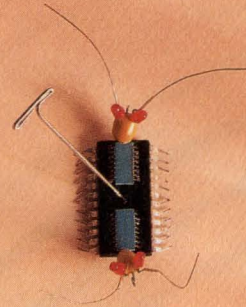

RANDOM OUTPUT

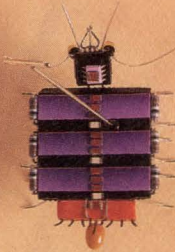

PARITY ERROR



UNEXPECTED EXCEPTION

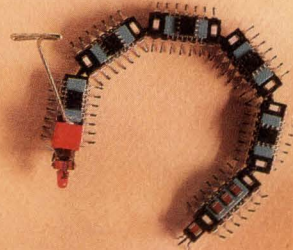

REPEATING RESET

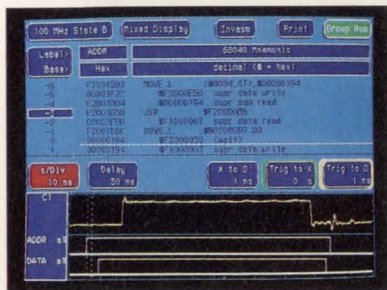

The HP16500A logic analysis system shows what's bothering your designs.

Power up a new design and you're in for a battle. That's when you need the HP 16500A logic analysis system. With one modular system, you can focus measurement power on those press-

ing problems. Before things get out of hand.

Choose from a wide range of modules. The state/timing module provides advanced capabilities, including 100 MHz state speed for debugging RISC and high-end CISC processors. There's a 1 Gsa/s scope for single-shot troubleshooting. A 1 GHz timing module for precision time-interval measurements. And pattern generation for functional testing.

And you get the industry's broadest microprocessor and bus support...more than 100 solutions to speed and simplify debugging of virtually any microprocessor based design. Plus an intuitive

full-color, touch-screen interface to make setup and operation easier too.

So take control of the debugging process. Call 1-800-452-4844. Ask for Ext.2604 and we'll send a brochure on the analysis system that can catch the toughest bugs before they start bothering you.

There is a better way.



* In Canada call 1-800-387-3867, Dept. 429.
©1991 Hewlett-Packard Co. TMCOL123/EDN

Correcting power-supply problems

To ensure proper operation of circuits that use high-speed op amps, you need to pay careful attention to power-supply bypassing. Of equal importance are layout techniques and the need to establish a proper ground plane.

Jim Williams, *Linear Technology Corp*

Two of the most common problems encountered in any circuit design that uses high-speed op amps are those of power-supply bypassing and pc-board layout techniques. Of these two problems, power-supply bypassing is by far the most common. Bypassing is necessary to maintain a low supply impedance. Any dc resistance or inductance in supply wires and pc-board traces can quickly raise this impedance to unacceptable levels. A high-impedance supply lets the supply voltage vary as the current levels of the devices connected to it change. Such a situation almost always causes unruly operation of the individual devices. Moreover, several devices connected to an unbypassed supply can "communicate" through the finite-supply impedances, causing erratic operating modes.

Bypass capacitors furnish a simple way to eliminate these problems by providing a local reservoir of energy at the device. A bypass capacitor acts like an electrical

flywheel to keep supply impedance low at high frequencies. The choice of the type of capacitor to use for bypassing is a critical issue. **Fig 1** shows the output of an unbypassed amplifier driving a 100 Ω load. The power supply the amplifier sees at its terminals has a high impedance at high frequencies. This impedance forms a voltage divider with the amplifier and its load, letting the supply move as internal conditions in the amplifier change. As shown, this action causes local feedback, and oscillation occurs. Therefore, always use bypass capacitors at appropriate supply-rail points.

In **Fig 2** the 100 Ω load is removed, and the amplifier

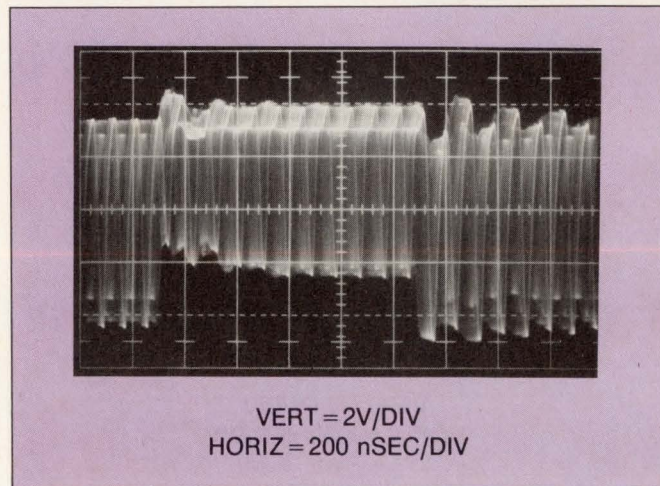

Fig 1—The output of an amplifier drives a 100 Ω load without bypass capacitors.

THE
JIM WILLIAMS
P A P E R S

displays a pulse output. The unbypassed amplifier responds surprisingly well, but overshoot and ringing dominate. Always use bypass capacitors to avoid overshoot and ringing. In Fig 3, the settling is noticeably better, but some ringing remains. This response is typical of lossy bypass capacitors, or good ones placed too far away from the amplifier. Use good quality, low-loss bypass capacitors, and place them as close to the amplifier as possible.

The multiple-time-constant ringing in Fig 4 often indicates a poor grade of paralleled bypass capacitors or excessive trace length between the capacitors. Although paralleling capacitors of different characteristics is a good way to get wideband bypassing, you need to consider such action carefully. Resonant interaction between the capacitors can also cause such a waveform after a step input. This type of response is often aggravated by heavy amplifier loading. When paralleling bypass capacitors, plan the layout and breadboard with the units you plan to use in production.

Fig 5 addresses a more subtle bypassing problem. The trace shows the last 40-mV excursion of a 5V step almost settling cleanly in 300 nsec. The slight overshoot is due to a loaded (500Ω) amplifier without quite enough bypassing. Increasing the total supply bypassing from 0.1 to 1 μF cured this problem. Use large-value paralleled bypass capacitors when you need very fast settling, particularly if the amplifier is heavily loaded, or sees fast load steps.

The problem of peaking on the leading and trailing corners (Fig 6) is typical of poor layout practice. Depicted here, a unity-gain inverter suffers from exces-

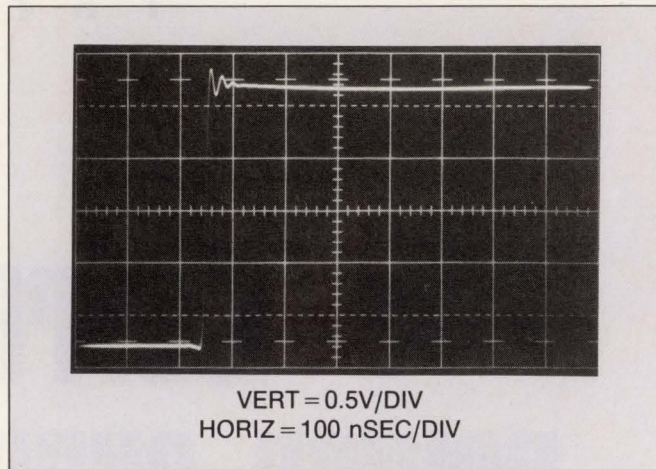

Fig 3—A poor-quality bypass capacitor allows some ringing in the amplifier's output.

sive trace area at the summing point. Only 2 pF of stray capacitance caused the peaking and ringing. Minimize trace area and stray capacitance at critical nodes. Consider layout as an integral part of the circuit, and plan it accordingly.

About bypass capacitors

Bypass capacitors are used to maintain low power-supply impedance at the point of load. Parasitic resistance and inductance in supply lines mean that the power-supply impedance can be quite high. As frequency goes up, the inductive parasitic becomes particularly troublesome. Even if these parasitic terms did not exist, or if local regulation is used, bypassing

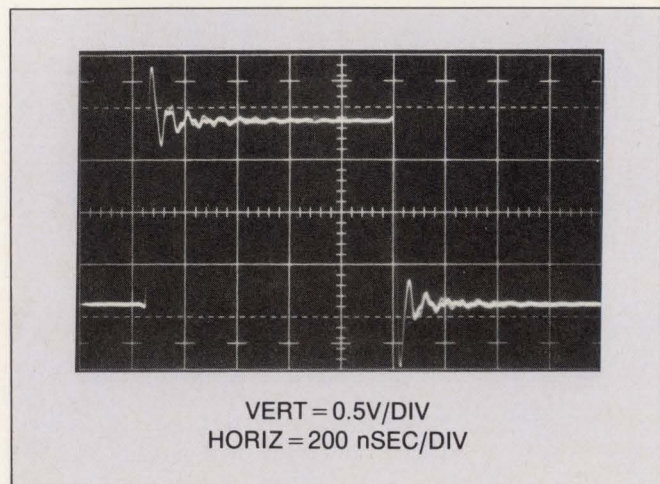

Fig 2—An unbypassed amplifier with no load can be surprisingly stable—temporarily.

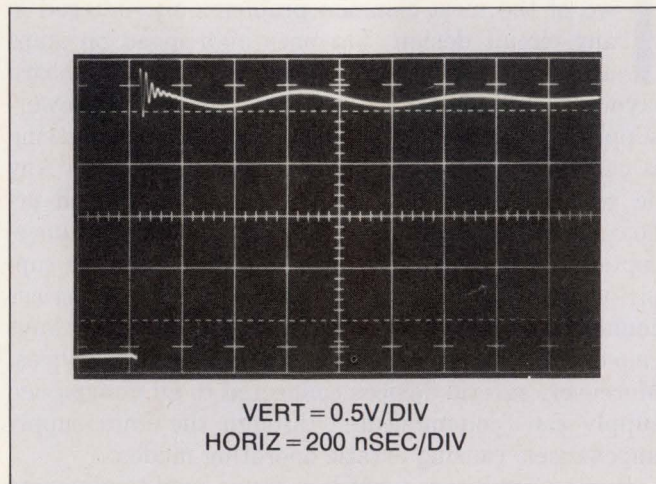

Fig 4—Paralleled bypass capacitors form a resonant network, which produces ringing.

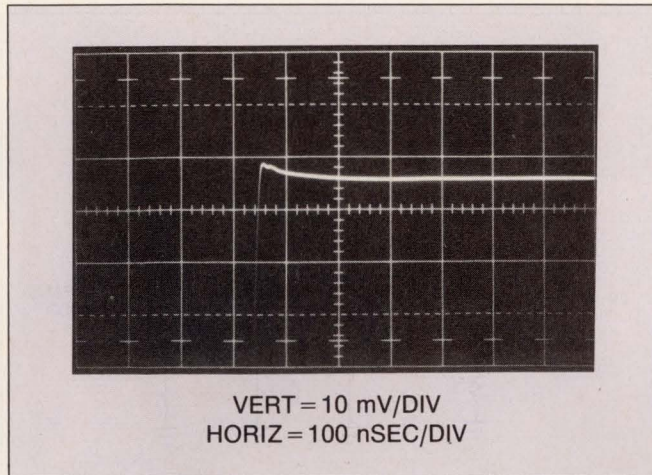

Fig 5—This waveform shows a more subtle bypassing problem. Not-quite-good-enough bypassing causes a few millivolts of peaking.

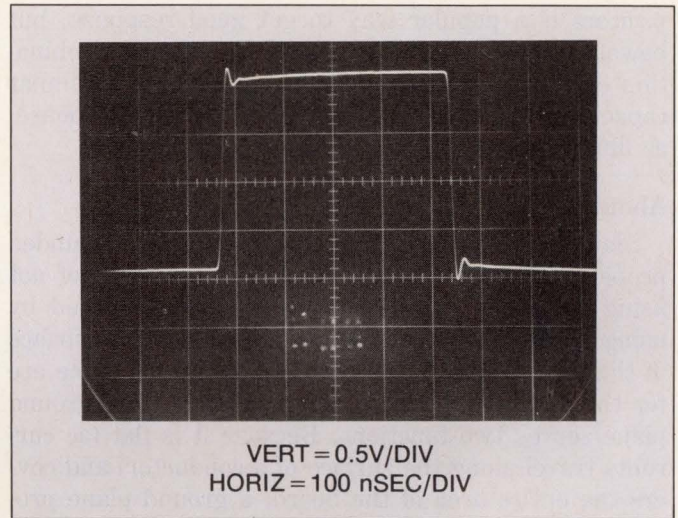

Fig 6—This waveform is a typical result of poor layout. Only 2 pF of capacitance at the summing point introduces peaking on the leading and trailing corners.

is still necessary because no power supply or regulator has zero output impedance at 100 MHz. You determine the type of capacitor to use by its application, the frequency domain of the circuit, cost factors, board space, and many other considerations. It is possible, however, to make some useful generalizations.

All capacitors contain parasitic terms (some examples of which appear in **Fig 7**). In bypass applications, leakage and dielectric absorption are second-order terms, but series resistance (R) and inductance (L) are not. These latter terms limit the capacitor's ability to damp transients and maintain low power-supply impedance. Bypass capacitors must often be large in value to absorb long transients, necessitating electrolytic types that have large values of series R and L.

Different types of electrolytics and combinations of electrolytic and nonpolarized capacitors have markedly different characteristics. Which type (or types) to use is a matter of passionate debate in some circles. The test circuit of **Fig 8** and accompanying photos are useful in evaluating the choices. The photos show the re-

sponse of five bypassing methods to the transient generated by the test circuit. **Fig 9a** shows an unbypassed line that sags and ripples badly at large amplitudes. **Fig 9b** uses a 10- μ F aluminum electrolytic to considerably cut the disturbance, but there is still plenty of potential trouble. A 10- μ F tantalum unit (**Fig 9c**) offers cleaner response, and the 10- μ F aluminum electrolytic combined with a 0.01- μ F ceramic type (**Fig 9d**) is even better. Combining electrolytics with nonpolarized ca-

Acronyms used in this article

- air wire**—A connection from lead-to-lead without going to a specific terminal or point.
- BNC**—BNC coax connector. A twist-lock connector for various types of RG-type coaxial cables.
- DAC**—Digital-to-analog converter
- IC**—Integrated circuit
- pc board**—Printed-circuit board
- pc card**—Printed-circuit card

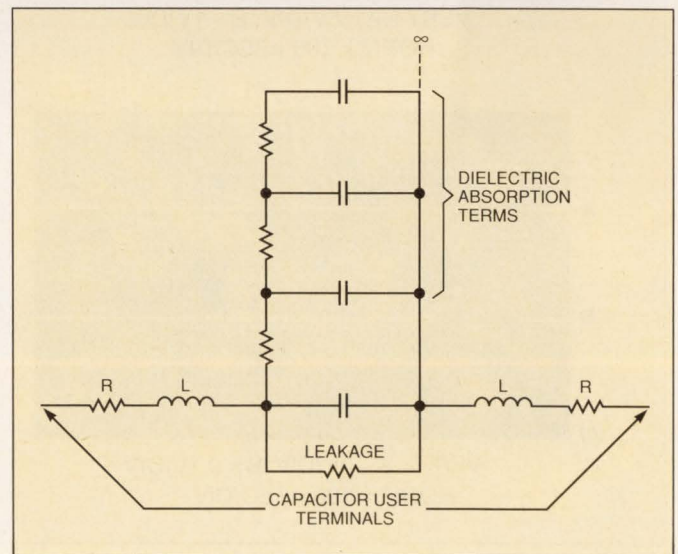
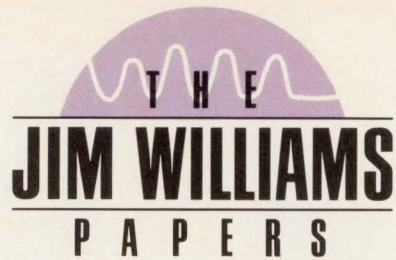

Fig 7—All capacitors have parasitics. In bypass applications, the series resistance (R) and inductance (L) limit the capacitor's ability to maintain a low supply impedance.



THE
JIM WILLIAMS
PAPERS

capacitors is a popular way to get good response, but beware of picking the wrong pair. The wrong combination of supply-line parasitics and paralleled dissimilar capacitors can produce a resonant, ringing response, as illustrated in Fig 10.

About ground planes

Similar to that resulting from a poorly grounded probe, the Fig 11 waveform shows the result of not using a ground plane. A ground plane is formed by using a continuous conductive plane over the surface of the circuit board. The only breaks in this plane are for the circuit's necessary current paths. The ground plane serves two functions. Because it is flat (ac currents travel along the surface of a conductor) and covers the entire area of the board, a ground plane provides a way to access a low-inductance ground from

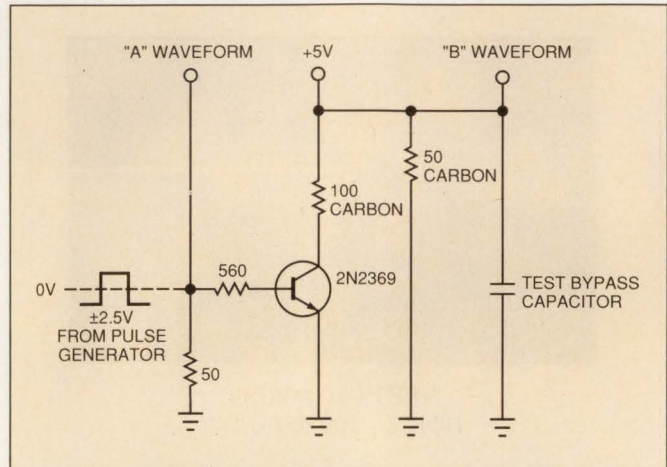

Fig 8—This test circuit, together with various types of bypass capacitors, produced the waveforms shown in Figs 9a through d.

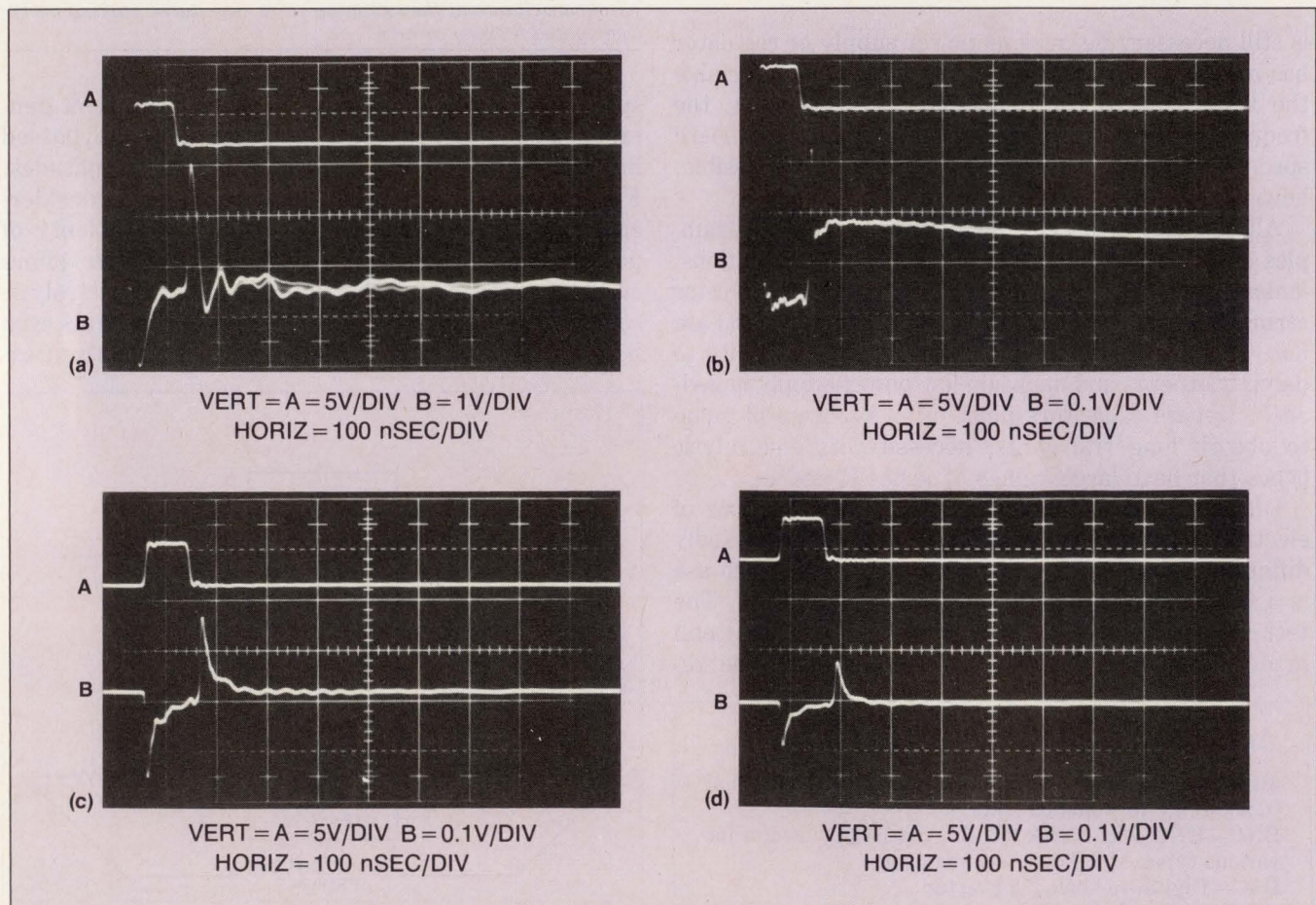

Fig 9—The response of this unbypassed line (a) sags and has a high ripple content. A 10- μ F aluminum-electrolytic capacitor (b) somewhat reduces that disturbance. A 10- μ F tantalum capacitor (c) offers cleaner response than that shown in b. Combining different capacitor types provides further improvement. A 10- μ F aluminum capacitor and a 0.01- μ F ceramic type (d) substantially smooth out the disturbance.

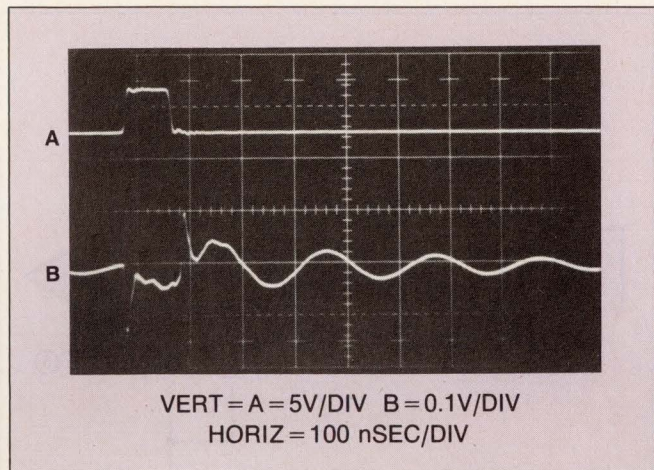

Fig 10—Some paralleled combinations can cause ringing. Always try various types before specifying.

anywhere on the board. A ground plane also minimizes the effects of stray capacitance in the circuit by referring them to ground. This reference breaks up potential unintended and harmful feedback paths. Always use a ground plane with high-speed circuitry.

Although the term ground plane is often used as a mystical and ill-defined cure for spurious circuit operation, there is actually little mystery to the usefulness and operation of a ground plane. Like many phenomena, the operational principle of a ground plane is surprisingly simple.

As previously mentioned, ground planes are primarily useful for minimizing circuit inductance. They do this by utilizing basic magnetic theory. Current flowing

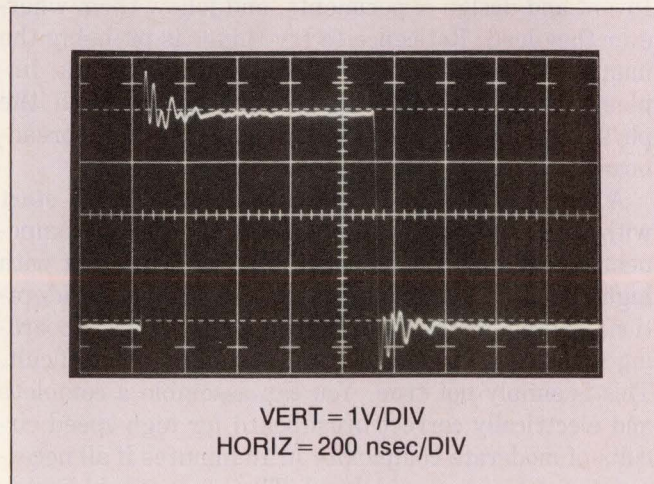

Fig 11—Instabilities caused by the lack of a ground plane can produce a result similar to that of a poorly grounded test probe.

in a wire produces an associated magnetic field. The field's strength is proportional to the current and inversely related to the distance from the conductor. Thus, we can visualize a current-carrying wire (**Fig 12a**) surrounded by radii of a magnetic field. The unbounded field becomes smaller with distance. A wire's inductance is defined as the energy stored in the field set up by the current flowing through the wire. To compute the wire's inductance requires integrating the field over the wire's length and the total radial area of the field. This computation implies integrating on the radius from $R = R_w$ to infinity—a very large number. However, consider the case that **Fig 12b** illustrates, where two wires in space carry the same current in either direction. The fields produced cancel.

When the fields cancel, the inductance is much smaller than in the single-wire case and can be made arbitrarily small by reducing the distance between the two wires. This reduction of inductance between current-carrying conductors is the underlying reason for ground planes. In a normal circuit, the current path from the signal source, through its conductor and back to ground, includes a large loop area. This path produces a large inductance for the conductor and can cause ringing because of LRC effects. It is worth noting that, at 100 MHz, a 10-nH inductor has an impedance of 6Ω . At 10 mA, a 60-mV drop results.

A ground plane provides a return path directly under

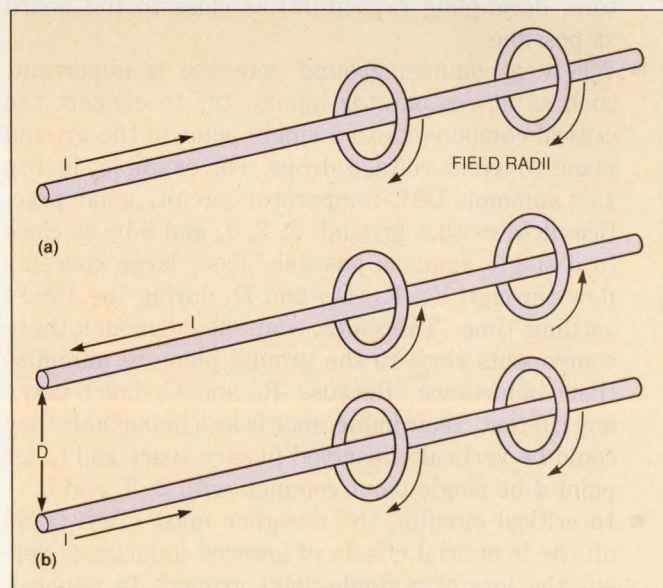

Fig 12—A current-carrying wire produces a magnetic field (a). Two wires in space, carrying the same current in opposite directions, produce a cancellation of the magnetic field (b).

THE
JIM WILLIAMS
P A P E R S

the signal-carrying conductor through which the return current can flow. The conductor's small physical separation means the inductance is low. Return current has a direct path to ground, regardless of the number of branches associated with the conductor. Current will always flow through the return path of lowest impedance. In a properly designed ground plane, this path is directly under the signal conductor. In a practical circuit, it is desirable to "ground plane" one whole side of the pc card (usually the component side for wave-solder considerations) and run the signal conductors on the other side. This procedure will provide a low-inductance path for all the return currents.

Aside from minimizing parasitic inductance, ground planes have additional benefits. Their flat surface minimizes resistive losses due to ac skin effects (ac currents travel along a conductor's surface). Moreover, ground planes aid the circuit's high-frequency stability by referring stray capacitances to ground.

Practical hints for ground planes

The following guidelines are useful in the establishment and use of a ground plane.

- Ground-plane as much area as possible on the component side of the board, especially under traces that operate at high frequency.
- Mount components that conduct substantial fast-rise currents (termination resistors, ICs, transistors, decoupling capacitors) as close to the board as possible.
- Where a common ground potential is important, such as at comparator inputs, try to connect the critical components to a single point in the ground plane to avoid voltage drops. For example, in Fig 13's common DAC-comparator circuit, good practice dictates that grounds 2, 3, 4, and 6 be as close to a single point as possible. Fast, large currents flow through R_1 , R_2 , D_1 , and D_2 during the DAC's settling time. Therefore, you should mount these components close to the ground plane to minimize their inductance. Because R_3 and C_1 don't carry any current, their inductance is less important; they could be vertically inserted to save space and to let point 4 be single-point common with 2, 3, and 6.
- In critical circuits, the designer must often trade off the beneficial effects of lowered inductance versus the loss of a single-point ground. In general, however, keep trace lengths short. Inductance varies directly with length, and no ground plane will achieve perfect cancellation.

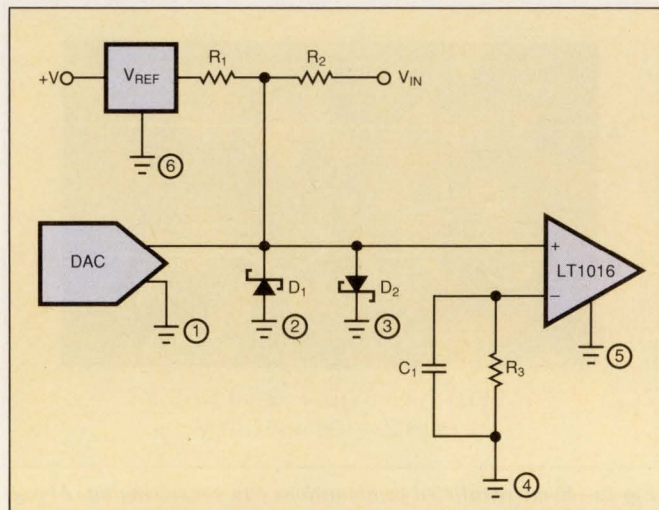

Fig 13—In this combination analog-digital circuit, good practice dictates that grounds 2, 3, 4, and 6 be as close to a single point as possible.

Putting the guidelines for capacitor choices and the establishment of a proper ground plane to practical use usually starts with a breadboard. The breadboard is both the designer's playground and proving ground. It is there that reality resides, and where paper (or computer) designs meet their master. More than anything else, breadboarding is an iterative procedure, an odd amalgam of experience guiding an innocent, ignorant, explorative spirit. A key is to be willing to try things out, sometimes for not very good reasons. Invent problems and solutions, guess both carefully and wildly, throw rocks and see what comes loose. Invent and design experiments, and follow them wherever they lead. Reticence to try things is probably the number one cause of breadboards that don't work. Implementing the above approaches begins with the physical construction methods used to build the breadboard.

A breadboard for a high-speed circuit must start with a ground plane. In addition, bypassing, component layout, and connections should be consistent with high-speed operations. Because of these considerations, there is a common misconception that breadboarding high-speed circuits is time consuming and difficult. This is simply not true. You can assemble a complete and electrically correct breadboard for high-speed circuits of moderate complexity in 10 minutes if all necessary components are on hand. The key to rapid breadboarding is to identify critical circuit nodes and design the layout to suit them.

Be cool. Cross over to NEC.



Purchasing won't get hot under the collar.

Now there's something Engineering and Purchasing can agree on: NEC 4-megabit DRAMs.

Engineering gets legendary NEC quality and reliability. Purchasing gets competitive prices and a single vendor for almost every package type and memory organization imaginable.

You won't just save power and board space; you'll save money. That way, nobody gets burned.

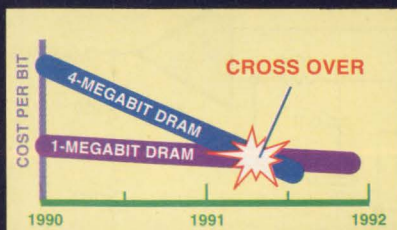

The sweetest memories under the sun.

NEC DRAMs come in all the cool flavors: 300/350 mil SOJ, ZIP, TSOP, modules, low power, byte-wide, word-wide, you name it.

And if you need to get to data at a sizzling pace, look no further than NEC. We offer access times from 60 to 100 nanoseconds.

Choose from x1, x4, x8, or x16 memory organizations to meet your present needs. And very soon, you'll be able to select x9 or x18 devices as well. We want to supply all your memory needs, including the most advanced 16 megabit devices.

Warm up to Roseville, California DRAMs.

We've invested \$600 million in our 72-acre Roseville wafer fabrication facility, located in California's gold country, near sunny Sacramento.

Our California plant has been producing DRAMs in high volume since 1984. It employs more than 700 skilled local workers. They join a worldwide team of more than 80,000 NEC employees that can meet challenges of almost any size.

Whatever your DRAM requirements, we have what you've been looking for. Now's a real cool time to cross over to NEC.

Modules (custom & standard)

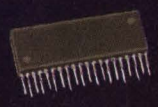
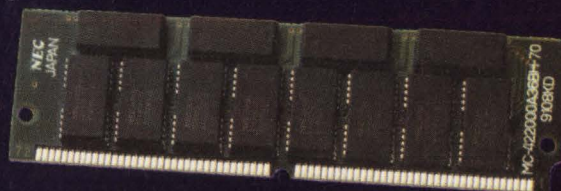

ZIP



SOJ



TSOP



Australia Tel:03-267-6355. Telex:38343. France Tel:1-3946-9617. Telex:699499. Germany Tel:0211-650302. Telex:8589960. Hong Kong Tel:755-9008. Telex:54561. Italy Tel:02-6709108. Telex:315355. Korea Tel:02-551-0450. Fax:02-551-0451. The Netherlands Tel:040-445-845. Telex:51923. Singapore Tel:4819881. Telex:39726. Sweden Tel:08-753-6020. Telex:13839. Taiwan Tel:02-719-2377. Telex:22372. UK Tel:0908-691133. Telex:826791. USA Tel:1-800-632-3531. Fax:1-800-729-9288.

© 1991 NEC Electronics Inc.

CIRCLE NO. 111

THE JIM WILLIAMS P A P E R S

This procedure permits most of the breadboard's construction to be fairly sloppy, saving time and effort. Use all degrees of freedom in making connections and mounting components. Don't be bashful about bending IC pins to suit desired low-capacitance connections, or air-wiring components to achieve rapid or electrically optimum layout. Save time by using components, such as bypass capacitors, as mechanical supports for other components. It's true that printed-circuit construction is eventually required, but when initially breadboarding forget about pc boards and production constraints. Later, when the circuit works and is well understood, you can take care of pc-board adaptations.

The Fig 14 amplifier circuit is a good working example of breadboarding techniques. This circuit is a high-impedance, wideband amplifier that has low-input capacitance. Q_1 and IC_1 form the high-frequency path, with the 900 to 100 Ω feedback divider setting the gain. IC_2 and Q_2 close a dc stabilization loop, minimizing the dc offset between the circuit's input and output. Critical nodes in this circuit include Q_1 's gate (because of the desired low-input capacitance) and IC_1 's input-related connections (because of their high-speed operation). Note that the connections associated with IC_2 handle only dc, and are much less sensitive to layout. These determinations dominate the breadboard's construction.

Fig 15a shows the initial breadboard construction. The copper-clad board is equipped with banana-type connectors. The connector's mounting nuts are simply soldered to the board, securing the connectors. After adding IC_1 and the bypass capacitors (Fig 15b), ob-

serve that IC_1 's leads have been bent out. Bending the leads permits the amplifier to sit down on the ground plane, minimizing parasitic capacitance. Also, the bypass capacitors are soldered to the amplifier power pins right at the capacitor's body. The capacitor's leads are returned to the banana power jacks. This connection method provides good amplifier bypassing, while mechanically supporting the amplifier. It also eliminates separate wire runs to the power pins.

Fig 15c shows the addition of discrete components in the high-speed path. Q_1 's gate is connected directly to the BNC input socket, as is the 10-M Ω resistor associated with IC_2 's negative input. Note that the end of this resistor that sees a high frequency is cut very short, while the other end is left uncut. The 900 to 100 Ω divider is installed at IC_1 , with very short connections to IC_1 's negative input. IC_1 's 10-M Ω resistor receives similar treatment to that of the BNC-connected 10-M Ω resistor; the high-frequency end is cut short, while the end destined for connection to IC_2 remains uncut. Q_2 's collector and Q_1 's source, both high-speed points, are tied closely together with IC_1 's positive input.

Finally, dc amplifier IC_2 and its associated components are air-wired into the breadboard (Fig 15d). Their dc operation permits this, while the construction technique makes connections to the previously wired nodes easy. You can bend the previously uncommitted ends of the 10-M Ω resistors in any way necessary to make connections. All other components associated with IC_2 receive similar treatment, and the circuit is ready for experimentation.

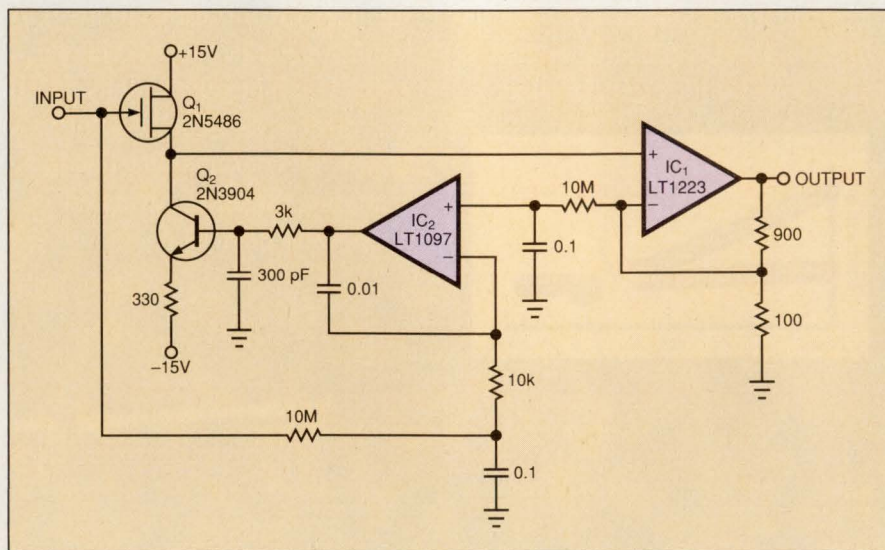
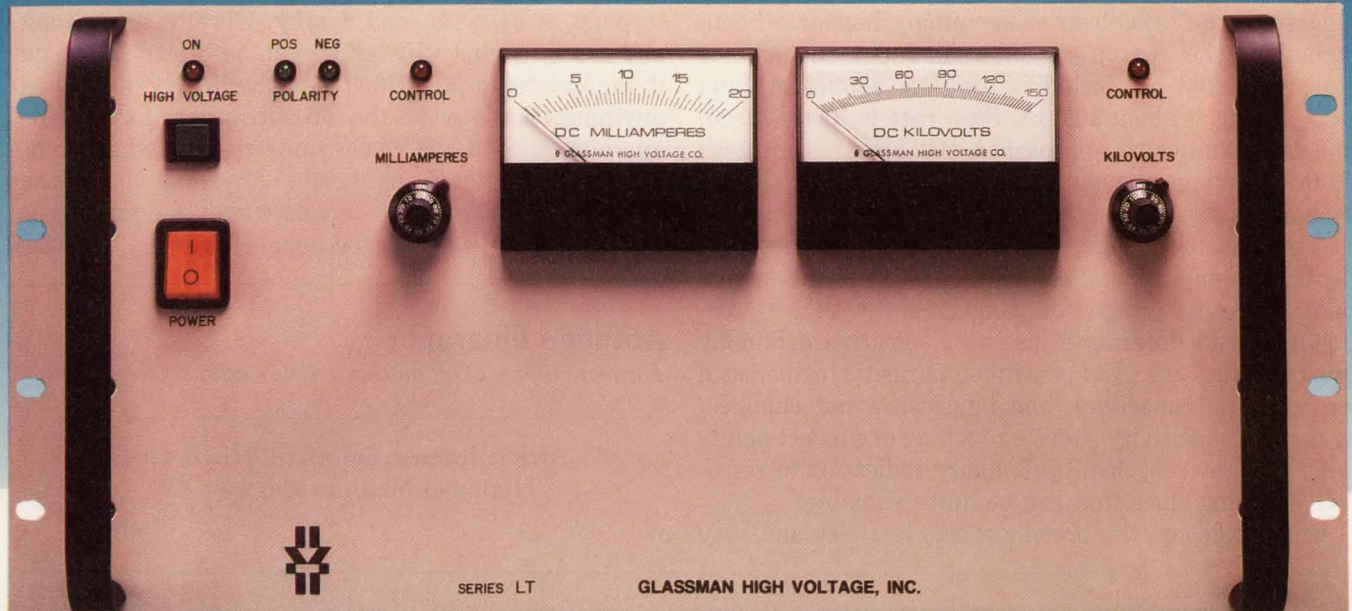

Fig 14—This stabilized FET-input amplifier is an example of the breadboarding techniques shown in Fig 15a through d.

Up to 125 kV...2 kW...Only 8.75 in.

WOW!



Glassman has the DC high voltage power supply for you. The new LT Series with 2 kW capability and 18 models from 0 to 1 kV through 0 to 125 kV...all packaged neat-as-a-pin in a 8.75 inch panel and weighing less than 47 pounds!

And every model comes with the Glassman advantages you've come to expect. Air insulation for low weight and easy serviceability. Pulse-width modulation for high efficiency and reliability. Low stored energy for safety. Automatic protection against overloads, shorts, and arcs. Your choice of analog or digital displays... even a blank panel for system applications. And full local and remote control and monitoring.

Consider these outstanding performance specs:

- Voltage regulation better than 0.005%, line or load
- Ripple less than 0.03% at full load
- Current regulation 0.05% from short circuit to rated voltage
- Positive, negative, or reversible polarity versions
- Line voltage 220/240 V single-phase

Call or write for full information on the new LT Series ...or other Glassman supplies from 1 kV to 500 kV, 15 W to 15 kW, and anything in between. All backed by responsive application assistance, the best on-time delivery in the industry, a 3-year no-nonsense warranty, and factory service available on three continents.

Innovations in high voltage power supply technology.

GLASSMAN HIGH VOLTAGE INC.



GLASSMAN U.S.A.

Glassman High Voltage, Inc.
P.O. Box 551
Route 22 East
Salem Industrial Park
Whitehouse Station, NJ 08889
U.S.A.
Telephone: (908) 534-9007
TWX: 710 480-2839
FAX: (908) 534-5672

GLASSMAN EUROPE

Glassman Europe Limited
Studio 4
Intec 2
Wade Road
Basingstoke
Hampshire RG240NE
England
Telephone: (0256) 810808
FAX: (0256) 810815

GLASSMAN JAPAN

Glassman Japan High Voltage Limited
Taira Building
1-17, Taira 1-chome
Miyamae-ku, Kawasaki 216
Japan
Telephone: (044) 877-4546
FAX: (044) 877-3395

CIRCLE NO. 112

189

THE JIM WILLIAMS PAPERS

Despite the breadboard's seemingly haphazard construction, the circuit works well. Input capacitance measures a few pF (including the BNC connector), and bias current is about 100 pA. Slew rate is 1000 V/ μ sec, and the bandwidth approaches 100 MHz. Even with 50-mA loading, the output is clean, with no sign of oscillation or other instabilities.

Once the breadboard seems to work, it's useful to begin thinking about the pc-board layout and component choices for production. Experiment with the existing layout to determine just how sensitive nominally critical points are. Add controlled parasitic terms, such as resistors, capacitors, and physical layout changes, to test for sensitivity. Gentle touching of suspect points with a finger can yield preliminary indication of sensitivity, giving clues that can be quite valuable.

Finally, design the breadboard to be quick and easy

to build, work with, and modify. Observe the circuit, and listen to what it is telling you before trying to get it the desired state. Don't hesitate to try just about anything; that's what the breadboard is for. Almost anything you do will cause some result—whether it's good or bad is almost irrelevant. Anything you do that enhances your ability to correlate events occurring on the breadboard can only be beneficial. **EDN**

Author's biography

For more information on this article's author, see pg 163 .

Article Interest Quotient (Circle One)
High 494 Medium 495 Low 496

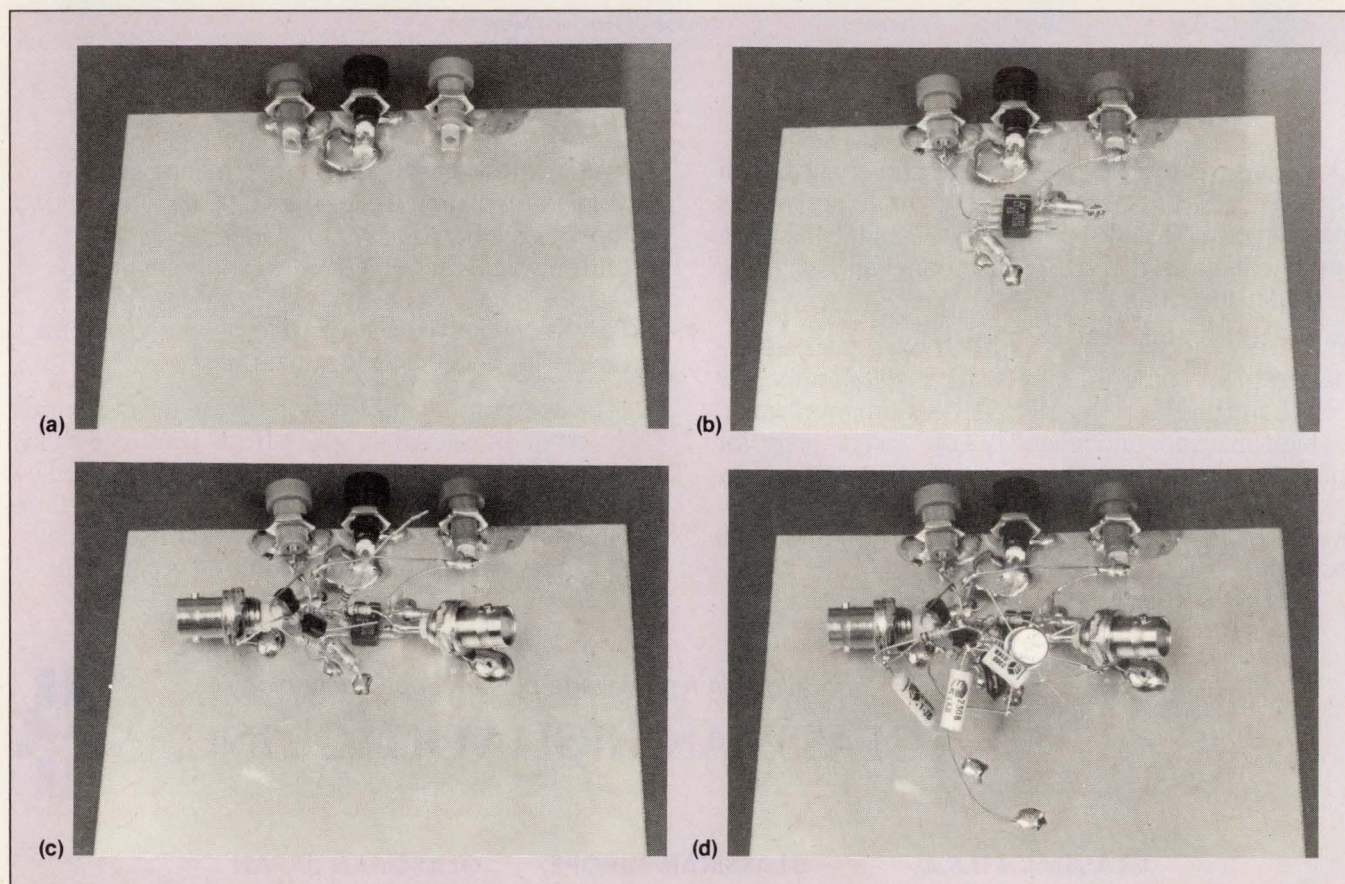
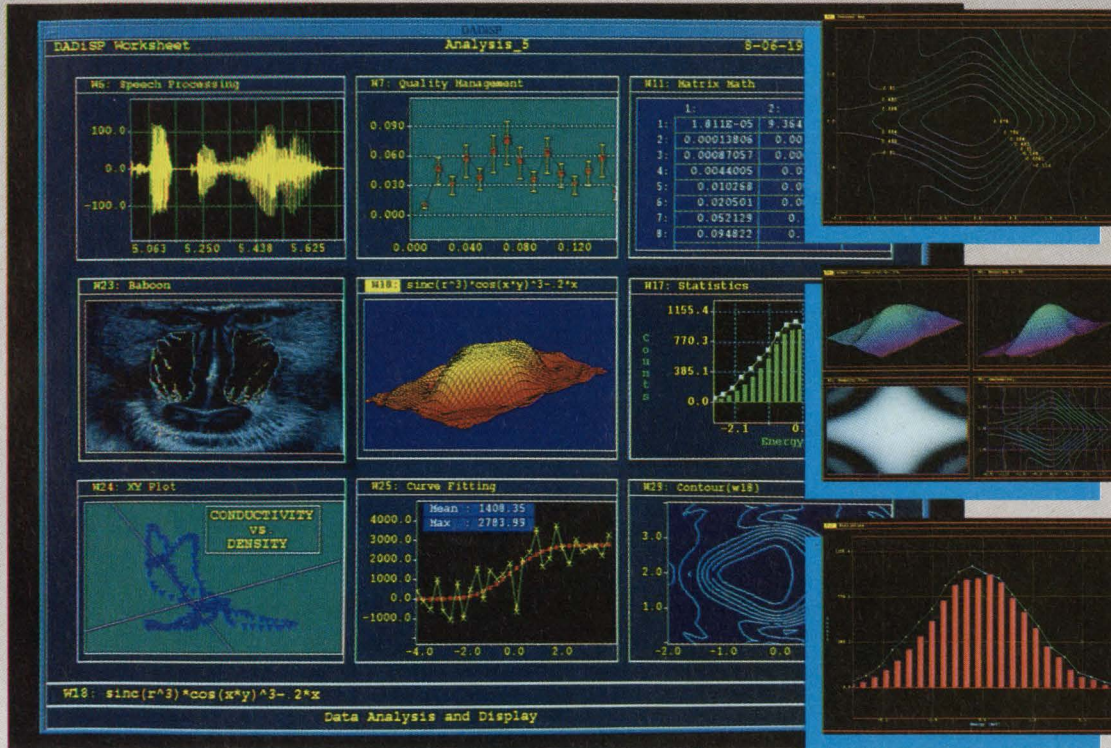

Fig 15—In the initial breadboard construction (a), banana jacks are soldered to a copper-clad board. With the addition of a high-speed amplifier, IC, (b), bypass capacitors provide support while the bent amplifier pins ease connections and minimize the distance to the ground plane. High-speed discrete components and BNC connectors are added to c. Note the short connections at the amplifier input pins (left side of package). The uncommitted ends of the 10-M Ω resistors are just visible. Finally, you wire the dc servo amplifier to complete the connections to the 10-M Ω resistors (d). This part of the circuit is not layout sensitive.

The Big Picture Just Got Bigger!



Matrix Processing

Inverse / Transpose
Eigen Values & Vectors
Matrix Math
2D FFTs and convolutions
3D and 4D Graphic Displays
Operations Research

Image Processing

Medical Imaging
Satellite
Seismology
Terrain Rendering
Communications

Lab Automation

Data Acquisition
IEEE-488
Test & Measurement
Process Control
Quality Improvement
Manufacturing Test

DADiSP 3.0

The Standard Worldwide — adopted by thousands of scientists and engineers for data analysis and graphics.



Just Point-and-Click...

DADiSP works the way you do — from input to output. DADiSP's point-and-click menus put you in control: from Data Collection, Reduction and Management, through Visual Data Analysis and Hypothesis Testing, on to final output with DADiSP's outstanding Presentation Quality Graphics.

DADiSP automatically builds a permanent and reusable worksheet as you work. Organize your data, methods and graphs in DADiSP worksheets — for future reference and future projects — you can even create your own macros and custom menus.

Run powerful add-in modules right from DADiSP menus — talk to your lab instruments with the DADiSP/488 driver, use DADiSP/LT for Data Acquisition, and run your own favorite programs right from DADiSP.

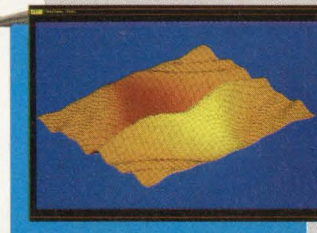

Science

Statistics
Experimental Design
Hypothesis Testing
Peak Analysis
Chemistry
Medical Research
Quality Management

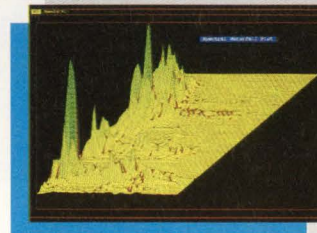

Engineering

Signal Processing & FFTs
Filter Design
Speech / Communications
Sonar & Radar
Electronics Design
Mechanical Test
Vibration Analysis

and more . . .

CALL 1-800-424-3131

for your free DADiSP trial disk. DADiSP is available now for your SUN, HP, IBM, NeXT, DEC, Concurrent and other workstation families, and of course, your IBM PC compatible.



DSP Development Corporation, One Kendall Square, Cambridge, MA 02139, 617-577-1133, FAX: 617-577-8211

CIRCLE NO. 113

Broaden your RF horizons.

S_{11} SWR
REF 1.0

THIS IS AMP TODAY.



RF performance, DC to 50 GHz.



START 0.0000GHz
STOP 50.0000GHz

No matter what range you're working, your work goes better and faster with connectors engineered for the right balance of properties. AMP has the coax connectors you need for top performance, consistent electrical characteristics, and maximum manufacturability.

Select from a line that spans the spectrum—DC to 50 GHz—in a variety of 50 or 75 ohm versions. Our selection delivers the advanced

design and controlled properties you need, with commercial versions that exhibit Mil-equivalent performance. Our fully Mil-qualified versions offer productivity gains, as well, including our proven crimp/seal technology.

We support the broadest selection of RF connectors available with the broadest range of mounting options as well: from cable to bulkhead, panel to board—and now including

custom and semi-custom high-speed coax and transmission cable assemblies.

We'd like to extend all that support to you. For literature or the name of your nearest AMP Distributor, call the AMP Product Information Center at 1-800-522-6752 (fax 717-561-6110). In Canada call 416-475-6222. AMP Incorporated, Harrisburg, PA 17105-3608.

AMP

THINK FAST. THINK LINEAR.



15 New High Speed Op Amps.

No Sacrifice For Speed. Not with Linear's new family of high speed op amps. LT1122, 1220, 1221, and 1222 provide 12 bit performance with nsec settling and bandwidths to 45 MHz. The LT1224, 1225 and 1226 are general purpose parts with the capability to drive unlimited capacitive loads. LT1190, 1191 and 1192 are video speed op amps with differential gain and phase errors of 0.1% and 0.06°. The LT1223, 1229 and 1230 are single, dual and quad current feedback amplifiers with high output drive current (50mA) and professional video quality differential gain and phase.

LT1228 is a high speed gain controlled amp with guaranteed operation down to $\pm 2V$ or 4V single supply and output swing to within 1V of the rails.

LT1122 is a JFET input op amp which slews 80V/ μs . LT1193 and 1194 are video differential input amplifiers with programmable or fixed gain powered from single 5V or $\pm 5V$ supplies with $\pm 50mA$ output drive.

Singles and duals are available in 8-pin DIP and 8-pin SOIC package, quads in 14-pin. For data sheets and a comprehensive 132 page application note contact Linear Technology Corporation, 1630 McCarthy Blvd., Milpitas, CA 95035. Or call 800-637-5545.

Parameter	1220	1224	1191	1223	1122	Units
S.R. Slew Rate (Typ)	250	400	450	1000	80	V/ μsec
G.B.W. Gain Bandwidth (Typ)	45	45	90	100	14	MHz
t_s Settling Time (to 0.1%) (Typ)	90	90	100	75	340*	nsec
AVOL Open Loop Gain (Typ)	50	7	45	28	450	V/mV
VOS Offset Voltage (Max)	1	2	6	3	0.9	mV
I _{OS} Offset Current (Max)	0.3	0.4	1	—	.00005	μA
I _B Bias Current (Max)	0.3	8	1.7	3	.0001	μA
e_n Voltage Noise (f = 10KHz)	17	22	25	3.3	15	nV/ \sqrt{Hz}
i_n Current Noise (f = 10KHz)	3	1.5	4	2.1	.002	pA/ \sqrt{Hz}
Min Gain Stable	1	1	1	1	1	
I _S Supply Current (Max)	10.5	9	40	10	11	mA
Price (100's) \$ (PDIP)	3.85	2.85	2.40	2.85	2.50	

*12 Bit Settling Time



TOUGH PRODUCTS
FOR TOUGH APPLICATIONS.

CIRCLE NO. 115

DESIGN IDEAS

EDITED BY CHARLES H SMALL

Circuit selects transformer-input tap

Jim Knipfer
Liebel-Flarsheim Co, Cincinnati, OH

The automatic voltage selector in Fig 1 operates on startup to configure an input transformer's primary winding for different applied voltages. The sensing circuit samples the transformer's center tap to keep the circuit's input at 115V ac. Resistor R_1 and varistor V_1 prevent transient voltages from tripping the circuit.

The bridge rectifier— R_2 , D_1 , and C_1 —powers the circuit and provides base drive for transistor Q_1 . The dc voltage from the bridge rectifier varies with the input ac voltage.

The 34064 undervoltage sensor, IC_1 , trips at 4.6V. Note that IC_1 's RESET pin is an output, not an input; the chip's intended function is resetting μP systems.

When the rectified line voltage is below IC_1 's trip point, RESET is low, which sets up R_3 and R_4 as a voltage divider.

When the input voltage goes above 4.6V, IC_1 trips, setting the RESET output high. RESET's going high turns on Q_1 , which energizes relay K_1 . K_1 reconfigures the transformer's primary for 220V. To prevent relay K_1 from oscillating or "hunting," resistor R_4 adds hysteresis to IC_1 's operation.

Relay K_1 cannot handle the large transient voltages that sometimes occur around the switching point. Transistor Q_2 and resistor R_5 limit current through K_1 to 10 mA. EDN BBS /DI-SIG #1035

EDN

To Vote For This Design, Circle No. 681

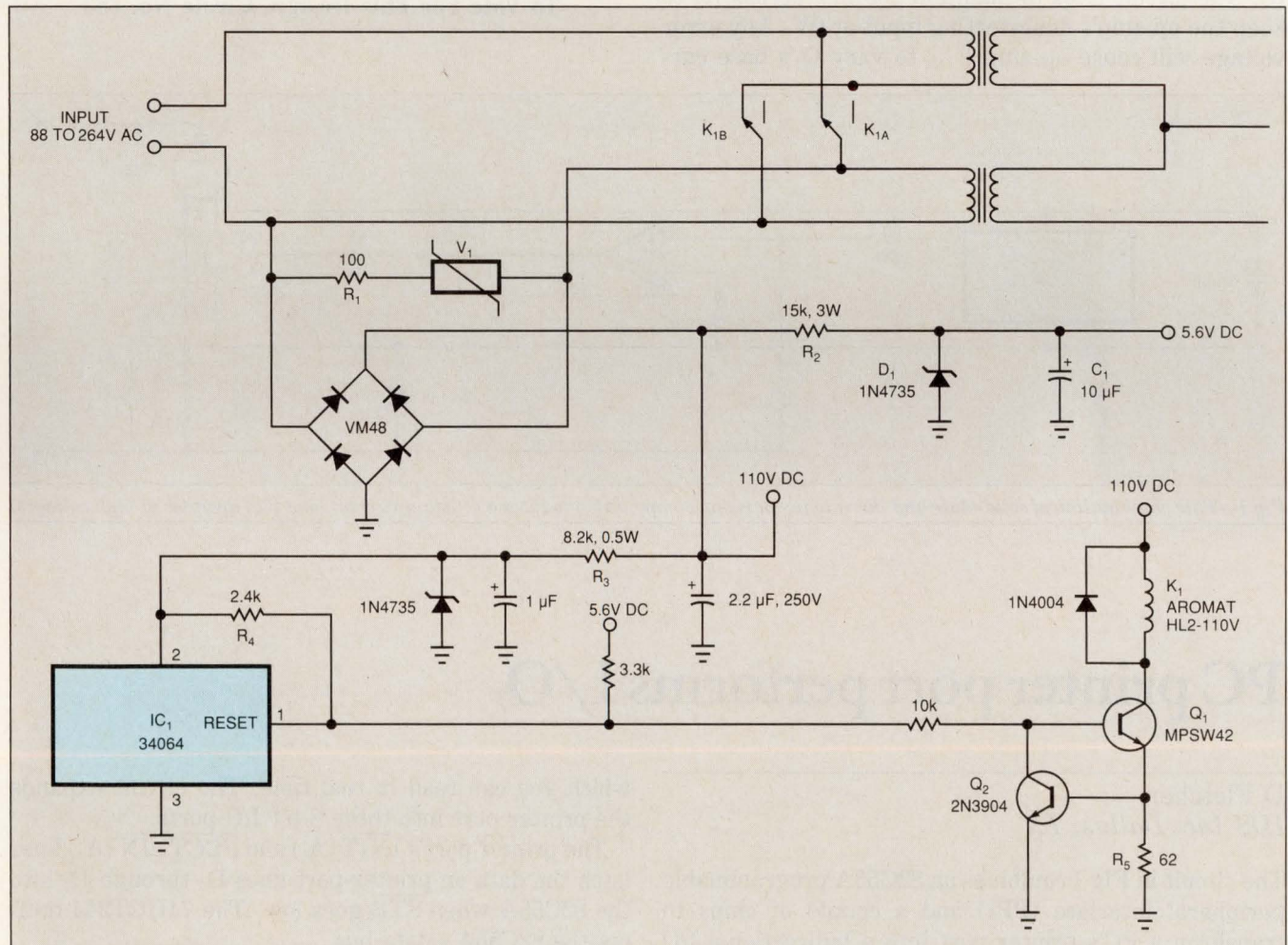

Fig 1—If this circuit sees more than 120V ac on startup, the undervoltage-sensing IC trips the relay, which reconfigures the transformer's primary for 220V ac.

Tube sinks constant current

Dave Cuthbert
Tektronix, Beaverton, OR

Contrary to popular belief, you can teach an old tube new tricks. The circuit in **Fig 1** maintains a 50- to 2000- μ A constant current over a compliance range of 200 to 10,000V. The frequency response of this load is 1 Hz. Because the circuit is compact and uses a single alkaline D cell for power, you can float it anywhere in a high-voltage circuit. Battery life is approximately 20 hours.

The circuit's pass element is a 1BY2 TV diode operating in the temperature-limited region. The circuit controls the filament's temperature to maintain a constant cathode current.

The 200-mV reference, IC₁, supplies 1 μ A through R₁. The circuit tries to maintain 200 mV across R_S to keep the op amp's noninverting input at 0V. Any error voltage will cause op amp IC_{1B} to vary Q₁'s base cur-

rent, which controls the filament's current. (The filament is a spiral of thin barium-oxide-coated wire.) The thermal time constant of the filament creates a pole; therefore, a lead-lag filter stabilizes the circuit's feedback loop. Although varying R_S appears to change the loop gain, such variation compensates for the reduction in the diode's gain at low currents.

Even though the tube has a 36-kV inverse voltage rating, field emission limits the forward-operating voltage to 10 kV. At higher voltages, the electric field at the thin filament becomes high enough for a cold filament to emit electrons; hence, the circuit cannot maintain regulation. International Components Corp carries the tube at a \$3.30 list price.

EDN BBS /DI_SIG #1037

EDN

To Vote For This Design, Circle No. 683

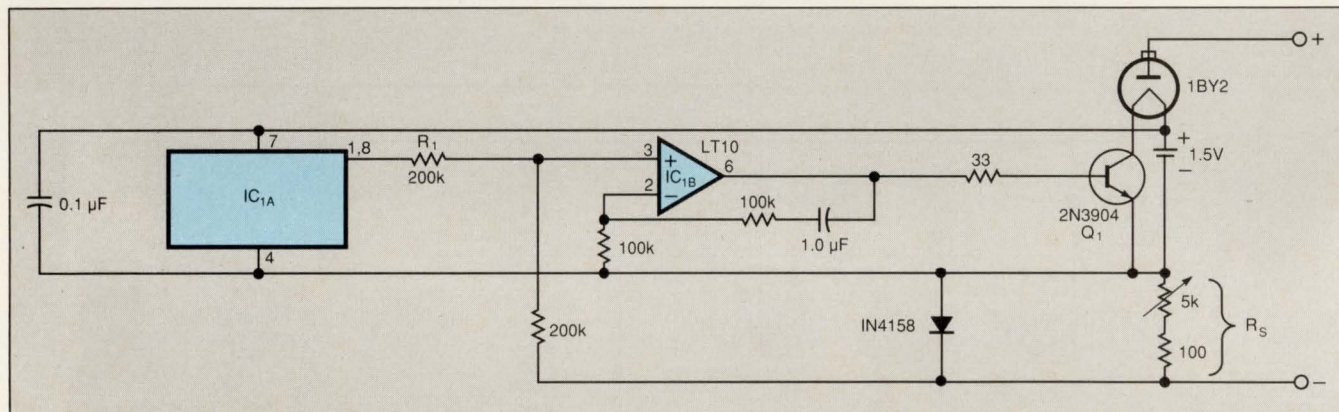

Fig 1—This combination of solid-state and thermionic-emission components produces a constant-current load that operates at high voltages.

PC printer port performs I/O

D Fletcher
IDS Inc, Dallas, TX

The circuit in **Fig 1** combines an 82C55A programmable peripheral interface (PPI) and a couple of chips to transform a PC's printer port into a bidirectional I/O port. The printer port provides 12 latched lines, which you can set under program control, and five inputs,

which you can read in real time. The circuit expands the printer port into three 8-bit I/O ports.

The printer port's INIT (A₀) and SLCT_IN (A₁) lines latch the data on printer-port lines D₀ through D₇ into the 82C55A when STB goes low. The 74HCT244 buffers the 82C55A's data bus.

Data from the 82C55A arrives a nibble at a time via the printer port's status lines: SLCT, PE, ACK, and

rugged plug-in amplifiers

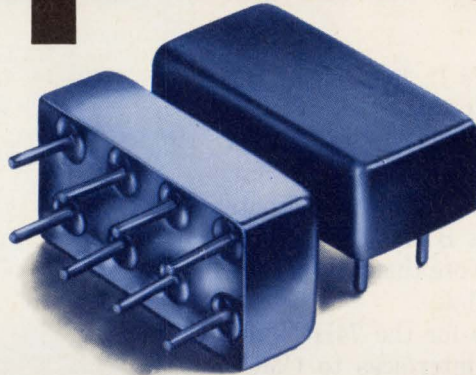

0.5 to 2000 MHz from \$13⁹⁵ (10 to 24 qty)

Tough enough to meet full MIL-specs, capable of operating over a wide -55° to $+100^{\circ}\text{C}$ temperature range, in a rugged package... that's Mini-Circuits' new MAN-amplifier series. The MAN-amplifier's tiny package (only 0.4 by 0.8 by 0.25 in.) requires about the same pc board area as a TO-8 and can take tougher punishment with leads that won't break off. Models are unconditionally stable and available covering frequency ranges 0.5 to 2000 MHz, NF as low as 2.8dB, gain to 28dB, isolation greater than 40dB, and power output as high as +15dBm. Prices start at only \$13.95 including screening, thermal shock -55°C to $+100^{\circ}\text{C}$, fine and gross leak, and burn-in for 96 hours at 100°C under normal operating voltage and current.

Internally the MAN amplifiers consist of two stages, including coupling capacitors. A designer's delight, with all components self-contained. Just connect to a dc supply voltage and you are ready to go.

The new MAN-amplifiers series...

- wide bandwidth • low noise • high gain
- high output power • high isolation

MODEL	FREQ. RANGE (MHz)	GAIN dB		MAX PWR [†] dBm	NF (typ)	ISOL. (typ)	DC PWR V/ma	PRICE \$ ea. (10-24)
	f_L to f_U	min	flat ^{††}		(typ)	(typ)		
MAN-1	0.5-500	28	1.0	+8	4.5	40	12/60	13.95
MAN-2	0.5-1000	18	1.5	+7	6.0	34	12/85	15.95
MAN-1LN	0.5-500	28	1.0	+8	2.8	39	12/60	15.95
◊MAN-1HLN	10-500	10	0.8	+15	3.7	14	12/70	15.95
MAN-1AD	5-500	16	.05	+6	7.2	41	12/85	24.95
MAN-2AD	2-1000	9	0.4	-2	6.5	28	15/22	22.50
MAN-11AD	2-2000	8	0.5	-3.5	6.5	22	15/22	29.95

^{††}Midband $10f_L$ to $f_{U/2}$, $\pm 0.5\text{dB}$ [†] 1dB Gain Compression ◊ Case Height 0.3 in. Max input power (no damage) +15dBm; VSWR in/out 1.8:1 max.

Free... 48-pg "RF/MW Amplifier Handbook" with specs, curves, handy selector chart, glossary of modern amplifier terms, and a practical Question and Answer section.

finding new ways...
setting higher standards

Mini-Circuits

A Division of Scientific Components Corporation
P.O. Box 350166, Brooklyn, New York 11235-0003 (718) 934-4500
Fax (718) 332-4661 Domestic and International Telexes: 6852844 or 620156

DESIGN IDEAS

BUSY. During reads, the printer's D₀ line selects the upper or lower nibble via the 74HCT157.

The Turbo C program in Listing 1 is an example of how to use the circuit. The function *wrt()* outputs data; the function *rd()* inputs data. The program outputs from port A and reads from ports B and C with port A looped back to ports B and C. Note that *rd()* assembles the two nibbles into a single byte.

If you substitute 74HC devices for the 74HCT devices and if the expanded port interfaces to CMOS devices downstream, you can power the circuit by diode-ORing the PC printer port's STB and AUTO_FD_XT lines together.

You can obtain the listing and an OrCAD schematic from the EDN BBS's DI Special Interest Group ((617) 558-4241,300/1200/2400,8,N,1—from Main System Menu, first enter *ss/di_sig*, then *rk1034*).

EDN BBS /DI_SIG #1034

EDN

To Vote For This Design, Circle No. 684

Listing 1—Turbo C control program

```
#include <stdio.h>
#include <dos.h>

#define PORTA 2 /* 82C55A port A */
#define PORTB 3 /* 82C55A port B */
#define PORTC 0 /* 82C55A port C */
#define CNTRL 1 /* 82C55A control port */

/* 82C55A write and read function declarations */

void wrt(int data_prt,int cntl_prt,int port,char outdata);
/* data_prt is printer data output address */
/* cntl_prt is printer control address */
/* port is 82C55A port (A,B,C, or control) */
/* outdata is data to be written to 82C55A */

unsigned char rd(int data_prt,int cntl_prt,int stat_prt,int port);
/* rd() returns 82C55A input data */
/* stat_prt is printer status port */

main()
{
    int printer=0x378,data_out,cntl_out,stat_in,x;
    unsigned char in1,in2,out=0;
    /* printer base addresses: 0x278,0x378,0x3bc */

    for(x=0;(256>x);out++) /* loop to output data from port A and read */
    {
        data_out=printer; /* set base address */
        cntl_out=printer+2; /* set control address */
        stat_in=printer+1; /* set status address */
        wrt(data_out,cntl_out,CNTRL,0x8b); /* set mode */
        wrt(data_out,cntl_out,PORTA,out); /* out to A */
        in1=rd(data_out,cntl_out,stat_in,PORTB); /* input B */
        in2=rd(data_out,cntl_out,stat_in,PORTC); /* input C */
        printf("Port A = %x, Port B = %x, Port C = %x\n",out,in1,in2);
        /* show results */
    }

    /* 82C55A write function */

    void wrt(int data_prt,int cntl_prt,int port,char outdata)
    {
        outportb(data_prt,outdata); /* write output */
        outportb(cntl_prt,(port<<(2:1))); /* enable '244 and /wr */
        outportb(cntl_prt,port<<(2)); /* disable '244 and /wr */
    }

    /* 82C55A read function */

    unsigned char rd(int data_prt,int cntl_prt,int stat_prt,int port)
    {
        unsigned char indata;

        outportb(data_prt,1); /* enable read of d7 - d4 */
        outportb(cntl_prt,port<<(2:2)); /* select port and enable /rd */
        indata=((inportb(stat_prt))&0x80)&0xf; /* read d7 - d4 */
        outportb(data_prt,0); /* enable read of d3 - d0 */
        indata|=((inportb(stat_prt))&0x80)>>4; /* read d3 - d0, form byte d7 - d0 */
        outportb(cntl_prt,port<<(2)); /* disable /rd */
        return(indata); /* return with byte */
    }
}
```

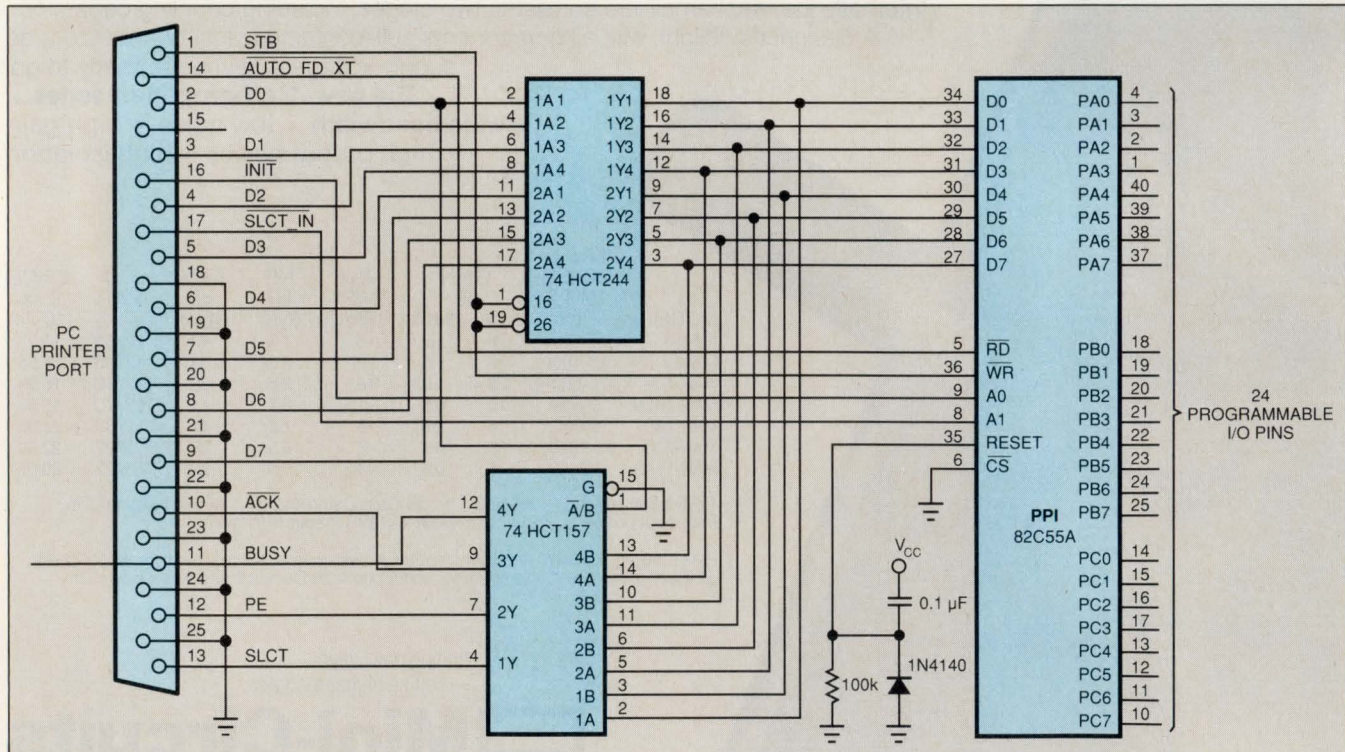

Fig 1—This circuit enables a PC's printer port to output data via its data lines and input data, a nibble at a time, via its status lines.

Looking to Add TCP/IP Network Access to Your System Designs?

Introducing . . .

FUSION *Developer's Kit*

Now you can incorporate the industry standard TCP/IP protocol suite in your system designs with FUSION Developer's Kit.

Designed for the OEM and systems integrator, FUSION Developer's Kit provides the full TCP/IP protocol suite including TELNET virtual terminal, file transfer protocol (FTP), and R-Commands to name a few.

FUSION Developer's Kit also has a flexible C-source code architecture, making it processor- and operating system-independent.

Currently used in hundreds of process control, embedded systems, and end user designs, FUSION Developer's Kit from Network Research comes with full support and porting services.

To receive a FUSION Developer's Kit information package, including data sheet, technical specifications and licensing plans call (800) 541-9508 or write to Network Research, 2380 N. Rose Ave., Oxnard, California 93030, FAX (805) 485-8204.

 **Network Research**

FUSION is a licensed trademark.

CIRCLE NO. 117

More Pease, Please!

Because so many of you have asked for Pease, we've put all 12 parts of the *Troubleshooting Analog Circuits* series published in EDN into one handy reference source.

This 101-page collection of articles was developed by Bob Pease, senior scientist in industrial linear-IC design at National Semiconductor Corp. and world-renowned analog-circuit designer.

Don't miss this exclusive reprint. Learn about troubleshooting analog circuits as only Bob Pease can tell it. This reprint is yours for only \$26.70 (U.S.A.) or \$29.95 (non-U.S.A.).*

- Part 1 • Troubleshooting is more effective with the right philosophy
- Part 2 • The right equipment is essential for effective troubleshooting
- Part 3 • Troubleshooting gets down to the component level
- Part 4 • A knowledge of capacitor subtleties helps solve capacitor-based troubles
- Part 5 • Follow simple rules to prevent material and assembly problems
- Part 6 • Active-component problems yield to painstaking probing
- Part 7 • Rely on semiconductor basics to identify transistor problems
- Part 8 • Keep a broad outlook when troubleshooting op-amp circuits
- Part 9 • Troubleshooting techniques quash spurious oscillations
- Part 10 • The analog/digital boundary needn't be a never-never land
- Part 11 • Preside over power components with design expertise
- Part 12 • Troubleshooting wrap-up

PLEASE PRINT CLEARLY Payment enclosed Bill me Visa Mastercard

Credit Card Number _____ Signature _____ Exp. date _____

Name _____ Title _____ Company _____

Address _____ City _____ State _____ Zip _____

Mail coupon to: Cahners Reprint Services, 1350 E. Touhy Ave., Des Plaines, IL 60018 U.S.A. or call 708/390-2240 or FAX your order: 708/390-2779.
*U.S.A. CURRENCY ONLY

Real Time Devices

"Accessing the Analog World"

Quality U.S.-manufactured PC Bus cards and software for single user, OEM, or embedded applications.

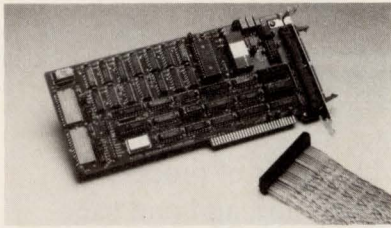

AD3700 - \$395

200 kHz THROUGHPUT

- 8 S.E. analog inputs, 12-bit 5 μ sec A/D
- FIFO interface & DMA transfer
- Trigger-in and trigger-out; pacer clock
- 4 Conversion modes & channel scan
- 4 Independent timer/counters
- 16 TTL/CMOS digital I/O lines
- Assembler, BASIC, Pascal & C source code

DataModule PRODUCTS

Plug-compatible with Ampro CoreModule

- DM402** 12-bit 100 kHz analog I/O board with trigger, T/C, DMA & 16 DIO lines **\$395**
- DM602** 12-bit 4-channel D/A; voltage range select; current loop & DIO control **\$289**
- DM802** 24-Line opto 22 compatible 82C55 PPI-based DIO interface **\$149**

POPULAR XT/AT PRODUCTS

- AD1000** 8 S.E. 12-bit A/D inputs; 25 kHz throughput; three 8-MHz timer/counters; 24 PPI-based digital I/O lines. **\$275**
- ADA1100** AD1000 with 38 kHz throughput, 2 D/A outputs, and configurable gain **\$365**
- ADA2000** 8 Diff./16 S.E. analog inputs; 12-bit 20 μ s A/D; 12 or 8 μ s A/D optional; two 12-bit D/A outputs; programmable gain; 3 T/Cs; 40 DIO lines from 82C55 PPI **\$489**
- ADA3100** 8 Diff./S.E. 12-bit analog inputs; 200 kHz throughput; gain select; FIFO interface & DMA transfer; pacer clock; external trigger; 4 conversion modes, multi-channel scan & channel burst; 4T/Cs; 16 DIO lines; two fast-settling analog outputs **\$659**
- AD510** 8 S.E. inputs; 12-bit integrating A/D with programmable gain **\$259**
- ADA900** 4 Diff./S.E. inputs; 18-bit V/F type A/D; variable resolution & conversion speed; 16-bit @ 16 Hz; 12-bit D/A, T/C & 16 DIO lines **\$410**
- DA600/DA700** Fast-settling 2/4/6/8 -channel 12-bit D/A; double buffered **\$192/359**
- DG24/48/72/96** Digital I/O lines; 82C55 based; optional buffers & line resistors **\$110/256**
- TC24** Am9513A System Timing & 82C55 Digital I/O control card **\$218**
- MX32** External analog multiplexer **\$198**
- ATLANTIS/PEGASUS/PEGASUS Acquire** Menu-driven, real-time monitoring, control, data acquisition and analysis turn-key software packages **\$150/290**

Call for your Free Catalog!

RTD logo, "Accessing the Analog World", and DataModule are trademarks of Real Time Devices, Inc. AMPRO and CoreModule are registered trademarks of Ampro Computers, Inc. opto 22 is a registered trademark of Opto 22, Inc.

Custom/OEM designs on request!

Real Time Devices, Inc.
State College, PA USA

rtdd Tel.: 814/234-8087
FAX: 814/234-5218

CIRCLE NO. 118

NEW PRODUCTS

COMPUTERS & PERIPHERALS

DSP Board

- Contains a TMS320C31 DSP chip and an 80386 μ P
- A custom IC gives DSP chip direct access to host memory

The DSP/PC single-board computer is a DSP board for a passive 16-bit ISA bus. It contains a TMS320C31 DSP chip and 2 Mbytes of static RAM, which connect to the company's 10 Mbyte/sec DSP-Link connector. The DSP chip communicates with an onboard 25-MHz 80386 μ P via a custom chip set, called Media-Link controller. The controller's signals match the 80386's and the TMS320C31's control signals. The controller transfers data between processors at 66 Mbytes/sec. The 2-chip set also gives the DSP chip direct access to the host's onboard memory and peripherals, such as frame grabbers and hard disks. The host's onboard dynamic RAM has 2 Mbytes, which is expandable to 8 Mbytes. The board has two RS-232C ports, a parallel printer port, and a dual floppy-disk controller. It runs on the Spox operating system. **\$3500.**

Spectrum Signal Processing Inc., Suite 301, 3700 Gilmore Way, Burnaby, BC, Canada, V5G 4M1. Phone (800) 663-8986; (415) 777-4161. **Circle No. 351**

Image-Compression Board

- Implements the JPEG standard
- Digitizes NTSC or PAL video signals

The Vidcom image-compression board for the ISA bus uses C-Cube Microsystems's CL550B chip, which implements the Joint Photographic Experts Group (JPEG) compression standard. It digitizes NTSC or PAL video signals. The board reduces the memory requirements from 1658.88 Mbytes to 20.736 Mbytes when storing 1 minute of real-time video having 640 \times 480 \times 24-bit reso-

lution. A 622.08 hard disk can store 1/2 hour of compressed video data. The compression algorithm reduces the data transfer rate from 27.65 Mbytes/sec to 345.6 kbytes/sec when transferring data from the board to a hard disk. The board also digitizes color or black-and-white images from a scanner having a resolution as high as 8192 \times 8192 \times 24 bits. **\$995.**

Specum Technologies Corp., 3673 Enochs St, Santa Clara, CA 95051. Phone (408) 736-7832. FAX (408) 736-7861. **Circle No. 352**

VMEbus to NTDS Interface Board

- Has 68020 μ P and a VIC068 VMEbus controller chip
- Conforms to MIL-STD-1397 type D, E, or J specifications

The Serial Hawke board adapts a VMEbus system to the Navy Tactical Data Systems's (NTDS) serial interface. The 6U or 9U board contains a 68020 μ P, a VIC068 VMEbus controller chip, as much as 1 Mbyte of DRAM, as much as 1 Mbyte of EPROM, and 512 kbytes of dual-port RAM, which is accessible to the CPU and the VMEbus. It's available in three versions that conform to MIL-STD-1397 specifications. One version conforms to the type-D, coaxial-cable interface. A second version conforms to the type-E, triaxial-cable interface, and a third version conforms to a type-J, fiber-optic interface. An RS-232C port lets a computer or dumb terminal access onboard development software. You can install as many as 16 boards in a card cage. Type D and Type E boards, \$4495; Type J board, \$4695. Delivery, stock to six weeks ARO.

Sabtech Industries Inc., 5411 E La Palma Ave, Anaheim, CA 92807. Phone (714) 970-5311. FAX (714) 970-5377. **Circle No. 353**

COMPUTERS & PERIPHERALS

VMEbus Single-Board Computer

- Has slot-1 controller and a 16-MHz 68HC000 μ P
- Draws less than 300 mA

The VME201, a single-board computer (SBC) for the VMEbus, has a 16-MHz 68HC000 μ P and complete slot-1 controller functions. It features two RS-232C ports, a 16-bit interrupt timer, four 32-pin JEDEC memory sockets for as much as 2 Mbytes of EPROM or 1 Mbyte of static RAM, a calendar clock, and a watchdog timer. An interrupt controller prioritizes interrupts from 12 sources including the seven VMEbus interrupts, Sysfail, an abort switch, an onboard DUART, and the watchdog interrupt. A standard version typically draws 700 mA from a 5V supply, and a low-power version draws less than 300 mA. Software options include Microware's OS9 and PDOS

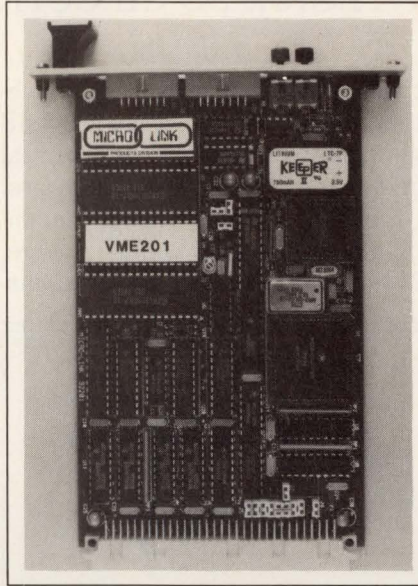

VMEPROM operating systems as well as the company's Microbug debugger and monitor. \$350 (100).

Micro-Link, 14602 N US Highway 31, Carmel, IN 46032. Phone (800) 428-6155. **Circle No. 369**



AUTOCAD
for
Electronic Engineers

AutoSchema[®]

- Only \$195
- New Symbol icon browsing
- Unlimited levels of hierarchy
- Spice & Susie interfaces

AutoPCB[®]

- Best performance on a P.C.
- Double sided SMT
- Real time design rule check
- Interactive push & shove routing

AutoHybrid[®]

- Worlds only P.C. Hybrid system
- Automatic component synthesis
- Custom die geometry
- 0.5 micron resolution

CADISYS

2099 Gateway Place,
Suite 400,
San Jose, CA 95110
USA
FAX (408) 441-8300

CALL FOR
CATALOG
408-441-8800
EXT 200

CIRCLE NO. 121

General Scanning's

AR-42

Thermal Array Printer

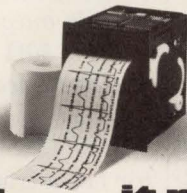

it prints

horizontal text — rows up to 12 characters.
vertical text — up to 24 characters/line.
138 ASCII/International characters available.

it plots

up to 3 simultaneous analog traces over
programmable background grids.

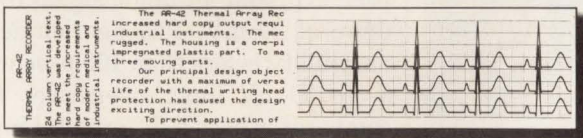

it draws

any user-developed patterns,
designs or symbols.

it jots

flexible, floating annotation
of real-time events.

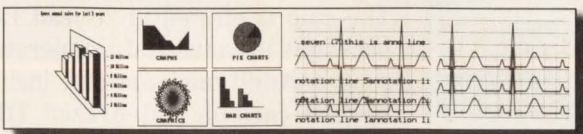

it excels.

Our smallest recorder gives you **BIG** performance.
For complete details write or call 800-342-3757

GS GENERAL SCANNING INC.

Recorder Products Division

37 Broadway, Arlington, Massachusetts 02174
PHONE: (617) 641-2702 FAX: (617) 648-4906

Data Entry Terminals

Low-Cost Data Terminals For Industrial Applications



QTERM-II
\$235
(1-6)

- 4x20 supertwist LCD display; backlight, wide-temp optional.
- 40- or 24-key tactile keypad.
- Handheld or panel-mount version.
- Keypads include a shift LED and row of user-programmable LEDs.
- RS-232, RS-422, RS-423 or 5-volt serial communications interface.
- Barcode wand interface available.
- Low power: RS-232 version uses only 11 mA operating, 2.2mA with display off.
- All keys programmable (both shifted and unshifted); up to 256 characters per key.
- Handheld RJ-11 jack exits top or bottom.
- **FREE!** Custom labeling of company name, user LED labels and top-row key legends.

QSI
CORPORATION

QSI Corporation
2212 South West Temple, #46
Salt Lake City, UT 84115 • USA
Telephone: 801-466-8770
(Fax: 801-466-8792)

NEW PRODUCTS

INTEGRATED CIRCUITS

Current Feedback Amplifier

- Operates at 100 MHz
- Suitable for video, communications, and data acquisition

The HA-5020 100-MHz current-feedback amplifier offers 800 V/ μ sec slew rate and 90-nsec settling

time. Video performance parameters for the amplifier include 0.1-dB gain flatness, 0.02% differential gain, and 0.03° differential phase. Other key specifications of the amplifier are its 2-mV offset voltage, 20 μ V/°C offset drift, 3-mA bias cur-

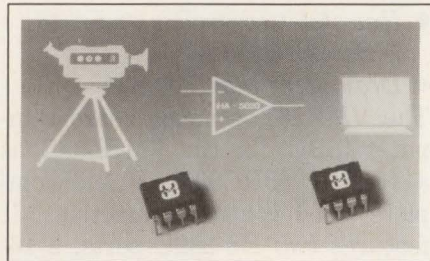

OTTO Precision Snap-Action Switches



More
than
just
the
Switch!

Because we have the broadest line of Basics...

...we offer you
"One-Stop Shopping"
Quality Design
Quality Manufacturing
Engineering Excellence

We offer you
Engineering
Excellence
Everyday

OTTO.
CONTROLS

Call or Fax
for our new 44
page Catalog
today.

2 E. Main St. • Carpentersville, IL 60110 • Tel: 708/428-7171 • Fax: 708/428-1956

rent, 20-M Ω input resistance, 50-dB common-mode rejection ratio min, and 100-MHz unity-gain bandwidth. An on-chip disable function eliminates the need for multiplexers in multichannel designs. Available in 8-pin SOIC and DIPs, the amplifiers operate over 0°C to 75°C and -40°C to +85°C ranges. \$2.85 and \$3.25 (100), respectively.

Harris Semiconductor, Box 883, Melbourne, FL 32901. Phone (800) 442-7747, ext 1134.

Circle No. 354

Voltage Comparator

- Data outputs provide 30 mA and drive 50 Ω loads
- Has typical propagation delays of 650 psec

The SPT9689 dual voltage comparator has a tracking bandwidth of 900 MHz at -3 dB, open-loop gain of 66 dB, propagation delays of 650 psec typ, and an input signal overdrive of 20 mV. Propagation-delay variability is less than 100 psec with 5- to 50-mV input overdrive. The comparator uses a differential input stage with a common-mode range of -2.5 to +4V and a typical input offset current of less than $\pm 1 \mu$ A. The chip is offered in 20-lead LCC packages in industrial temperature range. Additional options include 16-lead ceramic sidebraced DIPs and unpackaged die. Military versions are also available. \$11.70 (1000).

Signal Processing Technologies, Marketing Dept, 1510 Quail Lake Loop, Colorado Springs, CO 80906. Phone (719) 540-3999. FAX (719) 540-3970. Circle No. 355

End the connector compromise...

1. CONTACT WIPE ELIMINATES INTERMITTENTS

2. 80-700 CONTACTS WITH LOW INSERTION FORCE

3. JACK-SCREW ECONOMY AND RELIABILITY

...in test equipment

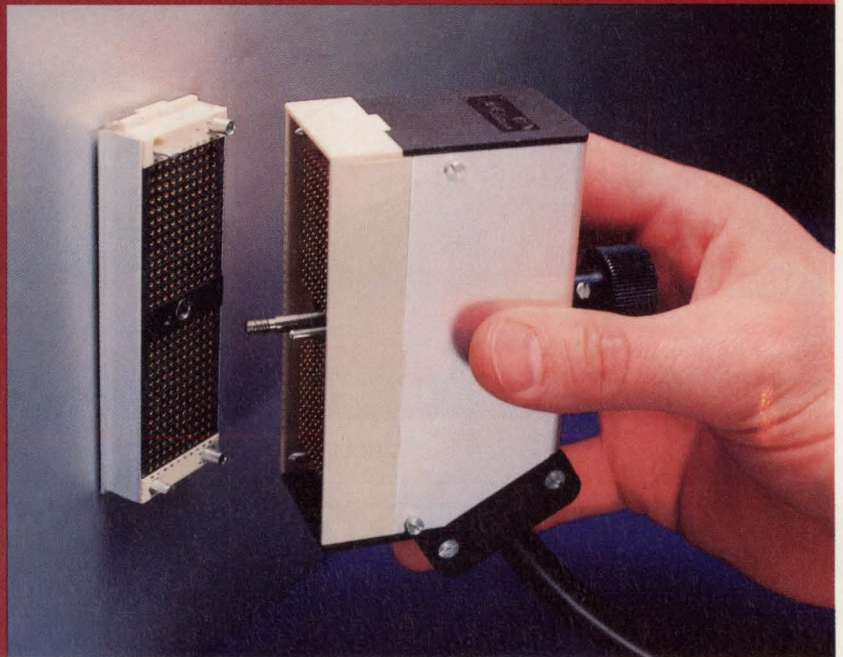

Only Hypertronics ends the compromise in multi-pin connectors—for heavy-duty power/signal applications—by replacing low wipe Zero Insertion Force (ZIF) contacts and expensive cams with low-force, high-cycle reliability.

Our N Series housing design accommodates 80 to 700 removable contacts, in a variety of types and terminations. And the wipe action of each Hypertac® contact maintains electrical continuity under corrosive conditions and extremes of shock and vibration...ending the problems of intermittents of ZIF contacts.

This design provides Low Insertion Force (LIF)—less than 45 pounds for a 700 contact connector—that eliminates the need for cams. A simple jack screw affords a more reliable and economical closure.

Now you can have it all...in connectors for power & signal applications in test equipment requiring up to 700 contacts. End the connector compromise by calling 1-800-225-9228, toll free.

HYPERTAC®:
Inserting pin into hyperboloid sleeve.

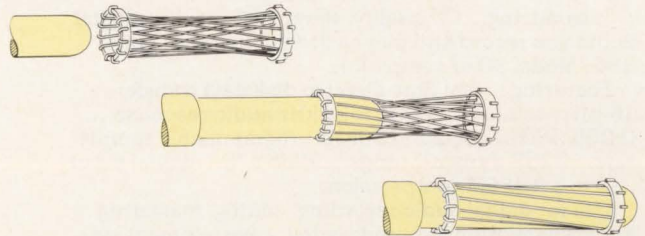

HYPERTRONICS CORPORATION

"New Horizons in Connectors"

16 Brent Drive, Hudson, MA 01749 (508) 568-0451 FAX (508) 568-0680

CIRCLE NO. 126

IT9010/IT9010M ASIC

Full featured VXI interface which handles all logic and protocol tasks necessary to interface with the VXI bus.

DT9110/DT9150

Designed around the IT9010 or IT9010M, these 13.5 sq.in. daughter-cards provide a comprehensive VXI interface.

BB9210VXI/BB9250VXI

Utilizing the DT9110 or DT9150 VXI daughter-cards, these "C" size VXI prototype modules provide over 90 sq.in. of custom VXI design space.

The Total VXI Interface Solution



REGISTER BASED & MESSAGE BASED



CIRCLE NO. 153

INTEGRATED CIRCUITS

Floppy-Disk Controller

- Incorporates 765B floppy-disk-controller core
- Offers software and hardware power-down/reset capability

The FDC37C75 floppy-disk controller includes an IDE interface that performs the decode logic for IDE hard-disk drives. The 68-pin controller also includes a digital-data separator, an on-chip address decoder, and game-port decode logic. On-chip circuitry allows single-crystal-oscillator operation and generates a 1.8432-MHz output clock signal for direct drive of external I/O devices. A software- or hardware-selectable power-down mode suits low power applications. \$3.95 (10,000).

Standard Microsystems Corp., Component Products Div, 35 Marcus Blvd, Hauppauge, NY 11788. Phone (516) 273-3100.

Circle No. 356

AUDIO PRO

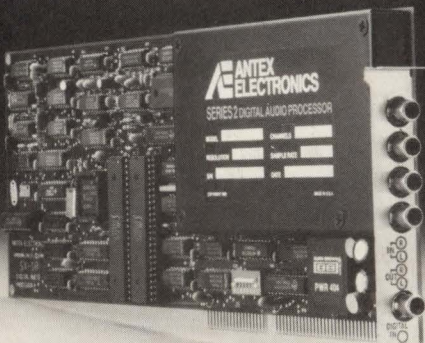

Introducing... CD quality, stereo high fidelity, digital audio you record and playback on your PC-AT/286/386/Model 30 or compatible.

Featuring... real time direct to disk data transfer... 16-bit resolution... 20Hz to 20kHz audio response... 0.005% THD... 6.25 to 50kHz programmable sample rate... 92dB dynamic range... 90db s/n... digital input... 4 to 1 ADPCM compression.

Use for digital audio recording, editing, mastering and transmission in broadcasting, entertainment systems, film production, audio/visual presentations and interactive CDI/DVI systems.

If you're an audiophile with microcomputer resources call 1-800-338-4231 (ex. CA.) for details on our Audio Pro... the Series 2/Model SX-10.



16100 S. Figueroa St. • Gardena, CA 90248 • Tel (213) 532-3092 • FAX (213) 532-8509

CIRCLE NO. 128

Silicon Sensors For OEM Designers.



Take advantage of NovaSensor's low-cost, high-reliability silicon technology.

- Acceleration ranges from ± 2 G to ± 50 G
- Widest pressure ranges from 2" H₂O to 10,000 psi
- Accuracies to $\pm 0.1\%$ full scale output
- 316 SS diaphragm for harsh media compatibility
- Superior stability and small size

Call or write for product brochure and application assistance.



1055 Mission Ct., Fremont, CA 94539, USA
Tel: (415) 490-9100; Fax: (415) 770-0645
Telex: 990010

CIRCLE NO. 129 EDN October 10, 1991



Build a Better Test System

Developing a PC-based test system with standard hardware and software saves valuable development time and produces a higher quality system. That's why National Instruments hardware and software products are built upon industry standards.

Our GPIB boards use the NAT4882™ chip for complete IEEE-488.2 compatibility. And our LabWindows® software combines powerful development tools with standard programming languages.

See us at ISA booth 5949

With LabWindows, you have the software tools you need to integrate all of the hardware in your test system. Use high-level 488.2 routines to simplify system programming or use drivers from the LabWindows Instrument Library to control your GPIB and VXI instruments without programming them at all.

LabWindows has tools for all phases of your development—data acquisition, analysis, and presentation. You can even create a graphical user interface so your test system is easy to operate.

CIRCLE NO. 130

To learn how to build a better test system, give us a call.

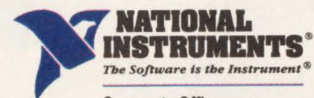

Corporate Office
6504 Bridge Point Parkway
Austin, TX 78730-5039
512 794-0100
(800) 433-3488 (U.S. and Canada)

International Branch Offices
AUSTRALIA (03) 879 9422 • DENMARK (45) 76 73 22
FRANCE (1) 48 65 33 70 • GERMANY (089) 714 5093
ITALY (02) 4830 1892 • JAPAN (03) 3788 1921
NETHERLANDS (01720) 45761 • NORWAY (03) 846 866
SWITZERLAND (056) 45 58 80 • SPAIN (908) 604 304
UNITED KINGDOM (0635) 523 545

© Copyright 1991 National Instruments Corp. All rights reserved.

See us at COMDEX booth R8629

NEW PRODUCTS

COMPONENTS & POWER SUPPLIES

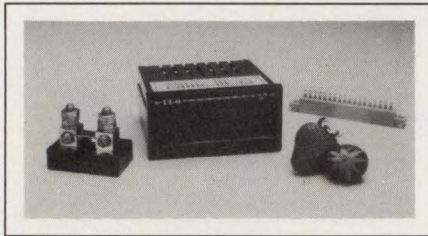

Ammeter Kit

- Designed for remote monitoring applications
- Meter features 0.5% accuracy

The model DP301-1S precision-digital-ammeter kit consists of a digital panel meter and an external shunt for monitoring dc current from a remote location. Monitoring distance can range to several hundred feet. Kits are supplied with external shunts of 5, 10, 50, 500, or 1000A. Measurement accuracy is better than $\pm 0.5\%$, and resolution ranges from 0.001 to 1A, depending on current range. In the event of a

reverse current flow, the $3\frac{1}{2}$ -digit LED readout will display a minus sign. A start/hold function allows the user to hold the current reading. The remote ammeter operates from a line voltage of 110 or 220V. From \$90. Delivery, stock to six weeks ARO.

D1 International Inc, 95 E Main St, Huntington, NY 11743. Phone (516) 673-6866. **Circle No. 357**

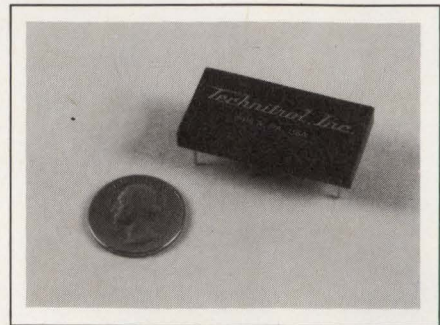

ers meet the requirements of MIL-T-27. Standard frequency is 400 Hz ± 20 Hz, and input and output voltages range to 11.8V. Standard power rating equals 30 mW. The devices are supplied in an epoxy-encapsulated package that measures 1.62 \times 0.81 in. Custom designs are available on request. \$60 (100).

Technitrol, 1952 E Allegheny Ave, Philadelphia, PA 19134. Phone (215) 426-9105. FAX (215) 426-2836. **Circle No. 358**

Scott-T Transformers

- Have a 0.01° accuracy
- Available in four versions

Measuring 0.25 in. high, these Scott-T transformers are guaranteed to meet a $\pm 0.01^\circ$ accuracy specification. The units are available in synchro-resolver (LSR), resolver-synchro (LRS), resolver-resolver (LRR), and synchro-synchro (LSS) versions. The transform-

How well does Texas Instruments support

The collage features several prominent documents:

- SCOPE Testability Products**: A yellow document with a blue header.
- TMS320C5x DSP Preview Bulletin**: A white document with a blue header.
- Texas Instruments Full Scan Automatic Test Pattern Generation Design Service**: A white document with a blue header.
- Texas Instruments Design-for-Testability Workshop**: A white document with a blue header.
- Texas Instruments CMOS Gate Arrays Product Bulletin**: A white document with a blue header.
- Texas Instruments Applications Guide**: A white document with a blue header.
- Texas Instruments TMS320 Digital Signal Processor Development Support**: A white document with a blue header.
- Texas Instruments Design-for-Test**: A white document with a blue header.
- Texas Instruments Parallel-Processing Floating-Point DSP**: A white document with a blue header.
- Texas Instruments Futurebus+ and Backplane Transceiver Logic**: A white document with a blue header.

DC/DC Converters-

- *Deliver 250W*
- *Feature redundant operation*

The μ V 48 Series dc/dc converters deliver an output of 200 to 250W. Housed in a package measuring 0.5x2.4x3.6 in., they feature a 58W/in.³ power density. They accept an input of 36 to 72V and output 5V at 40A, 12V at 20A, 15V at 16A, 24V at 10A, or 28V at 9A. Converter features include n+1 redundancy with current sharing and hot plug-in capability. Nonshut-down overvoltage protection, logic on/off, and short-circuit and overtemperature protection are all standard. An optional $\pm 10\%$ output-good signal is available. The converters comply with MIL-STD-810D requirements and with UL 1950 and IEC 950. A sync-pin option allows you to control and synchronize the frequency of several

converters externally. \$225. Delivery, stock to eight weeks ARO.

RO Associates Inc, 246 Caspian Dr, Sunnyvale, CA 94088. Phone (408) 744-1450. FAX (408) 744-1521.

Circle No. 359

Dual Relays

- *Provide two independent relay outputs in a single case*
- *Operate to 80°C*

DD Series solid-state relays provide two independent circuits in one standard hockey-puck case. The outputs are rated for 15, 25, or 40A, and the control voltage ranges from 3 to 15V dc. Load voltage measures 20 to 300V ac. Leakage current ranges from 10 to 20 mA, and the forward voltage drop at rated load equals 1.6V. The relays have reverse polarity protection on the input. Versions are available with

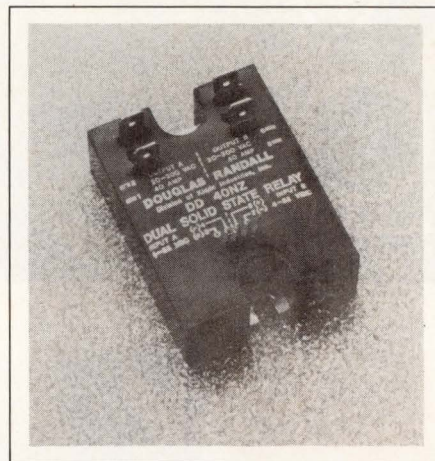

both zero-crossing and non-zero-crossing switching characteristics. Input-to-output isolation equals 2500V rms, and operating range spans -30 to +80°C. \$15 to \$25.

Douglas Randall, Box 506, Pawcatuck, CT 06379. Phone (800) 447-6799. FAX (203) 599-1754.

Circle No. 360

the JTAG/IEEE 1149.1 testability standard? Let us count the ways.



Texas Instruments was the first electronics company to develop products for implementing the JTAG/IEEE 1149.1 testability standard. Here's the latest of a fast-growing list of TI products compatible with the 1149.1 standard.

Standard Logic

1. BiCMOS (BCT) Octals (5)
2. Advanced BiCMOS (ABT) Octals (8)
3. Advanced BiCMOS (ABT) Widebus™ (7)

Support Devices

4. Test Bus Controller
5. Digital Bus Monitor
6. Scan Path Linker
7. Scan Path Selector

Application-Specific Memory

8. Diary

Digital Signal Processors

9. TMS320C40
10. TMS320C50
11. TMS320C51

Floating-Point Processor

12. TMS34082

Futurebus+™

13. Protocol I/O Controller
14. Arbitration Controller
15. Programmable Arbiter
16. Data Path Unit
17. Protocol and Cache Controller
18. Data Path for Cache

Gate Arrays

19. TGC100 Family (14 macros)
20. TGB1000 Family (15 macros)

Standard Cells

21. TSC700 Family (14 macros)

Diagnostic Software Tools

22. ASSET™

Comprehensive support

TI offers a wide selection of literature as well as training and educational testability courses.

For more information, call 1-800-336-5236, ext. 3911

If you would like to know more about JTAG/IEEE 1149.1 and how it's being supported by Texas Instruments, please request a copy of our "Testability Q&A Update."



When it comes to JTAG/IEEE 1149.1 testability support, you can count on TI.

™ Widebus and ASSET are trademarks of Texas Instruments Incorporated. Futurebus+ is a trademark of IEEE.



IOtech

Data Acquisition Instruments

Compare our new IEEE Data Acquisition Instruments to traditional instruments, plug-in boards, and VXI systems. You'll find that our high channel density, isolation, easy configurability, and proven technology are all available at a lower price per channel.

Couple them with our IEEE 488 hardware and software for IBM, Macintosh, Sun, NeXT and DEC computers, and you've got a complete data acquisition system.

Call, send, or fax for your FREE Technical Guide.

IOtech, Inc.
25971 Cannon Road
Cleveland, OH 44146
(216) 439-4091
fax: (216) 439-4093

- 16-bit, 100 KHz analog I/O
- 16 ch. analog signal conditioner
- 64 ch. analog multiplexer
- 8 ch. analog filter
- 32-bit, 1 MHz digital I/O
- 16 ch. DC/AC power control



CIRCLE NO. 140

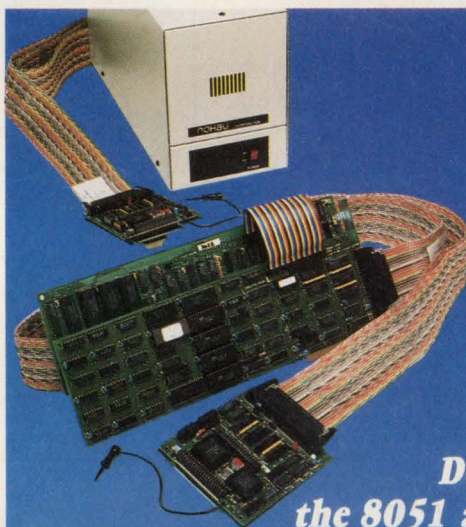

8051 & 68HC11

PC-Based
In-Circuit Emulators

**Nohau
Covers All Your
Development Needs for
the 8051 and 68HC11 Families!**

Free Demo

You can start your debugging with this **FREE** demo simulator. You can load up to 512 bytes of code, assembler, C, or PL/M and do full debugging/simulation in assembly and source level. A great way to get started for **FREE**. Fantastic for schools! Just call and we'll send it!

Full Simulator

The full-blown simulator is an extension of the DEMO. You can load up to 64K of code and use 64K of XDATA space. You can program an "external environment" to interact with your code to simulate your target system. The emulator is the hardware extension of the simulator!

In-Circuit Emulation

The 30MHz real-time emulator has been the industry standard for years. With its complex breakpoint logic and advanced trace, nobody can beat it for performance. Plug-in or RS-232 configuration. All 8051 derivatives are supported!

NOHAU
CORPORATION

51 E. Campbell Avenue, Campbell, CA 95008
(408) 866-1820 • FAX (408) 378-7869

Call Nohau's 24-hour
information center to
receive info on your
FAX 408-378-2912

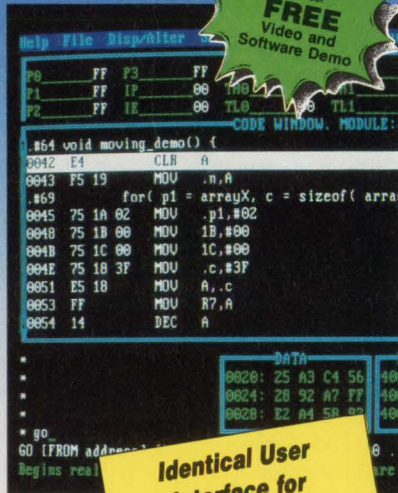

**Identical User
Interface for
All Three Products —
You Can't Go Wrong!**

Australia (02) 654 1873, Austria (0222) 38 76 38, Benelux +31 1858-16133, Canada (514) 689-5889, Czechoslovakia 0202-2683, Denmark (42) 65 81 11, Finland 90-452 1255, France (01)-69 41 28 01, Germany 08131-25083, Great Britain 0962-73 31 40, Greece 01-862-9901, Hungary (1) 117 6576, Israel (03) 48 48 32, Italy (011) 771 00 10, Korea (02) 784 784 1, New Zealand (09) 392-464, Portugal 01-80 9518, Norway 02-649050, Singapore (065) 284-6077, Spain (93) 217 2340, Sweden 040-9224 25, Switzerland (01) 740 41 05, Taiwan (02) 7640215, Thailand (02) 281-9596, Yugoslavia 061 621066.

NEW

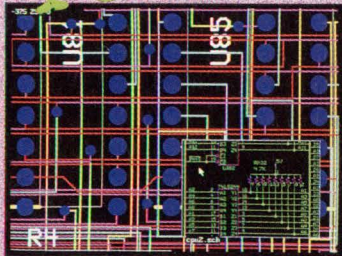

Integrated schematic and PCB software that was designed that way, not kludged that way.

- Imagine using the same drawing tools for both schematic drawings and PCB artwork.
- Picture the convenience of displaying and editing schematic and PCB drawings simultaneously.
- Visualize being able to create or modify library symbols in seconds using the same commands you use for other drawings.
- Envision a 100% completion rip-up-and-re-route autorouter that costs thousands less than comparable autorouters.
- Suppose you could unleash all this power by spending less than eight hours with the tutorial.
- Now fancy a toll-free number provided for no-charge technical support, and a 30-day, no-hassel, money-back guarantee.

Call today and let HiWIRE II turn your imagination into reality.



Wintek Corporation
1801 South Street
Lafayette, IN 47904
Fax: (317) 448-4823
Phone: (317) 448-1903 or
(800) 742-6809

CIRCLE NO. 131

EDN October 10, 1991

NEW PRODUCTS

INSTRUMENTS

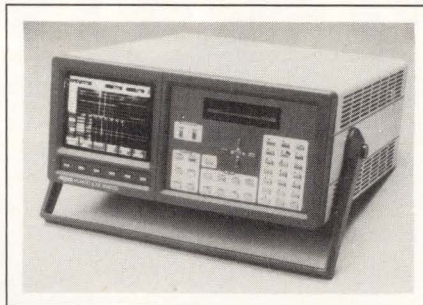

Logic-Analyzer Support For LR33000 μ P

- *Accepts data in every clock cycle or bus transaction*
- *Fully disassembles instruction and data cycles*

With the TGI-LR33K target-interface adapter, the vendor's ML4400 logic analyzer supports the LSI Logic's LR33000 reduced-instruction-set μ P. The μ P uses the MIPS Computer Systems architecture. The adapter plugs into the μ P's pin-grid-array socket in the target system. The logic analyzer fully disassembles the instructions and data flowing to and from the IC. A disassembler supports the μ P's complete instruction set and allows symbol tables to define as many as 10,000 symbols. The adapter permits processor clock speeds to 50 MHz. From \$10,000.

American Arium, 14281 Chambers Rd, Tustin, CA 92680. Phone (714) 731-2138. **Circle No. 361**

68302 Emulator

- *Operates to 25 MHz*
- *By changing personality cards, emulates other μ Ps*

The Mime-700 in-circuit emulator (ICE) supports the MC68302 single-chip microcontroller. The ICE operates to 25 MHz; by changing its personality card, you can configure it to support other processors. The ICE supports debugging of applications that use the 68302's complex communications facilities. Pipeline

EDN INFO CARDS

THE 2¢ SOLUTION

to your marketing budget blues—the EDN Info Card Pack. At 2¢ per name, the EDN Info Card Pack can reach over 123,000 engineering specifiers affordably.

Contact Heather McElkenny
EDN Info Cards, (617) 558-4282

EDN Magazine
Edition
News
Edition

A Partnership in Power
and Prestige Worldwide

Killer Specs.



Panther[®] SCSI

Stalking system performance is your goal. That's why Maxtor's 1.2GB SCSI Panther was designed to perform a data seek in just 13ms. No other drive in its class features such lightning speed.

Panther's hunting prowess of 2ms track-to-track seek time stands out compared to Seagate's Wren 7 seek time of 2.5ms. And Panther outruns the competition with a 30Mb/sec. internal transfer rate.

Experience counts. Panther uses the reliable head disk assembly used in the Maxtor XT-8000, which boasts more than 300,000 units in the field. Panther shreds the competition with the widest range of available controllers, an MTBF of 150,000 hours, Novell certification and a highly competitive price.

Call about the full line of Panther drives that range from 1.2GB to more than 1.7GB capacity. If you're stalking performance, check out Panther's killer specs. *Call your nearest Authorized Maxtor Distributor.*

1GB-plus Disk Drive Comparison Criteria	Maxtor Panther P0-12S	Seagate Wren 7
Capacity (unformatted)	1.2GB	1.2GB
Seek Time	13ms	15ms
Track-to-Track	2ms	2.5ms
Internal Transfer	17.4 to 29.7Mb/s	15-23Mb/s
Maximum Seek	26ms	34ms

We Drive Harder.

Maxtor[®]



© 1991 Maxtor Corporation
® Panther is a registered trademark of Maxtor Corp.



Call Your Authorized Maxtor Distributors

A.D.P.I.

1-800-275-2374
301-258-2744

Anthem Electronics
408-452-2287

Arrow Commercial Systems Group
1-800-323-4373

Arrow/Kierulff
1-800-777-2776

Avnet Computer
1-800-422-7070

ATS
1-800-359-3580

B.S.M./Business Solutions in Micro
1-800-888-3475
214-699-8300

Cal Abco
818-704-9100
800-669-2226

Compac Micro Electronics
1-800-426-6722
415-656-2244

Computer Brokers of Canada
416-660-1616
1-800-663-0042
1-800-361-6415

CPC
714-757-0505
800-582-0505

D & H Distributing Co.
717-236-8001

Data Storage Marketing (D.S.M.)
1-800-543-6098
303-442-4747

Firstop Computer
1-800-832-4322

Future Electronics
514-694-7710

Intellect
011-525-255-5325

Microland Electronics
San Jose, California
408-441-1688
Richardson, Texas
214-484-7515

Microware Distributors
1-800-777-2589
503-646-4492

Mini-Micro Supply Co.
408-456-9500
1-800-628-3656

Pioneer Standard Electronics
1-800-874-6633

Pioneer Technologies
1-800-227-1693

S.E.D.
1-800-444-8962
404-491-8962

Tech Data
1-800-237-8931
813-539-7429

Technology Factory
1-800-848-2073
1-800-227-4712

U.S. Computer
305-477-2288

Vitek Systems Distribution
1-800-366-6655

Wyle Laboratories
1-800-289-9953

INSTRUMENTS

tracking logic allows qualifying breakpoints on instruction execution, so that prefetched but unexecuted instructions do not erroneously trigger ICE operations. \$14,159.

Pentica Systems Inc., 1 Kendall Square, Bldg 200, Cambridge, MA 02139. Phone (617) 577-1101. FAX (617) 494-9162. **Circle No. 362**

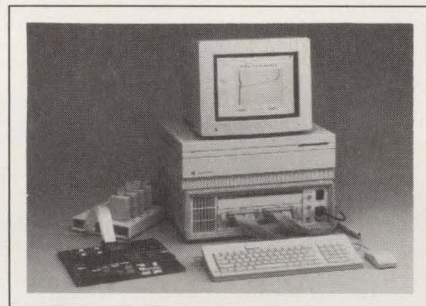

Software-Performance Analyzer

- Captures and displays values of variables in memory
- Captures and time tags value changes 20 nsec apart

The VVM-1 variable-value monitor is a hardware/software tool for analyzing software performance, especially in embedded systems. It captures the values of variables in a system's memory continuously, as they are stored, without adding bus cycles. It displays as many as 1000 values/sec in numeric form or in several graphic formats. It also replays recorded data. The displays let you determine what your code is doing; why it does what it does; and how well it does it. You can select the "watchpoints," that is, the variables and their values that the system looks for. The instrument time-tags each value it records. It can store changes separated by as little as 20 nsec. The vendor offers interfaces to μ Ps from five manufacturers. From \$19,950. Delivery, twelve weeks ARO.

Biomation Inc., 19050 Pruneridge Ave, Cupertino, CA 95014. Phone (800) 538-9320; (408) 988-6800. **Circle No. 363**

STD BUS SENSOR COPROCESSOR

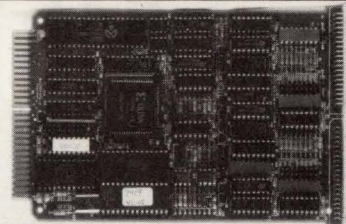

SUPPORTS WIDE VARIETY OF SENSORS

- Thermocouples
- RTD's
- Thermistors
- Strain & Pressure Gauges
- DC Voltage
- Resistance

ANY COMBINATION OF 16 AT THE SAME TIME!

Model 7419 Features

- 16 differential channels
- 16 bit resolution
- Integrating A/D converter — 45 conversions per second
- Pulsed sensor excitation
- Sensor linearization
- Digital filtering
- Limit checking & alarm generation
- Low power CMOS
- Auto self-calibrating
- Open sensor detection
- Low cost - \$750 — call for quantity discounts
- 8 channel version (7418) - \$595
- Screw termination board available

Software Support

- QuickSense™ will have you up and running in minutes — free with board purchase
- QuickBASIC & C Driver Libraries available to simplify your custom application

SENSORAY

15800-150 U. Boones Ferry Rd.
Lake Oswego, OR 97035

(503) 684-8005

CIRCLE NO. 133

THE POWER CHIPSET™ FOR NOTEBOOK COMPUTERS

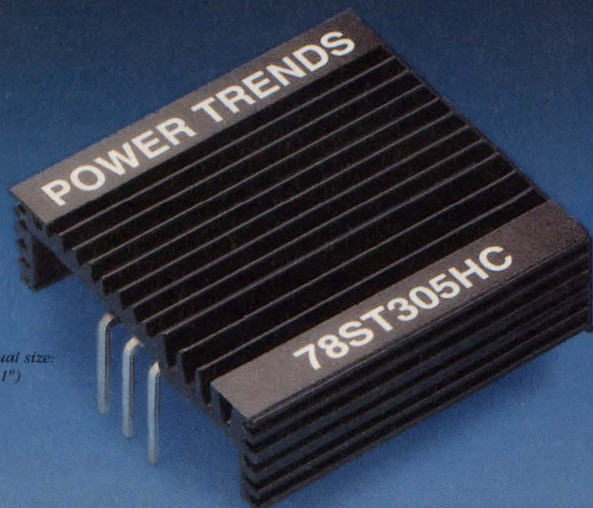

(Actual size:
1" x 1")

*A fully self-contained 3 Amp, 1 MHz,
step-down Integrated Switching
Regulator*

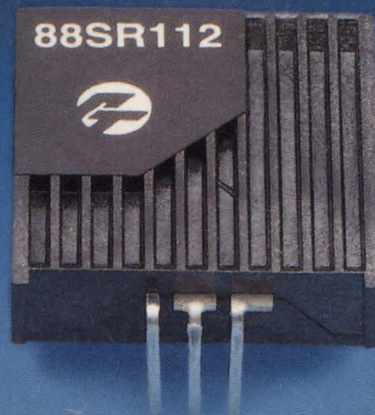

*A fully self-contained 1 MHz step-up
Boost Converter*

This new *Power Chipset™* from Power Trends provides the entire power supply for your notebook computer in less than 1 cubic inch. It features a +5 volt, 3 Amp, 1 MHz Integrated Switching Regulator (ISR) that provides state-of-the-art power density of more than 50 watts per cubic inch and a high 85% efficiency at maximum load. **This means less board space and longer battery life!**



And, for those who require a +12 volt output for flash memory or other functions, the companion unit offered is a 1 MHz step-up Boost Converter.

Power Trends' *Power Chipset™* drastically cuts component count and simplifies

your design. **This means lower costs and shorter time to market!**

Last year, Power Trends' 1.5 Amp product was voted the power supply innovation of the year by EDN magazine. Recently, the *Power Chipset™* has been recommended by Intel for use in their 386™SL Mustang Notebook Computer.

If you are designing notebook computers or other battery operated products, then Power Trends has the power conversion products for you. Call or write for more information about the *Power Chipset™* for Notebook Computers from Power Trends. Samples are available now. Call today.



POWER TRENDS

Power Trends, Inc. 1101 North Raddant Road, Batavia, IL 60510 • (708) 406-0900 • FAX (708) 406-0901

Be a Part of The Event that Will **SHAKE UP** San Francisco!

EDN's 2nd Annual
"Innovation and Innovator of
the Year" Awards Dinner

November 19, 1991
The Mark Hopkins Hotel,
San Francisco, CA



FAX now — attention
Pam Winch, EDN
Promotion Dept. at
617/558-4470 for more
information on how to
buy a ticket or sponsor a
table to what is fast-
becoming the electronics
industry's most
prestigious event.
Support innovation
—Be there!

EDN Magazine
Edition
News
Edition

Who Will Keep Dr. Klas Eklund Company this Year?



Last year during Wescon
Dr. Klas Eklund, VP of
engineering at Power Integrations
was named EDN's 1990
Innovator of the Year and he
needs some company.

Find out who will
stand aside the
reigning
Innovator



November 19th at
EDN's 2nd annual
**Innovation and Innovator of
the Year Awards Ceremony**
during Wescon '91 held at
the Mark Hopkins Hotel in
San Francisco. Last year, nearly
200 electronics industry
professionals from as far as Japan
and Germany joined us at what
is fast becoming the "industry
event of the year".

Fax now — attention
Pam Winch, EDN Promotion Dept.
at 617/558-4470 for more informa-
tion on how you and your
company can purchase a table and
be a part of EDN's Innovation
Awards Ceremony.

EDN Magazine
Edition
News
Edition

Now up to
100V DC Output

PICO DC-DC Converters

Wide Input Range
5 to 72V DC



Regulated 5 to 30 Watts

- 365 Standard Models
- Single, Dual & Triple Output
- Remote Disable Pin Standard
- Up to 100V DC Output now Standard
- 500V DC Isolated Input to Output
- All Units Shielded

MIL-STD-883 UPGRADES AVAILABLE

- **Expanded operating temp.**
(-55°C to +85°C)
- **No Heat Sink Required**
- **Stabilization Bake**
(125°C ambient)
- **Temperature Cycle**
(-55°C to +125°C)
- **Hi temp., full power burn in**
(100% power, 125°C case
temp.)

PICO also manufactures over 850
standard DC-DC converters and over
2500 ultra-miniature transformers,
inductors and new AC-DC power supplies.

Delivery—
stock to
one week

See EEM or
FAX 914-699-5565
or send direct for
FREE PICO Catalog

PICO
Electronics, Inc.

453 N. MacQuesten Pkwy. Mt. Vernon, N.Y. 10552

Call Toll Free **800-431-1064**
IN NEW YORK CALL **914-699-5514**

NEW PRODUCTS

CAE & SOFTWARE DEVELOPMENT TOOLS

PC Code Tool For Large Data Arrays

- Supports virtual memory arrays
- Unlimited array sizes

The Virtual Array/Numerical Analysis Toolbox provides very large array sizes. It can map arrays into lower memory, then extended memory (above 1 Mbyte), and finally to disk if there is not enough active memory. In this case, array sizes are limited only by available disk space. The package caches array or matrix elements for fast access. It also contains support routines for advanced analysis. These routines include functions for matrix math, large sets of linear equations (1000×1000 or larger), curve fitting, multiple and stepwise regression analysis, eigenvalues and eigenvectors, and statistical analy-

sis. According to the vendor, you can calculate a 65,536-(2¹⁶)-point FFT in 54 sec, using a 33-MHz IBM PC/AT. The functions can be called from Turbo Pascal (5.x, 6.x), Turbo C (2.x), Borland C++, Microsoft C (5.x, 6.x) and Quick C (2.x). \$300.

Quinn-Curtis, 35 Highland Circle, Needham, MA 02194. Phone (617) 449-6155. **Circle No. 366**

Interactive Development System For 8052 Systems

- Full-screen editing for 8052AH-Basic
- Modular, symbolic Basic code

Basikit provides a full PC-based, interactive development system for front-end embedded Basic running on 8-bit 8052s. Using this tool, you are no longer tied to the Basic inter-

preter's line-oriented, dumb-terminal interface. You can take advantage of the PC's processing power with a full-screen oriented interface, supplemented by any ASCII text editor. Using the software, you can build modern, symbolically labeled Basic code. You don't need line numbers. The software adds them for you and tracks them in conjunction with the 8052 interpreter execution for debugging. It also automatically converts old, line-oriented code as well. Using the code, you can download to RAM or build ROM-ready code for burn-in. Program output, memory dumps, and register dumps can be stored in files. The software also speeds up debugging: It can download and upload code at speeds as high as 38,400 bps. It enables you

PCB MANUFACTURING DESIGN AND ARTWORK !

ALL YOUR CIRCUIT BOARD NEEDS UNDER ONE ROOF

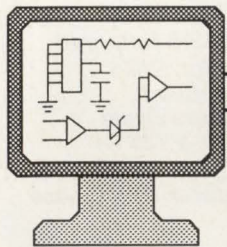

PCB MANUFACTURING

- 2 Day turn on multi-layers
- Prototype and production
- One tooling charge for both
- Turn-key assembled boards

PCB DESIGN

- Backplanes
- Impedance control
- Analog and ECL
- Surface mount

TECHNICAL ASSISTANCE

- PCB design tips
- Mfg cost cutting tips
- Testing guidelines
- We accept gerber data via modem (714) 970-5015

CALL FOR A QUOTE !

A MANUFACTURING, PCB DESIGN AND SUPPORT CENTER



MURRIETTA
CIRCUITS

4761 E. HUNTER AVE. ANAHEIM, CA. 92807
TEL: (714) 970-2430 FAX: (714) 970-2406

EE DESIGNER: Finally, All the Pieces Fit!

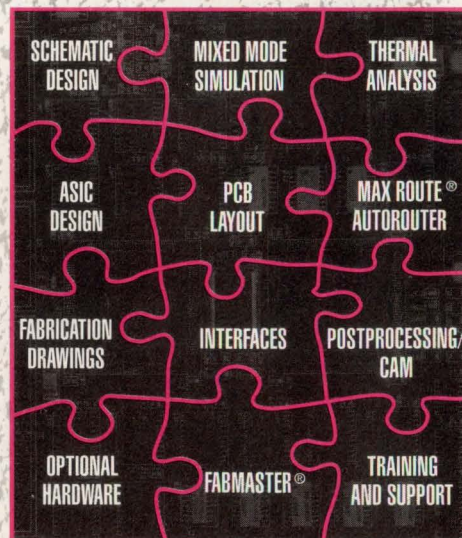

For more information, or to place an order, call: 1-800-553-1177



TEAM
VISIONICS

2953 Bunker Hill Lane, Suite 201, Santa Clara, CA 95054, Fax: (408) 492-1380

ANNOUNCING THE NEW
PADS-UNIX

WE'LL GIVE YOU THE WORLD

PADS-PRODUCT SEMINARS

October 15
Minneapolis, MN
VARS
612-546-5496

October 16
Cedar Rapids, IA
VARS
612-546-5496

PADS-PRODUCT SEMINARS

October 16
San Jose, CA
CAD Concepts Inc
408-281-9002

October 17
San Jose, CA
CAD Concepts, Inc.
408-281-9002

... Of Electronic Design

You asked for an integrated set of CAE/CAD design tools which could deliver every aspect of your engineering design needs **at an affordable price**. CAD Software offers the highest performing design system for your PC. Schematic capture, logic simulation, printed circuit board design, auto-routing, thermal analysis, and computer aided manufacturing are all within the PADS Design system.

Your design begins with **PADS-Logic**, the only PC-based schematic capture system which has a true multi-sheet database for quick and accurate design capture and data transfer to your PCB design. PADS-Logic has a large circuit capacity of over 1,000 equivalent IC's per design, a Hierarchical design ability with an unlimited number of levels, superb analog design capability, forward and backward annotation, a Part Editor and Graphical Library browsing.

PADS-PCB sets the standard for affordable high performance PCB design. A one mil database, 30 layers, automatic design rules checking, SMD ability, excellent interactive routing, and a set of ECO routines which ensure fast accurate changes, are just some of the features which have made PADS-PCB the #1 selling PC based PCB design system.

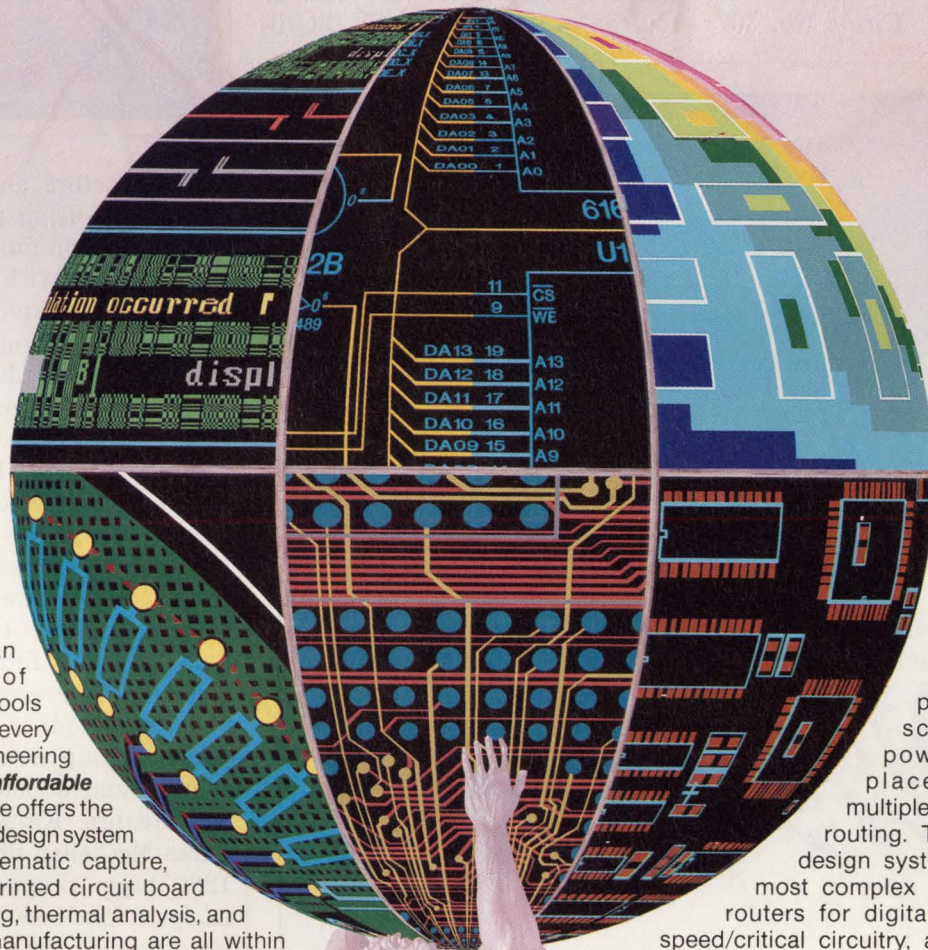

NEW! PADS-UNIX operates on the Sun Sparc Station family and contains all of the advanced features of the widely used **PADS 2000** product, including schematic capture, powerful component placement aids, and multiple approaches to track routing. This advanced PCB design system can handle the most complex designs, with auto-routers for digital, analog and high speed/critical circuitry, an unlimited design capacity, ERC and DRC checking, intelligent copper pour and T-routing, 0.1° parts/pads rotation, and much more!

Call CAD Software today for your local Authorized Reseller, or for a no-cost Evaluation Package, and experience the world of electronic engineering design:

CAD
Software, Inc.

(800) 255-7814
Inside MA
(508) 486-8929

119 Russell Street, Littleton, MA 01460

CIRCLE NO. 138

See Us at Wescon Booth #1428

to speed up your application by inserting assembly-language code anywhere in the application. The software comes with a number of utilities to convert and manipulate source and execution files. \$150.

MDL Labs, 15 Deerfield Rd, Chappaqua, NY 10514. Phone (914) 238-0416. **Circle No. 367**

Enhanced Filter-Design Package

- Designs filters for fixed DSPs
- Handles arbitrary size and phase IIR filters

Using the DFDP/3plus filter design package, you can interactively design DSP filters without coding. You can graphically specify the fil-

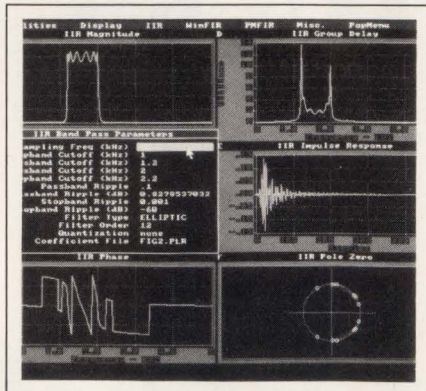

ter parameters and build FIR or IIR filters, using prebuilt analysis and generation functions. This version interacts with mouse selection and a color graphics system. You can design magnitude and arbitrary-phase IIR filters, using a special iterative design technique. FIR filters can be designs using the Parks-McClellan, Kaiser Window, and Window FIR methods. The software supports many different IIR filter-design methods including frequency-selective filters, differentiators, Hilbert transforms, and pulse shaping filters. Filter performance is presented in easy-to-read color plots of magnitude, phase, group delay, impulse response, and a pole/zero plot. You can design Kaiser Window or Parks-McClellan filters to 3071 and 1280 taps, respectively. Signal-analysis functions for the time domain include convolution, correlation, and signal statistics. For frequency-domain analysis the package supplies short-term Fourier transforms (STFT), inverse STFT, cepstrum, linear predictive-analysis and spectral-estimation techniques, and power-spectrum estimation methods. The DFDP/3plus package runs on a 640-kbyte PC, using DOS 3.1 or higher. \$1045.

Atlanta Signal Processors Inc, 770 Spring St, #208, Atlanta, GA 30306. Phone (404) 892-7265. FAX (404) 892-2512.

Circle No. 368

DESIGNED TO
BRING YOU
THE BEST OF
BOTH WORLDS



The new Toyocom VCTCXO Clock Oscillator for ISDN and LAN applications is truly exceptional, providing tremendous voltage and temperature control characteristics in one small package.

The VCTCXO will work to the most exacting performance specs, achieving superior frequency range up to 25 MHz and frequency stability of 10 ppm and 50 ppm, depending on the model selected.

To discuss your specific application needs, contact TOYOCOM, 617 E. Golf Road, Arlington Heights, IL 60005.

Phone Toll-Free today **1-800-TOYOCOM.**

TOYOCOM

TIMING IS EVERYTHING

CIRCLE NO. 139

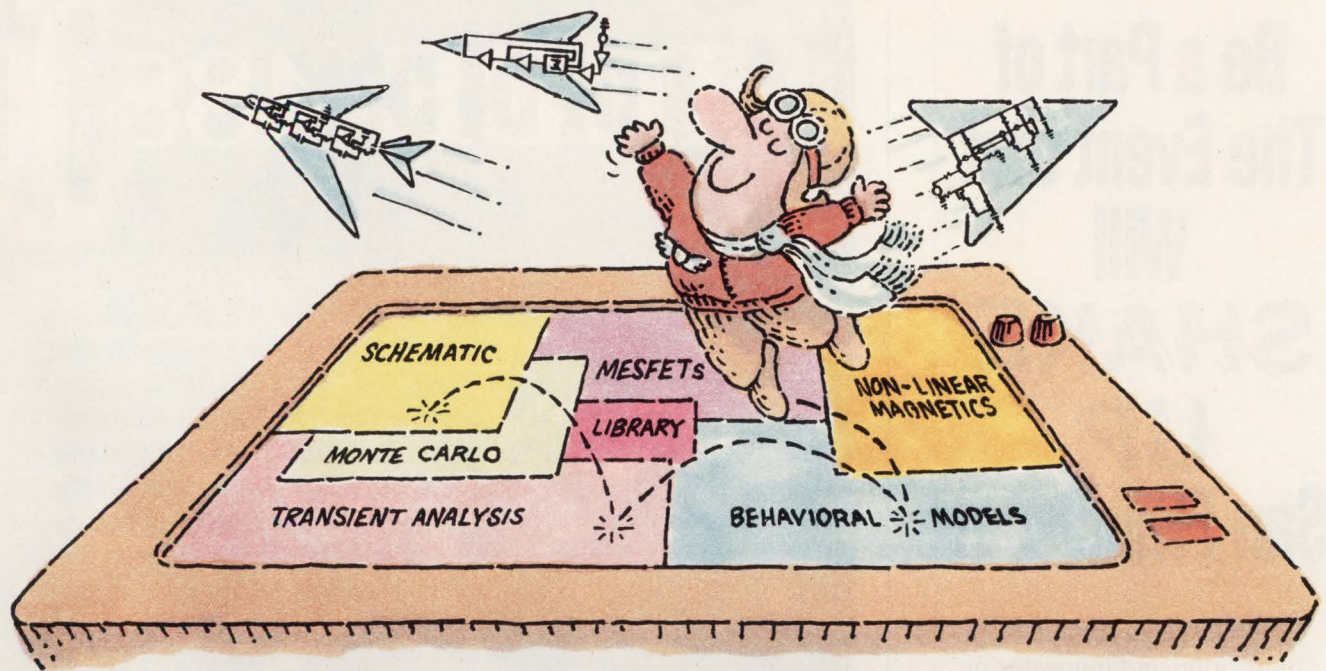

THE NEW MICRO-CAP III.™ SO YOU CAN TEST-FLY EVEN MORE MODELS.

It wasn't easy. But we did it. Made the long-time best-selling IBM® PC-based interactive CAE tool even better.

Take modeling power. We've significantly expanded math expression capabilities to permit comprehensive analog behavioral modeling. And, beyond Gummel Poon BJT and Level 3 MOS, you're now ready for nonlinear magnetics modeling. Even MESFET modeling.

Analysis and simulation is faster, too. Because the program's now in "C" and assembly language. That also means more capacity — for simulating even larger circuits.

As always, count on fast circuit creation, thanks to window-based operation and a schematic editor. Rapid, right-from-schematics analysis — AC, DC, fourier and transient — via SPICE-like routines. The ability to combine digital/analog circuit simulations using integrated switch

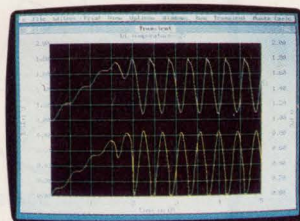

Transient analysis

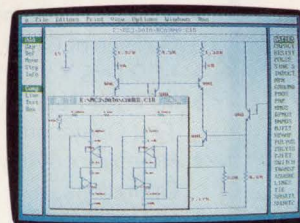

Schematic editor

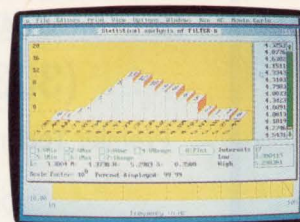

Monte Carlo analysis

models and parameterized macros. And stepped component values that streamline multiple-plot generation.

And don't forget MICRO-CAP III's extended routine list — from impedance, Nyquist diagrams and BH plots to Monte Carlo for statistical analysis of production yield. The algebraic formula parsers for plotting virtually any function. The support for Hercules, CGA, MCGA, EGA and VGA displays. Output for plotters and laser printers.

Cost? Still only \$1495. Evaluation versions still only \$150. Brochure and demo disk still free for the asking. Call or write for yours today. And see how easily you can get ideas up and flying.

spectrum

1021 S. Wolfe Road
Sunnyvale, CA 94086
(408) 738-4387

Be a Part of The Event that Will SHAKE UP San Francisco!

EDN's 2nd Annual
"Innovation and Innovator of
the Year" Awards Dinner

November 19, 1991
The Mark Hopkins Hotel,
San Francisco, CA



FAX now — attention
Pam Winch, EDN
Promotion Dept. at
617/558-4470 for more
information on how to
buy a ticket or sponsor a
table to what is fast-
becoming the electronics
industry's most
prestigious event.
Support innovation
—Be there!

EDN Magazine
Edition
News
Edition

You can control any IEEE-488 (HP-IB, GP-IB) device with our cards, cables and software for the PC/AT/386, EISA, Micro Channel and Macintosh II. You get fast hardware and software support for all the popular languages, plus a software library of time saving utilities. Instrument control has never been easier.

FREE
Informative Catalog 800-234-4232
Applications help (617) 273-1818

cec Capital Equipment Corp.
Burlington, MA. 01803

Micro Channel is a trademark of IBM

CIRCLE NO. 127



BREAKOUT BOXES

PRO TRACE II CABLE TESTER

- ◆ A Hand-Held Cable Tester,
- ◆ Tests Cables up to 2,400 Feet Long,
- ◆ With Adapters You Test Cables from 2 to 64 Pins in 2 Seconds,
- ◆ No Need to Remove Cables from Walls, Floors, Ceilings or Other Locations,
- ◆ LCD Lets You Know Test Results Immediately,
- ◆ 13 Push-Button Membrane Key-Pad for Control of Test Operation,
- ◆ Re-enforced Polypropylene Cases for Field Service Operations,
- ◆ Ni-Cad Batteries Optional; Ideal for Bench Top Harness Testing

CALL FOR 30 DAY EVALUATION INFORMATION

(303) 280-0442

Premier Technologies International, Ltd.

ATE Division
One Park Centre
1333 West 120th Avenue
Denver, CO 80234

from
Noritake

**Now you can afford
VFD quality...VFD visibility**



Call or write to see our entire line:

Noritake

CIRCLE NO. 143

Los Angeles
23820 Hawthorne Blvd.
Suite 100
Torrance, CA 90505
Tel. 213-373-6704
Fax 213-772-3918

Chicago
415 E. Golf Rd.
Suite 109
Arlington Heights, IL 60005
Tel. 708-439-9020
Fax 708-593-2285

Boston
263 Winn St.
Suite 1D
Burlington, MA 01803
Tel. 617-270-0360
Fax 617-273-2892

Dallas
2454 Trade Mart
Dallas, TX 75207
Tel. 214-742-9389
Fax 214-747-5065

Europe
Frankfurter Strasse 97-99
6096 Raunheim
F. R. Germany
Tel. 06142-43095/96/97
Fax 06142-22799

OakGrigsby On Optical Encoders

1

OF A SERIES

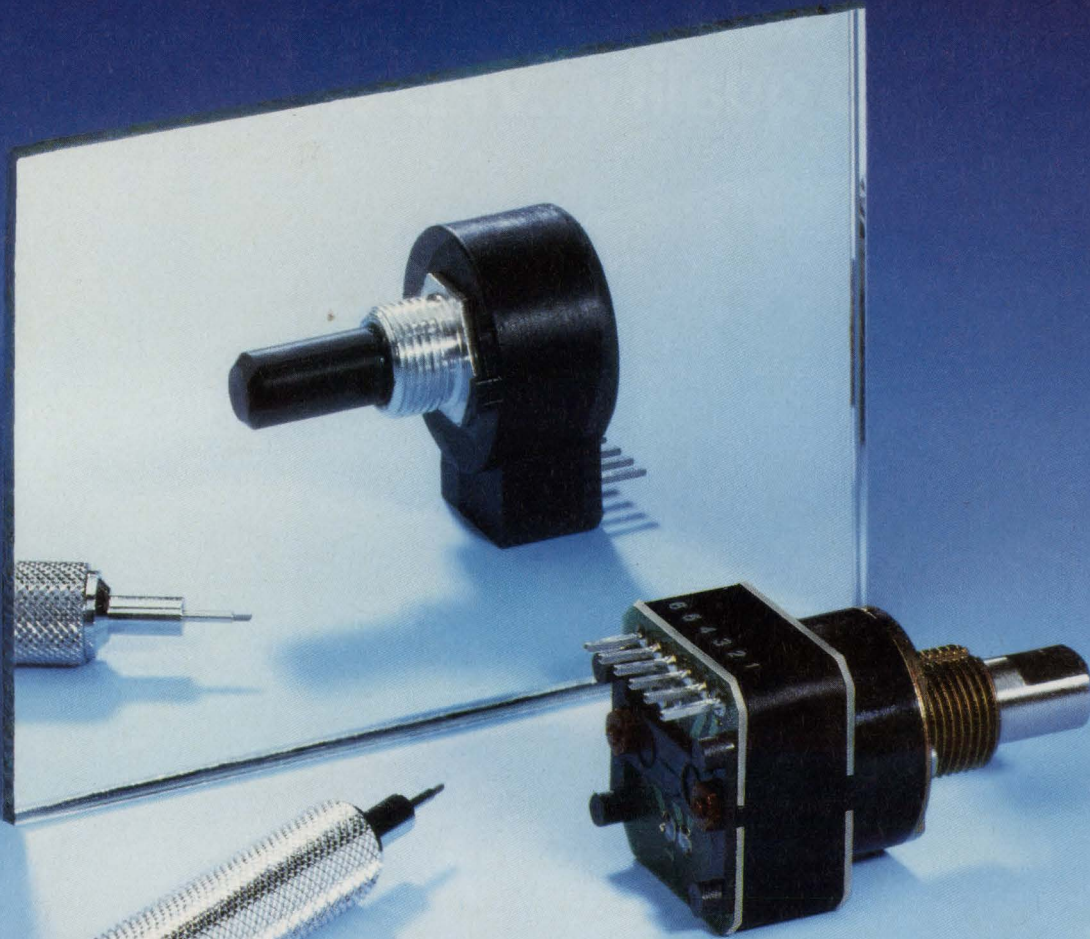

We See Both Sides Of The Issue.

Giving customers a choice. It's just another way OakGrigsby stands apart from the competition. By offering you the convenience of a *single source* for *both* optical switches and optical potentiometer applications.

Replacing your electromechanical switches and potentiometers has never been so easy or affordable! OakGrigsby's advanced optical technology eliminates metal fatigue, while our vibration-resistant interlock design assures perfect alignment of components. The result: improved accuracy, longer life, and no improper output code problems!

From prototype development through prompt delivery of your order, customer satisfaction is our goal. Discover today's most progressive electronics manufacturer. Discover the new OakGrigsby!

OAK GRIGSBY™

Committed to customer satisfaction.

88 North Dugan Road
P.O. Box 890
Sugar Grove, Illinois 60554-0890
Phone: 708/556-4200 • Fax: 708/556-4216

Custom Options:

Binary, gray, or custom codes. 128-152 position option. Ribbon cable or connectors. 16, 24, 32, 64 positions. P.C. lugs and right angle mounts.

MAXIMUM SURGE PROTECTION

Brute force protection in a compact package

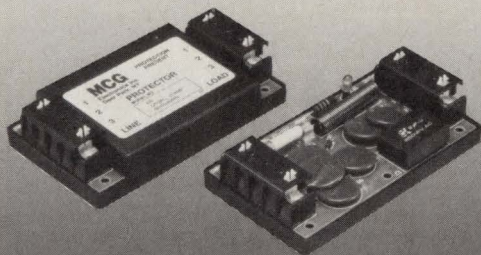

Your electronic equipment on the AC power line can easily be damaged when exposed to transient surges caused by lightning, elevators, motors, welders, etc. The result is downtime, aggravation and expense.

When high amplitude, high energy surges need to be diverted, it's no time to cut corners. And MCG doesn't. Model 415, on a 120VAC line, will reduce a 6000V/3000A impulse to 350 Volts!

Call : 1-800-851-1508 x1032

MCG SURGE PROTECTION

12 Burt Drive, Deer Park, NY 11729

Phone : 516-586-5125 x1032

CIRCLE NO. 145

Non-Contact Current & Voltage Transducers

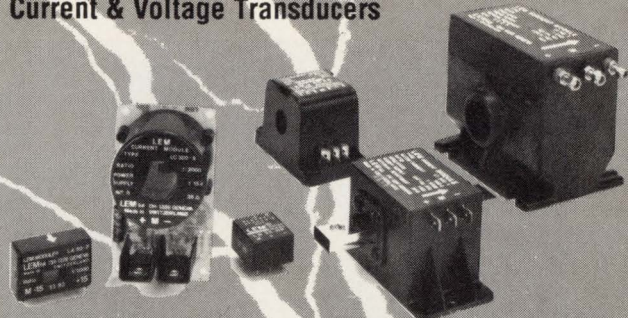

Measure Electrical Circuits Provide Control Outputs

Transducers that feed back Current & Voltage measurements for electronic control

- ✓ Measure DC, AC and pulse currents, bandwidth from DC to 100kHz.
- ✓ High degree of accuracy: 0.2% to 1% typical
- ✓ Currents to 500,000 amperes
- ✓ Voltages to 6,400 volts
- ✓ Instantaneous or True RMS outputs
- ✓ Open and closed loop systems
- ✓ Excellent Linearity: less than 0.1% typical
- ✓ Accuracy, stability and linearity guaranteed for life
- ✓ Reliable in hostile environments
- ✓ Rapid response time: better than 1μsecond
- ✓ Wide range of current measurement and large overload capacity

For technical assistance, call 1-800-236-5366

LEM USA
PIONEERING POWER ELECTRONICS

Look for us in EEM & Thomas Register
6663 W. Mill Rd. • Milwaukee, WI 53218
Tel: 414-353-0711 • Fax: 414-353-0733

CIRCLE NO. 146

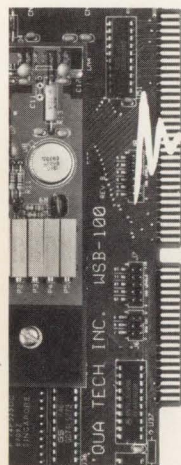

WSB-100 Waveform Board:
20MHz/32K
\$1290

The WSB-100 waveform synthesizer offers speed and memory at a price that's half what you'd expect to pay.

With its analog module, the WSB-100 becomes a 12-bit waveform board for the PC-AT and compatibles that can be used in a wide range of testing and control applications. Multiple boards can be connected to store longer waveforms or to run several waveforms simultaneously.

Optional modules enable the WSB-100 to act as a digital pulse generator or 16-bit word generator.

A 10 MHz/32K configuration is available at an even lower price.

Call for our free Interface Handbook:
1-800-553-1170

PC-AT is a registered trademark of IBM Corp.

QUATECH

662 Wolf Ledges Parkway
Akron, OH 44311

CIRCLE NO. 147

Be An Author!

When you write for EDN, you earn professional recognition. And you earn \$75 per published magazine page.

EDN publishes how-to design application information that is read by more than 137,300 electronics engineers and engineering managers worldwide. That's an audience that could belong to you.

If you have an appropriate article idea, send your proposal and outline to: EDN, Joan Morrow, 275 Washington Street, Newton, MA 02458-1630.

For a FREE EDN Writer's Guide—which includes tips on how to write for EDN and other technical publications—please circle number 800 on the Information Retrieval Service Card.

EDN

First in Readership among Design Engineers and Engineering Managers in Electronics.

221

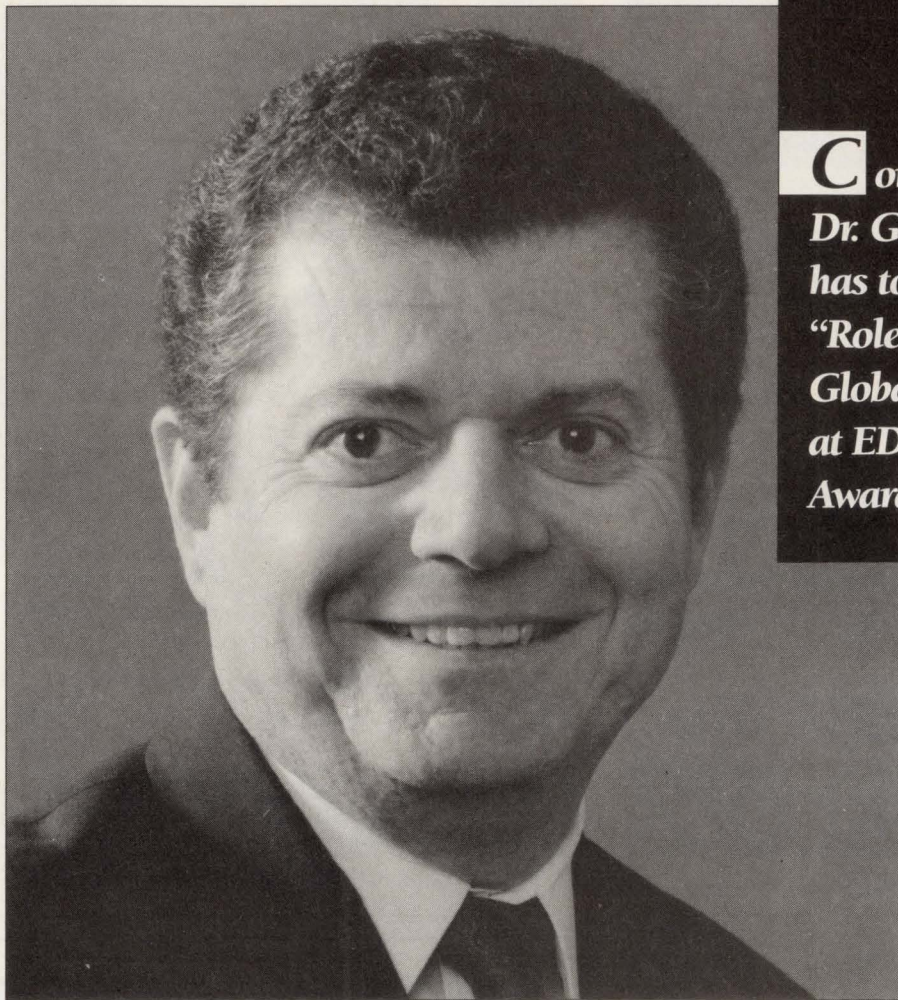

Come hear what
Dr. Gilbert Amelio
has to say on the
“Role of Innovation in
Global Competition”
at *EDN’s Innovation*
Awards Banquet.

Dr. Gilbert F. Amelio,
President and Chief Executive Officer
of National Semiconductor Corporation.



Dr. Gilbert Amelio, President and CEO of National Semiconductor Corporation, will be the keynote speaker at EDN’s Second Annual “Innovation and Innovator of the Year Awards” Banquet on November 19 during Wescon in San Francisco. EDN’s Innovation program recognizes the year’s most innovative products and innovative engineer or engineering team in the electronics industry. Dr. Amelio will speak on the “Role of Innovation in Global Competition.” Dr. Amelio holds 16 patents and is credited with being the co-inventor of the industry’s first charge-coupled image sensor. These devices are used in most consumer video cameras today.

Come hear what the leader of one of the world’s largest semiconductor corporations has to say about innovation. Support these innovative people and products awarded EDN’s 1991 “Innovation and Innovator of the Year Awards.”

To receive a reservation form for the industry event of the year, fax Pam Winch at (617) 558-4470.

EDN Magazine
Edition
News
Edition

EDN PRODUCT MART

This advertising is for new and current products.

Please circle Reader Service number
for additional information from manufacturers.

**BACKUP ALL OF YOUR PCs WITH
ONE PORTABLE TAPE SYSTEM**

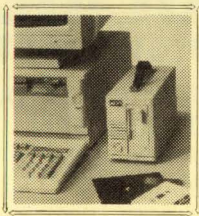

**NO MORE LOST DATA OR
FLOPPY DISKS TO MANAGE**

- No Add-In Cards
- Backup at 4½ Megabytes per Minute
- "Plug and Go" over Printer Port
- 160 Megabytes of Storage Per Data Cassette
- Easy "Windows Like" Menu-Driven Interface
- Portable, Small, and Lightweight
- Reliable TEAC Drive

ANALOG & DIGITAL PERIPHERALS, INC.



P.O. BOX 499
TROY, OHIO 45373
PHONE 513/339-2241
FAX 513/339-0070

CIRCLE NO. 325

68HC11
PC-based emulator for 68HC11

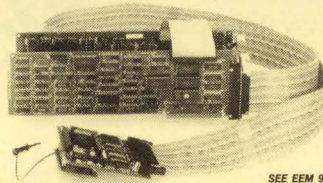

SEE EEM 90/91
Pages D 1320-1323

- PC plug-in or RS-232 box.
- Pull-down menus with full window support, combined with command-driven User Interface.
- Up to 16 MHz real time emulation.
- No intrusions to the 68HC11's resources.
- 48 bit wide 16K deep trace. All functions usable without disturbing emulation. Time stamping. Two level trigger.
- Symbolic and C Source Level Debugging, including in-line assembler and disassembler.
- Supports A, E, D, F, K and L parts.

Prices: 64K Emulator and pod \$2590; 4K Trace \$1995* (*US only)

CALL OR WRITE FOR FREE DEMO DISK!

NOHAU
CORPORATION

51 E. Campbell Avenue
Campbell, CA 95008
FAX: (408) 378-7869

Call 408-378-2912
Nohau's 24-hour
information center to
receive info via your FAX

See our ad on page 237.

CIRCLE NO. 326

**GUARDIAN®
Solenoids**

Standards or Specials

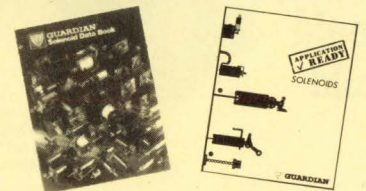

Call or write today for our full-line catalog
and "Application Ready" brochure
WE SPECIALIZE IN SERVICE



GUARDIAN®
Guardian Electric Manufacturing Co.

1425 Lake Avenue • Woodstock, IL 60098
1-800-762-0369 • FAX: 815-337-0377

CIRCLE NO. 327

Now Doubled in Library Size

DC/CAD

CAD Showdown Results!

HIGH DENSITY EXPERTS!

**Integrates Schematic Capture,
PCB Layouts & Autorouting**

This top-rated CAD out-routed the competition in the 1990 CAD Showdown. DC/CAD displayed its power and flexibility when routing a double-sided board while competing routers used four to six layers. This non-copy protected package with surface mount support includes:

- Multi-strategy 1-mil parts autoplacer
- "1-mil" autorouting w/ripup & retry
- Thorough annotating design rule checker
- Full 2-way GERBER and DXF support
- Optional autoground plane support with cross-hatching
- Optional simulation capability & protected mode for 386 users

Call today
DC/CAD \$595
(priced from \$395)

LEASE PROGRAM & SITE LICENSE AVAILABLE
30 DAY MONEY BACK GUARANTEE

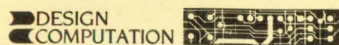

Rt. 53, Sherman Square Farmingdale, NJ 07727
(908) 938-6661 • (908) 938-6662 (FAX)

DC/CAD... Innovative, Intelligent & Integrated Software

CIRCLE NO. 328

**8 CHAN 12-BIT A/D CARD
FOR IBM PCs — \$395**

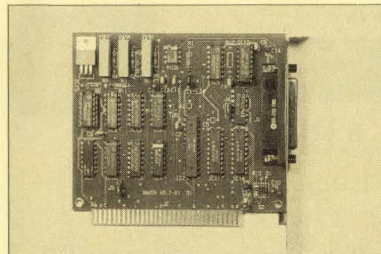

Advanced features for accurate sampling:

- Auto channel sequencing • DMA interface
- Also features — 1024 to 31250 samples/sec, ± 5 volt inputs, expandable MUX, sync I/O, power outputs. Software included.

Educational S/W — FFLAB. Create & analyze signals. Save, load & print. \$14.95

Other products — Instrument amplifiers and stand-alone DAC interfaces.

BAKER EE-CS

Ste. 102, Clairemont Sq., San Diego, CA 92117
(619) 273-2117 (Voice/FAX)

CIRCLE NO. 329

PX SERIES

**THREE PHASE, 10 KW
DC POWER SUPPLIES**

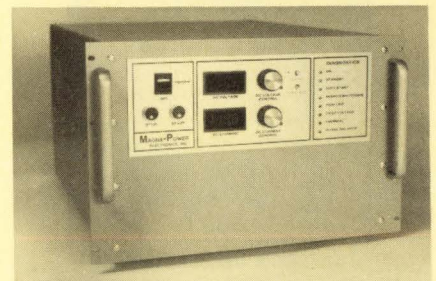

FEATURES

- 16 to 500 Vdc, 20 to 600 Adc
- Automatic V/I crossover
- IEEE-488 compatible
- Series parallel master slave
- OVP shutdown standard, SCR crowbar optional
- Control lines optically isolated
- Digital meters standard
- Power factor corrected
- Low line currents
- EMI meets VDE 871 A

MAGNA-POWER ELECTRONICS, INC.
135 Route 10, Whippany, NJ 07981
(201) 428-1197 FAX: (201) 428-2853

CIRCLE NO. 330

To advertise in Product Mart, call Joanne Dorian, 212/463-6415

ARINC 429

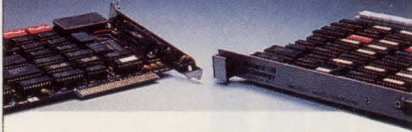

AFFORDABLE AVIONICS INTERFACES

MIL-STD-1553 and ARINC 429/629 databus boards and software for IBM-PC and VMEbus.

Call toll-free: **1-800-829-1553**

Ballard Technology

1216 NW 75th St., Seattle, WA 98117
(206) 782-8704 FAX: (206) 782-8174

CIRCLE NO. 331

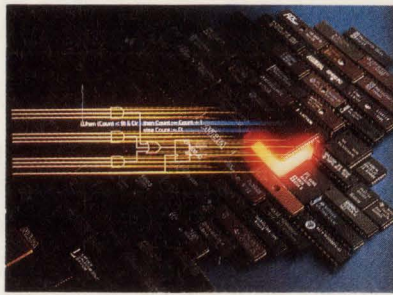

MacABEL
PLD Design on the Apple Macintosh!

Data I/O's industry-standard ABEL PLD design package is now available on the Macintosh, exclusively from Capilano Computing!
• Use Boolean and integer equations, state machines and truth tables to describe your design • Communicates directly with any serial PLD programmer • Best device support in the industry, including ALTERA, AMD, ATMEL, CYPRESS, GOULD, HARRIS, ICT, INTEL, LATTICE, NATIONAL, RICOH, SAMSUNG, SGS, SIGNETICS, SSS, TI, VTI and others • Interactive "in-circuit" schematic entry and simulation when used with DesignWorks

Call (800) 444-9064 Today for your free Demonstration Kit!
Capilano Computing
FAX: (604) 522-3972
(604) 522-6200

CIRCLE NO. 332

Protel Autotrax™

Best PCB design solution for mixed Digital, Analog, and SMT boards

Our NEW and POWERFUL Protel Autotrax™ is a fully integrated PCB layout system with automatic component placement and autorouting in a single working environment. Its latest features will definitely push the price/performance of mixed technology PCB designs to the highest level, boost your design productivity, and deliver your products to the marketplace faster than your competitors.

- Integrated automatic component placement and autorouting
 - On-the-fly library components creation
 - 45°, 90° and curve tracks routing
 - Powerful user-definable Macros
 - Auto-panning
 - PostScript™ printing
 - Switchable Metric/Imperial grid
 - Intelligent Pad to Pad autorouting
 - Automatic power/ground relief for SMD pads
- Automatic Copper Pour leaves clearance for tracks & pads

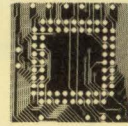

From schematic design, manual and automatic PCB design, Rip-up and Retry autorouting, to Gerber viewing and editing, we offer free tech and EMS support, 24-hour BBS and 30-day money back guarantee and our prices start at \$395.

Free Evaluation Package
Toll Free: **800-544-4186**

Protel Technology, Inc.
50 Airport Parkway, San Jose, CA 95110
Tel: 408-437-7771 Fax: 408-437-4913



CIRCLE NO. 333

Imagine if
YOUR
product
could
talk!

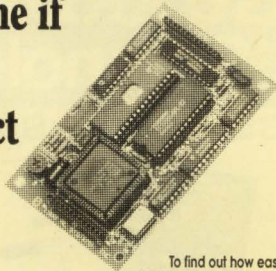

To find out how easy it is to add speech output to your own products, call for your free V8600 data book today!

- Converts plain ASCII text into high quality speech
- Requires only a single 5V supply and speaker
- Use in computers, voice-mail, warning systems, etc.
- Built in µP, serial and printer interfaces
- Less than \$100 in OEM quantities
- Customization services available

RC SYSTEMS USA/Canada - Phone/Fax: (206) 672-6909
121 W Winesap Rd - Bothell, WA 98012 Europe - 081 539 0285 Fax: 081 558 8110

CIRCLE NO. 334

CMOS 186
Single Board Computer

Runs C or QuickBASIC™ Programs

Powerful 16-bit computer directly executes EPROM's containing any C or BASIC .EXE file. NO LOCATORS! Software includes multi-tasking, multi-drop comm, PID control, OPTOMUX.™

- 10, 12, 16 Mhz 80C186
- CMOS design
- 512K RAM
- 384K EPROM
- STD BUS Expansion
- COM1 RS232/485
- COM2, LPT1
- RTC Avail
- 80C187 Avail
- OEM discounts

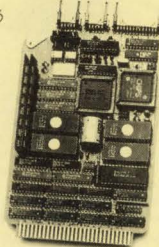

MICRO/SYS

1011 Grand Central Ave., Glendale, CA 91201
(818) 244-4600 FAX (818) 244-4246

CIRCLE NO. 335

DC-DC CONVERTER

- * 5W-60W, SINGLE, DUAL TRIPLE OUTPUT
- * Input Range: 9 to 18 V, 18 to 36V, 36 to 72V
- * Output Range: ±5V, ±12V, ±15V, ±24V
- * Input Pi Filter, EMI/RFI Shielding
- * Special and Custom Design

GALAXY MICROCAST SYSTEMS CO., LTD.

7FL., NO. 25, LANE 23, RUI-AN ST.,
TAIPEI, TAIWAN, R.O.C.
P O BOX 24-543, TAIPEI
TEL: 886-2-705 1622
FAX: 886-2-701 6600

CIRCLE NO. 336

48 Channel 50MHz Logic Analyzer

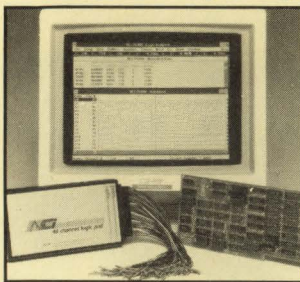

Complete System \$1895.00

New Windows 3.0 Compatible Software

- 48 Chnlns @ 50 Mhz x 4K words deep
- 16 Trigger Words/16Level Trigger Sequence
- Storage and recall of traces/setups to disk
- Disassemblers available for: 68000, 8088, 8086, 6801, 6811, Z80, 8085, 6502, 6809, 6303, 8031

NCI 6438 UNIVERSITY DRIVE,
HUNTSVILLE, AL 35806
(205) 837-6667 FAX (205) 837-5221

CIRCLE NO. 337

Just
\$495!*



ABEL-PLD:
Logic design for less.

- 150 PLD architectures supported (more than 4000 devices)
- Uses ABEL™ Hardware Description Language (ABEL-HDL™)
- Intelligent synthesis and optimization
- Upgradable to full-featured ABEL Design Software

Call for your FREE ABEL-PLD™ Design Software start-up kit!

1-800-3-DataIO
(1-800-332-8246)

*U.S. list price only.

DATA I/O
Corporation

CIRCLE NO. 338

Now
\$1495!*



Save \$1000
on our entry-level
logic system.

- Includes the 212 Multi Programmer with logic module, ABEL-PLD™ and PROMlink™ Ltd. PC Interface Software
- Supports 20- and 24-pin CMOS logic devices
- Full-hex keypad for extensive editing
- Compatible with JEDEC standard programming files

■ Optional EPROM and microcontroller modules

Call today to order!
No-risk, money-back guarantee!

1-800-3-DataIO
(1-800-332-8246)

*U.S. list price only.

DATA I/O
Corporation

CIRCLE NO. 339

To advertise in Product Mart, call Joanne Dorian, 212/463-6415

Precision Time Plug-ins

by **TRUETIME**

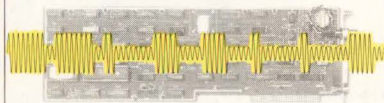

VME · Multibus · PC

TIME CODE

Time in various formats is furnished to the host computer over its particular bus. Time resolution to 1 microsecond is available.

SYNCHRONIZED CLOCKS

Available in a number of sizes and configurations, these boards provide 1 millisecond time synchronization referenced to UTC.

3243 Santa Rosa Avenue • Santa Rosa, CA 95407
(707) 528-1230 • FAX 707-527-6640 • TELEX 176687

TrueTime

CIRCLE NO. 340

TELEPHONE INTERFACE

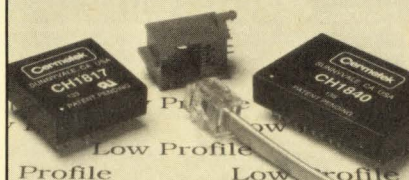

Modem DAA for Production or Prototype

- Build prototypes with CH1840 (FCC/68 pre-approved)
- Production with CH1817 (UL 1459 recognized and FCC approvable)
- 0.3" high, 1.0 in.² (1.5 in.² — CH1840)

Your Source for Modem Components



Tel: 408-752-5000
Fax: 408-752-5004

Cermetek Microelectronics, Inc.
1308 Borregas Ave. • Sunnyvale, CA 94089

CIRCLE NO. 341

GRAYBOX™
ELECTRONIC INSTRUMENT ENCLOSURES

"Perfect... just what I've been looking for."

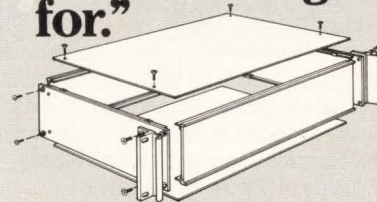

- Reasonably priced
- Wide range of stock sizes
- Readily customized by you or us
- Shortens time for prototyping and production
- For literature, pricing, and No-Risk Offer, call:

800-847-3535
Anywhere in the US or Canada

LANSING

Copyright © 1991, Lansing Instrument Corp., P.O. Box 730, Ithaca, NY 14851-0730

CIRCLE NO. 342

LOW COST Data Acquisition Cards for PC/XT/AT



12 Bit A/D & D/A [PCL711S] \$295

- A/D converter: 8 single-ended channels; Uses AD574 device; Conversion time is less than 25µsec; Input range: ±5V; Software Trigger Mode only.
- D/A converter: 1 channel; 12 bit resolution; 0 to +510V Output Range.
- Digital I/O: 16 In/Out (TTL compatible); External Wiring Terminal Board incl.
- Utility Routines and Demo/Sample Programs for BASIC and Quick-BASIC.

12 Bit A/D & D/A [PCL812] \$395

- A/D converter: 16 single ended inputs; Uses AD574; Conversion time less than 25µsec; Built-in programmable pacer; Input Ranges: ±10V, ±5V, ±1V.
- D/A converter: 2 channels; 12 bit resolution; Output Range 0-5V.
- Digital I/O: 16In/Out (TTL compatible); Programmable Counter/Timer (8254).
- DMA and interrupt capability. Utility software and sample program in BASIC.

Fast 12 Bit A/D/A [PCL718] \$785

- A/D converter: 16 single ended or 8 differential channels; 12 bits resolution; Programmable scan rate; Built-in Interrupt and DMA control circuitry. Conversion speed 60,000 samples/sec (standard), 100,000 samples/sec (optional).
- Input Ranges: Bipolar: ±10V, ±5V, ±2.5V, ±1V, ±0.5V; Unipolar: 10, 5, 2.5, 1V.
- D/A converter: 2 channels; Resolution: 12 bits; Settling time: 5µsec; ±5V.
- Digital I/O: 16In/Out (TTL compatible); Programmable Counter/Timer (8254).
- Software: Utility software for BASIC & QuickBASIC included. Supported by LabDAS, ASSYST, LABTECH, Unkelscope.

6 Channel 12 bit D/A [PCL726] \$495

- Output Ranges: 0 to +5V, 0 to +10V, ±5V, or sink 4-20mA.
- Settling time: 70µs. Linearity: ±1/2bit. Voltage output drive capacity: ±5mA.
- Digital I/O: 16 digital input and 16 digital outputs (TTL compatible).

MC/VISA/AMEX

Call today for datasheets!



B&C MICROSYSTEMS INC.
750 N. Pastoria Ave. Sunnyvale, CA 94086 USA
TEL: (408)730-5511 FAX: (408)730-5521

CIRCLE NO. 343

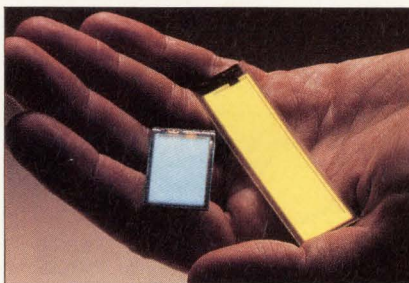

Finally, an EL with Longer Life and Higher Brightness

Thanks to our new proprietary Aurora phosphor, our EL (electroluminescent) lamps outperform every other EL in the industry. And, are even further enhanced with our new series of performance matched DC-AC inverters. Solid-state, low current and sized to your specs. Customized to your life/brightness requirements.

Loctite Luminescent Systems, Inc.
Etna Rd., Lebanon, NH 03766 603/448-3444

CIRCLE NO. 344

FUTUREBUS+

Mupac Offers More

- System Enclosures
- Backplanes/Subracks
- Wire Wrap Boards

Mupac Corporation

10 Mupac Drive, Brockton, MA 02401

TEL: (508) 588-6110 800-92 MUPAC FAX: (508) 588-0498



MUPAC

CIRCLE NO. 345

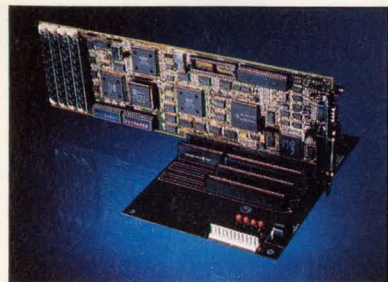

20 MHz 286 CPU CARD — \$595

- 2 Serial/1 Parallel Ports
- Up to 4 Meg DRAM: 0/1 WS
- Low Power 6-layer PCB
- Award BIOS — Norton SI 21.1
- Optional 287 Co-Processor
- Small Size (XT-Form Factor)
- User Replaceable Battery
- Made in USA
- \$595 qty 10 w/OK



295 Airport Road
Naples, FL 33942

TEMPUSTECH, INC.
1-800-634-0701

CIRCLE NO. 346

Interactive/Real-Time

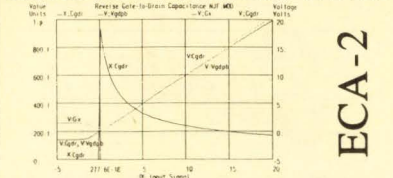

ECA-2

Analog Circuit Simulation

ECA-2 offers: • AC, DC, Transient, Fourier, Temperature, MonteCarlo and/or Worst-Case Analysis • Interactive or batch modes • Full nonlinear simulation • Sine, Pulse, PWL, SFFM, and Exponential generators • IBM PC/Mac • Multiple plots • On-line real time graphics — 2 to 50 times faster than SPICE • Advanced component parameters • Component optimization sweeping • New detailed 424 page manual

Call for FREE DEMO!



Tatum Labs, Inc.

3917 Research Park Dr. B-1, Ann Arbor, MI 48108
313-663-8810

CIRCLE NO. 347

Nichicon Electronic Components



Aluminum Electrolytic Capacitors, Plastic Film Capacitors, Positive Thermistors "Posi-R", and Hybrid I.C.s "Hi-Net", are all listed in Nichicon's latest full line catalog. Over 150 pages complete with operating and test specifications. Chip type, ultra miniature, standard type, high reliability, special type audio, and can type electrolytic capacitors. Also Positive Thermistors for color TV auto degaussing circuits, thermal protection and overcurrent protection. Hybrid I.C.s include diode arrays graphic equalizer, custom-made and switching regulator power series.

Nichicon (America) Corporation
927 East State Parkway, Schaumburg, IL 60173
Phone (708) 843-7500 FAX: (708) 843-2793

CIRCLE NO. 348

To advertise in Product Mart, call Joanne Dorian, 212/463-6415

200 MHz Logic Analyzer

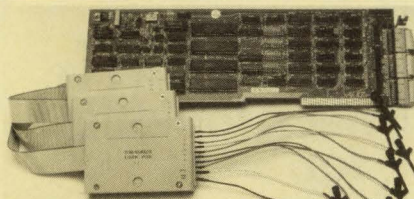

- 24 Channels (up to 50 MHz), Timing and State
- 200/100 MHz Max Sampling Rate (6 channel)
- Timing and State Simultaneous on Same Probe
- 16K Samples/Channel (6 channel mode)
- 16 Levels of Sequential Triggering
- Optional Expansion to 72 Channels
- Variable, TTL, or ECL Logic Threshold Levels
- 3 External Clocks and 11 Qualify Lines
- FREE Software Updates on 24 Hour BBS

\$799 - LA12100 (100 MHz)

\$1299 - LA27100 (100 MHz) Price includes Card, Pods, and Software

\$1899 - LA27200 (200 MHz)

UNIVERSAL PROGRAMMER

PAL
GAL
EPROM
EEPROM
PROM

87xxx...
22V10

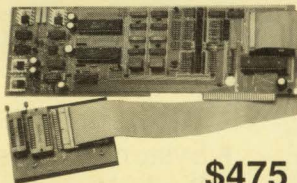

\$475

16Bit EPROMs FLASH EPROMs
5ns PALs 4 Meg EPROMs
FREE software updates on BBS

GANG PROGRAMMER

- 4 32pin Sockets (8 Socket option)
- 2716-27010 EPROMs

\$215

Call--(201) 808-8990

Link Computer Graphics, Inc.

369 Passaic Ave, Suite 100
Fairfield, NJ 07004 FAX:808-8786



CIRCLE NO. 752

8051 80C196 80C186
68HC11 64180



Orion's 8620 Analyzer-Emulator Supports These Processors & Over 180 More!

- Cost-effective, PC-based emulation for over 180 8- and 16-bit CPUs
- Source level and symbolic debug support
- Interactive triggering
- Program Performance Analyzer
- Tremendous macro capabilities
- Built-in EPROM programmer
- Two-week evaluation program
- Backed by over 11 years of emulation experience!

Call or fax today for more info and a FREE DEMO DISK.

Limited offer — 1 month free with 3 month rental!

1-800-729-7700

Fax 415-327-9881

ORION
INSTRUMENTS

180 Independence Dr., Menlo Park, CA 94025

CIRCLE NO. 350

SUPERPRO™

UNIVERSAL PROGRAMMER



\$795

- Programs PAL, EPLD, GAL, PEEL, FPL (upto 68 pin PLCC), E(E)PROM, Flash EPROM upto 4Mbits (40 pins), MICROS, & Bipolar PROM.
- Tests TTL/CMOS Logic, D/S Memory Device.
- High speed parallel interface card to IBM PC.
- Pulldown menu-driven Library Operating S/W.
- Fast Device Update on user's request.
- 40-pin GOLD ZIF socket.
- Lifetime Free Updates (BBS)
- User Device Library Generator (optional)

XELTEK 764 San Aleso Avenue Sunnyvale, CA
(408)745-7974 (800)541-1975

CIRCLE NO. 751

You don't need a lot of pull to get our free catalog.

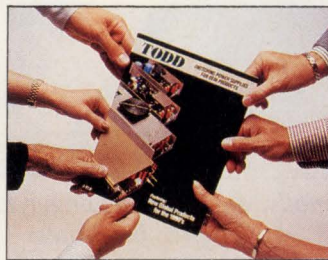

There's excitement brewing in the power supply industry! Get the details in TODD's free, 32-page full-color catalog. Full specs, performance, mechanical, pinout, mounting and applications information for over 100 outstanding OEM switching power supplies including the revolutionary, ultra-compact SUPERMAX 1000. **TODD**

CIRCLE NO. 753

Communicate Weekly

to the electronics OEM through EDN's Magazine and News Editions Product Mart

CIRCLE NO. 754

A 3"x 5" Single Board Computer with FREE C Source Utilities!

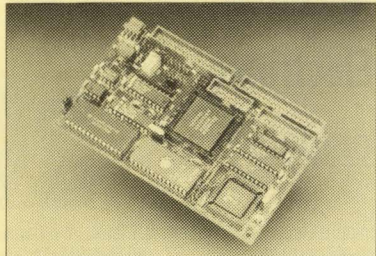

30-Day Money-Back Guarantee!

- 8051 type architecture
- Siemens 80C535
- 40 digital I/O lines
- 2 RS232 ports and 1 RS485 port
- 8-Bit A/D converter with 8 multiplexed inputs
- Power supervisory circuits
- 8KB or 32KB RAM / 32KB or 64KB EPROM
- 5x4 keypad encoder
- On board +5V regulation
- Optional real time clock
- Over 40 FREE C source utilities

TRI-L DATA SYSTEMS
94-871 Farrington Hwy, 2nd Fl.
Waipahu, HI, USA 96797-3146
Phone: (808) 671-5133
FAX: (808) 671-8543
Toll Free: 1-800-245-8745

CIRCLE NO. 755

BE AHEAD OF SCHEDULE



with the Susie Simulator!

- Find all conflicts and timing problems, automatically!
- Simulate multiple PLDs, FPGAs and ASICs at the board level!
- Correct all problems and make design changes in real-time!

Call us for the free evaluation package at 1-800-48-SUSIE

ALDEC
AUTOMATED LOGIC DESIGN COMPANY, Inc.

Tel: (805) 499 6867
Fax: (805) 498 7945

CIRCLE NO. 756

HEAT SINK

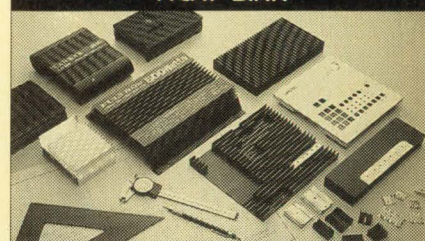

HPIC is a specialist manufacturer of aluminum products since 1972. Our experience and integrated production including extrusion, cutting, punching, drilling, lathing, CNC milling and anodizing etc. guarantee you the best price, quality products and prompt delivery. Many famous makers of household electronic/electric appliances, computers etc. purchase their heat sinks, front panels and metal parts from HPIC. Your inquiry are most welcome.

HUIJANG PIIN IND. CO., LTD.
NO.254, CHUNG CHENG RD., LOU-JOU HSIANG TAIPEI HSIEN TAIWAN, R.O.C.
TEL: (02)2816636-8 Telex: 33485 HPIC Fax: (02)2828180

HPIC

CIRCLE NO. 757

To advertise in Product Mart, call Joanne Dorian, 212/463-6415

MacAC II 2.0

Professional Analog Circuit Simulation

\$795.00

MacAC II integrates a full featured schematic editor, parts library, powerful data manipulation and plotting, and SPICE circuit simulation.

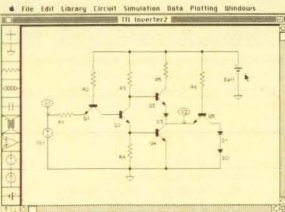

MacAC II was written on and for the Macintosh computer. It takes full advantage of the powerful graphical user interface.

ElseWare Corporation
3201 Fremont Ave. N. • Seattle, WA 98103-8866
Call (206) 547-9623

CIRCLE NO. 758

UNIVERSAL PROGRAMMER, EMULATOR & TESTER

TUP-300

\$ 695.00

- Programs virtually any device in the market today. Programs PLD (PAL, GAL, FPL, EPLD, PEEL, MAX, MACH...), E (EPROM up to 16 Mbit) Flash EPROM, Special PROM, MPU (87XX, 68XX, Z8, PSD301...).
- Covers DIP, PLCC, QFP and PGA with 8 to 84 pins. Gang programming adapters available also.
- EPROM EMULATION capability.
- Tests digital ICs and DRAMs (S1MM/SIP adapter available).
- Free software updates and new devices added upon request!!
- IC Manufacturers' approval.
- \$695 includes 40 pin ZIF socket programmer, s/w, and parallel interface card with D-25 cable.

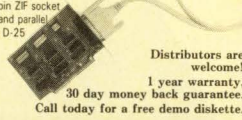

Distributors are welcome!
1 year warranty.
30 day money back guarantee.
Call today for a free demo diskette.

Tribal Microsystems Inc.
44388 S. GRIMMER BLVD, FREMONT, CA 94539
TEL (510) 623-8859 FAX (510) 623-9925

CIRCLE NO. 759

Analog Circuit Simulation SPICE FOR THE PC

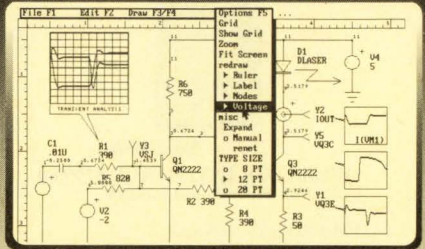

- Schematic Entry • SPICE Simulation
 - Model Libraries • Waveform Graphics
- Intusoft has it all at an Affordable Price!

INTEGRATED, EASY TO USE SIMULATION ENVIRONMENT, FEATURING:
A powerful SPICE (IsSPICE) simulator performing AC, DC, Transient, Noise, Fourier, Distortion, Sensitivity, Monte Carlo, and Temperature analyses. Extensive model libraries, Schematic entry, and Waveform processing. Starting at \$95 for IsSPICE, complete systems are available for \$890.

Call Or Write For Your Free Demo and Information Kit!
Tel. 213-833-0710

intusoft
P.O. Box 710 San Pedro, CA 90733-0710
Fax 213-833-9658

CIRCLE NO. 760

Small But Mighty

High Level Language and Math Library
On a Tiny I/O-Rich Microcontroller

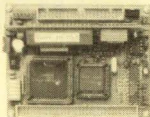

- 44 I/O Lines
- Floating Point Math
- Multitasking 68HC11
- 64K ROM, 128K RAM
- Resident Debugger

All the software you need for data acquisition, control, and instrumentation: high level FORTH language, assembler, debugger, multitasker, and extensive matrix math library including FFT and equation solution — all on the board.

Low power I/O-rich hardware: 8 A/D, 24 digital and 8 timer-controlled I/O lines, 2 serial links, 128K battery-backed RAM, only 300 mW, 3"x4".

QED Board and OEM versions are available now.

Mosaic Industries Inc. 415/790-1255
5437 Central Ave., Suite 1, Newark, CA 94560

CIRCLE NO. 761

RELIABILITY AND MAINTAINABILITY PREDICTION AND FMECA ANALYSIS SOFTWARE

Hundreds have used this leading
computer-aided engineering software
since 1982.

Powertronic Systems offers software to predict Reliability and Maintainability and for Failure Modes Effects and Criticality Analysis. Hundreds of users have selected from PSI's large, versatile and integrated software family for military and industrial equipment and for both electrical and mechanical systems. And, data inputs to these programs may be interactive or batch mode from other CAE or database programs.

Programs implement MIL-STD-1629; MIL-HDBK-217 including E Notice 1; and MIL-HDBK-472.

PSI Powertronic Systems, Inc.
P.O. Box 29109 New Orleans 70189
(504) 254-0383 FAX (504) 254-0393

CIRCLE NO. 762

PROTEUS - UNIVERSAL DEVICE PROGRAMMER from \$995

- Programs virtually all Memory & Logic Devices on the market
- 40 pins standard; Upgradeable internally to 104 pins, and via external adapter module to a total of 296 pins; DAC generated programming voltages
- Interfaces to any IBM-PC/XT/AT/PS2 via parallel port (cable included)
- Optional snap-in palmtop PC for stand-alone operation
- User friendly menu driven software with built-in full screen memory, fuse map and test editor; Fully integrated Algorithm Development Environment allows users to add parts to the device library or modify existing devices
- Powerful Macro Language allows for Batch Mode Operation
- True State Machine Testing capability (all pins clocked simultaneously)
- Fully overcurrent & overvoltage protected pin drivers (rise time < 100ns)
- Reads / Programs 1MB EPROMs in 10 / 35 seconds (using 16MHz PC)
- Gang / Set / Split programming capability; Register preload for logic devices
- Software selectable pin decoupling capacitors and clock sources
- True 100% Hardware Self-Calibration & Diagnostics via built-in A/D converter with 25mV resolution
- Device insertion detection (detects reversed and shifted insertions)
- Adapter Modules for GANG, PLCC, JEIDA Cards; Device Handler Interface
- Additional Adapter Modules and Software Packages allow reconfiguration as (PCB) Tester, Data Logger, Controller, Programmable Power Supply

MC / VISA / AMEX Call today for datasheets!

B&C MICROSYSTEMS INC.
750 N. Pastoria Ave., Sunnyvale, CA 94086 USA
TEL: (408) 730-5511 FAX: (408) 730-5521

CIRCLE NO. 763

Finally! A High Quality, Low Cost Digital Panel Meter for Under \$30! **



Compudigital Model DPM-2 (Cutout 3.6" x 1.65")

- High Accuracy - 3 or 3 1/2 Digit Models
- Fits standard Cutout - Slimline Design
- Easy Calibration from the Front
- Access to Decimal points via Header
- Large .55" High Brightness LED Digits
- 2 for 1 exchange on any factory defective meter*
- Direct Replacement for some other brands!

Ask About Our Evaluation Kit • DPM-2 Meter, Cable Harness and Lense with Instructions for \$24.95. (One per company please)

Compudigital Industries 8375 Oak Knoll Drive Granite Bay, CA. 95661

Tel: (800) 354-2222 or Fax: (916) 791-5551

*Some limitations may apply

** Quantity Pricing

CIRCLE NO. 764

High Fidelity Stereo Sound On The PC Bus

Recording rates of > 44.1 khz
Frequency response from 20hz - 20khz
AUDIO SC-208

Professional quality stereo digital recording and playback for the AT bus, 87 db dynamic range, optional MIDI interface. \$795.00 W/MIDI \$847.00
AUDIO MC-108

Mono digital recording and playback for XT bus, optional MIDI interface. \$225.00 W/MIDI \$277.00
AUDIO FX

Mono digital recording and playback with on-board Z80 controlled stereo synthesizer, plays up to 6 simultaneous voices. \$350.00

Optional UNIX drivers available



1555 E. Henrietta Rd. Rochester, NY 14623
Phone (716) 427-8595
FAX (716) 292-6353

CIRCLE NO. 765

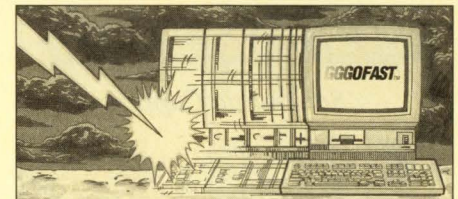

GOFAST™ Lightning-Fast Accelerators

Fast floating point, reentrant, and ROMable. Link and go with C: Microsoft®, Borland®, Intel®, MetaWare®, and WATCOM®. Dynamically replaces 80x87 coprocessors. GOFAST IEEE accelerators are optimized for 8051, 8096, 80386, i960, 6801, 6301, 6809, 68HC11, 68xxx, 8085, Z80, R3000 and more.

Call for your free GOFAST information diskette: 503-641-8446; FAX 503-644-2413; 800-356-7097.



14215 NW Science Park Drive
Portland, OR 97229
U S SOFTWARE®

© 1991 US Software Corporation. GOFAST is a trademark of US Software Corporation. All other trademarks belong to their respective owners.

CIRCLE NO. 766

To advertise in Product Mart, call Joanne Dorian, 212/463-6415

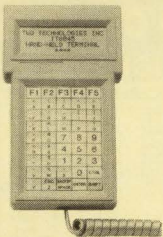

OPERATOR INTERFACE \$199.00
INDUSTRY PROVEN RELIABILITY

- * 30 or 45 key Tactile Keypad
- * 80 Character (4 Line X 20 Character)
- * 300 to 9600 BAUD
- * 15 Programmable Function Keys
- * RS-232 or RS-422 Interface
- * Simple Menu Set-up
- * Standard or Custom Keypad Graphics
- * 5 VDC or Extended 8-24 VDC
- * Less than 8 Ounces
- * Full Two Year Warranty



Two Technologies, Inc.
419 Sargon Way
Horsham, PA 19044
PHONE (215) 441-5305
FAX (215) 441-0423



CIRCLE NO. 767

**Relax
Reliability Software**

Innovative Software Designs offers an unbeatable set of reliability analysis software tools with its Relax product line. The Relax line includes electronic reliability analysis according to MIL-HDBK-217, Bellcore, and CNET, mechanical reliability, and failure modes and effects analysis. Also available are packages for thermal and Weibull analysis.

Relax products are noted for their outstanding quality, ease-of-use, flexibility, and comprehensive array of features. A wide range of packages are available to meet your price and product requirements. And all products are fully guaranteed!

Call today for more information and join ISD's long list of satisfied customers!

217
CNET
Bellcore
FMECA
Mechanical
217 Parts Count
Calculus Simplified
BETAsoft Thermal
WeibullSMITH Analysis

Innovative Software Designs, Inc.

One Kimball Ridge Court • Baltimore, MD 21228
(301) 747-8543 • Fax (301) 747-8599

CIRCLE NO. 768

THE LOGIC ANALYZER

MODEL 3625 32CH. 100MHZ
MODEL 3620 24CH. 100MHZ



- Runs on PC; Drives HGA, CGA, EGA, VGA, and MCGA.
- Up to 32 timing/state data channels, 2045 bits/channel.
- Sample rate up to 100 MHz asynchronous, 25 MHz sync.
- Sample data by rising, falling, both edge of two EXT clocks AND/OR logic combinations.
- Over 4000 multilevel combinational trigger conditions.
- Level/Edge trigger capability
- Data qualification with 8 channels qualifier.
- Easy-to-use menu-driven system software.
- FORMAT, TIMING, LIST, and DOS display Mode.
- Full color display enhances user interface.
- User-definable color set.
- 8 acquisition templates provide rapid setup and operation.
- 4 user-definable groups those can be displayed in separate BIN, OCT, HEX, ASCII, and DEC radices.
- Save/load acquisition data file and edit testing comment in DOS mode.
- Hardcopy at any moment, and dump the data of interest in timing diagram or state table.

**OEM AND
DISTRIBUTOR
WANTED!**



ARGOSY TECHNOLOGY CO., LTD.
8F, NO. 196, SEC. 2, KEELUNG RD., TAIPEI, TAIWAN, R.O.C.
TEL: 886-2-7371325 FAX: 886-2-7371342

CIRCLE NO. 769

**Little Giant™
New! Tiny Giant™**
C Programmable Controllers

We have miniature controllers with parallel I/O, solenoid drivers, A/D and D/A converters, clock, watchdog, LCD interface, RS485 serial, built-in power supply and much more! Use them to control anything. Our \$195 interactive Dynamic C™ development system makes software development easy. These units have high performance and serious software support. We also have design-your-own-board core modules as low as \$59.

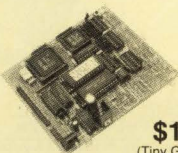

\$159
(Tiny Giant Digital, qty. 1)

Z-World Engineering

1340 Covell Blvd., Davis, CA 95616 USA
(916) 753-3722

Regular Fax: (916) 753-5141

Automatic Fax: **(916) 753-0618**

(Call from your fax, hear computer voice, use touchtone dial to request desired data sheets.)

CIRCLE NO. 770

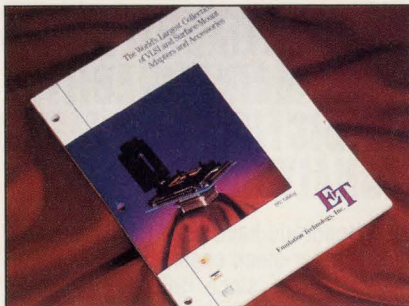

Free Catalog

The World's Largest Collection of Adapters & Accessories for VLSI/Surface Mount Devices

- Emulator Pods & Adapters
- Debug Tools
- Programming Adapters
- Socket Converters
- Debugging Accessories
- Prototyping Adapters
- Custom Engineering



Emulation Technology, Inc.
2344 Walsh Ave. Santa Clara, CA 95051
Phone: 408-982-0660 FAX: 408-982-0664

CIRCLE NO. 771

**Consistency
is
key**
to the power of
EDN Product Mart

CIRCLE NO. 772

SCHEMA III 3.3

Schematic Capture

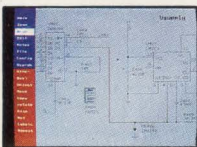

**COMPLETE
DESIGNS ON
YOUR PC OR
UPLOAD
TO YOUR
WORKSTATION**

FREE DEMO DISK

One schematic capture program stands alone in features, speed, user friendliness & performance - SCHEMA. The new SCHEMA III 3.3 is still only \$495.



800-553-9119

CIRCLE NO. 773

Lifetime **FREE** software updates via BBS/US Mail
Unlimited toll-free technical support in USA
CP-1128 Combination Programmer

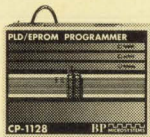

\$1295.00

- Supports over 2,000 devices
- Manufacturer approved algorithms
- Recommended by AMD, Signetics, National, Lattice, TI
- MACH 110/210/130 • PALCE/4 EPLDs • ECL PLDs
- All 4ns and 5ns TTL standard PALs • MAPL 128
- 7ns & 10ns 22V10, 22VP10 • 7ns GALs • BiCMOS devices
- Bipolar PROMs • 8-pin serial E/PROMs • IC Microwire
- E/PROMs and high-speed CMOS PROMs
- PIC & DSP microcontrollers
- Works under Windows • Parallel Interface • Single Executable file

Call 1-800-225-2102 for information.



BP Microsystems, Houston, TX 77043-3239
Phone: (713) 461-9430 Fax: (713) 461-7413

CIRCLE NO. 774

Baby Bullet-386SX™

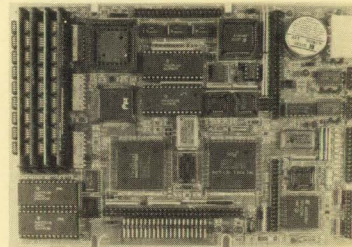

- Single Board Computer
- AT Compatible ■ SCSI Interface
- On Board Serial (2), & Parallel (1) Ports
- On Board Multiple Disk Interface
- Solid State Disk ■ Low Power — Only 5V
- Small Size — 5.25" Disk Form Factor
- Watch Dog Timer ■ Keyboard Interface
- Up To 16MB DRAM ■ AMPRO Compatible

Dyna Five Corporation
173 Freedom Avenue • Anaheim, CA 92801
(714) 525-8795 • FAX (714) 525-9310

CIRCLE NO. 775

To advertise in Product Mart, call Joanne Dorian, 212/463-6415

NEW.

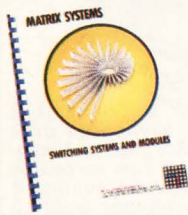

50 PAGE CATALOG—MATRIX SWITCHING SYSTEMS & MODULES

Over 50 data sheets arranged in convenient spiral binder provides descriptions, photos, specifications & interconnections, on broad-band reed relay and solid-state switching modules, matrices and systems. Audio, video & RF inputs are compatible with RS-232, RS-422, IEEE-488, 16 bit parallel, and the new VXI bus. Phone 818-992-6776 or FAX 818-992-8521.

MATRIX SYSTEMS

CIRCLE NO. 776

MaxCAD

MT2000
Single-Chip Card Controller
& Card System



Products * Single Chip IC Memory Card Controller
* IC Memory Card Interface Module
* IC Memory Card Notebook PC
* IC Memory Card

* Edge type * JEIDA standard
* Two piece type * Custom card

MaxCAD TECHNOLOGY CO., LTD.

276, Chung-Hwa 1st Road, Kaohsiung, Taiwan, R.O.C.
TEL: (886)7-5815310 FAX: (886)7-5815159

CIRCLE NO. 777

PROTOTYPING ADAPTORS

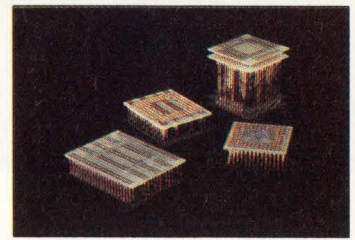

BY THE HUNDREDS

Our line of prototyping adaptors for VLSI devices including PGA, PLCC, LCC, ZIP, DIP and Quad Flat PAK is the most extensive available in the industry. These devices allow easy prototyping of these difficult to handle devices. Pins and sockets used are gold plated and of the highest quality. Parts are available in solder-tail or with 3 level wirewrap pins. All types of wirewrap panels are covered. Ask about our custom design services for unique solutions in packaging.

IRONWOOD ELECTRONICS

P.O. BOX 21151, ST. PAUL, MN 55121
(612) 431-7025; FAX (612) 432-8616



CIRCLE NO. 778

RELIABILITY PREDICTION SOFTWARE

ARE YOUR PRODUCTS RELIABLE?

The RelCalc 2 Software Package predicts the reliability of your system using the part stress procedure of MIL-HDBK-217E, and runs on the IBM PC and full compatibles. Say goodbye to tedious, time consuming, and error prone manual methods! RelCalc 2 is very easy to use, and features menu windows, library functions, global editing for what-if? trials, and clear report formats. Try our Demo Package for \$25.

T-CUBED SYSTEMS, 31220 La Baya Drive #110, Westlake Village, CA 91362. (818) 991-0057 • FAX: (818) 991-1281

CIRCLE NO. 779

NEW! iceMASTER™



YOUR WINDOW TO EMULATION PRODUCTIVITY

- Easy to learn & use
- Windowed interface -- user configurable
- FAST! Download -- < 3 sec. typ. at 115KB
- Source Level debug
- A 4K frame trace buffer with advanced searching capabilities.
- Hyperlinked On-line help guides you through the emulation process.
- iceMASTER connects easily to your PC, requires no disassembly, or expansion slots. Works on any PC (DOS or OS/2), MicroChannel or EISA. Even laptops!
- iceMASTER is versatile: iceMASTER-8051, iceMASTER-68HC11 and iceMASTER-COP8 support most family derivatives.
- Try iceMASTER risk free! Satisfaction Guaranteed or return for a full refund!*
- RENTALS AVAILABLE! Ideal for consultants and researchers!
- Call today for free demo disk and ask about a free 8051 Macro Assembler! (800) 638-2423

MetaLink Corporation

MetaLink Corporation P.O. Box 1329 Chandler, AZ 85244-1329
Phone: (602) 924-0197 FAX: (602) 926-1198 TELE: 49985050/INTL
* With 10-day trial period



CIRCLE NO. 780

Low Cost CAD Software

for the IBM PC and Compatibles
Starting at only \$99

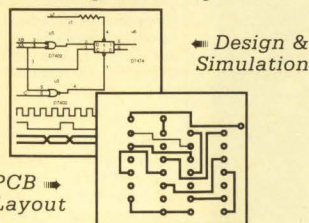

- Easy to use schematic entry program for circuit diagrams (SuperCAD)—Only \$99. Includes large library, netlist and dot matrix printer output.
- Powerful, event-driven digital simulator (SuperSIM) starting at \$99.00. Operates directly from SuperCAD menu and displays waveforms in built-in "logic-analyzer" display.
- Circuit board artwork editor and auto router programs, starting at \$99 each.

Write or call for free demo disks:

MENTAL AUTOMATION, INC.

5415 - 136th Place S.E.
Bellevue, WA 98006
(206) 641-2141

CIRCLE NO. 782



Break on through to innovation

Specialist fan maker Sunon proudly introduces an innovative, cost-efficient DC Brushless Fan Motor, which features

- improved performance: higher air flow but lower dBA
- extended life span: 50000 hours at 50 °C
- strengthened dielectric absorption: additional plastic insulation between stator and single-winded coil
- more choice: available from 120 x 38 mm to 40 x 12 mm
- better technology: SMT, automated control system
- approved quality: U.S. Patent No. 4.9.8.7.331.

SUNONWEALTH ELECTRIC MACHINE INDUSTRY CO. LTD.
149, YI YUNG RD. LING YA DT. KAOHSIUNG, TAIWAN, R.O.C.
P.O. BOX: 114361 KAOHSIUNG FAX: 886-7-7494953
TEL: 886-7-7496101 FAX: 886-7-7496100

CIRCLE NO. 783

Telecom Solutions from Teltone

Call Progress Tone Generator

M-991 generates precise dial tone, busy tone, reorder tone, ringing, and other call routing tones for use in telephone systems, test equipment, callback security, and other telecom applications.

- 14-pin CMOS DIP
- Single 5-volt power supply
- 3.58 MHz time base
- Combinations of all standard frequencies

1-800-426-3926

Or: 206-487-1515 Fax: 206-487-2288

TELSTONE®

INNOVATING SOLUTIONS
In Telecom Interface Components

Telstone Corporation, 22121-20th Avenue SE, Bothell, WA 98021

CIRCLE NO. 784

To advertise in Product Mart, call Joanne Doran, 212/463-6415

**QLLC X.25
ADCCP SDLC
TCP/IP HDLC
3270 BSC PAD**

- C source code
- ROM-able
- Full porting provided
- No OS required

GC GCOM, Inc.
1776 E. Washington
OM Urbana, IL 61801
(217) 337-4471

Specialists in Computer Communications
FAX 217-337-4470

CIRCLE NO. 785

\$249. TERMINAL

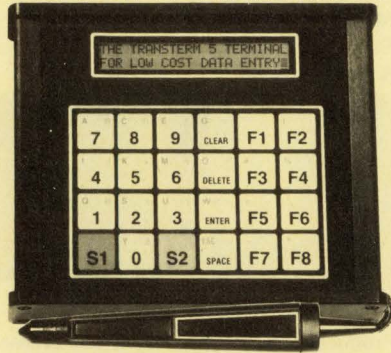

Featuring

- Standard RS-232 Serial Asynchronous ASCII Communications
- 48 Character LCD Display (2 Lines of 24 Each)
- 24 Key Membrane Keyboard with embossed graphics
- Ten key numeric array plus 8 programmable function keys
- Optional RS-422 multidrop protocol mode
- Keyboard selectable SET-UP features—baud rates, parity, etc.
- Size (5.625" W x 6.9" D x 1.75" H), Weight 1.25 lbs.
- 5 x 7 Dot Matrix font with underline cursor
- Displays 96 Character ASCII Set (upper and lower case)
- Optional Bar Code Wand (shown)

COMPUTERWISE, INC.

302 N. Winchester • Olathe, KS 66062 • 800-255-3739 • FAX (913) 829-0810

CIRCLE NO. 786

Pick Of The Week

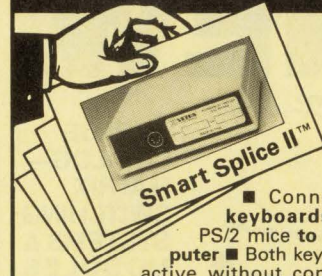

- Connects 2 keyboards or 2 PS/2 mice to 1 computer
- Both keyboards active without conflict
- Allows computer booting without keyboard present
- No power or special software required
- Only \$229 (PC/XT/AT versions)—1 year warranty

Communications
 Specialties, Inc.

TEL: 516-273-0404 FAX: 516-273-1638

CIRCLE NO. 787

**PICO III™
SLO-BLO®
PICOFUSE**

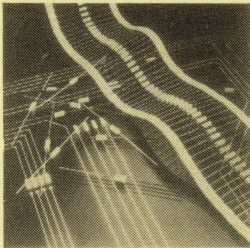

Proven PicoFuse reliability is now available with time delay performance characteristics in a space saving subminiature size. Ideal for applications having inrush currents that normally open a fast acting fuse. Eliminates problem of "nuisance blowing." Available in 3/8 to 7 amperes at 125 volts. U.L. recognized and CSA certified.

Call Littelfuse 708-824-0400

Littelfuse Inc.

CIRCLE NO. 788

ROM-IT EPROM EMULATION SYSTEM



**NEW
4-MEGABIT
VERSION**

- Emulates up to 8 4-Megabit EPROMs with one control card.
- Downloads 2-Megabit programs in less than 23 seconds.
- Allows you to examine and modify individual bytes or blocks.
- Accepts Intel Hex, Motorola S-Record and Binary files.
- Software available for IBM PC and compatibles and Macintosh systems.
- Base 27256 EPROM System \$395.00 Other configurations available.

**ORDER TODAY--IT'S EASY
CALL OR FAX FOR MORE INFORMATION**



Incredible Technologies, Inc.
(708) 437-2433
(708) 437-2473 Fax

VISA now accepted.

CIRCLE NO. 789

Combine Your Product Mart Ads

In EDN's Magazine
and
News Editions for
higher impact and a
lower rate.

CIRCLE NO. 790

NoiseKen
IEC Pub. 801-2
HIGH REPRODUCIBLE ESD TESTING.



**ELECTROSTATIC
DISCHARGE SIMULATOR** **ESS-630A**

U.S.A. WATAHAN NOHARA INTERNATIONAL, INC.
TEL (800)366-3515

CIRCLE NO. 791

High Density - Low Insertion Force 48-490 Position High Rel PC Connectors

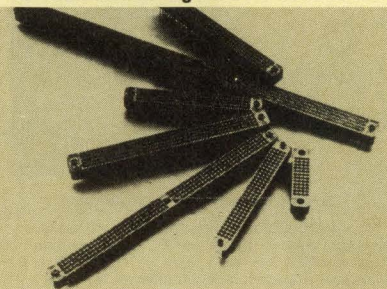

KA/254 Printed Circuit Board Connectors are available with 4 row models with from 48 to 392 positions, and 5 row models with from 230 to 490 positions. These connectors meet D55302 performance requirements. Crimp, flow solder, Wire Wrap® and solder cup terminations are available on .100" x .100" grid spacing.

**FOR ADDITIONAL INFORMATION, CONTACT:
HYPERTRONICS CORPORATION
16 Brent Drive, Hudson, MA 01749
(In Mass. & Canada (508) 568-0451)
(800) 225-9228 FAX: (508) 568-0680**

CIRCLE NO. 792

IND-286 SBC

**AT Compatible DISKLESS
SBC Includes DOS in ROM**

Complete 16MHz 80C286 Single Board Computer for embedded PC applications features a 4M-byte PROMDISK disk emulator with battery back-up and an MS-DOS 3.3 compatible disk operating system in ROM.

Features Include:

- 4M-byte DRAM
- Keyboard Port
- 2 COM, 1 LPT
- IDE Disk Port
- 4M PROMDISK
- 100% PC/AT Compatible
- XT Size Board
- 80287 Socket
- WatchDog Timer
- Floppy Port
- Optional Video Daughter Bd.

Other Products:

- IND-88 PC/XT Single Board Computers
- PROMDISK III & IV Disk Emulators
- FlexScan I & II Bar Code Decoders

mcsi micro computer specialists, Inc.
2598-g fortune way vista, ca 92083
phone: 619/598-2177 fax: 619/598-2450

CIRCLE NO. 793

To advertise in Product Mart, call Joanne Dorian, 212/463-6415

Their way.



Our way.



Here's how to turn a relay with 2 changeover contacts into one with 4.

The MT4, our new relay with 4 changeover contacts, hardly occupies more board space than the MT2, our relay with 2 changeover contacts.

So if you need 6 twin changeover contacts on your board, simply install an MT2 and an MT4. Two relays of virtually identical size.

And the expensive space you formerly needed for a third MT2 is now free for other important functions.

Plus: less testing, less component cost, less assembly effort, greater reliability.

What more can you want?

(The new MT4: Power consumption at 20°C 300 mW. Temperature range -55°C to 85°C. Space occupied per contact 12 M².)

I'm interested in the new MT4 relay. Please send me your literature.

Company _____

Name _____

Address _____

Telephone _____

EDN 10-10-91

Alcatel STR AG

CH-8055 Zurich/Switzerland, Friesenbergstrasse 75

▲
ALCATEL

STR

CIRCLE NO. 150

Commit To Excellence Join

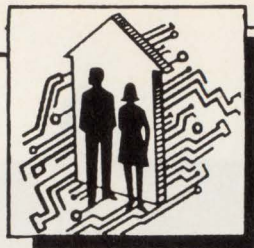

Materials Research Corporation is a leader in thin film deposition systems, dry etching systems and high-purity materials for applications in the microelectronics industry.

We offer experienced professionals unique opportunities to call on the full scope of their expertise to lead efforts that are truly on the cutting edge of the industry.

Director of Engineering

With approximately 60 people reporting to the function, you will lead the development of successful enhancements to current products, integrate new product introductions and establish strong relationships with Advanced Technology Development, Manufacturing and Applications Laboratory so that new product projects are transitioned to production smoothly; initiate and run Engineering project management system for new products or major product improvements; establish world-class concurrent engineering capabilities and drive PED efforts to reduce new production introduction cycle times; and provide engineering leadership for total quality programs.

To qualify, you should have excellent people skills, tact and be personable while at the same time setting high expectations and goals. You must also have an Engineering Degree, advanced degree desirable, and a proven track record of engineering responsibility for development design of capital equipment similar to that produced by MRC.

Senior Manager — Engineering

You will be responsible for directing the overall efforts of approximately 30 personnel engaged in the ongoing development of our semiconductor cluster tool equipment program. In addition, you will make formal presentations to management and customers, manage outside resources, handle all staffing issues, schedule cost management and conduct training in various areas of technology.

To qualify, you must have a BS in Physics, ME or EE, advanced degree desirable, and 15 years engineering technology experience. This experience should include 4 years managerial and 3 years program management involving the development of complex, computer controlled machinery. We prefer recent experience with high vacuum or semiconductor equipment, and "design for manufacturability" training/experience. Excellent presentation and communication skills are essential.

We offer excellent salaries, company paid benefits and relocation assistance to those that qualify in our state-of-the-art facilities located in suburban Rockland County, only 30 minutes North of New York City.

Send your resume and salary requirements, indicating position desired, to: Dick Feeney, Senior Personnel Manager, Dept. ED, Materials Research Corporation, 200 Route 303, Congers, NY 10920. We are an equal opportunity employer m/f/h/v.



MATERIALS RESEARCH CORPORATION

"Defining Excellence In Thin Films"

CAREER OPPORTUNITIES

1991 Recruitment Editorial Calendar

Issue Edition	Issue Date	Ad Deadline	Editorial Emphasis
Magazine Edition	Nov. 7	Oct. 17	High Performance DSPs • CAE/ASICs, Computers & Peripherals/Communications, Software, Wescon Show Issue
News Edition	Nov. 14	Oct. 25	Telecommunications**, Wescon Show Issue
Magazine Edition	Nov. 21	Oct. 31	18th Annual Microprocessor Directory • Test & Measurement, CAE/ASICs, ICs & Semiconductors
News Edition	Nov. 28	Nov. 8	PC Cards, Board Level**, Regional Profile: Wisconsin, Illinois, Michigan**, EDN's Innovator/Innovation Awards Coverage •
Magazine Edition	Dec. 5	Nov. 14	Product Showcase—Volume I • ICs & Semiconductors, Microprocessors, Power Sources, Hardware & Interconnect, Software
News Edition	Dec. 12	Nov. 20	DSP**, Regional profile: DC, Maryland, Virginia**
Magazine Edition	Dec. 19	Nov. 26	Product Showcase—Volume II • Test & Measurement, Components, Components & Peripherals, CAE/ASICs

East Coast: Janet O. Penn (201) 228-8610

West Coast: Nancy Olbers (603) 436-7565

National: Roberta Renard (201) 228-8602

SOFTWARE ENGINEERS

Loral Defense Systems-Akron, Ohio is currently seeking Software Engineers with experience in the following disciplines:

- Geographical data bases-Digital Cartography
- ADA & ADA Development environments
- DOD-STD. 2167A software development
- Trainer/simulator experience
- UNIX operating systems
- BSEE-Computer Science or Earth Science required
- Minimum 3+ years' experience

We offer a competitive salary and excellent benefits. For consideration, please fax your resume to **Bill Turnbow at 216-796-6604; or send to: Loral Defense Systems-Akron; Dept. 131; 1210 Massillon Road; Akron, OH 44315.**

Equal Opportunity Employer, 1X0200X

LORAL
DEFENSE SYSTEMS-AKRON
A DIVISION OF LORAL CORPORATION

THE GREAT ADVENTURE

Western Digital Corporation, is a New York Stock Exchange listed, 20 year old multinational Fortune 500 company, that designs and manufactures intelligent drive products for OEMs and resellers which service the microcomputer industry.

Our storage products are designed to work in concert with Western Digital's communications, video and systems logic products, and the resulting interarchitected products yield increased functionality and performance.

Our San Jose disk drive operation has grown 5 fold over the past 3 years and is continuing to expand. Recently, we significantly upgraded the capability of our Singapore drive manufacturing plant by investing in one of the industry's premier fully automated HDA manufacturing lines. We build well over 2 million 3 1/2" and smaller drives each year! Our new semiconductor manufacturing facility was recognized by Semiconductor International magazine as one of the top wafer labs in North America and is capable of building submicron geometry components.

The future is now at Western Digital. The time is right. And we're looking for "adventurers". People with foresight. Those unique few who can envision the future in the continuously evolving computer industry, to talk with us about exciting opportunities in San Jose.

Manager, Mechanical Design

Provide leadership and direction to the technical staff which designs and develops disk drives. Requires a minimum of 10 years drive development experience including team management experience. BSME/MSME.

Manager, Product Assurance

Irvine

Southern California Management position to support all aspects of off-shore manufacturing, quality, reliability and system reliability qualifications. Responsibilities will include managing 10-12 senior engineering personnel, interfacing with design and manufacturing organizations in support of continuous design and process improvements. Must be familiar with ongoing reliability test systems, thorough knowledge of statistical process control, design of experiments and ISO 9000 requirements. 10+ years of experience in manufacturing and/or product assurance preferably with 3 or more years of disk drive experience. BS/MS in EE or ME or equivalent.

Director, Manufacturing Engineering

Direction and leadership responsibilities for process development, sustaining (Far East) and tool design groups. Requires a minimum of 10 years experience to include HDAs, new product development and management experience. BS/MSME.

Manager, Firmware - Servo

You will manage and direct the firmware efforts of a design team. Requires 1 year of management experience plus 3 years in the design of motion control systems (Servo); real-time programming and firmware coding; and disk drive industry experience. BS/MSEE.

Director, Channel Design

A senior-level management with the overall responsibility for directing and managing a read/write channel design and development team. Requires thorough knowledge of read/write channels plus 3 years of management experience within the disk drive industry. BS/MSEE.

Firmware, Controller

Design, develop and test architecture for controller systems utilizing firmware real-time programming skills. Requires a minimum of 2 years of controller design, preferably in disk/tape drive or printers environment, plus 2 years of coding intelligent, self-test and real-time programming experience. BS/MSEE.

Firmware, Servo

Design, develop and test architecture for digital servo motion control systems utilizing firmware real-time programming skills. Requires a minimum of 2 years of motion control systems design, preferably in a disk drive, printer or tape drive environment, plus 2 years of coding and real-time programming experience. BS/MSEE.

Heads/Media

Be responsible for all phases of head/media evaluation and qualifications. Requires a minimum of 5 years of direct experience in a low cost/high volume disk drive environment. BS/MS in EE or ME.

Test Engineer

You will perform system-level failure analysis on new products. Requires a minimum of 3 years experience in the disk drive industry. BSEE.

Hardware/System Integration

Responsible for digital hardware design and firmware integration of a disk drive development project. Requires a BSEE and 3 years of disk drive experience.

Read/Write Channel

Responsible for the design and development of read/write channels with specific emphasis on optimizing and enhancing capabilities. BSEE and 5+ years experience required. MSEE preferred.

Hardware Digital Engineer

Familiar with disk or tape drive controller hardware. Minimum of 3 years experience in disk or tape drives. Responsibilities will include failure analysis and product enhancements to improve yields and performance.

Hardware Analog Engineer

■ Familiar with read/write channel concepts and servo system hardware. Minimum of 3 years experience in disk drives. Responsibilities will include failure analysis and product enhancements to improve yields and performance.

■ Be responsible for the design and development of VCM and Spindle Motor interface circuitry and new product development. A minimum of 5 years experience in the disk drive industry and a working knowledge of R/W channel required. BSEE/MSEE.

Mechanical Engineer - Tribology

You will evaluate head/media separation losses; perform analysis, verification and make recommendations. Requirements include a minimum of 5 years of HDA experience including head/media evaluation, strong analytical skills and a thorough knowledge of tribology and interface technology. BSME; MS preferred.

Mechanical Engineer - Development

Must have 5-10 years of industry experience to include castings, moldings, stamping, motors, and bearings. Disk drive manufacturing experience required.

Mechanical Engineer - Advanced Manufacturing

Must have 3-7 years of high volume electromechanical assembly experience, preferably in disk drive manufacturing. CAD skills a plus.

Senior R&D Technicians

Various positions requiring an AA/AS or equivalent and 5 years of disk drive experience including engineering/development.

We offer outstanding compensation, a 401(k) plan and a flexible benefits package that you can tailor to your situation. Please mail or fax your resume to: Western Digital, 6201 San Ignacio Avenue, San Jose, CA 95119. (408) 281-6450. EOE.



WESTERN DIGITAL

EDN Databank

Professional Profile

Announcing a new placement service for professional engineers!

To help you advance your career, Placement Services, Ltd. has formed the EDN Databank. What is the Databank? It is a computerized system of matching qualified candidates with positions that meet the applicant's professional needs and desires. What are the advantages of this new service?

- It's absolutely free. There are no fees or charges.

- The computer never forgets. When your type of job comes up, it remembers you're qualified.

- Service is nationwide. You'll be considered for openings across the U.S. by PSL and its affiliated offices.

- Your identity is protected. Your resume is carefully screened to be sure it will not be sent to your company or parent organization.

- Your background and career objectives will periodically be reviewed with you by a PSL professional placement person.

We hope you're happy in your current position. At the same time, chances are there is an ideal job you'd prefer if you knew about it.

That's why it makes sense for you to register with the EDN Databank. To do so, just mail the completed form below, along with a copy of your resume, to: Placement Services, Ltd., Inc.

IDENTITY

PRESENT OR MOST RECENT EMPLOYER

Name _____ Parent Company _____
Home Address: _____ Your division or subsidiary: _____
City _____ State: _____ Zip: _____ Location (City, State) _____
Home Phone (include area code): _____ Business Phone if O.K. to use: _____

EDUCATION

Degrees (List)	Major Field	GPA	Year Degree Earned	College or University

POSITION DESIRED

EXPERIENCE

Present or Most Recent Position _____ From: _____ To: _____ Title: _____

Duties and Accomplishments: _____ Industry of Current Employer: _____

Reason for Change: _____

PREVIOUS POSITION:

Job Title: _____

Employer: _____ From: _____ To: _____ City: _____ State: _____

Division: _____ Type of Industry: _____ Salary: _____

Duties and Accomplishments: _____

COMPENSATION/PERSONAL INFORMATION

Years Experience	Base Salary	Commission	Bonus	Total Compensation	Asking Compensation	Min. Compensation
Date Available	I Will Travel <input type="checkbox"/> Light <input type="checkbox"/> Moderate <input type="checkbox"/> Heavy			<input type="checkbox"/> I own my home. How long? _____		<input type="checkbox"/> I rent my home/apt. <input type="checkbox"/>
<input type="checkbox"/> Employed	<input type="checkbox"/> Self-Employed	<input type="checkbox"/> Unemployed	<input type="checkbox"/> Married	<input type="checkbox"/> Single	Height _____	Weight _____
Level of Security Clearance		<input type="checkbox"/> U.S. Citizen	<input type="checkbox"/> Non-U.S. Citizen	My identity may be released to: <input type="checkbox"/> Any employer <input type="checkbox"/> All but present employer		
<input type="checkbox"/> WILL RELOCATE		<input type="checkbox"/> WILL NOT RELOCATE		<input type="checkbox"/> OTHER _____		

EDN Databank

A DIVISION OF PLACEMENT SERVICES LTD., INC.

265 S. Main Street, Akron, OH 44308 216/762-0279

Engineers

Technology moves fast at Ford

It takes a savvy engineer to keep up with the rapid technological advances happening at Ford Motor Company's Electronics Division. Our world class team of engineers is involved in projects that will reshape automotive transportation now and in the 21st century.

Ford engineers are refining and enhancing technological advancements such as multipoint electronic fuel injection, distributorless ignition systems and the electronic engine control unit (EEC-IV). Futuristic instrumentation displays will provide drivers with extended diagnostic capabilities and holographic heads-up information readouts. The performing arts are also taking on new shape through Ford engineering innovation. For example, Digital Audio Tape players (DAT) bring a touch of tomorrow to today's driver.

If you would like to take an active role in the way the world will drive in the 21st century, we invite you to join us. We prefer a BSEE, BSME, a minimum of 3 years related product design experience with an advanced degree preferred, and a background in one of these technological areas:

**Air-Core Magnetic Gage Design
AM/FM RF and Audio Analog Circuit Design
Analog/Digital and Custom Integrated Circuit Design
Automated Controls System Engineering
Automated Software Assembly
Cellular Telephone Vehicle Applications**

**Computer Software Architecture Design
Digital Signal Processing
Electronics Components Packaging
Electronics Systems
EMC/Vibration Testing
Hardware and Software Development
Power Electronics Design
Powertrain Controls System Engineering
SMT/PWB Manufacturing Process Development
Thick Film Circuits
Vehicle Controls Development
Vehicle Navigation Systems
VLSI and Memory Component Testing**

Our Southeastern Michigan location offers an excellent lifestyle with four beautiful seasons, a reasonable cost of living, several major universities, and a variety of social and cultural activities. The proximity of Detroit puts the sophisticated advantages of a major metropolitan area within easy reach. For more information on careers with the Electronics Division, send your resume in confidence to:

**Ford Motor Company
Electronics Division
Product Engineering Office
Room E-130, EDN1010
Post Office Box 6010
Dearborn, Michigan 48121**

By choice, we are an Equal Opportunity Employer.

Electronics Division



ENGINEERING, DP/MIS/IS & PROGRAMMING PROFESSIONALS

IF YOU'RE EVEN THINKING ABOUT LOOKING FOR A JOB, YOU SHOULD COME TO WHERE THE JOBS ARE.

Attend L.A.'s largest career conference for technical professionals — CCC Technical Career Conventions. If you have three or more years of professional experience, don't miss this chance to explore hundreds of job opportunities. Meet with more than 40 technical and recruiting managers from leading local and national companies who are ready to hire qualified professionals, like you.

WHO SHOULD ATTEND:

Individuals with three or more years experience in

Electrical & Electronic Engineering •
Hardware Engineering • Electro-Optics &
Imaging • Data Processing • MIS •
Software Engineering • Mechanical
Engineering • Applications Programming •
Systems Analysis • Technical Writing •
Radar/RF/Microwave • Design & Test •
LANs • Realtime & Scientific
Programming • Artificial Intelligence • QA/
QC • C³I/SAT COM/EW • CAD/CAM/
CIM /CAE • Systems Integration & Test •
Computer Science • IDMS • IMS • ADA •
Tele/Data Communications • COBOL •
FORTRAN • PC/2 • PC/AT • "C" • UNIX •
CICS • SQL/QMS • DB2 • ATE • HP
3000 • dBASE • Pricing & Contracts
Administration • Technical Sales &
Marketing and many more...



MONDAY, NOVEMBER 4TH

Exhibit Hours: 2:00 pm - 6:00

TUESDAY, NOVEMBER 5TH

Exhibit Hours: 9:00 am - 12:30 pm

**AT THE
EMBASSY SUITES
HOTEL**

**AT LOS ANGELES
INTERNATIONAL AIRPORT**

9801 Airport Blvd, Los Angeles, CA 90045

For more information call 213-450-8831

We are not an employment agency. No registration required. All companies are direct, Equal Opportunity Employers. Candidates with EBI/SBI clearances are encouraged to attend. U.S. citizenship required for some positions.

ADMISSION IS FREE!

BUSINESS/CORPORATE STAFF

Peter D Coley, VP/Publisher
Newton, MA 02158; (617) 558-4673
Ora Dunbar, Assistant/Sales Coordinator

Mark J Holdreith, Associate Publisher
Newton, MA 02158; (617) 558-4454

Deborah Virtue, Business Director
Newton, MA 02158; (617) 558-4779

BOSTON

Chris Platt, Regional Manager
Clint Baker, Regional Manager
199 Wells Ave
Newton, MA 02159; (617) 964-3730

NEW YORK/NEW JERSEY

Daniel J Rowland, Regional Manager
249 West 17th St
New York, NY 10011; (212) 463-6419

PHILADELPHIA

Steve Farkas, Regional Manager
487 Devon Park Dr, Suite 206
Wayne, PA 19087; (215) 293-1212

CHICAGO

Greg Anastos, Regional Manager
Jack Johnson, Regional Manager
1350 E Touhy Ave, Box 5080
Des Plaines, IL 60018; (708) 635-8800

ARIZONA

John Huff, Regional Manager
44 Cook St, Denver, CO 80206
(303) 388-4511

COLORADO

Bill Klanke, Regional Manager
44 Cook St, Denver 80206
(303) 388-4511

DALLAS 75251

Al Schmidt, Regional Manager
12201 Merit Dr, Suite 730
(214) 419-1825

SAN JOSE 95128

Frank Granzier, Regional Manager
Bill Klanke, Regional Manager
Philip J Branon, Regional Manager
James W Graham, Regional Manager
3031 Tisch Way, Suite 100; (408) 243-8838

LOS ANGELES

Charles J Stillman, Jr Regional Manager 12233 W Olympic Blvd Los Angeles, CA 90064 (213) 826-5818	Susan Green Regional Manager 18818 Teller Ave, Suite 170 Irvine, CA 92715 (714) 851-9422
---	--

ORANGE/SAN DIEGO/RIVERSIDE COUNTIES

Jim McErlean, Regional Manager
18818 Teller Ave, Suite 170
Irvine, CA 92715; (714) 851-9422

PORTLAND, OREGON 97221

Pat Dakin, Regional Manager
1750 Skyline Blvd, Box 6
(503) 297-4305

EUROPEAN OPERATIONS

Tully Giacomazzi, Managing Director
27 Paul St, London EC2A 4JU UK
Tel: 44-71-628-7030
Fax: 011-44-71-628-5984

UK & BENELUX

Colin Smith
Oliver Smith & Partners
18 Abbeville Mews
88 Clapham Park Road
London SW4 7BX

SCANDINAVIA

Stuart Smith
27 Paul St, London
EC2A 4JU UK
Tel: 44-71-628-7030
Fax: 44-71-628-5984

FRANCE

Laura Whiteman
14 Rue des Parisiens
92600 Asnieres sur Seine
France
Tel: 331-47900507
Fax: 331-47900643

BAVARIA

Karin Steinbacher
New Media Munchen
Ismaninger Str 108
8000 Munchen 80
Germany
Tel: 49-89-98-51-35
Fax: 49-89-981-0117

DUSSELDORF/ NORTHEAST GERMANY

Brigitte Steinkraus
Xantenerstrasse 51A
D-4005 Meerbusch 1
Germany; Tel: 49 2159 8861
Fax: 49 2159 81256

ISRAEL

Asa Talbar, Talbar Media
Box 22917
Tel Aviv 61228, Israel
Tel: 972-3-223-621
Fax: 972-2-247-403

HONG KONG

Adonis Mak
Cahners Asia Limited
22nd fl, Lo Yong Court Commercial Bldg
212-220 Lockhart Road
Wanchai, Hong Kong
Tel: 852-572-2037; Fax: 852-838-5912

JAPAN

Kaoru Hara
Dynaco International Inc
Suite 1003, Sun-Palace Shinjuku
8-12-1 Nishishinjuku, Shinjuku-ku
Tokyo 160, Japan
Tel: 81-3-366-8301; Fax: 81-3-366-8302

KOREA

Jeong-guon Seo
DooBee International Inc
Centre Bldg, 1-11 Jeong-dong
Choong-ku, Seoul, Korea
Tel: 82-2-776-2096; Fax: 82-2-755-9860

SINGAPORE/MALAYSIA

Hoo Siew Sai
Ad Media Private Ltd
95, South Bridge Rd
#09-13 Pidemco Centre
Singapore 0105
Tel: 65-532-4026; Fax: 65-532-4027

AUSTRALIA

Alexandra Harris-Pearson
World Media Network Pty Ltd
Level 2, 285 Clarence Street
Sydney, NSW 2000 Australia
Tel: 61-2-283-2788; Fax: 61-2-283-2035

TAIWAN

Parson Lee
Acteam International Marketing Corp
Box 82153, Taipei, Taiwan ROC
Tel: 886-2-7114833; Fax: 886-2-7415110

PRODUCT MART

Joanne Dorian, Manager
249 West 17th St
New York, NY 10011
(212) 463-6415; Fax: (212) 463-6404

INFO CARDS

Heather McElkenny
Newton, MA 02158; (617) 558-4282

CAREER OPPORTUNITIES/CAREER NEWS

Roberta Renard, National Sales Manager
Janet O Penn, Eastern Sales Manager
Diane Philipbar, Sales Assistant
103 Eisenhower Pkwy
Roseland, NJ 07068
(201) 228-8602, 228-8610, 228-8608
Fax: (201) 228-4622

Nancy Olbers, Western Sales Manager
238 Highland St
Portsmouth, NH 03801
(603) 436-7565; Fax: (603) 436-8647

Direct Mail Service
(708) 390-2361

Wendy A Casella, Mary Beth Cassidy, Muriel Murphy
Advertising/Contracts Coordinators; (617) 964-3030

William Platt, Senior Vice President, Reed Publishing USA

Cahners Magazine Div
Terry McDermott, President, Cahners Publishing Co
Frank Sibley, Executive Vice President/General Manager,
Boston Div
Tom Dellamaria, VP/Production & Manufacturing

Circulation: Denver, CO: (303) 388-4511
Eric Schmierer, Group Manager

Reprints of EDN articles are available on a custom printing basis at reasonable prices in quantities of 500 or more. For an exact quote, contact Andrea Marwitz, Cahners Reprint Service, Cahners Plaza, 1350 E Touhy Ave, Box 5080, Des Plaines, IL 60017. Phone (708) 390-2240.

EDN's CHARTER

EDN is written for professionals in the worldwide electronics industry who design, or manage the design of, products ranging from circuits to systems.

EDN provides accurate, detailed, and useful information about new technologies, products, design techniques, and careers.

EDN covers new and developing technologies to inform its readers of practical design matters that will be of concern to them at once or in the near future.

EDN covers new products

- that are immediately or imminently available for purchase
- that have technical data specified in enough detail to permit practical application
- for which accurate price information is available.

EDN's Magazine Edition also provides specific "how to" design information that its readers can use immediately. From time to time, EDN's technical editors undertake special "hands on" engineering projects that demonstrate EDN's commitment to readers' needs for useful design information.

EDN's News Edition also provides comprehensive analysis and news of technology, products, careers, and distribution.

EDN

275 Washington St
Newton, MA 02158
(617) 964-3030

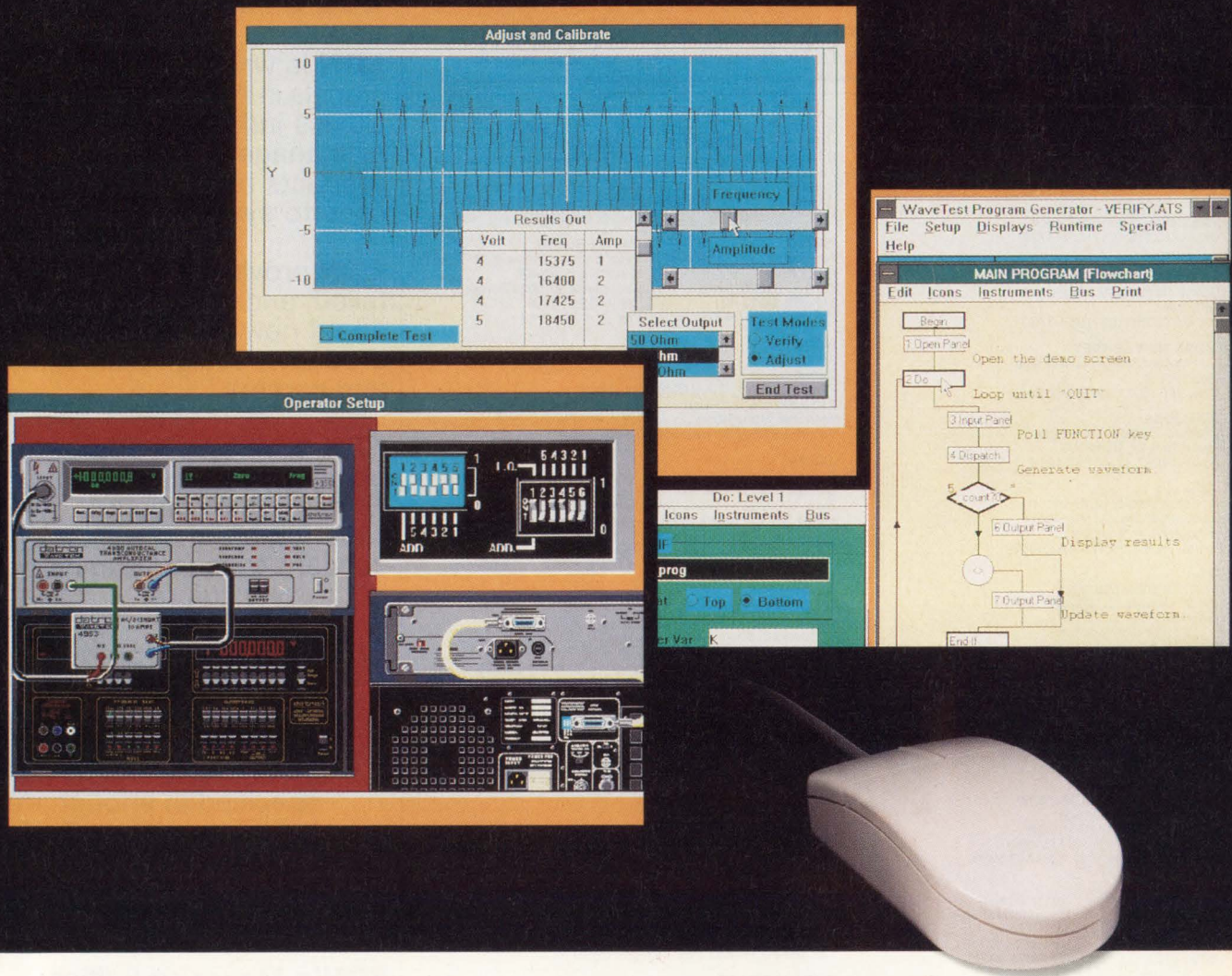

Some very sophisticated test programs are being written by mice.

Actually, they're not being written, they're being drawn. With WaveTest® software for PCs and workstations.

WaveTest provides a complete graphical programming environment, using Windows™ on a PC, or X Window™ on DEC™ workstations. Just draw a flow chart and you've written a program.

There are no more lines of code to deal with. Even loops and subroutines can be handled with simple program icons. And documentation is

automatic, making your programs simple to maintain.

Call up an instrument front panel (from a library of over 200 different manufacturers' instruments), adjust the controls, and you've written a GPIB/ VXI command sequence. An Instrument Search and Replace function makes it easy to change instruments for new or existing tests.

And when your test is running, you can see real-time data analysis, including statistics, FFTs and plots.

Dynamic Data Exchange with other Window's applications adds to WaveTest's flexibility in solving your test problems.

WaveTest has been proven in the field, so you know your test program will be reliable and of the highest quality.

Call 1-800-874-4835 for information about WaveTest and other Wavetek software, including WaveForm DSP for arbitrary function generators.

WaveTest® is a registered trademark of Wavetek Corporation. DEC™ is a trademark of Digital Equipment Corporation. Windows™ is a trademark of Microsoft Corp. X Window System™ is a trademark of MIT. ©1991 Wavetek Corporation

EDN's INTERNATIONAL ADVERTISERS INDEX

ACCEL Technologies Inc229	Intergraph42	RC Systems224
Acteam**	45, 81, 110	Intel	90-91, 103-105, 124-125	Real Time Devices200
Actel	50-51	Interface Technology201	Rekco Inc221
ADPI223	Interphase Corp89	Samsung Electron Devices240
Advanced Micro Devices	12-13, 32-33, 52-53, 178-179	Intusoft227	Samsung Semiconductor	14-15
Alcatel231	IOtech Inc237	SBE54
Aldec226	Ironwood Electronics Inc229	Sensoray211
ALS Design Corp155	John Fluke Manufacturing Co Inc	44-45	SenSym98
AMP	192-193	Keithley Instruments	139-141	Sextant Avionique**72
Amplifier Research127	Keppo Inc	16-17	Sharp Electronics56
Analogic Corp204	Lansing Instrument225	Siemens AG**	232-233
Antex Electronics218	LeCroy Corp153	Siemens*72
Argosy Technology Co Ltd228	Lem U.S.A.221	Signal Transformer Co IncC4
Ballard Technology224	Linear Technology Corp	64-65, 194	Software Component Group129
Baker Consulting223	Link Computer Graphics Inc226	Sony	40-41
BASF**	68-71	Littelfuse230	Spectrum Software217
Bayer AG**	30-31	Loctite Luminescent Systems Inc225	Sprague Goodman120
B&C Microsystems	225, 227	Magna Power Electronics223	Sunonwealth Electric Machine Industry Co Ltd229
Bopla Enclosures	34,	Matrix Corp229	Synergy Microsystems27
BP Microsystems228	Maxtor	210-211	Tatum Labs225
CAD Software Inc215	MaxCad229	T-Cubed Systems Inc229
Cadisy201	MCG Electronics Inc221	Team Visionics214
Capilano Computer Systems Inc224	MCSI230	Tektronix	18-21
Capital Equipment Corp218	Mental Automation229	Teltone Corp229
Cermetek225	MetalLink Corp229	Tempustech Inc225
Cherry Electrical Products Inc164	Microsys224	Teradyne Inc	36-37
Cirrus Logic90	Mini-Circuits Laboratories	3, 4, 28-29, 38-39, 197	Texas Instruments Inc	206-207
Communications Specialties Inc230	Mosaic Industries Inc227	Todd Products Corp226
Compu Digital227	Motorola Semiconductor Products Inc	94-95, 158-159, 208-209	Tokin Corp133
Computerwise Inc230	Mupac225	Toyocom216
Cypress Semiconductor25	Murrietta Circuits214	Tribal Microsystems227
Dale Electronics Inc1	National Instruments205	TrueTime225
Data I/O Corp224	NEC Corp	112, 187	Tri-L Data Systems Inc226
Deltron Inc	176A-D	NEC Electronics**48	TRW LSI Products Inc	142-143
Design Computation Inc223	NCI224	Two Technologies228
Dexter Magnetics138	NCR Corp	108-109	Underwriters Laboratories102
Diversified Technology	86-87	Nepcon West '92177	Universal Data SystemsC3
DSP Development191	Network Research199	US Software227
Duracell115	Nichicon Corp225	Vicor	85, 131
Dynafive228	Nohau Corp	223, 237	Wavetek238
Elseware Corp227	Noise Laboratory Co230	Westcor96
Emulation Technology Inc	88, 228	Noritake Electronics Inc219	WinSystems Inc88
Emulex Corp	92-93	Nova Sensor218	Wintek Corp209
Epson America Inc119	Nova Tran Corp35	Xeltek226
ERNI Components*81	Oak Grigsby220	Zax Corp213
Forte227	OKI Semiconductor	30-31	Zilog Inc	46-47
Galaxy Microcraft Systems224	Omaton Inc228	Z-World228
GCOM Inc230	Omnibyte Corp	121-122	Zycad63
General Instrument77	OrCAD Systems Corp	10-11		
General Scanning Inc201	Orion Instruments226		
Glassman High Voltage Inc189	Otto Controls202		
Guardian Electric223	P-Cad	156-157		
Hamilton Avnet Electronics	6, 101	Phihong Enterprise Co Ltd218		
Harris Semiconductor	66-67, 135	Philips T&M**44		
Harting Elektronik117	Pico	136, 213		
Hewlett-Packard Co	2, 22, 48*, 106-107, 144-145, 180	Power Trends Inc212		
Hitachi America Ltd*110	Powertronic227		
Hitachi America Ltd/Semiconductor and IC Div*	68-71	Precision Interconnect162		
Huntsville Microsystems IncC2	Premier Technologies International Ltd213		
Hwang Piin226	Protel Tech Inc224		
Hypertronics Corp	203, 230	Qua Tech Inc221		
IC Sensors	59, 61	Raltron138		
ILC Data Device Corp79	Raytheon	160-161		
Innovative Software Systems228	Rayovac137		

Recruitment Advertising 232-236

Ford Motor Co
Materials Research Corp
Western Digital

*Advertiser in International edition
**Advertiser in European edition

This index is provided as an additional service. The publisher does not assume any liability for errors or omissions.

HIGH RESOLUTION LCDs FROM SAMSUNG

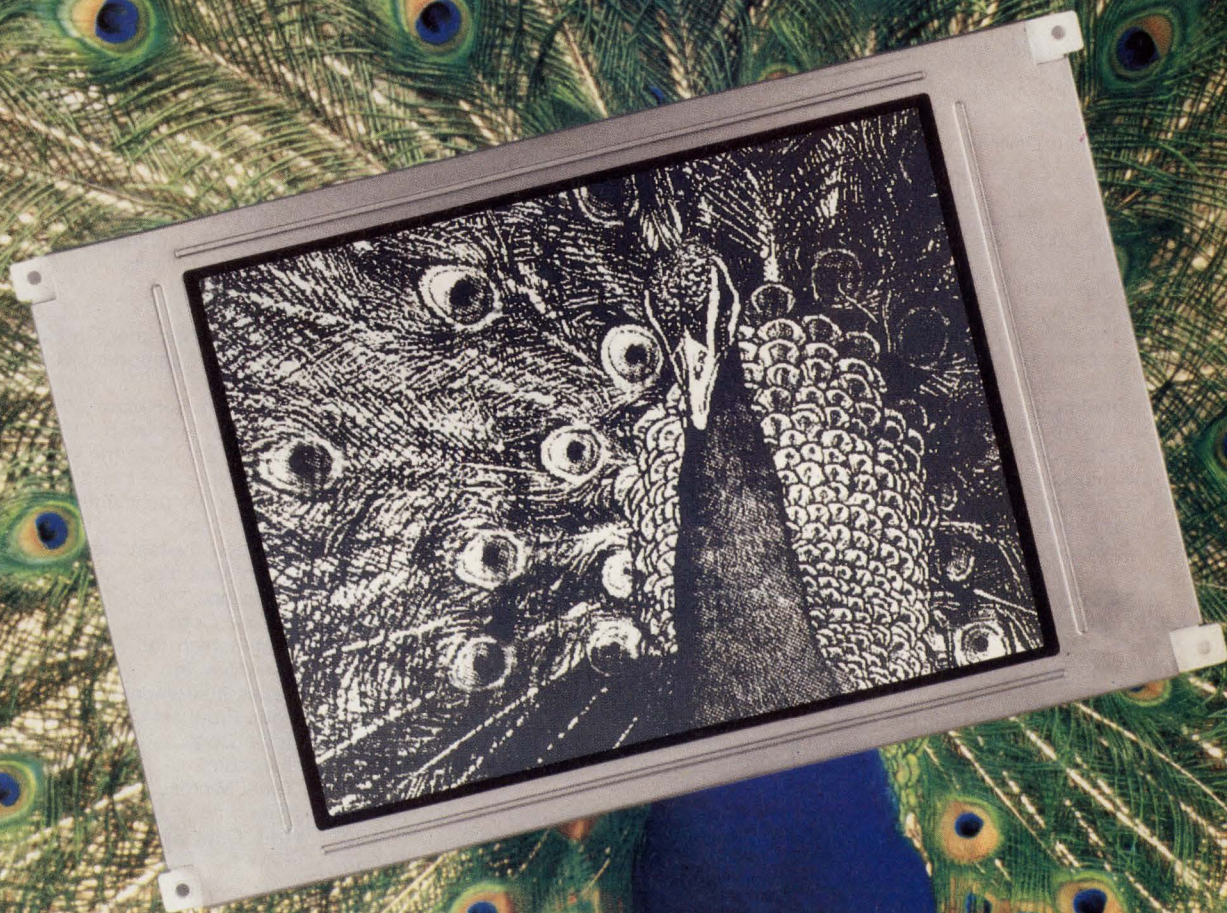

Experience the World of Larger, Sharper Liquid Crystal Displays.
Experience Samsung's World.

Samsung is opening up a whole new world in LCDs. They have higher resolution. They provide a wider viewing angle. They come in all kinds of sizes, from small character modules to giant graphic modules (up to 640x480). You can count on LCDs from Samsung to satisfy your every need.

Take a look around the Samsung LCD world
; you'll like what you see.

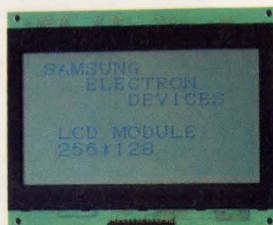

 **SAMSUNG**
Electron Devices

Head Office 12th Fl., Daekyung Bldg., 120, 2-Ka Taepyeong-Ro, Chung-Ku, Seoul 100-102, Korea Tel: (2) 727-3351/3 Fax: (2) 756-9111 Samtron Display Inc. (SDI) 14251, East Firestone Blvd., Suite 101 LA Mirada CA 90638 USA Tel: (213) 802-8425 Fax: (213) 802-8820 Samtron Frankfurt Office Tel: 06196-483829/3 Fax: 06196-483321 Tokyo Office Tel: (813) 3258-8550 Fax: (813) 3258-8534 London Office Tel: (4481) 862-9311/2 Fax: (4481) 862-0096/7 Hong Kong Office Tel: (852) 862-6053 Fax: (852) 866-1242 Singapore Office Tel: (65) 534-5301 Fax: (65) 534-3429

It's high noon for wireless datacomm

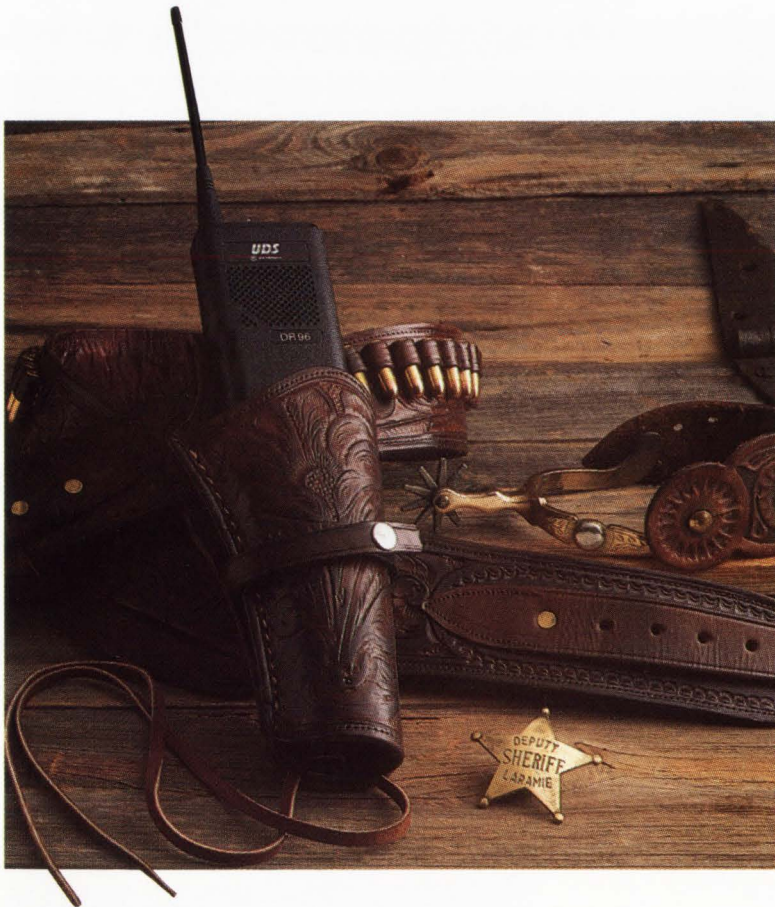

To build the fastest gun in the mobile remote data gathering business, UDS has combined a 9600 bps modem with a Motorola Radius crystal controlled radio. The combination, packaged in a single, high-impact polycarbonate case weighs in at 15.5 ounces and is the size of a walkie-talkie.

The result is the DR96, the ideal RF solution for point-to-point or point-to-multipoint data acquisition applications.

The unit's small size and light weight belie its usefulness, while its 2W transmitter gives it plenty of output muscle. The half-duplex modem communicates at 9600 bps, synchronous or asynchronous. It includes integral self-test capabilities and transmit/receive indicators. Since it has no protocol overhead, the full throughput of the channel is available for data handling. A nine-pin TTL DTE interface is provided, and an optional external interface can convert signals to standard RS-232 levels.

The frequency modulated Motorola radio operates in the 450-470 MHz commercial band. It is "keyed" by the RTS signal. There's even a belt clip for true portability and hands-free operation.

When you face a datacomm showdown in places where phone lines don't go, give yourself the edge. For specifications and prices on the DR96, contact UDS at 800/451-2369 (in Alabama, 205/430-8000); FAX 205/430-8926.

UDS
MOTOROLA

At Signal, getting through customs is a standard procedure.

One of the big headaches in the export business is wrestling your product through customs. If your magnetic components don't meet UL, CSA, VDE and IEC international standards, you can get left at the dock.

That's why it makes solid business sense to specify high quality Signal Transformers from our VDE certified International Series.

Engineered to meet all domestic and international standards, these high power transformers are like a passport to almost anywhere...Germany. France. The U.K. Japan. You name it.

American-built Signal transformers combine worldwide acceptance with world-class performance and dependability. For example, our PC board

mount ONE-4-ALL™ and chassis mount ALL-4-ONE™ transformers feature dual bobbins, an insulating shroud to provide 4000V RMS test voltage and a range from 2.5 to 175 VA. Our space-saving MORE-4-LESS™ transformers feature dual bobbins and an insulating shroud as well, while also providing 4000V RMS test in a range from 300 to 1000 VA.

All of these are in-stock and ready to ship direct - without a middleman or mark-ups. And we can ship them to you in quantity within 24 hours, thanks to our unique PRONTO service.

Signal's transformer experts are ready to support you with leading-edge thinking and total engineering support.

So, if you've got your eyes on the international market, arm your products with Signal's off-the-shelf VDE certified International Series of high-quality, high-power transformers. With Signal on your side, you'll be ready to take on the world.

For more information or a free catalog, contact: Signal Transformer, 500 Bayview Avenue, Inwood, NY 11696.

BUY DIRECT
(516) 239-5777



Signal Transformer.

The American Original.™