

# EDN<sup>®</sup>

**SPECIAL ISSUE:**  
**Communications Technology**

CAE tools help cure  
transmission-line woes pg 47

Fiber-optic transceivers pg 61

Real-time programming  
series—Part 11 pg 97

ELECTRONIC TECHNOLOGY FOR ENGINEERS AND ENGINEERING MANAGERS

Special Report: ISDN links  
product-development  
parties concurrently pg 80

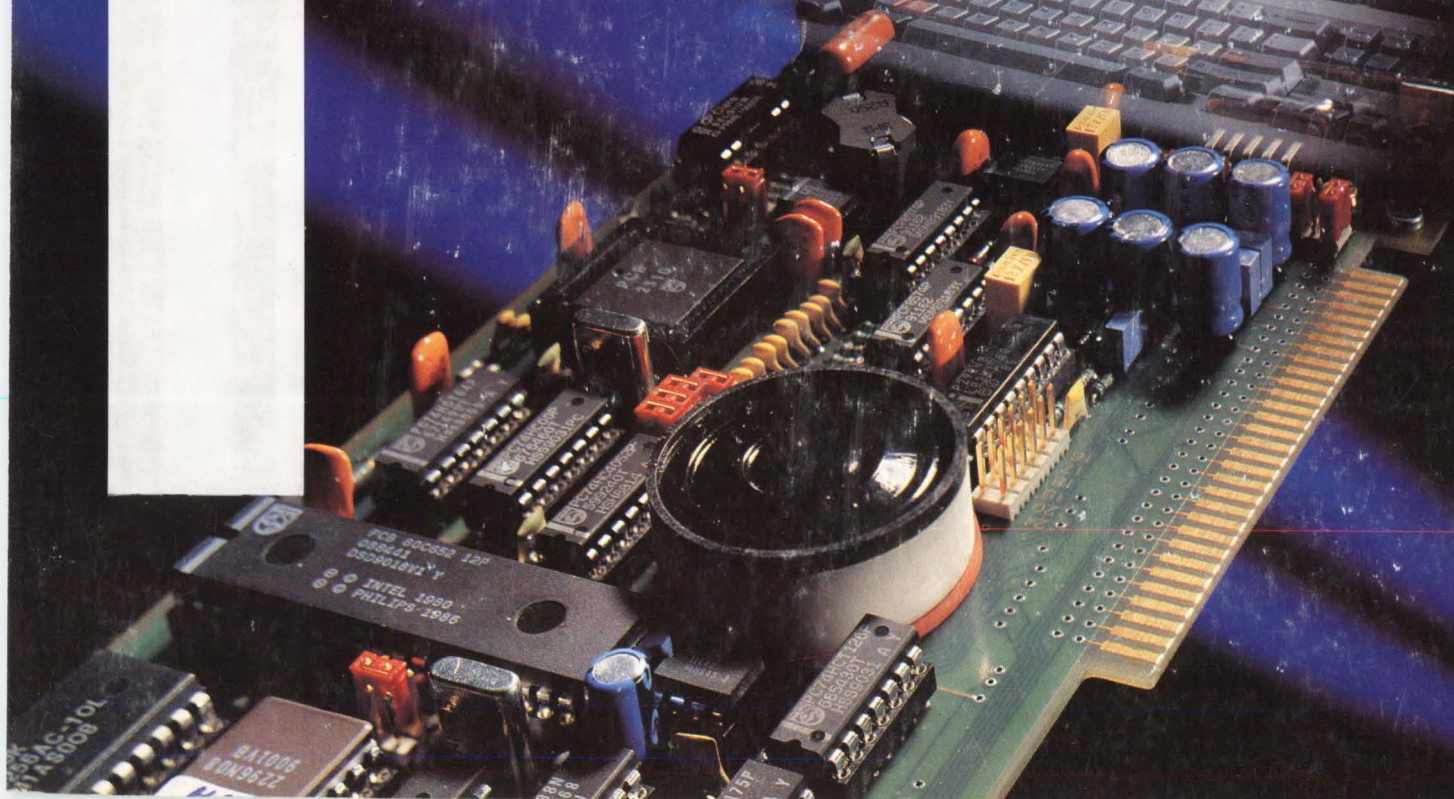

# Count On IDT

## The R3001 RISController™: The Embedded Processing Solution

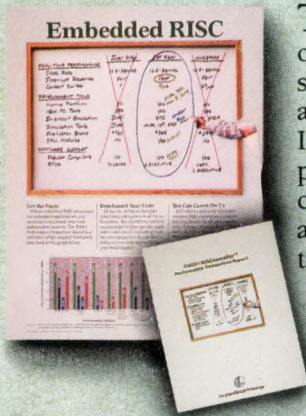

The R3001 is the first derivative of the R3000 processor designed specifically for embedded control applications. Compared to the Intel 960 and AMD 29K processors, the R3001 is the most cost-effective solution for these applications—we have the data to prove it! Call and ask for **KIT CODE 0091A** to get an **R3001 Performance Comparison Report**.

## BiCEMOS™ ECL SRAMs: Technology for the '90s

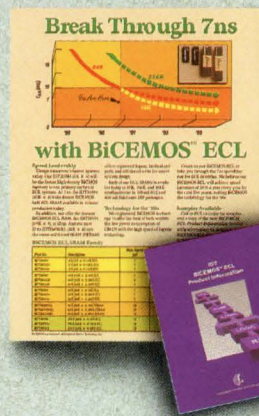

Design the fastest systems with IDT's BiCEMOS ECL family. At 7ns, the IDT10494 is the fastest BiCEMOS 64K ECL SRAM in production. 256K and synchronous self-timed SRAMs are also available in 10K/100K/101K configurations. Call and ask for **KIT CODE 0091B** to get a copy of the **BiCEMOS ECL Product Information** booklet.

## FCT-T Logic: Fastest Speed/ Lowest Ground Bounce



IDT's FCT-T Logic Family is the fastest logic family available and has the lowest ground bounce—up to 40% less than previous FCT devices! The FCT-T family provides direct TTL logic compatibility and is available in FCT, FCT-AT, and FCT-CT speeds. Call today for **KIT CODE 0091C** and get a copy of the **High-Speed CMOS Logic Design Guide**.

## The SyncFIFO™ Family: Double Your FIFO Performance



SyncFIFOs offer leading-edge performance that is 50% faster than other FIFOs. The synchronous architecture is easy to implement and reduces chip count 9-to-1. SyncFIFOs have 18-bit buses and are ideal for 32-bit systems. Ask for **KIT CODE 0091D** to get **AN-60: Designing with the IDT SyncFIFO™**.

## IDT Subsystem Modules: Building Blocks for the '90s



IDT offers a complete line of board-level subsystem products, including cache memory, shared-port memory, writable control store, RISC CPU, high integration modules, and custom designs for specific applications. Call today for **KIT CODE 0091E** and receive technical data and a **free IDT puzzle!**

## 12ns Cache Tag SRAMs: Wait No Longer



IDT's cache tag SRAMs have the features you want to design in: single-pin block reset, totem-pole match output, 4K and 8K depths, industry standard pinouts, and an on-board comparator to simplify design. Call and ask for **KIT CODE 0091F** to get **free samples** of the IDT6178 cache tag.

RISController, BiCEMOS, and SyncFIFO are trademarks of Integrated Device Technology, Inc. The IDT logo is a registered trademark of Integrated Device Technology, Inc.

Contact us today to receive data sheets and other design information on IDT's products.

**(800) 345-7015**  
**FAX: 408-492-8454**

3236 Scott Boulevard, P.O. Box 58015, Santa Clara, CA 95052-8015

CIRCLE NO. 42



When cost-effective performance counts

Integrated  
Device Technology, Inc.

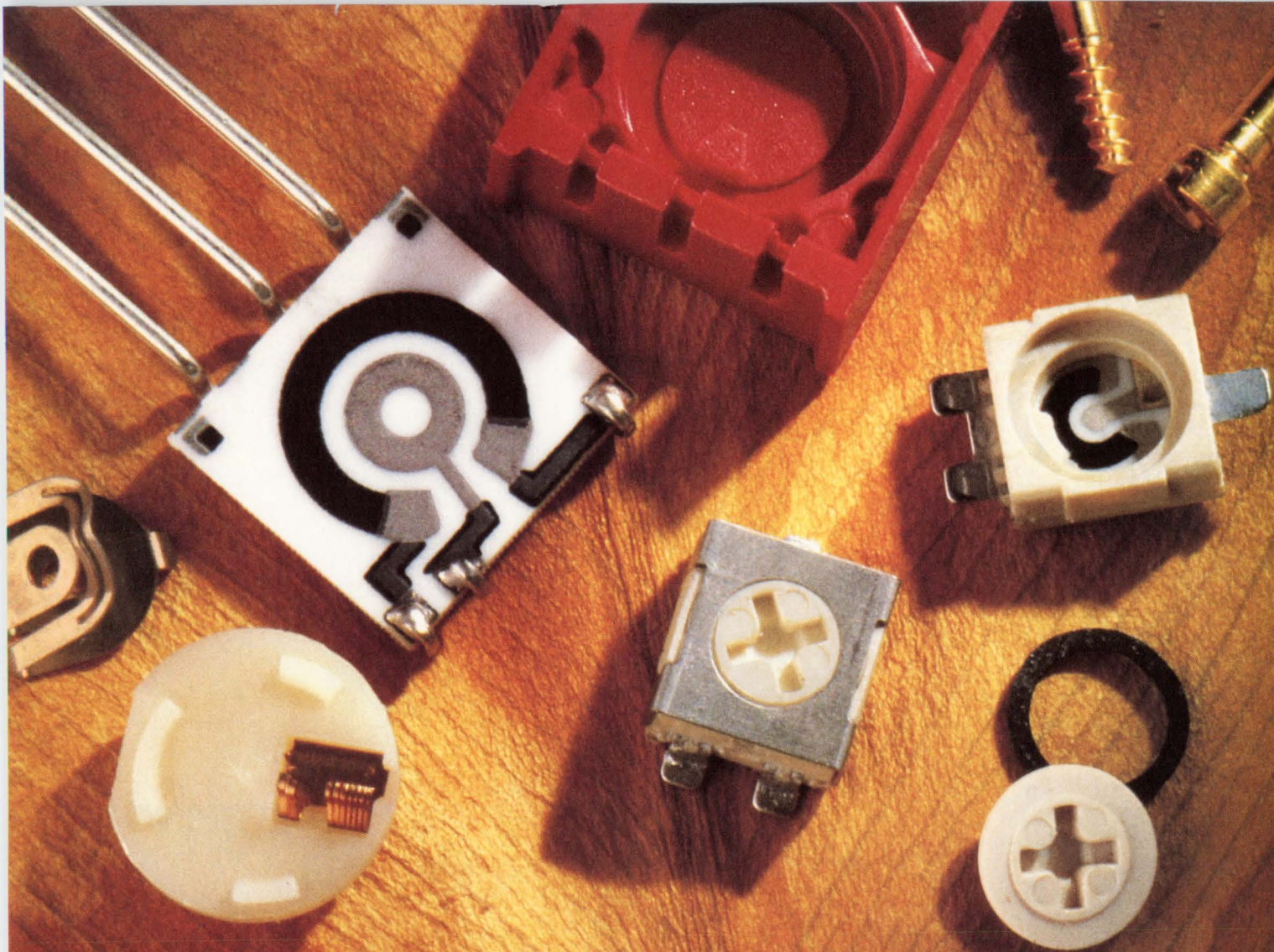

Wipers, collectors and screws  
can't help you trim  
circuit adjustment costs.

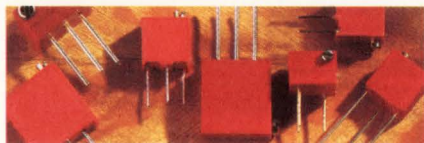

**MILITARY TRIMMERS** from the Techno Division include broad MIL qualification to RT24, 26, 27, RTR24, RJ24, 26 and RJR24, 26. Techno RJ24 and RJR24 trimmers offer you 25 turns for precision adjusting, while the RJ26 and RJR26 offer 22 turns. They have zero backlash and offer a monolithic clutch.

In addition, Techno offers 1/4" and 3/8" multiturn trimmers with a TCR of  $\pm 50$  PPM/ $^{\circ}$ C for precision applications. All Established Reliability trimmers meet the requirements of MIL-STD-202, Method 208.

Contact: **Techno Division**, Dale Electronics, Inc., 7803 Lemona Avenue, Van Nuys, California 91405-1139 **Phone (818) 781-1642.**

Circle No. 1

## Dale® Can.

Add trimmers to the list of ways Dale® can help keep your project under budget and on-time. We offer immediate interchangeability with models you're using now. Cermet, wirewound. Military, industrial, commercial. Square, round, rectangular. Surface mount and through-hole. Discover how Dale trimmers can end your search for multiple suppliers. More than ever we're your 1-stop source for resistive components — always ready to match your delivery schedule from factory or distributor stock. Call today.

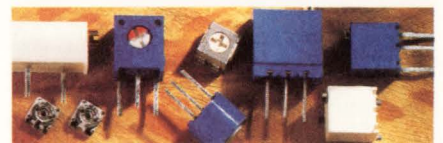

**COMMERCIAL TRIMMERS** include Surface mount: Thick film chips (.2W) plus .197" (.2W) and 1/4" (.25W) square cermet styles. Through-hole cermet styles include: .276" (.5W) round, 1/4" (.25W), 9/32" (.5W), and 3/8" (.5W) square cermet. Rectangular: 3/4" (.75W) wirewound.

For more information contact **Dale Electronics, Inc.**, 1155 West 23rd Street, Tempe, Arizona 85282-1883. **Phone (602) 967-7874.**



# Now, find errors fast, with a portable 1 GSa/s scope that gets right to the point.

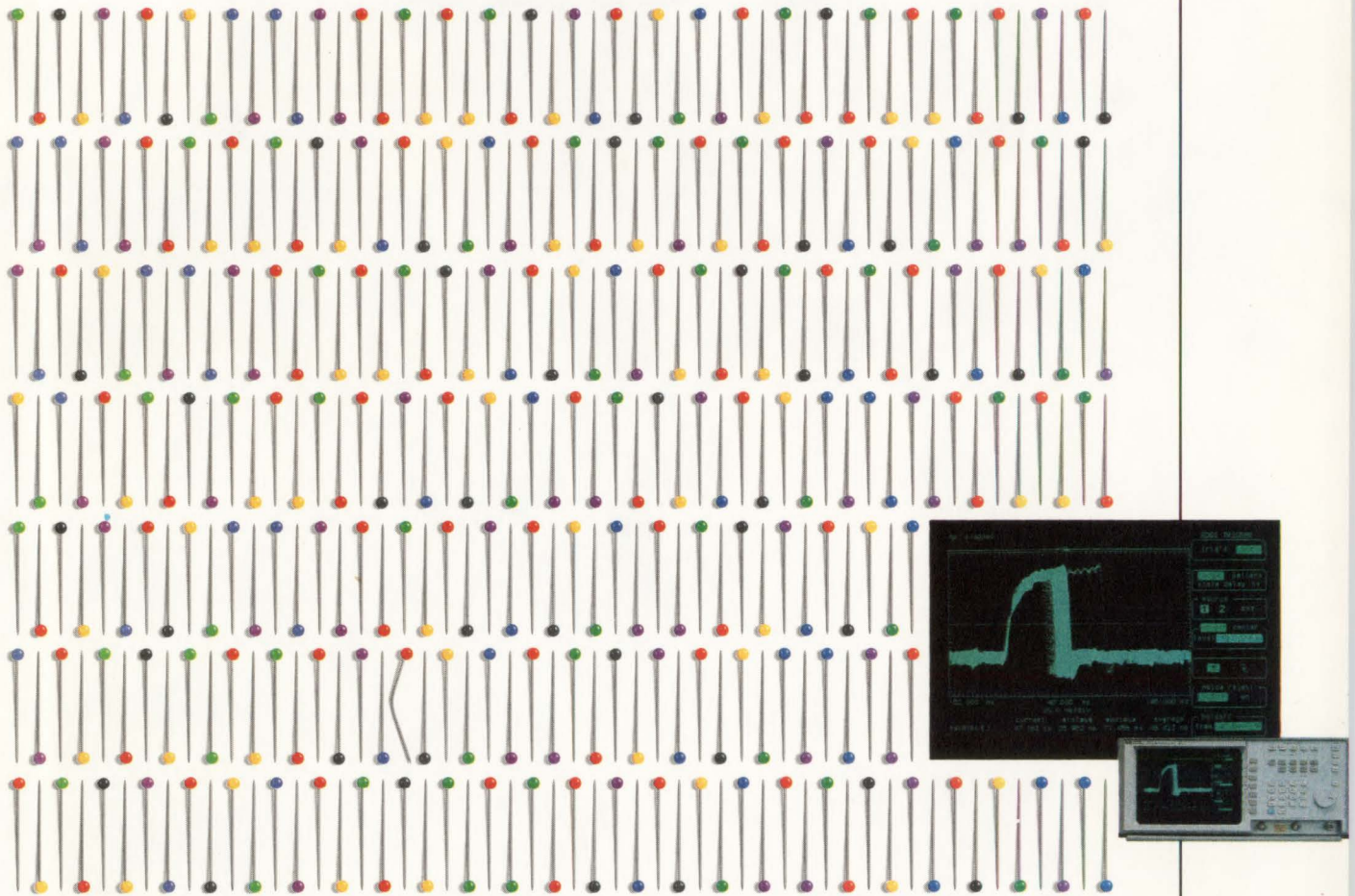

## At \$10,950\*, you won't find a better value in a digitizing scope.

When you need to troubleshoot and debug digital designs fast, you can't afford to miss a thing. And now, you don't have to. The HP 54510A looks at a billion samples a second with a time-qualified pattern triggering and an infinite persistence display to pinpoint rare events and elusive glitches the instant they happen.

You don't have to stick around to watch, either. The HP 54510A has 8k of memory per channel to capture and store single events. So, you can go back and get all the details you need—with razor-sharp, 8-bit resolution—and track the problem to its source. And to point you to the right solution, the HP 54510A gives you 17 pulse-parameter measurements, with better horizontal and vertical accuracy than the Tek DSA 602, at one-third of the cost.

So, if you're looking for a solution to high-speed troubleshooting, call **1-800-752-0900\*\***. Ask for **Ext. 1902**, and we'll send you an application note on the HP 54510A that shows you how to find faults fast.

\*U.S. price only.

\*\*In Canada call 1-800-387-3867, Dept. 423.

There is a better way.

 **HEWLETT  
PACKARD**

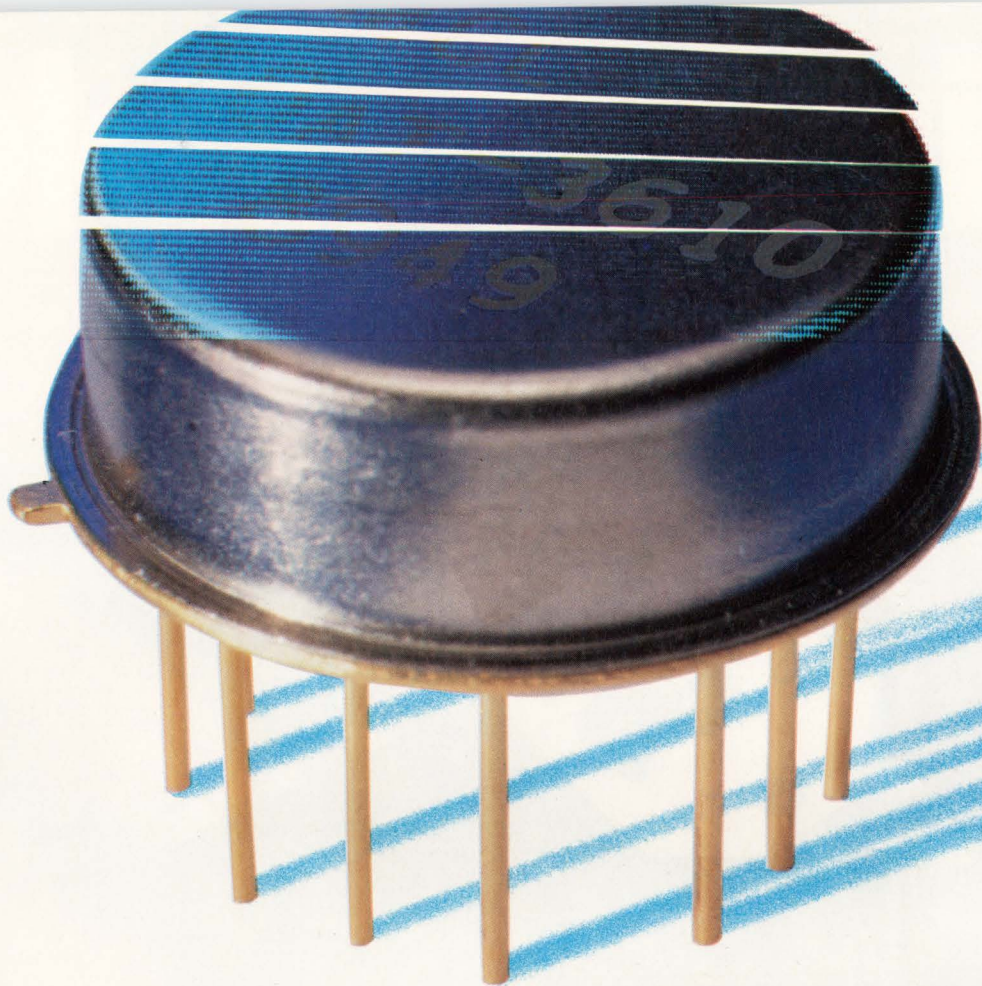

# PRECISION TTL-CONTROLLED ATTENUATORS

up to 35dB  
10 to 1000MHz  
only **\$5995**

TOAT-R512 Accuracy (dB) (+/-dB)		TOAT-124 Accuracy (dB) (+/-dB)		TOAT-3610 Accuracy (dB) (+/-dB)		TOAT-51020 Accuracy (dB) (+/-dB)	
<b>0.5</b>	<b>0.12</b>	<b>1.0</b>	<b>0.2</b>	<b>3.0</b>	<b>0.3</b>	<b>5.0</b>	<b>0.3</b>
<b>1.0</b>	<b>0.2</b>	<b>2.0</b>	<b>0.2</b>	<b>6.0</b>	<b>0.3</b>	<b>10.0</b>	<b>0.3</b>
1.5	0.32	3.0	0.4	9.0	0.6	15.0	0.6
<b>2.0</b>	<b>0.2</b>	<b>4.0</b>	<b>0.3</b>	<b>10.0</b>	<b>0.3</b>	<b>20.0</b>	<b>0.4</b>
2.5	0.32	5.0	0.5	13.0	0.6	25.0	0.7
3.0	0.4	6.0	0.5	16.0	0.6	30.0	0.7
3.5	0.52	7.0	0.7	19.0	0.9	35.0	1.0

bold faced values are individual elements in the units

Now...precision TTL-controlled attenuators accurate over 10 to 1000MHz and -55 to +100°C. Four models are available in the new TOAT-series, each with 3 discrete attenuators switchable to provide 7 discrete and accurate attenuation levels (see chart). Cascade all four models for up to 64.5dB control in 0.5dB steps. Custom values available on request.

The 50-ohm TOAT-series performs with 6μsec switching speed and can handle power levels up to 0dBm. Units are housed in a rugged hermetically-sealed TO-8 package to withstand the shock, vibration, and temperature stresses of MIL-STD-883. Connector versions are available. Take advantage of the \$59.95 (1-9 qty) price breakthrough to stimulate new applications as you implement present designs and plan future systems.



finding new ways...  
setting higher standards

**Mini-Circuits**

WE ACCEPT AMERICAN EXPRESS

CIRCLE NO. 108

P.O. Box 350166, Brooklyn, New York 11235-0003 (718) 934-4500 Fax (718) 332-4661 Domestic and International Telexes: 6852844 or 620156

F 140 REV. ORIG.

# incredible!

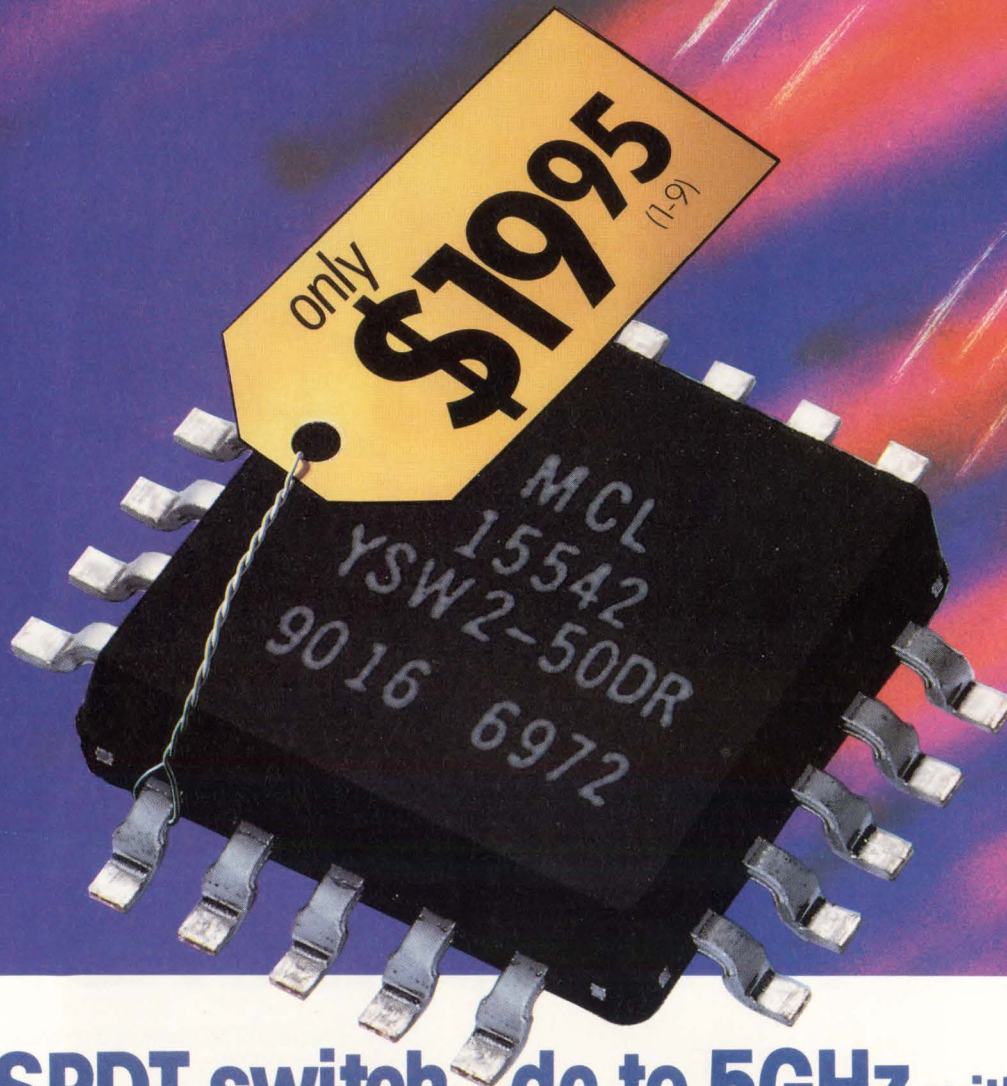

## SPDT switch dc to 5GHz with built-in driver

Truly incredible... a superfast 3nsec GaAs SPDT reflective switch with a built-in driver for only \$19.95. So why bother designing and building a driver interface to further complicate your subsystem and take added space when you can specify Mini-Circuits' YSW-2-50DR?

Check the outstanding performance specs of the rugged device, housed in a tiny plastic case, over a -55° to +85° C span. Unit-to-unit repeatability for insertion loss is 3-sigma guaranteed, which means less than 15 of a 10,000-unit production run will come close to the spec limit. Available for immediate delivery in tape-and-reel format for automatic placement equipment.

### SPECIFICATIONS YSW-2-50DR

	dc- 500MHz	500- 2000MHz	2000- 5000MHz
Insertion loss, typ (dB)	0.9	1.3	1.4
Isolation, typ (dB)*	50	40	28
1dB compression, typ (dBm @ in port)	20	20	24
RF input, max dBm (no damage)	22	22	26
VSWR (on), typ	_____	1.4	_____
Video breakthrough to RF, typ (mV p-p)	_____	30	_____
Rise/Fall time, typ (nsec)	_____	3.0	_____



\*typ isolation at 5MHz is 80dB and decreases 5dB/octave from 5-1000 MHz

finding new ways ...  
setting higher standards



## Mini-Circuits

WE ACCEPT AMERICAN EXPRESS

P.O. Box 350166, Brooklyn, New York 11235-0003 (718) 934-4500 Fax (718) 332-4661 Telexes: 6852844 or 620156



**On the cover:** Using existing telephone lines, the ISDN (Integrated Services Digital Network) lets marketing, design, test, and manufacturing teams merge their efforts simultaneously. See the Special Report on pg 80. (Photo courtesy Philips Components)

## SPECIAL ISSUE: COMMUNICATIONS TECHNOLOGY

### SPECIAL REPORT

#### ISDN-based concurrent design 80

High-bandwidth, all-digital telephone lines will let you develop products using simultaneous inputs from everyone with an interest in the product's success.—*Michael C Markowitz, Associate Editor*

### DESIGN FEATURES

#### Real-time programming—Part 11 97

Earlier parts of this series described several types of task coordination. This final installment classifies the various methods, diagrams the relationships among them, and provides guidelines for choosing methods that suit your requirements.—*David L Ripps, Industrial Programming Inc*

#### Spice simulations use controlled sources to model NTSC signals 117

You can use Spice-variety circuit-simulation software to model NTSC video signals. You can then use these models to design and test video circuits.—*Anthony M Radice, General Instrument Corp*

### TECHNOLOGY UPDATES

#### CAE tools help cure transmission-line woes 47

When pc-board traces act like transmission lines, all manner of problems can arise. CAE tools can help forestall those problems before you build your board.—*Richard A Quinnell, Regional Editor*

#### Fiber-optic transceivers: Modules satisfy FDDI and other standards 61

Transceiver modules are key factors in fiber-optic data links and can implement communications in both local- and wide-area networks.—*Dave Pryce, Associate Editor*

*Continued on page 7*

EDN<sup>®</sup> (ISSN 0012-7515) is published 48 times a year (biweekly with 2 additional issues a month, except for February, which has 3 additional issues and July and December which have 1 additional issue) by Cahners Publishing Company, A Division of Reed Publishing USA, 275 Washington Street, Newton, MA 02158-1630. Terrence M McDermott, President; Frank Sibley, Senior Vice President/General Manager, Boston Division; Jerry D Neth, Senior Vice President/Publishing Operations; J J Walsh, Senior Vice President/Finance; Thomas J Dellamaria, Senior Vice President/Production and Manufacturing; Ralph Knupp, Vice President/Human Resources. Circulation records are maintained at Cahners Publishing Company, 44 Cook Street, Denver, CO 80206-5800. Telephone: (303) 388-4511. Second-class postage paid at Denver, CO 80206-5800 and additional mailing offices. **POSTMASTER:** Send address corrections to EDN<sup>®</sup>, PO Box 173377, Denver, CO 80217-3377. EDN<sup>®</sup> copyright 1991 by Reed Publishing USA; Ronald G Segel, Chairman and Chief Executive Officer; Robert L Krakoff, President and Chief Operating Officer; William M Platt, Senior Vice President. Annual subscription rates for nonqualified people: USA, \$109.95/year; Canada/Mexico, \$135/year; Europe air mail, \$165/year; all other nations, \$165/year for surface mail and \$250/year for air mail. Single copies are available for \$10. Please address all subscription mail to Ellen Porter, 44 Cook Street, Denver, CO 80206-5800.

# THIS IS A BIG TIME GAL.<sup>®</sup>

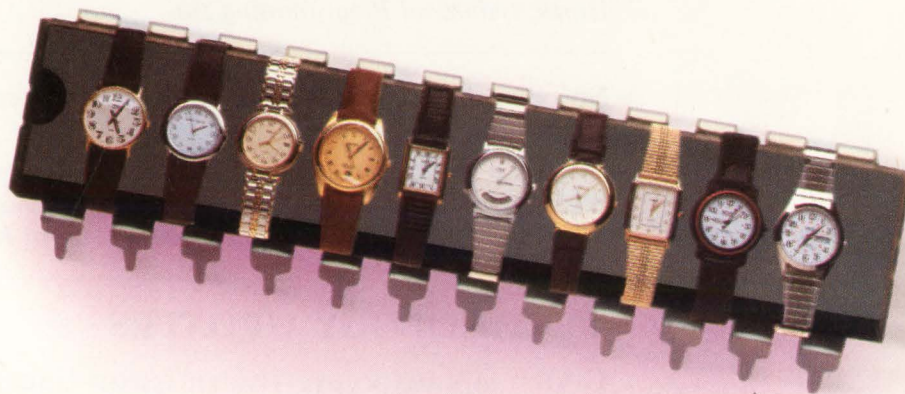

Time is finally on your side. Our new **GAL20RA10-15**, with ten individually programmable clocks and a 15ns propagation delay, offers the world's fastest performance. A combination that delivers the ultimate in design flexibility and speed, all in a 24-pin E<sup>2</sup>CMOS<sup>®</sup> GAL device.

For example, design engineers can independently clock, reset and preset each of ten output logic macrocells. These individually programmable clocks enable asynchronous designs, taking your system performance to even higher levels.

If your design is ready for the big time, call **1-800-FASTGAL**, and ask for dept. 203. We'll send you free samples and a data-book describing our entire line of high speed E<sup>2</sup>CMOS GAL devices. Fast.

**For Literature Circle 41**

 **Lattice**  
Semiconductor  
Corporation<sup>™</sup>

5555 Northeast Moore Court • Hillsboro, Oregon 97124

**Leader in E<sup>2</sup>CMOS PLDs.<sup>™</sup>**



**VP/Publisher**  
Peter D Coley

**Associate Publisher**  
Mark Holdreith

**VP/Editor/Editorial Director**  
Jonathan Titus

**Managing Editor**  
Joan Morrow Lynch

**Assistant Managing Editor**  
Christine McElvenny

**Special Projects**  
Gary Legg

**Home Office Editorial Staff**  
275 Washington St, Newton, MA 02158  
(617) 964-3030

Tom Ormond, *Senior Editor*  
Charles Small, *Senior Editor*  
Jay Fraser, *Associate Editor*  
John A Gallant, *Associate Editor*  
Michael C Markowitz, *Associate Editor*  
Dave Pryce, *Associate Editor*  
Carl Quesnel, *Associate Editor*  
Susan Rose, *Associate Editor*  
Julie Anne Schofield, *Associate Editor*  
Dan Strassberg, *Associate Editor*  
Chris Terry, *Associate Editor*  
Helen McElwee, *Senior Copy Editor*  
James P Leonard, *Copy Editor*  
Gabiella A Fodor, *Production Editor*  
Brian J Tobey, *Production Editor*

**Editorial Field Offices**

Steven H Leibson, *Senior Regional Editor*  
Boulder, CO: (303) 494-2233

Doug Conner, *Regional Editor*  
Atascadero, CA: (805) 461-9669

J D Mosley, *Regional Editor*  
Arlington, TX: (817) 465-4961

Richard A Quinell, *Regional Editor*  
Aptos, CA: (408) 685-8028

Anne Watson Swager, *Regional Editor*  
Wynnewood, PA: (215) 645-0544

Maury Wright, *Regional Editor*  
San Diego, CA: (619) 748-6785

Brian Kerridge, *European Editor*  
(508) 28435  
22 Mill Rd, Loddon  
Norwich, NR14 6DR, UK

**Contributing Editors**  
Robert Pease, Don Powers,  
David Shear, Bill Travis

**Editorial Coordinator**  
Kathy Leonard

**Editorial Services**  
Helen Benedict

**Art Staff**  
Ken Racicot, *Senior Art Director*  
Chinsoo Chung, *Associate Art Director*  
Cathy Madigan, *Staff Artist*  
Sharon O'Brien, *Staff Artist*

**Production/Manufacturing Staff**  
Andrew A Jantz, *Production Supervisor*  
Sandy Wucinich, *Production Manager*  
Melissa Carman, *Production Assistant*  
Diane Malone, *Composition*

**Director of Art Department**  
Robert L Fernandez  
Norman Graf, *Associate*

**VP/Production/Manufacturing**  
Wayne Hulitzky

**Director of Production/Manufacturing**  
John R Sanders

**Business Director**  
Deborah Virtue

**Marketing Communications**  
Anne Foley, *Promotion Manager*  
Pam Winch, *Promotion Assistant*

## EDITORS' CHOICE

Logic-synthesis software 73

## PRODUCT UPDATE

100-MHz-bandwidth DSOs 76

## DESIGN IDEAS

Amplifier scheme lowers drift and noise 135

IC converts from TTL to ECL and back 136

Feedback and amplification 138

## EDITORIAL

41  
Although we're in a recession, you can still work toward identifying technical and business opportunities.

## NEW PRODUCTS

Test & Measurement Instruments . . . . . 143

Integrated Circuits . . . . . 147

Computers & Peripherals . . . . . 155

CAE & Software Development Tools . . . . . 160

Components & Power Supplies . . . . . 166

## DEPARTMENTS

News Breaks . . . . . 15

Signals & Noise . . . . . 27

Ask EDN . . . . . 33

Career Opportunities . . . . . 174

Book Review . . . . . 181

EDN's International Advertisers Index . . . . . 183

Cahners Publishing Company, A Division of Reed Publishing USA  Specialized Business Magazines for Building & Construction  Research  Technology  Electronics  Computing  Printing  Publishing  Health Care  Foodservice  Packaging  Environmental Engineering  Manufacturing  Entertainment  Home Furnishings  and Interior Design. Specialized Consumer Magazines for Child Care  Boating  and Wedding Planning.

# NOW, LOGIC ANALYZERS AT THE SPEED

**The NEW Tek Centurion:**

**400 MHz timing analysis.**

**100 MHz state analysis.**

**100 MHz complex triggering.**

**100 MHz synchronous clocking.**

**100 MHz timestamp.**

RISC chips. CISC chips. High-speed busses. At the leading edge of clock speeds, channel counts and complex integration, one logic analyzer is equal to the test.

The Tek Centurion.

Centurion supplies an unprecedented 400 MHz timing. Plus 100 MHz synchronous acquisition on 96 channels at once—*all on one card.* You can expand to hundreds of channels in a single mainframe, with up to 32K memory depth per channel!

Add the most revealing disassembly in the industry, for any processor pictured here. Add the easiest, most compact probing. Get real powers of analysis, not just ordinary acquisition capabilities.

Call 1-800-426-2200 to learn more about this great leap forward in logic analysis. Or see your Tek sales engineer for a personal demo soon.

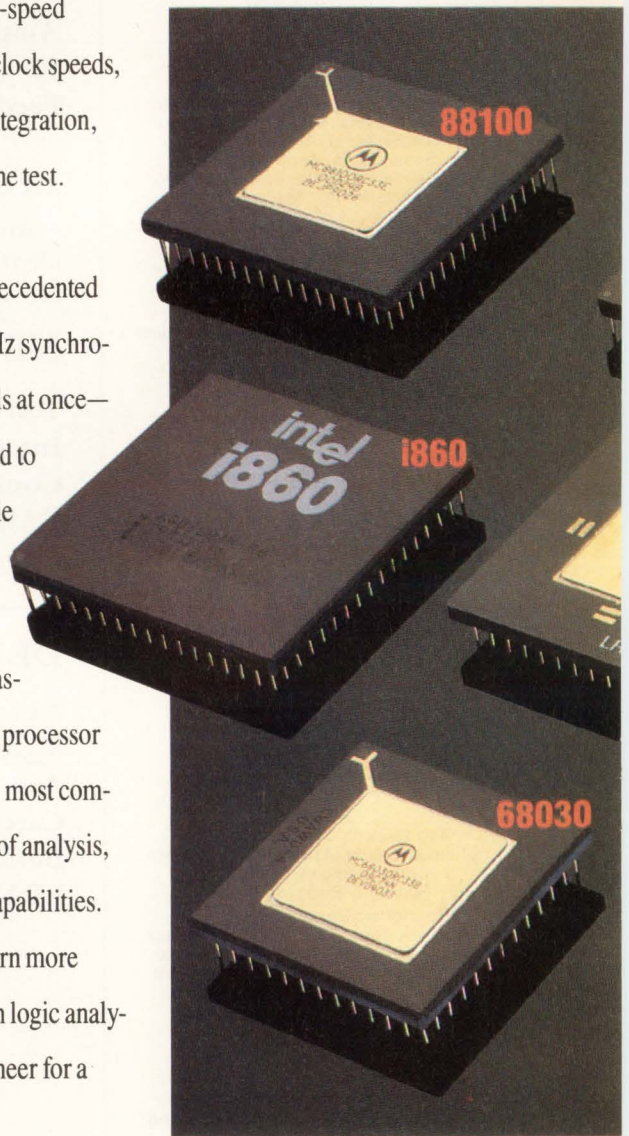

# ANALYSIS OF RISC.

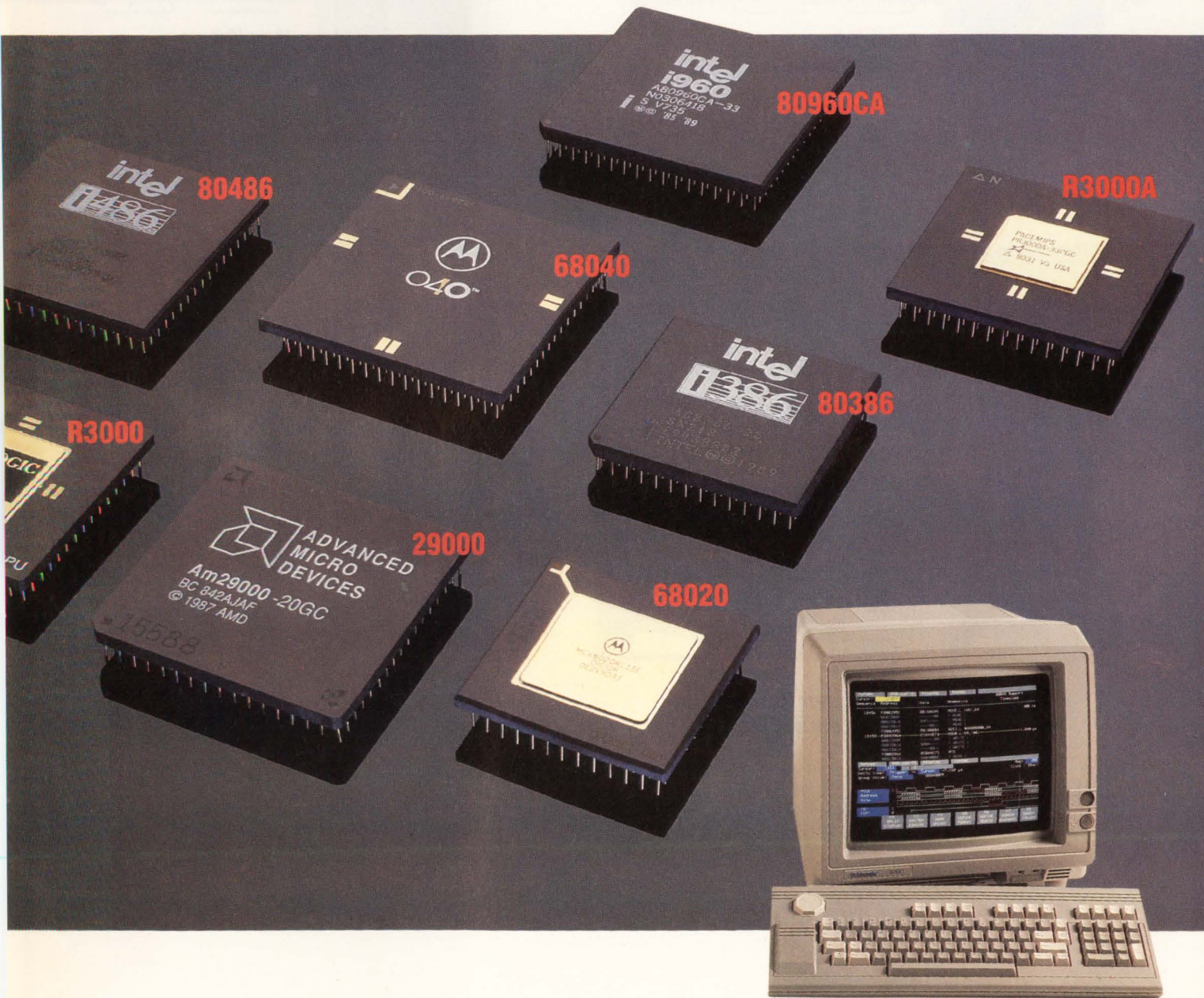

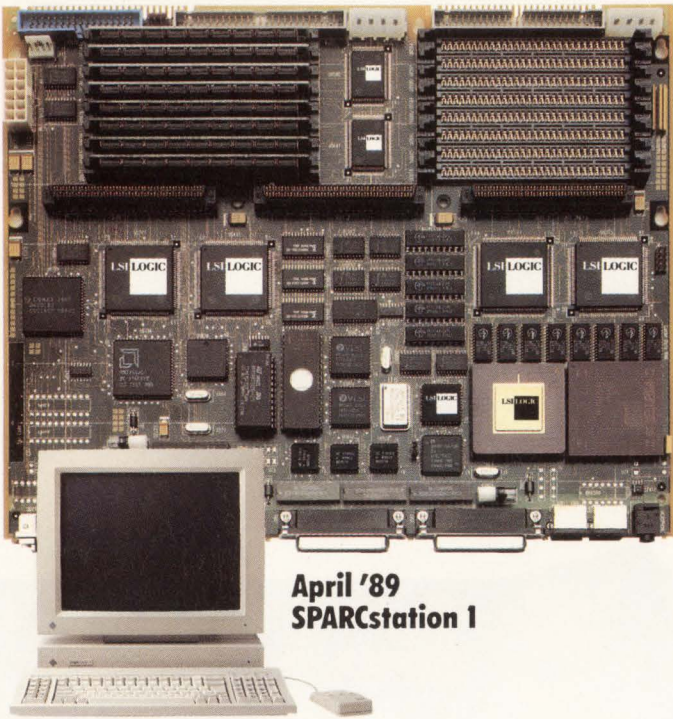

**April '89  
SPARCstation 1**

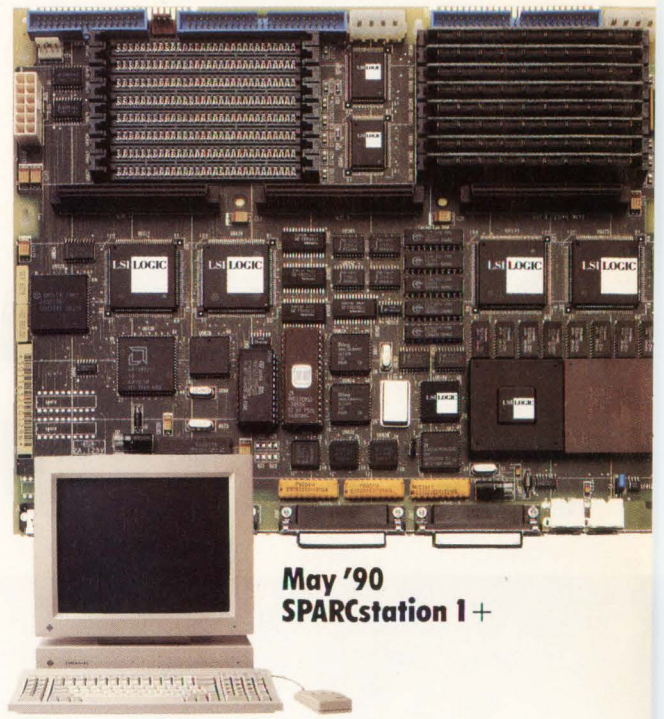

**May '90  
SPARCstation 1+**

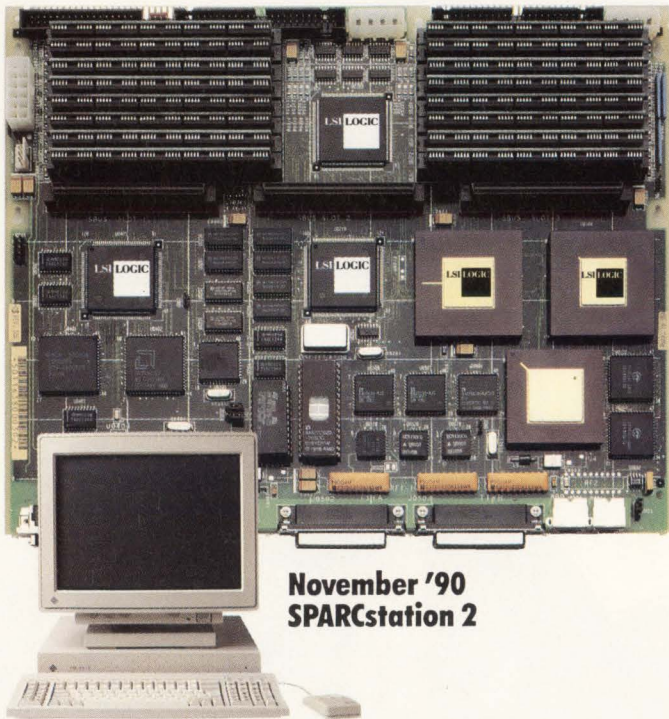

**November '90  
SPARCstation 2**

# LSI HAS ANOTHER

© LSI Logic Corporation 1990. Sun Microsystems is a registered trademark of Sun Microsystems, Inc. SPARC is a registered trademark of SPARC International, Inc., and SPARCstation is used under license therefrom. UNIX is a registered trademark of AT&T Bell Labs.

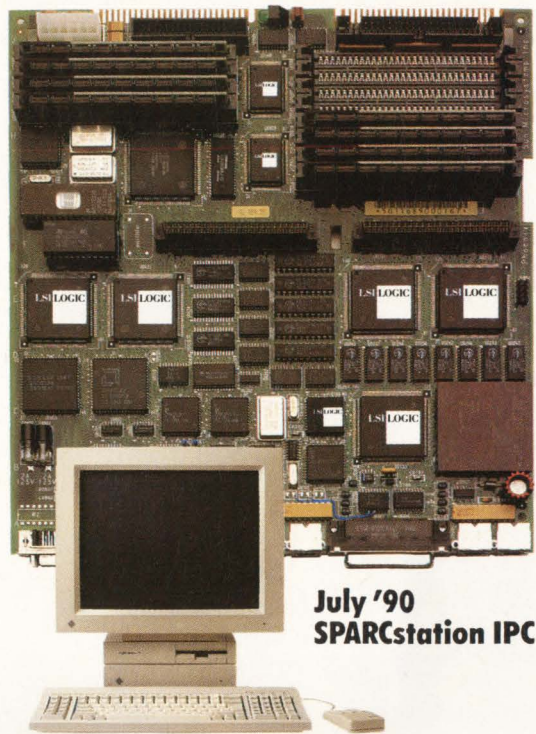
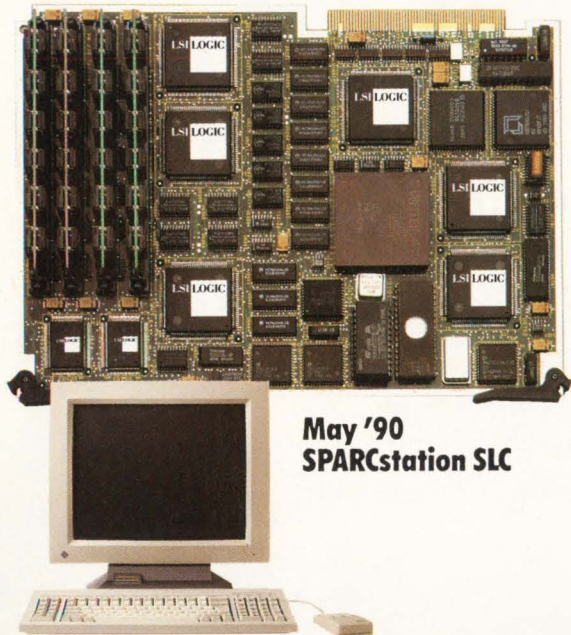

# S JUST MADE ER SUN SHINE.

Since introducing SPARCstation 1 in April '89, Sun has utilized LSI Logic's RISC and ASIC technology and design methodology to pack more processing power into smaller footprints.

This strategic partnership has enabled Sun to compress time to market to an unbelievable four months between new product announcements and has reduced their time to volume. Forever altering the rules on time to market. And capturing the dominant position in the workstation market in the process.

Sun's latest creation, SPARCstation 2, is a shining example. This powerful new workstation was brought to market just four months after the introduction of the

SPARCstation IPC. By leveraging the power of LSI Logic's RISC and ASIC technology, Sun has quickly introduced a whole new level of price/performance in UNIX workstations.

If you have some brilliant new product concepts on your horizon, with windows of opportunity opening as often as every four months, call us at 1-800-451-2742, or write to LSI Logic, 1551 McCarthy Blvd, MS D102, Milpitas, CA 95035.

We'd like to show you how quickly your new product can see the light of day.

LSI LOGIC®

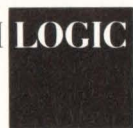

ACROSS THE BOARD

*“Technology Solutions”*

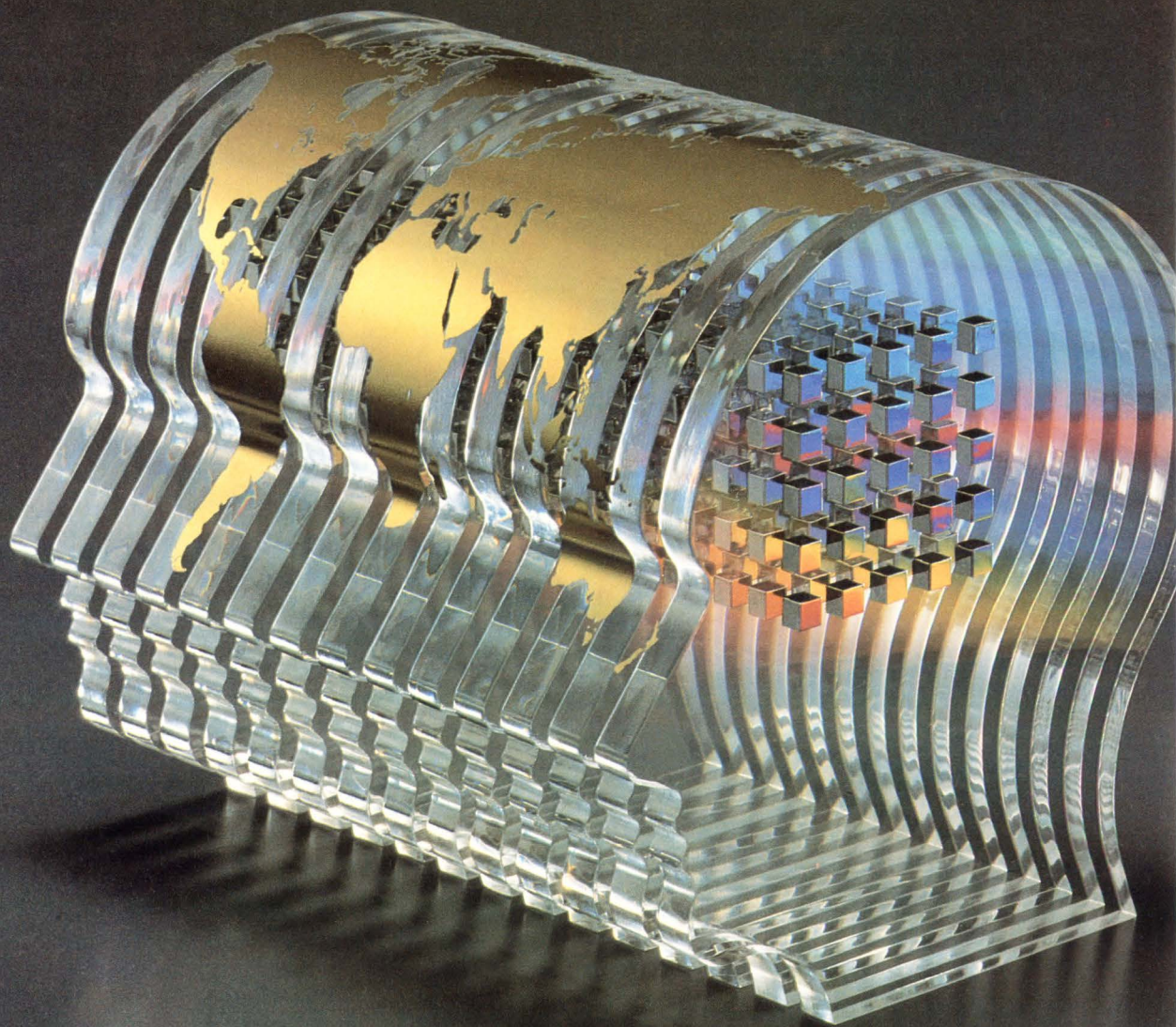

# from a Globewide Partner

## Better design and production solutions with Oki Systems Thinking

Around the world, Oki Systems Thinking takes an overall look at your project's many needs, based on our all-round expertise in design, packaging and manufacturing, and finds integrated solutions, to help you more easily meet every demand of the project. With Oki Systems Thinking, our goal is nothing less than total customer satisfaction.

### *Regional production centers*

Oki sometimes has to give you more than you ask for in meeting your diverse needs, such as regional production centers that assure you of stable supplies of critical components and enhance Oki's flexible customer support capabilities...

Oki is establishing these capabilities within each overseas market, whether its at Portland, Oregon; Nancy, France; Aguadilla, Puerto Rico, or Ayutthaya Province, Thailand. At Oki, manufacturing is closely integrated with our regional design and packaging facilities as part of Oki Systems Thinking—to provide "technology solutions" in memories, ASICs, microprocessors, custom LSIs, telecom LSIs and complex custom board-level products.

### *Sharing technology and manufacturing expertise*

Oki works hard to be a part of each

community we operate in, transferring expertise to local sites and forming joint ventures to more quickly integrate advanced technology into markets where it is needed.

And, speaking of technology, at Oki you'll find super-clean environments, ultra-fine rule process technology, advanced factory automation, and, of course, total quality control.



*Tualatin, Oregon, USA:* Oki's newest US semiconductor plant currently manufactures 1M DRAMS and SIMMs, with plans to diversify its production.

**Oki Electric Industry Co., Ltd.**  
**Electronic Devices Group**  
Overseas Marketing Group  
7-5-25 Nishishinjuku, Shinjuku-ku,  
Tokyo 160, Japan  
Tel: +81-3-5386-8100  
Fax: +81-3-5386-8110  
Telex: J27662 OKIDENED

**Oki Electric Europe GmbH**  
Hellersbergstraße 2, 4040 Neuss  
Germany  
Tel: +49-2101-15960  
Fax: +49-2101-103539  
Telex: 8517427 OKI D

**Oki Semiconductor Group**  
785 North Mary Avenue,  
Sunnyvale, CA 94086, U.S.A.  
Tel: +1-408-720-1900  
Fax: +1-408-720-1918  
Telex: 910-338-0508 OKI SUVL

**Oki Electronics  
(Hong Kong) Ltd.**  
Suite 1801-4, Tower 1  
China, Hong Kong City, 33  
Canton Road., T.S.T. KLN,  
Hong Kong  
Tel: +852-7362336  
Fax: +852-7362395  
Telex: 45999 OKIH HX



# OKI

**Oki Electric Industry Co., Ltd.**  
Tokyo, Japan

# We've put CMOS on display.

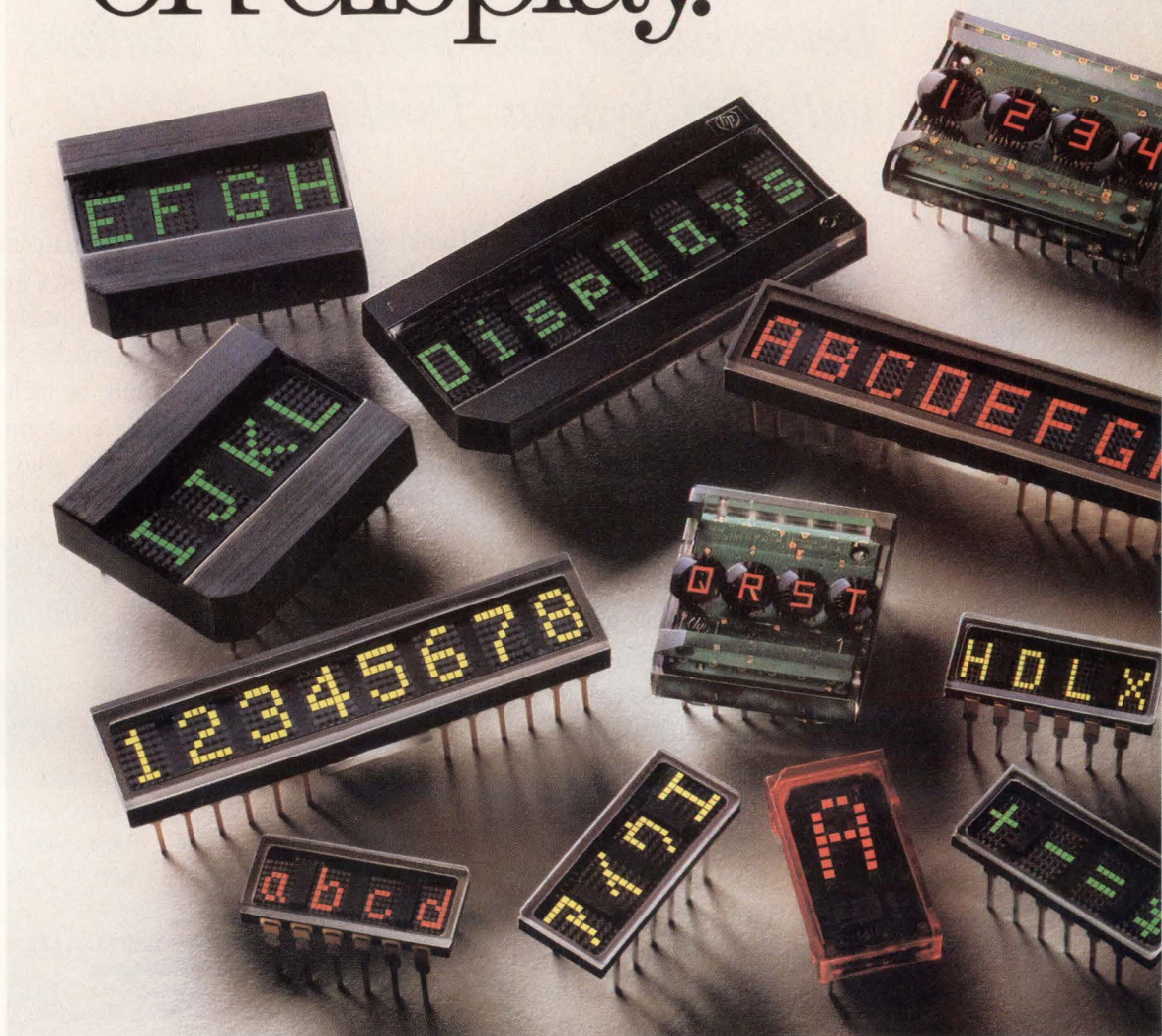

If you're looking for the right LED display solution, take a look at HP. We've got a full line of low-power, easy-to-use alphanumeric CMOS displays.

All featuring an integrated on-board CMOS IC. And all designed to provide you with a better way to meet your display requirements.

Take our eight-character 5 x 7 smart alphanumeric display, for example. It's the industry's only customizable display. With up to 16 user-defin-

able characters and the capability to generate foreign characters, special symbols and logos.

Or choose from four-character 5 x 7 CMOS displays in all four LED colors.

Smart 16-segment displays with built-in RAM, ASCII decoder and LED drive circuitry. Which also come in a drop-in 5 x 7 dot-matrix upgrade.

And single-character red hexadecimal displays with a 4 x 7 dot-matrix display.

Best of all, they're from HP. So you're always assured of HP's commitment to excellence in service, support and reliability.

For a free brochure describing our full line of CMOS display solutions, call 1-800-752-0900 ext. 233H. And see how easy it is to shine.

**There is a better way.**



CG08902



# NEWS BREAKS

---

EDITED BY SUSAN ROSE

## **PC-BASED SYSTEM READS 50,000 SAMPLES/SEC**

Dataq Instruments' Coda version 5.3 is a computer-based oscillograph for real-time data acquisition and analysis that combines IBM PC/AT hardware and MCA software. The oscillograph can acquire, display, and store waveform data at rates reaching 50,000 samples/sec over as many as 16 channels. The package lets you select from three real-time display modes, a variety of frequency-domain analysis tools, and a built-in statistics program. It also performs automatic date and time stamping, on-the-fly control of all recording functions, X-Y waveform plotting, and channel-by-channel scaling and calibration in any linear unit of measure. You can customize the \$2790 system by linking it to C-language programs. Dataq Instruments Inc, Akron, OH, (800) 553-9006, FAX (216) 434-5551.—J D Mosley

## **REPEATER IC HANDLES TWISTED-PAIR ETHERNET**

National Semiconductor's DP83950 repeater interface controller (RIC) for Ethernet hub applications has 13 ports. One port is Attachment Unit Interface (AUI) compatible; the other 12 have integrated 10Base-T transceivers. You can cascade devices to form a hub that contains as many as 832 ports and behaves as a single logical device.

The IC has internal counters and registers that collect network performance statistics, such as time between packets, collision occurrence, and phase-lock errors. It also provides status display signals that let you drive as many as 60 LEDs to indicate the status of each port visually. The IC includes an encoder/decoder and PLL clock-recovery circuits, an elasticity buffer for regenerating preamble codes, and a  $\mu$ P interface. The \$145 (100) IC is available in sample quantities. National Semiconductor Corp, Santa Clara, CA, (408) 721-7020, FAX (408) 732-9742.

—Richard A Quinnell

## **DEVELOPMENT BOARD INCORPORATES FERROELECTRIC MEMORY**

After five years of development, you can finally get your hands on nonvolatile memory based on ferroelectric materials from Ramtron Corp. However, you cannot buy the memory chips themselves. Instead, these devices are installed on the company's \$4995 FEDS-1 evaluation and development board. This board plugs into an IBM PC/AT bus slot and couples 16 FMx 1208 ferroelectric RAM chips to an Intel 8097 microcontroller. Each chip contains 512 bytes of 250-nsec, nonmultiplexed, ferroelectric-based dynamic RAM (DRAM). The board can operate this memory in two modes: In the dynamic mode, the ferroelectric RAMs operate like DRAMs with unlimited read/write capabilities. In nonvolatile mode, the memory chips will store data for more than one year without power and can endure more than  $10^6$  power cycles.

The onboard 8097  $\mu$ C and the host PC have access to the ferroelectric memory. The package includes development software that runs on the host PC and a monitor program that runs on the onboard 8097  $\mu$ C. The board is a demonstration vehicle for the company's initial ferroelectric parts; the company plans to offer higher-capacity parts later this year. Ramtron Corp, Colorado Springs, CO, (719) 481-7000, FAX (719) 481-9170.—Steven H Leibson

# NEWS BREAKS

---

## **PRECISION OP AMPS FIT IN DIGITAL BITS**

Max425 and Max426 CMOS op amps from Maxim Integrated Products use internal nulling for low drift. First, a nulling cycle shorts the op amps' input and determines a correction factor for zeroing the input stages. On-chip control logic stores the correction factor, which remains applied to the input stages via 8- and 16-bit DACs. You can program the 50-msec nulling cycle at power-up, once per minute, or on command. The second nulling technique uses a 300-Hz commutating input stage to minimize the effect of the op amp's input offset voltage ( $V_{IO}$ ) and 1/f noise. Key maximum specifications are 5- $\mu$ V  $V_{IO}$ , 0.05- $\mu$ V/ $^{\circ}$ C  $V_{IO}$  TC, and 200-pA input bias current.  $V_{IO}$  noise in a 0.1- to 10-Hz bandwidth is typically 0.25  $\mu$ V p-p. Both op amps have 140-dB-min open-loop voltage gain, and a common-mode and power-supply rejection-ratio of 120 dB min. Internal compensation yields gain bandwidths of 350 kHz and 15 MHz for the Max425 and Max426, respectively. Price is \$9.50 (100). Maxim Integrated Products, Sunnyvale, CA, (408) 737-7600, FAX (408) 737-7194.  
—Brian Kerridge

## **SCIENTISTS MASS PRODUCE SEMICONDUCTOR LASERS**

Scientists at IBM's Zurich Research Laboratory have fabricated between 5000 and 20,000 lasers on a 2-in. wafer by using 1/5000th-in.-deep trenches etched into a semiconductor wafer. In addition to being useful for reading compact discs, printing copy in laser printers, and transmitting information along fiber-optic networks, these lasers might be integrated onto optoelectronic chips that carry data using both light and current. Once etched into the wafer, the lasers are coated with a semireflective material that improves reliability. IBM Research Div, Yorktown Heights, NY, (914) 945-2885, FAX (914) 945-1263.—Michael C Markowitz

## **ASIC CHIP SET INTEGRATES TOUCH-INPUT TECHNOLOGY**

CT ASIC is a 3-chip set of mixed-mode ICs from Carroll Touch. The chip set includes one ASIC, a masked 80C52, and an EEPROM that stores your touch system's parameters. This chip set uses 40% less pc-board space than an equivalent circuit made from discrete components. The chips' phototransistor conditioning circuits handle complex signal-processing functions, such as calibration, gain storage, and ambient-light level tracking. The chip set starts at \$2000, which includes 10 hours of engineering consultation and support. You must negotiate a royalty fee and a per-program fee for the schematic. Carroll Touch, Round Rock, TX, (512) 244-3500, FAX (512) 244-7040.—J D Mosley

## **KIT LOWERS MULTIPROCESSOR DEVELOPMENT COST**

The Transputer Education Kit from Computer System Architects includes a PC-based expansion card (which incorporates one Inmos T400 Transputer), a large collection of development software, and 1500 pages of documentation. The \$236 kit eliminates one of the many factors impeding multiprocessor system development—the cost of development hardware and software. (Note: You must add 1 to 4M bytes of RAM chips to the board.) The expansion card incorporates five high-speed serial ports for connecting additional processor boards to create a multiprocessor system. Additional processor boards without software, documentation, or memory cost \$150. The development software package includes Occam and C cross-compilers; a cross-assembler; a source-level debugger; and example, demonstration, and diagnostic programs. Computer System Architects, Provo, UT, (801) 374-2300, FAX (801) 374-2306.—Steven H Leibson

# EMBEDDED CONTROL BOTTLENECKS ARE NOW JUST A FLEETING MEMORY.

## New 512K CMOS PROMs optimize performance.

As embedded control microprocessors shift into high gear, you need memory solutions that won't jam up system performance.

With access times as low as 20 ns, our 512K PROMs with fast column access let your microprocessor read right from PROM. For applications from communications and networking to peripherals and avionics, these high-performance, high-density, low-power, CMOS PROMs move embedded control performance into the fast lane.

Choose the CY7C285 or CY7C289 for a 64-byte page and WAIT signal that eliminates invalid data. Address latches in the CY7C289 give you the speed you need to support high-speed RISC or CISC microprocessors. Pick the CY7C286 for the highest overall performance available at 50 ns. The CY7C287 offers registered outputs and synchronous operation.

You get higher performance than bipolar PROMs, but the power savings of CMOS.



512K x 8 Reprogrammable Fast Column Access PROM, 20 ns



512K x 8 Reprogrammable PROM



512K x 8 Reprogrammable Registered PROM



512K x 8 Reprogrammable Fast Column Access PROM

## Highest performance PROMs optimize board space.

Reduce your board parts count with the CY7C289, featuring an ALE option for synchronous address registers or asynchronous address latches.

Eliminate SRAMs in program store applications. Slim 300-mil packages and on-board registers help you save even more space.

Don't let memory put the brakes on your system performance. Find out how you can make embedded control bottlenecks a distant memory with these and other high-speed PROMs from Cypress Semiconductor. Redeem your certificate for a free mechanical sample.

Call today for your  
Free Sample Part Certificate  
and PROM Information Kit.  
1-800-952-6300\*  
Ask for Dept C4N.



CYPRESS  
SEMICONDUCTOR

\*1-(800) 387-7599 in Canada. (32) 2-672-2220 in Europe.  
© 1991 Cypress Semiconductor, 3901 North First Street, San Jose,  
CA 95134. Phone: (408) 943-2600, Telex: 821032 CYPRESS SNJ UD,  
TWX: 910-997-0753.

# NEWS BREAKS

---

## **COMPLETE DATA-ACQUISITION SYSTEM ON ONE BOARD**

The DAP 800 from Microstar Laboratories is an IBM PC/XT and PC/AT data-acquisition board with an 80C188 processor and 256k bytes of buffer memory. The board accepts eight 12-bit analog inputs and provides two 12-bit analog outputs. A programmable gain amplifier offers gains of 1, 10, 100, and 1000. For digital signals, the board has 8-bit input and output ports. The sample rate is 60,000 samples/sec max.

The board comes with software for real-time multitasking data-acquisition and control. The software performs more than 100 standard data-acquisition and -processing functions from closed-loop process control to spectral analysis with fast Fourier transforms. You can also download custom commands from a host computer. Because the board logs and processes data internally, it doesn't slow down the host computer while operating, which frees the host for other activities. The board is \$1195. A higher-speed version of the board (100,000 samples/sec) is \$1295. A stand-alone version, the DAP 801, which requires a single 5V supply, is \$1395. Microstar Laboratories, Redmond, WA, (206) 881-4286, FAX (206) 881-5494.—Doug Conner

## **SPICE SIMULATOR MODELS SWITCH-MODE POWER SUPPLIES**

The PSpice circuit-analysis program, version 4.05, from Microsim Corp makes simulating switch-mode power supplies easier. A cycle-by-cycle simulation of switch-mode supplies is difficult for Spice-based simulators and usually lengthens simulation times. However, this program's behavioral modeling and mixed analog/digital simulation features, which are separately priced options, let you use PWM macro models that simulate the controller section in the digital domain. Other new features include .SAVEBIAS, .LOADBIAS, and .WATCH statements. You can also specify the voltage between two nodes using the .NODESET and .IC statements. Prices for the package start at \$950. A power-supply-simulation package costs \$3950. Microsim Corp, Irvine, CA, (800) 245-3022, FAX (714) 455-0554.—Anne Watson Swager

## **VTC VMEBUS CONTROLLERS STILL AVAILABLE**

The VIC068 and VAC068 interface and control ICs for the VMEbus, developed by Control Data Corp's VTC facility, are still available. Cypress Semiconductor, the facility's new owner, will operate the plant as a wholly-owned subsidiary, Cypress Minnesota Inc.

The two ICs provide interface and address control for central processors and peripherals connecting to the VME bus. The VAC068 provides address transceivers, address decoding, DMA, and block-level transfer circuitry. The VIC068 handles arbitration, interrupts, and data transfers. Both devices connect directly to CPUs in the 680X0 family, but are usable with other CPUs. In 144-pin plastic pin-grid arrays, the parts cost \$126 (100) for the VIC068 and \$159 for the VAC068. Cypress Semiconductor, San Jose, CA, (408) 943-2600, FAX (408) 943-2796.—Richard A Quinnell

## **CAE VENDOR STRENGTHENS HDL OFFERINGS**

Viewlogic Systems has enhanced their VHDL (VHSIC hardware description language) software tools with logic synthesis from personal-computer clone vendor Arche Technologies. The software is already integrated into Viewlogic's tools and includes VHDL synthesis, retargeting software, and a technology-library compiler. Viewlogic Systems, Marlboro, MA, (508) 480-0881, FAX (508) 480-0882. Arche Technologies, Fremont, CA, (415) 623-8100, FAX (415) 683-6754.—Michael C Markowitz

# OrCAD presents Release IV

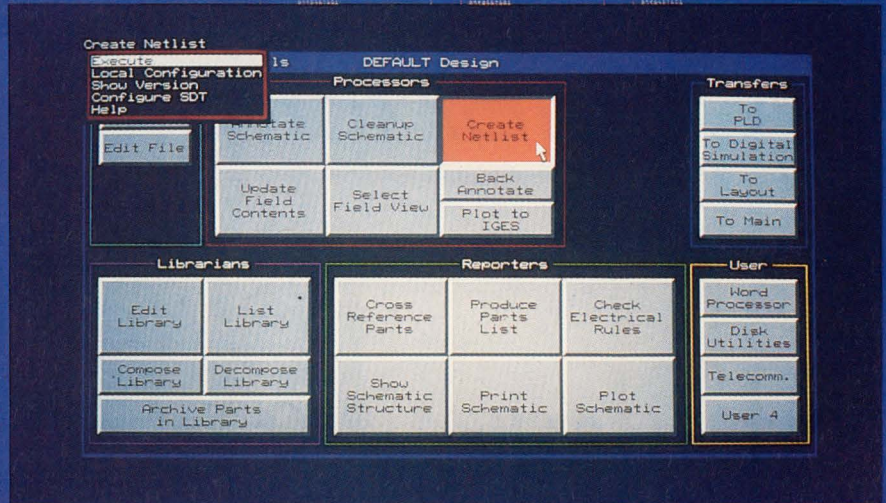
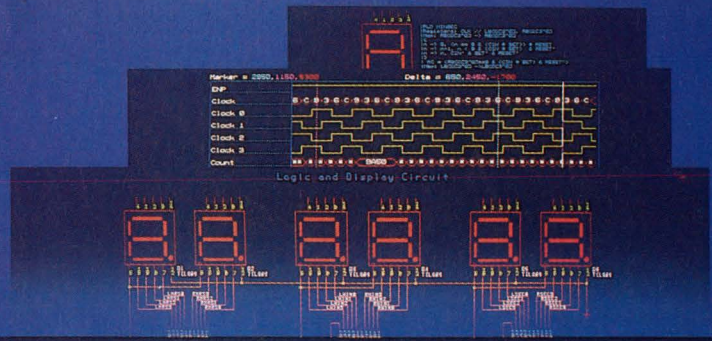

## The limits are gone

OrCAD has introduced the greatest product upgrade in its history. Memory limits, design restrictions, even boundaries between products are all disappearing.

For years, OrCAD's competitors have been playing a game of catch-up. With the introduction of Release IV, the race is over. No one will match our price/performance ratio on these features:

- Schematic Parts Library has been increased to over 20,000 unique library parts
- Digital Simulation process has been speeded up by an order of magnitude
- Printed Circuit Board Layout package offers autoplacement and autorouting at no extra charge
- Expanded memory capabilities

### Best of all, OrCAD introduces ESP

ESP is a graphical environment designed specifically for the electronic designer. Software tools appropriate for different stages in the design process are now linked together to form a seamless flow of information. This easy-to-use framework relieves the designer of time consuming tasks and the inconvenience of moving from one tool set to another. You can now spend more time productively designing.

### For more information . . .

You need to know more about Release IV and all of the benefits OrCAD has to offer. Call the telephone number below and we'll send you a free demonstration disk.



More designs from more designers

**For more information, call (503) 690-9881**

or write to OrCAD Sales Department, 3175 N.W. Alcock Drive, Hillsboro, Oregon, 97124

# THE WORLD'S LARGEST SELECTION OF **POWER SPLITTERS/ COMBINERS**

**2 KHz to 8 GHz** from **\$10<sup>45</sup>**

With over 300 models, from 2-way to 48-way, 0°, 90° and 180°, a variety of pin and connector packages, 50 and 75 ohm, covering 2KHz to 8000MHz, Mini-Circuits offers the world's largest selection of off-the-shelf power splitter/combiners. So why compromise your systems design when you can select the power splitter/combiner that closely matches your specific package and frequency band requirements at lowest cost and with immediate delivery.

And we will handle your "special" needs, such as wider bandwidth, higher isolation, intermixed connectors, etc. courteously with rapid turnaround time.

Of course, all units come with our one-year guarantee.

For detailed specs and performance data, refer to the *MicroWaves Product Directory, EEM or Mini-Circuits RF/IF Signal Processing Handbook, Vol. II*. Or contact us for our free 68-page *RF/IF Signal Processing Guide*.

finding new ways ...  
setting higher standards

## Mini-Circuits

A Division of Scientific Components Corporation  
P.O. Box 350166, Brooklyn, New York 11235-0003 (718) 934-4500  
Fax (718) 332-4661 Domestic and International Telexes: 6852844 or 620156  
WE ACCEPT AMERICAN EXPRESS

CIRCLE NO. 111

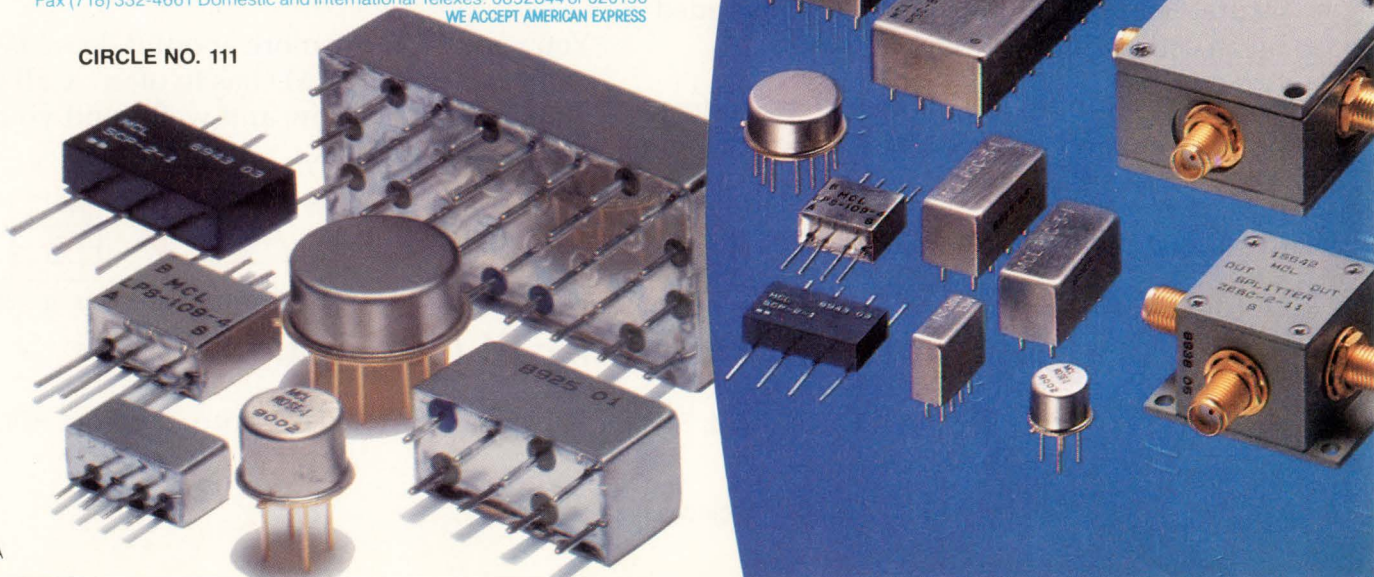

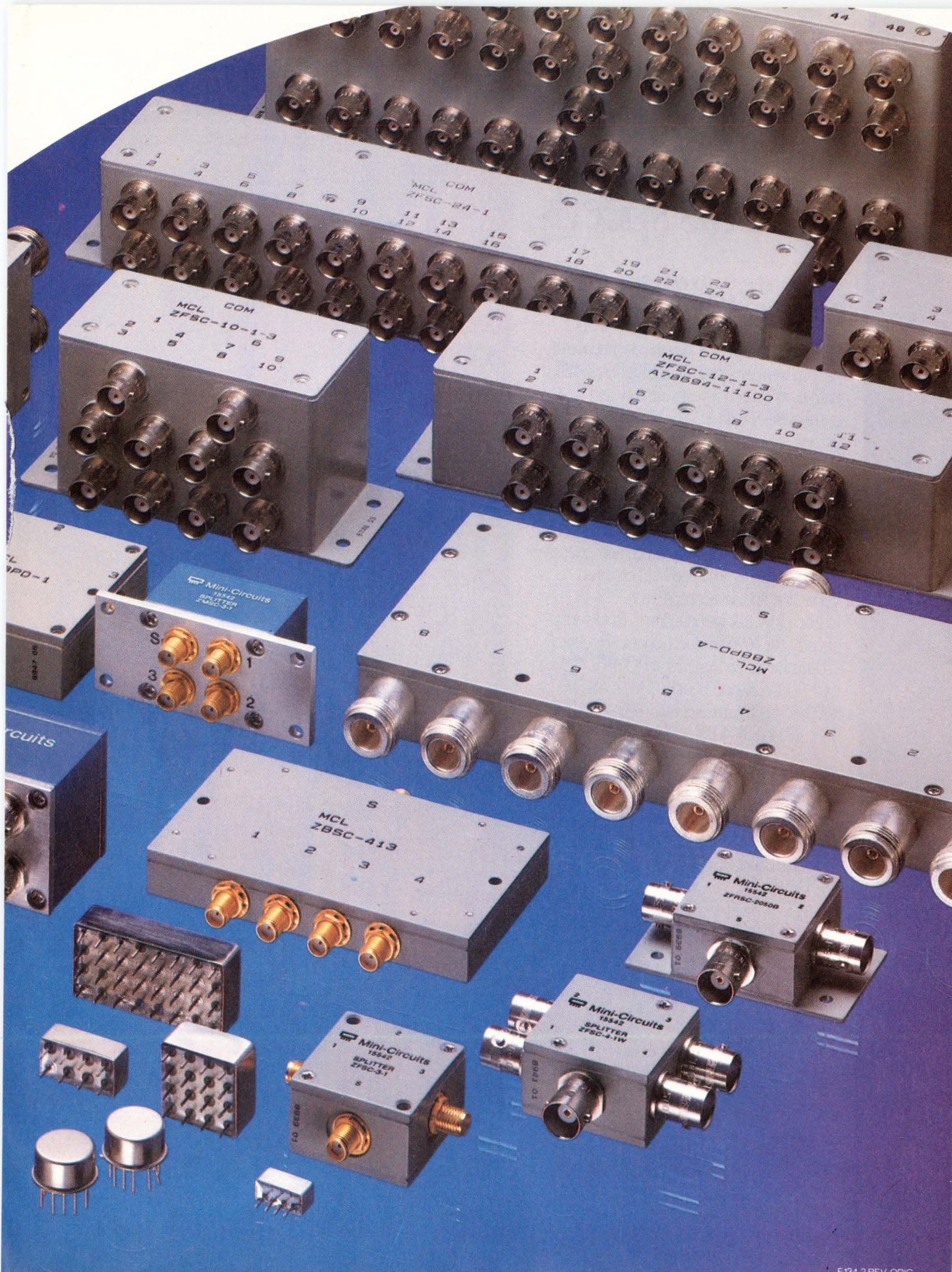

# Take the risk out of V.32 and V.32 bis speeds.

Reaching for the upper limits of modem performance needn't mean taking chances with the results. Rockwell International's RC9696 family gives you the confidence of proven turnkey solutions, the highest installed base in its class, a 5-year warranty and compatibility with V.32 or V.32 bis protocols, as well as with other Rockwell products.

For a basic modem with exceptional throughput, select the V.32/V.32 bis RC9696/14 for its 14.4 kbps speed and Group 3 fax compatibility. Or use the V.32 RC9696AC for 9600 bps speed and extensive features such as V.42 and V.42 bis error correction and data compression.

For a low-risk introduction to Rockwell's speedy RC9696 products, contact Rockwell Communication Systems at P.O. Box C, M.C. 501-300, Newport Beach, CA 92658-8902; (800) 854-8099; in California: (800) 422-4230. Fax—(714) 833-4078 or (714) 833-4391.

## RC9696/14

- Complete V.32 and V.32 bis compatibility
- Highest installed base
- First worldwide product compatible with Group 3 14.4 fax (V.17)\* and V.32 bis
- 14.4 kbps transmission speed, with 12.0 kbps fallback
- Extensive diagnostic capabilities
- Complies with all international standards, including V.22 bis, V.21 and V.23

## RC9696AC

- V.32 compatibility
- AT command set
- V.42 and MNP® 4 error correction protocols
- V.42 bis and MNP® 5 data compression
- Device set includes controller and protocol conversion chip
- Extensive compatibility with other Rockwell products

\*V.17 approval is anticipated in 1991.  
MNP is a registered trademark of Microcom, Inc.



**Rockwell  
International**

...where science gets down to business

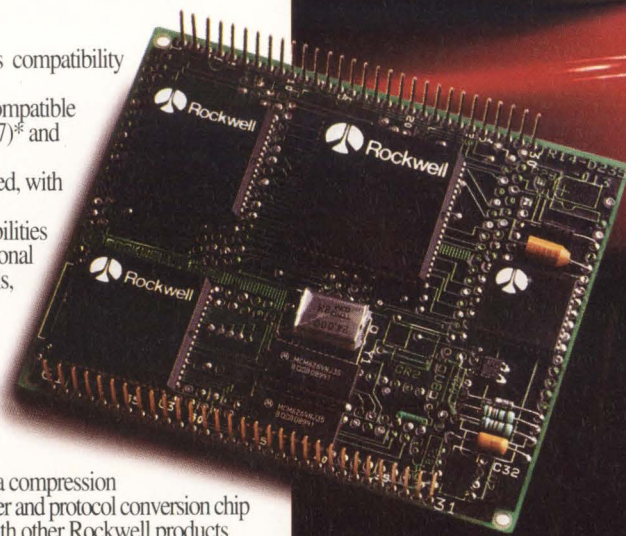



# E

## mulation. Finally, a break from tradition.

Traditional emulation techniques only provide a limited set of diagnostic capabilities and require highly-skilled engineers to prepare test programs and diagnose bad boards. *GenRad's solution automates both programming and diagnostics.*

Hardware interface boards (pods) are processor-specific, hard to develop, and must be continually maintained and verified. *GenRad's integrated emulation approach eliminates this.*

Many processor-specific pods are difficult to connect to the UUT. Some emulation systems even require that the micro-processor be removed, usually impractical in high-efficiency manufacturing operations. *Not so with GenRad.*

GenRad's 275X Performance Test Systems and the GENESIS™ software environment support GenRad's new SoftPod™, a software technology that eliminates the need for special-purpose hardware pods. Combined with GenRad's new Emulation Toolset for GENESIS (ETG™), you have an easy-to-use, integrated emulation test solution, complete with automatic program preparation and comprehensive diagnostics.

If you're ready for a new way of thinking about a cost-effective testing technique, request your copy of "Perspectives On Emulation: An Economic Test Technique."

Call 1-800-4-GENRAD in the U.S., or the GenRad office nearest you in Austria, Canada, England, France, Germany, Italy, Japan, Singapore, Switzerland.



**GenRad**

*A New Way of Thinking*

# WHY THE FIRST 040 VME MIGHT AS WELL BE THE LAST.

*Memory modules available in 4 and 16 MB DRAM or SRAM.*

*DRAM memory module supports burst fill mode for 50 Mbyte/sec memory bandwidth.*

*On board DMA-based architecture provides maximum performance and parallel real-time operation.*

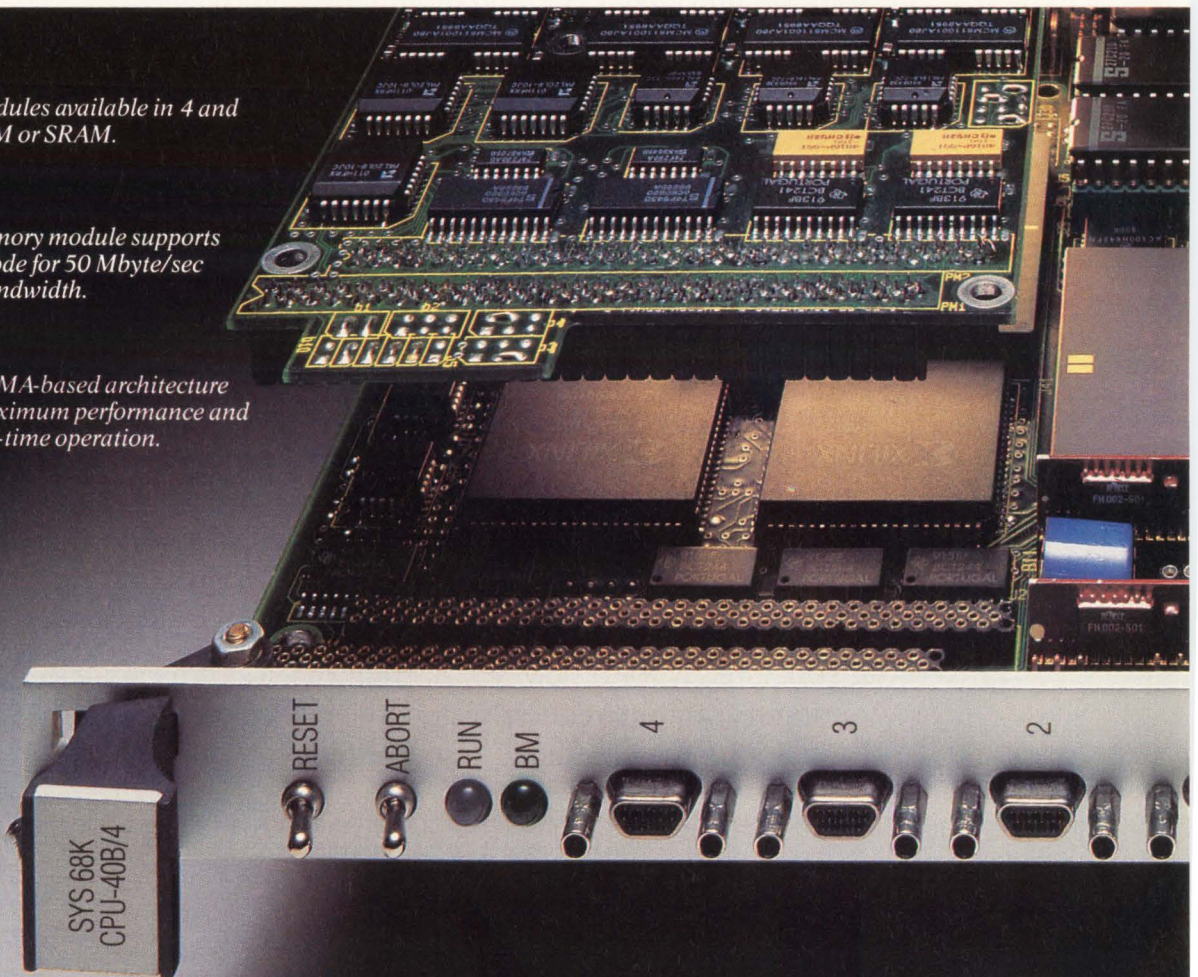



Second, setting else can

sustained at 25 MHz\*. And DMA transfers at a screaming 50 Mbytes per second sustained (3 microseconds on the VMEbus).

So it might just be the last 040 board you'll ever need.

That's because we've fully optimized the on-board architecture. Thanks to our 281-pin gate array, DMA operations can be handled between on-board RAM, the VMEbus and on-board I/O devices. Or through our FLXi interface to other I/O drivers.

All of which means the CPU is free over 75% of the time to run your application.

First, we're delivering 040 VME single board computers today. In quantity. So you can get started while the rest of the world waits for a delivery date from other suppliers.

our new CPU-40 board is performance standards nobody touch. Like 30,000 dhrystones

Developing new applications is also a snap. Choose from the broadest range of third-party software in the business, including VMEPROM™, pSOS+™, VRTX32™, OS-9™, VxWorks™, UNIFLEX™, MTOS™ and UNIX® 5.4.

Of course, we provide comprehensive support with the industry's best-rated documentation,\* complete systems integration support and technical assistance.

**CPU-40 PERFORMANCE CHARACTERISTICS**

Data from	CPU	CPU	CPU	CPU	VMEbus	SCSI*	Floppy Disk*	Ethernet*	Shared RAM*	VMEbus*
Transfer to	Shared RAM	EPROM	Serial I/O Timers	SCSI, Ethernet Controller, Floppy Disk	Shared RAM	Shared RAM	Buffer RAM	Dual-port RAM	VMEbus	VMEbus
Transfer Speed	53.7 MB/sec	16 MB/sec	2 MB/sec	2 MB/sec	5 MB/sec	4 MB/sec	500 Kbit/sec	10 Mbit/sec	15 MB/sec	15 MB/sec
Local 68040 CPU Operation	100%	100%	100%	100%	70%	80%	100%	100%	75%	100%

\*DMA x FPS

So be the first in your company to turn 040. Call 1-800-BEST-VME, ext. 40, for more information or fax a request to (408) 374-1146 for an immediate response.

It'll be to your lasting advantage.



VME at its best.

FORCE Computers, Inc. 3165 Winchester Blvd. Campbell, CA 95008-6557

\*Actual dhrystone results may vary depending on compiler used. \*\*Computer Design News, March 12, 1990. All brands or products are trademarks of their respective holders. © 1991 FORCE Computers, Inc.

CIRCLE NO. 92

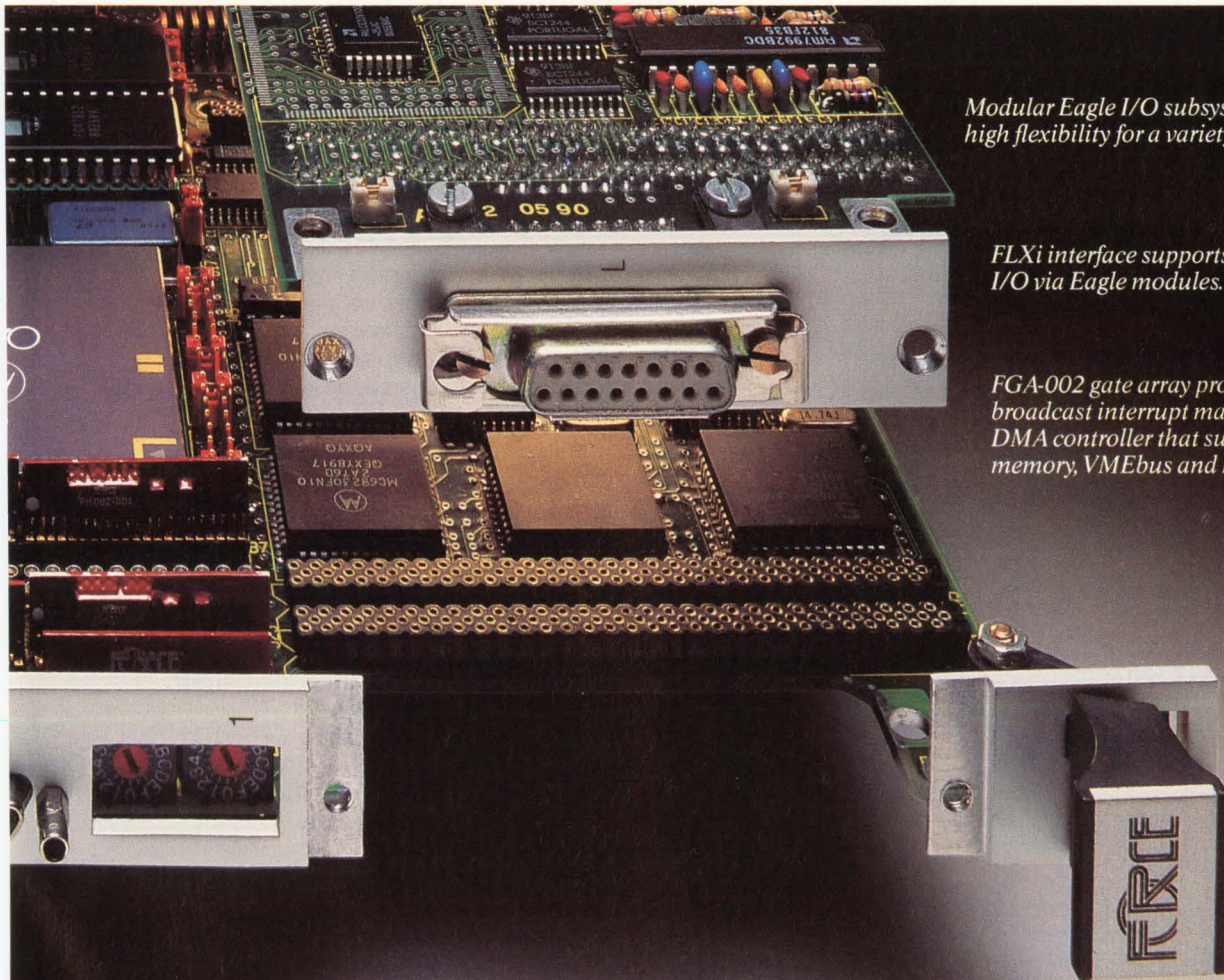

Modular Eagle I/O subsystems provide high flexibility for a variety of applications.

FLXi interface supports high-performance I/O via Eagle modules.

FGA-002 gate array provides message broadcast interrupt management. A 32-bit DMA controller that supports local shared memory, VMEbus and I/O data transfers.

Z I L O G



## Now you can build 10 Mbit high-performance into your single-channel designs.

Zilog's MUSC, mono-channel universal serial communications controller (Z16C33™), has been designed specifically for high-performance applications that require only one high-speed channel. And it costs you about 40% less than the dual-channel USC.

### All the performance you want.

The MUSC's 10 Mbit/sec data transfer rate makes it the fastest single-channel general purpose controller available. CMOS and Superintegration™ give you higher throughput,

while helping reduce the CPU workload. And the 32-byte FIFO transmit-and-receive buffers help reduce CPU overhead. So does the fact that the MUSC integrates two time slot assignment cells—one for receive and one for transmit. So data is automatically inserted into programmed time slots, reducing CPU overhead and external logic even more. And all of that frees up more CPU power for the system. The final touch is a separate 8-bit parallel I/O port, ideal for status or displays, that adds flexibility in local control or data presentation.

### All the flexibility you need.

The MUSC's multiprotocol design lets you adapt your system to a variety of networks. But not only do you get 10 protocols, you get 8 encoding formats—including asynchronous, bit and byte synchronous, isochronous, Ethernet, and MIL-STD 1553B. And the Open Systems Interconnect (OSI) model features Time Slot Assignment that allows transmission of time multiplexed Synchronous Data Link Control (SDLC) protocol to the ISDN link level.

### All the reliability you've come to expect.

Of course, the MUSC comes to you off the shelf, with Zilog's proven quality and reliability. And you have the advantage of CMOS and Superintegration. But you also have the MUSC's unique built-in bus-oriented testability, which allows access to nodes and registers for testing program functionality in real time. And, since dedicated pointer registers provide a window to serial flow during on-line testing, you can test transmission reliability of the controller during system operation.

To find out more about the MUSC or any of Zilog's rapidly growing family of Superintegration products, contact your local Zilog sales office or your authorized distributor today. Zilog, Inc., 210 Hacienda Ave., Campbell, CA 95008, (408) 370-8000.

### Expanding the USC family.

*Zilog's Superintegration™ technology has resulted in a rapidly growing library of working CPU and peripheral cores and cells that have been combined and enhanced for specific applications. And all of them use the same proven architectures and instruction sets you're already working with. For communications applications, specifically, we've developed the popular, fast-growing SCC and the high-performance USC families that provide the extra speed and performance you need to release the host CPU from simple I/O processing.*

*The high-performance USC family is a diverse one. Because, as our development of the single-channel MUSC illustrates, we're well aware of the needs of a wide range of users. And soon, the "smart" USC will take us to new, never-before-achieved levels of integration and performance in high-speed serial communications controllers.*

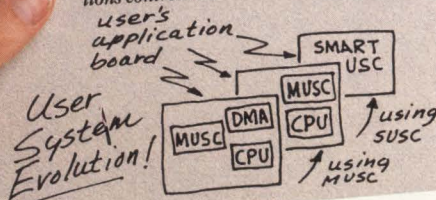

## Right product. Right price. Right away.



**ZILOG SALES OFFICES:** CA (408) 370-8120, (714) 838-7800, (818) 707-2160, CO (303) 494-2905, FL (813) 585-2533, GA (404) 448-9370, IL (708) 517-8080, NH (603) 888-8590, NJ (201) 382-5700, NC (919) 790-7706, OH (216) 447-1480, PA (215) 653-0230, TX (214) 987-9987, WA (206) 523-3591, CANADA Toronto (416) 673-0634, UNITED KINGDOM Maidenhead (44) (628) 39200, GERMANY Munich (49) (89) 672045, Sommerda (37) (626) 23906, JAPAN Tokyo (81) (3) 587-0528, HONG KONG Kowloon (852) 723-8979, KOREA (82) (2) 552-5401, SINGAPORE 65-235 7155, TAIWAN (886) (2) 741-3125, **DISTRIBUTORS:** U.S. Anthem Electronics, Hall-Mark Electronics, JAN Devices, Inc., Lex Electronics, Newark Electronics, Vargas Electronics, Western Microtechnology, CANADA Future Electronics, SEMAD, **LATIN AMERICA** Argentina—Tel.-(1) 46-2211, Brazil—Digibyte (011) 581-1945, MEXICO Semiconductores Profesionales (5) 536-1312, Proyeccion Electronica (5) 264-7482.

# SIGNALS & NOISE

## The B-2 is not just an airplane

Regarding the editorial by Jon Titus (EDN, November 22, 1990, pg 31), enough already. The B-2 is not just an airplane; it's a system. It has not just one manufacturer, but many. All share in a piece of the pie. No one, except those who have access to all characteristics and capabilities of the plane, can even come close to making a judgment about the worth of the program. At worst, it's no more than a public-works program.

Nor can anyone, except those with program clearance, even begin to judge the stealth abilities of the plane. It takes complete system knowledge.

As for the SR-71, when has the military ever given up something without getting something in return? Sure, the Black Bird is valuable, but is it as valuable as what

has replaced it? I wonder what that replacement is. I bet, if it is a plane, it's pilotless. No Gary Powers to worry about; I'll also bet it can be destroyed—completely—no pieces big enough to compromise its secrecy would be acceptable. Perhaps we'll be commenting about its moth-ball status 20 years from now.

Defense, no matter how costly, is the only thing our government is obligated to provide. Anything else, like HDTV, is a free ride.

*L Alan Kudravy  
Hawthorne, CA*

## What's the correct word?

In the second sentence of the second paragraph of the editorial (EDN, December 6, 1990, pg 51), did Jon Titus mean 'enormousness' rather than 'enormity'?

*Bill Woodward  
Westinghouse Savannah River Co*

## IT'S EASY TO HAVE YOUR SAY

EDN's Signals & Noise column provides a forum for readers to express their opinions on issues raised in the magazine's articles or on any topic that affects the engineering industry. You can use one of several easy ways to reach us. First, there's always the mail. Send your letters to Signals & Noise Editor, EDN Magazine, 275 Washington St, Newton, MA 02158. Or, send us a message via MCI mail at EDNBOS. Finally, EDN's bulletin-board system is ready for use—and it's free (except for the phone call). You can reach us at (617) 558-4241 and leave a letter in the EDITORS Special Interest Group. You'll need a 2400-bps or less modem and a communications program that is set for eight data bits, no parity, and one stop bit, or 1200/2400, 8N1 in shorthand.

**EDN**

Form. Fit. Function.  
It's all here  
in one special  
EMC design.



Available in new  
low force UltraSoft™

## Versatility was a prime consideration as we developed our Symmetrical Slotted Shielding Series.

For low force, secure mounting, and optimum attenuation, the gasket design is symmetrical.

Each gasket has a wide radius profile to create the greatest surface contact for maximum conductivity and increased cycle life. It also helps reduce compression requirements down to 10 to 35 lbs/linear foot, and provides a compression range up to 50% of free height.

In addition, the gaskets are bi-directional, allowing transverse movement in each direction over the width of the strip.

By design, you're assured of shielding effectiveness at a minimum of 100 dB at 100 MHz. And you have a choice of mounting methods: Sticky Fingers® self-adhesive backing for non-wiping applications, or rivet mounting where bi-directional stability is a requirement.

Next time you need the perfect blend of form, fit, and function in your EMC designs, draw one of our Symmetrical Slotted Shielding gaskets onto your blueprint. For more information, call us.



Where shielding  
is a science.

## Instrument Specialties

### Headquarters

Delaware Water Gap, PA 18327-0136  
TEL: 717-424-8510 FAX: 717-424-6213

**Western Division**—Placentia, CA  
TEL: 714-579-7100 FAX: 714-579-7105

**European Division**—Liege, Belgium  
TEL: 011-32-41-63-3021 FAX: 011-32-41-46-4862

Sticky Fingers is a registered trademark of Instrument Specialties Co., Inc.  
©1990 Instrument Specialties Co., Inc. All rights reserved.

# SIGNALS & NOISE

BY JOHN W. ...  
THE FIRST ...

...  
...  
...

...  
...  
...



# Introducing The Erector Set for Embedded Control Applications

Remember the challenge of constructing "engineering marvels" with your Erector® set? That red metal box held a complete set of interlocking pieces — all that was needed to assemble just about anything. Your imagination was the only limitation.

That's the idea behind Ampro's new way for OEMs to build embedded control applications. Put your application together, simply and quickly, using Ampro Embedded System Modules

Our CoreModule™ family packs ready-made full PC- or AT-compatible intelligence into 3.6" x 3.8" x 0.6". Just plug one into your circuit board — like plugging in a chip — to easily interface to your own logic. They operate over 0 to 70°C, and include a CMOS CPU, RAM, extended BIOS, Solid State Disk, serial and parallel I/O ports, keyboard and speaker interfaces, and a real-time clock.

Stack a CoreModule unit together with one or more of our expansion MiniModule™ peripherals (no backplanes or card cages needed). MiniModule products, also 3.6" x 3.8", can be used to add display controllers, more Solid State Disk capacity, network controllers, modem and facsimile features, additional I/O, and much more.

You'll get your product to market faster, with less risk, and at lower cost, because the CoreModule family is based on the most economical industry standard architecture. Now you can focus on the more challenging part of your system — the application itself.

Ultrasound monitors, point-of-sale terminals, robotics, network controllers — no matter what kind of "engineering marvel" you're building, you should be using Ampro's "Erector set" for your embedded control application.

Call **1-800-966-5200**. Get the Information Kit on CoreModule and MiniModule products today.



Pioneering Solutions for Embedded Control

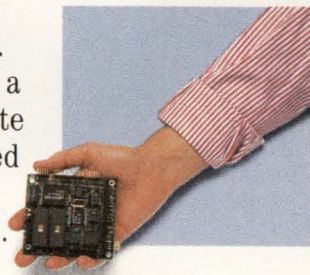

# FILTERS





# dc to 3GHz from \$1145

## lowpass, highpass, bandpass, narrowband IF

- less than 1dB insertion loss • greater than 40dB stopband rejection
- 5-section, 30dB/octave rolloff • VSWR less than 1.7 (typ) • meets MIL-STD-202 tests
- rugged hermetically-sealed pin models • BNC, Type N; SMA available
- surface-mount • over 100 off-the-shelf models • immediate delivery

### low pass dc to 1200MHz

MODEL NO.	PASSBAND, MHz (loss <1dB)		STOP BAND, MHz (loss >20dB)		STOP BAND, MHz (loss >40dB)		VSWR		PRICE \$ Qty. (1-9)
	Min.	Nom.	Max.	Max.	Min.	Max.	pass-band typ.	stop-band typ.	
PLP-10.7	DC-11	14	19	24	200	1.7	18	11.45	
PLP-21.4	DC-22	24.5	32	41	200	1.7	18	11.45	
PLP-30	DC-32	35	47	61	200	1.7	18	11.45	
PLP-50	DC-48	55	70	90	200	1.7	18	11.45	
PLP-70	DC-60	67	90	117	300	1.7	18	11.45	
PLP-100	DC-98	108	146	189	400	1.7	18	11.45	
PLP-150	DC-140	155	210	300	600	1.7	18	11.45	
PLP-200	DC-190	210	290	390	800	1.7	18	11.45	
PLP-250	DC-225	250	320	400	1200	1.7	18	11.45	
PLP-300	DC-270	297	410	550	1200	1.7	18	11.45	
PLP-450	DC-400	440	580	750	1800	1.7	18	11.45	
PLP-550	DC-520	570	750	920	2000	1.7	18	11.45	
PLP-600	DC-580	640	840	1120	2000	1.7	18	11.45	
PLP-750	DC-700	770	1000	1300	2000	1.7	18	11.45	
PLP-800	DC-720	800	1080	1400	2000	1.7	18	11.45	
PLP-850	DC-780	850	1100	1400	2000	1.7	18	11.45	
PLP-1000	DC-900	990	1340	1750	2000	1.7	18	11.45	
PLP-1200	DC-1000	1200	1620	2100	2500	1.7	18	11.45	

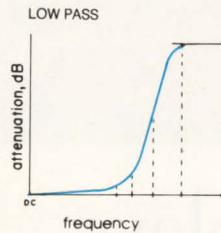

### high pass dc to 2500MHz

MODEL NO.	PASSBAND, MHz (loss <1dB)		fco, MHz (loss 3db)	STOP BAND, MHz (loss >20dB)		VSWR		PRICE \$ Qty. (1-9)
	Min.	Min.	Nom.	Min.	Min.	pass-band typ.	stop-band typ.	
PHP-50	41	200	37	26	20	1.5	17	14.95
PHP-100	90	400	82	55	40	1.5	17	14.95
PHP-150	133	600	120	95	70	1.8	17	14.95
PHP-175	160	800	140	105	70	1.5	17	14.95
PHP-200	185	800	164	116	90	1.6	17	14.95
PHP-250	225	1200	205	150	100	1.3	17	14.95
PHP-300	290	1200	245	190	145	1.7	17	14.95
PHP-400	395	1600	360	290	210	1.7	17	14.95
PHP-500	500	1600	454	365	280	1.9	17	14.95
PHP-600	600	1600	545	440	350	2.0	17	14.95
PHP-700	700	1800	640	520	400	1.6	17	14.95
PHP-800	780	2000	710	570	445	2.1	17	14.95
PHP-900	910	2100	820	660	520	1.8	17	14.95
PHP-1000	1000	2200	900	720	550	1.9	17	14.95

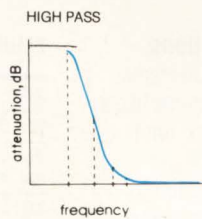

### bandpass 20 to 70MHz

MODEL NO.	CENTER FREQ. MHz F0	PASS BAND, MHz (loss <1dB)		STOP BAND, MHz (loss > 10 dB)				VSWR 1.3:1 typ. total band MHz	PRICE \$ Qty. (1-9)
		Max. F1	Min. F2	Min. F3	Max. F4	Min. F5	Max. F6		
PIF-21.4	21.4	18	25	4.9	85	1.3	150	DC-220	14.95
PIF-30	30	25	35	7	120	1.9	210	DC-330	14.95
PIF-40	42	35	49	10	168	2.6	300	DC-400	14.95
PIF-50	50	41	58	11.5	200	3.1	350	DC-440	14.95
PIF-60	60	50	70	14	240	3.8	400	DC-500	14.95
PIF-70	70	58	82	16	280	4.4	490	DC-550	14.95

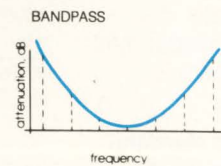

### narrowband IF

MODEL NO.	CENTER FREQ. MHz F0	PASS BAND, MHz I.L. 1.5dB max. F1-F2	STOP BAND, MHz I.L. >20dB		STOP BAND, MHz I.L. > 35dB		PASS-BAND VSWR Max.	PRICE \$ Qty. (1-9)
			F5	F6	F7	F8-F9		
PBP-10.7	10.7	9.5-11.5	7.5	15	0.6	50-1000	1.7	18.95
PBP-21.4	21.4	19.2-23.6	15.5	29	3.0	80-1000	1.7	18.95
PBP-30	30.0	27.0-33.0	22	40	3.2	99-1000	1.7	18.95
PBP-60	60.0	55.0-67.0	44	79	4.6	190-1000	1.7	18.95
PBP-70	70.0	63.0-77.0	51	94	6	193-1000	1.7	18.95

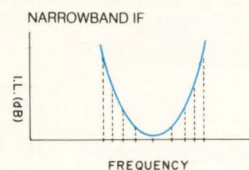

CIRCLE NO. 112

**Mini-Circuits**

P.O. BOX 350166, Brooklyn, New York 11235-0003 (718) 934-4500 FAX (718) 332-4661 TELEX 6852844 or 620156 WE ACCEPT AMERICAN EXPRESS

F132-2 REV. ORIG.

**FLUKE**®



**PHILIPS**

9.0125 V DC 17.728 mV AC



## Two displays. One great meter.

**Dual displays provide two accurate measurements. Combined with 16 different measurement capabilities. The Fluke 45 is making people take a second look.**

**The Fluke 45 has the specs to get the job done right.** 0.02% basic dc voltage accuracy and 100,000 count resolution on both displays. Basic dc current accuracy is 0.05%, making the 45 ideal for servicing 4-20 mA current loops. The Fluke 45 measures true-rms voltage and current, including ac + dc. Closed-case calibration simplifies the calibration process and increases uptime.

**Twice as much information.**

The 5-digit, 100,000 count dual displays give you more information in less time—and with less effort. For example, measure the VDC output of a power supply while measuring the VAC ripple. Or check the amplitude and frequency of an AC signal. From a single test connection!

**More measurement combinations.**

With the Fluke 45 complex measurements become simple, with standard features like a 1 MHz frequency counter, Min Max, limits testing (Hi/Low/Pass), Touch Hold® and Relative modes. There are 21 different reference impedances for dB measurements; in the 2Ω to 16Ω ranges, audio power can be automatically displayed in watts. The variety of electrical parameters, measurement functions and display combinations is incredible.

**Even an RS-232 interface is standard.**

Connecting the Fluke 45 to PCs, RS-232 printers and modems is as easy as attaching the cable. An IEEE-488.2 interface and internal, rechargeable lead-acid batteries are available as options.

**Get a great value.**

Contact your local distributor today for complete information on the new Fluke 45. Or call toll-free **1-800-44-FLUKE, ext 33.**

**FLUKE 45 DUAL DISPLAY MULTIMETER**

\$635*	dB, with 21 reference impedances, and audio power calculations
Dual Display	Compare and Relative functions
True-rms voltage and current, including ac + dc	Min Max and Touch Hold® functions
0.02% basic dc voltage accuracy	Optional PC software for RS-232 applications
0.05% basic dc current accuracy	Optional IEEE-488.2 interface, battery pack
1 MHz frequency counter	One year warranty
RS-232 interface standard	

\* Suggested U.S. List Price

John Fluke Mfg. Co., Inc. P.O. Box 9090 M/S 250C Everett, WA 98206  
 U.S.: 206-356-5400 Canada: 416-890-7600 Other Countries:  
 206-356-5500 © Copyright 1989, 1990 John Fluke Mfg. Co., Inc.  
 All rights reserved. Ad no. 00015. IBM PC is a registered trademark  
 of International Business Machines Corporation.

FROM THE WORLD LEADER  
 IN DIGITAL MULTIMETERS

**FLUKE**®

# ASK EDN

EDITED BY JULIE ANNE SCHOFIELD

Have you been stumped by a design problem so long that you don't know who to turn to? Are you having trouble locating parts? Finding companies? Can't interpret a spec sheet? Ask EDN.

This department will serve as a forum to solve nagging problems and answer difficult questions. EDN's editors will provide the solutions. If we can't solve a problem, we'll find an expert who can, or we'll print your letter and ask your peers for help. We can't answer every question, but we'll try to publish the ones that will help you most in your job.

Address your letters to Ask EDN, 275 Washington St, Newton, MA 02158. FAX (617) 558-4470; MCI: EDNBOS. Or, send us a letter on EDN's bulletin-board system. You can reach us at (617) 558-4241 and leave a letter in the /ask\_edn Special Interest Group.

## Free guide for modem standard

**I need a detailed description of the Microcom Network Protocol (MNP) 2-5, a kind of data transmission standard for modems. Would you mind helping me find out how I can get it? Thanks.**

**Gábor Kiss**  
*Software Consultant*  
*Budapest, Hungary*

We're here to help: The MNP guide is free from

Microcom Inc  
500 River Ridge Dr  
Norwood, MA 02062  
(800) 822-8224;  
in MA, (617) 762-9310.

## Tracking down a transmitter

**I'd like to know the names of some American manufacturers of stereo AM radio transmitters. Thank you for your help.**

**Bing Han**  
*Bolycore Enterprises USA*  
*Westlake Village, CA*

We tracked down three sources of such transmitters

Allied Broadcast Equipment  
Division of Harris Corp  
Box 4290  
Quincy, IL 62305  
(217) 222-8200

Continental Electronics  
Box 270879  
Dallas, TX 75227  
(214) 381-7161

Nautel Maine Inc  
201 Target Industrial Circle  
Bangor, ME 04401  
(207) 947-8200.

## PC-based layout packages not plentiful

**As director of technical services, it is my responsibility to keep my company's CAD capabilities current and adjust them to meet a changing technology. We currently have a CAD system consisting of three Applicon color workstations utilizing a PDP11/34 processing facility with a 216k-byte memory and a Cal-comp 965 pen plotter.**

**It is a company goal to retreat from the central CPU approach and place a personal computer at each design station. The reasoning was due in part to the inflexibility of a CPU-driven system and the reliance on one piece of equipment. Also, the current business picture does not allow for the purchase of a workstation. I have investigated one software package, Cadisys, which runs on an IBM 386/486, and found it to have limited autorouting capabilities. I have reached a dead end in trying to locate other PC-based layout packages for hybrids. Your assistance in this search would be greatly appreciated.**

**Len Giambald**  
*ILC Data Device Corp*  
*Bohemia, NY*

Mike Markowitz found the quasi-definitive word on PC-based hybrid software packages: According to Jim Hill of Layout Concepts (Boca Raton, FL, (407) 241-2823), Cadisys Corp's (San Jose, CA, (408) 441-8800) Cadisys is currently the best—and only—PC-based hybrid layout package. Layout Concepts has written a PC-based hybrid batch router, but the software needs another company to integrate it with tools that provide placement, support, and a user interface.

Don Davis of Accel Technologies, (San Diego, CA, (619) 554-1000) claims you can get away with using pc-board software from Accel, CAD Software (Littleton, MA, (508) 486-8929), and Orcad Systems Corp (Hillsboro, OR, (503) 640-9488) for mixed A/D hybrid designs. Unfortunately, Davis thinks that for ceramic substrates, you'll have to use a workstation.

# Gets

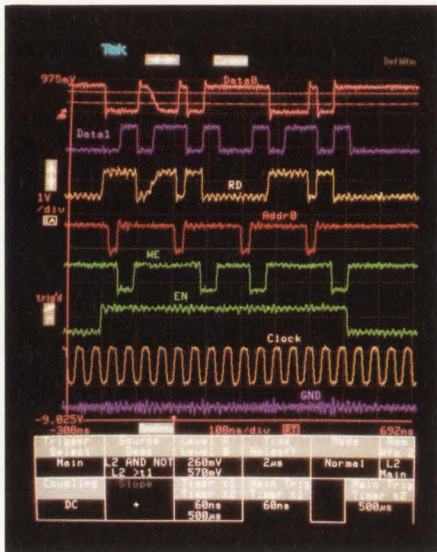

**Extended triggering.** Sophisticated triggering in the DSA600A reliably discriminates glitches, transition slew-rates, runt pulses and timing violations. Long memory and pre-trigger help reveal the cause.

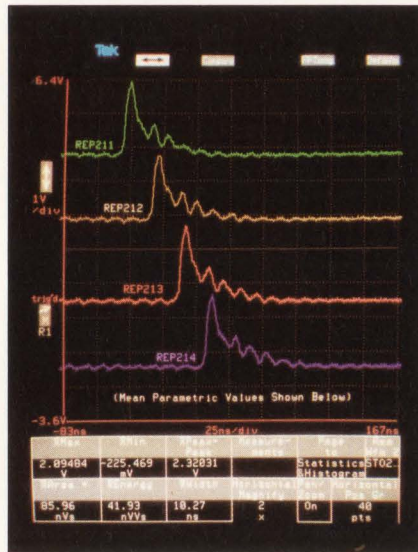

**Transient capture, analysis and storage.** Capture a series of transient events with automatic labeling and parametric analysis. Examine statistics of each measured parameter over the ensemble. Transport results using built-in (DOS-compatible) floppy disk.

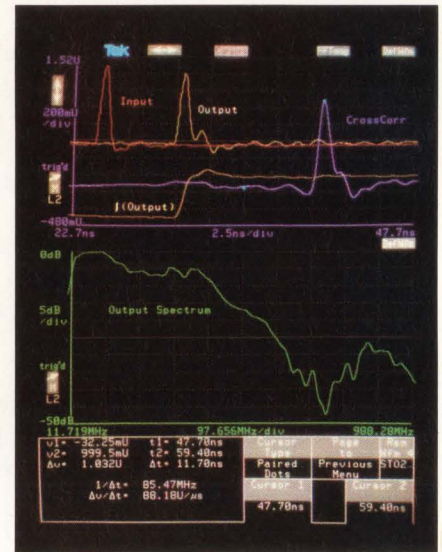

**Advanced signal processing.** Transform and combine acquired waveforms at visual real-time speeds to reveal key phenomena. FFT, correlation, convolution and calculus functions provide multiple views of critical events.

**When you need serious measurement, serious analysis, serious accuracy, nothing—but nothing—delivers it like Tek DSA 602A and 11403A oscilloscopes.**

When you expect your instruments to be as serious about the truth as you are, only the DSA602/11403A, with their superb new amplifiers and probes, their unrivaled accuracy, plug-in flexibility, and their powerful new set of waveform analysis and measurement functions, come through with results like you see above.

**Serious numbers? Try the new 2 GS/s, 1 GHz bandwidth Tek DSA 602A.** No other scope combines DSP hardware for live displays of FFTs, correlation or convolution, plus high signal fidelity and powerfully selective triggering modes. There's even a new disk drive in this latest DSA version to save setups and data.

**Pit the new 11403A Digitizing Oscilloscope, with 1 GHz bandwidth and 10-bit vertical resolution, against the toughest repetitive signals.** Get more than 30 pushbutton measurements, with statistical analysis and built-in pass/fail decisions from the most accurate scope of all. Put its new FFT features to work measuring total harmonic distortion, or use the statistical data base to characterize jitter.

**Configure and reconfigure your scope with new plug-ins like Tek's programmable 50 MHz current amplifier, four-channel 75Ω video amplifier and high-resolution video trigger.** Choose from our true differential amplifier and voltage comparator, our 50Ω and high-impedance amplifiers. Take advantage of their unequalled overdrive recovery and wide dynamic

# erious!

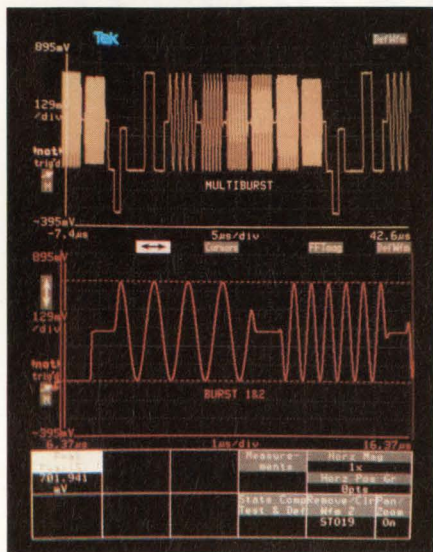

**Video and HDTV.** Analyze video waveforms, including HDTV. Line and field select on up to 1280 lines with the new 11T5H Video Trigger Unit. New 4-channel 11A34V 75Ω Video Amplifier provides excellent signal fidelity up to 300 MHz.

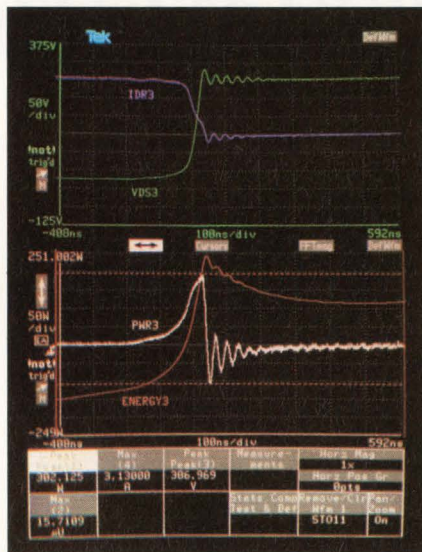

**Current and power.** Make accurate, high-bandwidth power measurements and energy calculations with our new 11A16 Programmable Current Amplifier. Current and voltage maintain their proper phase relationship to 50 MHz.

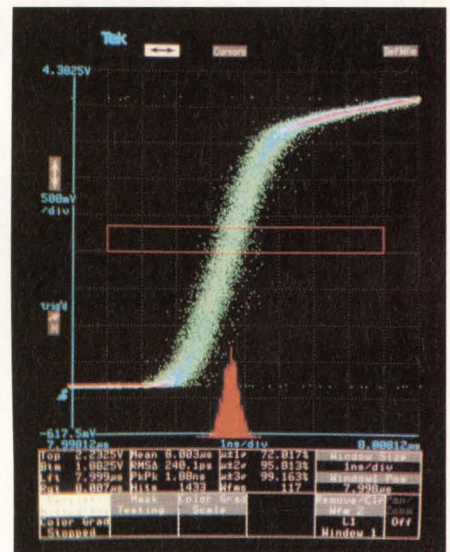

**Jitter and noise analysis.** Analyze jitter and noise with Tek's exclusive statistical data base. Color grading, statistic readout and histograms clearly show the distribution of the edge jitter.

range, while you mix and match to the capabilities, channels and bandwidths you need.

Finally, choose from our high-impedance, high-bandwidth probes for fast logic devices... high-voltage and current probes for power conversion analysis... optical-to-electrical converters for direct measurements on lightwaves... and more, from the best probing resource around.

**Current measurements, spectrum analysis, transient capture, glitch detection, precise power measurements, jitter analysis, high-definition video design**—when your work is this serious, you want serious solutions like the DSA602A/11403A. Contact your Tek sales engineer or return the card for more information.

## 1-800-426-2200

F A X 1 - 5 0 3 - 6 9 0 - 3 9 5 9



**One company measures up.**

**Tektronix**  
COMMITTED TO EXCELLENCE

# *“Integrating analog But we have a bigger tool anyone else in the world.”*

HOW NATIONAL SEMICONDUCTOR IS HELPING YOU PUSH THE LIMITS OF ADVANCED SYSTEMS PERFORMANCE.

*Tom Redfern*, National's Director of New Product Development, Interface/Peripherals Group, talks about the challenges of mixed analog+digital technology.

## Making Futurebus+ a reality.

“Traditional bus protocols are starting to hit the wall. They can't accommodate the wide data paths and high transfer rates demanded of the next generation of 32- and 64-bit microprocessors.

“That's why we've been an active participant on the IEEE's Futurebus+ committee since its founding in 1979. And that's why we invented the Backplane Transceiver Logic (BTL) that makes

Futurebus+ a reality today.

“Our first Futurebus+ chipset contains five devices, and they employ some of the most advanced analog+digital integration ever achieved. Our BTL drivers, for example, let the digital CPU send information to the digital memory over the analog bus at peak rates of 2-3 Gbytes/second!

“This is the future – and we've got it today.”

## Setting the pace in system-level integration.

“Another great example is CLASIC, our powerful Custom Linear ASIC family.

“To reach system-on-chip performance, you've got to integrate analog and digital functions onto the same substrate.

“Well, CLASIC does that.

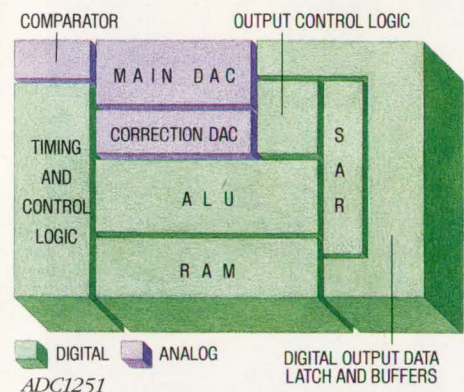

Op amps, comparators, references, DACs, VCOs, PLLs, plus digital cells – a huge library of building blocks. In bipolar, CMOS, and BiCMOS. With user-friendly design tools that let you do your own design on your PC or workstation.

“It's that simple.”

## Reaching a new level of ADC accuracy.

“Our new ADC1251 takes a quantum leap in integration. It's powered by a sophisticated digital controller and is totally self-calibrating, so it will maintain linearity over time, temperature, and supply voltage.

“You get 12-bit-plus-sign resolution with a 8.0µs conversion

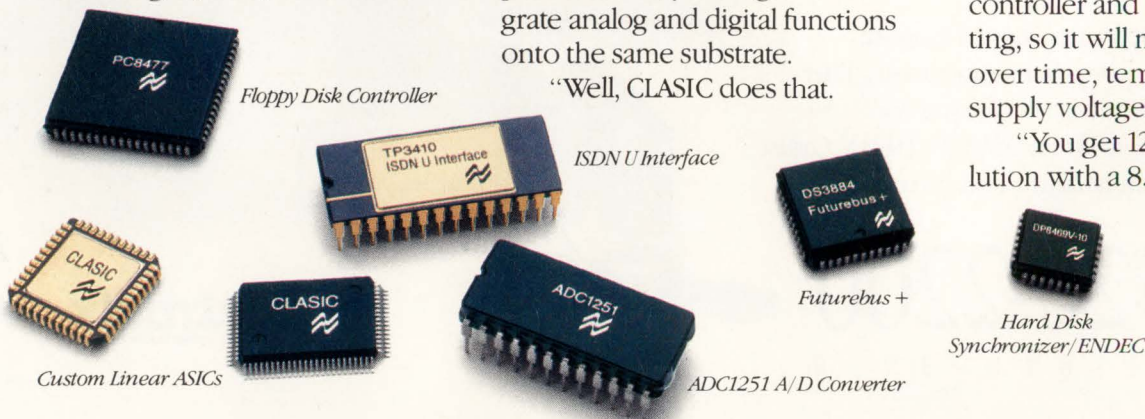

*and VLSI digital isn't easy.  
box for doing that job than*

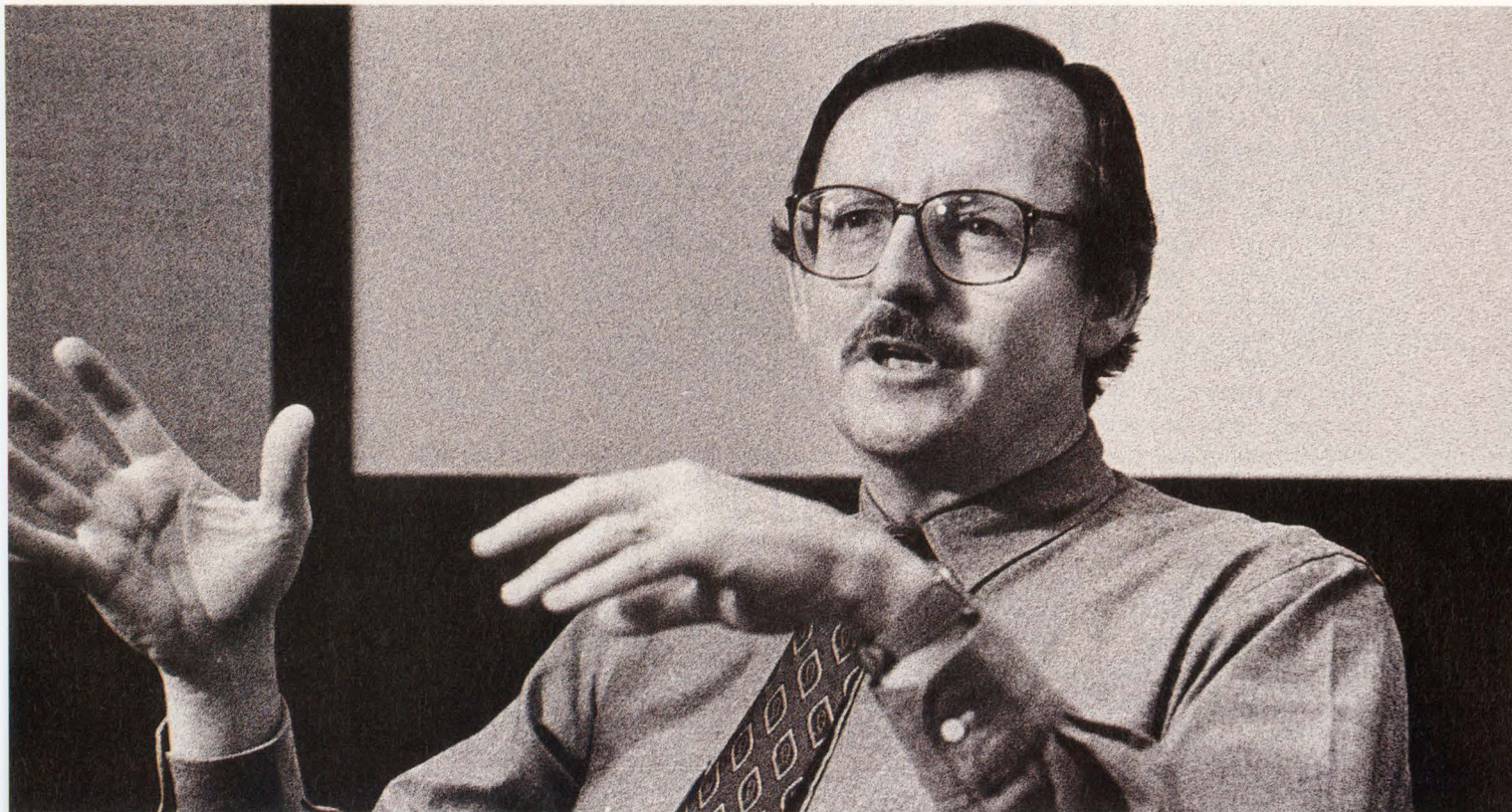

time and a  $\pm 1/2$  LSB non-linearity accuracy while dissipating 113mW max at  $\pm 5V$ .

"Try to find that in any other ADC. You can't."

### Pushing the limits of analog + digital integration.

"To achieve these levels of integration, you need powerful tools in the hands of experienced designers.

"We've got them. A full range of process technologies, including fourth-generation bipolar ECL and

BiCMOS, which give us  $0.8\mu$  lithographies with bipolar  $F_T$ s of 15GHz and 50ps gate delays.

"We also have some of the most advanced design tools in the industry, developed through our strategic alliance with Cadence.

"And we have seasoned analog and digital designers who know the art of putting those tools to work in advanced analog+ digital designs.

"This is the leading edge— and we're leading it!"

### Putting it all to work for you.

"The only way to make the systems-performance breakthroughs and the systems-cost breakthroughs demanded by next-generation products is to integrate analog+ digital. We're doing it all, right now. So if I were a designer, I'd call us. Soon."

1-800-NAT-SEMI, Ext. 117



© 1991 National Semiconductor Corporation  
CLASIC is a trademark of National Semiconductor Corporation.

# Greater Than The Sum Of Its Parts

## EEsof High-Frequency CAE Software Puts It All Together.

Frustrated by piecemeal CAE software that gives you partial solutions for circuit and system design but leaves you with pieces that don't fit together? EEsof's new Version 3.0 software suite cuts through multi-level microwave and high-frequency analog design problems with ease. Designed to work together from the ground up, Version 3.0 provides a smooth, seamless interface between simulation, modeling, and physical layout. Version 3.0 is a unified and upgraded release of our entire suite of high-frequency analog design tools. From device characterization to linear and nonlinear circuit design

# VERSION 3.0

to top-level hardware system design, Version 3.0 puts it all together.

## Designs Go Faster and Easier if You Have the Right Environment.

Version 3.0 lets you run EEsof's entire simulation suite through ACADEMY®, a single, easy-to-use graphical environment that is specifically

designed to meet your requirements. EEsof's simulators Touchstone®, Libra®, Microwave SPICE®, and OmniSys® are all available at a touch of a key, and data files from one are instantly available to others. ACADEMY makes linear and nonlinear hierarchical design practical, using high-frequency simulation techniques you already know!

## Call Us Today; Let Us Help You Put the Pieces of Your Puzzle Together!

For more information on EEsof's full suite of software tools for high-frequency analog design, call us today at (800) 624-8999, ext. 155. Or if you prefer, send the details of your CAE puzzle by FAX to (818) 889-4159. In Europe, call (49) 8105-24005, or FAX to (49) 8105-24000.

We'll answer your questions and send you a copy of our new Version 3.0 catalog.

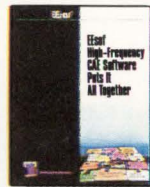

### Corporate office:

5601 Linder Canyon Road,  
Westlake Village, CA 91362

### European office:

Rudolf Dieselstrasse 17,  
D-8031 Gilching, Germany

*Breaking the Barriers...*

# EEsof®

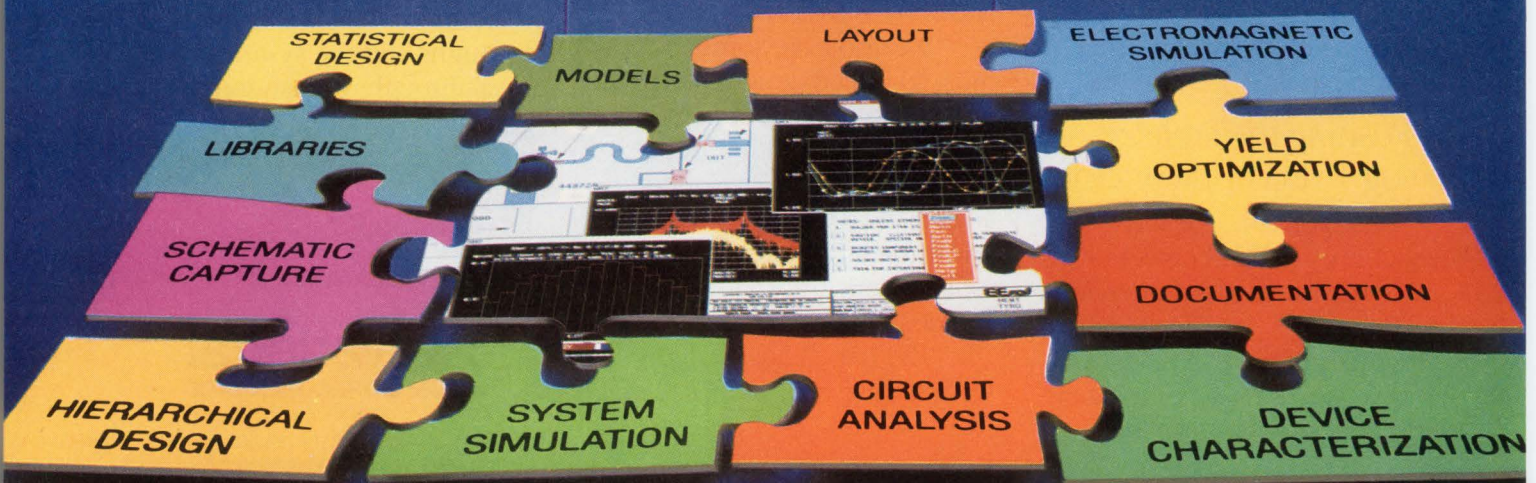



# EDITORIAL

## Look for recession opportunities

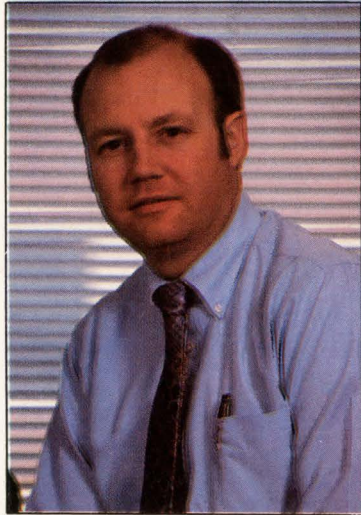

Without a doubt, the US and many of its trading partners are in a recession. Although the economic times look dim, opportunities still exist for those who are willing to pursue them. Over the last few years, I've come up with some observations that can help you identify present technical opportunities. Keep in mind that these points apply mainly to areas in which technical change is rapid.

1. Technology spreads downward. Put another way, technology destroys centralization. Several examples come to mind—the telephone, the photocopier, and the personal computer. When the telephone became popular, few people could imagine its rapid spread through businesses because there just wouldn't be enough people to act as central-office operators. Today's pushbutton phone lets me control a global communication network. The communication technology—and the control of the phone network—spread downward from large central offices to individual users. Similar stories exist for the copier and the PC. Many centralized technologies are ripe for “fragmentation.”

2. Innovative people bootleg technology. Take a look at the technology that people sneak into a company or organization to help them on the job. When personal computers became available, many people bought their own and put them in their offices. People will go to great lengths to get products that help them do a better job—even if those products aren't sanctioned or are forbidden by “management.” Locating bootlegged products can lead to opportunities and to plans for new products.

3. Late adopters often surpass early adopters. Although this sounds contradictory, it's true. Many of the newcomers to the semiconductor industry are the ones who are willing to learn from the mistakes of the early adopters and adapt their businesses to new conditions. If you need confirmation of this, simply try to recall the names of three of the earliest transistor manufacturers. Although we hear about shorter times to market and narrower market windows, it can pay to let someone else go first. You don't always have to create something brand new.

4. People buy tools, not technology. It's easy to forget that most people don't care what kind of microprocessor is in their personal computer. Likewise, customers don't buy a fax machine because of the type of modem circuits it uses. Keep your eye on solving the customers' problems and keep the technology secondary. Sure, the technology is important, but it's a means to an end. Don't fall in love with it.

5. Technology bottlenecks are opportunities. One of today's biggest bottlenecks is software development. We're still at the craftsman level—everyone develops their own software, and software is recreated endlessly. Computer-aided software engineering (CASE) and object-oriented programming may yet prove to be helpful, but the software world still awaits a breakthrough akin to the development of mass-produced integrated circuits. Taking the hardware analogy further, software is still at the level of point-to-point wiring. Identify bottlenecks and find innovative solutions to remove them.



Jesse H Neal  
Editorial Achievement Awards  
1987, 1981 (2), 1978 (2),  
1977, 1976, 1975  
American Society of  
Business Press Editors Award  
1988, 1983, 1981

A handwritten signature in black ink that reads "Jon Titus".

Jon Titus  
Editor

You can send me your comments via FAX at (617) 558-4470, or through the EDN Bulletin Board System at (617) 558-4241 2400,8,N,1.

# IMAGINE WHAT A CMO COULD DO TO YOU

Now you can really stick it to 'em. And you can be sure they'll get the point. Because our two new MAX® parts will make your next design

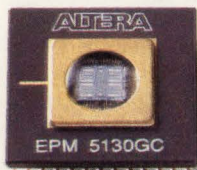

unbeatable. And get it to market faster.

Introducing Altera's 100-pin EPM5130 and 7500-gate EPM5192. Both packed with I/O and logic unheard of in a CMOS EPLD.

In fact, they're your best programmable alternative to gate arrays yet. Because

MAX delivers high logic density and superior 50 MHz *in-system* speed. All thanks to our innovative MAX architecture.

Even design is faster. That's because our new MAX+PLUS® II software takes full advantage of the enhanced memory management and multi-tasking capabilities of Windows™ 3.0.

MAX+PLUS II can also automatically partition large logic designs into a set of EPLDs. In minutes. So you can deliver your finished design while

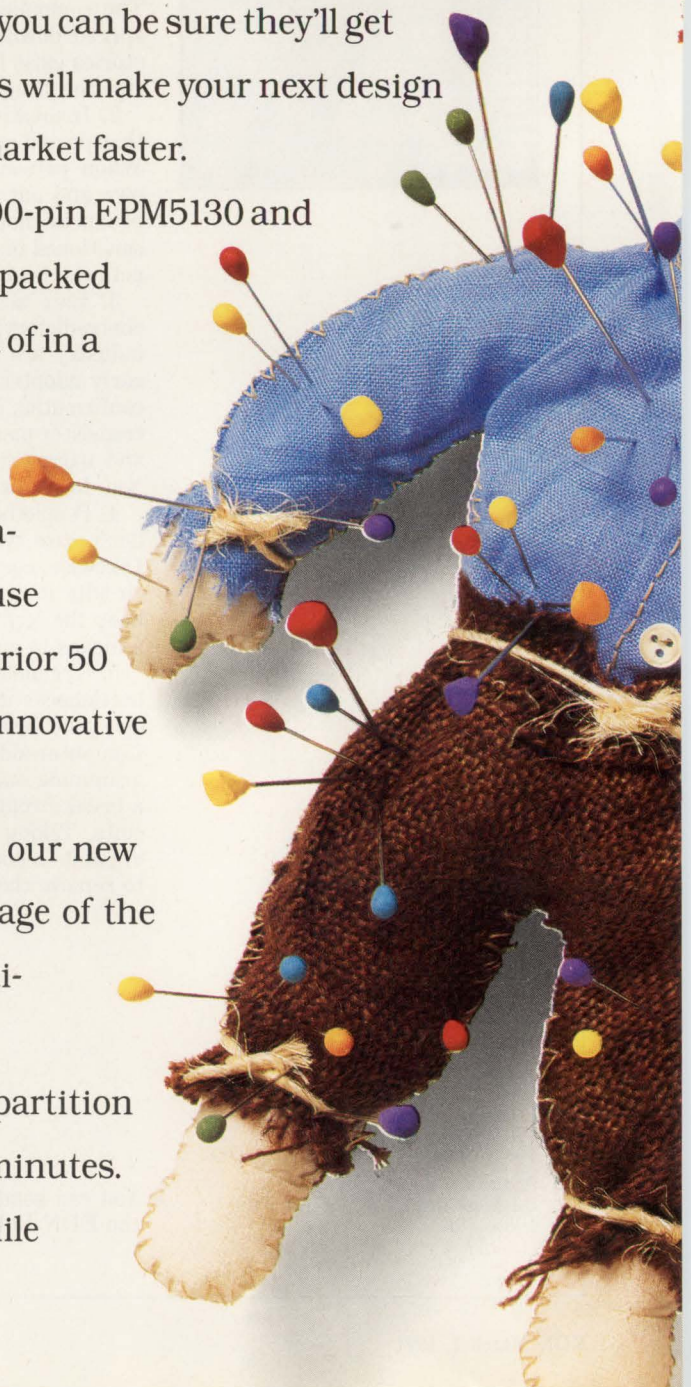

# S EPLD WITH 100 PINS UR COMPETITION.

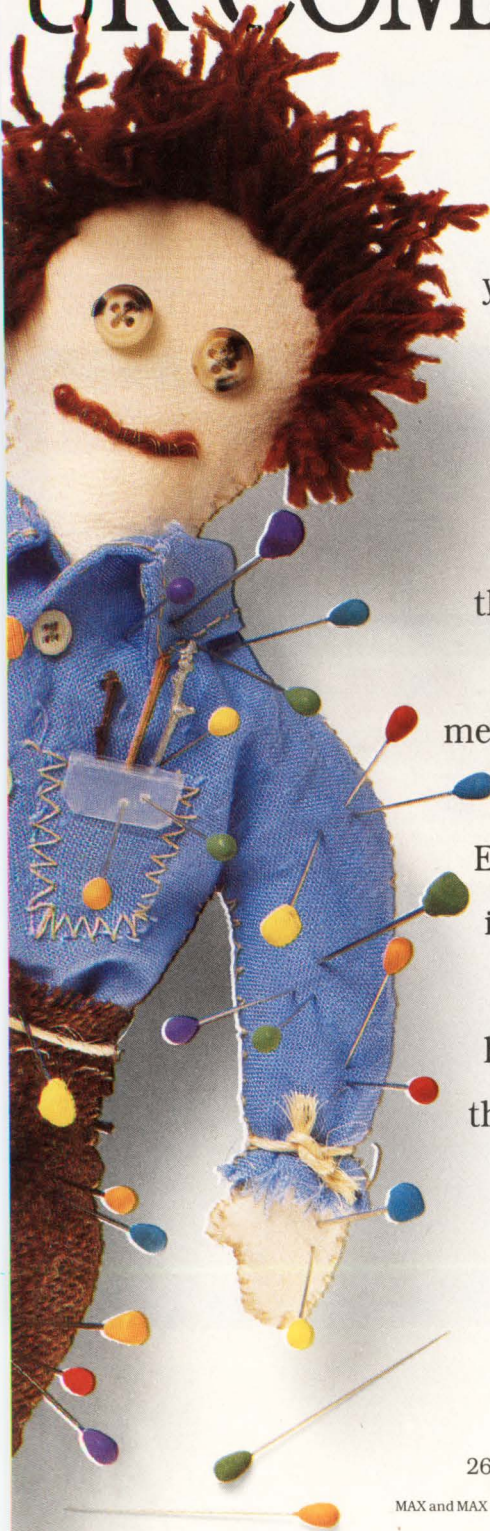

your competition's stuck manually partitioning his schematics.

You can even choose from a wide variety of erasable windowed and OTP packages. Including pin grid array, quad flat pack and PLCC package options. Which makes them perfect for full production or gate array prototyping.

Of course, the EPM5130 and EPM5192 are just two members of the modular MAX family. Devices range from 20 to 100 pins, 16 to 192 macrocells. In fact, there's an EPLD for every logic design task. Because we make the industry's broadest line of CMOS PLDs.

So if you're looking for devices with high density, high I/O and high speed, talk to the people who invented the EPLD. Call Altera today at (408) 984-2800.

We'll help you keep your competition pinned down.

# ALTERA

2610 Orchard Pkwy. San Jose, CA 95134-2020/(408) 984-2800/Fax: (408) 248-6924

MAX and MAX + PLUS are registered trademarks of Altera Corporation. Windows is a trademark of Microsoft Corporation. © 1991, Altera Corporation.

# Signetics. Because today's tomorrow's communic

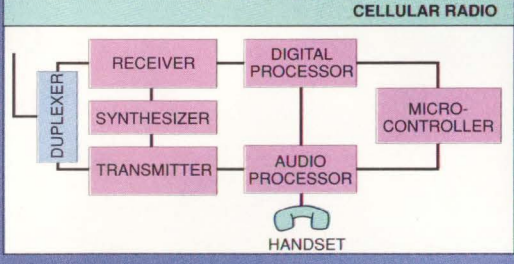
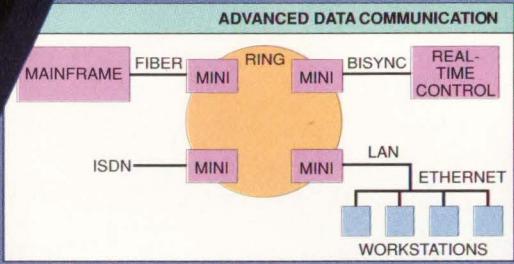
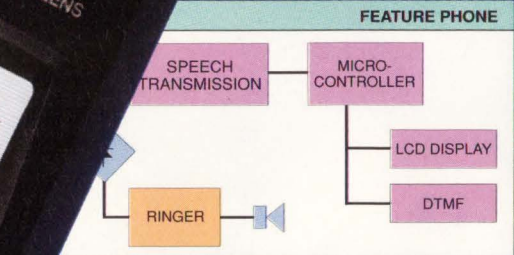

© 1990 NAPC

**Philips Components**

# remote possibilities are no longer imagination breakthroughs.

## FOR DESIGN INNOVATIONS, YOU NEED A FULL-SYSTEM SUPPLIER WITH NO STRINGS ATTACHED.

When it gets down to the wire, there's no better solution for your telephone, cellular, wireless or computer connectivity designs than Philips Components-Signetics.

We offer a complete range of high-performance ICs to tackle your ever-changing needs.

For compact radio designs, choose from a complete range of RF products. Including RF amplifiers, mixers and IF stages. As well as our fully programmable, low-power synthesizer with an RF divide from 400 MHz to over 1 GHz.

Plus there's our fully integrated cellular chip set. It includes demo-boards, software and software support and is the only complete solution for designing cellular radio applications. With it you can reduce the size of your portable product by reducing your chip count by up to 90%.

And for advanced feature phones, we offer a complete telephone solution including transmission circuits and feature circuits.

Or for high-speed computer connectivity there's our advanced Ethernet® chip set and 100 Mbit fiber

optic transceiver chip set. We also offer ICs that handle all popular protocols, including DUSCCs and UARTs.

We're building a broad base of state-of-the-art products utilizing our advanced, world-class BiCMOS process QUBiC. Combining the best features of Bipolar and CMOS, we're now creating new classes of high-performance devices within all our product families.

Each communication IC is an example of how Philips Components-Signetics is designing smarter devices to meet tomorrow's needs. Including the need for military products. So whether you're designing your first product or a new generation of products, remember that at Philips Components-Signetics we always keep the lines of communication open. Call now for your communications brochure: 800-227-1817, ext. 714D.

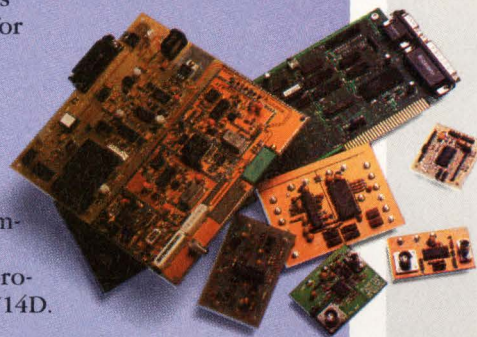

## Signetics

EXTENDING THE DIMENSIONS OF PERFORMANCE



# PHILIPS

The F80 Programmable Filter

# Another exciting episode of mission impossible.

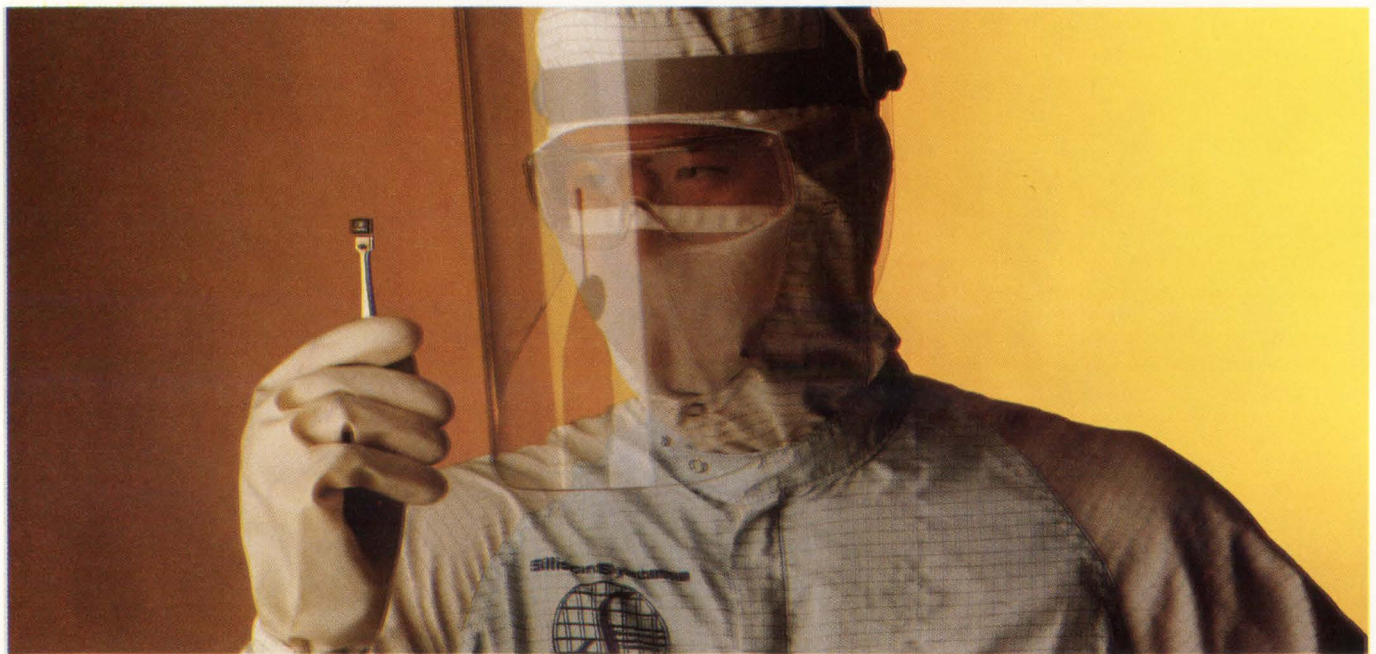

Many said it was impossible. Create a truly programmable filter that lets you skip over do-it-yourself passive-filter design and do away with many external components.

Well, they were wrong. Our F80 Series of Programmable Low Pass Filters do it dramatically. It's a real breakthrough that lets you program channel bandwidth from 5-13 MHz. Continuously. And easily. It lets you program on the fly and fully realize the potential of constant density

Circle #48 for Product Information

recording.

It's here. The F8011. One of a family of customizable filters designed for a variety of custom applications. It requires only a +5V power supply and reduces the costs and time associated with what had been one of the most engineering-intensive tasks in electronics design.

Whether you're designing hard disk drives, LANs, cellular telephone systems, radar systems or whatever, your next mission is to contact your nearest

Circle #49 for Career Information

Silicon Systems representative or distributor. Or call us for literature package SPD-4.

**Silicon Systems, Inc.**

14351 Myford Road, Tustin, CA 92680  
Ph 1-800-624-8999, ext. 151 Fax (714) 669-8814  
European Hdq. U.K. Ph (44) 79-881-2331  
Fax (44) 79-881-2117

*silicon systems*<sup>®</sup>

## CAE tools help cure transmission-line woes

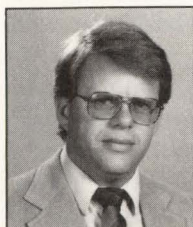

When pc-board traces act like transmission lines, all manner of problems can arise. CAE tools can help forestall those problems before you build your board.

**Richard A. Quinnell,**  
*Regional Editor*



**COMMUNICATIONS  
SPECIAL ISSUE**

**I**ncreasing logic speeds are forcing digital designers to consider transmission-line effects in printed-circuit boards. Yet most digital designers working with CMOS and TTL circuitry have little experience in recognizing and dealing with such effects. Fortunately, a variety of CAE tools can help to predict and correct transmission-line effects at all stages of pc-board design.

Transmission-line effects manifest in your circuit in many ways. They show up as delays that prevent clock and data signals from meeting IC setup and hold requirements. They also cause ringing signals, which can cross logic thresholds several times, thus wreaking havoc on counters and other edge-sensitive circuits. Ringing signals can swing beyond the rail voltages, possibly damaging components. Crosstalk noise can also be a manifestation of transmission-line effects.

ECL designers have long faced these problems and have developed a robust set of design rules to handle them. Unfortunately, well-established rules for high-speed CMOS and TTL design do not exist. There are guidelines, but those guidelines are broad rules of thumb (see **box**, "Do I need transmission-line tools?").

Such rules of thumb leave considerable room for error and are not adequate for many designs.

If the rule you follow is too loose, you may produce a marginal design. A conservative rule becomes a tyranny if you follow it blindly—for example, placing line terminations where they aren't really needed. The resulting pc board will be much more expensive than necessary. In either case, rules of thumb give only crude estimates of critical parameters such as timing delays.

Broad as they are, rules of thumb do provide adequate guidance if your circuit's timing is not critical and if board cost is not a design constraint. If the timing has little margin, or if cost is an issue, however, you'll want stricter guidance as you calculate the expected behavior of every potential transmission line in your circuit. In such circumstances, transmission-line CAE tools really prove their worth.

You can use transmission-line CAE

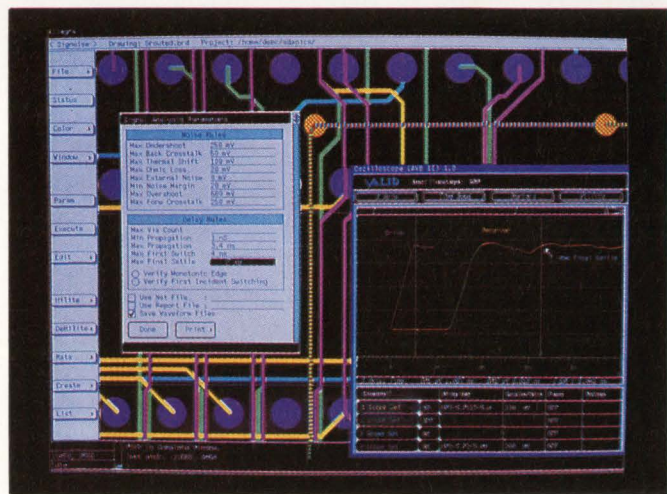

*Catching transmission-line problems before they happen is the job of transmission-line screening tools such as Valid Logic Systems' Signal Delay Analyzer. Working within the Allegro pc-board design tool, the analyzer finds and highlights problem traces.*

# TECHNOLOGY UPDATE

## Transmission-line CAE tools

tools at three stages in pc-board design: before beginning board layout, following component placement, and after routing. Not every tool is suitable for use at each stage, however. **Table 1** shows a representative selection of transmission-line CAE tools.

The tools fall into two categories: analysis and screening tools (**Ref 1**). The analysis tools analyze individual signal traces and let you study the circuit's behavior in detail using simulated waveforms. The screening tools check an entire circuit board in one pass but only give waveforms for selected traces. These tools produce tabular results for the remaining traces, flagging the ones that fail to meet noise margins. You can also use screening tools to analyze individual circuits.

A good use of analysis tools is to help establish design rules before you begin your pc-board layout. Use the tools to calculate the behavior of representative circuits. From these test cases, you can develop

design rules specifically for your board. The rules you'll want to establish include maximum trace and stub lengths, minimum trace separation, maximum length of parallel runs with critical circuits, and line-termination type and value. You can also use the test-case information to select parameters such as trace width, substrate type and thickness, and the number and placement of ground planes.

Screening tools let you check for transmission-line effects once you know what your circuit will tolerate. For example, a placement screening tool yields an estimate of trace delays given your component placement. These estimates use a network's Manhattan distances—the shortest possible routes between nodes if the traces were to follow an X-Y grid. Screening tools that have this capability include Shared Resources' Crystal Placement and Quad Design Technology's PDQ.

The placement-based delay esti-

mates will help you catch timing problems caused by long traces before investing time in a complete board routing. By feeding the estimated trace delays back into a logic simulator, you can determine whether the design possesses a fatal timing flaw.

If your timing simulator and the placement screening tool share the same database, you will save time and effort in arriving at a final layout. For example, a tool such as Valid Logic's Sigdelay, which is part of the company's Allegro pc-board CAD tool, lets you modify the board layout and quickly check the results using the same software. This interactive capability lets you quickly achieve a working design.

### Don't stop short

The accuracy of these delay estimates peaks at  $\pm 20\%$ . If your timing margins can absorb this error, you may be tempted to stop the analysis at this point. After all, you can usually add fixes for noise and

## Do I need transmission-line tools?

When you're not sure that your designs require transmission-line analysis, estimate the number of transmission lines your design has. If a large number of your traces are transmission lines, your design will likely benefit from CAE analysis tools.

One rule of thumb for identifying potential transmission lines is that an unterminated trace will act as a transmission line if the time it takes a signal to propagate down the trace and back is more than  $\frac{1}{2}$  the signal's rise time. More conservative versions of the rule cut that ratio to  $\frac{1}{4}$  or  $\frac{1}{5}$  (**Ref 2**).

**Fig A** translates these timing rules into suggested trace lengths for a given rise time. The graphs are for a propagation time of 2 nsec/ft, a typical value. You can use the chart to see if your circuits fall into the problem zone. If they do, you'll need to treat them as transmission lines to evade trouble.

Rules of thumb are only guidelines, however, and may be too loose or too tight. **Fig B** shows simulated waveforms for traces designed with the  $\frac{1}{2}$  and  $\frac{1}{5}$

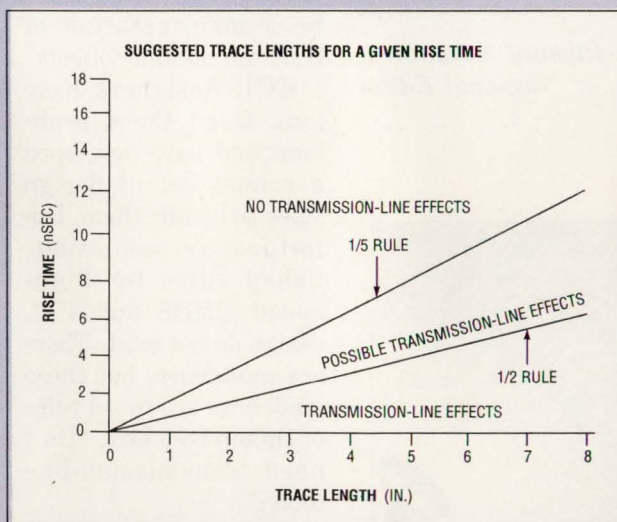

**Fig A—Rules of thumb help you determine** if a trace might act like a transmission line. The graph translates the  $\frac{1}{2}$  and  $\frac{1}{5}$  timing rules into suggested trace lengths for a given rise time. The graphs assume a propagation time of 2 nsec/ft, a typical value.



# TECHNOLOGY UPDATE

ringing problems after the board is fabricated. Only timing problems would have required you to do extensive redesign.

However, today's short design cycles may not allow you the luxury of chasing down noise and ringing problems. To minimize debug time, check your board's design for such transmission-line effects before building it. Use screening tools to check your board for crosstalk and ringing that violate the limits you set on each network. In addition, screening tools provide more accurate trace-delay information than placement-screening-only tools do. Several tools, such as Swiftlogic's Swiftline and Valid's Signal Noise Analysis tools, also check for signal overshoot and undershoot.

Here again, having the transmission-line CAE tool and your pc-board CAD system share the same database can be an advantage. For example, Valid's Sigdelay and Signal Noise Analysis tools will highlight the failed traces directly on

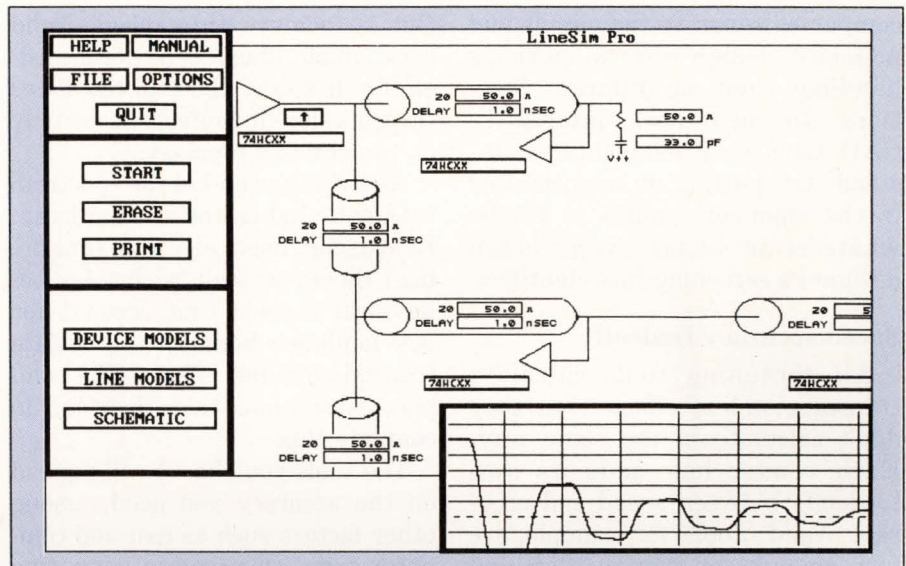

Analysis tools let you test single circuits and calculate the results in detail. Tools such as Hyperlynx's Linesim Pro also simulate waveforms.

the pc-board plot and let you correct the problem interactively. The Swiftlogic tools bring the same capability to Mentor Graphics' CAE tools. The ability to design interactively is more than a convenience. Moving traces on a fully routed

board can create new problems as fast as it cures old ones. Repeatedly iterating the design in batch mode can be quite tedious.

But such tight integration is advantageous only if you have access to the pc-board database. Some

rules. In this example, the traces are microstrips 6 in. long, 10 mils wide, and 20 mils above a ground plane. The  $\frac{1}{2}$  rule yields signals of marginal quality; the  $\frac{1}{5}$  rule yields extremely high-quality signals. Neither rule is the best choice for this board: The  $\frac{1}{2}$  rule might produce a marginal design, and the  $\frac{1}{5}$  rule would result in a board much more expensive than necessary.

These two rules, then, define a region of ambiguity. Outside the region you can be fairly certain that your trace either requires termination or doesn't. Within the region, the traces may or may not need termination; you can't tell without further analysis. If a significant number of your board's traces fall in the ambiguous region, a transmission-line CAE tool becomes almost a necessity.

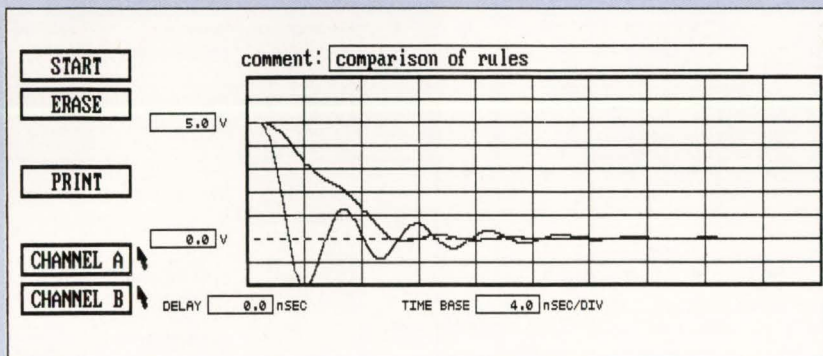

Fig B—Simulated waveforms for traces designed with the  $\frac{1}{2}$  and  $\frac{1}{5}$  rules can be generated with the Hyperlynx Linesim tool. In this example, the traces are microstrips 6 in. long, 10 mils wide, and 20 mils above a ground plane. The  $\frac{1}{2}$  rule gives marginal results; the  $\frac{1}{5}$  rule is too restrictive.

# TECHNOLOGY UPDATE

## Transmission-line CAE tools

companies separate the circuit and pc-board design efforts, perhaps handling them at different locations. In such cases, interactive CAD tools may be pointless. Instead, try putting an analysis tool in the engineer's hands to handle whatever problems the pc-board designer's screening tool identifies.

### Speed/accuracy tradeoffs

All screening tools calculate transmission-line effects, but they don't calculate in the same way. Each vendor has made its own tradeoffs between speed and accuracy. Valid's tools, for example, are fast enough for you to scan and modify your board interactively.

But to achieve this speed, Valid uses simple linear behavioral models for ICs, and the tool calculates transmission-line effects based only on the circuit's topology.

At the other end of the spectrum is Quantic Laboratories' Boardscan. Boardscan uses electromagnetic-field theory as well as complex behavioral models that account for ICs' nonlinear behavior to calculate transmission-line effects. The complex calculations take their toll in compute time.

The tools you choose will depend on the accuracy you need, among other factors such as cost and computer type. One way to determine the accuracy you require is to test

the tools using some of your existing pc-board designs. Then, check the results against the actual boards.

If you want to avoid transmission-line problems without using analysis tools, consider using one of the transmission-line-rule-driven pc-board autorouters. Valid's Allegro, Cadence's Amadeus Prance, and Shared Resources' Crystal pc-board design systems let you constrain their autorouters. You can use these tools to limit trace and stub lengths, match trace lengths, and control the connection ordering when routing. These features help control ringing and signal skew and ensure that signal transmitters and

**Table 1—Representative transmission-line analysis tools**

Company	Product name	Tool type	Features						Other features	Platforms	Price
			Post-placement screening	Trace delay	Settling delay	Multiple-threshold-crossing detection	Over-shoot/under-shoot	Crosstalk analysis			
Design Analysis Consultants	Timing Margin Analyzer	Analyzer		•	•				Worst-case timing analysis	IBM PC	\$350
Hyperlynx	Linesim	Analyzer		•	•	•	•			80286-, 80386-, and 80496-based PCs	\$495
	Linesim Pro	Analyzer		•	•	•	•			80386- and 80486-based PCs	\$995
Quad Design Technology Inc	Preroute Delay Quantifier (PDQ)	Screening	•	•						Daisix, HP/Apollo, Sun, Valid, Viewlogic workstations	\$11,000 for all
	Transmission-line Checker (TLC)	Screening		•	•	•			Also analyzes cables		
	Crosstalk Toolkit (XTK)	Screening						•	Also analyzes cables		
Quantic Laboratories Inc	Boardscan	Screening	•	•	•	•	•		Behavioral models	Unix workstation	\$15,000
	Greenfield	Analyzer		•	•	•	•	•	Electromagnetic-field analysis	Unix workstation	\$35,000
Shared Resources Inc	Crystal Placement Tool Set	Screening	•	•					Includes crystal pc-board design system	HP/Apollo, Sun workstations	\$40,000
Swiftlogic Inc	SwiftLine	Screening	•	•	•	•	•		Includes package models	HP/Apollo, Sun workstations	\$17,500 for both
	SwiftNoise	Screening						•			
Valid Logic Systems	Sigdelay	Screening	•	•	•	•			Lossy-line modeling	DECStation, VAXStation, Sun, IBM R6000 workstations	From \$12,500
	Signal Noise Analysis	Screening						•			

# NEWS

1553 DATA BUS  
SYNCHRO CONVERSION  
A/D & D/A CONVERSION  
POWER HYBRIDS  
SOLID-STATE POWER CONTROLLERS

**DDC**  
**ILC DATA DEVICE CORPORATION**

## SYNCHRO INSTRUMENTS ON CARDS

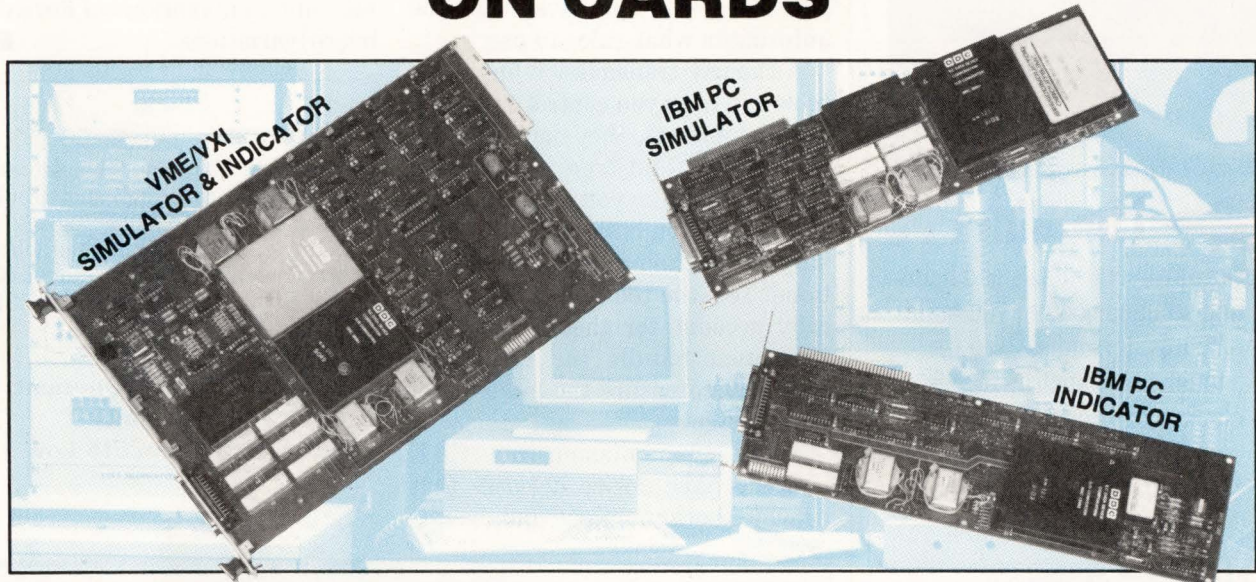

The **IAC-37001 Simulator and Indicator** provides independent channels for Synchro/Resolver-to-Digital and Digital-to-Synchro/Resolver conversion on the same VXI card. These instrument-grade converters operate independently with separate references and are mounted on a "C" size card conforming to VXI register-based specifications.

The S/D section allows selection of 20 or 16 bit mode, with accuracy to 18 arc seconds in either Synchro or Resolver mode. Signal inputs are transformer isolated, with programmable levels of 11.8, 26, or 90 volts L-L, and a frequency from 360 to 10KHz.

The D/S section of the IAC-37001 may be programmed for Synchro or Resolver output with an accuracy up to 20 arc seconds. A new feature is dynamic rotation, producing a constant clockwise rotation.

Applications include production testing, quality control inspection, and laboratory instrumentation. □

Sales Contact Circ. #35

Literature Circ. #36

**DDC**  
**ILC DATA DEVICE CORPORATION**

The **SIM-36010 Simulator** is a full size IBM PC® based card containing a single-channel, wideband, high-accuracy instrumentation-grade Synchro/Resolver Simulator.

It accepts either a 36 or 115 Vrms reference signal and outputs a Synchro or Resolver signal at 11.8, 26, or 90 Vrms L-L with a drive capability of 1.5 VA. It includes a programmable dynamic rotation feature that provides a constant output rate, clockwise or counterclockwise, from 0.07 degrees per second to over 30 revolutions per second.

The SIM-36010 is a versatile Synchro/Resolver instrument for production testing, quality control inspections, and laboratory instrumentation. It is ideal for use on a stand-alone simulator in an engineering department or as part of PC based Automatic Test Equipment (ATE).

Demonstration software, which shows the SIM-36010 capability is available with the card. □

Sales Contact Circ. #37

Literature Circ. #38

**HEADQUARTERS AND MAIN PLANT:** ILC Data Device Corporation, 105 Wilbur Place, Bohemia, NY 11716, (516) 567-5600, TLX: 310-685-2203, FAX: (516) 567-7358, (516) 563-5208  
**WEST COAST (CA):** GARDEN GROVE, (714) 895-9777, FAX: (714) 895-4988;  
**WOODLAND HILLS,** (818) 992-1772, FAX: (818) 887-1372; **SAN JOSE,** (408) 236-3260, FAX: (408) 244-9767  
**WASHINGTON, D.C. AREA:** (703) 450-7900, FAX: (703) 450-6610  
**NORTHERN NEW JERSEY:** (201) 785-1734, TLX: 130-332, FAX: (201) 785-4132  
**UNITED KINGDOM:** 44 (635) 40158, FAX: 44 (635) 32264; **FRANCE:** 33 (1) 4333-5888, FAX: 33 (1) 4334-9762  
**GERMANY:** 49 (8191) 3105, FAX: 49 (8191) 47433; **SWEDEN:** 46 (8) 920635, FAX: 46 (8) 353181  
**JAPAN:** 81 (3) 814-7688, FAX: 81 (3) 814-7689; **IRELAND:** 353-21-341065, FAX: 353-21-341568

The **API-36005 Indicator** is a full size IBM PC® based card containing a single-channel, wideband, high-accuracy, instrumentation-grade Synchro/Resolver Angle Position Indicator (API).

It accepts a reference signal of 26 or 115 Vrms, along with Synchro/Resolver signals of 11.8, 26, or 90 volts L-L, and converts these signals into 16 or 20 bits of binary angular information. Input signals are isolated over 360 to 5000Hz. It contains a built-in single-angle self-test feature for confidence testing. It is faster than conventional IEEE bus test systems.

It is ideal for use as a stand-alone Angle Position Indicator in the engineering lab or as part of PC based Automatic Test Equipment (ATE).

The API-36005 comes with an operating and maintenance manual, and demonstration software.

**For additional information, contact Bill Cullum, 1-800-DDC-1772 ext. 389.** □

©IBM is a registered trademark of International Business Machines.  
Sales Contact Circ. #39 Literature Circ. #40

# Transmission Line Problems?

Glitchy clocks?  
Overshoot and undershoot?  
Flaky system operation?

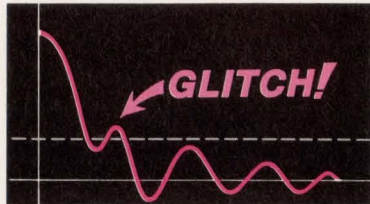

## New! LineSim Pro

spots problem signals and helps find solutions before you build boards. It handles even the toughest geometries: large clock nets, backplane designs, etc. Fully integrated and interactive: no netlists, no translations, no hassles.

### LineSim Pro features:

- simulations of up to 200 transmission line segments per electrical net
- push-button schematic
- oscilloscope display
- device-model library
- circuit-board-impedance calculators
- extended-memory support
- uses 386/486 protected mode

Or choose the original **LineSim**, a simplified version (two lines) for an unbeatable price. (It's upgradable, too.)

### LineSim Pro: \$995 (U.S.)

Requires 386/486 PC w/EGA/VGA; min. 2 Mb extended memory; mouse.

### LineSim: \$495 (U.S.)

Requires IBM PC w/EGA; min. 640k memory.

30-day money-back guarantee, w/\$25 restock fee.

## HyperLynx

Attention: Sales Dept.  
P.O. Box 3578  
Redmond, WA 98073-3578  
Tel. (206)869-2320  
Fax (206)881-1008

# TECHNOLOGY UPDATE

## Transmission-line CAE tools

terminators are at the ends of networks.

The boards a rule-driven autorouter designs will be correct by construction, in theory. But the design will only be as good as its design rules. You still have to tell the autorouter what rules to use.

Although transmission-line CAE tools can help you control transmission-line effects, they don't guarantee a problem-free production board. The ICs you purchase and the boards you build will inevitably vary from their nominal specifications. Yet, the tools don't automatically account for those variations. You must handle the variations manually to ensure the integrity of your design.

Many transmission-line CAE tools do have device libraries that provide both nominal and worst-

case models. No tool provides Monte-Carlo simulation using those models, however, nor do any handle variations in trace thickness or width. It's up to you to scan your design repeatedly to test for all relevant combinations of device and board variations. **EDN**

## References

1. Conner, Margery, "Simulators for high-speed board design spot trouble," *EDN*, December 21, 1989, pg 152.

2. Royle, David, "Rules tell whether interconnections act like transmission lines," *EDN*, June 28, 1988, pg 131.

## Article Interest Quotient (Circle One)

High 515 Medium 516 Low 517

## For more information . . .

For more information on the transmission-line products discussed in this article, circle the appropriate numbers on the Information Retrieval Service card or use EDN's Express Request service. When you contact any of the following manufacturers directly, please let them know you read about their products in EDN.

**Cadence Design Systems Inc**  
555 River Oaks Pkwy  
San Jose, CA 95134  
(408) 943-1234  
Circle No. 700

**Design Analysis Consultants**  
10014 N Dale Mabry  
Suite 101  
Tampa, FL 33618  
(813) 265-8331  
Circle No. 701

**Hyperlynx**  
Box 3578  
Redmond, WA 98073  
(206) 869-2320  
FAX (206) 881-1008  
Circle No. 702

**Quad Design Technology Inc**  
1385 Del Norte Rd  
Camarillo, CA 93010  
(805) 988-8250  
FAX (805) 988-8259  
Circle No. 703

**Quantic Laboratories Inc**  
46750 Fremont Blvd  
Suite 206  
Fremont, CA 94538  
(800) 665-0235;  
in CA, (415) 770-8888  
FAX (415) 770-8395  
Circle No. 704

**Shared Resources Inc**  
3047 Orchard Pkwy  
San Jose, CA 95134  
(408) 434-0444  
FAX (408) 434-0746  
Circle No. 705

**Swiftlogic Inc**  
5201 Great America Pkwy  
Suite 3223  
Santa Clara, CA 95054  
(408) 562-6060  
Circle No. 706

**Valid Logic Systems**  
2 Omni Way  
Chelmsford, MA 08124  
(508) 256-2300  
FAX (508) 250-0087  
Circle No. 707

# MEGA MEMORY.

SONY HIGH-DENSITY SRAMS				
MODEL	CONFIG.	SPEED (ns)	PACKAGING	DATA RETENTION
CXK581000P*	128K x 8	100/120	DIP 600 mil	L, LL
CXK581000M*	128K x 8	100/120	SOP 525 mil	L, LL
CXK581100TM*	128K x 8	100/120	TSOP	L, LL
CXK581100YM*	128K x 8	100/120	TSOP (reverse)	L, LL
CXK581001P	128K x 8	70/85	DIP 600 mil	L
CXK581001M	128K x 8	70/85	SOP 525 mil	L
CXK581020SP	128K x 8	35/45/55	SDIP 400 mil	
CXK581020J	128K x 8	35/45/55	SOJ 400 mil	

\*Extended temperature range available. L = Low power. LL = Low, low power.

# MEGA COMMITMENT.



As you can see, Sony's more committed than ever to meeting your high-density SRAM needs.

Just consider the enhancements we've made in a few short months: TSOP and TSOP-reverse packaging. Low data retention current. And extended temperature range.

All based on our unique 0.8-micron CMOS technology, and available in 32-pin DIP and surface-mount plastic packages.

Then consider our ever-increasing production capabilities. We've just added yet another SRAM facility in Japan. And acquired a large AMD facility in San Antonio, Texas.

So you can really count on us in a crunch. Need more proof we're serious about your each and every SRAM need?

Call us. We've got more breakthroughs on the way. Well over 100 SRAM products spanning the performance spectrum. And the desire to meet—or exceed—your toughest performance spec.

Sony high-density SRAMS are shipping now, complete with competitive pricing. So call (714) 229-4190 today. Or write Sony Corporation Of America, Component Products Company, 10833 Valley View St., Cypress, CA 90630, Attention: Semiconductor sales. FAX (714) 229-4285.

# SONY®

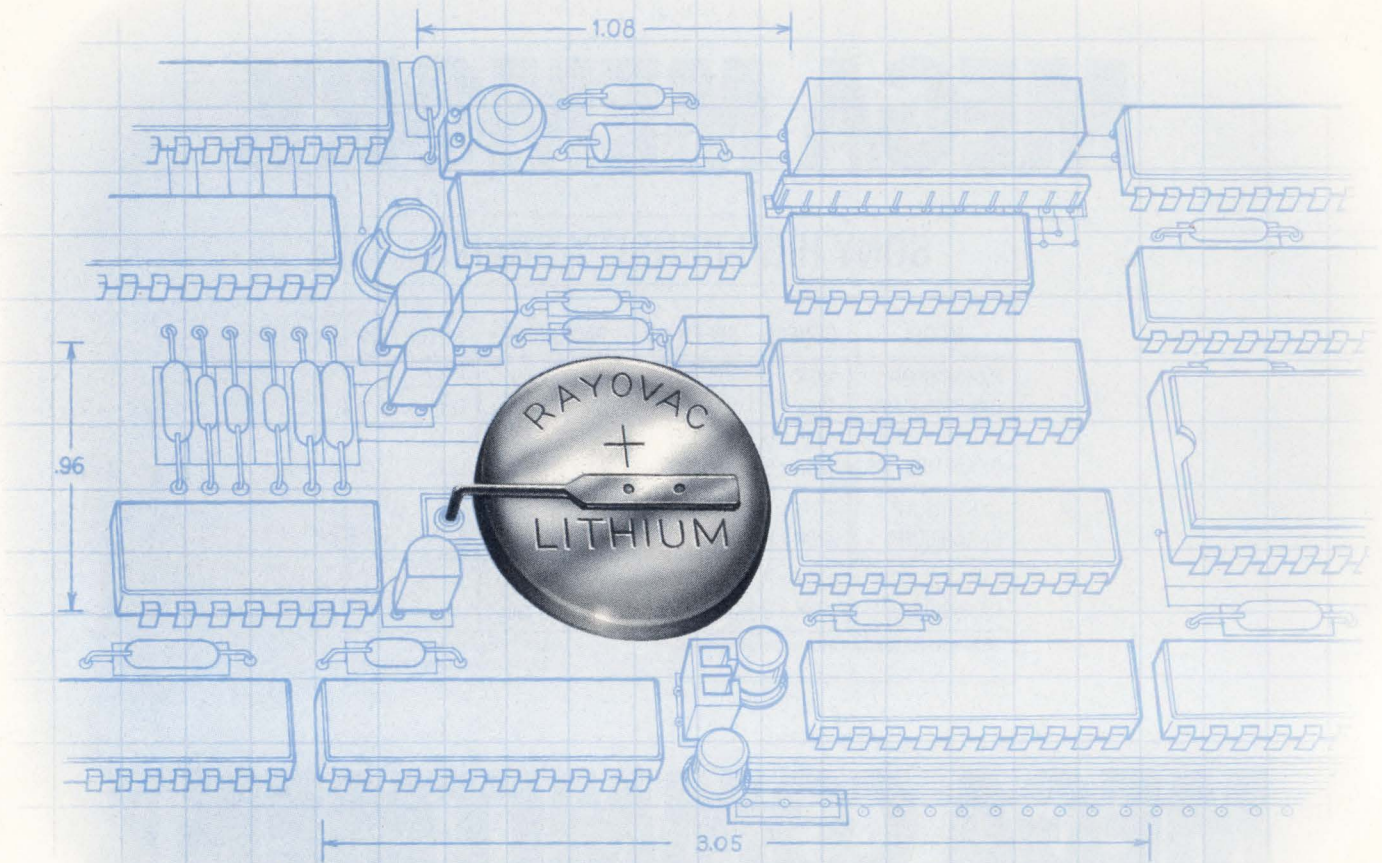

# HOW MORE COMPANIES ARE ADDING LIFE TO THEIR DESIGNS.

Rayovac Lifex™ Coin Cells and Lifex FB™ Batteries have the highest reliability ratings in the industry. That's why major electronics manufacturers worldwide already specify Lifex in their product designs.

Rayovac reliability is especially valuable for critical memory applications, such as encryption codes, cash values, or control parameters.

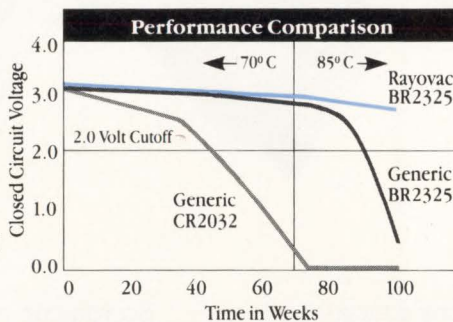

*In high-temperature sustained storage, Lifex continues strong long after others fade away.*

The Lifex FB offers extended temperature tolerance—operating comfortably in

a range of  $-40^{\circ}\text{C}$  to  $+100^{\circ}\text{C}$ . And our products are made in the U.S.A., with on-time delivery available around the world.

So add longer life to your design. Specify a Rayovac Lifex Coin Cell or Lifex FB Battery in your design. Call Rayovac's Technical Sales & Marketing Department for complete information and battery specifications at 608-275-4694.



# KILL THE NOISE WITH

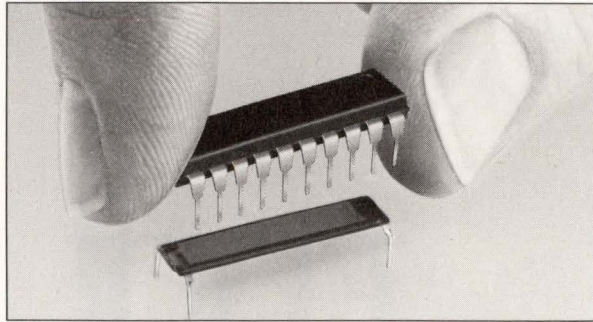

## MICRO/Q<sup>®</sup> CAPACITORS

Reduce voltage noise spikes in ICs by as much as a factor of 10. Without redesign. Without using additional space.

With Micro/Q<sup>®</sup> decoupling capacitors from Rogers. Micro/Q capacitors mount under the IC. Share mounting holes. To improve noise suppression where it's most effective—at the source.

Best of all, Micro/Q capacitors kill the noise without killing a lot of valuable time.

Micro/Q<sup>®</sup> is a registered trademark of Rogers Corporation. Another MEKTRON<sup>®</sup> Interconnection Product.

For all the facts, including the Micro/Q capacitor track record for noise-reduction in dynamic RAMs, EPROMs, static RAMs and boards that need EMI/RFI fix, call a Rogers' Product Specialist today at (602) 967-0624 (Fax 602-967-9385). And ask for a free sample.

*Technology for tomorrow built on TQC today.*



### ROGERS

Rogers Corporation  
Circuit Components Division  
2400 S. Roosevelt Street  
Tempe, AZ 85282

CIRCLE NO. 52

**DISTRIBUTION:** Europe, Japan, Taiwan, Singapore, Hong Kong, Korea, Brazil, Australia

### MICRO/Q 1000 STANDARD CAPACITORS

Improve board performance without redesign. Noise problems are solved by retrofitting on existing boards.



CIRCLE NO. 53

### MICRO/Q 1000 CUSTOM CAPACITORS

Special pinouts are available to address the wide variety of specialty DIPs such as analog devices, op-amps, and the center pinout advanced CMOS devices. Applications include: decoupling, EMI/RFI filtering, and compensation.

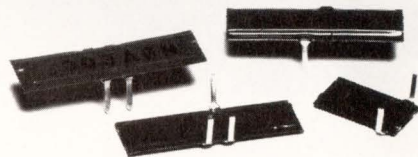

CIRCLE NO. 54

### MICRO/Q 3000 CAPACITORS

Reduces noise associated with the use of PGA and PLCC devices. Several part sizes are available to address a variety of package sizes. Micro/Q 3000 is designed to be used with all 16/32-bit MPUs, DSPs, GSPs, FPPs, gate arrays, standard cells, and fully custom ASICs.

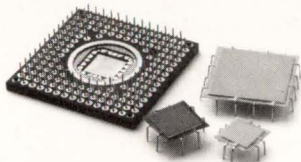

CIRCLE NO. 55

### MICRO/Q 3500SM CAPACITORS FOR SMT-PLCCs

Family of surface mount capacitors designed to fit under 44, 52, 68, 84/larger pin count PLCCs. Low inductance, 0.5 - 0.6 nanoHenries. Pads absorb coefficient of thermal expansion mis-match between board and device during soldering. Supplied in tape and reel or in bulk. Available with Z5V or X7R dielectrics.

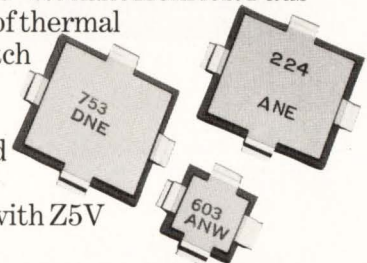

CIRCLE NO. 56



# FDDI.

## From deskwork to network.

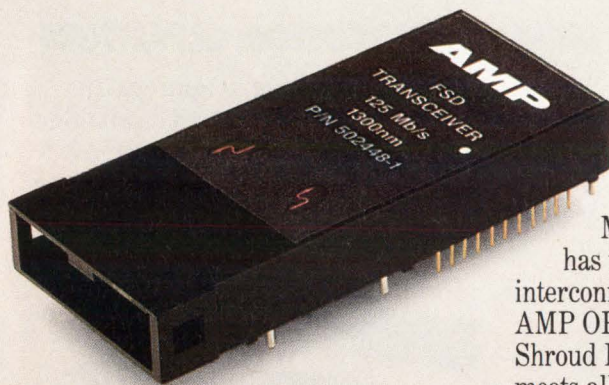

Good news for networks!  
*The X3T9.5 Task Group, under the procedures of ANSI Accredited Standards Committee X3, has reaffirmed approval of the Media Interface Connector (MIC) for the proposed FDDI (Fiber Distributed Data Interface) Physical Layer Medium Dependent (PMD) document.*

More good news! AMP has the complete fiber optic interconnection system—the AMP OPTIMATE Fixed Shroud Duplex System—that meets all FDDI PMD requirements. And includes all the physical components you need to make your fiber optic network a reality.

Of special note: the transceiver is capable of operating at data rates up to 125 Mb/s. Available in standard or raised (+5v) ECL logic, it gives you a compact, board-mount data link in an industry-standard 22-pin package. Reliable duplex mat-

ing and electro-optic conversion are now easier than ever.

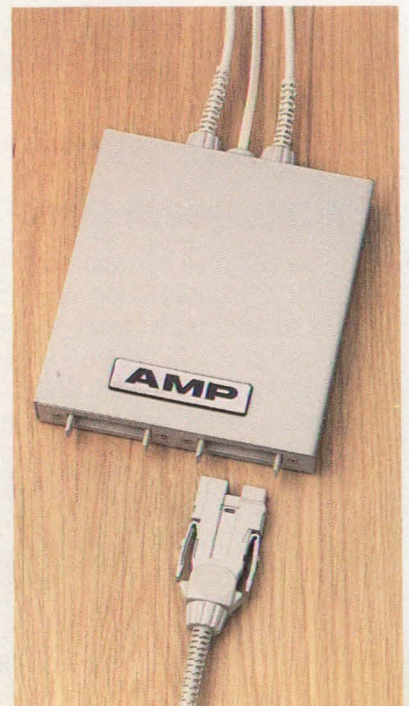



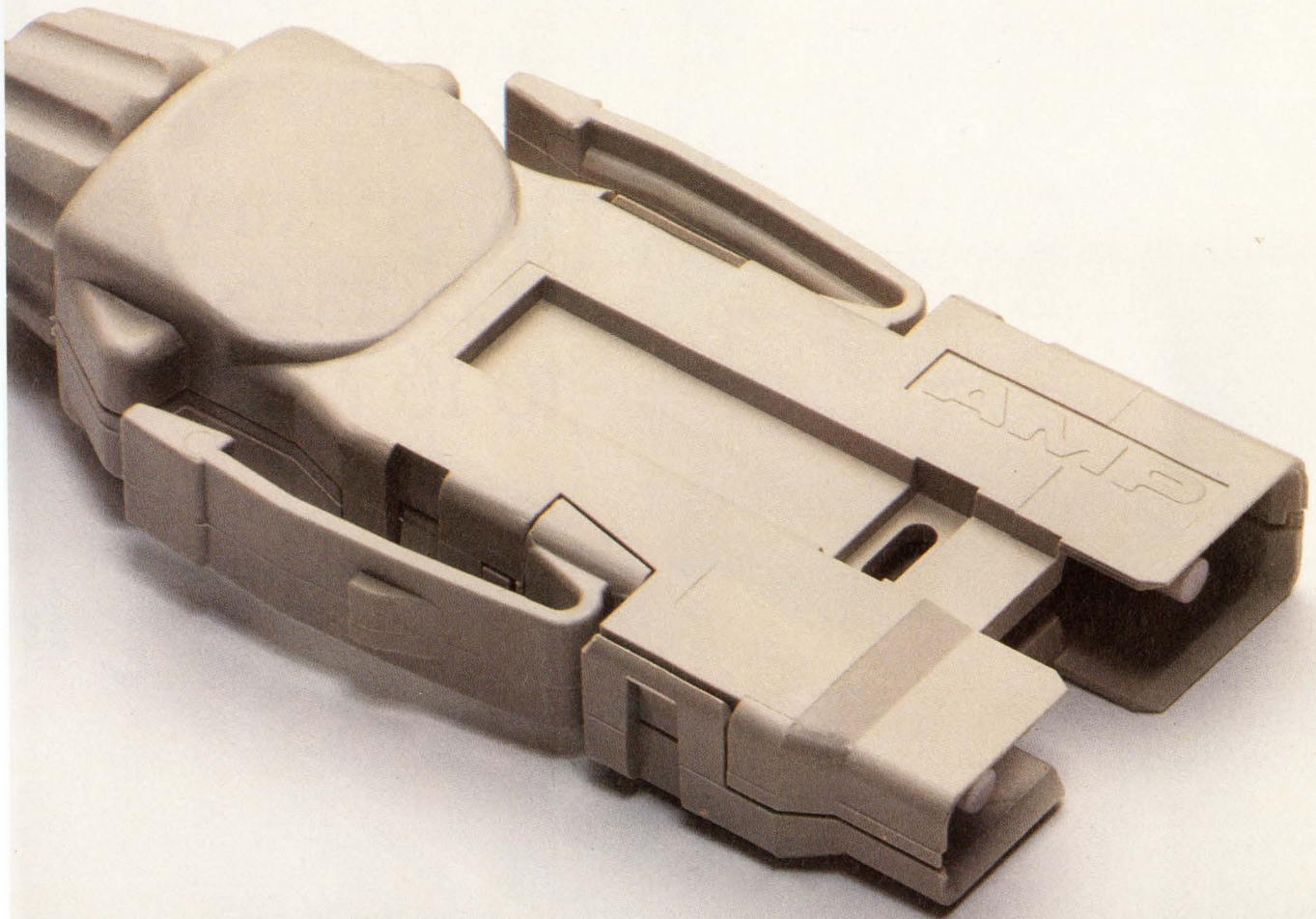

All system components, in fact, are easy to install and reconfigure. Our field termination kit makes short work of attaching duplex connectors to fiber cable. And because all interconnections use a floating interface, you get consistent, low-loss mating (0.6 dB typical) throughout.

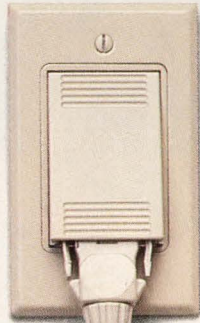

You can also order complete, custom-built cable assemblies from us. Either way, you'll have the assured compatibility that comes from dealing with only one supplier for all your FDDI interconnection components. A supplier whose capability

in fiber optic technology is everything you'd expect from the world's largest connector company.

For technical literature and more information, call 1-800-522-6752. AMP Incorporated, Harrisburg, PA 17105-3608.

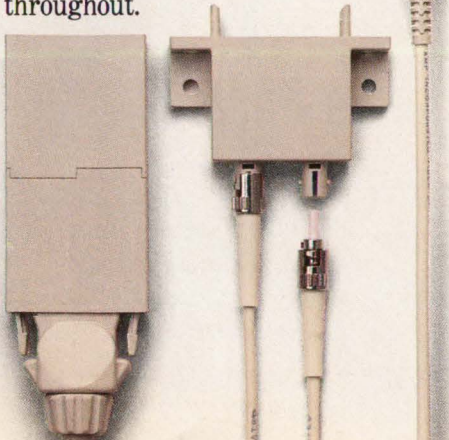

**THIS IS AMP TODAY.**

**AMP**



# Fasten Your Seat Belt... Token Ring Accelerates to 16 Mbps.

## Two New SBE 16 Mbps Controllers Bring High-Speed Token Ring to VMEbus/Multibus Systems.

One advantage of Token Ring is that it provides an efficient, high-performance interconnect with IBM mainframes. In a multinodal LAN environment, Token Ring provides *four times the throughput of Ethernet*.

SBE delivers high-performance Token Ring with two new intelligent 16 Mbps communications controllers that interface VMEbus/Multibus Systems with Token Ring LANs.

SBE's Token Ring Controllers include these features:

- Software-selectable interface for 4 or 16 Mbps.
- High-speed, on-board 32-bit 68020/68030 25MHz processors.
- 1 MB or 4 MB of DRAM.
- Support for IEEE 802.5 standards.

Turn to SBE and discover the difference these new 16 Mbps VMEbus/Multibus Controllers can make in your LAN application.

*For fast action, call: 1-800-347-COMM.*

*SBE, Inc., 2400 Bisso Lane, Concord, CA 94520*

**SBE**  
Communications &  
Real-time Solutions

## FIBER-OPTIC TRANSCEIVERS

# Modules satisfy FDDI and other standards

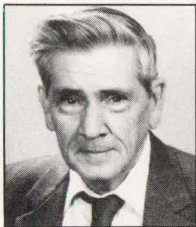

Transceiver modules are key factors in fiber-optic data links and can implement communications in both local- and wide-area networks.

*Dave Pryce,*  
Associate Editor

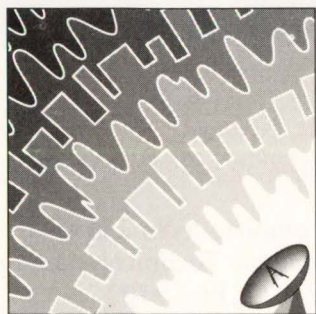

**COMMUNICATIONS  
SPECIAL ISSUE**

Advances in fiber-optic components and the implementation of new standards are having a dramatic effect on both short- and long-haul telecommunications. Rather than using a traditional copper-based system with its inherent bandwidth limitations and EMI/RFI problems, an increasing number of communications networks are implemented with fiber-optic cables. Local-area networks (LANs) based on the Fiber Distributed Data Interface (FDDI) are making their presence felt, and the emerging Synchronous Optical Network (SONET) standard will likely play a major role in long-distance applications. (For a description of these standards, see **box**, "Fiber-optic-network standards," pg 64.)

Of critical importance to the implementation of these state-of-the-art networks are the transmitter and receiver modules, which interface with the fiber-optic link. Many of these modules take the duplex form of a transceiver, which combines the functions of both the transmitter and receiver.

Typical of these transceivers are the multi-sourced FDDI modules available from such companies as AT&T, Hewlett-Packard, AMP, and Siemens. These modules have similar circuitry and feature a similar package

that mounts on a printed-circuit board.

In the Hewlett-Packard version of the FDDI transceiver (**Fig 1**), the transmitter section consists of a 1300-nm InGaAsP LED and a single custom bipolar LED-driver IC. The driver circuit provides temperature compensation to regulate the optical output power. The receiver section of the FDDI module consists of a 1300-nm InGaAs PIN (positive intrinsic negative) photodiode and two custom bipolar ICs. The preamplifier IC mounts in the optical subassembly with the PIN detector to maximize receiver sensitivity. The quantizer IC provides the final pulse shaping for both the logic output and the signal-detect

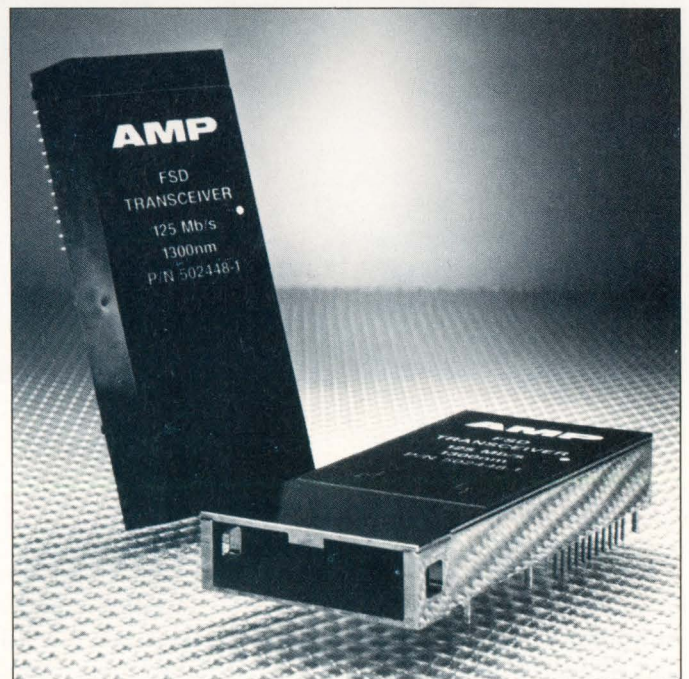

*This pin-compatible multisourced FDDI transceiver from AMP is similar to those available from Hewlett-Packard, AT&T, and Siemens.*

# Sprague<sup>®</sup>

## TANTALUM CHIPS TO GO.

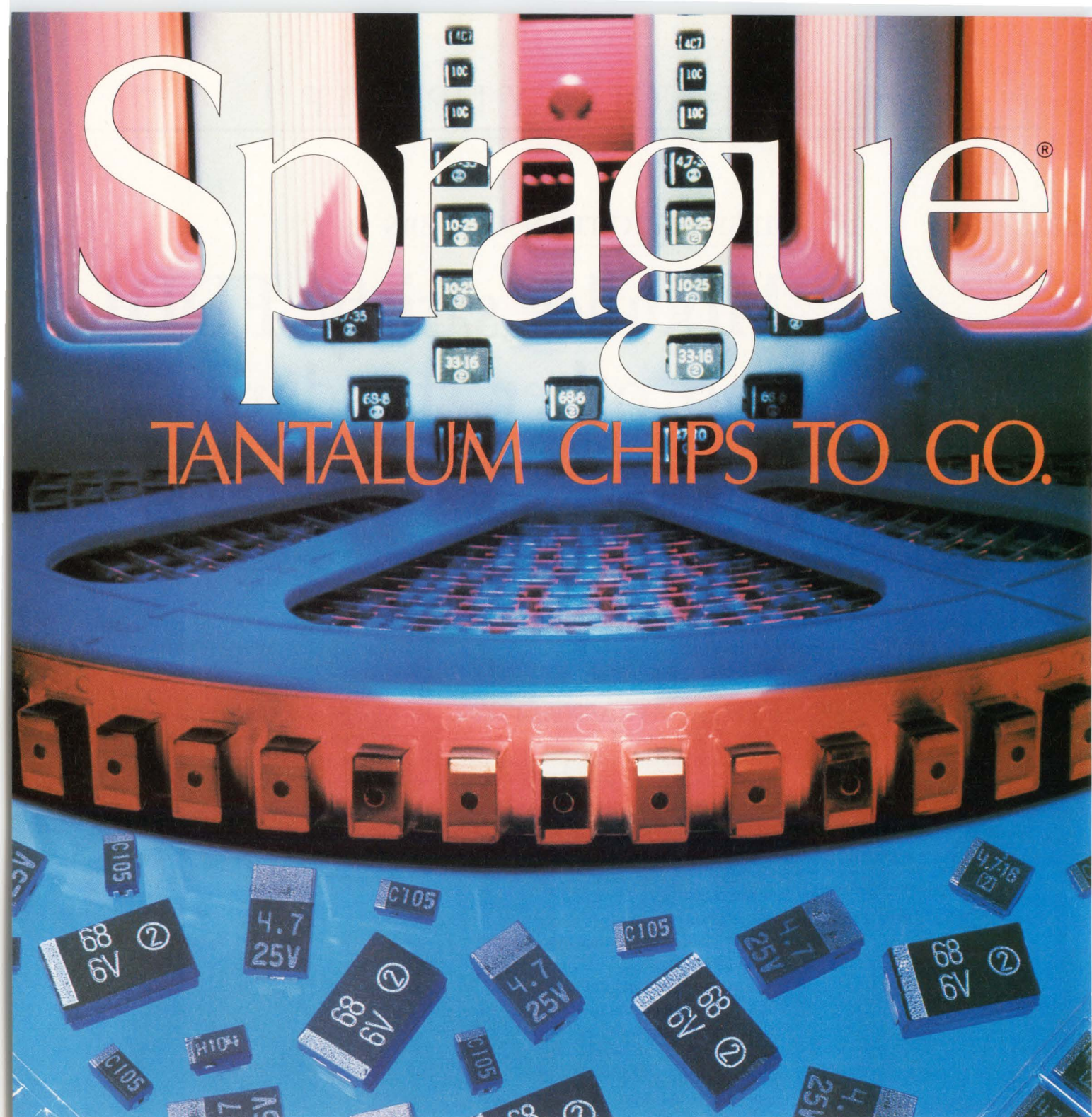

8008P191(444)

## Sprague delivers tantalum chips off-the-shelf.

Need tantalum chip capacitors in a hurry? Need ten thousand? Or hundreds of thousands? Sprague can deliver Type 293D TANTAMOUNT<sup>®</sup> tantalum chip capacitors from stock to meet your surface mount requirements. Featuring rugged, fully molded construction, they conform to EIA

IS-28. Depending on size, they are supplied taped on 8mm or 12mm reels per EIA 481A, for automatic placement. Available in four package sizes covering 4 to 50 WVDC ratings. Capacitance values: 0.10 to 100 $\mu$ F. When it comes to machine-friendly tantalum chips, we're ready NOW!

For complete technical data, write Sprague Technical Literature Service, P.O. Box 9102, Mansfield, MA 02048-9102. Or call 1-800-SPR-0800.

CIRCLE NO. 58

 **SPRAGUE<sup>®</sup>**

# TECHNOLOGY UPDATE

## Fiber-optic transceivers

function. The data input to the transmitter and the data and signal-detect logic outputs of the receiver are differential, 100K ECL-compatible circuitry referenced to a 5V power supply.

Regardless of any minor circuit variations between FDDI transceiver modules from different vendors, all work in the same manner and provide essentially identical performance. Moreover, all come in a similar-size package with identical pin arrangements in the form of two rows of 11 pins each for pc-board connection. The module also has a built-in MIC (media interface connector) receptacle for connection to the fiber-optic link. Hewlett-Packard sells its HFBR-5125 version of these multisourced transceiver modules for \$550 (1 to 9).

Hewlett-Packard also offers individual transmitter (HFBR-1125) and receiver (HFBR-2125) modules for \$270 and \$330, respectively. These FDDI-compatible modules come in a smaller 20-pin package with an ST simplex connector originally developed by AT&T. This combination is handy

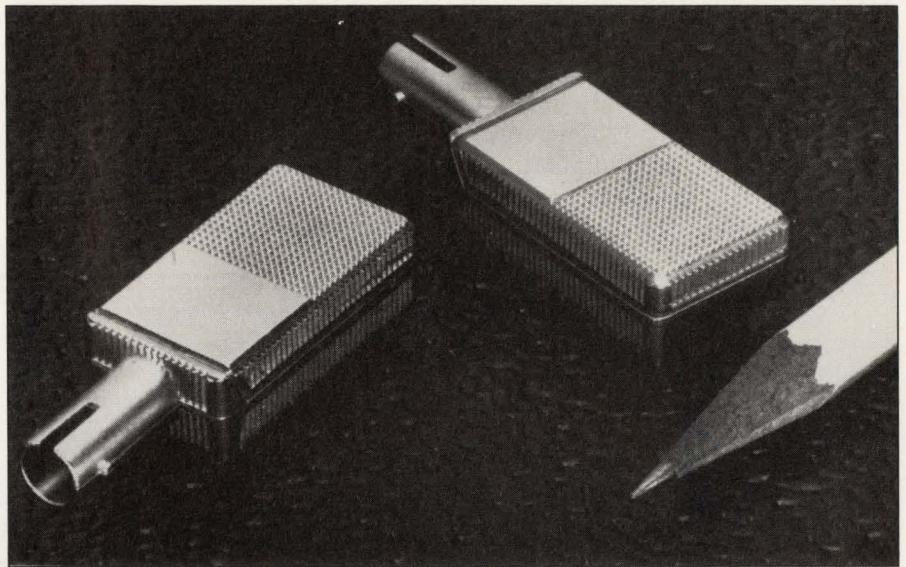

*FDDI modules are also available in simplex form. These transmitter and receiver modules from Hewlett-Packard are individual, 20-pin devices with an ST-style fiber-optic connector.*

for designs, such as equipment that uses optical bypass switches, that can't use the duplex MIC connector.

FDDI-compatible products and applications have been expanding at an accelerated pace, but the same has not been true for the still-emerging SONET standard. Nevertheless, authorities such as Mark Melliar-Smith, chief operating officer

of the lightwave unit of AT&T Microelectronics, remain convinced that the networks of the future will likely be SONET networks. This conviction is a sound one. By standardizing transmission-line rates and specifying common rules of operation, SONET enables equipment from different vendors to function seamlessly across network boundaries.

AT&T, among others, is backing up its conviction in SONET's future with products that are available now. At the Conference on Optical Fiber Communications recently held in San Francisco, AT&T introduced several SONET-compatible modules as part of its Astrotec series. Among these modules are the 1227 transmitter and 1310 receiver, which the company sells as a pair for \$900 to \$1100 (1000).

The 1227 transmitter consists of an InGaAsP 1300-nm Fabry-Perot laser diode, a low-power CMOS IC, and an InGaAs PIN photodetector as a backface monitor. These devices are contained in a hermetically sealed 20-pin package for pc-board mounting. Although uncooled, the transmitter meets all

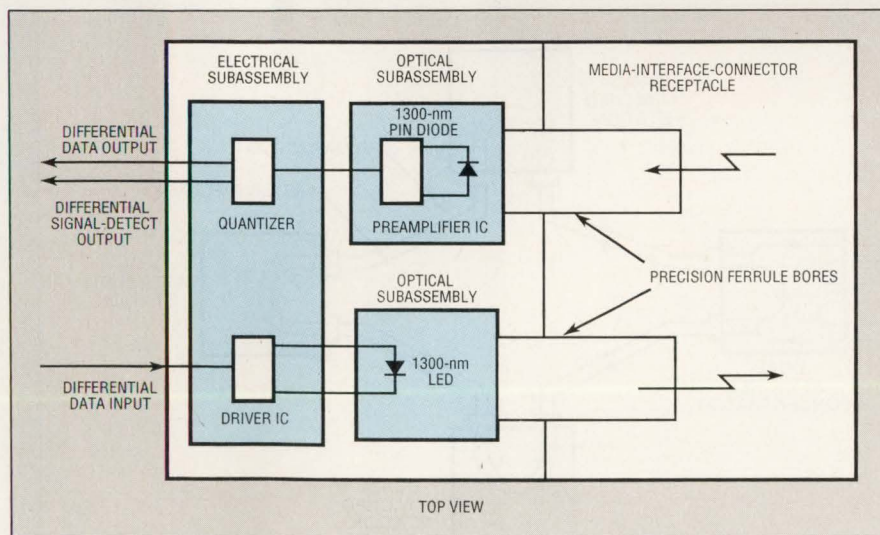

*Fig 1—Multisourced FDDI transceivers all work in the same manner. In Hewlett-Packard's version, the transmitter section uses a 1300-nm InGaAsP LED and custom driver IC. The receiver section uses a 1300-nm InGaAs PIN photodiode and two custom ICs. Regardless of the manufacturer, these FDDI modules come in similar-sized packages with identical pin connections.*

# TECHNOLOGY UPDATE

## Fiber-optic transceivers

SONET specifications over the  $-40$  to  $+85^{\circ}\text{C}$  range. The transmitter operates from a single 5V supply and can serve intraoffice links as long as 15 km. The 1227 operates at line rates of 51M, 155M, and 622M bps. At the latter rate, the transmitter can carry the equiva-

lent of 8064 2-way voice telephone connections.

The 1310 receiver consists of an InGaAs PIN photodetector, a GaAs preamplifier, and a silicon bipolar comparator circuit. Like its companion transmitter, the receiver operates over the  $-40$  to  $+85^{\circ}\text{C}$

range. You can optimize the performance of the receiver for any data rate from 20M to 650M bps. In addition, the receiver is SONET compatible at 51.84M and 155.52M-bps data rates for intraoffice distances as long as 40 km. The device requires  $-5.2$  and 5V supplies.

## Fiber-optic-network standards

Networks with bit rates greater than 50M bps are handled by ANSI (American National Standards Institute). The two principal ANSI standards for use with fiber-optic networks are FDDI and SONET.

The ANSI Fiber Distributed Data Interface (FDDI) uses counter-rotating dual rings (Fig A). The topology is essentially compatible with the IEEE-802.5 token-ring standard, but is slightly altered to accommodate high data rates. FDDI improves on the 802.5 standard by allowing the ring to pass the token to the next station for immediate access after transmitting the information packet. As a result, more than one packet of information can circulate at a time. The conventional 802.5 standard requires that the token return to the originating station before the next token is passed.

FDDI networks operate at 100M bps. They have a 2-km maximum cable length between nodes (stations), a 100-km maximum ring circumference, and

a maximum of 500 nodes. The total length of the network can be 200 km. In contrast, Ethernet networks have a 0.5-km maximum cable length between nodes and a maximum length of only 2.8 km. Although the actual data rate for FDDI is 100M bps, the 4-bit/5-bit encoding scheme requires a 125M-baud transmission rate. The FDDI standard also specifies a 1300-nm LED for the photoemitter and a 1300-nm PIN diode for the photodetector. FDDI networks use multimode fiber cable with a core/cladding diameter of  $62.5/125\ \mu\text{m}$ .

Conceptually, a large-scale implementation of FDDI (Fig B) can support front-end, back-end, and backbone networks. The front-end network operates through a wiring concentrator to link equipment such as engineering workstations. The back-end network supports communications between mainframe computers or minicomputers and their associated storage devices. The backbone network uses gate-

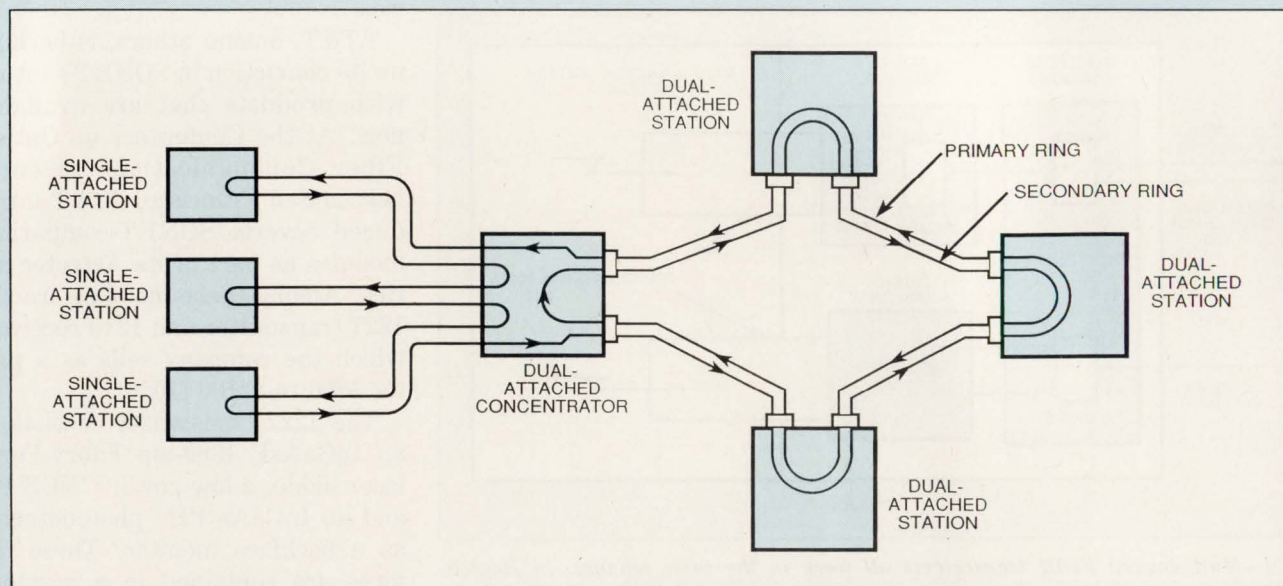

Fig A—The Fiber Distributed Data Interface (FDDI) uses counter-rotating dual rings, which allows more than one packet of information to circulate at a time.

# TECHNOLOGY UPDATE

The implementation of FDDI-based systems is probably the most prevalent and the development of SONET-based systems the most dynamic among fiber-optic-transceiver applications, but many other applications exist for the devices.

Perhaps one of the least known,

but most noteworthy examples is the use of fiber-optic transmitters and receivers in CATV systems. These systems use seemingly countless numbers of amplifiers to transmit and receive wide-band signals over 75Ω coaxial cable. By replacing the coaxial cable with fiber,

CATV companies can greatly reduce the number of amplifiers in the typical system while reducing noise levels and expanding the bandwidth. Indeed, many suppliers of CATV equipment believe that future systems must use fiber if channel capacities are to grow beyond

ways to tie together various types of lower-speed LANs such as Ethernet, token-bus, and token-ring to form larger wide-area networks.

The ANSI Synchronous Optical Network (SONET) is not, by original intent, a local-area network. The standard was created to standardize transmission-line rates and architectures for long-haul fiber-optic systems. By specifying common rules of operation, SONET enables diverse vendor equipment to function seamlessly across network boundaries while transporting high-volume digitized voice, image, or data communications. SONET specifies a 1300-nm data link using either LEDs or lasers, depending on the distance and line rate. The standard encompasses line rates of 51.84M to 2488.32M bps and assigns specific line rates for each

optical-carrier (OC) level. Examples include

Optical-carrier level	Line rate (M bps)
OC-1	51.840
OC-3	155.520
OC-9	466.560
OC-12	622.080
OC-18	933.120
OC-24	1244.160
OC-36	1866.240
OC-48	2488.320

Although SONET's primary application is in long-haul transmission over the switched telephone network, the standard may also prove useful for local loops. For example, SONET-compatible products are available that function well in single-mode FDDI applications as well as other single-mode private networks needing high capacity or lengths of 2 to 40 km.

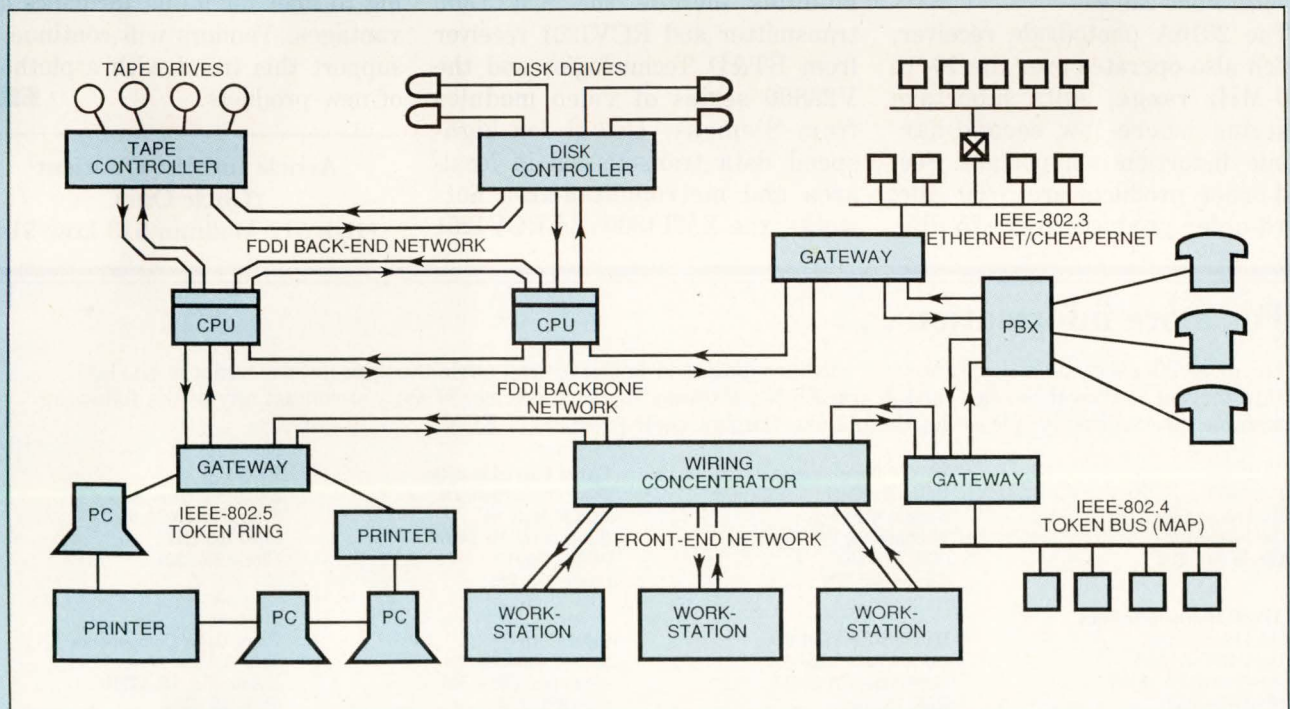

Fig B—The FDDI standard supports the requirements of many networks, including Token Ring, Token Bus, and Ethernet.

# TECHNOLOGY UPDATE

## Fiber-optic transceivers

today's 550-MHz, 80-channel limit.

One of the companies addressing this need is Ortel Corp, which offers transmitter and receiver modules for CATV systems. Although expensive—single-quantity prices are \$10,530 for the 1610A transmitter and \$2295 for the 2610A receiver—these modules can be cost effective in certain sections of a CATV system. For example, the trunk network that moves signals from the head end to distant neighborhoods typically extends 15 to 20 miles. Spanning this distance using coaxial cable requires 30 to 50 amplifiers. A single laser-based transmitter can easily power a fiber-optic cable for a distance of 10 to 15 miles.

Ortel's 1610A CATV transmitter uses a distributed-feedback laser integrated with an optical isolator. The low-noise laser, which emits light at 1310 nm, suits 10- to 550-MHz AM CATV links for fiber-backbone and super-trunk applications. The optical output power is greater than 4 mW into single-mode  $9/125$ - $\mu$ m fiber cable.

The 2610A photodiode receiver, which also operates over the 10- to 550-MHz range, suits suboctave systems where low second-harmonic distortion is important. Second-order products are -60 dBc; third-order products are -75 dBc.

The module, which has a gain 7 dB higher than that of an unmatched photodiode, uses a broadband RF output circuit to maximize delivered power. Like the transmitter, the receiver uses single-mode  $9/125$ - $\mu$ m cable.

### Other applications

In addition to the fiber-optic modules suitable for FDDI, SONET, and CATV systems, a variety of general-purpose types are available for point-to-point and data-bus applications. Typical of these are the TX5000S010 transmitter and RX5237S010 receiver (\$297/pair) from Litton Poly-Scientific. These modules operate at NRZ data rates of 1M to 25M bps and can serve a wide range of commercial and military applications. The modules have ECL-compatible inputs and require a single 5V supply. Both the transmitter and receiver come in 24-pin hermetically sealed packages that you can mount on a pc board.

Other examples of fiber-optic modules include the XMT1300 transmitter and RCV1201 receiver from BT&D Technologies and the V23800 series of video modules from Siemens. Useful for high-speed data transmission in local-area and metropolitan-area networks, the XMT1300 and RCV1201

modules are capable of data speeds as fast as 1.2G bps at distances of 10 km. Both the transmitter and receiver utilize GaAs integrated circuits to achieve this performance. The modules come in 28-pin,  $1.5 \times 1.0 \times 0.25$ -in. hermetically sealed packages. The transmitter and receiver cost \$860 and \$1000 (1000), respectively.

The V23800-S1 and V23804-E1 video modules from Siemens suit security and surveillance applications. Using FM transmission, the 1300-nm devices can handle 7-MHz single-channel operation. The modules can transmit video signals over distances greater than 4 miles without a repeater. The  $45 \times 22 \times 9$ -mm, 16-pin package lets you place as many as four modules on a single VMEbus board. In OEM quantities, the modules cost \$260 each.

Although fiber-optic cables are not likely to completely replace the ubiquitous twisted pairs of copper wire and coaxial cable, an increasing number of applications are turning to fiber for its performance advantages. Vendors will continue to support this trend with a plethora of new products. **EDN**

Article Interest Quotient  
(Circle One)

High 512 Medium 513 Low 514

## For more information . . .

For more information on the transceiver modules discussed in this article, circle the appropriate numbers on the Information Retrieval Service card or use EDN's Express Request service. When you contact any of the following manufacturers directly, please let them know you saw their products in EDN.

**AMP Inc**  
Box 3608  
Harrisburg, PA 17105  
(800) 522-6752  
Circle No. 718

**AT&T Microelectronics**  
555 Union Blvd  
Dept 52AL330240  
Allentown, PA 18103  
(800) 372-2447  
Circle No. 719

**BT&D Technologies**  
Delaware Corporate Center  
2 Righter Pkwy  
Wilmington, DE 19803  
(800) 545-4306  
Circle No. 720

**Hewlett-Packard Co**  
19310 Pruneridge Ave  
Cupertino, CA 95014  
(800) 752-0900  
Circle No. 721

**Litton Poly-Scientific**  
Fiber Optic Products  
1213 N Main St  
Blacksburg, VA 24060  
(800) 336-5917  
Circle No. 722

**Ortel Corp**  
2015 W Chestnut St  
Alhambra, CA 91803  
(818) 281-3636  
Circle No. 723

**PCO Inc**  
2020 Sunburst St  
Chatsworth, CA 91311  
(818) 700-1233  
Circle No. 724

**Siemens**  
Fiber Optic Components  
3846-A First Ave  
Evansville, IN 47710  
(800) 827-3334  
Circle No. 725



**We developed  
LONWORKS technology,  
a better way to add control and  
communications capabilities  
to your products  
quickly and inexpensively.**

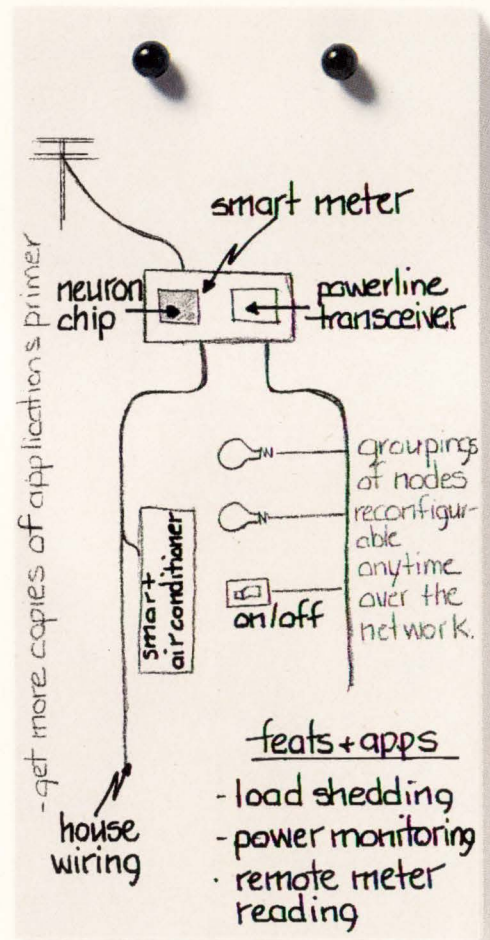
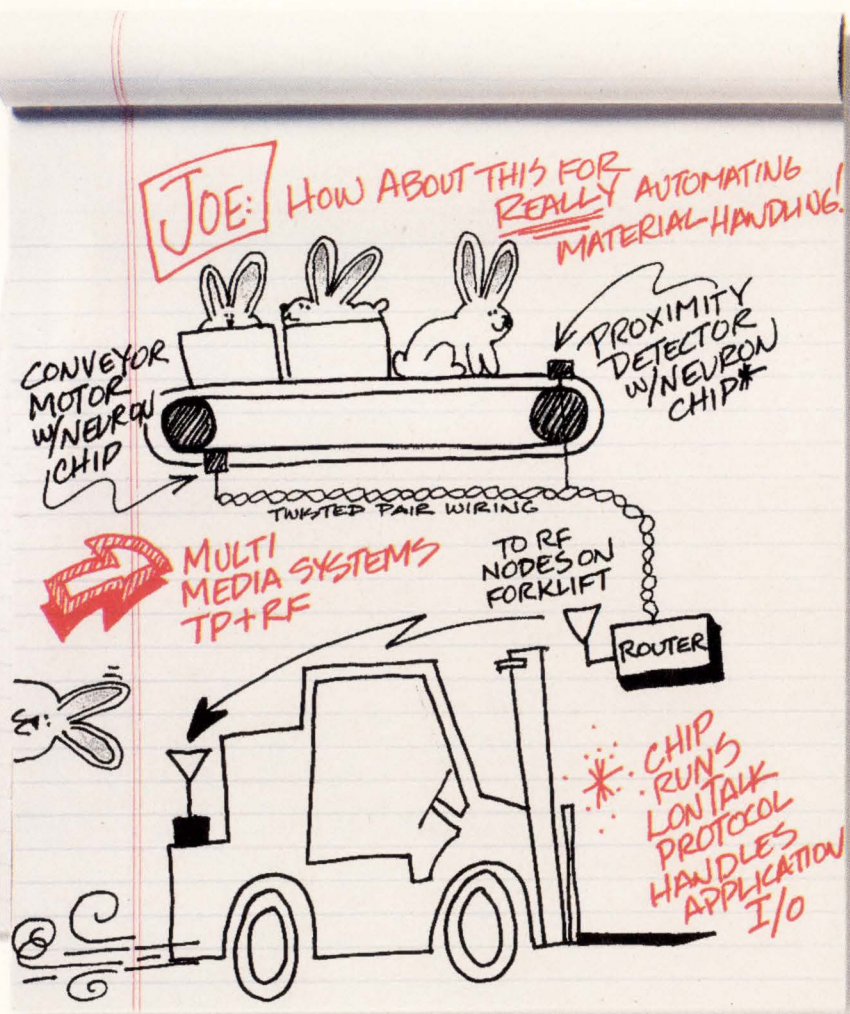
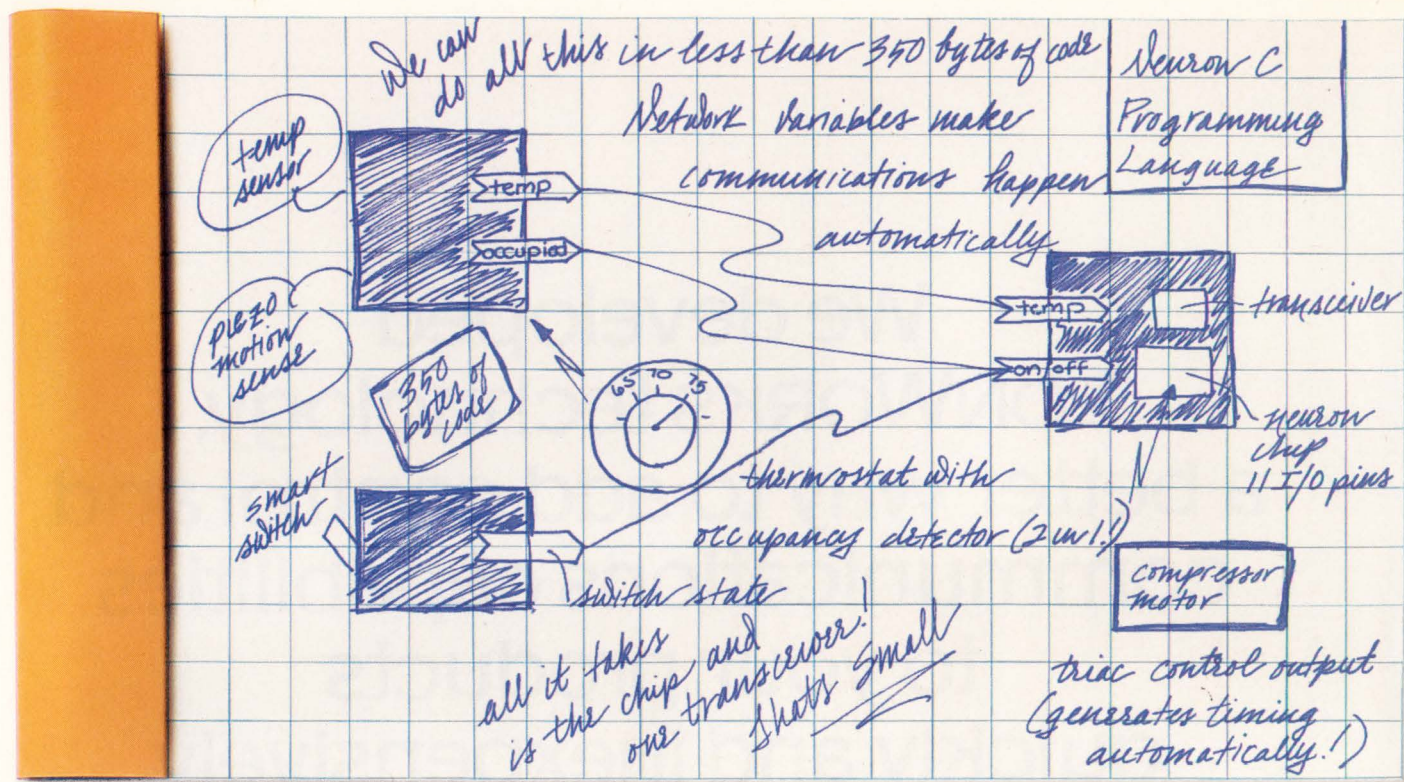

© 1991 Echelon Corporation. LONWORKS, LONBUILDER and LONTALK are trademarks, and ECHELON, LON, and NEURON are registered trademarks of Echelon Corporation. Other names may be trademarks of their respective companies. Some of the LONWORKS tools are subject to certain Terms and Conditions. For a complete explanation of these Terms and Conditions, please call 1-800-258-4LON.

## ECHELON SEMINAR

- o WE CAN DO ALL THESE WITH 1 WIRING HARNESS
- o PRIORITY FEATURE OF LONTALK PROTOCOL GUARANTEES RESPONSE TIME FOR CRITICAL FUNCTIONS
- o NEW APPLICATIONS? RF TO AUTOMATIC TOLL SENSOR?
- o CHIPS
  - 3 CPUS
  - RAM, EPROM (ROM)
  - COMM & I/O
- MULTIPLE SOURCES
  -  TOSHIBA
  - 14mm
  - MOTOROLA TOSHIBA

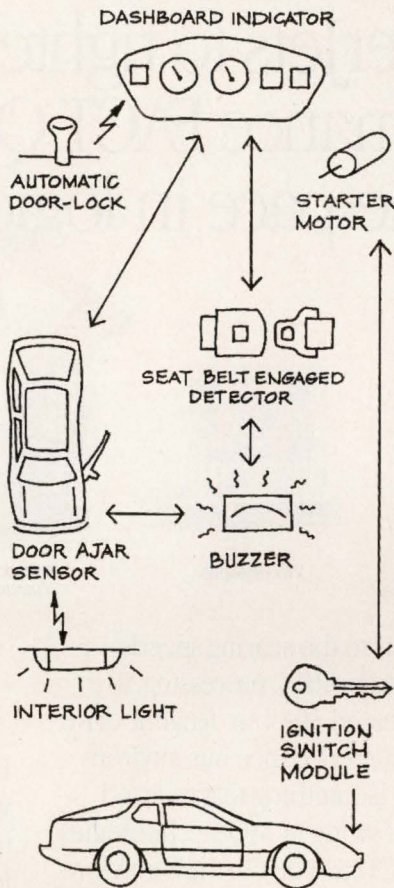

## LONWORKS SEMINARS

ARIZONA	Phoenix	June 25
CALIFORNIA	Irvine	May 2
	Los Angeles	March 13
	San Diego	March 12
	Santa Clara	March 14
COLORADO	Denver	June 26
CONNECTICUT	Stamford	June 18
FLORIDA	Fl. Lauderdale	April 9
	Orlando	April 10
GEORGIA	Atlanta	April 11
INDIANA	Indianapolis	June 5
ILLINOIS	Chicago	March 21
KANSAS	Kansas City	March 26
MARYLAND	Baltimore	April 2
MASSACHUSETTS	Boston	April 3
MICHIGAN	Detroit	March 28
MINNESOTA	Minneapolis	March 19
MISSOURI	St. Louis	June 6
NEW HAMPSHIRE	Manchester	May 7
NEW JERSEY	Fairfield	June 12
NEW YORK	Albany	June 19
	Long Island	April 4
	Rochester	June 11
	Tarrytown	May 9
OHIO	Cleveland	March 27
	Dayton	June 4
OREGON	Portland	April 16
PENNSYLVANIA	Philadelphia	May 8
	Pittsburgh	June 20
TEXAS	Dallas/Ft.Worth	May 1
	Houston	April 30
VIRGINIA	Tysons Corner	June 13
WASHINGTON	Seattle	April 17
WISCONSIN	Milwaukee	March 20
UTAH	Salt Lake City	June 27
CANADA	Montreal	April 24
	Ottawa	April 23
	Toronto	April 25
	Vancouver	April 18
EUROPE	Düsseldorf	May 20
	London	May 16
	Milan	May 28
	Munich	May 21
	Paris	May 30
	Stockholm	May 14
	Zurich	May 23
JAPAN	Osaka	(TBA)
	Tokyo	(TBA)

1-800-258-4LON  
For Reservations and Information

# What You Do With It Is Your Business.

Spend a day in one of our free LONWORKS™ seminars and we'll change the way you develop products forever.

You'll learn about the technology that uses the latest computer, semiconductor and networking advances to add control and communication capabilities to your products.

You'll see the heart of LONWORKS, the NEURON® CHIP that's small enough to fit into any product. Smart enough to control and respond to other devices. Flexible enough to communicate over standard media. Inexpensive enough that everyone can afford it.

You'll discover how easy it is to program and link NEURON CHIPS into virtually invisible networks of intelligent devices.

How our powerful LONTALK™ protocol lets you use electrical powerlines, twisted pair, radio waves, and other common media as communication paths.

How our LONBUILDER™ Developer's Workbench helps you design LONWORKS networks into your products to make them work "smarter." How to connect your LONWORKS-based products into smart systems. And how to connect those systems into interoperating LONWORKS environments as large as a building, a home or a factory. All in far less time and for much less money than it takes to develop your own protocols and tools.

LONWORKS technology is something every designer in every industry can use. A day at a LONWORKS seminar will give you the information and inspiration to make your products sense, control, communicate and cooperate better than ever.

So find the seminar nearest you. Call 1-800-258-4LON for your reservation. And learn all about the new technology that will help you improve your products. And your business.



# From LaserJets® to fighter jets, our high-performance FACT QS and FCTA set the pace in logic.

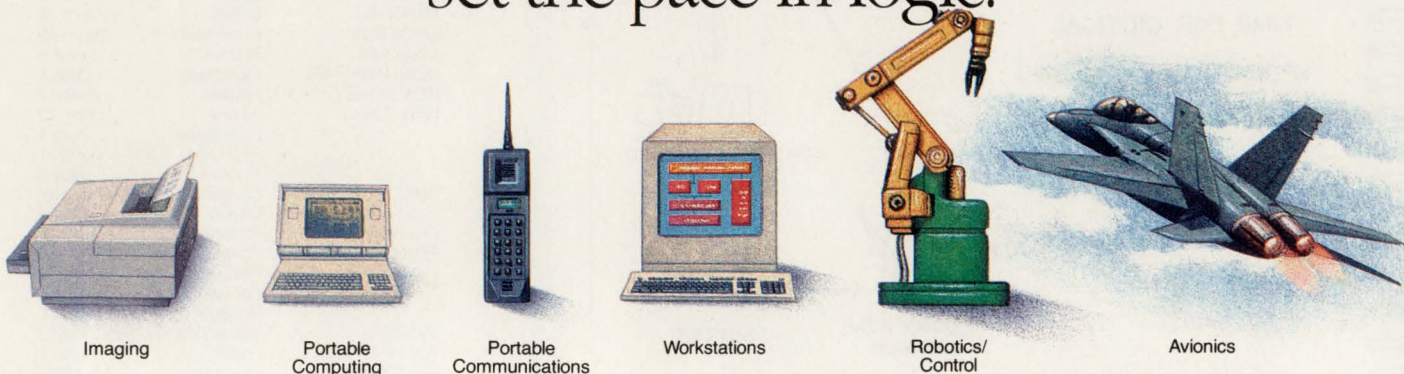

Delivering high performance to a broader range of applications.

Whether it's a printer churning out 8 PPM or an F-18 scorching the sky at Mach 2+, your application requires advanced logic solutions that deliver low power. Which is exactly what you get with our low-noise FACT Quiet Series and high-speed FACT FCTA families.

Together, these devices provide innovative solutions to the distinctly different needs of a broad spectrum of high-performance applications.

Needs that range from the ultra-low power of battery-operated

systems to the searing speeds dictated by RISC processing. To guaranteed 50-ohm dynamic drive for low-impedance bus environments (something that reduced-output swing CMOS technologies and BCT can't do). To the 64mA low-level static drive required of VME-type termination schemes.

## Silencing noise with advanced circuitry.

Beyond speed, power, and drive there's the issue of noise. Our USC™ (Under-Shoot Corrector) and patented GTO™ (Graduated Turn-On Output) circuits enable our devices to offer the lowest ground bounce of any CMOS family. And their split-ground bus results in the best dynamic noise margins of *any* logic technology.

Plus, with controlled output edges and negligible ringing, FACT QS generates lower spectral content than BCT and non-standard-pin-out ACL families\*.

## Producing a complete family of CMOS logic.

With our high-performance FACT QS and FACT FCTA devices, we've enhanced our multi-functional, broad-based line of CMOS logic devices, which already includes standard FACT and FCT. What's more, FACT is available with Standard Military Drawings, JAN 38510 level B, and S-level processing. So regardless of your application, we have the solution.

## Keep pace with the leaders in logic.

For more information, including datasheets and samples, on our CMOS families, call or write us today.

We'll get you up to speed in no time at all.

1-800-NAT-SEMI, Ext. 111  
National Semiconductor Corp.  
P.O. Box 7643  
Mt. Prospect, IL 60056-7643

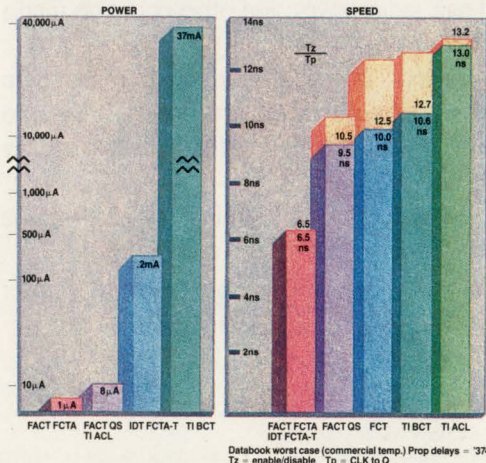

© 1991 National Semiconductor Corporation. USC and GTO are trademarks of National Semiconductor Corporation. LaserJet is a registered trademark of Hewlett-Packard Company.

\*From a 1990 study conducted by Washington Labs Inc., a subsidiary of Violette Engineering Corporation.

## Logic-synthesis software shares simulation model libraries

The Improvisor and Optimisor are logic-synthesis tools that begin their existence using the Verilog HDL (Hardware Description Language). Unlike synthesis tools that accept VHDL (VHSIC Hardware Description Language) input, these tools can synthesize any construct allowed by the HDL.

Although the IEEE has sanctioned VHDL as an industry-standard HDL (IEEE-1076-1987), VHDL has a few shortcomings. The Improvisor and Optimisor synthesis tools address the major chinks in the VHDL armor.

First, Verilog-HDL ASIC libraries are currently more prevalent than VHDL ASIC libraries. The synthesis tools allow you to use the same library to drive both the synthesis and the simulation of your design. Rather than simulating to verify the approximate delay paths provided by the synthesis models, the delay from the synthesis tools will be the delay from the simulator. As a result, the tools perform some static-timing analyses. Consistent model libraries also allow you to use the Veritime and Verifault timing- and fault-analysis tools.

VHDL's second weakness is that, as a simulation language, it cannot synthesize some of its constructs. This shortcoming can cause problems for designers who don't limit their use of VHDL in designs that are to be synthesized. The synthesis tools, however, can synthesize the entire Verilog HDL.

Like the synthesis tools from

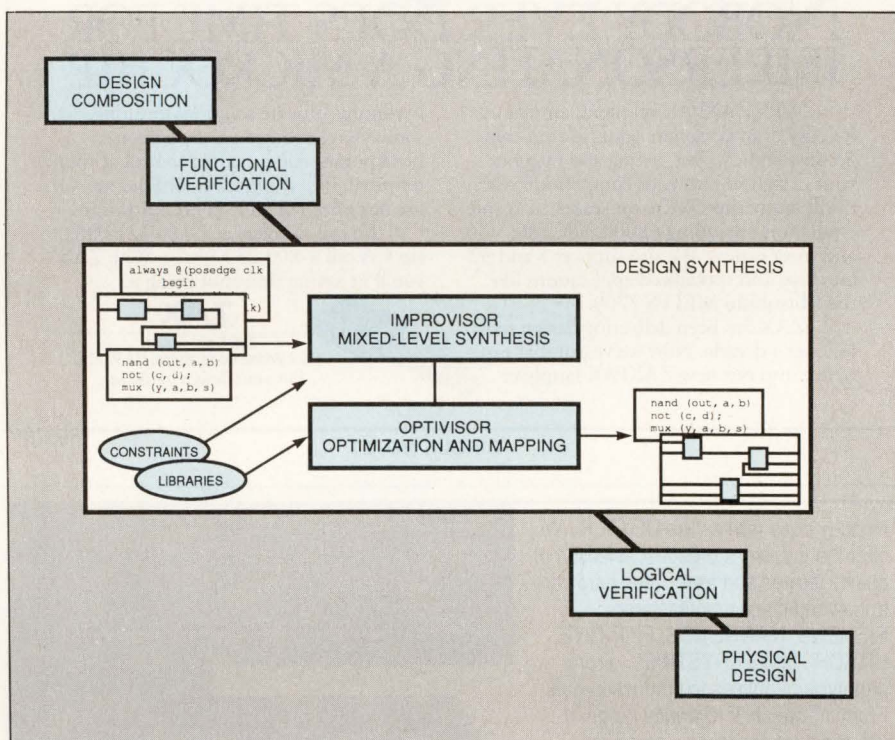

*By sharing a single model library with simulation and layout tools, the Improvisor and Optimisor logic-synthesis software can closely integrate the design flow.*

Synopsys (Mountain View, CA), these tools divide the conversion of HDLs into logic as two operations. First, the Improvisor lets you perform architectural tradeoffs using RTL-level behavioral models. Then the Optimisor allows you to optimize the design for your particular performance or area needs.

The synthesis tools are integrated within the company's IC- and systems-design tool suites. In fact, where many simulation tools can extract delay information introduced by a circuit's physical layout, the Improvisor goes one better. Because the synthesis tools use the same library as the simulation tools,

the synthesis software accepts delays added by the layout.

Back-annotated physical delays allow you to find, modify, and resynthesize paths whose performance falls out of specification as a result of layout effects. You can minimize the effect and time penalty of resynthesis by defining the section of code you want to synthesize. Also, going back to the HDL source code maintains data consistency and the integrity of your design.

To optimize your logic, the software uses two algorithms. A fast algorithm optimizes the circuit, using algebraic rules that treat the

Microprocessor names and logos are trademarks of their makers.

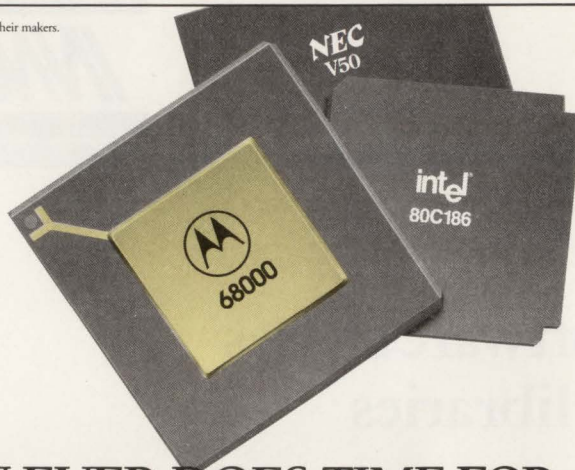

## NOBODY EVER DOES TIME FOR IMPERSONATING A MICROCHIP.

With ZAXPAK in-circuit emulators, it's easy to impersonate your favorite chip. So now you can test, debug and integrate your design so fast, your competition will think it's a crime. We're the leader in 16-bit emulation, including 68000, 80C186, V50 and most others. We also support 8 and 32-bit chips and specialized applications like the Mitsubishi MELPS 7700.

ZAX has been delivering design tools for over a decade. Now we've put that experience into our new ZAXPAK family of

hardware/software solutions featuring source-level debug and one million breakpoints. All under the control of your terminal, PC, workstation or Ethernet. Or use our optional built-in host platform.

So call us today at 1-800-421-0982. (In CA call 1-800-233-9817). With ZAX you'll be saving time, not doing it.



**ZAX**

Zax Corporation  
2572 White Road, Irvine, CA 92714.  
Put your design to the test.

CIRCLE NO. 27

Nobody does ferrites like DEXTER. We offer the industry's broadest selection of quality ferrites and associated hardware from world-class manufacturers.

SIEMENS, MAGNETICS, FAIR-RITE, HITACHI, MMG/KRYSTINEL. From prototype quantities to production runs. From off-the-shelf to a wide range of value-added services — precision fabrication, E-core and pot-core gapping and testing, sorting and selecting by electrical specs.

Call Toll Free 1-800-345-4082 for Free Catalog and Nearest DEXTER Location

## FERRITE CORES:

**THE DEXTER DIFFERENCE —**  
One-Stop-Shopping for all your ferrite needs.



THE DEXTER CORPORATION  
ATLANTA • BOSTON • CHICAGO • DALLAS •  
LOS ANGELES • MINNEAPOLIS/ST. PAUL •  
NEW YORK • SAN FRANCISCO • TOLEDO/DETROIT •  
ENGLAND • WEST GERMANY

## OUR FIELD OF EXPERTISE

CIRCLE NO. 19

## EDN EDITORS' CHOICE

circuit as a polynomial equation. This algorithm temporarily replaces variables that it can't understand, such as inverted signals, with variables that it can understand. The second, more thorough algorithm optimizes the logic, using Boolean algebra rules where concepts such as inverted signals make sense.

You can choose the algorithm that applies to your circuit. However, because the second algorithm is more CPU intensive, it may be more appropriate for arithmetic circuit functions. Conversely, the vendor claims the first algorithm works better on control and random logic.

Both software packages run on Unix workstations from DEC, Sun, and HP/Apollo. The logic-synthesizing Improvisor costs \$15,000. The cost of the optimization tool, the Optivisor, depends on your hardware configuration. The software's price starts at \$35,000 and requires at least one copy of the Improvisor. A subsequent release of the software will accept a subset of VHDL.—**Michael C Markowitz**

*Cadence Design Systems Inc,  
555 River Oaks Pkwy, San Jose,  
CA, 95134. Phone (408) 943-1234.  
FAX (408) 943-0513.*

Circle No. 731

## WHAT'S COMING IN EDN

EDN Magazine's March 28, 1991 issue will be accompanied by a special supplement on software engineering. That issue begins with a guide to embedded DOS. Also, see our staff-written report on object-oriented programming and other useful software-related stories.

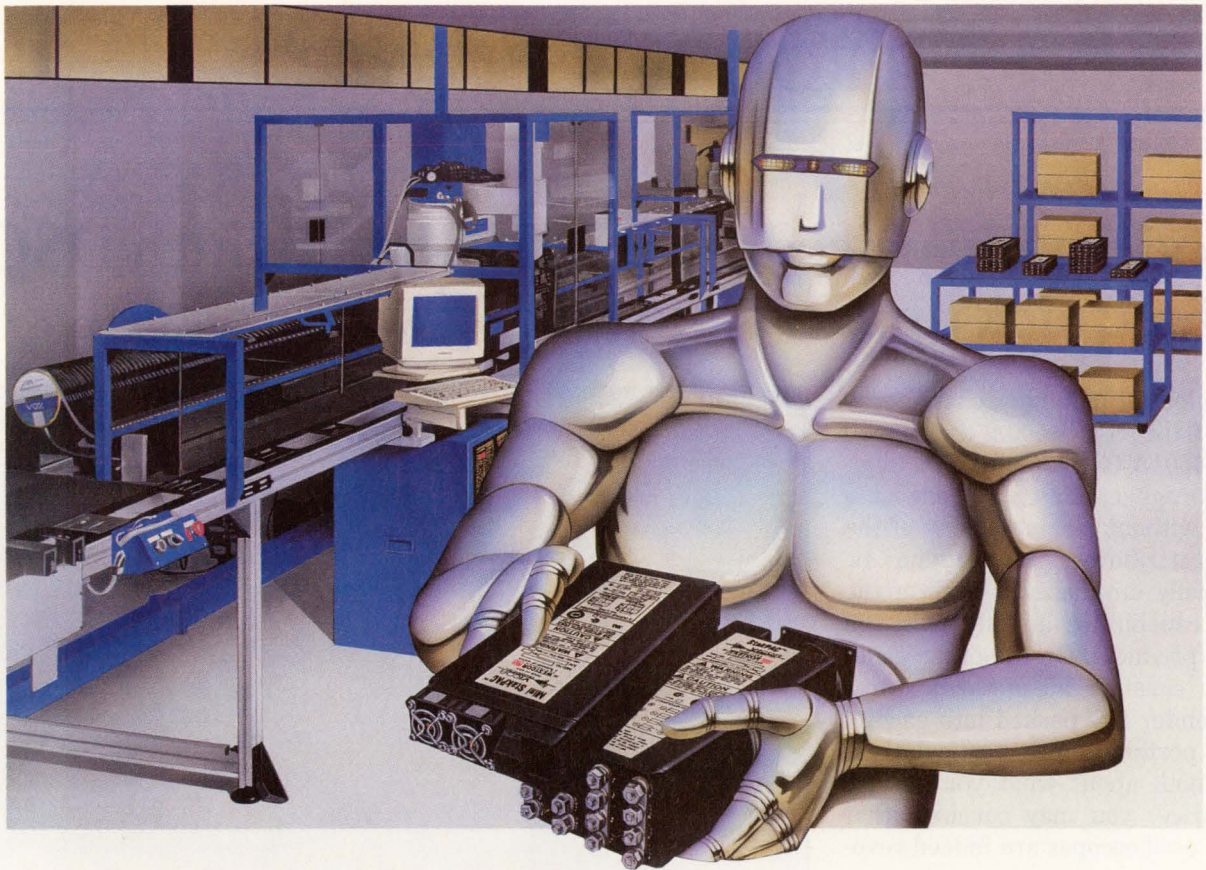

# ROBOPOWER

STAKPAC™		MINI STAKPAC™
1200 Watts	<b>Power</b>	600 Watts
110/220 VAC	<b>Input</b>	110/220 VAC
Up to 8	<b>Outputs</b>	Up to 5
3.2"x5.5"x11.5	<b>Dimensions</b>	1.9"x5.5"x12"
Fan-Cooled	<b>Cooling</b>	Twin Fans

Each StakPAC output is factory configured utilizing Vicor's robotically manufactured power converters...VI-200 series modules. Consider the advantages of a StakPAC customized for your system needs with automated power modules:

**USER DEFINABLE OUTPUTS**—The use of proven standard catalog modules offers the features of a custom without the associated risk or investment.

**STANDARD MODELS**—Many preconfigured standards available.

**QUICK DELIVERY**—Typical delivery 1 week or less for custom or standard evaluation units.

**COMPACTNESS**—Low profile packages provide up to 6 watts/cubic inch, twice the industry norm.

**UL, CSA, TUV SAFETY AGENCY APPROVAL**—All StakPAC configurations are approved, standard or custom.

**EMI**—FCC/VDE Level A, conducted.

StakPACs are designed and built by Westcor Corporation, Los Gatos, CA, a Vicor subsidiary. StakPACs are sold world-wide through Vicor Corporation, Andover, MA.

## STAKPAC STANDARDS 1200 WATT MODELS

Model	Output Voltage (VDC) and Maximum Current (amperes) per Channel				
	#1	#2	#3	#4	#5
<b>Single Output</b>					
SP1-1801	2 @ 240	Total output power may not exceed 1200* watts for any model, single or multiple output. Lower power StakPAC models and many other configurations are available.			
SP1-1802	5 @ 240	*Standard models supply 1100 watts; high-powered version 1200 watts. Please contact the factory.			
SP1-1603	12 @ 100				
SP1-1604	15 @ 80				
SP1-1605	24 @ 50				
SP1-1606	28 @ 42				
SP1-1607	48 @ 25				
<b>Dual Output</b>					
SP2-1801	2 @ 120	5 @ 120			
SP2-1802	5 @ 120	5 @ 120			
SP2-1803	5 @ 120	12 @ 66			
SP2-1804	12 @ 66	12 @ 66			
SP2-1805	15 @ 53	15 @ 53			
<b>Triple Output</b>					
SP3-1801	5 @ 180	12 @ 16	12 @ 16		
SP3-1802	5 @ 150	12 @ 33	12 @ 16		
SP3-1803	5 @ 180	15 @ 13	15 @ 13		
SP3-1804	5 @ 150	15 @ 26	15 @ 13		
<b>Quad Output</b>					
SP4-1801	5 @ 150	12 @ 16	12 @ 16	5 @ 30	
SP4-1802	5 @ 150	15 @ 13	15 @ 13	5 @ 30	
SP4-1803	5 @ 150	12 @ 16	12 @ 16	24 @ 8	
SP4-1804	5 @ 150	15 @ 13	15 @ 13	24 @ 8	
<b>Five Output</b>					
SP5-1801	5 @ 120	12 @ 16	12 @ 16	5 @ 30	24 @ 8
SP5-1802	5 @ 120	15 @ 13	15 @ 13	5 @ 30	24 @ 8
<b>Seven Output</b>					
SP7-1801	5 @ 60	12 @ 16	12 @ 16	24 @ 8	24 @ 8
	#6	#7			
	5.2 @ 28	2 @ 30			

## MINI STAKPAC STANDARDS 600 WATT MODELS

Model	Output Voltage (VDC) and Maximum Current (amperes) per Channel				
	#1	#2	#3	#4	#5
<b>Single Output</b>					
ST1-1401	2 @ 120	Total output power may not exceed 600 watts for any model, single or multiple output. Lower power Mini StakPAC models and many other configurations are available. Please contact the factory.			
ST1-1402	5 @ 120				
ST1-1301	12 @ 50				
ST1-1302	15 @ 40				
ST1-1303	24 @ 25				
ST1-1304	28 @ 21				
ST1-1305	48 @ 13				
<b>Dual Output</b>					
ST2-1401	2 @ 60	5 @ 60			
ST2-1402	5 @ 60	5 @ 60			
ST2-1403	5 @ 60	12 @ 33			
ST2-1404	12 @ 33	12 @ 33			
ST2-1405	15 @ 26	15 @ 26			
<b>Triple Output</b>					
ST3-1401	5 @ 60	12 @ 16	12 @ 16		
ST3-1402	5 @ 60	15 @ 13	15 @ 13		
ST3-1501	5 @ 90	12 @ 8	12 @ 8		
<b>Quad Output</b>					
ST4-1401	5 @ 30	12 @ 16	12 @ 16	5 @ 30	
ST4-1402	5 @ 30	15 @ 13	15 @ 13	5 @ 30	
ST4-1403	5 @ 30	12 @ 16	12 @ 16	24 @ 8	
ST4-1501	5 @ 30	15 @ 13	15 @ 13	24 @ 8	
ST4-1502	5 @ 60	12 @ 16	12 @ 8	5 @ 15	
ST4-1503	5 @ 60	15 @ 13	15 @ 7	5 @ 15	
ST4-1504	5 @ 60	12 @ 16	12 @ 8	24 @ 4	
ST4-1505	5 @ 60	15 @ 13	15 @ 7	24 @ 4	
<b>Five Output</b>					
ST5-1501	5 @ 30	12 @ 16	12 @ 16	5 @ 15	24 @ 4
ST5-1502	5 @ 30	15 @ 13	15 @ 13	5 @ 15	24 @ 4

For ordering information call Vicor Express at 1-800-735-6200 or (508) 470-2900 at ext. 265.

For technical information contact Westcor at (408) 395-7050 or FAX (408) 395-1518 or call Vicor.



Common Stock Traded on NASDAQ under "VICR"

**WESTCOR CORPORATION**  
485-100 Alberto Way  
Los Gatos, CA 95032

**VICOR CORPORATION**  
23 Frontage Road  
Andover, MA 01810

## Moderately priced, 100-MHz-bandwidth DSOs offer quick updates and analog-scope "feel"

If you look at individual characteristics of the HP 54600A (2-channel) and 54601A (4-channel) DSOs (digital storage oscilloscopes) one at a time, without looking at any of the other attributes, you may not be especially enthusiastic; each of the DSO capabilities already exists in other products. On the other hand, if you consider all of the features the vendor has packed into each of these portable units, particularly if you think about what you get for the price, you may conclude that these oscilloscopes are indeed revolutionary.

You would be hard-pressed to disprove the assertion that no scope makes the power of digital technology more accessible. In this case, accessibility refers to affordability as well as ease of use. The 2-channel unit costs \$3000, and the 4-channel unit costs \$3500. Moreover, the controls have the familiar "feel" of analog-scope controls.

Although the use of analog-style controls—separate knobs for such functions as gain, position, and sweep speed—is hardly new in DSOs, these scopes are the vendor's first to incorporate the feature. (The vendor notes that it has no intention of abandoning the menu-driven interface that characterizes its DSOs. The new products, however, will appeal to a wider audience—one for which the analog feel is more appropriate.)

Unlike the majority of comparable units, these units accompany the analog controls with a fast display-update rate. No perceptible lag appears when you observe the output of a circuit under test and manually adjust the parameters of that circuit. With the exception of a few scopes that incorporate high-

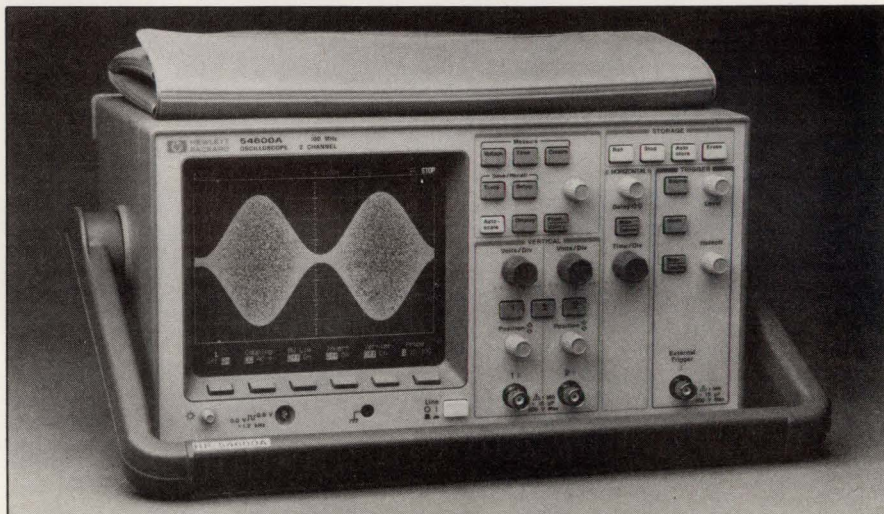

*"Analog feel" in a digital scope involves more than just familiar controls. The HP 54600A and 54601A DSOs offer users a speedy display-update rate. In addition, an autostore mode provides infinite persistence in combination with a superimposed bright display of the last waveform captured.*

speed DSP  $\mu$ Ps (such scopes have much higher prices than those of the new units), nearly all DSOs exhibit a noticeable lag in display updates. DSO vendors don't like to talk about this lag; understandably, their demonstrations don't make it obvious.

The 100-MHz analog bandwidth of the new scopes represents a "magic number." Despite the continuing increase in circuit clock rates, many users still regard 100 MHz as marking the boundary between low- and high-performance scopes. In these units, the bandwidth is usable when you view repetitive waveforms. In addition to their bandwidth, the scopes' maximum vertical sensitivity of 2 mV/div and 8-bit resolution contribute to their broad applicability.

The A/D-conversion rate is 20M samples/sec. Unlike scopes from this vendor that are optimized for capturing single-shot events, these units incorporate no reconstruction

filters. Therefore, to obtain repeatable results with nonrepetitive waveforms, you should take 10 samples of each signal cycle. Observing this caveat limits the scopes to displaying single-shot events whose frequency is less than about 2 MHz.

When a DSO designer endows a product with an analog feel, the product need not sacrifice the conveniences users have come to expect of digital scopes. In these units, conveniences include cursor measurements of voltage and time and 12 automatic measurement modes. With an optional parallel, RS-232C or IEEE-488 interface and a graphics-capable printer, you can obtain hard-copy output. Internal memories can store 16 setups, and you can also use the RS-232C and IEEE-488 interfaces to control the scopes.—**Dan Strassberg**

*Hewlett-Packard Co, 19310 Pruneridge Ave, Cupertino, CA 95014. Phone (800) 752-0900.*

**Circle No. 730**



AT&T.

Nobody makes more connections.

AT&T provides all your end-to-end transmission solutions with our full line of fiber optic, copper cable and connecting components.

If your regular route just isn't getting you there, make a right turn. AT&T has the connections you need.

Like data cable, composite fiber/copper cable and optical cable and fiber. Connecting components like ST® connectors and FDDI jumpers. 110 connecting blocks. Splicing and test equipment. Plus, tactical fiber assemblies for harsh environments.

Everything you need in copper and fiber optics for the transmission of voice, data, image and remote sensing. In both network and component solutions. For present and future needs.

But when you buy even just one AT&T component, you're getting more than just a "part."

You're getting over 100 years of AT&T cable and apparatus manufacturing and development experience. Plus the design expertise of AT&T Bell Laboratories.

So take the route you know will make all your connections. AT&T. Just give us a call at 1 800 344-0223, ext. 020.

The components of success.



AT&T  
Network Systems

CIRCLE NO. 61



# INTRODUCING THE BEST DISK DRIVES

The newest generation of disk drives from Conner. Lighter. Cooler. Smarter. Faster. With more capacity than ever before. Precisely what high-performance dreams are made of.

And, for the fourth consecutive year, Conner is delivering a generation ahead of the competition. Helping major OEMs get new systems to market faster than they ever dreamed possible.



Summit 510MB

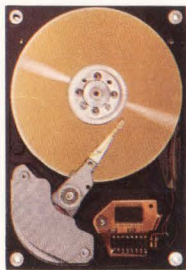

Hopi 80MB



Pancho 30, 40, 60 MB

## Sell. Design. Build.

Before we design or build a product, our engineers work closely with the most respected experts in the industry — our customers. By asking the right questions, we identify specific needs. Sooner. And fill those needs with the right products. Faster.

So it's no surprise that more of the world's leading OEMs work with Conner.

World Headquarters: 3081 Zanker Road, San Jose, CA 95134 Telephone: (408) 456-4500 FAX: (408) 456-4501 Sales Offices: Asia — Singapore: (65) 2961992 • Taipei: (886) 2-718-9193 • Tokyo: (81) 3-485-8901 • Seoul: (82) 2-551-2777 Europe © 1991 Conner Peripherals, Inc.

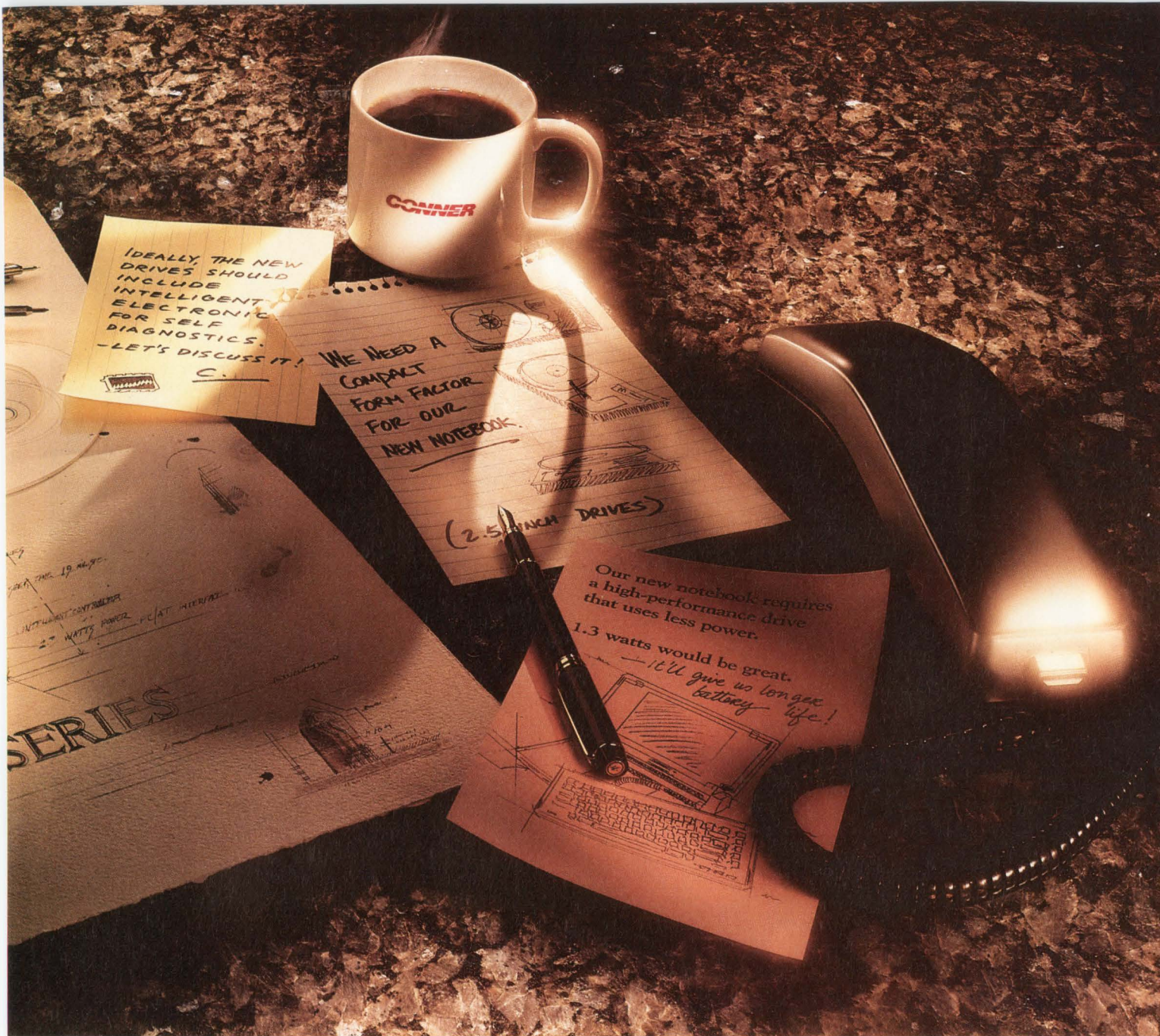

## OUR CUSTOMERS COULD DREAM UP

Because we consistently design the exact disk drives our customers need. Then build those drives — in volume.

### Keeping You A Generation Ahead.

The results of this unique sell-design-build strategy have been remarkable. Using proven technologies, our high-performance 3.5-inch and 2.5-inch disk drives continuously set the standards. For all major segments of the market.

The fact is, Conner delivers disk drives for today's powerful systems. From high-end workstations

and file servers to desktop, laptop and notebook PCs.

And Conner has sales offices and manufacturing facilities in Europe, Asia and America. Keeping us close to our customers around the globe.

So call Conner today. And we'll work together to turn your dreams into realities.

# CONNER

DELIVERING A GENERATION AHEAD.

London: (44) 249-444-049 • Munich: (49) 89-129-8061 • Paris: (33) 1-47-47-4108 • Ivrea: (39) 125-631715 • U.S. — Boston: (508) 660-1088 • Dallas: (214) 680-2913 • Los Angeles: (714) 455-2777 • Minneapolis: (612) 449-5186 • San Jose: (408) 456-4500.  
Authorized U.S. Distributors: Anthem Electronics, Avnet Computer, CAL-ABCO

# ISDN-based concurrent design



ISDN will let you hold desktop conferences with colleagues all over the globe. (Photo courtesy AT&T Microelectronics; Dave W Morrow, photographer; A Taryn Troiani, art director; Judy A Bullard, assistant artist)

**Michael C Markowitz, Associate Editor**

**T**he Integrated Services Digital Network (ISDN) can merge diverse product-development functions into a single operation. Recent standards-bodies decisions have finally stabilized ISDN, so vendors are beginning to develop applications that will fuse product definition, specification, and design. Don't hold your breath waiting for these new products, though; upgrading and installing all the switching equipment necessary to empower ISDN will take a few years.

ISDN applications fall into three categories: desktop conferencing, networking, and supplementary services. All are possible because of ISDN's inherent advantage over discrete networks: the existing telephone network of approximately 375 million miles of copper cable. The cable provides a universal local-, municipal-, and wide-area network that connects anyone or any machine with access to a telephone line.

Briefly (and with a minimum of acronyms—see **box**, "ISDN acronyms and terms," pg 84), the heart and soul of the Integrated Services Digital Network is a bidirectional, 192k-bps digital communications path. This path comprises two 64k-bps channels (B channels) for voice or data, one 16k-bps channel (D channel) for network signaling and control, and 48k bps of channel overhead for framing and error detection.

#### **Phone interface stays the same**

Under ISDN, ordinary phone calls have the same look and feel as they did before. But ISDN's internal workings differ significantly from those of the phone network you're using now. Consider how you place a call using a 2B+D ISDN

line. When you dial a number, information such as your number, the number you've dialed, and call-setup data all flow on the D channel to a central-office switch. The switch routes the call through the local or long-distance carrier to the call destination's central office and, ultimately, to the number dialed.

The destination terminal reacts to the call by returning an acknowledgment over the D channel. Your receipt of the acknowledgment completes the connection and lets you send voice or data over one of the B channels. The second B channel gives you a range of options. You could carry on a conversation on one B channel while exchanging data on the other B channel. Alternately, you could send information on the second B channel to a second destination. You can use the D channel to send messages or data to yet another destination. Now, apply this convenience to your design responsibilities.

Sequential product design begins when marketers create a specification. They then turn this spec over to the designers. Design engineers design to meet the spec before throwing the project over the wall to the test and manufacturing people. The inefficiencies of this sequential method have forced companies to consider multidiscipline project teams that include marketing, design, test, and manufacturing personnel. Merging all of a product's development into a single operation is called concurrent engineering and is much easier when all personnel are on one campus.

Multisite concurrent engineering becomes possible by integrating design, marketing, manufacturing, reliability, and management functions via a dial-up, universal network. ISDN extends concurrent en-

**High-bandwidth, all-digital telephone lines will let you develop products using simultaneous inputs from everyone with an interest in the product's success.**

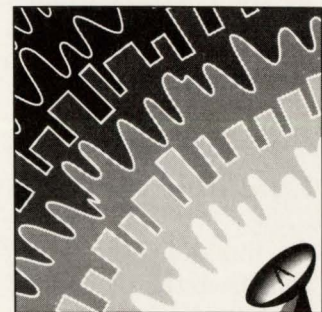

**COMMUNICATIONS  
SPECIAL ISSUE**

## **ISDN can connect any person, computer, or machine that has access to a phone line to any other person, computer, or machine with similar access.**

engineering to include both customers and suppliers. Including the customer and supplier in the design from the beginning offers substantial benefits: You ensure a buyer for the product you're creating, and you'll know that the components you need will be available.

### **Request, send, and analyze data in one call**

Contrast a voice and data party line with using a facsimile machine. A simple fax transaction currently requires three separate phone calls—the first to request the fax, the second to send it, and the third to discuss it. Using ISDN lets you complete the same transaction with one call. While you and your associate converse on one B channel, you can send your data across the second 64k-bps B channel, which is more than six times as fast as 9600-baud fax machines.

To lower costs, future fax machines could use either the high-speed B channel or the slower-speed D chan-

nel. Most users could send facsimile transmissions on the 16k-bps D channel using fax machines connected to their computer networks. The speed and image quality would be comparable to the transmissions of existing fax machines. The costs, however, will be lower because the D channel sends packet-switched data, for which you pay by the packet rather than for connect time. Engineering users who need better quality and faster throughput than D channel transmissions offer could attach next-generation fax machines to a B channel to transmit at either 64k or 56k bps.

But sending a fax is hardly concurrent engineering. Desktop conferencing *is* concurrent engineering. An ISDN 2B+D line lets two people in remote locations converse and share a workstation session via access to each other's local-area network. You and a colleague could discuss and write a project specification using a word-processor program, enter financial projections into a spreadsheet, draw a schematic, or run and evaluate a circuit simulation.

One workstation controls the application; the other acts as a dumb terminal. Control of the application passes between the two users via a message on the D channel. The desktop conference would demand only that each workstation have an internal ISDN terminal adapter. Expanding the conference to include multiple

## **An ISDN acronym workout**

No article about ISDN would be complete without a quick tour of the network. And no tour of ISDN would be complete without using at least 10 acronyms:

The CCITT (Consultative Committee on International Telegraph and Telephone) standard defines several reference points within ISDN (**Fig A**). Starting at the CO (central office) switch, the V interface connects the ET (exchange termination) to the LT (line termination). The V interface, ET, and LT all exist within the CO.

A 2-wire link called the U interface runs from the central-office switch to the subscriber's premises. Inside the premises, the 2-wire link becomes a 4-wire

link at the NT1 (network termination 1) box. The 4-wire link allows extension phones; the 2-wire link doesn't.

If the box connects to company-owned or -leased private switchboards, it uses the T interface and terminates at an NT2 (network termination 2) box. Otherwise, the box uses the S interface to connect to the TE1 (terminal equipment 1). You can also connect non-ISDN equipment to the network by inserting a TA (terminal adapter) between the TE2 (non-ISDN equipment) and the S interface.

The S interface, unlike the other interfaces, allows point-to-multipoint operation in addition to point-to-point operation, but

does not let you cascade ISDN terminals. As a result, the network permits additional extensions only from the T interface at the NT2 box.

Many of the capabilities that ISDN provides are available today via leased 24-channel, 1.544M-bps lines (T1). However, these lines are dedicated and inflexible, and you pay for them whether you use them or not. In contrast, ISDN offers on-demand, dial-up access for any two ISDN-ready sites. And because ISDN is a switched rather than a dedicated service, ISDN can route around failed network components.

participants would require adding control software. This ISDN conference would minimize or eliminate throw-it-over-the-wall sequential design flow by putting project team members a phone call away.

**ISDN is a network**

In addition to desktop conferencing through workstations connected directly to ISDN, you can also use ISDN to connect to existing local- and wide-area networks. These gateway applications let you connect to any remote homogeneous or heterogeneous networks via the telephone network.

Using an RS-232C cable between a Macintosh Appletalk network and an ISDN terminal adapter, you can use ISDN as a gateway into Appletalk. An ISDN-Ethernet bridge allows access into Ethernet networks. ISDN also enables gateways between token-ring networks.

Some of the supplementary features of ISDN also facilitate concurrent engineering. Engineering organizations can use these features to provide better service to their customers and tighter integration to their field representatives. These features include automatic number identification, automatic call back, messaging, electronic directories, call waiting, and call forwarding.

Because your number is sent out with the call-setup

data, equipment at the destination can decode the source address and reference it to data stored in a computer memory. Based on the results of the comparison, an internal network at the destination can identify the calling party and route the call to a specific application, shipping, marketing, or design source. In addition, the person who fields the call can have all appropriate information on his or her workstation terminal before picking up the handset.

In fact, a mail-order firm had this capability in an ISDN trial a few years ago. The firm thought answering the phone with the customer's name would improve both service and customers' impressions. The company learned otherwise. Customers became highly suspicious, confused, or disoriented when they were greeted by name before they even had a chance to say hello.

Although the initial results of this trial were disappointing, consider the time savings for both callers and callees. Suppose, for example, your personal computer goes down or you need to order more memory to run a CAE application in Windows 3.0. You call your friendly out-of-the-neighborhood mail-order company, but all the attendants are busy. Do you postpone everything else while you hold the line? If the mail-order company has the appropriate ISDN services, you're

*Text continued on pg 86*

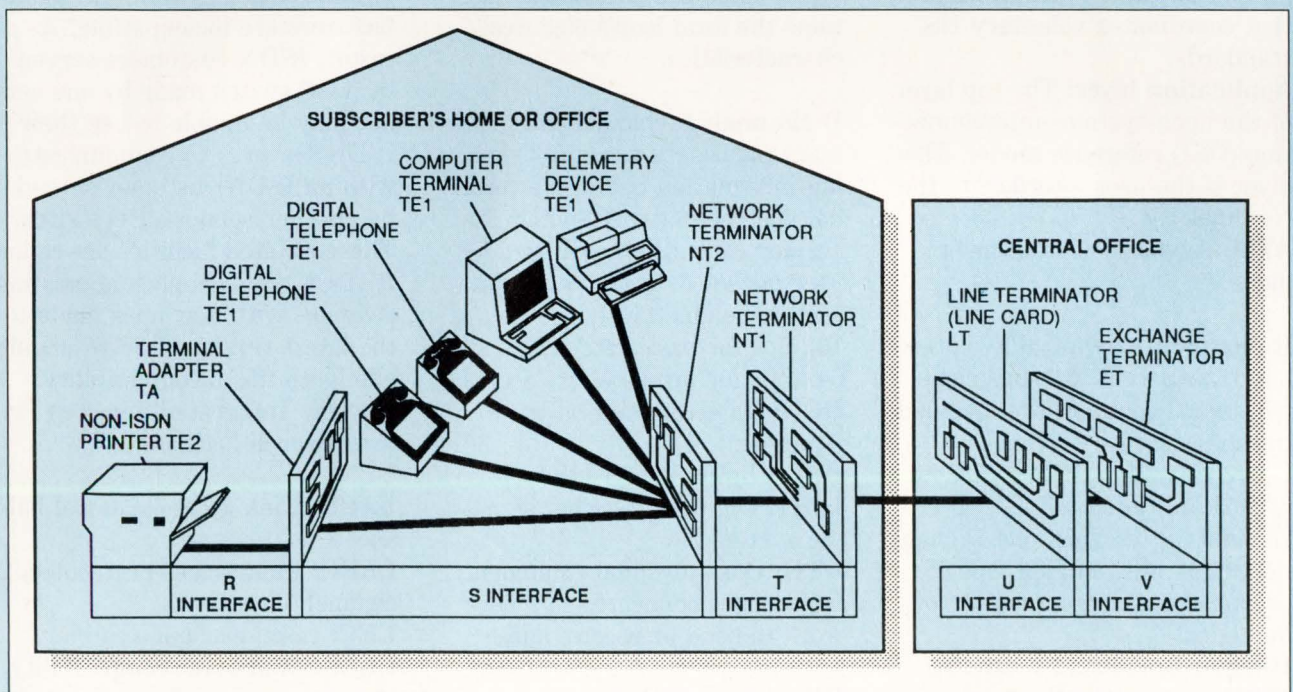

*Fig A—Understanding all the interfaces and equipment that you can connect to ISDN is easier if you visualize the network.*

## ISDN acronyms and terms

Historians credit former US President Franklin Delano Roosevelt and the New Deal with creating an avalanche of acronyms to lift America out of the Great Depression. Roosevelt and the New Dealers have nothing on ISDN.

You won't need an immersion language course to use the features that the Integrated Services Digital Network provides. However, you'll need more than just a quick read through the following list to understand the technobabble spouted by the ISDN intelligentsia, who seem to create an acronym for any combination of words they use more than once. (ISDN elite might want to test themselves by seeing how many of the 68 acronyms they can define.)

**ADPCM:** Adaptive differential pulse-code modulation.

**AMI:** Alternate Mark Inversion. A trilevel coding scheme for transmitting data.

**ANI:** Automatic number identification.

**ANSI:** American National Standards Institute. The organization that coordinates voluntary US standards.

**Application layer:** The top layer of the open-systems-interconnection (OSI) reference model. This layer is the user interface to the terminal.

**ATM:** Asynchronous transfer mode.

**B channel:** A switchable, optionally transparent, 64k-bps channel; two B channels are included in the basic-rate service.

**Basic rate:** An ISDN access rate of 192k bps allocated as two B channels of 64k bps, one D channel of 16k bps, and 48k bps of overhead for framing and error detection.

**BISDN:** Broadband ISDN. An ISDN that carries digital data at rates of 1.544-MHz or higher by

putting the data into fixed-length packets.

**BRA:** Basic-rate access.

**BRI:** Basic-rate-access interface.

**BRITE:** Basic-rate-interface T extension.

**CCITT:** Consultative Committee on International Telegraphy and Telephony. The international standards body responsible for ISDN.

**CCS:** Common-channel signaling. See also SS#7.

**Circuit switching:** Establishing a dedicated path between two devices via switching nodes.

**CO:** Central office.

**Codec:** Coder-decoder. A device that translates analog data into digital bit streams and vice versa.

**Common carrier:** In the US, generally long-distance telecommunications companies.

**CPE:** Customer-premises equipment.

**CRC:** Cyclic redundancy check.

**CSD:** Circuit-switched data.

**CSDN:** Circuit-switched digital network.

**CSU:** Channel service unit. Provides signal conversion and maintains the local loop's electrical characteristics.

**D channel:** A channel whose primary purpose is to convey signaling information between a terminal and the network switch. Its surplus capacity can be used for user packet data and other data such as telemetry. It operates at 16k bps for basic-rate access and 64k bps for primary-rate access.

**DCE:** Data communications equipment.

**DSL:** Digital subscriber loop.

**DSS1:** Digital subscriber signaling system 1.

**DTE:** Data-terminal equipment. Equipment connected to a network to send or receive data.

**EC:** Echo canceling.

**ET:** Exchange termination.

**FDM:** Frequency-division multiplexing. Multiple-source data transmission over a line using different transmission frequencies for each source's data.

**4B3T line code:** 4 binary bits are converted into 3 ternary bits for transmission across the U interface.

**Frame:** Transmitted bits that define, either through timing protocols in synchronous transmission or sequence in asynchronous transmission, a transport element.

**Gateway:** A connection between multiple networks.

**HDLC:** High-level datalink control. A protocol for bit-oriented, frame-delimited data communications.

**IDN:** Integrated Digital Network.

**ISDN:** Integrated Services Digital Network. Supports digitized voice, data, text, and image transmission.

**ISDN islands:** Central-office switches made by different manufacturers are incompatible. As a result, ISDN customers served by a CO switch made by one vendor may be unable to use their ISDN features to communicate with an ISDN customer served by another vendor's CO switch. These isolated facilities are called ISDN islands. Replacing existing switches with new ones made to the latest version of SS#7 should eliminate this incompatibility.

**ISPBX:** Integrated-Services Private-Branch Exchange.

**LAPB:** Link-access-protocol balanced.

**LAPD:** Link-access-protocol on D channel.

**LEC:** Local-exchange carrier.

**LLC:** Lower-layer compatibility element.

**LT:** Line termination. A line card



that terminates the subscriber loop at the PBX or central office.

**NCTL:** Network channel-terminating equipment.

**NT1:** Network termination 1. A box that physically and electromagnetically terminates the 2-wire U-interface transmission line and converts the line into the 4-wire S or T interface.

**NT2:** Network termination 2. A box that switches and concentrates subscriber's lines at the S interface.

**OSI reference model:** Defines a 7-layer architecture of communications functions that contains the application, presentation, session, transport, network, data-link, and physical layers.

**PABX or PBX:** Private (automatic) branch exchange. Essentially an automatic private switchboard linked to the central office via a trunk line.

**Packet switching:** Transmission by breaking up messages into smaller packets and independently sending them to their destination, where they are reassembled to recreate the message.

**PCM:** Pulse-code modulation. Regularly sampling an analog signal and converting the sample to a binary number.

**PCTA:** Personal-computer terminal adapter. Allows the personal computer to act as an ISDN terminal.

**PDN:** Public data network.

**PID:** Protocol identifier.

**POTS:** Plain, old-fashioned telephone service.

**PRA:** Primary-rate access.

**Primary rate:** An ISDN access rate of either 1.544M bps—23 B channels and one 64k-bps D channel, which is the North American and Japanese standard—or 2.048M bps—30 B channels and one D channel, which is the European standard.

**PRI:** Primary-rate access interface.

**PSDN:** Public-switched data network.

**PSPDN:** Public-switched packet data network.

**PSTN:** Public-switched telephone network.

**R interface:** Connects TA to non-ISDN TE2 equipment, often through an RS-232C port.

**RBOC:** Regional Bell operating company.

**S interface:** A reference point at the customer premises to which you can connect either an ISDN terminal (TE1) or a terminal adapter (TA); for example, the interface through which a digital telephone could connect to a PABX. This interface accommodates point-to-point and point-to-multipoint operation.

**SAPI:** Service access point identifier.

**SDLC:** Synchronous data-link control. A bit-oriented data communications protocol that IBM developed.

**SLIC:** Subscriber's line interface circuit.

**SMDI:** Simplified message desk interface.

**SNA:** Systems network architecture. A network architecture for IBM computer products.

**SONET:** Synchronous optical network. A standard for optical network elements.

**SS#7:** Signaling system 7. A family of standards that define message-transfer protocols, error and overload recovery, and call-related services.

**STDM:** Statistical time-division multiplexing. Allocates bandwidth based on the amount of data being sent by assembling data packets.

**T1:** The US's basic 24-channel, 1.544M-bps pulse-code-modulation system.

**T1D1:** The subcommittee (D1) of the T1 committee of the American National Standards Institute responsible for ISDN.

**TA:** Technical advisory.

**TA:** Terminal adapter. Connects non-ISDN terminals (TE2) to the digital network via the S interface. The interface between the TA and the TE2 is the R interface.

**TCM:** Time-compression multiplexing.

**TDM:** Time-division multiplexing. Using time divisions to combine many signals into a higher-bandwidth signal.

**TE:** Terminal equipment. A TE1 or a TA and a TE2.

**2B1Q line code:** 2 binary bits are converted into 1 quaternary bit for transmission across the U interface.

**TE1:** Terminal equipment type 1. Standard ISDN terminal equipment that you can connect to the S or T interface.

**TE2:** Non-ISDN terminal. Connects to ISDN via a terminal adapter.

**TEI:** Terminal endpoint identifier.

**T interface:** Electrically identical to the S interface, the T interface has a different protocol than the S interface to link NT2 boxes to the NT1 box.

**TR:** Technical requirements.

**U interface:** A twisted-pair subscriber loop that provides basic-rate access to the NT1 reference point from ISDN. Supports only point-to-point operation.

**V interface:** At the central office, the interface between the line termination and the exchange termination.

**VAN:** Value-added network.

**X.25:** CCITT standard that defines the interface between packet-type equipment and the phone system.

## ISDN-based concurrent design

treated to a personalized message that promises the company will call you back when an attendant is available.

The order takers at mail-order companies would spend less time on the phone with each customer because order entry would be limited to the order itself; the customer's name, address, phone number, and account history would appear on the attendant's workstation as the attendant answers the phone. Similarly, when the order taker returns your call, all your account information would already be on the workstation before you answer.

### Line busy? Leave a message

To improve the security of their local-area networks, many companies without ISDN use automatic call back to prevent unauthorized access. ISDN extends this application by enabling your internal communications system to monitor your phone. If you are unavailable for a call—either because you're away from your desk or on another call—the system reads the incoming call

data. The system then looks up the phone number in an on-line database and stores the pertinent information in a call-back file. Your phone system also sends a message to your terminal notifying you of a message.

When you query the system, it displays the phone number stored during the initial call. The system can also display other relevant information, such as the caller's name, account, and clearance level. In addition, the system could call back the originating number. Automatic call back ensures that companies don't accidentally ignore customers' orders, requests, and comments; suppliers' inventory questions; test engineers' test-program development questions; or product managers' feature-analysis suggestions.

ISDN also gives users the ability to leave voice messages. Like the voice-mail systems in vogue today, ISDN could give users their own message-service box. The network could function as an executive assistant by letting you record a message for the network to deliver to one or more people. You could even schedule the message for delivery at a specific date or time.

## Manufacturers of ISDN ICs

For more information on ISDN ICs, circle the appropriate numbers on the Information Retrieval Service card or use EDN's Express Request service. When you contact any of the following manufacturers directly, please let them know you saw their products in EDN.

**Advanced Micro Devices**  
5900 E Ben White Blvd  
Austin, TX 78741  
(512) 462-5395  
Circle No. 650

**AT&T Microelectronics**  
Dept 52AL330240  
555 Union Blvd  
Allentown, PA 18103  
(800) 372-2447  
Circle No. 651

**Hitachi America Ltd**  
Semiconductor and IC Div  
2000 Sierra Point Pkwy  
Brisbane, CA 94005  
(800) 448-2244;  
in CA, (415) 589-8300  
FAX (415) 583-4207  
Circle No. 652

**Level One Communications**  
105 Lake Forest Way  
Folsam, CA 95630  
(916) 985-3670  
FAX (916) 985-3512  
Circle No. 653

**Mietec Alcatel**  
Raketstraat 62  
B-1130 Brussels, Belgium  
(32) 02-728-1811  
FAX (32) 02-242-7552  
Circle No. 654

**Mitel Corp**  
Box 13089  
Kanata, Ontario  
Canada K2K 1X3  
(613) 592-2122  
FAX (613) 592-6909  
Circle No. 655

**National Semiconductor**  
2900 Semiconductor Dr  
MS11-125  
Santa Clara, CA 95052  
(408) 721-6944  
FAX (408) 733-0613  
Circle No. 656

**NEC Electronics**  
401 Ellis St  
Mountain View, CA 94039  
(800) 366-9782;  
in CA, (415) 965-6159  
FAX (415) 965-6437  
Circle No. 657

**Philips International BV**  
Bldg BAF-1  
Box 218  
5600 MD  
Eindhoven, The Netherlands  
(011) 31 40 722 243  
FAX (011) 31 40 724 825  
Circle No. 658

**SGS-Thomson Microelectronics**  
1000 E Bell Rd  
Phoenix, AZ 85022  
(602) 867-6136  
FAX (602) 867-6291  
Circle No. 659

**Siemens Components Inc**  
2191 Laurelwood Rd  
Santa Clara, CA 95054  
(408) 980-4500  
Circle No. 660

**Signetics Corp**  
811 E Arques Ave  
Sunnyvale, CA 94088  
(408) 991-4519  
FAX (408) 991-2069  
Circle No. 661

### VOTE . . .

Please also use the Information Retrieval Service card to rate this article (circle one):

**High Interest 473**  
**Medium Interest 474**  
**Low Interest 475**

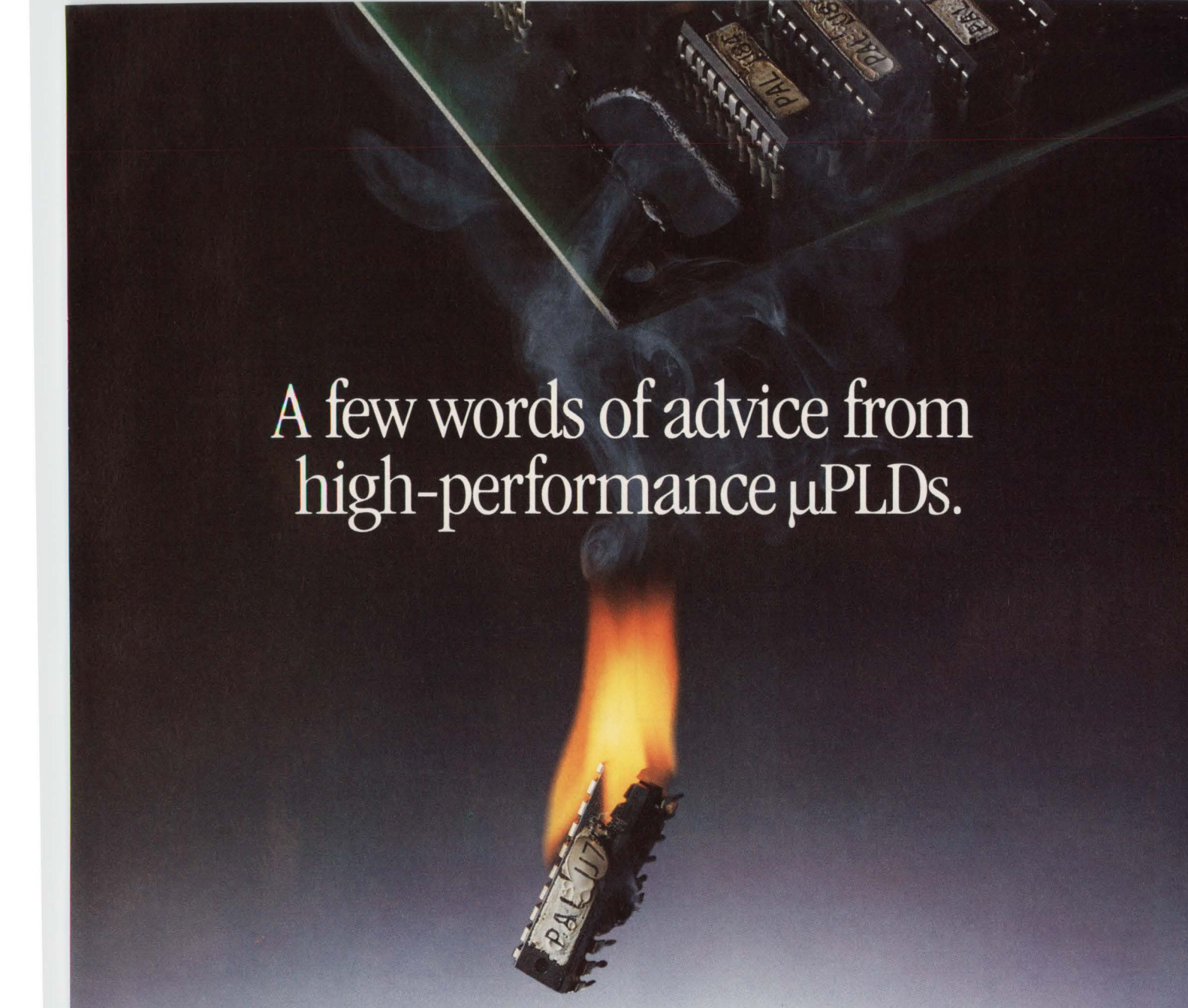
A black and white photograph of a hand holding a small integrated circuit (PAL) chip. The chip is glowing with a bright orange and yellow flame, indicating it is overheating. In the background, a green printed circuit board (PCB) is visible with several other PAL chips mounted on it. The overall scene is set against a dark, smoky background, emphasizing the heat and the need for a solution.

# A few words of advice from high-performance $\mu$ PLDs.

## Chill out, PAL.

Many designers have hot, high-performance designs. Literally.

Fortunately, Intel has a simple way to reduce system heat and still get incredible performance. The  $\mu$ PLD Family of programmable logic devices.

Take, for example, the 85C220 and 85C224. They operate at 80MHz (100 MHz internally) with only a 10ns total propagation delay.

And since  $\mu$ PLDs are manufactured using Intel's CHMOS\* technology, they require just 1/4 the power of their pin-compatible bipolar PAL\* alternatives. Which means they can lower

system heat by 35 percent and help reduce board-level failures, too. So they're certain to give your high-performance system a boost. And send chills up the spine of your motherboard.

Learn more about Intel  $\mu$ PLDs and receive a  $\mu$ PLD/PAL heat comparison. Call (800) 548-4725 and ask for Literature Packet #1A28.

Otherwise, you could take some heat over your system design.

The Intel logo, consisting of the word "intel" in a lowercase, sans-serif font with a registered trademark symbol (®) to the upper right of the letter "l".

intel®

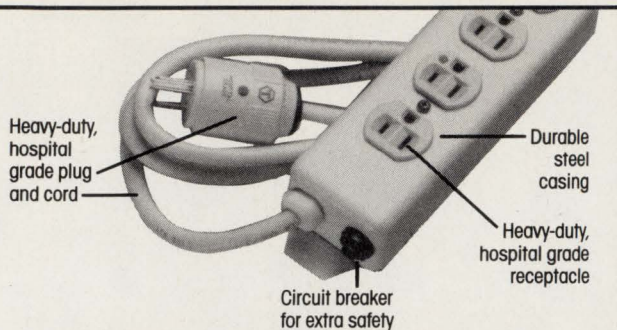

## Outlet strips with hospital grade components

When performance is critical, SL Waber performs. Our heavy-duty outlet strips with hospital grade components mean reliability and safety you can count on in labs, hospitals, clean rooms and other exacting environments. With components tested to UL Standard 544, these strips offer guaranteed voltage breakdown, superior ground integrity and low leakage current. And as the world's largest manufacturer of custom design outlet strips, we can handle anything else you need. Because if you use electricity, you need SL Waber.

These products are not recommended for use in patient care environments or near explosive gases.



**WABER, INC.**

A Subsidiary of SL Industries, Inc.  
(800) 634-1485 • In NJ call (609) 866-8888

CIRCLE NO. 32



## Brushless DC motors provide extended life in demanding applications

These compact 12-24 VDC motors are designed for tape cartridge drives, business machines, medical equipment, pumps/compressors and similar applications. Available in 2.0" and 3.2" diameters with stall torque from 10 to 84 oz-in. Custom shaft and housing and configurations to match your requirements. AMETEK, Lamb Electric Division, 627 Lake Street, Kent, OH 44240. Tel: 216-673-3451. Fax: 216-673-8994. In Europe, Friedrichstrasse 24, 6200 Wiesbaden, Germany. Tel: 6121-370031. Fax: 6121-370033.

**AMETEK**  
LAMB ELECTRIC DIVISION

CIRCLE NO. 29

## ISDN-based concurrent design

A feature of ISDN not possible with a nonintegrated voice and data communications network is electronic directory service. To find a phone number and other, nonprivate information about a subscriber, you could query an electronic-directory database. After you receive the response from the database, you could place the call. The distinction from today's system is that rather than manually dialing the number, you hit the Enter key on your telecommunications terminal—much as you would place a call from a communications program. The directory, too, enhances concurrent engineering by putting you closer to the networks of data and people most likely to help your product design.

Most of the capabilities that ISDN offers aren't new. Many, in fact, are available today. What ISDN promises is lower cost and greater convenience than current phone systems. Today you must use multiple phone lines to perform multiple functions. In the future, ISDN will use one phone line to make your workstation both a computation engine and an integrated voice and data transporter.

**EDN**

## References

1. *ISDN Sourcebook*, Information Gatekeepers Inc, Boston, MA, 1990.
2. *Compilation of ISDN Applications*, Information Gatekeepers Inc, Boston, MA, 1990.
3. Hardwick, Steve, *ISDN Design: A practical approach*, Academic Press, San Diego, CA 1989.
4. Leibson, Steven H, "ISDN," *EDN*, November 12, 1987, pg 118.
5. Markowitz, Michael, "The U interface comes of age," *EDN*, April 27, 1989, pg 53.
6. Morgan, David, Michael Lach, and Roger Bushnell, "ISDN as an enabler for enterprise integration," *IEEE Communications Magazine*, Vol 28, No 4, April 1990, pg 23.

**Note:** For more information on Refs 1 and 3, see the Book Reviews on page 181.

Article Interest Quotient (Circle One)  
High 473 Medium 474 Low 475

# 68040 VME 33 MHz 0-Wait-State

Your Vision  
of High Performance  
at an Affordable Price  
is Now Real!

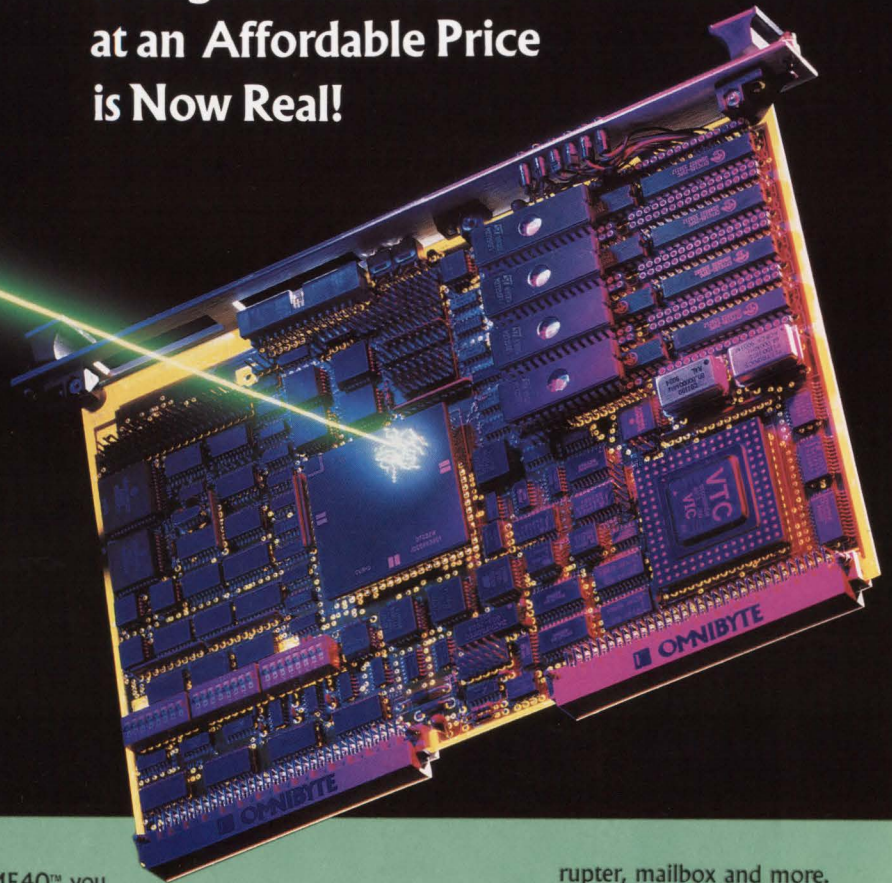

With the OB68K/VME40™ you no longer have to compromise on performance or price in your VME embedded control application. We start by giving you a very basic board which includes:

- 25-33MHz 68040.
- (8) 28-pin RAM sockets for up to 256KB of dual access 0-wait-state static RAM (32KB standard).
- (8) 32-pin sockets for up to 8MB of ROM.
- (2) asynch RS232C serial ports.
- (16) lines of parallel I/O.

You can configure it with just the right amount of RAM and ROM you need.

And you do not have to sacrifice features. Our Omnimodule™ modular I/O connector allows you to implement a wide variety of serial, parallel, SCSI, GPIB, analog, digital and other I/O options - all fitting into one slot. Other features include:

- VTC's VICO68 VME interface chip with arbiter, inter-

rupter, mailbox and more.

- Terminal monitor/debugger/diagnostic firmware program included.
- 2 year limited warranty.
- Worldwide availability.

All of this gives you a high performance board at a price you can afford with the features you need.

To learn more about our OB68K/VME40 contact our Marketing Manager, Pete Czuchra at 1-800-638-5022 or (708) 231-6880 in Illinois.

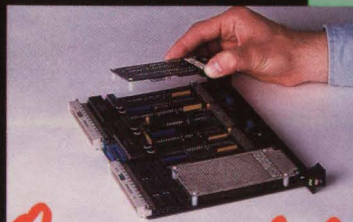

*Omnimodules™*



**OMNIBYTE™**

**OMNIBYTE CORPORATION**  
245 W. Roosevelt Road  
West Chicago, IL 60185-3790  
Fax No. 708-231-7042  
CALL TOLL FREE 1-800-638-5022  
In IL 708-231-6880

CIRCLE NO. 120

# Our VME and Multibus Product Lines Stretch for Over 124 Miles

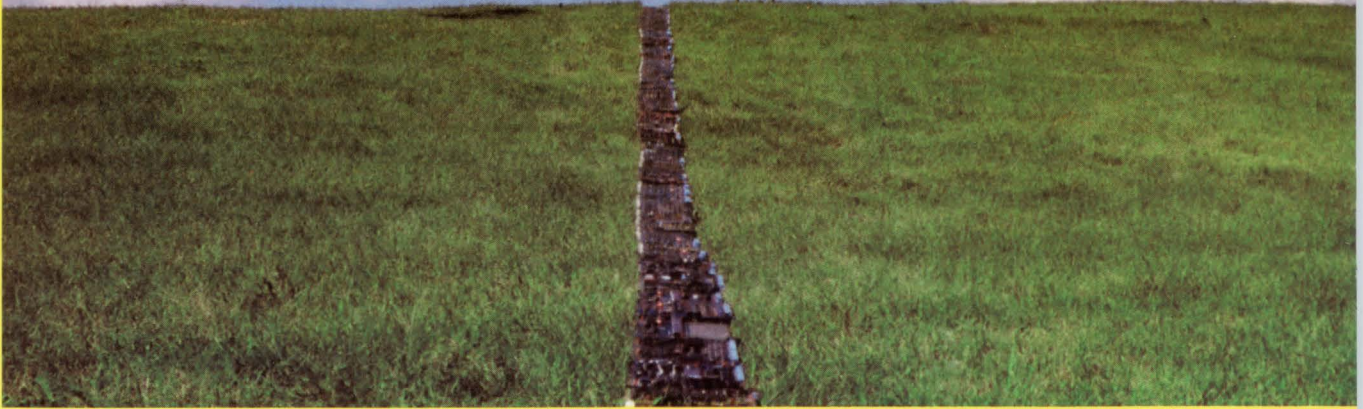

That's 854,738 uniquely configured boards to choose from and all from Omnibyte. You can choose from different processor types, RAM sizes, I/O options and other features to put together a board that gives you the features you need. With Omnibyte's quality, selection and 2 year limited warranty, you can count on finding exactly what your looking for.

Here are just a few of the boards we offer:

## OB68K/VME20™ VME SINGLE BOARD COMPUTER

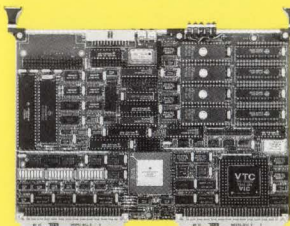

- 68020 16.66 - 33 MHz CPU
- (8) 28-pin RAM sockets for up to 265KB of dual-access zero-wait-state static RAM
- (8) 32-pin sockets for up to 8MB of ROM, (4) sockets may be EEPROM
- (2) RS232C asynch serial ports
- (16) lines of parallel I/O
- (1) OMNIMODULE socket for a wide variety of I/O (i.e. 2 serial ports, 20 parallel lines)
- VICO68 VME Interface Controller

## OB68K/VSBC20™ VME SINGLE BOARD COMPUTER

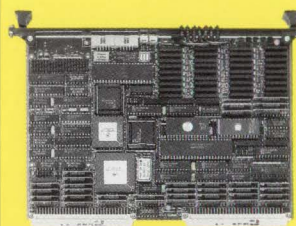

- 68020 16-33MHz, CPU
- 1-4 MB of dual-access, zero-wait-state DRAM with parity
- 68882 (optional)
- (2) 32-pin ROM sockets
- (2) RS232C serial ports
- (2) 8-bit parallel ports
- (1) OMNIMODULE socket for a wide variety of I/O (i.e. 2 serial ports, 20 parallel lines)
- 4 level bus arbiter (optional)

## OB68K/VSBC1™ VME SINGLE BOARD COMPUTER

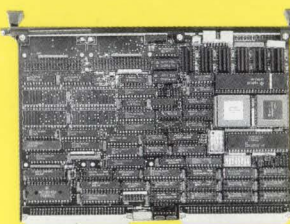

- 68000 12.5MHz 16/32 bit CPU
- 512KB of dual-access, zero-wait-state DRAM with parity
- (4) 28-pin ROM sockets
- (3) 16-bit counter/timers
- (2) Omnimodule™ I/O sockets for a wide variety of I/O (i.e. 4 serial ports, 40 parallel lines)
- DMA controller (optional)
- VME bus interrupt generator (optional)
- Optional 4 level bus arbiter
- Two year limited warranty

## OB68K/VME1™ VME SINGLE BOARD COMPUTER

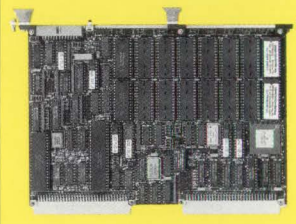

- 12.5 MHz 68000 CPU
- (8) pairs of 28-pin sockets for RAM or ROM
- (2) RS-232C serial ports
- (2) 8-bit parallel I/O ports
- System Controller

## OB68K/VIO™ VME UNIVERSAL I/O BOARD

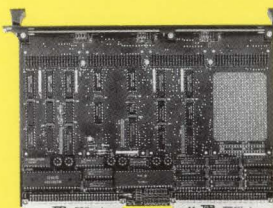

- (4) Omnimodule I/O sockets for a wide variety of I/O (i.e. 8 serial ports, 80 parallel lines)
- One (1) interrupt per Omnimodule, two (2) optional

## OB68K/MSBC30™ MULTIBUS I SINGLE BOARD COMPUTER

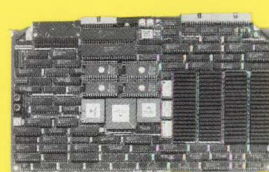

- 25-33 MHz 68030 CPU
- 4-32 MB dual access, zero-wait-state DRAM w/parity
- 68882 Math Co-Processor (optional)
- 2 channel DMA controller (optional)
- (2) RS232c sync/asynch serial ports
- (2) 8-bit parallel ports
- (1) OMNIMODULE™ socket
- (4) 32-pin ROM sockets

All our different configurations are built to give you the best in quality. And they are backed by our famous 2 year limited warranty. For more information call Pete Czuchra today. He'll help you pick the card you need.

**OMNIBYTE™**  
A Look at Today...a Vision of Tomorrow

CIRCLE NO. 119

**OMNIBYTE CORPORATION**  
245 W. Roosevelt Road  
West Chicago, IL 60185-3790  
Fax No. 708-231-7042  
CALL TOLL FREE 1-800-638-5022  
In IL 708-231-6880

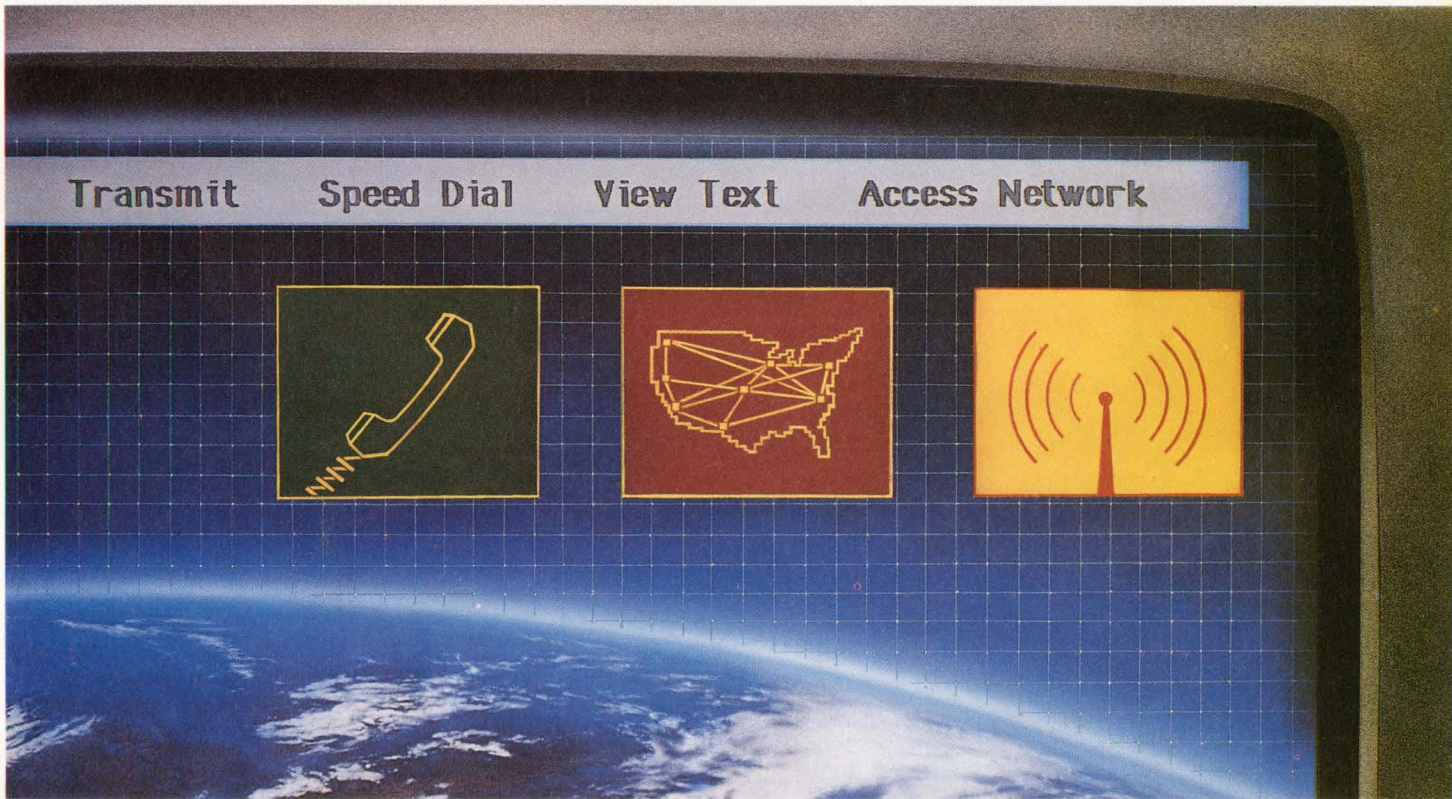

## International Exchange.

**Siemens integrated circuits help bring the world closer together with telecommunications.**

Siemens is continuing to provide innovative solutions in communications which are making a sound impact, throughout the industry. And the world.

We offer the most comprehensive communication IC family in the world, facilitating the incorporation of data, speech, and picture sources, to meet your application-specific needs.

With the development of our PEB2091 ISDN Echo Cancellation Circuit (IEC-Q), we introduced the industry's first single-chip CMOS solution for the standardized U-interface. It can double the traffic-handling capability of existing



High-integration echo cancellation transceiver for ISDN.

telephone lines. And it's ideal for transmission systems such as digital added main line and other pair gain systems and intelligent channel banks.

For applications such as cellular or full-featured telephones or line cards, which require lower power consumption, we offer CMOS 8-bit microcontrollers based on the 8051 architecture. Like the SAB80C537, which features 16-bit hardware multiply/divide, and 8 data pointers.



CMOS 8-bit Microcontrollers.

Siemens CMOS ASIC technology features both Sea-of-Gates and standard-cell families. Our 1.5, 1.0 and sub-micron technologies are compatible with Toshiba even at the GDS2 database level, for true alternate sourcing

worldwide. And they come with the European content and U.S. design support you need, as well as the best service in the industry.

For the most advanced telecommunications ICs, hook up with the leader.

For details, call (800) 456-9229, or write:

Siemens Components, Inc.  
2191 Laurelwood Road  
Santa Clara, CA 95054-1514.

Ask for literature package M12A 010.

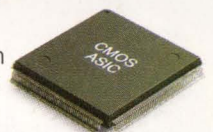

ASIC solutions in both Sea-of-Gates and standard-cell.

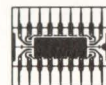

**Siemens  
World Wise, Market Smart.**

# Power tool

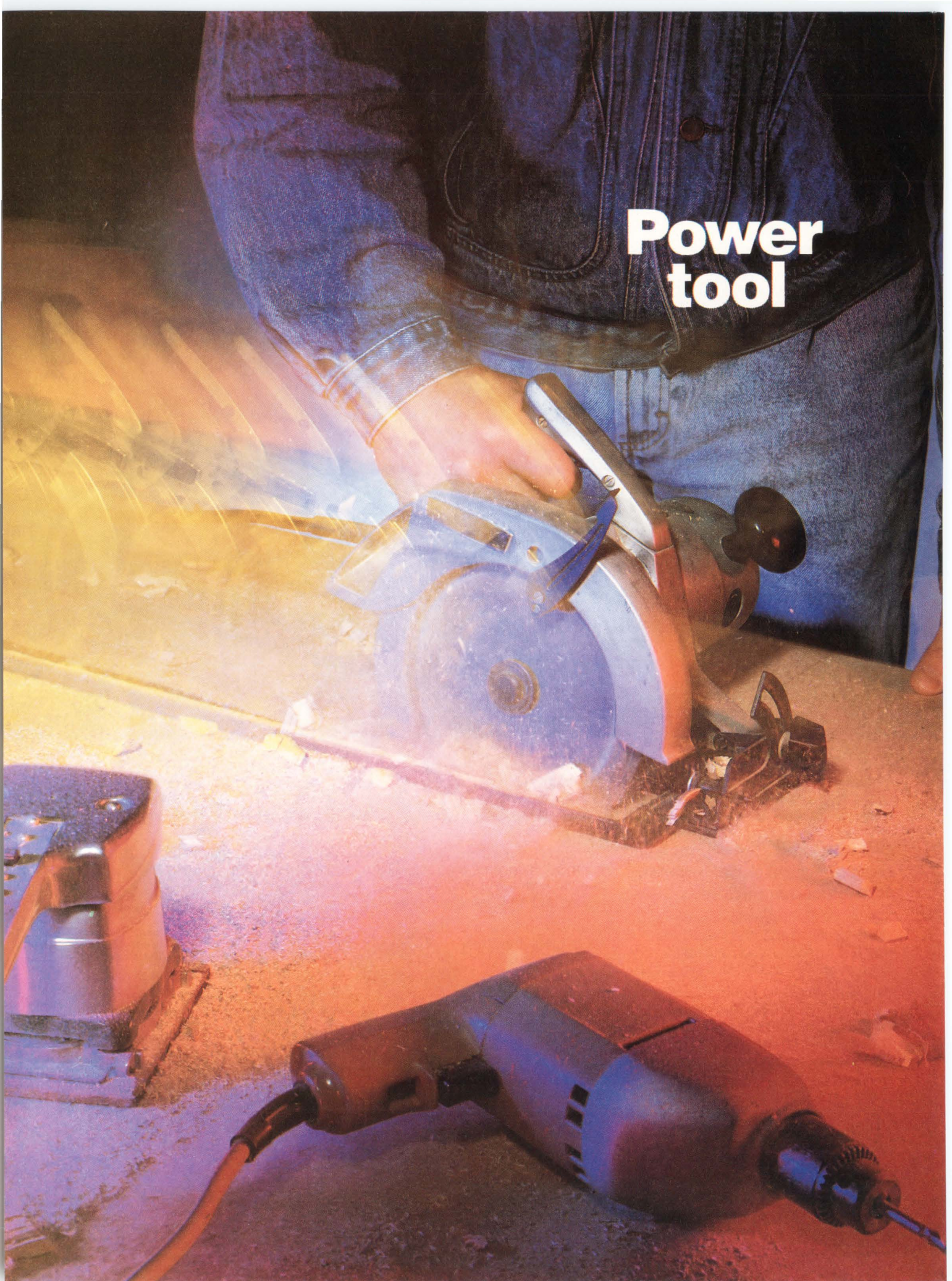



# Power tools

## KEPCO DIGITAL POWER CONTROLLERS

Choose your tools carefully for the work at hand. Choose a single unit ATE power supply and drive it with an SN digital analog interface to translate GPIB commands to useful voltage and current or choose a multiple-unit TMA-MAT system and drive up to 27 independent voltages and currents from a single GPIB address with full status monitoring and read back of actual values.

Kepeco's power tools are carefully calibrated to provide you with just the right combination for the work you need to do.

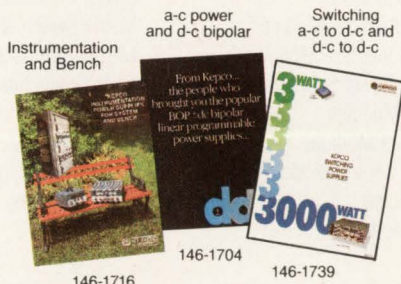

Call/fax/write to Dept. LVT-12 for any of our three catalogs.

Kepeco, Inc., 131-38 Sanford Avenue, Flushing, NY 11352 USA (718) 461-7000 • FAX (718) 767-1102 • Easylink (TWX): 710-582-2631

KEPCO EUROPE, LTD., London, England: Salamander Quay West, Park Lane, Harefield, Middlesex UB9 6NZ •

Tel: +44 895 825046 • Fax: +44 895 825045 BRITISH ISLES: PPM Instr. Ltd. • Tel: (0483) 301333 • Fax: (0483) 300862

GERMANY: Compumess Elektronik GMBH • Tel: (089) 32 00 95 56 • Fax: (089) 32 00 95 25 FRANCE: M.B. Electronique •

Tel: (1) 39 56 81 31 • Fax: (1) 39 56 53 44 ITALY: Sistrel, S.p.A. • Tel: (02) 618 1893 • Fax: (02) 618 2440



### dc, unipolar power

- Listen only, GPIB
- 12 bit control, 0-6V to 0-325V, unipolar dc
- Power: 50W, 100W, 250W, 500W, 1000W
- Control one, four or eight units, analog drive

Kepeco Group SN/ATE Power Supplies



### dc, bipolar power

- Listen only, GPIB
- 12 bit control,  $\pm 20V$  to  $\pm 200V$  bipolar dc
- 100W, 200W, 400W
- Single unit, self-contained

Kepeco Group BIT/BOP Power Supplies



### dc, unipolar power

- Listen, talk-verify, GPIB
- 12 bit control, 0-6V to 0-325V unipolar dc
- Power: 50W, 100W, 250W, 500W, 1000W
- Control one to sixteen units, analog drive

Kepeco Group TLD/ATE Power Supplies

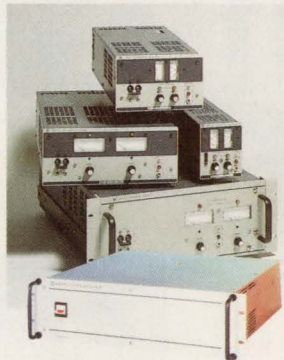

### dc (selectable polarity) power

- Talk-listen, GPIB, full read back of both voltage and current
- 12 bit control, 0-6V to 0-150V Unipolar dc with polarity selection
- Power: 360W, 720W, 1080W
- 1-27 unit control, digital (bit-bus) drive

Kepeco Group TMA/MAT Power Supplies

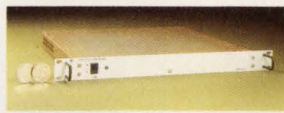

### software controller

- Talk-listen on bit-bus
- Control up to 27 power supplies (Kepeco type MAT)
- Plugs directly into DOS computer



### ac power

- Talk-listen, GPIB
- 12 bit control, 0-125V ac 47-2000Hz ac power
- 1KVA to 18KVA
- Expandable to 90KVA

Kepeco Group RGB/BOP Power Supplies

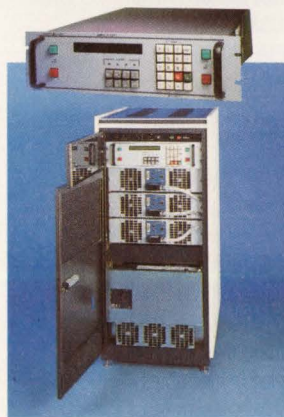

SEE OUR PAGES  
IN VOLUME D  
**eem** 93

# It's Everything a PC Isn't.

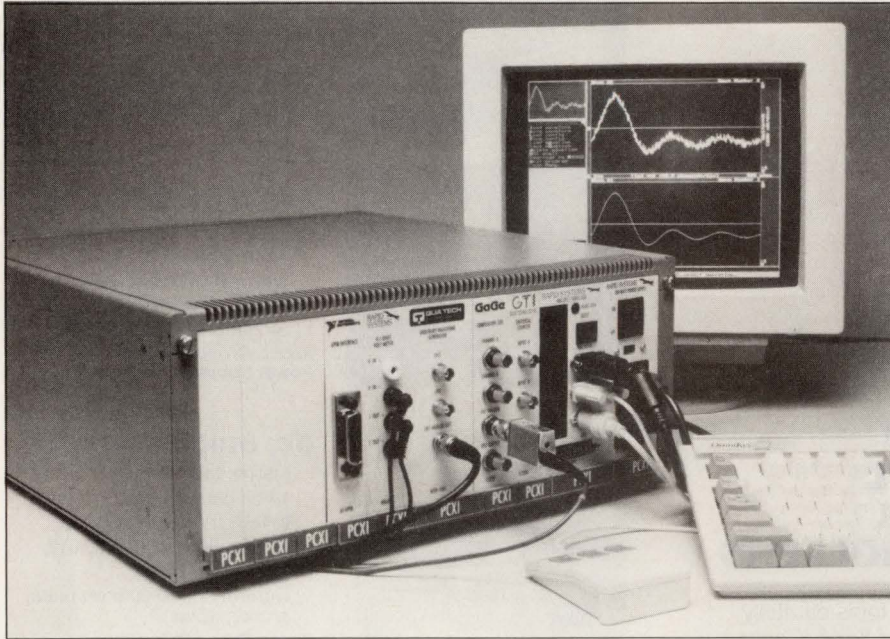

## PCXI IS ALSO EISA: 32 BITS AND BUS MASTERED.

The PCXI EISA system offers full PCXI modularity combined with the power and speed of 32-bit EISA capability: true multi-processing; 33 megabytes/second data transfer for bus masters and DMA; automatic configuration of system and modules.

It's the first ever EISA PC designed from the ground up for industry.

## ALMOST VXI FOR MUCH LESS.

If you have a true VXI application, we'd never suggest PCXI.

But for all those thousand and one other jobs, well, PCXI is a lot like VXI. VXI is modular and upgradeable, so is PCXI. They primarily use a 286/386 CPU, so do we (except we can also offer you a 486). VXI has quite a few instrumentation and function modules from manufacturers, so does PCXI (except there are thousands of modules, off-the-shelf, from hundreds of manufacturers). We even look alike.

The only difference is that we cost so much less.

## ALL THE BENEFITS OF A PC, NONE OF THE HASSLES.

We've changed the rules for industrial PCs.

PCXI is a modular, interchangeable, multi-vendor PC bus system. Noise, emissions, power, ground, airflow and cooling are specified and verifiable. All PC functions, from CPU (286/386/486) to power supplies, are enclosed in metal shielded modules.

Connectors are on the front panel.

It's what industrial PCs always should have been.

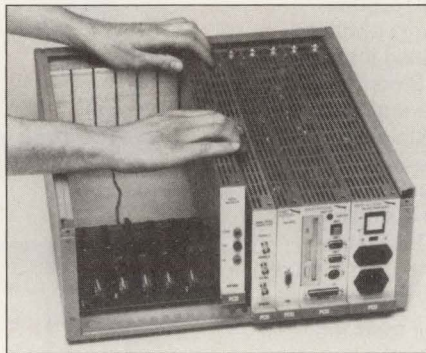

*PCXI modules plug interchangeably into slots in the ISA passive backplane. All PC boards are universally accommodated.*

# PCXI

**(206) 547-8311**

### WE'VE GOT THE PCXI SYSTEM FOR YOUR APPLICATION.

#### INDUSTRIAL COMPUTERS

ISA Chassis: Tabletop, Rackmount & Portable  
286/386/486 CPUs  
Hard/Floppy Drives  
Graphics  
Expansion Chassis  
Monitors/Keyboards/Mice  
PC Peripherals

#### EISA INDUSTRIAL COMPUTERS

EISA Chassis: Tabletop & Rackmount  
EISA 386 CPU  
EISA Function Modules

#### FUNCTION MODULES

Analog Input Modules  
Analog Output Modules  
Digitizer Modules  
Analog Filter Modules  
Logic Analyzer Modules  
Multiplexer Modules  
Relay I/O Modules

Time Modules  
Transducer Modules  
Counter/Timer Modules  
Data Logger Modules  
Multifunction A/D, D/A, DIO Modules  
Digital Scope Modules  
FFT Spectrum Analyzer Modules  
GPIB/IEEE 488 Interface Modules  
Programmable Power Supply Modules  
Signal Source Modules  
1553/ARINC 429 Modules  
Stepper Motor Control Modules  
Prototype Modules  
Bus Analyzer Modules

Communication Modules  
RS422/485 Interface Modules  
Industrial Modules  
Digital Signal Processing Modules  
Digital Multimeter Modules  
Digital I/O Modules  
Matrix Switch Modules  
Memory Modules  
Fiber Optics Interface Modules  
Image Processing Modules  
Digital Panel Meter Modules  
UPS Power Modules  
Voice Modules

## RAPID SYSTEMS

433 North 34th Street, Seattle, WA 98103 • (206) 547-8311 • FAX: 206-548-0322



# LINEAR SEMINAR FOR DESIGNERS BY DESIGNERS.

(New Product Workshop)

100 MHz Op Amp

0.1 Distortion  
Low Pass Filter

Free Application  
Handbook  
Free Databook

88% Efficiency  
Switchers

Free Lunch  
Free Samples

## Plan to attend this one day seminar given by Linear's top designers.

If you design analog circuits or sub-systems, this is one seminar you don't want to miss. It's presented by Linear Technology's senior design engineers. The emphasis is on "real world" applications and the typical challenges facing today's design engineer. Each application presented has been breadboarded at Linear Technology. And because our top engineers are also giving this seminar, they're intimately familiar with the ICs and their applications.

### Topics To Be Covered Include: Operational and Instrumentation Amplifier Applications

- High speed op amps with slew rates  $\geq 250$  volts/ $\mu$  sec.
- Single supply micropower devices
- Selection techniques to minimize noise

### Power Supply Design

- High efficiency ( $\geq 90\%$ ) switching regulators
- Transformer and inductor design/selection
- Micropower switchers
- Single cell converters

### Filter Applications and Design

- New family of high performance, low noise, switched capacitor filters.
- Filter design software ("FilterCAD")

### PHASE II

Seminar Number	Seminar Location	Date
12	Santa Clara	1/29
13	San Diego	2/6
14	Los Angeles/Woodland Hills	2/7
15	Baltimore	2/26
16	Orlando	2/27
17	Irvine/Garden Grove	2/27
18	St. Petersburg (FL)	2/28
19	Portland	3/19
20	Dayton	3/19
21	Detroit	3/20
22	St. Louis	3/21
23	Santa Rosa	3/21

We'll be adding additional seminar locations. Watch for them.



TOUGH PRODUCTS  
FOR TOUGH APPLICATIONS.

### Data Converters

- New A-D converters with serial protocol
- Simplified microprocessor interfacing

### Low Power Interface Circuits

- Both RS232 and RS485 transceivers
- Design and application notes for: Driving long lines • Capacitive loading • Power down and power up

### New Products

- Preview of new 1991 products

And these are just a few highlights from the topics to be covered. You'll also receive: Lunch • 1500 page Databook • 1000 page Application Handbook • NOISE Disk • SPICE Disk • FilterCAD Software and Filter Handbook • Product samples

Plan to attend now. You'll learn "tricks of the trade" from our Seminar Presentation Teams headed by industry experts including:

Bob Dobkin      Carl Nelson  
Jim Williams      George Erdi  
Nello Sevastopoulos

Cost is \$30.00 and you can register now by calling **800-637-5545**. VISA and MasterCard accepted. Or send your check to Linear Technology Corporation, 1630 McCarthy Blvd., Milpitas, CA 95035.



# Power to shrink the world.

Motorola's MEGAHERTZ Family of semiconductors increases power density in high-frequency power supplies.

Today's smaller, more advanced applications require compact, higher frequency power supplies. The MEGAHERTZ™ Family of semiconductors gives you the capacity to shrink your power supply designs through increased switching frequency. It's the total system solution for high frequency power supplies that gives you the key to more watts per cubic inch.

### Low loss, low noise Rectifiers.

The MEGAHERTZ Family includes the highest voltage Schottky barrier and ultrafast rectifiers in the industry. Schottky devices range from 20 amps and 30 volts to 20 amps and 200 volts in TO-220 packages. Ultrafast devices are rated from 8 amps and 400 volts to 8 amps and 1000 volts, also in TO-220 packages. They're avalanche energy rated and perfect for most high frequency switching power supplies and converters.

### TMOS Power MOSFETs.

MEGAHERTZ TMOS™ Power MOSFETs are designed to operate in switching environments from 100 kHz to 5 MHz. These devices have avalanche energy ratings and offer faster switching times, lower gate charge, lower turn off delay time and lower on resistance. They come in the popular TO-220 package and they're

compatible with all common square-wave topologies, including quasi-resonant.

### Linear MOSFET Driver and Mode Controller.

The MEGAHERTZ Family also includes Linear Integrated Circuits that operate in the MHz frequency range. There's a dual high speed MOSFET driver, a high performance resonant mode controller and a fixed frequency current mode controller.

### Yours free for the asking.

We've put together an information package, including free samples of three

rectifiers, one TMOS MOSFET and three Linear ICs. To get yours, simply complete and return the coupon below, write to us on your company letterhead at P.O. Box 20912, Phoenix, AZ 85036, or contact your local Motorola Sales office.

MEGAHERTZ is a trademark of Motorola Inc.  
TMOS is a trademark of Motorola Inc.



**MOTOROLA**

To: Motorola Semiconductor Products, Inc., P.O. Box 20912, Phoenix, AZ 85036  
Please send me the MEGAHERTZ information pack.

474EDN030191

Name \_\_\_\_\_

Title \_\_\_\_\_

Company \_\_\_\_\_

Address \_\_\_\_\_

City \_\_\_\_\_

State \_\_\_\_\_ Zip \_\_\_\_\_

Call me (\_\_\_\_\_) \_\_\_\_\_

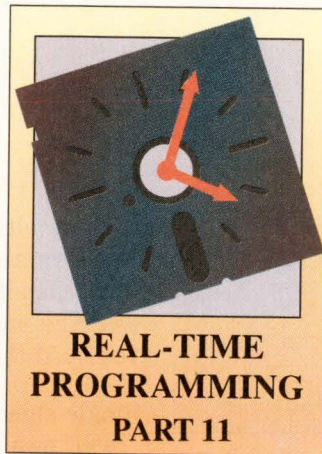

# Task coordination: specific methods, general principles

---

*Earlier parts of this series described several types of task coordination. This final installment classifies the various methods, diagrams the relationships among them, and provides guidelines for choosing methods that suit your requirements.*

---

David L Ripps, *Industrial Programming Inc*

Task coordination is a fundamental and essential part of a real-time application. In principle, each task is an independent program that is capable of running asynchronously with respect to all other tasks. In practice, tasks are highly interrelated; they work in unison. Specifically, most tasks act upon the same body of current data. Some tasks bring fresh data into the body, others transform the data, and finally, some output a product or response based on the data. In every case, tasks feed data to each other, with producers and consumers

coordinating to be sure that transformations are performed with consistent values.

The last few parts of this series described several different types of coordination that have evolved over many years and hundreds of applications. People have discovered that there is no one universal method that solves all coordination problems easily and efficiently. But they have also discovered that just a small set of basic techniques and methods does suffice for the vast majority of real-time applications.

In essence, coordination is the blocking of a task until some specified condition is met. Often, the condition is a function of information that is produced by one or more tasks and maintained by the operating system. But this need not be the case. With "pause/cancel-pause," for example, coordination is achieved without any transfer or permanent storage of information.

The specific methods of coordination described in previous parts differ significantly in both the nature of the unblocking condition and the type of information involved. These internal differences, in turn, lead to corresponding differences in the user-level characteristics and capabilities of the methods. As a result, the

---

From the book, *An Implementation Guide to Real-time Programming*, by David L Ripps, ISBN, 0-13-451873-X, ©1989. Excerpted by permission of Prentice-Hall Inc, Englewood Cliffs, NJ.

In principle, tasks are independent programs that can run asynchronously with other tasks. In practice, tasks are highly interrelated.

application designer can usually choose a scheme that is exactly right at each point for which coordination is needed.

Nevertheless, to make a proper choice of coordination scheme, the designer must understand what the underlying differences are and how they appear at the task level. This final part attempts to classify the various methods and to diagram the relationships among them. This is an expanded version of a classification scheme originally published in 1983 (Ref 1).

Many alternate diagrams could be drawn, each of which represents a valid classification. The goal is to find a classification that will guide in the selection process. The end product is essentially a decision tree: If you need this characteristic, choose this branch.

### Single-sided vs double-sided coordination

The first division (Fig 1) separates those methods in which only one partner can be held for coordination from those in which both partners are coordinating with each other. Single-sided methods are totally asymmetric: One task issues a wait for a certain condition to be true, another task sets the condition that ends the wait. However, the second task itself cannot be blocked while setting the condition. Furthermore, with most single-sided coordination methods, it is possible that no task waits since the end-wait condition may already have been set before the wait request is

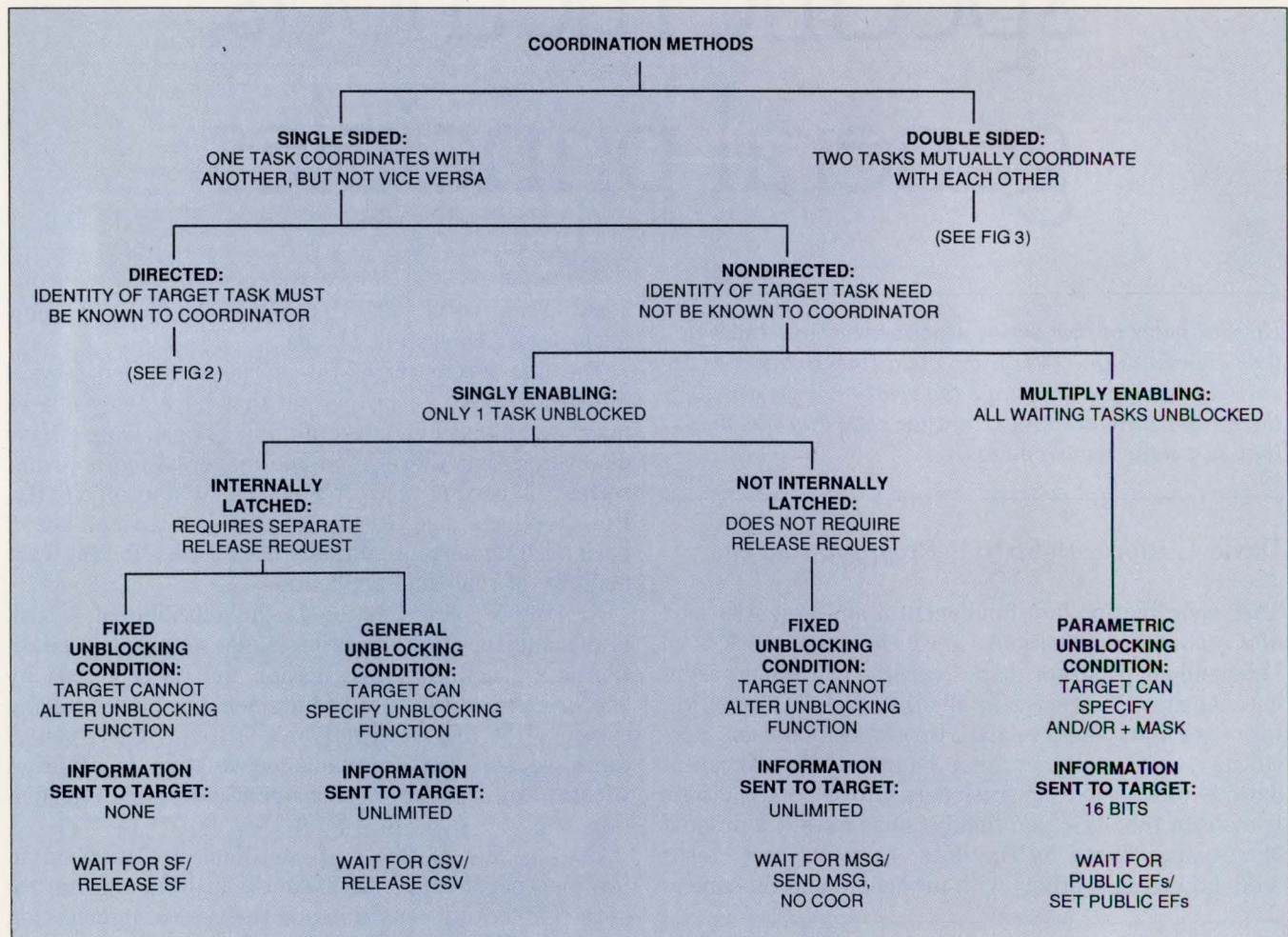

Fig 1—Task-coordination methods can be either single sided or double sided. Single-sided methods are asymmetric: One task issues a wait for a certain condition, and another task sets the condition. With double-sided methods, there is mutual coordination: Either task can wait for the other.

issued. Event flags always provide single-sided coordination.

Coordination can also be double sided to provide a greater degree of symmetry between the partners. With double-sided methods there is a mutual coordination between both partners; either partner can wait for the other. Specifically, the first task to issue a coordination request always waits for the second task to issue a matching request. One task always waits; there is no sense in presetting the end-wait condition. The pair "send-message-to-mailbox-with-wait-for-transfer/receive-message-from-mailbox-with-wait-for-transfer" produces this type of synchronization. However, unless both requests include the optional "with-wait-for-transfer," coordination via a mailbox will not be double sided.

### Single-sided coordination

For lack of better terms, the partners in single-sided, task-to-task coordination will be referred to as the coordinator (**C**) and target (**T**), respectively. The target issues the wait; the coordinator sets the end-wait condition to continue the target.

Referring again to **Fig 1**, the next division separates those single-sided methods for which the identity of the target task must be specifically known to the coordinator and those for which such knowledge is not necessary. Consider, for example, the coordination that can be produced by the services *pause* and *canpau* (cancel-pause).

Task **T** pauses (for a given maximum time interval, or "forever").

```
pause (200+MS);
```

When task **C** wants **T** to continue, it cancels that pause.

```
canpau (tskTid);
```

The cancel-pause is always directed at a specific task. Thus, the identity of the target inherently must be known. Furthermore, only that one target task is unblocked, and no message or other information is transmitted from **C** to **T**. (Strictly speaking, when the pause is for limited duration (rather than with **NOEND**), one bit of auxiliary information is sent: Did the pause end because the time elapsed or was it canceled early for coordination?)

The term "directed" refers to those coordination methods for which the identity of the target task inherently must be known to the coordinator. In contrast, coordination based on event flags or messages is "non-

directed." The task that supplies the unblocking information need never know the identity of the target task or tasks, if any.

Use directed methods whenever you need direct control over one specific task. Use nondirected methods whenever the coordination is not with any given task, but with any that may be interested or with the next task that has requested coordination. Among the nondirected schemes, public event flags provide broadcast, that is, coordination with any task that may be interested; message exchanges maintain multiple-server queues for coordination with the next available task.

In this discussion, the separation is based on inherent or necessary knowledge. In any given application, there could be only one task waiting for a particular public event flag or at a particular message exchange. Thus, there could be *a priori* knowledge of the coordination target even with public event flags or message exchanges. But this knowledge is not necessary to coordinate via public event flags or messages. With "pause/cancel-pause," target identity is an absolute necessity.

### Nondirected methods

At the next lower level in the diagram, nondirected methods can be split further into those that never unblock more than one task upon a change in coordination data and those that unblock all waiting tasks that meet some function of the data. The first class is called singly enabling, the second multiply enabling. Public event flags are multiply enabling. Multiply enabling methods are used mainly for the broadcast of binary coordination data.

Singly enabling coordination methods can be subdivided even further into those that are internally latched by the operating system and those that are not. With latched methods, there is an internal busy/free flag (the latch) that is maintained by the operating system as part of the coordination data. A target task (**TskA**) makes a request to wait until a certain facility (such as a semaphore) is free. When **TskA** is permitted to proceed, the OS sets the flag busy. While the flag is set, the OS will not permit any other target task (**TskB**) to proceed. **TskA** must issue a specific release request to unlatch the facility to permit **TskB** to continue. (In this special case, each task is first the target and then the coordinator for the next target.)

Latched coordination methods provide mutual exclusion, that is, one-task-at-a-time access. Examples are semaphores (SFs) and controlled shared variables (CSVs). The major difference between these methods is the amount of auxiliary information that is associated with the coordination mechanism and the flexibility of

Most tasks act upon the same data. Some tasks add fresh data, others transform the data, and some create a product or response based on data.

the unblocking condition. (The auxiliary information isn't transmitted directly from the coordinator to the target in the same sense that a mailbox message is transmitted. The auxiliary information is associated with the coordination mechanism as a whole, not with any single act of coordination. Thus, the CSVs that the target receives may have been set by several tasks, or by one task at several different times.) SFs work only with the busy/free latch, the identity of the current owner of the latch, and the wait queue; this is all the unblocking function can depend upon. In contrast, CSVs permit complete freedom to maintain any amount of auxiliary information and to use that information in any arbitrary way via the unblocking function.

A message exchange is not inherently latched and hence does not necessarily lead to mutual exclusion. If there are 10 messages available at the exchange, then 10 tasks will be permitted to proceed. Dijkstra's P/V coordination works the same way.

Of course, a designer can force a message exchange to be effectively latched by permitting only one message to be posted. The message becomes an external (task-level) latch. Whichever task has been given the message at a given moment has also been granted permission to continue.

### Directed methods

Now turn your attention to single-sided, directed methods (Fig 2). In selecting among these schemes, it is important to decide if the end-wait condition supplied by the coordinator should be stored or transient. Transient means that the end-wait information is lost if the target is not already blocked. The coordination provided by "pause/cancel-pause" is transient. So is "pause-for-signal/send-signal." (With this mechanism, for pure coordination without "side effects," the response of the target should be to ignore the signal.)

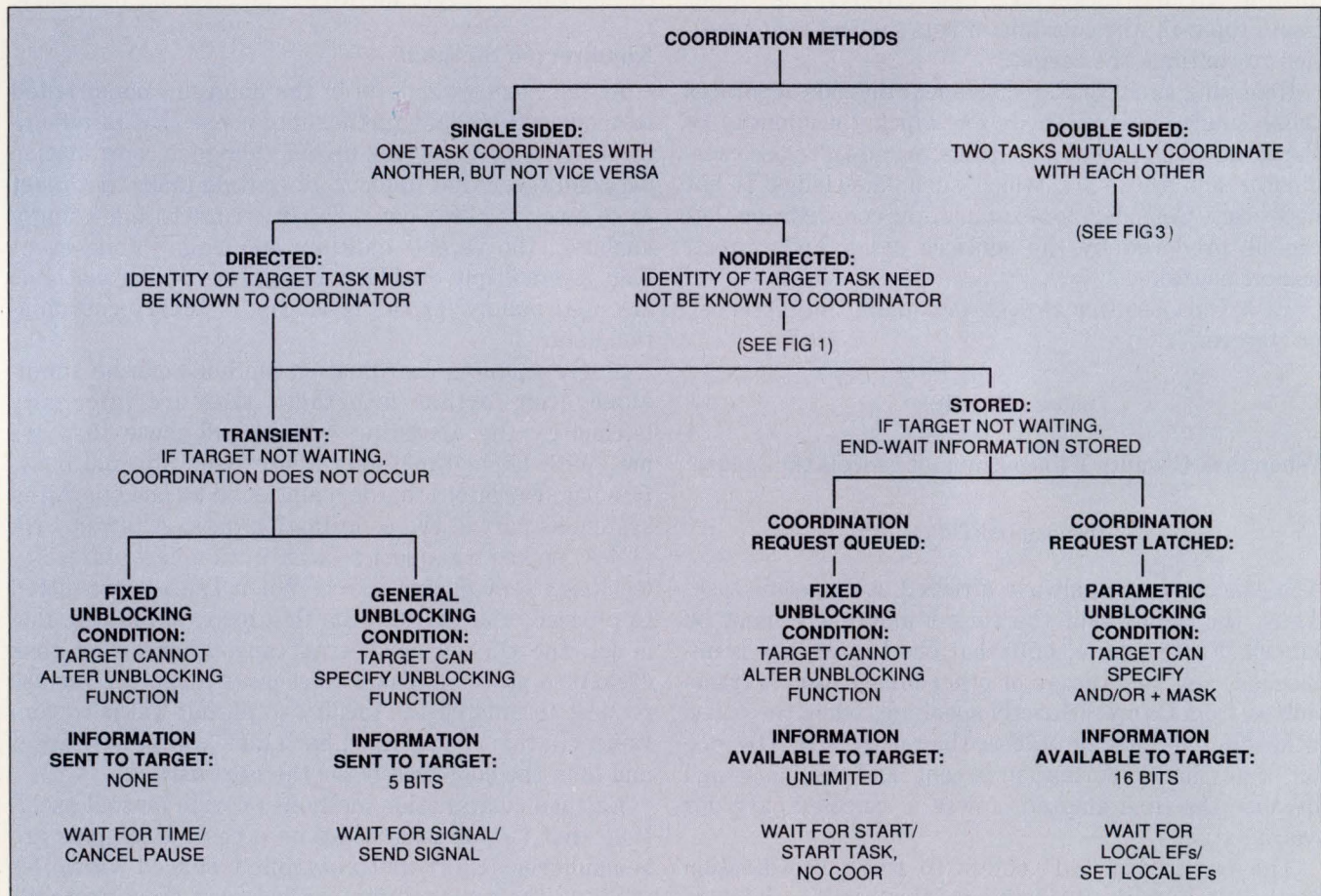

Fig 2—Single-sided task-coordination methods can be either directed—when the coordinating task knows the identity of the target task—non-directed.



Of the two, "pause/cancel-pause" requires less internal overhead and thus is recommended if no auxiliary data needs to be sent to the target. Since the target task is told which of the 32 signals ended the pause, "pause-for-signal/send-signal" inherently transmits five bits of auxiliary data. Nevertheless, the OS does not retain those five bits after coordination is achieved. If the target doesn't save the information, it is lost.

Use local event flags if you need directed coordination with storage of the unblocking data. Up to 16 bits of data are available per task. However, although the target receives a snapshot of the 16 event-flag bits, they are not strictly information transmitted from the coordinator to the target; other tasks may have set (or reset) some of the bits. Even more important, although the unblocking data is stored, it is held in a single variable (the current value of the local event flags); there is no sense of queuing. Thus, if more than one task attempts to start a given target by setting the same local event flag (or flags), there will be only one continuation.

"Wait-for-start/start-task-without-coordination" is another single-sided method that is directed to a specific task. In this special case, the target is Dormant while it waits. Without stretching the definition too much, interpret Dormant as wait-for-start.

"Wait-for-start/start-task-without-coordination" differs from the local event flags by queuing the requests and thus guaranteeing that each separate act of coordination (ie, start request) will eventually be serviced. Because of the runtime argument, the coordinator can send an unlimited amount of information to the target.

### Double-sided coordination

Next, focus your attention on double-sided coordination. The terms target and coordinator that were introduced for single-sided coordination must be redefined if they are to be applied to the partners of double-sided methods. Since in double-sided coordination either partner can wait, the target cannot be defined as the task that issues the wait request. However, double-sided methods always involve at least one transfer of information. The coordinator for double-sided methods is that task that supplies the information and the target is that task that receives the information (at the first transfer if there are two).

Double-sided methods can be subdivided into those that have a unidirectional transfer of information at the coordination point and those that have a bidirectional exchange of information upon coordination (Fig 3). When the coordination is achieved via a mailbox (with wait on both the send and receive), there is first a mutual and symmetric synchronization: The first task to arrive waits for the second. Once both tasks have reached the coordination point, the content of one mes-

### Attributes of task-to-task coordination methods

Method	1	2	3	4	5	6	7
pause (=wait for time)/ cancel pause	SS	DI	SE	NL	FC	TR	none
wait for signal/ send signal	SS	DI	SE	NL	FC	TR	signal number
wait for local EFG/ set local EFG	SS	DI	SE	NL	PC	ST	group value
wait for start/ start task without coordination	SS	DI	SE	IL	FC	ST	runtime argument
wait for semaphore/ release semaphore	SS	ND	SE	IL	FC	ST	none
wait for CSV/ release CSV	SS	ND	SE	IL	GC	ST	variables
send msg with wait/ receive msg without wait or recv msg with wait/ send message without wait	SS	ND	SE	NL	FC	ST	message
wait for public EFG/ set public EFG	SS	ND	ME	NL	PC	ST	group value
wait for start/ start task with wait	DS	DI	SE	IL	PC	ST	runtime argument
send msg with wait/ receive msg with wait	DS	ND	SE	NL	FC	ST	message

#### Notes:

- Column 1: SS = single sided, DS = double sided
- Column 2: DI = directed, ND = nondirected
- Column 3: SE = singly enabling, ME = multiply enabling
- Column 4: IL = internally latched, NL = not internally latched
- Column 5: FC = fixed unblocking condition (uc), PC = parametric uc, GC = general uc
- Column 6: ST = unblocking condition stored, TR = unblocking condition transient
- Column 7: Amount of information transferred

sage is transferred from the sender to the receiver. That ends the coordination partnership; both tasks then continue.

In contrast, with the pair "wait-for-start/start-task-with-wait-for-termination," there are two transfers of information, one into the target and another into the coordinator. The target is the task being started. It is either already at the coordination point by being Dormant (waiting for start) or arrives there by issuing a termination request (which is equivalent to wait for restart). The coordinator issues the start request with wait for termination. If the target is not Dormant, the coordinator waits until the target terminates and thus becomes available for restart. In either case, there is an initial mutual synchronization of the two partners. Next, the runtime argument is transferred from the coordinator to the target, and the target continues (restarts at its entry point). However, the coordinator does not continue. It takes a second event, the termination of the target, to continue the coordinator. At that second event, there is another transfer of information, this time a transfer of the return argument from the target back to the coordinator. You can characterize this type of coordination as stimulus/response. The simple Ada rendezvous is also of this type.

The two double-sided coordination methods that

Although no one method will solve all task-coordination problems easily and efficiently, a small set of basic methods can suffice.

have evolved happen to have another significant difference: Start task is directed, mailboxes are not. In choosing between these two methods, this difference can be decisive, especially if there are many transactions to perform by any of several equivalent tasks. If mailboxes are chosen, the parameters of the transaction can be queued as a message. When one of the equivalent consumer tasks becomes available, it seeks the next message from the mailbox. Thus, with the work queue maintained via a nondirected mailbox, there can never be both an available transaction and an available consumer task. In contrast, when the transaction parameters are sent to a specific consumer via a start-task runtime argument, you have no simple way to distribute the work equitably. You could have some consumers idle (Dormant) while others have a long queue of restart requests. To help balance the scales, start task has the advantage of bidirectional transfer of information, whereas the mailbox has only a unidirectional transfer.

In some cases, you have to decide whether it is

more important to have automatic load leveling (which favors mailbox coordination) or more important to be able to coordinate with the completion of the transaction (which favors start-task). When both features are required, it is necessary to combine two different methods of coordination. For example, a mailbox can be used to receive the transaction parameters. Included with the parameters is the identity of the task that produced the transaction. After depositing the parameters at the mailbox, the producer issues a wait for one of its local event flags. A consumer task receives the parameters, completes the transaction, and then sets the local event flag to continue the producer. Thus, you have achieved nondirected, double-sided coordination with two coordination points, but at the expense of extra service calls.

The concept of coordination, as expounded here, requires that each partner task issue a service call to indicate its desire to participate in the coordination. Consider a task that receives coordination information. It performs a willful act (the invocation of a service call) to activate the transfer of information. Since the receiving task selects the point within its code at which the information is to be received, this type of transfer is synchronous. Information transfer during coordination must be synchronous.

Of course, it is possible to send information to a task even when that task is not calling for it. Signals provide that type of asynchronous transfer whenever the re-

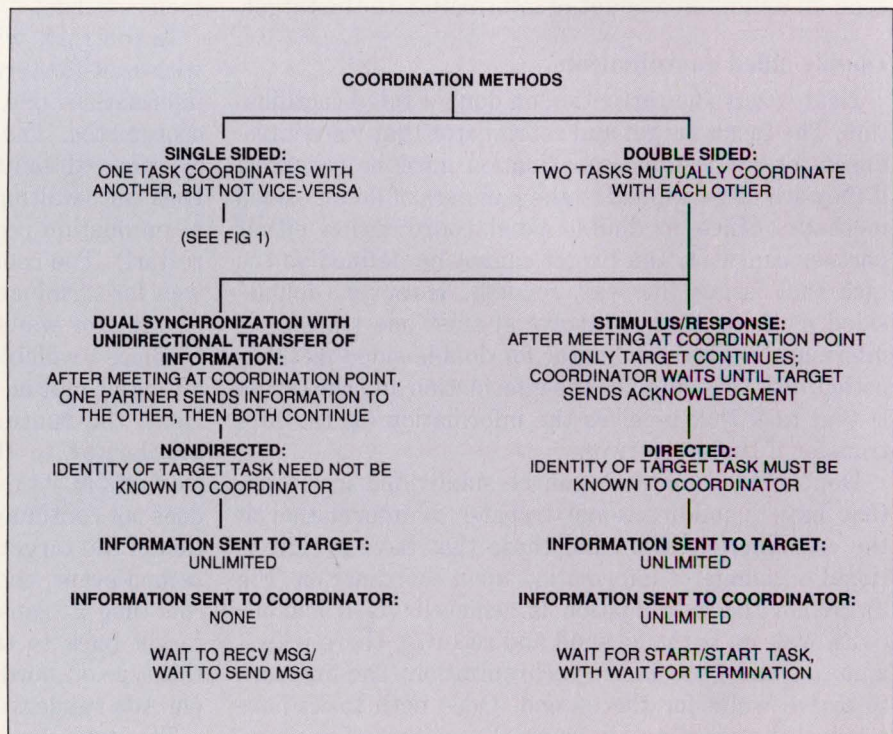

Fig3—Double-sided task coordination can involve either a unidirectional or a bidirectional transfer of information.

ceiving task has not issued a wait-for-signal. In this case, the sending task is imposing information on the receiver, not coordinating with it.

### Equivalence of coordination methods

Are the methods diagrammed in Fig 1 a fundamental set of coordination primitives, or can the coordination they provide be achieved by an even smaller set? You should consider three issues: (1) the extent to which the attributes of one class of methods can be simulated by restricting or limiting the use of another class, (2) the degree to which the unblocking function used in one method can be simulated using different methods, and (3) the efficiency, clarity, and vulnerability of such simulations.

### Altering attributes by restricted use

As you have already seen, nondirected coordination can always be reduced to a corresponding directed method by permitting only one task to be the target. Thus, if only one task ever waits at a given message exchange, any task sending a message to that exchange is, in effect, sending it to that specific task. However, this restriction is imposed by the application designer; it is not enforced by the OS.

Similarly, the mutual exclusion that results from internal latching can be achieved with message exchange, by providing external latching. Suppose a given exchange is primed initially with a single message. That message may be taken from the exchange and put back, but no other message is allowed to be posted. In this case, the message becomes the latch; the exchange functions as a (binary) semaphore.

Generally, singly enabling coordination becomes multiply enabling when each task immediately releases the facility to any other task that may be waiting. For example, suppose you need a big event-flag group, say one that is 128 flags long. You could use controlled shared variables to create the group and submit the address of correspondingly big AND and OR unblocking functions in the *waicsv* requests. Then, all you have to do is always follow the *waicsv* calls by *rlscsv* to make the big event-flag group multiply enabling.

Thus, you see that the inherent attributes of certain coordination methods can be simulated by imposing task-level restrictions on the use of more general (and hence slower) methods. It remains to be seen whether the unblocking functions themselves can be simulated.

### Synthesizing unblocking functions with CSVs

With a sufficiently general primitive, such as controlled shared variables, it is easy to synthesize the deblocking function of a wide range of other coordina-

tion methods. Making a priority-enqueued message exchange illustrates this point.

First, define a message structure, *msg*, that has a header (used to queue and control the message) and some text (shown as a nominal single character).

```
struct msg
{
    /*common header*/
    struct msg *nxt; /*pointer to next message, if any*/
    short int pty; /*message priority*/
    short int len; /*text length, if needed*/
    /*content*/
    char text;
};

#define msgptr struct msg* /*pointer to this type of message*/
```

If all messages are of known fixed length, *len* could be omitted; if the queue is first in, first out, *pty* could be omitted.

At the task level, the message exchange would be a group of controlled shared variables that contain a pointer to the first message and a pointer to the last message in the queue. Both are 0 when the exchange is empty.

```
struct mx
{
    msgptr first; /*pointer to first message*/
    msgptr last; /*pointer to last message*/
};

#define mxlen sizeof(struct mx) /*size of exchange*/
#define mxid struct mx* /*identifier of exchange*/
```

### Synthesize four basic functions:

```
mxid create_x (); /*create (empty) message exchange*/
int send_x (); /*send to message exchange*/
int receive_x (); /*receive from msg exchange*/
int delete_x (); /*delete message exchange*/
```

### Create entails just a direct call of *crcsv*.

```
mxid create_x (key) /*create (empty) message exchange*/
long int key; /*key of message exchange*/
{
    return ((mxid) crcsv (key, (long) mxlen));
}
```

### For example,

```
#define MEX1 0x4D455831

mxid mex1; /*id of message exchange*/

mex1 = create_x (MEX1); /*create message exchange*/
```

The delete follows a similar pattern.

The procedure to add a new message first waits for exclusive access to the exchange variables, inserts the new message, and then releases access. For efficiency, two special cases are recognized. The first is an empty exchange. In this trivial case, both exchange pointers

An application designer can usually choose a task-coordination scheme that is exactly right at each point for which coordination is needed.

are set to the new message. In the second special case—an incoming message with 0 priority—the message is immediately placed at the end of the queue. In the general case, the program must traverse the message queue.

```

send_x(xid, smsg)                /*send to message exchange*/
mxid xid;                        /*id of message exchange*/
msgptr smsg;                     /*ptr to message*/
{
    int result;                  /*result of OS service call*/
    msgptr prev;                /*ptr to previous messages*/
    msgptr next;                /*ptr to next messages*/
    short int npty;              /*priority of new message*/

    /*wait for exclusive access*/

    if ((result = usecsv(xid, WAIFIN)) != NOERR)
        return(result);         /*failure*/

    /*add new message to priority chain*/

    if (xid->first == 0)
    { /*exchange is empty*/
        xid->first = xid->last = smsg; /*new msg is only msg*/
        smsg->next = 0;              /*new msg is end of chain*/
    }

    if (smsg->pty == 0)
    { /*0 priority: place new msg directly at end*/
        next = xid->last;           /*get current last*/
        next->nxt = smsg;           /*chain new msg to last*/
        xid->last = smsg;          /*new msg is last msg*/
        smsg->next = 0;            /*new msg is end of chain*/
    }
    else
    { /*find proper place based on priority*/
        npty = smsg->pty;           /*get priority of new message*/
        prev = xid->first;         /*get current first on chain*/
        if (npty > prev->pty)
        { /*new message is to be first*/
            xid->first = smsg;      /*new msg becomes first msg*/
            smsg->next = prev;      /*connect msg to chain*/
        }
        else
        {
            while (((next = prev->nxt) != 0) && (next->pty >= npty))
                prev = next;       /*continue down chain*/
            prev->nxt = smsg;       /*connect msg to chain*/
            if ((smsg->nxt = next) == 0)
                xid->last = smsg;  /*new msg is new last msg*/
        }
    }

    /*release access*/
    return(rlscsv(xid));
}

```

Typical use would be

```

struct msg msg1;                 /*test message*/
...
send_x(mex1, &msg1);            /*send messages to exchange*/

```

The receive procedure waits for the exchange to be nonempty and then dequeues the first message.

```

int not_emp();                  /*unblocking function*/

int receive_x(xid, dmsg, dur)    /*receive from msg exchange*/
mxid xid;                       /*id of message exchange*/
msgptr *dmsg;                   /*ptr to message buffer*/
long int dur;                   /*max wait time*/
{
    int result;                 /*result of OS service call*/
    msgptr prev;                /*ptr to previous messages*/
    msgptr next;                /*ptr to next messages*/

    /*wait until there is a message*/

    if ((result = waicsv(xid, not_emp, dur)) != NOERR)
        return(result);        /*time or failure*/

    *dmsg = xid->first;          /*deliver current first on chain*/
    if ((xid->first = (*dmsg)->nxt) == 0)

        xid->last = 0;          /*exchange now empty*/

    /*release access*/
    return(rlscsv(xid));
}

int not_emp(xid)
mxid xid;                       /*id of message exchange*/
{
    if (xid->first == 0)
        return(1);              /*not empty: unblock*/
    else
        return(0);              /*empty: keep waiting*/
}

```

A sample receive call is

```

msgptr buf; /*buffer for addr of test messages*/
...
result = receive_x(mex1, &buf, 1+SEC); /*receive msgs from exchange*/
printf("Receive: result = %x, text = %c\n", result, buf->text);

```

By similar techniques the task-level programmer can fabricate a message exchange with whatever priority or nonpriority queuing algorithm is desired. The problem is efficiency. Every task waiting for a message has the same *not\_emp* calculation performed every time the exchange is released. Say there are four tasks waiting for a message at an empty exchange. A message is added. As a result, the same *not\_emp* calculation is performed four times: once (successfully) upon release after the message is added, and then three times (unsuccessfully) after the first task takes the message and releases the exchange.

However, you know by the inherent nature of an exchange queue that *not\_emp* must succeed for the first task and must fail for all remaining ones. Thus, you could build this knowledge into the specific send and receive request functions of an OS-level exchange and completely avoid the overhead of *not\_emp*. But, for a task-level exchange, you cannot do this. The generality of the CSV primitive requires that you compute

# ICS Stands Out in ASICS...



*Because people are part  
of the package.*

*Consider...a whole team of our specialists focusing on your ASIC requirements...both analog and digital.*

*Then see innovative ASIC solutions come to life in your next design.*

The level and scope of ingenuity and resources that ICS applies to each and every customer project is unprecedented in the industry. Over half the staff at ICS is comprised of seasoned design engineers, many of whom pioneered analog and digital technology long before the acronym ASIC was ever coined. Today they help ICS lead the way in providing turnkey design and production of advanced linear, digital and mixed signal chips...with success in over 400 customer specific designs in a wide range of applications.

It is from this accomplished staff that your ICS engineering team is selected. To assure speed, accuracy and qualified control, your ICS team works with you every step of the way from understanding your overall system requirements and specific ASIC goals through design, simulation, layout and verification of each circuit.

At ICS we're not satisfied to merely meet your system requirements. We succeed at developing well-tested system level solutions that consistently enhance performance while reducing manufacturing costs. Our outstanding engineers want your company to stand out with innovative ASIC packages that allow you to design smaller and smarter with greater reliability. So contact ICS today and turn your next ASIC challenge into an ICS solution.

Call toll free 1-800-220-3366.

CIRCLE NO. 68



**Integrated Circuit Systems, Inc.**

*Where ASIC experience sets new standards*

2626 Van Buren Avenue, P. O. Box 968 • Valley Forge, PA 19482-0968

Tel: (215) 666-1900 • FAX: (215) 666-1099

You can have a simple OS with just a few coordination primitives, but the application suffers as a result.

the unblocking function each time, since in principle, the result could be to block or unblock.

In addition, every message transfer with a task-level exchange requires four OS services: two to get the controlled shared variables and two to release them. An equivalent OS-level exchange uses only half that many calls and thus has only half that many context switches. As always, the penalty for generality is loss of efficiency. In real-time applications, the loss of efficiency is often disastrous to overall system performance.

### Synthesizing unblocking functions with mailboxes

Only the MTOS-UX operating system provides controlled shared variables. With most other real-time operating systems, the mailbox is the only general primitive with which all coordination is to be done. Can various unblocking functions be formed from just mailboxes?

A technique for simulating semaphores with mailboxes has already been described. Beyond that, the road becomes long and treacherous. To take one example, simulate the AND unblocking function of an event-flag group using only mailboxes. To make it even simpler, forgo the maximum wait limit; waits can be forever.

Define a public variable to house the value of the group

```
extern short int values; /*value of simulated EFG*/
```

and control access to that variable through a mailbox (MB1) that acts as a semaphore. MB1 is primed with a dummy initial message. A trivial implementation of *waiefg* would then be

```
short int curval; /*local copy of EFG*/
short int mask; /*AND mask for EFG*/
long int access; /*zero-length message for access to EFG*/
long int stabuf; /*status of service call*/

access = 0; /*make length of access message 0*/

do
{
    rcvmbx (MB1,&access,&stabuf,WAIFIN); /*gain access to EFG*/
    curval = values; /*capture value*/
    sndmbx (MB1,&access,0L,&stabuf,CTUNOC); /*release access*/
}
while ((curval & mask) != mask);
```

This method fails as soon as no task can use the group. At that point, the access message remains in the mailbox causing the **do** loop to be repeated constantly.

To avoid such repetition, after one unsuccessful test do not repeat the loop until some task has used and released the group. For this, you need a second mailbox. MB2 receives a dummy "group was released" message and is initially empty. The simulated *waiefg* now becomes

```
rcvmbx (MB1,&access,&stabuf,WAIFIN); /*gain access to EFG*/
curval = values; /*capture value*/
sndmbx (MB1,&access,0L,&stabuf,CTUNOC); /*release access*/

if ((curval & mask) != mask)
{ /*condition not immediately satisfied: wait for change*/
    do
    {
        rcvmbx (MB2,&access,&stabuf,WAIFIN); /*wait for change*/
        sndmbx (MB2,&access,0L,&stabuf,CTUNOC); /*release change msg*/

        rcvmbx (MB1,&access,&stabuf,WAIFIN); /*gain access to EFG*/
        curval = values; /*capture value*/
        sndmbx (MB1,&access,0L,&stabuf,CTUNOC); /*release access*/
    }
    while ((curval & mask) != mask);
}
```

The function to set some of the bits (corresponding to *srsefg*) is

```
rcvmbx (MB1,&access,&stabuf,WAIFIN); /*gain access to EFG*/
values &= onbits; /*set some bits*/
sndmbx (MB1,&access,0L,&stabuf,CTUNOC); /*release access*/

sndmbx (MB2,&access,0L,&stabuf,CTUNOC); /*indicate change*/
rcvmbx (MB2,&access,&stabuf,WAIFIN); /*cancel change*/
```

While this is a proper simulation of an event flag, it is terribly slow. The work performed by a single *srsefg* requires four separate calls in the mailbox simulation. Since most of the processing time of any service call is in the context switch and similar fixed overhead, the time required to do *sndmbx* or *rcvmbx* is about equal to that required for *srsefg*. Thus, the simulation of *srsefg* runs about four times slower. The simulation of *waiefg* is even worse. When *waiefg* is fabricated at the task level, it takes four mailbox calls per waiting task to do the unblocking calculations. This costs four context switches per task. When the same unblocking calculations are performed within the OS as part of *srsefg*, there are no additional context switches, no matter how many tasks are waiting for the event flags.

A mailbox simulation of an event flag is also subject to a serious side effect. After a task (C) changes the flag values, all waiting tasks must be continued via MB2 so that they can perform their coordination condition tests. While these tests are going on, C is blocked waiting for the access message to be passed from task to task. It is not until the last task has seen the change

# THE NETWORK SOLUTION.



Speed is of the essence when installing networks. The many practical ideas incorporated in Temprack are timesavers for your network project – both at the planning stage and during on-site assembly.

- 1.) Model: Temprack NS 19  
41 U\*, Width 800, Depth 800.  
with glass – door and raised top  
**Order No. 1.113.816.3**
- 2.) 19" distribution patch panel IBM for  
32 connectors with mounting-kit  
**Order No. 1.113.763.3**
- 3.) 19" fixed shelf, 2U\*  
perforated for air circulation  
**Order No. 1.113.737.3**
- 4.) Jumpering bracket for cable feed  
**Order No. 1.113.749.7/pair**

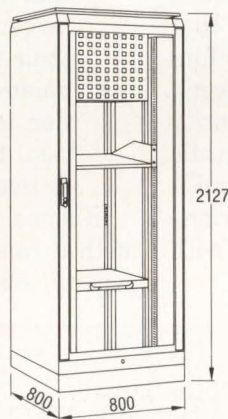

19" distribution patch panels also available for all other types of connector (IBM 8, 16, 32, 64 way, BNC, fiber optic connectors etc.).

Other types of racks:

- i.e. with swing frame
- i.e. for 650 mm wide equipment
- i.e. for 735 mm wide equipment
- i.e. for equipment 19" and 650/735 mm mixed also available as standard product.

Vast range of accessories available.



® KNÜRR – MECHANIK FÜR DIE ELEKTRONIK AG

Schatzbogen 29  
D-8000 München 82  
Telefon (089) 4 20 04-0  
Telex 5 29 608-10  
Telefax (089) 4 20 04-118

	bfr	FF	£	nkr	sfr	US \$	DM
1.)	44 236,50	7609,00	763,00	9047,00	1917,00	1662,00	1915,00
2.)	2788,20	480,00	41,90	571,00	121,00	105,00	135,80
3.)	1663,20	285,00	14,70	338,00	72,00	62,00	72,00
4.)	351,10	60,00	5,70	72,00	15,00	13,00	15,20
	Knürr NV	Knürr s.a.r.l.	Knürr (UK) Ltd.	Knürr Norge A/S	Knürr AG	Knürr USA Inc.	Knürr AG
	Tel. 03-326.02.99	Tel. (1) 43 77 85 85	Tel. 04 80-49 61 25	Tel. 02-65.02.20	Tel. 01-82 50 707	Tel. (805) 526-7733	Tel. (0 89) 4 20 04-0
	Fax 03-325.55.43	Fax (1) 43 39 02 10	Fax 04 80-49 63 73	Fax 02-65.32.30	Fax 01-82 50 803	Fax (805) 584-8371	Fax (0 89) 4 20 04-118
	(*) U = 1 3/4" = 44.45 mm						
	Delivery ex stock. Prices ex works, excluding packing, exclusive VAT.						

A classification guide for selecting task-control processes takes the form of a decision tree: If you need this characteristic, choose this branch.

and returned the message to **MB2** that **C** can continue. But if even one of the tasks that must see the change message is relatively low in priority, it can take indefinitely long for that message to work its way back to **C**. Thus, with a simulated event-flag group, a high-priority task can become blocked for reasons unrelated to it and beyond its control. However, when the OS does the unblocking, the calculations are performed directly and immediately so that there cannot be any uncontrolled delays.

High overhead and undesirable side effects are typical whenever one attempts to simulate a specific coordination method at the task level using general coordination primitives. To answer the question posed earlier, yes, you can have a simple OS with just a few coordination primitives, but the application suffers as a result.

To sum up, coordination is the blocking of one or more tasks until some specified condition is met. Over the years, various methods of coordination have evolved to solve the specific kinds of problems that arise in real-time applications. These methods are fundamentally different in their attributes and effects. For example, some methods require that the identity of the coordination partner be specifically known, while others work with total anonymity. Another basic difference is in the amount of auxiliary information transmitted during the act of coordination or associated with the coordination scheme.

This final part of the real-time programming series has analyzed and classified the major coordination schemes to help guide your selection of the most appropriate technique, based on desired coordination properties and communication requirements. The classification rests upon the following dichotomies:

- single sided vs double sided—Double-sided schemes are symmetrical; whichever task gets to the coordination point first waits for the other. Thus, two tasks are mutually coordinating with each other. In contrast, single-sided schemes are asymmetrical. One task coordinates with another, but not vice versa. The roles of the coordinator and target tasks are always distinct.
- directed vs nondirected—In directed methods the identity of the target task must be specifically known to the coordinator. In nondirected methods, the identity of the target is hidden.
- singly enabling vs multiply enabling—Singly enabling procedures permit only one task at a time to proceed when more than one is waiting for coordination. Multiply enabling procedures release all tasks that satisfy the coordination condition.
- transient vs stored—With a stored mechanism, the OS retains the coordination information until it is needed. With a transient mechanism, if the target is not waiting for coordination, the continue-task information is lost.
- unidirectional vs bidirectional—When coordination is accompanied by an exchange of information, the flow of that information can be in one or two directions.

In some cases, the properties of one coordination method can be constructed from another (often more general) scheme. For example, a nondirected mecha-

## Companion disk offer

All of the **C** examples in this series, plus applications of your own, can be run on a PC with a set of demonstration disks available from Industrial Programming Inc. The disks contain a full version of **MTOS-UX** for an IBM PC/AT or compatible. An application program is edited, compiled, linked, and loaded under **MS-DOS**. The **MTOS-UX** then takes over the hardware to execute the program in real time. At any

time, you can enter an **ctl/dlt** command from the console to return control to **MS-DOS**.

The demonstrator requires an AT with a least 512k bytes of RAM and a hard disk with 2M bytes available for **MTOS** libraries and scratch storage. Program preparation requires the Microsoft **C** compiler/linker, version 5.0 or later. Microsoft tools are not included with the **MTOS-UX** demonstrator.

The demonstration version has all of the features and facilities of standard **MTOS-UX**. However, there is a limit of six of each type (six tasks, six mailboxes, six semaphores, and so forth). The disk set costs \$25; unlimited versions are also available. For more details, call IPI at (800) 365-6867 or (516) 938-6600, or write to 100 Jericho Quadrangle, Jericho, NY 11753.





Your business is safe with us.  
Especially when it's serious business.



Small business is just as serious as big business. That's why, since developing the first data cartridge, we've continued to offer virtually every size and format data cartridge you'll need to help protect your business data—from 20 megabytes to 1.35 gigabytes.

No wonder more business protects important information on 3M brand diskettes and data cartridges than any other brand in the world. Call 1-800-888-1889 ext.8 to find out more.

Innovation working for you™

All data cartridges require a compatible drive. ©3M 1991.



Worldwide Sponsor 1992 Olympic Games  
36USC380

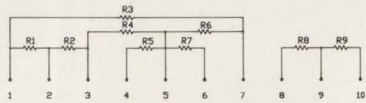

# CUSTOM THICK FILM NETWORKS

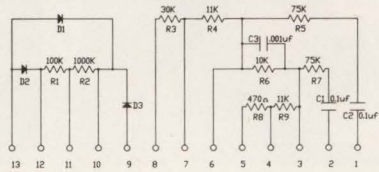

**Fast turnaround** on U.S. made DIPs and coated/molded SIPs. • Unlimited schematics combining resistors, inductors, capacitors and diodes. • Complete capabilities from design through production. • Lead lengths up to 0.290". • Special performance ranges, plus production and testing to M83401 levels.

Call or Fax your requirements to:

**DALE ELECTRONICS, INC.**  
Techno Division  
7803 Lemona Avenue  
Van Nuys, CA 91405-1139



**Phone (818) 781-1642 • FAX (818) 781-8647**

CIRCLE NO. 30

nism reduces to a directed one if (by the design of the application) only one task is ever allowed to be the waiting target. Furthermore, controlled shared variables are sufficiently general to enable the task-level programmer to build almost all the other coordination mechanisms. Nevertheless, such task-level constructions are very inefficient compared with OS-level services.

**EDN**

## Reference

1. Ripps, David L, "Multitasking OS Manages a Team of Processors," *Electronic Design*, July 21, 1983.

Article Interest Quotient (Circle One)  
High 497 Medium 498 Low 499

# Looking to Add TCP/IP Network Access to Your System Designs?

## Introducing . . .

# FUSION<sup>®</sup> Developer's Kit

Now you can incorporate the industry standard TCP/IP protocol suite in your system designs with FUSION Developer's Kit.

Designed for the OEM and systems integrator, FUSION Developer's Kit provides the full TCP/IP protocol suite including TELNET virtual terminal, file transfer protocol (FTP), and R-Commands to name a few.

FUSION Developer's Kit also has a flexible C-source code architecture, making it processor- and operating system-independent.

Currently used in hundreds of process control, embedded systems, and end user designs, FUSION Developer's Kit from Network Research comes with full support and porting services.

To receive a FUSION Developer's Kit information package, including data sheet, technical specifications and licensing plans call (800) 541-9508 or write to Network Research, 2380 N. Rose Ave., Oxnard, California 93030, FAX (805) 485-8204.

 **Network Research**

FUSION is a licensed trademark.

CIRCLE NO. 12

- Crystals
- Crystal Oscillators
- Crystal Filters
- Ceramic Resonators

# RALTRON

## ONLY RALTRON HAS IT ALL.

### THE PRODUCTS

RALTRON manufactures one of the industry's most complete product lines of high quality crystal units, oscillators, filters and ceramic resonators.

### THE PRICES

Because our product line is so complete, our inventory so large, and our nationwide distribution system so streamlined, RALTRON can offer pricing that is always competitive, and often far lower than the competition.

### THE PEOPLE

We've got some of the best people in the business — from technical support and sales to customer service and shipping. You can count on RALTRON people to come through for you on time, every time.

Call us today with your requirements or for our 28 page product catalogue.

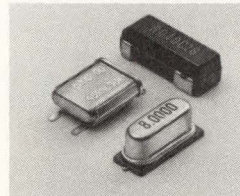

#### SURFACE MOUNT CRYSTAL UNITS HC-45/U SMD, TT SMD, HC-49S SMD

- Frequency Range: 3.5 MHz-360 MHz
- Mode of Oscillation: Fundamental to 9th O.T.
- Frequency Tolerance: @ 25°C: ± 2.5 ppm to ± 100 ppm
- Frequency Stability: ± 3 ppm ( - 10°C to + 60°C) to ± 100 ppm ( - 10°C to + 70°C)



#### WORLD'S SMALLEST OCXO, ROXO 210A

- Frequency Range: 1.0 MHz to 20.0 MHz
- Temperature Stability: ± 2 x 10<sup>-7</sup> ( - 20°C to + 65°C)
- Long Term Stability: ± 2 x 10<sup>-7</sup> per year
- Phase Noise: - 145 dbc (10 KHz offset)
- Power consumption (stabilized): 2.0 W
- Size: 35.3 x 27 x 25.4 mm (1.40" x 1.06" x 1.0")



#### SMALLEST VCXO WITH HIGH SENSITIVITY VC-7025

- Frequency Range: 2 MHz to 35 MHz
- Frequency Stability: ± 25 ppm (0 to 70°C)
- Deviation Sensitivity: ± 50 ppm/V typ. (up to ± 70 ppm/V)
- Size: 14 pin DIP package

### CRYSTAL UNITS

Microprocessor crystal units  
Microprocessor crystal units HC-49 short (AT strip)  
Microprocessor crystal units surface mount — "TT-SMD" family  
AT strip crystal units — cylindrical package  
Tuning fork quartz crystal units 32.768 KHz  
High accuracy crystal units

### OSCILLATORS

Clock oscillators  
TTL compatible  
Clock oscillators HCMOS compatible  
Clock oscillators surface mount  
Clock oscillators enable/disable  
Clock oscillators dual output  
Clock oscillators ECL compatible  
Temperature compensated crystal oscillators — TCXO  
Oven controlled crystal oscillators — OCXO  
Voltage controlled crystal oscillators — VCXO

### FILTERS

Monolithic crystal filters

### CERAMIC RESONATORS

Ceramic resonators — 200 to 800 KHz  
Ceramic resonators — 2.000 to 6.000 MHz

### RALTRON ELECTRONICS CORP.

2315 NW 107th Avenue  
Miami, Florida 33172  
FAX (305) 594-3973  
TELEX 441588 RALSENUI  
(305) 593-6033

*Only RALTRON has it all.*

ATTENTION!

**p-cad**  
PERSONAL CAD SYSTEMS INC.

**PADS-PCB™**  
**CADSTAR**

**AUTOCAD®**

**THE  
CAD  
T.E.A.M.**

NORTH AMERICA'S #1  
"SUPERVAR"

FREE DEMO DISKS

The CAD T.E.A.M. is a three-phase company:

- DESIGN SERVICE BUREAU
- CAD SOFTWARE/HARDWARE DISTRIBUTION
- CAD TRAINING CENTRE

We offer both the services/software and training you require to get the job done! Fast!

**WE USE WHAT WE SELL,  
AND WE SELL WHAT WE USE.**

Project Management  
VIEWPOINT  
TELEMAGIC

CAE

CAD

CAM

Schematic  
PCAD  
PADS-PCB  
RACAL-REDAC  
AUTOSCHEMA

Simulation  
P-SPICE  
SUSIE  
AUTOCAE

Thermal  
Analysis  
BETASOFT  
PACIFIC  
NUMERIX

Service  
Bureau  
PCB Layout  
Photoplotting  
Board Mfg.  
Assembly + Test

Board Layout  
PCAD  
PADS-PCB  
RACAL-REDAC  
AUTOPCB  
AUTOHYBRID

Autorouting  
MAXROUTE  
SUPERROUTE  
RIP N ROUTE

AutoCAD  
AUTOCAE  
AUTOPCB  
AUTOHYBRID

Photoplotter  
Lavenir 1620  
Lavenir 2024

Manufacturing  
DATA I/O  
QA3000  
ACEDAMI

CIRCLE 121

CIRCLE 122

CIRCLE 123

CIRCLE 124

CIRCLE 125

CIRCLE 126

CIRCLE 127

CIRCLE 128

CIRCLE 129

**PROJECT MGMT  
VIEWPOINT**

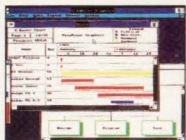

**CAD Systems for  
Project  
Management**

- No limits • Windows 3.0
- Mouse-operated

• Free Demo Disks  
**CIRCLE 130**

**TRAINING**

Complete training courses from our CAD CLUB

- ViewPoint • PCAD
- AutoCAD • PADS PCB
- Simulation
- Autorouting

Call for next class  
**CIRCLE 131**

**HARDWARE**

- 386/486 CAD Workstations
  - Sun Workstations
  - H.P. Pen Plotters
  - Electrostatic Plotters
  - LAN's • Printers/Mouse
  - Laptop CADstations
- CIRCLE 132**

**SIMULATION  
PSPICE**

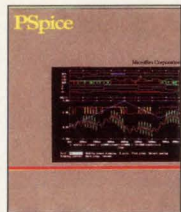

**Analog and Mix  
Mode Simulator  
from \$995.00 US**

- Breadboard on screen
- Save months in design
- Reduce number of revs
- Save money
- Greater product reliability

• Free Demo Disks  
**CIRCLE 133**

**SUSIE**

**The industry  
standard digital  
simulator**

- From \$995 US
- Support for all PC CAE vendors schematic capture

• Free Demo Disks  
**CIRCLE 134**

**PADS**

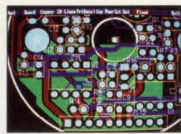

**PADS-LOGIC**

- 3rd generation schematic
- Multisheet database
- Unmatched group functions
- Interfaces to all CAD systems
- \$450 US

**PADS-PCB**

- World's most popular low cost ECAD system
  - Completely upgradable to 2000 from \$995 US
  - SuperRoute option
- CIRCLE 135**

**PADS-2000**

- 3rd generation PCB layout
- Full 32 bit system
- Virtual memory
- No limits
- On the fly design
- T-Routing
- Over 2000 IC capability
- Push n' shove
- \$6,995 US

• Free Demo Disks  
**CIRCLE 136**

**SERVICE**

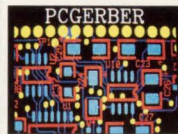

**SPECIAL**  
FROM  
**99¢ A PIN**  
FROM  
**\$13 A FILM**

**We can design  
your board and  
return it in any  
CAD system format!**

- SMT and analog specialists
  - Concept Engineering
  - Schematic Capture
  - Simulation
  - Board Layout
  - Autorouting
  - Photoplotting/MIVA25
  - PCB Manufacture
  - Assembly and Test
  - CAD Translations: to Mentor to PCAD to PADS-PCB to Racal Redac
- CIRCLE 137**

**ASK US ABOUT  
THE CAD CLUB**

for exclusive  
Savings on both  
services &  
software  
**CIRCLE 138**

**MAXROUTE**

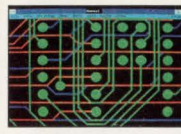

If you're using...  
RACAL-REDAC, P-CAD,  
PADS-PCB...you owe it  
to yourself to see the  
MAXROUTE Autorouting  
tool in action!  
**FREE BENCHMARKS!**

- UNIX and DOS
- Push/Shove/Rip up
- Use in conjunction with your present CAD

• Free Demo Disks  
**CIRCLE 139**

**PCGERBER**

If you work with Gerber data, you need:

**PCGERBER** - View and edit your Gerber files before you photoplot...\$995 US  
**GPLOT** - PenPlot & Print Gerber files...\$595 US

**CIRCLE 140**

**ECAM**

ECAM for only \$2,995 US yet provides PCB CAM features found in products retailing between \$7,000 and \$30,000 US.

• Free Demo Disks  
**CIRCLE 141**

**AUTOCAD®**  
for Electronic Engineers

**AUTOCAE**

- Schematic capture
- Analog/Digital
- PSpice/Susie simulation

**CIRCLE 142**

**AUTOPCB**

- PCB design
- SMT support
- Push & Shove Routing
- Real-Time DRC
- Bill of material

**CIRCLE 143**

**AUTOHYBRID**

- Hybrid circuit design
- World's only PC solution
- Component synthesis
- Auto die geometry
- Definable substrate pads
- Automatic ink list

• Free Demo Disks  
**CIRCLE 144**

**FABMASTER**

Putting CAD data on the factory floor

- Input any CAD data
- Output any manufacturing data
- Board tester
- Auto insertion
- Drilling profile

• Free Demo Disks  
**CIRCLE 145**

**THE CAD T.E.A.M.**

BOSTON • NEW YORK • TORONTO • ORLANDO • VANCOUVER • SAN FRANCISCO • L.A.

**1-800-668-0726**

US HEAD OFFICE: 1313 Main Street, Niagara Falls, NY 14301

# THE TOUGHEST FIBRE OPTIC CONNECTORS FOR ANY ENVIRONMENT



- Hughes fibre optic connectors are designed and manufactured for survivability and high reliability in hostile environments
- Designed to meet the requirements of military specifications

Connector MIL-C-83526

Terminal MIL-T-29504

- Repeatable characteristics after continuous mating
- Designed for Single and Multimode fibre
- Low insertion losses; as low as 0.5DB with certain cables
- Single and Multi-Channel product range
- Non-standard connector can be designed and manufactured to exact customer requirements

**NEPCON**  
Europe

19 • 21 MARCH 1991  
National Exhibition Centre,  
Birmingham, U.K.

CIRCLE NO. 72

Headquarters:  
Hughes Microelectronics Europa Ltd.  
Queensway Industrial Estate  
Glenrothes, Fife  
KY7 5PY, Scotland  
Tel: (0592) 754311  
Fax: (0592) 759775

Hughes Microelectronics Europa (France)  
Centre d'Affaires d'Antony  
2, rue de la Renaissance-R.N. 186  
92184 Antony Cedex, France  
Tel: (1) 40 96 10 10  
Telex: 632 743  
Fax: (1) 40 96 05 11

Hughes Microelectronics Europa  
(Deutschland)  
Landsberger Str 398  
D-8000 Munchen 60  
Deutschland  
Tel: (089) 580 81 01  
Fax: (089) 580 82 61

Hughes Microelectronics Europa Ltd.  
Clive House, 12/18 Queens Road  
Weybridge, Surrey  
KT13 9XD, England  
Tel: (0932) 847262  
Telex: 929727  
Fax: (0932) 845681

Hughes Microelectronics Europa  
España, S.A.  
C/ Caleta de Vélez, 27  
Poligono Industrial Santa Teresa  
29004 Malaga, España  
Tel: (952) 24.00.55  
Fax: (952) 24.24.38

**HUGHES**

Hughes Microelectronics Europa Ltd.  
Subsidiary of Hughes Aircraft Company

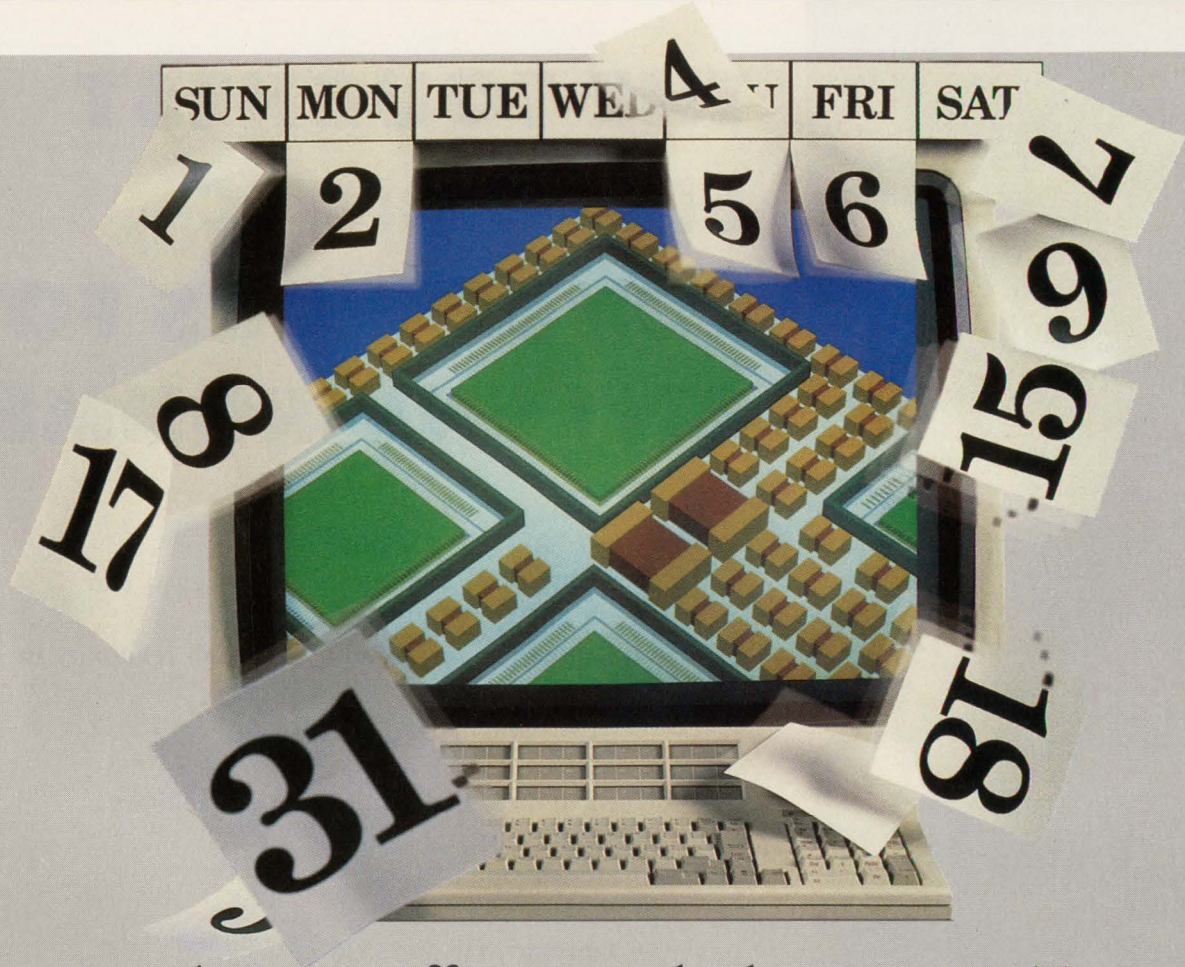

## Knock Days Off Your Multichip Design Time.

When it comes to building high-speed, high-density multichip modules, Intergraph has the technology you need.

**MCM Engineer Series.** A fully integrated family of advanced software that accelerates the entire MCM cycle. From design to manufacturing.

Component placement. High-speed layout analysis. Timing-driven routing. Area calculations. And much more – all under one common user interface.

Now, instead of relying on existing PCB or IC systems, you have technology developed specifically for MCM designers. Easily tailored to your requirements.



**Isn't that what you expect from Intergraph?** After all, we've installed microelectronics design systems at over a hundred sites. In almost every part of the globe.

Which is why customers worldwide rely on our integrated automation to trim product cycles. Improve quality. And reduce the cost of development and production.

For more information on the MCM Engineer Series, call us today at 800-826-3515. And discover the difference

our experience can make for you.

**INTERGRAPH**

Everywhere you look.

# Advanced Pressure Sensors

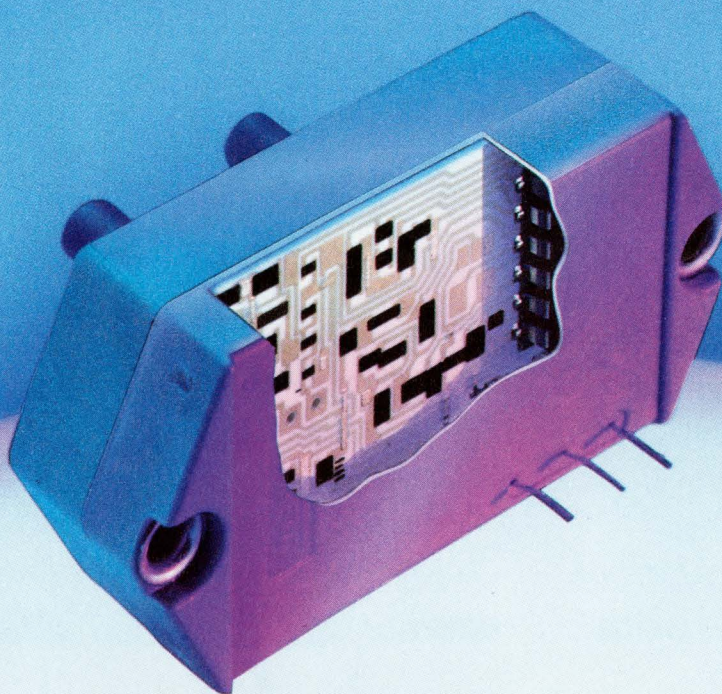

## FOR: MEDICAL INDUSTRIAL HVAC

### Sensym's 142/163 Series

#### Features Include:

- Guaranteed precision over temperature:  $\pm 1\%$  Max ( $-18^{\circ}\text{C}$  to  $+63^{\circ}\text{C}$ )!
- High level calibrated output:  $1.0\text{V} \pm 50\text{mV}$  offset  
 $5.0\text{V} \pm 50\text{mV}$  span
- Linearity:  $<0.75\%$  FSO Max

These precision transducers are priced starting at **\$40 ea/100's. Stock delivery.**

#### Available parts:

- 163SC01D48** ...  $-20$  to  $+120\text{cmH}_2\text{O}$   
**142SC series** ...  $0$  to  $1\text{psi}$  up to  $0$  to  $150\text{psi}$



### Free Handbook

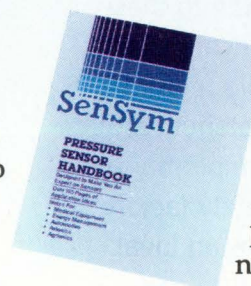

Sensym's new 1990 Sensor Handbook gives complete product specifications plus over 200 pages of application notes and ideas.

Call or fax us today for your free Sensor Handbook.

CIRCLE NO. 75

1244 Reamwood Avenue ■ Sunnyvale, CA 94089 ■ Tel: (408) 744-1500 ■ Fax: (408) 734-0407

# Uncanny capacitance.

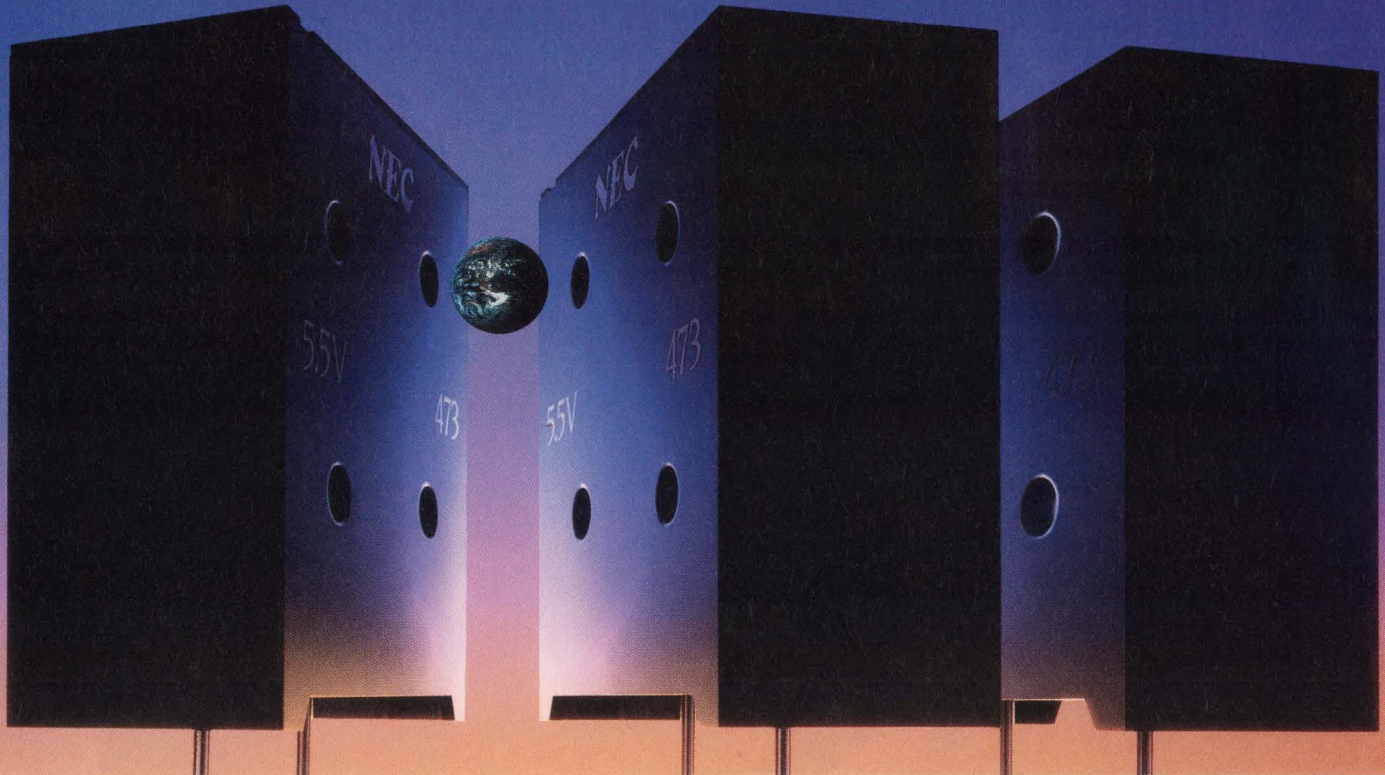

## NEC Supercaps offer out-of-this-world performance.

Creating high capacitance in small cases has been an NEC specialty for decades. The three new Supercaps in our FM series are an extraordinary example.

To equal the 0.169F capacitance that NEC has packed into these electric double-layer capacitors, Mother Nature would require 238 spheres the size of planet earth.

Fast charging, semipermanent life and excellent safety factors make NEC Supercaps an ideal

CIRCLE NO. 74

replacement for backup batteries.

Supercaps come in eight series, covering a wide range of backup needs from CMOS RAMs and microcomputers to large-current



applications. For more information, contact NEC today.

Series	Application	Capacitance (F)	Feature
FYD	RAM/microcomputer backup	0.022 - 2.2	Space saving
FYH		0.022 - 1.0	Low profile
FYL		0.01 - 0.047	Extra low profile
FM		0.022 - 0.1	Auto insertion/soldering
FR		0.022 - 1.0	Wide operating temperature (-40°C to +85°C)
FS	Medium backup current	0.022 - 1.0	
FA	Large backup current	0.047 - 1.0	5.5V
FE		0.022 - 0.47	11.0V
		0.047 - 1.5	Low ESR

### For fast answers, call us at:

USA Tel:1-800-632-3531. Fax:1-800-729-9288. Germany Tel:0211-650302. Telex:8589960. The Netherlands Tel:040-445-845. Telex:51923.  
 Sweden Tel:08-753-6020. Telex:13839. France Tel:1-3067-5800. Telex:699499. Spain Tel:1-419-4150. Telex:41316. Italy Tel:02-6709108. Telex:315355.  
 UK Tel:0908-691133. Telex:826791. Ireland Tel:01-6794200. Fax:01-6794081. Hong Kong Tel:755-9008. Telex:54561. Taiwan Tel:02-719-2377. Telex:22372.  
 Korea Tel:02-551-0450. Fax:02-551-0451. Singapore Tel:253-8311. Fax:250-3583. Australia Tel:03-267-6355. Telex:38343.

# NEC



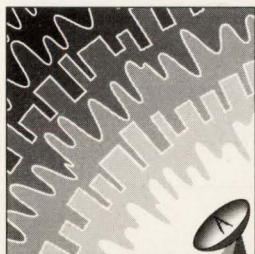

COMMUNICATIONS  
SPECIAL ISSUE

# Spice simulations use controlled sources to model NTSC signals

---

*You can use Spice-variety circuit-simulation software to model NTSC video signals. You can then use these models to design and test video circuits.*

---

Anthony M Radice, *General Instrument Corp*

As simulation tools become less expensive and more readily available to design engineers, simulating a design accurately before production release becomes more practical. Because the computer can do a spread of analyses while you work on something else (or even go home for the evening), being able to accurately describe a variety of conditions and operational models for a circuit is to your benefit. You could improve the accuracy of video-circuit models if you could simulate a video input signal. This article details how to use Spice to build models of NTSC video signals from a set of controlled sources.

The methods presented here were tested with Micro-Sim Corp's (Laguna Hills, CA) PSpice circuit-simulation software. With minor modification, the technique should work with any software that simulates independent and controlled voltage and current sources. The general procedure is to build several common video signals in a piece-wise, linear fashion. These signals are the modulated-ramp, multiburst, and composite test signals, and are typically used on the bench to do circuit testing. Thus, simulation results and actual tested results should match well. For background infor-

mation on PSpice, see **Refs 1 and 2**; for methods of testing video signals, see **Ref 3**; and for details on video-signal composition, see **Ref 4**.

To build simulated video signals, start by establishing some ground rules and setting up a template for a variety of signals. These chores are not difficult because video is very repetitive. You can make the following assumptions:

- Vertical sync will not be a factor at this time in this discussion.
- The horizontal interval is 63.56  $\mu$ sec. All timing signals are rounded to the nearest 0.01  $\mu$ sec, and all add up to the 63.56- $\mu$ sec period. The total cumulative rounding error, about 4 nsec, works out to an error of about 5.7°/line.
- All references to time are relative to the beginning of the "front porch" of the video signal. The front-porch interval is the first of the six video signal intervals and is 1.4  $\mu$ sec long.
- In the signal descriptions, volts will represent IRE levels, so the simulated output voltage will be 1.4V p-p. If 1V p-p is required, use a final scaling multiplier of 0.7143. An IRE (Institute of Radio Engineers) unit is a measurement unit used for video signals. It represents 1% of the voltage difference between blanking (where the visible spot is gone, or "blanked," and defined as 0 IRE) and peak = white level (defined as 100 IRE). The horizontal pulse of NTSC video signals, as well as other timing pulses, extend to a point 40 IRE below blanking, making the video signal 140 IRE p-p.

To build simulated video signals, start by establishing some ground rules and setting up a template for a variety of signals.

**Table 1—Parameters for PSpice PULSE command**

Symbol	Parameter	Default	Typical value
<v1>	Initial voltage	None	0V
<v2>	Pulsed (t0) voltage	None	1V
<td>	Initial delay	0	*
<tr>	Rise time	TSTEP	0.2 $\mu$ sec
<tf>	Fall time	TSTEP	0.2 $\mu$ sec
<pw>	Pulse width	TSTEP	*
<pr>	Cycle period	TSTEP	63.56 $\mu$ sec

\*Varies with selected waveform.

These simulations describe only the time response (.TRAN) of the circuit. You should undertake other analyses, such as .AC, .DC, and .NOISE, separately.

Before starting the waveform simulations, review the PULSE independent-voltage-source PSpice command. This command, whose parameters are given in Table 1, has the form:

```
V<name> <(+)node> <(-)node> PULSE(<v1>
+ <v2> <td> <tr> <tf> <pw> <pr>)
```

Each parameter is a separate entity. For example, the rise and fall times are not part of the pulse width. Thus, you can have a very long rise or fall time and a very short pulse width. The PULSE command builds up the gating signals necessary to turn various parts of the video signal on and off. Ref 1 gives detailed information about this command. Table 1 uses typical

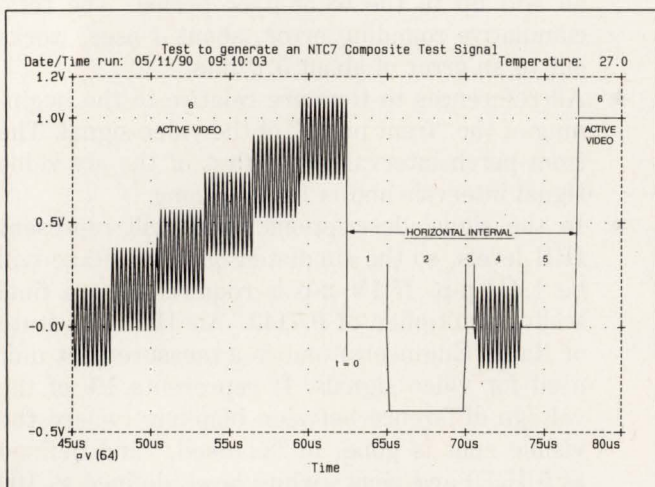

**Fig 1—A video line has six distinct periods.** The bulk of the line consists of active video information; the rest contains the front porch, the horizontal-sync pulse, the breezeway, the color burst, and the back porch.

values to build a template for this command; you can change these values to suit a particular application.

First, build up the horizontal interval and then use it as a template to build the test signals. Each video line comprises six distinct periods (Fig 1) totaling 63.56  $\mu$ sec. The horizontal interval consists of periods 1 through 5 in Table 2 and Fig 1. Active video occurs during period 6.

Using the information in Table 2, you can specify the horizontal interval as the sum of an independent pulsed voltage source and a controlled voltage source. The controlled source is a sine-wave generator for color burst. This generator is gated, or multiplied, by a pulse that enables it at the correct interval. Fig 2 shows the progression of this process. Fig 2a is the HSync pulse. Fig 2b is the gating pulse for the color-burst signal, followed by the 3.58-MHz sine-wave generator (Fig 2c). Fig 2d is Fig 2a plus the product of Fig 2b and Fig 2c.

The first Spice statement builds the negative-going horizontal=sync pulse. (Nodes are represented as <nnn>.)

```
V_HSync <+1> <-1> PULSE(0 -0.4 1.4u 0.2u
+ 0.2u 4.7u 63.56u)
```

The output of this pulse is zero for the front-porch interval (1.4  $\mu$ sec). The pulse has 0.2- $\mu$ sec rise and fall times, a full amplitude of -0.4V (-40 IRE), and a width of 4.7  $\mu$ sec. The period of this pulse is 63.56  $\mu$ sec.

To build the color-burst signal, start with a sine-wave generator that has a peak value of 0.2V and, thus, a peak-to-peak amplitude of 40 IRE:

```
V_CB <+2> <-2> SIN(0 0.2 3579545 0 0 0)
```

The generator's signal has a 0V offset, a 0.2V peak amplitude signal at 3.579545 MHz, and no delay, damp-

**Table 2—Video-signal intervals**

Interval	Length ( $\mu$ sec)	Transition time ( $\mu$ sec)
Front porch	1.4	0.2
Horizontal-sync pulse	4.7	0.2
Breezeway	0.5	0.2 (envelope)
Color burst	2.6	0.2 (envelope)
Back porch	1.4	0.2
Video information	51.76	0.2

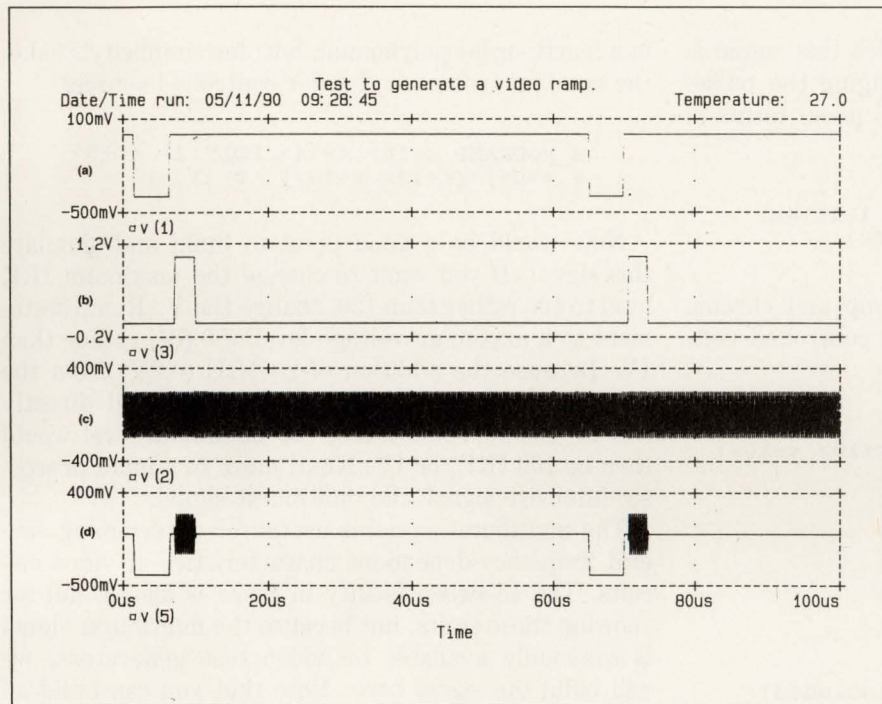

**Fig 2—Summing and gating various sources simulates the horizontal interval. The horizontal-sync pulse (a), summed with the product of the color-burst gating pulse (b) and the 3.58-MHz sine wave (c), produces the composite horizontal-interval signal in d.**

ing, or phase offset. The following pulse will gate this generator:

```
V_CB_Gate <+3> <-3> PULSE(0 1.0 7.0u
+ 0.2u 0.2u 2.6u 63.56u)
```

This pulse has a delay of 7  $\mu$ sec after the start of the front-porch interval, a 2.6- $\mu$ sec burst width, a  $\pm 20$ -IRE amplitude centered on 0 IRE, and a period of 63.56  $\mu$ sec. Now, multiply V\_CB and V\_CB\_Gate, which produces a gated, controlled voltage source, E\_CB:

```
E_CB <+4> <-4> POLY(2) (<+2> <-2>)
+ (<+3> <-3>) 0 0 0 0 1
```

Note that the terms following a second-order polynomial in Spice are the following “p” coefficients: p0 is the offset, p1 is the V1 term, p2 is the V2 term, p3 is the V1<sup>2</sup> term, and p4 is the V1 $\times$ V2 term. Because V2 (V\_CB\_Gate) is zero over all but the color-burst interval, this term effectively gates the color burst. This gating is the key aspect of all the signals you will build. Finally, add the terms E\_CB and V\_HSync to obtain another controlled source, E\_HI:

```
E_HI <+5> <-5> POLY(2) (<+1> <-1>) (<+4>
+ <-4>) 0 1 1
```

This expression shows that the summation of nodes  $\pm 1$  through  $\pm 4$  generates the horizontal interval. At this point, writing the previous terms into a simulation file and running it would be useful. Once successful, you’re ready to move to the next step. Use this horizontal-interval template to build the first of the full video signals: the modulated ramp.

The characteristic of the modulated ramp is a 40-IRE p-p chroma signal superimposed on a 0- to 100-IRE luminance ramp (Fig 3). This signal is useful for determining differential phase (change of phase relative to burst as a function of signal amplitude) and differential gain (change of gain as a function of signal amplitude). You can adjust the level of the envelope of the chroma so that it does or does not exceed the 0-IRE level, the 100-IRE level, or both. Start with a signal that has a minimum envelope value of  $-20$  IRE and a maximum envelope value of 120 IRE. Start with a specific chroma generator and its “switch”:

```
V_CHROMA <+10> <-10> SIN(0 0.2 3579545
+ 0 0 76)
V_CHR_SW <+11> <-11> PULSE(0 1 11.4u
+ 0.2u 0.2u 51.76u 63.56u)
```

These terms generate a chroma signal 76° ahead of the V\_CB generator, which has a phase of 0°. The signal is 40 IRE p-p and centered on the 0-IRE refer-

*First, build the horizontal interval and then use it as a template to build the test signals.*

ence. Now, generate the ramp to which this signal is added. Generate the ramp by rearranging the pulse-width (0.2  $\mu$ sec) and rise-time (51.756  $\mu$ sec) terms in the pulse specification:

```
V_RAMP <+12> <-12> PULSE(0 1 11.4u
+ 51.76u 0.2u 0.2u 63.56u)
```

You can now sum together the ramp and chroma signals using a third-order-polynomial controlled voltage source:

```
E_VID1 <+13> <-13> POLY(3) (<+10> <-10>)
+ (<+11> <-11>) (<+12> <-12>)
+ 0 0 0 1 0 1
```

```
p0 - Offset
p1 - V_CHROMA
p2 - V_CHR_SW
p3 - V_RAMP
p4 - V_CHROMA2
p5 - V_CHROMA * V_CHR_SW
p6 - V_CHROMA * V_RAMP (not included)
p7 - V_CHR_SW2 (not included)
p8 - V_CHR_SW * V_RAMP (not included)
```

As the terms of the polynomial increase, the coefficients can rapidly become difficult to visualize. Writing down the terms can help. The final step in building a modulated ramp is to sum this video signal with the horizontal interval. You could perform this summation

in a fourth-order polynomial, but, for simplicity's sake, the last term is a second-order controlled source:

```
E_MODRAMP <+14> <-14> POLY(2) (<+5>
+ <-5>) (<+13> <-13>) 0 1 1
```

Now would be a good point to build and simulate this signal. If you want to change the maximum IRE level to 100 rather than 120, change the V\_Ramp statement to a maximum voltage level of 0.8V, rather than 1V. Because the addition of 20 IRE (0.2V) from the maximum level of the chroma source would directly add to this 0.8V (80 IRE), the maximum level would then be 100 IRE, or 1V. Next, move to a more processor-intensive signal: the multiburst signal.

The multiburst signal is useful for determining several frequency-dependent characteristics of video circuits. The ac-sweep facility in Spice is also useful for showing these traits, but because the multiburst signal is commonly available on video test generators, we will build the signal here. Note that you can build all these simulated signals into subcircuits and then use the subcircuits in a library of analysis tools.

In the video portion, a multiburst signal consists of a white bar (100 IRE) and several bursts of frequencies: 500 kHz and 1, 2, 3, 3.579545, and 4.2 MHz. These frequencies are centered on 50 IRE and are 50 IRE p-p in amplitude (Fig 4). Sometimes these bursts are part of another test signal, such as the NTSC combina-

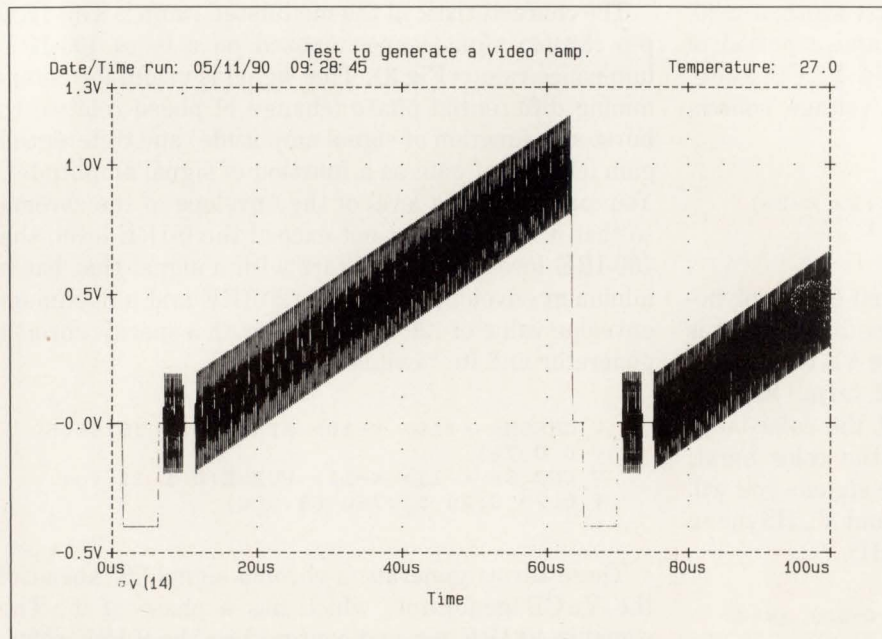

**Fig 3—The modulated ramp is useful for determining differential phase and gain. The signal is a 40-IRE p-p chroma signal superimposed on a 0- to 100-IRE luminance ramp. By manipulating the coefficients in the Spice listings, you can change chroma offset, ramp levels, and other parameters.**

tion test signal (Ref 4). But for this application, the bursts will take up the entire horizontal line.

Build the white bar by generating a pulse of 100 IRE, then dropping it to 50 IRE (by adding a -50-IRE term) to form the center of the bursts. Considering just this portion of the signal, you can generate

```
V_WB <+20> <-20> PULSE(0 1 11.4u
+ 0.2u 0.2u 51.76u 63.56u)
V_DRP <+21> <-21> PULSE(0 -0.5 15.4u
+ 0.2u 0.2u 47.76u 63.56u)
E_LUM <+22> <-22> POLY(2) (<+20> <-20>)
+ (<+21> <-21>) 0 1 1
```

V\_WB strongly resembles V\_CHR\_SW in the simulation of the modulated ramp. This term is useful for gating the entire video portion of the line. Now, generate the six frequency terms of the signal. They are all similar.

```
* 500-kHz Signal, 6-usec width, envelope
* +0.2 usec each end.
V_FR1 <+23> <-23> SIN(0 0.25
+ 500000 0 0 0)
V_FR1_SW <+24> <-24> PULSE(0 1 18.0u
+ 0.2u 0.2u 6.0u 63.56u)
```

```
* 1-MHz Signal
V_FR2 <+25> <-25> SIN(0 0.25 1MEG
+ 0 0 0)
V_FR2_SW <+26> <-26> PULSE(0 1 25.0u
+ 0.2u 0.2u 6.0u 63.56u)
```

```
* 2-MHz Signal
V_FR3 <+27> <-27> SIN(0 0.25 2MEG
+ 0 0 0)
V_FR3_SW <+28> <-28> PULSE(0 1 32.0u
+ 0.2u 0.2u 6.0u 63.56u)
```

```
* 3-MHz Signal
V_FR4 <+29> <-29> SIN(0 0.25 3MEG
+ 0 0 0)
V_FR4_SW <+30> <-30> PULSE(0 1 39.0u
+ 0.2u 0.2u 6.0u 63.56u)
```

```
* The "Magic Number", 3579545 Hz, zero
* reference phase.
V_FR5 <+31> <-31> SIN(0 0.25
+ 3579545 0 0 0)
V_FR5_SW <+32> <-32> PULSE(0 1 46.0u
+ 0.2u 0.2u 6.0u 63.56u)
```

```
* 4.2-MHz Signal
V_FR6 <+33> <-33> SIN(0 0.25
+ 4.2MEG 0 0 0)
V_FR6_SW <+34> <-34> PULSE(0 1 53.0u
+ 0.2u 0.2u 6.0u 63.56u)
```

You must gate each of the above frequency compo-

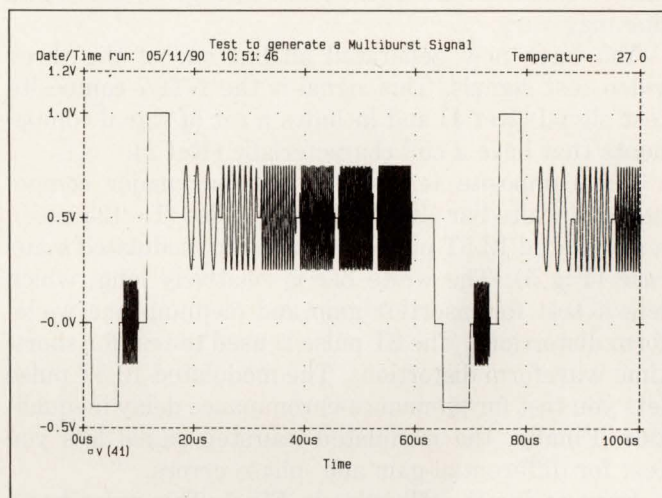

Fig 4—A multiburst signal contains bursts of six different frequencies. The Spice simulation of this signal uses an eighth-order polynomial to sum the individual frequency terms. You can modify these expressions to reflect different phases and burst widths of the individual frequency components.

nents, in its respective set, by the appropriate pulse. These terms are as follows:

```
E_F1 <+35> <-35> POLY(2) (<+23> <-23>)
+ (<+24> <-24>) 0 0 0 0 1
E_F2 <+36> <-36> POLY(2) (<+25> <-25>)
+ (<+26> <-26>) 0 0 0 0 1
E_F3 <+37> <-37> POLY(2) (<+27> <-27>)
+ (<+28> <-28>) 0 0 0 0 1
E_F4 <+38> <-38> POLY(2) (<+29> <-29>)
+ (<+30> <-30>) 0 0 0 0 1
E_F5 <+39> <-39> POLY(2) (<+31> <-31>)
+ (<+32> <-32>) 0 0 0 0 1
E_F6 <+40> <-40> POLY(2) (<+33> <-33>)
+ (<+34> <-34>) 0 0 0 0 1
```

Finally, sum the individual terms. Use an eighth-order polynomial because you are strictly taking a SUM. Not dropping any nodes is crucial, as Spice would deliver bizarre results.

```
E_MBRST <+41> <-41> POLY(8)
+ (<+ 5> <- 5>) (<+22> <-22>) (<+35>
+ <-35>) (<+36> <-36>) (<+37> <-37>)
+ (<+38> <-38>) (<+39> <-39>) (<+40>
+ <-40>) 0 1 1 1 1 1 1 1 1
```

As before, now is a good time to build this signal and simulate it. Variations on the signal include varying the phase of the individual components or the width of individual frequency components. Because of the rounding of the time periods, the phase of an individual

*You can specify the horizontal interval as the sum of an independent pulsed voltage source and a controlled voltage source.*

burst relative to the color burst in a given horizontal line may vary.

You have now generated all but one of the three video test signals. This signal is the NTC7 composite test signal (Ref 4) and includes a set of signal components that have a  $\sin^2$  characteristic (Ref 2).

The composite test signal has four major components: a white bar (100 IRE), a 2T pulse ( $T=125$  nsec), a modulated 12.5T pulse, and a 6-step modulated staircase (Fig 5). The white bar is relatively long, which lets it test for insertion gain and medium-time waveform distortions. The 2T pulse is used to test for short-time waveform distortions. The modulated 12.5T pulse lets you test for luminance-chrominance delay inequalities. Finally, the modulated-stairstep signal lets you test for differential-gain and -phase errors.

First tackle the 2T pulse in Fig 5. This pulse has a  $\sin^2$  characteristic and a pulse width equal to two periods of the 3.58-MHz chroma subcarrier. Therefore, take the output of a generator with a frequency of  $(3.58 \div 4)$  MHz (Fig 6a) and square it through a controlled-source polynomial. This squaring doubles the frequency to  $(3.58 \div 2)$  MHz and puts the voltage characteristics at the correct levels, which are between 0 and 1V (Fig 6b). Phase the generator properly to get the 0-IRE intercepts to match the gating generator and your desired location. First, generate the frequency and square the output.

```
V_2TGEN <+50> <-50> SIN(0 1 894886
+ 0 0 0) ; To Be Modified **
E_2TGN <+51> <-51> POLY(1) (<+50>
+ <-50>) 0 0 1
```

This pulse should be centered on 35.4  $\mu$ sec. (All numbers for location and pulse widths are from the NTC7 television report in Ref 4.) The pulse, from zero crossing to zero crossing, is  $1/(894,886 \times 2) = 0.559$ - $\mu$ sec wide. Because of the short length of this pulse, you must make an exception to the accuracy assumption. The gating pulse and its associated multiplication statement are, therefore,

```
V_2TGAT <+52> <-52> PULSE(0 1 35.125u
+ 0.001u 0.001u 0.559u 63.56u)
E_2TGTE <+53> <-53> POLY(2) (<+51>
+ <-51>) (<+52> (-52>) 0 0 0 0 1
```

You calculate the delay of the gating pulse (35.1205  $\mu$ sec) from the desired center location (35.4  $\mu$ sec) minus half of the 2T pulse width (0.559  $\mu$ sec). The 0.001- $\mu$ sec

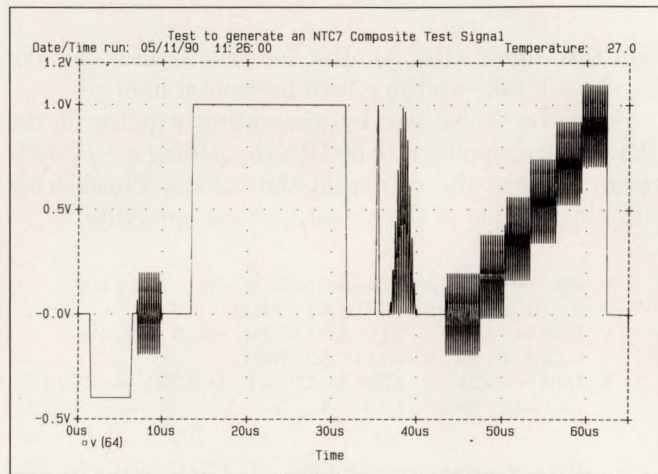

**Fig 5—Multiple video-system testing opportunities are inherent in the NTC7 composite test signal. The white bar is useful for testing insertion gain and medium-time waveform distortions; the 2T pulse lets you test short-time waveform distortions; the 12.5T pulse lets you test for luminance-chrominance delay disparities; and the modulated staircase provides a handy test for differential-phase and -gain errors.**

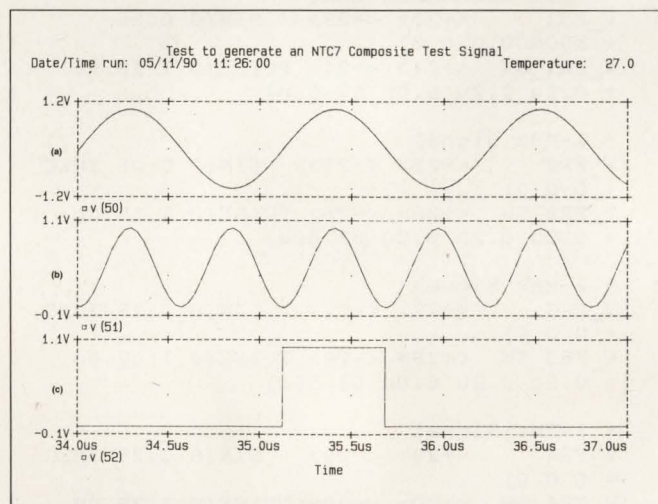

**Fig 6—To generate the 2T and 12.5T signals, square the output of an 895-kHz generator (a) to produce the 1.79-MHz waveform at the correct voltage levels in b. Several Spice manipulations are necessary to calculate correct delays and phasing to form the envelope of the output (c).**

rise and fall times and the 0.559- $\mu$ sec pulse width must total the zero intercepts of the 2T pulse because the rise and fall times and the pulse width are independent time periods. During the rise and fall times, the output product will not be zero because the gating signal has a value during the transitions. This transitional value helps form the envelope of the output (Fig 6c).

Now, you can calculate the phase of the 2T generator

**Table 3—Chroma staircase characteristics**

Burst	Amplitude (p-p)	Centered	Time ( $\mu$ sec)	Start ( $\mu$ sec)
1	40 IRE*	0 IRE	4	43.4
2	40 IRE	18 IRE	3	47.4
3	40 IRE	36 IRE	3	50.4
4	40 IRE	54 IRE	3	53.4
5	40 IRE	72 IRE	3	56.4
6	40 IRE	90 IRE	3	59.4

\*IRE stands for Institute of Radio Engineers. One IRE unit represents 1% of the voltage difference between blanking, which is 0 IRE, and peak white level, which is 100 IRE.

to "arrange" a zero crossing at exactly 35.1255  $\mu$ sec into the simulation. While performing this calculation, keep in mind that the  $\sin^2$  wave comes from a signal at half the frequency. You want to center either the 90° or the 270° peak at 35.4  $\mu$ sec. Because one period of the V\_2TGEN signal is 1.117  $\mu$ sec, the timing works out to 31.678 cycles to get from start at 0° phase to 35.4  $\mu$ sec into the signal. Subtracting the 31 cycles and converting to degrees ( $0.678 \times 360^\circ$ ), you can see that the generator's phase would be 244° if it started at reference 0°. The generator's phase should be 270°, so start the generator at reference 26°. The V\_2TGEN statement is thus

```
V_2TGEN <+50> <-50> SIN(0 1 894886
+ 0 0 203)
```

Put the 12.5T pulse aside for now and assemble the easy part of the line so you can experiment. The composite test signal has a white bar 18- $\mu$ sec long that starts at 13.4  $\mu$ sec and then drops to 0 IRE prior to the 2T pulse. After the 2T pulse, the signal drops to 0 IRE for the 12.5T pulse. The 12.5T pulse is centered at 38.4  $\mu$ sec. After this pulse, the composite signal drops to 0 IRE until 43.4  $\mu$ sec into the waveform. At this point comes the modulated-staircase signal, which you can regard as six bursts of chroma with the characteristics Table 3 shows.

The phase of this staircase signal does not change relative to each step and to the color-burst signal. You can build the signal from a chroma source and a series of pulses for the "steps." First, build the white bar, which resembles V\_WB of the multiburst signal, only shorter.

```
V_WB2 <+55> <-55> PULSE(0 1 13.4u 0.2u
+ 0.2u 18.0u 63.56u)
```

Now, assemble the staircase for the chroma. Because the first chroma burst is centered on 0 IRE, the first step of the staircase is 0. Thus, skip the first step and proceed to the remaining five. Each step adds 0.18V (18 IRE) to the base level of the chroma. Note that the chroma switches on at 43.4  $\mu$ sec and the first "riser" on the staircase switches on at 47.4  $\mu$ sec.

```
V_SC1 <+56> <-56> PULSE(0 0.18 47.4u
+ 0.01u 0.01u 15.0u 63.56u)
V_SC2 <+57> <-57> PULSE(0 0.18 50.4u
+ 0.01u 0.01u 12.0u 63.56u)
V_SC3 <+58> <-58> PULSE(0 0.18 53.4u
+ 0.01u 0.01u 9.0u 63.56u)
V_SC4 <+59> <-59> PULSE(0 0.18 56.4u
+ 0.01u 0.01u 6.0u 63.56u)
V_SC5 <+60> <-60> PULSE(0 0.18 59.4u
+ 0.01u 0.01u 3.0u 63.56u)
```

Because the phase should be 0° and V\_CB is already the correct amplitude, you can take the chroma itself directly from V\_CB. You now need to generate the correct gating pulse and gate the chroma.

```
V_CB_STC <+61> <-61> PULSE(0 1 43.4u
+ 0.01u 0.01u 19.0u 63.56u) E_CBSTC
+ <+62> <-62> POLY(2) (<+2> <-2>)
+ (<+61> <-61>) 0 0 0 0 1
```

You can now assemble the composite signal short of the 12.5T pulse. You can accomplish this task with one statement. Again, be very careful with node numbers.

```
E_COMP <+64> <-64> POLY(9)
+ (<+ 5> <- 5>) (<+55> <-55>) (<+50>
+ <-50>) (<+62> <-62>) (<+56> <-56>)
+ (<+57> <-57>) (<+58> <-58>)
+ (<+59> <-59>) (<+60> <-60>)
+ 0 1 1 1 1 1 1 1 1
```

The above statement is in the order horizontal interval, white bar, 2T pulse, space, and the chroma and staircase signal. Now would be a good time to assemble and simulate the above statements.

The last step in building the composite test signal is adding the 12.5T modulated pulse to the chroma signal. Build this pulse by generating an envelope of the 12.5T  $\sin^2$  characteristic, the modulation pulse, and the gating pulse. Then, multiply them together. You build the 12.5T pulse in much the same way as the 2T pulse. First, generate a sine wave at  $3.58 \div 25$  MHz, then square it to get a frequency of  $3.58 \div 12.5$  MHz

Each video line comprises six distinct periods totaling 63.56  $\mu$ sec. The horizontal interval consists of periods 1 through 5; active video occurs during period 6.

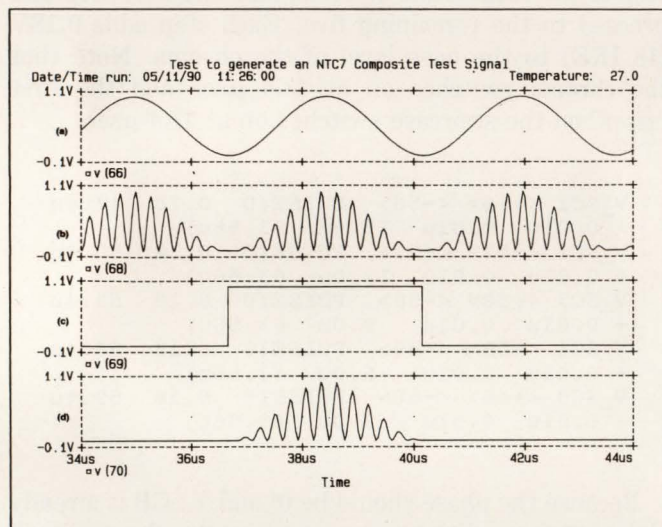

Fig 7—The last step in simulating an NTC7 composite test signal is adding the 12.5T modulated pulse to the chroma signal. Squaring a 3.58-MHz  $\div$  25 signal in a produces the 286.4-kHz waveform in a. Modulation produces the signal in b, and gating this signal with c yields the composite waveform (d).

(Fig 7a). The statements for these operations are

```
V_12TGEN <+65> <-65> SIN(0 1 143182
+ 0 0 0) ; To Be Modified **
E_12TGN <+66> <-66> POLY(1) (<+65>
+ <-65>) 0 0 1
```

Now, generate the modulation as a 100-IRE p-p chroma signal centered on 50 IRE, and multiply the envelope by the modulating signal (Fig 7b).

```
V_12TCHR <+67> <-67> SIN(0.5 0.5
+ 3579545 0 0 0) E_12TEM <+68> <-68>
+ POLY(2) (<+66> <-66>) (<+67> <-67>)
+ 0 0 0 0 1
```

The zero-crossing period of this signal is 3.492  $\mu$ sec. This signal should be centered at 38.4  $\mu$ sec. You can generate the gating pulse for the 12.5T signal (Fig 7c):

```
V_12TGAT <+69> <-69> PULSE(0 1 36.654u
+ 0.001u 0.001u 3.49u 63.56u)
```

Now, multiply the gating pulse by the product of the envelope and modulation (Fig 7d) and adjust the phase of the envelope to make the intercepts of the

envelope symmetrical at the 0-IRE level. The gating product is

```
E_12TPRD <+70> <-70> POLY(2) (<+68>
+ <-68>) (<+69> <-69>) 0 0 0 0 1
```

The zero-crossing point must occur at 36.654  $\mu$ sec, so the phase of V\_12TGEN must be

$$\text{MOD} \left[ \frac{36.654 \times 10^{-6}}{\left( \frac{1}{143,182} \right)} \right] \times 360^\circ = 89^\circ.$$

The modified simulation statement is

```
V_12TGEN <+65> <-65> SIN(0 1 143182
+ 0 0 89 )
```

Finally, change the summation statement to a tenth-order polynomial and add the E\_12TPRD term:

```
E_COMP <+64> <-64> POLY( 10 )
+ (<+ 5> <- 5>) (<+55> <-55>) (<+50>
+ <-50>) (<+70> <-70>)+ (<+62> <-62>
+ (<+56> <-56>) (<+57> <-57>) (<+58>
+ <-58>) (<+59> <-59>) (<+60> <-60>)
+ 0 1 1 1 1 1 1 1 1 1 1
```

Note the three separate changes in this equation with respect to the earlier E\_COMP equation, which had no 12.5T signal:

- Change the POLY term in the first line from a 9 to a 10
- Add nodes  $\pm 70$  in the second line
- Add a tenth 1 in the last line.

Fig 8 gives the Spice listing for the simulation of the NTC7 composite test signal. Note that both the 2T and the 12.5T pulses rely on low-frequency generators as sources. The phase relationship of these generators, relative to the respective pulse location, changes from line to line. Thus, the first simulation of these pulses is correct in time, but the next line is not. You could build up a longer simulation file to correct this problem. This more extensive simulation file would set up the various phase relationships between burst and the respective pulses; a final gating pulse train would enable the correct lines as outputs at the appropriate times. Such a subcircuit would be from two to four times the size of this model.

Text continued on pg 128.

EDN March 1, 1991





# "Voice Capability in a FAX Modem Chip from Yamaha LSI!"

## "Now We're Talking!"

Smart PCs and FAX machines are spreading the word. Because now they can have complete voice recording and playback capability! Easily. And quickly. With Yamaha's YM7109 FAX Modem chip and FAXSIM™ software.

The YM7109 gives designers a voice/FAX solution in a single chip. It provides a complete send/receive 9600bps Group 3 FAX Modem. Plus, 12-bit A/D and D/A converters sampling at 9.6k samples/second for high resolution voice processing. And voice quality that surpasses even today's digital telephone systems.

The YM7109 opens up a new world of applications. A FAX machine can answer phone calls and record messages. A PC can provide added utility as a FAX and telephone answering machine. Or a FAX board can greet callers and send requested information. The possibilities are endless.

But remember, those who get to market first — are the winners. That's where Yamaha's FAXSIM software gives you a head start.

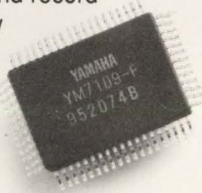

It includes all the FAX modules, plus Bulletin Board Service using EIA Binary File Transfer/Bell 103, and ADPCM for storing and playing back voice. The source code is available in Turbo C™ and makes integration a breeze. Letting you move from design to production fast.

Beat the competition. Call us at 1-800-543-7457.

## YAMAHA® LSI

Yamaha Corporation of America  
Systems Technology Division  
981 Ridder Park Drive  
San Jose, California 95131  
Telefax: (408) 437-8791  
Telephone: (408) 437-3133

Yamaha Corporation Japan  
Electronic Systems Division  
203 Matsunokijima, Toyooka-mura,  
Iwata-gun, Shizuoka-ken, 438-01 Japan  
Telefax: 81-539-62-5054  
Telephone: 81-539-62-4918

© 1990, Yamaha LSI, Systems Technology Division. Yamaha LSI, Systems Technology Division and the Yamaha logo are registered trademarks of Yamaha Corporation of America. FAXSIM is a trademark of Yamaha Corporation of America. Turbo C is a trademark of Borland Corporation.

```

Test to generate an NTC7 composite test signal
*
* Major point of this test signal is to develop the Sin2 characteristics
* of the 2T and 12.5T pulses.
*

* Horizontal Sync Tip
V_HSync 1 0 PULSE(0 -0.4 1.4u 0.2u 0.2u 4.7u 63.56u) ; Make HSync

* Color Burst
V_CB 2 0 SIN(0 0.2 3579545 0 0 0) ; Burst Amplitude 40
V_CB_Gate 3 0 PULSE(0 1 7.0u 0.2u 0.2u 2.6u 63.56u) ; When turn ON
E_CB 4 0 POLY(2) (2 0) (3 0) 0 0 0 1 ; X

* Horizontal Interval
E_HI 5 0 POLY(2) (1 0) (4 0) 0 1 1 ; Sum

* Active Video - White Bar
V_WB2 55 0 PULSE(0 1 13.4u 0.2u 0.2u 18.0u 63.56u)

* Active Video - 2T Pulse
V_2TGEN 50 0 SIN(0 1 894886 0 0 203)
E_2TGN 51 0 POLY(1) (50 0) 0 0 1
V_2TGAT 52 0 PULSE(0 1 35.1255u 0.001u 0.001u 0.557u 63.56u)
E_2TGTE 53 0 POLY(2) (51 0) (52 0) 0 0 0 1

* Active Video - Staircase
V_SC1 56 0 PULSE(0 0.18 47.4u 0.01u 0.01u 15.0u 63.56u)
V_SC2 57 0 PULSE(0 0.18 50.4u 0.01u 0.01u 12.0u 63.56u)
V_SC3 58 0 PULSE(0 0.18 53.4u 0.01u 0.01u 9.0u 63.56u)
V_SC4 59 0 PULSE(0 0.18 56.4u 0.01u 0.01u 6.0u 63.56u)
V_SC5 60 0 PULSE(0 0.18 59.4u 0.01u 0.01u 3.0u 63.56u)

* Active Video - Chroma
V_CB_STC 61 0 PULSE(0 1 43.4u 0.01u 0.01u 19.0u 63.56u)
E_CBSTC 62 0 POLY(2) (2 0) (61 0) 0 0 0 1

E_COMP 64 0 POLY(9)
+ ( 5 0) (55 0) (53 0)
+ (62 0) (56 0) (57 0) (58 0)
+ (59 0) (60 0)
+ 0 1 1 1 1 1 1 1 1 1

R0 1 0 1MEG
R1 2 0 1MEG
R2 3 0 1MEG
R3 4 0 1MEG
R4 5 0 1MEG
R5 50 0 1MEG
R6 51 0 1MEG
R7 52 0 1MEG
R8 53 0 1MEG
R8A 55 0 1MEG
R9 56 0 1MEG
R10 57 0 1MEG
R11 58 0 1MEG
R12 59 0 1MEG
R13 60 0 1MEG
R14 61 0 1MEG
R15 62 0 1MEG
R16 64 0 1MEG

.OPTIONS ITL5=0 RELTOL=0.01 ACCT
.TRAN 35nS 100uS
.PROBE
.END

```

**Fig 8—This routine lets you simulate the complex NTC7 composite test signal. The main complication in generating this signal is the careful attention you must devote to timing considerations. Once simulated, this signal lets you test a multitude of performance parameters in video systems.**

# Noritake

## Smaller Size, **BIGGER VALUE**

Now you can afford the quality and visibility of  
*itron* VFD T-Version Module.

- Low power · Long-term reliability · Surface mount technology
- ASCII, European, Japanese Katakana characters · Easy user interface
- Built in test function · Flexible control data · Parallel and serial input

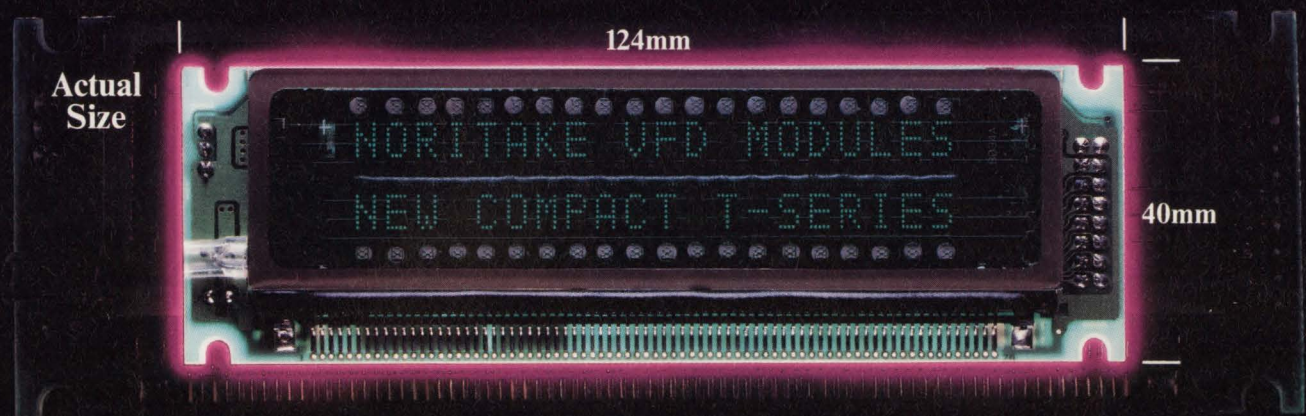

Part No.	No. of Characters	Character Size (WxH)mm	Tpy. Icc (mA)
CU165SCP-B-T20A*	1X16	3.05X 5.05	TBD
CU205SCP-B-T20A*	1X20	3.30X 5.00	TBD
CU209SCP-B-T20A	1X20	4.45X 8.80	300
CU406SCP-B-T20A	1X40	3.00X 5.00	350
CU20025SCP-B-T20A	2X20	2.60X 5.00	320
CU200211SCP-B-T60A	2X20	6.40X11.20	1200
CU40026SCP-B-T20A	2X40	3.30X 5.10	700
CU20045SCP-B-T23A	4X20	3.00X 5.00	400
CU20049SCP-B-T20A	4X20	6.40X 9.10	1100

\*Available April 1991

## Noritake

Los Angeles  
23820 Hawthorne Blvd.  
Suite 100  
Torrance, CA 90505  
Tel. 213-373-6704  
Fax 213-772-3918

Chicago  
415 E. Golf Rd.  
Suite 109  
Arlington Heights, IL 60005  
Tel. 708-439-9020  
Fax 708-593-2285

Boston  
263 Winn St.  
Suite 1D  
Burlington, MA 01803  
Tel. 617-270-0360  
Fax 617-273-2892

Dallas  
2454 Trade Mart  
Dallas, TX 75207  
Tel. 214-742-9389  
Fax 214-747-5065

Europe  
Frankfurter Strasse 97-99  
6096 Raunheim  
F.R. Germany  
Tel. 06142-43095/96/97  
Fax 06142-22799

You can use the modulated-ramp signal for determining differential phase and gain.

Fig 9 shows the equivalent circuit the routine in Fig 8 produces. As you can see, the circuit uses 15 pulse and sine-wave generators, as well as two squaring circuits and a large collection of signal summers and multipliers. The 1-M $\Omega$  resistors are tokens, essentially open circuits, inserted because Spice will not work without generator and load impedances. Configuring such a circuit without the aid of Spice would be frightening to contemplate.

If your simulation of this last test signal is complete, you have all the tools necessary to build video test signals. Every test signal is a composite of luminance and chrominance information. All you have to do is provide the timing; superposition takes care of the rest.

You should also now understand this technique well enough to tackle other complex waveforms. PAL and proposed HDTV signals are easy to simulate if you take the time to sit down and disassemble them into pulses, levels, and frequencies.

The computational load of these simulations is much greater than that of a simple transient or ac analysis of a circuit. Completing these simulations takes a correspondingly longer time. The signals described here were run on both a standard IBM PC/XT and a Compaq 386/25. The numbers in Table 4 are those for a Compaq 386/25. A VAX 780 would have comparable numbers, and a 4.77-MHz IBM PC/XT with a coprocessor would take approximately 18 times longer. At the completion

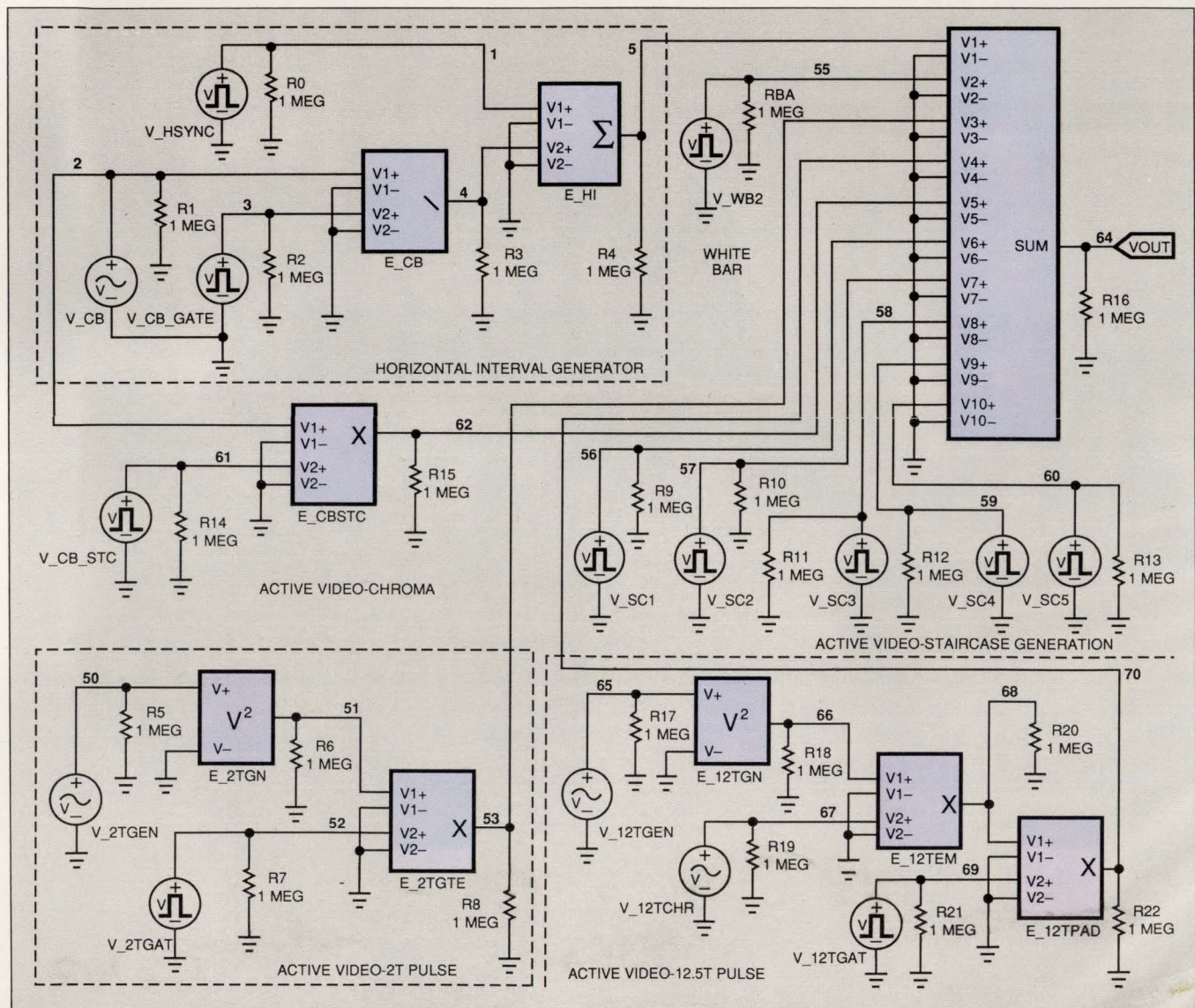
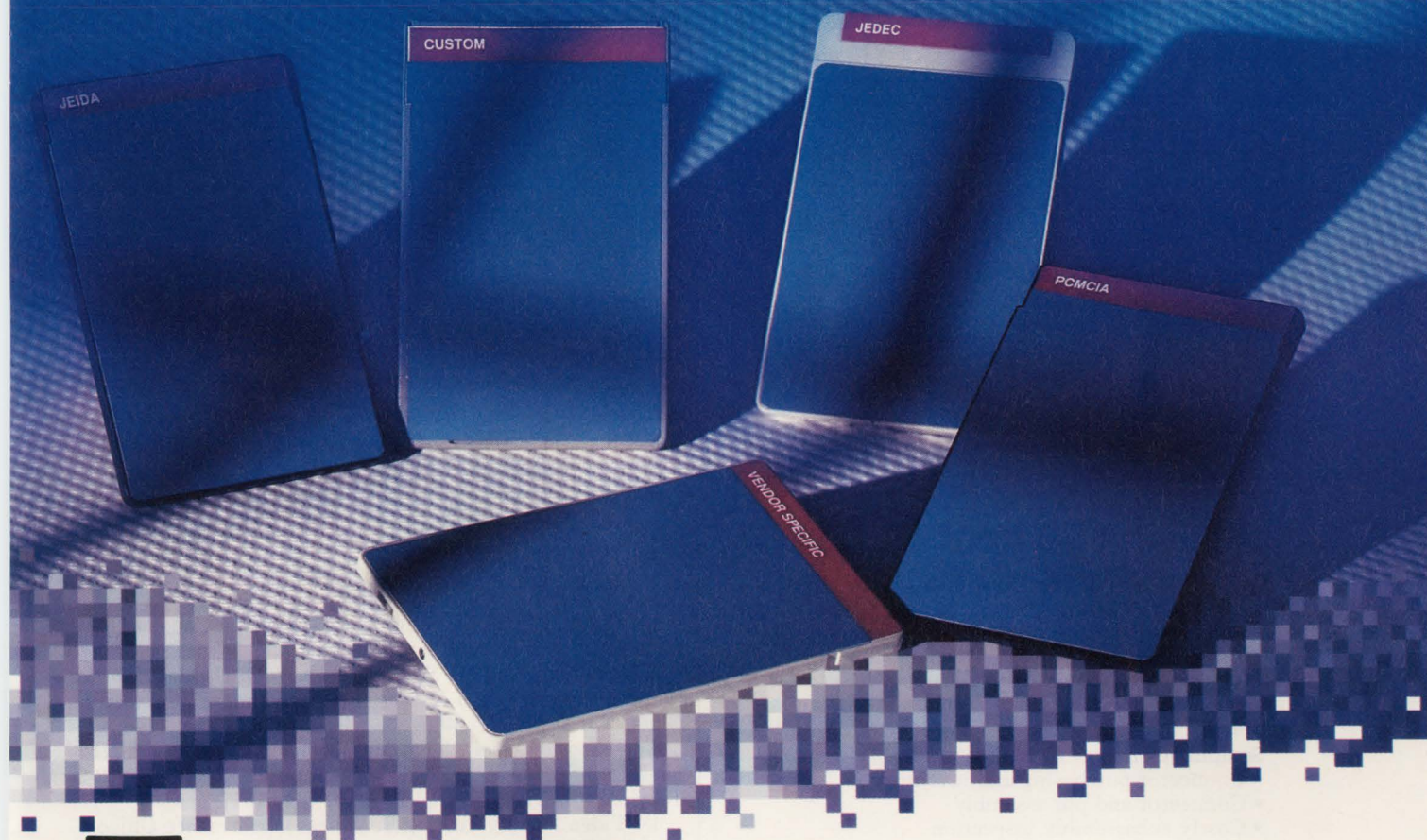

Fig 9—You need a plethora of generators, squarers, summers, and multipliers to generate the NTC7 test signal. This equivalent circuit, which is useful for testing all essential video parameters in a video-circuit model, corresponds to the PSpice listing in Fig 8.

# Decisions, Decisions, Decisions...



**T**he pressure is always on. You've got to figure out how to get to market faster and more cost-efficiently. You've got to reduce the after-sales service costs that dilute profitability. Plus, you've got to increase your share-of-market and maintain revenues that will keep your management and the stockholders happy.

Card technology offers the newest concept in memory storage. And, it's the technology that could catapult your company ahead of the competition.

But, once you've decided to base your next-

generation systems or software on memory cards, the design decisions don't stop there.

There's the issue of standard versus custom cards. And, with card standards garnering significant press coverage, plus some standards not yet finalized, every decision is critical.

Most important, whatever the decision, you need to know you can get your products to market on time and within budget. That means getting the memory type and density you need, standard or custom, from one convenient source. Solutions, fast and simple.

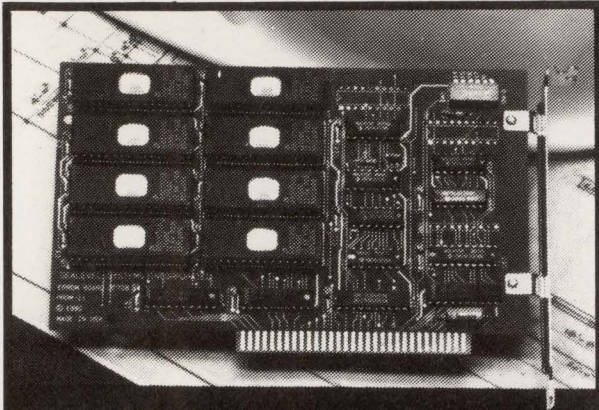

## PROM-III

- PUT DOS AND APPLICATION IN EPROM
- ALLOWS DISKLESS OPERATION
- UP TO 1 MBYTE ROM-DRIVE WITH 16K FOOTPRINT
- PROMKIT SOFTWARE BY ANNABOOKS
- FLASH EPROM SUPPORTED
- BATTERY RAM MODULES SUPPORTED
- DELIVERY FROM STOCK



SEALEVEL SYSTEMS INC.  
PO BOX 1808  
EASLEY, SC 29641  
(803) 855-1581

CIRCLE NO. 31

## When the problem is economics . . .

Sculptured® flexible circuits from ACT require no additional hardware such as staked-in pins or connectors to mate with PWBs. Your specified terminations are an integral part of the circuit conductors, not added on!

- Sculptured circuits, useable as received, eliminate:
- Connector purchasing and inventory
  - Connector and pin assembly
  - Costly subassembly inspection

To find out how you can save time and money with Sculptured circuits, call or write:



**Advanced Circuit Technology**  
We Make Interconnects Simple.  
Box 547X, Nashua, N H 03061 (603) 880-6000

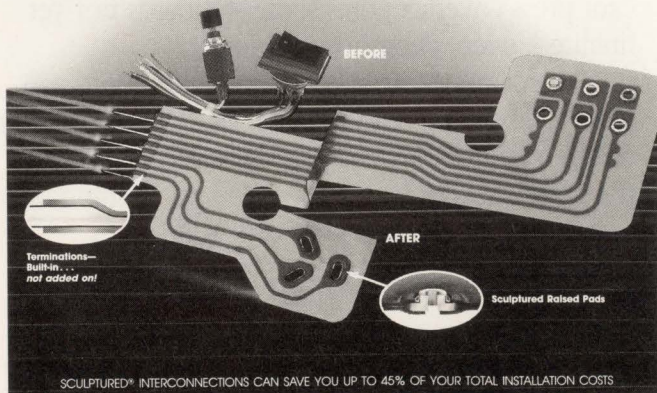

SCULPTURED® INTERCONNECTIONS CAN SAVE YOU UP TO 45% OF YOUR TOTAL INSTALLATION COSTS

CIRCLE NO. 28

**Table 4—Signal-execution loads**

Signal	Time to run	Extra nodes
Modulated ramp	1 min, 16 sec	10
Multiburst	3 min, 20 sec	27
NTC7 composite	2 min, 57 sec	24

of all computations, the PSpice .OPTIONS statement is set to

ITL5=0 ; Allow an unlimited number of iterations.  
RELTOL=0.01 ; This cuts down on computation time,  
; but does not seriously degrade accuracy.

Set up the PSpice .TRAN statement for an analysis length that's appropriate for your application. All the timing simulations performed here were executed to an analysis length of 100  $\mu$ sec. The PSpice .PROBE facility generated the plot files.

If you intend to do repeated simulations of video signals, try using the .SUBCKT facility in Spice to build up a repertoire of these signals. This utility lets you keep the circuits in a library and call them up when you need them.

**EDN**

## References

1. PSpice Manual, MicroSim Corp, 23175 La Cadena Dr, Laguna Hills, CA 92653.
2. Tuinenga, Paul W, *SPICE: A Guide to Circuit Simulation & Analysis Using PSpice*, Prentice Hall, Englewood Cliffs, NJ, 1988.
3. "Television Operational Measurements: Video and RF for NTSC Systems," TEK Television publication AX-3323-2, Tektronix Inc, Box 500, Beaverton, OR 97077.
4. "Video Facility Testing Technical Performance Objectives," NTC7 Report, Public Broadcasting Service, Engineering Services, 475 L'Enfant Plaza SW, Washington, DC 20024.

## Author's biography

*Anthony Radice is a senior digital design engineer in General Instrument's (Hatboro, PA) Broadband Communications Group, where he's worked for eight years. He's responsible for the design and development of digital audio and video transmission systems. He holds a BSEE from Drexel University. Tony is a volunteer fireman and enjoys personal computing as a hobby.*

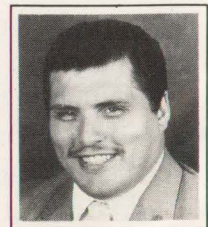

**Article Interest Quotient (Circle One)**  
High 476 Medium 477 Low 478

# Solutions.

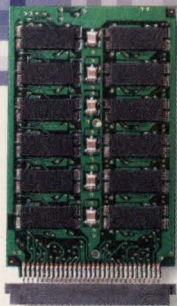

Mitsubishi pioneered the TSOP packaging technology that makes memory cards possible. Our TSOP is over four times smaller in volume than its equivalent pin-count, standard surface-mount package.

At Mitsubishi, we give you memory card solutions, not more decisions.

We help you determine the benefits of both standard and custom cards, then provide you with the version that best suits your design needs. We give you cards in the memory type you need. In quantity. Fast.

If your objective is hardware or software compatibility across several platforms, standard cards may be the best choice. As the world's leading

supplier of cards, Mitsubishi serves on all three standards committees (PCMCIA, JEIDA and JEDEC). So, our cards are available in the current version of each standard. Plus, we'll keep you abreast of the status and future of standards issues. In fact, over the past four years, we've found that our 50- and 60-pin devices have become standards for many users.

If a proprietary design is the only way to maintain your competitive edge, Mitsubishi offers custom cards. We mix memory types, consolidate logic into ASIC, even add

MCU on board. Whatever it takes, we work with you to achieve your custom card needs.

No matter what design decisions you face, Mitsubishi gives you the solutions. Standard or custom. All memory technologies. The highest densities. From the same source. Fast and simple.



## MITSUBISHI MEMORY CARDS

Memory Type	Density Range	PCMCIA	JEIDA	JEDEC	CUSTOM	MITSUBISHI 50- & 60-Pin (card-edge & pin-&-socket) UL Component Recognized
SRAM	128KB - 2MB	✓	✓		✓	✓
OTPROM	128KB - 4MB	✓	✓		✓	✓
MASK ROM	512KB - 8MB	✓	✓		✓	✓
	16MB	✓	✓		✓	✓
EEPROM	8KB - 192KB	✓	✓		✓	✓
FLASH EEPROM*	512KB - 2MB	✓	✓		✓	✓
	512KB - 2MB			✓	✓	✓
DRAM	4MB - 12MB**			✓	✓	✓

\* Available soon  
\*\* 12MB DRAM cards available soon

Recognized under the Component Program of Underwriters Laboratories Inc.

Call today and set your vision into action with memory card solutions. (408) 730-5900, ext. 2214.

 **MITSUBISHI**  
ELECTRONIC DEVICE GROUP

Free Samples

# 12 BIT A/D +

8chMUX + S/H + 4wire I/O + 13 $\mu$ s + 10 $\mu$ A Shutdown

# = \$15.95

## New LTC 1290 A to D System on a Chip.

Linear Technology presents the LTC1290, the new standard in serial 12-bit data acquisition solutions. With exceptionally stable accuracy over temperature, the LTC1290 includes an 8-channel MUX, S/H, and ADC all in one low power CMOS design. Normal power consumption is a mere 25mW, and its design includes a software selectable shut down that reduces consumption to microwatt levels.

And the LTC1290 is pin and function compatible with the LTC1090. That means that you can upgrade from 10-bit to 12-bit resolution and accuracy with a simple part change and little or no software modifications.

The LTC1290's efficient serial I/O allows easy interface to virtually any microprocessor and is ideal for remote or electrically isolated

	LTC 1290 CCN	AD 574 AKN	AD 7572 KN12
12 BITS	YES	YES	YES
BUILT-IN S/H	YES	NO	NO
8-CHAN MUX	YES	NO	NO
SINGLE +5V SUPPLY	YES	NO	NO
4-WIRE INTERFACE	YES	NO	NO
LOW POWER*	25mW/ 50 $\mu$ W	725mW	215mW
CONVERSION TIME	13 $\mu$ sec	35 $\mu$ sec	12.5 $\mu$ sec
<b>SOFTWARE PROGRAMMABLE FEATURES</b>			
POWER SHUT DOWN	YES	NO	NO
UNIPOLAR/ BIPOLAR INPUTS	YES	NO	NO
DIFFERENTIAL/ SINGLE ENDED INPUTS	YES	NO	NO
PRICE/100	\$15.95	\$36.70	\$40.00

\*50 $\mu$ W in shutdown

applications. The 50kHz throughput rate and S/H acquisition time of less than 1 microsecond make digitizing higher frequency waveforms easy. Software configurability of the MUX and analog to digital converter provide unmatched functional flexibility. The LTC1290 operates from either a single +5V supply for 0 to 5V inputs or  $\pm$ 5V supplies for -5V to +5V inputs and is available in 20 pin skinny DIP or SO packages.

Pricing for the LTC1290 commercial grade plastic device starts at \$15.95 in 100's. Take a hard look at the new LTC1290. We think you'll agree, it's the high performance 12-bit ADC solution to your data acquisition needs.

For additional information, contact Linear Technology Corporation, 1630 McCarthy Blvd., Milpitas, CA 95035. Or call 800-637-5545.

CIRCLE NO. 78



TOUGH PRODUCTS  
FOR TOUGH APPLICATIONS.



# DESIGN IDEAS

EDITED BY ANNE WATSON SWAGER

## Amplifier scheme lowers drift and noise

Jim Williams

Linear Technology Corp, Milpitas, CA

Fig 1's circuit combines a low-noise op amp, IC<sub>1</sub>, with a chopper-based carrier-modulation scheme to achieve a low-noise, low-drift dc amplifier whose performance exceeds any currently available monolithic amplifier. The amplifier's offset is less than 1  $\mu\text{V}$ , and its drift is less than 0.05  $\mu\text{V}/^\circ\text{C}$ . The circuit in Fig 1 has noise within a 10-Hz bandwidth less than 40 nV. The amplifier's bias current, which is set by the bipolar input of IC<sub>1</sub>, is about 25 nA. These specifications suit the demands of transducer signal-conditioning circuits.

The 74C04 inverters (IC<sub>3</sub> to IC<sub>6</sub>) form a simple 2-phase square-wave clock running at about 350 Hz. The complementary oscillator signals ( $\phi_1$  and  $\phi_2$ ) provide drive to S<sub>1</sub> and S<sub>2</sub>, respectively, causing a chopped version of the input to appear at IC<sub>1</sub>'s input. IC<sub>1</sub> amplifies this ac signal. S<sub>3</sub> and S<sub>4</sub> synchronously demodulate IC<sub>1</sub>'s square-wave output. Because S<sub>3</sub> and S<sub>4</sub> switch synchronously with S<sub>1</sub> and S<sub>2</sub>, the circuit presents

proper amplitude and polarity information to IC<sub>2</sub>, the dc output amplifier. This output stage integrates the square wave to provide a dc voltage output. R<sub>1</sub> and R<sub>2</sub> divide down the output and feed it back to the input chopper where the divided output serves as a zero signal reference. The ratio of R<sub>1</sub> and R<sub>2</sub> sets the gain, in this case to 1000. Because a 1- $\mu\text{F}$  capacitor ac-couples IC<sub>1</sub> to the output stage, IC<sub>1</sub>'s dc offset and drift don't affect overall circuit offset, resulting in the overall amplifier's low offset and drift.

When using this amplifier, it's important to realize that IC<sub>1</sub>'s bias current flowing through the input-source impedance causes additional noise. In general, to maintain low-noise performance, the source resistance should be below 500 $\Omega$ . Fortunately, the resistances of transducers such as strain-gauge bridges, RTDs, and magnetic detectors are well below this figure.

(EDN BBS /DL\_SIG #936)

EDN

To Vote For This Design, Circle No. 746

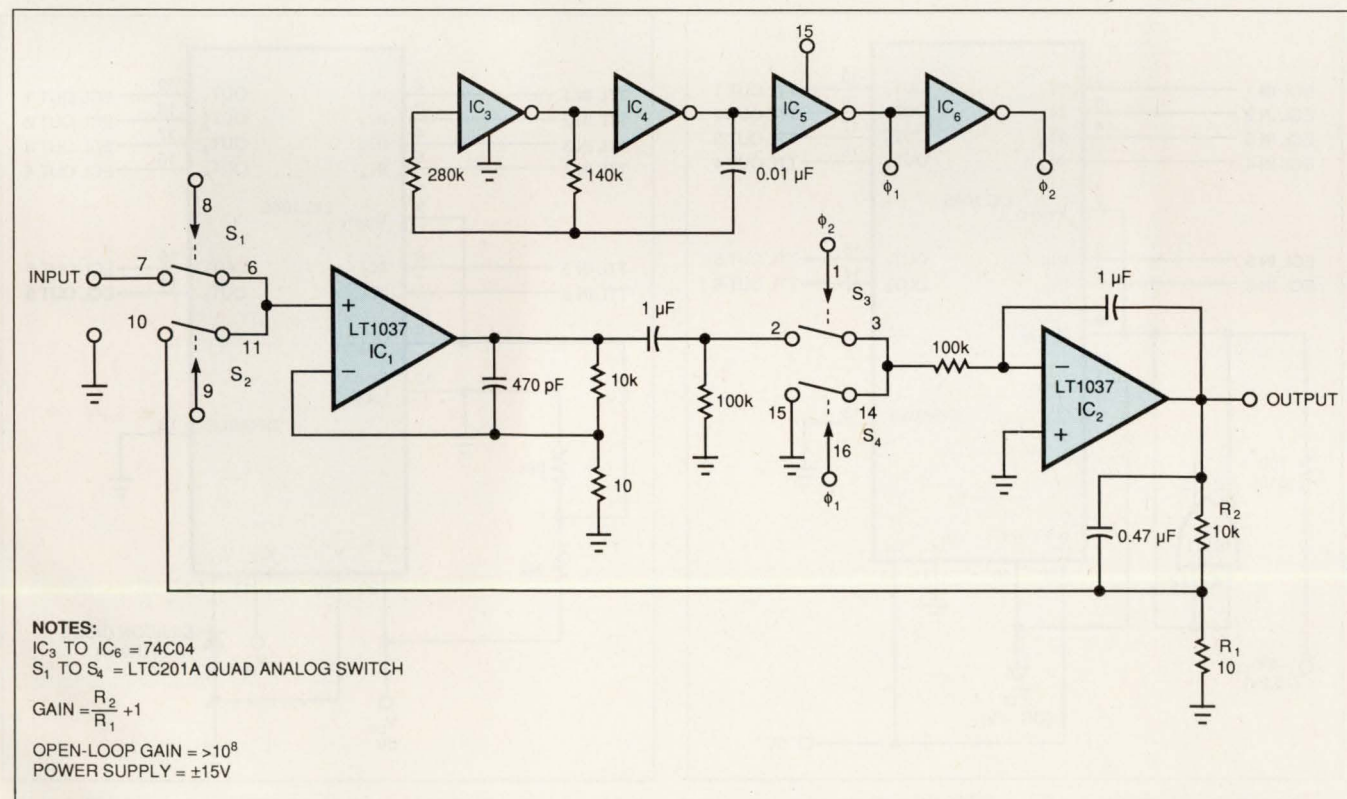

Fig 1—By synchronously modulating the input and ac-coupling a low-noise op amp to a dc amplifier, this circuit achieves noise and drift specs of 1  $\mu\text{V}$  and 0.05  $\mu\text{V}/^\circ\text{C}$ , respectively.

## IC converts from TTL to ECL and back

Rolf R Safferthal  
Independent Consultant, Dreieich, Germany

The circuits in **Fig 1** and **Fig 2** convert as many as six signals per chip either from ECL to TTL or from TTL to ECL using the same IC. The IC holds six translators and typically consumes less than 8 mW per ECL-TTL converter. It consumes 4 mW when converting from TTL to ECL. These power levels are 10 to 20 times less than the popular 10124 and 10125 translators. The tradeoff for lowering the power is speed—the propagation delay is 60 nsec for ECL-TTL translation and 100 nsec for TTL to ECL.

The data sheet for the LTC-1045 IC shows a typical application for ECL-to-TTL conversion. You can reduce the power consumption of this circuit by another 30% by reducing the  $-5.2V$  supply to  $-2V$ . Also, you can improve upon the reference-voltage generation.  $V_{TRIP1}$  is the reference input for inputs 1 through 4, and  $V_{TRIP2}$  is for inputs 5 and 6. A simple resistor divider works well with a clean ECL supply. However,

if the reference input picks up too much noise, you can easily replace the resistor divider by an unused, inverting 10101 ECL gate with direct feedback (**Fig 1**). The output of such a configuration delivers a stable reference voltage and exactly tracks the ECL trip point with voltage and temperature. To attain the highest possible speed and a hysteresis of approximately 20 mV, the  $I_{SET}$  pin should connect directly to  $V^-$ .

You can also use this IC as a TTL-to-ECL converter (**Fig 2**). The device has four power-supply connection pins. Two of them,  $V^+$  and  $V^-$ , power the internal circuit. The minimum voltage difference between these pins has to be 4.5V, and the input voltage must stay within these rails. For a TTL-to-ECL converter,  $V_{CC}$  normally equals 5V. Because the incoming voltage swing is relatively large with TTL, the easiest way for building up the reference voltage is with a resistor divider.

The other two power-supply connections,  $V_{OH}$  and  $V_{OL}$ , power the output-driver stage. The minimum voltage difference between these pins has to be 3V, and the values determine the output levels, swinging

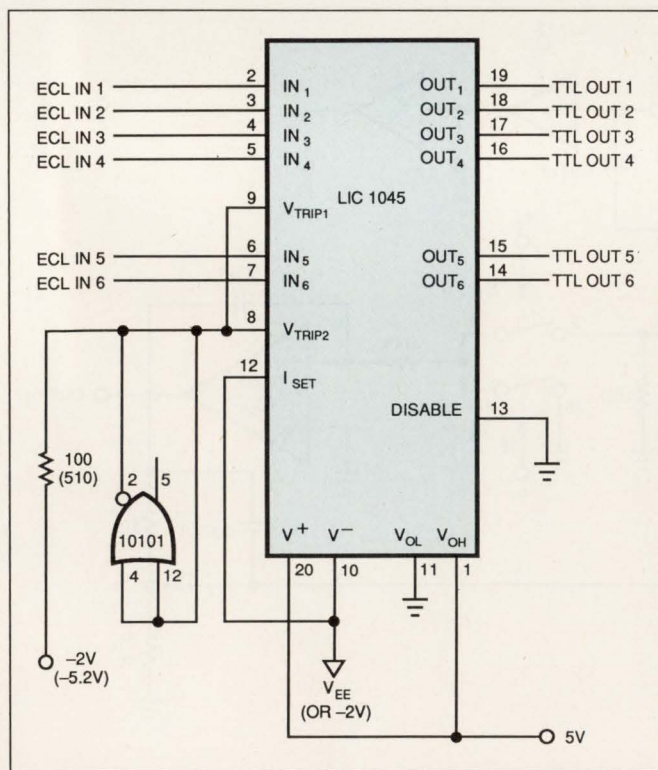

**Fig 1**—Improvements to a standard data-sheet application of the IC's ECL-to-TTL converter include lowering the supply voltage to  $-2V$  and using an ECL gate to generate the reference voltage.

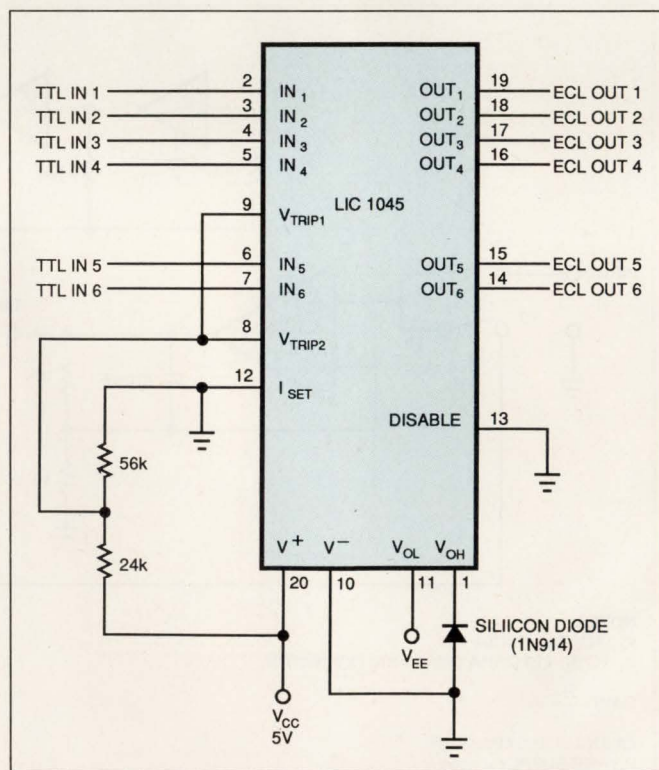

**Fig 2**—By tying  $V^+$  and  $V^-$  to TTL power levels, and  $V_{OL}$  to ECL levels, you can reverse the circuit in **Fig 1** and create a TTL-to-ECL converter.

# TINY SPDT SWITCHES

## ABSORPTIVE... REFLECTIVE

dc to 4.6 GHz from \$32.95<sup>(10-24)</sup>

Tough enough to pass stringent MIL-STD-883 vibration, shock, thermal shock, fine and gross leak tests... useable to 6GHz... smaller than most RF switches... Mini-Circuits' hermetically-sealed (reflective) KSW-2-46 and (absorptive) KSWA-2-46 offer a new, unexplored horizon of applications. Unlike pin diode switches that become ineffective below 1MHz, these GaAs switches can operate down to dc with control voltage as low as -5V, at a blinding 2ns switching speed.

Despite its extremely tiny size, only 0.185 by 0.185 by 0.06 in., these switches provide 50dB isolation (considerably higher than many larger units) and insertion loss of only 1dB. The absorptive model KSWA-2-46 exhibits a typical VSWR of 1.5 in its "OFF" state over the entire frequency range. These surface-mount units can be soldered to pc boards using conventional assembly techniques. The KSW-2-46, priced at only \$32.95, and the KSWA-2-46, at \$48.95, are the latest examples of components from Mini-Circuits with unbeatable price/performance.

Connector versions, packaged in a 1.25 x 1.25 x 0.75 in. metal case, contain five SMA connectors, including one at each control port to maintain 3ns switching speed.

**Switch fast... to Mini-Circuits' GaAs switches.**

### SPECIFICATIONS

Pin Model Connector Version	KSW-2-46 ZFSW-2-46	KSWA-2-46 ZFSWA-2-46
FREQ. RANGE	dc-4.6 GHz	dc-4.6 GHz
INSERT. LOSS (db)	typ max	typ max
dc-200MHz	0.9 1.1	0.8 1.1
200-1000MHz	1.0 1.3	0.9 1.3
1-4.6GHz	1.3 1.7	1.5 2.6
ISOLATION (dB)	typ min	typ min
dc-200MHz	60 50	60 50
200-1000MHz	45 40	50 40
1-4.6GHz	30 23	30 25
VSWR (typ)	ON 1.3:1 OFF —	1.3 1.4
SW. SPEED (nsec) rise or fall time	2(typ)	3(typ)
MAX RF INPUT (bBm)		
up to 500MHz	+17	+17
above 500MHz	+27	+27
CONTROL VOLT.	-8V on, OV off	-8V on, OV off
OPER/STOR TEMP.	-55° to +125°C	-55° to +125°C
PRICE (10-24)	<b>\$32.95</b> <b>\$69.95</b>	<b>\$48.95</b> <b>\$79.95</b>

finding new ways ...  
setting higher standards

**Mini-Circuits**

A Division of Scientific Components Corporation  
P.O. Box 350166, Brooklyn, New York 11235-0003 (718) 934-4500  
Fax (718) 332-4661 Domestic and International Telexes: 6852844 or 620156

WE ACCEPT AMERICAN EXPRESS

C 117 REV. G

CIRCLE NO. 110

# DESIGN IDEAS

## Design Entry Blank

**\$100 Cash Award for all entries selected by editors. An additional \$100 Cash Award for the winning design of each issue, determined by vote of readers. Additional \$1500 Cash Award for annual Grand Prize Design, selected among biweekly winners by vote of editors.**

To: Design Ideas Editor, EDN Magazine  
Cahners Publishing Co  
275 Washington St., Newton, MA 02158

I hereby submit my Design Ideas entry.

Name \_\_\_\_\_

Title \_\_\_\_\_ Phone \_\_\_\_\_

Company \_\_\_\_\_

Division (if any) \_\_\_\_\_

Street \_\_\_\_\_

City \_\_\_\_\_ State \_\_\_\_\_

Country \_\_\_\_\_ Zip \_\_\_\_\_

Design Title \_\_\_\_\_

Home Address \_\_\_\_\_

Social Security Number \_\_\_\_\_  
(Must accompany all Design Ideas submitted by US authors)

**Entry blank must accompany all entries.** Design entered must be submitted exclusively to EDN, must not be patented, and must have no patent pending. Design must be original with author(s), must not have been previously published (limited-distribution house organs excepted), and must have been constructed and tested. Please submit software listings and all other computer-readable documentation on a 5/4-in. IBM PC disk.

Exclusive publishing rights remain with Cahners Publishing Co unless entry is returned to author or editor gives written permission for publication elsewhere.

In submitting my entry, I agree to abide by the rules of the Design Ideas Program.

Signed \_\_\_\_\_

Date \_\_\_\_\_

### ISSUE WINNER

The winning Design Idea for the December 6, 1990, issue is entitled "Sensor and logic form digital compass," submitted by Brian Grenoble of Maxim Integrated Products (Sunnyvale, CA).

**Your vote determines this issue's winner.** All designs published win \$100 cash. All issue winners receive an additional \$100 and become eligible for the annual \$1500 Grand Prize. **Vote now**, by circling the appropriate number on the reader inquiry card.

nearly from rail to rail under moderate loads. The selection of these voltage levels does have some constraints.  $V^+$  must always be more positive than  $V_{OH}$ . For ECL output levels, you can use the standard ECL supply of  $-5.2V$ . To prevent saturation effects on high levels at a receiving ECL input, you should use a silicon diode between  $V_{OH}$  and ground to limit the high level to  $-0.7V$ . The IC has push-pull output stages. Therefore, it's not necessary to use pull-down resistors on the outputs. Compared with the 10124, the circuit in **Fig 2** saves 10 to 30 mW per converted signal.

(EDN BBS /DI\_SIG #940)

**EDN**

To Vote For This Design, Circle No. 750

## FEEDBACK AND AMPLIFICATION

### PLD is really a PROM

We did some checking for an interested reader and found out that a part an author (and company) called a PLD was really a PROM. The Design Idea "PLD adds flexibility to motor controller" on pg 177 of EDN's March 1, 1990 (DI #808) issue contains a part labeled PLE5P8. This part number is an obsolete MMI designation for a simple  $32 \times 8$ -bit PROM.

*Charles H Small and Anne Watson Swager*  
Design Ideas Editors

### Ladder improves design

Stephen C Hageman's Design Idea, "Peak detector holds signals indefinitely" (EDN, May 24, 1990, pg 173), will work better if you use an R/2R ladder network.

*Heiner V Schlichting*  
Project Engineer MBB  
342 Schrobenhause 8898, Germany

### EDN's bulletin-board is on line

Call EDN's free bulletin-board service (BBS) at (617) 558-4241 (1200/2400,8,N,1) and select /DI\_SIG to get additional information or to comment on these Design Ideas.

**EDN**

# More OP Amp Options

## Solve your toughest noise, DC, and dynamic error problems.

Need ultra-low noise or bias current? High speed? Exceptional precision? Low Power? Best performance /price?



Advanced water-level laser trimming assures maximum precision and stability for Burr-Brown op amps.

Choose the perfect part for your application from our selection of versatile op amps. No other supplier offers such a variety of performance options. With over 35+ years of op amp design, manufacturing, and quality assurance experience, no other supplier makes parts as good as these.

## Performance Choices

### Low Power, Dual OPA1013

- 150 $\mu$ V max offset
- 2 $\mu$ V/ $^{\circ}$ C max drift
- +5V to  $\pm$ 15V single or dual power supply
- from \$2.30\*

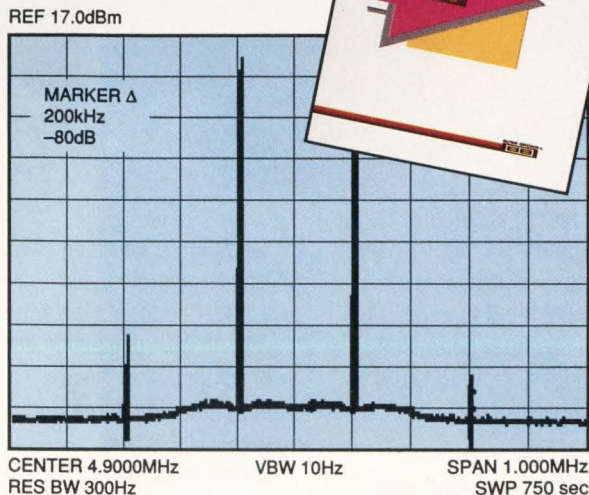
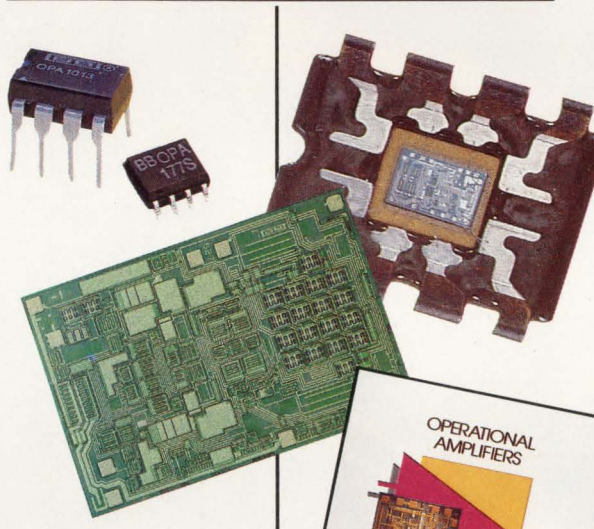
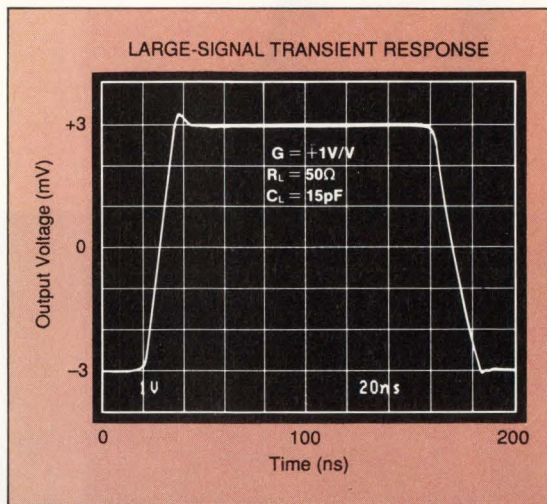

### High Speed, Current-feedback OPA603

- 1000V/ $\mu$ s slew rate
- 100MHz (G=1 to 10) bandwidth
- $\pm$ 4.5V to  $\pm$ 18V supplies
- from \$4.95\*

### Low Noise, High Speed OPA627/637

- 450ns (0.01%) settling
- 4.5nV/ $\sqrt$ Hz at 10kHz noise
- 0.8 $\mu$ V/ $^{\circ}$ C max drift
- from \$7.50\*

### Low Noise, Ultra-Precision OPA177/77

- industry-standard replacement
- 0.1 $\mu$ V/ $^{\circ}$ C max drift
- 1.5mA typ quiescent current
- from 95¢\*

### High Performance, RF/Video OPA620/621

- 500MHz gain-bandwidth
- $\pm$ 100 $\mu$ V offset
- 500V/ $\mu$ s slew rate
- from \$9.95\*

## Even more OP Amps

Our new *Operational Amplifiers* guide contains key product specs, applications information and more... including info on our newest amps. This free selection guide, data sheets, and evaluation samples are available now from your Burr-Brown sales rep or call **1-800-548-6132** for immediate assistance.

Burr-Brown Corp.  
P.O. Box 11400  
Tucson, AZ 85734

\*U.S. OEM prices, in 100s.

**BURR-BROWN®**  
**BB**

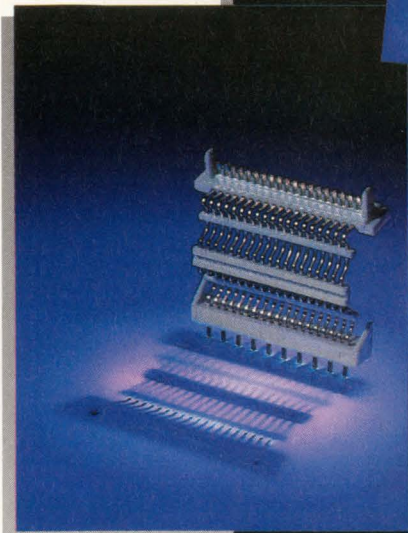
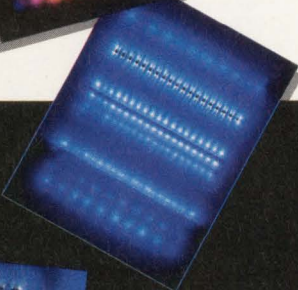

United States Europe Japan Korea Singapore

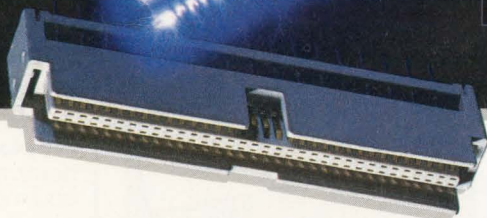
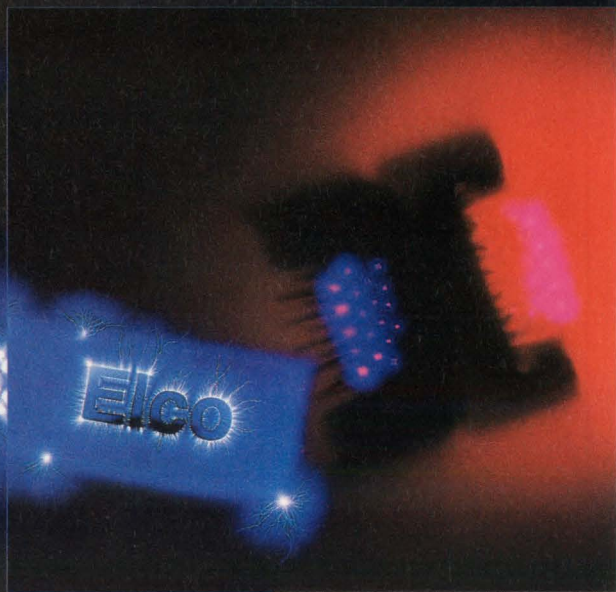

**GREATER  
WORLD CLASS  
POWER FROM  
OUR NEW  
GLOBAL  
CONNECTIONS**

The recent alliance of Elco and AVX with Kyocera forms a solid business relationship that gives us even stronger connections to today's exciting world of technology.

These connections strengthen our own high quality standards and link us to new sources of innovation throughout the world.

Together we combine our talents, energies, and experience to provide you with an ever-expanding line of advanced connector products of unsurpassed value. These new connections also contribute to a fresh spirit of efficient service and delivery and

assure you of timely response to your ever-evolving needs.

From a new source of energy emerges a powerful new Elco.



**World Class Connections**

Copyright 1990, Elco Corporation.  
All rights reserved.

Looking for a function generator  
with all the bells and whistles,  
like direct digital synthesis,  
arbitrary waveforms,  
and modulation,  
that doesn't cost an arm and a leg?



! 00 000 000 00 !

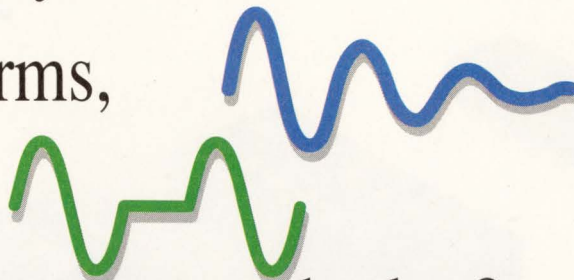

Take a look at the  
DS345 from SRS.



At \$1895, it's the only function generator you need.

It's a general purpose signal generator with standard waveforms, frequency sweeps, and synthesized accuracy. It's a 40 Msample/sec arbitrary waveform generator with 16k points of non-volatile memory. It's a complex signal source with amplitude, frequency, and phase modulation, complete with synthesized modulation waveforms. It's a remarkably agile source capable of making phase continuous frequency jumps in only 25 ns. And it's all available at the touch of a button.

What other generator has everything you want, and more?  
For more information about the DS345, call SRS at  
**(408) 744-9040.**

- 30 MHz direct digitally synthesized source
- 1  $\mu$ Hz resolution
- 12 bit arbitrary waveforms
- Fast phase continuous frequency switching
- Low phase noise and distortion
- Sine, square, ramp, and triangle waveforms
- Linear and log sweep with markers
- Frequency, amplitude, and phase modulation
- Arbitrary and burst modulation
- Optional GPIB/RS232 interfaces with Arbitrary Waveform Composer Software



**STANFORD RESEARCH SYSTEMS**

CIRCLE NO. 85

1290 D Reamwood Avenue, Sunnyvale, CA 94089 TEL (408)744-9040 FAX 4087449049 TLX 706891 SRS UD

# Our new GD DIPs let you have it your way!

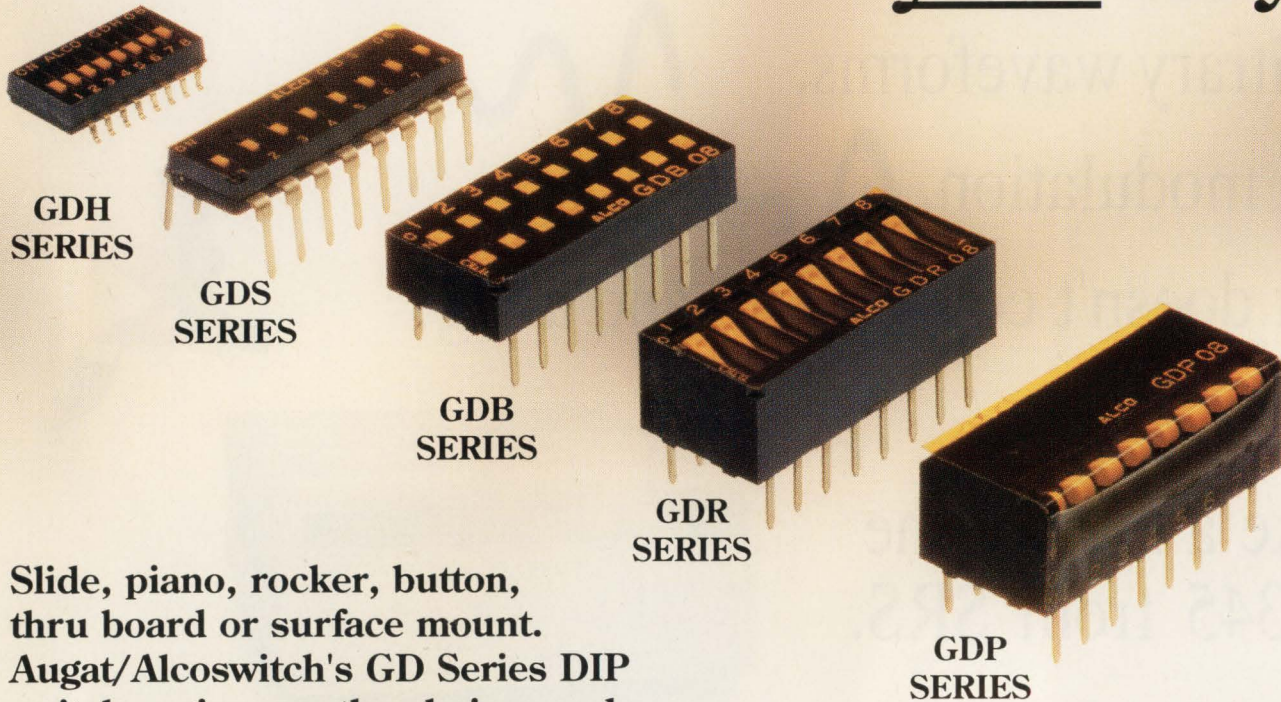

Slide, piano, rocker, button, thru board or surface mount. Augat/Alcoswitch's GD Series DIP switches give you the choices and options that you've been looking for.

## SAVE PCB REAL ESTATE.

The end stackable GDS model is up to 26% smaller than other low profile dip switches. This space saving design lets you reduce the size of your PCB or place more

components on it. Also,

laying out your board now becomes easier. All holes are on a .100 x .300 grid regardless of how many switches you stack.

## SAVE EVEN MORE.

For surface mount boards the GDH half pitch DIP is only .244"Wx.444"L for the 8 position version. All GD series DIPs are molded in high temperature polymer which withstands 260° continuous reflow soldering temperatures.

## EASE OF REMOVAL

No cumbersome tape tab to interfere with component placement equipment. Our unique corner notch allows easy tape removal.

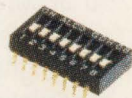

Learn how to buy it your way. Call or write for a copy of the new GD Series Dip switch brochure.

**AUGAT**® Alcoswitch®  
Quality and Innovation

Augat Inc., Interconnection  
Product Division

1551 Osgood Street, North Andover, MA 01845

(508) 685-4371

FAX (508) 686-9545

## INTERNATIONAL SALES OFFICES

AUGAT LIMITED	England	44908676655
AUGAT SA	France	33146683090
AUGAT GMBH	Germany	49896129090
AUGAT AB	Sweden	468960270
AUGAT SRL	Italy	39396058029
AUGAT ELECTRONICS INC.	Canada	4166701500
AUGAT PTY LTD.	Australia	6129137100
AUGAT KK	Japan	81448338671
AUGAT PTE LTD.	Singapore	657530688
AUGAT TAIWAN	Taiwan	88625812373



# NEW PRODUCTS

## TEST & MEASUREMENT INSTRUMENTS

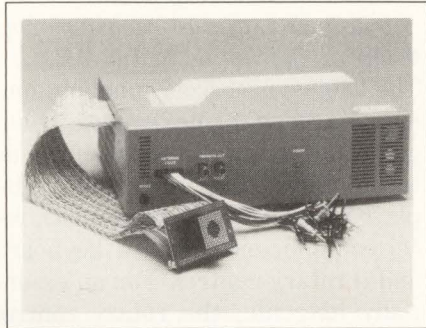

### 68302 In-Circuit Emulators

- Have two  $4k \times 72$ -bit trace buffers
- 256k-byte emulation memory expands to 2M bytes

The HMI-200-68302 supports all features of the 68302  $\mu$ P. The HMI-200-68000 with the HMI-240-68302 adapter also supports the 68302 but has some limitations. However, this

emulator and adapter also work with the 68000, 68008, and 68010. Both emulators permit real-time emulation, provide four complex break and trigger points, and offer a pair of  $4k \times 72$ -bit trace buffers. Emulation memory is 256k bytes expandable to 1M or 2M bytes. The Sourcegate debugger works with C, Pascal, Ada, and PL/M compilers from more than a dozen sources. A performance-analysis option is also available. HMI-200-68302, \$8995; HMI-200-68000 with HMI-240-68302, \$8495; Sourcegate for MS-DOS, \$1500; Sourcegate for Sun and Apollo workstations, \$3000; performance-analysis option, \$2495.

**Huntsville Microsystems Inc.**,  
Box 12415, Huntsville, AL 35802.  
Phone (205) 881-6005. FAX (205) 882-6701.

Circle No. 351

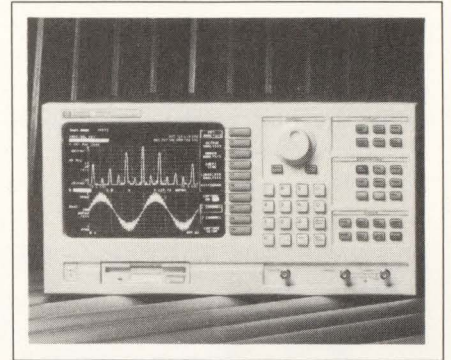

### FFT-Based Spectrum/Network Analyzer

- Makes swept-sine measurements
- Automates tests using programs written in Basic

The 35665A FFT-based instrument performs spectrum analysis to 102.4 kHz and network analysis to 51.2 kHz. Among the unit's capabilities are swept-sine measurements and

# More Emulation For Less!

**HIGH-LEVEL**  
language source lines and symbols are shown in both the disassembled trace and breakpoint displays.

**SPLIT-SCREEN**  
display provides multiple work areas and different views of data.

**BREAKPOINT**  
shows register contents and allows modification; registers are highlighted as they change.

```

D TIME      200E 00 (write)
E           200F 00 (write)
L0053_M2    count = 0; /* zero out the initial count */
F L0053_M2  F02C 5F          CLR B
11          F02D 4F          CLR A
13          F02E FD2010      STD COUNT
16 COUNT    2010 00 (write)
17          2011 00 (write)
L0054_M2    bits = 0x00; /* set
18 L0054_M2  F031 CC0000

Command>

L0052_M2    time = 0x000; /* set
PC=         MAIN          F026 CC0000
Command> Breakpoint set at L0053_M
A=00 B=00 X=C258 Y=BA00 SP=0
L0053_M2    count = 0; /* zer
PC=         L0053_M2      F02C 5F
Command> Breakpoint set at L0054_M

A=00 B=00 X=00,7 Y=BA00 SP=0
L0054_M2    bits = 0x00; /* set
PC=         L0054_M2      F031 CC0000
Command>

Orion Help Memory Files Analyzer Debug Epron Special Configuration
    
```

**ANALYZER TRACE**  
triggering shows realtime instruction execution enabling you to debug by symptom.

**DEBUG POPUP**  
gives immediate access to breakpoints, single-steps and all debug functions.

**POPUP MENUS**  
make the 8620 the easiest development system to learn and use.

Go ahead and compare the 8620. For 8- and 16-bit processors, there's nothing else like it. The feature-rich 8620 gets your product to market faster and costs less. Call for a demonstration and free demo disk. Orion Instruments, Inc.  
180 Independence Drive, Menlo Park, CA 94025. FAX (415) 327-9881.

**ORION**  
INSTRUMENTS

Computer Integrated  
Instrumentation Since 1980

EDN March 1, 1991

**CALL TODAY 800-729-7700**

CIRCLE NO. 11

FREE  
Demo Disk!



curve fitting. The analyzer's capture memory can store as many as 6.4M bytes. Frequency resolution is 400 lines. A 1.44M-byte floppy-disk drive stores instrument states, data, and programs. You can program the unit in the vendor's Instrument Basic language. In the fast-average mode, the analyzer

makes 30 sets of measurements/sec; with its display enabled, it updates its display to faster than 10 times/sec. From \$12,500. Delivery, 12 weeks ARO.

**Hewlett-Packard Co**, 19319 Pruneridge Ave, Cupertino, CA 95014. Phone (800) 752-0900.

Circle No. 352

# Super Cache

Bring your entire application aboard Mizar's MZ 7132.

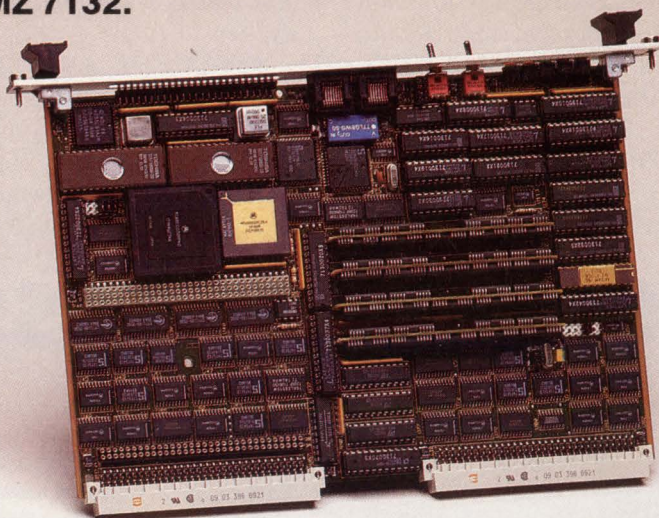

If your application requires not only superior 68030 performance, but plenty of on-board memory, Mizar's MZ 7132 is the answer. An economical, yet powerful, VMEbus single board computer, the MZ 7132 provides 16 Mbytes of dual-ported memory as well as a 16 Kbyte cache. Now, you can implement your memory-intensive applications more efficiently by avoiding the performance degradation of off-board memory. And, if you need more than 16 Mbytes, treat the on-board memory as a large cache and use the MZ 7132's optional VSB interface to access an additional memory pool.

The fully-featured MZ 7132 includes a 68EC030 or 68030 CPU with on-board SCSI, serial I/O, and optional Ethernet. OS-9™ and VxWorks™ support is also available. For more information on the MZ 7132 and other Mizar products, call today: 1-800-635-0200.

## MIZAR

1419 Dunn Drive/Carrollton, Texas 75006/214-446-2664/FAX 214-242-5997

©1991 Mizar, Inc.

Mizar is a registered trademark of Mizar Digital Systems, Inc.

Other names are trademarks of their respective manufacturers or developers.

## Synthesized Function Generator

- Generates sine, square, triangular, and ramp waveforms
- Operates from dc to 1.6 MHz

The 2003 synthesized function generator produces sine, square, triangular, and ramp waveforms from dc to 1.6 MHz. The unit, which displays messages on a 2-line LCD, receives commands from a keyboard and a rotary control. For an essentially long life, the rotary control is a position encoder, rather than a potentiometer. An optional RS-485 interface allows remote control. You can place several generators on a single serial loop and assign each generator a unique address. Output is 20V p-p into an open circuit and 10V p-p into 50Ω. \$500.

**Global Specialties**, 70 Fulton Terrace, New Haven, CT 06512. Phone (800) 527-1028; in CT, (203) 624-3103. FAX (203) 468-0060.

Circle No. 353

## V20H/V30H In-Circuit Emulator

- Has 131,072 hardware breakpoints
- Displays trace data in C or PL/M formats

The V20H/V30H Icealyzer is an in-circuit emulator for the NEC V20H and V30H μPs. It includes 131,072 hardware breakpoints that you can set on any condition or machine-cycle type—including data accesses. The included source-level debugger shows trace data in C, PL/M, or assembly language. A real-time performance analyzer identifies time-critical routines for optimization. The performance analyzer captures every instruction to ensure acquisition of infrequently accessed routines—for example, those that service interrupts. \$7295.

**Softaid Inc**, 8930 Route 108, Columbia, MD 21045. Phone (800) 433-8812; in MD, (301) 964-8455. FAX (301) 596-1852.

Circle No. 354

# Recording the Past... ...Plotting the Future

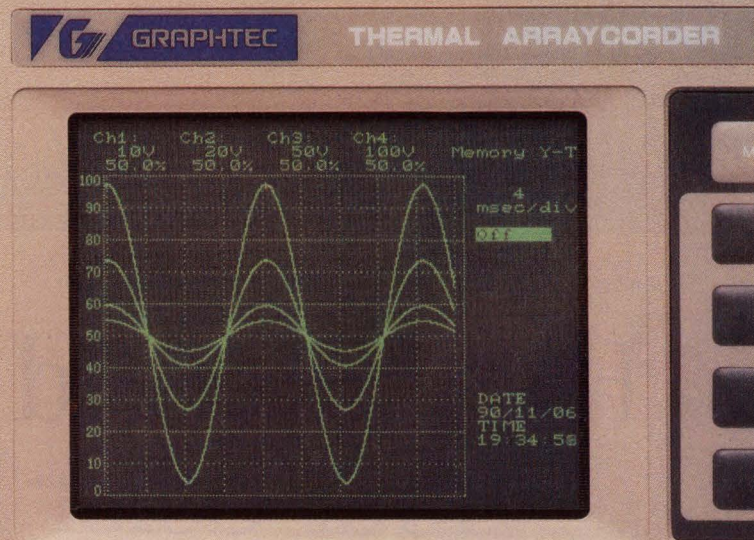
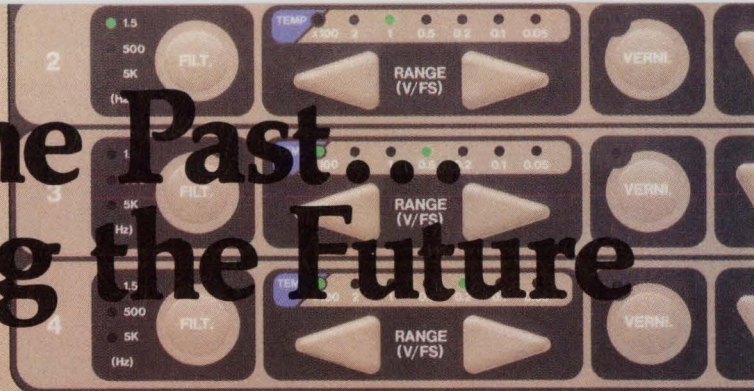
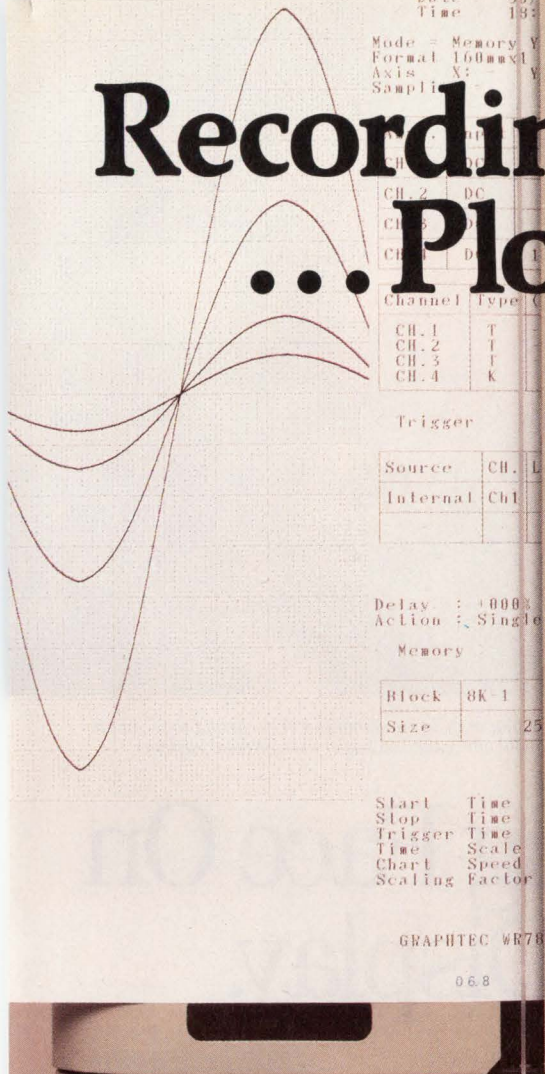

Our reputation precedes us! From 5 subsidiaries and 35 distributors in more than 40 countries worldwide, thousands of customers purchased more in 1989 than ever before. And they were able to choose new products from an ever-expanding array of plotters, penless plotters, digitizers, recorders and supplies.

The Graphtec reputation is one of building products that work well and last a long time. We earned that reputation the hard way, by delivering over 40 years of the best innovation, support, and after-sales service in the industry.

You really can see the difference in Graphtec products. Our new WR7800 Thermal Arrayorder not only has a 14-bit A/D converter for better waveform accuracy, it also includes an easy-to-read 320x256 dot electroluminescent screen for monitoring real-time or stored data. Other notable features include 32Kb and 256Kb memory cards, 3 built-in thermocouple inputs, an RS-232C interface (GPIB optional), and a jog dial for easy operability.

We invite you to go see a Graphtec WR7800 and experience these enhanced features firsthand.

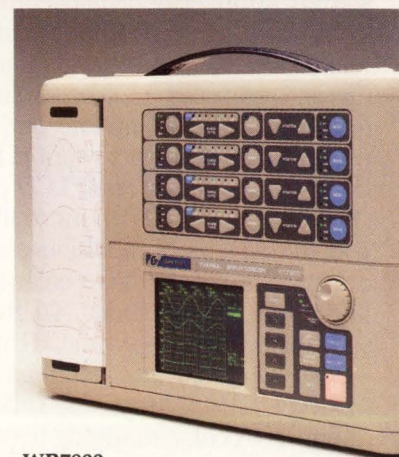

WR7800



**GRAPHTEC CORPORATION** 503-10 Shinano-cho, Totsuka-ku, Yokohama 244, Japan Tel: (045) 825-6250 Fax: (045) 825-6396  
**U.S.A.: Western Graphtec, Inc.** Tel: (714) 770-6010 Fax: (714) 855-0895 **Australia: Southern Graphtec Pty. Ltd.** Tel: (02) 748-4888 Fax: (02) 748-4882  
**Europe: Graphtec Europe GmbH** Tel: (040) 511-5059 Fax: (040) 511-9155 **United Kingdom: Graphtec (UK) Ltd.** Tel: (0270) 625-115 Fax: (0270) 626-733



Picture your flat panel display using Cirrus Logic controller chips. They actually add colors to your display capabilities for more realistic shading.

The same panel looks flat without our enhanced VGA capabilities. And it will lose face faster without our optimized power management system.

# How To Avoid Losing Face On Your Color LCD Display.

Face it. The first thing everybody notices about your newest laptop is the display quality. Is it bright? Are the images clear and well modeled? Are the colors vivid?

With Cirrus Logic LCD VGA controllers, your answer is yes. Which is why we're the leading supplier of display controller chips in the laptop and notebook market.

For life-like 3-dimensional imaging, Cirrus Logic color LCD controllers offer technology leadership for your color products. With direct support for the latest active-matrix color LCD panels. Our controller chips do more than support your panel's color capabilities — they enhance it with full VGA color support and a fuller color palette. To give you color so good it competes with CRT quality.

Our monochrome solutions give you displays that *PC Magazine* called "the stars of our VGA color-mapping tests"\* with up to 64 shades of gray. And with a lower dot clock rate, your power consumption

is lower than other solutions for longer battery operation.

Cirrus Logic LCD controllers are fully compatible with the popular PC video standards and will work with LCD, plasma, or electroluminescent displays.

Simplify your design job. A higher level of integration gives you all this in the smallest form factor available. We also supply software and hardware design notes and full design support. You get the results you want quickly and easily.

Design a more competitive product. One that looks better — and makes you look better. That lasts longer on a battery. Use the display solutions from a proven technology leader in laptop and motherboard VGA: LCD controller chips from Cirrus Logic.

Get the picture. Get more information on LCD controllers.

Call 1-800-952-6300, ask for dept. LL24

Cirrus Logic Color LCD Interface Controller Bulletin

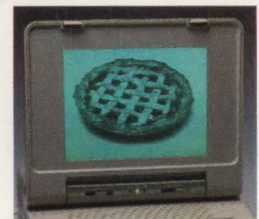

Cirrus Logic monochrome LCD controllers will also make everything from realistic scanned images to business charts look tastier.



C L O S I N G T H E G A P

©1991 Cirrus Logic, Inc., 3100 West Warren Avenue, Fremont, CA 94538 (415) 623-8300; Japan: 462-76-0601; Singapore: 65-3532122; Taiwan: 2-718-4533; West Germany: 81-52-2030/6203  
Cirrus Logic and the Cirrus Logic logo are trademarks of Cirrus Logic, Inc. All other trademarks are registered to their respective companies. \*PC Magazine, March 13, 1990, p. 204.

# NEW PRODUCTS

## INTEGRATED CIRCUITS

### Dual-Port RAMs

- Have 9-bit width
- Access times as low as 25 nsec

The first two members of this family of dual-port RAMs have configurations of  $1k \times 9$  bits (IDT70101, IDT7010, IDT70105) and  $2k \times 9$  bits (IDT70121, IDT7012, IDT7015). Speed ratings range from 25 to 55 nsec. The  $\times 9$  configuration of these devices allows designers to use the extra bit as a parity bit for error detection. In addition, the devices are true dual-port memories that include on-board arbitration logic—an arrangement that allows simultaneous access of data from both ports by multiple processors, without risk of data corruption. Another advantage is that the 25-nsec devices allow zero wait-state operation. The devices come in 48-pin DIP and

LCCs, and sidebraced 52-pin LCC and plastic leaded chip carriers. IDT70105-25P, \$21.65 (100).

**Integrated Device Technology Inc.**, Box 58015, Santa Clara, CA 95052. Phone (408) 727-6116. FAX (408) 988-3029. **Circle No. 355**

### Low-Voltage Compressor

- Operates from 2.1 to 7V
- Provides 40 dB of control

The MC33110 compressor IC contains two variable-gain circuits. One circuit is configured as an expander, and the other is configured as either a compressor or expander. Each circuit has a full-wave rectifier to provide average-value information to a variable gain cell located in either the input stage or the feedback path. A stable bandgap refer-

ence provides the necessary precision voltages and currents. Operating from a supply voltage of 2.1 to 7.0V, the compressor can compress an 80-dB dynamic range to 40 dB and re-expand it to 80 dB. The reference unity-gain level is 100 mV rms. 14-pin DIP or 14-pin SO package, \$0.82 (10,000).

**Motorola Inc.**, EL340, 2100 E Elliot Rd, Tempe, AZ 85284. Phone (602) 897-3615. **Circle No. 356**

### Video Crosspoint Array

- Has eight inputs and four outputs
- Bandwidth is 300 MHz

According to the vendor, the DG884 is the first monolithic crosspoint array to offer a 300-MHz bandwidth in an  $8 \times 4$  configuration. A digitally

# FACT:

## Parylene Coating Service Saves Manufacturing Costs

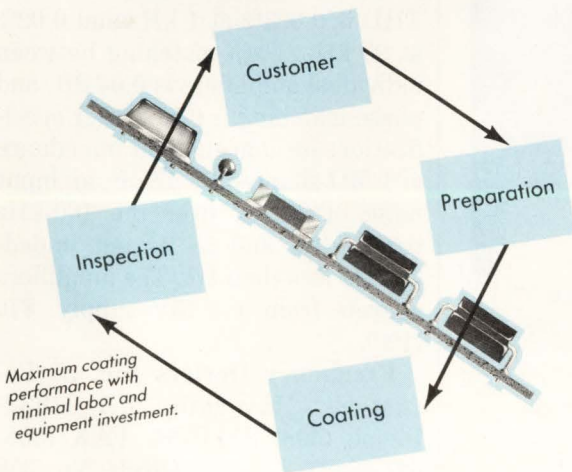

Off-site parylene coating service is your most effective and economical choice for conformal protection of circuit boards. Accomplished by practiced experts, the process eliminates concerns of contamination, pollution control and disposal. Labor, training, and costly space and capital equipment investments are also avoided.

Parylene is unmatched for conformal coating performance, meeting stringent Mil-I-46058C specifications, and preserving the repairability of costly circuits. No VOCs, environmentally safe. Nova Tran operates custom parylene coating centers in Wisconsin, Indiana, New Hampshire, California, Europe and Singapore, with application engineering services and fast turnaround. Call for more parylene facts.

**Parylene...conformal coating without compromise.**

**NOVA TRAN CORPORATION.**

100 DEPOSITION DRIVE  
CLEAR LAKE, WISCONSIN 54005  
715/263-2333/FAX 715/263-3189  
**1-800-554-1697**

CIRCLE NO. 13

UNION CARBIDE Subsidiary of Union Carbide Corporation  
Copyright ©1988 Nova Tran Corp.

selectable switching matrix is able to route any of the array's eight inputs to any of its four outputs. The use of DMOS switches connected in a T arrangement is instrumental in providing the -3-dB bandwidth of 300 MHz, and adjacent-input crosstalk of -85 dB at 5 MHz. The array also features an  $r_{DS(on)}$  resistance of

45Ω (typ) and an off-state input capacitance of 8 pF max. Extensive TTL-compatible control and two sets of on-chip latches simplify interfacing to a microprocessor data bus. The on-chip data latches also provide a readback feature to interrogate any of the switches' existing status in a network. The DG884 in

a 44-pin plastic leaded chip carrier or ceramic LCC, from \$24 (1000).

**Siliconix**, 2201 Laurelwood Rd, Santa Clara, CA 95054. Phone (800) 554-5565, ext 1900.

Circle No. 357

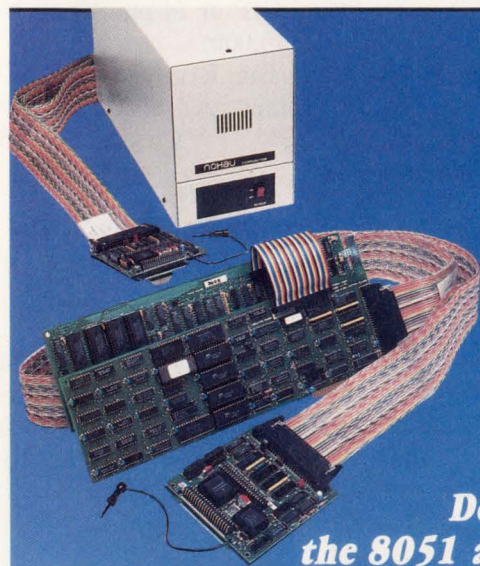

# 8051 & 68HC11

**PC-Based  
In-Circuit Emulators**

**Nohau  
Covers All Your  
Development Needs for  
the 8051 and 68HC11 Families!**

### Free Demo

You can start your debugging with this **FREE** demo simulator. You can load up to 512 bytes of code, assembler, C, or PL/M and do full debugging/simulation in assembly and source level. A great way to get started for **FREE**. Fantastic for schools! Just call and we'll send it!

### Full Simulator

The full-blown simulator is an extension of the DEMO. You can load up to 64K of code and use 64K of XDATA space. You can program an "external environment" to interact with your code to simulate your target system. The emulator is the hardware extension of the simulator!

### In-Circuit Emulation

The 24MHz real-time emulator has been the industry standard for years. With its complex breakpoint logic and advanced trace, nobody can beat it for performance. Plug-in or RS-232 configuration. All 8051 derivatives are supported!

**NOHAU**  
CORPORATION

51 E. Campbell Avenue, Campbell, CA 95008  
(408) 866-1820 • FAX (408) 378-7869

Australia (02) 654 1873, Austria (0222) 38 76 38, Benelux +31 1858-16133, Canada (514) 689-5889, Denmark (42) 65 81 11, Finland 90-452 1255, France (01)-69 41 28 01, Great Britain 0962-73 31 40, Hungary 01-137 2182, Israel (03) 48 48 32, Italy (011) 771 00 10, Korea (02) 784 784 1, New Zealand (09) 392-464, Portugal (01) 81 50 454, Sweden, Norway (040) 92 24 25, Singapore (065) 284-6077, Spain (93) 217 2340, Switzerland (01) 740 41 05, Taiwan (02) 7640215, Thailand (02) 281-9596, West Germany 08131-25083, Yugoslavia 061-57 19 49.

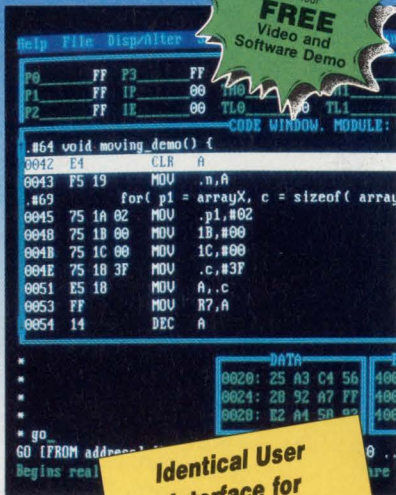

**Identical User  
Interface for  
All Three Products —  
You Can't Go Wrong!**

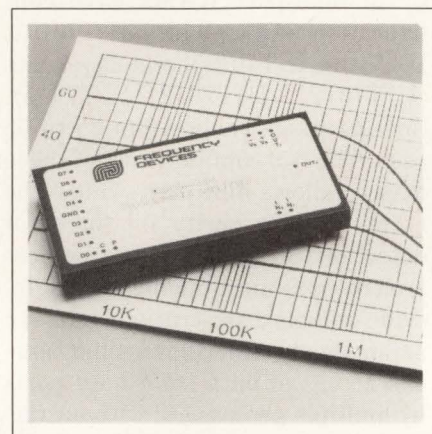

### Programmable-Gain Amplifiers

- Have 100-kHz bandwidth
- Three models available

Featuring a full-power bandwidth of 100 kHz, 830PGA programmable-gain amplifiers have a rated output of ±10V at ±10 mA. The amplifiers are available in gain ranges of 0 to 20 dB in 0.5-dB steps, 0 to 40 dB in 1.0-dB steps, and 0 to 60 dB in 2.0-dB steps. Gain selection is achieved by an 8-bit data word, a latch-strobe bit, and a transition-polarity bit, all of which are CMOS compatible. The amplifiers have a CMRR of 80 dB typ at 1 kHz and 60 dB min from 10 Hz to 100 kHz. THD is 0.003% at 1 kHz and 0.02% at 90 kHz. Gain matching between individual amplifiers is 0.04 dB, and phase matching is 0.5°. Other specifications include an input impedance of 1 MΩ shunted by 47 pF, an input noise of 20 μV over the 100-kHz bandwidth, and an output impedance of less than 1Ω. The amplifiers operate from a ±15V supply. \$70 (100).

**Frequency Devices Inc**, 25 Locust St, Haverhill, MA 01832. Phone (508) 374-0761. FAX (508) 521-1839.

Circle No. 358

# The Undercover Story On RF Performance.

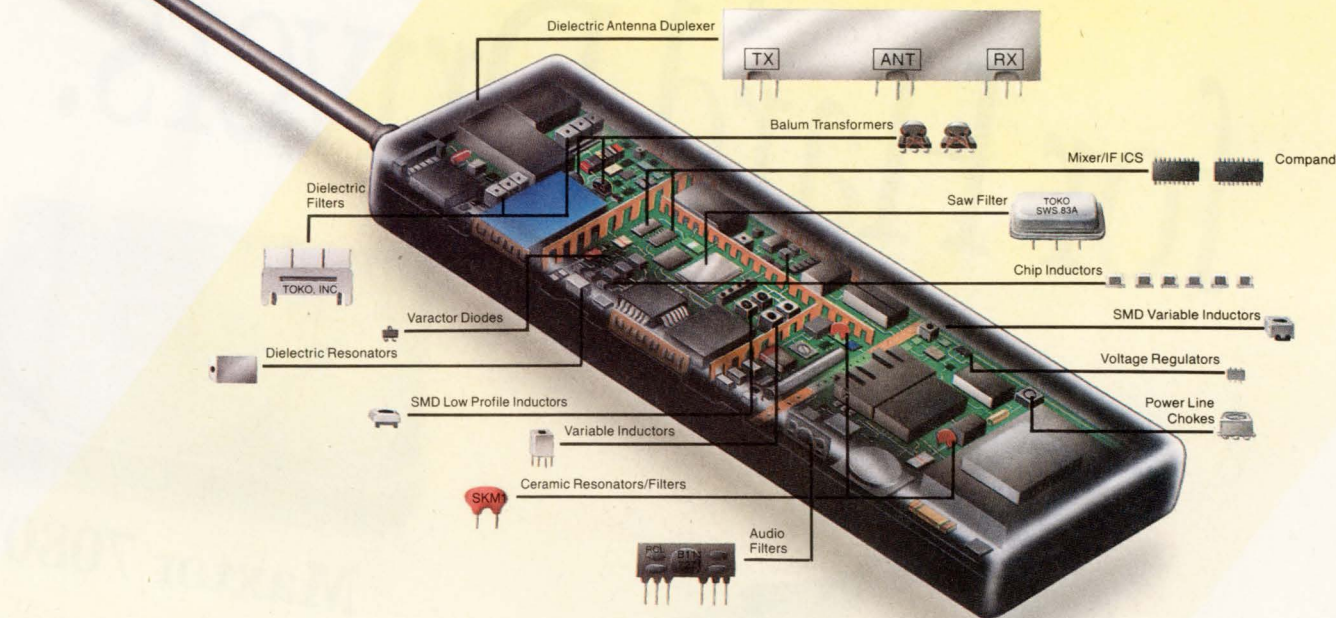

## For RF Components with the Quality and Performance Difference, the Name to Know Is Toko.

Look inside leading personal communications products, and you'll find more of Toko. From dielectric antenna duplexers to power line chokes, Toko can offer an application-specific RF solution for every stage of your design.

Our selection of RF components is the most comprehensive in the industry and includes: surface mount, fixed, variable, and molded inductors; LC, SAW, ceramic, helical and dielectric filters; Balun transformers; and communication-specific ICs.

All are designed to work together and feature low loss for exceptional performance. Tuneable or fixed construction magnetics, ceramics, hybrids, and ICs... all are available from one source: Toko.

Toko is also the world's largest manufacturer of coils and filters and one of the most vertically integrated. Our quality and reliability are unequalled; an enviable industry-low failure rate has resulted in numerous top supplier preferred classifications.

Whatever your RF/IF application—personal communications, satellite communications, computer, automotive convenience systems, or video—the name to know is Toko.

Discover the quality and performance difference Toko products can make in your RF/IF application. For more information, write Toko today, attention: RF/IF Engineering, or call the Toko location nearest you: Midwest, (708) 297-0070; East, (203) 748-6871; Southeast, (205) 772-8904; West, (408) 432-8281.

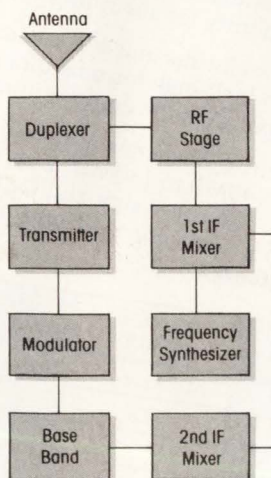

**TOKO**  
TOKO AMERICA, INC.

1250 Feehanville Drive, Mt. Prospect, IL 60056

*Your strategic partner...  
for all the right reasons.*

CIRCLE NO. 96

# Specs for Hard Drivers.



## Maxtor 7080

**Simplicity** of design makes Maxtor's Cheyenne Series inch-high 80MB 7080 disk drive the most reliable in its class. Compare Maxtor's four-head, two-platter design to Seagate's six-head, three-platter design. Fewer moving parts make Maxtor's drives inherently more dependable.

**Power** consumption is a very low 2.8 watts, making it one of the lowest in the 80MB class. The 7080 is also Novell Labs certified, and is available with either SCSI or AT interface, giving you flexibility for a winning system.

**Exceptionally** fast 17ms seek time and 32K cache buffer in the new generation inch-high form factor give Maxtor faster data throughput than the competition.

**Call** and ask about our entire Cheyenne family of disk drives with capacities from 40MB to 130MB. Don't fall for the off-the-wall claims. Give us a shot and we'll prove Maxtor specs can't be matched. **Call your nearest Authorized Maxtor Distributor.**

3.5-inch Disk Drive Spec.	Maxtor 7080A	Seagate 1102A
Seek Time	17 Msec.	19 Msec.
Standard Buffer Size	32K	8K
Form Factor	3.5" x 1"	3.5" x 1.6"
Heads-Disks	4/2	6/3
Avg. Power Consumption	2.8 watts	9 watts

**We Drive Harder.**  
**Maxtor**<sup>®</sup>

© 1991 Maxtor Corporation



**Call  
Your  
Authorized  
Maxtor  
Distributors**

**A.D.P.I.**

1-800-275-2374  
301-258-2744

**Anthem Electronics**  
408-452-2287

**Arrow Commercial Systems Group**  
1-800-323-4373

**Arrow/Klerulff**  
1-800-777-2776

**Avnet Computer**  
1-800-422-7070

**B.S.M./Business Solutions in Micro**  
1-800-888-3475  
214-699-8300

**Cal Abco**  
818-704-9100  
800-669-2226

**Compac Micro Electronics**  
1-800-426-6722  
415-656-2244

**Computer Brokers of Canada (C.B.C.)**  
416-660-1616  
604-273-1155

**CPC**  
714-757-0505  
800-582-0505

**Data Storage Marketing (D.S.M.)**  
1-800-543-6098  
303-442-4747

**Firstop Computer**  
1-800-832-4322

**Future Electronics**  
514-694-7710

**Intelect**  
011-525-255-5325

**JACO**  
214-733-4300

**Marshall Industries**  
1-800-522-0084

**Microware Distributors**  
1-800-777-2589  
503-646-4492

**Mini Micro**  
408-456-4500

**Pioneer Standard Electronics**  
1-800-874-6633

**Pioneer Technologies**  
1-800-227-1693

**S.E.D.**  
1-800-444-8962  
404-491-8962

**Tech Data**  
1-800-237-8931  
813-539-7429

**Technology Factory**  
1-800-848-2073  
1-800-227-4712

**Technology Marketing Group**  
1-800-688-7000  
612-942-7000

**U.S. Computer**  
305-477-2288

**Wyle Laboratories**  
1-800-289-9953

EDN March 1, 1991



# NEW PRODUCTS

## COMPUTERS & PERIPHERALS

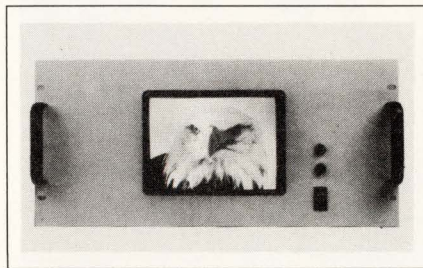

### Rack-Mount VGA Monitor

- Has a 10-in. screen with a 0.28-mm dot pitch
- Has 8.75 x 15.3-in. enclosure

The RMM-213 rack-mount, 10-in. color monitor comes in an 8.75 x 15.3-in. enclosure and is VGA compatible. It operates with computers that have an RGB analog video output and a TTL synchronization output. Its input-signal connector is a 15-pin D-shell. The CRT has a 0.28-mm dot pitch, and a short-persistence phosphor produces sharp pictures. The monitor produces 640 x 480-, 640 x 400-, and 640 x 350-pixel images. A tinted Lexan protective panel covers the screen. Front-panel controls include power on/off, brightness, and contrast. An internal switching power supply operates from 110V ac having 50- or 60-Hz line frequencies. The unit has a horizontal scan rate of 31.5 kHz ± 400 Hz and a vertical scan rate of 60 or 70 Hz. \$1095.

**Recortec Inc.**, 1290 Lawrence Station Rd, Sunnyvale, CA 94089. Phone (800) 729-7654; in CA, (408) 734-3443. FAX (408) 734-1240.

Circle No. 362

### NTDS Interface Adapter

- Contains single LLS channel for VMEbus
- Multichannel DMA controller permits full-duplex operation

The Model 10042601 VMEbus board provides a low-level-serial (LLS) Type-E interface for a Navy Tactical Defense System (NTDS). An MC68000  $\mu$ P lets you write applica-

tion software to integrate or emulate NTDS devices. The board's features include a 32k-word dual-port static RAM buffer, a 4-channel DMA controller, a 16-bit VMEbus data path, 24-bit VMEbus addressing, and programmable interrupt levels and vectors. The DMA controller permits full-duplex operation for the LLS channel. Software-controlled Abort and Interrupt features simplify LLS transaction protocols. An EPROM provides the device driver, which supplies buffer transfers, interrupt control, asynchronous data transactions, data and command detection, and configuration commands. The device driver also lets you use high-level languages, such as C, Fortran, or Ada, to control operations. \$4975.

**Get Engineering Corp.**, 9350 Bond Ave, El Cajon, CA 92021. Phone (619) 443-8295. FAX (619) 443-8613.

Circle No. 363

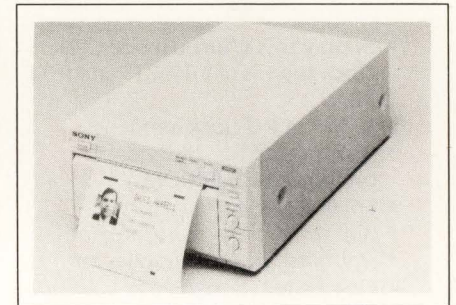

### Video Printers

- Include one color and two b/w models
- Produces peel-off adhesive-backed prints

The UP-910 b/w printer, one of three video-printer models, produces prints as large as 6 x 8 in. It produces 128 levels of gray and a maximum resolution of 750 x 508 dots. It takes 25 sec to produce a print, and it operates on EIA or CCIR b/w video standards. The UP-610 b/w sticker printer produces 2 1/8 x 3 1/2-in. prints. The unit

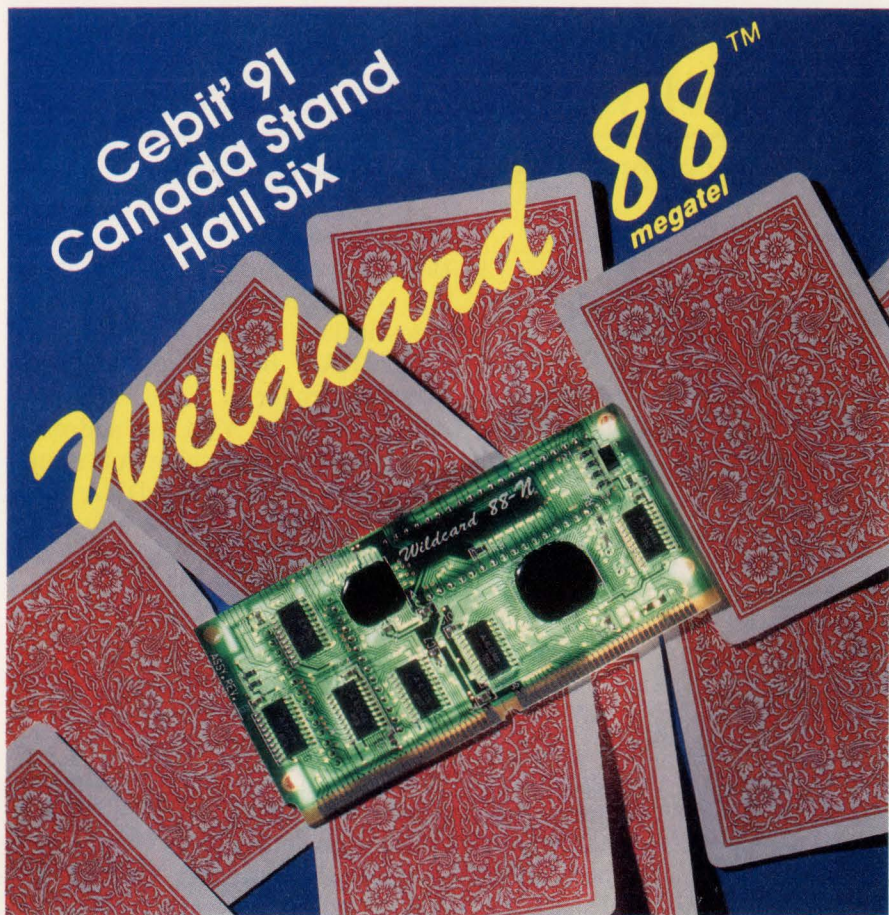

## Count yourself in with the Wildcard 88™

- Supports XT Turbo mode CPU clock speeds of 4.77, 7.15 and 9.54 MHz
- 10 MHz CPU clock frequency
- Supports up to 32K Bytes of onboard BIOS EPROM
- Small 2" x 4" form factor
- Bios available for easy integration
- Onboard DRAM controller for easy system design
- Onboard bus controller supports XT I/O channel
- Supports 8087 co-processor operation (with socket) for high speed numeric data processing
- Reduces XT parts count by 75%
- Supports up to 640K of system DRAM
- Onboard sound generator supports speaker control
- Improves total system reliability
- Reduces overall system costs and factory overhead
- Onboard Keyboard Controller card the size of a business card. For more information call us today.

**Magatel is expanding the Wildcard family to offer you more development flexibility.**

The Wildcard family offers the lowest cost, smallest footprint solution for your XT class system. It integrates all functions of the IBM PC, XT® motherboard minus DRAM and DRAM drivers. All on a circuit

**Megatel Computer Corporation**  
125 Wendell Ave., Toronto, Ontario M9N 3K9  
(416) 245-3324  
FAX (416) 245-6505

Wildcard 88™ is a trademark of Megatel Computer Corp. IBM PC, XT are registered trademarks of IBM Corp.

# — megatel —

CIRCLE NO. 34

## COMPUTERS & PERIPHERALS

produces peel-off, adhesive-backed prints. A typical application is the labeling of parts with a video photo; this application augments barcoding methods that are used to identify and control inventory. The UP-3000 color printer produces 500-line resolution prints. It produces 256 colors from a palette of more than 16 million colors/pixel. A wide-scan mode produces prints as large as 4<sup>3</sup>/<sub>8</sub> x 3<sup>1</sup>/<sub>4</sub> in. UP-610, \$2000; UP-910, \$2150; UP-3000, \$3895.

Sony Security Systems, 3 Paragon Dr, Montvale, NJ 07645. Phone (201) 358-4954. FAX (201) 358-4927.

Circle No. 364

### SCSI Supervisor

- Lets you remove devices while system is operating
- Runs 17 diagnostic tests on individual drives

The SSM6 SCSI Manager equips a SCSI-drive enclosure with a variety of supervisory functions. It lets you remove a SCSI disk, tape, or optical drive while the host system is operating, or "hot." The unit maintains the integrity of the SCSI bus so that removal or installation of a device in an active system doesn't affect ongoing operations. Because the unit can essentially isolate an attached device, it can also perform the following functions: change SCSI ID numbers; copy data from one device to another; compare contents in different devices; power individual devices up and down; format drives; run as many as 17 diagnostic tests on individual drives; and reset the SCSI bus. You can operate the unit from a front-panel keyboard and LCD or from a system terminal. A terminal connects to the unit via a serial port. The SSM6 adds approximately \$1500 to the price of a drive enclosure (OEM qty).

Sigma Information Systems, 3401 E La Palma Ave, Anaheim, CA 92806. Phone (714) 630-6553.

Circle No. 365

# EPSON

THE CRYSTALMASTER™

leads new  
crystal oscillator  
technologies into  
the 90's with...

the most cost effective hi-temp  
SMD crystals and oscillators and  
low cost plastic thru-hole crystal  
oscillators.

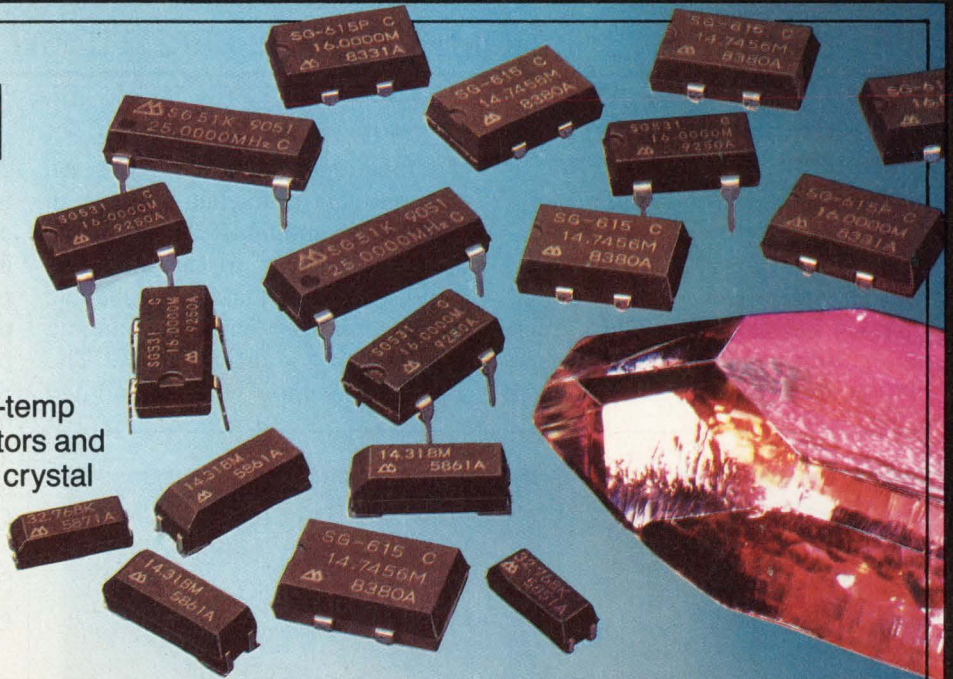

## EPSON SURFACE MOUNT CRYSTALS AND OSCILLATORS

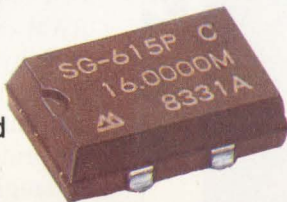
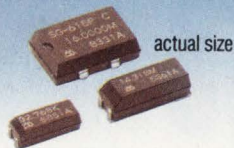

Epson has pioneered the first truly heat resistant crystal for use in its surface mount crystals and crystal oscillators. Capable of withstanding 260°C for 20 seconds... far above the demands of standard IR and vapor phase reflow processing systems... these labor-saving high-temp SMD crystals have become the accepted standard for surface mount crystal and oscillator components.

**MODEL SG-615 OSCILLATOR**  
Frequency: 1.5 to 66.7 MHz  
Symmetry: 45/55 (TYP)  
Rise/Fall Time: 5 nsec (TYP)  
Tristate: Available  
Compatible Technology: CMOS and TTL  
Op. Temp. Range: -40°C to 85°C

**MODEL MA 505/506 CRYSTAL**  
Frequency: 4.00 to 66.7 MHz  
**MODEL MC-405 CRYSTAL**  
Frequency: 32.768 KHz

**EPSON®** EPSON AMERICA, INC.  
Component Sales Department Telephone: 213/787-6300

## EPSON THRU-HOLE OSCILLATORS REPLACE METAL CAN OSCILLATORS

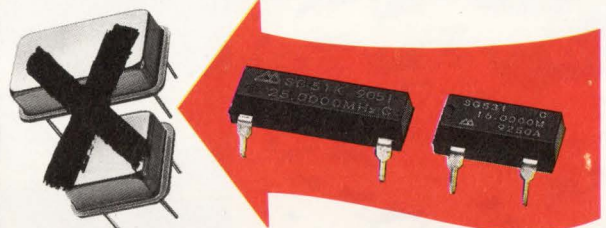

Epson has introduced the first plastic low cost, high performance auto-insertable thru-hole crystal oscillator. Its unique hermetically sealed crystal, embedded in a plastic package, gives the same EMI protection and higher performance than metal can oscillators... at a much lower cost. And, the auto-insertion feature reduces manufacturing costs associated with hand inserting metal cans... into standard full-size or half-size hole patterns.



**MODEL SG-51/SG-531  
OSCILLATOR**

Frequency: 1.5 to 66.7 MHz  
Symmetry: 45/55 (TYP)  
Rise/Fall Time: 5 nsec (TYP)  
Tristate: Available  
Compatible Technology: CMOS and TTL

**EPSON®** EPSON AMERICA, INC.  
Component Sales Department Telephone: 213/787-6300

### CALL YOUR SALES REP TODAY

EPSON Sales Representatives: AL-GA-TN Concord Components 205/772-8883 • AZ-NM Fred Board Assoc. 602/994-9388 • CA-No. Costar 408/446-9339 • CA-So. Bager Electronics 714/957-3367 • CO-UT Wn. Region Mktg. 303/428-8088 • FL Dyne-A-Mark 407/831-2822 • IL-WI LTD Technologies 708/773-2900 • IN-KY C C Electro 317/921-5000 • KS-MO-IA Microtronics 913/262-1444 • MA-NH-CT Rosen Assoc. 617/449-4700 • MD-VA Tech Sales Assoc. 301/461-7802 • MN Electro Mark 612/944-5850 • NC-SC WLA Assoc. 919/231-9939 • NJ JMR Sales 201/525-8000 • NY Elcom Sales 716/385-1400 • Metro, NY Niktronix 516/929-4671 • OH-MI J. D. Babb Assoc. 216/934-4454 • OR-WA Matrix 503/245-8080 • PA Omega Sales 215/244-4000 • TX-OK Component Tech. 214/783-8831 9101

**Rack-Mount Industrial Computer**

- Uses 80386 and optional 80486 module
- Has FCC Class A, UL, and CSA approval

The Selectable Performance rack-mount industrial computer is compatible with the IBM PC/AT. It has

a 25-MHz 80386  $\mu$ P and supports the functions of an 80486  $\mu$ P. An optional plug-in module contains an 80486  $\mu$ P running at 25, 33, or 50 MHz. According to the manufacturer, you can install the module in five minutes without changing the existing configuration. The computer comes with a modified

Award BIOS that runs the 386 or 486 CPU without modifications. Its features include 1M to 16M bytes of 32-bit memory, support for a numeric coprocessor, two RS-232C ports, one 8-bit and seven 16-bit expansion slots, a parallel-printer port, and a game port. A 16-bit SCSI controller permits data-transfer rates as fast as 10M bytes/sec. The computer meets the requirements for FCC Class A, UL, and CSA approval. \$6995.

VGS, 12165 Branford St, Unit Q, Sun Valley, CA 91604. Phone (818) 834-2852. FAX (818) 834-2854.

Circle No. 366

UNPARALLELED  
RELIABILITY

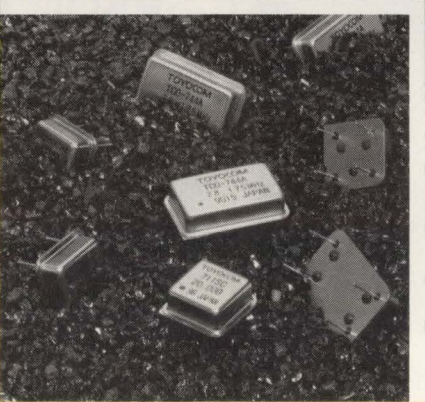

From the first discussion about your specs, through prototype design, testing, fine tuning and full-scale production, Toyocom is devoted to developing a completely reliable solution for your computer application – one that delivers maximum performance at a minimal price.

Our crystal clock oscillators offer performance you would typically associate with customization, at standard prices. Our TCO-700 series performs to the most exacting specs:

- TTL output levels to 100 MHz.
- CMOS output levels to 70 MHz.
- Full (14-pin) and half-size (8-pin) models.
- Tri-state output feature.

Let us develop a reliable solution for your computer applications. Contact TOYOCOM, 617 E. Golf Road, Arlington Heights, IL 60005.

Phone Toll-Free today **1-800-TOYOCOM.**

**TOYOCOM**  
TIMING IS EVERYTHING

CIRCLE NO. 9

**Dual-Port DSP Board**

- Uses 33-MHz TMS320C30 chip for the ISA bus
- Provides 512k bytes of static RAM and two RS-232C ports

The C30 DSP board for the ISA bus uses a 33-MHz TMS320C30 DSP chip and 512k bytes of static RAM (SRAM) that's expandable to 768k bytes. It also has two RS-232C ports, a DSP-Link parallel-expansion interface, and a reserved area for prototyping additional circuitry. A daughter board uses 64k byte dynamic RAMs (DRAMs) to expand the memory to the DSP chip's address capability of 16M words. Bank interleaving achieves one- to three-wait-state access times. Another daughter board contains as much as 1.28M bytes of SRAM with zero-wait-state access time. The memory is divided into five banks of 64k x 32 bits each. C30, \$3795; development package with TI's assembler-linker, TI's C compiler, and Spox operating system, \$5995; 256k-byte SRAM daughter board, \$595; 1M-word DRAM daughter board, \$2495.

**Spectrum Signal Processing Inc**, 3700 Gilmore Way, Suite 301, Burnaby, BC Canada V5G 4M1. Phone (800) 663-8986; in BC, (604) 438-7266. FAX (604) 438-3046.

Circle No. 367

# ***MEASURE LEADTIMES IN HOURS, NOT DAYS!***

***At Digi-Key, more than 99 percent of  
all orders are shipped within 24 hours!***

***For all your electronic component needs and  
free catalog, call toll free: 1-800-344-4539***



***Digi-Key***  
CORPORATION

701 Brooks Avenue South  
Thief River Falls, MN 56701

Toll-Free: 800-344-4539, FAX: 218-681-3380

# NEW PRODUCTS

## CAE & SOFTWARE DEVELOPMENT TOOLS

### Ada Editor And Tool Set For X-Window System

- *Syntax-directed editor assists Ada programming*
- *Direct access to text of Language Reference Manual*

Release 3.0 of the Keyone syntax-directed editor and design tool set

runs under the X-Window system and assists in the design, development, and documentation phases of Ada software projects. The editor displays Ada language control structures; access to the text of an integrated Language Reference Manual (LRM) is possible at any

time during an editing session. Language templates assist the user in selecting language constructs, and the editor's syntax analysis reduces the number of errors encountered during later compilation. The new release is available under the X-Window system on Hewlett-Packard, Sun, IBM RISC, and DEC workstations, and on IBM PS/2 computers. On Sun workstations, it is also available under Sunview and Openlook. From \$900 for PC systems to \$18,000 for large DEC VAX networked systems.

**Ada Technology Group Inc.**, 1900 L St NW, Suite 500, Washington, DC 20036. Phone (202) 296-1321. **Circle No. 376**

I G B T

## BUILT TO SURVIVE EASY TO USE

**Performance Proven Tough**

- Square Switching SOA Minimizes "Snubber" Cost
- Testing Proves That Powerex IGBT The Toughest On The Market
- Lower Overall System Design and Manufacturing Costs
- Voltage Drive Reduces Design And Manufacturing Costs

- Maximum Short Circuit Capability Insures "Latch Free" Operation
- The Best VCE(sat) Switching Loss Trade-Off
- Reduces Operating Power Losses
- 15-20 KHz/600A-1200V
- Higher Efficiency
- The Newest Technology Available

- Faster Switching
- Smaller Packaging

A continuing investment for the advanced products of tomorrow.

Joint Venture Corporation of Westinghouse, General Electric, and Mitsubishi Electric

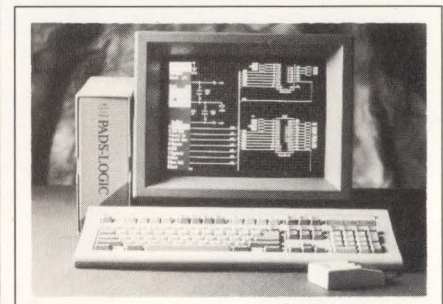

### Schematic-Capture Software

- *Runs on PCs*
- *Provides quick access to design information*

Version 2.0 of Pads-Logic schematic-capture software has the advantage of a multisheet database; it holds all design information in memory and it provides the quick response time of a single-sheet database. Enhancements in the new version include library browsing of graphical symbols and parts, a new graphics driver for additional graphics cards (including Metheus and Elsa cards), interfaces to laser printers and Post Script devices, and improved transfer of data to Pspice and Aldec's Susie Simulator. \$450.

**CAD Software Inc.**, 119 Russell St, Suite 6, Littleton, MA 01460. Phone (508) 486-9521. FAX (508) 486-8217. **Circle No. 377**

# ISS. We've driven a stake through the DRC vampire

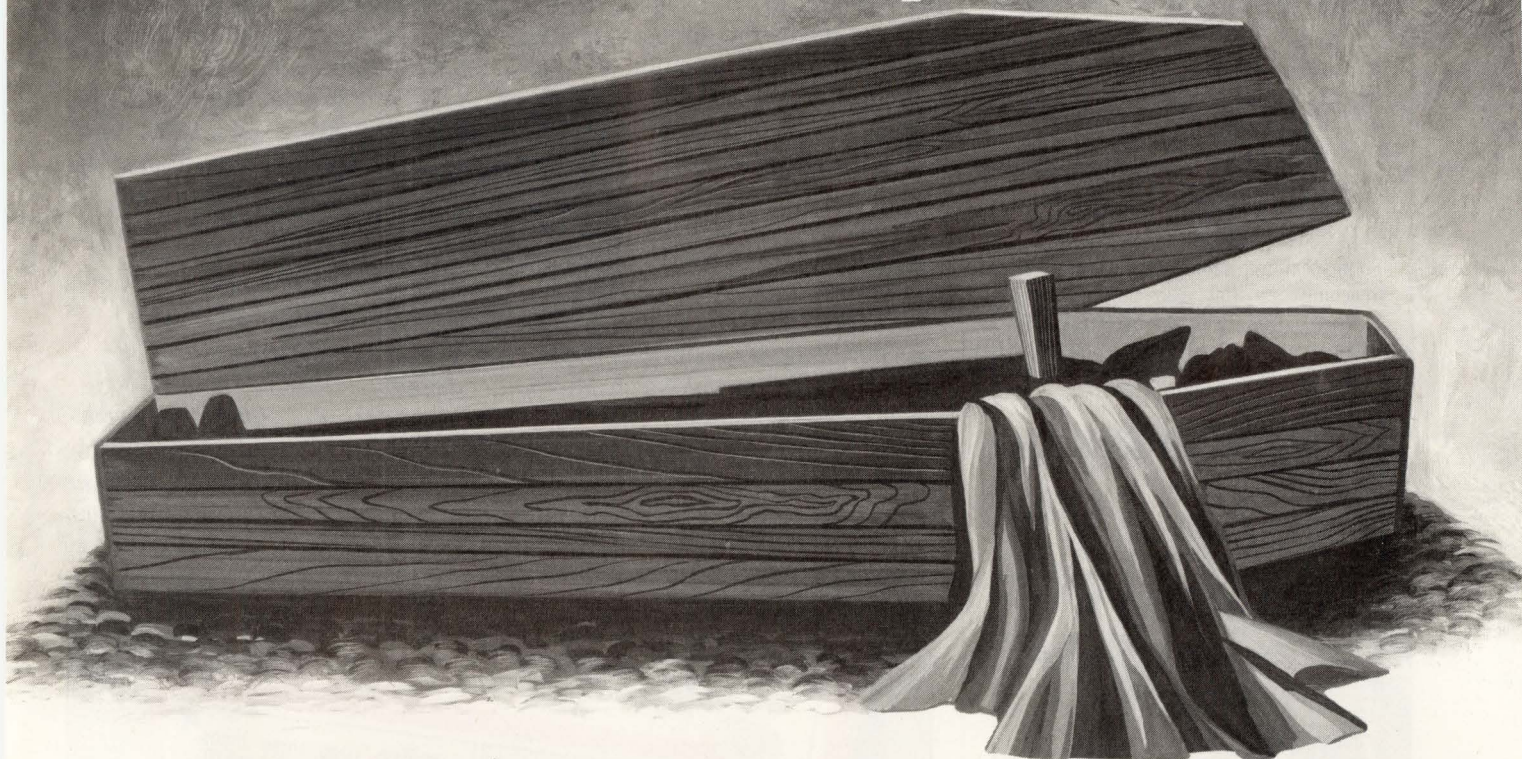

Don't let DRACULA™ hypnotize you into a dark corner. Before you choose a design rules checker, let ISS shed some light on the subject. We have DRC software in our design toolkit that's worth evaluating...

It's called LRC-2000™, and it's a true hierarchical design rules checker.

LRC-2000 is much faster than the vampire. And we pack it with more functionality—like reduced false errors, parallel processing, and a one-for-one conversion of DRACULA run sets.

With all these improvements over the DRC vampire, you might think our DRC costs more. The truth is you can buy ISS's DRC

package for much less. We won't bleed you dry.

So why not exorcise *your* vampire and try ISS's LRC-2000 free for 30 days. Install it on the workstation of your choice, or visit one of our sales offices for a demonstration.

You'll feel alive again!  
Call us toll free at—  
**1-800-4-CAD-LTL**

**ISS** *Integrated Silicon Systems, Inc.*  
*ISS. The IC CAD company that listens.*



CIRCLE NO. 100

P.O. Box 13665, Research Triangle Park, NC 27709 Phone: 919/361-5814 Fax: 361-2019  
Silicon Valley: 408/562-6154 S. California: 714/891-0203 Texas: 512/452-5814

# Slam chips

And everything in between.

When you need a creative solution for a packaging, size or interconnect problem, talk to the people with the most on the ball.

Pacific Hybrid Microelectronics.

We're experts in all facets of hybrid and surface-mount technology, no matter how exotic. If your application calls for a swizzle stick, single layer metalized chip, green tape, 2 mil spacing, combination or high-density pinhead solution, we can handle it.

Quickly, reliably, and economically.

So the next time a tough problem has you reaching for a drink, reach for the phone instead. And call PHM at 1-800-622-5574.

10575 SW Cascade Blvd. Portland, OR 97223  
(503) 684-5657 FAX (503) 620-8051



**PH** PACIFIC HYBRID  
**HM** MICROELECTRONICS

**We do small miracles.**

Copyright © 1990 Pacific Hybrid Microelectronics

CIRCLE NO. 16

## CAE & SOFTWARE DEVELOPMENT TOOLS

### Modeling Software For Mixed-Mode Designs

- Works with OrCAD/SDT III schematic capture
- Allows designing functions in block-diagram form

OOTM (Object-Oriented Transcendental Modeling) uses Orspice and OrCAD/SDT III to enhance the behavioral-modeling option available with Pspice. You can use it to graphically describe blocks of circuitry; you define block functions and link those definitions to icons. Using the OrCAD netlist, Orspice then matches each icon with the representative circuit netlist to generate a complete simulation file automatically. You can then evaluate your block diagram with the behavioral modeling option in MicroSim's Pspice simulation software by using "Probe" to display or print any voltage or current waveform. After completing your conceptual

design, you can substitute actual subcircuits for the conceptual blocks one at a time. The software runs on IBM PCs and compatible computers with floating-point processors. From \$2785 for a minimum DOS-only package (OrCAD/SDT III, Pspice/Probe with behavioral-modeling option, Orspice with Basic and OOTMs) to \$5540 for OS/2 and DOS/16M versions.

**NW Silicon Specialists Inc.**, 2700 NW 185th Ave, Suite 1200, Portland, OR 97229. Phone (503) 645-8297.

Circle No. 378

### Linker/Compressor For DOS Program Files

- Shrinks .EXE files as much as 50%
  - Runs fast and saves disk space
- Optlink/Compress 2.50, an upgrade version of a linker that produces compressed DOS program files,

**Q.** What is the world's most popular solution for modem and fax testing?

**A.** Drop three times from a height of 10'

**A.** Transfer files to all your friends

**A.** Build some kind of test gizmo

**A.** Buy the TAS 100



**You Gussed It!** TAS 100 Series Telephone Network Simulators provide full-featured modem and fax testing in a compact, easy-to-use package.

- Complete, bi-directional simulation of transmission impairments for thorough testing
- Fully automatic emulation of worldwide central office (exchange) formats

- Compatible with U.S., international, and major manufacturer standards
- Works with the TAS Gemini dual data analyzer and TASKIT software to provide completely automatic modem performance evaluation.



**TAS 100: Field-Proven Advanced Technology for Modem and Fax Testing**

Telecom Analysis Systems, Inc.

34 Industrial Way East, Eatontown, NJ, 07724-9917 • (908) 544-8700 • FAX (908) 544-8347

CIRCLE NO. 26



**EXPERIENCE THE FUTURE  
IN CAE/CAD**



# 2000 PADS

**2000** PADS is a Personal Computer based Printed Circuit board design system with many advanced features capable of outperforming most Workstation-based CAD systems—*at a fraction of the cost.*

As the most productive PC based board CAD system available today, PADS-2000 can handle even the most complex designs including: double sided surface mount boards, mixed technology boards, high speed designs and layouts exceeding 2000 IC's.

PADS-2000 design functionality includes:

- Over 11,000 parts/32,000 connections
- 1 micron Resolution
- True T-Routing capability

- Intelligent Copper Pour feature leaving isolated tracks and pads
- 0.1° parts/pads rotation
- Extensive Macro capability
- Digital, Analog and Critical Circuit autorouters

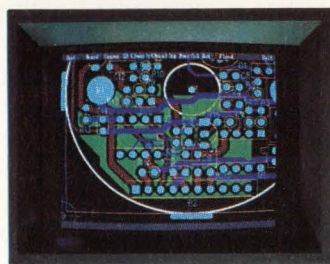

- On-line and Batch Design Rule Checking
- Instant track/segment length measurement
- Complete Forward/Backward ECO capability
- Uses 32 bit/386 native code for increased speed and functionality
- Easy-to-learn and Easy-to-use

Call today for a demonstration at your local authorized CAD Software Dealer.

*Ask about our affordable Leasing Plan.*

Call Today  
Inside MA:  
**(508) 486-8929**  
Outside MA:  
**(800) 255-7814**

**CAD**  
Software, Inc.  
119 Russell Street  
Littleton, MA 01460

# PICO POWER transformers & inductors

**PLUG-IN  
SURFACE MOUNT  
AXIAL INDUCTORS  
TOROIDAL  
INSULATED LEADS**

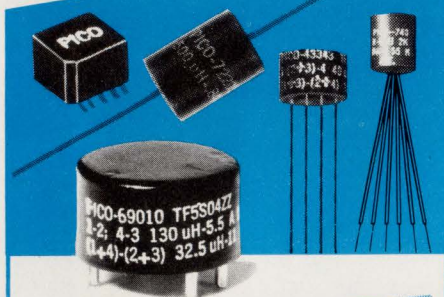

## TRANSFORMERS

QPL standards available MIL-T-27/96-01; 97-01 and 02; 103-1 thru 16; 172-1 thru 50; 277-01; 290-01; 357-1 thru 114; 358-1 thru 123; 359-1 thru 147.

- Audio Transformers ranging in size from 1/4" x 1/4" to 3/4" x 1 1/8". 20 Hz to 250 KHz. Up to 3 watts.
- Pulse Transformers .05μSEC to 100μSEC miniaturized construction.
- Ultra-miniature DC-DC Converter Transformers. 40 watts.
- Miniaturized Switchmode Inverter Transformers. 60 watts.
- 400 Hz Power Transformers. Primary voltages of 115V or 26V. Plug-in construction. Ultra-miniature
- Microphone/Transducer Audio Input.
- MIL-STD-1553 Interface Multiplex Data BUS Pulse Transformers.

## POWER INDUCTORS

QPL standards available MIL-T-27/356-1 thru 63

- Temperature range -55°C +130°C
- All units are magnetically shielded
- Inductance values to 20mH with DC currents to 23 amps
- Split windings

**PICO  
Electronics, Inc.**  
453 N. MacQuesten Pkwy. Mt. Vernon, N.Y. 10552

Call Toll Free **800-431-1064**  
IN NEW YORK CALL **914-699-5514**  
FAX **914-699-5565**

See EEM or  
THOMAS REGISTER  
or send direct for  
FREE PICO Catalog

CIRCLE NO. 17

## CAE & SOFTWARE DEVELOPMENT TOOLS

saves as much as 50% of file space. According to the supplier, it runs at least four times faster than Microsoft's Link. Each compressed .EXE file produced by the program contains an embedded decompression routine that requires less than 1k byte of extra memory. When you run the .EXE file, the decompression routine takes control and expands the compressed program back to its original form. Package for new buyers, \$250; users' upgrade, \$29.95.

SLR Systems, 1622 N Main St, Butler, PA 16001. Phone (412) 282-0864. FAX (412) 282-7965.

Circle No. 379

those of other vendors. It allows designers to create complex schematics for pc-board, PLD, and ASIC designs. Options include EDIF 2 0 0 translators, which allow the translation of complete schematics to workstations from Mentor Graphics, Cadence, and Valid. Other options allow translation to and from the Computervision CADDstation and the Intergraph EDA system. \$995.

Phase Three Logic Inc, 1600 NW 167th Pl, Beaverton, OR 97006. Phone (503) 645-0313.

Circle No. 380

## Development-Tool Package

- Allows programming in C for DSP
- Provides workstation functions on IBM PC

A new release of the Intertools software-development package helps embedded-systems designers develop applications for Motorola's DSP96002 on an IBM PC. It includes an optimizing C cross-compiler, a Motorola-compatible macro assembler, utility programs (runtime library routines, formatter, linking-locator, ROM processor, global symbol mapper, symbol list utility and librarian) and XDB, a source-level cross-debugger. This version offers the convenience of programming in C as well as taking advantage of the 96002's unique architecture. The C cross-compiler features optimization techniques that include instruction scheduling and coalescing, lifetime analysis, and C loop construct analysis. The package also provides hand-coding of critical routines through in-line assembler routines or through the use of the Motorola-compatible assembler. Compiler, \$1350; assembler, \$1100; debugger, \$2000.

Intermetrics Microsystems Software Inc, 733 Concord Ave, Cambridge, MA 02138. Phone (800) 356-3594; in MA, (617) 661-0072. FAX (617) 828-2843. Circle No. 381

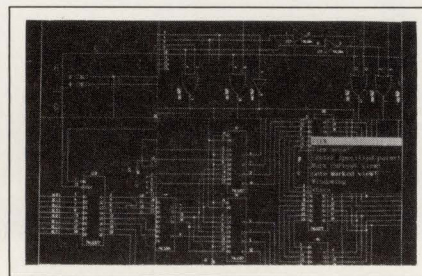

## Schematic Design

- Front-end schematic-design tools for ASICs, and PLDs
- Costs less than \$1000

Capfast, a schematic-design and interface package for Sun workstations, has a hierarchical multipage schematic editor, an on-line electrical rules checker, an interactive simulation grapher, a parts library, an intelligent packager, a symbol-creation editor, and interfaces for Spice, Hilo, Susie, Actel, Xilinx, and popular pc-board design packages. The Sun version is compatible with a PC version, so users can transfer schematics between the two types of computers without modifying their designs. The Sun version runs on all Sun models, color and monochrome, and comes with a year of free support. The package features ASCII file formats and open databases, allowing designers to integrate Capfast tools with their own applications and

# THE FASTEST, CHEAPEST, EASIEST ARRAY OF GATE ARRAYS.



When it comes to logic devices, no one offers you a wider array of programmable gate arrays than Xilinx.

With toggle rates of up to 100 MHz and densities up to 9,000 gates, Xilinx Field Programmable Gate Arrays offer you the speed you need.

And if that isn't enough, we'll soon be offering even higher speeds and greater gate densities.

All at a fraction of the cost of anything else in the industry.

What's more, our new

Automated Design Implementation and Design Manager software run on PCs and the most popular engineering workstations. So no matter what your platform, you'll benefit from the easiest interface in the industry.

Which means your turn-around time on design revs will be measured in hours, not months. And non-recurring engineering charges will simply be non-existent.

No matter what application you're developing, there's a Xilinx

Field Programmable Gate Array that will make your design faster, cheaper and easier than ever before.

Call 1-800-255-7778 or, if you're working in California, call 408-559-7778. And we'll send you a free copy of the FPGA fact book. It's an objective look at the key reasons why FPGAs should be in your next design.



**XILINX**  
The Programmable  
Gate Array Company.<sup>SM</sup>

# NEW PRODUCTS

## COMPONENTS & POWER SUPPLIES

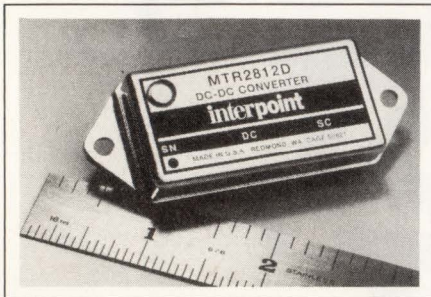

### DC/DC Converters

- Output 30W
- Offer single or dual outputs

Housed in a package that requires only 2.4 in.<sup>2</sup> of board space, MTR Series dc/dc converters output 30W. They operate from inputs of 16 to 40V and feature single or dual outputs of 5, 12, 15,  $\pm 12$ , and  $\pm 15$ V. Efficiency ratings equal 80% min, and typical line and load regulation measures 0.1%. In single-output models, remote sensing controls the converter output based

on the voltage levels at the load. Soft start and synchronization features are standard on all models. The converters are housed in hermetically sealed metal cases and offer full power operation from  $-55$  to  $+125^{\circ}\text{C}$ . Working in combination with the manufacturer's EMI filters, the converters comply with MIL-STD-461's CEO3 noise limits and MIL-STD-704's CS06 transient suppression standards. \$362 (100).

**Interpoint Corp.**, Box 97005, Redmond, WA 98073. Phone (206) 882-3100. FAX (206) 882-1990.

Circle No. 372

### Multiturn Trimmers

- Have a 200-cycle rotational life
  - Resistance values range to 2 M $\Omega$
- Model 3224 trimmers are 4-mm 11-turn trimmers that are sealed for compatibility with all surface-

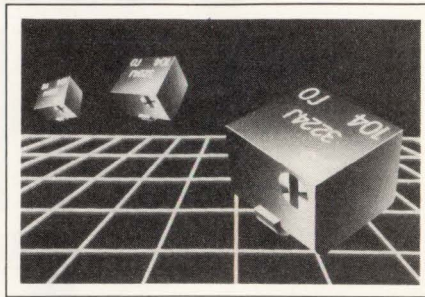

mount placement, soldering, and cleaning processes. The units have a rotational life of 200 cycles and are available with resistance values ranging from 10 $\Omega$  to 2 M $\Omega$ . Contact resistance variation equals 1%, temperature coefficient measures 100 ppm/ $^{\circ}\text{C}$ , and resistance tolerance equals 10%. Constructed of high-temperature plastic material, the units can be wave or reflow soldered. Also, they will survive cleaning systems that rely on aqueous or semiaqueous high-pressure wash

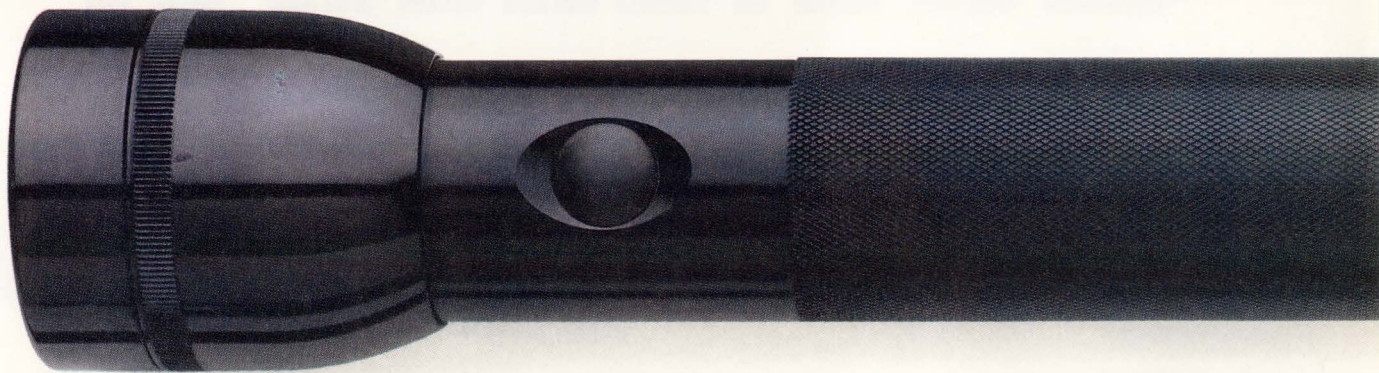

# Make your big ideas smaller, lighter and brighter.

**DURACELL<sup>®</sup> XL<sup>™</sup> DL123A Lithium Batteries give you the power to think small, improve performance and portability.**

Today's emphasis on smaller, lighter, more powerful portable devices requires a bright idea in battery technology. It's here.

Size for size, the DL123A delivers more combined power and energy than other consumer replaceable batteries. In fact, for high current applications, this compact 3-volt lithium battery delivers up to four times more energy than a 1.5-volt AA size battery — even more at low temperatures.

and solvent techniques. The trimmers feature a smooth-top surface and a flush side-adjustment screw. The trimmers are supplied on 12-mm-wide tape; the 7-in. reel has 500 pieces, and the 13-in. reel houses 3000 units. \$1.98 (1000). Delivery, eight weeks ARO.

**Bourns Inc.**, 1200 Columbia Ave, Riverside, CA 92507. Phone (714) 781-5071. TLX 676423.

**Circle No. 373**

### SIP Sockets

- Feature solderless termination
- Stackable side-to-side

These SIP sockets feature compliant pins, which permit solderless termination of components to backplanes and pc boards. The socket contacts feature posts that accommodate the standard plated-through-hole tolerance of 0.040 in.

The units have a 0.213-in.-high profile and are constructed of high-temperature-tolerant plastic. They feature a 0.025- to 0.03-in. standoff that facilitates board cleaning. The units are available with 6, 8, 10, or 12 positions and are end-to-end and side-to-side stackable. The units are compatible with robotic placement systems. \$0.05 to \$0.08/contact position.

**AMP Inc.**, Box 3608, Harrisburg, PA 17105. Phone (800) 522-6752.

**Circle No. 374**

### Subminiature Connectors

- Offer 78-position capacity
- Available in plug and receptacle versions

These high-density D subminiature connectors are available in board- and cable-mount versions. The board-mount units are available in

15-, 26-, 44-, and 62-position receptacles and 78-position plug and receptacle designs. The cable mount line includes a 15-position receptacle, a 62-pin plug, and 78-pin plug and receptacle designs. All units feature 30- $\mu$ m. gold plating on the contact area. All female contacts are protected by a closed-funnel entry design, which eliminates stubbing during mating. Board-mount units include a lock feature that reduces connector-assembly time. The connectors have a metal front shell and are available with female screw locks or threaded inserts. The connectors come in 15- to 78-position board-mount receptacles. \$1.41 to \$6.40 (10,000). Delivery, six to eight weeks ARO.

**ITT Cannon**, Components Div, 1851 Deere Ave, Santa Ana, CA 92705. Phone (714) 261-5300.

**Circle No. 375**

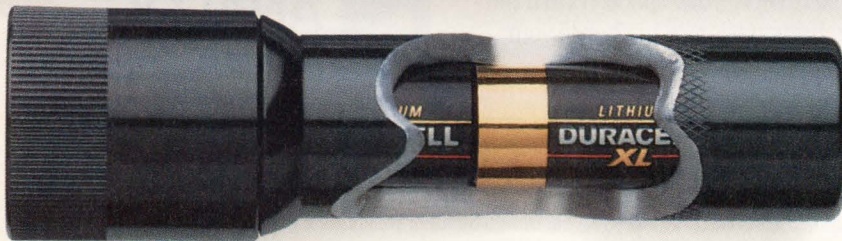

*DURACELL XL Lithium Batteries are engineered for single or multicell applications. They're made in the USA and distributed worldwide under the brand name consumers prefer most, DURACELL.*

*Find out what Duracell's latest high power technology can do for your bright ideas. Write or call for our updated DL123A Performance Portfolio. Or if you have an immediate need, contact our OEM battery engineers today.*



**DURACELL INC.**

### **DURACELL INC.**

New Products and  
Technology Division  
OEM Sales and Marketing  
Berkshire Industrial Park  
Bethel, CT 06801  
Toll-free: 1-800-422-9001 ext. 426  
Facsimile: 203-791-3273

©1989, Duracell Inc.

CIRCLE NO. 33

# Here's where the barricades start to come down in the mixed signal revolution.

## North American Locations & Dates

Cedar Rapids, IA March 18	Saddlebrook, NJ April 2	Woodland Hills, CA April 11	Toronto, Canada May 13	Bloomington, MN May 22
Cleveland, OH March 19	Westchester, NY April 3	San Diego, CA April 12	Santa Clara, CA May 14	Houston, TX May 23
Pittsburgh, PA March 20	Smithtown, NY April 4	McLean, VA May 6	Pleasanton, CA May 15	Dallas, TX May 24
Atlanta, GA March 25	Cromwell, CT April 5	Baltimore, MD May 7	Bellevue, WA May 16	Phoenix, AZ May 28
Clearwater, FL March 26	Santa Clara, CA April 8	Cherry Hill, NJ May 8	Beaverton, OR May 17	Denver, CO May 29
Orlando, FL March 27	Costa Mesa, CA April 9	Fort Washington, PA May 9	Woburn, MA May 20	Arlington Heights, IL May 30
Huntsville, AL March 28	Los Angeles, CA April 10	Raleigh, NC May 10	Montreal, Canada May 21	Rochester, NY May 31
Waltham, MA April 1				

Also at 24 locations in Europe and the Far East.



With the revolution in mixed signal technology, digital designers now need to know about analog. And the analog guys can no longer turn their backs on digital.

Mixed signal technology is the only way to smash the barriers to higher levels of system integration, better performance, and faster time to market. And it accomplishes these difficult tasks by combining both signals on a single chip.

Which is why designers from both camps should attend our Mixed Signal Design Seminar. A comprehensive full-day tutorial that covers everything from digital signal processing and sampled data systems to sigma delta converters, techniques for building a better board, and much more.

The mixed signal revolution has started, so make sure nothing stops you from attending this seminar. To reserve your space, return the coupon. For more information or to charge your

ticket, call (617) 937-1430 or (800) 262-5643.



## The Mixed Signal Design Seminar from Analog Devices.

I want to be part of the revolution, so don't start the Mixed Signal Design Seminar without me.

Name \_\_\_\_\_

Title \_\_\_\_\_

Company \_\_\_\_\_

Address \_\_\_\_\_

City \_\_\_\_\_ State \_\_\_\_\_ Zip \_\_\_\_\_

I'd like to attend in the following City: \_\_\_\_\_ Date: \_\_\_\_\_

Please include a check for \$20 payable to: Analog Devices. Return to: Analog Devices, Mixed Signal Design Seminar, 181 Ballardvale St., Wilmington, MA 01887. **EDN030191**

For more information, or to charge your ticket, call (617) 937-1430 or (800) 262-5643.

# EDN PRODUCT MART

This advertising is for new and current products.

Please circle Reader Service number  
for additional information from manufacturers.

## 48 Channel 25 MHz Logic Analyzer

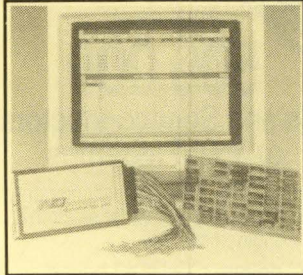

Complete System \$1695.00

- New Windows 3.0 Compatible Software
- 48 Chnlns @ 25 MHz x 4K words deep
- 16 Trigger Words/16Level Trigger Sequence
- Storage and recall of traces/setups to disk
- Disassemblers available for: 68000, 8088, 8086, 6801, 6811, Z80, 8085, 6502, 6809, 6303, 8031

**NCI** 6438 UNIVERSITY DRIVE,  
HUNTSVILLE, AL 35806  
(205) 837-6667 FAX (205) 837-5221

CIRCLE NO. 325

☆☆☆☆  
"The Best 8051 Emulator"

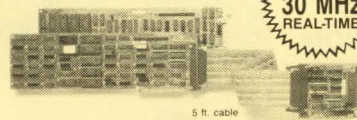

**NEW**  
30 MHz  
REAL-TIME

**8051** SEE EEM 90/91  
Pages D 1320-1323

PC based emulators for the 8051 family

8031, 8032, 8051, 8052, 80C152/154/321/451/452/51FA/51GB/515/517/535/537/552/562/652/851, 80532, 83C451/552/652/751/752/851, 8344, 87C451/552/751/752, 8751, 8752, D55000 + CMOS ... more.

- PC plug-in boards or RS-232 box.
- Up to 30 MHz real-time emulation.
- Full Source-level Debugger w/complete C-variable support.
- 48 bit wide, 16K deep trace, with "source line trace"
- "Bond-out" pods for 8051, 83C552, 83C451, 83C652, 83C751, 80C515/80C517, 83C752.

Prices: 32K Emulator 8031 \$1790; 4K Trace \$1495\*

CALL OR WRITE FOR FREE DEMO DISK!  
Ask about our demo VIDEO

**NOHAU** CORPORATION  
51 E. Campbell Avenue  
Campbell, CA 95008  
FAX (408) 376-7869  
(408) 866-1820 \*US only

CIRCLE NO. 326

## INTEGRATED ELECTRICAL SAFETY TEST STATION

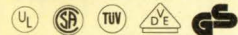
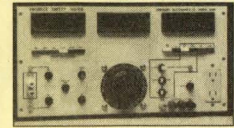

NEW FROM SORENSEN ELECTRONICS

- ✓ REDUCE TEST TIME BY 90%
  - ✓ DIGITAL TRMS VOLT-AMP-WATT METERS
  - ✓ 115V-230V A/C OR D/C VARIABLE TEST VOLTAGE
  - ✓ GROUND LEAKAGE & IMPEDENCE TESTING
  - ✓ ONE SECOND CAPACITIVE DISCHARGE TEST
  - ✓ INPUT LINE TURN-ON SURGE AND CURRENT CONTENT
- If you're serious about quick, convenient and repeatable testing for pre-submission electrical safety screening, then you need the Sorensen Model 1000 product safety tester.

For product demonstration information contact:  
Telephone (408) 336-8000 Fax (408) 336-2016

Marketing Consultants, LTD.  
277 Hillside Avenue  
Ben Lomond, CA 95005

CIRCLE NO. 327

## LOW COST INTERFACE CARDS FOR PC/XT/AT

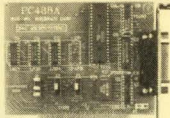

**RS-485/422 Card [PC485] \$95/125**

- Serial Async. Communication up to 4,000ft; 2 or 4 wires; NS16450 UART;
- COM1-4; Max. Baud Rate 56KB. High speed version (256KB) - \$165.
- Dual drivers/receivers; Handles 64 devices; Compatible with most comm S/W.
- DB9 or phonejack. Sample programs included. Optional sourcecode - \$150

**Dual-Port RS-485/422 [PCL743] \$175**

- Two independent channels/UARTs; 2 or 4 wire operation. Max. Baud 56KB.
- Dipswitch configurable as COM-4 (IRQ2-7). On board terminator resistor.

**IEEE-488 Card [PC488A/C] \$145/445**

- Includes DOS Device Driver and sample Communication program in BASIC.
- Additional sample programs in C, Pascal & Assembly - \$ 50.
- Selectable IRQ (1-6), DMA channel 1 or 2. Up to four boards per computer.
- Compatible with most IEEE-488 Software packages for IBM-PC.
- I/O Addresses and Control registers compatible with NT's GPIB-PCHA
- PC488C card version with Built-In Bus Analyzer hardware and software

**Stepper Motor Card [PCL838] \$395**

- Capable of independent and simultaneous control of up to 3 stepper motors.
- Programmable speed from 1 to 10,000 pps. Steps per command 1 to 65535.
- DIP switch selectable I/O port base address and wait state. 24 bit TTL I/O port
- Crystal based timing; All control signals opto-isolated.

**144 Bit Digital I/O [PCL722] \$345**

- 144 lines (24 bits x 6 ports) of TTL compatible digital I/O. Output buffers sink 24mA, source 15mA. Interrupt handling capability. Opto-22 module compatible.



**B&C MICROSYSTEMS INC.**  
750 N. Pastoria Ave., Sunnyvale, CA 94086 USA  
TEL: (408)730-5511 FAX: (408)730-5521

CIRCLE NO. 328

## FASTEST PCB PROTOTYPE!

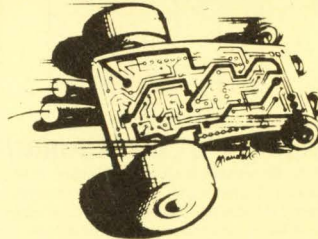

\$199 Investment  
One day turn In-house

With the **Fast-Proto PCB Kit**, your CAD system and pen plotter, you can prototype PCB's and avoid delays of photoplotting and vendor fabrications. This new process offers a fast and reliable alternative to costly quick-turn prototypes.

For more information call, FAX or write  
**GENERAL CONSULTING**  
12856 Inglewood Avenue  
Hawthorne, CA 90250  
(213) 679-1405 FAX (213) 679-2995

CIRCLE NO. 329

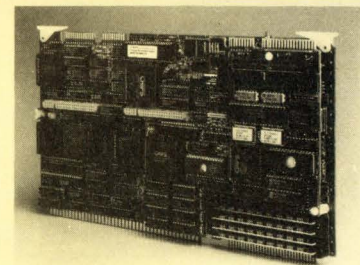

## PC/AT™ COMPATIBILITY ON MULTIBUS

In 1989 our MAT286™ SBC brought PC-DOS to Multibus 1. Since then no competitor has come close in terms of features, price, or technical support. We've added capabilities, such as 8 megabytes of onboard EPROM capacity, MATxSSD Solid-State Disk software, EMS 4.0, and low power CMOS components. Now we are announcing our new MATxSYSIO2 daughter-card with 16-bit VGA and LCD flat-panel interfaces, 1-1 interleaved MFM/RLL ST506 hard-disk/floppy disk controller, and a PC/AT Bus short-card adaptor. And, yes, we are working on MAT386, the 386-based Multibus AT that will be compatible with the 286-based standard, MAT286.

Phone (408) 253-0250 for more information.  
**Single Board Solutions, Inc.**  
20045 Stevens Creek Blvd, Cupertino, CA 95014  
PC/AT™ IBM

CIRCLE NO. 330

To advertise in Product Mart, call Joanne Dorian, 212/463-6415

## Analog Circuit Simulation

SPICE FOR THE PC (XT, AT, 386, 486)

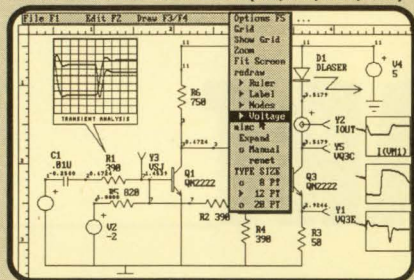

From Schematic Entry, through SPICE Simulation, to Graphical Post Processing, only \$790

**ISSPICE** - Full Featured SPICE Circuit Simulation  
**SPICENET** - Graphical Schematic entry for SPICE  
**INTUSCOPE** - Waveform Display and Plotting  
**PRESPICE** - Model Libraries, Monte Carlo analysis  
**SPICEMOD** - SPICE Model generation from data sheets



P.O. Box 710 Tele (213) 833-0710  
San Pedro, CA 90733-0710 FAX (213) 833-9658

CIRCLE NO. 331

## \$249. TERMINAL

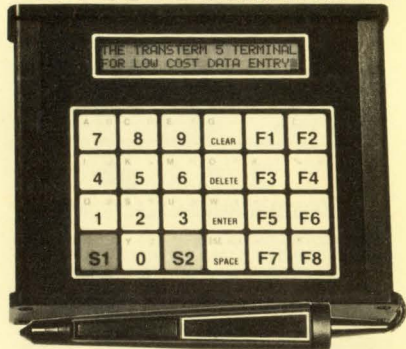

Featuring • Standard RS-232 Serial Asynchronous ASCII Communications  
• 48 Character LCD Display (2 Lines of 24 Each)  
• 24 Key Membrane Keyboard with embossed graphics  
• Ten key numeric array plus 8 programmable function keys  
• Optional RS-422 multidrop protocol mode  
• Keyboard selectable SET-UP features—baud rates, parity, etc.  
• Size (5.625" W x 6.9" D x 1.75" H). Weight 1.25 lbs.  
• 5 x 7 Dot Matrix font with underline cursor  
• Displays 96 Character ASCII Set (upper and lower case)  
• Optional Bar Code Wand (shown)

**COMPUTERWISE, INC.**

302 N. Winchester • Olathe, KS 66062 • 800-255-3739 • FAX (913) 829-0810

CIRCLE NO. 334

## 200 MHz Logic Analyzer

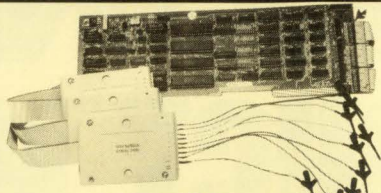

- 200 or 100MHz sampling
- 24 Channels
- Expansion to 72 channels
- 16 Levels of triggering
- 16K samples/channel
- Variable threshold levels
- 3 External Clocks
- 12 Clock Quality lines

\$ 799-12100 (100 MHz)

\$1299-27100 (100 MHz)

\$1899-27200 (200 MHz)

## UNIVERSAL PROGRAMMER

PAL  
GAL  
EPROM  
EEPROM  
PROM

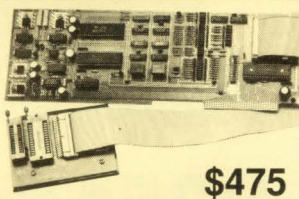

87C51...  
874x

\$475

5ns PALs 4 Meg EPROMs  
26V12 & 22V10 Gals  
FREE software updates on BBS

## GANG PROGRAMMER

- 4 32pin Sockets (8 Socket option)
- 2716-27010 EPROMs

\$215

Call - (201) 994-6669

**Link Computer Graphics, Inc.**

4 Sparrow Dr., Livingston, NJ 07039 FAX:994-0730

CIRCLE NO. 335

## 16 MHz 80C186/C187

R.L.C.'s large selection of 8 and 16-Bit STD Bus Single Board Computers offer an Intel 80C186/188 CPU and 80C187/8087

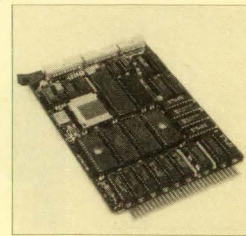

Numeric Co-Processor at true bus speeds up to 16 MHz. On-board functions include MEMORY, SERIAL PORTS, REAL TIME CLOCK, TIMERS, DMA, INTERRUPT CONTROLLER, and BATTERY BACK-UP, WATCHDOG TIMER and much more. R.L.C. also offers 16-Bit support cards, card cages and complete software support using the award winning TURBO-DEBUGGER. For more information and technical assistance please call Robert Coomer.

**R.L.C. Enterprises**  
(805) 466-9717

4800 Templeton Road Atascadero, CA 93422

CIRCLE NO. 333

Now Networkable!

Facts about

# 500,000

## ICs and Semiconductors at Your Fingertips

Cahners CAPS is the newest component search and selection tool for electronic design engineers:

- PC-driven, CD-ROM-based
- Includes unabridged manufacturers' datasheets
- Represents more than 450 manufacturers worldwide

Call toll-free: 1-800-245-6696

**CAHNNERS**  
**CAPS**  
Computer Aided  
Product Selection

275 Washington Street  
Newton, MA 02158-1630  
Telephone: 617-558-4960  
Facsimile: 617-630-2168  
Telex: 940573

CIRCLE NO. 336

## UNIVERSAL PROGRAMMER Lifetime S/W via BBS

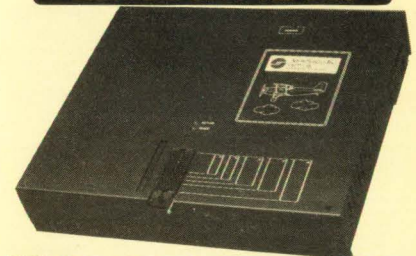

PILOT-U40 is our second generation 40-pin universal programmer, following our very successful and popular Sailor-PAL line of programmers. Programs PALs, GALs, PEELs, PROMs, E/EPROMs, micros, MACH, etc. 24-, 28- and 32-pin versions also available. Industrial quality. Starting from \$1,095. SATISFACTION GUARANTEED.

408-243-7000, 800-627-2456, Fax 408-736-2503



**ADVIN SYSTEMS INC.**  
1050-L E. Duane Ave., Sunnyvale, CA 94086

CIRCLE NO. 339

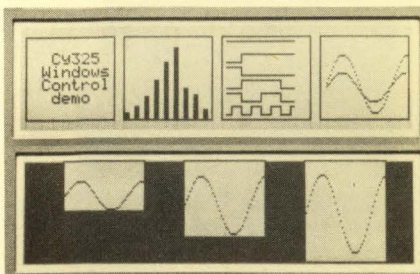

## LCD WINDOWS CONTROLLER

The CY325 supports LCDs up to 128x240 pixels (16x40 char) with easy-to-use high-level commands and Parallel or Serial interface to host computer. The 256 built-in windows (or make your own) support window-relative text, graphics, plotting, bargraphs, waveforms, scroll/wrap/clip, etc. Read from an A/D and Write into Window! Separate text and graphic planes can be written or erased in any window. Eight pins support a variety of functions (soft-keys, waveforms) or can be used for GP I/O. Icons or special fonts can be user defined. Giant character mode, etc. Save months of design time with the CY325. \$75 CMOS \$20/1000s.



**Cybernetic Micro Systems**  
PO Box 3000 • San Gregorio CA 94074  
Ph: (415) 726-3000 • Fax: (415) 726-3003

CIRCLE NO. 337

## Interactive/Real-Time

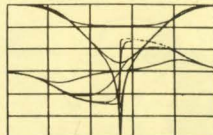

## Analog Circuit Simulation

ECA-2 Electronic Circuit Analysis offers: • AC, DC, Transient, Fourier, and Temperature Analysis with Nominal, MonteCarlo and/or Worst-Case component values • Interactive or batch modes • Full nonlinear simulation • Sine, Pulse, PWL, SFFM, and Exponential generators • IBM PC/Mac • Multiple plots • On-line real time graphics - 2 to 50 times faster than SPICE • Over 500 nodes • Advanced component parameters • Component optimization sweeping • Full editing, built-in or external • New detailed 424 page manual

Call for **FREE DEMO!**



**Tatum Labs, Inc.**

3917 Research Park Dr. B-1, Ann Arbor, MI 48108  
313-663-8810

CIRCLE NO. 338

To advertise in Product Mart, call Joanne Dorian, 212/463-6415



## PLCC LoClip - PLCC Probe

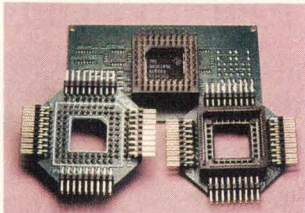

### NEW PRODUCT

The PLCC-LoClipXX line from Ironwood is a new product line allowing probing of surface mount PLCC's at a fraction of size of other clips. The U and L ver. have right angle leads (cable connect or probing). Device heights of 0.75", 0.57", and 0.45" for S, U, and L boards respectively enable probing of boards in backpanels. Interdevice spacing of 0.10" allowed. PLCC's from 24 to 84 pins supported. Kits of 10 with different sizes/carrying case available at substantial discount.

**IRONWOOD ELECTRONICS**  
P.O. BOX 21151, ST. PAUL, MN 55121  
(612) 431-7025

CIRCLE NO. 340

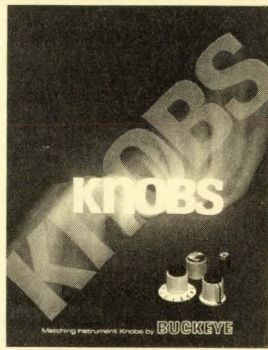

**FREE 26 Page CATALOG with all styles and designs of matching instrument knobs illustrated.**

*Fax us your specs—we will  
Fax you a quote...Immediately!*

**Buckeye**

555 Marion Road  
Columbus, OH 43207  
Fax: 614/445-8224 Phone: 614/445-8433

CIRCLE NO. 341

## LEMO'S NEW CIRCULAR CONNECTOR CATALOG

LEMO's new circular connector catalog highlights expanded shell and insert designs. Insert configurations are available in single, multi or mixed designs including signal, coaxial, triaxial, high voltage, fiber optic and fluidic/pneumatic. Shell styles are available in standard chrome plated brass, anodized aluminum or stainless steel.

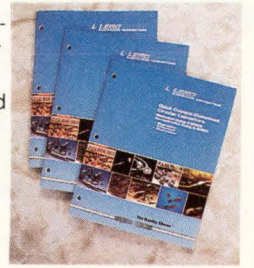

**LEMO USA INC**

P.O. Box 11488, Santa Rosa, CA 95406  
Phone (800) 444-LEMO, Fax 707/578-0869

CIRCLE NO. 342

## RELIABILITY AND MAINTAINABILITY PREDICTION AND FMECA ANALYSIS SOFTWARE

Hundreds have used this leading computer-aided engineering software since 1982.

Powertronic Systems offers software to predict Reliability and Maintainability and for Failure Modes Effects and Criticality Analysis. Hundreds of users have selected from PSI's large, versatile and integrated software family for military and industrial equipment and for both electrical and mechanical systems. And, data inputs to these programs may be interactive or batch mode from other CAE or database programs. Programs implement MIL-STD-1629; MIL-HDBK-217 including E Notice 1; and MIL-HDBK-472.

PSI

**Powertronic Systems, Inc.**  
P.O. Box 29109 New Orleans 70189  
(504) 254-0383 FAX (504) 254-0393

CIRCLE NO. 343

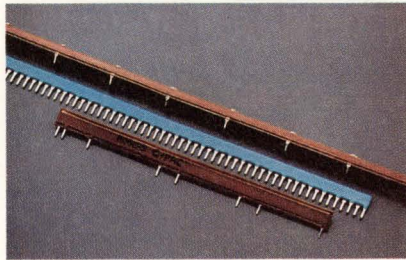

### SAVE SPACE WITH Q/PAC® COMPONENTS

- Provide built-in capacitance
- Eliminate decoupling capacitance
- Gain 4-layer board quietness with 2-layer economy
- Vertical or horizontal mounting

Send for Rogers Q/PAC® Application Bulletin.

Rogers Corp., 2400 S. Roosevelt St.  
Tempe, AZ 85282 602/967-0624  
CIRCLE NO. 344

## Multi-Tasking EXECS

U S Software offers hi-performance software tools for embedded applications.

Get the full details by calling:

800-356-7097  
503-641-8446  
503-644-2413 (FAX)



**U S SOFTWARE**

United States Software Corporation  
14215 NW Science Park Drive  
Portland, Oregon 97229

CIRCLE NO. 345

## FREE & EASY

Try SCHEMA III for free, and see how easy schematic capture can be. SCHEMA III performs more functions at the drawing sheet level and is compatible with workstation formats. Call Omaton for your FREE demo disk today!



1-800-553-9119

CIRCLE NO. 346

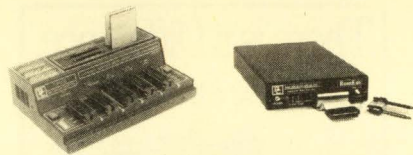

### RS232 EE/EPPROM, MICRO & MEMORY CARD PROGRAMMER \$345/495

- Programs EE/EPProms, Flash EProms, ZPRams, Intel Micros, Memory Cards.
- Stand-Alone Mode for EE/EPProms and Memory Card Duplication / Verify.
- All 24/28/32 pin EE/EPProms to 8 MBits (upgradable to 32 Megabits).
- Micros: 8741/A, 2/A, 4, 8, 9, S1, CS1, CS1FA/B, S2, S3, S5, CS21, CS41, 9761.
- Accepts dedicated modules: Memory Card Programming Module (Seiko/Epson) - \$145, Eraser/Timer Module - \$50, Gang Module (4 sockets) - \$145. Simultaneously duplicates up to 5 devices in stand-alone mode (with Gang).
- Can be operated with any computer containing an RS-232 serial port.
- User Friendly Menu-Driven Interface Program for IBM-PC or compatible.
- Full 1 year warranty. Customer support via voice line, fax or dedicated BBS.

### INTELLIGENT ROM EMULATOR \$395

- Emulates 2716 through 27512 EProms with a single unit. Access time 120ns.
- Connects to the standard parallel printer port via a standard printer cable.
- User friendly software. Command set includes: Load(data), Write(data), Display(memory), Type(of EProm), Edit(memory), Fill(memory), Calculator, Reset(target system), Activate(debugging feature), Monitor(selected feature), Address Compare with Halt output, Address Snapshot, Trigger input.
- Fast data loading via parallel printer port (64k bytes in less than 10 sec).
- Casable up to 8 units. Includes target cable with Trigger/Reset/Halt clips.
- CMOS (stand-alone) model with rechargeable NiCad battery backup: \$495

MC / VISA / AMEX

Call today for datasheets!



**B&C MICROSYSTEMS INC.**  
750 N. Pastoria Ave., Sunnyvale, CA 94086 USA  
TEL: (408) 730-5511 FAX: (408) 730-5521

CIRCLE NO. 347

## "Tango-PCB PLUS is the most intuitive CAD program I've ever used."

"The Tango-PCB PLUS circuit board design tool is light and simple. Its Windows™-like interface is very easy to use. Tango does what I want it to do in the logical way it ought to be done. I heartily recommend it to others."



Tango's feature-rich circuit board layout and autoroute packages offer high performance and ease of use. Their affordable prices include great documentation and tech support and a money-back guarantee.

**Tango**

See for yourself. Call today to order your free PCB/Route evaluation package.

800 488-0680  
619 554-1000 • FAX: 619 554-1019

ACCEL Technologies, Inc.  
6825 Flanders Drive • San Diego, CA • 92121 • USA  
Contact us for the representative nearest you.

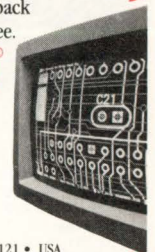

CIRCLE NO. 348

To advertise in Product Mart, call Joanne Dorian, 212/463-6415

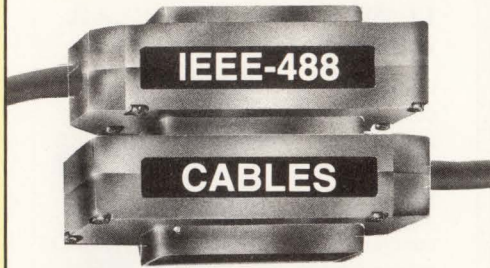

**IEEE-488, (GP-IB, HP-IB) CABLES**

- Reliable gold plated contacts.
- Durable metal connectors.
- High strength strain reliefs.
- Two shields for high noise immunity.
- Custom lengths at low prices.

**cec** Capital Equipment Corp.  
Burlington, MA. 01803

**Informative catalog 800-234-4232**  
**Applications help (617) 273-1818**

CIRCLE NO. 349

**Design PLDs**  
with ABEL-PLD,  
now just \$495.\*



**FREE**  
**ABEL-PLD**  
**start-up**  
**kit!**

- 150 PLD architectures supported (over 4000 devices)
- Uses ABEL™ Hardware Description Language (ABEL-HDL™)
- Intelligent synthesis and optimization
- Upgradable to full-featured ABEL

Call for your  
**FREE**  
**ABEL-PLD**  
**start-up kit!**

**1-800-247-5700**

\*U.S. list price only.  
Limited-time offer.

**DATA I/O**  
Corporation

CIRCLE NO. 350

**Program PLDs**  
and memories  
with the  
low-cost 212.



Now  
supports the  
**27C4001, 87C51**  
and  
**22CV10!**

- Supports more than 450 CMOS devices
- Memory cards for easy updates
- Extensive editing capabilities
- Compatible with JEDEC standard programming files

Call for  
your **FREE**  
212 15-day trial!

**1-800-247-5700**

**DATA I/O**  
Corporation

CIRCLE NO. 751

**SUPER UNIVERSAL PROGRAMMER**



**NEW!**  
**SUPERPRO**  
**\$795**

- FREE MULTIMETER SPECIAL**
- programs PAL, EPLD, GAL, PEEL, FPL (up to 68 pin PLCC)
  - E(E) PROM, Flash EPROM up to 4 Mbits (40 pins)
  - Microcontroller, Bipolar PROM.
  - Tests TTL/CMOS Logic, D/S Memory Device.
  - High speed parallel interface card to PC/XT/AT/386
  - Pull-down Menu driven, Library Operating software.
  - **Fast Device update** on user's request
  - 40-pin **Gold ZIP** Socket
  - Lifetime Free Updates (BBS)
  - User Device Library Generator (optional)

Call 1-800-541-1975 764 San Aleso Ave.  
Sunnyvale, CA 94086

**XELTEK**

TEL(408)745-7974  
FAX(408)745-1401

CIRCLE NO. 752

**MULTI FUNCTION IN ONE**  
**MFI-421**



**\$849**

- OVER \$ 1,200 VALUES IN ONE UNIT**
- Unique high Accuracy and low cost T&M System for Engineer's Work Bench.
  - Full Overload Protection
  - Power Supply  
Tripple output : 0-50V (0.5A Max);  
15V, 1A(Fixed); 5V, 2A(Fixed).
  - Function Generator  
Frequency Range : 0.02 Hz - 2 MHz  
Signe, Square(/TTL), Triangle  
Ramp, Pulse and Skewed wave forms.  
Linear and Log sweep.
  - Frequency Counter  
Range : 1 Hz -100 MHz; LED display  
Accuracy : +/- (1Hz + 1 dgt + Time  
Base Error)
  - Digital Multimeter  
3.5 digit LCD display ; Auto Ranging;  
DCV, ACV, DCA,ACA; Diode  
& Countinuity Check

**XELTEK**

764 San Aleso Ave.  
Sunnyvale, CA 94086  
TEL(408)745-7974  
FAX(408)745-1401

CIRCLE NO. 753

**EDN**  
**Product Mart**  
**Provides**  
**Consistent**  
**Results**

CIRCLE NO. 754

**PCB and SCHEMATIC C.A.D.**

**EASY-PC** **\$195**

Now even faster and with  
Laser Printer Output.

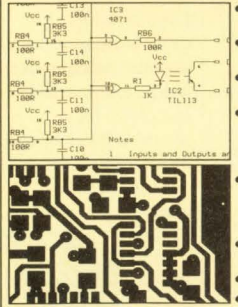

- Runs on PC/XT/AT/286/386 with CGA EGA or VGA.
- Design Single sided, Double sided and Multilayer boards.
- Provides Surface Mount support.
- Standard output includes Dot Matrix / Laser / Inkjet Printer, Pen Plotter, Photo-plotter and N.C. Drill.
- Award winning EASY-PC is in use in over 7000 installations in 50 countries world-wide.
- **SUPERBLY EASY TO LEARN AND USE.**
- **Not Copy Protected.**
- **Dealers Wanted.**

**FAST Professional Quality Output at an Affordable Price**

For full info, write, fax, call or use Inquiry #  
**Number One Systems Ltd. 1**

REF: EDN, HARDING WAY, ST. IVES, HUNTINGDON,  
CAMBS, ENGLAND, PE17 4WR.  
Telephone: Fax:  
USA: 011-44-480-61778. USA:011-44-480-494042 AMEX,VISA,  
Intnl:- +44-480-61778 Intnl:- +44-480-494042 MasterCard  
UK :- 0480 61778 UK :- 0480 494042 Welcome

CIRCLE NO. 755

**There is a Difference.**  
*Lifetime Free Updates*

**EP-1140**  
**\$895**



A programmer is not just another programmer. That is why BP Microsystems is committed to bringing our customers the highest quality programmers at an affordable price. This commitment is evident in our EP-1140 E/EPROM programmer supporting thousands of 24-, 28-, 32- and 40 pin devices. A 32-pin model, EP-1132, is available also for \$685. And, all of our programmers include future chip support at no charge and an unconditional money back guarantee.

**BP MICROSYSTEMS**  
**1-800-225-2102**  
(713) 461-9430

CIRCLE NO. 756

**EMI?**  
**Take One - Pass FCC**

Now in the USA the patented Filmac® EMI filters from Japan. Find out why they are used by most big Japanese makers to pass FCC class B.

- Low cost
- Capacitor like construction
- Distributed low pass filter
- Sales over 1 million pcs /month
- Better results than built up filters



14 piece sample kit. Call today.

**800-899-7888**  
**Zyrel, Inc.**

1900 McCarthy Blvd.  
Suite 201  
Milpitas, CA 95035

CIRCLE NO. 757

To advertise in Product Mart, call Joanne Dorian, 212/463-6415

# 4 Color Product Mart Ads Are Now Available In EDN's Magazine and News Editions!

Call Joanne Dorian for  
more information  
**(212) 463-6415**

CIRCLE NO. 758

## DEVELOPERS' TOOLS

The Total Solution Programmer—  
The best-selling Programmer since 1985  
Appreciated by over 50,000 users worldwide

TUP-300  
Universal Programmer  
& Tester (PC based)  
from \$ 595-

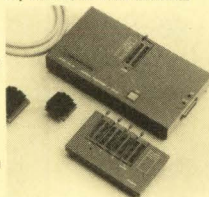

- 40-Pin ZIF socket can be expanded up to 68 Pin for 8 to 68 Pins DIP or PLCC chips.
  - Programs 20 to 68 Pin PLD (PAL, CPAL, IFL, GAL, PEEL, EPLD, EEPLD), EPROM (up to 16 Mbit), EEPROM, Serial PROM, Special PROM, Bipolar PROM & MPU (8741/42/48/49, 8051/51FA, FB, FC/521/541/252/751/752/552/451, 8796/97, 68705, Z86E11/21, TMS7742, TMS77C82, 8755A, ...)
  - Tests TTL (74/54), CMOS (4045), SRAM, DRAM, SIP DRAM and SIM DRAM.
  - Full screen edit, HEX to OBJ, 2-way or 4-way Binary File Splitter and Shuffler, 6 MPU Dis-assemblers.
  - 34 various adapters (4 sockets, ROM-RAM, PLCC, ...) from \$95.-
  - Other high quality programmer cards at low cost available from \$119.-
  - UV Eraser (UV-32) for 32 pcs at \$95.-
- Call us today for complete product line
- 1 year warranty, 30 days money back guarantee
  - 1 year free software updates and Customer Support

TRIBAL MICROSYSTEMS

Tel: (415)623-8859 Fax: (415)623-9925  
44388 S. Grimmer Blvd. Fremont CA 94538

CIRCLE NO. 759

## ROM-IT

EPROM EMULATION SYSTEM



NEW  
4-MEGABIT  
VERSION

- Emulates up to 8 4-Megabit EPROMS with one control card.
- Downloads 2-Megabit programs in less than 23 seconds.
- Allows you to examine and modify individual bytes or blocks.
- Accepts Intel Hex, Motorola S-Record and Binary files.
- Software available for IBM PC and compatibles and Macintosh systems.
- Base 27256 EPROM System \$395.00 Other configurations available.

ORDER TODAY--IT'S EASY  
CALL OR FAX FOR MORE INFORMATION



Incredible Technologies, Inc.  
(708) 437-2433  
(708) 437-2473 Fax  
VISA now accepted.

CIRCLE NO. 760

### Elegant, concise, fast & standardized FLOATING POINT libraries for embedded applications

Based on the IEEE 754 standard, FPAC (32 bit) and DPAC (64 bit) libraries are mature, well documented, and fully tested. The libraries are fully ROMable and include the following:

- Basic Operations
- Square Root
- Trigonometric
- ASCII Conversion
- Integer Conversion
- Logarithmic

U S Software supports most Intel, Motorola, Zilog and Hitachi micros, including 80X86, 80386, 680X0, 80960, 8051, 8096, 68HC11, Z80, 6809 and 6301.

For additional information, please contact:



U S SOFTWARE

United States Software Corporation  
14215 NW Science Park Drive  
Portland, Oregon 97229  
**800-356-7097**  
**503-641-8446**  
**503-644-2413 (FAX)**

CIRCLE NO. 761

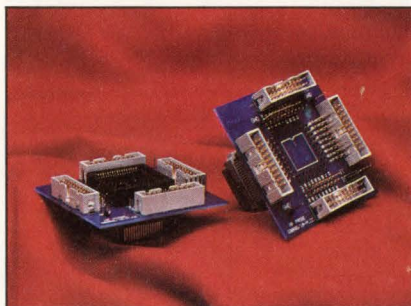

### Attn: HP Logic Analyzer Users

- PQFP, PLCC, PGA, and DIP pre-processor interfaces for 1650 and 16500 Series HP logic analyzers.
- Available for Intel, Motorola, Mips, Zilog, and IDT microprocessors.
- Plugs between the analyzer and the target CPU socket or surface mount pads.
- Inverse assembler and configuration files included. Call for a free catalog.

Emulation Technology, Inc.  
2344 Walsh Ave. Santa Clara, CA 95051  
Phone: 408-982-0660 FAX: 408-982-0664



CIRCLE NO. 762

## Little Giant™

C Programmable Controller

This shirt pocket sized computer interfaces directly to the outside world. Use it to control anything. Instantly programmable using your PC with Dynamic C. ROM and battery backed RAM

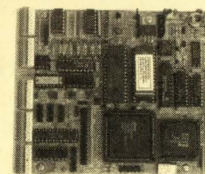

to 1024k bytes. 8 Channel, 10/12 bit, A/D with conditioning. High voltage and current drivers. Battery backed time and date clock. Watchdog and power fail. 4 serial channels. 24 parallel I/O lines. Timers. Integral power supply. Terminations for field wiring. Expansion connector. Plastic or metal field packaging available. OEM versions from \$199.00.

Z-World Engineering

1340 Covell Blvd., Davis, CA 95616  
**(916) 753-3722**  
Fax: (916) 753-5141

CIRCLE NO. 763

## Wave Form 20MHz - 32K \$1290

The WSB-100 Wave Form Synthesizer Board from Quatech has the best set of numbers in the market. With speed to 20MHz and a 32K memory at \$1290, it's making waves in more ways than one. The WSB-100 is also a star performer as a digital pulse/word generator with the optional digital module.

Call for our free  
PC Interface Handbook  
**1-800-553-1170**

**QUATECH**

662 Wolf Ledges Parkway  
Akron, OH 44311

CIRCLE NO. 764

## RS-422/RS-485 Boards for AT, Micro Channel

RS-422/RS-485 asynchronous serial communication boards from Quatech available in 1 to 4 ports for PC-AT and compatibles and 1 to 4 ports for PS/2 Micro Channel.

Call for our free  
PC Interface Handbook:  
**1-800-553-1170**

**QUATECH**

662 Wolf Ledges Parkway  
Akron, OH 44311

PC-AT, Micro Channel, and PS/2 are trademarks or registered trademarks of IBM Corp.

CIRCLE NO. 765

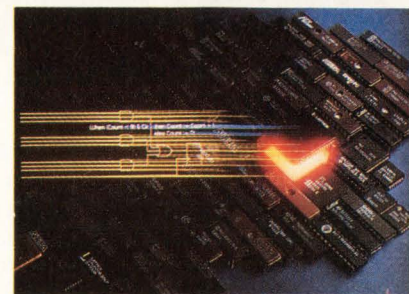

MacABEL

PLD Design on the Apple Macintosh!

Data I/O's industry-standard ABEL PLD design package is now available on the Macintosh, exclusively from Capilano Computing!  
• Use Boolean and integer equations, state machines and truth tables to describe your design • Communicates directly with any serial PLD programmer • Best device support in the industry, including ALTERA, AMD, ATMEL, CYPRESS, GOULD, HARRIS, ICT, INTEL, LATTICE, NATIONAL, RICOH, SAMSUNG, SGS, SIGNETICS, SSS, TI, VTI and others • Interactive "in-circuit" schematic entry and simulation when used with DesignWorks

Call (604) 669-6343 today for your free demo kit!

Capilano Computing  
FAX (604) 669-9531

CIRCLE NO. 766

To advertise in Product Mart, call Joanne Dorian, 212/463-6415

**E**ven with our sophisticated technology, people play the leading role in DSC's success. Part of these accomplishments include the development of one of the first software programmable cross connect systems, and one of the largest Signal Transfer Points (STP) for use within the long distance and local exchange networks. These are just a few of the many complex systems our employees have created.

**INTELLIGENCE  
AT WORK**

Today, we are developing the next generation of cross connect and enhancing our existing platforms. We are committed to taking on the challenges this age of communications has created.

### SONET Software Engineers

These positions require BSCS or equivalent and 3-5 years' programming experience with "C" in a UNIX environment (Apollo Workstations). Experience with 68XXX processors and a telephony background are advantageous. Opportunities exist for involvement in the entire life cycle of software development including new designs, coding and testing. Additional positions are available for software and integration test engineers.

### SONET Hardware Engineers

You will design, debug and test complex digital logic printed circuit boards. Requires a BSEE and knowledge of worst case timing analysis, microprocessor and programmable logic design experience. Telecommunications, DS3 or SONET experience a plus; 2-5 years' experience required.

Electro-optic design engineers for OC-12 and OC-48 SONET optical interface development. Requires device, clock and data recovery circuitry expertise. Minimum of 2-5 years' development experience required.

### Sr. IC Design Engineers

Convert system requirements into ASIC specifications, create system and logic designs using advanced CAE tools, perform verification simulations, generate test programs, and certify prototypes. Experience with MENTOR GRAPHICS CAE tools highly desired. Requires BSEE and 5-8 years' experience in system application of ASIC's logic/test design, test/stimulus languages and fault simulation.

DSC Communications Corporation is located in the Dallas suburb of Plano, Texas. This sprawling community enjoys a mild climate, offers an excellent public school system and features quick access to an abundance of cultural and recreational activities. For immediate consideration, please send your resume with salary history, indicating the position of interest to: DSC Communications Corporation, ATT: HR Technology/EDN, 1000 Coit Rd., MS 110, Plano, TX 75075. Principals Only.



**DSC Communications Corporation**

An Equal Opportunity Employer, M/F/H/V.

## CAREER OPPORTUNITIES

### 1991 Recruitment Editorial Calendar

Issue	Issue Date	Ad Deadline	Editorial Emphasis
Magazine Edition	Mar. 28	Mar. 7	ICs & Semiconductors/ Microprocessors, Software • CAE • Computer Boards, Electro Preview Issue
News Edition	Apr. 4	Mar. 15	Optical Interconnects, Automotive Electronics**, Electro Show Issue

Call today for information on  
Recruitment Advertising:

East Coast: Janet O. Penn (201) 228-8610  
West Coast: Nancy Olbers (603) 436-7565  
National: Roberta Renard (201) 228-8602



Engineering

## WARM UP TO FLORIDA.

*And heat up your career  
with an industry leader.*

Situated between the shores of Daytona Beach and metropolitan Orlando, talented professionals set the pace at **Sparton Defense Electronics**, a Fortune 900 company involved in the design and high volume manufacture of expendable submarine tracking devices.

The following opportunities are currently open to qualified design engineering personnel for exploration:

- BSEE's (no EET degrees) with 2 to 4 years current experience in board level audio/voice frequency (0-20 kHz) analog product design for a high volume manufacturer. Background must include microprocessor programming (i.e., 6800/assembly) and exposure to SMT (surface mount technology). U.S. citizenship required for clearance.
- BSEE's (no EET degrees) with 5 years current RF (UHF/VHF) experience specifically in a.m. receivers and multichannel synthesized f.m. transmitters. Small stowable antenna design is highly desirable. U.S. citizenship required for clearance.
- BSME's (no MET degrees) with 2 to 5 years current experience in the design of injection molded plastic, die cast metal, and stamped metal parts for a high volume/low cost manufacturer. Solid experience in finite element analysis (FEA) and knowledge of design for assembly (DFA) concepts is highly preferable. Tooling vendor interface and production floor support backgrounds are necessary. U.S. citizenship is required for clearance.

As a team member of **Sparton Defense Electronics**, expect a stimulating, career-building technical challenge, a high quality lifestyle with a low cost of living, no state income tax, proximity to exciting Florida attractions, and a fine compensation package that rewards your skill, knowledge, imagination, and performance. Relocation package is available. For prompt, confidential consideration, please present your credentials with salary expectations to:

**SPARTON**  
DEFENSE ELECTRONICS

ATTN: Mr. John S. Gould, Employment Manager  
5612 Johnson Lake Road • DeLeon Springs, Florida 32130  
NO AGENCIES PLEASE/NO PHONE CALLS PLEASE/EEO-M/F/H/V

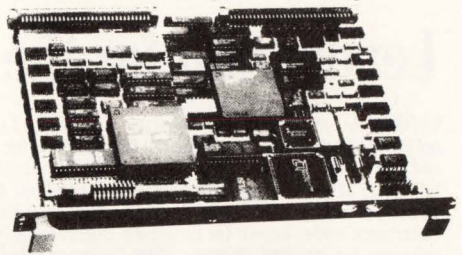

# INTERPHASE

## SEEKING SENIOR DESIGN ENGINEERS

**INTERPHASE CORPORATION** is seeking individuals to participate in the development of RISC—based FDDI VMEbus products. Position leads to project-level management of board-level and standalone FDDI products as well as opportunities in an existing well-established Ethernet product development organization. Familiarity with UNIX as a target environment (system level) with five years design experience required.

### FIRMWARE/HARDWARE DESIGN

- Logic design using state-of-the-art CAD/CAE equipment.
- High-speed memory system design using VRAM.
- RISC microprocessor design experience desired.
- VMEbus architecture desired.
- C language programming experience required.
- BSEE or equivalent required. Emphasis on high-speed microprocessor development.

### SOFTWARE DESIGN

- UNIX, Kernal I/O, TCP/IP or other protocol experience on super-microcomputer or mini-computer required.
- Minimum one year writing UNIX device drivers.
- C language programming experience required.
- RISC microprocessor desired; (M68000 required).
- BSCS or equivalent required. Emphasis on design of high-performance software interface.

Interphase Corporation offers competitive compensation and complete benefits, including a tax-deferred savings plan (401K), educational assistance, employee paid group insurance and much more.

**For immediate consideration, use the coupon below and/or send your resume to:**

**INTERPHASE CORPORATION  
HUMAN RESOURCES DEPT.  
13800 Senlac  
Dallas, Texas 75234**

**FAX # 214/919-9200—ATTN: HUMAN RESOURCES DEPT.**

*Interphase Corporation is an equal opportunity employer.*

Name \_\_\_\_\_

Address \_\_\_\_\_

City \_\_\_\_\_ State \_\_\_\_\_ Zip \_\_\_\_\_

Telephone (Home) \_\_\_\_\_ (Business) \_\_\_\_\_

Position/s of Interest \_\_\_\_\_

Previous Design Experience \_\_\_\_\_

# Leadership for the 90's.

Codex is the world's leading independent supplier of complete networking solutions. We provide all the elements for distributed data and voice networks, from a broad line of communications products to a full range of services, including systems integration. As a wholly owned subsidiary of Motorola, Inc., a worldwide communications and electronics leader known for its proven commitment to quality, we have one fundamental objective: Total Customer Satisfaction.

We are building upon our expertise to provide advanced private networking solutions for the 1990's. Areas of activity include systems architecture and design of integrated switching nodes, software architecture, design and implementation of real-time distributed multi-processor networking products, ISDN call processing and frame relaying, system and networking software.

If your career is at a crossroad and you're seeking a renewed challenge and spirit of growth, we invite your inquiry. Our unique Advanced Sourcing concept allows you to investigate opportunities as they arise and when you feel the time is right, to take advantage of that opportunity.

We are currently seeking qualified candidates for the following positions to be located at our corporate headquarters in **Mansfield and Canton, MA:**

## Software Development Engineers

Positions are at all levels, from 2+ years' experience and up. If you possess a BSEE or BSCS (MSEE or MSCS preferred) with experience in one or more of the following areas, we invite your inquiry.

- ISDN signalling technology
- IBM SNA or X.25 protocols
- Communication protocol software
- Loading, initialization, configuration and fault management software for networking nodes
- Directory services and call processing software
- Network design algorithms
- Network management software development
- IBM/PC applications software under MS Windows
- Database definition and/or Database tool development
- LAN interconnect bridges and routers
- Fast packet switching technology
- T1 technology and services
- Performance tuning/systems programming on VAX, Apollo, and/or Sun
- Software tools development/installation on VAX, Apollo, and/or Sun
- Shell and utility programming in UNIX™, Ultrix, and/or VMS

Preference will be given to those candidates with significant experience programming in "C", MC68000 Assembly, and/or Object-Oriented Languages for Real-Time Embedded Systems Software applications.

## Software Q/A Engineers

## Business Process Q/A Engineers

## Product Management Engineers

## Product Marketing Engineers

In addition to the positions listed above, we have a need for the following experienced professionals to work at various field locations throughout the U.S.

## Applications Engineers

## Product Support Engineers

## Sales Representatives

Codex offers an excellent environment conducive to professional growth, competitive salaries and a comprehensive benefits package including profit sharing, 401K and a generous pension plan. Our Advanced Sourcing concept allows you to add your resume to our database now and be reviewed against current and future openings based on your goals and requirements.

Qualified candidates, please send your resume to the Advanced Sourcing Group, Codex Corporation, Dept. EDN301, 20 Cabot Boulevard, MS M4-70, Mansfield, MA 02048. An Equal Opportunity Employer.

**codex** | THE NETWORKING EDGE



UNIX is a registered trademark of AT&T Bell Laboratories.

## Telecommunications Professionals

Seiscor Technologies, Inc. is a manufacturer of telephone transmission equipment and a subsidiary of Raytheon, a Fortune 500 company.

### Software Engineers

Qualified candidates should possess a B.S. in Computer Science or Electrical Engineering, development and test with emphasis on micro-processor, real time software and telephone transmission products using C language and X.25 protocol.

### Sr. Analog Design Engineer

Requires a B.S.E.E. with experience in designing Line Cards for Digital Loop Carrier. Knowledge of Bell LSSGRs, TR-57 and TR-303 is a must. SLIC, ASIC, and SMT background is desirable.

### SONET Engineers

Hardware/Engineer with a B.S. degree experience in design of fiber optic based transmission and subscriber loop products. Requires thorough knowledge of North American and International Standards for T1, DS1, DS3, and SONET.

Systems Engineer with B.S. degree and ten years experience in transmission telephony. Most recent experience should be fiber optic Add/Drop Multiplexors, and Terminating Multiplexors. Familiarity with TA-253 requirements is required.

Call Personnel at 1-800-331-4048 or send Resumé to :

**Seiscor Technologies, Inc.**

PO Box 470580

Tulsa, OK 74147-0580

An Equal Opportunity Employer, Affirmative Action Employer, M/F/V/H

**Seiscor Technologies**

A Raytheon Company

# Your Future Starts Here

**EDN** Magazine Edition  
News Edition

If You're  
Looking  
For a Job,  
You've  
Come to  
The Right  
Place.

# Join The Company That Accelerates The Industry

When you join Allen-Bradley, you join a world leader in industrial automation controls and factory information systems. We're developing tomorrow's technology today that keeps our customers in the forefront of their industries.



At Allen-Bradley, you'll have the opportunity to apply your skills to challenges as varied as our global customers. From the automotive and packaged goods to manufacturing and steel industries, we have the variety and technology you

need to be challenged both personally and professionally.

If you're an experienced engineer with the desire to be in the forefront of technology, join us in one of the following areas:

- Commercial Engineering/Technical Marketing
- Technical Support
- Quality Engineering
- Systems Engineering

In return for your contributions, we'll provide you with a competitive salary; comprehensive benefits; generous relocation assistance; and the opportunity to appreciate not only where you work, but where your work is put into use. For additional information or for immediate consideration, please forward your resume in confidence to: **Human Resources; Dept. EDN31; Allen-Bradley; 747 Alpha Drive; Highland Heights, Ohio 44143.** An Equal Opportunity Employer, M/F/H/V.

EDN CAREER  
OPPORTUNITIES

**EDN**



**ALLEN-BRADLEY**  
A ROCKWELL INTERNATIONAL COMPANY

*It's not only where you work,  
but where your work is.*

# Everything You Ever Wanted In UNIX. And Less. \$99.95\*

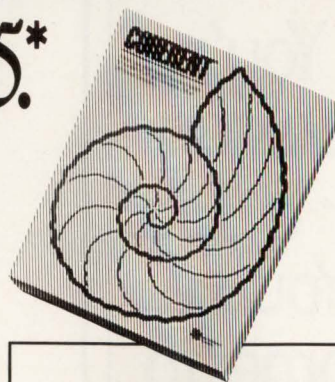

OK. We know it's hard to believe. So just consider this. Coherent™ is a virtual clone of UNIX. But it was developed independently by Mark Williams Company. Which means we don't pay hundreds of dollars per copy in licensing fees.

What's more, Coherent embodies the original tenet of UNIX: small is beautiful. This simple fact leads to a whole host of both cost and performance advantages for Coherent. So read on, because there's a lot more to Coherent than its price.

## SMALLER, FASTER... BETTER.

Everybody appreciates a good deal. But what is it that makes small so great?

For one thing, Coherent gives you UNIX capabilities on a machine you can actually afford. Requiring only 10 megabytes of disk space, Coherent can reside with DOS. So you can keep all your DOS applications and move up to Coherent. You can also have it running faster, learn it faster and get faster overall performance. All because Coherent is small. Sounds beautiful, doesn't it?

But small wouldn't be so great if it didn't do the job it was meant to do.

<b>LESS IS MORE!</b>	Coherent For the IBM-PC/AT and compatible 286 or 386 based machines.	Santa Cruz Operation's XENIX 286, Version 2.3.2
No. of Manuals	1	8
No. of Disks	4	21
Kernel Size	64K	198K
Install Time	20-30 min.	3-4 hours
Suggested Disk Space	10 meg	30 meg
Min. Memory Required	640K	1-2 meg
Performance*	38.7 sec	100.3 sec
Price	\$99.95	\$1495.00

\*Byte Exec benchmark, 1000 iterations on 20 MHz 386. Hardware requirements: 1.2 meg 5¼" or 1.4 meg 3½" floppy, and hard disk. Does not run on Microchannel machines.

## EVERYTHING UNIX WAS MEANT TO DO.

Like the original UNIX, Coherent is a powerful multi-user, multi-tasking development system. With a complete UNIX-compatible kernel which makes a vast world of UNIX software available including over a gigabyte of public domain software.

Coherent also comes with Lex and Yacc, a complete C compiler and a full set of nearly 200 UNIX commands including text processing, program development, administrative and maintenance commands plus UUCP.

## CRITICS AGREE: IT'S AN INCREDIBLE VALUE!

*"Mark Williams Co. seems to have mastered the art of illusion; Coherent comes so fully qualified as a UNIX clone, you find yourself thinking 'I can't believe it's not UNIX.'"*

—Sean Fulton, UNIX Today!, November 26, 1990

*"...(Coherent) may be the best thing that has happened to UNIX yet."*

—William Zachmann, PC Week, November 5, 1990

*"If you want to come as close as you can to real UNIX for a low price, COHERENT can't be beat."*

—Warren Keuffel, Computer Language Magazine, November 1990

*"If you want a UNIX-like development and learning system for less than \$100... I don't see how you can go wrong with Coherent."*

—David Fiedler, BYTE Magazine, November 1990

## EXPERIENCE, SUPPORT AND A 60-DAY MONEY BACK GUARANTEE.

Wondering how something as good as Coherent could come from

## **NEW COHERENT RELEASE 3.1 NOW WITH...**

- elvis: vi editor clone
- SCSI (Adaptec AHA 154x series and more on the way.) and ESDI support
- UUCP Bulletin Board System
- RAM disk support
- And much, much more!

**OVER 10,000 SATISFIED USERS!**

nowhere? Well it didn't. It came from Mark Williams Company, people who've developed C compilers for DEC, Intel, Wang and thousands of professional programmers.

We make all this experience available to users through complete technical support via telephone. And from the original system developers, too!

Yes, we know \$99.95 may still be hard to believe. But we've made it fool-proof to find out for yourself. With a 60-day money-back no-hassles guarantee.

You have to be more than just a little curious about Coherent by now. So why not just do it? Pick up that phone and order today.

You'll be on your way to having everything you ever wanted in UNIX. And for a lot less than you ever expected.

**1-800-MARK WMS**  
(1-800-627-5967 or 1-708-291-6700)  
FAX: 1-708-291-6750

**60-DAY MONEY BACK GUARANTEE!**



**Mark Williams Company**  
60 Revere Drive  
Northbrook, IL 60062

\*Plus shipping and handling. Coherent is a trademark of Mark Williams Company. UNIX is a trademark of AT&T. XENIX is a trademark of Microsoft.



# Triple Port DRAMs

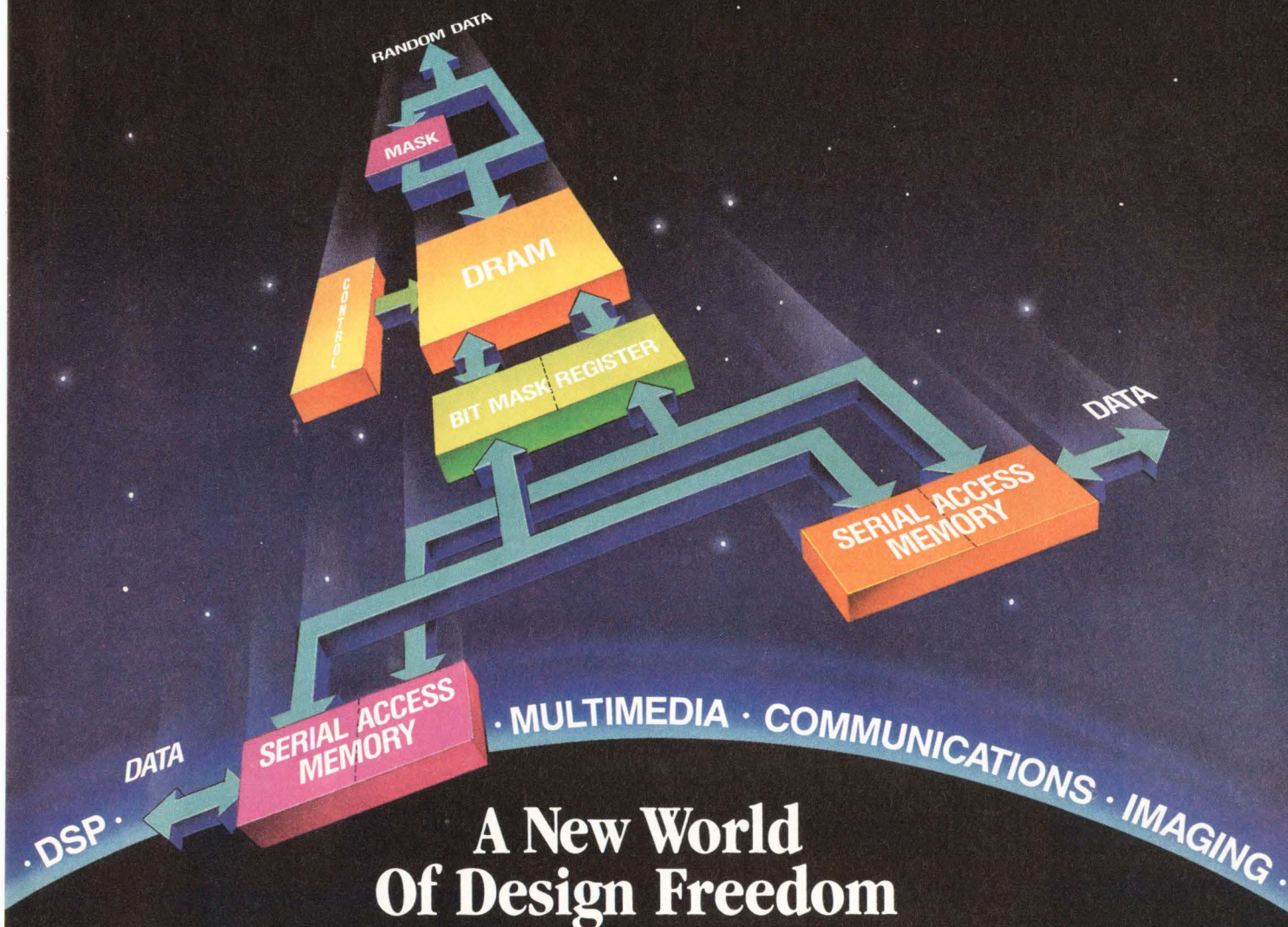

## A New World Of Design Freedom

Experience a new world of design freedom with Micron's 1 Meg Triple Port DRAM — the first DRAM designed to dramatically speed up and simplify your data manipulation. With three ports rapidly accessing a common memory array, you won't be tied down with data bottlenecks.

Our Triple Port DRAM provides three independent, asynchronous and bi-directional ports. Data may be read from and written to memory through both of the fully-static Serial Access Memory ports while normal functions of the DRAM port are also performed. Plus, multiple data input or output operations can occur at the same time — resulting in faster data transfer and more design freedom.

The Triple Port DRAM also features a Bit Mask Register for built-in masking, including windowing, and Split Read or Write Transfers that make transfer timing much easier.

So, whether you're designing multimedia workstations,

super computer networks, satellite communication links or full-motion video frame buffers, you will be worlds ahead in speed and simplicity.

Enjoy your design freedom and stay on the leading edge by calling Micron at 208-368-3900.

Micron. Working to improve your memory.

Part #	Organization	Speed	Package	Availability**
MT43C4257	256K × 4 DRAM 512 × 4 SAMs	80,100,120 25,30,35	40-Pin SOJ	Samp: Now Prod: Mar 91
MT43C4258*	256K × 4 DRAM 512 × 4 SAMs	80,100,120 25,30,35	40-Pin SOJ	Samp: Now Prod: Mar 91
MT43C8128	128K × 8 DRAM 256 × 8 SAMs	80,100,120 25,30,35	52-Pin PLCC	Samp: Now Prod: 2Q91
MT43C8129*	128K × 8 DRAM 256 × 8 SAMs	80,100,120 25,30,35	52-Pin PLCC	Samp: Now Prod: 2Q91

\*Provides SAM stop address input \*\*Call for military availability

**MICRON**  
TECHNOLOGY, INC.

2805 E. Columbia Rd., Boise, ID 83706 (208) 368-3900

©Micron Technology, Inc. 1991

CIRCLE NO. 104

# Inductive Components for ISDN

## Success through new materials

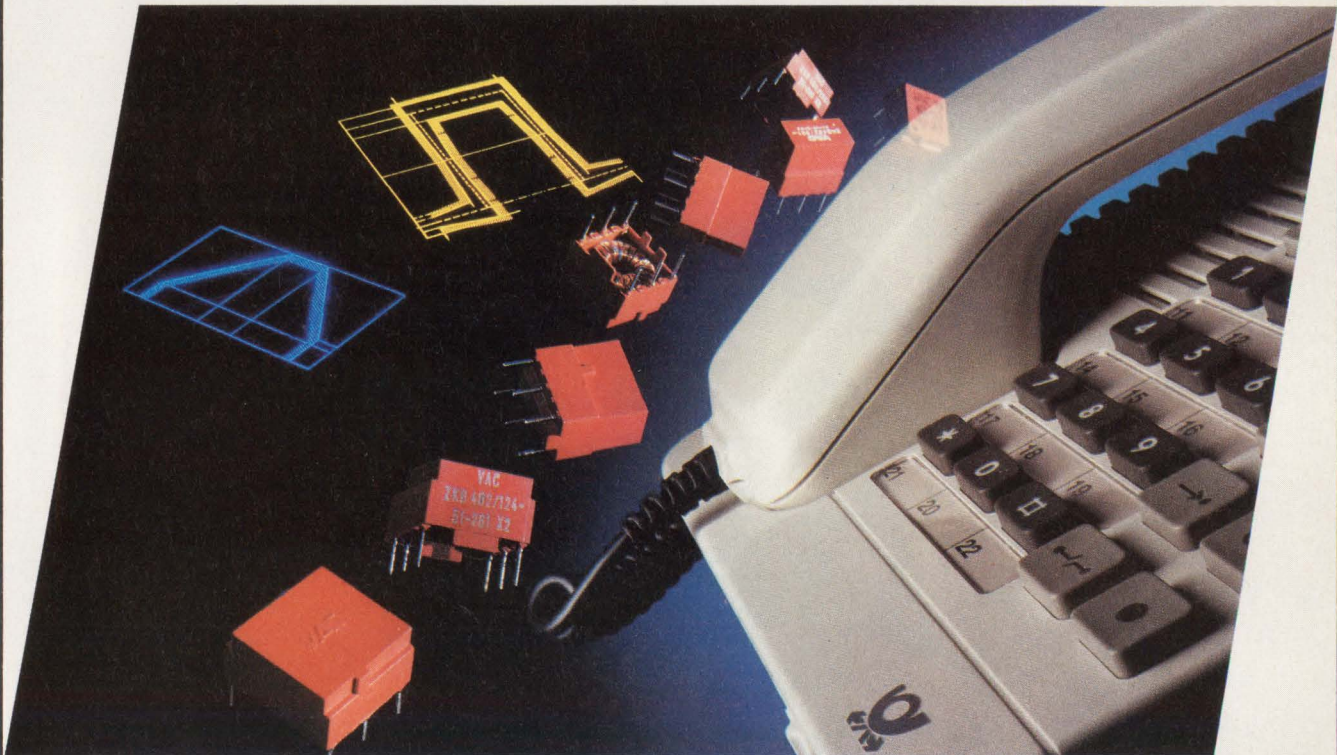

*Do you need signal transformers for S<sub>0</sub>-interfaces or common mode chokes for RFI suppression, maybe for applications in consumer terminal equipment or terminal adaptors or for network terminal devices or extension equipment? Contact us immediately if you intend to be more successful than your competitors. Using our ISDN purpose developed core materials as a basis we offer:*

- *a reduction in volume up to 50% achieved through new high permeability core materials*
- *considerably improved assembly and cost-effectivity achieved through module design*
- *components meeting technical specifications as, e.g. in CCITT, FTZ, BABT and CNET*
- *high insertion losses in the frequency range specified*

*Forward your individual requirements right away. You won't have to wait long for our solution.*

M-125

## VACUUMSCHMELZE GMBH

186 Wood Avenue South · Iselin, N.J. 08830 ☎ (201) 494-3530 [Fax] (201) 3213 029 [Tx] 4 900 006 431

Grüner Weg 37, D-6450 Hanau · ☎ (\*\*49) 61 81/38-0 · [Fax] (\*\*49) 61 81/38-26 45 · [Tx] 4184 863 vac d

# BOOK REVIEW

## ISDN from A to Z

*The ISDN Sourcebook*. 607 pgs; \$225. Information Gatekeepers Inc, Boston, MA, 1990.

*The Basics Book of ISDN*. 48 pgs; Free. Codex Corp, Mansfield, MA, 1990.

*ISDN Design: A Practical Approach*, by Steve Hardwick. 152 pgs; \$34.95. Academic Press, San Diego, CA, 1989.

The ISDN Sourcebook contains plenty of information for both ISDN aficionados and neophytes. Starting from an explanation of what the Integrated Services Digital Network is, the 607-page soft-cover book progresses through a brief description of the international, US governmental, and US nongovernmental organizations involved in specifying or implementing ISDN.

The guide contains a bibliography covering ISDN literature from 1982 to 1988. Also included in the bibliography are references to Bellcore publications; a listing of company, professional-society, and trade-journal special issues on ISDN; and a directory of publications that focus on ISDN.

Another chapter provides insight into the current worldwide status of ISDN. Two chapters enumerate the US companies that implement ISDN and provide a list of mostly US suppliers of ISDN equipment, software, and services. The book also contains a section devoted to ISDN applications. A telecommunications calendar lists events from 1990 to 1998. Not surprisingly, the calendar is heavily weighted toward the present and lists no events for 1995 to 1997. The final 23-pg chapter is a somewhat self-serving description of the numerous ISDN publications of the book's publisher, Information Gatekeepers.

The book concludes with 17 appendices, which include information ranging from a description of US

and foreign tariffs and services to user-forum and study-group recommendations. Unfortunately, many of the pages in the appendix are photocopies and, occasionally, are of too poor quality to be of much use.

One item missing from *The ISDN Sourcebook* is a comprehensive glossary. Although short, partial glossaries are included in some of the appendices, the book doesn't contain a thorough dictionary of terms. Otherwise, the publication is a useful, detailed guide to most anything you'd ever want to know about the Integrated Services Digital Network.

*The Basics Book of ISDN*, which the Codex Corp publishes and distributes free of charge, is a short, light approach to ISDN. The short book—or long pamphlet—explains how you can assess your communications needs and how ISDN might fit into your plans. With the exception of one chapter that discusses ISDN products and equipment, you can even read the text without an ISDN glossary.

Although ISDN texts tend toward the incomprehensible, some clear, understandable design books do exist. One such text is *ISDN Design: A Practical Approach*, by Steve Hardwick. The book is tailored for managers who evaluate the ISDN marketplace. It starts with a mostly acronym-free introduction to ISDN and progresses to cover standards, ISDN terminals, exchanges, and software. With the current emphasis on design for testability, the chapter on testing ISDN systems is timely. The conclusion looks at a company's decision to build ISDN products. This source comes up short, though, in its optimism for the ISDN marketplace. Although ISDN has been the technology of the future for several years now, the book ignores the arguments for and against ISDN's ultimate success.

—Michael C Markowitz

## Steal 150 watts of rf power.

At a price you'd gladly pay for only 100 watts, the new Model 150L delivers a *minimum* of 150 very clean and reliable watts through a bandwidth of 10 kHz to 220 MHz.

And that bandwidth is instantly available without need for tuning or bandswitching—important when you're sweeping for rfi susceptibility,

in wattmeter calibration, antenna testing, or countless other rf tasks.

Latest FET technology has enhanced the linearity and phase response of the lower-power stages, and the final output stage contains an advanced vacuum-tube amplifier. There's total immunity to load mismatch from sky-high VSWR—even

shorted or open output terminals—assuring freedom from burnout, fold-back, or oscillation.

Oh yes—the price. The new Model 150L is truly a steal. The cost-per-watt has just plummeted by 30%!



**AMPLIFIER  
RESEARCH**

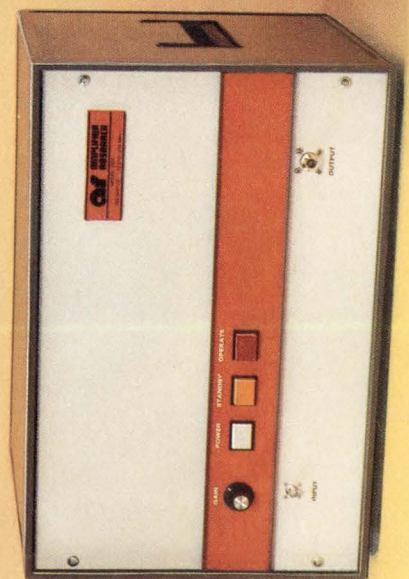

160 School House Road, Souderton, PA 18964-9990 USA • TEL 215-723-8181 • TWX 510-661-6094 • FAX 215-723-5688

8547

# At last, an entirely new approach to clock speed

**Get five times faster throughput from NEC K-Series™ microcomputers.**

As a developer of real-time control systems, you know that designing in a faster CPU is not enough. You also need intelligent I/O management for the best possible system throughput.

NEC's K-Series™ microcomputers are perfect for real-time control designs requiring multi-tasking, such as automotive control, ISDN and computer peripheral controllers.

## **Peripheral Management Unit™**

The K-Series' unique architecture includes a revolutionary Peripheral Management Unit™ macro service for nonstop instruction execution while processing up to 16 I/O requests at the same time. By designing in the K-Series microcomputer, you can improve your system throughput by as much as 5X.

The K-Series 8-bit and 16-bit microcomputers give you a real-time output port; an advanced counter/timer system; a high-speed, high-resolution A/D converter; and many other on-chip intelligent peripherals.



**Not since the invention of the hourglass has anyone come up with a more ingenious way to speed up silicon.**

The K-Series provides you a worry-free upgrade path from the 8-bit K2 microcontroller family to the 16-bit K3 devices. And your future designs will exploit the power of the lightning-fast 125-ns K6, with real-time operating system in

microcode, and complete K3 software compatibility.

To learn more about the K-Series microcomputers with up to 1K bytes of on-board RAM, 32K bytes of ROM/EPROM, and Peripheral Management Unit coprocessing power, call now.

## **For fast answers, call us at:**

Australia Tel:03-267-6355. Telex:38343.  
 France Tel:1-3067-5800. Telex:699499.  
 Germany Tel:0211-650302. Telex:8589960.  
 Hong Kong Tel:755-9008. Telex:54561.  
 Ireland Tel:1-6794200. Telex:90847.  
 Italy Tel:02-6709108. Telex:315355.  
 Korea Tel:02-551-0450. Fax:02-551-0451.  
 The Netherlands Tel:040-445-845. Telex:51923.  
 Singapore Tel:4819881. Telex:39726.  
 Spain Tel:1-419-4150. Telex:41316.  
 Sweden Tel:08-753-6020. Telex:13839.  
 Taiwan Tel:02-719-2377. Telex:22372.  
 UK Tel:0908-691133. Telex:826791.  
 USA Tel:1-800-632-3531. Fax:1-800-729-9288.

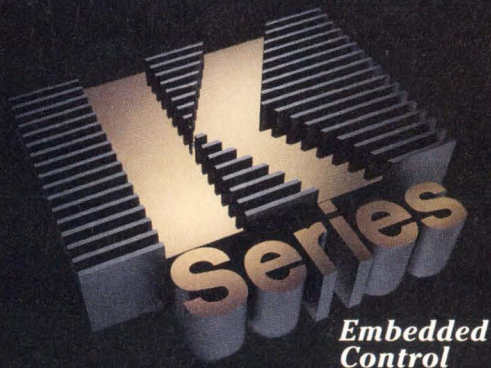
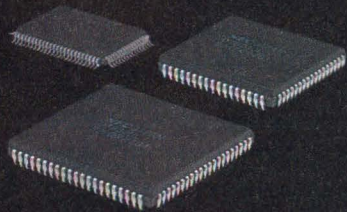

# EDN's INTERNATIONAL ADVERTISERS INDEX

ACCEL Technologies Inc . . . . .	171	NEC Corp . . . . .	116, 182
Advanced Circuit Technology . . . . .	130	Network Research . . . . .	110
Advin Systems . . . . .	170	Nohau Corp . . . . .	148, 169
Altera Corp . . . . .	42-43	Noritake Electronics Inc . . . . .	127
Ametek . . . . .	88	Nova Tran Corp . . . . .	147
AMP . . . . .	58-59	Number One Systems Ltd . . . . .	172
Amplifier Research . . . . .	181	OKI Electric . . . . .	12-13
Ampro . . . . .	28-29	Omaton Inc . . . . .	171
Analog Devices Inc . . . . .	168	Omnibyte Corp* . . . . .	89-90
AT&T Technologies . . . . .	77	OrCAD Systems Corp . . . . .	19
Augat . . . . .	142	Orion Instruments . . . . .	143
B&C Microsystems . . . . .	169, 171	Pacific Hybrid Microelectronics . . . . .	162
BP Microsystems . . . . .	172	Pico . . . . .	164, 183
Bruel & Kjaer Instruments** . . . . .	28A	Powerex Inc . . . . .	160
Buckeye Stamping Co . . . . .	171	Powertronic . . . . .	171
Burr-Brown Corp . . . . .	139	Qua Tech Inc . . . . .	173
CAD Software Inc . . . . .	163	Quantic . . . . .	144
Cad TEAM . . . . .	112	Raltron . . . . .	111
Cahners CAPS . . . . .	170	Rapid Systems . . . . .	94
Cahners Exposition Group . . . . .	149-152	Rayovac . . . . .	56
Capilano Computer Systems Inc . . . . .	173	RLC Enterprises . . . . .	170
Capital Equipment Corp . . . . .	172	Rockwell Elec Oprtn . . . . .	22
Cirrus Logic . . . . .	146	Rogers Corp . . . . .	57, 171
Computerwise Inc . . . . .	170	SBE . . . . .	60
Connor Peripherals . . . . .	78-79	Sea Level Systems . . . . .	130
Cybernetic Micro Systems . . . . .	170	SenSym . . . . .	115
Cypress Semiconductor . . . . .	17	Siemens Components Inc* . . . . .	91
Dale Electronics Inc . . . . .	1, 110	Signal Transformer Co Inc . . . . .	C4
Data I/O Corp . . . . .	172	Signetics Corp* . . . . .	44-45
Dexter Magnetics . . . . .	74	Silicon Systems . . . . .	46
DigiKey . . . . .	159	Single Board Solutions . . . . .	169
Duracell . . . . .	166-167	SL Waber . . . . .	88
Echelon . . . . .	67-69	Sony . . . . .	55
EEsof . . . . .	40	Sorensen Electronics . . . . .	169
Elco Corp . . . . .	140	Sprague Electric Co . . . . .	62
Emulation Technology Inc . . . . .	173	Stanford Research Systems Inc . . . . .	141
Epson America Inc . . . . .	157	Tatum Labs . . . . .	170
Force Computers Inc . . . . .	24-25	Tektronix . . . . .	8-9, 34-37
General Consulting . . . . .	169	Telecom Analysis Systems . . . . .	162
GenRad . . . . .	23	Toko America Inc . . . . .	153
Graphtec Corp . . . . .	145	Toyocom . . . . .	158
Gregor** . . . . .	88B	Tribal Microsystems . . . . .	173
Hewlett-Packard Co . . . . .	2, 14	Universal Data Systems . . . . .	C3
Hughes Microelectronics Europe Ltd . . . . .	113	US Software . . . . .	171, 173
HyperLynx . . . . .	52	Vacuumschmelze . . . . .	180
ILC Data Device Corp . . . . .	51	Westcor . . . . .	75
Incredible Tech . . . . .	173	Xeltek . . . . .	172
Instrument Specialties Co Inc . . . . .	27	Xilinx . . . . .	165
Integraph . . . . .	114	Yamaha LSI . . . . .	125
Integrated Circuit Systems Inc . . . . .	105	Zax Corp . . . . .	74
Integrated Device Technology Inc . . . . .	C2	Zilog Inc . . . . .	26
Integrated Silicon Systems . . . . .	161	Z-World . . . . .	173
Intel . . . . .	87	Zyrel . . . . .	172
Intusoft . . . . .	170		
Ironwood Electronics Inc . . . . .	171		
John Fluke Mfg Co Inc* . . . . .	32		
Keithley Instruments* . . . . .	53-54		
Kepco Inc . . . . .	92-93		
Knuerr AG . . . . .	107		
Lattice Semiconductor Corp . . . . .	6		
Lemo USA Inc . . . . .	171		
Linear Technology Corp . . . . .	95, 134		
Link Computer Graphics Inc . . . . .	170		
LSI Logic Corp . . . . .	10-11		
3M Co . . . . .	109		
Mark Williams . . . . .	178		
Maxtor . . . . .	154-155		
Megatel Computers . . . . .	156		
Micron Technology Inc . . . . .	179		
Mini-Circuits Laboratories . . . . .	3, 4, 20-21, 30-31, 137		
Mitsubishi . . . . .	129, 133		
Molex Inc . . . . .	184		
Motorola Semiconductor Products Inc* . . . . .	96		
National Semiconductor Corp* . . . . .	38-39, 70-72		
NCI . . . . .	169		

## Recruitment Advertising 174-178

Allen-Bradley  
Codex Corp  
DSC Communications  
Interphase Corp  
Smarton Electronics

\*Advertiser in US edition  
\*\*Advertiser in International edition

This index is provided as an additional service. The publisher does not assume any liability for errors or omissions.

## High Voltage DC-DC Converters

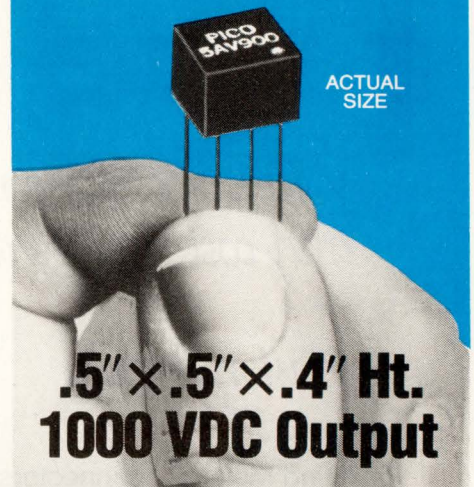

**.5" x .5" x .4" Ht.  
1000 VDC Output**

- **New Series AV—  
56 Standard Models**
- **100 VDC to 1000 VDC  
Output**
- **Ultra-miniature Size  
Weight: 4 Grams  
0.1 Cubic Inch Volume**
- **Standard Input Voltages  
5, 12, 24 and 28 Volts DC**
- **Operating Temperature  
Standard: -25°C to +70C  
Optional: -55°C to +85°C**
- **MIL-STD-883  
Screening Available**
- **Isolated: Input to Output  
up to 1500 VDC**

PICO also manufactures over 800 regulated and isolated DC-DC Converters and AC-DC Power Supplies and over 2500 standard ultra-miniature Transformers and Inductors.

Delivery—  
stock to  
one week

SEE EEM,  
THOMAS REGISTER  
OR SEND DIRECT FOR  
FREE PICO CATALOG

**PICO  
Electronics, Inc.**  
453 N. MacQuesten Pkwy. Mt. Vernon, N.Y. 10552  
Call Toll Free **800-431-1064**  
IN NEW YORK CALL **914-699-5514**

CIRCLE NO. 18

*With our SL™ connector system, design flexibility and cost savings are yours.*

*Automatically.*

You'll find Molex SL connectors in some of the world's leading—and most dependable—makers of electrical and electronic equipment. Of course, reliability is a big reason for this preference.

But the versatility and lower applied cost that SL provides are critical factors, too, especially in systems with several interconnections.

Modular, stackable, and lower in profile, SL connectors give you virtually unlimited flexibility when you're designing wire-to-wire, wire-to-board, and ribbon cable systems.

The single-piece IDT connectors feature, pre-assembled terminals in the housings, and interconnects with locking shrouded headers. In short, they're ideal for high-speed, high-efficiency automated assembly.

Ask your Molex representative about SL connectors, and learn how they can multiply design options and automate assembly.

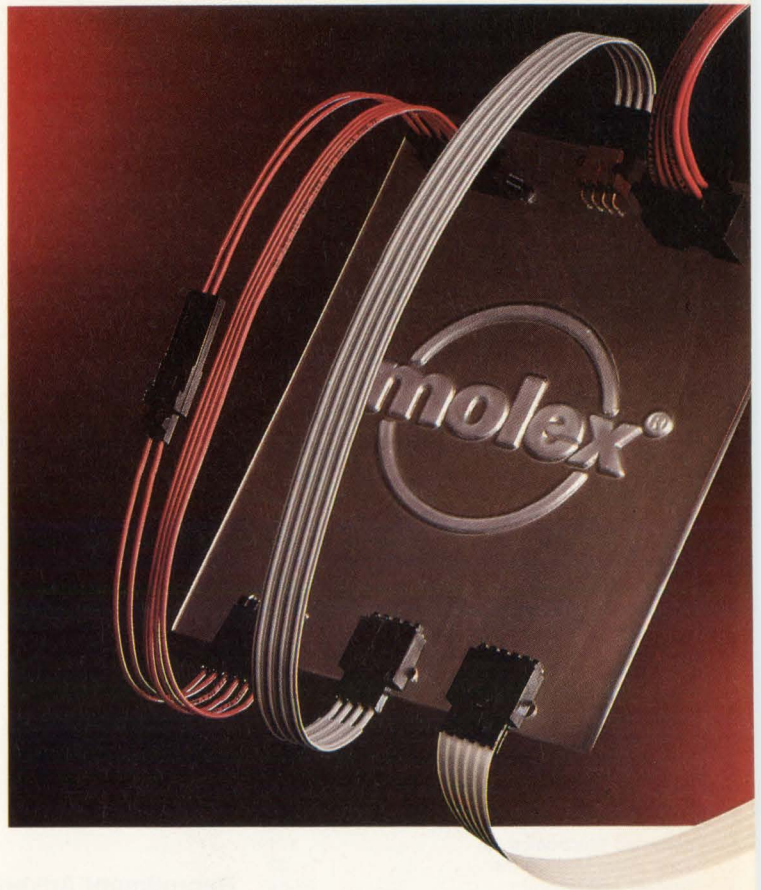

*Bringing People & Technology Together, Worldwide<sup>SM</sup>*

Corporate Headquarters: 2222 Wellington Ct., Lisle, IL 60532 U.S.A., Tel: (708) 969-4550 • European Headquarters: Munich, West Germany, Tel: 49-89-413092-0  
Far East North Headquarters: Tokyo, Japan, Tel: 81-427-21-5539 • Far East South Headquarters: Jurong Town, Singapore, Tel: 65-660-8555

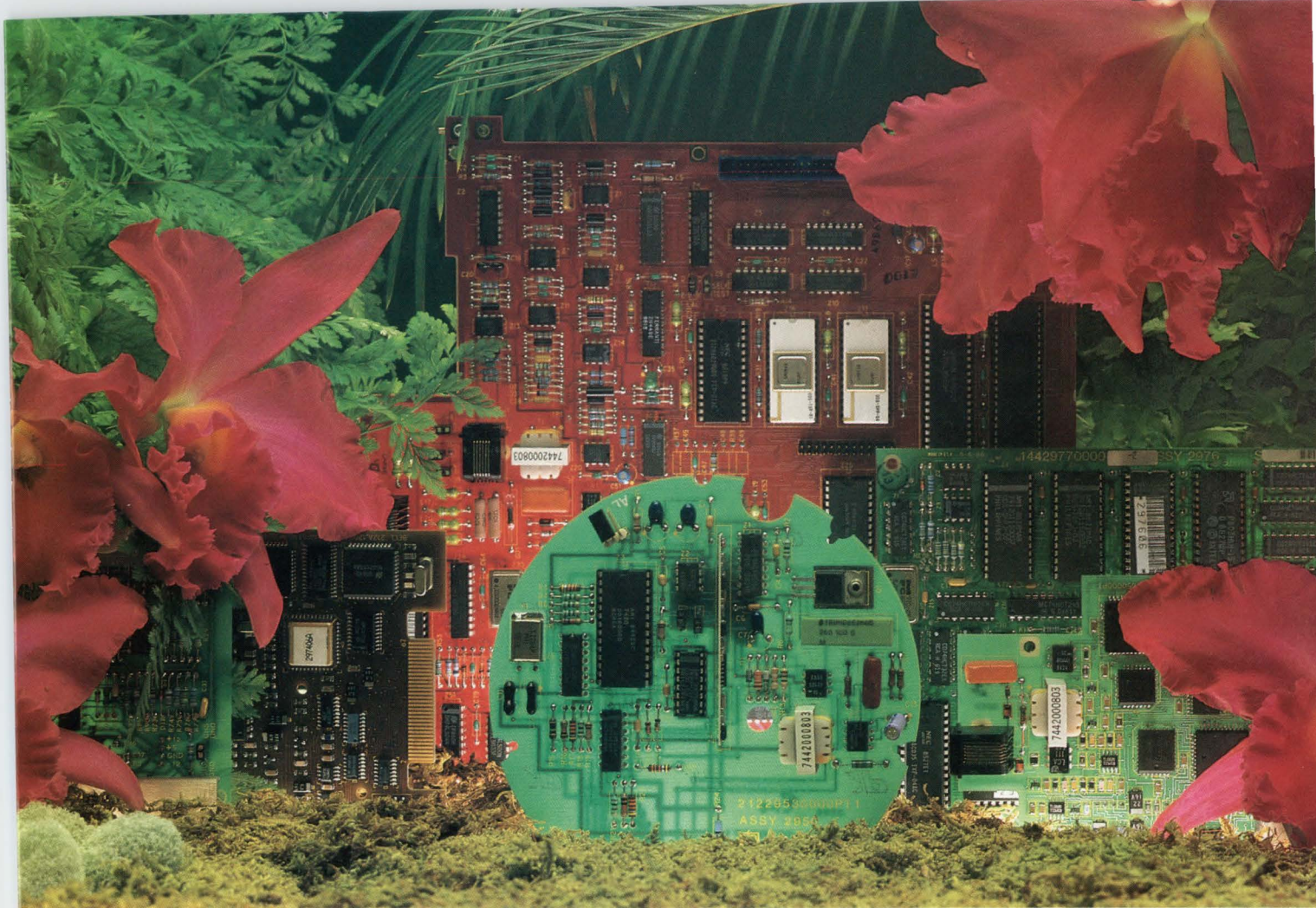

# Exotic Customs at UDS

The special requirements of data communications OEMs have resulted in some pretty exotic custom modem cards from UDS.

Funny form factors are routine fare for our custom designers. Nooks, crannies and odd card configurations are no problem, given sufficient square inches of real estate. UDS engineers have even designed a complete 2400 bps modem that's the size of a credit card.

Non-standard modem functions are another specialty of the house. For example, UDS engineers have already designed and delivered a hand-held RF modem operating at 9600 bps!

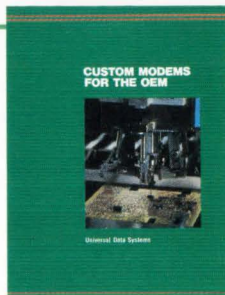

*For a generous sampling of UDS' custom design capabilities, ask for the new, free OEM modem brochure.*

UDS has successfully handled more than 3,000 custom OEM modem design assignments — and we can handle yours. To begin an exotic custom, contact UDS, 5000 Bradford Drive, Huntsville, AL 35805-1993. Phone 205/430-8000; FAX: 205/430-8926.



# NEW DUAL BOBBIN DESIGN TRANSFORMERS.

## ONE-4-ALL™ TRANSFORMERS FEATURE HIGH ISOLATION FOR TRIPLE OUTPUT REGULATED POWER SUPPLIES IN MICROPROCESSOR APPLICATIONS.

Once again, Signal "The American Original" comes through with a complete line of 50/60 Hz transformers for triple-output regulated supplies. These new "one-4-all"™ transformers feature the same dual high-temperature bobbin construction and insulating shroud originally developed for the company's very successful International Series. Because they have high isolation and reduced interwinding capacitance characteristics, and require no electrostatic shield, the transformers are an ideal low noise alternative to multi-output switchers. They satisfy UL 506 requirements, and CSA safety and performance standards.

Offered in PC and chassis mount versions, the "one-4-all" has dual complementary outputs ( $\pm 15$  VDC and  $\pm 12$  VDC) and additional isolated single output for +5 VDC with in-circuit performance specs.

Signal transformers are available through Signal's PRONTO 24-Hour Off-the-Shelf shipment program. For additional technical data, contact Signal Transformer, 500 Bayview Avenue, Inwood, N.Y. 11696.

**BUY DIRECT**  
**(516) 239-5777**  
 Fax: (516) 239-7208.

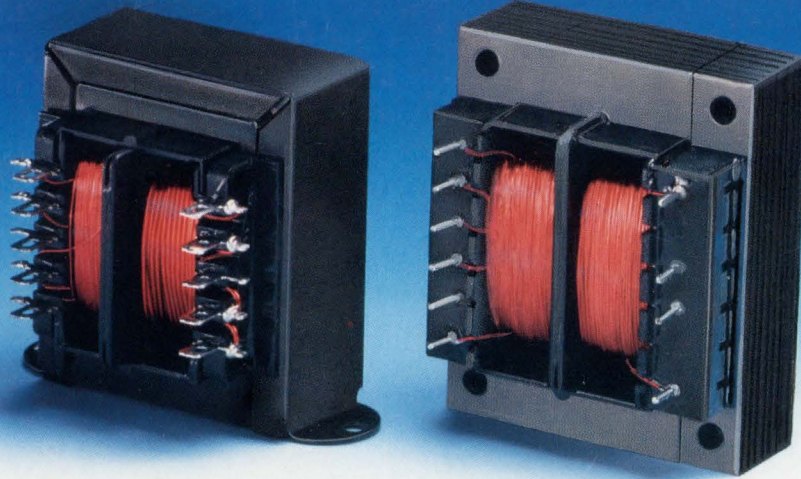

PART NUMBER PRIMARY 50/60 Hz	DC OUTPUT		VA	PRICE
	Regulator 1	Regulator 2		
115/230V				
A41-25-512	5V @ 1.25A	$\pm 12$ V @ 150MA	25	16.25
A41-25-515	5V @ 1.25A	$\pm 15$ V @ 130MA	25	16.25
A41-43-512	5V @ 2A	$\pm 12$ V @ 300MA	43	20.75
A41-43-515	5V @ 2A	$\pm 15$ V @ 250MA	43	20.25
A41-80-512	5V @ 3.5A	$\pm 12$ V @ 600MA	80	28.50
A41-80-515	5V @ 3.5A	$\pm 15$ V @ 500MA	80	28.50

PART NUMBER PRIMARY 50/60 Hz	DC OUTPUT		VA	PRICE
	Regulator 1	Regulator 2		
115/230V				
14A-20-512	5V @ 750MA	$\pm 12$ V @ 200MA	20	15.00
14A-20-515	5V @ 750MA	$\pm 15$ V @ 175MA	20	15.00
14A-30-512	5V @ 1.25A	$\pm 12$ V @ 250MA	30	17.75
14A-30-515	5V @ 1.25A	$\pm 15$ V @ 200MA	30	17.25
14A-56-512	5V @ 3A	$\pm 12$ V @ 300MA	56	21.00
14A-56-515	5V @ 3A	$\pm 15$ V @ 250MA	56	21.00

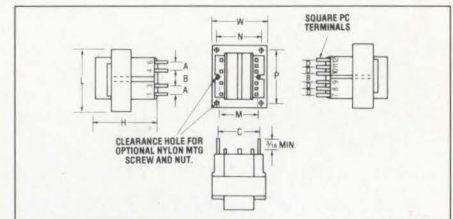
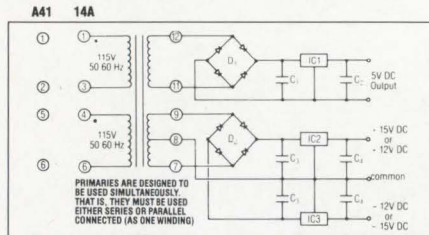
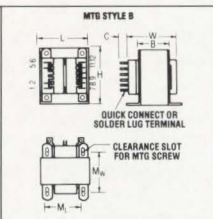
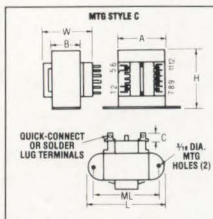

VA	Dimensions						Terminals	Mtg. Style	Mtg.			Lbs.
	L	W	H	A	B	C			ML	MW	Screw	
25	2 <sup>13</sup> / <sub>16</sub>	1 <sup>1</sup> / <sub>8</sub>	2 <sup>3</sup> / <sub>16</sub>	2	1 <sup>1</sup> / <sub>8</sub>	3 <sup>1</sup> / <sub>8</sub>	3 <sup>1</sup> / <sub>16</sub> (.187)	C	2 <sup>1</sup> / <sub>8</sub>	-	#6	1.25
43	3 <sup>1</sup> / <sub>8</sub>	2 <sup>1</sup> / <sub>16</sub>	2 <sup>1</sup> / <sub>16</sub>	2 <sup>1</sup> / <sub>8</sub>	1 <sup>1</sup> / <sub>8</sub>	3 <sup>1</sup> / <sub>8</sub>	3 <sup>1</sup> / <sub>16</sub> (.187)	C	2 <sup>1</sup> / <sub>16</sub>	-	#6	1.6
80	2 <sup>1</sup> / <sub>2</sub>	2 <sup>3</sup> / <sub>8</sub>	3	-	1 <sup>1</sup> / <sub>8</sub>	3 <sup>1</sup> / <sub>8</sub>	3 <sup>1</sup> / <sub>16</sub> (.187)	B	2	2 <sup>1</sup> / <sub>16</sub>	#6	2.8

VA	Dimensions							Pin Dimensions	Mtg.			Mtg. Screw		Lbs.
	L	W	H	A	B	C	D		M	N	P	Size	Quantity	
20.0	2 <sup>1</sup> / <sub>4</sub>	1 <sup>1</sup> / <sub>8</sub>	1 <sup>1</sup> / <sub>8</sub>	.400	.400	1.460	.200	0.038SQ	1 <sup>1</sup> / <sub>2</sub>	-	-	#4	2	0.90
30.0	2 <sup>3</sup> / <sub>8</sub>	2 <sup>3</sup> / <sub>16</sub>	1 <sup>1</sup> / <sub>8</sub>	.550	.275	1.680	.275	0.045SQ	-	1 <sup>1</sup> / <sub>4</sub>	2 <sup>3</sup> / <sub>16</sub>	#6	4	1.15
56.0	3	2 <sup>1</sup> / <sub>2</sub>	1 <sup>1</sup> / <sub>16</sub>	.600	.300	1.900	.300	0.045SQ	-	2	2 <sup>1</sup> / <sub>2</sub>	#6	4	1.70

**signal**  
 TRANSFORMER

The American Original™