

# EDN<sup>®</sup>

Designer's Guide to  
state machines—Part 1

Designer's Guide to  
noise analysis—Part 2

Software function libraries

Uniting ultrasonics  
and microelectronics

ELECTRONIC TECHNOLOGY FOR ENGINEERS AND ENGINEERING MANAGERS

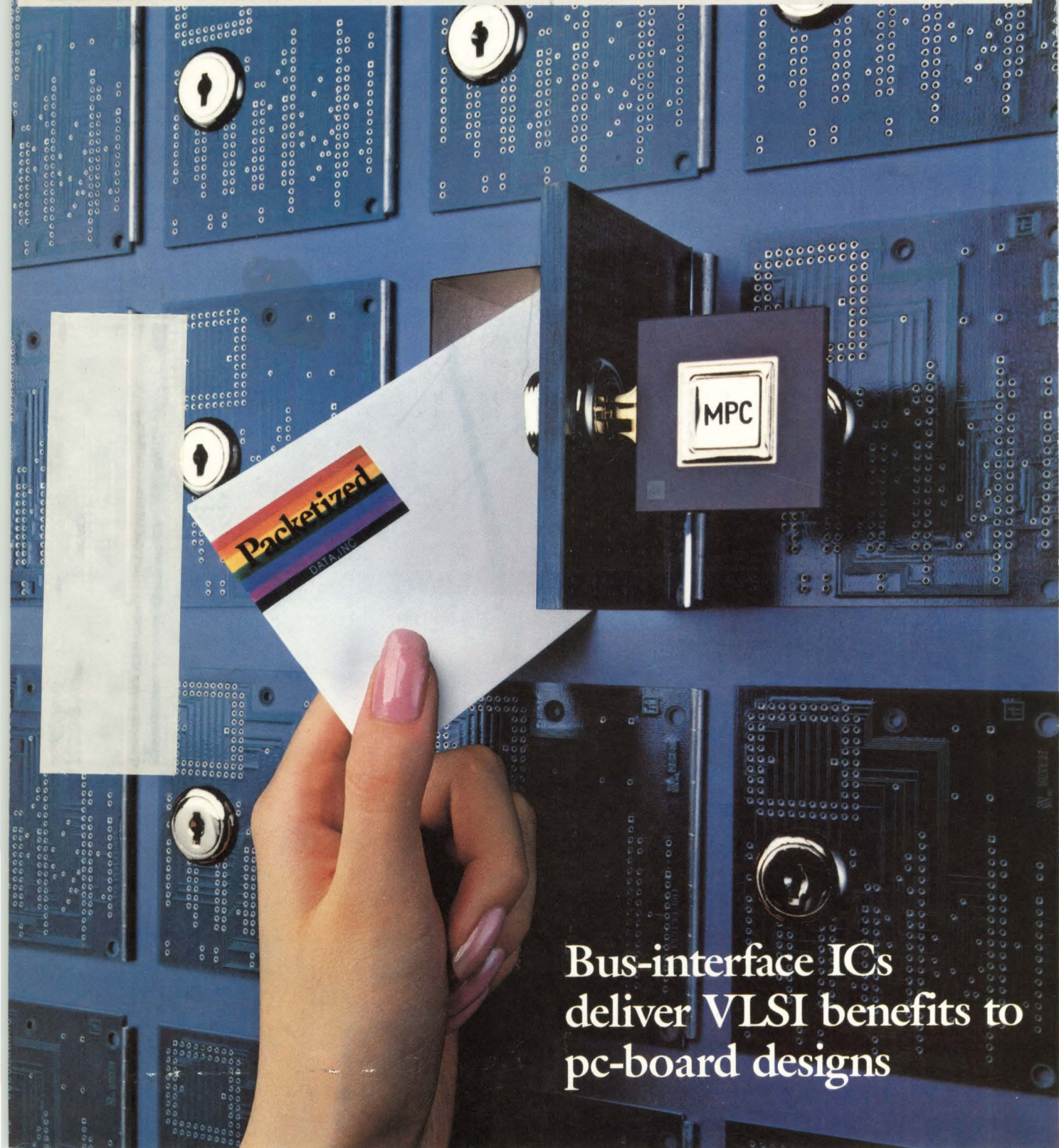

**Bus-interface ICs  
deliver VLSI benefits to  
pc-board designs**

# **Devices' 29K. platform.**



Call toll-free (800) 222-9323. Advanced Micro Devices, Inc., 901 Thompson Place, P.O. Box 3453, Sunnyvale, CA 94088.  
29K logo is a trademark of Advanced Micro Devices, Inc. © Advanced Micro Devices, Inc. 1988. 

**CIRCLE NO 175**

***Advanced Micro***  
***The next***

---

---

Seventeen MIPS with a single  
32-bit RISC chip. Sustained. 42,000  
dhrystones. In CMOS. On the shelf.  
Complete hardware and software  
development support. Optimizing  
compilers. Assemblers. Debuggers.  
Industry standard operating systems.  
Hardware development tools.



Documentation,  
training and customer  
support. Now.

---

# Solutions

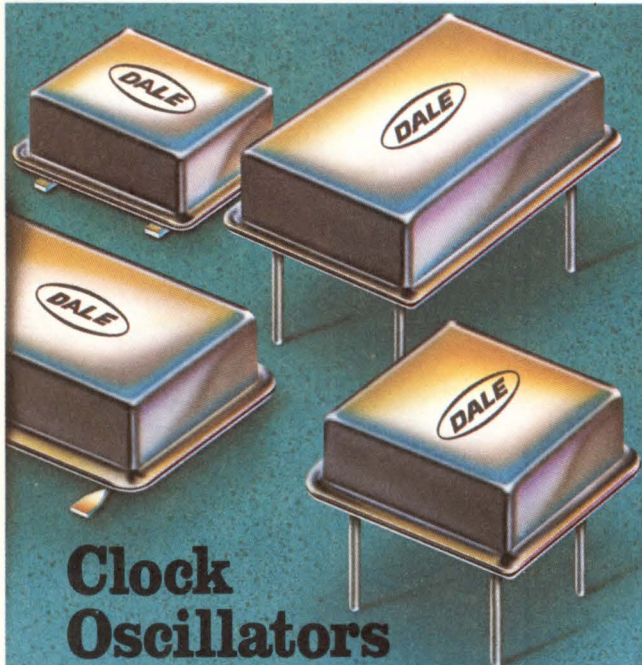

**Clock  
Oscillators  
to fit your board.**

## **Dale's XO Series.**

Call Dale® to match your clock oscillator requirements for timing, board space...and cost. Our versatile oscillator family includes both surface mounted and standard DIP styles with low profile, hermetically sealed metal cases. This broad selection offers frequencies from 250 KHz to 60 MHz...compatibility with most logics...plus delivery from stock of standard frequencies. Check our competitive pricing, including the new XO-51B (.50" sq.) and XO-54B models. Contact Dale Electronics, Inc., 1155 West 23rd Street, Tempe, AZ 85282.

For more details, call: **602-967-7874**

CIRCLE NO 13

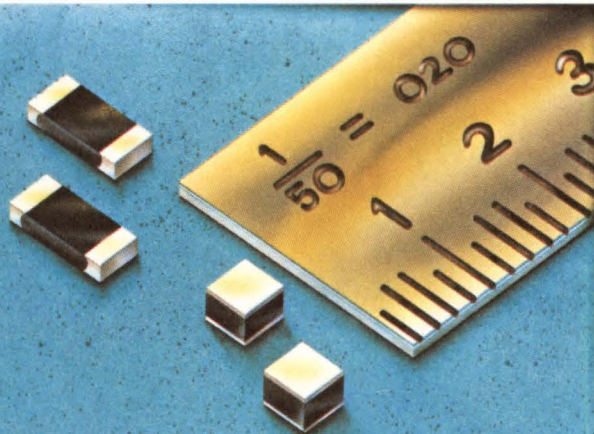

**NTC  
Thermistors  
for Surface  
Mounting.**

## **Dale's H and W.**

A choice of two Dale chip-style thermistors makes it easier to integrate temperature measurement and control into hybrid and surface-mounted design. Type "H" has silver wraparound terminations on each end. Type "W" has silver terminations on top and bottom surfaces. Both are available in  $\pm 5\%$  and  $\pm 10\%$  tolerances with  $R_{25}$  values from 50 ohms to 1 meg., depending on type and size. For information and technical assistance, contact: Dale Electronics, Inc., Western Thermistor Division, P.O. Box 26728, El Paso, TX 79926.

Phone this number today: **915-592-3253**

CIRCLE NO 14

*Dale makes your basics better.*

**DALE**

British Telecom says,

# “Fifty approvals from one lab – Thanks DS&G!”



Gavin Steven  
British Telecom/  
Mitel Datacom

“At British Telecom we knew that a single compliance problem could have crippled our introduction and damaged our reputation. So we chose the best facility.” They chose DS&G.

## No Lab Offers More Approvals

DS&G offers every approval you will ever need. They offer a complete line of EMI, telecom, and safety certifications. For EMI, they can get approval by the FCC, the Canadian DOC, the German VDE, and the Japanese VCCI. For telecom, they offer FCC, DOC, BABT (British), and JATE (Japanese) approval. For safety, they can obtain the marks of UL, CSA (Canada), and TUV (Germany).

## DS&G Does It All

DS&G works with you all the way from initial design to complete retrofit. They can handle every aspect of your compliance program, including liason with government agencies. But DS&G does even more. It annually publishes the industry's reference book on designing for compliance, “Compliance Engineering.” It also consults with U.S. and foreign governments on developing technology and regulations. So you know you are getting the most comprehensive, up-to-date service.

## “On Time and On Budget!”

British Telecom was particularly impressed that DS&G got so many approvals without any delays or cost overruns. Your approval program can go as smoothly as their's did. You can choose DS&G. Call now at 617 263-2662.

Dash Straus & Goodhue, Inc.  
593 Massachusetts Ave.  
Boxborough, MA 01719  
(617) 263-2662  
After 7/19/88: (508) 263-2662

**DSG**  
Dash Straus & Goodhue



# tiny SPDT switches

*absorptive... reflective*

*dc to 4.6 GHz from \$32<sup>95</sup>* (1-24)

Tough enough to pass stringent MIL-STD-883 tests, useable from dc to 6GHz and smaller than most RF switches, Mini-Circuits' hermetically-sealed (reflective) KSW-2-46 and (absorptive) KSWA-2-46 offer a new, unexplored horizon of applications. Unlike pin diode switches that become ineffective below 1MHz, these GaAs switches can operate down to dc with control voltage as low as -5V, at a blinding 2ns switching speed.

Despite its extremely tiny size, only 0.185 by 0.185 by 0.06 in., these switches provide 50dB isolation (considerably higher than many larger units) and insertion loss of only 1dB. The absorptive model KSWA-2-46 exhibits a typical VSWR of 1.5 in its "OFF" state over the entire frequency range. These surface-mount units can be soldered to pc boards using conventional assembly techniques. The KSW-2-46, priced at only \$32.95, and the KSWA-2-46, at \$48.95, are the latest examples of components from Mini-Circuits with unbeatable price/performance.

Connector versions, packaged in a 1.25 x 1.25 x 0.75 in. metal case, contain five SMA connectors, including one at each control port to maintain 3ns switching speed.

**Switch fast... to Mini-Circuits' GaAs switches.**

## SPECIFICATIONS

Pin Model	KSW-2-46		KSWA-2-46	
Connector Version	ZFSW-2-46		ZFSWA-2-46	
FREQ. RANGE	dc-4.6 GHz		dc-4.6 GHz	
INSERT. LOSS (db)	typ	max	typ	max
dc-200MHz	0.9	1.1	0.8	1.1
200-1000MHz	1.0	1.3	0.9	1.3
1-4.6GHz	1.3	1.7	1.5	2.6
ISOLATION (dB)	typ	min	typ	min
dc-200MHz	60	50	60	50
200-1000MHz	45	40	50	40
1-4.6GHz	30	23	30	25
VSWR (typ)	ON	1.3:1	1.3	
	OFF	—	1.4	
SW. SPEED (nsec)				
rise or fall time	2(typ)		3(typ)	
MAX RF INPUT (bBm)				
up to 500MHz	+17		+17	
above 500MHz	+27		+27	
CONTROL VOLT.	-5V on, OV off		-5V on, OV off	
OPER/STOR TEMP.	-55° to +125°C		-55° to +125°C	
PRICE (1-24)	<b>\$32.95</b>		<b>\$48.95</b>	
	<b>\$72.95</b>		<b>\$88.95</b>	

finding new ways ...  
setting higher standards

**Mini-Circuits**

A Division of Scientific Components Corporation

P.O. Box 350166, Brooklyn, New York 11235-0003 (718) 934-4500  
Fax (718) 332-4661 Domestic and International Telexes: 6852844 or 620156

C 117 REV. D

CIRCLE NO 184

# SURFACE MOUNT MIXERS



**\$2.49**  
(1,000 qty)

The opportunity for automated, low-cost assembly is a key benefit of surface-mount technology, but is often wiped out by the high price of surface-mount components. Now, Mini-Circuits offers a new series of mixers to meet the pricing demands of SMT ... only \$2.49 in 1,000 quantity (\$3.75 ea. in quantity of 10) ... at a cost even lower than most conventionally-packaged mixers.

The SCM-1 spans 1 to 500MHz with only 6.0dB conversion loss, 45dB LO-RF isolation, and 40dB LO-IF isolation. Housed in a rugged, non-hermetic 0.4 by 0.8 by 0.3 in. high (maximum dimensions) plastic/ceramic package. Spacing between connections is 0.2 in. The mixer is offered with leads (SCM-1L) or without leads (SCM-1NL) to meet a wide range of pc board mounting configurations.

Each SCM-1 is built to meet severe environmental stresses including mechanical shock/vibration as well as temperature shock. The operating and temperature storage range is -55°C to +100°C. Each SCM-1, designed and built to meet today's demanding reliability requirements, carries Mini-Circuits' exclusive 0.1% AQL guarantee of no rejects on every order shipped (up to 1,000 pieces).

When you think SMT for low-cost production, think of Mini-Circuits' low-cost SCM mixers.

SPECIFICATIONS (typical)	SCM-1L (with leads)	SCM-1NL (no leads)
FREQ. RANGE (MHz)		
LO, RF	1-500	
IF	DC-500	
CONVERSION LOSS (dB)		
Mid-Band (10-250MHz)	6.3	
Total Range (1-500)	7.5	
ISOLATION (dB)	(L-R)	(L-I)
Low-Band (1-10MHz)	60	45
Mid-Band (10-250MHz)	45	40
High-Band (250-500MHz)	40	35
PRICE	\$2.49 (1,000 qty)	\$3.75 (10-49)

Units are shipped in anti-static plastic "tubes" or "sticks" for automatic insertion.

finding new ways ...  
setting higher standards

**Mini-Circuits**

A Division of Scientific Components Corporation  
P.O. Box 350166, Brooklyn, New York 11235-0003 (718) 934-4500  
Fax (718) 332-4661 Domestic and International Telexes: 6852844 or 620156





**On the cover:** Bus-interface chips open up pc-board real estate, allowing you to incorporate extra features and functions. See pg 122. (Photo courtesy Intel Corp)

## DESIGN FEATURES

### Special Report: Bus-interface ICs

122

Commercially available VLSI ICs enable designers to pack more functions onto pc boards compatible with standard 32-bit multimaster buses. In Multibus II and VME Bus applications, bus-interface ICs can replace anywhere from a dozen to several dozen discrete and programmable-logic chips.—*Maury Wright, Regional Editor*

### Clever techniques improve thermocouple measurements

145

Thermocouple (TC) measurements require linear-circuit proficiency. To ensure accurate results, you should understand the need to compensate for parasitic junctions, the importance of certain characteristics of the op amps and associated components, and the ways to otherwise condition and linearize the TC's low-level output signals.

—*Jim Williams, Linear Technology Corp*

### Designer's Guide to noise analysis—Part 2

165

An ordinary electronic spreadsheet can help you evaluate and correct noise problems in an electronic system. This article, the final part of a 2-part series, shows how you can use a spreadsheet program to evaluate the system's overall performance as you modify the individual elements.—*Peter Fazekas, ILC Data Device Corp*

### Designer's Guide to state machines—Part 1

177

This article, part 1 of a 2-part series, provides a refresher in the basic theory of state machines and offers two detailed examples of synchronous-state-machine design with common PLDs. Part 2 will follow up with an example of a more difficult, asynchronous state machine and will give some background information on state-machine software packages.—*Stan Kopec, Altera Corp*

### Timing analysis improves efficiency of ASIC design

195

Timing analysis can complement simulation in the ASIC-design process. Knowing how to effectively choose and use a timing analyzer can help you cope with the ever-growing complexity of ASIC designs and the increasingly frantic pace of product development in the electronics industry.—*Dennis Hara and Jeffrey Stone, Seattle Silicon Corp*

*Continued on page 7*

EDN® (ISSN 0012-7515) is published 40 times a year (biweekly with 1 additional issue a month, except for July which has 3 additional issues) by Cahners Publishing Company, A Division of Reed Publishing USA, 275 Washington Street, Newton, MA 02158-1630. Terrence M McDermott, President; Frank Sibley, Electronics/Computer Group Vice President; Jerry D Neth, Vice President/Publishing Operations; J J Walsh, Financial Vice President/Magazine Division; Thomas J Dellamaria, Vice President/Production and Manufacturing. Circulation records are maintained at Cahners Publishing Company, 44 Cook Street, Denver, CO 80206-5191. Telephone: (303) 388-4511. Second-class postage paid at Denver, CO 80206-5191 and additional mailing offices. POSTMASTER: Send address corrections to EDN® at the Denver address. EDN® copyright 1988 by Reed Publishing USA; Saul Goldweitz, Chairman; Ronald G Segel, President and Chief Executive Officer; Robert L Krakoff, Executive Vice President; William M Platt, Senior Vice President. Annual subscription rates for nonqualified people: USA, \$100/year; Canada/Mexico, \$115/year; Europe air mail, \$135/year; all other nations, \$135/year for surface mail and \$210/year for air mail. Except for special issues where price changes are indicated, single copies of regular issues are available for \$6, \$8, and \$10 (USA, Canada/Mexico, and foreign). Please address all subscription mail to Eric Schmierer, 44 Cook Street, Denver, CO 80206-5191.



▽BPA ABP



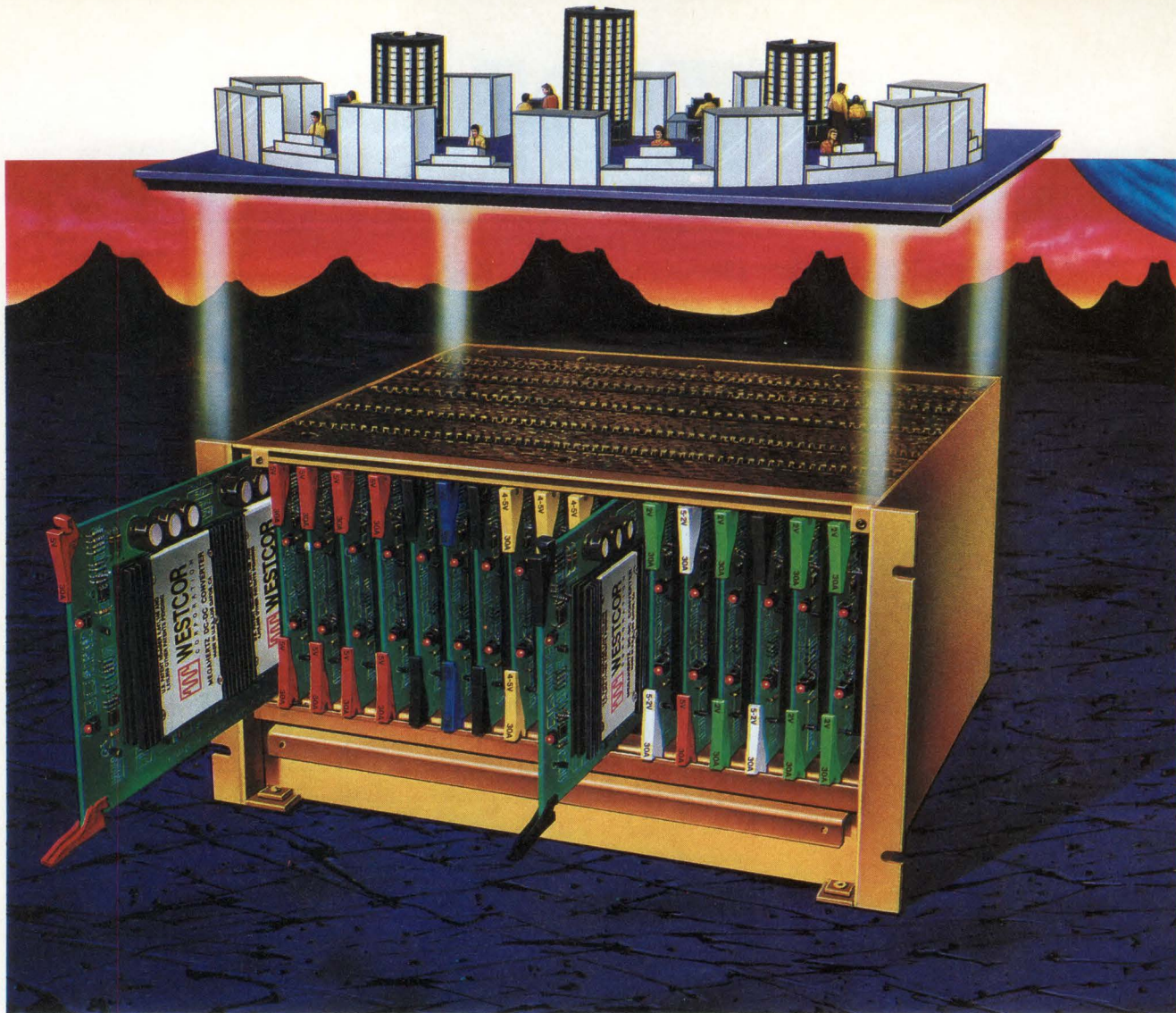

# A NEW WORLD OF HIGH POWER FLEXIBILITY

Westcor's PowerCage™ and PowerCards™ comprise a modular power supply system of galactic power (7200 watts max.), flexibility (36 outputs max.) and efficiency (80% typ.). More like an expandable computer mainframe in design and concept than a standard high power supply, the PowerCage offers space-age alternatives to users of outdated 5x8x11 inch box switchers.

Measuring 19x10.5x11.25 inches deep the PowerCage fits into a standard NEMA rack and powers 18 slots for single or dual output PowerCards or dummy cards. PowerCage backplanes provide connections for easy configuration by the user.

Low profile (.8") PowerCards supply single outputs from 2 to 75 VDC at up to 400 watts (outputs from 2 to 5 VDC limited to 60 amperes). Dual output cards source two isolated outputs each at half of the above ratings. Single output cards can be paralleled with current sharing to provide kilowatts via simple backplane configuration.

The nucleus of each PowerCage system is Westcor's patented 1 MHz, high power density, high reliability converter. Consider these benefits and features: 208 VAC 3 phase input; remote/local sense on all outputs; TTL power good signal and status LED's; designed to meet UL, CSA and VDE safety requirements; TTL inhibit; over-temperature, over-current, over-voltage protection; "hot" card insertion; full power at 50°C.

Future options include: DC input; IEEE-488 programmability; fault tolerant operation and battery backup. To discover a new world of high power flexibility, please contact us.

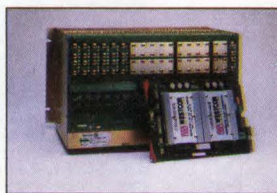

WESTCOR CORPORATION • 485-100 Alberto Way • Los Gatos, CA 95032 • (408) 395-7050 • FAX (408) 395-1518 • TWX 910-240-2108.

CIRCLE NO 182

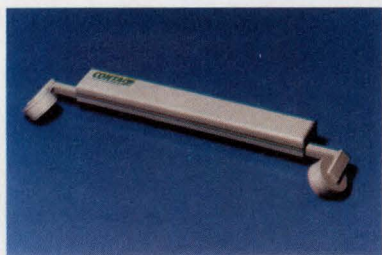

Ultrasonic ranging systems suit applications that require the sensing of relatively large objects over great distances (pg 61).

EDN magazine now offers Express Request, a convenient way to retrieve product information by phone. See the Reader Service Card in the front for details on how to use this free service.



## TECHNOLOGY UPDATE

### Uniting ultrasonics and microelectronics reaps a cost-effective ranging system 61

Proximity detection and position measurement are no longer "contact sports": Techniques that remotely sense the presence of an object are replacing mechanical devices, such as feelers, rollers, and floats, which make direct contact with the object to be detected.

—John Gallant, Associate Editor

### Function libraries can expedite the development of application programs 81

Portability, connectivity, and productivity. If you're designing applications software for the microcomputer market, you need to achieve success in all three areas—and that's where function libraries can play a very useful part.—Chris Terry, Associate Editor

## PRODUCT UPDATE

Logic analyzer	91
PC-based resistor-network CAD	94
Modular logic analyzer	96
Microcode development system	98
BiCMOS chips	100
RISC chip set	103
Logic-analyzer modules	107

## DESIGN IDEAS

Circuit screens narrow pulse widths	209
Tachometer circuit reduces parts count	210
Circuit doubles digital frequency	212
Battery-backup circuit offers system reset	212
Timer output has variable duty cycle	214

Continued on page 9

Cahners Publishing Company, A Division of Reed Publishing USA  Specialized Business Magazines for Building & Construction  Manufacturing  Foodservice & Lodging  Electronics & Computers  Interior Design  Printing  Publishing  Industrial Research & Technology  Health Care  and Entertainment. Specialized Consumer Magazines:  American Baby  and Modern Bride.



# THE UNISITE 40 PROGRAMMER: BECAUSE STATE-OF-THE-ART IS A STATE OF CHANGE.

## PROGRAMMING TECHNOLOGY THAT SUPPORTS ADVANCED DESIGNS— TODAY AND TOMORROW.

The UniSite™ 40's universal programming technology is the fastest and easiest way to keep up with new devices and packages. Its software-configured pin driver system provides a single site for programming any DIP device up to 40 pins, including PLDs, PROMs, IFLs, FPLAs, EPROMs, EEPROMs and microcontrollers. The same site accommodates the most popular surface-mount packages— PLCCs, LCCs and SOICs.

And now the UniSite 40 is also a gang/set programmer. With the new SetSite™ module, you can program and test as many as eight devices, up to 40 pins each, simultaneously.

## INSTANT ACCESS TO NEW DEVICES.

The UniSite 40's universal pin driver



electronics stores device-specific instructions on a 3 1/2" micro diskette. To update your UniSite 40 with the latest device releases, simply load a new master diskette.

**FAST, EASY PROGRAMMING.** Menu-oriented operation with step-by-step prompts makes programming simple.

Or bypass the menus and zoom directly to specific operations by selecting key commands. Help messages are available whenever you need assistance.

To speed parts selection, the UniSite 40 provides a built-in list of devices. And you can save your most frequently-used programming parameters for instant recall.

## DESIGN FREEDOM FOR TOMORROW.

When leading-edge designers use the latest devices in their designs, they need the programming freedom only the UniSite 40 provides. Call Data I/O® today and ask about the UniSite 40. Because state-of-the-art never stops changing.

**1-800-247-5700**

**Dept. 614**

Data I/O Corporation 10525 Willows Road N.E., P.O. Box 97046, Redmond, WA 98073-9746, U.S.A. (206) 881-6444/Telex 15-2167  
Data I/O Canada 6725 Airport Road, Suite 302, Mississauga, Ontario L4V 1V2 (416) 678-0761/Telex 06968133  
Data I/O Europe World Trade Center, Strawinskyalaan 633, 1077 XX Amsterdam, The Netherlands +31(0)20-622866/Telex 16616 DATIO NL  
Data I/O Japan Sumitomoseimei Higashishinbashi Bldg., 8F, 2-1-7, Higashi-Shinbashi, Minato-Ku, Tokyo 105, Japan  
(03)432-6991/Telex 2522685 DATAIJ

©1988 Data I/O Corporation

CIRCLE NO 181

# DATA I/O

EDN May 26, 1988

**VP/Publisher**  
F Warren Dickson

**VP/Associate Publisher/Editorial Director**  
Roy Forsberg

**Editor**  
Jonathan Titus

**Managing Editor**  
John S Haystead

**Assistant Managing Editor**  
Joan Morrow

**Special Projects**  
Gary Legg

**Home Office Editorial Staff**  
275 Washington St, Newton, MA 02158  
(617) 964-3030

Tom Ormond, *Senior Editor*  
Deborah Asbrand, *Associate Editor*  
Joanne Clay, *Associate Editor*  
Tarlton Fleming, *Associate Editor*  
John A Gallant, *Associate Editor*  
Clare Mansfield, *Associate Editor*  
Dave Pryce, *Associate Editor*  
Cynthia B Rettig, *Associate Editor*  
Charles Small, *Associate Editor*  
Dan Strassberg, *Associate Editor*  
Chris Terry, *Associate Editor*  
Ron Gilbert, *Staff Editor*  
Valerie Lauzon, *Staff Editor*  
Helen McElwee, *Staff Editor*  
Steven Paul, *Senior Production Editor*

**Editorial Field Offices**

Margery S Conner, *Regional Editor*  
Los Osos, CA: (805) 528-0833

Doug Conner, *Regional Editor*  
Los Osos, CA: (805) 528-0865

Bob Cushman, *Special Features Editor*  
Port Washington, NY: (516) 944-6524

Steven H Leibson, *Regional Editor*  
Boulder, CO: (303) 494-2233

J D Mosley, *Regional Editor*  
Arlington, TX: (817) 465-4961

Richard A Quinnell, *Regional Editor*  
San Jose, CA: (408) 296-0868

David Shear, *Regional Editor*  
San Jose, CA: (408) 997-5452

Maurry Wright, *Regional Editor*  
San Diego, CA: (619) 748-6785

Peter Harold, *European Editor*  
0603-630782  
(St Francis House, Queens Rd,  
Norwich, Norfolk NR1 3PN, UK)

**Contributing Editors**  
Robert Pease, Bob Peterson,  
Don Powers, Bill Travis

**Editorial Services**  
Kathy Leonard, *Office Manager*  
Loretta Curcio, Nancy Weiland,  
Sharon Gildea

**Art Staff**  
Kathleen Ruhl, *Art Director*  
Ken Raciocot, *Assistant Art Director*  
Chin-Soo Chung, *Graphic Designer*  
Cathy Filipski, *Graphic Designer*

**Production/Manufacturing Staff**  
William Tomaselli, *Production Supervisor*  
Donna Pono, *Production Manager*  
Andrew A Jantz, *Production Assistant*  
Linda Lepordo, *Production Assistant*  
Diane Malone, *Composition*

**Graphics Director**  
Norman Graf

**VP/Production/Manufacturing**  
Wayne Hulitzky

**Director of Production/Manufacturing**  
John R Sanders

**Director of Research**  
Deborah Virtue

**Marketing Communications**  
Janice Molinari, *Manager*  
Anne Foley, *Promotion Assistant*

## EDITORIAL

55

Some electronic companies take the sue-the-bastards attitude. Unfortunately, it seems to be spreading.

## NEW PRODUCTS

Computers & Peripherals . . . . .	220
Integrated Circuits . . . . .	232
Components & Power Supplies . . . . .	240
CAE & Software Development Tools . . . . .	252
Test & Measurement Instruments . . . . .	260

## PROFESSIONAL ISSUES

279

Differential equations and Shakespeare: Melding engineering studies and liberal arts.—*Deborah Asbrand, Associate Editor*

## LOOKING AHEAD

291

Worldwide GaAs IC market expands at robust pace. . . Continuous industries falter in MAP plans.

## DEPARTMENTS

News Breaks . . . . .	23
News Breaks International . . . . .	26
Signals & Noise . . . . .	34
Calendar . . . . .	46
Readers' Choice . . . . .	113
Leadtime Index . . . . .	116
Literature . . . . .	275
Business/Corporate Staff . . . . .	276
Career Opportunities . . . . .	282
Advertisers Index . . . . .	288

**SONAR**



**COMMS**

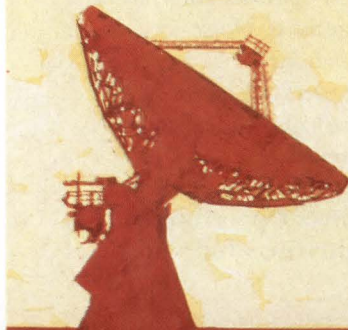

**RADAR**



**SIGNALLING A NEW ERA**

# IMAGE PROCESSING

## THE IMS A100 CASCADEABLE SIGNAL PROCESSOR

Using pulse compression to improve range resolution, a modern radar system compares signals transmitted to and reflected from a target.

A typical system may use a pattern 512 samples long, collected at a data rate of 2.5 MHz.

This requires more than a billion multiplications a second! Yet the INMOS A100 Cascadeable Signal Processor enables a pulse compressor with this capability to fit a circuit board half the size of a typical PC card and dissipates less than 30 Watts.

A combination of performance, low power dissipation and reduced board area that means significant reductions in systems costs. Equally impressive results are found in applications such as beamforming, filtering and image processing.

Whatever DSP area you are in the INMOS IMS A100 processor is the only serious contender.

The following features show why the IMS A100 signals a whole new era in DSP. If you would like more information, clip the coupon today.

- Full 16 bit, 32 stage, transversal filter
- 36 bit internal precision
- Block floating point support
- Complex number support
- Easy to control from most ordinary and DSP microprocessors
- Data throughput to 10 MHz
- Power dissipation 1.5 Watts
- Fully static CMOS implementation
- 84 pin Ceramic PGA and Cerquad Packages
- MIL-STD-883C processing available

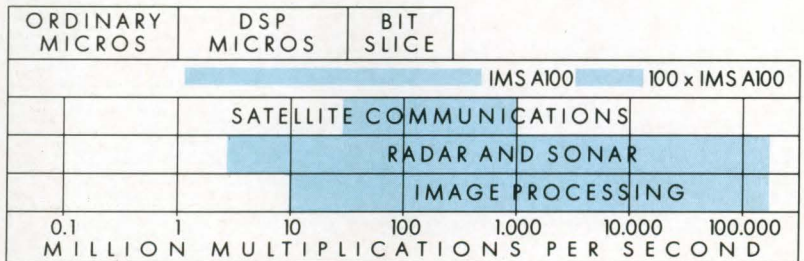

INMOS, Colorado Springs, Colorado 80935. Tel. (719) 630-4000.

Orange County - 714-957-6018  
Baltimore - 301-995-6952  
Boston - 617-229-2550

Denver - 303-368-0561  
Santa Clara - 408-727-7771  
Atlanta - 404-242-7444

Dallas - 214-490-9522  
Minneapolis - 612-932-7121  
New York - 914-897-2422

Please send me information on the INMOS DSP family. My main area of interest is

Sonar  Comms  Radar  Imaging  Other (please specify)

Name \_\_\_\_\_ Title \_\_\_\_\_

Company \_\_\_\_\_ Address \_\_\_\_\_

\_\_\_\_\_ Zip \_\_\_\_\_ Tel \_\_\_\_\_

# IN DSP.

# (Forward Thinking, Re

It takes more than desk-changing for two companies to merge. They need to have a shared vision of the world and the future.

With AMD and MMI, the calling was clear. To produce advanced programmable logic devices for a wide range of needs. To lower system costs. To develop higher performance designs. And to get your products to market as soon as possible.

We're delivering on this promise of the future in myriad ways. With a product line that doesn't stop halfway. With the first 10ns parts for designs where speed's

important. In CMOS, we have the broadest line of parts, including the industry standard, C22V10. And for high density, no one can beat our programmable gate arrays. We've got the best selection of PAL<sup>®</sup> parts around. (And no one sells more to the military.)

We're bringing new meaning to the term "product availability." Our combined manufacturing capacities mean we have more PAL chips coming out of our pipeline. Ready to be put into yours.

And more Field Application Engineers give you more answers to get



# sponsive, Meticulous)<sup>2</sup>

projects up and running.

Because it's impossible to create great designs without great software, we also offer PALASM<sup>®</sup> software, the industry standard. We're investing heavily to keep PALASM as current as our hardware.

With the best network of distributors, we can now offer a whole new concept in distributor support: TestPro Centers. Now you can speed through programming and testing at authorized centers.

Just bring your logic pattern to your closest TestPro Center. They'll program and they'll test the parts to factory quality

standards. Relieving you of the burden of test vector generation.

And we'll always be here with immediate and expert help in getting your design moving. Just call AMD at (800) 222-9323.

Or write Advanced Micro Devices, Inc., 901 Thompson Place, P.O. Box 3453, Sunnyvale, CA 94088.

One try and you'll be sharing our vision, too.

**Advanced Micro Devices**   
**Monolithic Memories** 

PAL and PALASM are registered trademarks of Monolithic Memories, Inc., a wholly owned subsidiary of Advanced Micro Devices, Inc. ©1988 Advanced Micro Devices, Inc.

**“Ideally,  
software should never  
be more than  
a one-time investment.”**

**Terry Smith**  
Software Planning Manager



"Motorola's built its reputation on supplying a broad line of *hardware* products, based on the latest technology. What people don't realize is that we actually offer a comparable number of *software* choices.

Well over 100, in fact.



### **Making your hardware investment work harder.**

"From chips, to VME boards, to boxes, Motorola *combines* high-performance hardware with software that's optimized for our products. And since they're all based on compatible MC68000 family processors, they play together smoothly. From the early O10s to the O30 and beyond—including the new RISC chips. So there's a built-in equity.

### **Tailoring the solution to your environment.**

"Whatever application you're targeting, chances are we have the right software to build it—including a family of commonly used languages and a comprehensive set of development tools. Our UNIX® environment, for one, is exceptionally rich. It's based on AT&T's System V, but with enhancements like local and wide area networking, X-windows and MAP/TOP protocols. There are now something like 400 utilities that work with it.

"For *real-time*, we have our own robust operating system, as well as real-time kernels from eight other independent suppliers. We're also about to release our VMEexec™ software, which will allow real-time applications—from different vendors—to be developed and run in conjunction with our standard UNIX environment.

### **Protecting your software investment for the future.**

"Through joint development efforts, Motorola is working hard to ensure the *portability* of applications that run on our products, based on the latest AT&T UNIX platform. That's the only way our OEM customers can effectively minimize their software costs—which have become *the* major development expense.

"All of which reflects our viewpoint on software for the VME marketplace. Namely, it should make your hardware work harder, in either a multi-user or real-time environment. And it should enable you to port your applications to newer, more powerful systems—economically. Motorola is, I believe, the *only* VME supplier whose software covers all those bases. That's what being the leader means."



**MOTOROLA Microcomputer Division**

*Approaching our technology from your point of view.*

For reprints of this series, call 1-800-556-1234, Ext. 230; in California, 1-800-441-2345, Ext. 230. Or write: Motorola Microcomputer Division, 2900 South Diablo Way, Tempe, AZ 85282.

UNIX is a registered trademark of AT&T.

VMEexec is a trademark of Motorola.

**CIRCLE NO 178**

Your next destination:



# The AC/ACT Computer Age.

## The future belongs to computers and peripherals built with RCA Advanced CMOS Logic.

The pressure is on to make your systems smaller, faster, cheaper.

Some of your competitors are doing just that by incorporating AC/ACT into their new designs. If you want to stay on the fast track, you can't afford not to consider AC/ACT.

### The computer of the future.

Imagine a computer with power dissipation so low you could eliminate all cooling systems. Or design a sealed system to prevent dust problems. And get dramatically improved reliability, thanks to the far lower heat generated. As well as far smaller system size.

You'd also be able to use it in a far wider operating temperature range (-55°C to +125°C). Even in high-noise environments.

### FAST\* speed, CMOS benefits.

Advanced CMOS Logic gives you high speed (less than 3ns propagation delay with our AC00 NAND gate) and 24 mA output drive current.

But unlike FAST, it gives you a whole new world of design opportunity for computers, peripherals, telecommunications and other speed-intensive applications.

Advanced CMOS Logic dissipates less than 1/8 Watt while switching, compared to 1/2 Watt for a FAST IC (octal transceiver operating at 5 MHz). And quiescent power savings are even more dramatic: AC/ACT idles at a small fraction of the power of a FAST IC.

In addition, AC/ACT offers balanced propaga-

\*FAST is a trademark of Fairchild Semiconductor Corp.

tion delay, superior input characteristics, improved output source current, low ground bounce and a wider operating supply voltage range.

### Latch-up and ESD protection, too.

Latch-up concern is virtually eliminated, because AC/ACT uses a thin epitaxial layer which effectively shorts the parasitic PNP transistor responsible for SCR latch-up.

And a dual diode input/output circuit provides ESD protection in excess of 2KV.

### A broad and growing product line.

Our line already includes over 100 of the most popular types (SSI, MSI and LSI). More are coming soon. And many are available in High-Rel versions.

### All this at FAST prices.

Our AC/ACT line is priced comparably to FAST. So you get better performance at no extra cost.

Why wait, when your competition is very likely designing its first generation of Advanced CMOS Logic products right now?

Get into the passing lane, with RCA AC/ACT from the CMOS leader: GE Solid State. Free test evaluation kits are available for qualified users. Kits must be requested on your company letterhead. Write: GE Solid State, Box 2900, Somerville, NJ 08876.

For more information, call toll-free 800-443-7364, extension 24. Or contact your local GE Solid State sales office or distributor.

In Europe, call: Brussels, (02) 246-21-11; Paris, (1) 39-46-57-99; London, (276) 68-59-11; Milano, (2) 82-291; Munich, (089) 63813-0; Stockholm (08) 793-9500.



**GE Solid State**

**GE/RCA/Intersil Semiconductors**  
Three great brands. One leading-edge company.

**TEK 4200 SERIES TERMINALS**

**WHY TEK BUILDS A  
BETTER GRAPHICS TERMINAL  
FOR IBM AND DEC  
THAN IBM AND DEC.**



**The terminals of most main-frame builders are little more than slaves to the host. But Tek's 4200 Series gives you local manipulation, powerful graphics, and the option to use any host you choose.**

Only the 4200 Series offers up to 1.5 MB of memory, with the local capabilities that let you use your host most efficiently.

Only the 4200 Series offers dual connection to both IBM and DEC and other ASCII hosts. You can work with up to six databases concurrently.

Only the 4200 Series delivers

interactive true zoom and pan with the other superb graphic and alphanumeric features made famous by Tektronix.

**Tek Software and peripheral compatibility is without equal in the graphics industry.**

The 4200 Series is supported by more than 175 world-class software vendors offering a full range of solutions for MIS, manufacturing and engineering.

To bring your applications to life, you can use the 4200-compatible 4690 Family of color printers. Or other popular monochrome and color output

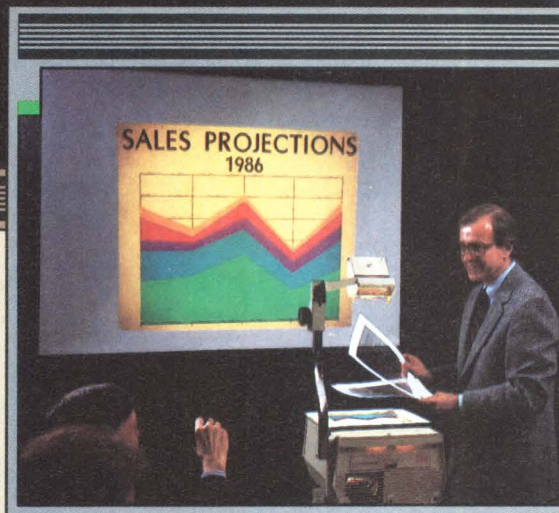

devices.

4200 Series are immediately available from authorized distributors or by contacting your local Tektronix representative. For information:

**call 1-800-225-5434.**

In Oregon, 1-235-7202.

#### Comparison of Graphics Terminals

	TEK	DEC	IBM
DEC Host Compatible	Yes	Yes	No
IBM Host Compatible	Yes	No	Yes
Multiple Active Sessions	Yes	Yes	No
Tek 4010-4100 Command Set	Yes	No	No
Segments	Yes	No	No
True Zoom and Pan	Yes	No	No
IBM GDDM (Graphical Data Display Manager) Support	Yes	No	Yes
Graphics Addressability of 4096 x 4096	Yes	No	No
VT200 Alphanumerics	Yes	Yes	No
Background Hardcopy	Yes	No	No
Separate Graphics and Alphanumeric Regions	Yes	No	Yes

**Tektronix**  
COMMITTED TO EXCELLENCE



PHILIPS

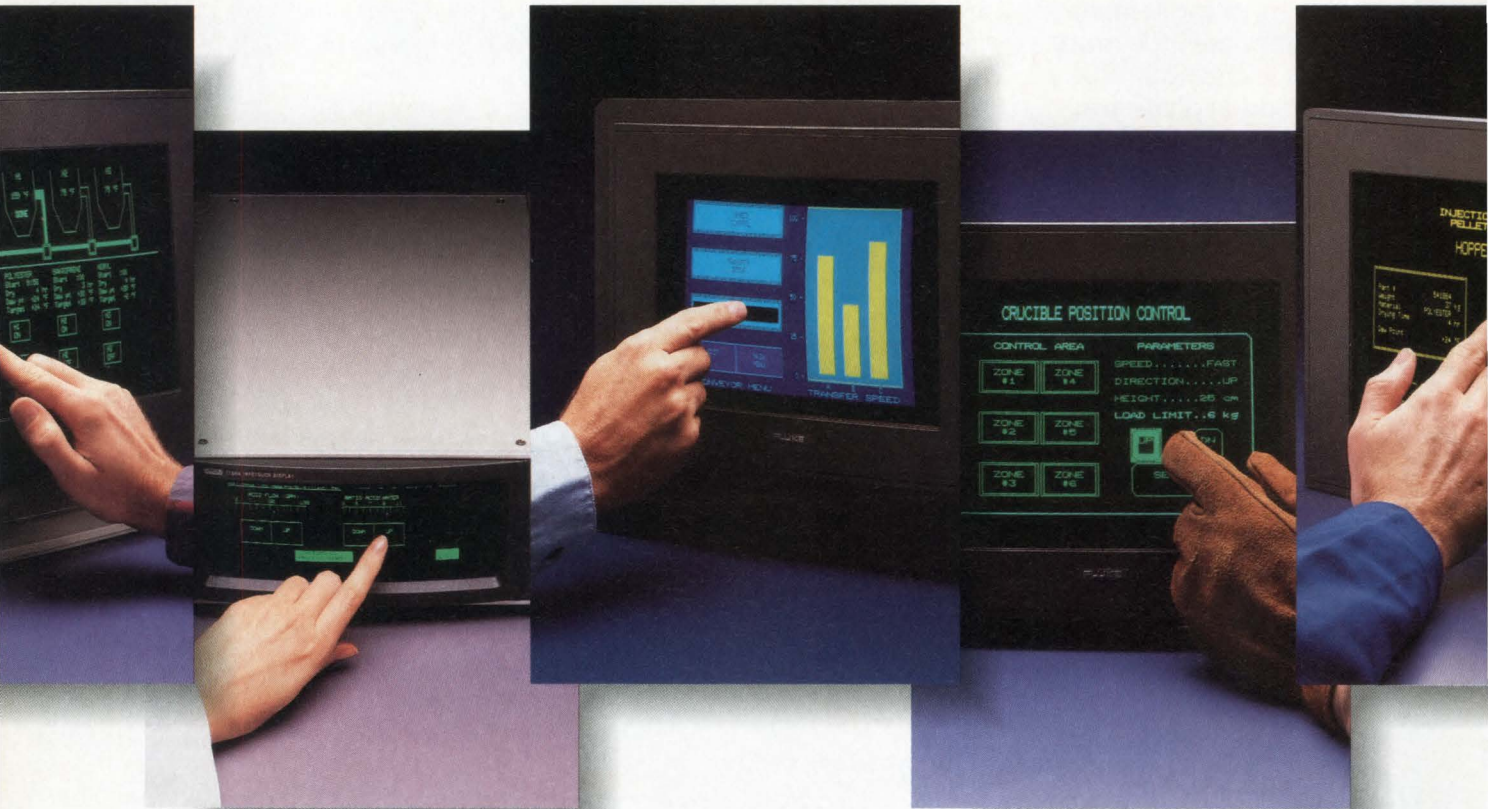

## More ways to get in touch.

**We've added a new color screen to our full line of touch control operator interfaces.**

Fluke gives you more ways to improve the operator interface of your computer-based machine. Prompting operators through the sequence of your machine, touch control from Fluke reduces both input error and training time. Your customers will appreciate the value these state-of-the-art interfaces add to computer-based products. Our broad line spans a variety of models, from the economical to the most sophisticated, from panel mount to bench top—and now we've added color. The new 1050 gives you a palette of 32 brilliant colors—more ways to

create effective displays, with the same confidence in quality.

Every Fluke Touch Control Screen offers the advantages of an integrated subsystem, eliminating costly and time consuming integration of touch panel, display and logic components. Our rigorous quality-control procedures ensure that every unit operates reliably. And our touch control screens operate under the toughest of environmental conditions.

Fluke has been designing and manufacturing quality touch control subsystems for the past ten years. As an experienced OEM vendor, we understand your needs. You'll find us a reliable business partner, ready with the support you need: competitive discounts,

complete documentation, powerful software tools and worldwide service.

When you want to get customers in touch with your machine, get in touch with Fluke. Contact your local Fluke Sales Engineer or call **1-800-44-FLUKE**.

John Fluke Mfg. Co., Inc., P.O. Box C9090, M/S 250C, Everett, WA 98206  
U.S.: 206-356-5400 CANADA: 416-890-7600.  
OTHER COUNTRIES: 206-356-5500.

© Copyright 1988 John Fluke Mfg. Co., Inc. All rights reserved.  
Ad No. 1173-F90.

THE FIRST CHOICE  
IN TOUCH CONTROL





# NEWS BREAKS

EDITED BY JOANNE CLAY

## **FIVE COMPANIES PARTICIPATE IN ARCNET DEMONSTRATION**

Visitors to the Control Expo '88 show in Chicago, IL (June 7 to 9, 1988) will be able to witness a practical demonstration of the Arcnet network's ability to interface a range of dissimilar hardware and software systems. Five companies—Contemporary Control Systems Inc (Downers Grove, IL, (312) 963-7070), Comendec Ltd (Birmingham, UK, TLX 33435), Matrix Corp (Raleigh, NC, (919) 833-2000), Xycom Inc (Saline, MI, (313) 429-4971), and Ziatech Corp (San Luis Obispo, CA, (805) 541-0488)—will link their equipment via an Arcnet network. The networked equipment will include STD Bus systems running MS-DOS and VME Bus systems running MS-DOS and OS9/68k, all of which will operate as process controllers. In response to requests from these process controllers, a VAX/VMS computer will download data to them over the network.—Peter Harold

## **CMOS ARITHMETIC LOGIC UNIT OPERATES IN 26 NSEC**

If you're designing pipeline signal-processing circuitry, you may want to consider the L4C381 arithmetic logic unit (ALU) from Logic Devices (Sunnyvale, CA, (408) 720-8630). This device offers 10 arithmetic and logical functions on two 16-bit inputs. The ALU offers add, subtract, negate, and accumulate functions, which it completes within 26 nsec. Both the inputs and the output have 16-bit registers that can be used or individually bypassed. You can cascade the devices for calculations that use more than 16 bits. The ALU comes in a 68-pin, plastic leaded chip carrier (PLCC). The 26-nsec version costs \$24 (1000).—Richard A Quinnell

## **PATENT GRANTED FOR SERIAL / PARALLEL ONBOARD TEST TECHNIQUE**

The US Patent Office has granted a patent (number 4,720,672) to Logical Solutions Technology Inc (Campbell, CA, (408) 374-3650, TLX 172867) for its serial/parallel testability system. The company claims that this test technique, which it offers in the form of testability chips and technology licenses, adds only 1% to the amount of circuitry on a pc board. Contributing to this low overhead figure is the fact that the company's testability chips can replace more-conventional shift registers, multiplexers, and decoders while adding testability to the board.—Steven H Leibson

## **CONFIGURABLE $\mu$ C FAMILY INCLUDES EMULATOR**

You can customize the TMS370 family of 8-bit  $\mu$ Cs from Texas Instruments (Dallas, TX, (800) 232-3200, ext 700) by choosing the peripherals you want on chip. The company will initially offer six standard components that meet most customers' needs. Because of the family's modularity, you can configure an emulator to emulate any of the possible combinations of standard components that can be placed on chip. The list of components, which is expected to grow, includes EEPROM, ROM, RAM, serial I/O ports, timers, and 8-bit A/D converters. The price of the  $\mu$ Cs ranges from \$3 to \$10 in production quantities.—David Shear

## **GRAPHICS CHIP COMBINES FUNCTIONS OF TWO EARLIER PARTS**

Because it combines the functions of two earlier parts, the HD63487 Memory Interface and Video Attribute Controller (MIVAC) from Hitachi America (San Jose, CA, (408) 435-8300) may help you shrink your graphics-system design. The MIVAC has a 33-MHz pixel rate and a 1M-byte memory space. You can program it for a variety of display modes, such as a monochrome, 640x480-pixel mode or a color, 16-bit, 640x400-pixel mode. The device comes in a 68-pin PLCC and costs \$25 (5000); it will be available in production quantities in the third quarter of 1988.—Richard A Quinnell

# NEWS BREAKS

---

## **HALF-HEIGHT, 5¼-IN. DRIVE STORES 71M BYTES**

Model 3085 is a half-height, 5¼-in., hard-disk drive from Miniscribe (Longmont, CO, (303) 651-6000) that stores 71.3M bytes and features a 22-msec average access time. A rotary voice-coil actuator and a closed-loop servopositioning feature give the drive its fast access time and 1100-tpi track density. The drive incorporates a standard ST412 disk-drive interface and costs less than \$700 (1000).—Steven H Leibson

## **LOGIC SYNTHESIS AND TTL LIBRARY FOR PGAs**

You can now use standard TTL functions to design a programmable gate array (PGA) without paying a gate penalty. Xilinx (San Jose, CA, (408) 559-7778) offers automated-design-implementation software with a library of 40 TTL functions. This supplement to the Xact development system allows you to design a combination of TTL functions and PLDs, then strips out unused logic to conserve gate usage. The \$1500 software package also converts schematic net lists and PLD equations to a PGA net list and provides automatic placement and routing. The TTL library is priced separately at \$500.—Richard A Quinnell

## **PLOTTERS GUARD DATA AGAINST ELECTRONIC EAVESDROPPERS**

If your designs must remain secret, consider using the Tempest Draftmaster I and II E-size plotters from Hewlett-Packard Co (Palo Alto, CA, phone local office). The plotters meet Tempest NACSIM 5100A electronic-security standards and are listed on the US Government's preferred-products list. The single-sheet HP 7595A-T and roll-fed HP 7596A-T Tempest Draftmaster plotters are essentially electromagnetically hardened versions of the company's 7585B and 7586B plotters. They cost \$14,900 and \$16,900, respectively.—Steven H Leibson

## **DIGITAL SAMPLING OSCILLOSCOPE OFFERS 2-GHz BANDWIDTH**

The PM3340 2-GHz sequential-sampling digital oscilloscope from Philips (Eindhoven, The Netherlands, TLX 35000; in the US: John Fluke Mfg Co Inc, Everett, WA, (206) 347-6100) gives you 10-bit resolution and a 512-point record length. This oscilloscope has all the measurement features normally found on a digital storage oscilloscope; for example, it has voltage and time cursors, automatic measurements, and waveform math. The PM3340 also has some useful but less-common features. An "eye pattern" display mode allows you to examine digital communication signals. The voltage-histogram display mode shows the distribution of amplitude probabilities over a selected time interval. The scope's fast Fourier transform (FFT) function lets you examine signals in the frequency domain. The PM3340 includes both IEEE-488 and RS-232C interfaces and costs \$16,000.—Doug Conner

## **1.5-μm ANALOG-CELL FAMILY COEXISTS WITH DIGITAL CIRCUITS**

NCR Microelectronics Div (Fort Collins, CO, (800) 334-5454) will add a family of analog cells to its VS1500 1.5-μm CMOS ASIC-cell library in July. These analog functions include an op amp, a comparator, a bandgap voltage reference, two analog switches, an ECL input buffer, matched resistor blocks, and analog input and output pads. The company has already added these analog cells to its VS2000 2-μm cell library. Earlier this year, the company introduced a family of high-speed digital cells to the VS1500 library; the family includes 48-mA output drivers, Schmitt-trigger input buffers, and flip-flops that can attain 140-MHz toggle rates.—Steven H Leibson



# THE 2-WATT, 1-INCH-HIGH, 18-OZ., 20 MB 3 1/2-INCH DRIVE. WE'RE SHIPPING TODAY!

Conner Peripherals' new CP-3022 (20 MB\*) is the only Winchester drive delivering everything you need to make your laptops perform like desktops. It is clearly the new world standard.

Featuring the lowest power (2 watts). The smallest size (1-inch high, including drive and embedded controller). And the lightest weight (18 ounces). All in a form factor that fits anywhere a one-inch high 3 1/2-inch floppy can. Requiring substantially less space than any other hard disk.

Our CP-3022 is the quietest drive in the industry. It features exceptionally fast access time (27 msec. average). The new industry standard PC/AT®-compatible interface for easier integration.

And durability (75G shock resistance) and reliability you demand in all our high-performance drives.

Today's new generation of high-performance laptops

require the new

standard in low power, height, and weight, high-performance Winchesters. Only Conner

Peripherals has the insight and the drives to make your laptops perform like desktops.

We're shipping today! Call now for an evaluation unit and more information. Thanks to Conner Peripherals, the disk drive industry will never be the same.



**CP-3022**

CIRCLE NO 163

**CONNER**  
**PERIPHERALS**



THE INSIGHT  
AND THE DRIVE.

# NEWS BREAKS: INTERNATIONAL

---

## **PHONE-SET IC FEATURES DYNAMIC AUDIO GAIN LIMITING**

In addition to performing all the speech and line-interface functions required in telephone sets, the TEA1064 IC from Philips Components Div (Eindhoven, The Netherlands, TLX 51573) features dynamic gain limiting in its microphone channel. As a result, the audio signal transmitted to the telephone line remains relatively free of distortion, irrespective of the loudness of the phone user's voice. You can use it with dynamic, magnetic, piezoelectric, or electret microphones, and it provides a single-ended or differential drive for a variety of earpieces. It can operate from phone-line voltages as low as 1.7V, and it includes a 3-mA supply output for peripheral circuits such as dialers, microcontrollers, and displays. The device meets the performance requirements of all the major PTTs (post, telephone, and telecommunications authorities) in Europe, the USA, and the Far East. The IC is available in a 20-pin DIP or surface-mounting mini-pack; it costs around gld 3 in high volume.—Peter Harold

## **VISIBLE-LIGHT LASER DIODE EMITS 3 mW AT 680 NM**

Targeting the replacement of bulky HeNe gas lasers, the NDL3200 semiconductor laser from NEC Corp (Tokyo, Japan) and its US affiliate, NEC Electronics Inc (Mountain View, CA), emits more than 3 mW of visible energy with a 680-nm wavelength at room temperature. The laser will sell for \$500 in the US. Unlike the larger gas lasers, this device is packaged in a petite, 9-mm can. It consumes far less power than a gas laser does: It runs on 100 mA at 2.2V. The company claims that the 680-nm light is 1000 times more visible to the human eye than competing 780-nm semiconductor lasers. The firm also asserts that the shorter wavelength will allow optical-disk manufacturers to achieve smaller spot sizes; let printer, facsimile, and copier vendors increase product speeds; and permit fiber-optic sensors to achieve greater sensitivities.—Steven H Leibson

## **ANALOG / DIGITAL ASIC MERGES STANDARD CELLS AND ARRAYS**

The Expert Array from Mietec (Oudenaarde, Belgium, TLX 85739) allows you to subdivide a mixed analog/digital ASIC into sections that are implemented with standard cells and sections that are implemented with mask-programmable arrays of analog components and logic gates. Both the standard-cell and the array sections are integrated on the same silicon die with the company's 40V SBIMOS technology. You can use the technique to produce standard-function parts that you can modify for different applications—for example, telephone ICs that you can adapt to different international standards. Alternatively, you can use the technique to accelerate the prototyping phase of a custom design by implementing well-defined circuitry with standard cells, and using arrays to implement any circuitry that may require redesign. The initial nonrecurring engineering (NRE) charges for the Expert Array are similar to those for normal standard-cell designs.—Peter Harold

## **AMERICAN FIRM LICENSES EUROPEAN VERSION OF MULTIBUS I**

Micro Industries (Westerville, OH) has licensed the Advanced Multibus System (AMS) line of boards from Siemens AG (Munich, West Germany) for manufacture and distribution in the US. The AMS boards support Intel's Multibus I electrical specification but do not use that standard's card format or connector system. The double-Eurocard-size AMS boards use DIN pin-and-socket connectors instead of the edge connectors employed by Multibus I cards. US prices for AMS cards range from \$500 for digital I/O boards to \$7500 for an 80386-based CPU card.—Steven H Leibson

# The Blues always help you see things more clearly.

If you've been singing for higher contrast Liquid Crystal Displays, Seiko Instruments has some happy news for you.

Thanks to the unique blue characters on their LCD modules, seeing what's on the screen is easier than ever.

Another big advantage of getting the blues from Seiko is their extremely wide viewing angle. The widest available for small LCDs. So your customers can read the screen from positions that are comfortable to them. Little extras that mean a lot when it comes to making a design decision.

If all this sounds good, there's one more feature that'll be music to your ears. Plug-in compatibility.

Simply drop in the new modules wherever you were using Seiko's parallel interface, TN

type modules. Making a visible improvement in your products easy. Quick. And free of retooling costs.

And, with a variety of these easy-to-read modules ranging from 1x16 to 4x40, Seiko's bound to have what you need.

Call Seiko Instruments today at (213) 517-7770 and ask about their LCDs with the blue characters. It'll give you, and your customers, a whole new outlook on your products.

Seiko Instruments, USA, Inc.  
Electronic Components  
Division

2990 West Lomita Blvd.  
Torrance, CA 90505  
(213) 517-7770  
FAX (213) 517-7792



## Seiko Instruments

# rugged plug-in amplifiers

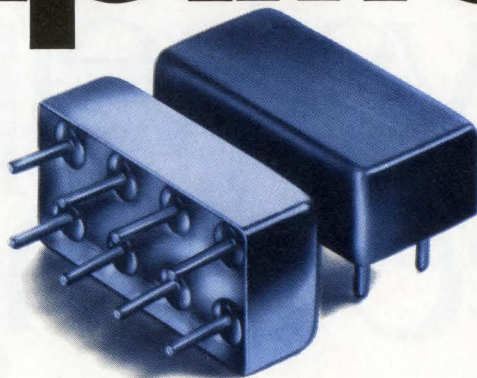

0.5 to 1000 MHz from \$13<sup>95</sup> (5 to 24 qty)

Tough enough to meet full MIL-specs, capable of operating over a wide -55° to +100°C temperature range, in a rugged package... that's Mini-Circuits' new MAN-amplifier series. The MAN-amplifier's tiny package (only 0.4 by 0.8 by 0.25 in.) requires about the same pc board area as a TO-8 and can take tougher punishment with leads that won't break off. Models are unconditionally stable and available covering frequency ranges 0.5 to 500MHz and 0.5 to 1000MHz, and NF as low as 2.8dB.

Prices start at only \$13.95, *including* screening, thermal shock -55°C to +100°C, fine and gross leak, and burn-in for 96 hours at 100°C under normal operating voltage and current.

Internally the MAN amplifiers consist of two stages, including coupling capacitors. A designer's delight, with all components self-contained. Just connect to a dc supply voltage and get up to 28dB gain with +9dBm output.

**The new MAN-amplifier series ...  
another Mini-Circuits' price/performance  
breakthrough.**

MODEL	FREQ. RANGE (MHz)	GAIN dB		MAX. OUT/PWR† dBm	NF dB (typ)	DC PWR 12V, mA	PRICE \$ ea. (5-24)
	$f_L$ to $f_U$	min	flatness††				
MAN-1	0.5-500	28	1.0	8	4.5	60	13.95
MAN-2	0.5-1000	19	1.5	7	6.0	85	15.95
MAN-1LN	0.5-500	28	1.0	8	2.8	60	15.95
◇MAN-1HLN	10-500	10	0.8	15	3.7	70	15.95

†† Midband  $10f_L$  to  $f_{U/2}$ ,  $\pm 0.5$ dB      † IdB Gain Compression      ◇ Case Height 0.3 In.  
Max input power (no damage) +15dBm; VSWR in/out 1.8:1 max.

finding new ways ...  
setting higher standards

**Mini-Circuits**

A Division of Scientific Components Corporation  
P.O. Box 350166, Brooklyn, New York 11235-0003 (718) 934-4500  
Fax (718) 332-4661 Domestic and International Telexes: 6852844 or 620156



*value-packed*  
**filters** **\$9.95**  
 from

dc to 3GHz

- less than 1dB insertion loss over entire passband
- greater than 40dB stopband rejection
- 5 section, 30dB per octave roll-off
- VSWR less than 1.7 (typ)
- over 100 models, immediate delivery
- meets MIL-STD-202
- rugged hermetically sealed package (0.4 x 0.8 x 0.4 in.)
- BNC, Type N, SMA available

finding new ways...  
 setting higher standards

**Mini-Circuits**  
 A Division of Scientific Components Corporation

P.O. Box 350166, Brooklyn, New York 11235-0003 (718) 934-4500  
 Fax (718) 332-4661 Domestic and International Telexes: 6852844 or 620156

LOW PASS	Model	*LP-	10.7	21.4	30	50	70	100	150	200	300	450	550	600	750	850	1000	
Min. Pass Band (MHz) DC to			10.7	22	32	48	60	98	140	190	270	400	520	580	700	780	900	
Max. 20dB Stop Frequency (MHz)			19	32	47	70	90	147	210	290	410	580	750	840	1000	1100	1340	
Prices (ea.): P \$9.95 (6-49), B \$24.95 (1-49), N \$27.95 (1-49), S \$26.95 (1-49)																		

HIGH PASS	Model	*HP-	50	100	150	200	250	300	400	500	600	700	800	900	1000
Pass Band (MHz)	start, max.		41	90	133	185	225	290	395	500	600	700	780	910	1000
	end, min.		200	400	600	800	1200	1200	1600	1600	1800	2000	2100	2200	
Min. 20dB Stop Frequency (MHz)			26	55	95	116	150	190	290	365	460	520	570	660	720

Prices (ea.): P \$12.95 (6-49), B \$27.95 (1-49), N \$30.95 (1-49), S \$29.95 (1-49)

\*Prefix P for pins, B for BNC, N for Type N, S for SMA *example: PLP-10.7*

**OKI DSP CMOS**



**True 22-bit Floating Point – 100ns cycle**

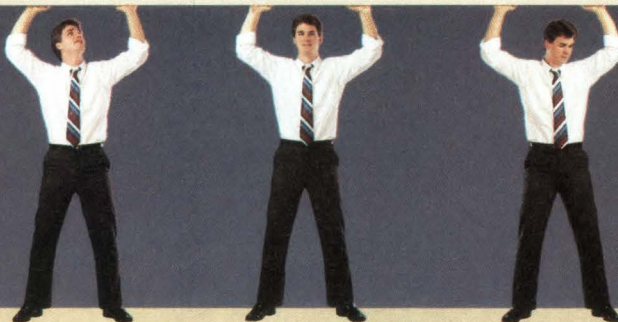

**New OKI 699210 – Internal memory doubled**

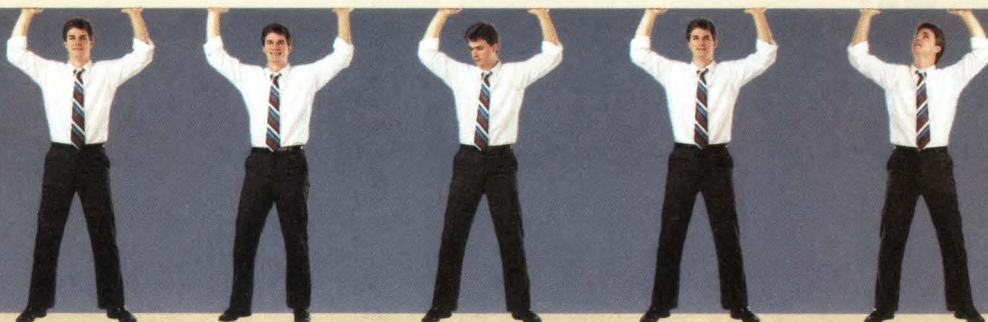

**Solid PC-based Development Support – High-level assembler**

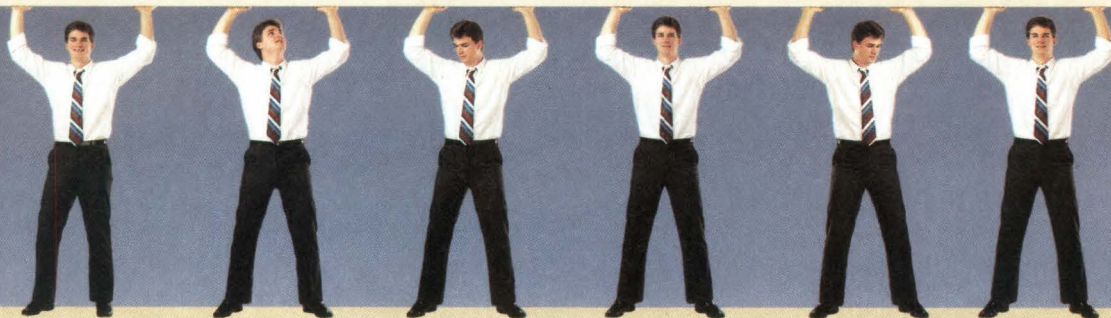

**OKI System Technologies for Customer Solutions**

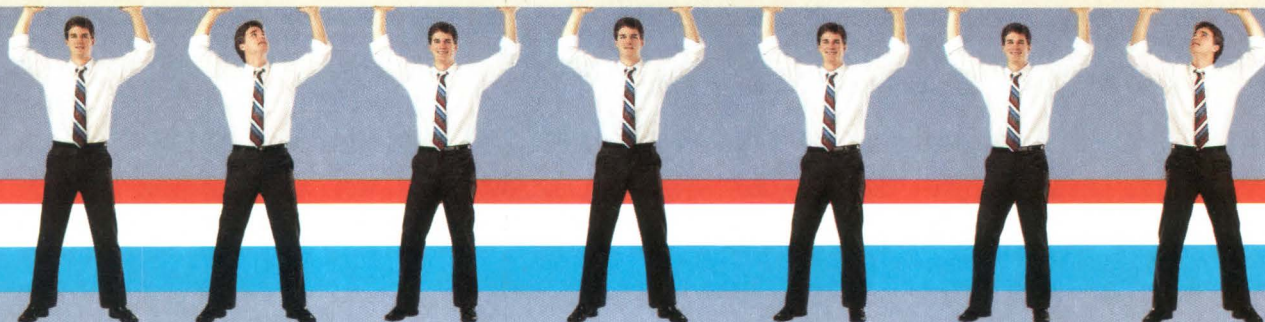



# The OKI DSP 22-bit Floating Point flexibility, on a single CMOS chip.

- + Expanded on-board RAM and ROM
- + Powerful instruction expansion
- + High-speed cycle times
- + Unique application ease.

OKI gives you a big lift in Digital Signal Processing. With the fastest-growing family of CMOS devices and high-level support tools on the market today. Only OKI now offers *true* floating point CMOS DSP solutions, because we target our system technologies to customer needs.

## The OKI DSP chips.

Now joining our widely-applied 6992 DSP: the new *code-compatible* OKI 699210, setting new benchmarks in both price and performance. A 1.5 micron CMOS design, the new 210 significantly expands your DSP capabilities—at a significantly lower cost.

We built in twice as much internal memory: 512 × 22-bit words of data RAM; 2K × 32-bit words of instruction ROM. 210 instructions have been expanded to include a power-down mode, save and recover modes, as well as the ability to inhibit post-normalization. Plus programmable wait states for interfacing with slow memory.

Both single-chip DSPs, 6992 and 210, can be configured for floating point format, fixed data format or logical data format. Both offer 100ns instruction cycle times. And any code written for the 6992 can be run on the 210.

## The OKI DSP support.

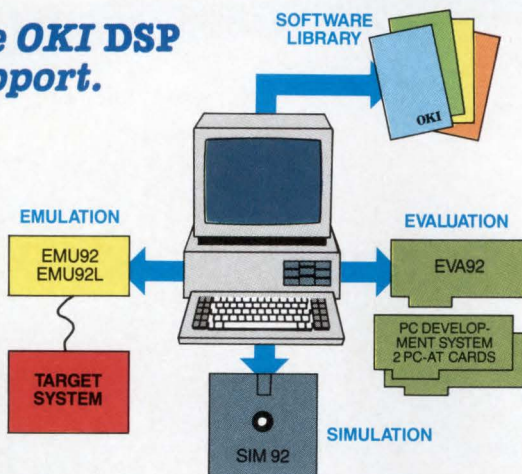

All our device-family innovations are enhanced by OKI's complete family of DSP support tools. These cover every development and programming function involved in any DSP design effort. Quickly, simply and cost-effectively.

Your total development process is PC-based, using OKI's own DSP hardware and software tools. Plus you can assemble in high-level mnemonics, with our Intermediate Language Assembler. Makes programming easier since the pipeline is invisible, while still producing very efficient code.

We've made debugging easier too. With SIM92/210 software for simulation, and the EVA92/210 board for evaluation. To handle emulation, we can supply an ICE for realtime development. Or use our special PC-AT cards. The first is a digital card for ICE-less emulation. The other provides 12-bit ADC-DAC conversion, with programmable sampling rates and anti-aliasing filter.

**It's all here:** high-level math processors plus a high-level development process. True DSP solutions, simplified by the industry's most committed system technologies.

## OKI DSP — Set yourself up!



Please send complete DSP technical data package for:

- OKI 6992 — 22-bit Floating Point CMOS DSP.
- OKI 699210 — 22-bit Floating Point CMOS DSP.
- Call me. I have immediate requirements.

Tel: (\_\_\_\_) \_\_\_\_\_

Name/Title \_\_\_\_\_

Company \_\_\_\_\_

EDN052688

Please clip coupon to business card or letterhead and return to:  
**DSP Customer Service, OKI Semiconductor,**  
650 N. Mary Avenue, Sunnyvale, CA 94086. (408) 720-1900.

**OKI**  
SEMICONDUCTOR  
CIRCLE NO 159

# VME/PLUS™ gives view of your

**H**old on to your seat. You're about to discover an entirely new level of VME performance.

Meet VME/PLUS. Our new family of VMEbus products with a host of sophisticated features that will give

**VME/PLUS**

your project the kind of performance you've only dreamed about.

VME/PLUS gives you a choice of microprocessors, including a 68030 running at 25MHz without wait states. Complemented by 1MB of local memory. There's also a new VSB interface on P2. Which lets you add lots of local memory and I/O without

increasing bus overhead. You also get two serial ports and up to 4MB of EPROM.

The result is system throughput that's way ahead of anything else in the VME world.

Think about the possibilities for real-time applications. For the first time, you can squeeze every ounce of performance from every processor. With no wasted overhead. And no stalls. But that's only the beginning. The newest

**AVAILABLE WITH 68030**

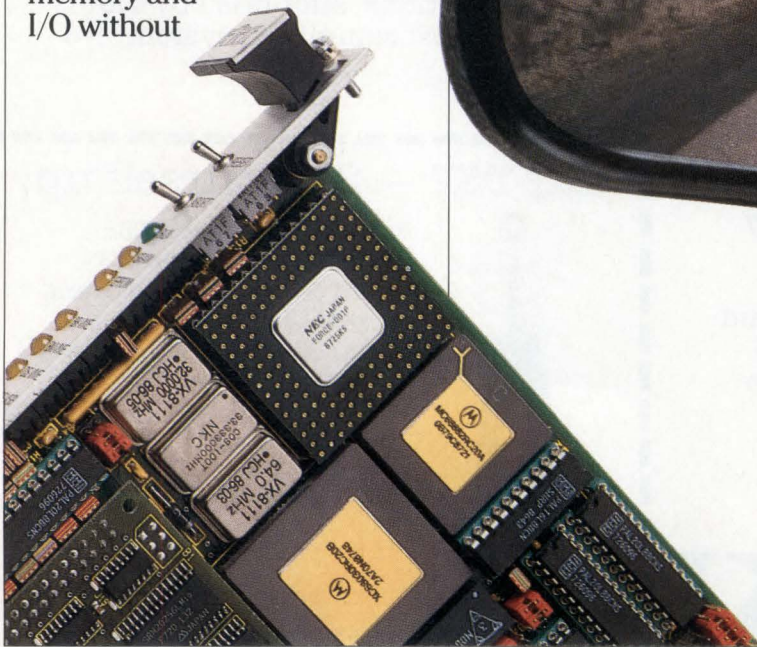

# you a different competition.

member of the VME/PLUS family, CPU-32, comes with



a powerful new real-time, multitasking monitor called VMEPROM. It's resident in

EPROM, so there's no license required and no extra charge.

CPU-32 also includes full support for real-time operating systems and UNIX 5.3.

What this new technology means for you is unprecedented levels of speed and system throughput, exceptional reliability and—here's

#### CPU-32 CHARACTERISTICS

PROCESSOR	68030/16.7 TO 25 MHz
CO-PROCESSOR	68882/16.7 TO 25 MHz
ZERO-WAIT-STATE	
SRAM	1MB
VMEPROM	REAL-TIME, MULTITASKING MONITOR UP TO 4MB @ 1 WAIT-STATE
EPROM	2 RS-232 CHANNELS
SERIAL I/O	
SECONDARY BUS SUPPORT	VSB

the best part—lower total system cost.

And if that's not enough, we also offer a full set of off-the-shelf peripheral boards

and software. All VMEbus compatible. And guaranteed to cut the wait states out of your design cycle.

So if you're looking for the best way to stay ahead of your competition and your deadline, take a close look at VME/PLUS.

Call us today at 1 (800) BEST VME, and ask for our new 550-page, 1988 data book. You'll get such a great view of VME performance, you'll never look back.



**VME at its best.**

FORCE COMPUTERS, INC.  
3165 Winchester Blvd., Campbell, CA 95008  
Telephone (408) 370-6300  
Telefax (408) 374-1146

FORCE COMPUTERS, GmbH  
Daimlerstrasse 9 D-8012 Ottobrunn  
Telefon (089) 60091-0 Telex 524190 forc-d  
Telefax (089) 6 097793

© 1988 Force Computers, Inc.  
VME/PLUS is a trademark of Force Computers, Inc. UNIX 5.3 is a trademark of AT&T, Bell Laboratories.

# SIGNALS & NOISE

## Current-feedback amp has limitations

I agree with David Nelson's comments (in *Signals & Noise*, February 4, 1988, pg 34) about the use of the term "transimpedance amplifier." The circuit used in Analog Design's AD9610 should correctly be called a "current feedback" configuration.

I would like to make a few observations about the gain-bandwidth-independence property of the current-feedback configuration. I can specifically remember using a Class A all-npn amplifier of this type in 1960 as a video amplifier in the first TV studio camera to use transistors. The complementary configuration now being presented by Comlinear, Analog Devices, Elantec, and other companies represents a Class A-B version capable of operating in an op-amp configuration. However, its so-called gain-bandwidth independence is achieved only at the ex-



pense of limiting unity-gain bandwidth by the value of the series resistor in the feedback path. The need to use low values of feedback elements to obtain wide bandwidths also represents a severe limitation when low-power or inverting-mode operation is required.

I have devised a solution to the above limitations in the form of a complementary quad input configuration that allows for gain-bandwidth optimization while also maintaining true op-amp high-voltage impedance and differential-input capability (the patent application is pending). I would be pleased to discuss these ideas with anyone who is interested in obtaining wide-bandwidth, wide-dynamic-range amplifiers using complementary bipolar processes.

*Derek Bray*  
Director, Design Services  
Analog Design Tools Inc  
Sunnyvale, CA

## A fair hearing for transconductance

I have some comments on Keats Pullen's recent letter (*Signals & Noise*, March 17, 1988, pg 34). I

## FREE THIRD EDITION NEW Handbook For Data Acquisition

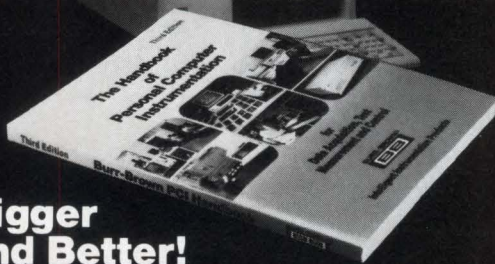

### Bigger and Better!

Our newly expanded *Handbook of Personal Computer Instrumentation for Data Acquisition, Test, Measurement, and Control* contains more than ever before. It has everything you've ever wanted to know, and much more. Almost 300 pages include:

- A tutorial
- A chapter on available software
- An applications section
- System configuration guides
- Example programs
- Technical specifications

This \$15 value is FREE for the asking. Write on your company's letterhead to:

The New PCI Handbook, Burr-Brown Corp.  
Intelligent Instrumentation  
1141 West Grant Rd., #131, Tucson, Arizona 85705

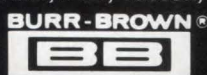

## On-board Transceiver Modules for Ethernet\* LAN

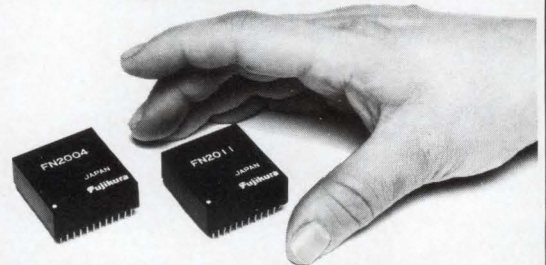

- Compact** — Saves board space
- Fast** — Saves assembly time
- Sure** — Saves testing

*At a price competitive with discreet production.*

All transceiver circuits are contained in one chip with no tedious analog design required. Extremely small and lightweight construction conforms to DIX2.0/IEEE802.3. Highest reliability at low cost. Call for prices.

**Fujikura America, Inc.**

455 One Allegheny Square  
Pittsburgh, PA 15212  
(412) 323-9696

\*Ethernet is a trademark of Xerox Corp.

# 100 V/ $\mu$ s GUARANTEED

**PMI's OP-44** also guarantees a 15 MHz GBW and full power BW of 1.5 MHz. And no compromises on accuracy...

## OP-44 HA-2520

$V_{OS}$	1.0	8	mV max
$TCV_{OS}$	4	20	$\mu$ V/ $^{\circ}$ C typ
$A_{VOL}$	200	10	V/mV min
$I_B$	0.2	200	nA max
CMR	86	80	dB min

The OP-44 is available now... in 883 too. Get the high-speed facts from our 12-page OP-44 data sheet. Circle the reader service number or call 1-800-843-1515.

Precision Monolithics Inc.  
A Bourns Company  
Santa Clara, California USA  
408-727-9222

5V

500ns

ORANGE COUNTY: (714) 637-9602, LOS ANGELES: (818) 886-6881, MILPITAS: (408) 942-8060,  
DALLAS: (214) 341-1742, CHICAGO: (312) 250-0808, ATLANTA: (404) 263-7995,  
PHILADELPHIA: (215) 675-7600, BOSTON: (617) 794-0026



*The precision solution.*

CIRCLE NO 156

# SIGNALS & NOISE

helped Tarlton Fleming review Keats Pullen's original submission to Design Ideas, and I think EDN is being fairer than fair.

Keats criticizes electronics engineers in general, and EDN's editors in particular, for not being properly appreciative of transconductance, or  $g_m$ , and of how important it is in the circuit-design process. On the contrary, many of us engineers appreciate that  $g_m$  is a very essential phenomenon. And we take it for granted. Specifically, most bipolar transistors have a  $g_m$  that's so close to theoretical that you *can* take it for granted:  $g_m = 39 \cdot i$  (and the corollary: current is an exponential function of  $V_{be}$ ). Yet Keats Pullen wants me to measure the  $g_m$  on every transistor I use, and I have found that I don't have to do that.

Keats says that as long as beta is greater than some nominal value, such as 20, "it's unimportant." Keats may work with circuits in

which any beta over 20 is perfectly adequate, but I work with many circuits in which a minimum beta of 100 or 300 or 700 is essential. And I work on other designs in which a maximum limit for beta is enforced. In other cases, the betas must be matched very carefully. I don't think it's proper for Keats to essay to tell everybody that measuring or specifying beta for their transistors is wrong. He can't tell everybody how to do their jobs.

He's correct in saying that voltage gain often has linearities, and he's correct in implying that it would be foolish to assume that voltage gain is a linear and constant function for all sizes of signal. But I don't know any engineer who's so foolish as to refuse to acknowledge that gain can vary or distort. Keats is setting up a straw man when he tells us not to trust voltage gain.

On the other hand, using *only* transistors (bipolar or FET), I have

designed current amplifiers that have excellent linear and stable gain over wide ranges of current. Apparently Keats Pullen thinks I'm imagining things when I rely on the excellent linearity and constancy of the gain of modern planar transistors?

Furthermore, Keats tells us that the  $g_m$  of tubes and FETs is  $(q/kT)$  times the device's operating current, for small currents. Unfortunately, that is a case of gross oversimplification. For some devices, it's approximately true, but for others,  $g_m$  per unit of current is never more than a small fraction of  $(q/kT)$ , depending on device physics, geometries, etc. And apparently Keats has a fixation on "inherently exponential nonlinearities," but conveniently ignores the fact that FETs and tubes are most often operated in their square-law regions. Doctrinaire opinions must be rejected whenever they are wrong.

## AUDIOFILE

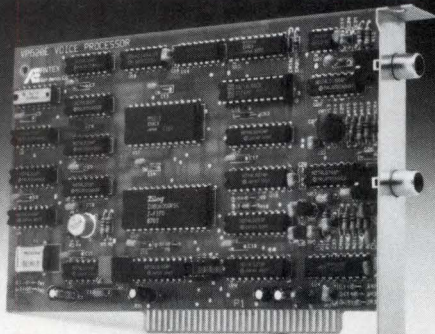

Sing it! Say it! Play it!... now in high fidelity! The new enhanced VP620E Voice Processor converts 20Hz to 7.0 kHz audio inputs into ADPCM encoded digital data for hard disk recording on your PC/XT/AT/386 or compatible. Playback flawless, authentic audio when and where you want it from background DOS commands.

Just plug it in, load menu driven software and 29 MB will give you 1 hr. of full fidelity digital audio from your PC. Its quick, easy and suprisingly affordable.

Use it for telecommunications, broadcasting, robotics, interactive video, process control prompting, and other off-screen operator interface applications.

Call 1-800-338-4231 (not Ca.) for facts on the new VP-620E 16kHz board that will make your PC sing!

**ANTEX ELECTRONICS**

16100 S. Figueroa St. • Gardena, CA 90248 • (213) 532-3092 • FAX (213) 532-8509

## Contactless De-Soldering and Soldering

with the Leister-Labor "S" Hot Air Tool

Electronic Temperature Adjustment from 20 to 600°C.  
Electronical Air Volume Adjustment from 1 to 150 litres per minute.

For contactless de-soldering and soldering of SMD and DIP components in 2-4 seconds.

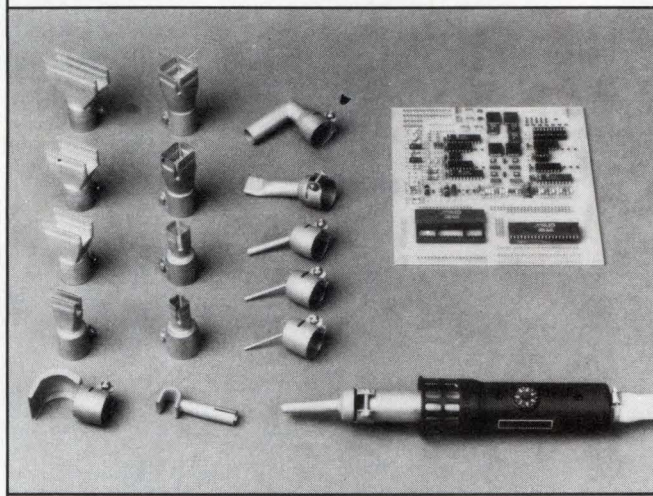

### ASK FOR FREE BROCHURE UW 109

Brian R. White Co. Inc., 313 Henry Station Road  
Ukiah, CA 95482  
Farmingdale, NJ 07727

phone: (707) 462-9795  
phone: (201) 938-2700

# Saratoga 64K SRAMs.

**Besides speed,  
our new  
TTL SRAMs  
have a lot  
going for them.**

Fast static RAMs have been disappearing fast lately. Some, by going up in a cloud of vapor. Others, like our new 64Ks, by breaking speed barriers.

They're taking off fast for good reason. Because for one thing, our new SRAM family is the only one being made in BiCMOS by a U.S. manufacturer. So you get both the high speed of bipolar and the low power of CMOS. Putting the technology of tomorrow into your products today.

**Old memories are  
going, going, gone.**

No matter what memory technology you're now using, our BiCMOS parts can replace it directly. They're pin-for-pin compatible with all industry-standard SRAMs. So you can go on working with the design rules you know. Yet get the advantages of next-generation process technology.

Advantages like a choice of 20-

25-, 35-, or 45-nsec speeds. Yet these SRAMs draw no more current than conventional CMOS parts, while delivering twice the output drive. And they come in by-8 and by-4 organizations, with all the popular packaging options. In both commercial and military temperature ranges.

**Order some to go today.**

All your SRAM systems can be "go" today, with Saratoga's BiCMOS

parts. Besides our 64K TTL line, we're shipping volume orders of our 4K and 16K TTL families, plus ECL SRAMs in 4K and 16K densities. These parts feature speeds as fast as 8 nsec, and full military temperature range operation.

So if you're not sure whether those other fast SRAMs are coming or going, check Saratoga. Call (408) 864-0500 today, or write Saratoga Semiconductor, 10500 Ridgeview Court, Cupertino, CA 95014.

# At 20nsec, they're going fast.



**Saratoga  
Semiconductor**

The Leader in BiCMOS

CIRCLE NO 155

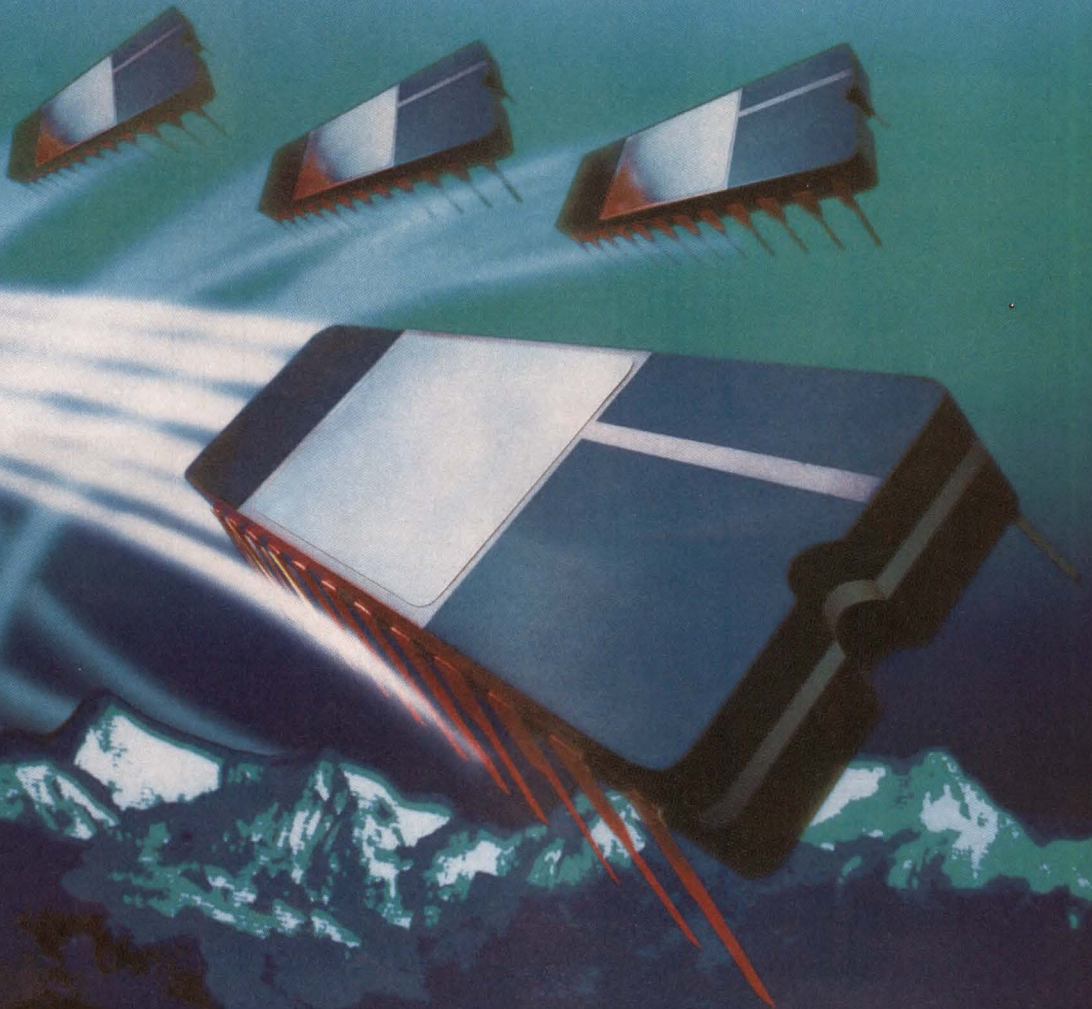

Keats has argued that measuring the  $g_m$  and its deviation from theoretical is very important for the design of low-distortion circuits. In some fields (RF or microwave amplifiers?) he is correct, but in other areas, the use of feedback makes the need to compute the distortion an obsolescent art. Modern operational amplifiers and other feedback am-

plifiers can now provide low-distortion gain, which, only 20 years ago, did require strenuous and rigorous low-distortion circuit design. It's also true that modern circuit-analysis simulators such as Spice can provide rather accurate treatment of the linear and nonlinear parts of  $g_m$  and of other circuit elements, so it's not always necessary for the engi-

neer to give any particular thought to that part of the analysis. (I agree with Jim Williams; I believe it's wrong to do low-distortion circuit design without thinking about it, and I myself refuse to do so, but it is possible to do so . . .)

I have no objection to the use of  $g_m$  as a tool that's useful in design. But I do object to being told that other tools are not useful.

Incidentally, as I recall the original Design Idea submission by Keats Pullen, he stood on his soapbox and proclaimed that you really must measure the  $g_m$  of the devices, but he never showed any advantages or useful design tricks that would make your circuit design easy and neat after you had measured  $g_m$ . So, if he could show us an example of a useful circuit in which his  $g_m$  analysis made for new and improved insights, I'd have no objection to seeing it published. But as it is, he just seems to be hollering, "Look, everybody's out of step with Johnny. . . ."

*Robert A Pease*  
Electronics engineer  
National Semiconductor  
San Francisco, CA

## SOLID-STATE

# SILICON ACCELEROMETERS

### HIGH PERFORMANCE AT LOW COST

There's a revolution taking place in the measurement of acceleration, shock, and vibration—and our new piezoresistive accelerometers are leading the way.

The combined accuracy, DC response, wide bandwidth, damping, overrange protection, low mass, small size, light weight, and low cost of these sensors make them a natural choice for a wide variety of applications, including:

- Air bag deployment
- Active suspension
- Braking systems
- Computer disk drives
- Vibration monitoring
- Military arming & fuzing

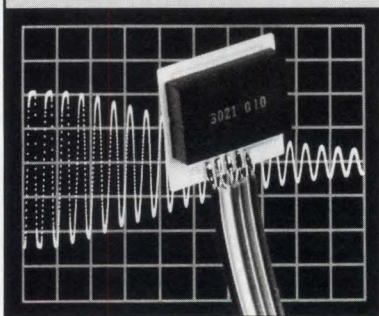

Ranging from below  $\pm 1g$  to greater than  $\pm 500g$ , both standard or custom products are available. IC Sensors specializes in producing custom designs.

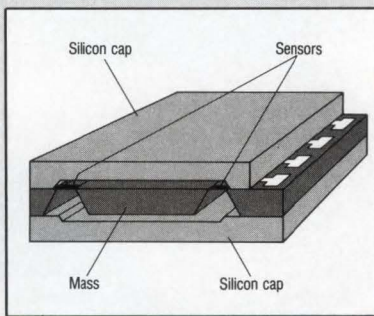

The 3-layer micromachined silicon sandwich incorporates a tiny, but protected, suspended mass. Batch fabrication assures uniformity, low cost, and built-in reliability.

# IC SENSORS

1701 McCarthy Blvd., Milpitas, CA 95035  
FAX: (408) 434-6687 Telex: 350066 Phone: (408) 432-1800

CIRCLE NO 19



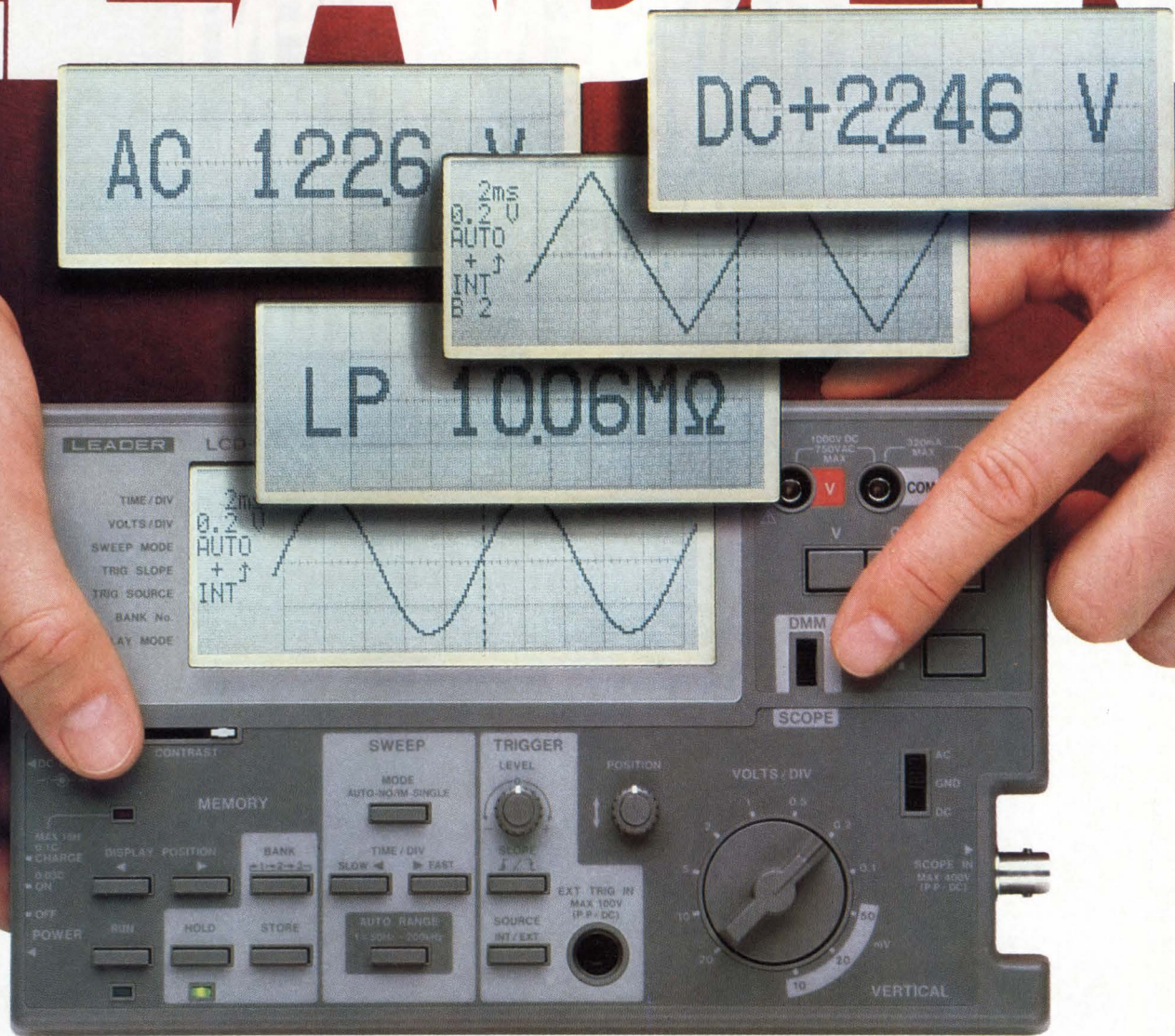

# Portable Problem Solver

## Ultra-compact Digital Storage Oscilloscope-Multimeter.

Easily carried in a tool kit or attache case—powered by batteries or supplied ac adaptor—this 2-in-1 lightweight is always ready for hand-held action.

## Multi-function, 200-kHz DSO.

Just flip the switch from DMM to SCOPE and the performance of a professional Digital Storage Oscilloscope is at your fingertips. Lets you capture and analyze single-shot and very slow phenomena. Stores up to three waveforms, and has such top-of-the-line features as auto-ranging time base setting, pre-trigger, roll mode, and on-screen readout of setting conditions. Low-power indicator

alerts you when batteries need recharging, while a separate back-up system protects memory.

## Full-function, 3½-digit DMM.

Precise measurement of ac/dc voltage, current and resistance is easy to see on the large, high-contrast, display. Automatically selects range which provides greatest accuracy and resolution.

## Perfect for many applications.

LCD-100 is a unique combination instrument that can confirm that its DMM is measuring a desired signal. Better by far than a DMM alone... more useful in the field than any benchtop DSO in this bandwidth, LCD-100 is ideal for servic-

ing a broad range of electromechanical, electrical and electronic systems.

Call toll-free  
**1-800-645-5104**  
 In NY State  
**(516) 231-6900**

Ask for an evaluation unit, our latest Catalog, more information, or the name of your "Select" Leader Distributor.

For professionals  
 who know  
 the difference.

**LEADER**  
 Instruments Corporation

380 Oser Avenue, Hauppauge, New York 11788  
 Regional Offices:  
 Chicago, Dallas, Los Angeles, Boston, Atlanta  
 In Canada call Omntronix Ltd. (416) 828-6221

Circle 116 for Information

Circle 117 for Demonstration

# DC TO 6 GHz TRANSIENT EVENT CAPTURE. A WORLD WHERE TEK STANDS ALONE.

In a world of extremely high-frequency, ultra-fast signal transitions, there are two instruments that thrive: the Tek 7250 Transient Digitizing Oscilloscope and Tek 7912HB Transient Waveform Digitizer.

No other digitizing oscilloscope can automatically capture and record lightning-fast events whether single-shot or low-rep rate that more and more applications — from particle physics and lasers to

semiconductor characterization — regularly encounter.

The 6 GHz Tek 7250 can capture transients of 50 ps rise time at 1 picosecond/point; with 11-bit vertical and 9-bit horizontal resolution. Menu-

driven, with on-board measurements and integral monitor, it is easily the highest performance transient digitizing oscilloscope ever made.

The Tek 7912HB achieves 10 ps/point time resolution, allowing capture of events

with transitions of less than 575 ps. In addition to its 750 MHz analog bandwidth, triggering capabilities and 10 waveform-per-second data transfer rate, the 7912HB offers the plug-in module flexibility of a Tek laboratory oscilloscope, such as the new 7A29P programmable amplifier.

For more information on the world of Tek digitizing, call 1-800-835-9433. Or contact your Tek representative.

Characteristics	7250	7912HB
Analog Bandwidth	6 GHz	750 MHz
Rise Time	50 ps	575 ps
Fastest Time/Point	1 ps/pt.	10 ps/pt.
Max. Points/Second	1000 GS/s	100 GS/s
Vertical Resolution	11 bits	9 bits
Input Signal Range Vertical	5V full scale, 10 divisions	80mV to 8V full scale, 8 div.
Input Sensitivity	500mV/div.	10mV/div. to 1V/div.
Fully Programmable	Yes	Yes

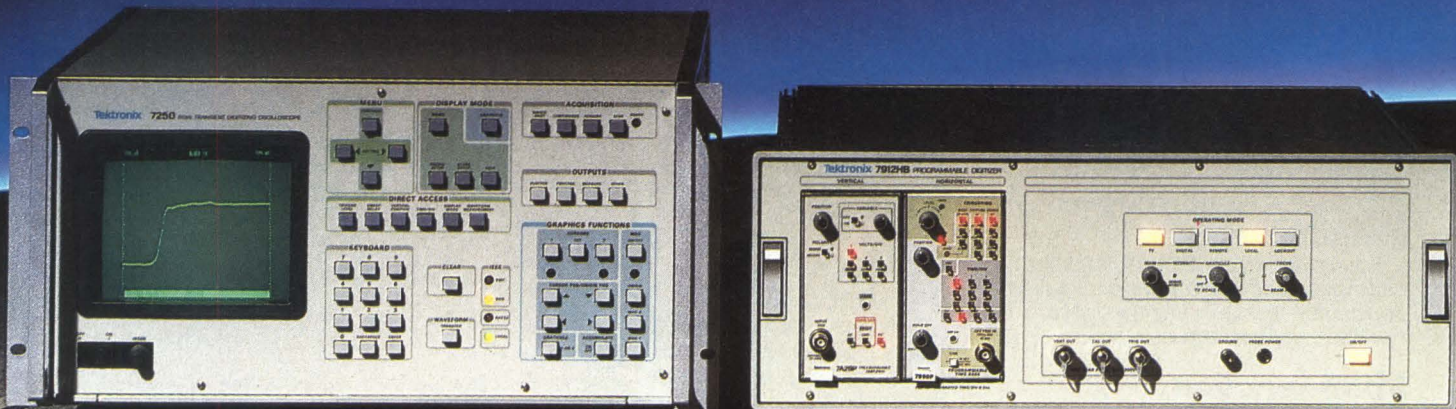



CIRCLE NO 154

FROM  
NOW ON,  
THERE'S  
ONLY ONE  
RISC\*  
WORTH  
TAKING.

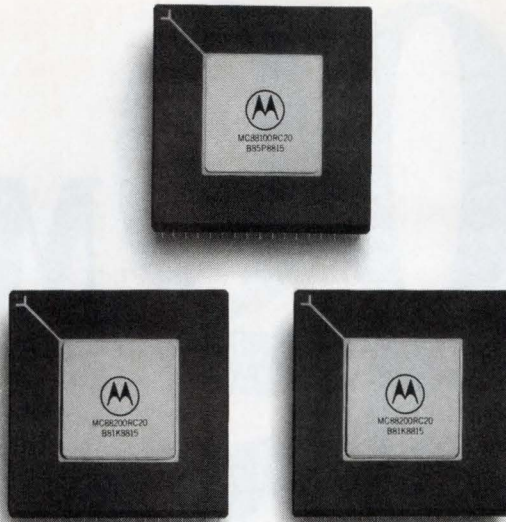

## INTRODUCING THE MOTOROLA 88000 MICROPROCESSOR FAMILY: THE GREATEST RISC OF ALL.

The future of RISC computing has been reduced to three small, but amazingly powerful chips.

Namely, the Motorola 88000 family.

One awesome microprocessor unit, supported by two cache memory management units. Designed to take RISC architecture far beyond anything else in the marketplace.

The 88000 runs at a blistering 14-17 MIPS, 7 million floating point operations per second, and an incredible 50 MIPS in parallel processing applications (using just four 88000 chip sets on our HYPERmodule™ card).

Which makes everything from multi-user business systems to fault tolerant on-line transaction processing systems to artificial intelligence systems several times faster and more powerful than ever before.

What's more, it comes with absolutely every bit of hardware and software needed to build your system of the future, today. In fact, many leading hardware and software companies, including those in the independent consortium 88open, are already designing systems around the 88000. And many more will follow.

So make sure your future is as rewarding as it can possibly be. Call us for more information at 1-800-441-2447. Or write Motorola Inc., P.O. Box 20912, Phoenix, AZ 85036.

Because the greater the RISC, the greater the reward.



**MOTOROLA**

*\*Reduced Instruction Set Computer*

© 1988, Motorola Inc.  
HYPERmodule is a trademark of Motorola Inc.

$$\begin{array}{r}
 200 \text{ MB} \\
 + 15 \text{ ms} \\
 \hline
 = 3\frac{1}{2} \text{ in.}
 \end{array}$$

**SWIFT™ 3½" HIGH-CAPACITY, HIGH-PERFORMANCE  
DISK DRIVES NOW AVAILABLE FOR EVALUATION.**

Get the 3½" disk drive that sets the standard for capacity and performance. We combined the two most important things everyone wants in a storage device—capacity and speed. And packed it into the size everyone would like... 3½".

**CAPACITY PLUS PERFORMANCE**

Swift disk drives feature a blistering 15 ms average seek time. The top model offers 200 Mbytes of unformatted storage with high-performance device level or intelligent interfaces. Swift drives feature 1-to-1 interleave, synchronous or asynchronous operation and a 32k cache buffer with read ahead capability to optimize performance.



**DESIGNED FOR RELIABILITY**

A rotary voice coil actuator, advanced surface mount electronics and a unique high torque, phase-locked in-hub spindle motor are just a few of the advanced features that make Swift the industry's leader.

**SWIFT IS A FAMILY**

Production shipments of 100 and 150 Mbyte models are already underway. Now you no longer have to limit the capacity or performance of your system just because you need a 3½" drive.

If you're a qualified OEM, you can get an evaluation unit now.

**GD CONTROL DATA**



SHOWN  
ACTUAL  
SIZE

Model	Capacity (Mbytes)	Avg. Seek (ms)	Interfaces	Transfer Rate (MHz)
9435X	200	15	SCSI, ESDI, AT	10
	150	15	SCSI, ESDI, AT	10
	150	15	ST506/412 (RLL)	7.5
	100	15	ST506/412 (MFM)	5

# PRESSURE PRESSURE PRESSURE PRESSURE

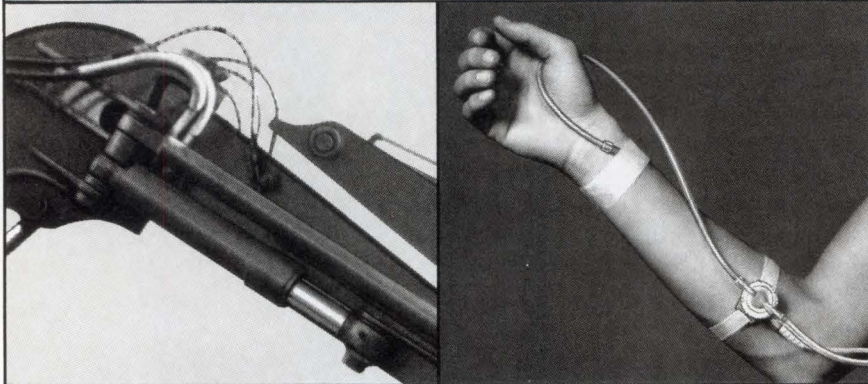

## Ametek's transducer technology solves OEM problems, from hydraulic fluid at 15,000 psig, to a diastolic of 80 mm Hg.

Ametek low-cost pressure transducers are proven performers in hydraulic systems, HVAC, engine monitoring, medical instrumentation and just about every other application you might imagine.

The Ametek PT-206 combines wetted parts of corrosion-resistant metals with the reliable technologies of a bourdon tube and LVDT to give you economical monitoring up to 15,000 psi.

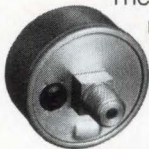

Our IPT is a compact, quick-response, solid-state unit for a variety of industrial applications. Featuring a corrosion-resistant ULTEM\* housing, it's offered in ranges up to 500 psi.



Other solid-state units include the Model 55, a true wet-to-wet differential transducer; the ultra compact Model 5701 which is pc-board mountable, and the Model 5702 with ranges up to 1000 psi.

When you're looking for answers to your OEM pressure sensing problems, contact AMETEK, U.S. Gauge Division, Sellersville, PA 18960. (215) 257-6531, Ext. 358.

# AMETEK

\*™, General Electric Co.

## CALENDAR

**Troubleshooting Microprocessor-Based Equipment and Digital Devices** (seminar), Dallas, TX. Micro Systems Institute, 73 Institute Rd, Garnett, KS 66032. (800) 247-5239; in KS, (913) 898-4695. May 31 to June 3.

**42nd Annual Frequency Control Symposium**, Baltimore, MD. R L Filler, US Army Electronics Technology and Devices Lab, Attn: SLCET-EQ, Ft Monmouth, NJ 07703. (201) 544-2467. June 1 to 3.

**Personal Computer Interfacing for Scientific Instrumentation Automation** (short course), Blacksburg, VA. Linda Leffel, CEC, Virginia Tech, Blacksburg, VA 24061. (703) 961-4848. June 2 to 4.

**International Summer Consumer Electronics Show**, Chicago, IL. Consumer Electronics Shows, 2001 Eye St NW, Washington, DC 20006. (202) 457-8700. June 4 to 7.

**FiberTour 88**, Boston, MA. Joan Barry, Xpos, Box 8872, Salem, MA 01971. (617) 744-9767. Conference cosponsored by Lightwave magazine. June 7 to 8.

**ATE & Instrumentation Conference East**, Boston, MA. MG Expositions Group, 1050 Commonwealth Ave, Boston, MA 02215. (800) 223-7126; in MA, (617) 232-3976. June 7 to 9.

**International Conference on Consumer Electronics**, Rosemont, IL. Geriann Van Calbergh, 4924 N Cumberland, Norridge, IL 60656. June 7 to 10.

**25th Design Automation Conference**, Anaheim, CA. MP Associates, 7366 Old Mill Trail, Suite 101, Boulder, CO 80301. (303) 530-4333. June 12 to 15.



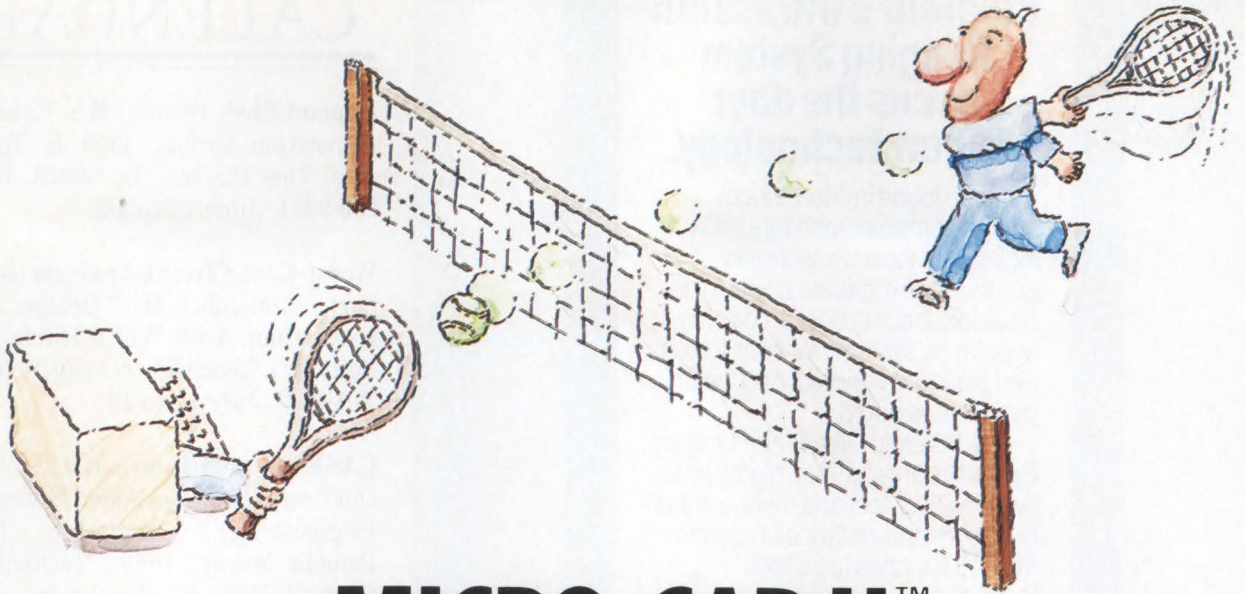

# MICRO-CAP II.™

## The CAE tool with fully interactive analog simulation for your PC.

Spectrum Software's MICRO-CAP II® is fast, powerful, and feature rich. This fully interactive, advanced electronic circuit analysis program helps engineers speed through analog problems right at their own PCs.

MICRO-CAP II, which is based on our original MICRO-CAP software, is a field-proven, second-generation program. But it's dramatically improved.

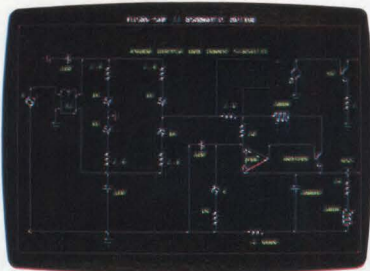

*Schematic Editor*

MICRO-CAP II has faster analysis routines. Better resolution and color. Larger libraries. All add up to a powerful, cost-effective CAE tool for your PC.

The program has a sophisticated integrated schematic editor with a pan capability. Just sketch and analyze. You can step

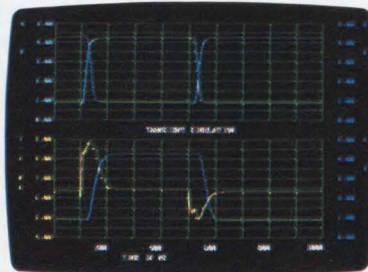

*Transient Analysis*

component values, and run worst-case scenarios—all interactively. And a 500-type\* library of standard parts is at your fingertips for added flexibility.

MICRO-CAP II is available for IBM® PCs and Macintosh.™ The IBM version is CGA, EGA, and Hercules® compatible and costs only \$895 complete. An evaluation version is available for \$100. Call or write today for our free brochure and demo disk. We'd like to tell you more about analog solutions in the fast lane.

- Integrated schematic editor
- Fast analysis routines
- High-resolution graphic output
- Standard parts library of 500\* types

\*IBM versions only.

- Transient, AC, DC, and FFT routines
- Op-amp and switch models
- Spec-sheet-to model converter\*
- Printer and plotter\* hard copy



*AC Analysis*

**spectrum**

1021 S. Wolfe Road, Dept. E  
Sunnyvale, CA 94087  
**(408) 738-4387**

MICRO-CAP II is a registered trademark of Spectrum Software.

Macintosh is a trademark of McIntosh Laboratory, Inc. and is being used with express permission of its owner.

Hercules is a registered trademark of Hercules Computer Technology

IBM is a registered trademark of International Business Machines, Inc.

## Polaroid's Ultrasonic Ranging System opens the door to new technology.

It can be found in "non-touch" screen computer monitors, AGV's, industrial robotics, electronic games, tape measures, aids for the disabled, loading docks, collision avoidance systems for cars, trucks and pleasure vehicles. And, yes, it even opens doors.

The Polaroid Ultrasonic Ranging System is an accurate, highly sensitive way to detect and measure the presence and distance of objects from 10.8 inches to 35 feet. What's more, accuracy, sensitivity and range can all be improved with circuit modifications.

**Three of a kind.** Polaroid offers three ultrasonic transducers for a wide variety of applications. You can choose the original instrument-grade transducer, proven in millions of SX-70 Sonar Autofocus cameras. Or our Environmental Transducer, available in a sturdy housing to withstand exposure to rain, heat, cold, salt spray, chemicals, shock and vibration. And now you can select our newest, smallest transducer, developed for Polaroid Spectra, the camera of the future. All use reliable, accurate and sensitive electrostatic transducer technology. All are backed by Polaroid.



**Get a \$2 Million Head Start.** Polaroid spent over \$2 million developing the Ultrasonic Ranging System. But now you can get this technology in our Designer's Kit for only \$165\*. To order your Designer's Kit, please send a check or money order for \$165 for each kit, plus all applicable state and local taxes, to: Polaroid Corporation, Ultrasonic Components Group, 119 Windsor Street, Cambridge, MA 02139. Questions? Call Polaroid's Applications Engineers at 617-577-4681.

\_\_\_\_\_ Please send me \_\_\_\_\_ Designer's Kit(s).

\_\_\_\_\_ Please send more information.

Name \_\_\_\_\_

Title \_\_\_\_\_

Company \_\_\_\_\_

Address \_\_\_\_\_

City \_\_\_\_\_ State \_\_\_\_\_ Zip \_\_\_\_\_

\*Pricing subject to change

EDN052688



**Polaroid**

"Polaroid", "SX-70"® "Spectra"™

CIRCLE NO 21

## CALENDAR

**Nepcon East**, Boston, MA. Cahners Exposition Group, 1350 E Touhy Ave, Des Plaines, IL 60018. (312) 299-9311. June 14 to 16.

**Worst-Case Circuit Analysis** (seminar), Honolulu, HI. Design and Evaluation, 1000 White Horse Rd, Suite 304, Voorhees, NJ 08043. (609) 770-0800. July 11 to 13.

**CASE '88** (2nd International Workshop on Computer-Aided Software Engineering), Cambridge, MA. Pamela Meyer, Index Technology Corp, 1 Main St, Cambridge, MA 02142. (617) 494-8200, ext 1988. July 12 to 15.

**Siggraph**, Atlanta, GA. Barbara Voss, Robert P Kenworthy Inc, 866 United Nations Plaza, Suite 424, New York, NY 10017. (212) 752-0911. August 1 to 5.

**Midcon**, Dallas, TX. Electronic Conventions Management, 8110 Airport Blvd, Los Angeles, CA 90045. (800) 421-6816; in CA, (213) 772-2965. August 30 to September 1.

**Surface Mount '88**, Marlborough, MA. MG Expositions Group, 1050 Commonwealth Ave, Boston, MA 02215. (800) 223-7126; in MA, (617) 232-3976. August 30 to September 1.

**Modern Electronic Packaging** (seminar), Santa Clara, CA. Technology Seminars, Box 487, Lutherville, MD 21093. (301) 269-4102. September 7 to 9.

**12th International Fiber Optic Communications and Local Area Networks Exposition**, Atlanta, GA. Information Gatekeepers, 214 Harvard Ave, Boston, MA 02134. (800) 323-1088; in MA, (617) 232-3111. September 12 to 16.

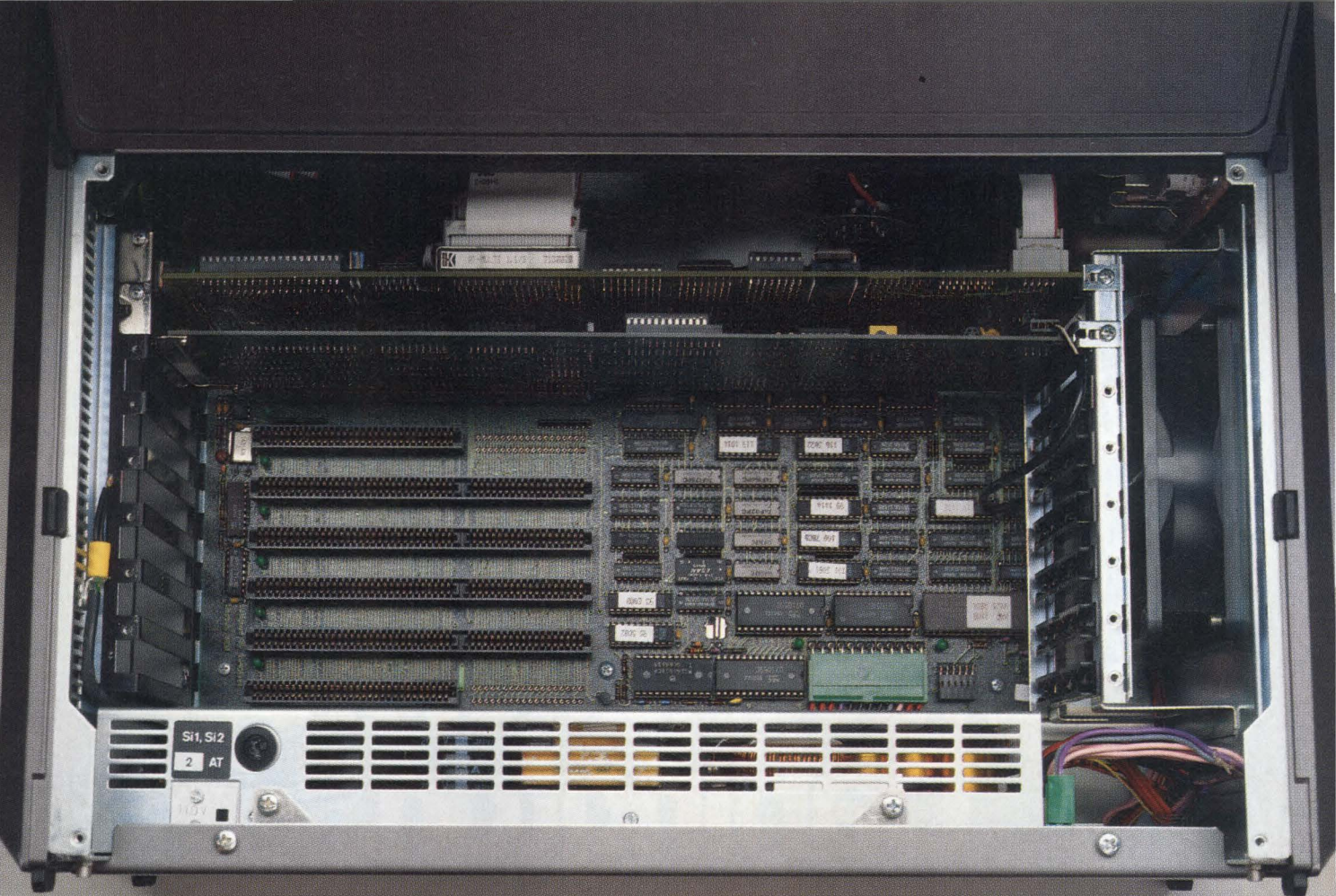

# We Suggest You Approach Your Logic Analyzer Decision Backwards.

Up front, the PLA 286 gives you more of what you need to solve even the toughest timing problems. Much deeper memory, for example, than you'll find anywhere else: Up to 4K per channel for state analysis; up to 8K for timing. And from 48 up to 112 channels. So you get a much bigger window into problem areas.

But what you see when you look behind the machine may impress you even more. Because in addition to being a powerful logic analyzer, it's also a powerful 10-MHz, 0-wait-state, AT-compatible computer.

There they are. Count 'em.

Six standard slots, waiting to turn the PLA 286 into any-



thing else you want it to be. Now, or later. Pattern generator. Oscilloscope. SCSI tester. Frequency counter. Ethernet node. Whatever.

So when you look at it backwards, the PLA 286 is a very forward-thinking machine, indeed. Fold up the keyboard, grab the handle, and it moves from heavy-duty, complex R&D lab applications, to complete, multi-function field analysis. All the power, depth, range, and flexibility you need for the most

demanding software and hardware analysis, in one, neat box.

The PLA 286 is one decision you can back into, and feel great about. Give us a call. (800) 227-8834.

**KONTRON  
ELECTRONICS**

United States KONTRON ELECTRONICS INC., 630 Clyde Avenue, Mountain View, CA 94039-7230, Toll free number 800-227-8834  
Europe KONTRON MESSTECHNIK, GmbH, Oskar-von-Miller-Str.1, 8057 ECHING/W. Germany, Phone: 49 (08165) 77-0

**Who offers you  
the broadest line  
of power  
semiconductors...**

**Darlington,  
FETMOD,<sup>TM</sup>  
MOSBIP,<sup>TM</sup>  
SCR/diode  
modules,  
rectifiers and  
thyristors?**

# Only POWEREX.

Powerex gives you what no one else does. Our one-source convenience and compatibility eliminate multi-source doubt. Our off-the-shelf availability means just-in-time delivery, instead of back-order delays or high inventory costs. We'll provide engineer-to-engineer phone conversations for an unbiased view of application needs and alternative component solutions. Best of all, POWEREX gives you leading-edge technology, rather than last-generation obsolescence. Take a look.

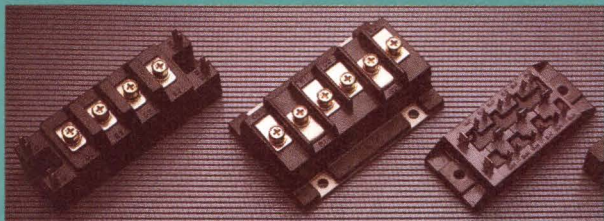

**Only POWEREX** offers you such a broad line of advanced power semiconductor modules, including next generation FETMOD and cascade or cascode MOSBIP, rated at 8-300 A, 50-1,000 V for applications up to 100 kHz.



**Only POWEREX** offers you the complete line of GE/RCA low-power triacs and SCRs as part of the broadest line of power semiconductors available.

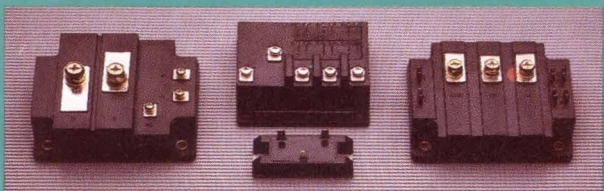

**Only POWEREX** offers you more advanced Darlington modules, including Application Specific (ASM™) modules: Single device, Phase-Leg, H-Bridge, Three Phase, Chopper and Common Emitter, 5-600 A, with  $V_{CEV(SUS)}$  from 200 to 1400 V.

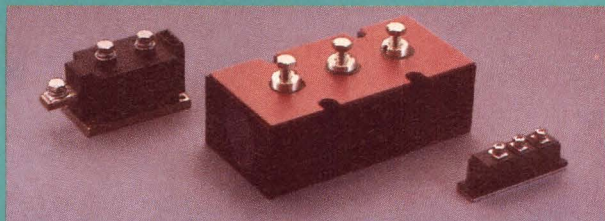

**Only POWEREX** can provide a modular solution for all the key power components from logic interface devices, input rectifiers and DC regulating components to the output power stage. POWEREX now offers the world's widest array of input power stage thyristor and diode modules. Ratings of 20-800 A, with  $V_{DRM}/V_{RRM}$  from 400 to 3000 V. Circuit configurations include Single device, Phase-Leg, Three Phase Bridge and Center Tap in common cathode or common anode configuration.

Recent additions to the product line are a family of Center Tap fast recovery diodes rated at 20-100 A up to 1200 V, a new compact 150 A/1600 V Dual thyristor module, and a new 1200 V/300 A GTO thyristor module.

**Only POWEREX** offers you all this. For product literature, call POWEREX at 1-800-451-1415, Ext. 300. (In New York, 315-457-9334.) For application assistance, call 412-925-7272, or write POWEREX, Inc., Hillis Street, Youngwood, PA 15697.

## POWEREX

Joint Venture Corporation of Westinghouse, GE and Mitsubishi.

CIRCLE NO 150

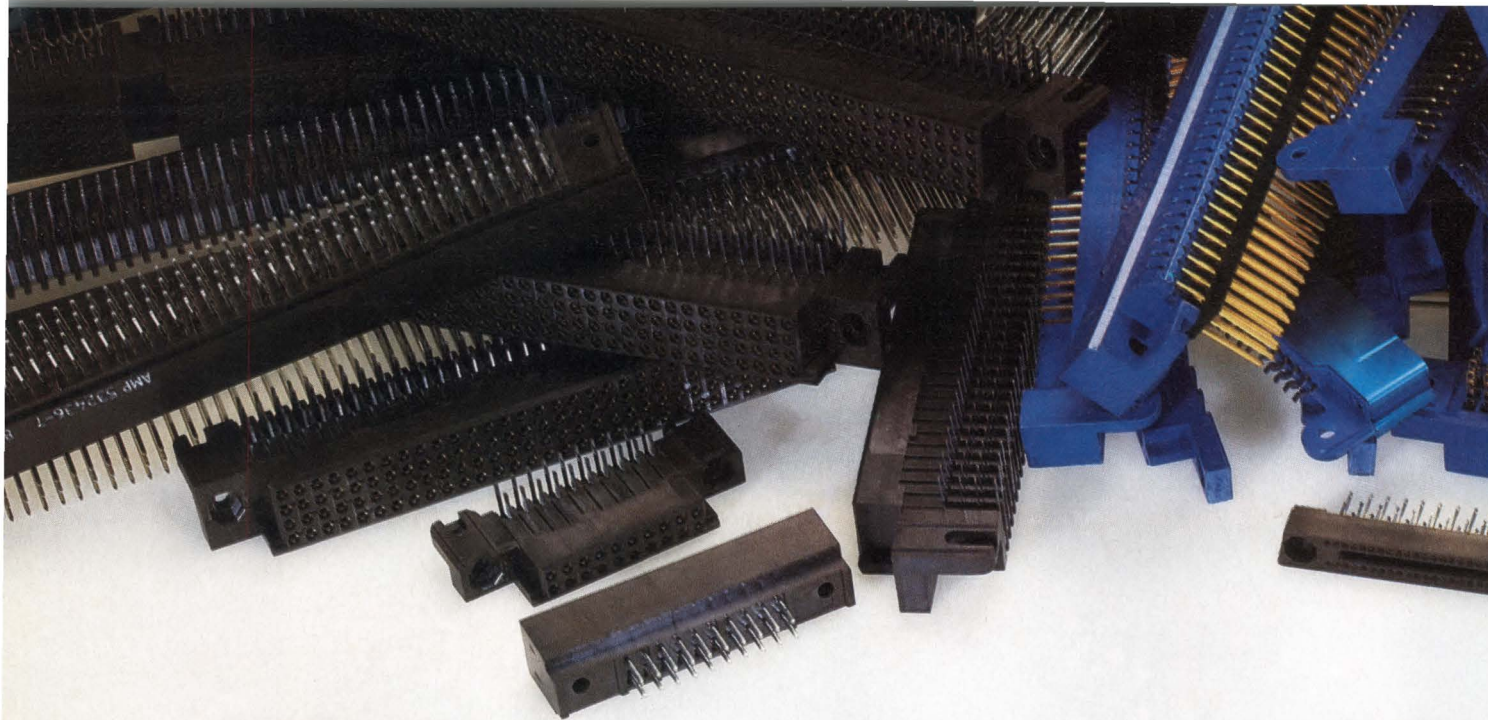

# Out of many comes

It takes a lot to keep our two-piece connector customers happy. Reliability. Quality. Availability.

And enormous selection.

We're confident we've got one for you, too.

**A.** Example. Our AMPMODU two-piece connectors, 12-200 positions, 2 row and 30-300 positions, 3 row, in horizontal and right-angle versions. Our worldly (and world-famous) post

and receptacle design—dual cantilever beams, anti-overstress, post-stop. Clean, elegant, reliable.

**B.** Or our high-pin-count contender, the AMP-HDI connector group. Available to 684 positions on a

0.100" grid, with four-way contact on every pin. Power and miniature coax contacts available, too. All in all, hard-working state of the art.

**C.** Or our Box Contact group. Same contact design as AMP-HDI—

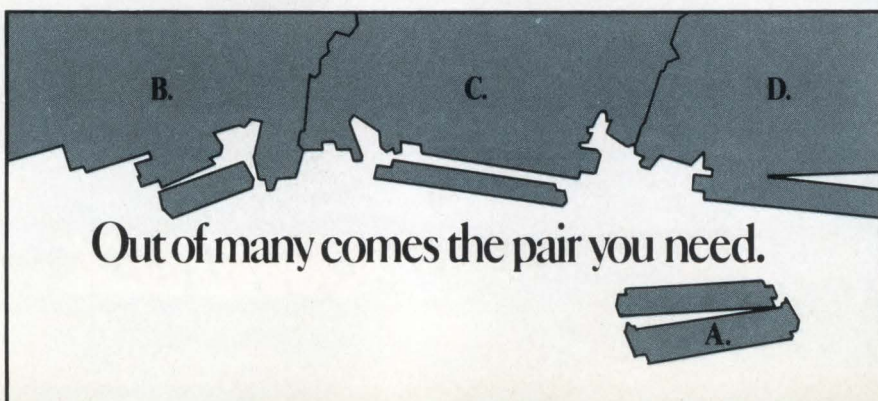

Out of many comes the pair you need.

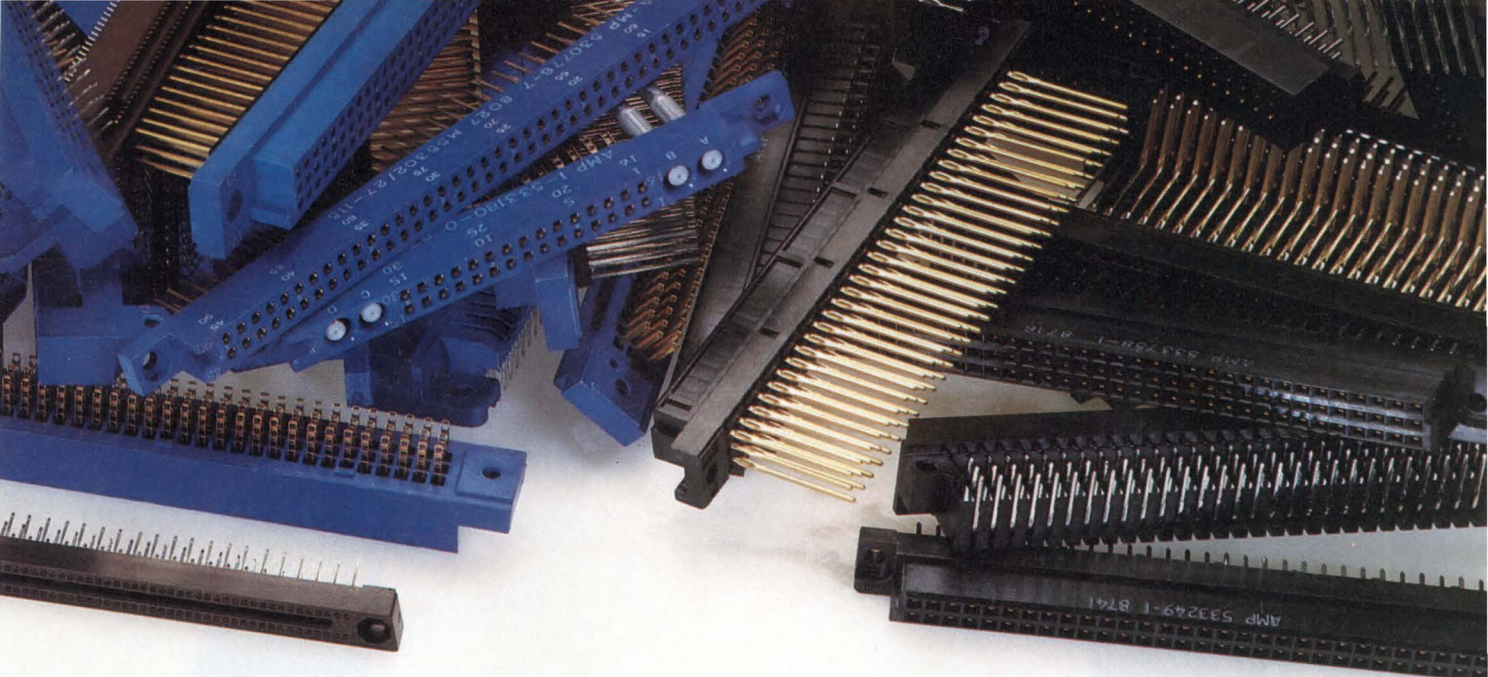

# the pair you need.



very forgiving of pin angle during mating. Very reliable. And available on 0.100", 0.075", and 0.050" CLs, with microminiature coax. MIL-C-55302s available as well.

D. And Eurocards, compatible with DIN 41612 types, available in 1/2s, reverses, expanded 2 and 3 row specials to 150 positions. Made worldwide by AMP, available nearby.

All these choices come with options, of course—special platings, ACTION-

PIN press-fit contacts, and more. All in the name of having exactly the one you need.

For information on AMPMODU Two-Piece Connectors or others in our lineup, call the AMP Information Center, 1-800-522-6752. For charac-

terized backplane assemblies, contact AMP Packaging Systems Inc., P.O. Box 9044, Austin, Texas 78766, (512) 244-5100, or your AMP Sales Engineer. AMP Incorporated, Harrisburg, PA 17105-3608.

**AMP** Interconnecting ideas

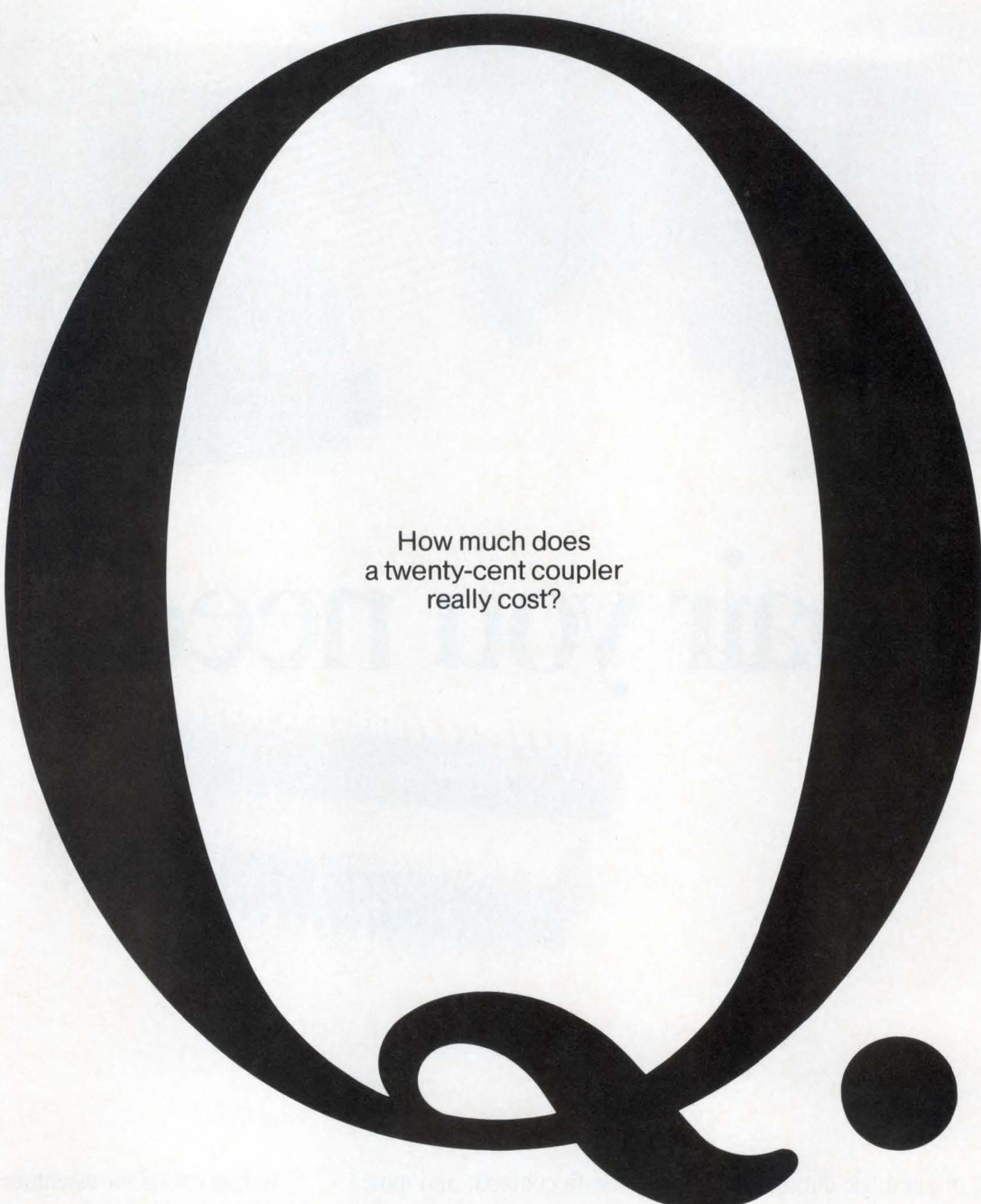

How much does  
a twenty-cent coupler  
really cost?

**A.** What you're buying with a 20¢ coupler isn't just a part. It's an insurance policy. You don't think about it until it fails, then you're out a lot more than 20¢. That's why as General Instrument we reduced our defect rate to fewer than 50 ppm. And now, as Quality Technologies we maintain that standard on our complete line of optocouplers. To provide smoother production and better performance. So, if the question is where to find quality optocouplers, the answer is Quality Technologies. (800) LED-OPTO.



Quality is always the answer.



# EDITORIAL

## An industry named Sue

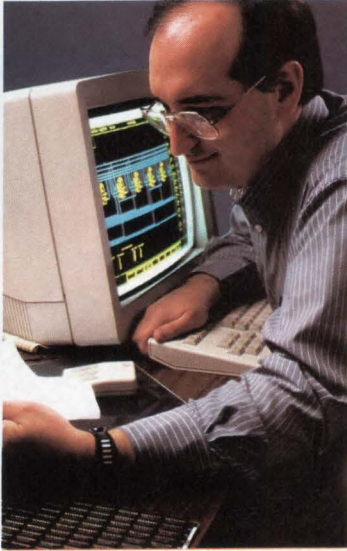

Lawsuits seem to be taking up more and more time in the electronics industry. Perhaps the most widely publicized suit in recent days is the copyright-infringement suit being brought against NEC by Intel. Intel claims that NEC incorporated Intel's copyrighted 8086 microcode in NEC's V Series  $\mu$ Ps. NEC counters that it did not appropriate the 8086 microcode, but that even if it had, it wouldn't be in violation of copyright—Intel's copyright was already forfeit, NEC claims, because Intel had built several million 8086-family  $\mu$ Ps without prominently displaying a copyright symbol.

Meanwhile, Zilog—which acquired the rights to build NEC's V Series  $\mu$ Ps—is also suing NEC, because the NEC-Intel suit raises questions about the future value of V Series chips. Because of their uncertain future, the V Series chips appeal to fewer designers, claims Zilog. NEC is countersuing Zilog for infringing on a host of unrelated patents. But wait: NEC has also brought up an old legal issue, that of Zilog's copyright on the letter Z.

Legal actions involve prices as well as copyrights. For example, shortly after the current US-Japan semiconductor trade agreement went into effect, the supply of dynamic RAMs (DRAMs) dried up and prices skyrocketed. Today, the prices originally agreed upon would look very good, but you won't find any DRAM chips on the market for those amounts. However, says Atari, a contract is a contract. The company is currently suing Micron Technology because Micron won't deliver DRAMs at an agreed-upon price that's lower than the DRAMs' current market value.

On the software front, Apple is suing both Microsoft and Hewlett-Packard for reproducing Apple's copyrighted Macintosh user interface in windowing products for IBM PCs and compatible computers. Apple filed a similar suit some time ago against Digital Research but settled the suit out of court. Along somewhat different lines, Hewlett-Packard and a host of other vendors of Unix-based workstations may take AT&T and Sun Microsystems to court over the future existence of Unix as an open standard.

Sometime soon, we'll see a manufacturer test the legal status of IBM's PS/2 architecture and the associated Micro Channel bus. You can expect to see Computer Automation enter the fray as well to defend its patented addressing scheme, which IBM licensed and incorporated in the PS/2.

These companies all have the right to defend their intellectual properties, the fruits of their investments, and their contractual rights. So where do all the lawsuits leave you? Well, before you include any product or technology in future designs, you must now investigate and consider its legal status. To play it safe, you should do thorough research for any possible patent infringement and then tread lightly by not calling unnecessary attention to your technological innovations. In addition, you might consider pursuing a law degree to complement your technical diploma. It looks as though the demand for engineer/lawyers is about to explode.

*Steven H. Leibson*

Steven H Leibson  
Regional Editor

# After 4 years of we're announcing

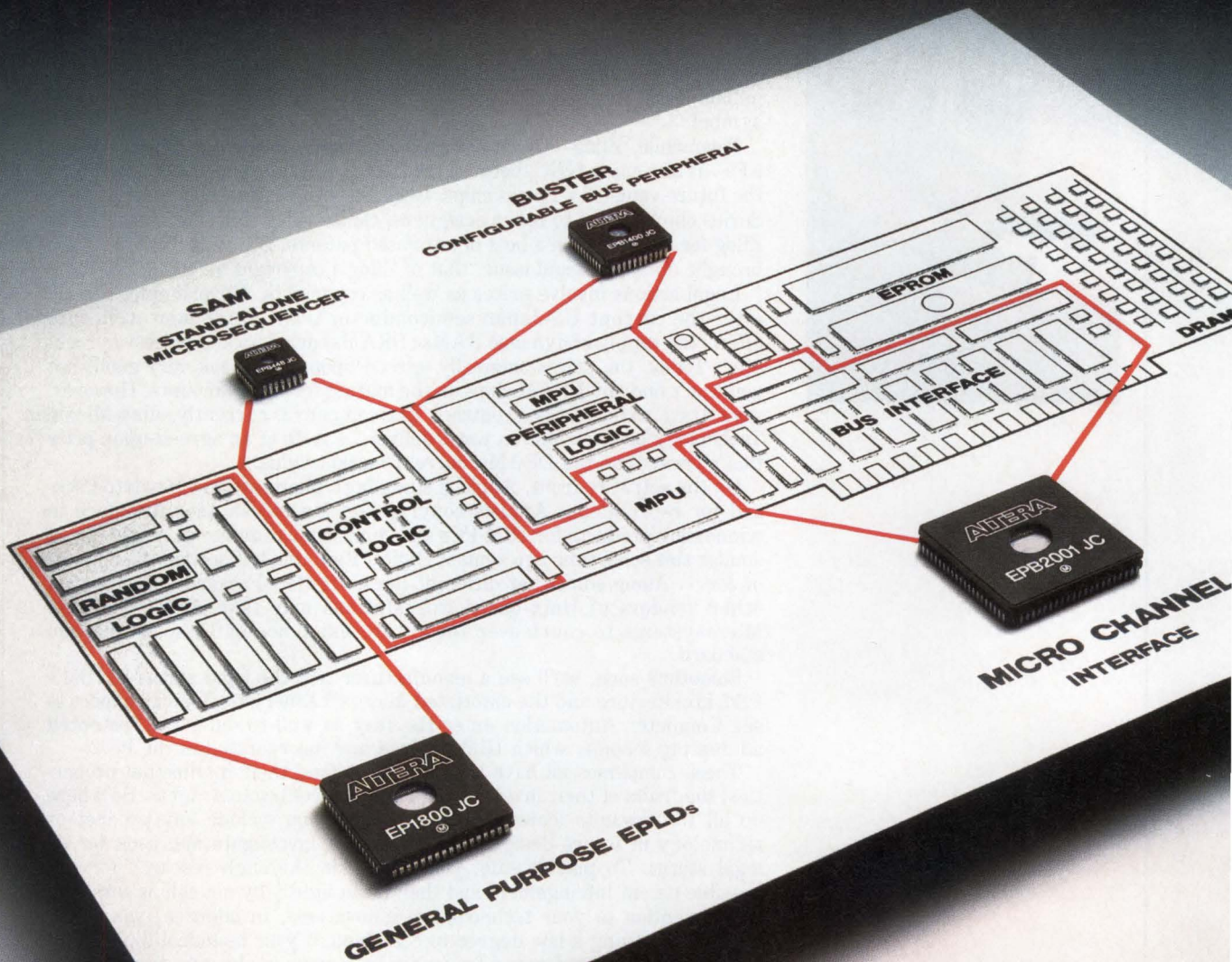

# rapid growth, major cutbacks.

## In your costs.

If there's one idea that has driven all our products since the beginning, it's cutting costs without cutting corners.

And now that idea can drive all your design projects.



Because Altera has expanded its original EPLD concept into a complete family of inexpensive, off-the-shelf, user-configurable parts. Which lets you create high-density, custom logic without long design cycles, high tooling costs or dedicated inventory burdens.

With Altera, you get the broadest choice of EPLDs. Not just general purpose, but function-specific devices for control and peripheral logic; even a configurable bus interface for the IBM Micro Channel™

All of them save you time, money and board space.

And all it takes to get going is your PC and a desktop.

## And your deadlines.

Simply put, Altera is the fastest route from design to silicon.

Our CAE development system lets you enter your design using familiar TTL macrofunction as well as Boolean and state machine approaches.



And our new A+PLUS design processor delivers 20 times more throughput than any other PC-based software.

So you can automatically fit a typical 1000-gate design, not in 30 minutes, but in 90 seconds or less. And program your EPLD even faster.

That's why designers measure our products not just in microns or nanoseconds, but in something far more important.

Time-to-market.

## In fact, across the board.

Board space may be the kindest cut of all.

Our EPLDs can integrate dozens of parts into a single device.



And Altera has more ways to develop more of your real estate.

Our new EP 610 and 910 devices, for example, give you 16 and 24 macrocell densities with access times as fast as 25 nanoseconds.

And our new EPB 2001 and 2002 interface chips are opening doors to the Micro Channel.

So call (408) 984-2800 to cut your costs, deadlines and space.

The more we cut back, the more you get ahead.

# ALTERA

3525 Monroe Street  
Santa Clara, CA 95051

*Four competitors had no solution to this tough connector problem.*

Working closely with customer engineers the RN "P/Q Team" designed, produced, tested and delivered a state-of-the-art connector that *had never been made before*. And they did it within the 16-week time frame required by this major OEM customer. Four major connector firms had already indicated that it could not be done!

The incorporation of this new RN connector enabled our OEM customer to reduce his product size by 80%...improve operating reliability by 300%.

This is the RN "Partners in Quality Team" in action. It brings all of our engineering, production and quality control resources together with customer experts to solve socket and connector problems with speed and efficiency. Call on the RN "P/Q TEAM" for *your* interconnect solutions.

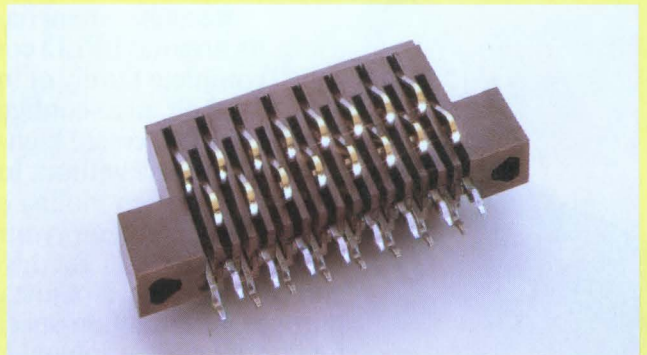

This is the connector competition couldn't make! It is a state-of-the-art compression connector with contacts on 50-MIL centers. It features retent solder tails for robotic board placement and withstands IR reflow surface mount soldering. It also maintains contact integrity in extremely difficult operating environments.

CIRCLE NO 130

**Robinson**  
**Nugent**

800 East Eighth Street, New Albany, Indiana 47150 • Phone: (812) 945-0211 FAX: (812) 945-0804  
In Europe: Rue St. Georges 6, CH 2800 Delemont, Switzerland • Phone: (066) 22 9822 FAX: 011-41-622-9813

# The RN "Partners in Quality Team" delivered a state-of-the-art connector in 16 weeks!

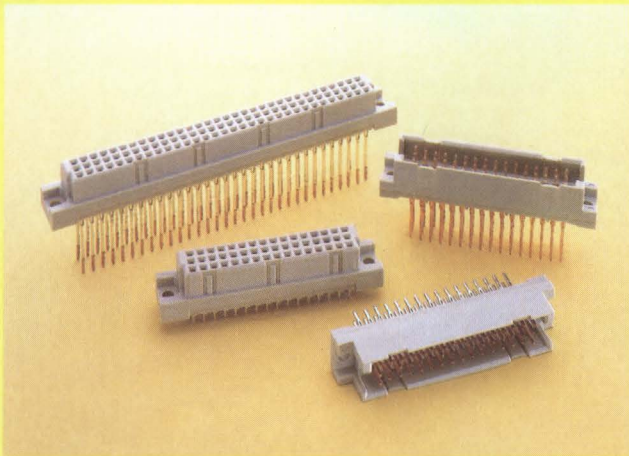
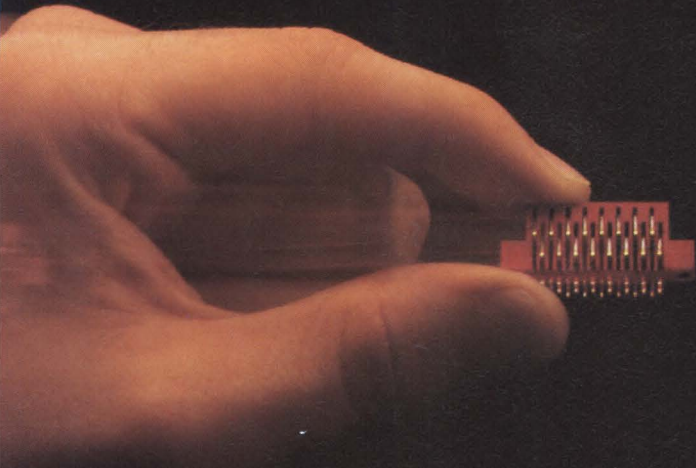

**RN offers a wide variety of DIN Connectors.** Half-size, standard and high density DIN connectors—120 or 150 positions. Completely repairable solderless FLEX PRESS™ contacts in male and female styles. Custom Early Mate/Late Break grounding pin location. Available in "better than gold" ROBEX® plating. Write for complete catalog.

CIRCLE NO 131

"The RN 'P/Q TEAM' concept brings all of our design, engineering and production skills to bear on your unique socket/connector problems. We work closely with your people to create solutions that are delivered on-time and defect-free. You have my personal guarantee on it."

R. A. Lindenmuth  
President/CEO

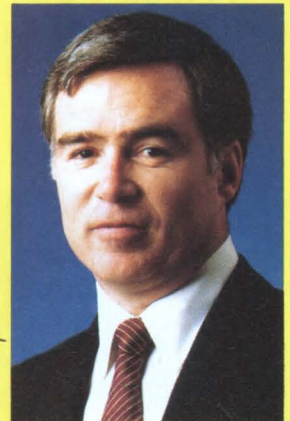

**Write or call today** for the comprehensive new brochure: "The RN P/Q Team in Action". You'll learn how smart companies are putting the brains, resources and experience of RN engineers to work to solve tough interconnection problems with speed and efficiency.

CIRCLE NO 132



The RN "P/Q TEAM"...your Partners in Quality

## Make it friendly. Touch it.



Design a system that gives you a competitive edge. Make it simple to use. Easy to learn. Make it friendly. With a touch input system from Carroll Touch, the world's leading OEM supplier of touch products.

Discover the full line of solutions Carroll Touch offers. From infrared to overlay touch products. Select from a wide range of standard add-on units in a variety of sizes. Or from a line of fully integrated computer displays equipped with touch. Or specify your own unique requirements.

Once you've chosen the Carroll Touch product that's right for your system, you'll discover even more. Exceptional quality and ruggedness. High reliability. Low maintenance. Making touch more affordable and cost-effective than ever.

Whether it's sophisticated test equipment for automotive technicians. Or a medical diagnostic system for patient care. Make your next system friendly. Touch it. Begin by calling 512/244-3500.

### Carroll Touch

a subsidiary of AMP Incorporated

P.O. Box 1309  
Round Rock, Texas 78680  
512/244-3500 Telex 881906  
**CIRCLE NO 129**



# TECHNOLOGY UPDATE

## Uniting ultrasonics and microelectronics reaps a cost-effective ranging system

John Gallant, *Associate Editor*

Proximity detection and position measurement are no longer "contact sports": Techniques that remotely sense the presence of an object are replacing mechanical devices, such as feelers, rollers, and floats, which make direct contact with the object to be detected. One of these technologies is ultrasound. If you have an application that requires the sensing of relatively large objects (anywhere from a few inches in diameter to a few feet) over great distances (as much as 50 ft), you may want to consider an ultrasonic ranging system.

Ultrasonics involves transmitting a burst of ultrasonic waves (greater than 20 kHz) and listening for an echo return from an object. The formula for determining the distance from the transmitter to the object is

$$D = V \times t / 2,$$

where D equals the distance to the object in feet, V equals the speed of sound in feet/sec (1125 feet/sec in air at 22°C), and t equals the time elapsed between the transmitted pulse and the return echo in seconds. In effect, an ultrasonic-ranging system acts like a pulsed-radar system using ultrasonic waves, therefore allowing you to employ many radar signal-processing techniques, such as chirping, range windowing, and time-sensitivity control, to aid in ranging.

Even though this article concentrates on ultrasonic devices operating in air, it is also possible to transmit ultrasonic waves through liquid media. Fish finders use this technology, for example, as well as medical

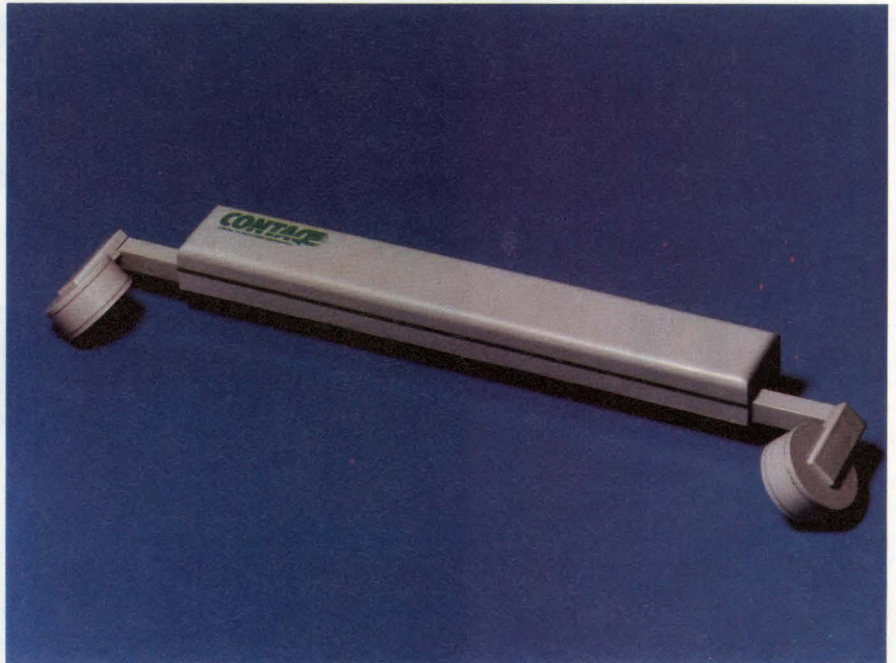

*The \$695 PointScreen, an ultrasonic input device from Contac Technologies Corp, attaches to the front of a computer display. When you point your finger within an inch of the screen, two electrostatic transducers report your finger position to the terminal.*

electronics, which transmits ultrasonic waves into the body. In fact, ultrasonic liquid-level detectors can operate in one of two ways: ultrasonic waves traveling in air and an echo reflecting from the surface of the liquid to a receiver in the air, or ultrasonic waves traveling in the liquid and a reflecting echo to a submerged receiver when the surface level is detected.

### The transducer comes first

An ultrasonic-echo ranging system consists of a transducer and an electronic module. One popular transducer on the market is an electrostatic device available from Polaroid Corp. It is composed of a very thin, Kapton foil that transforms electrical energy into sound waves and, conversely, sound waves into electrical energy. The foil, which has a conductive (gold) coating on its

front side, is stretched over a metallic (aluminum) backplate. The backplate has a series of concentric grooves over which the foil is suspended.

The foil and the backplate represent an electrical capacitor. When charged, the foil experiences an electrostatic force. An ac voltage at a given frequency (nominally between 40 and 100 kHz) forces the foil to move at the same frequency and emit sound waves. A returning echo signal produces an electrical voltage. A perforated front cover mechanically protects the foil with only a small sacrifice in signal strength.

The company specifies the minimum transmit sensitivity as follows: 110 dB above a 20- $\mu$ Pa (micro Pascals) sound pressure level at a distance of 1m from the transducer, with an applied 150V dc bias signal and a 300V ac, 50-kHz signal. The

# Who drives Power Mosfets faster, at lower power, for less? The General does.

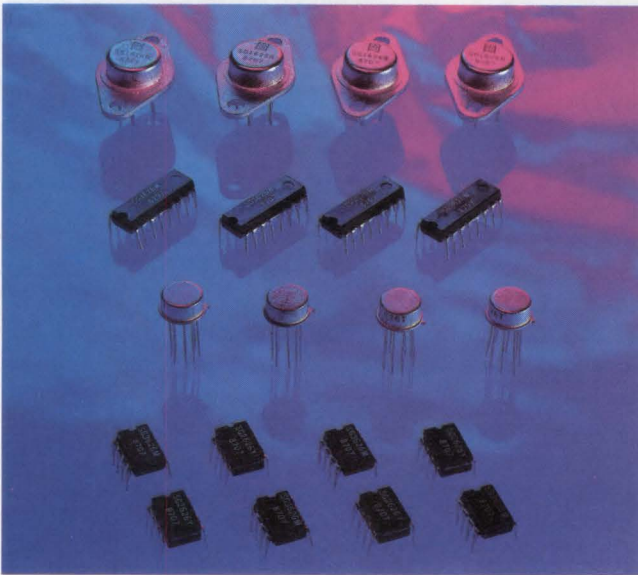

Silicon General's new line of dual high speed drivers do the job of driving power MOSFETS better than anything else on the market today.

Against 3 out of 4 competitors, the new SG1626/SG3626 operates 1.5 to 3 times faster.

Versus the long time industry standard, the SG1626/SG3626 dissipates only half the power at similar switching times.

Compared to another competitor, the SG1626 is 50 percent faster on 2 critical parameters, TPLH (turn-on-delay) and TTHL (turn-off fall time).

Our prices are low. It's more than a tad unlikely anyone will beat them.

#### Ideal for switching power supplies and motor control.

The SG1626/SG3626 is a dual inverting driver ideally suited to drive power MOSFETs and other applications calling for the conversion of digital input signals to high speed outputs to drive large capacitive loads. A non-inverting version, the SG1625/3625, is also available.

These devices use high voltage schottky logic to convert TTL signals to high speed outputs up to 18 volts. Totem pole outputs have 3.0 amperes peak current capability so they can drive 2500 picofarad loads in less than 40 nanoseconds.

#### Pin for pin compatible.

The SG1626 is pin for pin compatible with National's DS0026, Motorola's MMH0026, Teledyne's TSC426 and Intersil's ICL7667.

#### Call us for samples and data.

Several packages are available including 8 pin plastic, cerdip, ceramic, TO-99, TO-66 and 16 pin batwing. Best temperature range is -55° C to 125° C. Other parts operate from -25° C to 85° C and 0° C to 70° C.

To arrange shipment of sample quantities and/or receive full technical information, please address Silicon General, Inc., Semiconductor Group, 11861 Western Avenue, Garden Grove, California 92641. Telephone (714) 898-8121. TWX: 910-596-1804. FAX (714) 893-2570.

**SILICON  
GENERAL**



# TECHNOLOGY UPDATE

minimum receive sensitivity with an applied 150V dc bias is -42 dB below 1V/Pa at 1m.

Polaroid has three versions of the electrostatic transducer for sale. In minimum-quantity orders of 10, an instrument-grade unit (cold-roll-steel housing) costs \$15, an environmental-grade unit (aluminum housing) costs \$17, and a reduced-size unit (7000 Model) costs \$14.50. Prices drop considerably for large-quantity orders. For example, the 7000 Model transducer costs \$2 in quantities of 500,000 to 1,000,000.

## Piezoelectric wonders

Although the electrostatic transducer appears to be the most popular, the phenomenon of piezoelectricity provides another viable means for developing ultrasonic transducers. These types of transducers use the piezoelectric properties of synthetic polycrystalline ceramics such as barium titanate and lead zirconate titanate. A polarization process aligns the molecular dipoles of the ceramics in one direction (the poling axis). Applying an electrical field along the axis produces a mechanical deformation. Compressing or stretching forces produce a voltage.

Because piezoelectric ceramic—piezoceramic—transducers have to

achieve sufficient amplitude before they can function as ultrasonic transmitters and receivers, they are generally connected as benders. One such bender configuration cements together two discs or rectangular strips of ceramic of opposite polarization (Fig 1). When you apply a voltage, one piece contracts while the other expands. Although the actual deformation is small, the displacement of the entire assembly is relatively large. Essentially, the bender behaves like a heated bimetal strip.

Piezoceramic transducers offer advantages in severe operating environments because, thanks to their configuration, they can be packaged in hermetically sealed cases. They generally exhibit a sharp resonant peak at the frequency of operation, however. The bandwidths of these devices can be less than 1 kHz. Tuning techniques can broaden the frequency-response characteristics to tens of kHz, but a sacrifice in sensitivity will result.

Blatek uses various bender techniques to produce its 8000 Series of piezoceramic transducers, which have standard frequencies of 25, 40, 100, and 200 kHz. A 40-kHz version of the 8010 transducer, for example, achieves a transmit sensitivity of 25.0 dB referenced to 1  $\mu$ bar/V mea-

sured at a distance of 1m from the transmitter; the receive sensitivity is -60.0 dB relative to 1V/ $\mu$ bar at a distance of 1m. The untuned 6-dB bandwidth is specified at 400 Hz. The aluminum housing of the 200-mW 8000 Series measures 1 in. in diameter and  $1\frac{3}{16}$  in. in depth (including mounting pins). Each family member sells for \$10.95.

## Side lobes can cause trouble

All ultrasonic transducers have a power-radiation pattern similar to that of an electromagnetic antenna. This pattern exhibits a main beam with side lobes for both transmit and receive modes. The Polaroid transducer, for instance, has a nominal 10° beamwidth (3 dB) at 50 kHz with the first side lobe nominally 28 dB below the main-beam peak response. If the receiver sensitivity is set below the side-lobe level, the ranging system can erroneously detect an ultrasonic echo off the main axis. With the Polaroid device, you have to ensure that the receiver sensitivity is below any echoes returning from the side lobe.

Massa Products Corp manufactures a number of piezoceramic transducers that virtually eliminate side lobes. Two products, Models E-152 and E-188, generate a broad-beam and a narrow-beam pattern, respectively.

Model E-152 comes in two versions and uses proprietary technology to generate a 75° beam at 40 kHz and a 60° beam at 75 kHz without side-lobe patterns. The manufacturer specifies the transmit sensitivity as 10 dB relative to 1  $\mu$ bar/volt at 1 ft from the transducer (untuned). The untuned bandwidth is 1 kHz. The 40-kHz product has a receive sensitivity of -57 dB relative to 1V/ $\mu$ bar (untuned); the 75-kHz model has a receive sensitivity of -62 dB relative to the same reference.

Model E-188 also comes in two versions. Operating at 215 and 220 kHz, respectively, each version generates a 10° beam. Both specify a

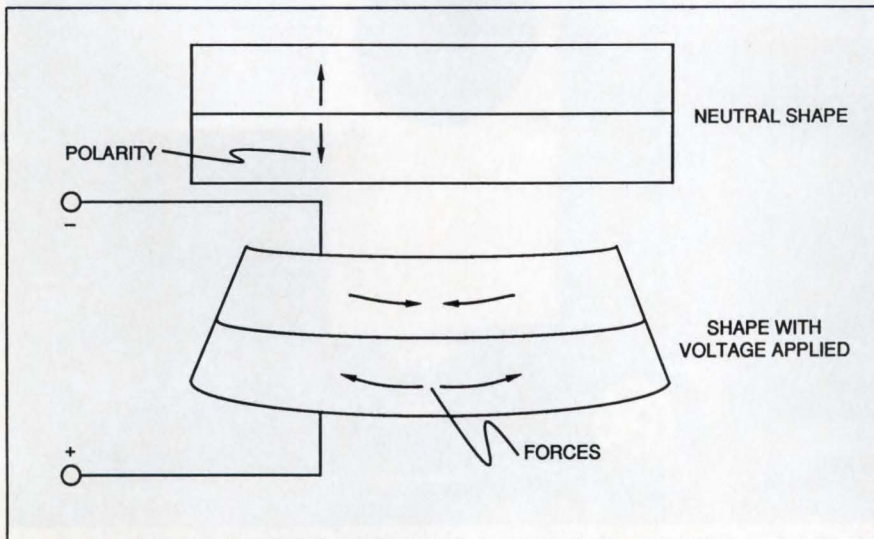

Fig 1—This bender configuration places two oppositely polarized piezoceramic materials back-to-back.

# TECHNOLOGY UPDATE

transmit sensitivity of 20 dB above 1  $\mu\text{bar}/\text{V}$  measured 1 ft from the transducer and a receive sensitivity of  $-77$  dB relative to  $1\text{V}/\mu\text{bar}$  measured from the same distance.

The Model E-152 transducer measures 0.437 in. in diameter  $\times$  0.397 in. in depth, and Model E-188 measures 0.510 in. in diameter  $\times$  0.580 in. in depth. All models cost \$66 (the minimum order is \$100).

Although the transducer is an essential ingredient of an ultrasonic ranging system, it represents only one-half of the design. An electronic module is still required to drive the transducer and detect echo returns. You can accomplish this at the chip level or purchase ranging modules with the electronics optimized for a particular transducer.

Texas Instruments' offering is a 2-chip set intended to interface to a 50-kHz, 300V ac transducer. The TL852 Sonar Ranging Receiver has a digitally programmable gain; the TL851 Range Control Chip measures distances from 6 in. to 35 ft and has an internal oscillator that supplies a 50-kHz signal to the transducer. Essentially, the TL852 is an op amp with a gain control block. You can change the overall gain in steps dependent on the transmit time, permitting the selective detection of objects as a function of range.

You can also opt for TI's SN28827 Sonar Ranging Module, which incorporates the TL851 and the TL852 chip set on a  $2.21 \times 1.89$ -in. pc board. The board requires no additional circuitry to interface to a 300V ac electrostatic transducer. When coupled to the transducer, the module transmits 16 cycles of ultrasonic waves at 49.4 kHz. An external blanking input selectively excludes echoes in a multiple-echo environment. The module sells for \$13.80 (100). The individual 100-piece price for the TL851 and the TL852 is \$2.16.

If you want, Polaroid offers a starter kit that you can use to evaluate its ultrasonic transducer for dis-

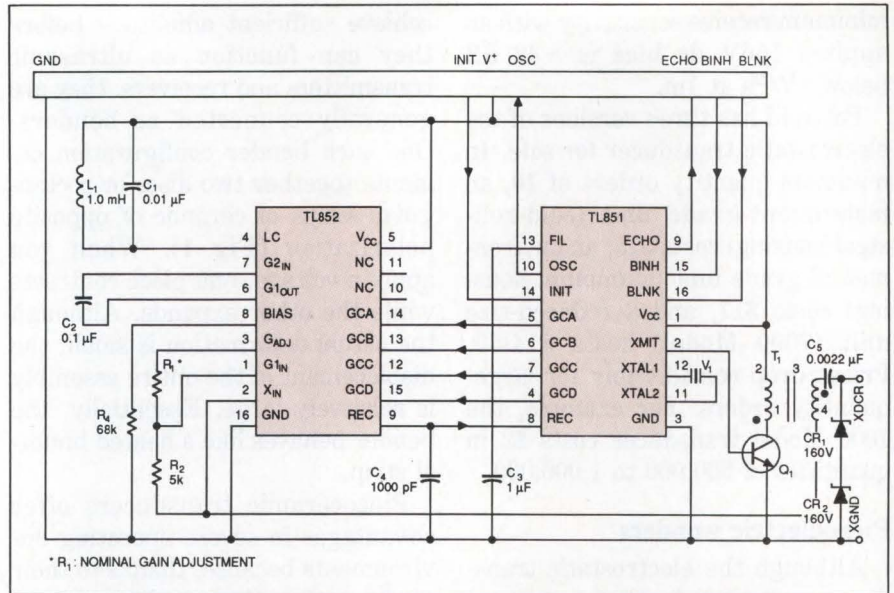

**Fig 2—When interfacing with a 50-kHz, 300V electrostatic transducer, the SN28827 Sonar Ranging Module from Texas Instruments transmits 16 cycles of ultrasonic waves at 49.4 kHz.**

tance measurements. The \$165 kit contains an instrument-grade transducer, a modified ranging board, a demonstration board that drives the ranging board and displays distances in 0.1-ft increments on a 3-digit LED display, two Polapulse 6V batteries, a battery holder, and

two manuals.

A number of manufacturers offer ultrasonic-ranging systems with the transducer and electronics packaged in a single enclosure. The Agastat line of sensing systems from Electro Corp, for instance, combines the transmitter and the



**Intended for applications that demand the sensing of light-transparent objects, the Ultra-Beam Series of ultrasonic ranging systems from Banner Engineering is constructed with epoxy-encapsulated circuitry and is housed in a glass-filled Valox enclosure.**

# When World Class Precision and Performance Are Required

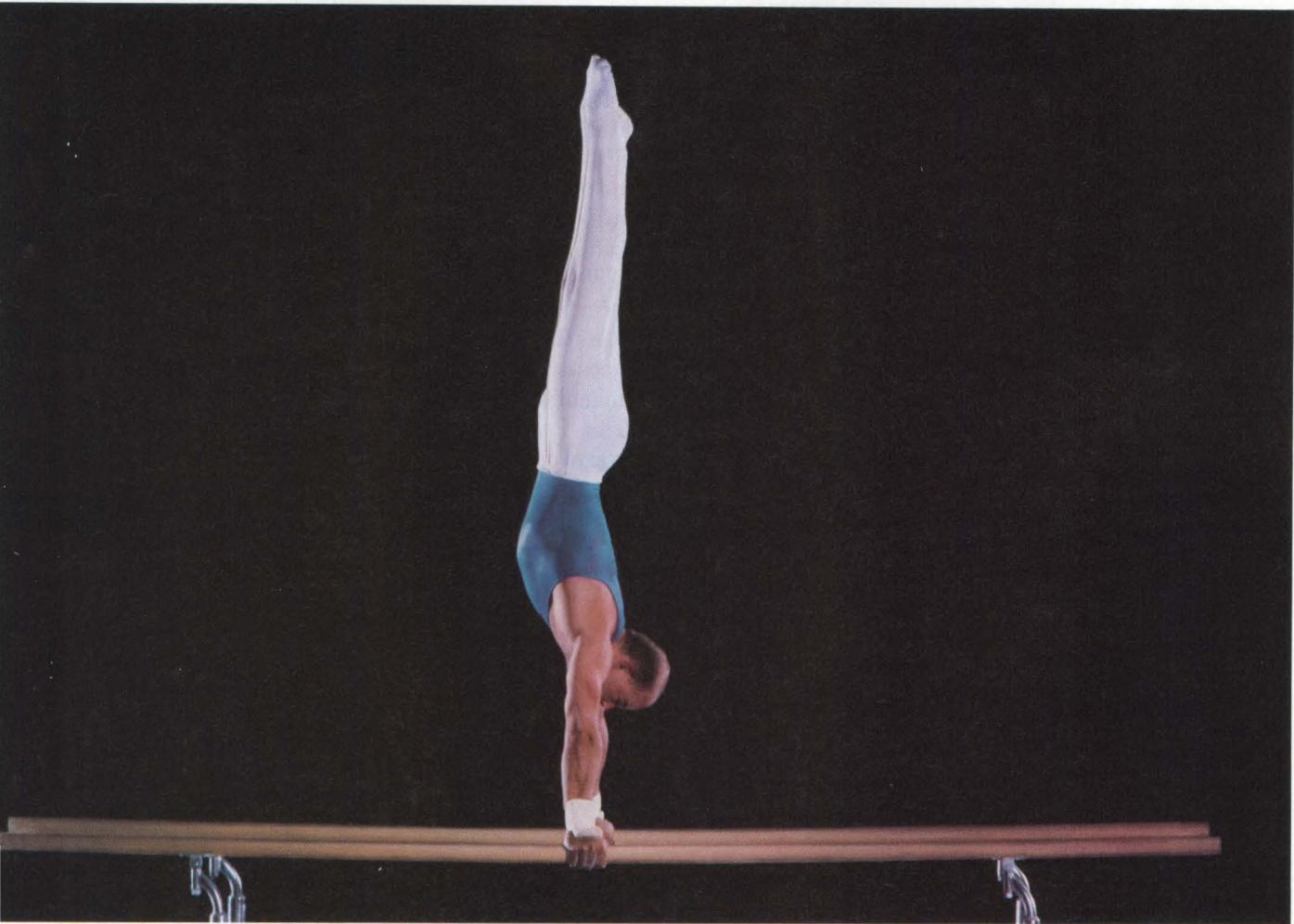

***Highest precision available with 10  $\mu\text{V}$  input offset voltage from Raytheon.***

Raytheon's RC4077 Series high-precision op amp family offers the highest performance in the industry. Looking for the lowest input offset voltage—Raytheon has it. The lowest power dissipation—Raytheon has it. The 4077 Series can upgrade your system to new heights of precision and performance. You can depend on Raytheon's reliability and advanced design techniques to enhance your system.

**Ultimate precision:**  $\pm 10 \mu\text{V}$  maximum guaranteed input offset voltage, delivered in a variety of package types including low-cost commercial plastic DIPs, sets the RC4077 series apart from other precision op amps. No monolithic op amp—except noisy chopper-stabilized types—has better  $V_{OS}$  perfor-

mance. Additionally Raytheon offers an 8-lead SOIC specified at  $\pm 25 \mu\text{V}$ .

**Well balanced specs:**

$I_B$ : 2 nA maximum  
Gain: 5 million minimum  
Power dissipation: 50 mW maximum  
CMRR: 120 dB minimum  
PSRR: 110 dB minimum

**Companion product:** Raytheon's LT1001 high-precision, high-performance op amp follows RC4077's lead with a very low 15  $\mu\text{V}$  offset voltage. The LT1001 offers 2 nA offset current and gain of .45 million minimum.

**No wait:** The RC4077, LT1001 and other members of Raytheon's broad line of op amps are available now from your

local distributor. The RC4077 with 10  $\mu\text{V}$  offset is priced at \$3.00 each in 100-piece quantities.

Call Raytheon for access to the right operational amplifier technology at the right price. We offer the precision and performance your system needs to compete.

Raytheon Company  
Semiconductor Division  
350 Ellis Street  
Mountain View, CA 94039-7016  
415/966-7716

*Access to the right technology*

**Raytheon**

# TECHNOLOGY UPDATE

receiver in one unit. The PLE version uses the Polaroid transducer and senses objects within the range of 4 in. to 21 ft. The unit is available with either an analog output that spans a 4- to 20-mA current range or a switched output that gives a normally open (NO) or normally closed (NC) output when it detects an echo. A  $\mu$ processor (the COPS400) selects three overlapping ranges; you select the desired range by inserting a key into the module.

The PCU version uses a Massa Products' piezoceramic transducer and senses objects within the range of 4 to 30 in. The PCU units are

designed for hostile environments that preclude the use of electrostatic transducers. Analog units come with either 4- to 20-mA or 0 to 5V outputs, and switched-output units (NO or NC) provide either npn or pnp output switches. On the analog models, you can adjust the minimum range point and the span by means of multiturn potentiometers. A PLE analog version costs \$320, and a switched-output version costs \$270. A PCU analog version costs \$240; a switched-output version costs \$210.

Although primarily a manufacturer of photoelectric products, Banner Engineering Corp is aware of the

suitability of ultrasonic ranging in certain applications and is now offering a series of such systems. The Ultra-Beam Series is intended to solve the problem of proximity detection for ranges that fall beyond the limits of photoelectrics and for applications that require sensing of light-transparent objects.

The series uses the Polaroid transducer operating at 50 kHz and senses objects within a range of 20 in. to 20 ft. For reliable detection, objects must present at least one square foot of surface area for each 10 ft of range between the sensor and the object.

## Misuse of ultrasound can cause headaches

As with most distance-measuring technologies, ultrasound displays advantages in certain applications and disadvantages in others. One advantage, regardless of application, is its ability to sense virtually any material, whether solid or liquid. An echo results whenever an ultrasonic beam encounters a medium with a different acoustic impedance than the medium in which it is traveling. Independent of color, the reflecting medium can be transparent, translucent, or opaque. Typical applications that are well-suited to ultrasonic detection are shown in Fig A.

Electro-optical waves travel at the speed of light. To economically use electro-optics, therefore, the transducer must rely on intensity measurements, which have limited range and are subject to air contamination such as dust and fog. Ultrasound, in contrast, propagates at the speed of sound (1125 feet/sec at 22°C in air). Thus, with the aid of inexpensive electronics, you can detect echoes from objects a few inches away to as far away as 50 feet.

The decrease in intensity of ultrasonic waves in the direction of propagation is principally a combination of two effects. One effect is the inverse square law in which the intensity drops 6 dB when the distance to an object doubles. The other is due to the absorption of sound in air, which varies somewhat with humidity and dust content, but most importantly with frequency. For example, the absorption at 40 kHz is approximately 0.08 dB/ft, whereas the absorption at 150 kHz is about 2 dB/ft.

Ultrasound is not problem free, however. The principle environmental consideration is the temperature-dependent velocity of sound in air. The ve-

locity varies according to the equation:

$$V_{\text{AIR}} = 1087 \sqrt{(273 + T^{\circ}\text{C})/273} \text{ feet/sec,}$$

where T°C equals the temperature in degrees Centigrade.

This variation produces a 7% measurement error when the system is operating over a temperature range of 0 to 40°C without temperature compensation. Feasible compensation schemes include temperature measuring and positioning a reference object a known distance from the object. For example, Electro Corp (Sarasota, FL) sells a \$15 temperature-compensation reference target that attaches to the company's PLE ultrasonic modules. Because the reference target is a fixed distance (6.56 in.) from the transducer, the time elapsed between a transmit pulse and the detected echo calibrates the velocity of sound at a particular temperature. The module ignores the echo from the reference target when making range measurements from an object.

## Windy environment can prove troublesome

Air turbulence can also cause problems in ultrasonic ranging. Air currents and layers of different densities cause refraction of the sound wave, which can be a significant source of error when sensing hot objects or detecting targets in windy environments.

Humidity and air pressure are other minor considerations. For a change in relative humidity of 20%, humidity effects a propagation delay of 0.07%. Although normal atmospheric air-pressure changes have no substantial effect on measurement

# TECHNOLOGY UPDATE

The Ultra-Beam 925 is a switched-output model with spdt C-type relay outputs. The Ultra-Beam 923 provides two analog outputs with adjustable positive or negative slopes. You can adjust the range limits for the 0 to 10V dc and 0- to 20-mA outputs with potentiometers. Both units come in NEMA-1, -2, and -12 housings with a red LED indicator that lights up when the unit detects an object. The Ultra-Beam 925 costs \$150; the 923 costs \$10 more.

The 942 Series of ultrasonic distance sensors from Micro Switch includes a model that provides two

independent switched outputs (NO or NC). The states change when a target moves through two set points, independently adjustable in 0.04-in. steps. In addition, the unit provides two analog outputs with 0 to 10V dc and 4- to 20-mA ranges. A 215-kHz piezoceramic transducer generates a 10° beam that covers a range of 5.9 to 59 in.

A \$1603 integral version, which has the electronics and transducer enclosed in an aluminum housing, has the capability of manually rotating the sensor 360°. A \$1627 remote version, which has the transducer remotely wired to the housing

through a 39.4-in. cable, has a beam-concentrator accessory that narrows the beam width to 4° for sensing objects within a range of 2 to 79 in. The beam-concentrator accessory costs \$45.

Ultrasonic-ranging systems are also available as computer-board products and with RS-232C interfaces for communicating with a computer or a terminal. Contac Technologies Corp manufactures one distance-measuring plug-in board for the IBM PC bus (the UDM-PC) and one for the STD Bus (the UDM-STD).

The boards interface with the Po-

accuracy, you can't use ultrasonic techniques in high or low air-pressure chambers. Sound cannot travel in a vacuum.

Sound pollution is one other possible source of

error in an ultrasonic-ranging system. You should take care that external noise sources do not generate ultrasonic harmonics that the receiver will detect.

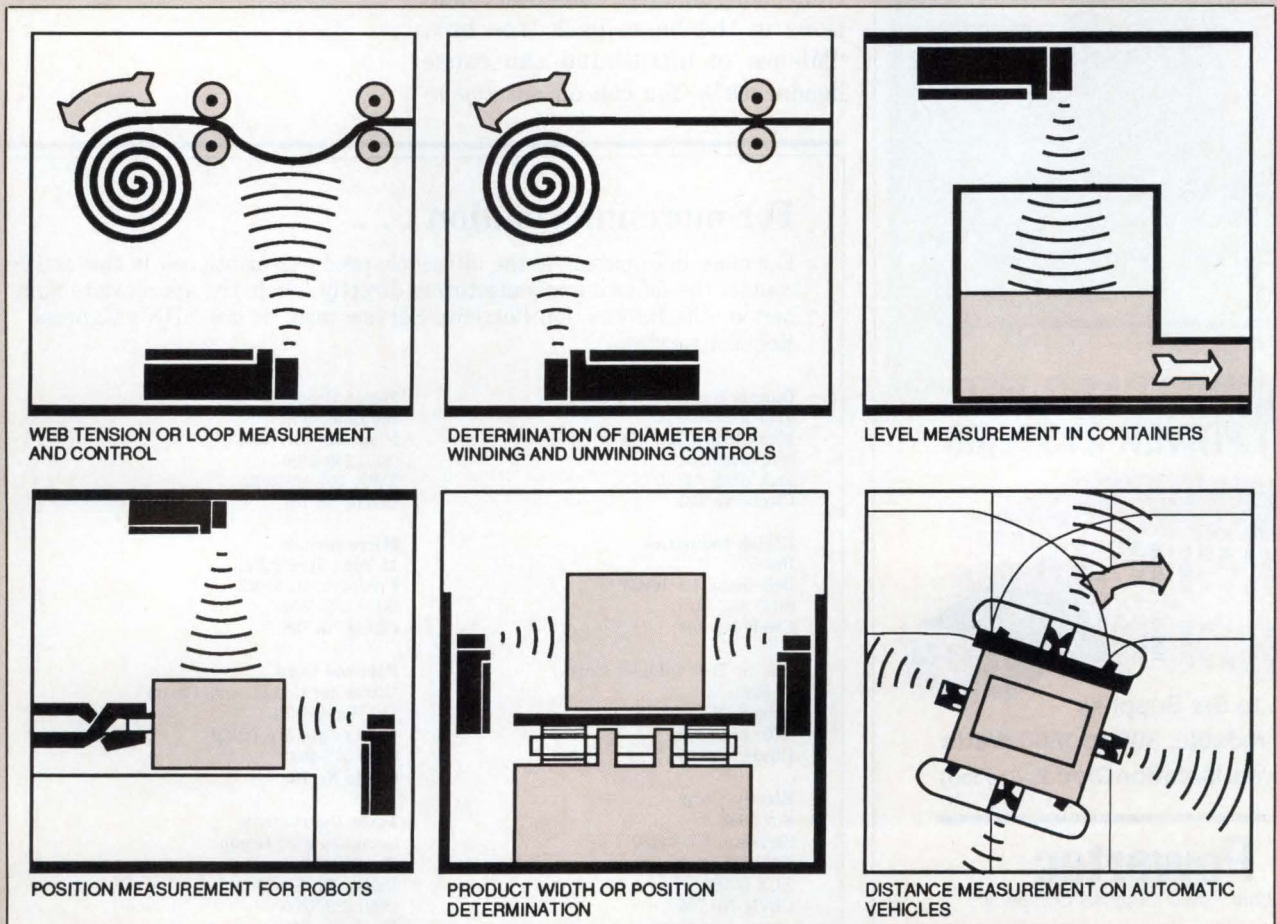

Fig A—Ultrasonic ranging is well-suited to a number of applications (courtesy Micro Switch, a Honeywell Div).

# NEW! SWITCHMODE POWER SUPPLIES FROM STOCK

- 2 to 48 VDC Outputs
- Automatic Current Sharing On All Outputs
- N+1 Capabilities



## MULTIPLE OUTPUT

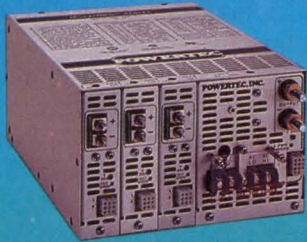

- 350 to 1500 Watts
- 3 to 15 Outputs

## SINGLE OUTPUT



- 400 to 3000 Watts in 5" x 8" Standard Package
- 155,000 Hrs. Demonstrated MTBF

## Hot Plug-In FAULT TOLERANT (N+1) POWER SYSTEMS



- Two to Six Supplies
- Expandable, 300 to 1800 Watts
- Internal Isolation Diodes (Option)

## Powertec

A Bonar Power Supplies Company

20550 Nordhoff Street Chatsworth, CA 91311  
(818) 882-0004 • FAX (818) 998-4225

# TECHNOLOGY UPDATE

laroid transducer and provide range detection from 6 in. to 35 ft with a resolution of 0.05 in. and an accuracy of  $\pm 1\%$ . The IBM PC product comes with I/O driver software and demonstration programs on a floppy disk. The STD bus product can either operate in a stand-alone mode or respond to jumper-selectable interrupts. A \$369 multiplexer board is available for interfacing as many as seven ultrasonic transducers to the UDM-PC and -STD boards. The two boards sell for \$436 and \$369, respectively.

A similar computer product, the UDM-RMU, can interface two ultrasonic transducers to an RS-232C port communicating at 9600 baud. The \$495 remote unit gets its power from a wall-mounted power supply and measures 6.5x3.5x1.38 in.

Although ultrasonic techniques are well matched to certain measurement applications, they suffer from changing environmental conditions in the beam path (see **box**, "Misuse of ultrasound can cause headaches"). You can obtain *expen-*

*sive* ultrasonic ranging systems that include elaborate environmental-compensation techniques, but these types of systems are not within the focus of this article. Therefore, you may have to resort to some imaginative signal processing. Fortunately, you can solve many of these problems, or lessen their effect, by using  $\mu$ processor techniques and look-up tables for temperature, atmospheric pressure, and humidity-compensation data.

**EDN**

Article Interest Quotient  
(Circle One)

High 518 Medium 519 Low 520

## For more information . . .

For more information on the ultrasonic products mentioned in this article, contact the following manufacturers directly, circle the appropriate numbers on the Information Retrieval Service card, or use EDN's Express Request service.

**Banner Engineering Corp**  
9714 10th Ave N  
Minneapolis, MN 55441  
(612) 544-3164  
FAX (612) 544-3213  
Circle No 703

**Blatek Industries**  
Box 574  
Bellefonte, PA 16823  
(814) 355-4910  
Circle No 704

**Contac Technologies Corp**  
15 Main St  
Bristol, VT 05443  
(802) 453-3332  
Circle No 705

**Electro Corp**  
Box 3049  
Sarasota, FL 34230  
(813) 355-8411  
TLX 52683  
Circle No 706

**Massa Products Corp**  
280 Lincoln St  
Hingham, MA 02043  
(617) 749-4800  
TWX 710-348-6932  
Circle No 707

**Micro Switch**  
11 West Spring St  
Freeport, IL 61032  
(815) 235-6600  
Circle No 708

**Polaroid Corp**  
Ultrasonic Components Group  
119 Windsor St  
Cambridge, MA 02139  
(617) 577-4681  
Circle No 709

**Texas Instruments**  
Semiconductor Group  
Box 809066  
Dallas, TX 75380  
(800) 232-3200  
Circle No 710

DRAMs,  
SRAMs,  
EEPROMs,  
CMOS Logic,  
Flash Converters,  
SOT-23s,  
Linear,  
MOSFETs:

Samsung sets the pace.

# Samsung. Setting the pace.

Samsung is a leading semiconductor company with worldwide resources. In process, design and manufacturing, we're setting the pace for the industry.

To date, Samsung has invested more than \$600 million in the development of new products. By 1989, this will have grown to one billion dollars. Such commitment will place Samsung among the top ten producers in the world by the beginning of the next decade.

Samsung is a leader in the manufacture of products utilizing state-of-the-art CMOS processes. Our 6-inch wafer fabrication lines in Korea are some of the most advanced in existence, as is our Class I wafer fab facility in San Jose, the heart

of Silicon Valley. Not only are we able to produce such leading edge products as DRAMs, SRAMs, CMOS Programmable Logic and Advanced CMOS Logic, but we produce them in high volume at low cost.

Samsung maintains advanced R&D facilities in Kiheung and Bucheon, Korea and in San Jose, California. At each of these facilities we have not only created our own advanced designs for current products, but we are at work now on our 4-megabit DRAM and our 1-megabit SRAM designs.

As you read on, one thing will be clear: Samsung is committed to designing, developing and delivering sophisticated products.

Products that set the pace.



*Samsung's sophisticated manufacturing facility at Bucheon employs internally-developed Advanced CMOS and Bipolar processes.*



*Samsung's high-volume manufacturing facility at Kiheung has one of the world's most advanced 6-inch wafer fabrication lines.*

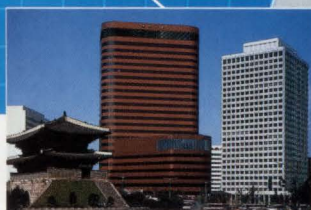

*Samsung's World Headquarters in Seoul is the center of a global organization comprised of 26 companies which operate worldwide.*



*Samsung's U.S. Headquarters in San Jose includes Engineering, Marketing, Sales and Administration and also boasts state-of-the-art R&D and Class I manufacturing wafer fabrication.*



# Samsung's new 1Mb DRAMs set today's fast memory pace.

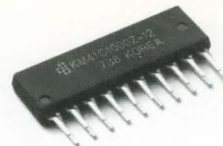

*In the 1Mb DRAM, Samsung's pacesetting CMOS technology provides superior immunity to electrostatic discharge, lower soft error rates and high immunity to latchup.*



The KM41C100X and KM44C25X series of one-megabit DRAMs in CMOS technology are our latest high-density memory offerings. Fabricated using Samsung's internally developed CMOS technology, they feature line widths as fine as 1  $\mu\text{m}$ .

This leading technology enables us to offer a device with very low power consumption and high-speed access times. Our pace setting

*Samsung technology has evolved from 2.5 micron to sub-micron in just four years.*

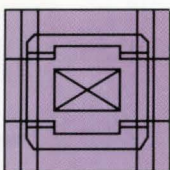

**1984-64K**  
117 $\mu^2$  cell size  
2.5 $\mu\text{m}$  geometry

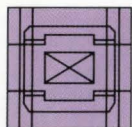

**1985-256K**  
62.5 $\mu^2$  cell size  
1.6 $\mu\text{m}$  geometry



**1987-1Mb**  
27 $\mu^2$  cell size  
1.0 $\mu\text{m}$  geometry



**1988-4Mb**  
10.25 $\mu^2$  cell size  
0.8 $\mu\text{m}$  geometry

DRAMs are designed for computing applications from mainframes and minis to high performance graphics stations and work stations, as well as for instruments and telecommunications products.

Our 1Mb DRAMs are manufactured in production volumes at our 6-inch wafer fabrication facility, considered to be one of the most advanced of its kind, using very high-resolution steppers and state-of-the-art etching and implantation equipment. Samsung is adding

DRAM wafer capacity with a new 6-inch facility which will be equipped to manufacture our 4Mb DRAM.

Samsung 1Mb DRAMs are available in a wide variety of options and organizations. We offer a choice

of 256K x 4 or 1M x 1 organizations with features like Fast Page, Nibble and Static Column modes. With the addition of the 1Mb to the 64K and 256K, Samsung's dynamic RAMs cover the entire range of densities and organizations.

All are available in plastic DIP, ZIP, and SOJ or PLCC industry standard packages.

Our packaging technology is not limited to components. Samsung SIP and SIMM memory

modules for the 256K and 1Mb DRAMs offer a cost effective method of utilizing surface mount technology to increase board density.

Fill out the coupon on the back page of this insert for data sheets and a reliability report.

Part Type	Organ.	Features	Speeds	Packages	Avail.
KM41C1000	1M x 1	Fast Page mode	100,120	DIP, ZIP, SOJ	Now
KM41C1001	1M x 1	Nibble mode	100,120	DIP, ZIP, SOJ	2Q '88*
KM41C1002	1M x 1	Static Column mode	100,120	DIP, ZIP, SOJ	2Q '88*
KM44C256	256K x 4	Fast Page mode	100,120	DIP, ZIP, SOJ	2Q '88
KM44C258	256K x 4	Static Column mode	100,120	DIP, ZIP, SOJ	2Q '88
KM41256	256K x 1	Page mode	120,150	DIP, ZIP, PLCC	Now
KM41257	256 x 1	Nibble mode	120,150	DIP, ZIP, PLCC	Now
KM41464	64K x 4	Page mode	120,150	DIP, ZIP, PLCC	Now
KM4164	64K x 1	Page mode	120,150	DIP	Now
KMM48/9256	256K x 8/9	Page or Nibble modes	120,150	SIP module	Now
KMM58/9256	256K x 8/9	Page or Nibble modes	120,150	SIMM module	Now
KMM48/91000	1M x 8/9	Fast Page mode	100,120	SIP module	2Q '88
KMM58/91000	1M x 8/9	Fast Page mode	100,120	SIMM module	2Q '88

\*Samples available now.

*Samsung's 6-inch wafer fabrication facility in Kiheung is one of the most advanced in the world, boasting a Class 10 level clean room. Samsung is now expanding its 6-inch capacity.*

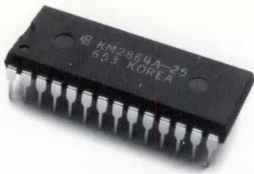

Advanced Samsung 16K and 64K EEPROMs are now available in production quantities.

# Samsung EEPROMs also outpace industry standards.

Samsung's 64K and 16K EEPROMs meet or surpass all industry standards for performance, reliability and quality. They have standard endurance ratings of 10,000 erase/write cycles and data retention

ratings of 10 years. cated with our pacesetting floating gate CMOS processing. It features low power dissipation of 100 $\mu$ A standby and access times of 150ns, 200ns and 250ns. These advanced 8K x 8 EEPROMs also feature a 32-byte page mode to slash write times to 150 microseconds per byte and a 5-millisecond write cycle.

Part Type	Organization	Speed	Features	Technology	Pinout	Availability
KM2816AP	2K x 8	250,300,350	10ms (max) write time	NMOS	24 pin	Now
KM2817AP	2K x 8	250,300,350	Ready/Busy, 10ms (max) write time	NMOS	28 pin	Now
KM2864AP	8K x 8	250,300,350	Data Polling, 10ms (max) write time	NMOS	28 pin	Now
KM2865AP	8K x 8	250,300,350	Data Polling, Ready/Busy, 10ms (max) write time	NMOS	28 pin	Now
KM2864AHP	8K x 8	250,300,350	Data Polling, 2ms (max) write time	NMOS	28 pin	Now
KM2865AHP	8K x 8	250,300,350	Data Polling, Ready/Busy, 2ms (max) write time	NMOS	28 pin	Now
KM28C64P	8K x 8	150,200,250	Data Polling, 32-byte Page Mode, Low Power, 5ms (max) write time	CMOS	28 pin	May '88*
KM28C65P	8K x 8	150,200,250	Data Polling, 32-byte Page Mode, Low Power, 5ms (max) write time	CMOS	28 pin	May '88*

\*Samples available now.

And our "H" version 64Ks offer a quick 2 millisecond per byte write time, reducing

write time by a factor of 5. Our new 64K KM28C64 series (available 2nd quarter 1988) is fabri-

This allows the entire 64K memory to be written in only 1.3 seconds.

Samsung's EEPROMs excel in such rugged applications as communications, instrumentation, robotics and industrial control. All our EEPROMs meet JEDEC pinout standards.

Fill out the coupon on the back page of this insert for samples, a data sheet, and reliability report.

Circle No. 168



Samsung's 256K (32K x 8) KM62256 SRAMs are available with access times of 100ns, 120ns and 150ns, all in low-power versions with standby current of only 4 $\mu$ A (typical).

# The fast pace continues with Samsung low power SRAMs.

The pace of Samsung's technology development in static RAMs is as strong as it is for all our memory products. With the introduction of the KM62256 (32K x 8) SRAM Family, we now offer a wide low power CMOS SRAM line, including our KM6264A industry standard 64K SRAMs.

The KM62256 256K SRAM is fabricated using our internally developed 1.2  $\mu$ m CMOS technology which meets both high speed and low power requirements. We offer 80ns 64K SRAMs and 100ns 256K SRAMs in high volume. They're

ideal for process control, medical instruments, and hand held devices.

Samsung is ramping up production of both the 256K and 64K

Part Type	KM62256L	KM6264AL
Organization	32K x 8	8K x 8
Speeds	100, 120, 150ns	80, 100, 120ns
Package	28 DIP	28 DIP
Max Current (standby)	100 $\mu$ A	100 $\mu$ A
Availability	Now	Now

CMOS SRAMs. Our complete line is available now in industry standard packages and pinouts.

Fill out the coupon on the back page of this insert for a data sheet and reliability report.

Circle No. 169

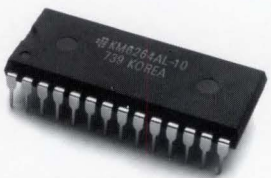

Samsung SRAMs are fabricated using 1.2  $\mu$ m CMOS technology. In 1988, we are ramping up 256K and 64K SRAM production.

# Samsung Advanced AHCT CMOS Logic Family keeps pace with the fastest 16- and 32-bit microprocessors.



*Samsung's Advanced CMOS Logic is available in both DIP and SOIC packages.*

Available now in production quantities, our Advanced AHCT CMOS Logic Family meets the demands of your 16- and 32-bit designs for high speed, high drive and low power.

Samsung has 111 of the most popular standard logic functions available off the shelf now, with samples free for the asking. By mid-year, we will add

another 50 part types to the list. This means you can design our part

into your product and move into production now with no waiting.

For power reduction in your existing designs, AHCT offers pin-for-pin, part-for-part replacement for ALS and FAST™. It fits right in and reduces power tenfold. Yet our AHCT doesn't have a premium price. It costs the same as ALS.

Fill out the coupon on

the back page of this insert for free samples and a data book.

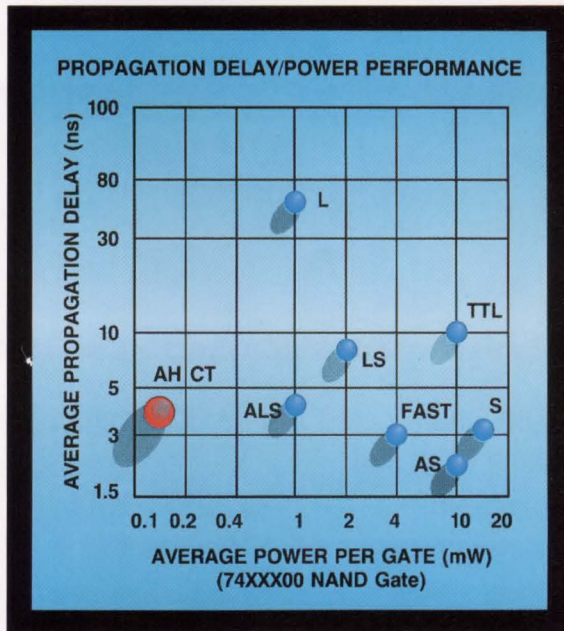

## KS74AHCT PARTS LIST

Circle No. 170

Gates and Inverters		Flip-Flops		Transceivers/Registered Transceivers			Multiplexers	
00	20	73	399	242*	643	652*	151	253
01	21	74	534	243*	645	658*	153	257
02	22	76	564	245	646	659*	157	258
03	27	78	574	640	648	664*	158	352
04	30	107	670		651*	665*	251	353
05	32	109	794*	<b>Counters</b>			<b>Shift Registers</b>	
08	51	112	821*	160	190	590*	164	299
09	58	173	822*	161	191	591*	165	595
10	86	174	823*	162	192	592*	166	596
11	132	175	824*	163	193	593*	194	597
12	133	273	825*	168	390*		195	
14	266	374	826*	169	393		<b>Arithmetic Circuits</b>	
<b>Buffers &amp; Line Drivers</b>		377		<b>Decoders/Encoders</b>			181*	522*
125	367	<b>Latches</b>		42	148*	238	182*	679
126	368	75*	793*	138	154	239	183	680
210	465*	77*	841*	139	155		280	682
240	466*	259	842*	<b>Multivibrators</b>			518*	684*
241	467*	373	843*	121*	123*	423*	519	686*
244	468*	533	844*	<b>Logic Level Converters</b>			520*	688
365	540	563	845*	4049	4050*		521	689*
366	541	573	846*					

\*Part types available in 2Q '88. All other part types available now.

# Samsung's KSV3110 combo A/D-D/A and KSV3208 A/D set the pace in flash converters.

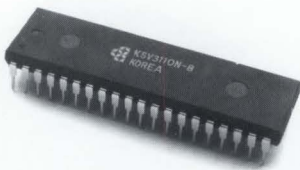

KSV3110 Combo A/D-D/A Flash Converter



KSV3208 A/D Flash Converter

The pacesetting technology of our single-chip KSV3110 A/D-D/A data converter provides independent 8-bit A/D converter functions and 10-bit R-2R D/A converter functions over an operating range of DC to 20MHz.

With the ease of design you get with the KSV3110's two chips in one, you'll save both money and real estate, leaving room and resources to add other features. And having fewer parts cuts down power drain and boosts system reliability.

The KSV3110 gives TTL-compatible input/output, 1% absolute non-linearity and selectable peak level input or keyed clamping.

The impressive linear characteristics of the KSV3110 are shared by our new KSV3208 A/D flash converter. It provides the same features for applications that don't require D/A conversion.

Samsung also offers the support chips to ease the integration of the KSV3110

into video applications. For example:

- KA2606 Sync Separate IC
- KA2153 Chrominance Signal Processor for NTSC systems
- KA2154 Video Chroma Deflection System for NTSC and PAL systems

Fill out the coupon on the back page of this insert for samples and a Flash Converter IC Data Book.

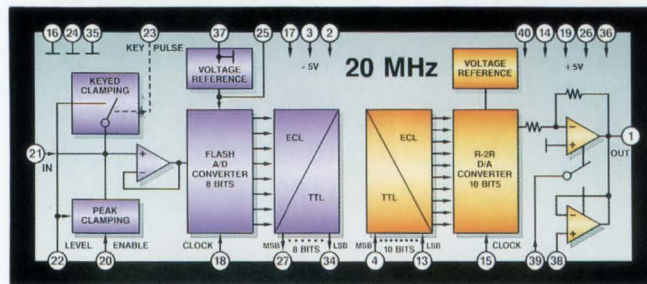

Circle No. 171

Part Type	Resolution		Linearity		Conversion Speed	Industry Part
	A/D	D/A	A/D	D/A		
KSV3110N-10	8 bits	10 bits	$\pm \frac{1}{2}$ LSB	$\pm \frac{1}{2}$ LSB	20 MSPS	
KSV3110N-9	8 bits	10 bits	$\pm \frac{1}{2}$ LSB	$\pm 1$ LSB	20 MSPS	
KSV3110N-8	8 bits	10 bits	$\pm \frac{1}{2}$ LSB	$\pm 2$ LSB	20 MSPS	
KSV3110N-7	8 bits	10 bits	$\pm \frac{1}{2}$ LSB	$\pm 4$ LSB	20 MSPS	
KSV3100AN-8	8 bits	10 bits	$\pm \frac{1}{2}$ LSB	$\pm 2$ LSB	20 MSPS	UVC3101
KSV3100AN-7	8 bits	10 bits	$\pm \frac{1}{2}$ LSB	$\pm 4$ LSB	20 MSPS	UVC3101
KSV3208N	8 bits		$\pm \frac{1}{2}$ LSB		20 MSPS	
KAD0820ACN	8 bits		$\pm \frac{1}{2}$ LSB		1.5 $\mu$ sec	ADC0820BCN
KAD0820BCN	8 bits		$\pm 1$ LSB		1.5 $\mu$ sec	ADC0820CCN
KAD0808IN	8 bits		$\pm \frac{1}{2}$ LSB		100 $\mu$ sec	ADC0808CCN
KAD0809IN	8 bits		$\pm 1$ LSB		100 $\mu$ sec	ADC0809CCN
KDA0800CN		8 bits		$\pm \frac{1}{2}$ LSB	*100 nsec	DAC0800LCN
KDA0801CN		8 bits		$\pm 1$ LSB	*100 nsec	DAC0801LCN
KDA0802CN		8 bits		$\pm \frac{1}{4}$ LSB	*100 nsec	DAC0802LCN
KDA0806CN		8 bits		$\pm 2$ LSB	*150 nsec	DAC0806LCN
KDA0807CN		8 bits		$\pm 1$ LSB	*150 nsec	DAC0807LCN
KDA0808CN		8 bits		$\pm \frac{1}{2}$ LSB	*150 nsec	DAC0808LCN
KS7126CN	3½ digit		$\pm \frac{1}{2}$ LSB		333 msec	TSC7126
KS25C02	CMOS 8-bit successive approx. register					DM2502
KS25C03	CMOS 8-bit successive approx. register					DM2503
KS25C04	CMOS 12-bit successive approx. register					DM2504

\*Settling Time

# Samsung's SOT-23s set the pace for surface mount technology.



Samsung has 100 types of SOT-23 available now.

Samsung has introduced 100 types of SOT-23s with an AOQL of 100 ppm or better—all with competitive pricing. They're ideal for both hybrid and surface mount applications. The entire line is in full production and available from stock. Samsung can deliver SOT-23s in the quantities you need when you need them.

Samsung now has available a new family of digital transistors, the KSR1000 Series (NPN) and KSR2000 Series (PNP), with 40 part types in each family. They're especially useful for applications where logic circuits are being interfaced with electromechanical systems.

We also offer an extensive line of industry standard TO-92, TO-126, and TO-220 transistors, plus TIP-Series power transistors, small signal transistors, high speed high voltage switching power transistors, Darlington power transistors and 1500V TO-3P transistors.

Fill out the coupon on the back page of this insert for samples and a copy of our new Transistor Data Book.

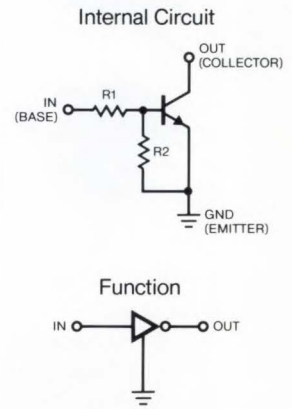

Samsung's new KSR1000 and KSR2000 Series digital transistors are especially useful for applications where logic circuits are being interfaced with electromechanical systems.

## SOT-23 PART TYPES

MMBR5179	MMBT5087	MMBTA55
MMBT2222A	MMBT5088	MMBTA56
MMBT2484	MMBT5401	MMBTA63
MMBT2907A	MMBT5550	MMBTA64
MMBT3904	MMBT6428	MMBTA70
MMBT3906	MMBTA05	MMBTA92
MMBT4123	MMBTA06	MMBTA93
MMBT4124	MMBTA13	MMBTH10
MMBT4125	MMBTA14	MMBTH17
MMBT4126	MMBTA20	MMBTH24
MMBT4401	MMBTA42	BCX70G
MMBT4403	MMBTA43	BCX71G

66 other types also available

Circle No. 172

## Samsung sets a fast pace in delivering linear ICs.

The quality of Samsung linear ICs has gained them solid market acceptance. We now have over 250 industry-standard ICs available for immediate delivery. And Samsung has invested substantially to ensure that you get the latest technology, with high reliability in high volume at very low cost.

Fill out the coupon on the back page of this insert for samples and a data book.

### Voltage Regulators

KA336Z-5 (LM336-5)  
KA431CZ\* (TL431)  
KA431CN (TL431)  
LM723CN  
LM317T  
MC78TXXCT  
MC78BXXCT  
MC78BXXACT  
MC78LXXACZ  
MC78MXXCT  
MC79LXXACZ  
MC79MXXCT  
MC79XXCT  
 $\mu$ A78S40CN  
KA385Z-1.2 (LM385-1.2)

### OP AMPS

KA301AN\* (LM301A)  
LM741CN\*  
MC1458CN\*  
MC4558CN\*  
LM358N\*  
LM358AN\*  
LM348N\*  
LM324N\*  
LM324AN\*  
MC3403N\*  
KS271 (TLC271)  
KS272 (TLC272)  
KS273 (TLC273)

### Telecommunications ICs

KA2410N—Tone ringer  
KA2411N—Tone ringer  
KA2418N—Tone ringer with bridge diode  
KA2412FN—Speech network  
KA2413N—DTMF  
KS5808N—DTMF  
KS5805AN/BN—Pulse dialer  
KS5819N—Pulse/DTMF (22 DIP)  
KS5820N—Pulse/DTMF (18 DIP)  
KT3040—CODEC filter  
KT5116—CODEC  
LM567N\*—Tone decoder  
LM567LN—Tone decoder Micropower

### Timers

KS555N\* (CMOS)  
KS555HN\* (CMOS)  
KS556N\* (CMOS)  
NE555CN\*  
NE556CN\*  
NE558CN

### Comparators

KA319N  
KA710CN  
LM311N\*  
LM393N/AN\*  
LM339N/AN\*  
KS374N (TLC374)  
KA361N (LM361)

### RS-232 Interface

MC1488N\*—Driver  
MC1489N/AN\*—Receiver

Circle No. 173

\*Also available in surface-mount package (SOIC).

# Samsung's MOSFETs have had fast-paced market acceptance.

Samsung's industry-standard power MOSFETs have rapidly gained market acceptance. Independent testing has demonstrated their excellent quality and superior ruggedness (2J at 500V). Each is screened to MIL-STD-750 specifications.

Our MOSFETs directly replace IR and Motorola®. They're available in a variety of packages, including lead-formed TO-220s, state-of-the-art TO-247 FULL PACK and DPAK.

And Samsung is an established supplier with over 400 part types, in both N and P channel, one of the broadest lines on the market. Our MOSFETs range from 60V to 700V. Plus, we're especially deep in the 500V to 700V range. All with competitive pricing.

Fill out the coupon on the back page of this insert for samples, a data book, and a ruggedness application note.

Circle No. 174

*Samsung's high-quality, industry-standard MOSFETs directly replace IR and Motorola® and are competitively priced.*

<b>TO-247 Full Pack</b>	<b>TO-3 Package</b>	IRF9220	IRF9232	
<b>N-Channel Types</b>	<b>P-Channel Types</b>	IRF9221	IRF9233	
IRFS130 IRFS443	IRFP9120 IRFP9220	IRF9222	IRF9240	
IRFS133 IRFS450	IRFP9121 IRFP9221	IRF9223	IRF9241	
IRFS140 IRFS453	IRFP9122 IRFP9222	IRF9230	IRF9242	
IRFS143 SSS4N70	IRFP9123 IRFP9223	IRF9231	IRF9243	
IRFS150 SSS6N70	IRFP9130 IRFP9230			
IRFS153 SSS10N70	IRFP9131 IRFP9231	<b>TO-220 Package</b>		
IRFS230 SSS4N60	IRFP9132 IRFP9232	<b>N-Channel Types</b>		
IRFS233 SSS6N60	IRFP9133 IRFP9233	IRF510	IRF741	
IRFS240 SSS8N60	IRFP9140 IRFP9240	IRF511	IRF742	
IRFS243 SSS15N60	IRFP9141 IRFP9241	IRF512	IRF743	
IRFS250 SSS8N55	IRFP9142 IRFP9242	IRF513	IRF820	
IRFS253 SSS8N55	IRFP9143 IRFP9243	IRF520	IRF821	
IRFS330 SSS15N55		IRF521	IRF822	
IRFS333 SSS20N50	<b>TO-3 Package</b>	IRF522	IRF823	
IRFS350 SSS20N45	<b>N-Channel Types</b>	IRF523	IRF830	
IRFS353 SSS25N40	IRF120	IRF423	IRF831	
IRFS430 SSS25N35	IRF121	IRF430	IRF832	
IRFS433 SSS40N20	IRF122	IRF431	IRF833	
IRFS440 SSS40N15	IRF123	IRF432	IRF840	
	IRF130	IRF433	IRF841	
	IRF131	IRF440	IRF842	
	IRF132	IRF441	IRF843	
	IRF133	IRF442	IRF543 SSP3N70	
	IRF140	IRF443	IRF610 SSP4N70	
	IRF141	IRF450	IRF611 SSP4N60	
	IRF142	IRF451	IRF612 SSP4N60	
	IRF143	IRF452	IRF613 SSP6N60	
	IRF150	IRF453	IRF620 SSP6N55	
	IRF151	SSM3N70	IRF621 SSP4N60	
	IRF152	SSM4N70	IRF622 SSP4N55	
	IRF153	SSM6N70	IRF623 SSP4N50	
	IRF220	SSM10N70	IRF630 SSP4N45	
	IRF221	SSM4N60	IRF631 SSP6N40	
	IRF222	SSM6N60	IRF632 SSP6N35	
	IRF223	SSM8N60	IRF633 SSP7N20	
	IRF230	SSM15N60	IRF640 SSP8N20	
	IRF231	SSM4N55	IRF641 SSP7N18	
	IRF232	SSM6N55	IRF642 SSP8N18	
	IRF233	SSM8N55	IRF643 SSP7N15	
	IRF240	SSM15N55	IRF712 SSP8N15	
	IRF241	SSM4N50	IRF711 SSP7N12	
	IRF242	SSM20N50	IRF712 SSP8N12	
	IRF243	SSM4N45	IRF713 SSP12N10	
	IRF250	SSM20N45	IRF720 SSP10N10	
	IRF251	SSM5N40	IRF721 SSP12N08	
	IRF252	SSM25N40	IRF722 SSP10N08	
	IRF253	SSM5N35	IRF733 SSP12N06	
	IRF320	SSM25N35	IRF730 SSP40N06	
	IRF321	SSM7N20	IRF731 SSP10N06	
	IRF322	SSM8N20	IRF732 SSP12N05	
	IRF323	SSM40N20	IRF733 SSP10N05	
	IRF330	SSM7N18	IRF740	
	IRF331	SSM8N18		
	IRF332	SSM7N15	<b>TO-220 Package</b>	
	IRF333	SSM8N15	<b>P-Channel Types</b>	
	IRF340	SSM40N15	IRF9510	IRF9610
	IRF341	SSM7N12	IRF9511	IRF9611
	IRF342	SSM8N12	IRF9512	IRF9612
	IRF343	SSM12N10	IRF9513	IRF9613
	IRF350	SSM10N10	IRF9520	IRF9620
	IRF351	SSM12N08	IRF9521	IRF9621
	IRF352	SSM10N08	IRF9522	IRF9622
	IRF353	SSM12N06	IRF9523	IRF9623
	IRF420	SSM10N06	IRF9530	IRF9630
	IRF421	SSM12N05	IRF9531	IRF9631
	IRF422	SSM10N05	IRF9532	IRF9632
			IRF9533	IRF9633
			IRF9540	IRF9640
			IRF9541	IRF9641
			IRF9542	IRF9642
			IRF9543	IRF9643
			<b>TO-126 Package</b>	
			<b>N-Channel Types</b>	
			IRFA120	IRFA123

Please select below what you would like to receive on each Samsung product and mail this coupon to Product Marketing Department,

DRAMs	<input type="checkbox"/> Data Sheet	Part Type _____
	<input type="checkbox"/> Reliability Report	_____
SRAMs	<input type="checkbox"/> Data Sheet	Part Type _____
	<input type="checkbox"/> Reliability Report	_____
EEPROMs	<input type="checkbox"/> Samples	Part Type _____
	<input type="checkbox"/> Data Sheet	_____
	<input type="checkbox"/> Reliability Report	_____
ADVANCED CMOS LOGIC FAMILY	<input type="checkbox"/> Data Book	Part Type _____
	<input type="checkbox"/> Samples: KS74AHCT	_____
FLASH CONVERTERS	<input type="checkbox"/> Samples	Part Type _____
	<input type="checkbox"/> Data Book	_____
SOT-23s	<input type="checkbox"/> Samples	Part Type _____
	<input type="checkbox"/> Data Book	_____
LINEAR ICs	<input type="checkbox"/> Samples	Part Type _____
	<input type="checkbox"/> Data Book	_____
POWER MOSFETs	<input type="checkbox"/> Samples	Part Type _____
	<input type="checkbox"/> Data Book	_____
	<input type="checkbox"/> Ruggedness Application Note	_____

Samsung Semiconductor, Inc., 3725 North First Street, San Jose, CA 95134-1708.

Please rush to:

Name \_\_\_\_\_

Title \_\_\_\_\_

Company \_\_\_\_\_

Address \_\_\_\_\_

City/State/Zip \_\_\_\_\_

Telephone (\_\_\_\_\_) \_\_\_\_\_

*Setting the Pace.*



**SAMSUNG**

Semiconductor

3725 North First Street,  
San Jose, CA 95134-1708

# FOR SALE ERROR PROOF DATA

## X.25 LAPB AND/OR MNP LEVEL 4

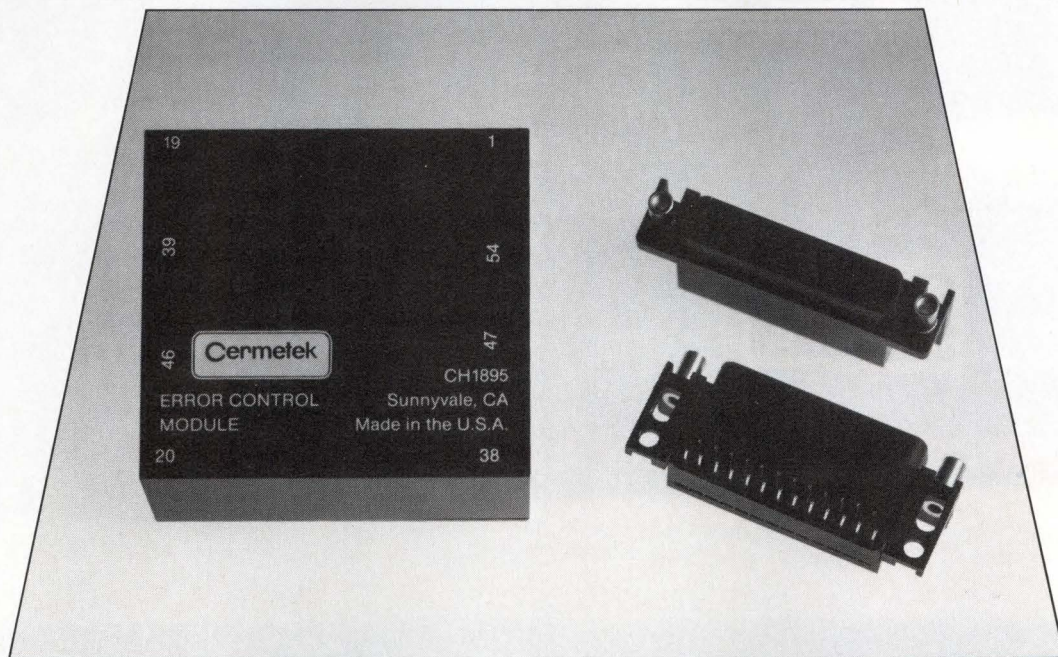

Ever worry about transferring bad data on a block transfer? Bad data can be prevented by the use of industry standard error correcting protocols. Our CH1890 series of backward error correcting components insure absolutely reliable data transfer. A bad bit cannot get through the link. Cermetek's error correcting components can be incorporated in a host of communication products with speeds up to 19.2K bps supported.

### Easy to design in

Cermetek has eliminated the guesswork in deciding which error correcting protocol to choose when designing your product. This is accomplished by offering two popular methods of error correcting, X.25 LAPB and MNP Level 4, in one component. Now there is a single source for all your error correcting needs. Both methods are available individually also.

Each error control component provides two separate RS-232 ports, a data pass through mode and individual component control by hardware straps or extended AT commands.

The CH1890 series provide error free data transfers and also application flexibility for CAD/CAM graphics, asynchronous dial-up, file transfers and backward error correcting for high speed modems such as V.32.

The CH1890 series are low profile, low power and low cost. Write or call today for more information.

### 1890 SERIES ERROR CORRECTING COMPONENTS

FEATURES	CH1895	CH1891	CH1890
Speed: 300-19.2K bps	X	X	X
MNP Level 1-4	X		X
X.25 LAPB	X	X	
Session Transfer Full Duplex	X	X	X
AT Commands	X	X	X
Pass Through Mode	X	X	X
In band/Out band flow control	X	X	X
Low Power 5V Operation	X	X	X
Low Profile (2.2" L x 2.4" W x 0.5" H)	X	X	X



Cermetek Microelectronics, Inc.  
1308 Borregas Avenue Sunnyvale, CA 94088  
Telephone: 408/752-5000  
Fax: 408/752-5004  
Twx: 910-379-6931

MNP is registered trademark of Microcom Corp.

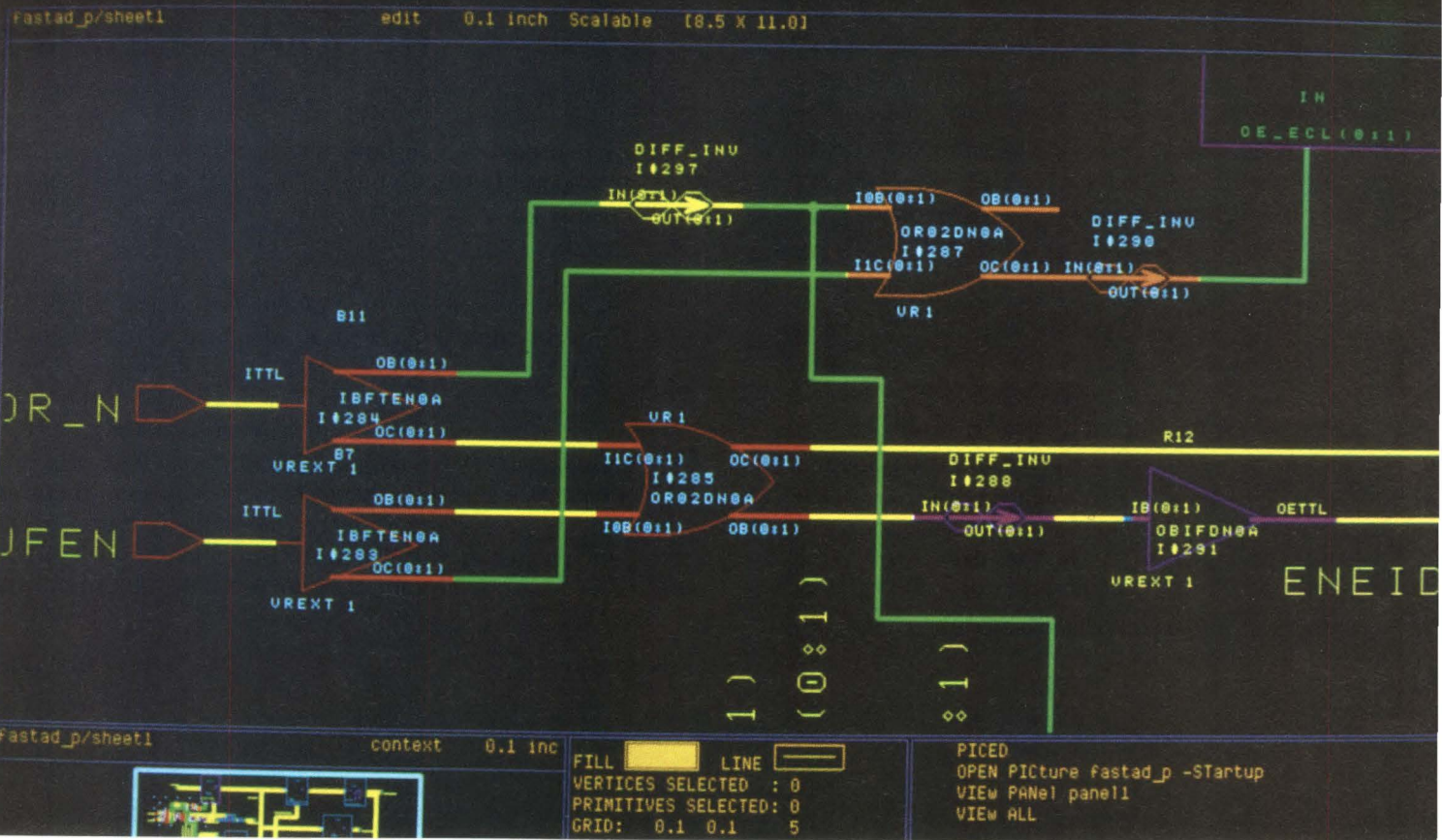



# The logic in choosing National.

---

## ANNOUNCING A TOP-DOWN COMMITMENT TO FAST AND FACT LOGIC

---

From design to delivery, no one is doing more than National to meet your advanced logic needs. In fact, no one even comes close.

Only we can offer you the Fairchild tradition of advanced logic technology and applications leadership. Plus our own industry-recognized expertise in manufacturing, packaging, and quality & reliability. All backed by a management commitment to supporting you with service second to none.

Take a moment to examine the logic of our position.

---

## WE'RE CREATING INDUSTRY STANDARDS

---

You can expect stepped-up product development in both FAST™ (Fairchild Advanced Schottky TTL) logic and FACT™ (Fairchild Advanced CMOS Technology) logic. Without resorting to padding the lines with seldom-used parts impractical for high-speed logic designs.

In FACT, 77 parts are available today. And we're committing here and now to offer you a total of 150 commercial parts by January 1. Including four LSI functions.

Now think FAST. We've got 135 parts on the shelf right now, 13 of which are LSI functions. 25 new parts will be added to stock by year end.

And we've secured Hitachi and Motorola as world-class alternate suppliers for FACT logic to ensure availability in peak demand periods.

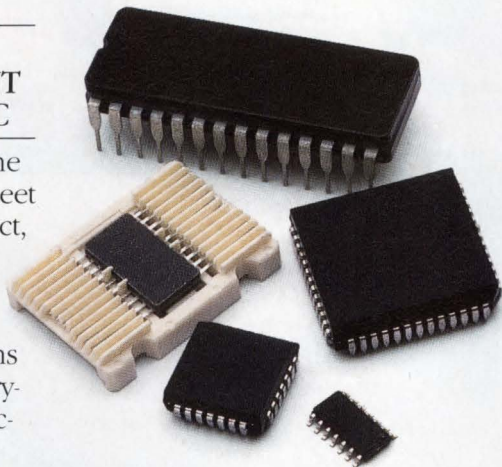

And only National offers you all the key logic families. Including FACT, HC/HCT, CD4000 and 74C in CMOS. And FAST, ALS, AS, Schottky, LS-TTL, STD-TTL and F100K ECL in bipolar.

---

## WE'RE SETTING THE PACE IN QUALITY AND RELIABILITY

---

We were the first to implement 100% AC, DC and function testing. Our pioneering use of Statistical Process Control techniques from wafer fab through assembly enables us to ship both lines at defect rates of less than 50 ppm.

Our gains in reliability have been equally significant. For example, we process our FACT products with epitaxial silicon for improved latch-up and ESD specifications. The result? The industry's first latch-up and ESD guarantees.

---

## WE'RE LEADING THE FIELD IN MILITARY APPLICATIONS

---

No other logic supplier offers military customers so many products specifically designed to meet critical mil-specs. Including 77

MIL-STD-883C, 49 JAN Class B and 38 JAN Class S FAST parts. And 23 FACT Standard Military Drawings.

We can supply radiation-tolerant FACT products as well. And we even perform our own radiation testing with an in-house cobalt source.

---

## WE'RE PROVIDING SOLUTIONS IN A VARIETY OF PACKAGES

---

Our FAST and FACT products are available in a full range of package options, including PDIP, CDIP, SO, LCC, PLCC and Flatpak configurations.

---

## WE'RE MAKING IT HAPPEN RIGHT NOW

---

With fully trained field sales, applications and product specialists located in 46 offices across the nation. A variety of dependable delivery programs from which to choose. And a network of 20 distributors with more than 200 total branch locations.

For details on the logic in choosing National, call today for our latest Advanced Logic Product Status Guide.

1-800-252-4488, ext. 730

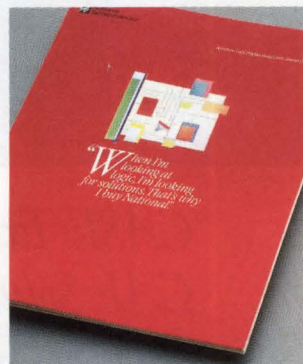

 **National  
Semiconductor**



## *“CASE Technology: CAE Solutions Planned Right from the Start”*

CASE Technology's new Vanguard CAE Design System supports a full range of industry standard hardware platforms — DEC VAX (VMS), Sun (UNIX) and PC (DOS) — and a comprehensive set of electronic design applications for PCB and ASIC design. Applications include schematic capture, digital logic simulation, circuit simulation and PCB design capabilities.

Since initial product introductions four years ago, CASE Technology has been setting trends in the computer-aided engineering

industry. CASE was the first to introduce:

- a PC-based CAE solution in June 1983
- an integrated PC to VAX solution in November 1985
- a PC as an intelligent graphics terminal for CAE in February 1986
- a complete Sun Workstation-based CAE solution in October 1986

In 1986, CASE also announced major marketing agreements with Digital Equipment Corporation and Sun Microsystems for the joint promotion of the Vanguard CAE Design System on the VAXstation and Sun-3 series of high performance engineering workstations.

Over the last three years, CASE Technology has experienced explosive growth to the rate of 80 percent per year and has remained profitable every quarter since the first product shipped. Today, CASE has over 3000 installations of the Vanguard CAE Design System worldwide, in companies

such as Hughes Aircraft, Honeywell, and Rockwell International.

Why has CASE Technology been so successful? It's simple. We listen to our customers very carefully. Corporate and engineering managers want *solutions* that work. CASE provides electronic design solutions through a well-conceived, long term plan for product migration, an open database philosophy, and data and operating system independence.

Before you make a decision on CAE, take the time to see what CASE has to offer.

CASE Technology, Inc., 2141 Landings Drive,  
Mountain View, California 94043  
Phone (415) 962-1440; Telex 506513;  
FAX (415) 962-1466.

**CASE  
TECHNOLOGY**

EDN May 26, 1988

## Function libraries can expedite the development of application programs

Chris Terry, *Associate Editor*

**P**ortability, connectivity, and productivity. These three concepts are tossed about so freely today that they are in danger of losing their significance. But if you're designing applications software for the micro-computer market, you need to achieve a certain level of success in all three areas—and that's where function libraries can play a very useful part.

You need portability because your customers may be using anything from a 1982 clunker running MS-DOS 1.1 to a lightning-fast 80386 machine running PC-DOS 3.3 or even OS/2. You need connectivity because users who travel don't want to waste time exiting from your application to bring up Crosstalk or Relay Gold. They want to be able to dial up the office computer from within their applications programs, send their data, and get right back to generating or analyzing more data. Finally, you need productivity to get your software to the market before someone else does—and that means not reinventing the wheel, however graceful and elegant your version of the wheel might be.

It's likely that one of the many available libraries of C, Pascal, or Basic functions can help you meet all three of the goals for the development of successful applications programs. Most of the libraries provide a wide range of both general and special functions at prices that range from \$50 to \$500. If you're writing for the IBM PC or PS/2 families and compatibles, you'll find that almost every library contains

routines for screen handling, pop-up menus, and windows. Some libraries offer completely independent windowing functions; others have an interface to the Microsoft Windows package, with plans for interfacing to the OS/2 Presentation Manager when that is released.

Typical of these general libraries is the C-Worthy Interface Library (Solution Systems), which costs \$195 for object code only and \$495 for object code with forms interface and library source code. You can order this library to work with the C compilers from Microsoft, Borland International (Scotts Valley, CA), or Lattice (Lombard, IL). It contains more than 350 C functions and 75 functions written in assembly language. The library also has menu functions; 62 DOS interface functions (including file-handling, directory, and time and date conversions); system and context-sensitive help functions; screen-handling and windowing functions; and a form-interface library for database applications.

The interface library is useful if you have overseas customers, because all the messages are isolated in separate files so that you can, if you wish, translate them into foreign languages. The package does not, however, have any communications functions.

Two of the most comprehensive library collections are those from Greenleaf Software and Essential Software. Both of these collections

do offer communications libraries that are available separately, but, for the sake of consistency, it's probably best to use them in conjunction with the general functions.

Greenleaf Functions, version 3.10, is the set's general library and contains 297 C functions that cover all DOS and BIOS capabilities, string handling, serial ports, graphics, printers, random numbers, clock/calendar handling and time and date conversions, and system interfacing (including interrupt handling). Another library, named Datawindows, provides all the C functions you need for a complete data-entry system. Object code for the general library costs \$185; for Datawindows, it costs \$225; source code is extra, but you can order various money-saving combinations of these libraries with or without source code.

The Greenleaf Comm library (\$185) contains about 120 routines that are completely compatible with

**Y**ou don't have to write validation routines for a data-entry system. Instead you can use pretested date, numerical, and value-range validation routines.

those of both the general library and Datawindows and ensure that, when the user terminates an application, an orderly exit to the operating system is guaranteed. If your system contains a multiport expansion board from Digiboard Inc (St

# 0 to 60 in 5 seconds

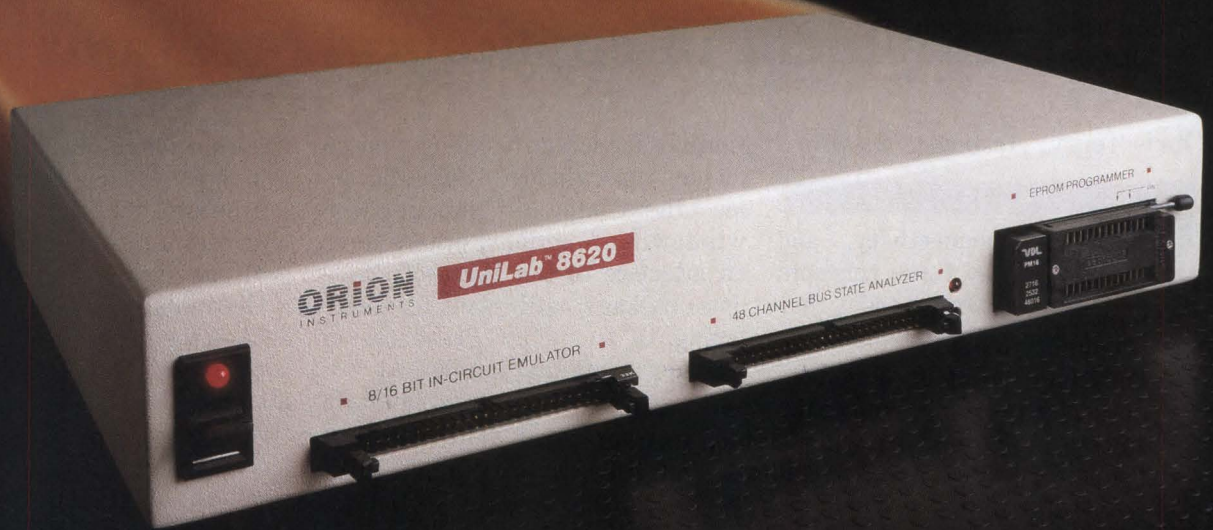

## with new UniLab 8620 analyzer-emulator.

- 64Kbytes from hard disk in 5 seconds. That's moving. But today you've got to be fast just to stay in the race for better micro-processor designs.
- The secret is a new, high-speed parallel interface: the Orion bus. Which zips data between your PC/AT and the 8620 analyzer-emulator, breaking the RS-232 bottleneck.
- The 8620 with O-bus gives you complete program diagnosis — and solutions — in real time. For more than 150 different micro-processors. Using **the same command set** environment.

■ A generous 2730 trace-cycle buffer with selective filtering lets you cut through the clutter and display just the traces you wish. And you get 1μsec resolution in program time measurement. Plus continuous InSight monitoring of your program's key functions as they are performed.

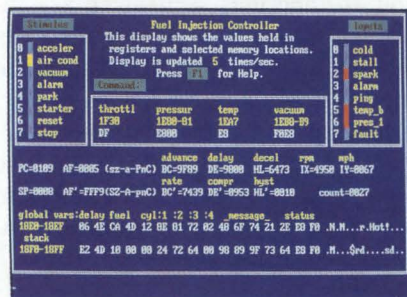

**InSight Display.** InSight blends analyzer-emulator techniques to give you continuous, real time monitoring of key processor functions. And still services user interrupts. It displays changing register contents, I/O lines, ports, user-defined memory windows. With your own labels.

- On top of that, you get UniLab's trademark ability to debug by symptom, not just by breakpoint and single step. And, to help you complete the job on time, on the spot, a stimulus generator and EPROM programmer are included.
- Ease of use, another Orion trademark, is also built in. So you have all the familiar features and formats you're used to working with. It doesn't matter if your project is a single chip controller or complex 16-bit

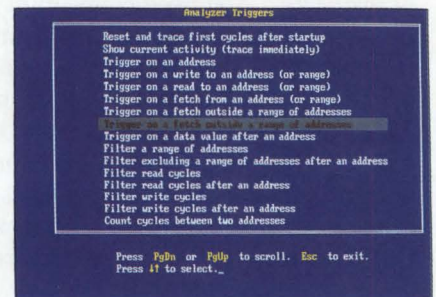

**Analyzer Triggers.** Commonly used triggers can be selected quickly from a list of standard and user-defined triggers.

microprocessor, the 8620 is the top price/performance analyzer-emulator that does it all. At just \$4380. With processor Personality Paks typically \$550 each.

■ UniLab 8620. Fast-lane debugging that gets you to market quicker.

**Call toll-free: 800/245-8500.**

**In CA: 415/361-8883**

**ORION**  
INSTRUMENTS

See us at Electro  
Booth 2741-45

702 Marshall St., Redwood City, CA 94063  
TLX 530942 FAX 415/361-8970

Computer Integrated Instrumentation

# TECHNOLOGY UPDATE

Louis Park, MN), you can open and close as many as eight serial ports and define all port parameters.

## Controlling modems

Status functions let you determine the status of the line, of the modem, of the buffer, and of other important flags and semaphores; you can also customize some of these routines so that the system ignores certain types of errors. In addition, timing and timer functions are included. A comprehensive set of modem-control functions lets you control all the operations of Hayes-compatible intelligent modems.

## Protocol sequences available

You don't have to construct protocol sequences from these basic building blocks; the communications library includes block- and file-level protocol sequences that you can call in order to transfer files in either direction using XON/XOFF or hardware RTS/CTS flow control, or the XMODEM protocol, which is the widely used public-domain protocol originated by Ward Christensen for user-group bulletin boards.

It's a pity that the Greenleaf Comm library supports only the XMODEM checksum error-detection scheme. This scheme detects only 99.2% of transmission errors, whereas the later CRC scheme detects 99.997% and it's not much more complex. Most public-domain communications programs and many commercial programs that implement XMODEM use CRC as the primary mode, and fall back to checksum mode only if the computer at the other end of the line can't provide the CRC mode.

The Essential Software collection of C functions offers some capabilities that other collections do not. The C Utility Library (\$185) has system, screen-handling, and graphics routines that differ little from those of the other collections; it also contains functions that initial-

ize the COM: ports to the desired word format and data rate, and that let you transfer asynchronous characters to and from either port.

## Advanced graphics applications

Essential Graphics sells for \$299 and has all the functions that you need for advanced graphics applications; it supports a wide variety of displays and hard-copy devices. One distinctive library in this group is ResidenC, a tool kit for the development of TSR (terminate and stay resident) programs. Another library, Screenstar, lets you design easy-to-use screens and menus and validate all keyboard input according to the requirements of individual fields (eg numerical, character, date, phone number). ResidenC and Screenstar each cost \$99.

The Essential Communications library contains functions that let you communicate, at speeds as fast as 9600 bps, with any asynchronous RS-232C device via the PC's COM: ports. In addition to functions for setup and for setting the port parameters, this library has services for keyboards, screens, low-level interrupts, and timers. In addition, a complete set of functions for controlling Hayes-compatible intelligent modems is included; flow-control functions allow you to use hardware RTS/CTS handshaking or XON/XOFF flow control; and a set of higher level functions implements the XMODEM protocol with CRC error detection.

You can buy this library for \$185. A supplementary debugger, named Breakout, is unique to this collection. It allows you to turn your PC into a data-line monitor that detects most setup and transmission errors (such as speed mismatch or incor-

rect RS-232C cable connections) and that also scans the XMODEM protocol interactively. The debugger costs \$125.

The Entelekon collection is large, and, although it doesn't include any communications functions, it's comprehensive enough for most purposes. The C Function Library contains more than 500 C functions divided into 12 groups: 18 system-status and -control functions; 70 string functions, 24 cursor-control functions; 47 keyboard-control and data-entry management functions; 28 time-related functions; 30 general utility functions such as numerical format-conversion routines; 86 video-control functions; 15 graphics functions; 6 linked-list operations for linking, unlinking, and finding records in doubly linked lists; 88 printer-control functions; and 18 functions for constructing menus and validating keyboard input. The \$159.95 price includes all source code.

## Windowing power

The C Power Windows library provides functions for constructing as many windows as you like (only the size of available memory sets a limit). When purchased alone, it costs \$159.95. You can obtain the C

**I**f you need communications capability, look for a library that has modem-handling functions both for bare-bones modems and Hayes-compatible modems.

Functions Library and Power Windows, together with a library of Superfonts for C, on 20 diskettes, for \$199.95.

A third library in this collection is the B-Tree Library and ISAM (Indexed Sequential Access Method)

# TECHNOLOGY UPDATE

driver, which lets you construct a B-tree database manager with as many as 16.7 million records per file and the same number of keys. The functions include facilities for constructing indexes and finding keys by Boolean selection.

According to the vendor, the functions in these libraries complement, rather than duplicate, the functions found in libraries supplied with the Borland and Microsoft C compilers. Furthermore, a few complex, multipurpose functions, which you can call by means of macros, considerably reduce the size of the code that you finally incorporate into your application programs.

## A low-priced C alternative

A comprehensive but reasonably priced collection of C functions comes from Zortech. All of the libraries are intended for use with Borland's Turbo C or Microsoft's Quick C. The company also supplies a C compiler, and a \$295 C video tutorial on ten 1-hour tapes. Hotkey is a tool kit for TSR programs; Supertext is a text editor that is compatible with Wordstar; Pro-screen lets you draw data-entry screens to suit your application and then generates the C source code to

The cream of the collection is Comms, which also costs \$49.95 and contains not only a full set of modem-control functions for Hayes-compatible intelligent modems, but also various functions that emulate VT52, VT100, and ANSI terminals. You can use as many as eight serial ports. The basic functions support data rates as fast as 38.4k bps, but successful use of rates higher than 9600 bps depends on the efficiency of other parts of your applications program.

The character flow-control functions include hardware RTS/CTS and DTR/DSR handshaking, and XON/XOFF flow control. For block-mode transfers, you can choose the Kermit or XMODEM protocols. The XMODEM functions use CRC as the error-detection scheme, and automatically revert to checksum mode if the remote station does not support CRC. The distribution disk includes two demonstration programs.

The 121-page paperback manual for Comms presents a useful introduction to serial communications, and clear descriptions of each of the functions. Technically, it is well organized, comprehensive, and easy to use. However the manual is

marred by a large number of typographical and grammatical errors, which tend to stop you cold and make you read a sentence again to be sure you understand it.

Libraries similar to the ones

written in C are also available for Pascal programmers. Blaise Computing offers Power Tools Plus for \$129. A set of general-purpose functions are designed to complement and enhance the libraries supplied with Borland's Turbo Pascal; Turbo C Tools, at the same price, is a

similar set of tools for Borland's Turbo C or Microsoft's Quick C. Versions that work with Microsoft's C 5.0 and Pascal compilers are also available for \$175 each.

C Asynch Manager and Pascal Asynch Manager furnish functions at several levels. At level 0 are the most basic hardware-control functions such as port initialization, interrupt services, and data transfers between the circular buffers and the ports. These functions are all written in assembly language. Using the functions at level 1, you can set port parameters, write characters to the output queue or read characters from the input queue, establish XON/XOFF flow control, and perform other relatively rudimentary operations. Level 2 contains the more complex operations involved in controlling Hayes-compatible intelligent modems and transferring files in block mode. Special functions allow you to implement the XMODEM protocol (with CRC error detection). C Asynch Manager and Pascal Asynch Manager cost \$175 each.

## Few choices in Basic

Not many general and specialized libraries are available for Basic, perhaps because Pascal and C are overtaking Basic in popularity for commercial application programs. One very good collection, however, is sold by Hammerly for \$99. It's called ProBas, and it works with all versions of Microsoft's QuickBasic and Business Basic compilers, as well as IBM's BasCom compiler. The general ProBas library lets you use virtual screens and has a complete set of I/O routines written in assembly language and optimized for speed. This library also includes more than 200 high-level functions for screen control, file and string handling, data compression and expansion, and many other features. It has numerous low-level functions for serial-port initialization and

**Y**ou can sometimes mix-and-match functions from different libraries, but more often you're better off writing the few functions you lack.

implement them. Windows lets you design any number of windows into your application. Finally, Games furnishes the source code for various games, including chess and backgammon. Each of these libraries costs \$49.95, including source code.

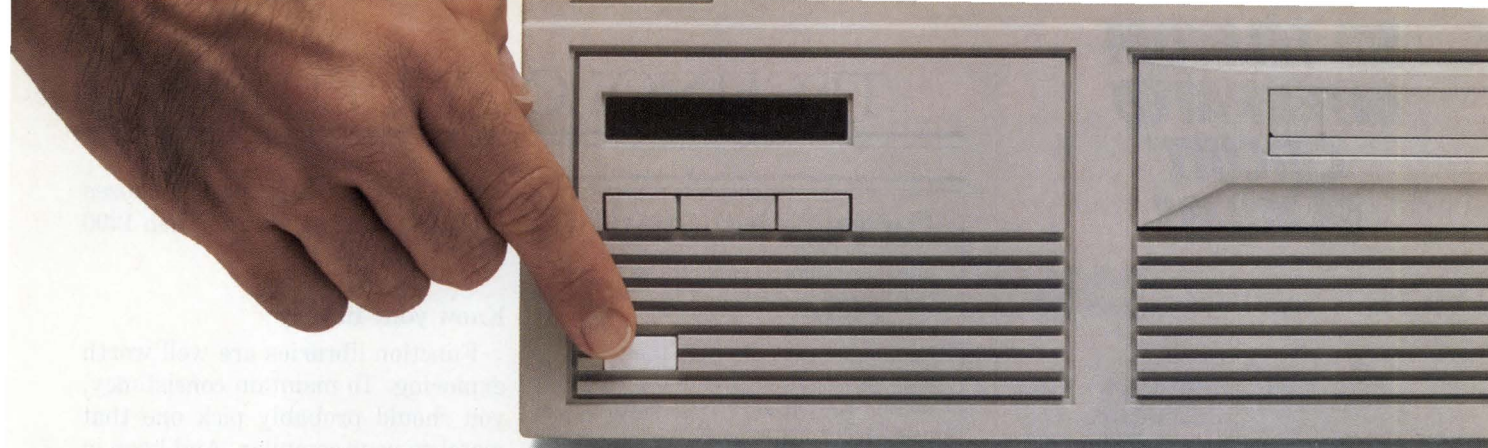

# Push button backup.

Low-cost backup  
for HP9000 users.

For all the times you've wanted a simpler, smarter, more reliable way to backup your data, Bering has the answer.

Introducing ECHO. Automatic tape backup you can count on time after time after time.

Our ECHO 40MB tape backup drive is compatible with all HP9000 Series 200/300/500 users. It incorporates the kind of sophisticated features you'd expect from an expensive drive. Yet it's priced at about *half* the price of comparable systems.

ECHO doesn't sacrifice quality, either. It's extremely reliable, with built-in error corrections that let you rest assured you're not missing anything.

At the push of a button, your ECHO drive can copy 40MB of data from your hard disk, creating a "mirror image" of your



files. Other features like off-line operation let you perform backup or restore without a CPU. ECHO's timed-backup lets you automatically backup a project without being present. Menu-driven selections and LCD displays make operation easier. And at 2.4MB per minute, ECHO's backup is *very* fast.

Last, but not least, ECHO uses the latest space-saving 3M DC2000 mini tape cartridges—a tidy little addition to over-crowded work areas.

For a data sheet or more information, call us at **800 BERING 1**. Bering Industries, 240 Hacienda Ave., Campbell, CA 95008.

**BERING™**

**Innovative storage for Hewlett-Packard**  
ECHO is a trademark of Bering Industries. HP9000  
Series 200/300/500 are trademarks of Hewlett-Packard.

# SSI TELECOM INTEGRATED CIRCUIT FAMILIES

**SPOTLIGHT #32**  
IN A SERIES

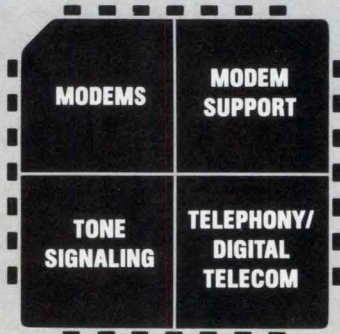

Silicon Systems has developed the following families of advanced telecommunication chips.

**MODEMS:** Silicon Systems offers the industry's most advanced designs in single-chip modem IC's. All members of the SSI K-Series family of one-chip modems are designed to the same footprint, with total hardware and software compatibility, allowing easy product upgrading over the entire Bell and CCITT range of full-duplex, split-band standards at data transfer speeds from 300 to 2400 BPS.

**MODEM SUPPORT:** SSI has designed a line of high performance filters, special purpose FSK modems, and high speed modem analog processors, which make possible efficient modem designs for custom applications.

**TONE SIGNALING:** Since pioneering the DTMF receiver, SSI has not only developed a whole family of DTMF receivers but has also introduced DTMF transceivers that can both generate and detect all 16 standard Touch-Tone digits. This Tone Signaling Family of products also includes a group of telephone-band call progress detector chips, which simplify design of automatic calling systems.

**TELEPHONY / DIGITAL TELECOM:** This family is comprised of standard integrated circuits for use in T1 transmitters and receivers, as well as chips for DS-1 line interfacing, central office MF tone detection, and 4-wire loopbacks for use in low-cost maintenance termination units.

Send for the Silicon Systems Telecom and Modem brochures today. **Silicon Systems**, 14351 Myford Road, Tustin, CA 92680.

Phone: (714) 731-7110, Ext. 575

*silicon systems*  
INNOVATORS IN INTEGRATION

CIRCLE NO 24

## TECHNOLOGY UPDATE

### For more information

For more information on the function libraries discussed in this article, contact the following manufacturers directly, or circle the appropriate numbers on the Information Retrieval Service card, or use EDN's Express Request service.

**Blaise Computing Inc**  
2560 9th St, Suite 316  
Berkeley, CA 94710  
(415) 450-5441  
Circle No 711

**Entelekon**  
12118 Kimberley  
Houston, TX 77024  
(713) 468-4412  
Circle No 712

**Essential Software Inc**  
76 S Orange Ave, Suite 3  
S Orange, NJ 07079  
(201) 762-6965  
Circle No 713

**Greenleaf Software Inc**  
16479 Dallas Pkwy, Suite 570  
Carrollton, TX 75248  
(214) 446-8641  
Circle No 714

**Hammerly Computer Services Inc**  
8008 Sandy Spring Rd  
Laurel, MD 20707  
(301) 953-2191  
Circle No 715

**Solution Systems**  
541-D Main St, Suite 410  
S Weymouth, MA 02190  
(617) 337-6963  
Circle No 716

**Zortech Inc**  
366 Massachusetts Ave  
Arlington, MA 02174  
(617) 646-6703  
Circle No 717

38,400 bps (its predecessor causes problems at rates greater than 1200 bps).

### Know your library

Function libraries are well worth exploring. To maintain consistency, you should probably pick one that matches your compiler. And keep in mind that some libraries suit some applications areas better than others do. Then get to know your library really well. If you later find that you need functions that aren't in your library, you may be able to find them in a different collection. But you need to be careful: It's not always easy to assess if and how functions from different collections can work smoothly together. Unless you're a very skilled programmer and know both your language and your library inside out, mixing functions from different collections may give you more trouble than writing the missing functions yourself. **EDN**

Article Interest Quotient  
(Circle One)

High 515 Medium 516 Low 517

character I/O, including checksum and CRC computations for error detection.

The Tele Comm Toolkit (\$75) from the same collection contains high-level functions for the control of intelligent modems, for terminal emulation (VT52, VT100, and ANSI), and for file transfer using XMODEM protocol with both CRC and checksum error-detection modes. This library is unique in having the YMODEM protocol as well; although similar to XMODEM, it works at data rates from 300 to



# "YOU NAME THE APPLICATION— WE'VE GOT THE MODEM IC."

## For Today's Designs

A quick glance at our Selection Chart shows that at data transfer speeds of 300 to 2400 BPS for U.S. or world-wide market applications, Silicon Systems has the industry's most advanced family of pin-compatible, single-chip modems available now for your current designs.

## For Tomorrow's Designs

We call this versatile family the SSI K-Series line of single-chip modems. These CMOS integrated circuits are all software and hardware compatible, allowing for easy product upgrading over the entire Bell and CCITT ranges of full-duplex, split-band telecom standards needed for your present and future designs.

## Special Features For Special Applications

The family includes an easy-to-use micro-processor control interface, and versatile features suitable for a wide variety of applications. The "U" versions integrate an industry standard UART with the modem function in a design optimized for integral bus applications, and the low-power "L" versions operate from a single + 5 volt supply, making portable, battery, or line powered designs possible.

**Call Now!**

(714) 731-7110, Ext. 575

For more information on the K-Series Family, or our complete line of Tone Signaling, Telephony, and Digital Telecom products, send for our Modem and Telecom brochures today.

**Silicon Systems,**  
14351 Myford Road,  
Tustin, California 92680.

*silicon systems*<sup>™</sup>  
INNOVATORS IN INTEGRATION



## MODEM IC SELECTION CHART

APPLICATIONS	PRODUCTS	OPERATING MODES						PRODUCT FEATURES
		103 0-300 BPS	212A 1200 BPS	V.21 0-300 BPS	V.22 600/ 1200 BPS	V.22 bis 1200/ 2400 BPS	V.23 0-1200 BPS	
<b>UNIVERSAL APPLICATIONS</b> Stand-Alone or Integral Modem Designs	73K212	█						High performance single-chip modems with easy-to-use cost-effective features.
	73K221			█				
	73K222				█			
	73K224					█		
<b>LOW POWER APPLICATIONS</b> • Lap Tops • Portable Terminals • Line Powered Modems • Battery-Powered Units	73K212L	█						High performance single-chip modems providing low-power operation from a single + 5 volt supply.
	73K221L			█				
	73K222L				█			
	73K224L					█		
<b>DEDICATED INTEGRAL APPLICATIONS</b> • Bus-Oriented Systems • Credit Verification • Automatic Teller Machines • Pay Telephones • Diagnostic Equipment	73K212U	█						Enhanced single-chip modems with a fully integrated 16C450 UART function, and added circuitry to simplify integral designs.
	73K221U			█				
	73K222U				█			
<b>EUROPEAN DATA COM APPLICATIONS</b> Multi-standard modems requiring videotex compatibility	73K322*			█				Single-chip modems add V.23 and special features to standard operating modes; available in + 12 volt or + 5 volt versions. * Available 1988
	73K322L*			█				
	73K324*				█			
	73K324L*				█			

*"Where we design to your applications."*

Circle 115 for Career Information  
Circle 114 for Product Information

# BUILD KILLER CELLS.

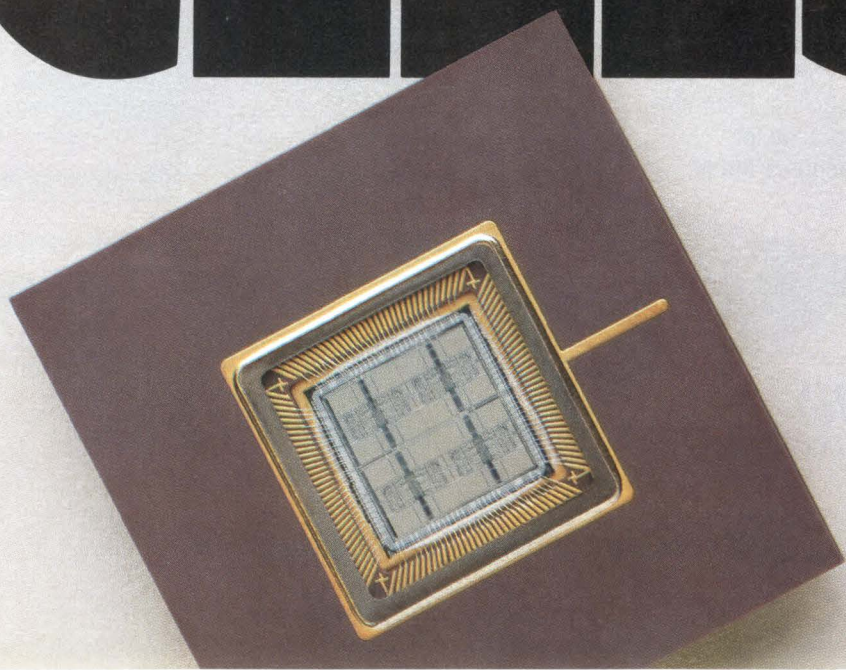

This is the stuff reputations are built on.

A cell design with 100,000 gates. More than 1000 library elements. 2MB of memory. And sub-micron HCMOS technology.

You can search high and low, but there's only one place in the world you can find a chip of such staggering complexity.

LSI Logic. Designs like this are precisely why we're the #1 domestic ASIC supplier with more than 4,000 working cell and array-based designs in the field.

And why our Modular Design Environment (MDE)<sup>™</sup> software is the best foundation for building killer cells.

MDE is the industry's most advanced design software for ASICs. It arms you with the capability to build today's most sophisticated cell-based designs. Easily. And with the smallest possible die size.

Besides MDE, LSI Logic delivers more than 400 LSI and VLSI building

blocks, including 16 and 32-bit micro-processor cells and industry-standard processor and peripheral functions; the longest list of SSI and MSI functions; and memory compilers to develop exactly the RAM or ROM your chip requires.

And if your application calls for lower densities, that's covered, too. Because LSI Logic has more cost-effective cell-based solutions than you can imagine.

No matter what kind of Cell-Based ASIC you build, LSI Logic will deliver a fully-tested prototype in as little as 4 weeks.

All in the production quantities you want, thanks to our advanced worldwide wafer fabrication, assembly, and test facilities.

So find out more about LSI Logic's Cell-Based ASICs by calling the sales office nearest you.

After all, we can help you make a killing.

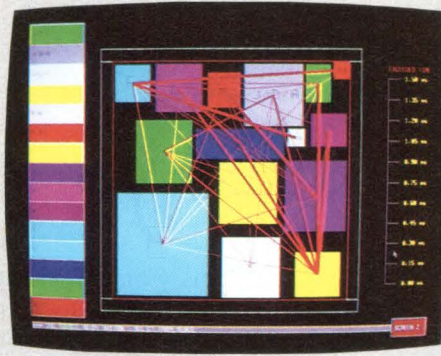

*High complexity Cell-Based ASICs require advanced tools like the MDE chip floorplanner to optimize delays and verify performance prior to layout.*

LSI LOGIC

LSI Logic Sales Offices and Design Resource Centers: Scottsdale, AZ 602-951-4560, Milpitas, CA 408-433-8000, San Jose, CA 408-248-5100, Irvine, CA 714-553-5600, Sherman Oaks, CA 818-906-0333, Denver, CO 303-756-8800, Altamonte Springs, FL 305-339-2242, Boca Raton, FL 305-395-6200, Norcross, GA 404-448-4898, Chicago, IL 312-773-0111, Bethesda, MD 301-897-5800, Waltham, MA 617-890-0161, Ann Arbor, MI 313-769-0175, Minneapolis, MN 612-921-8300, Bridgewater, NJ 201-722-7522, Poughkeepsie, NY 914-454-6593, Raleigh, NC 919-783-8833, Worthington, OH 614-438-2644, Beaverton, OR 503-644-6697, Trevose, PA 215-638-3010, Austin, TX 512-338-2140, Dallas, TX 214-788-2966, Bellevue, WA 206-822-4384, Calgary, Alta 403-262-9292, Paris, France 33-1-46212525, Israel 972-3-403741/6, Milan, Italy 39-39-651575, Tokyo, Japan 81-3-589-2711, Seoul, Korea 82-2-785-1693, Nidau/Biel, Switzerland 032-515441, Bracknell, United Kingdom 44-344-426544, Munich, West Germany 49-89-926903-0. © 1988 LSI Logic Corporation. Modular Design Environment and MDE are trademarks of LSI Logic Corporation.

# Now benchpress 400 MHz. Easy.

Arium introduces The Tool for your bench. The 400 MHz logic analyzer at a price you can handle as easily as the ML4400 handles multiple pods simultaneously . . . starting at \$4995.

Arium does it again.

We just redefined high-end logic analyzers in terms of low-end cost. With the 8/16/32-bit ML4400, you can combine up to four independent-clock cards (user-selectable) to get 16 channels at 400 MHz, 64 channels at 100 MHz (synchronous), or 160 at 50 MHz (synchronous). That means you can now handle full-speed 68030s or 80386s, as well as 68020s and 8086s. And, uniquely, up to four different microprocessors, simultaneously. That's speed our competition can't catch up with. Now for ease of use.

Easy. Redefined. What does ease of use mean to you? If it means: Single key menu access to all

screens. Complex triggering (Boolean, multilevel, repeat functions) with cross-triggering between state and timing, and between pods. Cross-time stamping. Transitional timing. All software resident . . . Then, you'll find them all, and more, in the ML4400.

Why Arium? How can Arium be the first to put this much low-cost power on your bench? Because we've always been first, ever since we redefined performance/price logic analyzers with our ML4100. When will the competition catch up with the performance/price of our new ML4400? Don't hold your breath.

For more data on the new ML4400, as well as on our family of Arium 8/16/32-bit logic analyzers at prices as low as \$2495, contact ARIUM CORPORATION, 1931 Wright Circle, Anaheim, CA 92806-6052. Telephone 800/TO-ARIUM (800/862-7486), (714/978-9531 in CA).

**ARIUM**  
CORPORATION

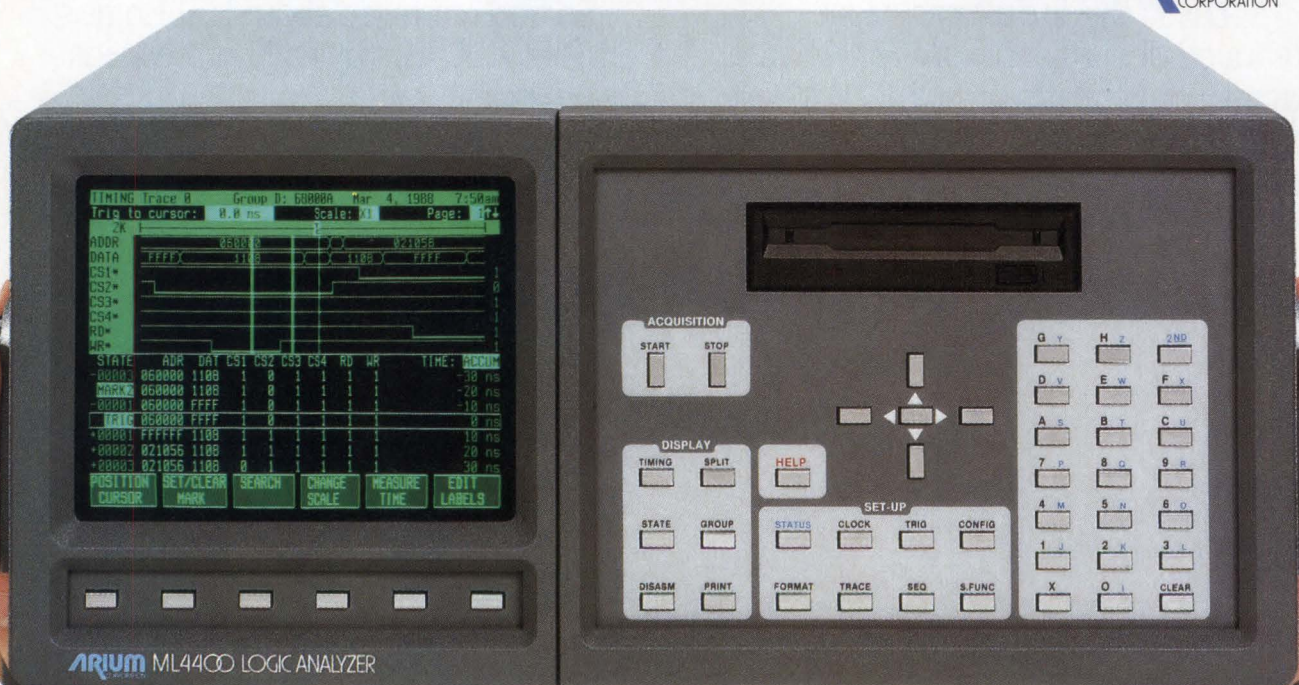

**Arium does it again!**

CIRCLE NO 120

## Logic analyzer samples at 1 GHz and handles 320 channels with 64k-word memory

You can no longer regard logic analyzers that plug into the IBM PC Bus merely as tools for the debugging of 8-bit systems with modest clock speeds. With pricing that begins at \$2995, the model 40, 80, and 320 logic analysis systems provide a combination of features heretofore associated with more expensive stand-alone instruments. Ranging from a 40-channel system with a 4k-word ROM to a 320-channel system with a 64k-word memory, the family's logic analysis systems perform 125-MHz timing analysis, incorporate a 16-level sequential-triggering scheme, and accept an optional pod that permits 1-GHz equivalent-time sampling of repetitive patterns.

Systems that have 160 or fewer channels include personal computers and are roughly the size of sew-

ing machines. They incorporate backlit LCDs or, optionally, electro-luminescent displays. The 40-channel system's computer is IBM PC/XT compatible and based on a 10-MHz 8088  $\mu$ P; the PCs that come with the larger systems are IBM PC/AT compatible and employ 10-MHz 80286  $\mu$ Ps. You can configure custom systems by mounting logic analysis boards in PC- or PC/AT-compatible chassis. The vendor offers the logic analyzers with pattern generators, comparators, and test-development software as a low-cost automatic test system for complex devices and circuit boards.

To prevent future obsolescence, both the timebase generator and the comparators that trigger the analyzers are housed on submodules that plug into the PC Bus-mounted logic analysis boards. If your system

includes multiple analyzer boards, a private trigger bus that runs across the tops of the boards synchronizes their operation. The inability to synchronize such multiple-board configurations was a shortcoming of some earlier PC-based logic analyzers.

You can operate these logic analyzers as state analyzers synchronously with a SUT (system under test) clock running at 25 MHz max, clocking from the logical combination of three external rising edges and two falling edges. You can also operate the logic analyzers asynchronously as timing analyzers; when the analyzer is running in the asynchronous mode, you can set its internal clock to run at 133 rates from 125 Hz to 25 MHz. Channel multiplexing enables the analyzers to operate to 125 MHz but reduces the number of channels to  $\frac{1}{3}$  that

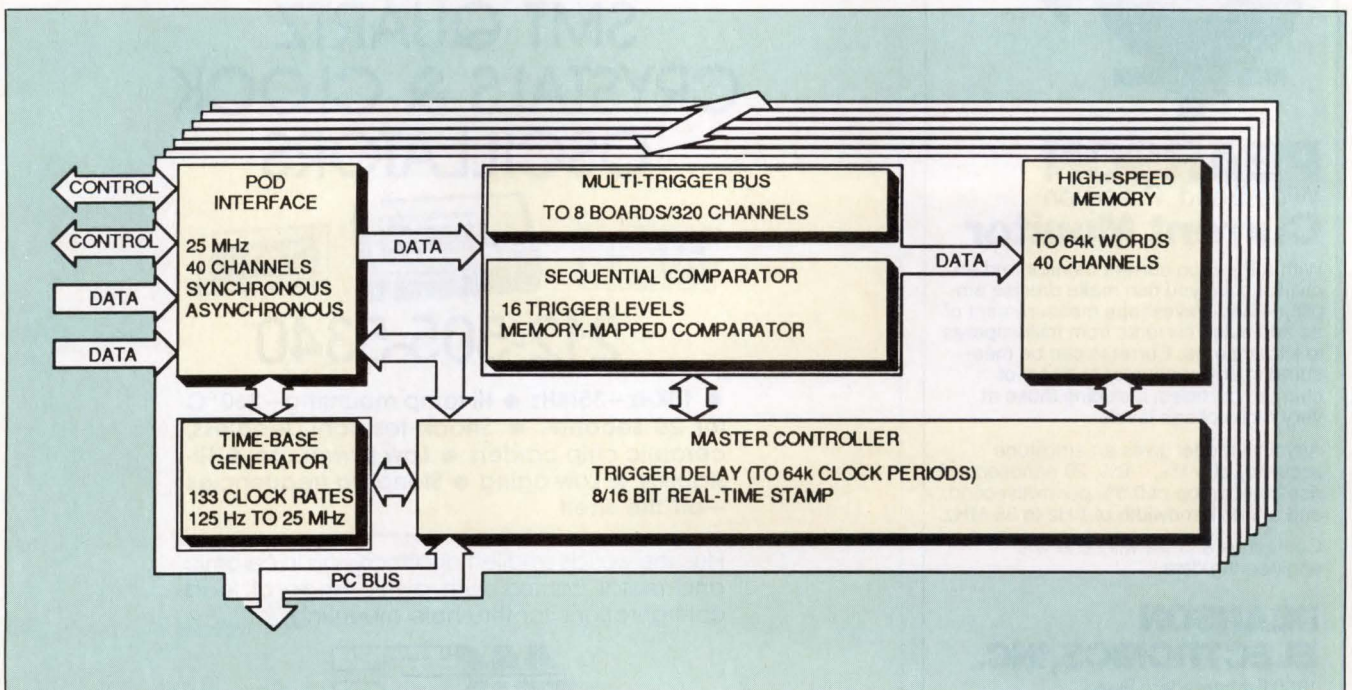

The block diagram of this logic-analyzer family reveals the private trigger bus that synchronizes multiple boards and the plug-in submodularity of the time-base generator and comparator.

# PRODUCT UPDATE

available at 25 MHz. However, multiplexing increases by 5× the amount of samples the logic analyzer's memory can store: for example, a system with 64k words of memory can store 320k samples at 125 MHz.

Instead of using single-word comparators, the logic analyzers base their triggering on truth tables stored in RAM. You can set them to trigger on the logical AND of five 8-bit comparison bytes. Thus, triggering can occur on individual addresses, rather than on an entire address range, which may contain addresses of no interest.

A 16-level trigger sequencer uses eight qualifier inputs from the pod. You can use the sequencer to trigger any logic-analyzer module in the system or to trigger an external instrument, such as a digital storage oscilloscope. The analysis systems also permit triggering to occur as late as the Nth ( $N \leq 256$ ) occurrence of an event. When not using quali-

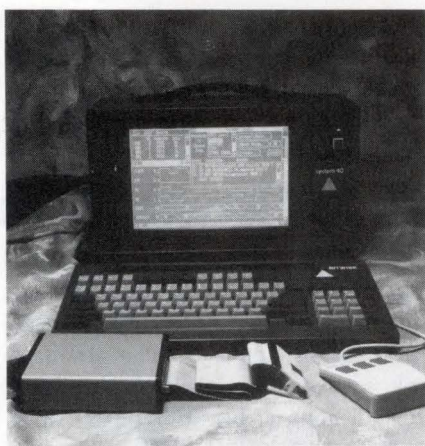

*A small portable case houses everything but the pod in systems that have 160 or fewer channels. An equivalent-time-sampling pod acquires data on repetitive patterns at 1 GHz.*

ers, you can employ the trigger delay in regard to 64k states.

A Multi-Trace feature lets you track down intermittent faults without running the risk of missing the problem you are trying to isolate. You can partition the memory to

collect as many as 256 sets of data in a single trace, which permits you to collect different data without having to stop and then restart tracing.

You can substitute an internally generated time stamp for either eight or 16 channels of data. To track down multilevel trigger sequences, you can insert the trigger level into the time-stamp data stream. You can also measure frequencies and time events with reloadable 8-bit counters (there is one counter for each trigger level) and link counters to create delays as long as  $2^{40}$  events.

System with 80 channels and 64k-word memory, \$15,000. 1-GHz, equivalent-time sampling pod for 40 channels, \$1800. —**Dan Strassberg**

*BitWise Designs Inc, 297 River St, Suite 501, Troy, NY 12180. Phone (800) 367-5906; in NY, (518) 274-0755. TWX 710-110-1708.*

**Circle No 699**

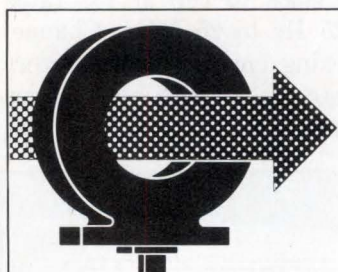

**PEARSON**  
Wide Band, Precision  
**Current Monitor**

With a Pearson current monitor and an oscilloscope you can make precise amplitude and waveshape measurement of ac and pulse currents from milliamperes to kiloamperes. Currents can be measured in any conductor or beam of charged particles, including those at very high voltage levels.

A typical model gives an amplitude accuracy of +1%, -0%, 20 nanosecond rise time, droop of 0.5% per millisecond, and a 3 db bandwidth of 1 Hz to 35 MHz.

Contact us and we will send you engineering data.

**PEARSON ELECTRONICS, INC.**  
1860 Embarcadero Road  
Palo Alto, Calif. 94303, U.S.A.  
Telephone (415) 494-6444  
Telex 171-412 · FAX (415) 494-6716

## WORLD'S SMALLEST SMT QUARTZ CRYSTALS & CLOCK OSCILLATORS



**212-505-5340**

- 10KHz—35MHz ● Hi-temp mounting—260 °C for 20 seconds ● Shock-resistant, leadless, ceramic chip carriers ● Low power use ● Hi-stability ● Low aging ● Standard frequencies —off the shelf

Plus, the world's smallest quartz crystals in ceramic and metal carriers with a full range of lead configurations for thru-hole mounting.



MICRO CRYSTAL DIVISION / SMH  
35 EAST 21st STREET, NEW YORK, NEW YORK 10010

**CIRCLE NO 87**

# The hot single shot.

we never stop asking

“What if...”

The HP 54111D digitizing oscilloscope has your numbers: 1 gigasample/s\*, 250 MHz single-shot and 500 MHz repetitive bandwidth.

The HP 54111D brings you the blazing speed and complex waveform triggering you need to capture those elusive glitches that cause headaches.

The HP 54111D is loaded with features you can appreciate: simultaneous two-channel capture; 8K memory per channel; up to eight bits of vertical resolution; waveform math which now includes A vs B, A x B, and integrate; and the advantages of HP digitizing technology including automatic answers, one-button hard copy output, auto-scale, digital storage, and HP-IB programmability (waveform capture and transfer now three to six times

faster in ATE applications).

Plus the exceptional reliability you've come to expect from HP scopes, and extended warranty coverage as well.

**Call HP today!**  
1-800-752-0900, ext. 215T.

We'll send all the details including Application Note *Sub-nanosecond Single-shot Digitizing Using The 54111D*, HP 54111D Data Sheet, and our brochure *Feeling Comfortable with Digitizing Oscilloscopes*. Or contact your local HP sales office listed in the white pages and ask for your HP rep.



HP-IB: Not just IEEE-488, but the hardware, documentation and support that delivers the shortest path to a measurement system.

© 1988 Hewlett-Packard Co. E115801/EDN(B)

\*See our Application Note on 2 gigasample/s performance.

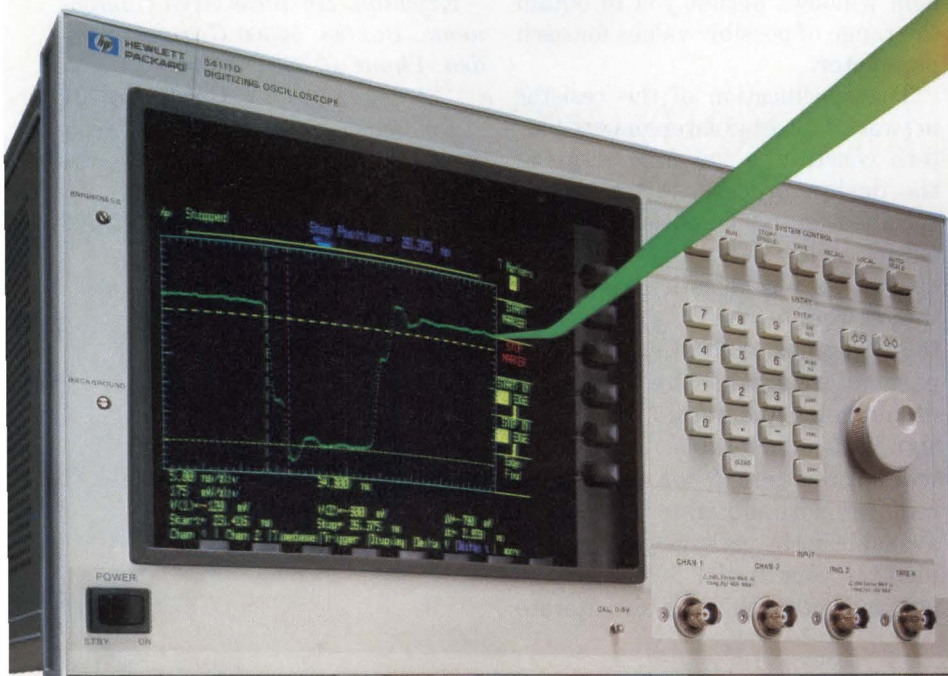

 **HEWLETT  
PACKARD**

## PC-based resistor-network CAD handles a variety of package types

The Resicalc CAD program for the IBM PC and compatible computers not only allows you to design semi-custom resistor networks, it provides guide-price information and dial-up access to quotations, delivery information, and order-placement facilities. Because the program incorporates the company's resistor-network design rules, it can immediately apprise you as to whether or not your design is manufacturable. If your initial design violates these design rules, you can conduct "what-if" experiments to decide on a suitable design compromise.

The program allows you to design single-in-line-packaged networks or design networks packaged in surface-mounting leadless carriers with leadouts suitable for either through-hole or surface mounting. You specify the number of pins (4 to 13), the lead pitch (0.05 or 0.1 in.), the maximum height of the network, and the number of resistors that the network must contain; the program then calculates the network's length for you. You can also specify an unpassivated network, a network passivated with an epoxy or plastic coating, and whether the networks should be delivered on tape, in sticks, or packaged in boxes.

To specify the electrical parameters of the resistor network, you enter each resistor's absolute value, absolute tolerance, tolerance relative to another specified resistor, absolute temperature coefficient, temperature coefficient relative to another specified resistor, and maximum power dissipation. The absolute resistor tolerance can be as good as 0.5%, the relative tolerance as good as 0.1%, the absolute temp-

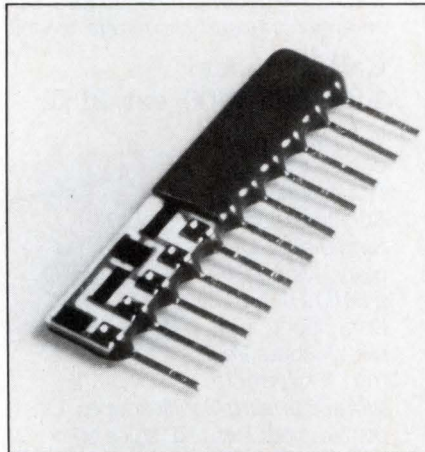

*The Resicalc CAD package lets you design through-hole, surface-mount, or leadless-carrier resistor networks on an IBM PC or compatible, and allows you to access the vendor's mainframe to place an order or to obtain price and delivery information.*

erature coefficient as low as 50 ppm/°C, and the relative temperature coefficient as low as 20 ppm/°C. The ability to specify relative tolerances and relative temperature coefficients makes the CAD package suitable for the design of temperature-tracking resistive dividers. Its help windows permit you to obtain the range of possible values for each parameter.

The specification of the resistor network's internal interconnect pattern constitutes the final stage of the design process. After you've specified an input and output leadout for each resistor, the CAD package draws a schematic diagram of the network on the PC's monitor. It then proceeds to check your design parameters against the company's design rules to determine if the design is manufacturable. Your design will fail this test if, for example, it requires more substrate area than is available in the package you've specified. If your initial design proves unmanufacturable, you can iterate

the design until it complies both with your requirements and the company's resistor-network design rules. (The design editor in the Resicalc version evaluated for this article could have been more sophisticated, but was nonetheless useable.)

After you've designed your resistor network, Resicalc can provide you with a guide price; if your PC is equipped with a modem, Resicalc lets you obtain actual price and delivery information by using a toll-free number to phone the company's computer. You can also use this phone link with the company's computer to place an order for prototype or production quantities of the resistor network. Alternatively, Resicalc can print out a completed order form for you, or can transfer your order and design file to a floppy disk for mailing to the company.

The company supplies the Resicalc CAD package free-of-charge on an IBM PC-compatible floppy disk. —Peter Harold

*Ericsson, Business Area Components, Box 98, 56300 Granna, Sweden. Phone 46-39011020.*

**Circle No 701**

*Ericsson Components, 3255 Scott Blvd, Suite 4D, Santa Clara, CA 95054. Phone (408) 988-3603.*

**Circle No 702**



# SONY'S ECL LOGIC HAS THE GUTS TO CHALLENGE GaAs PERFORMANCE.

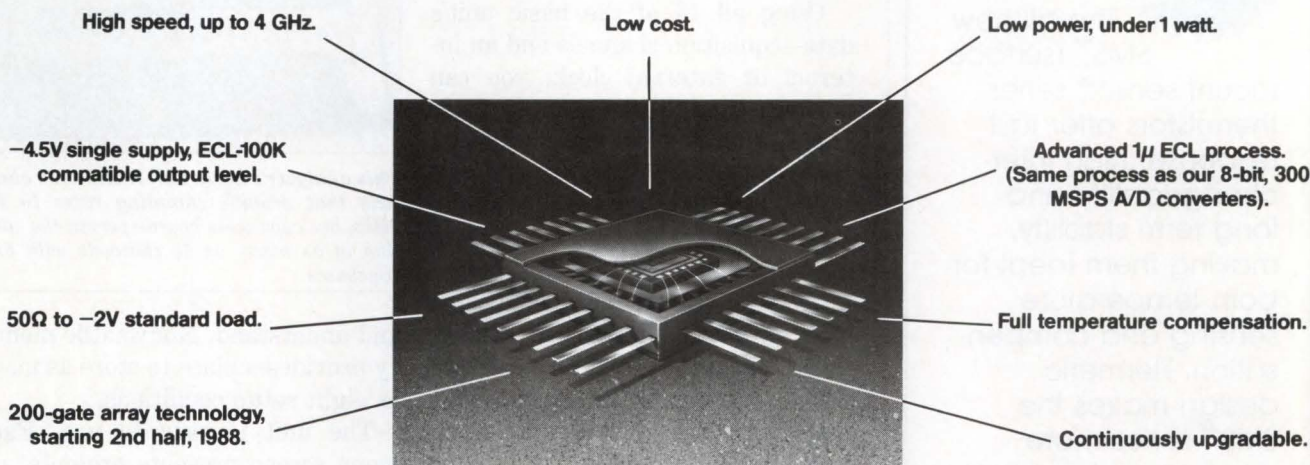

When you need high-speed logic, it really pays to look into Sony's ECL logic family.

Because like GaAs technology, you'll find incredibly fast process speeds. Up to 4 GHz.

But unlike GaAs technology, you'll also find amazingly low costs and design simplicity.

Not to mention that our ECL technology, unlike most, requires very low power. Under 1 watt, in many cases.

Sony's ECL logic family is made possible by our unique 1-micron, 10-GHz, FT process. The very process that's made our high-speed, 8-bit, 300 MSPS, A/D converters so popular.

And via our 200-gate array technology, we offer a limitless range of logic functions. Many available in 24 and 32-lead flat

## SONY'S HIGH-SPEED ECL LOGIC FAMILY

Part Number	Function	tpd	fmax	Power	Package
CXB1100Q	Quad 3-in OR/NOR	390 ps	1.5 GHz	530 mW	24 FLAT
CXB1101Q	Quad 3-in AND/NAND	470 ps	1.5 GHz	700 mW	24 FLAT
CXB1102Q	Quad 2-in EXOR/NOR	490 ps	1.5 GHz	680 mW	24 FLAT
CXB1103Q	Quint Line Receiver	410 ps	1.5 GHz	650 mW	24 FLAT
CXB1104Q	Dual D Flip Flop	620 ps	3.2 GHz	520 mW	24 FLAT
CXB1105Q	Triple Fan-out Buffer	590 ps	1.5 GHz	720 mW	24 FLAT
CXB1106Q	4-Stage Ripple Counter		3.4 GHz	720 mW	24 FLAT
CXB1107Q	Decision Circuit		3.2 GHz	430 mW	24 FLAT
CXB1108Q	Laser Driver		2.0 GHz	740 mW	16 FLAT
CXB1109Q	Quad D-FF with Master Reset	620 ps	3.4 GHz	790 mW	24 FLAT
CXB1110Q	16 to 1 Multiplexer	610 ps	1.5 GHz	680 mW	24 FLAT
CXB1111Q	Look Ahead Carry Block	580 ps	1.5 GHz	610 mW	24 FLAT
CXB1112Q	Phase Frequency Detector	720 ps	0.8 GHz	500 mW	24 FLAT
CXB1113Q	4 to 1 Multiplexer		2.0 GHz	950 mW	24 FLAT
CXB1114Q	1 to 4 Demultiplexer		2.5 GHz	1100 mW	24 FLAT
CXB1130Q	9, 8, 4-bit Multiplexer		1.6 GHz	730 mW	32 FLAT
CXB1131Q	9, 8, 4-bit Demultiplexer		1.6 GHz	1000 mW	32 FLAT
CXB1132Q	9, 8, 4-bit Universal Shift Register		1.3 GHz	910 mW	32 FLAT
CXB1133Q	22, 15, 7-Stage Scrambler		1.6 GHz	600 mW	24 FLAT
CXB1134Q	22, 15, 7-Stage Descrambler		1.6 GHz	610 mW	24 FLAT
CXB1135Q	8-16 bit Comparator		1.3 GHz	630 mW	32 FLAT
CXB1136Q	8-bit Universal Counter		1.2 GHz	730 mW	32 FLAT
CXB1137Q	8-bit Shift Matrix	1250 ps		700 mW	24 FLAT
CXB1138Q	4-bit Arithmetic Logic Unit	1460 ps		680 mW	24 FLAT

packs. The list you see here is only partial. So if you don't see what you need, please inquire with your specific requirements.

Sony's ECL logic family is available now, backed by the quality, reliability and nationwide service you expect from any Sony product.

So get all the information on our high-speed ECL logic family today. Because when it comes to high-speed logic performance, Sony's got the guts to deliver.

Just call the Sony representative nearest you, or call (714) 229-4192. Or write Sony Corporation of America, Component Products Division, 10833 Valley View Street, Cypress, CA 90630. FAX (714) 229-4271.

# SONY®

AL Huntsville (205) 533-1730  
Mobile (205) 478-1036  
AZ Phoenix (602) 257-9015  
CA Los Angeles (714) 855-0233  
San Diego (619) 729-9216  
San Francisco (415) 960-3880

CO Aurora (303) 695-8903  
FL (214) 234-8438  
GA Norcross (404) 449-8680  
IA Cedar Rapids (319) 393-2232  
IL Chicago (312) 382-3001  
IN Carmel (317) 844-5222  
Fl. Wayne (219) 486-1912

MD Randallstown (301) 655-2265  
MA Boston (617) 894-8400  
MI Livonia (313) 844-5222  
MN Eden Prairie (612) 944-7274  
MO Bridgeton (314) 291-4230  
Raytown (816) 358-8100

NJ Mt. Laurel (609) 866-1234  
NM Albuquerque (505) 345-3591  
NY Jamaica (718) 291-3232  
Syracuse (315) 699-2671  
Huntersville (919) 544-6630  
NC Durham (919) 544-6630  
Huntersville (704) 892-1366  
OH Cincinnati (513) 385-1105

Cleveland (216) 261-9705  
Tulsa (918) 744-9964  
OR Tigard (503) 620-3280  
PA Pittsburgh (513) 395-1105  
Greenville (615) 639-3491  
TN Austin (512) 346-9186  
Dallas (214) 234-8438

Houston (713) 782-4144  
UT Salt Lake City (801) 264-8050  
VA Sterling (703) 478-2480  
WA Bellevue (206) 455-3460  
Spokane (509) 924-4410  
WI Waukesha (414) 542-5352

## New hermetically sealed surface mount thermistor!

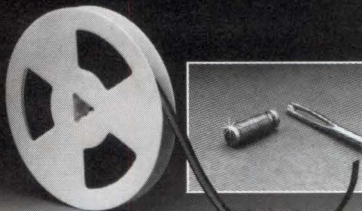

Available in bulk or tape and reel for automatic surface mounting.

The all new SMS™ (surface mount sensor) series thermistors offer fast response, high interchangeability and long term stability, making them ideal for both temperature sensing and compensation. Hermetic design makes the SMS™ series more durable and resistant to cleaning materials. The availability of a wide range of resistance values and slopes allows more flexibility in designing with surface mount applications.

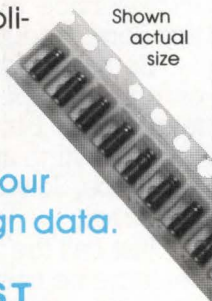

Phone or write for your free design data.

**MIDWEST  
COMPONENTS  
INC.**

P.O. Box 787  
1981 Port City Boulevard  
Muskegon, MI 49443  
(616) 777-2602  
TWX: 510-394-4130

CIRCLE NO 25

## PRODUCT UPDATE

### Modular logic analyzer offers expansion and ease of use

The Model 1230 modular logic analyzer consists of a basic unit to which you add plug-in boards to provide extra channels and other features as needed.

Using all 16 of the basic unit's data-acquisition channels and an internal or external clock, you can perform data capture at 25 MHz max. Using the internal clock and eight or four channels, you can capture data at a maximum of 50 or 100 MHz, respectively. Glitch capture is available on eight of the channels.

You can increase the analyzer's capacity to 64 channels by adding three expansion boards, each of which duplicates the basic unit's data-capturing capability and features its own timebase.

The analyzer stores data in any of four nonvolatile, 2047-bit/channel-deep memories. You can compare memories for display and view highlighted differences, or you can use memory comparison in trigger conditions. The system visually presents the data in memory as a timing diagram, a state display, or, if an optional probe is employed, as a disassembly of  $\mu$ P code.

The basic unit, as well as each expansion board, comes with a programmable threshold probe. This probe allows you to select from preset threshold values for TTL, ECL, and CMOS, or to program a threshold in 100-mV increments from -9 to +9V. Among the options you can obtain for the unit are TTL-only probes and disassembly probes for various 8- and 16-bit  $\mu$ Ps.

The unit offers 14 levels of triggering, with three IF-THEN-ELSE conditions available on each level. You can assign names to as many as 24 data values, then use these names as data in the triggering setup, making it easy to read

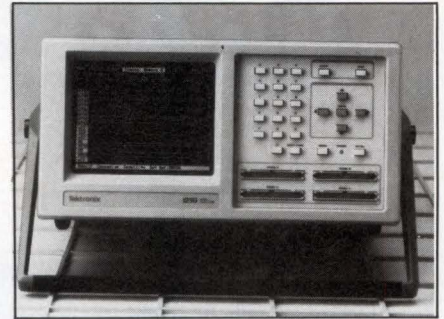

*This analyzer's basic unit features 16 channels that provide sampling rates to 100 MHz, but expansion boards permit the addition of as many as 64 channels with four timebases.*

and understand. Nonvolatile memory provides a place to store as many as eight setup conditions.

The unit is easy to use. Each menu screen presents prompts, reminding you which buttons to employ in making selections. Pressing the Notes key elicits a detailed explanation of the current menu selection. If you obtain the international-notes option, the unit will present these explanations in French, German, Spanish, or Dutch.

The basic unit comes with an RS-170 video output of the display screen. You can add a parallel printer port to produce hard copies of the display or to list the contents of the memory on a graphics printer.

You can also add an RS-232 or GPIB interface, permitting a host controller to block transfer data and setups and to emulate keystrokes for remote control of the unit.

Basic unit, \$2795; each channel-expansion board, \$1200; other options, from \$200;  $\mu$ P probes, from \$600. Delivery, for some options, 8 to 10 weeks ARO.

—Richard A Quinnell

*Tektronix, Box 12132, Portland, OR 97212. Phone (800) 245-2036; in OR, (503) 627-7111. TLX 151754.*

Circle No 698

# That "new" company making your Mallory-brand Aluminum Electrolytic Capacitors is lengthening its product line & shortening its name!

Our name has been

**AEROVOX  
MALLORY\***

Our new name is  
**Aerovox M**

Introducing American-made Snap-In/Snap-Mount Aluminum Electrolytic Caps



On-Shore Availability · Competitive Pricing · Superior Product!

There's not much to tell about our new, shorter Aerovox M name... except it's easier to say, and becomes official June 26th. There's a lot to tell about our new Made-in-U.S.A. snap-in/snap-mount LP, LPH and LPR series aluminum electrolytic capacitors!

When we took over Mallory's aluminum electrolytic product line last year, we were determined to bring this vital product back home... to again provide the closely coordinated engineering, production and on-time delivery missing since these products went offshore.

How can Aerovox M make them when other U.S. capacitor companies are still Asian-sourced? By installing a whole new automated department in our new Glasgow, KY plant! We've made the investment it takes in Computer Integrated Manufac-

turing (CIM), and continuous SPC QC to offset cheaper labor. The end result will be products that not only can be specified, engineered, tested and delivered faster than any competitor's, but snap-in/snap-mount products that are actually better built and more consistent! Our new all-welded design will provide superior performance throughout the life of the product.

We're in our final test-run mode and samples of this superior U.S. product are already being shipped. Now's the time to join our American Revolution and request your samples! Just tell your Aerovox representative — or us — your needs. Also, watch for 3rd Quarter announcements about a whole new family of miniatures and sub-miniatures soon to be available from Aerovox M — "The Source" for Aluminum Electrolytics!

# RTE Aerovox M

Glasgow, Kentucky 42141 • (502) 651-8301 • FAX 502-651-9312

**(502) 651-8301**

\*MALLORY is a trademark owned by and used under license from Emhart Industries, Inc.

Send for our new LP, LPH and LPR Series technical bulletins today!

**THE PROVEN  
PERFORMERS  
FOR 40 YEARS!**  
**JANCO ROTARY  
SWITCHES**

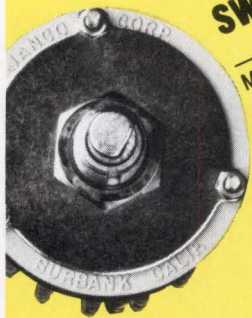

MINIATURE

**MIL SPEC  
QPL**  
MIL-S-3786  
and  
MIL-S-22710

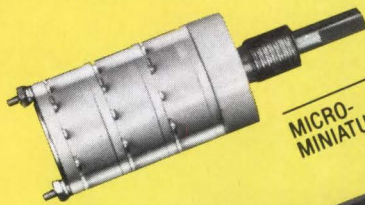

MICRO-  
MINIATURE

PUSHBUTTON  
ROTARY

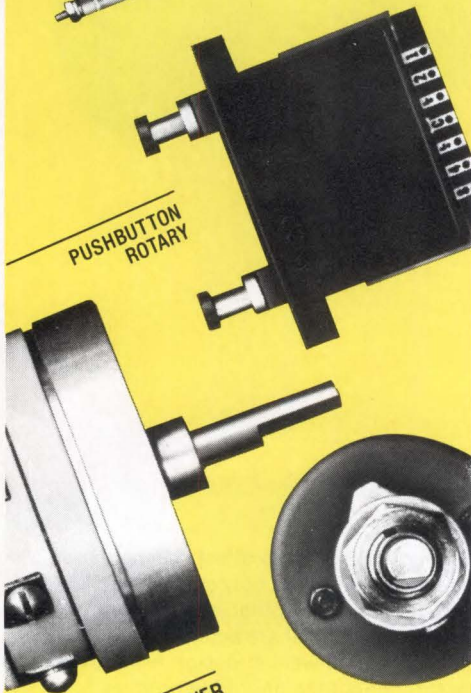

POWER

PRINTED CIRCUIT

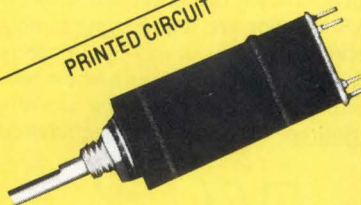

**Janco**  
AN ESOP CORP.

3111 Winona Avenue, Burbank, CA 91504  
(818) 846-1800 • TWX: 910 4982701

## PRODUCT UPDATE

### Microcode system puts control store in pod

The DS5000 microcode development system has its control-store ROM-emulation RAM (writable control store) in its target-system interface pods. The emulation memory of earlier microcode development systems resides in the chassis of these development systems. The longer connecting cables needed for the earlier architecture cause a significant propagation delay. The DS5000 exhibits 15- to 150-nsec access times, depending on the memory pod selected, for the system under development.

The DS5000's chassis has 16 card slots that will accept either memory-pod interface cards or logic-analysis cards. Thus, the system can either emulate a 512-bit-wide control-store ROM or perform 256-channel logic analysis—or provide some intermediate mix of the two functions. Each memory-pod interface card and logic-analysis card has its own independent clock.

The system's memory depth ranges from 1k- to 64k-words, depending on the configuration. Its 8- to 512-bit microcode word is addressable in 8-bit increments. It emulates ROMs, PROMs, and static RAMs—both registered and non-registered. Each emulated memory device can have as many as three chip-select inputs. The system is therefore more suitable for micro-programmed  $\mu$ Ps and ASICs that use conventional, byte-wide ROMs than for bit-slice  $\mu$ Ps, which need more flexible control stores.

Each logic-analyzer card features 16-level state-machine triggering with four word-recognizers per level. The cards can operate independently to monitor multiple asynchronous processes while one card—typically the one monitoring the

fastest process—serves as a synchronizing time stamp for the rest. The logic-analyzer cards perform software-performance analysis as well as state and timing analysis. The maximum timing resolution is 15 nsec. The memory pods provide only a TTL-level interface, but the logic-analysis cards handle ECL levels as well as TTL levels.

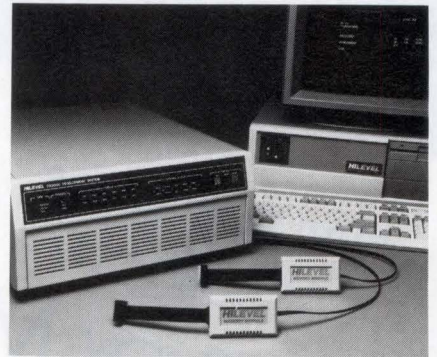

*The DS5000 microcode development system has its ROM-emulation writeable control store in its target-system interface pods, thus minimizing propagation delays caused by interconnecting cables.*

The unit requires a computer for control. Software is available for the IBM PC/AT and DEC VAX, Sun, or Apollo workstations. The cost of typical systems ranges from \$10,000 to \$20,000, depending on the configuration. You can expect delivery six weeks ARO.—**Charles H Small**

*HiLevel Technology Inc, 31 Technology Dr, Irvine, CA 92718. Phone (800) 445-3835; in CA, (714) 727-2100. TLX 655316.*

**Circle No 697**

# The complex world of microprocessor development just got simpler.

As the challenges of developing and debugging embedded microprocessor designs becomes more and more complex, you need the best development tools possible.

And nobody offers you higher reliability, better performance or a quicker way to develop and debug your 8, 16 or 32-bit systems than Applied Microsystems.

Our emulators, for example, can be controlled from the host computer you work with (VAX, Sun, Apollo, IBM PC or compatible). Your target system will run exactly as if its microprocessor were in place. And you'll get a clear picture of your design and how it interfaces with interrupts, clocks and the flow of software.

Our emulators are designed to work with easy-to-use VALIDATE software to give you powerful source level or symbolic debugging capabilities. You also get our powerful Event Monitor System, a hierarchical, real-time breakpoint and triggering system.

The list of benefits goes on and on; but the end result is a faster, easier and more accurate approach to developing, debugging and integrating your design.

To find out more, write Applied Microsystems Corporation, P.O. Box 97002, Redmond, Washington, USA 98073-9702. Or call (800) 426-3925, in WA call (206) 882-2000.

In Europe contact Applied Microsystems Corporation Ltd., Chiltern Court, High Street, Wendover, Aylesbury, Bucks, HP22 6EP, United Kingdom. Telephone 44-(0)-296-625462. AMC-230



Applied  
Microsystems  
Corporation

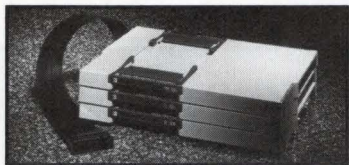

High-performance 8, 16 and 32-bit emulation.

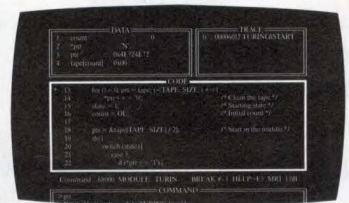

Software development tools, including source and symbolic level debuggers.



Motorola, Intel, Zilog and Hitachi microprocessor support.

# PRODUCT UPDATE

## BiCMOS chips expand memory applications of static RAMs

By combining the speed of ECL and the circuit density of CMOS, BiCMOS static RAMs have surpassed the performance of many bipolar and CMOS equivalents. As a result, BiCMOS chips with ECL I/O promise to supplant a growing number of existing memory devices in cache- and main-memory applications. (Three such BiCMOS devices were presented at the International Solid-State Circuits Conference in February.)

National Semiconductor's model NM5100 will be offered with access times of 15 and 18 nsec. You can buy sample quantities of the 18-nsec version now, and production quantities should be available in September; the 15-nsec version is scheduled for the first quarter of 1989. The device has 262,144-bit storage locations configured as two matrices of 16 blocks each; each block has 64 columns and 128 rows. By selecting only 64 cells at a time, the chip minimizes row-line delay and dc power consumption.

The NM5100's  $-5V \pm 10\%$  supply voltage allows an interface with 10K and 100K ECL. The chip draws 180 mA of quiescent current (0.9W dc power dissipation), and its input terminals meet the 2-kV ESD rating of MIL-STD-883.

The company proposes a new figure of merit for high-speed memories. By forming a product of two existing figures of merit—speed-power product and cost per bit—you obtain speed-power-cost per bit (in nanoseconds - milliwatts - cents/bit), allowing you to consider all the major tradeoffs when comparing memory ICs. This mode of comparison places the NM5100 ahead of most CMOS, bipolar, and GaAs memory devices.

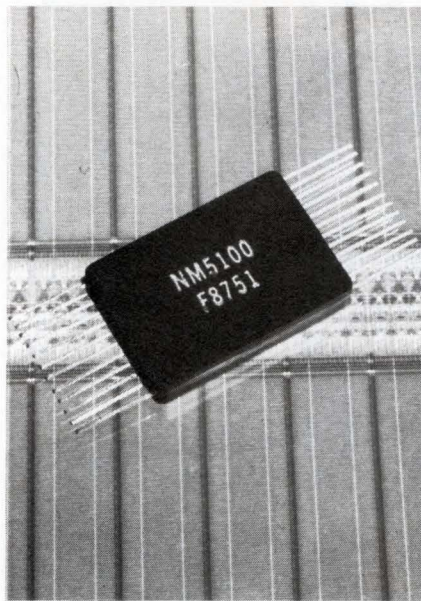

*Targeting workstation and large-computer applications, the model NM5100 BiCMOS, 256k-bit static RAM achieves access times as low as 15 nsec.*

The 1- $\mu$ m BiCMOS III process used to fabricate the NM5100 includes systems in the manufacturing line for monitoring device reliability during production. These systems define the process margins by correlating various device and process parameters with yield and burn-in data. By combining this data with statistical process-control techniques, production engineers can detect process-parameter drifts early enough to correct and stabilize them.

The NM5100 chip measures 213 $\times$ 386 mils. The packages include a 24-pin, 365 $\times$ 535-mil ceramic flat-pack with a 30-mil lead pitch, and a 24-pin, 400-mil-wide ceramic DIP. 18-nsec version, \$96; 15-nsec version, \$125 (100).—**Tarlton Fleming**

*National Semiconductor Corp., Box 58090, Santa Clara, CA 95052. Phone (408) 749-7421. TLX 346353.*

**Circle No 700**

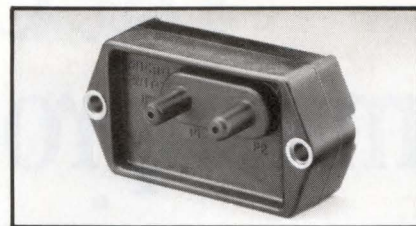

### Pressure sensors provide amplified output

140PC pressure sensors are individually calibrated and temperature compensated, then amplified so they can directly interface to control circuitry or A/D converters. They're ready to use, off-the-shelf.

These sensors provide a higher degree of accuracy than low level output products, and are interchangeable. PCB terminals exit on the opposite side of the ports. Optional 12-inch, 24 gauge color-coded leadwires are also available.

For more information or a FREE catalog covering our full line of pressure sensors, write MICRO SWITCH, The Sensor Consultants, Freeport, IL 61032. Or call 815-235-6600.

**CIRCLE NO 139**



### Up to 500 psi pressure sensor

The 240PC Series offers pressure sensing options ranging from -15 to 500 psi.

A rugged aluminum housing makes these sensors suitable for applications where durable packaging is required. Several types of internal O-ring seals are available for wide media compatibility with non-caustic fluids.

Accuracy comes from temperature compensating circuitry, computer-consistent calibration of null and full scale output, plus excellent repeatability. These sensors are amplified and fully signal conditioned.

For more information or a FREE catalog covering our full line of pressure sensors, write MICRO SWITCH, The Sensor Consultants, Freeport, IL 61032. Or call 815-235-6600.

**CIRCLE NO 140**

# How to sense liquid pressure without getting soaked.

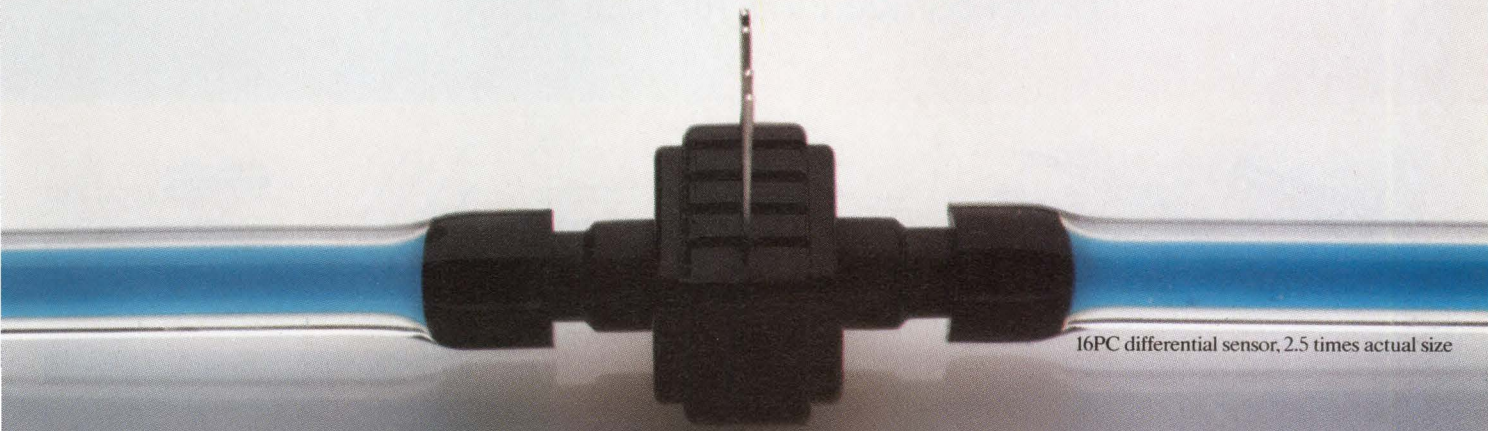

16PC differential sensor, 2.5 times actual size

At about \$15 a sensor, the 16PC is the lowest cost method of sensing the differential pressure of liquids and high-humidity gases.

And while our new miniature sensor is economical, it's also very reliable. Thanks to the unique new chip mounting technique we use. It seals the sensing element so that moist media can be applied to both sides of the sensor chip.

Temperature compensation and on-chip laser trimming add to reliability as well, ensuring high stability over 0-5, 0-15 and 0-30

pressure sensing ranges.

The 16PC Series is compatible with high volume circuit board assembly processes and is available in differential, gage and modular versions.

Applying technology innovatively is just one of the ways we can help you save money. To find out more, call us at 815-235-6600. Or write MICRO SWITCH, Freeport, IL 61032.

Together, we can find the answers.

**MICRO SWITCH**  
a Honeywell Division

CIRCLE NO 141

JOIN US AT CONTROL ENGINEERING EXPO, JUNE 7 BOOTH #507

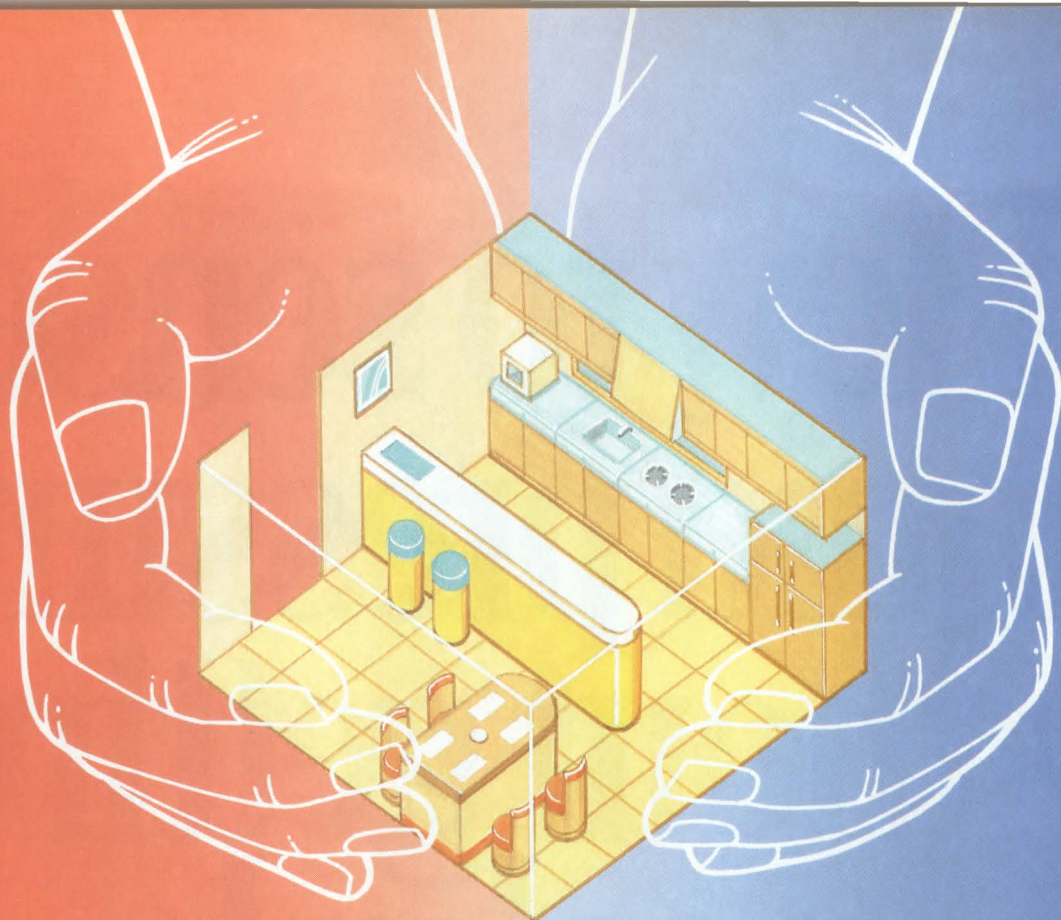

## The Gift of Security—TDK Sensors

Talk to TDK about temperature sensing and control components for your appliances.

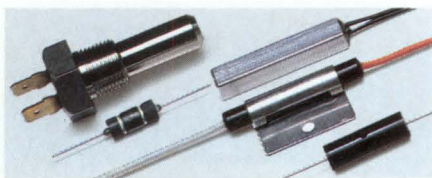

### TDK Temperature Responsive Reed Switches

Constant temperature switches. Sensors utilizing ferrite + ferrite magnet technology. Vastly more accurate than bimetal switches. High stability and reliability, made for the long haul. Freely selectable activation temperatures between  $-10$  and  $+130^{\circ}\text{C}$  ( $14$  and  $+266^{\circ}\text{F}$ ). Standard increments of  $5^{\circ}\text{C}$  ( $9^{\circ}\text{F}$ ).

#### **New! Completely molded type**

Totally molded for extra compact size, highest stability and unvarying sensitivity. TDK Temperature responsive reed switch to choose for critical applications.



### TDK PTC Thermistors

Positive temperature coefficient thermistors made of semiconductive  $\text{BaTiO}_3$  ceramic. The sudden surge of electrical resistance at a given Curie temperature opens up a wide range of applications in temperature sensing. Curie temperature point freely selectable (by proper choice of materials), from  $-20$  to  $+330^{\circ}\text{C}$  ( $4$  to  $626^{\circ}\text{F}$ ). Also usable in constant temperature heating devices and current limiting elements.

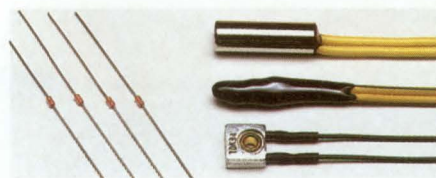

### TDK NTC Thermistors

Negative temperature coefficient thermistors obtained by sintering oxides of Mn, Co, Ni, etc. Resistance drops abruptly at a given temperature. Widely used in temperature sensing and control applications. Hermetically sealed in glass, therefore impervious to high temperatures and humidities. Good temperature vs. resistance linearity, high long-term reliability.



TDK CORPORATION OF AMERICA HEAD OFFICE 1600 Feehanville Drive, Mount Prospect, IL 60056, U.S.A. Phone: (312) 803-6100 CHICAGO REGIONAL OFFICE Phone: (312) 803-6100  
 INDIANAPOLIS REGIONAL OFFICE Phone: (317) 872-0370 NEW YORK REGIONAL OFFICE Phone: (516) 625-0100 LOS ANGELES REGIONAL OFFICE Phone: (213) 539-6631  
 DETROIT DISTRICT OFFICE Phone: (313) 353-9393 NEW JERSEY DISTRICT OFFICE Phone: (201) 736-0023 HUNTSVILLE DISTRICT OFFICE Phone: (205) 539-4551 GREENSBORO  
 DISTRICT OFFICE Phone: (919) 292-0012 DALLAS DISTRICT OFFICE Phone: (214) 506-9800 SAN FRANCISCO DISTRICT OFFICE Phone: (408) 437-9585  
 TDK CORPORATION. TOKYO, JAPAN.



## RISC chip set has CPU, floating-point and integer math, cache, and MMU

The Motorola 88000 chip set takes advantage of the silicon-saving RISC architecture to integrate all the major CPU-board functional blocks. The 88100 CPU includes multiple pipelined execution units, and integer and floating-point math processors. The 88200 CMMU (cache memory management unit) features an MMU (memory management unit), a cache controller, and a 16k-byte cache.

Based on a Harvard-type architecture, the 88100 implements separate instruction and data paths. The 88100's minimum configuration connects to two 88200 CMMUs, one for data and one for instructions, whereas the 88000 chip set's minimum configuration provides both 17 MIPS and 34,000 Drhystones (the MIPS spec is normalized to VAX MIPS). Using the 88000 chip set in multiprocessor designs further boosts performance specs.

These processors provide such high performance levels because the RISC architecture's characteristics require less silicon to implement than do the CISC architecture's. Therefore, designers can add to chips such features as pipelining, multiple execution units, and combined MMU and cache controllers. This integration eliminates chip-to-chip delays and lets operations occur concurrently, resulting in a faster CPU.

Consider, for example, the 88200 CMMU chip, which includes both an MMU and a cache. The IC concurrently performs the MMU address-translation task and effects the access to on-chip cache memory. This concurrency results in zero-wait-state access on cache hits, despite the fact that the cache is physically mapped to ensure cache coherency. Designs employing a separate,

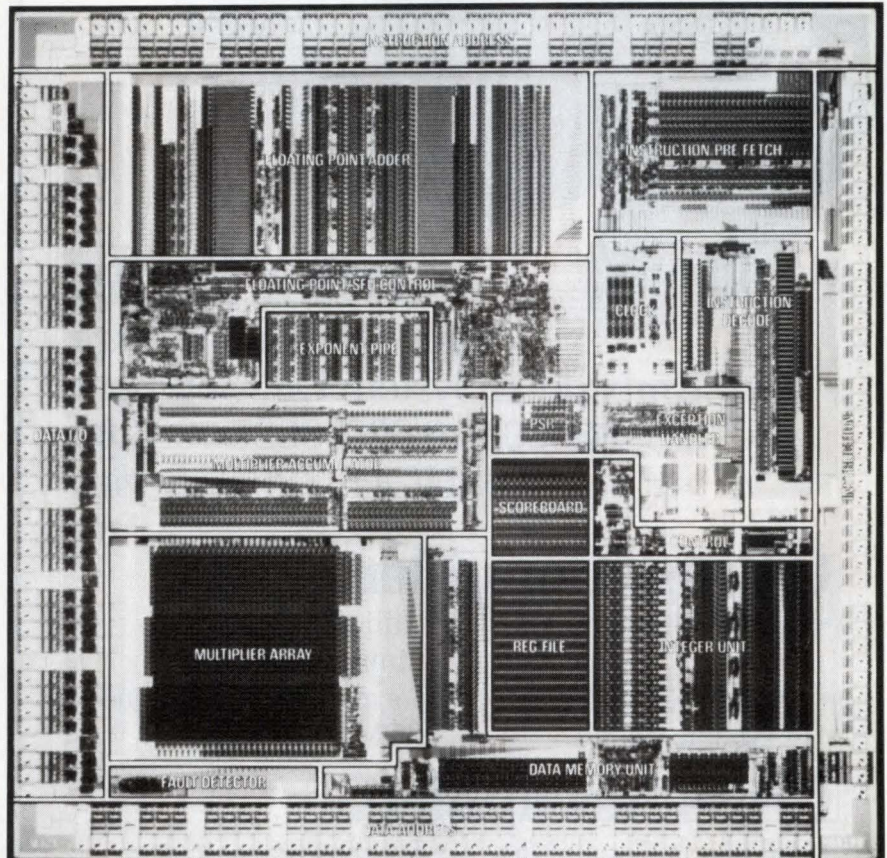

*Multiple execution units and register scoreboarding allow the RISC-based 88100 CPU to launch an instruction every clock cycle.*

physically mapped cache and an MMU usually have to implement virtual caches to achieve zero-wait-state operation.

The 88200 includes a 16k-byte, 4-way-set-associative cache; increasing the number of associative sets in a cache improves the hit rate more than does merely increasing the cache's size. The cache controller employs a "least recently used" algorithm to replace cached data. You can connect as many as four 88200s to the 88100's instruction pipeline, and four more 88200s to the data pipeline. The controller also monitors all memory-bus operations to automatically maintain cache coherency when multiple

CMMUs are used.

The 88100 CPU includes separate pipelines for instructions and data. The chip includes 32 general-purpose registers and uses register "scoreboarding" techniques to accommodate the concurrent execution and manipulation of multiple instructions. All the integer, logical, bit-field, and branch operations execute in one clock cycle. The concurrency achieved by the pipelines and register scoreboard allows the chip to launch an instruction every cycle.

The initial version of the chip features a 20-MHz clock. Motorola plans to speed up the chip and may build the device with ECL technology in the future. At the 20-MHz

processor clock speed, the buses between the CPU and CMMU chips operate at 160M bytes/sec, and the cache to main memory bus operates at 64M bytes/sec.

The 88000 chip set is suitable for use in tightly coupled multiprocessor systems. You can interface as many as four 88000 chip sets to one block of main memory and have the four processors execute a single copy of the operating system. The 88200 CMMU units include hardware to maintain cache coherency in such multiprocessing environments.

Motorola's Microprocessor Products Group plans to make the chips available in PGA (pin grid array) packages in the third quarter at a cost of \$375 for the 88100 and \$480 for the 88200 (100). In addition, Motorola's Microcomputer Div plans to offer the chips on an 8.5x3.4-in. hybrid module that will accommodate as many as four 81000 and eight 82000 chips in a multiprocessor configuration. A single-processor module, the HM88K-1P32, with one CMMU for instructions and one CMMU for data, will be offered at a cost of \$1400 (100) in the third quarter.

For development support, the company currently offers in limited quantity a system with an 88100 chip but a discrete MMU/cache. In the third quarter, it will offer a system that includes the full chip set. Both systems incorporate the AT&T Unix 5.3 operating system and assembler; a linker; and C and Fortran software packages. For software development, you can also purchase prerelease versions of an assembler, linker, and simulator that execute on 68000-based systems. —**Maury Wright**

*Motorola Microprocessor Products Group, 6501 William Cannon Dr W, Austin, TX 78735. Phone (512) 440-2839.*

**Circle No 695**

*Motorola Microcomputer Div, 2900 S Diablo Way, Tempe, AZ 85282. Phone (602) 438-3500.*

**Circle No 696**



## InterTools™ Time Saving Software For Embedded System Development 68000/010/020, 8086/186/286 68HC11, Z80, V Series

### C Cross Compilers

- Global Optimization Features
- Produce Re-entrant, ROM-able Code
- Utilities include Linkers, Locators, Formatters, and Unique ROM Processor

### Cross Assemblers

- Full Macro Capabilities
- Include Complete Utilities Set
- Support Relocatable, Combinable, and Absolute Segments

### XDB Cross Debuggers

- Debug at C or Assembly Source Code Level
- User-Friendly Interface and Command Set
- Powerful Assertion, Breakpoint Commands
- Direct Command Interface to Emulator

InterTools are available for VAX, SUN, Apollo, HP, IBM PC, and other engineering computers.

Demo Disks available.

**Intermetrics, Inc.**  
**Software Products Division**  
**733 Concord Avenue**  
**Cambridge, MA 02138**  
**(617) 661-0072**  
**Toll-Free: 1-800-356-3594**



**Intermetrics**

CIRCLE NO 27

# IF YOU'RE WASTING TIME LOOKING FOR THE BROADEST LINE OF SMD<sup>®</sup> PASSIVES,

## CUT IT OUT!

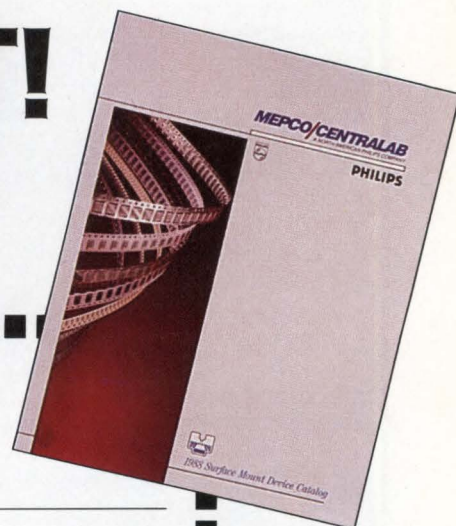

**Mail to: Mepeco/Centralab, Attn: Corp. Advertising  
2001 W. Blue Heron Blvd., Riviera Beach, FL 33404.**

Mail this coupon today to request your personal copy of the new Mepeco/Centralab Surface Mount Device Catalog, containing important design, performance and specifying data on America's broadest line of SMD<sup>®</sup> passive components:

- Tantalum and monolithic ceramic chip capacitors
- Aluminum electrolytic capacitors
- Thick-film and precision metal-film resistors
- Power resistors
- High-performance trimmers
- Selector switches

Or ask for our valuable data book on leaded resistors and capacitors.

**Please send me these specification guides:**

- 1988 Surface Mount Device Catalog  
 Resistor/Capacitor Data Book

Name \_\_\_\_\_  
Title \_\_\_\_\_  
Company \_\_\_\_\_  
Dept. / Div. \_\_\_\_\_  
Address / MS \_\_\_\_\_  
City \_\_\_\_\_  
State / Zip \_\_\_\_\_

EDN052688

**MEPCO/CENTRALAB**  
A DIVISION OF NORTH AMERICAN PHILIPS CORPORATION

**PHILIPS**



®SMD is a service mark of North American Philips Corporation.

**CIRCLE NO 143**

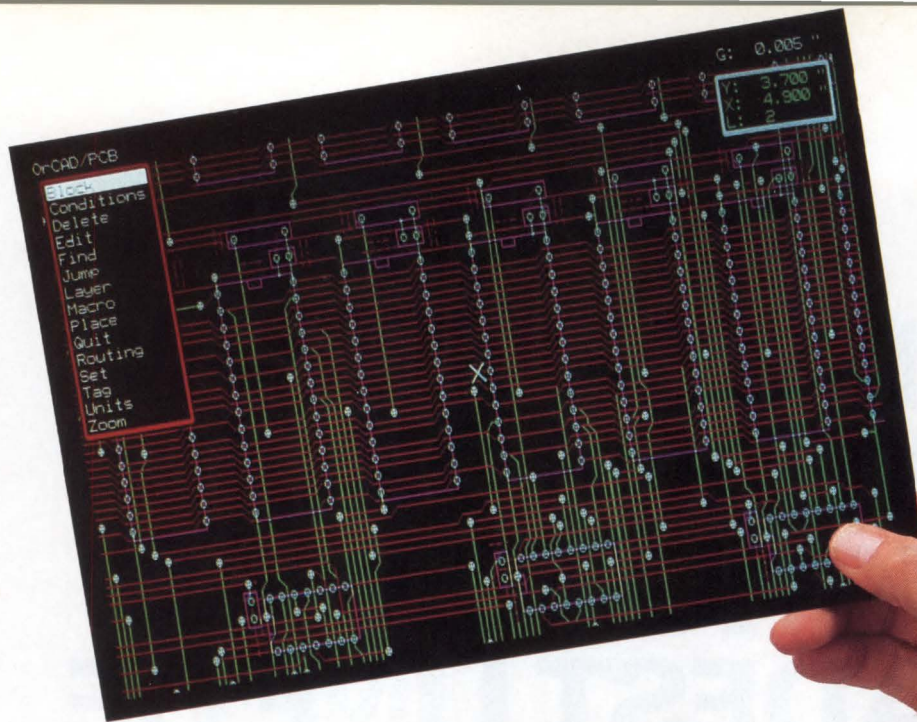

## PCB LAYOUT ON YOUR PC. FOR ONLY \$1495. OrCAD PCB COMES TO LIFE.

**W**ith nearly 10,000 systems already in use, electrical engineers like the no-nonsense capability of OrCAD/SDT schematic capture. Well, now there's even more to like. Introducing OrCAD/PCB. A fast, easy-to-use PCB layout package that runs on your PC. And costs only \$1,495.

### A NO-NONSENSE DESIGN TOOL FOR NO-WAIT DESIGNERS.

OrCAD/PCB pumps up your productivity. Pop-up menus appear in a flash. Macros speed repetitive operations.

Bit-mapped graphics make redraws, zooms and pans instantaneous. And, since you know SDT, you have no new commands to learn; PCB's interface is exactly the same.

### POWER AND FLEXIBILITY MINUS CLUTTER.

OrCAD/PCB produces structured, elegant PCB layouts. It auto-routes boards up to 32"x32" with up to 8,000 track segments and 16 layers, taking into account manually routed connections. And, it adapts to your design with features like:



Find your OrCAD region number on this map; then locate your sales and support representative on the list below.

- Selectable track and via widths from 0.001" to 0.255"
- Square, rectangular, round, elliptical, and SMD pads.
- Grid bases of 100, 50, 25, 10 and 5 mils. Or, go off grid to 1 mil.

- Support for digital and analog components and surface-mount devices.
- Ratsnest and force vector placement.
- Definition of board edge, forbidden zones, and copper zones.

### GIVE OUR DEMO DISK A SPIN.

If you need affordable, no-nonsense PCB layout, call for a free OrCAD/PCB demo disk. Not an OrCAD user? Call for the SDT demo disk while you're at it (OrCAD/SDT costs only \$495). Then, watch your PCB layouts take shape.

#### OrCAD sales and support representatives.

- |  |  |  |   |
|--|--|--|---|
| 1. WA, OR, MT, ID, AK<br>Seltech, Inc.<br>206-746-7970               | 5. ND, SD, MN, W, WI<br>Comstrand, Inc.<br>612-788-9234              | 11. FL<br>High Tech Support<br>813-920-7564                        | 16. BC, AB, SK, MB<br>Interworld Electronics &<br>Computer Industries, Ltd.<br>604-984-4171 |
| 2. N. CA, Reno NV<br>Elcor Associates, Inc.<br>408-980-8868          | 6. NE, KS, IA, MO<br>Walker Engineering, Inc.<br>913-888-0089        | 12. DE, VA, MC, DC<br>MGM Visuals<br>703-352-3919                  | 17. ON, PQ<br>Electralert, Ltd.<br>416-475-6730   |
| 3. S. CA<br>Advanced Digital Group<br>714-897-0319                   | 7. TX, OK, AR, LA<br>Abcor, Inc.<br>713-486-9251                     | 13. MS, AL, GA<br>Electro-Cadd<br>404-446-7523                     |   |
| 4. Las Vegas NV, UT, AZ, NM, CO<br>Tusar Corporation<br>602-998-3688 | 8. MI, E, WI, IL<br>Cad Design Systems, Inc.<br>312-882-0114         | 14. E. PA, NJ, NY<br>Beta Lambda, Inc.<br>201-446-1100             |   |
|  | 9. IN, OH, KY, WV, W. PA<br>Frank J. Campisano, Inc.<br>513-574-7111 | 15. CT, RI, MA, VT, NH, ME<br>DGA Associates, Inc.<br>617-935-3001 |   |
|  | 10. TN, NC, SC<br>Tingen Technical Sales<br>919-878-4440             |  |   |

OR8801

**OrCAD**<sup>™</sup>  
Systems Corporation

1049 S.W. Baseline St., Suite 500  
Hillsboro, OR 97123  
503-640-5007

## Mix-and-match logic-analyzer modules fit acquisition needs

The ML4400, a modular logic analyzer, is based on a mainframe that can take as many as four capture modules. Each capture module time-stamps the acquired data, thus allowing you to display this data from each of the modules simultaneously on a split screen. All data, both synchronous and asynchronous, is lined up on the screen in time for easy viewing. You can use cross-triggering to trigger the modules together, or you can use each module as a separate logic analyzer.

For example, a single ML4400 can be configured to analyze two 68020  $\mu$ Ps, 20 channels at 100 MHz, and 4 channels at 400 MHz. You can cross-trigger all of these modules, and with time-stamping, you can display data captured from any module with that from another module.

The standard capture module acquires 20 channels containing 8192 samples at 100 MHz asynchronous and 40 channels containing 4096 samples at 50 MHz synchronous. The ability to acquire data at 50 MHz synchronously should keep up with available  $\mu$ Ps for some time. It is necessary to use synchronous acquisition when analyzing  $\mu$ Ps in order to gather data when it is stable.

The logic pods available for the standard capture module are the standard 100-MHz pod and the 80-channel, 25-MHz expansion pod. The expansion pod multiplexes the input to allow 80-channel acquisition for the standard 100-MHz pod with a maximum rate of 25 MHz.

The  $\mu$ P pods interface with the standard capture module. Pods for the 8086, 68000/68010, 68020, 8085/8031/8035, 6800/6802/6808, 6809/6809E, 6502, NSC800, and Z80 are available. All of the  $\mu$ P pods include



*The keypad, soft keys, menus, and on-line help screens make this logic analyzer easy to use. The keypad tilts up to allow easy access to the logic-pod input connectors without giving up front panel space.*

the ability to disassemble the captured data. Also, if you have pods that work with the ML4100, you can get an adapter for the ML4400.

The high-speed capture module acquires 4 channels at 400 MHz with a sample depth of 32k samples. It can also be used to capture 8 channels with 16k samples at 200 MHz or 16 channels with 8k samples at 100 MHz. The high-speed capture module can also support transitional timing.

Two logic pods are available for the high-speed module—the 400- and the 200-MHz pods. The 400-MHz pod has 16 channels so you need only one of these pods for as many as four high-speed capture modules. You can use the 200-MHz pod for more than one application—for example, using 8 channels at 200 MHz, the 200-MHz pod provides glitch-capture circuitry, or it can acquire 16 channels at 100 MHz synchronous.

You control the ML4400 from a front panel keypad and soft keys under the 7-in. display or with a standard IBM PC-style keyboard. The system is set up via menus and has on-line help screens. When the logic analyzer is turned on, it de-

**DISPLACEMENT** This DC-operated linear displacement sensor incorporates unique monolithic circuitry and ratio-metric design for accurate, repeatable measurements — at very affordable prices.

With an operating temperature range of +32° to +160°F and linearity at 0.25% full range, our DC-LVDT operates efficiently in tough environments.

Measuring DISPLACEMENT, PRESSURE, ACCELERATION, FORCE/WEIGHT, SLOPE/TILT, or VELOCITY? For nearly half a century, we've demonstrated our commitment to sensor technology with products for a variety of measurement applications.

For complete information on the DC-LVDT, write Schaevitz, U.S. Route 130 & Union Avenue, Pennsauken, NJ 08110 or call our **Hot Line: 609/662-8008.**

Grid Scale: 3/8" x 3/8"

**At Last . . .  
High  
Performance  
DC-LVDTs  
Become  
AFFORDABLE**



**schaevitz**

The Name in Sensor Technology

Single Output Up To 400A  
**RELIABLE SYSTEM  
 POWER. PERIOD.**

Case 10

- 750 to 2000 Watts
- 5" x 8" x 11"
- N + 1 Redundancy
- AC and DC Inputs
- 1 to 5 Outputs
- 50A Auxiliary Mag
- Amp Output Ch 2

For 5x8x11 "slot" switching power supplies from 750 to 2000 Watts, the Qualidyne Case 10 is all you need to know. MTBF of 150,000 hours. Single or multiple (up to 5) fully regulated outputs from 2 to 48 VDC. Precision paralleling for N+1 redundancy. AC and DC input voltages. Safety listings from UL, CSA and TUV. Compliance with IEC 380 & VDE 806. FCC 20780 Class A filtering. Nothing fancy, just reliable slot power—period.



**THE SWITCHER FIT FOR YOUR NEEDS**

**Qualidyne**

Qualidyne Systems, Inc.

3055 Del Sol Boulevard, San Diego, CA 92154  
 (619) 575-1100 Telex: 709 029 FAX: 619 429 1011  
 (800) 445-0425 In Calif. (800) 237-6885

CIRCLE NO 29

**Well-Connected**

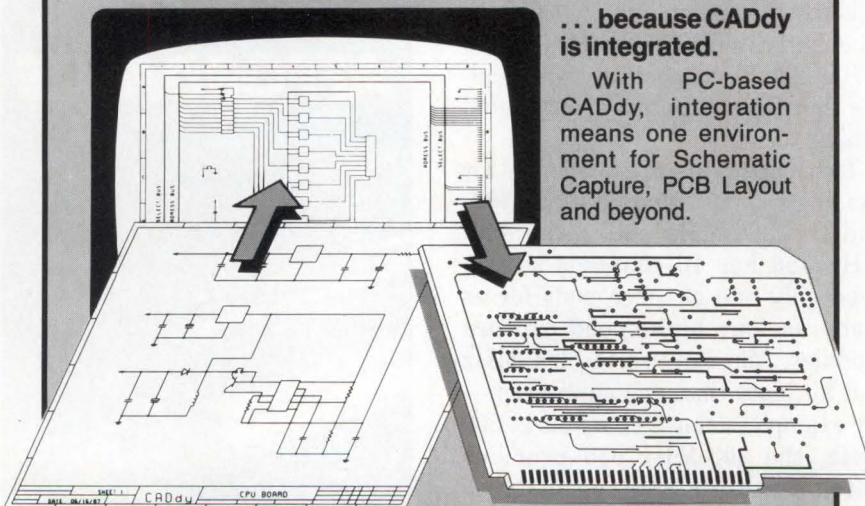

... because CADdy is integrated.

With PC-based CADdy, integration means one environment for Schematic Capture, PCB Layout and beyond.

Multi-sheet schematics with dynamic dragging, auto-naming/numbering, board pin/gate swapping with back-annotation, manual routing and multi-layer, gridless, rip-up/retry auto-routing, Gerber and Excellon: all on XT, AT, 386, PS/2 with co-processor . . . all **well-connected**.

**CADdy Corporation**  
 3401 Algonquin, Suite 340  
 Rolling Meadows, IL 60008  
 Call (312)394-7755 or 1-800-CADdy 11

**CADdy**

CIRCLE NO 30

**UPDATE**

faults to a mode that allows simple types of acquisition for inexperienced users.

The pods connect to the front of the ML4400 where you can access the connectors by lifting the tilt-up front panel. This arrangement provides easy access to the cables on the front of the instrument and avoids wasting front-panel space.

The mainframe comes standard with serial and parallel printer interfaces, trigger outputs, a color-video interface for the IBM EGA, CGA, and compatibles, an IBM PC-style keyboard interface, eight non-volatile setups, and a ROM emulator interface without the probe. An optional 3½-in. floppy-disk drive is available for data storage.

A starter system is available that includes the mainframe, a standard capture module, and a 40-channel logic pod for \$4995. The mainframe costs \$2895, the standard capture module is \$1795, the high-speed capture module is \$1995, the 200- or the 400-MHz pod costs \$1995, and the μP pods range from \$500 to \$1690. You can expect delivery in four to six weeks ARO.—**David Shear**

*Arium Corp, 1931 Wright Circle, Anaheim, CA 92806. Phone (800) 862-7486; in CA, (714) 978-9531.*

**Circle No 694**

***LOOK WHAT ELEVEN  
YEARS, 2 MILLION CPUs, AND  
16 THOUSAND BOARD AND  
SYSTEM BUILDERS ARE DOING  
TO THE WORLD'S FIRST  
OPEN STANDARD BUS...***

# ...THEY'RE MAKING IT STRONGER, POWERFUL, AND MORE POPULAR

## MULTIBUS I: TODAY'S MOST POPULAR, BEST SUPPORTED AND EASIEST TO IMPLEMENT OEM BUS.

Back in 1976 when Intel introduced Multibus I, it was 8-bits wide and supported the only major microprocessor then in existence, the 8080.

The world loved the open bus concept and jumped on the Multibus bandwagon. Quickly, Multibus I gained a level of acceptance that remains unequalled today.

*1976: The debut of Multibus I. Few would have dared to predict the impact it would have on the world.*

And, while Multibus I has remained true to its foundation as a solid, dependable standard, it has undergone a carefully controlled evolution that has produced a thoroughly modern architecture. One capable of supporting the newest 32-bit microprocessors, as well as the first Multibus board ever built, *in the same system!*

This unmatched compatibility, coupled with the ability to absorb new technology, has made Multibus I today's most popular, most versatile, best supported and easiest to implement OEM bus architecture.

### FOUNDATION OF THE MULTIBUS FAMILY.

In 1982, Intel introduced Multibus II, a totally new *advanced* bus architecture designed not to replace Multibus I, but to open

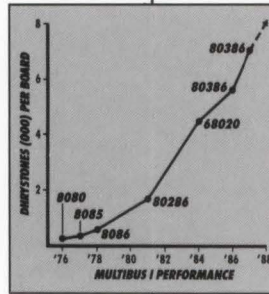

up entire new classes of applications impossible with Multibus I, VME or other traditional architectures.

Today, Multibus I remains the architecture

of choice for a myriad of new designs, and provides a smooth, economical upgrade path for existing applications.

### KEEPING PACE WITH TECHNOLOGY, WITHOUT COMPROMISING COMPATIBILITY.

Multibus I has done what no other architecture

*Today's Multibus I supports every major microprocessor architecture.*

**INTEL DELIVERS THE WORLD'S FIRST SINGLE BOARD COMPUTER**



**NOW MULTIBUS I CAN PROCESS THE BIGGEST NUMBER IN COMPUTING.**

*1986: The world's most powerful 32-bit microprocessor, the 80386, is introduced on Multibus I before any other bus.*

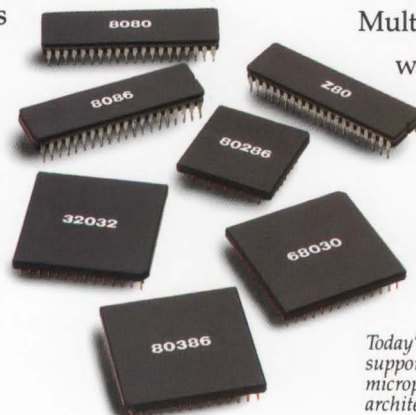



# FASTER, MORE THAN EVER BEFORE.

in history has been able to do: successfully absorb more than a decade of rapid technological advancement without compromising compatibility. From one generation of products to the next.

And  
from one vendor  
to the next.

In part this is due to the architecture itself, refined over the years by IEEE committees. In part it is due to the series of bus extensions that have helped Multibus I keep pace with the performance of newer buses.

But, mostly, Multibus I's success can be attributed to more than 240 manufacturers who have added their ingenuity to develop over

2,000 different Multibus I products to solve a wider range of applications than any other bus. Period.

## WHAT'S NEW ON MULTIBUS I TODAY?

Today's Multibus I is loaded with exciting new products incorporating the latest VLSI and specialized technologies. You can use it to solve new applications efficiently and economically. And breathe new life into existing Multibus I applications.

Without expensive redesigns. And, without abandoning the comfort and security of the bus that's supported more success stories than we can even count.

## THE BEST IS YET TO COME.

Recent months have seen many important new Multibus I hardware and software products. For the full story, circle the reader service number or contact the Multibus Manufacturers Group.

Each of the companies on the back of this ad will send you complete technical data

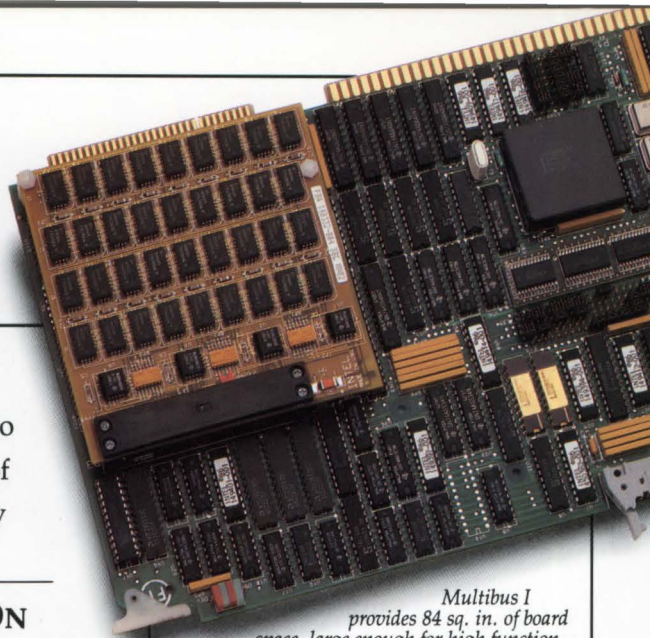

*Multibus I provides 84 sq. in. of board space, large enough for high functionality, yet small enough to be economical in low density designs. The LBX and SBX bus extensions add low-cost memory expansion and I/O customization.*

on their latest offerings. Plus timely announcements of future new products.

And, to keep your Multibus I library organized, we'll send you this convenient, indexed bookshelf binder absolutely free.

So don't delay. Find out what's new on Multibus I. And discover why the most successful commercial bus architecture in history is

stronger,  
faster,  
more powerful,  
and more popular than  
ever!



**CIRCLE NO. 98**



**MULTIBUS MANUFACTURERS GROUP**

P.O. Box 6208 Aloha, OR 97007 (503) 629-8497

Multibus® is a trademark of Intel Corp.

# WE'RE HERE FOR YOU!













The companies listed below would like you to know that Multibus I is alive and well and prospering. Multibus I offers the broadest product family. Plus scores of new products incorporating the very latest technology.

Whether you're developing new applications or upgrading existing ones, these industry leading companies offer a wide range of Multibus I products to give you the competi-

tive edge. Today. And long into the future.

For your free Multibus I Data Book plus future new product announcements, just return the reader service card. Or for faster response, call the MMG or one of the participating companies listed below.

Discover the many *new* reasons Multibus I is today's most popular, most versatile, best supported and easiest to implement OEM bus.

		CPU's	Digital I/O	Analog I/O	Special I/O	Periph Cont	Comm/Net	Graphics	Memory	Software	Packaging	Systems		
	P.O. Box 1037 Attleboro, MA 02703 Contact: Dept. X2403 (617) 222-2202 FAX (617) 226-5257											*	245 West Roosevelt Road West Chicago, IL 60185 Contact: Peter A. Czuchra (800) 638-5022 In IL: (312) 231-6880	
	1602 Newton Drive Champaign, IL 61821 Contact: Mike Heins (800) 482-0315 FAX (217) 359-6904	*	*		*	*	*		*	*	*	*	2400C Bisso Lane Concord, CA 94520 Contact: Sales Admin. (415) 680-7722 TWX 910-366-2116	
	6790 Flanders Drive San Diego, CA 92121 Contact: Frank Hom (800) 854-7086 In CA: (800) 772-7086								*			*	3445 Fletcher Avenue El Monte, CA 91731 Contact: Mike Burton (800) 227-0557 FAX (818) 444-3953	
	Intel Corporation 3065 Bowers Avenue Santa Clara, CA 95051 (800) 548-4725	*	*	*	*	*	*	*	*	*	*	*	339 N. Bernardo Avenue Mountain View, CA 94043 Contact: Jerry Tennant (415) 964-5700 Telex 184160	
	2925 Merrell Road Dallas, TX 75229 Contact: Sales Admin. (214) 350-9000 FAX (214) 350-1433				*	*							53 Third Avenue Burlington, MA 01803 Contact: Kindra Alaimo (617) 272-8140 FAX (617) 273-5392	
	785 Lucerne Drive Sunnyvale, CA 94086 Contact: Bill Burton (408) 720-9300 FAX (408) 773-9475	*	*	*	*	*	*	*	*	*	*	*	6700 Sierra Lane Dublin, CA 94568 (415) 828-3000 Telex 910-389-4009 FAX (415) 828-1574	
	10 Mupac Drive Brockton, MA 02401 Contact: Steve Cobb (617) 588-6110 FAX (617) 588-0498										*		<i>Use this convenient product reference guide to quickly locate the companies that offer the types of Multibus I products you need.</i>  <b>CIRCLE NO. 98</b>	

The Multibus Manufacturers Group, or MMG, is dedicated to the proposition that everyone benefits from strong, open standards. Membership is open to hardware and software manufacturers, application integrators, end users and even students.

To learn more about what the MMG can do for you, contact Dan Fink, MMG executive director.

**MULTIBUS MANUFACTURERS GROUP**

P.O. Box 6208 Aloha, OR 97007 (503) 629-8497



# READERS' CHOICE

Of all the new products covered in EDN's **March 3, 1988**, issue, the ones reprinted here generated the most reader requests for additional information. If you missed them the first time, find out what makes them special: Just circle the appropriate numbers on the Information Retrieval Service card, refer to the indicated pages in our **March 3, 1988**, issue, or use EDN's Express Request service.

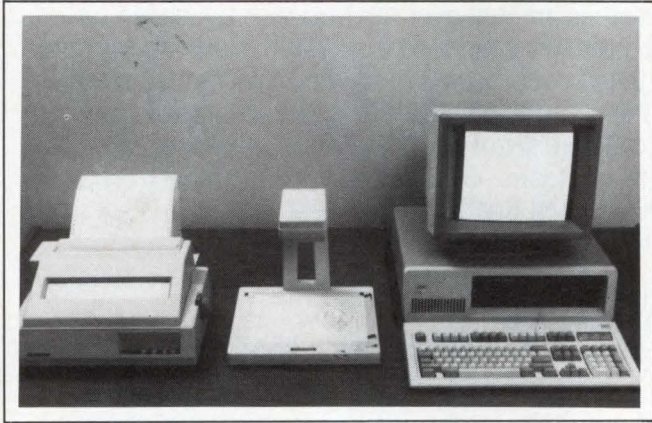

## ◀ IMAGE SCANNER

The N-205 image scanner provides user-selectable resolution to 200 dots/in. and employs an image sensor that performs overhead scanning of documents (pg 190).

**Chinon America Inc.**

**Circle No 604**

## PC AUTOROUTER

PADS-SuperRouter is a 3-stage pc-board routing package that runs on 80286- or 80386-based computers (pg 208).

**CAD Software Inc.**

**Circle No 606**

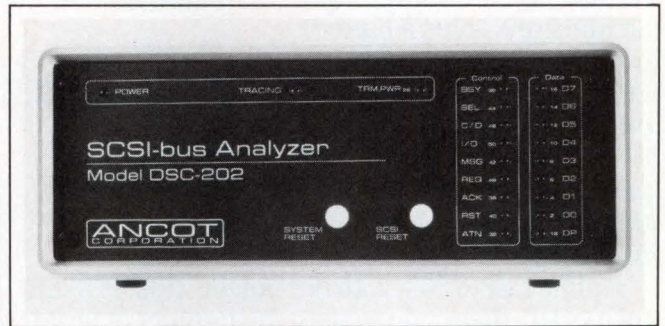

## ▲ SCSI-BUS TESTER

The DSC-202 SCSI-bus analyzer/emulator can trace activity on the SCSI bus without affecting bus operation; it can record 32,000 56-bit-wide events and display them in several formats (pg 201).

**Ancot Corp.**

**Circle No 605**

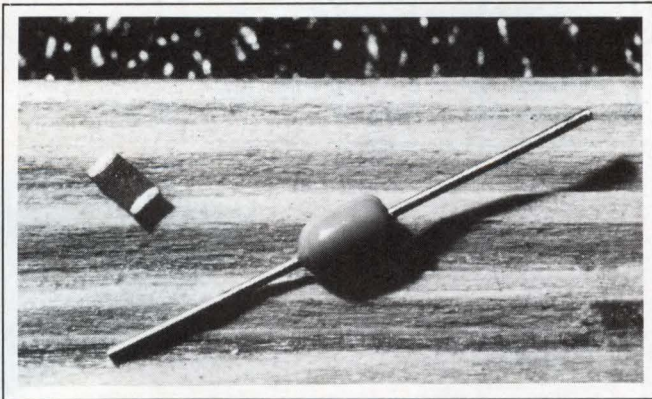

## ▲ MULTILAYER VARISTORS

The MLV multilayer varistors can protect sensitive I/O signal lines from voltage spikes caused by ESD, lightning, nuclear-electromagnetic pulse, or other transient phenomena (pg 95).

**AVX Corp.**

**Circle No 601**

## AUDIO AMP

The TDA7350 audio power amplifier can operate as a 12W/12W stereo amplifier or as a 24W bridge amplifier (pg 182).

**SGS-Thomson Microelectronics (Italy).**

**Circle No 602**

**SGS-Thomson Microelectronics (USA).**

**Circle No 603**

# Launch your design with an 8K × 8 SRAM that uses ZEROPOWER.™

Launch your design with ZEROPOWER—the static RAMs that keep data afloat in any non-volatile memory application.

SGS-THOMSON Microelectronics backs you with a whole ZEROPOWER UL recognized family, and each member has a built-in lithium battery that maintains complete data retention, even in the event of system power loss.

All ZEROPOWER RAMs use full CMOS process technology to ensure low current drain. Plus, each device combines analog power fail detect and switching circuitry.

The big news is SGS-THOMSON's MK48Z08. The MK48Z08 has an 8K × 8 architecture—plus a battery cell life of over 11 years at 70°C. Four configurations are offered for maximum design flexibility. Each conforms to JEDEC 28-pin DIP packaging to allow direct replacement of conventional 8K × 8 SRAMs, 2764 EPROMs or 8K × 8 EEPROMs.

Unlike EEPROMs, with our unique ZEROPOWER memories, there's no limit to the number of write cycles you can perform. Plus, the combination of fast read and write cycles and no additional circuitry requirements makes the chip a breeze to interface with your microprocessor.

Don't worry about reliability, either. Our 16K and 64K ZEROPOWER devices (even higher

densities are just over the horizon) are based on the industry's most sophisticated assembly technology and over 5 years of proven battery experience.

For convincing reliability documentation and a complete set of application notes, contact the winning team—SGS-THOMSON Microelectronics, 1000 E. Bell Road, Phoenix, AZ 85022. 602/867-6259.

DEVICE	TEMP RANGE	WRITE PROTECT VOLT.	BATTERY LIFE OVER TEMP	U.L. RECOG	SPEED	KEY FEATURES
MK48Z02	0-70 C	4.75V	11 yrs.	Yes	120-250ns	2K × 8 SRAM unlt'd. write cycles
MK48Z12	0-70 C	4.5V	11 yrs.	Yes	120-250ns	2K × 8 SRAM unlt'd. write cycles
MK148Z02	-40-85 C	4.75V	6 yrs.	Yes	120-250ns	2K × 8 SRAM indust. temp. range
MK148Z12	-40-85 C	4.5V	6 yrs.	Yes	120-250ns	2K × 8 SRAM indust. temp. range
MK48T02	0-70 C	4.75V	11 yrs.*	Yes	120-250ns	2K × 8 SRAM w/realtime clock
MK48T12	0-70 C	4.5V	11 yrs.*	Yes	120-250ns	2K × 8 SRAM w/realtime clock
MK48Z08/09	0-70 C	4.75V	11 yrs.	Yes	150-250ns	8K × 8 SRAM w/additional CE and power fault flag (-09)
MK48Z18/19	0-70 C	4.5V	11 yrs.	Yes	150-250ns	8K × 8 SRAM w/additional CE and power fault flag (-19)

\*3.3 yrs. minimum clock operating in battery backed mode.

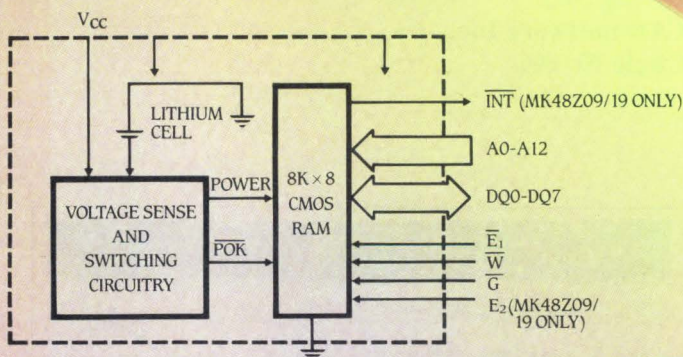

# Join The Winning Team

ZEROPOWER is an outstanding example of the advanced capability of SGS-THOMSON.

But just one. Join the winning team and we'll back you with a range of performance proven products that covers everything from transistors to complex signal processing chip sets to full service ASICs. You'll be a winner, too. For your free product literature portfolio, call 602/867-6259.

Or write SGS-THOMSON  
Microelectronics,  
1000 E. Bell Road,  
Phoenix, AZ 85022.

CIRCLE NO 145



**SGS-THOMSON**  
MICROELECTRONICS

# LEADTIME INDEX

Percentage of respondents

## ITEM

### TRANSFORMERS

ITEM	Off the shelf	1-5 weeks	6-10 weeks	11-20 weeks	21-30 weeks	Over 30 weeks	Average (weeks)	Last month's average (weeks)
Toroidal	0	25	50	13	12	0	9.7	7.3
Pot-Core	0	20	40	40	0	0	10.0	7.8
Laminate (power)	10	30	20	30	10	0	9.6	8.3

### CONNECTORS

Military panel	0	22	45	22	11	0	10.4	10.8
Flat/Cable	13	47	33	7	0	0	4.7	5.6
Multi-pin circular	0	25	33	25	17	0	11.6	9.4
PC (2-piece)	8	25	50	17	0	0	7.2	7.4
RF/Coaxial	13	47	27	13	0	0	5.2	5.3
Socket	12	63	19	6	0	0	3.7	4.7
Terminal blocks	19	31	37	13	0	0	5.7	5.4
Edge card	12	29	53	6	0	0	5.8	5.7
D-Subminiature	13	50	31	6	0	0	4.4	5.1
Rack & panel	10	40	30	20	0	0	3.2	6.4
Power	20	30	40	10	0	0	5.4	5.5

### PRINTED CIRCUIT BOARDS

Single-sided	0	71	29	0	0	0	3.7	5.4
Double-sided	0	25	75	0	0	0	6.5	5.8
Multi-layer	0	20	67	13	0	0	7.8	7.5
Prototype	6	81	13	0	0	0	2.7	4.3

### RESISTORS

Carbon film	47	32	16	5	0	0	2.7	4.2
Carbon composition	42	21	26	11	0	0	4.3	4.0
Metal film	30	25	45	0	0	0	4.1	4.4
Metal oxide	18	55	18	9	0	0	4.0	4.6
Wirewound	11	39	28	22	0	0	6.5	8.8
Potentiometers	5	53	32	10	0	0	5.2	6.1
Networks	19	38	24	19	0	0	5.7	6.3

### FUSES

	39	33	28	0	0	0	2.9	4.4
--	----	----	----	---	---	---	-----	-----

### SWITCHES

Pushbutton	10	50	35	5	0	0	4.6	5.8
Rotary	0	33	47	20	0	0	7.6	6.1
Rocker	0	55	36	9	0	0	5.4	5.4
Thumbwheel	0	33	25	42	0	0	9.4	7.7
Snap action	0	46	36	18	0	0	6.7	6.5
Momentary	0	58	25	17	0	0	5.9	6.3
Dual in-line	0	55	27	18	0	0	6.1	6.6

### WIRE AND CABLE

Coaxial	15	54	31	0	0	0	3.6	4.2
Flat ribbon	12	65	23	0	0	0	3.1	5.5
Multiconductor	13	47	40	0	0	0	4.1	4.6
Hookup	35	40	25	0	0	0	2.8	3.2
Wire wrap	31	46	23	0	0	0	2.8	4.2
Power cords	18	65	12	5	0	0	3.1	5.9

### POWER SUPPLIES

Switcher	7	43	21	22	7	0	7.9	7.4
Linear	0	29	50	14	7	0	8.6	7.7

### CIRCUIT BREAKERS

	20	27	13	33	7	0	8.7	8.0
--	----	----	----	----	---	---	-----	-----

### HEAT SINKS

	7	53	27	13	0	0	5.3	5.1
--	---	----	----	----	---	---	-----	-----

### RELAYS

General purpose	12	47	18	23	0	0	6.1	6.1
PC board	6	28	33	33	0	0	8.5	7.2

## ITEM

### RELAYS

Dry reed	0	23	31	31	15	0	11.8	8.6
Mercury	0	25	38	25	12	0	10.7	9.1
Solid state	0	25	33	33	9	0	10.8	8.9

### DISCRETE SEMICONDUCTORS

Diode	23	36	18	14	4	5	7.0	7.0
Zener	5	44	17	22	6	6	9.2	7.3
Thyristor	7	27	33	33	0	0	8.5	8.8
Small signal transistor	13	37	31	13	6	0	6.9	7.4
MOSFET	0	37	36	27	0	0	7.9	10.2
Power, bipolar	0	45	18	37	0	0	8.3	9.3

### INTEGRATED CIRCUITS, DIGITAL

Advanced CMOS	7	20	40	27	6	0	9.5	9.6
CMOS	6	29	41	24	0	0	7.7	7.1
TTL	23	15	54	8	0	0	5.9	6.5
LS	21	22	43	14	0	0	6.1	5.9

### INTEGRATED CIRCUITS, LINEAR

Communication/Circuit	10	40	40	10	0	0	5.6	8.7
OP amplifier	20	27	33	20	0	0	6.4	6.3
Voltage regulator	16	28	39	17	0	0	6.4	7.2

### MEMORY CIRCUITS

RAM 16k	11	34	22	33	0	0	7.7	9.7
RAM 64k	8	25	25	34	0	8	10.4	8.8
RAM 256k	7	14	36	0	14	29	15.8	10.0
RAM 1M-bit	0	13	37	0	25	25	17.5	12.5
ROM/PROM	0	34	33	22	0	11	10.3	11.0
EPROM 64k	0	25	42	25	0	8	10.3	9.5
EPROM 256k	0	42	25	25	0	8	9.3	9.3
EPROM 1M-bit	0	0	33	17	33	17	19.4	11.6
EEPROM 16k	0	13	37	37	0	13	13.2	10.6
EEPROM 64k	0	20	40	30	0	10	11.5	10.9

### DISPLAYS

Panel meters	9	36	46	9	0	0	5.8	6.7
Fluorescent	0	33	45	22	0	0	7.8	8.5
Incandescent	0	66	17	17	0	0	5.4	6.5
LED	10	53	21	16	0	0	5.3	8.1
Liquid crystal	15	15	39	31	0	0	8.4	10.5

### MICROPROCESSOR ICs

8-bit	0	34	58	8	0	0	6.6	7.6
16-bit	0	12	88	0	0	0	7.3	9.3
32-bit	0	0	78	22	0	0	9.8	7.6

### FUNCTION PACKAGES

Amplifier	0	22	45	33	0	0	9.3	6.4
Converter, analog to digital	8	17	42	25	8	0	9.8	8.6
Converter, digital to analog	10	20	30	40	0	0	9.2	9.2

### LINE FILTERS

	17	33	33	17	0	0	6.0	9.4
--	----	----	----	----	---	---	-----	-----

### CAPACITORS

Ceramic monolithic	6	55	33	6	0	0	4.7	5.8
Ceramic disc	12	47	24	17	0	0	5.8	5.1
Film	0	57	29	14	0	0	5.7	4.8
Aluminum electrolytic	5	47	27	21	0	0	6.5	4.8
Tantalum	0	47	29	24	0	0	7.1	6.2

### INDUCTORS

	0	42	42	16	0	0	6.8	9.3
--	---	----	----	----	---	---	-----	-----

Source: Electronics Purchasing magazine's survey of buyers

What do you need to build  
on a rough application concept?



# AT&T. The comp





# onents of success.



Whether you're building a visionary home—or a breakthrough product or system—getting from concept to completion demands more than bricks and mortar, or metal and silicon.

There are other components that can make a critical difference in meeting your market window on time, and on budget.

We call them the components of success—ready for immediate delivery from AT&T.

**The component of commitment: here today, here tomorrow.**

AT&T is in the components business to stay. We have formed a separate unit, AT&T Microelectronics, to bring our more than 100 years of electronic components experience to the marketplace. And, we have the capital, people, and technical savvy to meet our commitment to the future.

**The component of innovation: AT&T Bell Labs.**

Count on Bell Laboratories to help make your 'blue-sky' designs a reality. With everything from DSPs and optical data links, to custom designed products such as ASICs, multilayer boards, and power supplies. And throughout planning and manufacturing, count on AT&T to keep your product up to the minute with the latest Bell Labs advances.

**The component of quality.**

Through our Integrated Quality System, Bell Labs engineers work with our quality professionals to meet customer-defined criteria. At AT&T quality is

our history—and our future.

**The component of management involvement.**

AT&T Microelectronics gives you total support, right up to its president, Bill Warwick. If our solutions aren't on the money, call him at 1 201 771-2900.

**The component of quick response.**

With 12 plants and an extensive network of design centers and sales offices worldwide, AT&T is ready to meet your volume demand for components. Ready with everything you need to get ideas off the ground and in the market—successfully.

To learn why AT&T is more than ever the right choice, just give us a call.

**DIAL 1 800 372-2447**

**AT&T Microelectronics**  
**Major Product Lines:**

ASICs  
Digital Signal Processors  
Communication ICs  
32-bit Microprocessors  
and Peripherals  
Solid State Relays  
Multilayer Circuit Boards  
HICs  
Optical Data Links  
Fiber Optic Components  
Power Products  
Transformers and Inductors  
Wound Film Capacitors

© 1987 AT&T



**AT&T**

**The right choice.**

The new modem family promises to be really hot. Without a doubt the next-generation leader.

But the designers need more time and money to go for it. And his market window is disappearing fast.

**“It was either find the right modem or lose a big chunk of the market.”**

His team calls the company that sets the industry standards in modems: Rockwell International. He knows that'll save design time and costs, plus provide worldwide compatibility from 300bps to 14.4kbps.

And with one basic design, engineering can spin off a dozen different products by using Rockwell's OEM modem series with its compatible hardware features. It's a complete solution to all their modem needs. The clincher: Rockwell's 5-year standard warranty assures his customers of quality and reliability.

He'll beat the competition to market with the right products. And that's what it's all about.

Call the leader in modem technology. Rockwell *is* solutions.



**Rockwell International**

...where science gets down to business

Aerospace / Electronics / Automotive  
General Industries / A-B Industrial Automation

CIRCLE NO 148

Semiconductor Products Division,  
Rockwell International,  
P.O. Box C, M.S. 501-300, Newport Beach,  
CA 92658-8902 (800) 854-8099.  
In California, (800) 422-4230.

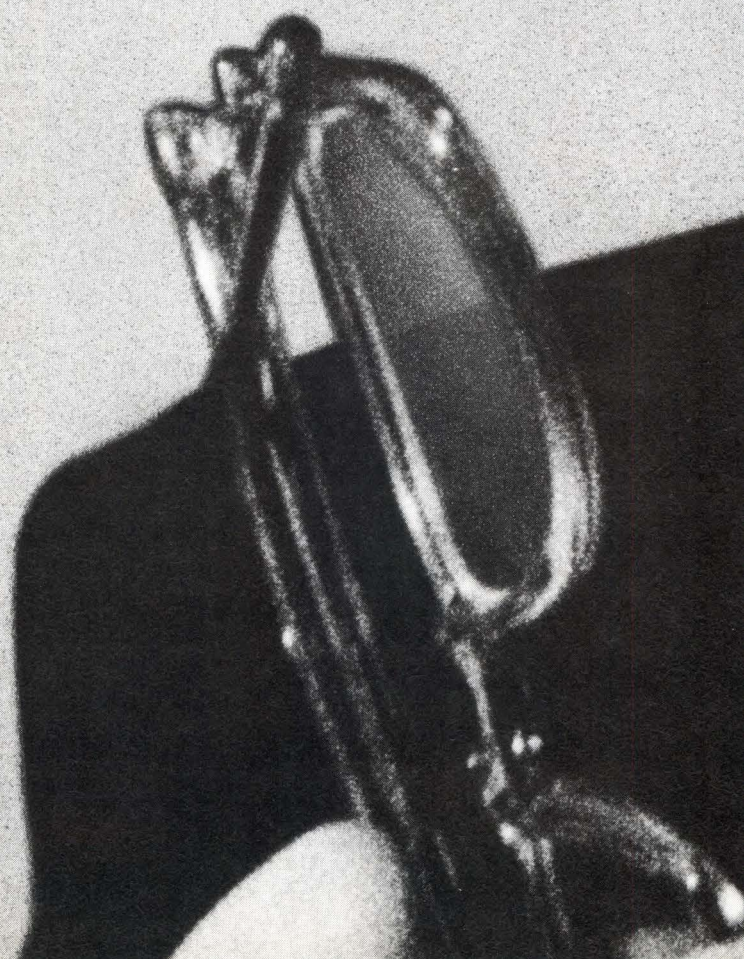

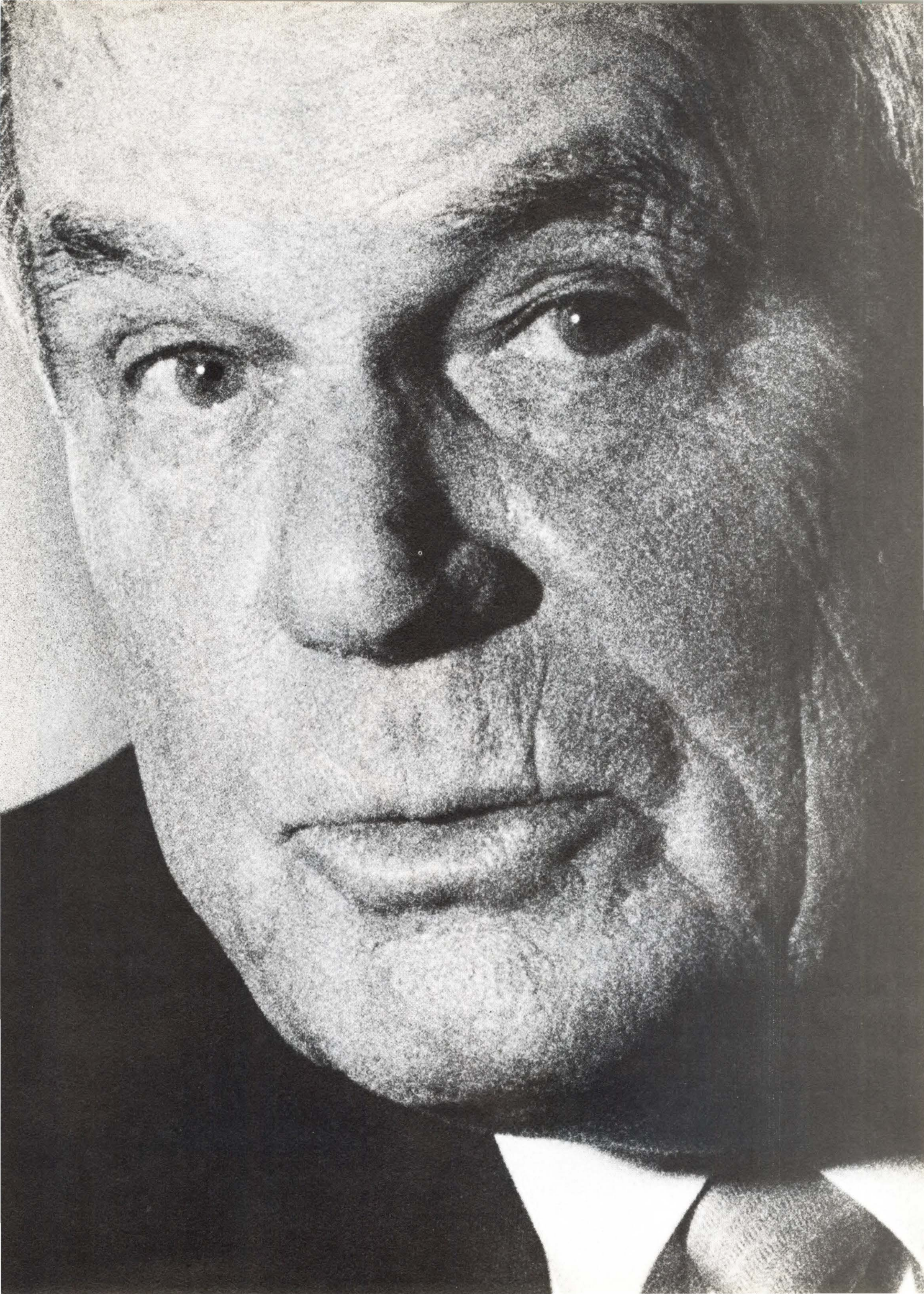

Commercially available VLSI ICs enable designers to pack more functions onto pc boards compatible with standard 32-bit multimaster buses. In Multibus II and VME Bus applications, bus-interface ICs can replace anywhere from a dozen to several dozen discrete and programmable-logic chips.

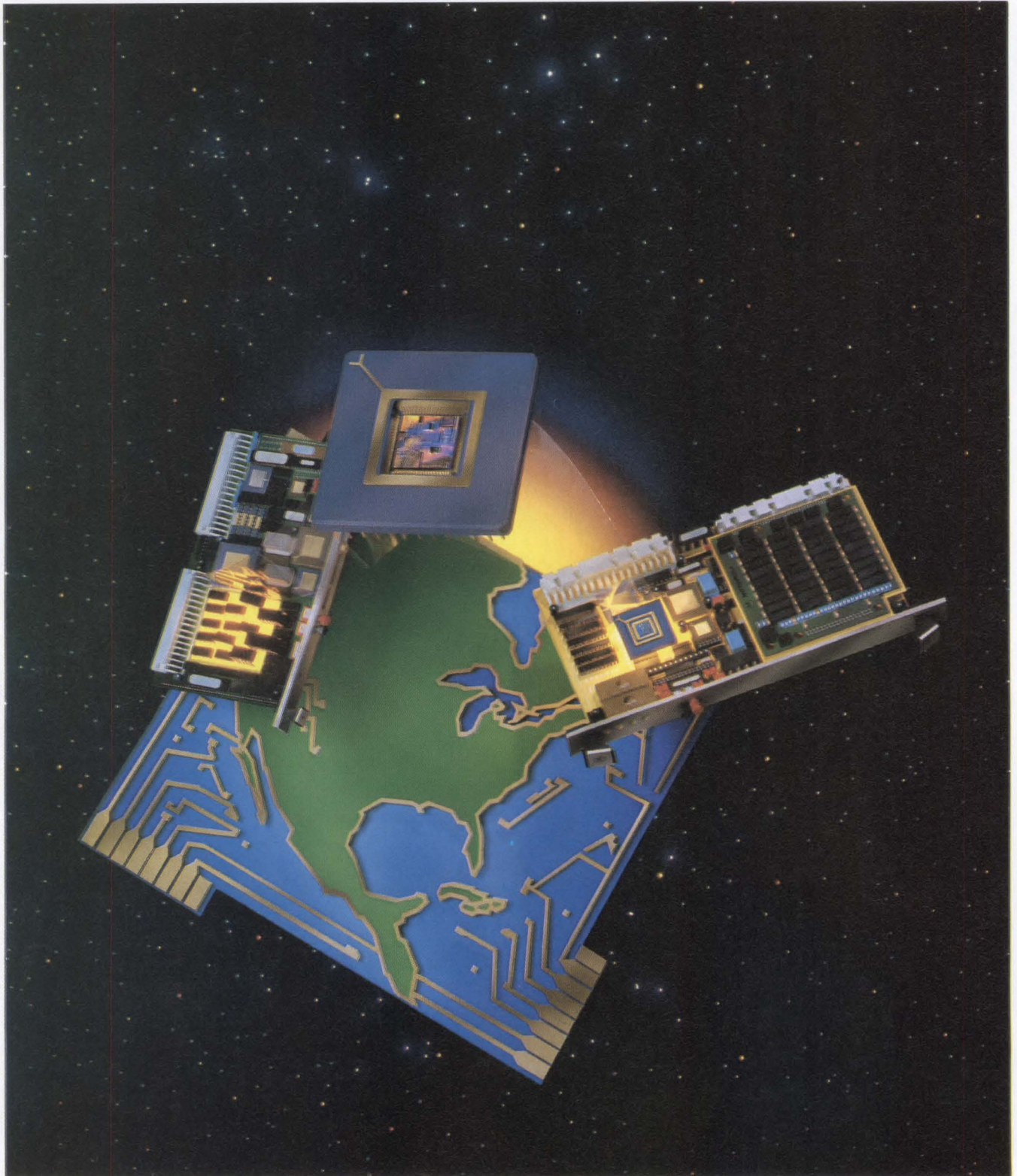

*Designers of Multibus II and VME Bus boards will encounter a world of difference when they design with VLSI bus-interface ICs. (Photo courtesy Motorola Microcomputer Div)*

# Bus-interface ICs

Maury Wright, *Regional Editor*

Now, years after the development of the bus specs themselves, VLSI chips for commercial 32-bit multimaster bus interfaces are readily available and economically feasible. Application-specific VME Bus- and Multibus II-interface ICs offer pc-board designers the same advantages as other VLSI chips: lower parts count, lower power consumption, and lower cost. Moreover, because of the extra pc-board real estate that an interface chip affords, you can add features and functions—even though the size of the board is fixed.

Without bus-interface ICs, designers of Multibus II or VME Bus boards must dedicate a substantial amount of pc-board real estate to bus-interface circuitry. Interfaces implemented with discrete ICs or PLAs can take up 20 to 30% of the real estate available. In contrast to the simple interfaces of older 8- and 16-bit buses such as the STD Bus and Multibus I, the 32-bit multimaster buses, with their interrupt-structure, arbitration-scheme, and burst-data-transfer features, result in the added interface complexity.

Thirty-two-bit multimaster buses are necessary to harness the power of 32-bit  $\mu$ Ps, custom processors, and RISC  $\mu$ Ps in open systems. The architecture of these high-performance systems has generated the system-on-a-board distributed-intelligence concept. Most boards of this type include a local  $\mu$ P and memory, and communicate with other boards by transferring commands and blocks of data across the bus.

The trend toward distributed intelligence increases

the need to place more functions on a single board, and therefore bus-interface ICs will play an important role in the design of new boards. DEC, for instance, employed a custom VLSI interface chip on every board intended for its 32-bit BI bus. In fact, DEC developed and produced the chip before beginning to use the BI bus. You can also expect interface chips to be very important in designing boards compatible with IBM's Micro Channel bus. The Micro Channel bus's small board size and power limitations make VLSI interfaces mandatory for most add-in-card applications (see **box**, "ICs mate cards to Micro Channel size/power specs").

The system-on-a-board concept is useful in the creation of multiprocessor systems, but it is also commonly used to partition a typical single-CPU system into functional blocks. Disk or communication boards, for example, can function as a system just as a CPU board can. And, you can design disk and communication boards as bus masters.

Bus-interface ICs for VME Bus or Multibus II designs greatly simplify the task of designing a system on a board. And, you can use the saved real estate to add value to your product. In some cases, the different features of the chips themselves may sway you to choose a particular bus. For example, several VME Bus chips are available that implement an interface appropriate for any kind of board; although a simple A/D-converter board may not need to incorporate a system on a board, it may reside in a powerful system. Or, you may find that you want the inherent message-passing function of the Multibus II Message-Passing Coproces-

---

Boards designed without VLSI bus-interface chips sacrifice 20 to 30% of their available real estate to the PLAs and discrete logic implementing the interface.

---

sor (MPC) chip to provide a standard platform on which to build your system.

Briefly, consider the two bus architectures. The VME Bus is based on the shared-memory concept. During a bus cycle, a bus master addresses memory or I/O space on another board. To communicate, one board

writes command and status information into a mailbox on another board. Boards can perform block transfers of data across the bus.

Although Multibus II can operate as a shared-memory bus, the Multibus II spec defines a message-passing scheme. The message-passing protocol provides a

---

## ICs mate cards to Micro Channel size/power specs

Although IBM developed the Micro Channel bus for use in its personal computers, the 32-bit multimaster bus has features comparable to the commercially available multimaster buses discussed in the accompanying article. The bus supports burst data transfers, arbitration, direct DMA operation between bus masters, and automatic system configuration. And, because of its size and power specs, you may find bus-interface ICs even more helpful in Micro Channel board design than in VME Bus and Multibus II board design.

Micro Channel-compatible cards have only about 33 in.<sup>2</sup> (3×11½ in.) of available pc-board real estate. Furthermore, each board in a Micro Channel system can only draw 1.4A. You can design full-featured cards that meet the spec, however, by employing VLSI interface ICs.

Chips and Technologies Inc offers four single-chip interfaces for Micro Channel boards—notwithstanding that the company may be better known for its personal-computer mother-board chip sets. Each of the four chips is packaged in a 68-pin PLCC, and each consumes less than 100 mA.

The 82C611 and 82C612 cost \$7.80 and \$10 (10,000), respectively, and connect directly to the Micro Channel bus. You only

need external bus drivers for the data lines. The chips fit applications for general-purpose Micro Channel cards, and include the POS (programmable option select) registers for storing board-configuration information. The chips also include decoders for low-order address bits, and control circuits that can drive external circuits during Micro Channel board-identification operations. In addition, the 82C612 has circuitry that handles DMA handshake and arbitration functions.

The company's 82C574 and 82C575 single-chip interfaces target simple applications such as serial-port cards and modems and cost \$5.60 and \$6.40 (10,000), respectively. These ICs also include the POS registers. They perform I/O and address decoding and require virtually no support chips in most designs. The 82C574 includes one block of sixteen 8-bit general-purpose I/O ports, and the 82C575 includes two such blocks.

Altera Corp also offers a single-chip Micro Channel interface. The EPB2001 connects directly to the bus and only requires bus drivers for the data bus. The 84-pin IC is priced at under \$12 (10,000) and consumes less than 200 mA. Along with the interface circuitry, the IC includes a block of programmable logic and

EPROM. Users can program the Micro Channel identification in the EPROM. The programmable logic allows the customization of POS-configuration and address-decoding functions.

### Two-chip set includes DMA

By combining the EPB2001 with the EPB2002 DMA arbitration chip, you can also use the chip in applications such as disk controllers that require DMA capabilities. The DMA chip costs less than \$5 (10,000), and the 28-pin IC draws less than 200 mA.

PLX Technology Corp has taken a different approach to bus-interface chips. The company designed a PLD equipped with high-current bus drivers, and it offers the chip programmed in a Micro Channel interface configuration. The 24-pin MCA 1200 performs bus-request and local-arbitration protocols. The \$26 chip does not include all the features of the VLSI devices discussed above, but with the PLD approach you can customize the standard configuration to fit your application.

Finally, for designers of memory boards, Edsun Laboratories Inc offers a 2-chip set for implementing 512k- to 8M-byte Micro Channel boards. The EL2010 chip set costs \$35 (1000) and includes POS registers, selectable

standard way for all boards to pass commands, status information, and data. Interrupts are contained in message packets and are handled by software. In fact, Multibus II has no hardware interrupt lines. You can implement a message-passing protocol in a VME Bus system, but no specification for doing so exists.

To implement message passing for Multibus II, you must have a bus-interface IC. The lack of availability of an MPC chip has actually hampered the bus's acceptance. Intel introduced Multibus II and the concept of message passing at the same time, and the company planned the MPC chip from the onset. Most designers

identification codes, and decoding for one parallel and two serial ports. The company also offers the \$2500 Designware

package, which includes a sample memory board, artwork and other manufacturing information, an on-board BIOS, and

EMS (enhanced memory specification) 4.0 software drivers.

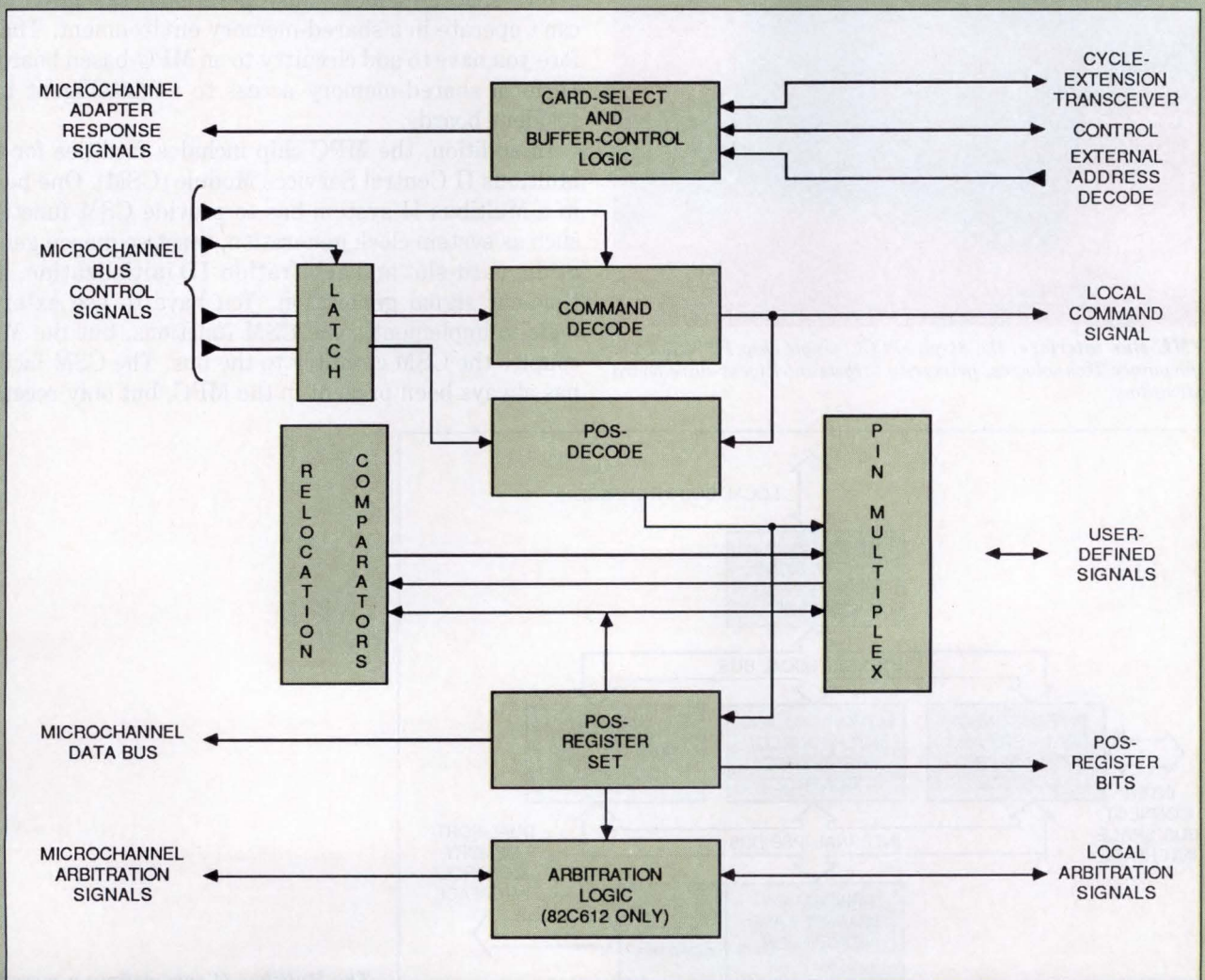

*Integrating the Micro Channel bus interface into a single chip allows manufacturers to design multifunction boards within the bus's 33-in.<sup>2</sup> size and 1.4A power constraints. Chips and Technologies includes POS registers and decoders on its 82C611/612 ICs, which come in 68-pin PLCCs and draw less than 100 mA.*

The delay in availability of the Message-Passing Coprocessor chip hurt the popularity of Multibus II.

interested in Multibus II were also attracted by the message-passing concept, but the chip has only been available during the past year. In fact, when NCR implemented Multibus II in its Tower family of computers, it had to develop a proprietary VLSI Multibus II-interface chip set. (NCR's Microelectronics Div in Colorado, CO, may someday put the 2-chip set on the market.)

You can now purchase the MPC chip from both Intel

and VLSI Technology. VLSI Technology has always acted as a foundry and a source for the IC, but recently Intel has also started to produce the IC. VLSI Technology sells the part for \$175 (1000), yet expects the chip to drop to the \$100 range before the end of the year; Intel prices its chip at less than \$100 (1000). VLSI Technology also plans to offer a version of the MPC that complies with MIL-STD-883B. The military version will be available at the end of the second quarter and initially will cost about \$1000 in single quantities.

**Interface provides  $\mu$ P independence**

The MPC provides a processor-independent interface to Multibus II, but you must use external bus drivers to physically connect to the bus. Although Multibus II allows shared-memory bus operations, the MPC chip can't operate in a shared-memory environment. Therefore you have to add circuitry to an MPC-based board to perform shared-memory access to nonintelligent bus-resident boards.

In addition, the MPC chip includes facilities for the Multibus II Central Services Module (CSM). One board in a Multibus II system has to provide CSM functions such as system clock generation, reset-sequence generation, card-slot and arbitration-ID initialization, and time-out signal generation. You have to use external logic to implement some CSM functions, but the MPC couples the CSM circuitry to the bus. The CSM facility has always been present in the MPC, but only recently

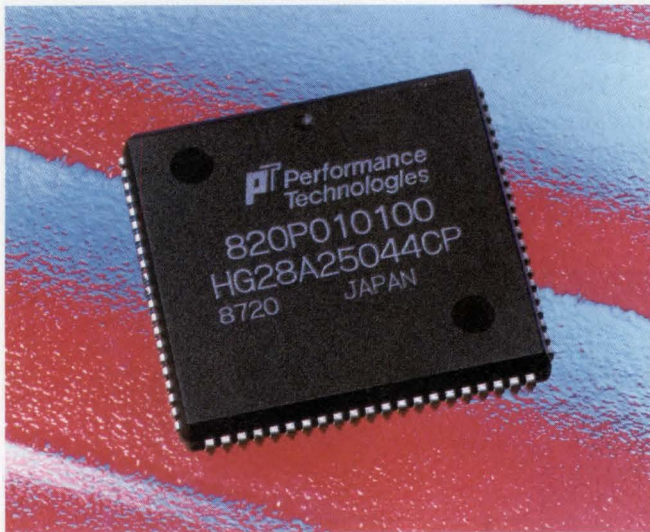

A VME Bus interface, the 84-pin PLCC single-chip PT-VSI from Performance Technologies, primarily targets intelligent-slave-board applications.

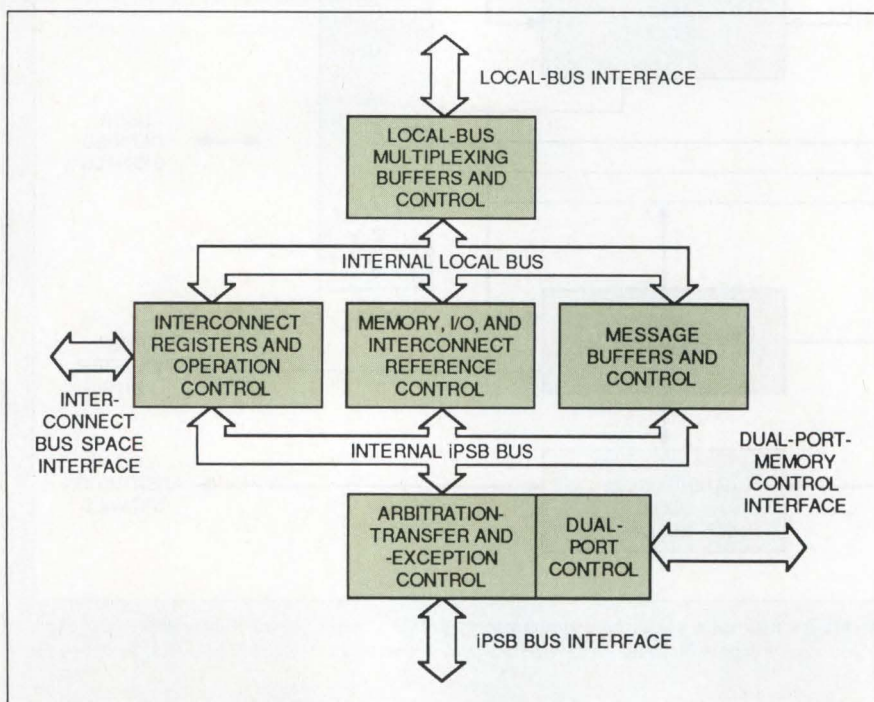

The Multibus II spec defines a message-passing protocol, and the MPC chip, available from Intel and VLSI Technology, implements the protocol along with the bus-interface circuitry.



## VME Bus manufacturers address compatibility issues

Recently, reports have surfaced in the trade press regarding the incompatibility of VME Bus boards from different vendors. Manufacturers of VME Bus boards claim that compatibility problems have been minor, and the worldwide volume of VME Bus board sales may belie the fact that customers have really found incompatibilities. But, with new systems operating faster, and as more board designers implement VME Bus features to reduce latencies, you should ensure that the boards you buy or design meet the VME Bus spec. Indeed, compatibility issues have spawned at least two new business ventures.

### Early designs violated spec

Most manufacturers of VME Bus boards admit that early board designs may have violated the spec. According to VME Bus specialist Shlomo Pri-Tal of Motorola, however, spec violations rarely occur now. Pri-Tal believes incompatibility primarily shows up at a logically higher design layer than the VME Bus spec defines. For example, some VME Bus boards support software message passing, though the spec does not define a message-passing protocol.

Motorola has started a software standardization effort for VME Bus systems. The company proposes standardizing the way software drivers and operating-system kernels interface to VME Bus hardware. The idea received a generally warm reception from VME Bus vendors and customers at the recent Buscon trade show in Anaheim.

Two start-up companies have involved themselves in testing the compatibility of VME Bus boards and systems. One of these, Ultraview Corp, offers the \$1995 VBAT (VME Bus anomaly trigger) VME Bus board that monitors 94 VME Bus signals and detects 27 classes of timing violations. You simply install the VBAT in your system, and the board continuously monitors violations by any board in the system.

### Test for spec compliance

The board is suitable for use in either development or strictly test applications. It indicates violations via LEDs on the VME Bus front panel; to detect the source of these violations, you can use the VBAT in combination with a logic analyzer.

Joel Libove, Ultraview president, claims that the VBAT board has detected some violation in 80% of the VME Bus systems he has tested. A single board can cause a violation in a system. Libove admits that many violations often have no effect on system operation. For example, he has found many boards that don't hold data stable for the entire data strobe, and other boards that generate a glitch in the bus-busy signal.

But Libove has also found more serious violations. For example, the VME Bus spec defines an overlapped arbitration capability: A board can begin arbitration during the last phase of the previous bus cycle and therefore reduce bus latency. Most boards today don't implement overlapped arbitration, however.

And Libove points out that many boards don't respond to overlapped arbitration correctly, and could cause a failure in a system with boards that do implement this feature.

VMElaboratories has experienced similar spec violations, according to VP of operations Joel Witt. Witt claims that boards often violate the VME Bus address-pipelining feature. Address pipelining allows a bus master to broadcast a new address on the bus before the previous data transfer is complete. Again, many boards don't presently implement this feature, but boards that don't handle address pipelining correctly can cause system failures. Witt points out that more and more boards will implement features that can possibly improve system performance.

### You can get a certificate

VMElaboratories is the other start-up that offers testing services to manufacturers of VME Bus boards. The company provides certification that a board meets the VME Bus spec. When the company detects violations, it gives the board manufacturer directions on revising the board to meet the spec. The certification includes examination of the board design to ensure that specs such as trace length from connector to bus driver are met, and the boards go through full functional testing. The certification process costs \$3500 to \$4000 for simple memory boards and can range to \$7000 or more for high-end CPU boards.

ICs that implement the VME Bus interface invariably have been designed for use with 68000 family  $\mu$ Ps.

have Intel and VLSI Technology provided a description of its operation and certified that the CSM facility is operational.

Having but a single choice of an interface IC for Multibus II actually presents designers with some advantages. Every board vendor implements a nearly identical interface, and therefore all boards plug together and work together. The message-passing protocol is well-defined and fully operational. MPC-based boards can sustain a 32M-byte/sec data-transfer rate; Multibus II specs a maximum 40M-byte/sec rate.

When you consider VME Bus ICs, you confront the exact opposite situation. A lot of companies are involved in developing VME Bus interface chips. Although, at the time of this writing few, if any, board manufacturers have purchased VME Bus interface chips, there will be a number of chips from which to choose by the time this article is printed. Several board

manufacturers have made use of bus-interface ICs developed in house, and at least five board manufacturers who have done so are now offering the ICs for sale. Several more board vendors are in the process of developing similar ICs. And the VITA (VME Bus International Trade Association) Technical Consortium—a group of VME Bus board manufacturers that funded the design of an interface chip—expects the first chips to be out by the end of the second quarter.

Most of the currently available VME Bus boards employ an interface made of PLAs and discrete logic. Because the VME Bus spec does not include a message-passing protocol, you don't have to use an interface chip, but VME Bus boards benefit from their use as much as Multibus II boards. Moreover, the use of such chips will most likely provide some amount of commonality among the interfaces of different boards. Incompatibility hasn't been a widespread problem for VME

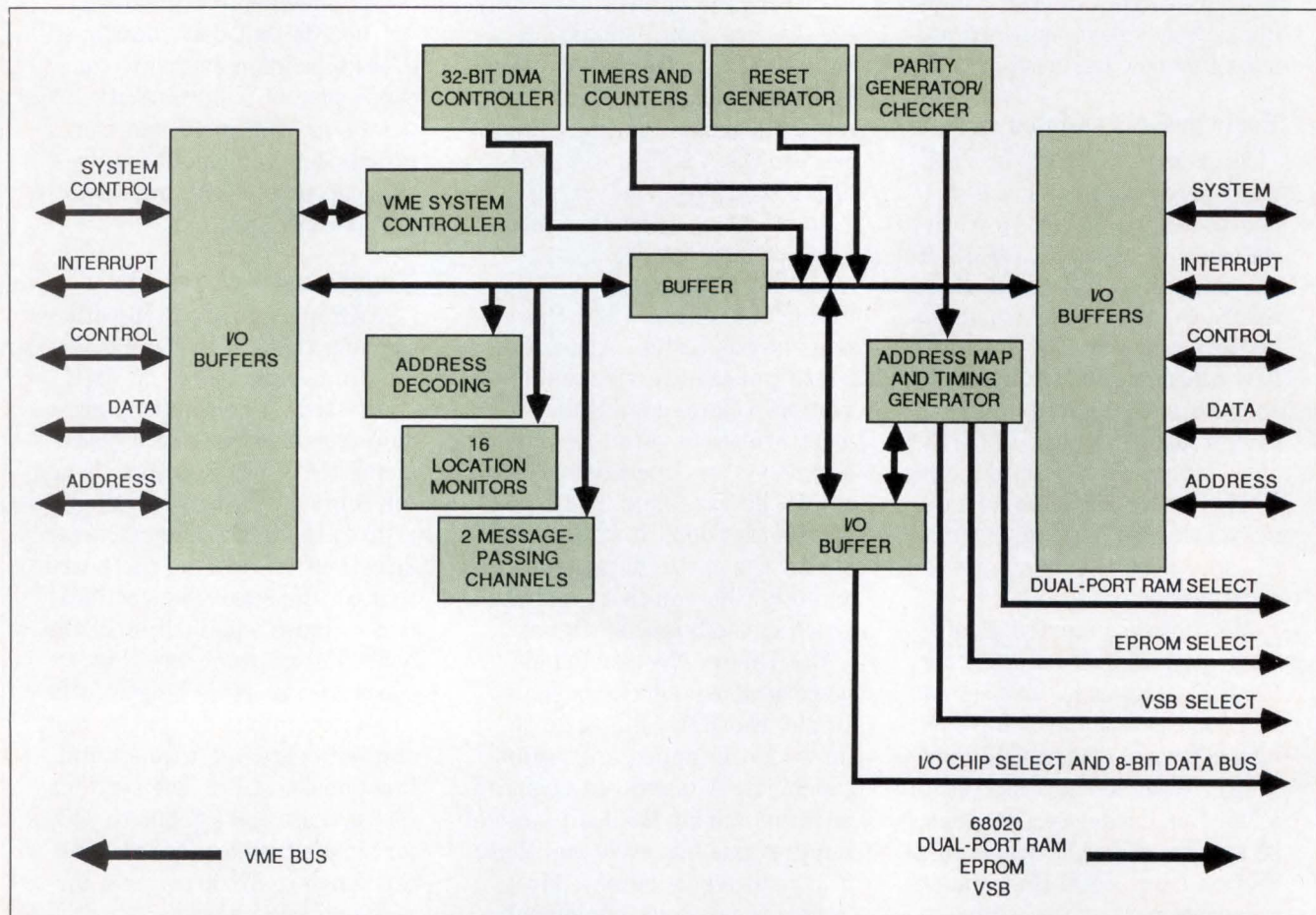

*Packaged in a 280-pin PGA, the Force FGA-002 VME Bus chip includes a DMA controller and a dual-port RAM interface. It also implements a programmable message-passing facility.*

Bus users, but some such instances have surfaced (see **box**, "VME Bus manufacturers address compatibility issues").

### VME Bus suits wide-ranging applications

The number of available and planned VME Bus chips is an indication of the flexibility possible when implementing the interface. You can build relatively low-cost systems with half-sized VME Bus boards for factory automation, and you can also find VME Bus boards in high-performance computers and workstations. Because the spec does not tie a designer to a specific protocol such as message passing, you can tailor the interface on a board for a specific application.

You will find few common architectures among the various VME Bus chips except that all of the chips work most effectively with the 68XXX family  $\mu$ Ps. For now, using a different  $\mu$ P will force you to use a substantial amount of glue logic. Otherwise, the ICs have overlapping features, but no two manufacturers have chosen to implement the same feature set.

Force Computers chooses to implement a 2-channel message-passing capability in its FGA-002 interface

chip. You can program the protocol that the chip uses to pass messages, but a board based on the chip can still operate in a shared-memory environment. The chip also includes 16 location monitors, an on-chip 32-bit DMA controller, and a dual-port RAM interface. It can implement either the VME Bus master or slave interface.

The FGA-002 is packaged in a 280-pin PGA and probably includes more overall features than the other chips available. The chip does not include a bus interrupter, however, and only includes a single-level arbiter. Some applications demand the ability to nest more levels of arbitration, or to use different schemes such as round-robin arbitration.

The Force IC also carries a hefty price tag. In addition to the purchase price, you have to pay a \$40,000 1-time licensing fee. The fee entitles you to a development board that includes 1 chip, a manual, 90 days of support, and 3 days of training for 3 people. The IC sells for \$690 in single quantities or \$390 in 1000-piece quantities and will be available in August.

Electronic Modular Systems Inc (EMS) has also announced plans to ship an interface chip in the third quarter. Like the chip from Force, the 208-pin-PGA

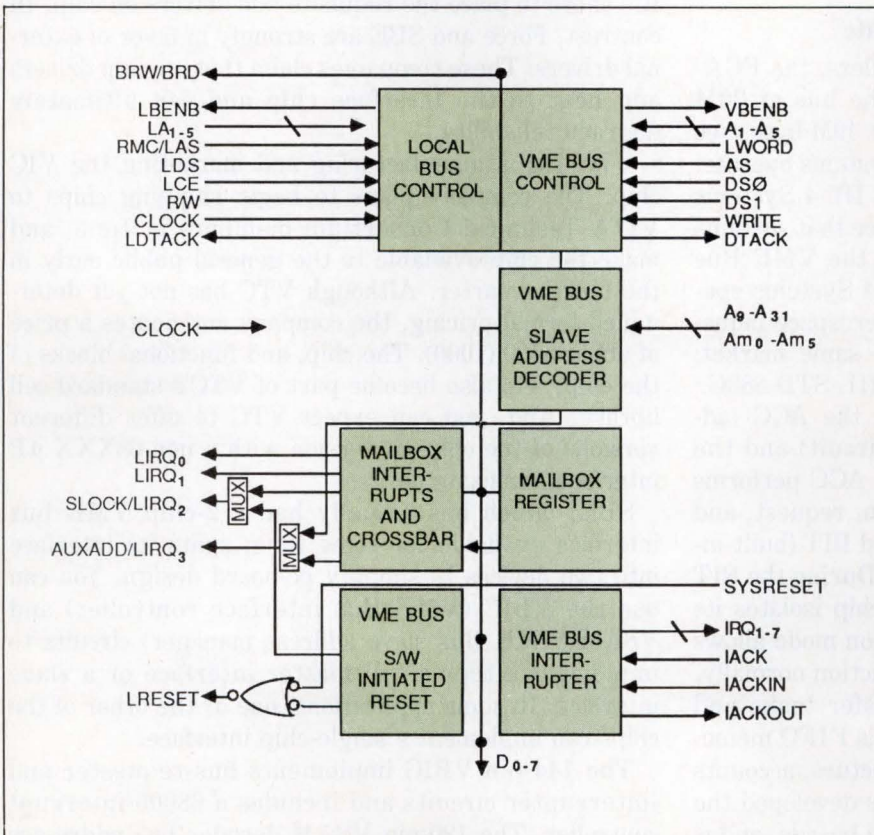

*A bus-interrupter circuit and 16 dual-ported read/write mailboxes match Performance Technologies' PT-VSI interface chip to peripheral-control applications.*

---

## Manufacturers of VME Bus interface chips disagree on whether high-current bus drivers should be on or off chip.

---

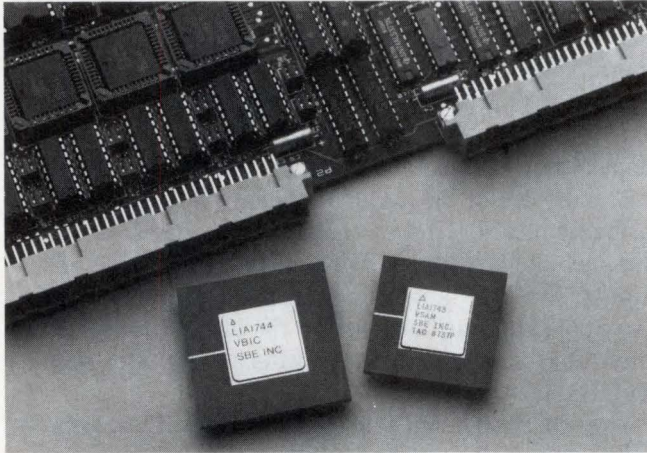

*By partitioning its interface into two ICs, SBE offers designers of VME Bus boards a choice of a single-chip interface for slave applications or a 2-chip, slot-1 master implementation.*

EMS chip will include a 32-bit DMA controller, but will also contain a combination static-RAM/dynamic-RAM controller. Other features include a multimode arbiter and a bus interrupter. The company estimates that the chip will cost \$300 to \$400.

### Chips sustain 40M-byte/sec transfer rate

Thanks to their on-chip DMA controllers, the FGA-002 can send bursts of data across the bus at 30M bytes/sec, and the EMS chip can do so at 40M bytes/sec—faster than most present VME Bus systems operate. For applications requiring more speed, DY-4 Systems has developed a 2-chip VME Bus interface that sustains memory-to-memory data transfers at the VME Bus theoretical limit of 40M bytes/sec. DY-4 Systems specializes in boards and systems for the aerospace industry and designed the chip set for the same market; versions will be available qualified to MIL-STD-883C.

The interface consists of two chips: the ACC (advanced system architecture control circuit) and the DARF (data address register file). The ACC performs typical functions such as bus arbitration, request, and control. The chip also offers a specialized BIT (built-in-test) function and a bus-isolation mode. During the BIT procedure, and upon any failure, the chip isolates its host board from the system. The isolation mode allows the rest of the system to continue to function normally.

The DARF chip handles data-transfer tasks and includes an 8×70-bit FIFO memory. This FIFO memory, along with a write-optimized architecture, accounts for the fast transfer rate. DY-4 Systems developed the ACC and DARF chips for use on its own boards, and is

currently only offering the chip set for sale to its board and system customers. You can expect the chips to be available to the public in the third quarter, however; prices will vary from \$250 to \$400 per set.

### Chip targeted for universal applications

Unlike Force Computers and DY-4 Systems, Motorola has taken the approach of building a general-purpose chip to fit the widest variety of master and slave applications. The company recently began selling its MVME6000 interface chip for \$175, and is also considering licensing a third-party semiconductor house to sell the chip.

The MVME6000 includes four location monitors, a bus interrupter, multiple arbitration modes, and a system clock driver. The 6000-gate chip is packaged in a 132-pin PGA and is fabricated with a bipolar process, which supports on-chip drivers. The device includes drivers for the bus-control signals and for the lower eight data and address bits.

Of all the bus-interface ICs available, Motorola's MVME6000 and VITA's VME Bus Interface Chip (VIC) exhibit the most similarity. The designers of both ICs chose to place the requisite bus drivers on chip. In contrast, Force and SBE are strongly in favor of external drivers. These companies claim that on-chip drivers add heat to the interface chip and can ultimately degrade reliability.

VTC Inc is manufacturing and marketing the VIC chip. The company plans to begin shipping chips to VITA Technical Consortium members in June, and make the chip available to the general public early in the fourth quarter. Although VTC has not yet determined formal pricing, the company anticipates a price of about \$100 (1000). The chip, and functional blocks of the chip, will also become part of VTC's standard-cell library. And, you can expect VTC to offer different versions of the chip—a version with a non-68XXX  $\mu$ P interface, for example.

SBE, which has actually had a 2-chip VME bus interface available for some time, splits its interface into two devices to simplify pc-board design. You can use the VBIC (VME Bus interface controller) and VSAM (VME Bus slave address manager) circuits to implement either a full master interface or a slave interface. In some applications, one or the other of the chips can implement a single-chip interface.

The 144-pin VBIC implements bus-requester and -interrupter circuits and includes a 68000 interrupt controller. The 120-pin VSAM decodes bus addresses

# Feel trapped by one ASIC supplier? Reach for the Super Foundry.



Now you can design complex ASICs to meet your needs, not to fit one supplier's limited capabilities. The Super Foundry™ offers the combined resources of the world's premier CMOS manufacturers. Our process independent design tools and production services give you

maximum freedom and control—from concept through delivery.

## **FREE. ASIC Estimating Kit.**

*What will it take to do your ASIC? With our free ASIC Estimating Kit, you can analyze design-process trade-offs and explore the performance, cost and scheduling implications of your design in a variety of processes. Take control of your ASIC design and avoid the single-supplier prison. Call the Super Foundry for your free ASIC Estimating Kit: 1-800-FOR-VLSI ext. 100.*

## **THE SUPER FOUNDRY** SEATTLE SILICON

3075-112th Ave NE., Bellevue, WA 98004, (206) 828-4422.

Copyright 1988, Seattle Silicon Corp. Super Foundry is a trademark of Seattle Silicon Corp.



Multibus II's local bus, the Multibus II iLBX, essentially implements nothing more than a data and address extension of the local  $\mu P$ 's bus.

and includes the location monitor, status register, and mailbox register. The set costs \$175 (1000), but it should drop to \$125 by year's end. To obtain the ICs, you also have to make a \$1395 1-time developer-kit purchase that includes chips, manuals, documentation,

and unlimited telephone support. Later this year SBE plans to introduce a second version of the VSAM chip that will be self-configuring and therefore usable as a slave interface on boards with no  $\mu P$ .

Two other companies have introduced chips targeted

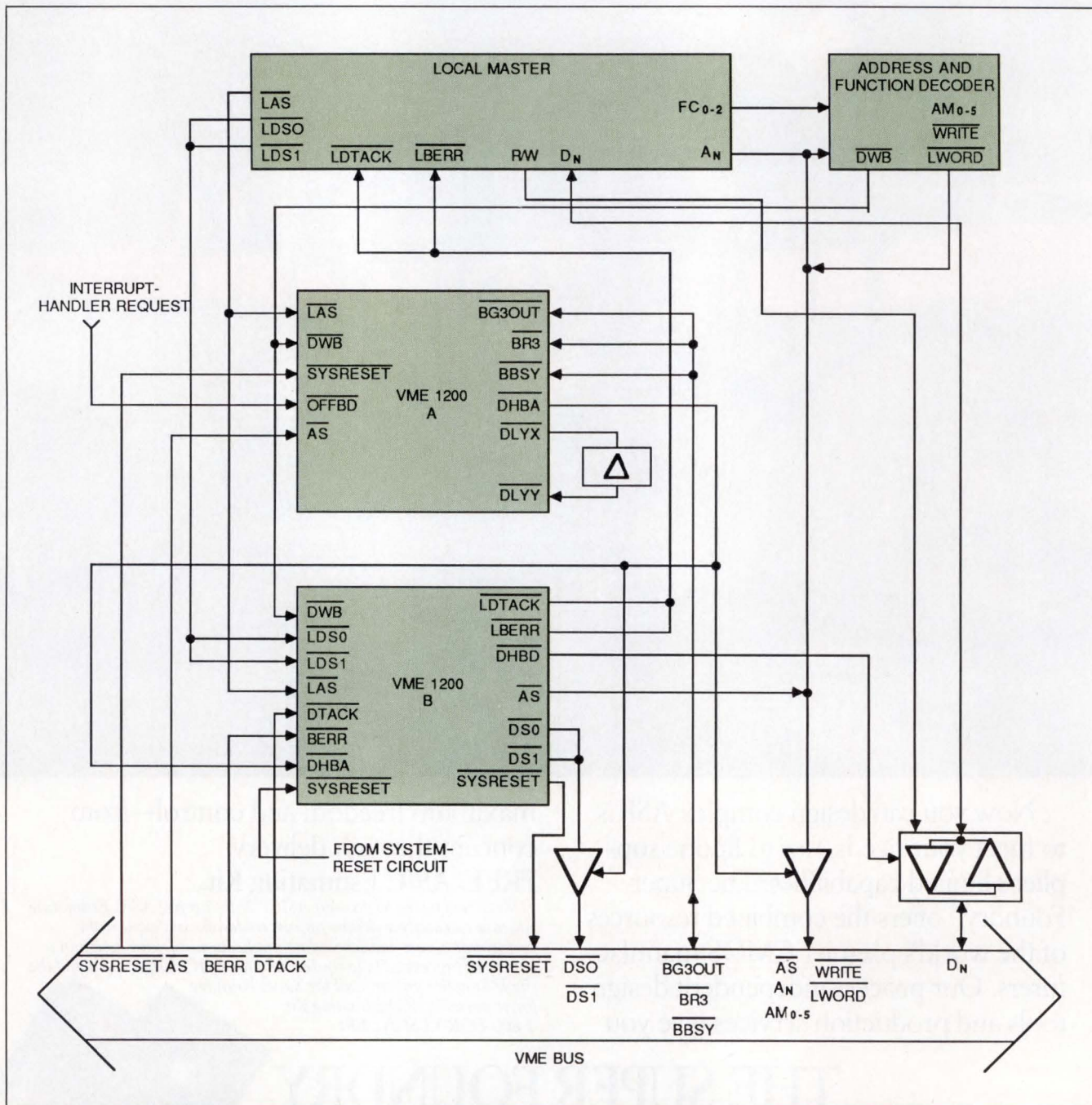

*Designers can customize a VME Bus interface with the programmable-logic devices from PLX Technology. The ICs' design includes on-chip high-current drivers. You can also buy preprogrammed versions that implement the VME Bus interface.*



# A FIRST FROM TEKTRONIX TURN BACK THE CLOCK ON MICROPROCESSOR PROBLEMS!

Now see what your hardware and software are really doing, in real time, without waiting for problems to repeat. Nothing else comes close to tools like these in Tek's DAS9200 Digital Analysis System:

#### ■ Register deduction.

Acquire and disassemble up to 32K samples of processor activity. The DAS9200 can show you the contents of the register before the problem occurred!

#### ■ Stack deduction.

Similarly, you can scroll through changes in a stack model and end the

painstaking process of tracking contents by hand.

■ **Data display.** Watch as your variable space is modified by the software. No more trial-and-error to it—you can see when variables get clobbered.

■ **Subroutine trace.** Follow the flow of high-level language subroutines using address symbolics.

■ **Performance analysis.** Plot execution times, times within subroutines, and more, for an invaluable graphic overview.

**Monitor and integrate up to six 8-, 16- or 32-bit micros at once!** That's just one of many other ways the DAS9200 helps you beat the clock in system design. To learn more, contact your local Tek representative. Or call:

**1-800-245-2036.**  
In Oregon, 231-1220.

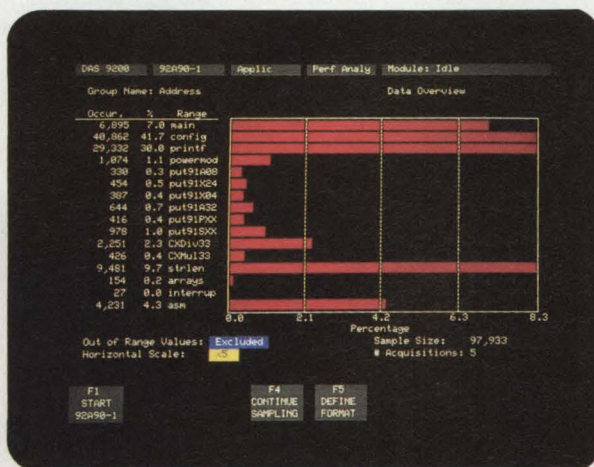

Circle 112 for Literature

Circle 113 for Sales Contact

**Tektronix**  
COMMITTED TO EXCELLENCE

---

The VME subsystem bus includes arbitration capabilities and is suitable for hosting graphics and I/O processors.

---

strictly for intelligent-slave applications such as I/O controller boards. Performance Technologies introduced its PT-VSI chip last fall and has sold a number of evaluation units. The 84-pin PLCC consumes only ½W and costs \$75 (100). The chip provides address-decoding functions, a bus-interrupter circuit, and 16 dual-ported read/write mailboxes. The chip can also interface with as many as four local μPs for multiprocessor applications.

Ciprico's Pipeline System Interface (PSI), enclosed in an 84-pin PLCC, includes VME Bus slave logic for control-register decoding, an interrupt generator, and the bus interface; it's up to you to add external arbitration capabilities. Actually, you can use the PSI chip on any board compatible with a bus based on the shared-memory architecture. The IC includes a pipeline to ready the next data-transfer address while a data transfer is in progress. Ciprico only plans to offer the IC in quantities of 5000 or more, and has priced the chip at less than \$50 in such quantities.

#### Programmable devices include bus drivers

In some cases, you may prefer to implement simple master or slave interfaces with some type of programmable logic. To that end, PLX Technology has devel-

oped a programmable-logic device with high-current outputs just for such applications. The VME 1200, for example, includes two chips that perform as a bus master. Selling for \$52, the set includes a single-level arbiter and a bus requester. For slave applications, PLX offers the single-chip VME 2000 for \$26. This interface supports address pipelining and block-move data transfers.

PLX will also support your efforts to customize one or more programmable devices for your application. You can start with a preprogrammed device such as the VME 2000, and modify the programming codes to meet your needs. PLX also offers a device for the Micro Channel bus (see **box**, "ICs mate cards to Micro Channel size/power specs"). The VSB 1200 and VSB 2000 are intended for master and slave VSB (VME Subsystem Bus) implementations; each of these cost \$26.

The VME Bus industry has accepted the VSB as the standard local bus for the VME Bus. You can employ the VSB to expand the functionality of a VME Bus board and maintain the system-on-a-board concept. Motorola offers a full VSB master/slave chip, the MVSB2400, for \$175. The chip includes master-mode control logic, a master and slave block-transfer control module, the VSB requester, the VSB arbiter, a time-

---

## Manufacturers of bus-interface ICs

For more information on bus-interface ICs such as the ones discussed in this article, contact the following manufacturers directly, circle the appropriate numbers on the information Retrieval Service card, or use EDN's Express Request Service.

**Altera Corp**  
3525 Monroe St  
Santa Clara, CA 95051  
(408) 984-2800  
Circle No 650

**Chips and Technologies Inc**  
3050 Zanker Rd  
San Jose, CA 95134  
(408) 434-0600  
Circle No 651

**Ciprico Inc**  
2955 Xenium Lane  
Plymouth, MN 55441  
(612) 559-2034  
Circle No 652

**DY-4 Systems Inc**  
21 Credit Union Way  
Nepean, Ontario, Canada K2H9G1  
(613) 596-9911  
Circle No 653

**Edsun Laboratories Inc**  
9 Spring St  
Waltham, MA 02154  
(617) 647-9300  
TLX 853664  
Circle No 654

**Electronic Modular Systems Inc**  
1325 Capitol Parkway  
Carrollton, TX 75006  
(214) 446-2900  
Circle No 655

**Force Computers Inc**  
3165 Winchester Blvd  
Campbell, CA 95008  
(408) 370-6300  
Circle No 656

**Intel Corp**  
5200 Elam Young Parkway  
Hillsboro, OR 97124  
(800) 548-4725  
Circle No 657

**Motorola Microcomputer Div**  
2900 S Diablo Way  
Tempe, AZ 85282  
(602) 438-3500  
Circle No 658

**Performance Technologies Inc**  
435 W Commercial St  
East Rochester, NY 14445  
(716) 586-6727  
Circle No 659

**PLX Technology Corp**  
520 Weddell Dr, Suite 3  
Sunnyvale, CA 94089  
(408) 747-1711  
Circle No 660

**SBE Inc**  
2400 Bisso Lane  
Concord, CA 94520  
(415) 680-7722  
TWX 910-366-2116  
Circle No 661

**Ultraview Corp**  
Box 14734  
Fremont, CA 94539  
(415) 657-9501  
Circle No 662

**VLSI Technology Inc**  
8375 South River Parkway  
Tempe, AZ 85284  
(602) 752-6200  
Circle No 663

**VMelaboratories**  
Box 50208  
Denton, TX 76206  
(817) 387-5425  
TLX 495-2091  
Circle No 664

**VTC Inc**  
2401 E 86th St  
Bloomington, MN 55425  
(800) 882-2667  
Circle No 665





## IN VANCOUVER, WASHINGTON, WE'VE JUST ISSUED PERMITS TO BREAK SPEED LIMITS.

How do you keep ninety of the country's hottest design engineers happy? First, give them permission to pull out all the stops. Then give them a place to do it.

That's exactly what we've done at our new Sharp Microelectronics Technology Center in Vancouver, Washington. There we've provided our outstanding staff with the most advanced CAD systems available. And we've backed them with a world-class 1.2 micron production facility in Japan, along with a national network of salespeople and distributors.

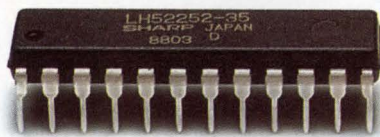

Sharp's new LH52252 64k x 4 SRAM

The purpose of all this? To aggressively carve a niche for ourselves by creating a select line of high-speed chips. Like the new Sharp LH52252, our 64k x 4 SRAM that operates at 35 ns cycle time and consumes just 100 microamps in standby mode. It's the first of many high performance products you can expect from our new design center. And it's available right

now at Marshall, Milgray, Western Microtechnology, Space Electronics, and Added Value.

If you have specific questions, we invite you to call Sharp at (201) 529-8757. Especially if moving at 35 ns or faster

SHARP'S NEW HIGH-SPEED CMOS SRAMs			
DEVICE#	ORGANIZATION	ACCESS TIME	AVAILABILITY
LH52252	64k x 4	35 ns/45 ns/55 ns	Immediate
LH52259	32k x 9	35 ns/45 ns/55 ns	3Q 1988
LH52251	256k x 1	35 ns/45 ns/55 ns	3Q 1988
LH52256	32k x 8	70 ns/90 ns/120 ns	Immediate
LH5261	64k x 1	25 ns/35 ns	1Q 1989
LH5262	16k x 4	25 ns/35 ns	4Q 1988

sounds appealing. Because if you like breaking speed limits, Sharp has just the ticket.

**SHARP**  
ELECTRONIC COMPONENTS DIVISION

**IF IT'S SHARP, IT'S CUTTING EDGE.™**

**NEW...**  
From the Originators of 'Tri-Barrier'  
**Depluggable  
Tri-Barrier  
Terminal Blocks**

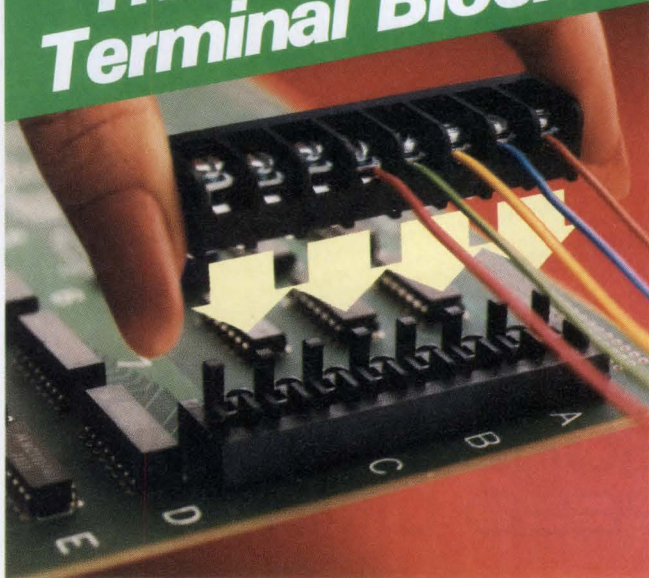

**Series #4** — .325" center spacing  
**Series #6** — .375" center spacing

- Available in 2-16 positions
- Positive positioning and latching
- Fast, efficient P.C.B. replacement
- Standoffs for flux removal
- No special tools required
- No extra P.C.B. space required



Ask us about our full line of Terminal Blocks, Electrical/Electronic Interface Modules and **SNAPTRACK™** Assemblies

Request literature on our full line of Terminal Blocks.

**For Samples and Quotations**  
**1-800-682-7333**  
In Illinois 1-312-682-4100

**AUGAT® RDI**

**Quality and Innovation**

525 Randy Road  
Carol Stream, Illinois 60188  
Tel. (312) 682-4100 FAX 312-682-4562

In Canada: AUGAT Electronics, Inc., Mississauga, Ontario,  
Tel. (416) 677-1500

CIRCLE NO 31

out module, status and control registers, and bus drivers.

Multibus II's local bus, the Multibus II iLBX, essentially implements nothing more than a data and address extension of the local  $\mu$ P's bus. The VSB, however, supports arbitration, and you can use it to host graphics and I/O processors. In fact, you can expect to see multiprocessor subsystems hosted on the VSB in the future. Only the 6-slot bus capacity will limit the scope of VSB applications.

**EDN**

Article Interest Quotient (Circle One)  
High 470 Medium 471 Low 472

**CY525 3rd generation  
STEPPER MOTOR CONTROLLER**

most intelligent controller offers linear ramping, 10,000 steps/sec, unlimited stepping, change rate on the fly, read position on the fly, and much more.

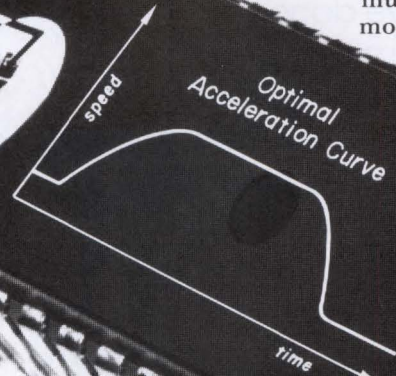

CY512 compatible, 40 pin, +5 volt TTL, 8 bit I/O interface to  $\mu$ computer. \$195 ea (\$80/100) Prototyping board available.



**Cybernetic Micro Systems**  
P.O. Box 3000, San Gregorio, CA 94074  
(415) 726-3000 Telex: 171-135 attn: Cybernetic

CIRCLE NO 32

**NEW INTEL  
TECHNOLOGIES  
OFFER  
EMBEDDED  
CONTROL  
DESIGNERS  
WHAT THEY  
WANT MOST.**

# MORE CONTROL.

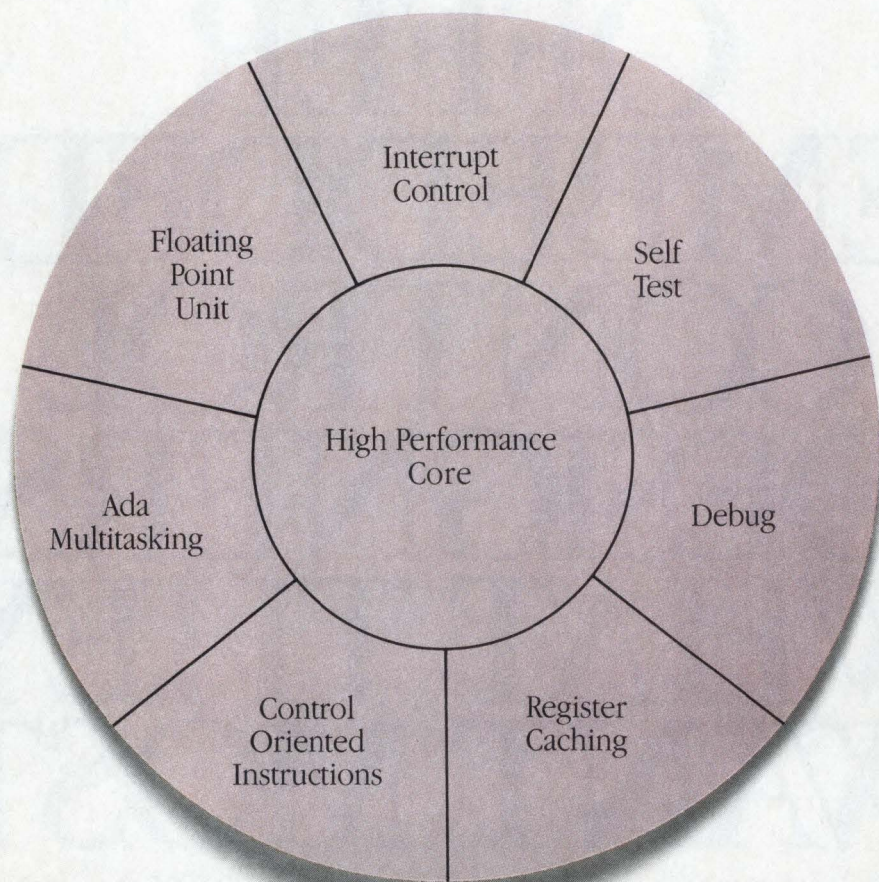

## **A NEW 32-BIT ARCHITECTURE SPECIFICALLY DESIGNED FOR EMBEDDED CONTROL.**

Now you can go beyond the performance limitations of existing microprocessors and microcontrollers. And get to a whole new level of embedded control capabilities.

With the Intel 80960. We

created its architecture with the intelligent use of RISC techniques and extensive use of parallelism. This will provide a level of performance far beyond today's microprocessors which are scaled to linear

clock speed increases.

The 80960 also supports on-board register caching, which significantly reduces the number of memory accesses for every subroutine executed. Even more performance is gained through the 80960's register scoreboarding capability that allows overlap of memory and CPU operations for maximum possible throughput.

And you can begin designing with our new 32-bit technology today. With our highly-integrated 80960KB microprocessor.

It's a complete CPU sub-system on a single chip that delivers 7-10 VAX\* MIPS, with burst rates of up to 20 VAX MIPS.

To make it even better for embedded control designs, the 80960KB integrates Boolean and bit instructions, self-test and built-in debug capability. Add to that an on-chip instruction

and register cache, plus a 4-input interrupt controller. And you have the most highly integrated single-chip, 4 Mega-Whetstones floating-point solution available.

Best of all, it's on your distributor's shelf today.

Then there's our pin-compatible 80960KA without floating point, which will be available later this year. Or, if you require a military temperature range, the 80960MC military version, optimized for Ada, will be available in Q3 '88.

Of course, we provide the wide range of development tools it takes to get started on your design today.

The 80960 architecture can easily be evaluated and code developed immediately with your PC and a Starter Kit that includes languages and an evaluation board.

As a result, you'll get to market faster.

What more could a designer want?



# SIMPLER CONTROL.

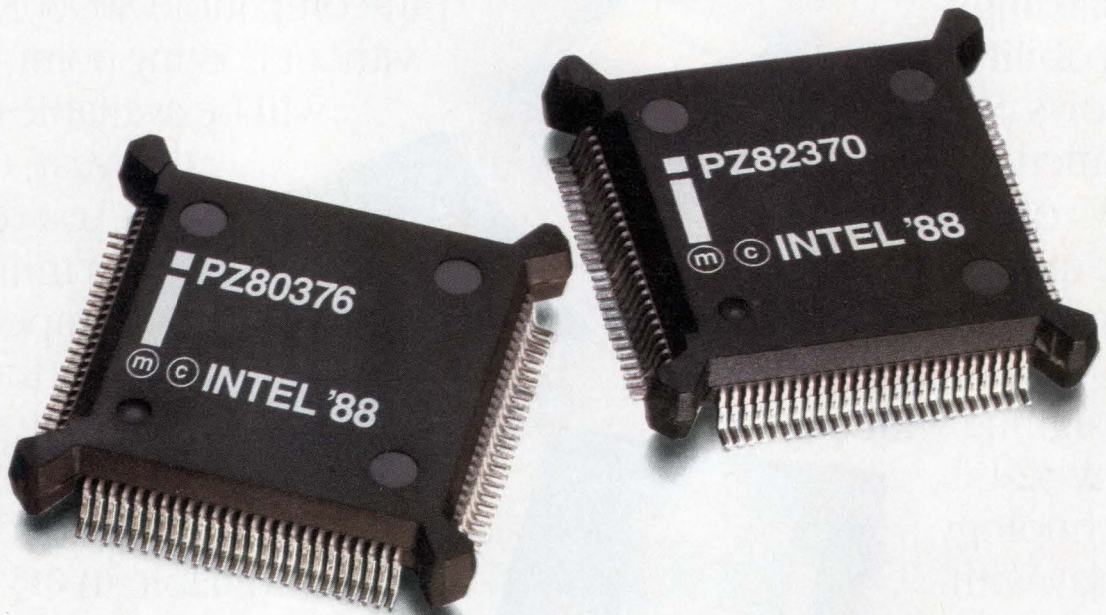

## OUR 386™ MICROPROCESSOR TECHNOLOGY ADAPTED ESPECIALLY FOR EMBEDDED CONTROL.

Consider the power of 386™ microprocessor technology controlling a robot arm. Or pumping data through a PBX. Now, with Intel's new 376™ processor it's simple.

We simplified the Intel386™ architecture by eliminating the features not necessary for

embedded control applications. The result is a full 32-bit architecture capable of handling high performance embedded applications and a 16-Mbyte address space that is easy to use.

Together with the 82370 multifunction peripheral, the

376 processor offers you a complete CPU and I/O subsystem with the cost and form factor of 16-bit systems. And if you've ever worked with other products from our '86 family, this new 376 processor technology will be even easier to work with.

To make things easier yet, we simplified your I/O subsystem design. The 82370 packs 22 chips into one small package, providing eight channels of 16-Mbyte/sec DMA transfer rate.

Which means you'll have no more problems matching DMA memory timing to CPU memory timing. Or fitting DRAM refresh into the memory controller. Or getting a refresh into long DMA activities.

We also simplified our proven 386 microprocessor technology and used it in the 376 processor. To make it an

even better fit, we produced the 376 chip in an inexpensive, plastic surface mount, gull wing, fine pitch package. So we can offer you 5000 Dhrystone performance in a smaller, lower-cost package.

And getting the development support you need for the 376 processor couldn't be simpler. There's a full line of proven 386 microprocessor software tools that can be used on the 376 processor. Even for debugging. You can use established real-time 32-bit kernels

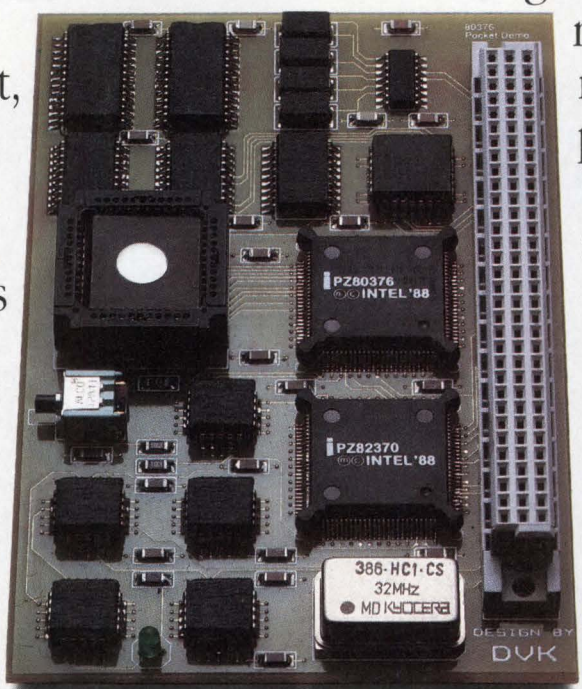

**THE INTEL 376™ PROCESSOR CARD IS A COMPLETE 32-BIT SYSTEM SMALLER THAN 3" x 5".**

like our iRMK™ kernel.

Of course, we have the ICE™ 386 in-circuit emulator available for the fastest and simplest integration of hardware and software. You can even run and debug your application on any 386 microprocessor based PC.

Simpler control. Isn't that something every designer wants?

# COST CONTROL.

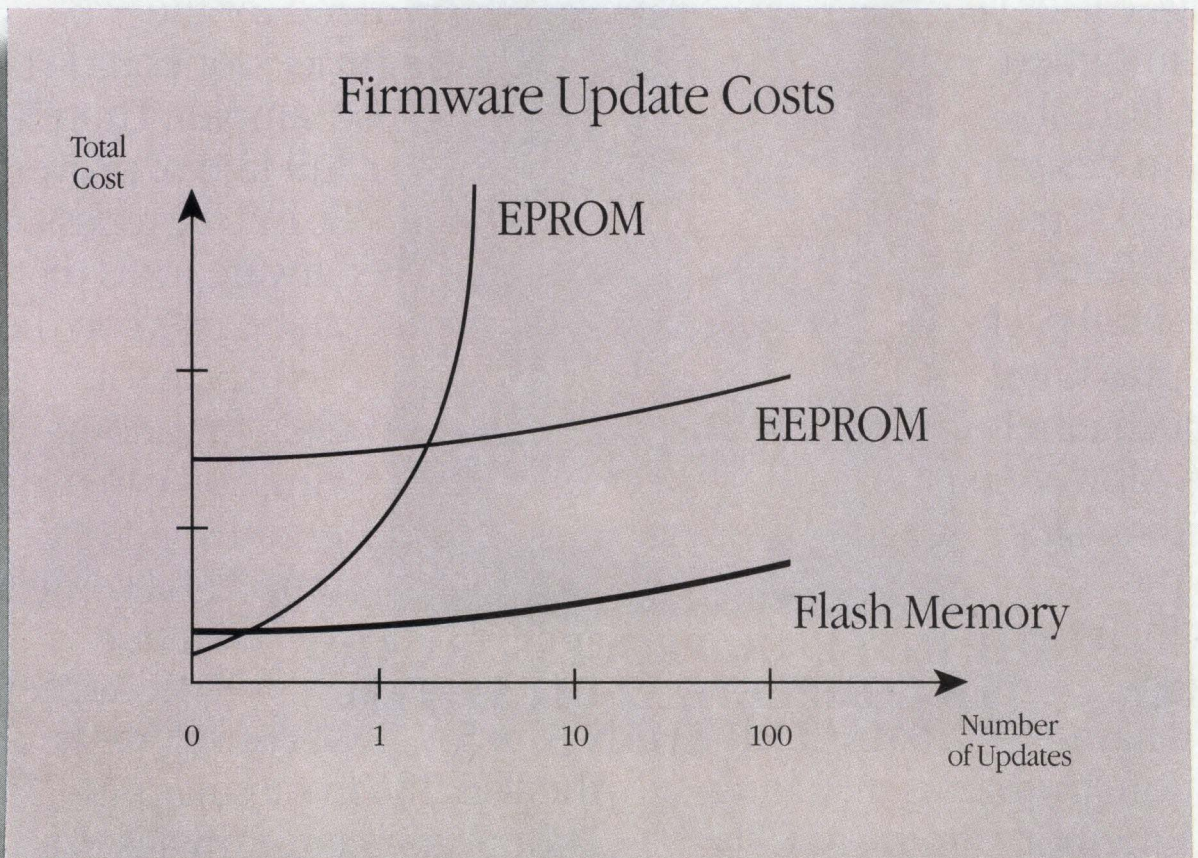

Until now, the only way designers could easily alter code in an embedded system was to upgrade from low-cost EPROM to expensive EEPROM.

Now, we've invented a way to incorporate electrical

erasure into our proven EPROM process. We call it ETOX™ (EPROM Tunnel Oxide) Flash technology. And we think it's a major breakthrough in non-volatile memory technology. ETOX Flash memory allows you



to cut the cost of code or parameter changes by over 50%.

The ETOX process breaks through the technology barrier between low-density, high-cost EEPROM and dense, low-cost EPROMs. It combines the electrical erase capability of an EEPROM with the single transistor cell of EPROM.

And ETOX Flash technology delivers 10,000 cycle endurance capability with a reprogramming failure rate at or below the lifetest failure rate of other components in your system. Our proven EPROM manufacturing process assures unmatched reliability for your embedded control applications.

With Intel's new flash memory, you can execute code changes almost instantaneously. Over phone lines,

in-system, or at the end of the production line. Without the hassle of UV erasure. So after just one update it can be cheaper than EPROM. Making it the most cost effective, nonvolatile memory solution for updating code in advanced embedded control designs.

And Intel's complete family of ETOX Flash memories is available now! Our 27F64 and 27F256 28-pin flash devices provide pinout and read compatibility with equivalent density EPROMs, making the flash memory design-in process easy. Our 28F256 device is available in both 32-pin CERDIP and 32-

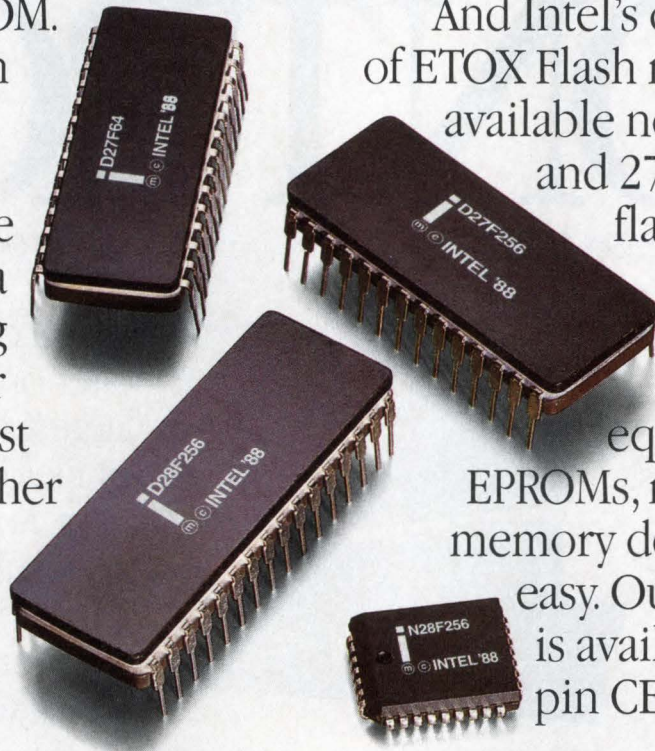

**A NEW FLASH MEMORY THAT DRAMATICALLY LOWERS THE COST OF EMBEDDED CODE UPDATES.**

lead PLCC packages that provide upgrade

capabilities to 2 megabits. So you can start designing Intel's ETOX Flash memories into your 8-, 16- and 32-bit embedded control applications today.

Cost-effective embedded code updates in a flash. What more could you ask for?

Technology	Reprogramming Failure Rate	
	100 Cycles	10,000 Cycles
Flash Memory	<.01%	.1%
EPROM	2%	—
EEPROM	—	5%

# AND COMPLETE CONTROL.

To help you increase control over your designs, we're committed to supporting you at every stage of the development process.

To begin with, we offer a complete line of highly integrated development tools. We've designed them to work with each other, to maximize the power and performance of each component, and to give you the most powerful debug capability available.

And behind these tools, you'll find our design support and training teams. With the expertise to help you create custom hardware and software solutions.

Our worldwide service organization provides hardware maintenance and software support for all 960 or

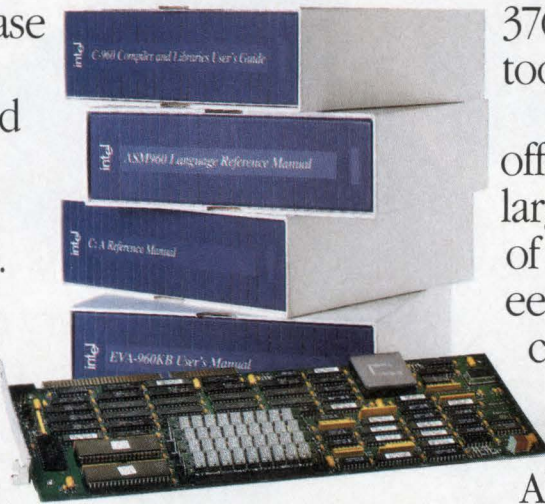

376 processor development tools.

Of course, we also offer one of the world's largest, best trained groups of Field Applications Engineers. And engineering consulting services to help you throughout your design cycle.

All of which helps you get a better product to market. Faster. So if you're designing advanced embedded systems and want more information on these new embedded control technologies, call us at 800-548-4725 and ask for our Literature Department.

We'll give you all the answers you want.

**intel**<sup>®</sup>

VAX is a trademark of Digital Equipment Corporation. 386, 376, Intel 386, iRMK, ICE and ETOX are trademarks of Intel Corporation. © 1988 Intel Corporation.

# Clever techniques improve thermocouple measurements

*Thermocouple (TC) measurements require linear-circuit proficiency. To ensure accurate results, you should understand the need to compensate for parasitic junctions, the importance of certain characteristics of the op amps and associated components, and the ways to otherwise condition and linearize the TC's low-level output signals.*

Jim Williams, *Linear Technology Corp*

Thermocouples are inexpensive, but achieving reasonable accuracy—say  $\pm 0.5^\circ\text{C}$ —requires careful signal conditioning and cold-junction compensation. Although thermocouples don't require any external excitation, and their small size and low output impedance produces wideband, low-noise output signals, their nonlinear, millivolt-level outputs degrade measurement sensitivity.

A TC senses ambient temperature by producing, across the junction, a small voltage proportional to temperature. To measure that voltage, you must connect the TC wires to an amplifier or voltmeter, creating two unwanted parasitic junctions that produce error voltages in series with the desired signal (Fig 1). These parasitic junctions must have the same temperature. To

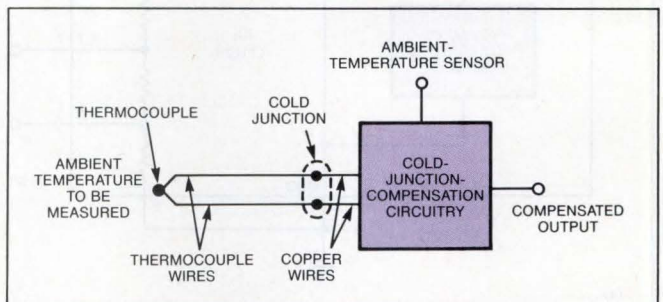

**Fig 1**—For accurate thermocouple measurements, the thermocouple's cold junction and the compensation circuit's temperature sensor must be isothermal.

interpret the TC voltage as an absolute-temperature signal, you must either maintain these parasitic junctions at a known temperature or compensate for their effect electronically. The TC, in effect, measures temperature at its "hot" junction with respect to temperature at the two parasitic junctions—historically called the "cold junction."

## Cold junctions generate spurious voltage

The term "cold junction" derives from the practice of maintaining the parasitic junctions at  $0^\circ\text{C}$  by immersing them in a mixture of ice and water. Although very accurate, this approach is impractical for most applications. As another option, you can simulate the ice bath by servo-controlling a Peltier cooler, but again this approach is too complex and bulky for most applications.

*Thermocouples are by far the most widespread contact-type temperature transducers in use today.*

A better technique (Fig 2a) employs an electronic-compensation circuit, which tracks the cold-junction temperature instead of maintaining the junction at a constant temperature. The circuit offers the same result as an ice bath, but is simpler to implement. It produces 0V at 0°C, and its slope of output voltage vs temperature is the same as that of the thermocouple,

over the expected range of cold-junction temperatures. For proper operation, the compensator's temperature sensor must be isothermal with the cold junction.

The cold-junction compensator, IC<sub>1</sub>, measures the cold-junction's ambient temperature and generates output voltages that are scaled for use with E-, J-, K-, R-, S-, and T-type thermocouples. Low supply current in

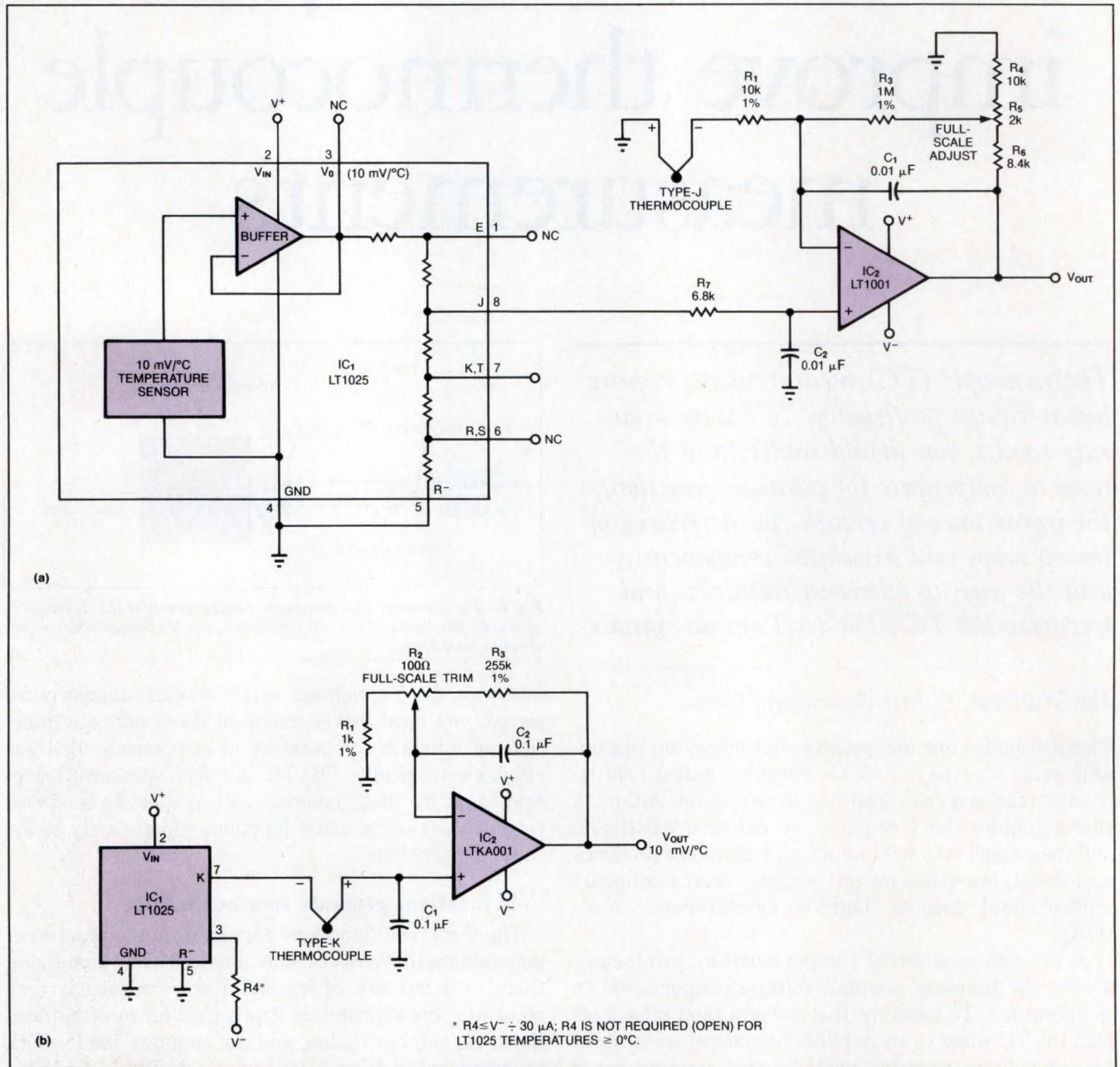

**Fig 2—Each of these circuits combines the thermocouple's output with the electronic cold-junction compensation of IC<sub>1</sub>. Circuit a subtracts these voltages; circuit b arranges the voltages in a series-opposed fashion and amplifies the difference.**

IC<sub>1</sub> minimizes the self-heating that would otherwise degrade isothermal operation with the cold junction; low power consumption also supports battery operation. The chip's  $\pm 0.5\%$  accuracy is compatible with the overall accuracy achievable in a thermocouple-based system.

### Subzero temperature swings V<sub>OUT</sub> negative

The op amp in Fig 2a amplifies the difference between the thermocouple voltage and the cold-junction-compensation voltage from IC<sub>1</sub>. C<sub>1</sub> and C<sub>2</sub> provide filtering, and potentiometer R<sub>5</sub> trims the signal gain. R<sub>6</sub> has a typical value; another value may better accommodate the desired trim range. Reducing R<sub>6</sub> and increasing R<sub>5</sub>, for example, will provide higher gain with lower trim resolution. Fig 2b shows a similar circuit, for a type-K thermocouple, which combines the TC and compensation voltages in series-opposed fashion. The optional pulldown resistor (R<sub>4</sub>) allows V<sub>OUT</sub> to swing negative, thereby representing sub-0°C temperatures.

Low bias current in IC<sub>2</sub> is important to avoid offset errors due to the op amp's input filter (R<sub>7</sub>, C<sub>2</sub>) and the output impedance of IC<sub>1</sub>. Type-J, -K, -E, and -T thermocouples, which have Seebeck coefficients of 40 to 60  $\mu\text{V}/^\circ\text{C}$ , require high-grade precision bipolar amplifiers such as Fig 2b's LTKA001. (This device provides 30- $\mu\text{V}$  offset voltage, 1.5- $\mu\text{V}/^\circ\text{C}$  drift, and 1-nA input bias current.)

Particularly critical applications call for a chopper-stabilized amplifier such as Fig 2b's LTC1052 (5- $\mu\text{V}$  offset, 0.05- $\mu\text{V}/^\circ\text{C}$  drift, 30-pA input bias current, and  $30 \times 10^6$  open-loop gain). This amplifier is appropriate for use with type-R and -S thermocouples (whose

Seebeck coefficients range from 6 to 15  $\mu\text{V}/^\circ\text{C}$ ), especially if the application covers a large swing in ambient temperature or does not allow offset adjustments.

Another source of error in thermocouple amplifiers is inadequate open-loop gain. An amplifier for type-K thermocouples, for instance, which produces 100 mV/°C, must have a closed-loop gain of 2500. In this application, an ordinary op amp that specs a minimum open-loop gain of  $50 \times 10^3$  would produce a  $(2500/50,000) \times 100 = 5\%$  gain error! Although normally you would calibrate the closed-loop gain by trimming, temperature drift in the open-loop gain can still degrade the output accuracy. The minimum recommended open-loop gain for use with type-E, -J, -K, and -T thermocouples is 250,000. This value is also adequate for use with type-R and -S thermocouples, if the amplifier's output produces 10 mV/°C or less.

### Eschew kovar package leads

Regardless of the type of op amp that you choose, a dual-in-line package is preferable to a TO-5 metal can, especially if the op amp's supply current exceeds 500  $\mu\text{A}$ . The TO-5's kovar leads introduce thermocouple effects that can generate ac and dc offsets in the presence of external air motion or thermal gradients in the package.

You should also be aware of considerations related to, but external to the thermocouple amplifier itself. These include overvoltage protection, common-mode voltage, and noise. Protection is necessary because thermocouple wires often pick up static voltages or make contact with high voltage that can damage the amplifier circuit.

The R<sub>LIMIT</sub> resistor in Fig 3a, for instance, attenuates

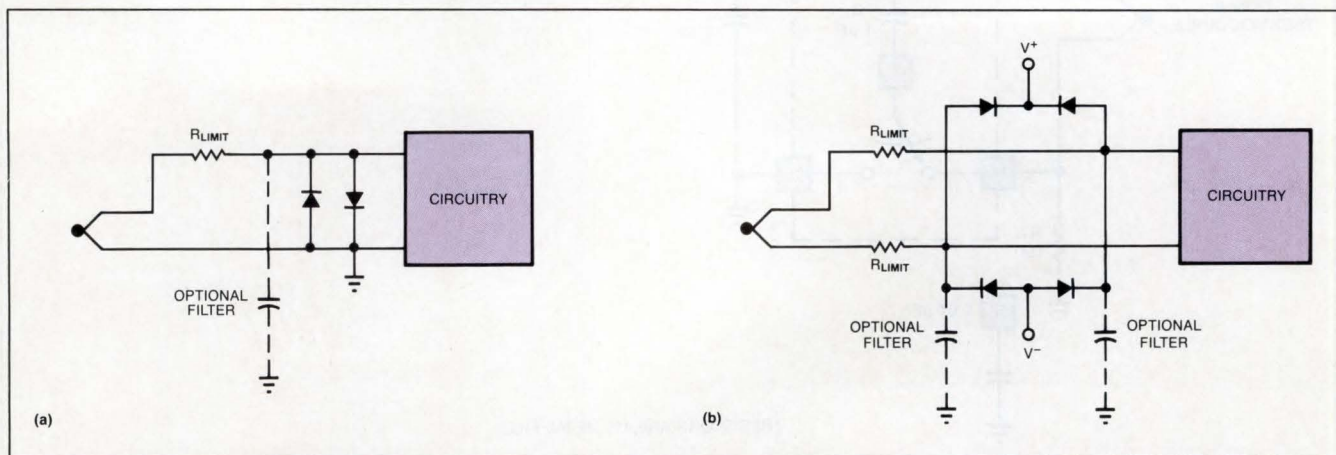

Fig 3—The resistors you see here protect the circuits from overvoltage on the thermocouple lines. The optional capacitors provide signal filtering for grounded or battery-operated systems (a), or for systems (b) subject to open ground connections or open thermocouple lines.

*Electronic cold-junction compensation tracks the junction temperature instead of maintaining the junction at a constant temperature.*

fault voltages. And, by adding a capacitor (shown as dashed lines), you can obtain signal filtering as well. **Fig 3b's** circuit shows balanced protection for a differential input. Again, connecting the optional capacitors provides lowpass signal filtering in addition to overvoltage protection. The diodes are effective in clamping the signal path to the supply voltages, but you must evaluate the effect of diode-leakage currents, especially if the limit resistors have high values. Similarly, bias currents flowing into the amplifier circuitry through high-value limit resistors can generate measurement errors. In some cases you must compromise accuracy to meet a system's requirements for voltage protection and noise rejection.

The amplifier circuit of **Fig 4** combines filtering with full differential sensing of the thermocouple voltage. If

all signals remain within the supply-voltage range of the switched-capacitor building block ( $IC_1$ ), the circuit provides 120 dB of common-mode rejection. (If the signals exceed this range, the circuit may require protection networks as discussed with regard to **Fig 3**.) Switch action within  $IC_1$  transfers charge from the external "flying capacitor"  $C_1$  to the external output capacitor,  $C_2$ . You can vary this rate of transfer, and hence the overall bandwidth, by controlling the chip's commutating frequency. Resistor  $R_1$  provides a bias-current path for  $IC_1$ 's floating inputs, and the pull-down resistor (shown as dotted lines) enables subzero-temperature readings.

Protection networks and differential operation may not suffice in thermocouple applications that have high levels of noise and common-mode voltage. Industrial

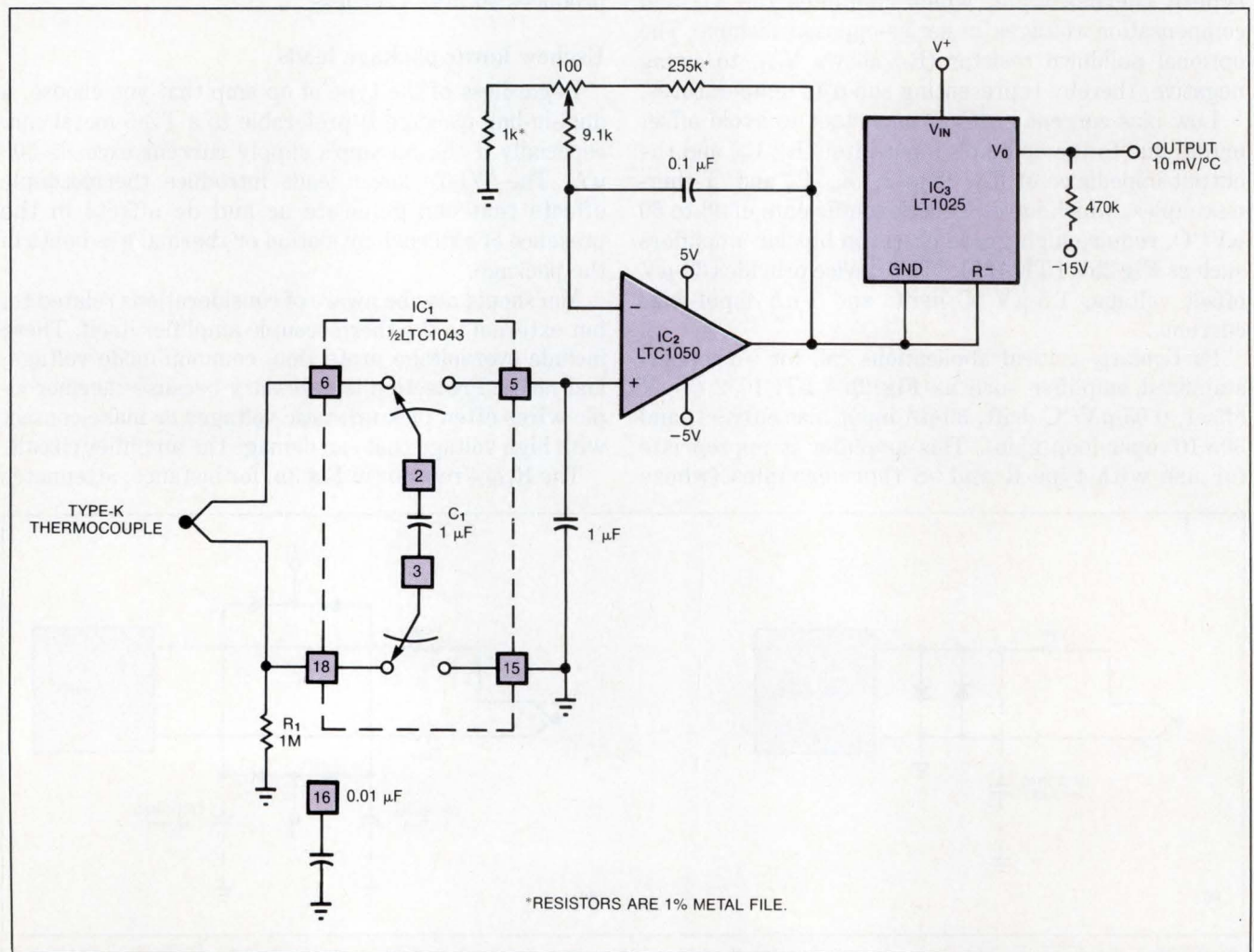

**Fig 4—This differential-input thermocouple amplifier implements "flying capacitor" isolation with a switched-capacitor circuit ( $IC_1$ ).**

environments, for example, can generate ground-potential differences of 100V or more. For these conditions, you must galvanically isolate the thermocouple and its signal-conditioning circuitry from ground. The circuit requires a fully isolated power source and an isolated signal-transmission path that is referred to ground at the output. Careful design allows a single path to transfer both the floating power and the isolated signals. What's more, thermocouples allow you to trade bandwidth for dc accuracy.

### One transformer isolates signal and power

The isolated signal conditioner of Fig 5 provides  $\pm 0.25\%$  accuracy in the presence of 175V common-mode voltages. A single transformer,  $T_1$ , transmits the isolated power and data. First of all, take note of the oscillator circuit consisting of inverter  $IC_{1A}$  and associated components, which generates the clock signal shown in Fig 6, trace A. Inverters  $IC_{1B}$ ,  $IC_{1C}$ , and associated components stretch the positive pulses in

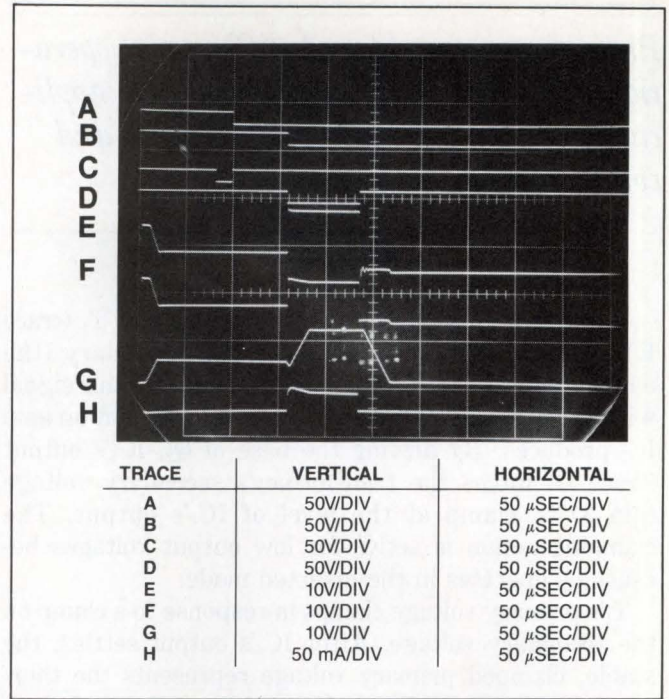

Fig 6—These waveforms depict selected signals from Fig 5's circuit. The negative-pulse level in trace E, for example, represents the desired thermocouple temperature.

this signal (trace B), and apply them to the 2.2-k $\Omega$  resistor,  $R_1$ . The pulse amplitudes are stable because the inverters obtain a stable supply voltage from the (approximate) 10.7V regulator consisting of  $IC_2$  and  $IC_3$ .

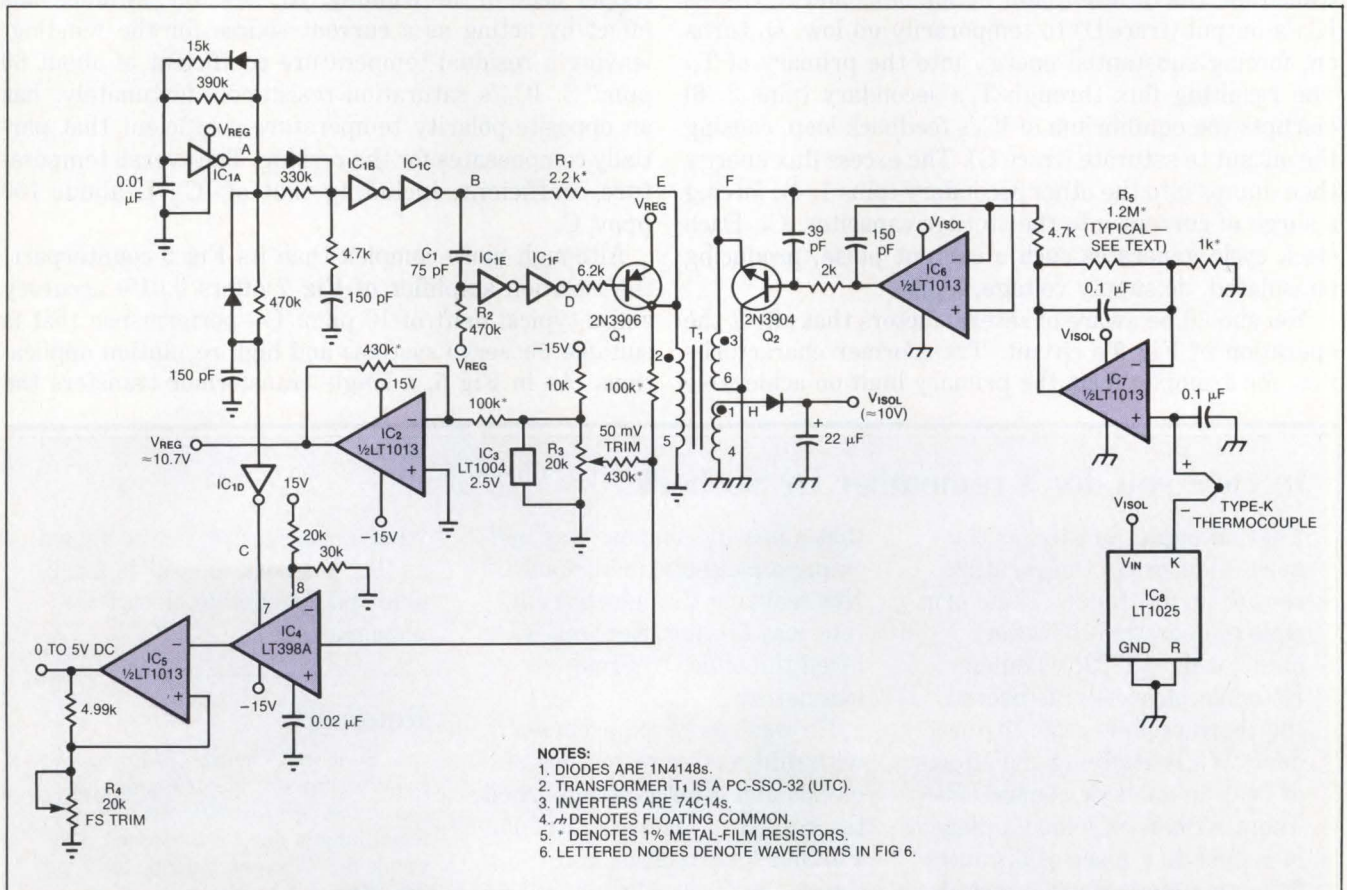

Fig 5—Transformer  $T_1$  provides 175V isolation for the power and signals of this thermocouple-signal conditioner. Accuracy is  $\pm 0.25\%$ .

---

*Protection networks and differential operation may not suffice in thermocouple applications that have high levels of noise and common-mode voltage.*

---

Current pulses in  $R_1$  drive the primary of  $T_1$  (trace E), producing voltage pulses in the secondary (the emitter of  $Q_2$ , trace F). Op amp  $IC_6$  compares this signal with the conditioned thermocouple voltage that op amp  $IC_7$  produces. By driving the base of  $Q_2$ ,  $IC_6$ 's output (trace G) forces the transformer's secondary voltage (pin 3) to clamp at the level of  $IC_7$ 's output. The clamping action is active for low output voltages because  $Q_2$  operates in the inverted mode.

$T_1$ 's primary voltage clamps in response to a clamp on the secondary voltage. After  $IC_6$ 's output settles, the stable, clamped primary voltage represents the thermocouple's output signal. Meanwhile, a delayed clock signal (trace C) from inverter  $IC_{1D}$  controls the sample/hold amplifier,  $IC_4$ , causing that device to sample the  $T_1$  primary voltage.  $IC_4$  returns to the hold mode when the clock waveform (trace A) goes low. Potentiometer  $R_3$  adjusts the sample/hold signal's offset, and potentiometer  $R_4$  adjusts the gain.

When  $IC_{1C}$ 's output (trace B) makes a high-to-low transition, the differentiator action of  $C_1$  and  $R_2$  causes  $IC_{1F}$ 's output (trace D) to temporarily go low.  $Q_1$  turns on, forcing substantial energy into the primary of  $T_1$ . The resulting flux through  $T_1$ 's secondary (pins 3, 6) disrupts the equilibrium of  $IC_6$ 's feedback loop, causing the output to saturate (trace G). The excess flux energy then dumps into the other secondary (pins 1, 4), forcing a surge of current into the storage capacitor,  $C_3$ . Each clock cycle generates such a current pulse, producing an isolated, dc supply voltage,  $V_{ISOL}$ .

You should be aware of several factors that affect the operation of Fig 5's circuit. Transformer characteristics, for example, form the primary limit on achievable

accuracy. The clamping scheme relies on avoiding saturation of the transformer's core. The clamp interval must be short, and  $T_1$ 's primary current during this interval should remain extremely low with respect to the core-saturation value. The power-refresh pulse occurs immediately after the data transfer rather than before, to allow a pause for the transformer's core to recover from saturation. The low clock frequency (350 Hz) ensures adequate time intervals for this purpose; the resulting low bandwidth is not of consequence in most thermocouple applications.

To trim the circuit's gain, select  $R_5$  ( $IC_7$ 's feedback resistor) according to the desired maximum temperature and the thermocouple type. You should set  $IC_7$ 's output to 50 mV before adjusting the offset trim ( $R_3$ ); the circuit cannot read  $IC_7$  outputs below 20 mV because of saturation in  $Q_2$ . The drift of the output voltage vs temperature depends on constant-magnitude current pulses into the primary winding of  $T_1$ , which in turn depends on the temperature coefficient of the copper used in the winding.  $R_1$ , however, swamps this effect by acting as a current source for the winding, leaving a residual temperature coefficient of about 60 ppm/ $^{\circ}C$ .  $IC_{1C}$ 's saturation resistance, fortunately, has an opposite-polarity temperature coefficient that partially compensates for the residue. The overall temperature coefficient, including that of  $IC_3$ , is about 100 ppm/ $^{\circ}C$ .

Although more complex than its Fig 5 counterpart, the isolation amplifier of Fig 7 offers 0.01% accuracy and a typical drift of 10 ppm/ $^{\circ}C$ —performance that is suitable for servo systems and high-resolution applications. As in Fig 5, a single transformer transfers the

## In case you don't remember Dr Seebeck

Thermocouples are by far the most widespread temperature sensors in use today. Their principle of operation, however, dates back to 1822, when an Estonian physician discovered the thermocouple effect by accident. While studying the effects of heat on galvanic connections, Thomas Seebeck joined a piece of copper to a piece of bismuth, forming a loop. He then noted

that a nearby compass was indicating a magnetic disturbance. Not realizing that electric current was flowing, Seebeck labeled the effect "thermomagnetism."

He went on to experiment with different combinations of metals and eventually published the results of his work (Ref 1). Further investigations, of course, have established that

"thermomagnetism," now known as the "Seebeck effect," is a reliable and repeatable electrical phenomenon.

### Reference

1. Seebeck, Thomas, *Magnetische polarisation der metalle und erze durch temperatur-differenz*, Abhandlungen der Preussischen Akademie der Wissenschaften, 1823, pg 265-373.



isolated data and power. The thermocouple voltage, however, undergoes pulse-width modulation before coupling across the transformer. The circuit then demodulates this signal back to dc.

Again, inverter  $IC_{1A}$  generates the clock waveform (Fig 8, trace A). This waveform's high-to-low transition sets flip-flop  $IC_2$  (trace B), after a small delay introduced by inverters  $IC_{1B}$ ,  $IC_{1C}$ , and associated components. The clock signal, buffered by inverters  $IC_{1D}$  and  $IC_{1E}$ , also drives the primary of  $T_1$  (trace C). As a result, the  $T_1$  secondary receives energy and delivers it to the storage capacitor,  $C_1$ , creating  $V_{ISOL}$ , the isolated supply voltage for that side of the circuit.

Besides generating  $V_{ISOL}$ , pulses in the  $T_1$  secondary clock the pulse-width modulator, a closed-loop circuit that includes  $IC_{4B}$ ,  $IC_{6B}$ ,  $IC_{7A}$ , and  $IC_{7B}$ . Op amp  $IC_8$  amplifies the thermocouple signal and applies it to the noninverting input of  $IC_{6B}$ , which in turn servo-biases comparator  $IC_{7A}$ . Each time that  $IC_{7B}$  allows  $C_2$  (trace E) to receive charge via resistor  $R_1$ ,  $IC_{7A}$  produces a

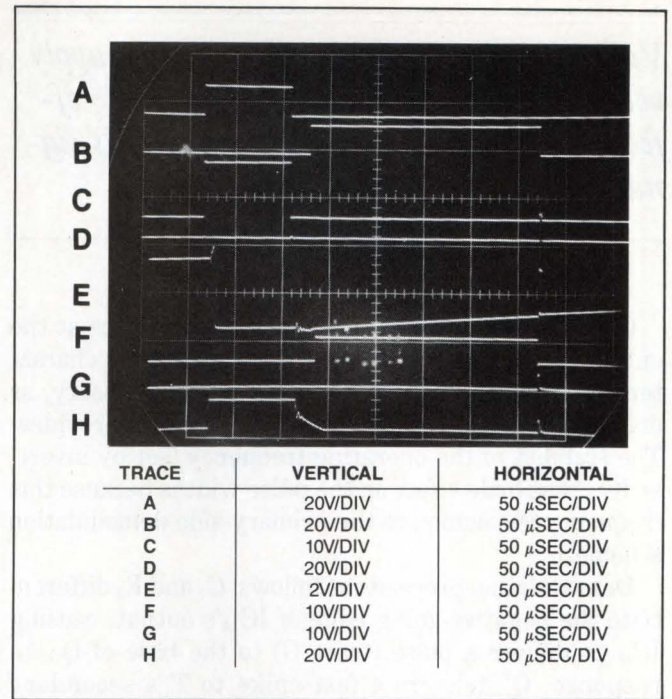

Fig 8—The positive pulse width in trace B of the Fig 7 circuit corresponds to the thermocouple's temperature.

pulse whose duration is proportional to the thermocouple voltage. After inversion by  $IC_{2A}$ , these pulses also drive the  $R_2/C_3$  integrator, which delivers a dc voltage to the inverting input of  $IC_{6B}$ .  $C_6$  provides compensation for the feedback loop.

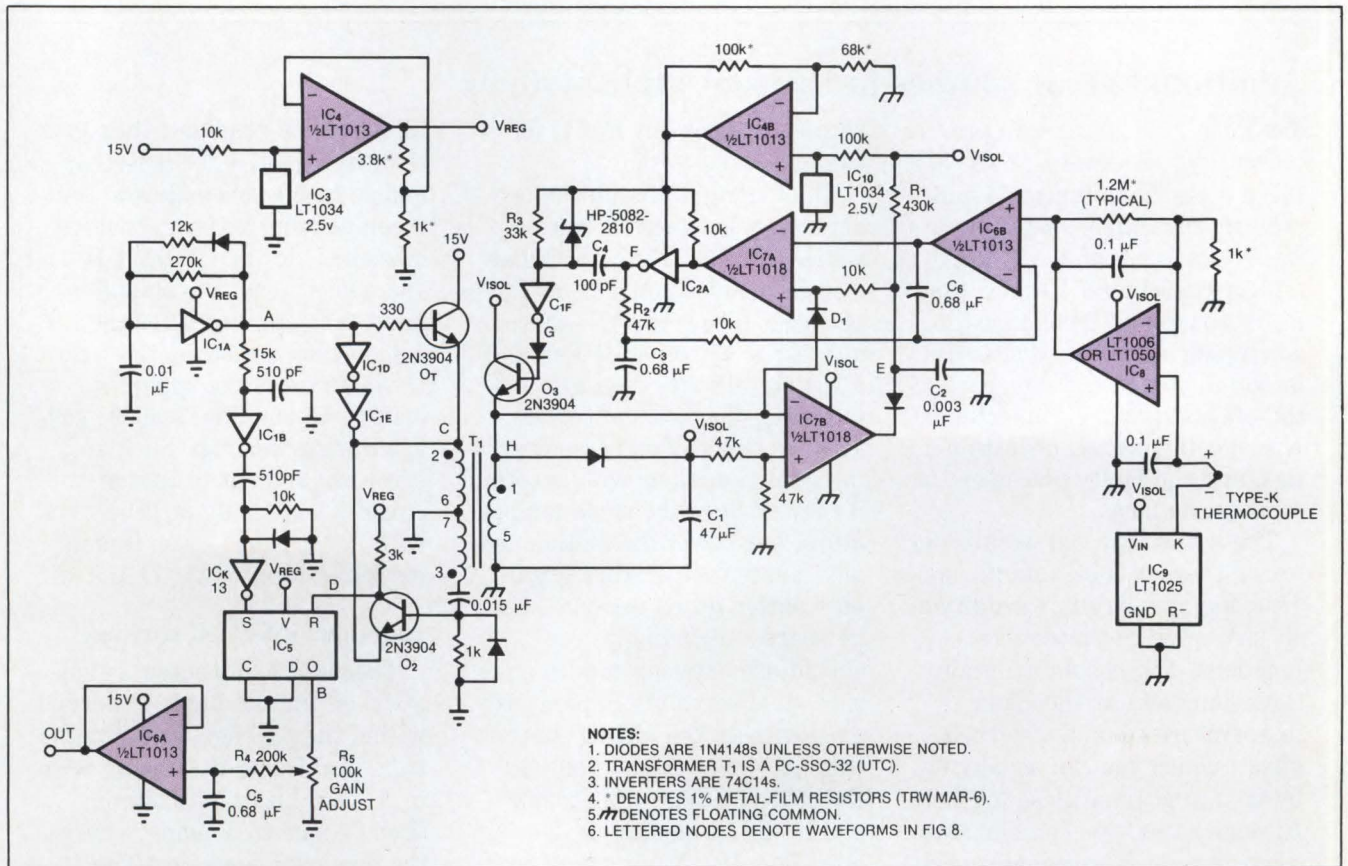

Fig 7—In this isolation circuit, pulse-width modulated thermocouple signals are transferred across the transformer barrier. Accuracy is  $\pm 0.01\%$ .

---

*Variations in ambient temperature, supply voltage, and clock frequency have little effect on the PWM isolation amplifier's signal output.*

---

Circuit accuracy demands stable pulse widths at the output of IC<sub>2A</sub>. IC<sub>2A</sub>'s low-loss, MOS switching characteristics contribute to the precise timing necessary, as does the stabilized supply voltage that IC<sub>4B</sub> provides. The stability of the operating frequency (set by inverter IC<sub>1A</sub>) has little effect on the pulse widths because this frequency is common to the primary-side demodulation scheme.

Demodulation proceeds as follows: C<sub>4</sub> and R<sub>3</sub> differentiate the negative-going edge of IC<sub>2A</sub>'s output, causing IC<sub>1F</sub> to deliver a pulse (trace G) to the base of Q<sub>3</sub>. In response, Q<sub>3</sub> delivers a fast spike to T<sub>1</sub>'s secondary (trace H). (Diode D<sub>1</sub> at IC<sub>7A</sub>'s noninverting input breaks a regenerative loop that could cause oscillation.) T<sub>1</sub>'s primary section between pins 7 and 3 receives the spike, which then drives the base of Q<sub>2</sub>. Q<sub>2</sub> behaves as a clocked demodulator, pulling its collector low (trace D) only when its base is high and its emitter is low—when T<sub>1</sub> is transferring data rather than power.

The collector spike from Q<sub>2</sub> resets flip-flop IC<sub>5</sub>. Like

IC<sub>2A</sub>, this flip-flop is an MOS device powered by a stable supply (obtained from IC<sub>4</sub>), and clocked by the same frequency as the pulse-width modulator. As a result, the flip-flop's Q output signal has a dc-average value that depends primarily on the desired thermocouple signal at IC<sub>8</sub>'s output. Variations in the ambient temperature, supply voltage, and clock frequency have little effect.

#### Delay translates to offset error

Filter components R<sub>4</sub> and C<sub>5</sub> extract the signal's dc value; R<sub>5</sub> permits adjustment of the overall gain. The voltage follower, IC<sub>6A</sub>, produces the circuit's output. Because this scheme depends on the accurate timing of edge signals at the flip-flop, you must account for the small delay in discharging C<sub>2</sub> (trace E) to avoid a small offset error. The delay in IC<sub>5</sub>'s S (set) line compensates for this error by setting the rising edge of trace B coincident with that of trace F. Trace B's falling edge requires no such compensation because wideband cir-

## Additional error sources in thermocouple systems

You must exercise care in processing the low-level signals that thermocouples produce. In general, thermocouple *system* accuracies greater than 0.5°C are difficult to achieve. Besides the major sources of error that the accompanying article discusses in detail, you should be aware of the effects that the connection wires, cold-junction uncertainties, and the faulty placement of sensors can have.

The wires that you use to connect a thermocouple and its conditioning circuitry form additional, unwanted thermocouple junctions. You should maintain these junctions at the same temperature to minimize their effect, which you can usually do by mounting them close together. In some cases, you can eliminate a junction by selecting appropriate connecting wires and other

accessories; consult **Ref 1**, for example.

The joining of dissimilar metals always produces a thermocouple junction. Such dissimilar metals include the leads of IC packages (kovar in TO-5 cans; alloy 42 or copper in DIPs), and a variety of other metals found in plating finishes and solders. The net effect of all these thermocouple junctions will be zero if they all have the same temperature, but power dissipation usually causes temperature gradients within an IC package or a pc board. Accordingly, you should use extreme care to ensure an absence of temperature gradients, in the vicinity of the thermocouple terminations, in the cold-junction compensator, and in the thermocouple amplifier.

If you can't eliminate a given

temperature gradient, then position the sensitive leads isothermally. In the schematics in the accompanying article, sensitive leads include the LT1025's R<sup>-</sup> and output pins, the amplifier-input pins, and leads for the gain-setting resistors. One effect to watch for is the apparent drift in an amplifier's offset voltage during warmup. Such an error can amount to tens of microvolts, especially in TO-5 cans with kovar leads—even if drift measures zero for the chip itself.

#### Junctions infest IC package

The culprit, of course, is mismatched thermocouple materials within the package, in the path from lead frame to bonding wire to IC metallization to silicon. (Lead frame to bonding wire is the dominant junction.) The effect is proportional to power dis-

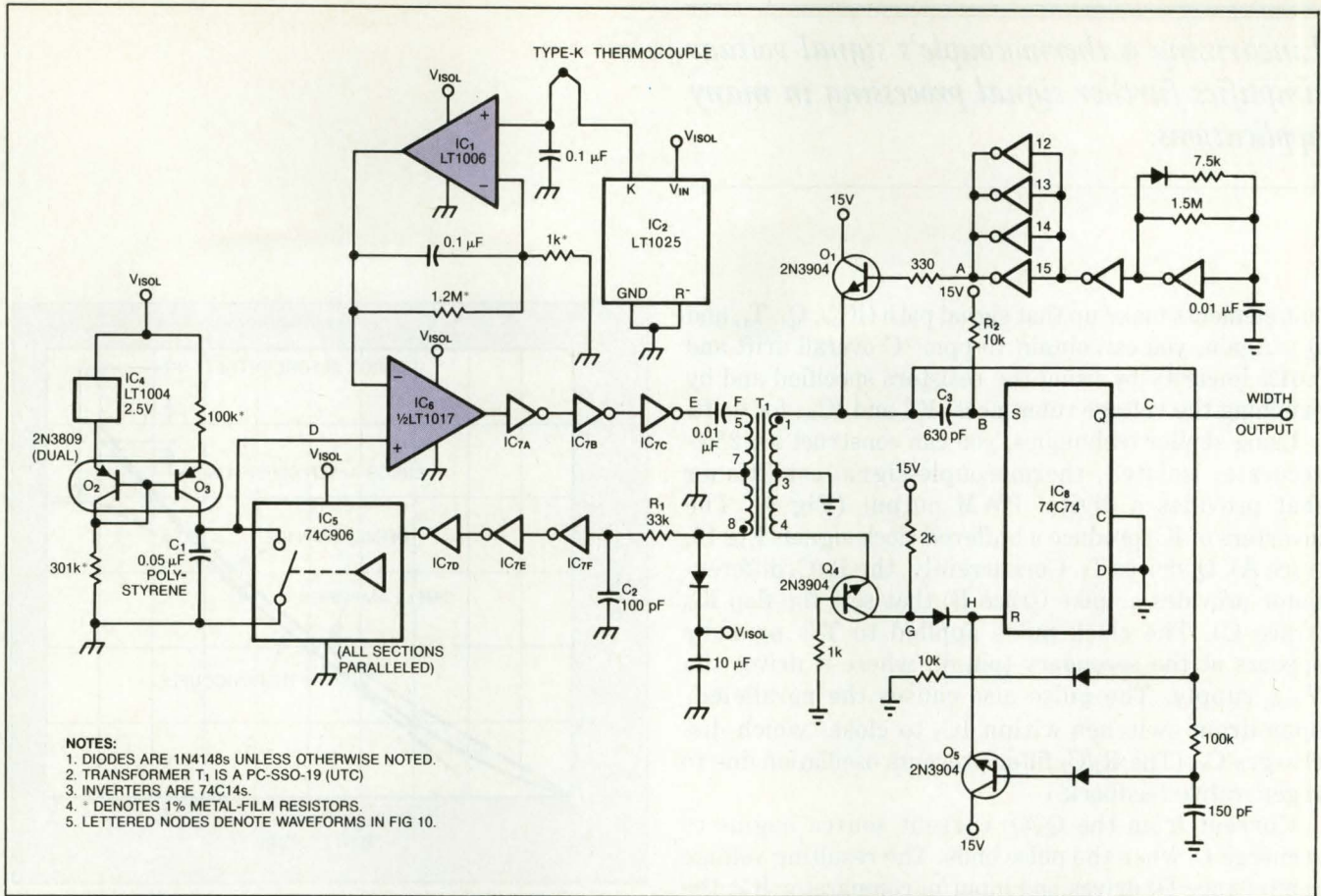

Fig 9—This thermocouple amplifier provides signal conditioning, isolation, and a pulse-width modulated output.

sipation, and you can minimize it by choosing ICs that draw low supply current, by operating them at low supply voltages, and by avoiding TO-5 cans. You can accommodate the remaining drift by specifying a 5-minute warmup before calibrating the system or measuring its performance.

The thermocouple's cold junction is another significant source of error. A true cold junction (ice-bath reference) will contribute error according to slight deviations from the desired temperature, but an active-compensator IC makes errors in the process of sensing and tracking the ambient temperature. You must take measures to ensure accurate tracking by maintaining the cold junction and the IC at the same temperature. These measures in-

clude the use of high-thermal-capacity blocks and thermal shrouds.

Because a thermocouple measures its own temperature, the placement of the thermocouple can also be a source of error. In fluid systems, for instance, eddy currents or the effects of laminar flow around the thermocouple can cause remarkably large errors. Even a simple surface measurement can be inaccurate because of poor thermal conductivity between the surface and the sensor.

Silicone thermal grease can ease this problem, and you should mate as much of the sensor surface as possible to the measured surface. (Ideally, the thermocouple should lodge tightly in a hole drilled in the surface.)

Keep in mind that thermocou-

ple leads act as heat pipes that provide direct thermal paths to the sensor. This isn't a problem if the surface has a large thermal capacity, but other situations may require some thought. For example, you might thermally mate the lead wires to the surface. Also, coiling the wires within the ambient temperature of interest will minimize their heat-pipe effects. You should be skeptical of results, even for applications that are apparently simple. Experiment with several sensor positions and mounting options, and if the results agree you are probably on the right track.

### Reference

- Omega temperature measurement handbook, Omega Engineering, Stamford, Connecticut, 1987.

*Linearizing a thermocouple's signal voltage simplifies further signal processing in many applications.*

cuit elements make up that signal path (IC<sub>1F</sub>, Q<sub>3</sub>, T<sub>1</sub>, and Q<sub>2</sub>). Again, you can obtain 10-ppm/°C overall drift and 0.01% linearity by using the resistors specified and by matching the voltage references, IC<sub>3</sub> and IC<sub>10</sub>, for drift.

Using similar techniques, you can construct a 0.25%-accurate, isolated, thermocouple-signal conditioner that provides a digital PWM output (Fig 9). The inverters of IC<sub>3</sub> produce a buffered clock signal (Fig 10, trace A). Q<sub>1</sub> drives T<sub>1</sub>. Concurrently, the R<sub>2</sub>/C<sub>3</sub> differentiator provides a spike (trace B) that sets flip-flop IC<sub>8</sub> (trace C). The clock pulse applied to T<sub>1</sub>'s primary appears at the secondary (pin 8), where it drives the V<sub>ISOL</sub> supply. The pulse also causes the paralleled, open-drain switches within IC<sub>5</sub> to close, which discharges C<sub>1</sub>. (The R<sub>1</sub>/C<sub>2</sub> filter prevents oscillation due to regenerative feedback.)

Current from the Q<sub>2</sub>/Q<sub>3</sub> current source begins to recharge C<sub>1</sub> when the pulse ends. The resulting voltage ramp (trace D) drives one input of comparator IC<sub>5</sub>; the signal related to the thermocouple voltage drives the other input. The comparator switches high when these voltages reach equality, causing a pulse to ripple down the IC<sub>7A</sub>, IC<sub>7B</sub>, IC<sub>7C</sub> inverter chain (trace E) and drive T<sub>1</sub>'s secondary. (Three inverters serve to sharpen the signal's low-to-high transitions.) As a result, T<sub>1</sub>'s pri-

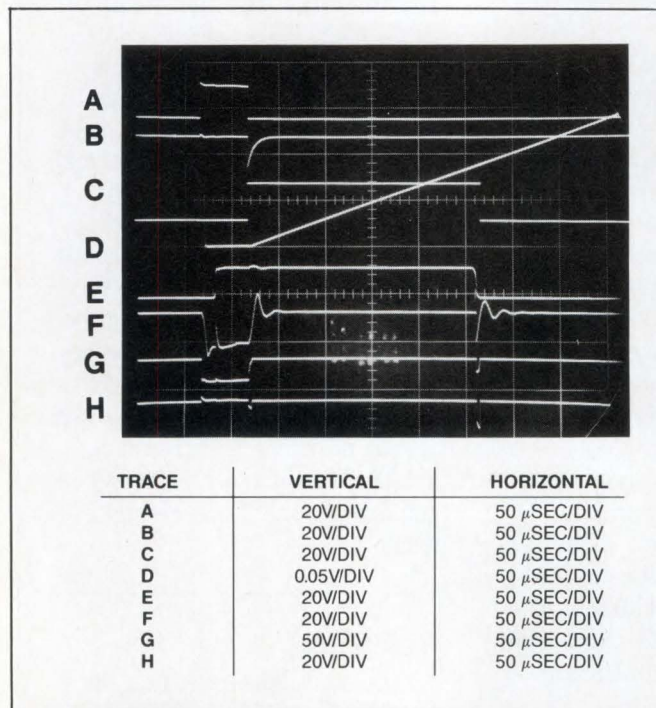

Fig 10—Of particular interest in these waveforms of the Fig 9 circuit is the pulse-width-modulated output (trace C).

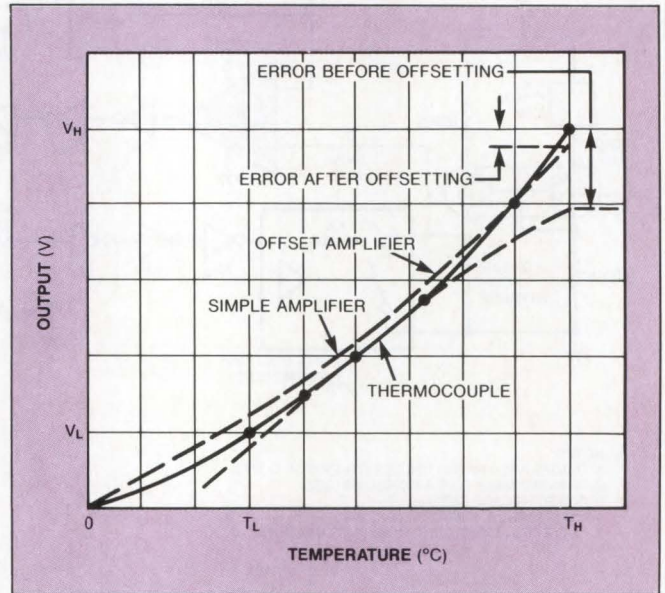

Fig 11—By introducing an offset voltage and shifting the gain of a simple amplifier, you obtain an output that more closely matches the thermocouple characteristic.

mary produces a negative spike (pin 4) that biases Q<sub>4</sub>, causing its collector to go low (trace G).

Transistors Q<sub>4</sub> and Q<sub>5</sub> form a clocked, synchronous demodulator that pulls IC<sub>8</sub>'s R (reset) pin low only when the clock signal (the emitter of Q<sub>1</sub>) is low; this condition occurs during data transfer but not during power transfer. The demodulated output (trace H) contains a single negative spike that resets the flip-flop. Because this spike is synchronous with the high-to-low transition of trace E, IC<sub>8</sub>'s output-pulse duration (trace C) is proportional to the thermocouple temperature.

#### Four techniques linearize TC signal

Because a thermocouple's response to temperature is nonlinear, its signal-conditioning circuit produces a nonlinear signal. By linearizing this signal, however, you can simplify further signal processing in many applications. Offset addition, breakpoints, analog computation, and digital correction are four techniques useful for this purpose.

Offset-addition schemes rely on biasing the nonlinear "bow" with a constant term. The resulting output voltage is high at the low end and low at the high end, but errors between these two extremes are reduced (Fig 11): The compromise reduces overall error. This approach is suitable for applications in which nonlinearity is either slight over a wide range or great over a narrow range.

# Superior Semiconductor Test Performance

Matrix Switching Solutions  
for your ATE

Look to  
the leader in  
low-current perfor-  
mance to meet your  
semiconductor test needs.

The new Model 707 Switching Matrix includes two sub-picoamp and two high frequency CV matrix switching paths. Four additional triaxial inputs provide signal paths with performance to 20pA. Mix general purpose and coaxial matrix cards to switch an entire spectrum of signals from 5 $\mu$ V to 200V, DC to 30MHz, in configurations up to 2880 relay crosspoints (8x360).

Integrate the Model 707 into your system quickly and easily, with preassembled cables and standard connecting hardware. General purpose, semiconductor, and coaxial switching cards are automatically interconnected through the analog backplanes, and are easily removed for maintenance.

Relay status is continually displayed on the 707's front panel. And the interactive Programming Light Pen accessory reduces program development time by eliminating keystrokes. Store up to 100 configurations in the 707's built-in, non-volatile memory for instant recall or fast triggered relay sequences.

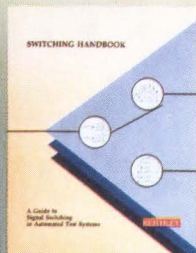
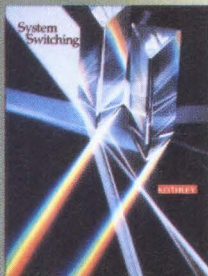

Technical support literature and our Applications staff will help you select the appropriate system configuration.

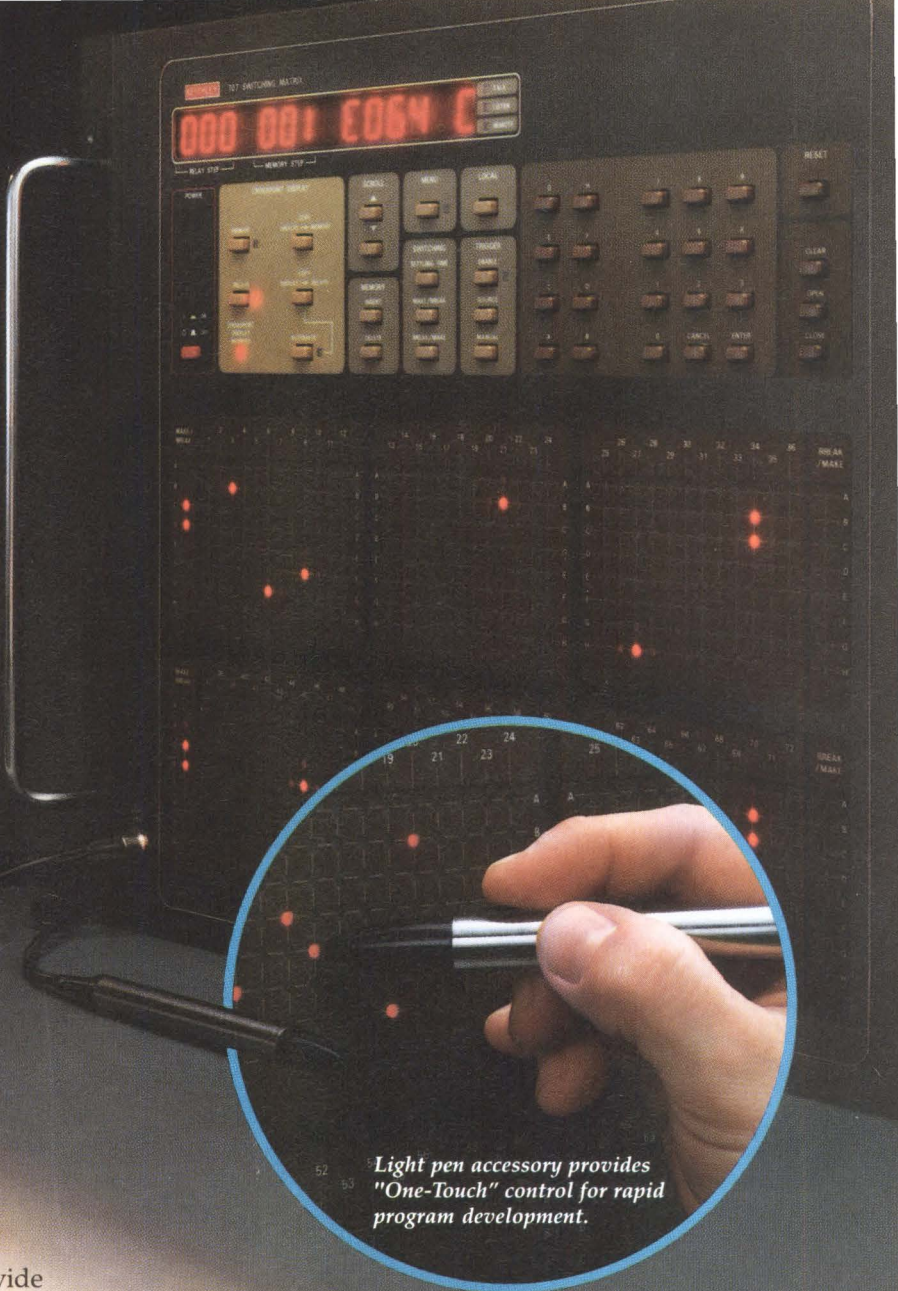

Light pen accessory provides "One-Touch" control for rapid program development.

To get the complete story on Keithley switching, call 1-800-552-1115.

## The Model 707 Switching Matrix

**KEITHLEY**

Type-S thermocouples are relatively nonlinear—they generate  $6 \mu\text{V}/^\circ\text{C}$  at  $25^\circ\text{C}$  and  $11 \mu\text{V}/^\circ\text{C}$  at  $1000^\circ\text{C}$ . Fig 12 shows an offset-addition linearizing circuit for such a thermocouple. This circuit is similar to that of Fig 2b, except for the offset term derived from IC<sub>2</sub> and applied through R<sub>4</sub>. IC<sub>3</sub> is a chopper-stabilized op amp, useful for minimizing drift. Circuit accuracy is  $\pm 3^\circ\text{C}$  for the range of 800 to  $1200^\circ\text{C}$ . To calibrate the circuit, set  $V_T=0.0000\text{V}$  and trim R<sub>5</sub> so that  $V_{\text{OUT}}=1.669\text{V}$ . Then, set  $V_T=9.585\text{V}$  ( $T=1000^\circ\text{C}$ ) and trim R<sub>2</sub> so that  $V_{\text{OUT}}=9.998\text{V}$ .

The Fig 13 circuit is an adaptation of a configuration (Ref 1) that uses breakpoints to change circuit gain as the input signal varies. This method requires that you scale the input and feedback resistors associated with amplifiers IC<sub>4A-4D</sub>, IC<sub>3B</sub>, and IC<sub>3D</sub>. Current summation at IC<sub>3C</sub>'s inverting input produces an output voltage that is linear with the thermocouple temperature. Different-value input resistors cause each of the amplifiers, IC<sub>3D</sub>, IC<sub>4A</sub>, IC<sub>4B</sub>, and IC<sub>4C</sub>, to begin contributing current at a

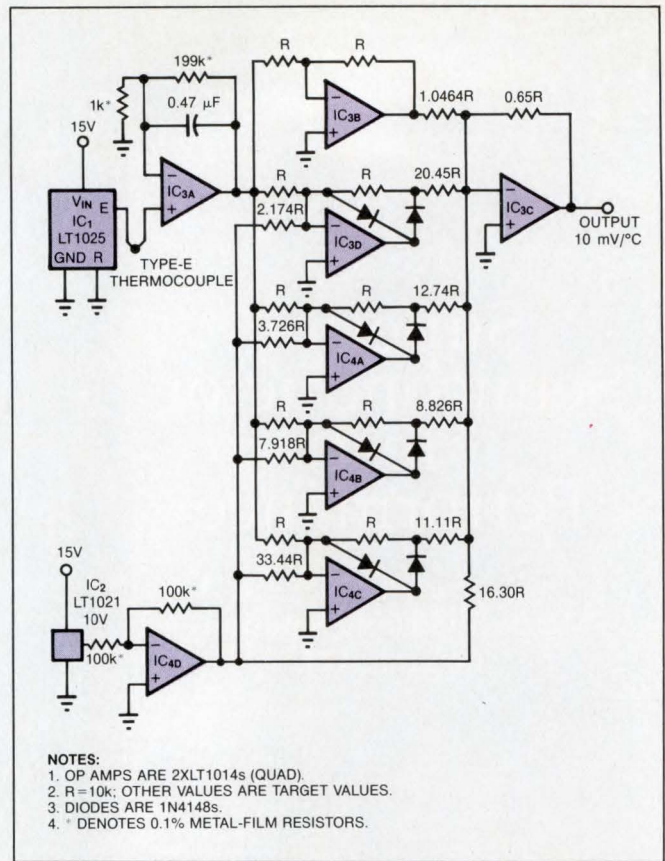

Fig 13—The thermocouple's output is linearized thanks to the introduction of discrete breakpoints (amplifiers IC<sub>3D</sub>, IC<sub>4A</sub>, IC<sub>4B</sub>, and IC<sub>4C</sub>), which become active at different signal levels.

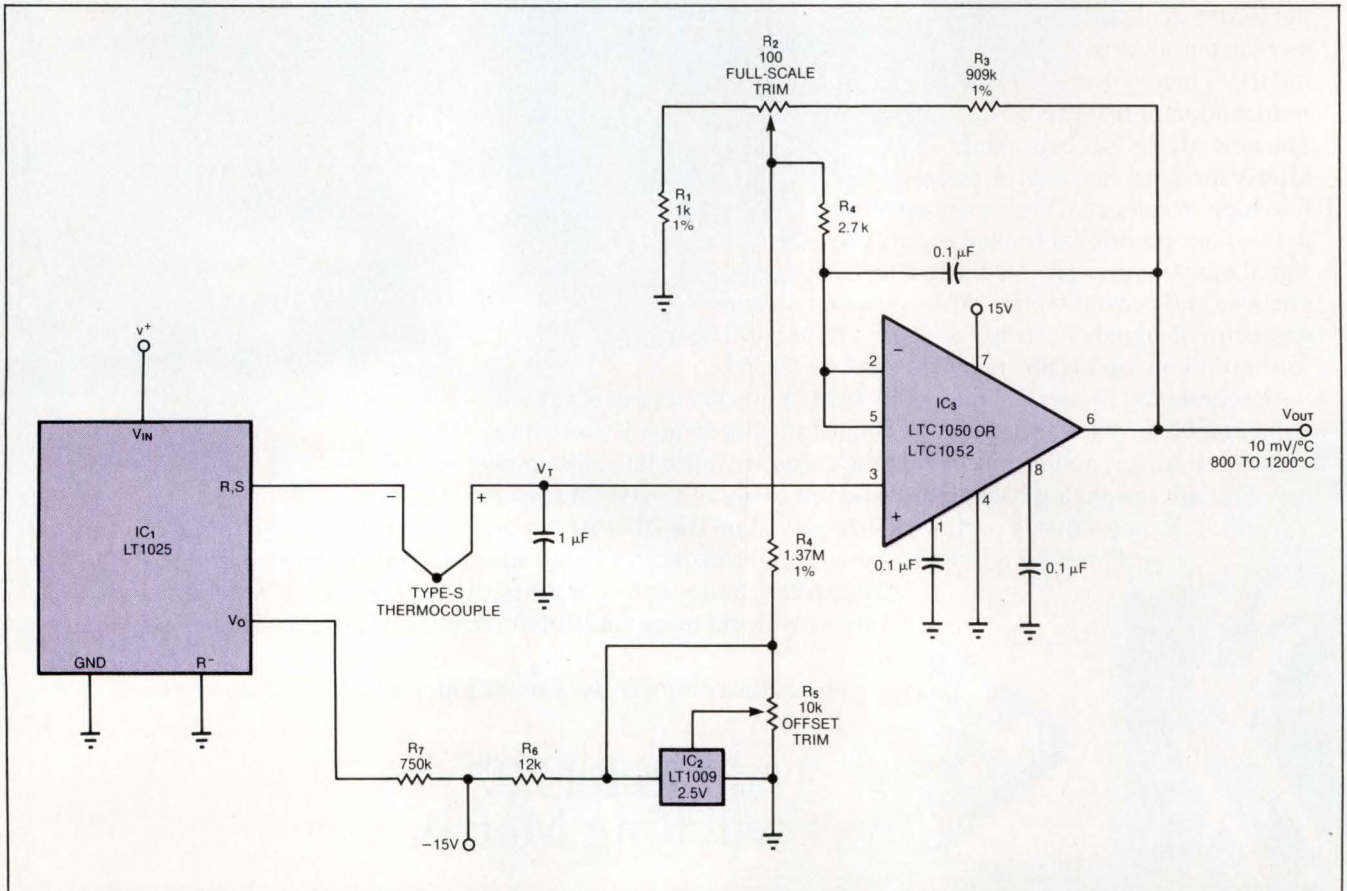

Fig 12—This circuit derives its offset term from the 2.5V reference (IC<sub>2</sub>) and uses it to help linearize the type-S thermocouple's output.

# We've Invented the Future of Instrumentation Software . . . Twice.

With Words

With Pictures

## Acquisition

Integrated libraries for GPIB, RS-232, A/D-D/A-DIO plug-in cards, and modular instruments.

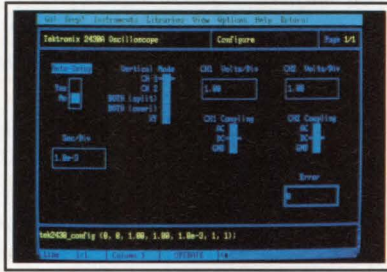

Intuitive character-based function panels that automatically generate source code.

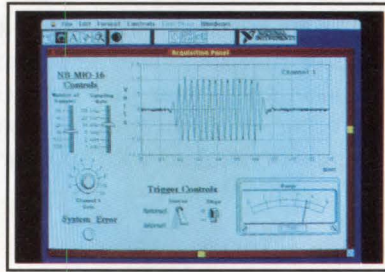

Front panel user interface with virtual instrument block diagram programming.

## Analysis

Extensive libraries for data reduction, digital signal processing, and statistical analysis.

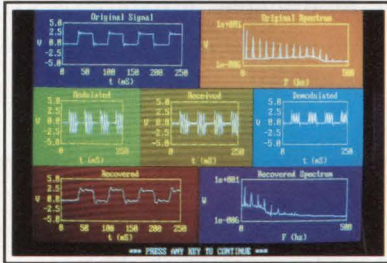

Over 100 analysis functions plus all the built-in functions of your language.

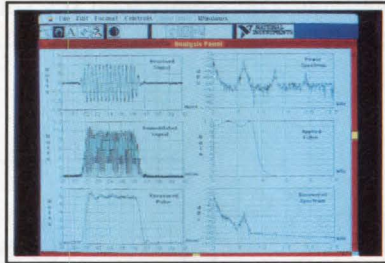

Over 250 icons for computation and analysis.

## Presentation

Flexible high-performance graphics and report generation.

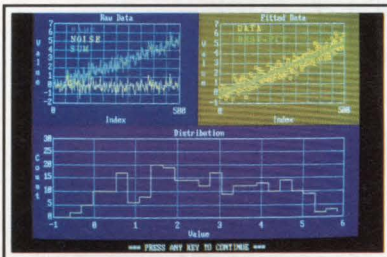

Extensive graphics support for CGA, EGA, MCGA, VGA, and Hercules.

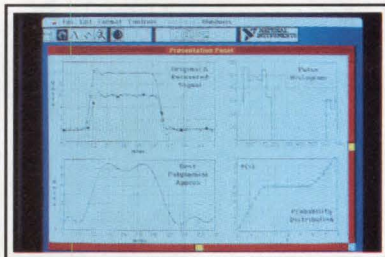

Macintosh Desktop Publishing compatibility.

*The Software is the Instrument*

**LabWindows™**—  
for the DOS-based PC and PS/2,  
with Microsoft QuickBASIC or C.



12109 Technology Boulevard  
Austin, Texas 78727-6204  
800/531-4742 512/250-9119

**LabVIEW®**—  
for the Apple Macintosh

Because they eliminate calibration trimming, digital techniques have become a popular method for linearizing thermocouple signals.

different level of input signal, and the switching diodes produce a piecewise-linear response from each amplifier. For the range of 0 to 650°C, typical circuit accuracy is  $\pm 1\%$ .

Fig 14's circuit (Ref 1) replaces the breakpoints with continuous analog-computer functions, uses fewer amplifiers and resistors, and offers similar performance. The multifunction converter, IC<sub>4</sub>, linearizes the response by combining a single breakpoint with appropriate scaling.

### Implement breakpoints in software

Digital techniques have become popular for linearizing thermocouple signals because they eliminate calibration trimming. For instance, the Fig 15 circuit—which Guy M Hoover of Linear Technology Corp developed—feeds a digitized thermocouple voltage to a  $\mu P$  that implements a large number of breakpoints in software. To use the circuit, you simply load the soft-

ware and apply power; the  $\mu P$  then linearizes the digitized thermocouple signal and stores the result. (Ed Note: The listing that provides all the necessary code for this application is available by sending a self-addressed, stamped envelope (\$0.39 postage) to Software Listings Editor, EDN, 275 Washington St, Newton, MA 02158).

IC<sub>4</sub> is a 10-bit A/D converter that gives 0.5°C resolution over the 0 to 500°C range. IC<sub>2</sub> amplifies and filters the thermocouple signal; IC<sub>1</sub> provides cold-junction compensation; and IC<sub>3</sub> provides an accurate reference voltage. (To maintain accuracy, the reference requires a minimum 6.5V supply; the A/D converter monitors this voltage via the R<sub>1</sub>-R<sub>2</sub> divider.) The 1024-step resolution that IC<sub>4</sub> provides (24 more than the required 1000) ensures 0.5°C of temperature resolution, even for the nonlinear thermocouple characteristic. Linear interpolation between temperature-data points spaced 30°C apart, for example, introduces less than 0.1°C of error.

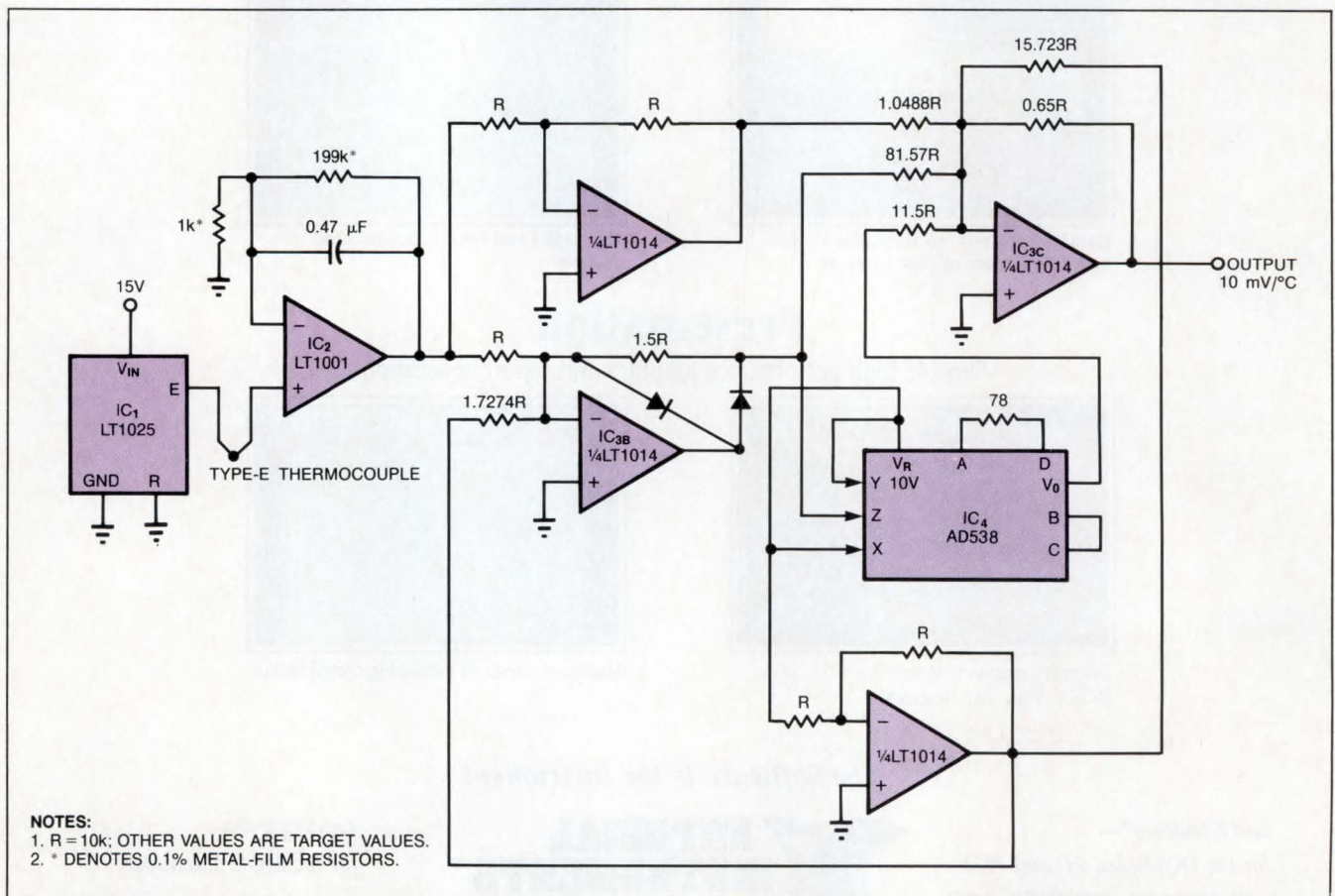

Fig 14—Offering performance comparable to that of Fig 13, this linearizing circuit uses analog-computer functions in place of breakpoints.



# One board not five.



If you're looking for a quick, economical and reliable solution to the problem of getting your 68020 system up and running - and who isn't? - you couldn't find a better answer than the TP22V from Tadpole Technology.

The TP22V does the job of up to 5 cards: processor card, memory card, Ethernet controller, communications controller and SCSI/floppy disk controller with no piggyback modules!

Its features include:

- MC68020 32-bit processor, 16-20MHz
- 4Mb dual-ported DRAM
- Ethernet IEEE 802.3 interface
- 8 TTL asynchronous ports
- RS232 synchronous console port
- RS232 asynchronous console port
- MC68851 PMMU
- SCSI interface
- Floppy disk controller
- Battery backed up real time clock
- Optional MC68881 Floating Point Unit
- UniPlus+ System V.2.2 or TP-IX System V.3.1
- OS-9 Real Time Operating System
- VRTX Executive

And with power like this you can use it on its own, as a complete, low-cost UNIX multi-user system.

Like to know more about the TP22V?

**Just phone 0223 461000 (UK)**

**or 415 828 7676 (USA) for information.**

***You may as well throw  
the other cards away!***

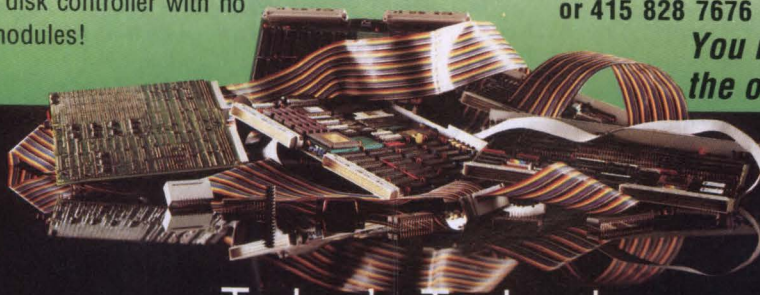

**Tadpole Technology**  
*the driving force in 32-bit design*

Tadpole Technology plc  
Titan House, Castle Park, Castle Hill, Cambridge CB3 0AY, UK  
Telephone: 0223 461000 Telex: 818152 TADTEC Fax: (0223) 460727  
Tadpole Technology Inc

6747 Sierra Court, Suite K, Dublin, California 94568, USA. Telephone: 415 828 7676 Fax: 415 828 9340

UNIX is a Trademark of AT & T Bell Labs OS-9 is a Trademark of Motorola Corporation Ethernet is a Trademark of Xerox VRTX is a Trademark of Rhaps Systems UniPlus+ is a Trademark of Unixsoft

*Eddy currents and the effects of laminar flow around a thermocouple can cause remarkably large measurement errors.*

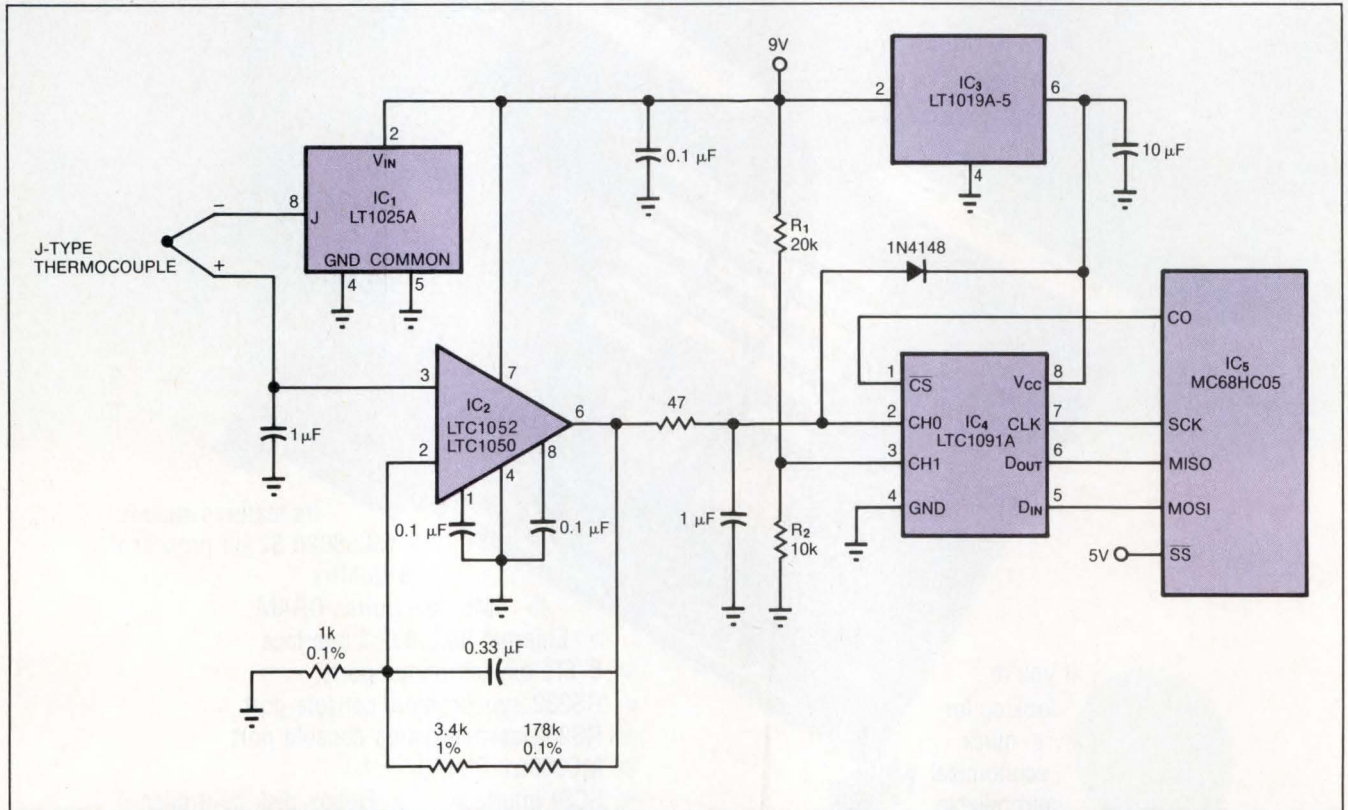

**Fig 15**—By introducing a microcomputer (IC<sub>5</sub>) to implement breakpoints in software, this thermocouple-linearizing circuit eliminates calibration trimming. The software listing is available from EDN; see text for details.

The cold-junction compensator, IC<sub>1</sub>, dominates the offset-error budget by contributing errors as high as 0.5°C. (IC<sub>1</sub>'s 5-μV offset contributes no more than 0.1°C.) The gain error is 0.75°C max, due primarily to the use of gain resistors with 0.1% tolerance values. IC<sub>3</sub>'s output-voltage tolerance and IC<sub>4</sub>'s gain error also contribute to the overall gain error; you can reduce this figure by trimming IC<sub>3</sub>'s gain resistors. The A/D converter maintains a linearity error below 0.15°C. Typically, these errors combine to produce an overall value of 0.5°C or less, exclusive of the thermocouple itself. Additional wire-connection errors of 0.5 to 1.0°C are not uncommon in practice, but with care you can keep these errors below 0.5°C.

**EDN**

## References

1. Sheingold, D H, *Nonlinear circuits handbook*, pgs 92-97, Analog Devices Inc, Norwood, MA, 1974.
2. Williams, J, "Designer's guide to temperature sensors," *EDN*, May 5, 1977, pg 77.
3. *Practical temperature measurements*, application note #290, Hewlett-Packard Co, Palo Alto, CA, 1983.

4. *Thermocouple reference tables*, NBS monograph #125, National Bureau of Standards, Boulder, CO, 1975.

5. *Manual on the use of thermocouples in temperature measurement*, ASTM special publication #470A, American Society for Testing of Materials, Philadelphia, PA, 1974.

## Author's biography

*Jim Williams, staff scientist at Linear Technology Corp (Milpitas, CA), specializes in analog-circuit and instrumentation design. He has served in similar capacities at National Semiconductor, Arthur D Little, and the Instrumentation Development Lab at the Massachusetts Institute of Technology. A former student of psychology at Wayne State University, Jim enjoys tennis, art, and collecting antique scientific instruments.*



Article Interest Quotient (Circle One)  
High 488 Medium 489 Low 490

# POWER

# Briefs

## COMPACT 250 & 400 WATT SWITCHERS FEATURE FOUR-OUTPUT PARALLELING

The PPM and PFS Series 250 and 400 Watt cased switchers incorporate a unique closed-loop current sharing control circuit which permits simultaneous paralleling of up to four outputs, each with remote sensing. In addition, a single-point failure protection circuit assures that a single failure in a redundant power system will not cause the power bus to fail.

The series can provide as many as seven outputs.

incorporated in three plug-in modules. Control circuitry is fabricated on a single circuit board using surface-mount technology. Standard features include switch selectable 115/230 VAC input, input line filter, remote on/off, power good signal, remote sensing, thermal protection with warning signal, overload protection, overvoltage protection, soft start and inrush current limiting. Optional features include current sharing, OVP crowbar and DC OK signal on main output, current monitor signal and others.



Low profile cases only 5" wide by 2.75" high permit convenient stacking of the supplies. Power density is up to 2.4 Watts per cubic inch, and all models are efficiently cooled by a miniature internal ball bearing DC fan.

These switchers employ a bridge-driven forward converter using 100kHz MOSFET switching. The auxiliary outputs have either linear or magnetic amplifier regulation and are

There are 25 stocked standard models in the 250W and 400W series. The models are UL recognized, CSA certified, and TUV approved.

### Key Specifications:

Line Regulation	.....	0.2%
Load Regulation	.....	0.2%
Holdup Time	....	30 msec. min.
Efficiency	.....	70 to 85%
Oper. Temp. Range	...	0° to 65°C

From Computer Products/Power Products

**Circle No. 1**

## NEW 4.5 WATT DC/DCs NEED ONLY HALF THE SPACE

The AF Series DC/DC converters produce 4.5 Watts of DC power in half the space of previous industry-standard units.

With a case size of only 1.0 x 2.0 x 0.375 inches, they replace standard 2 x 2 inch converters, yet have the same pinouts.

This series is fabricated with surface-mounted components on a miniature thick-film substrate to achieve 6 watts per cubic inch power density and efficiencies up to 66%. Available in single (+5, +12 or +15V) and dual ( $\pm 12V$  or  $\pm 15V$ ) outputs, the input voltage can be either +5 or +12VDC

Other key specifications include  $\pm 1.0\%$  line regulation, 0.5% load regulation, and 40mV p-p ripple and noise. These converters are ideal for board-mounted applications in computers, I/O boards, telecommunications, process control and scientific instruments. The AF Series is on distributor shelves now.

From Computer Products/Stevens-Arnold

**Circle No. 2**

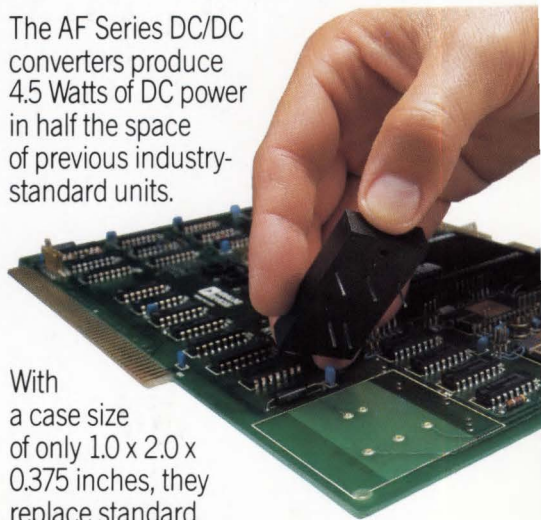

## UNIVERSAL INPUT SWITCHERS OPERATE FROM 85 TO 264 VAC

Operate from any line voltage from 85 to 264 VAC without changing jumper wires or switches. Computer Products/Boschert's new NFS40, NFS50 and NFS110 Universal Input Series open frame switchers eliminate worldwide

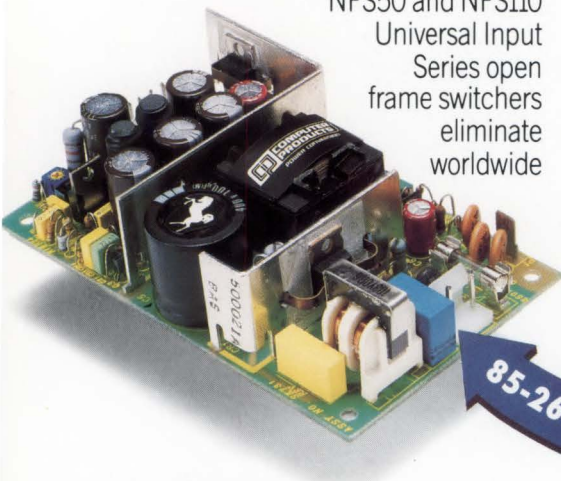

line voltage selection problems and offer system design flexibility.

On the low end, the NFS40 series of single and multiple output 40 watt switchers measures a tiny 5" x 3" x 1.2". These switchers provide more than 2.2 watts/cubic inch, and will fit into very small spaces. The NFS50-7608 50 watt switcher directly replaces the industry standard 6.3" x 3.9" 40 watt unit. No need to mechanically redesign. Just drop it in and enjoy the benefits of universal input, plus 10 additional watts for any system extras.



For small to medium systems, check out the NFS110 series 110 watt switchers. The +12V output will deliver up to 9 amps to start disk drives. The small 7.0" x 4.25" x 1.8" size delivers more than 2.0 watts per cubic inch.

All of these switchers will operate reliably with no load on the output, making them ideal for expansion systems. Also, each output is fully regulated. NFS40 and NFS110 evaluation units are now available. NFS50 is in distribution. From Computer Products/Boschert **Circle No. 3**

## POPULAR DC/DC CONVERTERS HAVE NEW LOW PRICES

Design in high performance and reliable operation at new low prices. The ES, EA and H series have filled a lot of PC boards to date but never so economically. Prices have been reduced by 10% for the ES series and 15% for the H and EA series. Also, the H and EA series are available in new 1.0 x 2.0 x 0.38 inch non-conductive packages. Check the table below and send for the latest data on our top performers. Or better yet, call your distributor for these low cost solutions.

Series	Output Power	Output Type	Input Voltage	Output
H	1 Watt	Single	5, 24, 48V	±5V @ 200mA
EA	1.8 Watts	Dual	5V	±12 or ±15V @ 60mA
ES	15 Watts	Triple	12, 24, 48V	+5V & ±12V +5V & ±15V or ±5V & +12V

From Computer Products/Stevens-Arnold **Circle No. 4**

## TAKING THE RISK OUT OF CUSTOM OPEN FRAME SWITCHERS

Computer Products/Boschert can take the risk out of custom switcher development. You get a predictable, highly reliable switcher, based on our well-known standard circuits.

Here's why:

### Field-Proven Building Blocks.

The quickest, least expensive way to build a custom switcher is using existing circuits. Computer Products/Boschert has hundreds of building blocks, field proven over our 15 year history. We understand their use and limitations. Your custom design is predictable, economical and virtually risk-free.

### Appropriate Topology.

Using the wrong topology is either costly or unreliable. Since we understand and build virtually every type of switcher, there is no need to squeeze your custom needs into our favorite topology. You get the correct topology for your power requirement.

**Experience.** Your supply is built by a company exclusively dedicated to switchers for 15 years. Our ability to integrate electrical, mechanical and thermal designs is exceptional. Our new medium power designs deliver more than 2 watts/cubic inch. The result is a highly compact switcher that meets or exceeds your system requirements.

**Safety Approval.** UL and CSA usually take no more than eight weeks. Full VDE certification usually takes only 12 to 16 weeks after your final prototype approval. TUV approval is

also available.

**Manufacturability.** Every supply we make is designed with manufacturability in mind. We use a common parts base, with well characterized components that meet our conservative stress derating guidelines. Check for further information on custom switchers.

From Computer Products/Boschert **Circle No. 5**



## LINEAR POWER MODULES MEET UL544 MEDICAL REQUIREMENTS

For UL544 approval you can rely on Computer Products/Power Products new MED 300/500 Series of AC/DC encapsulated power modules. They meet or exceed the stringent UL544 requirements for medical equipment. These supplies are recommended for use in non-patient contact medical, dental and laboratory applications where high isolation and low leakage are critical. The MED 300/500 series is provided in single, dual and triple output models offering 63 different output voltage and current variations.

The units are linear regulated and have output power from one to 15 watts with popular output voltages of 5, 12, 15, 24,  $\pm 12$ ,

$\pm 15$  VDC, plus others available. Standard protection features such as overtemperature, overload and short circuit protection are included. The power modules incorporate a split-bobbin wound transformer which provides high isolation between primary and secondary with low coupling capacitance. This results in 2500 VAC isolation voltage and less than 10uA leakage current. The units are available in either printed circuit mountable or chassis mountable packages. In addition to UL544 approval the series is CSA certified.

From Computer Products/Power Products **Circle No. 6**

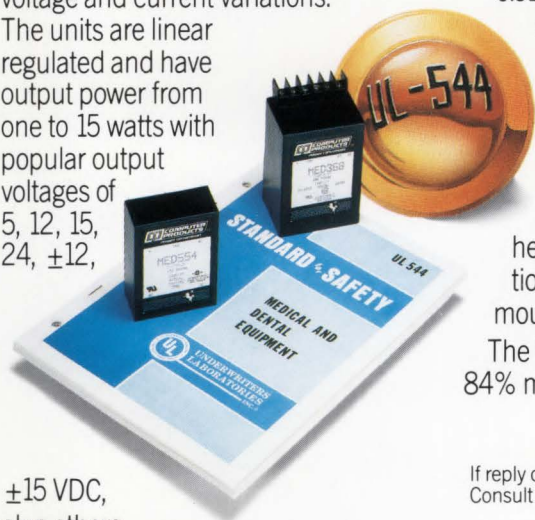

## 100 WATT DC/DC CONVERTERS HAVE LOW PROFILES, HIGH EFFICIENCIES

Designed primarily for telecom and computer applications, the new WS Series from Computer Products/Stevens-Arnold offers 100 watts with single, dual, and triple

outputs. The converters are packaged in a low profile case (3.5 x 5.5 x 0.91 inches) producing a power density of 5.7 watts per cubic inch. Available in chassis mount with screw terminations or printed circuit board mounting. The PCB mount version is supplied with a heat sink (adds 0.35 inches to height) which allow for conventional cooling with *no* special mounting required.

The WS Series has an efficiency of 84% minimum and a 2:1 input range



of either 18 to 36 VDC or 36 to 72 VDC. Output ranges supplied are single (+5, +12 or +15V), dual (+5 and +12V), or triple (+5 and  $\pm 12$ V, +5 and  $\pm 15$ V).

Other important features include 500 VDC isolation, input surge protection, reverse voltage protection and remote on/off control with idle currents down to 10mA.

Key Specifications:

- Line Regulation . . . . .  $\pm 0.5\%$  max.
- Load Regulation . . . . . 2.0% (to no load)
- Ripple and Noise . . . . . 100mV p-p max.

This series is available through distribution.

From Computer Products/Stevens-Arnold **Circle No. 7**

If reply card is missing, please circle reader service number. Consult 1987/88 EEM, page 643 for local sales office or call (305) 974-5500, Ext. 7514.



NO POSTAGE  
NECESSARY  
IF MAILED  
IN THE  
UNITED STATES

**BUSINESS REPLY MAIL**  
FIRST CLASS MAIL PERMIT NO. 251 POMPANO BEACH, FLORIDA

POSTAGE WILL BE PAID BY ADDRESSEE



2900 GATEWAY DRIVE  
POMPANO BEACH, FL 33069-9944



## UP TO 591,000 HOURS MTBF WITH OPEN FRAME LINEARS

Step up to higher standards of reliability with the World-Standard Series of open frame linears. The aluminum frames and power

TYPICAL CALCULATED MTBFs		
Output Voltage <sup>1</sup>	Output Current	MTBF <sup>2</sup>
5V	3.0A	591,533 hrs
12V	6.8A	417,240 hrs
15V	6.0A	420,943 hrs
24V	4.8A	328,798 hrs
5V±12V	3A/±1.0A	261,201 hrs

<sup>1</sup> Consult factory for additional models.

<sup>2</sup> Calculations per MIL-HDBK-217E @ 100% load; 115 VAC line; 25° C ambient temperature; ground, benign

ratings of the World-Standard Series are form, fit, and function replacements for all other open frame linear power supply manufacturers. With four different AC input line voltage ranges, these supplies can be connected for use in any country of the world.

These units have a VDE construction power transformer with enclosed split-bobbin windings and 3750 VAC minimum isolation. The designs are conservative with efficiencies up to 60% and all power supplies

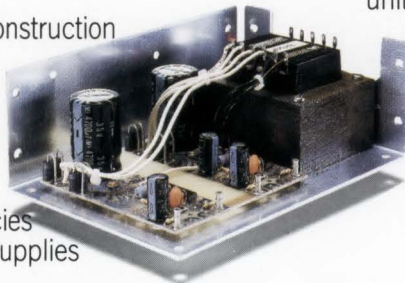

If reply card is missing, please circle reader service number. Consult 1987/88 EEM, page 643 for local sales office or call (305) 974-5500, Ext. 7514.

receive a four-hour burn-in before shipment.

Other features include current-limiting short circuit protection on all outputs, overvoltage crowbar on 5V outputs, remote sensing on single outputs and the 5V output of triples, reverse voltage protection on all outputs, and operation from 0°C to 50°C with no derating. The World-Standard Series (PL Series) are UL

recognized, CSA certified, and TUV approved.

Custom versions of this series are also available with outputs from 2 to 32VDC and output power levels of 15 to 150 watts. Your local Computer Products distributor has units available now.

From Computer Products/Power Products  
**Circle No. 8**



## MIL-SPEC POWER SUPPLIES FOR RUGGED ENVIRONMENTS

From missiles to submarines Computer Products/Tecnetics has been solving Mil-Spec problems for over thirty years.

Specialists in Mil-Spec AC/DC power supplies and DC/DC converters, Computer Products/Tecnetics has participated in many major military programs including F-16, Tomahawk, EA-6B, MSE and E2-C. From state-of-the-art topologies to advanced package design, every attention is paid to cost-

effective custom designs for demanding environmental requirements. Let us modify an existing standard product or develop a totally new design to meet your system specifications. We are certified to manufacture to Mil-Q-9858A and conform to the guidelines of NAVMAT P4855-1. Send for your free copy of our Mil-Spec Power Supply catalog. From Computer Products/Tecnetics  
**Circle No. 9**

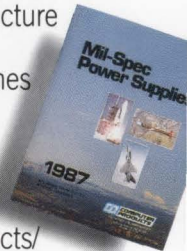

## QUICK ACTION REPLY CARD

### PLEASE SEND:

- |                         |                          |  |
|-------------------------|--------------------------|--|
| 1. PPM/PFS Series       | 5. Custom Switchers      | 9. Mil-Spec Catalog                    |
| 2. AF Series            | 6. MED Series            | 10. Engineering Handbook               |
| 3. NFS 40/50/110 Series | 7. WS Series             | 11. Have an Applications Engineer Call |
| 4. ES/EA/H Series       | 8. World-Standard Series | 12. Have a Sales Person Call           |

Name \_\_\_\_\_ Title \_\_\_\_\_  
 Company \_\_\_\_\_ Dept/MS \_\_\_\_\_  
 Street \_\_\_\_\_  
 City \_\_\_\_\_ State \_\_\_\_\_ Zip \_\_\_\_\_  
 Telephone (    ) \_\_\_\_\_

EDN

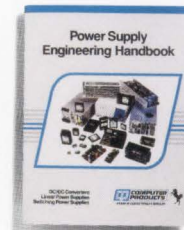

**FREE!**

Send for your free copy of our Power Supply Engineering Handbook providing specifications for our complete line of power supplies with power ranges from 1/2 Watt to 1500 Watts.

**Circle No. 10**



**(305) 974-5500**

**Your Partner in Power**

# Spreadsheet helps you evaluate system noise

---

*An ordinary electronic spreadsheet can help you evaluate and correct noise problems in an electronic system. Part 1 of this 2-part article described techniques for analyzing the noise contributions of a system's individual elements. This article, part 2, shows how you can use a spreadsheet program to evaluate the system's overall performance as you modify the individual elements.*

---

Peter Fazekas, *ILC Data Device Corp*

To optimize the noise performance of an electronic system, you need to determine the noise contributions of each of the elements of the system and then replace or modify the sections you identify as troublesome. An ordinary electronic spreadsheet can be an invaluable aid in analyzing and modifying a system's noise performance.

Your first task in setting up a system for noise analysis is to draw a block diagram of the system. This diagram should include all of the major functional blocks (such as transducers, amplifiers, and filters), and any individual components that might contribute to the overall noise level of the system. You then assign a table of attributes to each functional block and individual element. At the very least, the table should contain the following information:

- The equivalent input noise voltage and/or noise current of the block
- The input and output impedance of the block, if applicable
- The power-supply rejection ratio (PSRR) of the block, if applicable
- For filter blocks, the noise equivalent bandwidth (NEBW) of the filter's corner frequencies (upper and lower).

With the above information, you can calculate the effective rms noise (at the system's output) that's caused by each source. First, you determine the effective NEBW filter corner frequency from the input of each block to the system's output. Next, you find the equivalent output-noise spectral density caused by each source (to calculate it, you multiply the input-noise spectral density by the signal gain from the source to the output). Finally, you calculate the total rms noise level by multiplying the output-noise spectral density by the square root of the effective NEBW that you've calculated for each block. Later, you'll enter all of the calculated values in the above sections in your electronic spreadsheet.

Fig 1 is a block diagram of a typical system (a data-acquisition system, in this case) that's suitable for noise analysis with a spreadsheet. Before you can make the optimum tradeoffs between noise and other parameters, you must thoroughly understand your circuit's functions. The A/D converter you choose should be

*To analyze noise in a system, you first set up a block diagram that includes all of the functional elements that contribute to the total noise level.*

transparent to the system—in other words, the speed and resolution of the converter should be high enough to reproduce the signals accurately. The sample system in **Fig 1** uses the ADC-00300 converter (from ILC Data Device Corp); the part has a conversion-rate capability of 2 MHz and a resolution of 12 bits, which more than meet the system's requirements.

The signal amplifier you choose for such a circuit must be able to amplify the signal without adding any observable noise of its own, and without causing distortion because of its limited bandwidth.

The bandpass filter is the system's frequency-shaping network; it determines the dominant corner frequencies of the noise bandwidth. The preamplifier is normally the major noise-determining component in the system. Ideally, the preamplifier noise would be lower than that of the transducer; if you can't make it so, you should do your best to reduce the preamplifier's noise contribution by optimizing its gain and its signal-to-noise ratio.

### Using the spreadsheet in noise calculations

A spreadsheet is helpful in calculating system noise, because when you change any of the parameters of the individual circuit elements, the spreadsheet can imme-

diately show you the effects of those changes on the overall system noise. To use a spreadsheet most efficiently for noise analysis, you should begin by entering the characteristic values of the system as variables, and then direct all subsequent references to these values back to the appropriate data cell. Thus, you need to change a value only once instead of each time you use it in the calculation.

**Tables 1** through **6** represent an electronic spreadsheet. **Table 1** tabulates the data describing the characteristics of the individual sections of the system. **Table 2** is a systematic evaluation of the NEBW of each section of the circuit. You calculate the NEBW in two parts: the low-frequency corner ( $f_L$ ) and the high-frequency corner ( $f_H$ ). It's convenient to start at the section closest to the output (the signal amplifier in this case), and work toward the input (the transducer).

If two first-order filters have  $-3$ -dB corner frequencies of  $f_a$  and  $f_b$ , then the NEBW corner frequency is  $f_a = \pi/2f_a$  if the filter is a lowpass type, and  $f_a = 2/\pi f_a$  if the filter is a highpass type. Also, the equivalent NEBW corner frequency of the two combined filters is  $f_L = f_D/(1 - (1/(1+R)))$  for a highpass filter, and  $f_H = f_D \cdot (1 - (1/(1+R)))$  for a lowpass filter. In these equations,  $R$  is the ratio of the larger corner frequency

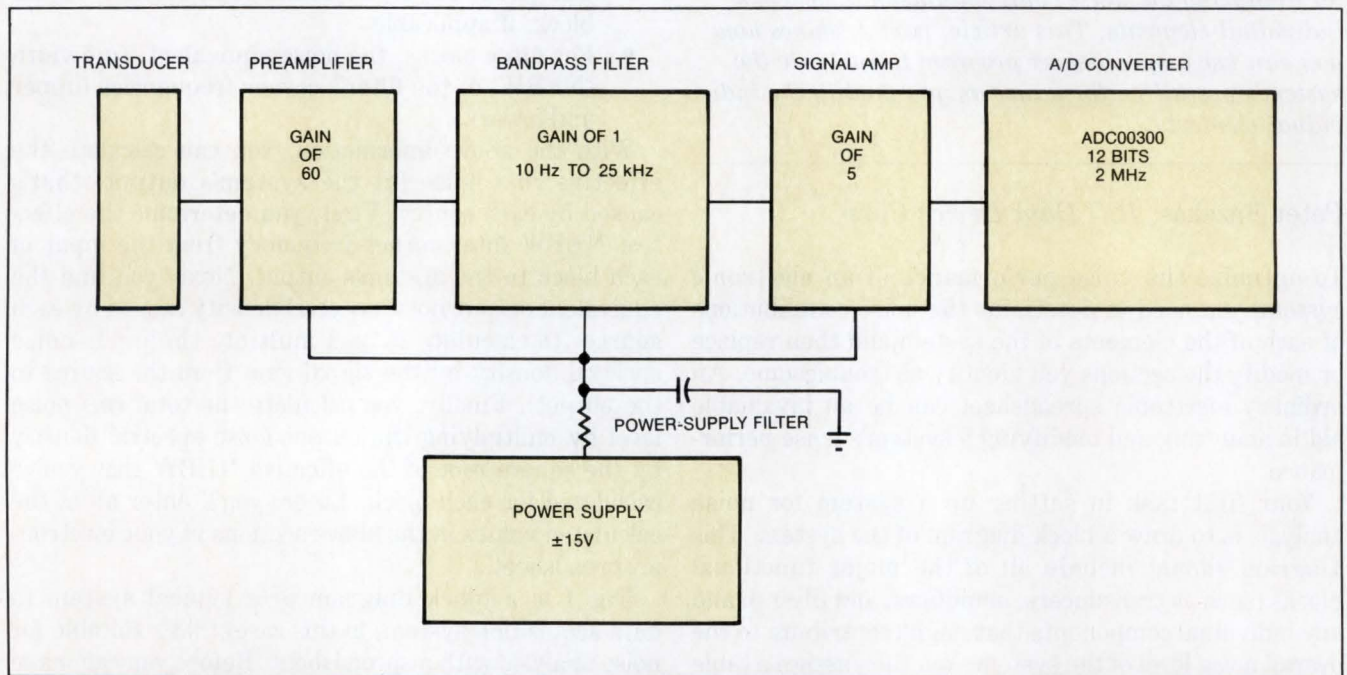

**Fig 1—Systematic noise analysis is helpful** in designs such as this typical data-acquisition system. By using an electronic spreadsheet to evaluate the effect of design changes on the system's noise characteristics, you can easily modify the system to achieve optimum noise performance.



divided by the smaller one, and  $f_D$  is the dominant NEBW corner frequency (the one closest to the center of the signal passband). The individual elements of **Table 2** are defined as follows:

- *Self corner frequency* is the NEBW of the particular stage you're evaluating
- *NEBW to output* is the combined NEBW of all stages following the stage under evaluation
- *Dominant pole* is the value of  $f_D$
- *Correction factor* is the value  $1/(1-(1/(1+R)))$  for the lowpass filter and  $1-(1/(1+R))$  for the high-pass filter
- *Combined corner* is the value of  $f_L$  and  $f_H$
- *Total NEBW* is  $f_H-f_L$ .

**Table 3** calculates the amount of noise contributed by the individual sources. The parameters are defined as follows:

- *Noise input* is the self-noise at the input to the stage under evaluation. This value comes directly from **Table 1**.
- *Total NEBW* is the combined NEBW of the section under consideration and all subsequent sections in the system, as evaluated in **Table 1**.
- *Noise gain* is the gain of all the stages between the noise source and the output of the system.
- *RMS noise* is noise input  $\times$  noise gain  $\times$  (NEBW)<sup>0.5</sup>.

**Table 4** compares the total noise and signal levels of the system. Most of the elements in this table are

**TABLE 1—SPREADSHEET VALUES**

<b>TRANSDUCER</b>				
INPUT NOISE	1.28 <sup>-8</sup>	V/RT Hz		
OUTPUT IMPEDANCE	10000	OHMS		
CORNER FREQ	45000	-3 dB HI	70685.83	NEBW HI
	3	-3 dB LO	1.91	NEBW LO
MAX SIGNAL	5.00 <sup>-3</sup>	V		
<b>PREAMPLIFIER</b>				
INPUT NOISE	1.50 <sup>-8</sup>	V/RT Hz		
	9.00 <sup>-12</sup>	A/RT Hz		
PSRR	316.23	RATIO	50	dB
CORNER FREQ	50	-3 dB HI	78.54	NEBW HI
STAGE GAIN	60	RATIO	35.56	dB
CORNER FREQ	10000000	-3 dB HI	1.57 <sup>7</sup>	NEBW HI
	1.00 <sup>-3</sup>	-3 dB LO	6.37 <sup>-4</sup>	NEBW LO
<b>BANDPASS FILTER</b>				
INPUT NOISE	5.00 <sup>-8</sup>	V/RT Hz		
PSRR	1778.28	RATIO	65	dB
CORNER FREQ	200	-3 dB HI	314.16	NEBW HI
STAGE GAIN	1	RATIO	0	dB
CORNER FREQ	25000	-3 dB HI	39269.91	NEBW HI
	10	-3 dB LO	6.37	NEBW LO
<b>SIGNAL AMPLIFIER</b>				
INPUT NOISE	5.00 <sup>-8</sup>	V/RT Hz		
PSRR	1000	RATIO	60	dB
CORNER FREQ	500	-3 dB HI	785.40	NEBW HI
STAGE GAIN	5	RATIO	13.98	dB
CORNER FREQ	100000	-3 dB HI	157079.63	NEBW HI
	2	-3 dB LO	1.27	NEBW LO
<b>POWER SUPPLY</b>				
INPUT NOISE	1.00 <sup>-5</sup>	V/RT Hz		
CORNER FREQ	1591.55	-3 dB HI	2500	NEBW HI
	1.00 <sup>-3</sup>	-3 dB LO	6.37 <sup>-4</sup>	NEBW LO
<b>A/D CONVERTER</b>				
MAX SIGNAL INPUT	1.50	V		
RESOLUTION	12	BITS		
LEVEL OF 1 LSB	3.66 <sup>-4</sup>	V		
SAMPLE RATE	60000	PER SEC		
QUANTIZATION NOISE	1.06 <sup>-4</sup>	V		
CORNER FREQ	30000	-3 dB HI	47123.89	NEBW HI

NOTE:  
RT Hz =  $\sqrt{\text{Hz}}$

*A spreadsheet is a useful tool for analyzing the effects of changes in the noise contribution of individual elements on the performance of the whole system.*

self-explanatory. The measures of system performance are the S/N ratio and the noise figure. The S/N ratio is the peak signal divided by the total noise. The noise figure is the S/N ratio at the output divided by the S/N ratio at the input (it's also defined as the total noise divided by the source noise).

In an optimum design, the noise generated by the input device is the limiting factor in the system's S/N ratio—all other sources contribute lesser amounts of

noise, so they don't degrade the overall noise performance. The design shown in Fig 1 is not an optimum one. In it, the preamplifier's noise voltage and noise current, as well as the power-supply noise through the preamplifier, are the same as or higher than the self-noise of the transducer. As a result of these noise contributions, the S/N ratio of the system is far from optimum.

The input noise voltage of the preamplifier is a

**TABLE 2—NEBW CALCULATIONS**

<b>SIGNAL AMP</b>				
SELF CORNER FREQ	1.27	NEBW LO	157079.63	NEBW HI
NEBW TO OUTPUT	1.00 <sup>-5</sup>	NEBW LO	1.00 <sup>10</sup>	NEBW HI
DOMINANT POLE	1.27	LO FREQ	157079.63	HI FREQ
CORRECTION FACTOR	1.00	LO FREQ	1.00	HI FREQ
COMBINED CORNER	1.27	LO FREQ	157077.17	HI FREQ
TOTAL NEBW	157075.89	Hz		
<b>BANDPASS FILTER</b>				
SELF CORNER FREQ	6.37	NEBW LO	39269.91	NEBW HI
NEBW TO OUTPUT	1.27	NEBW LO	157077.17	NEBW HI
DOMINANT POLE	6.37	LO FREQ	39269.91	HI FREQ
CORRECTION FACTOR	1.20	LO FREQ	0.80	HI FREQ
COMBINED CORNER	7.64	LO FREQ	31415.83	HI FREQ
TOTAL NEBW	31408.19	Hz		
<b>PREAMPLIFIER</b>				
SELF CORNER FREQ	6.37 <sup>-4</sup>	NEBW LO	1.57 <sup>7</sup>	NEBW HI
NEBW TO OUTPUT	7.64	NEBW LO	31415.83	NEBW HI
DOMINANT POLE	7.64	LO FREQ	31415.83	HI FREQ
CORRECTION FACTOR	1.00	LO FREQ	1.00	HI FREQ
COMBINED CORNER	7.64	LO FREQ	31353.12	HI FREQ
TOTAL NEBW	31345.48	Hz		
<b>TRANSDUCER</b>				
SELF CORNER FREQ	1.91	NEBW LO	70685.83	NEBW HI
NEBW TO OUTPUT	7.64	NEBW LO	31353.12	NEBW HI
DOMINANT POLE	7.64	LO FREQ	31353.12	HI FREQ
CORRECTION FACTOR	1.25	LO FREQ	0.69	HI FREQ
COMBINED CORNER	9.55	LO FREQ	21719.37	HI FREQ
TOTAL NEBW	21709.82	Hz		
<b>POWER SUPPLY—SIGNAL AMP</b>				
SELF CORNER FREQ	6.37 <sup>-4</sup>	NEBW LO	2500	NEBW HI
NEBW TO OUTPUT	1.27	NEBW LO	157077.17	NEBW HI
DOMINANT POLE	1.27	LO FREQ	2500	HI FREQ
CORRECTION FACTOR	1.00	LO FREQ	0.98	HI FREQ
COMBINED CORNER	1.27	LO FREQ	2460.83	HI FREQ
TOTAL NEBW	2459.56	Hz		
<b>POWER SUPPLY—BANDPASS FILTER</b>				
SELF CORNER FREQ	6.37 <sup>-4</sup>	NEBW LO	2500	NEBW HI
NEBW TO OUTPUT	7.64	NEBW LO	31415.83	NEBW HI
DOMINANT POLE	7.64	LO FREQ	2500	HI FREQ
CORRECTION FACTOR	1.00	LO FREQ	0.93	HI FREQ
COMBINED CORNER	7.64	LO FREQ	2315.72	HI FREQ
TOTAL NEBW	2308.08	Hz		
<b>POWER SUPPLY—PREAMP</b>				
SELF CORNER FREQ	6.37 <sup>-4</sup>	NEBW LO	2500	NEBW HI
NEBW TO OUTPUT	7.64	NEBW LO	31353.12	NEBW HI
DOMINANT POLE	7.64	LO FREQ	2500	HI FREQ
CORRECTION FACTOR	1.00	LO FREQ	0.93	HI FREQ
COMBINED CORNER	7.64	LO FREQ	2315.38	HI FREQ
TOTAL NEBW	2307.74	Hz		

**TABLE 3—CONTRIBUTION OF INDIVIDUAL SOURCES**

SECTION	INPUT NOISE (V/RT Hz)	NEBW (Hz)	NOISE GAIN	RMS NOISE (V)
TRANSDUCER	1.28 <sup>-8</sup>	21709.82	300	5.67 <sup>-4</sup>
PREAMPLIFIER				
VOLTAGE	1.50 <sup>-8</sup>	31345.48	300	7.97 <sup>-4</sup>
CURRENT	9.00 <sup>-12</sup>	31345.48	3000000	4.78 <sup>-3</sup>
BANDPASS FILTER	5.00 <sup>-8</sup>	31408.19	5	4.43 <sup>-5</sup>
SIGNAL AMPLIFIER	5.00 <sup>-8</sup>	157075.89	5	9.91 <sup>-5</sup>
POWER SUPPLY				
PREAMPLIFIER	1.00 <sup>-5</sup>	2307.74	9.49 <sup>-1</sup>	4.56 <sup>-4</sup>
BANDPASS FILTER	1.00 <sup>-5</sup>	2308.08	2.81 <sup>-3</sup>	1.35 <sup>-6</sup>
SIGNAL AMPLIFIER	1.00 <sup>-5</sup>	2459.56	5.00 <sup>-3</sup>	2.48 <sup>-6</sup>
A/D CONVERTER				1.06 <sup>-4</sup>

**TABLE 4—SYSTEM PERFORMANCE EVALUATION**

NOISE FROM TRANSDUCER (V)	5.67 <sup>-4</sup>
NOISE FROM ELECTRONICS (V)	4.87 <sup>-3</sup>
A/D QUANTIZATION NOISE (V)	1.06 <sup>-4</sup>
TOTAL NOISE	4.90 <sup>-3</sup>
1 LSB OF A/D CONVERTER (V)	3.66 <sup>-4</sup>
PEAK SIGNAL LEVEL (V)	1.50
SIGNAL-TO-NOISE RATIO (dB)	49.71
NOISE FIGURE (dB)	18.74
RATIO OF NOISE TO 1 LSB	13.39

characteristic of the particular amplifier you select; you can improve the performance of the preamplifier only by selecting a device with lower input noise. For example, you can choose state-of-the-art op amps whose input noise voltage ( $3^{-9}V/\sqrt{Hz}$ ) is 20% that of the device shown in Fig 1.

You can reduce the input noise current in two ways.

First, you can replace the preamplifier with a device having superior characteristics. That way, you can easily improve the performance ( $9^{-12}A/\sqrt{Hz}$ ) of the selected device by two orders of magnitude, but you may incur a large cost penalty. Second, you can select a transducer with a lower output impedance. The self-noise of the transducer will drop as a function of the square root of the resistance, and the noise-current gain will drop linearly with resistance, thus providing a net increase in the S/N ratio. You can also decrease the resistance by placing a transformer in front of the preamplifier.

The easiest way to reduce power-supply noise is to place a filter at the supply's output. If you use a filter with an  $f_H$  of 10 Hz, for example, the overall noise bandwidth drops to 10 Hz-7.64 Hz, or 2.36 Hz. This amount of filtering may be neither necessary nor practical, however. If the system's space allocations limit the

**TABLE 5—CONTRIBUTION OF INDIVIDUAL SOURCES (REVISED DATA)**

SECTION	INPUT NOISE (V/RT Hz)	NEBW (Hz)	NOISE GAIN	RMS NOISE (V)
TRANSDUCER	1.28 <sup>-8</sup>	21709.82	300	5.67 <sup>-4</sup>
PREAMPLIFIER				
VOLTAGE	3.00 <sup>-9</sup>	31345.48	300	1.59 <sup>-4</sup>
CURRENT	9.00 <sup>-14</sup>	31345.48	3000000	4.78 <sup>-5</sup>
BANDPASS FILTER	5.00 <sup>-8</sup>	31408.19	5	4.43 <sup>-5</sup>
SIGNAL AMPLIFIER	5.00 <sup>-8</sup>	157075.89	5	9.91 <sup>-5</sup>
POWER SUPPLY				
PREAMPLIFIER	1.00 <sup>-5</sup>	92.04	9.49 <sup>-1</sup>	9.10 <sup>-5</sup>
BANDPASS FILTER	1.00 <sup>-5</sup>	92.04	2.81 <sup>-3</sup>	2.70 <sup>-7</sup>
SIGNAL AMPLIFIER	1.00 <sup>-5</sup>	98.66	5.00 <sup>-3</sup>	4.97 <sup>-7</sup>
A/D CONVERTER				1.06 <sup>-4</sup>

*In an ideal system, the preamplifier (first stage) would largely determine the overall system noise.*

size of the filter, as they would in a hybrid microcircuit, you can gradually adjust the filter's corner frequency until it's just low enough to do the job. This adjustment is easy to do on a spreadsheet; you reduce the corner frequency (while watching the S/N ratio) until you note no further improvement.

Tables 5 and 6 show the revised data that results when you add the characteristics of an improved op amp and a band-limited power supply—preamplifier noise voltage=3 nV/ $\sqrt{\text{Hz}}$ , preamplifier noise current= $9^{-14}$  A/ $\sqrt{\text{Hz}}$ , and power-supply upper NEBW corner frequency=100 Hz—to Table 1. Tables 5 and 6 show the revised spreadsheet results for Tables 3 and 4.

### Evaluating the revisions

As evidenced by the magnitude of the individual sources, the major contributor to the overall system noise, both before and after modification, is the transducer. The 0.73-dB noise figure indicates that the electronics increases the noise level of the transducer by only 0.73 dB (8.8%). In most cases, you don't need to attempt further improvement, and you can consider the design completed.

**TABLE 6—SYSTEM PERFORMANCE EVALUATION (REVISED DATA)**

NOISE FROM TRANSDUCER (V)	5.67 <sup>-4</sup>
NOISE FROM ELECTRONICS (V)	2.18 <sup>-4</sup>
A/D QUANTIZATION NOISE (V)	1.06 <sup>-4</sup>
TOTAL NOISE	6.17 <sup>-4</sup>
1 LSB OF A/D CONVERTER (V)	3.66 <sup>-4</sup>
PEAK SIGNAL LEVEL (V)	1.50
SIGNAL-TO-NOISE RATIO (dB)	67.72
NOISE FIGURE (dB)	0.73
RATIO OF NOISE TO 1 LSB	1.68

The techniques described here provide a systematic method for comprehensive noise analysis. You can perform this analysis with relative ease and freedom from error-prone manual calculations. Keep in mind, however, that these methods are general approximations of the required solutions. They will suffice for most systems because noise, by nature, is a random variable whose amplitude is only an approximation. If you need a more exact value for the noise amplitude, you can use the integrals described in part 1 of this series ("A systematic approach facilitates noise analysis," EDN, May 12, 1988, pg 153) to obtain a more accurate result.

**EDN**

### References

1. Bohn, D, *Audio Handbook*, National Semiconductor Corp, 1976.
2. Buckingham, M J, *Noise in Electronic Devices & Systems*, John Wiley & Sons, New York, NY, 1983.
3. Fitchen, F C, *Low Noise Electronic Design*, John Wiley & Sons, New York, NY, 1973.
4. Lathi, B P, *Signals, Systems & Communications*, John Wiley & Sons, New York, NY, 1965.

### Author's biography

Peter Fazekas is a senior design engineer at ILC Data Device Corp (DDC) (Bohemia, NY), where he's currently responsible for the design of hybrid microcircuits. Before joining DDC two years ago, he was employed by Spar Aerospace Ltd in Toronto, Canada. Peter holds a BA in science from the University of Toronto. In his spare time, he enjoys racquetball, scuba diving, and underwater photography.

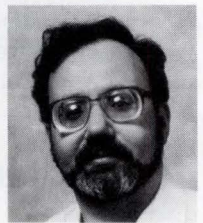

Article Interest Quotient (Circle One)  
High 494 Medium 495 Low 496

LANCE NEIBAUER AND JOHN MARCONI. NEW ACHIEVERS IN SCIENCE.

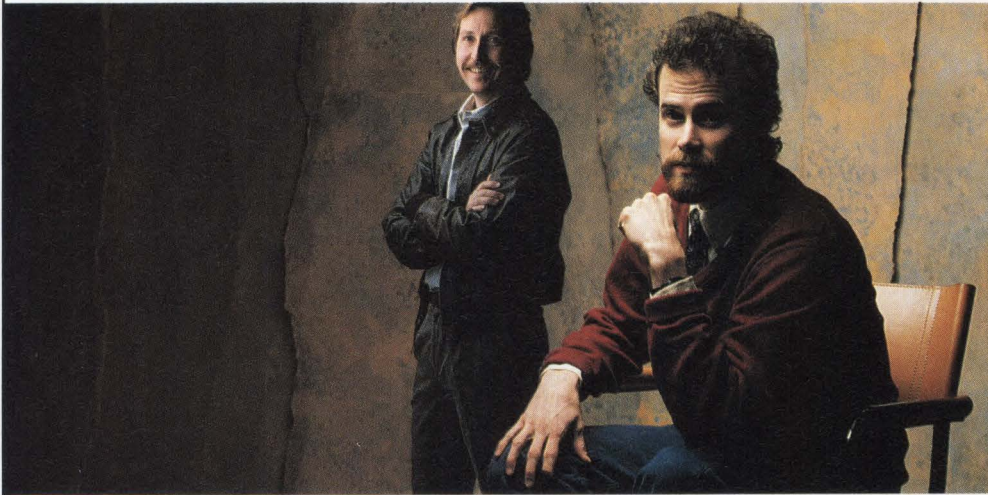

*we never stop asking*

*What if...*

**L**ance Neibauer. Aircraft designer. His award-winning Lancair kitplanes are the nation's top-selling homebuilts. Now using the new HP-28S, the only calculator that can do symbolic algebra and calculus, retrieve and combine graphs instantly. HP Solve lets him enter his own formulas. More than 1500 functions and 32K bytes of RAM make it the world's most powerful scientific calculator. **J**ohn Marconi. Air pollution control engineer. Project leader for study on cancer-causing air pollutants. Needs to solve statistical and financial problems.

**Innovation takes a calculator packed with new ideas.**

Perfect job for the new HP-27S. It's the only scientific calculator with business functions. It also offers easy-to-follow menus and optional solutions books. Hewlett-Packard's new range of calculators is built for your success. For the name of your nearest Hewlett-Packard dealer, call 1-800-752-0900, Ext. 215P

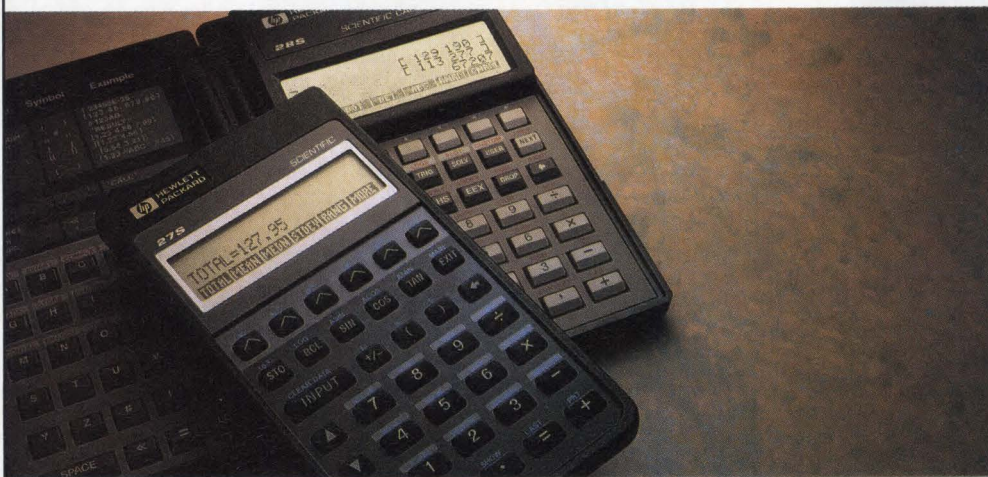

NEW ACHIEVERS: THE HP-28S AND HP-27S SCIENTIFIC CALCULATORS.



*“I shop the specs*



# *because it's my job. But I buy the product because it's my career."*

WHAT YOU SHOULD KNOW ABOUT THE NEW PRODRIVE SERIES™ OF 3½-INCH HARD DISK DRIVES FROM QUANTUM.

The numbers are the easy part. Either a product has them or it doesn't.

But you can't build a system out of specs.

You also need dedicated product-support people who will sit down and help you solve some tough engineering problems and put those specs to work.

Quantum is ready to deliver both.

Our new ProDrive Series of 3½-inch hard disk drives offers you the broadest range of capacities in the broadest range of interfaces in the industry. 42 and 84 megabyte formatted with embedded SCSI interface right now. And later this year, up to 168 megabytes, in SCSI, ESDI, and AT-Bus. Ten new drives in all.

With access times of 19 ms or less.

With synchronous data transfers to the SCSI bus of 4 megabytes per second, and asynchronous data transfers of 2 megabytes per second.

With an MTBF of 50,000 hours.

And with DisCache™, Quantum's unique 64 kilobyte data-buffering scheme that can make our 19-ms intelligent drive perform like a 12-ms drive—or even faster, depending on your application.

But Quantum also offers you the people who can help you put those numbers to work in your own system. A dedicated team of engineering professionals who understand the particular needs of the systems designer—and can help meet those needs quickly, efficiently, cost-effectively.

The new ProDrive Series. The specs you want. The support you need.

That's what Quantum delivers.



#### *INTRODUCING THE PRODRIVE SERIES*

- 3½-inch form factor
- 42, 84, 103, 120, 145, 168 MBs formatted
- SCSI, ESDI, AT-Bus
- 19 ms or faster average access time
- 64 KB buffer with exclusive DisCache™
- 50,000-hour MTBF
- 42, 84 MB SCSI units in mass production now
- 42, 84 MB AT-Bus units available early summer '88

**Quantum**

Quantum Corporation  
1804 McCarthy Blvd.  
Milpitas, CA 95035

ProDrive and DisCache are  
trademarks of Quantum Corporation.

# MEET THE BRAINS BEHIND INTEL'S NEW 8-BIT MICROCONTROLLER.

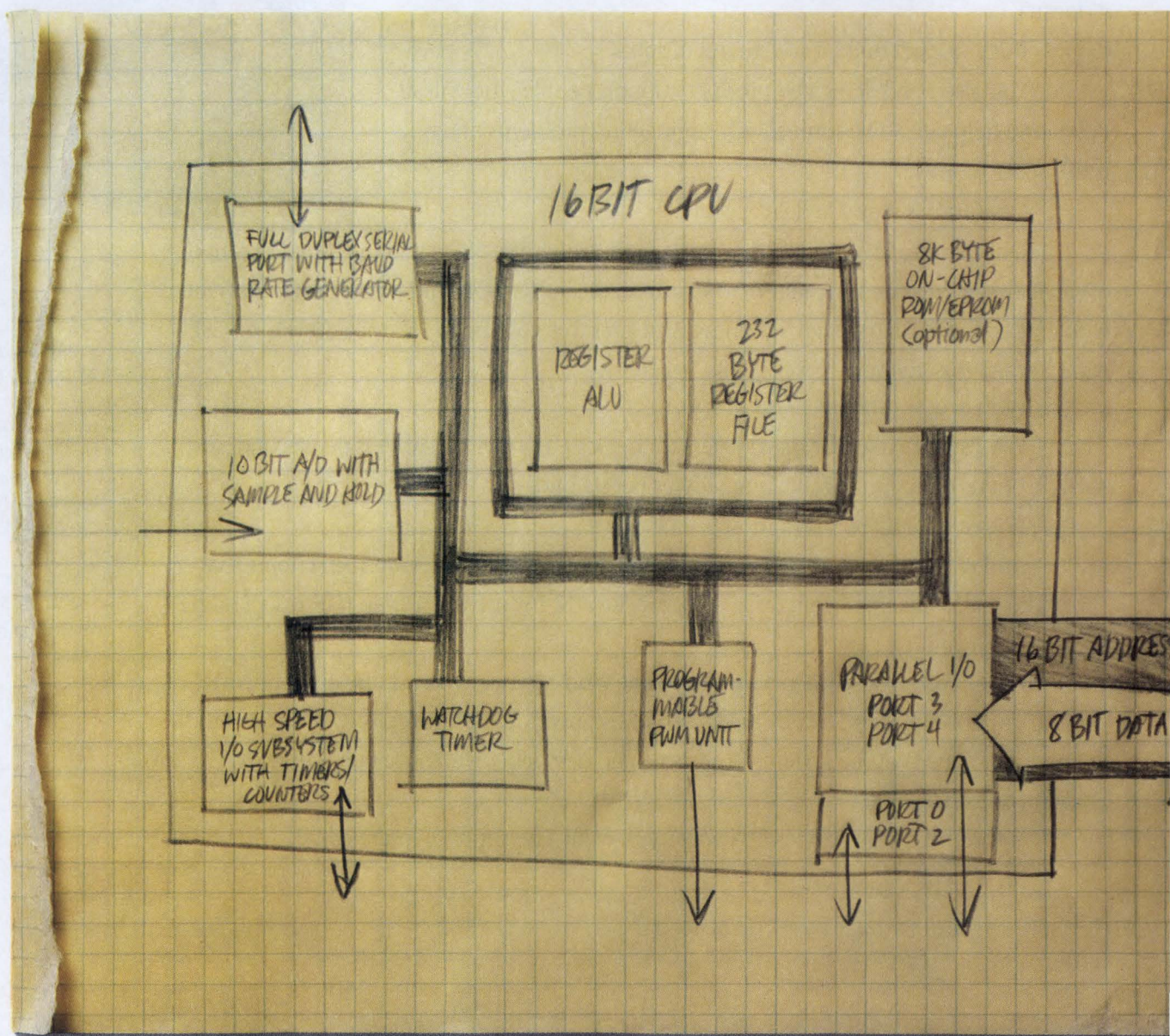

## OUR 16-BIT CPU.



If you could use a lot more performance, but system cost and board space are limiting you to an 8-bit design, our new 8098 microcontroller is the most intelligent solution yet.

Outwardly, it's an 8-bit chip. It's priced like an 8-bit, it has an 8-bit bus, and it'll fit into your 8-bit design.

But it does things that only a 16-bit controller can do. Like a 16 x 16 multiply or a 32/16 divide in just 6.25 microseconds. Which makes it the highest performance 8-bit embedded controller available.

Best of all, with the price of the 8098, you can add more features and performance to your existing 8-bit design.

Without exceeding your budget.

We've also given you a lot of new functionality to work with. The 8098 has on-chip peripherals, like a 10-bit A/D converter, serial port, and

high-speed I/O. There's also on-board RAM. And versions available with ROM and EPROM. So you have the flexibility to add more features to your design.

Of course, we also make it easy for you to get to market faster. Our full-function ICE™ development tool eliminates a lot of guesswork.

And comes with an affordable price. Our Field Application Engineers give you training seminars and on-site technical support. Which helps you design more sophisticated products in less time. And our complete documentation makes the process even simpler.

For more information on the 8098, call (800) 548-4725, and ask for Literature Department W444.

We'll show you how easy it is to get 16-bit performance out of your 8-bit budget.



**intel**®

# NOW YOUR RIGHT HAND CAN KNOW WHAT YOUR LEFT IS DOING.

Ever seem like your CAE and CAD people are playing for different teams? Chances are it's because your design systems can't communicate critical information from the engineer to the layout designer. So instead of a smooth handoff, you get hand-to-hand combat.

But now, there's a system that streamlines the way CAE and CAD teams work together.

It's Daisy's BOARDMASTER™. The first automated system that plays by the rules of real world system design.

With its rules-driven PCB design environment, BOARDMASTER gives engineers the flexibility to specify key design rules in the schematic. Rules for signal priority. Ordering and termination for ECL nets. Package types and power definition. Pre-packaging and pre-placement priorities. Pin and gate swapping. And many other important design considerations.

This critical information becomes part of the design database. And is passed directly to BOARDMASTER's powerful set of PCB layout tools.

With these rules guiding the process, layout designers can concen-

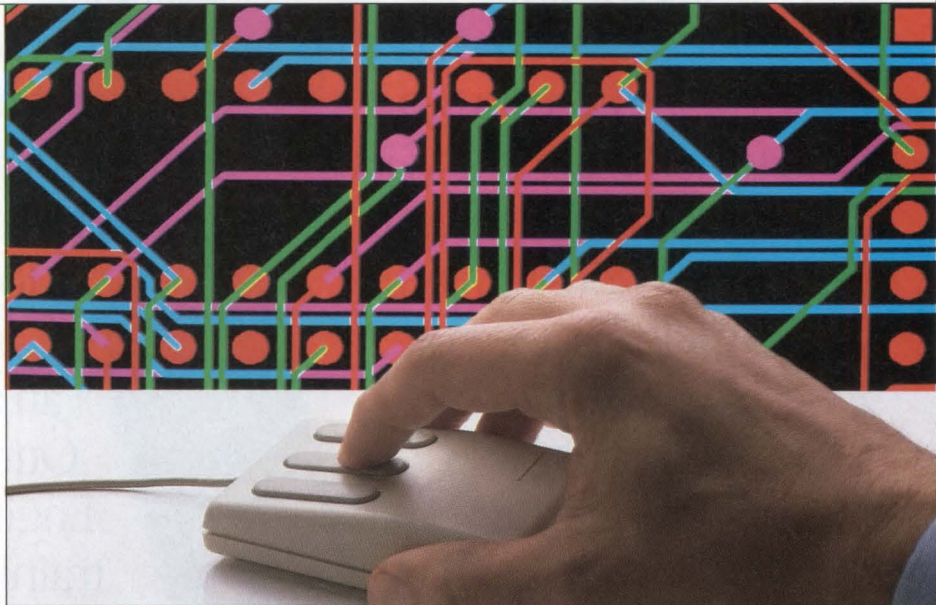

trate on maximizing the quality and manufacturability of the layout without having to second-guess the engineer's real intentions.

BOARDMASTER comes with the most advanced set of layout tools available anywhere. Like 100% autorouting. Full support for SMD, ECL, analog and ultra fine line designs. Plus a variety of manufacturing

interfaces. There's even a Sun-4™ based routing accelerator to make short work of your most complex layouts.

BOARDMASTER even takes the frustration out of design changes. Because it updates only the parts of the database that need updating. Which keeps ECO from becoming a four-letter word.

So if you'd like to get a grip on better board design, put BOARDMASTER to the test in your next project. And give your entire team a hand.

For a demonstration or more information, call Daisy at:  
1 (800) 556-1234, Ext. 32.  
In California: 1 (800) 441-2345, Ext. 32.

European Headquarters:  
Paris, France (1) 45 37 00 12.  
Regional Offices:  
England (256) 464061;  
West Germany (89) 92-69060;  
Italy (39) 637251.

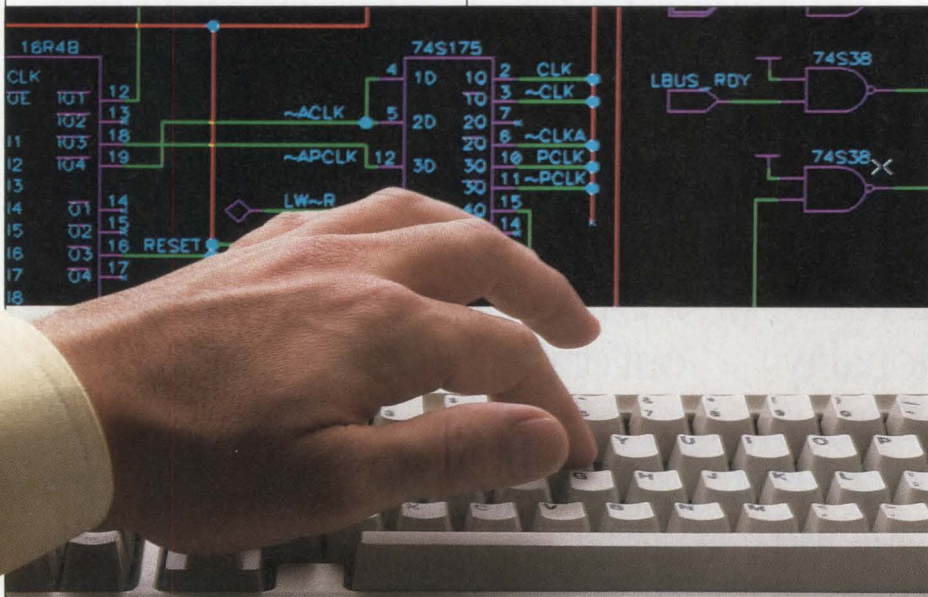

# State machines solve control-sequence problems

---

*This article, part 1 of a 2-part series, provides a refresher in the basic theory of state machines and offers two detailed examples of synchronous-state-machine design with common PLDs. Part 2 will follow up with an example of a more difficult, asynchronous state machine and will give some background information on state-machine software packages. Part 2 will also detail a PLD having a novel architecture that suits large state machines.*

---

Stan Kopec, *Altera Corp*

The state-machine design method provides a structured, systematic approach to the task of designing stand-alone signal-generation or control circuitry for arbiters, bus controllers, encoder/decoders, sequencers, or special counters. You can implement state machines with a variety of logic building blocks, such as TTL SSI/MSI devices, programmable logic devices (PLDs), and ASICs. The user-configurable features of PLDs lend themselves to these control-logic tasks because such tasks often entail making design changes and correcting errors. With PLDs, you can easily and quickly modify your design as you discover errors or as design requirements change. Combining a state-machine game plan with a PLD implementation provides an effective means of solving some knotty control-logic design problems.

Nevertheless, approaching your first PLD state-machine design can be an intimidating prospect. Like mathematical proofs, state-machine design—the way it's presented in many textbooks—often has an air of unreality about it. A few concrete design tips that show how PLDs and state machines mesh, however, can turn the mystery into reliable, working logic.

You can obtain a wide variety of PLDs. Both bipolar and CMOS versions are available; EPROMs, EEPROMs, or fuse links provide the programmability. PLDs have a very regular structure. You can think of a PLD as a stack of identical slices. Each slice of a PLD, beginning with inputs, proceeding through an AND/OR array, and terminating in a possibly registered logic output, is a macrocell. Structurally, the architectures of common, established devices reduce to two basic forms: PLAs, which have a programmable-AND/programmable-OR array, and PALs, which have a programmable-AND/fixed-OR array (newer architectures employing NAND/NAND and NOR/NOR arrays are becoming available, but are not yet in common use).

Each category contains devices that provide either a logic array only (combinatorial PLD) or a logic array plus dedicated registers (registered PLD). A combinatorial PLD is useful only in asynchronous machine designs or for decoding outputs. A PLD with all outputs registered is useful only in synchronous designs. You can also obtain a third kind of PLD—one that allows you to program combinatorial or registered operation on a macrocell-by-macrocell basis (**Table 1**).

*Combining a state-machine game plan with a PLD implementation provides an effective means of solving some knotty control-logic design problems.*

**TABLE 1—PLD FUNCTIONAL FEATURES AND STATE-MACHINE UTILITY**

FEATURE	STATE-MACHINE VALUE
PROGRAMMABLE LOGIC ARRAY OUTPUT INVERSION	DeMORGAN'S INVERSION OF FUNCTIONS: REDUCE P-TERMS
PROGRAMMABLE REGISTERED/ COMBINATORIAL MACROCELLS	STATE VARIABLES/OUTPUT DECODING IN SINGLE DEVICE MACROCELL CASCADING IN SINGLE DEVICE
PROGRAMMABLE FLIP-FLOP TYPE	FLIP-FLOP SELECTION FOR MINIMUM P-TERM CONSUMPTION
PLA ARCHITECTURE	P-TERM DISTRIBUTION AS REQUIRED BY EQUATIONS
VARIABLE/PROGRAMMABLE P-TERM DISTRIBUTION	HIGH P-TERM MACROCELLS FOR COMPLEX EQUATIONS/P-TERM REALLOCATION BETWEEN MACROCELLS
POWER-ON RESET OF FLIP-FLOPS	STATE FLIP-FLOPS START IN KNOWN STATE (ZERO) ON POWER-UP

By using these chips, you can design state machines having either a synchronous or an asynchronous clocking mode.

### Flip-flops for different uses

When you design synchronous state machines, having different register or flip-flop types available on the same PLD can prove useful. Older PLDs offer you a single type of flip-flop, typically the D or SR type. Newer PLDs frequently provide you the option of a user-selectable flip-flop type. In practice, D flip-flops sometimes give you a more efficient synchronous-state-machine implementation; at other times T, SR, or JK flip-flops provide a more efficient synchronous-state-machine implementation. A 4-bit, binary up-counter, which is a basic state machine, provides an example of flip-flop usage.

The fundamental units of a PLA (programmable logic array) are its programmable AND structures. To logically AND logic signals is to take their logical product; therefore, these AND structures are called product terms, or p-terms. Determining which flip-flop type is most efficient for an application requires that you analyze the state-transition logic of your state machine. In a synchronous state machine implemented with D flip-flops, for example, the most significant bit (MSB)—or most significant state variable—of the 4-bit counter requires five p-terms; in a synchronous state machine implemented with T flip-flops, it requires only one p-term (Fig 1).

PLD p-terms implement the state-transition logic and output decoding for your state machine. The programmable-OR structure of a PLA allows you to allocate the p-terms where needed. You pay for this flexibility in performance and total p-term count. The PLA's added programmable logic stage can increase the chips' overall array delay over that of the fixed-OR stage of a PAL (programmable array logic). In terms of sheer capacity, typical PLAs provide 48 or fewer p-terms; typical PALs have from 64 to 480 p-terms, or more.

### PAL structure lacks flexibility

The PAL's drawback is that p-terms are assigned in a fixed way to its macrocells. Once you use up the p-terms, you must cascade macrocells (reducing efficiency and performance) or rework the design. To avoid this problem, some PLDs have variable p-term distribution, which varies the p-term count between macrocells. This approach tends to give the PLD a little more

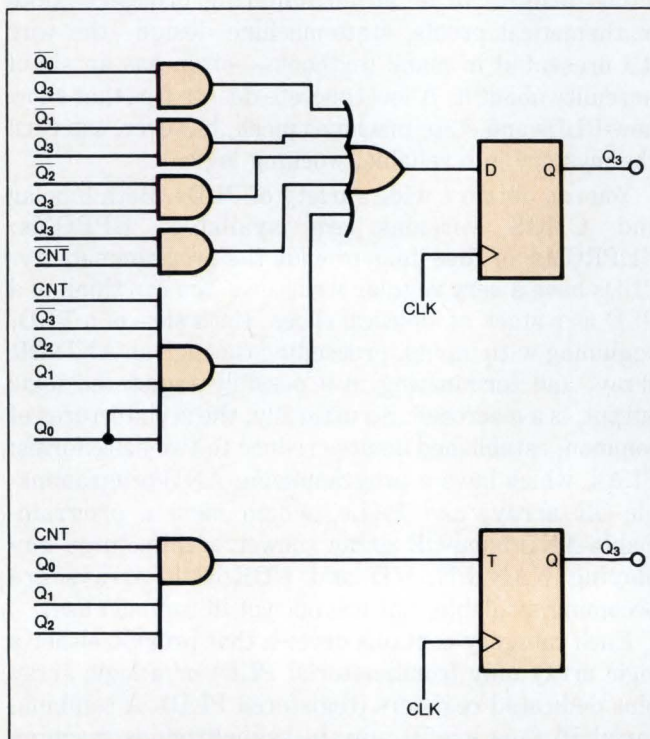

**Fig 1—To determine which flip-flop type is most efficient for an application you have to analyze the state-transition logic of your state machine. For example, when implemented with D flip-flops (as shown), this 4-bit counter requires five p-terms for its MSB (or most significant state variable). If it's implemented with T flip-flops, it requires only one p-term.**

flexibility in fitting a given state-machine design. To get the best fit, however, you must consider p-term count and flip-flop type jointly.

Some PLDs also give you the option of inverting their logic-array outputs. This inversion can increase p-term packing by allowing you to use deMorgan's Theorem:  $\overline{(A+B)} = \overline{A} \cdot \overline{B}$ . Slightly extending this basic statement shows how you can use selective inversion to transform an expression having two p-terms ( $A+B$ ) into an expression having a single p-term:

$$A + B = \overline{\overline{A + B}} = \overline{\overline{A} \times \overline{B}}$$

Similarly, you can trade off p-term count for input-variable count in more complex expressions. The p-term savings can sometimes be very dramatic.

#### A synchronous DMA state machine: $M_1$

A DMA controller is a good example of a synchronous state-machine design. It's very similar to many state-machine designs you might encounter in a  $\mu$ P-based

system. Thinking through the overall design and discussing implementation tradeoffs is a good way to get a feel for the design task.

The DMA controller actually consists of two linked synchronous state machines, as Fig 2 shows. The master state machine ( $M_1$ ) controls the overall type of transfer to be executed and decides what types of bus cycles to run. The slave state machine ( $M_2$ ) actually runs the bus cycle, issuing control signals, etc. to execute the transfer. (Ref 1 thoroughly covers the procedure of partitioning a state machine.)

Three loadable down-counters provide address and byte-counting functions. The byte-counting functions interact with the state machines. Four byte-wide data-holding registers permit the assembly of bytes into words, which increases transfer efficiency; they also perform the required byte swapping.

The data bus in this design is a 16-bit 8086 bus. The bus can support 8- and 16-bit peripherals. For efficiency, the memory is accessed only 16 bits at a time. All peripheral transfers start with a DMA request (DREQ)

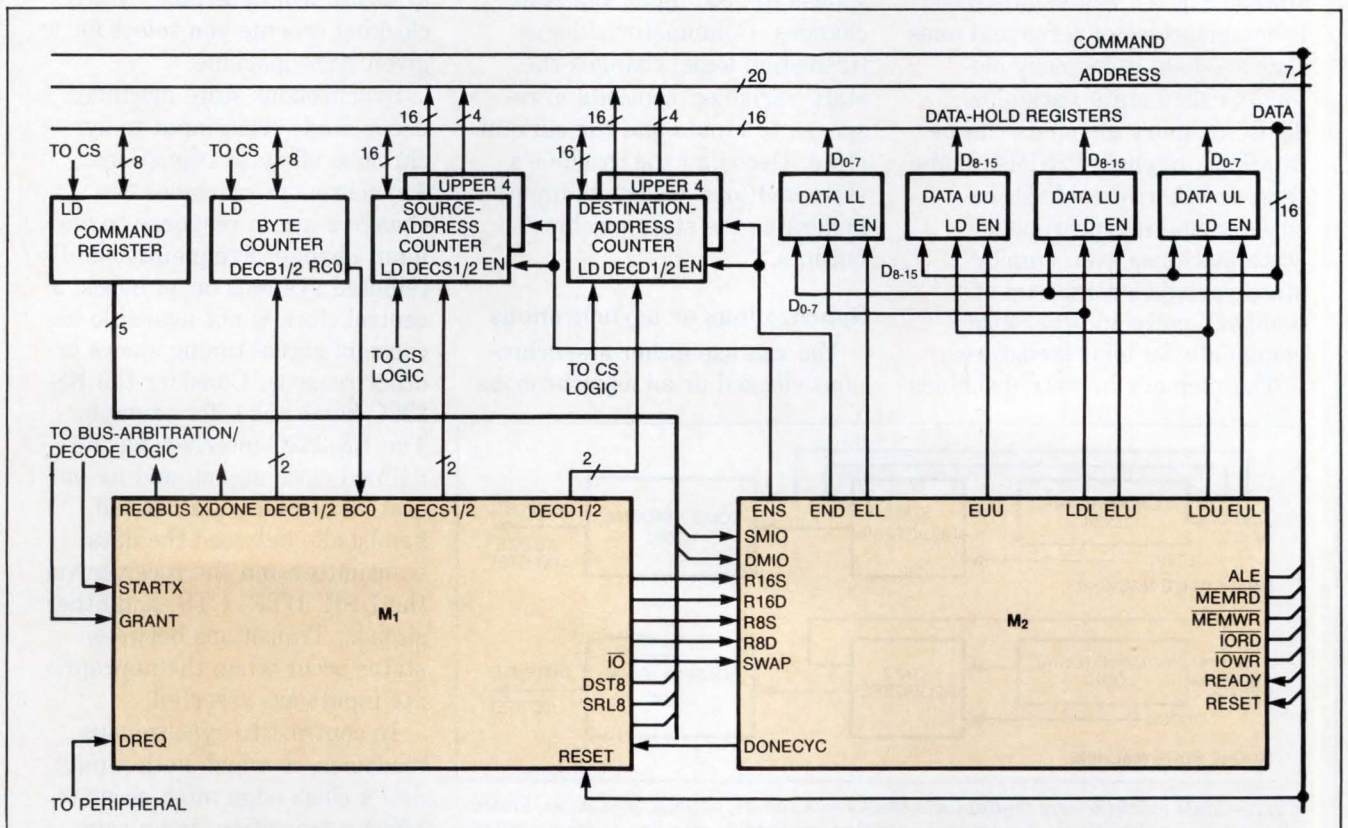

Fig 2—This DMA controller comprises two linked synchronous state machines. The master state machine ( $M_1$ ) controls the overall type of transfer to be executed and decides what types of bus cycles to run. The slave state machine ( $M_2$ ) actually runs the bus cycles.

*State-variable assignment is one area of state-machine design that is not very algorithmic.*

from the peripheral to trigger transfers of data. This sequence holds true whether the peripheral is the source or the destination of the data.

The DMA controller will have to contend with the following possible combinations of data sources and destinations:

DATA SOURCE	DESTINATION
16 MEM	16 MEM
16 MEM	8 I/O
16 MEM	16 I/O
16 I/O	16 MEM
8 I/O	16 MEM

The DMA controller will read or write two consecu-

tive byte-wide bus transfers when an 8-bit peripheral is involved.

The sequence of events required to execute a transfer are as follows:

- 1. The  $\mu P$  loads the source and destination pointer register/counters, byte counter, and command register
- 2. The  $\mu P$  gives the STARTX signal to the DMA controller
- 3.  $M_1$  requests the bus (REQBUS) from the  $\mu P$  (on DREQ if I/O is involved)
- 4. The  $\mu P$  grants the bus (GRANT) to  $M_1$
- 5.  $M_1$  initiates the bus cycle
- 6.  $M_2$  runs the source/destination bus cycles requested
- 7.  $M_1$  decrements the byte counter by 1 or 2

## State-machine basics

State machines are digital logic blocks with inputs, outputs, and states (Fig A). States are specific combinations of zeros and ones that are held in memory elements called state variables. These memory elements can be flip-flops, latches, PROMs, counters, or other bistable structures. Some (asynchronous) state machines even employ state variables composed of feedback paths in otherwise combinatorial logic structures.

The memory in state machines

allows them to follow your predefined sequence of states in response to both input and state changes. Combinatorial logic (transition logic) changes the state variables' contents in response to inputs and the current state. Decoding the machine's state and (optionally) its inputs generates the state machine's outputs.

### Synchronous or asynchronous

You can use either a synchronous clocked or an asynchronous

unlocked mechanism for your state machine. Your application typically will determine which clocking scheme you select for a given state machine.

Synchronous state machines use a single clock input to synchronize all state transitions. Asynchronous machines can change state in response to any input change. Frequently, in distributed systems or on buses, a central clock is not available because of signal-timing skews or other reasons. Consider the RS-232C handshake, for example. The RS-232C interface has no defined clock signal, and its operation consists of a defined handshake between the data transmitter and the receiver via the DSR, DTR, CTS, and other signals. Transitions between states occur when the appropriate inputs are asserted.

In contrast to synchronous machines, in which both inputs and a clock edge must occur to effect a transition, in an asynchronous machine, any input

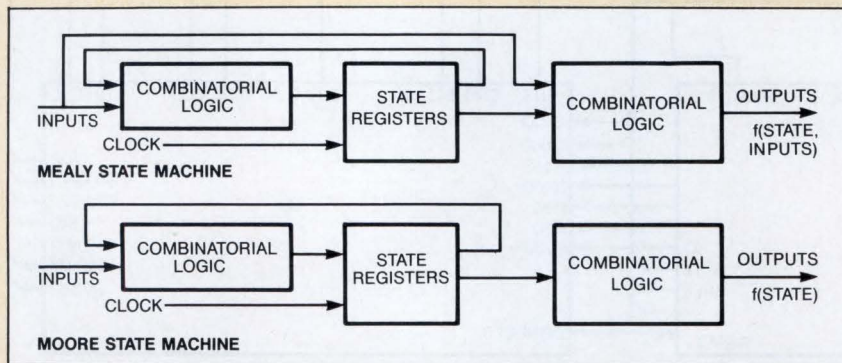

**Fig A—State machines are digital logic blocks with inputs, outputs, and states. States are specific combinations of zeros and ones that are held in memory elements called state variables.**

- 8. Loop back to Step 5 until the byte counter equals zero (BC0)
- 9.  $M_1$  releases the bus after the transfer is complete
- 10.  $M_1$  asserts the XFERDONE line
- 11. Loop back to Step 1.

Fig 3 shows the state-transition diagram of a state machine that implements  $M_1$  with 13 states. For simplicity, the diagram does not show any holding (hold-state) transitions. (You can assume that each state has such a transition, whose equation is the complement of the logical OR of all transition terms that force a new state.) Neither is the state-transition diagram cluttered with all the possible paths back to the RESET state. However, just because the state-transition diagram shows no hold-state and reset transitions does not mean

you can ignore these transitions when you write your state-variable excitation equations—you must include the equations in your PLD specification.

In a synchronous state machine, functions next to the transition arrows must be true on the rising edge of CLK in order for the state change to occur. Outputs for a given state are in the states' circle symbols (they're in typical Moore-machine notation; a Mealy machine would associate outputs with transition arrows, not states).

### List inputs and outputs

The first step in designing the logic to implement the state machine is to list inputs and outputs. The state diagram shows that  $M_1$  has nine inputs (exclusive of CLK) and 13 outputs. Because you have 13 states, you

glitch is unqualified and can cause problems. In such designs, you should use Schmitt-trigger buffers or filtering to condition the inputs for added safety.

In general, synchronous machines are easier for you to design and less error prone than asynchronous ones; the synchronous state machine's single clock source lets you more easily avoid spurious machine transitions. Asynchronous designs should be a last resort.

### Mealy and Moore machines

The two basic classes of state machines are Mealy and Moore machines. Mealy machines have outputs that are combinatorial functions of the state and the inputs. Moore machines' outputs are functions only of the machine state. Moore outputs change only on state transitions; Mealy outputs can change directly in response to inputs. Mealy machines can give you more-efficient implementations (that is, implementations having

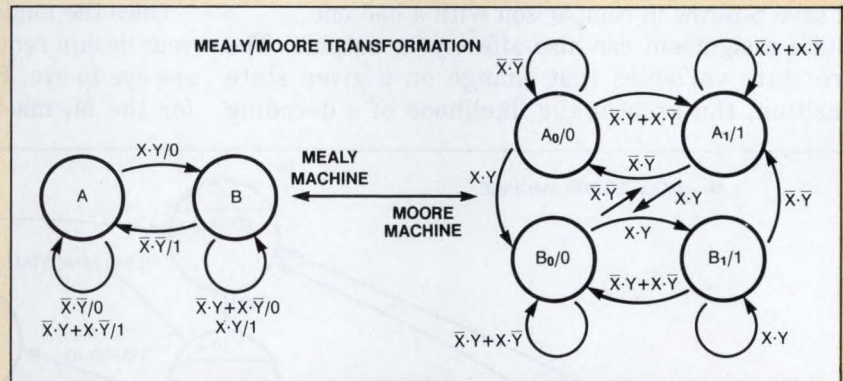

Fig B—You can implement any state-machine specification as either a Mealy or a Moore machine. The Mealy version has two states (one state variable) and one output, which varies according to the input combination of  $X$  and  $Y$ . The equivalent Moore version has four states (two state variables) that generate the corresponding output function.

fewer state variables) in those applications requiring many output combinations per state.

Fig B shows two alternative implementations of the same state machine. The Mealy version has two states (one state variable) and one output, which varies according to the input combination of  $X$  and  $Y$ . The Moore version has four states (two state variables), which generate the corresponding output

function.

The differences in the operation of these two implementations are externally undetectable. In fact, you can always transform your Mealy machine design into an equivalent Moore machine: For each Mealy-machine state transition that has a different output value (or values), you insert a new state in the Moore machine.

*Most designers use a trial-and-error method of state assignment to see if the target PLD has enough p-terms to satisfy the state machine's requirements.*

know that you can encode these states with four state variables (that is, four flip-flops:  $2^4=16$ ). The outputs plus the state variables equal 17, so an initial estimate is that you'll need a PLD (or PLDs) with at least 17 macrocells and nine inputs.

The second step is to assign state-variable combinations to particular states. State-variable assignment is one of the areas of state-machine design that is not very algorithmic. Most designers use a trial-and-error method of assignment: they assign variables, generate flip-flop excitation equations for different types of flip-flops, and see if the target PLD has enough p-terms to satisfy the equations' requirements. Some PLD-software packages can automatically look for a PLD or group of PLDs that will hold your equations.

You'll have three unused states, because you need only 13 of the 16 possible state-variable combinations. You should strive to achieve an optimal state-variable assignment, because a good state-variable assignment will save p-terms in comparison with a bad one.

State assignment can also affect your outputs. The more state variables that change on a given state transition, the greater the likelihood of a decoding

glitch. If your outputs will drive edge-sensitive logic directly, you may want to consider using a state assignment that's similar to a Gray code. This type of assignment allows only one variable to change at a time. By allowing only one variable to change at a time, you eliminate glitches.

After making the state assignment, you generate the state-transition equations. If you decide to use D flip-flops, the flip-flop excitation equations must cover all instances in which the flip-flop's output in the next state is a one. This coverage includes hold-state transitions as well as transitions between states. The equations for SR flip-flops, on the other hand, reflect only transitions between states and are frequently more compact. You can minimize the equations by using methods outlined in most basic logic-design texts (see **Ref 1** or **2**) or, with some practice, you can learn to minimize the equations for most designs by inspection. For complex designs, you may need state-machine-design software.

Once the minimization is done, you're ready to see if your design requirements and the PLDs you've chosen see eye to eye. **Fig 4** shows a typical state assignment for the  $M_1$  machine. The figure contains excitation

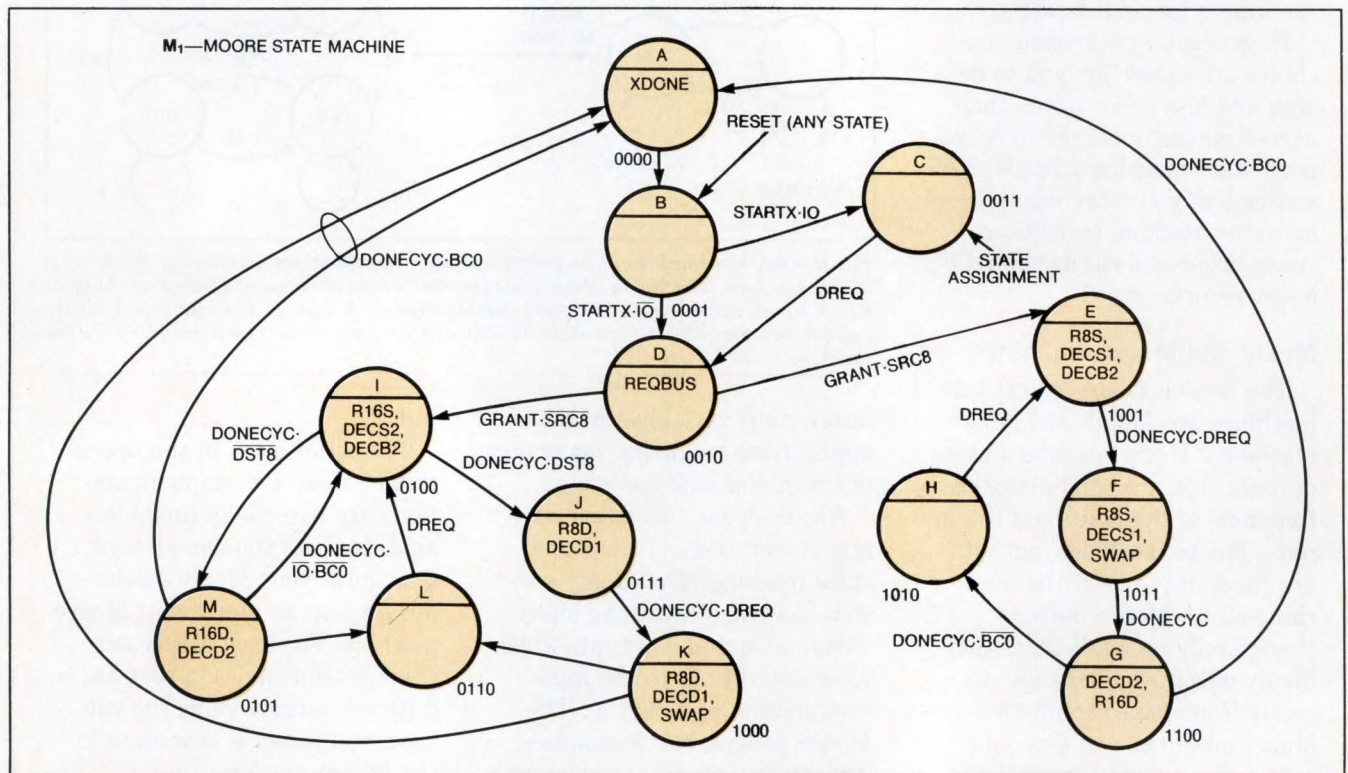

**Fig 3**—This state-transition diagram for  $M_1$  comprises a Moore machine with 13 states. For simplicity, the diagram does not show any hold-state transitions, nor is it cluttered with all the possible paths back to the RESET state.



equations for both D-flip-flop and SR-flip-flop realizations. The p-term requirements for state variables of the D-flip-flop implementation are 11, 12, 9, and 6. The p-terms for the SR-flip-flop design are (set/reset) 4/6, 5/7, 2/3, and 2/3. So, in this instance, the availability of SR flip-flops in the target PLD is a plus. Output p-term decoding requirements are much more modest: A typical output consumes two p-terms.

Most PLDs don't directly satisfy the high p-term counts of the D-flip-flop implementation of  $M_1$ . Given

the macrocells of most basic PLDs, only one equation of the D-flip-flop realization would fit within an 8-p-term macrocell. To increase the logic-term count, you'd have to cascade macrocells to build up an adequate number of terms. If you used traditional 20-pin PALs (or equivalents), you'd need three devices: a 16R4 for the registered/state-variable part of the job and two 16L8s for the combinatorial-output decoding and p-term expansion.

Higher-density PLDs such as the EP600/900 and

State	State Variables			
	Q3	Q2	Q1	Q0
A	0	0	0	0
B	0	0	0	1
C	0	0	1	1
D	0	0	1	0
E	1	0	0	1
F	1	0	1	1
G	1	1	0	0
H	1	0	1	0
I	0	1	0	0
J	0	1	1	1
K	1	0	0	0
L	0	1	1	0
M	0	1	0	1
Unused	1	1	0	1
	1	1	1	0
	1	1	1	1

M1 D Flip-Flop Excitation Equations:

$$D3 = (0111 * DONECYC * DREQ + 1X00 * DONECYC' + 0010 * GRANT * SRC8 + 10X1 + 1100 * DONECYC * BCO' + 1010) * RESET' \quad (6 \text{ TERMS})$$

$$D2 = (1011 * DONECYC + 1100 * DONECYC' + 1100 * BCO + 0010 * GRANT * SRC8' + 0100 + 01X1 * DONECYC' + 011X * DREQ' + 0101 * IO * BCO' * DONECYC + 1000 * DONECYC * BCO') * RESET' \quad (9 \text{ TERMS})$$

$$D1 = (0001 * STARTX + 0010 * GRANT' + 0011 * DREQ' + 0100 * DONECYC * DST8 + 0111 * DONECYC' + 0111 * DREQ' + 0101 * DONECYC * IO * BCO' + 1X00 * DONECYC * BCO' + 0110 * DREQ' + 1001 * DONECYC * DREQ + 1011 * DONECYC' + 1010 * DREQ') * RESET' \quad (12 \text{ TERMS})$$

$$D0 = 0000 + 0001 * STARTX' + RESET + 0001 * STARTX * IO + 0X11 * DREQ' + 0100 * DONECYC + 0101 * DONECYC' + 0111 * DONECYC' + 0010 * GRANT * SRC8 + 1001 + 1011 * DONECYC \quad (11 \text{ TERMS})$$

M1 SR Flip-Flop Excitation Equations:

$$S3 = 0111 * DONECYC * DREQ + 0010 * GRANT * SRC8 \quad (2 \text{ TERMS})$$

$$R3 = RESET + 1000 * DONECYC * BCO' + 1100 * DONECYC * BCO \quad (3 \text{ TERMS})$$

$$S2 = 0010 * GRANT * SRC8' + 1011 * DONECYC \quad (2 \text{ TERMS})$$

$$R2 = RESET + 0111 * DONECYC * DREQ + 1100 * DONECYC \quad (3 \text{ TERMS})$$

$$S1 = 0001 * STARTX + 1001 * DONECYC * DREQ + 1X00 * DONECYC * BCO' + 0101 * IO * BCO' * DONECYC + 0100 * DONECYC * DST8 \quad (5 \text{ TERMS})$$

$$R1 = RESET + 0001 * STARTX * IO' + 0010 * GRANT + 0111 * DONECYC * DREQ + 0110 * DREQ + 1010 * DREQ + 1011 * DONECYC \quad (7 \text{ TERMS})$$

$$S0 = 0000 + 0010 * GRANT * SRC8 + 1010 * DREQ + 0100 * DONECYC \quad (4 \text{ TERMS})$$

$$R0 = RESET + 0001 * STARTX * IO' + 0011 * DREQ + 1011 * DONECYC + 0101 * DONECYC + 0111 * DONECYC * DREQ \quad (6 \text{ TERMS})$$

Fig 4—This typical state assignment for  $M_1$  also has excitation equations for both D-flip-flop and SR-flip-flop realizations. For  $M_1$ , the availability of SR flip-flops in the target PLD is a plus. The p-term decoding requirements of the output are modest: A typical output consumes only two p-terms.

*The more state variables that change on a given state transition, the greater the likelihood of a decoding glitch.*

22V10 have higher macrocell and output counts. They can also mix and match combinatorial and registered functions. For example, two EP600s or 22V10s, or a single EP900 (24 macrocells/12 inputs), could potentially implement  $M_1$ . The EP1210s' and the 22V10s' variable p-term distribution can support  $M_1$ 's high p-term count. The EP600/900s also have programmable flip-flop types, so they allow an SR implementation; for  $M_1$ , SR flip-flops require the fewest p-terms.

Which devices you use to implement your state-machine design will depend on the device speed, component cost, board space, and personal preference. Low-density, bipolar PALs offer the highest speed; CMOS PLDs have higher densities and a more flexible architecture. A PLA's architecture can also implement the SR design of the  $M_1$  machine effectively. The SR design requires 32 p-terms. Because popular PLAs such as the 82S105 supply 48 p-terms, they can contain this design. However, you must use external PLDs to decode the PLA's state variables, and the result is still a multichip design.

### A synchronous bus controller: $M_2$

The  $M_2$  machine implements the flow shown in Fig 5.  $M_2$  requires a minimum of eight CLK edges to perform a bus transfer. The machine requires nine basic states, including IDLE. Each type of cycle (memory read, memory write, I/O read, and I/O write) requires  $M_2$  to stimulate distinct output-control lines. This machine is therefore a good candidate for a Mealy design.

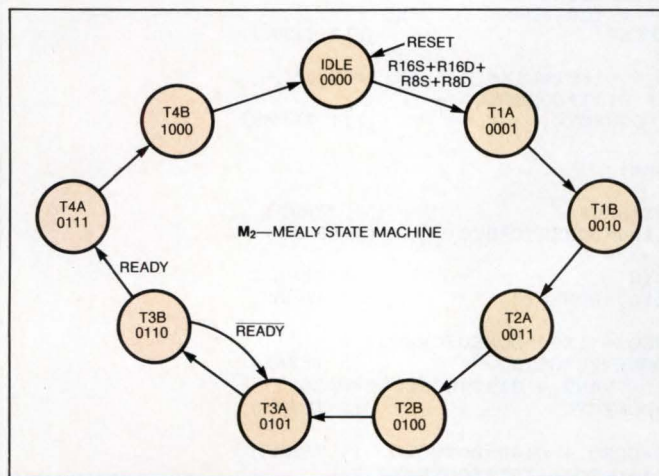

**Fig 5—**From  $M_2$ 's state-transition diagram, you can see that each type of cycle (memory read, memory write, I/O read, and I/O write) requires  $M_2$  to stimulate distinct output-control lines. This machine is therefore a good candidate for a Mealy design. (The unlabeled transitions are unconditional.)

The machine takes its primary inputs from  $M_1$  for 8- and 16-bit source and destination commands—R8S, R16S, R8D, and R16D—along with SWAP. Additional inputs consist of an external ready line (READY), as well as the source and destination control lines for memory and I/O operations. The source and destination control lines come from the command register.

The machine generates two types of outputs. One type—MEMRD, MEMWR, IORD, IOWR, and ALE—effects  $\mu P$  communication and bus control. The remaining lines decrement the appropriate address counters by either one or two, signal  $M_1$  that transfer is complete (DONECYC), and enable address and data information on the computer's buses at the appropriate times.

$M_2$  has nine inputs and 14 outputs. You need four state variables to encode the nine states, leaving seven states unused.  $M_2$  has very little internal branching in its control flow (Fig 5). This lack of branching is typical of many sequencer applications. The implementation of the machine resembles that of a modulo 9 counter, except that the READY input causes a wrinkle at states T3A and T3B: HOLSTATE if READY not active.

Fig 6 shows both D and T flip-flop excitation equations for  $M_2$ . The D implementation in this case actually requires fewer p-terms than the T. This situation occurs partially because of the complexity of implementing the RESET terms with toggle equations.

One solution for the problem of implementing RESET is to take advantage of the separate flip-flop reset-input terms that many PLDs have. If you define the reset state as 0000, you can reduce the logic-term requirements.

Outputs consume between one and six p-terms; the four control lines (IORD, MEMWR, etc) consume four to six p-terms each. Because no function requires more than eight p-terms for the D-flip-flop design, these equations fit into an 8-p-term macrocell (which is common to many PLDs) with no cascading. In this case, the macrocell consumption is equal to outputs plus state variables, or a total of 18.

An alternative implementation of this machine as a Moore machine would require 33 states: eight clocks times four cycle types, plus IDLE. These states would require six state variables to encode them, plus the output decoding for the 14 outputs, increasing the total number of macrocells required to 20.  $M_2$  shows the economy of a Mealy machine when the machine flow is constant, but the outputs vary depending on the inputs.

Predicting the performance of your synchronous state machine isn't difficult if you read the PLD's data

# TEK'S NEW \$2795 16-64 CHANNEL LOGIC ANALYZER. EASY TO START WITH. TOUGH TO OUTGROW.

For \$2795, you can have a logic analyzer that makes things simple when you're just starting out. That may never make you rummage through the manual. But that recognizes you won't be a rookie forever.

Starting with 16 channels, Tek's new 1230 guides the new user through timing and state analysis with on-screen prompts. We kept keystrokes to a minimum, common sense to a maximum.

As you grow more experienced, and your applications grow more ambitious, the 1230 gives you room to grow—to 32, 48 or 64 channels with 8 and 16-bit microprocessor debug capability—via

expansion cards and probes you can easily add yourself.

You can do hardware analysis and microprocessor systems integration, using up to four 2K deep memories for reference and comparison. You can do sophisticated triggering. Acquire and compare signals automatically via built-in babysitting mode. Or, take the 1230 into the field: its rugged package takes rough handling in stride.

No other logic analyzer is so affordable,

**expandable and hassle-free.**

For further proof of why the Tek 1230 boasts the shortest learning curve and the longest

life expectancy, talk to your Tek representative soon.

Or call (800) 245-2036.

In Oregon, 231-1220.

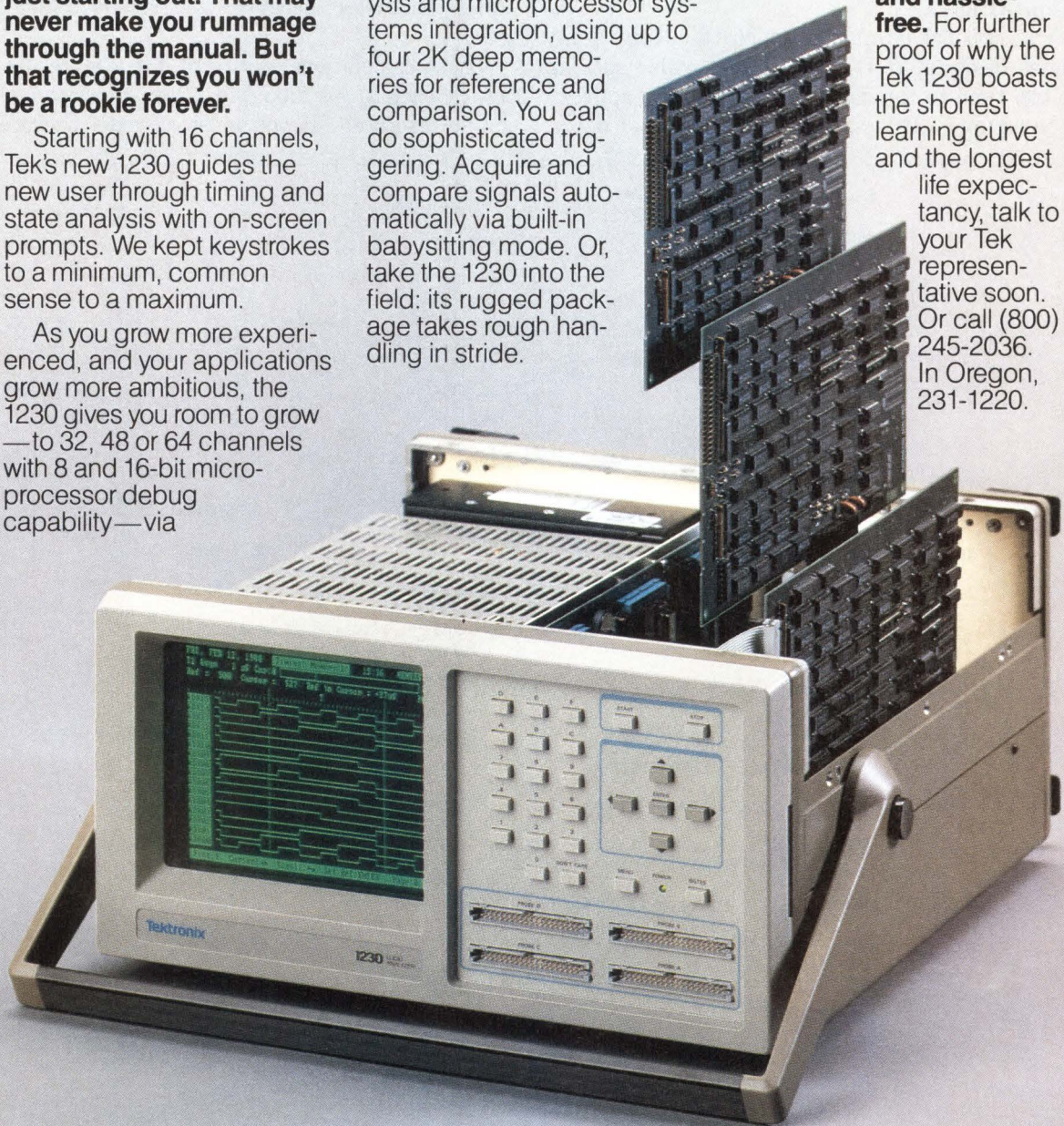

Circle 110 for Literature

Circle 111 for Sales Contact

**Tektronix**  
COMMITTED TO EXCELLENCE

*Which devices you use to implement your state-machine design will depend on the device speed, component cost, board space, and personal preference.*

sheet carefully. Although PLD data sheets typically quote an  $f_{MAX}$  number in megahertz, don't confuse this frequency with the potential operating frequency of your machine. The  $f_{MAX}$  is typically an internal flip-flop toggle rate that benchmarks the absolute frequency. Your machine will be interacting with other circuitry, and you need to factor several additional specs into your calculations (Fig 7).

The first critical number is clock-to-output delay (sometimes designated  $T_{CO}$ ). Most PLDs also spec an input setup time to the clock ( $T_{SETUP}$ ).  $T_{SETUP}$  approximates the actual PLD logic array's input-output delay.

The inverse of the sum of these two numbers is the fastest actual clock rate at which your state machine will probably be able to run. If the clock period is greater than this sum, you'll be able to take an output from your machine and feed it back into an input to affect the state transitions. Many designs include external logic in the PLD's output-input loop; you shouldn't ignore this logic, because its delays will lengthen the period.

These calculations hold true for a state machine in which each state variable is implemented in only a single macrocell. If you must cascade macrocells, you

State	State Variables Q3 Q2 Q1 Q0
-----	-----
IDLE	0000
T1A	0001
T1B	0010
T2A	0011
T2B	0100
T3A	0101
T3B	0110
T4A	0111
T4B	1000
Unused	1001-1111

M2 D Flip-Flop Excitation Equations	
D3 = 0111*RESET'	(2 TERMS)
D2 = (0011 + 010X + 0110)*RESET'	(3 TERMS)
D1 = (0010 + 0X01 + 0110*READY)*RESET'	(3 TERMS)
D0 = (0000*R16S + 0000*R8S + 0000*R8D + 0000*R16D + 0010 + 01X0)*RESET'	(6 TERMS)
M2 T Flip-Flop Excitation Equations:	
T3 = 0111 + 1XXX*RESET	(2 TERMS)
T2 = 0X11 + X1XX*RESET	(2 TERMS)
T1 = 00X1 + 0111 + 0110*READY'+ XX1X*RESET	(4 TERMS)
T0 = 1XXX + X1XX + XX1X + XXX1 + 0000*R16S + 0000*R8S + 0000*R8D + 0000*R16D + XXX1*RESET	(9 TERMS)
M2 Output Equations (Selected)	
ENS = 0001*R16S + 0001*R8S	(2 TERMS)
ENLL = R16D*(0011 + 01X0 + 0101) + R8D*SWAP'* (0011 + 01X0 + 0101)	(6 TERMS)
LDL = 0110 * SWAP' * (R8S + R16S)	(2 TERMS)
IORD' = (0011 + 010X + 0110) * SMIO'* (R16S + R8S)	(6 TERMS)
MEMWR' = (0101 + 0110) * DMIO * (R16D + R8D)	(4 TERMS)

**Fig 6—For M<sub>2</sub>, the D-flip-flop implementation in this case actually requires fewer p-terms than does the T-flip-flop implementation. This situation occurs partially because of the complexity of implementing the RESET terms with toggle equations.**

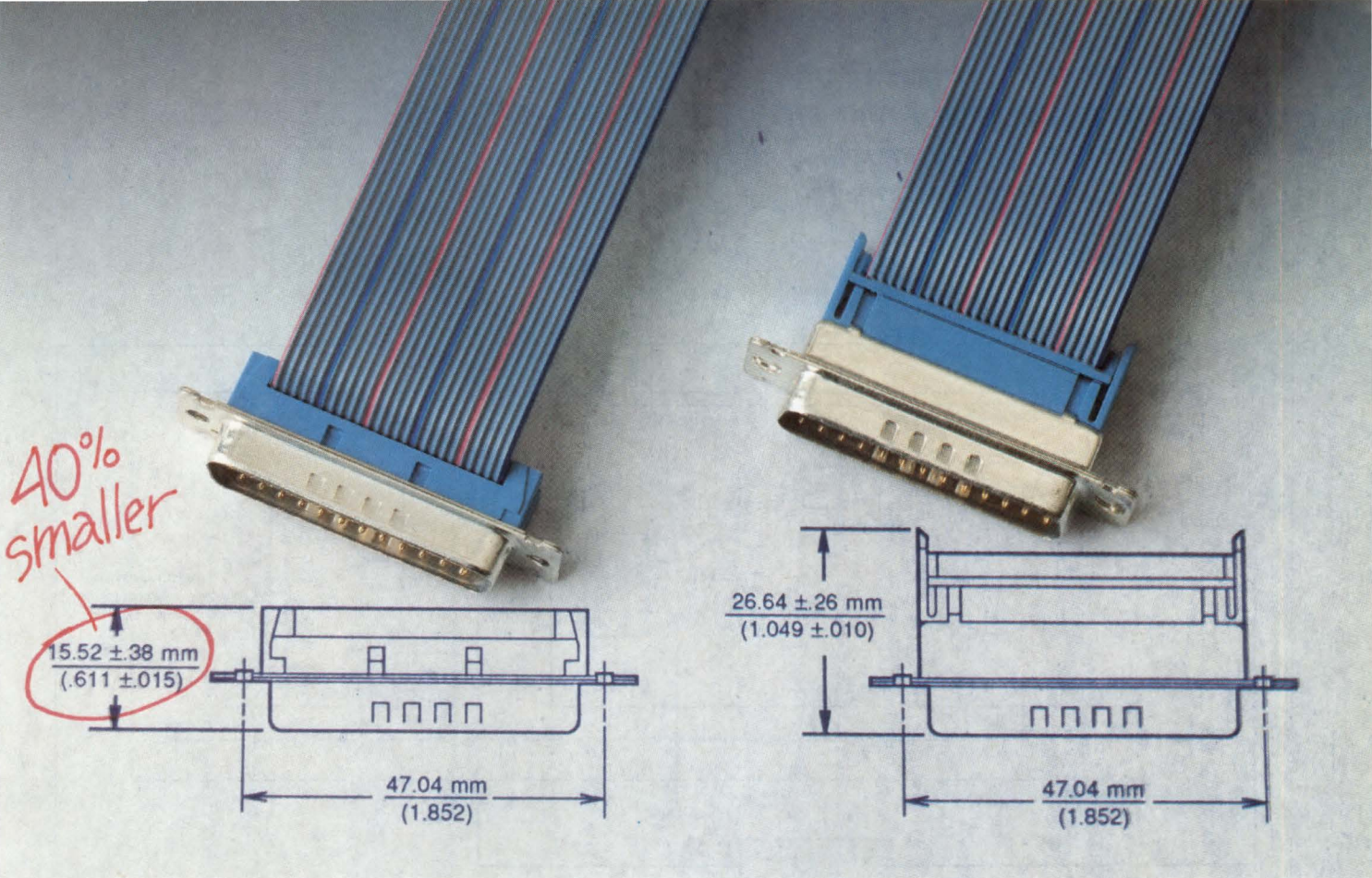

# WHEN SPACE-SAVINGS IS CRITICAL, WE MAKE SMALLER, SMARTER.

Our new connectors match their bigger brothers in performance and reliability. There's one big difference — they save you space... a lot of space. Compact, convenient, cost-effective, these space savers offer improved system flexibility and superb electrical integrity and strength. And, lots of new space saving possibilities.

The Ansley® Metal Shell Low Profile "D" connector, for example, does exactly what the full-sized "D" connectors do, but in about half the space — .602" male, .612" female and .990" matched pair. Low Profile "D" connectors are compatible with all standard "D" connectors. They're available with plated and unplated backshells for both flat or round cable. Strain reliefs and mounting hardware accessories are also available.

**Ansley® Slimline Connectors**  
The new Slimline PCB Solder Tran-

sition Connectors provide extra fast flat cable soldering to printed circuit boards.

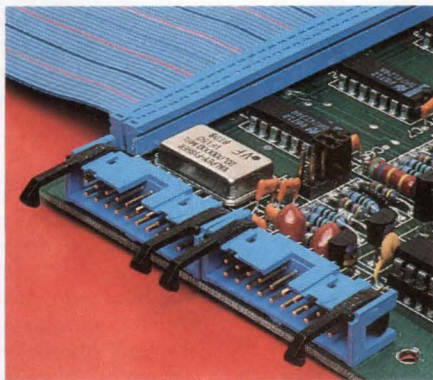

*Slimline PCB Connector, Vertical Ejector Headers*

Choose from 16 contact sizes and a variety of solder tail lengths, our Slimline design helps you to maximize your packaging density.

## Ansley® Low Profile Vertical Ejector Headers

These new headers provide the stability and convenience you need

whenever repeated connection and disconnections are required. *Unlike conventional designs where the ejector latches swing left and right, the Low Profile Vertical Ejector latches swing front and back, permitting you to make maximum use of your PCB space.*

These new connectors are just one *small* accomplishment from Thomas & Betts. So, when your space is at a premium, think smart... think Thomas & Betts. *For complete detailed information*, write or call Thomas & Betts Corporation, Electronics Division, 1001 Frontier Road, Bridgewater, NJ 08807, (201) 685-1600.

## Thomas & Betts

*Predicting your synchronous state machine's performance is not difficult if you read your PLD's data sheet carefully.*

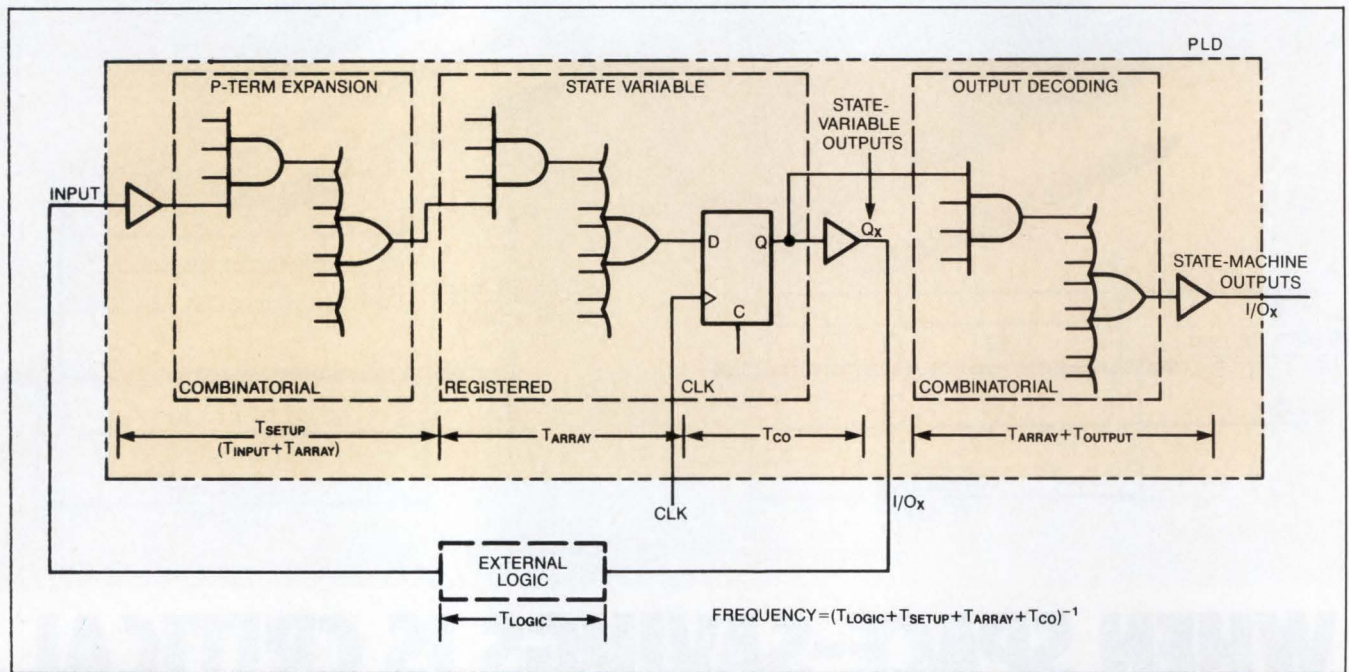

**Fig 7**—Although PLD data sheets typically quote an  $f_{MAX}$  number in megahertz, don't confuse this frequency with the potential operating frequency of your machine. Your machine will interact with other circuitry, and you need to factor all the specs shown in this diagram into your calculations.

must add an additional  $T_{PD}$  (logic array) delay for each level of cascading. Depending on your application's requirements, this additional delay may or may not be a problem.

For example, when  $T_{CO}=15$  nsec and  $T_{PD}=25$  nsec, an added level could depress the operating rate from  $[1/(15 \text{ nsec} + 25 \text{ nsec})]=25$  MHz, to  $[1/(15 \text{ nsec} + 25 \text{ nsec} + 25 \text{ nsec})]=16$  MHz.

$T_{PD}$  also determines output-decoding time when you use separate PLDs for registered and combinatorial functions. This separation can prove to be a source of unacceptable clock-to-machine output skews.  $T_{CO} + T_{PD}$  is the overall delay in this arrangement (15 nsec + 25 nsec = 40 nsec for a typical PLD). This delay limits such a multichip design to applications with 10-MHz or slower clocks.

If skews arising from the decoding's propagation delay do become excessive, you can modify the design to register the control outputs. This modification involves pipelining the control outputs. You clock each output flip-flop with the master machine's clock. The result is that the control lines are only one clock-to-output delay ( $T_{CO}$ ) behind the clock. Unfortunately, pipelining can be very complex because of the look-ahead nature of output logic. Therefore, pipelining is best left as a last recourse.

**EDN**

## References

1. McCarthy, Clive M, "Partitioning adapts large state machines to PLDs," *EDN*, September 17, 1987, pg 163.
2. Fletcher, William I, *An Engineering Approach to Digital Design*, Prentice-Hall, Englewood Cliffs, NJ, 1980.
3. Friedman, Arthur D, and Menon, Premachandran R, *Theory and Design of Switching Circuits*, Computer Science Press, Rockville, MD, 1975.

## Author's biography

Stanley Kopec is manager of product planning for programmable logic at Altera Corp in Santa Clara, CA. He has been with Altera for three years. Prior to joining Altera, Stan worked for Exel Microelectronics and was in charge of  $\mu P$ -peripheral development. He holds a BSEE from the State University of New York at Buffalo and an MSEE from the University of Illinois. In his spare time he enjoys racquetball, skiing, and reading.



Article Interest Quotient (Circle One)  
High 491 Medium 492 Low 493

we never stop  
asking

What if...



## HP's perfect balance between price and performance in logic analysis.

The balance is called value! And nobody can put more value on your bench than HP. With the HP 1650A and HP 1651A, you get powerful capabilities at prices that keep the bottom line where you like it—low.

### HP Logic Analyzers: the extra measure.

The exceptional value stems from HP's proprietary "logic-analyzer-on-a-chip" technology which integrates state analysis, timing analysis and acquisition memory on a single IC. You get features like 25MHz state/100MHz transitional timing on all channels and two independent analyzers in a single instrument.

If your application is digital hardware, or if you're working with popular 8-bit  $\mu$ Ps, choose our 32-channel HP 1651A at only \$3,900.\*

For your 8-, 16-, or 32-bit  $\mu$ P development applications, choose the 80-channel HP 1650A analyzer at only \$7,800.\* It offers full support for most popular  $\mu$ Ps including the Motorola 68020 and the Intel 80386.

Both analyzers are capable of cross-domain triggering which lets you simultaneously capture and display state and timing information with time correlation for powerful cause/effect problem solving. Each has a built-in disc drive for storage of setups and measurements. And additional software tools to make your measurement tasks easier.

**Call HP for your free video!**  
**1-800-752-0900, Ext. 215V**

Get a hands-on feel for our HP 1650A and HP 1651A logic analyzers with our demo video and literature. They're free!



You'll see how we balanced price and performance—perfectly.



©1988 Hewlett-Packard Co. EI15711/EDN

 **HEWLETT  
PACKARD**

Systems Design Handbook  
SECOND EDITION  
The Applications Handbook  
Programmable Logic Data Manual  
HIGH PERFORMANCE CMOS DATA  
FACT DATA BOOK  
MOS Memory Data Book  
1986  
1986  
Handbook/Data Book  
1987  
Commercial/Military  
1986 Data Book  
Commercial/Military



view  
today



# Highest performance designers know where to turn.

Our customers design the world's highest performance computer-based products.

It's hard work. We make it easier, with a large variety of the highest performance ICs. All in cool, low power CMOS, delivered in small, space-saving packages.

That's why when you visit any design lab where highest performance is critical, you'll likely find a very well-worn Cypress Semiconductor databook.

Highest performance designers turn to our specs for fast solutions to tough design problems.

They specify our parts with confidence, because we take pains to outperform our own specs.

## **CMOS High Speed Logic Family:**

The world's fastest 16-bit-slice, our 7C9101, for starters. Our Logic Family also includes the fastest available 64 x 8 to 2K x 9 cascadeable FIFOs (35MHz performance). Our databook will also show you lightning-fast 4-bit-slice parts, 12-bit controllers, 16 x 16 multipliers, and more.

## **CMOS High Speed SRAM Family:**

Featuring our blazing, 12ns 4K and 7ns 1K TTL-compatible SRAMs. Plus a variety of 15ns, 25ns, 35ns, and 45ns

parts, too. Nibble-wide, bit-wide, byte-wide, ranging from 64-bits through 64K-bits. Plus, our 8K or 16K 25ns dual-port SRAMs.

## **CMOS High Speed PROM Family:**

Surpassing bipolar with the *fastest* registered PROMs at HALF bipolar power. Parts feature speeds to 18ns set-up, 12ns clock-to-output, all with low CMOS power. Byte-wide family available in 4K, 8K, 16K, 64K, and 128K densities! Windowed versions available for convenient reprogrammability. All available in space-saving, money-saving skinny DIP 300 mil packages.

## **CMOS High Speed PLD Family:**

Our 25ns Quarter-Power 55mA windowed 22V10 EPLD has set the performance standard for programmable logic. Now, we're introducing our new PLD 7C300 family, functionally partitioned to address specific application needs. Synchronous, Asynchronous, or Combinatorial versions bring unprecedented gate utilization and programming flexibility, yielding twice the performance and density, using only half the power of previous PLD generations.

**And now, the new DataBook.**  
**Yours free, for a toll-free call.**

### **DataBook Hotline:**

**1-800-952-6300**

**Ask for Dept. C41**

**1-800-423-4440 In CA**

**Ask for Dept. C41**

**(32) 2-672-2220 In Europe**

**(416) 475-3922 In Canada**



**CYPRESS  
SEMICONDUCTOR**

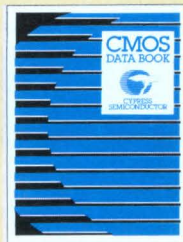

Cypress Semiconductor, 3901 North First Street, San Jose, CA 95134, Phone: (408) 943-2666, Telex: 821032 CYPRESS SNJ UD, TWX: 910-997-0753. ©1988 Cypress Semiconductor.

# CMOS LOGIC FROM THE MANUFACTURER OF

TOSHIBA INTRODUCES  
**150milSOIC**  
 AVAILABLE IN THE TC74HC AND TC4000 SERIES.  
 CONTACT YOUR TOSHIBA REP TODAY.



ALABAMA, Marshall Electronics Group, (205) 881-9235, Milgray Electronics, Inc. (404) 393-9666, Repron Electronics, (404) 446-1300; ARKANSAS, Marshall Electronics Group, (214) 233-5200, Milgray Electronics, Inc. (214) 248-1603, Sterling Electronics-Dallas, (214) 243-1600; ARIZONA, Marshall Electronics Group, (602) 495-0290, Sterling Electronics-Phoenix, (602) 265-2121; CALIFORNIA, Image Electronics, (714) 259-0900, (818) 707-0911, Marshall Electronics Group, (818) 407-0101, (714) 458-5395, (408) 942-4600, (916) 635-9700, (818) 578-9600, Merit Electronics, Inc. (408) 434-0800, Western Microtechnology, (619) 453-8430, (714) 637-0200, (408) 725-1660, (818) 707-0377; COLORADO, Marshall Electronics Group, (303) 451-8383, Sterling Electronics-Denver, (303) 792-3838; CONNECTICUT, Cronin Electronics, Inc. (203) 265-3134, Marshall Electronics Group, (203) 265-3822, Sterling Electronics-Wallingford, (203) 265-9535; DELAWARE, General Components, Inc. (609) 768-6767, Marshall Electronics Group, (301) 840-9450, Milgray/Delaware Valley, Inc. (609) 983-5010, (800) 257-7808, (800) 257-7111, Sterling Electronics-Sterling, (703) 450-2373; DISTRICT OF COLUMBIA, Marshall Electronics Group, (301) 840-9450, Milgray/Washington, Inc. (301) 621-8169, (800) 638-6656, Sterling Electronics-Sterling, (703) 450-2373; FLORIDA, Marshall Electronics Group, (305) 767-8585, (813) 576-1399, (305) 977-4880, Repron, (813) 855-4656, (305) 735-1112; GEORGIA, Marshall Electronics Group, (404) 923-5750, Milgray Electronics, Inc. (404) 393-9666, Repron, (404) 446-1300; IDAHO, Marshall Electronics Group, (801) 485-1551, Western Microtechnology, (503) 629-2082; ILLINOIS, Good Electronics, (312) 593-3220, Marshall Electronics Group, (312) 490-0153, (314) 291-8554, Milgray Electronics, Inc. (913) 236-8800, (312) 350-0490; INDIANA, Good Electronics, (312) 593-3220, Marshall Electronics Group, (317) 297-0483, Milgray/Chicago, Inc. (312) 350-0490; IOWA, Dee Electronics, Inc. (319) 365-7551, (800) 332-5478, (800) 553-5421, Marshall Electronics Group, (612) 558-2211, Milgray Electronics, Inc. (913) 236-8800; KANSAS, Marshall Electronics Group, (913) 492-3121, Milgray Electronics, Inc. (913) 236-8800; KENTUCKY, Marshall Electronics Group, (513) 898-4480, Milgray/Cleveland, Inc. (216) 447-1520, (800) 321-0006; LOUISIANA, Marshall Electronics Group, (214) 233-5200, Milgray Electronics, Inc. (214) 248-1603, Sterling Electronics-Dallas, (214) 243-1600; MAINE, Cronin Electronics, Inc. (617) 449-5000, Marshall Electronics Group, (617) 658-0810, Sterling Electronics-Boston, (617) 938-6200, Western Microtechnology, (617) 273-2800; MARYLAND, Marshall Electronics Group, (301) 840-9450, Milgray/Washington, Inc. (301) 621-8169, (301) 621-6169, (800) 638-6656, Sterling Electronics-Sterling, (703) 450-2373; MASSACHUSETTS, Cronin Electronics, Inc. (617) 449-5000, Marshall Electronics Group, (617) 658-0810, Sterling Electronics-Boston, (617) 938-6200, Western Microtechnology, (617) 273-2800; MICHIGAN, Calder Electronics, (616) 698-7400, Marshall Electronics Group, (313) 525-5850; MINNESOTA, Marshall Electronics Group, (612) 559-2211, Repron Electronics, (612) 938-0000; MISSISSIPPI, Marshall Electronics Group, (205) 881-9235, Milgray Electronics, Inc. (404) 393-9666; MISSOURI, Marshall Electronics Group, (913) 492-3121, (314) 291-8554, Milgray Electronics, Inc. (913) 236-8800, Sterling Electronics-Kansas, (913) 236-5589; NEBRASKA,

# WORLD'S LARGEST CMOS. TOSHIBA.

**But if you don't have our CMOS LOGIC data book, how could you know we're that strong?**

Toshiba is a CMOS logic pioneer, and in the 16 years since we first developed our CMOS logic line, we've become the world's largest supplier.

Toshiba offers the most comprehensive CMOS logic line available. From the standard 4000/4500 series up to our new highest speed TC74AC series — tomorrow's standard logic family.

With its high noise margin, high speed and low power consumption, the TC74HC series creates efficient device opportunities for designers of high speed portable instruments, telecommunications equipment, or any digital system.

## WE WROTE THE BOOK

It's all in our Book. Detailed specifications on our complete line. Our Book is the definitive source for the newest and best in CMOS logic. If you don't have a current copy, get one today.

And remember, you can order Toshiba logic with confidence. Confidence that Toshiba can ship

higher volumes of CMOS logic than anyone else. And ship it on time at competitive prices. Confidence, too, that Toshiba ships only quality assured products.

So when you select logic, talk to the people with the power. Talk with Toshiba.

Characteristics/ Logic Families	New HS-C <sup>2</sup> MOS (74AC Series)	HS-C <sup>2</sup> MOS (74HC Series)	LSTTL	*Std. C <sup>2</sup> MOS (4000/4500 Series)
Prop. Delay Time (typ) GATE (C <sub>L</sub> = 15pF)	3.5ns	8ns	9ns	125ns
Max. Clock Freq. (typ) J/K F·F (C <sub>L</sub> = 15pF)	150MHz	60MHz	45MHz	2MHz
Quiescent Power Diss. (typ) (GATE)	0.01μW	0.01μW	8mW	0.01μW
Noise Margin V <sub>IH(min)</sub> /V <sub>IL(max)</sub>	3.5V/1.5V	3.5V/1.5V	2.0V/0.8V	3.5V/1.5V
Output Current I <sub>OH</sub> (min)/I <sub>OL</sub> (min)	24mA/24mA	4mA/4mA	0.4mA/4mA	0.12mA/ 0.36mA
Op. Volt. Range	2-6V	2-6V	4.75-5.25V	3-18V
Op. Temp. Range	-40-85 °C	-40-85 °C	0-70 °C	-40-85 °C

\*Data believed to be accurate and representative of each logic family.

## TOSHIBA. THE POWER IN LOGIC.

### TOSHIBA AMERICA, INC.

Logic Marketing Manager  
9775 Toledo Way  
Irvine, CA 92718

EDN052688

Send me your data book detailing the newest and best in CMOS Logic.

Name \_\_\_\_\_

Title \_\_\_\_\_

Company \_\_\_\_\_

Address \_\_\_\_\_

City \_\_\_\_\_ State \_\_\_\_\_ Zip \_\_\_\_\_

Marshall Electronics Group, (913) 492-3121, Milgray Electronics, Inc., (913) 236-8800, Sterling Electronics-Kansas, (913) 236-5589, NEVADA, Marshall Electronics Group, (916) 635-9700, (602) 496-0290, Sterling Electronics, (602) 268-2121, Western Microtechnology, (408) 725-1660, NEW HAMPSHIRE, Cronin Electronics, Inc., (617) 449-5000, Marshall Electronics Group, (617) 658-0810, Sterling Electronics-Boston, (617) 938-6200, Western Microtechnology, (617) 273-2800, NEW JERSEY, General Components, Inc., (609) 768-6767, Marshall Electronics Group, (201) 882-0320, (809) 234-9100, Milgray Electronics, Inc., (516) 420-9800, (800) 257-7808, (800) 257-7111, Sterling Electronics-So. Plainfield, (201) 769-7000, NEW MEXICO, Marshall Electronics Group, (602) 496-0290, Sterling Electronics-Albuquerque, (505) 884-1900, NEW YORK, Marshall Electronics Group, (516) 273-2424, (607) 798-1611, (716) 235-7620, Milgray Electronics, Inc., (516) 420-9800, (716) 235-0830, Rome Electronics, (315) 337-5400, NORTH/SOUTH CAROLINA, Marshall Electronics Group, (919) 878-9882, Milgray Electronics, Inc., (404) 393-9666, Resco Raleigh, (704) 588-1530, (919) 781-5700, NORTH/SOUTH DAKOTA, Marshall Electronics Group, (612) 559-2211, Repron Electronics, (612) 938-0000, OHIO, Marshall Electronics Group, (513) 898-4480, (216) 248-1788, (614) 891-7580, Milgray/Cleveland, Inc., (216) 447-1520, (800) 321-0006, Repron Electronics, (514) 436-8675, (216) 349-1415, OKLAHOMA, Marshall Electronics Group, (214) 233-5200, Milgray Electronics, Inc., (214) 248-1603, Sterling Electronics-Tulsa, (918) 663-2410, OREGON, Marshall Electronics Group, (503) 644-5050, Western Microtechnology, (503) 629-2082, PENNSYLVANIA, General Components, Inc., (609) 768-6767, Marshall Electronics Group, (609) 234-9100, (412) 983-0441, Milgray/Cleveland, Inc., (216) 447-1520, (800) 321-0006, Milgray/Delaware Valley, Inc., (609) 983-5010, (800) 257-7808, (800) 257-7111, RHODE ISLAND, Cronin Electronics, Inc., (617) 449-5000, Marshall Electronics Group, (617) 658-0810, Sterling Electronics-Boston, (617) 938-6200, Western Microtechnology, (617) 273-2800, TENNESSEE, Marshall Electronics Group, (205) 881-9235, Milgray Electronics, Inc., (404) 393-9666, Resco Raleigh, (919) 781-5700, TEXAS, Marshall Electronics Group, (214) 233-5200, (915) 593-0706, (713) 895-9200, (512) 837-1991, Milgray Electronics, Inc., (214) 248-1603, Sterling Electronics, (713) 623-8600, (512) 836-1341, (214) 243-1600, UTAH, Marshall Electronics Group, (801) 485-1551, Sterling Electronics-Denver, (303) 796-7338, VERMONT, Cronin Electronics, Inc., (617) 449-5000, Marshall Electronics Group, (617) 658-0810, Sterling Electronics-Boston, (617) 938-6200, Western Microtechnology, (617) 273-2800, VIRGINIA, Marshall Electronics Group, (301) 840-9450, Milgray/Washington, Inc., (301) 621-8169, (800) 638-6656, Resco Raleigh, (919) 781-5700, Sterling Electronics, (703) 450-2373, (804) 226-2190, WASHINGTON, Marshall Electronics Group, (206) 747-9100, Western Microtechnology, (206) 881-6737, WISCONSIN, Gould Electronics, (312) 593-3220, Marshall Electronics Group, (414) 797-8400, Milgray/Chicago, Inc., (312) 350-0490, Repron Electronics, (612) 938-0000, CANADA, Space Electronics Sales Corp., (514) 697-9676, (416) 636-8614, (615) 596-5340, (604) 294-1166.



PHILIPS



# Counter-fit

If you think all low-cost frequency counters are inferior imitations of precision lab instruments, guess again. Fluke has a new 120 MHz counter that's a perfect fit for test systems, bench tops and budgets.

**Honest performance at only \$995.**

The Philips PM 6666 counter delivers seven full digits of resolution at gate times of one second. More than 20 measurement functions. Automatic trigger-level setting. And first-rate input protection to

350V. All packaged in a rugged, shielded metal case.

Add full programmability with the GPIB/IEEE-488 option. A 1.1 GHz input. Or Philips' unique mathematically-controlled crystal oscillator timebase for precise measurements with no warm-up time.

All this performance is backed up by one of the most trusted names in instrumentation: Fluke, with service and support that's never more than a phone call away.

So don't take chances. For genuine

solutions to fit your test and measurement needs, come to Fluke. For more information and complete specifications, phone **1-800-44-FLUKE ext. 77.**

John Fluke Mfg. Co., Inc., P.O. Box C9090, M/S 250C, Everett, WA 98206.  
U.S.: (206) 356-5400 CANADA: (416) 890-7600.  
OTHER COUNTRIES: (206) 356-5500.

©Copyright 1987 John Fluke Mfg. Co., Inc.  
All rights reserved. Ad No. 1071-P6666.



# Timing analysis improves efficiency of ASIC design

---

*Timing analysis can complement simulation in the ASIC-design process. Knowing how to effectively choose and use a timing analyzer can help you cope with the ever-growing complexity of ASIC designs and the increasingly frantic pace of product development in the electronics industry.*

---

Dennis Hara and Jeffrey Stone,  
Seattle Silicon Corp

You can employ timing analysis to raise both the quality and efficiency of your design-verification process. Timing analysis can pinpoint timing problems in designs that simulators (the tools that many engineers had thought were adequate for thorough design verification) have pronounced error-free.

## **Timing analysis complements simulation**

Note that timing analysis doesn't replace simulation. Simulation continues to provide a proven means of testing the function of a design by exercising and evaluating circuit logic (with a set of input patterns called test vectors). A thorough simulation can reveal a variety of errors, such as reversed polarities, missed clocking periods, or incorrect logic implementation.

Widely available simulators have simplified the generation of test vectors and made simulation a time- and cost-efficient method of uncovering certain circuit-behavior problems prior to test-program development or production.

Design verification using simulation has some significant limitations, however, particularly for VLSI circuit designs. Thorough simulation of large designs can require a prohibitive level of user input and system memory (200k bytes of test-vector input is not unusual for large circuits). And because simulation only exercises circuit functionality to the degree enabled by the input vectors, an incomplete set of input test vectors can severely limit the value of the results.

Simulation also fails to provide complete information about timing errors that occur because of the makeup of sequential systems. In such systems, signal propagation is not simultaneous—for example, many delays can influence the arrival time of signals at the several inputs of a single gate. Before you can safely finalize a design, you must solve timing problems caused by these delays—but simulation's pattern-dependent approach makes it impossible to detect all of them.

## **Simulation can't locate critical paths**

For example, if a signal misses a given clock period, simulation might show an error, but it cannot report the path that introduced the critical delay. If the delay occurs under marginal conditions, simulation might not reveal the error at all, and the circuit could go to

---

*Undiscovered timing problems can pervade VLSI designs that simulators have pronounced error free.*

---

production with a flaw destined to make it fail under certain conditions. So, though simulation alone can detect some timing errors, it cannot fully analyze circuit timing.

These limitations of simulation, along with the steady increase in VLSI circuit sizes, have prompted many designers to include timing analysis as part of their overall verification scheme (Fig 1). Before you espouse timing analysis, however, you should understand what it can bring to your own design process.

Timing analyzers detect hazardous timing situations—and in very large designs, at least a few of these situations are likely to go undetected by simulation. In addition, timing analysis can help you identify long delay paths that affect the maximum speed of your design. Some timing analyzers report delay information only on selected paths, and some report delays on all the paths in a circuit. Either approach lets you speed up your design by finding the slowest propagation paths (called critical paths), pinpointing the troublesome delays, and allowing you to make necessary changes. For designers working with VLSI circuits, critical-path reporting is an effective alternative to guessing at the slowest paths in advance.

Timing analysis has its own inherent limitations, of course. For instance, static timing analysis cannot recognize or exercise circuit functionality, so it may report on logically impossible paths (although some tools allow you to specify and disable these paths), and it does not verify the logical correctness of the design. So timing analysis is an adjunct to—not a replacement for—simulation in ensuring proper logic function.

#### **Picking a timing analyzer is complex**

Once you accept the fact that timing analysis is essential to efficient VLSI design, you must address several questions:

- Is error detection enough, or do you need more detailed analysis of circuit timing (that is, information for optimizing circuit speed)?
- Will you need information about every path in certain circuits?
- How will you calculate delays through and between blocks when generating models?
- Does your average design-cycle time demand a timing analyzer that runs interactively, or will batch mode be acceptable?

You can obtain the answers to these questions only through an understanding of available approaches. In some cases, you can make definite value judgments; for

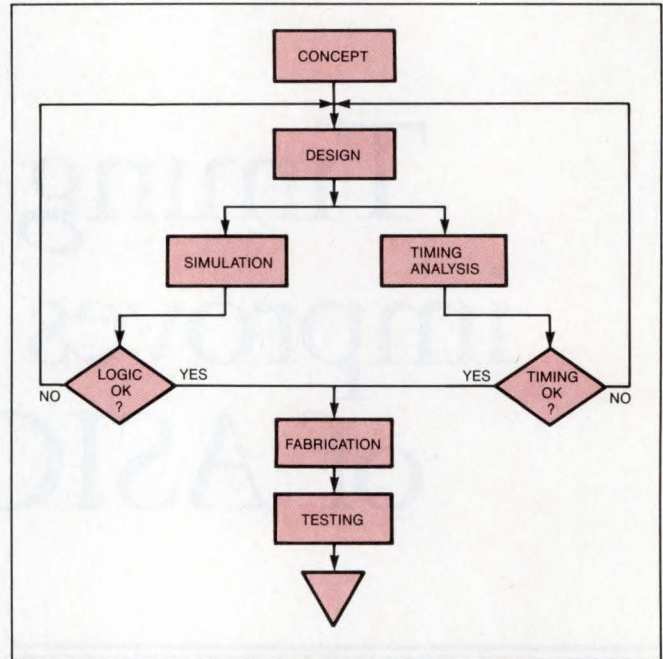

**Fig 1—When ASIC design employs both simulation and timing analysis, the complementary approach to verification can result in significant cost and time savings.**

example, static timing analysis is frequently preferable to dynamic timing analysis. In other instances, your choice of analysis tools will depend on the nature of the designs and technologies you routinely encounter. Delay calculation for boards consisting of standard TTL parts, for instance, is straightforward because logic delays are nearly independent of the logic implementation. In such cases, you can rely on libraries of basic gate delays in assembling a picture of system timing. But in VLSI MOS circuits, basic delay calculations are more complicated. When selecting a timing analyzer for MOS environments, you will therefore want to select a tool that provides carefully calibrated gate-level models—or, perhaps, one that can carry out analysis on the transistor level (Ref 1).

#### **Dynamic analysis finds state dependence**

At the heart of any timing-analysis method is the concept of the critical path—the slowest of all signal-propagation paths during a given cycle of circuit operation. Some timing analyzers require you to guess the critical path, exercise it with input vectors, and see if any errors occurred during that exercise. This technique is known as pattern-dependent, or dynamic, timing analysis, and it runs as an integrated extension to simulation. The dynamic approach detects errors by

## Timing analyzer is integral to ASIC compiler

The Concorde timing analyzer from Seattle Silicon (Bellevue, WA) is an integral part of the Concorde ASIC Compiler, a combination of automated tools for ASIC design.

The compiler supplies logic synthesis and generation of simple cells and complex modules for specific semiconductor processes. It links to CAE gate-level simulators and provides a set of tools for placement and routing in complex VLSI circuits. The tools allow designers with limited IC design experience to use a CAE workstation to construct high-end ASIC designs.

### Match circuit size

The Concorde timing analyzer is exclusively a full-coverage static timing analyzer, but it is database compatible with simulators so that static analysis and simulation share the same models and delay calculations.

Concorde's static approach and path-pruning capability make it fast and memory efficient (memory usage in the Concorde critical-path algorithm varies linearly with circuit size).

The static approach provides comprehensive path information on the gate and block levels and relieves you of the responsibility for creating test vectors. When coupled with traditional analysis tools, Concorde provides a practical, efficient methodology for performing path analyses and finding timing errors.

Concorde performs both critical-path and full-path enumeration; you may select either algorithm for any portion of a design. The critical-path delay computations include interconnect capacitance. A path-disable utility lets you temporarily disable illogical paths that may be listed during critical-path analysis.

As a companion to traditional

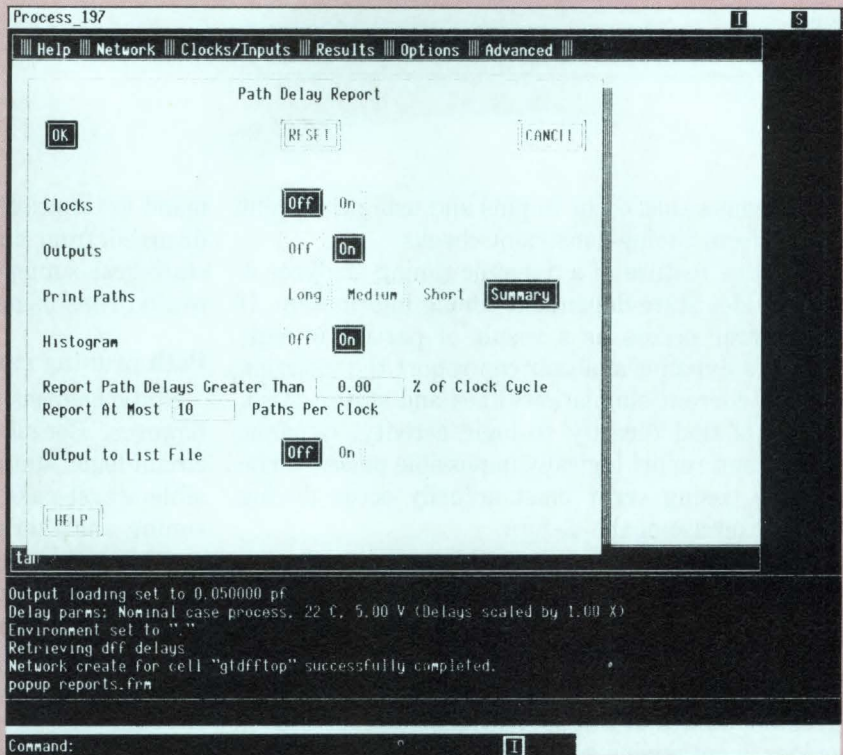

*The user interface for the Concorde timing analyzer lets you control major functions from a single menu.*

logic-simulation tools, the Concorde timing analyzer allows you to detect many timing errors that simulation alone might miss: setup and hold errors, pulse-width constraint violations, warnings about glitches on gated clock lines, and long path errors. With Concorde, you can find and fix such problems while you can still do it economically. In addition to flagging errors, Concorde provides you with circuit-speed estimates that you can use to optimize overall performance.

Concorde can derive gate and interconnect models from the circuit geometry of the target process. The models are calibrated for accuracy and allow you to examine how process, temperature, and voltage variations affect timing. Concorde's modeling is integrated with the cell and module generators, so it automatically incorporates changes and generates new mod-

els based on the options you choose during design modification.

### Track down critical paths

The Concorde timing analyzer provides other features that are useful in the VLSI-development environment: full support and recognition of multiple clocks within circuits; full path disabling, including state assignment to primary inputs; a critical-path query mode that allows you to locate the critical path to a node, from a node, or between specified nodes; a histogram-output mode that graphically shows clustering of path delays relative to the driving clock signal; and timing analysis of asynchronous portions of the design, such as preset and clear circuitry.

---

*Simulation only exercises circuit functionality to the degree enabled by the input vectors.*

---

buffering events that occur in pins and using the event data to perform timing-constraint checks.

One positive feature of a dynamic timing analyzer is that it provides state-dependent timing information. If a timing error occurs as a result of particular logic conditions, a dynamic analyzer can report the violation in terms of current simulation times and states. Also, because it is tied directly to logic activity, dynamic analysis cannot report logically impossible paths—to be detected, a timing error must actually occur during functional exercise of the design.

However, several important problems can make dynamic timing analysis an unattractive alternative to static timing analysis for VLSI design. One disadvantage to pattern-dependent tools is that they fail to provide any comprehensive path information. One of the greatest values of timing analysis is the assistance it provides in optimizing circuit speed. But, particularly in VLSI circuits, such optimization depends on efficiently identifying paths prone to troublesome delays. Because dynamic timing analyzers do not take a path-oriented approach, they aren't always the best tools to assist with your optimization efforts.

Another related drawback of dynamic analyzers is the amount of time and user input they can require. Because dynamic timing analyzers perform timing checks only on those portions of a circuit they fully exercise with test vectors, dynamic analysis of large circuits usually demands multiple runs. In addition, dynamic analysis causes a slowdown in simulation time because it requires that the simulator (and/or models) continually evaluate relationships among signals arriving at components.

### Static timing analysis is path oriented

These drawbacks can make dynamic timing analysis cumbersome for many design situations. But in nearly all cases, you can use path-oriented static timing analysis, which is based on an algorithm that sums component and interconnect delays either forward or backward along each path. This computation does away with dynamic timing analysis's pattern dependency. Because simulators calculate worst-case delays (those responsible for the slowest path in a circuit) directly from component and interconnect delays, static timing analyzers do not force you to guess at critical paths. The pattern-independent, path-oriented approach of static timing analyzers accurately identifies your critical paths for you.

Static timing analyzers also do away with the de-

mand for multiple runs. Because the static approach is divorced from circuit functionality, you can obtain a statistical summary for all circuit paths without repeated runs using multiple input vectors.

### Path pruning can prevent false alarms

Static analysis does have some limitations of its own, however. Because it traces paths without exercising circuit logic, static analysis can report a logically impossible worst-case path. For this reason, good static timing analyzers include some kind of path-pruning capability that allows you to disable illogical or impossible paths for subsequent iterations. Also, a static analyzer might not report all state-dependent timing errors because it can't always determine the state of a pin at any given time—it is only aware of potential transitions.

Fig 2 illustrates some of the differences discussed above. Accurate dynamic analysis of this circuit requires full test vectors and accurate models of each of the five gates. Even with full user input, this approach provides no hard information about the delays along the various paths. However, it does report on dynamically detectable state-dependent timing errors. For instance, if the D and CLK signals arrive at the flip-flop simultaneously, dynamic timing analysis can detect and report the resultant setup violation, but it cannot identify the paths involved. Static timing analysis of the circuit in Fig 2 can identify the setup violation, identify the slowest path to the D input, and identify the node-to-node delays along both the path to D and the path to CLK. Knowing the component delays within specific paths allows you to modify design elements to speed up

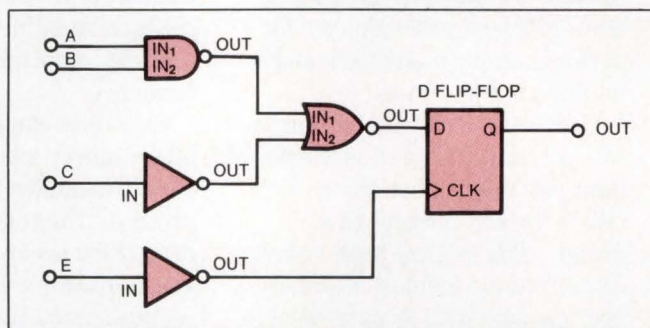

**Fig 2—A simple circuit** illustrates the differences between dynamic and static timing analysis. Dynamic timing analysis would report that a setup violation occurs if signals reach the flip-flop's D and CLK inputs at the same time. Static timing analysis would report the same violation but would also report the slowest path to D (A, B, or C to D) and also provide the delays between nodes on both the critical path to D and the path to CLK.



a path. A static timing analyzer provides all this information quickly and automatically without requiring you to supply input vectors.

In addition to choosing between static and dynamic timing analysis, you must choose among several modeling levels when implementing timing analysis. Fig 3 shows the circuit of Fig 2 as it appears to a timing analyzer operating on each of three useful levels of analysis: transistor, gate, and block levels.

Analysis on the transistor level (Fig 3a) yields highly accurate timing information, but such thorough analysis can be slow. And if the circuit in question uses bidirectional transistors, you may need to devote additional time to manually providing directionality information. Without such input, the transistor-level timing analyzer may stall in endless loops caused by directional ambiguity.

When a transistor-level model is the only circuit model available, or when the need for high accuracy justifies the added input and CPU time, transistor-level analysis is the mode to choose. If you routinely generate full geometry in designing circuits, you might want to purchase an extractor to draw accurate transistor-level models directly from your design. In this case, transistor-level analysis is relatively efficient.

### Design and analyze at the same level

Often, however, designers work on the gate level from the outset. In these cases, gate-level analysis (Fig 3b) is preferable. This approach relies on standard gate-level delay models rather than on transistor representations. Because each gate typically comprises four or five transistors, gate-level analysis is significantly faster than transistor-level analysis. But with some gate-level analyzers, in order to approach the accuracy of transistor-level analysis, you have to spend time calibrating delay models. Gate-level timing analysis eliminates the directionality problems common to the transistor-level approach.

Some timing analyzers permit analysis on an even higher level. The block-level approach (Fig 3c) fully analyzes pin-to-pin delays for any specified path. This approach is perhaps most useful in conjunction with gate-level analysis or in analysis of large functional blocks (such as RAMs and ROMs) that do not lend themselves to gate-level implementations. You might also use block-level analysis to accelerate your timing-analysis cycle or to describe the timing of a block not yet implemented.

A final consideration important to implementing a

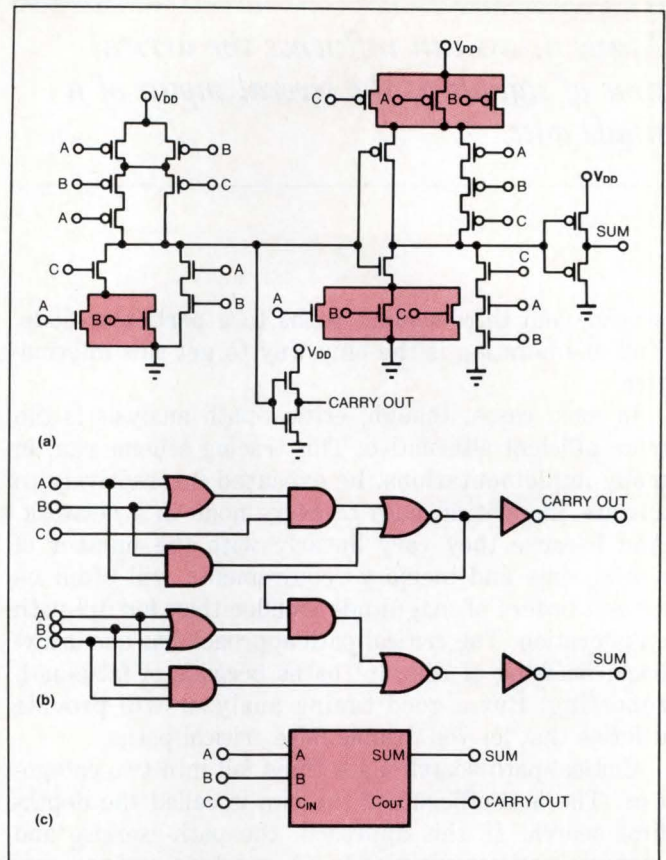

Fig 3—Timing analysis may be conducted on three different levels in any circuit: transistor-level (a), gate-level (b), and block-level (c).

timing-analysis routine has to do with the way the timing analyzer traces through the net list. Here you have two primary choices: full path enumeration, which traces every path through a design, or critical-path analysis, which searches for and identifies only the fastest and slowest paths converging at a node. The latter method is sometimes called "block-oriented" analysis.

Full path enumeration provides comprehensive information about every path and delay in a circuit. You can run it forward from a specified input or backward from a chosen output. However, some problems make this approach impractical for many applications. In large designs, so many paths exist that full enumeration requires too much CPU time and memory—and these requirements increase exponentially with the number of nodes. Also, this approach is so thorough that it frequently reports superfluous information; many paths that might be identical from your viewpoint will be enumerated and flagged. For instance, if your design includes a 32×32-bit register file to which a bit may be written in any location, full enumeration would nonetheless report on all 1024 equivalent paths—although some timing analyzers do sort through and eliminate such redundancies (Ref 2).

For these reasons, full enumeration is not always justifiable, though at times the comprehensive output it provides may prove worth the time and memory required. For instance, in the course of optimizing the speed of your design, it may help you to know the

*Many delays can influence the arrival time of signals at the several inputs of a single gate.*

second- and third-slowest paths to a particular node. Full enumeration is the only way to get this information.

In most cases, though, critical-path analysis is the more efficient alternative. This tracing scheme can, in many implementations, be executed interactively to analyze the critical path to every node in a network. And because they vary linearly with the number of nodes, time and memory requirements will often be several orders of magnitude smaller than for full-path enumeration. The critical-path approach has one drawback: masking of relevant paths because of false-path reporting. But a good timing analyzer will provide utilities that let you disable false critical paths.

Critical-path search algorithms fall into two categories. The less efficient of the two is called the depth-first search. In this approach, the path-exercise and -determination routine runs several times for every node with multiple fan-ins or fan-outs. For instance, signal A occurs before signal B in the circuit shown in Fig 4. A depth-first search of this circuit would process signal E once when A occurs and again when B occurs. It's not difficult to see that this repeated application of the delay-modeling routine is inefficient.

#### Breadth-first searches wait for all inputs

The alternative is the breadth-first search, in which the analyzer's application of the delay-modeling routine waits for all inputs to arrive before processing a given block. A breadth-first search applied to the circuit in Fig 4 would wait to process signal E until both A and B had arrived at the node.

So breadth-first searching is more efficient than depth-first. However, the depth-first search does make it easier to detect and prune feedback loops as you scan, because the loops appear when you first process a block; the breadth-first search requires that you wait until multiple signals arrive at a node. This aspect of choosing a tracing method is most important for circuits with many static latches, because a pure breadth-first approach will not effectively break loops with multiple entry and exit points (Ref 2).

To summarize, then, the following questions and considerations are relevant to the selection of a timing-analysis tool:

- Which method of timing analysis is best, dynamic timing analysis or static timing analysis?

When answering this question, you will want to consider the timing-error-detection capability of existing simulation tools, the availability of adequate struc-

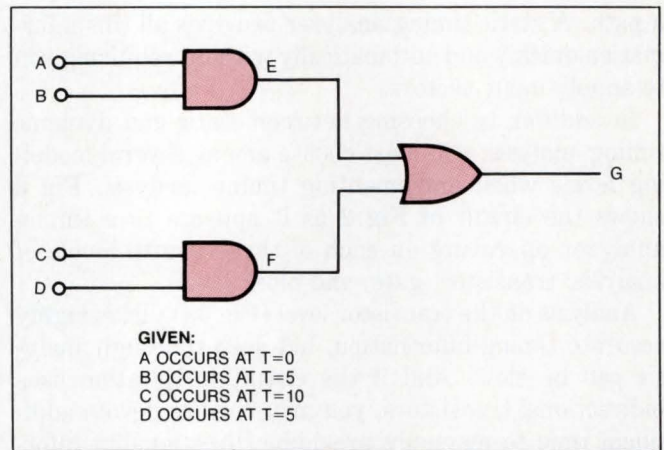

**Fig 4**—A breadth-first search through this circuit waits for both A and B to occur before processing signal E. A depth-first search processes signal E twice: once when A occurs, and again when B occurs.

tural and functional delay models, the time available for the timing-analysis cycle, and your need for state-dependent timing information and path information.

Your decision will depend primarily on your environment. Unless you routinely work with fairly simple circuit designs and have much time for modeling, input, and multiple runs, static timing analysis is usually preferable.

- What circuit levels will you routinely analyze—transistor-level, gate-level, or block-level?

Here, you must consider the time investment required for accurate transistor-level analysis, whether you need full chip analysis, and the availability of appropriate gate-delay models. Mixed-level automated analyzers provide the greatest flexibility. In general, gate-level analysis will probably prove most useful in the widest range of situations—particularly when well-calibrated gate-level models are available. The transistor- and block-level approaches offer particular advantages in certain environments: the former when an extractor or switch-level models are available, the latter when a top-down analysis is desirable.

- What tracing algorithms do the timing-analysis tools you're considering offer—path enumeration, critical-path analysis with a depth-first search routine, or critical-path analysis with breadth-first search routine?

Which algorithm is best for your application depends on the available time and memory, on whether you need information on every path, and on whether you need best/worst case information. The two methods of critical-path analysis provide good best- and worst-case information with reasonable run times. Although high-



MOTOROLA

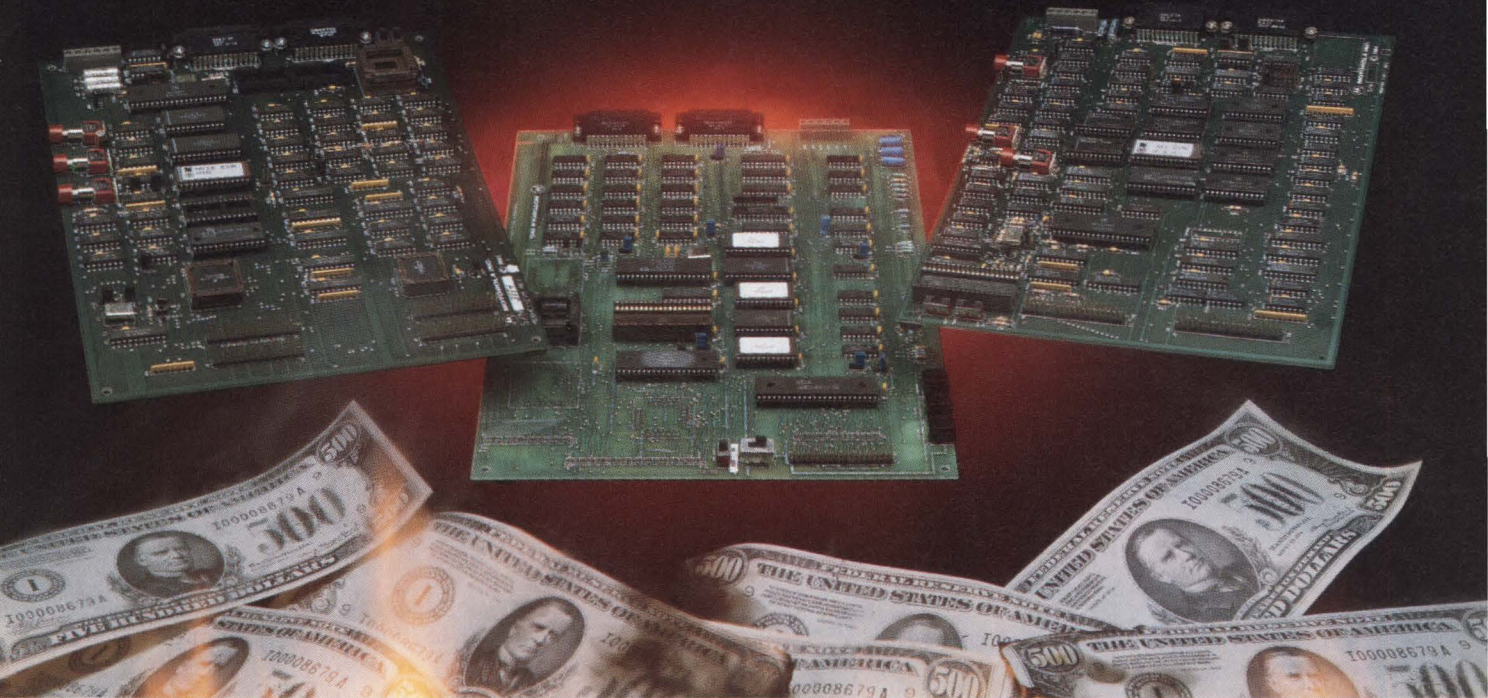

# Emulate 8-bit Microcontrollers for \$500—a smoking deal.

Motorola offers the lowest cost development tools ever.

Finally, you can emulate your favorite Motorola 8-bit MCUs without burning a fortune. Motorola offers high quality development tools that fit your budget; our complete line of single-board EVMs are just \$500 each.

Device Supported

MC6801
MC6801U4
MC68701
MC68701U4
MC6803
MC6803U4
MC68041P2
MC6804P2
MC68704P2
MC68HC04J2/P3
MC6805P2/P4/P6
MC6805R2/R3
MC6805U2/U3
MC68705P3/P5
MC68705R3
MC68705U3/U5
MC146805F2
MC146805G2
MC1468705F2
MC1468705G2
MC68HC05C2/C3/C4/C8
MC68HC05L6
MC68HC805C4
MC68HC11A0/A1/A8
MC68HC811A2
MC68HC99
MC68000

Evaluation Modules/Boards

M68701EVM	M68705EVM	M68HC04EVM	M68HC05EVM	M68HC11EVM	M68HC99EVM	M146805EVM	M68HC11EVB	MEX68KCEB
-----------	-----------	------------	------------	------------	------------	------------	------------	-----------

●●●●								
●●								
		●●●						
		●●●						
							●●●	
								●

System Modules and Development Stations

DSP56000ADS Application Development System
HDS-200 Hardware/Software Development Station
HDS-300 Hardware/Software Development Station

MS-DOS is a registered trademark of Microsoft.

All EVMs communicate via RS-232-C to your favorite software development host. Motorola even gives you the software free. Just call our software line at (512) 440-FREE, anytime day or night and check out our new MS DOS and Apple Macintosh tools (auto bauds up to 2400 bps).

To obtain an EVM, contact your local sales office or authorized Motorola Distributor.

## One-on-one Design-in help.

Once you've obtained Motorola's economical design tools, we'll be happy to help you solve your design-in problems.

1-800-521-6274

Call toll free any weekday, 8:00 a.m. to 4:30 p.m., M.S.T. For printed data on Motorola's evaluation products, complete and return coupon below.

We're on your design-in team.



MOTOROLA

To: Motorola Semiconductor Products, Inc., P.O. Box 20912, Phoenix, AZ 85036  
 Please send me more information on Motorola's low cost development tools.  
 Please send me more information on Motorola's higher performance development systems.

362EDN052688



Name \_\_\_\_\_

Title \_\_\_\_\_

Company \_\_\_\_\_

Address \_\_\_\_\_

City \_\_\_\_\_ State \_\_\_\_\_ Zip \_\_\_\_\_

Call me (\_\_\_\_\_) \_\_\_\_\_

## V SERIES SWITCHING POWER SUPPLIES

Engineered and Manufactured  
by Perfectionists!

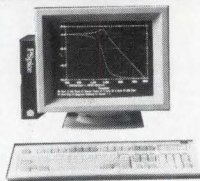

Simulations by SPICE

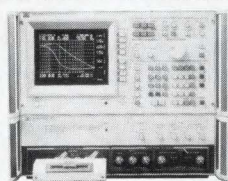

Stability by HP/VENABLE

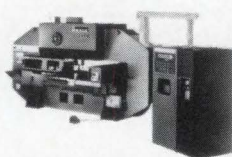

Sheet Metal by AMADA



Auto Insert by UNIVERSAL

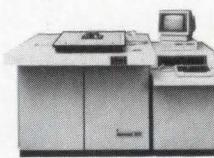

Testing by ZEHNTEL

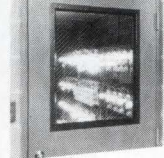

Burn In by CENTIGRADE



Service by PHILLIPS

Call Toll Free 1-800-523-2332

**Deltron inc.**

P.O. BOX 1369 ■ WISSAHICKON AVENUE, NORTH WALES, PA 19454  
PHONE 215/699-9261 TWX 510/661-8061

CIRCLE NO 22

## Robotics, Industrial Drives, Railways, U.P.S., Welding Machines COUNT on LEM MODULES

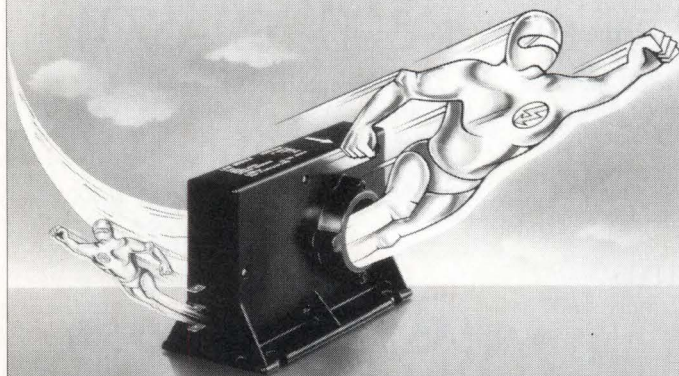

Like an insulated shunt. A perfect feed back system  
between power current and electronic control.

- Accuracy, stability and linearity guaranteed for life
- Response time better than 1  $\mu$ s. Bandwidth DC to 100 kHz.
- Reliable in hostile environments  
MTBF  $2 \times 10^6$  hours.
- Large range available  
for all applications  
(up to 50 kA).

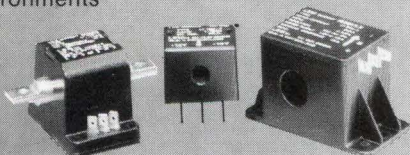

Manufactured by Liaisons Electroniques Mecaniques, SA., Switzerland.

**REKCO**  
INCORPORATED

P.O. Box 162  
New Berlin, Wisconsin 53151  
414/784-3430 • TWX 910-262-3005

CIRCLE NO 23

ly time and CPU intensive, full-path enumeration proves useful when you require comprehensive information about paths and delays. (When you use critical-path methods, guard against the masking caused by false-path reporting.)

You needn't deal with all of these considerations before purchasing an automated timing-analysis tool. A good timing analyzer will provide the necessary operational features and modeling libraries so that you can address at least some of the questions and considerations on a design-by-design basis.

**EDN**

### References

1. Wei, Y P, C Lyons, and S Hailey, "Timing Analysis of MOS VLSI Circuits," *VLSI Systems Design*, August 1987, pg 52.
2. Jouppi, N P, "Timing Analysis and Performance Improvement of MOS VLSI Designs," *IEEE Transactions on Computer-Aided Design*, July 1987, pg 650.
3. Rizzatti, L, and M Wasilewski, "Worst-Case Timing Analysis Ensures Board Reliability," *Computer Design*, November 15, 1987, pg 90.
4. Zhong, M, Y J Oyang, and S S Wang, "A Mixed Level Timing Verifier for Digital Systems," *VLSI Systems Design*, March 1987, pg 74.

### Authors' biographies

*Dennis Hara is manager for module development/verification tools at Seattle Silicon Corp in Bellevue, WA. In this job, he oversees development of timing analyzers and simulation models. He is also responsible for compiler-development tools. He holds a BSEE from the University of Hawaii and an MS in Computer Science from the University of Washington. Before joining Seattle Silicon three years ago, he worked for Boeing Aerospace Co.*

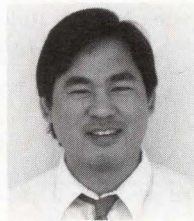

*Jeffrey Stone is a senior software engineer responsible for software development at Seattle Silicon. He holds a BS in Engineering from the University of Illinois at Chicago. He joined Seattle Silicon four years ago; before that he worked at GTE Business Communications Systems in Northlake, IL.*

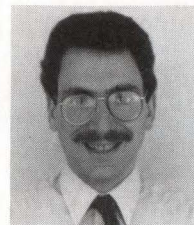

Article Interest Quotient (Circle One)  
High 497 Medium 498 Low 499

# The Greatest Find Since Dr. Livingstone.

Before your desk becomes a jungle, check out Tokin's unique MDP (Mass-storage Data Processor). A breakthrough in floppy disk management, MDP relieves the stress of handling massive amounts of data, and reveals new applications that till now have been as inaccessible as deepest Africa.

Imagine... no more rummaging through files and boxes; no more overtime. Now, you can search, store and retrieve data from any microfloppy disk on file, up to 64 per cartridge, and make rapid multiple copies, all at the touch of a button.

It works like this: MDP's built-in magnetic strip reader reads the indexed data that you print on the special magnetic strip of each Tokin disk. This enables

MDP to operate as an external storage, using the external disk drive interface. Just touch the MDP control panel to access your desired disk, or call it up on your computer, using the standard RS232C interface.

Actually, you can connect up to four MDPs to a single personal computer, for a total of 256 megabytes. And by switching cartridges, each containing up to 64 disks, MDP lets you build an infinite storehouse of data, a disk at a time, while keeping costs to an absolute minimum.

Get Tokin's MDP and discover the civilized efficiency it brings to your desktop — and the added time it gives you for life's more adventurous, and productive, pursuits.



Mass-storage Data Processor  
**MDP-6400**  
*Patent pending*



**Tokin Corporation**

Head Office: Hazama Bldg., 5-8, Ni-chome, Kita-Aoyama, Minato-ku, Tokyo 107, Japan. Tel: Tokyo (03) 402-6166 Fax: Tokyo (03) 497-9756  
Telex: 0242269 TOKIN J

**Tokin America Inc.**

155 Nicholson Lane, San Jose, California 95134, U.S.A. Tel: 408-432-8020 Fax: 408-434-0375  
Chicago Branch: Presidents Plaza I, Suite 200N, 8600 W. Bryn Mawr, Chicago, IL 60631 Tel: 312-380-0930 Fax: 312-693-8334

**München Lipson Office**

Elisabethstraße 21, 8000 München 40, Bundesrepublik Deutschland Tel: (089) 271 75 22 Fax: (089) 271 75 67 Telex: 5 24 537 tokin d

You can reach our agents by phone: London 01-837 2701, Paris 1-45 34 75 35, Milan (0331) 678058, Munich (089) 5164 0, Seoul (02) 777-5767, Taipei (02) 7311425, Hong Kong 3-315769, Singapore 747-8668

**CIRCLE NO 68**

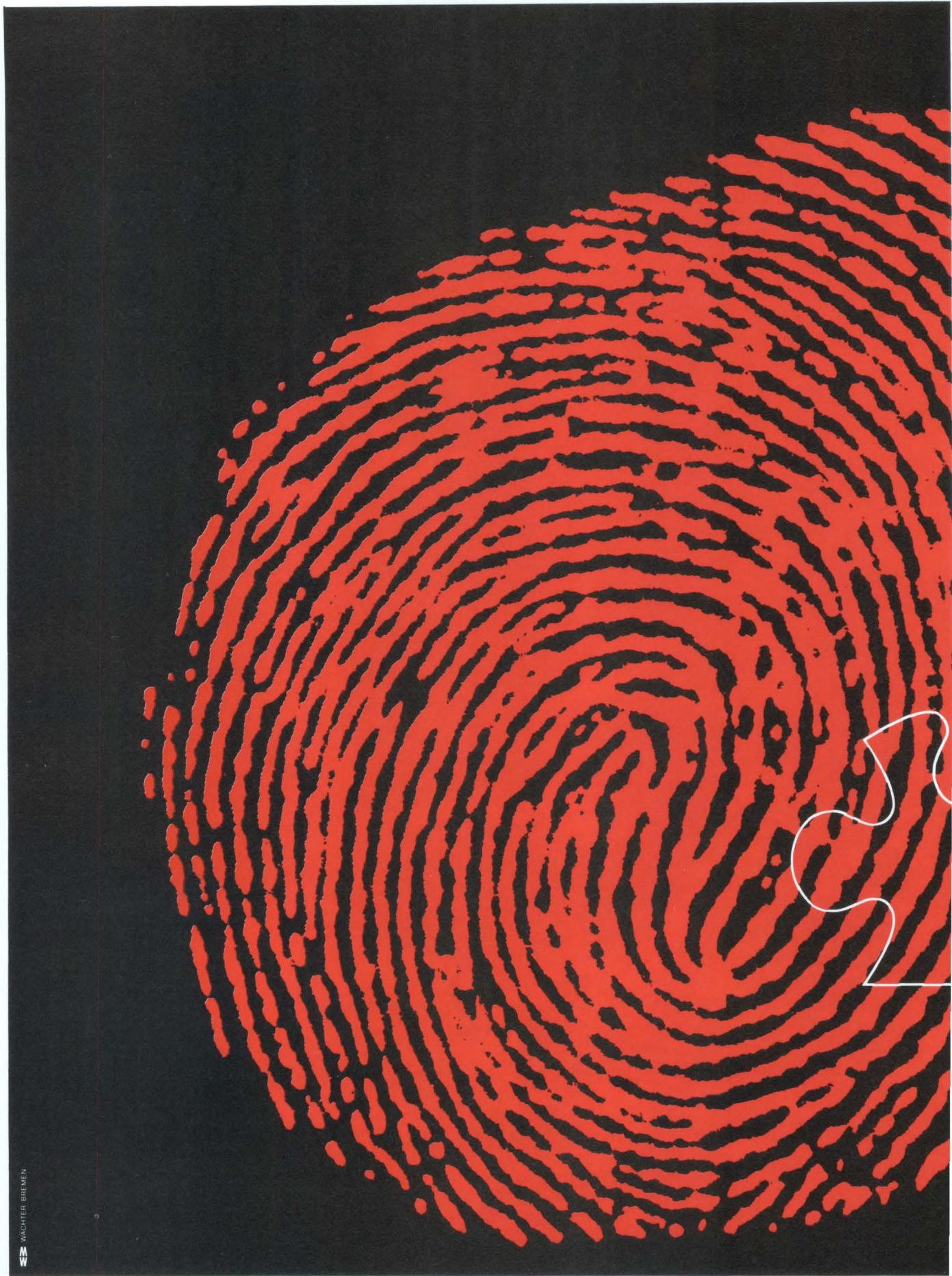

WÄCHTER BREMEN

HARTING / Austria, Vienna, Tel. 0222-68 68 18-0 · HARTING / Belgium, Relegem, Tel. 02-465.42.40 · HARTING / France, Fontenay-sous-Bois Cedex, Tel. (1) 487706 21  
HARTING / Great Britain, Biggin Hill, Tel. (0959) 714 11 · HARTING / Italy, Pioltello (Milan), Tel. 02-92100 847 · HARTING / Japan, Yokohama, Tel. 045-931.571

## SOME THINGS CAN'T BE COPIED.

That's something we at HARTING learned long ago. For instance, our engineers and designers invested years of hard work to develop our "HARTING Industrial HAN® Connector." Their goal was to get every little detail just perfect so that state-of-the-art production processes and high-tech robots could be used to produce the definitive connector.

Well, our HAN® Connectors were a big success worldwide – and they still are. Of course, it didn't take long before similar connectors with similar names hit the market. But the original HAN® still hasn't been equalled.

Because it's unique – just like your fingerprints. After all, it's the only one produced in completely automated high-tech production facilities. Each individual component part is made of

the very best material available. And each part has to go through a

whole series

of quality-control stations.

That's how we manage to make sure that every HAN® Industrial Connector that leaves our plant is absolutely perfect. And the millions of our connectors in use throughout the world today are proof of this unprecedented reliability.

World headquarters:

HARTING ELEKTRONIK GmbH

P. O. Box 1140 · D-4992 Espelkamp

West Germany

☎ (057 72) 47-1 · ☎ 9 72 310-11 he d

**CONNECT UP WITH QUALITY –  
WITH HARTING.**



HARTING/Netherlands, AM Etten-Leur, Tel. 01-608-35400 · HARTING/Norway, Oslo, Tel. 02-64 75 90 · HARTING/Sweden, Spanga, Tel. (08) 761 79 80 · HARTING/Switzerland, Schwerzenbach, Tel. 01-8 25 51 51 · HARTING/USA, Chicago, Tel. (312) 519-7700

# Choose Teledyne First!

## AUTHORIZED DISTRIBUTORS

### Alabama

Marshall Industries  
Huntsville, AL  
(205) 881-9235  
Quality Components  
Huntsville, AL  
(205) 830-1881

### Arizona

Future/Cetec Electronics  
Phoenix, AZ  
(602) 968-7140  
Marshall Industries  
Phoenix, AZ  
(602) 496-0290

### California

All American  
Torrance, CA  
(213) 320-0240  
All American  
San Jose, CA  
(408) 287-0190  
Future Electronics  
San Jose, CA  
(408) 434-1114  
Marshall Industries  
Milpitas, CA  
(408) 942-4600  
Marshall Industries  
Rancho Cordova, CA  
(916) 635-9700  
Future/Cetec Electronics  
Chatsworth, CA  
(818) 700-0914  
Marshall Industries  
Chatsworth, CA  
(818) 407-0101  
Marshall Industries  
El Monte, CA  
(818) 459-5500  
Future/Cetec Electronics  
Irvine, CA  
(714) 250-4141  
Marshall Industries  
Irvine, CA 92718  
(714) 859-5050  
Future/Cetec Electronics  
San Diego, CA  
(619) 278-5020  
Marshall Industries  
San Diego, CA  
(619) 578-9606  
Micro-Die Systems  
Torrance, CA  
(213) 373-0687

### Colorado

Future Electronics  
Westminster, CO  
(303) 650-0123  
Marshall Industries  
Thornton, CO  
(303) 451-8383

### Connecticut

Future Electronics  
Bethel, CT  
(203) 743-9594  
Marshall Industries  
Wallingford, CT  
(203) 265-3822

### Florida

All American  
Miami, FL  
(305) 621-8282  
Chip Supply  
Orlando, FL  
(305) 298-7100  
Future Electronics  
Clearwater, FL  
(813) 578-2770  
Future Electronics  
Altamonte Springs, FL  
(305) 767-8414  
Marshall Industries  
Ft. Lauderdale, FL  
(305) 977-4880  
Marshall Industries  
Altamonte Springs, FL  
(305) 767-8585  
Marshall Industries  
St. Petersburg, FL  
(813) 576-1399  
Quality Components  
Tampa, FL  
(813) 854-2614

### Georgia

Future Electronics  
Norcross, GA  
(404) 441-7676  
Marshall Industries  
Norcross, GA  
(404) 923-5750  
Quality Components  
Norcross, GA  
(404) 449-9508

### Illinois

Advent Electronics  
Rosemont, IL  
(312) 298-4210  
Future Electronics  
Schaumburg, IL  
(312) 882-1255  
Marshall Industries  
Schaumburg, IL  
(312) 490-0155

### Indiana

Advent Electronics  
Indianapolis IN  
(317) 872-4910  
Marshall Industries  
Indianapolis, IN  
(317) 297-0483

### Iowa

Advent Electronics  
Cedar Rapids, IA  
(319) 363-0221

### Kansas

Marshall Industries  
Lenaxa, KS  
(913) 492-3121

### Maryland

All American  
Rockville, Maryland  
(301) 251-1205  
Future Electronics  
Columbia, MD  
(301) 995-1222

Marshall Industries  
Gaithersburg, MD  
(301) 840-9450  
Pyttronic Industries  
Savage, MD  
(301) 792-0780

### Massachusetts

Now Electronics  
Framingham, MA  
(617) 872-5876  
Future Electronics  
Westborough, MA  
(617) 366-2400  
Marshall Industries  
Wilmington, MA  
(617) 658-0810

### Michigan

Advent Electronics  
Farmington Hill, MI  
(313) 477-1650  
Marshall Industries  
Livonia, MI  
(313) 525-5850  
Future Electronics  
Detroit, MI  
(313) 261-5270

### Minnesota

All American  
Minneapolis, MN  
(612) 884-2220  
Marshall Industries  
Plymouth, MN  
(612) 559-2255  
Future Electronics  
Eden Prairie, MN  
(612) 944-2200

### Missouri

Marshall Industries  
Bridgeton, MO  
(314) 291-4650

### New Jersey

Future Electronics  
Mt. Laurel, NJ  
(609) 778-7600  
Marshall Industries  
Mt. Laurel, NJ  
(609) 234-9100  
Future Electronics  
Fairfield, N.J.  
(201) 227-4346  
Marshall Industries  
Fairfield, NJ  
(201) 882-0320

### New York

All American  
Ronkonkoma, NY  
(516) 981-3935  
Future Electronics  
Liverpool, NY  
(315) 451-2371  
Future Electronics  
Rochester, NY  
(716) 272-1120  
Marshall Industries  
Hauppauge, LI, NY  
(516) 273-2424  
Marshall Industries  
Johnson City, NY  
(607) 798-1611

Marshall Industries  
Rochester, NY  
(716) 235-7620  
Future Electronics  
Hauppauge, NY  
(516) 234-4000

### North Carolina

Marshall Industries  
Raleigh, N.C.  
(919) 878-9882  
Quality Components  
Raleigh, N.C.  
(919) 876-7767  
Future Electronics  
Charlotte, N.C.  
(704) 529-5500

### Ohio

Hughes-Peters, Inc.  
Cincinnati, OH  
(513) 351-2000  
Hughes-Peters Inc.  
Columbus, OH  
(614) 294-5351  
Marshall Industries  
Dayton, OH  
(513) 898-4480  
Marshall Industries  
Solon, OH  
(216) 248-1788  
Marshall Industries  
Westerville, OH  
(614) 891-7580

### Oklahoma

Quality Components  
Tulsa, OK  
(918) 664-8812

### Oregon

Cetec Future  
Beaverton, OR  
(503) 645-9454  
Marshall  
Beaverton, OR  
(503) 644-5050

### Pennsylvania

Marshall Industries  
Pittsburgh, PA  
(412) 963-0441  
Pyttronic Industries  
Montgomeryville, PA  
(213) 643-2850

### Texas

All American  
Richardson, TX  
(800) 541-1435  
Future Electronics  
Richardson, TX  
(214) 437-2437  
Marshall Industries  
Austin, TX  
(512) 837-1991  
Marshall Industries  
Carrollton, TX  
(214) 233-5200  
Marshall Industries  
Houston, TX  
(713) 895-9200  
Marshall Industries  
El Paso, TX  
(915) 593-0706

Marshall Industries  
Brownsville, TX  
(512) 542-4589  
Quality Components  
Addison, TX  
(214) 733-4300  
Quality Components  
Austin, TX  
(512) 835-0220  
Quality Components  
Sugarland, TX  
(713) 491-2255

### Utah

Future Electronics  
Salt Lake City, UT  
(801) 972-8489  
Marshall Industries  
Salt Lake, UT  
(801) 485-1551

### Washington

Future Electronics  
Redmond, WA  
(206) 881-8199  
Marshall Industries  
Bellevue, WA  
(206) 747-9100

### Wisconsin

Marshall Industries  
Brookfield, WI  
(414) 797-8400  
Taylor Electronic Co.  
Mequon, WI  
(414) 241-4321

### Alberta

Future Electronics  
Calgary Alberta  
(403) 235-5325  
Future Electronics  
Edmonton, Alberta  
(403) 438-2858

### British Columbia

Future Electronics  
Vancouver, B.C.  
(604) 294-1166

### Ontario

Future Electronics  
Ottawa, Ontario  
(613) 820-8313  
Future Electronics  
Downsview, Ontario  
(416) 638-4771

### Quebec

Future Electronics  
Pointe Claire, Quebec  
(514) 694-7710  
Future Electronics  
St. Foy, Quebec  
(418) 682-5775

### Manitoba

Future Electronics  
Winnipeg, Manitoba  
(204) 339-0554



# DC to DC Power Simply

Have you ever been disappointed in switched capacitor, high voltage DC to DC converter output current capability? The **CMOS TSC962** will look like it was designed just for you.

Low output resistance improves voltage transfer efficiency and increases current output. We guarantee a low  $35\Omega$  maximum output resistance for an 80mA output current. **THREE TIMES BETTER** than existing parts. Input voltage range extends from 3V to 18V. CMOS technology keeps quiescent current to just  $510\mu\text{A}$ .

Only two external capacitors are needed for a complete positive to negative converter. By using the unique **FREQUENCY DOUBLER** pin, even the capacitors size can be reduced. Plus an on chip 6.4V zener for regulation applications.

More power, more functions and pin compatible to the SI7661, ICL7662, LTC1044 and ICL7660 parts. The TSC962 can be the standard DC to DC converter in your existing products and make your future designs easier.

Call or write for full information, design help and data sheets. Samples and production volume available now for you.

**All devices are backed by Teledyne's reputation for quality, service and support — a reputation earned through 25 leadership years in the semiconductor industry.**

**Choose Teledyne First!**

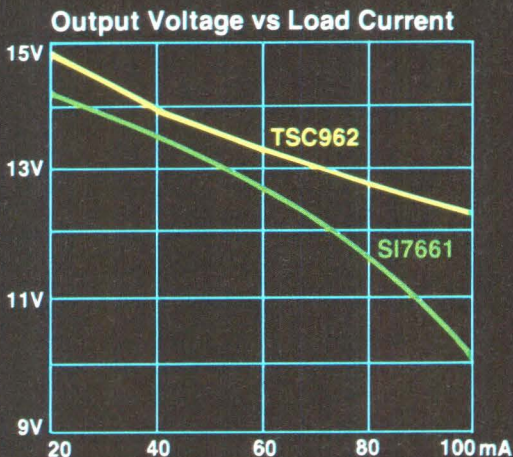

**800-888-9966**  
**415-968-9241**

1300 Terra Bella Avenue  
Mountain View, CA 94039  
TWX: 910-379-6494  
FAX: 415-967-1590

 **TELEDYNE  
SEMICONDUCTOR**

# The only processor we can't talk to



Our new LTC1090 monolithic 10-bit CMOS data acquisition system-on-a-chip talks to virtually every microprocessor and microcontroller on the block today. It is one in a family of serial input/output data acquisition system products using our exclusive LTCMOS™ technology.

LTC1090 enhances analog performance, without limiting system accuracy or flexibility. The system includes a software-controlled 8-channel analog multiplexer with sample-and-hold, a 10-bit A/D converter, and it's fully compatible with all existing MPU serial interface ports.

Software-programmable features of the LTC1090 are extensive. Unipolar/bipolar conversions. Four differential/eight single-ended inputs. MSB or LSB first data sequencing. And variable data word lengths (8, 10, 12 or 16 bits). The LTC1090 IC uses single supply 5V, 10V or ±5V power. Guaranteed conversion time is 20 μsec.

The LTC1091 is a monolithic CMOS data acquisition system in an 8-pin package. This system combines on a single chip a 10-bit

## 0.25°C Accurate Temperature Measurement System with no Calibration

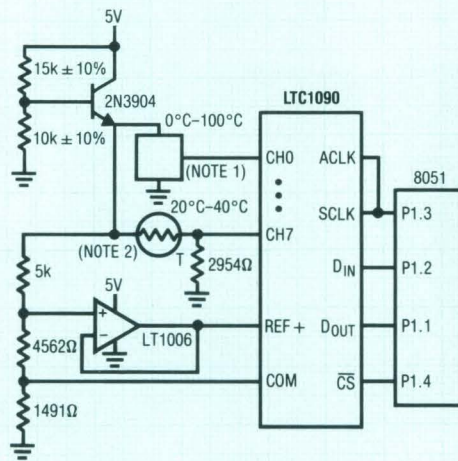

NOTE 1: YELLOW SPRINGS INSTRUMENT P/N 44201  
NOTE 2: YELLOW SPRINGS INSTRUMENT P/N 44007

analog-to-digital converter, a two-channel multiplexer, a built-in sample-and-hold, and a versatile serial I/O interface. The software-programmable LTC1091 features 20 μsec. conversion time.

The third family member is the LTC1092. It's a serial output successive approximation A/D converter with a single differential analog input, and an independent reference input enabling true 10-bit accuracy in reduced span applications down to 200mV full scale. LTC1092 features single supply operation (5 to 10V), differential input, and direct three-wire interface to a wide variety of MPU serial and parallel ports.

The LTC1090/91/92 are available in plastic or ceramic DIP packages. Pricing for the LTC1090CN is \$11.95, and for the LTC1091CN8 and LTC1092CN8 it's \$10.95, in quantities of 100. Military versions of each are also available.

For additional information, contact Linear Technology Corporation, 1630 McCarthy Blvd., Milpitas, CA 95035. Or call 800-637-5545.



TOUGH PRODUCTS  
FOR TOUGH APPLICATIONS.

# DESIGN IDEAS

EDITED BY TARLTON FLEMING

## Circuit screens narrow pulse widths

Irwin Cohen

Hewlett-Packard, Rockaway, NJ

The Fig 1 circuit passes a pulse from  $V_{IN}$  (A) to  $V_{OUT}$  (B) only if the pulse duration exceeds a minimum value, determined by R and C. The minimum values for positive and negative pulses ( $t_P$ ,  $t_N$ ) differ somewhat:

$$t_N = RC \ln \left( \frac{V_L}{5} \right)$$

$$t_P = RC \ln \left( \frac{5 - V_H}{5} \right).$$

Based on the states of A and B, the dual 2- to 4-line decoder ( $IC_1$ ) delivers control signals to the bases of  $Q_1$  and  $Q_2$ . (The #1 decoder operates as a simple inverter; if necessary, you can substitute an inverter such as a  $\frac{1}{6}$ 74HC14.)

If A is low, for example, then B is high,  $Q_1$  is cut off, and  $Q_2$  is saturated. When the arrival of a positive pulse drives A high,  $Q_2$  cuts off almost immediately, allowing C to charge through R. If A goes low before node X

crosses  $IC_2$ 's switching threshold (meaning the pulse is too narrow),  $Q_2$  turns on and discharges C—the circuit then waits for the next pulse. Otherwise, B goes low and  $Q_1$  turns on, quickly pulling X to the level of A, and allowing the B output to emit an approximate replica of the pulse.

When A is high and B is low, a sequence similar to the above enables the circuit to screen negative-going pulses. In either case, the R value should conduct much less current than that in the collector of either transistor. Note that the Schmitt-trigger thresholds of  $IC_2$  are not symmetrical with respect to 5V and ground, which results in different values for  $t_N$  and  $t_P$ . You can, however, make these values equal by using an analog comparator to construct a symmetrical-threshold Schmitt trigger. Further, you can achieve independent control of  $t_N$  and  $t_P$  by introducing an analog switch to select the value for R. **EDN**

To Vote For This Design, Circle No 746

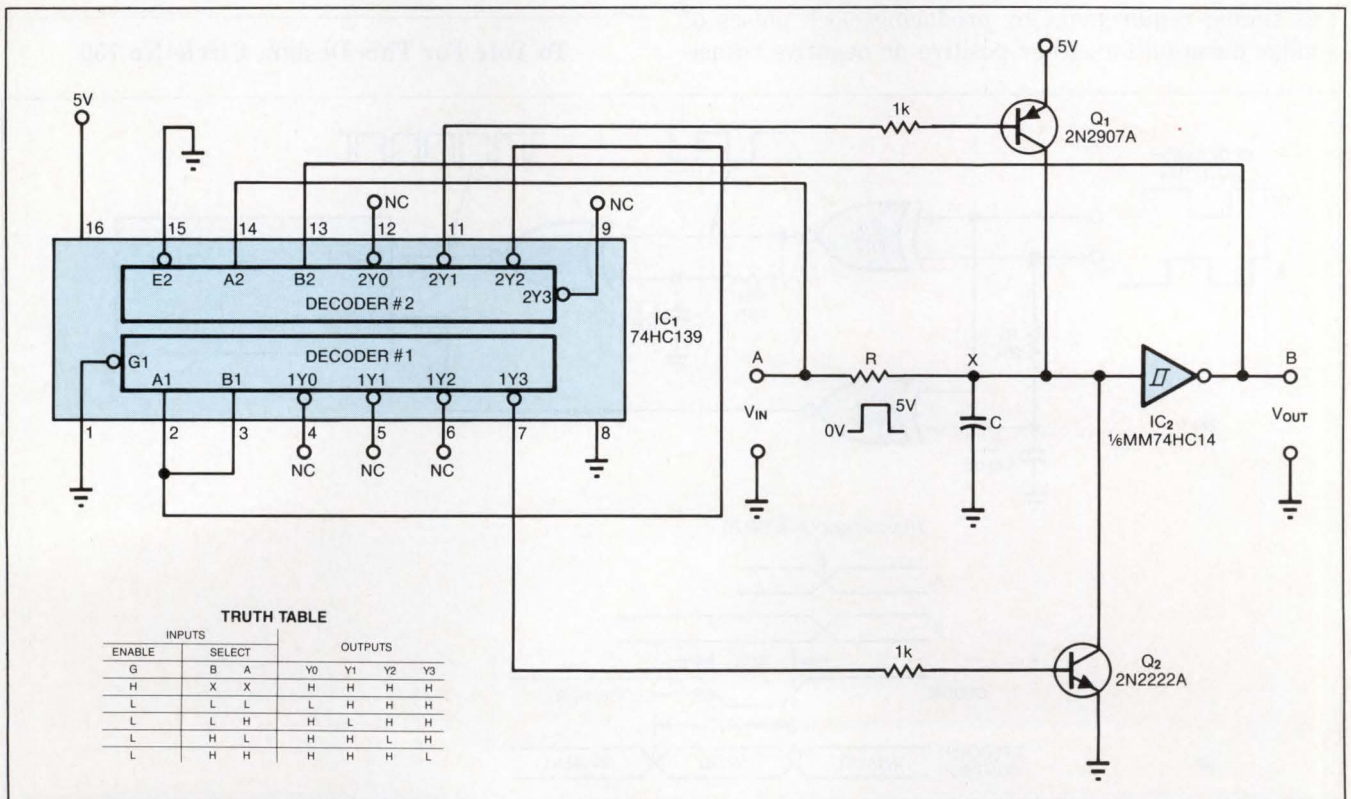

Fig 1—This circuit monitors the digital input  $V_{IN}$ , blocking any pulse interval (high or low) whose duration is less than the interval set by R and C.

## Tachometer circuit reduces parts count

William McClelland  
*Stahl Research, Port Chester, NY*

The tachometer circuit of **Fig 1** requires only one IC (besides the counter), yet it achieves the same resolution and eliminates backlash just as the 3-IC circuit of an earlier Design Idea did ("Improved tachometer eliminates backlash," March 31, 1987, pg 210).

A standard shaft encoder's A and B ports generate square waves with the same frequency as the shaft turns. The phase of A will lead or lag that of B by 90°, depending on the direction of rotation. To obtain maximum resolution, the tachometer circuit must count every change of state for the A and B signals. Each such change causes a change of state at IC<sub>1A</sub>'s output, followed by a 1-μsec negative pulse at the output of IC<sub>1C</sub>. These clock pulses' positive (trailing) edges cause the counter to count up or down according to the direction of shaft rotation.

You should set the R<sub>1</sub>C<sub>1</sub> time constant such that it is approximately twice that of the R<sub>2</sub>C<sub>2</sub> product, to ensure adequate setup and hold times for the up/down signal with respect to the positive clock edges. IC<sub>1C</sub> supports this timing requirement by producing clock pulses of similar duration for either positive or negative transi-

tions from IC<sub>1A</sub>.

The exclusive-NOR logic of IC<sub>1B</sub> generates the correct polarity of the up/down signal when necessary—at the positive clock edges—by combining the A value with the B value just prior to a transition of either A or B. C<sub>1</sub> provides memory by storing the B value voltage for about 2 μsec. (To understand this single-gate encoding, note that, because the phase relationship of B and A is + or -90°, adding -90° to B makes the phase difference 0 or -180°, depending on the direction of rotation. Therefore, an exclusive-NOR operation on A and a phase-shifted B produces a logic 1 when the inputs are in phase, or a logic 0 when they are 180° out of phase.)

If necessary, you can invert the up/down signal's polarity by swapping the A and B connections or by using a fourth X-NOR gate as a selectable inverter buffer. To invert the clock signal, substitute identical-pinout, X-OR gates (4070s) for the 4077 X-NOR gates. And if necessary to guarantee standard CMOS rise and fall times, you should buffer the A and B signals with Schmitt-trigger gates such as 74C914s. The maximum frequency for A or B is approximately  $(4R_1C_1)^{-1}$ . **EDN**

To Vote For This Design, Circle No 750

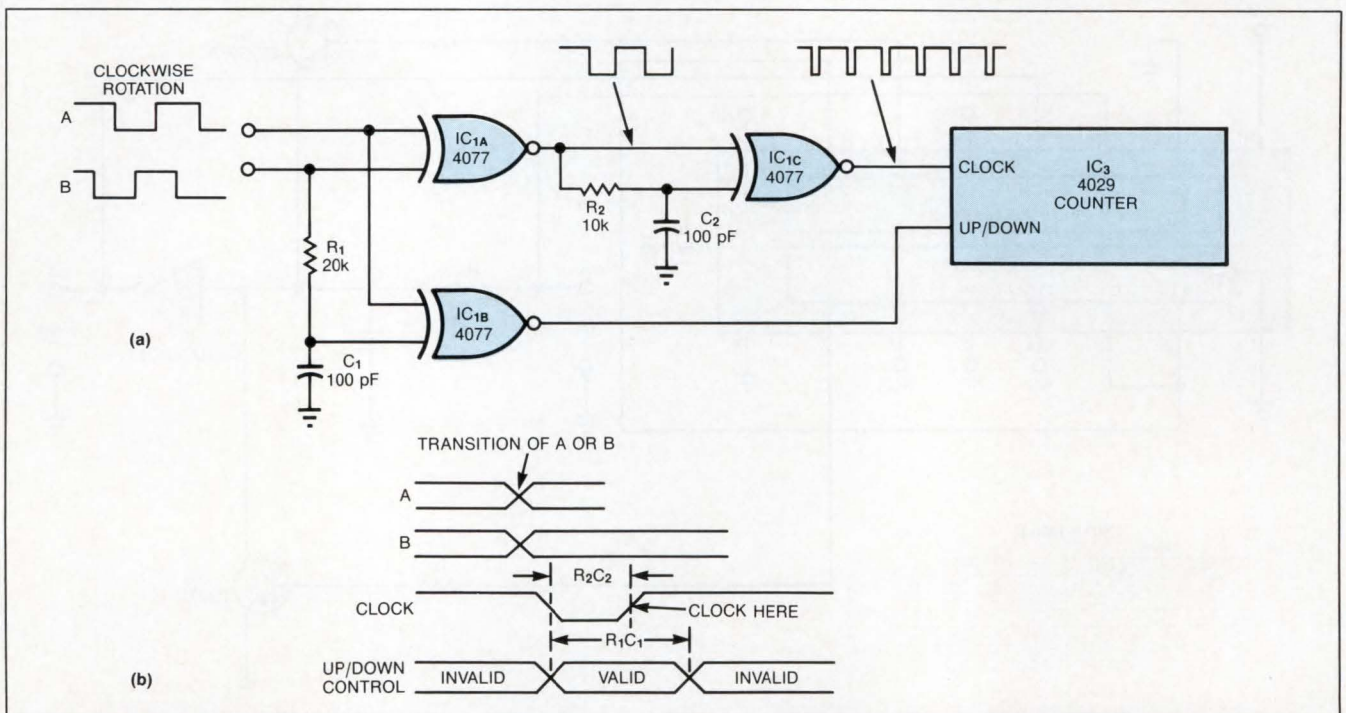

**Fig 1—This 1-chip tachometer circuit** drives the counter up or down, according to the speed and direction of shaft rotation (the shaft encoder isn't shown).

# 99¢

from

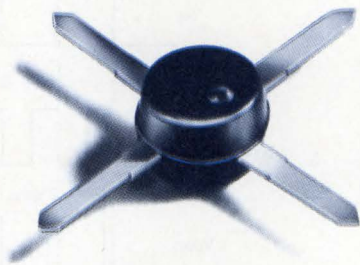

## dc to 2000 MHz amplifier series

### SPECIFICATIONS

MODEL	FREQ. MHz	GAIN, dB			Min. MHz (note)	• MAX. PWR. dBm	NF dB	PRICE \$ Ea.	Qty.
		100 MHz	1000 MHz	2000 MHz					
MAR-1	DC-1000	18.5	15.5	—	13.0	0	5.0	0.99	(100)
MAR-2	DC-2000	13	12.5	11	8.5	+3	6.5	1.50	(25)
MAR-3	DC-2000	13	12.5	10.5	8.0	+8□	6.0	1.70	(25)
MAR-4	DC-1000	8.2	8.0	—	7.0	+11	7.0	1.90	(25)
MAR-6	DC-2000	20	16	11	9	0	2.8	1.29	(25)
MAR-7	DC-2000	13.5	12.5	10.5	8.5	+3	5.0	1.90	(25)
MAR-8	DC-1000	33	23	—	19	+10	3.5	2.20	(25)

NOTE: Minimum gain at highest frequency point and over full temperature range.

- 1dB Gain Compression
- +4dBm 1 to 2 GHz

### designers amplifier kit, DAK-2

5 of each model, total 35 amplifiers

only \$59.95

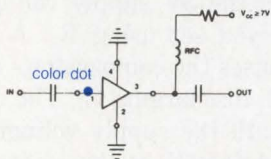

Unbelievable, until now... tiny monolithic wide-band amplifiers for as low as 99 cents. These rugged 0.085 in. diam., plastic-packaged units are 50ohm\* input/output impedance, unconditionally stable regardless of load\*, and easily cascable. Models in the MAR-series offer up to 33 dB gain, 0 to +11 dBm output, noise figure as low as 2.8dB, and up to DC-2000MHz bandwidth.

\*MAR-8, Input/Output Impedance is not 50ohms, see data sheet.  
Stable for source/load impedance VSWR less than 3:1

Also, for your design convenience, Mini-Circuits offers chip coupling capacitors at 12 cents each.†

Size (mils)	Tolerance	Temperature Characteristic	Value
80 x 50	5%	NPO	10, 22, 47, 68, 100, 470, 680, 100 pf
80 x 50	10%	X7R	2200, 4700, 6800, 10,000 pf
120 x 60	10%	X7R	.022, .047, .068, .1µf

† Minimum Order 50 per Value

finding new ways...  
setting higher standards

## Mini-Circuits

A Division of Scientific Components Corporation  
P.O. Box 350166, Brooklyn, New York 11235-0003 (718) 934-4500  
Fax (718) 332-4661 Domestic and International Telexes: 6852844 or 620156

## Circuit doubles digital frequency

John R French  
Singer Co, Wayne, NJ

The circuit in **Fig 1** doubles the frequency of a digital signal by operating on both signal edges. Each transition causes the exclusive-OR gate, IC<sub>1</sub>, to produce a pulse, which clocks flip-flop IC<sub>3</sub> after propagating through buffers IC<sub>2C</sub> and IC<sub>2B</sub>. If you remove capacitor C<sub>1</sub>, the circuit produces narrow output pulses. By including C<sub>1</sub>, you can obtain a desired duty cycle for a given input frequency f<sub>IN</sub>. The C<sub>1</sub> value for an approximate 50% duty cycle is

$$C_1 = \frac{1}{2R_1 f_{IN}}$$

When f<sub>IN</sub> = 1 MHz, for example,

$$C_1 = \frac{1}{2 \times 2400 \times 10^6} = 208 \text{ pF.}$$

Gate delays limit the maximum output frequency, f<sub>LIMIT</sub>:

$$\begin{aligned} f_{LIMIT} &= \frac{1}{t_{plh_{IC_1}} + t_{plh_{IC_{2A}}} + t_{plh_{IC_3}} + t_{phl_{IC_1}}} \\ &= \frac{1}{(23 + 25 + 100 + 22) \times 10^{-9}} \\ &= 5.8 \text{ MHz.} \end{aligned}$$

EDN

To Vote For This Design, Circle No 747

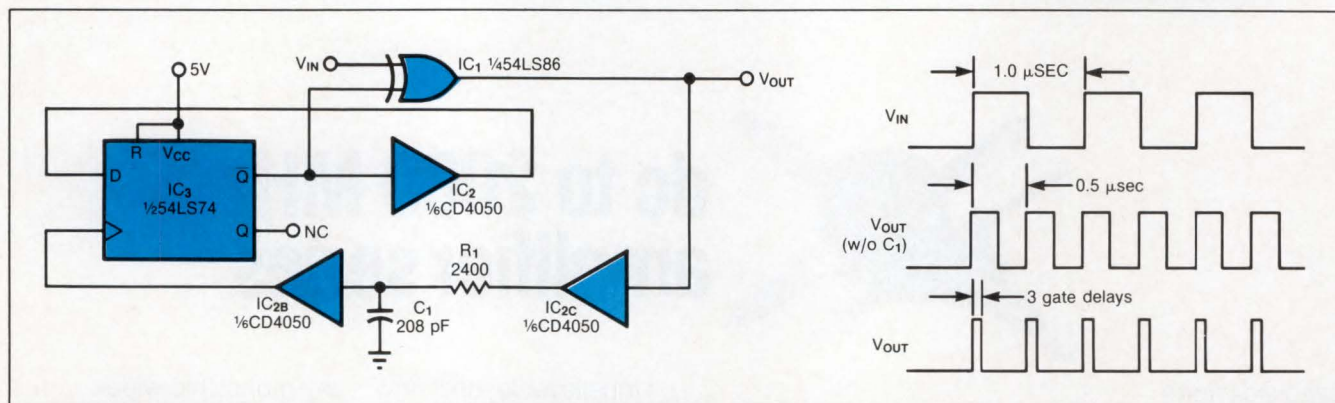

Fig 1—This circuit doubles the frequency of V<sub>IN</sub> for inputs as high as 5.8 MHz.

## Battery-backup circuit offers system reset

Terry Patterson  
Research and Productivity Council, Fredericton,  
New Brunswick, Canada

On many microprocessor boards, during power-up a simple RC circuit maintains the reset state until the μP and the power supply have stabilized. When the μP powers down during a brownout, though, these circuits don't provide a reset pulse nor do they protect a battery-backed RAM system from spurious write oper-

ations. The Fig 1 circuit does both.

Comparator IC<sub>1A</sub> senses the 5V supply voltage according to the threshold you set using R<sub>1</sub>. A 4.75V threshold, for instance, causes the comparator's output to switch low at that level, discharging C<sub>1</sub>. The capacitor remains discharged until the supply voltage rises above its upper threshold (4.84V in this case), then begins to recharge; 6 msec later, comparator IC<sub>1B</sub> pulls the reset line high, producing a minimum 6-msec reset pulse. IC<sub>1B</sub>'s open-collector output allows the μP and

# KILLER I/O

## The Z84C90: Two serial, three parallel ports and a counter/timer on one chip. Just think what you can do with it.

Zilog's Z80 SPCT, Killer I/O," gives you a true "System on Silicon."™ With all the advantages of CMOS technology, Superintegration," and proven Z80 performance. Think of it as the door to a whole lot of new opportunities.

### Lots of I/O.

You're simply not going to get more serial/parallel I/O anywhere. We've put together the most popular combination of discrete devices . . . two independent synch/asynch serial channels, two independent parallel ports, an 8-bit programmable port and four counter/timers. And, since they're all fully compatible with PIO, SIO and CTC devices, you have the advantage of "commonality."

### Lots of performance.

Superintegration and CMOS technology mean the Z84C90 provides plenty of performance and flexibility. 8 MHz speed for instance. Plus you've got four independent counter/timers and on-chip oscillator to work with. And the peripherals can be used in any combination you need.

### Lots of benefits.

You're designing with a highly integrated chip. And you're working with the familiar software and proven performance of the Z80 Family. That's enough to make the Killer I/O the best choice. But think about the lower cost you get from less real estate, lower manufacturing cost and reduced inventory. Think about improved time to market. Or the higher performance and reliability that come with super integration. And it's all off the shelf and backed by Zilog's proven quality.

So whether you're upgrading existing designs or looking for solutions in new applications like cellular phones, personal computers, industrial control, or data communications, you owe it to yourself to contact your local Zilog sales office or your authorized distributor today. Zilog, Inc., 210 Hacienda Ave., Campbell, CA 95008, (408) 370-8000.

### The Z80 Family: Still growing strong.

*The Z80 remains the most commonly used 8-bit microprocessor in the industry. No wonder. As the family has continued to develop, so have the advantages: the familiarity of working with devices you know and trust, the tremendous value of being able to use software you've already developed, and, of course, there's the impressive Z80 performance.*

*As the Z80 Family has evolved through NMOS, CMOS, high-performance and high-integration, our commitment to Z80 has never wavered. New products have continued to be developed. Besides the 16-bit Z280 and the new Z84C90—the Killer I/O—there are a few more you really ought to look at:*

- ▶ **Z84C80/81** Z80-based systems GLU logic that can be used in every Z80 application
- ▶ **Z80180** the Z180 8-bit MPU combines a Z80 CPU, MMU, 2 UARTs, DMA, a C/T and more, with no extra logic needed for Z80 peripherals
- ▶ **Z84C01** combines a Z80 CPU with an on-board oscillator

Right product. Right price. Right away. **Zilog**

**ZILOG SALES OFFICES:** CA (408) 370-8120, (714) 838-7800, (818) 707-2160, CO (303) 494-2905, FL (813) 585-2533, GA (404) 923-8500, IL (312) 885-8080, MA (617) 273-4222, MN (612) 831-7611, NJ (201) 288-3737, OH (216) 447-1480, PA (215) 653-0230, TX (214) 231-9090, CANADA Toronto (416) 673-0634, ENGLAND Maidenhead (44) (628) 39200, WEST GERMANY Munich (49) (89) 612-6046, JAPAN Tokyo (81) (3) 587-0528, HONG KONG Kowloon (852) (3) 723-8979, R.O.C.: Taiwan (886) (2) 731-2420, U.S. AND CANADA DISTRIBUTORS: Anthem Electric, Bell Indus., Hall-Mark Elec., JAN Devices, Inc., Lionex Corp., Schweber Elec., Western Microtech., CANADA Future Elec., SEMAD.

# DESIGN IDEAS

other devices to take control of the reset line as required. IC<sub>2</sub> provides a 2.5V reference for the comparator, and S<sub>1</sub> gives you manual-reset capability.

The circuit protects the static RAM by pulling its  $\overline{CE}$  (chip enable) input high during low-voltage conditions, and by providing a minimum of 2V to the V<sub>DD</sub> terminal. The 3V lithium battery delivers current (1  $\mu$ A typ)

through a Schottky diode, D<sub>2</sub>, resulting in the static RAM's V<sub>DD</sub> being only 0.1V below the system's V<sub>CC</sub>. To reduce power consumption, you should ground the unused IC<sub>2</sub> inputs. **EDN**

To Vote For This Design, Circle No 749

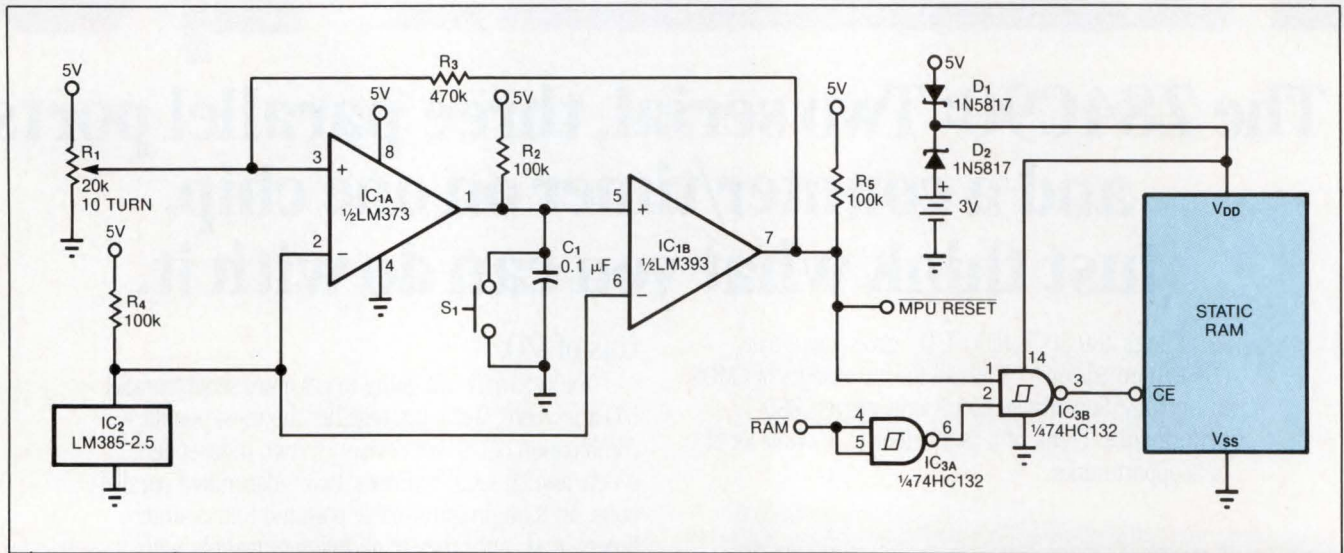

**Fig 1**—This circuit protects a  $\mu$ P system by asserting a minimum 6-msec reset pulse during power turn-on or brownouts, by providing at least 2V to the static-RAM system, and by deselecting the static RAM to avoid spurious write operations.

## Timer output has variable duty cycle

George Indorf  
Intronics Inc, Edwardsville, KS

When configured as a free-running multivibrator, a 555 timer provides no more than a 50% duty cycle. By adding two transistors, however, you can obtain a variable, 5 to 95% duty cycle without changing the sum of the on and off times (Fig 1). When V<sub>OUT</sub> goes low, Q<sub>1</sub> is on and Q<sub>2</sub> is off, disconnecting V<sup>+</sup> while the timing capacitor (C<sub>2</sub>) discharges into pin 7 of the timer. When V<sub>OUT</sub> goes high, Q<sub>2</sub> reconnects V<sup>+</sup> for recharging C<sub>2</sub>.

Adjusting the linear trimming potentiometer (R<sub>3</sub>) to increase the charging resistance increases the on time, but decreases the off time by the same amount by decreasing the discharge resistance (the converse is also true). As a result, the sum of the on and off times remains constant. R<sub>2</sub> protects Q<sub>2</sub> and the timer against high charge/discharge currents. **EDN**

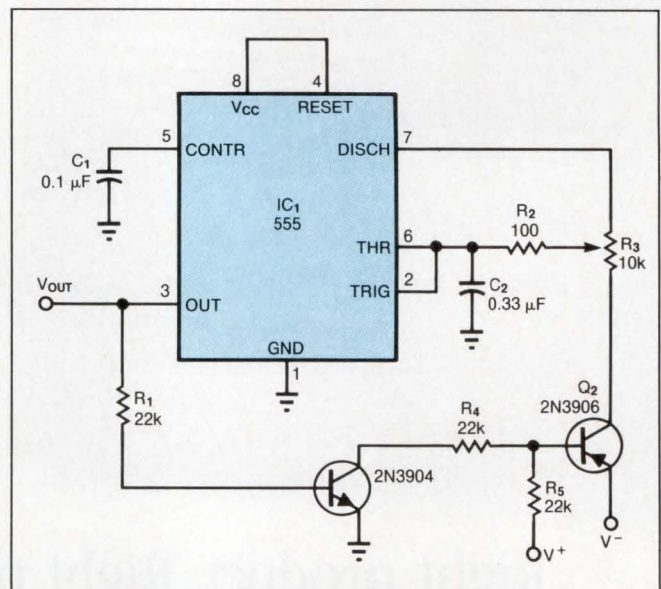

**Fig 1**—Adjusting this circuit's trimming potentiometer, R<sub>3</sub>, varies V<sub>OUT</sub> from 5 to 95% without affecting the IC's time constant.

To Vote For This Design, Circle No 748



# Who manages the power in Perkin-Elmer's Modular 430 MBE Series?

## KEPCO POWER MANAGERS™

Perkin-Elmer's highly automated 430 MBE systems use molecular beams for the epitaxial growth and doping of silicon layers of extremely high uniformity.

To achieve such uniformity, voltage must be constant to within 0.0005%; and to provide such constant voltage, Perkin-Elmer relies on one 1100-Watt and six 540-Watt Kepco JQE Power Managers.

The Power Managers are Kepco's programmable linear power supplies, and no other power sources on the market can even approach them for accuracy, stability and reliability. JQE Power Managers control and stabilize voltage to within 0.0005%, with current limiting, and their output voltage is fully programmable throughout their rated range. Other Kepco Power Managers stabilize either voltage or current, with automatic crossover, and our bipolar Power Managers provide both negative and positive voltage and current, and act not only as a source but as a sink.

All the Power Managers can be digitally controlled using Kepco Digital Programming Interfaces. A Kepco Power Management System™ (a Power Manager/Programming Interface combination) gives you, in fact, the most accurate, the most versatile control of power you can buy. For complete information, send for our new 64-page brochure "The Kepco Power Managers and Management Control Systems." Call or write Dept. KEF-12, KEPCO, INC., 131-38 Sanford Avenue, Flushing, NY 11352 USA • (718) 461-7000 • TWX #710 582 2631 • FAX (718) 767-1102.



CONSOLE AREA MOUNTS THE KEPCO POWER MANAGERS

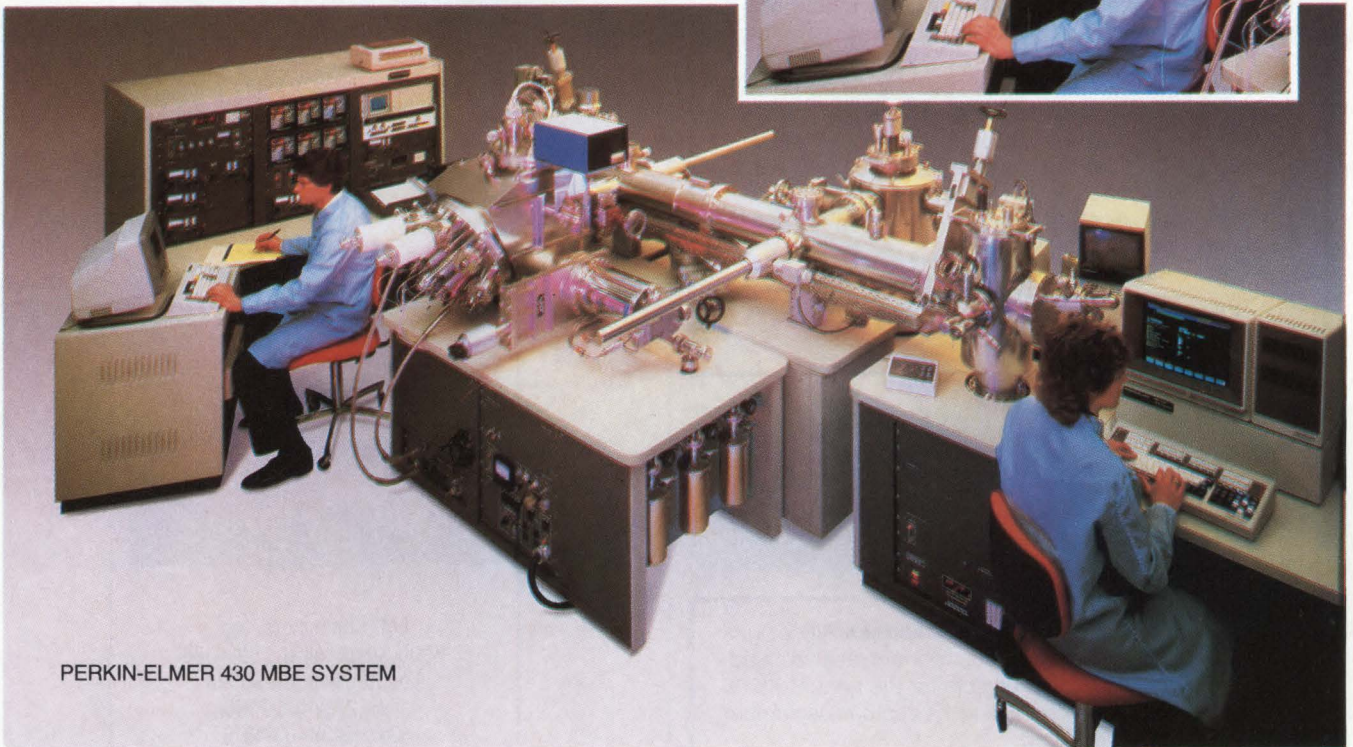

PERKIN-ELMER 430 MBE SYSTEM

KEPCO, INC. • 131-38 SANFORD AVENUE • FLUSHING, NY 11352 USA • (718) 461-7000 • TWX #710-582-2631 • FAX: (718) 767-1102

# DESIGN IDEAS

## Design Entry Blank

**\$75 Cash Award for all entries selected by editors. An additional \$100 Cash Award for the winning design of each issue, determined by vote of readers. Additional \$1500 Cash Award for annual Grand Prize Design, selected among biweekly winners by vote of editors.**

To: Design Ideas Editor, EDN Magazine  
Cahners Publishing Co  
275 Washington St, Newton, MA 02158

I hereby submit my Design Ideas entry.

Name \_\_\_\_\_

Title \_\_\_\_\_ Phone \_\_\_\_\_

Company \_\_\_\_\_

Division (if any) \_\_\_\_\_

Street \_\_\_\_\_

City \_\_\_\_\_ State \_\_\_\_\_ Zip \_\_\_\_\_

Design Title \_\_\_\_\_

Home Address \_\_\_\_\_

Social Security Number \_\_\_\_\_

(Must accompany all Design Ideas submitted by US authors)

**Entry blank must accompany all entries.** Design entered must be submitted exclusively to EDN, must not be patented, and must have no patent pending. Design must be original with author(s), must not have been previously published (limited-distribution house organs excepted), and must have been constructed and tested.

Exclusive publishing rights remain with Cahners Publishing Co unless entry is returned to author or editor gives written permission for publication elsewhere.

In submitting my entry, I agree to abide by the rules of the Design Ideas Program.

Signed \_\_\_\_\_

Date \_\_\_\_\_

### ISSUE WINNER

The winning Design Idea for the March 3, 1988, issue is entitled "Tachometer measures low frequencies," submitted by Ricardo Jimenez-G of the Mexicali Technological Institute (Mexicali, Baja California, Mexico).

**Your vote determines this issue's winner.** All designs published win \$75 cash. All issue winners receive an additional \$100 and become eligible for the annual \$1500 Grand Prize. **Vote now**, by circling the appropriate number on the reader inquiry card.

## NEW CONNECTORS FAMILY REFERENCE 202.400

Wire insert and tighten on the same plane. Screw, wire and screwdriver are in the same plane when you use the new technology in pluggable connectors by LMI.

Ease of operation (user friendly), low profile and thread protection (.118" O screws) are but a few of the customer benefits.

Now available from stock are male connectors, (open) or closed header ends, 2 to 20 positions, 0.2" (5.08mm) centers, female connectors, 10 Amp, 300 volts.

Please contact us for additional information *free* samples and a visit from one of our experienced Field Sales Engineers.

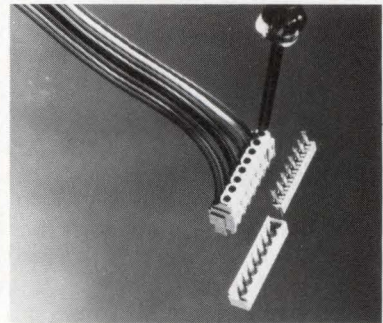

## NEW CONNECTOR TYPE 302.432

Less P.C.B. Real Estate Required!

with LMI's new technology, low cost, compact 32 position screw connectors. Other features: new clamping device with screw and wire insertion on the same plane, .118" (3 mm) O screws protecting threads, 0.2" (5.08 mm) centers, 6 Amps, 300 volts.

Please contact us for additional technical data, free samples or to request a visit from a field sales engineer.

Call us today so you may begin to enjoy the benefits of leading edge technology connection.

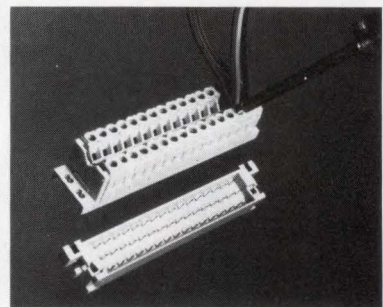

LMI Connectors, Inc.  
6290 Sunset Blvd., Ste 1126  
Los Angeles, CA 90028  
Tel: (213) 463-2295  
Tax: (213) 463-4319



# If this is your perception of terminal blocks, we've got nothing to talk about.

Some designers, and even some manufacturers, see terminal blocks as technological knick-knacks. Items to be bought and sold with all the consideration due a dime-store notion. We don't. At Dialight, the Kulka products that ultimately connect one system to another warrant somewhat more significance. The way we build them proves it.

Instead of simple plastic, we use special aggregates in our high temperature models that withstand 220 degrees centigrade. Making Kulka the only manufacturer to meet classes B,F and HT of Mil-T-55164/C. We even offer terminal blocks for commercial and industrial applications that meet the same high standards.

While most manufacturers insist on using steel for their screws, we opt for the highest grade brass with a nickel plate. A combination that won't compromise the integrity of a termination with the electronic intermittance caused by oxidation.

And in our Military line, brass mounting plates that prevent breakage from overtorquing are molded right into our special aggregate. The same goes for terminal contacts. A technique we've been using for thirty years to achieve pull-out resistance more than twice that of ultrasonically inserted contacts.

It's this kind of innovative design that makes itself manifest throughout Dialight's unrivaled selection of Kulka terminal blocks. Flat-mount, Military class, Navy class, miniature, high density and insulated feed-thru types.

All examples of what we perceive to be the best engineering in its class. And all available through our free catalog by dialing 201-223-9400. Or by writing; Dialight Company, 1913 Atlantic Ave., Manasquan, NJ 08736. End of discussion.



**DIALIGHT COMPANY** A Division of  
North American Philips

**DIALIGHT · KULKA · HHSMITH**

Engineering is the only commodity we sell.

# Our ASIC line-up is only half the story.



When it comes to delivery of high-quality, reliable ASICs, S-MOS wrote the book.

We did it in collaboration with our manufacturing affiliate, Seiko Epson. With 18 years of CMOS experience, Seiko Epson is one of the world's most advanced CMOS IC manufacturers.

Through Seiko Epson's high-yield manufacturing technology, we ship millions of ASIC units a month, and

with a reject rate of less than .0001%. That's our quality story.

Now we've added a new chapter on design. At our advanced R&D design facility, engineers from S-MOS and Seiko Epson are developing new software to simplify circuit design, simulation and the creation of new megacells for our extensive cell library.

Of course, you can still take advantage of our established design

tools because S-MOS supports such workstations as Daisy, Mentor, Calma and PC-based systems using FutureNet, OrCAD and ViewLogic.

Our proprietary LADS simulator will speed up the design process. The S-MOS engineering team will support you from concept to production.

If you are looking for an ASIC program that can make your designs best sellers, call us. (408) 922-0200.



#### CMOS Gate Arrays

- Up to 38,550 available gates
- SLA8000 (800 ps)\*  
1.2μ drawn, 1.0μ Leff.
- SLA7000 (1.0 ns)\*  
1.5μ drawn, 1.2μ Leff.
- SLA6000 (1.8 ns)\*  
2.0μ drawn, 1.5μ Leff.
- SLA700B High Drive Output
- SLA100L Low Voltage

#### CMOS Standard Cells

- Complexities to 16K gates\*\*
- SSC1000 (1.4 ns)\*  
1.8μ drawn, 1.4μ Leff.
- Fully migratable from S-MOS gate arrays
- RAM and ROM blocks available

#### Compiled Cell Custom

- The Alternative to Full Custom*
- 1.8μ CMOS process
- Can utilize dissimilar cell geometries
- 3-button approach to custom design
- Currently over 300 fully characterized cells
- Fast 14-week implementation time
- Timing-driven TANCELL® place-and-route software

TANCELL is a registered trademark of Tangent Systems.

\*Typical propagation delay of 2-input NAND gate driving 2 internal loads with 1mm of interconnect.

\*\*Maximum gate utilization depends on amount of interconnect used.



S-MOS SYSTEMS, INC.  
2460 North First Street  
San Jose, CA 95131-1002

# NEW PRODUCTS

## COMPUTERS & PERIPHERALS

### CASSETTE MEMORY

- Uses a removable RAM cassette
- System asynchronously transfers data at 3M bytes/sec

The 234/334C is a cassette memory system for the STD bus. It comes in two versions. Model 234-1 comes with a TTL bus card; model 334C-1 is the CMOS bus version. You can insert the credit-card size RAM into a socket mounted on the card. The system transfers data asynchronously to the cassette at rates of 3M bytes/sec. The card appears to the host processor as four sequential ports in the I/O map. The board has a counter which holds the current cassette address. Following each read/write from the host, the counter is incremented to the next data location in the cassette. The cas-

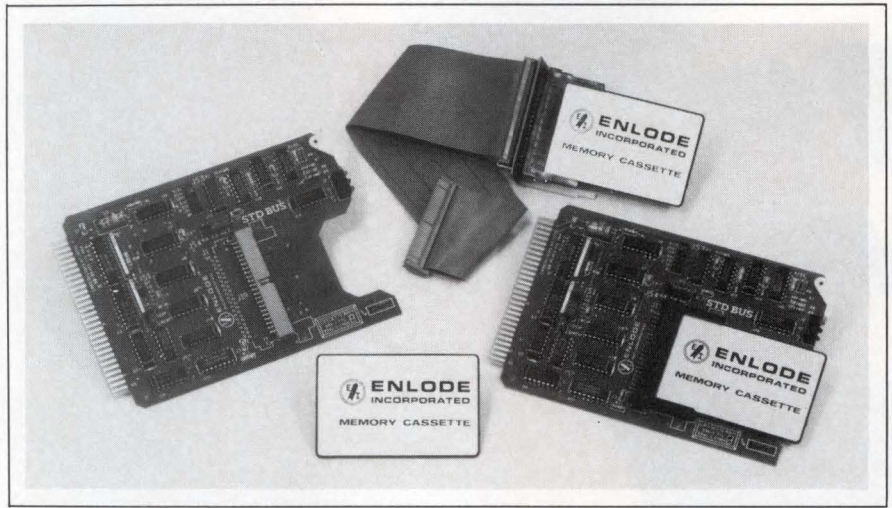

ettes have CMOS static RAM, a write-protect switch, and a replaceable lithium battery which provides data retention for three years min. Cassettes have capacities of 64k, 128k, 256k, and 512k bytes. Board,

\$285. Prices vary for the cassettes according to capacity.

**Enlode Inc**, 1728 Kingsley Ave, Orange Park, FL 32073. Phone (800) 874-7729. TLX 466036.

**Circle No 365**



### LAN CONNECTOR

- Serves as many as four Ethernet or Starlan networks
- System connects ISO, TCP/IP, DECnet, XNS, and TOP

The ILAN-1 networking system can integrate multiple LANs in a single communication network. The basic node system chassis serves as many as four Ethernet or Starlan networks in any combination. Modular interface cards let you accommodate growing or changing network configurations. The system features protocol transparent connectivity allowing ISO, DECnet, TCP/IP,

XNS, and TOP protocols to be mixed on any of the interconnected LANs. A plug and play feature automatically determines network-device locations and passes packets from one network to another when necessary. The nodes are cascadable to accommodate large networks and modular software defines the network configuration. Remote network-management software monitors network statistics and security. Prices range from \$4575 to \$10,850.

**CrossComm**, 133 E Main St, Marlborough, MA 01752. Phone (617) 481-4060.

**Circle No 366**

### NETWORK CARD

- Allows IBM PS/2 model 50, 60, and 80 to operate under Netware
- Board uses the SMC-9026 controller chip

Micronet is an ArcNet network card for the IBM PS/2 model 50, 60, and 80 computers. The single-slot short

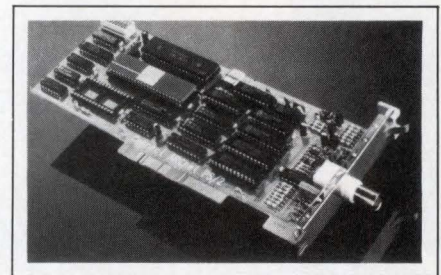

card operates under Novell's Netware network operating system. The card utilizes the SMC 9026 controller chip and a custom transceiver with a cable driver. It comes with a floppy disk containing automatic software setup routines for I/O address, interrupt, and memory addresses. It supports up to 7 different I/O port addresses, 7 memory buffer addresses, and 8 interrupt levels. The board connects to RG-62/U or other 93Ω cable through a BNC connector. A high speed cache-buffer arrangement increases the throughput speed. \$398.

**C&C/Connect**, Box 280, Batavia, IL 60510. Phone (312) 879-7003.

**Circle No 367**

# WHAT IS MILITARIZED, RELIABLE, OFF-THE-SHELF...?

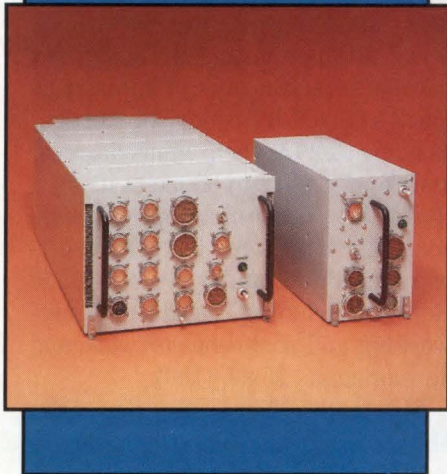

SECS 80 FULL & 1/2 ATR



SECS 80/RM19

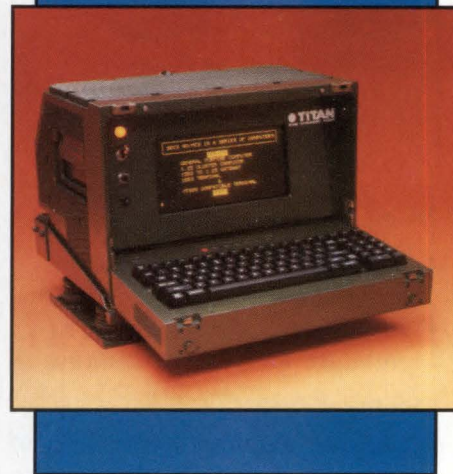

SECS 80/MCS

## SECS 80 COMPUTER SYSTEMS THAT'S WHAT!

### AND NOW...COMPLETE SYSTEMS

The **NEW** TITAN/SESCO now delivers complete systems, not just black boxes. We are major participants in such programs as FOG-M, North Warning, Dead-Eye and MARC to name a few. Our turn-key systems come with a range of integrated software starting from built-in-test (BIT) test firmware to complete applications software developed and validated by TITAN/SESCO.

The **NEW** TITAN/SESCO also offers standard turn-key SECS 80 based computers directed at stand-alone general purpose computing, X.25 communications, X.25 to 1553 gateway networking, and LAN applications.

### MILITARY ENVIRONMENTS

**Tough** — All TITAN/SESCO products are designed and tested to meet MIL-E-16400, MIL-E-5400, and MIL-E-4158 — and **Radiation Hardened** too!

**Reliable** — *TITAN/SESCO's products stay in the field.* We enjoy a return rate of less than 1% and we back all SECS 80 products with a one year warranty.

### THE NDI ADVANTAGE

Building systems based on Non-Development Item (NDI) products means fast deliveries at very low development cost. TITAN/SESCO's SECS 80 Product Line is the most comprehensive line of NDI Multibus computer products in the world and is available now! Match cost to performance with SECS 80 computers ranging from 8080A based 8-bit computers to the 80286 16-bit computer and all those in between. Complete the system with the wide range of serial, parallel and analog I/O, MIL-STD-1553 and peripheral interfaces available.

### CUSTOM DESIGN CENTER

TITAN/SESCO has developed a custom design center proficient in systems engineering, software engineering, electronics design, power supply design and EMI control.

**THE NEW TITAN/SESCO Has It All . . .** NDI products on-the-shelf, custom hardware and software design center and high capacity MIL-Q-9858A manufacturing facilities . . . all ready to deliver system solutions to your door!

 **TITAN**  
SEVERE ENVIRONMENT SYSTEMS

A Subsidiary of The Titan Corporation

20151 Nordhoff St., P.O. Box 2668 • Chatsworth, CA • 91313-2668 • In CA (818) 709-7100/Telex 69-1404

**800-423-5527**

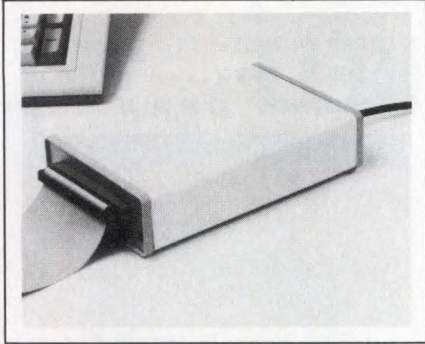

## SCSI EXTENDER

- Uses coax or fiber optics to increase communication distance
- Fiber cable operates full SCSI standard for a 2-mile distance

The Paraline SCSI bus extender extends the communication distance of the SCSI bus by a distance of more than 2 miles over a single fiber-optic cable or as far as 1000 ft with coaxial cables. An extender is required on each end of a cable run. The product is completely transparent in that the system operates as if connected by the SCSI standard. A Parahub model has one parallel port and four serial ports, which you can use as a node for branch networks. When connected, the system can transmit asynchronous data at 1.5M bytes/sec and synchronous data at 4.5M bytes/sec, which is compliant with the SCSI standard. Coax extender, \$395; fiber-optics extender, \$820; coax Parahub, \$1195; fiber-optics Parahub (available in June), \$2625.

**Paralan Group**, CDR Systems Inc, 7171 Ronson Rd, San Diego, CA 92111. Phone (619) 560-1272.

Circle No 368

## CPU BOARD

- Runs Unix and real-time applications
- Board uses a 25-MHz 68030  $\mu$ P and 1M or 4M bytes of RAM

The HK68/M130 is a single-board computer for Multibus I. The board features a 25-MHz 68030 CPU, 1 or 4M bytes of dynamic RAM with parity, as many as 2M bytes of EPROM, and a 4-channel 32-bit

DMA. In addition, the board includes a SCSI interface, four RS-232C serial I/O ports, a 16-bit parallel port, and an 8-bit iSBX connector. It includes 128 bytes of non-volatile RAM, three 16-bit counter/timers, an iLBX memory-expansion port, mailbox interrupt support, and a full master/slave interface to Multibus I. The device's optional features include a 68881 or 68882 floating-point coprocessor and a time-of-day clock with battery back-up. The board runs under Unix System V.3, Ready System's VRTX Real-Time Executive, and Microware's operating systems. Board with 4M bytes of dynamic RAM, \$4995.

**Heurikon Corp**, 3201 Latham Dr, Madison, WI 53713. Phone (608) 271-8700. TLX 469532.

Circle No 369

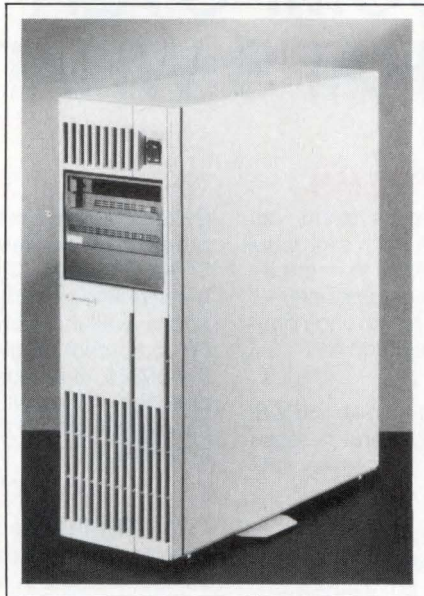

## UNIX SYSTEM

- Operates at 4.5 MIPS using a 20 MHz 68030  $\mu$ P
- VME Bus system supports 20 asynchronous devices

Model 3300 is a member of the company's VME Delta Series of Unix-based computer systems. The system achieves 4.5 MIPS using a single-board computer with a 20 MHz 68030  $\mu$ P. The system occupies

a single slot in a six-slot VME Bus chassis; the five remaining slots are expansion slots. The board has 4M or 8M bytes of RAM, a 68882 floating-point coprocessor, a SCSI interface, an Ethernet interface, four serial I/O ports, and a Centronics parallel interface. It can support as much as 300M bytes of disk storage, as many as 20 asynchronous devices, and connectivity to 96 users using a DeltaLink controller option. The computer runs a broad base of software products under System V/68 Rel 3 including local-area networking and real-time software and development. \$6995 (100).

**Motorola Microcomputer Div**, Marcom Dept-DW283, 2900 S Diabolo Way, Tempe, AZ 85282. Phone (800) 556-1234.

Circle No 370

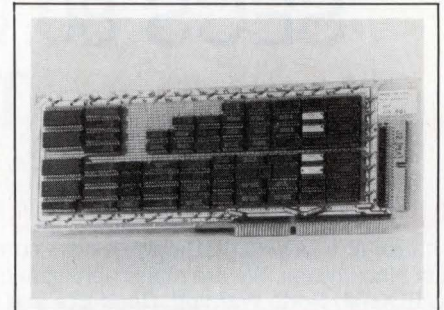

## INTERFACE BOARD

- Emulates a Gould computer HSDII card for IBM PC/AT
- Onboard FIFO allows burst transfer rates of 6.6M bytes/sec

The PCHSD IBM PC/AT board emulates the functions of a Gould HSDII (high-speed data interface). It provides a high-speed bidirectional link for transferring control, status, and data between the computer and devices that connect to a Gould HSDII. The board can also communicate with an HSDII in a Gould machine. It transfers 16-bit words to and from main PC memory, and 32-bit words to and from the external device. The board can reformat the words by byte swap and word swap. A high-speed FIFO buffer allows burst transfers at 6.6M



bytes/sec between the PC and the external device. C subroutines supplied with the board provide the software for writing control, reading status, and reading and writing data. \$4675. Delivery, 30 to 60 days ARO.

**Applied Data Sciences Inc.**, Box 814209, Dallas TX 75381. Phone (214) 243-0113. TLX 247799.

**Circle No 371**

### PRINTER

- *Color graphics with 360×360 dot/in. resolution*
- *Prints draft-quality material at a 216-cps rate*

The P321SLC 24-pin dot-matrix printer can produce color graphics at 360×360 dots/in. Besides black, it prints in orange, green, purple, yel-

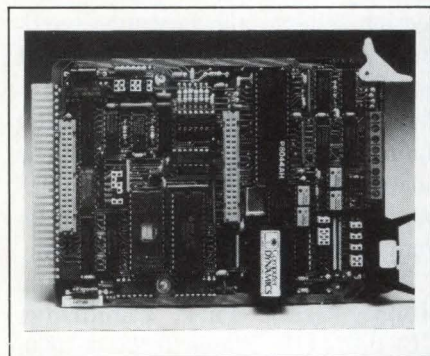
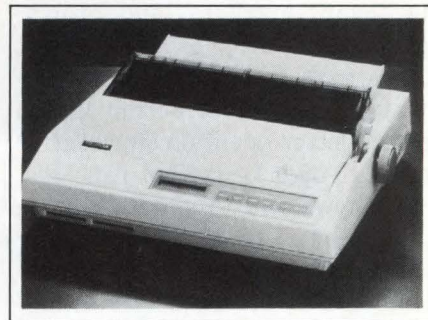

### BITBUS BOARD

- *Can operate in four modes*
- *As a gateway, it lets STD Bus processors talk to Bitbus*

Using Intel's 8044 Bitbus Enhanced  $\mu$ P, the STD-BitBoss STD Bus board provides an interface to the Bitbus and sockets for as many as 64k bytes of EPROM and 40k bytes of RAM or EEPROM. It operates in four different modes. First, it can act as a gateway that allows STD Bus processors to communicate with the Bitbus. Second, it can act as a remote peripheral, responding to input and output commands. Third, programs can be burned into an EPROM on the board through the Bitbus, allowing flexible communications to the host or other nodes in the system. Fourth, it can act as a host CPU for the STD Bus. The board permits transmission at speeds as high as 62.5k bps for a distance of 13.2 km, and as high as 375k bps for a distance of 900m. \$300 (OEM qty).

**Computer Dynamics Inc.**, 105 S Main St, Greer, SC 29651. Phone (803) 877 8700.

**Circle No 372**

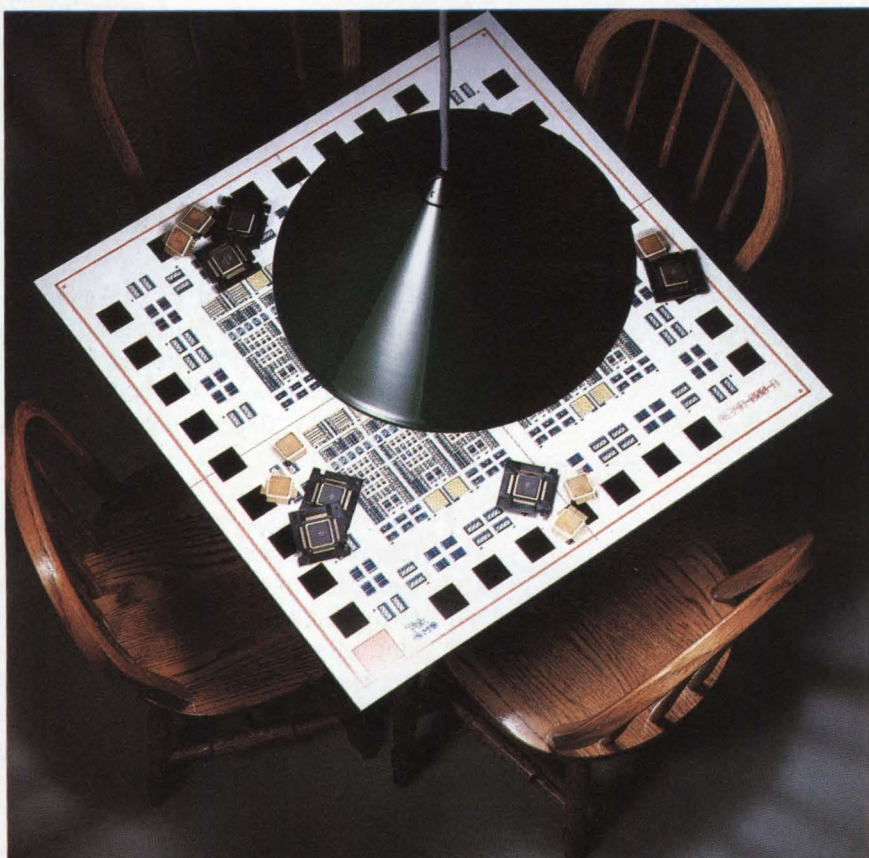

## GET INTO THE FASTEST GAME IN TOWN.

High-speed chips, high-speed QuickChip™ turnaround — it's our 8.5 GHz process... that's our game. For semicustom ICs, there's no better, faster source. Bet on it.

For a sure win, call Tektronix:  
1 800-835-9433. Ask for Ext. 100.

**Tektronix**  
COMMITTED TO EXCELLENCE

Copyright © 1988, Tektronix, Inc. All rights reserved. CHP-127

**CIRCLE NO 35**

low, cyan, magenta, and brown, using a special color ribbon that comes with the printer. The unit prints draft-quality output at 216 cps and letter-quality material at 72 cps. A 16-digit LCD front-panel display allows you to choose from a variety of print modes including font selection, pitch, printer emulation, and four preset printer configurations. The printer has a built-in tractor for fanfold paper, and a fanfold bypass allows you to print on cut-sheet paper without unloading the fanfold paper. The unit contains 32k bytes of resident memory for a print buffer or downloadable fonts. An additional 32k-byte memory card is available as an option. \$949.

**Toshiba America Inc**, Information Systems Div, 9740 Irvine Blvd, Irvine, CA 92718. Phone (800) 457-7777.

**Circle No 373**

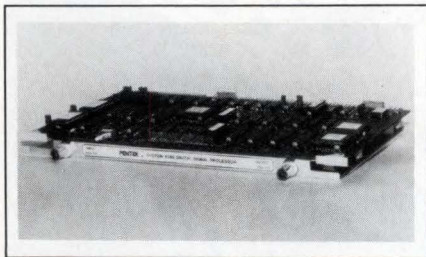

## DSP SYSTEM

- Employs three TI TMS320C25 DSP chips for Multibus I
- Companion analog I/O board has 16-bit ADCs and DACs

The System 4080 digital signal processor (DSP) board and a mating analog I/O board are integrated as a module for the Multibus I. The Model 4182 DSP board contains three TMS320C25 DSP chips arranged as a master and two slaves. The master processor runs at 20 MHz, and the two slave processors run at 40 MHz. The master processor has a 32k×16-bit static CMOS RAM, and each slave has an 8k×16-bit static CMOS RAM. The host has access to the board through a 1k×16-bit static dual-port RAM. The board contains two sockets for

8k-byte or 32k-byte EPROMs. The Model 4062 analog I/O board features 16-bit A/D and D/A converters, a 7th-order elliptic antialiasing input filter and an output filter. The conversion rates are programmable to 50 kHz. Model 4182, \$5500; Model 4062, \$1495.

**Pentek Inc**, 10 Volvo Dr, Rockleigh, NJ 07647. Phone (201) 767-7100.

**Circle No 374**

## MOTHER BOARD

- Features 12-MHz 80286 for IBM PC/AT and compatibles
- 1M byte of RAM and EGA graphics capability

The SBC-286 IBM PC/AT-compatible mother board features a 12-MHz 80286  $\mu$ P and 1M byte of RAM. It also includes a Western Digital WD37C65 floppy-disk controller that supports both 5¼- and 3½-in. floppy-disk drives, a SCSI interface, EGA graphics capability based on Chips & Technologies devices, a Centronix parallel printer port, and two RS-232C ports. Eight expansion slots provide for future upgrades to OS/2. The board measures 8½×13 in. and comes with a one-year warranty. Board with a custom diagnostic program, \$875.

**Logos Computers**, 555 W Lambert Rd, Suite L, Brea, CA 92621. Phone (714) 255-8105.

**Circle No 375**

## SCSI BOARD

- Operates in Multibus II systems
- Provides two independent SCSI bus interfaces

The TP600 SCSI bus controller board for Multibus II systems features two independent synchronous/asynchronous SCSI bus interfaces, an onboard 68020  $\mu$ P, and from 1M to 4M bytes of parity-checked dynamic RAM. Separate DMA controllers direct data transfers between the iPSB message-passing

coprocessor (MPC) and onboard memory, as well as transfers to and from the SCSI buses. The DMA controller that transfers data between the MPC and onboard memory is configured as a 32-bit controller to maximize iPSB bus throughput. The DMA controller that transfers data to and from the SCSI bus interfaces has a 32-byte buffer that allows it to convert 8-bit SCSI bus data transfers into 32-bit memory transfers. A memory-protection scheme allows you to partition the onboard memory so that you can implement onboard executive programs or a multitasking operating system. You can use the board as a system master in multiprocessing systems or as an intelligent file-manager resource. £3423.

**Tadpole Technology plc**, Titan House, Castle Park, Cambridge CB3 0AY, UK. Phone (0223) 461000. TLX 818152.

**Circle No 376**

**Tadpole Technology Inc**, 6747 Sierra Ct, Suite K, Dublin, CA 94568. Phone (415) 828-7676.

**Circle No 377**

## INDUSTRIAL NETWORK

- Provides low-cost networking for process control
- Allows point-to-point and broadcast data transfer

Operating over low-cost 2-wire cabling, the Signatrans-ZM50 modular industrial-networking system allows you to transmit data and commands between as many as 256 network stations. It is suitable for data acquisition and process control, using a range of sensors and actuators. In its simplest mode, by setting DIP switches to allocate the same address to an input channel and an output channel, you can cause the network to automatically transfer data from the input to the output channel. You can set up as many as 128 of these I/O pairs, joining input and output channels anywhere in the network. By using a

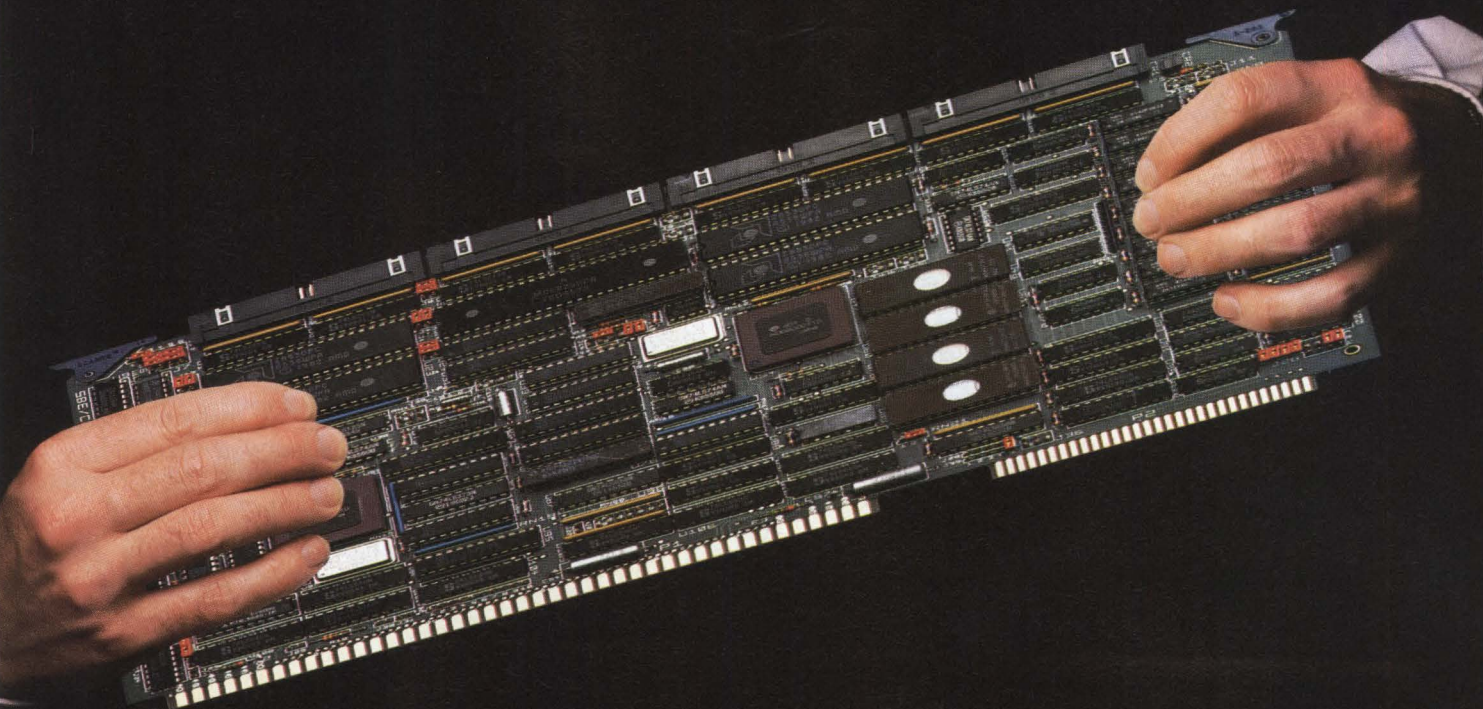

# Stretch the life of Multibus I

You don't have to abandon Multibus<sup>®</sup> I to take advantage of today's emerging technologies. SBE can help you increase performance in process control, data acquisition, data communications and other applications—without the learning curve or investment required by a new bus architecture. SBE will also help qualified OEMs develop custom solutions.

SBE high-performance solutions stretch the life of your current products, by offering

- Processor boards with 68020-based 32-bit performance to deliver as much

as five times the speed of 68000-based systems.

- A wide range of communications boards—from multiprotocol, eight-channel COM-8 to an Ethernet board that also streams data at T1 rates.

- Data communications software, including RTCK<sup>™</sup>, the SBE real-time communications kernel that handles communication using TCP/IP, X.25 or UDP protocol packages.

- REGULUS<sup>®</sup>, the complete operating system and development environment from SBE that offers real-time task support and prioritization, and

full UNIX<sup>®</sup> System V compatibility.

When you call SBE, you're calling a company with a solid commitment to Multibus I. We provide the best engineering, the best manufacturing quality (we control it in-house), and the best support in the industry.

**SBE, INC.**  
MICROCOMPUTER BOARDS AND SYSTEMS

2400 Bisso Lane, Concord, CA 94520  
FAX: 415-680-1427

## For solutions in Multibus I, call 1-800-221-6458

(1-800-328-9900 in California; 514-445-0898 in Canada)

\*UNIX is a registered trademark of AT&T. REGULUS is a trademark of Alcyon Corp. Multibus is a registered trademark of Intel Corp. RTCK is a trademark of SBE, Inc.

handheld programming unit, you can program the system to perform point-to-multipoint transfers, so that the information on one input channel automatically appears at several output channels. As an alternative, you can add a communications processor station on the network, which, in addition to providing a gateway to other net-

works, provides terminal control of the network. Network topology can be either open ended or in ring configurations, and the network can be as long as 20 km. A typical station, with I/O modules to provide analog and digital I/O capabilities, costs approximately DM 2000.

**Funke & Huster GmbH**, Lange-marckstrasse 28, 4300 Essen 1,

West Germany. Phone (0201) 22091. TLX 857637.

Circle No 378

## Programmable Anti-Alias Filters for Critical A/D Prefiltering

**848P8E Series are Elliptic lowpass filters providing extremely sharp roll-off for A/D prefiltering.**

### Features:

- 8 pole, 6 zero elliptic lowpass filters
- Digitally programmable corner frequency
- Shape factor of 1.77 at 80db
- 8 bit (256:1) tuning ratio
- Internally latched control lines to store frequency selection data
- Ideal for single or multi-channel applications
- Plug in, ready to use, fully finished filter modules
- Five frequency ranges to 51.2kHz

### Other Filter Products Available:

- Linear phase • Programmable
- Fixed frequency • Instrumentation
- Custom designs

For more information about how Frequency Devices can meet your most critical filtering requirements, call our applications engineers at **(617) 374-0761**.

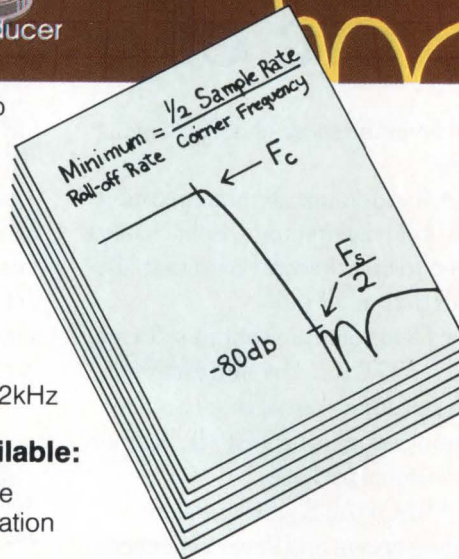
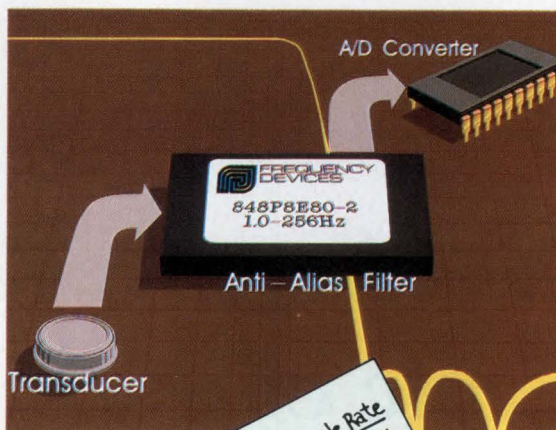

**FREQUENCY DEVICES™**

25 Locust Street  
Haverhill, MA 01830  
(617) 374-0761

## 386 EMULATOR

- Maps ROM contents into overlay memory at 20 MHz
- System consists of an in-circuit probe and chassis

The HyperICE-386 real-time in-circuit emulator lets you develop systems based on Intel's 80386  $\mu$ P. The system consists of an in-circuit probe and a universal chassis. You can map a system's ROM contents into the unit's 128k bytes of overlay memory in a real-time rate as high as 20 MHz. Only one wait state is necessary for systems operating from 20 to 25 MHz. Three 8000-gate gate arrays provide extensive trigger logic, which can stop the emulator at any point, down to the register level. Transparent tracing records all chip functions as it runs in real time. You can define any combination of address, data, status, and logic probe events as the criteria for a trace. Probes are also available for Motorola's 68000, 68008, and 68010  $\mu$ Ps. From \$17,500.

**Microcosm Inc**, 15275 SW Koll Parkway, Beaverton, OR 97006. Phone (503) 626-6100. TLX 759527.

Circle No 379

## COMPUTER BOARD

- Runs a 68020  $\mu$ P and 68881 math coprocessor
- Interfaces with the IIOC bus

The 10632-E32 single-board computer for the IIOC (Intelligent I/O channel) bus is a low-cost I/O bus for VME Bus systems. By utilizing surface-mount components, the single-Eurocard board houses a 16.7-MHz 68020  $\mu$ P and 68881 math coprocessor, 512k bytes of zero-wait-state static RAM, four 32-pin EPROM sockets, two serial I/O ports, a 68230 parallel I/O timer, a SASI/

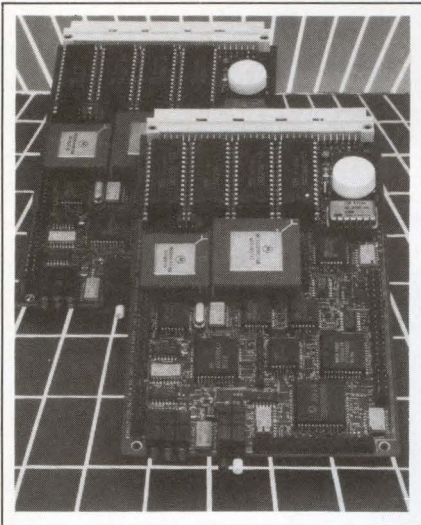

SCSI-compatible I/O port, and a real-time clock/calendar. You can run Microware's OS-9/68020 operating system on the board. DM 2480.

**EKF Elektronik GmbH**, Weidekampstrasse 1A, 4700 Hamm 1, West Germany. Phone (02381) 12630. TLX 828621.

Circle No 380

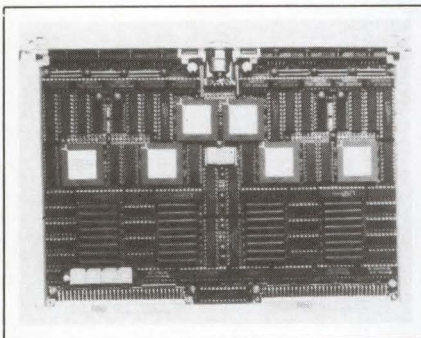

**TRANSPUTER BOARD**

- Contains 4 32-bit transputer nodes
- Board contains 1M byte of RAM for each of the four nodes

The VMTM module is a double-height Eurocard for the VME Bus that contains 4 transputer processing nodes. Each node is built from a T800 or T414 transputer with 1M byte of local memory. This combination offers up to 40 MIPs and 6M flops of parallel-computing power. The nodes communicate via 16 link-channels at 20M bps each and are configurable under software control using a C004 link switch.

You can access the nodes independently from the VME Bus. Four link adapters are address mapped to the VME Bus. You can combine any number of these boards within the VME system using plug connectors. The hardware is supported by Occam and compilers for C, Pascal and Fortran 77. Each board supports as many as four users in a

multi-user environment. A Megatool development package is available for all OS-9 systems as well as for Sun workstations running Unix. \$8375. Delivery, 4 to 6 weeks ARO.

**Parsytec GmbH**, Juelicher Strasse 338, D-5100 Aachen, Germany. Phone (241) 1822275.

Circle No 381



# BASU

NEW  
68020/SCSI  
Combo

## Model CPU20 with Dual-Ported, One kbyte, SRAM Mail Box for Multiprocessor Applications

Standard Features

- 32 Bit-Wide Address & Data Range.
- Clock Rates = 12.5 & 16.
- One Mbyte (4 Mbyte) DRAM with Parity Option.
- One Mbyte EPROM Space.
- SCSI Interface.
- Two Serial Ports
  - RS 232C
- One Parallel Port
  - 24-Bit Counter/Timer
- NOVRAM
  - An SRAM that saves special or user-definable variables, even at Power Fail or Power Down.

Special Features

- Four LEDs.
- Four-Digit Programmable Alphanumeric Display.
- Four Soft Touch Control Buttons with LEDs.
- EPROM Space = One 32-Pin Socket.

Marketed in the US by

Dage Precision Industries Inc.  
PO Box 120A, Santa Clara, Ca 95052  
Ph. (408) 727-1932

European Headquarters

MicroSys GmbH, Anzinger Str. 1  
D-8000 Munich 80, Ph. (89)63801-0  
TLX 5213288 mibad

Options

FPU (MC68881) & PMMU Piggy Back

Operating Systems

OS-9	(*Microware)
PDOS	(*Eyring)
UNIPLUS+	(*Unisoft)

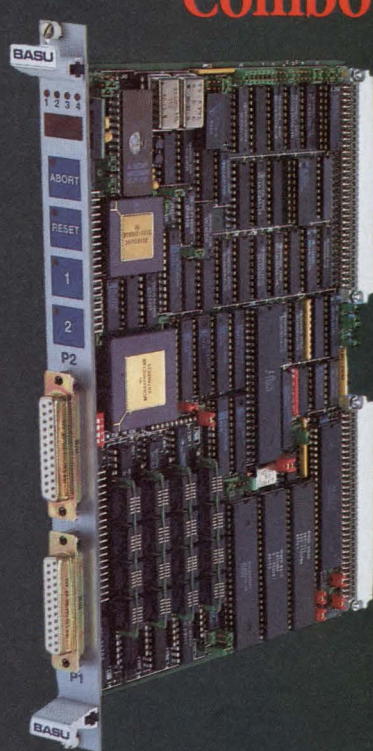

VMEbus

Ask about our soon-to-be announced CPU21 & 22 (68020 w/ Dual Ported SRAM or DRAM)

EDN May 26, 1988

CIRCLE NO 37

227

# SINGLE-SHOT PULSES TO 350 MHz

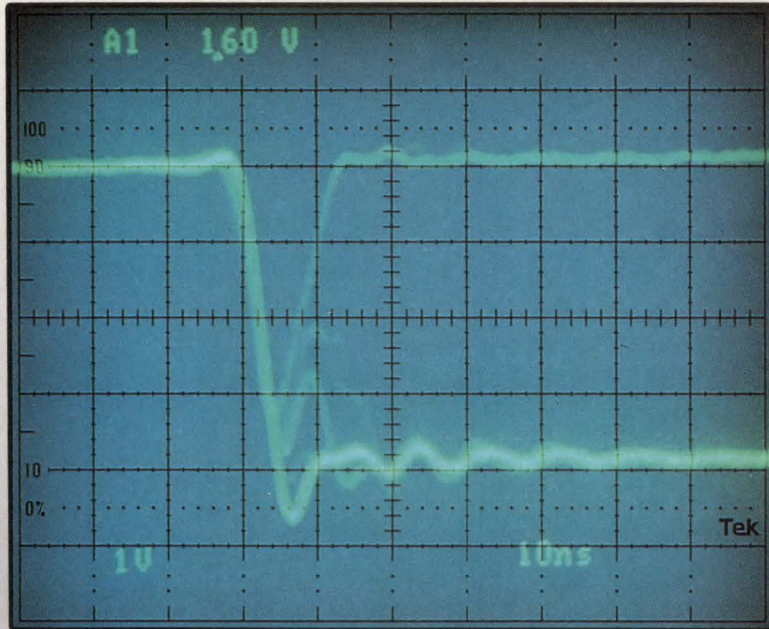

# VISIBLE! ONLY FROM TEK.

Now you can locate elusive glitches, pulses and infrequent events other scopes fail to show—using the 350 MHz Tek 2467 Transient Intensifying Oscilloscope.

faults in normal room light. You don't need a viewing hood. Being able to pinpoint problems this readily makes the critical difference in many troubleshooting situations. In short, seeing is believing.

## 350 MHz Tek 2467.

The 2467's 4 cm/ns visual writing speed is 100 times faster than that of any other portable instrument, thanks to Tek's patented microchannel plate CRT.

## What it displays, competitors don't even see.

The result: you see everything that happens in your circuit, whether it occurs once or repetitively. Including asynchronous noise, crosstalk, bus contention, marginal timing, metastability and even the one-in-a-million anomaly.

Because the 2467 specifies *visual* writing speed, not the *photographic* writing speed of other scopes, you can view all

Four independent channels, 500 ps/sec sweep speeds, 1% timing accuracy and 2% vertical accuracy enhance the 2467's problem-solving power.

Built-in automation features help speed your troubleshooting even more and make this one of the easiest scopes to use. It sets up in seconds, for example, at the push of a button.

Ask your Tek representative for a 2467 demonstration—and see just what you've been missing. For additional information, return the reply card or call Tek direct: 1-800-426-2200.

## A complete measurement package that sets up in seconds.

## When the measurement counts, count on Tek.

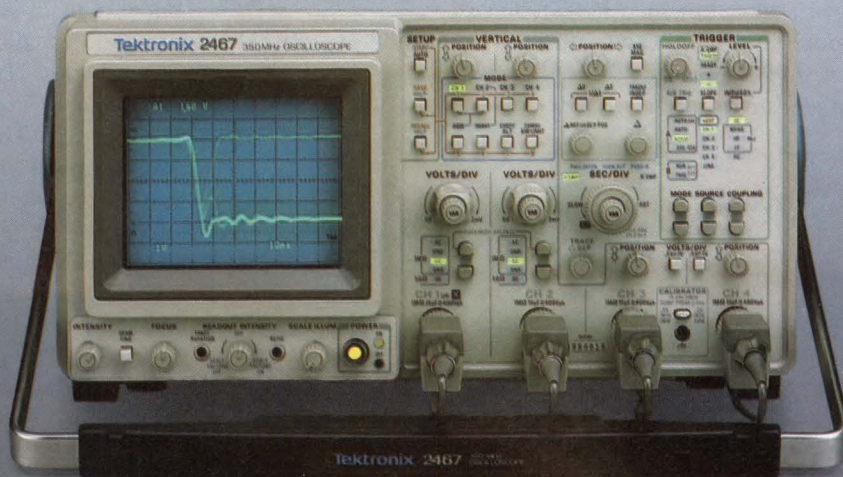

**Tektronix**  
COMMITTED TO EXCELLENCE

# NEW PRODUCTS

## INTEGRATED CIRCUITS

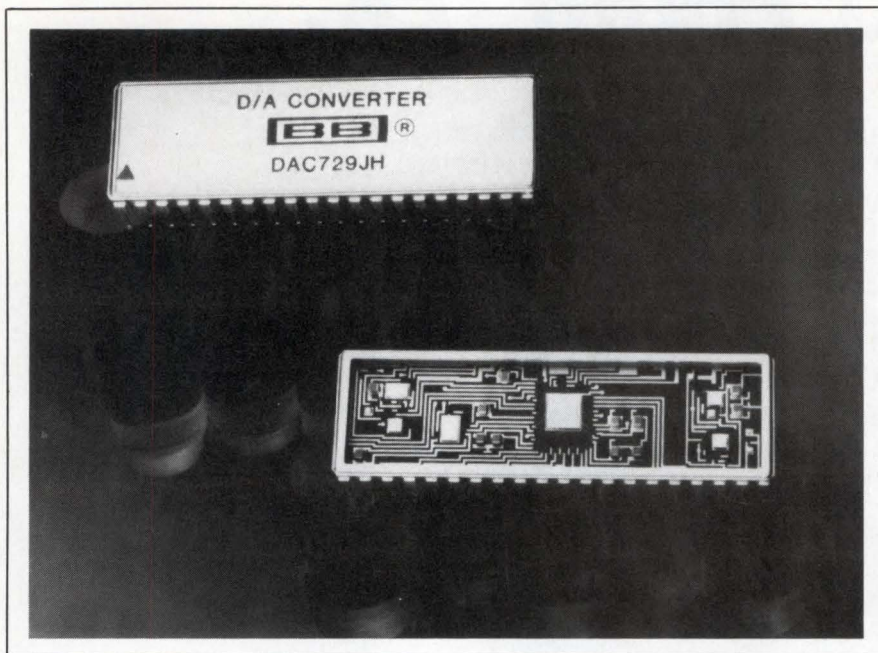

### 18-BIT DAC

- Ultra-high resolution
- Fast-settling internal op amp

As supplied from the factory, the DAC729 features a guaranteed linearity of 16 bits and is user adjustable to 18-bit linearity. It includes a low-drift 10V reference and a low-drift, low-noise output amplifier. The device settles to  $\pm 0.00076\%$  of full-scale range in 8  $\mu\text{sec}$  for a full-

scale voltage step, and in 300 nsec for a full-scale current step. The DAC729 is offered in two performance grades and has a specified 0 to 70°C temperature range. The voltage output ranges include  $\pm 2.5$ ,  $\pm 5$  and  $\pm 10\text{V}$ . In a 40-pin ceramic DIP, \$141 (100).

**Burr-Brown**, Box 11400, Tucson, AZ 85734. Phone (602) 746-1111. TWX 910-952-1111.

Circle No 351

tion from  $-55$  to  $125^\circ\text{C}$  and meet the requirements of MIL-STD-883B/S. 2473, \$443; 2478, \$502; 2491, \$292 (100).

**Teddyne Philbrick**, 40 Allied Dr, Dedham, MA 02026. Phone (617) 329-1600.

Circle No 352

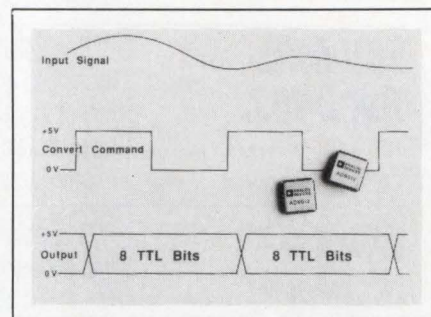

### 8-BIT FLASH ADC

- 180-MHz bandwidth
- TTL compatible

The AD9012 monolithic 8-bit flash A/D converter provides typical word rates of 100 MHz and has TTL-compatible digital outputs. It has a guaranteed minimum encoding rate of 75 MHz, and its 180-MHz bandwidth allows signal-sampling beyond the Nyquist rate without the need of an external track-and-hold circuit. The device features an input capacitance of only 16 pF, thereby reducing the demands on an input buffer. The S/N ratio is  $>46$  dB, and the harmonic suppression is 54 dB from dc to 1.23 MHz. The linearity grades are  $\pm 1/2$  LSB and  $\pm 3/4$  LSB. The power consumption is  $<1.2\text{W}$ . You can order the AD9012 in either a 28-pin DIP or a 28-pin ceramic LCC package. The device is available in both industrial and military temperature grades. From \$70 (100).

**Analog Devices**, Literature Center, 70 Shawmut Rd, Canton, MA 02021. Phone (617) 935-5565. TWX 710-394-6577.

Circle No 353

### SMPS POWER HYBRIDS

- MIL-STD-883 3-chip set
- Operates to 500 MHz

With the addition of a transformer, input and output filters, and two capacitors, the 2473, 2478, and 2491 hybrid ICs form a complete switch-mode power supply. The 2491 is a regulating pulse-width modulator that provides all the control functions for a dc/dc converter. Operating at 167 kHz as normally supplied, the factory can modify the 2491 to operate at any frequency from 50 to 500 kHz. The 2473 is a power driver/switcher that includes two 30A FET

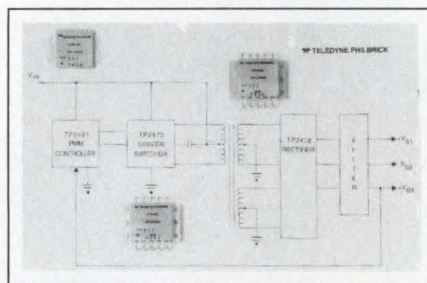

switches. Configured for a 100W converter, the 2473 is capable of 85% efficiency. The 2478 is a combination full-bridge/half-bridge Schottky rectifier that features a low forward-voltage drop of 0.9V at 20A, and a maximum rating of 40A. The hybrids are specified for opera-



# Sweet 16! (MHz)

## Our new static CMOS 80C286!



### Low power is the icing on the cake.

Now you can have your cake and eat it too: a 16 MHz high-throughput microprocessor with low CMOS power consumption.

Complete compatibility with the NMOS 80286: same pinout, same advanced multitasking architecture, same instruction set, same software. But with 16 MHz performance and a 60% reduction in operating power.

Static CMOS design eliminates trade-offs required by NMOS microprocessors. You get top-end throughput (@ 10, 12.5, or 16 MHz) when you need it or you can stop our 80C286 and put your system into standby without

fear of data loss or instruction execution errors. In either case, the Harris 80C286 has the lowest power requirement of any 80286.

Designed with multitasking in mind, the 80C286 is an exceptional performer in real-time control, portable instrumentation and data acquisition applications. And, coupled with our 80C86, 80C88 and F.O.R.C.E.-based microprocessors for distributed processing, the 80C286 is a great host.

Upgrading your system performance is a piece of cake with our 80C286. Give us a call and join the party. In U.S. phone 1-800-4-HARRIS, Ext. 1286.

In Canada, 1-800-344-2444, Ext. 1286.

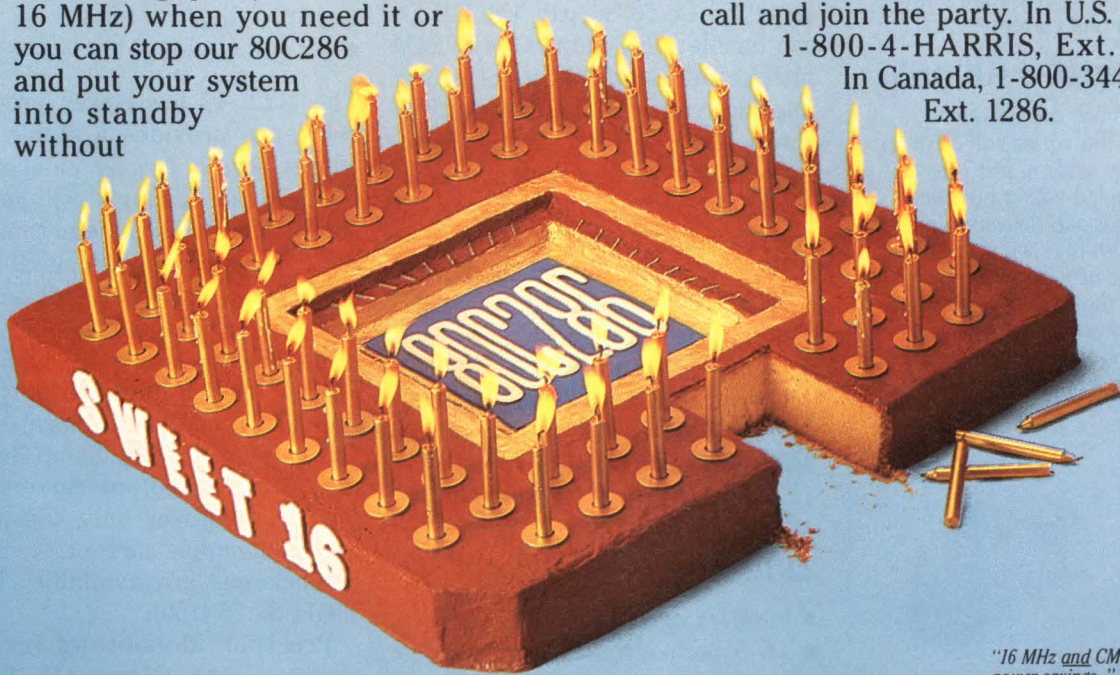

IN MICROPROCESSORS,  
THE NAME IS  
**HARRIS**

Harris Semiconductor: Analog - CMOS Digital  
Gallium Arsenide - Semicustom - Custom



"16 MHz and CMOS power savings..." "NMOS can't hold a candle to it!"



Because you're thinking fast... count on us for the speed you need.

## Now, 19ns settling op amps that survive saturations and shorts...

Comlinear's two new high-speed op amps bring you built-in protection against saturation. Plus simple short-circuit protection. That means easy solutions for fast input and output amplifiers in systems where signal level or load can't be controlled.

## use as little as 57mW...

Our new 170MHz CLC205 offers fast dynamic performance and power consumption down to 57mW (with  $\pm 5V$  supplies). A settling time of 24ns to 0.05% is complemented by the drive performance of a  $\pm 12V$  output swing and  $\pm 50mA$  output current.

## or drive up to $\pm 100mA$ .

For higher drive, call for our 180MHz CLC206 which will drive up to  $\pm 100mA$  and settle in just 19ns (to 0.1%). It is coupled with a high slew rate of  $3400V/\mu s$  and delivers a large-signal bandwidth of 70MHz at  $20V_{pp}$ .

Both of these new op amps give you saturation and short-circuit protection plus *tested and guaranteed performance at half the price of other high-speed amps*. Now you can be safe at high speed.

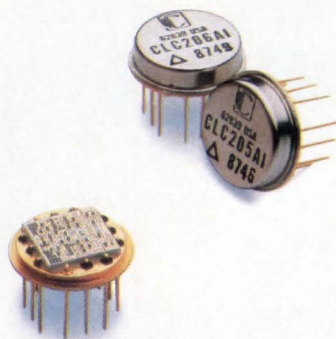

CIRCLE NO 38

**Comlinear Corporation**  
Solutions with speed

4800 Wheaton Drive  
Fort Collins, Colorado 80525  
(303) 226-0500

©1988 Comlinear Corporation

## INTEGRATED CIRCUITS

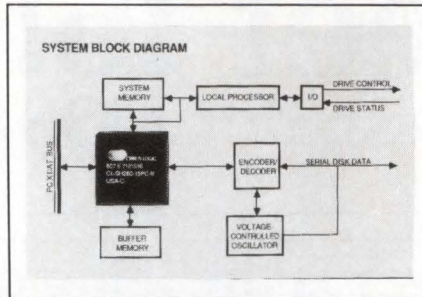

### DISK CONTROLLER

- Interfaces with bus for IBM PC/XT and PC/AT
- Integrates three functions

The CL-SH260 hard-disk controller chip provides a real-time hardware and software interface for the IBM PC/XT, PC/AT, and compatible computers. The device integrates formatter, buffer-manager, and bus-controller functions on a CMOS chip. Designed for computers using an 80286 or 80386  $\mu P$ , the SH260 can handle NRZ data rates to 24M bits/sec and supports a 1:1 sector interleave on the hard disk. The chip's bus interface includes automatic wait-state generation for compatibility with  $\mu P$ s running at speeds from 6 to 20 MHz. The SH260 is compatible with ST506, ST412, ST412HP, ESDI, and SMD disk interfaces. The chip is packaged in an 84-pin PLCC. \$30 (5000).

Cirrus Logic, 1463 Centre Pointe Dr, Milpitas, CA 95035. Phone (408) 945-8300. TLX 171918.

Circle No 354

### 32-BIT RISC $\mu P$

- 25-MHz operating frequency
- 4G-byte direct-address space

Fabricated in standard-cell CMOS, the S-25 RISC (reduced-instruction-set computer)  $\mu P$  can sustain an average processing rate of 15 MIPS at a clock rate of 25 MHz. Using the chip's SPARC (Scalable Processor Architecture) design, it is possible to develop compatible products that increase in performance. The chip also provides a 4G-byte direct-address space and 256 pages of 4G-byte indirect-address space. The

majority of S-25 instructions execute in a single cycle. Samples will be available in July, with production scheduled for September 1988. \$325 (5000).

Fujitsu Microelectronics, 50 Rio Robles, San Jose, CA 95134. Phone (408) 922-9000.

Circle No 355

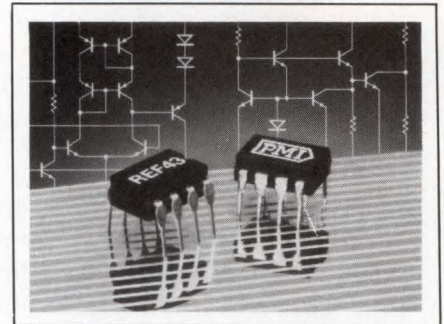

### LOW-POWER REFERENCE

- 2.5V output
- 1.5-mV tolerance

The REF-43 low-power precision reference provides a stable 2.5V output that is largely independent of variations in supply voltage, load conditions, and ambient temperature. The reference is suitable for use in 8-, 10- and 12-bit data-acquisition systems, including those operating from a single 5V rail. The REF-43 has an initial output tolerance of 1.5 mV and a thermal drift of  $<10$  ppm/ $^{\circ}C$ . Capable of delivering 10 mA of output current, the REF-43 requires only 450  $\mu A$  of quiescent supply current. A variety of packages are available. REF-43GP, \$3.75 (100).

Precision Monolithics Inc, Box 58020, Santa Clara, CA 95052. Phone (408) 727-9222.

Circle No 356

### DUAL COMPARATOR

- 2.3-nsec propagation delay
- Low power dissipation

The HCMP96870A ultra-high-speed dual comparator is an improved version of the industry-standard AM6687. The improvements include

# High-Rel ACL Reporting for Duty



**Advanced CMOS Logic is the newest reinforcement in the world's broadest High-Rel CMOS product line.**

If you're designing tactical military systems, it's more logical than ever to come to GE Solid State for all your High-Rel logic needs. Because we've just introduced well over 50 ACL logic devices that give you the speed of FAST<sup>†</sup> plus all the benefits of CMOS. These devices, fully compliant to Mil-Std-883 Rev C, are available in both AC and ACT (TTL-compatible) versions.

**Call toll-free, 800-443-7364 ext.23**

In Europe, call: Brussels, (02) 246-21-11; Paris, (1) 39-46-57-99; London, (276) 68-59-11; Milano, (2) 82-291; Munich, (089) 63813-0; Stockholm (08) 793-9500.

## Reporting for Duty

Two Hex Inverter/Buffers\*

Three Quad 2-Inputs\*

Three Dual Flip-Flops

Two 3- to 8- Line Decoder

Demultiplexers\*

Two Quad 2-Inputs Multiplexers

\*Standard Military Drawings available

One 4-Bit Full Adder with Fast Carry

Two 4-Bit Binary Counters

Two Synch 4-Bit Binary Up-Down Counters

Two Octal Buffer Line Driver 3-State\*

Two Octal BUS Transceiver 3-State\*

One Quad 2- to 4- Line Data Selector

One 9-Bit Odd/Even Parity Generator/Checker

Three Octal Buffer Line Driver 3-State (Inverting)\*

One Octal Transparent Latch 3-State

One Octal D-Type Flip-Flop 3-State\*

One Octal Transparent Latch 3-State(Inverting)

One Octal Inverting Transparent Latch 3-State

<sup>†</sup> FAST is a trademark of Fairchild Semiconductor Corp.



**GE Solid State**

**GE/RCA/Intersil Semiconductors**

Three great brands. One leading-edge company.

\*Trademark of General Electric Company, U.S.A.

a shorter propagation delay of 2.3 nsec, faster rise and fall times of 1.2 nsec, reduced hysteresis, and higher input slew rates. The device also features a power dissipation of 250 mW, which is lower than that of competitive devices, according to the manufacturer. It's available in a 16-pin ceramic DIP and a 20-terminal LCC. The operating temperature range is  $-25$  to  $+85^{\circ}\text{C}$ . In a 16-pin DIP, \$8.49 (100).

**Honeywell Inc**, 1150 E Cheyenne Mountain Blvd, Colorado Springs, CO 80906. Phone (719) 540-3900.

**Circle No 357**

## 2- TO 6-GHz MMIC

- *Small-signal gain of 11.5 dB*
- *Power output of 13 dBm*

Fabricated in GaAs, the HMM-10620 MMIC (monolithic microwave IC) operates over a frequency range of 2 to 6 GHz with a typical gain of

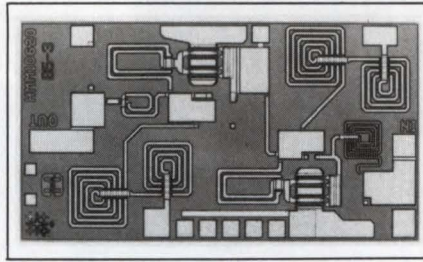

11.5 dB. Gain flatness is  $\pm 0.5$  dB. The MMIC includes two GaAs FET gain stages that have negative feedback. At a supply voltage of 8.5V, the typical current drain is only 40 mA. Power output at 1-dB compression is 13 dBm (typ); the noise figure is 5.5 dB (typ). The HMM-10620 is directly cascadable; it does not require external dc-blocking at the RF output port. The chip uses a TiPtAu metallization system and is available screened to MIL-S standards. \$50 (1000).

**Harris Microwave Semiconductor**, 1530 McCarthy Blvd, Milpitas, CA 95053. Phone (408) 433-2222.

**Circle No 358**

## LCD DRIVER

- *Handles 32 LCD segments*
- *2000V ESD protection*

Fabricated in CMOS, the AY0438I is a 32-segment liquid-crystal-display (LCD) driver that provides ESD (electrostatic discharge) protection to 2000V. The AY0438I can drive any parallel LCD, whether standard or custom. The driver accommodates 7-, 9-, 14-, or 16-segment characters as well as decimals and positive and negative symbols. To reduce the number of control lines to three, the device uses serial inputs. The AY0438I, which includes

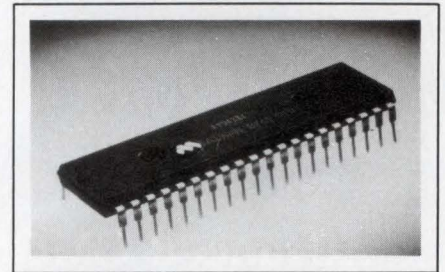

# Color by

**S**un Microsystems' Sun-4/260 workstation with the TAAC-1 Applications Accelerator lifts visualization capabilities to new heights. Brooktree provides the lift with four Bt458 RAMDACs small enough to fit on a single board. The result: Amazing detail in both pseudo and true color.

an on-chip oscillator, is compatible with CMOS, NMOS and TTL devices. \$2.45 (5000).

**Microchip Technology Inc**, 2355 Chandler Blvd, Chandler, AZ 85224. Phone (602) 963-7373.

**Circle No 359**

## DUAL S/C FILTERS

- 30-kHz and 150-kHz capability
- All filter configurations

The ML2110 and ML2111 switched-capacitor (S/C) filters work at frequencies to 30 kHz and 150 kHz, respectively. Both filters provide bandpass, lowpass, highpass, allpass, and notch outputs. The devices support all filter configurations, including Butterworth, Chebyshev, Bessel, and Cauer. Each unit includes two independent second-order filters on a single chip. You can use each of the independent filters as a first-order or second-

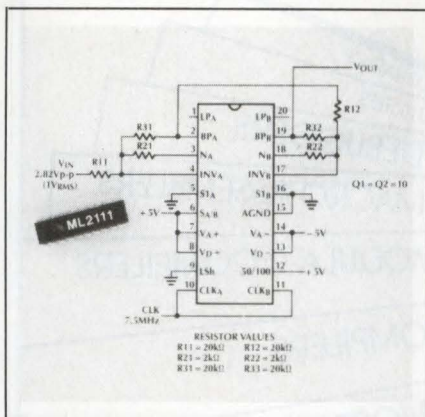

order (quadratic) filter. With one ML2110 or ML2111, a user can realize two second-order filters or a single fourth-order filter. The devices differ from each other only in their maximum operating frequency and the product of Q and the center frequency. They operate from  $\pm 5V$  or  $\pm 2.5V$  (the latter voltage provides a reduced frequency capability). Packages include 20-pin DIP and 20-pin SOIC. In a 20-pin DIP, ML2110, \$3.75 and ML2111, \$6.75;

in a 20-pin SOIC, ML2100, \$3.85 and ML2111, \$7.15 (100).

**Micro Linear Corp**, 2092 Concourse Dr, San Jose, CA 95131. Phone (408) 433-5200.

**Circle No 360**

## PBX FILTER CHIP

- Digital operation
- C-Message weighted

Fully digital in its operation, the S3541 filter chip has a C-Message weighted filter for sounds in the 35-Hz to 4-kHz range, a 35-Hz highpass filter to remove low frequencies, and a 1-kHz notch filter for use within US telephone-system voice- and data-communications channels. It's designed for installation directly on a customer line to remove noise, for line-test instrumentation systems, or in PABX diagnostic sections to monitor line noise. According to the vendor, the

# Brooktree®



**Brooktree Bt458.** Triple 8-bit color RAMDAC. Available in speeds from 80 MHz to 125 MHz.

**Sun Microsystems' Sun-4/260 Workstation with TAAC-1.** Provides pseudo color (8 bit) and true color (24 bit), with a choice of 256 colors or 16.8 million colors.



Brooktree Corporation,  
9950 Barnes Canyon Road,  
San Diego, California 92121  
1-800-VIDEO IC.

© Copyright Brooktree Corporation 1988.

**CIRCLE NO 47**



**INTROL CORPORATION**  
647 W. Virginia St.  
Milwaukee, WI 53204  
Phone: 276-2937  
Fax: 276-7026

LIBRARIES  
UTILITIES  
DEBUGGERS  
MACRO ASSEMBLERS  
MODULA-2 COMPILERS  
C COMPILERS

**MAKE THE MOST EFFICIENT USE OF YOUR TARGET PROCESSORS' RESOURCES WITH INTROL CROSS DEVELOPMENT TOOLS.**

■ TARGETS SUPPORTED:  
6804 6805 6301/03 6801/03  
6809 68HC11 68000/08/10/12  
68020/30/881/851 32000/81/82

■ Available for the following hosts:  
■ VAX ■ APOLLO ■ SUN  
■ PC, XT, AT & COMPATIBLES  
■ GOULD POWER NODE

CIRCLE NO 45

## X.25 Software

**Before you make a decision, make a phone call.**

- C source code license
- Rsys™ PAD option
- Certified—Telenet, Tymnet, DDN, European PTTs
- Multiple X.25 line capability
- On-line configuration
- Runs on any hardware for which a C compiler exists



One phone call can save you tens of thousands of dollars and cut many months off your product development schedule. Let us give you more details on the benefits of Gcom X.25 and show you how affordable superior data communications software can be.



**Gcom, Inc.**  
Specialists in Computer Communications  
41 E. University  
Champaign, IL 61820  
Phone (217) 352-4266  
Telex: 910-240-1477

CIRCLE NO 46

## INTEGRATED CIRCUITS

chip offers several advantages over comparable analog products, such as freedom from temperature drift, an efficient serial interface, a compact parallel  $\mu$ P interface, and better accuracy. The device meets all specifications of Bell publication 41009 and IEEE Standard 743. In a 28-pin DIP, \$17.95 (1000).

**Gould Inc.**, Semiconductor Div, 3800 Homestead Rd, Santa Clara, CA 95051. Phone (408) 246-0330.

Circle No 361

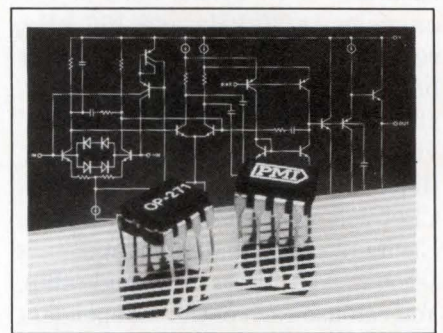

### DUAL OP AMP

- 5-MHz gain-bandwidth product
- Low offset voltage

The OP-271, a unity-gain-stable dual op amp, features a typical slew rate of  $8.5\text{V}/\mu\text{sec}$ , a settling time to 0.01% of  $2\ \mu\text{sec}$ , and a gain-bandwidth product of 5 MHz. The input offset voltage is  $75\ \mu\text{V}$  typ and  $200\ \mu\text{V}$  max. The open-loop gain exceeds 400,000 and the input bias current of 20 nA minimizes the dc error caused by source resistance. The common-mode rejection is a minimum of 106 dB. Packaged in an 8-pin ceramic DIP, the device conforms to the industry-standard dual op amp pinout and is a pin-compatible upgrade for the TL072, TL082, LF412, and 1458/1558 dual op amps. Industrial grade, \$4.50; military grade, \$10.50 (100).

**Precision Monolithics Inc.**, Box 58020, Santa Clara, CA 95052. Phone (408) 727-9222. TLX 713719541.

Circle No 362

# PHILIPS IR SENSORS



## YOUR DESIGN ENGINEER MAY BE OVERWHELMED BY THE SELECTION.

Go ahead. Indulge yourself. Philips offers the broadest selection of low-cost, high performance ceramic Pyroelectric Infrared (PIR) sensors. From \$2.75 to \$595. No matter what your application, Philips has a PIR sensor with the performance you need, at a price you've been looking for. Pick your application. We've got you covered. From the top-of-the-line TO-5 standard package to the "flatpack" series: KRX-10 (with filtered window for simplifying circuit design) and KRX-11 (with un-coated window for lower cost).



### WRITE YOUR IR APPLICATION HERE:

Then mail this coupon and we'll send you technical publications and data sheets on Philips PIR sensors. Also included: a free samples offer.

Name \_\_\_\_\_

Title \_\_\_\_\_

Company \_\_\_\_\_

Address \_\_\_\_\_

City/State/Zip \_\_\_\_\_

Telephone/ext. \_\_\_\_\_

Your application: \_\_\_\_\_

Your specific interest: \_\_\_\_\_

Mail to: Amperex Electronic Company, 1 Providence Pike, Slatersville, RI 02876  
EDN052688  
ATTENTION: Marketing Communications

NOTE: Only Philips combines a "flat-pack" design that cuts costs with a patented process that boosts signal output. The result: range and performance that are much more than you'd expect...at a price you wouldn't. Also note that products are normally supplied in "bandolier" packaging for compatibility with automatic insertion equipment.

IR sensor applications are growing. You need a reliable supplier, a high quality product, and a full product range to meet all your needs. Think Philips. We have a low cost, high quality PIR sensor for any and all applications. And our large in-place capacity guarantees on-time, promised deliveries.

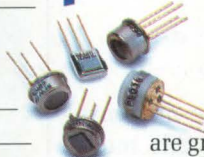

# Amperex®

OPTOELECTRONIC PRODUCTS GROUP

## PHILIPS



CIRCLE NO 86

# NEW PRODUCTS

## COMPONENTS & POWER SUPPLIES

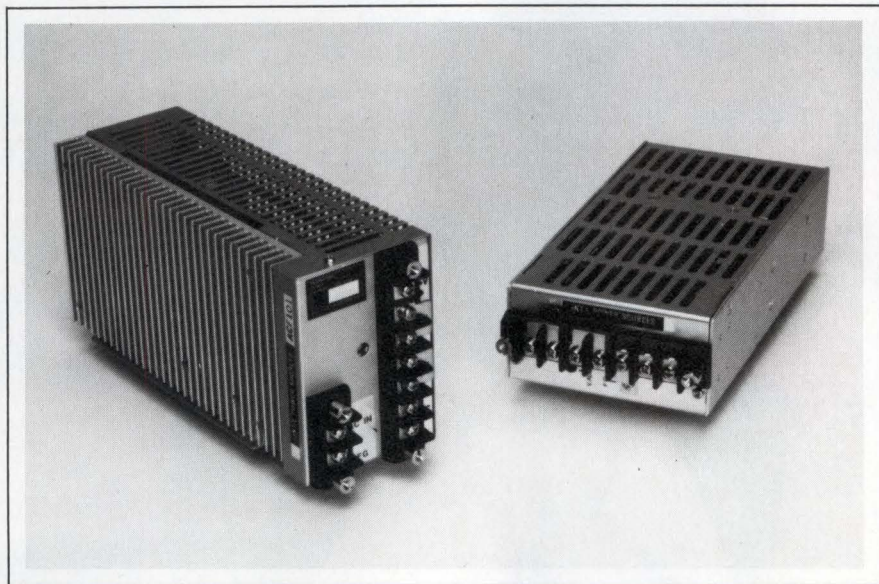

### DC/DC CONVERTERS

- Have efficiency ranges to 90%
- Feature adjustable outputs

The chassis-mount DCE Series 100W and DCF Series 150W dc/dc converters feature efficiencies as high as 90%. Outputs of 5, 12, 15, and 24V are available from four nominal inputs of 12, 24, 48, and 110V. These convection cooled units are packaged in brushed aluminum cases and are specified for full rated

load to 50°C. All models feature adjustable outputs ( $\pm 10\%$ ), input filter, overvoltage protection, and short circuit protection. In addition, the DCF units include remote sense and disable as standard. DCE Series, \$129 (OEM qty); DCF Series, \$199. Delivery, six to eight weeks ARO.

**International Power Sources Inc.**, 10 Cochituate St., Natick, MA 01760. Phone (617) 651-1818.

Circle No 385

### SWITCH MODULE

- Features a 24×36-pixel display matrix
- Integrates an LCD and driver into spst switch keycap

Designed to minimize the man/machine interface problem, this module integrates a low-power LCD, with LED backlighting, and a custom IC driver into the keycap of a spst, momentary-action switch. The super-twist LCD consists of 864 pixels in a 24×36 matrix which provides full screen graphics capability. You can also operate the unit as a 5×7 alphanumeric display and realize three lines of as many as six characters per line. The 0.875×0.75-

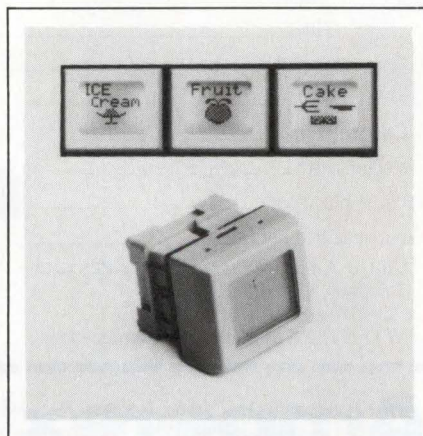

in. module is designed for through-panel mounting and requires only 0.75 in. behind-the-panel space. It has a 0 to 40°C operating range, 1 $\Omega$  max contact resistance, and a life-

time spec of one million operations. \$40.72 (100).

**IEE Inc.**, Component Products Div, 7740 Lemona Ave, Van Nuys, CA 91409. Phone (818) 787-0311.

Circle No 386

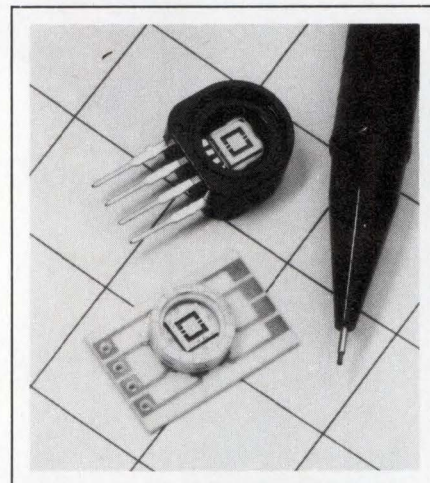

### ACCELEROMETER

- Specified for 12V operation
- Has 200g measurement capability

The SXL Series accelerometers employ a 0.16×0.16-in. sensor chip. A special cavity and boss structure are micromachined into each chip and four piezoresistive elements are ion-implanted into each chip to form a wheatstone bridge sensor. The three units in the series have measurement capabilities ranging to 10, 50, or 200g. While the devices are specified for operation at 12V dc, you can operate with any supply between 3 and 15V. Typical full scale outputs are 50 to 100 mV and accuracy is better than 0.1% of full-scale output (FSO). Cross-sensitivity is less than 1% FS output. Standard units are housed in a ceramic package. Other package options are available on request. \$57

**Sensym Inc.**, 1255 Reamwood Ave, Sunnyvale, CA 94089. Phone (408) 744-1500.

Circle No 387



**ONCE YOU'VE  
SEEN FUJITSU'S AC  
PLASMA DISPLAY,  
YOU'LL TAKE A  
DIM VIEW OF  
ANYTHING ELSE.**

CIRCLE NO 93

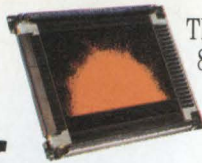

The only way our bright new 8050 display looks anything like the others is through a pair of sunglasses.

That's because the 8050 is without a doubt the brightest, most readable display in its class.

It's the first 10-inch, AC-memory, flat panel display to deliver 640 x 400 resolution with an extraordinary 44 foot-lamberts of brightness. Along with a contrast ratio of greater than 20:1. All in a package just over one inch thick.

In fact, the only thing more impressive than these numbers is looking at the display yourself. Then you'll really appreciate its exclusive solid black background. And the brightness and flicker-free clarity of text and graphics.

And what's truly amazing is that you'll get this remarkable performance under some of the worst possible conditions. Like bright sunlight. And viewing angles up to 120 degrees.

So if your application calls for the clearest images with maximum contrast, call us today at **1-800-556-1234, Ext. 238**. Inside California call, **1-800-441-2345, Ext. 238**. Or write Fujitsu Component of America, Inc., 3330 Scott Boulevard, Santa Clara, CA 95054-3197.

We'll brighten your day.



**FUJITSU**

**COMPONENT OF AMERICA, INC.**

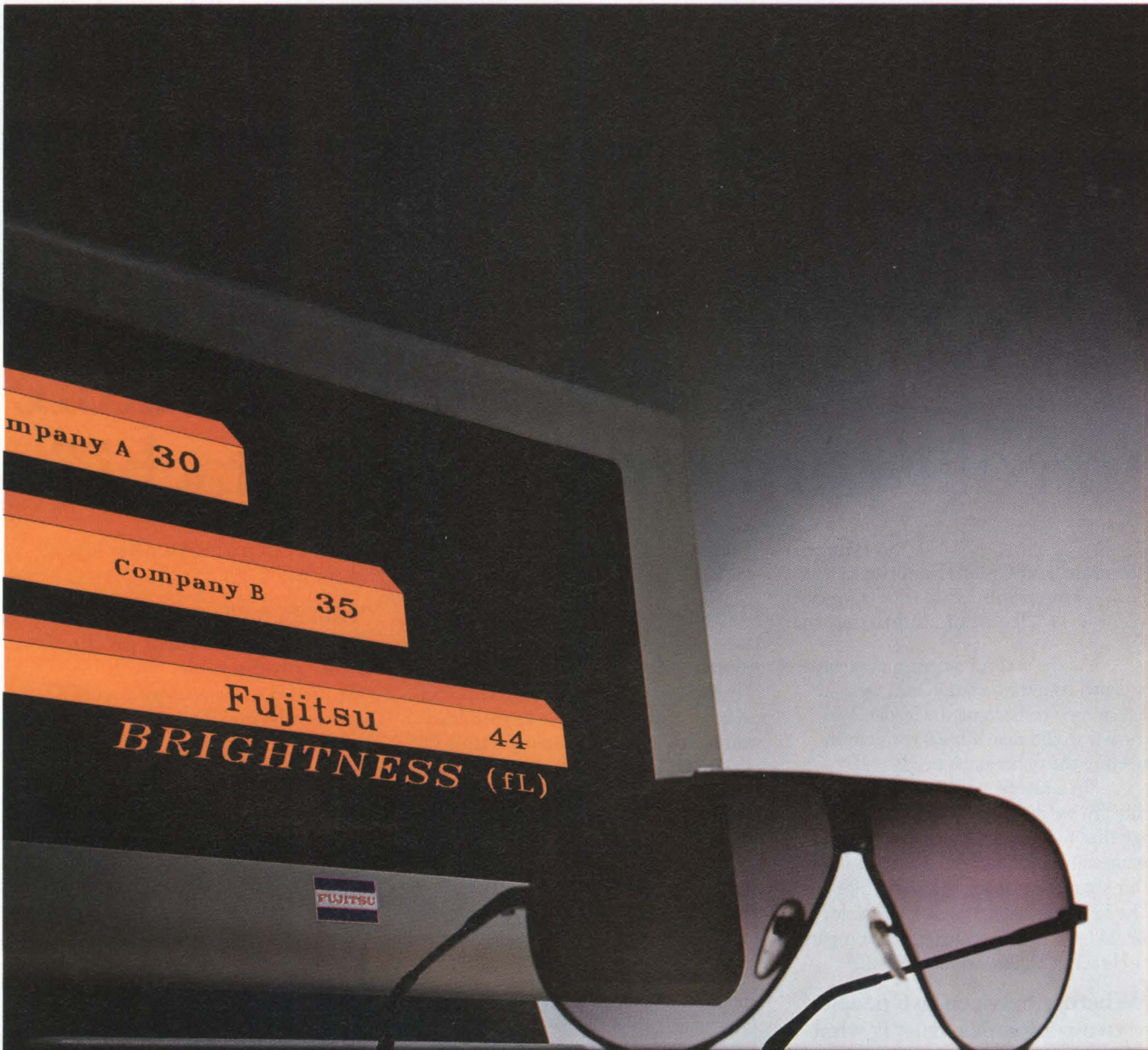

© 1988 Fujitsu Component of America, Inc.



# “We bet our entire company’s future on our partnership with Hitachi.”

—Jim Balkcom  
President and Chief Executive Officer  
Humminbird® Depth Sounders  
Techsonic Industries, Inc.

“As the second largest manufacturer of depth-sounding equipment, we were determined to become the leader. We knew it would take a breakthrough in meeting the fisherman’s needs.

“In strategic partnership with Hitachi, we developed the LCD technology that redefined the depth-sounder market and ultimately quadrupled its size. Our share went from 20 to over 50%. The new technology was a big risk for us. We laid the whole future of our company in Hitachi’s hands, and it paid off.”

**“Whether between two people, or two companies, trust is what makes partnerships work.”**

“We’ve shared technologies, design concepts, marketing plans and other critically confidential information across both sides

of the table. That’s partnership. Trust makes it work... and continue to grow.”

**“Hitachi defines quality the same way we do—meeting customers’ needs.”**

“Hitachi gives Techsonic the technological edge, and more. We’ve learned it’s a waste of time to do incoming testing on Hitachi LCDs. And when we sold over three times our forecast, they were flexible enough to come through for us. Whatever support we need, we get.

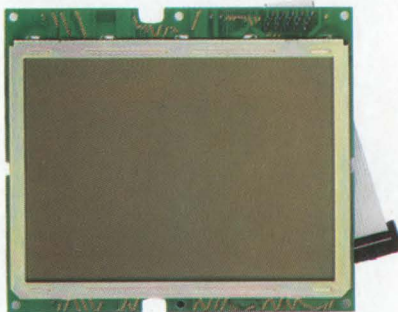

And the best part is, we never have to ask for it.”

**“Hitachi makes it clear that their most important product is our product.”**

“We needed to team up with an LCD supplier who had the expertise, the capabilities, and the desire to work with us to develop the right solutions. Partnering with Hitachi made Humminbird No. 1, and we’re sure it’s going to keep us there.”

To learn about how partnering with Hitachi can benefit your company, call Tom Klopocic or David Ross at (312) 843-1144. Or write to Hitachi America, Ltd., Electron Tube Division, 300 N. Martingale Road, Suite 600, Schaumburg, IL 60173.

 **HITACHI®**  
Hitachi America, Ltd.  
Electron Tube Division

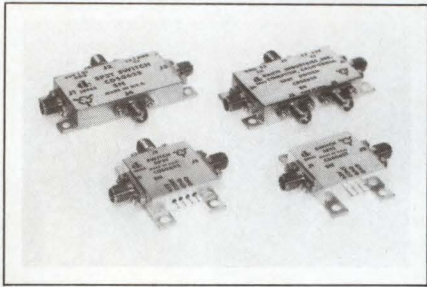

**RF SWITCHES**

- Feature replaceable SMA connectors
- -55 to +155°C operating range

Operating over 20 to 2000 MHz, CDS062X switches handle as much as 14 dBm of RF power over the full military range of -55 to +125°C. All of the switches feature standard replaceable SMA connectors. Each switch features integral TTL drivers, 50Ω terminations, and low power consumption—for example, 12 mA at 5V for the CDS0622. The typical isolation is more than 75 dB at frequencies as high as 1 GHz and

56 dB above 1 GHz. The insertion loss measures 0.9 dB below 1 GHz and 1.4 dB above 1 GHz. The switches are available with optional military screening. CDS0621 spst, \$270; CDS0622 spdt, \$336; CDS0623 sp3t, \$336; CDS0624 sp4t, \$372.

**Daico Industries Inc**, 2139 E Del Amo Blvd, Compton, CA 90220. Phone (213) 631-1143.

Circle No 388

**PANEL COUNTER**

- Provides a 7-digit count with two threshold levels
- Has several control outputs

The Dino panel counter can perform a variety of simple control functions—for example, level or positional control—without additional circuitry. Its DIN-standard 72-mm-square front panel houses an LCD display and a control keyboard. A 7-digit display indicates the current count,

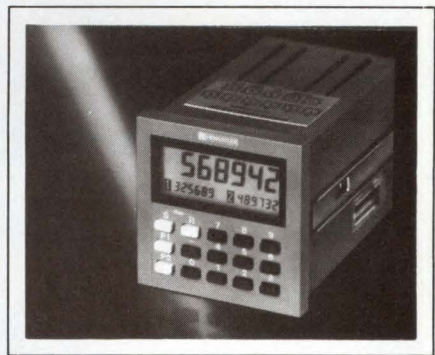

and two 6-digit displays indicate two preset counts that you can enter via the keyboard. To prevent unauthorized changes, you can totally or partially disable the keyboard. When the current count coincides with either of the preset counts, a corresponding control output is activated. The DIP-switch settings allow you to program these outputs into a bistable (above/below threshold) mode, or one of them into a monostable mode. Depending on the model, these outputs may be either changeover relay contacts or short-

FLUKE AND PHILIPS - THE GLOBAL ALLIANCE IN TEST & MEASUREMENT

What kind of power do Fluke 5100B Series Calibrators deliver best?

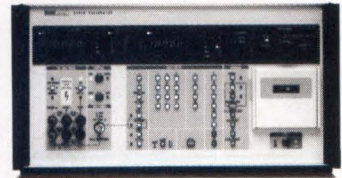

**Staying Power.**

More than 6,000 users have made the Fluke 5100B and 5101B Calibrators the standard in 4½ digit meter calibration. They're proven performers that can handle a big part of your meter calibration workload at a very affordable price. To get the latest on the Fluke 5100 B series, call us at **1-800-44-FLUKE**.



©1988 John Fluke Mfg. Co., Inc. Ad no. 0381-F5100

# CTS SOLID CERAMIC Surface Mount Resistor Networks

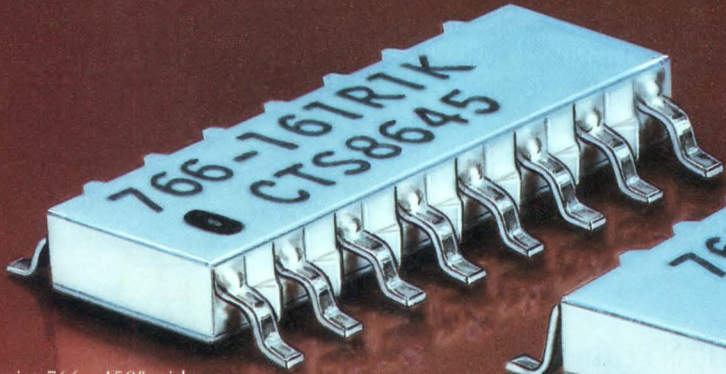

Series 766—.150" wide.  
Available in 14 and 16-pin styles.

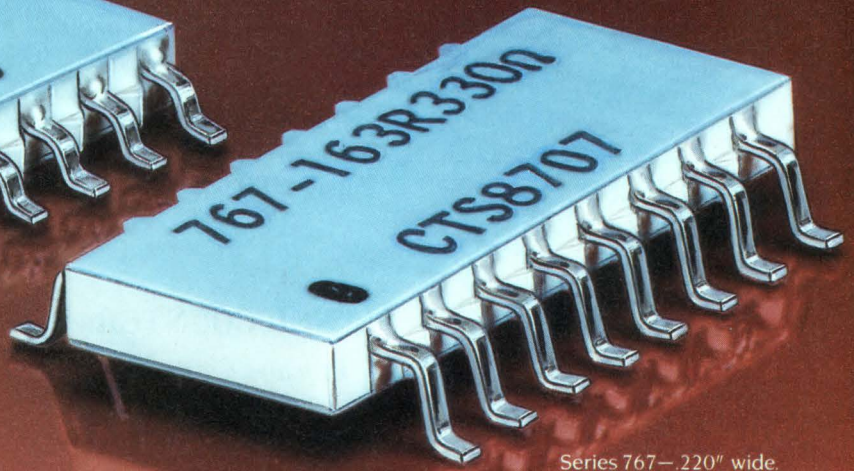

Series 767—.220" wide.  
Available in 14 and 16-pin styles.

## Now in two sizes... .150" and .220" wide

### CONSIDER THESE CTS SOLID CERAMIC ADVANTAGES:

- Compatible with all SOIC processes
- Custom circuits readily available
- Maximum power dissipation
- Dimensional accuracy and stability
- Vapor phase or IR solderable
- Meets MIL-R-83401 environmental test requirements

These CTS Solid Ceramic Surface Mount Resistor Networks are backed by the same resistor reliability that has set the industry standards for decades! Over 150,000 element years of continuous life testing confirms the reliability of each and every CTS network.



WRITE TODAY for new brochure entitled "CTS Surface Mount Resistor Networks." Contact: CTS Corporation, Berne Division, 406 Parr Road, Berne, IN 46711. Phone: (219) 589-8220. TWX: 810-323-1580.

CIRCLE NO 102

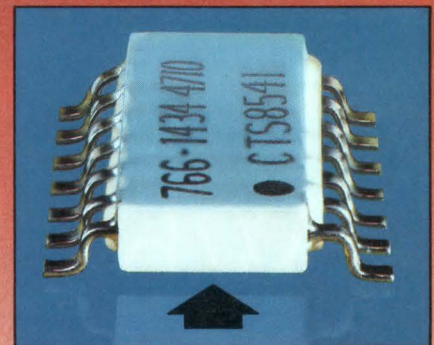

Ample space is provided between body and board for fast thorough cleaning after soldering.

Call TOLL FREE 1-800-982-0030  
for name and location of nearest  
CTS Sales Engineer

## CTS MEANS RELIABILITY

CTS CORPORATION • ELKHART, INDIANA

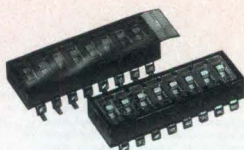

**Series 207—Surface mount,** process compatible AUTO-DIP™ Switches.  
Phone: (805) 238-0427  
CIRCLE NO 103



**Surface Mount Hybrid Clock Oscillators**  
Fully hermetic resistance weld packages.  
Phone: (815) 786-8411  
CIRCLE NO 104

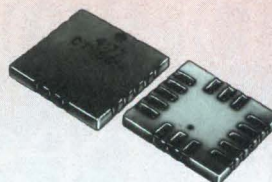

**Series 763 .350" x .350" Leadless**  
Up to 20 pads. Meets LCC pad configurations.  
Phone: (219) 589-8220  
CIRCLE NO 105

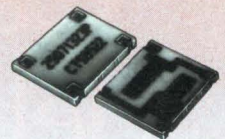

**Series 762 User Trimmable**  
Available in 8, 14, 16 or 18 solder pads.  
Phone: (219) 589-8220  
CIRCLE NO 106

circuit-protected transistor outputs. An additional output is provided to indicate a zero count condition, and a direction output indicates the current direction of counting. Nonvolatile storage of the control output conditions during power failures is available as an option. You can configure the counter inputs for continuous up or down counting, for difference counting, or as a 1-, 2- or 4-phase phase discriminator. The input frequency limits are 5 kHz and 30 Hz for electronically and mechanically generated pulses, respectively. The device operates from a 10 to 30V dc supply, or from a 100 to 270V ac supply. DM 500.

**Hengstler GmbH**, Postfach 100, 7209 Aldingen 1, West Germany. Phone (07424) 891. TLX 760422.

**Circle No 389**

**Hecon Corp.**, 15 Meridian Rd, Eatontown, NJ 07724. Phone (201) 542-9200. TLX 132457

**Circle No 390**

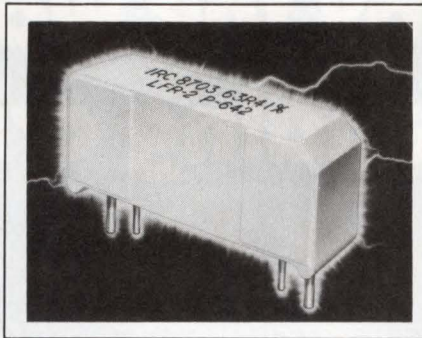

### THERMAL PROTECTORS

- Meet FCC, EIA, UL and CSA requirements
- Rated for 2W at 25°C

Units in the LFR-2 family of line-feed resistors provide board-level thermal protection for line cards and tip-and-ring circuits. The devices meet FCC, EIA, UL, and CSA safety requirements and are available in two basic versions: precision-grade and commercial-grade. Resistance values span a 1 to 30 kΩ range, power rating equals 2W at

25°C, and operating range equals -40 to +85°C. Temperature coefficients are as low as 40 ppm/°C for the precision units and 300 ppm/°C for commercial grade devices. Resistance tolerance measures 1, 2, and 3% for precision units and 5 and 10% for the commercial devices. LFR-2 units come in a 4-pin SIP. \$1.50 to \$2.50 (5000).

**IRC Inc.**, Box 1860, Boone, NC 28607. Phone (800) 255-4472; in NC, (704) 264-8861.

**Circle No 391**

### POWER MOSFET

- Dissipates 125W
- Features a Kelvin pin to eliminate internal voltage drops

The MTP40N06M power MOSFET is a current sense type device. It is rated for 40A, 60V and has a minimum on-resistance of only 40 mΩ. The device is housed in a 5-pin

FLUKE AND PHILIPS - THE GLOBAL ALLIANCE IN TEST & MEASUREMENT

What do you  
call Fluke  
5440B and  
5450A  
Calibrators?



## Tried and True.

When it comes to stable, repeatable performance, the Fluke 5440B DC Calibrator and 5450A Resistance Calibrator stand alone. They are simply the most accurate calibrators available. To find out more, call Fluke at **1-800-44-FLUKE**.



©1988 John Fluke Mfg. Co., Inc. Ad no. 0381-F5440/50

# E-T-A<sup>®</sup> Circuit Breakers. Accepted by the world's most demanding critics.



UL, CSA, VDE. Just some of the international approvals for the full line from E-T-A—an international manufacturer of some of the finest circuit breakers in the world.

E-T-A Circuit Breakers, including commercial-grade thermal, magnetic, and combination thermal-magnetic, are trip-free and foolproof. Each undergoes 100% calibration and testing. And there's one that's just right for your application.

E-T-A's line of On-Off Switch/Circuit Breakers, with options in illumination, handle color and style, offers you further design flexibility. The single or double-pole units fit in the same panel cutout. The balance of the line includes a variety of products with non-standard current ratings, as well as shunt tap and auxiliary contact options.

The same industry-pacing standards apply to E-T-A electronic flow and level sensors, and digital display instruments.

Call today or circle the number below for your E-T-A Specifications Catalog. E-T-A Circuit Breaker quality will quickly earn your approval too.



## E-T-A<sup>®</sup> CIRCUIT BREAKERS GROUP

**Setting the pace for circuit protection**

7400 NORTH CRONAME ROAD  
CHICAGO, ILLINOIS 60648  
312/647-8303  
FAX: 312/647-7494

TO-220 which is capable of dissipating 125W. The pinout includes the standard gate, drain, and source of the FET as well as a mirror and a Kelvin pin. You use the Kelvin pin to eliminate internal voltage drops which would cause erroneous sense voltage and an error in the current being sensed. This device mirrors the load current and reduces it by a factor of 900—the current mirror ratio—to reduce the power loss in the sense resistor by the same fac-

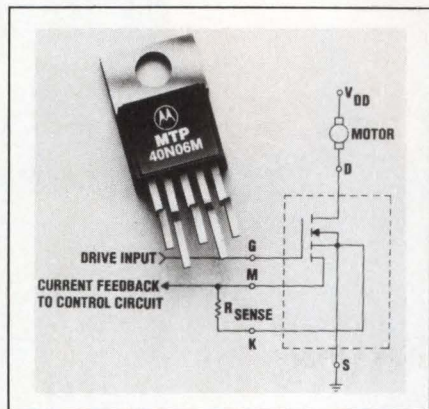

tor. \$2.80 (100). Delivery, four to 10 weeks ARO.

**Motorola Inc**, Semiconductor Products Sector, Box 52073, Phoenix, AZ 85072. Phone (602) 244-4911.

Circle No 392

**SWITCHES**

- *Designed for hazardous environments*
- *Immune to EMI/RFI*

These metal-cased units contain a fiber-optic snap-action switch. The enclosure is designed to provide protection for indoor/outdoor use as defined by NEMA standards for type 4 enclosures. Two switch types are available. One works with 230  $\mu$ m glass fiber to accommodate long distance applications. The second switch is compatible with 1000  $\mu$ m plastic fiber for use in short distance applications. Both types operate

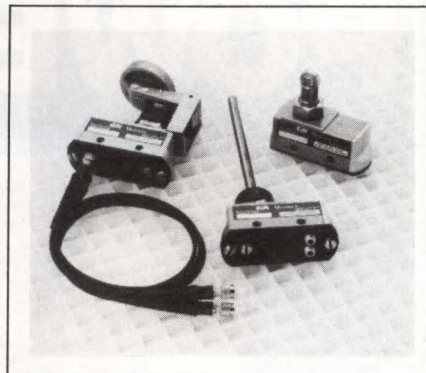

over a  $-54$  to  $+71^{\circ}\text{C}$  range. The switches are immune to EMI/RFI and do not introduce any EMI/RFI into the environment. The enclosures are available with a variety of actuators—plain plunger, roller plunger, rod actuator, large knob, roller lever, and spring-loaded roller. \$40 to \$150. Delivery, six to eight weeks ARO.

**C&K/Unimax Inc**, Ives Rd, Wallingford, CT 06492. Phone (203) 269-8701.

Circle No 393

FLUKE AND PHILIPS - THE GLOBAL ALLIANCE IN TEST & MEASUREMENT

How do you get the legal volt from Fluke?

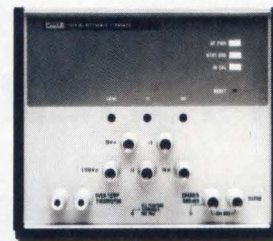

Standard Delivery.

The Fluke Direct Voltage Maintenance Program can deliver the standard legal volt right to your lab. It's the most convenient way to maintain your traceability to national standards, while minimizing downtime. And only Fluke has it. Call us at 1-800-44-FLUKE for details.



©1988 John Fluke Mfg. Co., Inc. Ad no. 0381-DVMP

CONFIGURE-YOUR-OWN  
MIL SPEC • HIGH RELIABILITY  
**POWER SUPPLIES**



## A HIGHER LEVEL OF PERFORMANCE

INTRODUCING EL 2000 SERIES

Complete AC to DC and DC to DC multi output systems.

### MORE BENEFITS

**Save Space:** Completely protected AC-DC systems with rugged high density packaging to 8 watts/in<sup>3</sup>.

**Less Heat:** Efficiencies to over 80% with next generation circuitry.

**Higher Reliability:** MTBF to 500,000 hours with conservative design criteria including NAVMAT guidelines.

### MORE CHOICES

- Up to 8 DC outputs to 500 watts.
- 1 $\phi$ , 3 $\phi$  and DC inputs.
- -55°C to +85°C operation.
- Mil-Std-704A-D, 1399 and 1275 input surge and spike protection.
- Meets many provisions of Mil-Std-810D, Mil-E-5400 and Mil-E-16400.

**Call or write for our new EL 2000 Catalog today!**



## ARNOLD MAGNETICS CORPORATION

4000 Via Pescador, Camarillo, California 93010-5049

Phone: (805) 484-4221 • TWX 910-343-6468 • FAX: (805) 484-4113





**DISPLAY**

- Operates over  $-30$  to  $+85^{\circ}\text{C}$
- Available in pinned and pinless versions

Model FE0203 is a  $3\frac{1}{2}$ -digit liquid crystal display. In addition to the 0.5-in. digits, the display includes three decimal points, a low battery annunciator, a plus/minus sign, and a colon. The unit comes in transmissive, reflective, and transfective versions and is available with DIP connector pins or is pinless for use with elastomeric connectors. The displays measure  $2 \times 1.2$  in. Its

standard operating range equals  $-20$  to  $+60^{\circ}\text{C}$ , but is available with an extended operating range of  $-30$  to  $+85^{\circ}\text{C}$ . \$7.98 (100).

AND, 770 Airport Blvd, Burlingame, CA 94010. Phone (415) 347-9916.

Circle No 394

**INDICATOR**

- Compatible with multiple sensors
- Has automatic resolution capability

Model 500T, a digital temperature indicator, is compatible with type J, K, T, E, R, S, and B thermocouples and platinum RTDs with alpha of 0.00385 or 0.00392. A miniature rotary switch allows users to select the sensor type. The indicator features an automatic resolution capability. For measurements below  $1000^{\circ}$ , resolution equals  $0.1^{\circ}$ . From



$1000^{\circ}$  up, resolution automatically switches to  $1^{\circ}$ . Measurement capability ranges from  $-346$  to  $+3325^{\circ}$  in either F or C. The device provides a single-limit set point that can be set at any point within the indicator's range. The indicators also have a 0.5A relay for powering alarms. Measurement accuracy equals  $\pm 0.5^{\circ}$ . \$299.

Beckman Industrial Corp, 3883 Ruffin Rd, San Diego, CA 92123. Phone (619) 495-3236.

Circle No 395

FLUKE AND PHILIPS - THE GLOBAL ALLIANCE IN TEST & MEASUREMENT

What do you get  
when you cross  
a calibration  
lab with  
Fluke support?

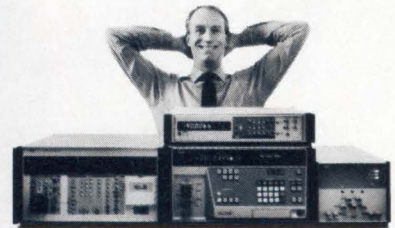

No Problems.

The key to a problem-free calibration lab is a well-designed system. The kind you get with Fluke assistance and consulting. We can help you with everything from training to calibration, to customized hardware and software. For the whole story call Fluke at 1-800-44-FLUKE.



©1988 John Fluke Mfg. Co., Inc. Ad no. 0381-SERV

# WE CAN SHAPE YOUR FUTURE

MHS has a proven track record in the integration of very fast, low-power systems on silicon: SRAM, microcontrollers, ASIC, and telecom chips.

Because we built our 0.7/1.2 micron Super-CMOS wafer fab for volume and quality, it is fully qualified by the highest military & space authorities, and praised by some of the world's most demanding IC users.

The dedicated engineering teams demonstrate the IC expertise for your applications.

OS technology.  
MOS SRAM.  
el layers gate



Our heart is  
Our t

MATRA DESIGN SEMICONDUCTOR  
2895 Northwestern Parkway  
SANTA CLARA - CA 95015, USA  
Tel. 408-986 9000, Tx 299 656

MATRA HARRIS SEMICONDUCTEURS  
BP 309  
78054 SAINT-QUENTIN-YVELINES CEDEX  
FRANCE - Tel. 1-30 60 70 00, Tx 697 317

# Our customers will go to great lengths to prevent you from finding out about us.

## And it's not surprising.

No matter whether it's for standard devices or custom designs, MHS has committed itself to meeting our customers specific needs in CMOS semiconductor technology.

Efficiently. Quickly. Quietly... But impressively: we ship over 12 million devices per year.

And yet we don't spread ourselves too thin by trying to meet all of the needs, all of the time. Because we've made a choice: to be the best there is in the areas we're strongest in.

For example, areas like complex VLSI, obtained through advanced circuit compilation techniques. Or like unmatched

components, such as the 30ns 20 $\mu$ A, 64 K SRAM we designed for military and space.

In the field of data communication, our researchers have mastered aggressive mixed analog/digital processes, and we've put more intelligence on silicon.

Not to mention our ability to ship very fast SRAM in volume, or to design very smart memories in record time. Advantages our data processing customers are the first to appreciate.

With our variety of design tools and methodologies, we place the full weight of our expertise at our customers' service.

Behind MHS you'll find the experience and strength of the MATRA group – a world leader in space and defense, transportation systems, telecommunications and data processing.

Considering the edge on the competition MHS products give them, it's no wonder our customers want to keep us to themselves.



**The best-kept secret  
in semiconductor technology.**

PARIS    LONDON    MUNICH    MILAN    STOCKHOLM    HONG KONG    SANTA CLARA

MHS. A subsidiary of the MATRA Group

# NEW PRODUCTS

## CAE & SOFTWARE DEVELOPMENT TOOLS

### NETWORK OS

- Works with a 4M-bit/sec, twisted-pair network
- Provides caching in LIM expanded memory

Version 1.2 of the PC/NOS network operating system works with the vendor's Omninet/4 LAN, which provides a 4M-bit/sec data-transfer rate over a twisted pair of cable. The operating system provides distributed resource sharing, so you don't need a network file server; it also provides file and record locking under DOS 3.1 and later. The OS can use any expanded memory that conforms to version 3.2 or later of the LIM standard; you can specify the amount of expanded memory

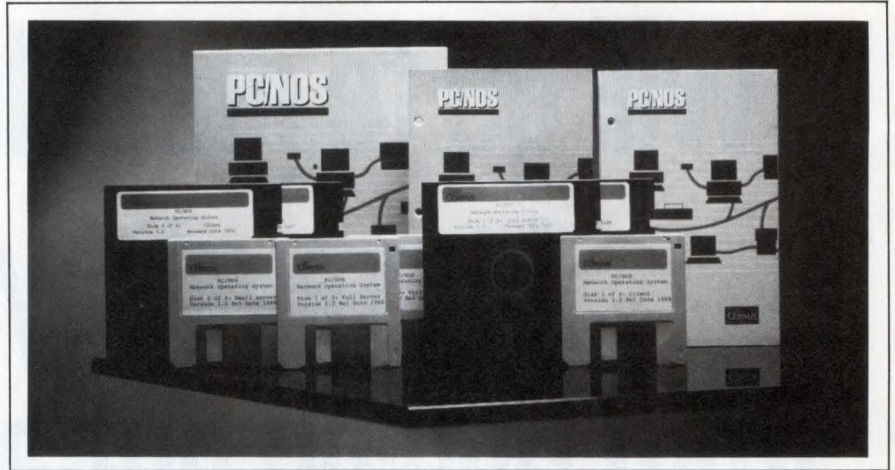

that the OS will use for caching, as well as the number of packets and open files. The OS employs standard DOS commands and, according to the vendor, is very easy to install

and use. \$695.

**Corvus Systems Inc**, 160 Great Oaks Blvd, San Jose, CA 95119. Phone (408) 281-4100. TLX 278976.

Circle No 400

### SOFTWARE

- Demonstrates qualities and capabilities of neural networks
- Simulates paradigms for solutions to difficult problems

The Awareness software package runs on IBM PCs and compatibles and consists of programs that demonstrate four neural-network paradigms. The generalization paradigm uses a generalized learning rule and demonstrates that a layered neural network can solve the exclusive-OR function, which perceptrons cannot do. The associative paradigm exhibits many of the computational capabilities of neural networks, such as preferential learning, fault tolerance, differentiation, and association. The optimization paradigm is an example of a neural network that can produce solutions to combinatorial optimization problems. The self-organization paradigm is an example of a nearest-neighbor classifier that behaves as an optimal signal processor in the presence of noise. The documentation contains introductory material on neural networks, together with the equations

and references from the original papers that describe each paradigm. To run this software, you'll need an IBM PC or compatible that has a graphics card and at least 256k bytes of RAM. A math coprocessor is recommended but not essential. \$250.

**Neural Systems Inc**, 2827 W 43rd Ave, Vancouver, BC V6N 3H9, Canada. Phone (604) 263-3667.

Circle No 401

### VME BUS FORTH

- Lets you develop real-time Forth programs
- Provides math library and database facilities

The PolyForth V4000 software development system is for use on VME Inc's V4000 VME Bus CPU board. The V4000 board is based on NCR's NC4016  $\mu$ P, which executes high-level Forth code as its native instruction set. The NC4016 chip runs at 8 MHz; at this speed, according to the vendor, Forth programs execute 19 times faster than do compiled C programs running on

a 10-MHz 80286. The software package includes complete source code, an optimizing compiler, clock/calendar management facilities, and utilities. You can create ROM-resident Forth programs as large as 64k bytes for embedded applications. At additional cost, you can obtain extensive libraries of mathematical and database-management routines. Software only, \$2950; software and CPU board, \$5745.

**Forth Inc**, 111 N Sepulveda Blvd, Manhattan Beach, CA 90266. Phone (213) 372-8493. TLX 275182.

Circle No 402

### FORTH FOR OS/2

- Has segmented memory model
- Same file interface for paths and directories

UR/Forth is a high-performance Forth programming environment for 80286- and 80386-based personal computers and runs in protected mode under Microsoft's OS/2 operating system. The package provides a segmented memory model and places code and data in one seg-

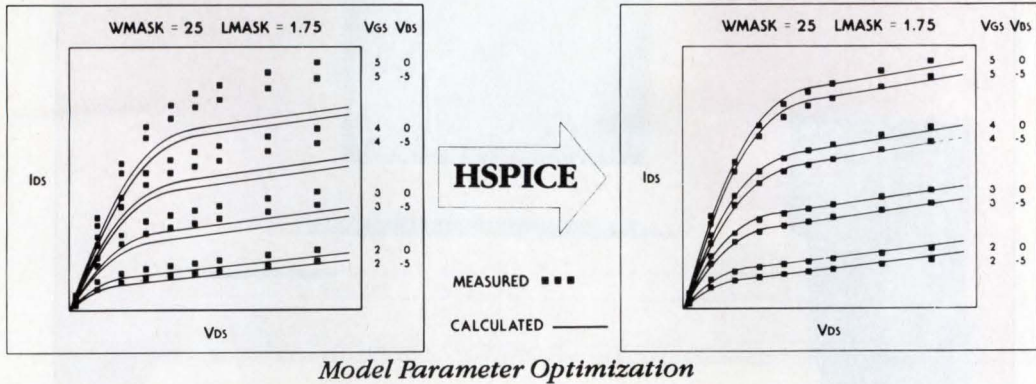

## Optimizing HSPICE

Meta-Software announces Optimizing HSPICE, incorporating full optimization into the HSPICE circuit simulator.

HSPICE is now a multi-target optimizer that supports all SPICE and HSPICE models. Optimization is included with HSPICE as a new feature, and is available to all HSPICE customers on Software Maintenance at no extra charge.

HSPICE is an integrated solution, optimizing not only DC currents for models, but also capacitance for AC analysis and transient parameters for transient analysis.

HSPICE effectively replaces the functionality of SUXES-10 with full multi-target optimization capabilities. No pre- or post-processing is required.

HSPICE is the result of more than ten years of research in both optimizing algorithms and in user interface. The optimizing function has been integrated into the core of HSPICE, resulting in optimum efficiency. Optimizing HSPICE results will always agree with HSPICE circuit simulation.

### Special features of Optimizing HSPICE include:

- Incremental optimization technique, DC, AC and transient optimization
- Uses HSPICE language format
- Model, device, subcircuit and circuit level parameters may all be optimized
- Optimizing Results Targets include Device Currents, Capacitance, Power, Time Delays, Unity Gain Frequency and S Parameters

Meta-Software also offers an extensive Discrete Device Library, HSPLIT graphics post-processor, ATEM process characterization system, Discrete ATEM for characterizing BJTs, MOSFETs, JFETs, HEXFETs and diodes, MetaTestchip™, and the Circuit PathFinder path timing analysis tool.

### Other new features of HSPICE:

- Monte Carlo Analysis
- Pole Zero Analysis
- S Parameter Output
- Mixed Domain Analysis
- Instantaneous and RMS power
- Individual element temperature
- Measure Statement
- Multi-Gamma Model for MOS 6 Level
- Small Signal Network Analysis
- ALTER Statement
- Improved BSIM Model
- Data Statement

Meta-Software, Inc. ● 50 Curtner Avenue, Suite 16 ● Campbell, CA 95008  
Phone (408) 371-5100 ● FAX (408) 371-5638 ● TLX 910-350-4928



# PSpice

## The Standard for Analog Circuit Simulation Now Available on the Macintosh II

Since its introduction just over four years ago, MicroSim's PSpice has sold more copies than all other commercial Spice programs combined. In addition to running on the IBM PC family, including the new PS/2, the Compaq 386, the Sun 3 workstation and the VAX/VMS family, PSpice is now available on Apple's Macintosh II.

All these features which have made PSpice so popular are available:

- Standard parts libraries for diodes, bipolar transistors, power MOSFET's, opamps, voltage comparators, and transformer cores.
- GaAs MESFET devices.
- Non-linear transformer devices modeling saturation, hysteresis, and eddy current losses.
- Ideal switches for use with, for example, power supply and switched capacitor circuit designs.

Please call or write today for a free evaluation copy of PSpice. Find out for yourself why PSpice is the standard in analog circuit simulation.

In addition, all these PSpice options are available on the Macintosh:

- Monte Carlo analysis to calculate the effect of parameter tolerances on circuit performance.
- The Probe "software oscilloscope", allowing interactive viewing of simulation results.
- The Parts parameter extraction program, allowing you to extract a device's model parameters from data sheet information.
- The Digital Files interface, allowing you to transfer data from your logic simulator to (or from) PSpice. The interface performs the necessary D to A or A to D conversions.

Each copy of PSpice comes with our extensive product support. Our technical staff has over 50 years of experience in CAD/CAE and our software is supported by the engineers who wrote it. With PSpice, expert assistance is only a phone call away.

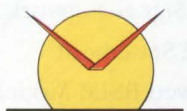

**MicroSim Corporation**

23175 La Cadena Drive, Laguna Hills, CA 92653 U.S.A. • (714) 770-3022 (800) 826-8603 • Telex 265154 SPICE UR

PSpice is a registered trademark of MicroSim Corporation; Macintosh II is a trademark of Apple Computer, Inc.; Compaq 386 is a trademark of Compaq Computer Corporation; IBM PC, PS/2 are registered trademarks of International Business Machines Corporation; Sun is a trademark of Sun Microsystems, Inc.; VAX and VMS are trademarks of Digital Equipment Corporation.

## CAE & SOFTWARE DEVELOPMENT TOOLS

ment, headers in another segment, and the dictionary hash table in a third segment. It uses dynamic memory-allocation functions in a "well-behaved" manner, and provides a uniform file interface that supports paths, directories, and fixed disks. You can store Forth programs and data in normal OS/2 files and manipulate them with standard system commands and utilities. The package includes a table-driven screen editor that can handle as many as six files simultaneously; a table-driven 80286/87 assembler; and three libraries of software floating-point, 80287-assisted floating-point, and 80387-assisted floating-point routines. To run the package, you'll need a PC/AT, PS/2 Model 50 or higher, or compatible machine that has 2M bytes of RAM, a hard-disk drive, and a graphics adapter compatible with the IBM MDA, CGA, EGA, or VGA. \$350.

**Laboratory Microsystems Inc.**, Box 10430, Marina del Rey, CA 90295. Phone (213) 306-7412.

**Circle No 403**

### DATA ACQUISITION

- *Matches Helios-I hardware to IBM PCs and compatibles*
- *Lets you store and analyze data acquired by Helios-I*

Three data-analysis packages that run on IBM PCs and compatibles have been adapted to work with the vendor's Helios-I measurement-and-control system. The CIMPAC data-acquisition and instrument-control software package provides animated graphics for the display of data values, trends, and alarm conditions. The package is menu driven and lets you set up complex control and data-acquisition command sequences on the Helios-I; it features extensive on-line help and has facilities for intelligent event processing and for the automatic generation of reports. Labtech Notebook, from Laboratory Technologies Inc (Wilmington, MA), and the vendor's He-

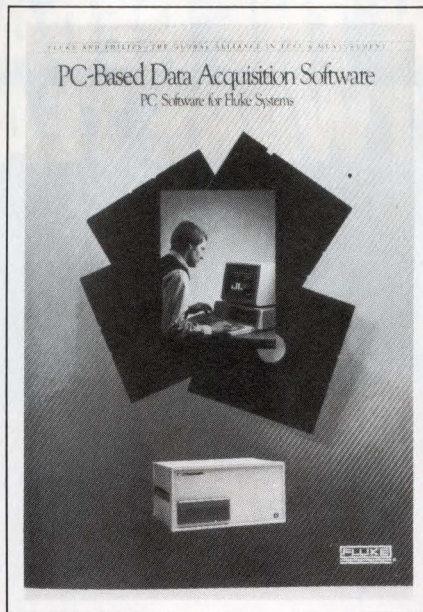

lios Toolbox are packages that help you develop software for the Helios-I system and enhance the system's performance. CIMPAC, including a hardware PC interface, \$3695; Labtech Notebook, \$995; Helios Toolbox, \$295.

**John Fluke Mfg Inc.**, Box C9090, Everett, WA 98206. Phone (800) 443-5853; in WA, (206) 347-6100. TWX 910-445-2943.

**Circle No 404**

### ASIC DESIGN TOOL

- *Automatic generation of test vectors*
- *Synthesizes ASIC layout from a logical input*

Two major options have been added to the Genesil IC design system, version 7.0: Automatic Test Generation (ATG) and Logic Compiler. The ATG option uses proprietary algorithms to identify and optimize the test vectors needed to achieve target test coverage at the gate level. You can use it for sequential circuits, as well as for RAMs, ROMs, 3-state and precharge signals, and combinatorial circuits. By using seed vectors generated by Genesil logic simulations of the ASIC design, you can achieve fault coverage for difficult circuits in the same amount of time usually needed for

System-Level Design Automation

# WHAT BERKELEY CAN TEACH YOU ABOUT SYSTEM DESIGN.

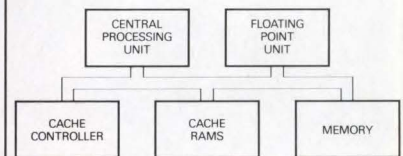

System-level design is no longer purely academic. As the engineers at U.C. Berkeley have discovered, ENDOT understands your system design issues. Our system-level design tools support the development of advanced architectures—in pipelined processors, multi-processing computers, controllers, and communications.

With ENDOT tools you can describe and verify the performance and function of an evolving design's hardware, firmware and software **before** a prototype is built. This reduces risk, saves time and money, and lets you readily evaluate design alternatives.

### ENDOT ADDRESSES FOUR MAJOR ISSUES IN SYSTEM DESIGN:

1. Management of concurrency
2. Speed/power/space trade-offs
3. Integration of hardware and software development
4. Performance evaluation

For a free copy of our system design tutorial, call us toll-free:

**SYSTEM-LEVEL  
DESIGN  
AUTOMATION  
GUIDE**

**1-800-545-8765**

# ENDOT

CIRCLE NO 52

# CADSTAR™ — THE NEWEST PLAYER ON THE REDAC SOFTWARE TEAM.



## TEAM UP WITH A STAR IN PC-BASED PCB CAD.

Gear up for winning play in PCB CAD with new *CADSTAR Design and Layout Software*. At last, one PC-based system can handle the multitude of PCB designs that cross your desk . . . from dual in-line designs to multilayer, double-sided surface-mount designs. And CADSTAR is compatible with its Redac software teammates, assuring you a game plan for future growth.

CADSTAR brings into play powerful features such as automatic component placement, automatic gate and pin swapping, dynamic rubber banding and automatic routing. They enable you to get your designs to the

market faster and with complete manufacturability.

What's more, CADSTAR is backed by the leading player in PCB CAD with over 20 years of experience in the field. From the PC-based systems to the engineering workstation-based Visula system, Racal-Redac supports every level of electronic design automation.

Team up with the winner! Also ask about our low-cost CADSTAR interactive package. Call for a demonstration.



# CADSTAR™

## RACAL-REDAC

238 Littleton Road  
Post Office Box 365  
Westford, MA 01886-9984  
Telephone: (617) 692-4900



## CAE & SOFTWARE DEVELOPMENT TOOLS

much less complex ICs. A coverage analysis report tells you whether your design is inherently testable or whether you need to add testability blocks. The Logic Compiler option helps you to improve IC design performance and density by automatically performing functional, logical, and physical optimization. You can use this compiler for individual blocks, collections of blocks, or complete ASIC chips. It accepts input in the form of net lists generated by Genesil, and compresses the overall logic to reduce the number of gates required; it then compiles the optimized circuitry into standard cells. As options to Genesil, the prices are ATG, \$39,500; Logic Compiler, \$24,500.

**Silicon Compiler Systems Corp.**, 2045 Hamilton Ave, San Jose, CA 95125. Phone (408) 371-2900.

**Circle No 405**

### UPGRADED PDL

- Enables laser-printer output for DoD-STD-2167 documents
- Compresses files to reclaim unused disk space

Version 2.1 of the Byron Ada program design language and document generator, which runs on VAX/VMS systems, has been recompiled to achieve a speed increase of approximately 50%. Byron now saves an intermediate form of the source code in a program library and lets you reclaim unused disk space by compressing the partition master file. This version of the program design language works with the LaTeX text formatter, available from Kellerman & Smith (Portland, OR) or from the vendor, and it lets you generate tables and laser-printer output for the STLDD and SDDD documents required by DoD-STD-2167. \$15,000 to \$35,000, depending on host configuration.

**Intermetrics Inc.**, 733 Concord Ave, Cambridge, MA 02138. Phone (617) 661-1840. TWX 710-320-7523.

**Circle No 406**

### C CROSS-COMPILER

- Runs on HP Series 300 host under HP/UX
- Generates code for 68000  $\mu P$  family

OS-9/XCC is a C cross-compiler that runs on Hewlett-Packard Series 300 workstations under the HP/UX operating system (a version of Unix). It generates assembly-language code for target machines that are based on the Motorola 68000 family of  $\mu P$ s and run under the OS-9 operating system. The package provides extensive libraries based on the Berkeley 4.2 version of Unix, including standard I/O and math routines. It also includes the C Executive, a preprocessor, a 1-pass C compiler, optimizer utilities, a macroassembler, and a linker. It produces compact, position-independent, re-entrant code for the OS-9 target machine. Two versions are available: One is for 68000 targets and costs \$3000; the other is for 68020 targets and costs \$4500.

**Microware Systems Corp.**, 1900 NW 114th St, Des Moines, IA 50322. Phone (515) 224-1929. TLX 910-520-2535.

**Circle No 407**

### GATE-ARRAY LAYOUT

- Automates the design of GaAs gate arrays
- Operates at the layout level

The TQ3000 TurnChip ASIC layout module extends the automation of GaAs gate arrays from concept to fabrication. It supports designs that use the TriQuint (Beaverton, OR) TQ3000 chip, a GaAs array of 3000 equivalent gates that can operate at toggle rates as high as 1 GHz and that has 64 I/O pins that you can program to interface with ECL, TTL, and CMOS devices. The package forms part of the vendor's Gate-Array WorkSystem, a set of modular CAE software tools that TriQuint employs to enable you to perform both logic-design and layout functions on the same computer.

System-Level Design Automation

# HOW TO VERIFY COMPUTERS BEFORE THEY'RE BUILT.

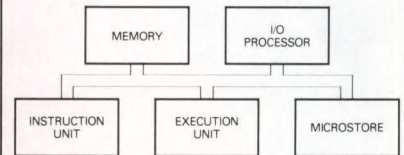

Put your computer through its paces, **before** you build a prototype, with ENDOT system-level design tools. ENDOT understands and supports the system issues of computer design—processing architectures, hardware and software partitioning, and performance analysis.

Our tools reduce risk, save time and money, and help you readily evaluate design alternatives.

### ENDOT ADDRESSES FOUR MAJOR ISSUES IN SYSTEM DESIGN:

1. Management of concurrency
2. Speed/power/space trade-offs
3. Integration of hardware and software development
4. Performance evaluation

For a free copy of our system design tutorial, call us toll-free:

**SYSTEM-LEVEL  
DESIGN  
AUTOMATION  
GUIDE**

**1-800-545-8765**

# ENDOT

CIRCLE NO 53

# Disk-Caching SCSI for Multibus\* II.

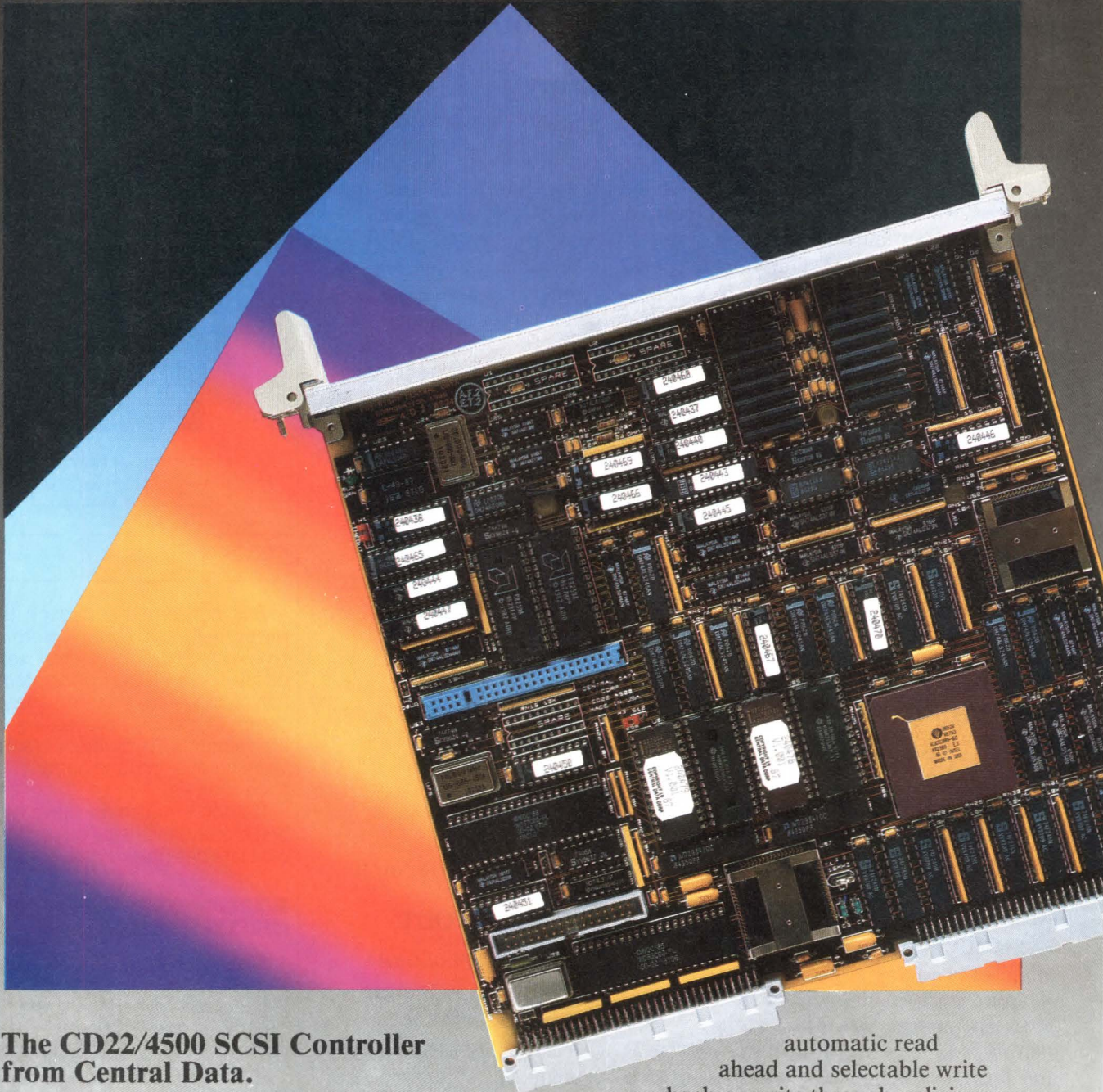

## The CD22/4500 SCSI Controller from Central Data.

Central Data is committed to a leadership role in the Multibus II market. With special emphasis on SCSI support.

The CD22/4500 provides the ultimate Multibus II SCSI solution. It's fast, transferring data at the limits of the SCSI bus. And versatile, providing either direct SCSI commands or Intel compatible PCI commands.

On-board disk-caching firmware makes it even faster. Up to 2 megabytes of parity protected RAM and 80186 CPU speeds of up to 12.5MHz mean cache hits are frequent and fast.

For extra efficiency, tune your systems using the four provided disk-sorting algorithms,

automatic read ahead and selectable write back or write through policies.

Design excellence, unparalleled account service, easy access to design engineers, even customizing for some applications. You'll find them in this and every Central Data product.

Call product manager Andre Felix today for a detailed product brochure on the CD22/4500.

## Central Data

1602 Newton Drive, Champaign, IL 61821-1098

1-800-482-0315

(In Illinois 217-359-8010)

FAX 217-359-6904

\*Multibus is a trademark of Intel Corporation.

CIRCLE NO 94

## CAE & SOFTWARE DEVELOPMENT TOOLS

The enhanced schematic net list provides all the information necessary for layout; you can interact with the net list to drive the layout process, and still retain control over device placement, priority nets, and critical signal timing. You only need to send minimal data to the foundry because it uses the same software; thus, the package not only shortens the development cycle by eliminating iterations between designer and foundry, but also improves the security of your design. \$3000.

**Tektronix CAE Systems Div,**  
Box 4600, Beaverton, OR 97075.  
Phone (800) 835-9433; in OR, (503)  
629-1152.

Circle No 408

### CROSS COMPILER

- Runs on an IBM PC, PS/2, or compatible
- Compiles Forth source code to TMS34010 code

The LMI Forth metacompiler runs on an IBM PC or PS/2 host or compatible and generates ROMable native code for Texas Instruments' TMS34010 graphics processor. The TMS34010 is a general-purpose CPU with machine-level instructions for both linear and XY-addressed line drawing, pixblt (pixel block transfer), region fills, clipping, and other graphics operations. The Forth metacompiler provides multipass, table-driven compilation; allows local labels and conditional compilation directives; and permits optional generation of "headerless code" to conserve memory in the target system. The package is compatible with the Forth-83 standard and lets you build applications in layers, using incremental compilations. You can create either ROMable or disk-based applications. To make programming easier, both the compiler and the cross-assembler accept byte addresses, automatically translating these into the bit addresses required by the TMS34010. The package includes a

loader program that not only uploads a compiled image into the RAM on a TMS34010 development board, but provides communication between the development board and the host PC. You'll need a host that has at least 320k bytes of RAM and runs under DOS 2.0 or later; because the source files for the TMS34010 target system require 400k bytes of disk space, the vendor recommends a hard disk. \$1000.

**Laboratory Microsystems Inc,**  
Box 10430, Marina del Rey, CA  
90295. Phone (213) 306-7412.

Circle No 409

### ZOOM FOR AUTOCAD

- Lets you set up, zoom, and pan with single-touch commands
- Eliminates drawing regenerations during zoom

ZoomIt is a software add-on for Autodesk's (Sausalito, CA) AutoCAD version 2.5 or higher. It requires less than 10k bytes of memory and operates in conjunction with a tablet template that fits into transparent areas of the AutoCAD tablet template and the vendor's own tablet template, The Standard. ZoomIt lets you initiate standard zoom and pan operations by touching one point on the template rather than by using three or more keystrokes. The package eliminates Zoom All regenerations, second regenerations caused by changes in drawing extents, and accidental regenerations that may occur while performing normal AutoCAD zooms. In normal use, the program will probably save you a 30-sec regeneration every 10 minutes or so. \$99.

**Palisades Research, 869 Via de la Paz, Pacific Palisades, CA 90272.**  
Phone (213) 459-7528.

Circle No 410

System-Level Design Automation

# A FAIL-SAFE WAY TO DESIGN FAIL-SAFE CONTROLLERS.

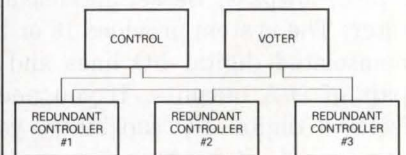

When there's no room for error, depend on ENDOT's system-level design tools. ENDOT supports your evaluation of high reliability system alternatives—hardware and software redundancy, analysis of architectural trade-offs, and top-down verification. We understand your system design issues.

With ENDOT tools you can describe and verify the performance and function of an evolving design's hardware, firmware and software **before** a prototype is built. This reduces risk, saves time and money, and lets you readily evaluate design alternatives.

### ENDOT ADDRESSES FOUR MAJOR ISSUES IN SYSTEM DESIGN:

1. Management of concurrency
2. Speed/power/space trade-offs
3. Integration of hardware and software development
4. Performance evaluation

For a free copy of our system design tutorial, call us toll-free:

SYSTEM-LEVEL  
DESIGN  
AUTOMATION  
GUIDE

**1-800-545-8765**

# ENDOT

CIRCLE NO 54

# NEW PRODUCTS

## TEST & MEASUREMENT INSTRUMENTS

### SIGNAL CONDITIONERS

- Allow analog and digital I/O
- Provide ohmic isolation to 1500V

The DT760 signal-conditioning system consists of a back panel that accommodates 16 ohmically isolated, 1500V breakdown analog-input modules from the vendor's DT500 Series, which also includes a 9-pole, lowpass, Bessel antialiasing filter. The system provides 16 or 32 nonisolated digital I/O lines and a pair of D/A outputs. If you need isolated digital I/O capability, you can include it by tying in one of Opto-22 Corp's PB16A panels. If you must provide 4- to 20-mA current-loop outputs, you can substitute V/I converters for four of the input signal conditioners. The back panel incorporates screw terminals for connection to the monitored and

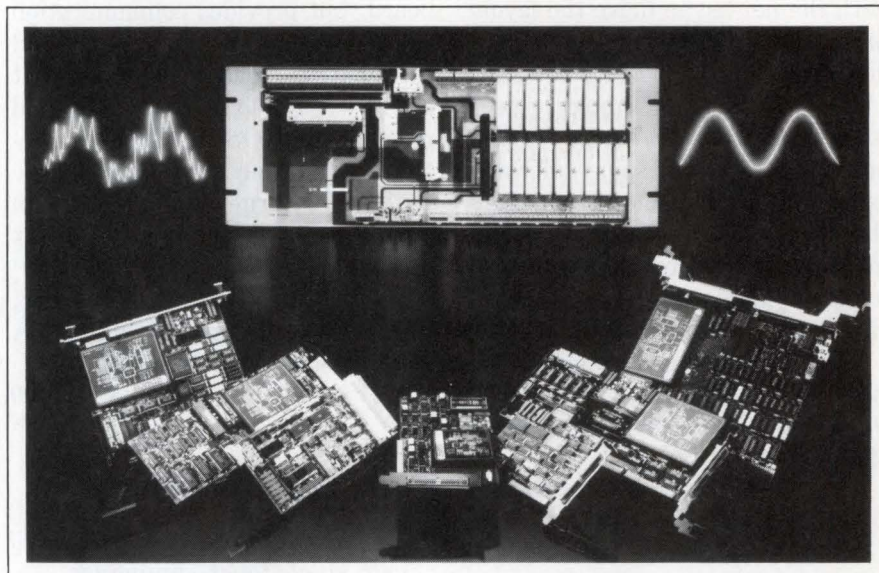

controlled devices, and features connectors for cables to a data-acquisition board in the host computer system. Mounted next to each pair of screw terminals is a thermistor that provides cold-junction compensation when you use the terminal pair as a

thermocouple input. \$395; when equipped with serial Bitbus output, \$550.

**Data Translation Inc**, 100 Locke Dr, Marlboro, MA 01752. Phone (617) 481-3700. TLX 951646.

Circle No 415

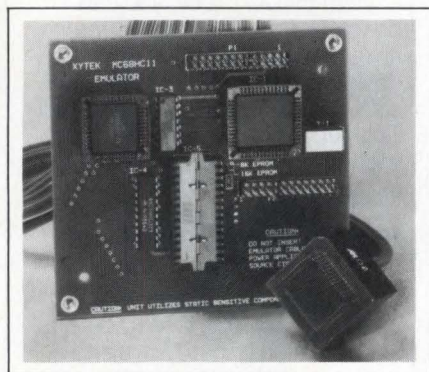

### 68HC11 EMULATOR

- Interfaces to 52-pin PLCC socket via one cable
- Uses microcode in 8k- or 16k-byte CMOS EPROM

This 68HC11 emulator aids microcode development. It draws power from the 52-pin PLCC socket on your board—the socket that normally accommodates the  $\mu$ P. Instead of storing your microcode in the 68HC11's mask-programmed ROM, you store it in an 8k- or 16k-byte

EPROM that you program off-line and insert into a ZIF (zero insertion force) socket on the emulator board. \$497.

**Xytek Industries Inc**, 19431 W Davison, Detroit, MI 48223. Phone (313) 838-6961.

Circle No 416

### 175-MHz SCOPE

- Stores 32k words/channel
- Offers 10-mV/div sensitivity

The 9400A digital storage oscilloscope features a bandwidth of 175 MHz at 10 mV/div and a bandwidth of 225 MHz typ at 1V/div. The scope can store 32k points/channel (192k points max). After capturing a waveform, you can expand it horizontally by a factor of 100 and search for events that might not be apparent in a more compressed display. Whatever the scope's sweep speed, its deep memory allows it to

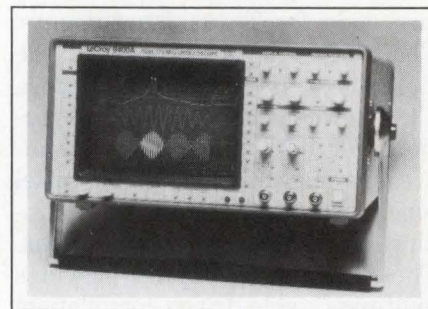

sample at higher rates than can scopes with shallower memories. Such higher rates of sampling prevent aliasing problems caused by sampling rapidly changing signals too slowly. An optional IEEE-488 interface and an IBM PC or compatible computer running optional software provide the scope with signal-analysis and long-term data-storage capabilities. \$9900. Delivery, six weeks ARO.

**LeCroy**, 700 Chestnut Ridge Rd, Chestnut Ridge, NY 10977. Phone (914) 425-2000. TWX 710-577-2832.

Circle No 417

ACME'S LAW  
OF NATURAL  
SELECTION

TO PROVIDE  
POWER  
SELECTIVITY,  
YOU MUST PROVIDE  
TOTAL POWER  
AVAILABILITY.



#### Acme Gives You The Power To Choose

Whether it's switch-mode or linear power supplies, or transformers, Acme's got what it takes to keep power at your fingertips. Standard, modified and custom models offer you the power you need for everything from routine applications to complex design challenges. Products with seventy years of power conversion technology packed into each and every one: switchers from 150W to 3000W; linears from 15W to 1500W; transformers from 50W to 5KVA; and a full line of catalog linear and switch-mode power supplies you know as Standard Power Products. All available through authorized *Acme Electronic* distributors.

When it's power you want, go with the natural choice: Acme Electric. We're putting power supplies in a whole new light.

- Standard, modified and custom power supplies.
- Switchers from 150W to 3000W.
- Linears from 15W to 1500W.
- Custom ferroresonant and linear transformers.
- Transformers from 50W to 5KVA.

 **Acme Electric**  
Power Products Group  
Cuba, New York 14727  
(716) 968-2400



## PROM PROGRAMMER

- Programs 24-, 28-, and 32-pin devices in gangs and sets
- Handles eight 1M-bit EPROMs simultaneously

When used with the vendor's PP42 programmer, the 42M101 programs EPROMs and EEPROMs with capacities as large as 1M bit. It handles devices in 24-, 28-, and 32-pin packages and can program as many as eight devices simultaneously; when operating in the gang mode, it programs all devices identically, whereas when operating in the set mode, it programs each device dif-

ferently. The programmer has two RS-232C ports. You can use either port to download information from a computer or from a development system. You can expand the programmer's RAM to hold 8M bits of data. The programmer recognizes Intelligent Identifier and Silicon Signature codes in the devices to be programmed and automatically configures the programming parameters accordingly. 42M101 module, \$1095.

**Stag Microsystems Inc**, 1600 Wyatt Dr, Santa Clara, CA 95054. Phone (800) 227-8836; in CA, (408) 988-1118. TWX 910-339-9607.

Circle No 418

## DATA ACQUIRER

- 8-bit, 500-kHz ADC with 2k-point memory fits PC Bus
- Includes five software packages

The R15 PC Bus 4-channel A/D con-

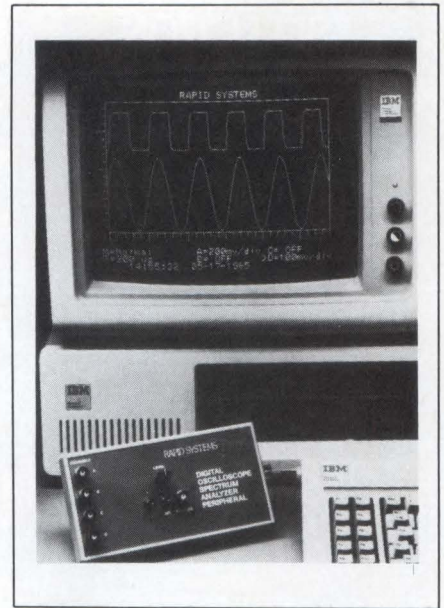

verter features software-programmable 10-mV/div to 20V/div preamplification, 8-bit resolution, a 500-kHz conversion rate, and 2048-point data memory. It comes with software for data logging direct to

Text continued on pg 266

## Capture Your Solutions

With SCHEMA PCB LAYOUT and SCHEMA AUTOROUTER



### Introducing The SCHEMA Family Of Integrated CAE Solutions.

Now, you can enter a schematic using SCHEMA II, then process it with SCHEMA-PCB and SCHEMA-ROUTE into a finished printed circuit card *in one easy step.*

The SCHEMA family of integrated CAE solutions makes it possible — for a fraction of the cost of design workstations costing \$50,000 or more:

- Boards of over 400 equivalent ICs, up to 32" x 32", and up to 30 layers
- Resolution on placement and tracking of 1 mil
- Autoplacement
- Selectable track width and pad size/shape (250 increments of 1 mil each)
- Integrated schematic input and back annotation
- Entry of engineering changes at the schematic level
- Autorouting with 4 separate algorithms for accuracy
- Complete manufacturing kit output
- 'Air Gap' and connectivity design rule checking

Capture your solutions by calling Toll Free: 1-800-553-9119 (in Texas, 214-231-5167). 30-Day Money Back Guarantee. Ask

about our SCHEMA Family Demo Evaluation Kit.



## OMATIOn

1210 E. Campbell Rd., Suite 100  
Richardson, Texas 75081

# ELECTRONICS ENGINEERS & DESIGNERS BOOK CLUB®

## Take any 3 books for only \$1.95 (Values to \$94.95)

SHARPEN YOUR SKILLS—With Quality, Affordable Professional Books

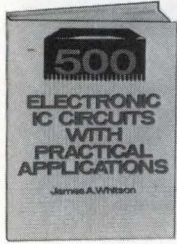

2920 Reg. \$28.95

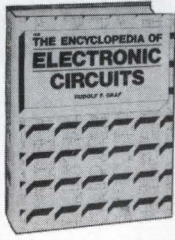

1938 Reg. \$60.00  
Counts as two.

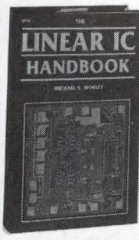

2672 Reg. \$49.50  
Counts as two.



2957H Reg. \$39.95  
Counts as two.



2888 Reg. \$26.95



2864 Reg. \$49.95  
Counts as two.

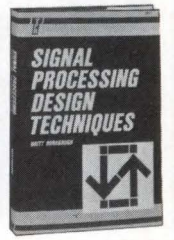

2657 Reg. \$32.50



2931 Reg. \$39.95  
Counts as two.

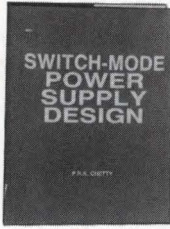

2631 Reg. \$22.95

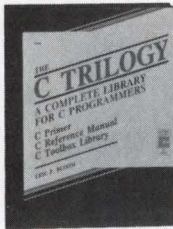

2890 Reg. \$32.95  
Counts as two.

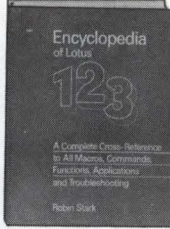

2891 Reg. \$29.95

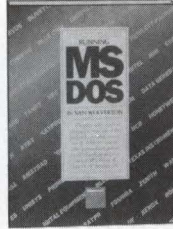

9119 Reg. \$35.00  
Counts as two.

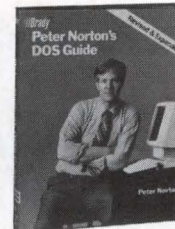

9083 Reg. \$29.95

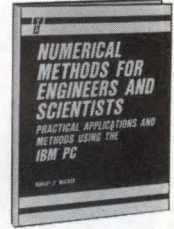

2697 Reg. \$19.95

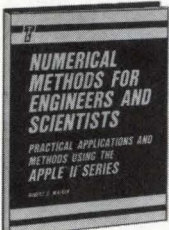

2647 Reg. \$19.95

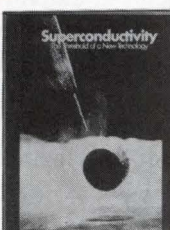

3022 Reg. \$18.95

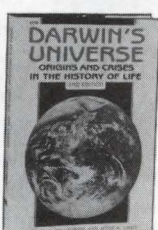

2773 Reg. \$21.95

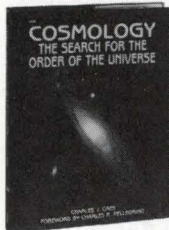

2626 Reg. \$16.95



2720 Reg. \$32.50

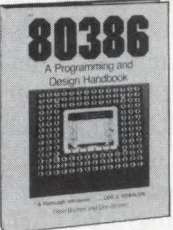

2937 Reg. \$29.95



2700 Reg. \$49.95  
Counts as two.

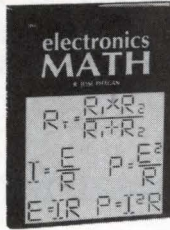

1962 Reg. \$22.95



2727 Reg. \$24.95



2612 Reg. \$25.95

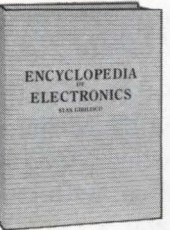

2000 Reg. \$60.00  
Counts as two.

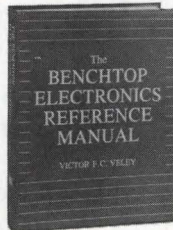

2785 Reg. \$34.95  
Counts as two.

### How the Club Works

**YOUR BENEFITS:** You get 3 books for \$1.95 plus shipping & handling when you join. You keep on saving with discounts up to 50% as a member.

**YOUR PROFESSIONAL BOOKSTORE BY MAIL:** Every 3-4 weeks, you will receive the EE&D Book Club News describing the Main Selection and Alternates, as well as bonus offers and special sales, with hundreds of titles to choose from.

**AUTOMATIC ORDER:** If you want the Main selection, do nothing and it will be sent to you automatically. If you prefer another selection, or no selection at all, simply indicate your choice on the reply form provided. As a member, you agree to purchase at least 3 books within the next 24 months and may resign at any time thereafter.

**BONUS BOOKS:** Starting immediately you will be eligible for our *Bonus Book Plan* with savings of up to 80% off publishers' prices.

**IRONCLAD NO-RISK GUARANTEE:** If not satisfied with your books, return them within 10 days without obligation!

**EXCEPTIONAL QUALITY:** All books are quality publishers' editions especially selected by our Editorial Board.

All books are hardcover unless number is followed by a "P" for paperback. (Publishers' Prices shown)

### SEND NO MONEY NOW!

#### INTRODUCTORY 10-DAY FREE EXAMINATION OFFER

#### ELECTRONICS ENGINEERS & DESIGNERS BOOK CLUB®

c/o Susanna Joannidis, Cahners Publishing Company  
275 Washington St., Newton MA 02158-1630

YES! Please accept my membership in the *Electronics Engineers & Designers Book Club®* and send me the volumes I have listed below, billing me only \$1.95 plus shipping and handling charges. I understand that the books are sent on a 10-Day Free Examination basis. If dissatisfied in any way, I may return the books within 10 days and incur no further obligation. Otherwise, I agree to pay the enclosed invoice promptly and to receive regular club bulletins as described in "How the Club Works." To complete my membership obligation I need only purchase 3 additional books at regular members prices during the next 24 months, and may resign at any time thereafter.

(write 2 or 3 title numbers of your choice above)

NAME

ADDRESS

CITY  STATE / ZIP

SIGNATURE

Valid for new members only. Foreign applicants will receive special ordering instructions. Canada must remit in U.S. funds. This order is subject to acceptance by the *Electronics Engineers & Designers Book Club®*. EDN-588

HIGH PROGRAMMING  
YIELDS

**EPROM  
PROM  
PLD**  
(LOGIC)

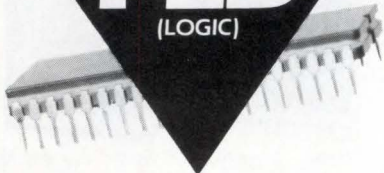

LOW  
PROGRAMMING COSTS



## PROGRAMMERS

A complete range of low priced separate products to meet your individual specific requirements (with device manufacturers' approvals).

- C41 up to 1 M bit EPROMs
- E9C 8 gang EPROM & editing
- E12C gang/set EPROM
- 1011 Bipolar PLD (logic)
- 1012 Bipolar PROM / EPROM
- 1013 set EPROM (to 32/40 pin)
- 1014 EPLD & CMOS PLD

Options cover single chip micros, simulators, PLCC, IBM/VAX remote drivers and ELAN LOG/IC compilers. Ask for our DEMO DISKS. Prices start at \$995.

in Europe:

GB (0223) 510448  
A (0222) 835646  
B (02) 2416460  
D (089) 780420  
E (01) 4054213  
F (014) 8632828  
I (02) 6120041  
I (02) 2440012

IRL (01) 501845  
NL (01720) 43221  
N (02) 846210  
P (01) 549011  
SF (00) 6926022  
S (0589) 14111  
S (08) 7349770  
CH (01) 7414644



Elan Digital Systems  
California  
Tel: 800-541-ELAN  
Telex: 9102400972

CIRCLE NO 56

## TEST & MEASUREMENT INSTRUMENTS

disk or to a plotter, for operation of the computer as a digital storage oscilloscope (DSO) or a spectrum analyzer, and for transferring data files to ILS, DaDisp, Lotus 1-2-3, and Ashton-Tate's dBase series. \$995.

Rapid Systems Inc, 433 N 34th St, Seattle, WA 98103. Phone (206) 547-8311. TLX 265017.

Circle No 419



## VOLUME PROGRAMMER

- Uses both 68000 and Z80 CPUs to speed programming
- Can handle 2M-bit devices with 24 to 40 pins

The P16-IV is suitable for programming large quantities of EPROMs and EEPROMs in a production environment. It employs a Z80  $\mu$ P and a 68000  $\mu$ P to achieve its speed. It can program devices that have capacities as large as 2M bits and that come in 24- to 40-pin packages. Its adapters accommodate devices housed in flat packs and leadless chip carriers, plastic leaded chip carriers, pin grid arrays, and small outline integrated circuit packages. The programmer includes a 2M-bit buffer that accepts data from a master device, serial port, Centronics-compatible parallel port, or IEEE-488 port or keyboard. \$4995 with either a 16-gang, 32-pin module or with an 8-gang, 40-pin module.

Adams-Macdonald Enterprises Inc, Promac Div, 800 Airport Rd, Monterey, CA 93940. Phone (408) 373-3607. TLX 882141.

Circle No 421

## PC-BASED DSO

- Performs 12-bit sampling to 1 MHz
- Rejects noise with true differential inputs

The R1200 allows your IBM PC or compatible computer to function as a 2-channel DSO (digital storage oscilloscope) with true differential inputs and a sampling rate you can vary from 1 Hz to 1 MHz. The

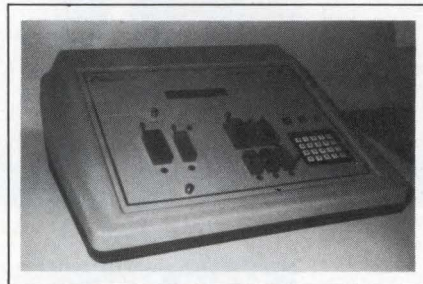

## PROGRAMMER

- Runs in stand-alone and computer-controlled modes
- Handles new device technologies via software updates

According to the vendor, the University programmer can program virtually any programmable memory or logic device on the market. The programmer supports more than 700 device types from 29 manufacturers. As devices that incorporate new technologies appear, the vendor will offer software upgrades and "technology modules" to provide the modifications required for the programmer to program these devices. The programmer's internal buffer accommodates 32k bytes; you can specify a 64k- or 128k-byte buffer as an option. You can operate the unit in a stand-alone mode via its 20-key touchpad and its 20-character LCD display. You can also operate it from a remote terminal or computer via its RS-232C port. The device-drive signals are furnished by high-speed D/A converters under control of an 8085  $\mu$ P. \$3495.

Advanced Programming Systems, 35623 Chaplin Dr, Fremont, CA 94536. Phone (415) 796-0682.

Circle No 420



## TEST &amp; MEASUREMENT INSTRUMENTS

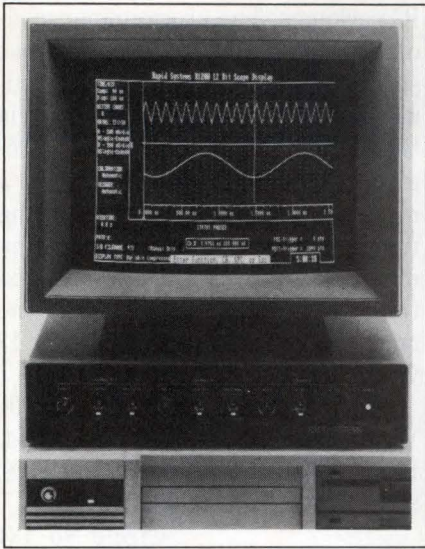

time-interval resolution. The standard timebase ages 3 parts/billion/day. An optional, ovenized timebase ages at 1/10 of this rate. You can also supply your own 5- or 10-MHz timebase. When the unit makes a 1-sec measurement of frequency, its 16-digit LED display presents 11 digits of meaningful data. The instrument can measure frequency to 1.3 GHz as well as interval, period, phase, pulse width, risetime, and falltime. An X-Y driver lets you use your scope to display histograms and trends; you can obtain hard copies on a printer interfaced to the Centronics-compatible port or on a plotter that supports HPGL (Hewlett-Packard Graphics Language). In addition to RS-232C and IEEE-488 ports, the counter has analog outputs that enable strip-chart recorders to plot mean and deviation data. The unit's built-in functions include the calculation of 1-million-sample Allan variance. \$3850.

**Stanford Research Systems Inc.**, 1290 D Reamwood Ave, Sunnyvale, CA 94809. Phone (408) 744-9040. TLX 706891.

Circle No 423

software lets you select sensitivities from 1 mV to 20V/div. Each channel has its own ADC and antialiasing filter. The trigger modes include pretrigger and posttrigger, internal and external trigger, and digital and analog trigger. The vertical zooming allows you to take advantage of the 12-bit amplitude resolution by expanding a portion of a displayed waveform for detailed analysis. An autosave feature can automatically store displayed waveforms on your hard disk. You can obtain real-time FFT spectrum analysis as an option. \$2995.

**Rapid Systems Inc.**, 433 N 34th St, Seattle, WA 98013. Phone (206) 547-8311. TLX 265017.

Circle No 422

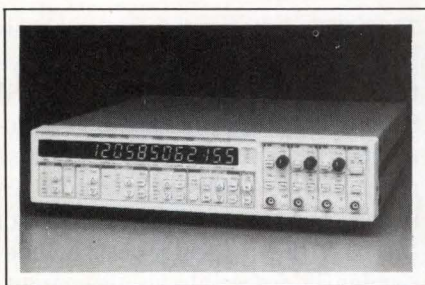

## INTERVAL COUNTER

- Resolves single-shot intervals to 4 psec
- Measures frequency to 1.3 GHz

The Model SR620 is a reciprocal interpolating time-interval counter that features 4-psec, single-shot

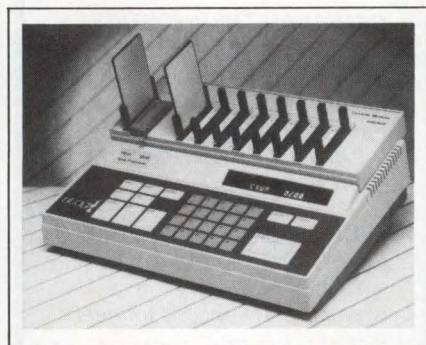

## PROGRAMMER

- Gang programs credit-card-size memory modules
- Loads data from EPROM, host system, or smart card

The 41M900 custom module for the vendor's PP41 programmer enables it to program credit-card-size "smart card" memory modules, which are easier for users to interchange than are more conventional

# Now in-house prototyping is truly affordable.

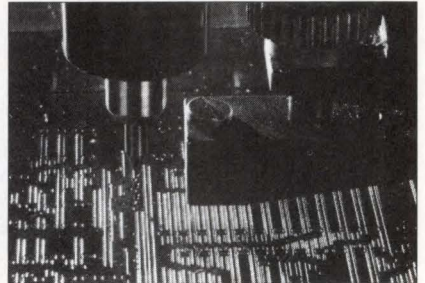

## Mills and drills circuits in minutes.

There's no reason to waste time and money sending out for prototype circuit boards any longer. With the new BoardMaker, you can make your own prototypes in your own lab directly from your PCB CAD—as fast as you need them.

## No delays or rush charges.

BoardMaker engraves single and double-sided boards, forming conductor lines as small as 5 mil. (There is a throughplate option too.)

A 2" x 3" board with medium density, for example, takes about 15 minutes. So you can save a week or more *at every level* of design development. You also save the money spent on outside sources, along with costly charges for rush service that can't compare with BoardMaker speed.

## No chemicals.

BoardMaker is totally *mechanical*. There are no chemicals, no fumes, and no toxicity problems.

## At \$5,000, pays for itself fast.

BoardMaker is revolutionary because it costs *one-sixth* the price of first generation prototype machines—and literally pays for itself after about a dozen boards. For more information, call (415) 883-1717 or use the reader card.



20A Pamaron Way  
Novato, CA 94948

CIRCLE NO 57

# INTRODUCING THE HI-REL MAJOR PATRIOT AC FAN

Comair Rotron's Hi-Rel Major and Patriot tubeaxial AC fans are 10% more efficient, offer 10°C cooler bearing temperatures and provide as much as five years longer life for continuous operation.

- Operating temperatures range from -10°C to +70°C at 240 CFM
- Fan diameter is 6.75" x 2" deep
- At 40°C Hi-Rel fans have an L10 Life of 102,000 hrs.

Comair Rotron's Hi-Rel fans continue the tradition of responding to the industry's increasing demand for higher reliability, precisely engineered airmovers. Comair Rotron. The First Name in Forced Convection Cooling Technology.



For literature only call 800-367-2662. In NYS and for product or technical assistance call our application Engineering Dept. at (914) 246-3615.

## HI-REL

# COMAIR ROTRON

a KLI company

12 North Street Sawyer Industrial Park, Saugerties, N.Y. 12477-1096  
Telephone: (914) 246-3615 TWX 910-333-7572 Telex: 551496

CIRCLE NO 58

## NEED PROTECTION?? SWITCH TO US..

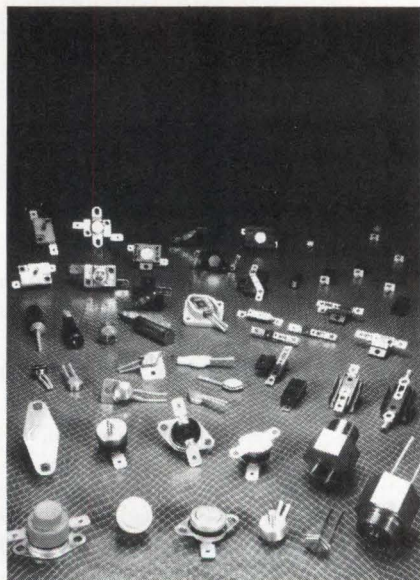

**CANADIAN THERMOSTATS** can offer you thermal protection for all your applications—motors, small appliances, transformers, power supplies, generators, transducers, and many more...

**MICROTHERM'S** high quality thermal protectors and current limiters are available with a wide range of options to meet your every need.

For more information, contact:  
**CANADIAN THERMOSTATS & CONTROL DEVICES LTD.**  
8514 Mountain Sights Avenue  
Montreal, Quebec H4P 2B8

TEL: (514) 739-3274  
FAX: (514) 739-2902



# CANTHERM

CIRCLE NO 59

## INSTRUMENTS

IC packages. The programmer module supports Seiko/Epson-format smart cards. The programmer module allows downloading of data via the PP41's RS-232C port. The programmer can also copy data from a master EPROM. You can use editing functions contained in the programmer's firmware to edit the data extensively before programming the smart cards. \$1475. Delivery, 12 weeks ARO.

**Stag Microsystems Inc**, 1600 Wyatt Dr, Santa Clara, CA 95054. Phone (800) 227-8836; in CA, (408) 988-1118. TWX 910-339-9607.

Circle No 424

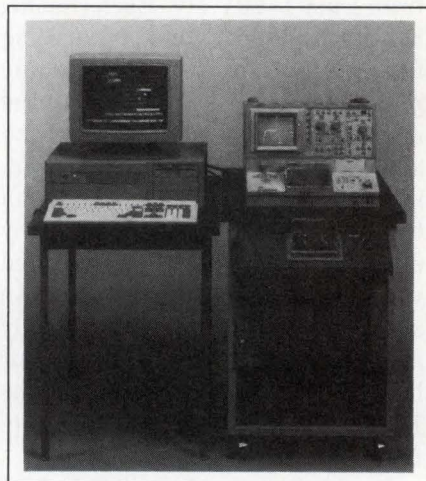

## FAILURE ANALYZER

- Based on device curve tracer
- Tests 192-pin devices in less than five minutes

The S3701 failure analysis system is based on the vendor's 370 curve tracer, PEP 301 computer, and TSI 8150 test-system interface. It automates the failure-analysis process and can test a 192-pin VLSI device in less than five minutes. Each pin of the DUT (device under test) is independently accessible under computer control. 140-channel system, \$39,250; 192-channel system, \$53,100. Delivery, eight to 12 weeks ARO.

**Tektronix Inc**, Box 1700, Beaverton, OR 97075. Phone (800) 835-9433. TLX 151754.

Circle No 425

# EDN PRODUCT MART

This advertising is for new and current products.

Please circle Reader Service number  
for additional information from manufacturers.



### Project: PCB +, now with VGR

The best bargain in PCB design software just got better. **Project: PCB**, with symbol/parts editors, schematic capture, board layout, interactive routing and auto-routing, is now available with **VGR**: a Variable Grid Router. **Project: PCB +** offers user-selectable routing grids, trace widths and via diameters. VGR can also access extra memory for larger boards.

**Project PCB +** is only \$1500.00 (EGA-compatible version).

Demo systems available.

**DASOFT Design Systems, Inc.**

1827-B Fifth Street, Berkeley, CA 94710  
(415)486-0822

CIRCLE NO 325

### AVPAL™ \$395

- Quickly and inexpensively create logic devices — simplify your project design.
- Program from, copy to standard JEDEC files.
- Free PAL starter kit included.
- Ask about our Logic Assembler.



For specs &  
free catalog, call:  
**800-448-8500**  
or (207) 236-9055

**AVOCET**  
SYSTEMS, INC.®

120 Union St., P.O. Box 490, Rockport, ME 04856

CIRCLE NO 326

### NEW \$195\* STD BUS CONTROL COMPUTER

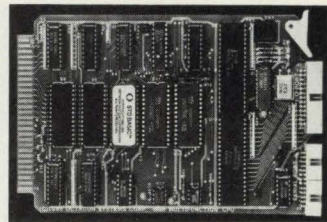

Includes multitasking BASIC that runs faster than BASICA on an IBM/AT! Ideal for cost-sensitive applications requiring high performance and software integration. The 8410 CPU card includes an 8088 CPU, 2 serial ports, 5 counters, 9 interrupts, 32K RAM, and 16 TTL I/O lines that can also drive an opto module rack. All hardware and interrupts supported in BASIC. Program size up to 64K on card, 256K with chaining using an optional memory card. Autorun from RAM or EPROM. Use your IBM PC to develop and debug programs. FREE 1988 STD BUS CATALOG.

\*\$195 in OEM quantities. Call 303-426-8540 for same day response on data sheet and pricing.

**OCTAGON SYSTEMS CORPORATION** 6510 W. 91st Ave.  
Westminster, CO 80030

CIRCLE NO 327

### TTC Low-Profile Plastic Leaded Chip Carrier Socket

Reliable products & Reasonable price!

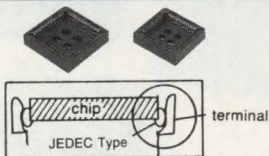

**Special design makes the contact stably.**

To be a connector manufacturer, we specialize in the following items:

1. PLCCS-44P, 68P, 84P
2. IC Socket (Dual in line)- 6P, 8P, 14P, 16P, 18P, 20P, 24P, 28P, 40P, 34P (4Rows)
3. Slot (Edge Card connector)- 36P, 50P, 62P, 80P, 86P, 98P, 100P
4. shunt (Mini Jumper)
5. Pin Header: 2P — 40P (Single Row or Double Rows, Straight or Right Angle)

((OEMs are welcome))

**TTC Shih Hsin Precision Corp.**

No. 2, Lane 75, San Jun Street, Shu-Lin Town, Taipei,  
Taiwan, R.O.C. Tel: 886-2-6894655, 689-4656  
Fax: 886-2-6894657 Telex: 33210 TTCCO

CIRCLE NO 328

### Custom Engineered Toroidal Transformers

Spang Supplies  
Solutions...Fast!

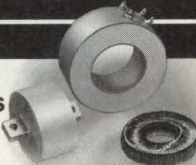

At Spang we're more than just a winding house, and our extensive experience proves it. Our engineers will detail the best overall design to meet your exact requirements. For fast solutions, call the toroidal transformer experts at Spang, or write for our free brochure.

**Spang Power Control**  
TM

P.O. Box 457 - Sandy Lake, PA 16145  
(412) 376-7515 - FAX 412-376-2249

CIRCLE NO 329

### the HUSKY™

EPROM  
PLD  
MICRO  
GANG  
SET

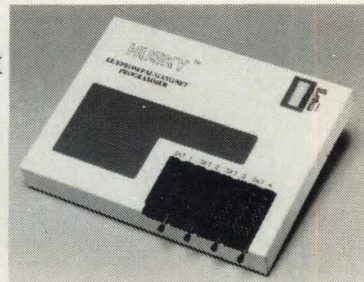

PC based PROGRAMMER  
\$599.00\*

\*modules not included.

From A Name You Can Trust

**LOGICAL DEVICES, INC.**

1201 N.W. 65th Place, Ft. Lauderdale, FL 33309

1-800-331-7766 (305) 974-0967  
Telex 383142 Fax (305) 974-8531

CIRCLE NO 330

To advertise in Product Mart, call Joanne Dorian, 212/463-6415

**IBM COMPATIBLE RS232 EASI-DISK  
3 1/2-5 1/2" FLOPPY DATA STORAGE &  
TRANSFER SYSTEM**



Information Transfer to/from Non IBM Compatible Systems  
to/from IBM & Compatibles: (Over RS-232 or 488 Interface).

- Reads & Writes MS DOS Disks
- RS-232/488 I/O
- Rugged Portable Package/battery option
- ASCII or Full Binary Operation
- Baud Rate 110 to 38.4K Baud
- Price \$895 in Singles—OEM Qtys. Less.

28 other systems with storage from 100K to 35 megabytes.  
**ADPU ANALOG & DIGITAL PERIPHERALS, INC.**  
1251 South Mulberry St. Troy, Ohio 45373  
P.O. Box 499 TWX 810/450-2685  
513/339-2241 FAX 513/339-0070

CIRCLE NO 331

**SCHEMA II  
Schematic Capture**

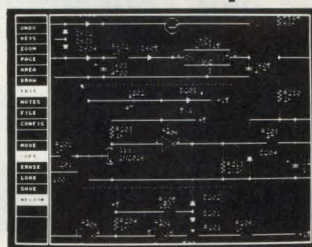

**FREE Demo Disk: 1-800-553-9119**

SCHEMA's success is the talk of the CAE industry and thousands of satisfied SCHEMA owners know why. Incredible speed, ease of use, and power have made SCHEMA a best-selling schematic capture program for engineering professionals the world over.



Now, SCHEMA II is available. SCHEMA II sells for \$495 and supports most common IBM PC/XT/AT configurations. Please call today for a free SCHEMA II demo disk.

**OMATION**

In Texas Call (214) 231-5167

CIRCLE NO 332

**IMS CHIP RESISTORS**

**0.1 - 10 OHMS**

.050" x .050" or .100" x .100"

**24 HOUR DELIVERY  
OUR SPECIALITY**

All Values 10 Ω - 1000 gighms  
Available in 16 other sizes

**401-683-9700**

International Manufacturing Services, Inc.  
50 Schoolhouse Lane, Portsmouth, RI 02871  
FAX: 401-683-5571

CIRCLE NO 333

**8051  
8048**

**SIMULATORS - CROSS ASSEMBLERS - PROGRAMMERS - SIM51 and SIM48** Software Simulators run on IBM-PC, CP/M-80, MS-DOS. Designed for validation & debugging application software. Simulation includes all on chip functions plus expansion chips. \$250, one year **FREE** updates. Formats: PC-DOS 2.x DSD, CP/M-80 8" SSSD, many 5 1/4" formats. Cross Assemblers and EPROM pgms also available. **Logical Systems Corp.** 6184 Teall Station, Syr., NY 13217 (315) 478-0722

**Logical Systems**

CIRCLE NO 334

**E & H Field Probes**

**\$495**



**EDN "Readers Choice" (6/25/87)**

Makes finding E & H Field emissions easy!

Use with any o-scope or spectrum analyzer. Set includes three H and two E field probes, extension handle, case, documentation, two year warranty. Pre-amp with battery charger, optional. Call, write to order or for brochure.

1-800-253-3761  
PO Box 1546 Austin, TX 78767



The Electro-Mechanics Company

CIRCLE NO 335

**TIGER POWER  
40-350W range of switching power supplies**

Model: BM-2150  
(Mini Tiger)



Lead Year's main SPSs products are:

- PS/2 models
- 286/386-type PC/AT models
- Mini Tiger super compacts
- Cubic Baby AT models
- PC/XT models
- OEM are welcome



Contact us today for more information on how Lead Year's Tiger Power make your electronics great!



Lead Year Enterprise Co., Ltd.  
3F, No. 481, Chung Hsiao E., Rd., Sec. 6,  
Taipei, Taiwan, R.O.C.  
TIGER POWER P.O. BOX 53-352 Taipei Tel: 886-2-7857858  
Tlx: 12862 LEADYEAR Fax: 886-2-7857852  
PCXT, PCAT, Baby AT and PS2 are trademarks of the international business Machines Corp.

CIRCLE NO 336

**VMEbus  
HIGH SPEED ANALOG-TO-DIGITAL CONVERTER**

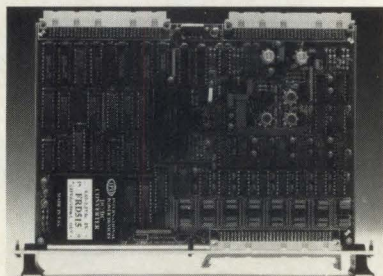

VMIC announces a high speed VMEbus, 12-bit analog-to-digital converter (VMVME-3101) with 32 single-ended/16 differential front panel inputs. A wide variety of input filter options are available. The new product features built-in-test. Each front-panel input is monitored by an unbuffered self-test multiplexer. The self-test multiplexer provides a means of testing all inputs, and enables buffer amplifier offsets to be eliminated in software. The product is designed with a provision for simultaneous settling and conversion which gives A/D conversion throughputs to 200 kHz. The A/D converter conversion time is 3μs. The price is \$2,895.00 with all options.

**VMIC**

12090 South Memorial Parkway, Huntsville, AL 35803-3308  
(205) 880-0444, or 1-800-322-3616

CIRCLE NO 337

**VMEbus  
HIGH RESOLUTION ANALOG-TO-DIGITAL CONVERTER**

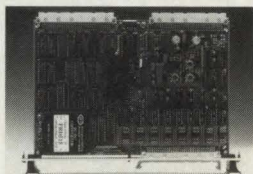

VMIC announces a VMEbus High Resolution Analog input board (VMVME-3116) that features built-in-test and auto-calibration. The new product is designed with 32 single-ended/16 differential front panel inputs with a wide variety of input filter options. The Built-in-Test hardware features on-board precision voltages which may be read for fault detection and isolation. Each front-panel input is monitored by an unbuffered self-test multiplexer. The self-test multiplexer provides a means of testing all inputs, and enables buffer amplifier offsets to be eliminated in software. The ADC board features a resolution of 16 bits and a conversion time of less than 20 microseconds.

The price is \$2,595.00 with all options.

**VMIC**

12090 South Memorial Parkway, Huntsville, AL 35803-3308  
(205) 880-0444, or 1-800-322-3616

CIRCLE NO 338

**SBSX MODULES**

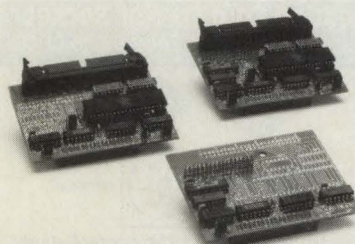

We've upgraded our SBSxSCSI module to support Block-Mode Pseudo-DMA transfers. That means CPUs without DMA can increase transfer speeds by not polling for READY on every byte. We've also added an optional Centronics-compatible printer port (SBSxSCSI/CEN). If you only need the printer port, save money with our low-cost SBSxGEN module. We also offer a Floppy-Disk Controller module (SBSxFDC) that handles 3 1/2", 5 1/4", and 8" drives with SD, DD and HD formats.

Call or write for more information.

**Single Board Solutions, Inc.**  
20045 Stevens Creek Blvd.  
Cupertino, CA 95014  
(408) 253-0250

CIRCLE NO 339

To advertise in Product Mart, call Joanne Dorian, 212/463-6415

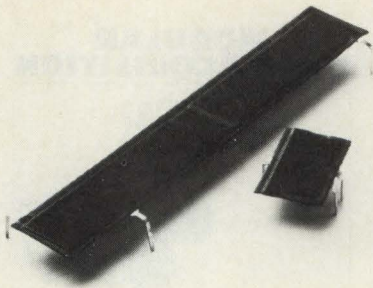

### SOLVE DECOUPLING PROBLEMS

MICRO/Q capacitors with special pinout configurations give superior noise suppression, design ease. Solve special decoupling, routing problems for 8-, 16-, or 32-bit microprocessors, ECL devices, and many other devices where power and ground are not at conventional positions. **Rogers Corp.**, 2400 S. Roosevelt St., Tempe, AZ 85282. 602/967-0624

CIRCLE NO 340

## PCB 'DEPENDABLE'

### ICP\* QUARTZ ACCELEROMETERS

Made in U.S.A.



ICP accelerometers simplify, improve and lower your cost of vibration measurement. They operate simply over ordinary coaxial cables from inexpensive PCB power sources or from newer FFT analyzers providing built-in current source for powering ICP sensors.

\*Integrated Circuit Piezoelectric

**PCB PIEZOTRONICS, INC.**  
3425 Walden Avenue  
Depew, NY 14043-2495  
716-684-0001



CIRCLE NO 341



### GANG/SET (E)EPROM MULTIPROGRAMMERS™

Model 135-E: \$995<sup>00</sup>

- BYTEK's 135 is a SET Programmer, GANG Duplicator, & UNIVERSAL Device Programmer.
- Programs virtually all 24, 28, & 32-pin (E)EPROMs.
- RAM expandable to 2MegaByte.
- Optional support for 40-pin EPROMs, Bipolar PROMs, 40-pin Micros, & (E)PLD/GAL/FPLA Devices.
- 18-Month FREE WARRANTY and also 12-Month FREE DEVICE UPDATES.

**1-800-523-1565**

In Florida: 1-407-994-3520



**BYTEK Corporation**  
1021 S. Rogers Cir., Boca Raton, FL 33487  
FAX: (407) 994-3615 Telex: 4998369 BYTEK

\* (U.S. Prices only)

CIRCLE NO 342

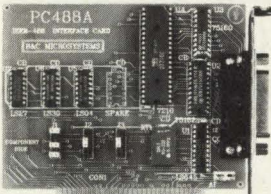

### PC488 \$145

LOW COST PC/XT/AT INTERFACE FOR IEEE-488 (GPIB/HPIB)

- INCLUDES INSTALLABLE DOS DEVICE DRIVERS
- 1 OF 6 INTERRUPT LEVELS
- 1 OF 2 DMA CHANNELS
- UP TO 4 BOARDS PER COMPUTER
- CONTROLLER / TALKER / LISTENER
- CUSTOM SOFTWARE SUPPORT AVAILABLE
- COMPATIBLE WITH MOST IEEE488 SOFTWARE PACKAGES FOR THE IBM PC
- QUANTITY DISCOUNTS

VISA MC AMEX Call today for datasheet!!

**B&C MICROSYSTEMS**

355 West Olive Ave, Sunnyvale, CA 94086  
PH: (408)730-5511 FAX: (408)730-5521 TELEX: 984185

CIRCLE NO 343

### WINPOINT A FULL RANGE OF CONNECTORS & SOCKET

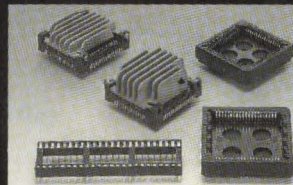

IC SOCKETS-8, 14, 16, 18, 20, 22, 24, 28, 40, 42, 48 contact  
LCC SOCKET-68 contact  
PLCC SOCKET-28, 32, 44, 52, 68, 84 contact series



**Winpoint Electronic Corp.**

P.O. Box 89-80, Taipei, Taiwan, R.O.C. Office: No. 47, Chi-Wei St., San Chung City, Taipei, Taiwan, R.O.C.  
Tel: (02) 986-0208, 984-0209  
Telex: 34227 WINPOINT Fax: 886-2-9838555

CIRCLE NO 344

### WE PROVIDE SOLUTIONS TO MANY INTERCONNECT PROBLEMS...



- Test Adapters (Socketed LCC/PLCC/PGA)
- Test Clips (Surface Mounted SOIC/PLCC)
- 150 Types of Prototyping Board Adapters
- 125 Types of Programming Socket Converters
- Many Types of Emulator Pod Converters
- PGA/PLCC Extraction/Insertion Tools
- And Much, Much More...



**Emulation Technology, inc.**

STATE OF THE ART VLSI and SURFACE MOUNT ACCESSORIES

2368-B Walsh Ave. • Bldg. D • Santa Clara, CA 95051  
TEL: (408) 982-0660 • FAX: (408) 982-0664

CIRCLE NO 345

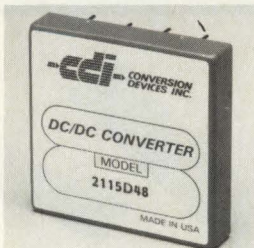

### 20W DC/DC CONVERTERS, 2100 SERIES BREAKTHROUGH IN SIZE/PERFORMANCE

- Dense power for great value
- 9-72VDC input range
- -25°C to +71°C ambient operation
- 2" x 2" x .375" shielded case
- Short circuit current limiting
- 100% Burn-in @ FL
- 13.3W/In<sup>3</sup> power density
- Single/dual output
- -55°C to +85°C optional extended case
- No heat sink required
- Remote ON/OFF Control
- \$129 (1-9) Del. 3-4 wks. ARO

**CONVERSION DEVICES, INC.**  
101 Tosca Dr., Stoughton, MA 02072  
Tel: (617) 341-3266, TLX: 920014

CIRCLE NO 346



### Great Designs Start With Tango-Schematic.™ Just \$495.

Designs quickly come to life with Tango-Schematic's easy-to-use drawing editor and extensive component libraries. Features four line types, four text sizes, repeat and block functions, unique built-in word processor. Includes DRC, BOM, Wire List, Net List outputs and crisp plots, prints, or laserprints. The perfect front end to our popular Tango-PCB and Tango-Route board design systems.

For IBM PC/XT/AT/PS2. Just \$495. Full-function Demo Package: \$10. Order toll-free 800 433-7801. VISA/MC. Thirty-day money back guarantee.

ACCEL Technologies, 7358 Trade St., San Diego, CA 92121  
Outside N., S. America contact HST Technology (Australia)  
Phone: 61-02-34-8499 FAX: 61-02-23-8771

CIRCLE NO 347



### Glide Through PCB Design.

**TangoPCB™** Create the toughest board designs with powerful layout software that's a snap to use. Function-rich Tango-PCB supports eight layers, 1 mil grid, OrCAD™ or Schema™ netlist input, print/plot/photoplot output, and more.

**TangoRoute™** Get impressive completion rates and remarkable speed with Tango-Route, a four layer, eleven pass autorouter.

**Just \$495 each.**

For IBM PC/XT/AT/PS2. Compare features and you'll buy Tango. Or try full-function Demo Package, just \$10. Order toll-free: 800 433-7801. VISA/MC. Thirty-day money back guarantee.

ACCEL Technologies, 7358 Trade St., San Diego, CA 92121

CIRCLE NO 348

To advertise in Product Mart, call Joanne Dorian, 212/463-6415

## ADSP-2100 DEVELOPMENT SYSTEM

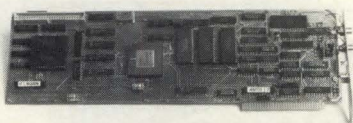

IBM-PC plug-in board with Analog Devices' ADSP-2100 processor for Digital Signal Processing (DSP) and high-speed numeric processing applications. 40Kw on-board RAM (45ns), user expandable to 112Kw, 12-bit A/D & D/A (200 kHz), input sample-and-hold, **DSP LINK™** standardized bus interfaces to data acquisition boards, supports multi-board applications. Debug monitor & Analog Devices' Cross-Software, Assembler/Linker & Simulator Application routines

US \$2,995.

ADSP-2100 Development System only, without Analog Devices' Cross-Software & Simulator Software \$2,595.  
ANALOG DEVICES "C" Compiler \$1,475.  
High-Speed Real-Time Data Acquisition Please Call

**SPECTRUM SIGNAL PROCESSING INC**

USA East: 1-800-323-1842 In Mass: (617) 890-3400  
USA West: 1-800-663-8986 In Canada: (604) 438-7266

CIRCLE NO 349

## TMS 320C25 DSP DEVELOPMENT SYSTEM

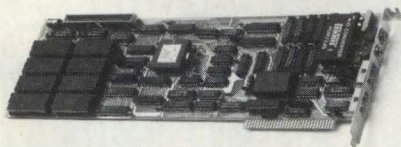

IBM-PC based Development System for Texas Instruments' 40 MHz TMS 320C25. With 16-bit 50kHz A/D & D/A, sample-and-hold, 16x16 RAM (35ns, 0 wait state) expandable to 128K on-board, I/O expansion, **DSP LINK™** standardized bus for interface to data acquisition boards, supports multi-board applications. Debug monitor provides single-step, breakpoints and full-speed operation.

US \$2,595.

TI's Macro Assembler/Linker - avail separately \$395.  
TI's "C" Compiler with COFF Assembler/Linker \$2,500.  
LSI's "C" Compiler \$1,995.  
TMS 32020 Development System \$2,295.

**SPECTRUM SIGNAL PROCESSING INC**

USA East: 1-800-323-1842 In Mass.: (617) 890-3400  
USA West: 1-800-663-8986 In Canada: (604) 438-7266

CIRCLE NO 350

## MODULAR DATA ACQUISITION

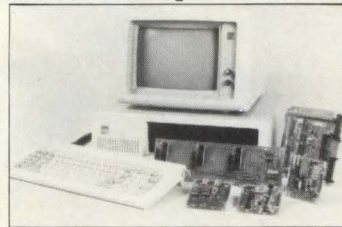

- For IBM & Compatibles
  - Flexible and Inexpensive
  - Money Back Guarantee
  - Free Technical Support
- Fast Delivery**

**QUA TECH**  
INCORPORATED

478 E. Exchange St. Akron OH 44304  
(216) 434-3154 TLX: 5101012726

CIRCLE NO 751

## IEEE-488

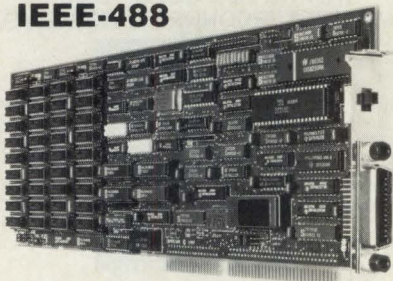

### IEEE-488, PARALLEL, and SERIAL PORTS PLUS 4M BYTES of MEMORY

- Control any instrument. RS232 or '488.
- 4Mbytes of extended/expanded memory.
- Software library and memory manager.
- High speed DMA. Risk free guarantee.

**cec**

Capital Equipment Corp.  
99 South Bedford St.  
Burlington, MA. 01803

FREE demo disk. Call (617) 273-1818

CIRCLE NO 752

## MEMULATOR II™ In-Circuit EPROM Emulator \$375\*

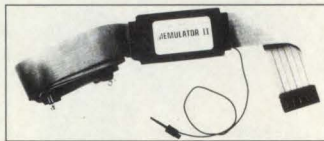

- Download via RS-232 up to 32K bytes in less than 10 seconds.
- Emulates 2716 - 27C256 devices
- Accepts Intel hex, Motorola S-record, and straight binary formats.
- 100ns or \*150ns access times.
- Monitor command set in firmware.

Inquire about our 16-bit in-circuit EPROM emulator.

**MEMOCOM**  
DEVELOPMENT  
TOOLS

1920 Arbor Creek Drive  
Carrollton, Texas 75010  
214/446-9906

CIRCLE NO 753

## 6800/6809 Micro Modules

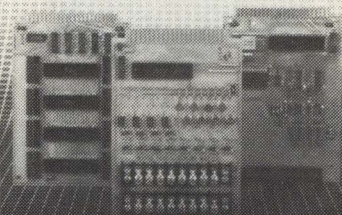

OEM 6800/6809 MICROCOMPUTER MODULES for dedicated control and monitoring. Interfaces for sensors, transducers, analog signals, solenoids, relays, lamps, pumps, motors, keyboards, displays, IEEE-488, serial I/O, floppy disks.

**WINTERK**

Wintek Corp.  
1801 South Street  
Lafayette, IN 47904  
317-742-8428  
800-742-8599

CIRCLE NO 754

## MIL-STD-1553



### MIL-STD-1553 Interface Board For IBM-PC/XT/AT or Compatibles

Dual redundant bus controller, remote terminal and monitor with powerful easy-to-use software. From only \$2095

Call now for free data & demo disc

**Ballard Technology**

1216 N.W. 75th St.,  
Seattle, WA 98117  
(206) 782-8704

CIRCLE NO 755

## UNIVERSAL LOGIC PROGRAMMER

- PROGRAMS, READS, DUPLICATES, TESTS AND SECURES HUNDREDS OF 20- AND 24-PIN DEVICES

- 23 UNIVERSAL PIN DRIVERS WITH INDEPENDENT DAC, ADC & SLEW FUNCTIONS PROGRAM ALMOST ANY LOGIC DEVICE
- MENU DRIVEN OPERATION IS EASY TO LEARN AND QUICK TO OPERATE

- CONNECTS TO ANY IBM COMPATIBLE VIA PARALLEL PRINTER PORT
- EDITS FUSE DATA & TEST VECTORS WITH FULL SCREEN EDITOR
- TESTS WITH VECTORS & SECURES AFTER PROGRAMMING
- SUPPORTS ALL POPULAR PLD DEVELOPMENT SOFTWARE
- ONLINE HELP FUNCTION
- SELF CALIBRATING
- JEDEC FILE INPUT & OUTPUT
- 30 DAY MONEY BACK GUARANTEE
- EPROM PROGRAMMERS ALSO

- ONE YEAR WARRANTY
- SAME DAY SHIPMENT
- GOLD TEXT TOOL ZIF IC SOCKET
- UPDATABLE VIA FLOPPY
- TOLL-FREE TECH SUPPORT
- JUST \$798

CALL FOR FREE DEMO DISK OR INFO 800/225-2102

**BP MICROSYSTEMS**

10681 HADDINGTON #190 HOUSTON, TX 77043  
713/461-9430 TLX: 1561477 FAX: 713/461-7413

CIRCLE NO 756

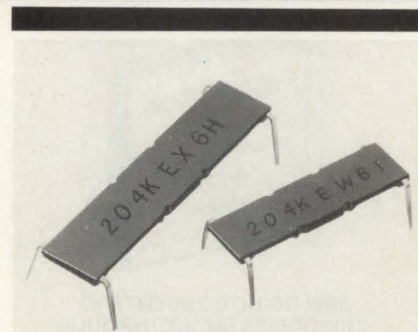

## MICRO/Q II

FOR A DECOUPLING CAPACITOR THAT SAVES SPACE, DEFEATS NOISE, IS SUITABLE FOR MILITARY APPLICATIONS AND BEATS HUMIDITY, HEAT AND COLD: ROGERS MICRO/Q® II

Rogers Corp., 2400 S. Roosevelt,  
Tempe, AZ 85282. 602/967-0624

CIRCLE NO 757

To advertise in Product Mart, call Joanne Dorian, 212/463-6415



## 72 DIGITAL I/O FOR PS/2

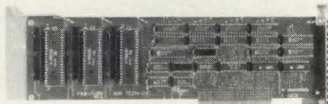

### MODELS 50, 60, 80

- Parallel Expansion
  - 72 I/O Lines
  - Address Selectable
- 1-800-553-1170**



478 E. Exchange St., Akron, OH 44304  
TEL: (216) 434-3154 FAX: (216) 434-1409  
TLX: 5101012726

CIRCLE NO 767

## "D" SIZE PLOTTER

\$2295<sup>00</sup>  
RETAIL

\$1695<sup>00</sup>  
INTRODUCTORY  
OFFER

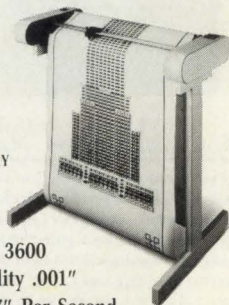

- Model PC 3600
- Repeatability .001"
- Speed at 7" Per Second
- Vacuum Paper Hold Down
- High Resolution Circles: Suitable for PCB Artwork

(415) 490-8380 **ZERICON**  
STEVENSON BUSINESS PARK  
BOX 1669 • FREMONT, CA 94538

CIRCLE NO 768

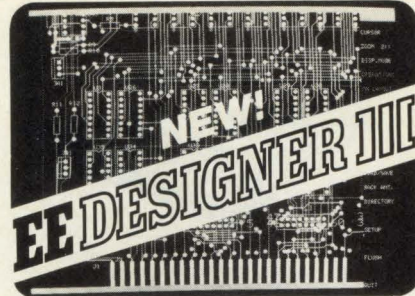

CAE/CAD Integrated Software Package  
for IBM PC/XT/AT/PS2  
**Weigh Cost Against Performance**

When you balance cost and performance, EE Designer III gives you more features per dollar than any other electronic design software package. You get full-featured PCB layout plus schematic capture, analog/digital circuit simulation, support for EMS memory, 45 degree autorouting, and full postprocessing functions. EE Designer packages start at \$995.

30 day money back guarantee. Full purchase price refunded if not completely satisfied. Call 1-800-553-1177 today to order your package. Bank cards welcome.

**VISIONICS** CORPORATION 343 Gibraltar Drive  
Sunnyvale, CA 94089

CIRCLE NO 769

the **LOGIC™  
LAB**



\$499<sup>00</sup>

the **LOGIC™  
LAB** is a complete logic development system

- \* Complete System Including Programmer, Sample GAL Devices, Software and all Cabling.
- \* Programs GAL Devices Including 16V8, 16Z8, 20V8, & 39V18.
- \* Allows Prototyping of 42 different standard PLD's.
- \* Includes Updated Equation Assembler Software.
- \* Accepts All Standard JEDEC Download Files.
- \* Software Updatable.
- \* 30 Day Money Back Guarantee.

\* Visa and Master Card Accepted \*  
CALL FOR FREE DEMO DISK

**Programmable Logic Technologies, Inc.**

P.O. Box 1567  
Longmont, CO 80501  
Ph. (303) 772-9059

GAL is a registered trademark of  
Lattice Semiconductor Corporation

CIRCLE NO 770

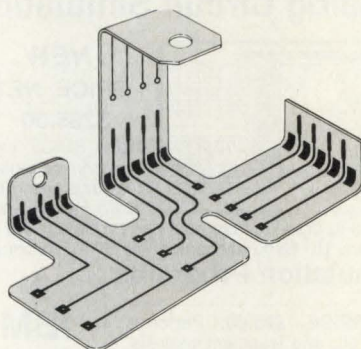

WE'RE BENDING THE RULES FOR CIRCUIT DESIGNERS

**BEND/FLEX™**, the bendable board material flexible enough to bend into any multi-plane shape. Eliminates stiffeners, flex-hardboard connectors. May reduce cost of two- and three-plane interconnect systems by as much as 30%!

**Rogers Corporation.** One Technology Dr.,  
Rogers, CT 06263. (203) 774-9605.

CIRCLE NO 771

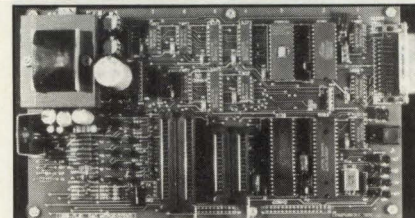

**UNIVERSAL E(E)PROM  
PROGRAMMER KITS FROM \$95**

- No personality modules; Menu-driven device selection.
- On board power supply (110/220V AC).
- Direct technical support; Full 1 year warranty.
- User friendly software; Complete help menu.
- Quick pulse algorithm (27256 under 60 sec).
- Programs 27xx to 1 Mbit, 25xx, 68xx, CMOS; EEPROMS.
- Micros: 8741, 8742, 8748, 8748H, 8749, 8749H & more.
- IBM-PC, Apple, CPM or Unix driver; Autobaud RS232.
- Offset/split Hex, Binary, Intel & Motorola 8,16,32 bit.
- Manual with complete schematics.

VISA MC AMEX Call today for datasheets !!

**B&C MICROSYSTEMS**

355 WEST OLIVE AVE. SUNNYVALE, CA 94086  
PH: (408) 730-5511 FAX: (408) 730-5521 TELEX: 984185

CIRCLE NO 772

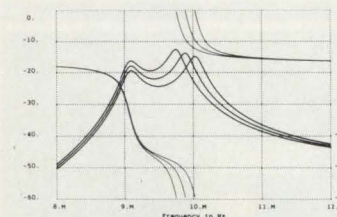

### ANALOG CIRCUIT ANALYSIS ECA-2

Introducing **ECA-2** for the Macintosh. **ECA-2** 2.31 includes more models, increased graphics capabilities, and expanded documentation.

- AC, DC, Transient
- Fourier, Temperature
- Worst-case, Monte-Carlo
- Full, nonlinear simulator
- Interactive or batch
- SPICE compatible models
- Twice as fast as SPICE
- Over 500 nodes
- Sine, Pulse, PWL, SFFM and Exponential generators
- Money back guarantee

**EC-Ace**, a subset of **ECA-2**, \$145

**ECA-2** IBM PC or Mac \$675

Call 313-663-8810 For FREE DEMO disk



**Tatum Labs, Inc**

1478 Mark Twain Court, Ann Arbor, MI 48103

CIRCLE NO 773



**PADS PCB**  
**\$975.00**

USA & CANADA ONLY

Everything you've always wanted in  
a CAD Engineering workstation  
and affordable!

- Inputs from FutureNet™, Orcad™, Schema™
- 1 Mil database, 32 x 32", 30 Layers
- Routing Grids: 1, 5, 10, 20, 25 & 50 Mils
- 1, 2 & 3 Tracks between IC Pads
- Interactive and Automatic Placement and Routing\*
- XT, AT & 386 (and compatibles)
- Full Air Gap & Connectivity Checking
- 200 IC Capability (400 IC optional)
- Full SMD & Analog Support
- Evaluation Kit \$50.00: contains actual software on multiple disks, and detailed manuals \* optional

Outside MA 1-800-255-7814

Inside MA 1-617-486-9521

**CAD Software, Inc.**

P.O. Box 1142, Littleton, Massachusetts 01460

CIRCLE NO 774



**smARTWORK® PCB Software.** In a fraction of the time hand taping requires, you can create double-sided printed-circuit boards with smARTWORK and your IBM PC. The program's features include continual design-rule checking, automatic pad shaving, a silkscreen, and text for all three layers. smARTWORK with autorouting is \$895 (without, \$495) and comes with a 30-day money-back guarantee. Credit cards accepted. Write or call

**Wintek Corporation**

1801 South Street, Lafayette, IN 47904  
(800) 742-6809 or (317) 742-8428

CIRCLE NO 775

To advertise in Product Mart, call Joanne Dorian, 212/463-6415



## LITERATURE

Building Blocks from ICS...  
the things you need  
to build IEEE 488 BUS Systems  
that do what you want them to do.

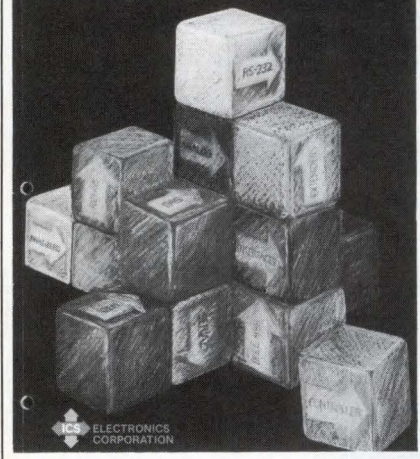

### Publication features IEEE-488 products

This 84-pg catalog surveys the vendor's IEEE-488 bus enhancement products, including interfaces, analyzers, extenders, and controllers. The product locator helps you find the eight main categories of IEEE-488 Bus products. A domestic price list, and a list of domestic sales representatives and international sales distributors are also provided.

**ICS Electronics Corp.**, 2185 Old Oakland Rd, San Jose, CA 95131.

Circle No 430

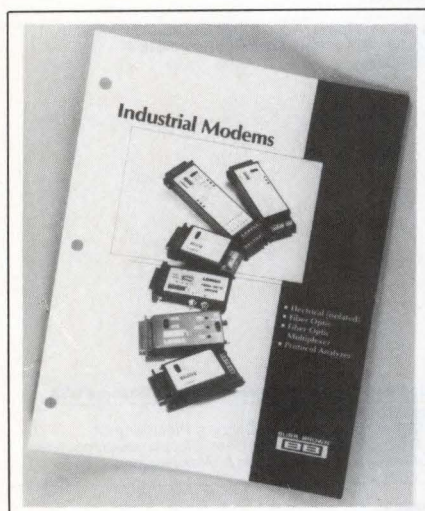

### Pamphlet summarizes modems

This 12-pg brochure focuses on the vendor's line of data-communications modems for both electrical and

fiber-optic applications. It features a 16-channel fiber-optic multiplexer that provides a high-speed link with total electrical isolation between clusters of computer or terminal ports.

**Burr-Brown Corp.**, Box 11400, Tucson, AZ 85734.

Circle No 431

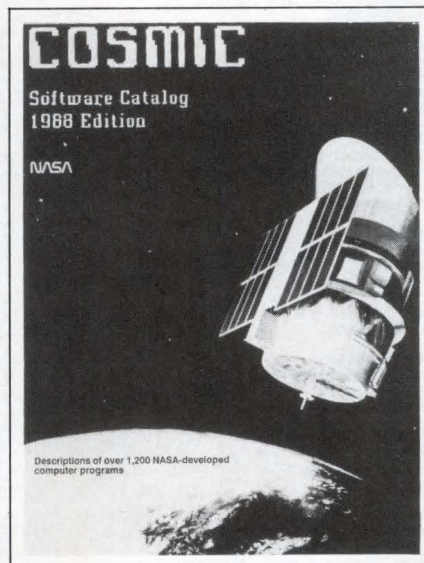

### Software developed under auspices of NASA

The 1988 Cosmic catalog describes 1219 computer software programs, as well as 50 newly added programs, that have been developed with the aid of NASA funding. The abstract for each program explains the program's capabilities, provides information to help you decide on applications, and lists the programming language, machine environment, size, and prices of the source code and supporting documentation. The publication also features keyword and author indexes, and subject classifications. Some of the program subjects include thermodynamics, structural mechanics, artificial intelligence, image-processing heat transfer, and circuit design. Printed edition, \$25; microfiche set, \$10; magnetic tape, \$50.

**Cosmic**, The University of Georgia, 382 E Broad St, Athens, GA 30602.

INQUIRE DIRECT

NTT GROUNDLESS POWER-LINE EMI NOISE FILTER

**NO GROUNDING.  
NO TRIAL AND  
ERROR.  
NO WORRIES.**

**NTT'S REVOLUTIONARY SUPER-  
ATTENUATING "GROUNDLESS"  
POWER-LINE  
NOISE FILTER!**



Pat. Pend.

NTT's advanced Power line Noise Filters ensure high attenuation in broad bands — without grounding! Trial-and-error countermeasures against noise are no longer necessary. Nor is worry about the protection of ungrounded factory, office and home electronic equipment. Consult NTT now for:

\*Guaranteed broad-band, high attenuation in lines from 0.15 — 50MHz.

\*Lightning-surge-protective effect.

\*High voltage pulse noise attenuation.

\*Significant cost saving

Send now for literature and specifications:

**NTT**  
Nippon Telegraph & Telephone  
International



NTT International Corporation

8F, 21st Mori-Building, 4-33 Roppongi 1-chome,

Minato-ku, Tokyo 106, JAPAN

Telephone: Domestic: 03-584-9962

International: 81-3-584-9962

Facsimile: 81-3-584-9977

Telex: 2425454 NTTIA J

**DISTRIBUTOR WANTED!!**

CIRCLE NO 60

## EDN's CHARTER

EDN is written for professionals in the electronics industry who design, or manage the design of, products ranging from circuits to systems.

EDN provides accurate, detailed, and useful information about new technologies, products, and design techniques.

EDN covers new and developing technologies to inform its readers of practical design matters that will be of concern to them at once or in the near future.

EDN covers new products

- that are immediately or imminently available for purchase
- that have technical data specified in enough detail to permit practical application
- for which accurate price information is available.

EDN provides specific "how to" design information that our readers can use immediately. From time to time, EDN's technical editors undertake special "hands-on" projects that demonstrate our commitment to readers' needs for useful information.

EDN is written by engineers for engineers.

# EDN

275 Washington St  
Newton, MA 02158  
(617) 964-3030

**F Warren Dickson**  
Vice President/Publisher  
Newton, MA 02158  
(617) 964-3030; Telex 940573  
Diann Siegel, Assistant

**Peter D Coley**  
VP/Associate Publisher/  
Advertising Sales Director  
Newton, MA 02158  
(617) 964-3030  
Ora Dunbar, Assistant/Sales Coordinator

**NEW ENGLAND**  
John Bartlett, Regional Manager  
Chris Platt, Regional Manager  
199 Wells Ave  
Newton, MA 02159  
(617) 964-3730

**STAMFORD 06904**  
George Isbell, Regional Manager  
8 Stamford Forum, Box 10277  
(203) 328-2580

**NEW YORK, NY 10011**  
Daniel J Rowland, Regional Manager  
249 West 17th St  
New York, NY 10011  
(212) 463-6419

**PHILADELPHIA AREA**  
Steve Farkas, Regional Manager  
487 Devon Park Dr, Suite 206  
Wayne, PA 19087  
(215) 293-1212

**CHICAGO AREA**  
Clayton Ryder, Regional Manager  
Randolph D King, Regional Manager  
Cahners Plaza  
1350 E Touhy Ave, Box 5080  
Des Plaines, IL 60017  
(312) 635-8800

**DENVER 80206**  
John Huff, Regional Manager  
44 Cook St  
(303) 388-4511

**DALLAS 75243**  
Don Ward, Regional Manager  
9330 LBJ Freeway, Suite 1060  
(214) 644-3683

**SAN JOSE 95128**  
Walt Patstone, Regional Manager  
Bill Klanke, Regional Manager  
Philip J Branon, Regional Manager  
James W Graham, Regional Manager  
3031 Tisch Way, Suite 100  
(408) 243-8838

**LOS ANGELES 90064**  
Charles J Stillman, Jr  
Regional Manager  
12233 W Olympic Blvd  
(213) 826-5818

**ORANGE COUNTY/SAN DIEGO 92715**  
Jim McErlan, Regional Manager  
18818 Teller Ave, Suite 170  
Irvine, CA  
(714) 851-9422

**PORTLAND, OREGON 97221**  
Pat Dakin, Regional Manager  
Walt Patstone, Regional Manager  
1750 SW Skyline Blvd, Box 6  
(503) 297-3382

**UNITED KINGDOM/BENELUX**  
Jan Dawson, Regional Manager  
27 Paul St  
London EC2A 4JU UK  
44 01-628 7030  
Telex: 914911; FAX: 01-628 5984

**SCANDINAVIA**  
Stuart Smith  
27 Paul St  
London EC2A 4JU UK  
01-628 7030  
Telex: 914911; FAX: 01-628 5984

**FRANCE/ITALY/SPAIN**  
Alasdair Melville  
27 Paul St  
London EC2A 4JU UK  
01-628 7030  
Telex: 914911; FAX: 01-628 5984

**WEST GERMANY/SWITZERLAND/AUSTRIA**  
Wolfgang Richter  
Sudring 53  
7240 Horb/Neckar  
West Germany  
49-7451-7828; Telex: 765450

**EASTERN BLOC**  
Uwe Kretschmar  
27 Paul St  
London EC2A 4JU UK  
01-628 7030  
Telex: 914911; FAX: 01-628 5984

**FAR EAST**  
Ed Schrader, General Manager  
18818 Teller Ave, Suite 170  
Irvine, CA 92715  
(714) 851-9422; Telex: 183653

**TOKYO 160**  
Kaoru Hara  
Dynaco International Inc  
Suite 1003, Sun-Palace Shinjuku  
8-12-1 Nishishinjuku, Shinjuku-ku  
Tokyo 160, Japan  
Tel: (03) 366-8301  
Telex: J2322609 DYNACO

**SINGAPORE/MALAYSIA/INDONESIA/THAILAND  
THE PHILIPPINES/AUSTRALIA/NEW ZEALAND**  
Asia Pacific Media House PTE Ltd  
Peter Cheong  
100 Beach Rd  
#24-03 Shaw Tower  
Singapore 0718  
Tel: 2915354; Telex: RS 50026 MESPLY

**HONG KONG**  
John Byrne & Associates Ltd  
1613 Hutchison House  
10 Harcourt Rd  
Central Hong Kong  
Tel: 5-265474; Telex: 61708 WEDIN HX  
FAX: 5-8106781

**TAIWAN**  
Acteam International Marketing Corp  
6F, No 43, Lane 13  
Kwang Fu South Rd  
Mailing Box 18-91  
Taipei, Taiwan ROC  
760-6209 or 760-6210  
Telex: 29809; FAX: (02) 7604784

**KOREA**  
Kim Kyong-Hae, BK International  
Won Chang Bldg, 3rd Floor 26-3  
Yoido-dong, Youngdungpo-ku  
Seoul 150, Korea  
Tel: 785-6665; FAX: 784-1915  
Telex: K32487 BIZKOR

**PRODUCT MART**  
Joanne Dorian, Manager  
249 West 17th St  
New York, NY 10011  
(212) 463-6415

**CAREER OPPORTUNITIES/CAREER NEWS**  
Roberta Renard, National Sales Manager  
(201) 228-8602  
Janet O Penn, Eastern Sales Manager  
(201) 228-8610  
103 Eisenhower Parkway  
Roseland, NJ 07068

Ellen Sherwood, Western Sales Manager  
18818 Teller Ave, Suite 170  
Irvine, CA 92715  
(714) 851-9422

Maria Cubas, Production Assistant  
(201) 228-8608

Susan M Campanella, Advertising/Contracts Coordinator  
Nan Coulter, Advertising/Contracts Coordinator  
(617) 964-3030

**William Platt, Sr, Vice President, Reed Publishing USA**  
Cahners Magazine Division  
Terry McDermott, President, Cahners Publishing Co  
Frank Sibley, Group Vice President, Electronics/Computers  
Tom Dellamaria, VP/Production & Manufacturing

**Circulation**  
Denver, CO: (303) 388-4511  
Sherri Gronli, Group Manager  
Eric Schmierer, Manager

Reprints of EDN articles are available on a custom printing basis at reasonable prices in quantities of 500 or more. For an exact quote, contact Joanne R Westphal, Cahners Reprint Service, Cahners Plaza, 1350 E Touhy Ave, Box 5080, Des Plaines, IL 60018. Phone (312) 635-8800.

# If It Heats Up, Cools Down, Feels The Pressure Or Moves, You Can Display It!

TEMPERATURE MEASUREMENT																													
	Maximum Reading	Resolution Available			Nominal Accuracy		Thermocouple							RTD			Thermistor												
		°F	1.0°	0.1°	0.01°	°F	°C	K	J	T	E	R	S	B	N	C	D	G	CGI	Fe Con	Cu Con	PT 385	PT 392	PT (OTH)	Cu 10	Ni 120	YSI 400	YSI 700	
60 Series	1999°F	•	•		3°	2°	•	•	•	•	•	•	•	•	•	•	•	•	•	•	•	•	•	•	•	•	•	•	•
400A Series	3392°F	•	•	•	1°	1°	•	•	•	•	•	•	•	•	•	•	•	•	•	•	•	•	•	•	•	•	•	•	•
600 Series	4200°F		•	•	0.5°	0.3°	•	•	•	•	•	•	•	•	•	•	•	•	•	•	•	•	•	•	•	•	•	•	•

VOLT, AMP, PROCESS SCALED AND STRAIN-GAGE MEASUREMENT									
	Maximum Display Counts	Nominal Accuracy	DC Input		Scaled DC		AC Input		Strain-Gage
			Volts	mAmps	Volts	mAmps	Volts	mAmps	
60 Series	19999	0.1%-0.03%	•	•	•	•	•	•	
400A Series	25000	0.1%-0.02%	•		•	•			
600 Series	99999	0.1%	•		•	•			•

## Digital Panel Indicators For Every Application

With a product selection second to none, Beckman Industrial is sure to have the indicator you need. As you can see from the table above, no matter what your measurement and application needs, one call to Beckman Industrial solves them all.



## Big Displays. Bigger Reliability.

**The Doric 400A Series.** Easy-to-read displays (a full 0.8" high) and unmatched quality continue to make this unit one of the most popular indicators in the industry. These indicators perform even in the toughest industrial environments thanks to their rugged metal casing and isolated electronics. You also have your choice of alarms, analog output and BCD output options. Multi-channel units let you switch 5, 10, 20 and more sensors into a single indicator to reduce individual sensor measurement costs to a fraction. And, with plug-in range modules, you're always prepared should your application ever change.



## Precision Measurement, Alarms, Analog And Digital Outputs, And More!

**The 600 Series.** When industrial measurements require laboratory precision, the 600 Series is the solution with five-digit (99999) resolution and 0.01% accuracy. The 600 Series accommodates wide range measurements of thermocouples, RTDs, thermistors, process voltages and current loops, and strain-gages. You'll also find a rugged metal case and fully isolated electronics, LED displayed engineering units and simple front-panel programming among the many standard features. And, 14 plug-in options like multi-channel switching, RS232C, IEEE-488, Max/Min, alarm relays and 4-20mA outputs let you tailor these meters to meet your most demanding applications.

*Your Way*

## Small Size And A Price To Match

**The 60 Series.** When you don't have a lot of panel space, the 60 Series will fit nicely into your plans. These economical meters provide 3½ (1999) and 4½ (19999) digit resolution displayed on bright LEDs. All are packaged in an easy-to-install, standard 1/8 DIN case. And, wire-up in no time to externally accessible universal screw terminals. For small size and price, with high quality and reliability, select the 60 Series from Beckman Industrial.

No matter what your measurement application, from hot to cold, pressure or voltage, you can display it. Call today for Beckman Industrial's new, 24-page Digital Panel Indicator catalog and the name of your nearest distributor. And display your own good business sense.



**Beckman Industrial™**

Beckman Industrial Corporation  
Instrumentation Products Division  
A Subsidiary of Emerson Electric Company  
3883 Ruffin Road, San Diego, CA 92123-1898  
(619) 495-3200 • FAX (619) 268-0172 • TLX 249031

In Digital  
Panel  
Indicators,  
We're The One.

# PROVEN

## 500 TO 1600 WATT POWER SUPPLIES

### NEW 1600W MULTI's

The industry's newest, smallest 1600W Multi output package. ACDC's JFM features unlimited flexibility of output voltage & current combinations.

Any combination you choose will be delivered in 2 weeks.

### PROVEN 1600W MULTI's

A new product that's proven?

YES—when it's based on ACDC's design used for the industry's most reliable "slot" supply.

YES—when it passes ACDC's rigorous, unforgiving quality & reliability test program.

### PROVEN 1000W & 800W MULTI's

Proven by our customers. Proven over a broad variety of applications. Don't compromise on output voltage. ACDC's REV 1000/800 Series has the output combination your design requires.

And you can have it in 2 weeks.

#### MODEL SELECTION CHART

WATTS	SINGLE	MULTI UP TO 5 OUTPUTS
1600	<input type="checkbox"/>	<input type="checkbox"/>
1500	<input type="checkbox"/>	<input type="checkbox"/>
1000	<input type="checkbox"/>	<input type="checkbox"/>
800	<input type="checkbox"/>	<input type="checkbox"/>
750	<input type="checkbox"/>	<input type="checkbox"/>
500	<input type="checkbox"/>	<input type="checkbox"/>

### PROVEN. 1500W, 1000W, 750W SINGLES

High performance, competitive pricing and 2 week delivery have made this the most popular proven "slot" supply in the industry.

Unequivocably.

### PROVEN FEATURES

- IEEE 587 input surge protection
- Current mode control
- Single wire paralleling
- On-board EMI filter (FCC Docket 20780, Class A and VDE 0871, Class A)
- Largest offering of standard options
- Active preload
- Dynamic soft-start
- International safety certifications

### PROVEN

ACDC electronics designs & builds quality, highly reliable power supplies. This has been PROVEN for over 30 years. And continues to be PROVEN every day.

# NEW

Now there are NEW solutions to your 500-1600W power supply requirements.

PROVEN solutions. Only from ACDC electronics. Want proof? Call for a DEMO today. (619) 439-4200.

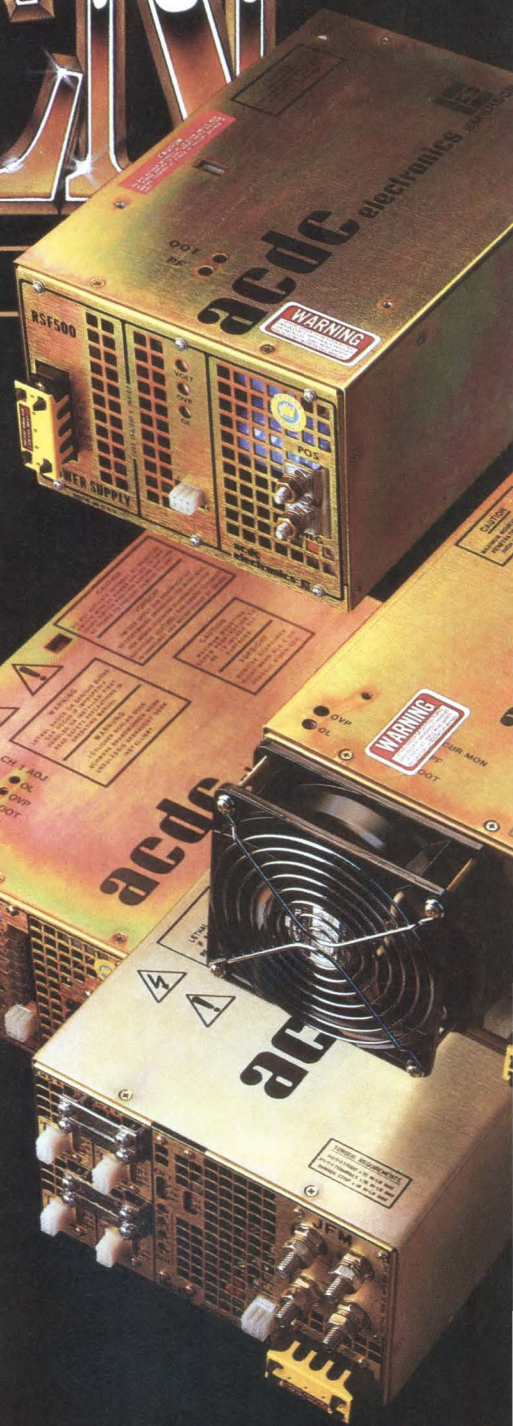

401 Jones Road, Oceanside, CA 92054  
TEL: 619/757-1880. TLX: 350227. FAX: 619/439-4243

**acdc**  
electronics

1600w 1500w 1000w 800w 750w 500w 400w 300w 220w 175w 135w 70w 40w 15w

ACDC's POWER OFFERING

CIRCLE NO 186

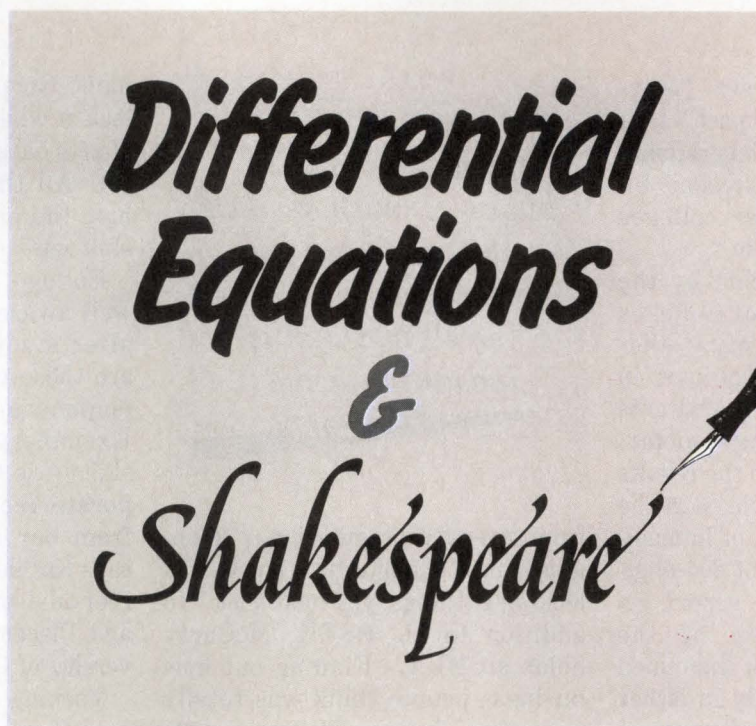

## Melding engineering studies and liberal arts

As a project engineer for Hughes Aircraft Co, Bob Wilson enjoyed supervising the engineering students who took summer jobs with the company—with one exception. When the students presented a paper on their project and then made an oral presentation of their findings, what Wilson read and heard sometimes made him cringe.

“These senior-level students could neither write nor spell adequately,” says Wilson. “They misunderstood what business or industry is all about and what industry is looking for in engineers.”

Similar complaints about the writing and speaking skills of newly graduated engineers are filtering through electrical-engineering circles. Such remarks aren't new, but they are increasing in number. Some observers dismiss the criticisms as workplace renditions of “when-I-was-a-kid” stories and say that young engineers' unpolished writing and speaking skills are a

Deborah Asbrand  
*Associate Editor*

function of the newcomers' youth. Others say, however, that the problem is genuine and fueled by the inability of engineering curricula to keep pace with the workplace changes that have occurred over the past two decades.

At many companies, engineers work more often than ever with sales and marketing staffs, and they need to be able to convey their ideas in clear terms to people who may have no technical background. Technical talent is as important as ever, but it's no longer enough.

The prime target for reform is the liberal-arts component of engineering programs. Although the Accreditation Board for Engineering and Technology requires students in accredited programs to take 12.5% of their classes in humanities and social sciences, engineering departments have generally soft-pedaled

the requirements and given their students little direction or support. Students often fulfill the requirement by enrolling in a string of assorted 101-level courses.

In recent years, the movement to change this scenario has gathered steam. It's been buoyed by a renaissance of appreciation for the study of liberal arts and the notion that familiarity with the arts, humanities, and social sciences isn't just an academic exercise but an important tool that will serve young people in their intellectual development, regardless of degree program. Engineering educators held two separate meetings last fall to discuss, among other things, how colleges and universities can incorporate more meaningful liberal-arts studies into their engineering programs.

Another important harbinger of change was last year's decision by MIT, the nation's leading engineering institution, to step up its students' participation in humanities

and social-science courses. "Anything MIT does has an impact," says Bill Grogan, dean of undergraduate studies at Worcester Polytechnic Institute. "A lot of other colleges would like to be like them."

Indeed, if a new report by the American Association of Colleges (AAC) is any indication, many other schools share MIT's problems in bringing worthwhile liberal-arts study to their engineering students. The AAC recently issued the results of a 2-year review that looked at the provisions for the study of humanities and social sciences of 204 engineering programs. The report reveals that while 45% of the engineering programs it examined did make advanced study in either the humanities or social sciences available to students, only 20% required it and 9% made it difficult or impossible for students to accomplish.

## A people-oriented profession

Given their expanded responsibilities, engineers say that their professional success hinges as much on their ability to work with other people as it does on their design of innovative products. "Our work is less engineering and more people-oriented," says Boeing test engineer Dale Ogle. Ogle counts among his most useful college courses the two philosophy classes he took. The knowledge he gained in those classrooms helps him "mainly in relating to others. We tend to think there's a right or a wrong to an issue, but there are always shades of gray."

Other engineers say that they've used their own initiative to acquire a diverse scholastic background. Although he's employed as a design engineer for a Melbourne, FL, maker of communications and computer equipment, Terry McCarty points to the dozen or so liberal-arts courses he took in the military as a crucial part of his undergraduate education. A richer education, he says, helps him examine a problem

*Engineers say that their professional success hinges as much on their ability to work with other people as it does on their design of innovative products.*



from several vantage points. "In engineering if you have just one way of looking at things, you miss a lot." In addition to his BSEE, McCarty holds an MBA. "Finding out how business people think was totally new to me," he says. "It was a whole new point of view."

Wilson says he began the groundwork for his future eight years ago, when he started taking speech and accounting courses at a college close to his Westminster, CA, home. "I knew I needed to know those things; I didn't look at it as an academic exercise," says Wilson. "This approach has allowed me to step off on my own." Last year, Wilson ended his 18-year career with Hughes to found Spectra Computer Services, a computer consulting company.

Corporate recruiters are looking for candidates who display similar well-roundedness. "Organizational boundaries have to be crossed frequently in order to get things done," says Hewlett-Packard corporate recruiting manager Barbara Waugh. "You really have to know how to present yourself, what you stand for, and what other people are saying. It doesn't work to have highly technical people who can't roll with the punches in volatile environments."

"When we interview people, we're trying to gain an understanding of their technical competence as well as what they're all about as people," says Russ Johnson, manager of strategic employment for Digital Equip-

ment Corp (Maynard, MA). "We look at whether a person has a liberal-arts background and a broad skill set. All things being equal, we'll hire the engineer with the mixed skill set."

College placement officials are well aware that the most sought-after students on their campuses are those who exhibit a facility for engineering and communication. Exemplary writing and speaking skills "are the main things that corporate recruiters are looking for from our engineering students," says Kathleen Stanton, technical career advisor for the Career Planning and Placement Center at the University of California at Berkeley.

Turning out more of these highly prized graduates, though, isn't readily done. In fact, engineering education has sagged under heavy criticism on several counts in recent years. It's estimated that \$2 billion to \$4 billion is needed to replace and repair deteriorating laboratory equipment, and faculty shortages combined with large student enrollments have led to lopsided student-to-teacher ratios. Given the wide scope of problems they have to tackle, undergraduate engineering departments have preferred to table the issue of how and whether to improve liberal-arts study.

A 1986 report by the National Science Board minced no words in condemning the state of most engineering programs. It deemed lab instruction to be "uninspired, tedious, and dull," and called courses and curricula "out of date in content, unimaginative, poorly organized, and failing to reflect recent advances in the understanding of teaching and learning."

The most persuasive case for beefed up liberal-arts study, however, comes from observing several longstanding campus programs that attest to the harmonious coexistence of the humanities, social sciences, and engineering. The prestigious California Institute of

Technology, for example, requires its students to complete 150 units of study in math, science, and technology and nearly the same number—108—in liberal studies. Harvey Mudd College, part of the Claremont College system in southern California, was founded on the belief that engineering students should have to grapple with advanced studies in the humanities and social sciences.

The program at Worcester Polytechnic Institute (WPI) in Worcester, MA, is among the most ambitious efforts. It mixes a tough technical curricula with an equally strenuous program of liberal studies. Unlike many schools, WPI splits its humanities and social-science components into two distinct areas of study. In the humanities, students must pursue a direction of study that leads to some form of accomplishment. Those who choose to study music, for example, must cap their classwork with a performance before a critical audience.

Students must take an equally active role in the area of social science. "There was a feeling that students needed an experiential requirement here," says undergraduate dean Grogan, who, as a member of the electrical-engineering faculty, was on the committee that devised the new requirements in 1970. To complete the social-science requirement, he says, "a student has to solve a problem dealing with technology and society, or human values." To facilitate the advanced study, WPI operates project centers in Washington, DC; San Francisco; London; and Dublin. Students travel to a center and work on their projects for seven weeks. In total, nonengineering classes account for nearly 22% of WPI students' studies, nearly twice as many credit hours as the accreditation board requires.

By sponsoring rigorous liberal arts studies and maintaining their high standings within the engineer-

*A 1986 report called courses "out of date in content, unimaginative, poorly organized, and failing to reflect recent advances in the understanding of teaching and learning."*



ing community, these and other programs lay waste to the idea that the study of liberal arts somehow undermines technical achievement. The schools further disprove the contention that four-year engineering programs simply don't allow time for the study of such "nonessentials" as history, literature, or music.

MIT, for example, elected not to increase the number of courses that its students were required to take, but to bring cohesiveness to the existing requirements. To accomplish the objective, the school has narrowed from 150 to 100 the courses students may choose from. It has also required students to actively pursue some depth of study in a nonengineering field of their choice.

### Student opposition

MIT encountered student opposition to its plans in the form of a petition signed by 1500 of its undergraduate engineering students. Among some engineers-to-be, liberal arts remains a dirty word. "When you start talking to engineering students about taking classes in the humanities and social sciences, particularly on big campuses, you begin to pick up this cynical feeling that those classes are weak and not as interesting as tough engineering courses," says Tad Beckman, chairman of the department of humani-

ties and social sciences at Harvey Mudd College.

Part of the problem is that many students subscribe to what Grogan calls a "zero sum" mentality—the belief that a facility for science and mathematics carries with it a natural weakness in another area. "Students go into engineering because someone in high school told them they were good at math," says Grogan. "The corollary is always that they're not good at something else. Our philosophy is, if you're good, you're good." Indeed, he adds, WPI's requirement that students not only pursue liberal studies but pursue a path that leads to accomplishment opens the eyes of many engineering students to their ability to succeed in nontechnical areas.

Behind students' distaste for liberal studies, though, lies widespread public misconception about what engineers do. John Lang, training and development manager for Analog Devices, says that when he addressed a group of high-school guidance counselors about careers in engineering, he stressed the need for students to write well and make polished presentations. "They were surprised at that because they thought engineers always had someone there to translate for them and so didn't need good communications skills," says Lang.

Certainly, the study of liberal arts is no panacea for improving engineering education. As the AAC report states, "Clearly, the influence of studying these fields can be overstated." Furthermore, while some engineering recruiters emphasize the need for students who have more diversified backgrounds, others say they're pleased with students' level of knowledge. Few, however, will dispute the value of training students to be people first, engineers second. **EDN**

Article Interest Quotient  
(Circle One)

High 512 Medium 513 Low 514

# CAREER OPPORTUNITIES

## 1988 Editorial Calendar and Planning Guide

# EDN

Editorial Emphasis

Issue Date	Recruitment Deadline	Editorial Emphasis	EDN News
June 23	June 2	Data Communications, DSP, Components	Closing: May 29 Mailing: June 16
July 7	June 14	Product Showcase—Vol. I, Power Sources, Software	Closing: June 23 Mailing: July 14
July 21	June 30	Product Showcase—Vol. II, CAE, Test & Measurement	Closing: July 21 Mailing: Aug. 11
Aug. 4	July 14	Sensors & Transducers, Analog ICs, Graphics	Closing: Sept. 1 Mailing: Sept. 22
Aug. 18	July 28	Military Electronics Special Issue, Displays, Military ICs	Closing: Sept. 1 Mailing: Oct. 20
Sept. 1	Aug. 11	Instruments, Op Amps, Computers & Peripherals	
Sept. 15	Aug. 25	Data Acquisition, Data Communications, Digital ICs	
Sept. 29	Sept. 8	DSP, Graphics, Optoelectronics	
Oct. 13	Sept. 22	Test & Measurement Special Issue, Instruments, Computers & Peripherals	
Oct. 27	Oct. 6	CAE, Computers & Peripherals, Integrated Circuits, Wescon '88 Show Preview	

Call today for information: East Coast: Janet O. Penn (201) 228-8610  
West Coast: Ellen Sherwood (714) 851-9422  
National: Roberta Renard (201) 228-8602

# CSC

Computer Sciences Corporation is the Engineering and Technical Support Services contractor for the Air Force Flight Test Center, Edwards AFB, California. We provide vital Flight Test Support and Range Systems Operations, Maintenance and Engineering Services. We have the following opportunities at our Edwards facility:

- **Senior Technical Support Engineer**—A solid electronics background including 4+ years direct Gould/SEL hardware experience in a lead capacity qualifies you for this technical engineering position. Maintenance on the 32/77 and 32/87 series is required. The application supports real-time aircraft missions involving telemetry, front-end systems and their interface with Gould/SEL computers. Multiple positions available.
- **Flight Test Engineers**—An engineering degree and 2+ years flight test work is required for this position supporting airborne test programs. Qualified candidates will be responsible for preparation of flight test plans and reports, preliminary data analysis and real-time data monitoring, and quality control of post flight data.

We offer excellent salaries and benefits as well as a promising future in our multi-service systems organization. For prompt consideration, please send your resume to: **Tom Pantall, Human Resources Dept. EDN688, Computer Sciences Corporation, Applied Technology Division, P.O. Box 0446, Edwards, CA 93523.** Equal Opportunity Employer. U.S. Citizenship Required for Some Positions.

**CSC**  
**COMPUTER SCIENCES**  
**CORPORATION**

## NATIONWIDE 2000 OPENINGS ENGINEERS MANAGEMENT

Salaries from 30K-100K  
exclusively employer fee paid  
These current openings need  
to be filled now  
Please send your resume  
today to:

**Personnel Recruiting  
&  
Placement Association**  
16 W. Pacific Ave., Suite 9  
Henderson, NV 89015  
OR  
2020 Cheviot Hills Dr.  
Springfield, OH 45505  
OR  
3824 Barrett Dr.,  
Suite 205 (A)  
Raleigh, NC 27609  
(702) 564-9007



# E N G I N E E R S

Home in on an extraordinary career at GE Government Electronic Systems Division. If you are an engineer with the ability to create sophisticated sonar systems, there is tremendous future within range.

Our Undersea Systems Department is a recognized leader in ASW technology for Surface Ship and submarine based systems. We continue to expand our technology and program base through our reputation for delivering quality products and well funded IR&D programs.

As ASW technology continues to grow, you owe it to yourself to grow with the leader.

## **Software Architecture**

Requires 7+ years experience in large systems design involving embedded programmable processors (68000 or similar processor). Familiar with top down structured design in ADA or Fortran.

## **Combat Systems Engineering**

Requires 5+ years in analysis, design and development of large scale ship-board ASW systems. Must be knowledgeable in weapons control systems engineering, reliability/ maintainability and human factors.

## **Acoustics/Signal Processing**

Systems engineers with 5+ years design experience involving towed and remote sonar arrays. Sensor systems design and algorithm development are key requirements, also target motion analysis.

## **Sonar Array Hardware**

Project engineers with 8+ years experience in advanced architecture and design of sonar hardware. Will lead a development team in all related functions: wide aperture array design, transmitter design, electronics packaging, cabinet design, simulation and modeling, etc.

## **Program Management**

Must have 10+ years in-depth experience in ASW systems development. Broad ranging software/hardware knowledge. Experience in large program prime contractor environment. Subcontractor management experience.

## **Software Quality Assurance**

Software engineers with 7+ years military electronic systems experience, including knowledge of MIL-S-483/2167/2168.

Additional positions are available. For prompt response forward your resume to:

GE-Government Electronic Systems Division  
Code ADEDN, Box 4840, CSP-4-48, Syracuse, NY 13221



**GE Government  
Electronic Systems**

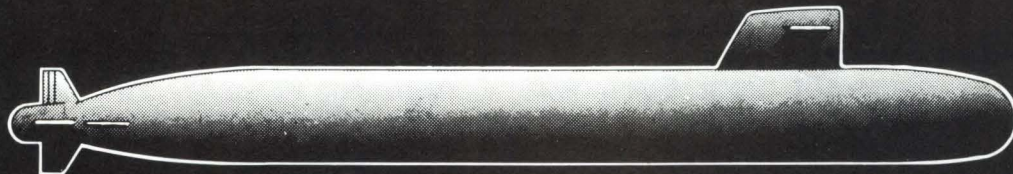

# **DON'T LET A GREAT OPPORTUNITY SLIP BY...**

*An Equal Opportunity Employer - No agencies please*

# At ABRAXAS the only speed is fast forward.

Abraxas is a top quality, dynamic growing company that offers opportunities within the telecommunications, data communications and information processing industries. We supply our blue chip clients with the very best engineers, either on a consulting basis or as permanent members of staff. And, we supply them **fast!**

That is how we, as a subsidiary of Abraxas Computer Services, Ltd., have developed into a blue chip company ourselves. Because of our "fast-forward" pace, we are seeking superior engineers who can apply their skills to the needs of our clients, who spread from coast to coast.

Right now, we are seeking candidates with the following skills:

- **Telecommunications - Software & Hardware Engineers:**  
ISDN, Common Channel Signalling #7, Call processing, Centrex, Pascal, 'C', Unix, Chill, T1-MUX, X.25 protocols. Central office, Class 5, PBX, RF and Cellular switching.
- **Data Communications - Software Engineers:**  
SNA, Netview, Packet switching, Network management, NCR Comten Software, Network Planning and Network Management Center consolidation and planning, decision support systems, LAN.
- **Information Processing:**  
Systems Programmers for MVS/XA, JES, IMS, CICS, automated systems operations, especially Netview; systems management (change, problem, performance, et al) experience; Centralized Operations consolidation and planning; knowledge based systems.

Come share in our success...either as an Abraxas consultant or as a permanent member of our client's staff. The rewards are impressive. We offer excellent salaries and an outstanding benefits package which includes a 100% paid for health plan, relocation assistance, and a strong philosophy of promotion from within.

For confidential consideration, please forward your resume and salary history to: **Abraxas International, Inc., 950 S. Winter Park Drive, Suite 301, Dept. EDN/0526, Casselberry, FL 32707, or call (407) 767-8704.** An Equal Opportunity Employer.

**ABRAXAS International Inc.**  
Fast forward to success.

# EMERSON ELECTRIC:

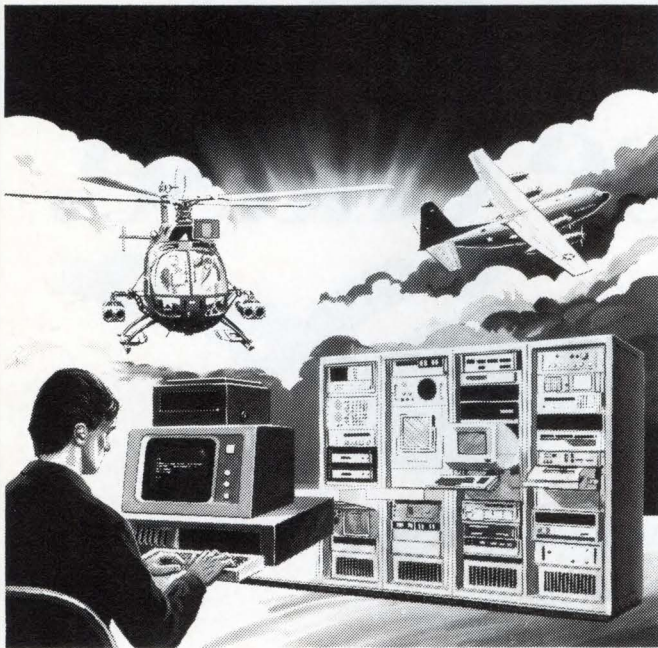

## EXCELLENCE IN ACTION FROM THE GROUND UP.

At the Government and Defense Group of Emerson Electric, excellence in defense and electronics is a tradition that goes back nearly 100 years. Today, we focus our expertise on a broad range of challenges from target detection and identification for ground and airborne systems in both the radar and infrared regions to producing the world's most advanced anti-armor systems. Rigid standards of performance and producibility are built into every Emerson product. That's the reason for our steady growth and profitability. And that's the stable, challenging environment you'll find now as one of the following:

### **SOFTWARE GROUP ENGINEER**

Provide technical direction, assign project tasks and monitor performance of group members. BSEE and BSCS and 5-10 years of experience in design and

development with 2 or more years of overall engineering responsibility required.

### **SOFTWARE DESIGN ENGINEERS**

Perform real-time signal processing software development with 6809, 68000 or 68020 microprocessors. BSEE or BSCS and 3 years experience in one or more of the following are required: VAX, VMS, 1750A, FORTRAN, ADA, JOVIAL, FORTH, ROLM, ATLAS or ASSEMBLER.

### **SENIOR SYSTEMS ENGINEERS**

Develop systems and subsystems, test requirements, and design validation. Requires specialization in anti-armor launching, fire support or target acquisition and the ability to communicate requirements to design engineering. BSEE and 5 years in optics, electro-stabilization, electronic design, or real-time software are desirable.

### **SENIOR TECHNICAL WRITER**

Develop new manuals/specs MILM 630368, 63038 or 38784 for both analog and digital electronic systems. BA or AS in electronics or 2 years equivalent experience in armament systems or radar/electronic systems preferred.

### **SENIOR INSTRUCTORS**

Six years experience, solid electronic background, and significant curriculum development in avionics, inertial navigation, fire control, or radar and significant curriculum development are required. Related Air Force or Navy experience preferred.

### **SENIOR STAFF ENGINEER (POWER)**

Generate, implement and monitor EMI, NEMP, ESD plans for electronic programs. Provide source data for filter procurement specs. MSEE or Applied Physics and 10 years specialized experience with MILSTD-461 and 462 EMI Control required. NEMP and nuclear effects experience desired.

### **DIGITAL DESIGN ENGINEERS**

Requires BSEE and 5 years experience with real-time computerized signal processor and image processing with radar interfacing. Design experience with VHSIC and/or ASIC desirable.

### **SENIOR MECHANICAL DESIGN ENGINEERS**

Requires BSME and 3 years experience in design, development, fabrication and testing that include knowledge of commercial (ASTM, SAE), government (DOD, OSHA, and DOT) and MILSTD and MILSPECS.

At Emerson, a century of excellence in national defense creates a future of opportunity for you. We offer you ongoing challenges, an excellent salary, and complete benefits. Plus we're located in St. Louis, one of the Midwest's most popular cities and an exciting environment for any lifestyle.

To explore these opportunities, please send your resume in complete confidence to:

Steve Borgmeyer  
Emerson Electric Co.  
Electronics and Space Division  
Mail Station 4690-EDN  
8100 W. Florissant Avenue  
St. Louis, MO 63136

An equal opportunity employer. U.S. citizenship is required.



**EMERSON ELECTRIC CO.**  
Government & Defense Group

# Job-hunting shouldn't be a wild goose chase.

Running all over town for interview appointments is for the birds. BPI TECH FAIR® lets experienced engineers, computer, DP/MIS or software professionals interview with dozens of companies at one time. In one place.



Visit BPI TECH FAIR.®  
And stop giving your career the run-around.

Each BPI TECH FAIR brings recruiters and line management from top local and national technical companies to your area. They're looking for experienced professionals like you. You'll get a chance to meet with many companies. Learn about other career opportunities. And save yourself a lot of time.

BPI TECH FAIR is completely confidential. There's no registration. *And we're not an employment agency. So there's no fee.*

If you're an experienced engineer, computer, DP/MIS or software professional, plan to attend the next BPI TECH FAIR. We'll take the hunt out of your job hunting.

#### SEARCH ME!

For on-line technical career opportunities and to transmit your resume:

**DIAL 612-941-3957**



On your PC or terminal and modem, enter the password "BPI." Search AdLine often, as companies are continually being added to the system.

Nation's #1 rated career event.

## TECH FAIR®

BPI • 100 North Seventh Street • Minneapolis, MN 55403 • (612) 890-5561

1988 Schedule: Boston/Braintree — Jan. 11-12/Jan. 13, Orlando — Jan. 18-19, Washington, D.C. — Feb. 1-2, Long Island — Feb. 8-9, Denver — Feb. 22-23, Minneapolis — Feb. 29-March 1, Washington, D.C. — EEO — March 7-8, Phoenix — March 14-15, Boston — March 21-22, Dallas — March 28-29, Los Angeles — April 11-12, Rockville, MD — April 13-14, Meadowlands, NJ — April 18-19, Chicago — April 25-26, Houston — May 2-3, Santa Clara — May 9-10, San Diego — May 16-17, Detroit — May 23-24, North Haven, CT — June 6-7, Washington, D.C. — AFCEA/EEO — June 14-15, Boston — June 20-21, Huntsville, AL — June 27-28, St. Louis — July 18-19, Washington, D.C. — July 25-26, Phoenix — August 1-2, Los Angeles — August 8-9, Columbia, MD — August 15-16, Boston/Braintree — August 22-23/ August 24, Denver — August 29-30, Washington, D.C. — Sept. 12-13, Long Island — Sept. 19-20, Santa Clara — Sept. 26-27, Minneapolis — October 3-4, Chicago — EEO — October 10-11, Los Angeles — October 17-18, Dallas — October 24-25, Boston — November 14-15, Washington, D.C. — November 21-22, Orlando — December 5-6.

# EDN Databank

## Professional Profile

### Announcing a new placement service for professional engineers!

To help you advance your career, Placement Services, Ltd. has formed the EDN Databank. What is the Databank? It is a computerized system of matching qualified candidates with positions that meet the applicant's professional needs and desires. What are the advantages of this new service?

- It's absolutely free. There are no fees or charges.

- The computer never forgets. When your type of job comes up, it remembers you're qualified.
- Service is nationwide. You'll be considered for openings across the U.S. by PSL and its affiliated offices.
- Your identity is protected. Your resume is carefully screened to be sure it will not be sent to your company or parent organization.

- Your background and career objectives will periodically be reviewed with you by a PSL professional placement person.

We hope you're happy in your current position. At the same time, chances are there is an ideal job you'd prefer if you knew about it.

That's why it makes sense for you to register with the EDN Databank. To do so, just mail the completed form below, along with a copy of your resume, to: Placement Services, Ltd., Inc.

#### IDENTITY PRESENT OR MOST RECENT EMPLOYER

Name \_\_\_\_\_ Parent Company \_\_\_\_\_  
 Home Address: \_\_\_\_\_ Your division or subsidiary: \_\_\_\_\_  
 City \_\_\_\_\_ State: \_\_\_\_\_ Zip: \_\_\_\_\_ Location (City, State) \_\_\_\_\_  
 Home Phone (include area code): \_\_\_\_\_ Business Phone if O.K. to use: \_\_\_\_\_

#### EDUCATION

Degrees (List)	Major Field	GPA	Year Degree Earned	College or University

#### POSITION DESIRED

**EXPERIENCE** Present or Most Recent Position From: \_\_\_\_\_ To: \_\_\_\_\_ Title: \_\_\_\_\_

Duties and Accomplishments: \_\_\_\_\_ Industry of Current Employer: \_\_\_\_\_

Reason for Change: \_\_\_\_\_

#### PREVIOUS POSITION:

Job Title: \_\_\_\_\_  
 Employer: \_\_\_\_\_ From: \_\_\_\_\_ To: \_\_\_\_\_ City: \_\_\_\_\_ State: \_\_\_\_\_  
 Division: \_\_\_\_\_ Type of Industry: \_\_\_\_\_ Salary: \_\_\_\_\_

Duties and Accomplishments: \_\_\_\_\_

#### COMPENSATION/PERSONAL INFORMATION

Years Experience	Base Salary	Commission	Bonus	Total Compensation

I Will Travel \_\_\_\_\_ Date Available \_\_\_\_\_

Light  Moderate  Heavy

Asking Compensation \_\_\_\_\_ Min. Compensation \_\_\_\_\_

I own my home. How long? \_\_\_\_\_ I rent my home/appt.

Employed  Self-Employed  Unemployed

Married  Single \_\_\_\_\_ Height \_\_\_\_\_ Weight \_\_\_\_\_

Level of Security Clearance \_\_\_\_\_  U.S. Citizen  Non-U.S. Citizen

My identity may be released to:  Any employer  All but present employer

WILL RELOCATE  WILL NOT RELOCATE  OTHER \_\_\_\_\_

# Brooktree™

## Opportunities in San Diego

Our mastery in Mixed Signal Technology enables us to achieve analog functionality in circuitry of digital simplicity using common CMOS and BiPolar technology.

As the leaders in Video DAC and RAMDAC products, we have successfully penetrated the graphics market, have developed applications in ATE and are now entering the military market. Applications for our technology abound, and new markets are constantly becoming available, yet it is the people at BROOKTREE that possess the special element which makes us successful. We currently have excellent career opportunities in the following areas:

- Design Engineers (SRAM or DRAM or Logic/Circuit Design/Simulation and Subsystems Board Design)
- CAD/CAE Engineers (Design tool evaluation/strategy, simulation, physical design)
- Layout Designer
- Test Engineer
- Product Marketing Management (Semiconductor and End User types)
- Product Engineers
- System Analyst/System Administrator (Engineering workstations—SUN, Apollo, Elxsi and networking)
- Sr. Failure Analysis Engineer—QA
- Sr. Process Engineer (Semi-conductor Technology)
- Manufacturing Engineer (Subsystems Division)

Along with the San Diego environment, we provide one of the industry's finest compensation/benefits/relocation packages, with the opportunity for stock participation. Please send resume to:  
**BROOKTREE CORPORATION,**  
 Professional Staffing, 9950 Barnes Canyon Road, San Diego, CA 92121.  
 We are an equal opportunity employer.

# EDN Databank

A DIVISION OF PLACEMENT SERVICES LTD., INC.  
 265 S. Main Street, Akron, OH 44308 216/762-0279

# ADVERTISERS INDEX

- ACCEL Technologies Inc . . . . . 271  
ACDC Electronics . . . . . 278  
Acme Electric Corp . . . . . 261  
ADPI . . . . . 270  
Advanced Micro Devices . . . . . C2, 12-13  
Advin Systems . . . . . 273  
Aerovox Mallory . . . . . 97  
Altera Corp . . . . . 56-57  
Ametek Inc . . . . . 46  
AMP . . . . . 52-53  
Amperex Electronic Corp\* . . . . . 239  
Antex Electronics . . . . . 36  
Applied Microsystems Corp . . . . . 99  
Arium Corp . . . . . 90  
Arnold Magnetics Corp . . . . . 248  
AT&T Technologies . . . . . 117-119  
Augat RDI . . . . . 136  
Avocet Systems Inc . . . . . 269  
Ballard Technology . . . . . 272  
Bayer AG\*\* . . . . . 114-115  
B&C Microsystems . . . . . 271, 273, 274  
Beckman Industrial Corp\* . . . . . 277  
Bering Industries Inc . . . . . 85  
BP Microsystems . . . . . 272  
Brooktree Corp . . . . . 236-237  
Burr-Brown Corp . . . . . 34  
BV Engineering . . . . . 273  
CAD Software Inc . . . . . 274  
CADDy Corp . . . . . 108  
California Scientific Software . . . . . 273  
Canadian Thermostats &  
Control Devices Ltd . . . . . 268  
Capital Equipment Corp . . . . . 272  
Carroll Touch Inc . . . . . 60  
Case Technology . . . . . 80  
Central Data Corp . . . . . 258  
Cermetek Microelectronics Inc . . . . . 77  
Ciba-Geigy\*\* . . . . . 206-207  
Comair Rotron Inc . . . . . 268  
Comlinear Corp . . . . . 234  
Computer Products Inc . . . . . 161-164  
Conner Peripherals . . . . . 25  
Control Data . . . . . 44-45  
Conversion Devices Inc . . . . . 271  
CTS Corp . . . . . 244  
Cybernetic Micro Systems . . . . . 136  
Cypress Semiconductor . . . . . 190-191  
Dage Precision Industries Inc . . . . . 227  
Daisy Systems Corp . . . . . 176  
Dale Electronics Inc . . . . . 1  
Dash, Straus, and Goodhue . . . . . 2  
Dasoft Design Systems Inc . . . . . 269  
Data I/O Corp . . . . . 8, 255, 257, 259  
Detrol Controls . . . . . 273  
Deltron Inc . . . . . 202  
Design Computation Inc . . . . . 273  
Dialight Components . . . . . 217  
Digital Media Inc . . . . . 273  
Elan Digital Systems . . . . . 266  
Electro-Mechanics . . . . . 270  
Emulation Technology Inc . . . . . 271  
E-TA Circuit Breakers . . . . . 246  
Force Computers Inc . . . . . 32-33  
Frequency Devices . . . . . 226  
Fujikura . . . . . 345  
Fujitsu Components of America Inc\* . . . . . 241  
GCOM Inc . . . . . 238  
GE/RCA Intersil  
Semiconductors . . . . . 16-17, 235  
Hall-Mark . . . . . 290  
Harris Semiconductor Products . . . . . 233  
Harting Electronics . . . . . 204-205  
Hewlett-Packard Co . . . . . 92A-B, 93, 171, 189  
Hitachi America Ltd . . . . . 242  
IC Sensors . . . . . 38  
Inmos Corp . . . . . 10-11  
Instant Board Circuits Corp . . . . . 267  
Intel Corp . . . . . 137-144, 174-175  
Intermetrics Inc . . . . . 104  
International Manufacturing Services . . . . . 270  
Introl Corp . . . . . 238  
Intusoft . . . . . 273  
Janco Corp . . . . . 98  
John Fluke Manufacturing  
Co Inc\* . . . . . 22, 194, 243, 245, 247, 249  
Karl Leister Electronics . . . . . 36  
Keithley Instruments . . . . . 155  
Kepco Inc . . . . . 215  
KO Sheng\*\* . . . . . 239  
Kontron Electronics Inc . . . . . 49  
Leader Instruments Corp . . . . . 39  
Leadyear Enterprise Co Ltd . . . . . 270  
Linear Technology Corp . . . . . 208  
LMI Connectors . . . . . 216  
Logical Devices Inc . . . . . 269  
Logical Systems Corp . . . . . 270  
LSI Logic Corp . . . . . 88-89  
Matra Harris Semiconducteurs . . . . . 250-251  
Memocom . . . . . 272  
Mepco/Centralab . . . . . 105  
Meta Software . . . . . 253  
Micro Switch . . . . . 100-101  
Microcrystal Div/SMH . . . . . 92  
MicroSim Corp . . . . . 254  
Midwest Components . . . . . 96  
Mini-Circuits Laboratories . . . . . 3, 4, 28-29, 211  
Molex Inc . . . . . 292  
Motorola Microcomputer Div . . . . . 14-15  
Motorola Semiconductor  
Products Inc . . . . . 42-43  
Motorola Semiconductor  
Products Inc\* . . . . . 201  
Multibus Manufacturers Group . . . . . 109-112  
National Instruments . . . . . 157  
National Semiconductor Corp . . . . . 78-79  
NTT International . . . . . 275  
Octagon Systems . . . . . 269  
OKI Semiconductor . . . . . 30-31  
Omaton Inc . . . . . 262, 270  
OrCAD Systems Corp . . . . . 106  
Orion Instruments . . . . . 82  
PCB Piezotronics Co . . . . . 271  
Pearson Electronics . . . . . 92  
Philips Elcoma Div\*\* . . . . . 22, 201, 277  
Polaroid Corp . . . . . 48  
Powerex Inc . . . . . 50-51  
Powertec Inc . . . . . 68  
Precision Monolithics Inc . . . . . 35  
Programmable Logic . . . . . 274  
Qua Tech Inc . . . . . 272, 274  
Qualidyne Systems Inc . . . . . 108  
Quality Tech . . . . . 54  
Quantum Corp . . . . . 172-173  
Racal-Redac . . . . . 256  
Raytheon . . . . . 65  
Rekco Inc . . . . . 202  
Robinson-Nugent Inc . . . . . 58-59  
Rockwell International . . . . . 120-121  
Rogers Corp . . . . . 271, 272, 273, 274  
Rohde & Schwarz\*\* . . . . . 194  
Samsung Semiconductor . . . . . 69-76  
Saratoga Semiconductor . . . . . 37  
SBE Inc . . . . . 225  
Schaevitz Engineering . . . . . 107  
Seattle Silicon . . . . . 131  
Seiko Instruments . . . . . 27  
SGS-Thompson Microelectronics\* . . . . . 114-115  
Sharp Electronics . . . . . 135  
Shin Hsin Precision . . . . . 269  
Siemens AG\*\* . . . . . 218-219  
Signal Transformer Co Inc . . . . . C4  
Silicon General . . . . . 62  
Silicon Systems Inc . . . . . 86-87  
Single Board Solutions . . . . . 270  
S-MOS Systems\* . . . . . 218-219  
Sony Corp of America . . . . . 95  
Spang Power Control . . . . . 269  
Spectrum Signal Processing Inc . . . . . 272  
Spectrum Software . . . . . 47  
TAB Books . . . . . 263-265  
Tadpole Tech . . . . . 159  
Tatum Labs . . . . . 274  
TDK Corp . . . . . 102  
Tektronix Inc . . . . . 18-21, 40-41, 133,  
185, 223, 228-231  
Teledyne Semiconductor . . . . . 206-207  
Thomas and Betts Corp . . . . . 187  
Titan/SESCO . . . . . 221  
Tokin Corp . . . . . 203  
Toshiba America Inc . . . . . 192-193  
Universal Data Systems . . . . . C3  
Vicor . . . . . 289  
Vishay . . . . . 243  
Visionics Corp . . . . . 274  
VME Microsystems  
International Corp . . . . . 270  
Westcor . . . . . 6  
Winpoint Electric Corp . . . . . 271  
Wintek Corp . . . . . 272, 274  
Zericon . . . . . 274  
Zilog Inc . . . . . 213
- ### Recruitment Advertising . . 282-287
- Abraxas International  
Computer Sciences Corp  
Emerson Electric  
GE Government Electronic Systems  
Personnel Recruiting and  
Placement Associates
- \*Advertiser in US edition  
\*\*Advertiser in International edition

This index is provided as an additional service. The publisher does not assume any liability for errors or omissions.

# Put Our DC-DC Converters To The OFF-LINE Test



## NEW AC INPUT / MODULE EVALUATION BOARD

Incorporating an on-board 750 watt AC front end, the VI-MEB-AC Module Evaluation Board is designed specifically for evaluation of Vicor converters in off-line applications. The front end features input surge protection, removable line cord, a visible power indicator, and provides easily accessible ON/OFF and 110/220 VAC range select switches.

Up to three 300 volt-input Vicor converters can be plugged into the assembly for evaluation of single, dual or triple output applications. Independent access to all converter interface

pins allows for easy configuration of virtually any multiple-output or array application with a total power output of up to 600 watts. The 10.5" x 12" assembly comes complete with module sockets, strappable heavy-duty output lugs, output measurement jacks, and provisions for accessing the Gate, trim and sense connections on each converter. Module inputs are individually fused and on-board sockets are provided for adding Vicor Phased Array controllers. A detailed user's manual is provided which covers measurement techniques and useful applications information.

*Vicor's "component level" megahertz converters allow power systems designers to focus on system solutions instead of circuit details. The benefits: fast, predictable design cycles; predictable field performance; and smaller, simpler, high reliability power assemblies with significantly reduced component count.*

Call Vicor today at (617) 470-2900, 23 Frontage Road, Andover, MA 01810 for the Module Evaluation Board data sheet and put Vicor modules to the test!



*Component Solutions For Your Power System*

**“When you’re going from digital to analog do you add one hour, or take it away...?”**



PAPORR-BLACK

Hall-Mark knows . . .

and can lead you through Texas Instruments' Linear Product Line.

Combining our application experience and off-the-shelf delivery with TI's expanding line of linear products, Hall-Mark can guide you through the process of finding the right linear device to meet your design requirements.

And, while TI is creating new Advanced Linear products

by applying new technologies such as Advanced LinCMOS™ to enhance performance, Hall-Mark continues to enhance its own service and delivery performance.

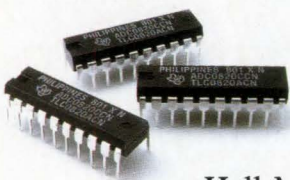

With quality in product from TI and quality in service from

Hall-Mark, we are working to gain your confidence: the most important “quality award”. In fact, a number of our customers require no additional product testing or incoming inspection of TI linear products from Hall-Mark.

If you think there's nothing new in linear, we can show you the difference in the Texas Instruments linear products line from Hall-Mark.

Not just parts, solutions.



Hall-Mark Electronics Corp. • Dallas, Texas • Subsidiary of Tyler Corp.

**Alabama**  
Huntsville (205) 837-8700

**Arizona**  
Phoenix (602) 437-1200

**California**  
Bay Area (408) 432-0900  
Orange County (714) 669-4100  
Sacramento (916) 722-8600  
San Diego (619) 268-1201  
San Fernando Valley (818) 716-3300  
West Los Angeles (213) 217-8400

**Colorado**  
Denver (303) 790-1662

**Connecticut**  
Connecticut (203) 269-0100

**Florida**  
Ft. Lauderdale (305) 971-9280  
Orlando (305) 855-4020  
Tampa Bay (813) 855-5773

**Georgia**  
Atlanta (404) 447-8000

**Illinois**  
Chicago (312) 860-3800

**Indiana**  
Indianapolis (317) 872-8875

**Kansas**  
Kansas City (913) 888-4747

**Maryland**  
Baltimore (301) 988-9800

**Massachusetts**  
Boston (617) 935-9777

**Michigan**  
Detroit (313) 462-1205

**Minnesota**  
Minneapolis (612) 941-2600

**Missouri**  
St. Louis (314) 291-5350

**New Jersey**  
Fairfield (201) 575-4415

**New York**  
Long Island (516) 737-0600

Rochester (716) 244-9290

**North Carolina**  
Raleigh (919) 872-0712

**Ohio**  
Cleveland (216) 349-4632  
Southern Ohio (614) 888-3313

**Oklahoma**  
Tulsa (918) 251-1108

**Pennsylvania**  
Philadelphia (215) 355-7300

**Texas**  
Austin (512) 258-8848

Dallas (214) 553-4300  
Houston (713) 781-6100

**Utah**  
Salt Lake City (801) 972-1008

**Wisconsin**  
Milwaukee (414) 797-7844

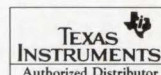

™Advanced LinCMOS is a trademark of Texas Instruments Incorporated.

© 1988 Hall-Mark Electronics Corp./400-3042

CIRCLE NO 189



# LOOKING AHEAD

## Worldwide GaAs IC market expands at robust pace

By 1992 the worldwide market for gallium arsenide ICs should reach \$962M, according to The Information Network, a market-research company based in San Francisco, CA. This forecast posits substantial growth for a market that grossed less than \$100M last year.

The US market will actually have the smallest—but still a quite healthy—growth rate of 50.7% through 1992. By comparison, Europe and Japan will enjoy compounded annual growth rates of 63.9% and 89.7%, respectively. Large demand in the communications and military sectors will stimulate growth in Europe; the communications and computer sectors will be the primary motivators in Japan.

The Information Network doesn't believe that Japan will necessarily dominate the worldwide market. The market researchers point out that Japan's vertically integrated structure dictates that almost all Japanese-produced GaAs ICs will remain in captive markets for the next few years. This high rate of internal absorption means that Japanese companies will not be free to sell these ICs abroad for some time. Consequently, Japan will test at home to achieve volume production, high yields, and low cost.

The GaAs industry in general has had to clear several hurdles, including processing methods, quality control, production yields, packaging, testing, and standards. The Information Network stresses, for example, that GaAs manufacturers must be successful at the LSI level in order to be cost effective. By offering increased logic density that results in a larger number of functions per chip, GaAs can offset the high cost of their devices, and at the LSI level, beat silicon in terms of price vs performance.

At present, a minimum of 50% of

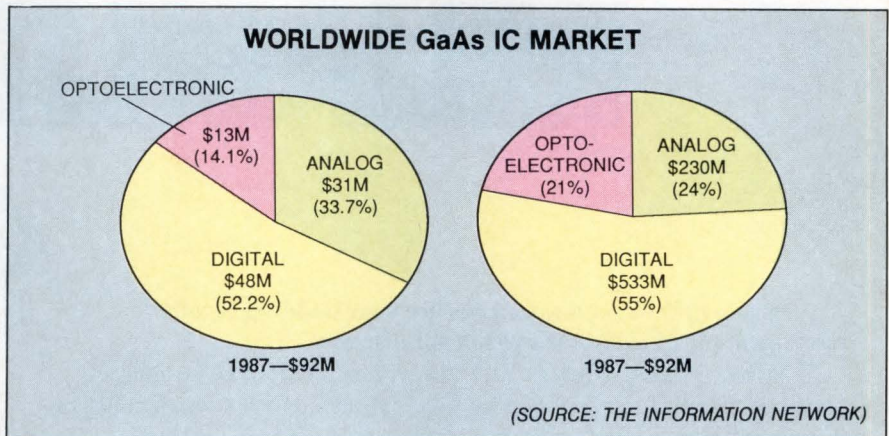

all applications for GaAs ICs goes for applications where only one additional GaAs chip substantially enhances the accuracy or bandwidth of

the general system, which is generally defined by ECL devices. The need for compatibility with ECL ICs is therefore quite clear.

## Continuous industries falter in MAP plans

Developed in the early part of this decade, MAP (Manufacturing Automation Protocol) represents a concerted effort, initially on the part of General Motors, to establish a standard means of communication between computers and other manufacturing equipment in factories. A number of other major users of factory equipment and industrial LANs soon joined GM in the project. Skepticism has been growing, however, in the past year or two, because of the slow development of MAP products and the ebbing support of equipment vendors, according to Venture Development Corp (Natick, MA).

The overwhelming need for multi-vendor compatibility, particularly in industries that manufacture continuously (as opposed to those who produce in a batch or discrete way), has left only the very largest companies with the biggest facilities willing to test and adopt MAP standards and products. Most continuous manufacturers, VDC concludes, will wait for the widespread acceptance of products and for general industry support before committing themselves to the new technology. MAP

thus faces a somewhat circular predicament.

The limited availability of MAP products biases companies against long-range purchasing plans that include MAP products. Continuous manufacturers, VDC found, tend to be quite conservative and will wait for strong vendor support before they commit to MAP technologies. Other manufacturers feel ill-equipped to adopt MAP standards, which they find too sophisticated and often a thing of the very distant future. Still others associate MAP with discrete manufacturing, partially because of GM's close ties to MAP development. Overall, however, most manufacturers concede the importance of communications standards for future automation development. Not only will standards ultimately solve the multivendor problem of incompatibility, but they will also streamline network design and reduce the costs of interfacing. The next few years will see a significant increase in the number of supervisory networks used in process plants, and hence this period may prove critical to the success of MAP standards and products.

Molex Is Making The Connection Between...

# FLEXIBILITY & RELIABILITY

**Eleven different components are your building blocks for thousands of interconnection solutions.**

Molex's unique family of KK® connectors provide the flexibility you need to build interconnections precisely suited to your applications. Choose either tin or cost-effective selective gold plating, .100" or .156" center spacing. Crimp, solder, or insulation displacement termination...top, side, or bottom pin entry...break-to-size pin headers...they're all standard in thousands of demanding applications.

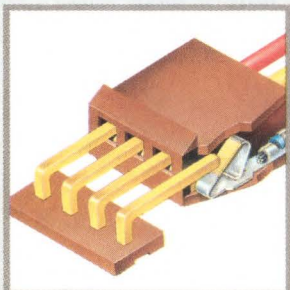

Gold plating placed selectively on terminal contact points means added economy.

**The KK® connector is just one example of how we take a total systems approach.**

The KK® System includes a complete line of wire termination tooling from simple hand crimp tools to the latest automated insulation displacement technology. The System also features sophisticated pinsetting equipment. Molex goes beyond merely supplying connectors to help today's manufacturers achieve lower installed costs.

**Dependable service worldwide.**

Our multi-national organization offers you interconnection design, manufacturing, and technology from around the globe, with dependable supply and local service.

Molex distributors stock the full line of flexible KK® connectors for your every need.

*Intensive QC programs provide reliable connectors that stand up to tough environmental conditions in a wide range of electronic applications.*

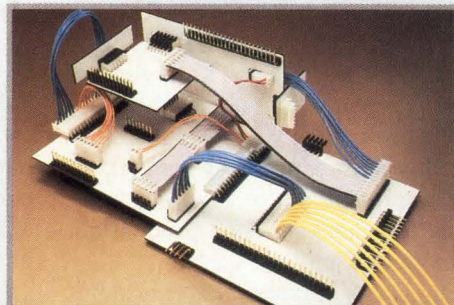

*Unique break-away design allows you to order pin headers in bulk and break off the exact lengths you need to save on inventory and waste.*



*Service To The  
Customer...Worldwide*

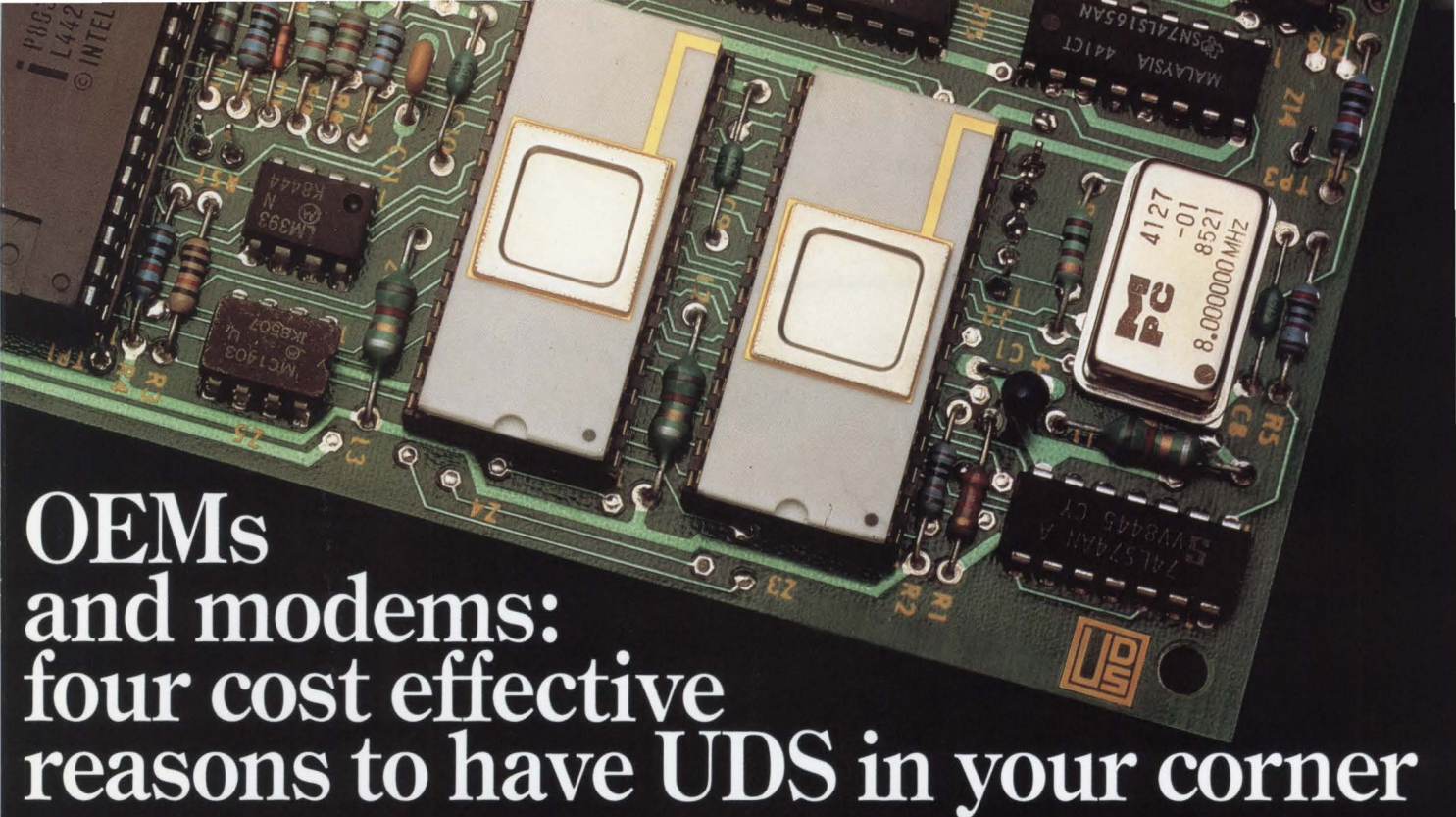

# OEMs and modems: four cost effective reasons to have UDS in your corner

## 1. Concentration: spend your time and money on what you do best.

You excel at what you do; we excel at designing and producing modems. Devote yourself to developing and marketing your products more effectively, and get the modems you need from us. We have invested heavily in automated production equipment, test instrumentation and a large technical staff so you won't have to.

## 2. Reliability: because nothing costs like something that doesn't work.

Once you receive an OEM modem from UDS, install it, ship it and forget it. Our quality assurance procedure ranges from incoming chip burn-in to 100% testing of all modems prior to shipment. This attention to quality assurance has put our historical reliability rate near the 99th percentile.

## 3. Experience: we have already solved most of your problems.

Over the past 15 years, we have designed, produced and delivered more than 1,500,000 modems in over 3,000 different configurations. We have proved our capability to fulfill nearly any form, fit and function requirement from 0-300 to 14,400 bps.

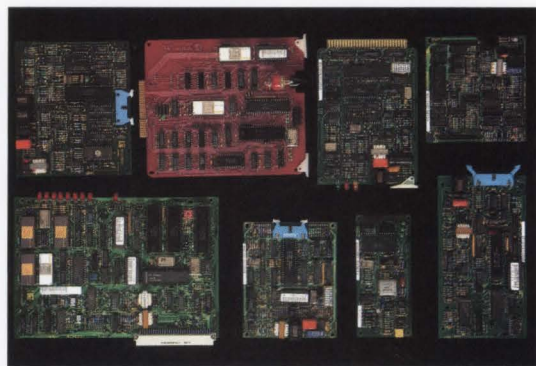

## 4. Commitment: more than a promise, it's our reputation.

Supplying an edge in price/performance begins and ends with commitment. UDS is committed to the manufacture of modems – and only modems. We're also committed to the needs of OEMs, who buy over 50% of the modems we make. We have built a position as an industry leader by honoring commitments –

commitments to your quality demands, commitments to your deadlines, commitments to your demand for value.

### Get us in your corner.

Contact us, and we'll help you corner your share of datacomm market. Let's talk specs and prices! Universal Data Systems, 5000 Bradford Drive, Huntsville, AL 35805. Telephone: 205/721-8000; Telex: 752602 UDS HTV.



Universal Data Systems



**TELEPHONE: 800/451-2369**

# Dual Personality.

**Custom or standard, Signal's ingenious split bobbin designs offer flexibility - at a very rational price.**

You already know that Signal is the world leader in off-the-shelf transformers. What you may not know is that we're equally dedicated to our custom business.

But it's true. You can get any of the three transformers you see here as standard - or customized to your exact specs. From the versatile Split/Tran® to the low profile Flathead® to the half-sized 2-4-1.

Whichever you choose, you'll also get Signal's innovative design.

It's become an industry standard. Because, unlike ordinary transformers which require shielding to obtain high isolation, ours separate the primary and secondary windings using the split bobbin design we pioneered. Not only does this guarantee high isolation, it delivers healthy savings as well.

As for customization, we give you the full treatment. Flexible modifications or custom designs. Fast quotes and prototypes. Even annual contracts.

Signal also meets important international standards. Our off-the-shelf units are UL recognized. Many of them meet VDE and offer optional CSA certification. What's more, every custom transformer is designed to meet UL standards, too.

And we deliver PRONTO. Standard prototypes are shipped within 24 hours. Your order is shipped factory-direct - so there's no middleman...no hidden costs.

Analyze the full line yourself. Call or write for our free catalog: Signal Transformer, 500 Bayview Avenue, Inwood, NY 11696.

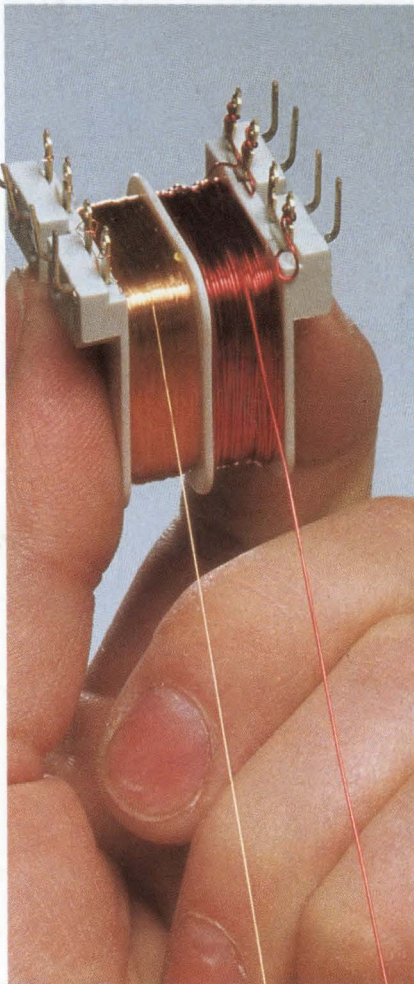

## SPLIT/TRAN®

2500V RMS HIPOT. Non-concentric windings and low capacitive coupling. Available with 115V or dual 115/230V primaries. Split secondary windings can be series or parallel connected.

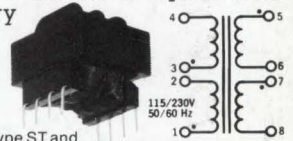

## FLATHEAD®

Ideal for low height, critical pc board power applications. 5 sizes from 2.5VA to 48VA. (Semi-toroidal windings.)

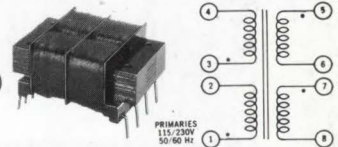

## 2-4-1

2500V RMS HIPOT. The signal for a 50% cut in transformer size and weight at a significantly lower cost.

Six sizes from 2.4VA-100VA.



Dual primary. Single primary also available.

**BUY DIRECT**  
**(516) 239-5117**

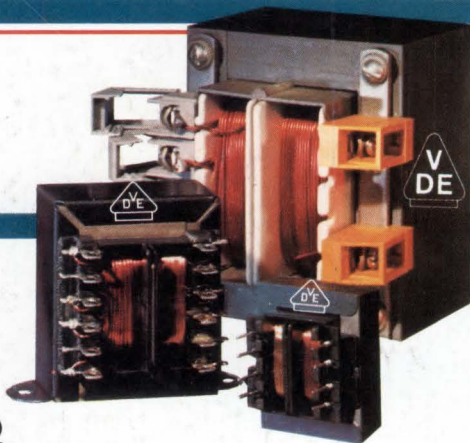

## Signal Transformer.

**The American Original.**

**Insilco**  
International Specialty Companies

CIRCLE NO 176