

EDN

SPECIAL ISSUE:
Communications technology
Token-ring controller
Transformer SLICs
LAN analyzers
ASIC packages

ELECTRONIC TECHNOLOGY FOR ENGINEERS AND ENGINEERING MANAGERS



ICs facilitate communication
over IEEE-802 networks

look at our new PAL 20D series, the fastest TTL PAL circuits on the market today. With a maximum propagation delay of 10ns, they're 33% faster than our 20B series. At no increase in power consumption.

Maybe you want to save a dozen parts or so. Then there's our new PAL32VX10, a pin-compatible superset of the 22V10. It has 10 user-configurable input/output macrocells, with a programmable flip-flop that can operate as D, T, S-R or J-K types, and can even be buried. So it's perfect for state machine design.

And if you want to save power, you should

see our new 24-pin ZPAL™ circuits. With zero standby power, they're the industry's first "true" CMOS PAL devices.

Now, if you'll just save the following address and phone number, you can contact us for your free copy of our new PAL Handbook.

Monolithic Memories, 2175 Mission College Blvd., Santa Clara, CA 95054.
(800) 247-6527, x6005.

It could be the answer to your prayers.

Monolithic Memories 

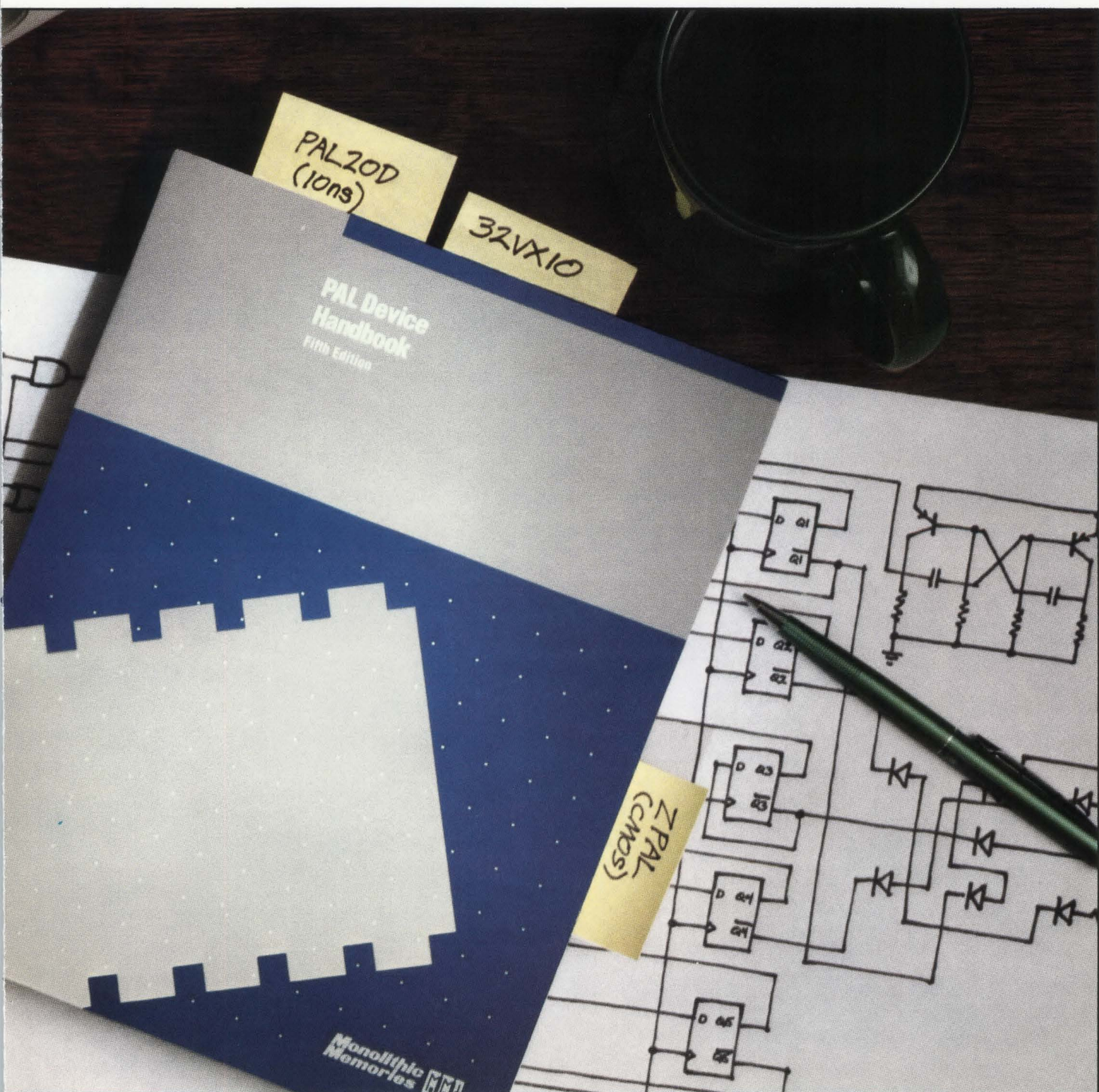

Read the good book.

Hallelujah.

Monolithic Memories' new PAL[®] Device Handbook is here. And it's full of ways to save your system time, parts and power.

There's more programmable logic than you'll find anyplace else. More architectures. Process technologies from ECL and TTL to CMOS. All supported by PALASM[®] 2 CAD software.

You'll also find three new families of PAL devices that can save your system in ways nothing else can.

Say you want to save time. Then take a

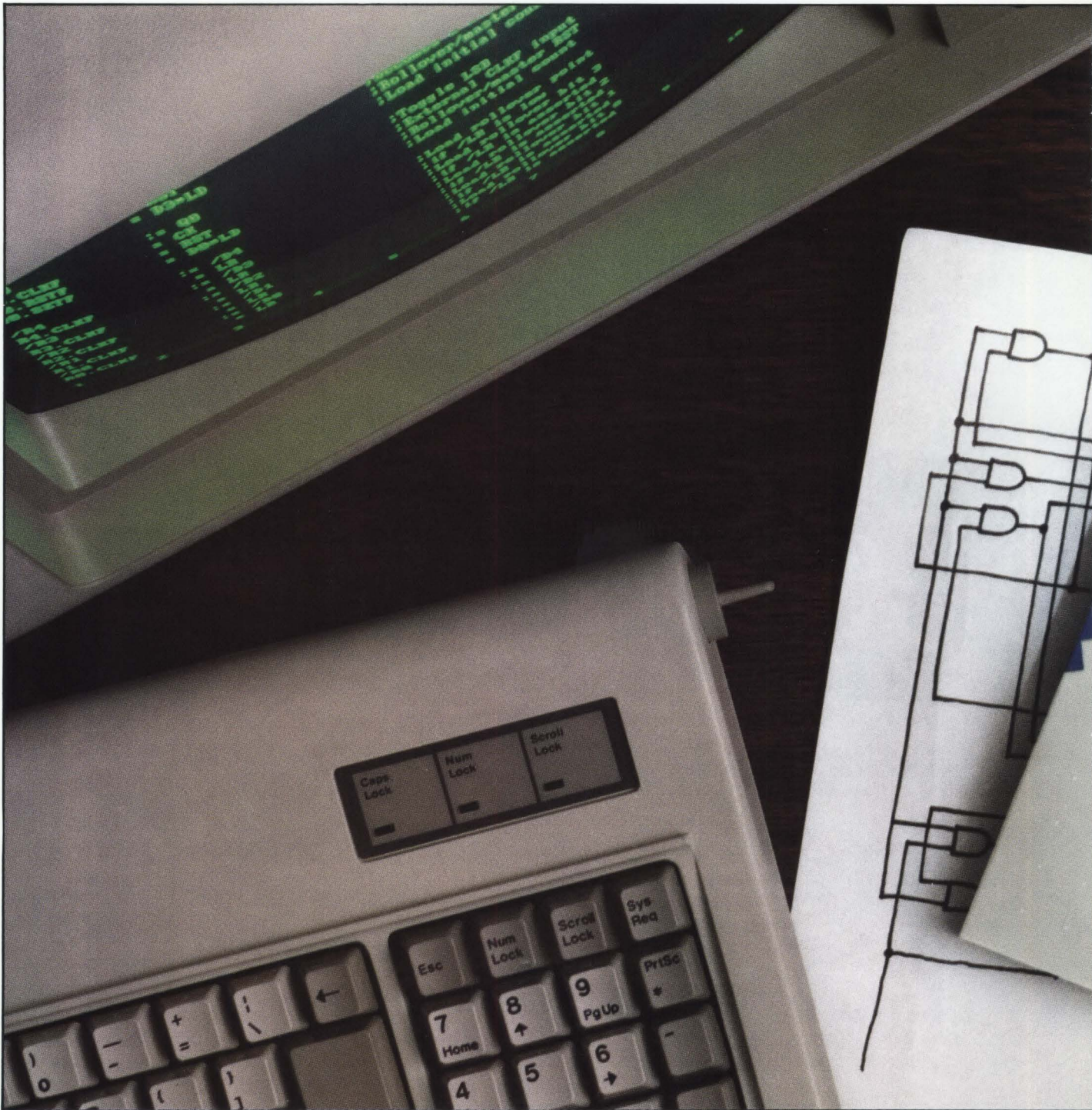

**Save
your
system.**

The Least Cost Networks.

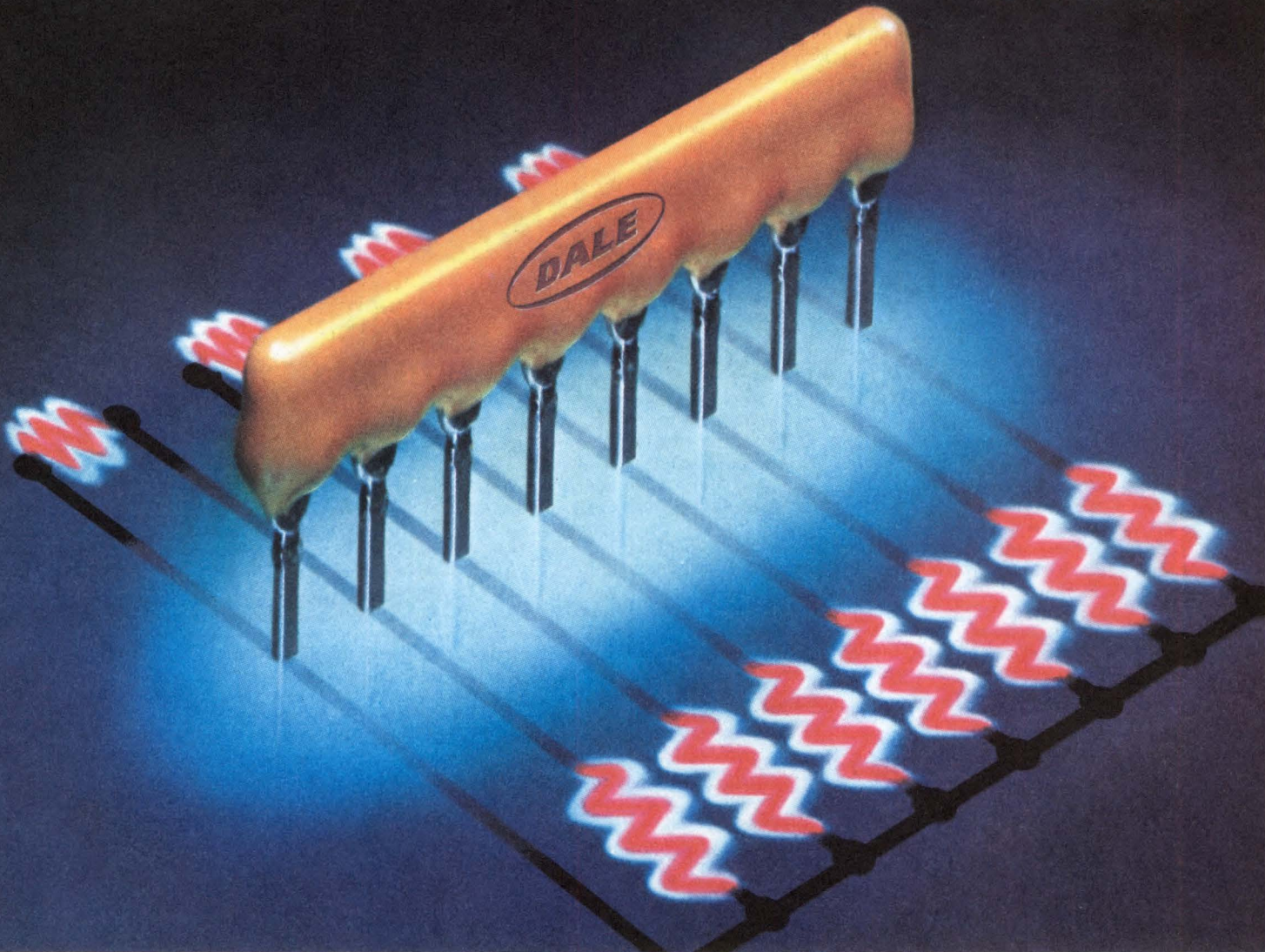

Forget about price. Pin for pin, Dale delivers the best value in commercial thick film networks.

Take a closer look at Dale networks. We're ready to deliver a lot more than just a competitive price. Dale's "least cost" advantages start with our exclusive ZIP® program. We guarantee our CSC, MSP and MDP networks will perform as specified without costly in-plant verification... and we guarantee shipment will be made on our confirmed date. Contact us for details on ZIP. It costs no more, and it's only the start of the advantages we offer.

You'll find we've anticipated your needs with systems that can make your planning — from design through production — much more efficient. We've made certain we have the capacity to match your requirements. Our production capabilities have grown every year — including a major 80% boost in 1984. And, additional space is being readied to accommodate more growth. These expansions include major stocking programs to meet more of

your needs directly from inventory. For long-term requirements, our system of statistical process controls assures the precise quality level you specify. And, we're initiating "just in time" and "partnership" programs with a number of customers.

Check this lineup...

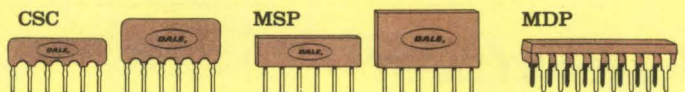

TYPE CSC, epoxy conformal coating, .195" or .250" profile. TYPE MSP, epoxy molded coating. Automatically insertable, .195" or .350" profile. TYPE MDP, epoxy molded coating, .190" profile. *Schematics: one pin common, isolated resistors, in all standard sizes.*

It adds up to the kind of capability and stability you need from a network supplier. Let's talk about building least cost into your network usage. Contact your Dale representative or call us today at **915-592-3253**.

Dale Electronics, Inc.,
Box 26728, El Paso, TX 79926



EMISSIONS CRACKDOWN— INSIDE THE FCC

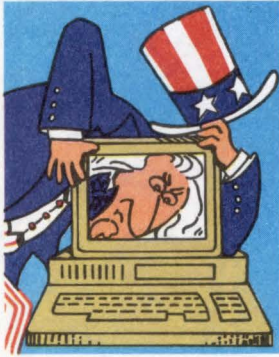

It began in August, 1985, with a one million dollar seizure at Seequa Computer, followed with a crackdown on microcomputer manufacturers (March, 1986). Then in April, the FCC swept through Comdex, levying more than \$250,000 in fines. The ominous nature of these actions by the FCC to enforce its computer emissions standards has left the industry wondering "What's next?" According to the leading laboratory in the field, Dash, Straus & Goodhue, Inc., of Boxborough, Massachusetts, it will be a move by the FCC to use its own

Laurel, Maryland, laboratory to test mass marketed PCs to see who's non-compliant. The full range of FCC penalties, fines, seizures and arrests, could follow. In addition, the FCC has begun checking Customs files to see if the required FCC "740" form has been included. Failure by importers to file can result in a host of Customs related penalties in addition to the FCC's.

Help is on the way, however, from Dash, Straus & Goodhue (617 263-2662), the Northeast's largest testing, research and development firm dedicated to EMI, telecom and safety compliance. Customers can call DSG and receive, over the phone, a commitment to have a device tested, modified (if necessary), retested and verified within a guaranteed time for a guaranteed rate. DSG is an NBS accredited laboratory for emissions and telecommunications testing.

Circle Reader Service No. 2 for Dash, Straus & Goodhue.

IS DDS THE NEXT TARGET FOR THE FCC?

Since it issued its Third Report and Order, Docket 81-216, in November of last year, the FCC has required nearly all manufacturers of Digital Data Systems to register their designs with the FCC. This includes Channel Service Units (CSU), Network Channel Terminating Equipment (NCTE), and nearly any device that interfaces with T1 or subrate lines. Also included are devices that encode analog signals, even though they interface through NCTE or CSU. Some manufacturers have been slow to comply, and their competitors have filed charges. The FCC has responded, issuing forfeitures to three manufacturers based on a complaint by Verilink.

Registering equipment for DDS connection is tricky. One lab proficient in the field is Dash, Straus & Goodhue, Inc., of Boxborough, Massachusetts. As an extra plus, the firm is one of the few labs also approved by the Canadian Department of Communications and can arrange for approvals in Canada as well.

PRODUCT SAFETY— REFORM GAINS BUT LISTING IS BEST

Efforts to reform product liability laws have made slow gains in Congress. The liability Tort Reform Bill S.2760 has passed the Senate Commerce Committee 10 to 7. Basically, it encourages settlement by requiring manufacturers to make a reasonable offer in settlement prior to trial. If not accepted, the injured party's claim for pain suffering is limited to \$250,000. But progress and reform is slow and sure to run into opposition in the House. The best bet to hedge



against lawsuits may be UL® listing and CSA® certification. While not a complete defense, failure to meet standards could leave a manufacturer with practically no defense in cases of shock or fire hazards. These and other worldwide safety approvals can now be obtained through one company, Dash, Straus & Goodhue, Inc. DSG can design, test, and coordinate submittals of products for UL, CSA, and West German approvals, often handling them simultaneously. Final tests carried out by these organizations are coordinated through DSG.

NEW INSTRUMENTS SPEED COMPLIANCE

An integrated workstation designed for the complete evaluation of telephones, modems, PBXs etc. for compliance with FCC Part 68, DOC CS-03 and EIA standards is now available from Compliance Design Inc. (617 264-4668). The

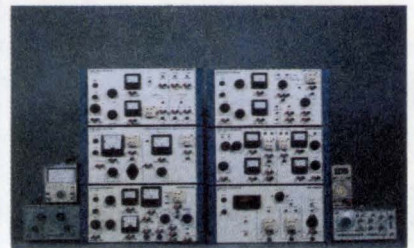

Workstation makes setting up Part 68 laboratories practical for those manufacturers who wish to avoid heavy independent laboratory testing fees. The Workstation has become especially popular for manufacturers since they now have to meet the FCC's requirement of a six-month recheck on all equipment previously registered.

To ensure EMI compliance, CDI also makes available the famous Roberts Antenna®. The antenna is known for its near lossless receive characteristics and is identical to those used by the FCC for 25 years. Now an industry standard, the company guarantees that any reasonable site can meet the FCC's critical site attenuation requirements of OST-55 by using these antennas. In fact, as part of a package, CDI's engineers will test any customer's site and file it with the FCC, a prerequisite to using it for EMI testing. The antenna was designed by Willmar Roberts, former Assistant Chief Engineer of the FCC's laboratory in Laurel, Maryland. It is available exclusively from Compliance Design.

Circle Reader Service No. 41 for Compliance Design Inc.

THE BEST IS AVAILABLE—FOR FREE!

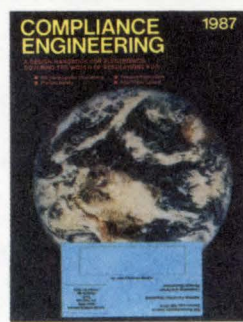

The industry's standard handbook on EMI, ESD, telecom and safety, Compliance Engineering 1987 covers specifications and methods of engineering for Safety, EMI, ESD, and Telecom compliance. With the need to comply with these specifications universally recognized, engineers have sought out, but been unable to find, authoritative sources for issues related to designing for compliance. Now in Compliance Engineering, separate sections covering EMI, safety, telecom and ESD give a step-by-step approach to control and

compliance. The 1985-86 edition drew rave reviews from its readers. You can receive the 1987 issue (available in January, 1987) free of charge just by circling the Reader Service Number below.

For COMPLIANCE ENGINEERING 1987, circle Reader Service No. 80.



value-packed
filters **\$995**
 from

dc to 3GHz

- less than 1dB insertion loss over entire passband
- greater than 40dB stopband rejection
- 5 section, 30dB per octave roll-off
- VSWR less than 1.7 (typ)
- over 100 models, immediate delivery
- meets MIL-STD-202
- rugged hermetically sealed package (0.4 x 0.8 x 0.4 in.)
- BNC, Type N, SMA available

finding new ways ...
 setting higher standards

Mini-Circuits

A Division of Scientific Components Corporation
 P.O. Box 166, Brooklyn, New York 11235 (718) 934-4500
 Domestic and International Telexes: 6852844 or 620156

CIRCLE NO 119

LOW PASS	Model	*LP-	10.7	50	70	100	150	200	300	450	550	600	750	850	1000
Min. Pass Band (MHz)	DC to		10.7	48	60	98	140	190	270	400	520	580	700	780	900
Max. 20dB Stop Frequency (MHz)			19	70	90	147	210	290	410	580	750	840	1000	1100	1340

Prices (ea.): P \$9.95 (6-49), B \$24.95 (1-49), N \$27.95 (1-49), S \$26.95 (1-49)

HIGH PASS	Model	*HP-	50	100	150	200	300	400	500	600	700	800	900	1000
Pass Band (MHz)	start, max.		41	90	133	185	290	395	500	600	700	780	910	1000
	end, min.		200	400	600	800	1200	1600	1600	1600	1800	2000	2100	2200
Min. 20dB Stop Frequency (MHz)			26	55	95	116	190	290	365	460	520	570	660	720

Prices (ea.): P \$12.95 (6-49), B \$27.95 (1-49), N \$30.95 (1-49), S \$29.95 (1-49)

*Prefix P for pins, B for BNC, N for Type N, S for SMA *example: PLP-10.7*

99¢

from

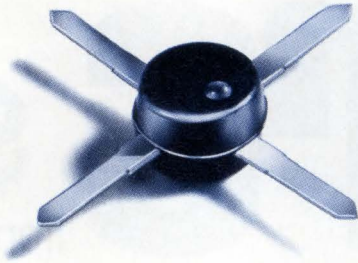

dc to 2000 MHz amplifier series

SPECIFICATIONS

Model	Frequency MHz	Gain, dB (min.)	Max. Power dBm (typ)	NF dB (typ)	Price \$ Ea.	Qty.
MAR-1	DC-1000	13	0	5.0	0.99	(100)
MAR-2	DC-2000	8.5	+3	6.5	1.50	(25)
MAR-3	DC-2000	8	+8	6.0	1.70	(25)
MAR-4	DC-1000	7	+11	7.0	1.90	(25)
MAR-7	DC-2000	8.5	+4	5.0	1.90	(25)
MAR-8	DC-1000	21	+10	3.5	2.20	(25)

Unbelievable, until now... tiny monolithic wide-band amplifiers for as low as 99 cents. These rugged 0.085 in. diam. plastic-packaged units are 50ohm input/output impedance, unconditionally stable regardless of load*, and easily cascadable. Models in the MAR-series offer from 7 to 21dB gain, 0 to +11dBm output, noise figure as low as 3.5dB (5.5dB typical), and up to DC-2000MHz bandwidth.

*3:1 load VSWR for the MAR-8

designers amplifier kit, DAK-1

5 of each model, total 30 amplifiers
only \$49.99

Also, for your design convenience, Mini-Circuits offers chip coupling capacitors at 12 cents each*

Size (mils)	Tolerance	Temperature Characteristic	Value
80 x 50	5%	NPO	10, 22, 47, 68, 100, 470, 680, 1000 pf
80 x 50	10%	X7R	2200, 4700, 6800, 10,000 pf
120 x 60	10%	X7R	.022, .047, .068, .1µf

* MINIMUM ORDER 50 PER VALUE

Typical Biasing Configuration

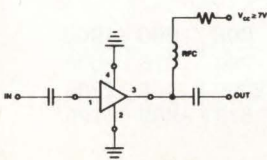

finding new ways...
setting higher standards

Mini-Circuits

A Division of Scientific Components Corporation
P.O. Box 166, Brooklyn, New York 11235 (718) 934-4500
Domestic and International Telexes: 6852844 or 620156



On the cover: Encoder and protocol ICs are not the only chips you need to implement a local-area network: Transceiver ICs provide the link to complete an IEEE LAN. See pg 130. (Cover concept and design by Mary Ann Toperzer and David Neal; photography by Joseph Savant; photo courtesy Texas Instruments)

DESIGN FEATURES

Special Report: LAN ICs for IEEE-802 networks 130

If you're going to build LAN hardware that conforms to existing IEEE standards, you have a variety of LAN ICs to choose from. When you get down to the physical level and choose your transceiver ICs, you may have to make decisions that can be revealing about the capabilities of the LAN itself.—*Jim Wiegand, Associate Editor*

Magnetic compensation gives new life to transformer-based SLICs 149

The transformerless monolithic SLICs that are becoming available are not yet proving to be cost-effective. A family of magnetic-compensation circuits offers an interim solution.—*Chris Stacey, National Semiconductor Corp*

Token-ring bus controller simplifies network design 159

You can simplify the design of factory-automation networks with the aid of a VLSI token-ring bus controller that conforms to IEEE Standard 802.4.—*Ivan Erickson, Motorola Inc*

Simple solution cures glitches on high-speed buses 173

High-speed bus systems such as Multibus II and the VME Bus have spawned a new gremlin: the ground-shift-induced logic fault. Unfortunately, such faults look like crosstalk in a system's backplane. The problem originates in the system's connectors.—*Richard M DeBock, Matrix Corp*

Page addressing expands addressable memory in μ P systems 189

Today's software-intensive applications have revealed a basic shortcoming of 8-bit processors—they often don't contain enough addressable memory. Page-addressing techniques can free your system from program-memory limitations.—*Terry Kendall, Intel Corp*

Designer's Guide to Codecs—Part 1 211

A codec—or coder/decoder—performs analog-to-digital (encoding) and digital-to-analog (decoding) conversion of the human voice. This article, part 1 of a 2-part series, provides an overview of a codec's structure and function and brings you up to date on the standard features that these workhorses offer.—*Brady Barnes, Inter-Tel*

Continued on page 7



BPA ABP



EDN® (ISSN 0012-7515) is published 38 times a year by Cahners Publishing Co, a Division of Reed Publishing USA, 275 Washington Street, Newton, MA 02158. William M Platt, President; Terrence M McDermott, Executive Vice President; Jerry D Neth, Vice President of Publishing Operations; J J Walsh, Financial Vice President/Magazine Division; Thomas J Dellamaria, Vice President Production & Manufacturing; Frank Sibley, Group Vice President. Copyright 1987 by Reed Publishing USA, a division of Reed Holdings Inc; Saul Goldweitz, Chairman; Ronald G Segel, President and Chief Executive Officer; Robert L Krakoff, Executive Vice President. Circulation records maintained at Cahners Publishing Co, 270 St Paul St, Denver, CO 80206. Second class postage paid at Denver, CO 80202 and additional mailing offices. Postmaster: Send address changes to EDN®, 270 St Paul St, Denver, CO 80206.

WHEN BUYING SWITCHES REMEMBER THREE THINGS.



C&K Components, The Primary Source Worldwide,[®] celebrates its 30th anniversary by expanding your sources for switches.

For toggle, rocker, slide, DIP and thumbwheel switches, your source is the original C&K Components, Inc.

For switchlocks, rotary and slide switches, your source is C&K Clayton Division.

For snap-acting and metal-cased control switches, your source is the new C&K/Unimax.

Whichever you choose, remember C&K gives you the broadest selection of switching configurations to meet a variety of changing needs plus quality, quantity, performance, delivery and low-cost.

Need proof? Just send us your specs and description of your application, we'll quickly send you a sample switch that fits your needs. Without charge or obligation.

Or, call for our FREE literature.

C&K[®]

C&K Components, Inc.
Newton, MA 02158
Tel. (617) 964-6400

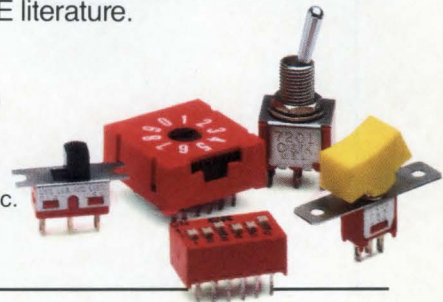

C&K[®]

C&K Clayton Div.
Clayton, NC 27520
Tel. (919) 553-3131

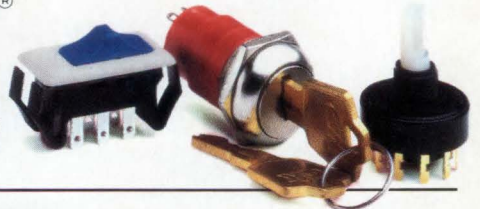

C&K / Unimax[™]

C&K/Unimax
Wallingford, CT 06492
Tel. (203) 269-8701

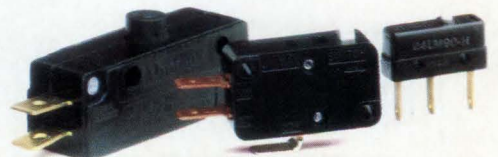

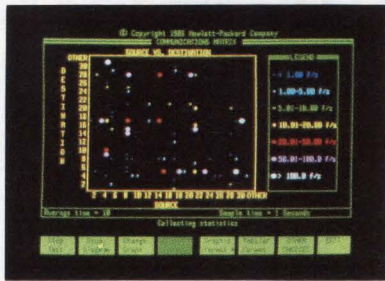

You can use a LAN physical tester or protocol analyzer for measuring the performance of a new network-protocol software release, resuscitating a crashed network, or tuning a LAN for peak performance (pg 59).

TECHNOLOGY UPDATE

IEEE 802.3 LAN testers and analyzers pinpoint network and equipment flaws 59

Troubleshooting an Ethernet local-area network can be a complex problem; sometimes magic seems to be the only solution. But instead of reaching for a book of incantations the next time you have to troubleshoot a LAN, consider using equipment specifically designed for testing networks.—*Steven H Leibson, Regional Editor*

Cost, device speed, size, and reliability determine the best package for an ASIC 77

When you order an application-specific IC (ASIC) from a foundry, the foundry does everything but specify the design and select the chip package. Yet the latter is no idle task.—*Eva Freeman, Associate Editor*

Ubiquitous conductive-rubber switches adapt to fit your application and budget 91

Versatile and inexpensive, conductive-rubber switches are one of the most commonly used switch types: Their applications range from VCR control panels to military electronics.—*Margery S Conner, Regional Editor*

PRODUCT UPDATE

DSP-chip family	103
Digital storage oscilloscope	108
Family of silicon compilers	111
SCSI development tools	112

DESIGN IDEAS

Diodes and capacitors imitate transformer	223
Compute magnitude, phase, and group delay	224
Multiplexed S/H amplifiers hide glitches	228
Second μ P enhances TMS32020 system	230
Circuit extracts square-wave pulse	234

Continued on page 9

Advertising and editorial offices: 275 Washington St, Newton, MA 02158. Phone (617) 964-3030. Subscription offices: 270 St Paul St, Denver, CO 80206. Phone (303) 388-4511. EDN® is circulated without charge to those qualified. Subscription to others: US, \$95/year, \$6/copy; Canada and Mexico, \$110/year, \$8/copy; Europe Air Mail, \$135/year, \$10/copy; all other nations surface mail, \$135/year, \$10/copy; all other nations Air Mail, \$200/year. Special issue prices may vary. Send requests for qualification forms and/or change of address to subscription office.
© 1987 by Reed Publishing USA, Division of Reed Holdings Inc. All rights reserved.

Introducing the new Wire-Wrap® XA3. It's operator friendly!



A turn of the outer knurled ring allows positioning of bit and sleeve to be adjusted to suit individual working styles.



Our designers call it "Operator Adjustable Indexing." It allows the operator to suit their own style of working by adjusting the index position of the bit and sleeve. It means faster, easier and more comfortable loading of the tool, more output and less fatigue for the operator. Inside the XA3 is an ultra tough drive train that features a planetary gear system to ensure quieter running, smoother operation, longer life, and easier servicing. It also enabled our engineers to design a slimmer, lighter tool that's more compact and comfortable to use for longer periods of time. Get to know the Wire-Wrap XA3 from CooperTools. It's the good looking, high quality tool that's going to make a lot of friends in wire wrapping circles.

CooperTools

BREWER-TITCHENER® CAMPBELL® COVERT® CRESCENT® LUFKIN® MERRILL®
NICHOLSON® PLUMB® TURNER® WELLER® WIRE-WRAP® WISS® XCELITE®

The Cooper Group PO Box 728 Apex NC, 27502 USA

Tel (919) 362-7510 Telex 579497



BACK AMERICA

VP/Publisher
F Warren Dickson

VP/Associate Publisher/Editorial Director
Roy Forsberg

Editor
Jonathan Titus

Managing Editor
Rick Nelson

Assistant Managing Editor
Joan Morrow

Special Projects
Gary Legg

Home Office Editorial Staff
275 Washington St, Newton, MA 02158
(617) 964-3030

Tom Ormond, *Senior Editor*
Deborah Asbrand, *Associate Editor*
Joanne Clay, *Associate Editor*
Tarlton Fleming, *Associate Editor*
Eva Freeman, *Associate Editor*
Clare Mansfield, *Associate Editor*
Dave Pryce, *Associate Editor*
Charles Small, *Associate Editor*
George Stubbs, *Associate Editor*
Chris Terry, *Associate Editor*
Jim Wiegand, *Associate Editor*
Valerie Lauzon, *Staff Editor*
Helen McElwee, *Staff Editor*
Cynthia B Rettig, *Staff Editor*
Steven Paul, *Production Editor*

Editorial Field Offices

Margery S Conner, *Regional Editor*
Newbury Park, CA: (805) 499-7901

Bob Cushman, *Special Features Editor*
Port Washington, NY: (516) 944-6524

Chris Everett, *Regional Editor*
San Jose, CA: (408) 296-0868

Steven H Leibson, *Regional Editor*
Boulder, CO: (303) 494-2233

J D Mosley, *Regional Editor*
Arlington, TX: (817) 465-4961

David Shear, *Regional Editor*
San Jose, CA: (408) 296-0868

Maury Wright, *Regional Editor*
San Diego, CA: (619) 748-6785

Peter Harold, *European Editor*
0603-630782
(St Francis House, Queens Rd,
Norwich, Norfolk NR1 3PN, UK)

Contributing Editors
Robert Pease, Bob Peterson, Don Powers,
Bill Travis

Editorial Services
Kathy Leonard, *Office Manager*
Loretta Curcio, Nancy Weiland,
Sharon Gildea

Art Staff
Kathleen Ruhl, *Art Director*
Ken Racicot, *Assistant Art Director*
Chin-Soo Chung, *Graphic Designer*
Deborah Queally, *Graphic Designer*

Production/Manufacturing Staff
William Tomaselli, *Production Supervisor*
Donna Pono, *Production Manager*
Beth Ann Cooper, *Production Assistant*
Andrew A Jantz, *Production Assistant*
Diane Malone, *Composition*

Graphics Director
Norman Graf

VP/Production/Manufacturing
Wayne Hulitzky

Director of Production/Manufacturing
John R Sanders

Director of Research
Deborah Virtue

Marketing Communications
Janice Molinari, *Manager*
Jennifer Ware, *Communications Manager*
Corie Rand, *Promotion Coordinator*
Anne Foley, *Promotion Assistant*

EDITORIAL

51

A new consortium has a chance to revitalize US manufacturing if government stays out of the way.

NEW PRODUCTS

Integrated Circuits	236
Components & Power Supplies	247
Computers & Peripherals	256
Test & Measurement Instruments	264
CAE & Software Development Tools	268

PROFESSIONAL ISSUES

285

Widespread practice of unpaid overtime levies burden on salaried engineers.—*Deborah Asbrand, Associate Editor*

LOOKING AHEAD

305

Market for linear-proximity, displacement sensors to grow . . .
“Moderate” growth forecast for semiconductors in 1987.

DEPARTMENTS

News Breaks	21
News Breaks International	24
Signals & Noise	32
Calendar	44
Readers' Choice	118
Leadtime Index	122
Literature	281
Career Opportunities	288
Advertisers Index	302
Business/Corporate Staff	303

Cahners Publishing Company A Division of Reed Publishing USA
Specialized Business and Consumer Magazines for Building & Construction
Interior Design Electronics & Computers Foodservice & Lodging
Manufacturing Book Publishing & Libraries Medical & Health Care
Child Care/Development



REMEMBER WHEN THE CHIPS WERE DOWN?

Your system, or maybe even your entire line, was down. The chips you ordered didn't meet spec, quantities were insufficient, or maybe they weren't produced at all. It's a hair-raising experience.

INMOS understands how you feel. That's why we're dedicated to the highest standards of quality and reliability, without compromising performance in any of our products: SRAMs, DRAMs, Microcomputer products or ASICs.

For example, our CMOS Static RAMs have quality levels better than 300ppm and reliability levels below 50 fits. This means with 16 of our 16K SRAMs, your cache memory should have better than 100 years of failure-free performance.

We know the stakes are high. At INMOS, you get products you can depend on from a company you can depend on.

16K CMOS SRAMs	
Device	Access Times
IMS1403 (x1)	20, 25, 35, 45ns
IMS1423 (x4)	25, 35, 45ns

64K CMOS SRAMs	
Device	Access Times
IMS1600 (x1)	35, 45, 55ns
IMS1620 (x4)	35, 45, 55ns
IMS1624 (OE, x4)	35, 45, 55ns
IMS1630 (x8)	45, 55, 70ns

LOWPOWERDATA RETENTION CMOS SRAMs		
Device	Access Times	Idr*
IMS1403L (x1)	25, 35, 45ns	0.5µA
IMS1601L (x1)	45, 55, 70ns	10µA
IMS1620L (x4)	45, 55, 70ns	10µA
IMS1624L (OE, x4)	45, 55, 70ns	10µA

All above products are available in MIL-STD-883C. *Idr = Typical Icc at 2V at 25° centigrade. inmos,  and IMS are trademarks of the INMOS Group of Companies.

CMOS STATIC RAMs



INMOS, Colorado Springs, Colorado, Tel. (303) 630-4000;
Bristol, England, Tel. (0454) 616616;
Paris, France, Tel. (1) 46.87.22.01;
Munich, Germany, Tel. (089) 319 10 28;
Tokyo, Japan, Tel. 03-505-2840.

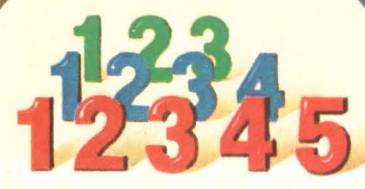
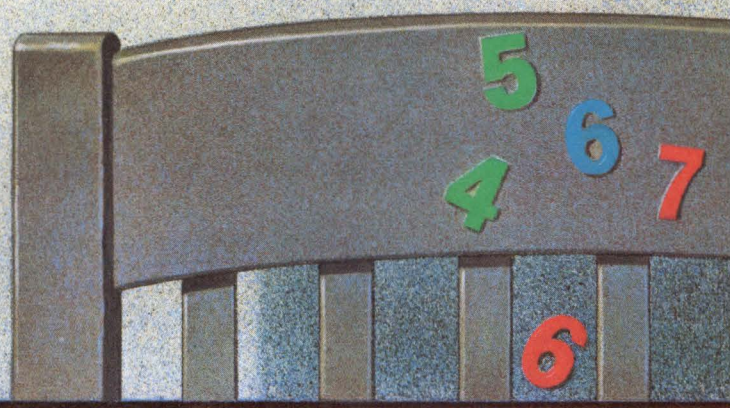
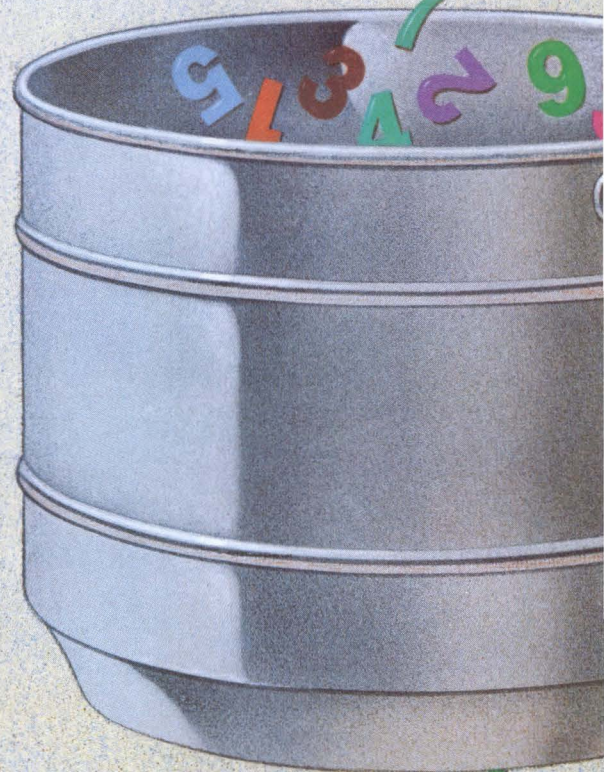
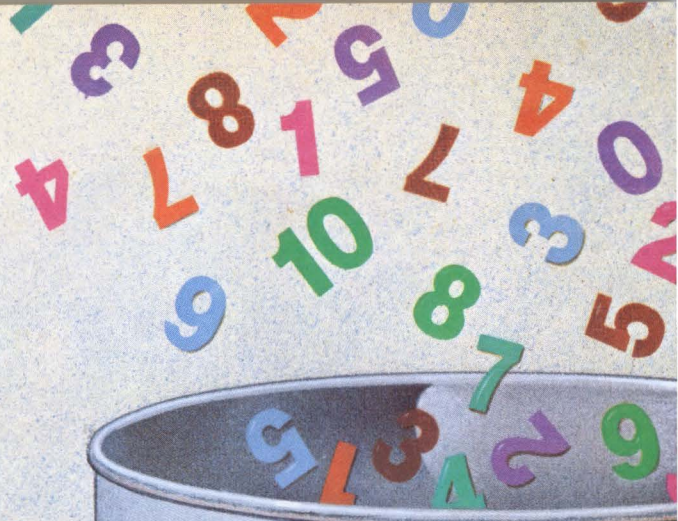



How the military broke The Second Law of Thermodynamics.

They called in contractors, suppliers and sent for extra coffee. Everyone phoned home to say they'd be a little late.

Eighteen months later, the DESC/MIL Standard emerged, bringing order out of chaos and defying entropy.

Advanced Micro Devices was there every spec of the way. Today we have the broadest

Entropy & The 2nd Law of Thermodynamics: Isolated systems tend toward disorder.

Physics for Scientists and Engineers, Serway, Raymond, 489-90. 1986 CBS College Publishers, N.Y.

range of high-end DESC/MIL products and technologies available anywhere. (No SSI and MSI here.) Over 100 parts are on our shelves now.

AMD parts meet DESC/MIL standards from the pins up. That means you can do something more productive than writing new Source Control Drawings. And the time you spend on documentation will drop to virtually zero.

If you'd like to see some of our DESC/MIL parts in your products just write for a free brochure. And if you're wondering if anyone here feels the slightest bit guilty about breaking The Second Law, the answer is, "Absolutely not."

Some laws just beg to be broken.

**Advanced
Micro Devices** 

901 Thompson Place, P.O. Box 3453,
Sunnyvale, CA 94088

CIRCLE NO 50

GET A QUOTE FROM A RELIABLE SOURCE.

For once you can believe what you hear. Because when you call Fujitsu, you'll get a competitive quote along with a very real delivery date.

Plus, you can get just about everything you need with that one phone call.

Memories in every important technology. With sizes and speeds



SRAMS

MB81C86
-55, -70 64Kx4
MB81C84
-45, -55 64Kx4
MB81C81
-45, -55 256Kx1
MB84256
-10L/LL 32Kx8
MB84256
-12L/LL 32Kx8
MB84256
-15L/LL 32Kx8
MB81C71A
-25, -35 64Kx1
MB81C71
-45, -55 64Kx1
MB81C74
-25, -35 16Kx4
MB81C75
-25, -35 16Kx4 (w/DE)
MB81C79A
-35, -45 8Kx9
MB81C79
-45, -55 8Kx9
MB81C78A
-35, -45 8Kx8
MB81C78
-45, -55 8Kx8
MB8464
-12L/LL 8Kx8
MB8464
-15L/LL 8Kx8
MB8464A
-10L/LL 8Kx8
MB8464A
-12L/LL 8Kx8
MB8464A
-15L/LL 8Kx8
MB8464A
-80L/LL 8Kx8
MB8464A
-10W, -15W 8Kx8

MB8167A
-55, -70 16Kx1
MB8167
-35, -45 16Kx1
MB8167
-45W, -55W 16Kx1
MB81C67
-35, -45 16Kx1
MB81C69A
-25, -30, -35, -45 4Kx4
MB81C68A
-25, -30, -35, -45 4Kx4
MB8168
-55, -70 4Kx4
MB81C68
-45W, -55W 4Kx4
MB81C68
-55, -70 4Kx4
MB8422
-90, -120 2Kx8
MB8421
-90, -120 2Kx8
MB8417A
-12, -12L 2Kx8
MB8417A
-15, -15L 2Kx8
MB8417
-20, -20L 2Kx8
MB8416A
-12L, -15L 2Kx8
MB8416
-20, -20L 2Kx8
MB8416
-25W 2Kx8
MB8128
-10, -15 2Kx8
MB85402
-25 16Kx16

ECL RAMS

MB70801
-15 512x9

MB70802
-20 512x9
MBM7700H
-5 256x16
MBM100422A
-5, -7 256x4
MBM10422A
-5, -7 256x4
MBM100490
-15 64Kx1
MBM100490
-25 64Kx1
MBM10490
-15, -25 64Kx1
MBM100480
-15, -25 16Kx1
MBM100480A
-10 16Kx1
MBM100484A
-10 4Kx4
MBM100484
-15 4Kx4
MBM10480A
-10 16Kx1
MBM10484A
-10 4Kx4
MBM10480
-15, -25 16Kx1
MBM7750
-10 1Kx16
MBM100470
-10, -15 4Kx1
MBM100474A
-5, -7 1Kx4
MBM100474A
-10, -15 1Kx4
MBM10470A
-10, -15 4Kx1
MBM10474A
-5, -7 1Kx4
MBM10474A
-10, -15 1Kx1
MBM10415AH
1Kx1

PROMS

MBM7226RA
-20, -25 512x8
MBM7226RS
-20, -25 512x8
MB7123E/H
-35, -45 512x8
MB7124E/H
-35, -45 512x8
MB7115E/H
-35, -45 512x4
MB7116E/H
-35, -45 512x4
MB7117E/H
-35, -45 256x8
MB7118E/H
-35, -45 256x8
MB7113E/H
-35, -45 256x4
MB7114E/H
-35, -45 256x4
MB7113L
LOW-PWR 256x4
MB7114L
LOW-PWR 256x4
MB7212RA
-20 32x8
MB7212RS
-20 32x8
MB7111E/H
-25, -35 32x8
MB7112E/H
-25, -35 32x8
MB7111L
LOW-PWR 32x8
MB7112L
LOW-PWR 32x8
MB7143E/H
-55, -65 8Kx8
MB7144E/H
-55, -65 8Kx8
MB7144Y
-45 8Kx8
MB7242RA
-20 4Kx8
MB7242RS
-20 4Kx8
MB7141E/H
-55, -65 4Kx8
MB7142E/H
-55, -65 4Kx8
MB7142E/W
-55, -65 4Kx8
MB7151E/H
-45, -55 4Kx4
MB7152E/H
-45, -55 4Kx4
MB7152Y
-35 4Kx4
MB7133E/H
-45, -55 4Kx4
MB7134E/H/Y
-35, -45, -55 4Kx4
MB7238RA
-20 2Kx8
MB7238RS
-20 2Kx8
MB7137E/H
-45, -55 2Kx8
MB7137E/H/SK
-45 2Kx8 (Skinny DIP)
MB7138E/H
-45, -55 2Kx8
MB7138E/H/SK
-45 2Kx8
MB7138Y/SK
-35 2Kx8
MB7138E/W
-55 2Kx8
MB7127E/H
-45, -55 2Kx4
MB7128E/H/Y
-35, -45, -55 2Kx4
MB7128E/W
-55 2Kx4
MB7232RA
-20, -25 1Kx8
MB7232RS
-20, -25 1Kx8
MB7131E/H
-45, -55 1Kx8
MB7131E/H/SK
1Kx8
MB7132E/H/Y
-35 1Kx8
MB7132E/H/Y/SK
1Kx8
MB7121E/H
-35, -45 1Kx4
MB7122E/H/Y
-30 1Kx4

DRAMS

MB85227
-10, -12 256Kx9
MB85226
-10, -12 256Kx9
MB85225
-10, -12 256Kx8
MB85224
-10, -12 256Kx8
MB85214
-12, -15 256Kx8
MB85213
-12, -15 256Kx8
MB85211
-12, -15 512Kx4
MB85210
-12, -15 512Kx4

MB85206
-10, -12 256Kx4
MB85205
-10, -12 256Kx4
MB85204
-10, -12 256Kx4
MB85203
-10, -12 256Kx4
MB81C4257
-10, -12, -15 256Kx4
MB81C4256
-10, -12, -15 256Kx4
MB81C4258
-10, -12, -15 256Kx4
MB81C4259
-10, -12, -15 256Kx4
MB81C1000
-10, -12, -15 1Mx1
MB81C1001
-10, -12, -15 1Mx1
MB81C1002
-10, -12, -15 1Mx1
MB81C1003
-10, -12, -15 1Mx1
MB85208
-10, -12 1Mx1
MB85201
-10, -12 1Mx1
MB81C258
-10, -12, -15 256Kx1
MB85108A
-10, -12 256Kx1
MB85103A
-12, -15 64Kx8
MB85101A
-10, -12 64Kx4
MB81C466
-10, -12, -15 64Kx4
MB81464
-10, -12, -15 64Kx4
MB81461
-12, -15 64Kx4
MB8266A
-10, -12, -15 64Kx1
MB8265A
-10, -12, -15 64Kx1
MB8264A
-10, -12, -15 64Kx1
MB85237
-10 256Kx9 (CMOS)

NON-VOLATILE MEMORY

MBM2212
-20, -25 256Kx8
MB831000
-15, -20 128Kx8
MB831124
-35 128Kx8

MBM27C1000
-20, -25 128Kx8
MBM27C1001
-20, -25 128Kx8
MBM27C1028
-15, -20, -25 64Kx16
MBM27C1024
-20, -25 64Kx16
MB83512
-15, -20 64Kx8
MBM27C512
-20, -25, -30 64Kx8
MB27C256H
-10, -12 32Kx8
MB83256
-25 32Kx8
MBM27C64
-20, -25, -30 32Kx8
MBM27C64
-25X, -30X/W 32Kx8
MBM27C256A
-20, -25 32Kx8
MBM27C256A
-20W, -25W 32Kx8
MBM27256
-17, -20, -25 32Kx8
MBM27256
-20X, -25X, -30X 32Kx8
MBM27C128
-20, -25 16Kx8
MBM27128
-20, -25, -30 16Kx8
MBM27128
-25X/W, -30X/W 16Kx8
MBM28C64
-25, -35 8Kx8
MBM28C65
-25, -35 8Kx8
MBM2764
-20, -25, -30 8Kx8
MBM2764
-30X, -30W 8Kx8

4-BIT MICRO-CONTROLLERS

MB8840 SERIES
48-PIN FPT
42-PIN DIP
28-PIN DIP
MB8850/H/B SERIES
48-PIN FPT
MB88200/H/B SERIES
16-PIN DIP
16-PIN FPT
MB88210 SERIES
20-PIN DIP

MB88400/H SERIES
48-PIN FPT
MB88410/H SERIES
42-PIN DIP
48-PIN FPT
MB88420/H SERIES
64-PIN DIP
MB88500/H SERIES
48-PIN FPT
42-PIN DIP
MB88510/B SERIES
64-PIN DIP
42-PIN DIP
MB88520/B SERIES
64-PIN DIP
64-PIN FPT
MB88530 SERIES
42-PIN DIP
48-PIN FPT
MB88540 SERIES
70-PIN FPT
80-PIN FPT
MB88550 SERIES
80-PIN FPT
MB88560 SERIES
80-PIN FPT
MB88P500/H SERIES
48-PIN FPT
MB88700 SERIES
64-PIN FPT

8-BIT MICRO-CONTROLLERS

MBL8749
EPROM
40-PIN DIP
MBL8742
EPROM
40-PIN DIP
MBL8649
40-PIN DIP
MBL80C39
CMOS SINGLE CHIP MCU
MBL80C49
CMOS SINGLE CHIP
MBL8039
MCU 128B RAM
MBL8C49
2KB ROM 128B RAM
MBL8035
MCU 64B RAM
MBL8048
1KB ROM 64KB RAM
MBL8042
UNIVERSAL PERIPH. INTERFACE
MBL8051AH
256B RAM
MBL8031AH
4KB ROM 245B RAM

unmatched in the industry. Micro-processors that talk 4-bit, 8-bit or 16-bit code. ASIC products that include standard cells and gate arrays. Even peripheral chips (like the async/sync SCSI we've been shipping for over a year and the world's fastest CMOS DSP).

You can also choose from the industry's widest variety of pack-

aging options. And count on the kind of quality and reliability that have set Fujitsu products apart from the crowd for so many years.

So talk to us about products, prices, delivery or technology. Just call your local sales office. Because after a few moments, you'll know you've heard a quote from a reliable source.

Northern California: (408) 866-5600
 Southern California: (714) 720-9688
 Atlanta: (404) 449-8539
 Chicago: (312) 250-8580
 Boston: (617) 964-7080
 Minneapolis: (612) 454-0323
 New York: (516) 361-6565
 Portland: (503) 684-4545
 Dallas: (214) 669-1616

FUJITSU **FUJITSU**
MICROELECTRONICS, INC.

Technology That Works.

16-BIT MICRO-PROCESSORS

- MB80188**
NMOS MPU
68-PIN LCC
- MB8089/-2**
I/O 40-PIN DIP
- MB8088/-2**
NMOS 40-PIN DIP
- MBL80286**
NMOS MPU
68-PIN LCC
- MBL80186**
NMOS MPU
68-PIN LCC
- MBL8086/-1/-2**
MPU 40-PIN DIP

PERIPHERALS

- MB8868A**
MOS UART
(TR1602A
COMPATIBLE)
- MBL82288**
BUS CONTROLLER
- MBL82284**
CLOCK GENERATOR
- MBL82C43**
INPUT/OUTPUT
EXPANDER (CMOS)
- MBL8243**
INPUT/OUTPUT
EXPANDER
- MBL8289**
BUS ARBITER
- MB89289**
BUS ARBITER
(CMOS)
- MBL8288**
BUS CONTROLLER
- MB89288**
BUS CONTROLLER
(CMOS)
- MBL8287**
BIPOLAR OCTAL BUS
TRANSCEIVER
- MB89287**
BIPOLAR OCTAL BUS
TRANSCEIVER
(CMOS)
- MBL8286**
BIPOLAR OCTAL BUS
TRANSCEIVER
- MB89286**
BIPOLAR OCTAL BUS
TRANSCEIVER
(CMOS)
- MB89237A**
DMA CONTROLLER
(CMOS)

- MB89251A**
SERIAL DATA
TRANSMITTER
(CMOS)
- MB89254**
PROGRAMMABLE
INTERVAL TIMER
(CMOS)
- MB89255A**
PARALLEL DATA
INPUT/OUTPUT
UNIT (CMOS)
- MBL8284A**
CLOCK GENERATOR
& DRIVER
- MB89284A**
CLOCK GENERATOR
& DRIVER (CMOS)
- MBL8283**
BIPOLAR OCTAL
LATCH
- MB89283**
BIPOLAR OCTAL
LATCH (CMOS)
- MBL8282**
BIPOLAR OCTAL
LATCH
- MB89282**
BIPOLAR OCTAL
LATCH (CMOS)
- MBL8259A/-2**
PROG. INTERRUPT
CONTR.
- MBL89259A/-2**
PROG. INTERRUPT
CONTR. (CMOS)
- MB88308/9**
CMOS OUTPUT
EXPANDER
- MB88306/7**
CMOS OUTPUT
EXPANDER
- MB88304/5**
NMOS 4/8-BIT I/O
EXPANDER
- MB4107**
DATA SEPARATOR
- MB1412AC**
LS-TTL ERROR
CHECKING/
CORRECTION
CIRCUIT (ECC)
- MB1426**
16-BIT ECC

SPECIAL CONTROLLERS (ASIC)

- MB8877A**
FLOPPY DISK
CONTROLLER

- MB8876A**
FLOPPY DISK
FORMATTER
 - MB89322**
CRT CONTROLLER
(6845 COMPATIBLE)
(CMOS)
 - MB89321**
CRT CONTROLLER
(6845 COMPATIBLE)
(CMOS)
 - MB89311**
FLOPPY DISK
CONTROLLER
 - MB88303P**
TELEVISION DISPLAY
CONTROLLER
- TELECOM**
- MB87006**
PLL
 - MB87004**
DTMF/PULSE DIALER
DIP
 - MB87003**
DTMF/PULSE DIALER
 - MB87001**
SYNTHESIZER
SYSTEM BLOCK
 - MB6024**
CODEC
 - MB6022**
CODEC
 - MB6021**
CODEC
 - MB501/L**
TWO MODULUS
PRESCALER
 - MB503/504/506**
TWO MODULUS
PRESCALER
- LINEAR**
- MB3712**
POWER AMP
 - MB3713**
POWER AMP
 - MB3722**
POWER AMP
 - MB3714A**
POWER AMP
 - MB3737**
POWER AMP
 - MB3730**
12W BTL
AUDIO AMP
 - MB3731**
18W BTL
AUDIO AMP
 - MB3752**
VOLTAGE
REGULATOR

- MB3759**
PULSE WIDTH
MODULATION
(PWM) CONTROL
 - MB3760**
PWM CONTROL
CIRCUIT
- DSP (DIGITAL SIGNAL PROCESSORS)**
- MB8764CR**
-001 88-PIN PGA
 - MB8764CV**
-001 84-PIN LCC
 - MB8764PR**
-001 88-PIN
PLASTIC PGA
 - MB87064P**
42-PIN PLASTIC DIP
 - MB87064C**
42-PIN CERAMIC
DIP
 - MB87069C**
64-PIN CERAMIC
PGA
- SCSI**
- MB87030**
SYNCHRONOUS S.P.C.
 - MB89351**
ASYNCHRONOUS
S.P.C.
- CONVERTERS**
- MB40547**
-7/-8 8-BIT UH
SPEED A/D
 - MB40576**
6-BIT UH SPEED
VIDEO A/D
 - MB40748**
-8/-9 10-BIT UH
SPEED D/A
 - MB40776**
6-BIT UH SPEED D/A
 - MB40778**
8-BIT HIGH SPEED
D/A
 - MB40788**
10-BIT UH SPEED
D/A
 - MB88301A**
6-BIT PWM NMOS
D/A
 - MB4052**
4 CHANNEL 8-BIT
A/D

- MB4053/63**
6 CHANNEL 8-BIT
A/D SUBSYSTEM
 - MB4072**
8-BIT HIGH SPEED
MULTIPLYING D/A
- ETHERNET**
- MB8795**
ETHERNET
CONTROLLER
 - MB87012**
802.3/ETHERNET
CONTROLLER
 - MB502**
MANCHESTER
ENCODER/DECODER
- CMOS GATE ARRAYS**
- UH SERIES:**
C20000UH
20,160 GATES
 - UM SERIES:**
C15006UM
15,120 GATES
+ 6K RAM
 - C10012UM**
10,080 GATES
+ 12K RAM
 - UHB SERIES:**
C12000UHB
12,734 GATES
 - C8700UHB**
8,768 GATES
 - C6000UHB**
6,000 GATES
 - C4100UHB**
4,174 GATES
 - C3000UHB**
3,066 GATES
 - C2200UHB**
2,220 GATES
 - C1700UHB**
1,724 GATES
 - C1200UHB**
1,233 GATES
 - C830UHB**
830 GATES
 - C530UHB**
530 GATES
 - C330UHB**
336 GATES
 - AV SERIES:**
C8000AV
8,000 GATES
 - C6600AV**
6,664 GATES

- C5000AV**
5,022 GATES
- C3900AV**
3,900 GATES
- C2600AV**
2,640 GATES
- AVB SERIES:**
C2000AVB
2,052 GATES
- C1600AVB**
1,674 GATES
- C1200AVB**
1,245 GATES
- C850AVB**
852 GATES
- C540AVB**
549 GATES
- C350AVB**
357 GATES
- C4002AVM**
4,087 GATES
+ 2K RAM
- C2301AVM**
2,375 GATES
+ 1K RAM
- C1502AVM**
1,564 GATES
+ 2K RAM
- CMOS STANDARD CELLS**
- AV SERIES:**
1.8μ 2-LAYER METAL
16K RAM, 64K ROM,
PLAs, REGISTERS
SPECIAL LSI
FUNCTIONS
>13K GATES
2 INPUT GATE
EQUIVALENT

- <1.4ns TYPICAL
<2.2ns WORST CASE
- AU SERIES:**
1.3μ DUAL-WELL,
2 AND 3 LAYER
METAL
32K RAM, 128K ROM,
PLAs, REGISTERS,
MULTIPLIERS, ALU
STANDARD LSI
EQUIVALENT
FUNCTIONS
>40K GATES
2 INPUT GATE
EQUIVALENT
<0.8ns TYPICAL
<1.3ns WORST CASE
- BIPOLAR LSTTL GATE ARRAYS**
- EQUIVALENT GATES**
(2 INPUT GATES)
- B240**
360 GATES
- B350**
540 GATES
- B350B**
528 GATES
- B600**
924 GATES
- B700B**
1,080 GATES
- B1100**
1,680 GATES
- B2000**
3,162 GATES
- BIPOLAR ECL GATE ARRAYS**
- EQUIVALENT GATES**
(2 INPUT GATES)
- ET750**
1,136 GATES

- ET1500**
2,192 GATES
 - ET3000**
4,344 GATES
 - ET4500**
6,280 GATES
 - ET2009**
2,640 GATES
+ 9K RAM
 - ET3004**
3,960 GATES
+ 4K RAM
- PACKAGING**
- PLASTIC PIN GRID ARRAYS**
 - FLAT PACK GULL WINGS**
 - 256-PIN CERAMIC GRID ARRAYS**
 - SMALL OUTLINE J LEADS (SOJ)**
 - PLASTIC ZIG-ZAG IN-LINE (ZIP)**
 - SHRINK DIPs**
 - SKINNY DIPs**
 - SMALL OUTLINE DIPs**
 - SINGLE IN-LINE PACKAGE (SIP)**
 - SINGLE IN-LINE MODULES**
 - PLASTIC GRID ARRAYS (PGA)**
 - CERAMIC GRID ARRAYS (PGA)**
 - PLASTIC LCCs**
 - CERAMIC LCCs**
 - PLASTIC FLAT PACK**
 - CERAMIC FLAT PACK**
 - FLAT PACKS w/ HEAT SINKS**
 - SMALL OUTLINE DIP**

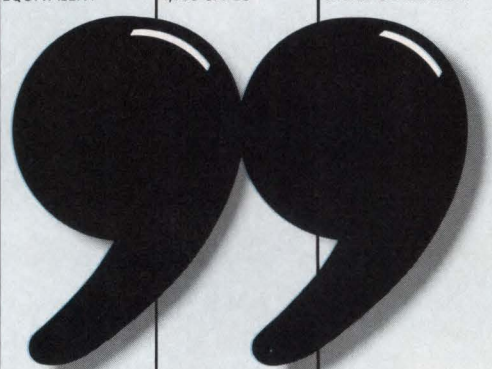

© 1987 Fujitsu Microelectronics, Inc.

**BEFORE THEY TRAVEL AT 17,500 MPH,
THEY TRAVEL IN HARDIGG CONTAINERS.**



For spaceborne telescopes as well as commercial satellites, some of the extremely sensitive components and assemblies are shipped and stored in specially designed Hardigg containers. So, before they travel the vacuum of space, they travel with us.

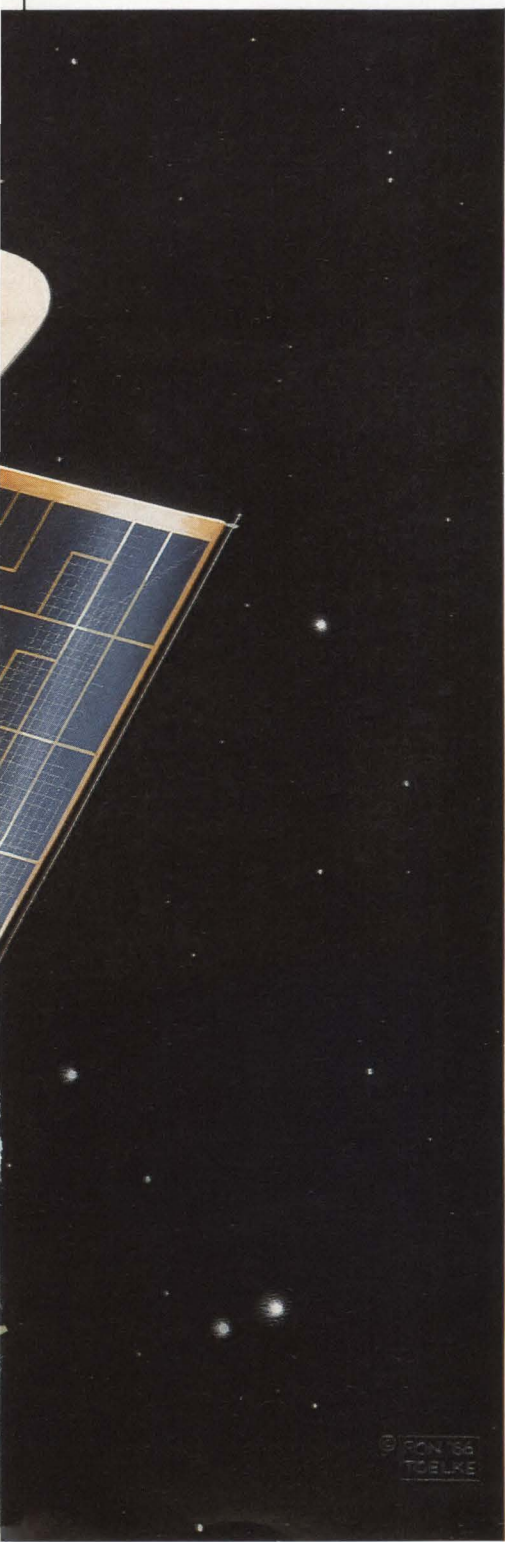

PROVEN PERFORMANCE

These components need to be safely contained in an extremely dry environment that could withstand shock up to 30g's. Not only did we meet the challenge, but provided a container that went well beyond the requirements. Just like we have with so many other difficult containerization problems for the commercial marketplace over the last twenty years.

Another example is a container we designed for a very delicate medical diagnostic component to a CAT Scan system. The units are stored and shipped all across the U.S., India, Africa, and Europe. We designed a container that not only protected the crystal elements from mechanical shock but also provided protection from damaging thermal shock as well.

PROVEN CAPACITY

The reason we can provide answers to so many difficult containerization problems rests on our skillful, knowledgeable Applications Engineering staff, and our complete manufacturing capabilities. Our engineers are shock-mitigation and environmental engineering specialists that live and breathe containerization. And our facilities enable us to provide high or low volume quantities, while controlling every aspect of the manufacturing process; from mold making to tooling, and metal working to plastic fabrication.

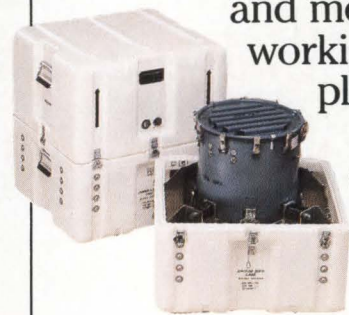

So, before you send your next product on a journey to outer or inner space, call the container company that's a proven traveller - Hardigg.



HARDIGG INDUSTRIES, INC.

P.O. Box 201
North Main Street
South Deerfield, MA 01373
Telephone: (413) 665-2163
Telex: 955431

CIRCLE NO 102

© RON '88
TELKE

A HYBRID IS A HYBRID

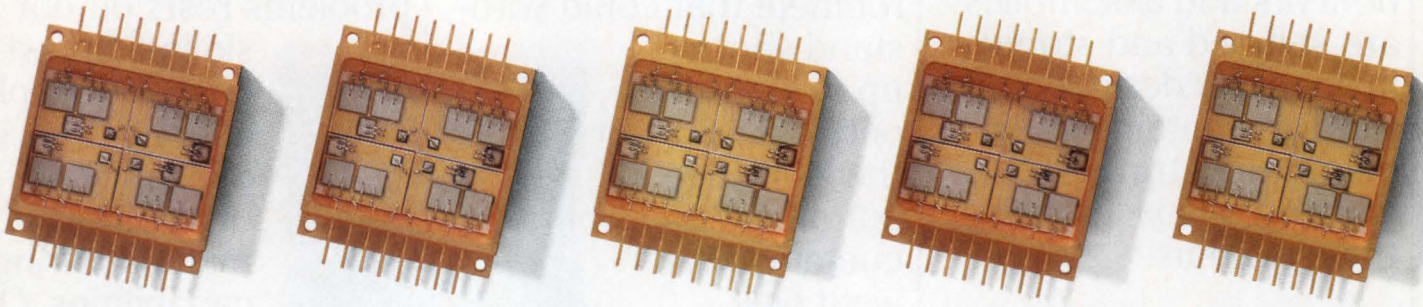

NOT TRUE

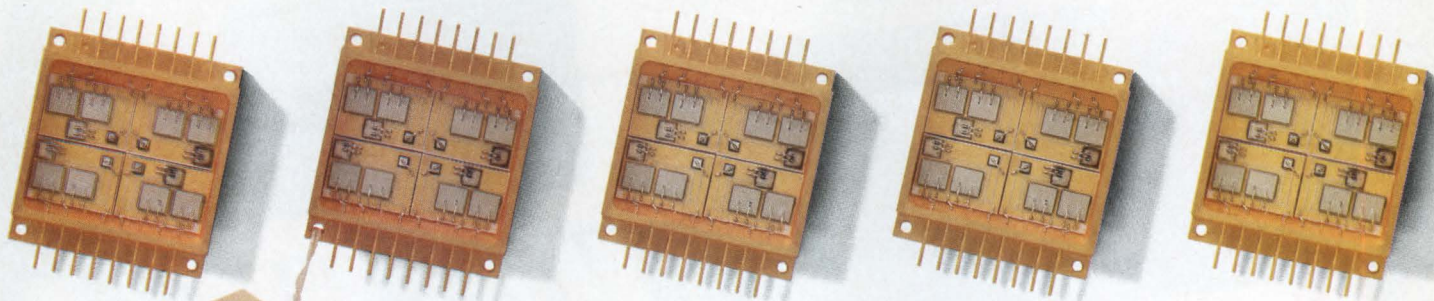

HI-REL

FOR *POWER* APPLICATIONS.

BECAUSE *ONLY* OMNIREL IS TOTALLY DEDICATED TO PRODUCING POWER HYBRIDS AND...

We have the resources to prove it.

- A team of leading industry talent with extensive technical, marketing and manufacturing expertise in power applications.
- A new advanced Class 10,000 clean room facility totally dedicated to Power Hybrids.
- The very latest, state-of-the-art equipment that gives Omnirel extensive in-house capability to design, manufacture, test and Hi-Rel screen standard and custom hybrid and component products.

Our totally dedicated base of resources offers you a company that can provide products with the highest performance and quality levels required by our Military and more demanding Industrial customers. Omnirel's sole purpose is . . . to be the leading manufacturer of the highest quality, high performance Power Hybrid circuits and to provide superior service to our customers.

If you are buying or designing equipment using Power Hybrids, you really should be doing business with Omnirel.

Call or write today for more information about Omnirel.



CALL OR WRITE TODAY FOR
OUR NEW BROCHURE.

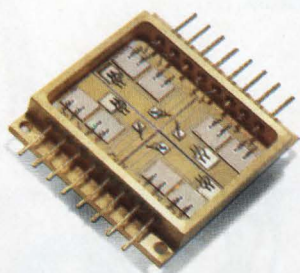

Omnirel

INNOVATORS OF POWER HYBRIDS

205 Crawford Street, Leominster, MA 01453 (617) 534-5776 FAX 617-537-4246

CIRCLE NO 133



To be #2 we developed a lot of firsts.

Firsts that will keep your Stag PPZ Universal Programmer from becoming obsolete in a few weeks... a few months... a few years.

Firsts like:

- Completely self-contained software control modules with proven programs for all programmable technologies including PAL[®]s, IFLs, and Micros, as well as bipolar and MOS PROMs and others
- 512K bits of memory, expandable to 64M bits
- Integral CRT with "super menu" techniques for fast, easy operation

- A light pen for dramatically simple interactive editing and programming
- Boolean entry support (BRAL[™]) for PALs and IFLs
- Two RS232C, an IEEE-488, and a parallel port to interface with any development system

And a whole lot more to ensure that your PPZ will be valuable to you for years.

We were the first to introduce software-controlled programmers way back in 1973.

And the first to program PALs and IFLs with a universal programmer.

For more firsts that are moving Stag from #2 to Data I/O's #1 position, call or write us today.

Stag Microsystems, Inc.
1600 Wyatt Drive
Santa Clara, CA 95054
(800) 227-8836
(408) 988-1118

3 Northern Blvd., Ste B1
Amherst, NH 03031
(800) 222-STAG
(603) 673-4380

©copyright Stag Microsystems, Inc.
PAL is a registered trademark of Monolithic Memories, Inc.
BRAL is a registered trademark of Stag Microsystems, Inc.

stag



Moving Quickly to Become

CIRCLE NO 151



NEWS BREAKS

EDITED BY JOAN MORROW

22-BIT ADC OFFERS 0.5-PPM/°C FULL-SCALE STABILITY

Thaler Corp's (Tucson, AZ) 22-bit, dual-slope integrating A/D converter, the ADC100, comes in a 1x2-in., 40-pin ceramic DIP and operates over 0 to 70°C. It requires 5V and $\pm 15V$ power supplies. The converter offers a full-scale stability of 0.5 ppm/°C max—which the company claims is 20 times better than the closest equivalent product. A floating current source, Vishay precision resistors, and calibration by an onboard μP reduce the total nonlinearity error to 3 ppm max. If you wish, you can autozero the linearity and the offset stability (0.1 ppm/°C max; 0.1 ppm/month max). With each converter ordered, Thaler provides the only additional parts needed for operation—a 25-MHz crystal and an integration capacitor. The ADC100 costs \$300 to \$500, depending on grade.—Tarlton Fleming

REPEATERS STRETCH MULTIPLEXED TERMINALS THREE MILES FROM HOST

Users of the HPS distributed communication subsystem family of multiplexers can now spread clusters of RS-232C terminals over cable distances as long as three miles. The Spur (Systech Pluriaxial Unplug Repeater) products include repeaters that connect with a mixture of coaxial and fiber-optic cables. Members of Systech Corp's (San Diego, CA, (619) 453-8970) HPS-5580 Spur family, which cost \$610 to \$2205 (100), provide flexibility in connecting cluster controllers to the LAN-based HPS multiplexer scheme. Each cluster controller interfaces to eight or 16 terminals via standard serial cables. Theoretically, the Spurs can connect 254 clusters, but host-adapter firmware currently supports 128 terminals.—Maury Wright

2400-BPS MODEM CHIP SET USES STANDARD COMPONENTS

Telebit Corp (Cupertino, CA, (408) 996-8000) is making available the license to build a 2400-bps modem with a 3-chip set based on readily available components. The design is based on the 320CM10 DSP chip, the 80C51 microcontroller, and the 6950B analog front end. These devices are supplied with mask-programmed code written by Telebit to perform all of the functions needed to implement a 2400-bps modem. You can purchase the microcode and design for a 1-time fee, or you can purchase the 3-chip set from the semiconductor manufacturers with the Telebit masks for less than \$30 including royalty (25,000). A half-card, PC-based evaluation board will be available in May for \$600.—David Shear

SOFTWARE DEVELOPMENT TOOLS SUIT REAL-TIME DSP APPLICATIONS

If your application needs to run complex DSP and image-processing algorithms at speeds reaching 8 MIPS, consider using EuclidTools from Datacube Inc (Peabody, MA, (617) 535-6644). This \$2000 set of software development tools is designed for use with your VME Bus-compatible, Euclid host-controlled programmable coprocessor. EuclidTools includes a C compiler, an assembler, a linker, and an interactive debugger. You also get libraries for math, signal, and image processing. Run-time support routines handle interrupt processing and hardware management. Device drivers for Unix 4.2 and Microware OS-9 operating systems come with the package, as does test, diagnostic, and demo code.—J D Mosley

TOOL KIT SUPPORTS GRAPHICS FOR NEW IBM PCs' PROTECT MODE

The Graphics Development Toolkit (GDT) 3.0 gives programmers direct access to the IBM Operating System/2 protect mode for graphics software development. It was

NEWS BREAKS

developed for IBM by Graphics Software Systems (Beaverton, OR, (503) 641-2200). You'll be able to buy it directly from GSS for \$495 this summer when IBM releases the Operating System/2's developer's tool kit.

Device-independent graphics interfaces have been available for previous IBM PC versions, but they did not gain widespread acceptance because software developers usually preferred to write their own hardware-dependent drivers and avoid the 5 to 10% speed penalty of the software interfaces. However, IBM's inclusion of their proprietary graphics coprocessor in the Personal System/2 8514/A intelligent high-resolution display adapter, as well as the move by add-in graphics-board manufacturers to base their new boards on graphics engines from TI, Intel, and Hitachi, can give graphics hardware the horsepower necessary to handle a device-independent software interface's overhead.—Margery S Conner

ALLIANCE WEDS LINEAR-DESIGN COMPANY TO WAFER-FAB GIANT

Texas Instruments (Dallas, TX) and Linear Technology Corp (Milpitas, CA) have jointly announced a strategic alliance that provides alternate sourcing for analog parts designed by Linear Technology. The 5-year agreement gives TI alternate-source rights to as many as 60 existing and future device designs from LTC's catalog of op amps, comparators, voltage references, data converters, switch-mode power converters, filters, and interface circuits. Five-year-old LTC, a haven for some of the US's most prominent linear-IC design engineers, gains access to TI's wafer-fab, assembly, and test facilities, and it gains a valuable second source for its parts.—Steven H Leibson

TAPE CONTROLLER PROVIDES MESSAGE-PASSING SUPPORT

The Tapemaster 2000 from Ciprico (Plymouth, MN, (612) 559-2034) provides intelligent control of tape operations. This Multibus II board controls as many as eight formatted start/stop or streaming Pertec-compatible ½-in. tape drives at burst transfer rates of 32M bytes/sec and tape transfer rates reaching 1.5M bytes/sec. Featuring an onboard message-passing coprocessor and a 512k-byte tape-data buffer, the Tapemaster 2000 asynchronously processes tape requests from the host system without handshake timing restrictions. This \$2495 controller also optimizes tape motion to minimize tape-repositioning cycles.—J D Mosley

CASCADABLE FIFOs BOAST 64-WORD CAPACITY AND 30-MHz SPEED

Consuming no more than 170 mA of power, three 64-word bipolar FIFO memories from Texas Instruments (Dallas, TX, (800) 232-3200) process data at rates as high as 30 MHz. When cascaded, the SN74ALS234, SN74ALS235, and SN74ALS236 can efficiently buffer long data streams between asynchronous subsystems operating at different speeds. The 'ALS234 and 'ALS236 sport 4-bit-wide organizations, input- and output-ready flags, and 30-MHz operating frequencies. The 5-bit-wide 'ALS235 specs a 25-MHz maximum frequency and offers flags to indicate input-ready, output-ready, half-full, almost-full, and almost-empty conditions. Each device sells for \$13.72 (1000).—J D Mosley

Now there's a 96MB drive with something extra:



Seagate quality.

If you're putting together multiuser or other high-end systems, Seagate has the manufacturing experience to deliver dependable, high-capacity 5 1/4" drives—whether you need 10 or 10,000.

Through precision production, our ST4096 hard disc drive provides 80MB of formatted capacity and stands up to rugged industrial environments as well as data-intensive office use.

For frequent and rapid data retrieval, the ST4096 has 28 ms average access time and 78,336 bytes per cylinder. Integration is handled through a standard ST412 interface, and a linear voice coil actuator ensures precise recording performance.

Each drive is built with the same skill and reliability that have made Seagate the world's leading supplier of 5 1/4" hard disc drives. People who demand performance have bought more than 5 million of our drives for small computer applications.

If you want Seagate quality in a high-capacity drive, call Hamilton/Avnet at 1-800-4-HAMILTON. Or call Seagate at 800-468-DISC. In California, 800-468-DISK.



NEWS BREAKS: INTERNATIONAL

125-MHz PULSE GENERATOR OFFERS 1-nSEC RISE TIME

The \$3385 PM5785 pulse generator from Philips I&E Div (Eindhoven, The Netherlands, TLX 35000; in the US, (201) 529-3800) has a repetition rate between 1 Hz and 125 MHz and features user-selectable rise times of 1, 1.5, or 2 nsec. In addition to controlling the pulse-repetition rate, duration, and delay, you can use external triggering and gating inputs to synchronize the generator to an external clock or to generate synchronized pulse bursts. You can also externally control the pulse duration. A burst-mode option allows front-panel selection of bursts with 1 and 9999 pulses. The device offers four output-level ranges between 0.2 and 5V; output impedance back-matching absorbs more than 95% of signal reflections from mismatched loads.

—Peter Harold

SINGLE-BOARD COMPUTER SUITS LOW-COST OS-9 DEVELOPMENT SYSTEMS

The CC97 single-board computer from Comcontrol (Eindhoven, The Netherlands, TLX 51603; in the US, (408) 356-3817) requires only the addition of SCSI-compatible disk drives to provide a complete OS-9 operating-system environment on the VME Bus. The board runs a 10- or 16-MHz 68000/68010 μ P, which is provided with 128k bytes of zero-wait-state static RAM, 2M bytes of dual port RAM, and space for as much as 256k bytes of EPROM. Battery backup is optionally available for 64k bytes of the static RAM. The board also includes a SCSI bus interface with DMA capability, four serial I/O channels (two of which have DMA capability), a real-time clock, a VME Bus interrupt requester and handler, and VME Bus system controller functions. The CC97 has an end-user price of approximately \$3000.—Peter Harold

ADD-IN BOARD INTERFACES IBM PC TO DATA NETWORKS

The SICC-PC add-in card for IBM PC, PC/XT, and compatible computers allows you to access the German Federal Mail Service's Datex-P network or similar networks operating in other European countries. Manufactured by Stollmann GmbH (Hamburg, West Germany, Teletex (17) 403226), the card provides an X.25 standard communications interface; a software packet assembler/disassembler, which supports CCITT X.28, X.29, and X.3 recommendations; and 3270 terminal emulation. The Z80A μ P-based board, which costs approximately DM 2950, is available with as much as 48k bytes of onboard parity-checked dynamic RAM. Physical communications interfaces include the X.21 and V.24; as an option, you can purchase an interface to plug the card into the IBM PC/AT bus.—Peter Harold

PEN RECORDERS FEATURE DIGITAL READOUT AND TRACE ANNOTATION

The SE110 and SE111 flat-bed pen recorders from BBC-Goerz/Metrawatt (Nuremberg, West Germany, TLX 623729; in the US, (303) 469-5231) are line/battery-powered, portable pen recorders that feature integral 3½-digit LCD readouts. Measuring 306×231×76 mm and weighing approximately 2.2 kg, the recorders write over a width of 100 mm on single-sheet or roll paper. Paper speeds range from 1 cm/hour to 60 cm/minute, and you can annotate the trace with instrument set-up information. Priced at 1650 DM, the SE110 has 18 dc measurement ranges between 1 mV and 500V full scale. The 1850 DM SE111 has 11 ac/dc voltage ranges between 0.15 and 300V full scale and 11 ac/dc current ranges between 0.6 and 1500 mA full scale. Separate probes increase the measurement range of the SE111 to 750V and 6A.—Peter Harold

There's a little tiger in every Cherry switch

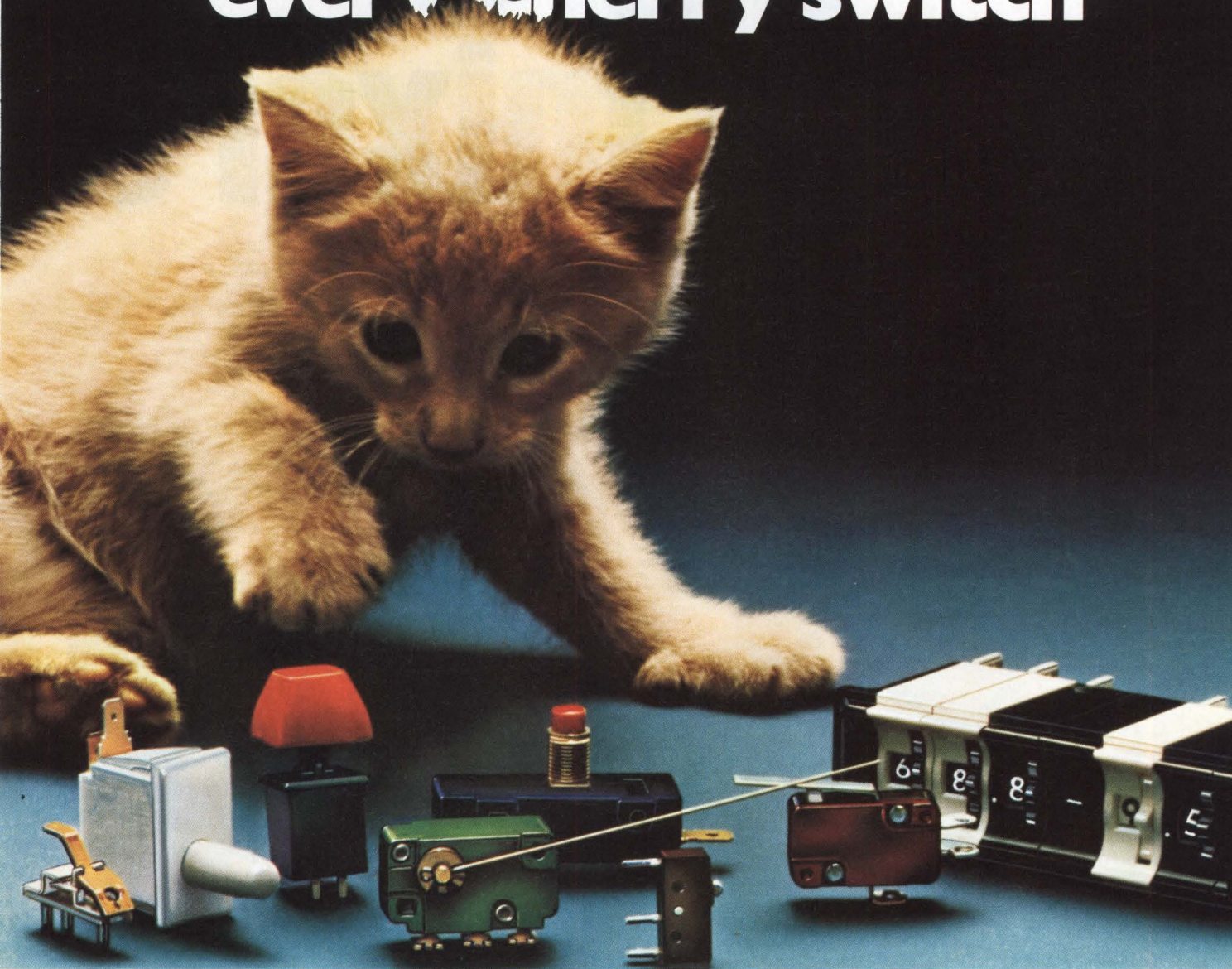

...but we're pussycats to do business with

Our products are tough, but our people aren't . . . and that's the beauty of dealing with Cherry.

You see, we can control the quality of our switches because we fabricate most of our own parts (moldings, stampings, springs, printed circuits, etc.). And we can keep the price down because we're loaded with automatic equipment to handle high volume.

But the real difference is in the *people* you work with at Cherry . . . from your first contact with a

technically trained sales representative . . . through careful analysis and recommendations by engineers who are really concerned about *your* problem . . . to production scheduling and customer service folks who follow-up and expedite to make sure we keep our delivery promise to you.

Of course we're proud of our modern facilities and equipment . . . but what we're proudest of is our reputation for customer service. Try some.

CHERRY  **SWITCHES**

CHERRY ELECTRICAL PRODUCTS CORP. 3600 Sunset Avenue, Waukegan, IL 60087 • 1-312/360-3500
CIRCLE NO 79

more tough mixers

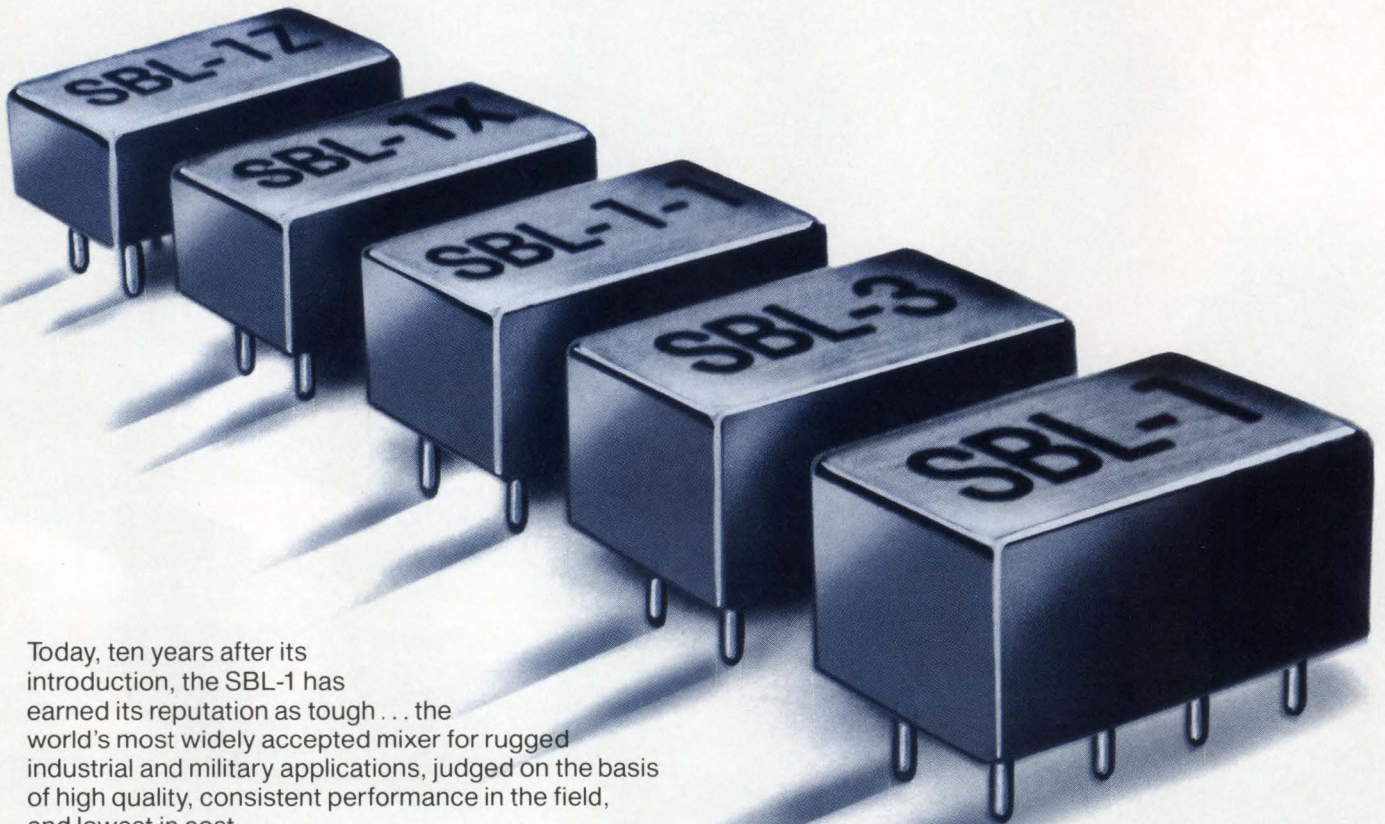

Today, ten years after its introduction, the SBL-1 has earned its reputation as tough... the world's most widely accepted mixer for rugged industrial and military applications, judged on the basis of high quality, consistent performance in the field, and lowest in cost.

And the winning formula is not a secret.

Using the latest automated production and test equipment available, Mini-Circuits stress tests each individual component before assembly and then subjects each assembled SBL-1 to 17 grueling tests before acceptance, date coding and close checking for unit-to-unit repeatability.

The SBL-1 does have one drawback however. It only covers 1 to 500 MHz. That's why we've expanded the product family with additional models to cover 25 KHz to 1000 MHz. The new units are assembled with the same production and test expertise as the SBL-1; that's why we can offer 0.1% AQL on all SBL models... no rejects, not a single one, on every order shipped. So don't compromise your design or settle for a poor imitation. Specify Mini-Circuits SBL Mixers.

For full specifications call or write for latest RF/IF Signal Processing Handbook or refer to EEM, Gold Book, or Microwaves Directory.

SBL SPECIFICATIONS (typ.)

Model	Freq. (MHz)	Conv. Loss	Isolation, dB		Price (10-49)
			L-R	L-I	
SBL-1	1-500	5.5	45	40	\$4.50
* SBL-1X	10-1000	6.0	40	40	\$5.95
SBL-1Z	10-1000	6.5	35	25	\$6.95
SBL-1-1	0.1-400	5.5	35	40	\$6.50
SBL-3	0.25-200	5.5	45	40	\$7.50

* If not DC coupled.

finding new ways...
setting higher standards

Mini-Circuits

A Division of Scientific Components Corporation
P.O. Box 166, Brooklyn, New York 11235 (718) 934-4500
Domestic and International Telexes: 6852844 or 620156

C104 REV. ORIG.

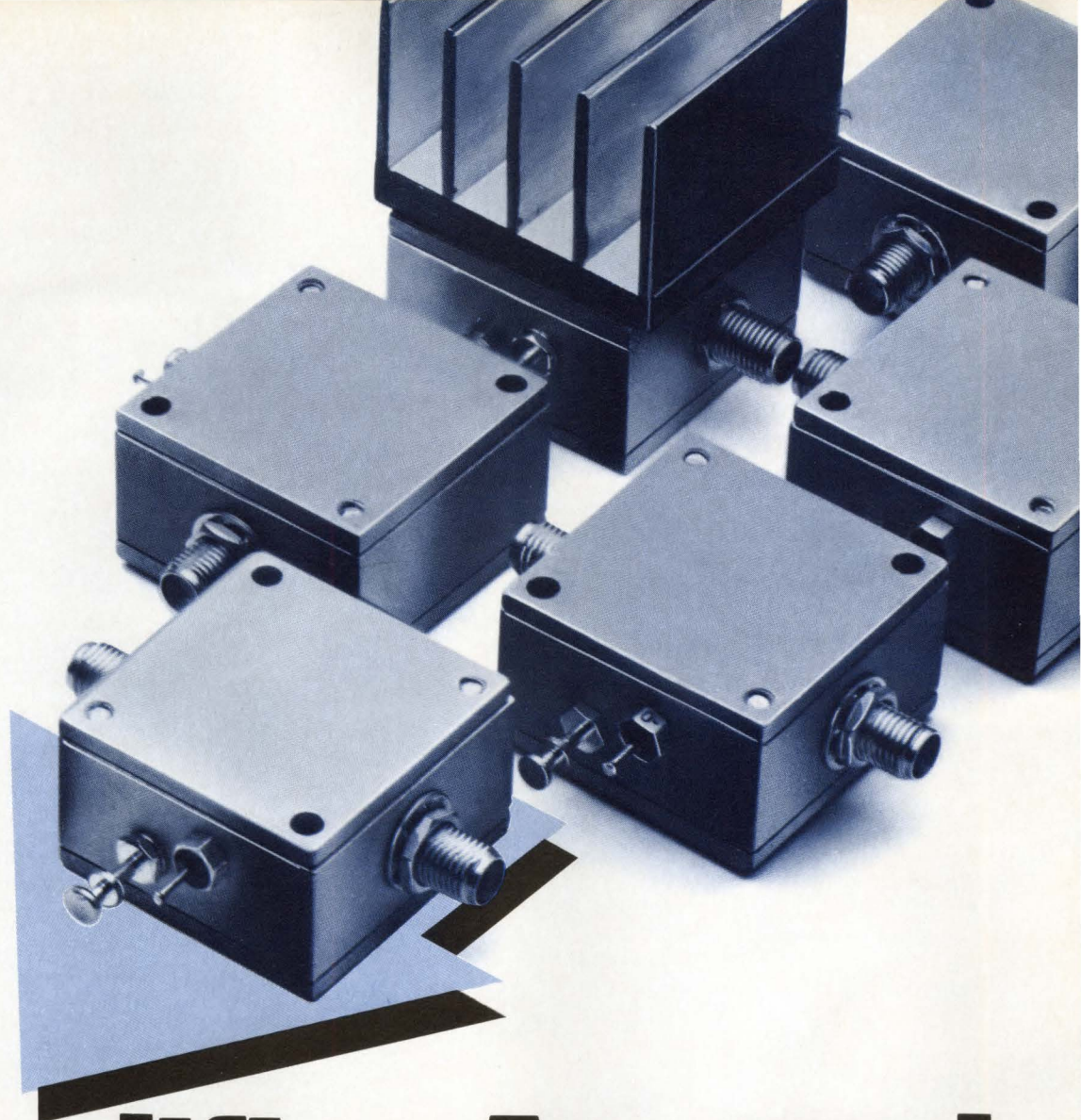

Amplifier Arsenal

50KHz to 2000MHz, 100mW output Gain Controlled From **\$69.95**

Our ZFL-2000 miniature wideband amplifier hit a bulls-eye when we introduced it last year. Now we've added more models to offer you a competitive edge in the continuing battle for systems improvement.

The ZFL-2000, flat from 10 to 2000MHz, delivers +17 dBm output and is still priced at only \$219.

Need more output? Our ZFL-1000H, flat from 10 to 1000MHz, delivers +20 dBm output.

Variable gain important? Our ZFL-1000G, flat from 10 to 1000MHz, delivers +3 dBm output with 30 dB gain control while maintaining constant input/output impedance.

Searching for a high-quality, low-cost amplifier? Our ZFL-500 flat from 50KHz to 500MHz, delivers 10 dBm output for the unbelievably low price of only \$69.

One week delivery... one year guarantee.

Gain the competitive edge... specify Mini-Circuits RF/IF signal-processing components.

SPECIFICATIONS

Model No.	ZFL-500	ZFL-1000G	ZFL-2000	ZFL-1000H
Freq (MHz)	0.05-500	10-1000	10-2000	10-1000
Gain (dB), Min.	20	17	20	28
Gain Flatness (dB) Max.	±1.0	±1.5	±1.5	±1.0
Max. Power (dBm)				
(1dB compression)	+10	+3	+17*	+20
NF (dB) typ.	5.3	12.0	7.0	5.0
3rd order				
Intercept pt (dBm)	+18	+13	+25	+33
Current at 15V dc	80mA	90mA	100mA	150mA
Price \$	69.95	199	219	219
qty.	1-24	1-9	1-9	1-9

For complete specs on these and our 1- and 2-W models refer to 1985-86 Gold Book or Microwaves directory.
*+15 dBm below 1000MHz

finding new ways...
setting higher standards

Mini-Circuits

A Division of Scientific Components Corporation
P.O. Box 166, Brooklyn, New York 11235 (718) 934-4500
Domestic and International Telexes: 6852844 or 620156

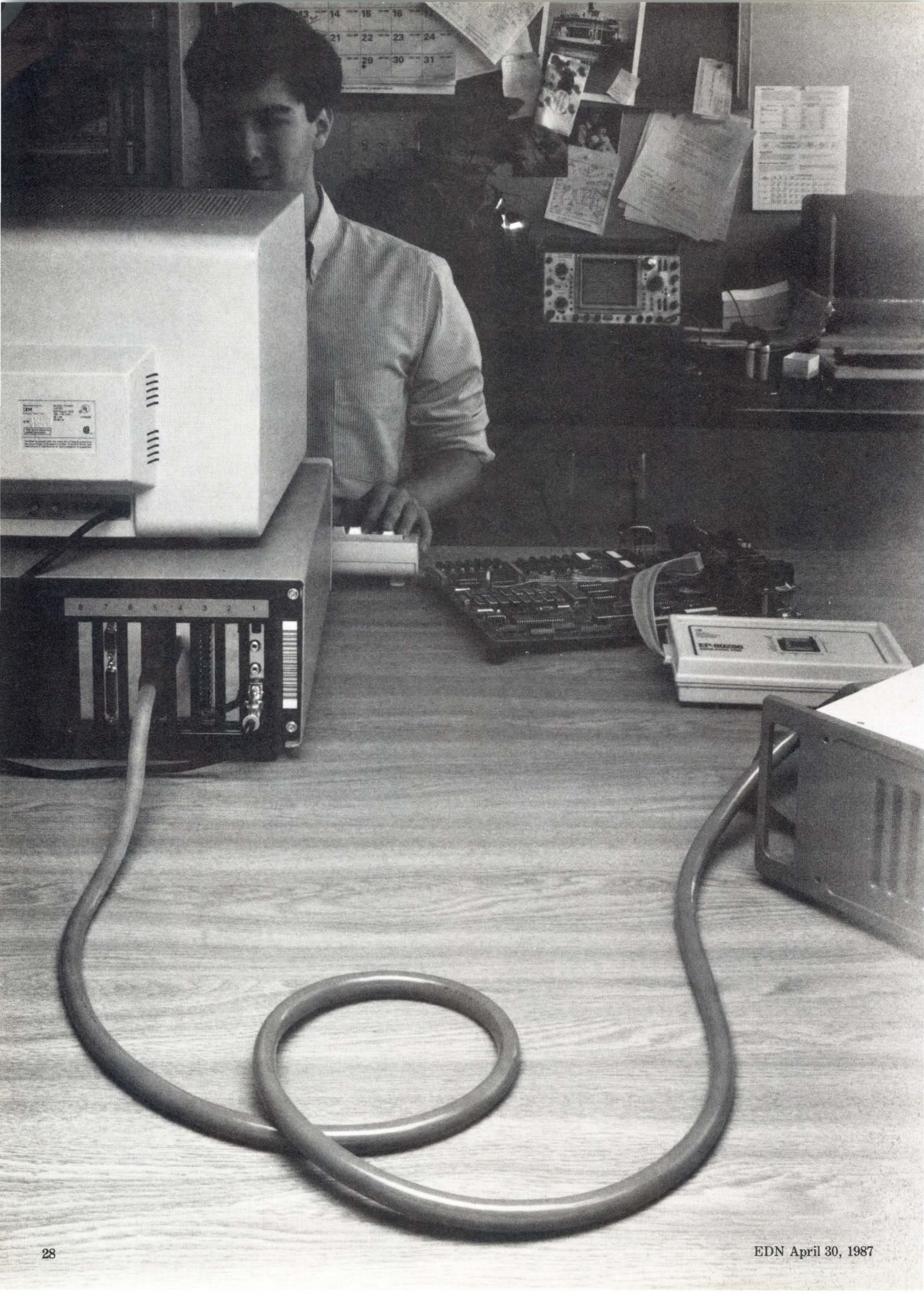

Data shouldn't take 30 minutes to travel two and a half feet.

Instead of killing time, you could be killing bugs. Because Applied Microsystems now offers a high speed emulator interface to rescue debug sessions bogged down by data throughput. It's the industry standard architecture called SCSI. The bus that can squeeze five-minute transfers into 10 seconds.

Downloading and transferring data at speeds up to 1.5 Mbytes per second over a SCSI bus gives you a powerful advantage. Your information is now moving up to 30 times faster than you're used to, creating a virtual link between your host and target system.

That advantage becomes even more important when you're working with big blocks of code as you would on a 68020 or 80286 design.

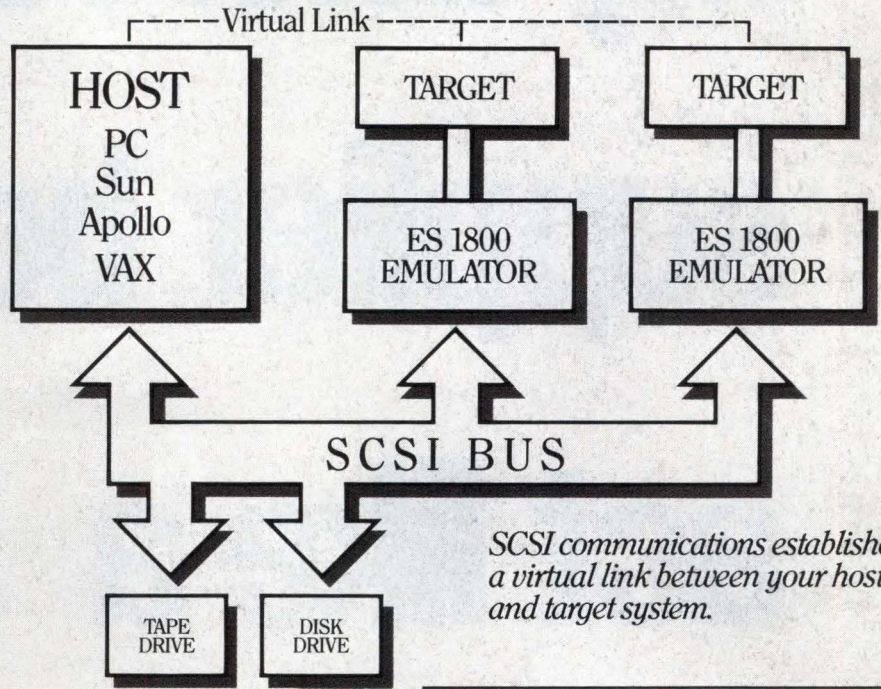

SCSI communications establishes a virtual link between your host and target system.

true interactive debugging becomes possible for the first time.

SCSI unites real-time emulation with source level debugging.

Thanks to SCSI's tremendous speed, the events of high performance emulation are transported to your host as they happen. Trace information appears on your computer in seconds, not minutes. And through VALIDATE™ you can immediately debug in your

source level language.

SCSI supports up to eight devices to achieve various multi-user or multi-instrument configurations. Combined with the full real-time capabilities of Applied Microsystems in-circuit emulation, now you can easily assemble a development system that's phenomenally fast and functional.

Call for the facts that speak for themselves.

Find out why Applied Microsystems emulation with SCSI is the most painless way to begin a design project and finish it on schedule. For full details, call 1-800-426-3925 toll-free and ask for Telemarketing. In Washington state call (206) 882-2000. Or write to Applied Microsystems, P.O. Box 97002, Redmond, WA 98073-9702.

In Europe contact Applied Microsystems Corporation Ltd., Chiltern Court, High Street, Wendover, Aylesbury, Bucks, HP22 6EP, United Kingdom. Call 44-(0)-296-625462.

UNIX is a registered trademark of AT&T.

HOSTS	OPERATING SYSTEMS	TARGETS	LANGUAGES	TOOLS
VAX	VMS	8051	C	Assemblers
MicroVAX	ULTRIX	8048 family	Pascal	Linkers
UNIX®	UNIX	8080, 8085, 8086/88,	FORTRAN	Locaters
workstations	XENIX	80186/188 and 80286	PL/M	Compilers
· Apollo	MS-DOS		Assembler	Symbolic debuggers
· Sun		68HC11,	Jovial	Source level debuggers
· IBM AT		6800/2/8,		Emulators
MS-DOS workstations		6809/9E,		
· PC		68000/8/10 and 68020		
· PC XT		Z80, MK3880/4 and Z8001/2/3		
· PC AT		NSC-800		
· Compatibles				

A stand-alone or host-control system of fully integrated debug tools built on high performance emulation.

With SCSI, your development environment takes on the dimension of immediacy. You have control and visibility without waiting. And



Applied Microsystems Corporation

**“My interconnect
supplier better
act like a
partner—
or he’s off
the list.”**

Tough customers team with 3M.

Tough, demanding customers like you are putting 3M at the top of the supplier list, to boost the design and production efficiencies that give you an edge in today's marketplace. Why? An expanded line of interconnect products and a growing commitment to service.

New, broader product line. With 3M as your partner, you get more choices than ever—at every interconnect level.

- 3M's advanced TAB technology bridges the IC-to-package gap with tapes that connect up to 400 peripheral leads per IC.
- Textool test, burn-in and end-use IC sockets and carriers are crucial to your product reliability.
- A growing array of PWB connectors and cables meets your tough design criteria.
- Application-specific IDC or molded cable assemblies are delivered promptly from assembly centers nationwide.
- Standard and customized transmission line assemblies match your high-speed data applications.

New, broader service commitment. Tough customers like you demand services that increase design and manufacturing efficiency. With 3M as your partner, you get more service than ever.

Need better response and updating on orders? 3M's Order ExpressSM pools order-processing activity at a single toll-free number. Ready to network your orders to complement JIT processing? 3M's EDI capabilities are

ready to serve your real-time ordering needs. Want a maximum first-pass yield on products you receive? 3M's Statistical Process Control means you receive on-spec products.

New, broader support capabilities. Tough customers with tough questions can get help over the phone from 3M technical personnel. We will provide you with specification or application data.

Backing up 3M in your area is our professional direct sales and distributor network. These experts respond promptly to your needs and get you the samples or data you need to move your design into production. We've even improved our product catalogs, so now it's easier than ever to specify 3M quality for your design. Even the one you need by yesterday.

Now that we've expanded our product line and services, teaming up with 3M is the surest way to cut costs and boost efficiency.

For sales and ordering information, dial 1-800-CALL-EPD or write Electronic Products Division/3M, Department T, P.O. Box 2963, Austin, TX 78769-2963.



SIGNALS & NOISE

Generalizations about ICEs were in error

Dear Editor:

Certain statements made in the article "µP simulators let you debug software on an IBM PC" (EDN, December 11, 1986, pg 196) are sufficiently misleading to confuse an uninformed reader. For example, the article stated that "PC-based simulators generally offer more sophisticated software-debugging features than do expensive in-circuit emulators" and "... ICEs are optimized for hardware debugging, not software debugging. Microprocessor simulators are much better for software debugging"

Further, the article stated that "... a simulator lets you easily set up and modify I/O conditions to test your software. Because ICEs are hardware tools, their I/O conditions are more difficult to modify." The article also claimed that "before you

can test code with an ICE, you have to load your code into ROM and into a real system."

Having spent several years in the emulator and software businesses, I would like to point out the following: First, the simulators discussed in the article do not offer features incremental to those available on today's in-circuit emulators.

Further, ICEs are a system-integration tool. They are optimized for both hardware and software. PC-based debuggers that work in conjunction with in-circuit emulation provide real-time code execution and the ability to handle asynchronous events (interrupts and exceptions) that are typical in embedded system design. No simulator can provide these functions.

Sophisticated emulators are perfectly capable of mimicking I/O transactions in the absence of target hardware. And since the earliest

days of in-circuit emulation, overlay memory has completely obviated the need for target-system hardware during development. It is totally incorrect to say that "you'd have to load your code into ROM."

Sincerely yours,

Steve Dearden

Applied Microsystems Corp
Redmond, WA

(Ed Note: The simulators discussed in the article provide engineers with a key feature—an operational software-development facility independent of the target hardware. You can use the simulators to test every possible path through your software, and you can also test all I/O conditions. Further, the top-of-the-line simulators include trapping and breakpoint capabilities that are superior to those of other tools such as in-circuit emulators (ICEs).

Multibus™ I & 68020: A New Standard of Power

Heurikon introduces the most powerful 32-bit single board microcomputer for Multibus I.

The HK68/M120 features include:

- Up to 25MHz Motorola 68020
- Up to 4MB on-board DRAM with parity
- 256K EPROM
- Optional 68851 PMMU
- Full SCSI interface
- 16-bit iSBX™ connector
- iLBX™ memory expansion bus
- Two serial ports
- Optional 68881 floating point coprocessor
- Mailbox interrupt support
- UNIX™ and real-time support.

HEURIKON
CORP

For more information, call 1-800-356-9602, Ext. 409

CIRCLE NO 104

Heurikon Corporation, 3201 Latham Drive, Madison, WI 53713

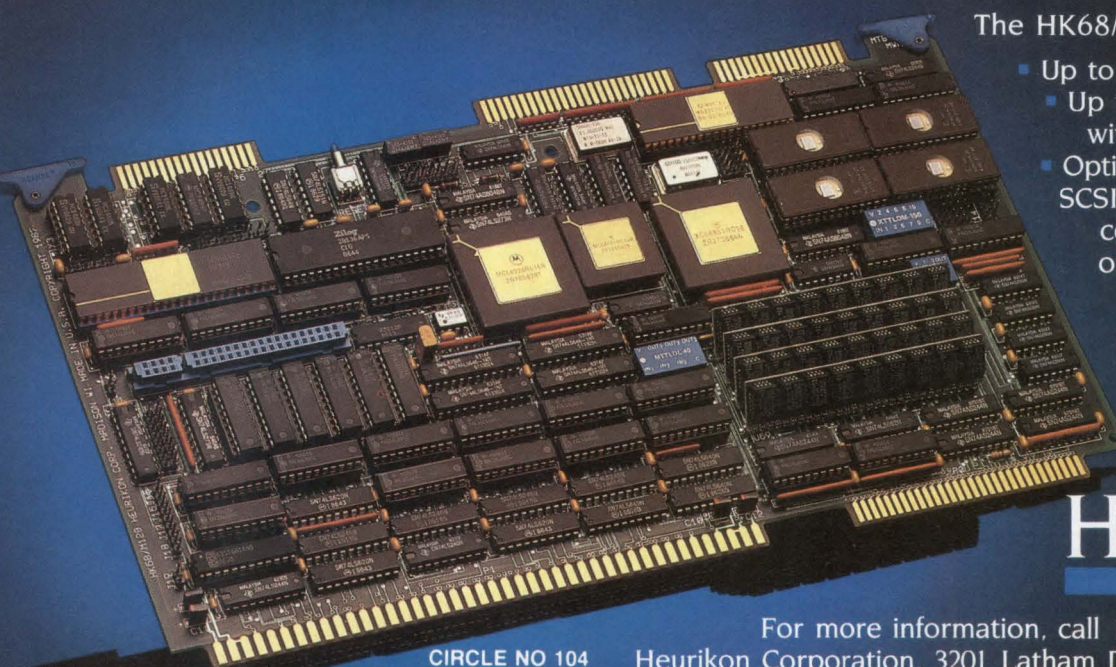

Reach out for good ideas

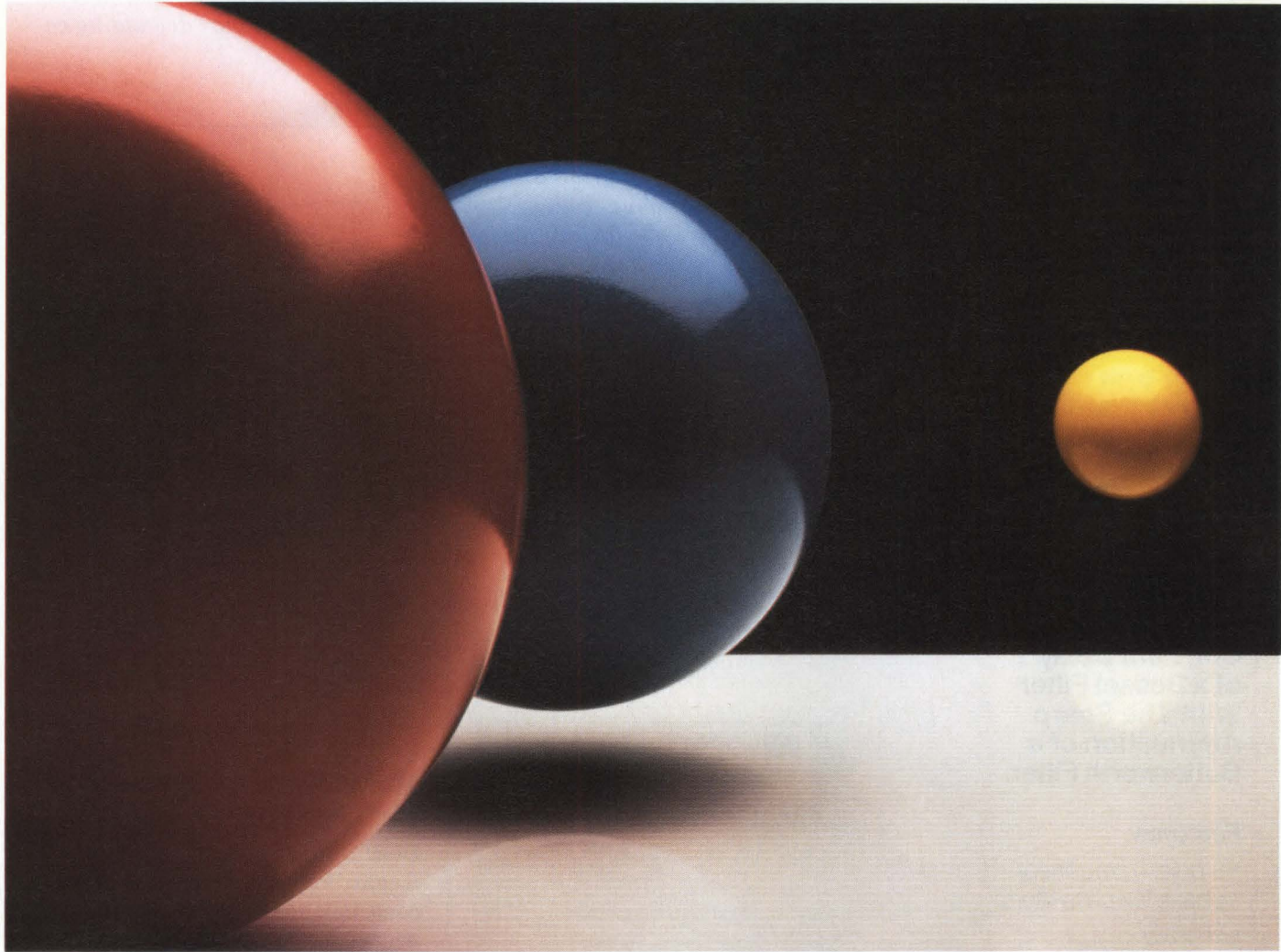

Good ideas come in smaller case sizes from the capacitor choice.

Nothing moves a product to market faster than timely good ideas.

That's why some of our biggest good ideas in capacitors now come in smaller packages. Features that can offer you new opportunities for improving designs, controlling costs and automatically inserting more high CV capacitors than ever before.

A perfect example is our VX miniature aluminum electrolytic capacitor series. These compact, general purpose, radial lead capacitors have been designed to be everything you expect a high-quality, high-reliability capacitor to be.

They meet JIS C-5141 and 5102 industry standards. 2,000 hour load



life test requirements. And include, both, our Anti-Solvent design feature, which resists harmful cleaning agents, and our unique safety vent design on units with diameters of 6.5mm and larger.

Or, if you need reliable performance up to +105°C, specify our VT Series.

Ask your Nichicon representative or distributor for your free copies of our VX and VT Series data sheets. Or call us at (312) 843-7500.

But we warn you, once you've considered the VX Series' size, performance specifications and price, you may think they sound like an impossibly good deal.

But then, we designed them that way.

nichicon[®]
The capacitor choice.

927 E. State Parkway • Schaumburg, IL 60173 • (312) 843-7500

© Nichicon (America) Corporation 1986

One good idea after another.

CIRCLE NO 53

The article was not meant to imply that simulators are replacements for ICEs. Although you don't have to use both an ICE and a simulator for every design, you can use the two tools together effectively for complex designs. You can test and debug your software with the simulator, but testing in real time with real-time I/O requires that you

test the target hardware. An ICE is the most effective tool for such testing.

Finally, some of the article's generalizations about ICEs were indeed in error. In fact, very few ICEs require that you program a PROM before testing your code. Many ICEs provide some facility for testing code with no target hardware,

and some ICE vendors also provide high-level-language debugging capabilities.)



Programmable Linear Phase Filters for A/D Prefiltering Applications

848DOW Series Combines Constant Delay of a Bessel Filter With The Sharp Attenuation of a Butterworth Filter.

Features:

- 8 pole, 6 zero linear phase lowpass filters
- Digitally programmable corner frequency
- 8 bit (256:1) tuning ratio
- Internally latched control lines to store frequency selection data
- Linear phase response to minimize phase distortion
- Sharp roll-off for anti-aliasing
- Plug in, ready to use, fully finished, filter module
- Five frequency ranges to 51.2kHz

Other Filter Products available:

- Elliptic • Programmable • Fixed Frequency
- Instrumentation • Custom Designs

For more information, please call us at **617-374-0761.**

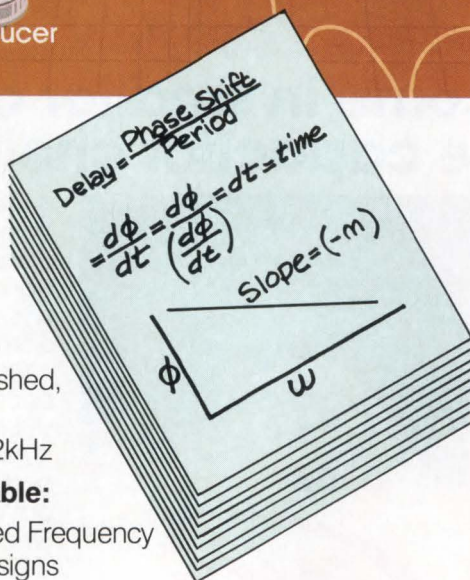
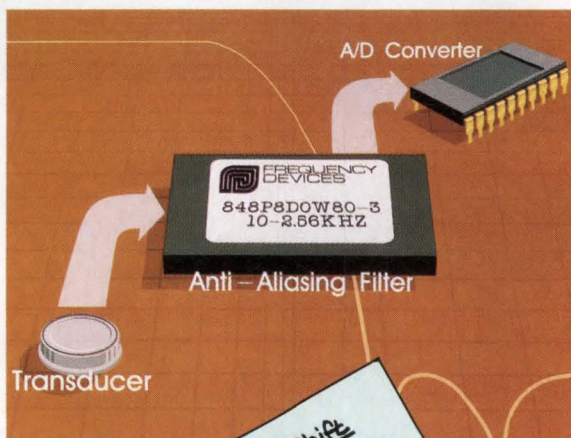

Moral criteria for engineering work

Dear Editor:

Regarding the "engineers' social consciousness" dialogue in your magazine: After some 25 years in our profession, I must be mellowing, because I can see that such a dialogue in a technical publication can be useful. However, it is a waste of our time to read more repetition of the superficial and politically motivated opinions that appear in the mass media. Let us see contributions that offer specific (not vague) technical and/or professional insight.

The assumption that working on military programs indicates a lack of "social consciousness" is not logical. Most of the engineers I know who work on such programs have considerable social consciousness. They have resolved that their work is in society's best interest. Obviously, there are those in our society who disagree, for their own political and social reasons. There is no reason to assume that the social consciousness

WHY WORK TO A MINIMUM STANDARD WHEN YOU CAN WORK TO A MAXIMUM STANDARD?

Two-Piece Connectors from Thomas & Betts. Beyond the standards.

Ansley® Two-Piece Connectors are built with quality you can anticipate for problems you can't — providing *superior* electrical and mechanical integrity in board-to-board packaging applications.

Ansley® standard, inverse and half-DIN connectors exceed DIN-41612 standards, incorporating a pre-loaded, dual cantilevered female contact for smooth, sequential engagement. That means maximum reduced mating/unmating cycles and longer life.

The ultra-low mating force contact design feature of our female Ansley® High Density and Expanded DIN connectors ensures superior contact wipe,



Dual Cantilevered Female Contact

Flex-fit™ Compliant Contact

Ultra Low Mating Force Female Contact

for optimum electrical performance — *the best in the industry.*

Our male Flex-Fit™ compliant contact design for press-fit applications accommodates a wide range of finished hole sizes and board thicknesses. Contact geometry virtually eliminates any chance of cut-through, and minimizes through-hole wall deformation. The Flex-Fit™ compliant contact also exceeds all stringent test requirements of MIL-STD-2166.

Challenge Us. Whether it's for a quality two-piece connector beyond the "standard", or one meeting your specific requirements, call us... not only for standard, inverse, half-DIN and high pin count connectors, but for board expansion and surface-attached backplane connectors, too. For more information, *and a FREE copy of our "Compliant Pin*

Technology: A User Perspective" brochure, write or call Thomas & Betts Corporation Electronics Division, 920 Route 202, Raritan, NJ 08869; 201-469-4000.

Thomas & Betts
Electronics Division

Other quality Thomas & Betts products include: IDC Cable and Connector Systems, DIP & VLSI Sockets, Fiber Optic Systems and Flexible Interconnects.

of those who oppose military programs is superior to that of those who work on such projects.

If we must question the social consciousness of engineers, let us establish moral criteria. Is it not illogical to compare the morality of a defensive system to that of crematoria or germ warfare? Let us also establish moral criteria for nonmil-

itary engineering work. Let us resolve the question: Is it the technology or the application that must be judged?

Finally, if we are to establish moral criteria for engineers' social consciousness, let us test them against those of members of other professions, such as editors, managers, politicians, etc.

Please continue the dialogue. Please help us find facts and resolve these issues with logic.

Sincerely yours,
Thomas L Poppelbaum
Clinton, NY

WORM disks can protect design files

Dear Editor:

The article "Optical-disk drives target standard 5½-in. sites" (EDN, December 25, 1986, pg 42) ignored a potentially lucrative market for optical disks. We currently spend a great deal of time and money developing software that will counteract the write capability of magnetic media. The data that depicts drawings and other "released" data must be protected from accidental or intentional changes. The average file sizes range from 20k bytes for CADAM files to 138k bytes for Computervision files and 1.5M bytes for CATIA files. These files must be readily accessible for use by downstream functions. New versions must be generated from copies of released files. Write-once/read many (WORM) optical disks are ideal for this application.

Sincerely yours,
Bill Holmes
Data Systems Div
General Dynamics
San Diego, CA

Sorry, wrong number

EDN's January 22 News Breaks (pg 19) contained an incorrect phone number for Viking Connectors. The correct number is (818) 341-4330.

WRITE IN

Send your letters to the Signals and Noise Editor, 275 Washington St., Newton, MA 02158. We welcome all comments, pro or con. All letters must be signed, but we will withhold your name upon request. We reserve the right to edit letters for space and clarity.



True Grey Shades at High Speeds for Less than \$5000

Raytheon's TDU-850, Thermal Display Unit, produces photo quality images on an 8¾" x 200 ft. roll. The TDU-850 prints 16 shades of grey in less than 20 milliseconds per line; black and white images at 5 milliseconds per line. Price per unit from \$4950, depending on interface and application. (Slightly higher overseas). Discounts for OEM large volume quantities. Fixed thermal head assures perfect registration. Resolution better than 200 dots/inch. Direct thermal technology requires no toners or developers. Standard or custom interfacing. For details, contact **Marketing Department, Raytheon Ocean Systems Company, 1847 West Main Rd., Portsmouth, RI 02871 Telephone (401) 847-8000 Telex 0927787**

Raytheon

CHINON: As serious about technology as you are.

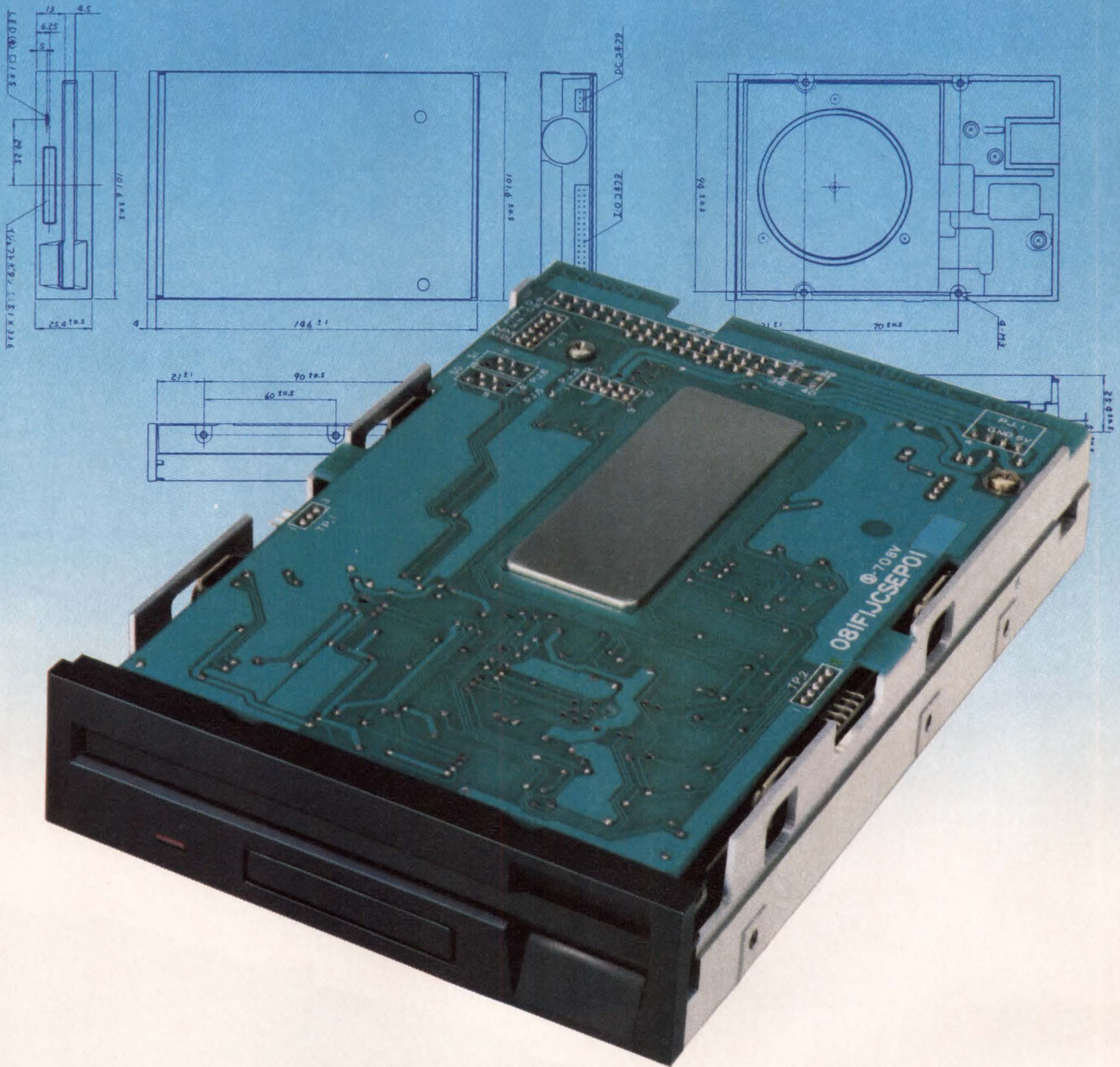

Chinon floppy disk drives are renowned in Japan for outstanding technical excellence and an extremely high level of overall quality. That kind of reputation doesn't come easy in a land where OEM's have some of the toughest standards in the world.

This same reputation is growing in the U.S. among serious designers, engineers and OEM management. We know how concerned you are about technological superiority, reliability and cost-effectiveness. We're just as serious. That's why we have an ongoing commitment at Chinon always

to produce technically advanced, reliable products. And we deliver on that commitment every time.

You're serious about your systems. Finally there's a disk drive manufacturer that's as serious as you are.

CHINON

The drive to succeed.

Chinon America, Inc., 6374 Arizona Circle,
Los Angeles, CA 90045. (213) 216-7611 FAX: (213) 216-7646

PICTURED IS CHINON F-354L: 5V, ONE-INCH, 1MB SLIM-LINE MODEL.

New GPS Series: with SmartCursors™

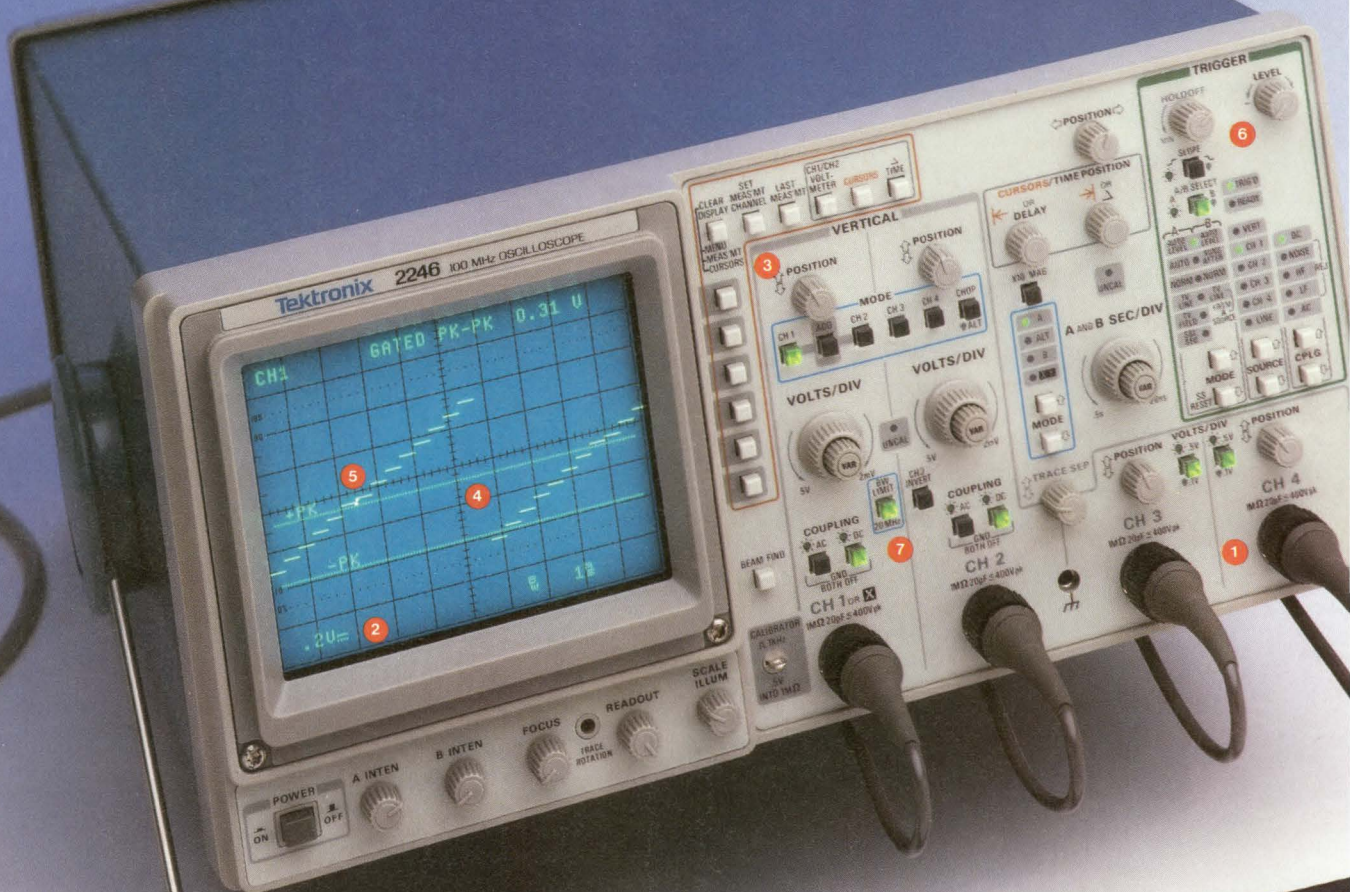

- 1 Four channels with 100 MHz bandwidth.
- 2 CRT readout of scale factors and measurement results.
- 3 Menu functions controlled by the top row of push buttons.
- 4 SmartCursors™ track \pm peak or peak-to-peak voltage measurements.
- 5 Gated voltage mode makes it possible to intensify a portion of a waveform and make voltage measurements on that segment only.
- 6 Versatile triggering lets you trigger the main or delayed sweep on any of the four channels.
- 7 Backlit control buttons verify that a function is active.

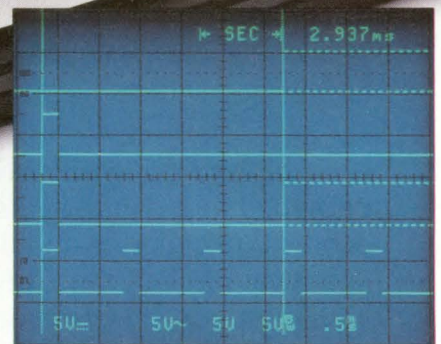

The 2246 provides direct time readout information when seconds is selected in cursor mode. You also have 1/seconds in Hz and phase capability.

Tek sets the pace and push-button ease.

Work faster, smarter, with two new general purpose scopes from Tek. The four-channel, 100 MHz 2246 and 2245 set the new, fast pace for measurements made daily at the bench or in the field. They're easy to use and afford, by design. And backed by Tek's three-year warranty that includes the CRT.

On top: the 2246 with exclusive integrated push-button measurements. Your measurements are accessed through easy, pop-up menus and implemented at the touch of a button. Measure \pm peak volts, peak-to-peak, dc volts and gated volts with new hands-off convenience and on-screen readout of values.

SmartCursors™ track voltmeter measurements in the 2246 and visually indicate where ground and trigger levels are located. Or use cursors in the manual mode for immediate, effortless measurement of waveform parameters like voltage, time, frequency, and phase.

Both scopes build on performance you haven't seen at the bandwidth or prices. Lab grade features include sweep speeds to 2 ns/div. Vertical sensitivity of 2 mV/div at full bandwidth for low-level signal capture. Plus trigger sensitivity to 0.25 div at 50 MHz, to 0.5 div at 150 MHz.

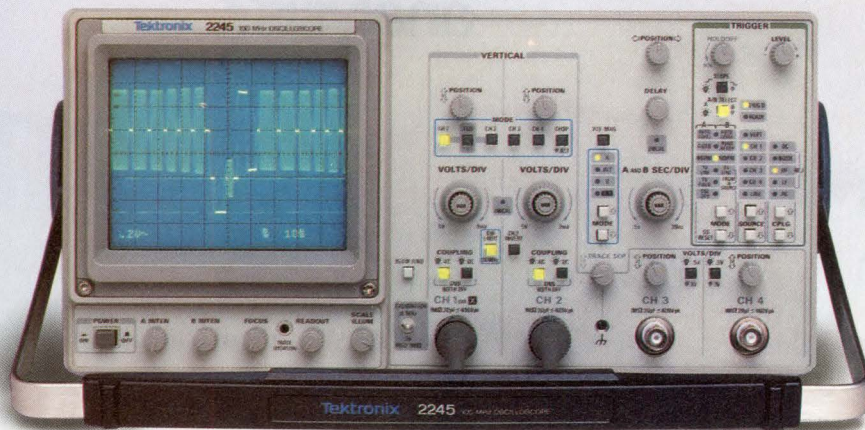

Features	2246	2245
Bandwidth	100 MHz	100 MHz
No. of Channels	4	4
Scale Factor Readout	Yes	Yes
SmartCursors™	Yes	No
Volts Cursors	Yes	No
Time Cursors	Yes	No
Voltmeter	Yes	No
Vertical Sensitivity	2 mV/div	2 mV/div
Max. Sweep Speed	2 ns/div	2 ns/div
Accuracy: Vert/Hor	2%/2%	2%/2%
Trigger Modes	Auto Level, Auto, Norm, TV Field, TV Line, Single Sweep	
Trigger Level Readout	Yes	No
Weight	16.5 lb/7.5 kg	16.5 lb/7.5 kg
Warranty	3-year on parts and labor including the CRT	
Price	\$2400	\$1875

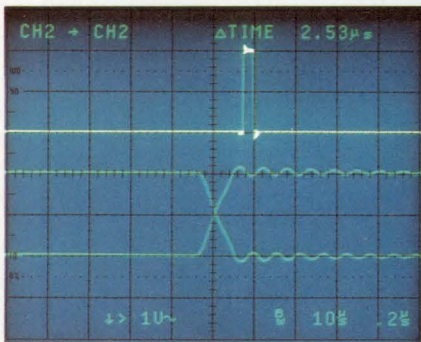

Conventional Δ Time measurement is also available from the menu in the 2246 for increased timing accuracy. Shown above: a Δ Time measurement of pulse width.

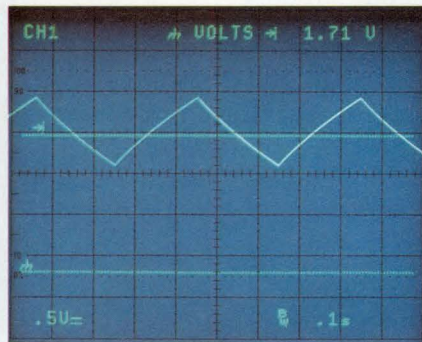

The 2246 also makes it possible to measure either Δ Volts or absolute volts from ground.

Best of all, high performance comes with unmatched convenience. You can see it and feel it—in the responsive controls and simple front-panel design, in extensive on-screen scale factor readouts, and in simplified trigger operation that includes Tek's Auto Level mode for automatic triggering on any signal. Start to finish, the GPS Series saves steps and simplifies tasks.

Get out in front! Call toll-free today to order, to get more details or a videotape demonstration.
1-800-433-2323
 In Oregon, call collect
1-627-9000

Tektronix®
 COMMITTED TO EXCELLENCE

The easiest setup in logic analysis?



Auto Setup™

You just put your finger on it.

Gould introduces Auto Setup™: from zero to 200 MHz in 26 seconds.

Gould already makes the industry's most powerful logic analyzer—the K450. Now, we make the easiest to use—the K450 with Auto Setup.™

Press a key, wait less than 30 seconds and, voila, you're ready to go.

What does Auto Setup™ do for you? Everything but connect the probes.

It checks probes for activity, sets the threshold, chooses the appropriate clock speed and arranges the channels on the screen, so that you can see exactly what you captured... instantly.

All high speed channels (24 at 200 MHz, 48 at 100 MHz) give you resolution to 5 ns. Sixteen interactive

levels of Trace Control™ recognize and record the exact state/timing event you want. No other analyzer offers better triggering.



Gould K450. The industry's most sophisticated analyzer is now the easiest to use.

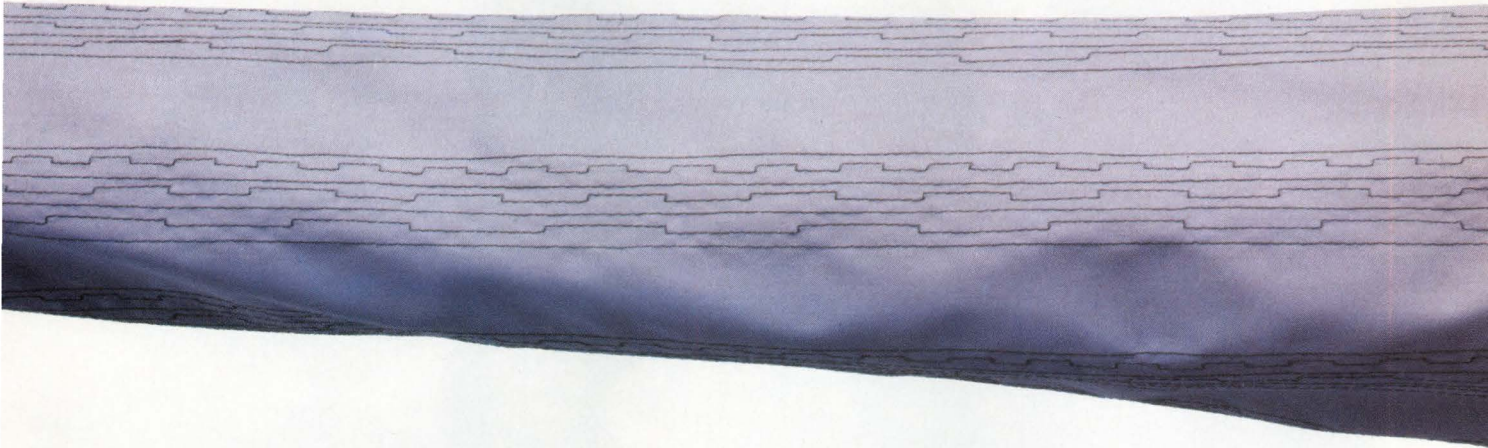

An ample 4K memory, Auto Save and a built-in disk drive give you all the capability you're likely to need. And of course, there's "Help" when you need it.

But the K450 is only the leader in an extensive Gould logic analyzer family. For nearly 20 years, we've been building special models to do special applications. One will be right for you.

For comprehensive data sheets on any Gould product, call TOLL-FREE (800) 538-9320. Or write: Gould Inc., Test & Measurement Group, 19050 Pruneridge Ave., Cupertino, CA 95014. Act soon—Auto Setup™ isn't the only hot button we have.



K115—The μ P Analyzer. Up to 72 ch., 200 MHz on 8 ch. Disassemblers for all popular μ Ps.



K500—The Mainframe. 500 MHz on all 8 channels! The super computer analyzer.



K125—for CAE/CAD/ATE verification. Also does functional testing of your production units.



PG4064—Data Word Generator. Simulates data words up to 64 channels wide, even bit slice μ Ps.



4070—Digital Storage Oscilloscope. The perfect 100 MHz analog oscilloscope replacement.



GOULD
Electronics

The one interconnect system

Thermoset rectangular connectors with 104 and 152 contact positions.

Pre-assembled thermoset MSM HYFEN™ rectangulars in 9 size (9-75 positions).

Reliable, low cost Thermoplastic QIKMATE™ plugs and receptacles in 10 sizes (2-36 contact positions).

BANTAM™ MIL-style at commercial prices with fixed thermoset inserts (4-48 positions).

you never outgrow!

Trim Trio™

Single contact system satisfies over 100,000 interconnect variations.

Designed for maximum flexibility, proven in millions of applications—Burndy's TRIM-TRIO contact/connector family lets you meet all your application needs—no matter how often they change—without changing your contact system! Your tooling! Or your installation procedures!

You simply select the contact/housing combination that best satisfies your current needs. Then, as needs change, you just change the combinations. Nothing else! Not your tooling! Not your operations. Nothing! And no matter what combination you choose—or how many—you still enjoy all the advantages of standardization. Which means faster, more economical assembly and greater quality control—all along the line.

So make it easy on yourself. Standardize on the proven reliability of the Burndy TRIM-TRIO interconnect system. The one system that offers you thousands of

variations. The one system you'll never outgrow. And to make things easier, all variations of the TRIM-TRIO family are available—off the shelf—at your local Burndy Distributor. For details, write: Burndy Corporation, TRIM-TRIO Product Manager, Norwalk, CT 06856. Or call: 203-852-8711.

THE TRIM-TRIO CONTACTS SYSTEM:

Closed barrel Machined Contacts for both crimp and wire-wrap power applications up to 13 amps. **Open barrel Precision Formed** contacts for power and signal applications. **Sub-miniature Coax** (one-piece or 2-piece) for coaxial cable, shielded conductors and twisted pairs. These three basic types (with variations for different conductors, contact platings and termination options) make up the TRIM-TRIO contact system. All can be intermixed in any of scores of Burndy connector housings designed around this contact system.



Offices in principal cities throughout the United States.

Versatile, quick disconnect cable splice.

METALOK™ THERMOPLASTIC CIRCULAR SERIES: with rugged metal bayonet coupling. 9 sizes (4 thru 48 positions).

BANTAMATE II™ low cost circulars—deliver up to 500 mating cycles. Positive polarization. Quick disconnect. 4 sizes (4 thru 30 positions).

CIRCLE NO 67

Analog Filters? Talk to Reticon®

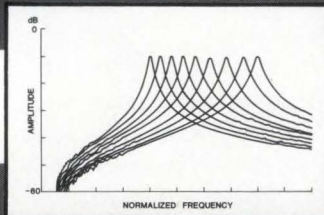

**General Purpose
Switched Capacitor**

Transversal

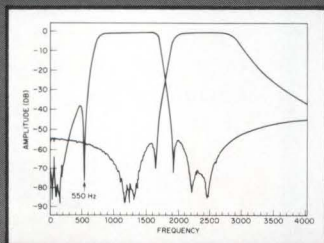
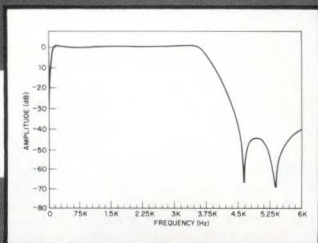
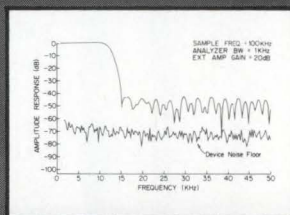
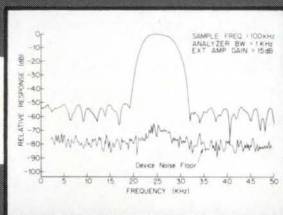

Modem

Our selection of standard filters is extensive. For telecommunications, data acquisition, musical effects, medical technology and general filtering applications, EG&G Reticon offers filters to fit your need. For over 13 years, Reticon has been proud to be the first to introduce high performance filters that are economical and you save design time and board space. We have a proven record of reliability as well.

Call us about your application, and we'll send you information. EG&G Reticon, 345 Potrero Avenue, Sunnyvale, CA 94086-4197 (408) 738-4266; or Boston (617) 745-7400; Japan 03-343-4411; England (0734) 788666; Germany (089) 92692-666.

EG&G RETICON
WHERE VISION AND TECHNOLOGY MEET

CALENDAR

Hands-on Programming in C, Los Angeles, CA. Integrated Computer Systems, Box 3614, Culver City, CA 90231. (800) 421-8166; in CA, (213) 417-8888. May 12 to 15.

First Annual Disk Drive Components Review, Sunnyvale, CA. Technology Review Manager, Peripheral Research Corp, (805) 963-8081 or (805) 494-4413. May 12.

Opportunities in Flat-Panel Displays, Boston, MA. Ronnie Sarkar, Arthur D Little Inc, 15 Acorn Park, Cambridge, MA 02140. (617) 864-5770, ext 2377. May 18.

EMC Expo, San Diego, CA. EMC Expo, Box D, Gainesville, VA 22065. (703) 347-0030. May 19 to 21.

Satellite Communications (short course), Sunnyvale, CA. Continuing Education Institute, 21250 Califa St, Woodland Hills, CA 91367. (818) 710-1142. May 19 to 21.

41st Annual Frequency Control Symposium, Philadelphia, PA. Synergistic Management, Box 826, Belmar, NJ 07719. (201) 280-0410. May 27 to 29.

International Workshop on Computer-Aided Software Engineering, Cambridge, MA. Index Technology Corp, 101 Main St, Cambridge, MA 02142. (617) 491-2100, ext 8000. May 27 to 29.

Personal Computer Interfacing for Scientific Instrument Automation, Blacksburg, VA. Linda Leffel, CEC, Virginia Tech, Blacksburg, VA 24061. (703) 961-4848. May 28 to 30.

Comdex/Spring, Atlanta, GA. Interface Group, 300 First Ave, Needham, MA 02194. (617) 449-6600. June 1 to 4.

Hands-on Programming in C, Washington, DC. Integrated Computer Systems, Box 3614, Culver

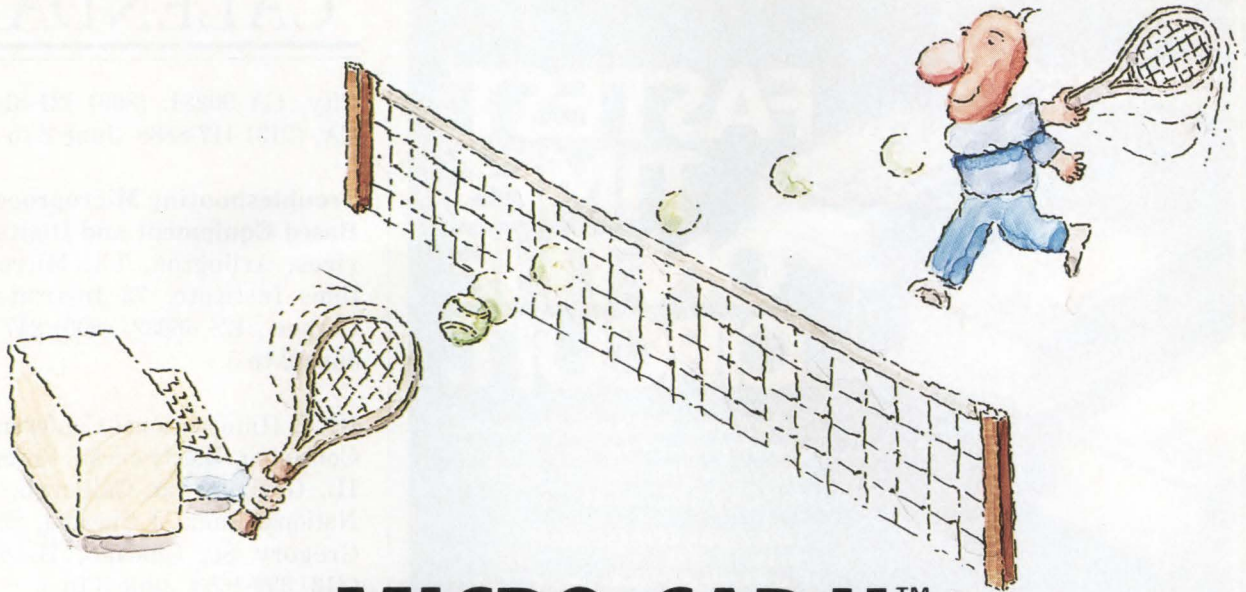

MICRO-CAP II.™

The CAE tool with fully interactive analog simulation for your PC.

Spectrum Software's MICRO-CAP II® is fast, powerful, and feature rich. This fully interactive, advanced electronic circuit analysis program helps engineers speed through analog problems right at their own PCs.

MICRO-CAP II, which is based on our original MICRO-CAP software, is a field-proven, second-generation program. But it's dramatically improved.

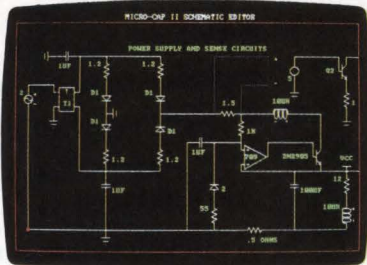

Schematic Editor

MICRO-CAP II has faster analysis routines. Better resolution and color. Larger libraries. All add up to a powerful, cost-effective CAE tool for your PC.

The program has a sophisticated integrated schematic editor with a pan capability. Just sketch and analyze. You can step



Transient Analysis

component values, and run worst-case scenarios—all interactively. And a 500-type* library of standard parts is at your fingertips for added flexibility.

MICRO-CAP II is available for IBM® PCs and Macintosh.™ The IBM version is CGA, EGA, and Hercules® compatible and costs only \$895 complete. An evaluation version is available for \$100. Call or write today for our free brochure and demo disk. We'd like to tell you more about analog solutions in the fast lane.

- Integrated schematic editor
- Fast analysis routines
- High-resolution graphic output
- Standard parts library of 500* types

*IBM versions only.

- Transient, AC, DC, and FFT routines
- Op-amp and switch models
- Spec-sheet-to model converter*
- Printer and plotter* hard copy

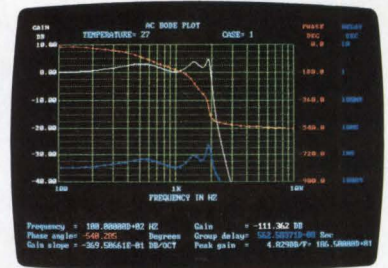

AC Analysis

spectrum

1021 S. Wolfe Road, Dept. E
Sunnyvale, CA 94087
(408) 738-4387

MICRO-CAP II is a registered trademark of Spectrum Software.

Macintosh is a trademark of McIntosh Laboratory, Inc. and is being used with express permission of its owner.

Hercules is a registered trademark of Hercules Computer Technology

IBM is a registered trademark of International Business Machines, Inc.

CALENDAR

City, CA 90231. (800) 421-8166; in CA, (213) 417-8888. June 2 to 5.

Troubleshooting Microprocessor-Based Equipment and Digital Devices, Arlington, TX. Micro Systems Institute, 73 Institute Rd, Garnett, KS 66032. (800) 247-5239. June 2 to 5.

ICCE (International Conference on Consumer Electronics), Rosemont, IL. Geriann Van Calbergh, First National Bank of Chicago, 8528 W Gregory St, Chicago, IL 60656. (312) 399-1653. June 3 to 5.

ISHM Europe (European Microelectronics Conference and Exhibition), Bournemouth, UK. Concorde Services, 10 Wendell Rd, London W12 9RT UK. 01 743 3106. June 3 to 5.

IEEE MTT-S International Microwave Symposium, Las Vegas, NV. Steven March, Symposium Steering Committee Chairman, Maury Microwave Corp, 8610 Helms Ave, Cucamonga, CA 91730. (714) 987-4715. June 9 to 11.

University /Government /Industry Microelectronics Symposium, Rochester, NY. Lynn Fuller, Rochester Institute of Technology, 1 Lomb Memorial Dr, Rochester, NY 14623. (716) 475-2035. June 9 to 11.

Troubleshooting Microprocessor-Based Equipment and Digital Devices, Atlanta, GA. Micro Systems Institute, 73 Institute Rd, Garnett, KS 66032. (800) 247-5239. June 9 to 12.

National Computer Conference, Chicago, IL. AFIPS, 1899 Preston White Dr, Reston, VA 22091. (800) 622-1987; in VA, (703) 620-8955. June 15 to 18.

ISDN, Atlanta, GA. Information Gatekeepers, 214 Harvard Ave, Boston, MA 02134. (617) 232-3111. June 15 to 19.

EDN April 30, 1987

CONNOR-WINFIELD
OSCILLATORS:

FASTEST TIMES ON THE CIRCUIT.

Performance. That's what you expect from a high-speed oscillator, and that's what you get from Connor-Winfield's HCMOS and ECL series.

Take a look at these specs:

Model: HC15R5

Fixed Frequencies Available: 1KHz to 50MHz

Supply Current: 25mA Max.

Model: ECLA, B

Fixed Frequencies Available: 8MHz to 200 MHz

Output: Squarewave 10K ECL or 100K ECL Compatible

Supply Voltage: -5.2 Vdc or -4.5 Vdc

Fire one up today. We have plenty of models available for a test drive.



CONNOR-WINFIELD CORPORATION

West Chicago, IL 60185 USA
Phone 1-312-231-5270
TLX 270244
Cable: CONWIN WCGO

CIRCLE NO 6

DYNAMIC MEMORY TIMER

- Triggered by a Single MREQ Pulse
- Rising-edge Triggered
- TTL Interfaced
- 14 Pins DIP
- Generates All Timing Pulses for DRAM Memory Board
- Precise and Stable Timing

data delay devices, inc.

385 Lakeview Avenue, Clifton, New Jersey 07011
(201) 772-1106

CIRCLE NO 7

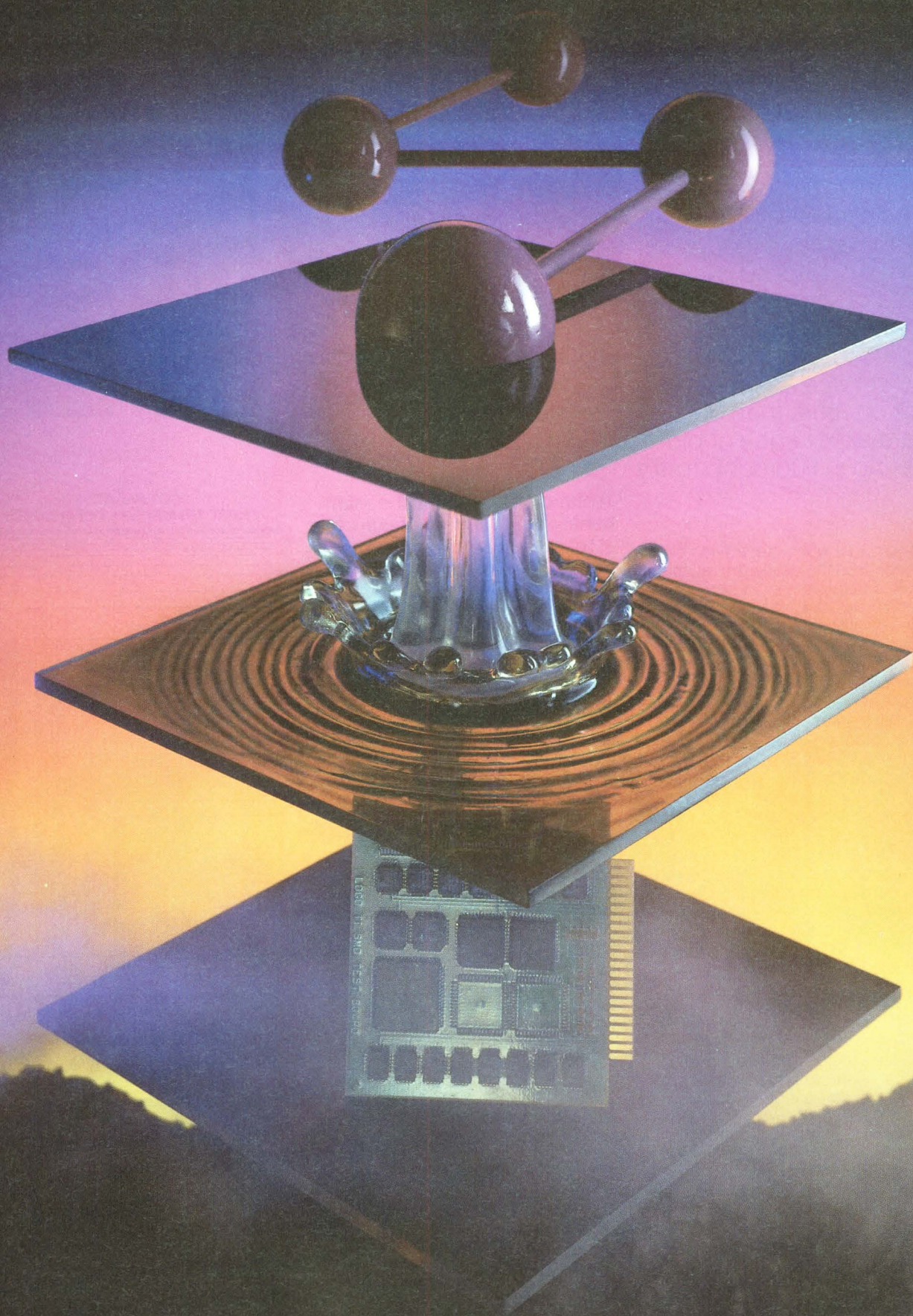

**Discover
Fluoronics Resources**

Fluorinert™ Liquids—products that power Fluoronics Resources.*

*Fluoronics Resources:

An exclusive 3M combination of innovative products backed by research and development, manufacturing expertise, technical data and service assistance built on more than 35 years' experience of pioneering in fluorochemistry.

3M has had a whole generation of experience in the development, manufacture and refinement of perfluorinated liquids. We first introduced these versatile liquids to electronics design, testing and production professionals in the fifties. Since then, Fluorinert Liquids have become the mainstays in electronic cooling, high reliability testing and vapor phase soldering.

Fluorinert Liquids, used as a direct contact heat transfer medium, offer a range of physical properties that make them particularly suitable for electronic uses. They are non-polar and exhibit no solvent action. They are colorless, low in toxicity, non-flammable and offer exceptionally high dielectric strength plus thermal and chemical stability. Most important, they have almost no chemical reactivity and they evaporate without leaving a residue on parts.

Buy the numbers

Our FC™ numbers — FC-40, FC-70, FC-77, etc. — are used to identify Fluorinert Liquids that offer certain physical characteristics to meet specific application needs. These FC numbers are solely 3M designations for various fluorochemical products.

Fluorinert Liquids are being used cost-effectively in cooling, high reliability testing and vapor phase soldering operations. When you are interested in applying these versatile liquids in your own production, 3M can provide an abundance of technical information and support.

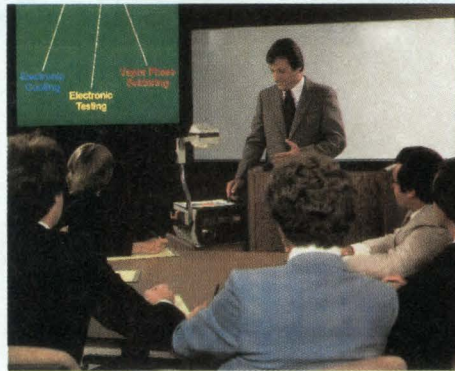

Technical assistance: the main benefit of Fluoronics Resources

3M offers prompt assistance to help you solve many production and testing problems. We provide comprehensive technical recommendations for specific fluids. We consult with you on the proper application equipment and help you evaluate production methods and results. Our service bulletins bring you up to date on the most recent advances in vapor phase soldering and high reliability testing. Ask us about 3M's audiovisual materials and on-site application training seminars.

Discover Fluorinert™ Liquids' heat transfer capability

What are your needs? A precise degree of temperature control? Fast, uniform heat transfer? High dielectric strength? Fluorinert Liquids offer the broad range of physical characteristics required in most applications.

Fluorinert Liquids are an effective direct contact heat transfer medium whether used in a liquid or vapor state. Their unique properties enable you to use them in contact with sensitive components and substrates.

Major differences between the various products in the Fluorinert Liquids family can be seen in their boiling points. These can range from 56°C to 253°C. Should you need products with intermediate boiling temperatures, the 3M staff will work with you to fashion a product especially for your needs. It's an example of how 3M's Fluoronics Resources provide you with "customized" service to solve special problems.

COMPARATIVE HEAT TRANSFER COEFFICIENTS

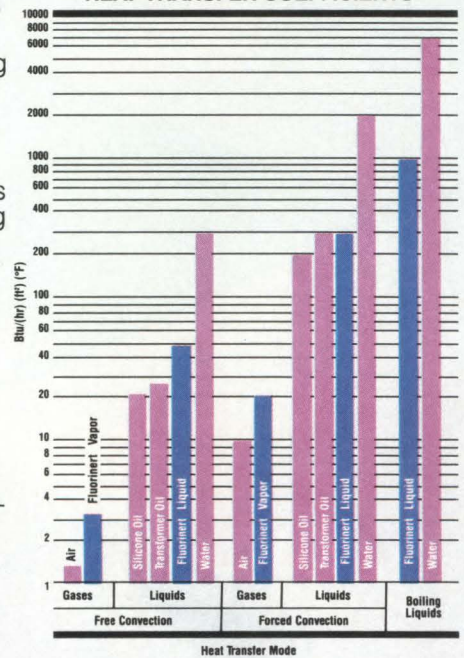

Fluorinert™ Liquids achieve accurate high reliability testing

It's a small world you work in. Where time ticks in nanoseconds and dimension is measured in Angstrom units. And as circuitry becomes more complex, a greater demand is placed on testing capability — not only in speed, but in higher reliability and accuracy.

Fluorinert Liquids meet those requirements by providing a controlled temperature environment and a high degree of electrical protection. They offer maximum compatibility between

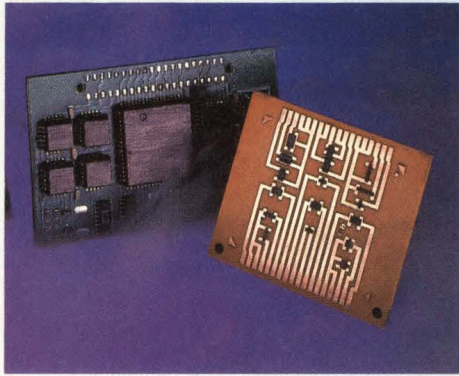

the heat transfer medium and the device under test. Fluorinert Liquids reduce testing costs by reducing testing time substantially. They do this by rapidly reaching test temperature and providing precise and uniform temperature control. You'll minimize the number of faulty units by detecting defects before they become rejects.

These liquids provide cost-effective tests such as gross leak, thermal shock, liquid burn-in, ceramic crack detection, electrical environmental, temperature calibration and failure analysis/short detection.

Fluorinert Liquids are specified in the MIL-STD's for thermal shock and gross leak testing.

THERMAL SHOCK TEST CONDITIONS

Military Standard 883-1011			Military Approved Fluorinert Liquids	
Test Condition	Hot Test Step 1	Cold Test Step 2	Hot Test Step 1	Cold Test Step 2
A	100°C	-0°C	Water, FC-40	Water, FC-40, FC-77
B	125°C	-55°C	FC-40, FC-70, FC-5311	FC-77
C	150°C	-65°C	FC-40, FC-70, FC-5311	FC-77
D	200°C	-65°C	FC-70, FC-5311	FC-77
E	150°C	-195°C	FC-40, FC-70, FC-5311	Liq. N ₂
F	200°C	-195°C	FC-70, FC-5311	Liq. N ₂

GROSS LEAK TEST CONDITIONS

Military Standards	Military Approved Fluorinert Liquids		
	Indicator Fluids	Detector Fluids	Absorption Fluids
MIL-STD 883-1014	FC-40, FC-43	FC-72, FC-84	Do not apply
MIL-STD 750-1071	FC-40, FC-43	FC-72, FC-84	FC-43, FC-75, FC-77
MIL-STD 202-112	FC-40, FC-43	FC-72, FC-84	Do not apply

Discover higher yields in vapor phase soldering

Fluorinert Liquids have been the industry's fluid of choice since the vapor phase reflow soldering (VPS) process was introduced in 1975. There are a number of good reasons for this universal acceptance. VPS with Fluorinert Liquids produces highly reliable solder joints. The system reduces reject rates, increases production, and lowers production costs. With Fluorinert Liquids, you can be assured that your products will never be exposed to a temperature higher than the selected liquid's boiling point. (See above)

You'll avoid those problems usually associated with other systems — shadowing, uneven heating, and overheating. The liquids are non-flammable. Their low surface tension helps them evaporate quickly from the work pieces without leaving a residue.

VPS with Fluorinert Liquids is especially suited for boards with high mass or complex geometries. The liquid vapors completely surround the assembly and penetrate remote recesses to heat all surfaces evenly. The vapors are 15 to 20 times heavier than air so they can be contained easily within the work area. The system offers an oxygen-free, non-corrosive environment to minimize rejects from oxidation contamination.

Some typical applications using Fluorinert Liquids in VPS include surface mounted leaded or leadless components, through-hole leads and wire-wrap pins, lead frame attachment, reflow of electroplated solder or tin and miscellaneous metal joining.

VPS SELECTION GUIDE

Fluorinert Liquid	Boiling Point	Typical Solders
FC-43	174°C/345°F	70 Sn/18 Pb/12 In 100 In 58 Sn/42 In 58 Bi/42 Sn
FC-70, FC-5311 FC-5312	215°C/419°F	63 Sn/37 Pb 60 Sn/40 Pb 62 Sn/36 Pb/2 Ag
FC-71	253°C/487°F	100 Sn 95 Sn/5 Ag 60 Pb/40 Sn

Discover the unique cooling benefits of Fluorinert™ Liquids

As the package size decreases, your need for more efficient heat dissipation increases in proportion. 3M Fluorinert Liquids are very efficient as a direct contact heat transfer medium, with the added advantage of having the high dielectric characteristics needed to meet stringent demands of the diversified electronics industry. We offer 11 liquids with boiling points that range from 56°C to 253°C.

These stable liquids allow you to maximize power density and miniaturize your package. Yet they reduce failure rates and increase reliability.

Fluorinert Liquids are used in such demanding applications as:

- Radar transmitters • Power supplies
- High voltage transformers • Lasers
- Radar klystrons • Computer modules
- Computer memories • Fuel cells

Typical properties of Fluorinert Liquids used in cooling are:

Fluorinert Liquid FC-77 (English Units)	Liquid		Vapor
	Room Temp. (77°F)	Boiling Point (207°F)	Boiling Point 207°F @ ATM
Density lb./ft ³	111	100	0.85
Thermal Conductivity Btu/(hr) (ft ²) (°F/ft)	0.037	0.033	0.008
Specific Heat Btu/(lb.) (°F)	0.25	0.28	0.23
Viscosity c.p.	1.42	0.46	0.02
Coefficient of Thermal Expansion ft ³ /(ft ³) (°F)	0.0008	0.0009	0.0015

Discover heating/curing with Fluorinert™ Liquids

Because they maintain their vapor temperature with absolute precision, Fluorinert Liquids can be used in many heating and/or curing operations. They serve as heat transfer media in solder mask and polymer thick film applications and for polymer processing. The non-corrosive vapors will not support oxidation. Ideal where solvent flash-off is a problem.

See us at NEPCON EAST, Booth #938

3M

Discover Fluoronics Resources

3M presents a unique short course in the use of Fluorinert™ Liquids for the electronics industry.

3M is now offering a series of Applied Fluoronics™ tapes demonstrating how Fluorinert Liquids are used in a number of applications. See first hand how these remarkable products can improve overall electronic production.

Three cassettes are available:

1. "Applied Fluoronics: High Reliability Testing"
2. "Applied Fluoronics: Vapor Phase Soldering"
3. "Applied Fluoronics: Direct Contact Cooling"

These informative VHS format tapes are available to qualified personnel in the electronics industry. Specify which cassette(s) you would like to view.

Write on your company letterhead, describing your general interest. Mail to: Fluoronics Resources, Industrial Chemical Products Division/3M, Building 223-65E-04, 3M Center, St. Paul, MN 55144-1000.

For technical information or assistance on High Reliability Testing and Cooling, call 612/733-6282; for Vapor Condensation Heating assistance, call 612/733-7424.

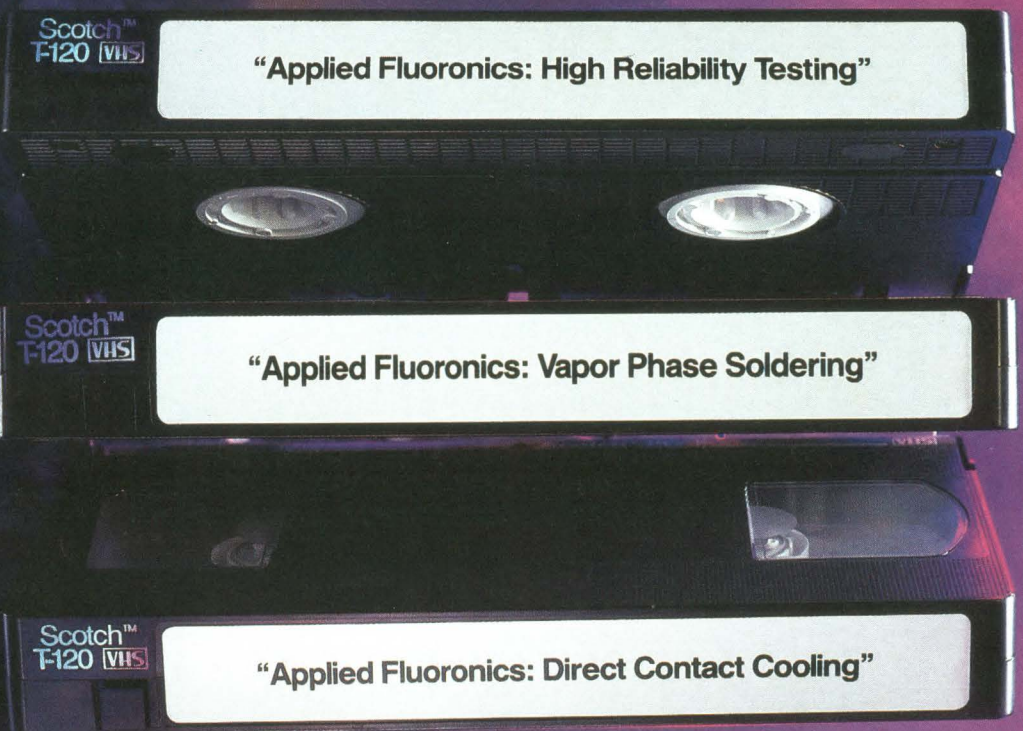

EDITORIAL

Hands off, Uncle Sam



If you think the US government does a good job of managing projects, consider two of Uncle Sam's recent ventures: tax simplification and arms sales to Iran. After such snafus, it seems wise to keep the government's involvement in most affairs to a minimum. However, industries and trade associations such as the Semiconductor Industry Association (SIA) continue to petition for government aid. The SIA's members want Congress to provide funds for the Semiconductor Manufacturing Technology Institute (Sematech). The institute's goal is to help US semiconductor companies compete with foreign manufacturing technology.

Facing similar competitive pressures from overseas manufacturers, 10 US companies founded the Microelectronics and Computer Technology Corp (MCC) in 1982. MCC now embraces 17 members, each of which contributes to the group's cooperative research into emerging technologies. The group receives no government money. Although MCC's research has yet to produce major new products, the corporation continues to attract new members. Sematech should follow a similar course, drawing its funds and expertise from member companies. The semiconductor industry cannot rely on government grants alone to fund manufacturing research and development.

Surprisingly, the Department of Defense agrees. Its Defense Science Board recommends that a private-industry consortium tackle the development of 64M-bit memory chips. Member companies would contribute \$250 million in start-up money, and the DoD would contract for \$200 million worth of research each year.

So far, though, Sematech's role is undecided. For example, Intel's executives argue that Sematech should manufacture and sell chips on the open market. Executives at IBM, however, want an organization that develops manufacturing technology to be licensed for use by all member companies.

The Sematech consortium sounds like a good idea. Once it decides where it is going, it can make a major contribution to developing new semiconductor-manufacturing technologies. The US government, however, has a poor record of bringing its ventures to profitable conclusions. The government's handouts are tempting, but let's keep Sematech in private hands.

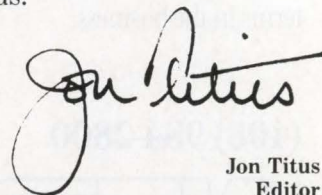

Jon Titus
Editor

Easy



You know them already. Familiar TTL terms like 7474, 74138, 74157, 74163, 74374 and hundreds more.

What you don't know is that these terms can now take you into the realm of instant, affordable VLSI logic. Because for the first time ever, you can use the TTL building blocks you already know to create your

own VLSI circuit. Without having to relearn Boolean algebra or other tedious PLD design techniques.

With our new high density EP1800 EPLD, you have over 2,000 gates available. And putting them to work in your circuit is easy because our new LogiCaps™ software gives you access to a complete library of TTL Macro-Functions. So you won't have to deal with the high cost and high pain associated with gate arrays (like time, money, money and money).

What's more, you won't get stuck with custom leadtimes and high inventory costs because our EPLDs are standard, off-the-shelf products.

Note, too, that the EP1800 is ideal for military (especially if you're still in the bidding process), instrumentation and telecommunications applications. You get high density, low power, TTL speed, fast prototyping (even prototyping for gate arrays) and no upfront development charges.

So call today to learn more. Because if you talk TTL, you can now talk affordable VLSI. With the easiest terms in the business.

(408) 984-2800

ALTERA

3525 Monroe Street
Santa Clara, CA 95051

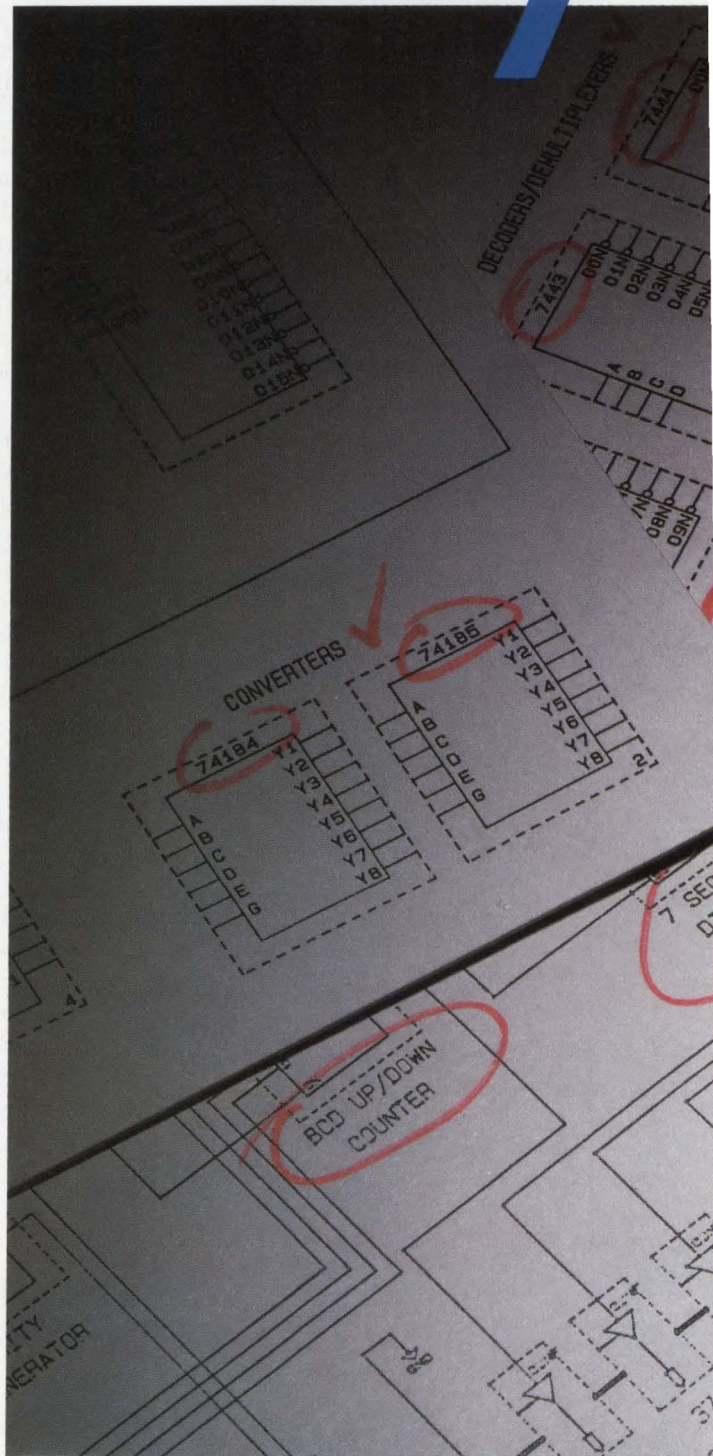

LogiCaps is a trademark of Altera Corp.
© 1986 Altera Corporation.

Terms.

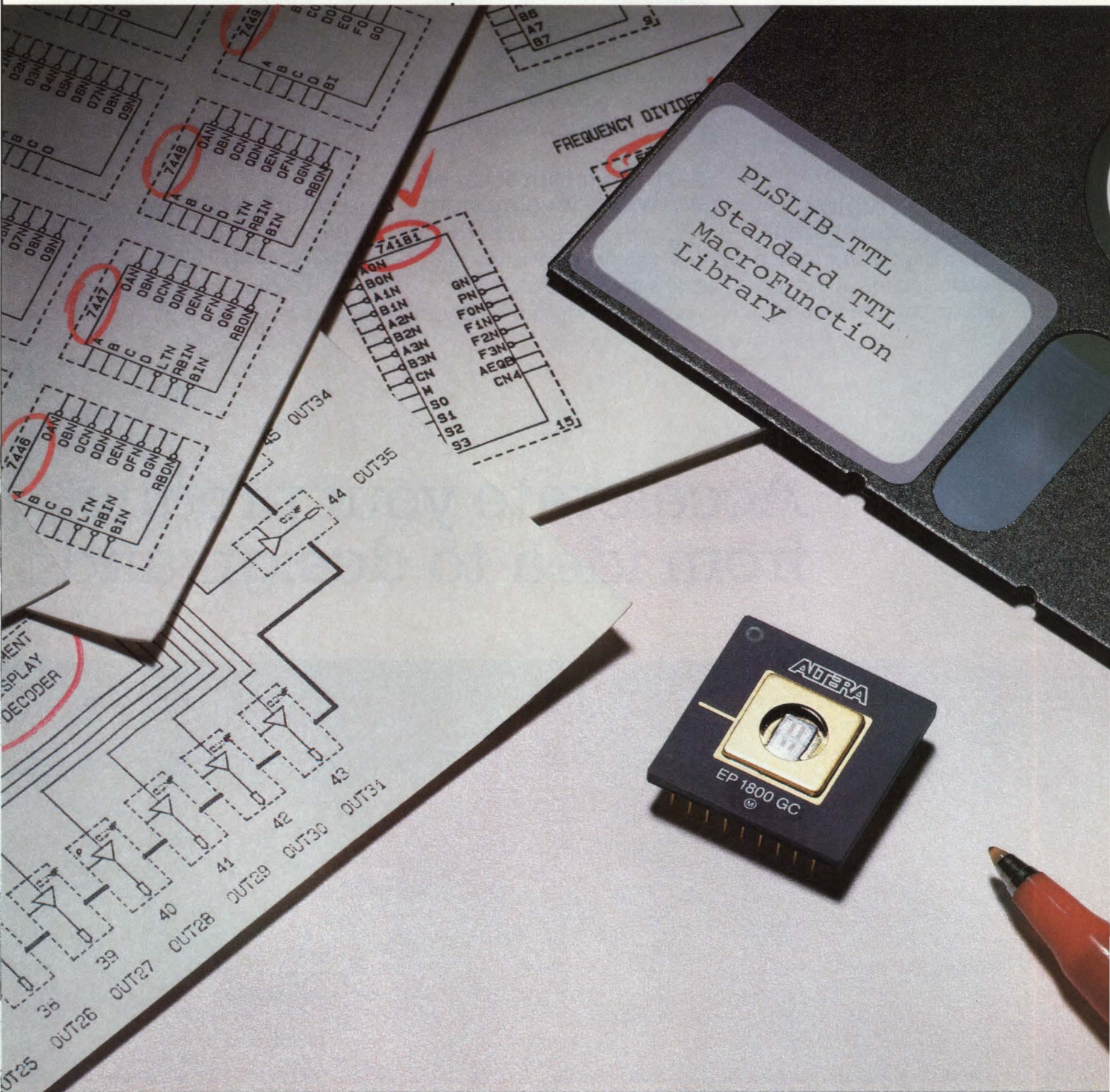

turn engineering ideas into finished printed-circuit boards quickly. And gives you the assurance that boards will match the approved design from engineering and be practical to manufacture.

You get a link from schematic capture to PCB design for highest design integrity, and system features that optimize designs for your actual manufacturing environment. The result is reduced manufacturing costs, higher yield, and improved reliability.

You can also transfer netlist and part information from PCB design to HP's board test system, ending manual-entry hassles and errors.

HP DesignCenter: our commitment to CAE/CAD

HP's CAE/CAD tools are part of HP DesignCenter... a powerful product development environment that unites the activities of electronic, mechanical, and software engineers through integrated systems, software, and support.

For all the facts, call your local HP sales office listed in the telephone directory white pages. Or call 1-800-447-3282 (in Colorado call 590-5540 collect) for free literature on our CAE/CAD solutions.



**HEWLETT
PACKARD**

we never stop asking
"What if..."

development
test.

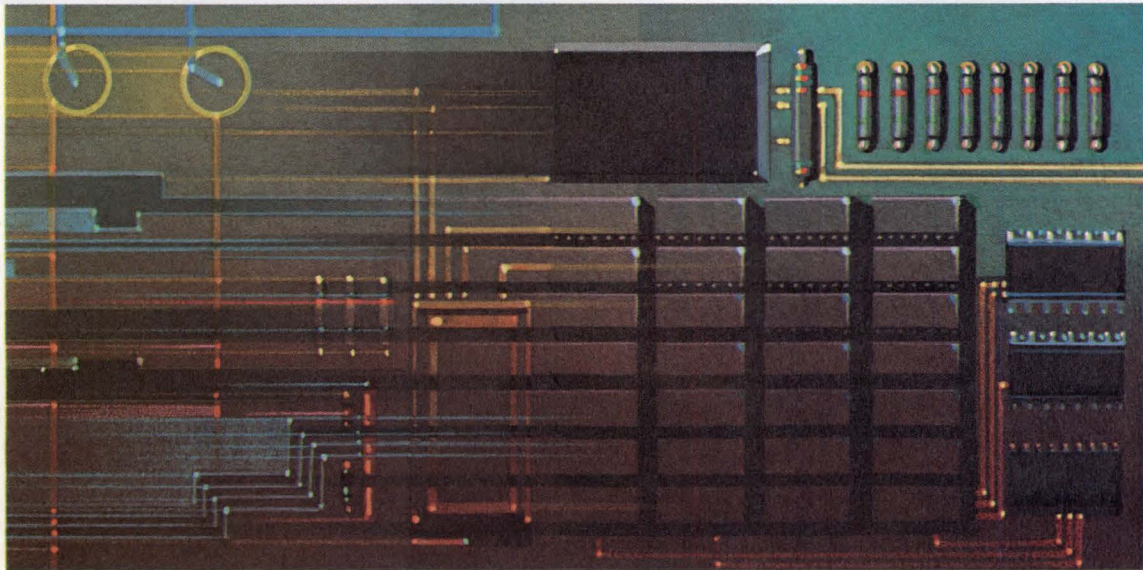

◊◊◊◊◊◊◊◊◊◊◊◊◊◊◊◊◊◊◊◊◊◊◊◊◊◊◊◊◊◊◊◊◊◊ to finished product faster



**Z-matched communications
connectors, from AMP.
Our premium performers
keep costs in line.**



AMP is a trademark of AMP Incorporated.

Data rates and operating frequencies are up, both in traditional communications and in the emerging cellular and networking areas. Yet budgets are as demanding as ever.

High performance in 50 ohm and 75 ohm applications calls for uncompromising connector design. So we impedance-match our 75 ohm versions, for example, to 1% tolerances — giving you a VSWR of

less than 1.3 out to 2 GHz, for maximum power transfer. In fact, our coax connector electrical performance is equivalent to that of much costlier MIL-C-39012 types.

And our proven dual-crimp design, backed by hand or automatic tooling, cuts termination time (and cost) on the line or in the field.

While our engineering leadership in press-fit technology gives you quick, solderless board-to-cable BNC transitions.

Contact your AMP Distributor or for literature call the AMP RF Connector Desk, (717) 780-4400. AMP Incorporated, Harrisburg, PA 17105-3608.

AMP Interconnecting ideas

CIRCLE NO 61

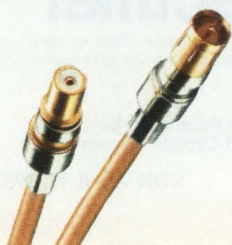

Complete range of communications connectors and hardware includes all popular contact types.

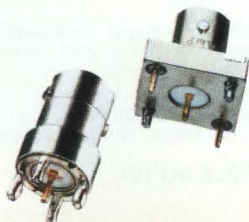

BNC receptacles simplify pcb termination. Compliant-pin styles eliminate soldering.



SMB connectors offer our unique, patented detent spring design for secure mating, long life.

**The perfect
low-cost
answer to
off-line
switching
250V**

NOW

HEXFETs®

In the past, designing power FET switching for 117V line operation meant paying for more power handling capability than you really needed. But not any more.

Our 250V HEXFET power MOSFETs offer a new family of *optimized* devices tailor-made to operate off-line – and all at prices of up to 50% less than conventional power FETs.

These cost-effective HEXFETs also guarantee you an extremely rugged device that handles full rated current/voltage without second breakdown, fast switching, and reliability second to none.

Five HEXFET 250V Series combine a wide variety of die sizes and package styles for off-line applications like battery chargers, hand drills, lighting ballasts, washing machines, dryers, and many others.

Rds (on) ranges as low as 0.13 Ohms, with current ratings as high as 28 amps depending on die size. For complete technical data, call (213) 607-8842. Today.

HEXFET Technology...

All 250V devices contain chips produced with our exclusive HEXFET process, resulting in unsurpassed quality and reliability.

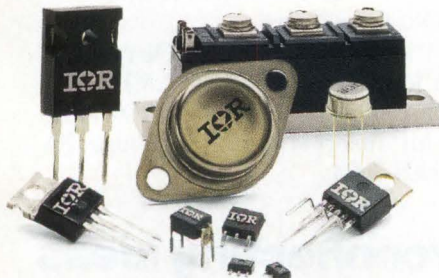

**Most HEXFETs now in stock
for immediate delivery!**

**Number 1 in
power MOSFETs**

**International
IOR Rectifier**

WORLD HEADQUARTERS: 233 KANSAS ST., EL SEGUNDO, CA 90245. U.S.A. (213) 772-2000. TWX 910-348-6291, TELEX 472-0403
EUROPEAN HEADQUARTERS: HURST GREEN, OXTEd, SURREY RH8 9BB. ENGLAND TELEPHONE (088 33) 3215/4231. TELEX 95219

Power MOSFETs • CMOS Power ICs • Commercial/Custom Power Packages • Schottkys Rectifiers • Thyristors (SCRs) • Diode Bridges • Molded Circuits • Assemblies

TECHNOLOGY UPDATE

IEEE 802.3 LAN testers and analyzers pinpoint network and equipment flaws

Steven H Leibson,
Regional Editor

Troubleshooting an Ethernet local-area network can be a complex problem; sometimes magic seems to be the only solution. But instead of reaching for beads and rattles or a book of incantations the next time you have to troubleshoot a LAN, consider using equipment specifically designed for testing networks. Whether you're measuring the performance of a new network-protocol software release, testing your product's LAN interface, persuading products from different manufacturers to talk to each other over the net, resuscitating a crashed network, or just tuning a LAN for peak performance, you'll find that a LAN physical tester or protocol analyzer can make your job much easier.

Ethernet LANs are complex, comprising seven layers in what is generally called the OSI (open system interconnection) model developed by the International Organization for Standardization (ISO). In addition to the seven layers it explicitly describes, the model implies another layer (layer 0), the transmission medium (Fig 1). Ethernet LANs usually implement layer 0 with a double-shielded coaxial cable.

Each network layer represents one or more physical components built from software, hardware, or a combination of both software and hardware. Any of these components can fail or be improperly designed. In addition, networks can include dozens or hundreds of nodes, each incorporating this complex, layered structure. Locating a network problem in all of this complexity is like looking for a needle in a haystack.

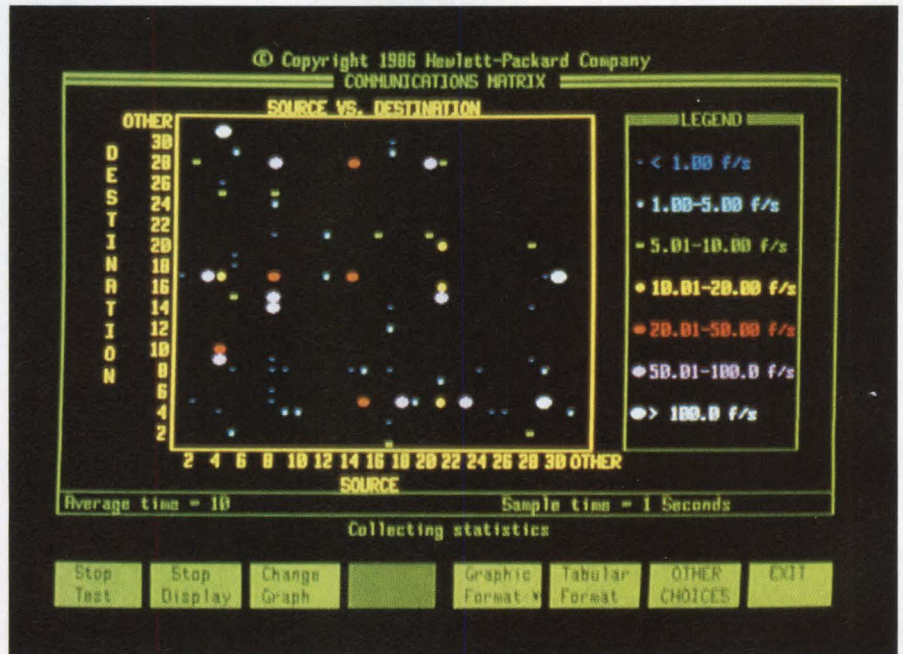

You can monitor communications among 31 nodes with this communications display by using the optional LAN-performance software package on the Hewlett-Packard 4971S protocol analyzer.

Xerox developed the Ethernet LAN more than a decade ago, and the IEEE published its Ethernet-based 802.3 standard in 1985. (In this article, the word "Ethernet" refers to both the Xerox LAN and the IEEE 802.3 LANs.) Ethernet LANs use a bus-contention protocol called the CSMA/CD (carrier sense, multiple access with collision detection), and they have a bus network topology. Although LANs using this technology have been operational for more than 10 years, instrument vendors started offering equipment for Ethernet LAN troubleshooting only within the last few years.

Strictly speaking, Ethernet and IEEE 802.3 define layer 1 and the media-access control (MAC) sublayer of layer 2. Within layer 1, a media-access unit (MAU, also called a transceiver) couples data-terminal

equipment (DTE) to the transmission medium. The MAC sublayer defines the bit sequence (called a MAC frame or packet) used to transmit information over the LAN (Fig 2).

The instruments for locating Ethernet LAN problems fall into two categories: physical testers and protocol analyzers. The physical testers, which cost less than protocol analyzers, test only the network protocol layers specified by IEEE 802.3 (layer 1 and the MAC sublayer) by checking individual LAN hardware components (cables and transceivers) for correct operation and certifying that these components are properly interconnected. Protocol analyzers perform some tests on the lower protocol layers but excel at studying communications in the upper layers.

The transceivers that are com-



YOUR FIBER, COAX AND TWISTED PAIR NETWORKS AREN'T FINISHED UNTIL THEY'RE TIED TOGETHER.

The days of running from vendor to vendor to configure a cohesive information management network are over. With the formation of the Augat Communications Group, you now have a *single source* for off-the-shelf twisted pair, fiberoptic and coax network products.

Augat not only makes the products you need, but offers the expertise and knowledge to tie your information management network together. Augat simplifies system design, specification and product acquisition. No one else makes it this easy.

We offer the broadest range of network interconnection products available today. These products include twisted pair connectors, coaxial connectors, fiberoptic connectors, terminal blocks, distribution frames, data links, amplifiers, line extenders, network expanders, taps, splitters, digital cross connect systems and much more.

Augat Communications Group meets your fiber, coax and twisted pair network needs by integrating the proven products and expertise of six Augat operations: Broadband, LRC, Melco, Telzon, Fiberoptics and Vitek. Whether your network requirements are for a LAN within a single office or a multi building complex; or a WAN throughout many states; or a connectorization and distribution system within a central office, Augat Communications Group can tie it all together with ease.

For more information on the *one* company that has the products, the capability and the experience to tie fiber, coax and twisted pair into a common network, contact Augat Communications Group, PO Box 1110, Seattle, WA 98111. Call us at 206-223-1110.

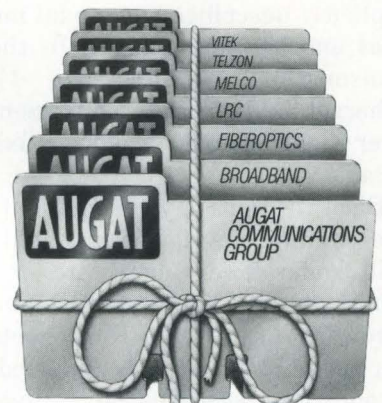

**WE'RE AUGAT
COMMUNICATIONS GROUP
WE TIE IT ALL TOGETHER
...WITH EASE.**

TECHNOLOGY UPDATE

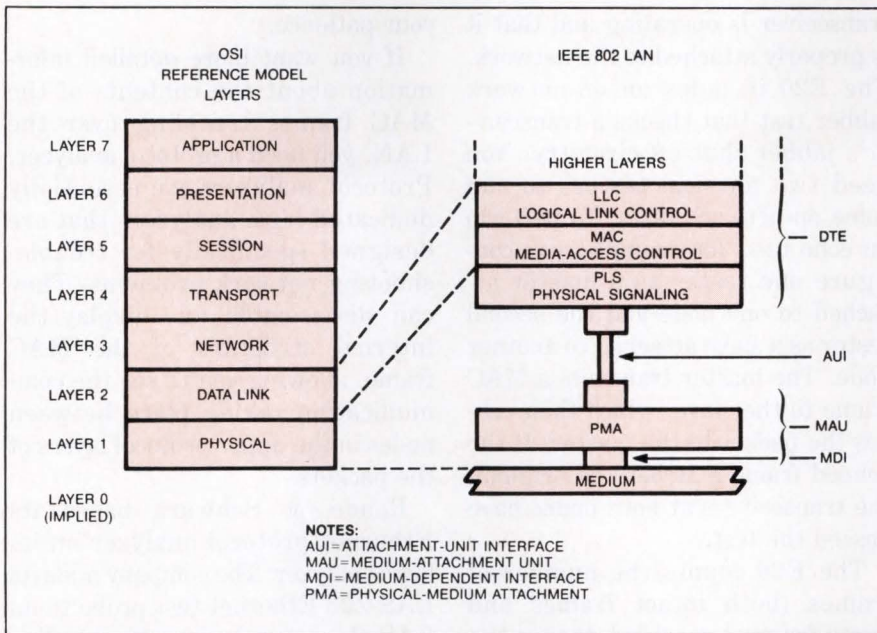

Fig 1—ISO's open system interconnection (OSI) model specifies seven layers, but the IEEE 802.3 standard and Ethernet define only layer 1 and the media-access control (MAC) sublayer of layer 2. The LAN's transmission medium represents an implied layer 0.

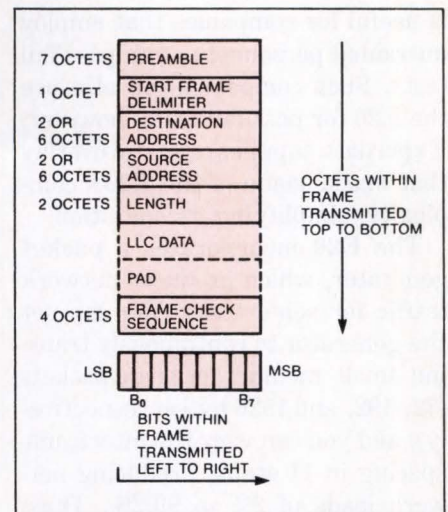

Fig 2—The MAC frame defined in the IEEE 802.3 standard comprises seven fields. All the protocols above the MAC sublayer reside within the MAC frame's data field. The 802.3 standard refers to 8-bit octets, commonly called bytes. Short frames use pads within the data field to attain the standard's 64-octet minimum legal size.

only used for implementing Ethernet LANs couple to the double-shielded coaxial cable through a side-entry connection called a vampire or stinger tap and employ baseband signaling. However, some vendors offer broadband and fiber-optic transceivers and transmission media. For LAN testing purposes, the key feature common to Ethernet transceivers employing any transmission medium is the attachment-unit interface (AUI), which is physically embodied in a standard, 15-pin D connector. This interface and the associated AUI cable provide entry points into the LAN for testing.

When you're testing a product's network interface for correct operation, you need to ensure that the AUI cables and transceivers you use in the tests are functioning properly. Experdata's E20 and Cabletron's LAN MD both certify AUI cables and transceivers (see **Table 1**). These testers also verify that the transceivers are properly mated to the transmission medium. The E20's built-in time-domain reflectometer (TDR) allows you to locate short and open circuits on the network's coaxial cable.

Although Cabletron's LAN MD and Experdata's E20 testers appear

to be physically similar, the instruments' features and operation differ. Both testers employ numeric LED displays; however, the LAN MD uses the numeric indicator to show test-status codes, and the E20 displays numeric information that includes the number of frames transmitted, collisions detected, and frames received with errors. Because it gives you this numeric data, the E20 lets you obtain quantitative as well as qualitative test results. The LAN MD gives you predefined status codes instead of quantitative test results.

The LAN MD's simpler operation

TABLE 1—PHYSICAL-LAYER TESTERS

	TESTS									
	TRANSCEIVER TESTS			JABBER	ECHO TEST	COLLISION TEST	BERR TEST	TDR	TRANSMITTER LEVELS AND COLLISION THRESHOLDS	ROUND-TRIP DELAY TEST
	OFF-NET	ON-NET								
CABLETRON LAN MD (\$4000)	YES	YES	NO	YES	YES	NO	NO	YES	NO	
EXPERDATA E20 (\$4500)	YES	YES	YES	YES	YES	YES	YES	\$185 OPTION	YES	

NOTES:

1. THE E20 PROVIDES FOR TRAFFIC MEASUREMENT AND HAS A TRAFFIC GENERATOR; THE LAN MD DOES NOT.
2. BOTH INSTRUMENTS PROVIDE DROP CABLE.
3. THE LAN MD'S ECHO TEST REQUIRES TWO TESTERS.
4. THE E20'S ECHO, COLLISION, LINE-QUALITY, AND ROUND-TRIP DELAY TESTS REQUIRE TWO TESTERS.

TECHNOLOGY UPDATE

is useful for companies that employ untrained personnel to run pass/fail tests. Such companies can also use the E20 for pass/fail tests, however: Experdata supplies a plastic overlay that masks some of the E20's complexity, simplifying its operation.

The E20 incorporates a packet generator, which produces network traffic for some tests. You can set the generator to continuously transmit small, medium, or large packets (72, 192, and 1526 bytes, respectively), and you can vary the interframe spacing in 11 steps, producing network loads of 2% to 99.2%. Thus, the generator can simulate network growth (more active nodes and more network traffic), allowing you to see how the devices on the LAN would respond to this extra traffic.

Both testers check transceivers for proper transmission and reception on and off the network. Off-network tests check a transceiver's basic components: the transmitter, receiver, and collision detector. One advantage the LAN MD enjoys over the E20 in testing transceivers is the ability to measure a transmitter's output-voltage levels and collision-detection thresholds by means of an off-network test. For the E20, this feature costs an extra \$185.

On-network tests prove that the

transceiver is operating and that it is properly attached to the network. The E20 includes an on-network jabber test that checks a transceiver's jabber shut-off circuitry. You need two physical testers to run some on-network tests. To perform an echo test, for example, you configure one tester as a master attached to one node and the second tester as a slave attached to another node. The master transmits a MAC frame to the slave, which then echoes the packet to the master. If the echoed frame matches the original, the transceivers at both nodes have passed the test.

The E20 counts the number of frames (both intact frames and error frames) received during the echo test and displays this information, yielding bit-error-rate information. Experdata suggests that this test is especially helpful in finding insidious shorts—for example, the kind that occurs when one strand of the coaxial cable's shield braid touches the transceiver's stinger contact intermittently, depending on cable flexure, vibration, or temperature. Unless you use a tester like the E20, finding such a short, which masquerades as an intermittent hardware or software problem in a DTE, can really test

your patience.

If you want more detailed information about the contents of the MAC frames traveling over the LAN, you need a protocol analyzer. Protocol analyzers are essentially dedicated logic analyzers that are designed specifically for troubleshooting network problems. They can disassemble and display the internal structure of the MAC frame, allowing you to see the communication taking place between nodes in the upper protocol layers of the packets.

Rohde & Schwarz bases its Ethernet protocol analyzer on its logic analyzer: The company adds its LAS-Z23 Ethernet test probe to its LAS (logic analysis system). The test probe (which is available separately and costs DM 9080) incorporates shift registers that link a network transceiver's receiver and transmitter sections to several of the logic analyzer's data-capture and word-generator channels, respectively. You can measure interframe timing and network loading by using the system's event-timing analysis features, and you can create traffic with its logic generator.

The Ethernet disassembler supplied with the LAS-Z23 probe allows you to set filters and triggers

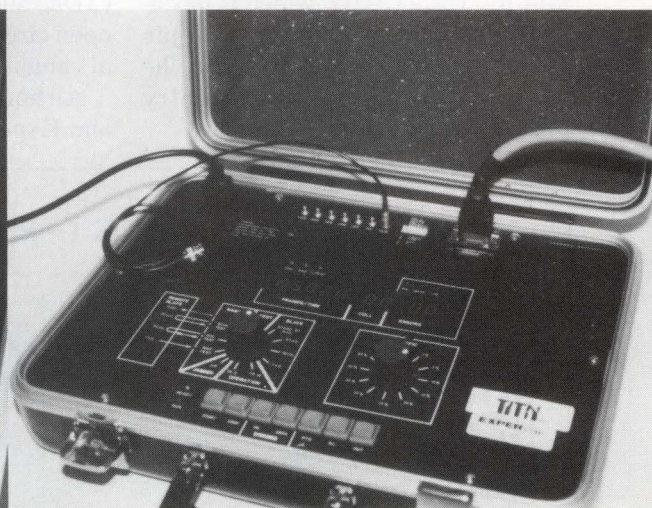
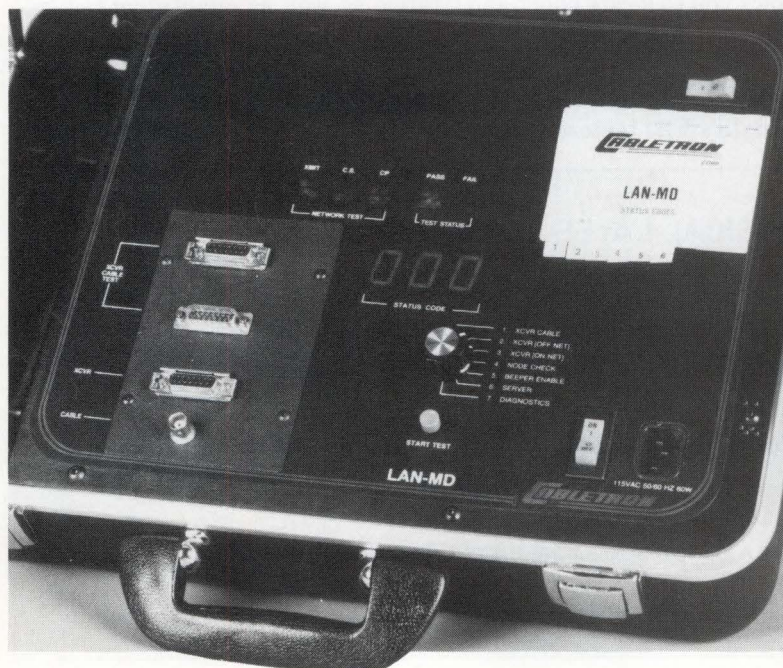

Although they look similar and perform similar tests, these LAN testers, the E20 from Experdata (above) and the LAN MD from Cabletron (left), present their results differently. The Experdata tester presents numeric results; the Cabletron unit gives status codes.

So, Is There a Real ASIC Second Source Setup in the Picture?

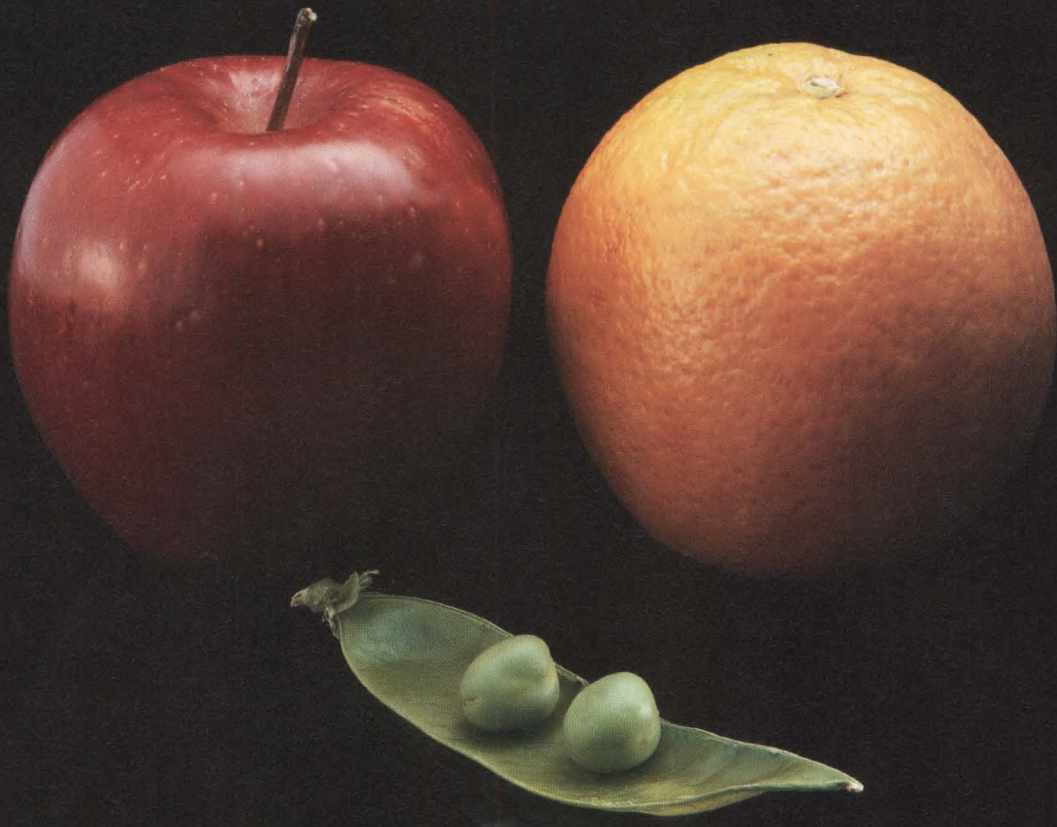

(Hint: Raytheon's RL7000 and LSI Logic's LL7000 are like . . .)

There's been a lot of wishful thinking about an active, genuine, semi-custom logic array second source. For very good reasons, but without a very good solution. Now, the right people, technology, and systems have been brought together. Raytheon and LSI Logic. It's happening.

Complete and identical: Long term maintenance and bilateral updates of well-known LDS™ front and back end software. The same methodology. The same libraries, logic design, physical design, testing. Identical.

The Right Product: According to the marketplace, 7000 Series is the leading choice in 2-micron HCMOS logic. Now, with a full-on second source, 7000 Series is the ASIC standard.

It's Happening: Raytheon has over ten years of logic array experience. LSI Logic has over five. Real time, in the market, with real products.

Now: You ought to can the apples and oranges routine. Call Raytheon for a real ASIC matchup.

Raytheon Company
Semiconductor Division
350 Ellis Street
Mountain View, CA 94039-7016
(415) 966-7716

Access to the right technology

Raytheon

LL7000 and LDS are trademarks of LSI Logic Corp.

TECHNOLOGY UPDATE

so that the analyzer can selectively capture packets and present the captured information in fields resembling the MAC-frame format. Packet-filtering criteria based on preamble, source, destination, type, data, and frame-check-sequence

(FCS) fields within the packet determine what information the analyzer keeps in its memory. The analyzer can also catch "runt" packets, frames shorter than 64 bytes.

To fit more frames into the analyzer's memory, you can choose to

retain only portions of the captured packets. For example, if you are interested only in the number of packets exchanged between two nodes, you would set the analyzer to save only the address fields from the packets and discard the other infor-

The \$49 LAN analyzer

If you need to analyze LAN performance for networks based on IBM PCs, you might want to try the \$49 Smart LPT (LAN performance tester) from Innovative Software (Lenexa, KS). The software tests many different kinds of network hardware (not just Ethernet or IEEE 802.3 networks) from various manufacturers and includes drivers for LANs that use Novell's Advanced Netware and IBM's Netbios.

The test software employs a unique stimulus for evaluating LAN performance: It directs file requests to a word processor, spreadsheet, and database manager contained within a demonstration version of the company's network-compatible, inte-

grated applications software, Smart. You install Smart, which comes with Smart LPT, on the network's file server. You can use this product to compare the performance of LAN hardware products from various manufacturers and to measure the effect of having different numbers of active users on a network.

The product allows you to specify the nodes' activity level for each simulation test. Plotting routines built into the software provide reports of the test performance, thus helping you to justify the purchase of one vendor's network over another's or to fine-tune the network-interface parameters in a file server for a given number of users.

TABLE 2—ETHERNET AND IEEE 802.3 PROTOCOL ANALYZERS

MANUFACTURER	MODEL	CAPTURE BUFFER (BYTES)	FILTER CHANNELS	GENERATOR CHANNELS	FILTER PROTOCOLS SUPPLIED	USER-DEFINED PROTOCOLS
COMMUNICATION MACHINERY CORP	DRN-1700 LANSCAN	192k	1	1	TCP/IP XNS ISO	NO
EXCELAN	EX5000E LANALYZER	700k	8	6	TCP/IP XNS ISO DECNET	YES
	EX5000EP LANALYZER	700k	8	6	TCP/IP XNS ISO DECNET	YES
HEWLETT-PACKARD	HP4971S	1M	16	16	TCP/IP XNS DECNET	YES
NETWORK GENERAL	SNIFFER	256k	1	1	TCP/IP XNS ISO SMB CORE NFS	YES
ROHDE & SCHWARZ	LAS 07	7k	12	1	NONE	NO

NOTES:

1. THE HP4971S COSTS \$18,541. YOU MUST ADD \$1390 TO \$4450 FOR A DUAL FLOPPY-DISK DRIVE OR A HARD-DISK/FLOPPY-DISK PERIPHERAL AND \$1495 FOR A VIDEO INTERFACE, MONOCHROME VIDEO DISPLAY AND KEYBOARD OR \$2150 FOR A VIDEO INTERFACE, COLOR VIDEO DISPLAY, AND KEYBOARD.
2. YOU CAN ADD ANALYSIS CAPABILITY FOR IBM TOKEN-RING LANs TO THE SNIFFER FOR AN EXTRA \$5000.

TECHNOLOGY UPDATE

mation contained in the frame.

The LAS protocol analyzer can also simulate a LAN, so you can perform tests on a DTE without a network. The analyzer's probe simulates a network transceiver and communicates directly with the DTE. You can create stimulus/response programs by using the CP/M-86 operating system and

Basic programming language supplied with the analyzer. This configuration gives you a tightly controlled system for conducting tests on unproven DTE hardware and software without wreaking havoc on an operational LAN.

Hewlett-Packard's 4971S protocol analyzer reveals its heritage through its keystroke-programming

language, which is similar to those incorporated in the company's logic analyzers. The keystroke-programming language allows you to configure the analyzer's 16 filters, which accept address fields, type fields, and as many as 46 bytes within the packet's data field as capture criteria. You can program each filter to look for errors such as bad FCS fields, misaligned frames, and runt frames, and you can specify frame length as a filter parameter.

The 4971S filters are capable of more than simple byte matching within the MAC frame. Various standards define some of the layers above the MAC sublayer, creating subfields inside the MAC frame's data field. Hewlett-Packard supplies several predefined protocol definitions (listed in **Table 2**) that allow you to work with packets at the protocol level instead of the byte level. If the files supplied by the company don't cover your application, you can define your own protocols.

The \$2000 18212A LAN-performance analysis software allows the 4971S to display a histogram showing the network's usage of selected node addresses plus the total network usage as a percentage of available bandwidth. You can select the communications matrix display that plots traffic among 31 user-selected node addresses. For systems with monochrome displays, the matrix indicates increasing traffic between nodes by using varying dot intensities; for systems equipped with color monitors, it uses different colors.

The 4971S contains 16 packet-generating channels, which can each send packets ranging from 5 to 2026 bytes (including the FCS) onto the network. Note that these limits exceed those specified by the IEEE 802.3 standard, so you can inject oversized and undersized frames into the network and use the analyzer to observe the effects on other network equipment. You can also use one of these generator channels

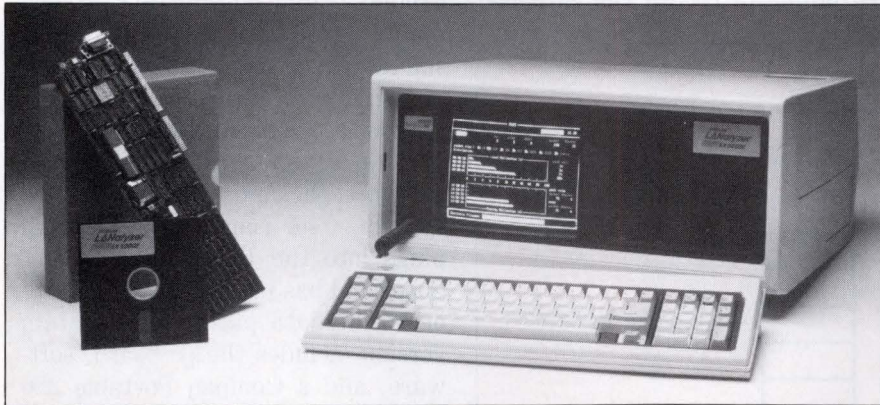

Available as a pc board and as a system, the Excelan EX5000 LAN protocol analyzer provides eight capture filters and six packet generators. The system versions include a Compaq Portable 286 computer as the host machine.

	NO OF SYMBOLIC NAMES	CONTINUOUS LOG TO DISK	TIME-STAMP RESOLUTION	TDR	PRICE	COMMENTS
	75	NA	NA	YES	\$8500	ALSO AVAILABLE FROM SPIDER SYSTEMS (EDINBURGH, UK)
	100 PER FILE	YES	10 μ SEC	YES	\$9500	PC BOARD PLUGS INTO PC OR PC/AT BUS; FREE DEMO DISK AVAILABLE
	100 PER FILE	YES	10 μ SEC	YES	\$19,500	FREE DEMO DISK AVAILABLE
	1000	YES	32 μ SEC	NO	\$21,426 TO \$25,141 ¹	
	>100	NO	1 mSEC	NO	\$19,000 ²	FREE DEMO DISK AVAILABLE
	12	NO	100 nSEC	NO	DM 52400	

KEY:
 TCP/IP=TRANSMISSION CONTROL PROTOCOL/INTERNET PROTOCOL
 ISO=INTERNATIONAL ORGANIZATION FOR STANDARDIZATION'S OPEN SYSTEM INTERCONNECTION
 XNS=XEROX NETWORK SERVICES
 CORE=NOVELL CORE PROTOCOL
 SMB=SYSTEM MESSAGE BLOCK (FOR IBM PC NETBIOS SYSTEMS)
 NFS=SUN MICROSYSTEMS' NETWORK FILE SYSTEM
 NA=NOT APPLICABLE

TECHNOLOGY UPDATE

to create a constant, background traffic level on the LAN by using a channel's packet-size and inter-frame-spacing control settings.

Generators as software probes

Packet generators can do more than merely create traffic on the network: You can also use them to test software performance in a developing product. Suppose you are

building a product similar to the DTE shown in Fig 3, and you have modularized your network-interface software to resemble the layers of the ISO model. If you install a switchable, loopback protocol in each software layer, you can use the protocol analyzer's packet generator to successively activate each loopback while using the analyzer's capture buffer to record the returned

frames. The analyzer time-stamps each echoed packet, allowing you to determine the response time or pass-through delay of each software layer.

Simultaneously, you can employ other packet generators within the analyzer to check your software's response to illegal packets, examine the effect of varying levels of background traffic on software performance, and test the response to simultaneous requests from multiple (simulated) nodes.

Excelan offers its Lanalyzer protocol analyzer as a pc board and software package or as a complete system. The Lanalyzer pc board plugs into the IBM PC or PC/AT buses and has jumper settings for 8- or 16-bit data paths. The system version includes the pc board, software, and a Compaq Portable 286 computer.

The Lanalyzer includes eight filters and six packet generators. Each filter accepts multiple criteria for source and destination addresses, type-field value, and byte values within the packet's data field. The generators can transmit illegal packets containing FCS and preamble errors, send packets with inadequate interframe separation, and create collisions with frames transmitted by other network nodes.

Because of the Lanalyzer's complexity, Excelan offers a free demo disk that allows you to experiment with the product's user interface. The demo disk runs on an IBM PC or compatible computer and serves as an extended, interactive data sheet. If you are in the market for a LAN protocol analyzer, it's a good idea to spend an hour running the demo: It will give you a deeper understanding of the Lanalyzer in particular and of LAN protocol analysis in general. **EDN**

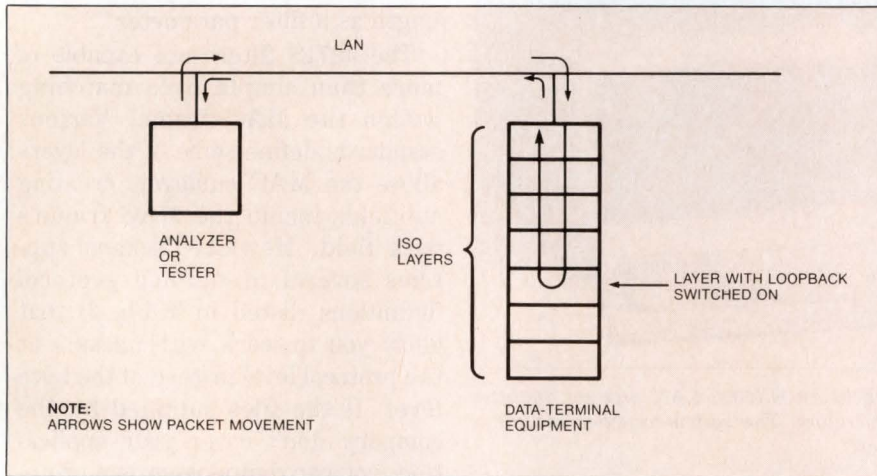

Fig 3—By using the loopback code in a DTE's software, as well as a packet generator, capture buffer, and time stamp on each received packet, a LAN protocol analyzer can sequentially exercise each protocol layer and determine the pass-through delay it exhibits.

For more information . . .

For more information on the LAN testers and analyzers discussed in this article, circle the appropriate numbers on the Information Retrieval Service card or contact the following manufacturers directly.

Cabletron Systems
Box 6257
Rochester, NH 03867
(603) 332-9400
TLX 988059
Circle No 710

Communication Machinery Corp
1421 State St
Santa Barbara, CA 93101
(805) 963-9471
TWX 910-334-3508
Circle No 711

Excelan
2180 Fortune Dr
San Jose, CA 95131
(408) 434-2300
TLX 176610
Circle No 712

Experdata Inc
10301 Toledo Ave S
Bloomington, MN 55437
(612) 831-2122
TLX 290992
Circle No 713

Experdata sa
14 Rue de Sully
92100 Boulogne-Billancourt, France
14 603 4854
Circle No 714

Hewlett-Packard Co
1820 Embarcadero Rd
Palo Alto, CA 94303
Phone local office
Circle No 715

Network General Corp
1296B Lawrence Station Rd
Sunnyvale, CA 94089
(408) 734-0464
Circle No 716

Rohde & Schwarz GmbH
Postfach 801469
D-8000 Munich 80
Federal Republic of Germany
(49 89) 4129
TLX 523703
Circle No 717

Article Interest Quotient
(Circle One)

High 503 Medium 504 Low 505



**The first LED pushbutton
that's as bright as an incandescent,
but doesn't burn out like one.**

Our AML pushbuttons, rockers, paddles and indicators have a new quad-chip LED that's at least twice as bright as ordinary LEDs. So it illuminates clearly in twice the ambient light.

It installs easily, uses a standard 5-volt power supply, comes in red, yellow or green, and like an incandescent lamp, lights an entire button face evenly.

But unlike incandescents, our LED resists shock and vibration. It operates on half the current. And, with a half-life of 100,000 hours or longer, it can outlast a half-dozen lamps.

You'll find even more bright features in the rest of our AML line, including keylocks, protective panel seals, switch guards, and solid state LED annunciators.

For more information, or the location of a sales office or authorized distributor near you, write MICRO SWITCH, Freeport, IL 61032. Or call 815-235-6600.

Together, we can find the answers.

MICRO SWITCH
a Honeywell Division

CIRCLE NO 38

SIEMENS

**Telecom components from Siemens...
tomorrow's ISDN devices for today's field trials.**

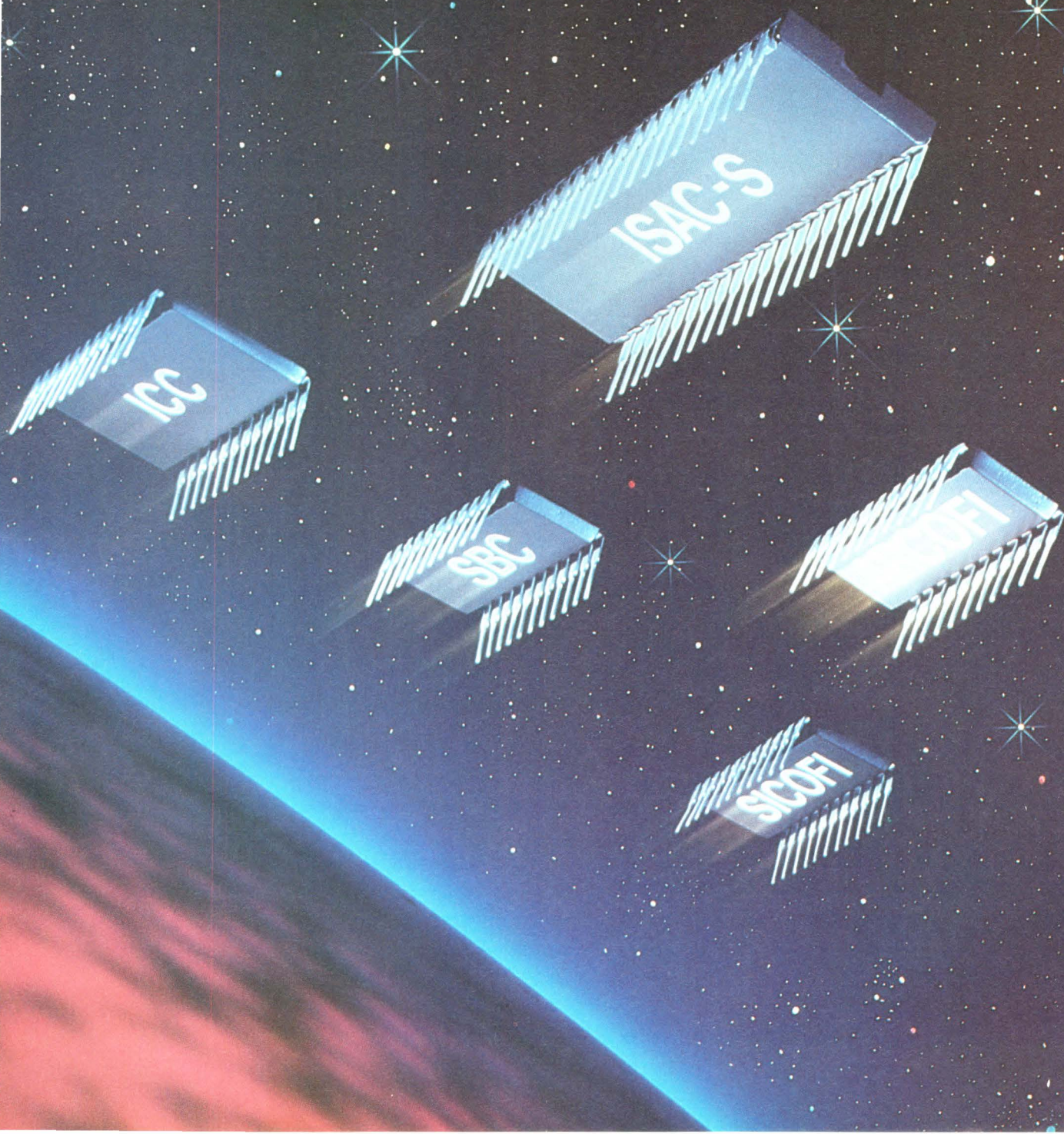

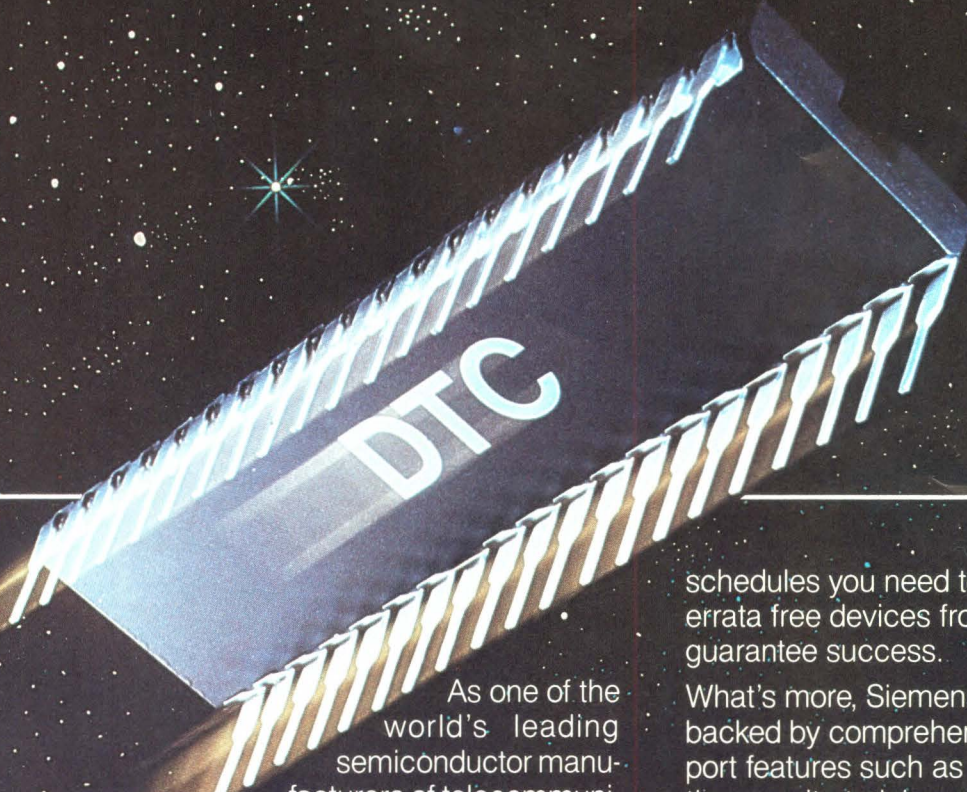

As one of the world's leading semiconductor manufacturers of telecommunication ICs, Siemens is the first to offer a complete range of world-class quality ISDN chips that allow quick access into the expanding ISDN market.

Benefit from complete "solutions for the future"...fully functional CCITT Standard "S" Interface ISDN devices that can do more, solve more, and perform better than incomplete imitations. If you have field trial

schedules you need to meet, go with the errata free devices from Siemens to guarantee success.

What's more, Siemens ISDN products are backed by comprehensive service and support features such as applications consultation, on-site training, demo boards, level 1 hardware drivers, LAPD level 2, and Call Control level 3 software, seminars and workshops, and a wide variety of technical literature. It's just what you'd expect from Siemens...your partner for the future.

For more information, call 408-980-4519. Or write to Siemens Components, Inc., Telecom Marketing Department, 2191 Laurelwood Road, Santa Clara, CA 94054.

Terminal Equipment

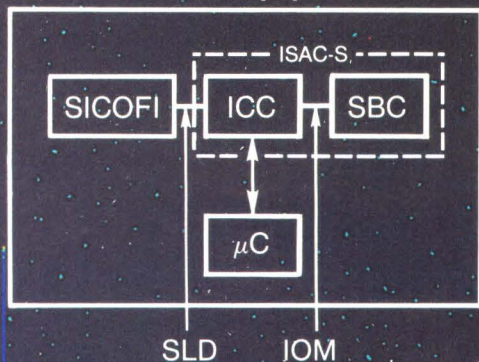

PABX

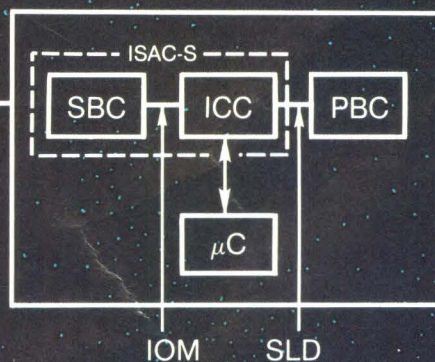

'S'



U.S. Distributors: Advent Electronics, Inc., Almo Electronics, Inc., Hall-Mark, Insight, Marshall, Quality Components and Western Microtechnology.

© 1987 Siemens Components, Inc.

CG/2000-400 WLM.554

Siemens...
your partner for the future.

CIRCLE NO 141

**New cell compilers can
make your ASIC design
really blossom,**



Thanks to Gould.

Introducing the revolutionary application-specific IC (ASIC) cell compiler, SCORE™.

With SCORE™, we create a new cell in one-tenth the time—usually less than a day. And that includes exhaustive design verification and full documentation. In short, you get a custom, proprietary circuit in little more time than a standard cell design—even with analog. Anyone can see the beauty in that.

SCORE™ generates cells a new way.

Typical cell compilers patch together pre-defined function blocks. The only way to customize performance is to stretch or connect gates in parallel. Not very efficient. SCORE™ configures cells from spatial and performance definitions. You customize by

simply changing cell definitions: propagation delay, load, cell height, function, functional options, feature size and process. SCORE™ “tunes” it to the rest of your circuit.

SCORE™ outputs geometrical mask data, a simulation model, a netlist for reverification, placement and routing frame data, and a data-sheet. The system also performs a design rule check and resimulation.

The bottom line? A true cell-based custom circuit. A layout virtually as tight as hand-drawn. And a lot of never-before-available time on your hands.

Bring your ideas into full flower at Gould.

To find out more about Gould and our cell compilers, call (408) 554-2311 and ask for the brochure, “ASIC Design: A Continuum of Alternatives.” Or write Gould Semiconductors, 3800 Homestead Road, Santa Clara, CA 95051. See if we don't grow on you.

Manufacturer of Gould AMI Semiconductors.



GOULD
Electronics

Three months

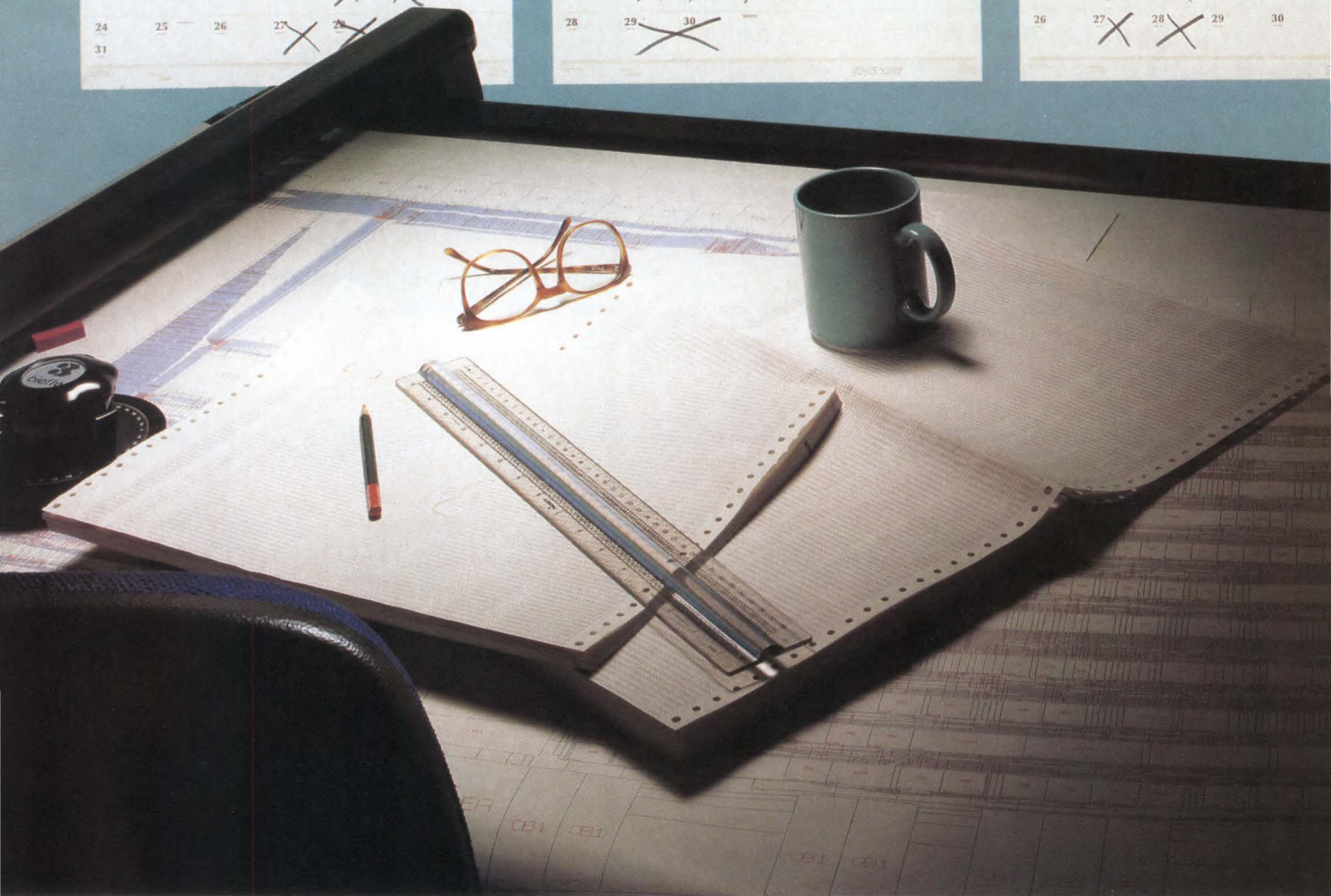
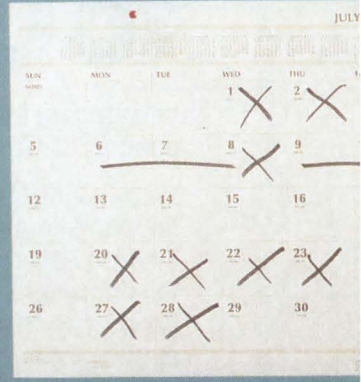
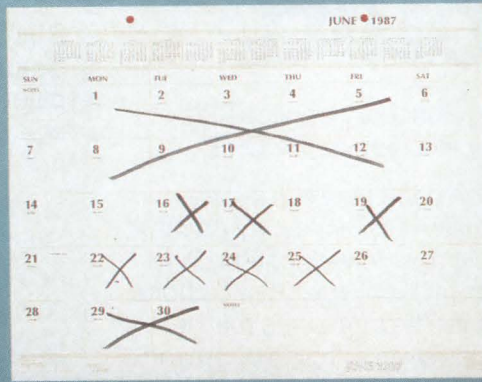
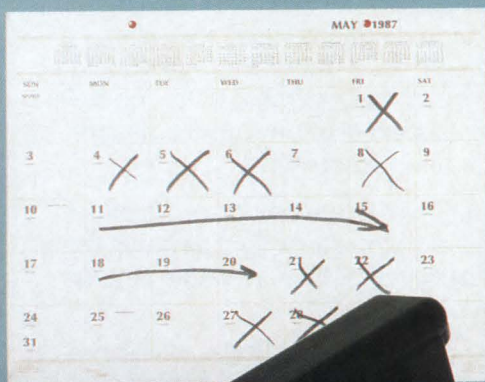

Compiled Cell Custom from S-MOS saves you valuable ASIC design time.

With S-MOS' new Compiled Cell Custom program, you can cut up to three months from your custom IC design cycle.

Simply by pressing three buttons.

C.C. Custom automates the design process by combining S-MOS' advanced LADS software with Tangent's Tancell®. The program allows you to create new designs based on standard

cells, our megacells, your megacells or any combination.

You can mix and match more than 300 standard macrocells simply by doing the schematic capture and simulation steps that you would do for a gate array.

The circuit is then laid out and routed automatically at our design center. The system is timing driven, so

new user-defined macrocells will match their simulations. The first time and every time.

With a full custom design, you typically have to wait half a year for the first chip samples. C.C. Custom can do it in 12-14 weeks with NRE charges normally associated with standard cells. Or about half what a full custom would cost.

So you get your products to market faster and more economically.

Since we produce our chips on the 1.5 micron line of our affiliate,

or three buttons.



Seiko Epson, you will also benefit from higher-speed operation and virtually nonexistent failure rates. Seiko Epson is one of the world's most automated and reliable CMOS manufacturers.

If you'd rather press three buttons than spend three additional months designing circuits, call us. (408) 922-0200.

S-MOS Systems
2460 North First Street
San Jose, CA 95131-1002

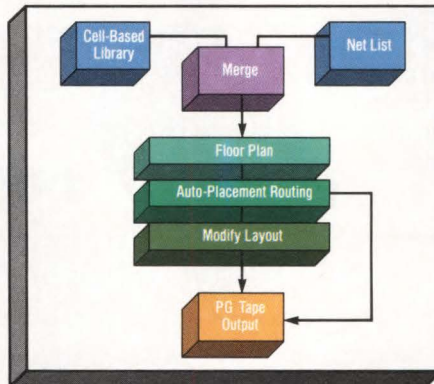

S-MOS
SYSTEMS
A Seiko Epson Venture

Tancell is a registered trademark of Tangent Systems.

Omron switches are slightly unconventional

Omron responds to your application needs by adding innovation to even the most basic switch. Automated assembly and 100% quality assurance are just the beginning of our attention to detail; we take pride in designing the "fine points" that distinguish an Omron switch from the others.

Internal Seals Reduce Soldering and Cleaning Time

Our internally-sealed DIP switches, basic switches and mechanical keyswitches are immersible for cleaning without a time-consuming taping operation. Sealed construction also prevents flux entry during automatic flow soldering. Designed for efficiency, our top-actuated DIP switches are also auto-insertable for quick assembly.

Advanced Computer Design Maximizes Performance

Omron's extensive line of pushbutton and lighted pushbutton switches are designed with the operator in mind. Using advanced computer techniques, we've designed a unique "triangle structure" actuator which provides constant force and ideal operating feel for maximum performance. Omron lighted pushbutton switches also feature uniform color illumination to add a quality appearance to your control panels.

Custom Options Accommodate Unique Applications

Omron's snap-action, miniature and subminiature basic switches are available in a wide variety of actuator types and contact configurations to meet your specifications. Switching capacities range from 0.1 to 21 amps, and sealed versions are available for direct soldering to PC boards. In addition, our new A3B lighted pushbutton switches provide water and oil resistance ideal for your machine tool and other harsh industrial applications.

Unconventional Switches for Exceptional Performance

Remember Omron when your switch application requires more than just standard performance. We'll work with you to develop solutions to your specific application problems, if we haven't developed one already. When it comes to photomicrosensors (optical), thumbwheel, basic snap action, keyswitches, DIP, or pushbutton switches, we don't mind being a little unconventional.

1-800-62-OMRON

OMRON[®]
Responsive Innovation

OMRON ELECTRONICS, INC.
One East Commerce Drive
Schaumburg, Illinois 60173

Circle Reader Service Number **54** for more information on Keyswitches, Pushbutton, Thumbwheel or DIP Switches.

Circle Reader Service Number **181** for more information on Basic Switches.

Take PLD/PROM Design Concepts To Programmed Results

(For PC Based PLD/PROM Programmer & Software Design Tools)

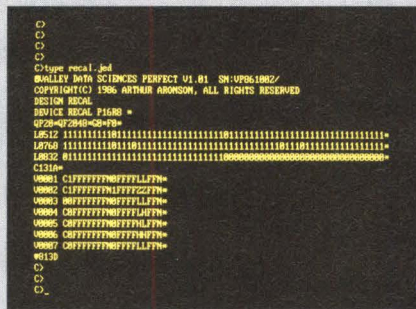
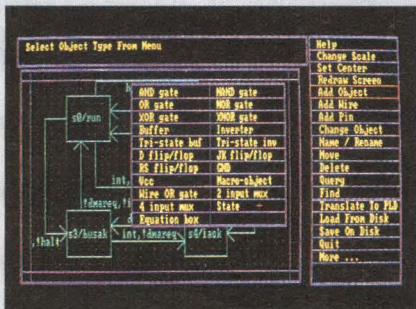

Vista

Graphic Design Software

Vista turns your PC into a Graphic Work Station for PLD design using your preferred choice of Gate Level Schematic entry, State Machine Diagrams, or Boolean Equations.

Vista reduces the likelihood of errors that may occur during the design input process. You can mix State Machine, Gate Level Schematic, and Boolean Equations in the same design. Then pass this information to the VDS Perfect compiler.

Perfect

Compiler/Minimizer/
Simulator

Perfect accepts input from text files containing State Machine Syntax, Truth Table, Vista Net-List, or Boolean Equations. After compiling and minimizing, it outputs JEDEC Fuse Files, Net-Lists, and other support documentation.

Other powerful features include: Timing Simulation, and Back Annotation - from JEDEC Fuse Files to Boolean Equations.

VDS160

Logic & Memory
Programmer

PLD and PROM Programming from the original software controlled PROM programmer manufacturer. The **VDS160** menu-driven programming software presents an easy-to-learn interface for the user.

Features include: Concurrent Operation of VDS160 and PC programs, Pop-Up Menus, Editor for Fuse/Data Files. New Device Support is easily accomplished via floppy diskette updates.

ValleyDataSciences

2426 Charleston Rd. Mt. View, CA 94043/(415) 968-2900

Germany (Macrotron) 89-4208100 France (Tekelec) 1-4547535 Sweden (Aktiv) 8-7390045 Denmark (C-88) 2-244888
England (DataTranslation) 734-793838 S.A. (Promilect Pty) 11-789-1400

And they're available now, to help your designs reach new peaks in performance.

Choose from a complete range of Sony 256K SRAMs, available in numerous speeds and data retention currents, in either DIP or SOP packaging.

For super-low data retention current, consider our CXK58256P-10LL/12LL, with just 10 μ A data retention current. Or our soon to be released CXK58255P-45/55/70 at 5 μ A, and CXK58255P-45L/55L/70L at just 2.5 μ A.

SONY SRAM DEVICES			
PART NUMBER	ORGANIZATION	SPEED (ns)	PACKAGE
CXK5814P—35L/45L/55L	2K x 8	35/45/55	300 mil DIP
CXK5816PN—10L/12L	2K x 8	100/120	600 mil DIP
CXK5816M—10L/12L	2K x 8	100/120	SOP*
CXK5416P—35L/45L/55L	4K x 4	35/45/55	300 mil DIP
CXK5864AP—70L/10L	8K x 8	70/100	600 mil DIP
CXK5864AM—70L/10L	8K x 8	70/100	SOP*
CXK5864PN—12L/15L	8K x 8	120/150	600 mil DIP
CXK5864M—12L/15L	8K x 8	120/150	SOP*
CXK5464P—45L/55L/70L	16K x 4	45/55/70	300 mil DIP

*Small Outline Package

No matter which SRAMs you choose, you also benefit from our immediate delivery. Plus the quality, reliability and performance found in all Sony products.

By calling today, you'll get all the details—plus a free data

book on our complete line of Sony SRAMs.

So call (213) 373-9425, or

PERFORMANCE OF 32K X 8 SRAM						
PART NUMBER	PROCESS	SPEED (ns)	PACKAGE	DATA RETENTION		
				CURRENT (MAX)	CONDITION	
CXK58256P—10L/12L	MIX MOS	100/120	600 mil DIP	50 μ A	0 to 70°C	
CXK58256MF—10L/12L	MIX MOS	100/120	SOP	50 μ A	0 to 70°C	
CXK58256P—10LL/12LL	MIX MOS	100/120	600 mil DIP	10 μ A	0 to 70°C	
CXK58255P—45/55/70	FULL CMOS	45/55/70	600 mil DIP	5 μ A	-30 to 85°C	
CXK58255P—45L/55L/70L	FULL CMOS	45/55/70	600 mil DIP	2.5 μ A	-30 to 85°C	

Sony's 256K SRAMs are taking current retention to a new low.

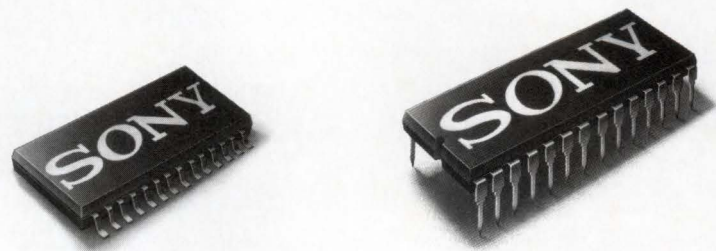

write Sony Corporation of America, Component Products Division, 23430 Hawthorne Blvd., Suite 330, Torrance, CA 90505.

Sony SRAMs. Setting higher performance standards with lower data retention current.

SONY®

Cost, device speed, size, and reliability determine the best package for an ASIC

Eva Freeman, *Associate Editor*

When you order an application-specific IC (ASIC) from a foundry, the foundry does everything but specify the design and select the chip package. Yet the latter is no idle task; choosing the best ASIC package requires some research on your part. The familiar, widely used plastic dual in-line package (DIP), for example—a package you might once have chosen without giving the matter much thought—slows signal transmission, requires considerable pc-board area, decreases reliability, and can even cost more than other ASIC packages.

The deficiencies of DIPs have led ASIC vendors to offer other packages: leaded and leadless chip carriers, pin-grid arrays (PGAs), small-outline packages, and flat packs. All foundries offer essentially the same set of packages. Choosing an ASIC foundry and selecting an ASIC package are, therefore, separate tasks.

The package, not the vendor

ASICs are custom products, so foundries calculate the price of each ASIC order, including the packages, individually. Shopping for a vendor that delivers quality ASICs for a low price can hold down expenses, but the package you choose affects the total cost of an ASIC more than your choice of foundry.

The price of a particular package type varies little from foundry to foundry, but prices for different types of package cover a wide range. For example, a leadless ceramic chip carrier costs about eight times as much as a plastic leaded chip carrier (PLCC). Furthermore, you can often avoid using an expen-



Pin-grid arrays provide more leads than any other package. VLSI Technology offers 84- to 149-pin packages in its plastic PGA product line; the company's ceramic PGAs are available in 68- to 224-pin versions.

sive ASIC package simply by approaching the design of your chip with greater care and partitioning it into sections that will fit into distinct packages (see **box**, "Partition your design to reduce packaging costs").

Before you jump into a detailed evaluation of your ASIC and its packaging requirements, however, take a careful look once again at the plastic DIP. If you can use one, you should. Plastic DIPs are inexpensive (1¢ to 3¢ per lead), easy to insert into pc boards, and easy to solder. The 0.1-in. spacing between leads in a DIP leaves plenty of room for interconnections on a pc board.

Yet despite the convenience and low cost, plastic DIPs don't work in every application. You can't use a plastic DIP if you need high reliabili-

ty, fast heat dissipation, a surface-mount design, a small package, or a low package profile.

When it comes to conserving pc-board surface area, small-outline packages are a good choice. These packages have an 0.05-in. pin spacing, a pitch that's half that of standard DIPs. Small-outline packages that have eight to 16 pins are 0.16 in. wide; small-outline packages with as many as 28 pins are 0.3 in. wide. DIPs are usually twice as wide as small-outline packages with the same number of pins.

You can use small-outline packages in surface-mount applications. The packages have gull-wing leads, which extend out from a package. The short leads of the small-outline package make it one of the most rugged packages.

The new VMPM68KC combines 32-Bit VMEbus computing performance with the SingleHeightEurocard for more compact and reliable systems in your industrial applications. Its clever architecture ensures uncompromised through-

put via full 32-Bit memory access.

With our VMPM68KC top of the line product, **PEP Modular Computers** provides you with the choice of 8-, 16-, or 32-Bit computing power, all on single height card format.

If your aim is high, examine the features:

- MC68020 CPU and MC68881 FPCP with 12.5 or 16.7 MHz
- 1 MByte zero wait state SRAM, dual ported

- Four 32-pin sockets for up to 512 KByte ROM

- Full 32-bit memory organization

- Two serial interfaces, each configurable as RS422/RS232/20mA

- Complete VMEbus system controller

- Supported by OS-9/68020*

*)Trademark of Microware Inc., USA

Ask how PEP can put you where you want to be.



**Powerfull 32 Bits
on Single Height Format**

The Compact 32-Bit Solution on VME

PEP Modular Computers®

Japan
Osaka
Tel. (6) 8 76-06 15

USA
Pittsburgh
Tel. (412) 2 79 66 61

Germany
Kaufbeuren
Tel. (83 41) 89 74

France
Paris
Tel. (1) 45 34 60 60

UK
High Wycombe
Tel. (62 85) 2 92 22

Sweden
Stockholm
Tel. (8) 7 56 72 60

Please call us tollfree: 1-800-228-1737 (outside PA), 1-800-255-1737 (inside PA).

CIRCLE NO 134

TECHNOLOGY UPDATE

Small-outline packages can help you shrink the size of a pc board, but only if your chips have modest I/O requirements. The packages are available only in 8- to 28-pin versions. And for the many ASIC designs that require more than 40 pins, DIPs aren't the best solution, either. For a given increase in the number of pins, a DIP increases in size by an even greater percentage; a DIP with more than 40 pins is thus a very large package. A 48-pin DIP has a width of 0.6 in., so the package requires a board area of 1.4 in². The width of a 64-pin DIP is 0.9 in., which gives the package an area close to 3 in². As Fig 1 shows, other packages require much less board area than large DIPs.

Besides using too much pc-board area, large DIPs have long internal interconnections. These intercon-

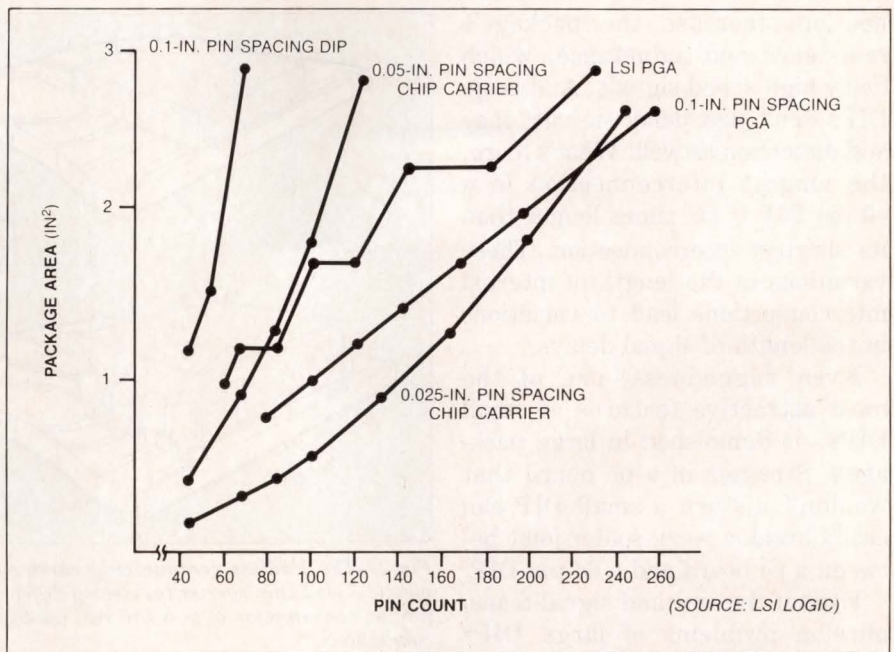

Fig 1—The size of a pc board depends largely on the size of the chip packages. If you switch from a 64-pin DIP to a 68-pin leaded chip carrier, for example, you can reduce the size of your package by two-thirds.

Partition your design to reduce packaging costs

When it comes time to package your ASIC design, don't be hamstrung by the idea that more packages mean higher cost. A 100-lead, plastic PGA, for example, costs more than two 68-pin PLCCs. Consequently, if you can partition your design to fit into two chip carriers, you'll spend less on packaging than if you use one PGA.

By partitioning a design that requires ceramic packaging, you can cut package costs considerably. Instead of placing the entire circuit into a ceramic package, look for sections that can function in a plastic package. If you move part of your design into a plastic package, you can choose a smaller, and therefore less expensive, ceramic package for the rest of the design.

To partition a design effectively, you must analyze all costs. A recent study of a 2300-gate, 125-pin gate array (Ref 1) showed that a single-package approach cost 2.3 times as much as a 2-package system. Partitioning the design reduced both the silicon costs and the package costs.

Don't take partitioning too far

You can, of course, partition a design beyond the point of utility. The use of three packages for the 2300-gate array resulted in a 14% cost increase over the 2-package approach. The 3-package configuration used less expensive packages and less ex-

pensive silicon dies than the 2-package implementation, but the sheer number of packages in the 3-package design outweighed the benefit of the smaller size of those packages.

To partition an ASIC circuit, you can use the same techniques that you use to partition a PLD circuit. For example, FutureNet's (Chatsworth, CA) Semicustom Development System software can divide a circuit into several PLDs or into several gate arrays (Ref 2). Using this logic-partitioning package, you can implement your design in various ways and find the most cost-effective solution.

An analysis of design costs is incomplete unless you assess the whole effect of partitioning a circuit. When you partition a chip, you increase the part count, which increases assembly costs. You also increase the amount of space you need on the pc board. The change in design may disrupt critical timing paths. Even so, if you can partition a large design, you can cut your ASIC costs in half.

References

1. Johnson, Dean P, and Jim Lipman, "IC packaging: An introduction for the VLSI designer," *VLSI Systems Design*, June 1986, pg 108.
2. Shear, David, "Tools help you retain the advantages of using breadboards in gate-array design," *EDN*, March 18, 1987, pg 81.

TECHNOLOGY UPDATE

nections increase the package's resistance and inductance, which delay high-speed signals. And large DIPs don't just delay signals; they add distortion as well. What's more, the longest interconnection in a 40-pin DIP is six times longer than its shortest interconnection. These variations in the length of internal interconnections lead to variations in the length of signal delays.

Even ruggedness—one of the most attractive features of small DIPs—is diminished in large packages. Stresses in a pc board that wouldn't disturb a small DIP can easily break a weak solder joint between a pc board and a 64-pin DIP.

Even if the size and signal-transmission problems of large DIPs don't deter you, you still can't use a DIP for very large ASICs. The largest DIP that you can buy from an ASIC vendor is a 64-pin package.

Into chip-carrier range

Like most ASIC vendors, VLSI Technology (San Jose, CA) recommends that you use DIPs only for designs that have 40 or fewer pins. If your design requires 44 to 84 pins, the company advises that you use a chip carrier.

A chip carrier has conductors that extend from the die cavity to the periphery of the package. All chip carriers are surface-mount components. Chip carriers can be leaded or leadless.

In a leadless chip carrier, the conductors extend from the silicon die just to the edges of the package. The absence of long leads reduces the capacitance of the package, but also prevents you from inspecting solder connections to a pc board.

Because they lack metal leads, leadless chip carriers form a rigid connection with the pc board. Any incompatibility between the thermal-expansion coefficient of a package and the pc board that the package is mounted on can cause the package to separate from the board.

You can mount only the smallest size of leadless ceramic chip carrier

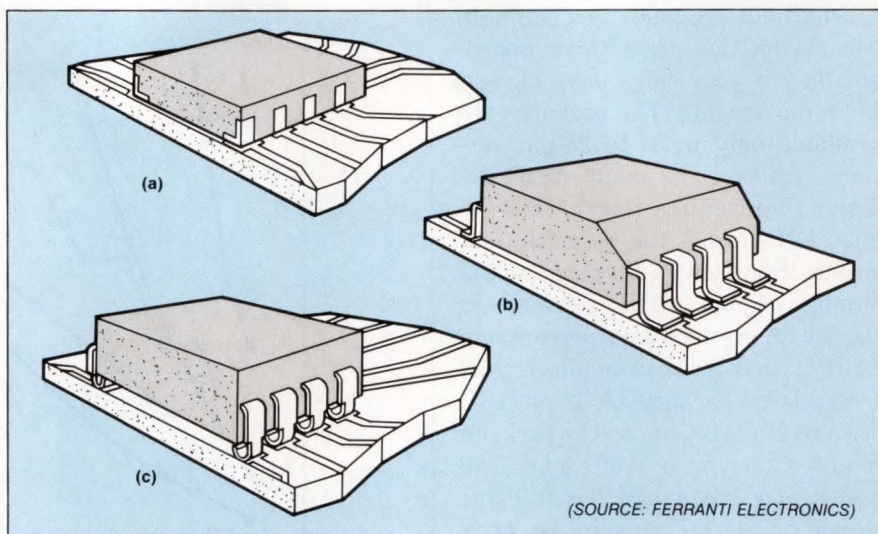

Fig 2—The leadless ceramic chip carrier (a), small-outline gull-wing package (b), and plastic J-lead chip carrier (c) clearly differ in the degree to which they emphasize pc-board profile, consumption of pc-board real estate, and the ease with which you can inspect solder connections.

on a conventional epoxy pc board. For larger leadless ceramic chip carriers, you must use a ceramic pc board. ASIC foundries don't offer plastic leadless chip carriers; no pc-board substrate matches the thermal-expansion characteristics of a plastic package.

The springiness of its metal leads gives a leaded chip carrier more compliance than a leadless chip carrier. Leaded chip carriers have leads shaped like the letter J, with the leads tucking under the package.

The J leads of leaded chip carriers and the gull-wing leads on small-outline packages have their respective advantages. On the one hand, J leads consume less board area than gull-wing leads. On the other hand, you can inspect solder connections on a gull-wing package easily, while the solder joints on a J-lead chip carrier are difficult to see. (Fig 2's diagrams compare the appearance of leadless, J-lead, and gull-wing packages.)

Because J leads can flex with a pc board, you can mount a J-lead package on any type of pc board, including epoxy, ceramic, and polyimide pc boards. You can also mount these packages in sockets.

ASIC foundries offer leaded chip

carriers both in ceramic and in plastic form. Each of these materials has its particular advantages (see **box**, "Ceramics vs plastics: Not an automatic choice").

A leaded chip carrier's leads don't need to be long, because the package needs to make contact only with the surface of the board. DIPs, which you must mount through a pc board, have longer leads than those of a leaded chip carrier. The latter's leads therefore add less capacitance than the pins of a DIP. A 48-pin DIP, for example, specs a capacitance of 2 pF; the capacitance of a 48-pin leaded chip carrier is 0.25 pF. Similarly, the capacitances of 64-pin DIPs and leaded chip carriers are 4 and 0.3 pF, respectively (Ref 1).

Leaded chip carriers don't solve every packaging problem. To solder a leaded chip carrier to a pc board, for example, you must ensure that the J leads are coplanar. If the leads aren't coplanar, the short leads won't contact the board.

Unlike leaded chip carriers, flat packs always form good contacts to pc boards. The leads in a flat pack extend straight out from the package, so you can make sure that all leads contact the pc board. Furthermore, you can see and repair any

Ceramics vs plastics: Not an automatic choice

Ceramic packages typically cost five to ten times as much as comparable plastic packages. You should therefore select plastic packages whenever possible (although many applications require the ceramic alternative). When it comes to encapsulating your prototypes, however, ceramic packages actually cost less than plastic ones, principally because it's easier to deliver small lots of parts encased in them.

For prototypes, the expense of the package is less important than fast turnaround time. An ASIC foundry can mount a prototype in a ceramic package manually and deliver it within a couple hours of your order. If you order a plastic package for your prototype, the foundry must set up an assembly line and then run the prototype through it—a procedure that can take several weeks. You should therefore choose ceramic packages for your prototypes even if you use plastic packages for your production models.

Ceramic packages are more reliable than plastic packages. VLSI Technology's package-engineering manager, Dean Johnson, notes that, although reliability is always important, it's less critical for production devices than for prototypes; you're checking the latter for design flaws, not production-type defects. "If you aren't sure that you have designed your prototype correctly," says Johnson, "you shouldn't have to worry about problems with the molding compound or molding temperature. The leads in ceramic packages also improve device reliability. Ceramic packages have gold-plated leads; plastic packages have tin- or solder-plated pins."

Ceramics satisfy reliability specs

Once you approve your prototype and start your production runs, you may switch to a plastic package. Even for production quantities, though, many applications require ceramic cases. Two characteristics of ceramics are superior to plastics: heat dissipation and chemical stability. The faster heat dissipation of ceramics enhances the reliability of ceramic ASIC packages. The chemical stability lets you use ceramics in contamination-sensitive applications.

Military contracts usually require ceramic packages. The government requires not only that ASICs operate in the -55 to $+125^{\circ}\text{C}$ temperature range, but also that they tolerate multiple cycles of temperature. Naturally, a package that specs a low thermal resistance can survive temperature cycles better than one that has a high thermal resistance.

TABLE A—TYPICAL THERMAL RESISTANCES

PACKAGE TYPE	θ_{JC} ($^{\circ}\text{C}/\text{W}$)	θ_{JA} STILL AIR ($^{\circ}\text{C}/\text{W}$)	θ_{JA} 300 FT/MIN ($^{\circ}\text{C}/\text{W}$)
16-LEAD DIP—CERAMIC	28	95	
—PLASTIC		150	
24-LEAD DIP—CERAMIC	16	45 TO 60	30 TO 40
—PLASTIC	50	110 TO 130	
40-LEAD DIP—CERAMIC		45 TO 50	25 TO 30
—PLASTIC	45	110 TO 125	
68-LEAD CHIP CARRIER WITH HEAT SINK	5	50	35 10 TO 20
68-LEAD CHIP CARRIER —CERAMIC			
IN SOCKET WITH HEAT SINK/SOCKET		40 25 TO 30	30 10 TO 25
68-LEAD CHIP CARRIER —PLASTIC			
IN SOCKET SURFACE MOUNT		45 43	
PIN GRID (CAVITY UP) CERAMIC 64 TO 100 PINS (10×10 GRID)		30 TO 35	20 TO 23
PLASTIC		30 TO 35	20 TO 25

NOTE: DIE SIZE IS 200 MIL² UNLESS LIMITED BY CAVITY SIZE.

LSI Logic has taken measurements that show, for a 24-pin DIP, that the thermal resistance between the encapsulated device and its plastic case is $50^{\circ}\text{C}/\text{W}$ (Table A). For a ceramic DIP, the thermal resistance is $16^{\circ}\text{C}/\text{W}$ —an improvement in thermal resistance by more than a factor of three.

Chemical stability for many environments

The figures for the thermal resistance between an encapsulated IC and still air aren't quite as impressive as the figures for device-case thermal resistance. Still, the thermal resistance between a device inside a plastic DIP and still air is twice that of a ceramic DIP in the same environment.

Most nonmilitary ASIC applications don't have such stringent thermal specifications. But the chemical stability of ceramics is vital for systems that can't tolerate contaminants. Indeed, chemical stability is the reason why Gary Kelson, chief technical officer of Silicon Systems (Tustin, CA), recommends ceramics to many of his customers.

"We have customers who build hard-disk drives," he says. "Plastic packages emit organic vapors and shed flakes. Any residue is fatal to the operation of a hard-disk drive. Fortunately, ceramic packages are stable enough even for hard-disk drives."

TECHNOLOGY UPDATE

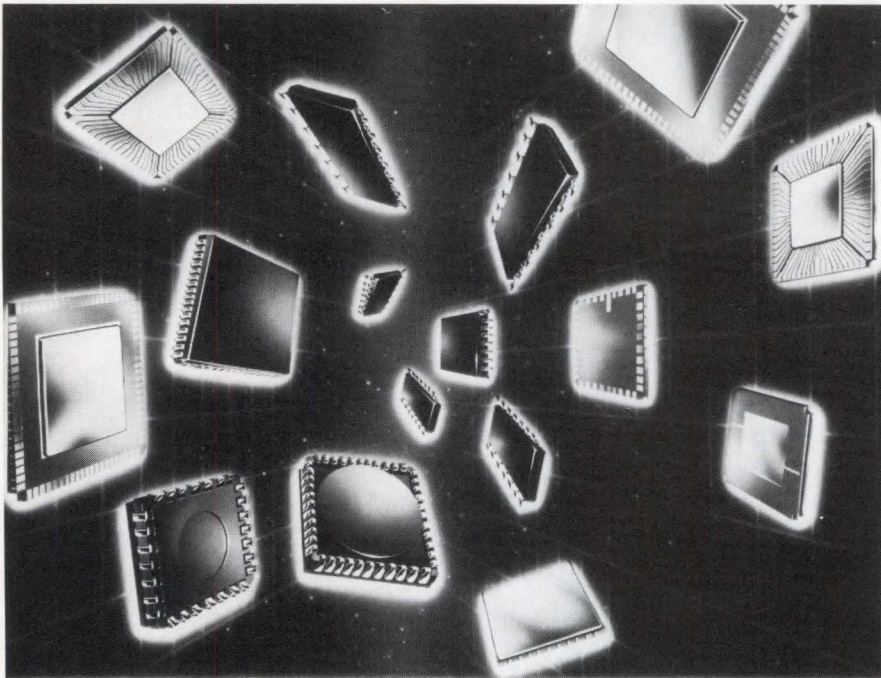

The constellation of packages for surface-mount ASICs includes leaded and leadless chip carriers, flat packs, and small-outline packages. Most ASIC vendors offer all of these packages. (Photo courtesy Ferranti Electronics)

broken connections. You must handle the leads with care, however; they break easily.

Flat packs are ideal for low-profile pc boards. They spec a 2-mm thickness, which makes them the thinnest of all chip packages. Yet even though they're so thin, they aren't the most compact way you can package an ASIC. For products that must fit into very small areas, you should use chip-on-board technology and forgo the package entirely.

The chip-on-board approach eliminates all problems traceable to the size and cost of packages because it eliminates the package itself. This approach is the least expensive packaging alternative. Instead of mounting your ASICs in packages, you simply use bare chips. To build a chip-on-board circuit, you bond ASICs to the metal traces on a pc board. You then cover the chips with epoxy, which holds the chip in place.

You can't replace an IC or repair a contact in a chip-on-board circuit, because you can't remove the epoxy. As a consequence, most chip-on-board circuits are in inexpensive

consumer products, which contain throwaway pc boards. Typical of the applications of chip-on-board technology are watches and calculators.

The chip-on-board approach is not really viable unless you have an automated pc-board assembly system. Robots can attach a chip to a pc board with the consistency you'll need to ensure a high yield of parts with good contacts. You'll often find that the cost savings of chip-on-board circuits offset the expense of automated assembly.

PGAs for high pin count

You can't choose your packaging technology if your ASIC's pin count reaches three digits; you must use PGAs. The highest pin count for a chip carrier, for example, is 84 pins. Other package types provide even lower maximum pin counts. A 68- or 84-pin PGA costs about twice as much as a chip carrier with the same pin count, but if your design requires more than 84 pins, and you can't feasibly partition it, you must bear the added cost.

A PGA's pin count has essentially no limit. These packages contain

tiny pc boards and one chip. Unlike all other packages, which have leads along their perimeters, a PGA has leads in rows under itself. Standard PGAs have as many as 224 leads. Custom PGAs can have close to 1000 pins. You can choose either plastic or ceramic PGAs. The ceramic versions cost about three times as much as plastic ones.

Right now, you can't mount a PGA on the surface of a pc board. The leads are long pins, which you must mount in holes in the pc board. Conceivably, however, by bending a PGA's pin, you can turn the pin into a J lead. Chip vendors are currently developing a J-lead PGA, which would mount on a pc-board surface. You may expect to see such packages by the end of the year.

Along with surface-mount PGAs, semiconductor manufacturers are developing inexpensive chip-bonding techniques and packages for high-speed devices. No new package will be as ubiquitous as the DIP, but the choice of packages should become broad enough to let you meet all system requirements. **EDN**

Reference

1. Booth, Willard, *VLSI-Era IC Packaging*, Electronic Trend Publications, Saratoga, CA 1987. \$1500.

Article Interest Quotient
(Circle One)
High 500 Medium 501 Low 502

Is your semicustom design
often treated like . . .

**JUST
ANOTHER
GOOD
MYSTERY?**

WHEN IT COULD GREAT SUCCESS

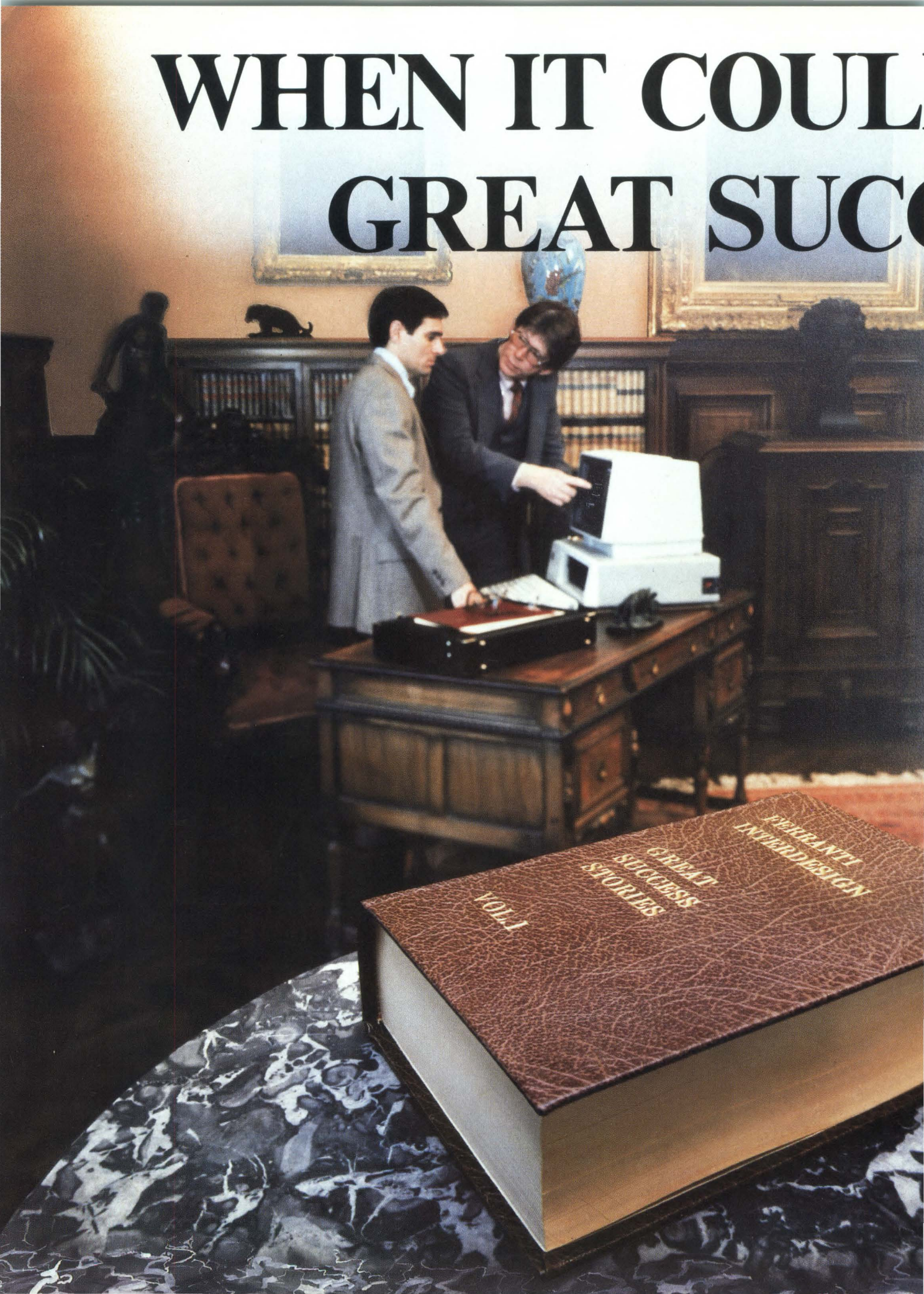

PARALENTI
IN PARADISICIN
GREAT
SUCCESS
STORIES
VOL. I

D BE ANOTHER CESS STORY

Ferranti Interdesign— the industry leader

Since 1972 when Interdesign introduced the world's first semicustom IC array for integrating linear circuits onto silicon, we have continued to provide the highest-quality, highest-performance semicustom linear, digital and digital/linear combination integrated circuits in the industry.

With an impeccable track record of over 5,000 successful integrations, Ferranti Interdesign has proven that our *easy-to-use* CAD-supported approach to semicustom circuit design can be both pleasurable and profitable—stripping away the mystique surrounding semicustom while turning *your* design into another in our long line of great success stories.

Continuing support—from design through production.

Ferranti Interdesign's total commitment to quality, military screening, advanced CAD systems, extensive engineering support and design aids are your assurance that at every stage of the program we will support you in achieving your goals of cost-reduction, space-reduction, power-reduction and design security while maintaining your competitive edge.

The industry's broadest selection of ASIC's.

Ferranti Interdesign offers the industry's broadest selection of semicustom integrated circuits and technologies for both linear and digital applications, in either bipolar or CMOS technologies. In addition we also offer the most advanced high-performance digital/linear combination circuits available. The growing need to manipulate larger amounts of data is making these high-speed, low-power ASIC's increasingly popular.

Full CAD support.

As a sophisticated designer of analog and digital circuits you know the importance of high-quality, CAD-

supported design tools. Ferranti Interdesign provides the designer with a variety of user-friendly design system options for both analog and digital circuits. With the customer always clearly in mind, Ferranti Interdesign's CAD is dedicated to the use of *proven* commercially available hardware and software, such as: the Mentor™, Sun™ or Apollo® Workstations, VAX™-based workstation, IBM AT/XT®, Analog Workbench™, FutureNet®, or PSpice™.

So, when it comes to *your* design, don't let it become just another good mystery, call Ferranti Interdesign today and get your name in our latest volume of great success stories.

For more information about Ferranti Interdesign and our quality products, please call us at (408) 438-2900.



FERRANTI Ferranti Interdesign Inc

Sequoia Research Park
1500 Green Hills Road
Scotts Valley, CA 95066

CIRCLE NO 100

Mentor is a trademark of the Mentor Graphics Corp., Sun is a trademark of Sun Microsystems, Inc., Apollo is a registered trademark of Apollo Computers, Inc., VAX is a trademark of the Digital Equipment Corp., IBM, AT & XT are registered trademarks of the IBM Corp., Analog Workbench is a trademark of Analog Design Tools, Inc., FutureNet is a registered trademark of FutureNet Corp., PSpice is a trademark of the MicroSim Corp.

***ATE was never intended to.
Instrument clusters can't.***

One way to verify an ASIC prototype's functionality is on an ATE system. But it's like using a sledge hammer to pound in a thumbtack.

Then again, there's the instrument cluster. Which is like assembling an entire watch just to check the time.

Either way, ASIC verification has been neither fast nor simple.

So we built the Logic Master Series, the first system designed specifically for the purpose of ASIC prototype verification.

The Logic Master avoids the pitfalls of ATE by presenting you with a simple, interactive interface instead of an arcane, batch-oriented programming language.



**The Logic Master.
A true ASIC verification system.**

It also eliminates both the design labor and performance uncertainty associated with instrument clusters. To guarantee maximum system-level accuracy, the Logic Master integrates an entire ASIC verification tool set into a single architecture:

Fixturing. Pattern generation. Data acquisition. Real-time compare. Even DC parametric measurements.

All in a host-independent package that's compatible with any logic simulator. And fits design engineering budgets, too.

Contact us for literature, information on our verification solutions seminar, or demo. If you've got an ASIC, we've got the verification solution you've been waiting for.



IMS

INTEGRATED MEASUREMENT SYSTEMS,™ INC.
9525 S.W. Gemini Drive • Beaverton, Oregon 97005 • (503) 626-7117

CIRCLE NO 106

IT'S A JUNGLE IN THERE.

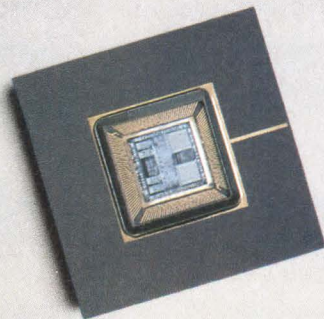

Designing chips is like charting the unknown. You're better off with an experienced guide.

Like LSI Logic.

Our advanced ASIC approach gets you where you're going as easily as board level or TTL. But it lets you put so much logic into so little space, you may never want to rely on standard parts again.

It's simpler than you might expect, too, because our ASIC designs mean fewer components.

And fewer components mean fewer bugs.

And smaller footprints.

And smaller manufacturing costs.

But the best news is how fast we get you out of the jungle and into the silicon.

With software that will guide your designs into production the same way it has already guided more than 3000 others: with a 100 percent hit rate. Guaranteed.

In as little as ten days.

Go from 500 to 129,000 available gates. On your own PC, workstation, mainframe or at any of our 30 design centers worldwide.

Where you'll get all the help you need to go from the drawing board to the assembly line.

You'll also get the optimum ASIC for the job, because you always have the optimum choice. From Gate Arrays, Compacted Arrays™ and Structured Arrays™ to Standard and Structured Cells™—the broadest product line in ASIC. All created with the same proven design methodology. And all processed in HCMOS technology.

Write to LSI Logic, 1551 McCarthy Blvd., MS D105, Milpitas, CA 95035 for your ASIC Starter Kit.

So the next time you have to trek across a blank CAD/CAM screen, you can do it with an experienced guide.

To the path of least resistance.

LSI LOGIC



Experience Counts.

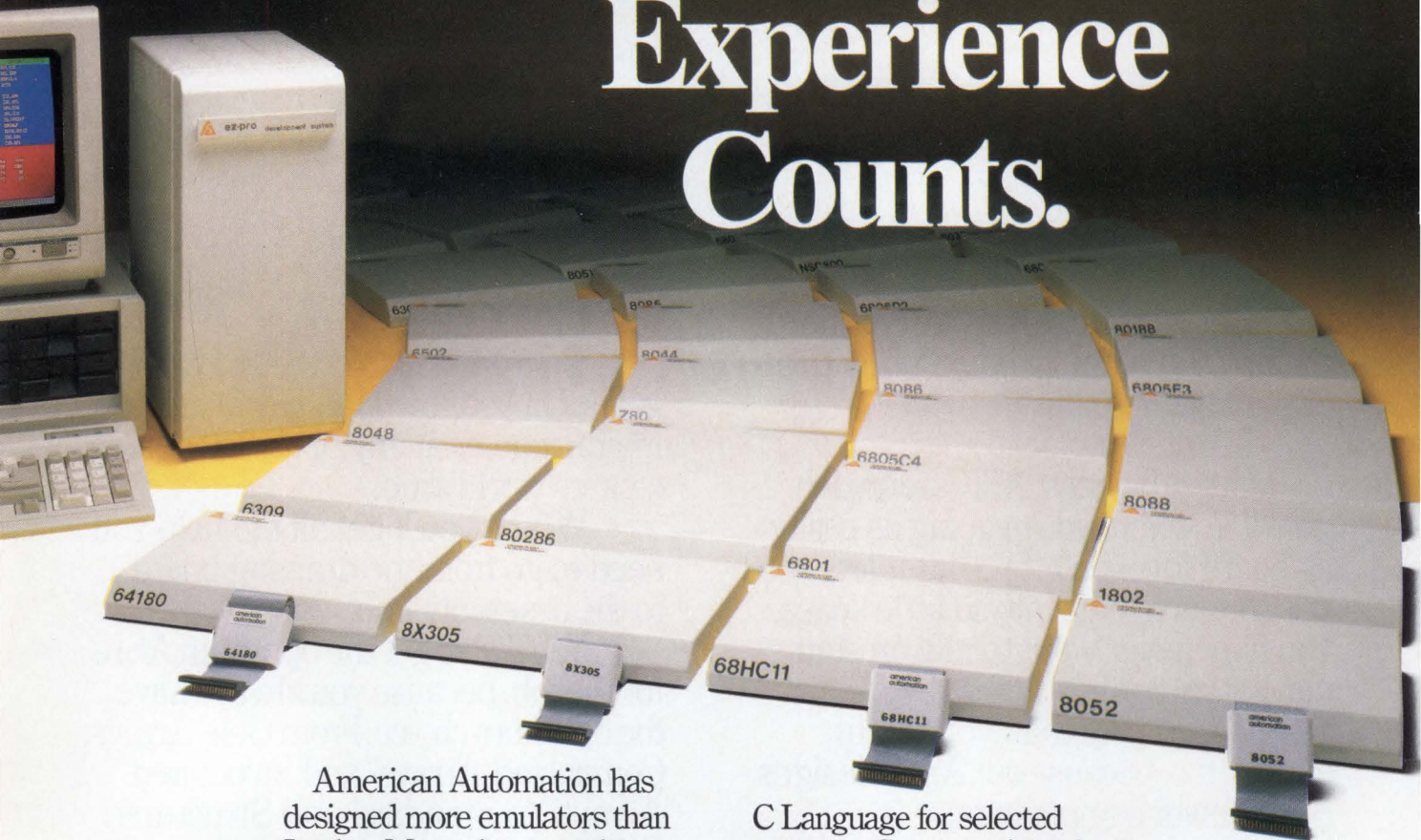

American Automation has designed more emulators than Intel or Motorola, more than Hewlett Packard or Tektronix, more than anyone. Count on American Automation's emulator experience.

For each EZ-PRO emulator, American Automation provides complete software support: macro cross-assembler, linker, symbolic debugger.

C Language for selected processors. Count on American Automation software.

Count on EZ-PRO from American Automation for the features you need for your projects, including Deep Trace™ 4,096 real-time events, 256 break-points with zoning, complex triggering, on-line assembly/disassembly.

EZ-PRO 2.1* SUPPORTS:

Intel:	8031 8032 8035 8039 8044 8048 8049 8050 8051 8052 8085A/A-2 8086 8088 80186 80188 80286	Motorola:	6800/B00 6801 6802/B02 146805E2 6803 6808 68B08 6809/09E 68B09/B09E 68HC11-A8 68000 68008 68010	Hitachi:	6301 6303 6309E 64180	Rockwell:	6502 6503 6504 6505 6506 6507 6512 6513 6514 6515
Harris:	80C86 80C88	NEC:	V20 V30	RCA:	1802 1805 1806 CDP6805C4 CDP6805D2 CDP6805E3	Signetics:	8X300 8X305
				Zilog:	Z80A Z80B Z80H Z8001 Z8002	National:	NSC800

...AND MORE.

*Connected to PC with MSDOS 3.1

american automation 

2651 Dow Avenue, Tustin, California 92680 (714) 731-1661
Telex II: 910-595-2670 AMAUTO TSTN

IBM is a trademark of International Business Machines, Inc.

Ubiquitous conductive-rubber switches adapt to fit your application and budget

Margery S Conner,
Regional Editor

Versatile and inexpensive, conductive-rubber switches are one of the most commonly used switch types: Their applications range from VCR control panels to military electronics. To specify the switch you need, you'll have to determine four parameters: tactile response, stroke length, contact resistance, and actuation force.

Two kinds of conductive-rubber switches are available: all-conducting and rubber-domed. The rubber-domed types are sold as part of an integrated custom keypad or keyboard, whereas the all-conducting types are sold as individual switches, which you then configure to your particular application.

Solution for a tight fit

Each all-conducting switch consists of an individual unit resembling a tiny hockey puck; the contact point protrudes from the bottom (Fig 1). All-conducting switches have the virtue of fitting in very small spaces such as car-radio control panels. Some, for instance, take up less than $\frac{1}{8}$ in². Unfortunately, because the entire switch (including the bending area) consists of stress-sensitive carbon-impregnated silicone, its life expectancy is much shorter than a rubber-domed switch—only about 100,000 cycles.

A rubber-domed switch has a life expectancy of typically 25M cycles. It consists of a dome molded into an elastomer such as silicone; on the inside of the dome is a small pad of carbon-impregnated rubber with a typical resistance of 150 Ω (Fig 2a). The contacts for the switch are separate interlaced traces on the key-



This rubber-dome keyboard, from Planar Products Div of IEE, uses hard-plastic key-caps to approximate the look and feel of a traditional typewriter keyboard.

pad's pc board. The molded-rubber keypad fits over the pc board; when you depress the dome it collapses, shorting the conducting rubber pad between the two contact traces. Note that keypads made of rubber-domed switches are inherently sealed; you can spill a cup of coffee on one with no ill effects. The silicone operates with no degradation over a range of -40 to $+120^{\circ}\text{C}$.

Rubber-domed switches have some drawbacks, however. The contact is momentary, so you have to supply any needed latching circuitry. Further, because of their 150 Ω contact resistance, these switches can't handle much power.

Selecting a dome shape

A typical rubber-domed switch will probably cost about \$0.07 apiece. This figure covers only the cost of the conductive elastomer and varies tremendously according to different specifications such as the switch's size and shape, the geometry of the dome walls, and the number of colors in the switch keypad. You'll also have to add the price of the pc board and the plastic housing.

If you decide that a rubber-domed conductive switch best suits the requirements of your application,

you'll need to generate a drawing of the individual switch dome as well as the overall keypad layout. The dome shape determines the switch's tactile response and actuation force.

To ascertain which dome shape has the tactile response that you need, refer to the force-vs-stroke curves in Fig 3. The curves for the cone and bell shapes show a single bump, which indicates two very different types of click. Because of the cone's steeper sides, the collapse is abrupt, giving a sharp click response. The bell's more rounded



Fig 1—This all-conducting switch from Digitran measures about $\frac{3}{16}$ of an inch in diameter. The switch fits nose down over the center contact just visible in the lower left-hand corner; a switch plate and keycap hold it in place. The switch's long nose keeps the outer wall of the switch from touching the contact encircling the center contact unless you depress the switch.

Looking for a faster amplifier?

Don't settle for more when the EL2020 offers so much less. Less settling time, less power consumption and less cost.

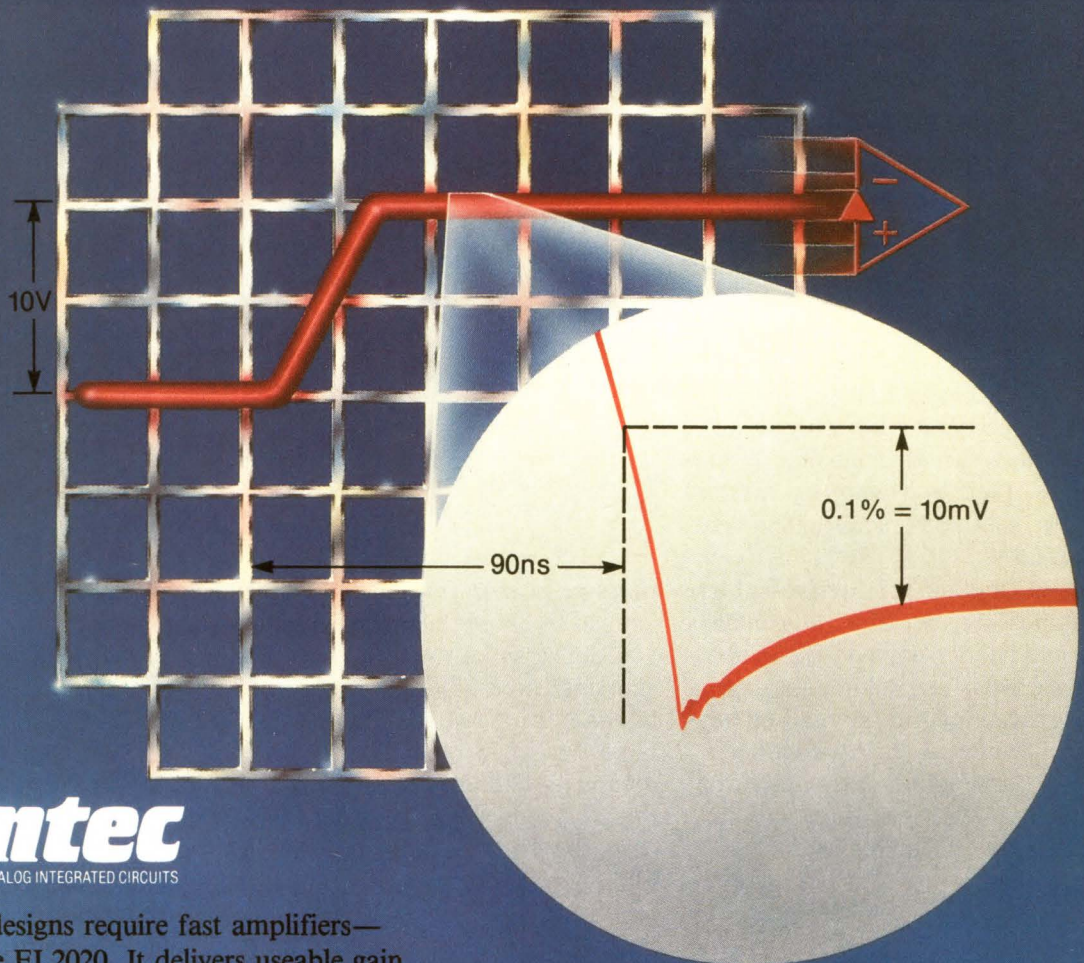

élantec

HIGH PERFORMANCE ANALOG INTEGRATED CIRCUITS

When your designs require fast amplifiers—scope out the EL2020. It delivers useable gain at high frequency, low settling time, high slew rate and less power consumption.

- AV = 2 at 65MHz
- 90 ns settling time to 0.1%
- 500V/ μ s slew rate
- 10ma supply current

The EL2020's unique circuit topology allows it to be used at closed loop gains from 1 to 10 with minimal sacrifice of bandwidth or slew rate, as is common with current generation op amps.

This low cost amplifier, fabricated via the Elantec monolithic Dielectric Isolation (DI) process, can drive coax directly—up to 50 Ω . Output Disable allows busing of multiple circuits. And short circuit protection prevents damage if the output is shorted.

The EL2020 is available in both military and commercial versions. Hybrid performance in a monolithic design. Gain with more accuracy at speed. And lower cost (\$4.95 @ 100—

EL2020CN) in a smaller package (plastic or ceramic 8-pin mini-dips).

Elantec—where élan is more than just a name—and service is more than just a word. We've got what you're looking for. And to prove it we offer the industry's only two-for-one guarantee on all our devices.

Set your sights on our high performance EL2020 amplifier. Write us on your company letterhead about your EL2020 application. We'll send you a free sample. Contact Elantec at 1996 Tarob Court, Milpitas, CA 95035. (800) 821-7429. In California, (408) 945-1323. Be sure to ask for our free 1987 Data Book.

Distributed by Future Electronics- GBL Goid Electronics-Gerber Electronics- Hammond Electronics-Intercept Electronics- Nu Horizons Electronics-Schuster Electronics-U.S. Hybrid Supply- Wyle Laboratories-Zeus Components- Insight Electronics

Elantec European Office:
87 Jermyn Street London SW1Y6JD England
Telephone: 44-1-839-3841
Telex: 917835 Fax: 44-1-930-0751



TECHNOLOGY UPDATE

sides impart a softer click response.

The secondary bumps on the double-cone and double-bell shapes indicate that these are keys with overtravel. Keys of this type have the spongier feel of the popular IBM typewriter keyboard. They do, however, require a separate keycap of hard plastic (Fig 2b). The dome has a flattened top surrounded by a thin ring of rubber. This ring supports the conducting rubber pad as if it were on a tiny trampoline; after you depress the plastic keycap, you can continue to press the switch past the contact point until the ring bottoms out on the board. Overtravel also increases the reliability of a switch's actuation-force contact because you can continue to push past the initial point of contact.

Keycaps have advantages other than overtravel: You can customize a switchpad by substituting caps with application-specific legends, or you can dress one up with metallic keycaps. Remember that you have to add the price of the keycap (about \$0.03 each in quantities of 50,000) to the total keypad price.

A key's stroke is the distance that a key travels before bottoming out on the underlying pc board, and it varies with the switch application. A typewriter keyboard stroke will range from 0.125 to 0.150 in.; a telephone-type keypad will range from 0.060 to 0.080 in.; and a calculator-type keypad will range from 0.030 to 0.040 in.

Some advice to follow

Harry Stern, vice president of engineering for Conductive Rubber Technologies, cautions against using an all-rubber switch in a long-stroke keyboard and recommends that you use keycaps if your application requires a long stroke. A long-stroke all-rubber key's top will tend to wobble as it slides down the key plate.

If you need a switch with a high degree of click, you may need to replace the carbon-filled conducting pad on the rubber dome with a snap

dome—a metal disk that mounts over the contacts. When you depress the rubber dome, you snap the metal disk down to make momentary contact. A disadvantage is that the metal disk is abrasive to the pc-board contacts.

If you require a switch with very low contact resistance, you can specify a silver-filled pad in place of the carbon-filled one; the silver-filled pad has a resistance of about 1Ω. Be aware that the price of a switch with a silver-filled pad is about \$0.16—or approximately twice that of one with a carbon-filled pad.

You must judge your need for high actuation force and sharp tactile feel vs a switch's life expectancy: A higher actuation force and a sharp tactile response result in a shorter switch life. In many military applications, the ability to withstand heavy environmental forces is a prerequisite. The steeper sides of cone-shaped domes support higher actuation forces as well as sharper tactile feel. However, their sides must flex more, which leads to a decrease in switch life. An average bell-shaped switch has a life of about 25M cycles; stiffer sides decrease the life by about 10%.

EPDM permits longer life

Substituting ethylene-propylene diene methylene (mercifully shortened to EPDM) for the silicone elastomer can increase switch life to over 50M cycles without sacrificing

any specs. EPDM is much more difficult for manufacturers to work with, however: They can't hold the molding process to a close tolerance. As a result, you can't use EPDM for switches with keycap sizes of less than 0.0625 in².

In addition, an EPDM switch's actuation force doesn't remain constant over time. Moreover, if you want backlighting, you can't use

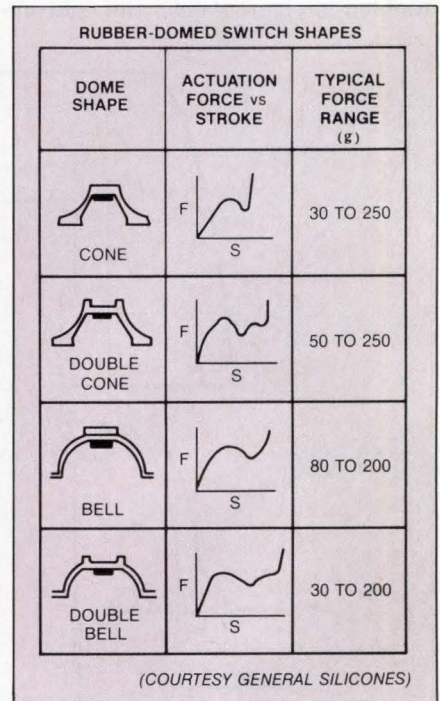

Fig 3—A cone-shaped-dome switch's tactile response is a sharper click than that of a bell-shaped switch. You can see the sharper tactile response in the force-vs-stroke curve. The steeper the slope of the curve after the contact point, the sharper the click. The steeper-sided cone-shaped domes sustain greater actuation forces.

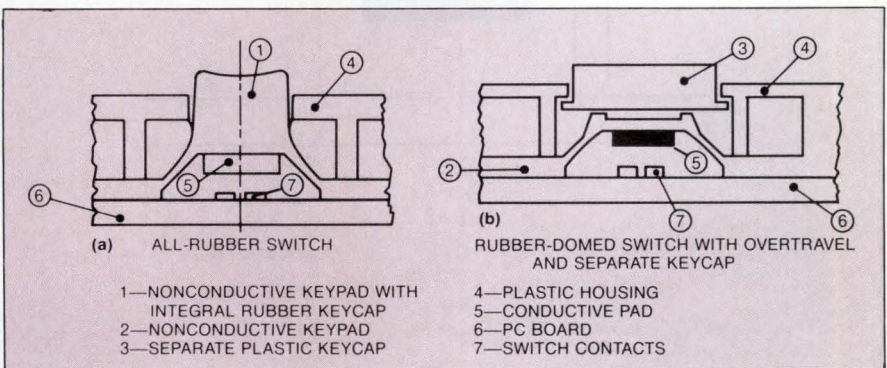

Fig 2—The most common form of conductive-rubber switch is the rubber-domed type, which consists of a molded elastomer keypad, a plastic keypad housing, and a pc board. Usually you'll find it cheaper to meld the keycap with the keypad (a), but if you need switch overtravel you'll have to use a separate plastic keycap (b).

TECHNOLOGY UPDATE

EPDM because it's opaque. Before using this synthetic rubber, you should make sure that you really need the longer switch life.

IEE, on the other hand, has increased the life of its FTMK (full-travel military keyboard) switch by applying silicone in an unconventional way. Each keystation (Fig 4) in the keyboard is a separate mechanical unit, but, just like in a molded-keypad sheet, the silicone

provides both the spring action and the conductive path between the two switch contacts. FTMK switches have a life expectancy that exceeds 50M cycles. Actually, IEE chose to stop the test at 50M cycles; the switch could very well last a lot longer. A 60-keystation MIL-STD-1280 (class 1, type 1) keyboard costs \$1200 (100).

Once you've decided on all four parameters needed to design the

switch tooling and compiled a drawing, it's time to contact a molded-rubber manufacturer. Your prototype tooling will probably be a single-cavity mold. Marketing manager for General Silicones, Homer Bastug, estimates that a single-cavity mold (including 25 prototype pieces) for a 12-key telephone dome-type keypad will cost between \$1800 and \$2000.

Tooling for a 6-cavity mold will run between \$2500 and \$3000; the keypads themselves cost about an extra \$0.35 (50,000). Don't forget that dome-type keypads require plastic keycaps at an additional charge. All-rubber keypads will have a higher price both in tooling (\$2300 to \$2500 for the single-cavity mold, \$4000 to \$4500 for the 6-cavity mold) and in production quantities (\$0.65 to \$0.70 each), but you won't have to pay for separate keycaps and assembly costs.

Recommendations for prototype

Bastug suggests that you check the quality of the prototype tooling by holding the first-article keypad up to the light: Look for an even lighting of the domed-switch sides. Any dark spots indicate irregularities in the mold. Similarly, look for a smooth, even surface on the flat rubber surrounding the switches. And check that the air bleed paths are in-line and even. Finally, verify that the actuation force meets the specifications: A quality mold should be able to hold its switch force to $\pm 10\%$ of the spec. Aside from the obvious plus that quality tooling forms a quality rubber part, higher quality tooling lasts longer.

You have a choice of dealing with the molded-rubber manufacturer yourself or going through a distributor. Moxness Products and EECO have their manufacturing facilities in the US. Conductive Rubber Technologies, IEE, and Digitran each work with a number of molding companies and are also able to supply complete switch assemblies. Kokoku and Shin-etsu are US sales

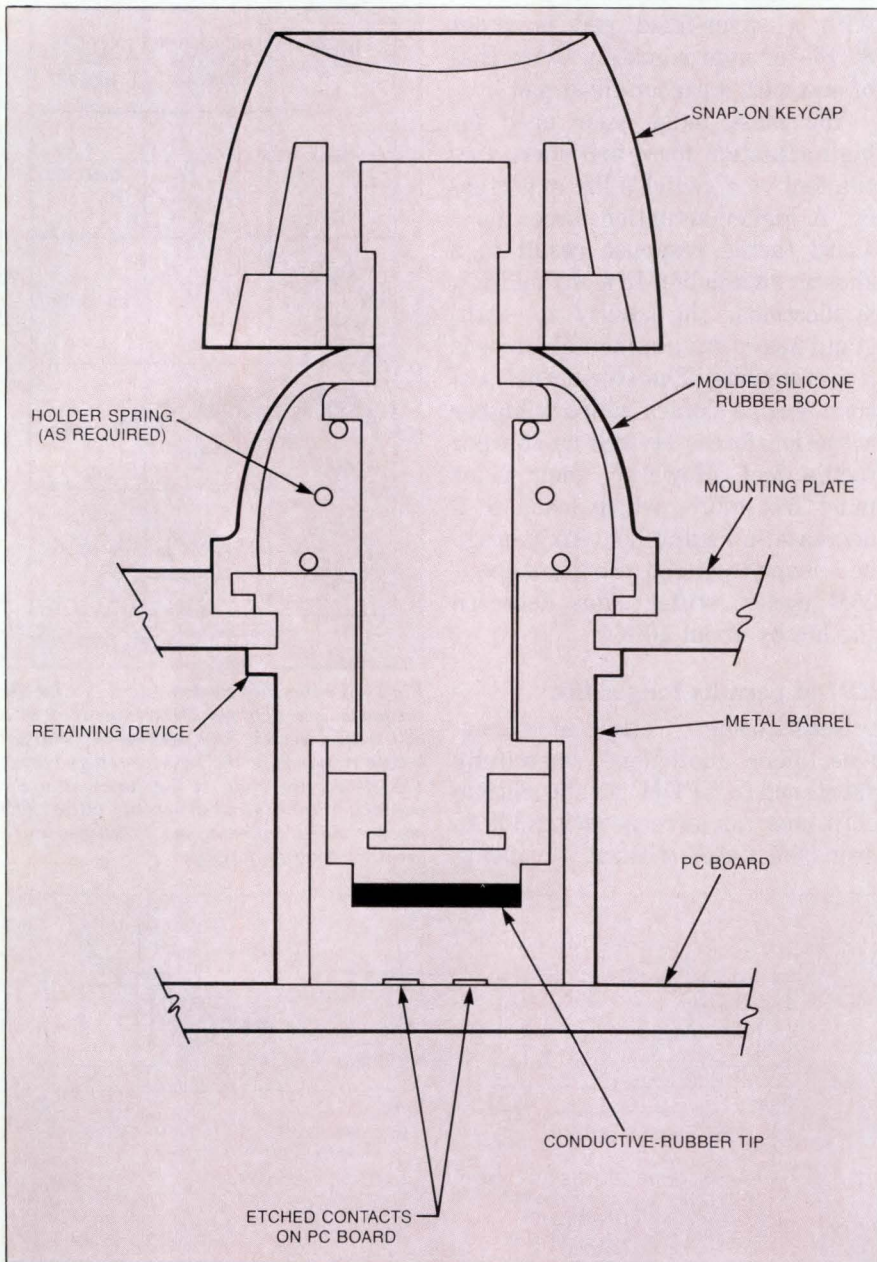

Fig 4—The FTMK switch is a modular single keystation that supports actuation forces as low as 90g. Its molded silicone rubber boot/spring can withstand submersion in three feet of liquid; the metal barrel provides EMI/RFI and Tempest shielding. (Courtesy Planar Products Div, IEE)

THE SMALLER WE ARE THE BIGGER WE GET.



A coax conductor so small it will pass through the eye of a needle. That's micro-miniature.

We've gathered 133 of these low capacitance coaxes into a precision cable with an OD just over half an inch. Without compromising speed, signal fidelity, flex life, or reliability.

We're using our special capabilities and experience in micro-miniature cables, connectors, and termination techniques to satisfy the demanding requirements of some of the world's largest diagnostic imaging manufacturers. The cable geometry must be precise; the manufacturing tolerances are diminishing. And the requirements are many: lower capacitance, higher speed, controlled impedance, and the continuing demand for toughness and reliability unique to hand-held devices.

What's next? Through our R&D, we've produced a prototype with even smaller conductors for a micro-miniature 512 50-ohm coax cable. The OD? Would you believe .600? Our products are getting smaller every day. And that's helping us to grow.



 **NATIONAL
ELECTRIC
CABLE**

*Micro-miniature cable and
connector solutions*

16640 S.W. 72nd Avenue
Portland, OR 97224
(503) 620-9400

Offices in San Francisco, Wilmington, Munich, and Tokyo

CIRCLE NO 128

TECHNOLOGY UPDATE

offices for their Japanese parent companies; General Silicones and Omni Switch are sales outlets for their Taiwanese parent companies.

Choose your source

Dave Cray, director of engineering at Moxness Products, believes that keeping the manufacturing facilities in this country has allowed Moxness to be more responsive to any unforeseen tooling design changes. He concedes that Taiwanese manufacturing plants can offer lower prices, but he argues that these are offset by the communications barrier. In addition, he notes that some military contracts stipulate all components be US made.

Another option is to deal directly with the overseas manufacturer. The majority of conductive-rubber switch molding houses are in Taiwan; you can get a list of them from United Pacific International Inc, publishers of the magazine *Taiwan Electronics Industry Components* (Box 81-417, Taipei, Taiwan, ROC, TLX 28784 UNIPAINC).

Be aware, however, that if you opt for direct correspondence with a foreign company, you must know exactly what you need in tooling design; the foreign manufacturer will not be able to offer guidance. Further, even if you have complete switch drawings and specifications, you'll find it hard to communicate about quality concerns, and the lan-

Conductive-rubber switches serve as transducers

Although you may choose to design with conductive-rubber switches because of their usefulness as on/off actuators, you can easily adapt them to applications requiring speed- and direction-sensing transducers.

To configure such a switch as a speed-sensing transducer, Harry Stern, vice-president of engineering for Conductive Rubber Technologies, suggests using a bell-shaped switch and molding a conducting ring close to the base of the dome. You'll need two sets of contact traces on the pc board; the first set will be shorted together by the conducting pad at the dome's top; the second will be shorted by the ring at the dome's base. Timing circuitry derives the switch's depression speed by measuring the time that elapses between the two contacts.

To use conductive-rubber switches as direction sensors, mold a pivot point into the bottom of a broad, flat switch top. For example, in the simplest case of a left/right or up/down sensor, the switch will have two conductive-rubber pads with corresponding contacts on the pc board. Depending on the side you press on, the switch will make contact with the pc-board traces on that side. You can expand this design to include a multiple number of contacts and pads to achieve a crude joystick.

In addition, a rubber-domed switch can also function as a pressure transducer if you mold the conducting pad into a convex instead of a flat surface. This configuration requires that one broad contact trace encircle the other. As you press harder on the switch, more of the pad makes contact with the outer surface and contact resistance decreases. You can create a transducer that discerns discrete levels of pressure by ringing the initial contact trace with concentric partial circles connected to separate traces.

guage barrier will inevitably cause misunderstandings. The first time you design with conductive-rubber switches, you should consider going through a manufacturer with a sales office or broker in the US. **EDN**

Article Interest Quotient
(Circle One)
High 506 Medium 507 Low 508

For more information . . .

For more information on the conductive-rubber switches discussed in this article, circle the appropriate numbers on the Information Retrieval Service card or contact the following manufacturers directly.

Conductive Rubber Technologies
121 Gray Ave
Santa Barbara, CA 93101
(805) 965-6511
Circle No 701

EECO Inc
1601 E Chestnut Ave
Santa Ana, CA 92702
(714) 835-6000
TWX 910-595-1550
Circle No 703

IEE Inc
Planar Products Div
7740 Lemona Ave
Van Nuys, CA 91409
(818) 787-0311
TLX 4720120
Circle No 705

Moxness Products Inc
Box 1174
Racine, WI 53405
(404) 554-5050
Circle No 707

Shin-Etsu Polymer Inc
1181 N Fourth St
San Jose, CA 95112
(408) 947-0311
TWX 910-338-2229
Circle No 709

Digitran
3100 New York Dr
Pasadena, CA 91107
(818) 791-5600
TWX 910-588-3794
Circle No 702

General Silicones Co USA Inc
650 W Duarte Rd, Suite 305
Arcadia, CA 91006
(818) 445-6036
TLX 3716189
Circle No 704

Kokoku Rubber Inc
200 E Howard St #206
Des Plaines, IL 60016
(312) 699-2880
Circle No 706

Omni Switch Inc
21630 N 19th Ave, Suite B-20
Phoenix, AZ 85027
(602) 582-0629
Circle No 708

SEE HOW YOUR CONNECTOR MEASURES UP TO OURS.

If your present I/O connector can completely cover the new Fujitsu Series 230 pictured on this page, you've got a large problem.

You're wasting valuable board space.

Space you could use to cram in a few extra components. Or space you could eliminate entirely to reduce manufacturing costs.

Fact is, the Series 230's remarkably compact 1.27mm (.50") pitch and remarkably efficient 4-row, zig-zag terminal layout pack provides all the pinout you're used to in 40% less real estate.

Impressive.

But that's just one small accomplishment. The big news is that you don't have to give up full-size connector convenience or reliability.

Every Series 230 connector includes features like a standard "D" shape polarization header, EMI shield, plug/socket lock and minimum-pressure insertion/withdrawal fitting. All with no extra size.

So before you run out of space in your next compact or portable system design, call us at (408) 562-1000. Or for a complete list of local distributors and representatives write to Fujitsu Component of America, Inc., 3320 Scott Boulevard, Santa Clara, California, 95054-3197.

We'll keep you from coming up short.

CIRCLE NO 52



FUJITSU
COMPONENT OF AMERICA, INC.

PHOTO SHOWN ACTUAL SIZE

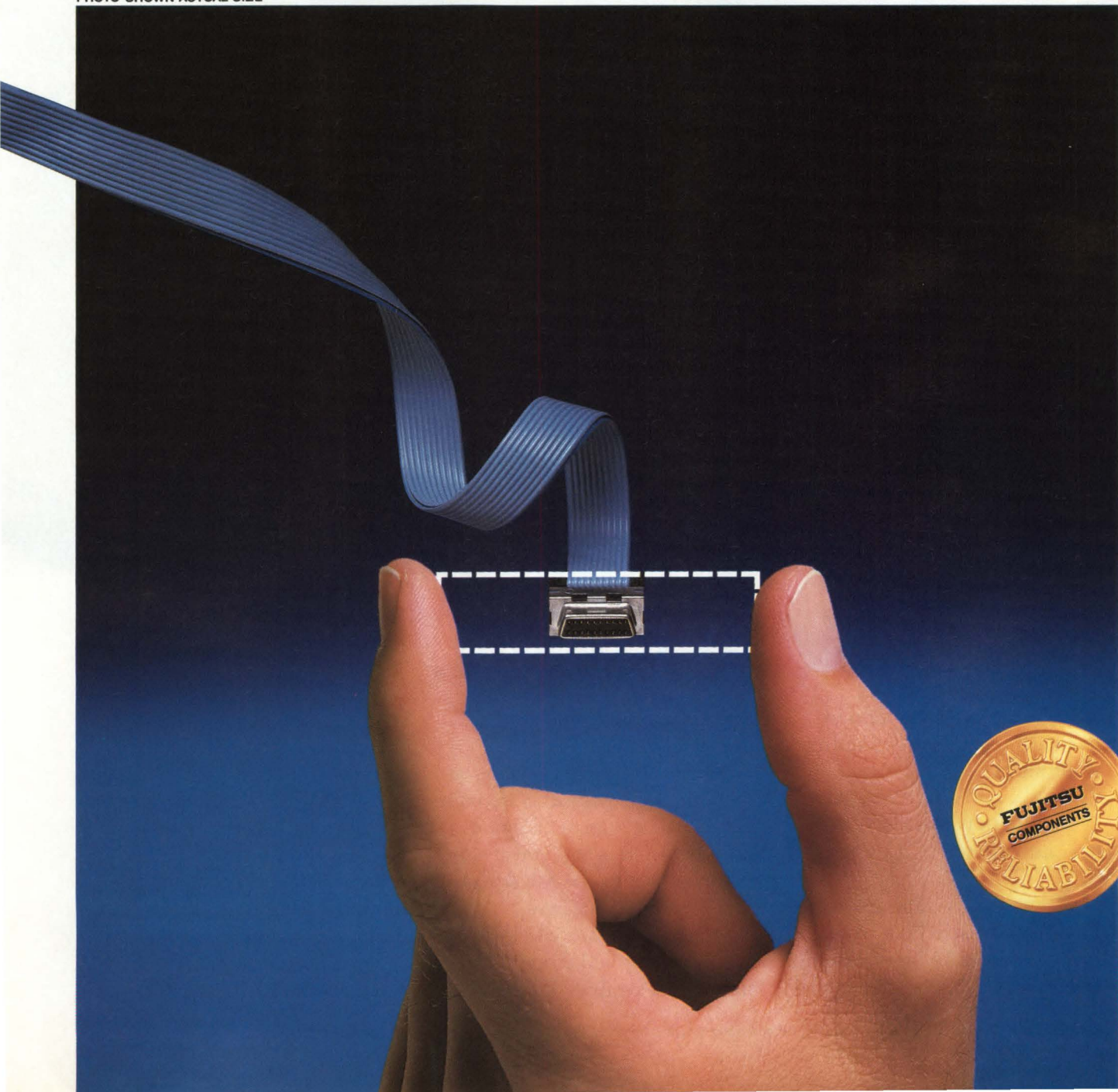

Shift your

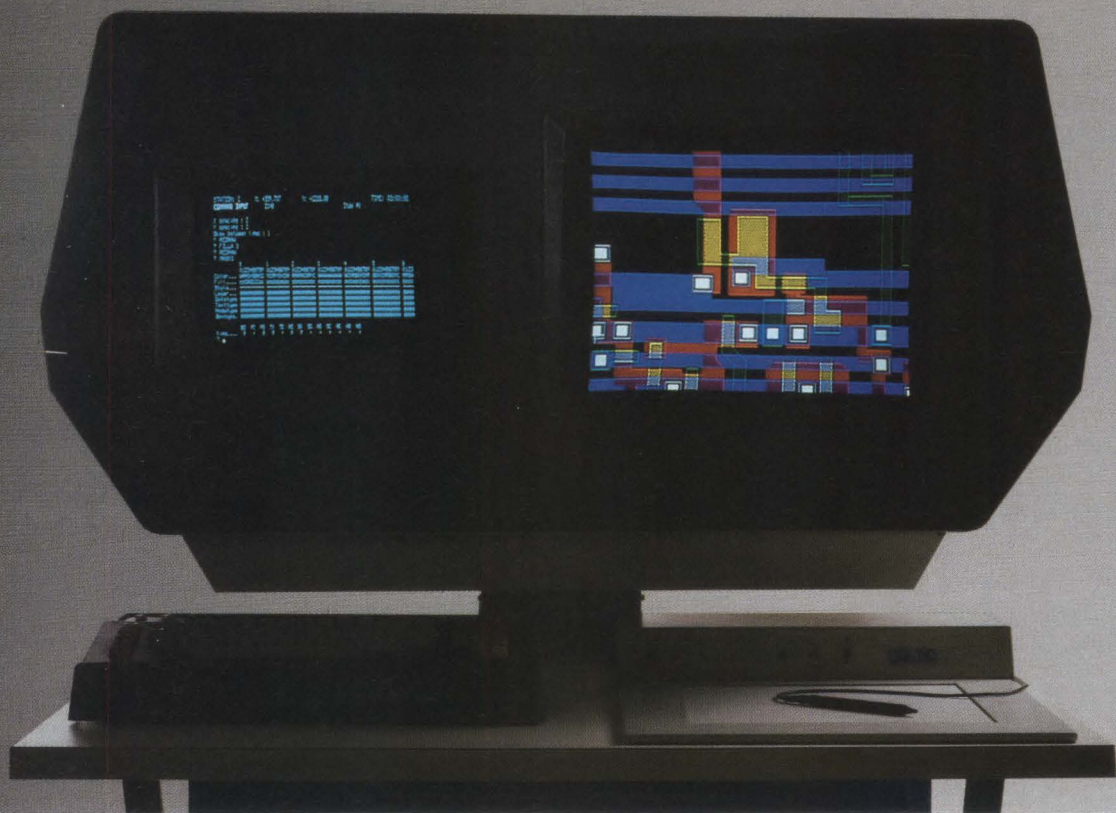

Manual.

We've taken the standard in manual IC design systems and made it automatic.

The new standard in automated IC design.

The new GE Calma automated IC design system is built around a fast, standalone 32-bit workstation and some of the hottest integrated

design software to come along in years.

And it's all designed to help you speed through more accurate, more intricate IC design in minimum time. In fact, it brings you as close as you can get to one pass design.

For openers, our new CustomPlus™ software lets you design quickly and easily with simple data symbols. Instead of

complex mask geometries.

And from there, it's a piece of cake. Go from logic to layout with a Netlist Driven Layout program that ties to any TDL and most ASCII netlist formats.

Tie it all together with our automatic block routing software. And space it as tightly as your design rules will allow with our automatic compaction program.

thinking.

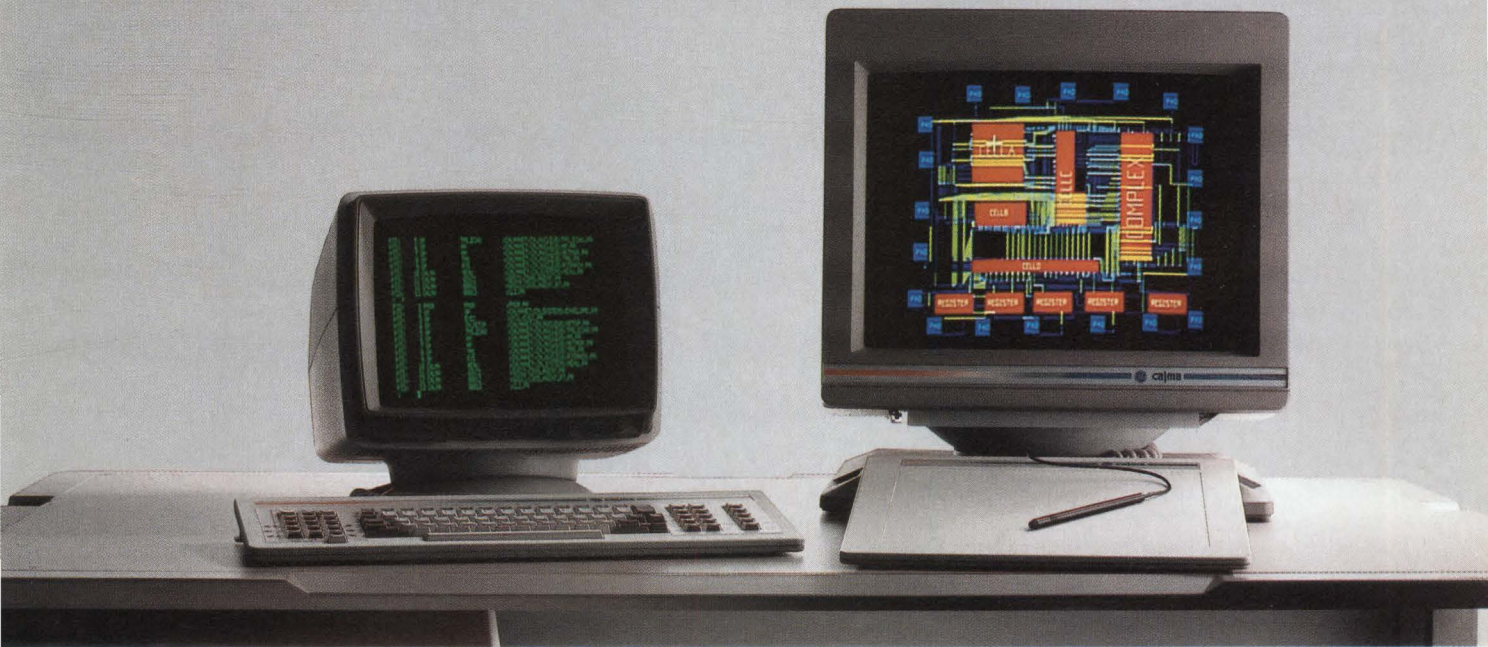

Automatic.

Then get it into silicon with our CAM package. It works with more CAM formatters than any other.

Or soup-up your
GDSII.[™]

Under all the new automation, the new system is still a GDSII at heart. Which means it shares the same commands and a host of other

features that you know by heart.

Better yet, it means that you can get a few more miles out of your clamshell. Because most of the new automated software can be added to your existing GDSII System.

Go for a spin.

To arrange a demonstration of the new automated IC design

system or for more information call 1-800-GE-CALMA, ext. 332.

And shift your designs into high gear.



calma

TOSHIBA CMOS

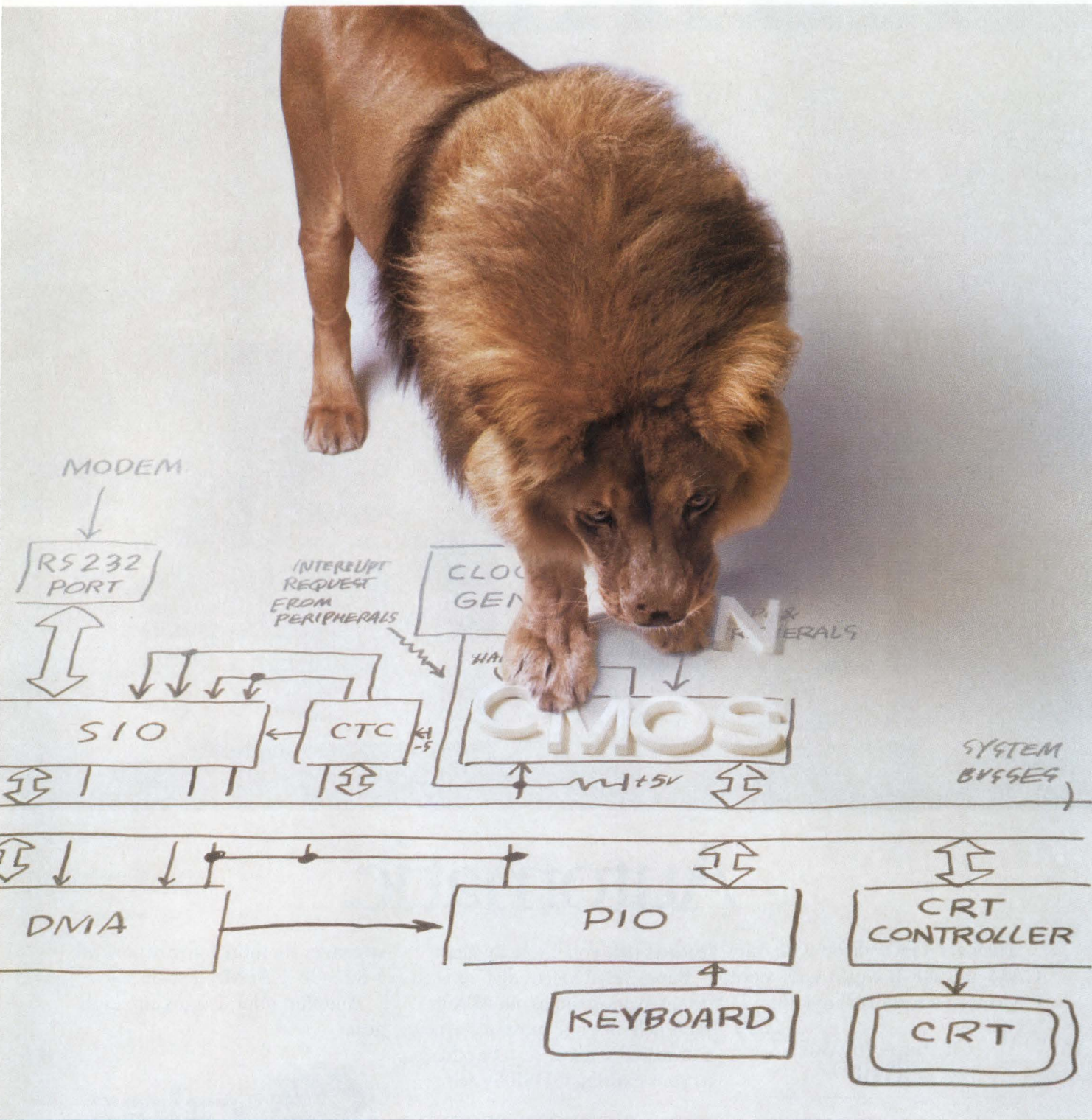

ALABAMA, Marshall Electronics Group, (205) 881-9235, Milgray Electronics, Inc., (404) 393-9666, Time Electronics, (404) 448-4448. ARKANSAS, Marshall Electronics Group, (214) 233-5200, Milgray Electronics, Inc., (214) 248-1603, Sterling Electronics-Dallas, (214) 243-1600, Time Electronics, (214) 241-7441. ARIZONA, Marshall Electronics Group, (602) 968-6181, Sterling Electronics-Phoenix, (602) 268-2121, Time Electronics, (602) 967-2000, Western Microtechnology, (602) 948-4240. CALIFORNIA, Image Electronics, (714) 259-0900, (818) 707-0911, Marshall Electronics Group, (818) 407-0101, (714) 458-5395, (408) 943-4600, (916) 635-9700, (619) 578-9600, Merit Electronics, Inc., (408) 434-0800, Rymo Electronics, (619) 453-8430, (714) 637-0200, Time Electronics, (714) 957-0911, (818) 998-7200, (213) 320-0860, (408) 734-9888, (619) 586-1331, Western Microtechnology, (408) 625-1660. COLORADO, Marshall Electronics Group, (303) 451-8383, Sterling Electronics-Denver, (303) 796-7338, Time Electronics of Colorado, (303) 799-8881. CONNECTICUT, Cronin Electronics, Inc., (203) 265-3104, Marshall Electronics Group, (203) 265-3822, Sterling Electronics-Wallingford, (203) 265-9535, Time Electronics, (203) 271-3200. DELAWARE, General Components, Inc., (609) 688-6767, Marshall Electronics Group, (301) 840-9450, Milgray/Delaware Valley, Inc., (609) 983-5010, (800) 257-7808, (800) 257-7111, Sterling Electronics-Sterling, (703) 450-2373, Time Electronics, (301) 337-0900. DISTRICT OF COLUMBIA, Marshall Electronics Group, (301) 840-9450, Milgray/Washington, Inc., (301) 621-6169, (301) 621-8169, (800) 638-6656, Sterling Electronics-Sterling, (703) 450-2373, Time Electronics, (301) 964-3090. FLORIDA, Marshall Electronics Group, (305) 841-1878, (813) 576-1399, (305) 928-0661, Reptron, (813) 855-4656, (305) 735-1112, Time Electronics-Florida, Inc., (305) 974-4800, (305) 841-6565. GEORGIA, Marshall Electronics Group, (404) 923-5750, Milgray Electronics, Inc., (404) 393-9666, Reptron, (404) 446-1300, Time Electronics, (404) 446-4448. IOWA, Marshall Electronics Group, (503) 644-5050, Time Electronics, (801) 973-8181, Western Microtechnology, (503) 625-2082. ILLINOIS, GBL Good Electronics, (312) 593-3220, Marshall Electronics Group, (312) 490-0155, Milgray Electronics, Inc., (312) 350-8800, (312) 350-0490, Time Electronics, (312) 350-0610. INDIANA, GBL Good Electronics, (312) 593-3220, Marshall Electronics Group, (317) 297-0483, Milgray/Chicago, Inc., (312) 350-0490, Time Electronics, (312) 350-0610. IOWA, Den Electronics, Inc., (319) 365-7551, (800) 332-5478, (800) 553-5421, Marshall Electronics Group, (612) 559-2211, Milgray Electronics, Inc., (913) 236-8800, Time Electronics Midwest, (314) 391-6444. KANSAS, Marshall Electronics Group, (913) 492-3121, Milgray Electronics, Inc., (913) 236-8800, Sterling Electronics-Kansas, (913) 236-5589, Time Electronics Midwest, (314) 391-6444. KENTUCKY, Marshall Electronics Group, (513) 236-8088, Milgray/Cleveland, Inc., (216) 447-1520, (800) 321-0006, Time Electronics, (614) 761-1100. LOUISIANA, Marshall Electronics Group, (214) 233-5200, Milgray Electronics, Inc., (214) 248-1603, Sterling Electronics-Dallas, (214) 243-1600, Time Electronics, (214) 241-7441. MAINE, Cronin Electronics, Inc., (617) 449-5000, Marshall Electronics Group, (617) 658-0810, Sterling Electronics-Boston, (617) 938-6200, Time Electronics-New England, (617) 532-6200, Western Microtechnology, (617) 273-2800. MARYLAND, Marshall Electronics Group, (617) 273-2800. MASSACHUSETTS, Cronin Electronics, Inc., (617) 449-5000, Marshall Electronics Group, (617) 658-0810, Sterling Electronics-Boston, (617) 938-6200, Time Electronics-New England, (617) 532-6200, Western Microtechnology, (617) 273-2800. MICHIGAN, Calder Electronics, (616) 698-7400, Marshall Electronics Group, (313) 525-5850, Semiconductor Reliability Assoc., Inc., (313) 965-8550. MINNESOTA, Marshall Electronics Group, (612) 559-2211, Reptron Electronics, (612) 938-0000, Time Electronics, (612) 944-9192. MISSISSIPPI, Marshall Electronics Group, (205) 881-9235, Milgray Electronics, Inc., (404) 393-9666, Time Electronics, (404) 448-4448. MISSOURI, Marshall Electronics Group, (913) 492-3121, Milgray Electronics, Inc., (913) 236-8800, Sterling Electronics-Kansas, (913) 236-5589, Time Electronics Midwest, (314) 391-6444.

Z-80[®] MPU.

**Identical fit, form and function
to the NMOS Z-80 you know and love.
Why wait to upgrade?**

Identical twins. The only way you can tell them apart is that Toshiba's CMOS Z-80 takes less power, runs cooler, extends reliability and expands the temperature operating range. And, it's second sourced.

Our CMOS Z-80 MPU and peripherals are interchangeable with the NMOS Z-80 family you've been using. 4 megahertz. Pinout compatible. Hardware compatible. Software compatible.

So there's no reason to wait to upgrade. Let us start delivering your CMOS Z-80s now, while you are completing the rest of your system design.

TOSHIBA IS MPU POWER

Of course, the CMOS Z-80 is only one of Toshiba's extensive

line of MPUs. From 4-BIT CMOS and NMOS MICROS — of which we are the second largest manufacturer in the world — to our line of 8-bit devices, including CMOS and NMOS 8048 and 8049, as well as the popular 8085 family.

Toshiba is the power in MPUs, and one of the reasons is Toshiba's proven volume production capability. Capability that assures you of the product you need — when you need it.

So when you are designing in a Z-80, talk with the people with CMOS Z-80 power. Talk with Toshiba.

® Z80 is a trademark of Zilog Inc.

8-BIT MICROPROCESSOR — CMOS Z-80 FAMILY				
Device	Description	Technology	Operating Current at 4MHz	Power-Down Current
TMPZ84C00	4MHz Z80A CPU	CMOS	15mA	< 10 μ A
TMPZ84C30	CTC: Counter/Timer Circuit	CMOS	3mA	< 10 μ A
TMPZ84C20	PIO: Parallel Input/Output Controller	CMOS	2mA	< 10 μ A
T6497	Clock Generator/Controller	CMOS	2mA	< 10 μ A
TMPZ84C40	SIO: Serial Input/Output Controller	CMOS	25mA	< 10 μ A
TMPZ84C10	DMA: Direct Memory Access Controller	CMOS	25mA	< 10 μ A

TOSHIBA. THE POWER IN MPUs.

TOSHIBA AMERICA, INC.

NEBRASKA, Marshall Electronics Group, (913) 492-3121, Milgray Electronics, Inc. (913) 236-9800, Sterling Electronics-Kansas, (913) 236-5589, Time Electronics Midwest, (314) 391-6444. NEVADA, Marshall Electronics Group, (916) 635-9700, Time Electronics-Nor/Cal, (408) 734-9888, Western Microtechnology, (408) 725-1660. NEW HAMPSHIRE, Crown Electronics, Inc., (617) 449-5000, Marshall Electronics Group, (617) 658-0810, Sterling Electronics-Boston, (617) 938-8200, Time Electronics-New England, (617) 532-8200, Western Microtechnology, (617) 273-2800. NEW JERSEY, General Components, Inc., (609) 768-6767, Marshall Electronics Group, (201) 882-0320, (609) 234-9100, Milgray Electronics, Inc., (516) 420-9800, (609) 983-5010, (800) 257-7111, SAI, Inc., (516) 293-2710, Sterling Electronics-So. Plainfield, (201) 769-7000, Time Electronics, (516) 273-0100. NEW MEXICO, Marshall Electronics Group, (602) 968-6181, Sterling Electronics-Albuquerque, (505) 884-1900, Time Electronics, (602) 967-2000, Western Microtechnology, (602) 948-4240. NEW YORK, Marshall Electronics Group, (516) 273-2424, (607) 798-1611, (716) 235-7620, Milgray Electronics, Inc., (516) 420-9800, (716) 235-0830, Rome Electronics, (315) 337-5400, Semispecialists of America, (516) 293-2710, Time Electronics, (516) 273-0100, (315) 432-0355. NORTH SOUTH CAROLINA, Marshall Electronics Group, (919) 878-9882, Milgray Electronics, Inc., (404) 393-9666, Resco Raleigh, (704) 588-1530, (919) 781-5700, Time Electronics, (800) 833-8235, (704) 522-7600. NORTH SOUTH DAKOTA, Marshall Electronics Group, (612) 559-2211, Repton Electronics, (612) 938-0900, Time Electronics, (800) 833-8235, (612) 944-9192. OHIO, Marshall Electronics Group, (513) 236-6086, (216) 248-1786, Milgray-Cleveland, Inc., (216) 447-1520, (800) 321-0006, Repton Electronics, (614) 436-8675, Time Electronics, (614) 751-1100. OKLAHOMA, Marshall Electronics Group, (214) 233-5200, Milgray Electronics, Inc., (214) 248-1603, Sterling Electronics-Tulsa, (918) 683-2410, Time Electronics, (214) 241-7441. OREGON, Marshall Electronics Group, (503) 644-5050, Time Electronics, (503) 684-3780, Marshall Electronics Group, (609) 768-6767, Marshall Electronics Group, (609) 234-9100, (412) 963-0441, Milgray-Cleveland, Inc., (216) 447-1520, (800) 321-0006, Milgray/Delaware Valley, Inc., (609) 983-5010, (800) 257-7808, (800) 257-7111, Time Electronics, (215) 337-0900, (614) 761-1100. RHODE ISLAND, Crown Electronics, Inc., (617) 449-5000, Marshall Electronics Group, (617) 658-0810, Sterling Electronics-Boston, (617) 938-8200, Western Microtechnology, (617) 273-2800. TENNESSEE, Marshall Electronics Group, (205) 881-9235, Milgray Electronics, Inc., (404) 393-9666, Resco Raleigh, (919) 781-5700, Time Electronics, (404) 448-4448. TEXAS, Marshall Electronics Group, (214) 233-5200, (915) 593-0706, (713) 895-9200, (512) 837-1991, Milgray Electronics, Inc., (214) 248-1603, Sterling Electronics, (713) 823-8600, (512) 838-1341, (214) 243-1600, Time Electronics, (512) 339-3051, (214) 241-7441, (713) 530-0800. UTAH, Marshall Electronics Group, (801) 485-1551, Sterling Electronics-Denver, (303) 796-7338, Time Electronics, (801) 973-8181. VERMONT, Crown Electronics, Inc., (617) 449-5000, Marshall Electronics Group, (617) 658-0810, Sterling Electronics-Boston, (617) 938-8200, Time Electronics-New England, (617) 532-8200, Western Microtechnology, (617) 273-2800. VIRGINIA, Marshall Electronics Group, (301) 840-9450, Milgray/Washington, Inc., (301) 621-8169, (800) 638-6656, Resco Raleigh, (919) 781-5700, Sterling Electronics, (703) 450-2373, (804) 226-2190, Time Electronics, (301) 964-3090. WASHINGTON, Marshall Electronics Group, (206) 747-9100, Time Electronics, (206) 882-1600, Western Microtechnology, (206) 881-6737. WISCONSIN, GBL Gould Electronics, (312) 593-3220, Marshall Electronics Group, (414) 797-8400, (612) 559-2211, Milgray/Chicago, Inc., (312) 350-0490, Repton Electronics, (612) 938-0000, Time Electronics, (612) 944-9192, (312) 350-0610. CANADA, Carsten Electronics, Ltd., (613) 726-9250, (416) 495-9999, (416) 495-7705, (514) 334-8321, Space Electronics Sales Corp., (514) 697-8676, (416) 636-8614, (416) 596-5340, (604) 294-1166.

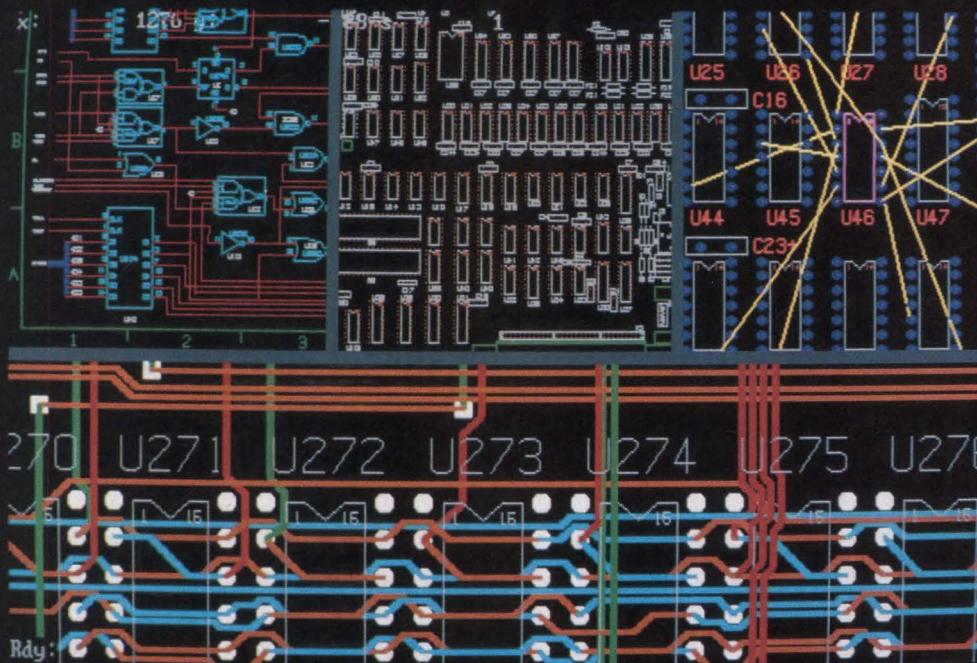

Pictured above is a DRAFTSMAN-EE screen showing various stages of PCB design. Schematic entry, PCB component placement, fine-tuning placement using rat's nest file, and editing the multilayer file. Design Computation brings professional CAE/CAD to PC-based workstations.

HIGH-END CAD SOFTWARE WITHOUT A HIGH-END PRICE TAG

Design Computation's sophisticated CAE/CAD design tools provide complete end-to-end solution for PCB design, at a value unmatched in the industry. IBM and AT&T compatible, all Design Computation products have a 30-day, unconditional money-back guarantee.

DRAFTSMAN-EE™

Design Computation's high-performance professional graphics editor for schematic capture and printed circuit design features unlimited zoom, orthogonal and diagonal rubberbanding modes, fast drawing speed, interactive autorouting and net list generation. DRAFTSMAN-EE™ can easily be configured with other Design Computation software for complete end-to-end solution for PCB design. DRAFTSMAN-EE™—powerful, flexible and fast—only \$749.

DC/CHECK+™

Design Computation's manual routing tools provide accurate checking for precise PCB design. Ideal for analog designers and others who want total control of the routing process. Includes rat's nest creation, PCB-to-schematic netlist comparison, design rule checking and automatic generation of art masters for silk screens, solder masks and drill holes.

Increase your productivity and reduce errors with DC/CHECK+™ (requires DRAFTSMAN-EE™)—only \$398.

DC/AUTOROUTER II™

Design Computation's professional autorouter offers high-end features and routing speed that put high-priced competition to shame. The field-proven DC/AUTOROUTER II™ is a true diagonal, 1-mil autorouter with typical completion rates of 93-99% and a cost-cutting route straightening and via minimization pass.

DC/AUTOROUTER II™ boasts expanded high-end power, permitting the use of memory boards adhering to the EMS standard. DC/AUTOROUTER II™ can handle over 500 IC's and boards as large as 32 x 32 inches. Medium sized boards with 70 IC's can be autorouted on a standard IBM PC/AT in under 2 hours.

DC/AUTOROUTER II™—the high-end autorouter you would expect to pay thousands more for—only \$2,450. (Requires DRAFTSMAN-EE™ and DC/CHECK+™).

THE DESIGN COMPUTATION CHALLENGE

We encourage you to compare Design Computation's software against ANY CAE/CAD SOFTWARE AT ANY PRICE. We think you will be amazed.

Discover why Fortune 500 companies and engineering firms of all sizes are choosing Design Computation. Call or write today for your free color brochure, updated data sheets and **FREE Autorouter Demo**.

SYSTEMS FEATURES

- Manipulation of screen regions
- A through E size schematics
- X,Y flip and rotation at any angle
- Flexible scaling of text and symbols
- Netlist, Bill of Materials, and Parts List utilities included
- Keyboard recording and command procedures
- Component library included
- Multiple, user expandable text fonts
- Concurrent mouse and keyboard support
- Area fill for analog boards
- 1-Mil "gridless" operation and placement
- True diagonal autorouting - an absolute must for medium to high density boards
- Up to 16 trace layers
- Variable route widths
- Variable pad, via & drill hole sizes
- Common planes for power and ground
- Exclusion areas
- Interruptable and re-entrant
- Gerber photoplotters, pen plotters, printer output, Excellon Automation drill hole tape files

**DESIGN
COMPUTATION**

Design Computation, Inc.
Ten Frederick Avenue, Neptune, NJ 07753
(201) 922-4111 TWX: 510-601-8352

International Distributors: In **Australia & New Zealand**: Hypec Electronics (2) 808 3666, TELEX AA71551, In **Italy**: Eledra (02) 81821 TELEX 332332, In **France**: Generim (1) 6 907 78 78, TELEX 691700F, In **Japan**: Teksel (03) 4615121, TELEX 23723, In **West Germany**: Elcoprint (0 85 41) 8046-8047, TELEX 57531, In **Taiwan**: Mitronics International (02) 7097626-9, TELEX 12621, In **Hong Kong**: Tektron Electronics, (852) 3-880629, TELEX 38513, In **Spain**: Aries (91) 2341183, TELEX 45251
In **Holland & Belgium**: Klaasing Electronics 01620-81600, TELEX 54598, In **Greece**: Elcam Electronics, in **Athens**, TELEX 224282

DSP chips provide building blocks for real-time signal processing

The MA7100 Signal Stream DSP chips handle 10-bit data at throughput rates as high as 20M samples/sec, allowing you to build DSP systems with a dynamic range of 60 dB and a bandwidth of 10 MHz. This level of performance makes the devices suitable for use in applications such as real-time video- and radar-image processing.

The family includes both algorithm-specific DSP ICs for linear and nonlinear filtering, and support ICs that allow you to combine devices to produce more complex DSP functions. The algorithm-specific DSP ICs comprise the MA7180 1- or 2-dimensional convolver and the MA7190 rank-order filter. The sup-

port devices include the MA7188 cascade ALU and the MA7186 video line buffer.

The MA7180 convolver performs a 2-dimensional convolution (sum of coefficient/data product pairs) on a 3x3 array of 10-bit data values with 8-bit coefficients, producing a 22-bit result. If you wish, you can round the result to 16 bits. The convolver allows you, for example, to perform lowpass noise filtering or edge detection on a video image by using a 3x3 array of pixel intensities extracted from the video image.

By adding one or more MA7186 video line buffers, you can perform 2-dimensional convolutions in real time, while a video image is being

scanned. Each MA7186 can store two 64-, 128-, 256-, or 512-pixel scan lines or one 1024-pixel scan line. The MA7186 delays each line so that the corresponding 10-bit pixels are synchronized with those in the current scan line, making up the 3x3 array of pixel values. To process larger arrays, you can cascade video line buffers and convolvers and use MA7188 cascade ALUs to accumulate intermediate results.

By driving the MA7180's three 10-bit input ports with the same data, you can configure the convolver to perform a 9-stage, 1-dimensional convolution. To perform an alternative method of 2-dimensional filtering, you can add video

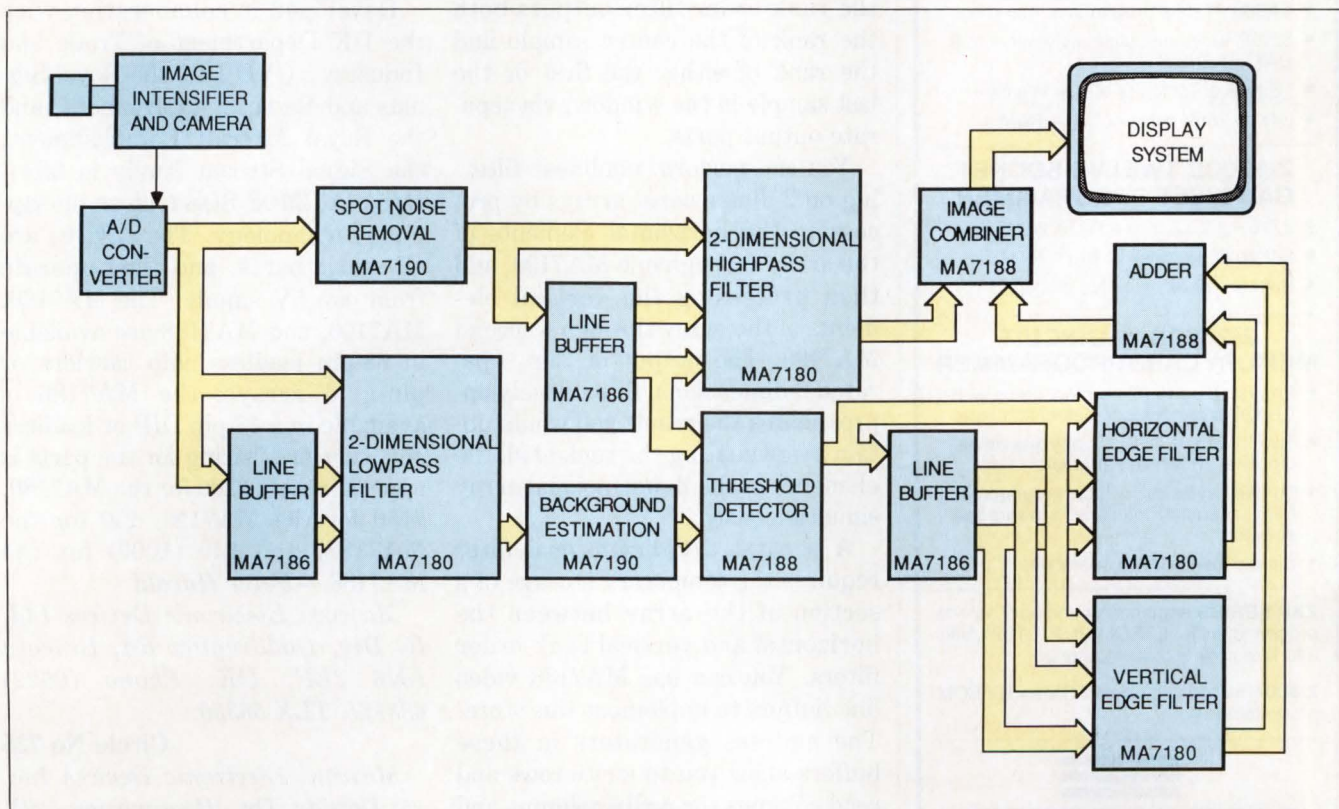

This DSP image-enhancement system operates in real time, while an image is being scanned. The upper signal pathway removes spot noise introduced by the image intensifier and enhances the contrast of the image. The lower pathway eliminates background information and highlights the edges of the image.

AMERICA'S BEST PROGRAMMERS



Z-1000B UNIVERSAL PROGRAMMER

- Over 600 PLDs, EPROMs, EEPROMs, Bipolar PROMs and INTEL MCUs.
- Separate D/A channels for each pin.
- Upgradeable PROM based software.
- Stand alone or PC/XT/AT operation.
- Two independent RS-232 ports.
- 64K or 256K bytes of DATA RAM.
- EXATRON handler interface is standard.



Z-3000 HIGH VOLUME GANG/SET PROGRAMMER

- 14,000 27256s programmed per day.
- 32 EPROMs simultaneously with 1 to 8 DATA BLOCKS.
- 16 Intel or Motorola MCUs at a time.
- 64K to 256K bytes of DATA RAM.

Z-1200B TWELVE SOCKET GANG/SET PROGRAMMER

- 2716 - 27512, 1 to 4 DATA BLOCKS.
- 64K to 256K bytes of DATA RAM.
- Software personality. No plug-ins.

Z-2500B IN-CIRCUIT MEMORYCARD PROGRAMMER

- Programs up to 32 memory cards with EPROMs or microcomputers at a time.
- Two 1.2 Mbyte DSDD floppy disk drives. Optional 20 Mbyte hard disk.
- Turnkey systems include programmer, terminal, custom interface hardware and software.
- Simple menu driven operation.

ZAP SERIES engineering and field service programmers for EPROMs to 27C1024, Intel and Motorola microcomputers.

Z-400 economical bipolar PROM and EPROM programmer.



SUNRISE ELECTRONICS, INC.

524 South Vermont Avenue
Glendora, California 91740
(818) 914-1926

CIRCLE NO 8

PRODUCT UPDATE

line buffers and cascade ALUs, cascading these 1-dimensional convolvers so that they process 2-dimensional arrays of data (for example, a 9x9 array of image pixels).

To implement functions that require nonlinear filters—functions such as spot-noise removal or background-level estimation—you can use the MA7190 rank-order filter. This device examines a moving window of 10-bit data values and reports the data value that occupies a specified rank within this window of values. The number of samples in the window (the filter length) and the rank of the data value selected for output is programmable, so you can implement various nonlinear filter functions, such as minimum, maximum, or median filters.

Alternatively, you can instruct the rank-order filter to give you the rank of particular samples in relation to the other samples contained within the window. In this mode, the rank-order filter outputs both the rank of the center sample and the rank of either the first or the last sample in the window, via separate output ports.

You can perform nonlinear filtering on 2-dimensional arrays by processing the horizontal elements of the array through one MA7190, and then processing the vertical elements of the array through a second MA7190. The output of this separated 2-dimensional filter closely approximates the result you would obtain by evaluating the rank of all the elements in the 2-dimensional array simultaneously.

A separated 2-dimensional filter requires the temporary storage of a section of the array between the horizontal and vertical rank-order filters. You can use MA7186 video line buffers to implement this store. The address generators in these buffers allow you to write rows and read columns (or write columns and read rows) of 10-bit data, simplifying the interface between the two filters. A second store, operating in

the write-column/read-row mode, serves to reconstruct the output of the vertical rank-order filter, yielding a conventionally scanned video image.

The MA7188 ALU provides the arithmetic and logic functions you need when you cascade multiple MA7180 convolvers or MA7190 rank-order filters to implement more complex DSP algorithms. The ALU provides for the addition, subtraction, exclusive-ORing, or ANDing of two 16-bit input values. It can also evaluate the input's absolute value and choose between the maximum and minimum input value. An integral 16-bit-wide data-delay line (you can program the delay to between 0 and 32 clock cycles) allows you to resynchronize two data streams that have acquired different latency times in other parts of the DSP system. Alternatively, you can use the delay line to deliberately introduce latency between data samples.

Developed in collaboration with the UK Department of Trade and Industry's CVD Div, the Royal Signals and Radar Establishment, and the Royal Aircraft Establishment, the Signal Stream family is fabricated in CMOS SOS (silicon-on-sapphire) technology. The devices are all static parts, and they operate from one 5V supply. The MA7180, MA7190, and MA7188 are available in 68-pin leadless chip carriers or pin-grid arrays; the MA7186 is available in a 48-pin DIP or leadless chip carrier. Pricing for the parts is approximately £200 for the MA7180, £150 for the MA7190, £50 for the MA7188, and £40 (1000) for the MA7186.—*Peter Harold*

Marconi Electronic Devices Ltd, IC Div, Doddington Rd, Lincoln LN6 3LF, UK. Phone (0522) 688121. TLX 56380.

Circle No 725

Marconi Electronic Devices Inc, 45 Davids Dr, Hauppauge, NY 11788. Phone (516) 231-7710.

Circle No 726

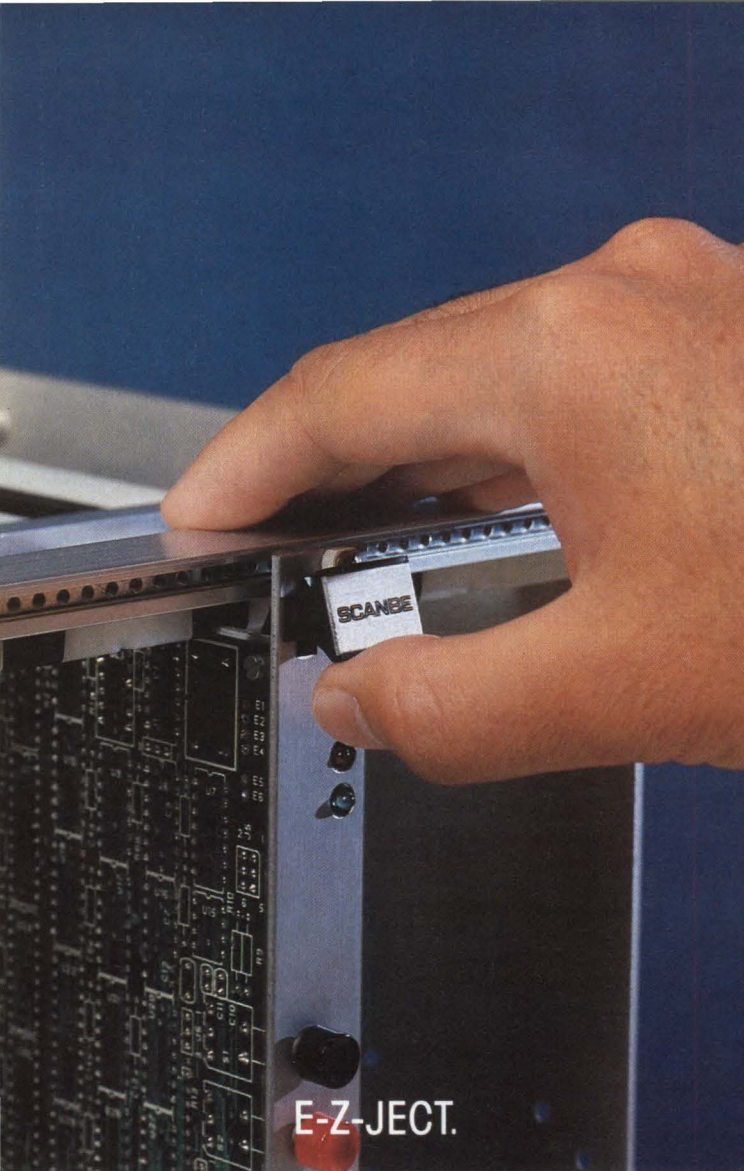

E-Z-JECT.

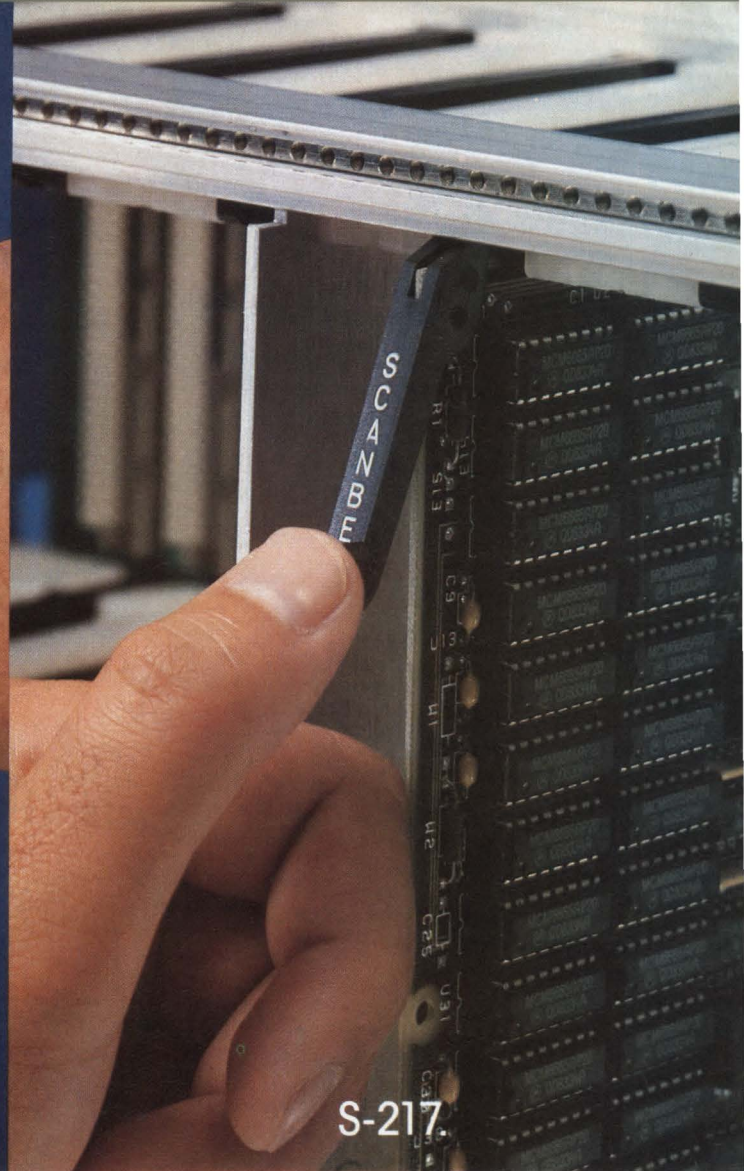

S-217.

AN OPEN AND SHUT CASE FOR VME.

DIN connectors are terrific for long life and resistance to corrosion, but they also resist being plugged in and out.

Your average VME card with 192 pins, for example, may take about 24 pounds to get out of your card cage. That's a lot of force to apply with a couple of fingers.

Scanbe has two fixes for the problem. Pick one or the other, or both, depending upon your packaging situation:

E-Z-JECT is a replacement for a standard VME front panel. It has a hinged handle that lets you pop out a VME card from its backplane without the yanking and struggling you're used to. It works in any standard VME card rack. It's the way the VME front panel should have been designed in the first place.

S-217 is an injector/ejector system that gives you a lot of leverage—about 3.5 to 1—for the easiest

insertion and ejection of cards without front panels. It's a great help for 6U cards and it's the ultimate answer if you're using 9U cards. (If you're using Euro-cards, you should be talking to us about our versatile standard and mixed-height Eurocard cages.)

Or you can use both. Our newest VME card cages let you intermix S-217 and E-Z-JECT.

So there's no mystery at all to getting VME cards in and out of your system. Just call Scanbe today for the solution:

800-227-0557 (in California **818-579-2300**)

ZERO **SCANBE**
UNIT OF ZERO CORPORATION

LEADERS IN PACKAGING TECHNOLOGY

3445 Fletcher Ave., El Monte, CA 91731-3001
TWX 910 587 3437

CIRCLE NO 154

Which is the



brighter power?

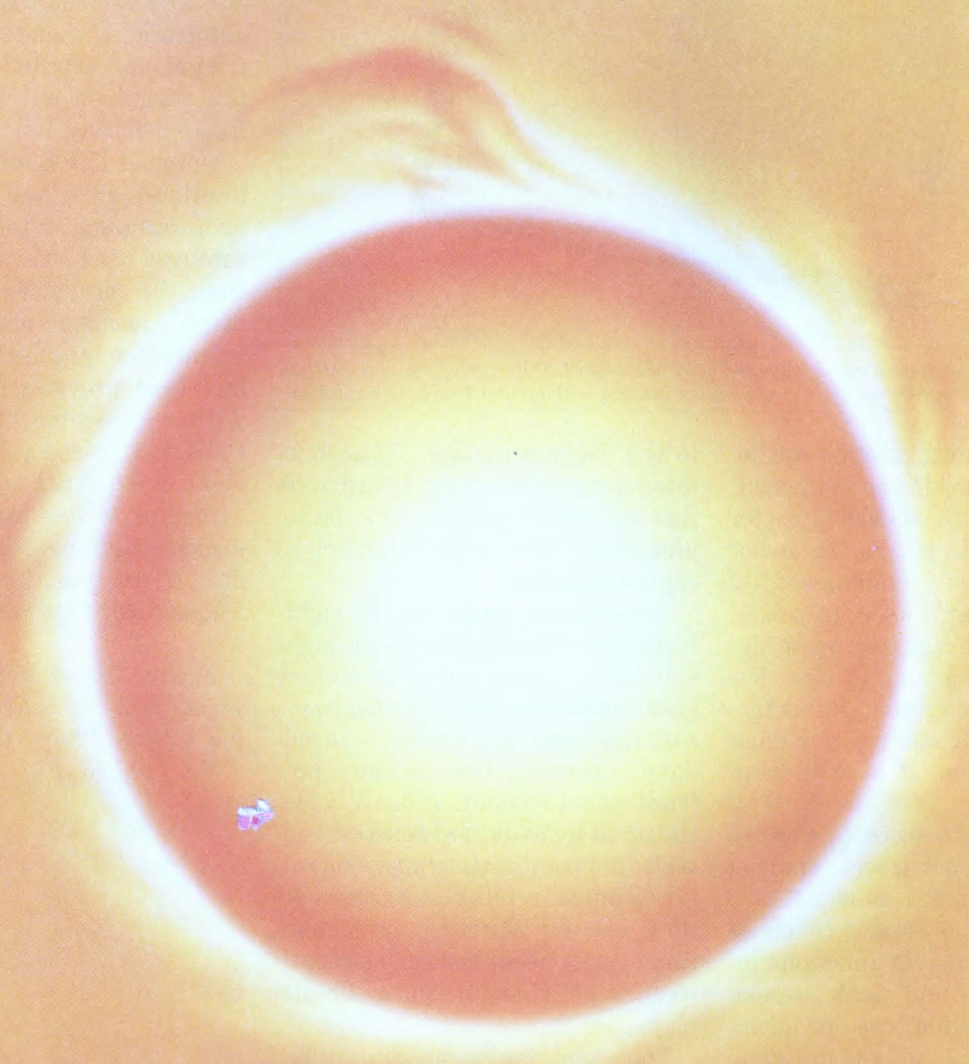

Digital storage oscilloscope captures 250M samples/sec, has 10-bit resolution

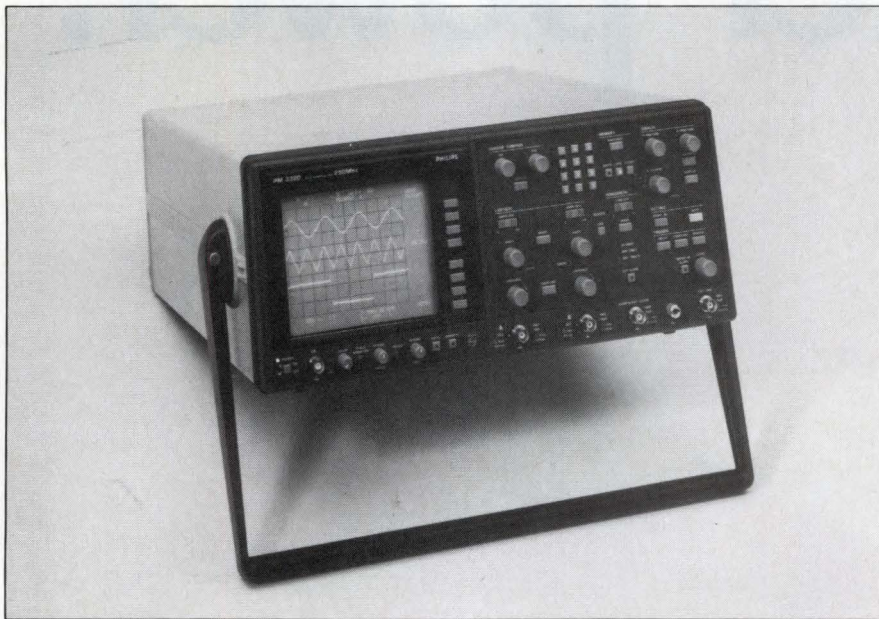

By positioning the on-screen cursors around part of an oscilloscope trace, you can retrigger the instrument to recapture an area of particular interest with greater timebase resolution.

The PM3320 digital storage oscilloscope (DSO) provides an equivalent analog bandwidth of 200 MHz for repetitive waveforms; in single-shot mode, it captures a minimum of 512 input samples at 4-nsec intervals. The instrument digitizes input signals to an accuracy of 10 bits. For single-channel operation, its memory depth is 4096 samples; for dual-channel operation, it is 2048 samples/channel.

You can set the scope to capture pre- or post-trigger traces, and you can capture glitches as short as 3 nsec even with the slowest timebase setting. Measurement functions include rise-time and peak-to-peak value determination, rms- or mean-value calculations, and the introduction of dc offsets as high as 300V.

The 10×12-cm CRT display includes an 8×10-cm graticuled trace area with annotation above and below the trace area, which indicates instrument settings relevant

to the displayed traces. This annotated data is part of the information that the DSO transfers to a digital plotter for hard-copy recording of captured traces.

Annotations appear on the right-hand side of the display for the eight soft keys, which select secondary instrument functions. By adopting a soft-key approach to these secondary functions, the oscilloscope's front panel remains relatively uncluttered by dedicated function controls; horizontal timebase control, for example, requires two pushbuttons: one for selecting a timebase range, and one for choosing a repetitive, single-shot, or roll-mode display.

The scope also has an autoset feature, which provides rapid trace location by automatically selecting appropriate timebase and vertical-deflection sensitivities. You can store as many as 77 (optionally as many as 250) front-panel setups in

nonvolatile memory and recall them either individually or in sequence.

Two on-screen cursors allow you to make measurements of captured traces. Moreover, you can use these cursors to define a portion of the captured waveform that you wish to view in more detail. The appropriate timebase and trigger delays are automatic so that the DSO can retrigger and capture this portion of the waveform with greater timebase resolution.

Optional IEEE-488 and RS-232C interfaces allow you to add remote programming and downloading of captured trace information. In addition, the interfaces enable you to display operator prompts or other information on the CRT. The interface card provides the instrument with a real-time clock also. The PM3320 is priced at \$9900; delivery, eight weeks ARO.—**Peter Harold**

Philips, Industrial and Electro-acoustic Systems Div, Box 218, 5600 MD Eindhoven, The Netherlands. Phone (040) 788620. TLX 35000.

Circle No 729

Philips Test & Measuring Instruments Inc, 85 McKee Dr, Mahwah, NJ 07430. Phone (201) 529-3800. TWX 710-988-5348.

Circle No 730

Of course.

...in terms of lumens or lux, the sun is the brightest source. However, in terms of smart power technology and power silicon system design know-how, it's hard to find a brighter power than SGS.

The industry itself has long acknowledged SGS' position as a leader. SGS power transistors and integrated circuits like the well established TDA 2005 audio amplifier or the L298 dual H-bridge motor driver have become industry standards, as have packages like the Multiwatt® and many others.

The brighter source is the one that can turn power system design ideas into silicon. That's why automotive, telecommunication, computer, peripheral, audio and video manufacturers look to SGS for realistic solutions to tough power problems.

We think it's time you looked into SGS. After all, the brighter your semiconductor source, the brighter your design's future.

Call 602/867-6259 now or write SGS Semiconductor Corporation, 1000 East Bell Road, Phoenix, Arizona 85022.



The brighter power™



Perfect Harmony!

Equal Sharing / N+1 / Reliability!

Switching Power's feed back current sharing amplifier allows equal power supply loading and higher reliability, (Load sharing of better than 5% is achieved). The telecommunication industry gets true redundancy and mainframe manufacturers can grow incrementally at low cost.

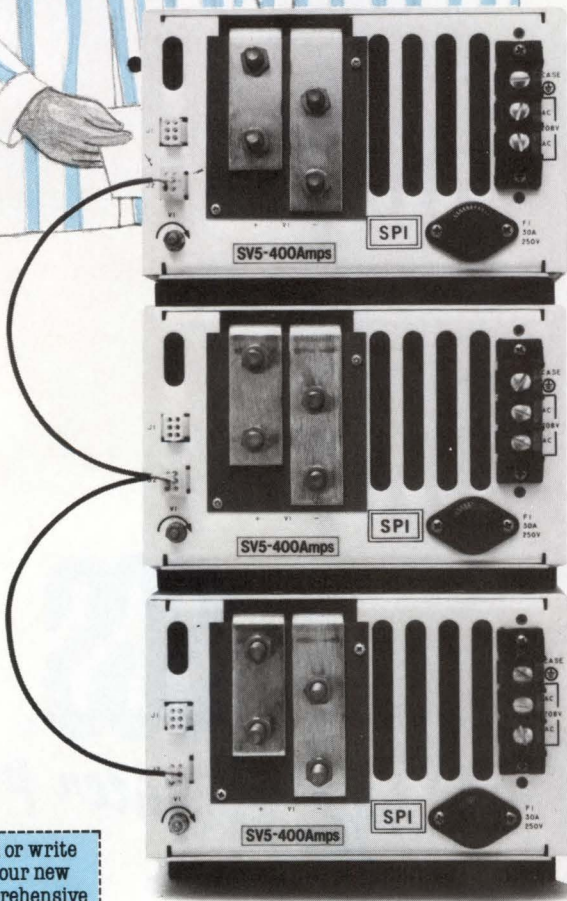

Call or write for our new comprehensive 24-Page Catalog

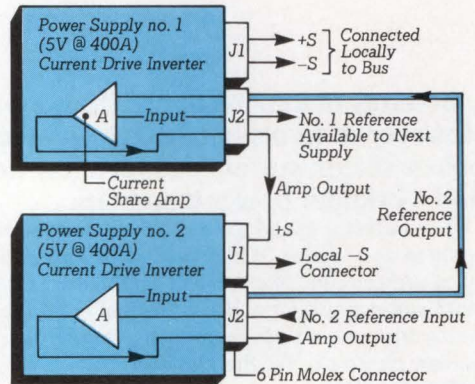

- ✓ 125 to 4000 Watts
- ✓ 50° C Power Ratings
- ✓ Remote Sense
- ✓ Reverse Voltage Protection
- ✓ Soft Start
- ✓ Up to 400 Amps
- ✓ Overvoltage Protection
- ✓ Short Circuit Proof
- ✓ International AC Input
- ✓ High Efficiency
- ✓ SELV Magnetics
- ✓ Thermal Protection
- ✓ Fully Regulated
- ✓ Certified Safety



SWITCHING POWER INC

3601 Veterans Highway, Ronkonkoma, NY 11779
 Tel. (516) 981-7231 - TWX: 510-220-1528
 Sunnyvale, Ca, Sales Office: (408) 732-1230

Powerful products for over a decade!

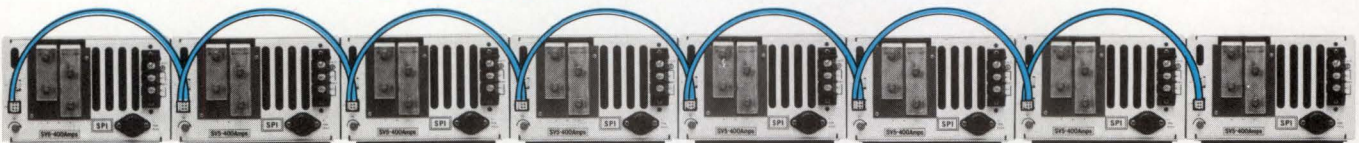

EDN NEWS



Family of silicon compilers aids system and chip design

To lower the cost of silicon-compiler software, the general-purpose Genesil program is now available as five individual special-purpose packages: MacroCompiler, LogicDesigner, ChipBuilder, Mentor Series, and Server. Each package targets the requirements of a different type of IC designer. For example, ChipBuilder assists IC-layout specialists, whereas LogicDesigner helps engineers who want to have a third party lay out their chips.

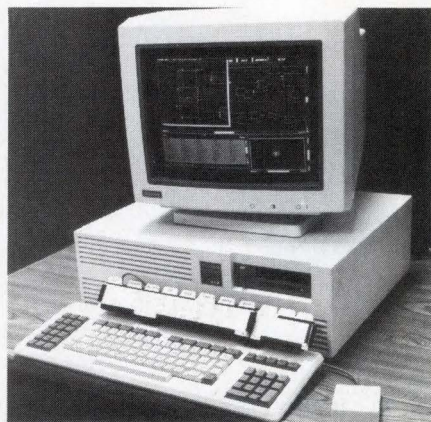

Once you've entered and simulated a design on a Mentor Graphics' workstation, you can use the Mentor Series package from Silicon Compiler Systems Corp (formerly Silicon Compilers Inc) to implement the design as a custom IC.

MacroCompiler compiles cell blocks, but it can't combine the blocks into a complete IC layout. It compiles cell blocks such as RAMs, ROMs, data paths, random logic, PLAs, and multipliers. The package generates a geometric database and a logic-simulation model of each block.

LogicDesigner doesn't lay out complete ICs either, but it calculates device speed and die size in addition to compiling blocks. To estimate the characteristics of a completed IC, the program creates a layout in generic 3-, 2-, and 1.25- μ m processes. Once you're satisfied with a design's speed and size, you can transmit a LogicDesigner file to the company's Prototype Tapeout Service, which optimizes the layout and places orders for prototypes from a foundry.

You don't have to transmit files to the Prototype Tape Service, however. You can lay out the chips yourself. The ChipBuilder package combines cell blocks into a complete IC layout and optimizes chip speed and size. It includes floor-planning, routing, and process-specific software.

The fourth package, the Mentor Series, provides both block-compilation and custom-IC layout tools. The

package runs on Mentor Graphics' (Beaverton, OR) CAE systems and uses that company's schematic-entry and logic-simulation software to generate cell blocks.

The Mentor Graphics software runs on Apollo (Chelmsford, MA) workstations, but silicon compilation requires the memory and speed of a VAX. By using the Server package, you can enter a design on an Apollo workstation and run compilation and analysis programs on a VAX. This package gives every node on an Apollo-based network access to silicon compilation.

MacroCompiler sells for \$75,000, and LogicDesigner costs \$79,500. The Mentor Series is priced at \$159,500; each Server package costs \$450. The price of ChipBuilder depends on the host computer. For a MicroVAX II, for example, it costs \$119,000; for a VAX 8650, it costs \$295,000.—*Eva Freeman*

Silicon Compiler Systems Corp, 2045 Hamilton Ave, San Jose, CA 95125. Phone (408) 371-2900.

Circle No 728

HOT NEWS OF PRODUCTS, TECHNOLOGY, AND CAREERS

EDN NEWS

Spotlight #24

IN A SERIES

**NEW + 5V/40mW
1200 BPS
SINGLE-SUPPLY
ONE-CHIP MODEM**

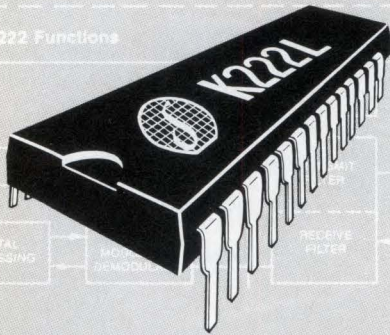

FEATURES:

- Single +5V power supply, 40mW max. power
- Integrates both Bell 212A/103 and CCITT V.22/V.21 1200/300 bps standards
- Offers all synchronous and asynchronous modes including 600 bps operation
- Interfaces directly with industry standard μ Ps (8051/8048)
- Provides wide dynamic range of 45 db, exceeding Bell specs
- Fully compatible with other SSI K-Series 1-chip modems for easy upgrades

Silicon Systems now offers the industry's only +5V single-supply, low-power modem IC family. The new SSI K222L modem IC adds its +5V single-supply capability to the K-Series family of products first introduced in 1985. The K222L integrates both the U.S. Bell 212A/103 and the CCITT V.22/V.21 1200/300 bps standards into one software configurable chip. This will permit users to build low-cost modems that can operate anywhere in the world.

Silicon Systems' K-Series modem family IC's are fully compatible, allowing 1200 bps modem designs to utilize any K-Series family member to meet different operating standards. In the same way, 2400 bps operation can be added using future SSI K-Series products.

Some of the SSI K-Series benefits to the user include: field upgradeability of the product, preservation of the user's hardware/software investments, reduction of user documentation requirements, and a general acceleration of the process of getting the end-user's product to the market faster.

For more information on the SSI K222L and the evolving SSI K-Series modem IC family, contact: Silicon Systems, 14351 Myford Road, Tustin, CA 92680. (714) 731-7110, Ext. 575.

silicon systems
INNOVATORS IN INTEGRATION

CIRCLE NO 10

PRODUCT UPDATE

SCSI development tools fill lab, field, or factory roles

The SDS family of products can aid you in designing and developing SCSI-based host-adapter and peripheral-controller applications. These IBM PC-based products also suit factory- and field-test tasks. The product family includes the SDS-2 SCSI development and test system, the SDS-100 SCSI test system, and the SDS-210 SCSI logic analyzer.

The SDS-2 combines initiator- and target-emulation capabilities, allowing you to test and debug both host-adapter and peripheral-controller SCSI designs. You can connect the personal computer that runs the SDS-2 software to a SCSI host via an RS-232C link, so you can control the entire test environment from the PC.

The SDS-2 system includes two different software packages with different user interfaces. One software package allows you to select test functions from a menu. The other package provides a C programming language that you can use to develop hands-off comprehensive and repetitive tests. The SDS-2 also offers a library for use with both packages; the library includes more than 250 test functions that can be used to construct test sequences.

For dedicated test operations, you can use the SDS-100 test system. It includes a board and a software package that provides more than 50 preprogrammed SCSI test functions. The software accesses the SCSI bus through a special-purpose test adapter. The SDS-100 can also execute SCSI test routines that you've developed on the SDS-2.

With either the SDS-2 or the SDS-100 you can purchase the SDS-210 SCSI logic analyzer. The logic

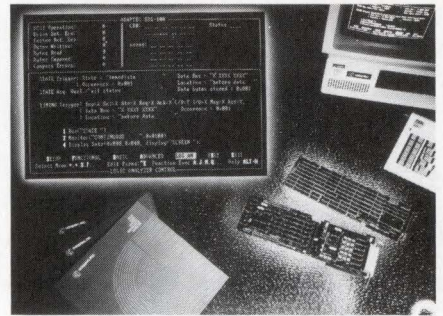

The SDS-2 development system and SDS-210 logic analyzer support the design and development of host-adapter and peripheral-controller SCSI implementations.

analyzer monitors and interprets SCSI-bus activity. Unlike μ P logic analyzers that sample data at given intervals, the SCSI logic analyzer samples the bus on an event-driven basis. The analyzer employs a 10-MHz internal reference clock, and it acquires data by means of user-selectable criteria. It displays its analysis results in a variety of nonbinary, high-level formats.

The SDS-2 package includes an IBM PC/XT computer, a SCSI test and development board, and software. The complete package costs \$19,500; you can buy the development system without the computer for approximately \$16,000. At \$5500, the SDS-100 add-in board and software fits factory- and field-test roles. You can add the SDS-210 logic analyzer to either system for \$3750 if you purchase it with the SDS-2 or SDS-100, or \$4500 if you purchase it later as an upgrade.

— Maury Wright

Adaptec Inc, 580 Cottonwood Dr, Milpitas, CA, 95035. Phone (408) 432-8600.

Circle No 727

SILICON SYSTEMS FIRST AGAIN— WITH THE ONLY +5V SINGLE-SUPPLY LOW-POWER MODEM IC FAMILY



Now, Silicon Systems has achieved a major technological breakthrough with the SSI K222L. This high-performance 1200 bps, single-chip modem IC requires only a single +5 volt supply and dissipates less than 40mW of power.

The K222L adds its +5V low-power capability to Silicon Systems' K-Series family of single-chip modem IC's without compromising the high standards of performance for which these products are noted. It integrates the Bell 212A/103 and the CCITT V.22/V.21 data communications capability into one compact CMOS chip and includes all features needed for easy

use in intelligent modem applications. This advanced integrated circuit reduces the power required for the modem function by an order of magnitude below other IC solutions, and eliminates the requirement for higher voltages or a separate negative power supply.

The K222L makes possible a variety of new applications. It is ideal for low-power, low-voltage modems; battery-powered, portable modems; power-sensitive laptop PC's; and telephone-line-powered modems—or any application where space and power is at a premium.

Best of all: the K222L is part of the

K-Series family, so all existing 1200 bps modems designed with the Silicon Systems K212L or K221L can be easily upgraded by plugging the K222L into the same socket. And in the future—all modems designed with the K222L can be further upgraded to 2400 bps operation with the Silicon Systems K224L.

For more information on the K222L, or the other K-Series modem IC's, contact: **Silicon Systems**, 14351 Myford Road, Tustin, California 92680, phone: (714) 731-7110, Ext. 575.

silicon systems™
INNOVATORS IN INTEGRATION

Here's the speed you

64 bit

CY7C189
16x4 15ns 90mA
CY7C190
16x4 15ns 90mA
CY27LSO3M
16x4 65ns 38mA

CY7C122
256x4 15ns 90mA
CY7C123*
256x4 7ns 120mA
CY93422
256x4 45ns 120mA
CY93L422
256x4 60ns 80mA

CY7C147
4Kx1 25ns 90/15mA
CY7C148
1Kx4 25ns 90/15mA
CY7C149
1Kx4 25ns 90mA
CY7C150
1Kx4 15ns 90mA

CY7C130*
dual port
1Kx8 35ns 120/30mA
CY7C140*
dual port
1Kx8 35ns 120/30mA

CY7C128
2Kx8 25ns 120/20mA 300 mil
CY6116
2Kx8 35ns 130/20mA
CY7C132*
dual port
2Kx8 35ns 120/30mA
CY7C142*
dual port
2Kx8 35ns 120/30mA
CY7C167
16Kx1 25ns 45/60mA
CY7C168
4Kx4 25ns 70/90mA
CY7C169
4Kx4 25ns 70/90mA
CY7C170
4Kx4 25ns 90mA
CY7C171
4Kx4 25ns 70/90mA
CY7C172
4Kx4 25ns 70/90mA

need.



64K

- CY7C185**
8Kx8 35ns 100/20mA 300 mil
- CY7C186**
8Kx8 35ns 100/20mA
- CY7C161**
16Kx4 25ns 70/20mA
- CY7C162**
16Kx4 25ns 70/20mA
- CY7C164**
16Kx4 25ns 70/20mA
- CY7C166**
16Kx4 25ns 70/20mA
- CY7C187**
64Kx1 25ns 70/20mA

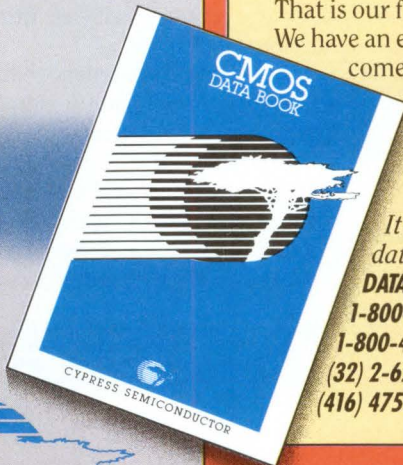

CYPRESS SEMICONDUCTOR



CMOS SRAM

If your job is building faster systems, here are a few compelling reasons to think Cypress Semiconductor when you think fast SRAM.

As the specs on the left indicate, we have the speed you need. In cool, low power CMOS.

And it's all available in the packaging you need. From CERDIP to plastic to surface mount to flat packs. Military versions? Yes *sir*.

A word on speed. And on choice.

We offer each of our SRAMs in a variety of configurations. So you only pay for the speed, size, or organization you need.

And if you need the highest speeds available, our customers tell us we are leading the way in delivering production quantities of the fastest, 25ns parts.

That benefit is a direct result of our success in producing the most advanced VLSI technology available.

As a result, when you design in our highest performance SRAM specs, you are designing in *deliverable* parts.

When you're in production, the ability to choose the speed you need and the ability to rely on production quantities become extremely important. Narrow-line SRAM suppliers don't always offer you these key benefits.

How to simplify your SRAM selection:

Beyond performance specs, look for a supplier in control of the fab process, for dependable delivery of the most demanding, high performance parts.

Look for a full line SRAM supplier, so you spend less time qualifying, and more time engineering.

That is our fast SRAM story.

We have an equally beneficial story to tell you when it comes to our other three product families:

- High performance PLD.
- High performance PROM.
- High performance LOGIC.

It's all in our new 1987 databook and our databook is yours for a phone call.

DATABOOK HOTLINE

- 1-800-952-6300, Ask for Dept CD1
- 1-800-423-4440 (In CA), Ask for Dept CD1
- (32) 2-672-2220 (Europe)
- (416) 475-3922 (In Canada)

New SRAM Highlights:

- 64K SRAM: A variety of configurations and speeds, including the ultra hard to find 25ns operating speeds.
- 1K SRAM: Scheduled for Q2, 1987, this 7 nanosecond SRAM will be the world's fastest TTL-compatible SRAM.

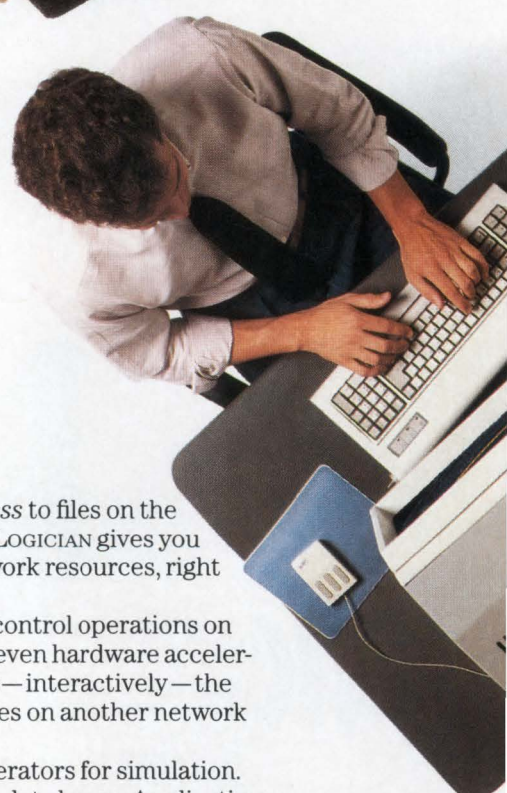
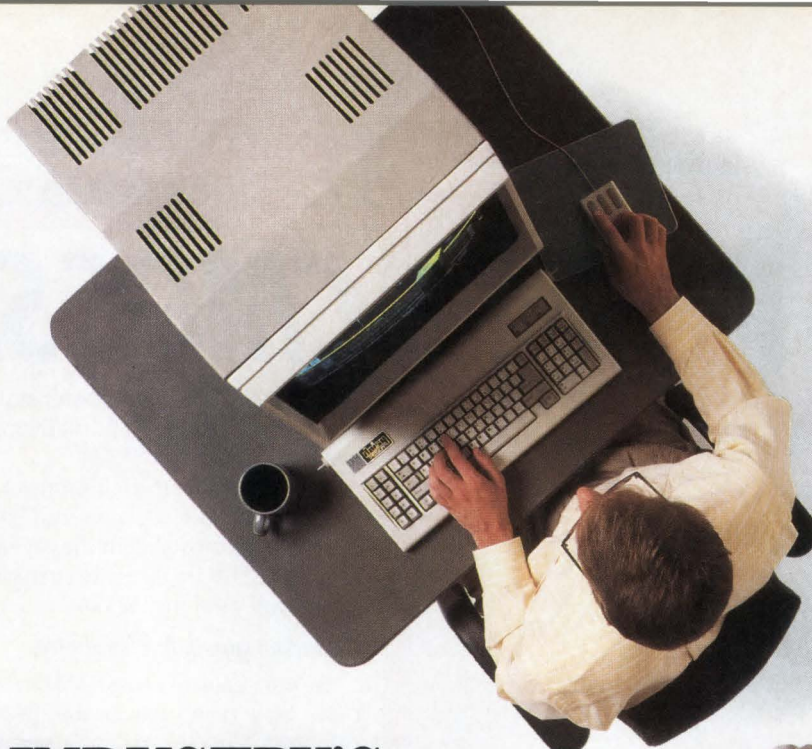

MEET THE INDUSTRY'S MOST WELL-CONNECTED PC. THE PERSONAL LOGICIAN.

The IBM PC-AT and Daisy's proven CAE tools.

Daisy's Personal LOGICIAN starts with the IBM® PC-AT™ platform, plus:

- High resolution, high performance workstation graphics.
- Multi-window, multi-tasking UNIX™ based DAISY-DNIX operating environment.
- Expanded memory — up to 6.5 Mb RAM, 140 Mb disk — enough capacity for large designs.
- Optional Physical Modeling, to plug actual chips into system simulations.
- The broadest range of CAE/CAD software available, including: Design Entry; Digital and Analog Simulation; Verification; Test.
- Plus these *new* additions: Personal BOARDMASTER for PCB design; Personal GATEMASTER for Gate Array Design; Personal CHIPMASTER for Custom IC Editing.

The result: A professional CAE/CAD workstation, at prices you can afford. For system design. For ASIC design. For custom IC editing.

Sit here. Run it there.

Beyond transparent *access* to files on the network, only the Personal LOGICIAN gives you transparent *control* of network resources, right from your desktop.

Just open a window, and control operations on other network resources — even hardware accelerators. That window displays — interactively — the remote process as it executes on another network resource or node.

Access and control accelerators for simulation. File server nodes for design data bases. Application nodes for layout verification. All *transparently*. The power of the Personal LOGICIAN gives you true CAE. A *networked* Personal LOGICIAN gives you the full power of CAE resources in a desktop system. By itself, a tool to accelerate the engineer. Networked, a tool to accelerate engineering *teams*, large or small.

Trademarks: DAISY-DNIX, Personal BOARDMASTER, Personal GATEMASTER, Personal CHIPMASTER — Daisy Systems Corp.; AT — International Business Machines; UNIX — Bell Laboratories, Inc.; VAX — Digital Equipment Corp. Registered Trademarks: IBM — International Business Machines Corp.; Daisy, Personal LOGICIAN — Daisy Systems Corp.

DAISY IS ENGINEERING

READERS' CHOICE



See how well-connected you can be.



Call for our free demonstration video*:
1-800-556-1234, ask for Ext. 32
1-800-441-2345, (In CA)
ask for Ext. 32

*We reserve the right to qualify recipients.
©1986, Daisy Systems Corporation.

CIRCLE NO 97

READERS' CHOICE

Of all the new products covered in EDN's **February 19, 1987**, issue, the ones reprinted here generated the most reader requests for additional information. If you missed them the first time, find out what makes them special: Just circle the appropriate numbers on the Information Retrieval Service card, or refer to the indicated pages in our **February 19, 1987**, issue.



▲ BAR-GRAPH ADC

Model ICL7182 is an A/D converter that not only directly drives a multiplexed LCD but also requires only three external components to drive a 101-segment bar graph (pg 245).

GE/Intersil.

Circle No 603



▲ SCANNER

The Image Scanner Option Kit for Epson's EX-800, EX-1000, and LQ-2500 dot-matrix printers works with IBM PCs and compatibles equipped with EGA, CGA, or Hercules display adapters (pg 235).

Epson America.

Circle No 602

MODULA-2 COMPILER

This Modula-2 compiler runs on any 8086/88-based machine under IBM PC-DOS or generic MS-DOS (pg 257).

Farbware.

Circle No 604

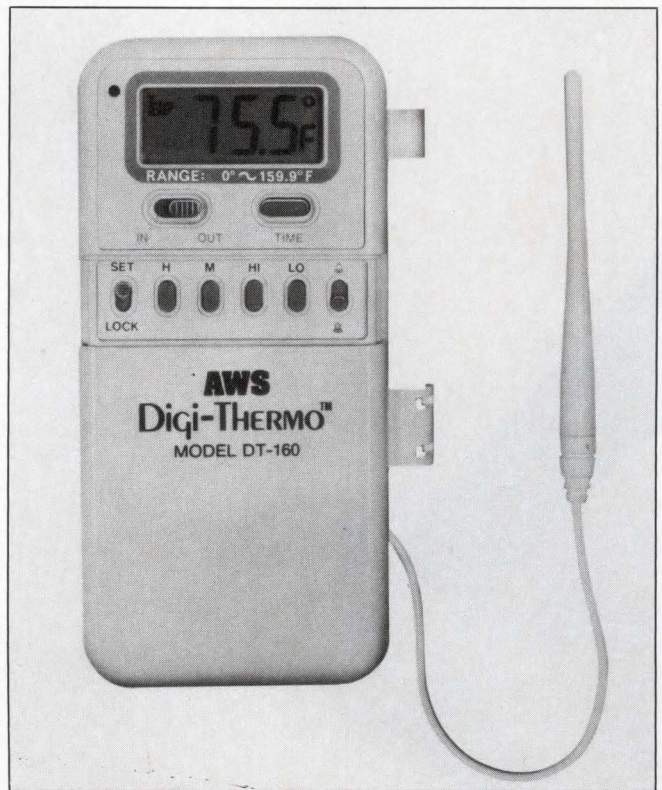

▲ DIGITAL THERMOMETER

The DT-160 pocket-sized digital thermometer measures 0 to 159.8°F. A temperature sensor mounted on the front panel allows you to display a room or probe temperature (pg 274).

A W Sperry Instruments Inc.

Circle No 605

BURN-IN SOCKET

Simple and quick loading of plastic leaded chip carriers (PLCCs) is a key feature of these 68-pin burn-in sockets (pg 211).

3M.

Circle No 601

(TEDDY TELLS ALL)

“WITHOUT THE MICROTEK MICE 2+, I MIGHT HAVE BECOME A FRANKENSTEIN INSTEAD...”

MICROTEK



Design time is critical. It can become an uncontrolled monster if allowed to continue unchecked. Bringing today's innovative electronic products and systems to market ahead of competition demands precise time-saving efficient development and debugging tools.

Look to Microtek for a powerful line of micro in-circuit emulators and software tools to assure rapid product development and shortened design-to-market cycles. Microtek emulators fully support most popular processors and micro controllers.

The bear loudly proclaims, “the MICE 2+ helped speed *my* creation — I can't bear to think that I might have become a monster instead of my lovable, talkative self.

“Grandpa Teddy was right, speak loudly and carry a small chip.”

Call New Micro for complete information and technical support. New Micro is the exclusive sales, service and marketing organization for Microtek in-circuit emulators.

Other processors supported by Microtek: 80386, 80286, 80186, 80188, 8086, 8088, 68000, 68010, 68008, Z80, NSC800, 8085, 6809, 6809E, 6502 (40 and 28 PIN) 8032, 8051, 8031, 8344, 8048, 8049, 8050, Z8, SUPER 8

NMI

New Micro, Inc.
16901 So. Western Ave.
Gardena, CA 90247
1-800-233-6048
In CA: (213) 538-5369

Micro Interfaces (S. East)
1-800-637-7226
In FL: (305) 623-9262

NMI is a Microtek company

ARGENTINA Microtec Ingenieria S.R.L. 54 (1) 46-8749/45-1934 • **AUSTRALIA** Macro Dynamics PTY LTD. 61 (03) 2207260 • **AUSTRIA** Allmos Electronic GMBH 43 (222) 627 19 54 • **BELGIUM** Simac Electronics B. V. 32 (02) 219 24 53 • **BRAZIL** Digibyte Sistemas Digitals LTDA 55 (011) 241-3611 • **CANADA** Tracan Electronics Corp 1 (416) 625-7752 • **CHILE** Equipos Industriales S.A.C.I. 56 (2) 382942 • **DENMARK** Metric A/S 45 (02) 80 42 00 • **FINLAND** Nurmikro KY 358 (0) 204981 • **FRANCE** Technologie Electronique 33 (1) 823. 15. 24 • **HONG KONG** Chai Luk Computer LTD. 852 (5) 751151/752172 • **HONG KONG** Idealand Electronics LTD. 852 (3) 7443516-9 • **ISRAEL** Aritmor 972 (03) 727317 • **ITALY** Pratica S.R.L. 39 (011) 50. 34. 27 • **ITALY** (Educational Market Only) Tekno Scuola SRL 39 (085) 693510 • **NETHERLANDS** Simac Electronics B.V. 31 (040) 533725 • **SINGAPORE** EPE Computronics PTE LTD. 65 7468182 • **SPAIN** Novatronic S.A. 34 (4) 4520811 • **SWEDEN** Nordisk Arrayteknik AB 46 (08) 7349935 • **SWITZERLAND** Traco Electronic AG 41 (01) 201 07 11 • **UNITED KINGDOM** ARS Microsystems LTD. 44 (0276) 685005 • **WEST GERMANY** Allmos Electronic 49 (089) 8572086-89 •

**OPEN A NEW
LINE OF
COMMUNICATION.**

Whether you're designing for Ethernet, lower-priced Cheapernet, or StarLAN, you need a supplier that can deliver all the network protocol-compatible products your datacom system demands.

Thomson-Mostek offers a complete product line for the datacommunication industry's leading protocols. Products like hub chips and media access controllers designed exclusively for StarLAN and general-purpose Manchester Encoder/Decoders. A Serial Interface Adapter and LANCE™ (Local Area Network Controller for Ethernet) and Cheapernet. We even have packet switching devices that meet the ISO full link Level 2 standards, including a

CMOS X.25 controller and CCITT Signaling System No. 7 device for common channel signaling applications.

Furthermore, Thomson-Mostek manufactures and distributes all our own datacom/network products. Which means you get state-of-the-art technology without relying on a half-dozen vendors. And without waiting.

So, if you need a dependable, one-stop datacom components source for Ethernet/Cheapernet, StarLAN, or even X.25 packet switching systems, our lines are open.

We're Thomson-Mostek. And we've got what it takes.

U.S. and Canadian Sales Offices

Western Area:

Santa Clara, CA
408/970-8585
Irvine, CA
714/250-0455
Woodland Hills, CA
818/887-1010
Seattle, WA
206/632-0245
Longmont, CO
303/449-9000
Scottsdale, AZ
602/998-1580
Tigard, OR
503/620-5517

Central Area:

Carrollton, TX
214/466-8844
Bloomington, MN
612/831-2322
Schaumburg, IL
312/397-6550
Austin, TX
512/451-4061

Eastern Area:

Burlington, MA
617/273-3310
Marlton, NJ
609/596-9200
Huntsville, AL
205/830-9036
Liverpool, NY
315/457-2160
Poughkeepsie, NY
914/454-8813
Dublin, OH
614/761-0676
Greensboro, NC
919/292-8396
Norcross, GA
404/447-8386

Canada:

Montreal, Quebec
514/288-4148
Brampton, Ontario
416/454-5252

For all other countries:

Thomson
Semiconducteurs
43 Avenue de l'Europe
78140 Velizy —
Villacoublay, France
(1) 39 46 97 19



DATA COMMUNICATION CIRCUITS

Part No.	Pins/ Package	Description	Features
StarLAN			
<ul style="list-style-type: none"> • 1.5μ CMOS technology • Complete solution (hub, station & MAC controller) • Automatic line reversal for low cost installation and maintenance 			
MK5030	48 pin DIP	Hub Chip	12 ports (cascadable) Extensive port status AT&T release 1 compatible
MK5032*	48 pin DIP	Media Access Controller	Ethernet LANCE™ compatible Selectable system clock rates NMOS
MK5033	28 pin DIP	General-Purpose Manchester Encoder/Decoder	Selectable controller interface Standard or Differential Manchester Many selectable options
MK5034*	28 pin DIP	General-Purpose Manchester Encoder/Decoder	With integrated drivers and receivers
MK5035	20 pin DIP	Station Device	Manchester Encoder/Decoder Robust collision detection Jabber to isolate network faults
MK5036*	28 pin DIP	Station Device	With integrated drivers and receivers
ETHERNET			
MK68590	48 pin DIP	Local Area Network Controller for Ethernet (LANCE)	Second sourced 48 byte FIFO for Bus latency Easy interface with most 16-bit CPUs Programmable options
MK68591	24 pin 600 MIL	Serial Interface Adapter (SIA)	Bipolar Manchester Encoder/Decoder, compatible with Ethernet and IEEE 802.3
MK68592	24 pin 300 MIL	Serial Interface Adapter (SIA)	Second sourced Bipolar Manchester Encoder/Decoder, compatible with Ethernet and IEEE 802.3
PACKET SWITCHING			
MK5025*	48 pin DIP	CMOS, X.25 Controller	Data rates up to 7 Mbps Complete Level 2 implementation On-chip DMA Programmable options 8- or 16-bit μp compatibility
MK5027*	48 pin DIP	CCITT Signaling System No. 7 Controller	Data rates up to 7 Mbps 8- or 16-bit μp compatibility On-chip DMA Pin compatible with MK5025

*Samples Q2 1987

LANCE is a trademark of Thomson Components-Mostek Corporation.

In addition to telecom/datacom devices, Thomson-Mostek manufactures MOS and bipolar devices for both commercial and military applications: microcomponents, memories and linear circuits as well as Discrete, RF and microwave transistors, passive components and ASIC.

LEADTIME INDEX

Percentage of respondents

ITEM	Off the shelf	1-5 weeks	6-10 weeks	11-20 weeks	21-30 weeks	Over 30 weeks	Last month's average (weeks)	Average (weeks)
TRANSFORMERS								
Toroidal	6	19	56	13	6	0	8.6	11.0
Pot-Core	11	22	34	22	11	0	9.6	10.2
Laminate (power)	7	20	60	6	7	0	8.1	9.3
CONNECTORS								
Military panel	0	25	38	25	12	0	10.8	13.7
Flat/Cable	25	25	25	25	0	0	6.6	5.1
Multipin circular	22	11	45	22	0	0	7.3	13.1
PC	15	31	39	15	0	0	6.4	6.2
RF/Coaxial	11	34	22	33	0	0	7.9	6.6
Socket	40	27	20	13	0	0	4.5	5.4
Terminal blocks	28	39	28	5	0	0	4.3	5.9
Edge card	15	39	31	15	0	0	6.0	6.3
Subminiature	22	34	22	22	0	0	6.0	5.7
Rack & panel	10	50	30	10	0	0	5.5	7.6
Power	22	34	33	11	0	0	5.4	7.6
PRINTED CIRCUIT BOARDS								
Single-sided	0	60	27	13	0	0	6.0	5.6
Double-sided	0	45	50	5	0	0	6.1	6.4
Multilayer	0	7	79	14	0	0	8.7	8.0
Prototype	0	71	23	6	0	0	4.9	4.8
RESISTORS								
Carbon film	42	16	26	16	0	0	5.0	2.5
Carbon composition	34	33	11	22	0	0	5.3	4.6
Metal film	29	24	24	23	0	0	6.2	4.0
Metal oxide	20	50	10	20	0	0	5.4	3.6
Wirewound	25	19	31	25	0	0	6.9	5.3
Potentiometers	20	16	48	16	0	0	6.8	5.9
Networks	17	16	39	28	0	0	7.9	6.1
FUSES								
	39	33	17	11	0	0	4.1	4.8
SWITCHES								
Pushbutton	31	19	38	12	0	0	5.5	7.5
Rotary	17	25	33	25	0	0	7.3	7.5
Rocker	31	31	31	7	0	0	4.6	7.2
Thumbwheel	34	11	33	22	0	0	6.4	10.5
Snap action	34	22	33	11	0	0	5.1	8.7
Momentary	27	9	37	27	0	0	7.4	8.7
Dual in-line	11	22	56	11	0	0	6.8	9.2
WIRE AND CABLE								
Coaxial	23	38	31	8	0	0	4.8	3.1
Flat ribbon	38	19	31	12	0	0	5.0	3.3
Multiconductor	29	28	36	7	0	0	4.8	3.8
Hookup	55	35	10	0	0	0	1.9	1.6
Wire wrap	45	33	22	0	0	0	2.8	2.1
Power cords	21	37	42	0	0	0	4.5	4.3
Other	25	0	75	0	0	0	6.0	4.9
POWER SUPPLIES								
Switching	14	7	50	22	7	0	9.4	9.8
Linear	18	18	37	18	9	0	8.6	6.2
CIRCUIT BREAKERS								
	20	40	27	13	0	0	5.4	7.4
HEAT SINKS								
	17	25	50	8	0	0	6.0	5.4

ITEM	Off the shelf	1-5 weeks	6-10 weeks	11-20 weeks	21-30 weeks	Over 30 weeks	Last month's average (weeks)	Average (weeks)
RELAYS								
General purpose	39	22	22	11	6	0	5.6	5.5
PC board	13	20	40	27	0	0	7.9	8.0
Dry reed	12	38	12	38	0	0	7.9	5.7
Mercury	12	0	63	12	13	0	10.1	7.7
Solid state	13	33	27	20	7	0	7.9	5.6
DISCRETE SEMICONDUCTORS								
Diode	25	25	30	20	0	0	6.3	4.3
Zener	24	29	18	29	0	0	6.9	6.3
Thyristor	0	40	30	30	0	0	8.3	5.4
Small signal transistor	13	27	33	27	0	0	7.6	7.0
FET, MOS	0	56	22	22	0	0	6.9	7.6
Power, bipolar	15	31	39	15	0	0	6.4	8.1
INTEGRATED CIRCUITS, DIGITAL								
CMOS	11	34	33	22	0	0	7.1	8.2
TTL	13	34	40	13	0	0	6.3	5.5
LS	7	33	47	13	0	0	6.8	5.9
INTEGRATED CIRCUITS, LINEAR								
Communication/circuit	22	11	34	33	0	0	8.2	9.4
OP amplifier	6	31	44	19	0	0	7.3	8.5
Voltage regulator	8	39	38	15	0	0	6.6	6.7
MEMORY CIRCUITS								
RAM 16k	31	15	23	31	0	0	7.1	5.5
RAM 64k	33	17	33	17	0	0	5.8	5.2
RAM 256k	20	10	40	30	0	0	8.2	6.9
ROM/PROM	27	9	46	18	0	0	6.7	5.9
EPROM	25	38	12	25	0	0	6.0	7.0
EEPROM	11	22	34	33	0	0	8.5	7.3
DISPLAYS								
Panel meters	11	11	56	22	0	0	8.2	5.7
Fluorescent	0	0	57	43	0	0	11.2	8.4
Incandescent	0	25	50	25	0	0	8.6	7.4
LED	12	31	44	13	0	0	6.4	6.3
Liquid crystal	0	25	37	38	0	0	9.6	8.2
MICROPROCESSOR ICs								
8-bit	7	36	29	28	0	0	7.8	7.4
16-bit	11	11	56	22	0	0	8.2	7.4
FUNCTION PACKAGES								
Amplifier	11	11	22	45	11	0	11.8	9.1
Converter, analog to digital	10	20	60	10	0	0	7.0	8.0
Converter, digital to analog	11	22	45	22	0	0	7.7	8.6
LINE FILTERS								
	12	13	50	25	0	0	8.3	7.0
CAPACITORS								
Ceramic	32	26	32	10	0	0	4.9	6.4
Ceramic monolithic	25	38	31	6	0	0	4.6	8.1
Ceramic disc	15	54	31	0	0	0	4.7	7.5
Film	23	23	54	0	0	0	5.0	8.1
Electrolytic	28	28	33	11	0	0	5.2	6.6
Tantalum	6	44	38	12	0	0	6.3	6.8
INDUCTORS								
	8	31	38	23	0	0	7.6	8.5

Source: Electronics Purchasing magazine's survey of buyers

**THE BIRTH OF A NEW
ERA IN DIGITIZING
AND ANALOG
OSCILLOSCOPES.**

Tektronix
COMMITTED TO EXCELLENCE

NOW THE FUTURE OF MEASUREMENT IS SO CLOSE YOU CAN TOUCH IT.

The Tek 11000 Series is nothing less than a new generation of oscilloscopes. What you can do with it, and the way you work with it, will fundamentally alter your expectations of a scope.

These fully programmable scopes display more traces (up to 8) at higher bandwidths (up to 1 GHz), with greater accuracy (1% vertical) and include more new functions for expediting the capture and processing of data than can ever be listed here.

Two digitizing scopes exert the power of three 16-bit processors towards longer records, more powerful triggering and higher throughput than ever before. Two analog scopes virtually eliminate manual computation, even for the most complex measurements.

Most startling is the simplification and automation of the whole measurement and analysis process. Large displays, touch-screen control, pop-up menus and built-in intelligence unclutter the front panel and keep eyes focused on the display. For the first time, you need know nothing about a scope's technology to get the most out of it.

The 11000 Series continues the plug-in versatility of the Tek 7000 Series. Five new plug-ins and three new probes tailor 11000 Series scopes to a full range of applications, from design and debug to production test.

Demonstrations are now in progress throughout North America.

To get in touch with the future of measurement, contact your local Tek sales engineer or call Tektronix at 1-800-547-1512.

DIGITIZING	11401	11402	ANALOG	11301	11302
Bandwidth	500 MHz	1 GHz	Bandwidth	400 MHz	500 MHz
Risetime	700 ps	350 ps	Risetime	875 ps	700 ps
No. Channels ¹	1-12	1-12	No. Channels ¹	1-8	1-8
Vert. Sensitivity ⁴	1 mV/div	1 mV/div	Vert. Sensitivity ⁴	1 mV/div	1 mV/div
Vert. Resolution	10-14 bits ³	10-14 bits ³			
Automatic Measurements	Min, Max, Mid, Mean, RMS, Peak-Peak, Rise, Fall, Width, Delay ¹ , Cross, Period, Frequency, Main → Window Trigger, YT Area, YT Energy, Cursors		Automatic Measurements	Peak-Peak, Min, Max, Mid, Frequency, Period, Width, Duty Cycle	
Timebase Accuracy	100 ps + .002% of the measured interval		Built-in counter/timer	500 MHz 6 Function 10 digits	500 MHz 6 Function 10 digits

¹Up to 8 traces may be displayed at once from any of up to 12 input channels.

²Absolute DC accuracy with full scale offset or Vc.

³14-bit resolution obtained using signal averaging.

⁴Except with 11A71 which has 10mV/div

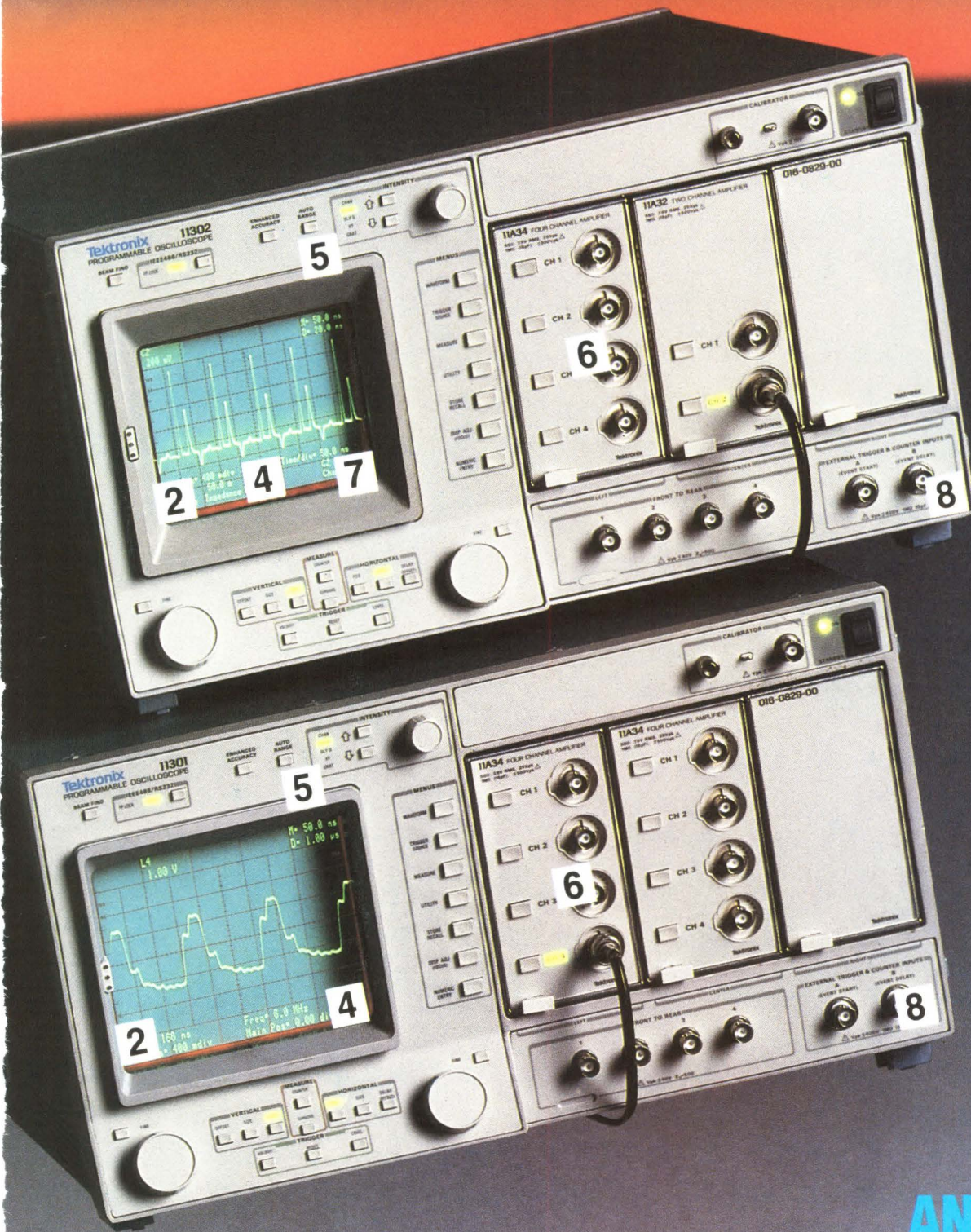

5 **AUTOSET FROM PROBE TIP.** Push a button on the front panel or on the probe to set up a scaled and triggered waveform display, or to sequence automatically through a series of tests.

6 **1 mV/DIV VERTICAL SENSITIVITY.** Applies across the full bandwidth, right at the probe tip. Achievable on three new plug-ins.

7 **MICROCHANNEL PLATE.** Enables a single shot trace brightness in the 11302 almost 1000 times brighter than on conventional scopes—making even the fastest transients clearly visible to the eye.

8 **500 MHz SIX FUNCTION COUNTER/TIMER.** With 2 ns single shot resolution — 10 ps with averaging. Use with dual delayed sweeps for precise timing measurements between selected points. Counter/timer view trace ends guesswork.

ANALOG

How the new technology will simplify your life.

The 11000 Series, makes it unnecessary to learn oscilloscope theory. You get more out of your scope with less effort than ever before.

Mechanical front-panel controls have all but vanished in favor of a touch-screen interface that presents only valid selections in logical groups. Select a trace, a trigger, a measurement or other function just by touching the appropriate area of the screen or by selecting from pop-up menus that fold down out of the way once selections are made.

Or, push a button on the new probes to initiate an auto-range or a sequence of stored test setups—your hands and eyes never leave the job.

11401/11402 Digitizing Oscilloscopes

One example of innumerable waveform processing capabilities: square a voltage waveform and divide by a load resistance — $(L^3 \cdot L^3)/10$ — to make a power measurement.

Customize automatic measurements to meet your needs. Touching any measurement result, for example, causes annotation to appear showing exactly where the measurement is being taken.

Point Accumulate Mode keeps all digitized points in display memory to help you handle complex displays such as eye diagrams, measure worst case jitter, or catch low rep-rate glitches.

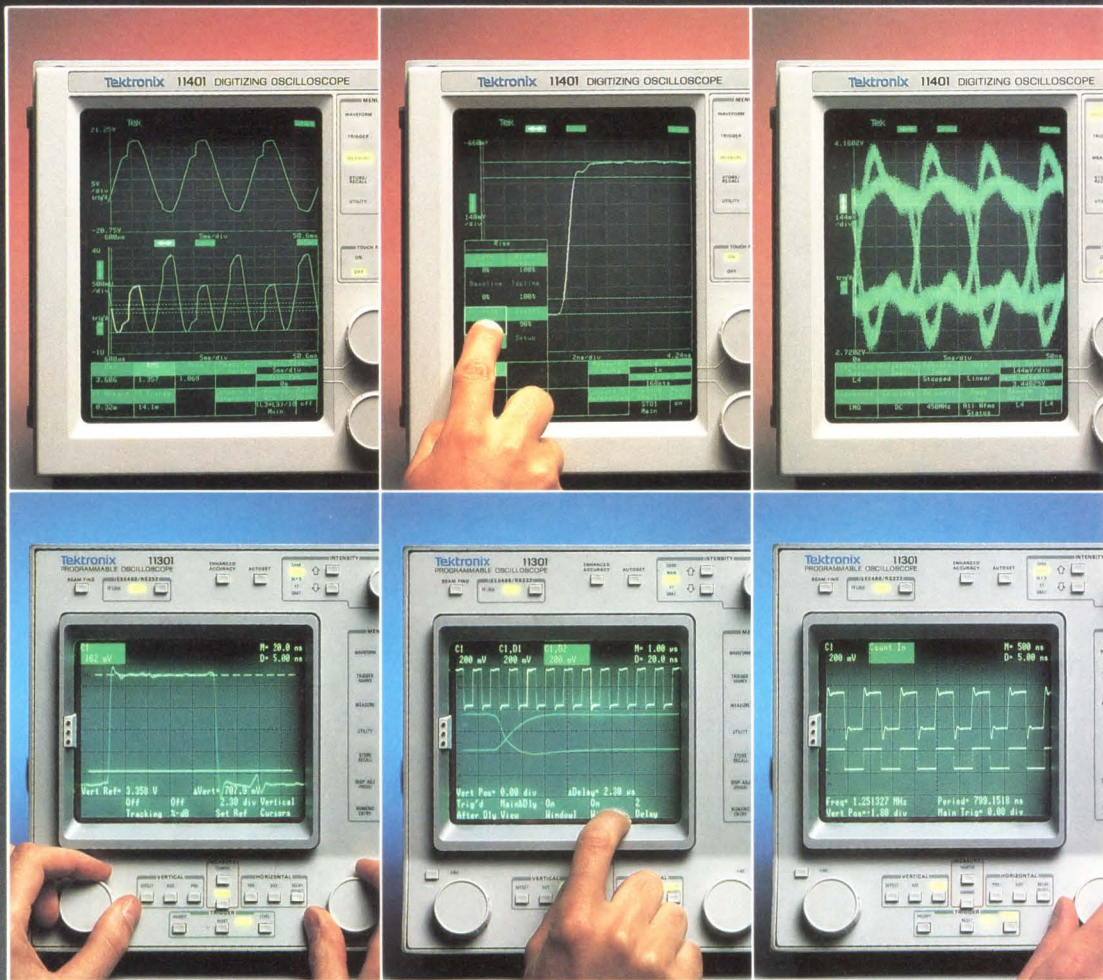

11301/11302 Analog Oscilloscopes

Call up cursors to help you make high-accuracy measurements, displayed in decibels, percent, degrees, volts or seconds.

Dual delayed sweeps allow expansion of the main sweep for close examination and accurate measurement of waveform parameters such as risetime and falltime.

Integrated 500 MHz universal counter/timer includes a unique counter-view feature that lets you see exactly what the counter/timer is triggering on.

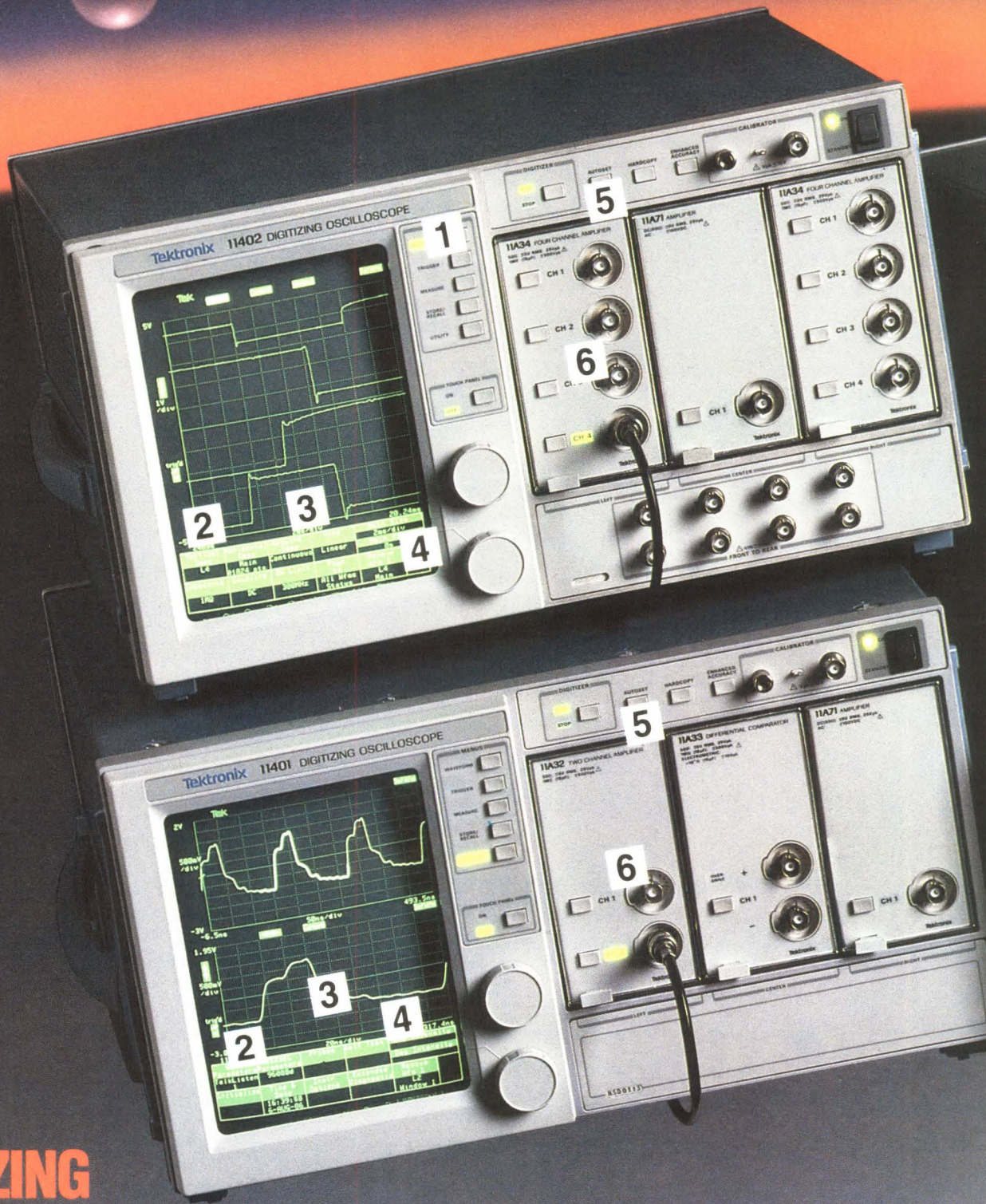

DIGITIZING

1 **1 GHz.** The 11402 Digitizing Oscilloscope features a full 1 GHz bandwidth right at the probe tip—with no sacrifice in vertical resolution—to help you make the most demanding voltage and timing measurements.

2 **UP TO 8 TRACES.** High-resolution screen lets you display up to eight waveforms simultaneously, with an update nearly as fast as an analog scope. No scopes ever let you see so much at once.

3 **10 ps HORIZONTAL RESOLUTION.** 10-bit vertical resolution is average-able to 14 bits. Self-calibration decreases error to less than 1% DC.

4 **TOUCH SCREEN OPERATION.** Procedures are fast, intuitive—the closest link ever between engineer and scope.

Tektronix, Inc.

SALES AND SERVICE OFFICES

ALABAMA

Huntsville 35805
4900 Corporate Drive
Suite H
Phone: (205) 830-9212

ARIZONA

(Phoenix)
3015 S. 48th Street, Suite 100
Tempe 85282
Phone: (602) 438-1011
Tucson Area: (602) 790-3099
Mailing Address:
P.O. Box 29540
Phoenix 85038

CALIFORNIA

(Concord)
3451 Vincent Road
Pleasant Hill 94523
Phone: (415) 932-4949
From Oakland/San Francisco: (415) 254-5353
From Sacramento: (916) 447-5072
From Fremont/Milpitas: (415) 490-7067
From Livermore: (415) 449-5176
Mailing Address:
P.O. Box 4040
Concord 94524-2040

Irvine 92714
17052 Jamboree Blvd.
Mailing Address:
P.O. Box 19523
Irvine 92713
Phone: (714) 660-8080
TELEFAX: (GP1)(714) 660-8080 X311

(Los Angeles)
21300 Erwin Street
Service Center
20920 Victory Blvd.
Woodland Hills 91367
Phone: (818) 999-1711
Mailing Address:
21300 Erwin St.
P.O. Box 8500
Woodland Hills 91365

San Diego 92123
5770 Ruffin Road
Phone: (619) 292-7330

Santa Clara 95054-1196
3003 Bunker Hill Lane
Phone: (408) 496-0800
TELEFAX: (GP 1) (408) 496-0800

COLORADO

(Denver)
393 Inverness Drive South
Englewood 80112
Phone: (303) 799-1000
Tele: (Infocom) 45-4455
From Colorado Springs: (303) 634-3933

CONNECTICUT

Milford 06460
40 Commerce Park Road
Phone: (203) 877-1494

FLORIDA

Fort Lauderdale 33309
2003 N.W. 62nd Street, Suite 102
(known as) Cypress Creek Road
Phone: (305) 771-9700
From Miami: (305) 947-6053
Also serves Puerto Rico and
U.S. Virgin Islands

Orlando 32803
3657 Maquire Blvd., Suite 100
Phone: (305) 894-3911
From the Cape Kennedy Area:
(305) 636-0343

Pensacola 32503
4700 Bayou Blvd., Bldg. 1
Phone: (904) 476-1897

GEORGIA

(Atlanta)
Technology Park/Atlanta
650 Engineering Drive
Norcross 30092
Phone: (404) 449-4770
Mailing Address:
P.O. Box 6500
Norcross 30091

HAWAII

Honolulu Service Center 96819
EMC Corporation
550 Paiea Street Suite 103
Phone: (808) 836-1138 (Service)
(800) 538-8125/6 (Sales)

ILLINOIS

(Chicago)
5350 Keystone Court
Rolling Meadows 60008
Phone: (312) 259-7580
TELEFAX: (GP 1) (312) 259-7580

INDIANA

Indianapolis 46268
8751 Wesleyan Road
Phone: (317) 872-3708

KANSAS

(Kansas City)
10513 West 84th Terrace
Lenexa 66214
Phone: (913) 541-0322
Omaha, Lincoln, Wichita
Enterprise 6537

LOUISIANA

(New Orleans)
1940 I-10 Service Rd.
Concourse Place
Kenner 70065
Phone: (504) 466-4445

MARYLAND

(Baltimore)
102 Lakefront Dr.
Cockeysville 21030
Phone: (301) 771-6400

DC

700 Professional Drive
P.O. Box 6026
Gaithersburg 20877
Phone: (301) 948-7151
TELEFAX: (GP 1) (301) 948-7151 X321

MASSACHUSETTS

(Boston)
482 Bedford Street
Lexington 02173
Phone: (617) 861-6800

MICHIGAN

(Detroit)
24155 Drake Road
Farmington 48024
Phone: (313) 478-5200

MINNESOTA

St. Paul 55126
4660 Churchill Street
Phone: (612) 484-8571

MISSOURI

(St. Louis)
2318 Millpark Drive
Maryland Heights 63043
Phone: (314) 429-7707

NEW JERSEY

Woodbridge 07095
40 Gill Lane
Phone: (201) 636-8616
TELEFAX: (GP 1) (201) 636-8616 X266

NEW MEXICO

Albuquerque 87108
1258 Ortiz Drive, S.E.
Phone: (505) 265-5541
Southern N.M. Area: Enterprise 678
Southern Nevada Area: Enterprise 678
El Paso, TX Enterprise 678
TELEFAX: (GP 1) (408) 358-3421

NEW YORK

Albany 12205
26 Computer Drive West
Phone: (518) 458-7291

(Long Island)
1895 Walt Whitman Road
Melville, N.Y. 11747
Phone: (516) 756-9690
NYC Customers (718) 895-8010

Poughkeepsie 12601
Beechwood Office Park
385 South Road
Phone: (914) 454-7540

Rochester 14623

1210 Jefferson Road
Phone: (716) 424-5800

(Syracuse)

1 Northern Concourse
North Syracuse 13212
Phone: (315) 455-6661

NORTH CAROLINA

Raleigh 27612
3725 National Drive, Suite 104
Phone: (919) 782-5624

OHIO

(Cleveland)
7830 Freeway Circle
Middleburg Heights 44130
Phone: (216) 243-8500 (Sales)
(216) 243-8505 (Service)

Dayton 45449-2396
501 Progress Rd.
Phone: (513) 859-3681

OKLAHOMA

Oklahoma City 73108
4400 Will Rogers Parkway
Suite 220
Phone: (405) 943-8127
Oklahoma Wats Only
Phone: (800) 522-8196

OREGON

10220 S.W. Nimbus Drive
Suite K-4
Portland 97223
Phone: (503) 620-9100

Factory Service Center
Tektronix Industrial Park
Beaverton 97077
Phone: (503) 642-8600
TWX: (910) 467-8708
TLX: 15-1754

PENNSYLVANIA

(Philadelphia)
450 Sentry Parkway
Blue Bell 19422
Phone: (215) 825-6400

Pittsburgh 15221
1051 Brinton Road, Suite 300
Phone: (412) 244-9800

TENNESSEE

Knoxville 37923
9041 Executive Park Drive
Suite 411
Phone: (615) 690-6422
From Oak Ridge (615) 482-7349

TEXAS

(Dallas)
1551 Corporate Drive
Irving 75038
Mailing Address:
P.O. Box 165027
Irving 75016
Phone: (214) 550-0525
Metro: (214) 751-0470
TELEFAX: (GP 1) (214) 258-0525 X256

Houston 77099
10887 S. Wilcrest Drive
Phone: (713) 933-3000
Mailing Address:
P.O. Box 4309
Houston 77210

San Antonio 78232
14800 San Pedro Avenue
Suite 112
Phone: (512) 496-1161
Kelly 78226
Billy Mitchell Center
227 Billy Mitchell Road
Phone: (512) 432-1341

UTAH

Salt Lake City 84115
Timesquare Park
300 Mercer Way
Phone: (801) 486-1091

VIRGINIA

(Crystal City)
Rosslyn Center
1700 N. Moore Street
Suite 1620
Arlington, VA 22209
Phone: (703) 522-4500
Newport News 23602
606 Denbigh Blvd., Suite 703
Phone: (804) 874-0099

WASHINGTON

(Seattle)
3709 157th Avenue NE.
P.O. Box 97021
Redmond, WA 98073-9721
Phone: (206) 885-0900

CORPORATE OFFICE

Tektronix, Inc.,
P.O. Box 500
Beaverton, Oregon 97077
Telephone: (503) 627-7111

PRINCIPAL PLANT

Tektronix Industrial Park,
Beaverton, Oregon 97077

DIRECT ORDER:

For Continental United States, Alaska, Hawaii, Virgin Islands and Puerto Rico. Contact our National Marketing Center: Phone: (800) 426-2200 For State of Oregon, call collect (503) 627-9000.

ADDITIONAL LITERATURE

or Tektronix Sales Office serving you:
P.O. Box 1700,
Beaverton, Oregon 97075
Phone: (800) 547-1512
Oregon only: (800) 452-1877
TLX: 151754,
TWX: (910) 467-8708
TEKTRONIX BEAV.

Copyright © 1986, Tektronix, Inc. All rights reserved. Printed in U.S.A. Tektronix products are covered by U.S. and foreign patents, issued and pending. Information in this publication supersedes that in all previously published material. Specification and price change privileges reserved. TEKTRONIX, TEK, PLOT 10, TEKTEST, SCOPE-MOBILE, and  are registered trademarks. For further information, contact: Tektronix, Inc., Corporate Offices, P.O. Box 500, Beaverton, OR 97077. Phone: (503) 627-7111; TLX: 151754; TWX: (910) 467-8708. Subsidiaries and distributors worldwide.

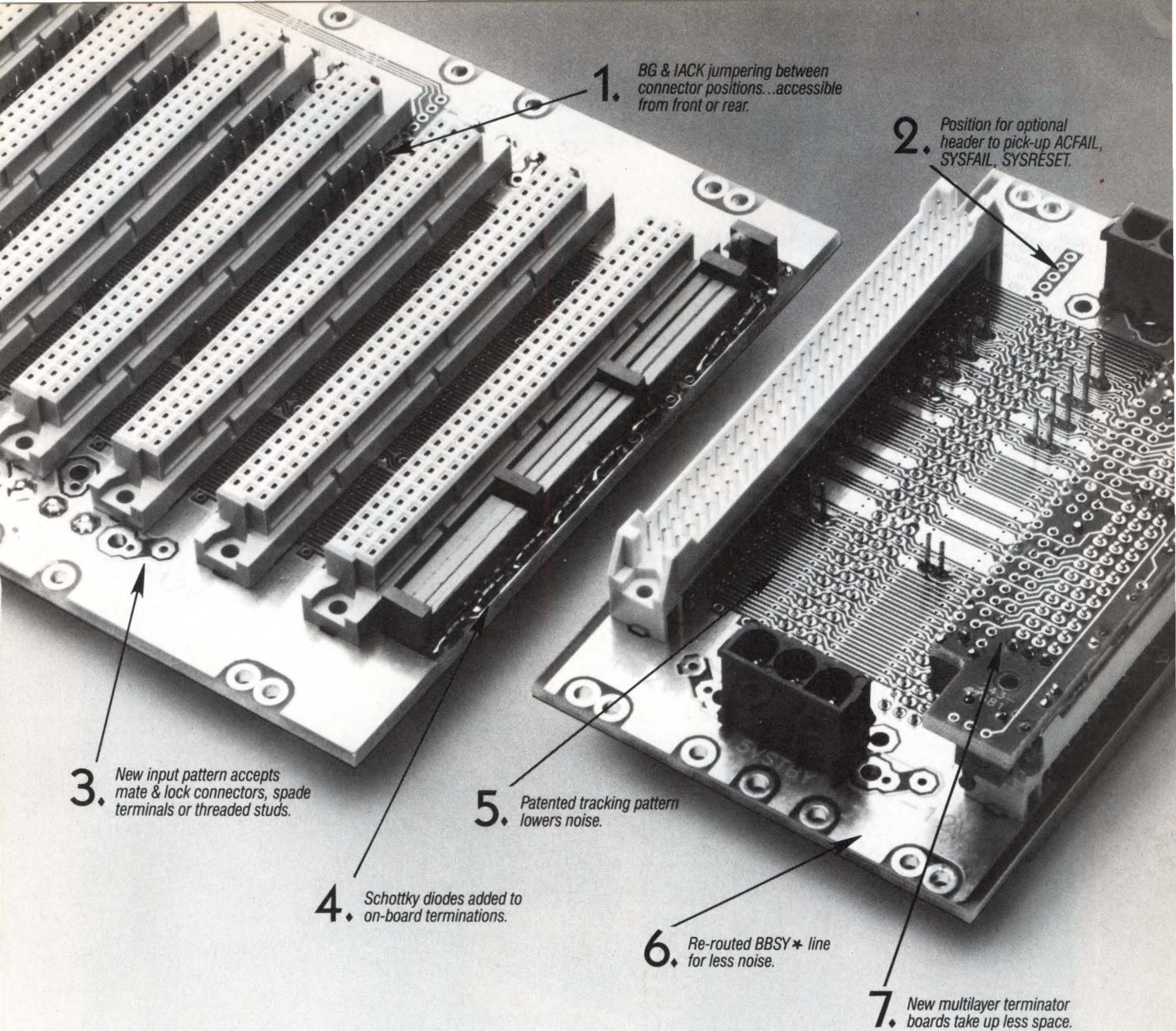

1. BG & IACK jumpering between connector positions...accessible from front or rear.

2. Position for optional header to pick-up ACFAIL, SYSFAIL, SYSRESET.

3. New input pattern accepts mate & lock connectors, spade terminals or threaded studs.

5. Patented tracking pattern lowers noise.

4. Schottky diodes added to on-board terminations.

6. Re-routed BBSY* line for less noise.

7. New multilayer terminator boards take up less space.

7 REASONS WHY...

BICC-VERO MAKES THE BEST VME BACKPLANES

You've already invested quality time and budget in building the very best VME computer system for your application.

Now, interconnect your components with the very best backplane. Select from the full range of sizes and configurations offered by BICC-VERO.

BICC-VERO supports their VME Backplanes with a full line of card frames, enclosures, and connectors. Ask for the details.

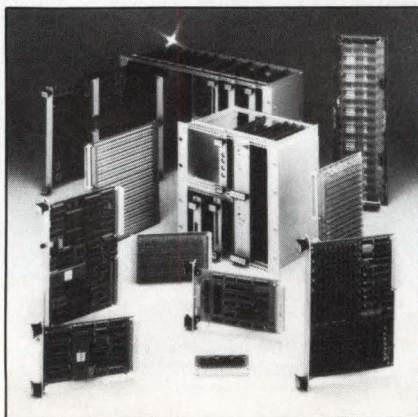

Call us or your BICC-VERO Distributor for complete information.



CIRCLE NO 66

BICC-VERO ELECTRONICS, INC.

1000 Sherman Avenue
Hamden, CT 06514

(203) 288-8001 TWX: 510-227-8890

If you're going to build LAN hardware that conforms to existing IEEE standards, you have a variety of LAN ICs to choose from. When you get down to the physical level and choose your transceiver ICs, don't be cavalier in your choice; you may have to make decisions that can be revealing about the capabilities of the LAN itself.

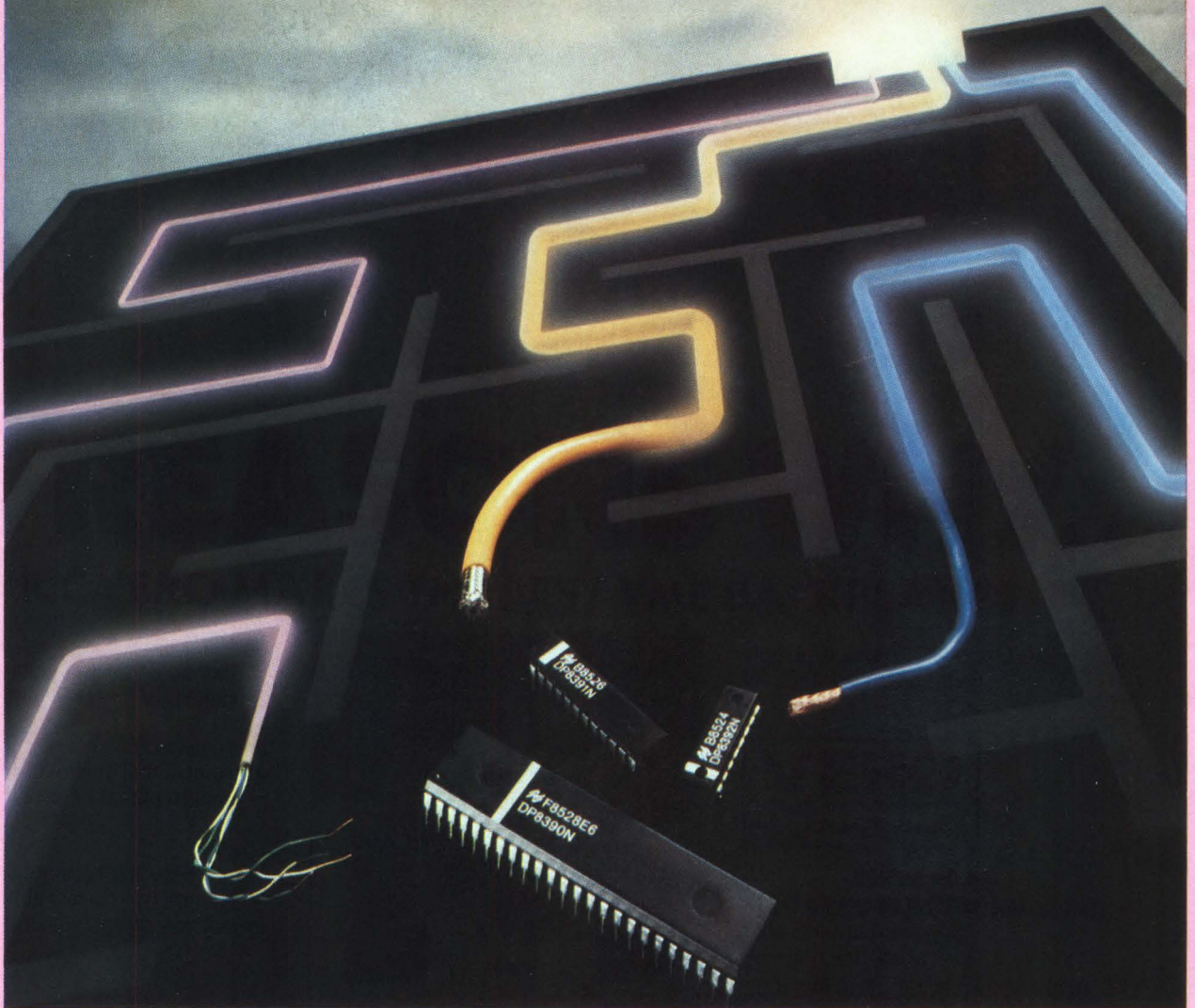

Effective LAN designs begin with IC families that support the physical level; these families, which include controllers and transceivers, can point the way through the bewildering maze of LAN architectures. (Photo courtesy National Semiconductor)

LAN ICs for IEEE-802 networks

Jim Wiegand, *Associate Editor*

The 7-layer Open Systems Interconnect (OSI) model for local-area networks (LANs), promulgated by the International Standards Organization, purports to specify all levels of the connection between the computer and the physical medium, from the topmost, application layer (layer 7) down to the physical layer (layer 1). You'll find that the physical layer is the best represented level of the network, with respect to available products, but the least discussed aspect of LANs. When you're selecting the ICs for your network hardware, however, you must pay as much attention to your choice of ICs for that physical level—the transceivers—as you do to the controller and encoder ICs. And when you're exploring the physical layer, you'll discover differences between the existing IEEE-802 architectures that are not often broached in the otherwise ample trade-press coverage of LANs.

In the US, the IEEE-802 LAN standards are becoming an increasingly popular realization of the OSI model (see **Ref 1**). **Table 1** (see page 133) lists the existing families of IEEE-802 LAN ICs, including transceivers. Transceivers provide the functions necessary to transfer data to and from a LAN's physical communications medium; you can't directly drive a coaxial cable, for example, with a protocol-controller chip. Transceivers are analog devices that provide buffering, filtering, level translation, and, in some cases, collision detection and clock generation.

They form part of the network node, along with the controller and encoder circuitry. Your choice of transceiver is determined by such factors as speed, signaling requirements, the type of transmission medium, and ancillary LAN functions.

You may distinguish the variety of IEEE-802 LAN architectures from one another by the method used to access the transmission medium. Networks conforming to the IEEE 802.3 standard—Ethernet, Thinnet (Cheapernet), and StarLAN—employ the Carrier Sense Multiple Access with Collision Detection (CSMA/CD) access scheme. Transceivers for Ethernet and Thinnet are listed in **Table 1**; you can use RS-422 drivers as StarLAN transceivers.

IEEE-802.4 specifies a token-passing-bus access method (token bus, for short). The Manufacturing Automation Protocol (MAP) promulgated by General Motors is the leading contender for LANs using this approach. IEEE-802.5 specifies a token-passing-ring access method (token ring, for short), and IBM's implementation of this scheme appears to be taking over as the de facto standard for this architecture.

A LAN's access method does not entirely dictate the type of medium, and consequently the type of transceiver, you must use for the first network layer. For example, existing CSMA/CD LANs that adhere to the 802.3 recommendations em-

Your choice of transceiver is determined by such factors as speed, signaling requirements, and ancillary LAN functions.

ploy a variety of coaxial and twisted-pair cabling schemes.

Ethernet is an 802.3-type LAN that uses 0.4-in. coaxial cable as its transmission medium. It's a base-band network that operates at a speed of 10M bps and is configured in a bus topology. Most transceivers for Ethernet systems provide three basic functions: collision detection, antijabber, and line driving. If you select a transceiver that's lacking one or more of these functions, you'll have to ensure that some other part of the system provides the functions in question.

In a bus-based CSMA/CD system such as Ethernet, each station (the user equipment and its associated network-node circuitry) attached to the network is responsible for monitoring the bus for collisions between two or more attempts to access the network. If the transceiver detects a collision, the transmitting stations jam the network long enough for other stations connected to the bus to recognize that a collision has occurred. The stations then wait for a pseudorandom period of time before attempting to retransmit.

Transceivers use a level detector to perform the collision-detection function. The level detector compares the transmitted signal with the signal on the bus. If the two signals are identical, then a proper transmission is under way. If a collision has occurred, the signal on the bus will be the sum of the colliding signals and will therefore trip the level detector. The transceiver will then relay this information back to the LAN controller.

Keep your terminal equipment honest

Transceivers provide antijabber protection through use of a watchdog timer, which ensures that the LAN station doesn't gain control of the bus, lose track of the program it's running (as a result of any of a variety of causes), and then tie up the bus indefinitely. The transceiver will disable itself if it finds that it has transmitted for a period of time that exceeds the jabber time period.

The Ethernet specification requires that data be Manchester-encoded for transmission. Some transceivers will accept both Manchester-encoded signals and NRZ signals. If you give such a transceiver NRZ signals, it will perform the Manchester encoding for you. Other transceivers accept only encoded signals.

Because collision detection is carried out by means of a level detector, you must configure the transmitter portion of your Ethernet transceiver as a current-source output, in order to allow for the superposition of colliding signals. You must be careful to load the bus as

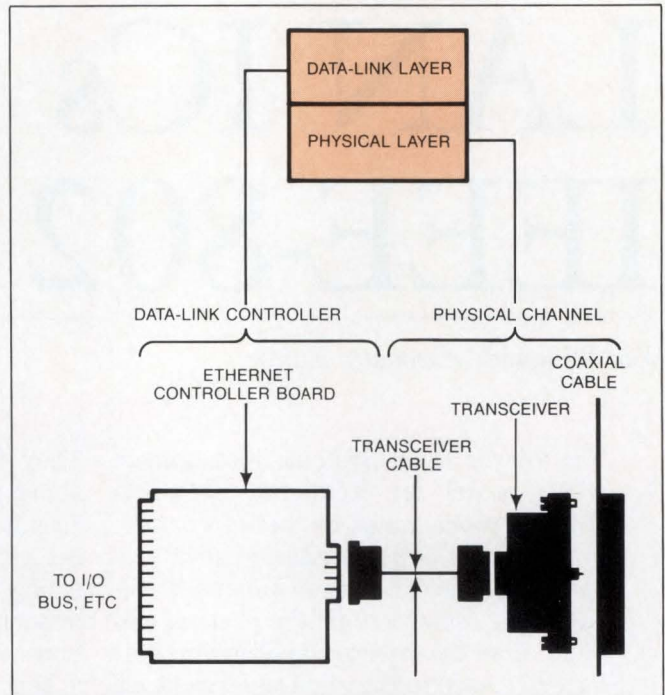

Fig 1—The Ethernet specification requires that you provide a separate, isolated transceiver module as the interface between the Ethernet controller and the Ethernet coaxial cable.

little as possible, to avoid reflections on the bus and to minimize attenuation. Good analog design practices, such as limiting the length of pc-board traces, will ensure that your transceiver interface doesn't overload the Ethernet bus.

The receive portion of the transceiver must filter the incoming signal from the transmission medium to eliminate noise and avoid the acquisition of false signals. The receiver will recover and separate the clock and data information from the bus. Manchester-encoded data consists of, first, the inverted signal, and then the noninverted signal, packed into one bit time. This type of encoding ensures that there is one transition per bit time, thereby incorporating a clock signal into the data stream. After recovery and separation, the transceiver sends the data and clock to the controller.

Configure transceiver in separate module

In the case of an Ethernet system, you build your transceiver in a separate module and isolate it from the Ethernet station (Fig 1). You can use pulse transformers or optoisolators to isolate collision, receive, and transmit signals. You can accomplish the requisite power isolation for the transceiver module through the use of a dc/dc converter. On the other side, you connect the transceiver to the Ethernet coaxial cable via an

TABLE 1—IEEE-802 LAN ICs

MANUFACTURER	PART	FUNCTION	IEEE APPLICATION	PRICE (100)*	COMMENTS	
ADVANCED MICRO DEVICES	7996	TRANSCEIVER	802.3	\$23.90	10BASE5 (ETHERNET); 10BASE2 (THINNET); INCLUDES COLLISION DETECTION	
	7990	CONTROLLER	802.3	\$54.95	10BASE5; 10BASE2	
	7992B	SERIAL INTERFACE ADAPTER	802.3	\$19.15	10BASE5; 10BASE2; INCLUDES MANCHESTER ENCODING	
EXAR	XRT82515	TRANSCEIVER	802.3	\$15 TO \$20 (SAMPLES)	1BASE5 (STARLAN)	
	XRT82C516	ENCODER	802.3	\$15 TO \$20 (SAMPLES)	1BASE5	
INTEL	82586	COPROCESSOR	802.3	\$45 (CERAMIC DIP) \$25.50 (PLASTIC DIP)	DEFAULTS TO 802.3; PROGRAMMABLE FOR OTHER FORMATS	
	82501	ENCODER	802.3	\$25	1BASE5	
	82588	CONTROLLER	802.3	\$27.50 (CERAMIC DIP) \$31.50 (PLCC)		
MOTOROLA	MC68184	BROADBAND INTERFACE CONTROLLER	802.4	\$35 (SAMPLES)	BACKBONE NETWORK	
	MC68824	TOKEN-PASSING BUS CONTROLLER	802.4	\$76	BROADBAND OR CARRIERBAND	
NATIONAL SEMICONDUCTOR	DP8390	NETWORK INTERFACE CONTROLLER	802.3	\$85 FOR 3-CHIP SET	MEDIA-ACCESS-CONTROL LAYER	
	DP8391	SERIAL NETWORK INTERFACE	802.3		INCLUDES COLLISION SENSING	
	DP8392	COAXIAL TRANSCEIVER	802.3			
SEQ TECHNOLOGY	8003	DATA-LINK CONTROLLER	802.3	\$48.85		
	8023	MANCHESTER-CODE CONVERTER	802.3	\$44.95		
SIGNETICS	NE5080	FSK MODEM TRANSMITTER	802.4	\$10	CARRIERBAND	
	NE5081	FSK MODEM RECEIVER	802.4	\$10	CARRIERBAND	
TEXAS INSTRUMENTS	TMS38030	SYSTEM INTERFACE	802.5	\$115 FOR ENTIRE CHIP SET	HOST INTERFACE	
	TMS38010	16-BIT COMMUNICATION CPU	802.5		MANCHESTER ENCODING AND CODE VIOLATION INCLUDES WRITE-FAULT DETECTION DRIVERS, PHASE DETECTOR, FREQUENCY DETECTOR	
	TMS38020	PROTOCOL HANDLER	802.5			
	TMS38C51	RING INTERFACE CONTROLLER	802.5			
	TMS38052	RING INTERFACE TRANSCEIVER	802.5			
THOMSON-MOSTEK	MK68590	CONTROLLER	802.3	\$45	10BASE5	
	MK68591	SERIAL INTERFACE ADAPTER	802.3	\$17	10BASE5 (NMOS)	
	MK68592	SERIAL INTERFACE ADAPTER	802.3	\$12.50	10BASE5 (BIPOLAR)	
	MK5030	CONTROLLER	802.3	\$52 (2nd QTR '87)	1BASE5	
	MK5032	CONTROLLER	802.3	\$45 (3rd QTR '87)	ALL	
	MK5033	MANCHESTER ENCODER	802.3	\$14 (2nd QTR '87)	WITH INTEGRATED TRANSCEIVERS	
	MK5034	MANCHESTER ENCODER	802.3	\$15 (2nd QTR '87)		
	MK5035	MANCHESTER ENCODER	802.3	\$13 (2nd QTR '87)	1BASE5	
	MK5036	MANCHESTER ENCODER	802.3	\$14 (2nd QTR '87)	SAME AS MK5035 WITH INTEGRATED TRANSCEIVERS	
	WESTERN DIGITAL	WD83C503	CONTROLLER	802.3	\$15.50 (DIP)	STARLAN MINIHUB CONTROLLER
		WD83C510	CONTROLLER	802.3	\$35	INCLUDES COLLISION DETECTION

*UNLESS OTHERWISE SPECIFIED.

A LAN's access method does not dictate the type of transceiver required for the LAN.

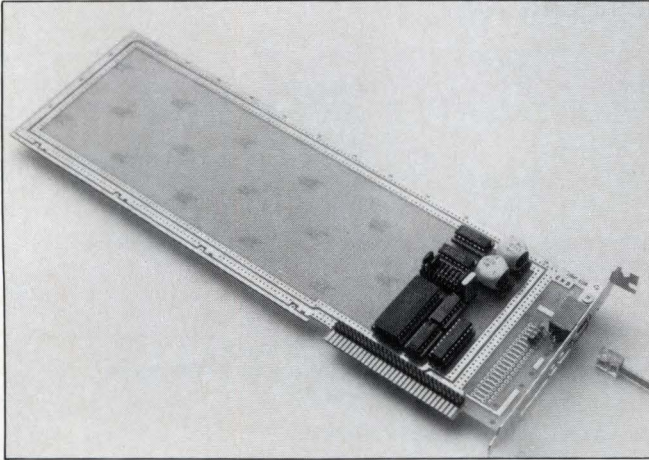

The simplicity of connection to the StarLAN network is evident in this IBM PC StarLAN card, which incorporates Intel's 82588 controller. Note the pulse transformers at the top of the card; these devices provide the requisite isolation of collision, receive, and transmit signals.

isolation diode (by contrast, a Thinnet system allows you to connect the transceiver directly to the coaxial cable).

Another CSMA/CD-based LAN, StarLAN, eases the requirements placed upon transceivers, both through its lower data rate—1M bps—and through its star topology. The latter unloads the collision-detection responsibility from the individual stations and places it with a hub controller. Chips like the Thomson-Mostek

MK5030 hub controller perform this function. The hub controller accepts transmissions from stations on the network and retransmits them on all outgoing wire pairs. It detects collisions and transmits a collision-presence signal to the connected stations.

Medium raises new problems

Although the topology and the lower data rate of StarLAN ease some aspects of transceiver design, the transmission medium—unshielded twisted-pair wire—raises its own problems. The IEEE-802.3 standard allows transmitted signals to be ideal binary signals; that is, the rise and fall times associated with the signals may be effectively close to zero. Although textbook representations of these signals may be aesthetically pleasing, when the transceiver operates with these high-speed transitions, it supplies power to the higher-order harmonics of the basic signal. Increased power in these higher-order harmonics leads to problems with crosstalk and EMI. To minimize these unwanted features, you must limit the signals' rise and fall rates to the lowest rate your system will allow. The degree to which you can do so will depend upon the amount of jitter that stations in the LAN produce, and the specified error budget for your receiver.

If, for example, cumulative errors around your LAN create ± 50 nsec of jitter at each transition, and you limit rise and fall times to 20 nsec, then the effective

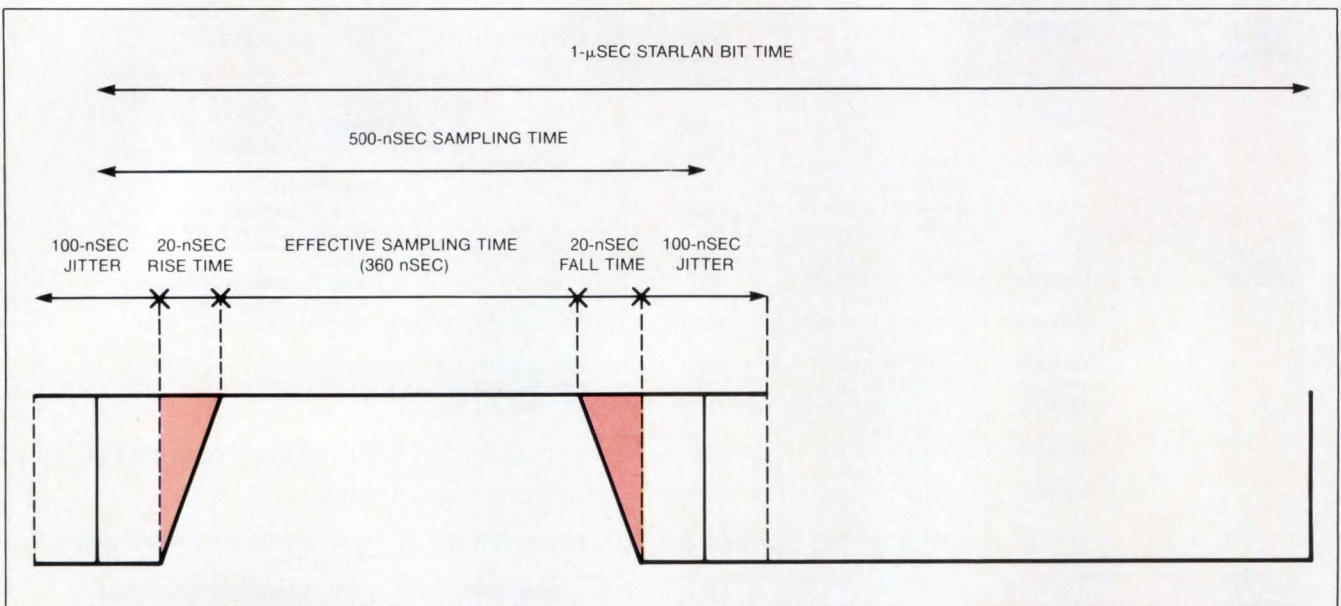

Fig 2—The effect of jitter and rise and fall times on the effective sampling time available to LAN receivers is considerable. In this example, the effective sampling time is reduced by 28%. The 1-μsec bit time is consistent with a 1M-bps LAN, such as StarLAN.

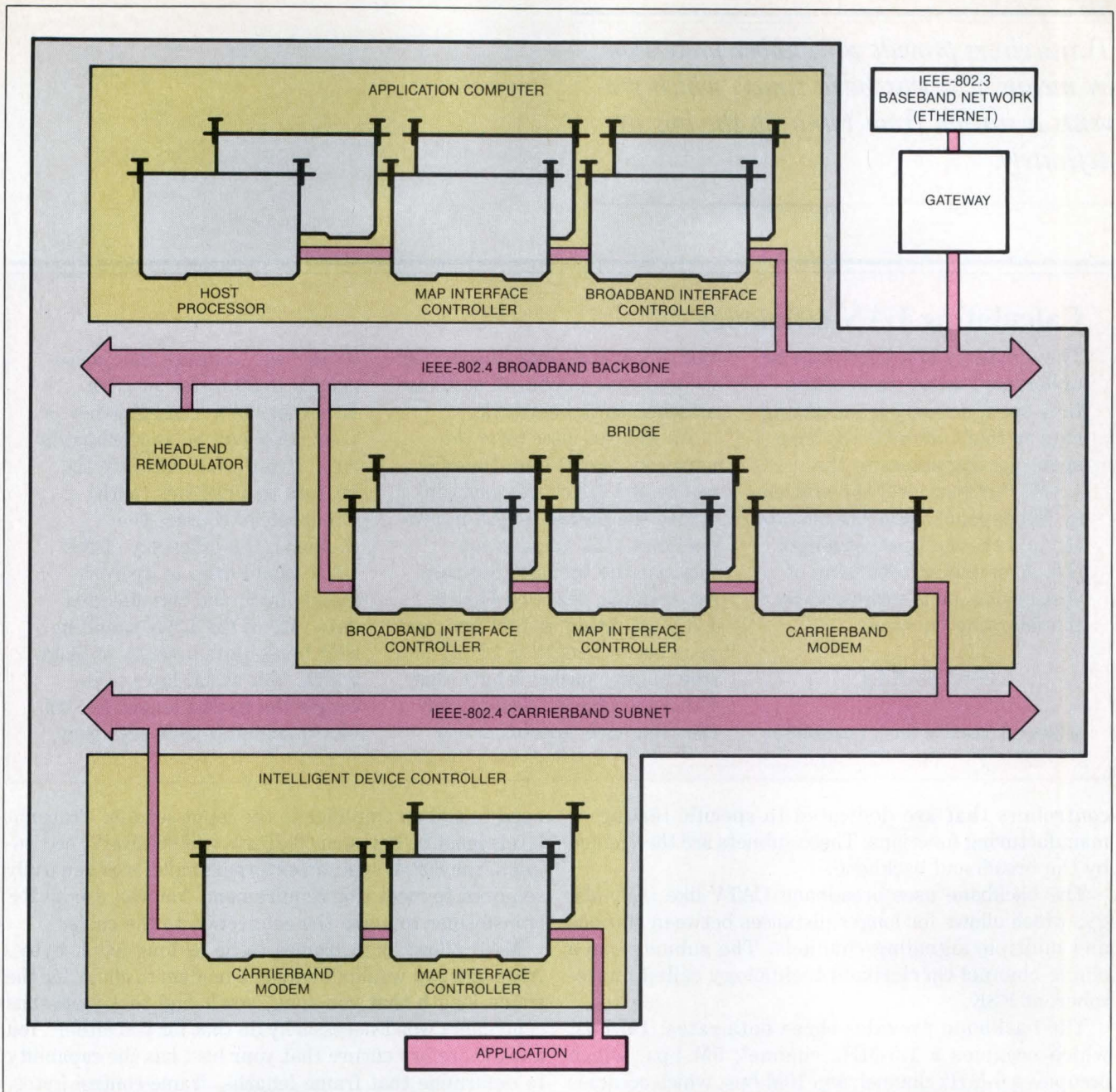

Fig 3—The hierarchical structure of MAP specifies a broadband backbone network that can contain carrierband subnets dedicated to specific testing or manufacturing functions.

sampling time available to your receivers for each bit falls from 500 nsec to 360 nsec (Fig 2). Furthermore, the receiver must sample the data at approximately 5 MHz. If you increase the rise and fall times, you'll have to increase the sample rate.

The CSMA/CD approach has two major disadvantages: Access is probabilistic—no station is guaranteed access to the bus upon each attempt—and the bus becomes less efficient under heavy load conditions. In real-time applications, probabilistic access is unacceptable. A station on the factory floor needs to have guaranteed access to the LAN if vital process-control information is to be transmitted in a timely fashion.

The principal effect of heavy loading is that, as more stations vie for the bus, the number of collisions, and the proportionate time spent dealing with collisions,

increases. Network efficiency decreases in proportion. And you must not fall into the trap of thinking that you can just increase the bit rate of the LAN to make up for increased collision time (see box, "Calculating LAN efficiency").

A different approach to LANs—one that overcomes the difficulties associated with a probabilistic approach to LAN access and is therefore more suitable for real-time applications—is the token-bus approach. The MAP network, the leading example of this type of LAN, follows the IEEE-802.4 token-bus specification for the data-link and physical layers (layers 2 and 1). The MAP LAN architecture is a hierarchical structure that consists of a broadband backbone network linking "carrierband subnets" (Fig 3). The carrierband subnets provide low-cost networks to localized groups of

Transceivers provide antijabber protection by means of a watchdog timer, which prevents a station from tying up the bus indefinitely.

Calculating LAN efficiency

The efficiency of a LAN may be understood as the ratio of the time spent actually transmitting data to that time plus the time spent gaining access to the LAN. Furthermore, the efficiency (E) depends upon the bit rate (R) and the data-packet length (L). A simplified rendering of these relations is expressed by the following equation:

$$E = (1 + RA/L)^{-1},$$

where A stands for a parameter

that, for a given bus length, varies with the number of stations attached to the network.

As you can infer from the equation, to maintain the efficiency of a LAN, you must increase the packet length in proportion to the amount you increase the bit rate. Suppose, for example, that you have a LAN operating at 10M bps, and your packet length is 12,144 bits (the longest packet length that Ethernet allows). Assume further that A is approximately

9×10^{-5} sec (a figure that corresponds to 20 nodes on a 1m Ethernet bus). The efficiency of your LAN will be approximately 90%. If you could increase the bit rate to 100M bps (with Ethernet, of course, you couldn't), the efficiency of the LAN would drop to approximately 60%, and the effective data rate of the LAN would be 60M bps—quite a waste of bandwidth. You would have to increase the packet length to 120k bits to maintain 90% efficiency.

controllers that are dedicated to specific testing or manufacturing functions. These subnets are then joined by the broadband backbone.

The backbone uses broadband CATV-like technology, which allows for longer distances between stations and multiple signaling channels. The subnets use a single-channel carrierband technology called phase-coherent FSK.

The backbone provides three data rates: 1M bps, which occupies a 1.5-MHz channel; 5M bps, which occupies a 6-MHz channel; and 10M bps, which occupies a 12-MHz channel. The carrierband subnets provide data rates of 5M or 10M bps at signaling frequencies of 5 and 10 MHz or 10 and 20 MHz, respectively.

Your MAP transceivers are RF modems

RF modems are the transceivers for MAP systems. Carrierband and broadband modem ICs connect to the MAP cable on one side and to the token-bus controller on the other. The modem IC modulates data from a serial interface and transmits this signal onto the network cable. It also receives signals from the network, demodulates the information, and passes it on to the token-bus controller. Your modem IC should also include an antijabber function and loop-back tests.

At the cable interface, the IEEE 802.4 spec requires a minimum receiver sensitivity of 10 dBmV for both 5M- and 10M-bps data. If the receiver section of your modem chip meets these requirements, you may connect it directly to the coaxial cable; otherwise, you will

need to add an amplifier to the input section. Transmit levels must be between 63 dBmV and 66 dBmV, according to the 802.4 spec; an external amplifier is generally required to meet this requirement. You can use an RF transformer to make the connection to the cable.

MAP allows data frames to be as long as 8k bytes. Although you wouldn't expect a modem to check for the frame length that you send, you'll find that token-bus controllers won't necessarily do that for you either. You must therefore ensure that your host has the capability to determine that frame lengths, frame-control bytes, the destination address, and the source address are correct as sent.

As with any design that uses high-frequency signals, you must be extremely careful with the layout of your modem card. All RF-carrying leads must be as short as possible, and a pc board with a good ground plane, both top and bottom, is recommended. The RF sections of your modem card may require separate EMI shielding as well.

Another access method that skirts the difficulties associated with CSMA/CD, and does so without the use of RF modems, is the token-ring approach delineated by IEEE 802.5. In a ring topology, all transmissions are point to point, which means that you can match the termination impedance of the medium very tightly, eliminating most reflections. In addition, each node is a regenerative repeater, thus easing timing constraints. Another advantage is the ease with which you can integrate fiber optics into the ring topology (the lack of

The CY233-

LINC*

* Local Intelligent Network Controller

connects your world so many ways at such a low price!

- 5v 40 pin CMOS
- 300 Baud to 57.6K Baud
- Selectable Token support
- Numerous Operational Modes
- \$75/ea., \$30/(100)

Parallel to Serial



Wire-Saver

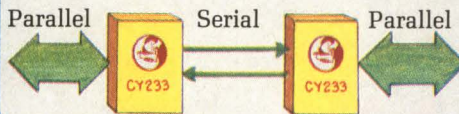

Serial to Parallel

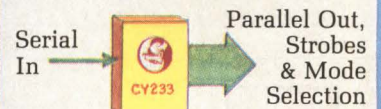

Peer Ring LAN

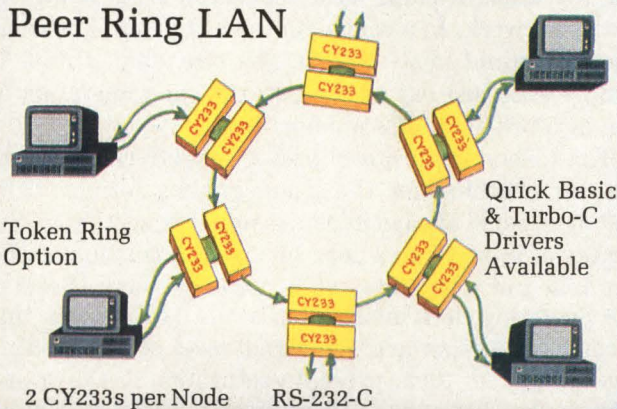

Host Ring

Serial Ring Network with up to 255 Nodes or Stations (2048 I/O Lines)

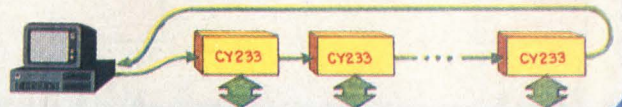

Party Line

Alternate Topology for 256 8-Bit Ports or 2K I/O Lines

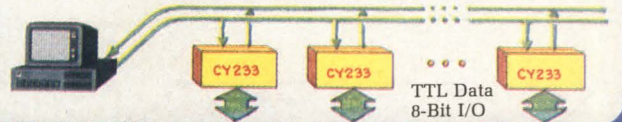

Host Ring LAN

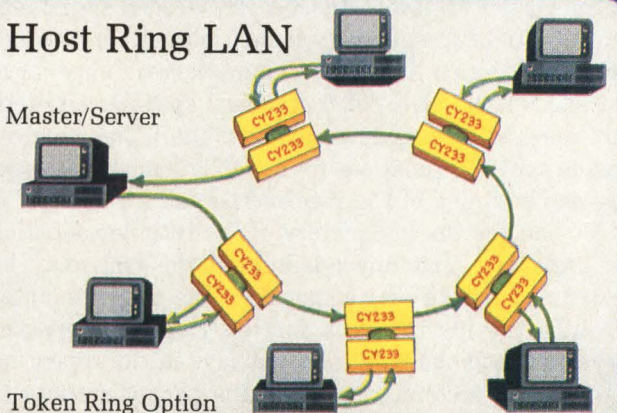

Cybernetic Micro Systems, Inc.

Box 3000 • San Gregorio, CA 94074 • USA
(415) 726-3000 • Telex: 910-350-5842

- Rush free data sheet on the CY233-LINC
- Send \$10 User Manual
- Send Manual and ___ chips at \$75 ea. + \$5 Shipping
 - California Residents add Sales Tax
 - Check enclosed Charge my MC/VISA/Amex card
 - Card # _____ expire _____ sign _____

Name _____ Title _____
 Company _____ Phone _____
 Address _____ Mail Stop _____
 City _____ State _____ Zip _____

EDN043087

In the case of an Ethernet system, you build your transceiver in a separate module and isolate it from the Ethernet station.

Manufacturers of IEEE-802 LAN ICs

For more information on IEEE-802 LAN ICs, contact the following manufacturers directly or circle the appropriate number on the Information Retrieval Service card.

Advanced Micro Devices Inc
901 Thompson Pl
Sunnyvale, CA 94088
(408) 732-2400
Circle No 650

Motorola Inc
3102 North 56th St
Phoenix, AZ 85018
(800) 521-6274
Circle No 653

Signetics Corp
811 E Arques Ave
Sunnyvale, CA 94088
(408) 739-7700
Circle No 656

Western Digital Corp
2445 McCabe Way
Irvine, CA 92714
(714) 863-0102
Circle No 659

Exar Corp
750 Palomar Ave
Sunnyvale, CA 94088
(408) 559-7000
Circle No 651

National Semiconductor Corp
2900 Semiconductor Dr
Santa Clara, CA 95051
(408) 721-5000
Circle No 654

Texas Instruments Inc
Box 1443, MS 6418
Houston, TX 77001
(713) 879-2373
Circle No 657

Intel Corp
1900 Prairie City Rd
Folsom, CA 95630
(916) 351-5000
Circle No 652

Seeq Technology Inc
1849 Fortune Dr
San Jose, CA 95131
(408) 262-5041
Circle No 655

Thomson Components-Mostek Corp
1310 Electronics Dr
Carrollton, TX 75006
(214) 466-6000
Circle No 658

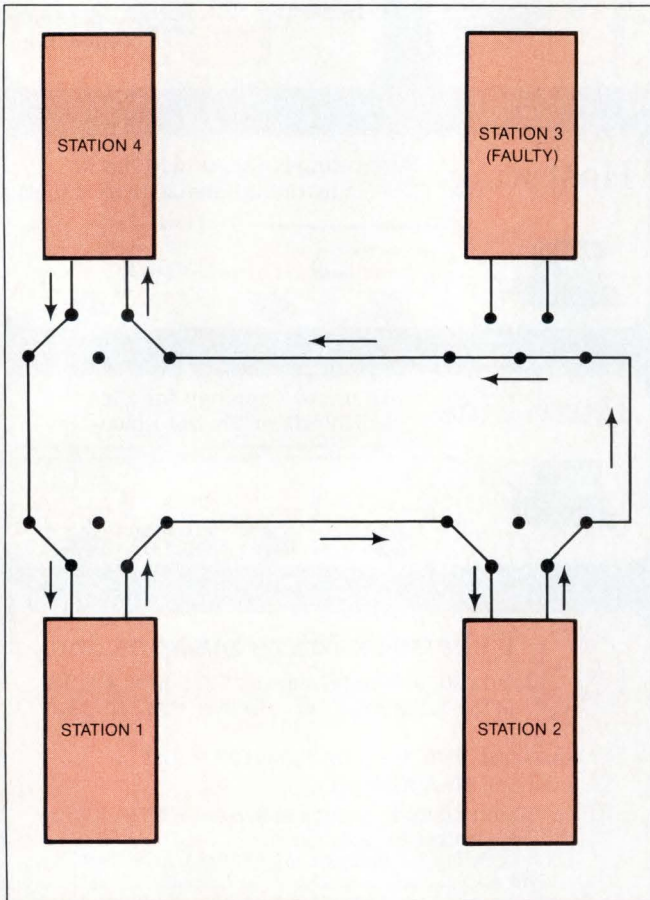

Fig 4—The star-wired ring topology marks an improvement over the simple ring architecture. It allows you to bypass any network node that has failed. In a simple ring network, failure of a node would bring the entire network to a halt.

low-cost taps precludes the use of fiber optics in a bus topology).

The ring configuration has one major reliability concern: What do you do when a node fails? In a simple ring configuration, a single node failure can bring down the entire network. In a variant of the basic ring, known as the star-wired ring (Fig 4), the offending station is simply switched out of the network, and operation of the network continues unimpaired.

The token-ring protocol prescribes differential Manchester encoding for the ring-signaling format. This coding scheme always injects a signal transition at the center of a bit time; a zero bit has a transition at the beginning of a bit time, while a one does not. Besides incorporating clock information in the data stream, this format assures an average signal level of 0V dc. This signal level, in turn, prevents saturation of the transformer that couples the transceiver to the ring.

In the token-bus network, the transceiver must transform a TTL-level, Manchester-encoded signal into a differential current that's compatible with a twisted-pair transmission line with a characteristic impedance of 150Ω. (The IEEE-802.5 standard specifies twisted-pair wire as the transmission medium.) The receiver section provides functions for equalization, signal shaping, and retiming of the received signal.

You can see the importance of the retiming function from the fact that any adapter on the ring may be designated as the active monitor. The active monitor provides the master clock for the ring. As a packet travels around the ring, phase delays in the repeating stations can accumulate. When the packet returns to

We won't just sell you a display—we'll make sure you buy the one that's right for you.

Choosing The Right Display... (continued)

WHAT ARE THE DIFFERENCES?

OPERATING TEMPERATURE RANGE

All IEE display modules operate within a temperature range of 0°C to +55°C. If your application requires operation below 0°C, you will need a special order. IEE offers display modules that can read down to -30°C. For applications requiring operation below -30°C, IEE offers a special order. IEE offers display modules that can read down to -30°C. For applications requiring operation below -30°C, IEE offers a special order.

AMBIENT LIGHT RANGE

You must also consider the ambient light conditions under which your display will be used. IEE offers display modules that can read down to -30°C. For applications requiring operation below -30°C, IEE offers a special order.

OPTICAL CHARACTERISTICS

Character height, character capacity, display color, and viewing angle are all important considerations in selecting the appropriate display module. For a general rule of thumb, you should allow 1 mm of character height for every foot of viewing distance. The size of your character height, as well as available viewing angles will determine your choice for character capacity. IEE offers display modules that can read down to -30°C. For applications requiring operation below -30°C, IEE offers a special order.

POWER AND INTERFACE CHARACTERISTICS

Power and interface requirements will also vary depending on the display technology in use. IEE offers display modules that can read down to -30°C. For applications requiring operation below -30°C, IEE offers a special order.

DAYSTAR HOUR LCD

Character height, character capacity, display color, and viewing angle are all important considerations in selecting the appropriate display module. For a general rule of thumb, you should allow 1 mm of character height for every foot of viewing distance. The size of your character height, as well as available viewing angles will determine your choice for character capacity. IEE offers display modules that can read down to -30°C. For applications requiring operation below -30°C, IEE offers a special order.

ARGANS DC Plasma

Character height, character capacity, display color, and viewing angle are all important considerations in selecting the appropriate display module. For a general rule of thumb, you should allow 1 mm of character height for every foot of viewing distance. The size of your character height, as well as available viewing angles will determine your choice for character capacity. IEE offers display modules that can read down to -30°C. For applications requiring operation below -30°C, IEE offers a special order.

Selecting Alphanumeric Display Modules

3-BIT STANDARD AS
ING VOLTAGES, 5V
T, CLEAR, SHAR
ARD MICROPROCESS

*** IEE DAYSTAR HOUR ***
WIDEST AVAILABLE
TEMPERATURE RANGE
FROM -30 TO +85°C

LOW COST *
6 VIF DISPLAY

*** IEE PRESENTS THE 4x48 DAYSTAR HOUR LCD ***
LARGE EASY-TO-READ CHARACTERS
NATIONAL E.V.L. BACKLIGHTING
OPERATING TEMP RANGE OF -30 TO +85°C

*** DAYSTAR**
LARGE .5"

IEE 40th Anniversary

Industrial Products Division

We're here to help you. IEE offers a wide variety of display technologies in an extensive assortment of sizes and formats. But that's not all. We also can provide you with all the technical support and expertise that you'll need to select and use the right display for your application.

To get you started, we'd like to send you a free copy of our product selector, titled *Selecting Alphanumeric Display Modules*. This informative, easy-to-understand guide contains the valuable information you'll want before buying an alphanumeric display. Just call or write today and let the display experts show you how you can become a display expert too.



INDUSTRIAL ELECTRONIC ENGINEERS, INC.
Industrial Products Division
7740 Lemona Ave., Van Nuys, CA 91409-9234
Tel.: (818) 787-0311, Ext. 418 • Telex: 4720693 IEE IPD
FAX: (818) 902-3723 (G2/G3)

For Immediate Application, Circle no 33.

For Reference Material, Circle no 72

Dumb keyboards. Smarter buys.



These new ASCII encoded keyboards from Cardinal Technologies are ideal for hostile working—and pricing—environments. And now they're upgraded with both parallel and serial outputs for even more flexibility.

Made in
U.S.A.

Feature for feature, dollar for dollar, Cardinal KB600 Series keyboards are smart money buys. ASCII encoding saves integration costs, and high quality and reliability keep these keyboards out in the field, not in the shop.

KB600 Series features include: spillproof, dustproof, unitized keypads; flexible membrane switches with a contact life rated at 10,000,000+ operations; finger-positioning overlay with positive, light-touch keys; high noise immunity integrated circuitry; 5V DC operation.

Both parallel and serial outputs are standard. Fully encoded 128 character alphanumeric ASCII keyboard with 58 light touch keys (plus 16 on KB671), and two user-definable keys. N-key roll-over reduces errors during data entry. Auto-key repeat.

CMOS and TTL compatible parallel output capable of driving two loads.

Three separate asynchronous serial data output modes: EIA RS232C compatible; 20mA current loop; TTL. Switch selectable format. Eight switch selectable baud rates: 110 to 19.2K. Power on/system busy LED.

Cardinal KB600 pricing gives you a competitive edge—along with Cardinal quality, proven performance, and high reliability.

Make a Smart Buy. Call 800-722-0094 (717-295-6922 in PA) for more information or to order. Or write: Cardinal Technologies, Inc., New Holland Avenue, Lancaster, PA 17604-7628.

CARDINAL
TECHNOLOGIES, INC. 

the active monitor, that device clocks the packet into a FIFO using a clock generated from the transceiver's phase-locked loop. The packet is clocked out of the FIFO and back onto the ring via the active monitor's master clock, thus resynchronizing the packet.

As you can see from **Table 1**, only Texas Instruments provides LAN ICs for the IEEE-802.5 standard, in the form of a complete chip set. You'll also note that the vast majority of today's LAN ICs are designed for the 802.3 standard. For the 802.4 standard, Motorola offers controller chips, and Signetics provides modem transmitter and receiver ICs. Look for modem ICs that will ease the design of board-level modems for both carrier-band and broadband applications to be available soon.

EDN

References

1. Cormier, Denny, "LAN ICs let you build networks for PCs," *EDN*, December 11, 1986, pg 136.
2. Coleman, Vernon, "VLSI and digital networking," *Integrated Circuits Magazine*, December, 1984, pg 36.
3. Teja, Edward R, "Powerful local-area-network controllers make networking more accessible than ever," *EDN*, March 3, 1983, pg 61.

Article Interest Quotient (Circle One)
High 470 Medium 471 Low 472

FlexOS™

Bringing Design Flexibility To Your Real-time Needs

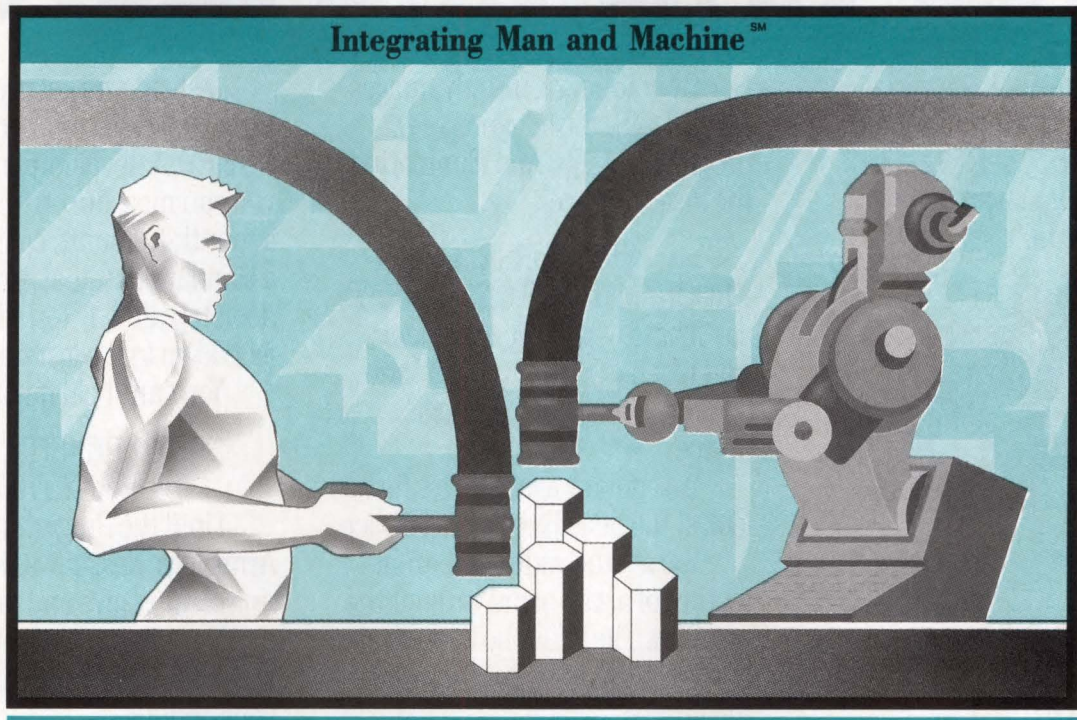

Introducing the FlexOS Family of real-time, multitasking, multiuser operating systems from Digital Research®

Real integration requires real performance and capability. While microprocessor technology has advanced to the point of competitiveness with mainframes and minis, operating system technology has left system developers frustrated—looking for the flexibility, reliability, and portability you need in an operating system.

The FlexOS family of operating systems brings you minicomputer capabilities on micros. Standard FlexOS features including **real-time kernel**, **event-driven dispatcher**, **multiuser file system**, and **asynchronous functions**, plus optional **DOS compatibility**, **graphics**, and **networking** provide the resources you need to do the job right. Developers will recognize functional similarities between FlexOS and the popular features of **UNIX®**, **DOS**, **Concurrent™ DOS**, and **RSX-11™**.

Flexibility: FlexOS has a modular architecture that lets you implement the services you need today and with full application compatibility, integrate the expanded capabilities your system requires in the future.

Reliability: FlexOS has undergone IBM's rigorous testing as the operating system of choice for the 4680 POS cash register system. FlexOS has also been designed into and approved for products from major OEM's including Siemens® Energy Division, Toshiba® and IBM® Plant Systems.

Portability: FlexOS versions are available for the **80186™**, **80286™**, **80386™**, **68000™** family and soon for the **NEC® V60**. This gives you the same program interface from the factory floor to the executive suite.

FlexOS derives from Digital Research's decade of experience developing multitasking, multiuser operating systems for microprocessor-based designs.

For more information on FlexOS or to order a FlexOS Developer Kit, call **408-649-3896**. Or write to:

FlexOS Customer Service
Digital Research Inc.
Box DRI
Monterey, CA 93942

 **DIGITAL
RESEARCH®**

FlexOS and the FlexOS logo are trademarks and Digital Research is a registered trademark of Digital Research Inc. Integrating Man and Machine is a service mark of Digital Research, Inc. Other computer, processor, company and software names are trademarks or registered trademarks of their respective manufacturers. Copyright © 1987, Digital Research, Inc. All rights reserved.

THE PROGRAMMABLE GATE YOU'VE ALWAYS WANTED.

We don't mean to be wishy-washy, it's just that our Programmable Gate Array delivers both more of what you want and less of what you don't.



Unlike a conventional gate array which is cast in cement at the factory, the Programmable Gate Array is user-programmable. So there's no risk in design or inventory. And that makes it a lot less dicey.

As in, more speed and less money.

More density and less risk.

And more design flexibility but less time to market.

How can one part offer so much?

By combining the advantages of VLSI with the advantages of programmability. And eliminating the disadvantages.

"OF COURSE. A PROGRAMMABLE GATE ARRAY."

That's what logic designers said when we asked them if they could describe the ideal logic device.

We couldn't agree more. Just look at the benefits of such a device.

You get the wide open architecture of a gate array, without the penalties. The NRE, the long development time, the inventory risk, the limited testability, and last but certainly not least, the 50-50 chance that system changes may mean another pass.

Instead, you get programmability. Unlimited reprogrammability. No NRE. A development cycle you can measure on one page of a month-to-month calendar. And a standard part that arrives on your doorstep already tested 100% perfect down to the last transistor.

You can't beat it with a stick.

SPEED, DENSITY, PRICE.

PICK ANY THREE.

Until the Programmable Gate Array, logic design was a frustrating game of give and take.

You gave up certain things as limited logic solutions took away your options.

With the Programmable Gate Array, you give up nothing.

You might not expect much speed in a part like this. But at 70 MHz, the Programmable Gate Array is more than fast enough for most applications. And with 1800 gates to work with, why shell out for a bunch of little PLDs?



Xilinx, Logic Cell, and XACT are trademarks and "The Programmable Gate Array Company" is a service mark of Xilinx, Inc. Other brand or product names are trademarks or registered trademarks of their respective holders. © 1986 Xilinx, Inc., 2069 Hamilton Ave., San Jose, CA 95125, (408) 559-7778.

ARRAY. IT'S JUST WHAT MORE OR LESS.



Does this picture remind you of a gate array? Perhaps if the bills were on fire. By comparison, there is no comparison. The Programmable Gate Array costs far less to develop. And nothing to change.

Let's look at logic design's Big Three: speed, density and price.

Our new Programmable Gate Array, the XC 2018, turns toggle rates of 70 MHz. And we've enhanced our original part, the XC 2064, to run just as fast.

There's more density, too. As promised, there are 1800 honest gates in the 2018. And thanks to our unique Logic Cell™ Array architecture, the magic number's going to be 8000 by year-end.

The price, however, is continuing to go down, just like the prices of other standard parts.

A FULL SET OF POWER TOOLS.

Everybody knows you can't do a good job without the right tools. So we offer everything you need.

We've connected with Future-

Net™ to bring you their schematic capture capabilities, the most powerful and popular in the industry. To which we've added our own auto-place-and-route.

This, in addition to our already extensive integrated XACT™ development system. Complete with an interactive graphics-based, mouse-and-menu driven design editor; a simulator; and the logic industry's only in-circuit emulator. It runs real I/O in real time, so you get real design verification, *in the system.*

Every bit of the above runs on an IBM® PC/XT™ PC/AT™ or clone. And you can get started for just \$3600.

JUST TELL US WHAT YOU WANT.

Like to see some more information so you can chew on it in the privacy of your home or office? We have a free design handbook that tells all.

Rather find out first hand what you can do with the Programmable Gate Array? Order our evaluation kit (affectionately known as EK-01). It has the software and documentation you'll need to evaluate your application on the Programmable Gate Array and see how it performs.

Better yet, why not get right down to business by talking with one of our field application engineers? They can answer any questions you might have. And you can get our application support right from the beginning.

All you have to do is call us. Toll-free at (800) 255-7778. In California, (408) 559-7778. Or contact your local Xilinx sales representative or Hamilton/Avnet distributor.

How many gates do you really get?

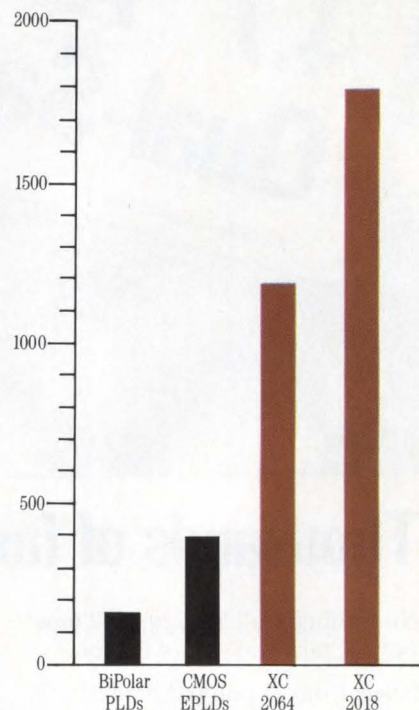

Other PLDs claim lots of gates, but their restrictive architectures only let you use a small fraction of them. Our patented Logic Cell Array architecture is more open. So you can use all the gates we claim. And there are more chips—with more gates—on the way.

After all, why use anything else when the Programmable Gate Array gives you so much more? And, so much less.



The Programmable Gate Array CompanySM

**FREE* TRW
4.7" AC Fan
Qual-Sample!**

*Available to qualified users.



Thousands of fans available now.

No waiting. Call 513.229.8542 now!
For the fans you're looking for.

Select from 15 popular models...six brushless DC and nine AC. Sizes from 2.4" (60mm) to 5.9" (150mm) and 0.8" (20mm) to 1.5" (38mm) thick. Outputs from 8 to 220 cfm. Wide choice of accessories.

TRW fans are backed by four decades of motion expertise in system cooling technology. That means quality. Superior life expectancy. And fans that run quiet. AC/DC models for virtually every application you can think of.

Prove it to yourself how good TRW fans are. Call 513.229.8542 and we'll send you one to try. Or, fill out the attached coupon and mail it to us. Or, call your local Arrow, Hall-Mark, or Hamilton/Avnet location. They have the full line in stock.

For your FREE TRW A47B15A15T3, clip, fill out and mail to:
Motor Division, TRW Electronic Components Group,
2275 Stanley Avenue, Dayton, OH 45424.

My application is _____

I'm currently using _____

Number of employees at my plant _____

Name _____ Title _____

Company _____

Address _____

City _____ State _____ Zip _____

Phone () _____

Please print

Preferred delivery (Check one):

- Arrow
- Hall-Mark
- Hamilton/Avnet

TRW

Motor Division
TRW Electronic Components Group

SAMSUNG Speaks

A NEWSLETTER FROM SAMSUNG SEMICONDUCTOR

VOLUME ONE, NUMBER TWO

Included in this issue:
 ► POWER MOSFETs ► DRAMs
 ► EEPROMs ► SRAMs ► SOT-23s
 ► AHCT/HCTLS CMOS LOGIC ► LINEAR ICs

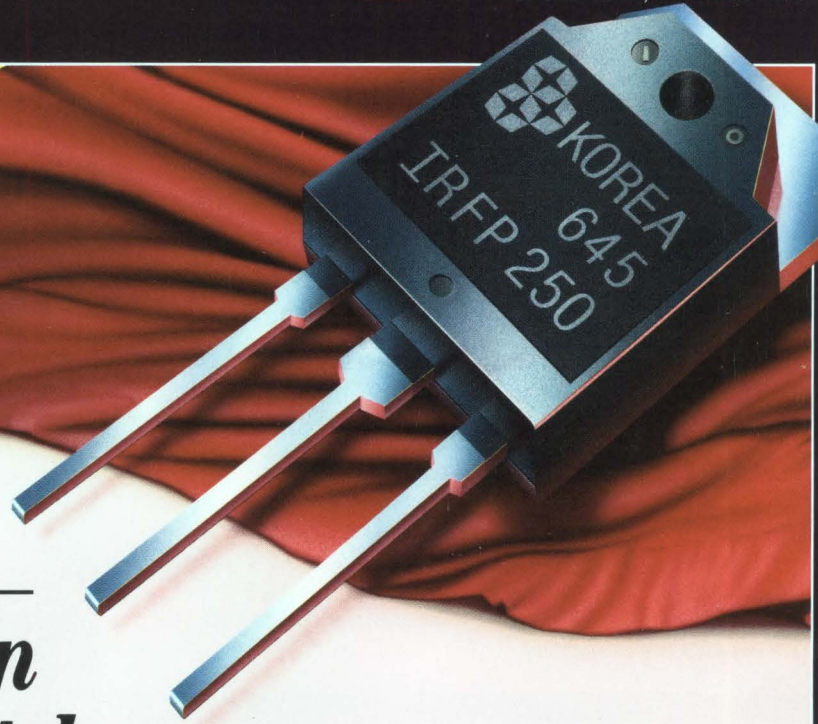

DIRECT REPLACEMENT POWER MOSFETS

*The competition
has met its match.*

Introducing direct replacement for IR and Motorola® MOSFETs. Samsung MOSFETs. The fastest, most rugged, most reliable MOSFETs in the industry. (2230 mJ at 500 v.)

We have the broadest product line of any supplier—over 300 part types in both P- and N-channels are available for immediate delivery, ranging from 60v. to 700v. In TO-3P, TO-220, TO-3 and TO-92L packages.

We are the first and only supplier to use bulk CMOS processing that delivers smaller

die, higher yield, and lower cost. The entire family is supported by our technological partner, IXYS.

*Samsung delivers
higher performance,
at lower price.*

So call your local Samsung sales office today. Ask for samples, a reliability

report, or our new data book. Now you can replace IR and Motorola MOSFETs with something better. Samsung MOSFETs. ■

P & N Channel Part Types Available NOW																
N-Channel	SSH20N50	IRFP152	IRFP322	IRFP430	IRFP9140	SSP4N60	IRF541	IRF710	IRF823	IRF9530	IRF9633	SSM6N55	IRF150	IRF253	IRF422	IRF9132
TO-3P	SSH4N50	IRFP153	IRFP323	IRFP431	IRFP9142	SSP6N55	IRF542	IRF711	IRF830	IRF9531	IRF9640	SSM4N55	IRF151	IRF320	IRF423	IRF9133
	SSH6N70	SSH25N40	IRFP231	IRFP433	IRFP9230	SSP2N55	IRF610	IRF713	IRF832	IRF9533	IRF9642	SSM20N50	IRF152	IRF321	IRF430	IRF9140
	SSH4N70	SSH25N35	IRFP232	IRFP440	IRFP9231	SSP4N50	IRF612	IRF720	IRF833	IRF9540	IRF9643	SSM4N50	IRF153	IRF322	IRF431	IRF9141
	SSH3N70	SSH15N10	IRFP233	IRFP441	IRFP9232		IRF616	IRF721	IRF840	IRF9541	IRF9644	SSM20N45	IRF220	IRF323	IRF432	IRF9142
	SSH15N60	IRFP130	IRFP240	IRFP442	IRFP9233	IRF510	IRF620	IRF722	IRF841	IRF9542	IRF9645	SSM25N35	IRF221	IRF330	IRF433	IRF9143
	SSH10N60	IRFP131	IRFP241	IRFP443	IRFP9240	IRF511	IRF621	IRF723	IRF842	IRF9543	IRF9646	SSM10N70	IRF120	IRF331	IRF441	IRF9230
	SSH8N60	IRFP132	IRFP242	IRFP444	IRFP9241	IRF512	IRF622	IRF731	IRF843	IRF9544	IRF9647	SSM6N70	IRF121	IRF332	IRF442	IRF9231
	SSH6N60	IRFP133	IRFP243	IRFP445	IRFP9242	IRF520	IRF623	IRF732	IRF844	IRF9545	IRF9648	SSM3N70	IRF122	IRF333	IRF443	IRF9232
	SSH4N60	IRFP140	IRFP250	IRFP453	IRFP9243	IRF521	IRF630	IRF733	IRF845	IRF9546	IRF9649	SSM4N70	IRF123	IRF334	IRF444	IRF9233
	SSH15N55	IRFP141	IRFP251	IRFP453	N-Channel	TO-220	IRF631	IRF740	P-Channel	IRF9511	IRF9612	SSM3N70	IRF123	IRF335	IRF445	IRF9234
	SSH10N55	IRFP142	IRFP252	IRFP453	TO-3P	IRF523	IRF632	IRF741	IRF9512	IRF9613	SSM15N60	IRF130	IRF233	IRF342	IRF451	IRF9241
	SSH8N55	IRFP143	IRFP253	IRFP453	TO-3P	IRF530	IRF633	IRF742	IRF9513	IRF9614	SSM10N60	IRF131	IRF234	IRF343	IRF452	IRF9242
	SSH6N55	IRFP150	IRFP320	IRFP453	TO-3P	IRF531	IRF640	IRF743	IRF9514	IRF9615	SSM8N60	IRF132	IRF241	IRF350	IRF453	IRF9243
	SSH4N55	IRFP151	IRFP321	IRFP453	TO-3P	IRF533	IRF642	IRF744	IRF9515	IRF9616	SSM6N60	IRF133	IRF242	IRF351	IRF453	IRF9243
				IRFP422	P-Channel	IRF533	IRF642	IRF745	IRF9516	IRF9617	SSM4N60	IRF140	IRF243	IRF352	TO-3	TO-92L
					TO-3P	IRF533	IRF642	IRF745	IRF9517	IRF9618	SSM15N55	IRF141	IRF250	IRF353	IRF9130	IRFL120
					TO-3P	IRF533	IRF642	IRF745	IRF9518	IRF9619	SSM10N55	IRF142	IRF251	IRF420	IRF9131	IRFL123
					TO-3P	IRF533	IRF642	IRF745	IRF9519	IRF9620	SSM8N55	IRF143	IRF252	IRF421		

Nobody is moving faster in memory technology development than Samsung.

Samsung now offers an extensive line of memories: DRAMs, EEPROMs and SRAMs. We are among the industry leaders, producing high quality, highly reliable memory products. Our industry-standard pin-for-pin compatible memories are all proprietary products of our own design, developed in our state-of-the-art R&D facility, utilizing our own technology and processing.

We are determined to be your long term memory supplier. Our production facilities are internationally recognized as being among the most advanced in the world. Samsung is one of the few semiconductor companies fabricating 6-inch wafers in produc-

tion quantities. This advanced processing technology allows us to keep costs down and volume up.

Samsung's commitment to winning the memory game is underscored by the \$600 million we're investing in memory product development and by our new 80,000 square foot headquarters in San Jose, staffed by our 160 person R&D team. This R&D facility has the ultimate in Class-1 clean room technology. A unique vertical laminar flow process helps us control every aspect of the fab environment to achieve the industry's most exacting quality standards. ■

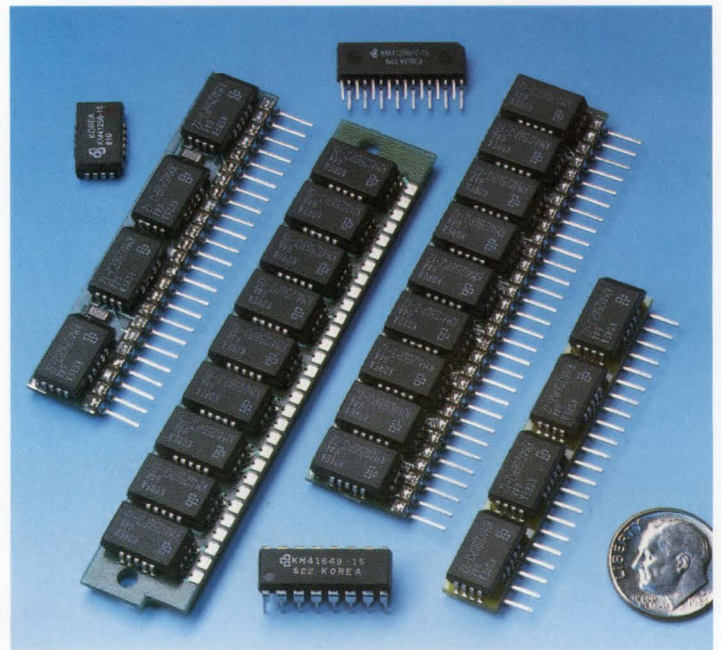

DRAMs

You can see how fast our DRAM technology is progressing in the graphs on the right.

Our 64K and 256K DRAMs are all available in production quantities now. You will be able to get engineering samples of our 1MB DRAM this quarter, qualification samples will be available in mid 1987 with production ramp starting in the third quarter.

Samsung now offers every major DRAM part type.

We're not stopping at 1-million bits. Our 4MB DRAM development program is right on track. Engineering samples will be available early next year.

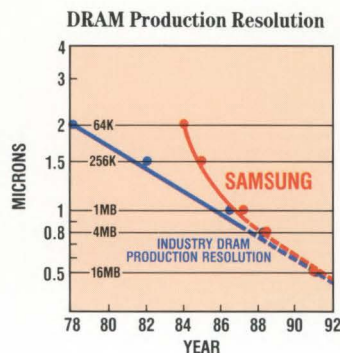
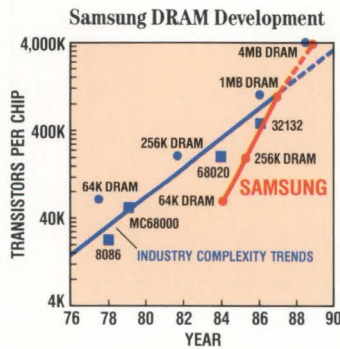

Samsung DRAMs are available in the most effective size, speed and organization combinations. Scan the chart below to find the right DRAMs for your applications.

You can see from the picture that we package our DRAMs the way you want them: DIP, PLCC, SIP/SIMM and ZIP*. If you're looking for state-of-the-art, check out our 256 x 8 (or x 9) SIP and

SIMM memory modules.

We have the technology, we have an aggressive memory development program in place and we have the memory products to meet your requirements, available now. Samsung is committed to being your memory supplier. Call your nearest Samsung sales office for samples and data sheets, today. ■

*Q3

CIRCLE NO. 166

DRAMs

Density	64K	256K	256K	1 Mb	1 Mb
Organization	64Kx1	256Kx1	64Kx4	1Mx1	256Kx4
Availability	Now	Now	Now	Q3'87	Q3'87
Technology	NMOS	NMOS	NMOS	CMOS	CMOS
Package	DIP	DIP, PLCC, SIP/SIMM, ZIP*	DIP, PLCC, SIP/SIMM, ZIP*	SOJ, SIP/SIMM, ZIP	SOJ, SIP/SIMM, ZIP
Speed	150 ns, 200 ns	120 ns, 150 ns	120 ns, 150 ns	80 ns, 100 ns, 120 ns	80 ns, 100 ns, 120 ns
Mode	Page	Page, Nibble	Page	Static Column Page, Nibble	Page

*Q3 '87

EEPROMs

Samsung 16K and 64K EEPROMs meet or exceed industry standards. Endurance is rated at 10,000 erase/write cycles. Data retention ratings are 10 years for our entire line. Moreover, our

When it comes to EEPROMs, we deliver.

pin-out permits you to upgrade EEPROMs without re-designing your entire PCB. Most importantly, our EEPROMs are

immediately available.

We offer industrial temperature operating range (-40° to $+85^{\circ}\text{C}$) and high performance 64K KM2864AH and KM2865AH EEPROMs. They feature write cycle times that are five times faster than standard parts.

Samsung is known for reliability, quality and performance. And nobody beats our EEPROM prices. See for yourself. Call your Samsung sales office to get our EEPROM reliability report, data sheets or samples. ■

CIRCLE NO. 167

EEPROMs

Density	16K	16K	64K	64K	64K	64K
Part Number	KM2816A	KM2817A	KM2864A	KM2864AH	KM2865A	KM2865AH
Availability	Now	Now	Now	Now	Now	Now
Package	24 Pin Plastic DIP	28 Pin Plastic DIP	28 Pin Plastic DIP	28 Pin Plastic DIP	28 Pin Plastic DIP	28 Pin Plastic DIP
Speed	250 ns, 300 ns, 350 ns	250 ns, 300 ns, 350 ns	200 ns, 250 ns, 300 ns	200 ns, 250 ns, 300 ns	200 ns, 250 ns, 300 ns	200 ns, 250 ns, 300 ns
Endurance	10,000 Erase/Write Cycles	10,000 Erase/Write Cycles	10,000 Erase/Write Cycles	10,000 Erase/Write Cycles	10,000 Erase/Write Cycles	10,000 Erase/Write Cycles
End of Write Scheme		RDY/BSY	Data Polling	Data Polling	RDY/BSY, Data Polling	RDY/BSY, Data Polling
Byte Write Time	10 ms write/byte	10 ms write/byte	10 ms write/byte	2 ms write/byte	10 ms write/byte	2 ms write/byte

SRAMs

Samsung is making the same commitment to SRAMs that we make to all our memory products. Samsung is increasing Static RAM production rather than cutting back the way some other manufacturers are. And we are expanding our SRAM line as

we develop the next generation 256K and fast 64K CMOS Static RAMs. Check our offerings in the chart below. Then call your Samsung sales office for samples and data sheets. Make Samsung your quality SRAM supplier. ■

CIRCLE NO. 168

SRAMs

Density	64K	64K	64K	64K
Part Number	KM6264-12	KM6264-15	KM6264L-12	KM6264L-15
Organization	8Kx8	8Kx8	8Kx8	8Kx8
Availability	Q4	Now	Q4	Now
Technology	MIX-MOS	MIX-MOS	MIX-MOS	MIX-MOS
Package	28 Pin DIP	28 Pin DIP	28 Pin DIP	28 Pin DIP
Speed	120 ns	150 ns	120 ns	150 ns
Standby Current	1mA Max.	1mA Max.	100 μA Max.	100 μA Max.

Samsung's 54/74 AHCT and 54/74 HCTLS CMOS Logic gives you the most comprehensive selection of LS, ALS and FAST™ replacements. 61 parts now-86 more in Q3.

Replace LS, ALS and FAST with AHCT and HCTLS CMOS logic parts from Samsung—right now. Look at the advantages we can offer you. And at prices comparable to bipolar!

Comparison of Key Parameters for a 244 Octal Buffer

	74AHCT	74HCTLS	74ALS	74LS	74ACT*
Max Propagation Delay ($C_L = 50\text{pF}$)	10ns	18ns	10ns	18ns	13.5ns
Drive Current, I_{OL}	24mA	24mA	24mA	24mA	24mA
Power Dissipation (at 100KHz)	0.6mW	0.6mW	70mW	120mW	1mW

*Fairchild FACT™

You get low power, wide operating supply and temperature ranges, superior noise immunity, rail-to-rail output voltage swings and the low input currents of CMOS, combined with the high speed and drive capability of bipolar.

Unlike older performance-limited HC and HCT logic families, Samsung's high performance CMOS logic matches bipolar speed and drive. 24 mA is guaranteed. Moreover, our CMOS logic allows you to interface directly with all types of TTL, NMOS and CMOS circuitry.

Compare the power dissipation of Samsung's AHCT/HCTLS logic to bipolar LS/ALS/FAST. Our logic consumes 100,000 times less power at low frequencies and 10 times less power at 10 MHz. CMOS voltage swings also give you up to three times the noise immunity.

Ask us and we'll send you two free samples each of up to five part types. Just call your local

Samsung sales office and specify AHCT or HCTLS with your part number. Use this list to order your samples and to see what's

Order your free samples today.

coming later this year. Take advantage of Samsung's cool running, highly reliable, high performance CMOS logic. (continued on next page)

CIRCLE NO. 169

FAST is a trademark of Fairchild Semiconductor Corp.

For product information call your local Samsung sales office.

SAMSUNG SAYS SO

Flash Converter features independent 8-bit A to D and 10-bit D to A functions on a single chip.

The new KSV3100A flash converter is the latest and most impressive addition to Samsung's extensive line of linear products. The monolithic KSV3100A provides independent 8-bit flash A/D converter and 10-bit R-2R D/A converter functions over an operating range of DC to 38.5 MHz.

The single-chip architecture of the KSV3100A allows you to design-in with a single board rather than many. This saves real estate and gives you room to add more features to your system. Using fewer parts also raises the reliability of your system.

Samsung has designed a number of useful features into our new flash converter. You can choose between selectable peak level or keyed clamping. And the device's absolute non-linearity is rated at 1 per cent.

We also provide you with the support chips you need. Our KA2606 Sync Separate IC,

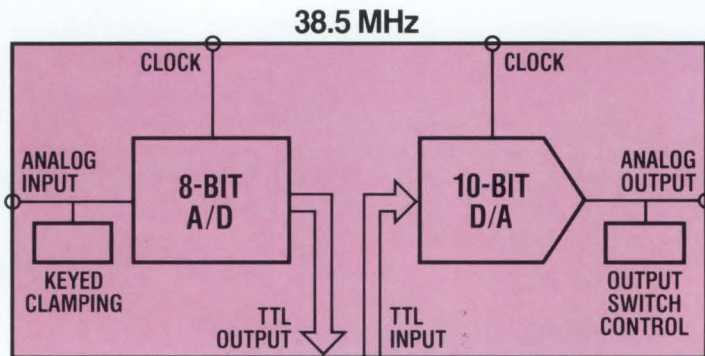

KA2153 Chrominance Signal Processor for NTSC systems, and KA2154 Video Chroma Deflection System for NTSC and PAL systems make it easy to integrate the KSV3100A into your video applications.

Samsung's flash converter prices are unbeatable. The chart shows our 100 piece KSV3100A Flash Converter prices:

KSV3100 AN -10	\$48.90	KSV3100 AN -8	\$24.45
KSV3100 AN -9	\$32.60	KSV3100 AN -7	\$14.67

CIRCLE NO. 170

CMOS LOGIC (Continued)

KS/74AHCT & KS/74HCTLS Part Types

Gates & Inverters	Flip-Flops	Transceivers/Registered Transceivers	Multiplexers
00 14*	73*	399*	151*
01 20*	74	534	257
02 21*	76*	564	257
03 22*	78*	574	157
04 27*	107	670*	158
05 32	109	794*	251*
08 51*	112	791*	353*
09 58*	173*	822*	
10 86	174	823*	
11 132*	175	824*	
12 133*	273	825*	
	266	374	
		377*	
Buffers & Line Drivers	Latches	Decoders/Encoders	Arithmetic Circuits
125*	367	259*	793*
126*	368	373	841*
210	465*	533	842*
240	466*	563	843*
241	467*	573	844*
244	468*		
365	540		
366	541		

Part Types Available in Q3—All Other Part Types Available Now.

CIRCLE NO. 169

SOT-23s

Samsung has the SOT-23s you're looking for: industry standard NPN and PNP epitaxial transistors implemented in the internationally standardized micro-package.

Samsung SOT-23s are ideal for both hybrid and surface mounting. Our SOT-23 micro-packaging saves real estate, slashes costs and boosts system reliability.

We also offer a broad range of TR products: industry standard TIP-series power transistors, high-speed high-voltage switching power transistors, power Darlington transistors and our TO-3P silicon mesa transistors—they're rated at 1500 Volts!

Call your Samsung sales office for our SOT-23s or New Transistor data book.

CIRCLE NO. 171

LINEAR ICs

Samsung offers a full line of linear products, in addition to converters, including: amplifiers, timers, regulators, comparators, telephone ICs, power amplifiers and a number of other ICs.

Samsung's entire line of standard parts is now available in production quantities. A number of our key linear offerings are listed below:

Data Conversion	
KS7126	3 1/2 Digit CMOS A/D Converter
KS25C02	8 bit CMOS Successive Approx. Register
KS25C03	8 bit CMOS Successive Approx. Register
KS25C04	12 bit CMOS Successive Approx. Register
Voltage Regulators	
MC78xx	Op Amps
MC78Lxx	LM741
MC79xx	MC1458
MC79Mxx	MC4558
LM317T	LM358/A
μA78S40	LM324/A
	LM3403
Timers	
KS555 (CMOS)	Comparators
NE555	LM311
NE556	LM393/A
NE558	LM339/A
Interface	
MC1488	Tone Decoder
MC1489/A	LM567
	LM567L
	(Micropower)
Telephone	
KA2410	Tone Ringer
KA2411	Tone Ringer
KA2412A	Speech Network
KA2420	Speaker Phone
KA2413	DTMF
KS5808	DTMF
KS5805A/B	Pulse Dialer
Others	
KS5803A/B	IR Transmitter
KA2181	IR Preamplifier
KA2182	IR Preamplifier
KA2183	IR Preamplifier
MC3361	FM IF Amplifier
KA2803	Ground Fault Detector
KA2084	Zero Voltage Switch
LM386	Audio Power Amplifier

Call your local Samsung sales representative for a Data Book that includes our Cross Reference Guide and samples.

CIRCLE NO. 172

SALES OFFICES

AL	EMA	(205) 536-3044	MI	C.B. Jensen	(313) 643-0506
AZ	Haas & Associate, Inc.	(602) 994-3813	MN	IEI	(612) 571-0000
CA	Quest-Rep	(619) 546-1933	NC	EMA	(919) 847-8800
CA	Samsung Semiconductor	(408) 727-7433	NJ	NECCO	(201) 461-2789
CA	Samsung Semiconductor	(714) 662-3406	NM	Nelco Electronix	(505) 292-3657
CA	SYNPAC	(408) 988-6988	NY	Reagan-Compar	(518) 489-4777
CA	Westar	(714) 835-4711			(716) 271-2230
CO	Electrodyne	(303) 895-8903			(607) 723-8743
CT	Phoenix Sales	(203) 438-9644			(315) 732-3775
FL	Lawrence Associates	(305) 368-7373	OH	J.N. Bailey	(513) 687-1325
		(813) 584-8110			(216) 273-3798
		(305) 339-3855			(614) 262-7274
		(404) 448-1215	OR	Earl & Brown	(503) 245-2283
GA	EMA	(312) 967-8430	PA	RJL	(215) 631-1414
IL	IRI	(312) 310-9790	SC	EMA	(803) 233-4637
IL	Samsung Semiconductor	(312) 844-9227	TX	Samsung Semiconductor	(214) 239-0754
IN	STB	(617) 273-4888	TX	Vielock	(214) 881-1940
MA	Samsung Semiconductor	(617) 449-7928	UT	Electrodyne	(801) 486-3801
MA	Tech Comp	(617) 449-7928	WA	Earl & Brown	(206) 885-5064
MD	ATS	(301) 789-9360	WI	IRI	(414) 259-0965
			CANADA	GNT	(604) 430-6677
			CANADA	Terrier	(416) 622-7558



SAMSUNG

Semiconductor
5150 Great America Parkway
Santa Clara, CA 95054

Magnetic compensation gives new life to transformer-based SLICs

The transformerless monolithic SLICs that are becoming available are not yet proving to be cost-effective. A family of magnetic-compensation circuits offers an interim solution that can help reduce the size and cost of the transformer in a magnetic SLIC while preserving all of the advantages of a transformer-based design.

Chris Stacey, National Semiconductor Corp

Although IC designers have successfully implemented voice-processing and switching functions on digital subscriber-line and trunk cards in VLSI, the subscriber-line interface circuit (SLIC) continues to present a challenge. Current monolithic SLICs are expensive and somewhat inflexible devices because of their large die sizes and the demands of high-voltage processing. Acceptable solutions for the comparatively simple requirements that PABX lines impose upon SLICs have appeared, but central-office and trunk lines have more demanding specifications in a number of critical areas.

One problem that has proved troublesome for SLICs—and in particular monolithic SLICs—is that of maintaining good longitudinal balance when there is current

induced into the subscriber's twisted-pair wiring by adjacent power cables, which may be comparable to the dc loop current. Other problems attend the reliability of the ring-tripping circuitry and of the device itself under overvoltage conditions. It's still the case, then, that a magnetics-based SLIC offers the most cost-effective and reliable solution for many phone-line applications.

Use of the TP3200 family of magnetic-compensation circuits, also known as SLIC-MCs (Fig 1), can help you trim both the size and the cost of the transformer in your SLIC design while retaining all of the transformer's advantages. The SLIC-MC cancels the dc flux set up by the loop current in the transformer core by forcing a proportional current in the opposite direction through a cancellation winding. When this task is accomplished with a high degree of accuracy, the net dc magnetizing flux can be reduced to zero, and this result in turn allows you to wind the transformer on a small pot core without an air gap. (For a discussion of the magnetic-compensation principle, see **box**, "How SLICs employ magnetic compensation.")

In the TP3200 circuits, a differential amplifier and a network of 200-k Ω resistors, which form a bridge across the external loop current feed resistors, sense the loop current. The sense bridge employs on-chip precision Si-chrome resistors to ensure at least 60 dB of longitudinal balance. Si-chrome, a thin-film technique in which resistors are deposited over the thermal oxide of the device prior to passivation, is far superior to diffused or

A magnetic-based SLIC still offers the most cost-effective and reliable solution for many applications, including line, trunk, and special service interfaces.

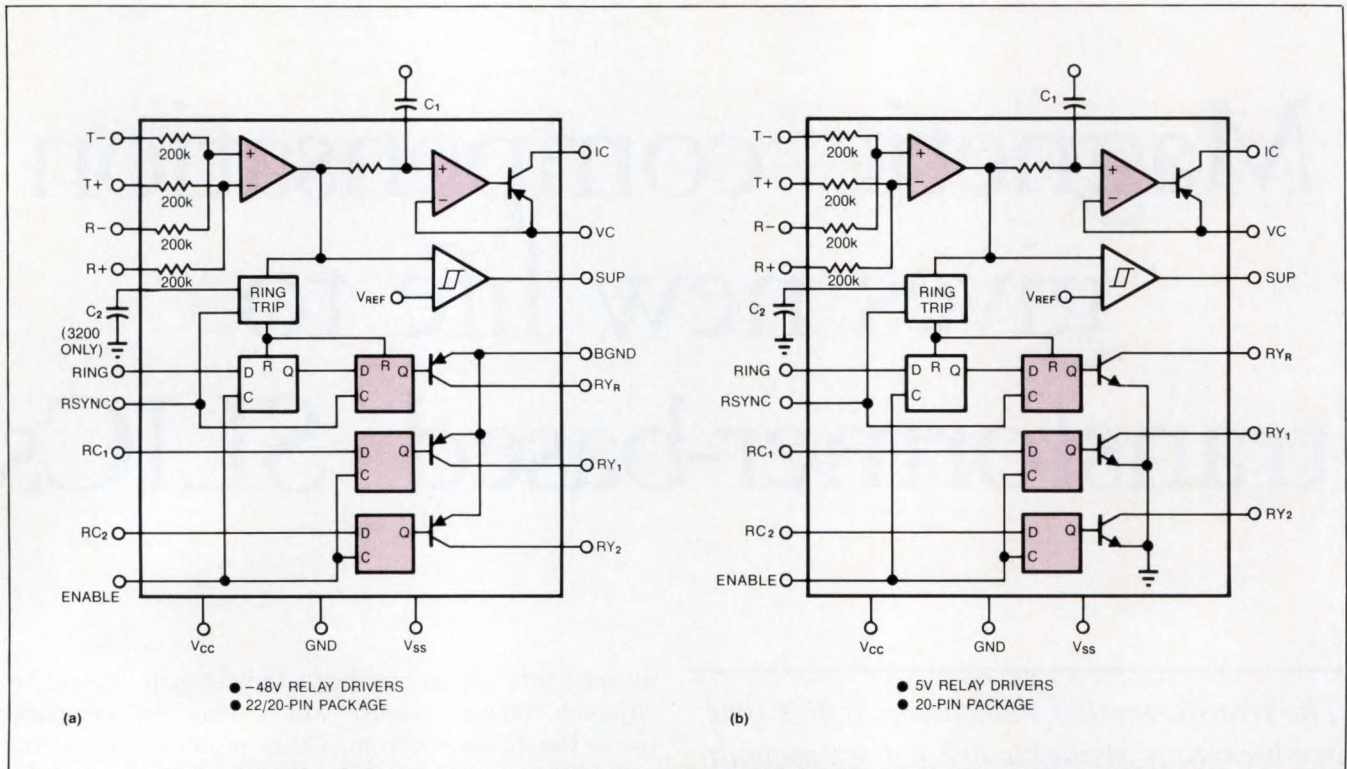

Fig 1—These magnetic-compensation circuits, the TP3200/3202 (a) and the TP3204 (b) include a differential amplifier for sensing the magnitude of the loop current and a current source to drive the cancellation winding. The ICs also include three latched relay drivers—two general-purpose devices and one designed specifically as the ringing relay.

polysilicon resistors with respect to matching tolerance and to breakdown voltage. Completing the flux-canceling part of the circuit is a high-compliance current source, which drives the cancellation winding. A single external resistor sets the gain of the cancellation path, providing you with full flexibility in designing the transformer to optimize the ratio of the number of turns on the cancellation winding to the number of primary turns. Ratios as high as 5:1 are practical.

Also in the device is a comparator that compares the loop current with an internal voltage reference to provide hook-switch detection via a supervision (SUP) output. In the presence of dial pulses, the comparator will provide a rectangular-wave replication at the SUP output.

Because the feed resistors and the transformer buffer the TP3200 itself from the line, the device is not directly subject to severe overvoltage conditions. In fact, the device needs only +5 and -5V power supplies, and it's fabricated with a standard 70V bipolar process that requires no expensive dielectric isolation. These factors help keep design and fabrication costs low.

Along with the magnetic-compensation circuit,

TP3200 Series devices also include three relay drivers each (the transistors associated with pins RY_R, RY₁, and RY₂), and each driver has a latched output. A common Enable input strobes the latches, thereby allowing you to multiplex the latched inputs of a number of SLIC-MCs without resorting to I/O expanders or decoders. Two of the relay drivers are general-purpose outputs, suitable for a test relay and a battery-reversal relay (pins RY₁ and RY₂; see Fig 2 for an example). The third driver is designed specifically for the ringing relay (pin RY_R). Following this latch is a flip-flop clocked by a Ring Sync input pulse, ensuring that the ring relay only makes and breaks coincidentally with a zero-crossing of the ringing voltage. This zero-crossing operation prevents arcing, which would wear down the relay contacts. The TP3200 and TP3202 have pnp drivers for use with -48V relays. The TP3204 employs npn drivers for use with +5V relays.

The SLIC-MC offers a choice of two methods for tripping the ringing signal upon answer—a fully automatic method, and a μ P-assisted procedure. Ring-tripping requires that the circuit reliably distinguish between the 16- to 20-Hz ringing current in the loop

and the direct current drawn as soon as the receiving telephone goes off-hook. Factors such as the number and type of ringers connected to the line (for example, bell or electronic ringers), the cable length and impedance, and the cable leakage all combine to produce considerable variations in the waveform of the ringing

current. A reliable ring-tripping circuit must not be fooled into falsely tripping before the phone goes off-hook, nor must it fail to trip when it does go off-hook (the latter event produces a deafening sound level in the receiver).

In the automatic method of ring-tripping, the SLIC-

How SLICs employ magnetic compensation

One of the few limitations of the humble transformer is the degradation of performance that results from direct current passing through any one of its windings. The constant magnetic flux set up in the core introduces an offset in the B-H characteristic, thereby limiting the degree of alternating flux the core can handle before reaching saturation. Once the core is saturated, ac signals become distorted.

Conventional dc feed circuits in a subscriber-line interface are designed to provide at least 20 mA of current on a long loop, rising to about 100 mA on a very short loop. This current is normally fed through a split transformer winding (Fig A). To carry these high dc levels without saturation, the transformer core usually employs magnetic-alloy laminates. You may also use ferrite cores, but these cores require a large air gap between the core pieces, thus reducing the inductance per turn. In any case, a primary inductance in the 1.5 to 2.5H range is necessary to meet return loss and frequency-response specifications in a typical 900Ω circuit, thus making the final transformer size larger than is desirable. What is needed is a method that will enable the transformer to be wound on a small pot core without an air gap.

Fortunately, a simple technique—magnetic compensation—cancels the dc component of the magnetic flux set up by the loop current. The following equation determines the core's flux density:

$$B = I \times N \times \mu / A$$

where N is the number of turns,

μ stands for permeability, and A represents the effective core area.

Consequently, for any given core where μ/A is a constant, you can cancel the flux by forcing a current with an equal ampere-turns product through an auxiliary winding in a direction opposite to that of the loop current.

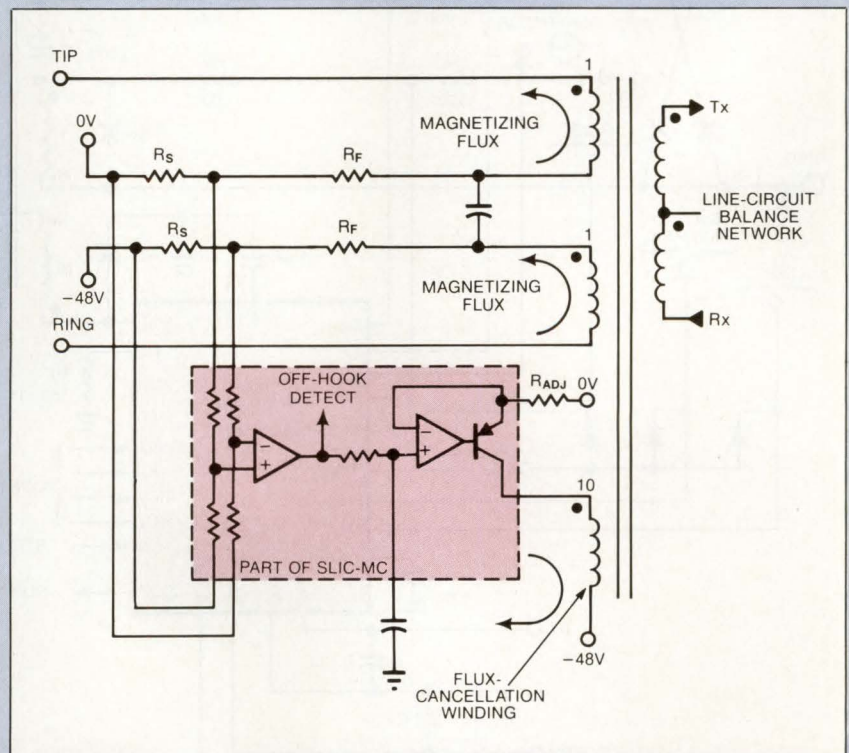

Fig A—Magnetic-compensation circuitry measures the loop current by sensing the voltage across two matched battery-feed resistors (R_s). Circuitry in the SLIC-MC amplifies this voltage and uses it to drive a flux-cancellation winding. With proper selection of R_{Adj} and transformer-winding ratios, the current in the cancellation winding exactly cancels the flux produced by the dc component in the loop current.

A magnetics-based SLIC cancels the dc flux set up by the loop current in the transformer core by forcing a proportional current in the opposite direction.

MCs use only one small, loose-tolerance capacitor (C_2) rather than a sharp lowpass filter, which would require several cumbersome off-chip capacitors. During ringing, on each positive half-cycle of the sensed line signal a fixed current charges C_2 . The current then discharges during the negative half-cycle. At the end of each ring cycle, a strobed comparator (not shown) checks to see if there is any residual voltage charge on C_2 . If the loop current contains no dc component, the positive and negative half-cycles are approximately equal in duration; consequently, C_2 has no residual voltage at the end of the cycle, and the ring relay stays set. As soon as a

direct loop current exceeding about 14 mA is drawn during ringing, the sensed ringing current signal becomes offset, resulting in a residual voltage on C_2 at the end of the full ring cycle. This sensed residual voltage automatically resets both latches and the ringing relay on the next Ring Sync input pulse.

The other ring-tripping method takes advantage of a line-card μ P to sense the state of the supervision (SUP) output during ringing. This signal is essentially a rectangular wave that, by careful choice of internal voltage thresholds, is designed to have a duty cycle greater than 50% (logic-one duration) during on-hook

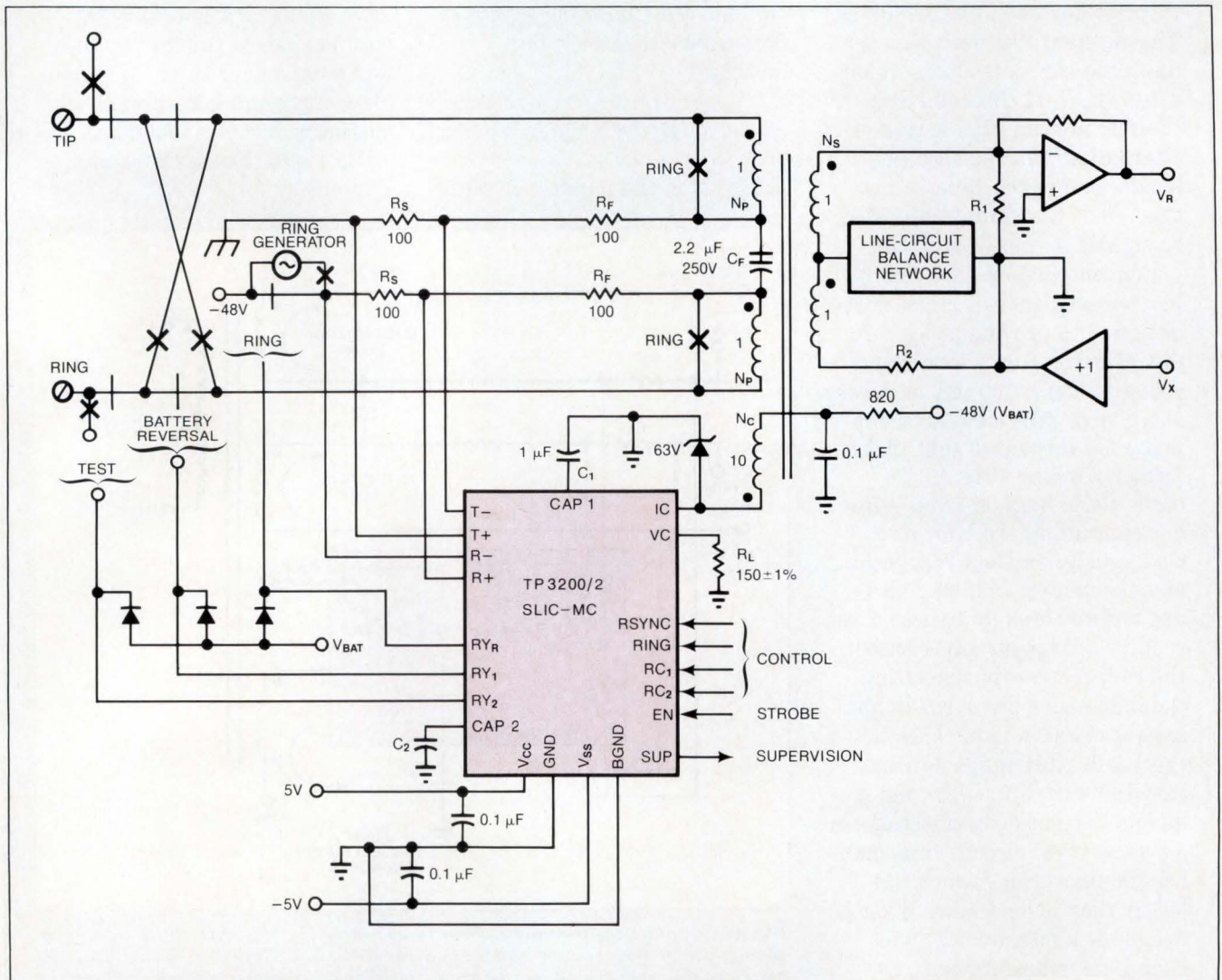

Fig 2—In this typical configuration for a -48V battery feed, the four 100Ω resistors provide current sensing and protection from line transients. The dc component of the magnetic flux set up by the loop current is effectively canceled by opposing current in the compensation winding.

The Most Powerful Instrument of its Kind in the World Today.



The New Data 6100 is The Most Comprehensive, Most Powerful Solution Available For Your Advanced Signal Acquisition and Processing Applications.

Take the pure processing power of over 40 pre-programmed and resident functions for both time and frequency domain measurements. Add total acquisition flexibility with digitizing plug-ins covering the entire dc to 1GHz bandwidth. Include accuracies

to better than 0.01% and resolutions up to a true 16 bits.

Now combine them all with the impressive signal acquisition and processing expertise and experience of Data Precision. What you'll get is the Data 6100 the world's best stand-alone solution for transient analysis, spectrum analysis, vibration analysis, ATE, FFT analysis and digital storage oscilloscope applications. And, you can get it NOW.

Call our **SOLUTIONS HOT LINE** at 1-800-343-8150. In Massachusetts call 617-246-1600. Give us the opportunity to tell you just how the Data 6100 or our other test instruments can be an affordable solution for you.

ANALOGIC ■

DATA PRECISION[®]

DATA PRECISION, Division of Analogic Corporation, Electronics Avenue, Danvers, MA 01923. Tel: 617-246-1600. Telex: 6817144.
ANALOGIC, Ltd., The Center, Weybridge, Surrey, England KT138BN. Tel: 0932-56011. Telex: 928030 ANALOG G.
ANALOGIC GmbH, Daimlerring 2, 6200 Wiesbaden-Nordenstadt, W. Germany. Tel: 06122-70060. Telex: (17)6122969 ANA D.

The SLIC-MC offers a choice of two methods for tripping the ringing signal upon answer—a fully automatic method, and a μ P-assisted procedure.

ringing. A change to off-hook ringing forces the duty cycle to shift to less than 50%. By sensing the supervision output at approximately 1-msec intervals, the μ P easily computes the change in duty cycle and then resets the ring relay.

Configuration shows design options

Fig 2 illustrates the use of the TP3200 Series in a specific configuration. In this circuit, a pair of 200 Ω resistances ($R_S + R_F$) works with a fixed -48V battery feed. The 100 Ω current-sense resistors (R_S) in series with the 100 Ω protection resistors (R_F) ensure that the Tip (T) and Ring (R) sense inputs of the device never see more than one half of any line-transient voltages, thereby simplifying the sensing requirements. The two general-purpose relay drivers operate a line-test relay and a battery-reversal relay. The ac line-termination impedance is determined by resistors R_1 and R_2 (which should be equal to balance the hybrid circuit properly) and the square of the turns ratio of the transformer— $(2N_P/N_S)^2$.

You insert the ring voltage into the circuit by breaking the battery-feed path and superimposing the ac voltage upon the battery voltage (shown in Fig 2 for ringing inserted in the more negative lead—that is, the Ring lead). To prevent the feed-bridging capacitor (C_F) from shunting the ringing current, you place a "break" contact in series with C_F . To prevent the line transformer's primary windings from attenuating the ring voltage or introducing distortion, you connect "make" contacts in parallel with the transformer's primary windings. Doing so ensures minimum shunt-path loss of the ringing current.

(Ed Note: Phone company conventions for drawing schematics call for a bold "X" for a make contact and a short bar for a break contact. You can see the break contacts in Fig 2 above C_F , along the Tip and Ring leads, and in parallel with the ring-generator circuitry near the -48V feed.)

Long live the transformer

The design of the transformer itself is somewhat of a black art, influenced by several interacting parameters:

- Low-frequency 2-wire return loss, dominated by the minimum inductance of the primary winding
- Worst-case loop-current compensation error, determined by the ampere-turn capacity before magnetic saturation of the core
- 4-wire path insertion loss, preferably limited to about 1 dB.

You must also carefully consider other factors in the construction of the transformer, including longitudinal balance and heat dissipation. A major advantage of using magnetic compensation is that most of these parameters become substantially constant over the full range of loop currents encountered in practice; without magnetic compensation, your circuit would normally exhibit large variations in these parameters. The compensation error is partly a function of the TP3200's design and partly a function of the tolerance of external components. The excellent properties of the Si-chrome resistors, along with careful control of device offsets and other tolerances, limit the typical compensation error to ± 2 mA. A variety of ferrite core types, such as RM8-T35, can handle the full range of line current without saturation.

No doubt monolithic SLICs will one day emerge with the right set of cost, size, and function compromises to offer attractive alternatives to transformer-based devices, even in central-office applications. While designers continue to grapple with the problem, the SLIC-MC offers an interim solution. At least for now, there's still life in the old transformer. **EDN**

Author's biography

Chris Stacey is the telecom applications manager at National Semiconductor Corp (Santa Clara, CA). Before joining the company he worked for Plessey Communications in England, from 1969 to 1978, as a design engineer for PCM channel banks, multiplexers, and digital line transmission systems. He has a BSEE from the University of Southampton and an MSEE in telecommunications technology from the University of Aston, both in the United Kingdom. Chris is married and has two children.

Article Interest Quotient (Circle One)
High 482 Medium 483 Low 484



REMOTE TESTING CHIP CAPABILITY AVOIDS OUTAGES IN THE OUTBACK.

As you pack more gates into logic arrays, you also pack more problems into the testing and maintenance of those systems. And if those systems are in remote locations, maintenance becomes even more of a problem. Control Data's Technology Application Center (TAC), however, applies a powerful design program called Modular Integrated Design

Automation System (MIDAS) to help you solve this problem.

MIDAS, teamed with a powerful CYBER® mainframe, can help you design VLSI gate array logic systems with unique on-chip self-test capabilities. In testing, 100% of all gates are tested so there's no margin for error with a TAC-designed system. Full system simulation assures that all components

work together. As a consequence, many MIDAS-designed systems are being used in such applications as A6-F and F-14D fighter aircraft programs, among others.

For information about the MIDAS system, write Control Data Corporation, Government Systems Resource Center, P.O. Box O, Minneapolis, MN 55440, or call us at 612/853-5000.



CONTROL DATA

THERE ARE CHEAPER WAYS TO MOVE DATA THAN WITH INTEL'S 588.

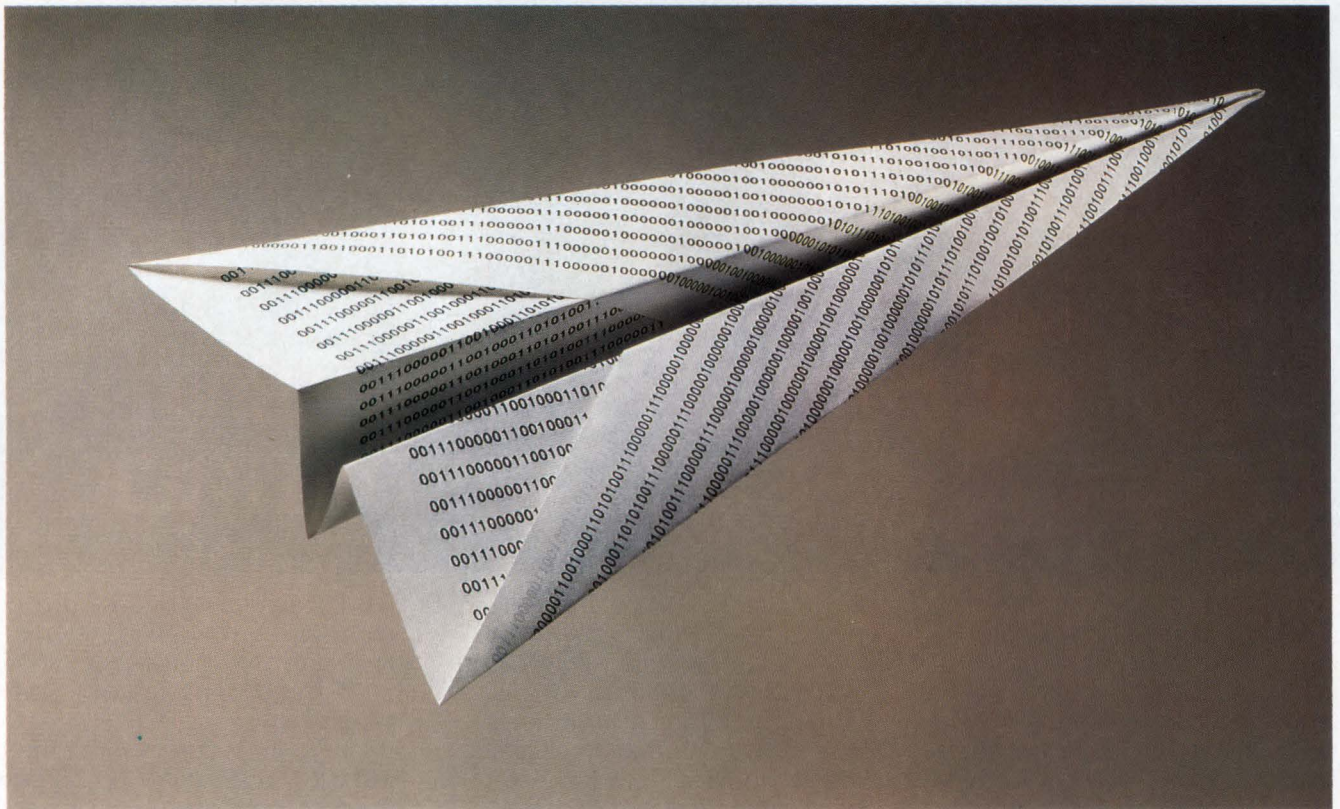

Now you can cut the cost of a PC LAN dramatically with our new 82588 LAN controller.

It's the most integrated networking solution in the 1-2 Mbps range.

And it's optimized to run with standard phone wiring.

Which means that low-cost PC LANs can finally get off the ground. And that's exciting. Especially when you consider that 10 million PCs out there could use an inexpensive way to connect.

That's a great reason to start designing now with the 82588. It's the LAN controller that reduces cost by cutting your board space in half. Saving you the bucks and bother of installing extra chips.

We put timing recovery, data encoding/decoding, collision detection and transmit clock generation all on a single chip. To lower your component count.

Which adds up to even more savings in areas like assembly, testing and reliability.

And we made sure that the 82588 supports emerging LAN standards like StarLAN.

It also supports the IBM® PC Network. Plus many other specialized baseband and broadband LANs.

And because it snaps together with Intel's world standard 186 and 188 micro-processors, you eliminate TTL glue and save even more money. While speeding up your design.

To help your LAN products take off, we're offering an easy-to-use design kit. Included are two 82588s plus all the essential hardware, software and documentation needed to tie two PCs together. And all for just \$65.

For information on how to get your kit, call Intel toll-free at (800) 548-4725 and ask for Lit. Dept. W-334.

Then see how high your profits can soar.

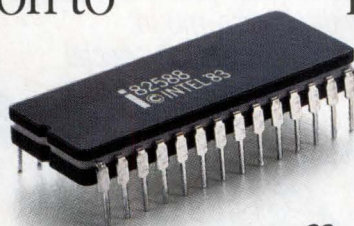

intel®

© 1986 Intel Corporation
IBM is a registered trademark of International Business Machines Corporation.

FROM ONE SOURCE: WORLD'S WIDEST SELECTION OF WIREWOUND RESISTORS.

With quality that goes straight to the core.

IRC is now **THE** largest supplier of wirewounds... standard products, special assemblies, and units with custom characteristics.

So you can buy with single-source ease, and readily tap our more-than-60-years of experience in resistor technology and applications.

We offer failsafe and flameproof units. Moisture-barrier vitreous enamelled units. Aluminum-housed chassis mounts. Custom TCs. Pulse and surge protectors with special fusing characteristics to meet your exact design needs.

We support your production efficiency, with chassis-mount designs and SMD packaging. And we can custom-produce special devices and assemblies to solve your circuit problems. Just ask us.

For product specs or application assistance, contact The Resistor People: IRC, Inc., Greenway Road, P.O. Box 1860, Boone, NC 28607. Phone (704) 264-8861.

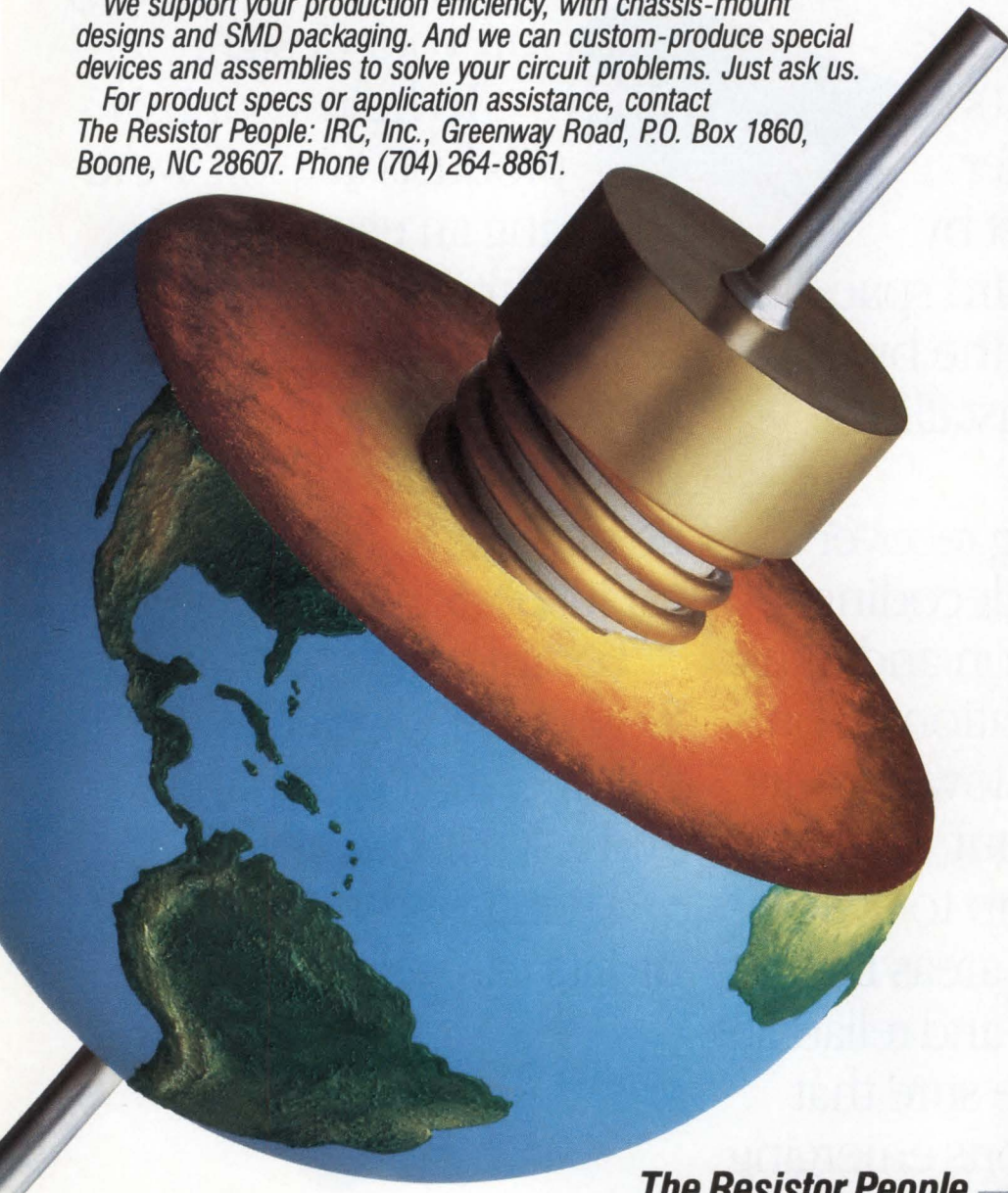

GENERAL PURPOSE
1 AND 2 W
0.1 TO 2400 Ω
TOL. \pm 5% AND 10%



FLAMEPROOF LINE FEED RESISTOR
2 W
1 TO 1600 Ω
TOL. \pm 1% TO 5%

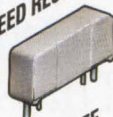

GENERAL PURPOSE AND FAILSAFE
1 AND 2 W
0.01 TO 2400 Ω
TOL. \pm 2% TO 10%



SEMI-PRECISION, TC \pm 20 ppm/ $^{\circ}$ C
0.5 TO 10 W
0.1 TO 175k Ω
TOL. \pm 0.1% TO 5%



VITREOUS ENAMELLED
2.5 TO 208 W
0.1 TO 250k Ω
TOL. \pm 1% TO 10%



LOW-RESISTANCE CURRENT-SENSING
3 TO 15 W
01 TO 1 Ω
TOL. \pm 1% TO 10%

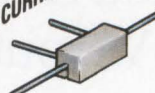

CHASSIS MOUNT
10 TO 50 W
0.05 TO 82k Ω
TOL. \pm 1% TO 10%

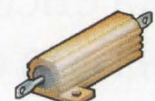

GENERAL PURPOSE POWER
2 TO 100 W
0.1 TO 30k Ω
TOL. \pm 5% AND 10%

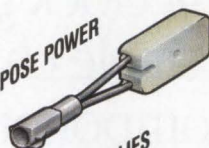

SPECIALS, CUSTOMS, ASSEMBLIES
2 TO 100 W
0.1 TO 60k Ω
TOL. \pm 5% AND 10%



The Resistor People



Token-ring bus controller simplifies network design

You can simplify the design of factory-automation networks with the aid of a VLSI token-ring bus controller that conforms to IEEE Standard 802.4. Because it handles the details of communication over the network, this intelligent controller allows you to simplify the network-control software you must write.

Ivan Erickson, *Motorola Inc*

By employing a single digital communications network to control all the automatic manufacturing equipment in a factory—instead of connecting machines via point-to-point links—a manufacturer can lower the cost of equipment installation and increase the speed of its manufacturing operations. To configure such a communications network, you need to use a standard bus architecture for all the transmission equipment and communications software on the network. You can simplify the configuration of such a network by basing your design on an intelligent, VLSI token-ring bus controller that conforms to IEEE Standard 802.4.

A number of manufacturers have already adopted the IEEE Standard 802.4 token-ring bus architecture as the standard for communication over such networks. This standard is part of a collection of standards for factory-automation networks known as the General

Motors Manufacturing Automated Protocol (MAP). The MAP generally follows the OSI (Open Systems Interconnection) scheme promulgated by the International Standards Organization.

IEEE Standard 802.4 defines both the physical layer and the media access-control (MAC) sublayer of the OSI. The physical layer defines the protocol for establishing and maintaining a connection; the MAC sublayer defines the protocol by means of which a node on the network gains access to the network and transfers data to another node.

Stations take turns starting communications

A token bus network can consist of any number of nodes connected to a common bus. **Fig 1** is a simple representation of a token bus network. In this example, stations A, B, C, and D form a logical ring; the other stations connected to the bus (E and F) can receive, but not initiate, communications. Control of the bus is

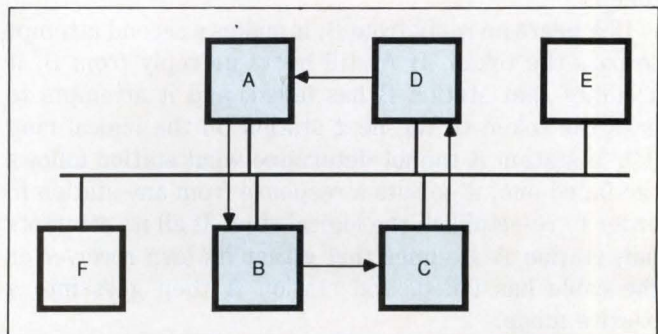

Fig 1—Stations forming a logical ring pass a token around the ring. Stations that are not in the logical ring can receive broadcast messages but cannot initiate communications.

On a token bus network, only the station holding the token can initiate communications.

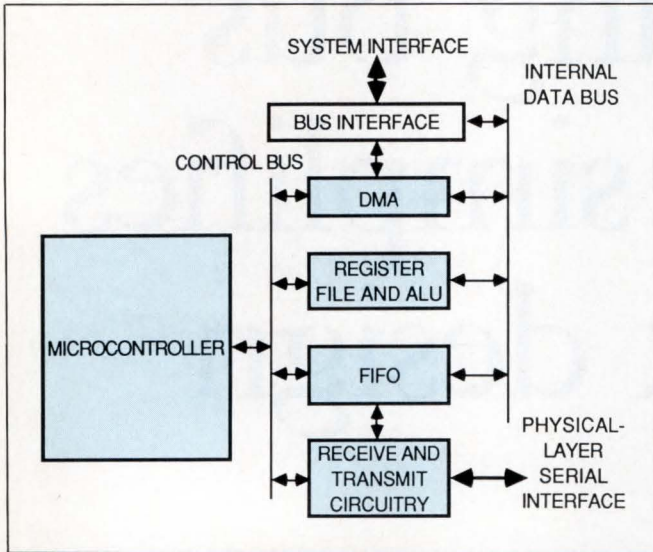

Fig 2—The TBC microcontroller manages the 40-byte FIFO buffer, the register file and ALU, the receive and transmit circuitry, and the DMA logic.

determined by a token that allows one node on the logical ring to initiate communication with another. The token is passed from node A to node B to node C to node D, and then back to node A. Stations that are logically next to each other on the logical ring (for example, B and C) do not need to be physically adjacent on the cable. Each station has a timer that governs the maximum time for which that station may retain control of the bus.

When a station (A, for example) has completed a task, such as the transmission of data frames or the performance of maintenance functions, or when its timer expires, it passes the token to the next station in the logical ring (B) and listens for a reply. If A receives a valid frame from B, it assumes that B has received the token.

If A hears no reply from B, it makes a second attempt to pass the token. If A still hears no reply from B, it assumes that station B has failed, and it attempts to pass the token to the next station on the logical ring (C). If station A cannot determine what station follows the failed one, it solicits a response from any station in order to re-establish the logical ring. If all its attempts fail, station A assumes that either its own receiver or the cable has failed, and station A then goes into a passive mode.

The station that holds the token periodically polls stations that are not part of the logical ring to see if any station wishes to join the logical ring. If the sending

station, A, receives a valid reply from, say, station E, station A patches station E into the logical ring by making E (instead of B) its logical successor on the logical ring.

VLSI chip provides simple bus interface

Interfacing a host computer to a token bus is relatively simple if you base your design on an intelligent VLSI token bus controller (TBC) IC that can perform all the functions required by the MAC sublayer of the OSI. Several such TBCs are available; Motorola's HCMOS MC68824 is an example. This microprogrammed TBC (Fig 2) has a 32-bit address bus, can handle four priority levels, and has built-in diagnostics to check both the serial interface and system operation. The TBC can also gather network statistics that will aid the designer in finding trouble spots in the network.

The MC68824 TBC can pass or accept pointers to buffer areas, data, and parameters contained in the host's memory. The DMA channel can then transfer the appropriate data, without any intervention by the host, at the highest rate that the host's bus and memory can support. Because the TBC handles the details of verifying that its associated modem is operating correctly, you can control communication over the network merely by passing simple instructions to the TBC; you don't need to write complex software to pass data to the modem character by character.

The receive and transmit circuitry of the MC68824 TBC communicates with the physical layer via an interface specified by IEEE Standard 802.4G. This standard lets the circuitry interface to any type of physical layer, whereas IEEE Standard 802.4 requires either broadband or carrierband physical layers (see box, "Broadband vs carrierband media").

The TBC communicates with a host by means of a shared memory area that's resident in the host. As Fig 3 illustrates, the TBC uses five different memory structures, all resident in the shared area: an initialization table, the TBC private area, a pool of free frame descriptors, a pool of free buffer descriptors, and a pool of data buffers.

The initialization table contains the pointer to the TBC's private area, as well as initial pointers to the priority queues, transmit queues, receive queues, target rotation time, statistics, and other parameters. The initialization table also contains the command parameter area, through which the host and the TBC pass parameters to each other.

The TBC private area is 256 bytes long; it acts as a

Broadband vs carrierband media

In selecting a transmission medium for use in an IEEE 802.4 token-ring network, you'll need to take into account both the layout of the network and your budget. At present, the standard gives you only two options: broadband or carrierband media.

If you use broadband media, you'll need only two frequencies for the data channels, so you can use the remaining portion of the cable's bandwidth for other networks or for video applications. However, broadband media operate at higher frequencies, and have tighter filtering requirements, than do carrierband media; broadband media are therefore more complex. Further, both broadband cable and broadband modems tend to be more expensive than their carrierband counterparts.

A single carrierband network uses the entire bandwidth of the cable, and all its nodes transmit and receive at the same frequency. However, although they are simpler than broadband networks, carrierband networks can operate only over a limited distance. Table A summarizes the advantages and disadvantages of the two media.

Because you'll probably want to carry other signals, such as TV signals, over your factory's backbone cable, you'll probably select broadband media for the backbone cable. As Fig A illustrates, you can then use gateway and bridge nodes to attach narrower-bandwidth carrierband

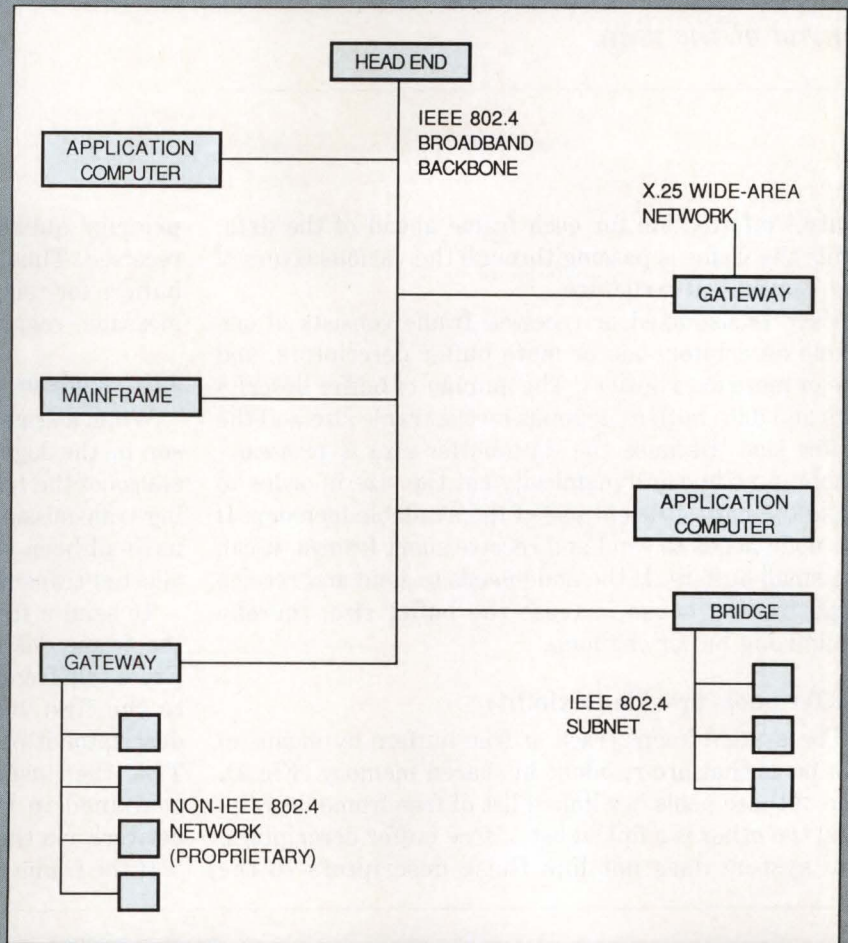

Fig A—A typical factory network uses a broadband medium to connect the main nodes to the backbone cable. You can connect subsidiary local networks to the main network by means of gateway or bridge nodes.

TABLE A—COMPARISON OF CARRIERBAND AND BROADBAND MEDIA

CHARACTERISTIC	CARRIERBAND	BROADBAND
DATA ERROR RATE	1×10^{-7}	1×10^{-9}
DISTANCE	2500 METERS (WITH REPEATERS)	40 MILES
NOISE VULNERABILITY	MEDIUM	LOW
MAINTENANCE	VERY EASY	EASY

subnetworks, including 802.4 subnets, wide-area networks,

and proprietary subnets that don't conform to IEEE 802.4.

scratch pad for the TBC. This area contains pointers to four transmit queues, four receive queues, the pool of free frame descriptors, and the pool of free buffer descriptors.

Each frame descriptor contains a confirmation word, a status word, a pointer to the next frame descriptor, a pointer to the first buffer descriptor, and the data length of the frame. In addition, the frame descriptor contains a pointer to the immediate-response frame, the source-node address, the destination-node address, and the control field of the frame. The IEEE 802.4

standard specifies that the frame be no longer than 8k bytes.

Each buffer descriptor contains a pointer to a data buffer, a pointer to the next buffer descriptor, the buffer length, an indication word, and control and offset values. Data buffers contain only data (no control information) and have a maximum length of 32k bytes. The offset count (in bytes), which is located in the last word of the buffer descriptor, indicates how far from the beginning of the data buffer the actual data starts. This parameter allows the system to place address and

A programmable timer governs the maximum time for which a station may retain control of the ring.

control information for each frame ahead of the data, while the frame is passing through the various layers of the 7-layer OSI structure.

Each transmitted or received frame consists of one frame descriptor, one or more buffer descriptors, and one or more data buffers. The number of buffer descriptors and data buffers depends on the frame size and the buffer size. Because the data-buffer size is programmable, a node can dynamically set the size in order to make the most efficient use of the available memory. If the node needs to send and receive short frames, it can use small buffers. If the node needs to send and receive large frames, it can increase the buffer size, thereby minimizing buffer chaining.

Buffer pools provide flexibility

The system keeps track of free buffers by means of two pools that are resident in shared memory (Fig 4). One of these pools is a linked list of free frame descriptors; the other is a linked list of free buffer descriptors. The system does not link these descriptors to the

priority queues until after a good frame has been received. Thus, the system can make efficient use of its buffers for received frames: It can use any buffer for a message, regardless of the message's priority.

TBC sends as many frames as possible

When a station receives the token from its predecessor in the logical ring, the station's TBC checks the status of the transmit queues. If any frames are awaiting transmission, the TBC transmits frames until they have all been sent or until it has used up the station's allotted transmission time.

To send a frame, the TBC first obtains a pointer to the frame descriptor of the first frame in the queue. From this frame descriptor, the TBC obtains a pointer to the first buffer descriptor, and from the buffer descriptor it obtains a pointer to the buffer itself. The TBC then uses its DMA channel to fetch the data contained in the buffer and sends the data to the network via the FIFO buffer and transmit circuitry.

If the frame has more than one buffer, the TBC goes

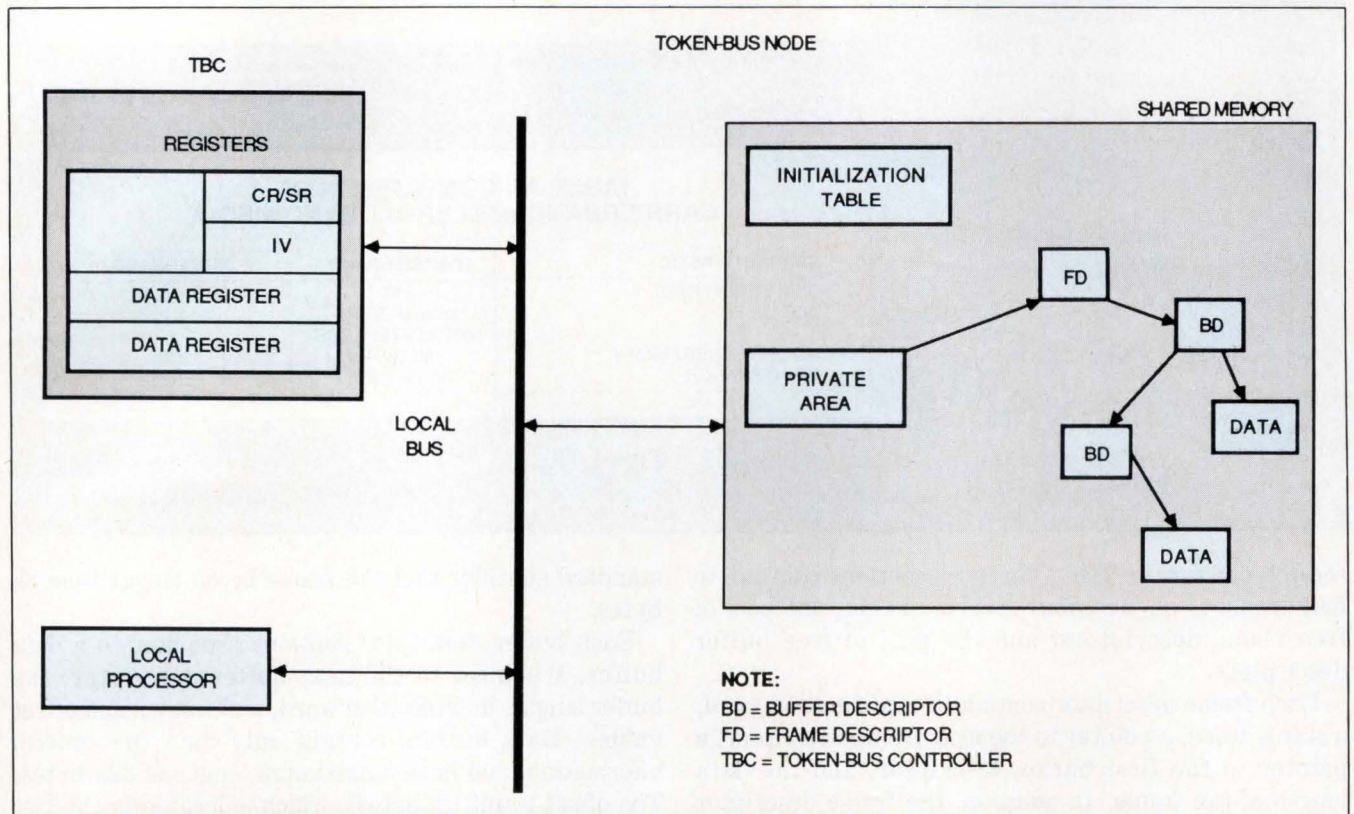

Fig 3—A network node consists of a host processor and a token bus controller (TBC). The host passes commands to the TBC and receives status reports from it over the local bus. Common memory, shared by both the host and the TBC, accommodates queues of messages received over the bus or awaiting transmission.

back to the frame descriptor, where it finds the pointer to the next buffer descriptor. In the new buffer descriptor, the TBC finds the pointer to the next data buffer. The TBC repeats this procedure until it has sent all the buffers of the frame and has appended the cyclic redundancy check (CRC) word. The TBC then writes a confirmation word into the frame descriptor; this word indicates either that the frame was successfully transmitted, or that the attempt failed.

To notify the host of the status of the frame, the TBC generates an interrupt request (provided that the interrupt mask allows TBC interrupts). The host services the interrupt and examines the confirmation to find the status of the associated frame. If its allowable token-holding time has not been used up, the TBC then returns to the transmission queue, finds the pointer to

the next frame descriptor, and sends the next frame.

All the stations except the token holder monitor the network continuously and check the destination address of any message they hear. If the address matches the address of an individual station, or if the address is the broadcast address, that station accepts the frame. From the pool, the receiving TBC takes a free frame descriptor; from the private area, it takes a pointer to a free buffer descriptor. It loads this pointer into the frame descriptor. The TBC then loads the frame descriptor with the MAC destination address, the MAC source address, and frame-control information.

Incoming data starts filling the 40-byte FIFO buffer. When the buffer is full, the TBC transfers the data, via the DMA channel, to the data buffer specified by the buffer descriptor. If the incoming frame needs more

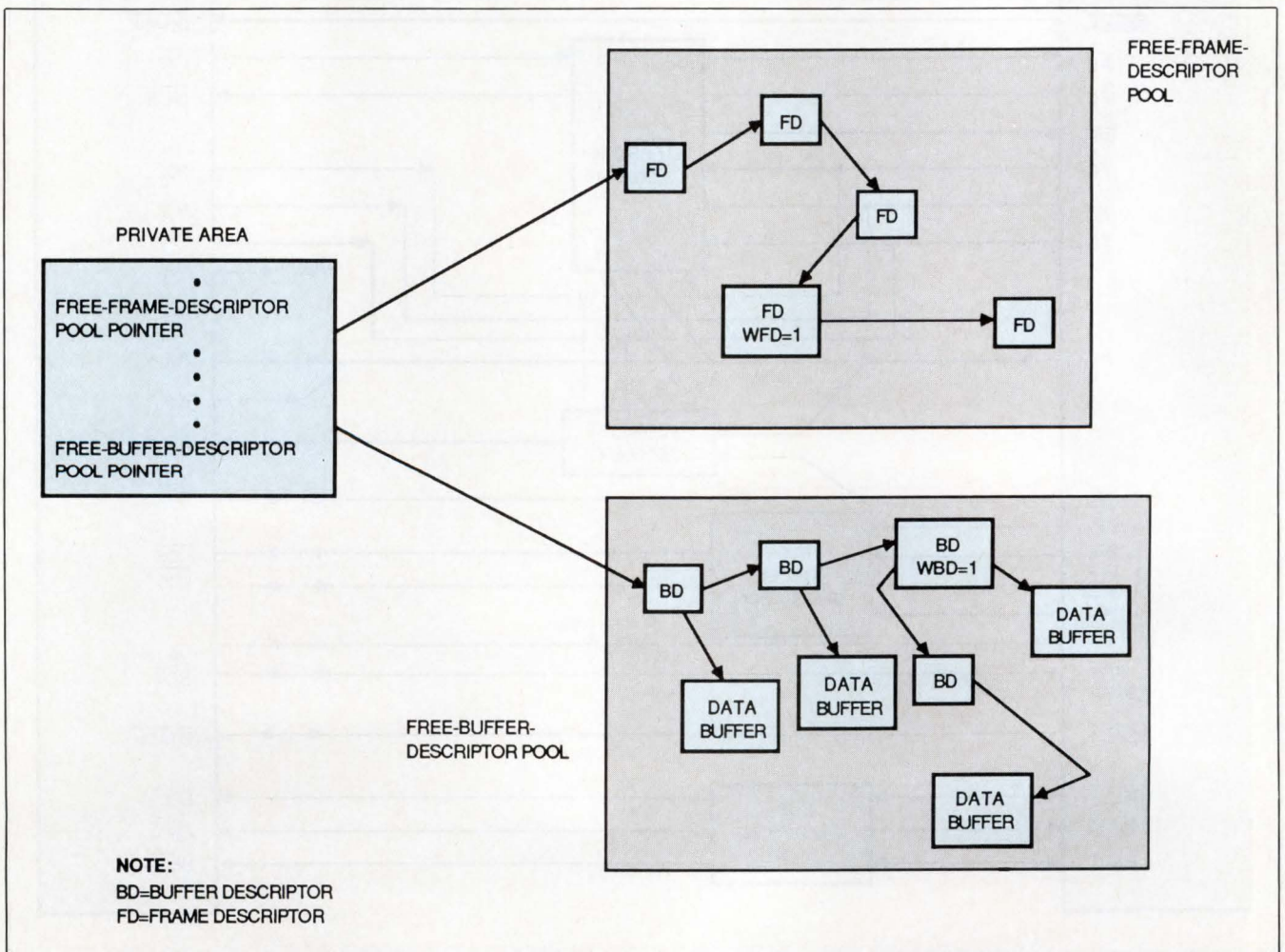

Fig 4—The host assembles message frames for transmission by drawing frame descriptors and buffer descriptors from a pool of free descriptors. The host assembles these into a transmit queue and sends the TBC a pointer to the head of the queue.

A host computer and a token bus controller pass data and parameters to each other via a shared area of memory.

than one data buffer, the TBC obtains additional buffer descriptors as necessary from the pool. If an error occurs, the TBC checks the error mask; if the mask is set to allow that type of error, the TBC notes the error in the frame descriptor and continues receiving until the frame is complete. If the mask does not permit the error, the TBC aborts reception.

The TBC now links the frame descriptor to the appropriate receive queue according to the priority of

the frame, and it sets a status bit in the frame descriptor to indicate that this frame is the last received frame. The TBC also changes the status of the previous frame descriptor on the queue, indicating that that frame is no longer the last received frame. If the interrupt mask permits, the TBC then generates an interrupt request to notify the host that a new frame has been added to the queue.

You can program the TBC to collect a variety of

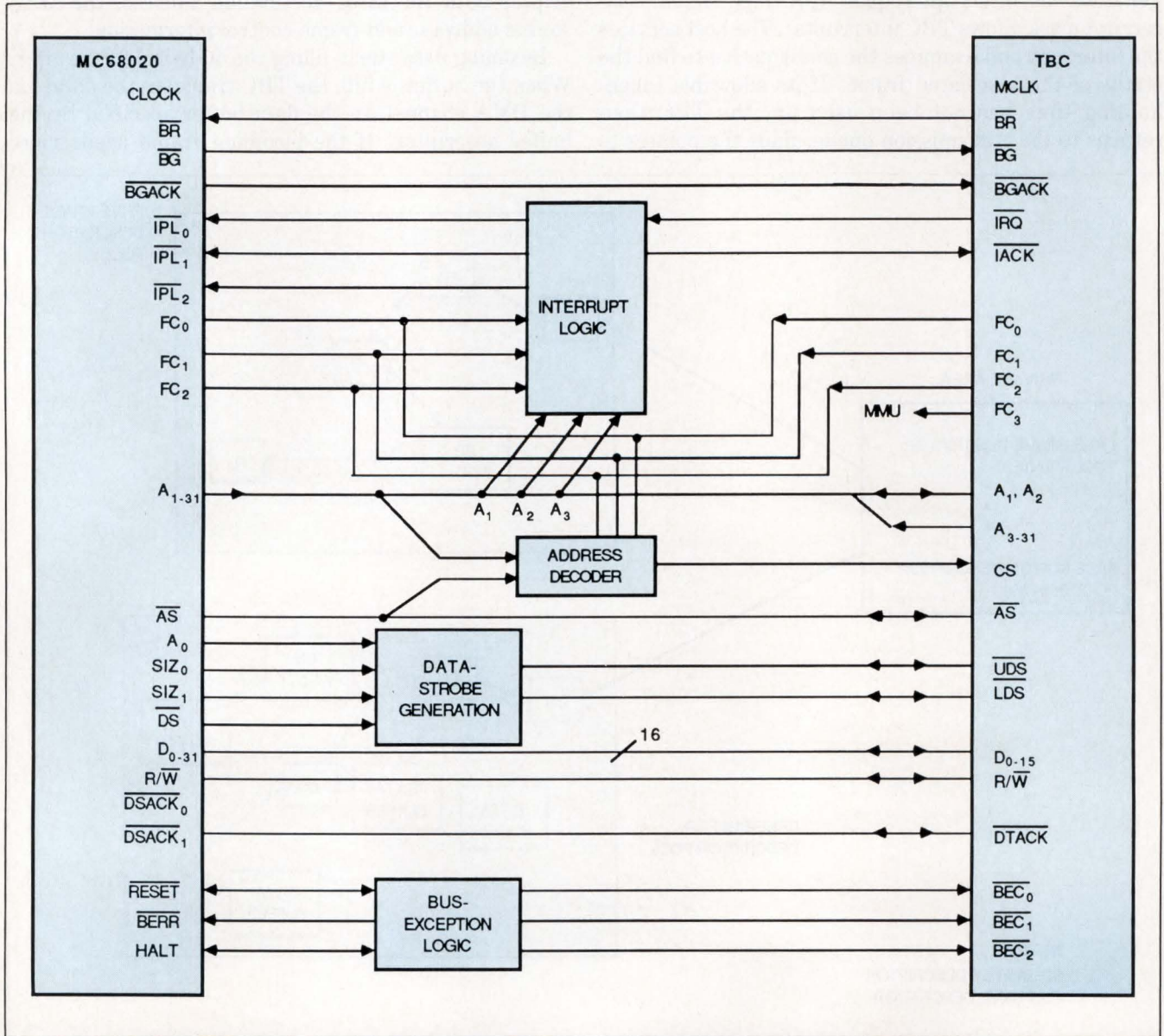

Fig 5—The MC68824 TBC interfaces easily to a 68020 μ P. If your host is based on some other μ P, you just change the interrupt, address-decode, data-strobe-generation, and bus-exception logic to match the signals available from the host.

Fluke. First Family of DMMs.



When accuracy, performance and value are important, professionals the world over look to Fluke — the first family of DMMs.

Reliable Fluke-quality 3½- or 4½-digit DMMs fit every need — from design engineering to industrial troubleshooting.

There's the low-cost 70 Series — the most DMM you can get for the money. The tough 20 Series — totally sealed and built to survive the dirtiest, grimeiest, roughest jobs. The reliable 8020B Series — made to withstand the rigors of the field service environment. The precise 8060A Series — the most powerful and complete test and measurement system available in a handheld package. And, of course, the versatile Bench/Portables that carry on the Fluke tradition for precision and durability in lab-quality bench instruments.

Fluke comes in first again with the world's largest selection of quality accessories to help extend the capabilities of your DMM even further.

There's no need to look anywhere else. Uncompromising Fluke design and leading edge technology are the reasons why attempts at imitation will never fool the millions of professionals that accept nothing less than a Fluke.

For your nearest distributor or more information, call toll-free
1-800-426-0361.

**FROM THE WORLD LEADER
IN DIGITAL MULTIMETERS.**

FLUKE®

IN THE U.S. AND NON-EUROPEAN COUNTRIES: John Fluke Mfg. Co., Inc., P.O. Box C9090, M/S 250C, Everett, WA 98206. Sales: (206) 356-5400. Other: (206) 347-6100.
EUROPEAN HEADQUARTERS: Fluke (Holland) B.V., P.O. Box 2269, 5600 CG Eindhoven, The Netherlands. (040) 458045. TLX: 51846.
© Copyright 1985 John Fluke Mfg. Co., Inc. All rights reserved. Ad No. 4701-8000/70/20

A token bus controller should provide facilities for testing data paths not only locally but across the network.

statistics (listed in **Table 1**) about the performance of the node. You can program a threshold value for each of these statistics. When a statistic's value exceeds its threshold, the TBC generates an interrupt request to notify the host. You can also program the TBC to act as a "promiscuous listener." In this mode, the TBC monitors the network and collects statistics on the number, types, and lengths of the frames sent by all stations on the network.

Host-processor interface

When you're designing products for operation over your network, you'll want to use a standard interface for all the products, regardless of the host's memory size or the type of processor on which the host is based. The MC68824 TBC lets you use a 32-bit address bus and either an 8-bit or a 16-bit data bus. Also, you can use either the Motorola/IBM (high, low) or the DEC/Intel (low, high) storage order for address bytes. You'll find it simple to interface the TBC to a 68020-based host (**Fig 5**), and you can easily modify the bus-interface signals if the host uses some other processor.

Four registers in the TBC's register file are accessible to you (**Fig 6**). You use the 8-bit command register (CR) to pass commands to the TBC, and the 32-bit data register (DR₀₋₃) to pass parameters to or from the TBC. The host can interrogate the 8-bit semaphore register (SR, which shares the command register location) in order to determine when a previously initiated command has been executed. The remaining register is the interrupt register (IR), which points to the TBC's interrupt vector.

The TBC's command set consists of 28 commands in seven different categories. The five Initialization commands initialize the TBC and provide a software reset. The four Set Operation Mode commands set or reset the various TBC parameters. The three TX Data Frames

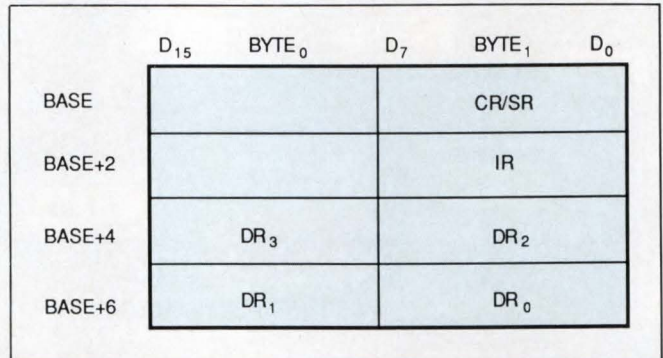

Fig 6—The internal registers of the TBC are 16 bits wide. The host can address these registers individually or in pairs.

commands let you start, stop, and restart the transmission of data frames. The seven Set/Read Value commands let you read parameters and statistical information or set the values of MAC parameters and TBC pointers. Another command group lets you enter or leave the modem-management mode and issue modem commands or set modem parameters.

The final command group lets you set up and execute four types of tests that help to isolate network problems during operation: a host-interface test that tests the path from the system memory buffer to the TBC's FIFO buffer and back to system memory; a full-duplex loopback test that tests the path from system memory to the FIFO buffer in both directions simultaneously; a transmitter test that tests the path from the transmit queue to the modem's transmitter circuits; and a receiver test that tests the path from the modem's receiver to the receive queue.

The TBC-modem interface

The TBC manages the physical layer of the node by means of a serial interface that allows it to pass commands and data to an intelligent modem. The TBC serial interface lets you use any modem that conforms to IEEE Standard 802.4G.

The TBC's serial interface (**Fig 7**) comprises two channels: a physical data-request channel and a physical data-indication channel. Some of the signals in both channels are multiplexed, and those signals have different meanings in each of the interface's two modes of operation. When the interface is in the station-management mode, the upper layers of the software can send management commands to the modem over the data-indication channel. Such commands may reset the physical layer, enable the transmission circuits, or establish loopback test conditions. Likewise, the modem can

TABLE 1—STATISTICS COLLECTED BY THE TBC

NUMBER OF TOKENS PASSED
NUMBER OF TOKENS HEARD
NUMBER OF PASSES THROUGH NO-SUCCESSOR-8 STATE
NUMBER OF "WHO FOLLOWS" INQUIRIES
NUMBER OF TOKEN PASSES THAT FAILED
NUMBER OF NON-SILENCE CHARACTERS
NUMBER OF FCS ERRORS
NUMBER OF E-BIT ERRORS
NUMBER OF FRAME FRAGMENTS
NUMBER OF FRAMES TOO LONG
NUMBER OF NO FRAME- AND BUFFER-DESCRIPTOR ERRORS
NUMBER OF OVERRUNS

Checkmate...

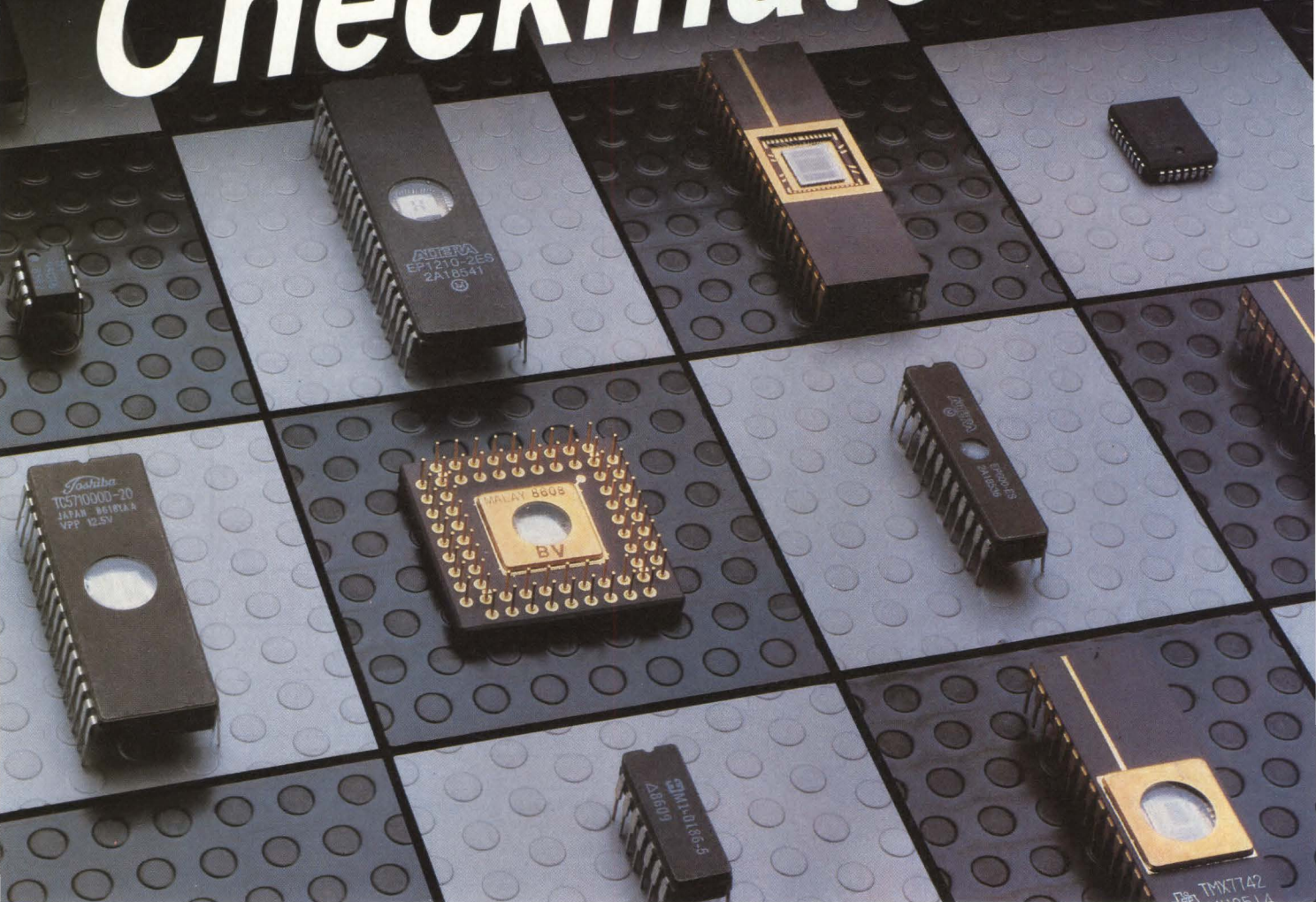

The game is over. OMNI. The only universal programmer.

A totally new concept in PROM Programming. OAE has drawn upon 12 years of research and manufacturing experience to develop the ultimate in software configured programmers. By combining up to 64 programmable pin drivers with a new database of over 1400 parts, the software configured OMNI can program hundreds of EPROMs, EEPROMs, EAROMs, bipolar and CMOS PROMs, PLDs,

microprocessors and ASICs (Application Specific ICs). *In fact, the OMNI's unique pin drivers can program and test all known programmable semiconductors, from bipolar diode arrays to ECL PLDs.* In addition, an optional parametric editor can be used to screen every device programmed to your company's own specifications.

- 100% Software Configured.
- Unlimited Free Library Updates available for 2 years.
- Plug compatible with over 350 different computers and operating systems.
- Over 20,000 devices may be added to the OMNI's new nonvolatile library.
- Fast high voltage, high current pin drivers can supply $\pm 1.5A$ continuous, and $\pm 4.5A$ to $\pm 10A$ peak at each pin.
- 100% laser trimmed references — no calibration is ever required.
- Over 4,000 steps of voltage and current resolution plus sub-

nanosecond timing resolution to program everything from CMOS to high power bipolar and ECL devices.

- The OMNI 64 supports ALL package types, including SOs, LCCs, PLCCs, PGAs, DIPs, etc.
- Full one year parts and labor and two year software warranty period.
- The OMNI is small, portable, and easy to use.

OMNI Series starts at just \$ 3250.00

NOW THAT THE HARDWARE GAME IS OVER... IT'S YOUR MOVE!

Call 1-800-828-0080 (1-800-423-8874 in CA) for a free demonstration today.



Oliver Advanced Engineering, Inc.
320 West Arden Street
Glendale, CA 91203
(818) 240-0080
TWX (510) 600-8099



Seal off the danger zone.

APM keeps the danger zone safe, with a full line of environmental pressure seals providing complete switch, circuit breaker and panel protection to keep equipment working by preventing destructive contaminants from penetrating to interior circuitry.

To keep the environment from playing dirty with your toggle, pushbutton or rotary switches, APM gives you a choice: low cost Snapseals[®] neoprene boots that snap comfortably over standard commercial switches; or the MIL-spec protection of Hexseals[®] silicone rubber boots to totally seal out dirt, dust, gas and moisture... handle 15 PSI internal or external pressures with ease. Doubling as both seal and vibration-resistant mounting nut, one-piece Hexseals come in special-use versions, too, including transparent boots for indicator and illuminated switches; and special EMI/RFI suppression boots.

We also shield circuit breakers and exposed panel openings with see-through, wide-angle boots that keep single, double and triple pole switching handles visible and accessible for easy manual switching. And, we custom-mold multi-switch panel seals, full panel splash covers, even self-sealing keyboards.

Write on your letterhead for a free sample kit. APM-Hexseal, 44 Honeck St., Englewood, NJ 07631; (201) 569-5700.

Telex: 13-3403
Telefax:
(201) 569-4106



APM-HEXSEAL
The Clean Fighters

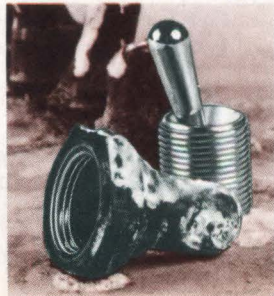

OPL
CERTIFIED
UNDER MIL-8-5423
Certification furnished upon request.

CIRCLE NO 13

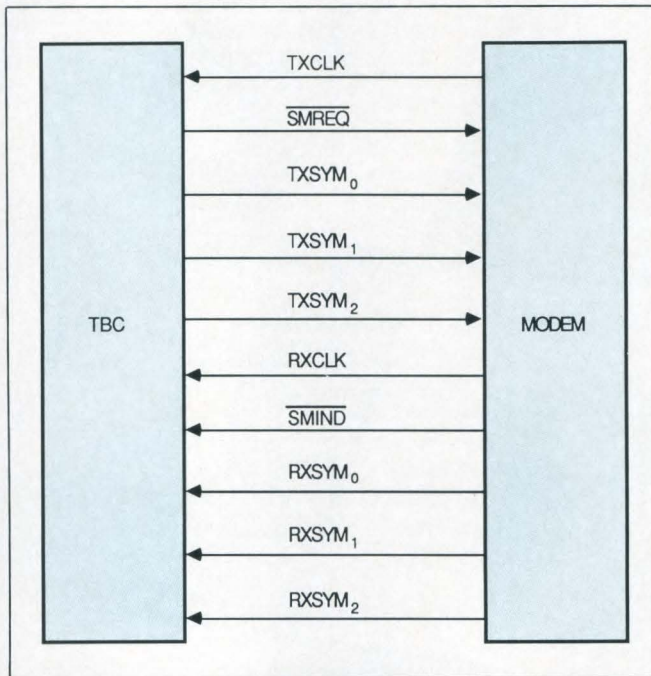

Fig 7—This serial interface conforms to the IEEE 802.4G standard. The three TXSYM and RXSYM signals are multiplexed, and they have different meanings according to the mode in which the TBC and the modem are operating.

return status information and any error conditions to the TBC over the data-indication channel.

When the interface operates in the MAC mode, the MAC layer uses the data-request channel to send encoded requests to the modem for data transmission. The physical layer (that is, the modem circuitry) returns encoded status information relating to its reception of data.

EDN

Author's biography

Ivan Erickson is marketing manager of communications devices at Motorola's Microprocessor Div (Austin, TX). He is responsible for the marketing of the 68824, 68605, 68184, 68194, and other intelligent communications ICs. Before joining Motorola, Ivan spent eight years with Texas Instruments, where he was product manager of business system computers. He holds a BSEE from the University of Maine and an MBA from Penn State University, and is a member of the IEEE. In his spare time he enjoys hiking, camping, and photography.

Article Interest Quotient (Circle One)
High 473 Medium 474 Low 475

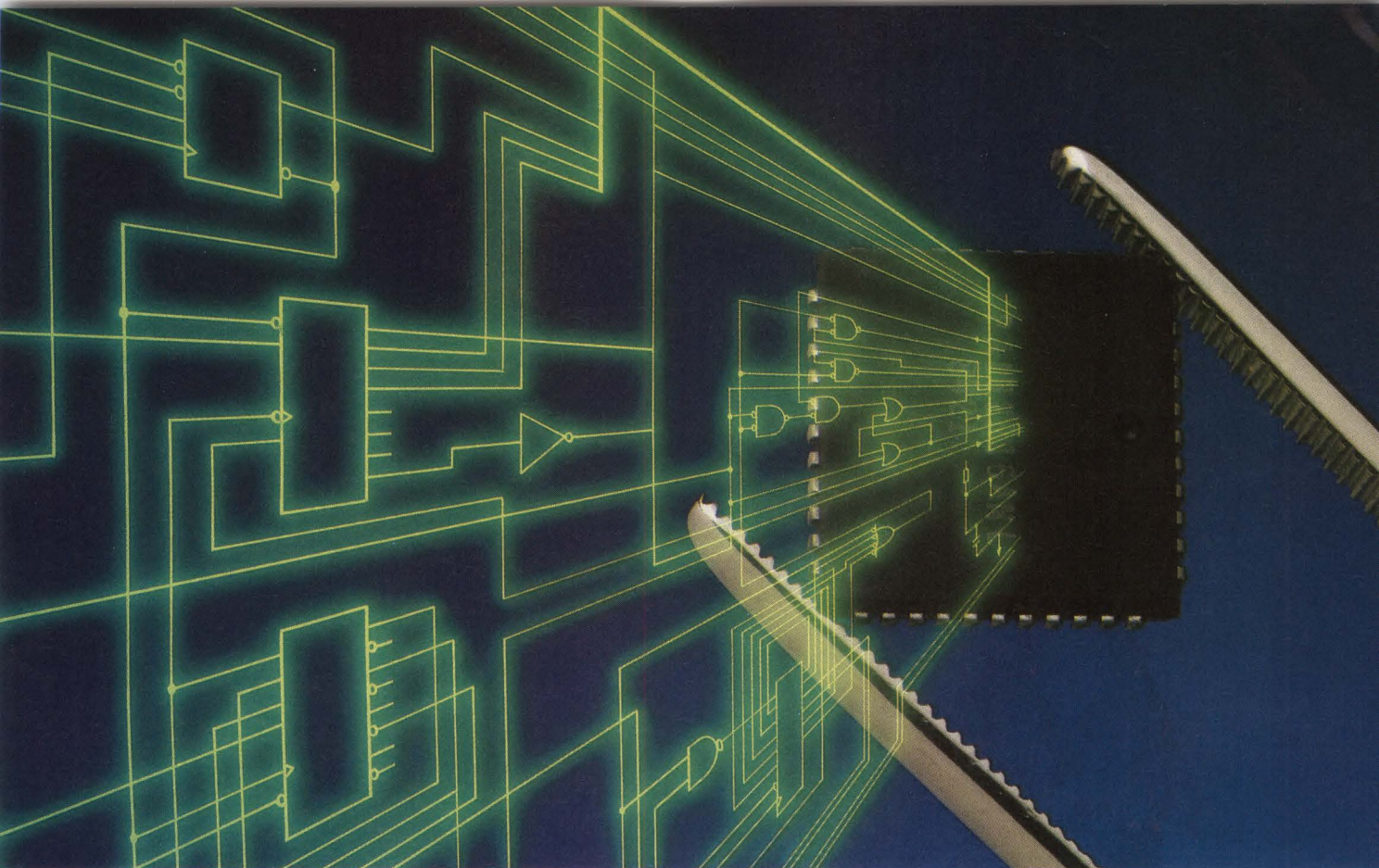

THE FIRST PROGRAMMER WITH A SINGLE SITE FOR EVERY DEVICE.

NEW UNISITE 40 HANDLES LEADING-EDGE DEVICES WITH SPEED AND EASE.

Now you can program and test the latest programmable devices and packages, fast and accurately — all in a single site. The first true universal pin drivers support any device of a given package type in the same site. The UniSite™ 40's single DIP socket handles any device up to 40 pins, including PLDs, PROMs, IFLs, FPLAs, EPROMs, EEPROMs, and microcontrollers. The same site accommodates the most popular PLCCs and SO packages. A 16-bit processor, coupled with custom ICs and high-speed RAM, set new speed records for programming and testing.

TIMELY ACCESS TO TOMORROW'S DEVICES. With universal pin driver electronics hardware, device-specific instructions can be loaded from one



3½" micro-diskette. When new devices are introduced, you simply load a new master diskette, and the UniSite 40 is quickly updated.

MENUS MAKE PROGRAMMING EASY. Use your cursor to select any function. Menu prompt you step-by-step and HELP messages assist you

throughout operation. A built-in listing of devices speeds part selection. The UniSite 40 can even save your most frequently used parameters for instant recall.

SHORTCUTS SPEED SETUP. More frequent users can bypass menus and zoom directly to specific operations by selecting key commands. Special software commands, like the ones in our QuickCopy™ mode, are also available to streamline your programmer operation.

DESIGN FREEDOM FOR TOMORROW. When leading-edge designers use the latest programmable devices in their designs, they need the design freedom only the UniSite 40 can provide. Call your local Data I/O representative or **1-800-247-5700** and ask about the next UniSite 40 demonstration in your area.

Data I/O Corporation 10525 Willows Road N.E., P.O. Box 97046, Redmond, WA 98073-9746, U.S.A. (206) 881-6444/Telex 15-2167
FutureNet 9310 Topanga Canyon Boulevard, Chatsworth, CA 91311-7528 (818) 700-0691/Telex 910-494-2681
Data I/O Europe World Trade Center, Strawinskylaan 633, 1077 XX Amsterdam, The Netherlands (20) 622866/Telex 16616 DATIO NL
Data I/O Germany Bahnhofstrasse 3, D-6453 Seligenstadt, Federal Republic of Germany (6182) 3088/Telex 4184962 DATA D
Data I/O Japan Sumitomoseimei Highashishinbashi Bldg., 8F, 2-1-7, Highashi-Shinbashi, Minato-ku, Tokyo 105, Japan
 (03) 432-6991/Telex 2522685 DATA J

CIRCLE NO 98

DATA I/O

TEK'S NEW EASY-TO-EXPERT LOGIC ANALYZER

\$3995.*

Introducing the Tek 1220 and 1225: the two newest members of the Tek 1200 Series of logic analyzers.

Nothing else in their price range delivers so much and makes it all so easy to use. Consider:

1 Powerful state, timing and disassembly analysis.

The 1220 and 1225 provide 32 or 48 data channels, respectively, in groups of 16-channels, with channel groups clocked independently or linked together — so you can

sample

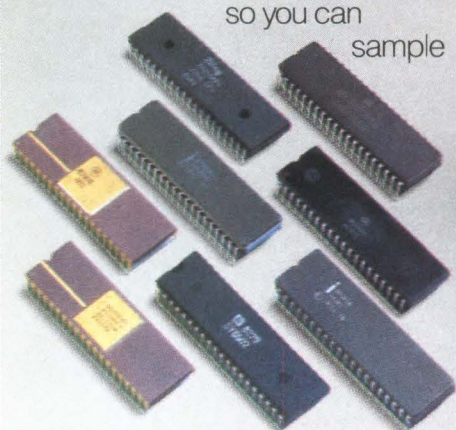

data from as many as three circuit sections at once.

Tek currently provides support for the most popular microprocessors, with additional 8- and 16-bit personality modules to be

introduced continually.

2 A total of four 2K nonvolatile memories support each channel.

Acquire data in one memory and compare it to data in any of the three other memories.

Clock/calendar plus storage for up to eight test setups are also in battery-backed memory. Date and time of storage are included with each data memory, so it's easy to find and interpret results.



```

MON, FEB 02, 1987 State: Memory 4 14:28 IOBOARD
Loc  Bh Bl  Ah  Al
(00937 differences in displayed bytes)
0510  88 50 10111101 00100001
0511  D4 50 10111101 00101000
TRIG  D4 5C 10011101 00111101
0513  D6 7C 11110111 00100000
0514  DE 7E 11110110 00100001
0515  FA 6E 11110110 01100100
STEP  17  C0 01001000 11011101
0517  15  EB 00100010 11000000
0518  1D 57 00100011 11000001
0519  39  F9 00100011 10000100
0520  39  99 00001111 00001111
0521  39  50 00111101 00010000
0522  80 50 10111101 00010001
0523  D4 50 10111101 00101000
STEP  17  FA 11010101 11101101
0525  FA C7 11101000 11110000
0526  5B C7 01101000 11110001
0527  17 C7 01101000 11010100
STEP  16  5C 10011101 00111101
0529  DE 7C 11110111 00100000
Func:F Scroll:← Cur:0,1 Locate, TRIG:2 Cond:3 Diff:F

```

Left Set reference cursors on the timing diagram to measure pulse width or the time between pulse edges. Above State tables are displayable in binary or hex formats.

3 Triggering can be as simple or sophisticated as you choose.

Specify up to 24 trigger conditions. Conditionally branch with up to 12 levels of IF... THEN... ELSE statements. Cross-trigger between channel groups. Do state and timing analysis simultaneously.

Capabilities like these make the 1220/1225 more than hardware analyzers. They are capable tools for both software debugging and system integration.

4 Pop-up menus are easy to use. Logically arranged. And respond instantly on command.

Push one button for on-screen notes appropriate to the current display.

Use the optional interfaces to control the instruments via computer and attach inexpensive dot matrix printers for immediate documentation.

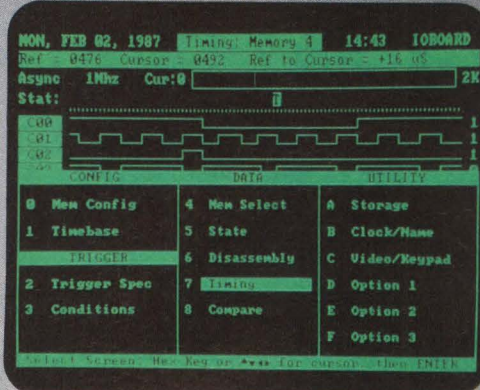

Above Pop-up menus, such as this main menu, are easy to understand and logically arranged.

5 This is affordable logic analysis in a league by itself.

Users can evolve from one unit to another, through the entire 1200 Series, with a minimum of readjustment. You can be confident that Tek quality is built in, and that documentation and service will be there when required.

Call 1-800-245-2036 (in Oregon, 231-1220) for more information or for the name of your nearest Tek sales engineer. Learn why these are the first low-cost logic analyzers that don't act like it.

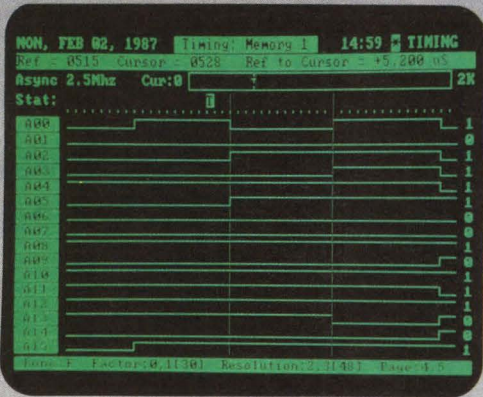

Tektronix
COMMITTED TO EXCELLENCE

Circle 34 for Literature

Circle 73 for Sales Contact

NDI Off-The-Shelf Systems NOW!

COMMUNICATIONS NETWORKING THAT REALLY WORKS!



TITAN/SESCO MILITARIZED COMPUTERS

Handle all communications problems, from simple to complex networking, with the high powered SECS 86 Communications Computer, a member of the turn-key family of Severe Environment Computer Systems from TITAN/SESCO.

COMPLETELY SELF-CONTAINED SYSTEM

The SECS 86 Communications Computer intelligently manages eight HDLC/SDLC Serial Channels, and supports RS232C or RS422A interfaces, asynchronous, bisynchronous, half/full-duplex, NRZ, NRZI, or FM Encoding/Decoding operations. Complete Built-In-Test is standard. Down-load test and additional serial channels are available options. It is available with RMX™, VRTX™ or other popular Real-Time operating systems, and offers features

and expandability options unsurpassed by any other system.

X.25 COMMUNICATIONS COMPUTER SYSTEM

When the X.25 firmware package is included, it transforms the SECS 86 Communications Computer System into an X.25 Communications Engine which fully conforms to CCITT X.25 recommendations. The software is Defense Data Network (DDN) qualified to handle communications details for ISO layer 1, 2 and 3, and to directly connect to a Packet Switching Network. Multiple host capability can set a virtual circuit and communicate at the process level or as a remote PAD with log-in capabilities to a local host.

Solve any high performance problems TODAY... with the SECS 86 Communications Computer!

Solve any high performance problems TODAY... with the SECS 86 Communications Computer!

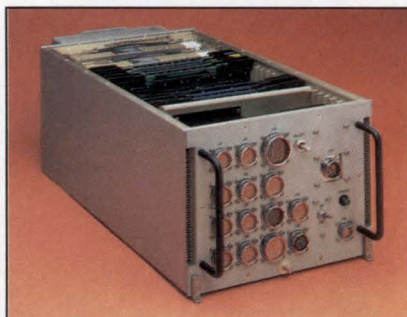

SECS 80 FULL ATR

™ RMX86 is a trademark of the Intel Corporation

™ VRTX is a trademark of Hunter & Ready

TITAN
SEVERE ENVIRONMENT SYSTEMS

A Subsidiary of the Titan Corporation

CIRCLE NO 160

20151 Nordhoff St., P.O. Box 2668 • Chatsworth, CA • 91313-2668 • In CA (818) 709-7100/Telex 69-1404

800-423-5527

Simple solution cures glitches on high-speed buses

High-speed bus systems such as Multibus II and the VME Bus have spawned a new gremlin: the ground-shift-induced logic fault. Unfortunately, such faults look like crosstalk in a system's backplane. Engineers have wasted a lot of time and money chasing these faults when the problem really originates in the system's connectors.

Richard M DeBock, *Matrix Corp*

IC design houses have long known of ground-shift phenomena. The issue has surfaced publicly in the debates over the placement of power and ground pins on advanced CMOS logic devices. The same physics applies to digital board designs for high-speed buses. The advent of Multibus II and VME Bus products, coupled with speed and current-drive improvements of TTL buffers, has now brought the problem of ground shift to light in bus systems.

Ground shift is the movement of a component's ground reference away from 0V and results from switching too much current too quickly. If the ground shift in a digital system is large enough, then logic

faults occur. Perhaps surprisingly, you can often trace these logic faults to a system's connectors. In order to convince you who the real culprit is, some theoretical discussion is called for.

Each pin of a connector acts as though it were an inductor with a series resistor, paralleled by a capacitor tied to the neighboring pins. Although the connector hardly affects the shape of signals with long rise and fall times, Multibus II and VME Bus both require high-speed switching and drive characteristics such that you can no longer ignore the analog nature of the connectors.

Both buses specify DIN41612-type pin-and-socket connectors, which can have a maximum of 38-nH series inductance (with 0.02Ω series resistance) and 0.7-pF pin-to-pin capacitance. Because of the capacitive loading and current drive on these buses, you can ignore the connectors' resistive and capacitive effects, but because of the fast switching times of the signals, you can't ignore the pins' inductance.

In a simplified bus-connection model (**Fig 1**), a board with Schottky-TTL drivers connects to a backplane via a bus connector. The model neglects the connector's capacitance and resistance and simply shows the inductance. To simplify the math, all the signal-line impedances are Z_0 . (In a real system the Z_0 of one line doesn't necessarily equal the Z_0 of any other line.) The model also shows the power supply's impedance and the power-supply and ground connections from the backplane

If the ground shift in a digital system is large enough, logic faults will occur.

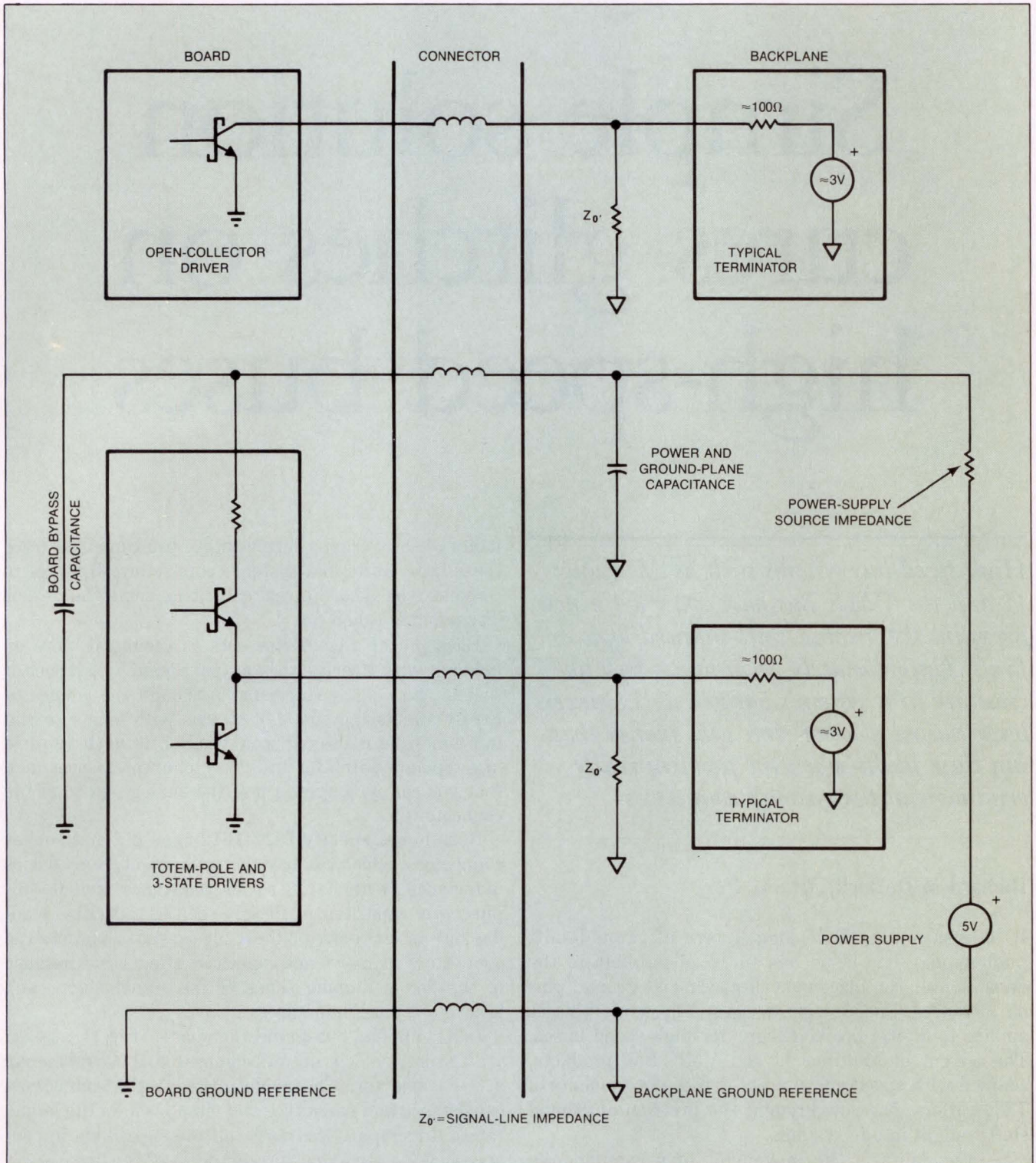

Fig 1—This simplified model neglects the bus connector's capacitance and resistance and is simply inductance. The model lumps together all signal-line, bypass, power- and ground-plane impedances and capacitance. The backplane's terminators are a simple voltage source and a series resistor.

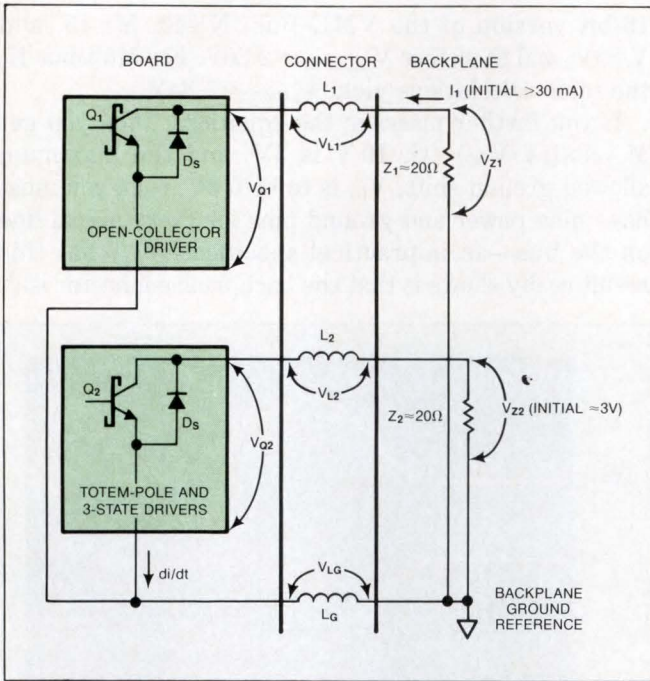

Fig 2—In this example, an open-collector driver holds a signal line low while a second totem-pole driver attempts to drive its own signal line low. Q_1 is the open-collector driver, and Q_2 is the bottom part of the totem-pole driver.

to the board, and it lumps together the bypass, power, and ground-plane capacitance. The backplane's terminators are a simple voltage source and a series resistor.

In order for a board to change a logic level on a line that goes to the backplane, it must change the direction of the current flow—either into or out of the line. Moreover, the current flow's behavior depends on the total impedance of the line, the connector, the backplane termination, and other components attached to the line.

An example will help you understand just how connectors can cause ground-shift-induced logic faults. In this instance, an open-collector driver holds a signal line low while a second totem-pole driver attempts to drive its own signal line low (**Fig 2**). Q_1 is the open-collector driver, and Q_2 is the bottom part of the totem-pole driver. D_S is the substrate-to-collector diode associated with each device and results from IC manufacturing methods. (Later, D_S will figure as an unexpected current source.) Z_1 and Z_2 represent the characteristic impedance of a modern, fully-loaded backplane, about 20Ω .

Initially, Q_1 is on and sinks at least 30 mA because of current from the backplane termination and the input loading of the receivers connected to that line. At this

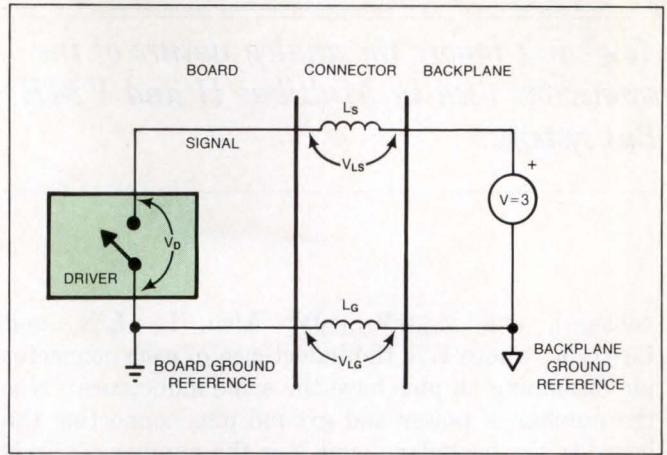

Fig 3—Calculating how large V_{LG} can be requires a model of worst-case conditions. The driver can switch the signal current infinitely fast, and the signal leads have no resistance.

time, V_{Z1} is 0.5V. Because Q_2 is off, and because of the backplane's termination and the upper part of the totem-pole's driver, V_{Z2} has an initial voltage of approximately 3V. Also, V_{L1} , V_{L2} , and V_{LG} are all 0V because the circuit is in a steady-state condition. (V_{LG} is the voltage developed across the combined inductance of all the power and ground pins; this inductance will later figure in the nonsteady-state analysis.)

Next, Q_2 switches on. Immediately, the V_{L2} and V_{LG} voltages develop across the connector because of the change in current flow (di/dt). In this simplified model, Q_2 doesn't necessarily represent just a single line; it can represent many lines switching at once—often the case in bus systems.

If many lines switch on simultaneously, the result is a large total di/dt , computed by adding each individual di/dt of each line. This large di/dt , in turn, causes V_{LG} to rise from 0V. The rising V_{LG} reduces Q_1 's V_{CE} . If V_{LG} is large enough (greater than V_{Z1} 's initial voltage), then Q_1 gets cut off, and I_1 changes direction and starts flowing away from the collector of Q_1 . This reverse flow makes Q_1 's collector look as if it is sourcing 30 mA across 20Ω and yields a 0.6V jump over the steady-state value of V_{Z1} . If the steady-state voltage, $V_{Z1\text{INITIAL}}$, is 0.5V, then the resulting V_{Z1} pulse becomes 1.1V with respect to the backplane's ground reference. This voltage is high enough to cause a logic fault in some receivers.

If V_{LG} , the board's ground-shift voltage, moves far enough positive with respect to Q_1 's collector voltage such that D_S turns on, then the open-collector driver will source current into the signal node, thereby adding to the signal line's voltage jump.

Worst-case scenario is enlightening

To enhance your understanding of ground-shift disturbances, it's useful to determine the upper limits of V_{LG} . For this exercise, a model of worst-case conditions will suffice. This model is one in which the driver can switch the signal current infinitely fast (an ideal switch) and one in which the signal leads have no resistance (**Fig 3**). In the steady-state condition, with the driver not conducting, $V_D = V = 3V$ (the terminator's

You can't ignore the analog nature of the connectors used in Multibus II and VME Bus systems.

voltage), and $V_{LS}=V_{LG}=0V$. Also, $L_S=L/N$, and $L_G=L/M$, where L is the inductance of each connector pin (assuming all pins have the same inductance), N is the number of power and ground pins connecting the board to the backplane, and M is the number of signal pins that can switch low simultaneously.

After the switch closes, $V_D=0$, and $V_{LS}+V_{LG}=V=3V$. Also, $V_{LG}=V \times L_G / (L_G + L_S)$. Substituting for L_G and L_S yields $V_{LG}=V \times (L/M) / [(L/M) + (L/N)]$. Simplifying the equation yields $V_{LG}=V \times N / (N + M)$. For the 32-bit version of the VME Bus, $N=64$, $M=17$, and $V=3.0V$, and therefore $V_{LGMAX32}=2.37V$. For the

16-bit version of the VME Bus, $N=40$, $M=13$, and $V=3V$, and therefore $V_{LGMAX16}=2.26V$. For Multibus II, the same calculations yield $V_{LGMAX}=1.84V$.

If you further massage the equations, then you get $M=N \times [(V/V_{LG}) - 1]$. If V is 3V, and the maximum allowed ground shift, V_G , is to be 0.3V, then you must have nine power and ground pins for every signal line on the bus—an impractical specification. What this result really shows is that the backplane connector isn't

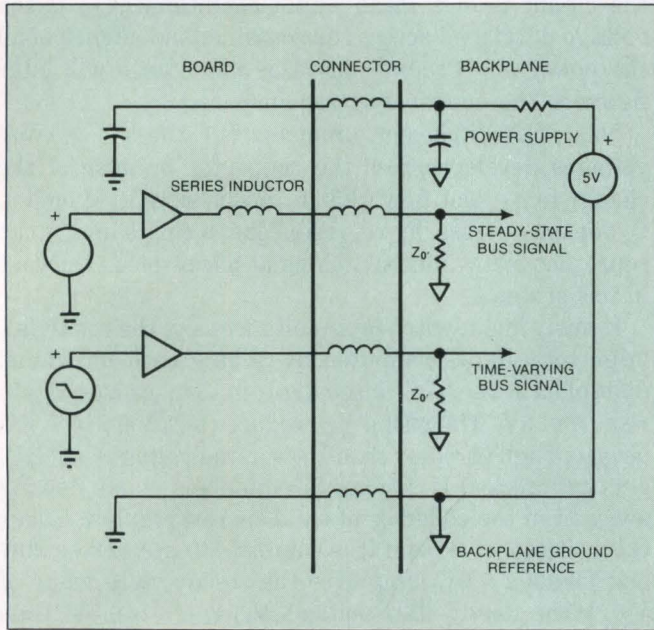

Fig 4—In this solution, a series inductor divides the ground-shift voltage between itself and the backplane's and connector's inductance so that the series inductor drops the majority of the ground-shift voltage.

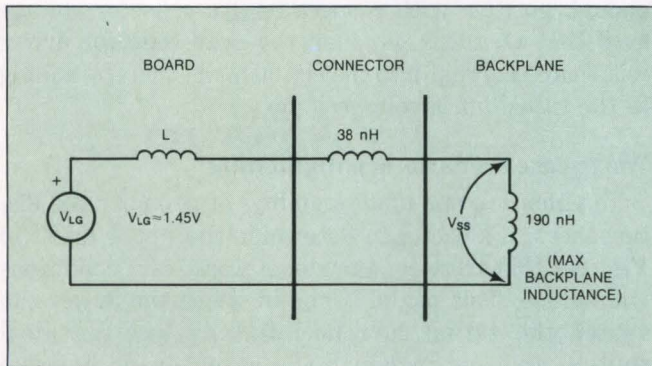

Fig 5—You can calculate the value of the inductor from this circuit model.

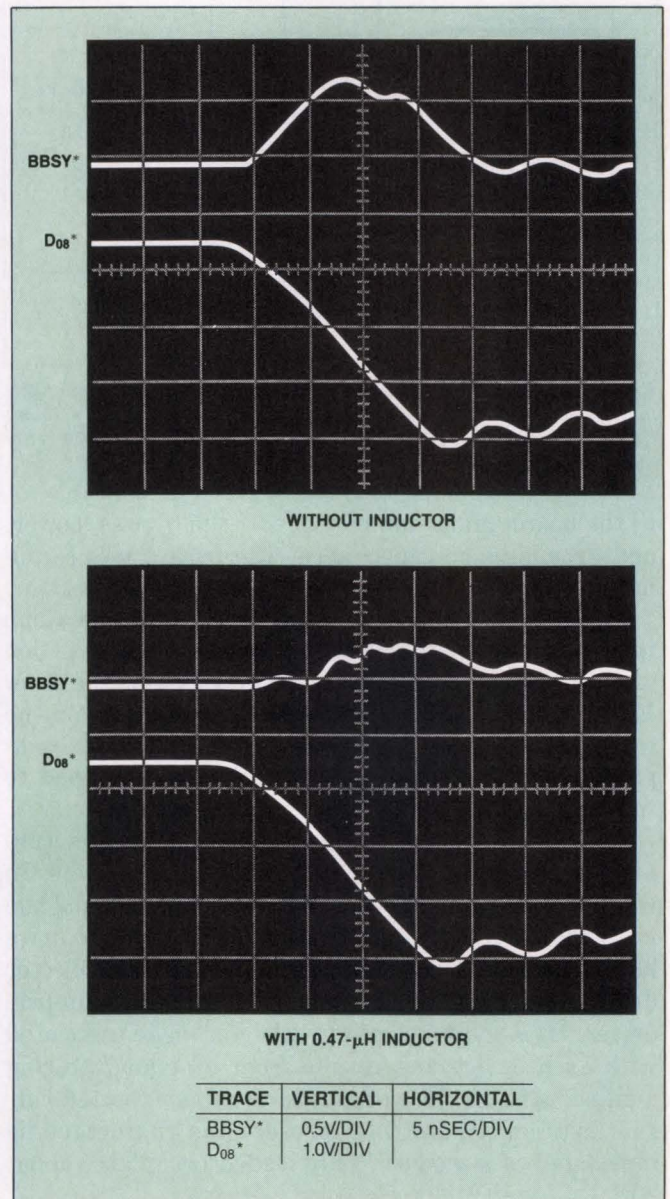

Fig 6—This test setup for verification includes a 20-slot VME Bus backplane with standard terminators, one driver board, and 19 load boards.

the best way to provide power and ground to a board.

Fig 4 shows a workable solution. An inductor is in series with the buffer of the "steady-state signal" line and the line's connector pin. (A steady-state signal is one that must stay at a known level as a group of signals change state simultaneously.) The series inductor divides the ground-shift voltage between itself and the backplane's and connector's inductance so that the added series inductor drops the majority of the ground-shift voltage.

You can calculate the value of the inductor from the circuit model of Fig 5. V_{LG} is in this case the theoretical maximum ground-shift voltage calculated earlier, and

V_{SS} is the maximum allowed shift in the steady-state signal's level. If V_{SS} is 0.4V, for example, then $L = 190 \times [(V_{LG}/V_{SS}) - 1] - 38 = 461$ nH. The closest, larger standard value is 0.47 μ H. Matrix Corp has successfully specified this inductance value on its VME Bus boards.

Although the calculated ground-shift voltages are theoretically obtainable, fortunately they aren't really possible except with an ideal switch—and a transistor isn't an ideal switch. When high-speed TTL devices drive the bus, the ground shift is actually about 1.25V for eight lines simultaneously switching from a high to a low level. The ground shift peaks at approximately 1.45V when more than 12 lines simultaneously switch

Common approaches don't circumvent glitches

All high-speed bus systems will eventually experience glitches from ground shift, unless you take precautions designing the boards that interface with them. Proponents of various bus schemes make claims and counterclaims that one bus or another doesn't experience these glitch problems for various reasons (buried control lines, extra ground pins, synchronous or asynchronous protocols, or address and data multiplexing), but none of these claims are valid.

- Burying the control lines between or within the power and ground planes of a backplane can undermine the worst-case signal-line skewing assumptions that are built into any bus specification. For example, the VME Bus specifies a maximum signal skew of 10 nsec between like-specified control lines. If you use a different layout for some control lines, then more than 10 nsec of skew may occur.

- Extra ground pins are impractical. If you don't have nine power and ground pins per sig-

nal line, then ground shift will occur if the drivers do not restrain the board's total di/dt.

- Even with synchronous protocols, if the drivers don't restrain the board's total di/dt, then ground shift will result. The ground shift can cause double clocking of inputs on the receiving board before the inputs are stable and desynchronize the board with respect to the bus activity.

- Similarly, with asynchronous protocols, even though address and data lines change state randomly, each group of signals usually changes as a result of some externally or internally generated event. If eight or more lines change simultaneously, then ground shift may occur.

- Address and data multiplexing means that fewer signal lines switch simultaneously than in nonmultiplexed systems, but nevertheless guarantees that all grouped signal lines (address or data) switch simultaneously. If the drivers don't restrain the board's total di/dt, then ground shift will result.

- Specifying drivers with controlled rise and fall times such that the maximum total di/dt of the drivers is small enough to limit the ground shift to an acceptable level is unrealistic. In order to be practical, these drivers would have to be bidirectional octal devices, operate at TTL signal levels, and be readily available.

In general, none of today's high-speed buses adequately addresses the ground-shift problem. This oversight isn't from lack of foresight on the part of the original bus designers but is due to unprecedented performance improvements in semiconductor logic. Tomorrow's buses will, in all likelihood, consider the ground-shift problem in the original design stages; however, for today's TTL-based bus structures, you should use a series inductor on any signal line that must be held in a steady-state low condition as a large group of signal lines changes state simultaneously.

The backplane connector isn't the best means of providing power and ground to a board.

from high to low. The reason for the peaking is that the ground shift constitutes negative feedback for the output transistors of the TTL buffers. This negative feedback reduces the transistors' current-sinking capability, and this reduction causes the total di/dt to peak long before you can obtain the maximum ground-shift voltage (as calculated from the simplified model).

The test setup of choice for experimental verification of the preceding calculations is a 20-slot VME Bus backplane with standard terminators, one driver board,

and 19 load boards. The load boards produce a worst-case load on connector pins A_{1-8} and C_{1-8} . These pins connect to the data lines D_{0-15} . One other line, $BBSY^*$ (Bus-Busy), connects to pin B_1 , and this line too has a worst-case load applied to it. Using 74F245 transceivers, the driver board drives D_{0-15} low while holding $BBSY^*$ low with a 74S38, an open-collector driver.

For these first tests, the driver board resides in slot 20, and measurements are taken at each slot. The load board in slot 1 provides the largest $BBSY^*$ pulse (Fig

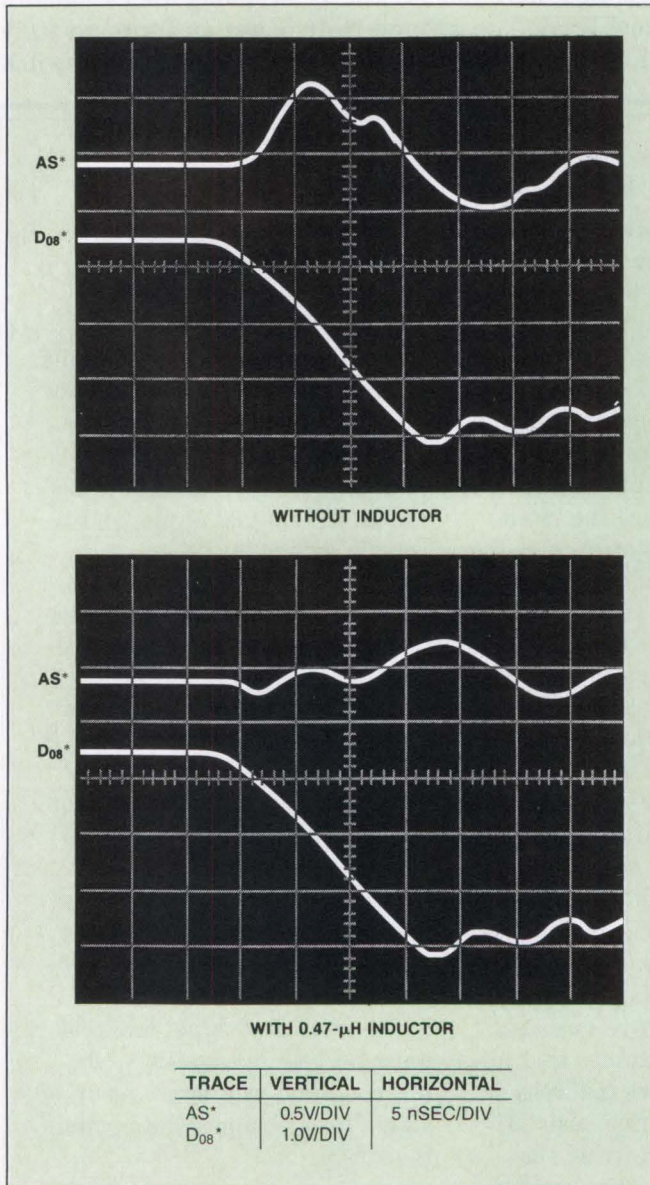

Fig 7—In this test for glitches on AS^* , the results are similar to those of Fig 6.

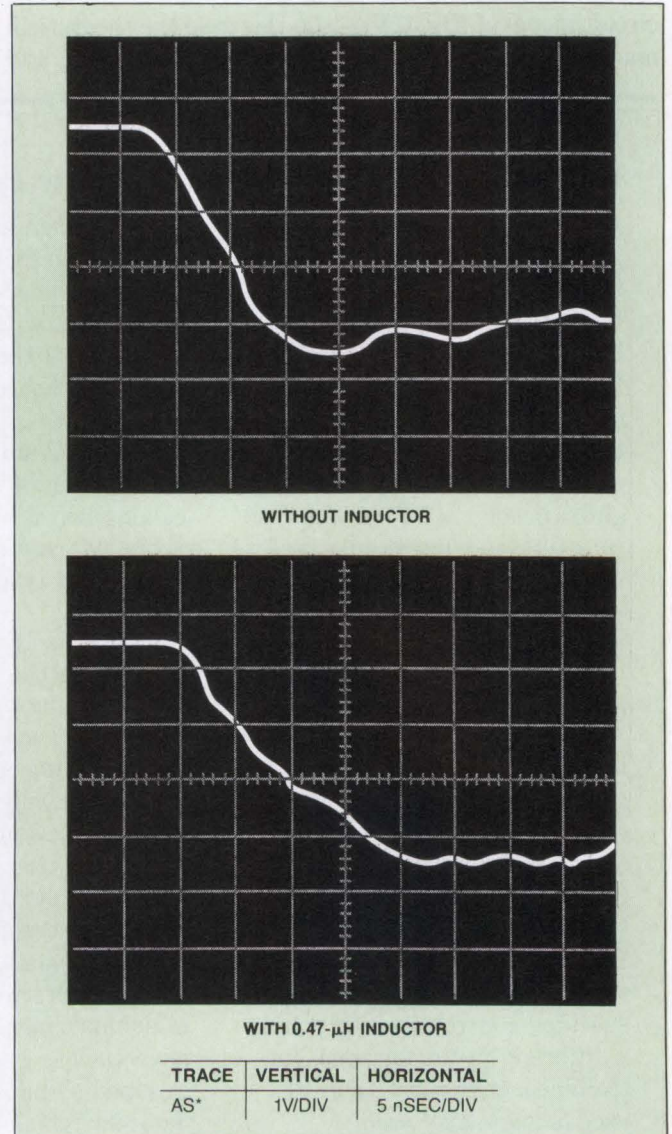
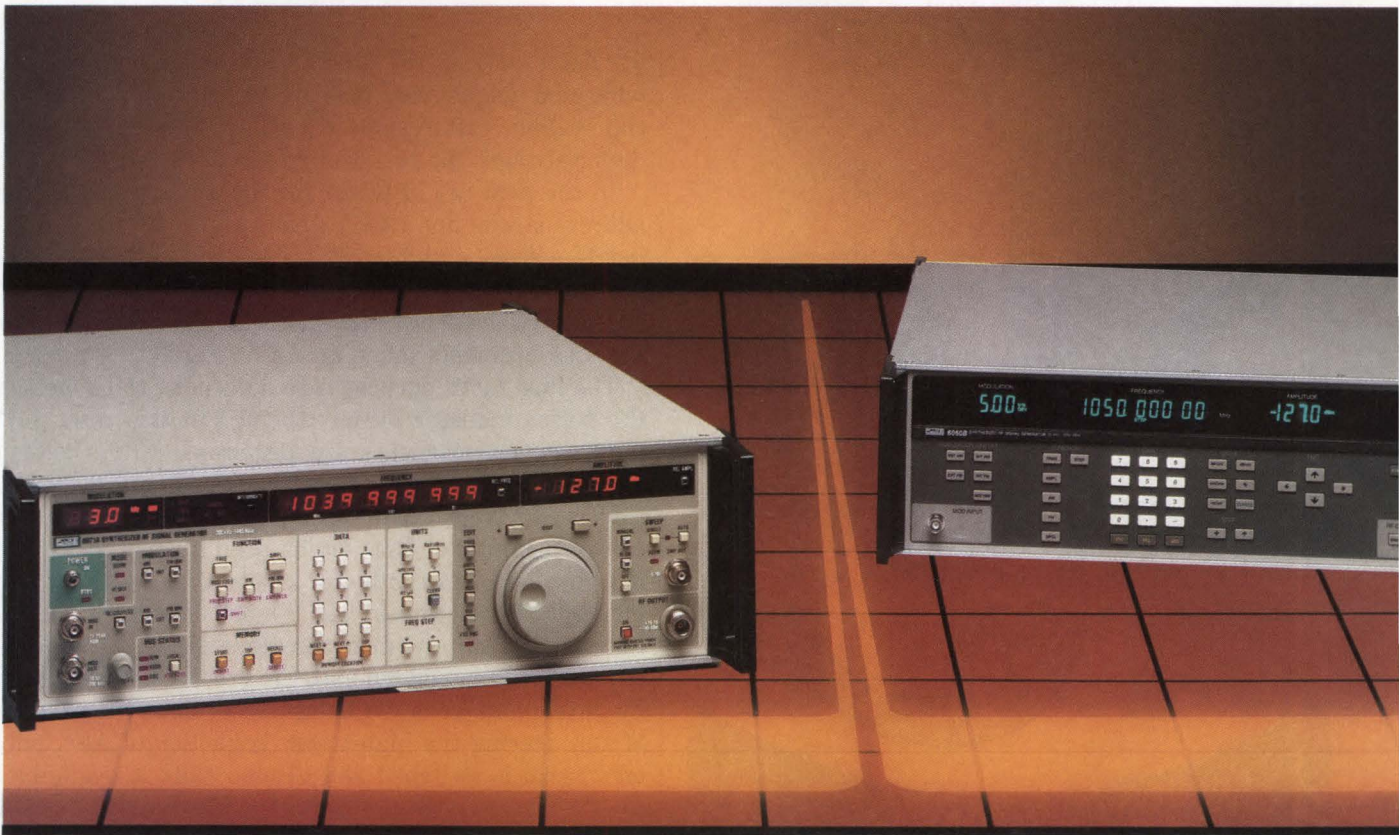

Fig 8—To determine the effects of the series inductor on bus timing, these AS^* full-time measurements were performed holding D_{0-15} high while toggling AS^*_0 . Although the inductor didn't affect the rise time, the fall time did stretch out.

We're even better than you think. Absolutely!



Now the 6071A and the 6060B Signal Generators have a guaranteed absolute level accuracy of 1.0 dB.

Whether you need the highest spectral purity (6071A) or are required to do general-purpose testing (6060B), you'll benefit from being able to rely on our improved signal generator accuracy. And, it won't cost you a penny more!

Fluke signal generators are designed for critical applications in the military, defense and mobile communications industries. You'll find them optimized for high-volume production. They're easily integrated, and our fast switching rates will save you production time.

SPECIFICATIONS	6071A	6060B
Frequency	200kHz to 1040MHz	10kHz to 1050MHz
Amplitude	-127dBm to +13dBm	-127dBm to +13dBm
Accuracy	± 1.0dB (520MHz)	± 1.0dB
Spurious	< -90dBc (520MHz)	< -60dBc
Modulation	AM, FM, φM	AM, FM

The unique architecture of these programmable signal generators allows us to emphasize low noise/spurious signals, while reducing expense to you through the use of innovative circuit designs.

You also get superior RF shielding with the 6071A and the 6060B. Our cast aluminum housing and RFI gasket-sealed covers result in low radiated EMI and microphonics.

Whatever your performance needs are, Fluke's family of signal generators offer you an unbeatable value. And, our after-sales support is unparalleled.

Find out what we mean. Call **1-800-426-0361** today or contact your local Fluke sales engineer or representative.



IN THE U.S. AND NON-EUROPEAN COUNTRIES: John Fluke Mfg. Co., Inc., P.O. Box C9090, M/S 250C, Everett, WA 98206. Sales: (206) 356-5400. Other: (206) 347-6100.
EUROPEAN HEADQUARTERS: Fluke (Holland) B.V., P.O. Box 2269, 5600 CG Eindhoven, The Netherlands, (040) 458045, TLX: 51846.
© Copyright 1985 John Fluke Mfg. Co., Inc. All rights reserved. Ad No. 4401-6060/6071

NEW!

A LOW PROFILE PCB SWITCH...

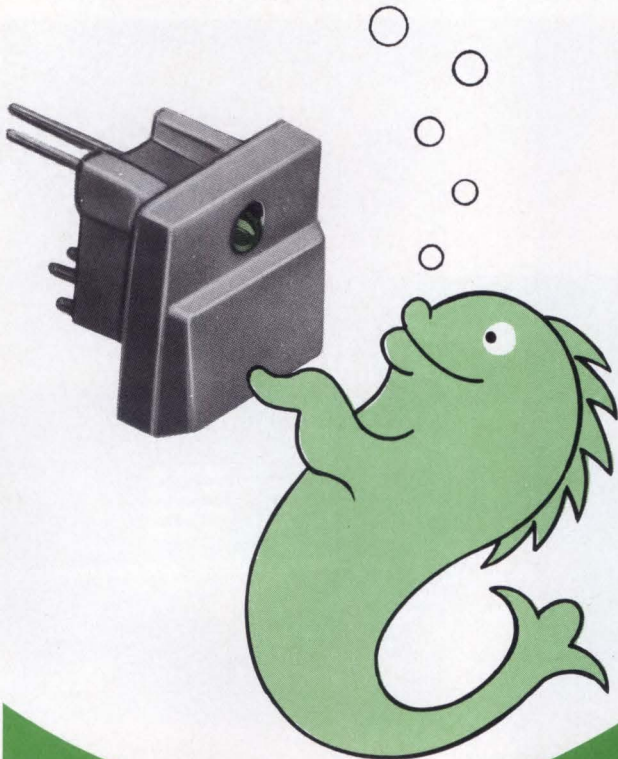

that's also watertight

The new Series 98 from EAO has the great styling of a low profile control with an important difference: it's the only low profile PCB switch that's completely sealed. Built to IP-67 standards (similar to NEMA 4 and 13), this newest EAO switch remains watertight in up to 3 feet of water at temperatures from -25°C to $+85^{\circ}\text{C}$.

Watertight seals aren't all. The Series 98 has gold plated, low bounce contacts with an estimated lifetime of 5 million operations. Rated at 50 VAC/72 VDC @ 100mA, 3W maximum, it's available in three sizes and several configurations including non-illuminated, illuminated with one or two LED's, momentary or maintained action (Form C), four cap colors and a film insert.

Stop fishing around. Now EAO has a great looking, low profile control with the added security of a watertight seal. It's your ideal catch!

EAO Switch. You can feel the difference.

Only from

EAO

 SWITCH CORPORATION

BOX 552, MILFORD, CT 06460 • 203/877-4577
TLX: EAO SWITCH MFRD 964347

CIRCLE NO 14

6). After moving the BBSY* line to a connector pin where no neighboring pins are driven by any board in the system, test results are still identical: The pulse definitely isn't the result of crosstalk.

In the next set of tests, the driver board holds the address strobe line (AS*) steady-state low while driving D_{0-14} from a high to a low level. A 74F245 drives AS*. The greatest measured perturbations on AS* occur when the driver board is located in slot 20, and for the measurements taken at slot 1 (Fig 7).

The final test's purpose is to determine the effects of the series inductor on bus timing. In this case, AS* fall-time measurements are performed while holding D_{0-14} high and toggling AS*₀ (Fig 8). The slowest fall time occurs when the driver board resides in the center of the backplane. Rise times aren't affected by the installation of the inductor. Note that, without the inductor, the fall time of AS* is much faster than the fall time of D_{08} from the previous scope photos. The negative feedback associated with the ground shift produced by the simultaneous switching of D_{0-14} slows the fall time of D_{08} . During the high-to-low transition of AS*, only one signal is switched and ground shift is negligible.

EDN

Author's biography

Richard M DeBock is the R&D manager for Matrix Corp in Raleigh, NC, where he oversees VME Bus new-product development. Prior to joining Matrix, he spent 14 years with Motorola in Phoenix, AZ, where he was involved in semiconductor R&D, process engineering, and μP product design. He obtained a BSEE from Arizona State University and is a member of Tau Beta Pi and Eta Kappa Nu. His hobbies include hiking and camping.

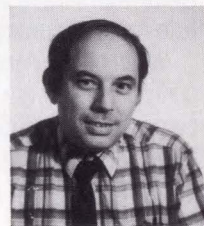

Article Interest Quotient (Circle One)
High 479 Medium 480 Low 481

**NOW THAT
WE'VE
COMBINED
RESOURCES...**



+

INTERSIL

+



PLENTY!



CMOS Logic

We make no TTL. CMOS is our future. And the future looks good, because we can supply you with standard CMOS logic, high-speed CMOS logic (HC and HCT) and Advanced CMOS Logic. Nobody offers a broader line of CMOS logic. Plus two CMOS μ p families: 1800 and 6805.



Power

GE and RCA comprise a powerhouse in power discretes, with one of the broadest lines of discrete bipolars, surge protection devices, optoelectronics and MOVs. But the real stars of the show are our power MOSFETs, including industry-standard IRF and proprietary types, n- and p-channel, logic-level, Rugged FETs, COMFETs and IGTs.

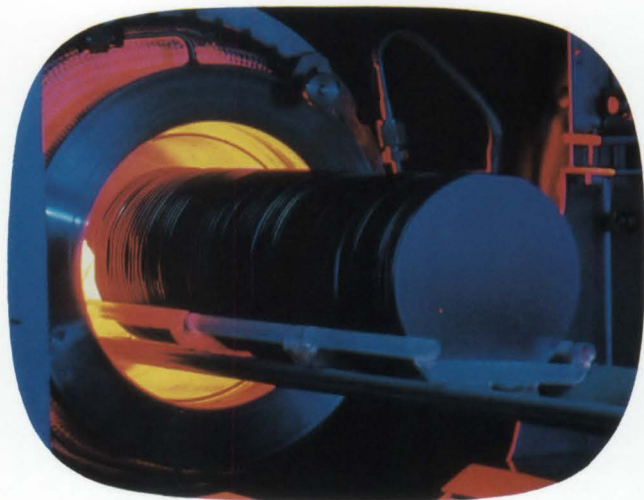

Manufacturing

Our Findlay, Ohio, plant is unique—a combined Class S and large-scale commercial facility. Now, we've added 1.25 μ capability, and we're upgrading our other U.S. wafer fab plants. This, plus world-wide packaging and assembly capability, enables us to build small-geometry devices in price-competitive quantities.



Quality

Our program can be described briefly: 50 ppm and better. And we're working closely with our customers to help eliminate incoming inspections.



World-class CMOS

It's fitting that, as the demand for CMOS takes off, three CMOS pioneers should join forces. RCA invented CMOS and SOS; Intersil invented analog CMOS; and GE has committed vast resources to Advanced VLSI CMOS 1.25 μ production technology. Together, we give you tremendous CMOS expertise.



ASICs

GE and RCA have more than 30 years combined experience producing ASICs that work. We've got an enormous line of standard cells and gate arrays, the ability to put dozens of macrocells on a single chip, and user-friendly design and editing software. And we'll soon have the only library of standard analog and SOS cells.

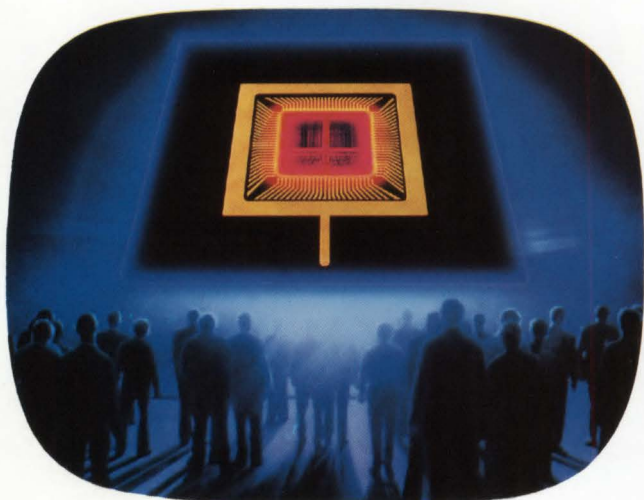

New Products

In 1986, we introduced hundreds of new devices, including Advanced CMOS Logic, SPI peripherals, signal converters, additions to our ASIC library, high-rel versions of standard products, rad-hard devices, codecs, modems, power MOSFETs and surge protection devices. And there will be even more this year.



Packaging

In addition to standard plastic and ceramic packaging, we've made our products available in small-outline packages, plastic chip-carriers and ceramic leadless-chip-carriers to help you get increased board density, lower lead inductances, and lower manufacturing costs.

WHAT DO WE HAVE



INTERSIL

TO OFFER YOU?





Linear

Very few companies have been as committed to linear as Intersil and RCA. Together, we have one of the broadest lines of proven linear devices in the industry. And we'll broaden that line with major new product introductions in the months to come.

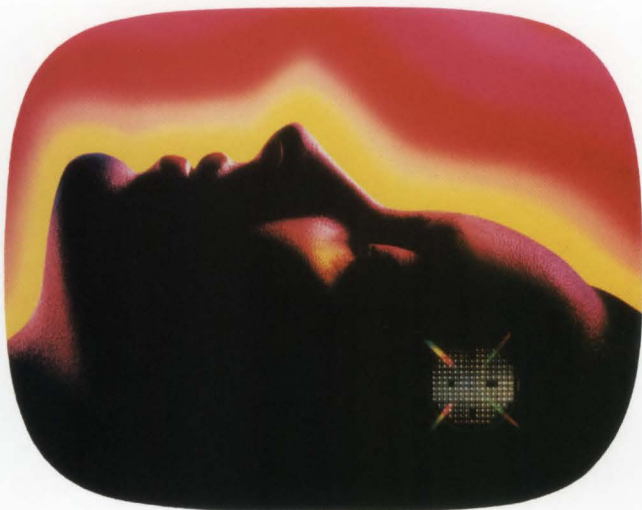

Memory

RCA's space-efficient silicon process enables us to produce CMOS ROMs that are smaller, cheaper and faster than even many NMOS ROMs.

We can also supply you with a wide variety of RAMs, including 64K static devices with access times as fast as 150ns.



Etc., etc.

All this is only a sample of what the new GE/RCA Solid State has to offer.

We're still in the process of combining the worldwide operations of our units. But we can already see the synergy at work.

Our merged operations will provide economies of scale. Our combined team of technical and

application specialists will provide outstanding support. And we'll combine our years of experience in an ongoing effort to provide the best customer service in the business.

Grab hold of the future.

The most important result of our new strength will be the capability it puts at your fingertips. Because now you have a partner in CMOS and Power who gives you options you never had before.

Separately, GE, RCA and Intersil were major players in the industry. Together, we have the resources—and the commitment—to help you conquer new worlds.

For more information on how GE/RCA can help you, call toll-free 800-443-7364, extension 17. Or contact your local GE/RCA sales office or distributor.

In Europe call one of the following offices: Brussels, (02) 720-89-80; Paris, (1) 39-46-57-99; London, 0276-685911; Milano, (02) 826-6747.



RCA



High-Rel

We were the first company qualified to MIL-M-38510 Class A. Today, we're number one in high-rel and rad-hard CMOS, with the broadest line of MIL 883 Rev C high-speed CMOS logic. Plus RAMs, ROMs, processors, analog switches, converters and ASICs screened to Class S and Class B, and an extensive selection of power devices.

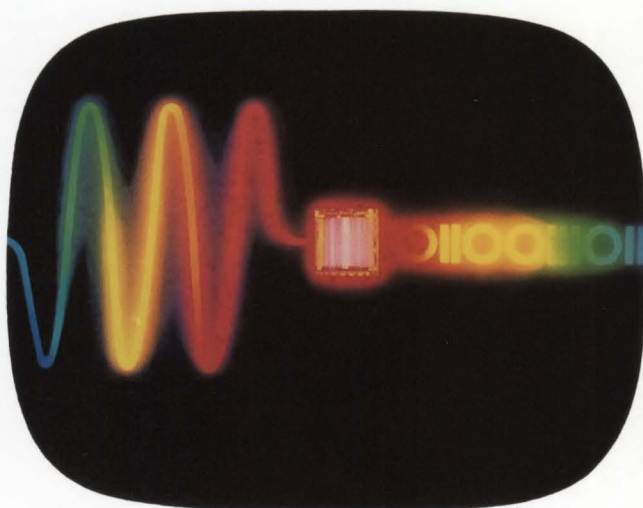

Signal Processing

We're pioneering Integrated Signal Processing. In particular, Intersil is providing cost-effective solutions for applications such as factory automation, sonar, missile guidance and radar systems, and medical imaging. Our line includes high-resolution A/D converters, digital filters, multiplexers, accumulators, high-speed D/A converters and Flash ADCs.



R & D

GE/RCA holds more U.S. patents than any other company in the world. We invented digital and analog CMOS, BiMOS, COMFETs and IGTs, the 200-volt CMOS process, and rad-hard SOS technology. Right now, our world-class R&D staffs are working on the next generation of new technologies.



Partnering

You'll benefit from our technological-partnership agreements—especially ASIC alliances. We're working with Toshiba and Siemens on small-geometry standard cells, with WaferScale Integration on macrocells, EPROMs and peripherals, with Silicon Compilers on advanced circuit-design software, and with Laserpath on gate array prototypes.

Cahners Magazines

American Baby	Graphic Arts Monthly
American Journal of Cardiology	Highway & Heavy Construction
American Journal of Medicine	Hotels & Restaurants International
American Journal of Surgery	Industrial Distribution
Building Design & Construction	Interior Design
Building Supply Home Centers	Library Journal
Childbirth Educator	Mini-Micro Systems
Childbirth '86	Modern Materials Handling
Chromatography	Packaging
CPI Purchasing	Physicians' Travel & Meeting Guide
Consulting/Specifying Engineer	Plant Engineering
Construction Equipment	Plastics World
Contractor Magazine	Professional Builder
Control Engineering	Publishers Weekly
Corporate Design	Purchasing
Cutis	Research & Development
Datamation	Restaurants & Institutions
Design News	School Library Journal
EDN	Security Magazine
EDN News	Security Distributing & Marketing
Electronic Business	Semiconductor International
Electronic Packaging & Production	Test & Measurement World
Electronics Purchasing	Traffic Management
Emergency Medicine	U.S. Industrial Directory
Foodservice Equipment & Supplies Specialist	V.A. Practitioner

Cahners Publishing Company

A Division of Reed Publishing USA

275 Washington Street
Newton, MA 02158-1630
617/964-3030

Page addressing expands addressable memory in μ P systems

Today's software-intensive applications have revealed a basic shortcoming of 8-bit processors—they often don't contain enough addressable memory. Even 16-bit systems can run short. Page-addressing techniques can free your system from program-memory limitations.

Terry Kendall, *Intel Corp*

For many of today's software-intensive applications, 8-bit microprocessor systems often require more memory than their μ Ps' address space can accommodate. Although an 8-bit processor's rich instruction set is usually adequate for most applications, the 64k-byte memory space of commonly used 8085s, Z80s, and 6800s can't accommodate enough RAM and flexible program memory for many modern applications. In fact, because firmware inhabits so much memory space, even 16-bit systems can run short of RAM. You can free both new and existing systems from program-memory limitations by using EPROMs, algorithms, and circuit techniques that let you implement page addressing.

Using page addressing to expand RAM is a well-established technique. You synthesize extra address lines by latching bits from the data lines that identify the page numbers.

For example, suppose that you need a 64k-byte memory space to hold your program, which is resident in four 16k-byte EPROMs. In a nonpaged 8085 system, four 16k-byte EPROMs would take up the 8085's entire 64k-byte memory space. You would have to address the EPROMs contiguously—at 0000 to 3FFF_{HEX}, 4000 to 7FFF_{HEX}, 8000 to BFFF_{HEX}, and C000 to FFFF_{HEX}. Thus, you'd have no room left for any RAM.

You can implement page addressing in such a system by adding latch and decoding circuitry that lets you stack the EPROMs in a 3-dimensional array. **Fig 1** shows an example of such a design. The design uses four 27128A 16k-byte EPROMs. In each plane, one EPROM occupies addresses in the 0000 to 3FFF range; the remainder of the address space (4000 to FFFF) in each plane can have RAM, or you can leave it vacant.

Implement page addressing in four EPROMs

Address decoder IC_{2A} generates EPROM and RAM block-select signals. When address lines A₁₄ and A₁₅ are TTL-low, IC_{2A}'s Y₀ output goes low, enabling decoder IC_{2B}. The value in IC₃'s 2-bit latch selects one 27128A. To change IC₃'s value, all you need to do is write a page number (0, 1, 2, or 3) to any address within the EPROM space, 0000H to 3FFFH. IC_{2A}'s Y₀ output will be low and the Write signal, \overline{WR} , will strobe a new page number (data bits D₀ and D₁) into IC₃, taking advantage of the EPROM's inherently free writable address space. During write operations, the EPROMs ignore any information on the data bus.

The R₁/C₁ network solves an important program-

An 8-bit μP 's 64k-byte memory capacity often can't hold enough RAM and program memory for many modern applications.

memory page-switching problem: that of boot-up initialization. At power-up, IC₃'s latches are reset and page 0 is automatically selected. The microprocessor will always boot up at the same starting page.

Although it does expand the system's addressable memory, the design in Fig 1 is not an ideal one. For one thing, putting so many devices on a board can impose capacitive and dc loading on address, data, and control lines, and can cause access-time and fanout degradation. It can also consume a lot of power and take up a lot of pc-board space. Further, the design doesn't let you easily add more program memory.

Replace four EPROMs with one

You can simplify the design by replacing the four 27128A EPROMs in Fig 1 with a single 27512 EPROM, as shown in Fig 2. The 27512 contains a decoder equivalent to IC_{2B} that selects pages depending on the

values of address lines A₁₄ and A₁₅. Because it has fewer chips, the circuit in Fig 2 exhibits less bus loading, consumes less power, and occupies less circuit board space than does Fig 1's circuit.

Like the design in Fig 1, the design in Fig 2 is not an ideal solution to the problem of expanding addressable memory: Although both these designs give your system added program memory, neither lets you easily expand the program memory further.

An ideal way to solve the problem would be to design an even simpler system that will permit future memory expansion. You can derive such a design from the circuit in Fig 2 by replacing the circuitry inside the dashed line—latch IC₃, OR gate IC₄, the R₁/C₁ reset circuit, and the 27512 EPROM—with one 27513 or 27011 page-addressed EPROM (see Fig 3).

You can also derive the design in Fig 3 directly from the circuit in Fig 1; this scheme lets you add address-

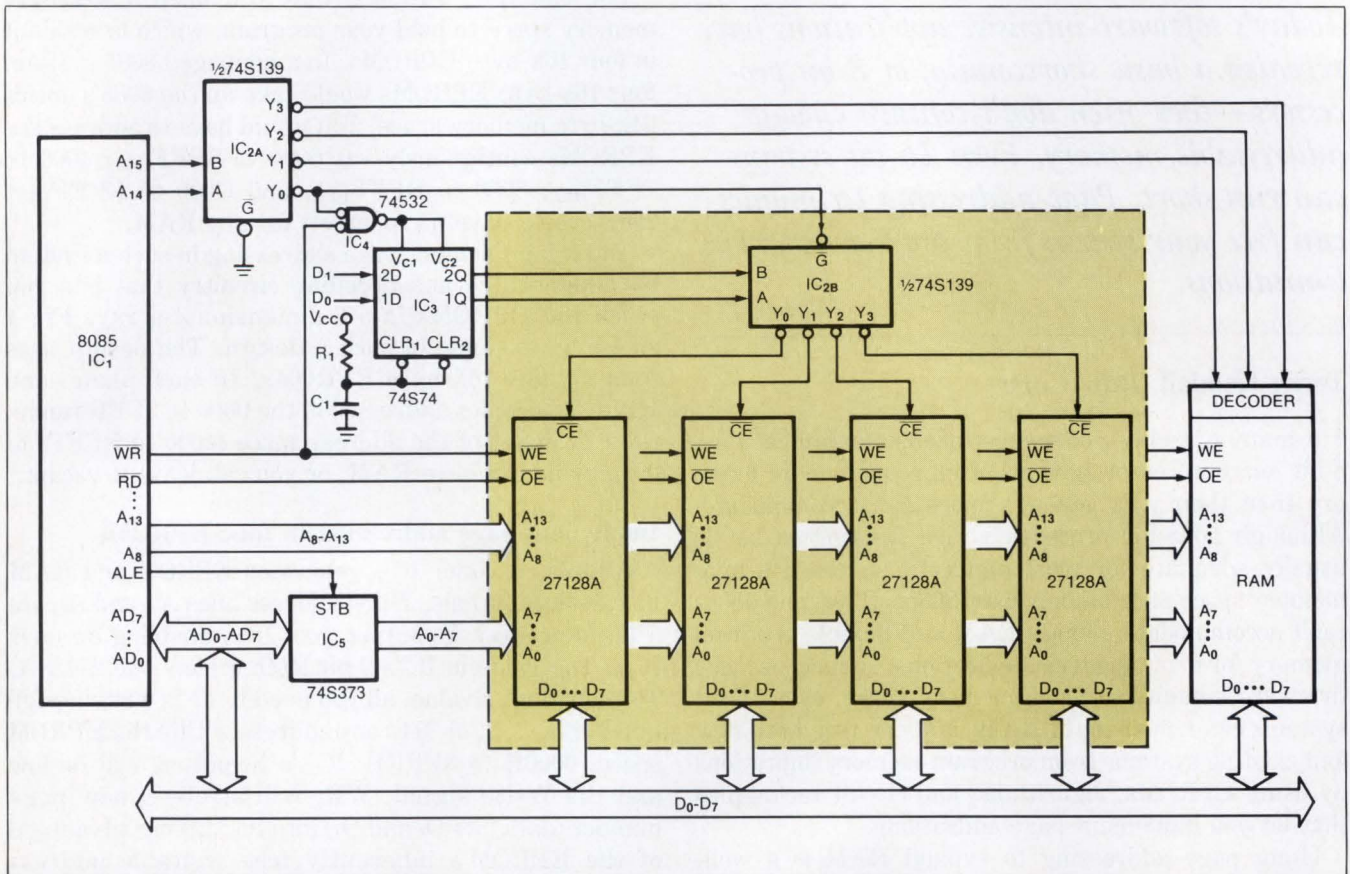

Fig 1—This block diagram of a typical 8-bit μP system uses bank-switching techniques to provide a 3-dimensional array of EPROMs. The latch and decoding circuitry lets you select one 16k-byte EPROM bank at a time. You can reduce the amount of circuitry in the design by replacing the circuitry in the dashed box with a single 27512 EPROM.

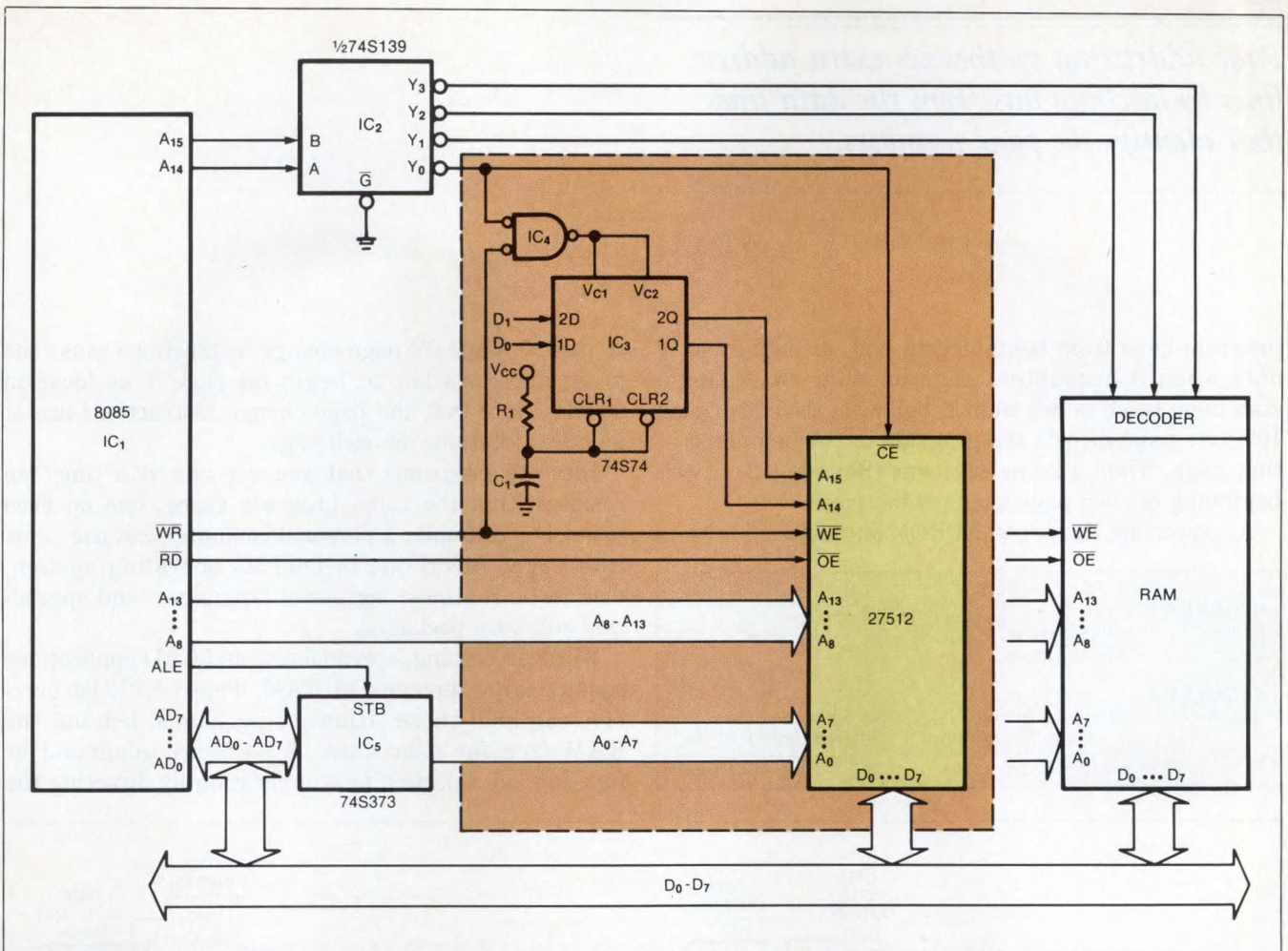

Fig 2—By replacing the four 27128A EPROMs in Fig 1 with a single 27512 EPROM, you can implement page addressing in a simpler fashion than Fig 1's circuit does.

able memory space to an existing system without adding circuitry. You simply replace one (or each) of the 16k-bit EPROMs (and IC_{2B}, IC₃, IC₄, and the reset circuitry) in Fig 1's design with a 27513 or 27011 page-addressed EPROM.

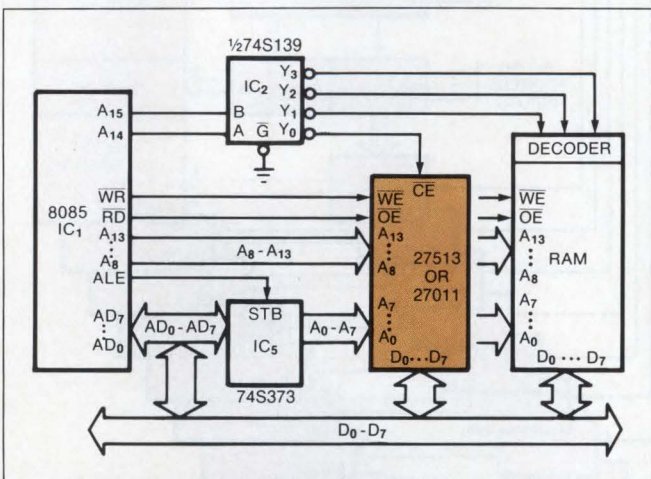

Fig 3—By using a 27513 or 27011 paged EPROM in place of the circuitry in the dashed box in Fig 2, you can both simplify your system design and provide an easily expandable memory space. This design can also be derived directly from the one in Fig 1: You merely replace one of Fig 1's 27128A EPROMs and the paging-support circuitry with a 27513 or 27011 EPROM.

The 64k-byte 27513 EPROM (Fig 4a) is organized as four 16k-byte pages. Systems requiring more program memory can use the 128k-byte, 8-page, 27011 EPROM (Fig 4b). These EPROMs contain latches, decoders, and reset circuitry in a single package. The 27513 and 27011 use industry-standard 28-pin DIPs (or 32-pin PLCCs) and plug into existing 27128 sites; pin 27 is wired to the \overline{WR} line. Next-generation upgrades of these EPROMs (to 4M bytes) will simply plug into existing 27513 or 27011 EPROM sites.

The designs in Figs 1, 2 and 3 all use identical page-addressing firmware. Changing pages is simple: You select the EPROM (any EPROM address will do) and write the page number, just as you would when writing data to RAM. After a page change, the first instruction on the new page must continue the logical program sequence.

Use paged EPROMs with continuous code

Page-addressable EPROMs are useful in applications that require continuous-code, discrete, and modular programs. How you write the programs that change the PROM pages depends on which of these applications you're running.

Continuous code, for example, does not use subroutines that reside on other pages. A continuous-code

Page addressing synthesizes extra address lines by latching bits from the data lines that identify the page numbers.

program runs from beginning to end, changing pages only when it encounters page boundaries. A single statement (such as **Segment 1**, below) at the end of each 16k-byte page directs the program to the beginning of that page. Then a 2-line segment (**Segment 2**) at the beginning of each page changes the page.

At power-up, the paged EPROM automatically resets

SEGMENT 1

ADDRESS	STATEMENT
3FFD	JMP CHANGEPG

SEGMENT 2

0000	CHANGEPG	MVI	A	(next page number 1, 2, 3, or 0)
0002		STA	0000H	;write page number to EPROM.
....				

to page 0. Page 0's page-change instructions cause the program execution to begin on page 1 at location 0005H. Note that the page-change instructions are at identical locations on each page.

Discrete programs that you use one at a time can reside within the same program space, one on each page. For example, a personal computer can use separate pages (overlays) to hold its operating system, diagnostic routines, high-level languages, and specialized software packages.

Word-processing, spreadsheet, and CAD applications require large amounts of RAM. Paged-EPROM overlays can hold these firmware packages, leaving the RAM free for user data. A software command or function key selects a new application by directing the

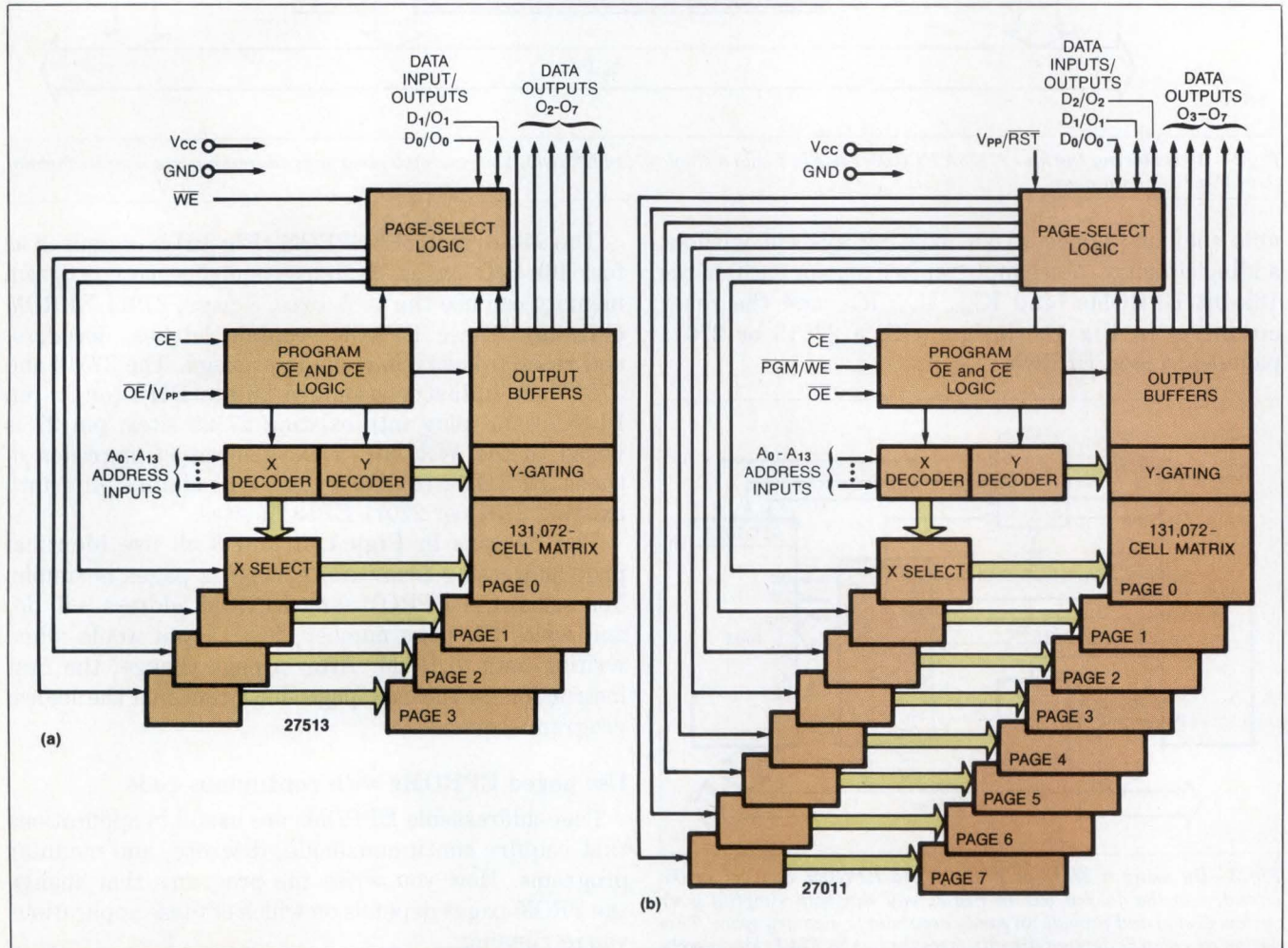

Fig 4—These paged EPROMs each provide 16k bytes per page. The 4-page 27513 EPROM (a) yields a total memory space of 64k bytes; the 8-page 27011 (b) provides 128k bytes.

microprocessor to the routine in **Segment 3**. Each page must contain these instructions—at identical locations. After a page change, the program flow continues, uninterrupted, on the new page.

Most software is written in modular form. Subroutines call one another or are linked by a central driving routine. Calls and jumps don't access routines on another page directly; they must do so indirectly. A calling routine supplies the destination's address and page number to a universal page-turning routine. The universal Call/Jump routine accomplishes the page change and jumps to the destination.

To implement page addressing in any of the three

systems illustrated, you can choose from three paging algorithms: the manual, look-up-table, and automatic paging algorithms. Although the algorithms are illustrated here by 8085 code, they adapt easily to 8-, 16-, or 32-bit systems.

SEGMENT 3	
SOURCE	STATEMENT
APPONE	LXI H (address of page 0 application)
	MVI M,00 ;"M"(HL register) points to EPROM, so change ;page to 0. Next instruction is on page zero.
	PCHL ;program counter gets "HL". Jump to routine.
APPTWO	LXI H (application-two (page 1) starting address.)
	MVI M,01
etc.	PCHL

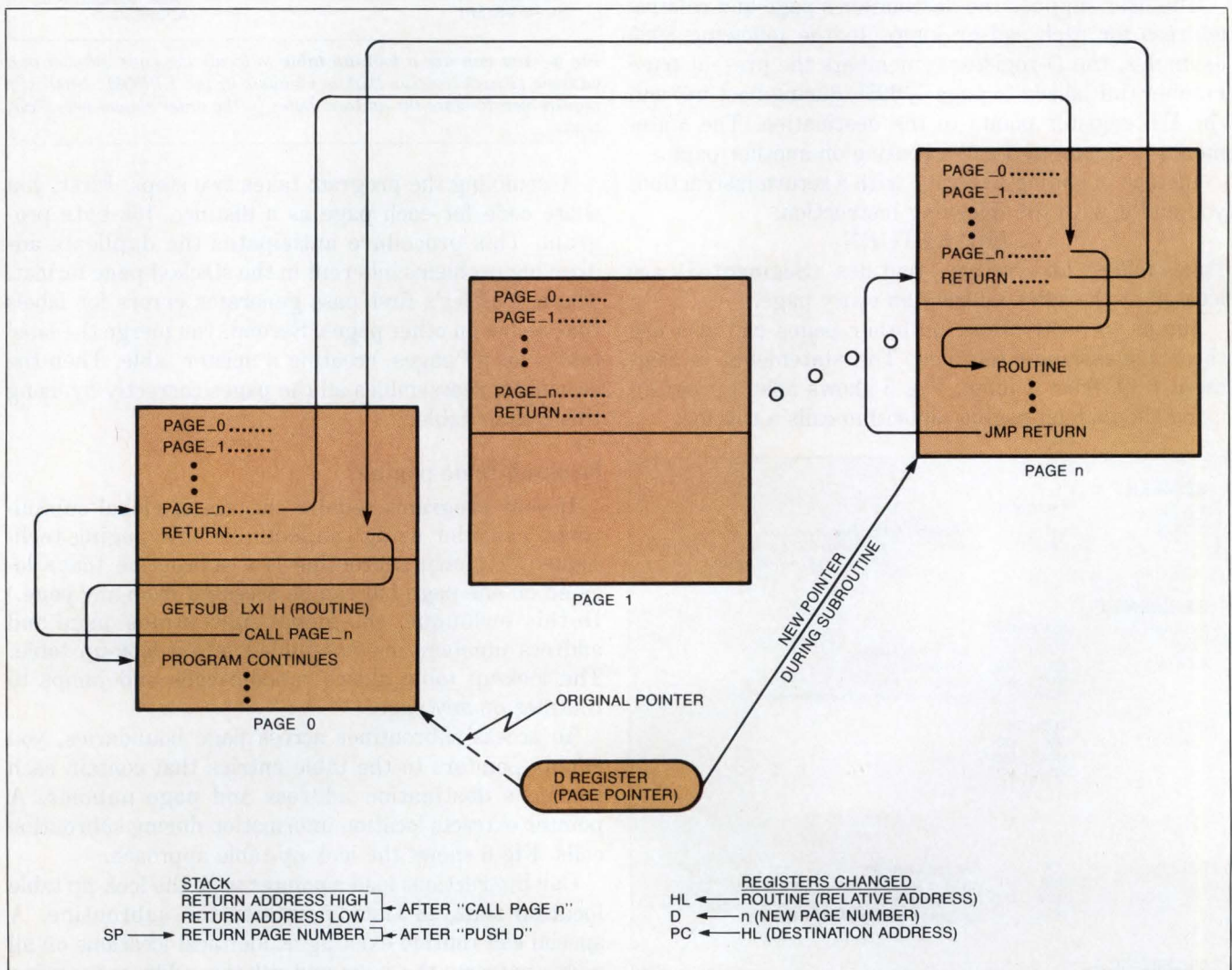

Fig 5—Manual paging requires a page-changing subroutine. The programmer determines the page in which each routine resides and calls the paging subroutine, using the appropriate page number as an argument. This figure shows the flow of control.

You can condense more program memory into a system by using page addressing within one EPROM instead of standard addressing within a group of EPROMs.

When you use the manual-paging algorithm, you determine the pages and relative locations for subroutines. This information is manually placed in Call instructions, which access subroutines on other pages. Manual paging is an easily understood approach that lets you change pages quickly and allows you to upgrade easily to higher-density EPROMs. It does have certain disadvantages, however. For one thing, you must know the page and relative location of every call and jump. Further, the assembler has difficulty in assigning addresses to labels that are referenced in overlapping memory pages.

The user supplies the destination's page and relative address for each call or jump. In the following 8085 examples, the D register remembers the present page number (initialized to page 0, 00H, during boot-up) and the HL register points to the destination. The statements in **Segment 4** call a routine on another page.

Instead of ending a routine with a return instruction, you end it with the following instruction:

JMP RETURN

Page-change and return routines (**Segment 5**) are located at the same address on every page.

Jumps to destinations on other pages can also use these page-change routines. The statements in **Segment 6** perform a jump. **Fig 5** shows how a program using the manual-paging algorithm calls a routine.

SEGMENT 4		
SOURCE	STATEMENT	
GETSUB	LXI	H(routine) ;"HL" gets destination.
	CALL	PAGE n ;call paging routine (n = 0, 1, 2, ...) that turns to the subroutine's page.
SEGMENT 5		
SOURCE	STATEMENT	
PAGE0	PUSH	D ;save present page.
TURNT00	MVI	D,00 ;new page.
	MOV	M,D ;change the page.
	PCHL	;program counter gets destination.
PAGE1	PUSH	D
TURNT01	MVI	D,01
	MOV	M,D
	PCHL	
		o
		o
		o
RETURN	POP	D ;retrieve old page.
	POP	H ;retrieve return address.
	MOV	M,D ;change page.
	PCHL	;program counter gets return address.
SEGMENT 6		
	LXI	H(destination) ;"HL" gets destination's address.
	JMP	TURNT0 n ;jump to paging routine (n = 0, 1, 2, ...).

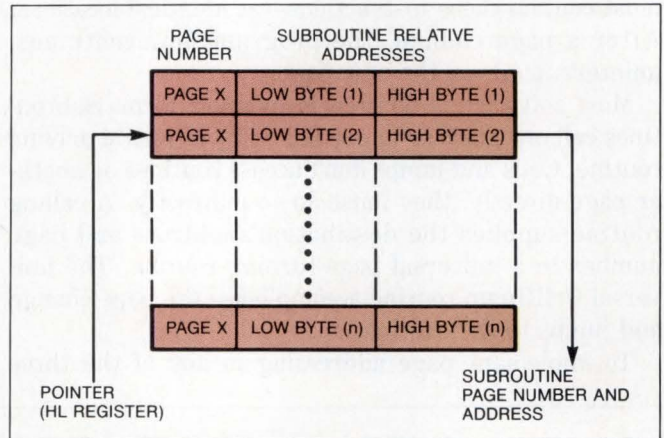

Fig 6—You can use a look-up table to locate the page number and address of each routine that is resident in the EPROM. Intel μ Ps require you to store the address bytes in the order shown here (low, high).

Assembling the program takes two steps. First, you write code for each page as a distinct, 16k-byte program. This procedure anticipates the duplicate-addressing problems inherent in the stacked-page format. The assembler's first pass generates errors for labels that reside on other pages. Second, you merge the label tables for all pages, creating a master table. Then the assembler reassembles all the pages correctly by using this master table.

Look-up-table paging

If your programs require the use of global subroutines, consider using the look-up-table paging technique. (A global subroutine is a subroutine that's located on one page but can be accessed from any page.) In this technique, the global subroutines' page and address numbers are assembled into a look-up table. The look-up table allows random calls and jumps to routines on any page.

To access subroutines across page boundaries, you supply pointers to the table entries that contain each routine's destination address and page number. A pointer extracts location information during subroutine calls. **Fig 6** shows the look-up-table approach.

Call instructions load a pointer with the look-up table location that, in turn, points to the subroutine. A special call routine existing at identical locations on all pages extracts the page and relative address by using the pointer. It then changes the page and jumps to the destination. A return routine transfers control to the

THE MASTER SERIES™ VME by MATRIX

Introducing
the New World of
Single-Height VME Systems

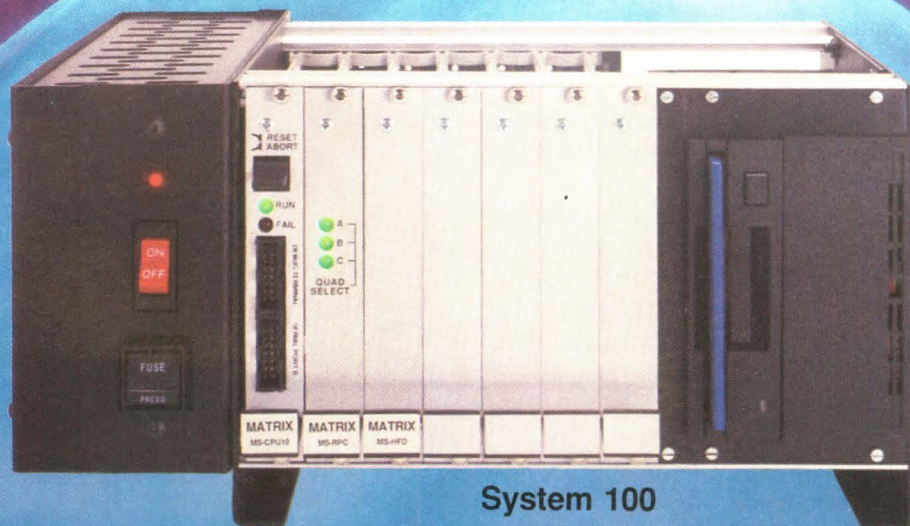

System 100



MATRIX CORPORATION

1203 New Hope Road • Raleigh, NC 27610 • Phone (919) 833-2000

CIRCLE NO 126

To implement page-addressing, you can choose from three paging algorithms: manual paging, a look-up-table method, and automatic paging.

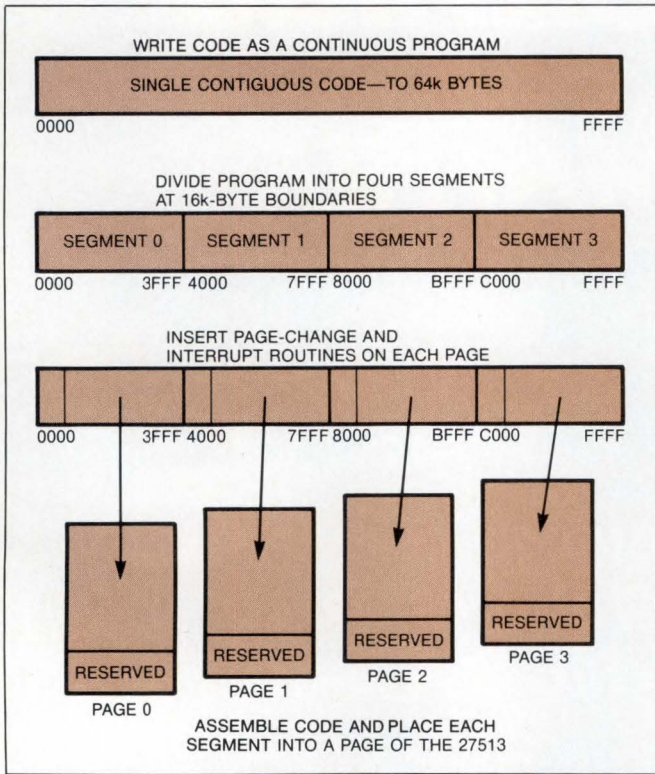

Fig 7—Automatic paging lets you write continuous code. After assembling the code, you must break it into 16k-byte segments, each of which has a page-changing routine at the end.

calling routine's page and relative address. **Segment 7** illustrates this technique.

A pagecall routine (**Segment 8**) extracts page and address information from the table. The JMP RETURN instruction at the end of a subroutine replaces the return instruction. Jumps between pages use the statements in **Segment 9**.

Each entry in the look-up table contains three bytes for page and address information. Thus, call and jump instructions supply labels that point to table entries for each routine. During program assembly, the assembler substitutes absolute addresses for the labels, and then places the addresses and page numbers in the table.

Automatic paging uses an index register

The automatic-paging algorithm allows you to write as many as 64k bytes of code in one block; however, the subroutine calls take place indirectly through an index register. Thus, the index register serves as a page and address pointer to subroutines. This algorithm uses a destination's two most significant address bits (as determined by the assembler) to determine the page

number. A paging routine separates the page number and the relative address from the 16-bit destination address. **Fig 7** shows how the single block of assembled code fits into the four separate pages.

Each page must contain page-change and interrupt routines to connect the segments. **Segment 10** shows 8085 code for calling a subroutine via the automatic-paging method. Reset and interrupt routines, as well as paging routines (**Segment 11**), are placed at identical locations on each page (**Fig 7**). Destination addresses are loaded into the HL register. The pagecall/pageturn routine (**Segment 11**) performs "bit stripping," which handles page selection and relative addressing. Although the program memory appears to overlap the RAM, the bit-stripping procedure ensures that each occupies its unique location.

In sum, the paging routine performs four functions: It saves the old page number, isolates the two most

SEGMENT 7

SOURCE	STATEMENT	
GETSUB	LXI H, SUBPTRn	;"HL" points to page information in table.
	CALL PAGECALL	;enter global call routine.

SEGMENT 8

PAGECALL	PUSH D	;save old page number.
PAGETURN	MOV D, M	;"D" gets new page.
	INX H	;point to destination's low byte.
	MOV E, M	;"E" gets low byte.
	INX H	;point to destination's high byte.
	MOV H, M	;"H" gets high byte.
	MOV L, E	;"L" gets low byte.
	MOV M, D	;change page.
	PCHL	;jump to routine.
RETURN	POP D	;retrieve old page.
	POP H	;"HL" gets return address.
	MOV M, D	;change the page.
	PCHL	;return to main program.

SEGMENT 9

	LXI H, JMPPTRn	;"HL" gets table location.
	JMP PAGETURN	;enter global call routine.

SEGMENT 10

SOURCE	STATEMENT	
GETSUB	LXI H, routine	;"HL" gets destination, as determined by the assembler.
	CALL PAGECALL	;call the paging routine.

SEGMENT 11

PAGECALL	PUSH D	;save old page.
PAGETURN	PUSH PSW	;save anything in accumulator.
	MOV A, H	;"A" gets high address byte.
	RLC A	;rotate two most significant bits to
	RLC A	least significant locations.
	ANI 0000011B	;mask all but page-number bits.
	MOV D, A	;"D" gets page number.
	MVI A, 00111111B	;"A" gets relative location mask.
	ANA H	;strip most significant bits from "H".
	MOV H, A	;"H" gets high relative-address byte.
	MOV M, D	;change to new page.
	POP PSW	;"A" retrieves old information.
	PCHL	;jump to subroutine.
RETURN	POP D	;retrieve old page number.
	POP H	;"HL" gets return address.
	MOV M, D	;change page.
	PCHL	;return to program.

Announcing - World's Biggest!

4Kx9 FIFO

50ns ACCESS TIME

Organization	Access Time	Features
512x9 IDT 7201	35ns	- Pin compatible - Half-full flag - Zero fall thru time - Easily expandable
1024x9 IDT 7202	35ns	" "
2Kx9 IDT 7203	50ns	" "
4Kx9 IDT 7204	50ns	" "

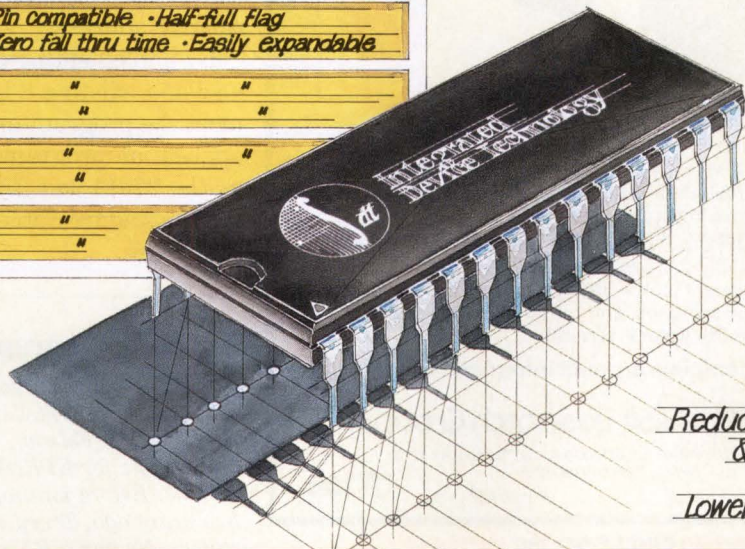

Replaces
8 IDT 7201's

Reduces pin count
& board space

Lower cost. per bit.

Introducing the world's first 4Kx9 CMOS FIFO.

Reduce your part count and lower the price per bit. The **IDT7204** 50ns (access time) 4Kx9 and **IDT7203** 50ns 2Kx9 are the world's largest fast FIFOs. Both are fast enough to interface with the fastest microprocessors available. Both are pin and functionally compatible with the **IDT7202** 35ns 1Kx9, and the **IDT7201** 35ns 512x9 FIFOs. A single **IDT7204** can replace eight **IDT7201**s.

Dual-ported architecture. Asynchronous and simultaneous read/write. Can buffer any data rate, with or without system clock. Zero fall thru time — able to write a word into the FIFO and read the same word out on the next cycle.

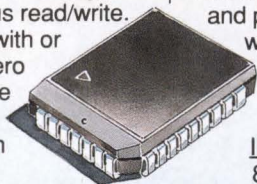

Flags. Three flags — full, J-leaded PLCC empty and half-full — indicate the extent of FIFO memory usage.

Data integrity. The x9 FIFO organization allows a parity or tag bit to be appended to a data word.

Easily expandable. Built-in hooks to make deeper and wider FIFOs without external logic. Deeper FIFOs are especially useful when performing data acquisition functions or when storing frame information in a graphics system.

Retransmit capability in single device mode. The retransmit pin resets the read pointer to the initial FIFO data position and restarts data transmission.

CMOS power. Maximum current is 120mA (commercial).

Packaging. Standard 28-pin ceramic and plastic DIPs and 32-pin LCC and PLCC.

High-density FIFO modules.

When we introduced our 512x9 and 1024x9 monolithics in 1984, we also introduced 2Kx9 and 4Kx9 modules and promised monolithic replacements would be available in the future.

We have kept that promise with the **IDT7203/4**. Now we have two new modules — **IDT7M206** 16Kx9 and **IDT7M205** 8Kx9 — providing extraordinary density and again paving the way for deeper monolithic FIFOs.

Introducing the world's fastest and largest parallel/serial FIFOs.

The **IDT72103** 2Kx9 and **IDT72104** 4Kx9 FIFOs perform serial-to-parallel, parallel-to-serial, serial-to-serial and parallel-to-parallel data operations. Flexishift™ feature allows you to program serial word widths to be anything from 4 bits wide to as wide as you want.

Fastest CMOS multipliers & MACs.

16x16 Multipliers: **IDT7216/7217** replaces MPY016H/K and Am29516/17. Com'l. speed (worst case) is 35ns.

16x16 Multiplier/Accumulators: **IDT7210** (35-bit output) replaces TDC1010. **IDT7243** (19-bit output) replaces TDC1043. Com'l. speed (worst case) is 35ns.

12x12 Multipliers: **IDT7212** replaces MPY012. **IDT7213** has a single clock. Com'l. speed (worst case) is 30ns.

12x12 Multiplier/Accumulator: **IDT7209** replaces TDC1009. Com'l. speed (worst case) is 30ns.

64-bit IEEE Floating Point Multiplier and ALU: **IDT721264/65** replaces Weitek 1264/65. 50% faster 12.5 megaflops, 64-bit ALU 6.25 megaflops 64-bit multiply 350mW per part, typical.

May we be of assistance?

If you need to design commercial systems with uncompromising performance at the right price, call your local **IDT** representative or **1-800-IDT-CMOS**.

When cost-effective performance counts



Integrated Device Technology

Digital Signal Processing Division

3236 Scott Blvd.
Santa Clara, CA 95054-3090
(408) 727-6116
TWX 910-338-2070
CIRCLE NO 108

DC-DC CONVERTERS

To 25 Watts — From ERG —
Your DC PowerHouse!



• ERG DC-DC CONVERTERS.

Inputs from 5 to 48 VDC. Outputs from 5 VDC to 1500 VDC. Single, dual, center-tap (+/-) outputs. Regulated and unregulated. **Ask about our New Step-Down converters for battery-powered logic and other applications!**

• SMART FORCE™ INVERTERS FOR EL LAMPS!

Smart Force DC-AC Inverters extend the useful life of Electroluminescent lamps. Power EL to backlight LCDs and membrane switches, and more! **Ask about our New miniaturized P Package Inverters!**

Call today for complete product information and pricing:



Endicott Research Group, Inc.

2601 Wayne Street P.O. Box 269 Endicott, NY 13760
© 607-754-9187 TWX 510-252-0155

FAX: 607-754-9255

©1986 ERG, Inc.



CIRCLE NO 180

WHAT DO YOU DO WITH EXCESSIVE BOARD HEAT?

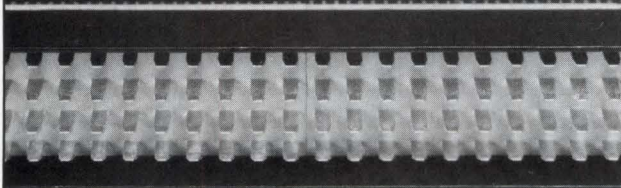

Since the late 1970's, Makco has been an innovator in the design, development, and implementation of standard military surface mount electronic modular (SEM) heatsinks. Makco's heatsink program is not limited to the SEM surface mounted technology only, but is easily adaptable to many different application and component packaging schemes. Even with the contour cut outs to accommodate component placement, Makco can furnish a finished heatsink ready for assembly.

So what do you do with excessive board heat? Contact Makco!

Makco Manufacturing Co., Inc. • Electronics Division
P.O. Box 830, Edinboro, PA 16412 • 814/734-4131

CIRCLE NO 15

significant bits of the destination (these bits contain the page number), uses these bits to change the page, and allows the remaining bits to contain the subroutine's relative address.

By implementing page-addressing techniques in your new and existing 8-bit- μ P designs, you can prepare to meet the program-memory requirements of tomorrow's application programs. If you use paged EPROMs such as the 27513 and 27011, you'll be able to expand your system's addressable memory to as much as 4M bytes in the future.

EDN

Author's biography

Terry Kendall is a technical marketing engineer at Intel's Memory Components Div (Folsom, CA), where he is responsible for EPROM-product applications. Before joining Intel almost two years ago, Terry worked as an architect. He has a BA in architecture from the University of Oregon and a BSEE from California State University at Sacramento. In his spare time, Terry enjoys skiing, backpacking, and playing the guitar.

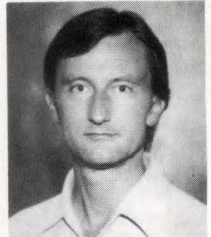

Article Interest Quotient (Circle One)
High 485 Medium 486 Low 487

FIRST
WE WROTE
THE BOOK ON
ASIC DESIGN.

THEN WE FILLED

GATE ARRAY MACROS & STANDARD CELLS



© 1986 VLSI Technology, Inc.

VLSI was developing silicon compilers for commercial applications back when ASIC was just a glimmer in your CRT. Our compiler family has already been proven in hundreds of designs.

We were the first to offer a whole lineup of industry-standard cells, megacells, and gate arrays.

And we pioneered high-integration ASIC.

Our library is filled with best sellers.

Looking for a way to shrink the size and costs of your existing 8086 and 8088 systems?

Our megacell library is filled with your old favorites: 68C45s, 82C50s, 82C88s, 82C54s,

82C37As, you name it.

We have the only megacells designed expressly as ASIC building blocks.

So now, for the first time, you can build your own ASIC microprocessor support system on one chip.

We let you integrate compilers, megacells, and standard cells to create systems that can rival custom designs in density.



D THE LIBRARY.

MEGACELLS



COMPILERS



And since all our libraries are defined in the same 2μ CMOS process, you not only get high performance, you can combine your choice of the elements in our library in one design.

Or if you're a 2901 fan, you can design your microprocessor system from the ground up by compiling it from 4-bits wide to 32-bits wide and combining it

with RAM, ROM, PLA, and multiplier.

If you want the right ASIC solution, come to the only place that has them all: programmable logic, gate arrays, standard cells, megacells, silicon compilation, tools, and fab.

You can check out our library at the VLSI Design Center nearest you.

Or call VLSI at 408-434-3100. Or write to us at 1109 McKay Drive, San Jose, CA 95131 and ask for our brochure.

It's one book you won't be able to put down.



VLSI TECHNOLOGY, INC.
NOT JUST YOUR BASIC ASIC.

Sockets are a

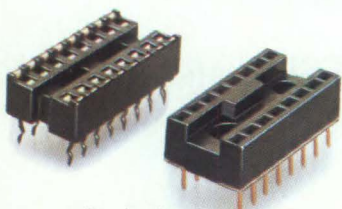

Production Sockets
CIRCLE NO 42

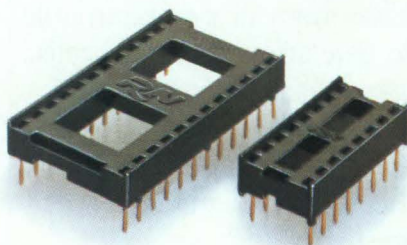

Low Profile Sockets
CIRCLE NO 43

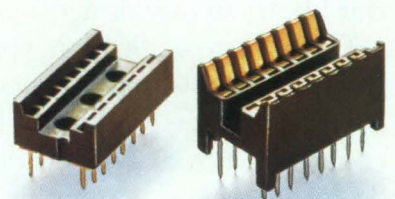

Burn-in Sockets
CIRCLE NO 44

pain-in-the-neck, right?

Wrong!

Sockets, used selectively, can eliminate 4 of your toughest, everyday board problems!

Take a fresh look at RN precision screw machine sockets. You may be surprised to see how many ways they can eliminate trouble, save real money and make you a hero to your boss:

- 1. Simplify board "trouble-shooting":** Socket your sophisticated circuits so that you can remove and test them without desoldering. Excessive de-soldering heat can cause costly board de-lamination as well as circuit damage.
- 2. Slash field service costs.** Simply unplug your circuits, test and replace in the field. No time-wasting de-soldering troubles.
- 3. Modify boards in the field.** It is as easy as unplugging a circuit and inserting the new or re-programmed IC package.
- 4. Have peace of mind by socketing** state-of-the-art devices that have not had MTBF standards established.

When you decide to eliminate board problems with sockets, be sure to specify the best you can get... RN Precision Screw Machine Sockets

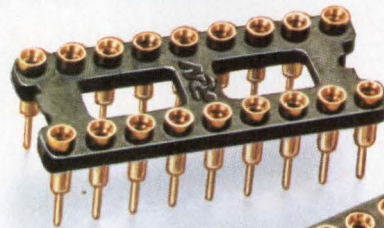

RN Series ICA/ICT Sockets Available with 6 to 64 contacts, solder or wrap pin.

Precision pin socket contacts for maximum reliability and high retention.

Technology innovations from RN include...

- Lowest profile in industry—
.122"
- High temperature: 200°C
- Lowest insertion force—
5 ounces, maximum
- .180" solder tail length available

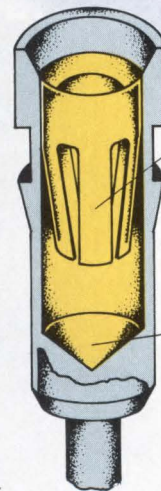

Four-finger BeCu contact assures solid gastight mating, even with short leads.

Contact available in gold or tinplate.

Closed bottom prevents flux and solder contamination.

Brass shell available in gold or tinplate.

WRITE TODAY

for information on the full line of RN sockets, contact:
Robinson Nugent, Inc., 800 E. Eighth St., Phone: (812) 945-0211.
New Albany, IN 47150.

CIRCLE NO 48

... connect with quality



Robinson Nugent

800 East Eighth Street, New Albany, Indiana 47150 • Phone: (812) 945-0211
In Europe: Rue St. Georges 6, CH 2800 Delémont, Switzerland • Phone: (066) 22 98 22

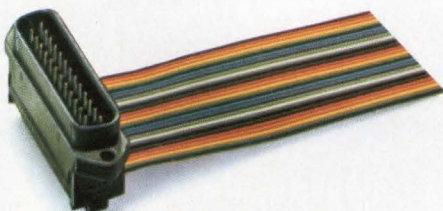

Flat Cable Connectors
CIRCLE NO 45

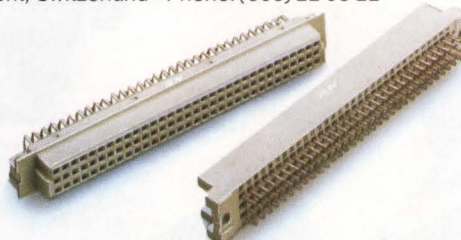

DIN Connectors
CIRCLE NO 46

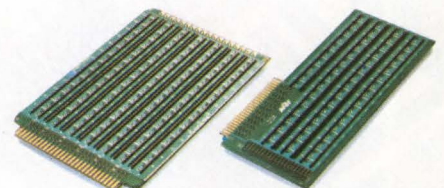

Quick/Connect Prototype Boards
CIRCLE NO 47

Announcing EDN Magazine's Exclusive Hands-On, Surface-Mount Design Series

Watch For It,
Starting May 28th.

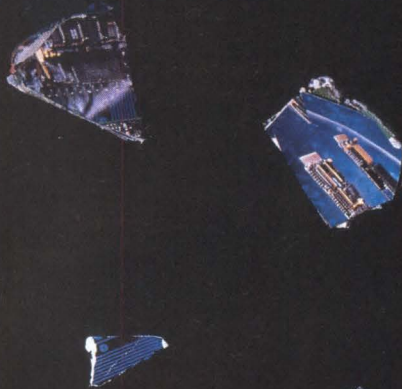
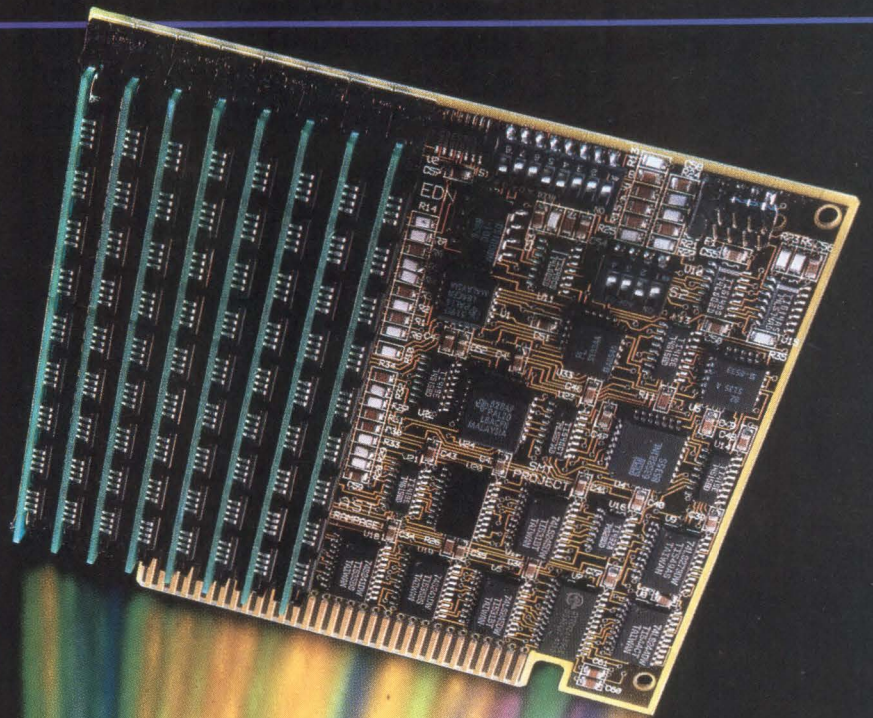

Consider standard features when selecting codecs

A codec—or coder/decoder—performs analog-to-digital (encoding) and digital-to-analog (decoding) conversion of the human voice. This article, part 1 of a 2-part series, provides an overview of a codec's structure and function and brings you up to date on the standard features that you can expect these workhorses of the telecommunications network to offer. Part 2, scheduled for the May 14 issue, will look at the advanced features offered by several codecs and will discuss noise considerations.

Brady Barnes, *Inter-Tel*

With the advent of ISDN (the Integrated Services Digital Network), the use of codecs is becoming increasingly widespread. Although different types of codecs fit different types of applications—for example, codecs may differ in their encoding (linear vs nonlinear), their word size (eight bits vs 16 bits), and their bit rate—their primary application is, of course, in the telecommunications industry. This 2-part series focuses on that type: the type now commonly being used in the transmission and switching of voice in digital systems and networks. Furthermore, it discusses only those codecs that have their own on-chip filtering: These codecs are often called codec/filter combos or, sometimes, cofidecs.

Here, however, they're referred to simply as codecs.

The codec can be divided into two sections: the transmit and the receive sections (**Fig 1**). The transmit section performs the analog-to-digital conversion; the receive section performs the digital-to-analog conversion.

When an analog signal is applied to the transmit section of a codec, the signal passes through a series of filters: A highpass filter rejects all low-frequency noise, such as 60-cycle hum. Then, a lowpass, antialiasing filter eliminates all frequencies greater than one-half the sampling rate so as to avoid a phenomenon called "foldover distortion," or aliasing. The net result for codecs designed for voice transmission over digital telecommunications links is an analog signal that's band-limited from about 300 Hz to about 3400 Hz.

Next, the analog signal enters the sample/hold circuit of the encoder. The encoder performs the analog-to-digital transformation. Inside the encoder, the analog signal is sampled at a rate of 8000 samples/sec (once every 125 μ sec). The sample is then converted to an 8-bit digital word, yielding a 64k-bps serial data rate. The data conversion is not uniform (that is, not linear); instead, the codec performs the conversion in accordance with a companding (compressing/expanding) characteristic. The codec's compander circuit compresses the dynamic range of the input and expands the signal back to its original form on the output.

Although companding serves several purposes, its

The codec's data conversion is not linear; instead, the codec performs the conversion in accordance with a companding characteristic.

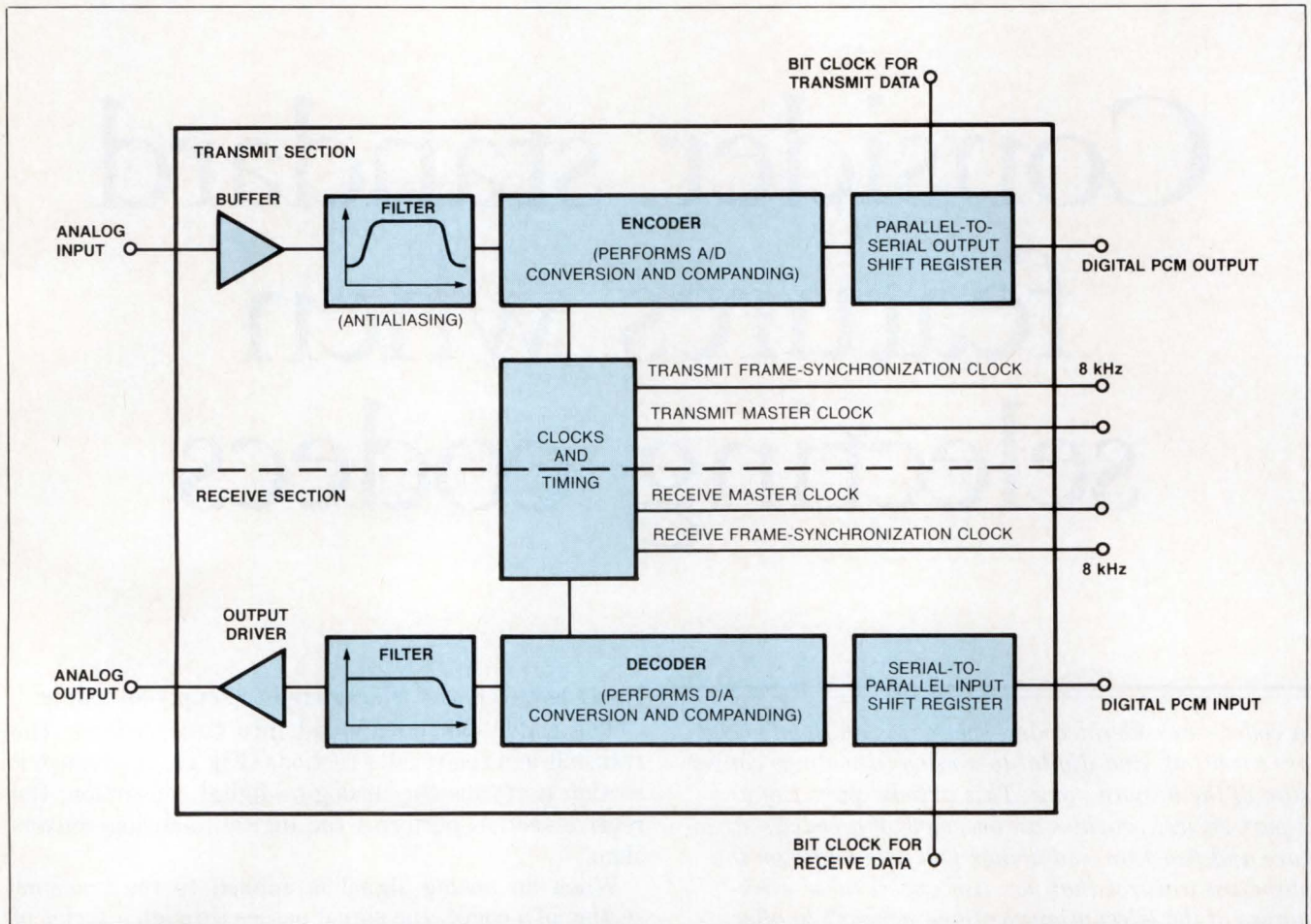

Fig 1—A single-chip codec/filter combination consists of a transmit section and a receive section.

most important function is to enhance the codec's signal-to-noise ratio and dynamic-range capability.

To understand companding's effect on S/N ratio, consider that although a codec's analog-input signal can take on a theoretically infinite number of amplitudes, the codec's corresponding 8-bit digital output can take on only 256 discrete values. That is, the codec's transformation of an analog signal to a digital value is only an approximation. The error introduced by the approximation is called the quantization error; if this error is large enough, the listener can hear it as distortion.

Linear encoding yields unfavorable SQR

For example, if the digital numbers 1, 2, 3, and so on correspond to the analog levels 1 mV, 2 mV, 3 mV, and so on, the quantization error is ½ mV. As you would expect, that ½-mV error on a signal of 100 mV is much less noticeable than the same ½-mV error on a signal of only 1 mV. The ratio of signal amplitude to quantizing

noise is called the signal-to-quantizing noise ratio, or just SQR.

Thus, for an encoder that uses a uniform (that is, linear) transformation, the larger (louder) signals will have a much better SQR than the smaller (quieter) signals. This situation is undesirable because loud signals tend to obscure not only quantizing noise but any other noise that's present as well, and noise due to any source is much more noticeable when the signals are quiet. Furthermore, small signals tend to occur more often than large signals during a normal phone conversation. The solution is to use proportionately smaller quantizing interval sizes for the smaller signals and to use proportionately larger quantizing interval sizes for the larger signals. Thus, the SQR will remain approximately constant over the entire amplitude range.

Changing the quantizing interval size with respect to the amplitude of the input signal is called nonlinear (or nonuniform) transformation, and is the function of the

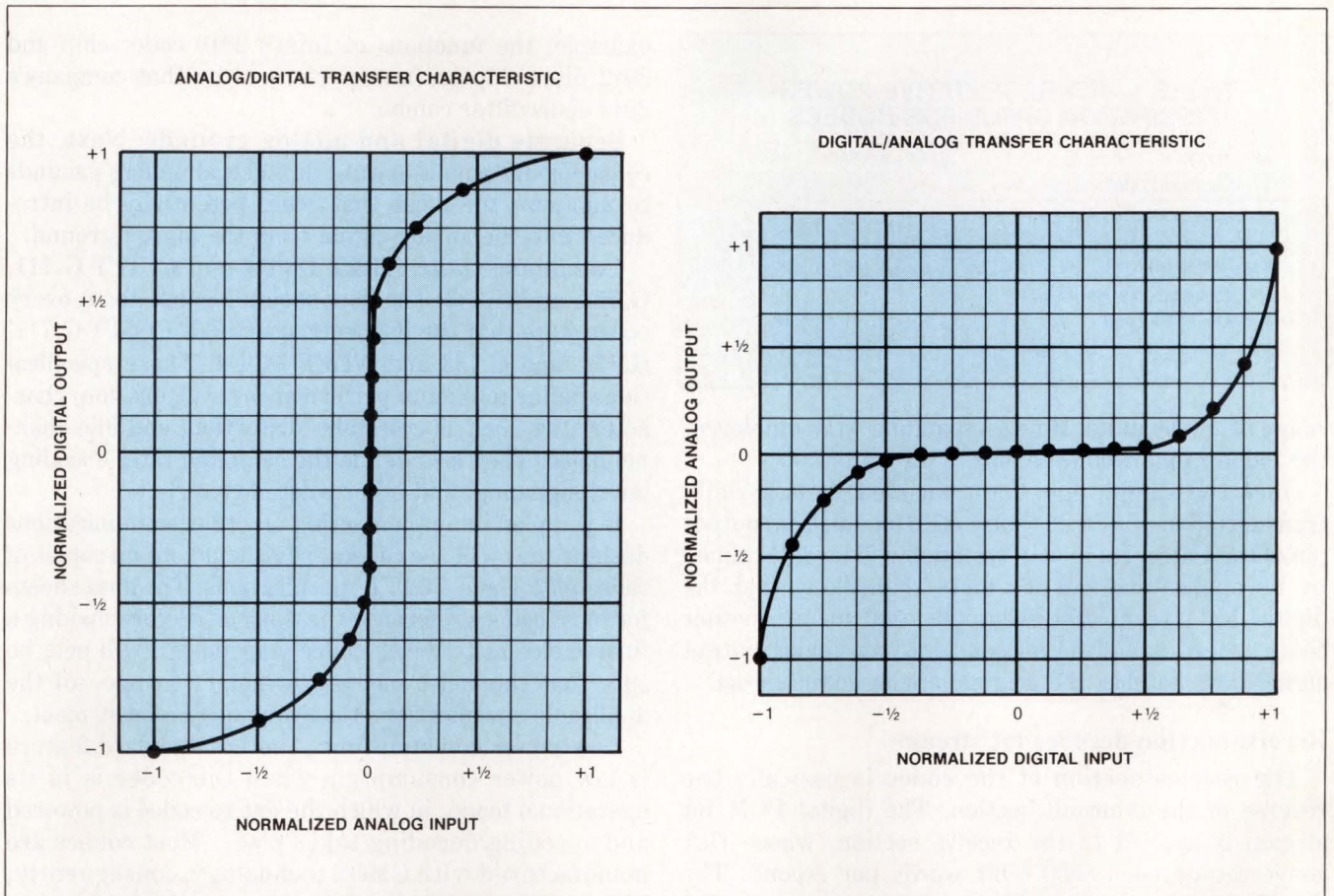

Fig 2—The μ -law characteristic, which finds use in North America and Japan, exhibits lower idle-channel noise than does the A-law, which is used in Europe. However, the A-law characteristic produces a slightly better S/N ratio for small signals. The differences between the μ -law and A-law curves are subtle.

companding circuit. In essence, it involves compressing the signal.

The two accepted companding characteristics in the telecommunications industry are the μ -law and the A-law characteristics. The μ -law is the standard for the North American and Japanese telephone networks, whereas the A-law is the standard in Europe. The primary difference between the two companding characteristics is that the μ -law has an associated lower idle-channel noise, and the A-law produces a slightly better S/N ratio for small signals. The transfer curves for the μ -law are shown in Fig 2.

The A-law companding curves are similar, but subtle differences do exist, as the curves' equations suggest. For a normalized input x between -1 and $+1$, the μ -law would result in the following output $f(x)$:

$$f(x) = \text{sgn}(x) \left[\frac{\ln(1 + \mu|x|)}{\ln(1 + \mu)} \right],$$

where μ , the compression parameter, equals 255. For the same input, the A-law would yield

$$f(x) = \text{sgn}(x) \left[\frac{A|x|}{1 + \ln(A)} \right] \text{ for } 0 \leq |x| < \frac{1}{A};$$

$$f(x) = \text{sgn}(x) \left[\frac{1 + \ln(A|x|)}{1 + \ln(A)} \right] \text{ for } \frac{1}{A} \leq |x| < 1,$$

where the compression parameter A equals 87.6. (Recall that the function $\text{sgn}x$ equals $+1$ when x is positive and -1 when x is negative.) Although these functions are smooth, continuous functions, codecs implement them by using a piecewise-linear approximation.

One final note about companding: Besides providing a nearly constant SQR over the entire amplitude range, it also provides a much wider dynamic range than would a linear encoder. In fact, the μ -law provides a value range of ± 8159 units, and the A-law provides a value

Small signals tend to occur more often than large signals during a normal phone conversation.

TABLE 1—REPRESENTATIVE POWER-DISSIPATION SPECS FOR CODECS

DESCRIPTION	BEST	AVERAGE	WORST
TYPICAL OPERATING POWER (mW)	30	70	140
MAXIMUM OPERATING POWER (mW)	40	115	240
TYPICAL POWER-DOWN AND/OR STANDBY POWER (mW)	0.1	5	20
MAXIMUM POWER-DOWN AND/OR STANDBY POWER (mW)	1.0	14	60

range of ± 4096 units. If no companding were employed, the value range would be only ± 128 units.

Once the sample has been encoded, it is serially transmitted on the PCM (pulse code modulation) output pin of the codec. Its final destination will be determined by its application, but it's more than likely that the digital bit stream will eventually end up at another codec where it will be decoded into an analog output signal that matches the original analog input signal.

Receive section decodes bit stream

The receive section of the codec is basically the reverse of the transmit section. The digital PCM bit stream is applied to the receive section, whose D/A converter decodes 8000 8-bit words per second. The decoder also performs the expansion necessary for restoring the compressed signal to its original form. The filtering performed in the receive section eliminates the high-frequency switching signals from the analog output. The final stage of the codec is typically a balanced (or unbalanced) line driver capable of driving a 600 Ω load.

\$4 to \$6 devices offer standard features

With respect to features, the vast majority of codecs can be grouped into two categories: standard and advanced. In general, codecs that offer just the standard features cost somewhere between \$4 and \$6 each in quantities of 10,000. Codecs that offer advanced features usually fall in the \$7 to \$9 range.

The standard features described in the following section are common to just about every codec on the market:

Combination codec and filter on one chip: First, the codec that you choose should actually be a codec/filter combo. Previously, the filtering was done by a separate chip, and consequently, you needed a 2-chip set in order to perform the codec/filter function. For

example, the functions of Intel's 2910 codec chip and 2912 filter chip are now performed by that company's 2914 codec/filter combo.

Separate digital and analog grounds: Next, the codec should have separate digital and analog grounds to minimize the noise that could potentially be introduced into the analog signal from the digital ground.

Compliance with AT&T D3/D4 and CCITT G.711, G.712, and G.733: The data sheets for just about every codec state that the IC meets or exceeds CCITT G.711, G.712, and G.733 and AT&T D3/D4. These specifications define minimum performance (transmission) characteristics such as crosstalk, distortion, and idle-channel noise. They also define the sampling rate, encoding laws, signaling, and other related criteria.

If you plan on implementing any telecommunications designs that will use codecs, you should obtain copies of these AT&T and CCITT specifications. The data sheets for most codecs reference these specs. Before making a final choice as to which codec your design will use, be sure that the codec meets *all*—not just some—of the applicable specifications that your design must meet.

Low power consumption: Another standard feature is low power consumption when the codec is in its operational mode, in which the entire codec is powered and encoding/decoding takes place. Most codecs are manufactured with CMOS technology; consequently, it's common to see operating-power requirements ranging from 50 to 100 mW.

Power-down or standby mode or both: Every codec has at least one mode in addition to the operating mode, and some even have two additional modes. These modes, which are called standby or power-down modes, usually cause the codec's power requirement to drop to somewhere between 1 to 20 mW. These low-power modes are implemented via control of an input pin or, on some advanced codecs, via control codes sent to the codec under software control.

The terms "standby" and "power-down" have different meanings for different manufacturers, and "standby" for one codec may mean exactly the same thing as "power-down" for another. Furthermore, some codecs support both a standby and a power-down mode. The important point to keep in mind is that these additional modes provide the user with a means of conserving power when the codec is not in use. And although such modes are standard on codecs, the actual power consumption in these modes (as well as in the operating mode) varies widely among the various devices. The power-consumption ranges shown in **Table 1** were ob-

16-Bit A/D Systems. 50kHz. \$170.*

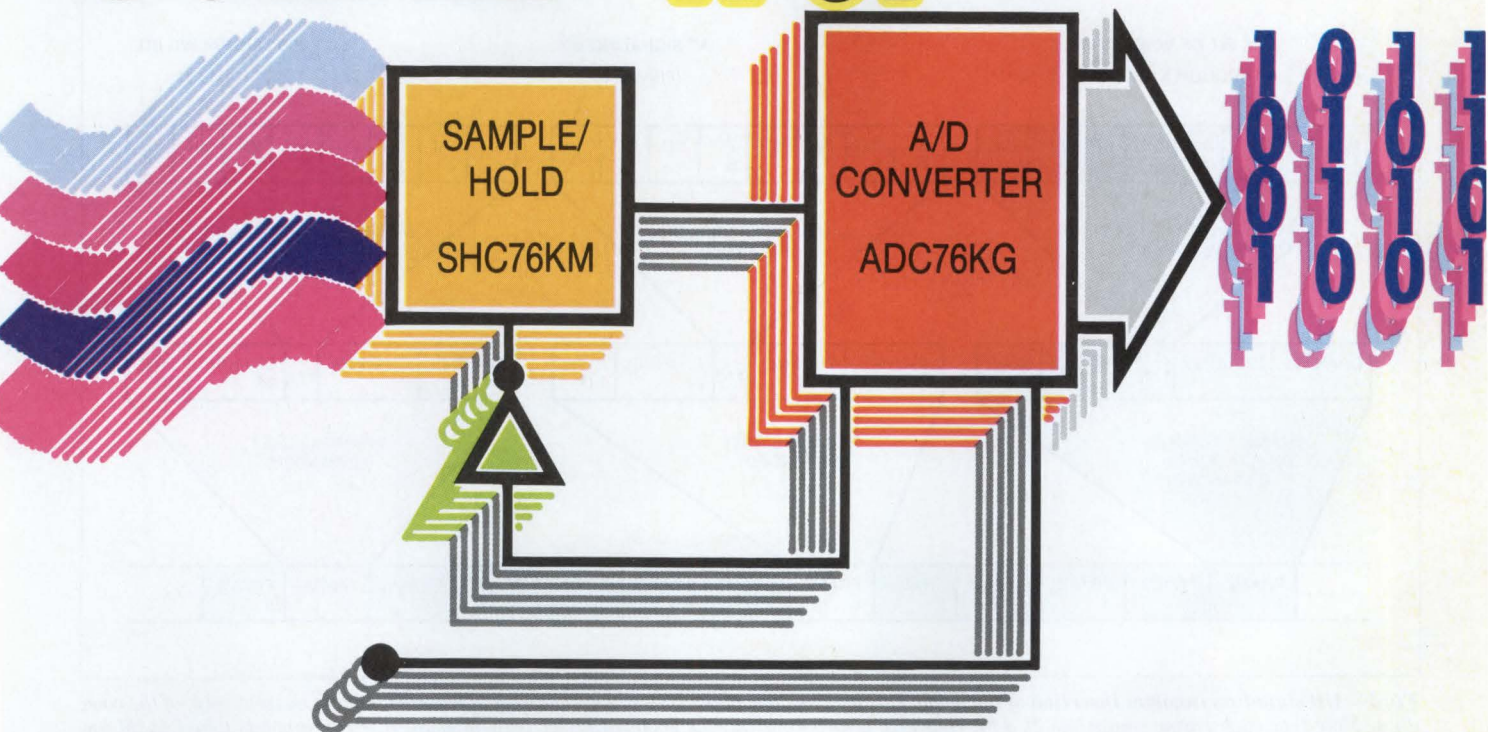

High Performance A/D Converters and Sample/Holds At The Industry's Lowest Prices!

You can specify high resolution digitizing systems costing two or three times as much without getting better performance or quality. Put our new SHC76 in front of any of these three leading ADCs and you'll get all the speed, accuracy, and reliability you need for your spectrum analysis or other digital signal processing applications.

Consider these outstanding features:

Fast Sample/Hold—SHC76

- 4 μ s acquisition time (14 bits)
- 400ps max "jitter"
- <250mW power dissipation
- 0/+70°C, -25/+85°C temp ranges
- From \$52 (SHC76KM)*

High Performance A/D Converter—ADC76

- 16-bit resolution
- 17 μ s max conversion time
- $\pm 0.003\%$ max linearity error
- Serial and parallel ports
- From \$99 (\$119 for ADC76KG)*

Special Audio A/D Converter—PCM75

- 16-bit resolution
- 17 μ s max conversion time (16 bits)
- 96dB dynamic range
- 0.004% total harmonic distortion ($V_{IN} = \pm FS$)
- From \$87 (PCM75JG)*

Low Cost 16-Bit A/D Converter—ADC71

- 16-bit resolution
- 50 μ s max conversion time (14 bits)
- $\pm 0.003\%$ max linearity error
- Serial and parallel ports
- From \$63 (ADC71JG)*



Ask your sales representative for complete details on these low cost, high performance digitizing solutions, or contact Applications Engineering, 602/746-1111. Burr-Brown Corp., P.O. Box 11400, Tucson, AZ 85734.

*U.S. prices, in hundreds.

CIRCLE NO 68

BURR-BROWN®
BB

Improving Data Conversion
Productivity

The μ -law characteristic is the standard for the North American and Japanese telephone networks, whereas the A-law is the standard in Europe.

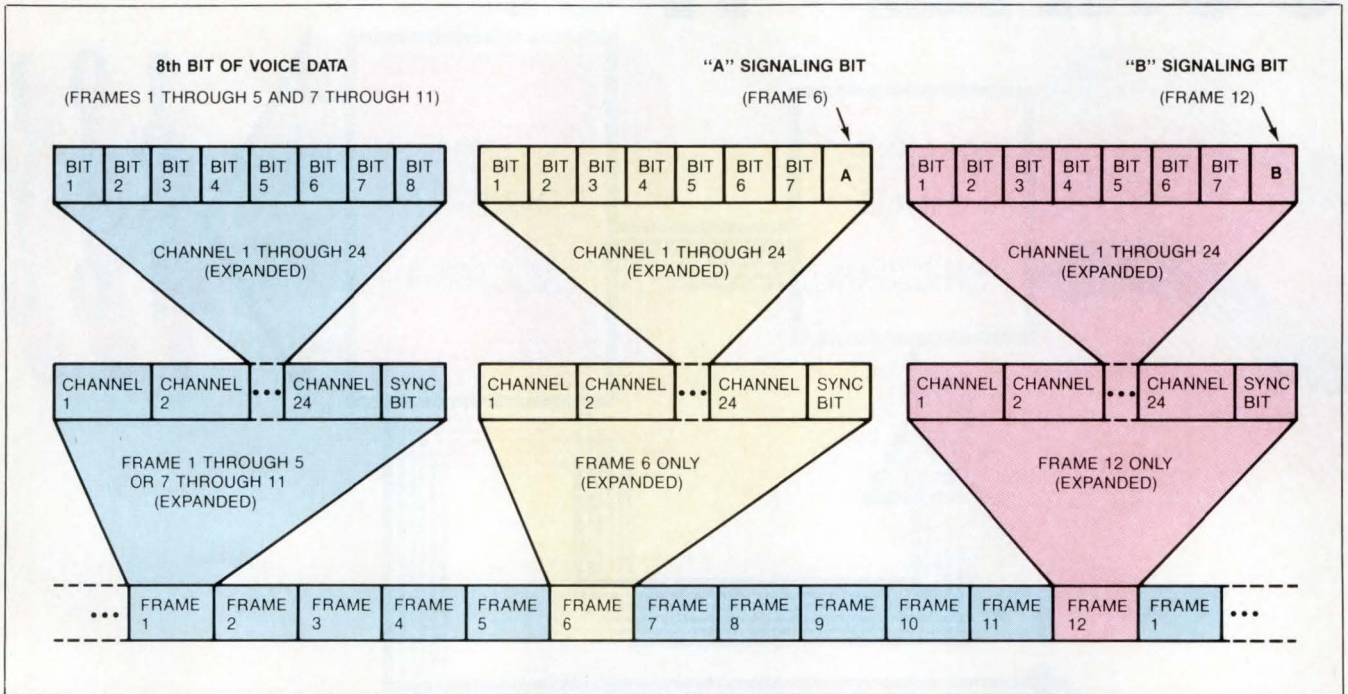

Fig 3—A/B signaling involves insertion of the A and B signaling data in the LSB of each channel in frames 6 and 12, respectively, of the voice data. Note that each frame comprises 24 8-bit channels plus a sync bit; the 8000-frame/sec transmission rate corresponds to a 1.544-Mbps rate.

tained from a survey of 20 codecs. (Most, but not all, were CMOS; for devices offering both power-down and standby modes, the mode offering the lower power consumption was used.)

Stable, on-chip voltage reference: Just about every codec has its own internal voltage reference or references for performing the A/D or D/A conversion. The voltage references determine, in part, the gain and dynamic-range characteristics of the codec. A few codecs allow you either to provide an external reference or to use an on-chip reference, and at least one codec requires an external reference. Normally, it's desirable to eliminate this external circuitry and select a codec that already has the voltage references built in. Nevertheless, you might encounter a special application that would benefit from an external voltage reference.

Low external parts count: Another standard feature to expect is a low external parts count. Most codecs require from zero to four external parts, such as resistors and capacitors. These external parts are typically used for setting a fixed transmit gain. The need for few external parts makes the design engineer's job almost trivial when he or she is designing these codecs into large systems.

Autozero circuit: The autozero circuit cancels any dc

offset that may be present on the input signal to the encoder. The technique used to perform the autozero function is referred to as the sign-bit averaging technique. The sign bit from the output of the encoder is long-term averaged and subtracted from the input to the encoder. In this manner, any long-term dc offset is canceled. At least one codec allows the user to enable or disable autozero operation by simply adding or removing a 0.1- μ F capacitor between two pins.

A-law and μ -law selection: Codec manufacturers allow you to select between the μ -law and the A-law companding characteristics in one of three ways. First, many manufacturers offer the same codec in either the μ -law or the A-law version. The pinouts are identical; should the need arise, you could switch from one companding characteristic to the other simply by swapping parts. Second, some manufacturers offer codecs that each include an input pin that you can drive high or low to select one characteristic or the other. Finally, some codecs—only the more advanced ones—allow you to use software codes to select the characteristic you want.

Power-supply operation of $\pm 5V$ dc: The standard power-supply voltages for codecs tend to be $\pm 5V$ dc, as you would expect, because codecs must interface with

SPEED WITHOUT COMPROMISE

**PMI's OP-42
Guarantees
Fast Settling
Plus DC Precision**

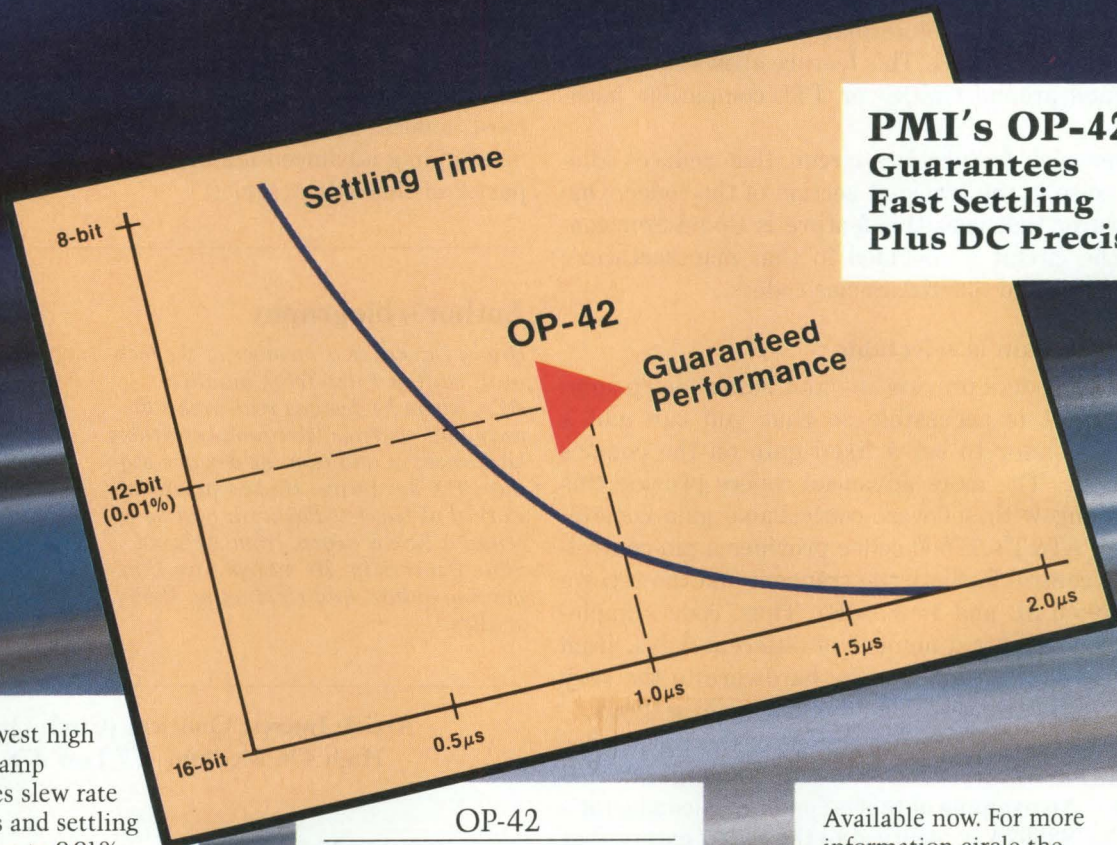

PMI's newest high speed op amp guarantees slew rate of $50\text{V}/\mu\text{s}$ and settling time of $1\mu\text{s}$ to 0.01% . With its 10MHz gain bandwidth and 850kHz full power BW, the OP-42 combines high speed with accurate DC performance.

OP-42

V_{OS}	$750\mu\text{V}$	Max
A_{VOL}	500,000	Min
CMR	88dB	Min
TCV_{OS}	$10\mu\text{V}/^\circ\text{C}$	Max

Guaranteed unity gain stability, capacitive load tolerance, and clean transient response make the OP-42 easy to use . . .

. . . with only 6mA of supply current max.

Available now. For more information circle the inquiry number or call us. 1-800-843-1515. In California, call 1-800-826-9664.

Precision Monolithics Inc.
A Bourns Company
Santa Clara, California, USA
408-727-9222

ANAHEIM: (714) 666-0140, LOS ANGELES: (818) 886-6881, SANTA CLARA: (408) 727-6616,
DALLAS: (214) 341-1742, CHICAGO: (312) 885-8440, ATLANTA: (404) 263-7995,
PHILADELPHIA: (215) 675-7600, BOSTON: (617) 794-0026



The precision solution.

Codecs that offer just the standard features cost somewhere between \$4 and \$6 each in quantities of 10,000.

digital logic that is typically driven by 5V levels.

These standard features are the ones that you can expect to run across in almost every codec that is currently available. However, you'll often encounter a few other features that don't qualify as advanced, but are not common enough to be considered standard.

One such feature is Motorola's pin-selection of TTL and CMOS digital levels. This feature allows the chip to be designed around CMOS- or TTL-compatible hardware.

Another such feature is a circuit that reduces idle-channel noise in the transmit section of the codec. One manufacturer that uses this feature is Gould Semiconductor; the circuit is included in that manufacturer's S3506, S3507, and S3507A Series codecs.

Input-buffer gain is selectable

Almost all codecs provide an input buffer (an op amp) whose output is accessible so that you can add a feedback resistor to set a fixed gain on the codec's analog input. The more advanced codecs provide this feature along with software-controllable gain control. Moreover, AT&T's T7500 codec provides a pin-controllable gain control for both the transmit and the receive sections (0=0 dB and 1=+3 dB). Thus, codecs implement gain control in a number of different ways, from the very basic fixed gain set by hardware to the very advanced software-controlled dynamic gain settings.

Some codecs have special versions of the basic codec that allow for what's called "8th-bit signaling" or "A/B signaling." An example of this is Gould Semiconductor's S3507. The S3507A is identical to the S3507 except that it provides A/B signaling.

Hide data signals in the voice

A/B signaling is simply a method by which signaling data is transmitted and received along with voice data. Signaling data could indicate (but is not limited to) hook status, loop closure, pulse dialing, or ring detection. A/B signaling need not be used with devices that support it. The disadvantage of using A/B signaling is that the signaling data is inserted in the least significant bit (LSB) of every 6th frame of the voice data, thus causing a slight increase in idle-channel noise and a slight decrease in the S/N ratio.

The A signal is inserted in frame 6, and the B signal is inserted in frame 12. Because the voice data is sampled 8000 times per second, a frame is 125 μ sec in length, and therefore the A and B signaling data are each updated once every 1.5 msec (1.5 msec=125 μ sec/

frame \times 12 frames). This scheme is shown in Fig 3.

An additional feature found on some codecs is a power amplifier in the analog output of the receive section. The amplifier provides a push-pull balanced output drive across a 600 Ω load. Some applications may need this added drive capability. One codec that provides this feature is the National TP3064 codec/filter combo.

The standard and nonstandard features thus far discussed are the ones that you're likely to encounter on most codecs. However, a few new codecs offer some outstanding advanced features. They'll be discussed in part 2 of this 2-part series.

EDN

Author's biography

Brady Barnes is a member of the technical staff at Inter-Tel (Chandler, AZ), where he designs real-time software that controls telecommunications hardware; in addition, he designs digital-PBX hardware. He has previously worked at Hewlett-Packard, and he received a BSEE degree from Arizona State University. He enjoys traveling, playing guitar, and conducting Bible studies.

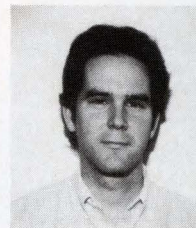

Article Interest Quotient (Circle One)
High 476 Medium 477 Low 478

We didn't get to be a major opto supplier by building minor products.



The fact is, we've been building industry leading optoelectronic products for over a decade. We've also built a reputation for creating products which consistently provide high performance and reliability.

Like our new alphanumeric intelligent displays featuring a CMOS IC containing ROM, RAM, decoder and drivers, with an ultra-fast 50 ns access time.

And the industry's widest selection of dot matrix displays which provide

unmatched brightness and uniformity with single, dual and tri-colored capabilities.

We also produce visible and infrared discrete components, custom visible display modules, surface mount LEDs and over 40% of the world's clock displays.

And because we are totally vertically integrated with major automated offshore manufacturing facilities, we have unlimited custom design and production capabilities.

So, if you need reliable, innovative

optoelectronic products, give us a call to get the name of the distributor or sales representative in your area. We'll show you why you should make Lite-On your major opto supplier.

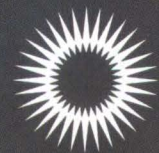

LITE-ON

Optoelectronics Products
M.S. 570
4951 Airport Parkway
Dallas, Texas 75248
(214)-239-3565



**This
publication is
available in
microform.**

University Microfilms International reproduces this publication in microform: microfiche and 16mm or 35mm film. For information about this publication or any of the more than 13,000 titles we offer, complete and mail the coupon to: University Microfilms International, 300 N. Zeeb Road, Ann Arbor, MI 48106. Call us toll-free for an immediate response: 800-521-3044. Or call collect in Michigan, Alaska and Hawaii: 313-761-4700.

**University
Microfilms
International**

EDN043087

Please send information about these titles:

Name _____

Company/Institution _____

Address _____

City _____ State _____ Zip _____

Phone () _____

Graphic proof of high-tech leadership.

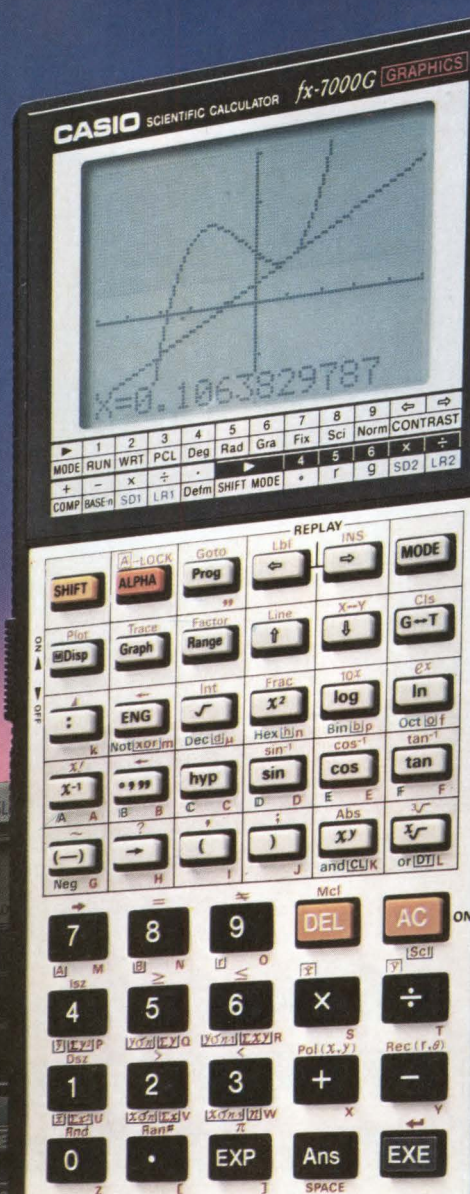

The Casio fx-7000G \$79.95. It's the world's first programmable scientific calculator with a graphic display. The only calculator that can give form to your figures, instantly drawing graphs that represent your formulas and calculations on its big LCD screen.

And with a screen measuring 16 characters by 8 lines,

the fx-7000G can display enough information for some of your biggest ideas. The formula or graph can then be stored and, when needed, brought back for an instant replay.

The fx-7000G has 193 total functions—including linear regression, standard deviation, as well as binary, octal and hexadecimal calculations—making it useful in virtually any scientific or technical endeavor.

In fact, without requiring computer knowledge—or costing computer dollars—the fx-7000G, with its 422 step memory, performs many

functions you'd otherwise find only on a computer.

If you need even more power, our fx-8000G (\$109.95) techs you even higher, with 1,446 memory steps and 255 functions. Plus, when hooked up to our optional FA-80 interface, the fx-8000G will work with most any dot matrix printer or plotter that has a parallel port.

If you have any doubt as to who's the leader in high-tech calculators, simply pick up an fx-7000G or fx-8000G and draw your own conclusions.

CASIO
Where miracles never cease

CIRCLE NO 87

Casio, Inc. Consumer Products Division: 15 Gardner Road, Fairfield, N.J. 07006
New Jersey (201) 882-1493, Los Angeles (213) 803-3411

fx-8000G

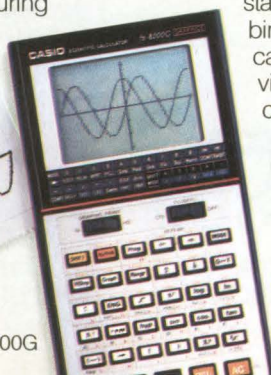

A REAL BREAKTHROUGH IN SWITCHING REGULATORS.

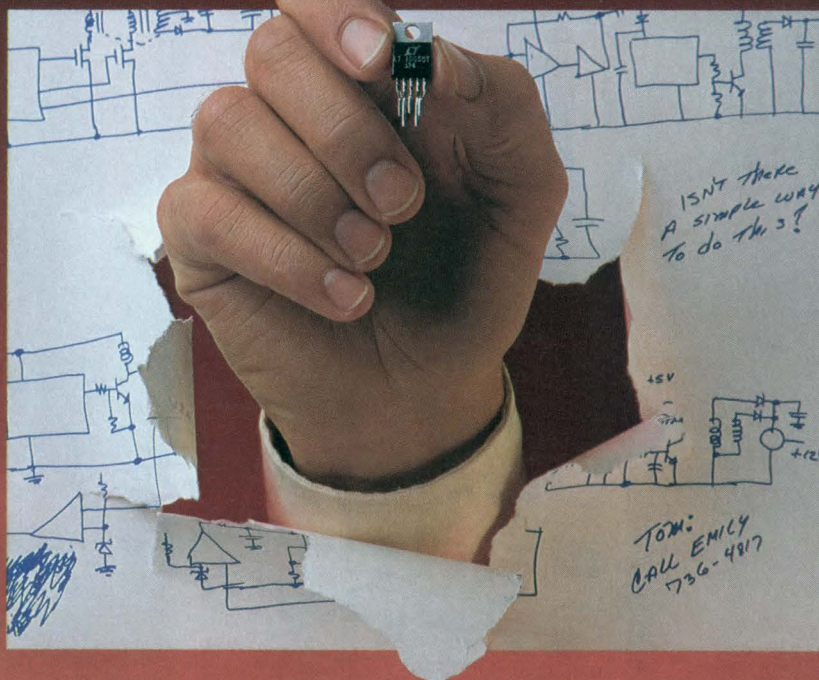

Linear Technology delivers a new all-in-one punch with its complete family of easy-to-use, monolithic switching regulators. This group of devices includes the LT1070 (5A), LT1071 (2.5A), and LT1072 (1.25A).

There's no more worry about possible board burn-up or using a large area of space for external parts. The LT1070 series operates safely from 3 to 60 volts—while drawing a very low supply current of 6 milliamps. The LTC switching regulator family simplifies design and reduces the board space needed for most applications because they contain all switching, protection and control circuitry (including the power transistor) *on a single chip*.

The LT1070 family packs a real wallop by delivering load power up to 100 watts, with no external power devices, yet are extremely efficient even at low power levels. By utilizing current-mode switching techniques, these devices provide excellent AC and DC load and line regulation. They operate in nearly all switching topologies. And in the

Boost Converter (5V to 12V)

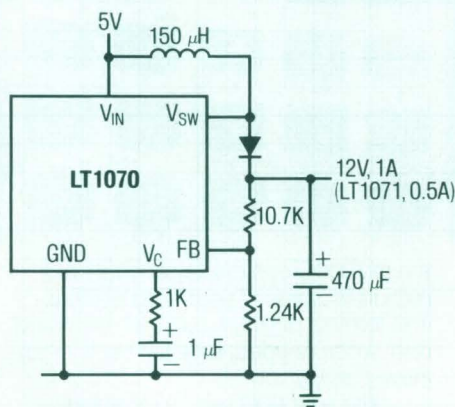

shutdown mode, the ICs draw only 50 μ A supply current.

This highly versatile family operates over an extremely broad range of input voltages, load currents and switching configurations. Switching configurations include: buck, boost, flyback, forward, inverting, and "Cuk."

These regulators offer many unique features not found on vastly more difficult-to-use low-power control chips on the market. All devices use an adaptive, anti-saturation circuit for high switching efficiency and fast switching times. The LT1070 (and the LT1071/72 versions) are available in either standard 5-pin TO-3 or TO-220 power packages.

Take the sweat out of switching regulator design with the new LTC1070/71/72 family. Pricing for LT1070CT is \$7.45 each in quantities of 100 (LT1071CT is \$5.70 ea./100). The LT1072 will be available in the first quarter of 1987. For additional technical details, contact: LINEAR TECHNOLOGY CORPORATION, 1630 McCarthy Blvd. Milpitas, CA 95035. (408) 942-0810.



TOUGH PRODUCTS
FOR TOUGH APPLICATIONS.

CIRCLE NO 115

DESIGN IDEAS

EDITED BY TARLTON FLEMING

Diodes and capacitors imitate transformer

Rudy Stefenel

Luma Telecom, Santa Clara, CA

The diode-capacitor network of **Fig 1** accepts low current at a high voltage and delivers higher current at a lower voltage, behaving like a step-down transformer. You drive the circuit with a square-wave input signal as shown.

When the input is at its peak voltage, V_P , current through D_{10} , D_7 , D_4 , and D_1 charges series capacitors C_4 , C_3 , C_2 , and C_1 . The voltage on each capacitor reaches approximately $\frac{1}{4}(V_P - 4V_F)$, where V_F is the forward-voltage drop across one diode. However, the total output voltage doesn't equal the sum of the voltages on the four capacitors; it's less than that by two diode drops. Consequently, the circuit is inefficient for low-amplitude drive signals (too much voltage is lost across the diodes).

For 15V and 60V p-p inputs, the circuit's corresponding outputs are approximately $-1.65V$ and $-12.9V$, depending on the load. An input of 28V p-p produces about $-5V$. Notice that the square-wave generator must sink more current than it sources: It charges the capacitors in series, but discharges them in parallel.

When the input terminal switches to 0V, it connects the capacitors in parallel by pulling the positive side of each capacitor near 0V. The capacitor voltages then produce current flow that creates a negative charge across the load capacitor (C_L). The voltages on C_3 , C_2 , and C_1 each charge C_L through two diodes in series, but the charging path through C_4 has only one diode, D_{11} . This configuration results in a higher surge current through D_{11} and C_4 and a slightly higher negative output voltage, unless you add a diode in series with D_{11} .

You can change the output voltage by adding or subtracting sections; C_1 , D_1 , D_3 , and D_2 constitute one section, for example. Make the series capacitors equal in value and the total value of these capacitors equal to the load capacitor:

$$C_L = \frac{I}{2V_R f},$$

where I is the load current, V_R is the maximum allowed p-p ripple voltage, and f is the input frequency. **EDN**

To Vote For This Design, Circle No 748

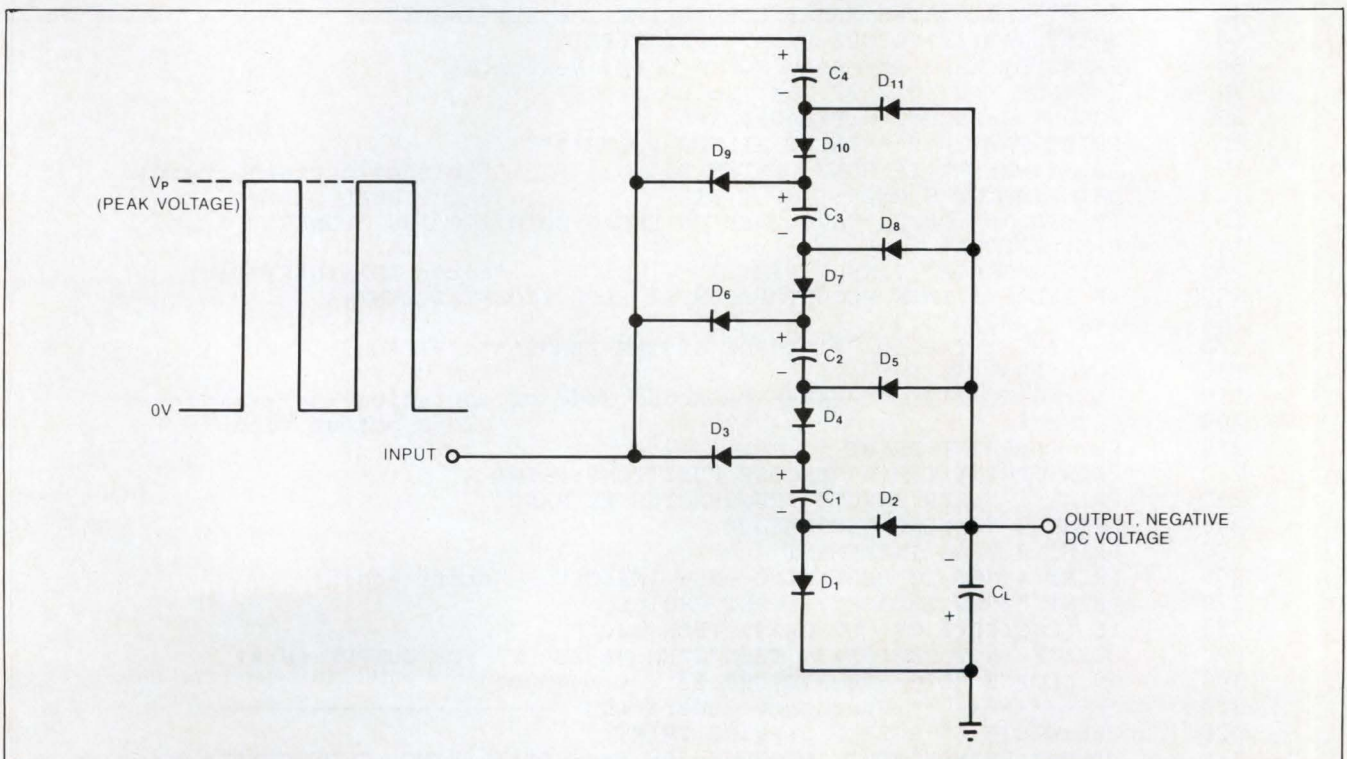

Fig 1—This diode-capacitor network converts an input square wave to a negative dc voltage.

Compute magnitude, phase, and group delay

Marc Thompson
For-A Corp, Newton, MA

The IBM PC Basic program of **Listing 1** calculates the magnitude, phase, and group delay for a transfer function with any reasonable number of poles and zeros. You can use the program in the design of analog video filters in which you must minimize group-delay ripple in the passband to avoid picture degradation.

The program first prompts you for the pole and zero locations (each of which you enter in terms of a real and an imaginary quantity), and then it asks you to choose a mode of operation.

For mode 1, you enter each frequency manually and get an (almost) immediate response in the following form:

FREQ (Hz)	MAG	dB	ANGLE (deg)	DELAY (sec)
4.0000E+06	0.99821	-0.0165	-120.05	1.0771E-07

For mode 2, you define a range of frequencies by entering a low and a high value plus a linear increment. The program then calculates the input frequencies automatically and displays data for each.

For mode 3, you define a range of frequencies in the same way as mode 2, but you enter a multiplicative constant for the frequency increment. This mode is useful for generating data on a log scale over several decades of frequency.

For modes 2 and 3, the program-execution time varies with the number of frequency values and the number of singularities (poles and zeroes) in the transfer function. Using an IBM PC/XT, for example, you can generate data for a function with six zeroes and seven poles, for 50 frequencies, in less than two minutes.

EDN

To Vote For This Design, Circle No 746

LISTING 1—IBM BASIC PROGRAM

```

10 DIM P(100) '-----Data Input-----
20 SCREEN 1:COLOR 1:PI=3.14159
30 PRINT"**Given Pole and Zero Locations**":PRINT
40 PRINT"CALCULATES MAGNITUDE":PRINT TAB(12)"ANGLE"
50 PRINT TAB(12)"GROUP DELAY":PRINT:PRINT
60 PRINT"By Marc Thompson FOR-A Corp. Newton,MA"
70 X=0:FOR X=0 TO 2222:NEXT X:CLS
80 PCOUNT=0:ZCOUNT=0:PFLAG=1:X=0
90 PRINT TAB(10)"***INPUT FILTER POLES***"
100 PRINT:PRINT"(IF NONE, ENTER D)" 'finished entering POLES?
110 PRINT:PRINT"SIGMA";:INPUT P$ 'enter REAL part
120 IF (P$="D" OR P$="d") THEN ON PFLAG GOTO 170,190 'DONE?
130 P(X)=VAL(P$)
140 PRINT "OMEGA";:INPUT P(X+1) 'enter IMAGINARY part
150 IF PFLAG=1 THEN PCOUNT=PCOUNT+1 ELSE ZCOUNT=ZCOUNT+1
160 X=X+2: GOTO 110
170 CLS:PRINT TAB(10)"***INPUT SYSTEM ZEROS***":PFLAG=2
180 GOTO 100
190 CLS: GOTO 210 '-----Choose Mode of Operation-----
200 CLOSE #1 'close output file
210 KEY ON:PRINT:PRINT
220 PRINT:PRINT TAB(6)"CHOOSE FUNCTION":PRINT
230 PRINT 1 "USER INPUTS FREQUENCIES BY HAND"
240 PRINT 2 "LINEAR INCREMENT"
250 PRINT 3 "LOG INCREMENT"
260 PRINT 4 "GO TO BEGINNING--NEW INPUTS" 'start again
270 PRINT "YOUR CHOICE";:INPUT CHOICE
280 IF (CHOICE<1 OR CHOICE>4) THEN 230
290 CLS:IF (NOT CHOICE>3) THEN OPEN "A:ZIPPY" FOR OUTPUT AS #1
300 ON CHOICE GOTO 320,370,390,20
310 '-----Frequency Generation-----
320 CLS:WIDTH 80:SCREEN 0:PRINT:PRINT
330 DISP=1:PRINT"INPUT FREQUENCY IN Hz---***IF DONE, TYPE D***".

```

Listing continued on pg 226

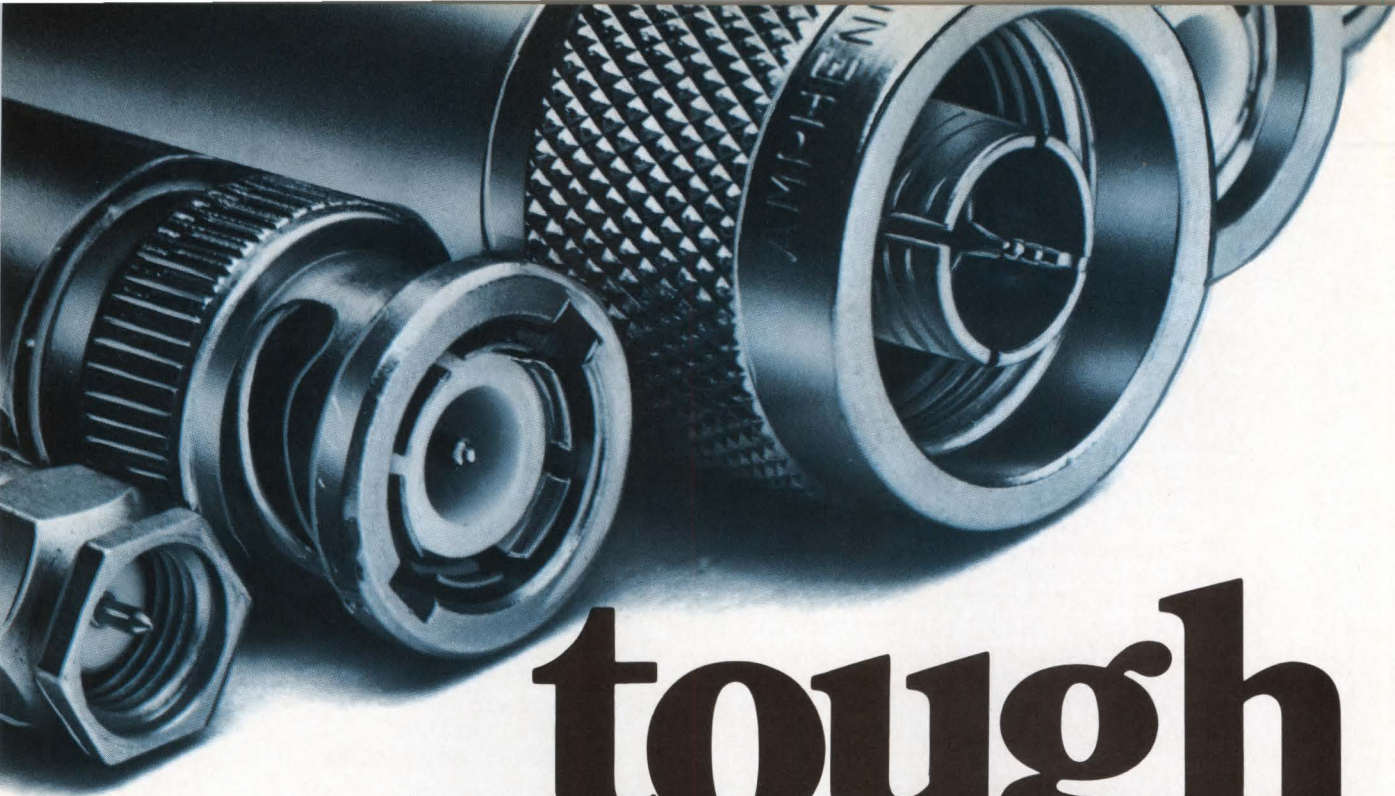

tough attenuators

\$11.95
from (1-49)

one-piece design defies rough handling

Check these features:

- ✓ Each unit undergoes high-impact shock test
- ✓ Available from 1 to 40 dB
- ✓ DC to 1500 MHz
- ✓ Unexcelled temperature stability, .002 dB/°C
- ✓ 2W max. input power (SMA is 0.5W)
- ✓ BNC, SMA, N and TNC models
- ✓ Immediate delivery, 1-yr. guarantee

NEW!

Precision 50-ohm terminations ... only \$6.95 (1-24)
DC to 2 GHz, 0.25W power rating, VSWR less than 1.1
BNC (model BTRM-50), TNC (model TTRM-50)
SMA (model STRM-50), N (model NTRM-50)

finding new ways ...
setting higher standards

Mini-Circuits

A Division of Scientific Components Corporation
P.O. Box 166, Brooklyn, New York 11235 (718) 934-4500
Domestic and International Telexes: 6852844 or 620156

*Freq. (MHz)	Atten. Tol. (Typ.)	Atten. Change, (Typ.) over Freq. Range		VSWR (Max.)	
		DC-1000	1000-1500	DC-1000 MHz	1000-1500 MHz
DC-1500 MHz	±0.3	0.6	0.8	1.3	1.5

*DC-1000 MHz (all 75 ohm or 30 dB models) DC-500 MHz (all 40 dB models)

MODEL AVAILABILITY

Model no. = a series suffix and dash number of attenuation.

Example: CAT-3 is CAT series, 3 dB attenuation.

■ denotes 75 ohms; add -75 to model no.

● denotes 50 ohms

ATTEN	SAT (SMA)	CAT (BNC)	NAT (N)	TAT (TNC)
1	●	●	●	●
2	●	●	●	●
3	●	●■	●	●
4	●	●■	●	●
5	●	●	●	●
6	●	●■	●	●
7	●	●	●	●
8	●	●	●	●
9	●	●	●	●
10	●	●■	●	●
12	●	●	●	●
15	●	●■	●	●
20	●	●■	●	●
30	●	●	●	●
40	●	●	●	●

PRICING (1-49 qty.): CAT (BNC)..\$11.95, SAT (SMA)..\$14.95
TAT (TNC)..\$12.95, NAT (N)..\$15.95

C 92 REV. B

DESIGN IDEAS

LISTING 1—IBM BASIC PROGRAM (Continued)

```
340 INPUT START$:IF (START$="D" OR START$="d") THEN 200
350 START=VAL(START$):RFREQ=2*PI*START
360 GOTO 500 'start calculation
370 DISP=1:PRINT"GENERATES FREQUENCIES":PRINT "USING LINEAR INCREMENT"
380 GOTO 400
390 DISP=1:PRINT"GENERATES FREQUENCIES":PRINT"USING LOG INCREMENT"
400 PRINT:PRINT"STARTING FREQUENCY";:INPUT START
410 IF START<0 THEN 400 'for MISTAKE
420 PRINT:PRINT"ENDING FREQUENCY";:INPUT LAST
430 IF START>=LAST THEN 400 'for MISTAKE
440 PRINT:PRINT"INCREMENT";:INPUT INC
450 PRINT:LINE INPUT"TITLE FOR GRAPH?";TITLE$
460 CLS:WIDTH 80:SCREEN 0:GOTO 490
470 IF CHOICE=2 THEN START=START+INC ELSE START=START*INC
480 IF START>LAST THEN 200
490 RFREQ=2*PI*START
500 X=0:PC=PCOUNT:POLE=1 '-----Singularity Calc.-----
510 MAG=1:ANGLE=0:DELAY=0 'initial values
520 IF NOT PC=0 THEN 550 'if done, goto ZERO
530 PC=ZCOUNT:POLE=2
540 IF PC=0 THEN 740 'if done, goto display
550 SIGMA=P(X):OMEGA=P(X+1)
560 IF SIGMA=0 THEN 710 'pole or zero on j-axis
570 M=RFREQ-OMEGA:P=M:M=M*M 'calc. temp. magnitude
580 M=M+SIGMA*SIGMA:M=SQR(M)
590 K=SIGMA*SIGMA+OMEGA*OMEGA:K=SQR(K)
600 SIGMA=-1*SIGMA:P=P/SIGMA:D=P
610 P=57.296*ATN(P) 'calc. temp. phase angle
620 D=D*D+1:D=D*SIGMA:D=1/D 'calc. temp. group delay
630 IF POLE=2 THEN 670
640 MAG=MAG*K/M 'for POLE
650 ANGLE=ANGLE-P
660 DELAY=DELAY+D:X=X+2:PC=PC-1:GOTO 520
670 MAG=MAG*M/K 'for ZERO
680 ANGLE=ANGLE+P
690 DELAY=DELAY-D:X=X+2:PC=PC-1:GOTO 540
700 '-----SINGULARITY AT ORIGIN OR J-AXIS-----
710 IF (RFREQ-OMEGA)>0 THEN P=90 ELSE P=-90
720 M=RFREQ-OMEGA: IF OMEGA=0 THEN K=1 ELSE K=OMEGA
730 D=0:ON POLE GOTO 640,670
740 IF DISP=0 THEN 830 '-----Display-----
750 IF CHOICE=1 THEN 760 ELSE PRINT #1,DATE$:PRINT #1,TIME$:PRINT #1,TITLE$
760 PRINT #1,:PRINT #1,"FREQ.(Hz)" TAB(22); 'to output file
770 PRINT:PRINT"FREQ.(Hz)"TAB(22); 'to monitor display
780 PRINT #1,"MAG."TAB(40);:PRINT"MAG."TAB(40);
790 PRINT #1,"dB"TAB(50);:PRINT"dB"TAB(50);
800 PRINT #1,"ANGLE(deg.)"TAB(65);:PRINT"ANGLE(deg.)"TAB(65);
810 PRINT #1,"DELAY(sec.)"::PRINT"DELAY(sec.)":PRINT
820 DISP=0:PRINT:PRINT #1, 'don't display head
830 PRINT #1,USING"###.###^";START;:PRINT #1,TAB(17);
840 PRINT USING"###.###^";START;:PRINT TAB(17);
850 PRINT #1, USING"#####.#####";MAG;:PRINT #1,TAB(35);
860 PRINT USING"#####.#####";MAG;:PRINT TAB(35);
870 IF MAG=0 THEN 960
880 MAG=ABS(MAG):DB=20*LOG(MAG)/LOG(10)
890 PRINT USING"#####.#####";DB;: PRINT TAB(50);
900 PRINT #1,USING"#####.#####";DB;:PRINT #1,TAB(50);
910 PRINT #1,USING"#####.###";ANGLE;:PRINT #1,TAB(65);
920 PRINT USING"#####.###";ANGLE;:PRINT TAB(65);
930 PRINT #1,USING"###.###^";DELAY
940 PRINT USING"###.###^";DELAY
950 ON CHOICE GOTO 330,470,470
960 PRINT #1,"-INFINITY"TAB(50); 'for MAG=0, dB=-INF
970 PRINT "-INFINITY"TAB(50);:GOTO 910
980 END
```

Looking for bargains in top quality peripherals? We've got your number.

Industry Standard SCC now in CMOS

The 8 MHz Z8530 combines the features of its popular NMOS counterpart with the low-power benefits of CMOS.

- Pin compatible with NMOS version
- Dual-channel/multi-protocol
- 40-pin DIP & 44-pin PLCC

\$11.10*

High integration, high value

The Z8536 CIO incorporates I/O and counter/timers in one chip.

- 2 and 1/2 parallel ports
- Three 16-bit counter/timers
- IEEE-488 compatible
- 4 handshake modes

\$4.30*

Ideal link between CPUs of different speeds

The Z8038 FIO is a skilled arbitrator with high-speed transfer logic.

- 128 x 8 asynch. bidirectional FIFO
- Bus or handshake-driven I/O
- Expandable with Z8560/Z8060

\$8.70*

Offload your CPU

The Z9516 DTC is a low cost, full-feature 2-channel DMA controller.

- 16 Mbyte addressing range
- Flowthrough and flyby mode
- Command chaining and pattern match logic
- Byte or word-oriented transfers

\$11.80*

The standard FDC for PCs

Because Zilog is the volume manufacturer, the Z765A is the most cost effective FDC on the market today.

- Supports FM and MFM
- PLCC and DIP packaging
- Supports up to 4 floppies

\$2.90*

The standard for mid-range graphics

The Z7220A GDC supports high-performance computer graphics systems.

- Simultaneous alphanumeric and graphics display
- Bit-mapped graphics
- Available in 6 & 8 MHz

\$10*

Encrypt/decrypt your data

The Z9518 Data Ciphering Processor is designed with three registers/master keys for improved security and throughput.

- National Bureau of Standards algorithms
- 3 standard ciphering modes
- Data rates greater than 1 Mbyte/sec
- Available in Z8068 version

\$23.60*

NMOS 5380 compatible

The CMOS Z5380 SCSI Controller is the low power alternative to AMD and NCR devices - it gives you CMOS at NMOS prices.

- Standard ANSI X3T9-2 protocol
- Initiator & Target modes
- Arbitration & programmable DMA

\$10.50*

Zilog's impressive family of peripherals includes some of the most popular in the industry. That's not surprising. A rapidly growing number are available in CMOS, and most are available in space saving PLCC versions. Plus they're compatible with all major 8-, 16- and 32-bit applications. Not to mention highly competitive prices, off-the-shelf delivery, and Zilog's solid

reputation for the highest quality. Nobody offers more universal peripherals than we do. So if you don't find what you need "on sale" here, contact your local Zilog sales office or your authorized distributor today. We've got your number. Zilog, Inc./210 Hacienda Avenue/Campbell, CA 95008-6609/(408) 370-8000.

*Prices based on volume, lowest priced package.

Right product. Right price. Right away.

ZILOG SALES OFFICES: CA (408) 370-8120, (714) 432-9971, (818) 707-2160, CO (303) 494-2905, FL (813) 585-2533, GA (404) 451-8425, IL (312) 885-8080, MA (617) 273-4222, MN (612) 831-7611, NJ (201) 288-3737, (609) 778-8070, OH (216) 447-1480, TX (214) 231-9090, CANADA Toronto (416) 673-0634, ENGLAND Maidenhead (44) (628) 392000, W. GERMANY Munich (49) (89) 612-6046, JAPAN Tokyo (81) (3) 587-0528, HONG KONG Kowloon (852) (3) 723-8979, R.O.C.: Taiwan (886) (2) 731-2420, U.S. AND CANADA DISTRIBUTORS: Alliance Elec., Anthem Electric., Bell Indus., Graham Elec., Hall-Mark Elec., JAN Devices Inc., Lionex Corp., Schweber Elec., Western Microtech., CANADA Future Elec., SEMAD.

Zilog
an affiliate of
EXON Corporation

Multiplexed S/H amplifiers hide glitches

Paul Swearingen
National Semiconductor, Santa Clara, CA

The circuit of **Fig 1** switches between the outputs of two low-cost sample/hold (S/H) amplifiers, thereby masking the glitches and slew-rate distortion of each. What's more, the circuit provides twice the sampling rate possible with one sample/hold amplifier alone.

Fig 2's scope photo compares the output of the circuit (trace D) with that of a typical LF398 S/H amp (trace C). Notice the undershoots, overshoots, ringing, and slew-rate limiting associated with each sampling interval in trace C. Most of these aberrations are absent in trace D because IC₃, the analog switch of **Fig 1**, disconnects each S/H amp during its noisy sample mode. The switch always connects the circuit output to an S/H amp that's in a quiet hold mode.

The digital ICs in **Fig 1** generate properly timed control signals for the S/H amplifiers and analog switch

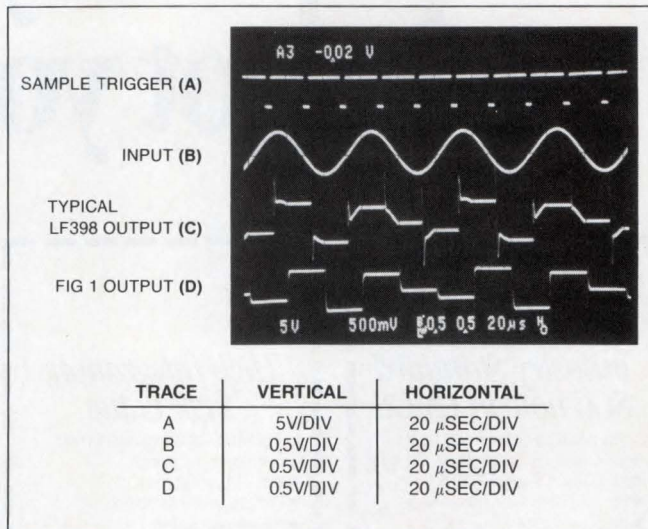

Fig 2—This scope photo compares **Fig 1's** output (trace D) with the noisier output of a typical LF398 sample/hold amplifier (trace C). Both circuits are sampling a 20-kHz sine wave.

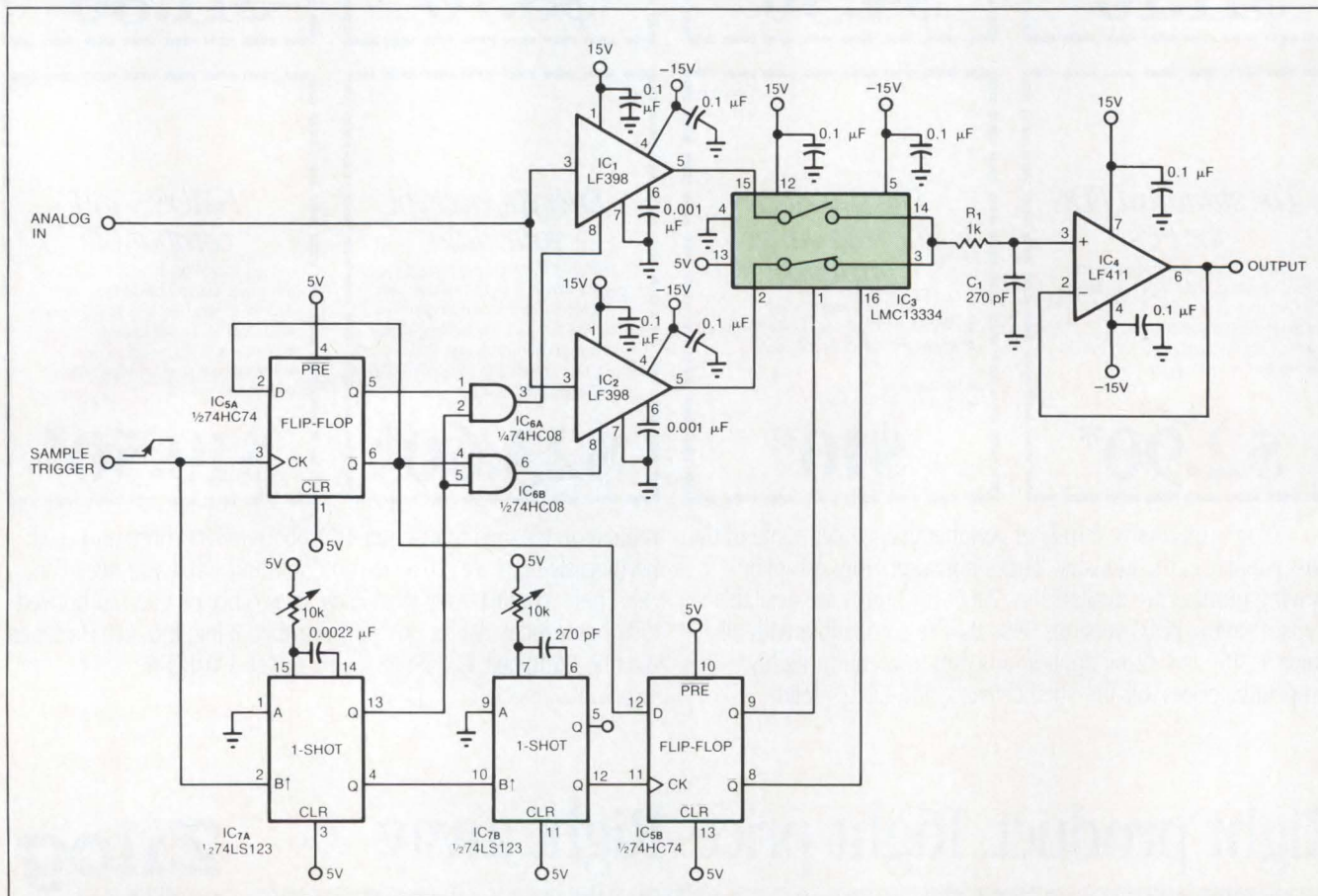

Fig 1—By using a switch (IC₃) between two sample/hold amplifiers, you can avoid passing the devices' sample-mode aberrations to the output. The sample/hold amp driving the output amplifier is always in the hold mode.

B I G E N O U G H T O C A R E
T O C O P E
S M A L L E N O U G H
T O C A R E

B I G E N O U G H T O C O P E
S M A L L E N O U G H
T O C A R E

Driver circuits that spoil you for choice. Intelligence and power on one chip. Load fault indication as well, with high current sink or source capability. Your pick of resistive or conductive loads up to 2 A. PBD 3545 and 3548 – the drivers tough enough for what you have in mind.

- built-in protection diodes
 - short circuit protection/detection
 - open circuit detection
 - LS-TTL, CMOS compatible inputs
 - 5–45 V operating voltage
 - TO 220, 5-pin package
- from

RIFA

RIFA AB, S-163 81 STOCKHOLM, SWEDEN, TEL 08-757 50 00
TELEX 13890 ELRIFA-S, TELEFAX 08-752 60 34



DESIGN IDEAS

(Fig 3). The monostable multivibrator IC_{7A} sets the acquisition time required by the S/H amplifiers, and IC_{7B} generates a delay that ensures each S/H amp has settled before the switch toggles. Break-before-make action in the switch directly affects the circuit's output

accuracy; R₁ and C₁ help filter switch transitions. EDN

To Vote For This Design, Circle No 750

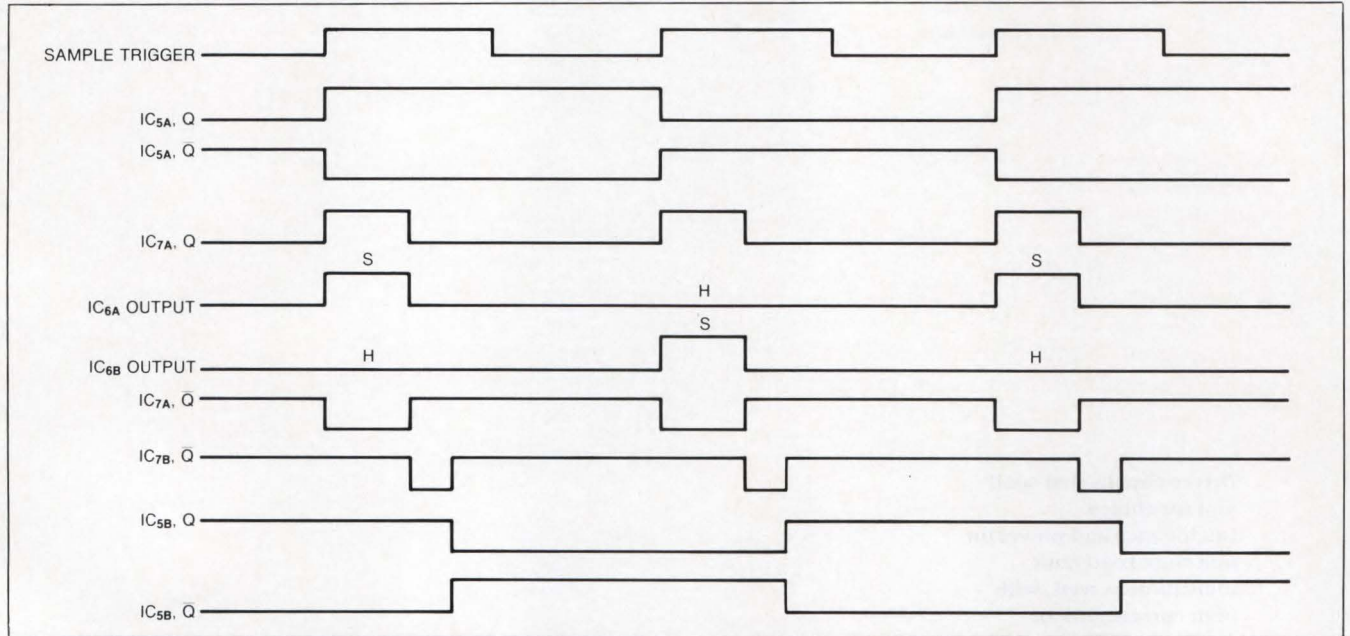

Fig 3—These Fig 1 timing waveforms illustrate digital control signals for the sample-and-hold amplifiers (IC_{6A} and IC_{6B}) and the delayed, complementary drive signals to IC₇'s analog switches (IC_{7B}'s Q and Q-bar output).

Second μ P enhances TMS32020 system

Luis Vieira de Sá
University of Coimbra, Coimbra, Portugal

You can double the processing power of a TMS32020-based DSP system by adding a second μ P capable of addressing the same memory without wait states or arbitration. Because the TMS32020 μ P uses its external data and address buses only a little more than half the time, two processors using address multiplexing and fast static RAM (40-nsec access time), can share the memory at full speed. This configuration increases the system's throughput by allocating different parts of an algorithm for simultaneous processing by the two μ Ps (Fig 1).

To function properly, the processors must operate in sync and from the same clock, but they must access the memory alternately through suitable address multiplexers and data buffers. The TMS32020's Sync input

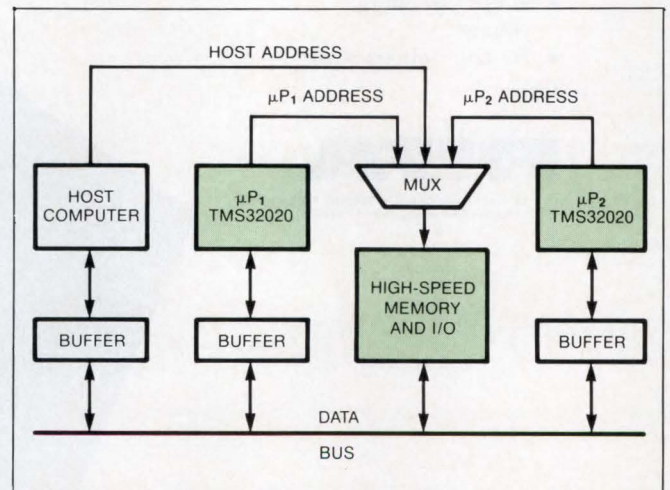
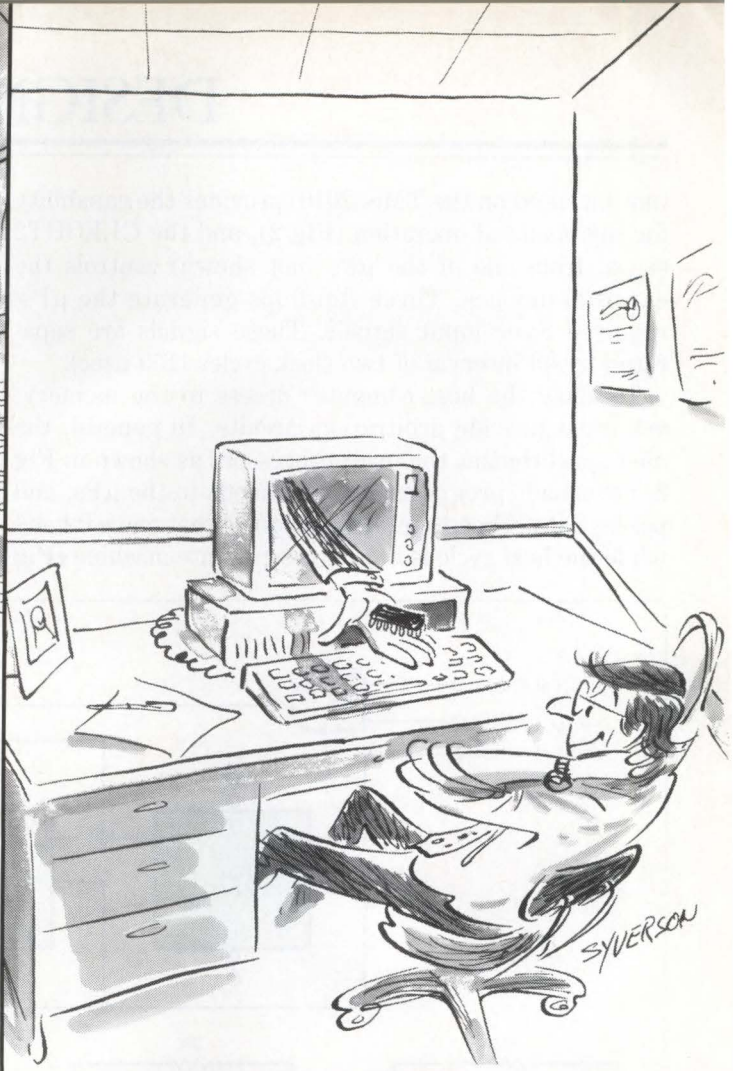

Fig 1—This system has a 3-port memory that lets μ P₁ collect data and store it in RAM while μ P₂ processes earlier data and the host removes the data already processed.



OUTDATED.



UPDATED.

Now there's a component information and ordering source with data that's never out of date.

If you're still designing the products of the future with the methods of the past, it's time you discovered VideoLog. The VideoLog Electronics Network frees you from the drudgery of component catalogs, spec sheets, and update bulletins by placing the data on more than 750,000 semiconductors online.

The information is instantly searchable. Updated daily. Creating a comprehensive engineering reference source that makes anything you could have on your shelves not just outdated—but in some cases obsolete.

VideoLog contains both commercial and military components, prices, alternate source cross-references, and new product announce-

ments. Enter up to 15 key parameters and get a list of components that match. Or enter a part number and find out the manufacturer, its electrical parameters, second sources, if it is still made, and whatever else you need to know. All within minutes.

Only SchweberNET gives you online ordering.

Once you know what you want, you can get pricing QuickQuotes and order parts right online. And have them shipped within 48 hours. Using SchweberNET, via the VideoLog Electronics Network, you're immediately in contact with the computerized inventory

of Schweber Electronics, one of the world's largest distributors of electronic components. In addition to semiconductors, SchweberNET lets you order computer products, connectors, and passives for all your prototype and small quantity needs.

Why use outdated sources when you can be updated so easily? For more information, call **1-800-VIDEOLOG** (1-800-843-3656).

In Conn.: 203-838-5100. Or write us at 50 Washington St., Norwalk, Conn. 06854.

FREE ONLINE DEMO: Dial 1-800-VIDPEEK (1-800-843-7335) with any ASCII (80 col.) terminal or PC, and 300- or 1200-baud modem (even parity, 7 data bits, 1 stop bit). In Conn: 203-852-1239.

VideoLog® Electronics Network

SchweberNET • VideoLog Engineering Reference • Cahners REACT

The fastest way to find electronic components.

DESIGN IDEAS

(not included on the TMS32010) provides the capability for this mode of operation (Fig 2), and the CLKOUT2 signal from one of the μ Ps (not shown) controls the external devices. Three flip-flops generate the μ Ps' required $\overline{\text{Sync}}$ input signals. These signals are separated by an interval of two clock cycles (100 nsec).

To allow the host computer access to the memory, you must provide arbitration circuits. In general, the host synchronizes the microprocessors as shown in Fig 2, downloads programs and commands to the μ Ps, and passes data. These operations require that one μ P halts while the host cycle is in progress; a state machine (Fig

3), which you can implement in one PLD, supervises this operation.

In response to the host's $\overline{\text{DS}}$ signal, the state-machine circuit controls the Ready input of μ P₂, which forces the μ P to wait during a host access. The circuit acknowledges the transfer of data by asserting the $\overline{\text{DTACK}}$ signal. ($\overline{\text{DS}}$ and $\overline{\text{DTACK}}$ are standard VME Bus signals; the majority of other bus systems have similar signals.)

EDN

To Vote For This Design, Circle No 749

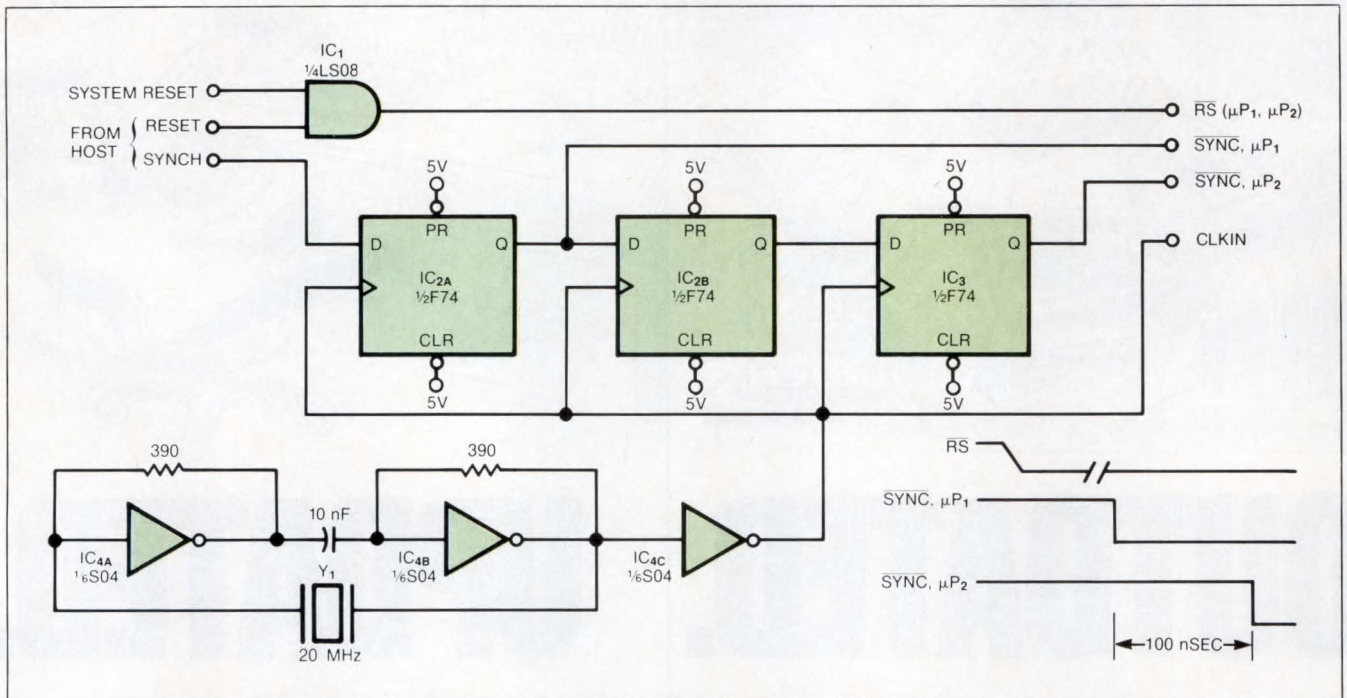

Fig 2—Fig 1's host computer uses this circuit to force the μ Ps' Sync inputs low during the time $\overline{\text{RS}}$ is active.

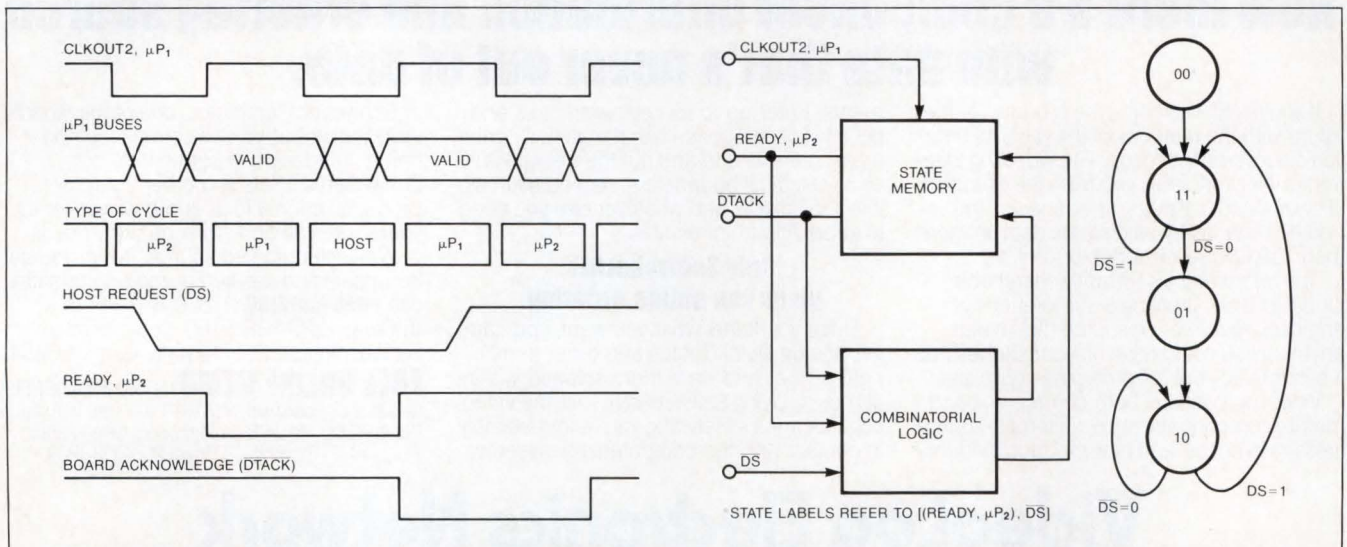

Fig 3—This state machine uses the CLKOUT2 signal of Fig 1's μ P₁ to define time slots for accessing the common memory. The circuit forces μ P₂ to wait during an access by the host.

Harris ICs: Certified for Active Duty!

Our tradition of great military service continues...with 883C-compliant circuits!

The audits are done. The test programs are verified. The certifications are complete:

Harris ICs are compliant to MIL-STD-883C!

That's what you would expect from Harris, with its twenty-year tradition of supplying reliable military circuits and systems.

Today, Harris has a full complement of ICs that meet the new, more stringent military and high-rel IC standards. To be sure of compliance, look no further than Harris.

Take your choice of high-performance analog circuits — op amps, multiplexers, switches, sample-and-hold amplifiers, and A/D and D/A converters.

Select from our low-power CMOS family — 80C86 CPU and peripherals, full 6T-cell CMOS static RAMs and RAM modules, and a powerful standard cell capability for your semicustom needs.

All are compliant with MIL-STD-883C, and are fully documented through product data sheets or in cooperation with DESC via the Military Drawing program. And they have guaranteed specs over the full -55°C to $+125^{\circ}\text{C}$ temperature range.

So you're assured of consistent performance and support from Harris, with **reliable ICs designed and built specifically for the military.**

Make Harris your first line of defense. For details, call 1-800-4-HARRIS, Ext. 1986 (in Canada, call 1-800-344-2444, Ext. 1986). Or write: Harris Semiconductor Products Division, P. O. Box 883, MS 53-035, Melbourne, Florida 32902-0883.



IN MILITARY ICs,
THE NAME IS
HARRIS

Harris Semiconductor: Analog - CMOS Digital
Gallium Arsenide - Semicustom - Custom



"Who says Harris ICs are qualified for military service?"

"MIL-STD-883C, paragraph 1.2.1!"



Design Entry Blank

\$75 Cash Award for all entries selected by editors. An additional \$100 Cash Award for the winning design of each issue, determined by vote of readers. Additional \$1500 Cash Award for annual Grand Prize Design, selected among biweekly winners by vote of editors.

To: Design Ideas Editor, EDN Magazine
Cahners Publishing Co
275 Washington St, Newton, MA 02158

I hereby submit my Design Ideas entry.

Name _____

Title _____ Phone _____

Company _____

Division (if any) _____

Street _____

City _____ State _____ Zip _____

Design Title _____

Home Address _____

Social Security Number _____

(Must accompany all Design Ideas submitted by US authors)

Entry blank must accompany all entries. Design entered must be submitted exclusively to EDN, must be original with author(s), must not have been previously published (limited-distribution house organs excepted), and must have been constructed and tested.

Exclusive publishing rights remain with Cahners Publishing Co unless entry is returned to author or editor gives written permission for publication elsewhere.

In submitting my entry, I agree to abide by the rules of the Design Ideas Program.

Signed _____

Date _____

Your vote determines this issue's winner. All designs published win \$75 cash. All issue winners receive an additional \$100 and become eligible for the annual \$1500 Grand Prize. **Vote now**, by circling the appropriate number on the reader inquiry card.

ISSUE WINNER

The winning Design Idea for the February 5, 1987, issue is entitled "MOSFET provides glitchless power backup." It was submitted by Tosh Mizuno of Dalmo Victor Co (Belmont, CA).

Circuit extracts square-wave pulse

Patrick Borel

Thomson Semiconducteurs, Grenoble, France

The Fig 1 circuit traps a single positive pulse from a square-wave train. Following the rising edge of an input command, the Pulse Out signal emits a replica of one positive pulse of the Clock signal simultaneous with the Clock signal's next rising edge.

The Input Command signal sets the Q_1 output of flip-flop IC_{1A}. Consequently, the next rising edge of the Clock signal sets the Q_2 output of IC_{1B}, which allows AND gate IC_{2C} to pass the Clock signal's next positive pulse. AND gates IC_{2A} and IC_{2B} prevent the generation of brief output glitches by delaying the Clock signal by t_D sec (two propagation delays).

EDN

To Vote For This Design, Circle No 747

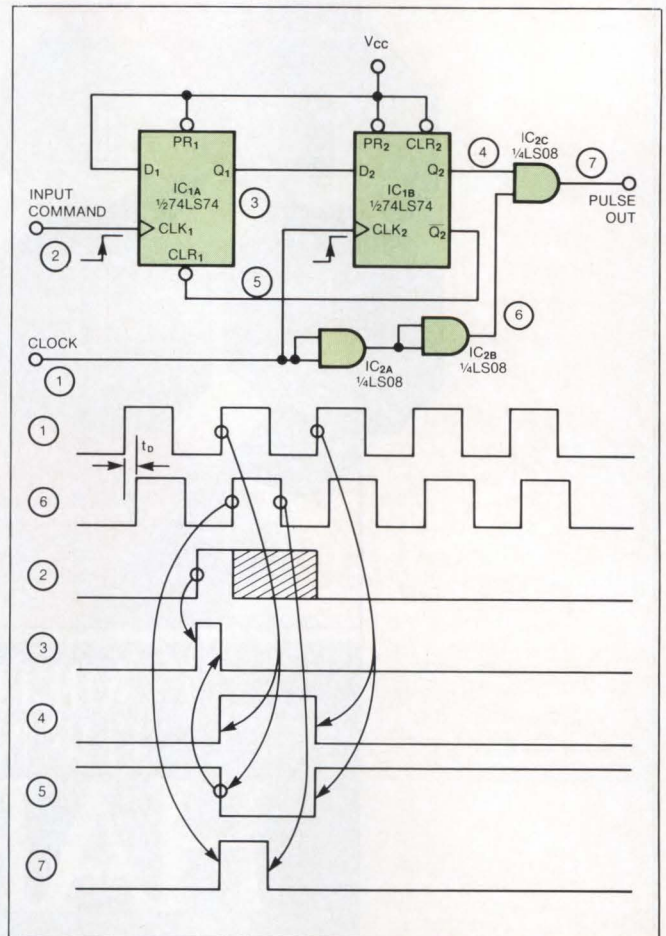
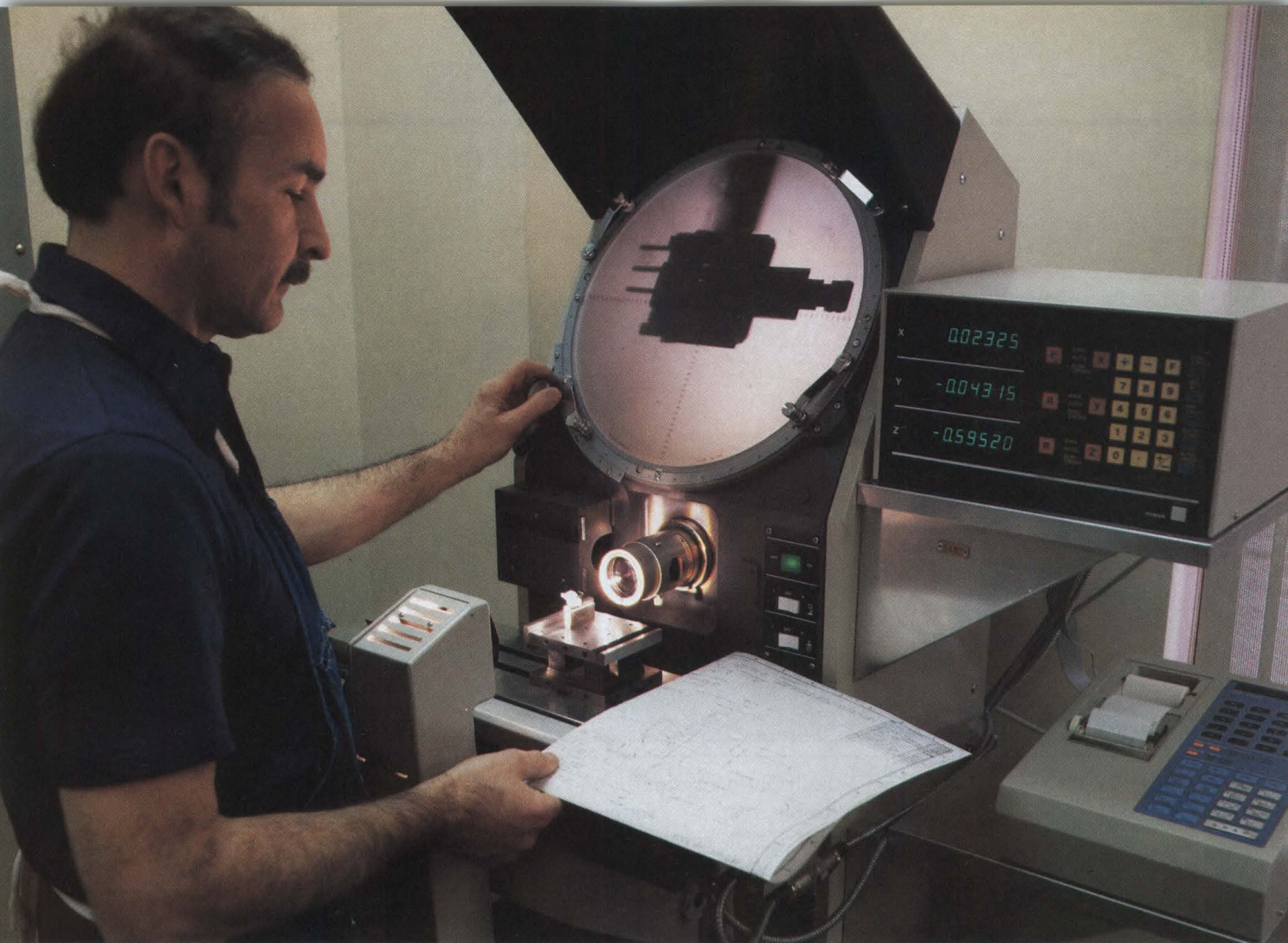

Fig 1—Each Input Command signal causes this circuit to issue one positive pulse from the Clock signal pulse train.



CALIBRATE OUR CALIBER

The suppliers you choose deserve close scrutiny. After all, they affect the success or failure of your products. That's why you should take our measure—and discover how well we size up.

START WITH SELECTION. With us, you can be picky. We offer more than 6000 standard, miniature and subminiature products and components.

UTILIZE OUR ASSISTANCE. A team of support engineers will not only customize any of our existing products, but work with you to develop a new one to fit your specific requirements.

INSPECT OUR QUALITY. We do, using statistical process control and 100% electrical/mechanical verification, we continually maintain precise quality.

EXAMINE OUR RECORD. For over 40 years, Switchcraft has been a



by-word for performance-conscious design engineers. Today, we're a prime source of supply in most countries—world-wide.

Any way you size us up, we calibrate to meet your needs. No matter what you're designing, we can be instrumental in the performance of your product. Contact us—we'll show you more reasons why we're right on the mark.

Send me information on your quality components: ED4-87

- Please have a representative contact me.
 Please send me your General Line Catalog covering the complete Switchcraft line.

My area(s) of interest is:

- Switches Connectors Power Cords
 EAC Receptacles Jacks/Plugs
 Molded Cable Assemblies Patch Panels

My application is Current

- Future (date) _____

Name _____

Company _____ Title _____

Address _____

City _____ State _____ Zip _____

Telephone () _____

Mail To: Marketing Communications Dept.,
 Switchcraft, Inc.,
 5555 N. Elston Ave.,
 Chicago, IL 60630

Switchcraft

A Raytheon Company

5555 N. Elston Ave.
 Chicago, IL 60630
 (312) 792-2700

NEW PRODUCTS

INTEGRATED CIRCUITS

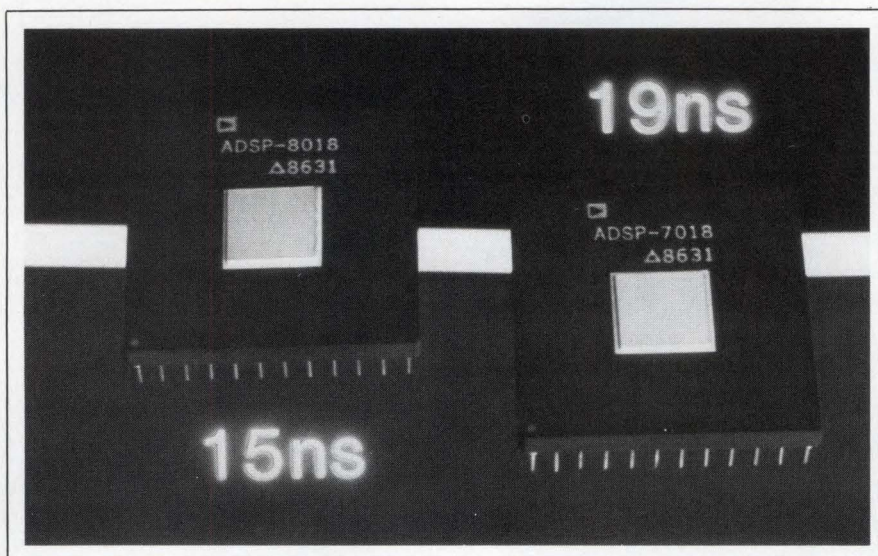

MULTIPLIERS

- Devices multiply 16-bit words in 15 or 19 nsec
- ECL- or TTL-compatible bipolar devices

According to the manufacturer, the ECL-compatible ADSP-8018 and the TTL-compatible ADSP-7018 are digital multipliers with the industry's fastest multiply times—15 and 19 nsec max, respectively. Based on a bipolar process featuring a 2- μ m device geometry, these products feature 300-psec gate delays and 300- μ W/gate power dissipation. Each device dissipates less than 3.5W total. The 32-bit output port presents the product of a 16 \times 16-bit

multiply operation in one cycle; for 16-bit systems, you can multiplex the result through a single port. Independent input, instruction-status, and output latches have a transparent mode of operation that simplifies system timing. The multipliers accept 2's-complement, unsigned-magnitude, and mixed-mode input code. Both devices come in 108-pin pin-grid array, spec'd for the commercial temperature range. ADSP-8018, \$260; ADSP-7018, \$205 (100).

Analog Devices Inc, Literature Center, 70 Shawmut Rd, Canton, MA 02021. Phone (617) 461-3672. TWX 710-394-6577. TLX 174059.

Circle No 351

A/D CONVERTER

- 8-bit resolution; 1.36- μ sec conversion time
- Comes in a 20-pin, small-outline package

You now have the option of obtaining the AD7820 8-bit A/D converter in a small-outline, surface-mount package in addition to the standard ceramic and plastic DIPs. The CMOS chip features an internal track/hold function and μ P-compati-

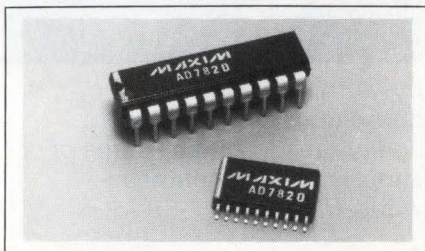

ble interface circuitry, and it uses a half-flash technique to achieve a 1.36- μ sec max conversion time. The converter operates from 5V and has a 0 to 5V analog input range. The

electrical grades include ± 1 -LSB and $\pm \frac{1}{2}$ -LSB versions for the commercial, industrial, and military temperature ranges. In a small-outline package, from \$10.95 (100).

Maxim Integrated Products, 510 N Pastoria Ave, Sunnyvale, CA 94086. Phone (408) 737-7600.

Circle No 352

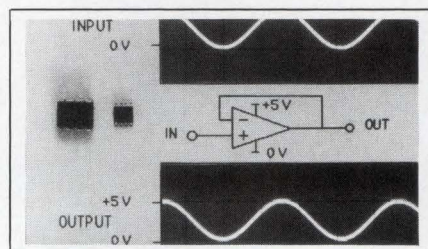

PRECISION OP AMP

- Rail-to-rail input- and output-voltage ranges
- Unity-gain stable with 800-pF load

The ALD 1702 is a laser-trimmed, silicon-gate CMOS op amp that specs offset-voltage grades of 0.9, 2.0, and 4.5 mV. Operating from a 5V supply or from bipolar supplies in the range ± 2.5 to ± 5 V, the amplifier provides input- and output-voltage ranges that include the supply rails. A compensation scheme allows the device to remain unity-gain stable while driving capacitive loads of 400 pF (noninverting mode) or 800 pF (inverting mode). The short-circuit-protected output can deliver 5 mA. Other specs include a 1.0-MHz min unity-gain bandwidth, a 1.4V/ μ sec min slew rate, and a 400V/mV open-loop, no-load voltage gain. The unit has a 741-type pinout and comes in an 8-pin plastic or ceramic DIP or a small-outline package. \$1.78 to \$3.89 (100).

Advanced Linear Devices Inc, 1030 W Maude Ave, Suite 501, Sunnyvale, CA 94086. Phone (408) 720-8737. TWX 510-100-6588.

Circle No 353

\$10,000 Performance for 1/10th the price.

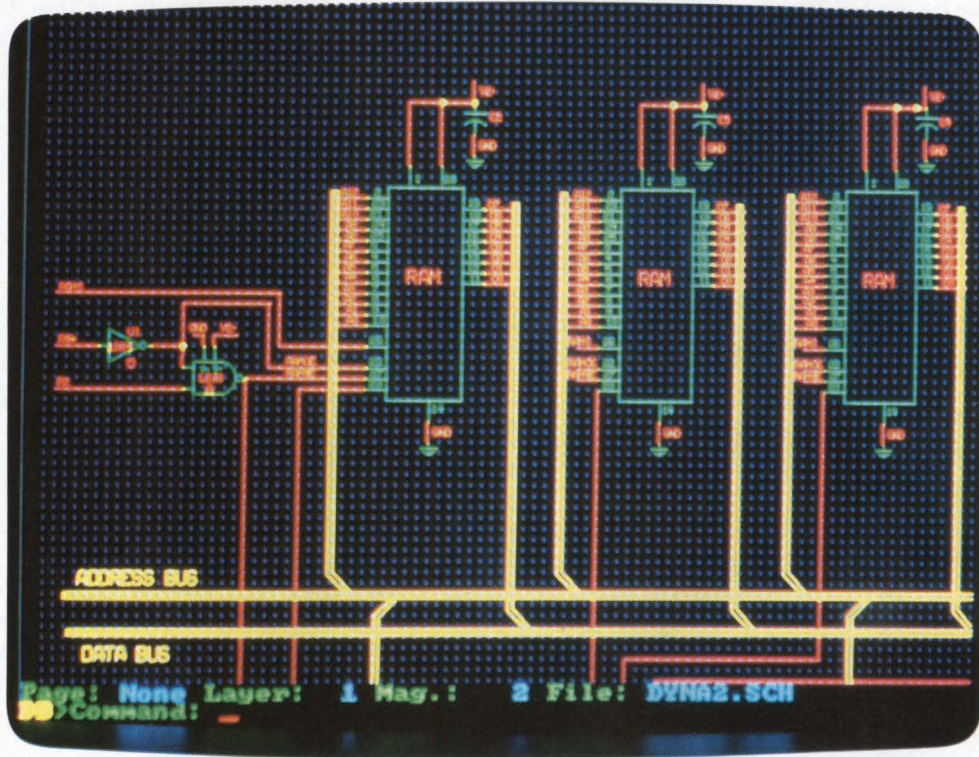

The Criterion I Schematic Capture package: \$1,000 gets you into entry level schematic design software—and saves you \$9,000 in the bargain.

Criterion is the first system to offer an easy upward and integrated path to functions that rival the \$100,000 workstations—and the only package that gets you into high-resolution CAD.

How it works: Criterion I takes advantage of low-cost graphics offered by the 640 × 350 pixel EGA card. Fast redraw time is made possible by the 8087 (or 80287 on the IBM PC/AT) math co-processor. Then, for PC board layout, Criterion II operates on a hi-res 1024 × 768 19" monitor. Through "intelligent transfer" it trades information with the Criterion I schematic capture program.

What you get: The Criterion I package includes: Utilities for Bill of Materials, Signal List, Net List, Ratsnest and Pen Plotter Output. Plus a Library Manager that supports seven major libraries: TTL, CMOS, ECL, Analog, Digital, Microprocessors and SMD.

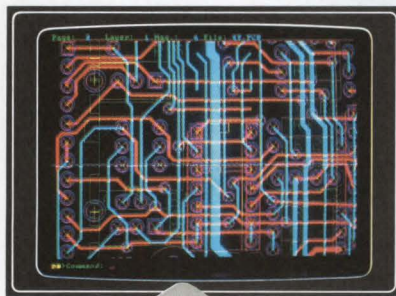

The Aptos Rental Plan: takes the risk out of a PC-based CAE/CAD system. We're the only company with a rental plan that allows you to see if Aptos products are right for you. Because only Aptos will rent the product month by month and allow you to apply 80% of the rental towards purchase.*

Buy now and get a \$500.00 value video training program—free!

Two video tape training programs—one on PC Board Layout and another on Schematic Capture are your's free if you buy the Criterion packages before June 15, 1987. Call collect today:

(408) 438-2199

*Aptos rental program available on minimum orders of \$9000.



Aptos Systems Corporation, 10 Victor Square, Suite 200
Scotts Valley, CA 95066 Telex: 3710387 APTOS SYS
Aptos Systems, European Headquarters
Frankfurt, West Germany. Phone: 069-782963

In the U.K., Telex Chiptech: 267107 CHIPALG. In France, Telex Tekelec Airtronic: 204552 TKLEC. In Italy, Telex Electronucleonica: 332033 NUCLEO I. In Germany, Telex Spezial-Electronic: 971624 SPEZ D. In Sweden, Telex Technical Partners: 10874. In Asia, Telex SPI: 4997020 SPIUS. In Hong Kong, Telex Techtrend: 81052. In Japan, Telex Toyo Corp.: 2222973.

MOTOR-CONTROL IC

- Drives 3-phase complementary output switch pairs
- Suppresses output pulses shorter than a minimum time

Designed for the control of 3-phase, variable-speed ac motors, dc brushless motors, or PWM converters, the MA 818P waveform-generator

IC includes all the logic necessary to produce 3-phase PWM output signals. The chip controls three complementary electronic switch pairs, which may be MOSFET, bipolar, or GTO thyristor devices, and you can program delays into the output waveforms to maximize the efficiency of the complementary switching. You configure the waveform genera-

tor via a μP interface. The MA 818P automatically inhibits narrow output pulses that are less than a pre-programmed minimum period; you can program this minimum period to be as short as 1 μsec . You can also switch the output phases to obtain forward or reverse motor rotation. The waveform generator accepts constant-carrier frequencies in the 600-Hz to 19.5-kHz range, and it has user-selectable power-frequency ranges of 0 to 50 Hz and 0 to 3 kHz. You can define the shape of the power frequency's waveform with data contained in an external ROM. The MA 818P is fabricated in CMOS technology with TTL-compatible inputs and outputs. £20 (100).

Marconi Electronic Devices Ltd, Lincoln Industrial Park, Dodington Rd, Lincoln LN6 3LF, UK. Phone (0522) 688121. TLX 56380.

Circle No 354

Marconi Electronic Devices Inc, 80 Smith St, Farmingdale, NY 11735. Phone (516) 420-8378.

Circle No 355

Shielded rooms with a roomful of benefits.

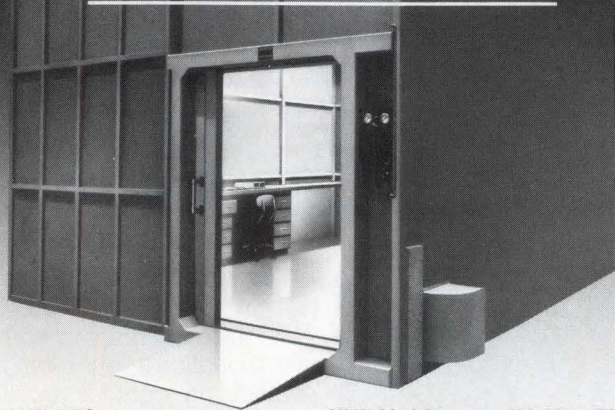

LECTROSHIELD® Clamp-Together Rooms — Shielding Effectiveness to 100 dB+.

- 1.0 KHz to 10 GHz attenuation for MIL-STD-285, NSA 65-6, FCC and VDE testing, MIL-STD-461/2/3, etc.

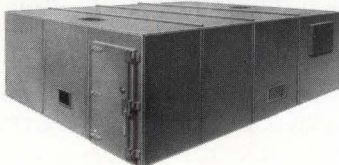

- Prefabricated, modular.
- 48 standard room sizes... 8' x 8' to 24' x 48' (interior), standard interior heights to 8', 10' and 12', plus custom sizes.
- Easily assembled and dismantled.
- High reliability electrical and structural.
- Meets stringent building and safety codes, including Seismic Code Zone IV.

All-Welded Rooms — Shielding Effectiveness to 120 dB- 140 dB+.

- Meets TEMPEST and other secure requirements.
- Ideal for EMP hardening.
- Free standing; total structural and seam integrity.
- Patented sliding doors exceed MIL-STD-285 and NSA 65-5.
- MIG welding throughout.
- TEMPEST shielded security vaults.
- Standard and customized sizes.
- Maximum fire protection.
- Complete design and turn-key facilities.

Plus... shielded anechoic chambers, chambers for Nuclear Magnetic Resonance (NMR) imaging systems, and a complete line of RFI/EMI filters and filter panels.

LMI has the shielding solution for you. Write or call the LMI Application Engineering Department.



Nationwide representatives

LECTROMAGNETICS, INC., 6056 West Jefferson Blvd., Los Angeles, CA 90016
(213) 870-9383, Toll Free (800) 325-9814-U.S.A. • (800) 325-9815-CA

CIRCLE NO 16

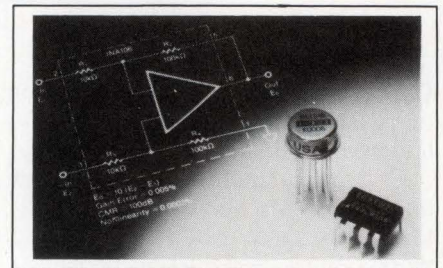

DIFFERENTIAL AMP

- Fixed gain of 10
- Better than $\pm 0.015\%$ accuracy

The INA106 differential amplifier provides a gain of 10 by combining a precision op amp and a 10- to 100-k Ω resistor network on a monolithic chip. Overall accuracy, including errors in gain, linearity, offsets, and CMR, is better than $\pm 0.015\%$. The amplifier's 20-mA output (for positive output voltages) simplifies the design of 4- to 20-mA transmitter circuits. Other specs include a minimum 100-dB CMR, a 5- μsec settling time (to $\pm 0.01\%$), and a 2-mA quies-



side view
(actual size)

With a Planar light-emitting electroluminescent flat panel display, you could use the rest of this space for anything you like. Call either 503-690-1100 or 503-690-1102, or write for a brochure: PLANAR SYSTEMS, INC. 1400 N.W. Compton Drive Beaverton, Oregon 97006.

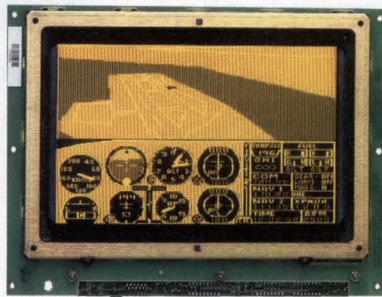

PLANAR

The Definition of Quality

INTEGRATED CIRCUITS

cent supply current. The device comes in a TO-99 can or a plastic 8-pin DIP, spec'd for the commercial, industrial, or military temperature ranges. From \$3.65 (100).

Burr-Brown Corp., Box 11400, Tucson, AZ 85734. Phone (602) 746-1111. TLX 666491. TWX 910-952-1111.

Circle No 356

A/D CONVERTERS

- Include track/hold function
- Convert in 13 μ sec

The CA3310 and CA3310A 10-bit CMOS A/D converters execute their successive-approximation algorithm by controlling charge redistribution on a capacitive ladder. The ladder provides an inherent track/hold

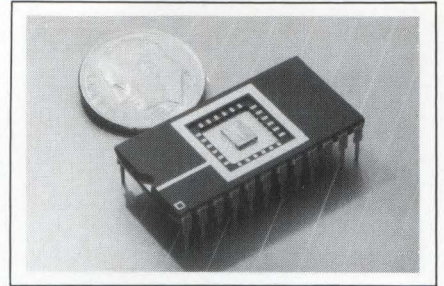

function. The converters require a 3 to 6V supply and draw about 3 mA at 5V. The analog input range includes both rails of the power supply. With a 1-MHz clock (13- μ sec conversion time), the 3310 specs $\pm 3/4$ LSB max for the integral- and differential-linearity errors, and $\pm 1/2$ LSB max for the gain and offset errors. Under similar conditions, the CA3310A specs $\pm 1/2$ LSB max for the integral- and differential-linearity errors, and $\pm 1/4$ LSB max for the gain and offset errors. The devices include μ P-interface circuitry and 3-state outputs. The converters come in 24-lead plastic and ceramic DIPs for the industrial and military temperature ranges, respectively. In plastic packages (E suffix), CA3310E, \$6; CA3310AE, \$8 (1000).

GE/RCA Solid State, Route 202, Somerville, NJ 08876. Phone (201) 685-6994.

INQUIRE DIRECT

**OAK
ROCKER
SWITCHES
FIT LIKE
A GLOVE!**

Oak rockers fit your design parameters. Choose from miniature, single and double pole, lighted and non-lighted varieties, in an assortment of colors and styles. Off-the-shelf capability means prompt delivery. Our rockers are designed to retrofit many existing switches and are UL, CSA and VDE approved.

Oak rockers fit your quality standards. Our half century of switch experience is your assurance of peak product performance.

Oak rockers fit your budget. Manufacturing know-how enables us to deliver the top quality rockers you need at a price that will make you more competitive. Specify the rocker switches that will fit all your requirements. Specify Oak rockers.



OAK Switch Systems Inc.

P.O. Box 517 • Crystal Lake, Illinois 60014
Phone 815/459-5000 • TWX 910-634-3353
TELEX 72-2447

OAK
*Your Partner
in Excellence*

CMOS RAM

- Has multiplexed address/data bus
- Retains data with a 1V supply voltage

The SAB 81C54 is a 512 \times 8-bit CMOS RAM that comes in a 16-pin DIP or an SO-20 surface-mount package. The RAM has two chip-select inputs and internal address latches. You can connect the device directly to the multiplexed address/data bus of a variety of 8-bit microcontrollers and μ Ps. It operates from a 2.5 to 6V supply range, and it retains data when the supply voltage is as low as 1V. In standby mode, the device consumes less than

"It's expanded as small as it can get."



1/2" ↓
↑

That's what he said. And he was right. You see, our SBC design engineer, Tom Murphy, was convinced he could come up with a better board than Intel's 286/12. For months he'd been working with our new Multibus* 80286 SBC, making sure it was compatible with Intel, but adding refinements, improvements and putting more capabilities onboard.

But more wasn't enough for Tom, he wanted less, too.

"There's gotta be a way to pack all these capabilities on to a board that only takes up one slot."

And that's just what he did. Our 80286 uses the latest in surface-mount and RAM packaging, putting it all onboard . . . not on top. That skinned it up right there. But Tom wasn't satisfied. He put four serial I/O ports onboard ("Intel has two, so we'll double it," he said). That means no more expansion modules, less bulk and less cost.

And what about DMA channel capabilities? Well, Tom feels pretty smug about that enhancement. Starting with full duplex DMA for two serial ports, he added multiplexed channels . . . eight to be exact. (Don't even bother to look for any on their board). So all four serial ports are serviced with three DMA channels left open. Open for whatever your creativity demands.

Tom came up with other great ideas, all of which are in our brochure, but think about what you can do with just what we've mentioned.

Then think about picking up the phone. Call Mike Heins, SBC Product Manager at 1-800-482-0315. It's toll free. (In Illinois, call 217-359-8010). Ask him to send you a brochure, give you specs and prices or, if you like, he'll even connect you directly to Tom.

Or write us, Central Data, 1602 Newton Drive, Champaign, IL 61821-1098.

Central Data

*Multibus is a trademark of Intel Corporation.

1 μ A. DM 4.50 (1000).

Siemens AG, Zentralstelle für Information, Postfach 103, 8000 Munich 1, West Germany. Phone (089) 2340. TLX 5210025.

Circle No 358

Siemens Components Inc, 186 Wood Ave S, Iselin, NJ 08803. Phone (201) 321-4842.

Circle No 359

D/A CONVERTER

- Includes three 8-bit video D/A converters
- Operates at 250 MHz

The Bt109 is the fastest triple D/A converter available, according to the manufacturer. Suitable for use in graphics, image-processing, and video-reconstruction applications,

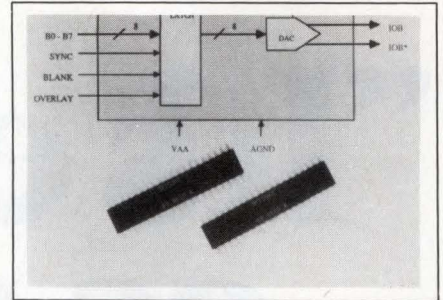

the device operates at 250 MHz and supports display resolutions as high as 2048x1536 pixels. The sync-blank and overlay control inputs are registered to maintain synchronization with the pixel data. The Bt109's RGB video signals are RS-343A compatible, and they can drive doubly terminated 75 Ω cables. Digital inputs are compatible with 10KH ECL. Rise and fall times are 1 nsec max; the integral- and differential-linearity errors are $\pm\frac{1}{2}$ LSB max over the full operating-temperature range. \$53 (100).

Brooktree Corp, 9950 Barnes Canyon Rd, San Diego, CA 92121. Phone (619) 452-7580. TLX 383596.

Circle No 360

ANALOG IS ALIVE AND WELL IN: A Designer's Guide to Innovative Linear Circuits

As exciting as digital technology is, you still need analog circuitry to operate on signals from real-world sources. Now, EDN is offering a wealth of analog design information in *A Designer's Guide to Innovative Linear Circuits*.

This 186-page collection of articles was developed by Jim Williams, one of America's foremost linear-circuit designers. It includes practical and efficient ways to use op amps, comparators, data converters, and other analog ICs, and discusses the theories behind all the design techniques presented.

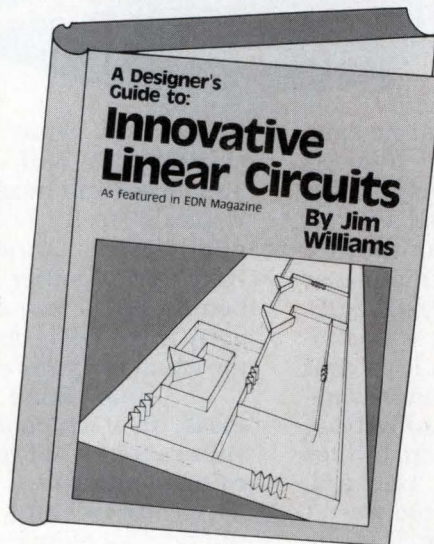

ANALOG SWITCH

- Handles $\pm 10V$ signals
- Provides 40-dB isolation at 100 MHz

The monolithic CDG2214N combines CMOS and DMOS (double-diffused MOS) technology to provide a high-speed (20 nsec off, 40 nsec on) spst analog switch with a CMOS-compatible control input. Principal specs include a 7.8-dB max insertion loss with a 50 Ω load at 200 MHz, 66 dB of off-isolation at 10 MHz, and a $\pm 10V$ analog input range. The device is available as a chip or in an 8-pin miniDIP. \$0.99 (1000). Delivery, six weeks ARO.

Topaz Semiconductor, 1971 N Capitol Ave, San Jose, CA 95132. Phone (408) 942-9100. TWX 910-338-0025.

Circle No 361

Mail coupon to:

Linear Circuits Reprints
EDN Magazine

Cahners Building
275 Washington Street
Newton, MA 02158-1630

Please send _____ copies of *A Designer's Guide to Innovative Linear Circuits*

- \$14.95 UPS
 \$19.95 non USA
(BANK DRAFT ONLY)

Check or money order made out to EDN REPRINTS must accompany each order. No COD. Mass. resident add 5% sales tax.

Please print clearly. This is your mailing label.

NAME _____

TITLE _____

COMPANY _____

ADDRESS _____

CITY _____

STATE _____ ZIP _____

EDN043087

Texas Instruments
Circle No. 30

TEXAS INSTRUMENTS REPORTS ON
GRAPHICS

IN THE ERA OF
MegaChip [□]
TECHNOLOGIES



Graphics in the Era of MegaChip Technologies:

New Texas Instruments lets you program circles plus filled polygons, spline curves, antialiased lines,



From PC displays to laser printers, the flexibility of TI's TMS34010 processor delivers the leading-edge performance you need today and to stay out in front tomorrow.

In TI's TMS34010 Graphics System Processor, you have a new and better graphics-design approach: The first high-performance, 32-bit CMOS microprocessor optimized for graphics applications. The 34010 can execute all functions needed by graphics operating environments; hard-wired coprocessors can only execute a small part.

32-bit graphics processor around competition... text, and more.



But there's an even more important aspect to consider. The 34010 will help keep your system ahead of competition because it is compatible with existing graphics hardware standards — CGA,[™] EGA,[™] and PGC[™] — and supports graphics software standards such as CGI, DGIS,[™] and MS-Windows.[™]

Standards like Windows and DGIS run faster on TI's TMS34010

The 34010 is also among the fastest microprocessors available. It handles six million instructions per second with a "draw" rate of up to an amazing 50 million pixels per second. Thus, it can boost total system performance.

Because of the support of MS-Windows and DGIS alone, many major applications software packages can already run on 34010-based systems.

TI's MegaChip Technologies

Our emphasis on high-density memories is the catalyst for ongoing advances in how we design, process, and manufacture semiconductors and in how we serve our customers. These are our MegaChip[™] Technologies, and they are the means by which we can help you and your company get to market faster with better products.

workstations, terminals, plotters, FAX, image processing, digital copiers, mass storage, robot vision, and communications.

TI's total systems solution

In implementing your design, you'll want to consider other building blocks TI has developed. Included are the single-chip TMS34070 66-MHz Color Palette that supports simultaneous display of 16 out of 4,096 colors and the

GRAPHICS-PRODUCTS ROAD MAP

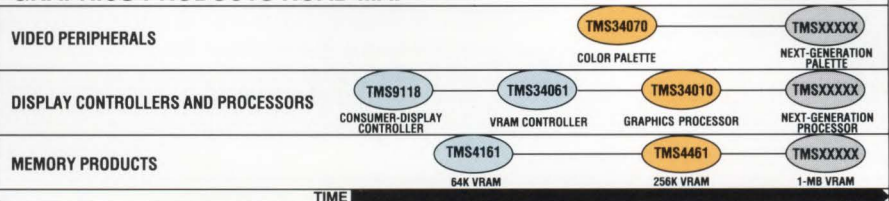

Road map to tomorrow's graphics systems: Next-generation additions to TI's innovative graphics-products family will allow you to build on your present designs to develop even higher-performance systems.

"You would think TI designed the 34010 with our technology in mind."

Luis Villalobos, Conographic president, refers to the power of the 34010 to process font outlines for desk-top publishing. Resolution up to 64K × 64K means no hardware limits for laser printers and other hard-copy devices.

Host independence and the flexibility of a device programmable in "C" language make TI's 34010 the cost/performance leader for PC displays, laser printers, desk-top publishing,

TMS70C42 Microcontroller that handles all serial interface duties.

Also included are high-speed video random-access memories (TMS4161 and TMS4461), plus linear small and large-area CCD image sensors.

To provide the host bus interface and any other customized functions you may require, TI offers quick design and production turnaround through its Application-Specific Integrated Circuits (ASICs) capabilities.

Development tools are available now for applying the 34010. Turn the page for details. ►



"Because the 34010 is programmable, it is in a league all its own."

Jim Richards, president of VMI, is talking graphics performance. You can program the 34010 processor to perform any graphics function you want, unlike hard-wired coprocessors. This means you can readily customize your system to outperform your competition.

"Texas Instruments had ready the full set of development tools we needed."

As William Frentz, executive vice president at Number Nine Computer, points out, TI has ready the hardware, software, and documentation you will need to make designing in the 34010 as fast and as easy as possible.

TI's 34010 software includes a full Kernighan and Ritchie "C" compiler with extensions and an assembler package for both MS-DOS™ and VAX™ operating environments.

A graphics/math library provides source code for more than 100 functions, whereas a typical controller chip offers only 15 to 20. A special font library contains more than 100 type fonts to expedite development of desk-top publishing applications.

The TMS34010 XDS/22 Emulator is a flexible, realtime, in-circuit emulator. It can be used in a stand-alone mode through a standard terminal or through a host computer with a powerful debugger interface.

To see immediately what TI's new graphics processor can do for you, just plug the TMS34010 Software Development Board into an IBM® PC-compatible or TI Professional computer. The board is populated with TI's 34010 Graphics Processor, Color Palette, and VRAMs. It provides an ideal environment for developing your own high-performance graphics applications.

For more information on TI's total graphics-system solutions, including details on TI's Graphics Design Kit and design training courses, complete and return the coupon today. Or write Texas Instruments Incorporated, P.O. Box 809066, Dallas, Texas 75380-9066.

FOR FREE ON-LINE INFORMATION, dial 1-800-345-7335 with any 80-column ASCII terminal or PC and a 300 or 1200 baud modem (EVEN or IGNORE parity, 7 data bits, 1 stop bit). At "Enter Response Code," type TIGRAFX. In Conn. dial (203) 852-9201.

™MegaChip is a trademark of Texas Instruments Incorporated. CGA, EGA, and PGC are trademarks of International Business Machines Corporation. DGIS is a trademark of Graphic Software Systems, Inc. MS-Windows and MS-DOS are trademarks of Microsoft Corporation. VAX is a trademark of Digital Equipment Corporation.

® IBM is a registered trademark of International Business Machines Corporation.

26-4537

© 1987 TI



To speed the design of your graphics system, TI's range of development tools includes a comprehensive design kit (left rear), a realtime emulator, and a plug-in software development board. On floppy and magnetic disks: "C" compiler, assembler package, and function and font libraries. User's guides, development books, product bulletins and data sheets, and TI's newsletter, *Pixel Perspectives*, are all readily available.

Hundreds of designers must be right.

Hundreds of hardware and software designers are making TI's 34010 the new graphics standard. Among them are leading board-development houses and major software vendors.

In fact, the wide range of graphics standards and application software already written for TI's 34010 makes it the easiest-to-use new graphics chip ever introduced. Here's just a sampling of the software that will run on top of Graphic Software Systems DGIS* 34010:

Software Products	Company
AutoCad™	AutoDesk
GSS*CGI™†	GSS
Master Series™	Ashton-Tate
Freelance Plus™	Lotus GPG
Graphics Development Toolkit™†	IBM
Harvard Presentation Graphics™	Software Publishing Corp.
ProDesign II™	American Small Business Computers
VersaCad™	VersaCad Corp.
Windows™†	Microsoft
Symphony™, 1-2-3™	Lotus Development
P-CAD™	Personal CAD Systems

™Trademarks are as noted.

†More than 100 graphics applications are currently available for these operating environments.

Texas Instruments Incorporated

SPV153ED700C

P.O. Box 809066
Dallas, Texas 75380-9066

YES, please send me information on TI's
Total Graphics-System Solutions.

NAME _____

TITLE _____

COMPANY _____

ADDRESS _____

CITY _____ STATE _____ ZIP _____

AREA CODE _____ TELEPHONE _____ EXT. _____

**TEXAS
INSTRUMENTS**

NEW PRODUCTS

COMPONENTS & POWER SUPPLIES

ACTIVE FILTERS

- 60- or 80-dB attenuation floor
- Tuning ranges to 51.2 kHz

Series 848DOW lowpass active filters are tunable over a 256:1 range. They employ an 8-pole, 6-zero design to achieve a response that approaches the constant group delay of a Bessel filter in the passband and the sharper attenuation of a Butterworth filter in the stopband. Ten models offer a choice of a fixed 60- or 80-dB attenuation floor. Factory-set maximum corner frequencies range from 25.6 Hz to 51.2 kHz. All models contain CMOS latches that accept data and command inputs. You can configure these latches to transfer tuning data on either edge of an 80-nsec strobe pulse. The filter modules spec a ± 0.5 -dB noninverting gain, a 20-k Ω input impedance, and

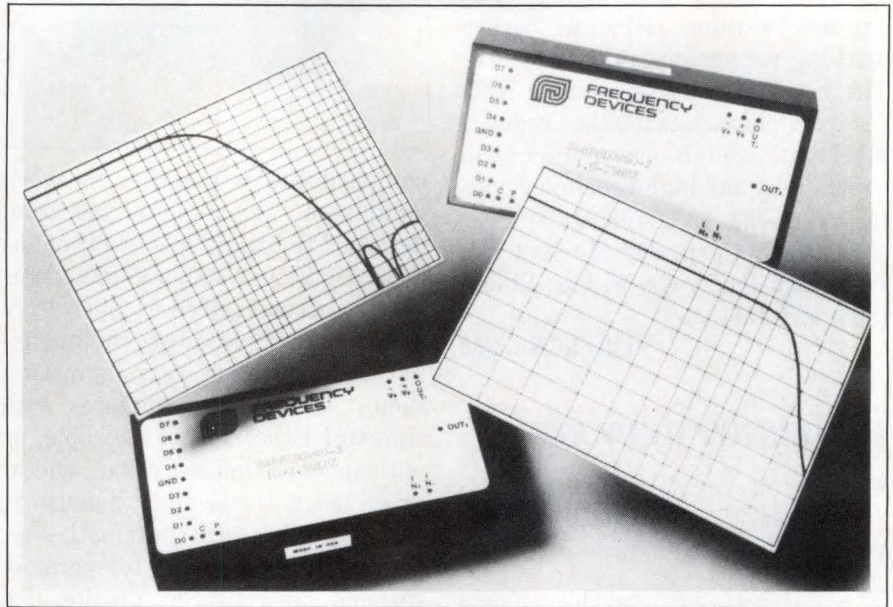

a 10 Ω output impedance. They operate from ± 12 to ± 18 V supplies. \$300.

Frequency Devices Inc, 25 Lo-

cust St, Haverhill, MA 01830. Phone (617) 374-0761. TWX 710-347-0314.

Circle No 362

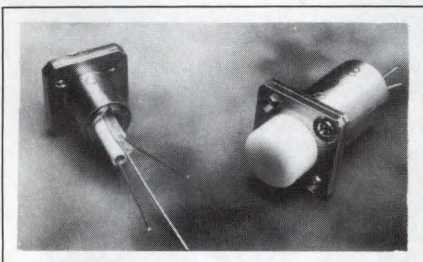

LASER DIODES

- Designed for local-area network applications
- Spec lifetimes of eight million hours min

Designed for short- and medium-haul local-area networks, the FU-05LD-N and FU-06LD laser-diode modules come with integral type-FC and -SMA connectors, respectively. They can deliver 1 mW into multimode, 50/125- μ m fiber. Both modules include a back-facet photodiode for power monitoring, and they can operate at data rates exceeding 600M bps. The devices' lifetime (at 25°C) specs at eight million hours min. FU-05LD-N, \$140; FU-

06LD, \$120 (10).

Mitsubishi Electronics America Inc, Semiconductor Div, 1050 E Arques Ave, Sunnyvale, CA 94086. Phone (408) 730-5900.

Circle No 363

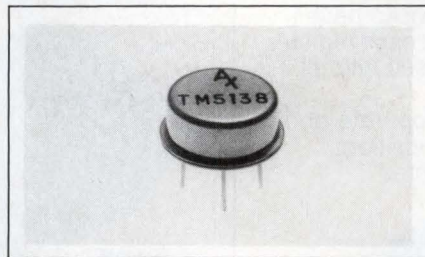

RF AMPLIFIER

- Offers 15-dB typ gain
- Meets MIL-STD-883B screening

Housed in a TO-8 hermetic package, Model TM 5138 provides a typical gain of 15 dB over the frequency range of 5 to 150 MHz. Other specifications include a 2.5 typ noise figure, 22-dBm output power at a 1-dB compression point, 2:1 input and

output VSWR, and a -55 to $+85^\circ\text{C}$ operating range. The amplifiers meet MIL-STD-883B screening. Power requirements are 15V at 65 mA. \$84.

Amplifonix Inc, 2010 Cabot Blvd W, Langhorne, PA 19047. Phone (215) 757-9600.

Circle No 364

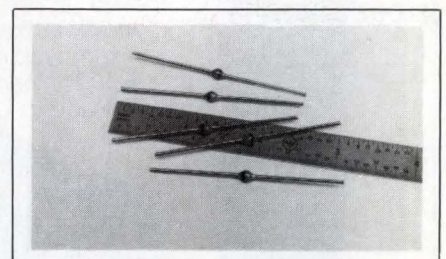

SILICON RECTIFIERS

- 30-nsec recovery time
- Handle voltages to 5000V

These hermetically sealed, glass-passivated, axial-lead silicon rectifiers feature a 30-nsec recovery time. They are available in 1A, 2A, and

180-mA versions. The 1A and 2A models (PFFX and 2PFFX, respectively) handle voltages from 200 to 1000V in 200V increments. The 180-mA version (PFF50) covers working voltages ranging to 5000V. The rectifiers operate with a soft-recovery characteristic that reduces EMI. All models are available in commercial and high-reliability military versions. \$0.62 (OEM qty).

Semtech Corp, 652 Mitchell Rd, Newbury Park, CA 91320. Phone (805) 498-2111.

Circle No 365

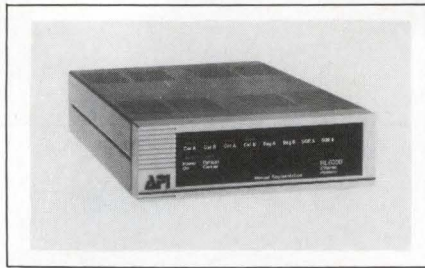

compatibility with other network equipment. The repeater has been designed to handle special problems of mixed V1.0, V2.0, and 802.3 networks. It can restore even severely distorted data packets to their original quality before retransmitting them. The repeater operates with standard Ethernet coaxial cable, or with smaller Thin-net cable, whether or not a transceiver heartbeat signal is present. An automatic-segmentation function will temporarily suspend the repeater function if a problem in one network section causes excessive data-packet collisions. The repeater also features

manual segmentation switches, which are useful during installation and for network trouble-shooting and problem isolation. \$1650.

American Photonics Inc, 71 Commerce Dr, Brookfield Center, CT 06805. Phone (800) 626-5745; in CT, (203) 775-8950. TLX 821353.

Circle No 366

FRONT PANEL

- Incorporates an onboard μP
- Snap-dome switches provide an enhanced tactile feel

This "smart" custom front panel incorporates a 2-line \times 40-character vacuum-fluorescent alphanumeric display and a module that includes an onboard μP . The display is mounted on a rigid panel, which also houses the keyboard. The keyboard uses snap-action dome switches to enhance tactile feel. The dome switches are covered with a poly-

ETHERNET REPEATER

- Meets or exceeds the specs of Ethernet V2.0 and IEEE-802.3
- Handles mixed networks

The RL6000L local repeater meets the stringent specifications of both the Ethernet V2.0 and the IEEE-802.3 standards to ensure complete

Anti-static

LOW COST 5-TUMBLER KEYLOCK SWITCHES

Our Type K keylocks have alarm, computer, cash register and equipment security all locked up with:

- Various key operate and removable positions
- 100% inspected
- Made in USA

Standard compact

For a free sample, write to:

OSLO CONTROLS

Oslo Controls, 328 Industrial Avenue, Cheshire, CT 06410.
(203) 272-2794. TWX: 710 455 3774.

GRAYHILL SOLID STATE RELAYS PROVIDE 100,000 HOURS MTBF, AQL OF 0.065%

Built with surface-mount technology for higher component density, better thermal management, greater manufacturing efficiency and better assembly control.

Grayhill SSR features:

- Demonstrated 100,000 hours MTBF (test data to date)
- AQL of 0.065%
- Excellent transient protection
- High blocking voltage components
- High surge current capacity
- Logic circuit compatibility
- Low EMI and RFI generation
- Inductive load switching capability
- Excellent shock and vibration immunity

MINI-PUCK SSR

- High dielectric voltage rating
- Maximum load current; minimum space
- 100% final testing
- SIP or Mini-Puck package styles
- DC-DC models available
- Competitive pricing

Available off-the-shelf from Grayhill or your local Grayhill distributor. For FREE literature, including specifications and prices, contact

561 Hillgrove Avenue, P.O. Box 10373
LaGrange, Illinois 60525-0373 USA
Phone: (312) 354-1040 TLX: 6871375
TWX: 910-683-1850 FAX: (312) 354-2820

CIRCLE NO 19

CIRCLE NO 20

SMART CHANGE.

CHANGE TO CHOMERICS FOR LOW-COST, COMMERCIAL GRADE EMI GASKETS

We heard you. You've wanted commercial-grade conductive elastomers priced competitively with wire mesh, carbon-loaded silicone, and metal finger stock. You also want them to deflect under low closure force.

They're here. Introducing the CHO-SEAL® 1000 series of low-cost silver-filled elastomers that give you the performance you need—60dB EMI shielding in the 30MHz to 1GHz range.

They're available in a variety of innovative shapes, with attachment time-savers like pressure-sensitive adhesives, mounting clips, and frames for pop-rivets. They can also be produced as custom designs. And of course you get the dust-sealing, acoustic, and cosmetic benefits which elastomers provide.

You get something else, too. Chomerics' years of EMI shielding experience, reputation for quality, and the most reliable products in the industry.

Make the smart change today. Call or write for the facts.

CHOMERICS
a GRACE company

77 Dragon Court, Woburn MA 01888
800-225-1936 (In MA: 617-935-4850)

CHOMERICS EUROPE
First Avenue, Marlow, Bucks, SL7 1YA England
(06284) 6030



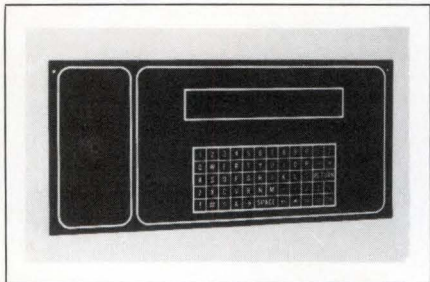

ter legend sheet; graphics are printed on the rear surface for durability and scratch resistance. Almost anything that can be photographed can be permanently printed on the legend sheet, including graphics, symbols, corporate logos, and numbers. You can also incorporate other human-interface devices into these custom panels, including annunciators, joysticks, trackballs, illuminated switches, and multiple displays. Enclosures are also available. \$550 (100). Delivery, 18 weeks ARO.

IEE Inc, Planar Products Div, 7740 Lemona Ave, Van Nuys, CA 91409. Phone (818) 787-0311. TLX 4720556.

Circle No 367

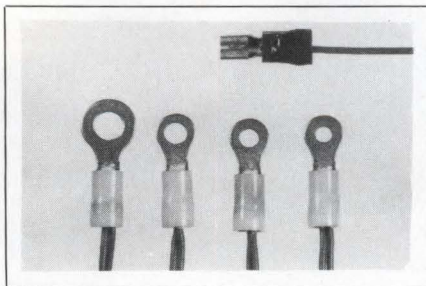

SENSORS

- Are fully recyclable
- -55 to +150°C operation

The Thermamount surface-mount ring sensors operate over a -55 to +150°C range. Unlike traditional protective devices, these NTC thermistors operate unattended and are fully recyclable. Resistance values (at 25°C) range from 50Ω through 5 MΩ, ±10%. The sensors are available in standard lug sizes of #6, #8, #10, and ¼ in. Tighter tolerances, special resistances, and extended operating ranges are available on

special request. Units in the Thermamount family feature 3.8% to 6.1% coefficients of resistance. \$4.75 (OEM qty).

Piezo Electric Products Inc, 212 Durham Ave, Metuchen, NJ 08840. Phone (201) 548-2800. TWX 710-998-0592.

Circle No 368

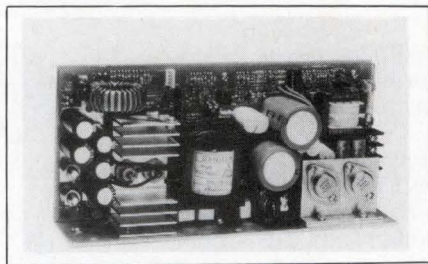

SWITCHING SUPPLIES

- 4W/in² power density
- 80% typ efficiency

V501 Series switchers are 500W, single-output supplies that offer a power density of 4W/in². Standard outputs include 5V at 100A, 12V at 42A, 15V at 33A, and 24V at 21A. Specs include an efficiency of 80%, ripple and noise of 1% or 100 mV p-p, and a peak transient of less than ±2% or ±200 mV. The supplies are UL recognized, CSA certified, and licensed by TUV. Overvoltage protection is standard. Options include a power-fail monitor, thermal shutdown, and logic inhibit. \$210 (OEM qty). Delivery, stock to eight weeks ARO.

Deltron Inc, Box 1369, North Wales, PA 19454. Phone (215) 699-9261. TWX 510-661-8061.

Circle No 369

BANDPASS FILTERS

- Insertion loss of less than 2 dB
- Center frequencies range from 125 to 525 kHz

These bandpass filters feature torsional-mode resonators and a coilless transducer design. Insertion loss specs at 2 dB max, and the third-order intercept point is greater than 55 dB. Center frequencies

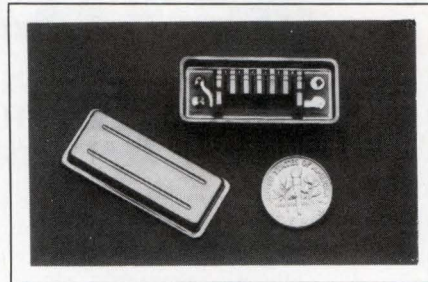

range from 125 to 525 kHz, with bandwidths ranging from 0.5% to 5% of the center-frequency value. The frequency-response characteristics range from equal-ripple pass-band responses to round-top Gaussian shapes, and the number of resonators can vary from one to as many as twelve. The filters are housed in hermetically sealed metal packages that are designed for pc-board mounting. \$65 to \$175 (100). Delivery, 6 to 13 weeks ARO.

Rockwell International, Filter Products, 2990 Airway Ave, Costa Mesa, CA 92626. Phone (714) 641-5311. TLX 685532.

Circle No 370

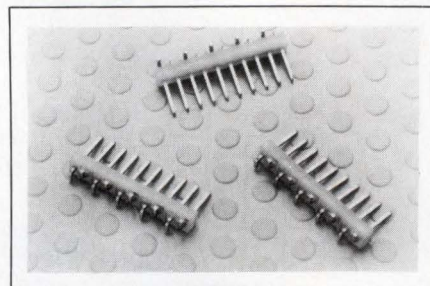

PIN-STRIP HEADERS

- Straight- and right-angle versions
- 94V-0 UL rating

These surface-mount pin-strip headers and socket strips feature 0.025-in. square leads for the connector end and 0.1-in. pin-to-pin spacings. The board-side leads have a gull-wing configuration. Straight and right-angle versions are available in both product lines. The polyamid insulation material has a 94V-0 UL flammability rating. Pins are made of drawn phosphor bronze with 50-μin. nickel underplating and 20-μin. gold plating at the contact

You've made power supplies smaller, lighter and quieter with a harmonica?

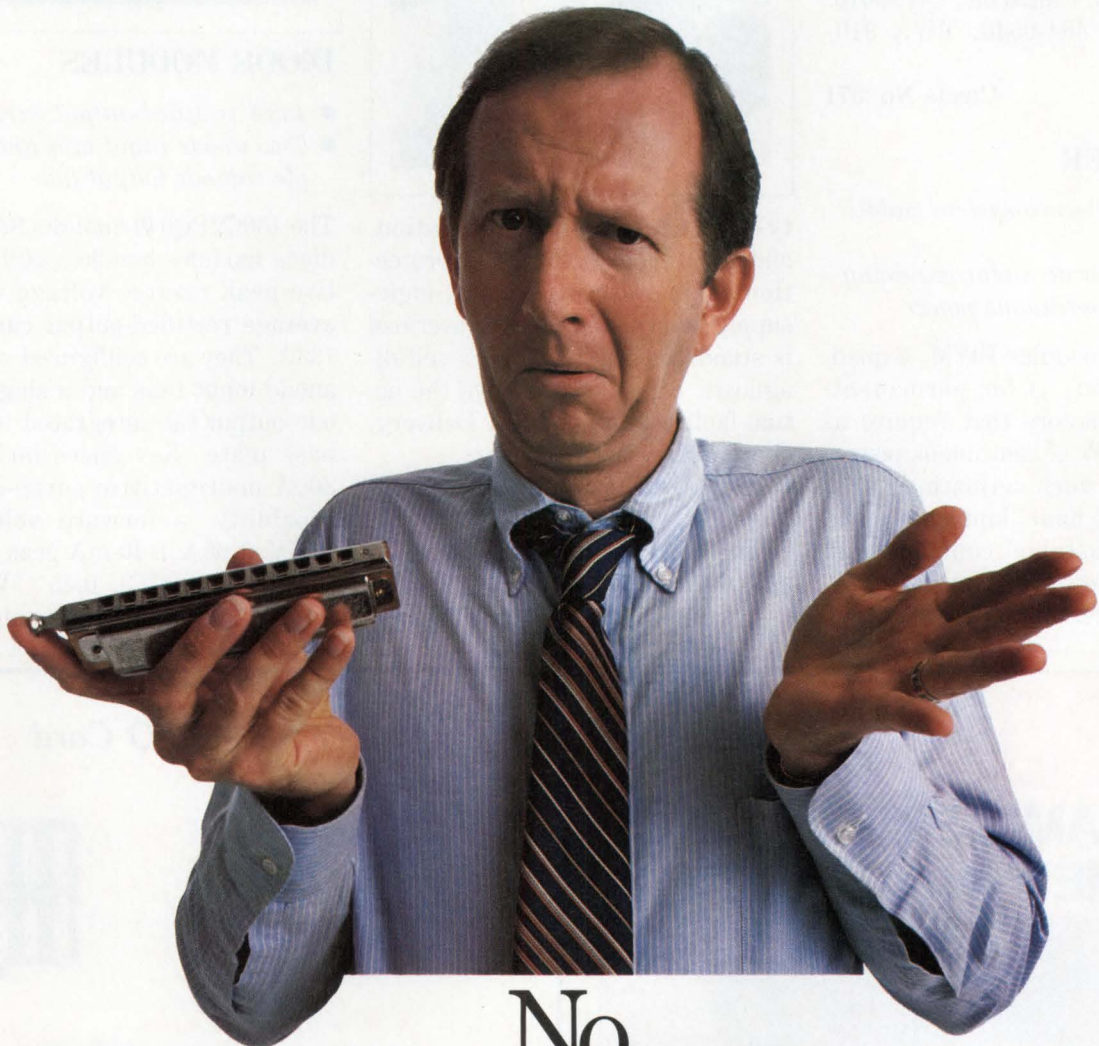

No, Harmonic Resonance!

Harmonic resonant, as a technology for our new line of power supplies, is practically as significant as going from linear to switching.

So, why did we develop it? It lets us make open frame switchers almost half the size of industry standards. Therefore, lighter. And quieter from a conductive noise standpoint. All for the same price you're paying now.

Of course, like all our power supplies introduced since 1983, this new 9S Harmonic Resonant line meets VDE, UL and CSA for safety. And VDE, FCC and IEC for conducted noise.

For more information on our new 9S Harmonic Resonant line (or where to get a nice harmonica), contact us today. Sierra Power Systems (formerly Sierracin), 20500 Plummer Street, Chatsworth, California 91311. Call toll-free (800) 423-5569. In California, (818) 998-9873.



Sierra Power Systems

Division of Valor Electronics, Inc.



area. Other specs include a 5A current rating, 4-mΩ max contact resistance, and 5-GΩ min insulation resistance. Headers, \$0.022 per pin; sockets, \$0.032.

Carrot Components Corp, 750 W Ventura Blvd, Camarillo, CA 93010. Phone (805) 484-0540. TWX 910-336-1237.

Circle No 371

AMPLIFIER

- Simplified servo-system stabilization
- Suitable for dc motor requiring 900W of continuous power

The Axa, a modular PWM, 4-quadrant amplifier, is for permanent-magnet dc motors that require as much as 900W of continuous power. It features such adjustments as peak-current limit, input gain, and offset. Adjustable compensation simplifies servo-system stabilization. Other features include veloci-



ty-loop or torque-mode operation, and a 1.01 form factor. Fault protection against excess current, logic-supply failure, and thermal overload is standard. The amplifier's self-diagnostic capability displays the actual fault condition. \$778. Delivery, six to eight weeks ARO.

PMI Motion Technologies, 49 Mall Dr, Commack, NY 11725. Phone (516) 864-1000. TWX 510-223-0007.

Circle No 372

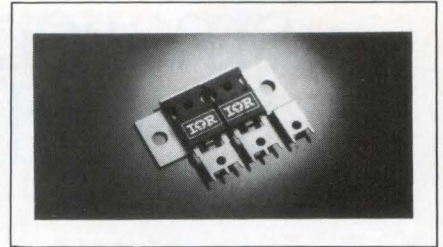

DIODE MODULES

- 133A rectified-output current
- Two anode input tabs and a single cathode output tab

The 130C2PQ040 dual-die Schottky-diode modules handle a 40V repetitive-peak reverse voltage with an average rectified-output current of 133A. They are configured with two anode input tabs and a single cathode output tab integrated with the base plate. Key specs include an 800A nonrepetitive surge-current capability, a forward voltage of 0.55V at 60A, a 40-mA peak reverse current (at 25°C), 0.45°C/W junction-to-case thermal resistance, and

320 SERIES

DYNAMIC SINGLE POLE MOMENTARY SWITCHES

A distinctive difference in tactile feel pushbuttons with flexibility of layout for single key or keyboard. Standard .1" installation grid. Choice of contact design for SPST, SPDT and SPST two output requirements. Dome contact tests to 1 million life cycles. Wide selection of cap styles, colors and graphics.

Send for samples and price information.

Subsidiary of Stein Industries Inc.

ELECTRONIC COMPONENTS GROUPE
26 North Fifth Street, Minneapolis, Minnesota 55403

800-826-8719 612-375-9639
TWX 62985650 FAX 612-375-1905

CIRCLE NO 21

Super Serial I/O Card

MODEL PCSS-8 8 PORT SERIAL I/O CARD

- 8 RS232 DOS compatible ports per board
- Up to 32 can be added to PC with four cards
- A simple prompt level command changes the port
- Can be used in real-time event driven applications
- Standard DOS interrupts and addresses used for all 8 ports

Also available — Personal EPROM systems, OEM programmers, and production programmers/duplicators

DRAWER 1346
BAY ST. LOUIS, MS 39520

GTEK, INC.

GTEK, PALASM, MS-DOS, PC-DOS, & PAL are registered trademarks

ORDER TOLL FREE
1-800-255-GTEK (4835)

CIRCLE NO 22

A Case For Pure Genius

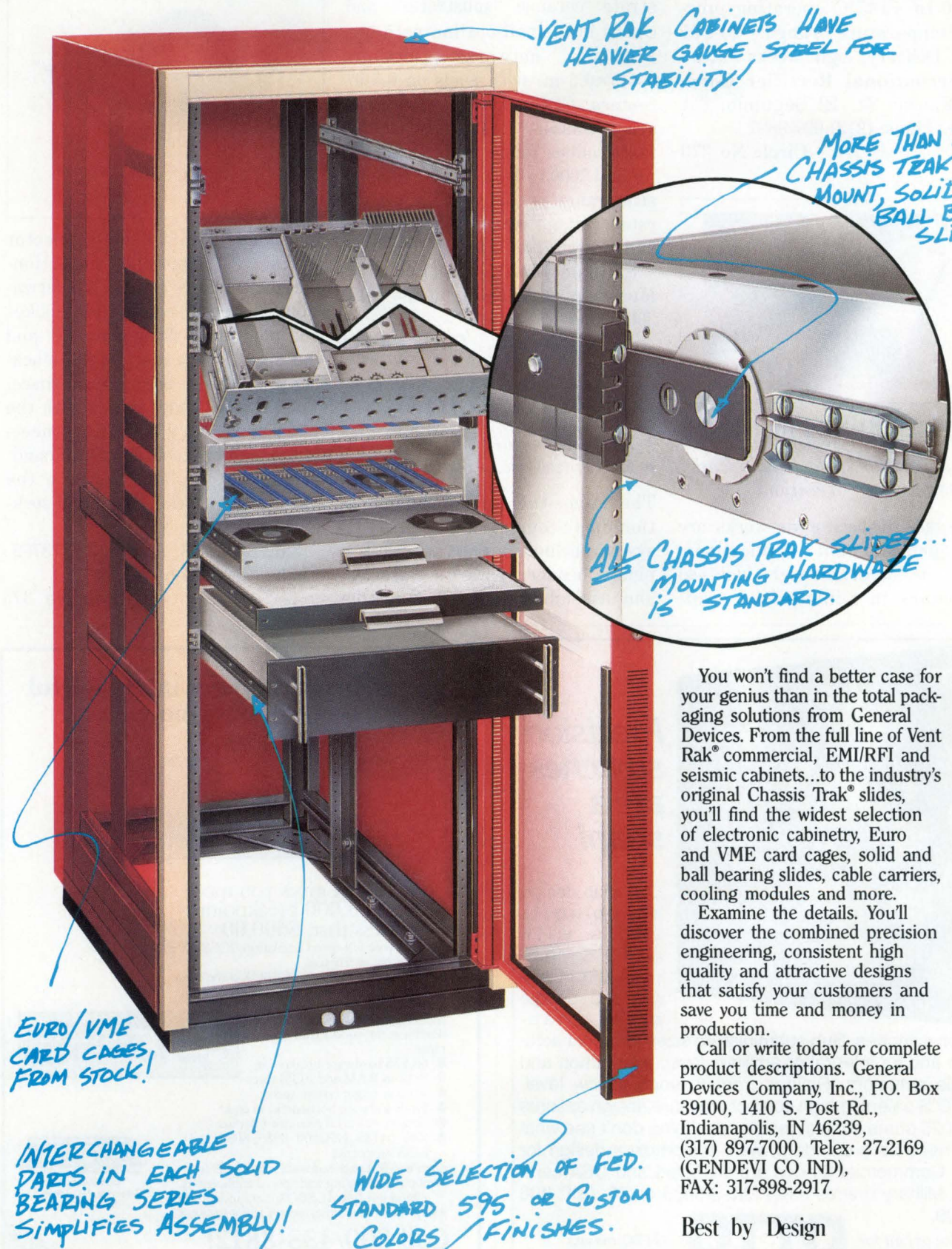

You won't find a better case for your genius than in the total packaging solutions from General Devices. From the full line of Vent Rak® commercial, EMI/RFI and seismic cabinets...to the industry's original Chassis Trak® slides, you'll find the widest selection of electronic cabinetry, Euro and VME card cages, solid and ball bearing slides, cable carriers, cooling modules and more.

Examine the details. You'll discover the combined precision engineering, consistent high quality and attractive designs that satisfy your customers and save you time and money in production.

Call or write today for complete product descriptions. General Devices Company, Inc., P.O. Box 39100, 1410 S. Post Rd., Indianapolis, IN 46239, (317) 897-7000, Telex: 27-2169 (GENDEVI CO IND), FAX: 317-898-2917.

Best by Design

GENERAL DEVICES
Electronic Packaging

CHASSIS TRAK® and VENT RAK® are registered trade names of General Devices Co., Inc.

a -40 to +125°C operating junction-temperature range. \$14.91 (100). Delivery, eight weeks ARO.

International Rectifier Corp., 233 Kansas St, El Segundo, CA 90245. Phone (213) 607-8837.

Circle No 373

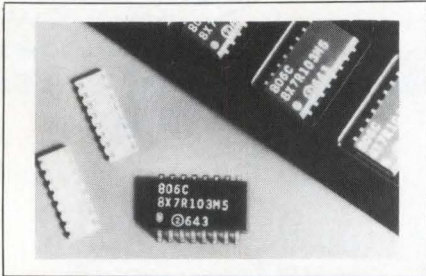

CAPACITOR NETWORKS

- Designed for surface mounting
- -55 to +125° operation

Type 806C capacitor networks are for surface-mount applications. Each one integrates eight identical capacitors in miniaturized Cap-

strate ceramic substrates and comes in a small-outline package. Finished networks measure 0.445×0.3 in. with leads on 0.5-in. centers. COG and X7R dielectrics are available. Respective capacitance values range from 27 to 2000 pF and 2000 to 47,000 pF. The operating range is -55 to +125°C. The rated voltage equals 100V at 85°C and 50V at 125°C. \$1.50 (10,000).

Sprague Electric Co., Box 9102, Mansfield, MA 02048. Phone (617) 339-8900.

Circle No 374

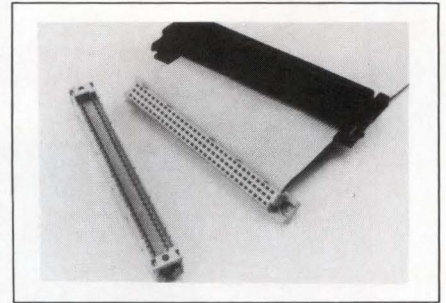

meets DIN 41612 blade-connector specs with controlled insertion-withdrawal force and 100% polarization. The DIN-compatible socket and plug allow daisy chaining, and the cover design allows closer stacking to maximize use of board space. The pinless header mates with the wrap posts of a 96-pin DIN connector. Assembly tools consist of hand-press locator plates for both the plug and the socket. Plug and socket, \$6.34 (1000).

3M, Box 2963, Austin, TX 78769. Phone (512) 834-6563.

Circle No 375

CONNECTOR SYSTEM

- Meets DIN 41612 standards
- Maximizes use of board space

The 64-position Scotchflex insulation-displacement connector (IDC) system includes a plug, a socket, a pinless header, related accessories, and assembly tools. The system



Precision switches are a snap!

One stop design shopping is yours with OTTO'S complete line of single and double break snap-action switches. Sub-subminiature sizes for direct actuation and for integral or auxiliary lever, pushbutton and toggle actuators. Ratings from 8 amps to low level. OTTO'S patented high contact pressure design assures <0.025 ohms contact resistance. If you don't see what you need as a standard, we'll customize a design for you. Commercial grades are UL listed and CSA certified. Military grades meet MIL-S-8805/4, /76, /101, /106 & /109.

OTTO CONTROLS OTTO means precision switches.

Write or call for Catalog 103.

2 East Main St. • Carpentersville, IL 60110 • 312/428-7171
FAX: 312-428-1956 • TELEX: 72-2426

CIRCLE NO 23

An in-circuit emulator this powerful should cost ten times more!



ICEBOX gives you more than 65,000 breakpoints for less than \$600.00

For true full-speed emulation, ICEBOX is the portable alternative.

Small and compact, ICEBOX is the most cost-effective microprocessor emulation tool available. Perfect for troubleshooting, hardware and software development, production test and repair.

- 65,535 hardware breakpoints
- Built-in RAM and ROM tests
- Runs at target system speed
- Finds software bottlenecks in code
- Simple, powerful operator interface
- Z80, 64180, NSC800, 8085, 8086, and 8088 supported

Optional ICEpack software is available for symbolic debugging and special applications. Find out how ICEBOX combines power and price to save time, money and guesswork!

Call 800/433-8812!

Ask About Our 14-Day Money Back Guarantee!

VISA, MasterCard, American Express Accepted!



8930 Route 108
Columbia, MD 21045-2101
301-964-8455

NOW AVAILABLE!
Model 8088 and 8086

CIRCLE NO 24

Introducing the Fastest Family of CMOS EPROMs on the Circuit

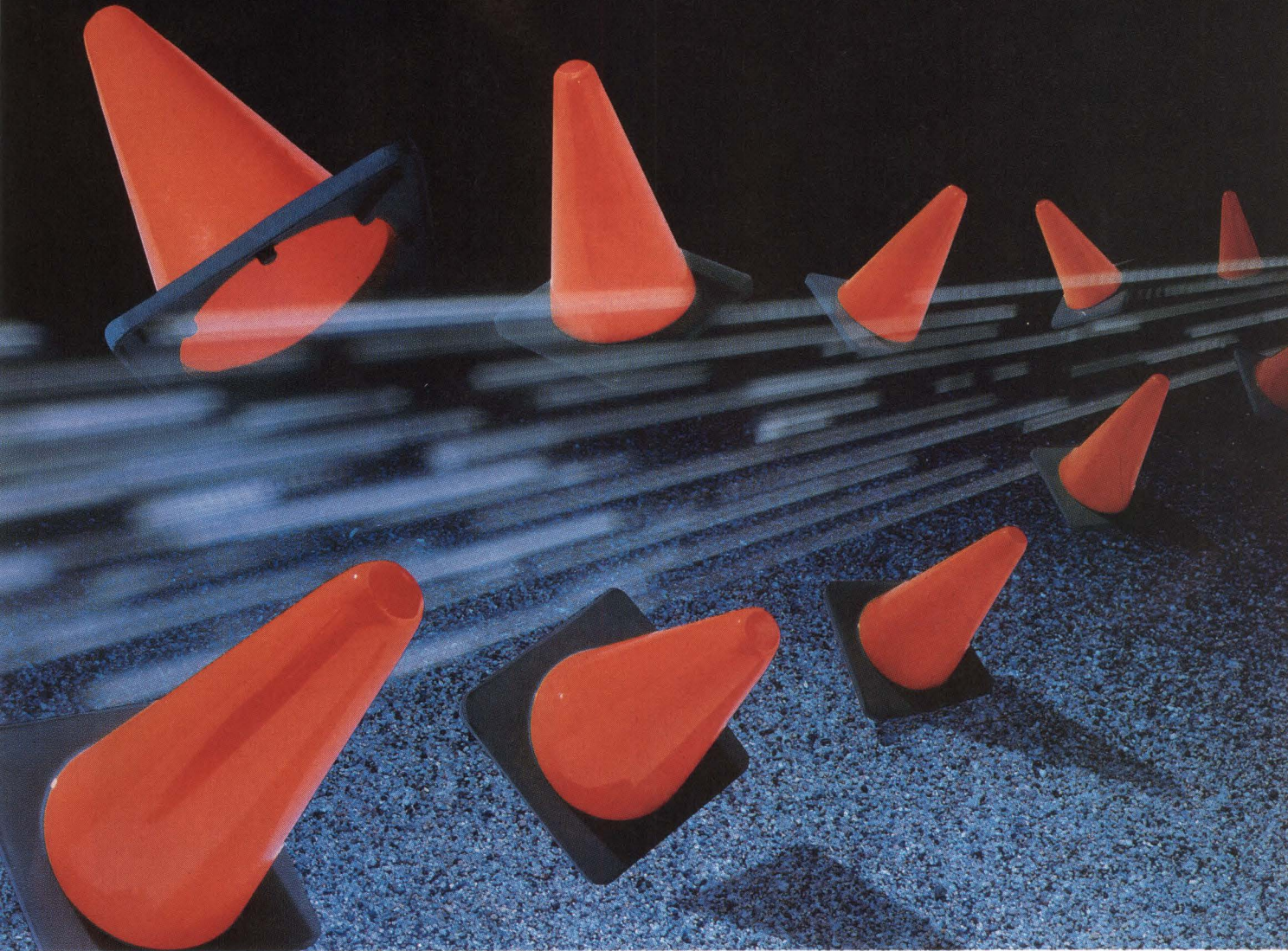

WSI EPROMs:
Twice as fast as
the Pack.

WSI's family of CMOS EPROMs keeps you in the fast lane with access times as low as 55 NS, leaving systems with wait states in the dust. That means you can now turbo charge your system. With EPROM architectures ranging from 8K x 8 to 16K x 16.

WSI R PROMs: Bipolar speed with CMOS low power. Our unique CMOS high-density Reprogrammable PROMs (R PROMs)

EDN April 30, 1987

match the speed of your favorite bipolar PROMs. So you can replace them with our pin-out compatible R PROMs. And get EPROM reprogrammability and low power consumption as well.

WSI: Puts you on track fast..... reliably.

Our EPROMs and R PROMs program in less than 16 seconds. Plus you get 200 MA of latch up protection and a minimum of 2000 V of ESD protection. So your production revs up faster. With more reliable, smoother running products.

Call the WSI team today. With this kind of speed and reliability, it makes sense to check out WSI's EPROMs and R PROMs.

So call us at (800) 331-1030, ext. 234, or in CA. (800) 323-3939, ext. 234. And we'll get you on the road to higher performance today. Waferscale Integration, Inc., 47280 Kato Road, Fremont, CA 94538

Part No.	Speed	Type
WS57C191/291	40 ns.	2k x 8 CMOS R PROM
WS57C43	55 ns.	4k x 8 CMOS R PROM
WS57C49	55 ns.	8k x 8 CMOS R PROM
WS57C64F	55 ns.	8k X 8 CMOS EPROM
WS57C128F	70 ns.	16k x 8 CMOS EPROM
WS57C256F	70 ns.	32k x 8 CMOS EPROM
WS57C65	55 ns.	4k x 16 CMOS EPROM
WS57C257	70 ns.	16k x 16 CMOS EPROM

Waferscale
INTEGRATION, INC.

CIRCLE NO 177

255

NEW PRODUCTS

COMPUTERS & PERIPHERALS



GRAPHICS SET

- *Display system for IBM PC*
- *Includes coprocessor board, monitor, and software*

The PC4100 graphics coprocessor board, together with a multiple-line-rate monitor and terminal emulation packages, provide you with Tektronix-compatible graphics on an IBM PC. The set displays 256 colors from a palette of 16 million and is compatible with the IBM PC's EGA and CGA boards. The board offers a resolution of 640×480 pixels. In its terminal-emulation mode, the board provides higher resolution and speed. The emulation software allows the PC to run the company's 4107 terminal's mainframe-based software applications. Because the board supports the manufacturer's 4696 color ink-jet printer, you copy the screen directly without using any separate application program's printer drivers. PC4100 board, \$1800; multiple-line-rate monitor, \$950; emulation software, from \$495.

Tektronix Inc., Box 15273, Portland, OR 97215. Phone (800) 225-5434; in OR, (503) 235-7202.

Circle No 376

GRAPHICS CONTROLLER

- *High-resolution controller for IBM PC*
- *1024×768-dot resolution*

The 1004 display controller offers 16 colors from a palette of 4096 and has a screen resolution of 1024×768

dots. The board requires one slot in an IBM PC/AT or PC/XT. When it emulates the IBM CGA, the board displays text in a 960×600-dot window. The text's legibility is superior to that provided by CGA, EGA, or PGC controllers, the vendor claims. The controller's bit-slice architecture provides drawing rates from 5M pixels/sec for random vectors to 42M pixels/sec for fill operations. The board is compatible with a variety of interface standards (including Gem, Halo, VDI, and MS Windows)

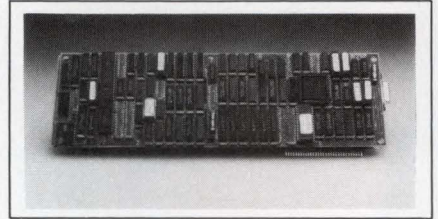

and CAD packages (such as AutoCAD, CADkey, CADvance, Omnidraft, and P-CAD). \$2995.

Metheus Corp., 5510 NE Elam Young Parkway, Hillsboro, OR 97124. Phone (503) 640-8000.

Circle No 377



WORKSTATION

- *Desktop system runs VAX software*
- *Workstation's performance equals MicroVAX II's*

The VAXstation 2000 is a desktop workstation that performs on a MicroVAX II level. The basic system includes the MicroVAX CPU chip, the desktop system box, 4M bytes of memory, a built-in Ethernet adapter, a 3-button mouse, a keyboard, a software license, a 1024×864-pixel monochrome monitor, and a 1-year on-site warranty.

A fully configured system includes the MicroVAX CPU chip; 6M bytes of memory; an expanded system box; a 71M-byte disk drive; a 95M-byte streaming-tape drive; the Ethernet adapter; a 3-button mouse; a keyboard; software licenses; a 19-in., 1024×864-pixel monochrome monitor, and a 1-year on-site warranty. Intermediate configurations are also available. \$10,500 to \$22,245.

Digital Equipment Corp., 146 Main St, Maynard, MA 01754. Phone (800) 344-4835.

Circle No 378

Here's your best combination of superior shielding,
attractive design and price:



Maximum
Shielding 77dB

Nominal
Shielding 55dB

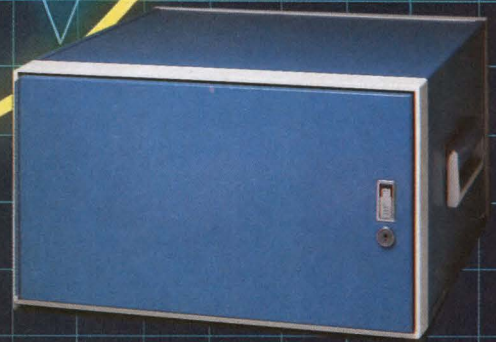

OPTIMA® EMI/RFI.

Superior Shielding. The numbers tell the story. An independent laboratory tested Optima® EMI/RFI cabinets, cases and accessories and proved a nominal 55dB shielding effectiveness throughout the 30 to 1000 MHz frequency range. Attenuation values at varied frequencies ranged up to 77dB!

Optima cabinets and cases come with 20 years of shielding know-how behind them, and with design features built-in that really make a difference. Like beryllium copper gasketing for all seams and joints. Heavier gage aluminum doors (.090") and tough, 3-point latch mechanisms for a tighter, uniform fit.

A Full Line. A complete line of Optima EMI/RFI accessories and cooling devices, designed to maintain shielding effectiveness, is available.

Active and passive cooling is

accomplished with combinations of vented doors, air plenums, honeycomb filters, perforated top and bottom panels, blowers and fans. Also available are multibay ganging kits, fully shielded drawers and retractable writing shelves.

Attractive Design. Optima has a reputation for aesthetically styled enclosures that's especially realized in its Optima EMI/RFI cabinets and cases. Put one next to any other enclosure available and judge for yourself. Plus they are engineered for unsurpassed structural integrity, thus assuring that the shielding effectiveness will remain intact for years to come.

Priced for Value. With all their superiority, Optima EMI/RFI enclosures are competitively priced to bring you the best value. Some

manufacturers have to make costly product and manufacturing changes to bring their enclosures to minimally acceptable shielding levels. But Optima standard enclosures have always been constructed with quality features, so less modification is necessary to produce a cabinet that shields effectively.

We're convinced that Optima EMI/RFI enclosures and accessories will provide you with a combination of shielding, attractiveness and value superior to any others on the market. Find out more. Write or call us and we'll send you the independent test data that proves it.

OPTIMA®
ENCLOSURES

Gichner Systems Group
A Division of The Union Corporation

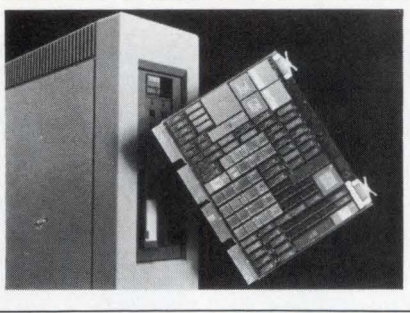

ARRAY PROCESSOR

- Array processor for MicroVAX II
- Performs signal and image processing

The MicroMSP-4 board performs numerically intensive signal and image processing 100 times faster than can an unaided MicroVAX II computer. The card occupies one slot in the backplane of a MicroVAX II. The board performs as many as 20M flops. It computes a 1024-point complex FFT in 4 msec, a 512×512 complex FFT in 2.5 sec, and FIR-filter tasks at 100 nsec/tap. \$5950.

CDA, 411 Waverly Oaks Rd, Waltham, MA 02154. Phone (617) 647-1900. TLX 922521.

Circle No 379

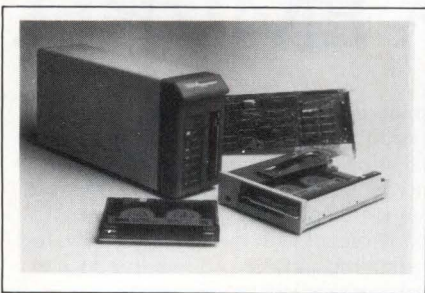

TAPE BACKUP SYSTEM

- For IBM PCs
- Features 125M-byte capacity

The QT-125 Series tape drives provide 125M bytes of storage in either an internal, half-height configuration or an external form. This Xenix-compatible system works with IBM PCs. It also works with Novell (Provo, UT), 3Com (Menlo Park, CA), and IBM token-ring LANs. The system offers file-by-file

and mirror-image options for backing up and restoring at data rates as fast as 5M bytes/minute. Drive-utility software is included. QT-125i (internal system), \$1895; QT-125e (external system), \$2495.

Tecmar Inc, 6225 Cochran Rd, Solon, OH 44139. Phone (216) 349-0600. TLX 466692.

Circle No 380

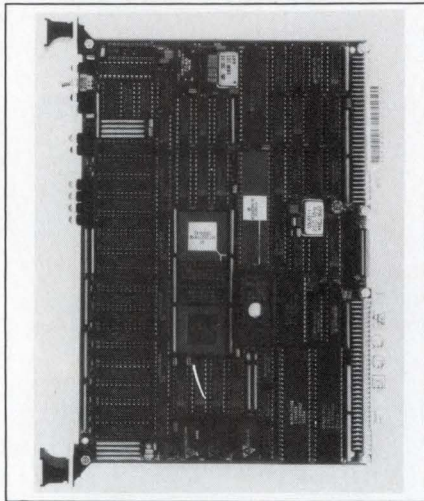

SCSI BOARD

- Has independent SCSI-bus and floppy-disk interfaces
- Incorporates 128k bytes of dual-port RAM

The SYS68K/ISCSI-1 double-Eurocard board for VME Bus systems includes an ANSI X3T9.2 standard SCSI and a separate disk-controller chip that allows direct connection of as many as four floppy-disk drives. You can operate the SCSI, which can achieve data rates as high as 1.5M bytes/sec, in a synchronous or an asynchronous mode, as a SCSI-bus target or initiator. The board has an onboard, 10-MHz 68010 μ P, which has zero-wait-state access to 128k bytes of dual-port static RAM (the other port goes to the VME Bus). Sockets are provided for as much as 128k bytes of EPROM, and the board comes with driver firmware to control the SCSI-bus and floppy-disk interface. Source code for the drivers is optional. In addition, the board has a

4-channel 68450 DMA controller. VME Bus access to the dual-port RAM is provided through an A24/D16/D8 VME Bus interface. The board also has a bus interrupter with four interrupt-request lines; the level and vector of each interrupt is software programmable. DM 4720.

Force Computers GmbH, Daimlerstrasse 9, 8012 Ottobrunn, West Germany. Phone (089) 600910. TLX 524190.

Circle No 381

Force Computers Inc, 727 University Ave, Los Gatos, CA 95030. Phone (408) 354-3410. TLX 172465.

Circle No 382



BAR-CODE READER

- For the HP-94 handheld computer
- Optically programmable

The HP Smart Wand is an optically programmable bar-code reader. If you use it with the HP-94 handheld computer, a software-development system, and software for host-computer data communications, you'll have a complete, portable data-collection system. The wand holds the decoding software for the bar-code reader, so the HP-94's memory remains free for application software. The reader recognizes major bar-code types, including Code 39, Interleaved 2 of 5, UPC/EAN/JAN, and Codabar. The scanner typically draws 9 mA in standby mode and 16 mA in operating mode. The reader can scan at angles from 0 to 45° at rates from 3 to 50 in./sec. \$350.

Hewlett-Packard Co, 1000 NE Circle Blvd, Corvallis, OR 97330. Phone local office.

Circle No 383

The Sine of a Good Generator



Purity • Precision • Speed

- typically 0,0006% (-105 dB) distortion in the audio range
- $\pm 0,1192$ mHz frequency accuracy throughout the 0,2 Hz to 200 kHz range
- precision attenuator with $\pm 0,026$ dB ($\pm 0,3\%$) accuracy across the entire $100 \mu\text{V}$ to 5 V range
- very fast response time for *all* functions via IEEE-488 interface
- heterodyne synthesis gives "instantaneous" settling ($< 0,1$ ms) of frequency and amplitude
- memory sweep feature with pre-defined amplitude weighting
- two models: Sine Generator Type 1051 and Sine/Noise Generator Type 1049

Brüel & Kjær 

Brüel & Kjær Instruments, Inc.

HEAD OFFICE: 185 Forest Street, Marlborough, Massachusetts 01752 · (617) 481-7000 · TWX: 710-347-1187
REGIONAL OFFICES: MA (617) 481-7000 ext. 139 · NJ (201) 227-6100 · MD (301) 948-0494 · GA (404) 951-0115
MI (313) 522-8600 · IL (312) 358-7582 · TX (713) 645-0167 · CA (714) 978-8066 · (415) 574-8155 · WA (206) 625-1112

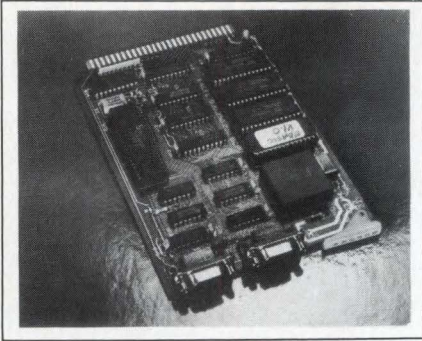

SINGLE-BOARD μ C

- CMOS computer for the STD Bus
- Has a multitasking Basic compiler

The BCPU64 is an STD Bus-compatible processor that is also compatible with the IBM PC. The card contains a multitasking Basic compiler, so you can run compiled code on an IBM PC or download it to the μ P board and run it there. The board includes 64k bytes of battery-backed CMOS RAM, a battery-backed clock and calendar, two RS-232C ports, and an STD Bus timing generator. The timing generator permits the CPU to operate at 10 MHz without violating the bus timing specifications. In addition to the compiler, the board includes a debugger that runs on the IBM PC and an 8k-byte BIOS and operating-system kernel that runs on the board itself. Serial communication between the board and a PC conforms to ISO X3.28. \$585.

Encel Systems Ltd, 5300 Memorial Dr, Atlanta, GA 30083. Phone (404) 292-3309.

Circle No 384

DISK DRIVES

- Offer capacities from 168M to 689M bytes
- Support Novell's Netware software

The N-8000 Series disk drives provide disk capacities of 168M, 374M, 510M, and 689M bytes of RAM. The drives have transfer rates of 2.45M bytes/sec (peak) and access times as low as 15 msec. The single-disk

689M-byte system is contained in an 11.5x5.5-in. package. Each drive features an SMD interface; by adding an NMSC 8600 controller, users of the Novell (Provo, UT) network can connect as many as four drives in daisy-chain fashion, thus making a 2700M-byte disk system. The 510M-byte disk system, \$10,900.

National Memory Systems Corp, 335 Earhart Way, Livermore, CA 94550. Phone (415) 443-1669. TWX 910-386-6006. TLX 821892.

Circle No 385

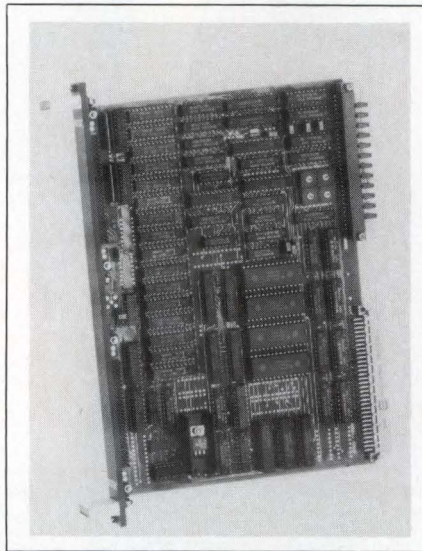

DATA INTERFACE

- Transmits 16-bit data at rates as high as 30M bytes/sec
- Buffers data in 128k bytes of on-board RAM

The Bift-1/68K interface board provides a 16-bit data interface capable of transmitting approximately 30M bytes/sec, plus 128k bytes of local buffer memory. It allows you to buffer high-speed data that's going to or coming from VME Bus systems. The board's separate 16-bit input and output ports operate asynchronously in conjunction with a 2-wire handshake and four control lines, or synchronously at programmable clock frequencies in the 100-kHz to 18-MHz range. A clock output allows you to synchronize such off-board devices as A/D converters. The double-Eurocard board in-

cludes a DMA controller for shifting data between the buffer memory and VME Bus global memory. The DMA controller operates in conjunction with a separate RAM/EPROM memory, into which you can program a user-defined target-address map. This map allows you to transfer any single 16-bit word in the buffer memory to a specified location in the VME Bus system. The board also includes a VME Bus interrupter with programmable vectors. DM 2900.

Eltec Elektronik GmbH, Galileo-Galilei-Strasse 11, 6500 Mainz 42, West Germany. Phone (06131) 50031. TLX 4187273.

Circle No 386



COMPUTER

- Has 32-bit access to local RAM, EPROM, and VME Bus
- Includes intelligent serial I/O and SCSI-bus cards

The Focus-32 PDOS System 21A is a fully cased, 12-slot VME Bus computer equipped with five VME Bus slots occupied by CPU, memory, serial-interface, mass-storage-interface, and system-controller cards. The card slots are arranged in two horizontal stacks of six slots each, and they include both J1 and J2 backplanes. You can mount the unit in either a tabletop or a tower configuration. The CPU card has a 20-MHz 68020 μ P, a 68881 math coprocessor, 512k bytes of zero-wait-state static RAM, space for as much as 512k bytes of EPROM, two serial I/O lines, and a VMX Bus primary master interface. All the

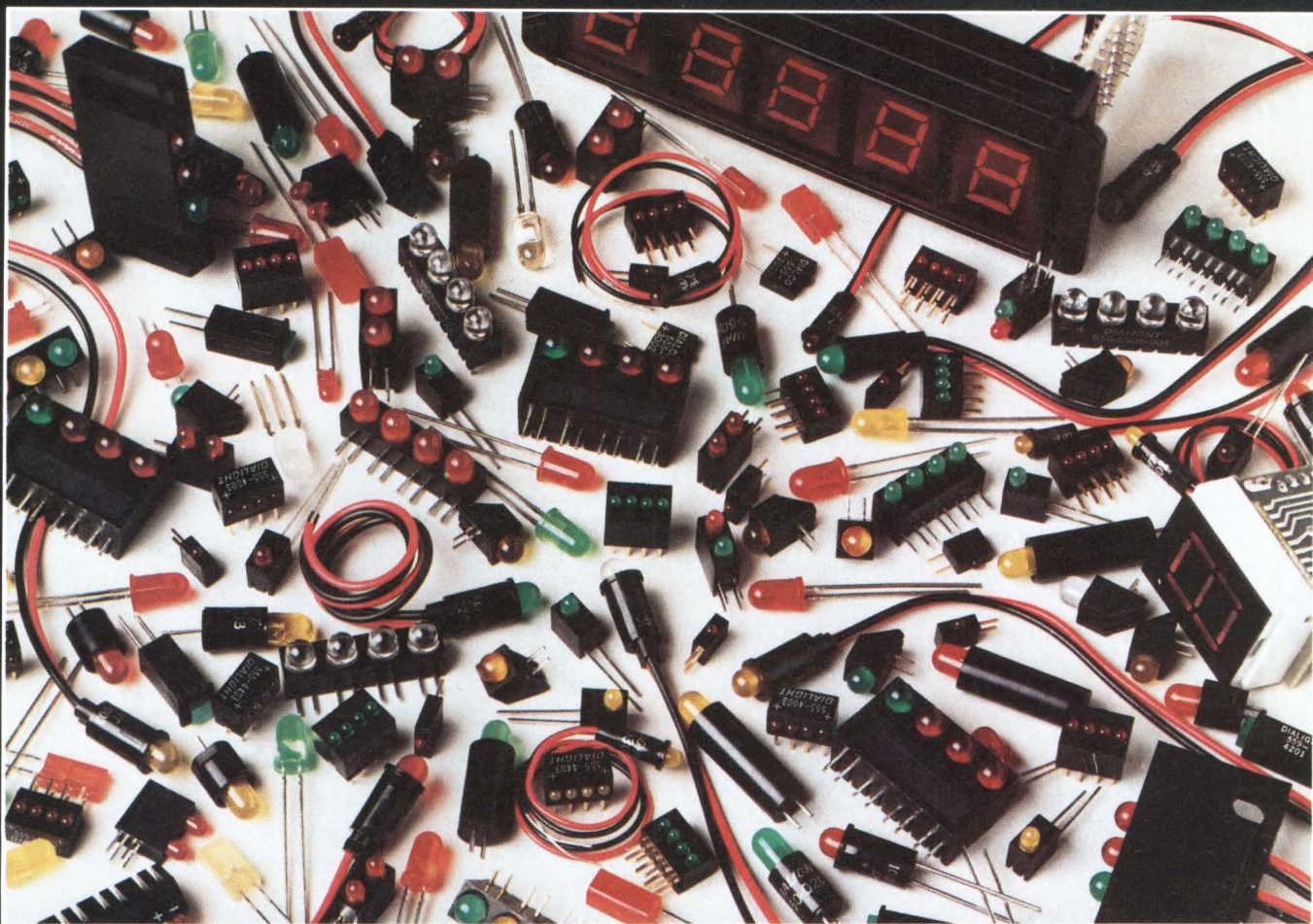

Dialight LED indicators. For a selection that makes a noticeable difference.

From discrete lamps to circuit board indicators no one gives you more alternatives for the high visibility finishing touch than Dialight. And more alternatives mean more design flexibility.

Take Dialight's labor-saving circuit board indicators, for instance. They plug right in, ready to solder. No delicate leads to bend, trim and possibly break. No expensive hand labor. And no doubts about which brand to choose.

Dialight designed the first circuit board indicator back in 1972 and we've been expanding our selection ever since. Developing hundreds of standard and custom designs for the largest corporate giants and the smallest of emergent growth companies.

In fact, no one sells more LED indicators, in more configurations, for more applications than Dialight.

Call us and we'll prove it.

(201) 223-9400. Or write, Dialight Corporation, 1913 Atlantic Ave., Manasquan, NJ 08736. Ask for our free catalogs. If you don't see what you need in 100% tested, precision engineered circuit board and panel indicators, readouts and lamps, ask for it. We'll design it for you.

After all, that's how we've developed a selection that's given us, and could give you, a noticeable difference.

DIALIGHT CORPORATION

DIALIGHT • KULKA • HHSMITH

A North American Philips Company

CIRCLE NO 96

Gang/Set Programmers The PP40 Series

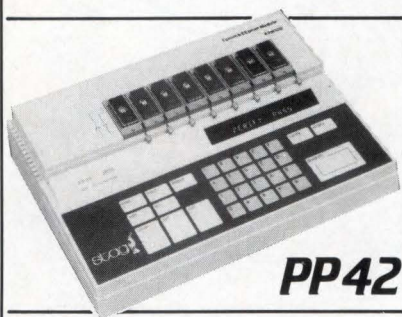

PP42

The PP40, PP41 and PP42 are low-cost MOS programmers, ideally suited to both the production and design environments.

- Programming support for 24, 28, 32 and 40-pin EPROMS and EEPROMS and 28 and 40-pin Single Chip Micro-processors.
- Quickly programs up to 8 devices using the fastest available algorithms such as Intel's Quick Pulse* and AMD's Flashrite*.
- Firmware upgradable to provide an ever increasing library of devices.
- Stag's unique 'Interlace*' technique allows fast programming of 8, 16 and 32-bit wide data.
- PP41 and PP42 RAM expandable to 64M bits.
- Margin testing
- Automatic system self-tests ensure operational integrity.
- Full editing capability on PP41 and PP42 enables powerful data manipulation.
- Non-Volatile storage of system parameters allows auto-recall on power-up.
- Bi-colored LEDs and a clear 16 character display for error reporting and system status.

For further information, contact:

Stag Microsystems Inc., 1600 Wyatt Drive, Santa Clara, CA 95054, (408) 988-1118 (CA), (800) 227-8836	Stag Microsystems Inc., 3 Northern Blvd., Amherst, N.H. 03031, (603) 673-4380 (800) 222-STAG
--	--

*Interlace is a trademark of Stag.
*Quick-Pulse is a trademark of Intel.
*Flashrite is a trademark of AMD.



Sophisticated systems for the discerning engineer

CIRCLE NO 25

COMPUTERS & PERIPHERALS

data pathways to local RAM and EPROM, and to the VME Bus, are 32 bits wide. The RAM card provides another 512k bytes of 32-bit, zero-wait-state local RAM. The serial I/O card, which has an onboard 68010 μ P, provides eight more serial I/O channels. The system's mass-storage devices, which include an 80M-byte Winchester disk drive, a 1M-byte floppy-disk drive, and an optional 50M-byte streaming-tape drive, are controlled via the system's 68010-based intelligent SCSI-bus controller card. The VME Bus system-controller card includes an IEEE-488 interface and a real-time clock. System 21A with PDOS operating system, DM 44,950.

Force Computers GmbH, Daimlerstrasse 9, 8012 Ottobrunn, West Germany. Phone (089) 600910. TLX 524190.

Circle No 388

Force Computers Inc, 727 University Ave, Los Gatos, CA 95030. Phone (408) 354-3410. TLX 172465.

Circle No 389

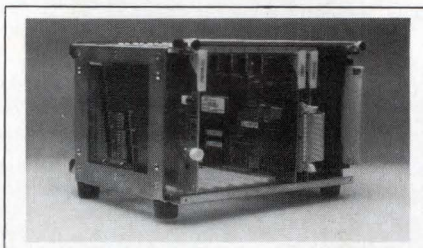

INDUSTRIAL μ C

- IBM PC-compatible μ C for factory environment
- Operates over 0 to 65°C

The System 2 computer is an IBM PC-compatible computer that operates from 0 to 65°C, can withstand 10G of shock, and offers an MTBF of >5 years at 55°C. This STD Bus-based computer runs Microsoft's MS-DOS 3.2 operating system. The central processor is a 5-MHz NEC V20 CMOS CPU, which is 8088-compatible. Model 10 comes with 128k bytes of CMOS static RAM that's expandable to 640k bytes, and a RAM disk; a 20M-byte hard-disk

drive is optional. Model 20 has a 3½-in. floppy-disk drive; a second floppy-disk drive and a 3½-in., 20M-byte hard-disk drive are optional. Model 10, \$1195; Model 20, \$1595.

Pro-Log Corp, 2560 Garden Rd, Monterey, CA 93940. Phone (800) 538-9570; in CA, (408) 372-4593.

Circle No 390

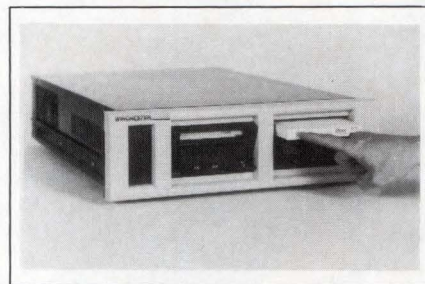

DISK SYSTEM

- Q Bus-compatible hard-disk cartridge system
- 26M-byte cartridges

The Datasafe family of DEC Q Bus-compatible Winchester disk subsystems, which use twin-drive Winchester technology, includes a 5¼-in. 26M-byte hard-disk cartridge drive coupled with a 5¼-in. fixed Winchester drive. Models are available with 80M, 110M, 165M, and 226M bytes of storage capacity. A dual removable-drive model with 52M bytes of capacity is also available. In each model, the two drives run on separate spindles and are housed together in a 5×19-in. NEMA rack-mount or tabletop enclosure. All the drives run standard LSI-11 and MicroVAX operating software. All storage is accessed as if it were DEC DU devices, and the subsystem operates with standard DU drivers. The dual-wide Q Bus controller implements DEC's MSCP protocol, supports both 18- and 22-bit addressing, and controls both the fixed- and the removable-disk drives. \$4995.

Winchester Systems, 400 W Cummings Park, Woburn, MA 01801. Phone (800) 325-3700; in MA, (617) 933-8500.

Circle No 391

EXAR's NPN is a PNP

TWINSTOR AS DUAL NPN

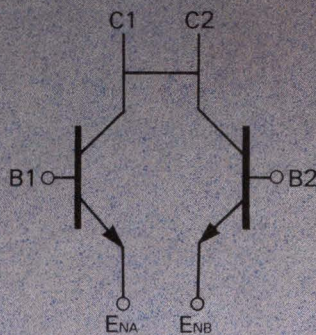
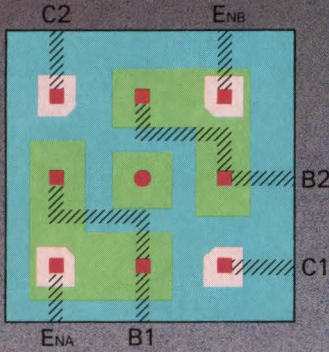

TWINSTOR AS DUAL PNP

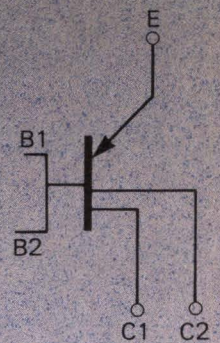
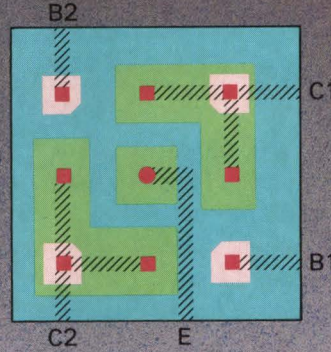

FLEXAR™

We pioneered linear semicustom 15 years ago! We're making history again!

What is FLEXAR™?

Based on the F L A (Flexible Linear Array) concept of programmable transistors, it is the revolutionary array introduced by Exar Corporation. A single layer metal mask programs the components to perform as either NPN, PNP, Resistor, Capacitor... or any combination of over three dozen options available.

What is so unique about FLEXAR™?

It's programmable gridded, cellular and symmetric. All these features make it suitable—a first in the industry—to have a true soft cell library. This, in turn, makes product introduction to the market faster and less expensive.

Soft Cell Library?

Yes, the unique architecture of FLEXAR™ lends itself perfectly to the automated soft-cells. Now, system engineers can be IC design engineers. We've done the homework for you!

CAD/CAE Tools?

Using an IBM (AT) you can perform schematic capture, netlist generation and simulation. You can send this information directly to our VAX-8600 via modem or on a floppy. We'll do the rest!

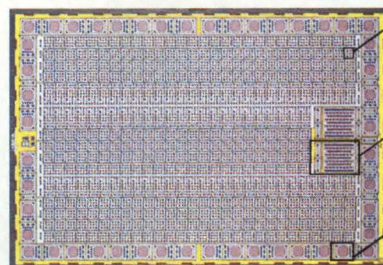

- A. **TWINSTOR**
The work horse of FLEXAR™. Use it as a NPN, PNP, SCR switch, or matched pair of resistors.
- B. **TWINBOOSTER**
A high power TWINSTOR. Drive a 500 mA load as a power NPN or a 50 mA as a PNP.
- C. **PADSTOR**
A multipurpose bonding pad. Use it as a NPN, PNP transistor, capacitor, or as a resistor.

Today, EXAR offers the most comprehensive Linear Custom solutions including industry standard, Bifet, switch capacitor filters and high voltage (75V) technologies.

For further information call: (408) 732-7970

EXT: 356 Custom Marketing



EXAR CORPORATION

750 PALOMAR AVENUE, SUNNYVALE, CA 94086 P.O. BOX 3575
(408) 732-7970 TWX 910-339-9233

NEWS FLASH!! EXAR IS NOW 883C COMPLIANT.

NEW PRODUCTS

TEST & MEASUREMENT INSTRUMENTS

SCANNER CARDS

- Cards fit scanner mainframes
- Include nanovolt scanner and low-current scanner

Increasing the company's scanner-card line to 17 products, these four scanner cards fit either of the company's scanner mainframes. The 7168 nanovolt scanner is an 8-channel, 2-pole unit that offers 20-nV differential contact potential between its channels. The 7158 low-current scanner can switch currents as low as 1 pA. The 7158 is a 10-channel card whose two outputs connect several scanner cards in a single system to one instrument. The 7067 4-wire or Kelvin scanner



has both current-source and low-voltage-sensing channels. The 7402 thermocouple scanner is a 9-channel unit that has built-in cold-junction compensation. 7168, \$1995; 7158,

\$950; 7067, \$630; 7402, \$500.

Keithley Instruments Inc., 28775 Aurora Rd, Cleveland, OH 44139. Phone (216) 248-0400. TLX 985469.

Circle No 392

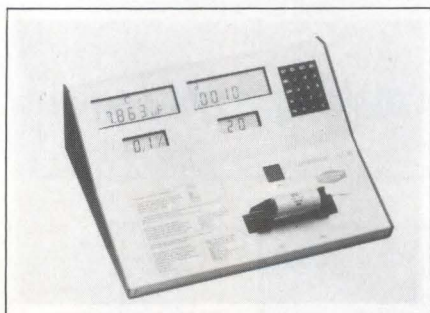

LCR BRIDGES

- Automatic bridges can sort components into bins
- RS-232C and IEEE-488 interfaces are standard

The CT10 and CT20 are automatic LCR bridges having 0.05% accuracy. The CT10 applies test signals at 111 Hz and 1 kHz. It can sort components into nine bins according to a primary characteristic and into a single bin according to a secondary characteristic. The CT20 adds a 10-kHz test signal and can sort components into 12 bins for a primary characteristic and four bins for a secondary characteristic. The CT20 measures a component in 50 msec. Both bridges come with RS-232C

and IEEE-488 interfaces. CT10, \$4200; CT20, \$6200.

RE Instruments Corp., 31029 Center Ridge Rd, Westlake, OH 44145. Phone (216) 871-7617.

Circle No 393

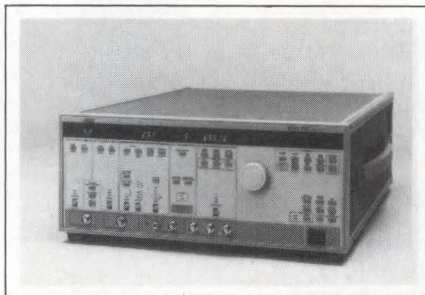

DIGITIZER

- Instrument digitizes at 200M samples/sec
- Unit features envelope-mode triggering

The RTD 710 dual-channel waveform digitizer has a single-channel digitizing rate of 200M samples/sec. It digitizes two channels simultaneously at 100M samples/sec, and its vertical resolution is 10 bits max. The instrument has a 64k-sample

memory (32k samples/channel). A direct digital output is available. You can trigger the instrument on complex signals or when the input differs from a preset envelope. The unit's IEEE-488 interface can transfer data at 250k bytes/sec. \$19,950.

Tektronix Inc., Box 1700, Beaverton, OR 97075. Phone (800) 547-1512; in OR, (800) 542-1877.

Circle No 394



80286 DEBUGGER

- 80286 debugger runs under iRMX 286
- Works with third-party in-circuit emulator

The iRMX 286 version of the company's Soft-Scope 80286 debugger pro-

Expand your bandwidth and maintain your gain...

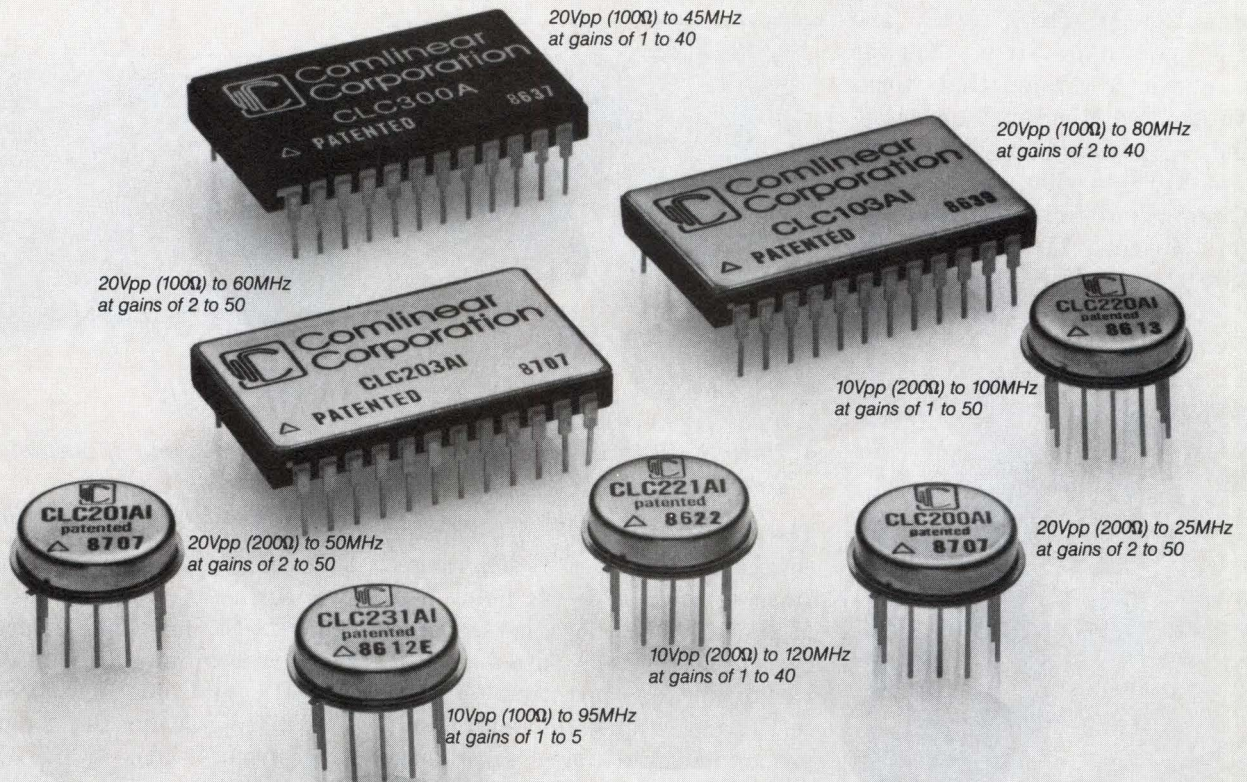

with these high-speed, high-drive op amps from Comlinear

With this op amp family, you don't sacrifice speed for gain . . . or for power. Because Comlinear designs eliminate traditional performance tradeoffs. Check the specs.

But there's more than performance. You also get complete min/max and over-temperature specifications. DC and AC parameter testing on every part. Unmatched ease of use (all are unity-gain stable, without compensation). Plus evaluation boards and top-notch design support. Which adds up to design productivity and confidence.

To expand your bandwidth, call (303) 226-0500 today. Or write Comlinear Corporation, 4800 Wheaton Drive, Fort Collins, Colorado 80525.

SPECIFICATIONS (Typical)

	-3dB Bandwidth (MHz)		Settling Time	Slew Rate	Output
	$A_v = 4$	$A_v = 40$	to 0.1% (nsec)	(V/ μ sec)	($\pm V$, mA)
General Purpose					
CLC103	170	130	10 (to 0.4%)	6000	11,200
CLC200	100	90	18	4000	12,100
CLC220	200	160	8	7000	12,50
CLC300	105	70	20	3000	10,100
Low Offset ($V_{os} \leq 1\text{mV}$, $10\mu\text{V}/^\circ\text{C}$)					
CLC201	100	90	18	4000	12,100
CLC203	180	130	15 (to 0.2%)	6000	11,200
CLC221	200	120	15	6500	12,50
CLC231 ¹	165 ($A_v = 1$)	120 ($A_v = 5$)	12	3000	11,100



vides full support for the 80286's protected mode, including the handling of hardware-protection traps. The source-level debugger can run programs written in Intel's PL/M, C, Pascal, Fortran, and assembly language. It displays all variable types including Pascal records, PL/M and C structures, multidimensional arrays, and real types. Other versions of the debugger run under the MS-DOS, ISIS, and iNDX operating systems. You can also obtain a version that works with Applied Microsystems' (Redmond, WA) ES 1800 in-circuit emulators. \$1000 to 1500.

Concurrent Sciences Inc, Box 9666, Moscow, ID 83843. Phone (208) 882-0445. TLX 4942758.

Circle No 395

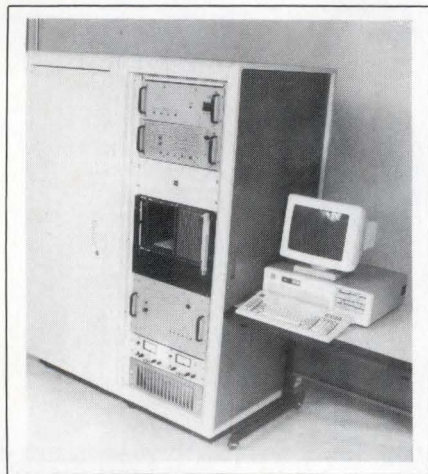

MATE ATE

- Commercial-grade MATE ATE system uses IBM PC
- ATE system suits factory environment

The Factory Mate 390 ATE (automatic test equipment) system is suitable for use in factories that produce MATE-compatible products. The system can have as many as 240 test pins with 16k bits of pattern/capture memory per pin. It also includes four programmable clocks that have 10-nsec resolution and three programmable power supplies. Its software includes an editor and an Atlas compiler. A represen-

tative system with a 120-pin, 20-MHz digital subsystem and basic analog functions (including a timer/counter, DMM, and frequency synthesizer) costs \$250,000. Delivery, six months ARO (typ).

GAI Inc, 21 White Deer Plaza, Sparta, NJ 07871. Phone (201) 729-5888. TLX 910-380-0362.

Circle No 396



RF GENERATOR

- Includes AM, FM, and phase-modulation capabilities
- Has a built-in AF generator and sinad meter

The PSG1000 RF signal generator covers the 10-kHz to 1-GHz range. Its resolution is 10 Hz below 128 MHz and 100 Hz above that frequency. The generator's output level is variable in the range from 0.05 μ V to 1V, and because the unit doesn't use frequency doublers to produce its high frequency ranges, the output isn't corrupted by subharmonics. The standard unit's modulation capabilities include amplitude, frequency, and phase modulation; pulse modulation is available as an option. In addition to 1-kHz fixed-tone modulation, the PSG1000 has an audio frequency synthesizer that generates modulation frequencies between 10 Hz and 10 kHz. The unit also has an external modulation input, which you can dc-couple. You can select multiple modulation un-squelching tones to test CTCSS, CCIR, EEA, ZVEI-1/2, EIA, Natel, and Selcall systems. The built-in sinad meter simplifies receiver-alignment checks. The non-volatile memory allows you to store front-panel setups, and an IEEE-

488 remote-control interface is standard. Control via a handheld calculator is optional. The PSG1000 operates from line supplies or from 12V (optionally 24/28V) dc supplies. £3250.

Farnell International Instruments Ltd, Sandbeck Way, Wetherby, West Yorkshire LS22 4DH, UK. Phone (0937) 61961. TLX 55478.

Circle No 397

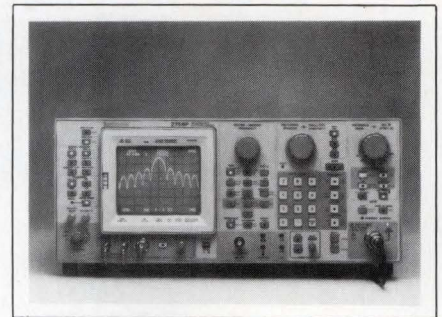

ANALYZERS

- Analyzers come in portable and lab versions
- MATE interfaces are available

Five spectrum analyzers pad out two of the company's lines: The 2756P, 2753, and 2753P enlarge the 2750 Series, and the 494A and 494AP round out the 490 Series. The 2756P covers the frequency range from 10 kHz to 325 GHz. It has -134-dB sensitivity and 10-Hz resolution. The 494A and 494AP are portable analyzers whose performance specs are identical to those of the 2756P. The 2753 and 2753P cover 100 Hz to 1.8 GHz and have built-in signal processing. An option allows the analyzers to understand MATE/CIIL commands. The "-P" models are programmable versions. 2756P, \$46,245; 2752/2753P, \$26,250; 494A/494AP, \$41,425. Delivery, 15 weeks ARO.

Tektronix Inc, Box 15149, Portland, OR 97215. Phone (800) 835-7732; in OR, (503) 235-7315.

Circle No 398

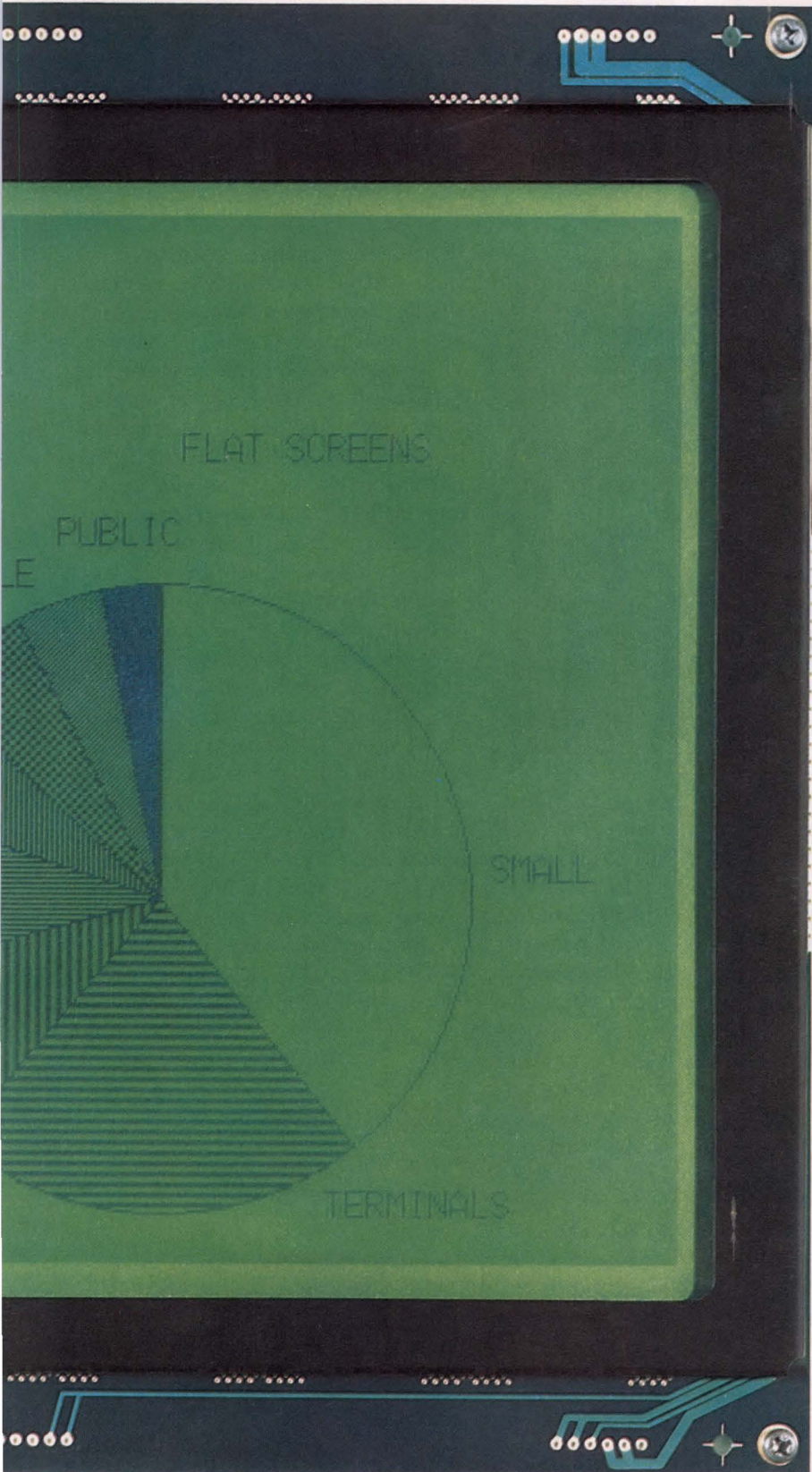

Seiko's
640 X 400 Dot
Graphic Display
Gives You
High-Quality
Contrast And Wide
Viewing Angle In
A Compact,
Low-Power Package.

SEIKO'S advanced engineering programs have produced a dramatic improvement in LCD display technology. The new "Seiko Twist" LCD display module combines improved visual performance and flexibility in an economical, flat panel package.

"Seiko Twist" modules are available with anti-glare polarizer in the most popular configurations. Options include reflective or transfective mode, and positive or negative character image. Optional electroluminescent (EL) backlighting is available for limited light environments.

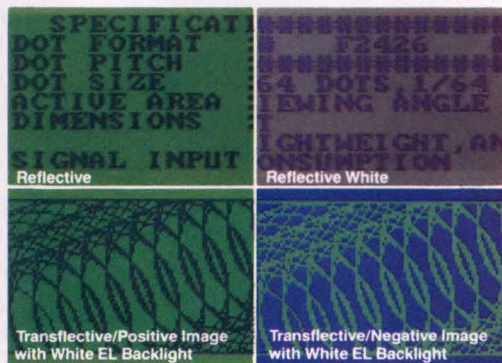

Optional screen configurations

Seiko Twist

So, if you need a flat-panel display with the viewing area of a CRT, call today for information on the "Seiko Twist." Any way you look at it, SEIKO is your first choice for displays.

SEIKO INSTRUMENTS U.S.A., INC.
2990 W. Lomita Blvd.
Torrance, CA 90505
PHONE: (213) 530-8777
TWX: 910-347-7307
FAX: (213) 539-8621

NEW PRODUCTS

CAE & SOFTWARE DEVELOPMENT TOOLS

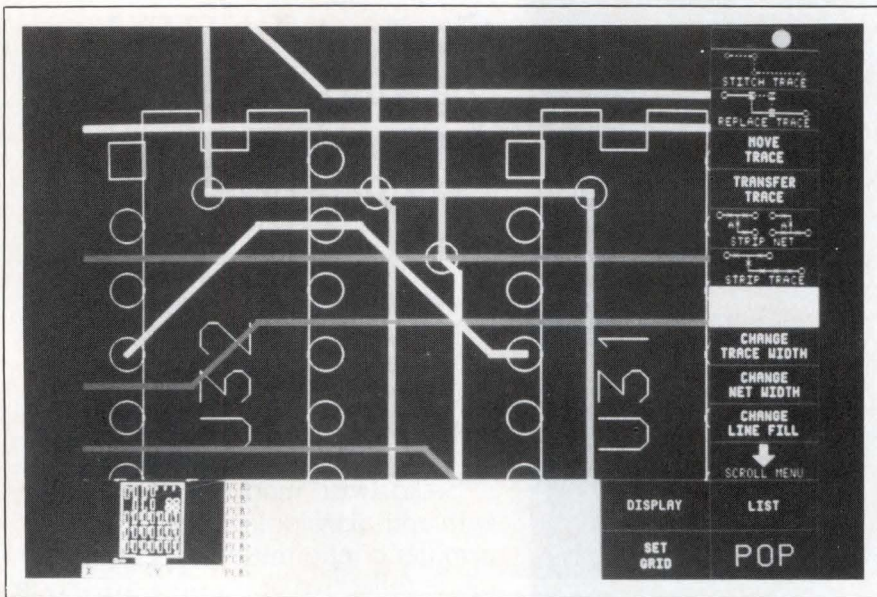

PC-BOARD DESIGN

- Lets you design and route buried vias
- Allows direct communication with simulators and testers

The Board Series programs let you design and route high-density, multilayer pc boards that contain blind vias (those that are visible but don't go all the way through the board) and buried vias (those that are inside the pc board and are invisible on the surface). You can also use one power plane for two or more voltages and embed signal traces within a given power plane. A net-list interface lets you pass net-list information from another CAE system to this software for layout and routing; you can then pass pin numbers, reference designations, and similar information back to the CAE system for back-annotation and documentation. The Board series consists of four packages that all run on Apollo DN570, DN3000, or DN3000+ workstations and have different capabilities to suit different applications. The Designer package provides full design capabilities, including schematic capture, packaging and pin assignment, auto-

placement, interactive and automatic routing, simulation, and CAM capability. Editor Plus has the same design and layout features as Designer, but does not include routing or CAM features. Scribe performs only schematic capture and packaging. Editor and Scribe are intended for use as low-cost nodes on an Apollo 3000 that's linked to another workstation running Designer. Likewise, Expeditor is a high-performance routing package that provides CAM features but needs to be linked to Designer for full design capability. \$30,000 to \$90,000.

Calma Co., 501 Sycamore Dr, Milpitas, CA 95035. Phone (408) 434-4000. TLX 3720067.

Circle No 399

ENHANCED CAD TOOL

- Lets you define line widths
- Allows you to exchange drawings with other CAD systems

Generic CADD version 3.0 is the latest version of a drawing tool that runs on the IBM PC and compatibles. According to the vendor, version 3.0 runs as much as 20% faster than previous versions. The en-

hancements include user-defined line widths; the ability to restore the last four items that you erased; and a feature that lets you name a view displayed on the screen as a separate file, and retrieve or plot that view while you're working on another part of the drawing. The plotting module lets you plot drawings made with the program on any one of more than 100 dot-matrix and laser printers. You can also exchange drawings with AutoCAD, Ventura, and other software that uses the DXF (Drawing Exchange Format). An autodimensioning module automatically inserts dimensions, legends, extension lines, leaders, and arrows as you define them. Another module lets you exchange drawings with minicomputer and mainframe CAD software that uses the IGES (International Graphics Exchange Standard) format. \$99.95.

Generic Software Inc., 8763 148th Ave NE, Redmond, WA 98052. Phone (206) 885-5307.

Circle No 400

CAD DRIVERS

- AutoCAD driver-update disk
- For dot-matrix and laser printers

The driver-update disk for AutoCAD, which runs on the IBM PC, includes new drivers for 10 I/O devices and upgraded drivers for six other I/O devices. The new drivers let you use AutoCAD with the Advanced Matrix Technology (Newbury Park, CA) Office Printer, the Cordata LP300X Laser Printer, the Cordata 400 Display, the H-P HIL Digitizer, the H-P Mouse, the IBM Proprinter and Proprinter XL printers, the Metheus (Hillsboro, OR) Omega-PC Display with version 2.2 microcode, the Postscript Writer for laser printers, and the Toshiba 3-in-One Printer/Plotter.

NEW
Powermag A1500.
Packs 1500 Watts of
dependable power in a compact unit.



Five volts of regulated DC power at up to 300 Amps and failsafe redundancy! That's what the new Powermag A1500 Switching Power Supply delivers.

This 5" x 8" x 11" high power-density 1500-Watt unit from Advance Power Supplies provides 3.4 Watts per cubic inch from either 110V or 220V nominal, 47 to 440 Hz input. It's perfect for systems using large amounts of solid-state mass storage.

Virtually any number of Powermag units can be interconnected to provide parallel redundancy and meet heavy power demands. Current-sharing capability is built-in, so each unit shares the load equally. Should one unit fail, the others will automatically redistribute and assume the load (up to their rated capacities). And the Powermag meets major international safety and RFI requirements.

Standard features include electronic soft-start; self-diagnostics; over-current, overvoltage and overtemperature protection; selectable dual-input voltage;

local and remote sensing; and full-cycle holdup. A variety of signal facilities and optional output voltages (2V, 12V, 24V, 48V) make the Powermag A1500 one of the most versatile power supplies available. For complete details on the high-power, affordably priced Powermag A1500, contact your Advance Power Supplies representative. Or call (216) 349-0755.

Advance Power Supplies
32111 Aurora Road
Solon, OH 44139

 **ADVANCE
POWER SUPPLIES**

CIRCLE NO 64

Both the new and the replacement drivers are standard in version 2.52 of AutoCAD; users of earlier versions can purchase the update disk separately. \$80.

Autodesk Inc., 2320 Marinship Way, Sausalito, CA 94965. Phone (415) 331-0356.

Circle No 401

CAD FOR MACINTOSH

- For 2- and 3-D designing
- Has animation features and removes hidden lines

SpaceEdit is a 2- and 3-D CAD software package that runs on an Apple Macintosh equipped with 512k bytes of memory. If your system has an onboard floating-point coprocessor, the program will use it. You can create drawings with the mouse, the keyboard, or a digitizing tablet. You can send output to a laser printer or a plotter. The software offers unlimited zooming; a hidden-line remover; windowing; rotation of an image about the X, Y, and Z axes; and 3-D animation. You can export images created with the program to MacDraw, MacPaint, MacDraft, and other graphics programs. \$625.

Abvent, 9903 Santa Monica Blvd, Suite 268, Beverly Hills, CA 90212. Phone (213) 659-5157. TLX 4949496.

Circle No 402

MODULA-2 COMPILER

- Generates native 8086/88 code
- Comes with a Make utility

This Modula-2 compiler provides all features of the language as Niklaus Wirth defined them in *Programming in Modula-2*. The compiler generates native 8086/88 machine code in files that are compatible with most MS-DOS and PC-DOS link utilities. On the first pass, the program performs all lexical and syntactical analysis and generates an intermediate file; the second pass only processes internal symbols

from the executable code, so you can use symbols before defining them. The distribution disk includes source code for the low-level PC-DOS interface, which is coded in assembly language, and source code for several other modules. The package comes with a Make utility similar to that of Unix and complete source and object code for the runtime system. The vendor does not charge royalties for run-time object code distributed as part of an application, and the compiler is not copy-protected. Complete package, \$89.95; manual only, \$25.

Farbware, 1329 Gregory, Wilmette, IL 60091. Phone (312) 251-5310.

Circle No 403



HYBRID-CIRCUIT CAE

- Generates automatic thick-film resistors
- Runs with vendor's graphics system

The hybrid-circuit design module for thick-film circuits is a CAD module that runs with the vendor's Engineering Graphics System. It can operate in conjunction with other modules of the company's Electronic Design System. All the software modules run on the HP 9000 Series 200 and 300 workstations. The software's automatic and interactive features include automatic thick-film-resistor generation; a starter library containing more than 300 hybrid parts and subparts; and the ability to work with irregularly shaped conductors and to add dielectric crossovers. You can specify

either English or metric units; the schematic-drawing module automatically generates a parts list. A rat's-nest generator lets you add connectivity information between parts. Using the editing features, you can move, rotate, stretch, or mirror parts or conductors on a grid that provides a resolution of 0.00001 mil; placement-snapping modes ensure that the parts and conductors are precisely placed. You can vary the width of the conductors; system messages help you to route multi-layer conductors. You can also generate a connection list from your completed layout. A connection-list comparison program ensures that this list agrees with the list generated by the schematic-drawing module. Design module, \$4000; the engineering-graphics module, \$6000; optional schematic-drawing module, \$1000.

Hewlett-Packard Co., 1820 Embarcadero Rd, Palo Alto, CA 94303. Phone local office.

Circle No 404

FILTER DESIGNER

- Selects the filter types that produce a desired response
- Works with elliptic filters that use VCVS circuits

Active Filter Design version 2.10 prompts you to specify a frequency response; it then presents a menu of filter types that produce this response. For each type (Butterworth, Chebyshev, elliptic, and Bessel), the program shows the required filter order and the stopband attenuation. In addition, you can enter pole and zero locations, or a transfer function, from the keyboard and instruct the program to generate the desired filter configuration from that data. The software works with manual or automatic pole-zero pairings, as well as with uneven gain distribution. It can also calculate the component values required to implement your filter by means of MFB (multiple feedback),

Lockette™

New keylock switch with interchangeable core speeds installation, simplifies inventory, permits quick lock change on site.



Choose .187 tab, solder lug, P.C., or wire leads.

Die-cast metal or molded thermoplastic bezels and housings. Thermoplastic bezels available in colors for identification or improved appearance.

Four-tumbler removable lock core system (patent pending) allows for easy mixing, matching and changing of locks to customer requirements.



Single- or double-pole switches with higher electrical ratings and international approvability. UL and CSA ratings: 10A 125VAC and 5A 250VAC. European approvals pending.

Control key removes the lock core.

User key operates switch at up to 8 positions, with a selection of key removable positions.

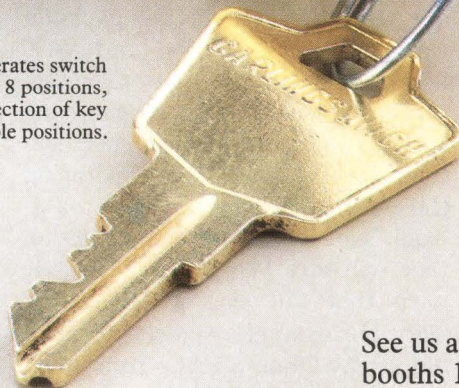

See us at Electro, booths 1972-1976

For more information on this innovative, economical keylock switch, write or phone Carlingswitch, Inc., 60 Johnson Ave., Plainville, CT 06062-1156, (203) 793-9281.

For the name of your local Carlingswitch distributor, call toll free: 1-800-243-8160.

CARLINGSWITCH
INNOVATION BY DESIGN

ULTRA-MINIATURE

DC-DC Converter Transformers

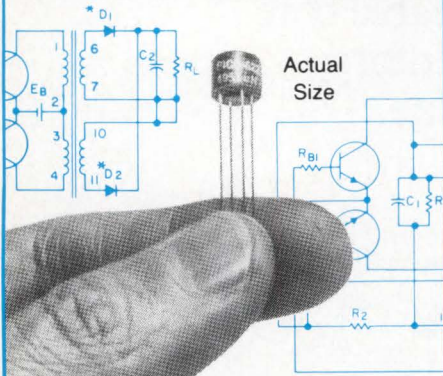

- Power levels up to 40 Watts
- Input voltages of 5V, 12V, 24V and 48V
- Standard output voltages up to 300V (special voltages can be supplied)
- Can be used as self-saturating or linear switching applications
- Operation over ambient temperature range from -55°C to +105°C
- All units meet MIL-T-27 (TF5S40ZZ)
- Secondary can be connected for full-wave or dual bridge
- All units are magnetically shielded
- Schematics and parts list provided with transformers
- Delivery-stock to one week

SEE EEM, GOLD BOOK OR THOMAS REGISTER OR SEND DIRECT FOR FREE PICO CATALOG

PICO Electronics, Inc.
453 N. MacQuesten Pkwy. Mt. Vernon, N.Y. 10552

Call Toll Free **800-431-1064**
IN NEW YORK CALL **914-699-5514**

Send for PICO's new catalog featuring Ultra Miniature Transformers/Inductors/DC-DC Converters

CAE & SOFTWARE DEVELOPMENT TOOLS

VCVS (voltage-controlled voltage source), biquad, state-variable, or Reticon switched-capacitor techniques. The program can produce a filter description, pole-zero locations, transfer functions, and component values, as well as the amplitude, phase, and group-delay frequency response of the complete filter or of any individual filter section. You can store the data in a disk file for later analysis or modification. A companion program converts the circuit file created by the design package to a Spice-compatible net list. The programs run on IBM PC-family and compatible computers having at least 350k bytes of RAM and PC-DOS 2.0 or a later version. The programs can use an 8087 numeric coprocessor. Design package, \$525; Spice file-conversion program, \$125; both, \$625.

RLM Research, Box 3630, Boulder, CO 80307. Phone (303) 499-7566.

Circle No 405

PLD DATABASE

- Lists device makers and specs
- Enhances Logic design package

This database of programmable logic devices works with the vendor's Logic logic-design package that runs on IBM PC and VAX hosts. The database lists manufacturers of PLDs, the devices they supply, and the technical specifications for each part. When operating the design package with the database, you can compile a program that will give you a list of specific parts that will work with your design. For example, you can obtain a list of any 20-nsec PALs from MMI that will work with your design. You can also search for parts by using any of the other specs listed in the database as criteria. The database also lets you display the characteristics of any PLD in the library, including the number of product terms per input, the number of inputs and outputs, and the

electrical characteristics of the device. The company issues PLD database updates three times per year; you can review each update before purchasing it. From \$500 for the IBM PC version. Delivery, six weeks ARO.

Kontron Electronics, 630 Clyde Ave, Mountain View, CA 94039. Phone (415) 965-7020.

Circle No 406

CAE NETWORK

- Ethernet link uses thin cable
- 25 PCs can share central file server

Dash-Net allows engineers working on a common project to share central design libraries and databases and to communicate with VAX computers that use the TCP/IP protocol. The network is fully compatible with the company's CAE tools. The network has three main components: a DN3-Server, which serves as many as 25 workstations and includes a 70M-byte disk, 960k bytes of memory, and a 60M-byte cartridge-tape-backup unit; the DN-Station Ethernet board and network at each node; and DN-CABL Ethernet cable. DN3-Server, \$11,950; DN-Station hardware and software, \$650 per node; DN-CABL, \$45 (7m) to \$200 (100m).

FutureNet, 9310 Topanga Canyon Blvd, Chatsworth, CA 91311. Phone (818) 700-0691. TWX 910-494-2681.

Circle No 407

STRUCTURED ANALYSIS

- Automates system-requirements modeling
- Uses Yourdon-DeMarco data-flow techniques

SA Tools-IBM PC is a structured-analysis tool that allows analysts and engineers to define system requirements with the aid of Yourdon-DeMarco data-flow diagrams, a data dictionary, and minispecifications. You can nest the data-flow diagrams

Superior Electric gives today's motion control the feel of the future with its completely new family of step motor drives and programmable motion controllers—THE SLO-SYN® MICRO SERIES.

superior innovation in MOTION CONTROL

Micro size. Here are the smallest, most powerful step motor drive modules available today. Optically isolated and designed for top efficiency, these chopper drives are rated 2A and 3.5A per phase, 30VDC, 20kHz.

Micro processor based, data-driven programmable preset indexers and motion controllers use industry standard machine tool language RS274 X, G and F codes for maximum application flexibility. Program storage up to 400 lines, 2 programmable inputs, 2 programmable outputs and overtravel limit switches. Provide RS232C interface, parallel switch interface and PLC operating mode. Up to 99 units can be daisy chained.

Micro stepping AC line operated step motor drives of the 3180 Series are available with either 1/125 or 1/10 micro-step as well as full and half step. An innovative current control method assures smooth operation over a broad range, outperforming other drives on the market. And at lower cost.

For detailed product specifications and to arrange for an engineering test sample, write to The Superior Electric Company, 383 Middle Street, Bristol, CT 06010. For immediate action, call 203/582-9561.

CIRCLE NO 150

 **Superior Electric**
® *The right amount of automation.*

© 1986 Superior Electric Co.

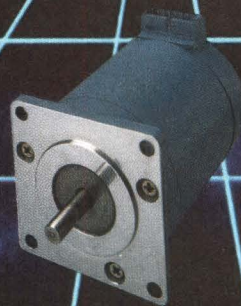
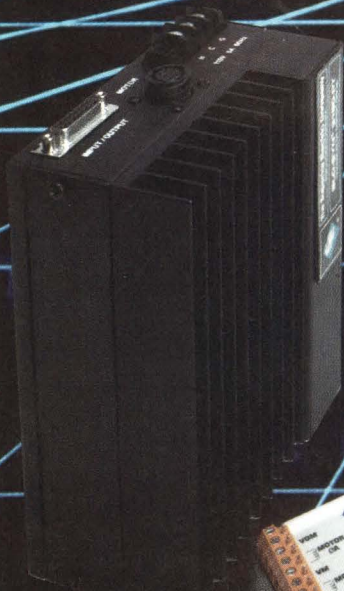

25 levels deep. The software checks all the diagrams against each other and against the data dictionary for consistency; it then reports undefined or inconsistent processes or data-item names. You can use the PC as an independent structured-design workstation. For more extensive design aids, you can link the PC to a VAX host that runs the vendor's structured-analysis real-time tools, structured-design tools, and language-development tools. To run the software, you'll need an IBM PC/XT, PC/AT, or compatible machine, equipped with 512k bytes of memory, 1.3M bytes of disk space, and PC DOS version 3.1 or later. You can use the Hercules monochrome, the IBM EGA, or a compatible graphics adapter card, and an appropriate monochrome or color monitor. The package works with mice from Microsoft and Mouse Systems (Santa Clara, CA). \$1950.

Tektronix Inc, CASE Div, Box 14752, Portland, OR 97214. Phone (800) 342-5548; in OR, (503) 629-1573.

Circle No 408

REAL-TIME 8086 OS

- *Multitasking OS interfaces with Unix*
- *For real-time applications*

MTOS-UX/86 is a multitasking, multiprocessor operating system for real-time, embedded systems based on the 8086 and other μ Ps. This OS can operate with as many as 16 processors that are connected to the bus in a tightly coupled, symmetrical fashion. You can dynamically create and delete tasks, mailboxes, semaphores, event flags, and memory-buffer pools; the operating system automatically balances the load among processors. A terminal-emulator module lets the system log

onto a Unix host and invoke programs that run under Unix. You can also use the Unix host as a file server. The system assumes that application programs are written in C, and it issues requests for service by means of C function calls. This assumption simplifies the process of picking command parameters off the stack. The nucleus occupies only 16k bytes of memory. From \$5000.

Industrial Programming Inc, 100 Jericho Quadrangle, Jericho, NY 11753. Phone (516) 938-6600. TLX 429808.

Circle No 409

MICROWAVE CAE LINK

- *Links schematic-capture and circuit-design programs*
- *Enhances tools used for microwave circuit design*

The DDSC/Super-Compact interface links Tektronix's DDSC (Designer's Database Schematic Capture) software with the vendor's microwave-circuit-design programs, Super-Compact and AutoArt. The package includes a file-extraction tool that automatically creates a Super-Compact file from a DDSC schematic. DDSC lets you include, directly on the schematic, all the information that Super-Compact needs for analysis and optimization; DDSC then back-annotates the results of the optimization to the schematic so that you can easily track the design specifications and changes to them. The interface also provides access to the vendor's AutoArt layout program, so that you can use the same DDSC file both for schematic capture and for final layout. The interface package provides extensive on-line help and an on-line Super-Compact manual. Interface, \$5000.

Compact Software, 483 McLean Blvd, Paterson, NJ 07504. Phone (201) 881-1200.

Circle No 410

QUICK—Memorize this list:

175.69	18.905	1.7868	171.67	143.98
1.6523	153.47	15.097	132.69	185.36
17.546	185.98	16.264	1.3789	1.6243
1.5136	175.16	18.079	158.77	17.265
154.52	19.090	15.778	197.35	16.230
188.58	129.34	174.58	19.875	1.9465
1.3876	101.09	16.790	1.9721	1.6759
1.7566	18.236	1.7805	198.67	189.20
187.43	17.647	152.78	189.36	17.654
18.347	16.154	1.5737	18.745	195.86
17.961	1.8497	15.876	191.60	17.949
16.975	186.67	175.87	15.134	145.87
1.8264	13.478	16.783	16.598	157.83
15.783	1.1654	136.56	11.387	1.6781
15.786	118.75	158.70	114.36	17.169
11.080	1.1342	178.67	10.287	1.6085
1.2136	1.8514	10.562	1.2905	191.70

The 175 Autoranging DMM can—up to a hundred readings, and automatically determines **minimum** and **maximum** values. Five full functions and a lot more—for \$449. IEEE-488 and battery options, too. QUICK: Call (216) 248-0400. Or write:

Product Information Center: Keithley Instruments, Inc.,
28775 Aurora Road
Cleveland, Ohio 44139.



KEITHLEY

Make it friendly. Touch it.



Design a system that gives you a competitive edge. Make it simple to use. Easy to learn. Make it friendly. With a touch input system from Carroll Touch, the world's leading OEM supplier of touch products.

Discover the full line of solutions Carroll Touch offers. From infrared to overlay touch products. Select from a wide range of standard add-on units in a variety of sizes. Or from a line of fully integrated computer displays equipped with touch. Or specify your own unique requirements.

Once you've chosen the Carroll Touch product that's right for your system, you'll discover even more. Exceptional quality and ruggedness. High reliability. Low maintenance. Making touch more affordable and cost-effective than ever.

Whether it's sophisticated test equipment for automotive technicians. Or a medical diagnostic system for patient care. Make your next system friendly. Touch it. Begin by calling 512/244-3500.

Carroll Touch

a subsidiary of AMP Incorporated

P.O. Box 1309
Round Rock, Texas 78680
512/244-3500 Telex 881906

CIRCLE NO 77



WHAT DOES MONOLITHIC MEMORIES SAY ABOUT TRUE CMOS FIFO STANDBY POWER? ZERO.

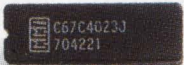

There's not much else to say when you're the only supplier of true CMOS technology offering zero standby power. But, that's what happens when you're the leading supplier of FIFOs in the world.



Like MMI's 67C740XX series devices, designed to operate at full performance with very low power consumption. That means lower power overhead for buffer memory applications.



And remember, nobody can deliver Monolithic Memories' products like Marshall. We've been serving the electronics industry for over 30 years. So stop wasting energy, call Marshall today for MMI's CMOS FIFOs Data Package.

What else can we say?

CALL MARSHALL FOR MMI'S TRUE CMOS FIFOs. AND FOLLOW THE LEADERS.

- | | | | | | |
|-------------------------------|-----------------------------------|---------------------------------|----------------------------------|-------------------------------|-----------------------------------|
| (*Authorized Locations) | San Diego (619) 578-9600* | GA Atlanta (404) 923-5750* | MI Michigan (313) 525-5850* | Rochester (716) 235-7620* | El Paso (915) 593-0706* |
| AL Huntsville (205) 881-9235* | San Francisco (408) 942-4600* | IL Chicago (312) 490-0155* | MN Minneapolis (612) 559-2211* | OH Cleveland (216) 248-1788* | Houston (713) 895-9200* |
| AZ Phoenix (602) 496-0290* | CO Denver (303) 451-8383* | IN Indianapolis (317) 297-0483* | NC Raleigh (919) 878-9882* | Dayton (513) 236-8088* | San Antonio (512) 734-5100* |
| Tucson (602) 790-5687 | CT Connecticut (203) 265-3822* | KS Kansas City (913) 492-3121* | NJ N. New Jersey (201) 882-0320* | OR Portland (503) 644-5050* | UT Salt Lake City (801) 485-1551* |
| CA Irvine (714) 859-5050* | FL Ft. Lauderdale (305) 977-4880* | Wichita (316) 264-6333* | Philadelphia (609) 234-9100* | PA Pittsburgh (412) 963-0441* | WA Seattle (206) 747-9100* |
| Los Angeles (818) 407-4100* | Orlando (305) 841-1878* | MA Boston (617) 658-0810* | NY Binghamton (607) 798-1611* | TX Austin (512) 837-1991* | WI Wisconsin (414) 797-8400* |
| Sacramento (916) 635-9700* | Tampa (813) 576-1399* | MD Maryland (301) 840-9450* | Long Island (516) 273-2424* | Dallas (214) 770-0616* | |

EDN PRODUCT MART

This advertising is for new and current products.

Please circle Reader Service number
for additional information from manufacturers.

LONG-DISTANCE, HIGH-SPEED OPTICAL TRANSMITTER/RECEIVERS

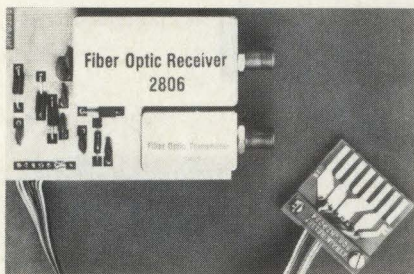

Ready-to-use, high-speed Micro-Optical T/R pair with long distance optical capability can transfer data from DC to 20 megabits per sec. over 6560 ft. without EMI/RFI worries. Very compact; ideal for board mounting in OEM data links. Operating temperature is 32 to 158 F. Delivered ready for mounting. Available in SMA or AMP Optimate connector styles; also with power supply and controls in stand-alone Bit-Driver® package. For details contact:

s.i. TECH

901 North Batavia Avenue
Batavia, IL 60510 (312) 232-8640

CIRCLE NO 325

IPC WIDE BAND CURRENT MONITOR



IPC's current monitors measure AC and fast pulsed currents in physical isolation from the conductor, thus eliminating ground loops and interference noise.

Many standard designs are available with a sensitivity from .001 to 1 V/A. Peak currents up to 100,000 AMPs and higher for special models.

For further information, write or call:

ION PHYSICS CORPORATION
323 Andover Street
Wilmington, Mass. 01887
Tel. (617) 658-6030
Telex 5106006134

CIRCLE NO 326

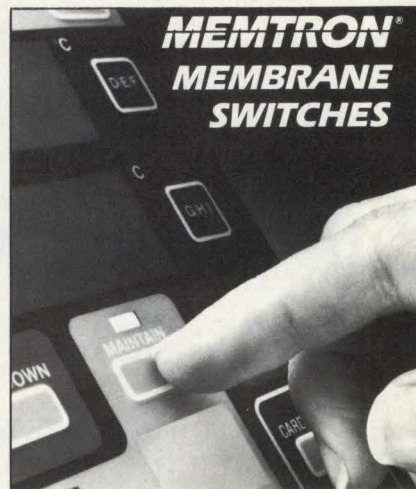

Switch options and innovations ...
"In touch with your technology"

**MEMTRON
TECHNOLOGIES INC.**
Forkenmuller, Memphis 40/34

For the name of our nearest representative
or for literature and details, call:
1 (800) 245-7525

CIRCLE NO 327

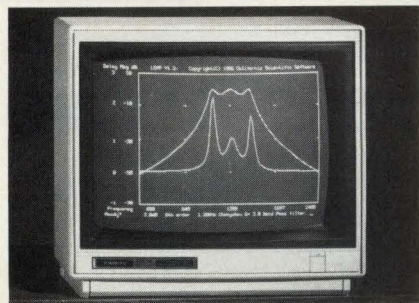

NEW ENGINEERING SOFTWARE

Filter designs active filters up to order 30. Bessel, Butterworth, Chebyshev, Allpass; High, Low Band-pass and Bandstop. Fully menu driven, Filter designs, plots, and selects component values for any filter in seconds. **LSAP analyzes linear systems** producing Bode, Nyquist, Impulse, Step Response and Root-Locus plots. **Micro-CSMP simulates control and servo systems** with full support for non-linear behavior. Filter is \$750, LSAP is \$450, Micro-CSMP is \$900 for the IBM PC.

California Scientific Software

1159 North Catalina Ave, Pasadena, CA 91104
(818) 798-1201

CIRCLE NO 328



SGUP-85 UNIVERSAL PROGRAMMER

MPUs
BPMOM
PAL IFL
E/EPLD E/EPROM
IC TESTER

**SIMPLE
POWERFUL
MODULAR
COST-EFFECTIVE**

IC TESTER include a wide range of logic, memory (SRAM, DRAM) device tests with testing vector editing capability.

SYSTEM-GENERAL CORPORATION
P.O. BOX: 53-591, Taipei,
Taiwan, R.O.C.
FAX: 886-2-7212615
TLX: 13810 SYSGEN
TEL: 886-2-7212613

U.S.A.:
**STORAGE SYSTEM
ENGINEERING**
3105 El Camino, #201
Santa Clara, CA 95051
TEL: 408-554-0841

CIRCLE NO 329

SOFTWARE VERSION CONTROL

The **POLYTRON** Version Control System (PVCS) provides precise & flexible configuration management for Software Development projects on Personal Computers and PC LANs, including:

- Storage and retrieval of multiple revisions of source code.
- Maintenance of separate lines of development using branching.
- Merging of simultaneous changes.
- Modules can be reviewed by their own revision number, system version number, or specified date.
- Efficient disk storage. PVCS uses a very intelligent difference detection technique that minimizes the amount of disk space required to store a new version.

Personal PVCS — Offers most of the power and flexibility of Corporate PVCS. **\$149**

Corporate PVCS — Offers features to maintain source code of very large and complex projects that may involve multiple programmers. **\$395**

Network PVCS — Extends Corporate PVCS for use on Networks. File locking and security levels can be tailored for each project. Call (503) 645-1150 for pricing on Licenses for more than 5 Stations. **\$1000**

Requires DOS 2.0 or higher. Compatible with the IBM PC, XT, AT and other MS-DOS PCs. Works with ANY Language.

TO ORDER: VISA/MC 1-800-547-4000.

Dept. No. 322. Oregon and outside US call (503) 645-1150.
Send Checks, P.O.s to: **POLYTRON Corporation**,
1815 NW 169th Place, Suite 2110, Dept 322, Beaverton, OR 97006.

CIRCLE NO 330

To advertise in Product Mart, call Joanne Dorian, 212/576-8015

LAYOUT PCB DESIGN

by NELSON GRAPHICS

Turn your idea into a finished product. From your schematic, we can design your PCB using CAD system or hand layout (to give you the best price and delivery.) We can also make your production films and your PC board and 'stuff it', if you wish. Some of our staff have a 25 year association with printed circuit design and manufacture. Send your schematic or sketch; we'll give your quotation 1 day turnaround. Or give us a call at—

1-216-464-0200
(ask for Lou or John)

NELSON GRAPHICS, INC.
23500 Mercantile Road
Beachwood, Ohio 44122

CIRCLE NO 331

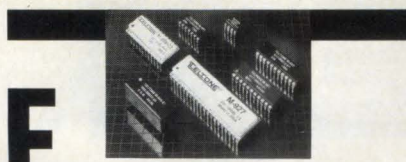

F For all your telecom equipment design needs:

- **Call Progress Tone Detectors & Generator**
CMOS detectors for telephone system tones (dial tone, ringback, busy, special information); CMOS generator for standard call progress tones.
- **DTMF Receivers**
High quality receivers for all applications.
- **MF Receivers & Generator**
CCITT RI & R2 receivers; CMOS generator IC.
- **DC Signalling Products**
Line sense relay; Dial pulse counter & hook status monitor IC; Binary input pulse dialer IC.

TELONE®

10801-120th Ave. NE, Kirkland, WA 98033, (206) 827-9626

1-800-426-3926

CIRCLE NO 332

AUGAT IS INNOVATION

Our PGM Series Pin Grid Array Sockets. More footprints than anybody else. Custom constructions on request. Even a kit for you to build your own prototypes. Takes the lid off what you can do with Pin Grid:
Tel: (617) 222-2202.

TWX: 710.391.0644.

THAT WORKS.

CIRCLE NO 333

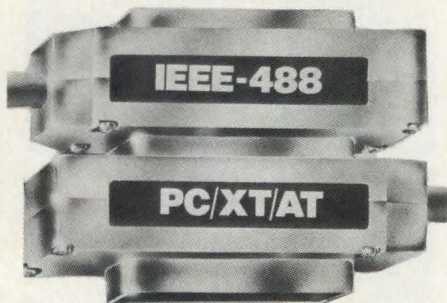

IEEE-488 CONTROL FROM YOUR PC.

- Emulate hp and Tektronix controllers.
- Fast and easy-to-use. Thousands sold.
- Program in BASIC, C, FORTRAN, or Pascal
- Hardware and software - \$395 complete.



Capital Equipment Corp.
99 South Bedford St.
Burlington, MA. 01803
Call today 617-273-1818

CIRCLE NO 334

AUGAT IS INNOVATION

Our Sub-miniature Test Jack Families. Horizontal or vertical mount. For meter probe input, crystal socket, circuit test point ID. 80 mil dia probe. Bright colored nylon insulators for fast test point ID. Largest line of mil approved to 39024. Platings, ad infinitum.
Tel: (617) 222-2202.
TWX: 710.391.0644.

THAT WORKS.

CIRCLE NO 335

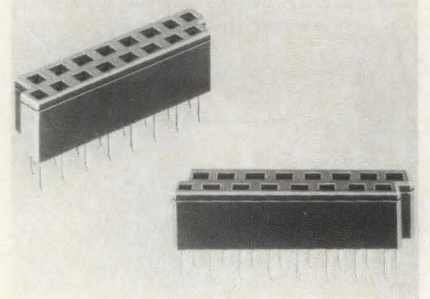

New Samtec Hi-Density Low Profile ZIP Connectors

New Samtec ZIP connectors for zig-zag memory packages are low profile (.205" high) for high density boards. Features: closed entry body protects double side-wipe contacts, phosphor bronze contacts mate with both sides of flat surface of leads for low contact resistance and longer connector life. Contacts available with tin or selective plating. Glass filled polyester body UL rated 94V-0. Both side and end stackable for maximum density. Contact: **Samtec, Inc.**, P.O. Box 1147, New Albany, IN 47150. Phone: (812) 944-6733. TWX: 810-540-4095. FAX: 812-948-5047.

CIRCLE NO 336

AUGAT IS INNOVATION

Our 8080 Series Socket. For TO-3 power transistors. For small and large signal devices. The only socket qualified to ML-12883/42. For power supplies, power amplifiers, sweep amplifiers, machine control equipment. Perform constantly "ON"stantly.
Tel: (617) 222-2202.
TWX: 710.391.0644.

THAT WORKS.

CIRCLE NO 337

IEEE-488

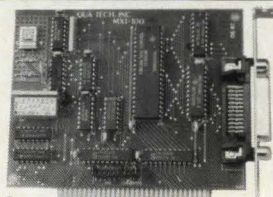

MXI-100

- GPIB controller board for IBM PC/XT/AT
- Control up to 14 Devices
- User friendly Software Commands
- DMA Transfer to 200k byte/sec.

\$345.00 including software
QUA TECH, INC.

478 E. Exchange St. Akron, OH 44304
(216) 434-3154 TLX: 5101012726

CIRCLE NO 338

RS-422/232 CURRENT LOOP

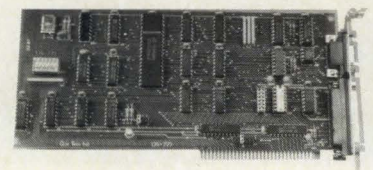

DS-225

- Single channel async communication board for IBM PC/XT/AT
- Software selectable to be RS/422/485, 232 or Current Loop
- Selectable Address & Interrupt

QUA TECH, INC.

478 E. Exchange St. Akron, OH 44304
(216) 434-3154 TLX: 5101012726

CIRCLE NO 339

To advertise in Product Mart, call Joanne Dorian, 212/576-8015



Schematic-Capture Software from Wintek

Create and revise schematics quickly and simply with **HIWIRE**® and your IBM PC. With a click of the mouse button, select a symbol from our extensive library; with a few more clicks, modify our symbols or create your own. Netlist, bill-of-materials, and **smARTWORK**® cross-checking utilities are included. **HIWIRE** is \$895 and guaranteed.

Wintek Corporation
1801 South St., Lafayette, IN 47904
(800) 742-6809 or (317) 742-8428

CIRCLE NO 340

IEEE 488 INTERFACE

FROM A PERSONAL COMPUTER TO A PERSONAL CONTROLLER...
...FOR \$195.00

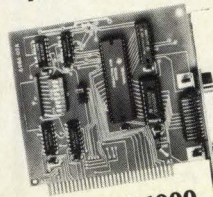

BBS GPIB-1000

- For PC XT/AT or compatibles
- Routines, sequences and terminology similar to HP-85
- Won't 'hang up' bus during use
- BASICA, assembly language, Microsoft & Lattice C and compiled basic support packages available

Need additional information on pricing, volume discounts, or technical information?

Call us toll free at (800) 227-7317
In Ohio (216) 349-3444.



6200 SOM Center Rd. • Suite C23
Solon, OH 44139

CIRCLE NO 341

Sprague-Goodman Surfcoil® And Wirewound Inductors

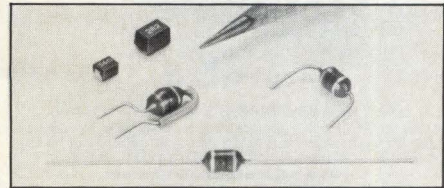

- High Q
- High SRF
- Surfcoil surface mounting and leaded (axial, radial or vertical) available
- Inductances from 0.22 to 1000µH
- Low DC resistance
- Wide range of values



Sprague-Goodman Electronics Inc.
(An affiliate of the Sprague Electric Company)
The First and Last Name in Trimmer Capacitors

134 Fulton Avenue, Garden City Park, NY 11040-5395
516-746-1385/TWX: 510-600-2415/TLX: 14-4533

CIRCLE NO 342

F & W: Specialists in Graphics and CAD

O E M SPECIAL!!
PC-COMPATIBLE HIGH-RESOLUTION DISPLAY SUBSYSTEM

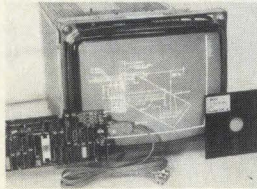

- * 800 X 640 X 16 colors
- * IBM XT, AT, RT compatible
- * Ikegami in-line tube, high scan rate, non-interlaced, flicker-free 14" monitor
- * Controller card is ARTIST, AutoCAD software compatible
- * All software, cable, installation instructions included—plug into your computer and GO!
- * Special Offer—Buy 1 at our usual 100-piece price \$995.

—Also available: 19" systems, digitizer tablets, plotters at O E M prices!

ARTIST is a registered trademark of Control Systems. AutoCAD is a registered trademark of Autodesk.
F & W COMMUNICATIONS 194 Main Street
Marlborough MA 01752 Tel. (617) 485-1144

CIRCLE NO 343



the **LOGIC LAB**

is a complete logic development system

- * FAST MAP™ quickly and easily transforms your logic equations into a JEDEC fuse map.
- * The LOGIC LAB™ PROGRAMMER produces programmed GAL® devices to be tested in your prototype circuit.
- * The included GAL® devices may be reprogrammed up to 100 times as you refine your design and test new prototypes.
- * The LOGIC LAB PROGRAMMER may produce your GAL® devices for production or you may send the JEDEC file to a programming center and produce nearly any manufacturer's PLD.

Demo Disk Available from:
Programmable Logic Technologies, Inc.
P.O. Box 1567 Longmont, CO 80501 GAL is a registered trademark of Lattice Semiconductor Corporation
Ph. (303) 772-9059 FAX (303) 772-5617

CIRCLE NO 344

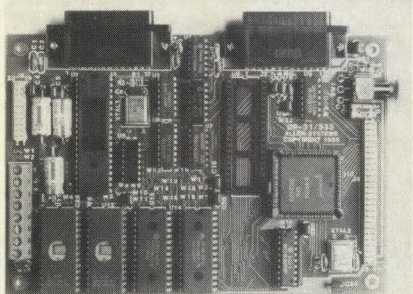

8051/80535 BASED SINGLE BOARD COMPUTER

The DP-31/535 uses either a standard 8051 or enhanced 80535. The board supports up to 120K of EPROM/RAM, 8 channel eight-bit A/D converter, 5 eight-bit parallel ports, 2 RS-232C buffered serial ports, and 7 timer/counters. We also feature boards based on the 8096, 68HC11, and 68008. Available as bare boards or assembled and tested. EPROM resident System Monitors and BASIC Interpreters are also available.

ALLEN SYSTEMS
2151 Fairfax Road, Columbus, OH 43221
614-488-7122

CIRCLE NO 346

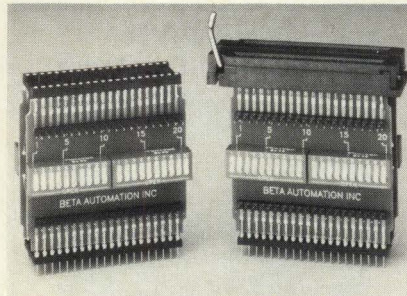

DIP ISOLATOR. Isolate any pin of a socketed DIP IC. Test points on both sides of each isolation switch allow monitoring or connection. Ideal for prototype debugging. Models available from 8 to 40 pins. Choose gold hi-rel or ZIF socket.

BETA AUTOMATION INC.
3541 Old Conejo Rd.
Newbury Park, CA 91320
805/499-5785

CIRCLE NO 347

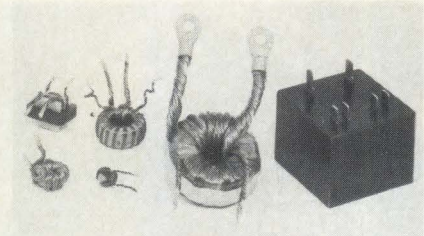

LITZ WIRE MAGNETICS

FAST SERVICE 100KHZ SWITCHERS

Magnetic offers hi frequency transformers and Inductors. Full MIL SPEC custom designs with a fast service engineering sample policy, and on time production. Reproduceability and reliability by the design and production techniques.

Automated Test

Call Harold Eicher at (516) 654-1166 or send spec. to **MAGNETICO, INC.**, 182 MORRIS AVENUE, HOLTSTVILLE, NY 11742

CIRCLE NO 348

To advertise in Product Mart, call Joanne Dorian, 212/576-8015

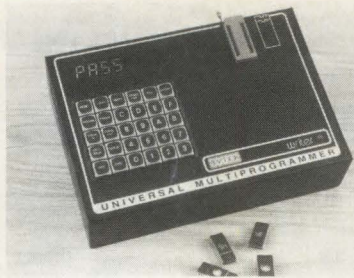

30 KEY STAND ALONE (E)EPROM PROGRAMMER - ONLY \$495.00

The WRITER™ supports virtually all MOS and CMOS EPROMs and EEPROM up to 512k. The WRITER has complete STAND ALONE programming capabilities, including data EDITing, or PC Remote Control with the standard RS232 interface.

STANDARD FEATURES OF THE WRITER include:

- Programs all popular 2716 - 27512 EPROMs & 2816 EEPROM
- 32k BYTES RAM (512k Bits)
- Large 6 Digit LED Display
- 14 Functional Keys, including: LOAD, PROGRAM, EDIT, DISPLAY, ERASED CHECK, FILL & VERIFY
- RS232 PC Interface
- 12 Popular RS232 Formats
- Baud Rates: 110-9600
- Single 28 pin ZIF socket
- Fast Intelligent Algorithms
- One Year Warranty
- UV Erasers from \$47

BYTEK - the #1 CHOICE in (E)EPROM MultiProgramming Equipment & UV Erasing Products. Made in the USA. Call or write for full product line catalogue.

ORDER TOLL FREE: (800) 523-1565
In Florida: (305) 994-3520



Corporation
Instrument Systems Division
1021 S. Rogers Cir., Boca Raton, FL 33431
FAX: (305) 994-3615 TELE: 4998369 BYTEK
Our new CA Sales Office: (415) 487-4694

CIRCLE NO 349

EPROM PROGRAMMER \$349

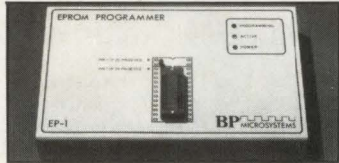

The EP-1 is a great value, here's why:

- IBM PC Software included or RS-232 to any computer
- ASCII Command driven operation. All intelligence in unit
- Reads, Programs, Copies over 150 types from 2716 to 27512
- Optional Intel microcontroller programming head
- Menu-driven Chip Selection, No Personality Modules
- Fast, Slow, Quick-Pulse Programming Algorithms
- Intel (8080 & 8086), Motorola, Tekhex, Straight Hex Files
- Splits Files by Base Address and Odd/Even (16 bit systems)
- Gold Textool ZIF IC socket
- Generate & Set Checksums
- Over-Current Protection
- 8 Baud Rates 300 to 38,400
- Full One-Year Warranty
- 5 1/2" 5.25" 25V Programming
- U.V. Erasers from \$34.95
- Same Day Shipment



10681 Haddington, #190 / Houston, TX 77043
(713) 461-9430 (800) 225-2102

CIRCLE NO 350

IBM PC to HP file interchange !!!

1. PCLIF (Rev 2.5) - New release of the software utility that allows the transfer of files between an IBM PC and HP computers using floppy disks.
 - 5.25" transfers don't require any additional hardware!
 - 3.5" disk transfers require an ISS FDD35 drive system.
 - runs on the IBM PC, XT, AT and the HP Vectra.
2. FDD35 - An external 3.5" DS/DD floppy disk drive system for the IBM PC and XT.
 - easy connect to IBM PC disk drive controller.
 - can be used by DOS and PCLIF.

INNOVATIVE SOFTWARE SYSTEMS
1611-D Crenshaw Blvd. Suite 122
Torrance, CA 90509
(213) 544-2465

CIRCLE NO 751

Schematic to PC Layout \$350

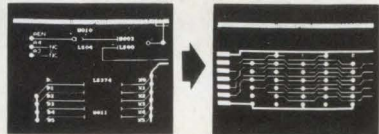

SCHEMATIC CAPTURE \$100

- A through D size drawing
- 3 levels of zoom
- uses keyboard and or mouse
- User expandable library has over 1000 parts
- Prints bill of material net list (Futurenet, EDIF)

PC BOARD LAYOUT \$250

- Board size 36 x 36
- 256 layers include silkscreen & solder mask
- User definable pad and hole shape sizes
- Trace width .001 inch to 0.255 inch
- Connectivity check with NETLIST
- Optional autorouter \$ 250 available soon

Both packages support IBM PC with CGA, EGA & HGA graphics cards IBM, Epson, Okidata printers and Hewlett-Packard, Houston instrument and all other plotters. **Demo Disk \$ 10**

(305) 975-9515 **ams** 800-9PC-FREE

ADVANCED MICROCOMPUTER SYSTEMS, INC
2780 S.W. 14th Street Pompano Beach, FL 33069

CIRCLE NO 752

ELECTRONIC ENGINEERS TECHNICIANS MANAGERS You Need BUYERS



For PC Compatibles
GENERATES ERROR FREE REPORTS
Parts Listing Summary Bill of Materials

Easy to Learn Easy to Use Well Documented

DATA FIELDS INCLUDE
Reference Designator Mil Spec Number
Part Type/Value Preferred Manufacturer
Company Part Number Description (Comments)
Cost



NOW \$59.95
Add \$3.00 Shipping and Handling (In California add 6.5% sales tax)
Send check or money order to:
LIVEWIRE SOFTWARE
P.O. Box 773
Pacific Palisades, CA 90272
(213) 454-4492

CIRCLE NO 753



EE DESIGNER™
CAE/CAD Integrated Software Package
for IBM PC, XT or AT **\$975**

At only \$975, no electrical engineer can afford to be without this end-to-end circuit design, simulation and PCB layout tool. You can pay up to 15 times more and still not get all the features offered by EE Designer—Schematic Capture...Circuit Simulation...PCB Layout. 30 day money back guarantee. Full purchase price refunded if not completely satisfied. Call 1-800-553-1177 today to order your package. Bank cards welcome.



CIRCLE NO 754

SCHEMA II Schematic Capture

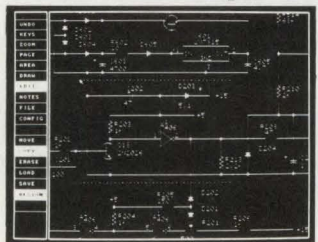

FREE Demo Disk: 1-800-553-9119

SCHEMA's success is the talk of the CAE industry and thousands of satisfied SCHEMA owners know why. Incredible speed, ease of use, and power have made SCHEMA a best-selling schematic capture program for engineering professionals the world over.

Now, SCHEMA II is available. SCHEMA II sells for \$495 and supports most common IBM PC/XT/AT configurations. Please call today for a free SCHEMA II demo disk.



OMATION

In Texas Call (214) 231-5167

CIRCLE NO 756

6800/6809 Micro Modules

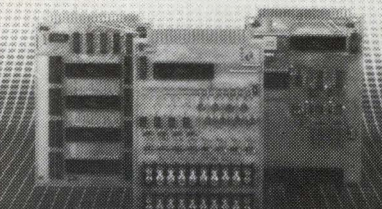

OEM 6800/6809 MICROCOMPUTER MODULES for dedicated control and monitoring. Interfaces for sensors, transducers, analog signals, solenoids, relays, lamps, pumps, motors, keyboards, displays, IEEE-488, serial I/O, floppy disks.



Winter Corp.
1801 South Street
Lafayette, IN 47904
317-742-8428
800-742-6809

CIRCLE NO 757

To advertise in Product Mart, call Joanne Dorian, 212/576-8015

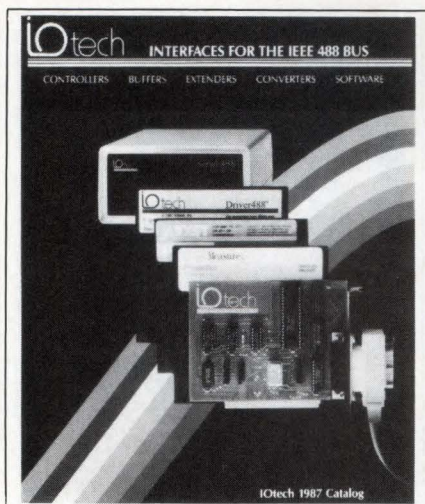

Catalog describes IEEE-488 interfaces

The 1987 catalog of *Interfaces for the IEEE-488 Bus* includes a listing of seven new PC products, which provide an interface between IEEE-488 instruments, plotters, and printers and IBM PCs or compatible computers. The publication describes how the manufacturer's Personal488 hardware/software combination makes programming IEEE instruments from the IBM PC easier.

IOtech Inc, 23400 Aurora Rd, Cleveland, OH 44146.

Circle No 411

Publication discusses specs for analog ICs

The *Elantec 1987 High Performance Analog Data Book* presents complete technical specifications for the company's high-speed analog ICs. The book is organized into six chapters of data sheets; selection guides precede each chapter. Additional chapters provide information about the manufacturer's reliability and quality-assurance programs, and its monolithic and hybrid military IC processing programs. Package outlines are also included. Request the book on company letterhead.

Elantec Inc, Marketing Communications, 1996 Tarob Ct, Milpitas, CA 95053.

INQUIRE DIRECT

Source- and date-code numbers listed

The *1987 Source Code and Date Code Booklet* contains an alphabetical and numerical listing of code numbers that are affixed to electronic products to identify the source or the vendor. The engineering department of the Electronic Industries Association assigns and registers these numerical symbols. Free to EIA members; \$1 for non-members.

Electronic Industries Association, 2001 Eye St NW, Washington, DC 20006.

INQUIRE DIRECT

Guide details MS-DOS 3.2

The *MS-DOS Version 3.2 Pocket Command Summary*, a 10-pg document, updates the original MS-DOS reference (which covered Versions 2 and 3) and includes all the new commands in MS-DOS Version 3.2. This alphabetical listing details command syntax, simplifies the search for the correct command within the DOS environment, and describes the options available for each command. \$3.

Specialized Systems Consultants Inc, Box 55549, Seattle, WA 98155.

INQUIRE DIRECT

Software directory

This year's edition of the *Business Software Catalog* lists 1390 business application programs divided into 558 classifications. The programs run on hardware from such companies as IBM, DEC, Honeywell, and NCR. The catalog lists packages offered by 300 publishers in 10 countries: Australia, Belgium, Canada, France, New Zealand, Singapore, South Africa, UK, US, and Switzerland. The book includes a list of 206 consultants, which is cross-referenced for ease of use. \$39.95.

IDBMA Inc, 9740 Appaloosa Rd, Suite 104, San Diego, CA 92131.

INQUIRE DIRECT

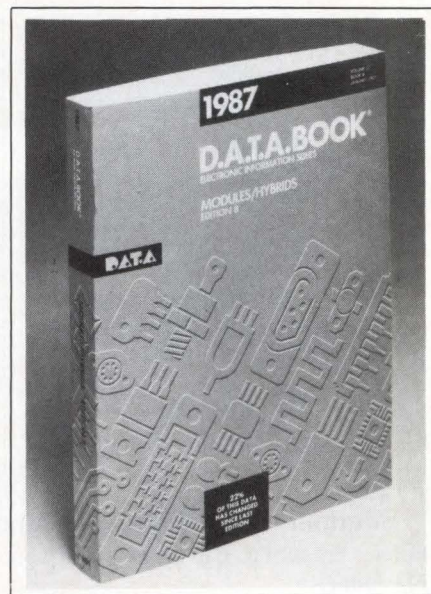

Specs on ICs

The eighth edition of *Modules/Hybrids* provides device specifications on more than 11,500 linear and digital hybrid ICs and modules from 84 manufacturers worldwide. This edition covers nearly 1000 new parts and contains updated information on another 500. In addition, it refers many new sources for these off-the-shelf hybrid ICs and modules. Sample products include wideband amplifiers, synchro-to-digital and digital-to-synchro converters, operational amplifiers, A/D and D/A converters, active filters, oscillators, and overvoltage-protection devices. Logic/circuit drawings and outline drawings complete the treatment. \$95.

DATA Inc, Box 26875, San Diego, CA 92126.

INQUIRE DIRECT

Catalog lists optical and industrial products

This 4-color, 148-pg catalog features more than 5000 of the vendor's optical and industrial products. It includes a comprehensive section, addressing precision lenses, optics, mirrors, prisms, fiber optics, optical instruments, and lasers, as well as a section on magnifiers, magnets, microscopes, telescopes, and accessories.

LITERATURE

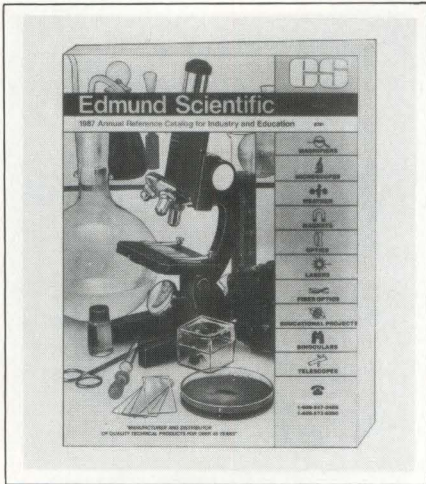

Edmund Scientific Co, Dept
5554, Edscorp Bldg, Barrington,
NJ 08007.

Circle No 417

Brochure discusses product for memory-repair systems

This brochure describes the Verifier, a product that measures the positioning and alignment accuracy of

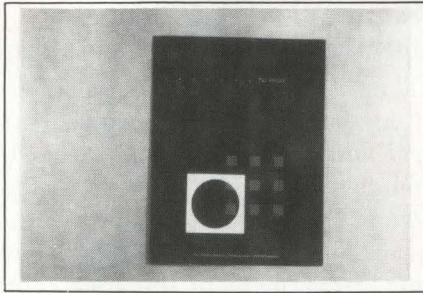

memory-repair systems. The 4-pg pamphlet lists what the package includes and presents three figures.

**Teradyne Inc, Inquiry Systems
and Analysis, 25 Drydock Ave, Boston,
MA 02210.**

Circle No 418

App note covers test system

This application note describes the automatic parameter test (APT) system for the Model 2955 radio-communications test set. It also discusses the system's design, software, and typical operation displays. It includes illustrations of



screen displays.

**Marconi Instruments, 3 Pearl
Ct, Allendale, NJ 07401.**

Circle No 419

BE ARBITRARY.

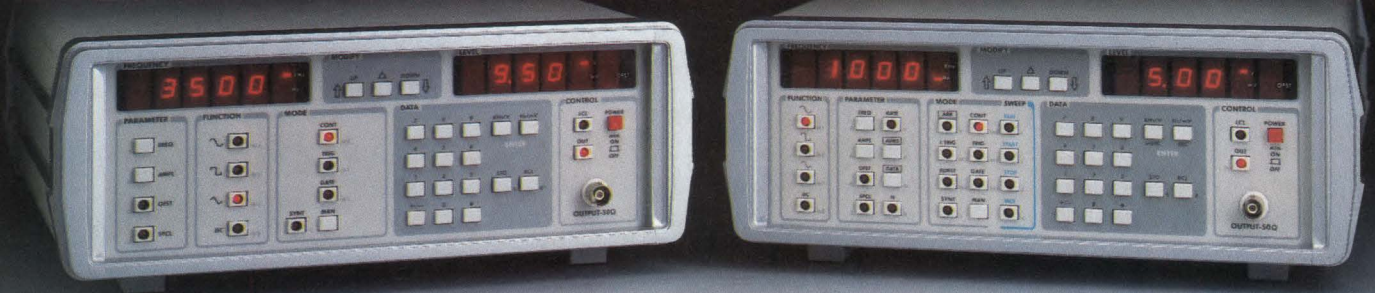

Nicolet Programmable Function Generators

- Fully GPIB (IEEE-488) programmable
- Arbitrary waveform generation (12-bits x 2k)
- Standard functions to 4 MHz
- Comprehensive sweep capabilities including arbitrary sweep!
- Simultaneous display of amplitude and frequency
- Nonvolatile storage of 99 setups
- Frequency accuracy of 0.2%, optional synthesizer frequency accuracy of 0.005%

800/356-3090 or 608/273-5008

Nicolet
"Instruments of Discovery"

Nicolet Test Instruments Division P.O. Box 4288 5225-2 Verona Road Madison, WI 53711-0288

You need speed plus precision to push the limits.

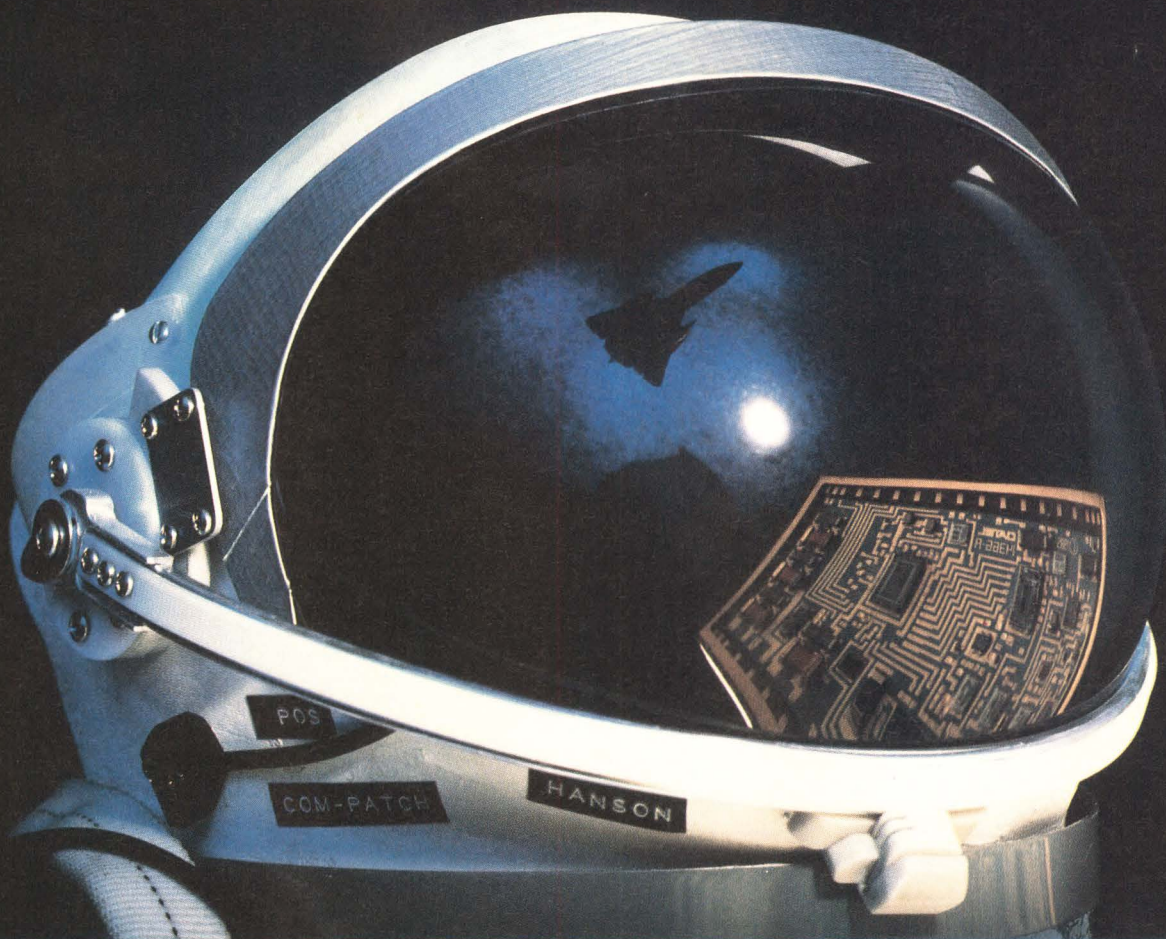

Datel's 500nSec 12-bit A/D converter.

It's high-speed performance plus true 12-bit precision. It's the new ADC-500 from Datel. And it gives you a combination of speed, accuracy, low power, and compact size that no other A/D converter can match.

Very fast. The 500nSec maximum conversion time speeds throughput, boosts performance.

Very accurate. The ADC-500 offers *true* 12-bit precision. So you don't have to sacrifice performance for speed.

Very cool. Power is less than 1.7W for cool operation, with no need for heatsinks or restricted temperature ranges.

Very compact. The ADC-500's 32-pin hybrid package and built-in functionality save space and minimize the need for additional components.

What's more, the ADC-500 offers some

special application-based features: a sample/hold trigger pin, complementary output pin, and an overflow pin that shows when signals are above or below full scale. And MIN/MAX specifications over operating temperature and power supply ranges give you a worst case design analysis—and help prevent surprises. With this innovative new converter, you can push design limits in both military and commercial applications.

Find out more about what our great new performer can do for you. Call (617) 339-9341, extension 241 to discuss your application and request additional information on the ADC-500.

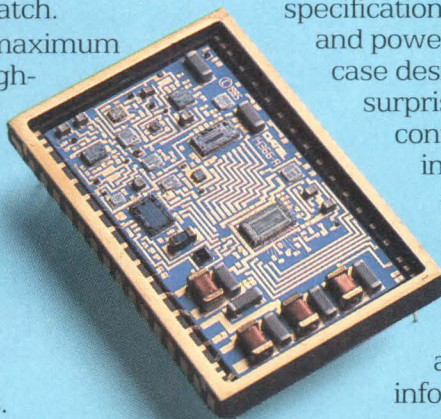

DATEL

LEADERS IN DATA CONVERSION TECHNOLOGY
11 Cabot Boulevard, Mansfield, MA 02048
(617) 339-9341

NOW MAGNETIC CIRCUIT BREAKERS BELONG ON YOUR DIN RAIL.

So what's a DIN rail? It's a concept developed in Europe for quick and easy mounting of electrical and electronic devices. And now that concept includes something new. Airpax introduces magnetic circuit breakers made specifically for the 35mm symmetric rail. They snap on. They snap off. That's why DIN rails are all over Europe—and why they're coming to the U.S. as well.

Leave it to Airpax to combine the simplicity of the rail-mount design with the superior performance of magnetic circuit breakers. These new IELR breakers feature ratings from 0.050 to 50 amps with toggle-style handles in a choice of seven colors. They're UL recognized and meet CSA certification and VDE spacing requirements. Best of all, they're the only rail-mounting circuit breakers which offer the performance and quality that have earned them the Airpax name.

Now is your chance to get a head start in the U.S. while you expand your marketing potential in Europe. With magnetic rail-mounting circuit breakers—a great new idea backed by an old commitment to excellence. Your first step is easy. In fact, it's a snap. Call or write for more information. Airpax Corporation, Cambridge Division, Woods Road, Box 520, Cambridge, MD 21613, (301) 228-4600. Fax: (301) 228-8910. A North American Philips Company.

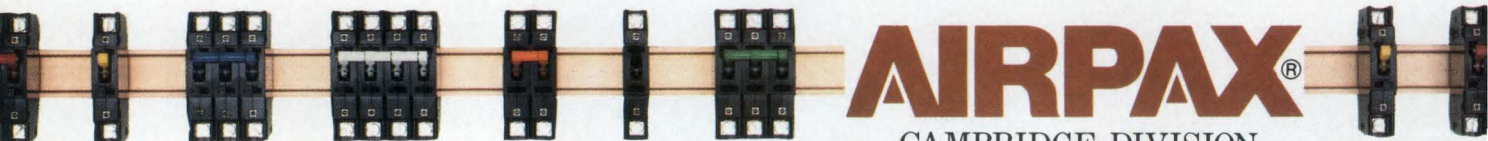
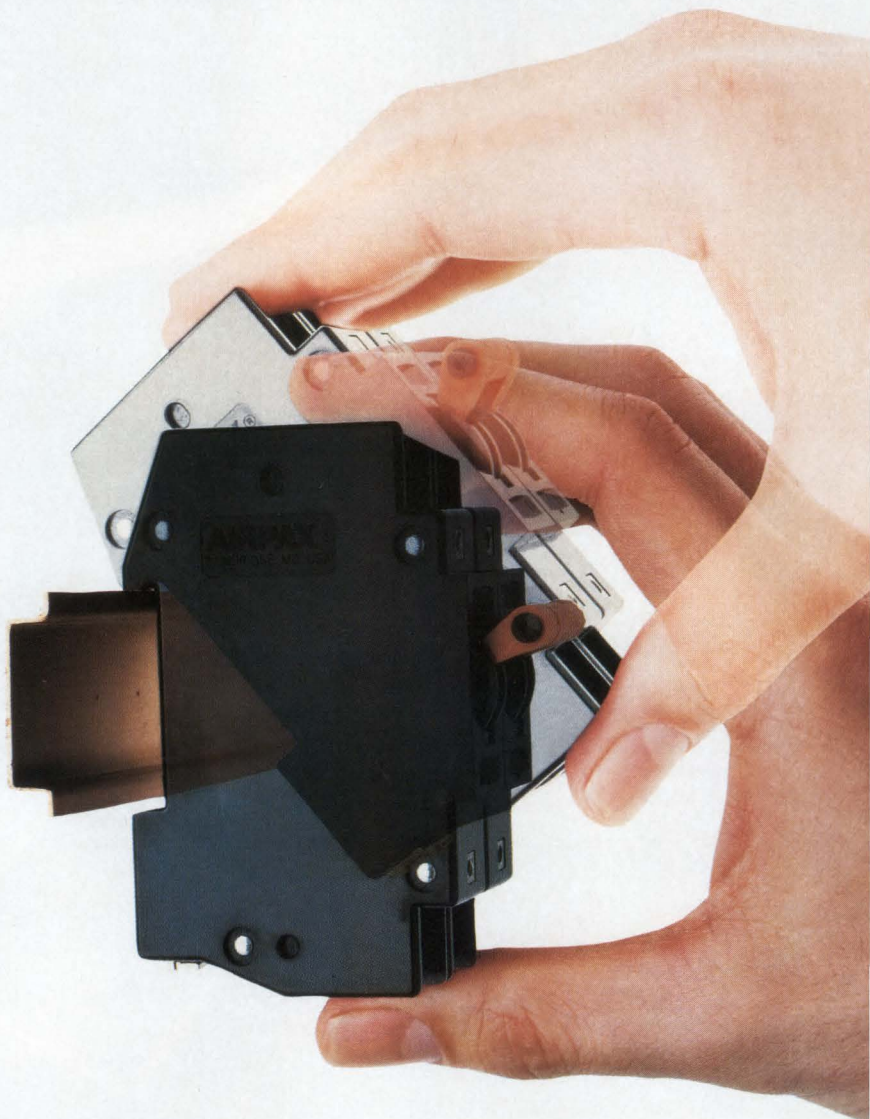

AIRPAX[®]
CAMBRIDGE DIVISION

PROFESSIONAL ISSUES

Widespread practice of unpaid overtime levies burden on salaried engineers

Deborah Asbrand, *Associate Editor*

If you work more than a few hours of overtime each week, you're far from alone. If you aren't paid for the overtime you work, you have nearly as much company. And if you feel that turning away from such overtime demands would incur unfair challenges to your professionalism and risks to your career, you are probably, once again, part of a large community of engineers.

Seventy-six percent of the respondents to the IEEE's 1985 Salary and Fringe Benefit Survey claimed to work some amount of overtime each week.

One third said they worked seven or more hours of overtime each week. Sixty-eight percent of the respondents to the IEEE survey reported they receive no compensation for the extra hours they work.

Overtime appears to be a pervasive, if unpleasant, aspect of the workplace. And apart from government contractors and the handful of companies that have engineering unions, few companies extend overtime compensation to their engineers. The opinion that unpaid overtime is the curse of salaried professionals appears to be widespread. Yet the practice goes on at the level of the unwritten rule, the unspoken code. And even professional associations and related organizations have done or said very little about the issue. (In fact, the practice is

such a commonplace feature of the corporate landscape that one director of engineering at Analog Devices assumed his company had no overtime provisions, only to discover upon thumbing through his employee handbook that there was an allowance for paid overtime. He said that he had never seen the policy used.)

As noted, engineers in some electronics-industry sectors do receive overtime pay. Government contracts, for example, often compensate engineers who work the

overtime that has been scheduled for a project. Legislators have limited paid overtime on government projects in some cases, though, since it was revealed that several large contractors were overcharging the federal government for contract costs.

Members of engineering unions also are paid for any extra hours they work at their employers' request. Members of the Seattle Professional Engineering Employees Association receive their regular hourly pay plus five dollars for each hour of overtime they work at the request of their employer, Boeing Corp. At the Camden and Moorestown, NJ, facilities of RCA, the 2000 engineers that constitute the Association of Scientists and Professional Engineering Personnel earn straight time plus four dollars per hour for scheduled overtime.

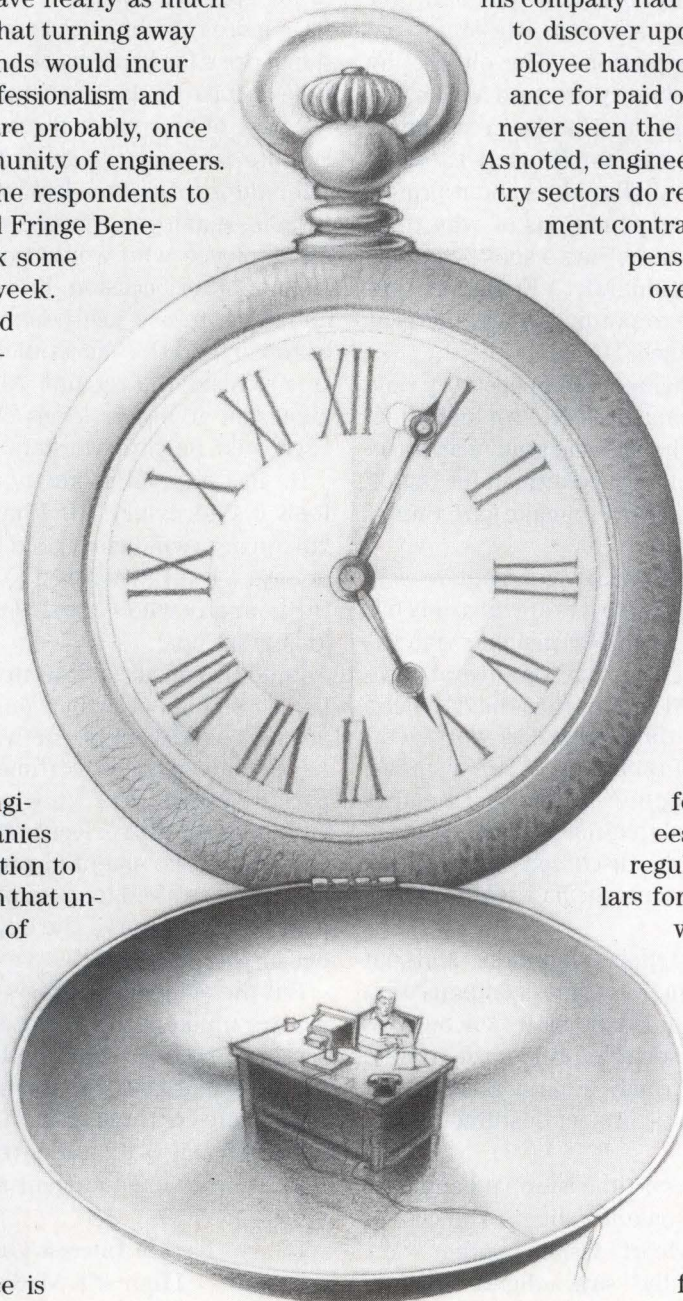

Illustration by Michael Young

PROFESSIONAL ISSUES

Beyond the spheres of government contracts and unions, however, industry watchers report that unpaid overtime is a tacit fact of the workplace. "Most of the major electronics organizations don't pay overtime to engineers," says Susan Reynolds, a principal partner with the benefits consulting concern Sibson and Company in Princeton, NJ.

Company representatives cite a variety of reasons to explain why they don't pay engineers for any extra time they put into a project. The most common response is that engineers' salaries reflect the overtime they often must work. "We don't pay overtime to engineers, but we feel we have a very generous salary and compensation plan," said a spokesman for Cullinet Software (Westwood, MA).

In other cases, company representatives refer to federal fair-labor laws, which specify overtime payment for hourly workers, but exempt salaried workers from requirements for such compensation. "The philosophy is that those in the exempt category are paid a salary to perform certain responsibilities in whatever reasonable time it takes," said a spokesman for Hewlett-Packard. Other representatives echoed similar ideas about professional responsibility in their explanations of why their company did not pay for overtime. Says a spokesman for Massachusetts-based Data General: "Engineers are project-driven. They're going to put in as many hours as required to complete the project."

A few employers do offer engineers compensatory time off after working long hours on a project. "An individual manager quite often may work out some kind of arrangement with an employee," offered a spokesman for Digital Equipment Corp. "There's an effort to make sure there's some kind of fairness."

Yet engineers working in the intensely competitive electronics industry say that some employers are anything but fair in their overtime policies. One IEEE member who has held a number of local offices says that, on several occasions, members have confided to him that they've been told by their employers that their failure to work overtime could result in the loss of their jobs. In one instance, he remembers receiving a telephone call from a member who would be unable to attend that night's local meeting, during which the subject to be discussed was working conditions. The reason? His employer had required that he work late.

Some engineers believe that their exemption—and that of other professionals—from overtime compensation according to the dictates of fair-labor laws encourages companies to draw up unreasonable project timetables. If employers were required to pay engineers overtime, one engineer says, more realistic project deadlines would soon appear.

Although most engineers' overtime is unpaid and thus doesn't appear on corporate balance sheets, the cost of long stretches of overtime is clearly visible in other ways. "Morale goes down very rapidly," says a digital designer

in Phoenix, AZ. In addition to morale problems, long hours on the job can lead to fatigue and costly errors. For example, along with its other findings, the presidential commission investigating last year's explosion of the Challenger shuttle criticized the National Aeronautics and Space Administration for shuttle workers' frequently long hours on the job.

In order to avoid the high personal costs of overtime—which include long periods of time away from family and home—one engineer relates that he has on many occasions refused to work overtime and chosen to incur the professional costs. The 33-year-old digital designer says that his decision not to work overtime was not at any time a sign of disloyalty or irresponsibility, but was made to balance his professional obligations with his responsibility to his growing family.

On more than one occasion he has paid a steep professional price for his decision. After declining to work overtime on a particular project, he still managed to complete his part of the work three weeks ahead of schedule. Despite this performance, he was transferred shortly afterwards to another, less interesting project—a message from his employers, he says, that they would not tolerate an employee who would not follow orders.

On another occasion, he explained to his boss that he and his wife had just bought a house that was in need of repair, and that he would need to keep his weekends free to make the repairs. Although his boss understood, managers at higher levels offered less sympathy: They suggested he hire workers to do the repairs.

He has no qualms about working overtime when he feels it's necessary. "If I have to come in early or stay late on my own, I get a good feeling of accomplishment," he says. "But I'm married to my family, not my job. I pity the poor guy who's married to his job. I like watching my kids grow up."

Benefits consultant Susan Reynolds says that overtime is an issue about which engineers are becoming more vocal. A handful of research and development companies have changed their overtime policies, she says, in anticipation of engineers' growing frustrations. ITT, Bechtel Corp, and the Microelectronics and Computer Technology Corp have implemented programs to reward engineers who have worked long hours. In most cases, the reward comes in the form of the opportunity to work on a project of the individual's own choosing.

But the evidence suggests that the majority of employers are unlikely to change their policies soon. Private-sector companies find safe harbor from overtime pay in the fair-labor laws. Companies that do pay overtime will most likely continue to do so, as the high costs of benefits packages makes it more attractive for them to pay overtime than to expand their staffs.

EDN

Article Interest Quotient (Circle One)
High 488 Medium 489 Low 490

Our SCSI selection is getting bigger. And smaller.

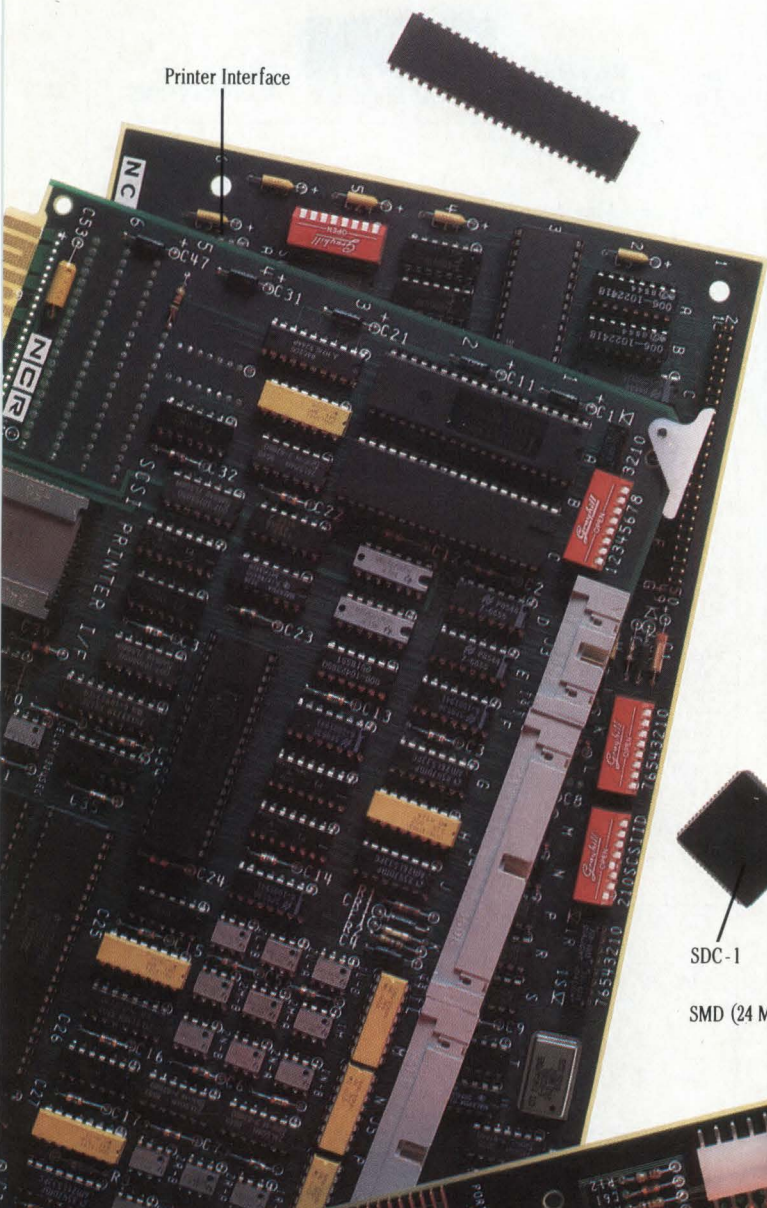

Printer Interface

Bigger with the addition of a new SMD controller board that's setting speed records and the first SCSI printer interface board. And smaller as we continue to reduce chips and boards through VLSI technology, while adding functions. (Even down to a controller on a single chip.) So call 1-800-325-SCSI, and find out what NCR and SCSI can do for you.

SCSI Disk Controller Chip

SDC-1 A highly integrated, programmable, general-purpose SCSI disk controller chip.

SCSI Board Products

- ADP-31S PC to SCSI Host Adapter
- ADP-32 Multibus I™ to SCSI Host Adapter
- ADP-33 VME to SCSI Host Adapter
- ADP-20 SCSI to Flexible Disk Controller
- ADP-46 SCSI to ST-506/SA-400 Disk Controller
- ADP-47 SCSI to ESDI Disk Controller
- ADP-48 SCSI to SMD (10, 15, 20 or 24 MHz) Disk Controller
- ADP-53 SCSI to 1/2" PERTEC Tape Controller
- ADP-55 SCSI to QIC-36 Tape Controller
- ADP-60 SCSI to Dataproducts Printer Interface (Long Line)
- NCR 6343 1/4" Cartridge Streaming Tape Drive With SCSI.

SCSI Storage Subsystems

Tabletop or desk-side storage subsystems with disk and tape configurations from 172 MB to 2.1 gigabytes.



SDC-1



1-800-325-SCSI
E&M — Wichita
OEM Products
CIRCLE NO 129

SMD (24 MHz) Controller

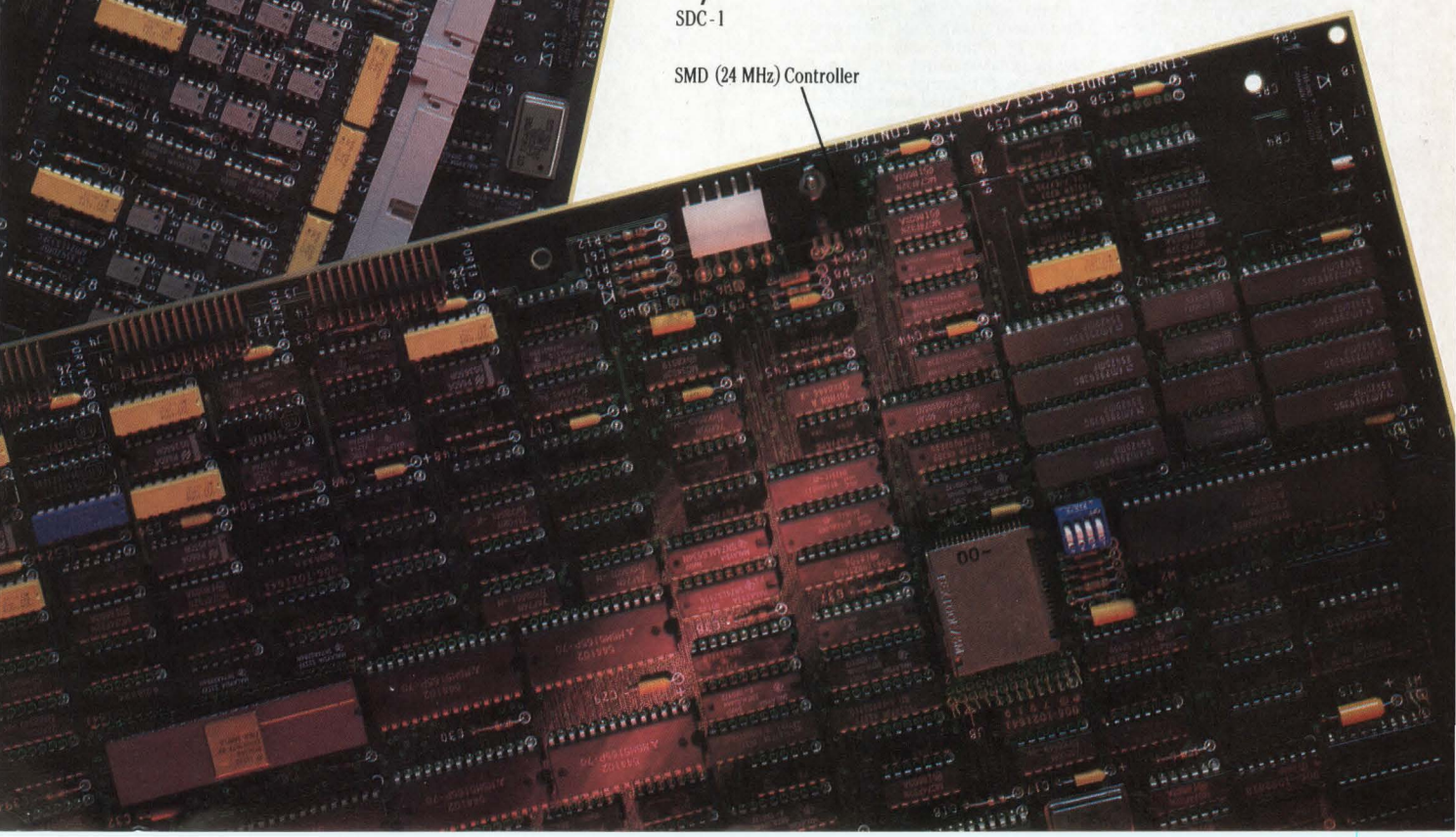



Manufacturing Engineering Opportunities

TRW Electronic Products Inc. is an industry leader in the manufacture of state-of-the-art military and aerospace communications equipment. The following outstanding opportunity is now available to qualified individuals.

Manufacturing Engineers

Requirements include a B.S. degree in industrial engineering (mechanical engineering preferred) and seven years of experience including flight and ground hardware assembly line support. Familiarity with quality/reliability standards and procedures is essential. SMT experience is a plus.

Our excellent working conditions and superior benefits package all add up to make us the best in the West. Tomorrow is taking shape at a company called TRW. Send your resume to **TRW Electronic Products Inc., Employment Department HS-ME, 3650 N. Nevada Avenue, Colorado Springs, CO 80907.**



Equal Opportunity Employer
U.S. Citizenship Required
Principals Only Please

SYSTEM INTEGRATION ENGINEER Design, develop, fabricate, test and troubleshoot the electronic circuits and software necessary for a translation box to be used between a laboratory balance and an IBM mainframe to assure that the box will properly function as a protocol or language convertor between the laboratory automation system and the IBM mainframe. Will program and debug problems on multi-tasking operation system and remote telecommunication software development. Will program in PASCAL, Fortran, 8086, 80286, Basic and Z80. Requires B.S. degree in Electrical Engineering with major field of study in Computer Engineering. Education to include use of PASCAL, Fortran, 8086, 80286, Basic and Z80 languages in any coursework as well as courses in (1) Operating Systems, (2) Compilers Design, (3) Data Structures, (4) Computer Graphics, (5) Digital Microprocessor, (6) Digital Engineering Lab, (7) Communication Systems, and (8) Control Systems. Hours: 8:00 a.m. - 5:00 p.m. 40 hours per week at \$581.00 per week salary. Please send resume to: Wisconsin Job Service, Attn: George Kammerer, Telephone Number (608) 266-3140, 206 North Broom Street, P.O. Box 7943, Madison, Wisconsin 53703, Job Order #1285847, AN EMPLOYER PAID AD.

Senior Hardware Engineer: Responsible for the design of a new line of office communications system. Duties include the use of digital design to add new features to product for digital voice messaging as well as use of systems designs to interface with marketing in specifying and costing new product offerings. Supervises hardware engineering staff. Must have 4 yrs. experience in the design of digital analog hardware and in design and development of digital PBX systems employing TDM bus. Must be familiar with software and hardware design of microcomputer applications. Must have 4 yrs. experience in bus structures and high speed multiplexed serial links. MS in electronics and 4 years experience in position or as Systems Designer/Communications. Salary 50,000/YR. Applications by resume. Contact your nearest job service center referring to job order number C02734076.

ELECTRONICS • AEROSPACE NATIONWIDE \$30-80K

Opportunities for Engineers & Professionals in Defense/Aerospace and Commercial Industries. Send Resume to:

JACK PORTER ASSOCIATES, INC.
385 Front St. N., Issaquah, WA 98027
(206)455-4928

All fees paid by client companies.



First in Readership Among Design
Engineers and Engineering
Managers in Electronics

CAREER OPPORTUNITIES

1987 Editorial Calendar and Planning Guide

Issue Date	Recruitment Deadline	EDN Editorial Emphasis	EDN News
May 28	May 7	Computer Peripherals; Software; Power Sources/Devices	Closing: Apr. 30 Mailing: May 21
June 11	May 21	Math ICs; CAE; Computers	Closing: May 14 Mailing: June 4
June 25	June 4	ASIC (Semiconductors) Directory; Analog ICs; Surface-Mount Technology	Closing: May 28 Mailing: June 18
July 9	June 18	Product Showcase-Volume I; ICs & Semiconductors; Software	Closing: June 25 Mailing: July 16
July 23	July 2	Product Showcase-Volume II; Computers & Peripherals; Test & Measurement Instruments	Closing: July 9 Mailing: July 30
Aug. 6	July 16	Computer Boards; Digital Signal Processing; Test & Measurement; Top Ten Reader Vote Contest	Closing: July 23 Mailing: Aug. 13
Aug. 20	July 30	Military Electronics Special Issue; Fiberoptics; Software	Closing: Aug. 6 Mailing: Aug. 27
Sept. 3	Aug. 13	Analog ICs; CAE; ASICs	Closing: Aug. 20 Mailing: Sept. 10
Sept. 17	Aug. 27	Memory Technology; Communications Technology; Software	Closing: Sept. 3 Mailing: Sept. 24
Oct. 1	Sept. 10	Surface-Mount Technology; Computers & Peripherals; Industrial Product Showcase	Closing: Sept. 17 Mailing: Oct. 8
Oct. 15	Sept. 24	Test & Measurement Special Issue; Analog ICs; ASICs	Closing: Oct. 1 Mailing: Oct. 22
Oct. 29	Oct. 8	Computers & Peripherals; ICs & Semiconductors; Wescon '87 Product Preview	Closing: Oct. 15 Mailing: Nov. 5
Nov. 12	Oct. 22	Wescon '87 Show Issue; ICs; Computers & Peripherals	Closing: Oct. 29 Mailing: Nov. 19
Nov. 26	Nov. 5	Microprocessor Technology Report & Directory; Analog ICs; Sensors & Transducers	Closing: Nov. 12 Mailing: Dec. 3
Dec. 10	Nov. 19	Product Showcase-Volume I; ICs and Semiconductors; Software	Closing: Nov. 26 Mailing: Dec. 17
Dec. 24	Dec. 3	Product Showcase-Volume II; Computers & Peripherals; Test & Measurement Instruments	

Call today for information.

East Coast Janet O. Penn (201) 228-8610
West Coast Dan Brink (714) 851-9422
National Roberta Renard (201) 228-8602

E-SYSTEMS



Careers grow at E-Systems. Families grow in Greenville.

E-Systems Greenville Division offers high-tech professionals an exceptional opportunity for career growth. Few companies anywhere can match our resource and expertise in the field of advanced electronic and avionic systems.

And for wholesome family living, few communities anywhere can match the charm of Greenville, Texas. Excellent schools, low tax rates, ample recreation, and the convenience of nearby Dallas/Fort Worth add up to a picture-perfect environment for your family.

We currently have positions available for experienced engineers in electronic design and analysis, EMI, specialized receiver design, and full-scale multi-array systems design, definition and integration.

Any way you look at it, E-Systems Greenville Division means growth — for you, *and* your family. To learn more, send your resume (in confidence) to: **Staffing, E-Systems, Inc., Greenville Division, P.O. Box 1056, CBN 81, Department EDN-0528ES, Greenville, Texas 75401.**



E-SYSTEMS

The science of systems.

SIEMENS

The difference and other start-

140 years of

At Siemens, you can have the best of two worlds: the excitement of a start-up operation and the resources of a giant in the electronics field.

When we formed our semiconductor group in Santa Clara in 1986, we wanted to foster the entrepreneurial spirit necessary to continue our successful record of product innovations. But unlike other start-up operations — of any age — we aren't encumbered with all the financial and cultural problems new companies face.

We currently have the following opportunities available on our team for experienced engineering professionals who want to make a contribution.

Product Marketing — LAN
Telecom Applications Engineer
Product Specialist — Central Applications
Product Specialist — Consumer Products
Product Marketing Engineer —
Microprocessor/Microcontroller
Smart MOS IC Design Engineers
CIM Engineer
Smart Power Applications Engineer
ASIC ECL Logic/Circuit Design Engineer
Product Line Manager — Intelligent
Displays/Couplers
Product/Test Engineers
CAD/CAE Software Development Engineers

e between us -up operations: of success.

At Siemens, you'll enjoy our responsive, highly successful management approach, in addition to our competitive salaries and extensive benefits package. So get behind the semiconductor company that's been getting behind its engi-

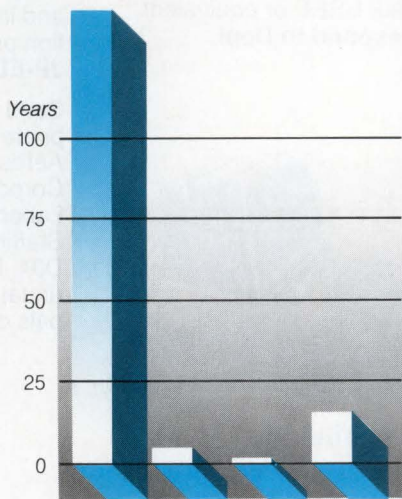

Graph compares Siemens with recent as well as more established start-ups.

neers and scientists for well over a century. For immediate consideration, send your resume to: Siemens Semiconductor Group, Dept. 7816, 19000 Homestead Road, Cupertino, CA 95014. We are an equal opportunity employer. Principals only please.

Siemens.
A World Leader In Semiconductor Technology.

We're the hottest company in the business!

Western Development Laboratories Division has dozens of contracts underway, many in multi-year programs, with a backlog stretching well into the 1990s. Our success is due to many factors — technological innovation, a reputation for quality and reliability, and a diverse set of capabilities, from software development to spacecraft construction.

You can find out more by applying for one of the following current openings:

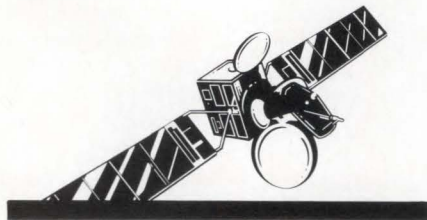

Systems/Satellite Transponder Design Engineers

Responsibilities will include analysis, development and design of satellite communications systems. Requires a BSEE, or equivalent, plus 5-8 years of experience in microwave transponder/subsystem design. Familiarity with all aspects of communications transponders required — TT&C transponder design a plus. **Respond to Dept. PF-EDN04.**

Systems/Satellite Data Receiver Engineers

Analyze, develop, and design survivable satellite data communications systems. Requires 3-10 years' PCM modem experience (including phase lock loops and digital data recovery), a BSEE/MSEE or equivalent. Familiarity with all aspects of satellite data receiving equipment desired. **Respond to Dept. PF-EDN04.**

Communication Hardware Engineers

System design, equipment specification, development, integration, and testing of telecommunications subsystem for secure data and voice transmission. Minimum 8 years' experience should include digital switching, multiplexing, modems, and digital fiber optics equipment. Experience with state-of-the-art tech control facility or design/implementation preferred. BSEE or equivalent required. **Respond to Dept. JP-EDN04.**



COMSEC Engineers

System design, equipment specification, development, integration and testing of secure voice/data systems.

Minimum 8 years' experience including design and integration of systems with current crypto equipment, modems and muxes. Should be familiar with red/black isolation requirements, Autodin, and DDN interfacing. BSEE or equivalent required. **Respond to Dept. JP-EDN04.**

Principal Image Processing Engineer

Must possess an extensive knowledge of image processing subsystem design and implementation with 12 years of related experience. Requires a solid system hardware and software implementation background rather than theoretical systems analysis. Will provide technical guidance and be responsible for overseeing the technical progress of design and implementation of a total image exploitation segment. Responsible for the implementation and integration of the design verification prototype. **Respond to Dept. JP-EDN04.**

Send your resume, indicating appropriate department, to Ford Aerospace & Communications Corporation, Western Development Laboratories Division, Professional Staffing, 3939 Fabian Way, M/S D04, Palo Alto, CA 94303-4697. An equal opportunity employer. Principals only, please.



Ford Aerospace & Communications Corporation

Western Development Laboratories Division

Out-Think.

But do it quietly. The business of security is extremely sensitive, so we can't really talk about what we do. And neither can the dedicated people who work here. But we will say that TRW's Command Support Division creates systems that communicate faster, more accurately, and with greater imagination. Systems that outthink the opposition and outdo our competitors. At TRW, you'll be asked to outthink...you just won't be able to think out loud.

SENIOR COMPUTER SYSTEMS ENGINEERS

- Analyze and develop functional, performance, and security requirements for strategic command and control information systems
- Document system-level requirements and specifications
- Define a multi-computer system architecture for information management
- Structure local networks that conform with data communication standards
- Identify issues and risks associated with critical functions and new technology
- Prepare development plans, schedules and technical reviews

SENIOR COMPUTER ENGINEERS

- Evaluate resource-sharing data communication and security capabilities of off-the-shelf computer technology
- Analyze computing and data communication workloads
- Perform computer-communication tradeoff analyses
- Identify suitable man-machine interface criteria for terminals and workstations
- Design multi-computer information management systems
- Write preliminary design specifications and interface control documents
- Design and implement prototype configurations, and experiments and exercises to evaluate them

SENIOR HARDWARE ENGINEERS

- Apply hardware solutions for fast text-search and high-density (optical) storage
- Design and develop secure voice and telecommunication systems
- Design and implement custom computer-data communication interfaces
- Perform hardware-firmware trade-off analyses
- Define methods for built-in test and fault isolation
- Write preliminary design specifications and interface control documents

SENIOR SOFTWARE SYSTEMS ENGINEER

- Develop functional and performance requirements for strategic command and control information systems
- Conduct functional and information flow analyses
- Document system-level requirements and specifications
- Develop software requirements for information security, communication and management
- Prepare a software development plan consistent with TRW standard procedures
- Manage all software design and development
- Prepare development plans, schedules and technical reviews

SENIOR SOFTWARE ENGINEERS

- Analyze computing and data communication workloads
- Analyze hardware-software tradeoffs
- Design software for information security, communication and management
- Write preliminary design specifications
- Develop experiments and exercises to evaluate prototype software
- Design prototype software

SOFTWARE ENGINEERS

- Perform software maintenance on long-term classified project in message processing, operator support, data management, system services, or facilities and operations support
- Experience on VAX or Sun with UNIX and/or ingres required

PROGRAMMER-ANALYSTS

- Develop prototype software for information security, communication and management

EMP HARDENING ENGINEER

- Harden electronic communication, data processing and support systems against nuclear electromagnetic pulse
- Knowledge of circuit interface protection, shielding, and grounding and isolation schemes required
- Familiarity with protection hardware, and with techniques and procedures necessary to avoid degradation of designed hardness during system deployment and operation also required

VAX SYSTEMS ENGINEER

- Must have VAX/VMS experience. Real-Time applications, and be proficient in MACRO Assembly language

We can offer highly competitive salaries and our benefits plans are among the most attractive in the industry. Make this your chance to join a company that sees the big picture in communications. A company called TRW.

Please send resumes to: TRW Command Support Division, Dept. EDN-4, One Federal Systems Park, FP2-6245, Fairfax, VA 22033, Attention: Dane Smith.

Equal Opportunity Employer. U.S. Citizenship Required.

Get the big picture at a company called TRW.

TRW

Command Support Division
TRW Federal Systems Group

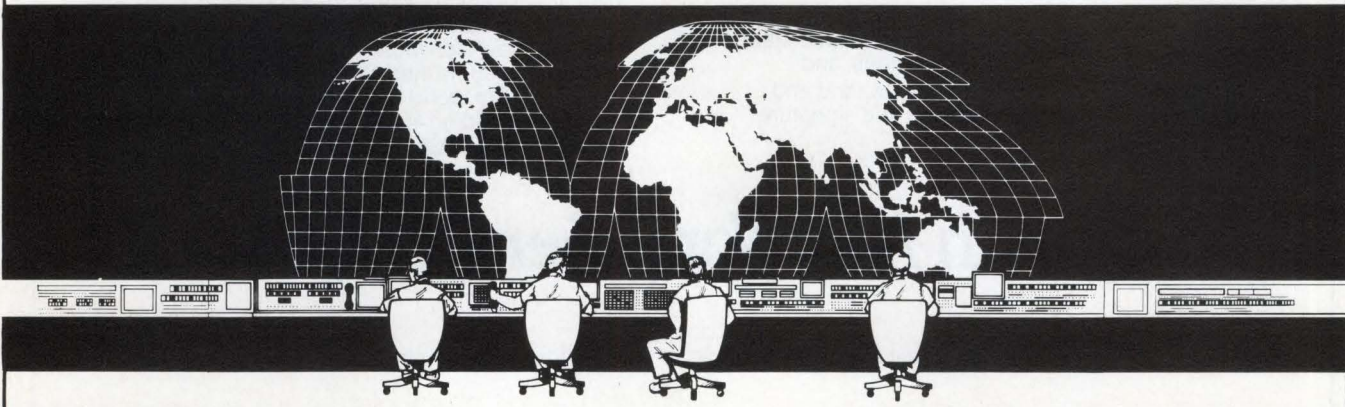

Engineers:

Pan Am World Services, Inc.
provides exactly the
range that brilliant
careers require.

One range is geographical

World Services is prime contractor to the U.S. Air Force for the planning, engineering and operation of the Eastern Test Range. It stretches 10,000 miles from Cape Canaveral to Pretoria, South Africa, and includes some 1,800 ship and land based tracking units.

Another is professional

We have long been involved with the entire space program. Missiles. Satellites. Space Shuttle. You name it. Depending on orientation, you'll be seeing, and contributing to, the last word in radar, optical instrumentation, telemetry, communications, data handling, C², statistical data reduction, meteorology, timing/firing, frequency control, shipboard instrumentation . . . and related technologies.

The third range is choice

Following is a diverse array of engineering opportunities. Each requires an appropriate degree and at least 5 years relevant experience.

TELEMETRY SYSTEMS ENGINEER

Will accomplish design, acquisition, installation and evaluation of antennas, preamplifiers, mixers, down-converters, filters, demodulators, decommutators and computer interfaces for large aperture S-band telemetry antenna systems. Must perform hardware design and system analysis.

DATA SYSTEMS ENGINEER

Will accomplish design, acquisition, installation and evaluation of data acquisition, transmission, processing and display systems for distributed instrumentation complexes. Must have substantial experience in system/subsystem design, test and evaluation.

RADAR SYSTEMS ENGINEER

Will perform design, acquisition, installation and evaluation of high power transmitters, solid-state receivers, and digital range machines, and preparation of specifications for new land and shipboard radar used in tracking and signature



data collection. Must be experienced in system/subsystem design, test and evaluation.

OPTICAL SYSTEMS ENGINEER

Will perform system design, installation, modification and evaluation of manned and unmanned optical tracker and camera systems.

COMMUNICATIONS SYSTEMS ENGINEER

Will accomplish design, acquisition, installation and evaluation of subsystem equipment and systems to support communications and timing requirements. ETR Communications Systems include analog and digital communications systems, red and black switching systems, long and short haul data transmission over HF, Microwave, Satellite and Cable (copper and fiber optics) Systems and Electronic Security Systems. Timing includes state-of-the-art PTTI systems.

Other attractions

Florida at its best . . . specifically, the Cocoa Beach area, excellent salaries, extensive benefits, stimulating associates, excellent career prospects, and eligibility for 75% discount travel on Pan Am for yourself and each eligible family member. Learn more. Contact Don Mosby at (305) 494-7322, or send your resume indicating position of interest to him at Pan Am World Services, Inc., Ref. 87-72, P.O. Box 4608, Building 423, MU 100, Patrick Air Force Base, Florida 32925.



Pan Am World Services, Inc.

An Equal Opportunity Employer • U.S. Citizenship Required

Computer Sciences Corporation

Meeting the Integration Challenges of Today's Communications Networking Systems.



Computer Sciences Corporation is one of the world's largest computer services companies. At CSC's Systems Division, we specialize in the integration and interface of computer information systems. We've been solving complex systems problems for DoD and non-DoD customers for over 25 years. During that time we've made continuous strides improving the speed, accuracy and economy of a variety of information processing systems.

With our latest expansion, CSC now has total integration systems responsibility for the U.S. Air Force Systems Command to supply and support the Local On-Line Network System (LONS). The ultimate balance between state-of-the-art and proven technology, it will integrate 13,000 workstations and several thousand peripherals using local area networks.

The Communication Network Operations of CSC's Systems Division is one of our most exciting and fastest growing technology areas. Here you'll find that, utilizing UNIX® operating systems, we're developing next generation software for electronic forms and conferencing, document flow processing, interactive graphics, ETHERNET/TCP/IP, and DDN.

If you're an experienced technical professional and would like the opportunity to work on CSC's LONS or other communications projects consider the following areas:

PRINCIPAL ENGINEER

Will be responsible for proposal preparation for local area network engineering. Requires BSEE plus minimum six years experience in local area communication engineering and hands-on experience with any of the following: DECNET, SNA or ETHERNET.

COMPUTER SCIENTIST

Will be responsible for evaluating communication software offered by vendors. Will integrate and verify the interoperability of these packages. Requires a BSCS and minimum eight years experience in communication protocols, multi-vendor interoperability and

communication equipment. Background in protocol development or interfacing between modem protocols and applications is also required. Knowledge of TCP/IP, NETBIDS, DECNET, SNA and IEEE/802 protocols is desired.

SOFTWARE DEVELOPMENT

Requires BSCS plus three to six years of experience, with at least two of those years in software development utilizing "C" language and UNIX operating systems.

SYSTEMS ENGINEERING

Various positions require some or all of the following experience including implementation of at least one system utilizing some of the following products: VAX/ULTRIX (UNIX 4.2 BSD), IBM PC-AT, XENIX, impact and laser printers, modems, Applitek LAN, ETHERNET/TCP/IP, OCR's and DDN interface. Must also have the ability to add a new device driver to kernel, perform operating system tuning, operate test equipment such as Line Monitor, Protocol Analyzer, and Breakout Box. (One supervisory position is also available).

CONFIGURATION MANAGEMENT

Will be responsible for configuration management activities in support of the LONS project. Requires BS degree and four years experience in coordinating the preparation of project configuration management standards and procedures. Must also have experience preparing project configuration management plans and coordinating the activities needed to support physical and functional configuration audits.

PROGRAMMER/ANALYST

Will assist and document test bed integration and installation procedures for VAX, Peripherals and LAN. Experience in the operation, administration and integration of VAX hardware,

UNIX, ETHERNET/TCP/IP, and peripherals is also required.

IBM SYSTEMS PROGRAMMERS (Mid - Senior Level)

Requires experience in assembler programming of new functions, installation of new releases or software packages, systems maintenance, investigation of systems problems, and general user aid to application developers.

FIELD SERVICE ENGINEERS

Requires a minimum of AA degree in electronic technology with at least four years of related electronics experience. Must possess electronic communications experience to include broad band cable/CATV, with exposure to 449, 232, SDLC, SNA, CSMA, or X.25 protocols. Also requires experience in electro-mechanical assemblies such as printers or copiers. Must be knowledgeable of personal computers, use of signal generator, DVM, Breakout Box and oscilloscope. This position will involve extensive customer relations and requires excellent interpersonal skills. Proven ability at assuming responsibilities, particularly in a military environment is desirable.

At Computer Sciences Corporation we offer our technical professionals a high-tech, state-of-the-art laboratory setting and individual workstations with IBM PC-AT's. You'll also receive a competitive salary and comprehensive benefits package and the opportunity to advance your career. For immediate consideration please forward your resume with salary history to: Computer Sciences Corporation, Systems Division, 6565 Arlington Blvd., (M/C 218 - JLB 702), Falls Church, VA 22046. An equal opportunity employer. U.S. Citizenship Required.

UNIX® is a registered trademark of AT&T.

CSC
COMPUTER
SCIENCES
CORPORATION

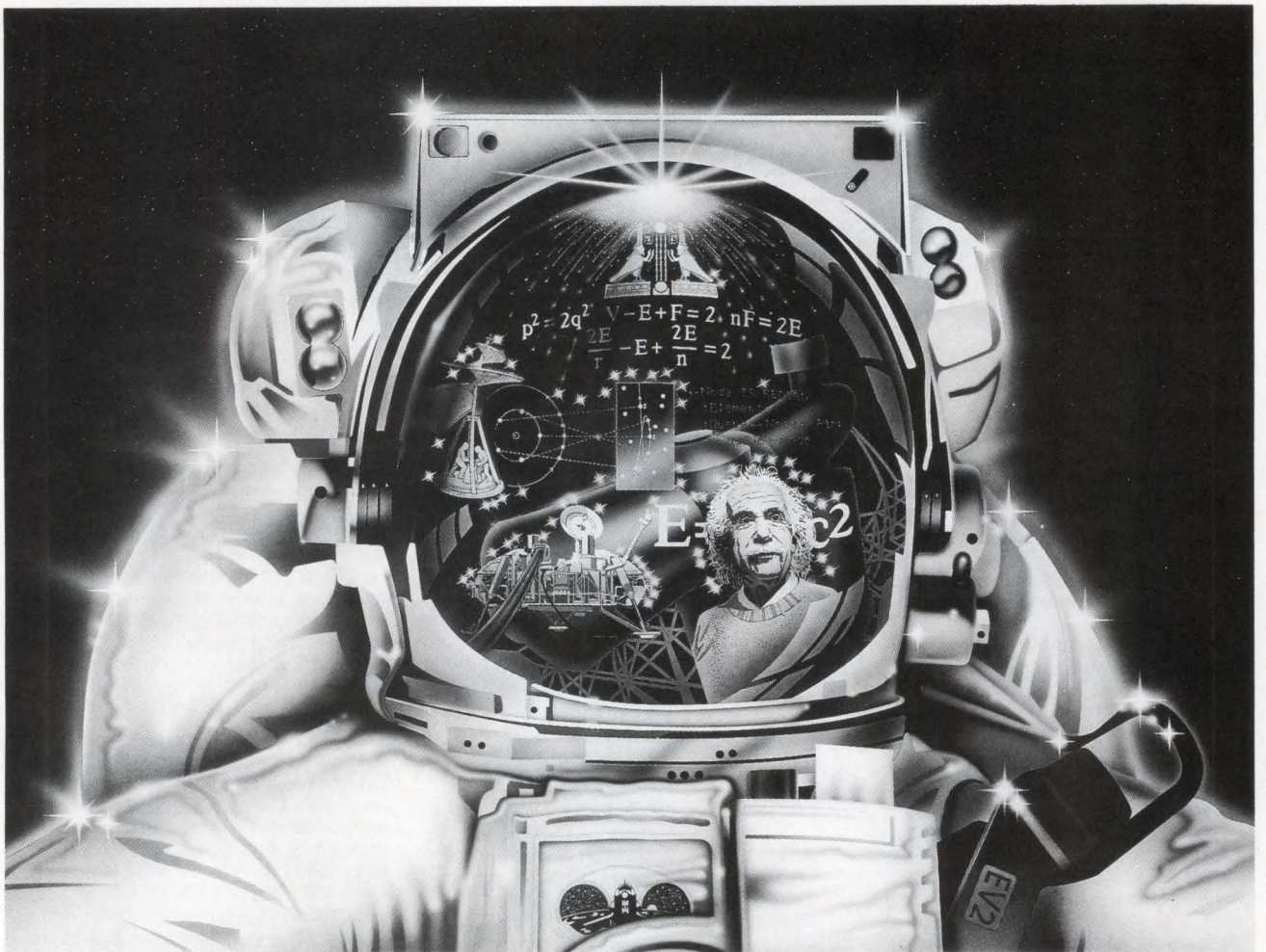

With your help, we'll mastermind still more of tomorrow's space and defense systems technologies.

Mastermind a Dream.

If an idea is good, it shouldn't stay an idea for long. At Martin Marietta Denver Aerospace, dreams—even the "impossible" ones, the long shots—can come true.

Working with highly advanced equipment in state-of-the-art facilities, our engineers tackle a broad variety of interesting and challenging assignments each day—an unmatched repertoire of advanced launch and space propulsion systems, spacecraft, instruments and strategic defense systems.

We're looking for top engineers with a B.S. degree or equivalent (advanced degree desirable) in electronic engineering or physics and 5 to 15 years of experience to take several leading-edge programs from the conceptual stage forward.

Antenna System Engineers Antenna Design Engineers

Several opportunities exist in conceptual design, analyses and laboratory development of advanced microwave antennas or similar work in electromagnetics.

Communication Systems Engineers

Explore exceptional opportunities in spacecraft and missile communication systems design and analysis.

Microwave and Millimeter Wave Systems Engineers

We have multiple opportunities in the conceptual design and analysis of advanced microwave and millimeter wave systems.

Sr. Spacecraft Controls System Analysts

Here are several opportunities for specialists with 5 to 10 years of

experience which includes digital computer modeling and flexible/rigid bodies.

Sr. Guidance and Control Hardware Engineers (PIE)

You'll need 5 to 10 years of experience in systems integration and knowledge of subcontract work involving gyros, accelerometers, momentum wheels, star trackers, star scanners, sun sensors and related areas.

AN FBI/SBI BACKGROUND INVESTIGATION MAY BE REQUIRED.

Please send your resume to Martin Marietta Denver Aerospace, Personnel Department, P.O. Box 179, G1311, P70038, Denver, Colorado 80201. No agencies, please. We're an Affirmative Action Employer actively seeking veterans and the handicapped. U.S. Citizenship is required.

MARTIN MARIETTA

Involvement through Innovation.

That's the success tradition at Rockwell International's Telecommunications Businesses.

We create traditions that evidence involvement. The fruit of our lateral integration strategy, for instance, offers the opportunity to work across the entire technological spectrum. By placing product planning, advanced technology, R&D, manufacturing and quality in one central location we achieve a focus on technical excellence.

Our far-reaching commitment to R&D and innovation is reflected by our market leadership position. We were the first leading equipment maker to offer completely digital systems and helped pioneer both analog and digital microwave systems. Today, product lines that include the most advanced, high performing one gigabit fiber optic transmission systems, digital and analog multiplex systems, and 1.7 to 19.7 GHz frequency microwave communications systems are the foundation of our strong reputation in telecommunications.

Our development teams pursue lightwave, microwave and digital innovation combining technology, involvement and company support. To become involved, consider the following:

Software Engineers

BS/MS in Computer Science and 5 plus years software architecture/design experience. Position involves software development for distributed multiprocessor network control systems. Experience in circuit switched and packet switched network control is necessary. Team software development experience for Motorola 68000 systems is desirable. Candidates with "C", UNIX™, ADA and OSI data communications experience will be given special consideration.

Mechanical Engineers

BSME/MSME and minimum 5-8 years experience in high density digital electronics and/or RF packaging design and development. Requires experience in use of surface mount technology as well as the ability to provide thermal design and packaging of high density lightwave and digital muldem telecommunications products. Proficiency in the use of Computer Vision mechanical CAD system is desirable.

High Speed Digital Engineers

BSEE/MSEE plus 6-8 years experience in digital logic circuit design. Position involves digital circuit design on a switch matrix. Requires 40-50 mhz CMOS or TTL discrete logic circuit design, and SRAM, DRAM high speed memory design. Knowledge of switch matrices is desirable.

Digital Circuit Design Engineers

BSEE plus 4 years experience in high frequency analog and digital circuit design. Position requires experience in discrete amplifier design (15mhz+), clock recovery circuit design, phase lock loop design (15mhz+) and line conditioning for line buildout circuits. Telephony background and knowledge of DS1-DS3 signals are required. Experience in functional partitioning is desirable.

High Speed Modem Engineers

MSEE/Ph.D with 4-6 years experience required. Position involves performing hardware design of digital modems with data rates in the 1 to 180 Mb/s range. Knowledge of digital signal processing theory and implementation methods required. Effective communication skills needed.

Coherent Optics Engineers

MS/Ph.D EE/Physics with 2-3 years experience or equivalent combination required. Involves conducting independent investigation of optical amplification and/or integrated optics. Will function as part of advanced technology team investigating feasibility of coherent optical communications utilizing multiple gigabit technologies.

Digital Telecom Systems Product Specialists

BSEE/MSEE and 2-3 years experience required. Position involves product planning/application of digital/lightwave products. Requires good working knowledge of telecommunications networks with emphasis on technical familiarity with SONET, SYNTRAN, HDLC/X.25 protocols. Ability to work closely with customer network planners to assess product requirements and trends. Interface/experience with Bell Operating Companies essential.

Rockwell International's compensation package includes a saving/stock ownership plan, comprehensive medical coverage, dental insurance, retirement plan, tuition reimbursement and much more!

We are interested in hearing from you immediately. Please send your resume to: **Richard Skelnik, Rockwell International, Telecommunications, M/S 401-152, #8518, P.O. Box 10462, Dallas, Texas 75207.** Permanent Residency Required. Equal Opportunity Employer M/F.



Rockwell International

...where science gets down to business

™ UNIX is a trademark of AT&T Bell Laboratories.

EDN Databank

Professional Profile

Announcing a new placement service for professional engineers!

To help you advance your career, Placement Services, Ltd. has formed the EDN Databank. What is the Databank? It is a computerized system of matching qualified candidates with positions that meet the applicant's professional needs and desires. What are the advantages of this new service?

- It's absolutely free. There are no fees or charges.
- The computer never forgets. When your type of job comes up, it remembers you're qualified.
- Service is nationwide. You'll be considered for openings across the U.S. by PSL and it's affiliated offices.
- Your identity is protected. Your resume is carefully screened to be sure it will not be sent to your company or parent organization.
- Your background and career objectives will periodically be reviewed with you by a PSL professional placement person.

We hope you're happy in your current position. At the same time, chances are there is an ideal job you'd prefer if you know about it.

That's why it makes sense for you to register with the EDN Databank. To do so, just mail the completed form below, along with a copy of your resume, to: Placement Services, Ltd., Inc.

IDENTITY

Name _____ Parent Company _____
 Home Address: _____ Your division or subsidiary: _____
 City _____ State: _____ Zip: _____ Location (City, State) _____
 Home Phone (include area code): _____ Business Phone if O.K. to use: _____

PRESENT OR MOST RECENT EMPLOYER

EDUCATION

Degrees (List)

Major Field	GPA	Year Degree Earned	College or University

POSITION DESIRED

EXPERIENCE

Present or Most Recent Position _____ From: _____ To: _____ Title: _____

Duties and Accomplishments: _____ Industry of Current Employer: _____

Reason for Change: _____

PREVIOUS POSITION:

Job Title: _____
 Employer: _____ From: _____ To: _____ City: _____ State: _____
 Division: _____ Type of Industry: _____ Salary: _____
 Duties and Accomplishments: _____

COMPENSATION/PERSONAL INFORMATION

Years Experience	Base Salary	Commission	Bonus	Total Compensation	Asking Compensation	Min. Compensation
Date Available	I Will Travel <input type="checkbox"/> Light <input type="checkbox"/> Moderate <input type="checkbox"/> Heavy			I own my home. How long? _____		I rent my home/apt. <input type="checkbox"/>
<input type="checkbox"/> Employed	<input type="checkbox"/> Self-Employed	<input type="checkbox"/> Unemployed	<input type="checkbox"/> Married	<input type="checkbox"/> Single	Height _____	Weight _____
Level of Security Clearance	<input type="checkbox"/> U.S. Citizen	<input type="checkbox"/> Non-U.S. Citizen	My identity may be released to: <input type="checkbox"/> Any employer <input type="checkbox"/> All but present employer			
<input type="checkbox"/> WILL RELOCATE <input type="checkbox"/> WILL NOT RELOCATE <input type="checkbox"/> OTHER _____						

EDN Databank

A DIVISION OF PLACEMENT SERVICES LTD., INC.

265 S. Main Street, Akron, OH 44308 216/762-0279

Reduced Recruitment Rates!

Place equivalent space
in both EDN Career
Opportunities and
EDN News in
the same month and get
a 1/3 discount off the
News rate.

EDN

McDATA Corporation

McDATA Corporation is the designer and manufacturer of information system products which effectively integrate communications, computing and data management.

Our rapid growth has created the following positions at our facilities in Broomfield, a northern suburb of Denver.

SOFTWARE ENGINEERS

Will be involved with all or part of the following communications controller development:

- Asynchronous communications and terminal emulation
- Local and wide area networking interfaces and connectivity solutions
- Diagnostic software for manufacturing and customer service
- Communications and network software test and verification
- Software development tools

These positions require 2-10 years of development experience, preferably in data communications systems, "C" language and Intel microprocessor experience with a BSCS/BSEE. Position level to correspond with experience.

HARDWARE ENGINEERS

Will develop microprocessor based hardware modules for data communications products from product inception through release to manufacturing.

Requires experience in digital logic design employing complex LSI chips. BSEE preferred.

McDATA is committed to a smoke free environment.

To the selected candidates we offer a competitive salary, excellent benefits package, plus an opportunity to grow in an exciting fast paced and results-oriented environment.

If you are interested in becoming a part of a dynamic, progressive, people-oriented organization, please submit resume including salary history to:

McDATA CORPORATION
295 Interlocken Blvd
Broomfield, CO 80020
Attention: Robert E. Bales
Manager of Personnel

We are an equal opportunity employer

McDATA
CORPORATION

YOUR NEXT JOB IS ON THE LINE.

Whether you're just a little curious or actively pursuing a new job, you'll find what you're looking for on-line with BPI AdLine.™ The new, convenient way for you to communicate with high tech employers via computer. Just call up BPI AdLine™ on your PC or terminal, at home or work, at your leisure. The service is free and operates around the clock—24 hours a day.

Once you're on-line, explore Fortune 1000 companies; their job openings, employee benefits, corporate facilities and much more company related information. You can even enter your resume into the system and rest assured it will be in the right hands, right away.

BPI AdLine™ is designed for you, the experienced technical professional. It's easy. It's quick. And it's completely confidential. BPI AdLine™ is the convenient way for you to explore your professional potential and discover the job that awaits you... on the line. *Companies are continuously added to the system. Please check regularly for updates.*

Created by the same people who bring you the original BPI TECH FAIRS. You can also use BPI AdLine™ to check on dates, times and locations of upcoming TECH FAIRS in your area.

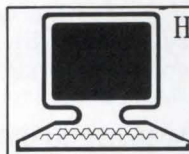

How to get on-line with BPI AdLine™

DIAL 612-941-3957

on your PC or terminal

ENTER the password "BPI"

BPI AdLine™

"We are not an employment agency."

Business People Inc., 100 North Seventh Street, Minneapolis, MN 55403

612-370-0550

Engineering Opportunities . . .

The Computer Company With A Difference!

Today's engineering professional has a lot of options, but very few real choices—so many companies look the same; except Telex. While most high tech companies are slowing down these days, Telex Computer Products marches on. Developing the advanced, innovative technological "firsts" we've grown famous for, making us the recognized industry leader for terminals, printers and enhancements in the 3270 protocol-compatible market.

Come join a team that's:

ON THE MOVE . . . As annual sales approach the \$1 billion dollar level and Telex sets its sights on Fortune 100, in addition to launching an aggressive expansion campaign including acquisitions, increased telecommunications product lines and international business.

IN THE NEWS . . . In 1986 alone, Telex made headlines in Fortune and Forbes magazines for recordbreaking sales, catapulting Telex into the Fortune 500 listings, and was ranked FIRST in earnings per share among the top 23 computer firms, according to Forbes. In addition to receiving the largest European contract from terminal subsystems ever awarded in U.S. history.

IN THE LEAD . . . Telex's state-of-the-art professionals receive exciting, stimulating opportunities to create the kind of leading edge products that most companies are still dreaming about! And as we currently make major contributions to the integration of voice, data and visual communications, there's no better time for these professionals to take advantage of our unique challenges.

Our current requirements include:

SOFTWARE ENGINEERS

We have several openings in each of the following areas:

- **Requires** BSEE, BS Computer Science or BS Computer Engineering and 3-5+ years experience. Should have strong microprocessor programming background in 8088, 8086, or 80186 or similar and knowledge of telecommunications or voice/data systems. Experience with IBM 3270 systems is helpful.
- **Requires** BSEE, BS Computer Science or equivalent and 3-5+ years related software experience. Individual will be responsible for LAN product development to include knowledge of IEEE 802.2 (LLC) and 802.3, 802.4 or 802.5 standards. Will also have responsibility for WAN product development; knowledge of IBM SNA/SDLC and X.25 communications protocol required. Working knowledge of OSI standards such as FTAM and MHS a plus.
- **Requires** BS in Computer Science, EE or related field and 3-5+ years experience. Microprocessor programming experience, software development experience and a strong assembly language programming background are required with experience in "C" programming. IBM 3270 data stream, Motorola 68000, BSC and SDLC/SNA all highly desirable.
- **Requires** BS in Computer Science, BSEE or equivalent and 1-5+ years of related programming experience. Individual will work with a design team in developing a processor/controller for a graphics printer. Should be proficient in assembly language and familiar with system level design, operating systems and buffer management. Experience with Intel/Zilog family processors, Realtime systems, multitasking, IBM system 3X and 3270 communications preferred.
- **Requires** BSCS/Computer Engineering, or equivalent and 3-5+ years of related programming experience. Must be familiar with C language, Intel 8088, and microprocessor-based applications. Individual will develop software for a color graphics terminal.
- **Requires** BSCS, or equivalent, and 5+ years of experience, preferably in LAN product development. Should be familiar with IEEE 802.2 (LLC), 802.3, 802.4, and 802.5, as well as SNA/SDLC and X.25 protocols. Knowledge of OSI standards, FTAM, and MHS is helpful.

- **Requires** BSCS, or equivalent, and 5-7+ years of experience. Specific experience in LAN development and IEEE 802.2 is preferred. 8086 assembler language desired.

HARDWARE DESIGN ENGINEERS

We have several openings in each of the following areas:

- **Requires** 3+ years of related hardware and software design experience. Should have digital design experience with high speed TTL logic (FAST, ALS, etc.), PALs, LSI and microprocessors, preferably Motorola 68000 or other 16 bit microprocessors. ASIC design experience is preferred and experience in the following communication areas helpful: X.25, Token Ring, IBM Channel or other LAN's.
- **Requires** BSEE, or equivalent, and 5+ years of experience in digital design, including microprocessor circuitry. Experience with assembly-level programming, higher-level languages, ASIC design, and video circuitry are all pluses.

SENIOR SYSTEMS ENGINEER

Requires BSEE/Computer Engineering, or equivalent, and 7+ years of related system design experience. Individual must have knowledge of 3274/3276 control units and devices using both Binary Synchronous and SNA/SDLC Protocols, Programmed Symbols (PS), and Intelligent Printer Data Streams (IPDS). Must also be familiar with Coax interface protocol. Systems experience with VM/SP, DOS/VSE, or MVS operating systems and programming in CICS (macro or command level) or IMS is helpful.

RELIABILITY ENGINEERS

Requires BSEE or equivalent and 2+ years of related electronic product experience. Will be responsible for reliability design review and reliability test of digital/analog assemblies and systems. Will also develop strategies for achieving reliability performance objectives under customer usage, and identify and reconcile variances in reliability performance. Should be familiar with reliability performance prediction methodologies as well as testing based on the Weibull and exponential distribution.

DESIGNER II (SCICARD SUPPORT)

Requires AAS in Electronics or equivalent and 5+ years of related design experience. Individual will assist CAD group by providing support to the SCICARDS, users, maintaining system operation and developing system capabilities. Must be able to work with logic diagrams and mechanical board blank drawings. At least 3 years experience with SCICARDS CAD System and design of high density double-sided multi-layer PC boards.

For prompt consideration, please forward your resume, including salary history and requirements in strictest confidence to:
**Manager of Staffing and Development, Dept. EDN 4/30,
TELEX COMPUTER PRODUCTS, INC., 3301 Terminal
Drive, Raleigh, NC 27604. Equal Opportunity Employer
M/F/H/V.**

TELEX®

TELEX COMPUTER PRODUCTS, INC.

ADVERTISERS INDEX

Advance Power Supplies Inc*	269	Innovative Software Systems	280	Switching Power Inc	110
Advanced Micro Devices	12-13	Integrated Device Technology Inc	197	System General	277
Advanced Microcomputer Systems Inc.	280	Integrated Measurement Systems Inc	86-87	Tektronix Inc	38-39, 123-128, 170-171
Airpax Corp/Cambridge Div	284	Intel Corp	156-157	Teltone Corp	278
Allen Systems	279	International Rectifier	58	Texas Instruments Inc	243-246
Altera Corp	52-53	Ion Physics Co	277	Thomas and Betts Corp	35
American Automation	90	IRC Inc	158	Thomson Components-Mostek*	120-121
American Research and Engineering	301	J Nelson Graphics	278	3M Electronic Products	30-31
AMP Inc	56-57	John Fluke Manufacturing Co Inc	165, 179	3M Industrial Chemical Products	47-50
APM-Hexseal Corp	168	Kepco Inc	205-210	Titan/SESCO	172
Applied Microsystems Corp	28-29	Lectromagnetics Inc	238	Toshiba America Inc/Memory Div	100-101
Aptos	237	Linear Technology Inc	222	TRW Motor Division	144
Augat-Interconnection Systems	278	Lite-On	219	Universal Data Systems	C3
Augat/Telzon & Augat/Melco	60	Live Wire Software	280	Valley Data Sciences	75
BBS Electronics	279	LSI Logic Corp	88-89	Videolog Communications	231
Beta Automation Inc	279	Magnético Inc	279	Visionics Corp	280
BICC-Vero Electronics Inc	129	Makco Mfg Co Inc	198	VLSI Technology Inc	199, 200-201
BP Microsystems	280	Marshall	276	Waferscale	255
Bruel & Kjaer Instruments	259	Matrix Systems Corp	195	Wintek Corp	279, 280
Burndy Corp	42-43	McGill Mfg Co Inc, Electrical Div	262A-B	Xilinx	142-143
Burr-Brown Corp	215	Memtron Technologies	277	Zilog Inc	227
Bytek Corp	280	Micro Switch*	67		
California Scientific Software	277	Mini-Circuits Laboratories	3, 4, 26-27, 225		
Capital Equipment Corp	278	Molex Inc	306		
Cardinal Technologies Inc	140	Monolithic Memories Inc	C2		
Carlingswitch	271	National Electric Cable	95		
Carroll Touch Inc*	275	NCR Corp	287		
Casio Inc	221	New Micro	119		
Central Data	241	Nichicon (America) Corp*	33		
Cherry Electrical Products Inc	25	Nicolet Test Instruments Div	282		
Chinon America Inc	37	Oak Switch Systems Inc	240		
Chomerics Inc	249	Oliver Advanced Engineering Inc	167		
C&K Components Inc	6	Omatron Inc	280		
Comlinear Corp	265	Omnirel	18-19		
Connor-Winfield Corp	46	Omron Electronics Inc*	74		
Control Data Co/ Government Systems	155	Optima Enclosures	256		
Cooper Tools*	8	Oslo Controls	248		
Cybernetic Micro Systems	137	Otto Controls	254		
Cypress Semiconductor	114-115	PEP Modular Computers	78		
Daisy Systems Corp	116-117	Pico Electronics Inc	272		
Dale Electronics Inc	1	Planar Systems	239		
Dash, Straus, and Goodhue	2	Polytron	277		
Data Delay Devices	46	Precision Monolithics Inc	217		
Data I/O Corp	169	Programmable Logic	279		
Data Precision Corp	153	Qua Tech Inc	278		
Datel	283	Raytheon Ocean Systems	36		
Design Computation Inc	102	Raytheon Semiconductor Div	63		
Dialight Corp	261	Rifa Inc	229		
Digital Research Inc	141	Robinson-Halpern	279		
EAO Switch Corp	180	Robinson-Nugent Inc	202-203		
EG&G Reticon	44	Samsung Semiconductor	145-148		
Elantec Inc	92	Samtec Inc	278		
Electronic Components Groupe	252	Scanbe, Div of Zero Corp	105		
Endicott Research Group	198	Seagate Technology	23		
Exar Corp	263	Seiko Instrument	267		
Ferranti Interdesign Inc	83, 84-85	SGS Semiconductor Corp	106-107, 109		
Frequency Devices	34	SI Tech	277		
Fujitsu Components of America Inc*	97	Siemens Components Inc*	68-69		
Fujitsu Microelectronics Inc*	14-15	Sierra Power Systems	251		
F&W Communications	279	Signal Transformer Co Inc	C4		
GE Calma	98-99	Silicon Systems Inc	112, 113		
General Devices Inc	253	S-MOS Systems*	72-73		
GE/RCA Solid State	181-188	Softaid Inc	254		
Gould/AMI Semiconductors*	70-71	Sony Corp of America	76		
Gould Test & Measurement	40-41	Spectrum Software	45		
Grayhill Inc	248	Sprague-Goodman Electronics Inc	279		
GTEK Inc	252	Stag Microsystems Inc	20, 262		
Hardigg Industries Inc	16-17	Standard Microsystems	304		
Harris Semiconductor Products	233	Statek	280		
Heurikon Corp	32	Sunrise Electronics Inc	104		
Hewlett-Packard Co	54-55	Superior Electric Co	273		
Industrial Electronic Engineers Inc	139	Switchcraft	235		
Inmos Corp	10-11				

Recruitment Advertising

Computer Services Corp Syst Div	295
E Systems, Greenville	289
Ford Aerospace	292
Fragomen, Del Rey, Bernsen & Inman	288
Jack Porter Assoc	288
Martin Marietta, Denver	296
Pan Am World Services	294
Rex Technologies	288
Rockwell Collins	297
Siemens	290
TRW Command Support Div	293
TRW Electronic Products	288

*Advertiser in US edition

**Advertiser in International edition

This index is provided as an additional service. The publisher does not assume any liability for errors or omissions.

BUSINESS/CORPORATE STAFF

F Warren Dickson
Vice President/Publisher
Newton, MA 02158
(617) 964-3030
Telex 940573
Diann Siegel, Assistant

Peter D Coley
Associate Publisher/
Advertising Sales Director
Newton, MA 02158
(617) 964-3030
Dianne Riddell, Assistant

NEW ENGLAND
John Bartlett, Regional Manager
Chris Platt, Regional Manager
199 Wells Ave
Newton, MA 02159
(617) 964-3730

STAMFORD 06904
George Isbell, Regional Manager
8 Stamford Forum, Box 10277
(203) 328-2580

ROSELAND, NJ 07068
Daniel J Rowland, Regional Manager
103 Eisenhower Parkway
(201) 228-8619
(201) 228-8620

PHILADELPHIA AREA
Steve Farkas, Regional Manager
999 Old Eagle School Rd
Wayne, PA 19087
(215) 293-1212

CHICAGO AREA
Clayton Ryder, Regional Manager
Randolph D King, Regional Manager
Cahners Plaza
1350 E Touhy Ave, Box 5080
Des Plaines, IL 60018
(312) 635-8800

DENVER 80206
John Huff, Regional Manager
270 St Paul St
(303) 388-4511

DALLAS 75234
Don Ward, Regional Manager
13740 Midway, Suite 515
(214) 980-0318

SAN JOSE 95128
Walt Patstone, Regional Manager
Bill Klank, Regional Manager
Philip J Branon, Regional Manager
Mark Holdreith, Regional Manager
3031 Tisch Way, Suite 100
(408) 243-8838

LOS ANGELES 90064
Charles J Stillman, Jr
Regional Manager
12233 W Olympic Blvd
(213) 826-5818

**ORANGE COUNTY/
SAN DIEGO 92715**
Jim McErlean, Regional Manager
18818 Teller Ave, Suite 170
Irvine, CA
(714) 851-9422

PORTLAND, OREGON 97221
Pat Dakin, Regional Manager
Walt Patstone, Regional Manager
1750 SW Skyline Blvd, Box 6
(503) 297-3382

UNITED KINGDOM/BENELUX
Jan Dawson, Regional Manager
39A Bowling Green Lane
London EC1R/0BJ UK
44-1-278-2152
Telex: 28339

SCANDINAVIA
Stuart Smith
27 Paul St
London EC2A 4JU UK
01-628 7030
Telex: 914911; FAX: 01-628 5984

FRANCE/ITALY/SPAIN
Alasdair Melville
27 Paul St
London EC2A 4JU UK
01-628 7030
Telex: 914911; FAX: 01-628 5984

WEST GERMANY/SWITZERLAND/AUSTRIA
Wolfgang Richter
Sudring 53
7240 Horb/Neckar
West Germany
49-7451-7828; TX: 765450

ISRAEL
Igal Elan
Elan Marketing Group
13 Haifa St, Box 33439
Tel-Aviv, Israel
Tel: 972-3-268020
TX: 341667

EASTERN BLOC
Uwe Kretschmar
27 Paul St
London EC2A 4JU UK
01-628 7030
Telex: 914911; FAX: 01-628 5984

FAR EAST
Ed Schrader, General Manager
18818 Teller Ave, Suite 170
Irvine, CA 92715
(714) 851-9422; Telex: 183653

TOKYO 160
Kaoru Hara
Dynaco International Inc
Suite 1003, Sun-Palace Shinjuku
8-12-1 Nishishinjuku, Shinjuku-ku
Tokyo 160, Japan
Tel: (03) 366-8301
Telex: J2322609 DYNACO

TAIWAN
Acteam International
Marketing Corp
4F, No 87, Kwang-Fu N Rd
Taipei, Taiwan ROC
760-6209 or 760-6210
Telex: 2004HORTEX
FAX: (02) 7604784

KOREA
Korea Media Inc
Rm 110, A-11 Bldg 49-4,
Hoihyundong 2-Ka, Chung-Ku
CPO Box 2314, Seoul, Korea
Tel: 82-2-755-9880
Telex: K26249

SINGAPORE
Cheny Tan Associates
1 Goldhill Plaza
No 02-01
Newton Rd
Singapore 1130
Tel: 2549522
Telex: RS 35983 CTAL

PRODUCT MART
Joanne Dorian, Manager
475 Park Avenue South
New York, NY 10016
(212) 576-8015

**CAREER OPPORTUNITIES/
CAREER NEWS**
Roberta Renard
National Sales Manager
103 Eisenhower Parkway
Roseland, NJ 07068
(201) 228-8602

Janet O Penn
Eastern Sales Manager
103 Eisenhower Parkway
Roseland, NJ 07068
(201) 228-8610

Dan Brink
Western Sales Manager
2041 Business Center Dr
Suite 109
Irvine, CA 92715
(714) 851-9422

Diann Siegel
Boston Sales Representative
Newton, MA 02158
(617) 964-3030

Maria Cubas
Production Assistant
(201) 228-8608

Cahners Magazine Division
William Platt, President
Terry McDermott, Executive Vice President
Frank Sibley, Group Vice President
Tom Dellamaria, VP/Production & Manufacturing

Circulation
Denver, CO: (303) 388-4511
Sherri Gronli, Group Manager
Eric Schmierer, Manager

Reprints of EDN articles are available on a custom printing basis at reasonable prices in quantities of 500 or more. For an exact quote, contact Joanne R Westphal, Cahners Reprint Service, Cahners Plaza, 1350 E Touhy Ave, Box 5080, Des Plaines, IL 60018. Phone (312) 635-8800.

WORLD'S SMALLEST DIP SWITCH

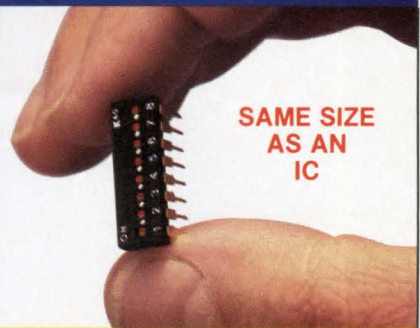

BETTER HEAT CONVECTION.

OLD DIP SWITCH



HIGH DIPS SHADOW LOW IC'S

NEW DIP SWITCH



THE LOW PROFILE K40 DIP IS THE SAME SIZE AS AN IC

NO MORE HAND LABOR.



YOU CAN USE AUTOMATIC INSERTION EQUIPMENT!

If you don't have automatic insertion equipment, we're banking that some day you will. To prove that, we'll charge you the same low price for all your purchases—no more need for the low-volume premium prices you're paying now.

AVAILABLE IN 2, 3, 4, 5, 6, 7 & 8 POSITIONS

FREE SAMPLE!
WITH STAPLED BUSINESS
CARD TO YOUR LETTERHEAD

AMERICAN RESEARCH & ENGINEERING

1500 EXECUTIVE DRIVE
ELGIN, IL 60120
312-888-7245



America can do it better!



CELEBRATING THE FIRST SINGLE-CHIP IMPLEMENTATION OF IBM® 5250 PROTOCOL.

The COM52C50 TWINAX Interface Controller from Standard Microsystems.

Here's to your future success!

With our new COM52C50 TWINAX controller designed into your system, you could enjoy vintage sales years ahead.

Good news!

Standard Microsystems, the leader in micro-peripheral IC controllers, offers a one-chip solution to your System/3X connectivity requirements. This new CMOS VLSI circuit, which conforms to the IBM® 5250 System Standard and replaces as many as 50 to 100 SSI/MSI/LSI/ IC's, implements the interface...more easily, at a fraction of the cost and with a significant reduction in required board space.

Maximum performance in minimum space.

The COM52C50 generates and detects all the handshakes and Manchester II encoded data formats

at the 1Mbps data rate required by the protocol. These include Single/Multibyte transfers, Odd/Even parity generation and detection, as well as error detection and flagging.

What's more, the COM52C50 integrates some very powerful and advanced features. It allows concurrent access up to 7 host sessions, user programmable Interframe Zero Bit Insertion, Internal/External Loopback Diagnostics, Hi-speed, no wait state, Microprocessor interface, and internal Receive FIFO. An on-chip crystal oscillator with an 8MHz general-purpose clock output further simplifies circuit implementation.

IBM® System /34/36/38 in your plans?

If System/3X compatibility is in your plans, the COM52C50 TWINAX should be in your design. It's your sim-

plest, most cost-effective solution—whether you manufacture PC's, displays, terminals, printers, plotters, PBX's, modems, terminal emulators, LAN's, gateways, protocol converters or data concentrators.

So, help make your system the toast of the industry. Design in the new COM52C50 TWINAX controller from Standard Microsystems.

It's available now in 28-pin ceramic, cerdip and plastic DIP packages or PLCC configurations for surface mounting. For immediate delivery, contact Standard Microsystems Corporation, 35 Marcus Boulevard, Hauppauge, NY 11788. (516) 273-3100.

IBM® is a registered trademark of the International Business Machines Corporation.

STANDARD MICROSYSTEMS CORPORATION

LOOKING AHEAD

EDITED BY GEORGE STUBBS

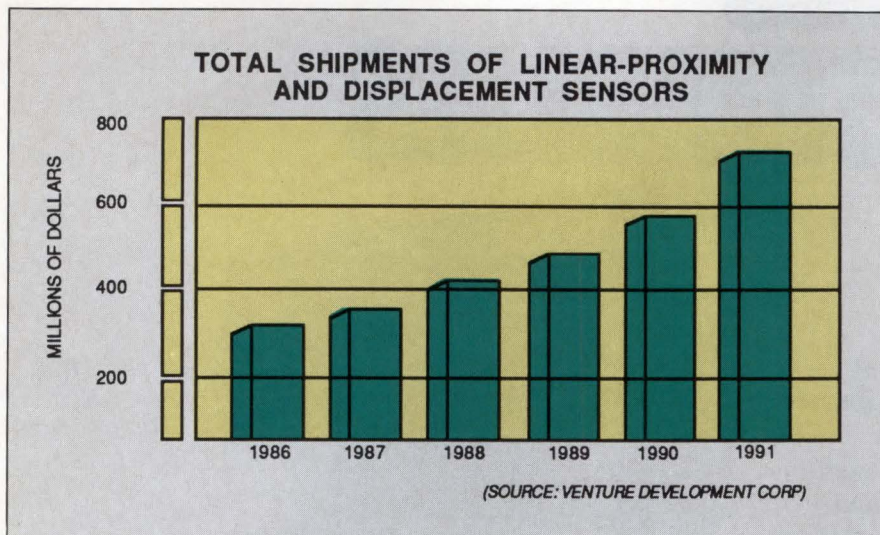

Market for linear-proximity, displacement sensors to grow

The aggregate of shipments of linear-proximity and displacement sensors will grow at a 16.1% average annual rate over the period 1986 to 1991, according to the market-research company Venture Development Corp (Natick, MA). Through that period the dollar value of the combined market will grow from \$328 million to \$691.6 million. Sensor types in this market segment include photoelectric, inductive, capacitive, ultrasonic, and other types of linear-proximity sensors as well as linear variable differential transformers (LVDTs), linear potentiometers, linear encoders, and other types of displacement sensors.

VDC notes several general trends that characterize the current market. Factory-automation companies have entered the proximity-sensor market as part of their attempts to provide comprehensive automation systems and services. Proximity-sensor manufacturers are introducing "an almost endless stream" of new product lines in various technologies, in order to provide solutions to the full range of proximity-sensing problems. Even manufacturers of electromechanical switches are adding proximity sensors to their product lines, in order to protect their customer bases. Meanwhile,

foreign suppliers continue to enter the US proximity-sensor and linear-encoder markets. Foreign invasion of the US LVDT market is likely to expand as well.

In the proximity-sensor market segment, ultrasonic sensors are expected to show above-average annual growth in shipments through the specified 5-year period. Recent improvements in the design of these devices include temperature compensation and increased gain in the electronic circuitry and encapsulation. Inductive sensors will also show above-average annual growth in sales over the forecast period. On the other hand, photoelectric sensors—the largest proximity-sensor market segment—will show healthy annual sales growth but will not outpace the market. Growth in demand for capacitive sensors will also be less than the 16.1% annual rate.

Sales of linear-displacement sensors will increase at even faster rates than sales of proximity sensors. The military and aerospace industry will be a driving force in the demand for LVDTs, which accounted for more than half of the revenues generated by linear-displacement sensors. Some of the anticipated growth in LVDT sales will come at the expense of linear-potentiometer sales, says VDC. And despite expectations of steady growth,

linear encoders will not make the gains in popularity that other types of linear-displacement sensors will see.

"Moderate" growth forecast for semiconductors in 1987

The consumption of semiconductor chips in North America will total \$11.5 billion in 1987, says the market-research company Dataquest (San Jose, CA). This figure marks a 12.7% increase over the 1986 market—a growth rate Dataquest characterizes as "moderate," in spite of the fact that it's approximately twice the 6.5% increase of the 1986 market over 1985 sales.

The predicted growth appears moderate in comparison with the boom years, 1983 and 1984, when growth rates reached a peak of 44%. More and more individuals and companies involved in the semiconductor industry are starting to regard those years as the exception rather than the norm, and Dataquest analysts urge vendors to prepare for steadier growth: "The challenge for the North American semiconductor industry is to learn to cope with moderate growth in consumption. Industry participants continue consolidating and restructuring to deal with the reality of lower long-term growth rates." Still, Dataquest does not rule out growth exceeding 20% in 1988.

Two principal factors are moderating the current fortunes of the semiconductor industry, says Dataquest. One is modest growth in sales of equipment having semiconductors; such equipment includes computers, communications equipment, industrial equipment, military hardware, consumer electronic products, and automobiles. The other factor is a shift in purchasing patterns on the part of semiconductor procurement managers, from the US to the Pacific Basin.

Making the Connection Between...

SWITCHES & ASSEMBLIES

From standard membrane switches to custom hybrid control panels, Molex makes the connection.

Molex's high quality, pretested switch assemblies integrate LED's, tactile feedback, cable interconnections, and switches into one compact, custom design. We eliminate the need for the complex and costly assembly of separate parts. With Molex assemblies you'll lower applied costs, improve reliability, and reduce the number of vendors you must deal with. Molex has the economical, dependable solutions to all your touch panel needs.

Rigid Molex quality standards mean long life, low cost, and zero defects.

You can depend on Molex for quality. We've got one of industry's most comprehensive quality control programs. Our high-precision tooling and intensive quality efforts result in membrane switches that last longer and cost less while providing an uncommonly high level of reliability.

Quality products and dependable service worldwide.

Our multi-national organization offers you design, manufacturing, and technology from around the globe, with dependable supply and local service. Look to Molex. We can help you find the answers that turn switches into pre-assembled performance leaders. Ask for our 24-page technical brochure on pushbutton and membrane switches.

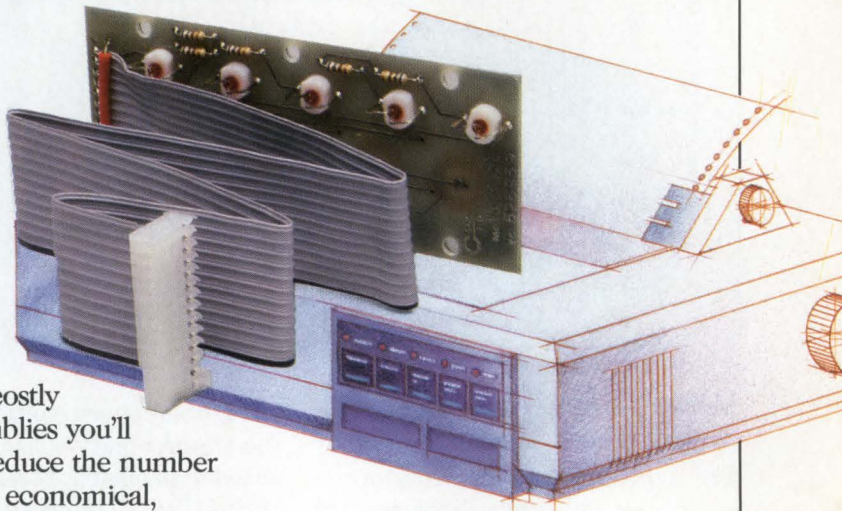

Unique hybrid switches combine LED's, tactile feedback, resistors, flat cable, and connector into one cost-effective assembly.

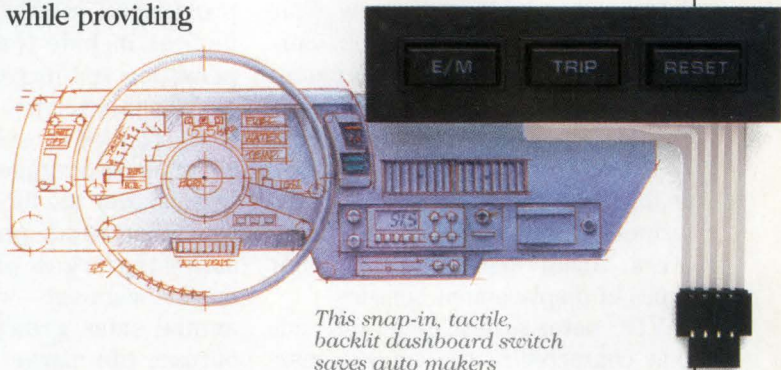

This snap-in, tactile, backlit dashboard switch saves auto makers time and money.

We eliminate the costly need for assembling multiple components by providing all-in-one switch designs.

Service To The
Customer...Worldwide



A special kind of craftsmanship

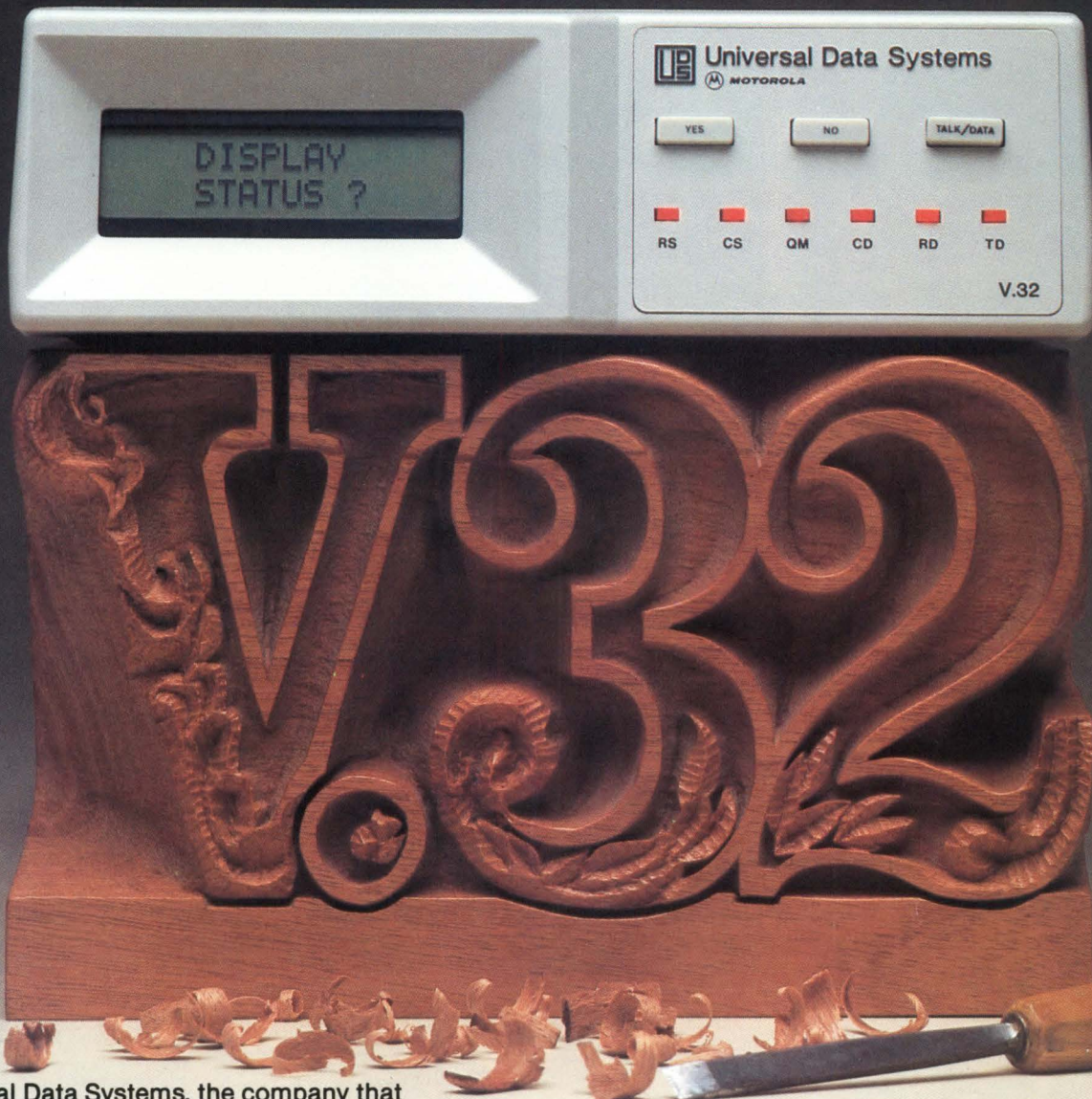

Universal Data Systems, the company that developed the first 9600 bps dial-up modem, has now applied its special brand of craftsmanship to the CCITT V.32 specification.

The result is a *full-duplex* 9600 bps device for the switched telephone network. When substandard line conditions are encountered, the device offers automatic fallback to 4800 bps, while maintaining the full-duplex communications capability.

As you expect from UDS, the device fully utilizes the latest in CMOS technology for low-noise performance and very low (less than 20W) power consumption. A new LCD control panel displays and configures modem set-up selections and displays outputs from the unit's comprehensive self-test regime. Auto-dial capability is also included.

If your system must accommodate periodic bursts of high-throughput, full-duplex communication, UDS craftsmanship and the V.32 standard provide a reliable, cost-effective solution. For complete technical details and quantity prices, contact Universal Data Systems, 5000 Bradford Drive, Huntsville, AL 35805. Telephone 205/721-8000; Telex 752602 UDS HTV.

\$2495⁰⁰
Quantity One

CIRCLE NO 163



Universal Data Systems



MOTOROLA INC.
Information Systems Group

UDS modems are offered nationally by leading distributors. Call the nearest UDS office for distributor listings in your area.
DISTRICT OFFICES: Apple Valley, MN, 612/432-2344 • Atlanta, GA, 404/998-2715 • Aurora, CO, 303/368-9000 • Blue Bell, PA, 215/643-2336 • Boston, MA, 617/875-8868 • Columbus, OH, 614/895-3025 • East Brunswick, NJ, 201/238-1515 • Glenview, IL, 312/998-8180 • Houston, TX, 713/988-5506 • Huntsville, AL, 205/721-8000 • Issaquah, WA, 206/392-9600 • Livonia, MI, 313/522-4750 • Mesa, AZ, 602/820-6611 • Milwaukee, WI, 414/273-8743 • Mission Viejo, CA, 714/770-4555 • Mountain View, CA, 415/969-3323 • Richardson, TX, 214/680-0002 • St. Louis, MO, 314/434-4919 • St. Peters, MO, 314/434-4919 • Silver Spring, MD, 301/942-8558 • Tampa, FL, 813/684-0615 • Uniondale, NY, 516/222-0918 • Van Nuys, CA, 818/891-3282 • Willowdale, Ont, Can, 416/495-0008 • Winston-Salem, NC, 919/760-4184

You can put a cheap knock-off in your product. It might even work as well as ours.

Then again...it might not.

It is evident that some companies are taking Signal's designs and knocking them off. That's very flattering to us, but risky for you since we haven't found one yet that's been able to knock-off Signal's reliability. After all, just because a transformer looks like Signal's doesn't mean it will perform like Signal's.

Our *innovation, creativity and reliability* are one-of-a-kind. For example, we pioneered the high isolation split bobbin design.

Now our exciting new *VDE certified International Series* takes another leap forward with a dual, high-temperature bobbin and insulating shroud that provides significantly better performance at lower costs than ever before. These *One-4-All™* and *More-4-Less™* transformers are so reliable they meet – or surpass – every important international specification (UL, CSA, VDE and IEC).

We also introduced low-profile *Flathead™* plug-in transformers. Our latest series, which is available in five sizes, is arguably the best in the industry. The innovative non-concentric winding configuration eliminates the need for an electrostatic shield and features hum-bucking construction.



Beyond that, Signal has a full line of superior low power *PC board transformers*, as well as the smaller-than-ever "*2-4-1*" Series, competitively-priced *rectifier power transformers*, *chokes* and industrial-grade step-up and step-down power isolation transformers.

We maintain significant levels of our stock transformers and sell direct – without a middleman to slow things down...or mark prices up. Even better, we can ship to you in quantity within 24 hours. We call it our *PRONTO* service.

Of course, if we don't have a standard stock item that fits your needs, our custom engineering department will gladly quote your specific requirements. *PRONTO*.

Signal offers you the products, the service and dependability you need. Sure, you could buy a cheap knock-off. But why would you?

For the complete free catalog on the American Originals contact: Signal Transformer, 500 Bayview Avenue, Inwood, NY 11696.

BUY DIRECT
(516) 239-5777

Signal Transformer.

The merican
Original.

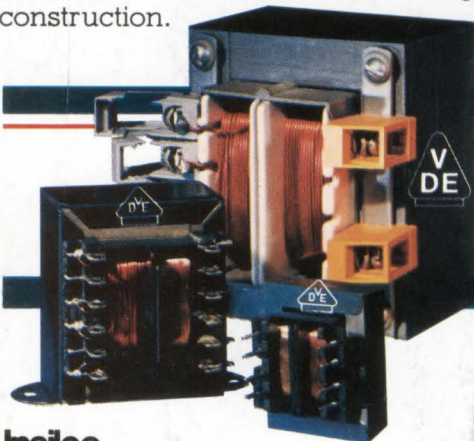

Insico
International Specialty Components