

Digital Design

Computers • Peripherals • Systems

THE GEORGE E. FREEMAN LIBRARY
STATE TECHNICAL INSTITUTE AT MEMPHIS
3902 Macon Cove at Interstate 40
Memphis, Tennessee 38119



Speakout **4**

Technology Trends **6**

FORTH From A to Z **12**

Designers' Guide
To Noise Suppression **26**

Survival In **36**
The Compat Marketplace

Raster Monitor **40**
Evaluation And Selection

Equipment Manufacturers Drive **46**
Data Communications Industry

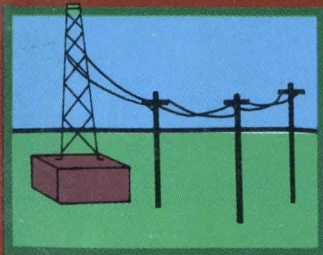

Innovative Design **50**

Product Index **52**

COMPAT Design **56**

New Products **58**

Designers' Notebook **68**

Advertisers Index **72**

Copyright © 1982
a Morgan-Grampian company
Postmaster, send address
corrections to:
Morgan-Grampian Publishing Co.
1050 Commonwealth Ave.
Boston, MA 02215
2nd class postage paid at
Boston, MA and additional
mailing offices.
Publication Number: USPS 407-



When you ask some people about backup — they back off.

And for good reason. Ask any other supplier of peripheral products for system backup, and you'll find that some can supply a disk, some can supply a cartridge recorder, others a streaming transport. But none can supply the choice which Kennedy can offer.

Kennedy is the only company that can offer an SMD compatible, 8" 40 MByte disk drive (Model 7300) and an 80 MByte 14" Winchester disk drive (Model 5380). To back them up, Kennedy has a 1/4" cartridge recorder (Model 6450), and Model 6809, 1/2" Data Streamer Tape Transport.

KENNEDY INTERNATIONAL INC.

U.K. and Scandinavia
McGraw-Hill House
Shoppenhangers Road
Maidenhead
Berkshire SL6 2QL England
Tel: (0628) 73939
Telex: (851) 847871 KEN UKS G

KENNEDY INTERNATIONAL

Koningin Elisabethplein, 8
B-2700 Sint-Niklaas
Belgium
Tel: (031) 771962
Telex: 71870 KEN CO

Kennedy was the first to utilize the 1/4" 3M cartridge for disk backup; Kennedy was the pioneer in Winchester disk technology, and was a leader in developing a low cost streaming tape drive.

All of these products were conceived and designed to meet the need for reliable, low cost backup — for our systems or for any other system.

Kennedy has always backed its products. That's why we're No. 1. Call or write us about your problem.

We won't back off.

KENNEDY

An Allegheny International Company

1600 Shamrock Ave., Monrovia, CA. 91016
(213) 357-8831 TELEX 472-0116 KENNEDY
TWX 910-585-3249



KENNEDY • QUALITY • COUNT ON IT

Circle 1 on Reader Inquiry Card

Most digitizers are pretty much alike... the New CalComp 9000 Series is the exception.

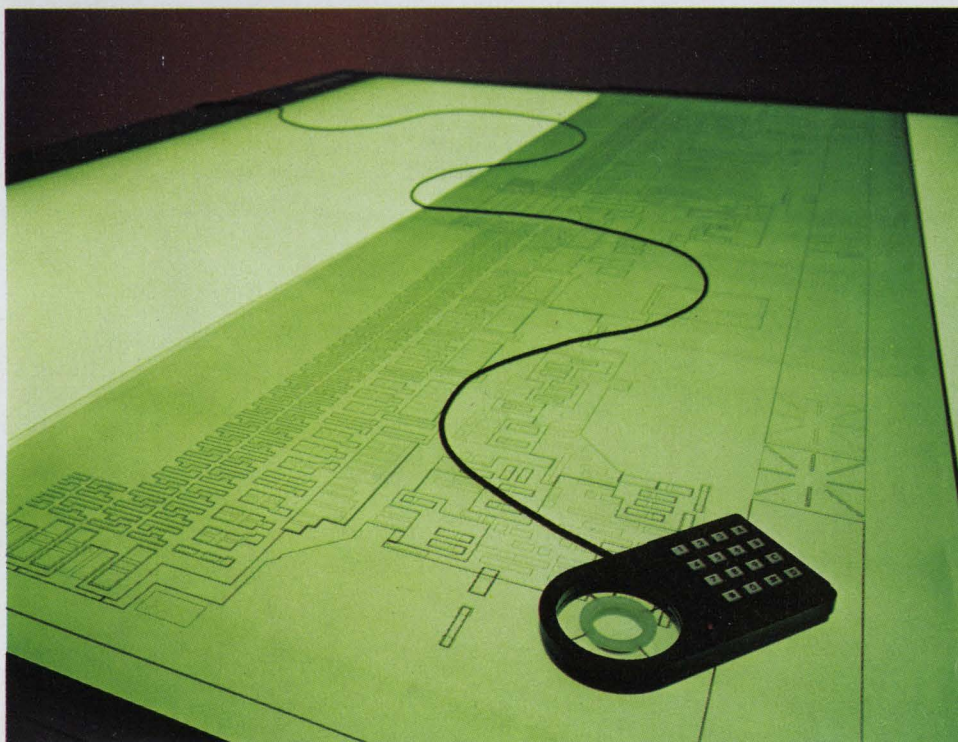

**Most are priced alike...
except the CalComp 9000.**

The new CalComp 9000 Series Digitizer gives you the best performance features at the lowest price. Only the new CalComp 9000 allows you to customize application configurations by switch selectable character framing, data rate, operating modes and interfaces.

**Most have the same features...
except the CalComp 9000.**

Check the specs and you will find that accuracy, resolution, digitizing surface sizes and even transducers are just about the same on most competitive models.

Then consider these CalComp digitizer features: You can choose a digitizing surface and transducer to fit your application. Solid or backlit surfaces are available in sizes from 12" x 12" to 60" x 44". All have standard accuracy of ± 0.0105 inch and resolution of 1000 lines per inch. Transducer choices include a pen stylus, and 4, 12 or 16-button cursors.

The compatible 9000 Series lets you communicate simultaneously with several host computers and/or peripherals via multiple interfaces.

And, you can count on CalComp to keep your digitizer operating at peak efficiency. Each CalComp 9000 Series Digitizer carries a full one-year

warranty on parts and labor. Reliable, nationwide direct sales and service guarantee quick response time.

The new CalComp 9000 Series is an exceptional digitizer. Point for point, when it comes to price and performance, CalComp is the choice.

Call or write today for complete specs on the 9000 Series.

CALCOMP
A Sanders Graphics Company
SANDERS

California Computer Products, Inc.
2411 West La Palma Avenue
Anaheim, California 92801
Telephone (714) 821-2011

Circle 5 on Reader Inquiry Card

THE ZENDEX¹ MODEL 835 DEVELOPMENT SYSTEM

**"High Performance
At A Low Price"**

Plug compatibility. That's what the ZENDEX Line offers you. Any board or software that works on your Intel² Intellec² System will also work in the ZENDEX Model 835. That includes ISIS-II Single or Double Density, In-Circuit-Emulators, and Universal PROM Programmers.

The Model 835 System includes a cabinet with two Shugart SA801R Drives, and a CPU cabinet that utilizes the powerful ZX-85 SBC CPU, ZX-200A MMFM & FM Diskette Controller, and parallel IO Interfaces for CRT, TTY, LPT & UPP. CP/M³ Operating Systems included.



Licenses to run Intel Software on ZENDEX products must be obtained from Intel Corp.

1 — TM ZENDEX Corp.
2 — TM INTEL Corp.
3 — TM Digital Research

ZENDEX DELIVERS VALUE!



Zendex[®]
corporation

6644 Sierra Lane, Dublin, California 94566
Tel.: (415) 828-3000 TWX 910 389 4009

In England call Giltspur Microprocessor Systems
74/76 Northbrook Street
Newbury, Berkshire RG13 1AE
Tel.: Newbury (0635) 45406 TWX 848507

Circle 6 on Reader Inquiry Card

Digital Design

Computers • Peripherals • Systems

Publisher Jeffrey C. Hoopes
Editor Paul Snigier
Technical Editor Dave Wilson
Managing Editor Bob Hirshon
West Coast Technical Editor Bill Groves
East Coast Technical Editor Nicolas Mokhoff
New Products & Directory Editor Martha Hawkins
International Electronics Editor Ron Neale
International Computers Editor Eric Wignall
Art Director Richard Sarno
Assistant Art Director Josh Randall
Staff Artists Jacky Brill, Laurie R. Guptill, Donni Richman
Production Manager Erik W. Slickman
Production Noel J. Boulanger, Jon Buchbinder, Amy Gerber, Joan Scheffler
Marketing Services Manager C. King
Circulation Elizabeth Mahon-Laidlaw, Mgr. Sarah Binder, Regina Harrington, Lynda Neue, Jennifer Wood
Composition Don Spencer, Mgr. Lorraine Cooley, Yva Doricent, Judy Lungelow, Debbie O'Connell
General Administration Karen Melanson, Mal Rankin

Publication Development
H.G. Buchbinder

Group Publishing Director
Albert J. Forman

SUBSCRIPTION POLICY

DIGITAL DESIGN is circulated only to qualified research, development and design engineers in all branches of industry, government institutions and universities. To obtain a complimentary subscription, request (on company letterhead) a qualification card from Circulation Director. For change of address, attach old address label from recent issue to new company letterhead or note. Send this plus request for new qualification card to:

Circulation Department
DIGITAL DESIGN
1050 Commonwealth Ave.
Boston, MA 02215

Subscription rates: non-qualified subscribers (US and Canada) — \$35/yr.; non-qualified foreign — surface mail — \$45; air mail — \$70.

DIGITAL DESIGN solicits editorial material and articles from engineers and scientists. Contributors should submit duplicate manuscripts typed with two spaces between lines. All illustrations should be clear; components on all schematics and line drawings should be labeled. The editors assume no responsibility for the safety or return of any unsolicited manuscripts.

Published monthly by Morgan-Grampian Publishing Company, Domenic A. Mucchetti, President; Executive, Editorial and Subscription Offices, 1050 Commonwealth Ave., Boston, MA 02215. Telephone: (617) 232-5470.

Morgan-Grampian also publishes American City & County • Circuits Manufacturing • Contractor • Design Engineering • Electronics Test • Industrial Distribution • Industrial Product Bulletin • Mart • Municipal Index

Tell us your thoughts

Digital Design is your forum — your inputs help keep the magazine interesting and vital to

the design community. So let us know how we're doing and how we can serve you better in the future. We want to know what you like or dislike about *Digital Design*, the subjects you'd like to see us address, how you feel about the problems you face every day as design professionals.

If you have thoughts your peers should know about, put them in a letter in *Digital Design*. Have your say in *your* magazine! Send letters and comments to: Editor, *Digital Design*, 1050 Commonwealth Ave., Boston, MA 02215.

DILOG NUMBER 1 FOR DEC 11*

With LSI 11/PDP 11 Software Compatible Disc/Tape Controllers Offering Single Board Low Power μ P Based Design and Low Cost... Plus Many Other Good Reasons!

The reasons start with DILOG'S (Distributed Logic Corp's.) full time engineering and design staff. *Not outside suppliers.* That means when you contact DILOG for product selection or after sale service, you'll get "first hand" assistance... along with years of experience manufacturing μ P based controllers that interface with DEC 11 CPUs.

The intelligent products you'll discuss all utilize common proprietary architecture and DILOG automated design techniques—products with exceptional reliability and cost efficiency... mostly available from stock. And

when you plug a DILOG controller into your DEC CPU it's ready-to-run because it's *fully operating system software compatible.*

These high performance data storage interface products also feature • minimum bus/space requirements • up to 60% less power • 10 to 50% lower cost • automatic self-test... and numerous other features for easy system integration.

Consult the DILOG/disc-tape compatibility table for your needs. Then ask for detailed data on existing, or future products from DILOG... #1 in single board DEC 11 compatible disc/tape controllers. Distributed Logic Corp., 12800-G Garden Grove Blvd., Garden Grove, CA 92643, Phone: (714) 534-8950 • 64-A White Street, Red Bank, New Jersey 07701 Phone: (201) 530-0044

DISC/TAPE DRIVE MANUFACTURER COMPATIBILITY CHART

MAGNETIC TAPE		DISC				
½" REEL-TO-REEL STD. & STREAMER	2315/5440/RK05 CARTRIDGE CLASS	CMD CARTRIDGE MODULE	SMD STORAGE MODULE	WINCHESTER 5¼", 8" OR 14"	¼" TAPE CARTRIDGE	FLOPPY DISC DRIVE
AMPEX CIPHER CONTROL DATA DIGI-DATA KENNEDY MICRODATA PERTEC TANDBERG DATA (IDT) WANGCO TDX	AMPEX CAELUS CENTURY DATA CONTROL DATA DEC DIABLO IOMEC MICRODATA PERTEC WANGCO WESTERN DYNEX DRI	AMPEX CONTROL DATA	AMPEX CENTURY DATA CONTROL DATA BALL COMPUTER MITSUBISHI	AMPEX BASF CENTURY DATA CONTROL DATA FUJITSU IMI KENNEDY MEMOREX MICROPOLIS NIPPON PER. LTD. PRIAM QUANTUM SHUGART SEAGATE TECSTOR	DEI KENNEDY PEREX QUANTEX	BASF DECITEK MICROPOLIS PERTEC REMEX SHUGART
CAPACITIES 2.5 TO 300 MB						

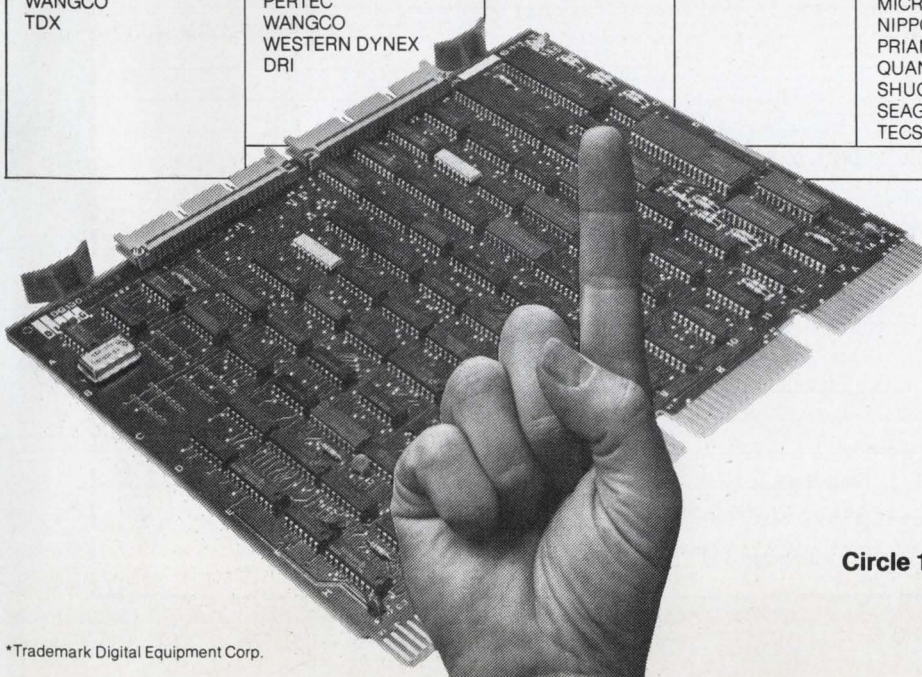

**DISTRIBUTED
LOGIC CORP.**
DILOG

Circle 13 on Reader Inquiry Card

*Trademark Digital Equipment Corp.

Compatible Computer Directory

by Paul Snigier, Editor

This year **Digital Design** is providing something extra: a 13th issue dated October 15, 1982 that will be a comprehensive computer compatible directory. It will be our third directory of this type. The previous two — published in January and August/September 1981 — were extremely well-received by our readers.

Like its predecessors, this third directory is designed to meet your needs as well as those of OEM integrators and system designers. Searching for compatible memory and peripherals for manufacturers' computers can be a hassle. Where do you look? We understand that many system designers scan through publications, and some save back issues or tear out ads. Since most major manufacturers of compatible computer boards and peripherals advertise in **Digital Design** often, at least once each six months, this is a workable solution. However, we want to do more for you and publish compatible computer equipment directories and listings of firms that manufacture/service compatible memory and peripherals.

Compatible computer manufacturers' responses to our questionnaires were more than we expected: they were overwhelming! In addition, there was strong, favorable reader response. Many called or wrote to say that the time had come for such a directory.

Because of such favorable response, we will expand the directory. We will publish descriptions of new devices that will have been introduced by then and will include those manufacturers who missed last August's questionnaire. If you were left out and want to be listed in the expanded directory, then please fill out this questionnaire. Use photocopied forms for each product. Don't take the easy way out and write: "See spec sheet." (We cannot reprint spec sheets.) Include in your mail-back, press releases, photos, manuals, literature, articles, etc. Also, let us know whom to contact for more information.

Remember, if your firm manufactures compatible computer products, this is an excellent opportunity to be listed in a directory that will reach 60,000 direct (159,000 total) readers — leading computer system integrators throughout the industry. This directory issue will be saved by system integrators and designers, and will be actively referred to over the next 12 months and beyond. **D**

If your firm manufactures compatible memories, peripherals or equipment for DEC, Data General and other manufacturers, then let our 60,000 direct (159,000 total) readers know. Send us all the product literature you've got. Please place one product per page (make photocopies as desired). Give brief description and important specs. Please do not write: "See Spec Sheet." (We cannot reprint spec sheets.) All product information must be in before August 13, 1982.

Category (for this product)

- | | | |
|---|--|--|
| <input type="checkbox"/> Magnetic Media Drive | <input type="checkbox"/> Printers and Plotters | <input type="checkbox"/> Power Supplies/UPS/Line Conditioners |
| <input type="checkbox"/> Add-In/Add-On Memory | <input type="checkbox"/> Interface Board (Controllers, Converters, Special I/O, etc) | <input type="checkbox"/> Packaging, Hardware, Backplanes, Enclosures |
| <input type="checkbox"/> Communications | <input type="checkbox"/> Test Equipment/Instrumentation | <input type="checkbox"/> Services |
| <input type="checkbox"/> Array Processor | | <input type="checkbox"/> Software |
| <input type="checkbox"/> Display Terminal | | |
| <input type="checkbox"/> Other (describe) _____ | | |

Product Name/Model No. _____

Description/specs _____

This product is compatible with? _____ DEC, _____ DG, _____ P-E, _____ HP, _____ Intel, _____ Other

Price(s) _____

Do you manufacture? wholesale? service? other? describe _____

Check type(s) of maintenance available:

_____ Return to factory (RTF) _____ Third party service (3rd P)

_____ Other? describe _____

Number of your field offices: _____ FO.

Company contact (sales) _____

Company Name/Division _____

Street/Box # _____

City _____ State/Zip _____ Phone () _____

Whom should our editors contact? _____

Mail this form to Directory Editor, *Digital Design*, 1050 Commonwealth Ave., Boston, MA 02215 (617) 232-5470

Image processing systems Modular graphic display systems Frame buffers—Television monitors

Grinnell has them all, for almost any application: from simple black and white line drawing to full color image processing. Select a packaged system, or configure one "your way."

GMR 270 Series: 512 × 512 frame buffers and full color pipeline image processing systems.

GMR 260 Series: 1024 × 1024 frame buffers for greyscale, black and white, pseudo color and full color.

GMR 27 Series: 256 × 512 to 1024 × 1024 high speed, modular graphic and image display systems.

All systems are available in both U.S. and European versions, with plug-compatible interfaces to most minicomputers (including DEC, Data General and PRIME). Proven system designs ensure reliability, and an expanded FORTRAN library and driver package makes operation easy.

So, whether you need a complete system, or just a card set to embed in a larger system, Grinnell has an optimum cost/performance solution. For complete specifications and/or a quotation, call or write today.



GRINNELL SYSTEMS

2159 Bering Drive, San Jose, California 95131 (408) 263-9920 TWX 910-338-2145

Circle 4 on Reader Inquiry Card

Public And Private Demand For Data Security Increases

The rapidly increasing role of computers is making a growing volume of data on individuals and businesses available to an expanding number of people. Behind the familiar CRT terminals in banks, airline ticket reservation counters, hospitals and places of employment, computers store data bases that often contain private or sensitive personal or business information.

There is a growing need for security to provide privacy for this confidential data. Public awareness of this problem is creating a concern over the need for adequate safeguards to ensure that information given in confidence will remain confidential. In addition to general public concern, business management is becoming increasingly interested in ensuring that adequate data security measures protect sensitive financial information from unauthorized access.

The widespread use of terminals to access data dictates some kind of at-the-terminal security system. Such systems have traditionally suffered from being too costly or in the interest of cost effectiveness, supplying too little security.

One solution to the problem comes from TEC. They combine their model 630 video terminal with a magnetic stripe reader designed to read the IATA (International Air Transport Association) track of standard magnetic stripes found on bank cards. In operation, users simply pass a card with a magnetic stripe containing a security code through the reader. The μ P in the 630 then calculates parity and performs a CRC check on the data without displaying the security code. After the magnetic stripe data is accepted by the terminal, the security code can be used by the computer system to ensure that the operator is authorized to access the data base. Since the IATA track contains 60 alphanumeric characters, there is plenty of room to accommodate even the most complex security codes.

The magnetic stripe system solves many of the problems associated with other security systems. The most com-

mon problem associated with systems that key in passwords from a terminal, for example, is that in order to convey sufficient information, passwords must be too long to memorize. In practice, terminal operators typically write the password down on a piece of paper, and copy it into the terminal, with possible onlookers around. Also, all too often, the piece of paper containing the password is lost — sometimes to be found by unauthorized personnel who can then access, and possibly alter, a previously secure data base.

Other traditional security systems often fail to provide the level of security desired by their users. Some systems restrict sensitive information to specific terminals that are usually in the office,

or under the supervision of authorized personnel. However, these systems are vulnerable to a breach of security because unauthorized employees may gain the use of these terminals when authorized personnel are absent during breaks or after normal working hours. Protecting terminals with a lock and key has proven to be less desirable from a security standpoint. All too frequently, keys to "secure" terminals are left in unlocked desk drawers.

Unlike keys or strips of paper, terminal security systems based on magnetic stripe readers can offer many of the advantages of credit cards. Like a credit card, the plastic cards containing the magnetic stripe can be impressed with unique numbers. If such a card is



Tec's Model 630 video terminal integrates a magnetic stripe reader allowing only authorized personnel to access the data base.

BULK SEMI

THE BIG IDEA IN MEMORY: UP TO 32 MB/CHASSIS

Now, from the memory leader, you can get 32 MB of high-performance memory in a compact 15 $\frac{3}{4}$ " system.

With chassis interface slots that allow you to use your own interface (our library of logic cards facilitates your designs!). Or choose a Dataram BULK SEMI interface that operates with DEC®, Data General, Perkin-Elmer, MODCOMP, or Honeywell minicomputers. SMD, MULTIBUS®, and AMPEX 4666-compatible interfaces are also available. And we have BULK SEMI for CSPI array processors too.

BULK SEMI. It offers single- or dual-port capability. Word lengths up to 72 bits/word. Optional battery backup. And the ultimate in price/performance.

BULK SEMI has been proven in seismic processing, process control, telecommunications, and array processing

Circle 3 on Reader Inquiry Card

applications — anywhere microsecond speed, megabyte main memory or peripheral memory is required. Our 16-page BULK MEMORY brochure will tell you more. And you can have it at no charge by completing the coupon below, or calling us at 609-799-0071.

DEC and MULTIBUS are registered trademarks of Digital Equipment Corporation and Intel Corporation, respectively.

**DATARAM
CORPORATION**

Princeton Road
Cranbury, New Jersey 08512
Tel: 609-799-0071 TWX: 510-685-2542

WHAT'S THE BIG IDEA?

- Send me your 16-page brochure detailing BULK SEMI.
- Please call me to discuss my application.

Name _____ Title _____
Company _____
Address _____
City _____ State _____ Zip _____
Telephone _____

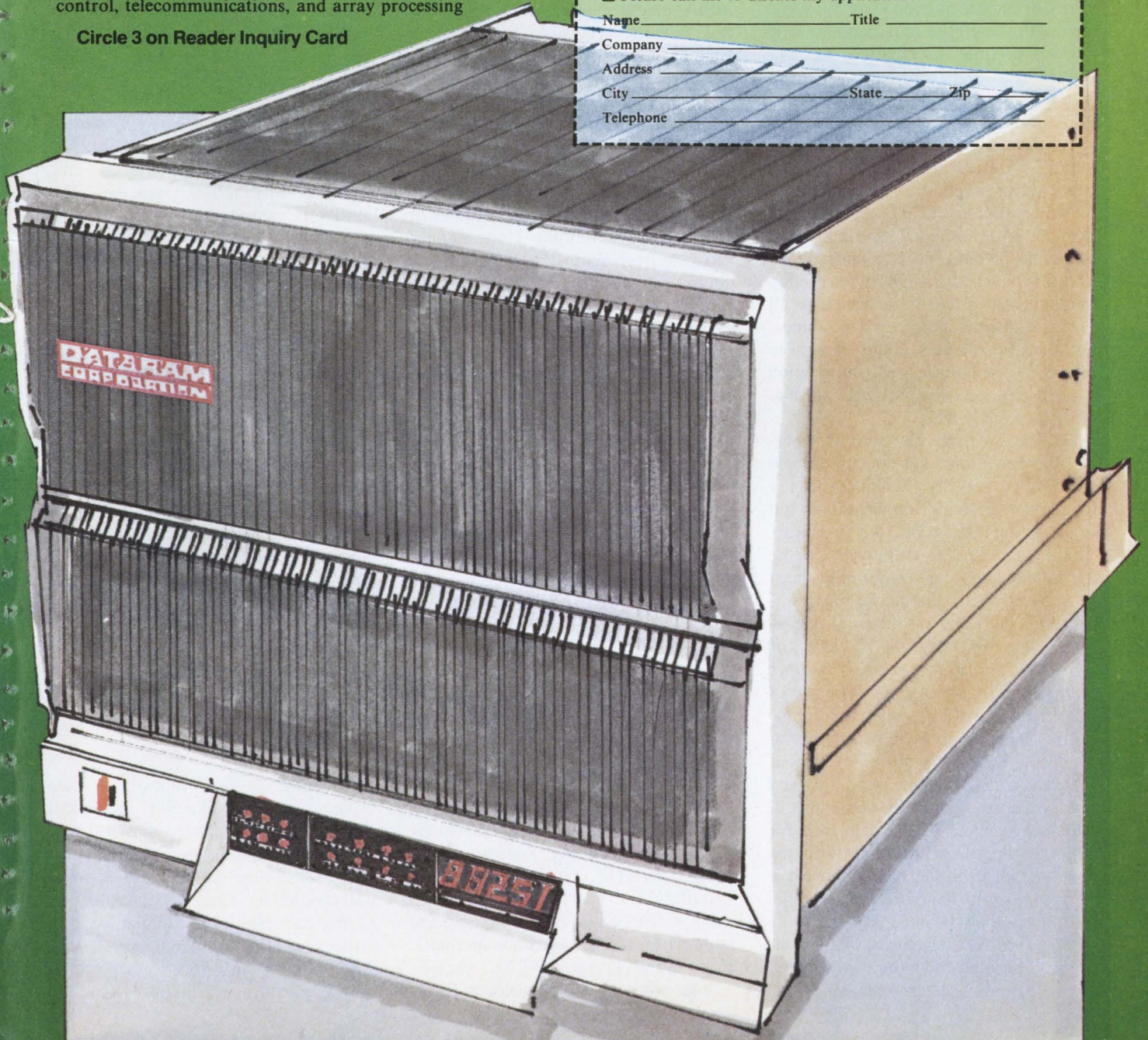

lost or stolen, its number can be flagged on the computer data base as invalid — immediately disabling the card's authorization code and protecting the data base from being accessed with a stolen card.

Security measures can be extended a step further using the card system. Computer authorization cards can be integrated with employee identification cards. If employees are required to show such cards when entering the plant, it is unlikely that the loss of a card would go unnoticed for more than one working day. Such a system can prevent long time lapses between the loss of an authorization code and detection of the loss. If lost, unrecorded strips of paper, or even keys to locked terminals, could go unnoticed for long periods of time, especially if the employee who lost them had no need to access the computer for several days.

In use, the card-based security system offers great flexibility. Employing an authorization hierarchy, a company can control levels of data availability. At the lowest level, only that information that is of immediate use in a particular task would be available to an employee; at the highest level, top management could have access to all data. Between these two extremes, authorization levels could be set to allow just the necessary information availability according to the need to know at each level.

Besides overall hierarchical security, the card-based system can provide specialized security. Consider the case of a manufacturing organization's bill of materials program, for example. There may be 50 employees in the manufacturing organization who need to access the bill of materials program, to obtain part and lot numbers to perform their job functions. However, of those 50 employees, perhaps five are properly authorized to alter the bill of materials program — to order new parts, or delete obsolete part numbers, for example. By providing two types of security codes on cards, read only and read/write, the company can allow all necessary access of the data base for efficient work flow, yet still restrict the ability to alter the data base to those five employees who have been issued cards with the read/write authorization code.

The card-based security system can be as beneficial for individual privacy as for the corporate environment. Con-

sider the case of a hospital, for example. With proper construction of the patient data base, hospital computer authorization codes can be developed to ensure that only relevant data is available to various hospital staff. The patient's doctor, and the nursing staff, for example, might be able to access all medical information on the patient. The hospital administration and accounting staff, on the other hand, might be able to access only the information related to calculating the patient's bill: duration of stay in the hospital, type of accom-

modations, tests, the number of staff in the operating room, and type of insurance. Although the security afforded in this hospital situation is but a single example, parallel privacy could be easily obtained for other data bases such as those in banks and at the IRS.

As the use of computer terminals for data base access grows, there will be a corresponding demand for satisfactory security for personal and business data. This will create an ever-growing market for cost-effective versatile terminal-based security systems.

μ Ps Influence Printer Reliability, Cost and Features

The development of μ Ps continues to influence the design of electronic printing devices according to O. Ralph Finley, vice president of Dataquest (Cupertino, CA) and Director of the Electronic Printer Industry Service.

As a result of the growing demand for printed information and the supply of increasingly cost-effective printers, the printer market has grown rapidly in the last ten years, with the number of printers in use in the United States growing from about 250,000 in 1971 to about 3.5 million in 1981. Strong future growth, to about 11.6 million, is expected by 1986. Despite the increasing proportion of small printers, often sold at prices affordable by average consumers, the revenues have grown from about \$600 million in 1971 to nearly \$5 billion in 1981, and are expected to exceed \$14 billion in 1986.

The most recent influence of μ Ps has been the addition of features on electronic printers. As an example, dot matrix printers are now capable of printing more than simple 96-character fonts. They offer full graphics capabili-

ties, block printed letters, multiple fonts, and features such as proportional spacing and right-justification. These types of features are now easier to design into printers due to the use of μ Ps and their associated software.

In an exciting new class of printers, that of intelligent page printers such as the Xerox 9700, μ Ps provide the ability to print forms along with data. This ability is extended to the use of company logos, the ability to shade areas to highlight information, and the ability to actually sign computer letters with good representations of signatures.

During the 1980s, expect continued strong-but-slowing growth in the traditional products sold for DP and WP users, i.e., impact line printers and daisywheel printers. Two areas, however, should see exciting growth — shared-application printers that will displace a combination of devices including photocopiers, facsimile machines, offset duplicators and traditional printers; and very low cost printers for use with personal computers that are starting to invade the consumer market.

Digital Announces Performance Service for PDP-11S

A new computer system performance service helps users optimize operation of PDP-11 computers running under the RSX-11M operating system. Designated CPS-11M, it includes license and installation of performance measurement software and on-site training and support by a DEC software specialist. Price of the service is \$9370.

The software performance monitor,

SPM-11M, is an event-driven data collection and reduction instrument that monitors hardware and software resources including the CPU, memory, I/O and storage devices, file system, and task loader. Collected data are used to analyze resource use at total system, collective and individual task levels. The monitor aids location of bottlenecks, performance analysis of appli-

THE NEWEST IN COMPUTER POWER CONDITIONING EQUIPMENT

INTRODUCING DELTEC'S ADVANCED NEW GSC SERIES — COOL, QUIET, EFFICIENT.

Prevent AC Power Problems. Our new AC line conditioners will protect your computer from the most common AC power problems such as noise spikes, transients and low line brownouts.

Solid State Quiet. These new line conditioners are whisper quiet . . . well below your normal office background noise level.

Wide Range of Models Available. Four sizes are available in the GSC Series to meet your system needs: 500VA; 1200VA; 2500VA; and 5000VA.

New Switching Technology. They use a new electronic tap switching technique which eliminates potentially damaging transients that can occur with other designs.

Designed For The Office. We have styled these conditioners to fit in your office environment. They are not only pleasing to the eye, but rugged too.

Economical. You save in many ways. Our design gives you greater efficiency, is most cost effective, and the price is surprisingly low.

Call or write Deltec for more information.

THE AC POWER SPECIALISTS

2727 Kurtz St., San Diego, CA 92110
Phone (714) 291-4211 TWX: (910) 335-1241

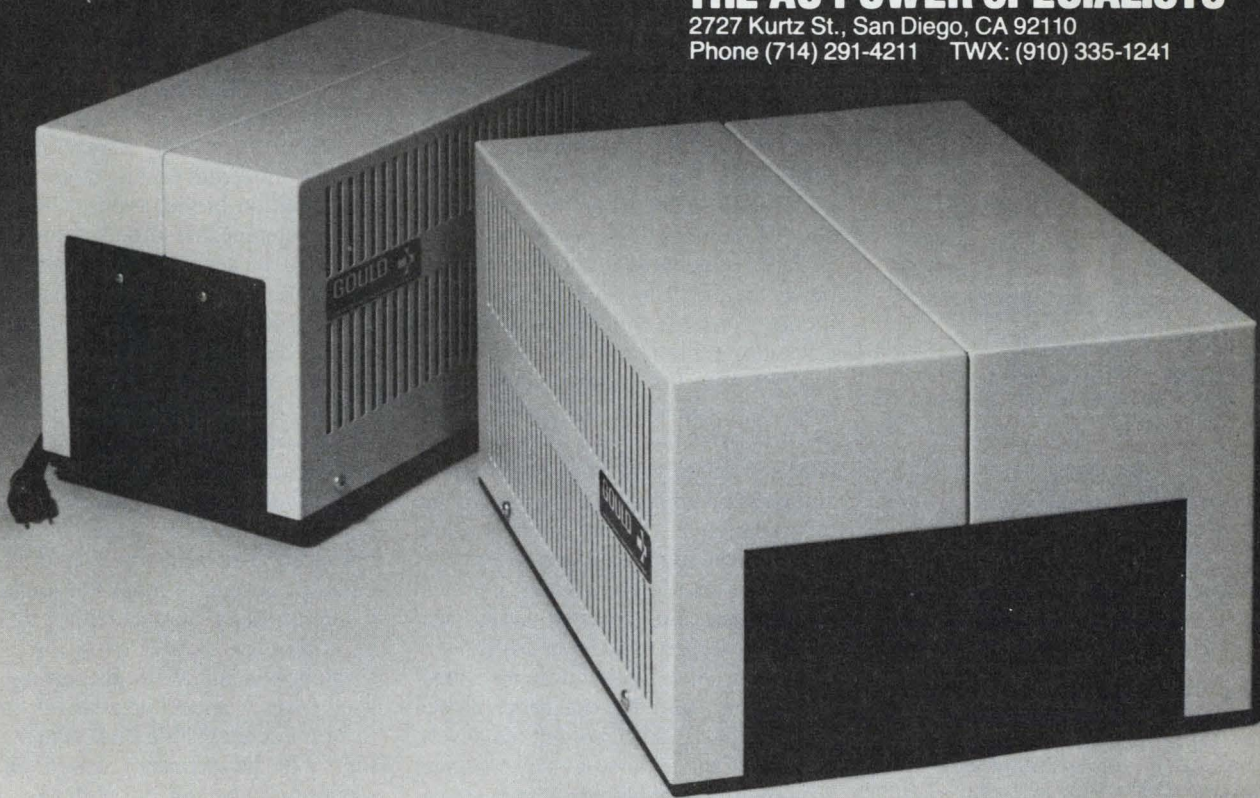

 **GOULD**

Electronics & Electrical Products

Circle 12 on Reader Inquiry Card

FEBRUARY SPECIAL

EPSON \$449.00
MX-80

INTERFACES & CABLES

IEEE \$55

APPLE INTERFACE
& CABLE \$90.

RS-232 \$70, TRS-80 CABLE \$35.



Technology Trends

ation programs, measurement of workload trends for planning system expansion, and system tuning for improved performance.

SPM-11M software is a low-overhead, event-driven monitor capable of high resolution (10 μ sec clock) and flexible application. The monitor permits both overall RSX-11M system evaluation and isolation of particular subsystems or application programs by allowing the user to select either continuous or sample monitoring as well as specific tasks and resources for data collection. Likewise, performance reports can be generated to show either the effects of total system workload or the impact of individual tasks and runs.

Dermot Bredin, computer performance services manager for DEC's

Software Services Group, said that the CPS-11M service is designed to meet a real and significant business need: to make optimum use of computer systems and staff. "Computer systems are corporate resources, and system performance can impact many levels of company activity," Bredin said. "It has a direct bearing on programmer productivity and on the level of service a computing facility provides to its users.

"With the monitoring capability of SPM-11M, system managers can pinpoint existing problems with overloaded resources and prevent new ones from developing," he said. "They can improve the job mix and reduce the waiting time for resource usage, thereby improving response time for users. System planners can also measure the growth of workloads and gauge the true capacity of the system, and that helps financial managers to plan capital investments for system expansion more accurately."

PERSONAL COMPUTERS

NEC 7710 and 7730 Spinwriter	\$2345.00
NEC JB1201 M 12" Monitor	159.00
Okidata Microline-80	379.00
Okidata Microline-82A	499.00
Okidata Microline-83A	729.00
Diablo 630	1995.00
Televideo 912C	669.00
Televideo 920C	729.00
Televideo 950	929.00
CBM 8032 Computer	1149.00
CBM 8050 Disk Drive	1349.00
CBM VIC-20	269.00
Amdek 100G	169.00
Amdek Color - 1 13" Monitor	329.00
Qume Sprint 9/45 (Full Panel)	2295.00
Atari 400 16K	349.00
Atari 825 Printer	599.00
Atari 850 Interface	139.00
Atari 810 Disk Drive	449.00
Atari 800 16K	749.00
Epson MX-70	349.00
Epson MX-80	449.00
Epson MX-80 FT	549.00
Epson MX-100 FT	729.00

CALL OMEGA TOLL FREE!

WEST COAST
1-800-235-3581
OMEGA SALES CO.

3533 Old Conejo Rd. #102
Newbury Park, CA 91320

1-805-499-3678

CA. TOLL FREE 1-800-322-1873

EAST COAST
1-800-556-7586
OMEGA SALES CO.

12 Meeting St.

Cumberland, RI 02864

1-401-722-1027

We Accept C.O.D.'s • Stock Shipments Same Day
or Next • No Surcharge for Credit Cards • All
Equipment Factory Fresh w/MFT Warranty • We
Carry the Complete Line of Personal Software •
Prices do not Reflect Shipping Charges
Sales Tax Where Applicable

OMEGA SALES COMPANY

PRICES ARE SUBJECT TO CHANGE WITHOUT NOTICE

Memory Technology To Experience Transitions

Progress in silicon device complexity for the 1980s will continue at a fast pace according to a 1200 pg. study by Mackintosh International. MOS DRAMs will be four times more advantageous than SRAMs, and the use of CMOS technology to implement SRAM memory devices will increase.

Bipolar technologies will continue to be extensively used for high speed memory devices with the newer gallium arsenide technologies providing faster devices with lower power dissipation. Josephson Junction technology will provide even faster speeds, but is considered unlikely to find wide use in commercial applications because of the inconvenience of the liquid helium environment required. Gallium arsenide memories operating at liquid nitrogen temperature are expected to provide comparable speed and power dissipation.

Despite the withdrawal of three companies from the magnetic bubble business, it is expected that the development of the technology will continue with magnetic bubble devices having a factor-of-four packing density advantage over semiconductor devices. For those applications requiring non-volatile storage and high reliability, magnetic bubbles will provide ideal solutions.

Continued development of magnetic recording will lead to further develop-

ment of rigid disk systems involving integrated film heads, multiple heads per disk surface, high efficiency coding schemes and the widespread acceptance of high coercivity plated medium. Following recent trends, there will be a continuation of the emphasis on fixed, non-exchangeable disk systems based on Winchester, MiniWinchester and MicroWinchester technologies.

Dramatic developments will occur in floppy disk technology with the introduction of buried servo-on-track techniques, improved media and heads. Orders-of-magnitude increases in track and bit-density will be achieved by the end of the 1980s. Extensions of the current range of products to provide cost-effective mini and micro disk backup storage for many consumer and office product applications will be a feature of this decade.

Magnetic tape will increasingly be used to provide backup archival storage to non-exchangeable disk systems and this will be primarily based on the streaming tape concept with new, high performance cartridge products being introduced.

The development and introduction by 1990 of storage systems using perpendicular (vertical) recording will achieve a factor-of-ten increase in storage density compared to normal in-

Circle 19 on Reader Inquiry Card

plane recording.

The main growth of memory usage in the consumer sector will be associated with the increase in shipments and use of low-cost personal computers. In the business computer sector, increasing computer shipments, particularly in the lower cost systems range, and memory usage will accelerate as memory prices continue to fall.

Memories in the computer peripheral sector are primarily associated with the many types of terminals and, to a lesser extent, with controllers for printers, disk and tape systems. The development of low-cost terminals and their penetration into the domestic and business environment will expand and create new market opportunities for electronic and electromechanical memories.

New facilities and services being offered in the telecommunication sector will provide opportunities for the memory vendors: an increasing quantity of high speed memories will be required to handle the burgeoning electronic mail traffic and to provide the data base storage for public information and transaction services.

In the office equipment sector, WPs will continue to provide expanding opportunities for the memory suppliers. The consultants also predict that the development of intelligent, electronics-based collating copiers will also provide a large opportunity for memories. Of significance is the dramatic increase in memory requirement that will accompany the provision of facilities for the manipulation, transmission and processing of graphics. Such facilities will be found in electronic mail, electronic document storage and in integrated information systems.

Worldwide shipments of electronic memory bits will grow from \$4 billion in 1980 to more than \$50 billion in 1990. The market for magnetic bubbles will consistently remain at 1% of the total solid state memory market.

Worldwide markets of electro-mechanical memories (OEM values) will increase from \$5 billion in 1980 to more than \$60 billion in 1990. In value terms, floppy disk memory shipments will exceed those of rigid disk systems with major new opportunities for floppy disks occurring in the consumer and office products sectors. Mackintosh also predicts that there will be significant shipments of optical disk systems from 1985 onward. Want more information? Contact: Yves G. Blanchard, Director of Marketing, Mackintosh Consultants, Inc., 2444 Moorpark Avenue, Suite 211, San Jose, CA 95128.

Reconfigure your PDP11 Unibus* with the push of a button.

Do you need to share peripherals?
Do you have multiple cpu's with a limited number of peripherals?
Do you need to selectively choose which peripheral is on the bus?

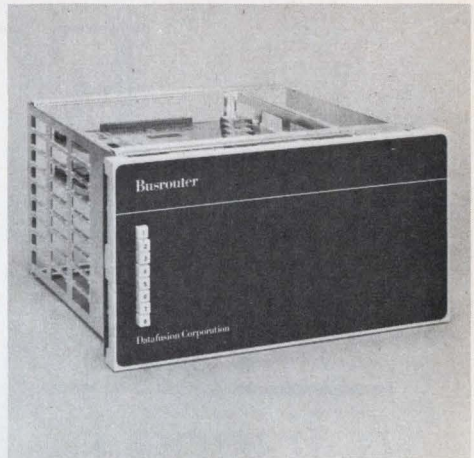

If so, Datafusion Corporation's OSR11-A Busrouter can help. It is a passive, manually operated device to perform the physical and electrical switching of the Unibus* for PDP11 series computer systems: up to eight switching planes (i.e., configurations); electromechanical switching relays (simple, high reliability, minimal electrical loading).

Essentially, each Busrouter switching plane can be viewed as a single pole, multiple throw switch.

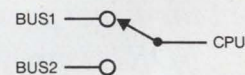

The application shown here is a situation opposite the first, where one peripheral bus can be switched between two cpu's with the cpu not selected being terminated.

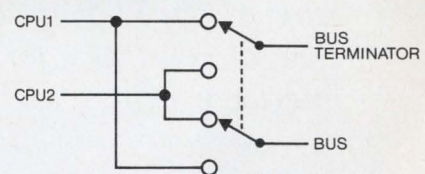

Many more configurations are available such as sharing multiple peripheral devices between multiple cpu's and then selectively choosing to switch each one or all to one cpu or another.

Other PDP11 products available are a bus repeater, bus cable tester, and an associative processor for high speed text search — a hardware approach.

We also have some ideas for the application of our products which might not have occurred to you. If you can't get the performance that you would like from your PDP11 system, maybe we can help. Please telephone our Marketing Manager at (213) 887-9523 or write to Datafusion Corporation, 5115 Douglas Fir Road, Calabasas, California 91302.



*TRADEMARK OF DIGITAL EQUIPMENT CORPORATION

Circle 14 on Reader Inquiry Card

FORTH

From A to Z

a listing of FORTH products and services including specifications, prices and other information

This special FORTH Directory marks a historic first: it is the largest of its kind, and certainly the first ever published by any publication in the trade press.

FORTH provides advantages few other languages can offer; and, as stated in our May 1981 article, "FORTH: Exaggeration Or Panacea?" (P. Snigier, pp. 52-57): "FORTH provides a general, compact and powerful core of constructs for arithmetic, logic, data structures, mass storage interface, editing and assembly. It offers extensibility to your specific problems, non-linking multi-level programming, interactivity, handling and mass storage, and development simplicity."

A
B
C
D
E
F
G
H
I
J
K
L
M
N
O
P
Q
R
S
T
U
V
W
X
Y
Z

NEW! Sophisticated Computer Access and Security



TEC SERIES 630
DATA-SCREEN[®]
TERMINAL

TEC's new Series 630-C Video Display Terminal offers its magnetic stripe card reader keyboard to protect your confidential computer files through error-free computer authorization.

- Cards encoded to IATA, ABA, and Thrift standards.
- ASCII data is read from the card and sent to the CPU, and is stored in the terminal's memory but not necessarily displayed, to provide security.
- Offers ability to control access to computer and data files by requiring each operator to have a card, possibly containing a user identification number and security level code.
- Applications include credit card sales transactions, airline ticketing, security, identification, and audit trailing.
- Cost effective, state-of-the-art.
- The 630C can be custom tailored to meet your exact requirements.

CREDIT CARD

CREDIT CARD

Circle 16 on
Reader Inquiry Card

**AVAILABLE
NOW**

Distributor
Inquiries
Welcome



TEC, Incorporated Corporate Headquarters, 2727 N. Fairview Ave., P.O. Box 5646, Tucson, AZ, USA 85703
(602) 792-2230 • TWX 910-952-1377 Telex 16-5540

SALES OFFICES IN THE FOLLOWING LOCATIONS

- BOSTON (617) 879-6886
- LOS ANGELES (714) 848-3111
- SAN FRANCISCO (415) 572-1566
- CHICAGO (312) 655-1060
- MINNEAPOLIS (612) 941-1120
- WASHINGTON D.C. (703) 354-1222
- DALLAS (817) 274-9827
- PHILADELPHIA (201) 780-6700

DISTRIBUTORS IN MOST
INDUSTRIALIZED COUNTRIES

FORTH

From A to Z

A

ZFORTH for CP/M 8" Floppy

FORTH for CP/M Ver. 2.2 and MP/M 1.1. A unique dictionary lookup routine provides an average of 2.1 probes for a fail and 1.8 probes for a successful find of a word in one vocabulary. Loading times are much faster than threaded dictionaries. Good speed improvement is realized while retaining FIG standard (except Dictionary Structure). String Editor provided. Unit price, \$350.

FORTH for MDX STD Bus

Same as above for FLPDOS 8" Floppy Media. \$350.

ZFORTH/Plotting Package Utility

This plotting package for Tektronics graphics terminals provides simple commands for plotting two arrays. Commands such as AXIS, GRID, TITLE CURVE, PLOT, XLABEL, YLABEL and ENDPL give the user a very versatile package for generating plotted hardcopy data from two arrays. Unit price, \$250.

Dynamic Data Base Utility

The Dynamic Data Base is an options package for ZFORTH providing a Data Description Language (DDL), yielding an efficient report writer with output formatting and auto headings. Keys are maintained in AVL trees with data storage space automatically recovered on record deletion. Blank compression is automatic. Unit price, \$175.

Floating Point Package Utility

An options package providing a complete fast floating point package is available. Support for the STD-BUS ATC-MATH coprocessor hardware or a Software Floating Point Package with our hardware is available. Pricing starts at \$150 for software without hardware; software and hardware, \$850.

Speech Utility

Software Utility provides a text-to-speech routine to support the STD Bus. ATC-Speech hardware device utilizing the Votrax SC01. Requires ZFORTH language. Unit price, \$575.

FORTH Software for TRS-80

FORTH for TRS-80 provides as standard a Z80 FORTH Assembler, Floating Point Package and Line Editor (String Editor Listing provided). Supplied on 5¼" floppy, requires TRS Model I & 32K memory. Options include phoneme assembler for voice synthesis and data base utility. Unit price, \$129.95.

Norm McCollough Advanced Technology Corp.

P.O. Box 726

Clinton, TN 37716

Circle 210

microSPEED Language System

The microSPEED Language System (a hardware-assisted superset of FORTH) employs an interactive compiler and the AM9511 Arithmetic Processor to provide increased performance for the Apple II, II+ and III. Features order-of-magnitude speed improvement and greatly enhanced programming facilities beyond those of BASIC and Pascal,

including print formatting, enhanced high-resolution graphics, and extended, high-speed mathematical functions. Over 300 operators available to the user. Extensive, optionally loadable utilities include Diagnostics, Text Editor and Mini-Assembler. System software diskettes, Auxiliary Processor Card and 160-page User's Manual comprise the complete package. Unit price (complete system), \$495; manual only (deductible), \$35.

Janet Carmody

Applied Analytics Inc.

8910 Brookridge Drive, Suite 300,
Upper Marlboro, MD 20870

Circle 211

8080/Z80 fig-FORTH for CP/M

The fig-FORTH model in machine readable format. This package contains two 8" diskettes. The first diskette contains 8080 and enhanced Z80 source code that is readable and executable on Digital Research CP/M or Cromemco CDOS operating systems. The 2nd diskette contains FORTH readable screens including a full screen editor originally published in FORTH DIMENSIONS. The entire work is donated to the public domain in the manner and spirit of the original work upon which it is based. Copies may be made and distributed when proper notice is included. Price, \$25.

Dennis Lee Wilson

Aristotelian Logicians

2631 East Pinchot Ave.
Phoenix, AZ 85016

Circle 212

AYDOS Disk Operating System

An implementation of the FORTH language on the Aydin 5216 color graphics computer, Aydos is a user-oriented programming language and operating system. It is a stand-alone software product designed for fully interactive graphics program development and testing, and is a multi-level, multi-user system. The user can program in the higher level Aydos language, or, where the requirement for improved performance requires, can operate at a macro assembler level. Aydos 50 is a disk based system consisting of an Operating System, Assembler, Compiler, Interpreters, Editor, Virtual Utilization Memory, Debug facilities, File Management and Device Drivers. Aydos 10 is a PROM resident system without disk handling, Editor and File Management.

COMPARE FLEXIBILITY.



Model 950

- Advanced editing with wraparound
- Smooth scrolling
- 15 baud rates (50B to 19.2kB)
- Protected fields
- Underlining
- Split screen with line lock
- Non-glare screen
- Programmable function keys
- 15 special graphics characters
- Versatile screen attributes
- Self test
- 25th status line
- Buffered auxiliary port
- 14 X 10 character resolution
- Integral modem option
- Tiltable screen

Tailor this smart CRT terminal to your particular needs and make it your own. It has the flexibility and brains to provide all the performance you need but is priced to make sense whether you need 10 or 1,000.

The TeleVideo model 950 detachable keyboard CRT Terminal has 11 special function keys—22 functions with the shift key—that can readily be programmed to your requirements using 256 bytes of on-board RAM.

You needn't stop there. You can change keys, key functions, even keyboard locations. And the 950's micro-processor based design means you can customize the firmware for your system.

Of course the 950 has premium TeleVideo performance—advanced editing with wraparound, split screen with line lock, and smooth scrolling. It also features a

25th status line, speeds to a true 19.2 kilobaud, and 15 special characters for powerful line graphics.

Contact TeleVideo for a detailed brochure, or call today to discuss how you can use these capabilities to make this terminal uniquely yours. TeleVideo, Incorporated, 1170 Morse Avenue, Sunnyvale, CA 94086. (408) 745-7760.

Nationwide Field Service is available from General Electric Company, Instrumentation and Communication Equipment Service Shops.



Circle 25 on Reader Inquiry Card

COMPARE PRICE.

CALIFORNIA Santa Ana (714) 557-6095 • Sunnyvale (408) 745-7760 • MASSACHUSETTS Boston (617) 668-6891
NEW YORK/NEW JERSEY Morris Plains (201) 267-8805 • TEXAS Dallas (214) 980-9978
ILLINOIS Bloomingdale (312) 351-9350 • GEORGIA Atlanta (404) 255-9338
EUROPE London 44-9905-6464

A
B
C
D
E
F
G
H
I
J
K
L
M
N
O
P
Q
R
S
T
U
V
W
X
Y
Z

AYGRAPH 2D and 3D

FORTH based, 2D and 3D graphics packages used with Aydin 5216 graphics computer. Unit price is \$2500 and \$3500, with significant qty discounts.

J. Taylor

Aydin Controls

414 Commerce Dr.

Ft. Washington, PA 19034 *Circle 213*

B

figFORTH for Ohio Scientific

Full figFORTH for Ohio Scientific 6502 computers. Runs under OS-65D with full FORTH disk handlers. Comes with full screen editor, lots of utilities. Runs in 20K to 32K. 8" or 5¼" diskettes — specify when ordering. Unit price, \$875; quantity price, up to 60% off.

Blue Sky Products

FORTH Div

729 E Willow

Signal Hill, CA 90806 *Circle 214*

C

8080 figFORTH

8" disk contains source and object as published by Forth Interest Group. Price, \$50.

1802 Crossassembler

8" disk contains object and user manual on disk compiled from C source files. Price, \$25.

6800 Crossassembler

8" disk contains object and user manual on disk compiled from C source files. Price, \$25.

1802 figFORTH

8" disk; load with RCA CDOS and 32K RAM and UART board; disk contains source and object. Price, \$50.

1802 figFORTH

8" disk; load with RCA unit-track and 32K RAM and UART board; disk contains source and object. Price, \$50.

1802 figFORTH

8" disk; load with RCA unit-track and 32K RAM and UART board; contains

object code and misc. programs in fig-FORTH screen format. Price, \$50.

CMOSOFT

P.O. Box 44037

Sylmar, CA 91342 *Circle 215*

FORTH for CompuColor

This version of figFORTH for CompuColor is available on 5.25" floppy disk, with documentation. Unit price is \$79; each additional copy is \$69.

Colorware

P.O. Box 6733, Station J

Ottawa, Ontario

Canada K2A 3H2 *Circle 216*

FORTH Application Software

Cursor editors: all normal and special functions. Implementation for a wide range of terminals. Protocol emulators: different protocols (3270 a.o.). Advanced programmable controllers: user specified application languages and multi-tasking systems. Special debuggers.

Johan Norberg

Combinator Microcomputer

Applications (COMMIC)

Birger Jarlsgatan 97, S-113 56

Stockholm, Sweden *Circle 217*

Findcalls and Decompiler

These fig-FORTH compatible routines will determine what words call any other word. Now you can eliminate words which are not used, or combine words which are called by only one or two other words; fig-FORTH decompiler included. Sample printout on request. Available in 9+ screens: listing and manual alone, \$25; on disk (5" Apple and 8" sssd) — \$35.

R. E. Curry & Associates

P.O. Box 11428

Palo Alto, CA 94306 *Circle 218*

D

PROCON II

Unit is a low cost, async in, async out, Protocol Converter based on RCA 1802 CPU, programmed with a Forth Nucleus. Nicad backed CMOS RAM retains specific set up parameters. Main program is in EPROM. Full modem

control and error checking is provided. Unit price is approximately \$1075.

Mr. C. Holland

Datatrak Ltd.

Computer Centre, Bugbrooke Road, Gayton

Northampton NN7 3EU

UK *Circle 219*

plug-FORTH

ROMable fig-FORTH on diskette for LSI-11/PDP-11, MC68000, 8080/Z80; 68K-FORTH incl. Screen-Editor, Assembler. Diskettes available in CP/M or DEC-format. Stand alone FORTH for LSI-11. Unit price approx. \$200.

Datentec Kukulies

Heinrichsallee 35

Aachen, 5100

W. Germany

Circle 220

D-FORTH for the ACS-12, -14

Developed as an enhanced version of the FORTH language, D-FORTH is a ROM-based, high-level, interactive, fully-mnemonic language operating system. D-FORTH is user-configurable and generates ROMable code more compact than assembler. Unit price is \$100 for the 4 Kbyte kernel.

D-FORTH-09 for ACS-09

A stack-oriented programming language ideally suited for controller and development applications. Generates ROMable code with user control of interrupt. Developed in cooperation with Nortek, Inc. D-FORTH-09 is also marketed under the name SPICE (Stack-oriented Procedural Interactive Computer Environment). The initial 4-Kbyte kernel comprises a complete operating system, which includes keyboard interpreter, high-level compiler, debug facilities, and full dictionary extension capabilities. The 4-Kbyte extension PROM contains enhanced word-vocabulary, including tools to facilitate software development, and to provide advanced data structure capabilities. Extension also includes the ROM driver and software module autolink. Price for the 4-Kbyte kernel is \$100; the extension PROM sells for \$100 (qty 10).

Rob Schram

Datricon, Inc.

7911 NE 33rd Dr. Suite 200

Portland, OR 97211 *Circle 250*

E

Freedom Software

Operating system for software package for loan document preparation and processing.

Jeff Strickland
ECO Methods, Inc.
1756 Manhattan Beach Blvd.
Manhattan Beach, CA 90266

Circle 221

68KFORTH

A completely integrated disk-based system for MC68000 MPU; monitor, operating system, compiler, interpreter, assembler, virtual memory, screen editor, fast dictionary search algorithm, double precision arithmetic, optional software tools available. FORTH-79 standard vocabulary. Unit price is \$795; \$595 (100 unit +).

Lee Sorensen
Empirical Research Group, Inc.
P.O. Box 1176
Milton, WA 98354

Circle 222

ELFORTH

PROM based fig-FORTH for TI TM990/101M (9900 based boards). ELFORTH consists of six EPROMs containing fig-FORTH, the fig editor, a TIBUG type monitor, an assembler and a disk interface. The fig-FORTH MATH pack has been expanded and largely re-coded in assembly for speed. Additional words and documentation have been added to allow the easy implementation of interrupt driven routines. ELFORTH is configured for the development and implementation of real time, interrupt driven, PROM based monitor and control systems with or without concurrent operator access to the full FORTH system. Unit price is \$1000.

Walt Winter
Engineering Logic
1252-13th Ave
Sacramento, CA 95822

Circle 223

F

Utopia FORTH

Utopia FORTH is a new generation FORTH designed for a sophisticated

minicomputer environment, implemented on an INTEL 86/12 system. Features include directory-based file structure, full screen editor, generalized I/O, multiple vocabularies, dynamic memory allocation, and multitasker. Sophisticated interpreter gives programmer more control in user interface. Single step debugger, and documentation system with technical or user output modes included. Unit price is \$2200.

Functions and Floating Point Support

Sophisticated calculation environment through super-colon definitions called FUNCTIONS. Global and Local variables, floating point loops with localised name index, and multidimensional arrays are all supported. FORTRAN E- and F-like outputs, real-to-integer, and integer-to-real conversions included. Uses Intel 8087 numeric processor for fast, stable calculations. Transcendental math and single or double precision. Unit price is \$300.

Assembler and MetaForth

For iAPX 86/10 or 86/20 systems, creates target compiler environment to generate new FORTH Kernels or any software system. Non-RPN Assembler (very similar to Intel's ASM-86) supporting true labels with forward references. Colon definition compiler allows high-level routines in target software. Unit price is \$500.

Fillmore Systems, Inc.
5227 Highland Road
Minnetonka, MN 55343

Circle 224

polyFORTH™ Workshops

One-day session offering an in-depth analysis of polyFORTH and the power it gives you to write your own unique applications. By the end of the day attendees are able to write simple FORTH applications. Held in: Los Angeles, Boston, New York, Minneapolis, Philadelphia, Houston, Tampa, Palo Alto, Chicago, San Diego. Price is \$145.

polyFORTH Seminars

Half-day in Los Angeles, Boston, New York, Minneapolis, Philadelphia, Houston, Tampa, Palo Alto, Chicago, San Diego — for software managers and engineers to demonstrate how polyFORTH improves programmer productivity. Admission is free.

Specialized Workshops

FORTH, Inc. will provide specialized workshops at various intervals upon sufficient demand from its user base. We are also ready to build a program or seminar specially for any group or company who wishes to provide a FORTH overview on any FORTH related topic. Workshops currently available are: files, target compilation, project management, defining words, extensible languages, vocabulary, documentation, scheduling, curriculum design, product specification. Among past users of these services are corporations that wish to evaluate FORTH for projects or for general use.

THE THREAD

“The Thread” is formed of users of FORTH Inc. related software and services. THREADS exist in New England, New York, Delaware Valley, Washington D.C., Florida, Chicago, Minneapolis, Houston, Palo Alto, and Los Angeles, with chapters forming in Europe, Canada, and Japan. The user group provides inter-customer communications, a newsletter and a collection of user-developed software and techniques called “The Dictionary.”

Introductory Course

This intense one week hands-on course is taught on the premises of FORTH, Inc. in Hermosa Beach, California. Course outlines and schedules are available upon request. Who should attend? New FORTH programmers and project managers, language evaluators, product designers. Price is \$1125 for one person, \$1000 each for two or more.

Intermediate Techniques

This course is targeted at FORTH programmers who have either completed the preliminary course or have equivalent FORTH knowledge. Subject matter includes style and special techniques for many common programming situations. The course is a three day, hands-on experience with a lab. Price is \$750 for one person, \$650 each for two or more.

Educational Services

FORTH, Inc. welcomes inquiries from any FORTH user or implementor who needs course development and/or product training either for themselves or for their own customer base.

A
B
C
D
E
F
G
H
I
J
K
L
M
N
O
P
Q
R
S
T
U
V
W
X
Y
Z

Project Management Course

Targeted at individuals who wish to write, manage or schedule FORTH — or manage FORTH programmers projects, this 3 day course provides knowledge of coding styles, developing tools, documentation methods, personnel management and implementation. Price is \$600 for one person, \$450 each for two or more.

DBMS

In this one week hands-on course the student gains a working knowledge of FORTH, Inc.'s approach to Data Base, user interfacing, file organization and management techniques. Price is \$1200 for one person; \$1000 each for two or more.

Advanced Course

FORTH, Inc.'s hands-on advanced FORTH class provides the FORTH programmer with a thorough knowledge of polyFORTH multitasking and target compilation. These techniques can insure the success of a FORTH language-based product and can provide a significant decrease in the development cycle. The student actually develops a real-time process control application during the course. The 10% discount applies to software services subscribers. Price for one person is \$1500; two or more persons, each \$1250.

Applications Programming

Working in conjunction with your programming staff, FORTH, Inc. can supply special Application Programming. Our technical staff is experienced in process control, data acquisition, mathematical analysis, image processing, interactive graphics, and data base management.

Custom Processor polyFORTH

While they may not list your CPU as one of their standard products, FORTH, Inc. supports an array of systems and will supply on site installation in many cases.

polyFORTH

All polyFORTH systems are supplied with: polyFORTH Disk, PROMs (where noted), installation instructions (as needed), complete system source listings and glossaries. *Using FORTH Manual* (168 pp.), *polyFORTH Reference Manual* (320 pp.), CPU Supplement to the *Reference Manual*,

Stepping FORTH self-teaching diskette, 60-day warranty, and 60-day free Hotline Support.

DEC PDP- & LSI-11 polyFORTH

PDP-11 and LSI-11 products are the same. All DEC systems require 32 kB memory and a DL-11 or DLV-11 console. pF11/RX01, for RX01 Diskette is \$5.100; pF11/RX02, for RX02 Diskette is \$5.100; pF11/RL01, for RL01 Disk is \$7.300, including file management plus Media; pF11/RK05, for RK05 Disk is \$7.300 and includes File Management plus Media. Options include D00/11 file management, \$1.500; A05-14/11 14-bit Fixed-point Fraction Arithmetic, \$250; A05-15/11 15-bit Fixed-point Fraction Arithmetic, \$250; A06/LSI-11 Floating Point Package for LSI-11 EIS, \$500; A07/11 Normalized 16-bit Ratio of 32-bit ratio, \$125; A10/11 Integer Square Root (30-15 bits), \$75; A20-14/11 14-bit Trig Functions (incl. A05-14/11), \$300; A30-15/11 Log. Exponential Functions (15-bit fixed-point), \$300; V11/DZ DZ11 MUX Driver, \$500; V11/TU TU58 Cassette Driver & Utility, \$500; V11/MT TU10 Tape Driver & Utility, \$300; G01-TEK/11 Tektronix 4010 type Compatible Graphics, \$750.

Intel 8086 polyFORTH

For SBC-86/12 board; incl. four 2716 PROMs. pF8086/12-1 is for SBC-201 Disk Controller; pF8086/12-2 is for SBC-202 Disk Controller; and pF8086/12-4 is for SBC-204 Disk Controller. All are \$5.450. Options include D00/8086 File Management, \$1.500; A10/8086 Integer Square Root (30-15 bits), \$75; V8086/534 iSBC 534 4-port Serial MUX Driver, \$500; V8086/UPP UPP 101 PROM Programmer (incl. special cable), \$500; V8086/CEN Parallel Centronics Printer Driver, \$150.

Intel 8080 polyFORTH

pF8080/230B is for Intel MDS Series II Model 230, 235, and costs \$5.100; pF8080/1B is for Intel MDS-800, 201 Disk Controller, and costs \$5.100 (single density); pF8080/2B is for Intel MDS-800, 202 Disk Controller, and costs \$5.100 (double-density); pF8080/2 comes with SBC-416 PROM Board, \$5.550. The following systems for SBC-80/10 boards, include four 2716 PROMs: pF8080/10-1 for SBC-201 Disk Controller, \$5.450; pF8080/10-2 for SBC-202 Disk Controller,

\$5.450; and pF8080/10-4 for SBC-204 Disk Controller, \$5.450. Intel 8080 options include: D00/8080 File Management, \$950; A05-14/80 14-bit Fixed-point Fraction Arithmetic, \$250; A07/80 Normalized 16-bit Ratio of 32-bit, \$125; A10/80 Integer Square Root (30-15 bits), \$75; A20-14/80 14-bit Trig Functions (incl. A05-14/80), \$250; V8080/UPP UPP 101 PROM Programmer, \$300; V8080/ICE ICE-80 Driver, \$500; and V8080/534 iSBC 534 4-port Serial MUX Driver, \$500.

CP/M polyFORTH

The overall performance of CP/M based systems may be somewhat degraded in comparison with stand-alone polyFORTH implementations due to CP/M conventions. pF8080/CPM for 8080 or Z-80 based CP/M systems is \$5.100 (8" single-density floppy); pF8086/CPM for 8086 or 8088 based CP/M is \$5.100 (8" single-density floppy).

IBM Series/1 polyFORTH

pFS1 for IBM Series/1 includes File Management; driver for 3101 Terminal; driver for 4962, 4963, or 4964 disk; driver for 4978 display; driver for 4952 real-time clock; and driver for 4973 or 4974 printer. Price is \$8,250. VS1/MM 4955 Memory Management Package is available for \$2,000.

Motorola polyFORTH

pF6800/EX-B EXORcisor II for 6800 Processor is \$5.100; pF6809/EX-B EXORcisor II for 6809 Processor is \$5.100; pF6809/30 EXORset 30 (6809 Processor) is \$5.100. Options include: D00/6800 File Management for \$950; D00/6809 File Management for \$950; A05/14-09 14-bit Fixed-point Fraction Arithmetic for \$250; A10/09 Integer Square Root (13-15 bits) for \$75; A20-14/09 14-bit Trig Functions (incl. A05-14/09) for \$250; A30-14/09 Log. Exponential Functions (15-bit fixed-point), \$300; V6800/CEN Parallel Centronics Printer Driver, \$150; and G01/30 EXORset 30 Graphics for \$950.

pF68000

PolyFORTH for Motorola 68000 CPU.

RCA 1802 polyFORTH

pF1802-UT21 COSMAC CDS-007 and UT21 PROM Utility, \$5.100; pF1802-1K with 1kB of 2708 PROM, \$5.175; pF1802-2K with 2kB of 2708

ATE

SEMINAR/EXHIBIT

Automated Testing for Electronics Manufacturing

JANUARY 10-13, 1983 • ANAHEIM CONVENTION CENTER • ANAHEIM, CA

CALL FOR PAPERS

We invite technical papers on these subjects
for presentation in General Sessions and Workshops

Field Testing
Bare-Board Testing
Loaded Board Functional
and In-Circuit Testing
LSI Board Test
LSI Component Test
Digital Diagnostics
Microprocessor Bus
Fault Isolation

Analog Board Test
Analog Diagnostics
Bubble Memory Testing
Burn-In/Temperature Cycling
Logic Analysis Techniques
Waveform Analysis
Electro-Optic Testing
Test Requirements Analysis
Interfacing Devices
Simulation
Automatic Test Generation
Systems Support Management
ATE Management
ATE Acquisition
Testability
Economics of Loaded
Board Testing
ATE System Calibration
Using IEEE Bus Instruments
Signature Analysis

Abstract Deadline: **April 15, 1982**

Abstract Submission Form

Please attach this form with your abstract or paper idea.

DD 1/82

Name _____

Title _____

Company _____

Address _____

City _____ State _____ Zip _____

Phone No. () _____ ext. _____

Paper Subject _____

Please complete one: Abstract attached _____ Abstract to come by _____

Send abstracts (200-500 words) and short biographies by April 15, 1982 to Mary Habosian, ATE Seminar/Exhibit, Morgan-Grampian Expositions Group, 1050 Commonwealth Ave., Boston, MA 02215. Or call: (617) 232-5470.

PROM, \$5.225. Options include: V11-PL/1802 Prolog PROM Programmer, \$200; A05-14/1802 14-bit Fixed-point Fraction Arithmetic, \$250; A05-15/1802 15-bit Fixed-point Fraction Arithmetic, \$250; A10/1802 Integer Square Root (30-15 bits), \$75; A20-15/1802 15-bit Trig Functions (incl. A05-15/1802), \$300; and G01-TEK/1802 Tektronix Compatible Graphics, \$750.

RCA Microboard Development Systems

DS1802-2 includes CDP 18S601 board plus 16KB memory board, iCOM disk, parallel printer controller, UART board, power supply, chassis, case, with polyFORTH for \$12,500; DS1802-2U upgrades DS1802-1 (picoFORTH) to DS1802-2, \$11,950.

pFZ8000

PolyFORTH for Zilog Z-8000 CPU.

PicoFORTH Systems

PicoFORTH systems are supplied with: picoFORTH diskette; PROMs where noted; installation instructions as needed; *Using picoFORTH*; CPU *User's Manual*; *Stepping FORTH Tutorial*; and a 60-day warranty. cF8080/230B, Intel MDS Series II Model 230 is \$195; cF8080/1B, Intel MDS-800, 201 Disk Controller (single-density) is \$195; cF8080/2B, Intel MDS-800, 202 Disk Controller (double-density) is \$195; cF8080/CPM, 8080 or Z80 based CP/M system (8" single-density diskette) is \$195; cF6800/EX, Motorola 6800 EXORcisor II is \$195; cF6809/30, Motorola EXORset 30 is \$195; cF1802/UT21, RCA COSMAC CDS-007 is \$195; cF1802/601, set of picoFORTH PROMs for CDP18S601 Board is \$495; DS1802-1, RCA CDP18S601 Board with picoFORTH in PROM is \$995; cF11/RX01, DEC PDP- & LSI-11 (RX01 Diskette) is \$195; cF11/RX02, DEC PDP- & LSI-11 (RX02 Diskette) is \$195.

Support Services

All systems listed are fully supported by FORTH, Inc. A contract for polyFORTH Support Services is available on a one-year basis at these rates: when ordered with polyFORTH system, \$750; when ordered separately, \$950. PolyFORTH support services include

telephone "hotline" support; documentation updates on the *polyFORTH Reference Manual* and your CPU-specific *User's Supplement*; system updates (diskette and source listings); and two allowances of a 10% discount on FORTH, Inc. courses.

Starting FORTH

A 380 page tutorial by Leo Brodie on the FORTH language that offers clear explanations and examples for beginners as well as experienced users of FORTH.

Using FORTH

This user's manual covers all basic aspects of polyFORTH, with problems at the end of each chapter. Learn about postfix notation, the dictionary, logical operations, data structures, the text editor, string handling, and more. 168 pp; \$25.

Programmer Cards

Includes over 300 polyFORTH commands for handy reference. FORTH-79 Standard. Free.

FORTH, Inc.

2309 Pacific Coast Highway
Hermosa Beach, CA 90254 Circle 225

G

Development/Prototyping System

FORTH System when RS 232 terminal connected, with 12K FORTH ROM, 32K user RAM, 30 screens for source in RAM to FIG standard. When application code complete, can be used as prototype. Sealed case, built-in 9 day battery, 8 bit I/O port, tone keyboard, 8 digit display, 20 digit bar display. Designed for real time industrial applications in logging control. Many extra FORTH functions (320 in total). Unit price is \$2900; \$2610 (20 units).

David Esterson
Golden River Corp
7315 Reddfield Ct.

Falls Church, VA 22043 Circle 226

FORTH-6800

Fig-FORTH for SWTPC 6800 computer and Percom disk. Contains all of the high level commands published by the 1978 FORTH standards project, along with variable length names and

virtual memory. With manual and tutorial. Unit price is \$24.95.

Greene Software
6169 Fawn Meadow
Victor, NY 14564

Circle 227

I

Modem

Automatic Data Link (ADL) processor program processes ADL information on military data links to include Missile Battery Data Link (MBDL) and the classified Army Tactical Data Link One (ATDL-1) and Tactical Data Link-B (TADIL-B). ADL is processed and formatted for subsequent link and systems analysis.

Mr. R. Day
Intercon Systems Corp
P.O. Box 6024

El Paso, TX 79906

Circle 228

K

FOR/MAT

This screen editor has over 20 different commands for cursor positioning, text modification, tabs, relocating lines, spreading lines, and moving lines to other screens. Unit price is \$50.

Ron Huffman
KV33 Corp
P.O. Box 27246
Tucson, AZ 85726

Circle 229

L

Z-80 Development System

Complete program development system for Z-80 microcomputers including interpreter/compiler with virtual memory management, Z-80 and 8080 assemblers, line editor, screen editor, decompiler, utilities, and demonstration programs. 70 page user manual. Requires 32 kB RAM. CP/M 2.2 or MP/M 1.1 operating systems. Optional floating point arithmetic and cross-compiler packages also available at extra cost. Unit price is \$50.

Ray Duncan
Laboratory Microsystems
4147 Beethoven St.

Los Angeles, CA 90066

Circle 230

Operating System/Programming Language

This is the polyFORTH OS/language designed by FORTH Inc. but adapted and distributed by Lynx. It includes — an assembler, compiler, 2 levels of interpreter, virtual memory multitasking and debugger. Lynx supports CPUs not supported by FORTH Inc: TI 9900, DG NOVA and CAI-LSI-4 series. Unit price is \$4750.

Lynx
3301 Ocean Park Blvd, Suite 207
Santa Monica, CA 90405 *Circle 231*

M

Custom Medical Software

Clinical (not bookkeeping, billing, or accounting) record keeping.

William J. Schenker, M.D.
Medical Information Systems
2086 Essenay Avenue
Walnut Creek, CA 94596 *Circle 232*

MicroMotion FORTH-79

The only commercially available Apple II implementation of the new (Oct. 1980) international FORTH standard. Tutorial manual included. MicroMotion FORTH-79 includes a full screen editor, 6502 macro assembler and CORES graphics routines. Unit price is \$89.95 (qty discounts available).

MicroMotion
12077 Wilshire Blvd, Suite 506D
Los Angeles, CA 90025 *Circle 233*

Engineering Services

Hardware and software engineering services for μ P-based products. Complete facilities, including a universal development system with in-circuit emulation. Extensive FORTH library optimized for real-time applications: multitasking, I/O, floating point math, etc.

FORTH Real-Time OS

Efficient, stand-alone multitasking and I/O control system for time-critical, interrupt intensive applications. Supports code and high level tasks as well as multibuffered, interrupt-driven I/O for character and block devices. Drivers are table controlled and all run time code is in assembly language. Unit price is \$1750.

FORTH Compiler

ProFORTH for the Tektronix 8002, a powerful superset of FORTH-79 for the professional. Compiles ROMable code in place, even in a discontinuous memory configuration. Code, dictionary, and RAM areas can be separated as initially compiled. Multiple dictionaries with selective purging enable development of large applications on line. Unit price is \$2250.

Robert H. Hertel
Microsystems, Inc.
2500 E. Foothill Blvd., Suite 102
Pasadena, CA 91107 *Circle 234*

N

Nautilus System fig-FORTH Cross-Compiler

Cross-compiler the fig model or extension for ROMable, headerless code. Forward reference capability. Includes source of cross-compiler, 107-page document in 3-ring binder. Sold with single CPU license, no royalties claimed on anything cross-compiled. Machine readable versions CP/M, TRS-80, Z89 & Northstar. Unit price is \$200; \$150 after first order.

Jerry Boutelle
Nautilus Systems
P.O. Box 1098
Santa Cruz, CA 95061 *Circle 235*

SPICE for DEC Falcon

For DEC's KXT11 (Falcon) SBC, SPICE combines an operating system, high-level programming language, assembler, file system, and multitasking executive. It is designed specifically for system integration and controller applications and offers direct access to the machine's resources, making it ideally suited to hardware familiarization and debugging. By supporting mixed high-level and assembler code, critical routines can execute at full processor speed. While inspired by FORTH, SPICE offers the following advantages: is inherently ROMable; implements a consistent syntax; is user oriented in its messages; is modular and easily expanded; supports a full set of control structures; uses standard assembler notations; includes a set of primitives for process

control; greatly simplifies control of interrupts; includes a full multitasking executive; and, its file system is compatible with popular μ Ps. Implementations include PDP-11 family, Zilog Z80 and Z8000, Motorola 6809 and TI 9900. Single user Class A support starts at \$750.

Nortek Inc.
2432 NW Johnson St.
Portland, OR 97210 *Circle 249*

O

fig-FORTH for NOVA

The fig-FORTH model implemented for NOVA line computers. Supplied on a hard sectored diskette. An assembly listing file which can be assembled by Macro-Assembler and an assembled save file which can run standalone. Supplied with the source listing. Unit price is \$50.

Systems Guide To fig-FORTH

This book explains how's and why's of the fig-FORTH system, based on source codes of the fig-FORTH Model. 14 chapters on: language definition of FORTH; fig-FORTH: an operating system; text interpreter; address interpreter; compiler; error handling; terminal input and output; numeric conversions; dictionary; virtual memory; defining words and the code field; control structures and immediate words; editor; and assembler. Unit price is \$25 plus postage; qty discounts available.

Dr. C. H. Ting
Offete Enterprises, Inc
1306 S "B" St.,
San Mateo, CA 94402 *Circle 236*

P

FORTH Language and Utilities for the PDP-11

FORTH for the LSI-11 and other PDP-11 systems using the RT-11 operating system. Features include: a video screen editor, PDP-11 assembler, 8080 cross assembler, RT-11 system calls, interface to external program modules, floating point math, string operations, and extended program control structures, debugging tools, and other util-

A
B
C
D
E
F
G
H
I
J
K
L
M
N
O
P
Q
R
S
T
U
V
W
X
Y
Z

A
B
C
D
E
F
G
H
I
J
K
L
M
N
O
P
Q
R
S
T
U
V
W
X
Y
Z

ities. Unit price is \$495.

Peter Bates
Pacific Digital Associates
3308 E. Laurel Ln.
Phoenix, AZ 85028 *Circle 237*

FORTH Dialect for OASIS or CP/M OS

FIFTH is a FORTH style programming system with several major extensions including overlays and an extension of the FORTH compiler concept to give the user additional control of the system. FIFTH programs are ROMable. This feature, along with several cross-compilers (8080, Z80, 8048), makes FIFTH an ideal μ P development system.

Pacific Polytechnical Corp
P.O. Box 2780
Santa Cruz, CA 95063 *Circle 238*

fig-FORTH for Atari 800/400

pns-FORTH Version 1.3 (Minimum System) features: full screen (40 x 24) direct cursor control editor; standard fig tool words; relocatable disk buffers; keyboard filter (to reduce operator error); UN: compiler. System required is 16Kbytes RAM & at least 1 disk drive. Documentation supplied consists of: glossary of fig and extension words; source screens; equates; English description of commands. Unit price is \$50; qty discounts available.

pns-FORTH 1.3 With I/O Extensions

Features: pns-FORTH Minimum System plus: extension to provide hooks to Atari central I/O system for all resident device handlers; a complete player-missile (object oriented) graphic system is provided, in addition to bit-map graphics. Other modules include light pen interfacing and animated character displays. Extra documentation includes source & glossary. Unit price is \$70; qty discounts available.

pns-FORTH 1.4

Cross-compileable source screens for any 6502 μ P system. Produces headerless, ROMable code for any address space. Unit price is \$150.

Robert Gonsalves
Pink Noise Studios
1411 Center St.
Oakland, CA 94607 *Circle 239*

Custom Machine Control SW

Z-80 or 650X FORTH software for control of high-speed industrial machines and equipment. Light machinery control software includes the control of: four and five phase stepper motors, solenoids, industrial actuators, opto-electronic sensors, keyboards, displays etc.

William Reed
Polyarts Associated, Inc.
P.O. Box 23122
Seattle, WA 98111 *Circle 240*

Standard fig-FORTH for the Alpha Micro

This fig-FORTH (FORTH Interest Group) product is aligned with the 1978 standard of the FORTH International Standards Team and allows complete access to Alpha Microsystems' multi-tasking operating systems, AMOS. μ A/FORTH implements full-length names up to 31 characters, extensively checks code at compile-time with error reporting, contains string-handling routines and a string-search editor, and permits sealed vocabularies to control user access. Included is a FORTH assembler, permitting structured, interactive development of device handlers, speed-critical routines, and linkage to operating systems or to packages written in other languages. The distribution disk is in single density format, and includes all source code. The diskette includes an editor, a FORTH assembler, and string package in FORTH source code. Unit price is \$130.

Going FORTH

This computer aided instruction course by Creative Solutions, Inc. is intended to interactively guide the beginning FORTH user through initial terminal sessions. Over 100 frames of step-by-step instructions and clear examples are provided on the primary concepts of FORTH. Structured programming techniques are incorporated throughout the program development stages and a typical FORTH Text Editor is introduced. On diskette; license agreement required. Unit price is \$45, \$20 when purchased with μ A/FORTH.

Howard J. Dernehl
Professional Management Services
724 Arastradero Rd. #109
Palo Alto, CA 94306 *Circle 241*

Q

Q S FORTH

Fig-FORTH implemented on the Atari 800 Personal Computer; a disk based system. Five modules are included: the FORTH kernel, an EXTENSION that includes some additional useful words, an on-screen EDITOR, and an I/O module that makes I/O easy to set up. Unit price is \$79.95.

FORTH for the Sorcerer

Fig-FORTH implemented on the Exidy Sorcerer. Cassette storage plus simulated disk memory in RAM. Custom features added to fig-FORTH include an on-screen EDITOR, a serial RS-232 driver, cassette interface words, and option for 8-bit I/O to allow video graphics with the Sorcerer. Unit price is \$59.95.

Sandra Pierce
Quality Software
6660 Reseda Blvd., Suite 105
Reseda, CA 91335 *Circle 242*

R

6502 FORTH 2.0

A floating point math vocabulary with transcendental functions, a string handling vocabulary similar to BASIC, and a 6502 assembler with Macro defining capability are among the more notable features of 6502 FORTH 2.0. The language is available in versions which run on the KIM-1, AIM 65, and SYM-1 microcomputers (custom and EPROM version can be configured). Package includes a complete source listing, a user manual and the object code on cassette. \$90.

Brenda Rehnke
Eric C. Rehnke, Technical Services
1067 Jadestone Lane
Corona, CA 91720 *Circle 243*

S

AM-FORTH

AM-FORTH is an implementation of

the FORTH programming language and system on the Alpha Micro computer. Operating under the Alpha Micro Operating System (AMOS), it provides all the usual features of FORTH: interpreter, compiler, assembler, and disk file structure. Utility functions are also provided for a video and line editor, string operations, data structures, and floating point math. AM-FORTH is closely integrated in the AMOS environment: the program is re-entrant, allowing one copy to be loaded into AMOS system memory and shared by all users on the multi-user Alpha Micro system; AM-FORTH memory expands and contracts as needed to accommodate the FORTH dictionary; I/O is provided to AMOS random and sequential files; access to AMOS TIME, DATE, and special CRT functions is included. Complete implementation documentation is provided in the "Installation and User's Manual". AM-FORTH is delivered on an AMS or STD format disk including source code. Unit price is \$150.

Sierra Computer Co.
617 Mark NE
Albuquerque, NM 87123 *Circle 244*

T

tFORTH+ and firmFORTH

tFORTH+ is an extension of standard fig-FORTH for 6800 and 6809 μ P systems. Supplied on FLEX operating system diskettes (other arrangements possible), firmFORTH is a target compiler for making ROMable code of minimal size; requires tFORTH+. Screen editor and assembler and large collection of useful FORTH utilities supplied. Unit price, tFORTH+ — \$250; firmFORTH — \$350. Qty discounts available.

Raymond Talbot
Talbot Microsystems
5030 Kensington Way
Riverside, CA 92507 *Circle 245*

Custom Product Development/Manufacturing/Support

Development of FORTH Applications & hardware for real-time control. In-house support for LSI-11 & Apple. Expertise in single chip processors such as MCS-48 & 3870. Also experienced in 8080, 8085, & 6100 hardware &

software. Examples of previous products: Telephone call restrictors, specialized keyboard data entry/retrieval systems, thermal printers, RS232 data routing systems, printing press monitors, 1000 channel multiplexors, & traffic controllers. Also complete documentation & manufacturing facilities.

Robert F. Downs
Technology Management Inc/
Development Associates
1520 S. Lyon
Santa Ana, CA 92705 *Circle 246*

OSI-FORTH 2.0/fig-FORTH 1.1

This is a full implementation of the FORTH Interest Group Version 1.1 of FORTH. It runs under OS-65D3.2 (or 3.0, 3.1), on any disk-based Ohio Scientific system, and has access to all DOS commands and resources. Includes resident text editor, assembler, and utility screens for transferring the system to a new disk, initializing library and system disk block storage tracks, copying screens from disk to disk, and reconfiguring the system memory usage. Price is \$79.95.

Daniel B. Caton
Technical Products Co.
P.O. Box 12983
Gainesville, FL 32604 *Circle 247*

Language and Software Development System

An interactive software development system which incorporates a command processor, compiler, editor and assembler, all memory resident. Programming creates new commands which become available as sub-routines for subsequent commands. Product is based on figFORTH and further includes interleaved disk format that minimizes the time required for disk access, providing very fast disk I/O. Unit price is \$95 (if other than 8" disk, add \$15).

FORTH Development System

Same as above, but further includes: visual (screen) editor, machine coded array handling, very fast disk I/O, configurable to memory size, creates turn key applications, and CP/M file conversion & system calls. Unit price is \$235 (if other than 8" std. disk, add \$15).

ROMable FORTH

A complete interactive FORTH soft-

ware development system; products go into 8K or more of ROM, with 1K scratchpad RAM. It incorporates a command processor, compiler, editor and assembler, all memory resident. Programming creates new commands which become available as sub-routines for subsequent commands. Product is based upon figFORTH and further includes: visual (screen) editor, machine coded array handling, very fast disk I/O, configurable to memory size, creates turn-key applications, and CP/M file conversion & system calls. Unit price is \$350 (if other than 8" disk, add \$15.)

CP/M Utility Package

Converts CP/M files into FORTH screens and vice versa, either text format or binary image format. Loads (interprets) FORTH source from CP/M file enabling CP/M editor to create FORTH programs. Allows two way interchange between RAM and CP/M file; FORTH CP/M system calls, and creation of file control blocks. Code is well-documented, enabling user modification. Unit price is \$50.

FORTH User Manual & Tutorial

The FORTH user manual and tutorial is designed to be used at the terminal while FORTH is running. It leads the user through commands and computer responses. Price credits towards disk purchase. Unit price is \$20 (free with Timin FORTH purchase).

Diskette of FORTH Application Modules

Variety package of FORTH software; contains development tools, math routines, I/O routines, recursive examples, etc. Something for every FORTH user. Unit price is \$75.

Floating Point FORTH Vocabulary

Works with decimal numbers. Retains the 16-bit & 32-bit integer capability of figFORTH while adding a floating point mode. These are single precision floating point numbers with seven significant digits. All basic arithmetic functions, integer conversion and comparison are supported. Run time error messages warn of exceptional conditions. Unit price is \$100.

John H. Holmes
Timin Engineering Co
9575 Genesee Ave., Suite E2
San Diego, CA 92121 *Circle 248*

A
B
C
D
E
F
G
H
I
J
K
L
M
N
O
P
Q
R
S
T
U
V
W
X
Y
Z

Designers' Guide To Noise Suppression

*ignore noise suppression and grounding
rules at your peril*

Failure to follow proper noise suppression and grounding rules is leading to increasing problems for computer system designers. It is a growing problem due to systems that are more EMI-susceptible, unsophisticated users, increased number of computer systems.

by J. F. Kalbach

Inadequate noise suppression can damage your firm — perhaps even put it out of business. One large firm that used a second-sourced μ C chip that required extra care in noise suppression found its reputation tarnished after it had to wait for the installed subsystems to fail. The alternative was unthinkable: a massive recall. Other firms have run into worse problems.

Man-made noise currents and voltages arise from static as well as operation of power lines, electrical loads, telephones, radio, TV and radar. Since electrical resistance between two ground points is never zero, a broad frequency spectrum of electrical noise exists between any two earthed conductors. Although voltage can be reduced by connecting a conductor between them, the noise current which flows can induce a related voltage and/or current in nearby ungrounded circuits. If the interconnecting conductor is the grounded conductor of a signal pair or the outer conductor of a coaxial conductor, the noise will be mixed with the signal and possibly corrupt the transmitted intelligence.

This article will discuss measures that you should take to prevent your next system from falling victim to inadequate grounding and noise suppression.

installation of electronic equipment

In the interest of achieving high-signal processing rates, compact hardware and low energy requirements, electronic circuits and circuit elements are continuing a trend to very low energy signals at very high bit rates, typically greater than 10 Mbps. Frequency content of the output of signal drivers and ability of receivers to respond may be in the 30 to 100 MHz range or greater — in a frequency spectrum where wavelengths are shorter than many interconnecting cables. The behavior of conductors at such frequencies must be predicted on the basis of radio technology rather than power or voice frequency telephone circuits.

Manufacturers of computer and digital controller products will usually specify grounding techniques and arrangements to be used in their installations. Most of these are based upon legitimate engineering and physics principles. However, more often than not, these are followed by rote rather than through any basic understanding of the phenomena being

controlled. The problems and solutions can be complex.

Even if the manufacturer's grounding rules are followed, electrical noise can still be a problem which only a grounding specialist can identify and resolve. All the answers cannot be foreseen. However, a few basic explanations should help those involved with the installation and use of computer-type circuits and their grounding systems.

The overall noise problem is as follows:

- Overly sensitive electronic circuits may be in a highly disturbed environment.
- Disturbances may be externally or self induced.
- Interfering signals and circuit susceptibility may cover an extremely broad frequency spectrum (d-c to gigahertz).
- Symptoms may be intermittent. Interaction between randomly occurring noise impulses and the specific moments when signal circuits are enabled and are at their most susceptible phase has a low statistical probability of occurrence. Noise pulses capable of creating malfunctions will not always do so.
- Electrical noise, marginally defective components and software bugs can all create similar malfunctions, making it difficult to distinguish between various possible causes of signal or data corruption.

The three basic approaches to solving these noise problems are:

- Eliminating or reducing the noise at its source.
- Reducing the disturbed circuit's susceptibility.
- Reducing the intercoupling between noise source and disturbed circuit.

grounding functions

Grounding is a very important part of each of the above solutions. Although grounding accomplishes multiple functions, many an individual is concerned with only one and may violate the other requirements out of ignorance or because it is not his concern.

Safety considerations must take precedence whenever there is a conflict of interest. However, the task to be accomplished is to make the product installation safe and at

J.F. Kalbach is a consultant and is a recognized authority on noise suppression techniques. He can be reached at, 920 Alta Pine Drive, Altadena, CA 91001.



When was the last time you dramatically improved your printer's performance?

Today's measure of a printer's performance goes beyond line speed and purchase price. The true test is print quality and cost-per-character operating expense. Porelon ink rolls, designed specifically for impact printer ribbon cartridges, will dramatically improve the number of quality

impressions and greatly increase the life of every ribbon.

Better impressions, increased ribbon life. At less cost. That's what you'll get

every time you design a ribbon cartridge featuring Porelon ink rolls.

Find out how simple it is to add this performance feature to your impact printers. For further information, call 615/432-4134, or write: Porelon, Inc., 1480 Gould Drive, Cookeville, Tennessee 38501.

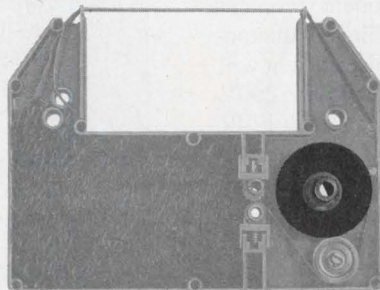

YOUR LAST IMPRESSION IS WHERE WE BEGIN

Circle 10 on Reader Inquiry Card

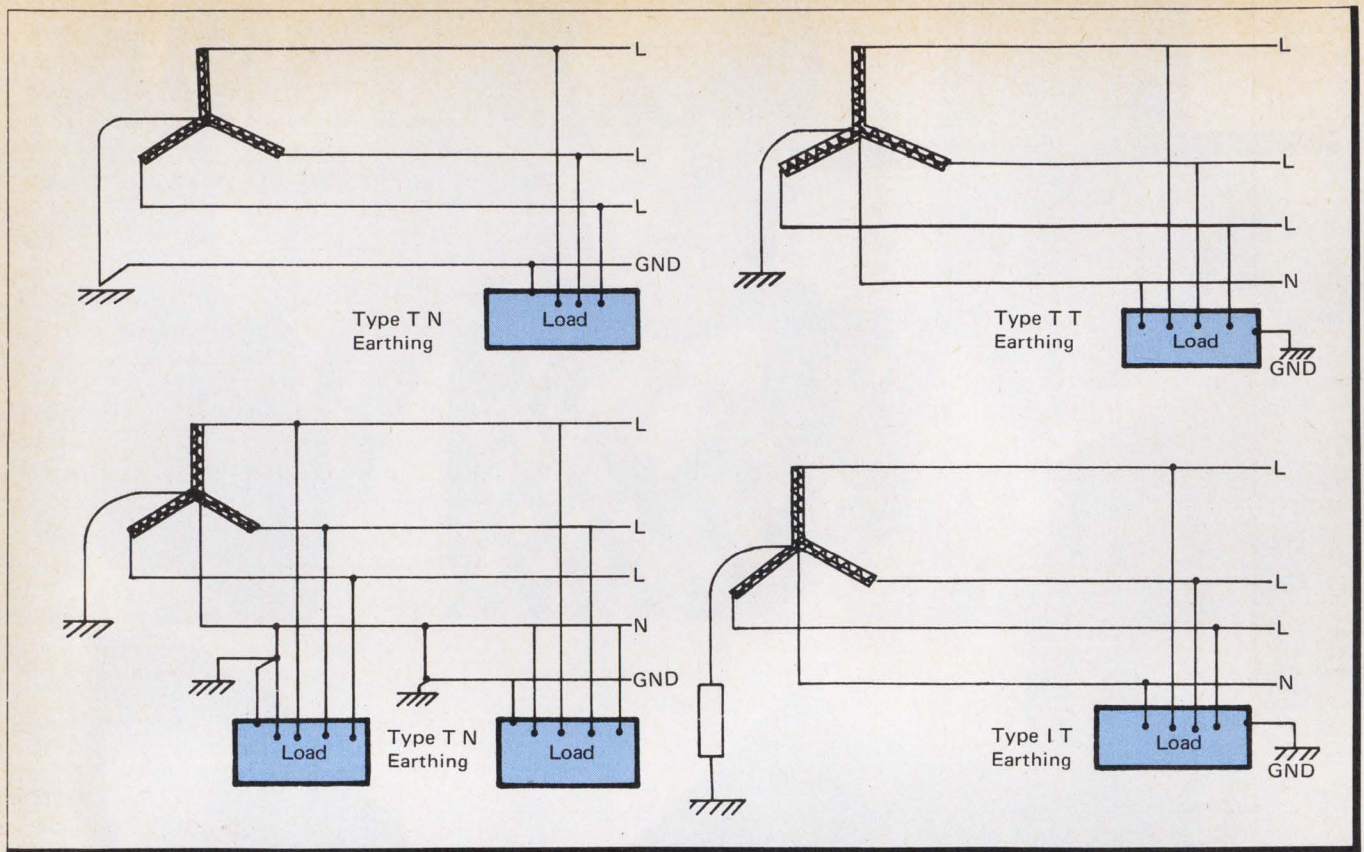

Figure 1: European classifications of systems for grounding show the TN, TT and IT earthing types. (From ECMA/TC12/775/52).

the same time satisfy all practical noise emission and susceptibility requirements.

The basic purposes of grounding are:

Safety: touch voltage limitation. Equipment ground conductors which connect the frames of products to ground and to each other are intended to limit touch voltages to safe values in the event of insulation or component failure within the product or in the conductors which supply power. Except during a fault to ground and until protective circuit elements interrupt power from the source, the voltage difference between both ends of an equipment ground conductor should ordinarily never exceed a fraction of a volt at power frequencies. The conduit and the grounding conductor are not intended to carry any portion of load current. They are to carry only fault currents, leakage currents and noise currents.

At power frequencies, 30V RMS is commonly specified as an upper limit for "safe" voltages. A momentary excursion above this during the time it takes for a fuse or circuit breaker to clear a fault is not considered a significant hazard.

At higher frequencies and impulses, the human body can tolerate much higher voltages and currents than at power frequencies. This is fortunate because as frequency content increases, the inductive impedance of grounding conductors and the voltage drop for a given leakage or noise current will also increase. Noise impulse voltage signals of 150 to 200V appear regularly on ground conductors associated with 120V circuits. However, their duration is usually measured in μ secs and they cannot normally be detected by touch.

Safety: ground fault return path. Any fault or leakage between an ungrounded conductor and a grounded enclosure will produce fault current. The leakage current may be harmlessly drained away, but a short circuit current must be promptly terminated by protective fuses or circuit breakers. If the same devices which protect against line-to-line or line-to-neutral faults are to protect against line-to-ground

Complying with FCC

The FCC recently promulgated acceptable limits of EMI-induced field strength at specific frequencies and distances from a radiating electronic device. These limits are shown below for compliance of Class A products and certification of Class B products; and the FCC promises strict enforcement. The FCC's acceptable limits of field strength are as follows.

Class A devices — At a distance of e meters

frequency	acceptable field strength
30 - 88 MHz	300 μ V/m
88 - 216 MHz	500 μ V/m
216 - 1000 MHz	700 μ V/m

Class B devices — At a distance of 3 meters

frequency	acceptable field strength
30 - 88 MHz	100 μ V/m
88 - 216 MHz	150 μ V/m
216 - 1000 MHz	200 μ V/m

Verification of Class A devices requires testing to insure prescribed limits of EMI radiation. The FCC requires the manufacturer to retain test data on file for the agency's review. Certification of Class B devices requires that test data, and upon request the product itself, be submitted to the FCC for approval. Certification follows approval.

Class A devices are those intended for use in "commercial, industrial or business environments." Specific examples include computers and peripherals, digital cash registers and electronic typewriters. Less likely to cause interference because of the "friendly" industrial environment, Class A devices must comply with generally lenient standards.

faults, the ground return path must not have a high enough impedance to limit the fault current. Otherwise, it would not promptly trip the protective device.

This requirement dictates that the electrically continuous conduit and equipment ground conductor be connected directly to the neutral of the power source at or very near its origin. This is at a secondary of a transformer, output of a motor-generator, or at the building entrance service equipment if no isolating transformer is interposed.

In the above connection between conduit or enclosure and neutral, fault current does not flow through a separate connection between the enclosure and a driven earth or other qualified ground connection — at least not from faults to enclosures. If an arrangement of grounding were to be used where fault currents had to pass through two driven earth stakes or rods, the resistance of these grounds would prevent many circuit breakers from tripping. A very low ground resistance for a driven ground might be 5 ohms (25 ohms is often acceptable). Two in series would be 10 ohms. In a 120 V circuit the 10 ohms of resistance in series with a ground fault would allow 12 A to flow. This is not enough current to trip the lowest circuit breaker rating in common use, namely a 15 A breaker.

To insure prompt operation, a circuit breaker must see 10 times its rated current protection or more. Ground path resistance between the fault point and connection to neutral plus all other circuit resistance cannot exceed 0.8 ohms for a 15 A circuit. For a 150 A circuit, this would be 0.08 ohms max. It is clear that driven grounding rods cannot meet this requirement, but direct connections can.

It should be pointed out that the grounded neutral protection system is not universally used throughout the world. In Europe, especially France, there is a system called an "IT" system where the power source neutral is allowed to float or is connected to ground through a high impedance. A line to ground fault creates no problem until there is another fault on another line or on the neutral to ground. A high neutral to ground voltage indicates the presence of a ground fault and can be made to actuate a shunt trip. Alternatively, current summing ground fault detectors can identify which branch circuit is at fault and selectively trip the proper circuit breaker.

Still another scheme is the "TT" system where power source and load are each independently grounded through their own respective driven earth grounds. As previously explained, a ground fault would not necessarily create sufficient fault current to ensure operation of the protective fuse or overload circuit breaker. A summing type ground fault detector would sense the fault, however.

The predominant type of grounding in Europe and United Kingdom is the "TN" system. Like that used predominantly in the US and Canada, this signifies a grounded power source with the frame of the load grounded directly through a separate safety ground conductor to the neutral at the power source.

Zero potential reference and voltage equalization. Connecting the frames of all parts of a system to a common point which is grounded is intended to bring them all to the same potential. This is supposed to eliminate voltage differences between various grounded parts in the system.

EMI Requirements

Class B devices, intended for use in a "residential environment", include personal computers, electronic games and calculators. The relatively "hostile" home environment with its greater opportunity for interference requires certification by the FCC to more stringent regulations.

Chomerics Radiation Test Services operates two facilities in its laboratory: a 1700 ft² indoor anechoic, three-meter test site; and an open field, 10-meter test site. Both are equipped with tunable dipole, biconical and log periodic antennas providing reception capability from 20 to 1000 MHz. Some of the measuring instruments available to the two sites include receivers for radiated measurements at frequencies of 30 to 1000 MHz, panoramic display systems, automated signal charting devices, spectrum display analyzers and calibration equipment.

Solving excessive EMI radiation problems is the end goal for which testing is but one key element. A broad problem-solving capability, such as at Chomerics, is needed, as the following example shows. This example deals with unacceptably high EMI emissions from remote typesetting terminals connected in two places by coaxial cables to a central electronic processing unit. The system handles information and generates, as a video output, high-speed graphics. The terminal comes equipped with a high-speed, μ P-based keyboard.

Initial radiation tests showed significant emanations from 50 to 250 MHz. Signals near to or exceeding the limits occurred at six places. Counting the repetition frequency of the resident line pattern indicated that these signals were closely related to the video content of the graphics screen. Without the graphics cable

attached to the terminal, little radiation was measured; with the cable attached, large amounts of radiation were detected whether or not the terminal power was on.

Modifying the terminal so that the shielding provided by the graphics coaxial cable would be maintained when it was connected to the terminal was indicated. The original design failed to recognize the importance of making frequent contact between the various metal chassis parts. Before assembly, the parts were either dipped or anodized, essentially insulating one from the other. Consequently, they failed to make good contact at RF frequencies, which is essential for shielding. To bring the terminal unit into compliance, the following modifications were made:

1. Paint at the screw holes was removed to allow contact between the chassis bottom, middle and side sections.
2. The anodized oxide coating and paint were removed at points of contact between the cabinet shroud and chassis. Placing a copper filled elastomer at these interfaces provided a conductive, slightly compressible gasket.
3. The video connectors, which had been mounted on insulating washers, were grounded to the chassis at the point of entry to the terminal.
4. Because they were picking up fields inside the terminal and reradiating them outside, all five keyboard leads were bypassed to the chassis at the point of exit with 100-pF disk capacitors.
5. Chomerics conductive shielding paint was applied to the cabinet's plastic shroud.

Iterative tests showed the unit's emission to be well under FCC and VDE limits from 30 MHz to 1000 MHz.

Chomerics, 77 Dragon Court, Woburn, MA 01888.

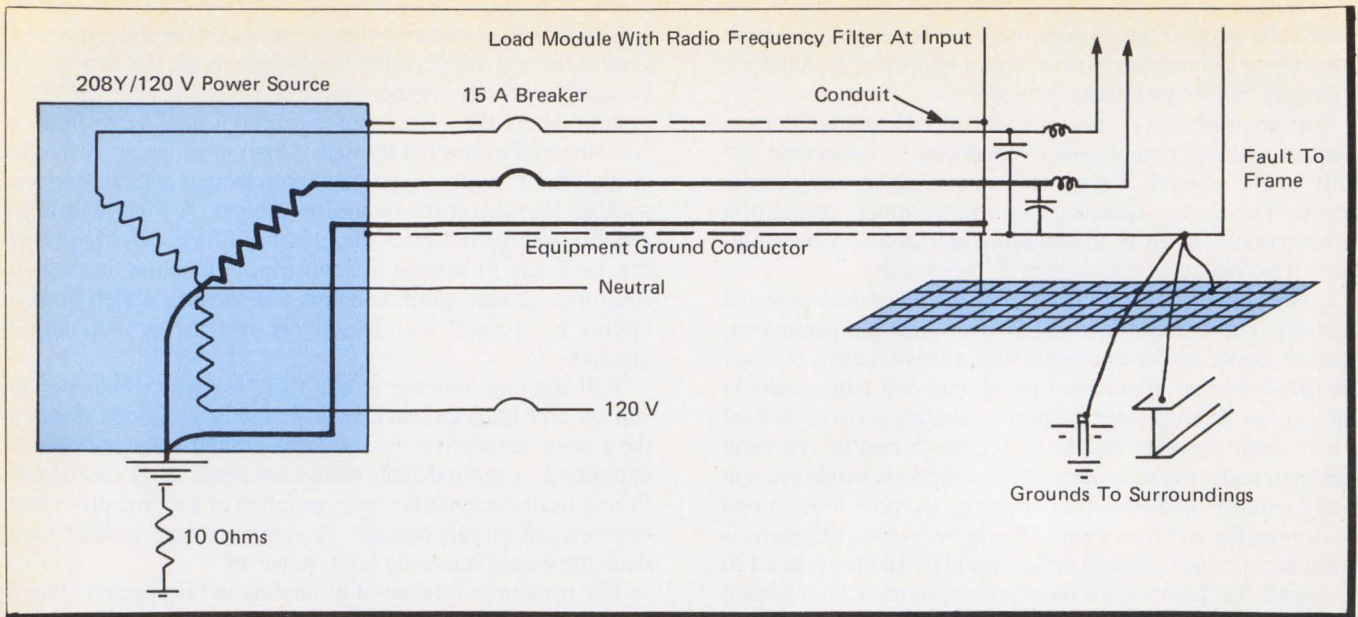

Figure 2: Equipment ground conductor and conduit are for safety circuit breaker trips fault current. Earth grounds are not involved in fault current path.

If some were connected to one ground rod and others connected to a separate ground rod, the noise which can be expected between the two rods will create noise currents and voltages in the computer system and its interconnecting data cables. It creates a ground loop.

Even if all ground conductors come together at one point which in turn is connected to a single earth ground rod, the high impedance at high frequencies of long conductors can interfere with the ground potential equalization which is desired. Noise currents which flow and which create voltage drops in ground conductors often originate in the computer or controller circuits (self generated) or may be capacitively or inductively coupled from nearby interference sources.

The maximum length of a wire which can effectively equalize voltage differences between its extremities is 1/10th to 1/20th of a wavelength. At high frequencies, travelling waves of voltage and current reflect from the extremities. At specific frequencies, resonances occur where successive voltage waves coincide with the reflection of the previous waves. At resonance, the impedance of the conductor appears to become very high and approaches infinity except for losses in the conductor and through electromagnetic radiation as a radio antenna. At partial resonance, the impedance becomes too high to be an effective conductor for voltage equalizing purposes.

Note that a resonant conductor will not only radiate energy, but can also receive energy from nearby sources which emit at the same resonant frequency. A nearby taxi radio transmitter, for example, may induce as much as several hundred volts into a conductor of the proper length and orientation. If this is intended to serve as a voltage equalizing conductor, it may do so only at low frequencies and at a few discrete high frequencies which represent "anti-resonance."

More will be said about improvements to ground potential equalizing conductors under the description of transmission and suppression principles.

Shielding. Grounded metallic enclosures, conduits and flexible metal wire braid surrounding conductors and electronic components shield them from external fields. Shielding effectiveness varies with frequency, metal thickness, conductivity and above all, geometry of the system.

Technical details of techniques and their effectiveness are beyond the scope of this description. It is a highly technical and complex subject on which books have been written and special seminars offered. There are military specifications in great detail.

Shielding performs its function in at least three major modes. First, it serves as a terminal for electrostatic coupling with another conducting body at a different potential. When interposed between the external body and the circuits which it protects, the a-c currents induced through the stray capacitance into the shield flow through the shield rather than through the protected circuits. This is effective at intermediate and low frequencies. At high frequencies where the shield itself may resonate or where cracks or openings in the enclosure admit specific noise frequencies, the problem requires special treatment.

Second, electromagnetic alternating fields induce currents in any conducting material. The induced currents are created in such a pattern as to try to neutralize the magnetic field which created them. Eddy current shielding depends on high conductivity provided by such metals as copper, aluminum and silver, and on thickness. Steel has much lower conductivity, but can usually provide ample thickness.

Third, magnetic fields can be steered around circuits by magnetic materials in the form of shields: electrical steel, permalloy, ferrite.

Shielding through eddy currents and magnetic properties does not depend upon grounding, but are traditionally grounded to avoid shock hazard and to simultaneously take advantage of electrostatic shielding properties of the material selected.

noise transmission and suppression principles

In describing the four basic functions of grounding, a number of basic principles and their applications have already been described. However these do not fully explain how high frequency noise can pass through or around grounded and shielded parts of systems.

A voltage impulse applied to one end or, as a matter of fact, anywhere on a conductor, cannot reach the other end instantly. Depending upon the geometry and the insulation dielectric between the conductor and the return path, elec-

trostatic fields and magnetic fields are created as the voltage wave moves toward the receiving end(s).

The energy in this voltage impulse wave does not exist in the conductor. The energy exists completely outside in the space between and around the conductor and its return path. It exists in the form of electrostatic fields between the conductors and magnetic fields around them.

Instead of energy flowing through the wires, a physicist will rightfully proclaim that the wires merely guide the field. Moreover, there is no such thing as current flowing through a conductor into a ground rod without a return path somewhere. All electricity flows in complete circuits. To be specific, if noise current is being detected in a ground conductor attached to a ground rod, whatever is flowing into the ground is returning somewhere else. Sometimes it is useful to find out what that "somewhere else" is. The magnetic field and capacitive field which contain the signal energy or noise energy are the result of current in a conductor and its return path.

Because conductor paths have distributed inductance and stray capacitance, these govern the propagation velocity of a traveling voltage and current wave. Typical velocities are 0.5 to 0.9 the speed of light, about 6-10 in./ns (500 to 850 ft./ μ s).

These may seem of academic interest only until one realizes that computer and controller circuits typically operate at 10 Mbits/sec or greater. If the frequency of the signal were only 10 MHz, the velocity of wave propagation would carry it typically only 85' during one complete cycle of the alternating voltage. As mentioned before, resonance effects of reflected waves affect the ability of a conductor to carry current without having it returned. To be effective as voltage difference equalizers, ground conductors carrying 10 MHz noise signals should be no longer than 1/10th or 1/20th of a wavelength, or no longer than 8.5' to 4.5'. If and when

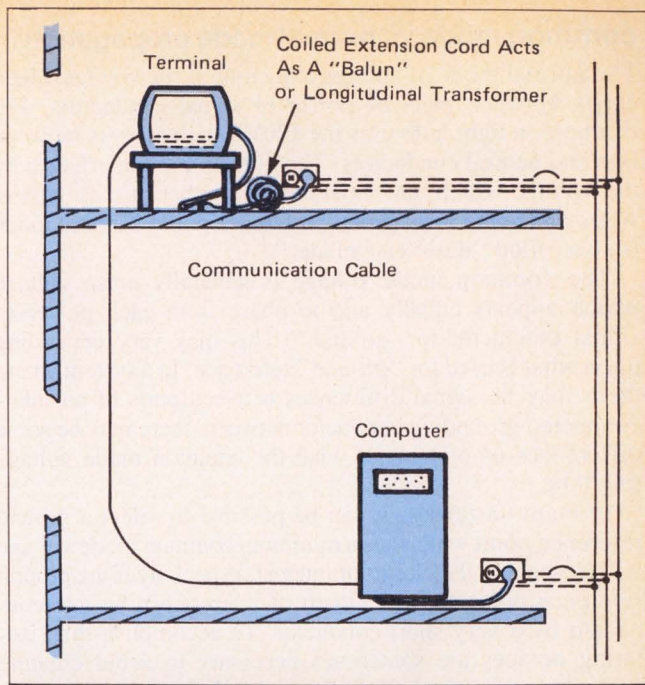

Figure 3: Common mode ground noise current can be reduced by the inductance of a coiled cord.

exceeded, the effectiveness of the conductor for equalizing voltage differences disappears. However, the conductor will still provide the safety functions of limiting touch voltage and enabling ground fault protection to perform properly.

In practice, traveling waves are difficult to absorb; unless impedances are carefully matched to that of the transmission characteristics of the conductors at their termination, the energy will be reflected or diverted. In the general case, there will be some absorption and some reflected or diverted energy.

Grounding and Noise Terminology

The IEEE Standard Dictionary of Electrical and Electronic Terms gives more than four pages of definitions devoted to grounding. A few of the many which are relevant to this discussion are as follows:

Ground (earth)

1. electric system: A conducting connection, whether intentional or accidental, by which an electric circuit or equipment is connected to earth, or to some conducting body of relatively large extent that serves in place of the earth. *Note:* It is used for establishing and maintaining the potential of the earth (or the conducting body) or approximately that potential, on conductors connected to it, and for conducting ground current to and from the earth (or the conducting body).
2. transmission path:

A. A direct conducting connection to the earth or body of water that is a part thereof.

B. A conducting connection to a structure that serves a function similar to that of an earth ground (that is, a structure such as a frame of an air, space or land vehicle that is not connected to earth).

Ground bus (electrical system)

A bus to which the grounds from individual pieces of equipment are connected, and that, in turn, is connected to ground at one or more points. *See:* ground.

Ground plane

1. transmission and distribution: An assumed plane of true ground or zero potential. *See also:* direct stroke protection.
2. electromagnetic compatibility: A conducting surface or plate used as a common reference point for circuit returns and electric or signal potentials.
3. antenna: A conducting or reflecting plane functioning to image a radiating structure. *Syn:* imaging plane.

Some of the noise definitions are also relevant here:

Electrical noise (control systems)

Unwanted electrical signals, which produce undesirable effects in the circuits of control systems in which they occur.

Noise

1. general: Unwanted disturbances superimposed upon a useful signal that tend to obscure its information content.
2. general: An undesired disturbance within the useful frequency band. *Note:* Undesired disturbances within the useful frequency band produced by other services may be called interference.

common mode vs normal mode propagation

The normal mode of voltage utilization is the voltage which exists between pairs of power or signal conductors. For example, a light bulb uses the 120V which appears between line and neutral conductors. The light bulb is not affected by the voltage which may exist between either of these power wires and some local ground reference point. Normal mode is also called "transverse mode."

The common mode voltage is generally noise voltage which appears equally and in phase from each power or signal conductor to "ground." This may vary depending upon what is used for "ground" reference. In a system where there may be signal differences between parts of an interconnected grounding conductor network, there may be some differences of opinion of what the common mode voltage might be.

In many instances, it can be possible to select a ground reference point which has a minimum common mode voltage with respect to the circuit of interest, especially if the ground reference point and the circuit of interest can be interconnected by a very short conductor. To accomplish this, isolating devices are sometimes necessary to avoid creating paths for noise currents to flow and electromagnetic fields around those paths which can couple into sensitive circuits.

Common mode noise may be caused by one or more of the following:

- Electrostatic induction. With equal capacitance between each of the signal wires and surroundings, the noise voltages and currents developed will be the same on both signal wires.
- Electromagnetic induction. With magnetic fields linking both wires equally, the noise signals developed in each wire will be the same.

In practice, there is rarely a pure, perfectly balanced common mode noise or signal. There is more often a component of common mode and another component of normal mode noise or signal. Unless circuits are extraordinarily well-balanced, one will convert some of its energy to the other mode.

A frequent source of combined mode and normal mode noise is the result of momentary impulse voltage differences between parts of a system which have different ground references. If the two systems are interconnected by a signal path in which one of the conductors is grounded at each end, the ground offset voltage impulse will create a current in the grounded conductor. As this current propagates, its distributed inductance and capacitance induces a similar voltage in the closely coupled return wire.

A longitudinal transformer called a "balun" can absorb the voltage difference and reduce the longitudinal current considerably while preserving the normal mode signal relationships between wire pairs and between each of the pair and a shield.

When interconnecting signal cables between systems having different ground references are very short, one balun between them may be sufficient. If the distances become longer such that the capacitance between the conductors or their shield and surroundings becomes significant, a balun at each end becomes appropriate. For still longer cables where the surroundings may not always be at the same potential, multiple baluns may be required.

grounding and noise control guidelines

Here are some applications of basic principles to corrective measures:

- Comply with safety code requirements: safety first.

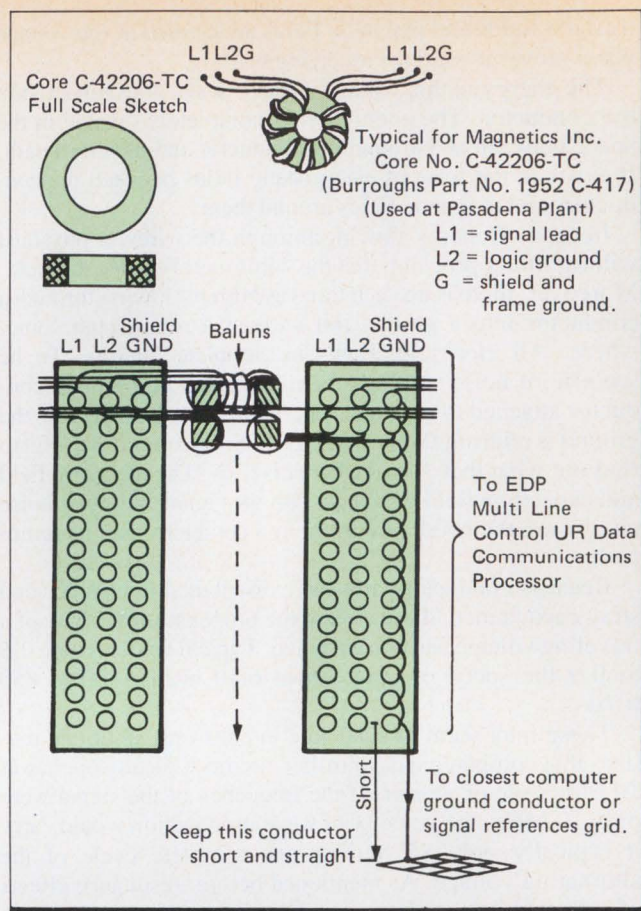

Figure 4: Suggested technique for installing baluns in data-comm lines (direct-connected). There will normally be one line per balun. However, if several remote terminals are located in a common location with common power source and grounding (not more than 50' apart), more than one line may share a common core. This is on the assumption that the ground voltage offset (voltage between remote ground and computer room ground, both steady state and impulse) will be the same for all units in a single remote location with respect to the computer system ground. The number of lines which can be accommodated with one core depends upon the core window and cross-section dimensions. Sufficient turns to give 300 to 500 μ h at very high frequency are needed.

However, do so in a manner which will also control or reduce potential noise.

- Use dedicated power feeders and if possible, also dedicated transformers for critical loads. Do not allow other non-essential or power disturbing loads to share the same power feeder and associated ground conductors other than a single common grounding point.
- Place the critical system's central grounding point for power and data communications or critical control circuits as close as possible to it. In order for the power source to be grounded at the same point, this requires an isolation transformer at the grounding point.
- If the critical load is spread out over a significant area with distances of 30' or more for high data rate cables, provide the system with a signal reference grid. This is a sheet of copper foil, a mesh of bonded copper wires, or a suitably bonded supporting steel structure for a raised floor (typically 2' by 2' square modular panels, supported by stanchions at the corners, and braced with bolted-down stringers which cross brace and provide an electrically continuous signal reference grid).

The impedance of the foil or grid at high frequencies is much lower than single conductors and has fewer resonant frequencies in the desired signal frequency range. Connect-

ing the frames of computer units of a system to the reference grid under the entire system will do much to keep the ground voltage differences between units at a minimum.

The signal reference grid is to be treated as a system component which is grounded to the same system grounding point as the frames of other system components.

The signal reference grid must never be used as a replacement for the equipment ground conductors required by safety codes. The grid should be used to supplement the normal grounding means and used as an addition to, rather than a replacement for, equipment ground conductors run with the power conductors.

Placing a power center with isolating transformer on the reference grid allows the secondary derived voltage to be grounded at the transformer to the reference grid. This, in turn, is connected to the nearest qualified ground in the surroundings, plus a connection to the principal electrical ground for the building via the input power conduit and ground conductor at the building service entrance equipment ground.

- Multiple power sources may be used to supply a critical computer load, if the power source grounds have no voltage differences between them. Unless both power sources originate at the same place (within, say 10' of each other), voltage impulses and high frequency voltages can easily exist between the two sets of power conductors, simply because their ground references are not the same.

Use of isolating transformers at the critical load, placed close together with secondary neutrals grounded at the same point or to a common underlying signal reference plane, will greatly reduce the possibility of common mode voltage differences. This reduction can be made even greater through the use of transformers which have a shield between primary and secondary windings. Such transformers cost 10 to 15% more than unshielded transformers and are used by manufacturers of power centers for computer rooms.

It is feasible to supply part of a critical load with uninterruptible power and part with regular utility power, provided that their ground reference voltages never differ from each other or from the critical computer system grounding point by an amount which the system units can tolerate. This may vary from less than 10V to more than 1,000V. The use of isolating transformers in the computer room is a good solution to this problem.

- Bypass circuits, both primary and secondary (primary = automatic bypass which is part of the UPS; secondary = external manual bypass for use when UPS bypass is to be serviced or replaced without having to shut down the critical load), should each make use of the same isolation transformer(s) in or next to the critical load as is used between the UPS and critical load. The apparent power source grounding point should not change as the power source is changed.

This can be accomplished by making the UPS input and output voltage the same so that its bypass and any other

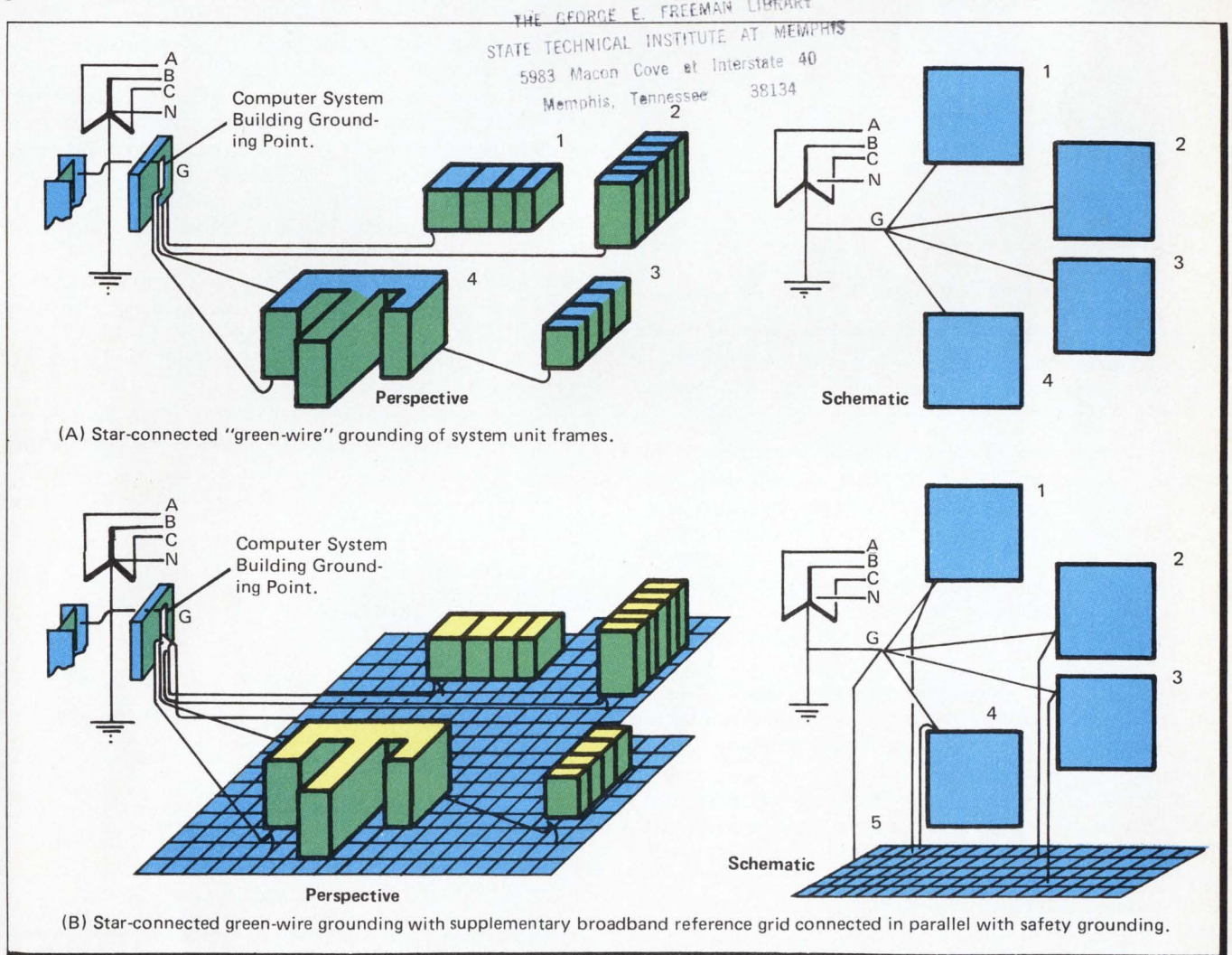
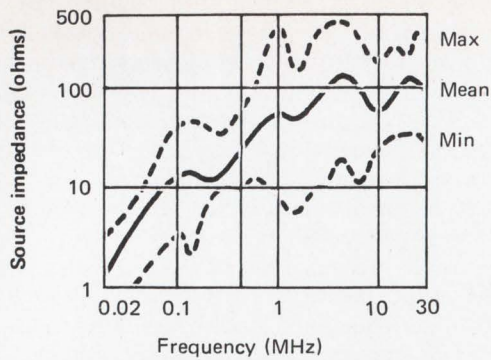
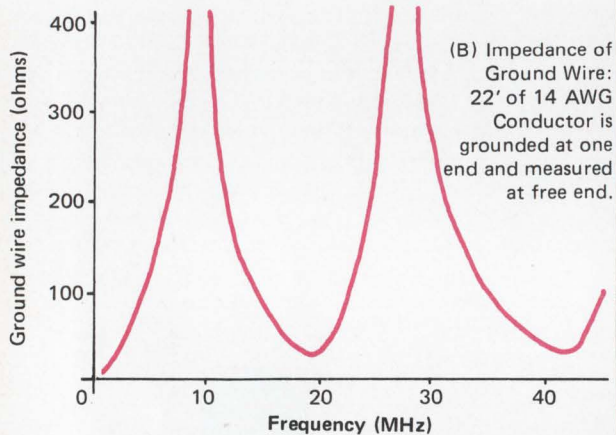

Figure 5: In these drawings "1" through "4" are typical computer system modules, and "5" is a "green wire" safety ground conductor for the floor structure.



(A) Typical power source impedances (CBEMA) ESC-SC5 Committee)



(B) Impedance of Ground Wire: 22' of 14 AWG Conductor is grounded at one end and measured at free end.

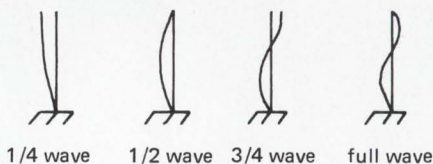

Figure 6: Power source impedance, Z , is plotted as a function of frequency; ground wire impedance, for a fixed length, approaches infinity at $1/4, 3/4, 1-1/4, 1-3/4, \dots$ wavelengths.

bypass do not need another transformer to step down the voltage. Voltage step-down, if required, should be done close to the computer room — preferably, in the computer room.

Ideal arrangement is 480V input and output at the UPS and its bypass circuits. Stepdown to final utilization voltage is accomplished at the computer room in a shielded, isolating transformer in a computer room power center.

• Interconnections between very large systems require a slightly modified approach. Each system with its own grounding reference conductor system may have a voltage difference with respect to the other. This may be a continuous a-c voltage difference or may be random impulse voltage differences.

Acknowledging that two acceptably grounded systems have voltage differences between them is the basis for predicting that noise currents will flow in any conductors which interconnect these separate grounds. An objective is to keep such noise current from flowing in any data cable interconnections.

Longitudinal transformers (also called "baluns" and "coaxers") can be used to increase the common mode impedance between the ends of communications, digital

control or power conductors without materially affecting the normal or transverse mode of voltage or current in wire pairs.

With baluns inserted to increase common mode impedance of signal interconnections, a shunt path for ground current to flow between the two grounded systems is needed to help equalize their voltage differences and further reduce the noise current which might otherwise flow in the signal cables.

• Make a practice of pairing conductors so that the circuit wire and its return path will always be together. This minimizes the area between conductors and the magnetic field which it either creates or intercepts to pick up noise. A ground conductor should also be included with each signal pair when ground is not one of the pair so that the same principle will apply to common mode noise generation and noise pickup.

If there are multiple, parallel ground paths provided as alternatives for signal return current, at high frequencies, the lowest impedance path with the smallest loop area between it and the outgoing path will carry the most current. This supports the practice of pairing signal wires with separate ground conductors, even though the ground conductors may be interconnected.

• Signal wire cables lying upon a subfloor in a computer room can pick up noise signal voltages by capacitive or inductive coupling with other surrounding structural steel and conductors. The reinforcing steel bars or wire mesh in the concrete is only one of these.

At the system central grounding point, connection should be made with the building steel wherever possible. If the reinforcing steel or mesh is inaccessible, a $4' \times 4'$ sheet of conducting metal such as copper, aluminum or galvanized steel may be placed directly upon the concrete subfloor and connected electrically to the system central grounding point. Capacitance between the plate and the reinforcing will provide a bypass current path, reduce the voltage difference and reduce coupling into the underfloor cables. This arrangement is known as a "Transient Trap."

• Review and plan the underfloor cable routing to provide the maximum isolation between circuits which can carry disturbances and those which can be disturbed.

Avoid parallel, nearby runs in which both electromagnetic and capacitive coupling will occur.

If one set of conductors must cross another, the possible intercoupling will be minimized if they cross at right angles

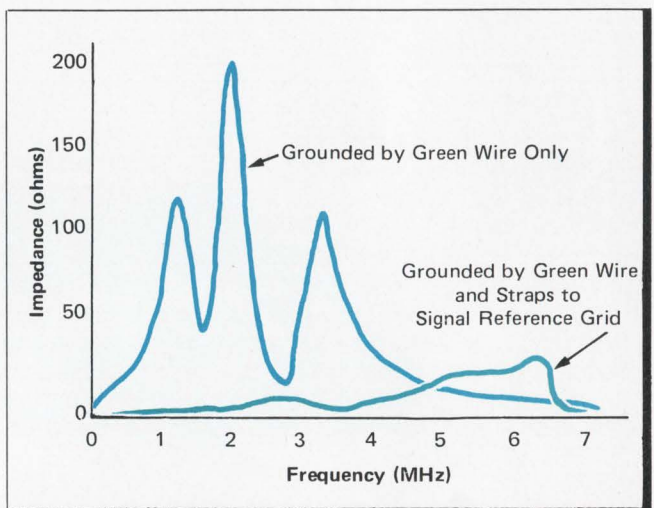

Figure 7: Cabinet-to-ground impedance is plotted as a function of frequency. Logic and power cables are attached in this typical multi-cabinet computer system.

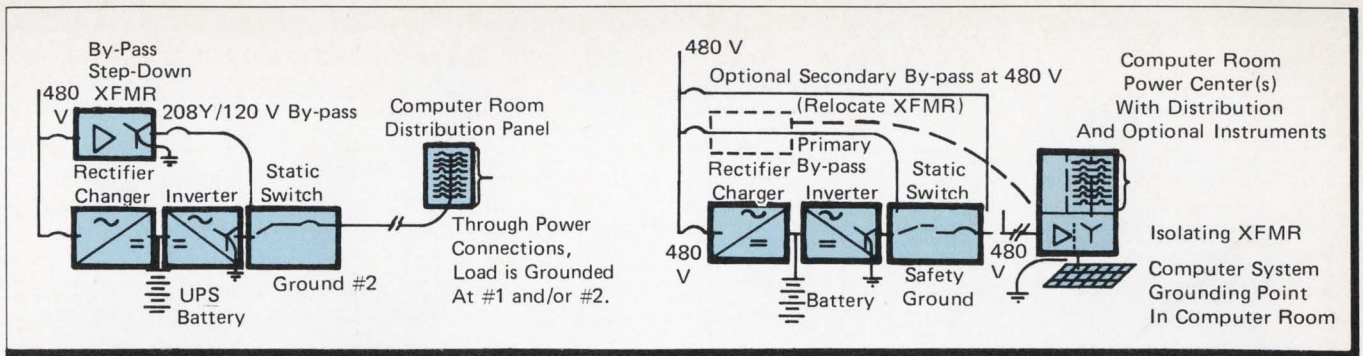

Figure 8: Locating the transformer close to the computer shortens ground conductors. It also provides other advantages. (A) conventional UPS configuration with XFMR in by-pass results in multiple grounds at a distance from computer. (B) Moving the XFMR to computer room shortens grounding conductors, simplifies installation and lowers cost of power conductors and switches. Optional secondary bypass (manual operation only) allows power to be removed from the entire UPS for service or replacement without computer shutdown.

and they are separated instead of lying one upon the other.

- Be particularly aware of the possibility of interference from conductors which extend outside of the computer area. These include refrigerant pipes, water pipes, fire alarm or water detector circuits and conduit, fire extinguishing system pipes and control wires, and both power and control wires for heating, ventilation and air conditioning. In addition, there may be metallic air ducts.

In many instances, the pipes and ducts can be installed with an insulating joint. This allows the portion under the computer critical load to be grounded to the computer system rather than to be a continuation of a virtual antenna extending outside the area. An example might be a coolant pipe from a penthouse on the roof which is exposed to lightning as well as being closely coupled to elevator and other equipment or neon signs which often create substantial radio frequency noise.

Where insulating joints in electrical conduit would violate safety code compliance, the insulating joints need not be installed if the conduit enters the computer area at the same point where the principal power input to a computer enters the area. They can be bonded together and to the computer system central grounding point, all at one point. This avoids the possibility of noise currents being injected into the computer system signal reference grid or into separate units of a total system through the creation of ground loops.

The advantages of a single point ground connection with external grounds are achieved more easily when the life-safety indicators, controls and wiring are coordinated with the power for the critical load in a common enclosure or through a closely located and interconnected junction box so as to provide a minimum of voltage difference between their respective "grounds".

- When providing surge arrestors which clip or bypass surge impulse voltages of significant magnitude (typically 250V or more on a 120V a-c line or 10V or more on a 5V signal line), remember that traveling voltage or current impulse waves cannot be absorbed by such devices. Most of the energy will be reflected or diverted to another path provided for the purpose.

If reflected, the voltage will try to approach double amplitude when it reaches an open circuit wire termination, or impedance which is higher than the surge impedance of the incoming line. A shunt with a long conductor to "ground" will have a high impedance and will most likely do very little to attenuate the impulse amplitude. However, it may reduce the total strength of the impulse by draining energy some time later in the pulse if it has a long duration.

Lightning arrestors do not belong in the computer room. They belong on utility poles and on the input high voltage winding side of transformers (above 4,000V, typically). They belong outside of the buildings or just inside the buildings they are intended to protect.

The distance between the service entrance and the load point within the building helps to attenuate residual voltage impulses which lightning arrestors (diverters) fail to handle. At the load, surge arrestors and surge absorbing capacitors may be appropriate, but closely coordinated with the recommended isolating transformer, shield between windings, life-safety wiring, communications circuits and any other conducting interfaces between the computer system central grounding point and surroundings.

- Remember that the energy of a voltage surge impulse lies outside the conductors which represent the source and return path of the pulse. One of these may be the ground conductor to the nearest earth ground rather than the conduit or equipment ground contained within it. The electromagnetic field created by this loop will induce voltages and currents in other nearby conductors depending upon their proximity and orientation. It is possible to arrange the conductors to minimize unwanted intercoupling from such surge impulses.

- Ground conduction paths to drain static electricity need not be low resistance, but must not exceed 10^9 ohms to be effective (1,000 megohms). To control static electricity, the following may be effective:

1. Keep relative humidity above 40% (50% is ideal; 40 to 60% range, OK).
2. Specify hard surface floor coverings with no greater than 10^9 ohms per square resistivity and not greater than 10^9 ohms to a grounded supporting structure such as concrete or raised floor structure. Pressure laminates are made for computer rooms to meet this requirement.
3. If carpeting is to be used, specify that the propensity for static electricity generation by walking upon the carpeting will not exceed 2,000V at 40% relative humidity.
4. Exercise some control over occupants' footwear and clothing. Some shoes with crepe rubber soles, for example, will generate static when walking on a steel floor, and much more on a carpet or pressure laminate floor. Clothing can often be treated with anti-static products during laundry. Nylon may still give problems.
5. Avoid furniture with plastic upholstery or other fabrics which cannot be treated to reduce static problems.
6. Use anti-static mats, with or without grounding conductor in work areas with static problems. Ground the mats in high traffic areas.

Survival In The Compat Marketplace

how to select compatible computer products and vendors

Compatibility is the game today within the increasingly competitive computer industry; particularly among companies that manufacture hardware and software which complement the major manufacturers' computers.

The marketplace for developing compatible equipment is wide open. DEC, for example, offers one of the largest selections of computers on the market today; and, because of this popularity, DEC has acquired a considerable following of manufacturers who produce products designed to improve DEC computer performance.

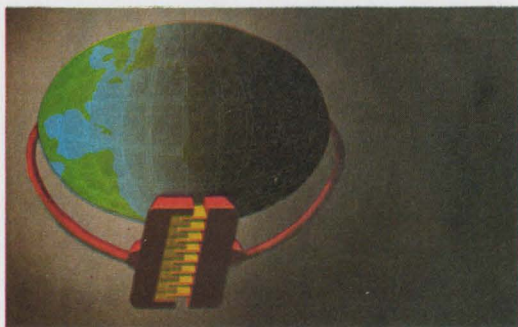

by Les Wellington

Compatible computer product manufacturers come and go with almost lightning regularity. We will provide some guidelines on how to avoid undesirable side effects.

reasons for failure

The short-lived nature of many compatible product firms is due to several reasons. The most common include: (1) their product is ill-conceived, (2) the product life span is limited, (3) the cost is too high, (4) dependability and service is limited and/or non-existent. There are more reasons why a vendor goes out of business, not the least of which is that the customer has become increasingly sophisticated about his computer system.

Customers are more selective today, and this affects firms. No longer will customers tolerate equipment that fails to meet their specific needs, or perform exactly as they want it to. They do not want to be limited to one specific computer or component supplier: if they can't get a part quickly from one company, they want to get it from another and know it will work just as well. They want flexibility in the performance of their computer and for it to grow as their needs expand. Customers also want equipment that is easy to use, does more than earlier models, and costs less to purchase and operate. Above all, they expect any product they use to be dependably supported.

Choosing a company that has the capability to satisfy these customer requirements is not simple. There are many firms who supply peripheral devices and add-on options for DEC. And since the current marketplace offers a sales potential estimated at half-a-billion dollars annually, more vendors keep popping up. But which do you safely choose?

Few firms have a good track record of designing and building successful products that are compatible; and those that do, compete for the lion's share of the marketplace. Those that fail to meet systems performance margins do not remain in the marketplace very long.

Product longevity, therefore, along with product reliability, plus availability, ease of installation and service after point-of-sale, have a great deal to do with a vendor's success and a customer's satisfaction. These criteria separate newcomers and hanger-ons from the few successful companies.

Les Wellington is Vice President and Director of Engineering at Able Computer, 1751 Langley Ave, Irvine, CA 92714.

what does DEC compatibility mean?

If you're talking hardware, you're talking about signal compatibility, its functional capabilities and its physical packaging — does it fit into the existing package? To be software compatible the product must operate under DEC diagnostic programs and operating system software.

Each of these criteria is constantly changing due to new innovations within the industry. About five years ago, for example, the μ P was in its infancy and looking for a direction to grow. Today, the μ P is used extensively because of the many factors that make it superior to early computer concepts.

The μ P didn't pop into existence because one day an engineer wanted one. It came into existence because the customer had a *need* for one. And once the bugs were worked out, the μ P improved the cost-performance ratio. It required fewer boards, it used less space and consumed less power. It was easier to manufacture and provided added flexibility to a computer because it added more features that customers wanted.

The bottom line to a vendor's success, therefore, is listening to what the customer wants. Vendors who don't pay attention to this are not long for this industry, because when push comes to shove, the customer will turn to another vendor.

The responsive add-on vendors, who fill a 5% to 15% void (which mainframe manufacturers cannot fill), can provide solutions to a specific market area because they are small and can move quickly without the sometimes cumbersome responsibilities that inhibit the reaction time of larger companies. This capability helps them maintain a hold on this portion of the marketplace and permits them to provide real alternatives for DEC customers.

today's selections

Most customers today are more mature in their attitude toward the use of computers, and therefore prefer keeping the system they have, expanding its power and capabilities as their growth dictates.

Expanding a system, however, reaches a limit when the mainframe manufacturer stops offering new products to support a current line in order to make way for a new generation of computers. When a user's needs grow and his system cannot, add-in vendors can provide solutions to extend the life of the current computer. They can provide users the alternative of getting more out of the system they already have, so that they can postpone moving up to the next-generation computer.

In selecting products from add-in vendors, the user should be certain that compatibility is maintained in the areas that are important to him. **Figure 1** lists areas of compatibility that might be evaluated in the purchase of an add-in product. Although not all areas are important to every user, it is important to have taken each into consideration prior to purchase.

For vendors to produce viable products, they must consider several variables. The product must rate favorably in price, product life, space, bus loading, power required, software compatibility, performance increase and anticipated volume.

One large area of add-in vendor activity is mass storage. DEC chose a modular approach to disk subsystem design which allows them to maintain a degree of component commonality with all their computers. In one approach, they designed a bus adaptor with a unique interface for each of their major computer buses, and with a standard interface for

Compatibility Check List			
CHARACTERISTIC	Check if Important	Product A Provides	Product B Provides
PHYSICAL			
Size			
Space Required			
Accessories Included (e.g., cables, mounting hardware)			
ENVIRONMENTAL			
Operating Temperature Tolerance Range			
Storage Temperature Tolerance Range			
Relative Humidity Tolerance Range			
ELECTRICAL			
Signal Compatibility			
Connector Pin Compatibility			
Power Consumed			
Bus Loading Requirements			
Battery Back-up			
SOFTWARE REQUIREMENTS			
Compatible with Manufacturer's Diagnostics Software			
Compatible with My System Software			
FUNCTIONAL REQUIREMENTS			
Operating Parameters (e.g., baud rates, full/half duplex)			
Options (e.g., memory parity, modem control)			

Figure 1: Add-in vendors provide solutions to extend the life of a user's current computer. This Compatibility Check List shows areas that might be evaluated in purchasing an add-in product. The user should be certain that compatibility is maintained in the areas that are important to him.

a device controller. This allows the more complicated disk controller design to be standard for all their systems.

While this satisfies their needs for the design, manufacture and support of mass storage subsystems, the manufacturing cost is increased due to the physical separation of the hardware. By attacking one segment, the add-in vendors can create a one-board interface for one computer resulting in a cost-and space-effective alternative.

To the vendor, there is the added benefit that if he has chosen to use a μ P design, he can provide controllers for other drives by simply changing the firmware. This contributes to high maintainability and reliability for the customer, as well as lower cost. It also means that customers are seeing a larger selection of product availability than ever before.

This results in more practical alternatives for growth both vertically and horizontally.

technical advances

There are many examples of the impact of technical advances. In the memory marketplace, continuing advances in semiconductor memory density allows the design of memory products with more memory capacity in less space using less power. The add-in vendors — those with the proper technological credentials — can utilize this technology faster, thereby providing a product at lower cost with attractive delivery dates. This capability is attractive to the customer, who not only wants this type of capability, but expects and demands it when dealing with a vendor.

In the mass storage controller and communications areas, for example, μ P-based architecture is the trend because physical requirements demand more capability and less space for a more cost-effective end product with greater flexibility. Purchase price is reduced by lower material and manufacturing costs through use of μ Ps which reduce the number of components and PC boards.

To the customer, μ P design means not only lower prices, but savings in space, power and bus loading burdens on their systems. In addition to emulation of compatible computer functions, μ Ps also allow the addition of extra features such as self-test diagnostics and user-selected options.

Add-in vendors assist customers in conserving system space through the denser, more bus-oriented ICs that are available today, and through use of the more sophisticated multilayer PC board designs. Multilayer printed wiring board technology has been around for several years and only recently has its cost benefit improved.

Historically, components were loosely populated on a printed wiring board. A product might have required multiple PC boards in a dedicated backplane. Today, because prices continue to rise, packaging plays a greater role in cost figures. So if a supplier can get more performance in a given area, it is worth his while in reducing cost as well as possibly significantly improving his MTBF.

today's market

In today's market, compatibility is multifaceted. To be lured away from a mainframe manufacturer, the customer must be assured of compatibility at all levels. Hardware must provide physical packaging compatibility, environmental compatibility, functional compatibility and electrical signals and connector pin equivalence. The hardware must also be compatible with the diagnostics and operating system software to provide an alternate choice to an OEM's product. This is often referred to as form, fit and function compatibility.

This all leads to one basic fact: unless the product is an "exact" copy of the compatible computer design, 100% compatibility is impossible. However, this is rarely a problem since all responsible add-in vendors define what their products cannot do as well as what they can do. Theoretical differences in implementation of a product will generally not affect an installation and application, but it is wise to be certain that your specific needs are met by a product.

A supplier must be aware of these criteria to survive in this increasingly competitive marketplace. Building a good product is not enough. Service is a big responsibility for the manufacturer because problems occur with anyone's product. When a vendor cannot react to these problems and prove he is a professional, the customer will look for someone who is. Ideally, if a vendor listens to what the customer's wants and needs are, and accepts this input, he

has the potential to provide a superior product that fills a variety of customer needs.

By getting to know the needs of the market as completely as possible, the add-in vendor is on stronger footing in the design, production and support of a high technology product. Or, at the minimum, a saleable product that is viable in today's marketplace.

a look at tomorrow

As the industry continues growing, attitudes continue changing. Most companies do not want to be tied down to just one supplier. They want alternatives. If they cannot buy what they need from "Company A," they want the option of buying from "Company B," and they want to know that "B" is either software transparent or can supply software that will interface with the equipment they originally obtained from "A".

This obviously develops more competition, and there will be those who cannot compete. It also develops the need for interchangeable components that fit the demands of more than one computer producer.

Today's customer needs the ability to obtain whatever storage devices, I/O devices, memory, hardcopy, video terminals, interface equipment, communications options and graphics equipment he requires so he can design the type of computer system that best suits his business and personal preferences. A customer understands this situation and will ensure that such standardization, reliability and cost does occur. A supplier/manufacturer who doesn't understand this will not last.

This trend exists now. In the computer industry today you will find a number of successful computer manufacturers and add-on companies that provide equipment for various computer systems. To select the best vendor, a customer must develop a list of those vendors that best fit his needs. He should find out what products are available and determine if there is a wide variety of choices within those parameters. He should also determine if there is a migration path leading from a lower cost system to the anticipated "ultimate" equipment, and if this migration is easily accomplished.

A customer entering the world of computers is provided a new efficiency factor that greatly improves his ability to meet the fast pace of today's business. A properly implemented computer system permits him to accelerate his business without requiring large volumes of people operating at breakneck speed to achieve the same amount of production provided by one computer system.

With this new tool, a business can reallocate its human resources into a more creative environment, while at the same time improving working conditions for the work force. Operating costs are also improved because of this redirection of human talent and energies.

But although growth will continue to accelerate within the computer industry and customer needs will continue to increase as well, budgets may grow tighter. This will present challenges to the add-in vendor to extend and utilize new technology to meet these increased needs and capture a portion of the market. It will become increasingly important to successfully second guess computer makers' directions in finding solutions.

Vendors unable to keep pace with the new technology — to meet the needs of the market — will gradually disappear. On the other hand, add-in vendors that can design and build successful products based on customer needs will continue to provide good alternative solutions for compatible computer product customers. D

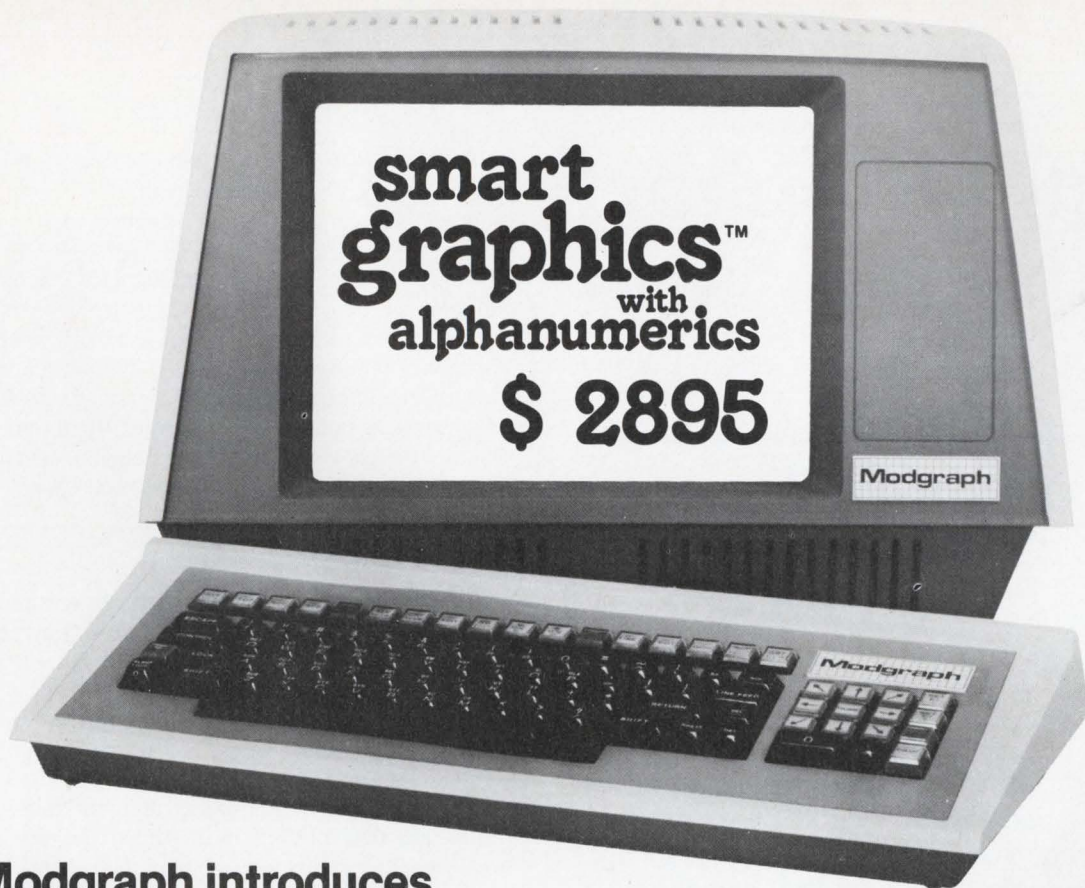

Modgraph introduces "Smart Graphics"

Featuring: 768 x 585 Resolution, RS-170 Video Output, Plot 10[®] Compatible, Independent Alphanumeric Plane, 15" P-39 Green Phosphor Screen.

Smart because one low cost terminal provides easy to use graphics and a completely independent alphanumerics overlay.

GRAPHICS FEATURES: 2 Pages 768 x 585 Resolution • RS-170 Video Output • Plot 10[®] Compatible • Selective Erase • Separate Graphics Cursor • Addressable Cursor • Cursor Pad — Slow and Fast Motion • Special Graphics Function Keys • Absolute and Relative Vectors • Dot, Dash, Solid Vector Styles • Hardware Graphic Characters

ALPHANUMERIC FEATURES: Independent Alphanumeric Plane • 7 x 9 Character Font With Attributes: Blink, Reverse Character, Underline • 96 Displayable Characters • 80 Character x 35 Lines • 3 Pages Scrollable Memory • 2nd Character Set Available • Status Line • Separate Alphanumeric Cursor • Tab, Backspace, Etc. • Special Alphanumeric Function Keys

GENERAL FEATURES: 15" P-39 Green Phosphor Screen • High Resolution CRT • Special Function Keys • Detachable Keyboard • RS-232C Interface • Set-Up Mode from Keyboard • Many Options Available

BOX 349
235 BEAR HILL ROAD
WALTHAM, MA 02154
(617) 890-5764

Modgraph inc.

Raster Monitor Evaluation And Selection

application and environment are pivotal to monitor selection

A review of today's technical literature indicates an almost infinite range of monitor sizes, types, and display capabilities. On closer examination, however, repetitive patterns become apparent, limiting the choice and forcing compromises which may require a reexamination of earlier design decisions.

While there may be a few specialized applications which can justify the costs of a "custom-built" CRT, competitive pressures will force most system designers to take advantage of the economies offered by CRTs which have been optimized for the mass entertainment marketplace. Monitor manufacturers may be able to add valuable graphics-display enhancements (e.g., long-persistence phosphors, extended-life cathodes), but the fact remains that the cake under the frosting was originally designed for non-graphics applications. The monitor-selection process becomes, therefore, a matter of finding the closest fit to a design objective, with the certain knowledge that price performance tradeoffs will be required.

aspect ratio and orientation

Until recently, raster graphics system designers have had exactly two choices in the selection of aspect ratios (display-screen width divided by height) and orientation (horizontal or vertical). They could choose either a 4:3 horizontal or a 3:4 vertical configuration. Rasters with any other aspect ratio, including 1:1, would have to fit within the limits set by the available monitors.

CRT monitors with 5:4, 4:5, and other full-screen aspect ratios are now offered in a limited number of sizes and models, allowing us to generalize the raster selection to one of three choices: a horizontal rectangle, a vertical rectangle, or a square. Each has its place, depending on the application, and the selection of the most suitable configuration represents one of the most fundamental decisions a systems designer has to make at the start of a design project. Display-memory architecture, interface circuitry, and almost all of the other monitor evaluation parameters are, in fact, directly impacted by this choice.

The dominant orientation has been, and will probably continue to be, the horizontal display rectangle. It matches the panoramic view provided by the human binocular visual system and can therefore serve as a natural "window" on reality — as evidenced by the theatrical stage, motion-picture screen, painted landscape, engineering drawing, and television picture.

Vertically oriented displays also have their antecedents in the form of printed pages of text and the illustrations designed to accompany text. Western typography is most legible and compact when it is organized into vertical columns composed of short horizontal lines. (Long lines require extra spacing for legibility, and this reduces the number of words which can be contained on a page.)

Square displays have their roots in the charting of scientific and financial information. Given a choice, similar or identical scales (coordinate lines or circular arcs) should always be used to represent two or more variables. Any departure from this convention incurs the risk of a visual distortion of the data. From clocks to compasses to oscilloscopes, the square or circle within a square has remained a basic display configuration.

*This article is excerpted from the **Raster Graphics Handbook**, written by the engineering staff at Conrac, 600 N. Rimsdale Ave, Covina, CA 91722.*

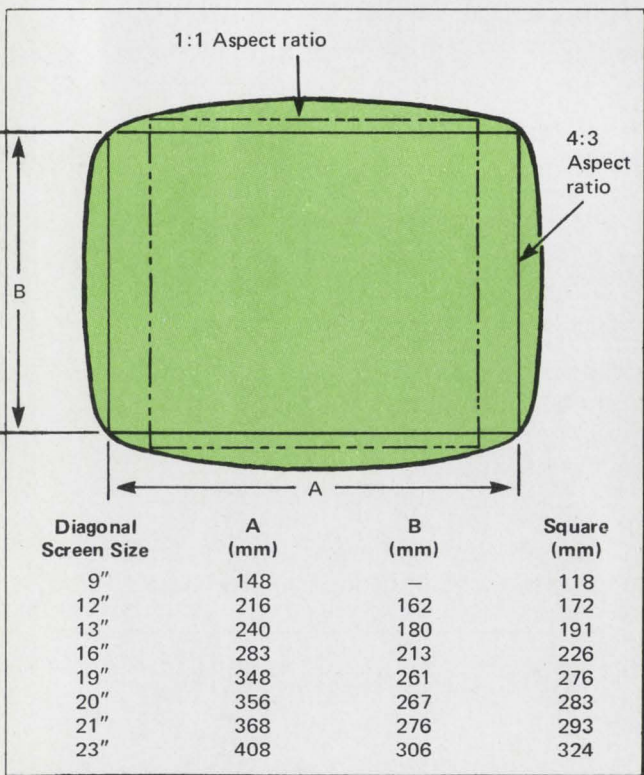

Figure 1: Raster dimensions as functions of the monitor screen size.

Aspect-ratio and orientation decisions depend, then, on the type of information being displayed. If the graphics consist of representational views, such as those created by a computer-aided-design system, a conventional horizontal orientation would normally be specified. If the displayed information consists primarily of text, or if the graphics are being designed to accompany text when reproduced in another form, a vertical orientation can make more effective use of the monitor screen. If charted data is being displayed, the decision will often be to create a square raster in the center of a conventional, horizontally oriented monitor screen.

raster-line orientation

There is no intrinsic reason why the raster on this conventional horizontal screen should consist of horizontal lines. The raster could be just as effectively "written" with vertical strokes. But this would result in a larger number of shorter lines — and a significant increase in the amount of time "wasted" by the need to return the electron beam to the starting edge before each line is traced. The horizontal-horizontal configuration minimizes the number of retrace strokes, allowing more time to scan the "active" lines as a percentage of the fixed refresh interval. The electron beam can scan at a slower rate, increasing the luminance of the display because more power is being delivered per unit area. The instantaneous data rate is also lower, which reduces the required bandwidth of the interface and monitor circuits and the readout rate of the display memory.

All of these benefits accrue to a vertically oriented display provided the raster lines are also scanned in a vertical direction (i.e., by turning a conventional monitor on its side). Such displays can be readily adapted to the generation of images, but they would require major restructuring of the text-oriented system architectures which could make maximum use of the vertical format. In most commercially available vertical-monitor systems, therefore, the raster lines are still scanned horizontally, from top to bottom.

The demands of this configuration on monitor performance can be impressive. One vertically oriented system, for example, scans (and retraces) 800 short raster lines at a full-frame refresh rate of 60 Hz. The horizontal-scan interval is only 20 μ secs, of which 25% is taken up by the retrace stroke. In order to display up to 8,000 characters on the screen, pulse rise/fall times have been reduced to 4 nanosecs, compared to a conventional 20 nanosecs. To provide this response, monitor circuits have been designed with a 100-MHz bandwidth — five to ten times the normal requirement.

A square raster centered on a horizontally oriented screen would nominally represent a midpoint between the horizontal and vertical configurations. The raster lines are shorter, as in the case of a vertical display. The number of lines remains the same as those of a horizontal display. But these comparisons are misleading. Customary practice is to "squeeze in" the sides of the raster without changing the horizontal-raster

timing relationships. There is no increase, therefore, in the percentage of time taken up by the retrace strokes. In fact, the shorter lines mean that the scanning speed is actually reduced, increasing the luminance and reducing the required monitor bandwidth. We will be using the centered-square configuration as our model raster in the following discussions on display size and resolution.

screen size

CRT monitors are available with nominal screen diagonals ranging from an inch to over 25". The selection of an appropriate monitor screen size becomes, therefore, another fundamental decision which the systems designer must make. Screen size affects the interaction with the operator, the perceived resolution of the display, the required bandwidth of the monitor and interface circuits, and ultimately the size (and cost) of the display memory. In the case of display memory, for example, there is no value in storing data for more pixels than can be displayed — or discerned — on the monitor screen.

Internally, a monitor CRT is a projection-type display device. The amount of information which can be theoretically projected onto the CRT faceplate remains constant, independent of screen size. The principal advantage to be gained by increasing the size is a broader spatial distribution of the display detail. Conversely, small screen sizes tend to compact the image elements, with a likelihood of overlapping and loss of information when a lower limit is exceeded.

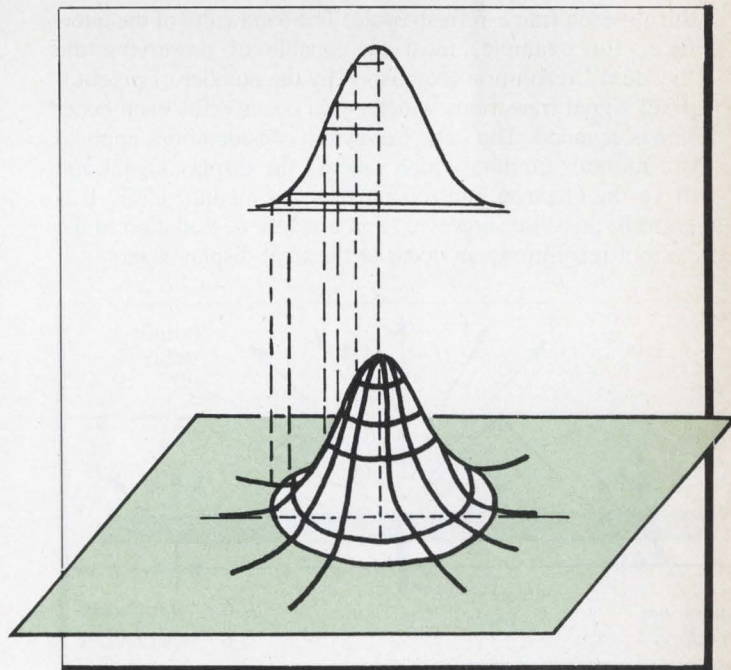

Figure 2: Gaussian distribution of electron-beam spot luminance. (Source: Reference 1)

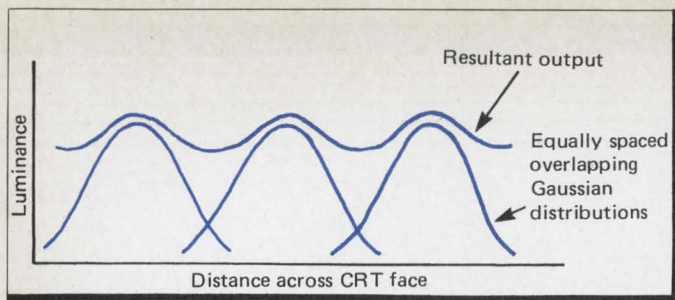

Figure 3: Effect of overlapping raster lines or pixel images. (Source: Reference 1)

Ergonomic considerations suggest the use of the smallest screen size that will allow the required information to be clearly "read" by the user. Small-screen luminances are generally higher, and the screen comes closer to matching the operator's field of maximum visual acuity. Small-screen monitors also offer advantages in terms of economy, ease of packaging, and extended cathode life due to the lower electron-beam current required for adequate display luminance. On the negative side, phosphor life may be significantly lower if the electron-beam density is elevated. With the same electron-beam current in both cases, the useful life of a 9" monitor may be less than a fifth as long as that of a 20" monitor.

Figure 1 indicates the maximum raster display areas obtainable on a range of monitor sizes. Monitor spec sheets often give "picture" (i.e., television) dimensions which must be adjusted downward when, as is usually the case, all four corners of a graphics image must be clearly visible. The millimeter values given in Figure 1 are, on the average, 10% less than the usual spec-sheet dimensions. The square-raster values take advantage of the slightly oval shape of most monitor bezels and are 6% higher than the vertical dimensions for 4:3 rasters (this amounts to 15 mm for a 19" diagonal screen monitor.)

display resolution

"Resolution" has been defined by the number of pixels stored in display memory and transmitted to the monitor during each frame-refresh cycle. The bandwidth of the interface, for example, must be capable of preserving the "system" resolution established by the number of pixel-to-pixel signal transitions which could occur while each raster line is scanned. The same bandwidth considerations apply to the monitor circuits which process the display signal and drive the electron gun (or guns) of the monitor CRT. It is entirely possible, however, that a severe degradation in the system resolution can occur at the final display stage — if

individual pixels can no longer be readily perceived by the operator.

Display resolution is determined almost entirely by dimensional mathematics. A square raster with 512 raster lines and 512 pixels per line contains a total of 262,144 pixels. Each pixel area is, in effect, a square with sides measuring approximately 0.002 of the raster height or width. When displayed on a 19" monitor, the pixels would measure 0.54 mm on each side. The same pixels on a 13" monitor would have side dimensions of only 0.37 mm.

The pixel images on the display screen are not, however, square. Instead, they are formed by an electron beam with, at best, a circular or slightly oval shape (depending on the position of the beam relative to the center of the screen). Moreover, the luminance generated by the beam has a Gaussian distribution, as shown in Figure 2. It is inevitable, then, that a certain amount of overlapping between pixel images will occur, especially if a further requirement is that each pixel area is to be "filled" with display luminance.

Overlapping is a benefit when images consist of solid areas or subtly changing intensities or colors. Figure 3 illustrates how a column of pixels can produce a relatively smooth luminous output across a group of raster lines. But the Gaussian spread of the electron beam creates major problems when sharp image transitions are required — as in the extreme case when graphic elements are to be separated by a single pixel width. The Gaussian "skirts" of the pixels on each side would raise the luminance in the intervening area, reducing the contrast between image and background.

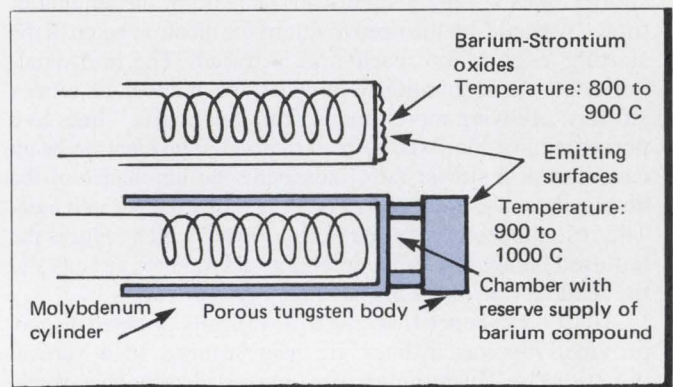

Figure 5: Conventional cathode compared with extended life cathode. (Source: Reference 1)

The loss of contrast from this effect is given a numerical value by the "modulation transfer function" (MTF) — the ratio between maximum small-area (pixel, raster line) and large-area contrasts. If there is no loss of contrast due to overlapping, the MTF is 1.0, 100%, or zero dB. A 50% contrast loss (-6 dB) is normally considered to be the limit for adequate monitor performance. Larger losses in contrast would have the effect of reducing the display resolution because individual pixels would be difficult to distinguish — even on close inspection.

The MTF can be improved, of course, by reducing the spot size of the electron beam. But this lowers the overall luminance of the display and may make the raster lines too distinguishable. A compromise is therefore required. Spot sizes, measured at the diameter of 50% maximum luminance, are generally set to approximately the same dimension as the raster-line spacing which would be on the order of 0.5 and 0.3 mm for the 19" and 13" monitors described above. Smaller monitors would require correspondingly smaller spot sizes to maintain an equivalent MTF,

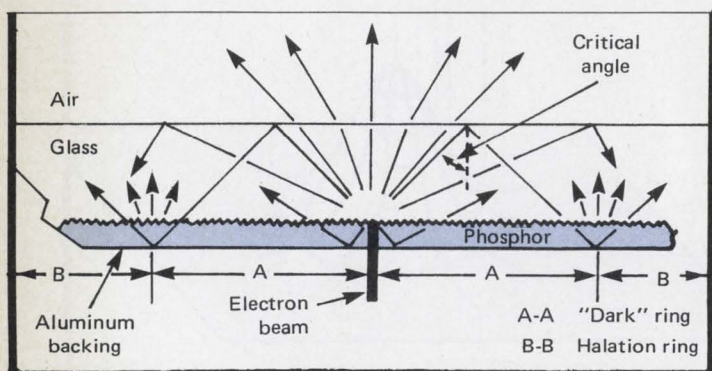
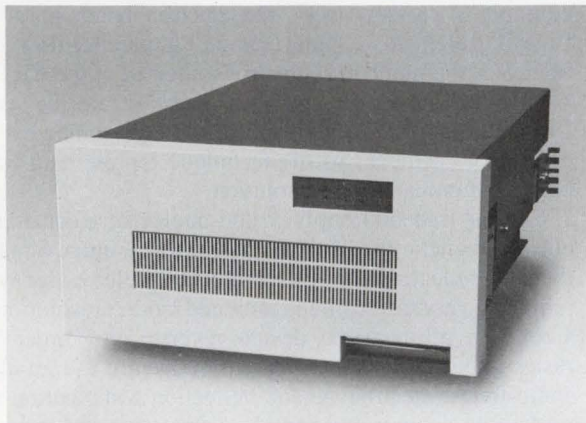

Figure 4: Halation ring formed by reflections within glass faceplate. (Source: Reference 1)



FOR DESIGNERS WHO WANT COST EFFECTIVE DISK BACKUP.



The Ampex TMS Streamer type tape drive solves your problem of cost effective Winchester backup. How? As a simplified tape subsystem it provides high on-the-fly throughput.

It's two drives in one. In the streaming mode it provides non-stop data save-and-restore. In the start/stop mode, the TMS performs traditional tape storage function. And up to 40 megabytes of data can be stored on a single reel of standard 1/2" computer tape.

Available in three configurations: rack mount, and horizontal or vertical desk type, the TMS can be positioned to suit your system requirements.

Cost effective: no capstan; no mechanical buffering. The TMS is an easy-to-thread manual load device and has only one PCBA.

Non-essentials were eliminated to create a low cost, high speed, small size, standard interface tape drive.

Easy on your checkbook. High in performance. And, in great demand as *the backup* for Winchester drives.

For additional information on how you can get low cost of tape ownership, contact Larry Russell at Ampex, Memory Products Division, 200 N. Nash St., El Segundo, CA 90245. (213) 640-0150.

AMPEX®
The Designer's Choice.

Circle 11 on Reader Inquiry Card

FOCUS DEFLECTION COMBINATIONS				
Deflection	Focus	Characteristics	Application	Resolution
Electrostatic	Electrostatic	High Speed Moderate Resolution	Oscilloscope	450 To 500
Magnetic	Electrostatic	Moderate to High Resolution	Television Computer Graphics	700 To 900
Magnetic	Magnetic	Highest Resolution	Projection Recording	1600 To 2000
Electrostatic	Magnetic	—	Not Generally Employed	

Figure 6: Electrostatic and electromagnetic deflection focus trade-offs. (Source: Reference 1)

and this eventually sets one of the lower limits on the extent to which the screen size can be reduced and still produce a crisp, high-resolution display. With 0.2 mm as a practical lower limit on spot size, the minimum square-raster dimensions for a 512-by-512 display would be on the order of 100 mm. For a 1024-by-1024 display, the minimum would be 200 mm — requiring at least a 13" monitor.

display filters

Contributing to the MTF loss — and the potential loss of display resolution — are the diffusing effects of secondary-electron emissions within the phosphor layer and the "halation" caused by reflections within the glass faceplate. **Figure 4** shows how halation rings may form around each pixel location, again reducing the effective display contrast.

Fortunately, most of the steps taken to minimize the contrast-reducing effects of reflected ambient light — such

Monitors are analog devices, with all the uncertainties inherent in such components.

as "etching" the faceplate or adding a filter — also lower the amount of contrast loss due to halation. Etching acts by diffusing the light at the glass-air interface. Normal practice is to bond a treated glass plate directly to the front surface of the CRT. The diffusing layer reduces the amount of light reflected back toward the phosphor. The displayed image is also slightly diffused, so etching represents a tradeoff between two negative effects.

Filters, either laminated to the faceplate or mounted separately, act by simply absorbing a fraction of the light — both wanted and unwanted. Luminance generated by halation tends to leave the surface at an oblique angle and therefore follows a longer path through the filter layer. The same would be true of oblique ambient light. In addition, reflected ambient light must pass through the filter twice and is consequently attenuated twice as much as light emitted by the phosphor layer. But again a tradeoff is involved. Filters reduce the display luminance and can also affect the display resolution.

A variety of filtering materials and processes are commercially available, often combined with such anti-reflection measures as vacuum-deposited optical coatings. Polarizing layers have proved particularly effective. In one instance, the "filter" is actually an assembly of miniature louvers which

shade the screen from overhead light sources.

monitor enhancements

Both the CRT and the graphics-display CRT monitor are still evolving as commercial products. A variety of monitor enhancements should be evaluated, therefore, before a selection is made.

Many of these innovations relate to reliability and device life. The use of impregnated cathodes is an example. Every CRT will eventually "burn out," just like any other electron tube. **Figure 5** illustrates how a reserve supply of barium compound can continuously refresh the surface of a porous tungsten cathode, allowing the CRT to be driven at very high current densities and still give thousands of hours of service.

Other enhancements relate more directly to performance and should be considered within the context of a specific application. The conventional CRT electron gun, for example, "crosses over" the electron beam to give the focusing elements a point source. A parallel-flow design increases the number of electrons directed at the CRT faceplate without a corresponding increase in the cathode "loading factor." Small spot sizes are somewhat more difficult to achieve, so the technique represents a tradeoff between luminance and resolution.

Similar tradeoffs apply to the choice of electrostatic or electromagnetic focusing and deflection. **Figure 6** indicates that an all-electrostatic design would be preferred for systems requiring very fast scanning rates and modest resolution (spot size). An all-magnetic design reverses this order. Most raster-scan graphics monitors consequently use an electrostatic-focus, electromagnetic-deflection combination which represents a compromise between resolution and speed.

Manufacturers may also incorporate special circuitry into the design of the monitor itself. One example is a "beam-current feedback" circuit which maintains the black level of the display at a constant value despite CRT aging and component drift. The CRT beam current is sampled during each vertical retrace. Feedback adjustments are then made to the DC level of the display-signal amplifier to correct for any detected error.

CRT monitors are analog devices, subject to all the uncertainties which affect the performance of such devices. Enhancements like the beam-current feedback circuit help to make the monitor a stable, dependable system component in an otherwise digital environment. **D**

Figures 2-6 reprinted courtesy of Lawrence E. Tannas, from Flat-Panel Displays, Van Nostrand Reinhold Co, New York, NY 1981.

BRAEGEN MPD HAS THE DESKTOP COMPUTER YOU NEED



Braegen's Minicomputer Peripherals Division is committed to providing the systems and peripherals DEC-users need . . .

FEATURES

- Based on *LSI 11/23 Processor
- Up to 256 KBYTES of MOS memory
- 24 MBYTE Winchester Disk
- 20 MBYTE cartridge tape back-up
- Available in desk-top or rack-mount configurations
- Four asynchronous communication ports
- Wide range of options available
- Quantity discounts available

For more information on the BC-223 family of desk-top systems or any of our full line of DEC-compatible disk and tape subsystems, terminals, printers, memories, multiplexors and more, please call or write:

Marketing Dept:



3320 East La Palma Avenue
Anaheim, California 92806
Telephone (714) 520-9200

"Be sure to ask about our field service force in over 50 cities nationwide"

*Trademark of Digital Equipment Corporation

Circle 8 on Reader Inquiry Card

Equipment Manufacturers Drive Data Communications Industry

computer-based equipment, and its hardware/software, today dominates telecommunications

The world of modern telecommunications has been slow to acknowledge that equipment, not transmission facilities, has emerged as the central feature of the information age. Manufactured equipment has for too long been regarded as allied, associated, ancillary or peripheral. Even the terms "interconnect" and "customer premises equipment" convey the notion of lesser or incidental status. But, it is the transmission medium which is becoming increasingly incidental to intelligent equipment. If we fail to recognize this, the true benefits of the Information Age may not materialize.

by Dr. John W. Wilson

Equipment has emerged as the driving force behind telecommunications. Unfortunately, terminology tends to bias the debate. Just as it is futile to wonder whether book publishers are printers of books or producers of information, it is even more difficult to speculate whether equipment manufacturers make products or produce systems that transmit, process and distribute information.

information business confusion

This sense of confusion is best dramatized in a matrix of the "Information Business" (Figure 1). It describes a galaxy of so-called information products and services linked by "conduits" of "content" between the sender and receiver. This cosmos of products and services is then obscured (Figure 2) by a cloud, which masks the true meaning of the dependence of information products and services on computer technology.

This simplistic formulation assumes a limited number of suppliers are now competing, or would like to compete, for the chance to furnish consumers with a unitary "information" system, complete with products, voice and data processing, transmission and information itself. It ignores the fact that competitive markets do not function in this manner and will not do so unless legislation requires or stimulates conditions which reinforce a monopoly or generate an oligopoly (a situation in which each of a few products affects but does not control the market).

Any policy which advances a system concept cannot expect to maintain or achieve competitive diversity. At best, it will produce some degree of oligopolistic market division between giants such as AT&T and IBM. The control, or capacity to gain control, of transmission networks, combined with the economic power to vertically integrate so-called information products and services, will necessarily limit the number of competitors, as well as the amount of technical innovation.

Dr. John W. Wilson is president of a research and consulting firm, J.W. Wilson & Associates, Washington, D.C. This article is taken from Dr. Wilson's testimony before the Subcommittee on Telecommunications, US House of Representatives.

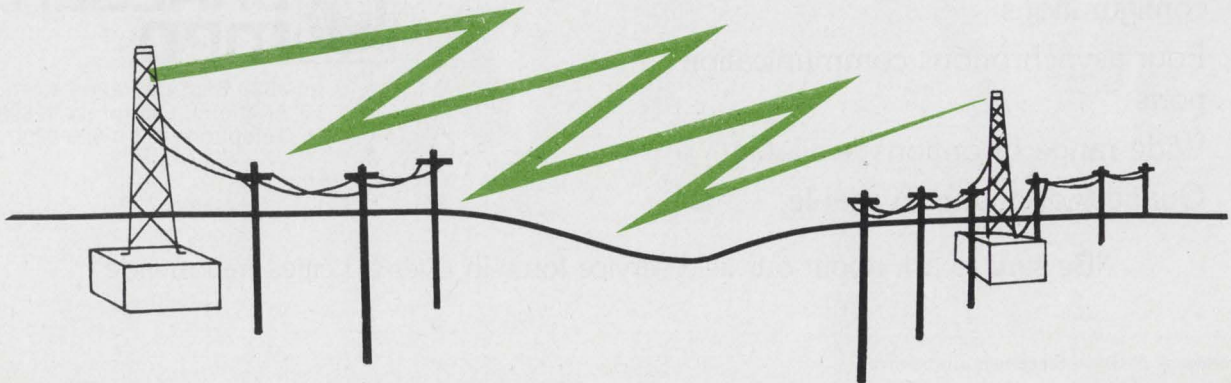

If the policy of competition is to be more than rhetoric, it must focus on distinctions between manufacturing and information services. Manufacturing includes: wire, telephones, PBXs, transmitter/receivers, modems, computers, digital data storage, data terminals, etc. Services include: various combinations of manufactured products used to provide services.

systems approach inadequate

Whether manufactured products can be used to provide diverse information services is largely irrelevant to the fact that diverse combinations of manufactured products are used to provide services.

The systems approach would have us look at printers, computers, data terminals, word processors, PBXs, telephones, controllers, multiplexers, and modems connected to telecommunications switching and transmission facilities interacting with controllers, multiplexers, modems, telephones, PBXs, computers, television sets and other terminals, as mere extensions of the telephone network. This view of an amorphous system masks the diversity of separate industries which are combined by the invisible hand of consumers creating their own information service capabilities. Thus, the information marketplace is not unitary. It relies instead on the existence of separate market sectors for innovation as well as supply.

There is the Computer Equipment Industry sector with its mainframes, minis, micros, data terminals, end-user periph-

erals and OEM peripherals. There is the Data Communications Equipment Industry sector with its controllers, multiplexers and modems. Then there is the Word Processing Equipment Industry sector. Third-generation products in this industry are capable of performing some functions of a mini-computer. Next there is the PBX and Telephone Instrument Industry which also includes key systems. These now include an increasing array of intelligent telephone sets and systems. And finally, there is the Network Switching and Transmission Equipment Industry. Taken together these diverse and discrete sectors create a synergy — not a system. They produce the potential for unlimited user selection — not unilateral supplier solutions.

an electronics-driven industry

Every one of these industry sectors is being driven by new generations of electronics. But dependence on electronics does not lessen the diversity of industrial opportunity. The fact that a company in one sector may cross over into another does not abridge their separation. Nor does it indicate any need for consolidation based on technological integration. Each, of course, has some need to use the transmission network, much in the way that each uses electricity. Yet, the common need for network facilities requires that no controlling entities be permitted to freeze out diverse, competitive access to that network.

Control of the network creates a potential conflict of interest with manufacturers dependent on the network. It

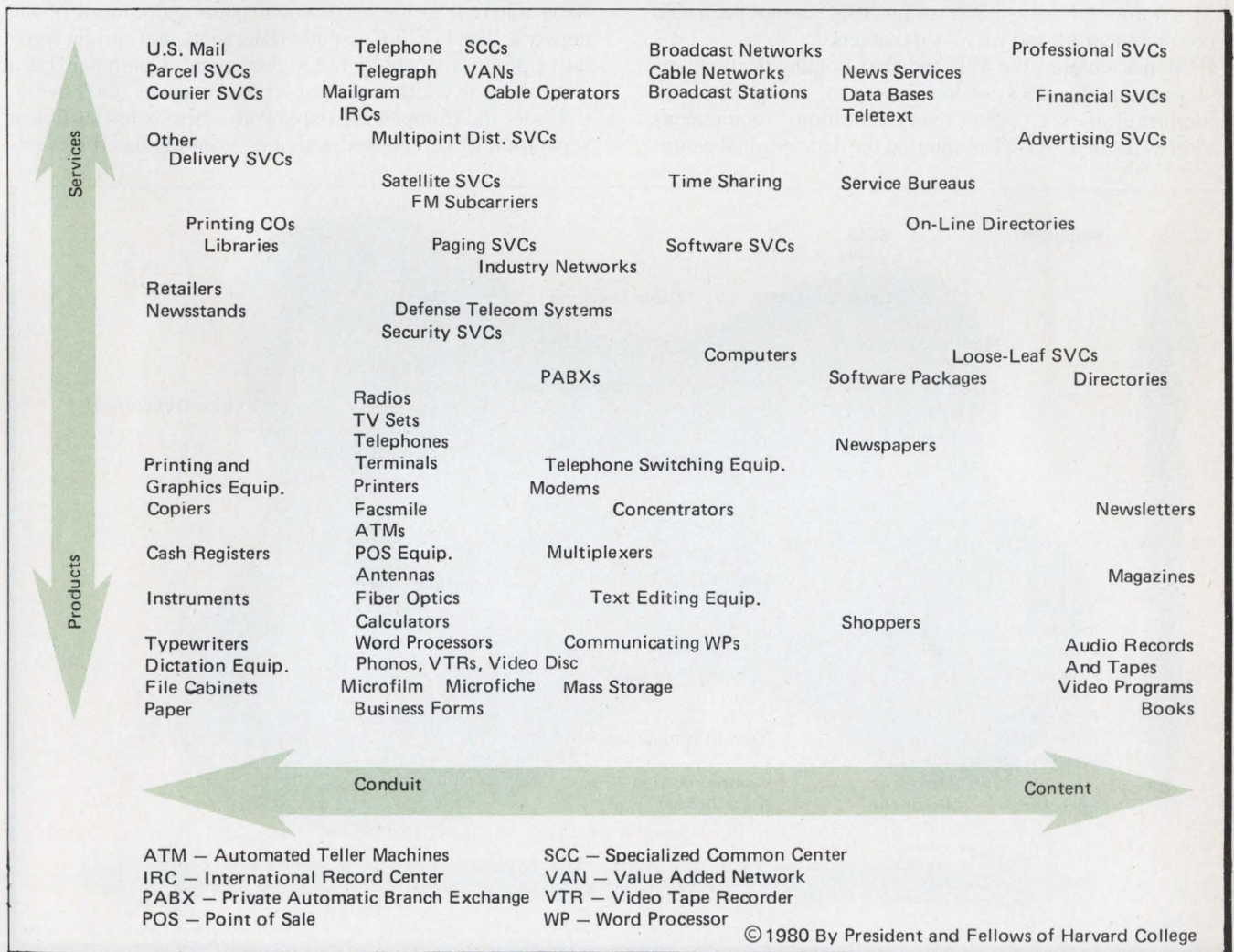

Figure 1: This matrix of the "Information Business" plots products and services as a function of "conduits" of "content."

creates an actual conflict of interest where the network supplier is, or may be, vertically integrated with a product manufacturing entity.

Looking at these separate industries, we find that, including AT&T and IBM, the total computer and communications equipment industry (excluding network, transmission equipment, electrical components and semiconductors), generated revenues of \$49 billion in 1980.

Total equipment revenues of \$49 billion excludes network transmission and central office switching. The market is as follows: data terminals, \$4.9 billion; microcomputers, \$0.7 billion; minicomputers, \$8.8 billion; mainframes, \$15.2 billion; end user peripherals, \$6.9 billion; OEM peripherals, \$3.8 billion; WP, \$0.9 billion; data communications equipment, \$1.2 billion; and voice communications equipment, \$6.6 billion. (The source for these figures is the Gartner Group and Trade Press).

The five largest components of these industries, and the ones most vulnerable to monopoly displacement, accounted for revenues of \$42.4 billion in voice communications equipment, computer mainframes, minicomputers, data terminals and end-user peripherals. Within the Computer Equipment Industry, 1980 revenues reached \$40.3 billion, averaging a growth rate of 32.5% over two years marked by recession. 1982 should be greater. The submarket for computer mainframes is the only sector where IBM achieves substantial monopoly dominance. However, healthy growth was recorded in all submarkets of the industry, as a variety of corporations developed and marketed products outside of IBM's dominant market; and, so far, IBM has not been able to commandeer the industry's submarkets.

IBM has entered the WP and data communications industry sectors, but does not dominate them; and its role in the modem/multiplexer (data communications equipment) market is limited. AT&T is entering the data terminal equip-

ment submarket of the computer equipment industry and has traditionally held a major portion of other data communications equipment submarkets.

In the PBX and Telephone Instrument Industry, AT&T currently plays the predominant role. The total industry recorded \$6.6 billion in revenues in 1980. Of the total industry, AT&T and independent telephone companies amassed revenues of \$4 billion in the submarket for PBX equipment and \$1.4 billion in the business telephone instrument submarket. In this market where carrier size and market power dominates, the asset value of PBX and telephone instruments owned by AT&T and independent telephone companies exceeds \$12 billion. Their installed base, including PBX, surpasses 186 million telephone instruments, in both residential and business markets. In business telephone instruments, AT&T owns 47,790,000 stations and 91% of the market in relation to interconnect competitors. Competition in the PBX and business telephone submarkets of the PBX and Telephone Instrument Industry has only achieved a 9% hold on the market over the past eleven years of its existence.

computer II decision

Each of these industry sectors is shown to exhibit their competitive condition. They now face AT&T and independent telephone company entry under the FCC Computer II decision and legislative proposals surfacing since 1976. As that event occurs, legislative policy, if it is to be affirmatively competitive, must deal with cross subsidies, tying and conflicts inherent in the carrier ownership and control of the network. The FCC's Computer II decision, and current legislative proposals, wholly fail in this regard. Computer II is a sieve through which regulated service revenues flood freely.

Under the Computer II framework, there is not sufficient separation of deregulated activities from regulated services

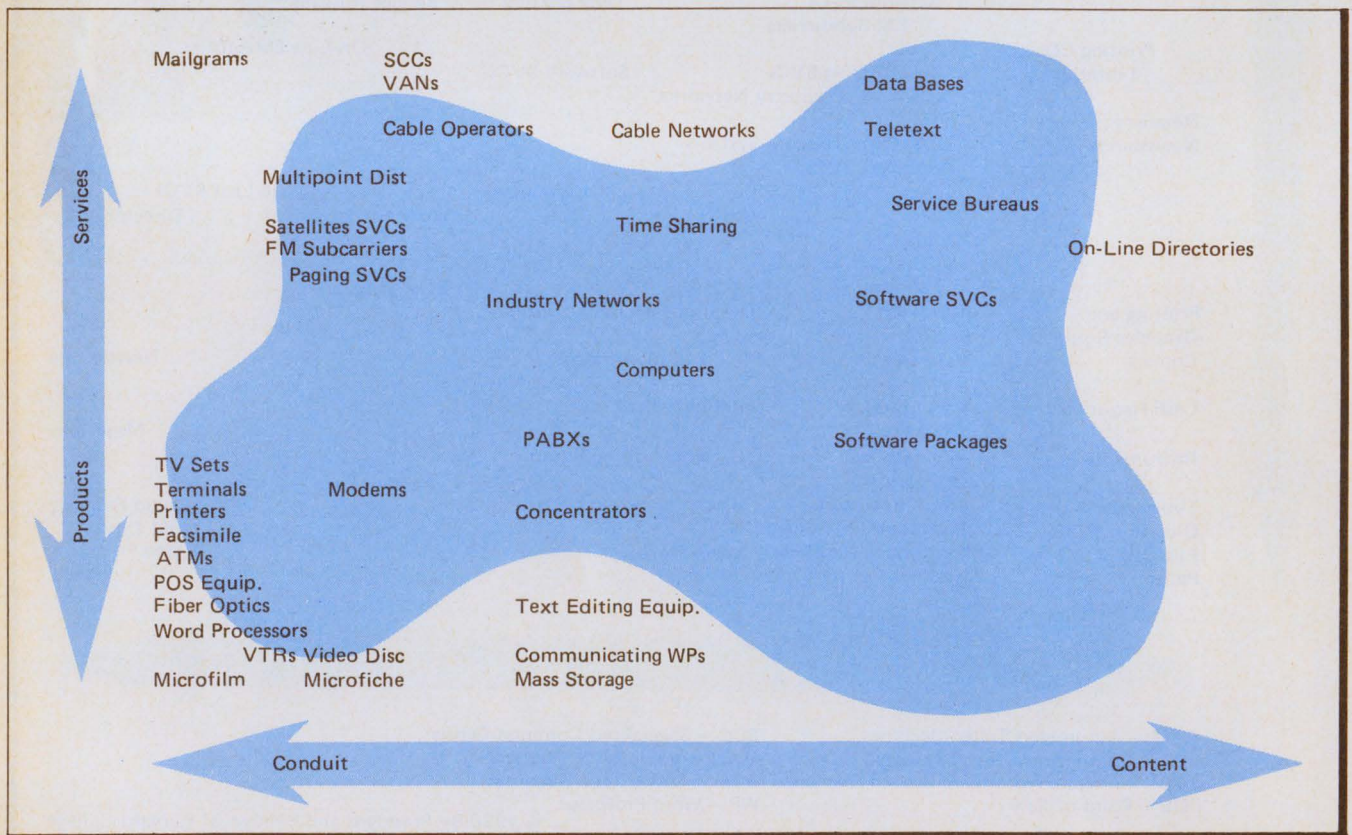

Figure 2: New products and services from 1930 through 1980 show the inherent dependence upon computer technology.

to prevent capital cost subsidization, or the subsidization of marketing, research, manufacturing, installation and maintenance of products. Nor is there sufficient separation, or continued regulatory control, to prevent the manipulation of accounting systems which facilitate the shedding of product costs in manufacturing and distribution operations conducted by carriers. And the cross-subsidy cake is handsomely frosted with joint advertising and market image-building.

Carrier control of the network remains one of the single most critical barriers to terminal equipment competition with carrier manufactured or purchased products. Under Computer II there is no obligation to publish technical information of changes in the network, or to publish revised standards and protocols, before carrier furnished equipment is first distributed to the marketplace. As a consequence, independent manufacturers are prejudiced by the denial of lead time in which to modify their products to altered network interfacing requirements. The refusal to provide competitive manufacturers with network load and response data is a source of persistent conflict.

people problems

There are, in addition, operating company conflicts of interest that impede access to the network. These are people problems. Whatever a customer's equipment needs, carrier employees will certainly refer them to the marketing department of the telephone company's manufacturing or product marketing affiliate. Moreover, under Computer II and sundry legislative drafts, there are no proscriptions to inhibit the disincentives of telephone company employees to furnish quality network services to products developed and delivered by non-carrier suppliers. Competitors rarely enjoy

installation and service priorities comparable to those assigned the product marketing arm of the telephone company.

Because wages, advancement and pensions are tied to the achievement of corporate objectives, carrier service personnel are all motivated to equate equipment sales losses to competitors with personal economic harm.

Conflicting corporate interests arise through the preferred knowledge carriers gain merely because of their network ownership. For example, under the FCC's equipment registration program, carriers obtain a trove of marketing data on each customer's equipment, whoever installs it. Such data is readily used to retard the progress of competitors who, by law, must provide it to the carrier.

These conflicts also impede the licensing and use of patents, and facilitate the rotation of managerial and other personnel having common knowledge of network functions and product performance. In addition, all conflicts of interests are hidden in the consolidation of financial and accounting data for joint operations; and in joint operations themselves.

These innumerable conflicts grow from the advantage of being both a provider of a bottleneck service and a supplier of the equipment that utilizes that service — if there is anyone else offering independently manufactured products performing the same or similar functions. Moreover, such conflicts and barriers are inherent in any structure predicated on the existence of a single corporate family simultaneously involved in regulated and unregulated telecommunications activities, equipment manufacturing and supply. The effect of such a construct is to destroy the very competition it purports to promote. D

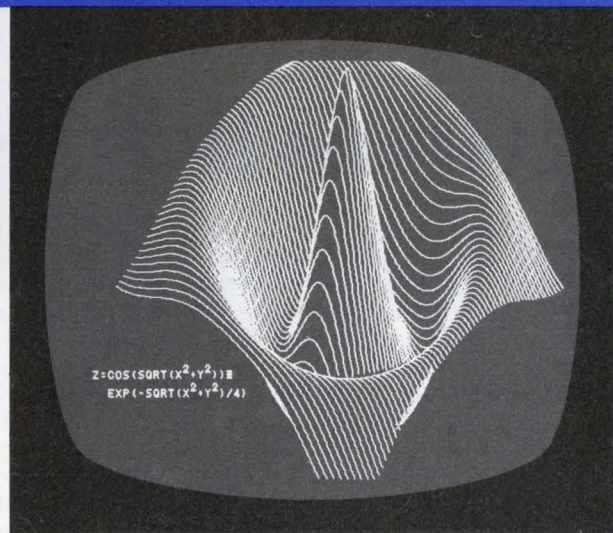

VIURAM video interfaces make your display I/O a natural extension of your computer software, not a choke point. Our direct-access display hardware, by avoiding cumbersome serial methods, provides maximum efficiency, fast character and pixel thruput, and extreme ease of software implementation.

LSI-II GRAPHICS

Model VRG-Q Add-In Graphics Memory for the Q-BUS

- 512 x 512 x 1 Frame Buffer
- Parallel Character Memory
- Dual-Height Card
- Line-By-Line or Direct Addressing
- TEK 4010 Emulation Software
- Low Cost, Available Now

Peritek
corporation

Contact Tom Birchell at:
3014 Lakeshore Avenue
Oakland, California 94610
(415) 465-9000
TWX: 910-366-2029

Computer Technology Division

Innovative Design

Tiny Core Memory Solves Big μ P Problem

Microprocessors are widely used in low cost controllers for "smart" machines and process equipment. In these applications RAM chips provide low cost but volatile storage and leave designers with a major problem for real-time applications: how to deal with power outages resulting in total loss of stored data, with costly, or even life threatening consequences. A solution is to provide some nonvolatile memory to prompt an automatic restart capability.

Core memories are ideal nonvolatile storage systems, and are widely used in large control applications, but tend to be more costly than volatile RAMs — especially in very small capacities. It is often possible to design controllers so that only a few words, or even a few bits need be saved in nonvolatile storage. Typical data so stored may be manually entered set points, tool positions, program counter state, position

of moving elements of a machine and process variables such as temperature and flow.

CMOS RAMs with battery backup can provide nonvolatile storage, but the long term reliability of batteries, especially under wide range temperature cycling and frequent charge-discharge cycles, is open to question. MNOS devices are another approach, but suffer from slow write times, and a unique type of fatigue termed "endurance."

A simple, low cost core module has been developed by Controlex Corp. The first member of the family, the 120, is a four bit module contained in a 14 pin DIP and supported by low cost TTL chips in simple circuitry. The core is of square loop magnetic material similar to that used in conventional core memories, with windings in a unique geometry so as to allow conventional TTL chips to provide the required drive

current. This results in a simple interface to the host system.

Operation of the core module is initiated by clearing the cores with a READ operation. To clear the core, it is forced to the "0" state by driving the set winding. This provides a known initial condition for the WRITE operation to follow. To write data, the core is either left unchanged (write "0") or forced to the opposite state (write "1") by current in the reset winding.

The 120 is intended for sequential operation under software control of a μ P I/O port. A typical system is an eight bit configuration using two 120 modules in cascade (**Figure 1**). To trace operation, assume that a READ operation has taken place, and that all cores are in the "0" state. This would be done by driving \bar{R} low for eight clock cycles, and switching address terms ABC through all eight combinations.

Clary 30kVA • The Silent UPS

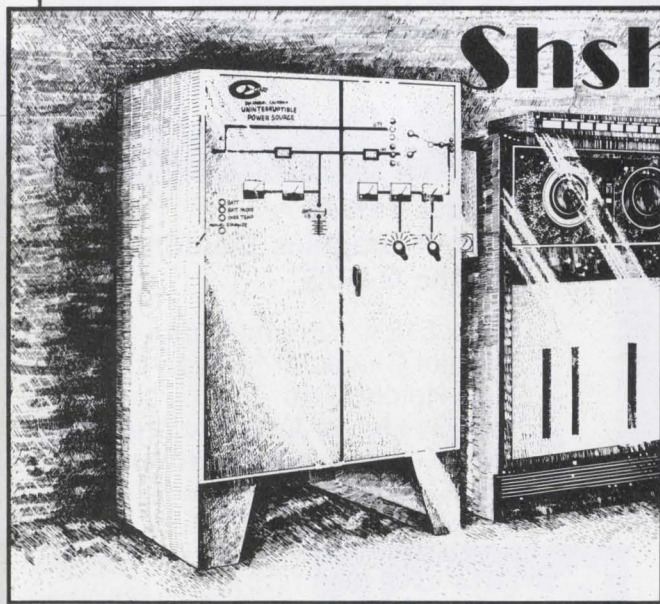

The Clary Corporation as a proven provider of reliable Uninterruptible Power Systems now has the quietest UPS of all. The 15kVA and 30kVA are so silent that they are a welcome addition to any computer room working environment. A Clary UPS protects sensitive computer systems in many applications such as telecommunications, security central stations, manufacturing process control, medical laboratories, business information systems and data processing. As an additional feature we can now supply a power distribution center to the UPS. UL listed File No. E68909 Models 1250-1, 2500-1, 5000-1, 5000-1/SBS, 10k-1, 10k-1/SBS with 15kVA pending. The complete power solution is now the quietest solution. For more information, please call or write us.



CLARY CORPORATION

320 W. Clary Ave., San Gabriel, California 91776 Phone (213) 287-6111 TWX 910-589-3369

PRECISION INSTRUMENTS DIVISION

Circle 15 on Reader Inquiry Card

To write, \bar{R} is pulled high for eight clock cycles, with ABC selecting all eight combinations, and data presented as desired for each address. The waveforms of Figure 1 show an alternating 1010... pattern. For the next READ operation, core outputs will follow this pattern, with a 2V pulse generated at the sense output for each "1" output. This is sufficient to drive a transistor directly to shape the output for TTL compatibility. The switching time of the core is about 1 μ s, allowing plenty of time to strobe the data back into the host system without latching.

An advantage of the sequential operation is that only one output line is required, and that low cost TTL decoder chips may be used directly for drivers. All timing is controlled by a single clock, which may be derived from the main system clock.

Many variations of the 120 are possible, and include both 8 and 16 bit units, as well as multiword (4x8) and parallel output versions.

Controlex is now in production on the 120, with price in OEM quantity of \$6.90 each.

Controlex Corp., 16005 Sherman Way, Van Nuys, CA 91406. Circle 197

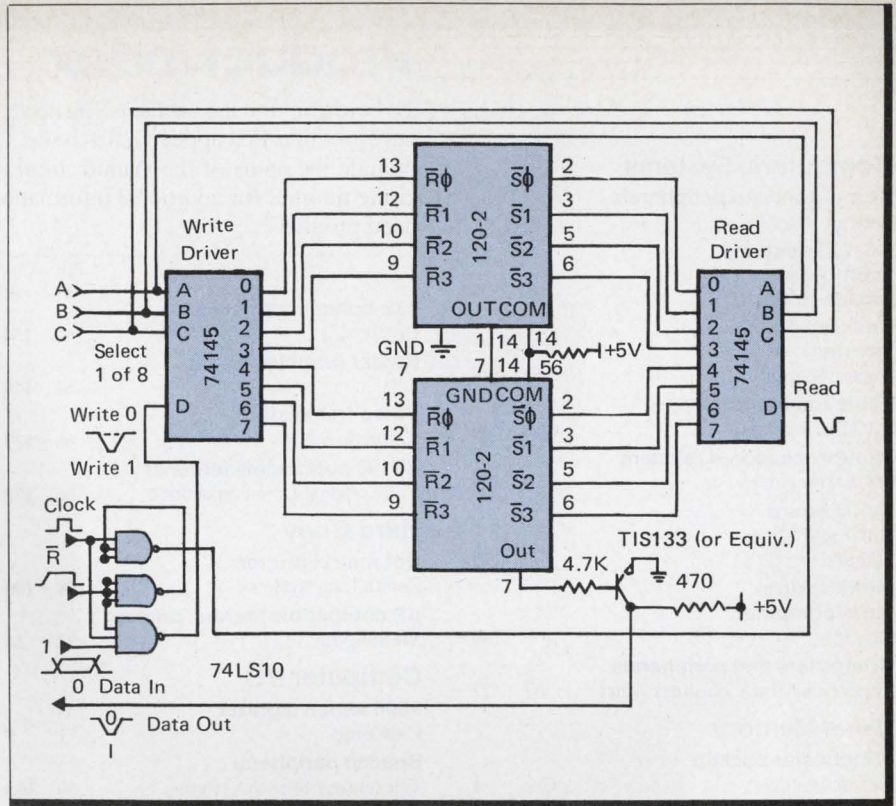
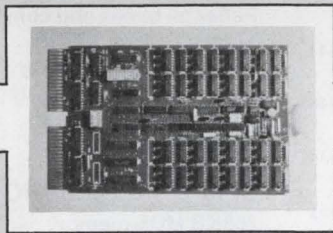

Figure 1: This tiny core memory application uses two 120-2 modules cascaded to provide nonvolatile storage. Write is accomplished by selecting 1 of 8 reset (\bar{R}) lines under I/O port control of ABC address terms sequentially. Data=1 allows switching current to flow during clock time. Read is accomplished by pulsing clock for each of 8 cycles while scanning ABC address lines.

256 KB MOS MEMORY for LSI-11/23™



4MB Addressing Standard/Parity Option

for **\$1200.00**

Contact:

PDS

2670 Walnut Avenue / Suite C
Tustin, CA 92680

(714) 730-7207

Circle 21 on Reader Inquiry Card

EXATRON'S RS-232C STRINGY/FLOPPY MASS STORAGE SYSTEM.



**Mini-disk speed, capacity and
reliability for only \$399.50.**

- Standard RS-232C communications link
- Built-in operating system
- Two file management structures: ASCII and binary
- Three baud rates available: 300, 1200 and 9600
- Busy/ready handshaking supported

Call our HOTLINE...
(800)-538-8559
In California,
Call **(408)-737-7111**

exatron

Exatron, inc.
181 Commercial Street
Sunnyvale, California 94086
(408)-737-7111

Circle 20 on Reader Inquiry Card

Product Index

To help you find the products you need, we've compiled a subject index of the ads and new products that appear in this issue. Organized by general product area, the listings include the name of the manufacturer, the page on which the product appears and a circle number for additional information on that product. Bold type indicates advertised products.

Computers/Systems

Computers and peripherals

Omega Sales 10 **19**

BC-223 desk-top computer

Braegen MPD 45 **8**

Desktop business system

Vector Graphic 59 **158**

Table top computer

IMS International 64 **159**

Multiprocessor μ C system

OSM Computer 64 **179**

S-100 board

Advanced Micro Digital 65 **170**

Multitasking minicomputer

Olivetti 66 **180**

Computers and peripherals

Scherer's Mini-Computer Mart 67 **27**

Mass Memory

Winchester backup

Kennedy C-2 **1**

Streaming tape backup

Ampex, Memory Products Div. 43 **11**

Winchester disk drive

Four-Phase Systems 58 **155**

Dual-density tape drives

Honeywell 58 **157**

45 ips tape transport

Datum 59 **135**

Streaming tape subsystem

Plessey Peripheral Systems 59 **146**

5 1/4 in. Winchester

DMA Systems 60 **133**

Solid state disk subsystems

Storage Technology 62 **148**

Floppy disk drive

Raytheon Data Systems 64 **166**

Winchester series

Century Data Systems 64 **130**

Disk subsystems

Information Products Systems 65 **142**

8 in. fixed disk drives

Ampex 65 **128**

RS 232C stringy/floppy mass storage

Exatron 51 **20**

19MB, 5 1/4 in. Winchester

Computer memories 66 **174**

Video Display/Image Processing

Image processing systems

Grinnell Systems 5 **4**

Display terminal w/card security

TEC 13 **16**

Video display terminal

TeleVideo Systems 15 **25**

Smart graphics terminal

Modgraph 39 **9**

Digitizer

GTCO 58 **156**

Image processing system

Comtal 58 **129**

132-column terminals

Datamedia 60 **154**

Raster graphics board

Selinar 62 **149**

Video frame store

Colorado Video 66 **173**

VT100 compatible terminal

Colorgraphic Communications 66 **172**

Hard Copy

Dot matrix printer

Zenith Data Systems 59 **160**

μ P compatible thermal printer

Memodyne 72 **24**

Computer I/O

9000 series digitizer

CalComp 1 **5**

Speech peripheral

Telesensory Speech Systems 60 **153**

PDP-11 parallel I/O

Computer Extension Systems 63 **147**

Add-In/Add-On Memory

Bulk semi memory

Dataram 7 **3**

Add-in graphics memory

Peritek 49 **7**

Maxiram storage system

Imperial Technology 71 **28**

Controllers, Interfaces

Disk/tape controllers

Distributed Logic (Dilog) 3 **13**

PDP-11 VAX controller

Spectra Logic 58 **143**

Disk drive controller

National Semiconductor 58 **141**

Mini-floppy controller

Micro Technology 58 **140**

Analog I/O controller

Datastream Systems 60 **134**

Ethernet controllers

3COM 60 **151**

LSI-11 interface board

Technical Magic 60 **152**

Low cost protocols

Intercon Research 62 **139**

Universal systems interface

Shugart Assoc. 62 **150**

Sampling LSI controller

Intel 62 **137**

Side door port

Kaufman Research 63 **145**

Test Equipment, Instrumentation, Development Systems

Advanced logic analysis

Dolch Logic Instruments C-4 **2**

Load test instruments

ACDC Electronics 59 **126**

Logic analyzer

Gould 59 **136**

8/16-bit ROM simulator

Inner Access 66 **177**

Multibus development control system

Distributed Computer Systems 57 **22**

Development system

Zendex 2 **6**

Power Supplies, UPS, Line Conditioners

Power conditioning

Gould-Deltec 9 **12**

Power purification systems

Controlled Power C-3 **70**

Silent UPS

Clary 50 **15**

Switching power supply

General Instrument 66 **176**

Communications

Asynchronous line driver

Bo-Sherrel 57 **23**

Full duplex modem

Fibronics 66 **175**

Computer site modem

Racal-Vadic 64 **165**

Data converter catalog

ILC Data Device 58 **138**

Components, Hardware, Packaging, Switching

Busrouter

Datafusion 11 **14**

DEC-compatible cabinets

Everest Electronic Equipment 56 **26**

Pedestal bases and components

Leggett & Platt, EST Div. 65 **17**

Tabletop microchassis

Configurable Micro Chassis 62 **132**

Fiber optic data sheet

Canoga Data Systems 59 **131**

Semiconductors, ICs, μ Ps

256KB MOS memory

Professional Data Systems 51 **21**

256K DRAM board

Rair Computer 64 **164**

CMOS static RAM

RCA 64 **181**

Software

Forth application modules

Timin Engineering 59 **144**

Other Products/Services

Array processors

Sky Computers 65 **18**

Accessories, Supplies

Printer ink rolls

Porelon 27 **10**

Employment Opportunities

μ P professionals

United Technologies 63

ATE SHORT COURSES

for Electronics Industry Professionals

These four informative short courses provide in-depth study at introductory intermediate and advanced levels in selection, implementation, and management of test and measurement equipment — hardware and software.

1982 SCHEDULE

March 1982 • San Jose, CA

June 1982 • Boston, MA

October 1982 • Rosemont, IL

November 1982 • Orlando, FL

ATE Software Tutorial — Definitions, Strategies, Management

Faculty: **Damon C. Hart**, *President*, Lexico Enterprises, Inc.
Roger L. Williams, *General Manager*,
Applications Support Division, Lexico Enterprises, Inc.

Description:

Educating the attendee on all aspects of ATE software, this course starts with introductory material for the beginner and builds up to advanced material for software engineers already familiar with test programming and control software. Specifically, the instructors give useful definitions and nomenclature; discuss the history of software; describe software views of test strategies; thoroughly cover test languages; review test system architecture including support, control and test application software; carefully analyze all the stages required for test program development; analyze the effectiveness of various software development tools; talk about software procurement and predict future trends for ATE software.

ATE: How to Select It — Apply It — Manage It

Faculty: **Arnold Greenspan**, *President*, AMG Associates
Ralph P. Anderson, *Product Line Manager*,
GenRad, Inc.

Description:

This course teaches the principles of automatic testing and their application to testing electronic assemblies. With emphasis on commercial ATE systems, the instructors provide an overview of all aspects of automatic testing, including hardware, system software, test application software and the tools used to develop, apply and manage a total ATE site or application. The course should prove of greatest value to engineers and managers who are newcomers to ATE, particularly those who are establishing and managing new applications. No prior experience in ATE is assumed, but attendees should have a basic understanding of electronics and the general capabilities of digital computers. The instructors encourage active participation by the attendees and will aid them in solving specific problems of interest to the class.

Advanced ATE Technology and Management

Faculty: **Paul J. Giordano**, *Chief Executive Officer*,
Giordano Associates, Inc.
Philip C. Jackson, *President*, Giordano Associates, Inc.

Description:

Focusing primarily on commercial applications of automatic test systems to factory and depot testing, this 2-day course covers such topics as component test and the use of systems and subsystems for diagnostics and go/no-go screening. The course provides an overview of the state-of-the-art of ATE technology: description of ATE elements, ATE acquisition process, design for testability, testing requirements and test program set generation. It includes a review of ATE hardware/software, state-of-the-art ATE configurations and future trends in ATE design. Finally, it gives members of the commercial sector an overview of military ATE: the criteria employed by major military programs to evaluate investments in ATE R&D funding, how these initiatives will affect available technology for commercial ATE and the impact of new military ATE concepts on aerospace manufacturers supplying equipment to that market.

Digital Board Testing

Faculty: **Andrew Herman**, *Director*, Test Engineering Institute, HHB, Inc.
Thomas W. Todd, *President*, Toddco General Engineering
Associates

Description:

This course provides a thorough treatment of all aspects of digital testing. It is intended for people who want to broaden their understanding of digital testing, either as programmers or as supervisors of a test operation.

Following an introduction to the basic concepts of Functional and In-Circuit testing, the student is presented with guidelines for the conceptualization and implementation of a test program. A sample circuit with its associated test program and interface test adaptor design are used to demonstrate procedures.

Following the discussion of test program generation, the student is presented with an overview of the hardware and software elements of a test system, including simulators.

The course concludes with a discussion on testing digital printed circuit boards containing LSI devices, including microprocessors.

Throughout the presentation, heavy emphasis is placed on the "how to do it" aspect of testing, especially in the area of test program generation and Interface Test Adaptor design.

For more information, please return this coupon or call Registrar, **ATE Short Courses, Morgan-Grampian Expositions Group**, 2 Park Avenue, New York, NY 10016 (212) 340-9700

Please send me further information on the 1982 ATE Short Courses

Name _____

Company _____

Address _____

City _____ State _____ Zip _____

Phone _____ DD 1/82

COMPAT Design

Q-Bus Controller for Winchesters Emulates DEC Devices and Supports Floppy Backup

Operating system software for widely used computers such as the DEC LSI-11 represent a significant resource for the user. Well documented, thoroughly debugged, and fully supported, these operating systems, along with the device driver programs they invoke, are designed for the CPU manufacturers' peripherals. System houses offering mixed vendor DEC-based systems can provide improvements in cost and performance by mating products of independent device makers with DEC processors and operating systems.

Andromeda Systems, Inc., a manufacturer specializing in LSI-11-based products, has done just this with its WDC11, a new family of multifunction Q-bus controllers. The WDC11, contained on a single dual-width card, plugs directly into the Q-bus back-

plane, and through its bipolar micro-controller and ROM firmware can cause popular independent and floppy disks to emulate a variety of DEC devices.

The WDC11 actually serves three functions at once: with Winchester disks it emulates DEC's RK05 or RL01/2 hard disks, and with floppy disks it emulates DEC's RX02 floppy. In addition, it provides an on-board ROM boot for system initialization.

The logical organization of the WDC11 is based on the 8X300 bipolar control chip, which provides the raw speed needed to handle high data rates inherent in Winchester devices. Data transfer to the host computer is via DMA, with 18 address bits implemented for direct addressing of 256kB of CPU memory space. Four additional

address bits are provided for the expected future DEC support of a 22 bit address field. Changeover to emulate one or another of the DEC devices is accomplished by merely plugging in the appropriate ROM chip containing the control firmware to drive the 8X300. The WDC11 represents one of the highest density packages for controllers on the market today, and the fitting of all of the required functions on a single dual width card is a significant packaging advance.

Depending on the device performing the emulation, a simple adapter or personality board may be required to accommodate differing connector pin outs and minor interface variations. These plug into the device proper and are entirely contained in its envelope. A variety of popular devices are currently

DEC COMPATIBLE CABINETS

- COMPLETE COSMETIC AND FUNCTIONAL INTERCHANGEABILITY WITH DEC
- DEC COMPATIBLE POWER SOURCING AVAILABLE
- INSTANT DELIVERY
- LOWER PRICES
- SUPERIOR QUALITY
- WELDED CONSTRUCTION



EH9602
19 INCH

EH9602
24 INCH

EH960

EH967

DEC CABINETS

**EVEREST
ELECTRONIC
EQUIPMENT**

(714) 634-2200

2100 E. Orangewood Ave., Anaheim, CA 92806

Circle 26 on Reader Inquiry Card

supported for the WDC11, including the Quantum 2000 and Shugart Associates SA1000 8" Winchesters, the Computer Memories CM5000 and Seagate Technology ST506 5-1/4" Winchesters, the Shugart SA800, SA850, and Tandon TM100-4 floppies or equivalents.

A significant feature of the WDC11 is its inherent ability to handle Winchester backup to a floppy, all in a single controller, thus eliminating one of the two controllers usually required.

Delivery of initial units of the WDC11 family have begun. Prices are \$2000 each for single quantities with OEM discounts offered.

Andromeda Systems, Inc., 9000 Eton Avenue, Canoga Park, CA 91304.

Circle 199

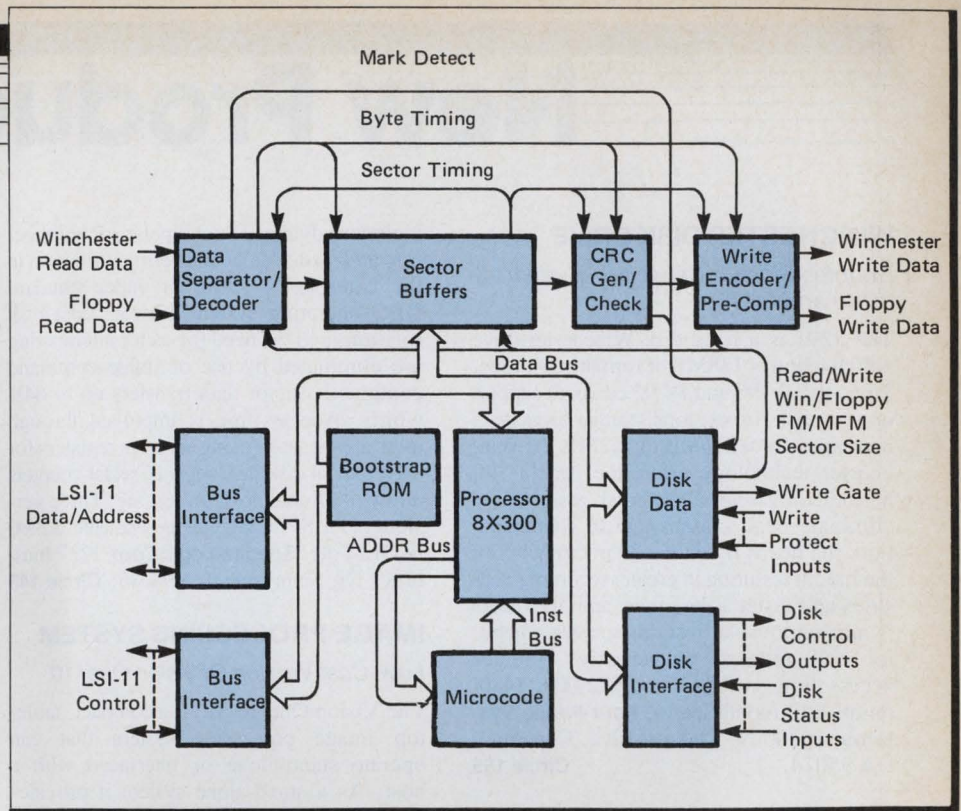

Figure 1: Functional block diagram of Andromeda's Winchester-Floppy controller for LSI-11 Q-Bus. The WDC-11 controller contains all interface, formatting and signal recovery circuitry. Data transfer to the host computer is via DMA, with 18 address bits implemented for direct addressing of 256 Kb of CPU memory space. In addition, 4 more address bits are included for future DEC support of a 22 bit address field.



The bo-sherrel M-3 Asynchronous Line Driver provides full duplex data transmission over regular 4-wire lines. It is end-to-end compatible with bo-sherrel's M-1 Short Haul Modem, but requires power from the attached terminal.

bo-sherrel co.

6101 Jarvis Avenue
Newark, CA 94560
415 + 792-0354

Quantity:	Price:
10 - 99	\$83.00
100 - 999	\$67.00
1000 - UP	\$51.00

Circle 23 on Reader Inquiry Card

DCS/86 (16 bit) Multibus® Development/ Control System \$6500

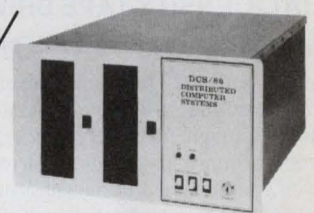

The DCS/86 is an industrial quality rack mountable Multibus* system based on the Intel 8086 16 bit microprocessor. A DCS/86 system includes dual 8" floppy disks with controller, DCS 86/16 CPU, 9-slot backplane, and heavy duty power supply. A 64K byte system with CPM/86** software is \$6500.00.

MULTIBUS HARDWARE - DCS designs and manufactures a complete line of Multibus compatible modules which includes the DCS 86/16 that contains an 8086, 3 serial ports (two of which are capable of high-level protocols including HDLC and SDLC), vectored interrupt, counter/timer, RAM/PROM, 24 bits of parallel I/O and full multimaster capability.

SOFTWARE - The DCS/86 utilizes CPM/86**, a complete disk operating system with assembler, editor and utilities. 8080, 8085, Z80 to 8086 translation software is also available. High level languages include Basic, Pascal, Fortran, PL/I (Subset G) and Cobol.

DCS/80 - 8080 based system prices begin at \$3995.

*Multibus TM of Intel, **CPM/86 TM of Digital Research

Distributed Computer Systems 617 899-6619
223 Crescent Street, Waltham, Ma. 02154 Toll Free 1-800-225-4589

Circle 22 on Reader Inquiry Card

New Products

WINCHESTER DISK DRIVE

Doubles Storage Capacity In System IV/90 and IV/95

The 8291 is a fixed-disk Winchester drive which features 138MB of formatted storage. Since the IV/90 and IV/95 can both support up to 4 disk drives, total storage capacity is increased from 276MB to 552MB. Its Winchester technology offers the benefits of: hermetically sealed head/disk assembly to eliminate head crashes due to contamination; the heads fly within 30 microinches of the media resulting in greater recording densities and faster access time; and, the media is non-removable, insuring greater reliability and reduced maintenance. Average access time is 37.12 ms. \$22,000; \$480/month (42-month lease). **Four-Phase Systems**, 10700 N. DeAnza Blvd, Cupertino, CA 95014. **Circle 155**

DIGITIZER

Low Cost 11 × 11" Graphics Tablet

The DEMI-PAD 5 includes industrial quality, 200 points/sec digitizing, dual RS232 interface, 1" lock height (digitize up to 1" off the tablet surface), and the Z-80A μ P which provides flexible output formatting. \$735; \$551 in qty 100. **GTCO Corp**, 1055 First St, Rockville, MD 20850. **Circle 156**

DUAL-DENSITY TAPE DRIVES

Supports Both GCR And PE Formats

For use with the DPS 6 and Level 6 small computers, the basic tape subsystem consists of a magnetic tape controller and one 9-track primary magnetic tape drive; 3 tape drives can be added to the subsystem for a total of 4 tape units. Each drive will operate in either 1600 bpi PE or 6250 bpi GCR. Standard tape speed is 125 ips for a maximum throughput of 780,000 bytes/sec. It is supported by GCOS 6 MOD 400 system software which allows it to configure itself for the number of devices and type of recording format. The subsystem is also compatible with ANSI-standard GCR/PE tapes created to run on IBM mainframes as well as on Level 66 and Level 68 Honeywell large-scale computers. First tape unit and controller is \$52,000. **Honeywell Inc**, 200 Smith St, Waltham, MA 02154. **Circle 157**

PDP-11/VAX CONTROLLER

SMD Controller With 2MB/Sec Transfer Rate

This Unibus-compatible controller attaches up to 4 SMD disk drives, and through switch selection, up to 16 different drive types can be configured on each of the 4 disk ports. It

includes advanced dual bipolar μ P architecture and switch selectable error correction in the controller's buffer or under standard DEC operating system control. Lost disk rotations and the need for sector interleaving are eliminated by use of single command contiguous sector data transfers up to 64K words. Access time is improved through overlapped seeks using separate registers for each logical disk, and separate sector counters allow rotational position sensing. Three versions of the SPECTRA 12 are available. \$2900 in OEM qty. **Spectra Logic Corp**, 1227 Innsbruck Dr, Sunnyvale, CA 94086. **Circle 143**

IMAGE PROCESSING SYSTEM

Low-Cost Version Of Vision One/10

The Vision One/10-M6 is a compact, tabletop image processing system that can operate stand-alone or interfaced with a host. As a stand-alone system it provides digital image processing in real-time (1/30 sec) and has a wide array of processing features. Features include real-time zoom



and roam, pseudocolor processing, and contrast stretching. The operating system is standard and the basic system includes memory control logic, pipeline processors, power supplies, and the system computer. It can store up to four 512×512 images in memory and has optional features such as frame grabber, small-area processing, color hardcopy, and real-time arithmetic functions. The Vision One/10-M6 is \$33,250. **Comtal Corp**, 505 W. Woodbury Rd, Altadena, CA 91001. **Circle 129**

DATA CONVERTER CATALOG

Includes Technical And Product Information

This 288 pp. applications and product catalog describes company's standard line of data converters, hybrid modules, synchro

instruments and data bus products. Nine separate product categories contain summary tables, background information, technical data, features, applications, block diagrams and outline drawings for each product in that category. Product categories include A/D and D/A converters, sample/hold and track/hold amplifiers, S/R to D and D to S/R converters, synchro instruments, SEM and MIL-STD-1553 data bus products. **ILC Data Device Corp**, 105 Wilbur Place, Bohemia, NY 11716. **Circle 138**

DISK DRIVE CONTROLLER

For IBM's 64.5MB Winchester

The QUAD 3000 is the first single-board DEC Q-bus controller for IBM's 64.5MB drive. It uses the same architecture as National's HEX 3000 Unibus multi-device controller and incorporates their proprietary controller microengine, the XPU (Transfer Processing Unit), which implements a 4 bit wide microword architecture with bit slice components. With an input aggregate data rate of over 2MB/sec, and a 4 kB on-board high-speed buffer, the unit offers highly reliable, flexible, guard-banded approach to I/O control. Under \$3000. **National Semiconductor Corp**, 2900 Semiconductor Dr, Santa Clara, CA 95051. **Circle 141**

MINI-FLOPPY CONTROLLER

DEC RX02 Hardware/Software Compatible

Utilizing a Tandon 96 tpi double-sided 5 1/4" mini-floppy disk drive, Model T100-4, the RX02 double-density format has been successfully mapped onto a 5-1/4" double-sided double-density diskette. It is compatible with LSI-11 computer systems. MXV22M features include all interface, bootstrap, and formatter electronics contained on one dual-height card; operation on standard device address and interrupt vector; 4 level device interrupt priority; Tandon model T100-4 or Shugart SA460 96 tpi double-sided mini-floppy interface compatible; 12 MHz crystal controlled clock; bit slice 2901 μ P Augmented Phase Locked Loop; concurrent operation with 8" floppy disk systems; write precompensation; IBM 3740 formatting; transparent firmware bootstrap; and power fail protection. The MXV22M is fully compatible with the DEC DY handler and will run under the RT-11, RSX-11, and RSX-11M operating systems. All operational and diagnostic software can be copied over to the 5-1/4" media on a system that contains an 8" and a 5-1/4" drive. \$1260, OEM qty 50 is \$945. **Micro Technology Inc**, 2192 Martin, Suite 230, Irvine, CA 92715. **Circle 140**

LOAD TEST INSTRUMENTS

Tests Variety Of DC Power Sources

As a basic load, the EL300 is a low cost solution for loading power supplies under test or for burn-in. Used with the EL301 Instrument Module it is a precision, programmable test system. The EL300 dynamic load module, with internal fan, can dissipate 300W continuously when operated from an AC Line. DC power sources from 4.5 to 60 VDC, up to 60A, can be tested for proper operation or burned in. As a portable test instrument it will operate with no line power and dissipate up to 250W @ 50% duty cycle (150W continuously). The EL301 instrument control module expands operational capabilities. It can monitor and program up to 6 loads, provides for testing DC levels as low as 1.8 VDC (1.5 VDC derated) and for dynamic loading in two modes. It also facilitates programming from a variety of external voltage waveforms. EL300 Load is \$495; EL301 Control Module, \$550; OEM discount avail. **ACDC Electronics**, 401 Jones Rd, Oceanside, CA 92054. **Circle 126**

FORTH APPLICATION MODULES

Contains Hundreds Of Definitions Not Previously Published

Included on the diskette are data structures, software development aids, string manipulators, an expanded 32-bit vocabulary, a screen calculator, a typing practice program, and a menu generation/selection program. In addition, the diskette provides examples of recursion, <BUILDS...DOES> usage, output number formatting, assembler definitions, and conversational programs. 100 screens of software and 100 screens of instructional documentation are supplied on the diskette. \$75. **Timin Engineering Co**, 9575 Genesee Ave, Suite E-2, San Diego, CA 92121. **Circle 144**

FIBER OPTIC DATA SET

Offers Complete Data Security

Model CSY-306 provides complete data security, error rates 10,000 times lower than comparable hard-wire connected modems, and complete electrical isolation. Inter-computer data transfer over distances up to 1 km or more is possible. Available with standard CCITT V.35, EIA RS449/422 or RS449/423 electrical interfaces, the CSY-306 operates at selectable data rates from 56 Kbps to 2.688 Mbps. Other data rates from 2.4 Kbps to 4.0 Mbps are possible using an external clock or an alternate internal crystal. This full duplex modem provides handshaking signal options including RTS, CTS, DTR, DCD, and DSR, and has a manually selectable remote loopback feature. To insure data loop integrity, optical signals in both directions are continuously monitored. \$1800, qty discounts avail. **Canoga Data Systems**, 21218 Vanowen St, Canoga Park, CA 91303. **Circle 131**

45 IPS TAPE TRANSPORT

Features Embedded Formatter

In addition to the host drive, the formatter can also service 3 additional, daisy-chained transports. A proprietary automatic restart function retensions the tape and puts the drive back on line after power interruption.

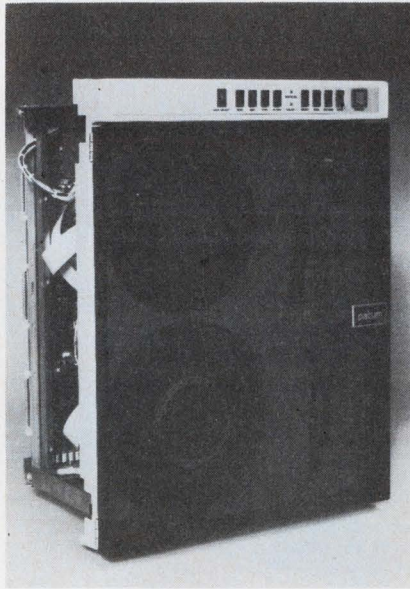

The drive's electronic design incorporates all read, write and control logic on one board, increasing reliability and enhancing maintainability. Powered by the D451, this embedded formatter performs 80-90% of standard controller functions. On 10-1/2" reels, the D451F powers 1/2" tape at 25, 37.5 and 45 ips. The drive encompasses either NRZI, PE or dual-density formats. IBM/ANSI compatible for 9-track units, with density selection available from the front panel. The D451F includes full 1 yr. warranty. \$6300, qty discounts avail. **Datum Inc**, 1363 S. State College Blvd, Anaheim, CA 92806. **Circle 135**

DESKTOP BUSINESS SYSTEM

New Level Of Cost/Performance

The 3032 μ C system has 32MB Winchester disk storage and a Z80b, 6 MHz μ P that increases system performance. The 8" Winchester disk enables full use of the maximum size files allowed by Vector's CP/M 2 operating system. The DualMode disk controller provides automatic error detection and correction to automatically



correct up to 5 erroneous bits in every 256 bytes transferred from disk to processor. This eliminates errors due to disk contamination, surface defects, etc. A 630 KB floppy disk, incorporated in the same module as the Winchester, is identical to that used in other Vector systems so programs and data can easily be transferred between the 3032 and other μ Cs. The 3032 is \$12,795. **Vector Graphic Inc**, 500 N. Ventu Park Rd, Thousand Oaks, CA 91320. **Circle 158**

LOGIC ANALYZER

Flexible Time And Data Recording Capability

Model K102-D is a lower-priced version of the K101-D that can be upgraded as needed. It has 32 data inputs and 8 clock inputs, and includes an internal clock which can sample data inputs as fast as 100 MHz. The K102-D offers versatile clocking modes, selective software tracing (recording), flexible signal conditioning, 4 input modes, 3 display formats, 3 standard interface features, an integrated digital voltmeter and a frequency counter. \$16,900. **Gould Inc**, Biomation Operation, 4600 Old Ironsides Dr, Santa Clara, CA 95050. **Circle 136**

DOT MATRIX PRINTER

Prints 150 CPS At Up To 300 LPM

The Z-25 interfaces with standard μ C systems using serial RS-232C or 20 mA current loop. Designed with 3 modules — print, paper handling and electronics — downtime is lessened since modules are simply swapped for maintenance. Features include quiet operation, an inked nylon cartridge ribbon for easy replacement, a 9x9 dot matrix, 95 ASCII characters, U/L case, and 33 graphics characters. Character width is selectable from 10, 12, 13.2 or 16.5 cpi on paper from 3.5" to 17.8" in width. **Zenith Data Systems**, 1000 Milwaukee Ave, Glenview, IL 60025. **Circle 160**

STREAMING TAPE SUBSYSTEM

Fast Backup For Q-Bus Disk Systems

The PM-CSV11A fits a standard 8" floppy drive enclosure and provides backup for a 28MB 8" Winchester-type drive in the SYST-23VTJ configuration. It stores 8000 bpi, recording 90 ips on 4 tracks. An RK05 disk can be backed up or restored in 30 seconds. Software to support streaming, the Cartridge Image Backup (CIB) is non-file structured similar to DEC's RSX-11M PRESRV utility. The subsystem consists of a dual-wide Q-bus controller, 1/4" tape drive, all related cables and the CIB utility. Rackmountable enclosure is also available. A 300' tape cartridge can backup 4 RK05 disk units, 2 RL01 units, an RL02 or an RK06 for approximately \$20.00. The PM-CSV11A is \$3600. OEM discounts avail. **Plessey Peripheral Systems**, 1691 Browning, Irvine, CA 92714. **Circle 146**

SPEECH PERIPHERAL

Broadens Voice Output Product Line

The SP1020 is a stand-alone electronic voice response unit which interfaces to almost any mainframe, mini or microcomputer system via an RS232C serial port. The enclosure contains the speech synthesizing unit, vocabulary memory, amplifier, power supply, interface electronics and front panel controls. Messages in virtually any language using male or female voices are stored on semiconductor memory devices for easy random access of words or whole phrases. Up to 200 seconds of speech may be stored. Vocabularies may be obtained to meet specific application requirements and direct access to encoded speech data over the telephone network is provided. The SP1020 Speech Peripheral is \$2500; Vocabulary Generation Services from \$50/custom word to \$1.60/word for Numerics Plus 62 word standard vocabulary. A SPEECH 1000 Synthesizer Board is \$1200. **Telesensory Speech Systems**, 3408 Hillview Ave. Palo Alto, CA 94304. **Circle 153**

ANALOG I/O CONTROLLER

Couples Analog Conversion Equipment To Q-Bus Systems

The design eliminates congested analog wiring to the controller board and allows the analog conversion system to occupy as much space as required for a given application. The DS100 is capable of continuous

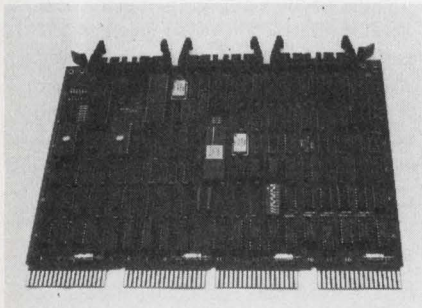

throughput exceeding 90,000 16-bit samples/sec to a 125 ips PE magnetic tape drive. Throughput to Q-bus memory is at 250,000 16-bit samples/sec. The controller board occupies one quad slot of a Q-bus backplane and provides control for up to 256 A/D input channels and 256 D/A output channels. The controller uses a Z8002 16-bit μ P to control its hardware functions with up to 4k words of program memory available. On-board diagnostic software aids in checking the controller functions and integrity of the data paths. The DS100 I/O controller board with software and integration to user's choice of analog conversion front-end subsystem is \$3500. **Datastream Systems**, 13516 Ring Rd. Poway, CA 92064. **Circle 134**

ETHERNET CONTROLLERS

LSI-11 Q-Bus And Unibus Compatible

The two products provide Ethernet controller functions at 10 megabits/sec for DEC systems. Either controller, with a 3C100 Ethernet transceiver, provides complete support for layers one (physical) and two (data link) of the International Standards Organization Open System Interconnection Reference Model so that any DEC computer

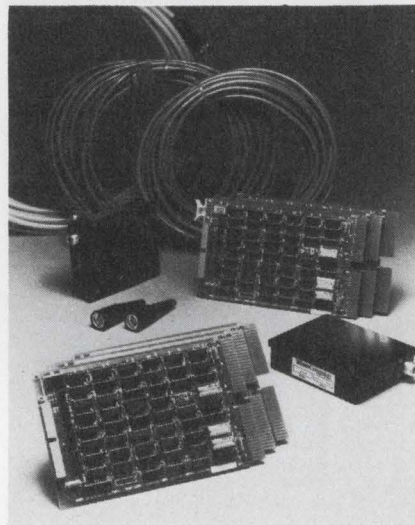

will be compatible with any other Ethernet-based system. A DEC computer running the UNIX operating system, with enhanced UNET, new controller, and transceiver, can become a complete Ethernet local computer network station. This system provides communication through all 7 levels of the ISO model, with UNET providing powerful file transfer, virtual terminal, electronic mail transfer and process-to-process communication capabilities via the 5 upper layers. The 3C200 Q-bus controller is \$2500; the 3C300 Unibus controller is \$3000; qty discounts avail. **3COM Corp**, 1390 Shorebird Way, Mountain View, CA 94043. **Circle 151**

5-1/4" WINCHESTER

With Fixed/Removable File Storage

The MICRO-MAGNUM 5/5 disk drive comprises two 5-1/4" disks. One is an internal, non-removable component of the disk drive, and the other disk is a removable,

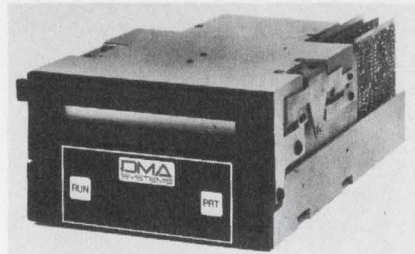

portable data cartridge. The unit provides mass storage, I/O, and back-up file generation. Storage capacity of each disk is 5 MB of formatted data, for a system total of 10 MB (13.5 MB of unformatted data). Aver-

age data access time is 40 ms, data transfer rate is 5 MHz. It mounts directly into housings designed for mini-floppy disks. A simple electronic interface gives OEM designers performance upgrade for mini-floppy-based systems as well as for 5-1/4" disk systems that only feature fixed media. Imbedded-servo technology improves track following and access time performance, complemented by an improved linear motor positioning system. In OEM qty the MICRO-MAGNUM 5/5 is \$1275. **DMA Systems**, 325 Chapala St. Santa Barbara, CA 93101. **Circle 133**

LSI-11 INTERFACE BOARD

Saves Backplane Space

The 8S half wide board is fully compatible with the LSI-11 Q-bus, contains 8 standard, full-duplex serial ports and features the use of leadless chip carriers. Selection of one of the 8 ports as the console is possible and each port can be independently configured for RS-232C, RS-422, or RS-423 communication protocol. Jumper plugs allow independent selection of word length, number of stop bits, parity checking, parity sense, and baud rates from 75 to 76.8K baud. An optional 153.6K baud rate is also offered. Addresses and vectors are jumper plug selectable over the full range and can be placed anywhere within the entire I/O

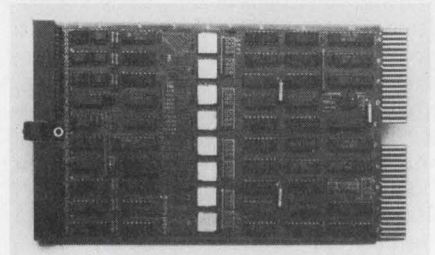

space. Completely DLV11-J plug compatible, the 8S has 4 selectable bits for the vector which permits up to 16 boards to be used in a backplane. \$650 (qty 100). **Technical Magic**, 17742A Mitchell Ave. Irvine, CA 92714. **Circle 152**

132 COLUMN TERMINALS

DG-Compatible Color And B&W Terminals

The terminals offer editing features not available with DG displays such as insert/delete a line, erase end of screen, clear highlighted areas, lock/unlock keyboard, foreground/background mode and secure field. They also offer bidirectional scrolling, split screen/regional scrolling, and a special set-up mode that allows operating parameters to be changed from the keyboard. Characters can be displayed in a variety of sizes and pitches; and, business graphic symbols are standard with the 128 ASCII character set. The monochromatic Excel 70 series starts at \$1395; the 8-color Colorscan 70 is \$3195; qty discounts avail. **Datamedia Corp**, 7401 Central Hwy, Pennsauken, NJ 08109. **Circle 154**

Broaden your testing knowledge and update your testing skills

11th Semi-Annual

ATE SEMINAR/EXHIBIT

Automated Testing for Electronics Manufacturing

JUNE 14-17, 1982
Hynes Auditorium
Boston, MA

The full scale technical conference offers a 3½-day program of workshops, technical papers, and an operating equipment exhibit. In addition you can select from a concurrent program of in-depth courses available in a special course/conference plan.

Specific information and application-oriented guidance from the faculty, augmented by equipment demonstrations at the large-scale exhibit of test and measurement equipment, will help you make the right decisions on investments and implementation.

For more information, send the coupon to:
ATE Seminar/Exhibit Registrar

Morgan-Grampian
Expositions Group
2 Park Avenue
New York, NY 10016
(212) 340-9700



Sponsored by

Electronics Test

co-sponsored by *Circuits Manufacturing, Digital Design*
and *Design Engineering*



THE ELECTRONICS INDUSTRY'S LARGEST EXHIBIT OF TEST AND MEASURE- MENT EQUIPMENT:

- Handlers • IC testers • Field, depot and maintenance testers
- Microprocessor troubleshooting and development tools • Automatic measuring instruments — meters, generators, analyzers, scopes, counters • Memory testers • Calibration instruments • System testers
- In-circuit testers • Bare board testers • PCB assembly testers
- Burn-in/Temperature cycling systems • Cable/wiring/harness testers • Test services • Interfaces

In conjunction with the ATE Seminar/Exhibit, other seminars and courses of interest to the test industry professional include:

ATE Software — Definitions, Strategies, Management
Advanced ATE Technology and Management

Automatic Test Equipment: How To Select It — Apply It — Manage It

Introduction to Digital Testing
Quality and Engineering Factors in Fabricating Printed Circuit Boards

WORKSHOPS AND ORIGINAL TECHNICAL PAPER SESSIONS ON THESE TOPICS:

Field Testing
Logic Analysis Techniques
Loaded Board Functional and In-Circuit Testing
Phase Measurement
LSI Component Test
Microprocessor Bus Fault Isolation
Spectrum Analysis
Analog Diagnostics
Burn-In/Temperature Cycling
Instrument Calibration
Test Requirements Analysis
Simulation
Signature Analysis
Systems Support
Management
ATE Acquisition
Impedance Measurements
Economics of Loaded Board Test
Bare Board Testing
LSI Board Test
Timer/Counter Measurement
Digital Diagnostics

Analog Board Test
Waveform Analysis
Bubble Memory Testing
Implementing the IEEE 488 Bus
Interfacing Devices
Automatic Test Generation
ATE Management
Testability
ATE Systems Calibration
Test Programming
Electro-Optic Testing
Using IEEE Bus
Instruments

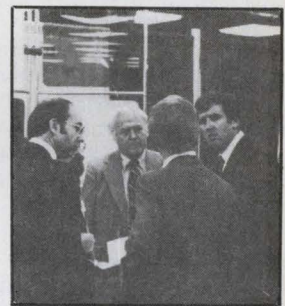

PLEASE SEND MORE INFORMATION

- ATE Seminar/Exhibit, June 14 - 17, 1982
- ATE Short Courses, June 15 - 17, 1982
- Quality and Engineering Factors in Fabricating Printed Circuit Boards, June 14, 1982

NAME _____ TITLE _____

COMPANY _____

ADDRESS _____ MAIL STOP _____

CITY _____ STATE _____ ZIP _____

Return coupon to **ATE Seminar/Exhibit Registrar**,
Morgan-Grampian Expositions Group
2 Park Avenue, New York, NY 10016 (212) 340-9700

DD 1/82

New Products

64-BIT DIGITAL I/O

Flexible I/O Interface For LSI-11 Series

The 1664ATTL card has 8 registers which can be jumper programmed to operate as input ports, output ports, or mixed I/O ports. When programmed as an input, the associated port accepts data from digital devices

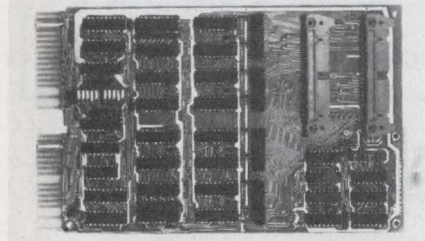

such as voltmeters, bit switches, and keyboards. As an output, the associated port drives devices such as printers and CRT's. Another jumper programmable feature permits all output latches to be set, or reset, upon power up initialization. Latching registers provide noise immunity against logic level changes. \$350; qty discounts avail. **ADAC Corp**, 70 Tower Office Park, Woburn, MA 01801. **Circle 127**

SOLID STATE DISK SUBSYSTEMS

Performance And Reliability Improvements

Both models are fully hardware and software compatible for virtual storage paging applications on IBM 370, 303X, 4300, 308X and equivalent processors. Both employ 16-kilobit, MOS RAM integrated circuits for data storage. The 4305-Model 3 provides 11.25 or 22.5 MB of semiconductor storage with a single controller. Access speed is 0.6 ms with initial data transfer rates of 1.0 and 1.5 MB/sec. From \$84,000 to \$141,160. The 4305-Model 6 provides 11.25, 22.5, 33 or 45 MB of semiconductor storage and either one or two control units. Data access speed is 0.3 ms. Model 6 offers more versatility than Model 3 with better data availability, higher transfer rates, and dual port and four-channel access. Transfer rates are 1.0 and 1.5 MB/sec, optional performance specifications include 3 MB/sec data rate in two-byte wide or data streaming modes. From \$140,380 to \$489,940. **Storage Technology Corp**, 2270 S. 88th St. Louisville, CO 80027. **Circle 148**

RASTER GRAPHICS BOARD

Graphics Output From DEC LA120 Terminal

The SG120R board does not affect the I/O circuitry of the LA120 and the printer retains all of its original capabilities while new

commands provide graphics capabilities. Maximum input data rate is 9600 baud, average printing rate is 752 graphics columns/sec with speed enhancement features to skip over blank areas. A graphics board enhancement for the VT100 is also available. With the LA120 and the SG120R, typical graphics images on the VT100 can be printed in 17 seconds with expanded size images in about one minute. A higher level of resolution than previously available in raster graphics is provided. The SG120R board is \$600. **Selanar Corp**, 437-A Aldo Ave. Santa Clara, CA 95050. **Circle 149**

LOW COST PROTOCOLS

For DEC VAX, PDP-11 And CP/M Micros

Intercon 100 Intelligent Interface offers a synchronous communication link via dedicated or dial up lines at data rates up to 9600 bps. It is a μ P-based stand-alone device with self contained protocols and async/sync data conversion. Software handlers are available for use with VMS, RSX-11M or CP/M. The unit allows mini/microcomputers to be transparent to the user and allows disk-to-

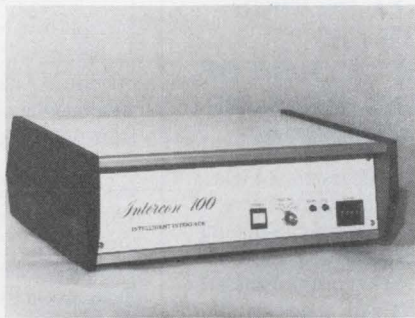

disk transfer of files between the remote host and users' local computer. Capacity for up to 4 PROM resident protocols are switch selectable. Presently available are: CDC 200UT, IBM 3780 and 2780. Intercon 100 with 1 protocol is \$3995, additional protocols are \$1000. **Intercon Research Corp**, 2603 Artie St. SW, Suite 14, Huntsville, AL 35805. **Circle 139**

UNIVERSAL SYSTEMS INTERFACE

Upgrade, Mix And Interchange Memory Peripherals

Without affecting the CPU operating system or applications program, SASI allows floppy, rigid, streaming tape cartridge and future generation optical disk drives to use a standard system interface. On the drive level, it eliminates the need for developing new controllers, host adapters and software drivers each time a new memory device is available. Standardization at the systems level allows the development of a standard set of custom LSI chips, resulting in significant cost savings and performance improvements. At the host CPU level, SASI permits a variety of memory subsystems (controllers and memory devices) to attach to different host CPU buses through the use

of standard host adapters. The SA1400 series of controllers with a SASI interface begin at \$565 in OEM qty. **Shugart Assoc**, 475 Oakmead Pkwy, Sunnyvale, CA 94086. **Circle 150**

SAMPLING LSI CONTROLLER

For 64K Dynamic RAMs

The 8203, an LSI peripheral controller chip, controls and automatically refreshes arrays of 64K dynamic RAMs in μ C systems and on memory expansion boards. It performs multiplexing of row/column memory addresses; generation of strobes used by RAMs to latch their addresses internally; initiation and control of memory refresh cycles; arbitration between simultaneous requests for memory access (R/W) and refresh; and, acknowledgement to the system CPU when memory access cycles actually begin. The 8203 has on-chip array drivers and damping resistors in series with the address multiplexer outputs, further reducing system chip count. It controls up to 64, 64K RAMs totalling 256 kB of capacity. It can also be strapped to operate with 16K dynamic RAMs. \$27.15 (qty 100). **Intel Corp**, 2625 Walsh Ave. Santa Clara, CA 95051. **Circle 137**

TABLETOP MICROCHASSIS

Holds 6 Multibus Cards And Two 5-1/4" Disks Or Bubble Memory

From 4 to 9 slot backplanes compatible with both the Multibus system bus and the IEEE P796 standard may be selected. The chassis contain switching power supplies from 60 to 200W. Configurations may include up to two 5-1/4" floppy or Winchester disk drives and up to 4 bubble memory modules. All include forced air cooling through the card cage, magnetic circuit breakers to prevent board failures from AC power supply arcing, power supplies allowing input voltage variations from 90-132 or 180-264

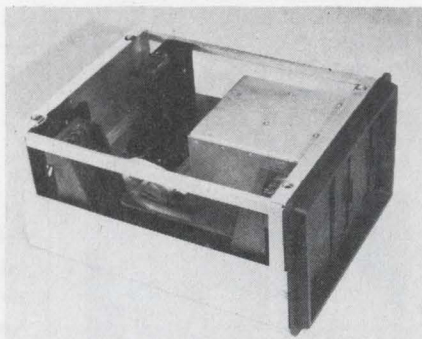

VAC, and 16 ms of full power availability after total power failures. Model CMC-6FF-160 with a 6 slot backplane and a rear panel with spate for up to 6 I/O connectors, a 160W switching power supply and dual minifloppy 440 kB capacity drives compatible with Intel iSBX-218 floppy disk controllers, is \$2800; chassis without drives is \$2100. OEM discounts avail. **Configurable Micro Chassis**, 34 Church Ave. Northport, NY 11768. **Circle 132**

PDP-11 PARALLEL I/O

*Hardware And Software Compatible
With DEC DR11C*

The PIO 11 requires one Quad SPC slot in the Unibus. It has been enhanced over the DR11C by an option that allows the user to select standard TTL output signals, or high current open collector output signals. On-

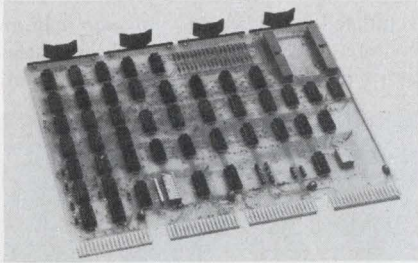

board DIP switches allow easy selection of address and vector locations. Complete hardware and software compatibility to all operating and diagnostic systems is maintained. \$395. OEM discounts avail. **Computer Extension Systems Inc.**, 17511 El Camino Real, Houston, TX 77058.

Circle 147

SIDE DOOR PORT

Enables Single Terminal To Talk To Two Computers

When a CPU has to perform protocol conversion, terminal emulation and polling operations, it ties up machine cycles and memory space. These tasks can be performed externally by the Side Door Line Interface Module (LIM), so the computer is freed to do other tasks. The Side Door LIM eliminates any requirement for adding wires, switches and enables the user to choose the computer he wants to talk to. No modifications of the host or local CPU software is necessary. The unit can talk with

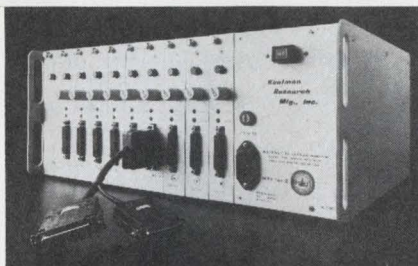

virtually any local computer which has an async port. Designated the DLA-100-SD, it is used in conjunction with the Kaufman Research True Port Concentrator. Both a polled concentrator and an emulator, these products support multidrop polling in multiple clusters of 8 terminals each. Any of a large number of ASCII devices can be supported, including special and non-standard terminals. True Port Concentrators are \$4890 with one LIM with Side Door, to \$10,595 for 8 LIMs and 8 Side Doors. For existing True Port Concentrators, the Side Door LIM is \$815. **Kaufman Research Manufacturing Inc.**, 2260 Mora Dr., Mountain View, CA 94040. Circle 145

U PROCESSOR PROFESSIONALS

Hamilton Standard, a world leader in sophisticated control systems and automatic test equipment, is currently seeking microprocessor professionals in the following disciplines to staff several of our exciting programs.

SOFTWARE DESIGN ENGINEERS

EXPERIMENTAL/ PROJECT ENGINEERS

SYSTEMS DESIGN ENGINEERS

HARDWARE DESIGN ENGINEERS

Among our programs are microprocessor based fuel controls for diesel and gas turbine engines, environmental control systems for aerospace applications, aircraft flight control systems, and special purpose automatic test equipment for aerospace and industrial systems. Our programs involve use of state-of-the-art and advanced circuitry such as commercially available and custom microprocessors to accomplish control and direction of a system.

Employment at Hamilton Standard will provide you with technical challenges and an opportunity to be involved in achieving major breakthroughs in technology.

We offer salaries fully commensurate with education and technical background, an excellent benefit package, and a challenging and rewarding future.

To be considered for these positions, please send your resume in confidence to:

Michael C. Bowen
Senior Professional Recruiter
Hamilton Standard Division
United Technologies
Windsor Locks, CT 06096

or call collect: (203) 623-1621, ext. 2372



**UNITED
TECHNOLOGIES
HAMILTON
STANDARD**

An equal opportunity employer

256K DRAM BOARD

Single-Board Memory Option

By using high-density 64K RAMs, a full 256kB of high-speed MOS memory is provided on a single board. Users of the Black Box range may incorporate 2 of the 10 x 4 1/2" boards into a single microcomputer to provide a full 1/2 MB of RAM storage.

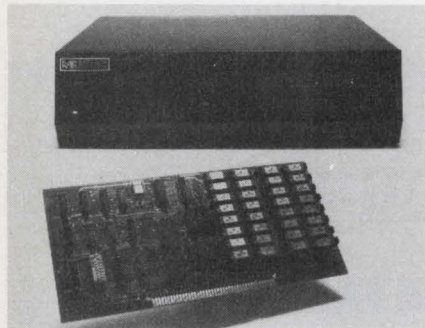

Access is via a powerful memory management unit, standard with Black Box systems, which extends the normal addressing range from 64K to 512K, and is fully supported by an advanced multi-user MP/M operating system. \$2500/256kB, the Black Box 3/30 is \$7500; qty discounts avail. **Rair Computer Corp**, 4101 Burton Dr. Santa Clara, CA 95050. **Circle 164**

CMOS STATIC RAM

Redesigned For Higher Speed And Performance

Faster versions of the MWS5114 4K static RAM, the MWS5114-3, -2 and -1 have access times of 200, 250 and 300 ns. Organized as 1024 words by 4 bits, the RAMs are fabricated in ion-implanted silicon-gate CMOS technology for low power consumption. They retain data at voltages as low as 2V over the 0 to 70°C operating range. This allows them to be applied in battery backup systems in which system power is provided by a standby battery when normal electrical power either fails or is intentionally shut down. All inputs and outputs to the devices are TTL compatible, giving users the benefits of low-

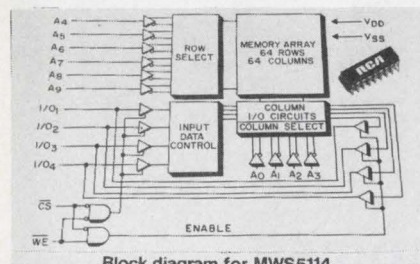

Block diagram for MWS5114

power CMOS and the high-speed of TTL in mixed technology systems. From \$6. to \$7.40 (100 qty); higher volume discounts avail. **RCA**, Solid State Div. Box 3200, Somerville, NJ 08876. **Circle 181**

COMPUTER SITE MODEM

Replaces 7 Bell Models

The VA 315 series direct connect, 300 bps full duplex modem, can automatically or manually originate or answer calls, and handles all applications for full duplex 0-300 bps data transmission over the dial-up network. It replaces Bell type modems: 103A, 103E, 103J, 113A, 113C and 113D. It is compatible with Model VA811 singleline/multiline automatic calling unit, making it possible for a single RS366 or RS232 computer port to provide automatic dialing for up to 60 VA315 modems. The VA315 contains extensive diagnostic and test features. The interface display coupled with local (analog) and digital loopback allows easy isolation of network problems. \$375. OEM discounts avail. **Racal-Vadic**, 222 Caspian Dr. Sunnyvale, CA 94086. **Circle 165**

TABLE TOP COMPUTER

Includes Winchester Plus Minifloppies

The 5000 SX table top computer has an integral 5.5MB Winchester drive and can also contain 2 double-sided, double-track-density floppies. The Winchester subsystem is comparable to large mainframe hard disk systems in terms of speed. A 20K program can be loaded in less than a second, about 10 to 12 times faster than with a floppy. Operat-



ing systems are CPM, MPM, Single and Multi-TurboDOS, BASIC, FORTRAN, and COBOL are available. **IMS International**, 2800 Lockheed Way, Carson City, NV 89701. **Circle 159**

FLOPPY DISK DRIVE

Supports PTS/1220 Distributed Processing System

Intended for the DDP user with limited storage requirements, the PTS/1220 offers up to 4.1MB on 4 daisy-chained drives. The direct-access, data storage devices use removable 8" diskettes. The processor's drive uses a two-sided, double-density, flexible diskette with a recording density of 6.816 bpi and a formatted capacity of 1.025MB. Track-to-track access time is 3 ms. Model 3831 Field Upgrade Diskette System with controller, adapter, expansion chassis and first 1.025MB diskette drive, cables and software is \$4100; Models 3832 and 3834, field or factory installed drives are \$1650; Model 3833 Diskette Expansion Chassis and 1.025MB drive is \$2850. **Raytheon Data Systems**, 1415 Boston-Providence Tpke, Norwood, MA 02062. **Circle 166**

WINCHESTER SERIES

190 And 380 MB Of Fixed Storage

The Advanced Marksman Series (AMS) initial offerings feature 190 and 380 MB of fixed storage in a drive that has the same form/fit as Century's 20, 40, 80 and 160 MB units. A linear motor positioner provides a fast positioning time for 14" Winchesters. Features include a spin motor brake, a carriage lock for use during shipment and a ventilated spindle to provide uniform cooling of the disks. This spindle eliminates the condition in which disks in multi-platter,

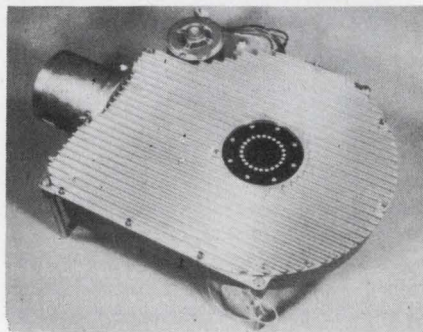

sealed drives expand at different rates and affect data reliability. **Century Data Systems**, 1270 N. Kraemer Blvd. Anaheim, CA 92806. **Circle 130**

MULTIPROCESSOR μC SYSTEM

Expandable From 1 To 64 Users

With ZEUS II each user has a dedicated single board computer module with a Z80A CPU, 64K RAM, and dual serial I/O. A similar two board module serves as a master supervising all user requests for shared storage and peripherals. The master processor module also includes on board floppy controller, peripheral interfaces, DMA, and real-time clock with battery backup. The

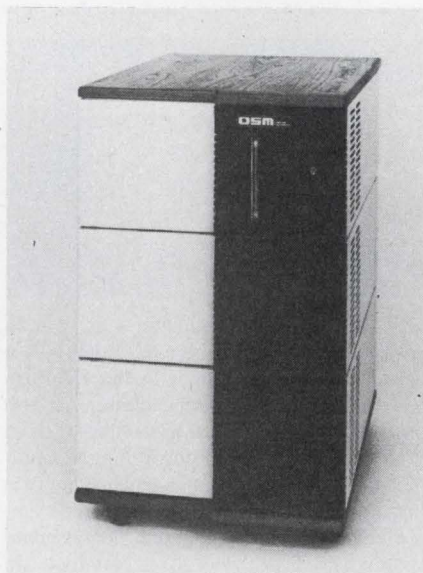

MUSE (Multi-User System Executive) operating system is CP/M compatible and provides a true multiuser environment. **OSM Computer Corp**, 2364 Walsh Ave. Santa Clara, CA 95051. **Circle 179**

DISK SUBSYSTEMS

Include Controllers To Monitor I/O Channels

Supporting PDP 11 and VAX 11/780, P-E 3200 series and DG Nova and Eclipse series computers, these subsystems are fully software transparent to the mainframe operating systems. True logical unit emulation is achieved through the controller design. The controllers are intelligent peripheral processors which monitor I/O channel activity to maximize system throughput. These systems support multiple sector buffering and extended data error recovery algorithms. Features include multi-drive support, overlap seek, burst error correction, and multi-drive radial interface. A 160 MB Winchester disk subsystem for the PDP 11-34 is under \$12,000. **Information Products Systems**, 6567 Rookin, Houston, TX 77074.

Circle 142

S-100 BOARD

Complete System On A Single Board

The SUPER/NET board consists of 64K bank select dynamic RAM, Z80A CPU, 2716 (2K) monitor EPROM, 5¼" and 8" floppy disk controller, two serial and two parallel interface ports and Z80A CTC for

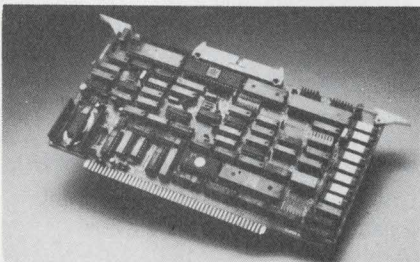

real-time interrupts. Full DMA operation is supported. SUPER/NET meets full IEEE-696 specifications and operates under both CP/M and MP/M software. As a single user system it allows addition of more user-defined options at lower cost. Its bus master ability suits it for use in a multi-user environment. \$1125. **Advanced Micro Digital Corp.**, 7201 Garden Grove Blvd, Suite # E, Garden Grove, CA 92641.

Circle 170

8" FIXED DISK DRIVES

49.7 And 82.9 MB Unformatted Capacity

The Scorpio family includes Model 48 with 49.7 MB and Model 80 with 82.9 MB of unformatted capacity and 20,160 bytes/track over 823 cylinders. Average access time is 30 ms with a data transfer rate of 1.2 MB and an average latency of 8.3 ms with a linear voice coil actuator in a closed-loop servo system. All critical recording components are enclosed in an environmentally sealed module. Integrity is further insured through the use of head landing zones, module shock mounting, and self-actuating head-carriage and disk-spindle locks. The drives initially offer the industry-standard SMD interface. **Amperex**, Memory Products Div., 200 N. Nash St., El Segundo, CA 90245.

Circle 128

pedestal bases and components for terminal stands



The EST Company offers a complete line of pedestal bases and components for stationary or movable stands for terminals or printers.

We offer seven styles of 4-leg pedestal bases in sizes from 19" to 34" spreads, and three styles of 5-leg pedestal bases in sizes ranging from 22" to 28" spreads.

Our line of uprights and top plates can match your needs for those stands.

Let us quote your custom casting needs or work with you on your stand unit design.



EST COMPANY, BOX 25A, GRAFTON, WI 53024 (414) 337-3270
A DIVISION OF LEGGETT & PLATT, INC.

Circle 17 on Reader Inquiry Card

LSI-11* Q-BUS* ARRAY PROCESSOR Full Floating Point, Under \$6K

Do you do... FFTs, digital filtering, vector math, matrix manipulations or other signal processing algorithms?

We do too!

Do you do them FAST on an 11/03, 11/2, or an 11/23?

We do!... and so can you.

In fact, the SKYMNK Micro Number Cruncher is already designed into:

- Seismic Modeling Systems
- Speech and Image Processing Systems
- Medical Electronics Systems
- Simulation Systems
- Laser Systems Analysis... and more

... and we're adding to the list every day.

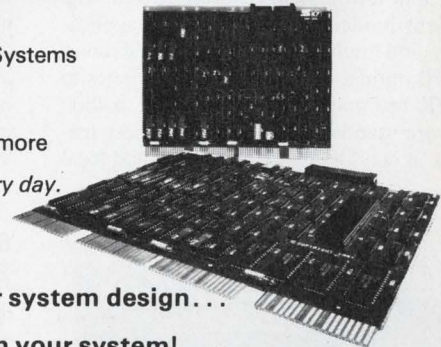

If a microcomputer is in your system design...

Maybe we should be in your system!

SKYMNK — THE Array Processor for microcomputers.
IMMEDIATE DELIVERY

Call or write for more information.

* tradename of Digital Equipment Corporation

ARITHMETIC PERIPHERALS FOR MICROCOMPUTERS



SKY COMPUTERS, INC., P.O. Box 8008, Lowell, MA. 01853 (617) 454-6200

Circle 18 on Reader Inquiry Card

New Products

SWITCHING POWER SUPPLY

Provides Linear Regulation

The OSP-50 provides the load regulation normally associated in a linear power supply with the size and weight advantages of a switching power supply. It features a user-selectable 120/240 VAC input and 3 fully regulated outputs. Standard DC outputs

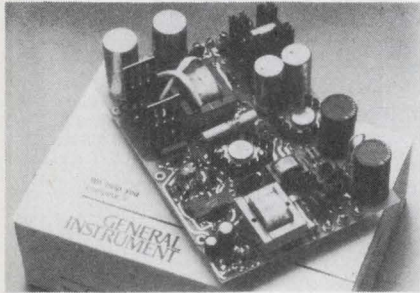

include +5V@8A, +12V@1A and -12V@1A; or, +5V@8A, +15V@1A and -15V@1A. The size of the supply is 2-1/2" x 8" x 5.65". Other standard features include free-standing PC board construction, soft start input, full overcurrent protection, input EMI filtering, +5V overvoltage protection, 65% typical efficiency and full brown-out protection. Primary application areas include VDTs, monitors, small computers and floppy disk systems as well as process control equipment. **General Instrument Corp.**, Computer Products Div., 1401 Lomaland Dr., El Paso, TX 79935.

Circle 176

FULL DUPLEX MODEM

Operates Over A Single Fiber

With the FM-801 modem, networking is simplified. For distances up to 3 km, only one-channel, PCS fiberoptic cable is needed. Thus, cable costs are reduced by 40% and termination costs are halved. The modem is ideal for point-to-point applications and multi-drop use (using Fibronics TS-10 optical splitters). Sync data rates to 19.2K bps and async transmission to 4800 bps are standard. Automatic self-test features as well as remote loopback and local



loopback capabilities verify link operation and offer complete and continuous fault monitoring control. All RS-232C handshaking features are built in. **Fibronics**, 655 Concord St., Framingham, MA 01701.

Circle 175

MULTITASKING MINICOMPUTER

16-Bit Mini with Multiuser Capability

Features of the S6000 include: expandability to 24 external peripherals, including terminal displays, printers, tape drives, etc; and, the ability to expand to 1 MB of memory and disk storage to a maximum of 360MB. It supports BASIC, PASCAL, LISP and Assembler programming languages plus a comprehensive text editing software package. It also features optional data communication capability. A variety of system configurations are available. All are supported by OMOS which supports several users on the system at the same time, all running the same or different programs. **Olivetti Corp.**, 155 White Plains Rd., Tarrytown, NY 10591.

Circle 180

19 MB, 5-1/4" WINCHESTER

3 Versions With 5 MB Formatted Data/Platter

The CM 5000 features Winchester technology, identical mounting to standard 5-1/4" floppy drives, and no-hysteresis positioning system. Other key features

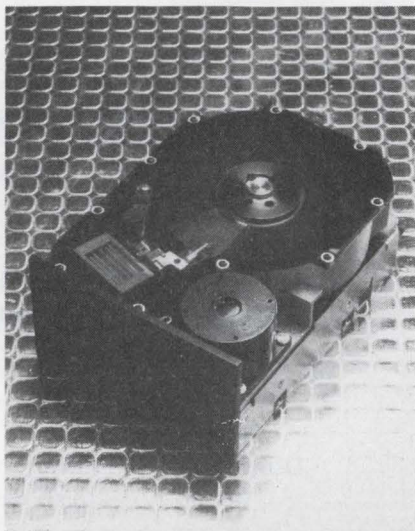

include: internal μ P; step-pulse buffering; high output and high resolution heads; off-track positioning capability; all electronics and motors located outside clean area; and, optional transfer rate for 8" Winchester compatibility. **Computer Memories Inc.**, 9233 Eton Ave., Chatsworth, CA 91311.

Circle 174

8/16-BIT ROM SIMULATOR

Speeds Software Design In S-100

The S-100 source computer loads the ROMSIM's resident RAM memory and then enables data to be accessed over cables by the destination board's byte- or word-wide ROM circuitry. Once this code has been debugged in the ROMSIM, burning a single set of PROMS completes the design cycle. ROMSIM is a 5x10" S-100 IEEE-696 compatible circuit card, supplied with driver software in BASIC and FORTH. Its RAM memory is loaded and verified through

4 user assignable I/O ports; no S-100 memory space is needed to hold ROM data. The board is provided with 4kB of RAM expandable to 16kB. \$495. **Inner Access Corp.**, 517-K Marine View, Belmont, CA 94002.

Circle 177

VIDEO FRAME STORE

Provides 2 Forms Of Image Modification

Model 274D Digital Video Frame Store provides two forms of video image modification with simple front panel controls. The basic memory captures a high quality 512 x 512 element image with 256 shades of grey. Front panel switches allow any or all of the grey scale components to be selected or deleted for posterization effects, and

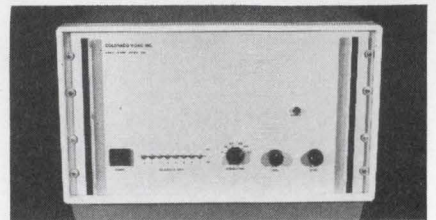

resolution of the frozen image is variable in steps down to 16 x 16 blocks. The 274D accepts standard video signals for freezing and processing, and may also be interfaced to conventional computers for more elaborate image alteration. \$9100. **Colorado Video Inc.**, Box 928, Boulder, CO 80306.

Circle 173

VT100 COMPATIBLE TERMINAL

Color Terminal That Operates With Existing Monochrome Software

The MVI-7, a 13" preconverted color terminal, features vertical and horizontal scroll, 4 independently addressable and scrollable screens, 2 pages of screen memory and 1280 user programmable symbols. The terminal is RS232C/RS422 or Current Loop compatible. It displays 80 characters by 24 columns in addition to a status line; and, memory may be configured for 80 x 56, 140 x 32 or 160 x 28 to allow for non-destructive horizontal and vertical scroll. The MVI-7 also has powerful local

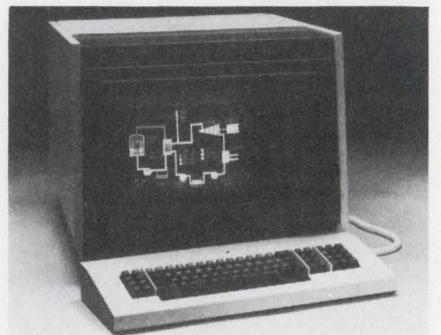

editing capability and control of many attributes. \$3500, qty discounts avail. **Colorgraphic Communications Corp.**, Suite 105, 2379 John Glenn Dr., Atlanta, GA 30341.

Circle 172

LA 120 GRAPHICS UPGRADE

Charts, Diagrams, Etc., From DEC Printer

DEC PLOT, a plug-in electronic module, provides a precision dot addressable plotting feature over the entire page, while maintaining all the speed and versatility of the conventional text printing mode of the LA120. This software conforms to the graphic protocol standards of DEC and is compatible with most DEC graphic terminal products, as well as with TEX PLOT, the portable graphics terminal based upon TI Silent 700 equipment. Only 3 simple commands, and none of the ASCII control characters, are required for plotting. Therefore, existing software programs may be easily modified for graphics without rewriting systems software. It is also compatible with ISSCO's DISSPLA and TELL-A-GRAF, and many computer time-sharing services. DEC PLOT plug-in modules are \$595. **Texprint Inc.**, 8 Blanchard Rd. Burlington, MA 01803.

Circle 184

121 MB STORAGE DISK

Winchester Technology For PDP-11 Computers

The RA80 rack-mount disk has a transfer rate of 1.2 MB/sec, a 25 ms average seek time, and an 8.3 ms average rotational latency. Software support includes the RSX-11M and RSX-11M-PLUS. Three RA80 drives, for a total storage capacity of



363 MB, can be mounted in a single 40" cabinet. Up to 4 units can be connected to a PDP-11 computer via the μ P-based UDA50 controller. The RA80 subsystem, with one disk drive and UDA50 controller, is \$24,000. Additional RA80 disk drives are \$17,500 each. **Digital Equipment Corp.**, Maynard, MA 01754.

Circle 183

IBM 3101 EMULATOR

Offers Both Conversation And Forms Mode Operation

Designed to emulate the IBM 3101, models 22 and 23, this display offers both conversation and forms mode operations in one unit.

This switch selectable feature reduces the investment costs of those buyers who are uncertain of the precise mix of 3101 models required for a specific application. The DM310 includes: an auxiliary printer port; flicker free 60 Hz screen refresh; 1920 character screen presentation with a 25th status line; 3101 compatible keyboard with 8 programmable function keys and 12 key numeric pad; P42 green phosphor; and extensive visual and logical field attributes. \$1295; also available for lease or rent. **Beehive International**, 4910 Amelia Earhart Dr. Box 25668, Salt Lake City, UT 84125.

Circle 171



DEC TERMINALS

VT101-AA.....NEW.....\$995

VT131-AA EIA w/Bik. Mode. editing **NEW**
.....\$1,575

VT100-AA EIA\$1,375

LA34-DA EIA825

LA34-AA EIA w/Forms.....875

LA34-RA EIA, Receive Only850

LA38-GA EIA, KP, & Tractor.....1,000

LA38-HA EIA, KP, Tractor & Stand1,100

LA38-AA EIA, KP, Forms, Tractor & Stand 1,150

LA120-RA EIA, Receive Only.....1,795

LA120-AA EIA, KSR, Keyboard Only.....1,995

LA120-BA EIA, Keyboard & Keypad, KSR 2,075

Cash Prices

Call Sonja at (614) 889-0810

**SCHERER'S
MINI COMPUTER MART**

6145 Dolan Place - Dublin, OH. 43017

BRAND NEW * WARRANTY

BRAND NEW * FULL 90 DAY WARRANTY * BRAND NEW * WARRANTY * BRAND

Circle 27 on Reader Inquiry Card

Power Conditioners Cut System Costs

There are essentially three types of common power line disturbances that affect computer operations: power line noise, voltage variations and power outages. Such noise disturbances and voltage variations account for 99.5% of all power-related computer problems. Of that percentage, 88.5% are noise problems. Consequently, noise-suppressing transformers have become basic peripherals in the computer industry.

Every transformer somewhat isolates one circuit from another electrically, while simultaneously coupling the two through magnetic induction. For low-gain circuits or insensitive loads, such elementary isolation is adequate. However, while power is being transferred between windings, noise potentials between the primary circuit and the ground are similarly being coupled to the secondary through capacitive resistive paths (Figure 1).

When the transformer must power a high-gain circuit, sensitive instrumentation, dp or communication systems, or telemetry equipment, then primary noise must be blocked to prevent degraded or inaccurate performance. Techniques for such isolation can be considered in four steps, each providing increasing degrees of protection from the effects of noise.

First, is separation of primary and secondary coils (Figure 2). Physical separation of coils placed side by side or on separate legs of the transformer's magnetic core will provide far less capacitive coupling than coils wound directly over one another. Although greater physical separation of coils produces less noise coupling, it also increases leakage inductance and results in reduced power transfer, thus limiting the effectiveness of this technique.

Second, is the Faraday shield (Figure 3). A grounded single turn of conductive foil placed between coils diverts much of the primary noise current to ground. Capacitance around the Faraday shield will still couple enough noise from primary to secondary to cause problems in sensitive equipment.

Third, is the box shield (Figure 4). It completely encloses the winding with a

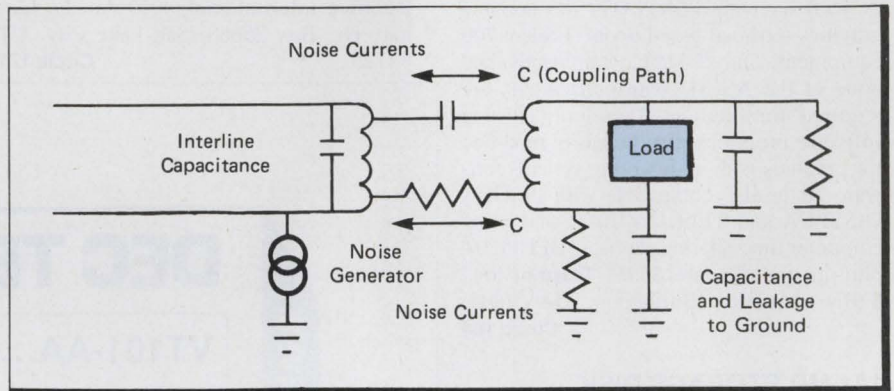

Figure 1: Along with power transfer, noise also passes through resistive and capacitive paths from primary to secondary and from secondary to primary. For higher-gain circuits or sensitive loads, this solution is inadequate.

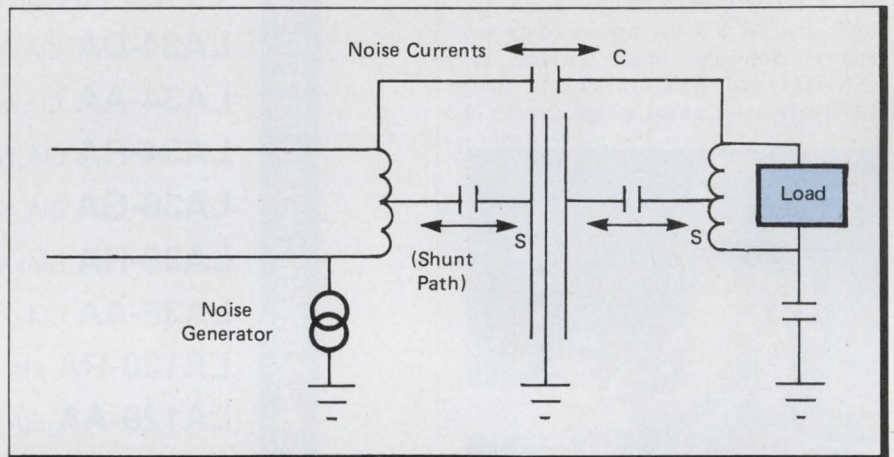

Figure 2: Smaller interwinding capacitances result from greater separation of primary and secondary coils. Physically separating coils lessens noise coupling but increases leakage inductance.

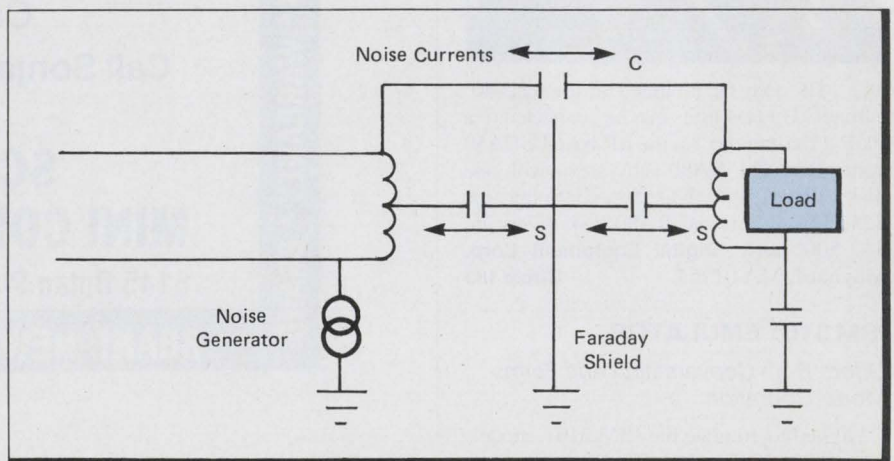

Figure 3: Noise is shunted to ground through a Faraday shield.

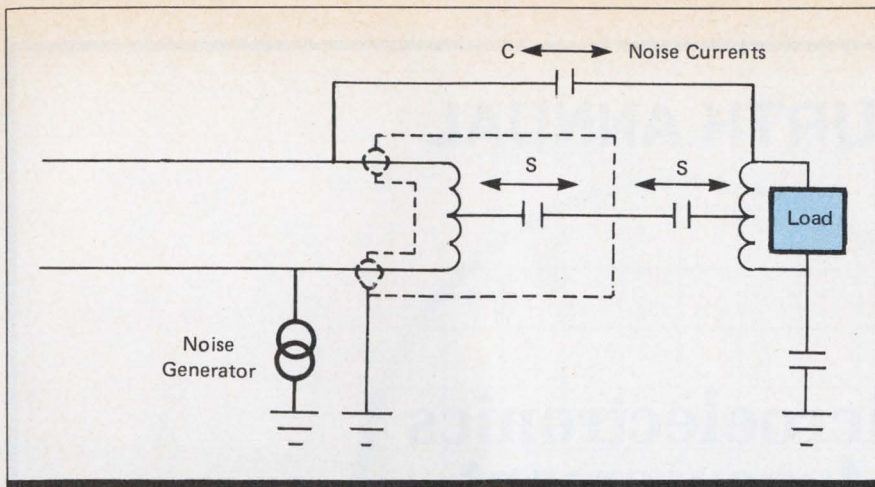

Figure 4: Interwinding capacitance is further reduced through use of a box shield.

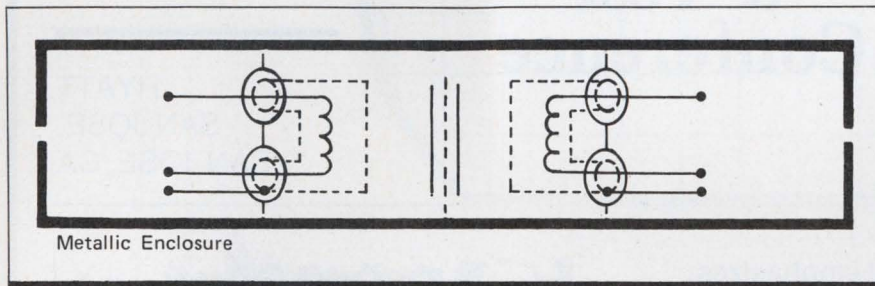

Figure 5: Shielding in an "Ultra-Isolator" or "Ultra-Isolation Transformer" is more sophisticated, isolating noise bidirectionally.

conductive foil and provides a ground path for primary circuit noise. Its advantage is that a much smaller capacitance exists between primary and secondary coils than in the case of a simple Faraday shield.

Fourth, the "Ultra-Isolator" or Ultra-Isolation Transformer (Figure 5), is the ultimate step in noise isolation. This triple box shielded transformer with coil separation stops noise currents from crossing the transformer in either direction. Each coil is completely enclosed in a wrapped foil box shield. Transformer enclosure and separator plates (special types of Faraday shields made from electrostatically coated aluminum) provide a second level of complete box shielding. In addition, transformer coils are physically separated for greater noise attenuation. This provides the greatest noise isolation available and protects against 88.5% of all error-producing power anomalies.

Voltage variations must be eliminated. Although undervoltages and overvoltages account for only 11% of the significant power line disturbances, they are blamed for over 50% of all power-related computer problems. The most common reasons for voltage variations are as follows.

- **Normal transmission line voltage**

drops between the utility substation and the user's service entrance. These voltage drops result from normal transmission line impedances that create lower voltage as the distance from the utility substation increases and as the load increases.

- **Intra-building voltage drops** between the service entrance and the distribution panels, and from the distribution panels to the point of usage. These result from normal impedances found in cables, connectors and fuses.

- **Brownouts** are initiated by the utilities during periods of high demand for power. Typically, these reductions are regulated in stages beginning with a 3% reduction, then progressing to a 5%

reduction, an 8% reduction and, in very severe cases, a 10% reduction in voltage.

- **Voltage sags and surges** are caused by faults on the power line and the resultant actions of fault-clearing devices, or by heavy loads on the power line (e.g., machine start-up) and the slow reaction time of utility regulating equipment.

The most common solution for voltage variations has been the AC line voltage regulator. Whether it's a ferro-resonant device or a sophisticated tap changer, results are similar: incoming voltages up to 13% above nominal and down to 25% below nominal are regulated to within an acceptable standard, perhaps $\pm 7\%$ of nominal. Today, however, the voltage regulator is being displaced by the power conditioner, a unique device that combines an "Ultra-Isolator" (or Ultra-Isolation transformer) with a voltage regulator to produce the most effective counter-weapon against noise and voltage variations yet devised. These new power conditioners are available in a wide variety of shapes and sizes, and in power ratings to suit most computer systems. They are reasonably priced and feature excellent efficiency, which helps lower operating costs. Power conditioners can solve 99.5% of all power disturbances, according to IBM researchers.

It's also necessary to protect against blackouts, which account for only 0.5% of power line disturbances yet are devastating occurrences that can wipe out entire programmes in a matter of milliseconds.

The most common solution to blackouts, the UPS, falls into two categories: on-line UPS and off-line UPS.

A typical on-line UPS has an isolation transformer, rectifier, battery charger, battery, static inverter and transfer switch. Figure 6 illustrates system operation. When the AC mains power is normal, power is passed through the isolation transformer, where

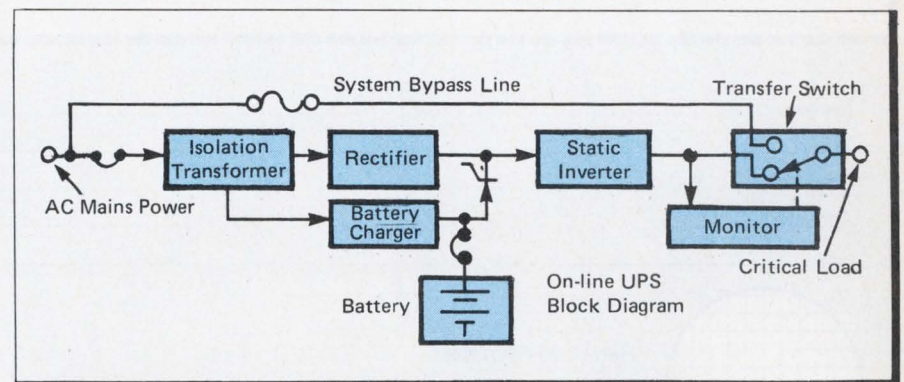

Figure 6: The typical on-line Uninterruptible Power Source has seven functional categories, as shown.

FOURTH ANNUAL

Microelectronics Measurement & Test Conference

MARCH
22-25, 1982

HYATT
SAN JOSE,
SAN JOSE, CA

This 4-day Conference & Exhibit emphasizes:

- Measurement technology to improve wafer processing yields
- Theoretical and empirical bases of measurement techniques
- Operation and programming of measurement tools
- Data handling — its analysis, display and interactive coupling



Technical papers and workshops offer state-of-the-art information on such topics as:

- Measurement and analysis tools: SIMS, Auger microscopy, SEM and microprobe
- Ion implantation, doping and damage measurements
- VLSI photomasking measurements
- Photoresist measurements and control
- Measurement and control in projection aligners
- Linewidth measurement: equipment; techniques; edge recognition; focus sensitivity; "standards"
- Laser annealing measurement and control
- Techniques to measure and control interface and insulator charge states
- Dry processing and plasma end-point measurements
- Toxic gas monitoring: chemical trace level/particle counter for VLSI/bubble memory production
- Intelligence in measurement tools
- Facilities: measurements and controls
- On line measurement systems for Si/Al, P/silox, Ni/Fe
- Automatic inspection for photomasks

For more information return the coupon below to Registrar, **Microelectronics Measurement & Test Conference**, Morgan-Grampian Expositions Group, 2 Park Avenue, New York, NY 10016 (212) 340-9700

DD 1/82

Name _____
Title _____
Company _____
Address _____
City _____ State _____ Zip _____

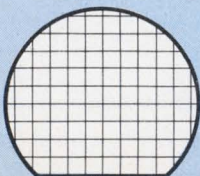

Return to Registrar

Microelectronics Measurement & Test Conference

Morgan-Grampian Expositions Group, 2 Park Avenue, New York, NY 10016 (212) 340-9700

Designers' Notebook

the extremely low interwinding capacitance eliminates high-speed, high-amplitude line transients. The transformer output is fed to the rectifier where AC power is converted to DC. The static inverter converts the DC input back into AC to drive the critical load.

AC mains power is also converted to regulated DC by the battery charger, maintaining the battery in a fully charged state. The regulated battery voltage is isolated from the rectifier output/inverter input by a power SCR.

If the AC mains voltage falls below a predetermined level, the SCR turns on, connecting the battery to the inverter input. The stored energy at the rectifier is sufficient to provide power to the inverter during turn-on of the SCR so that no discontinuity of power is seen.

When AC mains power is restored, the inverter is again automatically supplied with DC power from the rectifier. The SCR is then turned off and the battery is automatically recharged to ensure power to the critical load during the next AC mains outage. Should the monitor sense loss of AC voltage at the inverter

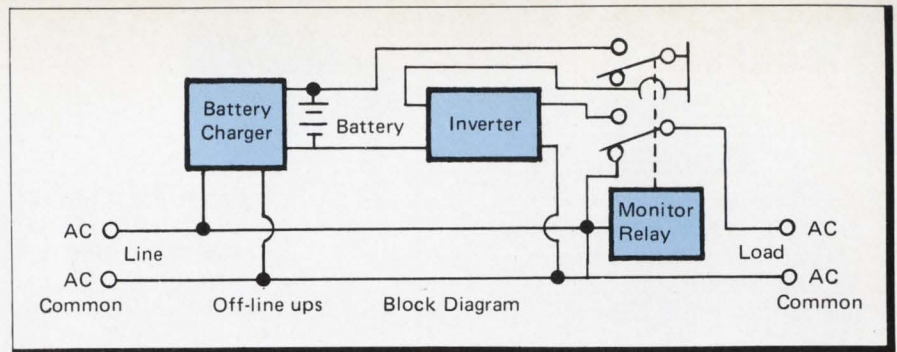

Figure 7: The typical off-line UPS system is configured as shown.

output, a transfer switch automatically transfers the load to the AC mains.

Typical off-line UPS systems are arranged with the load normally driven by the AC line (Figure 7). Loss of line voltage is detected by a monitor that automatically initiates transfer of the load to the inverter output. Power to the inverter is supplied by the batteries. When the line voltage is re-established, the load is automatically transferred back to the AC line and the battery charger recharges the batteries for protection against subsequent line failures.

As for the relative effectiveness of each of the previously discussed devices when it comes to protecting equipment from common power line

problems, keep the following points in mind. Power conditioners and UPS systems are the most comprehensive. UPS keep the computer operational during blackouts; but, because blackouts account for only 0.5% of power line disturbances, the power conditioner is probably the most logical choice for most computer applications — especially where cost is a primary consideration. Power conditioners cost approximately 45¢ per VA. UPS cost approximately \$2.50 per VA.

by Patrick K. Hallinan

Topaz, Inc., 3855 Ruffin Rd., San Diego, CA 92123.

We're Looking For Authors...

Starting January 1, 1982, we will pay authors an honorarium for articles and Designers' Notebooks submitted after this date at a rate of \$35 to \$75 per printed page for feature articles and \$70 for Designers' Notebooks. The exact amount depends upon how well the article is written and organized, the amount and quality of artwork (we prefer camera-ready art, but it's not essential), and how much extra work must be done by our editors and artists on your text and figures. Upon receipt of your article, we will mail you an "acknowledgement of receipt." After a review, your article will be accepted, rejected, or tentatively accepted (subject to your revisions). Upon publication of your article, you'll receive a complimentary magazine copy and your check.

Topics. What do we want? Problem and solution topics include, but are not limited to: microcomputers, minicomputers, buses and interfaces, power supplies, software (Ada, Pascal, assembly, etc.), printers, plotters, tape drives, floppy and hard disk drives, voice I/O, video display terminals, microcomputer development systems, logic analyzers, etc. Occasionally, we also run submitted engineering management and product buying guides. The technically "heavier" your article is, the more we (and our readers) like it.

Guidelines. For guidelines to Digital Design article requirements, format, submission and acceptance, write to: Features Editor, Digital Design, 1050 Commonwealth Ave, Boston, MA 02215.

High-Speed MAXiRAM Storage System

Offers superior performance, throughput and reliability!

Compatible with:

- D.E.C.
- Data General
- Westinghouse

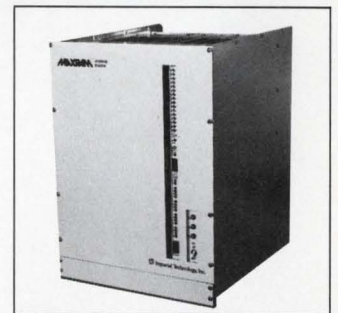

The non-rotating MaxiRam is a solid-state disc replacement storage system that operates at the speed of main memory. It is ideal for the following:

- ...if your processor is disc I/O bound.
- ...if your CPU spends too much time in the 'wait' state.
- ...if your present disc gives you reliability headaches.

Write or call to find out how *your* memory performance and reliability can be dramatically improved. Units available in both core and semiconductor.



Imperial Technology, Inc.

831 S. Douglas Street • El Segundo, California 90245 • Telephone: (213) 679-9501

Circle 28 on Reader Inquiry Card

What's Coming Up

Color Graphics

Whether you're designing a color graphics system or specifying one for your own use, February's **Digital Design** fills you in on the factors you'll need to consider before you act. Rapid advances in color graphics, especially in the area of price/performance, have opened up many new, previously impractical applications. As a result, color graphics system design has become a topic of considerable importance, both for engineers who design them and those who design with them.

Printing Terminals

Printing terminals for use in data communications represent one of the most active segments of the fast-moving printing industry. February's issue covers the latest technologies, as well as the most crucial technical marketing considerations.



MICROPROCESSOR COMPATIBLE THERMAL PRINTER

Model MAP-20P is a 20 column, alphanumeric panel mount printer that accepts 8 bit TTL parallel data at rates >2000 C.P.S. Complete with μ P controlled timing, character generation, printhead-drive, stepping — motor circuits, the unit also has its own self-test program and AC power supply. Weight is 4.2 lbs. and panel space is 14.8 sq. inches. Price is \$625.00 and in stock:

MEMODYNE CORPORATION
220 Reservoir Street
Needham Hgts., MA 02194
617-444-7000 Telex 92-2537

Circle 24 on Reader Inquiry Card

Looking for something but can't quite remember where? Check the Product Index on page 52.

Moving?

1 For FASTER service attach old mailing label in space below.

If mailing label is not available, print your old company name and address in this box.

Please allow six weeks for change to take effect

2 Print NEW business address here

NAME _____
TITLE _____
COMPANY _____
ADDRESS _____
CITY _____
STATE _____ ZIP _____

3 Mail to: Circulation Manager
Digital Design
1050 Commonwealth Ave
Boston, MA 02215

Advertisers' Index

Ampex-Memory Products Div.	43	Hamilton Standard (Electronics)	63
ATE Courses	55	Imperial Technology	71
ATE Seminar/Exhibit	21.61	Kennedy	C2
Bo-Sherrel	57	Leggett & Platt, EST Div.	65
Braegen MPD	45	Memodyne	72
CalComp	1	Modgraph	39
Clary	50	M.M.T. '82 Conference	70
Controlled Power	C3	Omega Sales	10
Datafusion	11	Peritek	49
Dataram	7	Porelon	27
Distributed Computer Systems	57	Professional Data Systems	51
Distributed Logic (Dilog)	3	Scherer's Mini Computer Mart	67
Dolch Logic Instruments	C4	Sky Computers	65
Everest Electronic Equipment	56	TEC	13
Exatron	51	TeleVideo Systems	15
Gould-Deltec	9	Zendex	2
Grinnell Systems	5		

Sales Offices

Northeast: John Moon (617) 232-5470, 1050 Commonwealth Avenue, Boston, MA 02215

Middle Atlantic/Southeast: Ben Rowe (212) 340-9700, Morgan-Grampian Publishing, 2 Park Avenue, New York, NY 10016

Midwest: Hank Bean (312) 475-7173, 2633 Hillside Lane, Evanston, IL 60201

South Central: Jerry Ambroze (718) 780-3326, Ambroze and Associates, 2186 Augusta, Houston, TX 77057

Northwest: Dwight L. Schwab, Jr. (408) 371-9620, 1901 S. Bascom, Suite 1005, Campbell, CA 95008

Southwest: Lindy Dolan (213) 981-3300, 15910 Ventura Boulevard, Suite 1215, Encino, CA 91436

Japan: K. Yanagihara (03) 350-0272, 10-10 Shinjuku 3-chrome, Shinjuku-ku, Tokyo 160, Japan Cable Address: Yanacour Tokyo

GARBAGE IN?

PURIFIED POWER OUT!

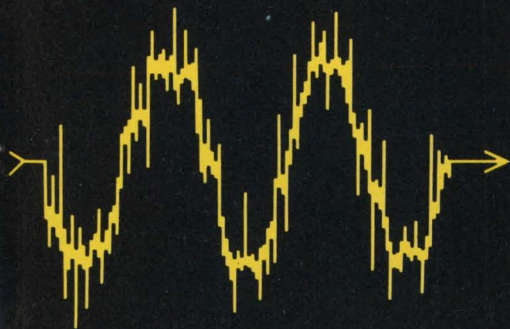

FOR *RELIABLE* COMPUTER OPERATION

SERIES 800

POWER PURIFICATION SYSTEMS

GUARANTEED PROTECTION

from

- Transients
- Noise
- Brown Outs
- Line Surges
- Other Line Disturbances

CONSTANT VOLTAGE TRANSFORMERS
FOR LINE VOLTAGE REGULATION,
CONDITIONING AND PURIFICATION.

for

- Mini Computers
- Large Computers
- Micro Processors
- Numerical Control Systems
- Communication Systems
- Programmable Controllers
- Other Sensitive Electronic Equipment

And other products to prevent
costly malfunctions and downtime
from input-power disturbances:

- Series 500 - Line Voltage Regulators
- Series 600 - Super-Isolation Transformers
- Series 700 - Line Voltage Conditioners
- Series 900 - Electronic Line Voltage
Regulators

In The United States

Call Toll Free

1-800-521-4792



**CONTROLLED
POWER
COMPANY**

1955 Stephenson Highway
Troy, Michigan 48084
313-528-3700

Dolch.

advanced logic analysis

THE GEORGE E. FREEMAN LIBRARY
STATE TECHNICAL INSTITUTE AT MEMPHIS
5983 Macon Cove at Interstate 40
Memphis, Tennessee 38134

à la carte

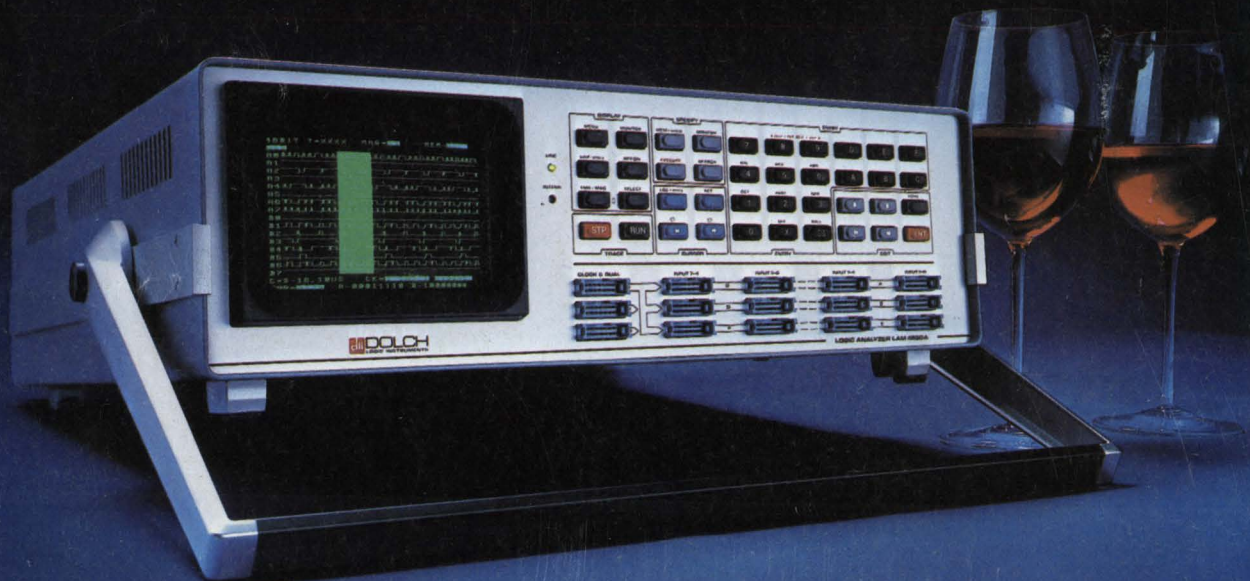

48 to 96 Channels, 300 MHz, plus Mnemonics

Order up your parameters. Dolch's LAM 4850A logic analyzer makes it easy with a new key — Monitor. Monitor gives you status information and comments on menu setups, and can be called up at any time to interpret each parameter, its range, and its interaction with the current setup. And, you can store your setups for three months without power, eliminating the need to reprogram.

Zero in fast. The LAM 4850A disassembles your code into Mnemonics and gives you the channels you need to trace data, address, port and control lines. And for future needs, you can expand to 64, or even 96, channels.

Hook up fast, too. Dolch personality probes clip right over your CPU chips so you don't waste time connecting dozens of individual hooks. And the probe takes care of clock, timing and signal interfacing — no need to worry about signal conditions.

300 MHz sampling across 16 channels. A revolutionary option gives you the ultimate in sampling resolution — 3.3 ns — to help you solve the toughest timing and phase related problems. A unique memory overlay configuration provides simultaneous dual asynchronous recording across 16 channels without compromising any of the LAM 4850A features.

Don't settle for less than Dolch. The basic LAM 4850A is truly a universal logic analyzer system with 50 MHz sampling rate, 1000 bits per channel source and reference memories, and sophisticated sequential trigger and multilevel clocking.

For details on the Dolch LAM 4850A, or any of our other troubleshooting tools, write: Dolch Logic Instruments, Inc., 230 Devcon Drive, San Jose, CA 95112. Or call toll free: (800) 538-7506; in California call (408) 998-5730.

dli **DOLCH**
LOGIC INSTRUMENTS

Circle 2 on Reader Inquiry Card