

December, 1977

Minicomputers ■ Microcomputers ■ Printers & Plotters

Tape & Disk Drives ■ Memories ■ Terminals

Digital Design

The Magazine of Digital Systems

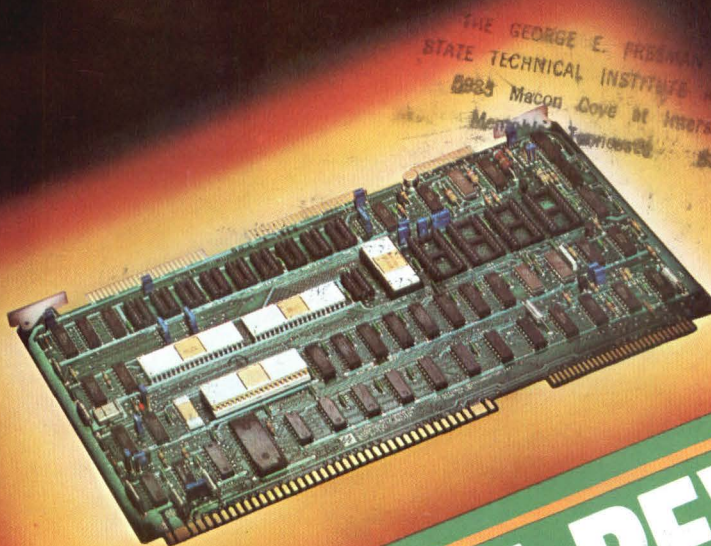

1977 YEAR IN REVIEW



is to take it apart piece by piece.

Compare the features of our S-100 bus system, the industry standard, to anyone else. After you've taken them apart piece by piece, you'll know why IMSAI is the system you can grow with. At a price you can live with.

IMSAI 80/30 Integrated Video Computer (with Intelligent Keyboard—IKB-1) Standard Features:

- Price assembled \$1499.** IMSAI is the only S-100 bus manufacturer that offers a micro-processor driven keyboard with "N" key roll over, 2¼K of RAM, 8 expansion slots, choice of 4K, 16K, 32K and 64K RAM expansion boards, 3K ROM monitor, synch/asynch serial interfaces, parallel and serial ports, high resolution CRT monitor, 24 x 80 display with graphic editing and data entry features, and 28 amp power supply for the incredibly low price of \$1499.
 - mpu Speed.** IMSAI is the only S-100 bus manufacturer that offers true 8080 compatibility, operating at 3 MHz.
 - RAM Included.** 2¼K.
 - Expansion Slots.** Eight expansion slots are provided in a new terminated and regulated motherboard (10 slots total).
 - RAM Board Sizes.** IMSAI is the only S-100 bus manufacturer to supply 4K, 16K, 32K, and 64K RAM memory expansion boards.
 - ROM Monitor.** IMSAI is the only S-100 bus manufacturer to provide 3K of ROM.
 - Asynch/Synch.** Only one other S-100 bus manufacturer provides both methods of data communication.
 - PIO/SIO.** IMSAI is the only S-100 bus manufacturer that provides two serial ports and one fully implemented parallel port at no extra charge.
 - Video I/O.** IMSAI is the only S-100 bus manufacturer to include a high resolution (14 MHz) monitor as an integrated part of the computer.
 - CRT Format.** IMSAI is the only S-100 bus manufacturer to provide a full 24 x 80 screen, which is two times the capacity of the common 16 x 64 screen.
 - Graphic/Edit.** IMSAI is the only S-100 bus manufacturer that provides graphics and text editing features with character and line insert/delete for your CRT display.
- Keyboard Included.** IMSAI is the only S-100 bus manufacturer to supply a micro-processor driven keyboard with "N" key roll over and tiered construction for a true typewriter keyboard touch.
 - 28 amp Power Supply.** The world famous IMSAI power supply assures stability and reliability of performance.
- Options:** IMSAI is the only S-100 bus manufacturer to provide a comprehensive array of fully integrated options including: line and character printers, CRT terminals, intelligent keyboard, ACR storage, standard and mini floppies, TTY BASIC with OS, 4K, 8K and 12K BASIC, audio cassette BASIC with OS, 8K disk operating system (DOS) based upon CP/M,* scientifically and commercially oriented disc BASIC and level 2 FORTRAN IV compiler.
- Printers.** Only one other S-100 bus manufacturer can supply both line and character printers.
 - CRT/Keyboard.** IMSAI is the only S-100 bus manufacturer to provide both CRT terminal and intelligent keyboard as separate options.
 - ACR Storage.** Available.
 - Floppies.** IMSAI is one of the few S-100 bus manufacturers to provide both standard and mini floppies and the only S-100 bus manufacturer that supplies double density standard floppies.
 - TTY BASIC.** IMSAI is one of the few S-100 bus manufacturers that provides self-contained operating systems with 4K, 8K and 12K BASIC.
 - ACR BASIC.** IMSAI supports ACR BASIC with an 8K version.
 - DOS.** IMSAI is the only S-100 bus manufacturer to provide an enhanced version of the control program monitor (CP/M*) that can support up to 18 disk drives.
 - Disc BASIC.** IMSAI is the only S-100 bus manufacturer that provides both scientific and commercial versions of compiler oriented BASIC.
 - FORTRAN IV.** IMSAI is the only S-100 bus manufacturer that offers a level 2 FORTRAN IV compiler that operates under an enhanced version of CP/M*.

Prices and specifications subject to change without notice.
*CP/M is a trademark of Digital Research Corporation.

Price/Performance no one else has put together.

IMSAI®

The Standard of Excellence
in Microcomputer Systems

The \$6,000* DP Center.



IMSAI Introduces the VDP-80

Until now, owning real computing power meant paying unreal prices. Announcing the IMSAI VDP-80 Video Data Processor, a complete computer, intelligent terminal and megabyte floppy disk mass storage system. All in one compact cabinet. All for just \$5995*. A complete desk top DP center.

For small business applications, the VDP-80 places a stand-alone computer at your fingertips. And, our full line of add-on peripherals, assures that the system can be expanded as your needs do.

For the large business user, with an existing central mainframe, the VDP-80 is the ultimate remote processor. You have the advantage of powerful local processing capability, plus the epitome in cost-effectiveness for implementing a distributed data communications network.

Take a close look at the following features. Then you'll know why we call our VDP-80 the desk top DP center.

□ **Powerful, High-Speed, Central Processor.** 3 mHz Intel 8085 microprocessor. 32K RAM memory (expandable to 196K). Parallel and serial I/O. Asynch, synch and bisynch communications. Programmable baud rates (.05-56 KB).

□ **Megabyte Mass Storage.** PerSci dual floppy, double density disk drive standard. One million byte storage capacity. Three floppy disk drives can be added-on, providing 4 million bytes of on-line storage.

□ **Drives Printers, Plotters, Terminals, Modems and Tape Drives.** Supports up to six terminals or modems, and four tape drives. Drives plotters, serial printers and line printers (up to 300 lpm).

□ **12" CRT, 24x80 Field, User Programmable Font.** Character and line insert/delete allows fast program correction and text editing. Inverse video and programmable field allows highlighting or enlarging graphics of information display. Titled fields protect information blocks from being written over accidentally. Programmable font (up to 256 different characters) allows foreign language and special purpose character forms.

□ **Alphanumeric Intelligent Keyboard.** 62-pad main keyboard. Programmable 12-pad numeric keyboard. 12-pad control keyboard. Standard typewriter and calculator keyboard layouts. "N" key roll over reduces operator error during high-speed data entry.

□ **Commercial BASIC, FORTRAN IV, DOS Software.** Built-in ROM monitor allows extensive debugging and diagnostics. BASIC, interactive or compiler version. FORTRAN IV level 2 ANSI compiler. DOS-enhanced CP/M.**

Distributed processing, financial reporting and analysis, word processing, whatever your application, the VDP-80 is your answer.

Dial (415) 483-2093, and we'll tell you how you can put our \$5995* DP Center on your desk top. When it comes to small business computers, Just Ask IMSAI.

*Base price VDP-80/1000, \$5995, with 32K RAM memory and dual double density floppy disk drive. U.S. Domestic Price Only. Features and prices subject to change without notice.
**CP/M is a trademark of Digital Research Corporation.

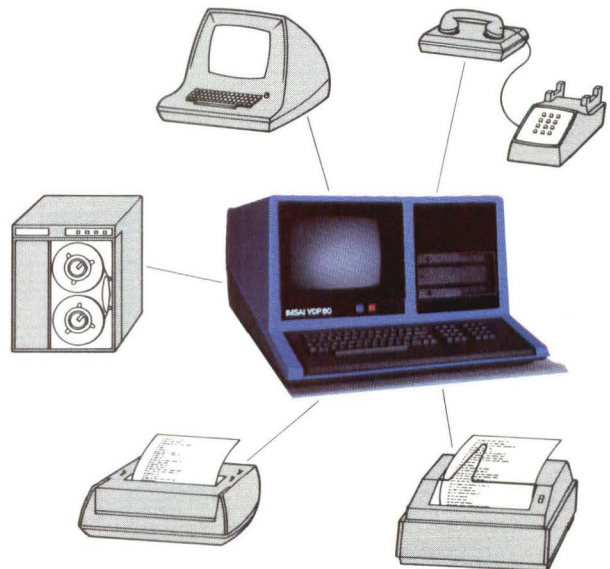

IMSAI®
The Standard of Excellence
in Microcomputer Systems

IMSAI Manufacturing Corporation
14860 Wicks Blvd.
San Leandro, CA 94577
(415) 483-2093 TWX 910-366-7287

the best way to build your system...

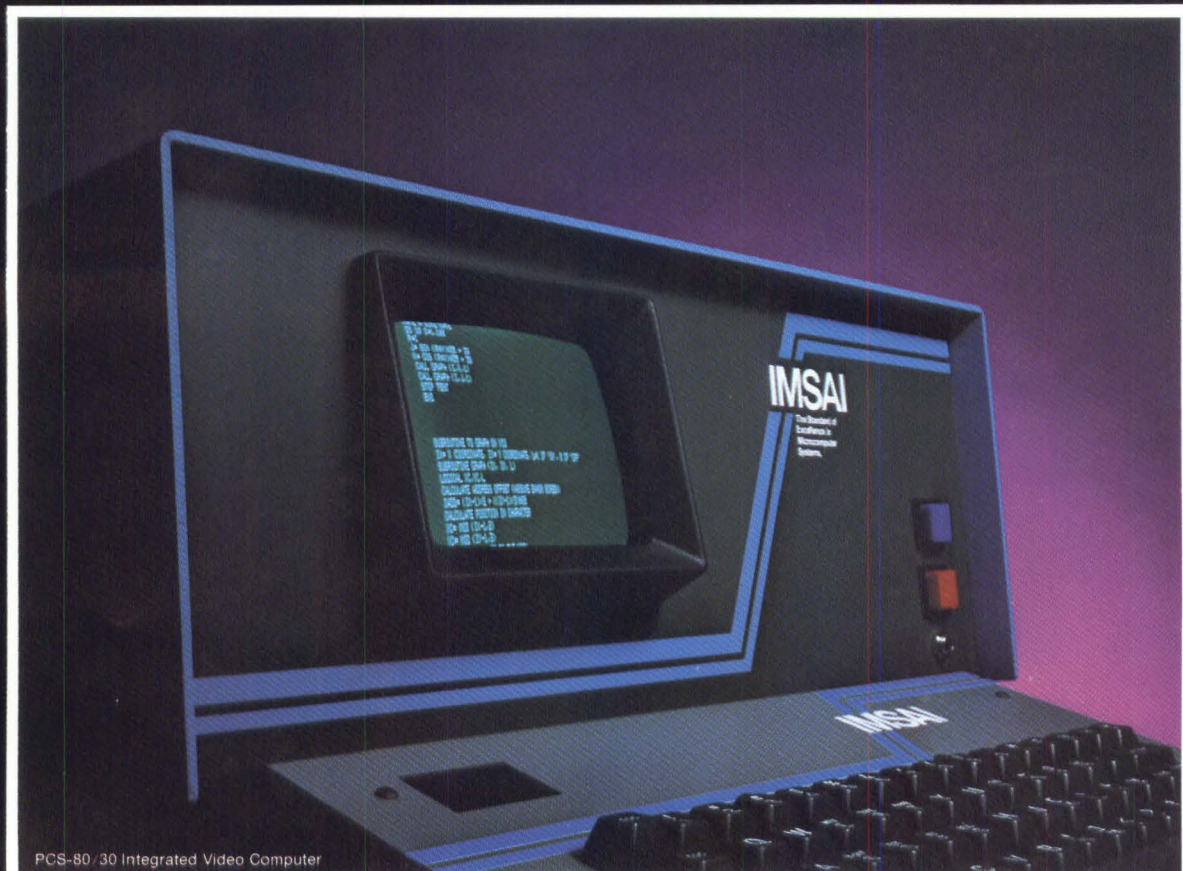

PCS-80/30 Integrated Video Computer



PCS-80/15 (w/KB-1)



PCS-80/30-80-25A DHMO



PCS-80/7 Components

IMSAI introduces the PCS-80 component system...

Now, a better impact on cost of ownership.

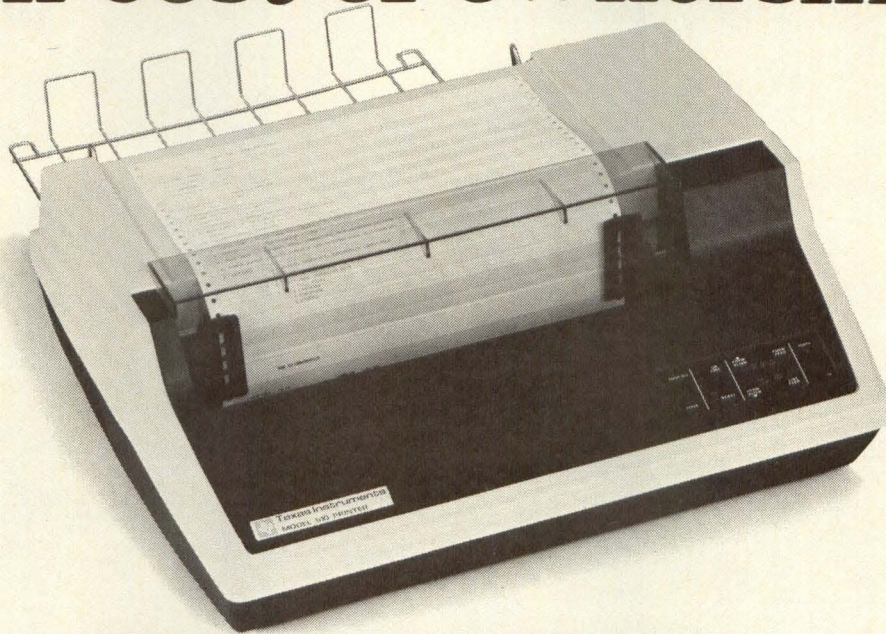

Model 810 Printer

\$1705.50

The low cost of ownership for the Model 810 Printer is now even lower!

With an OEM quantity 1 purchase price of just \$1705.50 and lower maintenance rates, the 810 impact serial printer can significantly reduce your cost of printing. And, the purchase price goes much lower with higher quantities.

New maintenance rates on the 810 are \$24 per month billed annually, or \$26 per month billed monthly. And now the 810 can be leased from \$95 per month on a 48-month lease plan to \$110 per month on a 12-month lease plan, including maintenance.

The 150-cps Model 810 Printer has all the standard features you expect, such as smart bi-directional printing, an EIA RS-232C interface, limited ASCII character set, built-in self-test capability, speeds from 110 to 9600

baud and outstanding 9x7 wire matrix character printing of an original and five copies.

Options include international character sets, full ASCII character set, expanded and compressed printing, forms length and vertical forms controls, and a variety of line interfaces.

All this adds up to a fully capable impact printer with an even lower cost of ownership. To see for yourself the kind of impact the 810 can have on your printing costs, fill out and mail the coupon, or call your nearest TI sales office, or Terminals and Peripherals Marketing at (713) 491-5115, extension 2124.



TEXAS INSTRUMENTS
INCORPORATED

Yes! I am interested in the 810 Printer.

16-12-DD

Please have your representative call me.

Please send me more information.

Name _____

Title _____

Company _____

Phone _____

Address _____

City _____ State _____ Zip _____

Mail to: Texas Instruments Incorporated
P.O. Box 1444, M/S 784, Houston, Texas 77001

Prices U.S. domestic only.

Copyright © 1977, Texas Instruments Incorporated

TEXAS INSTRUMENTS.

CIRCLE 5

DECEMBER 1977

Digital Design 1

Quality is known by the company it keeps



Quality is known by the company it keeps and here are eight reasons why COMPLØT® is outstanding in the field:

- | | | | |
|--------|---|--------------|--|
| DP-101 | All-new microprocessor-controlled plotter—\$3495 | PTC-5A | The new Remote Time Share Plotter Controller—two models—\$1945 & \$2595 |
| DP-1 | Classic 11" wide plotter—\$3550 | BTC-7 Series | Adds inexpensive graphic output to the CDC 734 and Cyber 18-5 Batch Terminals—\$2595 |
| DP-11 | Our newest 11" wide plotter at speeds up to 4000 steps/sec.—\$3995 | MTR-4 | Magnetic Tape Reader/Controller \$15,500
1600 CPI Phase Encoded Model—\$19,950 |
| DP-3 | Plotting on a 22" wide surface at 400 steps—\$5150 | | |
| DP-8 | One pen or three, 36" wide, super quiet, three models from—\$7600 to \$9500 | | |

houston instrument

THE RECORDER COMPANY

DIVISION OF BAUSCH & LOMB

ONE HOUSTON SQUARE (at 8500 Cameron Road) AUSTIN, TEXAS 78753

(512) 837-2820

TWX 910-874-2022

cable HOINCO

TELECOPIER

EUROPEAN OFFICE

Rochesterlaan 6 8240 Gistel Belgium
Phone 059/277445 Telex Bausch. 81399

® A registered trademark of Houston Instrument

US DOMESTIC PRICES ONLY

Plotters can be driven on-line, offline, time share or remote batch

FOR DEMONSTRATION CIRCLE 35, FOR LITERATURE CIRCLE 73.

INTERDATA USERS

*The TC-120 did it for Data General users
The TC-130 did it for DEC users*

**Now the TC-140
does it for you**

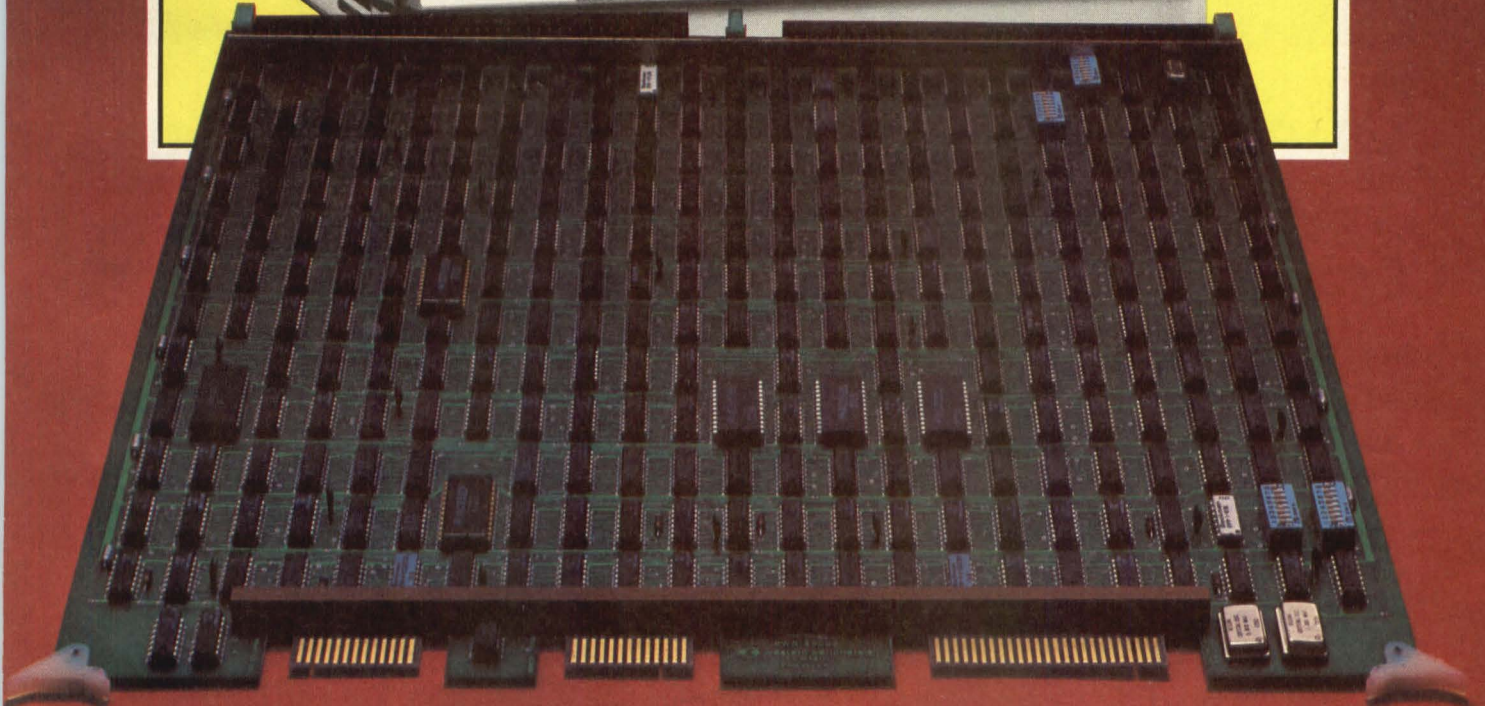
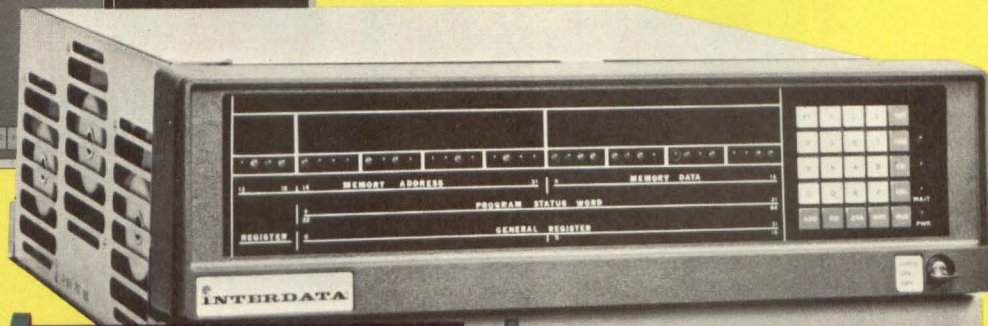

Single board, fully embedded, dual density tape system for PE and NRZ formats. Total Operating System compatibility. Allows up to 4 drives with any mix of NRZ 7 Track, NRZ 9 Track, PE and PE/NRZ to be operated from a single controller. That isn't all! You may select any two speeds in the range of 12.5 to 125 ips. Enhanced Command Set and Extended Status Register are standard in all TC-140's for those requiring a level of performance never before available.

LET US SEND YOU COMPLETE INFORMATION.



western peripherals T.M.

(714) 991-8700 • TWX: 910-591-1687 • Cable WESPER
1100 Claudina Place, Anaheim, CA 92805

The 8080 "Ice Breaker"

Portable, Flexible and Rugged for
Production Test and Field Service

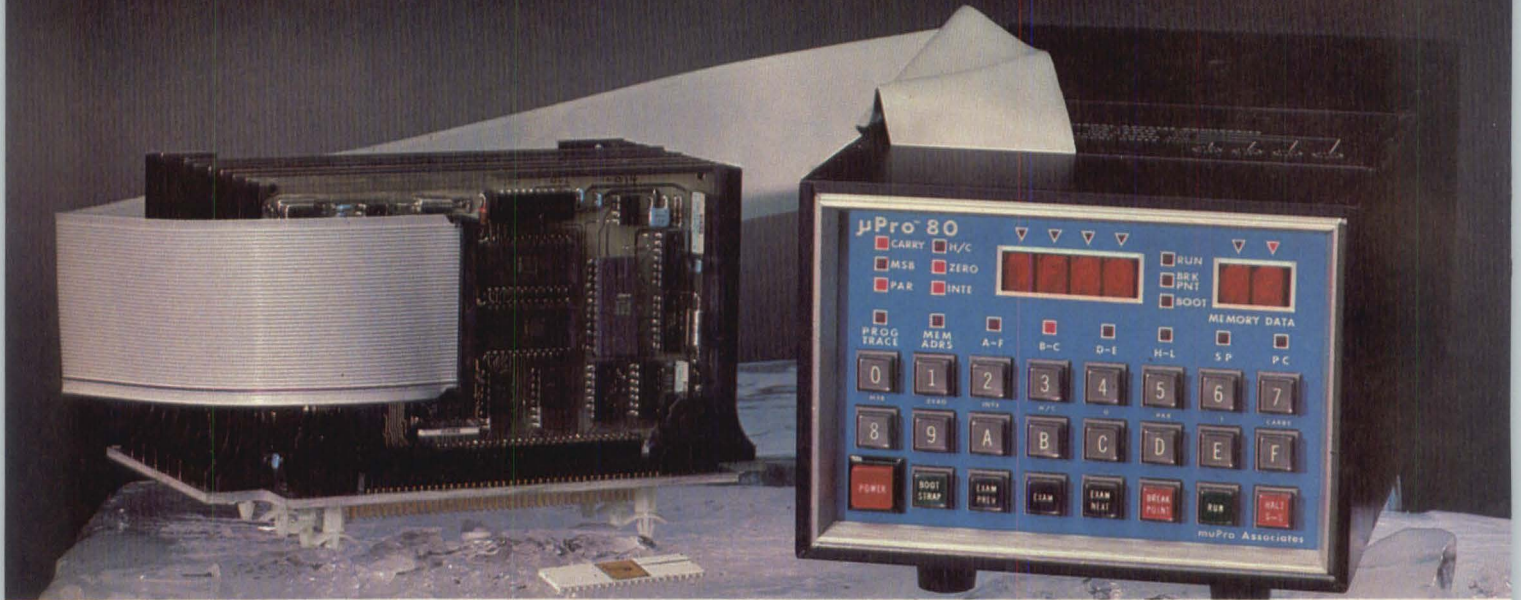

MUPRO 80E Emulator

MUPRO FEATURES

Real-Time Execution from emulator or user's system memory (no restrictions, no wait states)

Transparent Control/Display Console (terminal is not required)

Debug system totally implemented in emulator hardware

Hardware breakpoint, pass count and 64-instruction program trace

No overhead memory requirements

Optional plug-in Prom programmer card

Compact and ruggedized system packaging (4.6"H x 6.6"W x 15"L, 18 lbs)

The complete solution

YOUR BENEFITS

More thorough and flexible system test capability

Provides total use of microprocessor. No memory, I/O or interrupt restrictions.

No costly peripherals are required e.g. keyboard display, printer, etc.

Efficient control of program execution for hardware and software testing

All emulator memory available to user's program (up to 64K bytes)

Programs up to eight Proms simultaneously with same or different data

Single system provides total solution to production test and field service needs



MANUFACTURERS OF
INNOVATIVE MICROCOMPUTER
SUPPORT SYSTEMS

MUPRO

424 Oakmead Pkwy. Sunnyvale, Ca. 94086
(408) 737-0500 TWX 910-339-9251

Circle 4 for demo and technical data

Circle 100 for technical data

THIS MONTH

Features

23

1977 Year in Review

A special report on state-of-the-art developments in the digital systems industries, plus a look at what's coming in 1978.

26

Introduction

28

Minicomputers

36

Microcomputers and Microprocessors

42

Character and Line Printers

48

Computer Plotting Equipment

51

Core and Semiconductor Memories

58

Cassette and Cartridge Drives

60

Terminals: Smart and Dumb

68

Rigid and Floppy Disk Drives

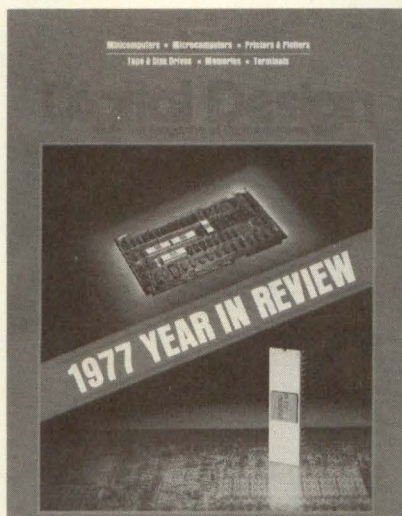

December, 1977

Vol. 7 No. 12

This month's cover depicts National Semiconductor's microcomputer in three stages: microcircuit, central processor chip and single-board computer. Cover design by Richard D. Sarno.

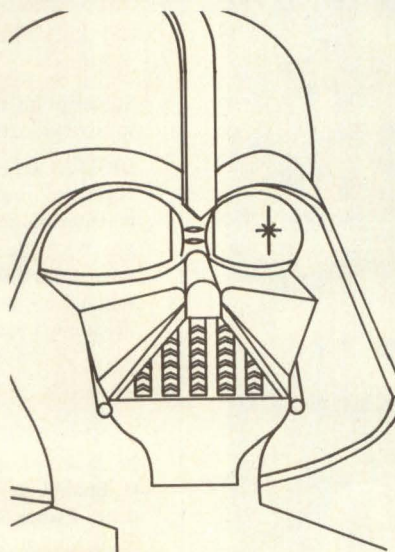

Departments

9

Letters

10

Tech Trends

New Breed of Prospector: Microcomputers on a Backpack.

Semiconductor Memory System Adds New Dimensions to Weather Study.

Standard Set for Terminal Interface.

75

Advertiser's Index

76

Alpha Bits

Transducers Serve Control Applications.

Selecting a Computer.

Using the ICU.

Microprocessors: How to Use Them.

Published monthly by Benwill Publishing Corp., 1050 Commonwealth Ave., Boston, MA 02215. Application to mail at controlled circulation rates is pending at Waseca, MN 56093. Copyright © Benwill Publishing Corp. 1977.

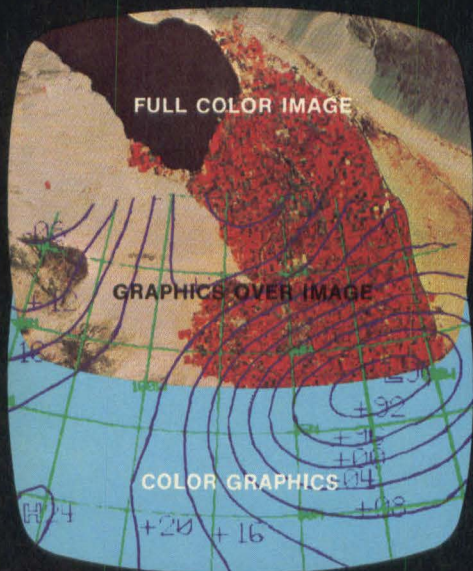

There's only one thing
about Genisco's full
color display systems
that isn't on the high side.

Their low price.*

High in performance, versatility, reliability, processing speed and data display density. These are just some of the highpoints that put Genisco's fully programmable GCT-3000 Series a whole generation ahead of stroke-writer and storage tube display systems. And they're expandable, so you can get "on-line" now at minimal cost, and make additions as the need arises. Check these feature highlights:

- Fully Programmable Microprocessor
with 150 ns Cycle Time**
- Fast Access MOS/RAM Refresh Memory**
- Automatic Color Circumfill**
- Selective Erase and Zoom/Scroll**
- 256 to 640 Elements per Scan Line**
- Up to 16 Bits per Pixel**
- Automatic DMA Access**
- High-Resolution Grey Scale Versions Too**

*All these highs, yet the basic GCT-3000 is priced on the low-profile pocketbook side — \$6,000 in OEM quantities; \$7,500 singly.

So contact Genisco, a name that has stood for technological leadership over the past 30 years, and get the whole story.



GENISCO COMPUTERS

A DIV. OF GENISCO TECHNOLOGY CORPORATION

17805-D SKY PARK CIRCLE DRIVE, IRVINE, CA 92714 • (714) 556-4916

Digital Design

The Magazine of Digital Systems

Publisher Yuri R. Spiro
Editorial Director Harold G. Buchbinder
Editor George King

Associate Editors William Belt
Jeff Spierer

West Coast Editor Henry K. Simpson, Jr.

Assistant Editor Carol Baran

Staff Artists Richard D. Sarno
Mike Barisano
Jane Higgins
Rene Stawicki

Production E. Storm
Sarah Jewler
Joe Gillis
Joe T. Ingram

Composition Nancy Aldrich
Paul Cioto

Circulation Regina Harrington

General Administration Esther Shershow
Sarah Binder
Margie Morse
Marion Pearlman
Charles Vigilante
Jonna Yager
Merrie Buchbinder

West Coast Editorial Office: George King, 442 Begonia,
Corona del Mar, CA 92625. (714) 675-7123, (213) 454-0624.

SUBSCRIPTION POLICY

DIGITAL DESIGN is circulated only to qualified research, development and design engineers in all branches of industry, government institutions and universities. To obtain a complimentary subscription, request (on company letterhead) a qualification card from Circulation Director. For change of address; attach old address label from recent issue to new company letterhead or note telling us what your old address was; send this plus request for new qualification card to:

Circulation Director
DIGITAL DESIGN
1050 Commonwealth Ave.,
Boston, MA 02215

Subscription rates: Domestic subscriptions for non-qualified subscribers, groups, libraries or companies, \$25.00 per year.

DIGITAL DESIGN solicits editorial material and articles from engineers and scientists. Contributors should submit their manuscripts in duplicate and typed with two spaces between lines. All illustrations should be clear; components on all schematics and line drawings should be labeled. The editors assume no responsibility for the safety or return of any unsolicited manuscripts.



**PRINT RUN
OVER 51,000**

Published monthly by Benwill Publishing Corporation, Harold G. Buchbinder, Chairman of the Board; George Palken, President; Esther Shershow, Treasurer. Executive, Editorial and Subscription Offices, 1050 Commonwealth Ave., Boston, MA 02215. Telephone: (617) 232-5470.

Sperry Univac's new mainframe-on-a-board: What you do with it is your business.

Whether your systems business is scientific, instrument control, or data communications, know this:

Our new V77-200 delivers more computing power than any other computer-on-a-board you can buy. Handling up to 32K/16-bit words of 660ns MOS memory.

Reason enough to call it the world's first mainframe-on-a-board. But there's more.

Because our new V77-200 comes loaded with "big machine" features. Like 8 programmable registers with byte, word and double word manipulation. Up to 32-bits of arithmetic precision. A powerful set of 187 instructions. Hardware multiply/divide. Direct memory access. Programed I/O. Multi-device automatic program loaders. A real-time clock. And a teletype/CRT controller. All standard. And all on a single 10.8" x 17" board.

There's even Virtual Console Logic that eliminates the need for a programmer's console by allowing you to control the V77-200 from a teletype or CRT keyboard.

You get "big machine" performance, too. Example: a microinstruction cycle time of 165ns that allows multiplication functions to be handled in just 4.9 microseconds — divide in just 8.

Plus your choice of OEM-tailored options. Like a variety of connector planes and general purpose interface boards for custom I/O designs. Three different 660ns memory boards (in 8K, 16K, and 32K-word modules). An operator's console. Power-fail detect and data save. Memory parity. Hardware for up to 64 priority vectored interrupts. An integral or modular power supply. And a system chassis. All the "unbundled" pieces you need for quick and easy system integrations.

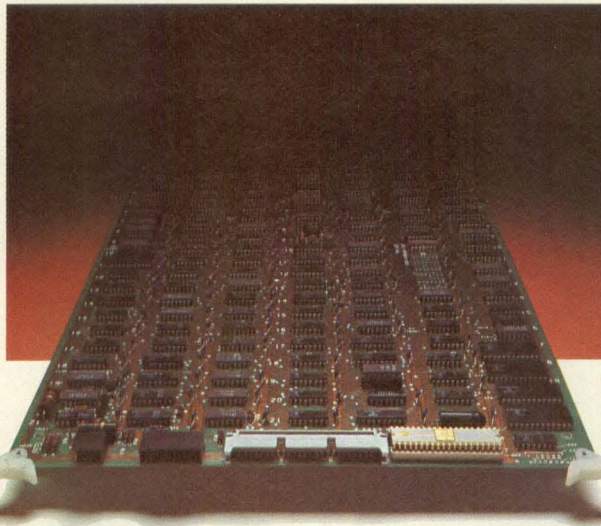

The new V77-200 also saves you time and money by allowing you to use Sperry Univac's well-established floppy or disk-based VORTEX real-time operating system. In effect, allowing you to concentrate on the development of your application software.

And giving you access to Sperry Univac's extensive library of software subsystems, language processors, and system utilities.

Best of all, the world's first mainframe-on-a-board has a base price of just \$1200. Plus a discount plan designed to give even modest-volume OEM buyers a big break. And you can take delivery in a matter of days — not months.

No matter how you configure it, the new V77-200 is the most economical Sperry Univac yet. Delivering the kind of price/performance value that just makes good sense. No matter what business your systems are in.

For more information on the world's first mainframe-on-a-board, please contact: Sperry Univac Mini-Computer Operations, 2722 Michelson Drive, P.O. Box C-19504, Irvine, California 92713, Telephone (714) 833-2400.

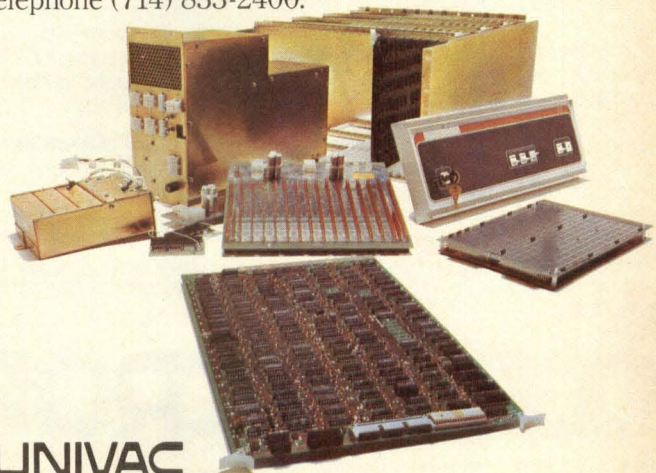

SPERRY UNIVAC

SPERRY UNIVAC IS A DIVISION OF SPERRY RAND CORPORATION

iCOM's Intelligent Floppy™

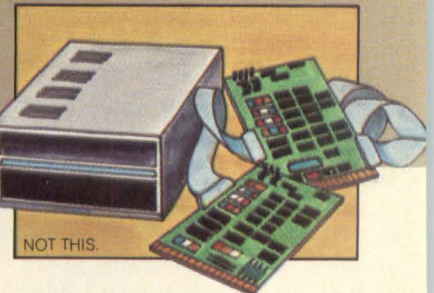
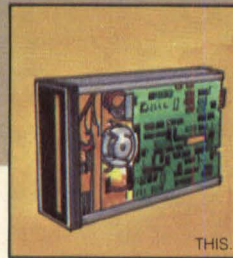
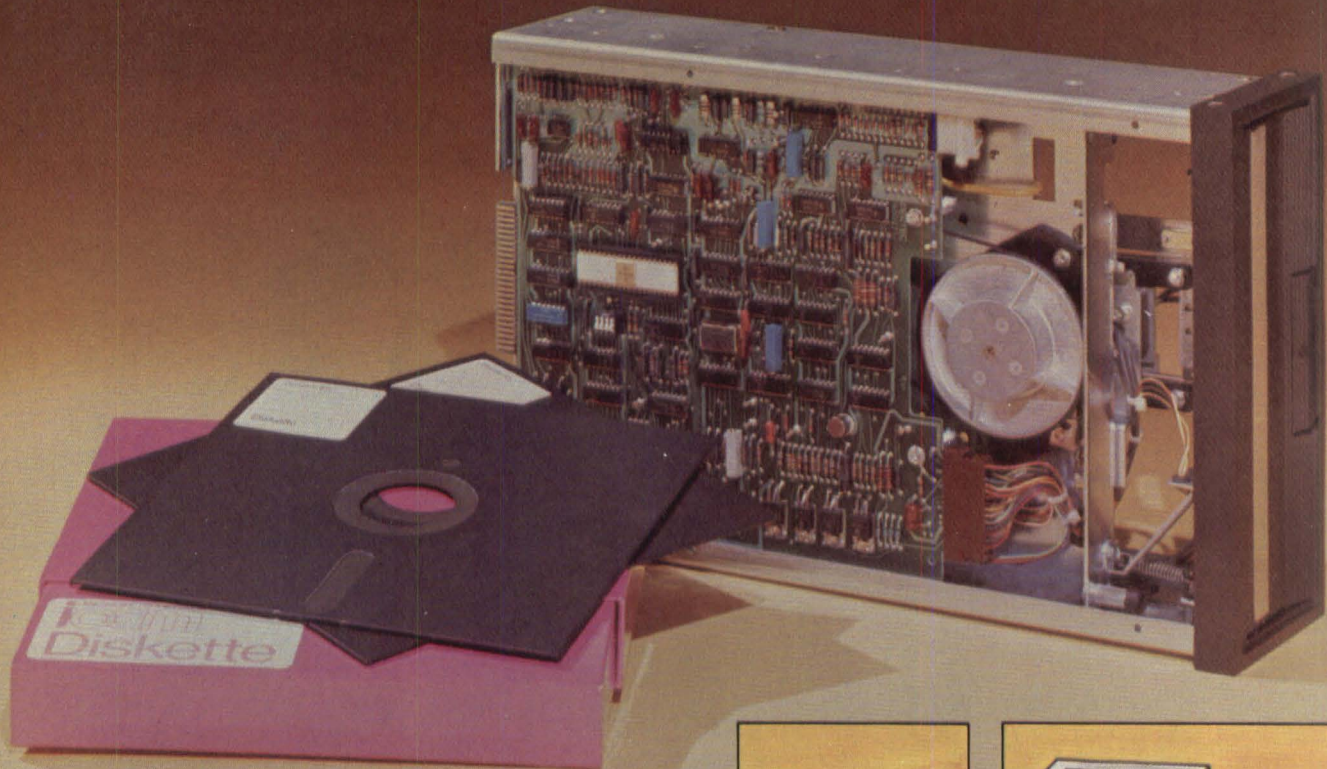

Controller/Formatter built-in. Packaging problems designed out.

When designing a floppy disk into a compact microcomputer-based system, engineers have been plagued with the problem of where to mount the controller/formatter cards and associated cables.

Our new FD5200 Intelligent Floppy™ solves this packaging dilemma by mounting all circuitry, including the single chip LSI controller/formatter, as an integral part of the disk drive chassis. A neat idea!

The 8 bit bi-directional bus makes it simple to integrate the iCOM® FD5200 into any system. Accrued benefits include: reduced hardware costs, smaller size, shorter assembly time, easier software development, improved reliability and lower maintenance. A mighty impressive list!

Compatibility to IBM3740 Format... and Others

The special LSI controller/formatter chip provides the complex logic needed to write data on the diskette in IBM 3740 format — or other user selected formats as well. Another big plus is a phase-locked-loop for data and clock bit separation, and address word detection, which maximizes data reliability.

Pertec Makes the Driving Easy...

Since a floppy disk drive system is only as good as the mechanics, we use our field proven Pertec drive with three step-per-track head positioning for better accuracy and the unique head retract system for longer media life.

Why iCOM®?

iCOM® part of Pertec Computer Corporation, is one of the world's largest manufacturers of Microperipherals®. Thousands of our floppy disk systems are operating reliably in the field. And many major computer manufacturers have incorporated iCOM® floppies into their systems. Which means we deliver — and will be around to give you service whenever and wherever you may need it.

Speaking of Delivery... and Price

Our new FD5200 Intelligent Floppy™ is available now at a unit price of just \$795. Naturally, OEM discounts are available.

So phone us today. Or send for our brochure.

iocom MICROPERIPHERALS®

Products of **PCC** Pertec Computer Corporation

Microsystems Division

6741 Variel Ave., Canoga Park, CA 91303 U.S.A.
Tel: (213) 348-1391 TWX: 910-494-2788

LETTERS

Lost Logic Analyzer

Dear Editor:

The article "What Do Logic Analyzers Do?" (September 1977) presents good, basic information about logic analyzers. Included in the article, on page 66, is a table that presents specific information on logic analyzing instruments. While the table represents a conscientious attempt to convey accurate product information to your readers, it contains several errors with respect to the Tektronix LA 501W, 7D01 and 7D01F Logic Analyzers. The LA 501W memory format is 4 x 1024, 8 x 512, and 16 x 256. The LA 501W, 7D01, and 7D01F all provide timing diagrams; in addition, the 7D01F has state diagram capabilities, including a memory map feature.

Although Tektronix was listed in the "Manufacturer's Guide to Logic Analyzers", Tektronix was left out of the discussion "Logic Analyzers: What You Can Buy" that starts on page 72 of the September issue. The Tektronix 7D01F Logic Analyzer with Display Formatter, as shown on page 54, makes a complete, basic logic analysis system when installed in a 7000-Series laboratory oscilloscope. Data sampling can be asynchronous or synchronous. The 7D01F provides four methods of obtaining a trigger, including word recognition, to store and display data which occurs before, after, or surrounding the trigger. 7D01 features such as EXCLUSIVE OR and auto SEARCH modes are particularly useful in engineering and production applications.

James H. Geisman
Tektronix, Inc.
Beaverton, OR 97077

Misprinter

In our printer report, MFE Corp. was listed as manufacturing a Medium to Large printer. MFE Corp. does not make printers; please do not contact them in this regard. They do make digital cassette drives and floppy disk drives.

There's an iCOM for Everyone at these Computer Stores...

ALABAMA

Computerland
Huntsville
(205) 539-1200

ARIZONA

Byte Shop of Arizona
Tempe
(602) 894-1129

CALIFORNIA

Byte Shop
Computer Store
San Rafael
(415) 457-9311

Byte Shop
Fresno
(209) 485-2417

Byte Shop Computer
Store of Diablo Valley
Walnut
(415) 993-6252

Computerland
of Hayward
Hayward
(415) 538-8080

Computerland of
Saddleback Valley
Mission Viejo
(714) 770-0131

Computerland
of San Diego
San Diego
(714) 560-9912

Computerland of
San Tustin
Tustin
(714) 544-0542

Computerland
of West L.A.
Inglewood
(213) 776-8080

The Computer Room
San Jose
(408) 226-8384

Byte Shop
Computer Store
Santa Clara
(408) 249-4221

Byte Shop
Computer Store
Santa Barbara
(805) 966-2538

Byte Shop III
of San Jose
San Jose
(408) 377-4685

Byte Shop
of Thousand Oaks
Thousand Oaks
(805) 497-9595

Tech-Mart
Tarzana
(213) 344-0153

Byte Shop of Tarzana
Tarzana
(213) 343-3919

Byte Shop of Pasadena
Pasadena
(213) 684-3311

Byte Shop of Lawndale
Lawndale
(213) 371-2421

Byte Shop
of Westminster
Westminster
(714) 894-9131

Orange County
Computer Center
Costa Mesa
(714) 646-0221

The Computer Mart
Orange
(714) 633-1222

Byte Shop of San Diego
San Diego
(714) 565-8008

Byte Shop of Hayward
Hayward
(415) 537-2983

Micro Computer Center
Anaheim
(714) 527-8080

COLORADO

Prime Radix
Denver
(303) 573-5942

Byte Shop
Boulder
(303) 449-6233

FLORIDA

Byte Shop of Miami
Miami
(305) 264-2983

Byte Shop
of Ft. Lauderdale
Ft. Lauderdale
(305) 561-2983

HAWAII

Capacity, Inc.
Maui
(808) 575-2930

ILLINOIS

The Itty Bitty Machine
Company
Evanston
(312) 328-6800

Bits and Bytes
Computer Store
Posen
(312) 389-7112

Computerland
of Arlington Heights
Arlington Heights
(312) 255-6488

Littipute Computer Mart
Skokie
(312) 674-1383

The Numbers Racket
Champaign
(217) 352-5435

Champaign Computer
Company
Champaign
(217) 359-5883

INDIANA

Byte Shop
The Data Group Inc.
Indianapolis
(317) 842-2983

KENTUCKY

Cybertronics
Louisville
(502) 499-1551

Computerland
of Louisville
Louisville
(502) 425-8308

LOUISIANA

Southern
Electronics, Inc.
Shreveport
(318) 222-8795

Computer Shoppe, Inc.
Metairie
(504) 454-6600

MARYLAND

The Computer
Workshop, Inc.
Rockville
(301) 468-0455

Computerland
of Rockville
Rockville
(301) 948-7676

MASSACHUSETTS

Computer Mart, Inc.
Waltham
(617) 899-4540

American Used
Computer Corporation
Boston
(617) 261-1100

MICHIGAN

General Computer
Troy
(313) 362-0022

Computer Mart
Royal Oak
(313) 576-0900

MINNESOTA

Microprogramming, Inc.
Burnsville
(612) 894-3510

Computer Depot
Minneapolis
(612) 927-5601

NORTH CAROLINA

Digital Dynamics
Corporation
Charlotte
(704) 374-1527

NEW HAMPSHIRE

Computer Mart of
New Hampshire
Nashua
(603) 883-2386

NEW JERSEY

Computer Mart of
New Jersey
Iselin
(201) 283-0600

Computerland
of Morristown
Morristown
(201) 539-4077

NEW YORK

Synchro Sound
Enterprises
Hollis
(212) 468-7067

Computerland
of Tonawanda
Tonawanda
(716) 836-6511

Computerland of Ithaca
Ithaca
(607) 277-4888

Computer Shoppe
Middle Island
(516) 732-4446

PENNSYLVANIA

Byte Shop of
Philadelphia
Brynmarw
(215) 525-7712

Personal Computer
Corporation
Frazer
(215) 647-8463

SOUTH CAROLINA

Carolina Computers
Columbia
(803) 798-7524

TEXAS

Micro Store (0010)
Arlington
(817) 461-6081

Microstore
Richardson
(214) 231-1096

Microtex, Inc.
Houston
(713) 780-7477

Electrotex
Houston
(713) 526-3456

Computer World
Arlington
(817) 469-1502

Computer
Terminal Store
El Paso
(915) 532-1777

Computer Shop
San Antonio
(512) 828-0553

The KA Computer Store
Dallas
(214) 634-7870

WISCONSIN

Madison
Computer Store
Madison
(608) 255-5552

CANADA

Computer Mart Ltd
Toronto, Ontario
(416) 484-9708

Computer Place
Toronto, Ontario
(416) 598-0262

iocom MICROPERIPHERALS™
6741 Variel Ave., Canoga Park, CA 91303 U.S.A. • (213) 348-1391 TWX 910-494-2788
a division of Pertec Computer Corporation

New Breed of Prospector: Microcomputer on a Backpack

Backpackers usually carry food, clothes, a stove and recreational material in their packs. Now, a geophysical exploration team carries a microcomputer on a pack frame.

Using a specially modified Kelty backpack, geophysicists can pack a National IMP-16 microcomputer card into places inaccessible to motorized vehicles. Designed into an extra-low-frequency (ELF) digital receiver called Geophase, the unit serves as a survey tool for detecting commercially attractive concentrations of metals, uranium, coal or petroleum, according to the designers, Exploration Data Consultants, Inc. (Edcon) of Denver, CO. It can also be used for geothermal exploration to locate feasible sites for geyser-powered electrical generators.

To conduct these mineral or geothermal explorations, a separate transmitter injects a high-current, low-frequency signal into the earth. The Geophase receiver measures the resultant signal over a specified grid pattern surrounding the transmitter site. Signals are logged, analyzed, and used to deduce the geophysical characteristics of the area.

Typically, the transmitter sends out square waves in a frequency range of 0.001 Hz to 10 Hz with power output on the order of 20KW. Attenuation at the higher frequencies limits penetration; deeper measurements must therefore be made at lower frequencies. Signals detected by the receiver range upward from the one millivolt level.

Methods of signal detection currently in use include portable analog receivers and truck-mounted minicomputer systems. Analog receivers measure the strength of reflected signals, providing either chart records or a meter indication of signal strength that usually require manual tabulation. After

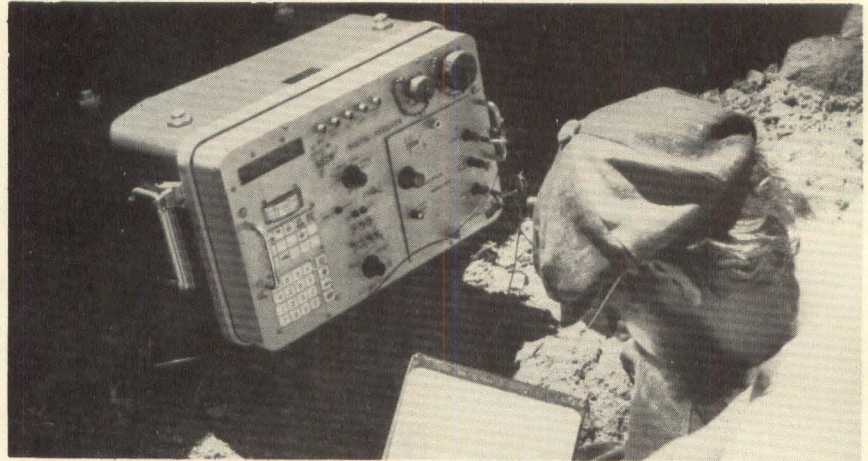

Fig 1 Geophase digital ELF receiver employs an IMP-16C microcomputer card to give high precision data and reduce field exploration time for geological surveys to a fraction of the time required by earlier systems.

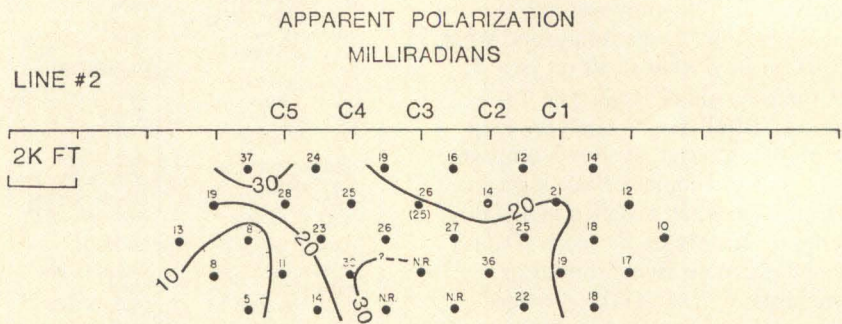

Fig 2 Isograph of apparent polarization aids geologists in determining metal or mineral content of the strata.

reception at the analog device, the data must then be brought back to the office for data reduction and analysis, often a long and laborious process.

Truck-mounted minicomputer systems allow data processing in the field, improving noise immunity and easing data-reduction tasks. Disadvantages of this method are the systems' relatively high cost and their inability to operate in rugged terrain.

By combining high noise reflection with the portability of previous analog units and the data processing capability of minicomputers, the lightweight, battery-powered Geophase receivers alleviate the disadvantages of the two current methods. They pack easily to locations inaccessible to motor vehicles, adjust quickly and take measurements, with operator prompting if necessary.

The method of signal measurement — induced polarization — uses multi-frequency, phase-sensitive measurement of electrical signals passing through the earth. Isograms connect two different sets of points determined from the signals, apparent resistivity in ohm-meters and phase shift in milliradians, which indicate the presence of metallic minerals in the strata. The electromagnetic effect (EM) is considered "noise" to be removed from most metallic- or clay-mineral exploration signals; in oil surveys, however, EM becomes important.

Digital combines with analog

National Semiconductor's IMP-16C/400 microcomputer card forms the keystone of the Geophase receiver. A true microcomputer, the IMP-16C/400 in-

Now-Remote Printing and Plotting: \$8180!*

You could pay more for a printer alone. But now you can have remote print stations with plotting capability . . . for no extra cost. A new opportunity that should interest you . . . more than remotely.

The Printronix 300 lpm impact matrix line printer is the one that offers you several advantages. Like print quality on six-part forms other printers can't match. Or a 160 character capacity that gives you a standard 96 character set plus another 64 characters, such as OCR-A, large block characters, Farsi and many others. And the capability to plot bar codes, charts, graphs, and anything else that can be displayed on a CRT . . . at the price of a printer alone.

Our new Model P-300DC printer/plotter has an integral microprocessor data communication interface for direct communication with your host computer over switched or private telephone lines, emulating any one of the following line protocols: IBM BISYNC (2780) (3780) (3270); Burroughs; Honeywell (VIP-7700); or UNIVAC (DCT-1000). Remote printing. Remote plotting. Anywhere. Anytime. For \$8180.

If you order one today, we'll ship it tomorrow.

*\$8180 is the domestic U.S. price, which includes installation and 90 days of on-site service. No "extra" costs. Just extra performance.

Printronix, Inc., 17421 Derian, Irvine, California 92714.
Call us at (714) 549-8272.



PRINTRONIX...
**More than a
remote possibility!**



It's What's Inside That Counts

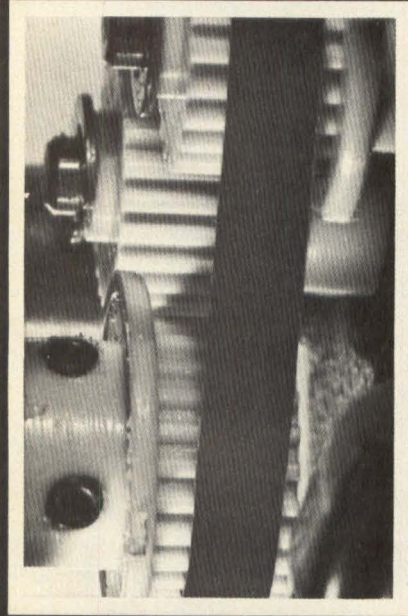

Fenner



"40 DP" TIMING BELTS

Recommended for light duty fractional horsepower applications Fenner "40 DP" timing belts offer the ultimate in synchronized engagement and precision performance. These belts have excellent flex as well as resistance to abrasion, ozone and oil. The slip-proof feature provides continuous accuracy and reduces strain on bearings as compared to flat belts or V-belts. Constant pulley gear contact insures smooth drive and minimum wear.



FENNER AMERICA
400 East Main St.
Middletown,
Conn. 06457
Tel: 203-346-7721

CIRCLE 11

TECHNOLOGY TRENDS

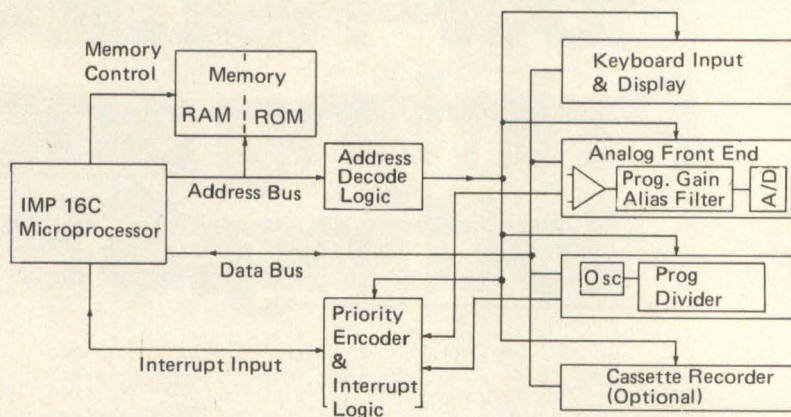

Fig 3 Block diagram of Edcon's microcomputer-controlled digital ELF receiver, Geophase, illustrates major components.

cludes 1K of 16-bit words of RAM and 1K of 16-bit words of PROM located on the circuit board. It also has a control read-only memory (CROM) containing 17 additional instructions such as double-precision add, double-precision subtract, multiply and divide.

According to Edcon Vice President Donald D. Snyder, the IMP-16C/400 was selected because the 16-bit processor accepts digital data from the converter at a maximum rate of 90K words per second, permitting accumulation of at least 128 data-points per cycle with better than four decimal-digit acquisition accuracy. The extended instruction set conserves memory because it allows resident double-precision memory without additional memory-resident subroutines.

One alternative to the IMP-16C/400, the 8080 8-bit processor, was determined to be just barely adequate for the job, according to Snyder, if quadruple-precision mathematical techniques were used. He said an 8-bit processor would restrict the frequency range over which the receiver could be applied since the frequency range depends upon both the number of data-points/cycle digitized and the amount of real-time processing performed.

System peripherals include an analog input subsystem, an analog-to-digital converter and a precision interval timer, as well as a keyboard & display module and an optional cassette transport.

Incorporating a high-input impedance isolation-amplifier, a 60Hz reflection filter, a low-pass filter and a gain amplifier, the analog portion of the Geophase receiver inputs subsystem

signals to a ten-bit A/D CMOS converter with conversion rates to 512 points per cycle under processor control.

The interval timer and synchronous clock follow the analog subsystem in importance. An oven-stabilized precision quartz oscillator gives the precise time reference necessary to make accurate quadrature measurements. According to Snyder, a periodic synchronization with an identical clock at the transmitter provides a local phase reference without the inconvenience of a wire link or the imprecision of a radio link in mountainous territory. Typical drift between the two clocks is less than 30 μ s per 8-hour day, amounting to less than 2 milliradian error at 100Hz.

The Geophase receiver uses a synchronous-demodulation algorithm to determine in-phase and quadrature signal components at a particular frequency. The digitized value of the transmitted signal is multiplied by the sine and cosine of the transmitted signal, as referenced by the receiver's synchronous clock. 16-bit sine and cosine values are obtained from look-up tables stored in PROM.

According to Snyder, "the detection method is essentially a digital heterodyning technique where the cosine product is proportional to the in-phase component and the sine product is proportional to the quadrature component." With digital data available, detection amounts to determining the Fourier coefficients for a single harmonic frequency of a periodic signal. Received signals at the same frequency as the local oscillator pass through with no amplitude attenuation. To eliminate amplitude components of har-

WANTED

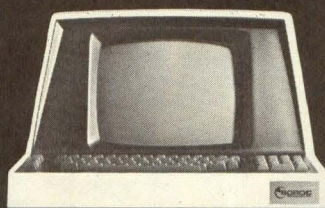

IQ 120

DESCRIPTION

- Lower Case
- Tabbing
- Dual Intensity
- 24 Line x 80 Char.
- Numeric Pad
- Auto Repeat
- Aux. Port
- Optional Printer Port & Block Mode
- Protect Mode
- 15 Baud Rates
- Addr. Cursor

at **\$750^{*}00** the

SOROC IQ 120 is the most wanted OEM terminal on the market.

For information concerning the REWARD contact...



SOROC
TECHNOLOGY, INC.

165 FREEDOM AVE., ANAHEIM, CA 92801
714-992-2860 / 800-854-0147

* 50-99 QTY./5-49 \$800 / 1-4 \$995

CIRCLE 12

monically-related frequencies and to attenuate non-harmonically related noise, the IMP-16 integrates over several cycles.

The frequency range of the Geophase receiver depends mostly on the real-time processing requirement of the detection algorithm. Using the POWR I/O

CROM for the IMP-16C provides an upper limit for the transfer of peripheral data to the memory of 90K words/sec. Hence, if a non-real time detection algorithm were used, the practical upper frequency limit of the receiver would be about 1KHz.

After the required integration, the

results appear on two four-digit LCDs. Savings in field-computation time have already been dramatic, according to Snyder. Previously an operator spent two to three times as long at each site, tuning the receiver, determining the values, using a handheld calculator and logging the data. Now when the cassette is used, an operator using the Geophase receiver does not even have to log the values. The cassette resident data can be input directly to a minicomputer in order to generate the resistivity and polarization isograms.

Love At First Byte...

Now there's an economical alternative for PDP-11 users who feel restricted by RK05J cartridge discs. With our DC-111 Controller you can increase system performance, while getting fixed-head reliability—all for less than \$9,000.

Installation of the DC-111 Controller is simple. Packaged as its own system unit on three DEC-type "quad" boards, it can be installed as a subchassis in the CPU—or be ordered with its own separate chassis.

Transparent to RSX-11 or RS-64 software, and fully Unibus-compatible, the DC-111 is the only controller available that makes a fixed-head disc "look" like a moving-head disc to the CPU. This means you can bootstrap directly from our Model 980 fixed-head disc, just as with an RK05J, and use the Model 980 cartridge feature. The system will emulate the RF-11 or RC-11, too.

With 8.5 ms or 10.5 ms average access time (depending on operating speed), at a transfer rate to 262K words/sec, the fast Model 980 system features our interchangeable Disc Cell™—a unique, fixed-

head disc cartridge containing spindle, Winchester-type media, and read/write head assemblies. Packaged and sealed for reliable operation in severe environments, Disc Cell is especially well-suited for rugged applications where there's little tolerance for downtime.

The Model 980 is compact and lightweight, and provides storage from 0.5 to 2.0 Mbytes, with larger capacities available by daisy-chaining. Its other features include an integral D. C. power supply, constant data rate and unchanged access time with 50-Hz power, highly flexible I/O, and a 10,000 hours MTBF rating.

For OEM pricing and complete technical details on the Model 980 and DC-111, circle the number or call us.

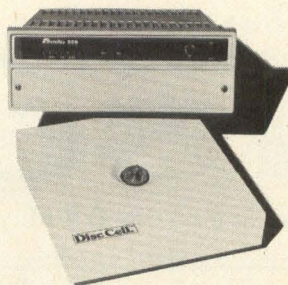

DATAFLUX

1050 Stewart Drive, Sunnyvale, CA 94086
(408) 732-7070 TWX 910-339-9399

Semiconductor Memory System Adds New Dimension to Weather Study

Once a folk art practiced primarily by arthritics and other sufferers, weather prediction has entered the domain of science in recent years. The scientists involved in weather forecasting depend heavily on satellite television pictures for their work; because of this, image processing has become a central concern in weather science. One study currently taking place at Colorado State University, Fort Collins, CO, uses advanced semiconductor memory technology to obtain better satellite weather pictures.

According to Eric Smith of CSU's Department of Atmospheric Sciences, objectives of the research include the development of near-automatic weather maps that will translate satellite data into superior video pictures with less human interaction; the tracing of invisible weather features (such as hot air masses) as visible color areas; and the combining of color with black-and-white in order to etch details more clearly. Smith points out that the key to such developments lies in the ability to use large amount of data in many different ways. Rather than employ a conventional computer system, CSU scientists and engineers worked with engineers from Intel Memory Systems to develop a system that incorporates an Intel-designed semiconductor memory system, a Hewlett-Packard HP2100 digital

CIRCLE 13

computer and a video subsystem consisting of a video overlay (512 x 512 x 8 bits), five digital-to-analog converters and five television monitors.

Special features of the memory system provide the unique capabilities that allow the sophisticated processing to take place. An array of Intel in-477 memories store and retrieve digital video image data while in-50 enhancement table memories provide image improvement. According to Bob Christensen, a systems engineer for Intel, the in-477 is designed specifically for television applications and has 'the unique ability to write data in as a 16 bit word, as in a standard memory board, or to write and read a single bit.' Thus you can assemble the memories, he explains, for unusual configuration requirements. In the CSU system, eight boards are used so that eight bits can be read at one time; because each dot on the video display consists of eight bits, this memory arrangement allows the meteorologists to work with partial dots, to overlay dots on one another and to manipulate the picture data in any number of ways. Also, each dot can be adjusted to one of 256 contrast levels.

As 'middle-man' between the HP2100's central processing unit and the video system, the in-477's must accommodate the data rates of both. Programmed from the CPU at 1600

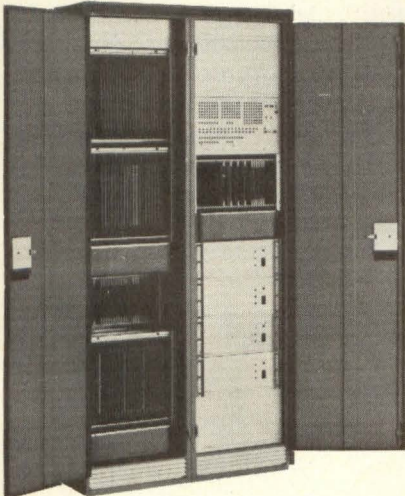

Fig 1 90" high and 38" wide, this cabinet houses memory and interface boards, power supplies, a control panel and the fast in-50 memories.

ns per 8-bit word, the memory transmits the data to a video monitor via

its built-in shift register at 100 ns per word, or 10 MHz. At a slower transmission rate, the human eye would see flicker in the final television image.

Designing in this high-speed capability entailed considerable engineering ingenuity. Christensen says that the boards were modified to convert

the 10 MHz serial data out to differential ECL. Further, Christensen says that he 'used a twisted pair from there to the I/O board that would receive the data and multiplex it to the output lines.' He pointed out that this setup ensured that there would be reliable transmission at 10 MHz

More Love At First Byte...

For Data General Users, We Now Provide A
4019* Compatible Controller For Our Fixed-Head

If you thought high cost and difficult maintenance were necessary evils in fixed-head storage, then you haven't heard about our rugged line of Model 980 discs and DC-100 Controllers.

Field-proven in more than 2,000 installations, our fixed-head disc memories feature an interchangeable Disc Cell™. This reliable, sealed unit has a self-contained spindle, Winchester-type media, and read/write head assemblies. The rugged Disc Cell seldom fails—but if it should, you won't incur costly downtime because it can be quickly removed and replaced.

Adding reliable fixed-head disc storage to your Data General or Rolm minicomputer couldn't be easier, using our DC-100 Controller. Transparent to RDOS software and boasting a fast transfer rate of 256K words/sec, the DC-100 slides con-



veniently into a circuit board slot in the CPU.

Once our DC-100 Controller is installed, your CPU can immediately interface with our Model 980 disc drive, with its sealed Disc Cell. In fact, up to eight Dataflux Model 980 disc drives can be daisy-chained and interfaced to a single DC-100 Controller. Each Model 980 is compact and lightweight, and provides storage from 0.5 to 2.0 Mbytes.

Seismic, Process Control, POS, Data Processing — whatever you have in mind, you can count on us for fixed-head storage systems that are priced commercially, but built to meet rugged environmental specifications.

For OEM pricing information and complete technical details on the Model 980 and DC-100, circle the number, or call us.

DATAFLUX

1050 Stewart Drive, Sunnyvale, CA 94086
(408) 732-7070 TWX 910-339-9399

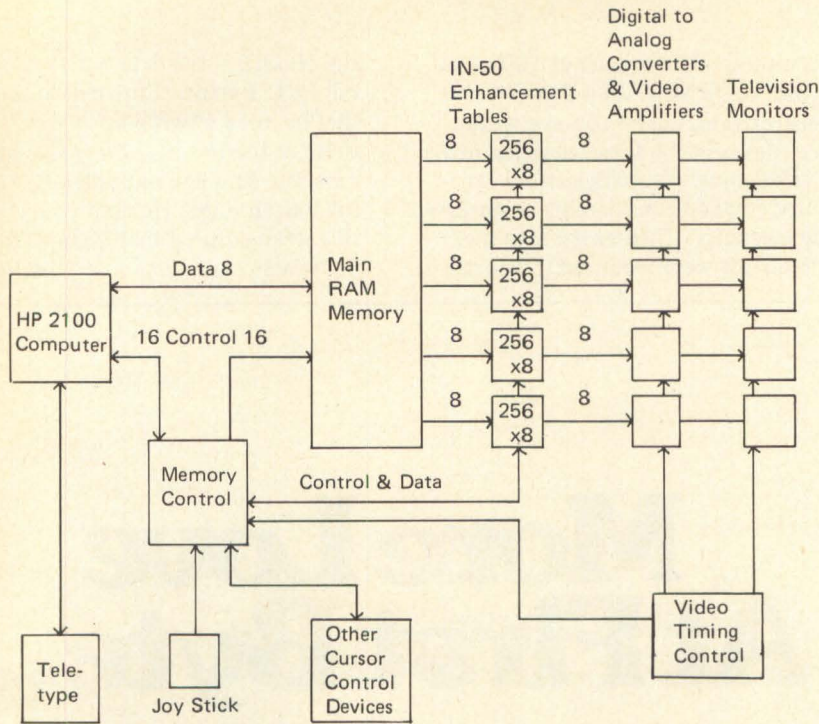

Fig 2 This block diagram shows how the Intel memory system fits into Colorado State University's image processing system.

for the output date.

En route to the video subsystem, the in-477's high-speed data output reaches the smaller, faster in-50 memories and acts as address input, causing the data to be relayed on from the in-50's in appropriately modified form (higher or lower contrast) and routed to the digital-to-analog converters. From there the data travels to the television monitor for display.

Christensen singles out two significant advantages that the memory system provides. First, it enables the scientists to handle immense amounts of data very quickly; otherwise, this data might be handled by very tedious methods such as writing data into tables and then reading it. Second, the data comes from satellites at a slow rate (thus ensuring accurate transmission); the data can then be processed at high speed.

For further information, write Intel Memory Systems, 1302 N. Mathilda Avenue, Sunnyvale, CA 94086 or call (408) 745-7120.

TV OVER PHONE LINES

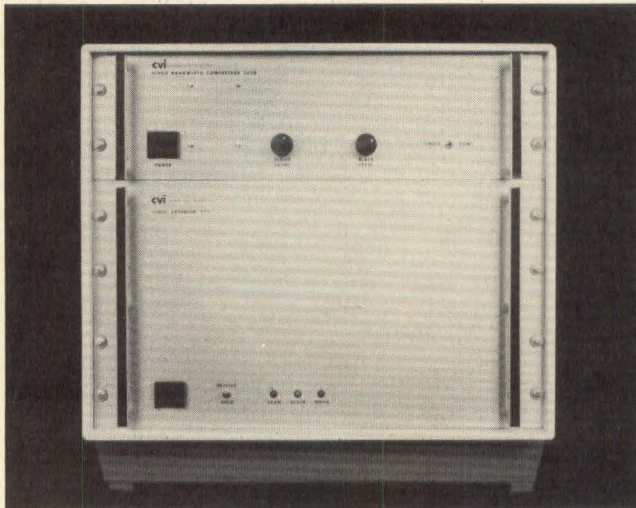

CVI's Video Compressor/Expander systems allow convenient transmission of visual information in a wide number of formats over the standard "dial-up" telephone network. Far more flexible than facsimile, CVI Compressed Video may be used to look at three-dimensional subjects, microscopic or macroscopic material. Still pictures only, please, as we need at least 35 seconds of phone time to transmit an image.

If words PLUS pictures can help speed your decision making, please contact us. We'll share our 12 years of experience with you.

cv*i*

Colorado Video, Incorporated
Box 928 • Boulder CO 80306 USA • (303)444-3972 • TWX 910-940-3248 (COLO VIDEO BDR)
CVI Boston (617)256-3381 • CVI Dallas (214)233-5497 • CVI Los Angeles (213)889-3653
CVI New York (212)246-2490

Video Instruments for Data Acquisition, Processing, Transmission, Display

CIRCLE 15

INTRODUCING THE FUNNEL A TAPE DRIVE CAPABLE OF EMPTYING A FIXED DISK INTO ONE 1/4" CARTRIDGE



The Funnel lets you pack more data onto a standard 1/4" cartridge than ever before—more than enough to load and unload an entire 10 M-Byte fixed disk.

Pay Less Than 2¢ A Kilobyte.

The Funnel out-transfers and out-stores a typical cartridge system 4 to 1. And it out-saves all systems on a cost per kilobyte basis. Featuring 4-track, serial recording at 6400 BPI, The Funnel boasts a transfer rate of 192 kilobits per second.

For OEM price quotations and more details, call 213/351-8991. Or write: The Funnel, Data Electronics, Inc., 370 N. Halstead St., Pasadena, Calif. 91107. Telex 67-5327.

Condensed from a recent independent, nationally published study.

	Typical Cassette	Double- Density Diskette	Typical 1/4" Cartridge	The Funnel
Data Transfer Rate (K Bits/sec.)	24	500	48	192
Recording Density (Bits/inch)	800	6400	1600	6400
Unformatted Capacity (M Bytes)	0.7	0.8	2.87	11.52

Add It To Your Mini System.

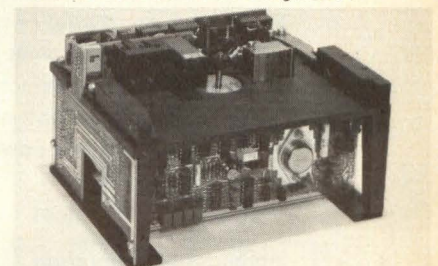

**WE STORE BYTES
IN M'S NOT IN K'S**

CIRCLE 16

CAMAC* and IEEE-488— a powerful combination for automated monitoring and control

**CAMAC microcomputer and
488-interface modules make it easy!**

— note these CAMAC features —

- numerous I/O modules to choose from
- infinite expansion and flexibility
- fast remote-point access via serial transmission
- proven worldwide in hundreds of installations
- powerful distributed control
- quick deliveries; most modules stocked

KSC offers you a CAMAC-to-488 interface as well as a 488-controlled CAMAC system. Write or call for more information.

*IEEE-583 Modular Interface Standard for Computer Automated Measurement And Control

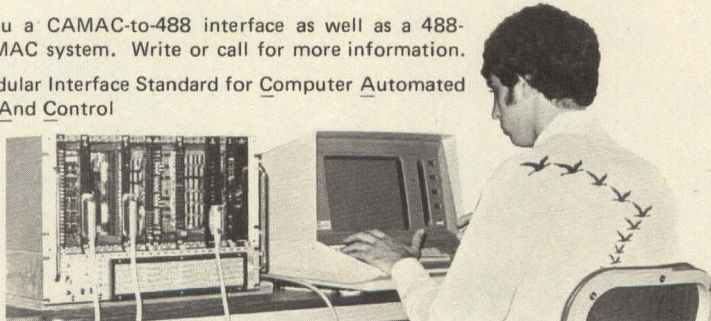

KineticSystems Corporation

Dept. DD127 11 Maryknoll Drive Lockport, Illinois 60441 Phone (815) 838 0005
6 Chemin de Tavernay 1218Geneva, Switzerland (022) 98 44 45

CIRCLE 17

MODEL 612



Paper Tape Transmitter

- 50-9600 baud
- RS 232 / Current loop or parallel outputs available
- 5-8 level tape, 7-11 frames per character
- Stops and starts on character at all speeds
- Uses manual control or x-on, x-off
- 90-260 volt, 50-60 Hz power
- Even or odd parity
- Desk top or rack mount

Addmaster Corporation
416 Junipero Serra Drive San Gabriel, California 91776
Telephone: (213) 285-1121

CIRCLE 18

TECHNOLOGY TRENDS

RS-449 Ousts RS-232

Developed to provide a functional interface between data terminal equipment (DTE) and data-circuit terminating equipment (DCE), Electronics Industries Standard (EIA) RS-449 retains all functional capabilities of EIA RS-232C and introduces ten new interchange circuits to enhance interface capabilities. RS-449 provides standardized 37-pin and 9-pin interface connectors together with latching arrangements for these connectors.

The resulting interface, said by the EIA to be compatible with the current state-of-the-art of integrated circuit technology, offers greater immunity to noise, increases the data signalling rate to 2 Mbit/sec and permits an increase up to 200 meters in the length of interconnecting cable.

The ten new interchange circuits defined in RS-449 not appearing in RS-232C include three circuits for control and status of testing functions in the DCE (Circuit LL — Local Loopback; Circuit RL — Remote Loopback; and Circuit TM — Test Mode), two circuits for control and status of the transfer of the DCE to a standby telecommunication facility (Circuit SS — Select Standby and Circuit SB — Standby Indicator) and a circuit for DCE transmit and receive frequency selection (Circuit SF — Select Frequency). The standard also defines a circuit providing an 'out-of-service' function under the control of the DTE (Circuit IS — Terminal in Service) and a circuit to provide a new signal function (Circuit NS — New Signal).

When necessary, equipment designed to use RS449 can operate with existing, unmodified RS-232C equipment, subject to the restrictions and technical limitations of RS-232C. The EIA provides detailed information on this matter in EIA Industrial Electronics Bulletin No. 12, 'Application Notes on Interconnection Between Interface Circuits RS-449 and RS-232C.'

To obtain a copy of RS-449, send \$9.50 to the Standard Sales Office, EIA, 2001 Eye St., N.W., Washington, D.C. 20006. To correctly interpret RS-449 and to facilitate the transition between RS-232 equipment and the equipment described in RS-449, the EIA recommends purchasing IEB Bulletin No. 12, available for \$4.25 from the Standard Sales Office.

OUR NEW PDP-II/LSI-II CARTRIDGE DISK CONTROLLER JUST PASSED ITS 4-WAY COMPATIBILITY TEST!

Software compatible, driver compatible, bus compatible, budget compatible! It's AED's four-way compatibility test, and the 2200A passed with flying colors. This new low-price cartridge disk controller now gives you more compatibility for your mini, with up to 20 megabyte capacity.

The AED 2200A Controller hooks up to your PDP-11 or LSI-11 minicomputer with absolutely no worry about OEM software maintenance, because it runs under DEC's own RK-11/RK-05 drivers. It also handles up to four Pertec 3000 Series drives with one pc board—

providing the lowest-cost cartridge disk storage on the market.

This remarkably compatible controller can be purchased as either a complete system or as a pc board controller only. And the price is the most compatible of all! Just \$1395 for the complete system with 5¼" RETMA cabinet, power supply and Unibus® cable connectors; or \$663 for the pc board controller and Unibus connectors only. Prices quoted are for quantities of 51 or more.

Call our marketing manager about delivery.

\$1395 for complete system. \$663 for controller board only.

**ADVANCED
ELECTRONICS
DESIGN, INC.**

440 Potrero Ave., Sunnyvale, CA 94086. Tel. 408-733-3555

® Registered trademark of Digital Equipment Corp.

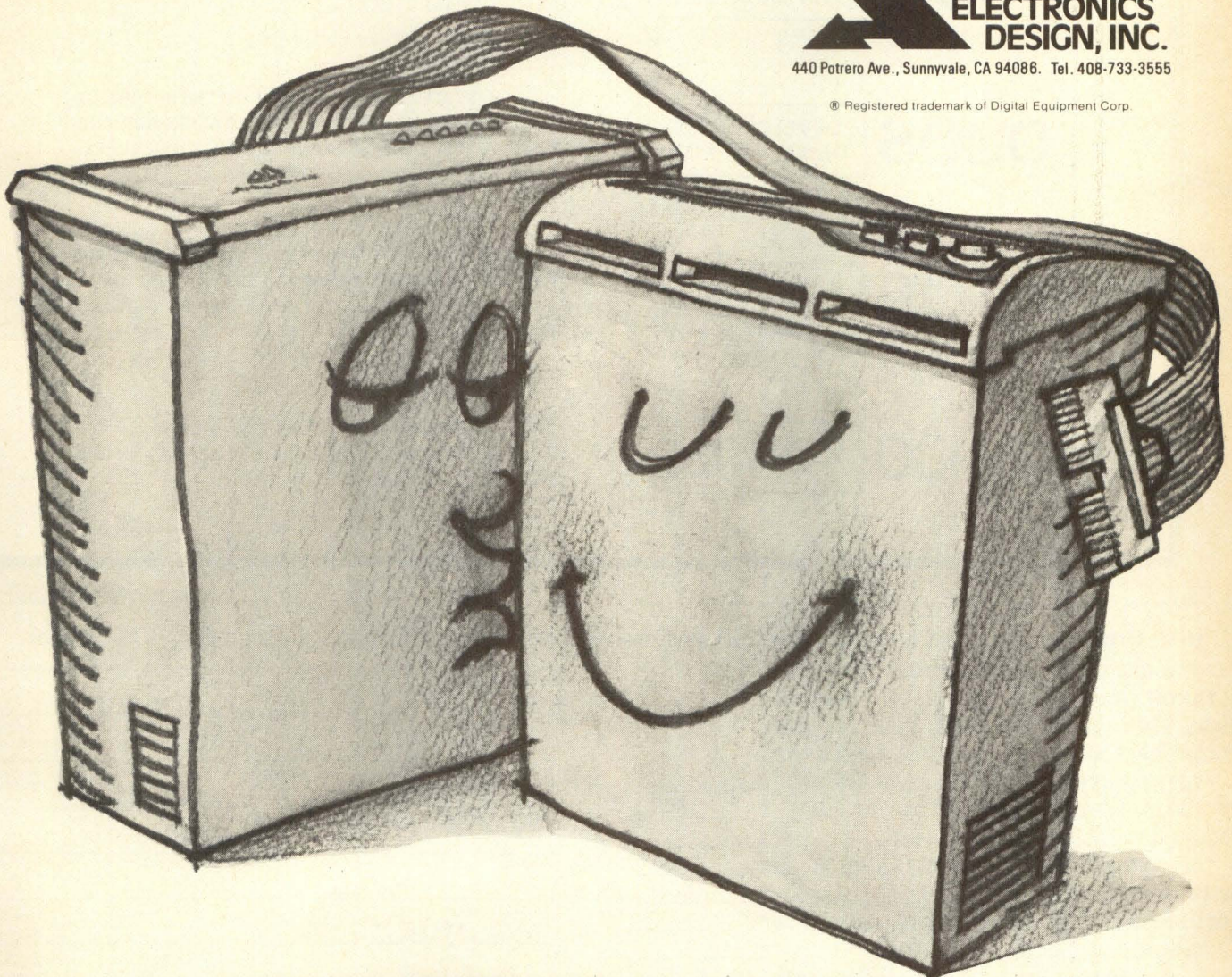

2200A. MORE CONTROLLER FOR YOUR MINI.

CIRCLE 19



TRIPLE SAVINGS!

(LIMITED TIME OFFER)

- 20% OFF ANY GROUP/3 EDUCATIONAL PRODUCT THIS MONTH
- FREE ATTACHE CASE AND RECORDER WHEN YOU ORDER ALL 4
- SAVE TIME AND INCREASE EFFICIENCIES IN YOUR SHOP

SOMETHING FOR EVERYONE! GROUP/3'S COMPLETE LINE OF DP EDUCATIONAL PRODUCTS COVERS ALL LEVELS OF COMPUTER USAGE AND MANAGEMENT – EVEN END USERS. EACH COURSE CONTAINS AUDIO CASSETTE INSTRUCTIONAL TAPES, WORKBOOKS, VISUALS AND REFERENCE MATERIAL.

CCM

COMPUTER CONCEPTS FOR MANAGEMENT

TEACHES THE BASIC FUNDAMENTALS ABOUT COMPUTERS IN NON-TECHNICAL LANGUAGE FOR TOP MANAGEMENT AND LINE MANAGEMENT.

DUOS

DEVELOPING USER ORIENTED SYSTEMS

PROVEN SYSTEMS DEVELOPMENT METHOD—PROJECT PLANNING AND CONTROL—DOCUMENTATION AND AUDIT PROCEDURES—BASIC STANDARDS AND PROCEDURES—ORIENTATION AND TRAINING GUIDE.

RPG-TOP

RPG II TECHNIQUES OF PROGRAMMING

BEGINNING RPG II FOR THOSE WHO WISH TO LEARN RPG II AS THEIR FIRST PROGRAMMING LANGUAGE OR WISH TO ADD IT TO THE LANGUAGE THEY ALREADY KNOW. PRE-REQUISITE FOR ADV-30.

ADV-30

ADVANCED RPG II & ARRAY PROCESSING

SAVES 30-50% IN PROGRAMMING TIME—ADVANCED RPG II TRAINING WHICH COVERS LOOK AHEAD, EXCPT, FORCE, READ AND ARRAY PROCESSING.



Rush Order Form or CALL NOW TOLL FREE (800) 423-5148 – In California, Call (213) 884-6678 Collect

PLEASE CHECK ONE OR MORE OF THE FOLLOWING:

- I'M TAKING ADVANTAGE OF THE 20% SAVING— PLEASE SEND ALL 4 PRODUCTS PLUS MY FREE ATTACHE CASE AND CASSETTE PLAYER/RECORDER
TOTAL PRICE: \$516.00 \$ _____
- CCM — \$120.00 (REGULARLY \$150.00) \$ _____
- DUOS — \$140.00 (REGULARLY \$175.00) \$ _____
- RPG-TOP — \$156.00 (REGULARLY \$195.00) \$ _____
- ADV-30 — \$100.00 (REGULARLY \$125.00) \$ _____
- \$3.00 Handling Charge (Omit if check is included) \$ _____
- Calif. Residents add 6% Sales Tax. \$ _____
- TOTAL \$ _____

- PLEASE SEND FREE GROUP/3 PRODUCTS CATALOG
ALL PRICES SUBJECT TO CHANGE WITHOUT NOTICE

COMPANY		
NAME	TITLE	
ADDRESS		
CITY	STATE	ZIP
PHONE	PURCHASE ORDER NO.	
SIGNATURE		DD

GROUP/3 GROUP 3 and Informatics are Registered U.S. Trademarks
GROUP 3 is a part of Informatics Inc., the world's largest independent supplier of software products.
P.O. Box 1452
21050 Vanowen Street Canoga Park, CA 91304

Digital Design

The Magazine of Digital Systems

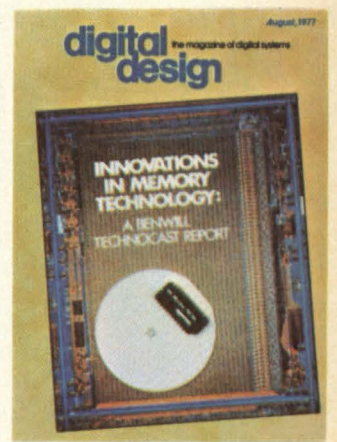
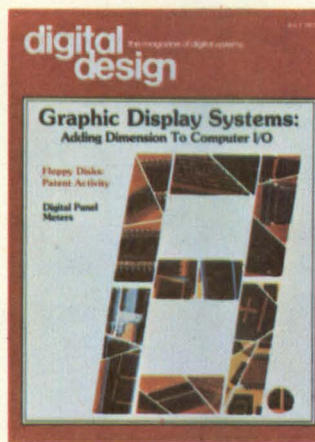
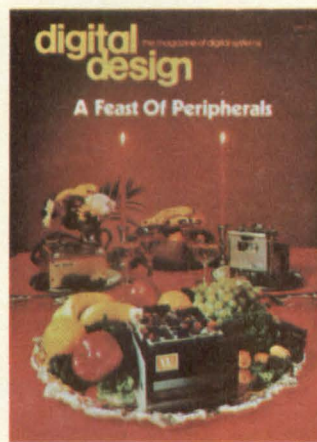
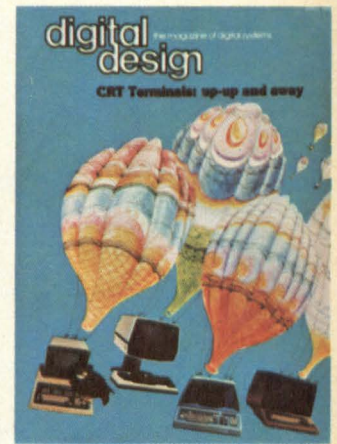
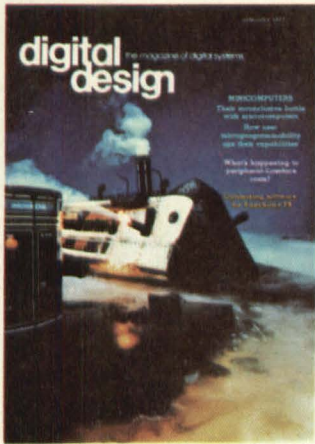

1977 YEAR IN REVIEW

YEAR IN REVIEW CONTENTS

28

Minicomputers

IBM Gets Into the Act • Improved Software for Minis • Smart Peripherals for Minis • More Packaged Systems • Minicomputers Evolve • Minicomputers and Security • Minis — A Look Into the Future

36

Microcomputers and Microprocessors

More Development Aids for Hardware and Software • More Software • More Smart Peripherals • Microprocessor Developments

42

Line and Character Printers

Smart Printers Come of Age • Matrix Printer Evolution • Small Printer Developments • Microprocessors Increase Flexibility

48

Computer Plotting Equipment

Electrostatic Plotter Developments • Pen Plotter Developments

51

Core and Semiconductor Memories

Semiconductor Memories • Extended Core Memories

58

Cartridge and Cassette Drives

Cartridge Drives • Minicartridge Drives • Cassette Drives • Minicassette Drives

60

Terminals: Smart and Dumb

New in 1977 • What About 1978?

68

Rigid and Floppy Disk Drives

Rigid Disk Drives • Floppy Disk Drives • Rumors for 1978

MINI 12

A POWERFUL, STAND-ALONE MINICOMPUTER

...for less than \$1000

You add it up!

MINI 12	\$895
8K x 12 Memory	N/C
Serial Interface	N/C
Parallel Interface	N/C
Real Time Clock	N/C
System Software	N/C
TOTAL	<hr/>



TLF

CORPORATION, Post Office Box 2298, Littleton, CO 80161

303/922-6241

TELEX 454541

77

IT WAS A GOOD YEAR

A major part of all changes and improvements in digital system technology during 1977 involved the microprocessor and associated LSI devices. One industry spokesman called it "the year of the microprocessor."

In the reviews of most of the subjects that follow this introduction you will find the effect of the microprocessor in these areas emphasized again and again. But finding out what happened was no problem for DIGITAL DESIGN's editorial staff. What did bother us was the scope of this review. If we could cover every area and describe all changes — major and minor — we obviously would have had to reprint not only the information that appeared in these pages in the last 11 issues, but a large part of what other trade journals published during the last year.

A World of Information on the Head of a Pin

How do you compress this enormous amount of information into a wieldy compendium? Obviously, you can't. So, what do you do? You choose a number of areas in which either major changes have taken place in 1977 or are expected to occur in 1978 and beyond.

We cannot relate in detail why we chose the topics that follow. Nor are we sure that we chose wisely or well. But we do know that, to the best of our ability, we are presenting a valid description of the changes in the state-of-the-art in 1977 and what to expect in 1978 in at least those areas covered in the ensuing pages.

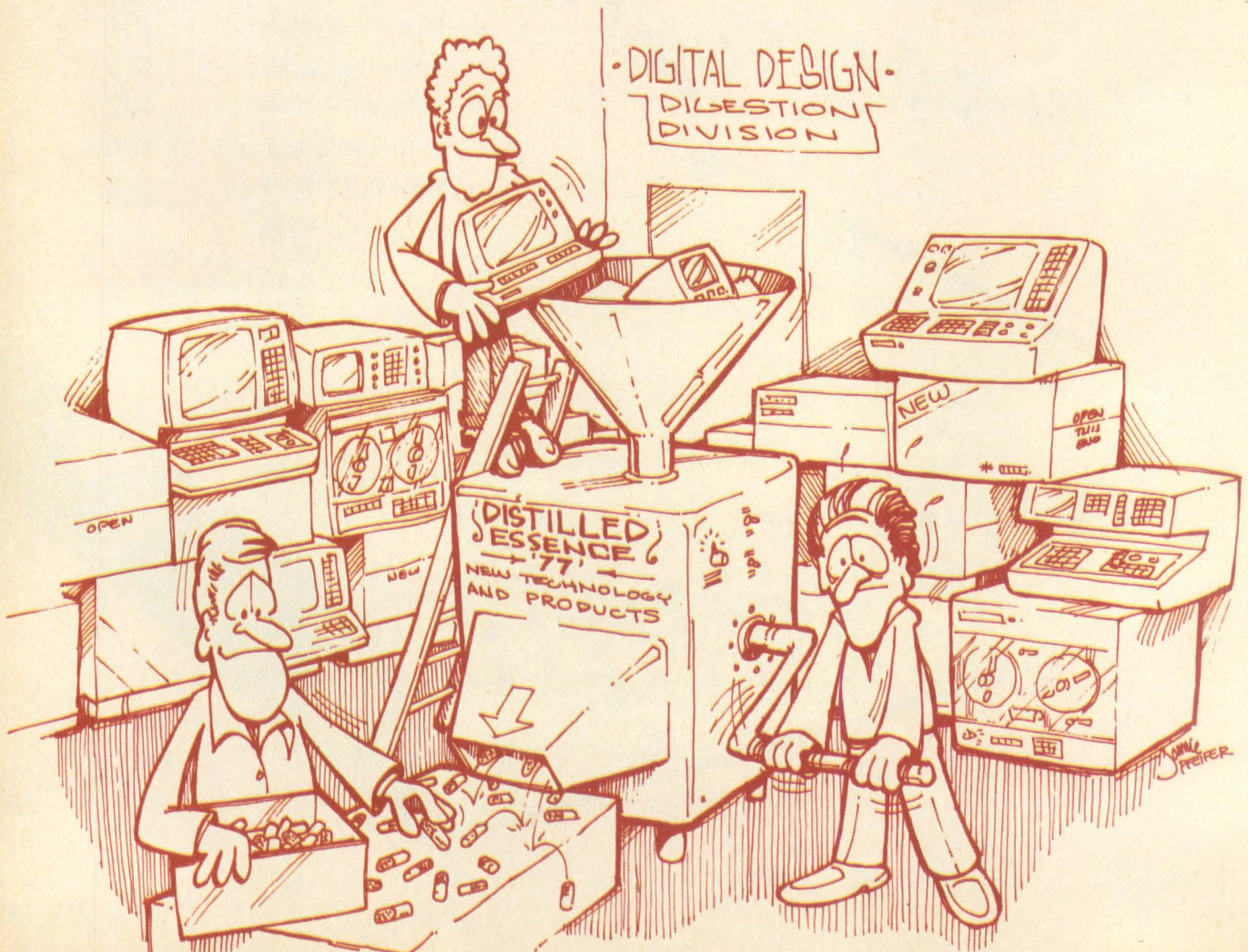



Cost efficiency you can put your finger on . . . CORTRON® SOLID STATE KEYBOARDS



Get your hands on a CORTRON Solid State Keyboard, and you'll soon find out why you can't judge all keyboards on initial price alone.

It's after installation that cost efficiency becomes most important. In life expectancy, ability to endure extreme environments, high speed operation without "misses," accuracy, downtime caused by beverage spillages, reliability, serviceability and human engineered features. That's where a CORTRON Solid State Keyboard really pays off.

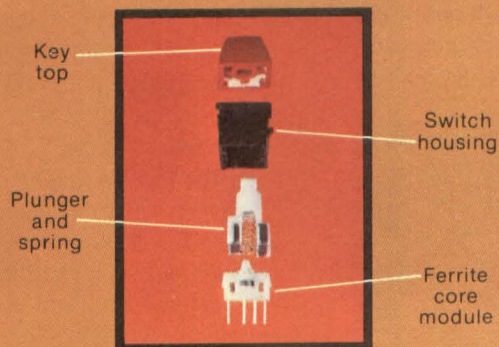

Unique contactless key switch makes the difference. Utilizing ferrite core switching technology, the CORTRON Key Switch is mechanically simple (only 4 basic parts!) and has an ultra reliable 100 million cycle life test rating. CORTRON Keyboard Professionals can translate what this can mean to you in cost efficiency terms of MTBF (mean time before

failure). CORTRON has actual customer experience of MTBF in excess of 40,000 hours.

They'll also explain other advantages you'll gain over competitive technologies such as Hall effect, reed switch, and capacitive switching. All in all, you'll find the CORTRON Key Switch offers unusual built-in protection against costly service calls and the hardship of downtime.

"Human engineered" keytops and key placement options give CORTRON low profile alpha numeric keyboards the familiar "typewriter feel" that promotes operator productivity and efficiency.

Nothing left to chance. CORTRON solid state keyboard materials, components, subassemblies, and final assembly are 100% inspected and tested to assure your specifications are met with plenty of room to spare.

These are just a few of the cost efficiency benefits CORTRON offers you and your customers.



Cost efficiency you can put your finger on. For a greater insight into the cost efficiencies attainable with a CORTRON Solid State Keyboard, write or call for details: CORTRON, A Division of Illinois Tool Works Inc., 6601 West Irving Park Road, Chicago, Illinois 60634. Phone (312) 282-4040. TWX 910-221-0275.



CORTRON
A DIVISION OF ILLINOIS TOOL WORKS INC.

THE KEYBOARD PROFESSIONALS

Minicomputers

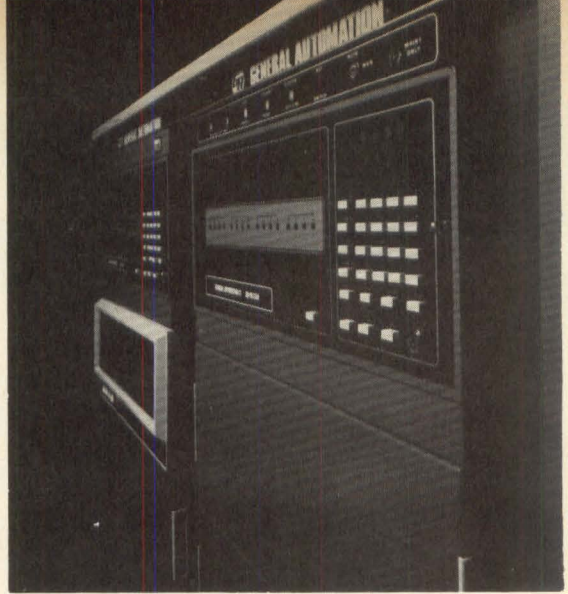

General Automation dual GA-16/550 Multiprocessor system interconnects two processors to same memory bank and achieves Multiprocessor capability.

Micros look more like minis, minis look more like mainframes

Minicomputer manufacturers didn't seem concerned by the onrush of the microcomputer. On the whole, they seemed ready to embrace LSI technology. They also pointed out that their minicomputers are putting pressure on mainframe manufacturers. These two themes — micro pushing mini and mini pushing mainframe — recur in much of what follows.

"In 1977 we witnessed an increased crossover between minis and micros," said John Bond, marketing communication manager for the DEC PDP-8 minicomputers. "Wait another year and there probably won't be much of a distinction. If you look at it right now, you can see that a lot of mini people use bit-slice microprocessors for designing minis. It's only a matter of time before we get the kind of speeds we want out of LSI devices, and then we'll be building a whole minicomputer on one board. The LSI-11 is on one board. We call it a microcomputer, but in fact in a lot of ways it's a minicomputer — when you put it in a PDP-11/03 with power supply and interfaces and so forth, it really becomes a minicomputer — it has the mini functionality. It's not quite as fast as a regular mini, but it's a lot cheaper."

Bond also felt that there was an increasing crossover between the more powerful minicomputers and mainframes. "At the high end of the mini field, you have a hard time distinguishing between mini and mainframe. The

PDP-11/70 with a lot of disks and so on has a hell of a lot of throughput and actually functions a lot like a mainframe."

"In 1977 we witnessed an increased crossover between minis and micros"

"In 1977, some of the competitive aspects between minicomputers and microcomputers became clarified," said Frank Madren, manager of product marketing for Data General. Madren felt that the microcomputer industry as a whole "grew up a little" during the year, and that the high performance end of the microcomputer industry was very active. "The 16-bit micro be-



Frank Madren of Data General.

came much more of a reality, appearing in systems, software and products compatible with minicomputers — that sort of thing," Madren said. "I think there are still substantial differences between minis and micros — particularly in systems and software. Micros are getting more powerful every day — more software, more peripherals and so on — and they can be used in more powerful applications. Still, I think that the differentiation between the level of support and service that goes with minis became somewhat clarified during '77. People tend to think that a micro is just like a mini and that you can run it if you have a chip that executes mini instructions. But that is not quite the case. The chip people are struggling to supply the software and services that typically go with a mini, and meantime the minicomputer manufacturers are continuing to sell what they've been selling all along."

Madren added that he thought that it was somewhat misleading to concentrate on the differences between minis and micros, noting that his own firm manufactures both and uses the same microprocessor — mN601 — in both. Rather, he would prefer to view the market as a "continuum" — from the simplest micro to the most elaborate mini — and stress the match between user requirements and available products. Stressing differences tends to cloud the continuity of the marketplace.

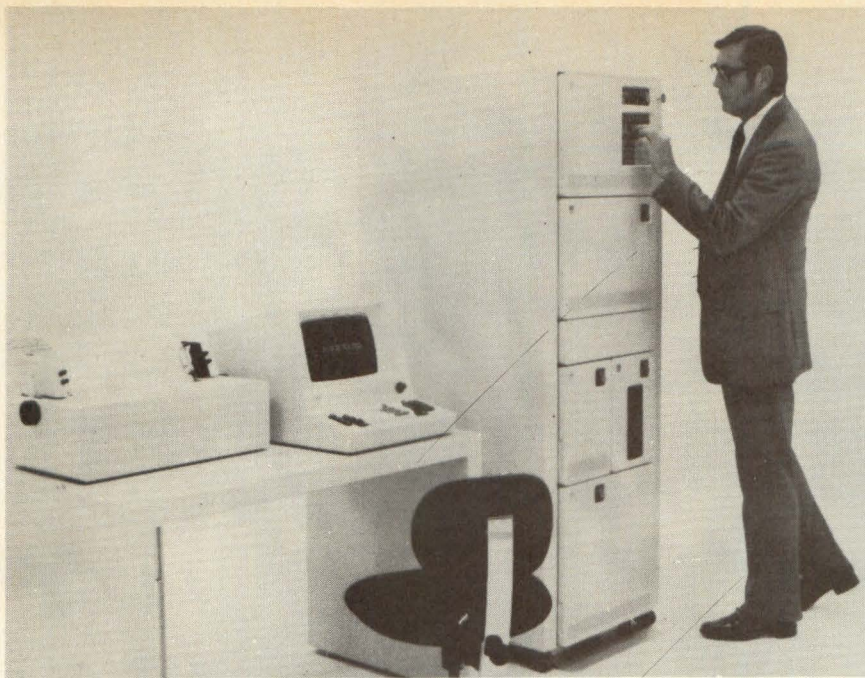

Fig 1 IBM Series/1 "small computers," first offered late in 1976 on a purchase-only basis, are available with memory capacity from 1 to 131 K bytes, depending upon model.

IBM Gets into the Act

Among the more interesting events of the year were IBM's entry into the mini-computer market with the Series/1 line and Univac's acquisition of a Varian division that builds minicomputers.

A spokesman for IBM said that the Series/1 line of computers was introduced late in 1976 and enhanced in 1977. IBM does not use the term "mini" in describing the Series/1 "because we have seen this term applied in so many different ways that it's not really clear what it means. Instead, we prefer to use the term 'small computer.'"

The spokesman said that IBM's entry into this market was far from revolutionary. "If you look at the record," he said, "you'll see that we've been in the small computer business for a long time. We were manufacturing machines for users who didn't need or couldn't afford a mainframe back in 1961. Look, for example, at the 1710 and 1130. At IBM we look upon the Series/1 as a natural extension of what we've been doing all along — to meet the needs of our customers."

The same spokesman refused to comment on IBM's possible entry into the microcomputer market. "Like every other company," he said, "we have an ongoing development program. We don't speculate on new products."

Improved Software for Minis

In 1977, makers of minicomputers intro-

duced increasingly sophisticated software — particularly for teleprocessing monitors and operating systems, according to Jim Orris, division marketing manager with Sperry Univac (Varian). An example of a teleprocessing monitor that Orris cited is Sperry's PRONTO, a unit that allows the minicomputer to insert itself between an IBM mainframe and terminal. "This takes up some of the workload from the mainframe using the distributed processing technique," Orris explained. "The mainframe doesn't know it's there." Orris also cited the closing gap between minicomputer and mainframe software: "All the leading mini manufacturers now offer about the same software as the mainframe manufacturers."

"The most prominent evolutionary step in the mini area was the increasing

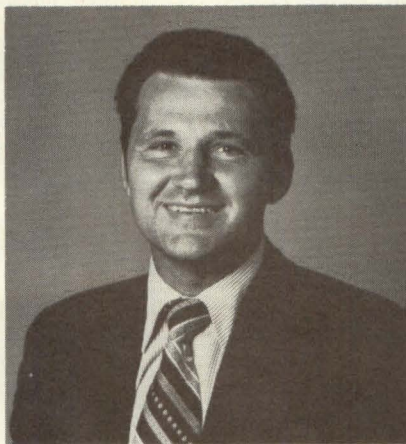

Jim Orris of Sperry Univac (Varian).

sophistication of available software," said Chris Hoppin of Interdata. "We introduced COBOL in '74 and at the time that was a big step. COBOL is fairly common in minis today — that's an example of a mainframe language in a mini."

"Smart" Peripherals for Minis

Peripherals "grew up" in 1977, according to Frank Madren of Data General. "These days you don't just design a disk controller that'll read and write," he said. "Now you design one that'll read and write — if it reads incorrectly it'll find the error and correct it and offset the track automatically. We're building higher and higher degrees of sophistication into machine controllers and peripherals to make them more and more reliable and easier to use — with error correcting memories, file handling techniques and so on."

Sperry Univac (Varian) recently introduced a disk controller that uses microprocessors, according to Jim Orris. "It's a very smart controller,"

"At the high end of the mini field, you have a hard time distinguishing between mini and mainframe"

he said. "A lot smarter than a dumb one. What has happened is that the basic mini has gotten so powerful that we are now offloading it with microprocessor controllers. All of the controllers we produce now are smart controllers — we wouldn't think of building one now without microprocessors."

More Packaged Systems

Minicomputer manufacturers were doing more for the customer in 1977 than in the past, according to Chris Hoppin of Interdata. He added that this was another way in which the minicomputer and mainframe businesses were converging. "Historically," he said, "mainframe companies have done more for the customer in terms of packaged systems, peripherals, software and so on, but now I think we see many of the mini manufacturers offering these same kinds of things. We recently introduced the LS-16 laboratory system, for example, a completely packaged FORTRAN

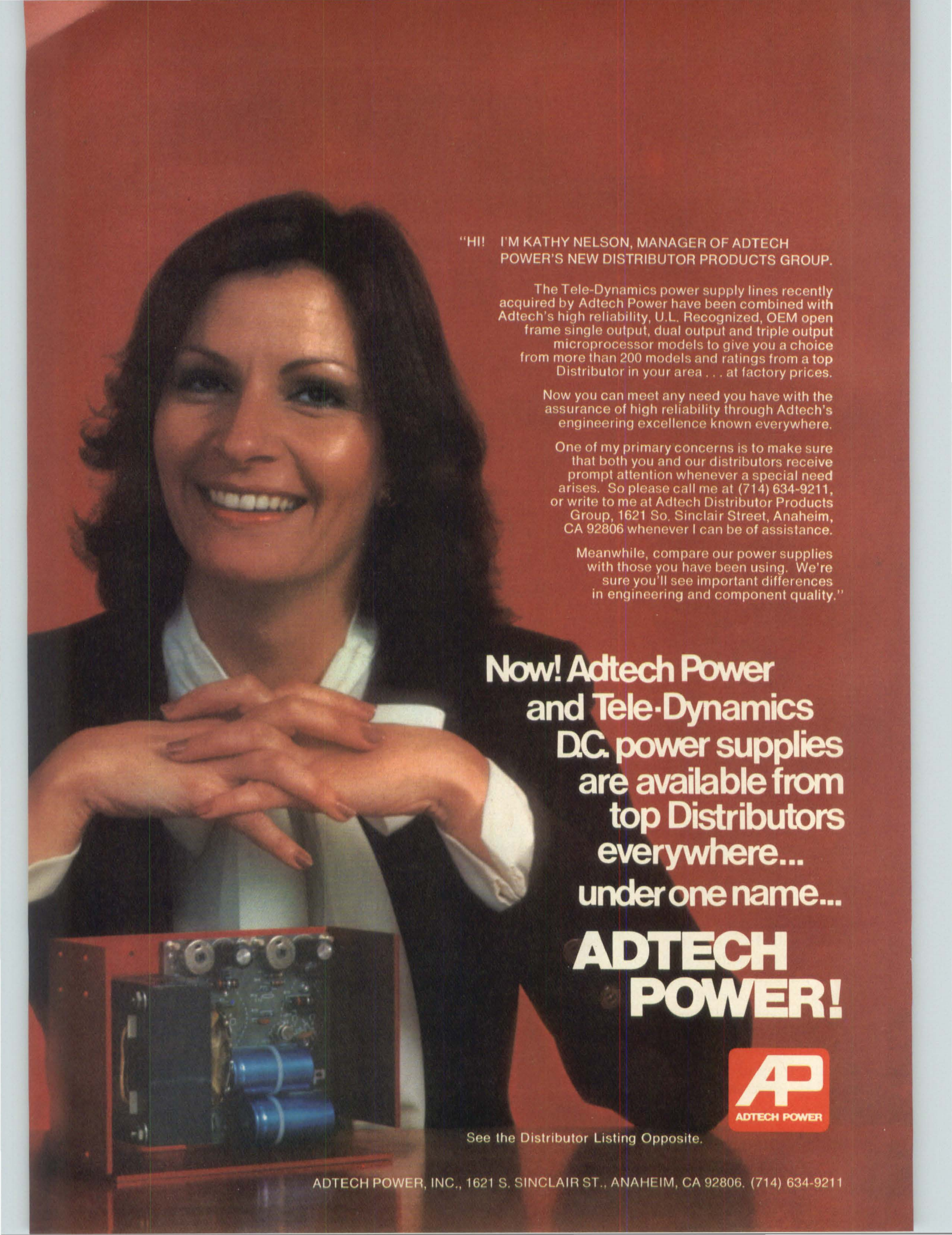

"HI! I'M KATHY NELSON, MANAGER OF ADTECH POWER'S NEW DISTRIBUTOR PRODUCTS GROUP.

The Tele-Dynamics power supply lines recently acquired by Adtech Power have been combined with Adtech's high reliability, U.L. Recognized, OEM open frame single output, dual output and triple output microprocessor models to give you a choice from more than 200 models and ratings from a top Distributor in your area . . . at factory prices.

Now you can meet any need you have with the assurance of high reliability through Adtech's engineering excellence known everywhere.

One of my primary concerns is to make sure that both you and our distributors receive prompt attention whenever a special need arises. So please call me at (714) 634-9211, or write to me at Adtech Distributor Products Group, 1621 So. Sinclair Street, Anaheim, CA 92806 whenever I can be of assistance.

Meanwhile, compare our power supplies with those you have been using. We're sure you'll see important differences in engineering and component quality."

**Now! Adtech Power
and Tele-Dynamics
DC. power supplies
are available from
top Distributors
everywhere...
under one name...**

**ADTECH
POWER!**



See the Distributor Listing Opposite.

ADTECH POWER, INC., 1621 S. SINCLAIR ST., ANAHEIM, CA 92806. (714) 634-9211

Now you have a wider choice!

Contact the Adtech Power Distributor near you for Catalogs on more than 200 Models.

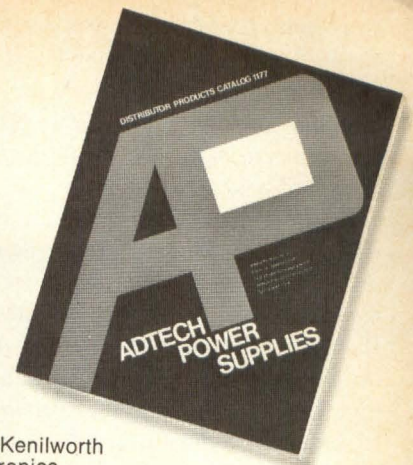

Arizona, Phoenix
Cramer/Arizona
Phone: (602) 267-7321

Arizona, Tempe
Newark Electronics
Phone: (602) 968-7441

California, El Segundo
T.I. Supply
Phone: (213) 973-2571

California, Garden Grove
Allied Electronics
Phone: (213) 598-8671

California, Goleta
RPS
Phone: (805) 964-4764

California, Inglewood
Newark Electronics
Phone: (213) 678-0441

California, Irvine
Cramer/Los Angeles
Phone: (714) 979-3000

California, Los Angeles
RPS
Phone: (213) 748-1271

California, Orange
Newark Electronics
Phone: (714) 997-9572

California, Palo Alto
Zack Electronics
Phone: (415) 326-5432

California, San Diego
Cramer/San Diego
Phone: (714) 565-1881

California, San Diego
RPS
Phone: (714) 292-5611

California, San Francisco
Zack Electronics
Phone: (415) 626-1444

California, Sunnyvale
Cramer/San Francisco
Phone: (408) 739-3011

California, Sunnyvale
T.I. Supply
Phone: (408) 732-5555

California, Van Nuys
Patane Avionics, Inc.
Phone: (213) 988-4455

California, Woodland Hills
Jaco Electronics, Inc.
Phone: (213) 887-6400

Colorado, Denver
Cramer/Denver
Phone: (303) 758-2100

Colorado, Denver
Electronics Parts Co.
Phone: (303) 744-1992

Colorado, Denver
Newark Electronics
Phone: (303) 757-3351

Colorado, Denver
T.I. Supply
Phone: (303) 751-1780

Connecticut, North Haven
Cramer/Connecticut
Phone: (203) 239-5641

Connecticut, Westport
Newark Electronics
Phone: (203) 226-6921

Florida, Fort Lauderdale
Newark Electronics
Phone: (305) 587-2372

Florida, Hollywood
Cramer/EW Hollywood
Phone: (305) 923-8181

Florida, Orlando
Cramer/EW Orlando
Phone: (305) 894-1511

Georgia, Atlanta
Cramer/Atlanta
Phone: (404) 448-9050

Georgia, Atlanta
Newark Electronics
Phone: (404) 321-0413

Illinois, Arlington Heights
T.I. Supply
Phone: (312) 593-7660

Illinois, Chicago
Newark Electronics
Phone: (312) 638-4411

Illinois, Elgin
Allied Electronics
Phone: (312) 697-8200

Illinois, Mt. Prospect
Cramer/Chicago
Phone: (312) 593-8230

Indiana, Indianapolis
Newark Electronics
Phone: (317) 634-7430

Iowa, Cedar Rapids
Newark Electronics
Phone: (319) 362-1171

Kansas, Shawnee Mission
Newark Electronics
Phone: (913) 384-4545

Louisiana, Alexandria
Ralph's of Lafayette
Phone: (318) 443-4517

Louisiana, Baton Rouge
Ralph's of Lafayette
Phone: (504) 344-8114

Louisiana, Lafayette
Ralph's of Lafayette
Phone: (315) 234-4507

Louisiana, Lake Charles
Ralph's of Lafayette
Phone: (318) 439-2493

Louisiana, Metairie
Newark Electronics
Phone: (504) 888-5174

Louisiana, Morgan City
Ralph's of Lafayette
Phone: (504) 384-9831

Louisiana, New Iberia
Ralph's of Lafayette
Phone: (318) 369-9816

Maryland, Beltsville
Newark Electronics
Phone: (301) 937-5085

Maryland, Gaithersburg
Cramer/EW Washington
Phone: (301) 948-0110

Maryland, Gaithersburg
Pioneer Standard
Phone: (301) 948-0710

Maryland, Hanover
Cramer/EW Baltimore
Phone: (301) 796-5790

Massachusetts, Braintree
Allied Electronics
Phone: (617) 848-4150

Massachusetts, Newton
Cramer/Newton
Phone: (617) 964-4000

Massachusetts, Waltham
T.I. Supply
Phone: (617) 890-0510

Massachusetts, Woburn
Newark Electronics
Phone: (617) 935-8350

Michigan, Oak Park
Newark Electronics
Phone: (313) 548-0250

Michigan, Wyoming
Newark Electronics
Phone: (616) 241-6681

Minnesota, Edina
Cramer/Bonn
Phone: (612) 835-7811

Minnesota, Minneapolis
Newark Electronics
Phone: (612) 331-6350

Minnesota, Minneapolis
Harry Stark's
Phone: (612) 332-1325

Mississippi, Pascagoula
Ralph's of Lafayette
Phone: (601) 769-1672

Missouri, Berkeley
Newark Electronics
Phone: (314) 521-7343

Missouri, St. Louis
Olive Industrial Electronics
Phone: (314) 863-7800

New Jersey, Cherry Hill
Cramer/Pennsylvania
Phone: (609) 424-5993

New Jersey, Clark
T.I. Supply
Phone: (201) 382-6400

New Jersey, Kenilworth
Newark Electronics
Phone: (201) 272-8410

New Jersey, Moonachie
Cramer/New Jersey
Phone: (201) 935-5600

New Jersey, Moorestown
Arrow/Angus
Phone: (609) 235-1900

New Mexico, Albuquerque
Cramer/New Mexico
Phone: (505) 265-5767

New York, Buffalo
Summit Distributors
Phone: (716) 884-3450

New York, East Syracuse
Cramer/Syracuse
Phone: (315) 437-6671

New York, Hauppauge, L.I.
Cramer/Long Island
Phone: (516) 231-5600

New York, Hauppauge, L.I.
Jaco Electronics, Inc.
Phone: (516) 273-5500

New York, Melville
T.I. Supply
Phone: (516) 293-2660

New York, Plainview
Fairmont Electronic Sales
Phone: (516) 694-8200

New York, Plainview
GLD Electronics
Phone: (516) 752-0022

New York, Rochester
Cramer/Rochester
Phone: (716) 215-0300

New York, Rochester
Newark Electronics
Phone: (716) 473-6600

New York, Rochester
Summit Distributors
Phone: (716) 334-8110

North Carolina, Greensboro
Pioneer/Carolina
Phone: (919) 273-4441

North Carolina, Winston-Salem
Cramer/EW Winston-Salem
Phone: (919) 725-8711

Ohio, Cincinnati
Newark Electronics
Phone: (513) 874-5115

Ohio, Cleveland
Cramer/Cleveland
Phone: (216) 248-8400

Ohio, Cleveland
Newark Electronics
Phone: (216) 361-4700

Oklahoma, Tulsa
T.I. Supply
Phone: (918) 437-4555

Pennsylvania, Horsham
Pioneer/Pennsylvania
Phone: (215) 674-5710

Pennsylvania, Philadelphia
Philadelphia Electronics
Phone: (215) 568-7400

Texas, Austin
Newark Electronics
Phone: (512) 459-3163

Texas, Beaumont
Ralph's of Lafayette
Phone: (713) 833-9443

Texas, Dallas
Cramer/Texas
Phone: (214) 661-9300

Texas, Dallas
T.I. Supply
Phone: (214) 238-6844

Texas, Fort Worth
Allied Electronics
Phone: (817) 336-5401

Texas, Garland
Newark Electronics
Phone: (214) 271-2511

Texas, Houston
Newark Electronics
Phone: (713) 782-4800

Texas, Houston
Ralph's of Lafayette
Phone: (713) 641-0267

Texas, Houston
T.I. Supply
Phone: (713) 785-4800

Utah, Salt Lake City
Cramer/Utah
Phone: (801) 487-4131

Utah, Salt Lake City
Newark Electronics
Phone: (801) 486-1048

Washington, Seattle
Cramer/Seattle
Phone: (206) 762-5755

Wisconsin, Brookfield
Newark Electronics
Phone: (312) 638-4411,
Ext. 359

Canada, Downsview, Ont.
Cramer/Electronics/Canada
Phone: (416) 661-9222

ADTECH POWER

DISTRIBUTOR PRODUCTS GROUP

ADTECH POWER, INC., 1621 S. SINCLAIR ST., ANAHEIM, CA 92806. (714) 634-9211

CIRCLE 23



processing system with large storage and high speed number-crunching capabilities. This is characteristic of the evolution in the mini business to provide more packaged systems to the user instead of boxes."

A greater trend toward vertical integration — with more in-house memories, disk drives and interfacing techniques for I/O — was seen by Frank Madren of Data General. "We had an outstanding year for vertical integration," he said. "Early in the year we introduced a number of products and now we're delivering them in quantity. One of our more interesting products in '77 was our CS-40 family of COBOL-based small business computers, with broad vertical integration."

"Two application areas are heating up right now," said Henry Heisler, promotion manager for the PDP-11 series at DEC. "One is small business computers for people with limited computer knowledge who just want to plug a system in and use it. The other is the personal computer market, which presently lacks only one thing — software. But

the software base is building up and more and more people are getting into personal computing. Digital is in the market right now with the LSI-11 board, which Heathkit is putting into its 16-bit personal computer. That system, unlike many personal computers, has a broad software base. It can use PDP-11 software."

Minicomputers Evolve

"The important event for the PDP-8 during 1977 was the introduction of the DECstation, which incorporates an LSI PDP-8, 16K of memory and interfaces, built into a terminal with floppy disk mass storage — all selling for under \$8000," said John Bond, marketing communication manager for DEC's PDP-8 series minicomputers. DEC classifies the DECstation as a minicomputer, despite its small size, because it uses an LSI version of the PDP-8 CPU.

Although the PDP-8 has changed over the years, Bond said that in certain fundamental ways it has remained the same. "The basic architecture has not



Neal Young of General Automation.

changed, despite the various modifications we have made, so the software remains compatible. The PDP-8 has been around for several years, but still sells very briskly. We just introduced three MOS memory models, and also introduced the capability to address 128K words of memory. In the past we could never address more than 32K. What we did was to put in a memory manager that enables the larger memory capacity without changing software."

Bond said that DEC would continue to employ new technology in the PDP-8, as it became feasible to do so. "This is a growing business," he said. "There are 40,000 PDP-8s out there and people still want them."

Looking across the minicomputer business as a whole, Bond predicted the increased emergence of 32-bit minicomputers and 16-bit microcomputers. Chris Hoppin of Interdata also foresaw increased popularity for 32-bit minicomputers. "We pioneered the 32-bit mini, bringing out ours first in '73. Like others, we have heard rumors of a 32-bit machine from DEC."

General Automation's most significant entry during 1977 was the 550 super-mini processor, according to Neal Young, director of market planning for the firm. "The 550 has the ability to interconnect two processors — it actually allows two processors to be connected to the same memory bank," he explained. "I suspect that we'll see more of that from other manufacturers for certain applications. It comes out of our experience with a communication system that was used in a network

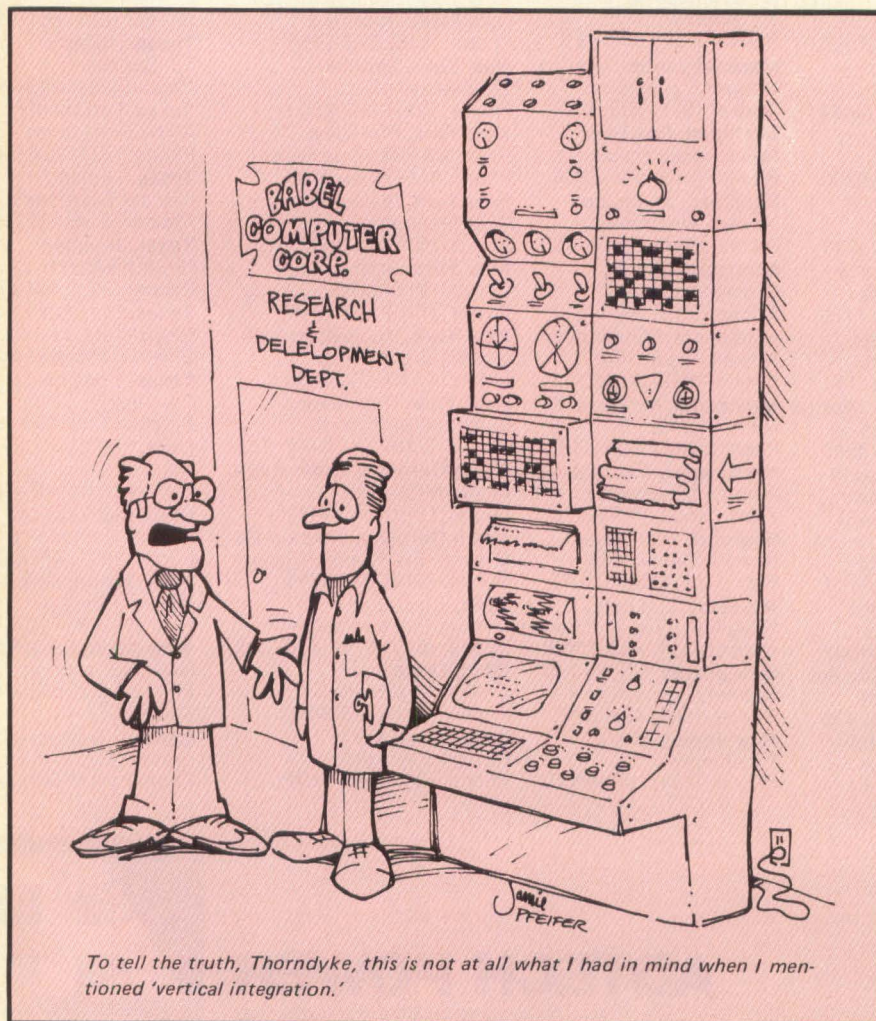

To tell the truth, Thorndyke, this is not at all what I had in mind when I mentioned 'vertical integration.'

to interconnect processors in a similar way. It takes a significant step toward achieving multiprocessor capability because the real connection between processors must happen on the memory side. This is somewhat like the 6800 microprocessor, whose peripherals are addressed through memory. We call this hookup 'tight-coupled,' as opposed to 'channel-coupled,' which we used a year ago. The 550 has under 500 ns cache memory, and the bus between memory and processor is 32-bits wide. Actually, this is a 16-bit machine, with a 32-bit memory."

Young explained that the multiprocessor capability is important in two different types of design — the first, to provide redundant processors in certain critical applications, such as nuclear

about high-technology users, of course. User microcoding has been evolving, but has become available as an option in minis only recently. Several major minicomputer manufacturers do not presently supply it and will probably announce it. I don't know when it will get down to the smaller computer companies, but I think it's coming — perhaps in '79."

Data General's S-130 minicomputer features user microprogramming, according to Frank Madren of Data General. "Microprogramming is nothing new," Madren said, "but this system brings the capability out in a form users can get their hands on. We are presently into the second generation of this product; other vendors in 1977 brought out their first generation of user-micro-

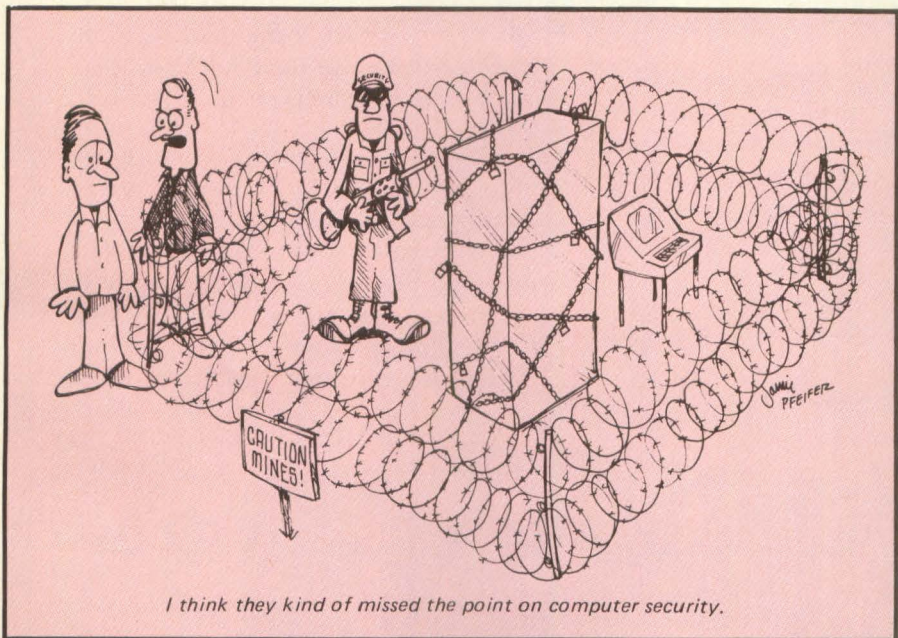

I think they kind of missed the point on computer security.

power plant control; the second, to allow modular expansion of computing capability.

The most important addition to the PDP-11 line during 1977 was the PDP-11/60 computer, according to Henry Heisler of DEC. PDP-11/60, a mid-range supermini replacement for the PDP-11/45, features integral bipolar cache memory which gives an effective cycle time of 532 ns and built-in floating point allowing very fast FORTRAN. The 11/60 also has writeable control-store option that allows users to enter their own function — for banking, fast Fourier transform, and other applications — in microcode. "User microcode is relatively new," Heisler said, "but many of our customers are sophisticated and want it. I'm talking

programmable systems. This is a continuing trend and we expect to see more of it in the future."

"One of the major new products to appear during the year was the 16K RAM," said Roger Ueltzen, product marketing manager for the Data Systems Division of Hewlett-Packard. Ueltzen added that HP is using these RAMs in its 21 MX minicomputer and its 1000 mini-based system. He said that over the years the average memory size of minicomputers has grown — that the memory capacity of HP's own product had quadrupled to 2 megabytes. HP has invested "upwards of 15 million dollars" in the SOS (silicon on sapphire) technology, and Ueltzen believes that this technology will "blossom" in 1978. SOS products

Now! Adtech Power, Tele-Dynamics and Adtech/Europe Power Supplies are now available through these Key Distributors in the United Kingdom and Europe under one name... ADTECH POWER!

Overseas Distributors

United Kingdom

London, Slough, Bucks.
T.I. Supply
Tel: Slough 33411

Southern, Southampton
Texas Instruments Ltd.
Tel: 0703-2767

Midland,
Sheldon, Birmingham
Texas Instruments Ltd.
Tel: 021-743-5293

North West,
Stockport, Cheshire
Texas Instruments Ltd.
Tel: 061-432-0645

Scotland, Edinburgh
Texas Instruments Ltd.
Tel: 031-229-1481

Germany, Berlin
Texas Instruments
Tel: 0311/7444041

Germany, Essen
Texas Instruments
Tel: 02141/20916

Germany, Frankfurt
Texas Instruments
Tel: 0611/726441

Germany, Freising
TISCO, GMBH
Tel: 08161/7411

Germany, Hanover
Texas Instruments
Tel: 0511/55.60.41

Germany, Munich
Bentron
Tel: 61181

Germany, Stuttgart
Texas Instruments
Tel: 0711/225092-3

Italy, Milan
Guisepe de Mico
Tel: 653131

Netherlands, Den Haag
De Buizerd Electronica
Tel: 469509

Sweden, Stockholm
Noack AB
Tel: 670820

Switzerland, Zurich
Seyffer & Co. AG
Tel: 628200

Europe

France, Paris
Omnitech
Tel: 2559705

France, Grenoble
Texas Instruments France
Tel: 90 45 74

France,
Le Plessis Robinson
TISCO France
Tel: 6302343

Adtech/Europe

FORMERLY / SOPHIA

46 BD. Roger Salengro
78200 Mantes La Ville, France,
Telephone: 4775301 +

SUBSIDIARY OF
ADTECH POWER, INC., ANAHEIM,
CALIFORNIA 92806, USA.

Why Toggle? (when you can turnkey)

Power-on-start means automatic program execution when computing with the Altair™ Turnkey Models from MITS. Both highly acclaimed Altair mainframes, the 8800b and 680b, are obtainable in easy-to-implement turnkey versions—offering the same capabilities as their full front panel counterparts—and then some.

Our 8800b Turnkey Model incorporates a Module Board complete with CPU, serial I/O channel, 1K of RAM, and provisions for 1K of PROM. All 8800 hardware and software are compatible with the 8800b Turnkey Model.

In addition to the 8800b Turnkey, we are introducing these new 8800 system peripherals. The Altair 88-AD/DA converter is our eight channel analog I/O system for applications where analog to digital and digital to analog conversion is necessary. For economical mass storage, the Altair Minidisk System (88-MDS) provides a fast access storage capacity of over 71K bytes per minidiskette.

A big computer in a small package—the Altair 680b Turnkey Model—is a low cost mainframe capable of home, business and process control applications. The 680b CPU module contains all the logic circuitry needed for immediate computing plus 1K of RAM, serial I/O port and provisions for 1K of PROM.

*MITS is a trademark of PCC Pertec Computer Corporation.

PCC PERTEC
COMPUTER
CORPORATION

Microsystems Division
21111 Erwin Street, Woodland Hills, CA 91367

You may expand your 680b Turnkey with these new additions to the 680b line. Load and save programs on audio cassette with the 680b-KCACR. This inexpensive mass storage device is highly reliable under widely varying conditions and requires no circuitry adjustments. Interface your 680b Turnkey to the practical world of process control with the 680b-PCI. Monitor and compensate for changes in any operation, from tracking the sun to watering the lawn.

 mits*



“Product introductions in the mini field are decreasing. The customer is looking more and more into the kinds of services provided.”

are presently being used in HP mini-computers.

Minicomputers and Security

Security is becoming increasingly important to users of minicomputers, according to Frank Madren of Data General. “Two or three years ago you didn’t have to worry about security on a mini, because they were put in a lab or someplace where they were locked up. Now, with multiprogramming and more use in the commercial marketplace, we must make minis more reliable and sophisticated. We must be able to guard certain sectors. We’re doing that in our commercial product line presently and a number of other manufacturers are doing it also.”

Minis — A Look into the Future

In the future, suggests Jim Orris of Sperry Univac (Varian), the minicomputer market will stabilize with customers looking increasingly for service and the kind of support that goes with a mature product. “The mini market has always been driven by products,” he said. “New product introductions in the mini field are decreasing. The customer is looking more and more into the kinds of services the manufacturer provides after purchase and considering them seriously.”

“There is definitely a trend in the industry toward higher-level languages in minicomputers,” said Roger Ueltzen of Hewlett Packard. Ueltzen added that he saw this trend continuing and also anticipates reduced hardware costs — by as much as 25%. Another important trend, he observed, is toward distributed processing. “During the year,” he said, “many mini and mainframe manufacturers announced long-term network strategies.”

“In the future, cost will be more critical than ever before,” said Chris Hoppin of Interdata. “I believe the competition will continue to have a significant impact on the minicomputer market.”

DD

VISIT YOUR NEAREST MITS DEALER

ARIZONA:

Altair Computer Center
4941 East 29th Street
Tucson, AZ 85711
602/748-7363
Contact: Armand Sperduti
Southwest Micro-Systems, Inc.
3815 North Third Street
Phoenix, AZ
602/957-3738
Contact: Darryl C. Goebel

ARKANSAS:

JFK Electronics
3702 JFK Blvd.
No. Little Rock, AK 72116
501/753-1414
Contact: George Luijet

CALIFORNIA:

Computer Kits
1044 University Avenue
Berkeley, CA 94710
405/845-5300
Contact: Pete Roberts
The Computer Store
820 Broadway
Santa Monica, CA 90401
213/451-0713
Contact: Dick Heiser

COLORADO:

Gateway Electronics of St. Louis
2839 West 44th Avenue
Denver, CO 80211
303/458-5444
Contact: George Mensik
Sound-Tronix
900 Ninth Avenue
Greeley, CO 90861
303/356-1588
Contact: Ronald Schuster
(have two other locations in Colorado)

FLORIDA:

Altair Computer Center of Miami, Inc.
Opa Locka Airport
Miami, FL 33166
305/688-0569
S.E. Micro-Data Corporation
6020 South Orange Blossom Trail,
Suite 602
Orlando, FL 32807

GEORGIA:

The Computer Systemcenter
3330 Piedmont Road, N.E.
Atlanta, GA 30305
404/231-1691
Contact: Rich Stafford, Lou Darby

ILLINOIS:

Chicago Computer Store
517 Talcott Road
Park Ridge, IL 60068
312/823-2388
Contact: Lou Van Eperen
Chicago Computer Store
4919 "B" North Sheridan Road
Peoria, IL 61614
309/692-7704

INDIANA:

Indianapolis Office Machines
6433 East Washington Avenue
Indianapolis, Indiana
317/353-9315

KANSAS:

Advanced Micro Systems, Inc.
7751 England
Overland Park, KS
913/649-2347
Contact: Phil Bouldin

KENTUCKY:

The Computer Store
Suite 5
Municipal Parking Bldg.
Charleston, West VA 25301
304/845-1360
Contact: Steven C. Payne

MICHIGAN:

The Computer Store of Detroit
505-507 West 11 Mile Road
Madison Heights, MI 48071
313/545-2225
Contact: Pete Blond
The Computer Store of Ann Arbor
310 East Washington Street
Ann Arbor, MI 48104
313/995-7616
Contact: Pete Blond

MINNESOTA:

The Computer Room
3938 Beau D'Rue Drive
Eagan, MN 55122
612/452-2567
Contact: Roger Hensen

MISSOURI:

Gateway Electronics of St. Louis
8123-25 Page Blvd.
St. Louis, MO 63130
314/427-6116
Contact: Lou Elkins

NEBRASKA:

Altair Computer Center
611 North 27th Street
Lincoln, NE 68503
402/474-2800
Contact: Steve Conover

NEW MEXICO:

Computer Shack
3120 San Mateo N.E.
Albuquerque, NM 87110
505/883-8282
Contact: Pete Conner

NEW YORK:

The Computer Store of New York
55 West 39th Street
New York, NY 10018
212/221-1404

OHIO:

The Computer Store
269 Osborne Road
Albany, NY 12211
518/459-6140
Contact: Charlie Olds

NORTH CAROLINA:

Computer Stores of Carolina
1808 East Independence Blvd.
Charlotte, NC 28205
704/334-0242
Contact: Grey Hodges

OHIO:

Altair Computer Center
5252 North Dixie Drive
Dayton, OH 45414
513/274-1149
Contact: John & Judy Potter

OHIO:

The Computer Store of Toledo
8 Hillwyck Street
Toledo, OH 43615

Southern Medical Clinic
3700 South Parsons Avenue
Columbus, OH 43207
614/497-1366
Contact: Dr. Robert Bertani

OKLAHOMA:

Altair Computer Center
110 The Annex
5345 East 41st Street
Tulsa, OK 74135
918/664-4564
Contact: Ray Koons

OREGON:

Altair Computer Center
8105 S.W. Nimbus Avenue
Beaverton, OR 97005
503/644-2314
Contact: Dick Landon

PENNSYLVANIA:

Microcomputer Systems Inc.
243 West Chocolate Road
Hershey, PA 17033
717/533-5880
Contact: Walter Hiester

Five H Corporation
740 Huntersrun Road
Pottstown, PA 19464
Contact: Michael Hegedus

TEXAS:

Swift Computers, Inc.
Suite 206
3208 Beltline Road
Dallas, TX 75234
Contact: Carl Swift

Swift Computers, Inc.
Fort Worth, TX
214/241-4088
Contact: Carl Swift

Burcon, Inc.
5750 Bintliff Drive
Suite 206
Houston, TX 77036
713/780-8981

Altair Computer Center
Computronics
5415 25th Street
Lubbock, TX 79407
806/797-4495

UTAH:

Microcosm Incorporated
534 West 9460
South Sandy, UT 84070
801/566-1322
Contact: John D. Anderton

VIRGINIA:

Computers-To-Go
1905 Westmoreland Street
Richmond, VA 23230
804/355-5773
Contact: Becky Willis

Microsystems Computer Corporation
Century Mall-Crystal City
2341 South Jefferson Davis Highway
Arlington, VA
703/569-1110

Contact: Russ & Gloria Banks
Megabyte Computer Association
700 Stoney Point, Suite 7
Newtown Road
Norfolk, VA 23502

WASHINGTON:

Altair Computer Center
8105 S.W. Nimbus Avenue
Beaverton, OR 97005
503/644-2314
Contact: Dick Landon

WEST VIRGINIA:

The Computer Store
Municipal Parking Bldg.
Suite 5
Charleston, West VA 25301
304/345-1360
Contact: Stephen C. Payne

WISCONSIN:

Chicago Computer Store
285 West Northland Avenue
Appleton, WI 54911
414/731-9559

Microcomputers

Microprocessors

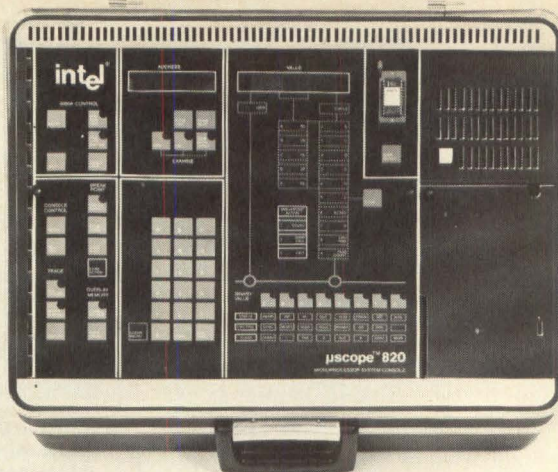

Intel's new Scope™ tool for field emulation enables user to "pull the microprocessor, plug in the emulator and step through a problem."

One-chip microcomputers arrive

"The emergence of one-chip microcomputers is very important," said Robert Walker, marketing communications manager for Intel. Some of these micros, announced in late '76, did not become a reality until '77."

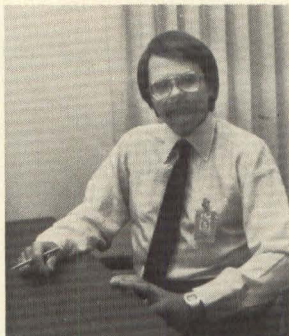

Robert Walker of Intel

In agreement was George Vashel, marketing manager for Signetics. "The 8048 and 3870 (from Intel and Mostek, respectively) made very significant statements," said Vashel, "and we at Signetics have taken a position to be a source of the 8048 family." Vashel believes that these small computers open up many applications in stand-alone controllers and distributed processing systems.

Ed Huber, marketing manager of MOS microprocessors for Texas Instruments, which in 1977 introduced a 16-bit single-chip microcomputer, felt that 1977 was the year in which single-chip microcomputer technology "came of age. We can put most of the memory requirements on a single chip and I think that we will see a definite trend away from multiple-chip processors and toward the single chip. We've already seen some evidence of that with Intel's 8048, Mostek's 3870 and of course TI's 9940. Our 9940 has considerable power — a 16-bit machine with 2K of program storage in ROM or EPROM and 128 bytes of RAM. You just look at over half of the microcomputer applications and you see that they can use a single-chip microcomputer like that. The counter-argument is that there are a lot of cases where additional memory will be required. But as the memory technology grows, we will take advantage of it. The memory of the 9940, for example, will accommodate a capacity of 64K. We can't do it now because the memory technology is not there, but it will be in the future and we will be able to do it."

Four bit microcomputers, traditionally limited to simple

control applications in such devices as microwave ovens, color television receivers and stereo systems, have become increasingly sophisticated, and now serve in programmable calculators, electronic cash registers and point-of-sale terminals. These new applications have come about, according to William Bottari, Product Manager for Panasonic Electronic Components, because the four-bit micros have become increasingly more complex. Bottari points out that Panasonic's MN1400 Series, introduced in 1977, has 75 instructions and runs with an instruction cycle time of less than 10 μ s. He adds that newer four bit micros, such as the MN1400 Series, incorporate a number of functions previously found on auxiliary chips: the MN1400 Series chips include an 8-bit presettable counter, a lock generator, a 1024 x 8 instruction ROM, a 64 x 4 RAM, I/O ports and the arithmetic logic unit.

More Development Aids for Hardware and Software

An important event during the year was the advent of floppy-based software development systems for high-end users, according to Ed Huber of Texas Instruments. Texas Instruments introduced its AMPL development system, and several other vendors, notably Tektronix, also made entries. Huber said that he saw two trends in software development systems — one toward multiple-chip systems such as the Tektronix 8000-series, and the other toward lower-cost systems dedicated to particular families of processors.

Huber said that hardware emulation had made some progress with the introduction of hardware emulation boards. "We introduced a hardware emulator for the TMS 1100 that we call an SC-1 board, selling for about \$200 a copy. You can load the program in EPROM, which is included on the board, plug it into your system and emulate the microcomputer. Mostek introduced something similar for their 3870. These boards are different from what was available before, which required you to use an MDS system or something like that with an umbilical cord. This is a lot simpler."

Have it your way.

Bit by bit our Standard Modular Memory lets you make every word count.

The Standard.

768K x 16 in one 5¼ x 19 inch chassis.

Need more?

You can address up to *eight* of our MSC 2601 Standard Modular Memory units for up to 6144K x 16.

Want it your way?

Our field-proven MSC 2601 uses dynamic 16K RAM elements. You can organize each card 16K x 1 to 64K x 9. Multiple cards give you almost any word and bit size you want.

Any way you like it.

Up to 14,155,776 bits in one MSC 2601.

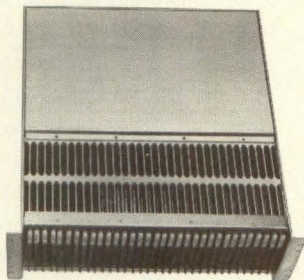

MSC - 2601

When you like it.

Access time up to 350 nsec. Cycle time as fast as 450 nsec.

Together in the rack.

RETMA rackmountable or freestanding. Self-contained with power supplies and forced air cooling. Battery backup available, too, for nonvolatile storage.

And for another way.

If you want 4K RAM our static or dynamic versions will let you have your way with up to 192K words.

Our way.

We use fewer components and low power for high reliability. Multiple source, full specification components tested, assembled and then systems tested under worst case operating conditions.

**The MSC 2601,
Standard Modular
Memory...**

We set the standard.



Monolithic
Systems corp.

14 Inverness Drive East
Englewood, CO 80110
303/770-7400

© 1977 Monolithic Systems Corp.

Increased sophistication in development systems and their support software was particularly important during the year, according to Jim Moon, engineering vice president of MuPro, manufacturer of 8080-based microcomputers and development systems. A notable entry during the year, according to Moon, was Tektronix with its 8000-series development system, which supports several different microprocessors. He cited this entry, and HP's rumored entry into the development system market, as indications that larger companies are beginning to realize the importance of the development system market and are going to get into it with both feet.



Fig 1 Tektronix 8002 microprocessor development system presently supports 8080, 6800, Z-80, 9900 and 8085 microprocessors, with other microprocessors to be added in future.

"Tektronix and Hewlett-Packard are traditionally makers of instrumentation," said Robert Walker of Intel. "Apparently they recognize the growing importance of development tools for system designers." Walker also cited Intel's new μ ScopeTM, a tool for field emulation enabling the user to "pull the microprocessor, plug in the emulator and step through a problem. This is the kind of thing the instrumentation people would have done," Walker said. "We're getting into it at the same time they're getting into the development system market."

"The continuing evolution of software development tools during the year is evidence of a maturing in the microprocessor industry," said George Vashel of Signetics. "It is a condition of the business nowadays that one has to support his products in this fashion." Vashel said that he had not seen any revolutionary software but does anticipate a revolution in compilers for microprocessor-based products. "In the future, compilers will be optimized around instruction sets of particular microprocessors, and will really be much more efficient than today's cross-assemblers," he said.

More Software

An overall trend during the year was toward "increased sophistication of operating systems for microcomputers," said Jim Moon of MuPro, who then cited MuPro's multi-user multi-task operating system, which supports several terminals. Across the entire field, he saw increasing availability of higher-level languages for microcomputers, pushing microcomputers ever more into minicomputer applications. In the future he sees this trend continuing, with an interesting example being an increased number of micro-

computers offered for small business applications, as higher level languages become increasingly available for them.

Another trend, Moon observed, was toward software becoming an "off-the-shelf" item. "People are starting to look at software as off-the-shelf material, much like hardware," he said. "Important entries during the year are our multitask operating system, Intel's announced RMX-80 operating system and several introductions made by software houses of FORTRAN and COBOL compilers for 8080, Z-80 and other microprocessors. BASIC has been out there for a long time, but '77 saw the introduction of reasonably well-debugged FORTRAN that you can count on getting up and running with minimal pain and strain."

More "Smart" Peripherals

"Peripherals were particularly important during 1977," said Robert Walker of Intel. He anticipates increasing emphasis on peripherals such as floppy disk controllers in the future. Walker cited two opposing industrial trends which presently exist side by side and with at present no clear movement from one to the other. "We are introducing a chip that is really a universal interface processor. If you want it to be a printer controller you program it to be that, but it is really a general-purpose processor. At the same time, we are introducing special-purpose processors — floppy controller, CRT controller and so forth. These two types of controller are at odds with each other. One does only one type of job; the other is general-purpose. Right now they coexist. Will that continue?"

"There was an expansion of computer peripherals during 1977 — what could be termed the big push on microprocessor-controlled peripherals to make line products smarter to do more things," said George Vashel of Signetics. In 1977 Signetics introduced its 2651 programmable communications interface and 2652 multi protocol communications circuit; both products are fairly representative of the trend Vashel mentioned.

In 1978, Vashel anticipates continued emphasis on peripherals throughout the industry. "This is a major emphasis with Signetics," he said, "and we expect to make a number of new introductions."

Microprocessor Developments

"Microprocessor CPU developments leveled off somewhat during 1977," said Jim Moon of MuPro. "The years '75 and '76 marked the entry of a number of new CPUs," he said, "but '77 indicates that manufacturers are putting more into LSI controllers for various peripherals such as floppy disks, CRTs and the like." Moon believes that further upgrades in CPUs are not presently justified from the manufacturer's standpoint in terms of investment until breakthroughs in the semiconductor manufacturing process occur. On the other hand, semiconductor manufacturers can offer new controllers to extract greater value at the system level. An exception to the leveling off that Moon saw was the appearance of several single-chip microcomputers. "These are notable entries into the marketplace," Moon said, "particularly for low-end users who want dedicated processors for particular applications such as controllers. The Intel 8048 is a significant entry."

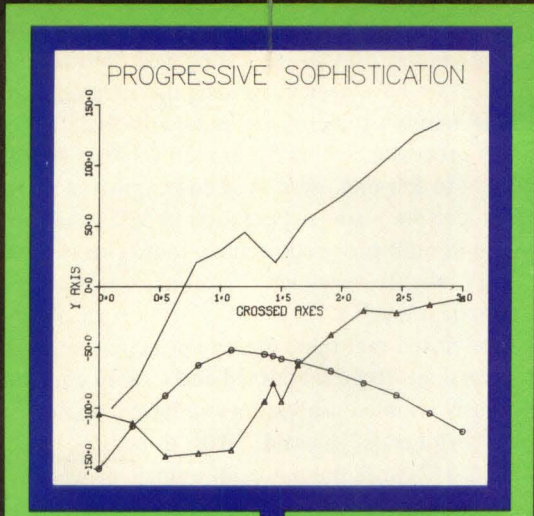

1

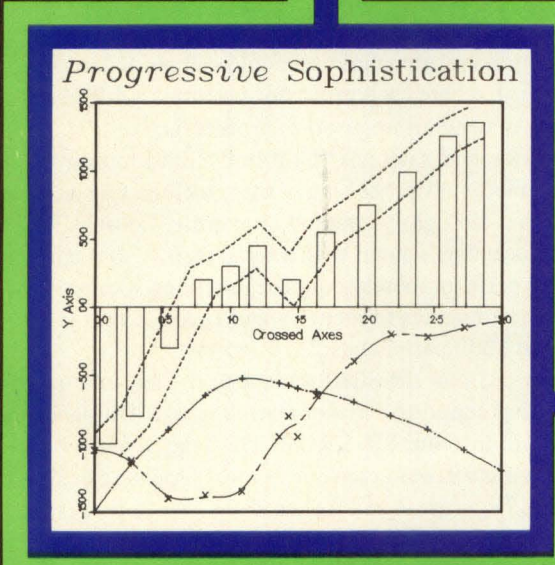
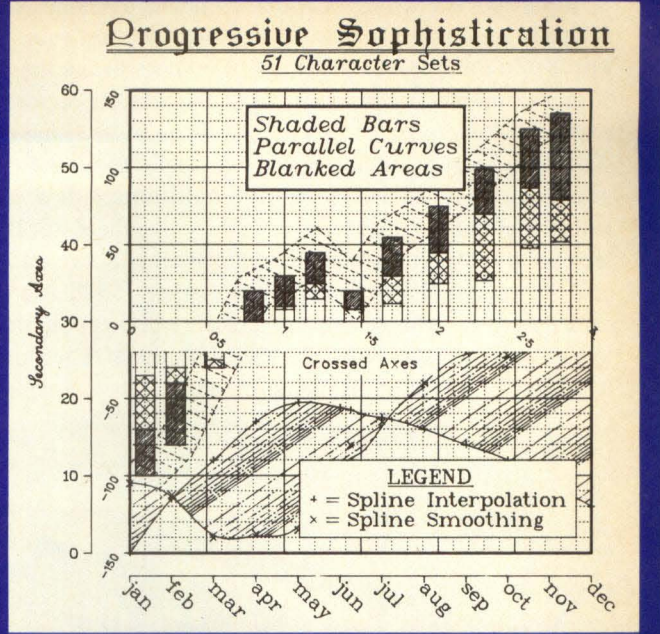

2

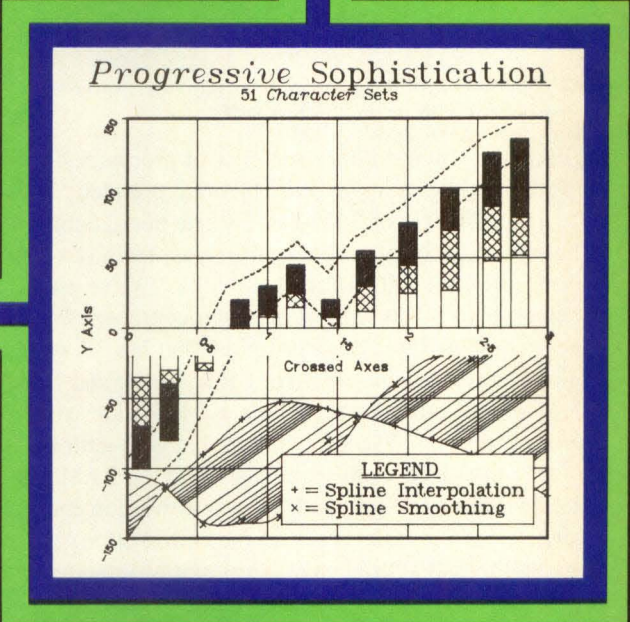

3

DISPLA® makes complex plotting simple.

Some of the best known computer centers in the world are our users. Many of them already had powerful graphics. So why choose DISPLA? Simple. It's **machine and device independent**. It offers unmatched features from publication quality fonts to 3-D hidden line surfaces and world maps. But, above all, it's easy to use.

- (1) Start with a simple plot of 3 curves. Scaling, centering and rounding are automatic unless specified otherwise.
 - (2) Add a few "calls" to (1) for italics, bars, parallel curves, dashed lines and smoothed connection. The calls of (1) are essentially unchanged.
 - (3) To (2) now **add** a grid, shading, legend, blanked areas and angled axis numbering. We **add to, not modify** previous instructions.
 - (4) The plot becomes complex simply—with a dotted grid, more axes, month labeling, text and even Gothic lettering!
- Draftsman quality plots are generated by the thousands every day on over fifty installations internationally. Ask our customers.

DISPLA®

Display Integrated Software System and Plotting Language

A proprietary software product of ISSCO

For information call Sunny Harris (714) 452-0170 or (714) 565-8098.
Or write

ISSCO®

Integrated Software Systems Corporation

4186 Sorrento Valley Blvd., Suite G, San Diego, CA 92121 (714) 452-0170

In Europe contact: Repko bv. van Blankenburgstraat 58
The Hague, Holland
Telephone 070-608425

Moon believes that 1978 will witness the introduction of a "pretty good range of new development and test tools. It will also to some extent shake out the processor market. Siemens' and NEC's commitments to the 8085 as opposed to the 8080 microprocessor will provide necessary time to show which way the industry will eventually go — whether most manufacturers will swing with multisourced devices or with something that has more capability like the Z-80. By the end of the year it should be clear whether 8080, 8085 or Z-80 will dominate the long term market. It will also enable us to see what the manufacturers will do about new technology such as Hewlett Packard with the SOS technology it will begin to offer in its own products."

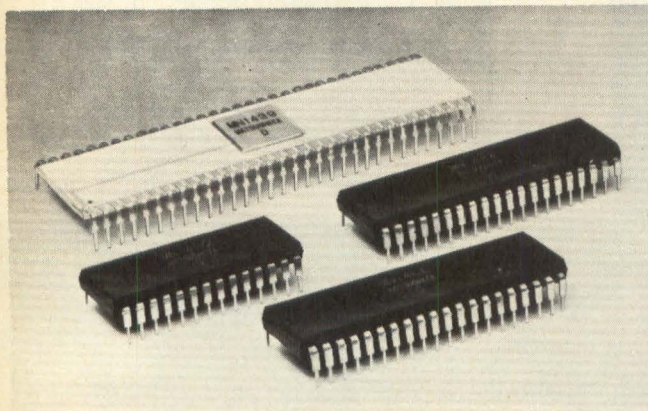

Fig 2 Panasonic's 4-bit, one chip microcomputers offer from 57 to 75 instructions with up to 256 bits RAM.

Taking a somewhat different view of processor developments during the year was Milt Hubatka, president of Space Byte, manufacturer of 8085-based single board computers. "The most significant product of the year from our viewpoint was the Intel 8085," said Hubatka. "We've used it in our single-card S-100 compatible microcomputer. What we've done is combine three cards onto one that has 3K system monitor, peripheral interface for CRT, printer and floppy disk — this has not been done before." Hubatka also cited as important the Intel 8155 I/O device that goes with the 8085 chip set and the Texas Instruments' 4K static RAM, which Hubatka said was a "tremendous step forward in the technology — and 6 months ahead of the competition." In 1978 Hubatka foresees a "tremendous amount of integration at the systems level. A lot of devices we are still at the point of reaching for. At the systems level we need to catch up with the technology available."

Hubatka added that another significant development of 1977 was increased acceptance of the S-100 bus. "We are an S-100 company," he said, "and we are biased toward that, but we saw a lot of money invested in it by the industry in the last year." For a long time S-100 compatible microcomputers were considered part of the hobbyist industry, but he believes that "vertical integration" of the industry has now begun. He cited the acquisition of MITS by Pertec and of Polymorphic by EM & M as evidence that the base of the hobby computer industry is expanding. S-100 compatible microcomputers are very cost-effective, according to Hubatka. "The bottom line is that completely integrated floppy disk development systems with higher-level languages based on the very inexpensive S-100 bus can be made available for under \$10,000."

"We saw a lot of growth in multiprocessing applications for microprocessors during 1977," said Howard Raphael, director of microprocessor marketing with National Semiconductor. "We have been enhancing the capabilities of our SC/MP family of microprocessors with the 8060 8-bit N-channel processor, selling for around \$5, that appeals particularly to low-end users. A good proportion of our SC/MP processors — somewhere around 50% — are now being used in multiprocessor applications. This is a very cheap, very reliable, very high performance way to go for certain applications."

Raphael noted that there are two principal forms of multiprocessing — tightly coupled and loosely coupled. "With tightly coupled processors you have common memories and peripherals," he said. "With three processors you get about 2-1/2 times the power of a single processor, but with four or more processors, the power increments are not very great. But at \$5 per processor, multiprocessing becomes very feasible. With loosely coupled processors, each processor has its own memory and I/O facilities and communicates by a common bus or memory. Whether tightly or loosely coupled, the multiprocessor system may be symmetrical — where the processors each perform the same function and are what you could call redundant — or asymmetrical, where each processor performs a different function and is dependent upon other processors."

SC/MP, Raphael said, has "built-in facilities to enable tightly-coupled multiprocessing — these include special pins and logic that aid tightly-coupled processing. Loosely-coupled processing is aided with a serial facility that enables the chip to perform loosely-coupled functions — essentially one bus that interfaces to memory and I/O, and that is compatible with 8080 peripherals."

Raphael said that the 8080 was the only "low-end microprocessor that supports a higher-level language. Our language, NIBL, is built into our 8295 ROM. This takes what is basically an esoteric software concept to most hardware engineers — high-level language — and makes it possible to program the processor in English language commands." Raphael added that National also offers higher-level language capability for the 8080 microprocessor in the form of the 8298 ROM.

"Single board computers matured during the year," said Robert Walker of Intel. "If you look at them you see that the ones the mini people make tend to have a little better software and the ones the semi people make tend to be less expensive, but all in all they're pretty close. Both mini and semi people are introducing cards and there is not a lot to choose between them. Relative cost is 2 or 3 to 1 for mini versus micro." The prices of cardsets are coming down, Walker added, mentioning Intel's recent introduction of microcomputer cardsets selling in the under \$100 price range.

"A major thrust of 1978 will be the appearance of 16-bit microcomputers," predicted George Vashel of Signetics. "Available to date have been fairly humble offerings. The 16-bit microcomputers from mini manufacturers are not necessarily humble, but they come from the mini-type guy who extends downward into the microcomputer market under the software umbrella of his minicomputers. Semi guys don't have that kind of software presence, but have the technology to bring high performance to the market. I expect significant products from the semi guys." DD

Introducing the SPACE BYTE™ 8085 CPU A self-contained computer

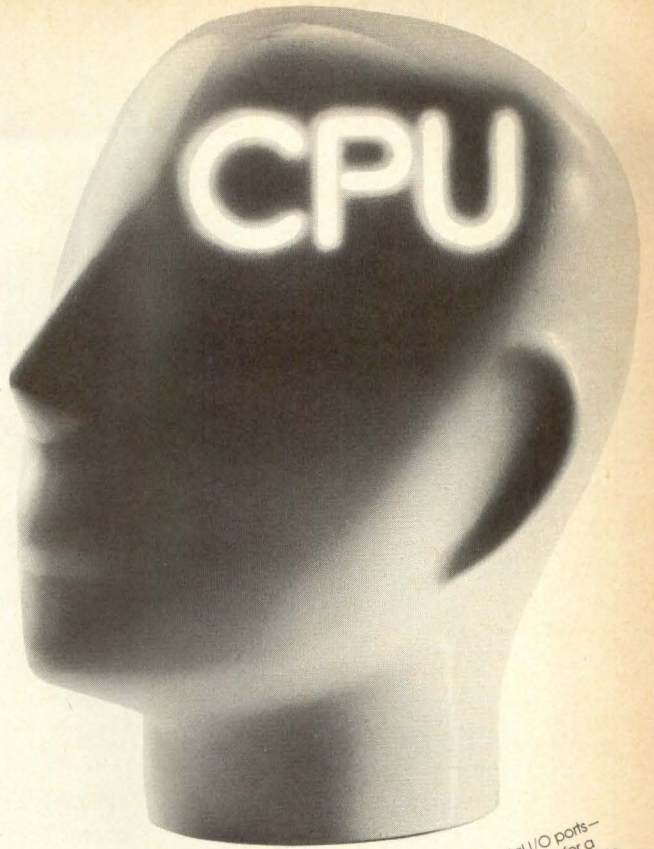

\$499. end user quantity one.
fully assembled, burned in and tested.
SPACE BYTE microcomputer products are available now
at computer retailers everywhere.

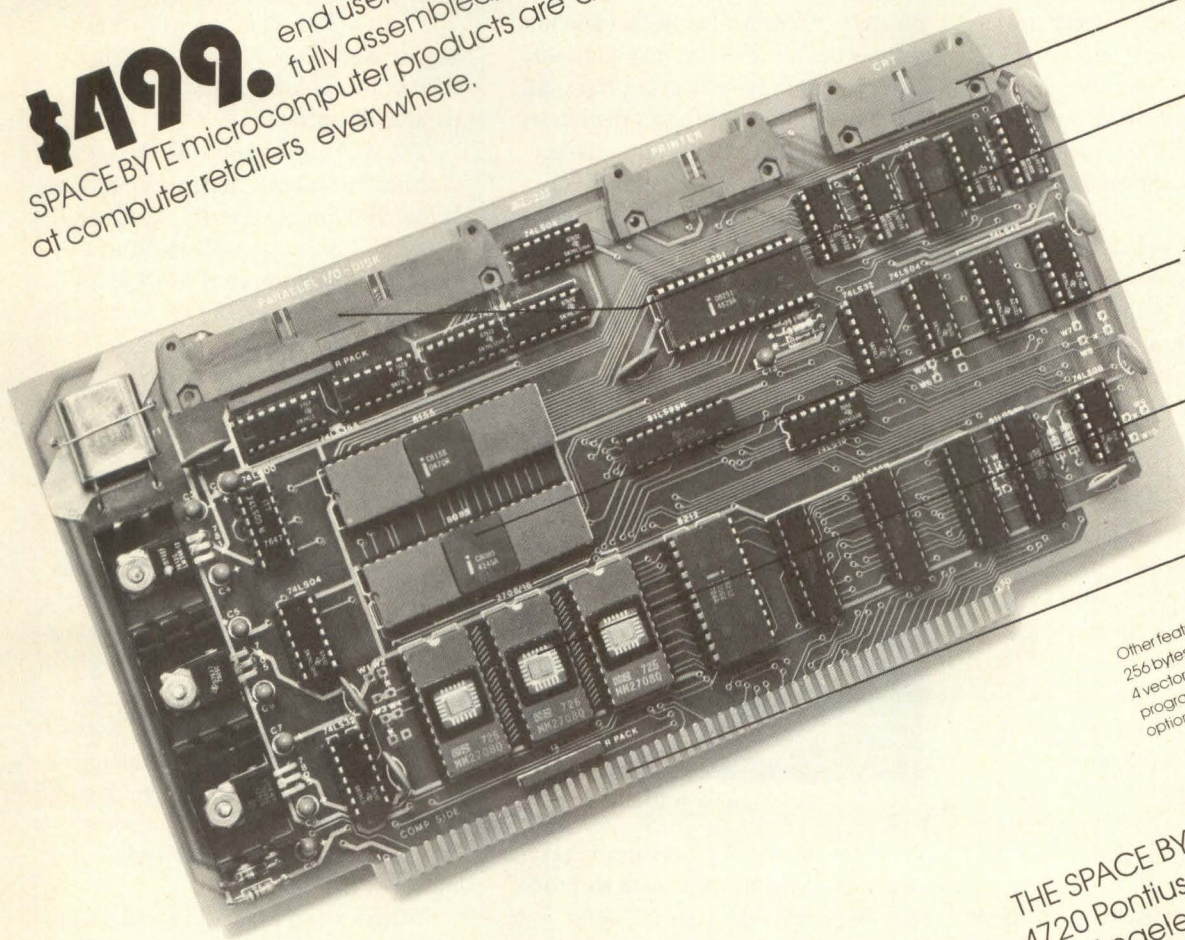

Two RS-232C serial I/O ports—
one for a CRT the other for a
printer with software selectable
baud rates.

Fully buffered parallel I/O ports
interface directly with the ICOM®
FD 3700 or Frugal Floppy disk
systems

The state of the art INTEL®
8085 CPU is 50% faster than the
8080A. It operates at 3MHz, using
450 ns memory and is fully
compatible with all existing 8080
software

Complete 3K system monitor with
2708* EPROMS including
extensive de-bugging, FDOs
Tarbell and video driver routines.
* Jumper selectable for use with
2716 EPROMS for up to 6K of on
board system monitor

The all popular S100 bus...

Other features include:
256 bytes of RAM
4 vectored interrupts
programmable 14 bit binary timer/counter
optional 2708 2716 EPROM PROGRAMMER

THE SPACE BYTE CORPORATION
1720 Pontius Ave. Suite 201
Los Angeles, California 90025
(213) 468-8080

Character and Line Printers

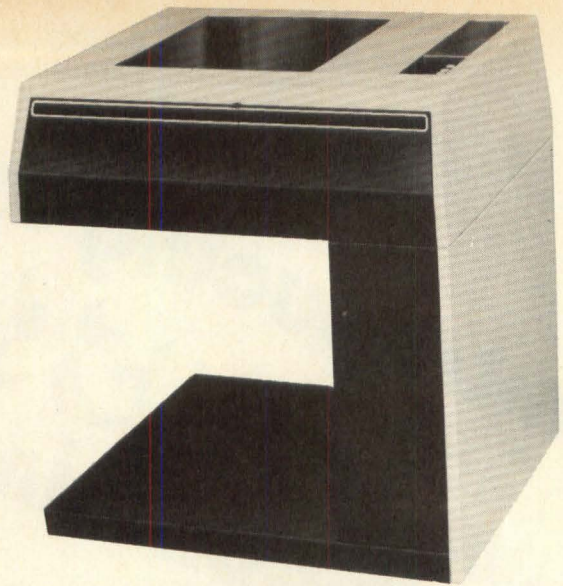

Model 5560 600-lpm printer contains microprocessor electronics, a replaceable character cartridge and an interface capable of emulating other popular line and serial printers.

Makers broaden their lines

Among the significant developments of 1977 was the broadening of the product lines of two major printer manufacturers. Both now provide printers ranging in speed from relatively slow to very fast. In this year, another maker extended its printer line by providing new, less expensive printers in its traditional under 300 lpm speed range and by introducing a new 600 lpm model.

A Centronics spokesman said that during the year the company had extended its inventory of printers by adding the 6000 series of fully-formed character line printers, with speeds of 75 through 1100 lpm, and the Micro-1 electric discharge printer, a compact, low-cost unit aimed at home, hobby and microprocessor markets. Late in 1976 Centronics introduced the eleven models of its 700-series impact serial dot matrix printers, with speeds ranging from 60 to 180 cps in 80 or 132-column format, depending upon model. "The big thing for us," the spokesman said, "is that instead of being only in one area, below the medium speed range, Centronics now runs the gamut — everything from microprinter to 1100 lpm line printer, in serial dot matrix or fully-formed character or electric discharge methods. We offer various technologies at various speeds, though we do not make large, fast electrostatic printers. We've con-

siderably expanded our market area potential — one estimate is by five times."

Asked to comment on Centronics' possible entry into the ink jet and laser printer field, the spokesman indicated that the company was doing research, but had nothing to offer in the immediate future. "I see the printer market stabilizing," he said. "Non-impact technologies are gaining greater acceptance and opening new market areas, but I don't see them threatening impact technologies, at least not in the near future."



Jerry Kaplan of OEM

A spokesman for Dataproducts said that the company expanded its product line during the year to "offer lower cost to the consumer" and to broaden our market. Dataproducts pioneered and has been the leading in-

dependent supplier of over 300 lpm machines," he said. "In June we introduced a new generation of band line printers, the B-series, starting with the 300 lpm B-300. This line will eventually expand upward, offering higher speeds, but at lower costs than comparable line printers."

The spokesman said that Dataproducts has introduced three new printers below 300 lpm. One entry, the B-180, is "a 180 lpm version of our band printer, oriented toward word processing applications." Dataproducts for the first time offered a dot matrix printer, the M-200, which uses a "dual column, 14-element, bidirectional printhead." The M-200, first member of a matrix printer family that eventually will expand to include other printers, prints at 330 cps (200 lpm). The final new Dataproducts entry was the T-80 thermal printer, a compact, 80 cps machine whose primary application is CRT printout.

The spokesman said that Dataproducts was in the "definition and research phase" with new printing technologies such as xerographic, ink jet and laser. He would not speculate on possible product entries using these technologies.

"There was a dramatic trend during 1977 toward low-speed (under 300 lpm), lower duty cycle, lower cost line printers," said Jerry Kaplan, director

of OEM marketing for Data 100. "In general," he continued, "people are looking for more printer for the buck, and do not require a heavy-duty work-horse in this speed range. Data 100 has been in this market for several years," Kaplan continued, "and intends to enhance its under 300 lpm printers in 1978 by adding more intelligence."

Another trend, Kaplan said, was that people would like to purchase as much as they could from one company. To broaden its market, Data 100 intends to expand its line of higher-speed line printers in 1978. The company earlier this year introduced the model 5560 processor-based 600 lpm line printer. A processor controls the internal workings of the machine and also performs diagnostic functions to determine type and location of malfunction. "The 5560 represents a market trend toward increased recognition of total cost of ownership," Kaplan said. "The diagnostic function saves a lot of service time and this means added cost savings to the customer." The 5560 also has an interchangeable print cartridge, which enables change of character set in "about a minute," according to Kaplan.

Like other companies, Data 100 is looking into non-impact printing technologies, Kaplan said. "However," he added, "we do not envision these technologies taking over from impact printers. People still need multiple copies."



Fig 1 One of several new Centronics' printer entries during 1977 was the 6000 Series of fully-formed character line printers with speeds between 75 and 100 lpm.



Fig 2 One of several new Dataproducts' printer entries during 1977 was the M-200 impact serial matrix printer, with a 14-element head and speed of 200 lpm

Smart Printer Comes of Age

"The most significant factor during the year was the coming of age of the smart printer," said Bill Bennett, director of printer products for Lear Siegler. This happened throughout the industry, he said. "In our own product line," Bennett continued, "microprocessors have allowed us to add several printer capabilities. For example, we are able to store multiple print formats within the machine, remotely call for forms, tabbing and so on, to extend into formless printing, so that in some cases it is feasible for our users to print on plain paper to generate forms on the fly. This is a real time-saver, because you don't have to stop the machine and change forms. We store the forms information locally, and access it as need be to generate the forms.

"Another capability we've added is for remote polling-addressing, to get the printer to emulate some other device, so that it can go into a communications system with existing terminals. You can then force the printer to emulate other terminals.

"One of the more interesting things we've done," Bennett went on, "is to give our communications terminal total code independence. We can make the same communications terminal listen to EBCDIC, Baudot, ASCII and several other communication codes, and dynamically reconfigure itself in what you could refer to as an 'adaptive'

way. The processor listens to the incoming data, determines the code and tells the front end what code conversion table to use.

"Like many printer manufacturers, we've been able to increase the speed of our printers by using microprocessors. We have a feature for throughput maximizing that we call 'addressable tabulation' which is a kind of vector addressing of particular print locations — instead of using conventional tabs and space codes we give a vector address that saves bits and time. Some of our users have been able to increase throughput by 3:1."

Matrix Printer Evolution

"One of the notable achievements of 1977 was the higher speed obtainable with impact serial matrix printers," said Glen Harmon, director of marketing for Florida Data. "A few years ago these printers ran much slower," he said, "but now matrix printer speeds are approaching line printer speeds. Our single moving head matrix printer prints at 600 cps, which translates to 240 to 1465 lpm."

Harmon said that the new Florida Data printer capable of these speeds, the PB-600, uses a Motorola 6800 microprocessor to control the printing head. "The speed is achieved with clever mechanical design," he said, "though I wouldn't classify it as a technical breakthrough." Harmon said that the microprocessor also contributed

to increased printer throughput capability.

Harmon said that his own company was doing developmental work on a matrix printer, to be available in mid-1978, that will print "solid characters using matrix techniques. We're using a microprocessor to control head and paper movement to the degree that we can put a dot anywhere on the paper and fill in the gaps left in matrix characters. The printer will have a speed of 600 cps with conventional matrix characters or 200 cps with solid characters."

There were no breakthroughs in basic printing mechanism technology during 1977, according to Bill Bennett of Lear Siegler, though he added that his own company has introduced an impact serial matrix printhead variant that is being picked up by several other printer manufacturers — NCR,



Len Wilker of Qume.

Hewlett Packard, Datapoint and Anderson Jacobs, to mention a few. The so called "ballistic printhead" has no armature coupled to the print wire; instead, it propels the wire against paper and lets it bounce back on its own, after very short dwell. Bennett claims that the printhead allows "on the order of one billion characters" to be printed by a single head, enough to last the life of the average printer. Speed is comparable to other impact serial matrix printheads — 150-180 cps — but power requirements are lower, about 15 W. "This low power requirement decreases heat and we have customers running some of these printers around the clock seven days a week," Bennett added.

Bennett believes printer users are

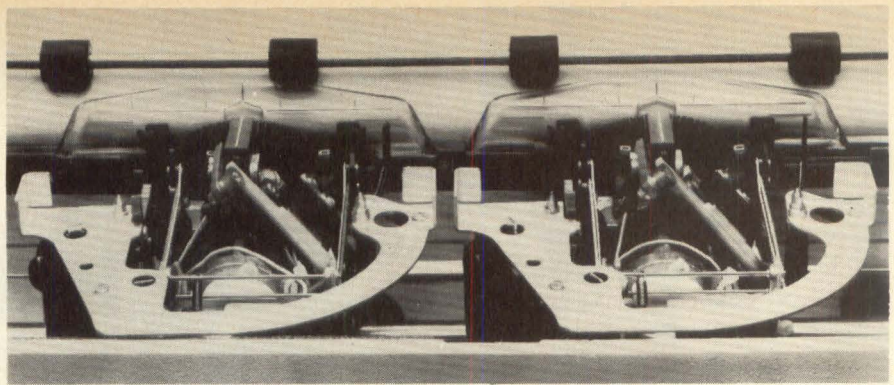

Fig 3 Qume Twintrack™ printer uses two daisy wheels to print at up to 75 cps with one character set (96 characters) or 45 cps with two different character sets (192 characters).

becoming more demanding and expecting printers to have such features as continuous duty capability, low service cost and long lives. "In the past," Bennett said, "people expected and accepted that printers were no damn good and that they broke down every six months or so and that you had to have a service man out, but they are changing and looking for greater reliability. This is a trend."

Small Printer Developments

One of Qume's most important introductions during 1977 was the Twintrack™, according to Len Wilker, national sales manager for the firm. The Twintrack, a daisy wheel printer with two daisy wheels, can print with two different 96 character sets (for a total of 192 characters) or at higher print speeds with two identical printwheels. Other improvements to the Qume printers during the year were a stack loader (called "speed feed") and an RS-232 interface to make the Qume printer more broadly compatible with data processing equipment.

One of the more interesting stories of the year came from Simon Harrison, executive vice-president of Axiom, manufacturer of small, low-cost electrostatic printers and plotters, who considers one of the most important events in 1977 to be "the impact of competition on the small electrostatic printer/plotter marketplace. The arrival of competition," Harrison said, "endorses the technology that we have been using for a couple of years. We are committed to electrosensitive printing, which we feel represents the simplest printing technique and is also the most cost-effective." Harrison added that in the last year a number of companies have gotten into or are about

to enter the small electrostatic printer market — notably SCI and Centronics, and possibly IBM — and that such companies recognize that these small printers appeal in applications previously limited to more expensive impact line printers. Small electrostatic printers are not suitable in all applications, Harrison noted, but they are "very cost effective in terms of cps per dollar. The EX-800, a moving-head printer using 5" paper, has been quite successfully making inroads with customers who want a line printer, but cannot afford the price of an impact machine and who find the low parts count and high reliability of the small electrostatic printer appealing." Harrison pointed out that his firm has in the last year sold 500 such printers to the government, to whom the low cost and high reliability particularly appealed. "Though we make a totally different kind of product," Harrison said, "we compete with manufacturers of the larger line printers."



Fig 4 Axiom EX-800 electrostatic printer prints 80 columns of data on 5" paper at 160 cps.

Paper size is smaller with the EX-800 than with larger impact line printers — 5" instead of the usual 8.5" or wider paper — but the EX-800, using variable dot size, generates smaller size characters and can still print 80 columns. Harrison said that such printers

Another first for **ISS**

THE INDUSTRY'S FIRST "SMART" FIXED MEDIA DRIVE

Announcing another in a long line of industry first's from ISS—the EFF 735—the first disk drive of its kind ever to employ an on-board microprocessor.

The advantages of microprocessor power in a disk drive are impressive. Complete internal drive diagnostics. Simplified circuitry because most analog circuits are eliminated. No field adjustments—ever. And a lot more, including microprocessor controlled routines that ease the load on the controller and the mainframe.

The EFF 735 gives you 353.8 megabytes on a single spindle using a fixed and sealed disk. There's one spindle per drive and each drive has its own internal power supply and air filtration system. Average access time is 23 milliseconds.

With our fixed head option, you get another 1.26 megabytes and zero access time.

Besides the microprocessor, the EFF 735

gives you a sweeping lineup of operating and maintenance features. A single phase motor. Dual port capability. A completely electronic tachometer. Total modularity of subassemblies. And truly outstanding serviceability, with no field adjustments and no requirement for special tools—one of the big reasons why your total cost of ownership is exceptionally low with the EFF.

EFF stands for Expandable File Family. The 735 is the first member of this new ISS family, later versions of which will have even greater capacities and capabilities. And all versions will be field upgradable so you can increase performance as your needs increase.

ISS is an operating unit of Sperry Univac bringing technological leadership for the generations ahead. For more details on the new EFF 735, write or call OEM Marketing, ISS, 10435 N. Tantau Avenue, Cupertino, California 95014, telephone (408) 257-6220.



Microprocessor makes it a "smart" drive.

Fixed disk pack holds 353.8 megabytes.

EFF 735. The first "smart" disk drive.

SPEARRY  UNIVAC

Sperry Univac is a Division of Sperry Rand Corporation

CIRCLE 29

in some cases appeal to OEMs, who use them in line printer applications that would not be cost effective for larger impact line printers. To a certain degree these printers may also appeal to hobbyists, Harrison said, though Axiom is not actively pursuing the hobbyist market at present.

Axiom also manufactures the EX-810 graphics printer which Harrison said particularly suits medical applications requiring the simultaneous presentation of graphic and alphanumeric information. "This printer, which can be OEMed for about \$500, lets you lay a dot anywhere on paper and puts down about 8000 dots per second, using the scanning principle," Harrison said.

Axiom will bring out a new graphic printer that can generate 8-level halftones using a "dot burst" principle, according to Harrison, 8 pulses from each dot, with duty cycle varied to change dot density. This printer, designated VP-100, with a 520 styli fixed head (EX-800 line printer and EX-810 plotter use 8-wire moving printhead), can generate high speed alphanumerics (3200 cps), graphs or photographs with an 8-level halftone scale.

Harrison believes that 1978 will be the "big year for electrostatic printers." His own company will introduce its video printer and a ticket printer; a number of other companies will enter the field with their own products. He does not expect a revolution in printer technology, but believes that users will increasingly recognize the suitability of electrostatic printers in certain applications.



Simon Harrison of Axiom.

Microprocessors Increase Flexibility

"1977 was the year of the microprocessor," said Tom Hall, national sales manager of Houston Instrument. "In '75 and '76 a lot of people talked about doing things with microprocessors, but in '77 they actually started

doing them. This seemed to happen en masse (on MOS?) in the industry."

Microprocessors have had significant impact on Houston Instrument's electrostatic printer, Hall explained. "They allowed us to expand our character set to 192 characters, under software control," and have also expanded other printer capabilities.

Hall said that Houston Instruments' electrostatic printer introduced late in 1976, was not attempting to compete with impact line printers. "We see ours as a fairly specialized product," he said. "When we brought our printer on the market it seemed as though no one had a screamingly fast, low-cost printer for use in applications where paper cost didn't matter. It is particularly good for development systems. We are not attempting to compete in the line printer market. Our paper is expensive — about four times what regular paper costs — but our printers are less expensive and you can buy more speed for the price. If you consider the cost of having a human waiting on the output of your system, a printer such as ours is often a very sensible choice." DD

MDB SYSTEMS presents... The Printer Connection

From DEC's PDP-11 & 8*, Data General NOVA*, Interdata and Hewlett Packard 21MX Computers, Plus the DEC LSI-11 Microcomputer to these popular model Line Printers:

DEC LA 180 • Centronics • Data Printer • Data Products • Data 100 • Mohawk • Printronix • Tally
New! Diablo 2300 Series

- Low-cost line printer controllers
- Completely software transparent to host computers
- Runs host computer diagnostics

MDB Systems controllers provide user flexibility in line printer selection with no change in host system software. Just plug-in the MDB module and connect your line printer. Each controller is a single printed

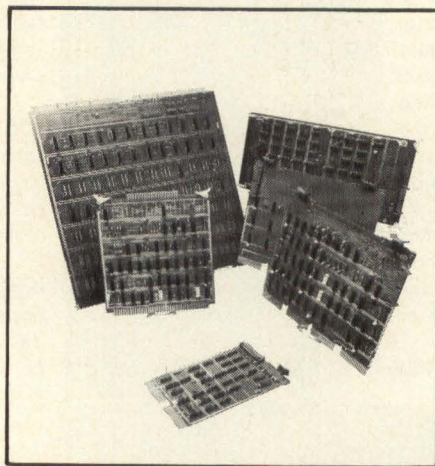

circuit board requiring one chassis slot. Fifteen foot cable length standard.

Transparent to the host computer, the controller is completely compatible with diagnostics, drivers and operating systems. Operation and programming considerations are exactly as described by the host computer manufacturer.

More than three dozen computer-to-printer controller combinations are available from MDB Systems as well as modules for other compatible parallel interface printers.

A long-line parallel operation option is available for most printers permitting full speed operation up to 3000 feet.

MDB Systems has an extensive repertoire of general purpose logic modules, device controllers and accessories for the computers listed. Your inquiry will receive a prompt response.

MDB

MDB SYSTEMS, INC.

1995 N. Batavia St., Orange, California 92665
714/998-6900 TWX: 910-593-1339

*TMs Digital Equipment Corp. & Data General Corp.

CIRCLE 30 FOR DEC; 31 FOR NOVA; 32 FOR INTERDATA; 33 FOR LSI-11; 80 FOR HP.

OEM, if you are using Dot Matrix Printers, see this...

FULLY FORMED CHARACTERS

2 3 4 5 6 7 8

The
New

EPSON
model 10

LINE PRINTER

uses a unique EPSON designed



The world's largest manufacturer of mini-digital printers for calculators now offers the desktop size model 10 Line Printer for OEM. Designed to operate faster and cost less than most Dot Matrix line printers, the model 10 prints out fully formed characters. To do this, it uses a unique EPSON-designed belt-impact printing

mechanism which prints a minimum of 150 lines per minute using a 64 character set in an 80 column format. OEM also can order the printing mechanism separately.

EPSON products are made by Shinshu Seiki Co., Ltd., Japan

Write or call for complete information

EPSON

EPSON AMERICA, INC.

23844 Hawthorne Blvd., Torrance, CA 90505
Telephone (213) 378-2220 · TWX 910 344-7390

Computer Plotting Equipment

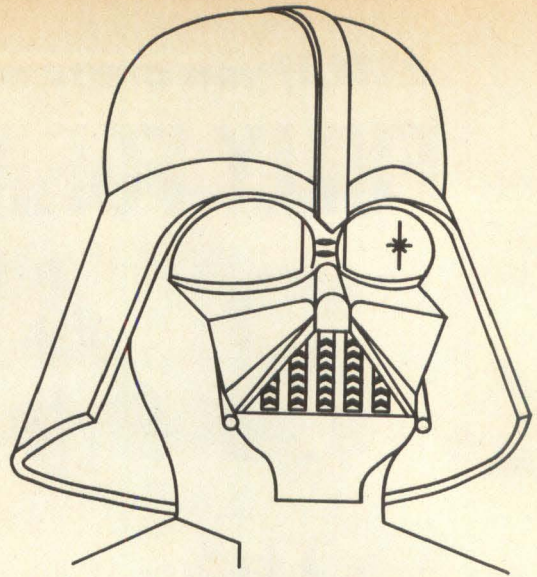

Microprocessor control speeds operation

Manufacturers were universal in their agreement that 1977 was the year for microprocessor-controlled "smart" plotters. Processors not only increased plotter speed, but unburdened main-frame CPUs thereby reducing CPU and telephone line costs. The impact of processors was felt by manufacturers of pen plotters and electrostatic plotters.

Electrostatic Plotter Developments

"The most significant occurrence of the year in plotters was the increase in on-line printing speeds obtainable with electrostatic plotters," said Peter Dietz, director of marketing for Varian Data, manufacturers of electrostatic plotters. "In the past," he said, "electrostatic plotters operated at high speed at relatively low cost, but could never take full advantage of that speed in on-line printing applications. This year we have introduced as options specialized processors that have enabled us for the first time to get full speed capability from our plotters. What we have developed is a control-store processor, a 40-bit microcomputer that operates at 5MHz, speeding up the whole plotting process. Versatec also increased the speed of their plotters, using a mini-computer — this seems to be a direction the industry is headed."

Dietz pointed out that the electrostatic process takes three steps: Generating a vector to locate a line; sorting vectors in sequence; and rasterizing vectors. The last step is "especially complex for most general-purpose

computers, because none was developed to optimize rasters. Our own processor is optimized for this application and can run from 20 to 200 times faster than with a mini."

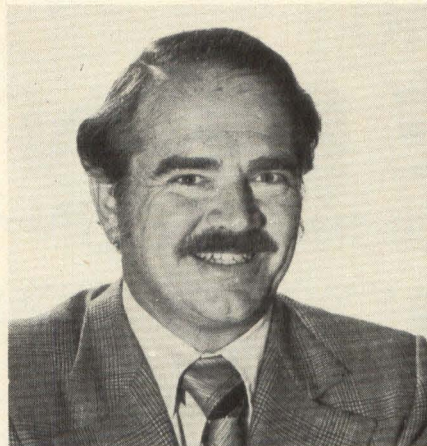

Peter Dietz of Varian Data.

At the present time, according to Dietz, plotters with processor capability can keep up with computer data output in "99% of cases" without going off line, recording and playing back. One example of this type of plotter is Varian Data's Graphware 1. Dietz believes that the industry trend is toward higher electrostatic plotter speeds, achieved by putting more "smarts," in the form of microprocessors, into computer plotting equipment.

Dietz added that increased on-line plotting speed is not the only advantage of making plotters smart. "This also opens up remote plotting applications," he said. "Remote plotting across telephone lines used to be very slow, because the bandwidth was

so lousy and it took so long to broadcast the data. But now, with Graphware 1, you can broadcast just the vectors and decrease the amount of information you pump over the line by a factor of 20 to 1 and get a plot much faster."

Pen Plotter Developments

"Microprocessors had a significant impact on plotters during 1977," said Ralph Manildi, marketing administrator of Zeta Research. "Microprocessors were extensively used in plotter controllers. A large proportion of the computing that would have been done in the host computer is now being done in the plotter."

During the year, Zeta introduced new software called GML (graphic machine language), used with microprocessor controllers, that Manildi claims reduces the load on the host computer by 70%. "Two-thirds of the computing that was formerly done in the host computer is now done in the plotter," he said. "This reduces the cost if you are paying for CPU and telephone line time."

Another way that microprocessors have affected plotters is by increasing the available character sets, according to Manildi. "We now have multiple character sets," Manildi explained. "You can have just about what you want — ASCII, APL — by adding a chip and extending the firmware."

Manildi noted that the speed of plotters produced by his own firm and others had increased during the year.

Tandberg's TDC 3000 Digital Cartridge Recorder.

WHAT'S IN A NAME?



Communication. With every computer.

Begin with the industry-proven Tandberg TDC 3000 Digital Cartridge Recorder. Add our new RS-232 I/O controller/interface. And you have a highly cost-effective recording system compatible with *every* computer.

There's a complete family of interfaces for the Tandberg TDC 3000. From the original design conceived by Tandberg of Norway, the \$150-million electronics firm that pioneered tape recorders internationally. The company that is to high quality electronic equipment what Rolls Royce is to automobiles. With a tradition of excellence that continues in a wide range of computer peripherals from Tandberg Data in the United States.

With *total* communications compatibility, the microprocessor-based RS-232 controller/interface from Tandberg Data is engineered according to EIA Standard RS-232-C, type D and E, and a "teletype-compatible current loop," recording in ANSI/ECMA/ISO-compatible format.

And from the substantial savings in line charges alone, the TDC 3000 with the RS-232 controller/interface will recoup its modest cost in a matter of months. It's hard to beat that kind of cost-effectiveness.

Conceived in the rugged Norse heritage, the Tandberg TDC 3000 is no wilting lily when it comes

to tough environments. Put it to work in subzero snow country or under a desert sun and don't worry about the bad vibes or emissions from nearby equipment. The TDC 3000 is engineered to roll with environmental punches.

Modular construction of the TDC 3000 enables the user to configure a system to individual needs. Applications include minicomputer input/output, minicomputer peripheral storage, terminal peripheral storage, software distribution, data entry via keyboard, local data collection, data transmission, and text editing. And a few other things yet to be dreamed up.

Besides RS-232, Tandberg Data provides TDC 3000 interfaces for HP 21MX, PDP 11, 8080 Microprocessor, AN/UYK-20 and 8-bit parallel general purpose. All give up to 48K bits transfer rate.

Tandberg Data Inc.
4060 Morena Blvd.
San Diego, California 92117
(714) 270-3990

TANDBERG 

He felt that Zeta had on the whole been faster, but that other manufacturers were "catching up."

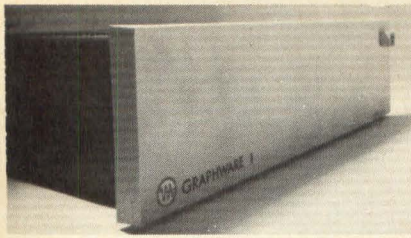

Fig 1 Varian Data's GRAPHWARE 1™ processor enables on-line plotting.

He also felt that plotter users were becoming more sophisticated in the use of multicolors and that there had been a real effort by plotter manufacturers to expand the multicolor plotter market. He noted that Zeta recently introduced a 4-pen programmable 12" plotter, aimed largely at the business market. "This has traditionally been a 12" plotter market," he said, "but until now there has been no 4-pen plotter available. For a long time we have had a 4-pen 36" plotter, and another manufacturer has had a 3-pen 36" plotter. We had a 12" plotter with 2-pen option. But business users want the 4-color capability in their size and so we introduced the Model 1400."

Manildi said that Zeta had also recently announced its second generation general purpose PDP-11/04 computer system, used as the control electronics for its off-line plotting system, with magtape drive and terminal. "This gives you a general-purpose computing system with hard copy output for system communication plus plotter," Manildi said. "You can use it for plotting or as a stand-alone computing system, with all the PDP-11 software, add-on memories and other options."

Looking into the future, Manildi anticipated several developments. "I think you'll see other manufacturers come out with multicolor pen hardware," he said. "I think we'll see additional uses of microprocessors and microcomputers in controllers, either built-in or in separate chassis."

"Generally, I think you'll see more sophisticated plotting systems. Two years ago you would buy a plotter and run it on-line with an interface to a computer, run it on remote with a controller or run it in an off-line system. Now we're seeing that where you have a stand-alone computer system with plotting capability you gain some addi-

tional flexibility.

"On-line plotting is becoming increasingly feasible. With our GML software, for example, we can achieve maximum plotting speed on any of our plotters — plot as fast as these machines can go. There's no longer any limitation in the controller end of it. The only limit is the plotter mechanism itself.

"One other area of microprocessor impact is in figure storage and retrieval. This will be made available in some of our products and probably will come from some of our competitors. What this lets you do is store figures you want to use from time to time — for example, Darth Vader of 'Star Wars' fame — in the controller and call them up for printout. This distributes the figure storage and retrieval function from the host computer and also lets you transform these figures at the controller level — scale up and down in size, rotate, slant, change aspect ratio and so on."

Manildi said that Zeta had reduced prices on two of its older plotters, but did not see any large price decreases forthcoming in its own product line.

controller interface devices. These products have enabled CalComp to enter a new marketplace, the spokesman explained. "Previously we had been mainly in off-line graphics, but the new model 906 can operate remotely, with timesharing systems or on-line to minis. What we're really acknowledging is the start of distributed processing and the placement of more, smaller pieces of equipment and intelligent terminals. Users are becoming more sophisticated and increasingly demanding of more options at each of these locations."

Microprocessors have made plotters more flexible, the spokesman continued, by making them usable in a wider range of situations. "This is an industry-wide trend, the direct result of microprocessors. The dropping cost of processors has made it feasible for us to employ them and distribute intelligence to remote stations. We can transmit data in highly-compacted form, cut down line time and do the translation to drive the plotters at remote stations. Other plotter manufacturers are doing the same thing. It makes a lot of sense."

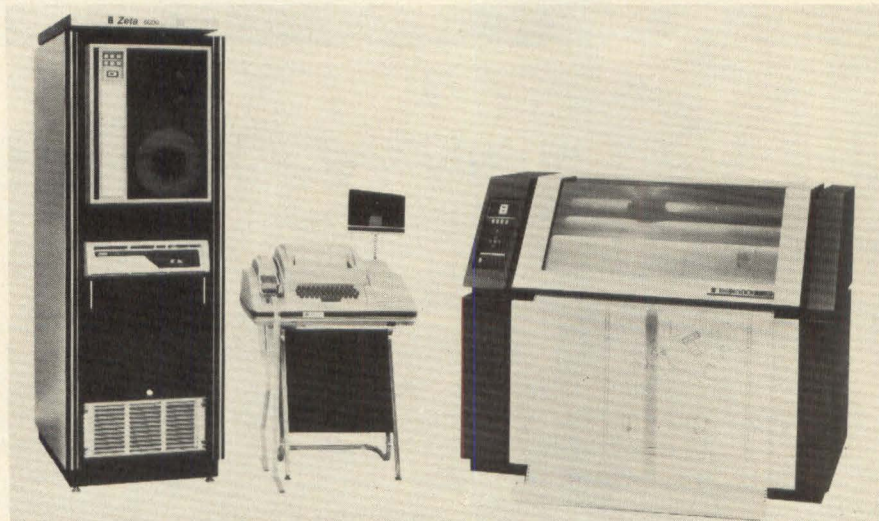

Fig 2 Zeta Research's second generation 6000 Series off-line controller uses PDP-11/04 computer, magtape drive and terminal for plotting or stand-alone computing.

The microcomputer controllers in newer Zeta plotters can be produced for about the same price as the controllers in older models and so buyers are able to obtain higher capability for comparable prices, he added.

Significant events during 1977 for CalComp included introduction of products with added intelligence through microprocessors, said a spokesman for the firm. New products included four drum plotters and two

The spokesman felt that the marketplace for plotters was expanding, because more and more people were becoming interested in obtaining graphic outputs. "They'll feel a need for graphics, get an inexpensive device, use it for a while, then want something fancier."

Looking to the future, the spokesman felt that the plotter marketplace would continue to expand, with graphic devices finding many users. DD

Core and Semiconductor Memories

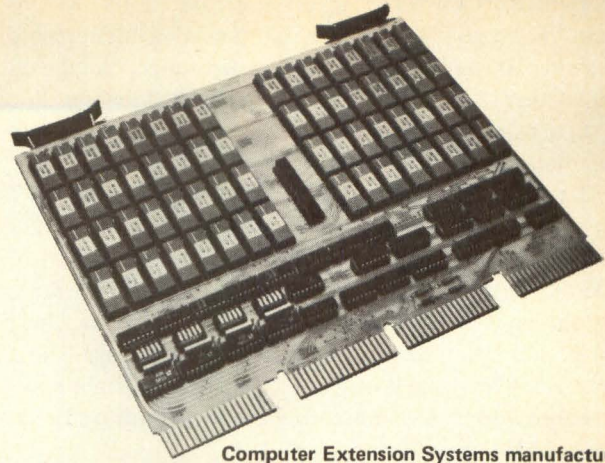

Computer Extension Systems manufactures this semiconductor memory.

Size increases in all categories

The year 1977 saw the entry of a large number of new semiconductor memories, using bipolar, MOS and bubble technologies. The extended core memory was another area of considerable action.

Semiconductor Memories

Gene Hnatek, manager of sales and marketing support for Monolithic Memories, had been researching a paper on semiconductor memories before we called, and gave us several of his impressions and opinions on significant memory developments during the year. Hnatek is well known in the semiconductor memory field — he has written a book and several articles on the subject. According to Hnatek, important developments took place in bipolar, MOS and magnetic bubble memories in 1977.



Gene Hnatek of Monolithic Memories

Significant bipolar entries appearing during the year, said Hnatek, included 8K PROMs (Monolithic Memories, Signetics), 16K ROMs (Monolithic) and 4K dynamic RAMs (Fairchild).

Hnatek cited several new MOS memories. These include 16K EPROMs (Intel, Texas Instruments) and a nonvolatile, low-power 8K EPROM from General Instrument. ROMs with up to 64K capacity for bulk storage became available from Mostek, Signetics, National and AMI — Hnatek felt that the makers of these new ROMs were “pushing the technology about as far as you can go with existing photolithographic techniques.” RAMs were a “big area in MOS, with everybody souping up their dynamic RAMs and going for lower power and higher speeds,” he added. During the year, 16K RAMs became available from Mostek, Motorola, Texas Instruments and Intel. “Static 4K RAMs really caught on this year,” Hnatek said. “These are available in 1 x 4 and 4 x 1 configurations. Pioneered by the semi divi-

sion of EM & M, they are now available from Mostek, AMD, Semi, Intel and Texas Instruments. Intel uses HMOS — scaled MOS — and can run at 55 to 70 ns maximum access time; it looks like they’re going after the bipolar market. The VMOS technology, pioneered by AMI is just coming into its own with 1K RAMs having 80 ns access times.” He predicted that many users of bipolar 4K RAMs might want to switch over to Intel or AMI scaled MOS devices, with their under 100 ns access times. “A real battle could develop there,” he added. “Several manufacturers brought out 64K CCD devices for bulk storage this year,” Hnatek said. “The manufacturer’s list includes Fairchild, Texas Instruments and Intel. These are slow devices and the price has to come down for them to take over from disks and drums.”

“A lot of companies have done work with bubble memories but TI actually entered the market with a device.”

Looking toward the future, Hnatek predicted the appearance of a 64K dynamic RAM and 16K static RAM in early 1978. CCD memories, he felt, would go to 256K, bypassing 131K sizes.

He felt that one of the important events of the year was Texas Instruments’ introduction of a 92K magnetic bubble memory. “A lot of companies have done work with bubble memories but TI actually entered the market with a device. They also put one in their line of Silent 700™ printing terminals. Magnetic bubble memories need a lot of circuits to go with them. You can’t really predict at this point where they’ll go.”

The most significant memory product entries of 1977 were Texas Instruments’ bubble memory chips and Silent 700™ bubble memory terminal, according to Gary Wagner, president of Computer Extension Systems, independent supplier of DEC-compatible memory products. “I can see tremendous use for these memory chips in certain applications such as geodetic survey-type work,” he said.

Another memory product that he found significant was the 4K static RAM, which his company uses in its own products. "Right now we use primarily the Texas Instruments 4K static," he said. "This is a true static device, like the old 2102. Other statics on the market are clocked devices. Prices on these parts are dropping, but they're still more expensive than dynamics."

The most important memory development during 1977 was a new process for making higher-density CMOS semiconductor memories, according to Charles Hochstedler, MOS memory applications engineer with Harris. "We are now able to get a 4K CMOS static RAM into a reasonable size die and make the memory in an 18-pin package," he explained. "We make both 4K x 1 and 1K x 4. Right now we make two versions, but before the year is out we'll have a family of six."

Hochstedler said that until Harris's introduction there hadn't been a 4K CMOS static RAM on the market. "The 6504 and 6514 are the first two being made with any feasibility at all. There have been N-channel devices before, but never CMOS. To get this density we are using what we call a self-aligned silicon gate process in which we use a second layer of polysilicon interconnect. Earlier we had used only one layer. This second layer has allowed us to go to much higher density, somewhere in the neighborhood of 27,000 devices on a single chip with a 156-mil by 212-mil die. The CMOS RAM has low power requirements, is very temperature stable and tolerates a wide voltage range."

Advances in process control allowed enhanced design, Hochstedler added. "We are getting a step closer now to the density required for 16K CMOS dynamic RAMs, but right now they are still over the horizon — some may appear in '78 or '79."

(Cont. on p. 54)

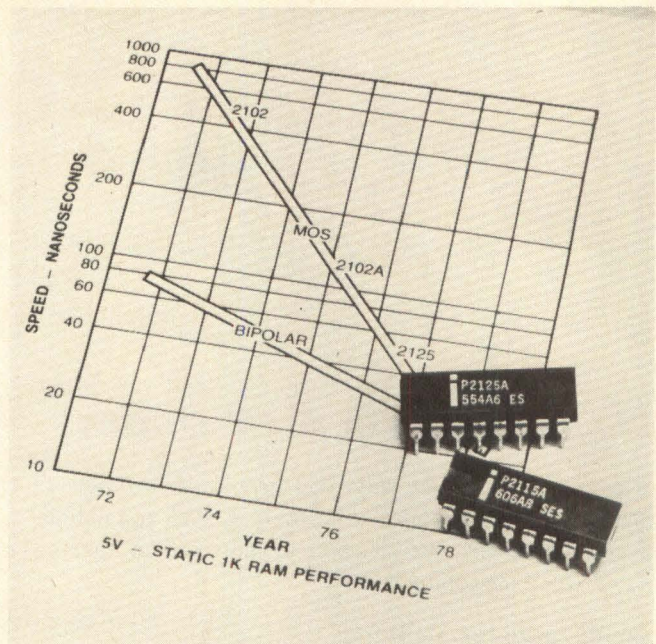
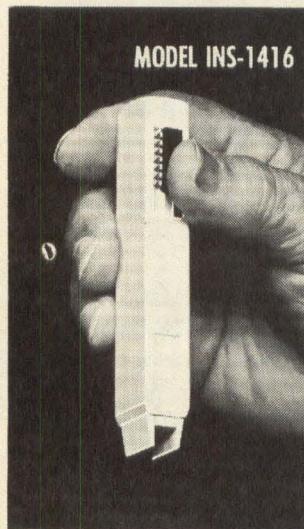

Fig 1 Speeds of MOS static RAMs are increasing, approaching bipolar speeds, as shown in this graph from Intel that compares speeds of two of their new 1K MOS static RAMs with earlier static RAMs.

IN ELECTRONICS HAS THE LINE...

DIP/IC INSERTION TOOL WITH PIN STRAIGHTENER



MODEL INS-1416

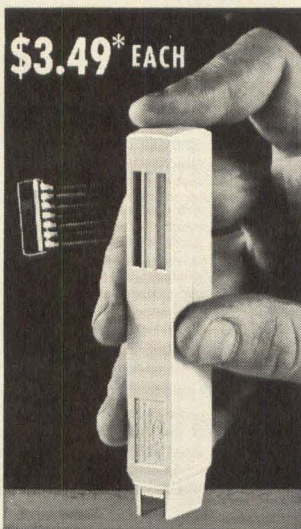

\$3.49* EACH

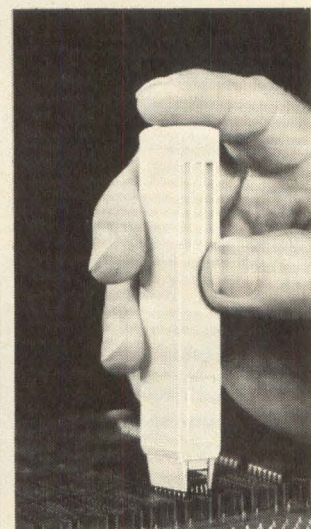
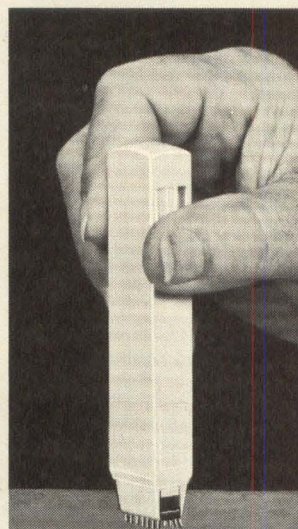

STRAIGHTEN PINS

RELEASE

PICK - UP

INSERT

* MINIMUM ORDER \$25.00, SHIPPING CHARGE \$1.00, N.Y. CITY AND STATE RESIDENTS ADD TAX

OK MACHINE AND TOOL CORPORATION

3455 CONNER STREET, BRONX, NEW YORK, N.Y. 10475 U.S.A.
PHONE (212) 994-6600 TELEX NO. 125091

CIRCLE 37

Our first SBC 80 compatible systems for 1977!

Visit us in Booth 121-123,
Mini/Micro 77
December 6-8, Anaheim, CA

4K to 64K RAM Up to 8K EPROM on one board

Now you can have RAM and EPROM on the same board and buy as much or as little memory as you need. And because our memories use 16 pin memory element sockets you can change your memory when you change your mind.

Speaking of changing your mind, when you want to change address locations of either RAM or EPROM, it's done with two, on-board switches—providing 16 possible start locations for each memory.

Compare these features with our much improved read, write and refresh cycle times and you'll choose MSC first.

16K RAM Version

Up to 16K × 8 of RAM and up to 8K × 8 of EPROM on the same board.

RAM expandable in 4K × 8 increments and EPROM expandable in 1K × 8 or 2K × 8 increments.

On-board DIP switches to select any of 16 address start locations for RAM and 16 address start locations for EPROM.

Cycle times:
Read, 350 nsec.
Write, 500 nsec.
Refresh, 500 nsec.

Totally SBC 80 and Intellec MDS hardware and software compatible.

Limited one year warranty on parts and labor.

Delivery 30 days ARO.

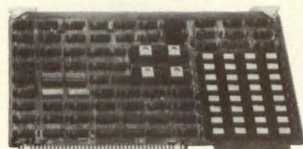

MSC 4502

64K RAM Version

Up to 64K × 8 of RAM and up to 8K × 8 of EPROM on the same board.

RAM expandable in 16K × 8 increments and EPROM expandable in 1K × 8 or 2K × 8 increments.

On-board DIP switches to select any of 16 address start locations for RAM and 16 address start locations for EPROM.

Cycle times:
Read, 350 nsec.
Write, 500 nsec.
Refresh, 500 nsec.

Totally SBC 80 and Intellec MDS hardware and software compatible.

Limited one year warranty on parts and labor.

Delivery 30 days ARO.

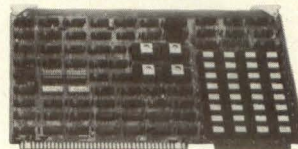

MSC 4602

Beginning firsts

Beginning with compatible memories, Monolithic Systems will continue to introduce SBC 80 systems with features which are firsts.

First to take advantage of the latest technology. And first in reliability, value and delivery.

You can be among the first, when you call us for SBC 80 compatible systems.

SBC 80 compatible systems... from the first.



Monolithic
Systems corp.

14 Inverness Drive East
Englewood, CO 80110
303/770-7400

Intellec is a registered trademark of Intel Corporation.

©1977, Monolithic Systems Corp.

Looking at the industry as a whole, Hochstedler felt that significant entries were 8K and 16K bipolar RAMs. These RAMs are available from many sources now, and at reasonable prices, he said.

Harris brought out the "world's first CMOS PROM this year," Hochstedler said. "Also we are producing a family of 1K CMOS devices in 1K x 1 and 256 x 4 formats with 100 ns access times. These speeds were previously unheard-of for CMOS."

"The Japanese were a big area of impact on the semiconductor market during 1977 with RAMs, PROMs and EPROMs."

"The new 5 volt EPROM technology that became widely used during 1977 was extremely important," said Robert Walker of Intel. "We now have three or four new products using this technology, including a 16K RAM," he said. "Another important technology during the year, HMOS, enables you to get bipolar performance with MOS. We produce a 4K RAM that has the highest performance you can get in any technology - 55 ns - and also a 1K RAM with 35 ns performance. These are fully as fast as the bipolars on the market."

"The Japanese were a big area of impact on the semiconductor market during 1977," said Gene Hnatek of Monolithic Memories. "They're really going great guns

with bipolar and MOS RAMs, PROMs and EPROMs. It looks like they're going all out and trying to take over. Their marketing organizations became more active while trying to get a bigger chunk of the market. The Japanese government is sponsoring research by the four top Japanese semi manufacturers - Nippon Electric, Fujitsu, Matsushita, Mitsubishi. By 1980 they want to come out with a one megabit CCD memory. They have developed a 131K bit CCD memory now and they're really pushing the technology."

Extended Core Memory

During 1977 core or bulk core memory usage grew, according to John Gilligan, president of Dataram. "People are extending memory with semiconductor or CCD or core, interfacing it as a peripheral," he said. "We introduced bulk core and have been supplying it to Microcomp. We developed an interface to emulate a fixed-head disk."

Gilligan said that he had seen people move to larger and larger core modules during the year. He also felt that small independent suppliers such as Dataram were gaining increased acceptance from users.

In the competition between core and semiconductor memories, Gilligan agreed that semiconductor manufacturers had increased their market share, but said that the sales of his own company had also been rising. "Our growth is mainly because of bulk core, which is just starting to catch on now. Our market share continues to grow, not at a huge rate, but it's growing. We sell reliability and nonvolatility." DD

Need a DEC Floppy System?

MF-11



The MicroFlop-11 is Your PDP-11V03 . . . in Half the Space . . . and at Half the Price.

Functionally identical to the PDP-11V03, and using only 10-1/2" rack space, the MF-11 houses the Shugart dual floppy system, the backplane for the LSI-11 with associated peripherals, and all needed power . . . at considerable dollar savings.

- | | | | | | | | |
|--|---|------------|--|-----------|--|-----------|-------------|
| <ul style="list-style-type: none"> • Compact Version of PDP-11V03 • Totally Software Compatible • RT-11 • Fortran IV • Basic • Bootstrap Loader • Optional Double Sided Drive • Optional Extended Backplane • 3740 Format | <table border="0"> <tr> <td style="text-align: right;">UNIT PRICE</td> <td></td> </tr> <tr> <td style="text-align: right;">\$3440.00</td> <td></td> </tr> <tr> <td style="text-align: right;">\$4290.00</td> <td style="text-align: right;">with LSI-11</td> </tr> </table> | UNIT PRICE | | \$3440.00 | | \$4290.00 | with LSI-11 |
| UNIT PRICE | | | | | | | |
| \$3440.00 | | | | | | | |
| \$4290.00 | with LSI-11 | | | | | | |

FD-11

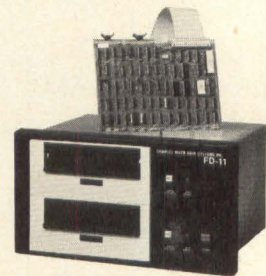

Our FD-11 Dual Floppy System Does Everything DEC's RX-11 Will Do . . . and a Few Things More . . . for a Lot Less.

FD-11 Dual Floppy Disk system with its Controller/ interface card offers you total software, hardware and media compatibility for all DEC PDP-11 and LSI-11 systems . . . and in addition:

- | | | | | | |
|--|--|------------|--|-----------|--|
| <ul style="list-style-type: none"> • Over 35% Price Savings • 8080 Based Controller • Industry Standard Drives • Write Protect Switches • Unit Select Switches • Bootstrap Loader • Formatter and Self-test Routine • Optional Double Sided Drives | <table border="0"> <tr> <td style="text-align: right;">UNIT PRICE</td> <td></td> </tr> <tr> <td style="text-align: right;">\$2750.00</td> <td></td> </tr> </table> | UNIT PRICE | | \$2750.00 | |
| UNIT PRICE | | | | | |
| \$2750.00 | | | | | |

For more details and pricing, contact: **Marketing Department**
CRDS Charles River Data Systems, Inc., 235 Bear Hill Rd., Waltham, MA 02154,
 Tel. (617) 890-1700

YOU ASKED US FOR A 21-COLUMN, ALPHANUMERIC IMPACT PRINTER AT A VERY SPECIAL PRICE. HOW ABOUT \$140.00*?

Whether or not your equipment is micro-processor based, here's a full alphanumeric impact printer that can upgrade hard-copy capabilities, increase reliability and maybe even cut costs, too.

Tape, tickets or both. In addition to our standard plain paper tape printer, you can also specify optional ticket and ticket/tape mechanisms. And with all of them, you have the extra flexibility that comes with the ability to make multiple copies.

"Spanning Hammers" raise reliability and lower your costs. Our innovative microprinters have only about one-third the number of parts you'll find in conventional single hammer per column printers. Ours are simpler. So they're more reliable and cost less. Each spanning hammer forms the characters for three columns—a total of seven hammers to print all 21 columns.

Full 54 character printing in all 21 columns. Our special bar matrix character formation permits printing of A-Z, 0-9 and eighteen additional symbols in all columns, at speeds up to 90 lines/minute and paper advance without printing of 600 lines/minute.

More good news... a 15-column printer for under \$110.00*. With all the versatility, simplicity and value of our 21-column unit. And at a price that's just as hard to believe. And you'll like the fact that all our printers are made right here in the U.S.A. So your design and engineering people can have easy access to our design and engineering people.

An 8-bit microcomputer, pre-programmed for our printers. Of course our printers are compatible with a wide range of microprocessors. But to make things quick and simple, we also offer a completely pre-programmed chip or a complete interface card including chip and drivers.

Try one at our 100-piece price. If you'd like to try one of our 15 or 21-column printers in your system, we'll be pleased to provide a single unit at the 100-piece price. For complete details, write or call: Sheldon-Sodeco, A Division of Landis & Gyr, 4 Westchester Plaza, Elmsford, N.Y. 10523; (914) 592-4400.

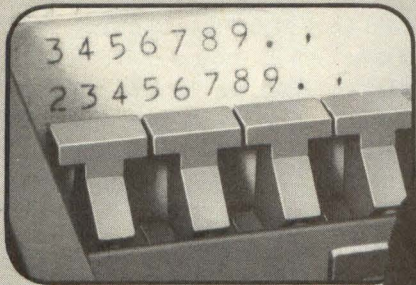
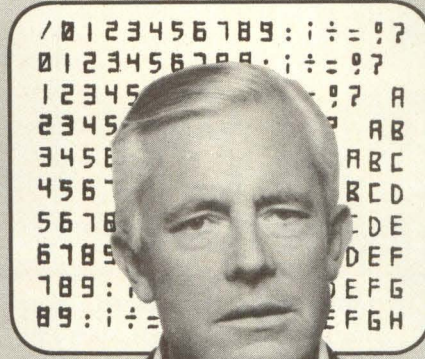

SHELDON-SODECO

LANDIS & GYR

CIRCLE 40

*In 100's(U.S. Domestic Prices)

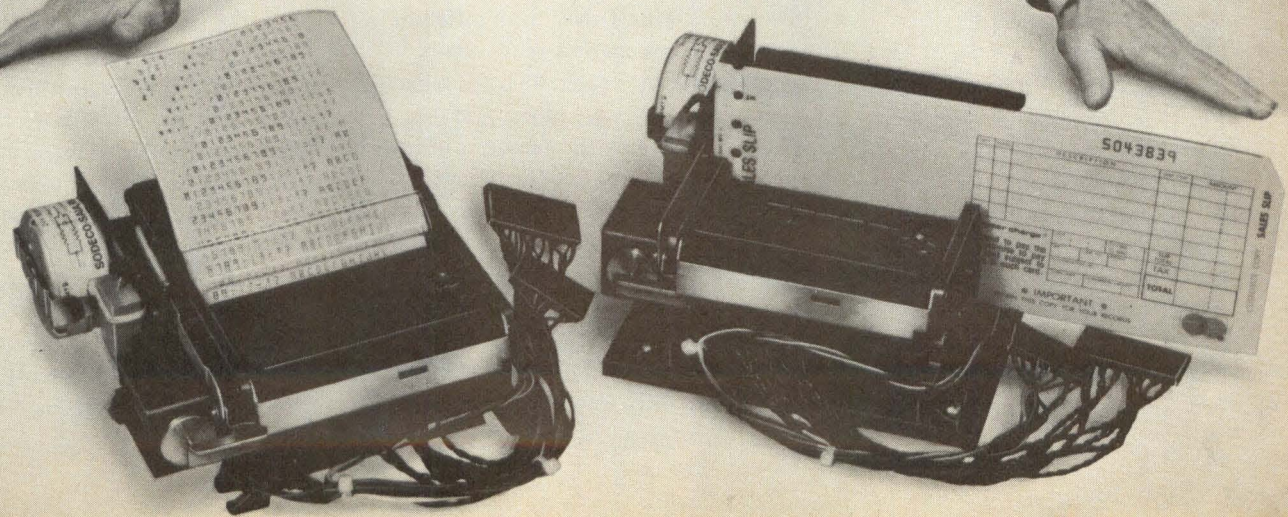

Cartridge and Cassette Drives

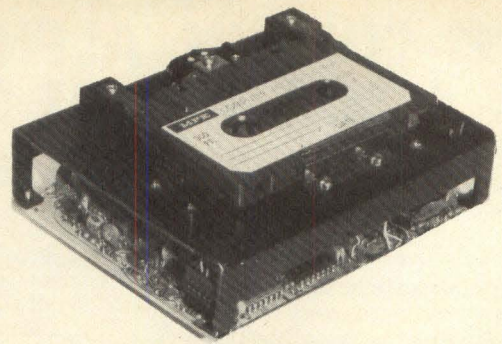

MFE's Model 250B digital cassette tape transport offers 15,000 MTBF and ANSI/ECMA compatibility.

Full size and minis can store more data

The name of the game in 1977 seems to have been improved storage capacity, for the more data each cartridge or cassette can hold, the more competitive the drives become with each other and with other types of memory. Since most manufacturers believe that neither of these two tape media have reached the theoretical capacity limit, they are still working to increase bit density and the number of tracks on each side of the tape. The results of this development work may not appear in 1978, but surely by 1979 some makers may announce drives with even greater storage capacity.

Cartridge Drives

During 1977, the number of cartridge tape drives that record data at the 3200-bpi density increased rapidly, declared Herm Brooks, director of operations, Tandberg Data. In round numbers, 80% of the machines sold record at 1600 bpi and 20% at 3200 bpi. In 1978, the rates will change to 70% and 30% respectively, he predicted.

Pointing out that the medium has not improved measurably during the past year, Brooks noted that though a 6400-bpi density is theoretically possible, the extra expense of the more complex electronics seems to work against this potential increase, because increased product volume has been lowering the price of drives and making higher-priced machines less attractive.

Customers want drives with more sophisticated I/O schemes, such as IEEE bus as well as SDLC (synchronous data link control) interfaces, introduced by IBM for protocol. Many cartridge drive manufacturers now offer this protocol in their products.

Cartridge limitations have kept tape speed for data transfer unchanged at 30 and 45 ips. These speeds are not expected to increase in 1978, because increased tape speed does not improve the transfer rate as much as an increase in bit density, according to Brooks, though the 120-ips rewind speed offered by manufacturers does help throughput.

A 6400-bpi density is theoretically possible in tape cartridges

Mechanism problems in cartridge drives are gradually disappearing, Brooks believes. Drives from different manufacturers are now more nearly competitive with each other for reliability than they were in the past.

In 1978 some manufacturers of low-end cartridge drives will introduce ECMA- and ANSI-compatible models to replace cassette drives in the hobby computer market, Brooks predicted.

Minicartridge Drives

"In early 1977, 3M introduced its DC-1 tape drive to use DC-100A

minicartridges. A short time later my company began selling a similar unit, which we call Model 200 Minidrive," said Leon Malmed, sales manager, Qantex. "Like most manufacturers, we offer interface electronics to our customers. At the present time, we market an interface for the Motorola 6800 microprocessor, but we are developing interfaces for other microprocessors and computers, such as the 8080 and the LSI-11."

Soon after introducing minicartridge tape drives, 3M, Qantex and others began marketing a two-track drive, thus doubling cartridge capacity from 160K to 32K bytes unformatted, according to Malmed. By doubling bit density from 800 to 1600 bpi, Qantex can now offer drives capable of storing up to 640K bytes of unformatted data. Although he doesn't expect bit density to increase in 1978, Malmed said that his company and its competitors are working on increased bit density drives.

In 1978, manufacturers will design and build militarized versions of their minicartridge tape drives. Since commercial units already offer about a 20,000-hour MTBF, Malmed expects that military models will experience about 40,000-hour MTBFs. He attributes this reliability to the drive's inherent simplicity — only one moving part, the motor shaft.

Minicartridge drives can compete successfully with 5.25" floppy units in many applications, claimed Malmed.

They store more data per unit of media, they consume less power — under 15 watts, they require only 2 voltages — +5 and +12, and occupy less space.

Cassette Drives

“Not until 1977 did cassette drives finally overcome all the objections held by the industry against their use for digital data storage,” began Jim H. Bartley, sales manager of OEM digital products, MFE Corp. “Because the cassette was originally designed for audio, not digital, applications, the early problems encountered by users turned them off. But by late 1976 and early 1977, cassette drive manufacturers convinced the industry that they had licked all the problems.”

Claiming that his company's drives offer a greater reliability than floppy disk machines, Bartley said that buyer confidence in product capability and quality rather than technological changes has boosted sales by about 40% in 1977. Users have begun to realize that digital cassette drives offer a low-cost method of loading programs into CPUs. Other applications include buffer storage, data acquisition and logging and even virtual memory. Cassette drives with a 32000 bps transfer rate can handle throughput fast enough for many microcomputer applications.

The application of cassette drives in instruments and systems operating in a hostile environment will grow in 1978, declared Jim Bartley. Since cassette drives can withstand hostile conditions encountered in field opera-

tion, manufacturers will install cassette storage in their products, such as surveying instruments and geophones. Growing in popularity, distributed processing systems with terminals at a large number of remote locations require buffer storage and perhaps local program loading. These terminals will absorb a large number of cassette drives in 1978.

Manufacturers will offer ceramic heads for their cassette drives in 1978, Bartley predicted. These heads will wear longer and prolong media life. Increased cassette drive volume will allow manufacturers to use customized LSI chips in the electronics to improve reliability and reduce costs to remain very competitive with floppy disk drives.

Digital cassette drives offer a low-cost method of loading programs into CPUs

The European market for cassette drives grew in 1977, especially in Germany, Great Britain, France and Switzerland, said Bartley. Although these drives now sell better than floppy disk machines, the rivalry will intensify in 1978. But business volume should remain good, because many European computer companies are just starting to grow. These firms use mostly American peripherals, because few European companies manufacture this type of equipment. However, the Japanese have gone into peripherals

manufacturing and will compete strongly with U.S. makers in Europe.

Minicassette Drives

“In 1977, the computer industry began to accept miniature cassette drives as useful products for instrumentation and program loading applications that require low-cost, low-power and small-size storage units,” declared Bud Gould, sales manager, Raycorder Products Div. of Raymond Engineering. “We believe that our customers are buying miniature cassette drives because they get the same reliability and quality they expect from standard-size units. They use these drives when they don't need as fast a data transfer rate and as much storage capacity as provided by full-size drives.”

Manufacturers of the minicassette improved the package in 1977 by replacing the pin guides with rollers, said Gould. That change extended the expected number of passes across the head by an order of magnitude — from about 200 to about 2000.

In 1977, and during 1978, makers began or will start offering, built-in interface electronics in their minicassette drives. For example, explained Gould, his company will shortly introduce RS-232C interface circuitry, so that customers can connect the drives to their CPUs, terminals or other gear without designing and building special electronics. In the future, his company expects to expand the number of interfaces to include most standard and some dedicated special types. **DD**



Fig 1 The Qantex Minidrive uses a minicartridge developed by 3M that contains 140 feet of 0.150-inch tape in a package measuring 2.4 x 3.2 x 0.5 inches. The transport employs a servo loop that includes a solid state optical tachometer for precise speed control of the low inertia DC motor.

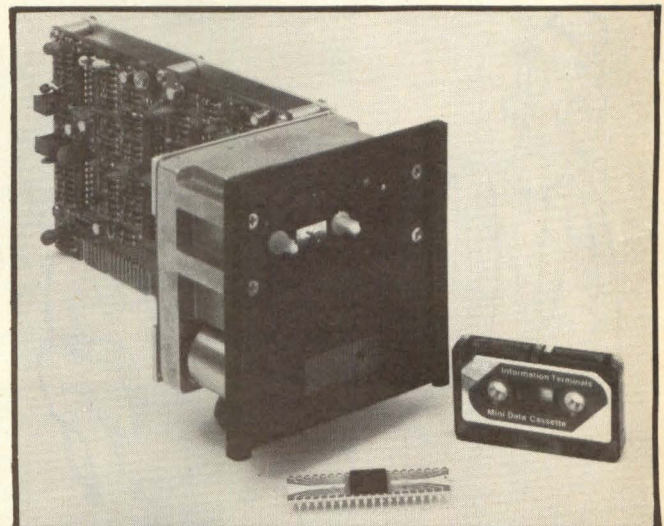
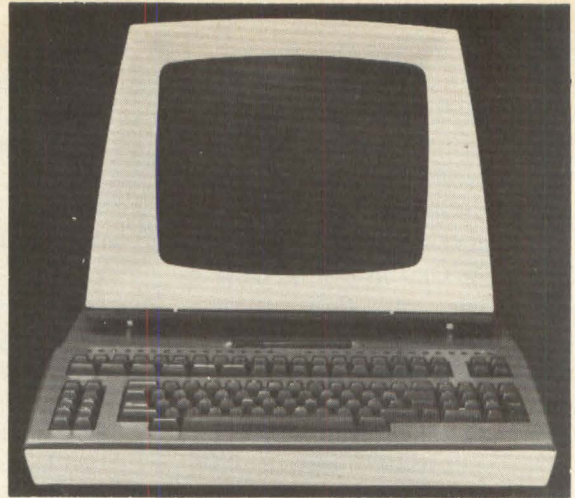

Fig 2 Model 6409 minicassette recorder from Raymond Engineering packs 64 Kbytes of unformatted information onto each side of the tape.

Terminals: Smart and Dumb



VDP-400 from the Data Products Group of Lear Siegler's Electronic Instrumentation Div. consists of 3 modules: keyboard, minicomputer and video display.

Microprocessors made them intelligent

Terminal manufacturers generally agreed that 1977 had seen the increased emergence of low cost terminals that use microprocessors. These terminals possess more power than previously available for the cost. Price drops for microprocessors and memory chips made the production of these terminals feasible, and also contributed to price drops of the more powerful "intelligent" terminals.

The emergence of low-cost microprocessor-controlled CRT terminals is the most significant event of 1977," said Jim Folts, terminal division vice president for Perkin-Elmer Data Systems. "What led to the price reduction," Folts continued, "was the dramatic reduction in the price of microprocessors and RAMs. The major part of manufacturing cost reduction was realized by replacing hard-wired logic with the microprocessor.

"Microprocessor-controlled terminals have been around for a while," Folts said, "and their basic technology was not actually new. What was new was the appearance of relatively low-cost terminals in the "dumb" and "smart" classes. Folts placed terminals with "intelligence" into three classes: "dumb," teletype replacements; "smart" or "editing" terminals; with built-in functions but non-programmable; and "intelligent," or programmable terminals. "In the last two years," Folts said, "we saw the microprocessor applied in intelligent terminals. In 1977 we saw processors used in dumb and smart terminals — a direct result of reduced microprocessor costs."

Folts said that Perkin-Elmer led the industrial trend toward added intelligence in dumb and smart terminals with its announcement in January of the FoxTM and



If you ask me, this terminal is a little too smart!

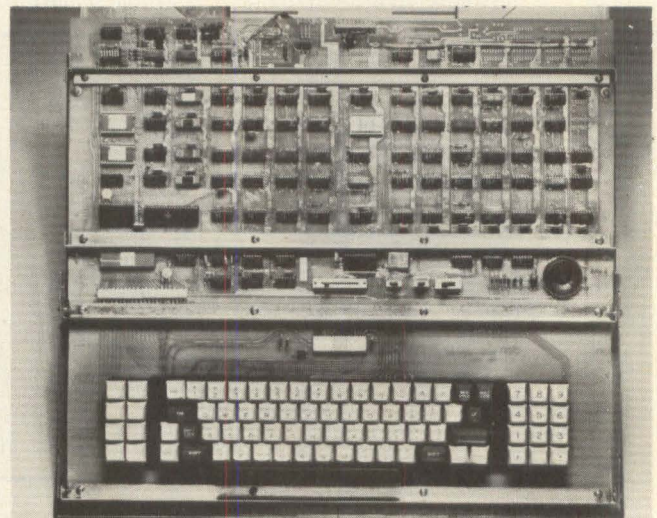
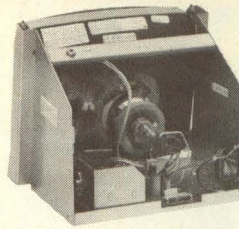

Fig 1 Perkin-Elmer Data Systems assembles its CRT terminals from basic building blocks designed around the 6800 microprocessor and various peripherals and communication interface chips.

If you make top-quality data terminals, here are four reasons to use Setchell Carlson CRT display modules in your system.

Reliability:



Our data displays are outstanding solid-state designs with critically matched magnetics to optimize the performance levels and dependability demanded by your customers. We use the most advanced engineering and production techniques to assure consistency of performance. No data display is built with more deliberate attention to quality and reliability.

Delivery:

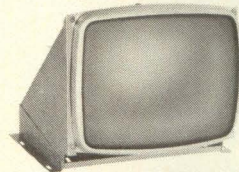

We have been in the display electronics business long enough to know about rush orders. If you need it yesterday — we'll try to get it to you yesterday.

Experience:

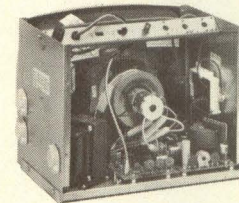

We've built thousands of displays for many of the major manufacturers in the country. Perhaps we already have a unit that would meet your requirements. With slight modifications. It would be less costly than starting from scratch. If you need a new, special package — we'll produce it for you, in the configuration you want, at minimal expense.

Cooperation:

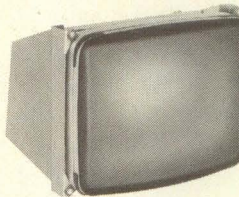

If you're developing a new data terminal, we will be glad to cooperate with your terminal design engineers in reviewing your exact specifications and developing the most economical display possible. And quickly! Whatever you need, we have the experience and talent to design it. And improve it.

But don't take our word. See for yourself by contacting us today.

You'll come up with your own reasons for using Setchell Carlson CRT display modules.

SC ELECTRONICS, INC.
A SUBSIDIARY OF AUDIOTRONICS CORPORATION
530 5th AVE. N.W. NEW BRIGHTON, MN. 55112 (612) 633-3131

OwlTM terminals. Many similar low cost terminals have since been introduced by other manufacturers, he added. The Fox model 1100 "dumb" terminal, a teletype replacement with CRT, uses a Motorola 6800 microprocessor.



Fig 2 TEC's Model 70 microprocessor-based video display terminal uses Intel 8080 firmware to direct all video control logic and I/O functions.

"With the processor," Folts said, "we achieved a parts count 25-30% lower than any equivalent device while at the same time making a bunch of functions that used to be optional standard — typomatic keyboard (where holding down a key makes it repeat), tab set and clear for any column of the CRT and so on." The Owl model 1200 "smart" terminal also uses a Motorola 6800. "Parts count was down 30-35%," Folts said. "With this kind of terminal you can really exploit the power of the microprocessor to make the terminal easy to program from the standpoint of the host computer and also taking the load off the host. One of the things we did with this terminal was make it give status information on the host computer to the operator. Heretofore this kind of information has only been available with high cost terminals, but we've made it available with a low cost one."

Folts said that the changes he had cited were happening throughout the industry; he expected increasing power in lower cost terminals in the future.

"The microprocessor had an impact on the entire electronics industry this year, not only on terminals," said Steve Marriott, applications engineering manager for TEC. "In our own product line, microprocessors allowed us to provide terminals that have more capability, at lower prices and in smaller enclosures than before. Major factors in terminal price reductions have been dropping costs for microprocessors and RAMs."

The microprocessor used in the TEC model 70 "smart" terminal enables TEC to "tailor our machine to customer specs," according to Marriott. The processor is also used in the design of different terminal interfaces — for Honeywell

"Microprocessors allowed us to provide terminals that have more capability, at lower prices and in smaller enclosures than before."

6600, Uniscop 100 and Burroughs TD 800, for example. Marriott said that the processor also serviced the monitor, accepted keystroke inputs from the operator and handled the communication line for CPU inputs.

"Today's typical low cost terminal is a teletype replacement," Marriott said. "The next generation of low cost terminals will have many of the features presently found in more expensive machines — programmability, edit functions, video enhancement capabilities." Marriott believed that there would be increased demand in the future for low cost terminals and that more would appear on the market in 1978.

Reduced microprocessor costs have enabled Tandberg Data to lower the cost of its TDV-2114 terminal, according to Gary Pyles, regional marketing manager. The TDV-2114, recently introduced to the U.S. market following use in the European market for over two years, may serve as a teletype replacement, intelligent terminal or stand-alone processor, according to Pyles.

"I think that it's fairly clear industrywide that the 16-bit processor has arrived," said Tom Viggers, marketing manager for Lear Siegler. "We can see the evidence in our own backyard in the VDP-400, a 16-bit terminal that comes standard with a 6K memory extendable to 32K. Eventually we will expand the VDP-400 into a more powerful intelligent terminal, the VDP-1000, that we will introduce sometime before mid-year in 1978. The VDP-1000 has even more memory than the VDP-400 and can stand alone a little bit more — you can edit with it, and it takes keystroke programming, for example."

Viggers said that there was a very definite trend in the industry toward less expensive "dumb" terminals. "Lear Siegler originated the DumbTM terminal with a product introduced in 1976 and then selling for about \$1300. There has



Tom Viggers of Lear Siegler

been a lot of competition in the dumb terminal market and prices have eroded. We're now selling a comparable terminal which the distributors market in the \$850-900 price range."

Viggers said he foresaw continued interest in dumb, smart and intelligent terminals. He noted that the power of intelligent terminals has increased, as exemplified in Lear Siegler's announced VDP-1000. "That kind of terminal has considerable power," he said. "The end user in general business applications can do quite a bit of his own computing right there, as well as down line with the mainframe. The terminal with its CRT, hard copy printer and substantial memory gets to be a lot like a mini."

The advent of LSI peripheral support chips and 16K erasable ROMs, in addition to the availability of the Z-80 micro-

Technological Leadership for 3 Decades!

Ampex, headquartered on the San Francisco Peninsula, is the company that "invented" the magnetic recording industry.

The technology pioneered by Ampex over three decades has affected many aspects of our modern lifestyles, and has established Ampex as a leader in magnetic recording. Our continued effort in developing new technology has always been the key to our leadership. Right now our Advanced Technology, Data Products and Audio-Video Systems Divisions are embarking on several new programs. To insure the success of these programs we are seeking innovative graduate engineers with experience in the fields listed below.

Opportunities like this don't happen very often. But they're happening at Ampex now.

Advanced Technology Division

- electron beam and optical recording
- magnetic recording
- tape or film handling
- servos
- high-bit rate digital circuit design
- optics
- signal analysis
- pattern recognition
- high frequency circuit
- communications theory

Data Products Division

- circuit/systems design of very high-bit rate systems

- disk read/write systems and equalizing systems for tape recorders
- codes for magnetic recording
- precision servo systems for both linear positioners and rotating systems
- mechanical design of high precision systems in disk recorders and in longitudinal, helical and transverse scan tape recorders

Audio-Video Systems Division

- analog videotape signal systems
- digital video signal processing
- servo systems
- videotape editing
- professional audio recorders
- head technology
- TV cameras

If you think you have something valuable to offer in any of these or closely related areas, and if you would like to join some of America's most talented engineers, please send your resume or a letter outlining your qualifications to: Ampex Corporation, ATTN: J.B. Puckett, Building 2, 2655 Bay Road, Redwood City, CA 94063. Or you can send us this coupon and we'll get back to you. We are an equal opportunity employer m/f.

**Manager Corporate Staffing
AMPEX Corporation
Building 2, 2655 Bay Road
Redwood City, CA 94063**

Dept. 3

Name _____
Address _____
City, State, Zip _____
Phone _____

Occupation _____
Years of Experience _____
Employer _____



CIRCLE 42

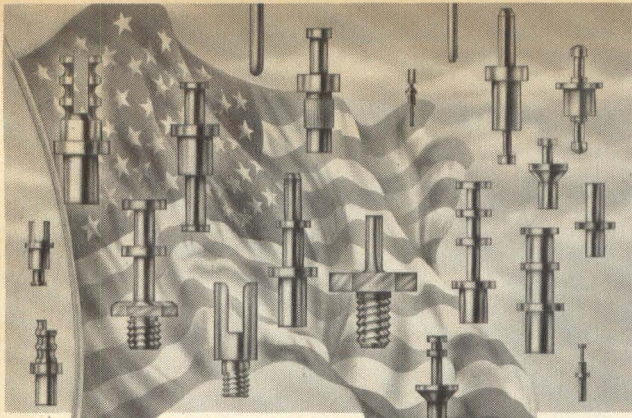

Our solder terminals never die, never fade away.

They are made of the finest materials, by people who care about quality and durability. CAMBION offers 96 basic styles, more than 400 types — the widest selection of off-the-shelf solder terminals you can get anywhere. Terminals come in swage, press and thread mount types. Single, double or triple turrets, pin types without turrets, feed-thru, double-ended, hollow, flared and forked types. Close tolerances, precision threads, durable finishes, the best quality base materials — all are standard from CAMBION. Try us. You will return. For a free catalog, write or call CAMBION. Cambridge Thermionic Corporation, 445 Concord Avenue, Cambridge, MA 02138. Phone: (617) 491-5400. In California, 2733 Pacific Coast Highway, Torrance, CA 90505. Phone: (213) 326-7822.

CAMBION

Guaranteed to be the right connection.

CIRCLE 43

Our adventures with LSI-11*

If you're at sea and about to sink, maybe we can help:

With MIK-11 (LSI-11 in CAMAC), Heavy Duty Packaging, E-PROM, Dual Port Memory, TRIAC Output and others.

Module of the Month:
Read Relay Output.

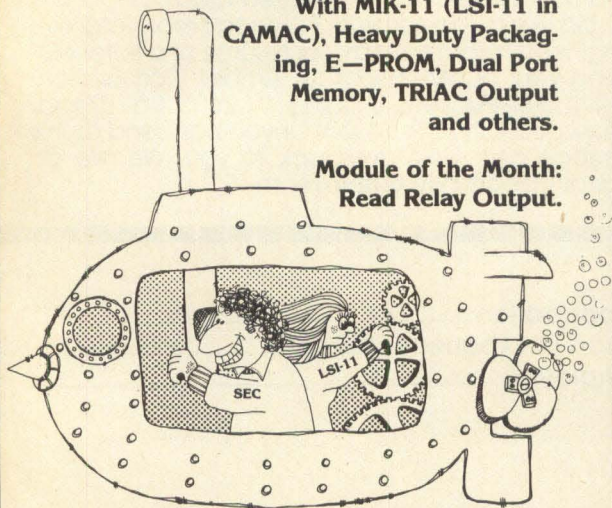

STANDARD ENGINEERING CORPORATION
44800 Industrial Drive • Fremont, Calif. 94538 • 415 657-7555

*Trademark Digital Equipment Corp.

“MOS RAM and IC chip prices have come down and eroded the end user cost for graphic display units.”

processor in production quantities, enabled Design 100 to enhance its daisy wheel printing terminal, according to Dave Crellen, engineering vice president. “This terminal was first introduced in '75,” said Crellen, “and was limited by the power of the chip we were then using. With the Z-80, new peripheral support chips and the 16K ROMs, we've reduced the terminal to a desk top unit, reduced our parts count to achieve greater reliability, reduced our production costs by about 30% and been able to pass the cost reductions on to the user.”

Crellen said that beside reducing the cost of the Design 100 daisy wheel terminal, the microprocessor enabled addition of features such as automatic justification of copy, centering and flush left or flush right margins.

The wider availability of intelligent terminals at increasingly competitive prices was the major breakthrough of 1977, according to Tyler Hunt, product manager for Magnavox Display Systems, manufacturer of terminals with plasma panel displays. “Microprocessor and memory costs have decreased,”



Tyler Hunt of Magnavox Display Systems

Hunt said. “Last year this enabled us to reduce the price of our Orion graphics terminal. We have also expanded this system into three grades of user programmability.”

Hunt explained that the Orion terminal has as an option an integrated, random access 35-mm slide projector that enables projected optical data in the form of charts, background maps and the like to be combined on the plasma panel display with terminal-generated alphanumeric data. According to Hunt the terminal has found its widest applications in medical education and process control.

Hunt said that the plasma panel display technology is still new and that prices are still high in comparison with older technologies such as CRTs. He believed that cost reductions would occur as production volume increased and manufacturing costs went down.



Joseph Morris of Ramtek Corporation

Reduced microprocessor and memory costs enabled manufacturers of color terminals to produce and market less expensive terminals, according to Joe Morris, marketing vice president of Ramtek, manufacturer of color terminals. “This year we introduced our Micrographic™ 6000 series terminal,” Morris said. “This terminal is sold at a price 75% cheaper than color terminals previously available. High-speed PROMs and microprocessor technology have made it possible. We use the Z-80 in this terminal, a nice little device, relatively fast, with a good instruction set. Basically, we're offering an easily pro-

grammable true vector system with a full repertoire of RGB colors and their combinations. The big breakthrough is being able to offer this capability at low price. We use 64 instead of the 4000 colors of our more expensive terminal and get by without doing D/A conversion for we do our processing in a simpler manner."

Morris said that color costs have come down throughout the entire field of color terminal manufacturers. He also observed that competition in the field has increased. "At last count there were about 27 companies making color terminals of one kind or another, many of them very specialized. Three or four were in direct competition with us. This year seven or eight new companies entered the field. I know Hewlett-Packard is working on a terminal, but they have not yet made an announcement."

Morris foresaw higher-resolution color displays coming in the future. He also anticipated color printer/plotters for printing out the display screens of color terminals. "Applicon has a color printer," he said, "and Xerox is coming out with one. They'll become increasingly common."



Fig 3 Ramtek's 6000 series Micrographic terminal displays graphics and alphanumeric in color or black and white.

"The major thing this year is that MOS RAM and IC chip prices have come down and eroded the end user cost for graphic display units," said Bill Huber, marketing vice president for Genisco Computers, manufacturer of raster-scan graphic display terminals. "The price reductions have really affected us," Huber continued. "Our units are MOS RAM-oriented, with 80 RAM chips on a board. Our system is 80% memory. RAM chip prices have dropped by one-half.

We've reduced our prices by 40% since September of '76."

Huber felt that the price impact had been greatest for raster scan displays since "a very large percent of the system is bit planes, which are mostly RAM. The storage tube people are stuck with the cost of their monitor and the stroke writer people are stuck with their technology. Prices haven't dropped as much for them."

Huber said that in the last year he had seen "development of demographic need for image type raster displays. Demand has gone up tremendously in the last 12 months for displaying such things as ERTS satellite information. For these users, instead of shipping systems with three color planes we're shipping systems with up to 24 planes."

Huber said he foresaw continued price drops in display systems using raster scan technology.

DD

MASS STORAGE CONTROLLERS FOR INTERDATA® COMPUTERS

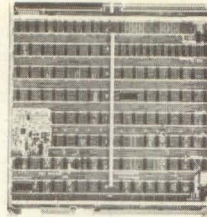

FDC203 FLOPPY DISK

1 to 4 drives/controller
Single or Double Density
Single or dual head
compatible with all popular drives
OS/16 support
Limited one-year warranty

\$1080
(at 10 per year)



MiniComputer
Technology

2470 Embarcadero Way • Palo Alto CA 94303

* Reg. TM. PERKIN-ELMER CORP.

CIRCLE 45

MiniComputer Technology

The probes for the PRO!

4 of the 25 reasons you should
be using the new KK 600
Series Logic Probes



- 1** Pulse — will capture and display a single 5NS (200 MHZ) Pulse.
- 2** Single or Dual Threshold®
- 3** "I" or "Hi" full time — DC to 200 MHZ
- 4** "O" or "Lo" full time — DC to 200 MHZ

 **Kurz-Kasch, Inc.**

ELECTRONICS DIVISION
BOX 1246
1501 WEBSTER STREET
DAYTON, OHIO 45401
(513) 223-8161

CIRCLE 46

Monday 8:30 AM Next Generation of Electronics	Tuesday 8:30 AM Next Generation of Electronics	Wednesday 8:30 AM Next Generation of Electronics
<ol style="list-style-type: none"> Introducing the R6500 Microprocessor Family. Designing with this 13-addressing-mode microprocessor series is simplified by use of the "System 65" hardware and software system. Ron Eufinger, Rockwell, Anaheim, CA PROM Programming Techniques. PROM programming hardware is now available to satisfy all the requirements that the engineering laboratory or production line might present. A new microprocessor-based programmer for MOS PROMs can program 16 devices at a time. Dick Woods, Data I/O, Issaquah, WA Introducing the "Micromachine" Microprocessor Family. Scheduled for sampling in early 1978, the F-3870 Micromachine series of 8-bit MOS microprocessor is intended for low-cost, low-power industrial and consumer applications. The family includes a μP with 2 k of ROM, another with 4 k of ROM, and a third with 2 k of EROM. Dave Hollinbeck, Fairchild, San Jose, CA 	<ol style="list-style-type: none"> Introducing a New Family of Single-Chip, Stand-Alone Microcomputers. This series of ICs includes the $\mu Com42$ for applications involving simple keyboards/display interfacing such as found in electronic cash register and point-of-sale applications; and the $\mu Com-43-45$ for general-purpose controller applications. Dwain Aidala, NEC Microcomputers, Lexington, MA A Low-Cost Z80 Development System. The SDB-80 single-board computer includes a Z80 CPU with a ROM-based relocating assembler, editor, linking loader and operating system. The system software ROM may be easily removed and replaced by user ROM or PROM to provide a fully tested OEM system board. Ron Baldrige, Mostek, Carrollton, TX The 16-Bit 9440 Microprocessor Family. The 9440 bipolar minicomputer, using PL technology, combines the high speed of bipolar construction with the low power usually associated with MOS. Structurally different from the Data General NOVA, the 9440 executes the same instruction set. Dan Wilnai, Fairchild, San Jose, CA 	<ol style="list-style-type: none"> Design Example: How to Design a Low-Cost Printing Terminal Using the TMS9940 Microprocessor. Designing with the 9940 will be contrasted against an existing design employing the 8080 microprocessor. Hardware and software differences will be analyzed and cost reduction implications will be discussed. Tom Miller, Texas Instruments, Houston, TX Considerations for Implementing a Double-Density Floppy Disc Controller Using the 8X300. The 8X300 bipolar 8-bit microcontroller is intended for control applications. It is bit-addressable at the I/O ports. Frank Brunot, Signetics, Sunnyvale, CA Applying an 8-Bit by 8-Bit Serial/Parallel Multiplier with Accumulator. Discussion includes programming the multiplier. Two cascaded devices perform full 16-bit multiplication. Using 2's complement, carry-save arithmetic, the 40-pin 25LS2516 delivers a 16-bit product in 8 clock cycles. Vernon Coleman, AMD, Sunnyvale, CA
MID-MORNING BREAK	MID-MORNING BREAK	MID-MORNING BREAK
<ol style="list-style-type: none"> Interfacing Between Microprocessors and Programmable Instrumentation. The MC68488 general-purpose interface adaptor provides the means for interfacing between IEEE Standard 488 standard digital interface and programmable instrumentation. Fifteen locations are accessible to the microprocessor data bus. George Nelson, Motorola Semiconductor, Austin, TX In-Circuit Emulation as a Microprocessor Development Tool. With one tool, the engineer can observe the interaction of hardware and software. Problems can be immediately pinpointed. Gordon Reid, Intel, Santa Clara, CA 	<ol style="list-style-type: none"> The 8048 Single-Chip Microcomputer. The single-chip microcomputer not only provides the engineer with a powerful stand-alone controller, it also changes the concepts governing use of peripheral control with a master microprocessor. The 8048 has on-chip ROM and RAM. Larry Goss, Intel, Santa Clara, CA The 8085 Microprocessor. What is happening to maintain the 8080 as an industry standard? The 8085, a program-compatible version of the 8080, uses the 8080 peripheral family but provides a higher level of integration, eliminating the need for a clock generator and bus controller. Bruce Burkhart, Intel, Santa Clara, CA 	<ol style="list-style-type: none"> The Micro Assembler. For a microprogrammed design, the Micro Assembler can be a valuable development tool. Use of this software package is explained. Steve Lau, Signetics, Sunnyvale, CA A New CMOS 4096-Bit Static RAM. Several systems applications for CMOS circuitry, with emphasis on need for memory non-volatility will be described. Advantages provided by 4096-bit RAMs will be discussed. Steve Diamond, Intersil, Cupertino, CA
LUNCH	LUNCH	LUNCH
<ol style="list-style-type: none"> Microprocessor Interface Circuits and National's "Microbus." The Microbus can be used for interfacing with complex peripheral circuits including a floppy disc controller, an SDLC communications controller and a single-chip data acquisition system. Art Gruszynski, National Semiconductor, Santa Clara, CA Interfacing the F8 Microprocessor to a Bulk Semiconductor Memory. Techniques to be used and pitfalls to be avoided. A design example using a 64 k charge-coupled-device (CCD) memory is included. Bruce Threewitt, Fairchild, Mt. View, CA 	<ol style="list-style-type: none"> Interfacing 16-Pin Dynamic RAMs to the Z80A Microprocessor. The Z80A allows transparent refresh for dynamic RAMs without the need for a refresh counter and its associated multiplexer. This does away with the necessity of stealing cycles or stopping the CPU, as would otherwise be required. A design example involving 4 k and 16 k RAMs is presented. Roy Blacksher, Zilog, Cupertino, CA Edge-Activated Memory Integrated Circuits. Considerations for designing with edge-activated memory products will be discussed; static RAMs, ROMs and dynamic RAMs are covered. Also treated are benefits of edge-activated ICs to users, design of the 5-volt edge-activated RAM and reliability aspects of edge-activated RAMs. Sam Young, Mostek, Carrollton, TX 	<ol style="list-style-type: none"> Applying the 4096-Bit Ultraviolet Erasable Complementary MOS PROM. Particularly suited for low-power, high-speed operation in hostile noise and temperature environments, this IC provides TTL compatibility over the entire CMOS power supply range and may be accessed at 200-ns by TTL circuitry. Steve Diamond, Intersil, Cupertino, CA Advanced Microprocessor Prototyping Lab. The AMPL is an integrated hardware and software development system for the TI 9900 family. It provides software development in either assembler or high-level languages. Bob Roosth, Texas Instruments, Dallas, TX
MID-AFTERNOON BREAK	MID-AFTERNOON BREAK	MID-AFTERNOON BREAK
<ol style="list-style-type: none"> Digital Signal Processing Using an 8 by 8 Multiplier. The single-chip MM167558 can multiply two 8-bit numbers in 100 ns, yet it dissipates only one watt. Shlomo Waser, Monolithic Memories, Sunnyvale, CA A 6800 Microprocessor Evaluation Board. Used in conjunction with a touch-control capacitive keyboard and an MOS top octave synthesizer, a 6800 microprocessor evaluation board can control a power-sonic electronic organ with tune memory. Ross Scott, AMI, Santa Clara, CA 	<ol style="list-style-type: none"> Announcing the 12-Bit AM2910 Bipolar Microprocessor Sequencer. This device can address up to 4096 words of microprogram memory. The 2910 has a 5 by 12 subroutine stack and internal register/counter. Vernon Coleman, AMD, Sunnyvale, CA Next Generation of 4-Bit Bipolar Microprocessor Slices and Memory Slices. The 2903 performs all the functions provided by the AM2901A, but offers much additional capability. The memory IC is infinitely expandable, has 3-address architecture and 3-bus architecture. Byte swapping is among applications covered. Vernon Coleman, AMD, Sunnyvale, CA 	<ol style="list-style-type: none"> Designing with the Tektronix Microprocessor Development Laboratory. How to set up and use the MDA8002 laboratory is described. The system includes computer, terminal, line printer, floppy disk, in-circuit emulator and real-time analyzer probe. Can be used with Z80, 8085, 9900, 8080, and 6800 microprocessors. Bill Burton, Tektronix, Beaverton, OR WD40 Single-Chip Microprocessor Applications. The 4-bit WD40 microprocessor directly handles keyboard and display switch matrices. It can drive up to 16 solenoid and on/off devices. Bud Sherman, Western Digital, Newport Beach, CA

Thursday

Next Generation of Electronics

- Designing with CRT Display Controller ICs.** The use of CRT display controller ICs in microprocessor-based systems is explored. Applications covered include split-screen and variable-format.
Don Lewis, Standard Micro Systems, Hauppauge, NY
- Introducing the HI-562 12-Bit Monolithic Digital-to-Analog Converter.** This bipolar monolithic converter with current mode output features 200-ns settling time. It has an absolute accuracy over temperature of 1.5 least-significant bits.
Dick Tung, Harris Semiconductor, Melbourne, FL
- Designing with Dedicated Controller ICs.** Applications for a multiprotocol communications controller are discussed. Areas covered include synchronous data-link control, high-level data-link control, advanced data communication control protocol, Bisync, and DEC digital communication protocol.
Don Lewis, Standard Micro Systems, Hauppauge, NY

MID-MORNING BREAK

- Two New Families of IC Op Amps.** The Op-8 and Op-12 are very high-performance versions of the low-power I08A op amp. The BiFET op amp Op-15 through Op-17 series are high-speed op amps with low-offset voltage and drift.
Shelby Givens, Precision Monolithics, Santa Clara, CA
- Applying BiFET Op Amps.** The TLO-81 family of BiFET op amps combined high impedance junction FET inputs with low-distortion bipolar output circuitry. A low-noise and a low-power series complement the general-purpose TLO-81 series.
Joe King, Texas Instruments, Dallas, TX

LUNCH

- Band-Gap Circuits Make Good Current Sources and Low-Drift References.** The LM134 current source is programmable by one resistor over the range 1 microampere to 5 milliamperes and regulates nicely from 1 V to 40 V.
Bob Dobkin, National Semiconductor, Santa Clara, CA
- The 9400 Voltage-to-Frequency Converter.** Combining bipolar and CMOS technology on the same chip the 9400 accepts a variable analog input signal and generates an output pulse train whose frequency is linearly proportional to the input voltage. Applications include interfacing with microprocessors, analog division, analog data transmission and tone decoding.
Mike Taiva, Teledyne Semiconductor, Mt. View, CA

MID-AFTERNOON BREAK

- Introducing the LM137 and the LM150.** The LM137 is an adjustable negative regulator; the LM150 is a 3-amp positive adjustable regulator. The LM137 can supply -1.2 to -37 V at 1.5 A with excellent regulation. Its accuracy is assured by a new specification for thermal regulation.
Bob Pease, National Semiconductor, Santa Clara, CA
- New Consumer ICs.** By applying delta modulation speech and voice recording, storage can be accomplished. New circuits for use in this area offer great flexibility to the designer.
Tom Hilleary, Consumer Microcircuits, Galesburg, IL

Friday

Next Generation of Electronics

- Introducing RCA's New Dual Linear ICs.** Included are the CA3240, a dual BiMOS op amp; the CA3290, a dual BiMOS comparator; and the CA3280, a dual voltage control amplifier. The 3290 is the industry's first BiMOS dual comparator. All three devices will be commercially available during the first quarter of 1978.
George Granieri, RCA, Somerville, NJ
- A New Family of Power Interface ICs.** Discussion includes the UDN2840B series of 1.5 amp Darlington drivers and their use in electronic discharge printers, bipolar dc motor drives, etc.; the UDS5790 and 5791 quad 120-V peripheral drivers; and the UDN2580A 8-channel, high-current sourcing driver for use with NMOS LSI.
Paul Emerald, Sprague, Worcester, MA
- New Components for Analog Sensing and Data Acquisition.** Three new ICs—a 10-bit A/D converter, a transducer, and a high-accuracy rms dc conversion IC are introduced.
Dave Kress, Analog Devices, Norwood, MA

MID-MORNING BREAK

- New Advances in Linear Power ICs.** A new switching regulator, the $\mu A7840$, which operates in several modes is described. Switching regulators, although somewhat more complex than fixed or adjustable output series pass regulators, offer designers greater flexibility and higher efficiency.
Ted Vaeches, Fairchild, Mt. View, CA
- Advanced Developments in ICs for AM/FM Receivers.** The ULN2204 and the 2242 represent the latest state-of-the-art in ICs for the general communications market. The 2204 requires only an FM tuner and a power source with a minimum number of external components to form a complete receiver design.
Oliver Richards, Sprague, Worcester, MA

LUNCH

- The RC4200, a New Analog Multiplier.** This device is the industry's first monolithic analog multiplier to offer compensation for nonlinearity, the primary source of error and distortion. It is also the first IC multiplier to have three on-board op amps designed specifically for use in multiplier logging circuits.
Tom Cate, Raytheon, Mt. View, CA
- A New Companding Converter Chip Set.** The DF331/32 Codec chip set offers the telecommunications industry an alternative to classical channel bank design. These ICs are the first commercially available analog-to-digital, digital-to-analog converters to use the capacitive array conversion technique.
Tom Mroz, Siliconix, Santa Clara, CA

MID-AFTERNOON BREAK

- Local and Remote Data Logging Systems Using the 7103 and 7104.** Both strobed and handshaking interfaces with UARTs and microprocessors are covered. The 7103 is a 4-1/2-digit chip pair.
Bill O'Neil, Intersil, Cupertino, CA
- Summary and Closing Remarks.** Jerry Eimbinder, *Electronic Engineering Times*, Manhasset, NY

NEXT GENERATION OF ELECTRONICS

Airport Hilton
San Francisco, CA
Jan. 30-Feb. 3, 1978

A new concept in product application conferences—talks aimed at updating the engineer in both new products and new instrumentation. The latest advances in integrated circuits, microprocessors and test equipment for the engineer's use are described. The emphasis is on improving the engineer's knowledge of designing techniques as well as his familiarity with recently introduced integrated circuits.

HOTEL ACCOMMODATIONS

Fill in below if overnight rooms are needed

ICA Conference
Electronic Engineering Times
P.O. Box 1021, Melville, NY 11746

I am attending "Next Generation of Electronics." Please reserve the following accommodations at the San Francisco Airport Hilton:

- Single at \$32, \$34, \$36, \$38, \$40 (circle preferred rate)
 Double at \$40, \$42, \$44, \$46, \$48 (circle preferred rate)
 Guaranteed payment, hold room for the late arrival

Arrival Date _____ Departure Date _____

Name _____ Title _____

Address _____

City _____ State _____ Zip _____

Signature _____

Accommodation requests must be received by January 15, 1978. The San Francisco Airport Hilton is located at the airport. Mailing address is P.O. Box 8355, San Francisco, CA 94128 (415) 589-0770.

CONFERENCE REGISTRATION/ INFORMATION (516) 829-5880

ICA Conference, Div. of
ELECTRONIC ENGINEERING TIMES
P.O. Box 1021, Melville, NY 11746

- Please register me for "Next Generation of Electronics," San Francisco Airport Hilton, January 30-February 3, 1978. Fee: \$200
- I plan to attend the Microprocessor Monday through Wednesday sessions only, San Francisco, CA, January 30-February 1, 1978. Fee: \$150
- I plan to attend the Linear/Digital Thursday and Friday sessions only, San Francisco, CA, February 2-3, 1978. Fee: \$100

Name _____ Title _____

Company _____

Address _____

City _____ State _____ Zip _____

Signature _____

Check enclosed Make checks payable to ICA Conference

Purchase order enclosed (pay at door)

Rigid and Floppy Disk Drives



The 5.25" floppy disk in this Micropolis 1054 Mod II System stores 1.26 megabytes.

Lower prices and increased disk capacity made news

Lower prices per bit for rigid disk drives and improved capacities for floppy disk drives headlined the events for 1977. Undoubtedly, the same trends will continue in 1978, but our informants say that some interesting technological changes in rigid disk drives will also take place in 1978. Although none of our informants would predict that improved density in floppy disk drives would also push prices per bit down, you know that competition from Japanese as well as this country's manufacturers probably will force floppy prices lower. The only question seems to be how much and how fast.

Rigid Disk Drives

The cost per bit for moving-head and fixed-head disk drives dropped by about one-third in 1977 and will continue to fall by about 20% in 1978, according to Mark Mougel, marketing manager for Dataflux Corporation. Since no important technological changes occurred in 1977, he attributed this drop in price to two causes. The first is a willingness by disk drive manufacturers to accept lower profit margins due to competitive pressures. The second is the outgrowth of Winchester technology for producing better heads and disks for greater packing density. The drive manufacturer may not use the Winchester technology in its entirety. For example, Dataflux, which manufactures fixed-head drives, uses Winchester media, but not heads, to improve density

and performance. Some manufacturers have reduced prices via mass production, continued Mougel, because they have been selling more and more units.

Cartridge-type and fixed-platter rigid disk drives of lower range capacity began appearing in 1977 with double-density storage, points out Jerome D. Kennedy, vice president of marketing, Advanced Electronics Design. Doubling the bit density gives the buyer more bits per dollar invested. Dual spindles for fixed and removable disks also became popular in 1977 — since each spindle and head shares the electronics, the dual arrangement lowers system cost per spindle.

Some companies now make controllers capable of handling a sizable number of spindles. For example, Kennedy points out that his company now markets a disk controller capable of handling up to 8 spindles. Consequently, the electronics cost per spindle is about one-eighth of the

price of a single-spindle unit. This type of multispindle controller allows designers to implement systems with a number of CPUs connected to one mass storage system.

Fixed disk drives with moving flying heads entered the marketplace in 1977, Kennedy continued, and will become more popular in 1978 for two reasons: They offer higher medium and head life and operating reliability, because they use an environment protected by air filters; and the price will follow the usual new product pattern of dropping from 25 to 50% in a relatively short period of time.

Mass storage capacity per rigid disk drive module also grew rapidly in 1977, Kennedy went on. Capacity grew from 80 Mbytes to 200 and 300 Mbytes per spindle of 11 platters.

In 1978 or 1979, plated Winchester disk drives will provide much greater track and bit densities than oxide-coated disks. Although track density as well as bit density will double to provide a fourfold increase in stored data, both increases will not occur simultaneously. For example, Dataflux has already developed a drive with double track density, but does not expect to release it until mid-1978.

Anticipating changes in technology, Dataflux plans to develop a hybrid disk system using a charge-coupled device in conjunction with a fixed-head disk. By providing improved performance at a relatively low cost per bit, this system is expected to be an interim version of a



Jerry Kennedy, Advanced Electronic Design

KERONIX

- ◎ MINI COMPUTERS
- ◎ PERIPHERAL CONTROLLERS
- ◎ ADD-IN MEMORIES
- ◎ ADD-ON MEMORIES
- ◎ TERMINALS
- ◎ SYSTEMS

mass store, filling a need that will exist until the price of CCD or bubble memories drops low enough to make them economically competitive, a condition that could occur in 1979, according to Mougel.

By planning to develop a semi-intelligent microprocessor-based controller for its mass storage systems, Dataflux expects that the controller will perform many of the functions now supplied by the host CPU. For example, the controller could supply the file management function for converting mass memory to a virtual device. It could also provide inter-device transfers without tying up the computer.

Some companies already use, or expect to use, microprocessors to provide feedback information to cut access time in moving-head disk systems. The feedback provides such information as the position of the head in relation to the tracks and its angular location. Lower access times for moving-head disk systems will affect fixed head disk sales, concluded Mougel.

"I don't believe bubble memories are going to make it as a mass storage device when competing with disk drives," said Mougel. "For one, they are too slow and expensive. A staff member at one of the semiconductor houses pointed out to me that since bubble memories do not use semiconductor technology, most semiconductor manufacturers — except possibly for TI, which already markets a bubble memory — will not produce these devices. Consequently, the usual sharp drop in price that almost always takes place after the introduction of a specific device may not occur. Without this price reduction, bubble memories will never make it."

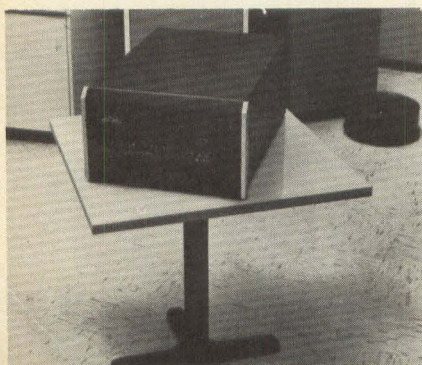

Fig 1 AED8000 controller from Advanced Electronics Design controls as many as eight rigid disk spindles.

Floppy Disk Drives

Three significant events connected with floppy disk drives occurred during 1977, according to Henry T. Meyer, the director of small disk operations for California Computer Products: The first involves the introduction of two-sided recording; the second, the introduction of minifloppy drives; and the third, the IBM announcement that it expects to begin marketing double-density floppy disk drives. Since IBM product distribution has not yet taken place, the industry is guessing what format IBM will use in its diskette systems.



Mark Mougel, Dataflux

IBM's introduction of the double-sided floppy drive forced most other makers to develop double-sided systems, stated Jim H. Bartley, sales manager of OEM digital products, MFE Corp. This development plus lower prices created by higher manufacturing volume has increased the number of applications for these drives, particularly in the hobby computer market.

Although IBM announced in 1977 that it was going to introduce a double density drive, it did not tip its hand on the format it was going to use. Consequently, many customers are holding off buying double-density machines until they know which format it will use in the units it expects to ship in January 1978. Will the format be MFM, M²FM or GCR? "We think that we have solved that problem; our double-density floppy disk drives can accommodate all standard formats, because the electronics can handle the bandpass characteristics, encoding schemes and phase shifting problems of the different formats," declared Bartley.

Almost all manufacturers except IBM already sell double-density drives, Hank Meyer pointed out. However, present volume of these drives is low,

because customers would rather buy equipment that conforms to an IBM format (which is expected to become a de facto standard) rather than originate their own.

Floppy disk drive manufacturers have increased the use of LSI devices in their products for a number of reasons, declared Meyer. The changeover to microprocessors and other chips displaces discrete logic and reduces the size of printed wiring boards — hence reducing the size of the drive. Microprocessor capabilities invite designers to add RAMs and ROMs, thus configuring controllers to preprocess data at the drive rather than at the CPU. These controllers relieve CPUs of some utility, editing and merging functions. Although not more than 10% of the OEMs incorporate a microprocessor in their drives at the present time, this configuration will grow more popular in 1978.

Some manufacturers originally bought floppy disk drives, developed or purchased controllers from others and marketed these assemblies as subsystems or peripherals, Meyer went on. Now these companies are buying CPUs and configuring a total system, including software. A limited number of minicomputer suppliers and nearly all manufacturers of microprocessors have entered the business of putting together and marketing computer systems, which usually include controllers as well as floppy disk drives, CRT terminals and printers. Similarly, floppy disk makers are adding value to the equipment they sell by incorporating controllers and adaptors for various makes of CPUs. If the drive manufacturers were to take the next logical step, they would add the CPU to the floppy to configure a more



Fig 2 Dataflux DC-111 fixed-head disk drive controller for the PDP-11 handles up to 8-daisy-chained drives.

A Total Systems Capability

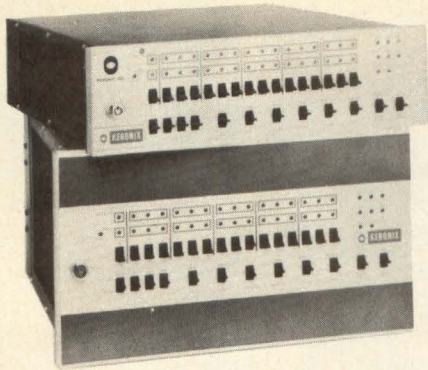

KERONIX IDS - 16 MINICOMPUTERS A 16-Bit Full Parallel Synchronous, High-Speed General Purpose, Mini Computer

- INSTRUCTION SET, I/O INTERFACE & MEMORY INTERFACE COMPLETELY COMPATIBLE WITH NOVA™ SERIES OF MINI COMPUTERS
- ADDRESS UP TO 65K (Without the Use of Costly Memory Management)
- HINGED FRONT PANEL WITH FRONT LOADING CIRCUIT BOARDS
- POWER FAIL & RESTART—STANDARD
- FOUR 16 BIT ACCUMULATORS
- 800, 1000, or 1200 NANOSECOND MACHINE CYCLE TIME USING ONE BOARD CPU'S
- 4, 8, 10, 13 OR 17 SLOT CAPACITY
- INTEGRATED MSI & LSI CIRCUITS THROUGHOUT. TRI-STATE ELEMENTS ARE USED FOR ALL I/O & MEMORY LINES
- FORCED-AIR COOLING (UP TO 4 COOLING FANS)
- POWER SUPPLY IS MODULAR FOR EASY SERVICING & PROVIDES UP TO 50% MORE POWER THAN COMPARABLE UNITS
- MANY OPTIONAL FEATURES AVAILABLE
- EXTENSIVE SOFTWARE AVAILABLE
- LOANERS AVAILABLE ON OUR ONE-YEAR WARRANTY

**LOOK FOR OUR COMPLETELY INTELLIGENT
KERONIX MODEL KX-8000, COMING SOON!**

For more extensive information on our IDS-16, please contact us directly.

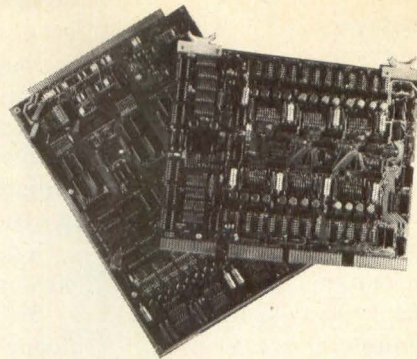

KERONIX ADD-IN MEMORY PRODUCTS 4K, 8K, And 16K Words PLUG COMPATIBLE CORE MEMORY SYSTEMS

- P-3 SERIES . . . FULLY COMPATIBLE WITH DATA GENERAL NOVA™ 1200 & DCC™-116
- P-4 SERIES . . . FULLY COMPATIBLE WITH DATA GENERAL NOVA™ 800, 820 and 840
- P-5 SERIES . . . FULLY COMPATIBLE WITH DATA GENERAL NOVA™ 2 SYSTEMS
- I SERIES . . . FULLY COMPATIBLE WITH INTERDATA™ 70, 74, 7/16, 7/32 SYSTEMS
- D SERIES . . . FULLY COMPATIBLE WITH PDP-11™_s
- J-1 SERIES . . . FULLY COMPATIBLE WITH MICRODATA™ 800 AND CIP™ 2000
- J-2 SERIES . . . FULLY COMPATIBLE WITH MICRODATA™ 1600
- G SERIES . . . FULLY COMPATIBLE WITH PRIME™ 100, 200, & 300
- E SERIES . . . FULLY COMPATIBLE WITH PDP™ 8E, F, M, AND A

IN ADDITION TO THE ABOVE, KERONIX MANUFACTURES ADD-ON MEMORIES, OEM MEMORIES, AND CUSTOM MEMORIES

**ONE-YEAR WARRANTY
WITH ALL KERONIX MEMORIES**

TM Trademarks registered by Data General Corp., Digital Computer Controls, Inc., Interdata, Digital Equipment Corp., Microdata, Cincinnati Milacron, and Prime. Endorsement of Keronix products not to be implied.

KERONIX INC.

WE HAVE REPRESENTATIVES AND DISTRIBUTORS WORLDWIDE

George Foldvary

250 E. Emerson St. • Orange, California 92662 • (714) 974-0800

TWX 910-593-1344

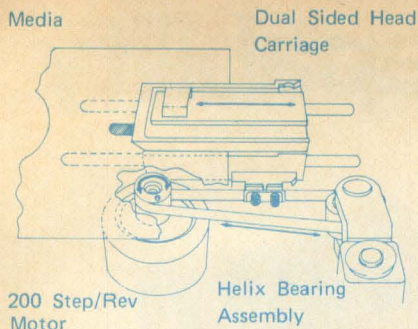

Fig 3 The Heli-Band™ mechanism in MFE's 700 Series floppy drive links the stepper motor to the head carriage.

complete system for software houses, which would, in turn, marry the system to a specific user task. This trend of passing through added value will continue to grow. It will provide more sources for products from which users may choose the system best suited for their needs.

Competition will become intensive in 1978, predicted MFE's Bartley. To indicate what could happen he mentioned an industry rumor forecasting that a major manufacturer will stop producing drives because of price erosion. This loss in profitability will hit those companies unable to sell drives in large volumes.

In 1978 increased track density will become a reality, declared Hank Meyer. It may not necessarily double; it may first go to 1.5 to 1.75 times its 1977 level. What will happen depends on what IBM will do and the quality of the medium that disk manufacturers can provide to reduce the limiting effects of the thermal coefficient of expansion, dirt and water vapor.

Many floppy disk drive makers are guessing that IBM will next increase disk track density, from 48 to 96 tpi, or even up to 144 tpi, according to Bartley. Limitations of the medium seems to be the major factor in holding back increased density.

A movement towards a miniature rigid disk drive is beginning to appear, Meyer said. Implemented basically as floppies, minidisk drives can rotate at higher speeds and can provide a high data transfer rate from the disk to the host CPU memory. The rigid disk acts as a buffer or swapping store. A few companies are presently developing these drives for use in this type of application, and Meyer expects some vendors to begin marketing rigid minidisk drives in 1978.

Confirming Meyer's disclosure of

a trend towards miniature rigid plated disk drives, Pravin Patel, vice president of Poly-Disc Systems, which manufactures disks only, described the systems under development. Refusing to divulge names, Patel said that a number of manufacturers he knows are developing 2- and 4-disk machines with 8" dia. by 0.075" thick disks in place of the same size floppies. These high-density disk drives can store 8000 bits per inch now and up to 10,000 bpi at a later date. At 8000 bpi density, each side stores up to 20 Mbytes, or 40 Mbytes per platter.

Bubble memories will coexist with floppy drives in the future, Meyer forecasted. Since the drives use replaceable media that can implement a library of information and bubble memories cannot, bubble memories will only displace floppies in a limited number of applications.

Since the price of bubble memories is still quite high and the makers have not solved all of their production problems, and since the number of companies with the expertise to use them is small, bubble memories will not compete too strongly in 1978, Bartley predicted. Eventually — by 1979 or 1980 — bubble memories will capture a meaningful segment of the floppy market. And only after manufacturers learn to produce low-cost pluggable bubble memories will these devices begin to replace floppy disk drives on a large scale.

5.25-inch Floppies

The rapid development of the 5.25" floppy disk drive was one of the major events in 1977, according to Stuart P. Mabon, president of Micropolis. Shugart originated the concept of the 5.25" floppy disk machine, which

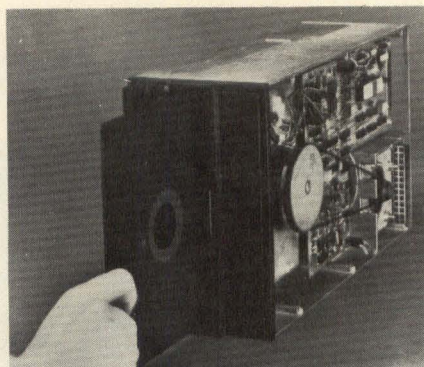
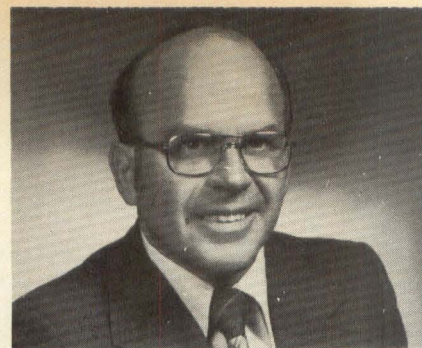

Fig 4 CalComp 143M two-sided, double-density floppy disk drive 12.8 megabits of unformatted data.



Henry T. Meyer, California Computer Products

it designed for very low-cost, low-capacity applications. In those applications, drives patterned after the Shugart model make sense when used for software distribution to customers and program loading.

Micropolos took a different view of potential applications of the 5.25" floppy, declared Mabon. "We elected to go with a more expensive, higher capacity, more industrial-type of a product. We use the same basic diskette to provide much more capacity than the Shugart version. Therefore, we made it a more useful tool for microcomputers that require data files of large capacity. So we developed a large-capacity drive by replacing the usual 48 tracks per inch (tpi) with 100 tpi. The drive remains toleranceable within the temperature and humidity specifications of the oxide medium on a worst case basis. We also made the decision to double the density of the number of bits per track over the Shugart model."

In 1978, makers of 5.25" floppy disk drives will bring out two-sided versions, predicted Mabon. He also stated that his company will increase bit density by 50% in 1978; a 5.25" disk will thus be able to store 0.5 megabyte per side, or a total of one megabyte of data.

Although industry gossip indicates that one or more companies will market an 8" floppy disk machine with a density of 100 tpi in 1978, Mabon said, "I think that it's unlikely that we will see one next year, because the physical size of the medium and the machine makes it difficult to tolerance the floppy in a worst case mode."

Rumors are rife that smaller than minifloppy disks will soon appear, reported Meyer. He expects that the hobby computer market will first use these drives.

DD

A Total Systems Capability

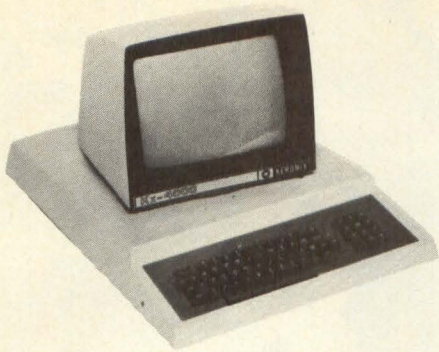

VIDEO DISPLAY TERMINAL KERONIX MODEL K-4000

- FULL KEYBOARD (Optional 10-Key Pad Available)
- HIGH RESOLUTION, NON-REFLECTING SCREEN; 9" X 7" (12" Diagonal); SWIVEL BASE; EASY VIEWING UP TO 10 FEET; BRIGHTNESS CONTROL; REVERSE VIDEO (Black Characters on White Background, Selectable)
- 80 CHARACTERS PER LINE, 25 LINES, 2000 CHARACTER DISPLAY; STORE UP TO 51 LINES & 4080 CHARACTERS; BLINKING CHARACTERS AT 3Hz RATE
- CURSOR CONTROL (Non-Destructive)
- INTERCHANGEABLE WITH TELETYPE USES STANDARD ASCII CODE
- INTERNAL POWER SUPPLY; RUNS OFF A SINGLE 15" X 15" P.C. BOARD
- VARIABLE BAUD RATE (75 to 9600 Bits Per Second); 10 OR 11 BIT CODE
- ODD OR EVEN OR MARK PARITY
- EITHER EIA OR 20 MA CURRENT LOOP

LOOK FOR OUR COMPLETELY INTELLIGENT

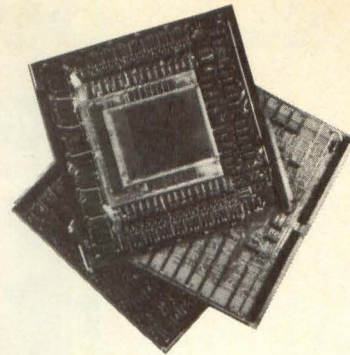

I/O AND PERIPHERAL CONTROLLERS FOR KERONIX IDS 16 COMPUTERS AND NOVA™ SERIES OF COMPUTERS

- 1007 I/O BOARDS
- 1008 REAL TIME CLOCK
- 1010 TTY INTERFACE
- 1011 PAPER TAPE READER CONTROL
- 1012 PAPER TAPE PUNCH CONTROL
- 1016 CARD READER CONTROLLER
- 1023 EIA INTERFACE
- 1034 LINE PRINTER CONTROLLER
- 1038 MULTI-PROCESSOR COMMUNICATIONS ADAPTER
- 1046 DISK CONTROLLER
- 1146 FLEXIBLE DISK CONTROLLER
- 1054 EXTENDER BOARDS
- 1060-4 FOUR LINE ASYNCHRONOUS MULTIPLEXER FOR FOUR EIA STANDARD LEVEL LINES (MUX)
- 1060-8 MUX FOR EIGHT EIA STANDARD LEVEL LINES

IN ADDITION TO THE ABOVE, KERONIX MANUFACTURES ADD-ON MEMORIES, OEM MEMORIES, AND CUSTOM MEMORIES

**ONE YEAR WARRANTY ON ALL KERONIX I/O
PERIPHERAL CONTROLLERS**

TM Trademarks registered by Data General Corporation
Endorsement of Keronix products by Data General not to
be implied.

KERONIX INC.

WE HAVE REPRESENTATIVES AND DISTRIBUTORS WORLDWIDE

George Foldvary

250 E. Emerson St. • Orange, California 92662 • (714) 974-0800

TWX 910-593-1344

Reach the rich European market... now



Many perceptive marketers get a third of their sales from Europe. Where U.S. technology is welcome.

There's no better time than now to parlay potential into profits. If you know where to go. And how to get your message across the Atlantic.

DIGITAL DESIGN gets it there. Talk to our regular U.S. readers at our normal low cost-per-thousand rates and you talk to our European readers at the same time.

Not just any Tom, Dick or Guisseppi either. Qualified prospects, all. Customers whose interests, installations and buying intentions are catalogued on our own com-

prehensive qualifications questionnaire. Rifle stuff, not shotgun.

We're in major international trade shows, too. With extra distribution. We monitor markets, sense trends, glean prospects, sift feedback. So that when you advertise in **DIGITAL DESIGN**, low cost-per-thousand isn't the only name of the game. It's sales.

Digital Design
The Magazine of Digital Systems
the market makers

Benwill Publishing Corp., 1050 Commonwealth Ave., Boston, MA 02215 ★ West (213) 454-0624 ★ East (617) 232-5470

ADVERTISER'S INDEX

- | | | | |
|----------|------------------------------|----------|------------------------------|
| 18 | ADDMASTER | 18 | KINETIC SYSTEMS |
| 30,31,33 | ADTECH POWER | 69,71,73 | KERONIX |
| 19 | ADVANCED ELECTRONICS DESIGN | 65 | KURZ-KASCH |
| 63 | AMPEX/REDWOOD CITY | 46 | M.D.B. SYSTEMS |
| 64 | CAMBRIDGE THERMIONIC | 65 | MINICOMPUTER TECHNOLOGY |
| 54 | CHARLES RIVER DATA SYSTEMS | 37,53 | MONOLITHIC SYSTEMS |
| 16 | COLORADO VIDEO | 4 | MUPRO |
| 27 | CORTRON | 52 | OK MACHINE & TOOL |
| 17 | DATA ELECTRONICS | 34,35 | PERTEC COMPUTER/MICROSYSTEMS |
| 14,15 | DATAFLUX | 11 | PRINTRONIX |
| 66,67 | ELECTRONIC ENGINEERING TIMES | 61 | SC ELECTRONICS |
| 47 | EPSON AMERICA | 57 | SHELDON-SODECO |
| 20 | EXXON | 13 | SOROC |
| 12 | FENNER AMERICA | 41 | SPACE BYTE |
| 6 | GENISCO TECHNOLOGY | 7 | SPERRY UNIVAC |
| C-4 | GRINNELL SYSTEMS | C-3 | SYSTEM INDUSTRIES |
| 2 | HOUSTON INSTRUMENTS | 49 | TANDBERG DATA |
| 8,9 | ICOM | 1 | TEXAS INSTRUMENTS/HOUSTON |
| C-2 | IMSAI | 25 | TLF |
| 39 | INTEGRATED SOFTWARE SYSTEMS | 3 | WESTERN PERIPHERALS |
| 45 | ISS/SPERRY | | |

SALES OFFICES

PUBLISHER Yuri Spiro **MARKETING PROGRAMS DIRECTOR** George Palken **NEW ENGLAND** George Palken 1050 Commonwealth Ave., Boston, MA 02215 (617) 232-5470 **NEW YORK, WASHINGTON, DC, PHILADELPHIA** Arthur Daks, 299 Madison Ave., New York, NY 10017 (212) 661-0360 **MIDWEST, SOUTH** Ralph Petersen, 1 Wheaton Center No. 1706, Wheaton, IL 60187 (312) 653-2480 **LOS ANGELES, PHOENIX, DALLAS, SAN FRANCISCO** Alan Cazier, 823 Enchanted Way, Pacific Palisades, CA 90272 (213) 454-0624 **WEST GERMANY** Maurice A. Coates Int'l. Media Reps. D-675 Kaiserlautern, Box 1610 **JAPAN** Hiro H. Irie International Business Corp., 11-8 Narita-Higashi 1-Chome, Suginami-KU, Tokyo 166 Phone (03) 311-1746

ALPHA BITS

Transducers Serve Control Applications

The use of computers in control engineering systems will continue to increase during the coming years. Many digitally controlled systems require input from transducers, and hence there is a need for transducers that produce a digital output. *Transducers in Digital Systems* by G.A. Woolvet describes

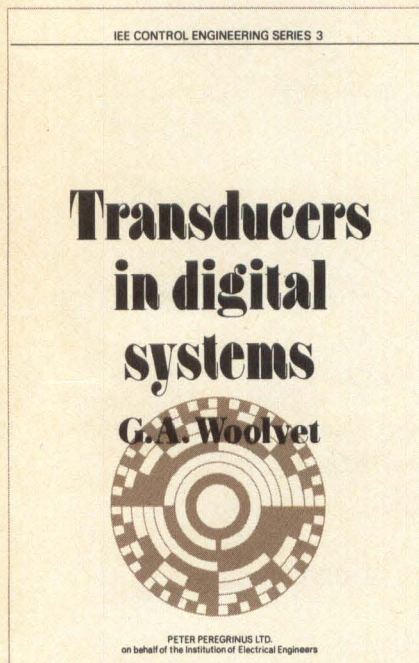

some of the developments that have gained popularity and some that are still in an infant stage. It explains how these devices operate and their role in digital systems, referring to transducers for measuring rotation, position, pressure, and temperature, and considers the advantages and disadvantages of each and their particular applications. Hardcover, \$19.95 from International Scholarly Book Services, P.O. Box 555, Forest Grove, OR 97116.

Selecting a Computer

Edward O. Joslin's *Computer Selection: An Augmented Edition* is a reference for management decision-making. An augmented version of the ori-

ginal edition, the book covers some significant aspects of selecting computers. Using a nontechnical approach to the management problems involved, Joslin shows how to establish procedures for selecting computer systems without resorting to complex techniques. He explains how to interact with vendors, evaluate proposals submitted by vendors and write specifications for the required computer system. New material in five additional chapters guides the reader in determining management's role, requirements costing, procurement plans, workload descriptions and small computer systems. This 216 page, hard cover book is available for \$20 from The Technology Press, Inc., Box 125, Fairfax Station, VA 22039.

Using the ICU

Designers of control systems often find themselves caught between using discrete logic or a microprocessor, when an in-between solution might prove more functional and cost-effective. Programmable logic controllers can provide the solution with one-bit programmable processing. Motorola's MC14500B Industrial Control Unit performs 16 instructions and serves such applications as relay ladder processing, moderate speed serial data manipulations and the unloading of overtaxed microprocessor-based systems. Showing you how to use this device in your control application, Motorola's Industrial Control Unit Handbook details programming of different structures including the IF-THEN structure, the IF-THEN-ELSE structure and the While structure. One application, the design of a traffic controller using the MC14500B, is discussed in depth, complete with state diagrams, flow charts, program listings and a schematic showing the required hardware. A useful final chapter demonstrates the reduction of Boolean equations to ICU code. The handbook costs \$3.00 and can be obtained from Motorola Semiconductor Products, 5005 East McDowell Road, Phoenix, AZ 85008.

Microprocessors: How to Use Them

Thanks to mass production, microprocessor circuits are now making possible advances in data processing power at low cost. To make the most of this technology, you have to leave behind many conventional design concepts and think in terms of the new system components. *Microprocessors and Small Digital Computer Systems for Engineers and Scientists* by Granino A. Korn, helps you do that by bringing you up to date on the latest equipment and applications, and giving you a grounding in the theory and practice of microprocessor technology. Material in the chapters includes: The Ingredients of Mini/Microcomputation; Processors and Instruction Sets; Programming with Assemblers and Macroassemblers; Interfacing Microprocessors

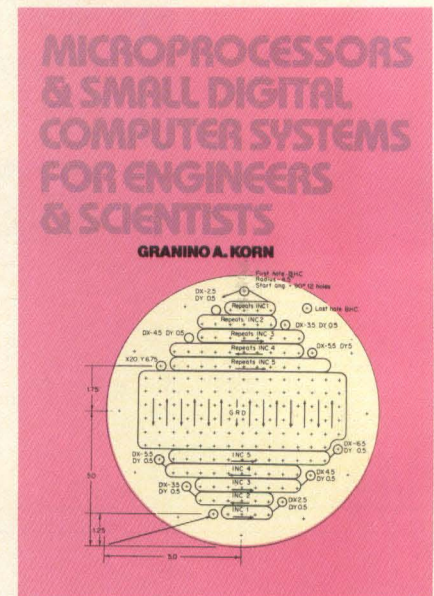

and Minicomputers with Real-World Devices; Computer Operations, Software, and Program Preparation; Microcomputer Systems and Design Decisions; and Micro/Minicomputer Families. Including two appendices and an index, 390 pages. \$24.50 hardcover from McGraw-Hill Book Company, 1221 Avenue of the Americas, New York, NY 10020.

When we installed our first minicomputer disk system, we talked a lot about **RELIABILITY.**



4000 systems later, our customers tell the story.

Reliability. We do more than just talk about it. We deliver it. That's one of the main reasons we're now the world's largest independent supplier of minicomputer disk storage systems.

We've delivered more than 4,000 systems since we installed our first one in 1971. That's strong evidence of hardware reliability and product acceptance.

There's a lot more to the story. Behind our reliable hardware is a reliable company that keeps delivery commitments, provides total software support and responds quickly to customer service requirements. Ask our customers.

We make good disk drives work better through *Extended Emulation*.™ This powerful approach adapts software to emulate the CPU manufacturer's operating systems—while still taking full advantage of the unmatched performance offered by our disk system. Whether you need disk storage for mini or micro, you need to know about the important benefits *Extended Emulation* can provide.

The diverse applications for our disk systems are regularly described in our quarterly newsletter, *The Bit*. If you'd like to be on our complimentary mailing list, use the coupon today. We'll send you the current issue. And if you need product data, or help with a specific application, contact the System Industries sales/service office nearest you.

System Industries
an equal opportunity employer

525 Oakmead Parkway
P.O. Box 9025
Sunnyvale, California 94086
(408) 732-1650, Telex: 346-459

Please add my name to your mailing list for *The Bit*.
Send product data on the follow disk systems:

2.5 MBytes 10 MBytes 300 MBytes

Name _____ Position _____

Company _____

Address _____

City _____ State _____ Zip _____

My need is urgent. Have an applications specialist phone me today: (_____) _____ ext. _____

Sales/Service Offices:

Boston: (617) 492-1791. **New York:** (201) 461-3242; (201) 694-3334; (516) 751-8686; (716) 385-3021.

Washington, D.C.: (202) 337-1160. **Cincinnati:** (513) 661-9156. **Los Angeles:** (714) 752-8904.

Houston: (713) 465-2700. **Atlanta:** (404) 491-0161. **Sunnyvale HQ:** (408) 732-1650.

Germany, Dusseldorf: 0211-400606. **Sweden, Stockholm:** 08-236-640.

United Kingdom, Woking: (4862) 70725.

GRINNELL DISPLAYS:

THE GEORGE E. FREEMAN LIBRARY
STATE TECHNICAL INSTITUTE AT MEMPHIS
5983 Macon Cove at Interstate 40
Memphis, Tennessee 38134

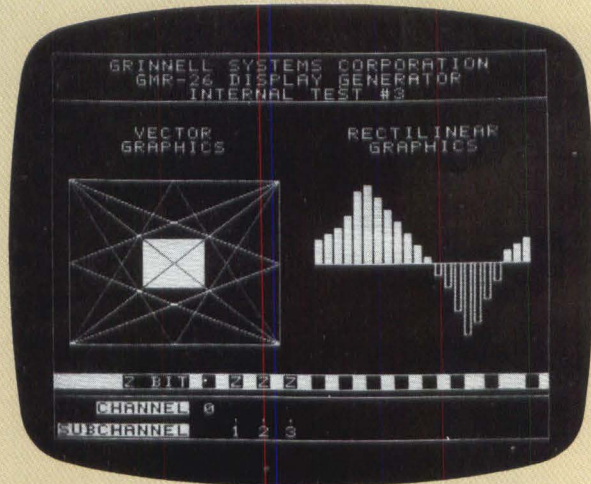
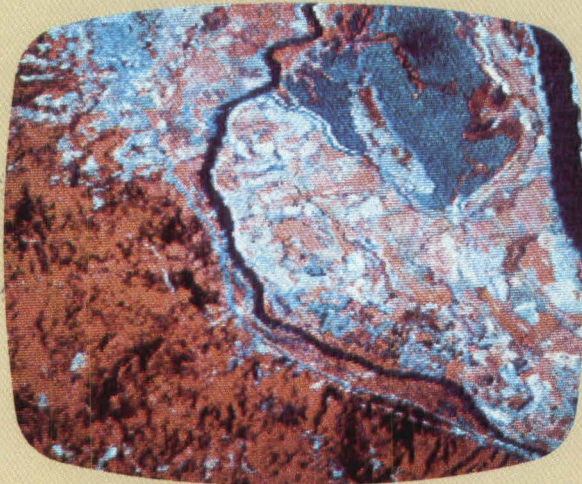
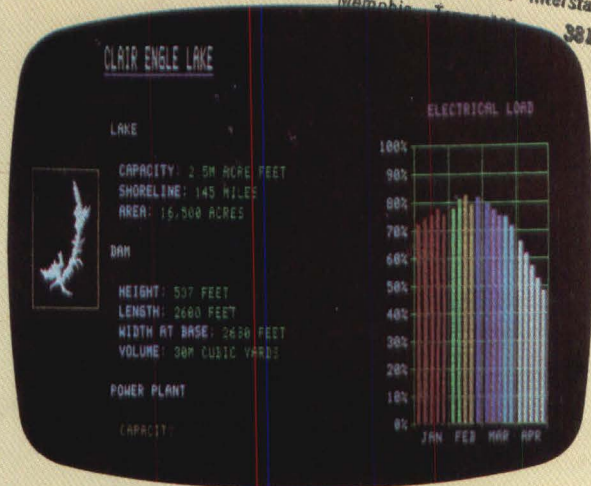
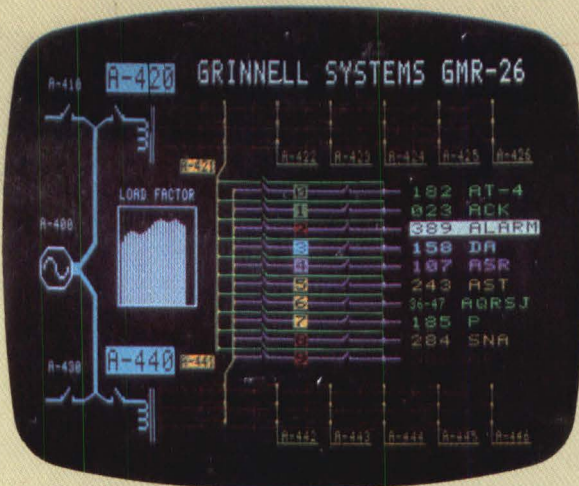

Complex color imaging . . . graphics . . . grey scale . . . basic black and white: our 100% solid state graphic television display systems can be matched to your computer display requirement, easily and economically.

And, they're intelligent. Powerful instruction sets minimize software overhead, simplify programming and eliminate the need for complex macro-instructions and

high order programming languages.

Further, every Grinnell system includes a standard computer interface, full alphanumeric and graphics, 4K MOS random access refresh memories and your choice of standard resolutions: 256 x 256, 256 x 512 or 512 x 512. Plug-compatible interfaces for most minicomputers are available, along with a large number of

operating options. All systems drive standard TV monitors.

So, before you make any decision about computer display systems, talk to the Grinnell experts. Our engineers have been in the display picture longer than most, and their experience shows. Complete operating systems start at \$5,700, and quantity discounts are available. For detailed specs and/or a quotation, call or write.

GRINNELL SYSTEMS

2986 Scott Boulevard, Santa Clara, California 95050 (408) 988-2100