

DATAAMATION

SEPTEMBER 15, 1988
A CAHNERS PUBLICATION

THE GEORGE B. FREEMAN LIBRARY
STATE TECHNICAL INSTITUTE AT MEMPHIS
8985 Macon Cove at Interstate 40
Memphis, Tennessee

The Politics of Network Management

- Also in this Issue:**
- **How To Motivate IS Personnel**
 - **Departmental Computing: Managing Change**
 - **DB2 Performance Gets Big Boost**
 - **Reusable Software: Passage to Productivity?**

The SAS® System

The Data Analysis Tool You Won't Outgrow.

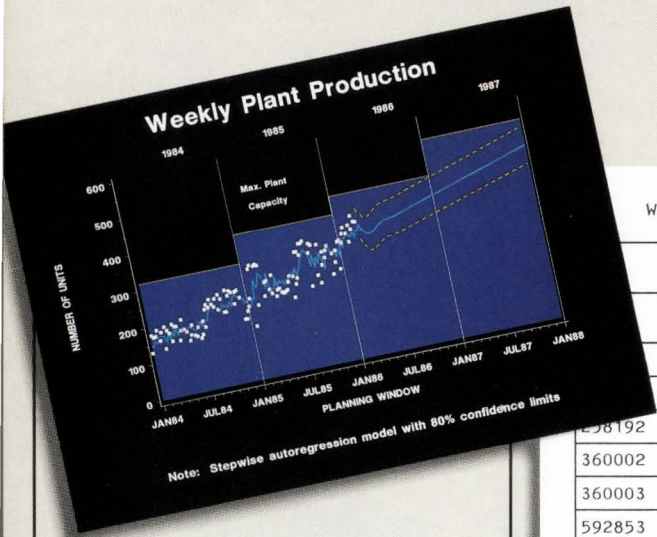

If your job demands a powerful data analysis tool, the SAS® System is your solution. The SAS System gives you ready-to-use procedures for performing every kind of analysis—from simple descriptive statistics to advanced regression, analysis of variance, discriminant analysis, clustering, scoring, and more.

The SAS System reads data in any structure from any kind of file. You can create new variables, modify old ones, combine files, detect errors, and accumulate totals. Once your analysis is complete, you can report your results in lists, tables, charts, or plots.

Warehouse Inventory Report - 16JAN87

	Quantity on Hand	Quantity on Order	Projected Reorder Date
	123980	10000	THU, FEB 12, 87
	89450	5000	FRI, FEB 20, 87
298192	20110	1000	MON, MAR 30, 87
360002	8585	0	TUE, FEB 10, 87
360003	15985	500	TUE, FEB 10, 87
592853	469120	20000	WED, FEB 18, 87

And as your needs grow, the SAS System grows with you. All the tools you need for color graphics, forecasting, modeling, "what if" analysis, project management, optimization, and quality control are available in the SAS System. You choose the products you need, and enjoy the same easy-to-use language and syntax in each. Plus, you can use the same software on your personal computer.

For details, send us your name and address. Or call a Software Sales Representative today.

The SAS System. It's the most widely installed tool for data analysis among VMS users*... And more.



SAS Institute Inc.
Box 8000 □ SAS Circle
Cary, NC 27511-8000
(919) 467-8000
Fax (919) 469-3737

* Computer Intelligence, January 1986.

The SAS System runs on these minicomputers: Digital Equipment Corp. VAX™ 8xxx and 11/7xx series under VMS™ and MicroVAX II™ under MicroVMS™; Prime Computer, Inc. Prime 50 series under PRIMOS®; and Data General Corp. ECLIPSE® MV series under AOS/VS. The SAS System also runs on IBM 370/30xx/43xx and compatible machines under OS, CMS, DOS/VSE, SSX, and ICCF; IBM XT/370 and AT/370 under VM/PC; and IBM PC XT and PC AT under PC DOS. Not all products are available for all operating systems.

SAS is the registered trademark of SAS Institute Inc., Cary, NC, USA. Copyright © 1986 by SAS Institute Inc. Printed in the USA.

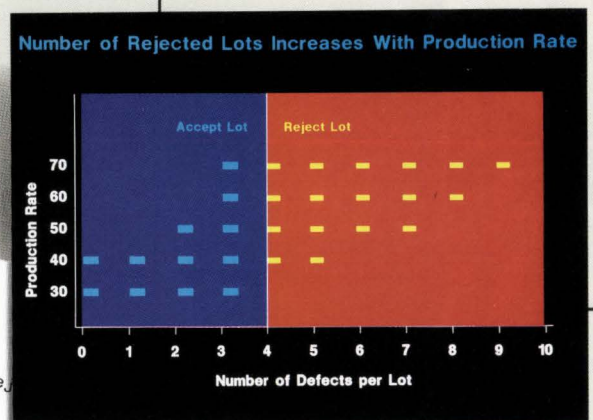

Production Rate

Production Rate	Rate	Lots Tested	Rejected Lot Statistics	Percent
			Lowest Highest Mean	
30	4	1	4	2.5
40	6	1	6	0
50	6	3	8	33
60	6	4	9	66
70	7	4	10	83
			7.0	85

For once, a micro-to-mainframe link that will cure your fear of mice.

It's called MacMainFrame™.

A totally transparent Macintosh®-to-IBM® mainframe connection that gives each one of your Macintosh

users access to all the corporate data they need to excel in their job. While giving you the flexibility you need to excel in yours.

For one thing, MacMainFrame is as easy to learn and as easy to use as the Macintosh itself. So there's no training for you to worry about.

With extensive security features, MacMainFrame lets you decide precisely who can and who can't get into your data. Which information is accessible and which isn't. So you don't have to worry about your mainframe being – if you'll pardon the expression – overrun with mice.

Plus, MacMainFrame supports every Macintosh from the 512Ke to the Macintosh II. It's affordable.

It works with IBM IND\$FILE. It's even available with an optional Application Programming Interface.

And it's all backed up by the Avatar® service and support network.

One which our competition, with all due modesty, would be hard pressed to duplicate.

If you'd like the name of the authorized MacMainFrame dealer nearest you, call 1-800-289-2526, extension 28. Or write Avatar Corporation, 99 South Street, Hopkinton, MA 01748. Admittedly, you could give your Macintosh users something less than MacMainFrame. But wouldn't that be just a little bit scary?

Avatar

DATA MAT

NEWS

11 **Look Ahead**

Bell Labs works on a new os for multiprocessors.

19 **Large-Scale Systems**

DB2, running on IBM's new 3090S models with MVS/ESA, gets a 56% performance pickup, reveals Jeff Moad.

21 **Personal Computers**

Robert Francis explores the mixed feelings vendors have about the new clout of informed users.

26 **Networking**

The systems behind the Seoul Olympics are a mix of IBM, AT&T, and Olivetti machines, reports Oles Gadacz. Homegrown software is boosting Korean IS. With:

27 *How the System Is Configured*

28 **Government**

Vendors who think they've unfairly lost bidding wars to fulfill government contracts aren't taking it lying down, reports Willie Schatz.

37 **Behind the News The New Maturity of Computer Science**

BY PARKER HODGES
Computer science departments in colleges and universities are feeling a surge of confidence in what they teach, who they teach, and how they teach.

40 **How College Students Choose IS Careers**

BY ROBERT ZAWACKI
A new study of more than 500 business students reveals that many chose careers in IS for the "wrong" reasons. The result is a potential for high turnover and low job satisfaction. With:

44 *The Study: Methodology and Definitions*

FEATURES



50

50 **The Politics of Network Management**

BY SUSAN KERR

Network management is facilitating a quiet reformation of corporate IS organizations, but who should have operational authority? With:

52 *The Elusive Definition of Network Management*

54 *Technology's Role in Network Management*

59 **Motivating IS Personnel**

BY J. DANIEL COUGER

As IS matures, the usual incentives are losing force. A recent survey holds good news: the top motivating factor is the work itself.

67 **The DATAMATION Hall of Fame**

BY LINDA RUNYAN

In tribute to the success of Unix, DATAMATION has selected Unix's authors, Ken Thompson and Dennis Ritchie, as its 1988 Hall of Fame inductees.

68 **Managing Technological Change: The Process Is Key**

BY DON MANKIN, TORA BIKSON, BARBARA GUTEK, AND CATHLEEN STASZ

The second part of DATAMATION's Departmental Computing series looks at three studies, which show that a management policy of minimizing change can be disastrous in implementing new technologies. With:

72 *The Study Process*

97 **Reusable Software: Passage to Productivity?**

BY EDWARD J. JOYCE

Meticulously planned software reuse could help break the programming bottleneck and increase programmers' productivity.

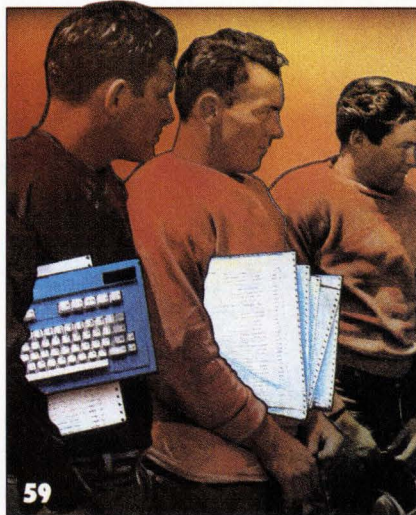

59



68

ION

NEW PRODUCTS

- 105 **Hardware**
Wang introduces four new minis with VS IN/ix.
- 109 **Software**
HP offers a CD-ROM system.

DEPARTMENTS

- 4 **Letters**
A reader says there's more to the VM story.
- 114 **Calendar**
CD-ROMs in Chicago, and Info '88 in New York.
- 116 **People**
William B. Patton took MAI/Basic 4 to solid success.
- 117 **Career Opportunities**
- 124 **Advertisers' Index**

Cover Photograph by Bob Lorenz

Coming in the next issue:

The DATAMATION Salary Survey: What Are You Worth in '88?

The 'Blues' Take the IS Cure

The Challenges of Information Technology: Part I of a McKinsey and Co. report.

CALLING ALL USER GROUPS!

Please send information about your user group to be included in DATAMATION's User Group Directory. Please include address, phone number, number of members, names of officers, date of next meeting, statement of purpose, and a list of services provided. The address is:
249 W. 17th St.
New York, NY 10011
Attn.: David R. Brousell

SEPTEMBER 15, 1988
VOLUME 34
NUMBER 18
THIS ISSUE, 184,186
COPIES



1988 JESSE H. NEAL AWARD



1987 JESSE H. NEAL AWARD

Editorial

The Constantly Moving Crisis

Computers have been blamed for a lot of things in their time. From structural unemployment to the deskilling of workers to tragic aviation disasters, it may seem that few contemporary unpleasantnesses have *not* been laid at the feet of the computer. Now, a new accusation has joined the traditional taunts: computer science is being asked to shoulder part of the blame for a coming decline in the nation's production of medical doctors.

Here's how the argument works: the practice of medicine has been made more difficult by lengthy, expensive training, malpractice suits, insurance costs, and new and hideous diseases; ergo, bright students who might naturally consider medicine as a career are taking other paths that promise to challenge minds and pay well. Prominently mentioned as an alternate being chosen by the ambitious: computer science.

What we have here is a prime example of the Constantly Moving Crisis. When I was researching this month's Behind the News article, "The New Maturity of Computer Science" (p. 37), David Gries, ex-head of Cornell University's Computer Science department, described the state of computer science this way: "It seems that we have emerged from the crisis."

The numbers justify Prof. Gries's good cheer. According to the most recent study of the field by the National Science Foundation, in 1975, there were 8,415 computer science grad students in the U.S. In 1986, the study found 30,726 computer science grad students.

Suddenly, it seems there are enough computer science students. Gries says, "Now, for the first time, good people who try to get into the top 10 or 15 schools are not getting in." And this turns out to be good for IS departments: he adds that many of these talented people, having hit an academic dead end, enter industry.

So, what we have here is a crisis solved, but with the solution leading to another crisis: a possible shortage of doctors. Don't stop there, however: Prof. Alton P. Jensen of Georgia Tech predicts a 50% shortfall of computer science PhDs by the year 2009. I'd be willing to bet that at some time during the first decade of the next century, you'll see a rash of articles suggesting that the new "crisis" in computer science can be laid at the feet of too many students enrolling in, say, medicine.

The Constantly Moving Crisis strikes once more, and the apothegm, "You can't win for losing," will have been proved yet again.



A handwritten signature in black ink that reads "Parker Hodges".

PARKER HODGES
MANAGING EDITOR/PRODUCTION
& SPECIAL PROJECTS

DATAMATION

Editor-in-Chief Tim Mead

Senior Editor Linda Runyan

Managing Editor/News & Features David R. Brousell

Senior Writer Ralph E. Carlyle

Deputy News Editor Theresa Barry

Deputy Features Editor Marsha J. Fisher

Editorial Assistant Karen J. Scher

Editorial Secretary Anne M. Mangieri

Managing Editor/Production &

Special Projects Parker Hodges

Copy Chief Steven Korn

Production Editor Hernalee Walker

Copy Editors René Matthews, John Quain

Production Assistant Suzanne P. Jones

International Editor Paul Tate

Editorial Assistant (London) Lauren Murphy

Correspondents James Etheridge, Paris; David

Hebditch, Eastern Europe; Janette Martin, Milan

U.S. Bureau Managers

Boston Gary McWilliams

Dallas Robert Francis

Los Angeles Tom McCusker

San Francisco Jeff Moad

San Jose Susan Kerr

Washington Willie Schatz

Art Director Robert L. Lascaro

Associate Art Director Anne Cooney

Assistant Art Director Carolee Young

Contributing Editors Joseph Kelly, Fred Lamond,

Hesh Wiener

Advisory Board Joseph Ferreira, John Imlay,

Angeline Pantages, Russell Pipe, Carl Reynolds

Publishing Director Donald Fagan

Associate Publisher William Segallis

Promotion Manager Stacy Aaron

Production Manager Eric Jorgensen

Research Manager Laraine Donisi

Director of Production Robert Elder

Director of Art Department Barrie Stern

Circulation Manager Cheryl Barnett

EDITORIAL OFFICES

Headquarters: 249 W. 17 St., New York, NY 10011, (212) 645-0067; telex 127703; fax (212) 242-6987. **New England:** 199 Wells Ave., Newton, MA 02159, (617) 964-3730; **Washington, D.C.:** 4451 Albemarle St. NW, Washington, DC 20016, (202) 966-7100; **Central:** 9330 LBJ Freeway, Suite 1060, Dallas, TX 75243, (214) 644-3683; **Western:** 12233 W. Olympic, Los Angeles, CA 90064, (213) 826-5818; 582 Market St., Suite 1007, San Francisco, CA 94104, (415) 981-2595; 3031 Tisch Way, Suite 100, San Jose, CA 95128-2593, (408) 243-8838. **Internationally:** 27 Paul St., London EC2A 4JU, England, (44-1) 628-7030, telex 914911; CPO Box 665, Tokyo, Japan, (81-3) 201-2335, fax 2135053.

DATAMATION (ISSN 0011-6963) Magazine is issued twice monthly on the 1st and 15th of every month by The Cahners Publishing Company, A Division of Reed Publishing USA, 275 Washington St., Newton, MA 02158-1630. William M. Platt, Chief Executive Officer; Terrence M. McDermott, President; Frank J. Sibley, Group Vice President; Jerry D. Neth, Vice President/Publishing Operations; J.J. Walsh, Financial Vice President/Magazine Division; Thomas J. Dellamaria, Vice President/Production and Manufacturing. Editorial and advertising offices, 249 W. 17th St., New York, NY 10011. Published at Woodstock, IL. Annual subscription rates: U.S. and possessions: \$60; Canada: \$85; Japan, Australia, New Zealand: \$155 air freight; Europe: \$135 air freight, \$250 air mail. All other nations: \$135 surface, \$250 air mail. Reduced rate for U.S. public and school libraries: \$40. Single copy: \$3 in U.S. Sole agent for subscriptions in Japan is Maruzen Co. Ltd., 3-10 Nihonbashi, 2-Chome, Chuo-ku, Tokyo 103, J.; sole agent for all other foreign subscriptions is J.B. Tratsart Ltd., 154 A Greenford Rd., Harrow, Middlesex HA13QT, England, (01) 422-8295 or 422-2456. No subscription agency is authorized by us to solicit or take orders for subscriptions. Circulation records are maintained at 44 Cook Street, Denver, CO 80206. Phone (303) 388-4511. Second-class postage paid at Denver, CO 80206 and at additional mailing office. DATAMATION copyright 1988 by Reed Publishing USA; Saul Goldweitz, Chairman; Ronald G. Segel, President and Chief Executive Officer; Robert L. Krafkoff, Executive Vice President. All rights reserved. DATAMATION is a registered trademark of Cahners Publishing Co. Reprints of articles are available; contact Frank Pruzina (312) 635-8800. Microfilm copies of DATAMATION may be obtained from University Microfilms, A Xerox Company, 300 N. Zeeb Rd., Ann Arbor, MI 48106. Printed by Graftek Press Inc. **All inquiries and requests for change of address should be accompanied by mailing label from latest issue of magazine.** Allow two months for change to be made. POSTMASTER: send address changes to DATAMATION, 44 Cook St., Denver, CO 80206.



Letters

The Real VM

Brad Schultz's article "VM: The Crossroads of Operating Systems" (July 15, p. 79) misleads the reader as to the nature and history of VM . . . —and other operating systems.

"VM's own batch facility" is CMS: the article makes it sound as if this were a separate operating system. While it is true that IBM made code changes to support CMS batch, the interactive and batch users not only run under the same version of CMS, but under the same physical copy (shared segment).

The author claims that "The only highly interactive IBM-originated mainframe operating system is Conversational Monitor System (CMS)," which must come as a real surprise to all of the TSO users out there, as well as to those still running TSS/370 (Time Sharing System/370, derived from TSS/360).

Talk of VM eclipsing VSE is a little strange, considering the number of VM shops where the principal guest operating system is DOS/VSE, and considering that the VM support for VSAM requires the VSE VSAM product.

I would be very surprised if the author could back up his claim that VM supports more commercial applications than any other operating system. I suspect that TPF (Transaction Processing Facility, formerly known as Airline Control Program) is the leader, but MVS also looks like a better bet. There are vast numbers of IMS applications that cannot be ported to CMS. Although there is a CMS version of CICS, it is not fully downward compatible, and not all of the array of CICS applications can be ported. On the flip side, many of the VM applications are based on ISPF (Interactive Structured Programming Facility) and could be easily moved.

The claim, attributed to George Schmid, that "TSO, however, can't support the level of editing and debugging tools that programmers generally prefer" is a strange one under the circumstances. TSO has a powerful interactive symbolic debugger, which CMS lacks. Further, MVS tools, although thought of as being for systems programmers, can be of immense help to applications programmers. The MVS/XA table and GTF traces are vastly more user friendly and comprehensive than their CMS and CP analogs, while anyone familiar with SLIP command could only view the CP PER command with disdain.

As for editing, the top-of-the-line

editing facility for VM is ISPF/POF; guess where it originated (that's right, TSO). In fact, the TSO and VM versions of ISPF and ISPF/PDF have code in common and are practically identical even where the code is different.

Despite the author's claim, CMS is not the same across all VM versions. The CMS in VMF/370 has not been enhanced in a decade, the CMS in VM/XA SF is backlevel, and the CMS in VM/PC is not only backlevel, but will remain so with the loss of support for VM/PC. Only with VM/SP release 6 (or 5.5) and the eventual demise of VM/XA and VM/XA SF will there be a consistent CMS.

With regard to the issue of OCO (Object Code Only), David McGorry's statement that "we intend for customers to be able to do just what they have always done" cannot be taken seriously. IBM has broken prior commitments about OCO, such as not going OCO without adequate reliability, documentation, and user exits; why is this promise more believable?

SEYMOUR J. METZ
Annandale, Va.

Refreshing

"CIO: Misfit or Misnomer?" by Ralph Emmett Carlyle (Aug. 1, p. 50) is a refreshing return to careful analysis and clear thinking. The statement by John Hammitt, vice president, Information Management for Pillsbury Co., "We don't control information, we make it flow," says it all. The episodes of agony and ecstasy inherent in our field will never change with a change of title, and anyone who thinks a CIO title is a stairway to Corporate Heaven is confused about which way the stairway is leading.

I don't know who actually started this CIO movement, but any vp of IS or director who in this day does not report to the president of their enterprise and does not sit in concert with other executive officers when automation issues are discussed had better reexamine his or her position.

Problems with egos and misperceptions are inevitable whenever power and authority are unevenly distributed, and that is evident in the CIO move. I've been in this field for over 30 years, and the Real Professional Directors and IS vps I know are too busy to be caught up in this hogwash.

WALTER X. KANE
Vice president, Information Systems
Neponset Valley Health System
Norwood, Mass.



Closer to Genius

Introducing PowerHouse PC™, the most powerful 4GL for serious application development on a personal computer.

PowerHouse PC delivers more power than any other PC application development product. It gives you OS/2™ performance and integrated communications. And it gives you all of this — today.

PowerHouse now lets you prototype and build serious business applications on your PC in addition to HP, Digital and DG mid-range computers. The simplicity of one language across architectures gives you the flexibility of choosing the production environment that best suits your needs.

Use PowerHouse PC as a *development workstation* to develop applications for your mini, as a *host extension* to offload processing, or for *stand-alone* applications. Complete with a communications facility, PowerHouse PC makes the most of your resources by allowing you to share applications and data between architectures. What makes PowerHouse PC even smarter is that it runs under both *DOS and OS/2*.

When you're ready for serious application development on a personal computer, you're ready for PowerHouse PC.

Call Cognos Direct, 1 800-4-COGNOS

COGNOS

OS/2 is a trademark of International Business Machines Corporation. The Cognos logo and PowerHouse are registered trademarks of Cognos Incorporated. PowerHouse PC is a Cognos trademark.

Cognos Corporation, 2 Corporate Place, 1-95, Peabody, MA, USA 01960, (800) 4-COGNOS. Cognos Incorporated, 3755 Riverside Drive, P.O. Box 9707, Ottawa, Ontario, Canada, K1G 3Z4, (613) 738-1440, Telex: 053-3836. Cognos Limited, Westerly Point, Market Street, Bracknell, Berkshire RG12 1QB, United Kingdom, National (0344) 486668, International +44 344 486668, Telex: 846337 Cognos G.

CONNECTIVITY



If your 3270 system can make the right connections, you win. If not, you lose. Only it's not a game.

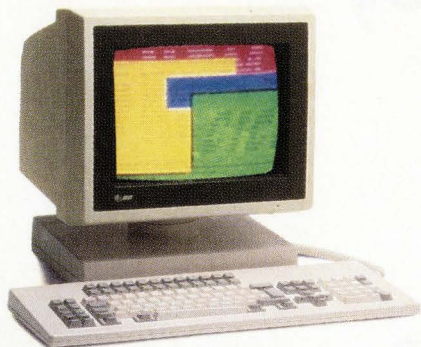

6500 SYSTEM DISPLAY

If your 3270 workgroups aren't getting the highest level of flexible functionality, you should be talking to AT&T about the 6500 Multifunction Communication System.

Your 3270-compatible system should be *solving* communications problems—not creating them. Today's corporate workgroups are diverse and complicated: mixes of mainframes, minicomputers, and other remote and local hosts coexist with scores of PCs and terminals spread around the company. The people who use them need to send and receive data with maximum efficiency. And you need assurance that your 3270 buy decisions are sound, long-term investments.

New pieces in the puzzle can create plug compatibility headaches and cabling problems. Users can end up with two terminals on their desks because system components don't talk to one another, and there's often no way to "cut and paste" crucial data among applications.

There's only one way to protect yourself: keep up with today's demands on your 3270-compatible



6572 PRINTER

system while you invest in a trouble-free future.

Protect your investment while preparing for the future.

The AT&T 6500 Multifunction Communication System does for data communications what a PBX does for voice: it helps you move closer to creating a single, highly productive data network that lets your equipment – and your company's workgroups – run at peak efficiency.

With the AT&T 6500 System you can instantly transfer data between windows, thereby transferring data between sessions or hosts. By eliminating the communications "Tower of Babel," the 6500 System lets users concentrate on the tasks that really matter.

Here's what the 6500 Multifunction Communication System gives you *right now*:

- IBM¹3270 plug compatibility.
- Functionality that includes: SNA/SDLC, 3270 BSC; Netview compatible, Protocol Conversion, X.25, Async access and others.



6500 SYSTEM DISPLAY

- As many as three simultaneous connections to synchronous host computers (one local and two remote, or three remote) with no changes to the applications software on the host. And all on one controller.
- Ability to add up to 32 synchronous devices, including PCs, displays, printer controllers, and printers.
- Ability to add up to 32

asynchronous devices, including minicomputers, PCs with async emulation packages, displays, and modems for dial-in.



6544 CONTROLLER

- Multi-host, multi-tasking windows. Users can bring data from multiple hosts (or multiple sessions with the same host) into four multi-tasking windows – all regardless of the type of host accessed.

- A choice from nine different types of displays. (Four are plug compatible with IBM 3270 controllers.)

- Cable and wiring flexibility. Host devices can be connected to the 6500 System through inexpensive twisted-pair wiring – or you can use coax.

Tomorrow's computing systems.

Computer technology is changing every day. And tomorrow's corporate workgroups will be even more diverse and decentralized. Forward-thinking MIS managers can protect their investments and plan for the future with the AT&T 6500 Multifunction Communication System. Its flexibility, transparency, and expandability will prepare you for anything the future has to offer.

To get more information, or to arrange a closer look, contact your AT&T Account Executive, Authorized AT&T Reseller or call 1 800 247-1212.

From equipment to networking, from computers to communications, AT&T is the right choice.

©1988 AT&T
IBM is a registered trademark of International Business Machines Corp.

 **AT&T**
The right choice.

**What looks like DOS,
acts like DOS,
is easy like DOS,
can hook everybody up
and keep 'em hopping
from program to program,
and costs less than
an office chair?**



The Comfortably Affordable (and already available) PC-MOS.™

If you can afford a nice leather chair for your office, you can afford a multi-user, multi-tasking operating system that's just as comfortable to use.

PC-MOS incorporates breakthrough technology that allows you to fully harness the power and capabilities of 80386-based computers, while maintaining the compatibility and ease of

use of DOS. So now you can have up to 25 inexpensive terminals driven by a single 80386 processor. You can continue to use your favorite software programs like Lotus 1-2-3,™ dBASE III,™ and WordPerfect,™ and you can keep using those familiar DOS commands like DIR and COPY. You can even run all those terminals as a single cluster

connected to a Novell server.

PC-MOS comes in single, five and 25-user versions starting at \$195. Your satisfaction is guaranteed or you get a complete refund.

For more information about PC-MOS and the name of the authorized dealer nearest you, call 1-800-451-LINK. Then you can sit back and relax.



THE SOFTWARE LINK

3577 PARKWAY LANE • NORCROSS, GEORGIA 30092
INSIDE GEORGIA: 404-448-5465 • FAX: 404-263-6474

PC-MOS is a trademark of The Software Link, Inc. All other brand names are the trademarks of their respective holders.

Circle 7 on Reader Card



France...The Channel waters are black with shipping, as reinforcements and supplies are funnelled ashore for the conquest of the Cherbourg Peninsula. (Credit: Bettmann)

New DADS/Plus.TM

Dynamic CICS Resource Management, On-Line, On Time.

Down time.

Even the words sound depressing.

And calling it unscheduled maintenance—or scheduled maintenance for that matter—doesn't make it sound much better.

Now you can just about eliminate planned down time from your DP vocabulary, because DADS/Plus lets you dynamically control your CICS environment—without stopping CICS.

So you can add or remove load libraries. Or modify the search order of these libraries.

You can choose which library a module will be retrieved from.

And rename or delete a module.

You can add FCT and DCT table entries, allocate and deallocate files and databases, effectively maintain multiple regions—and painlessly migrate new applications into production.

And you can do it all faster than ever—because DADS/Plus gives you a new level of control. Best of all, you can accomplish your CICS maintenance at your pace, to your schedule. While everything else is up and running.

To find out more about DADS/Plus, call us at 800-642-0177 today. In Canada, call 201-592-0009.

DADS/Plus

 **On-Line Software**
INTERNATIONAL

Authorities in IBM® Software

Look Ahead

BELL LABS BRAINSTORMS ON NEW OS

MURRAY HILL, N.J. -- Researchers at Bell Laboratories are brainstorming on a new operating system that will accommodate shared-memory multiprocessors and distributed computing. To do that, some of the intelligence will be loaded into the terminal, which will feature bit-mapped displays. The big surprise is that the software will not be Unix-compatible, even though programs written under it could be ported to the original portable OS. Unix co-developer Dennis Ritchie, who is helping out on the project, says that the Lab developers "are not trying to be completely compatible with what exists. We are rethinking things from the beginning and are willing to make changes in the interfaces to make things work more smoothly."

BRAZIL GOV'T STEPS INTO PC ARENA...

SÃO PAULO, BRAZIL -- Remember how Brazil's four-year-old protectionist law on information technology imports was supposed to help build a strong local base of microcomputer and minicomputer vendors? Well, the law, which reserves the low end of the computer market for Brazilian vendors, has helped lots of pc-compatible hardware makers get off the ground, but it hasn't made them strong or competitive. In fact, several are losing money, and the government is thinking about stepping in to force a consolidation of the country's micro industry, according to Luciano Coutinho, secretary general of Brazil's ministry of science and technology. The idea is supported by several of Brazil's larger pc vendors, including São Paulo-based SID, which was recently forced to seek a financial bailout from the Brazilian government.

... AND MAIN- FRAMERS CHALLENGE IBM

SÃO PAULO, BRAZIL -- Meanwhile, it looks like IBM is about to get some long-needed competition in the Brazilian midrange mainframe market. Brazilian users have been without a plug-compatible alternative to IBM's 4381 and 4341 mainframes, assembled by IBM in Brazil. But recently, the Brazilian government approved a plan by National Advanced Systems to market its midrange VL system in Brazil through Brazilian manufacturer CPM Informatica S.A. (São Paulo). The move follows Fujitsu's recent entry into Brazil with Amdahl's large-scale mainframes and suggests the Brazilian government is anxious for alternatives to IBM.

IMAGE PROCESS- ING PROTOTYPE IN THE WORKS

NEW YORK -- Developers at the headquarters of New York Life are busy writing code for a small prototype image processing system for its accounts payable division. Ted O'Leary, assistant vp, says it is "a bite-sized system, a simple solution to a problem that is compli-

Look Ahead

cated only in that there's a lot of paper. It will provide a nice index and the ability to find documents fairly easily." O'Leary says that if the head of accounts payable likes the system, he will give them the code without the usual charge. The system is being designed to complement a mainframe accounts payable system from Management Science America by providing the detailed information on individual receipts that the MSA system does not include. O'Leary says there is no need for a complicated interface to that mainframe system, though a simple one may eventually be built.

EUROPEAN EDI PROPOSAL FOR COMPUTERLAND

LUXEMBOURG -- Computerland Europe may beat out its American parent in connecting up electronically with its customers. Peter Kemp, director of distribution operations at the European headquarters, reports that his proposal for implementing electronic data interchange within two years is under consideration by Computerland brass in the States, with final word expected any day. "As I understand," says Kemp, "there is a very favorable response to what we want to do." The parent company is evidently looking into EDI itself, including a point-of-sale system for Computerland franchises. While there are no franchises in Europe, an EDI project there would hook up corporate offices, warehouses, and major clients, and Computerland might use it as a pilot for its own U.S. EDI efforts.

WAITING FOR THE DOD

WASHINGTON -- If you're wondering what the Department of Defense's next supercomputer move will be, so are the House Appropriations and House Armed Services Committees. The DOD was directed to submit to both committees by last June 1 a supercomputer plan for the acquisition and use of supercomputers with DOD. The plan is supposed to address, among other issues, the policies in place to ensure an adequate industrial base for supercomputer technology and the policies and programs of other federal agencies relating to the American supercomputer industry and how DOD acquisition and technology security policies are integrated with them. Robert Duncan, director of defense research and engineering, wrote to the House Defense Subcommittee "requesting your indulgence." DOD is still appealing to their largess.

HP READIES GATEWAY AND BRIDGE...

ORLANDO, FLA. -- In the next three to six months look for a Novell gateway to HP's OfficeShare pc networks. The gateway will let pcs on a Novell network access OfficeShare resources. What's not in the works, however, is making the HP 3000 act as a Novell server. The folks

I think we should turn off the computers . . .

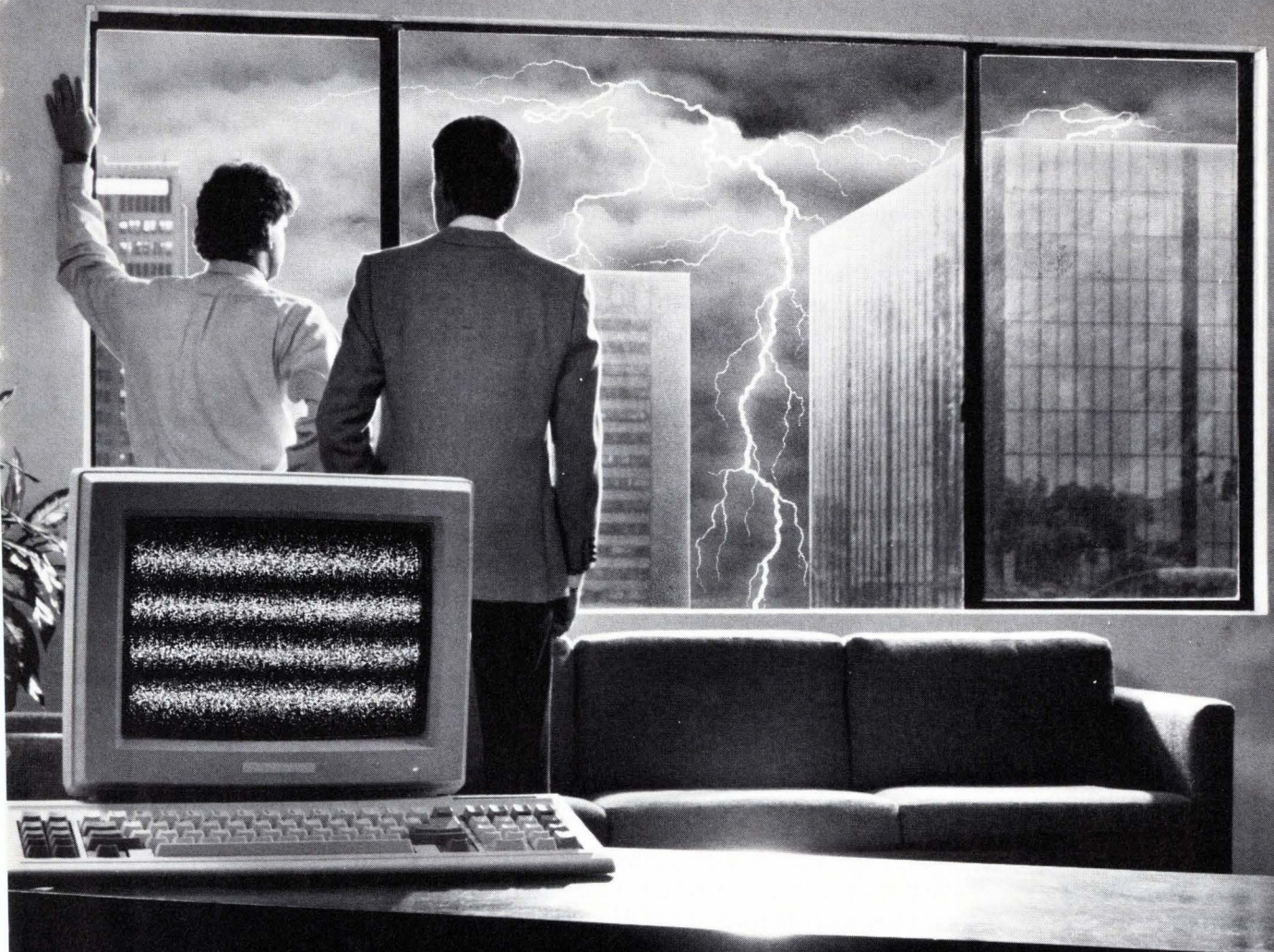

Don't you wish you had a Topaz?

Lightning strikes cause power problems that can destroy valuable data, ruin expensive computing equipment, or cause you to stop work. Unless you have a Topaz Uninterruptible Power System.

Many power problems are less spectacular, but they are just as dangerous to your system—and to your business—as the wildest electrical storm. Topaz protects against all of these, and offers you clean, continuous surge and spike free electrical power. And when line

conditions, brownouts or blackouts force your competition to stop work until the storm passes, you can continue operating. That's competitive advantage!

Topaz has engineered solutions to solve all power problems regardless of your systems size or the severity of the condition you face.

Topaz products are available from a worldwide network of local distributors supported by Topaz sales engineers who will help you weather the storm.

SOLUTIONS TO
POWER PROBLEMS

TOPAZ
Square D Company

9192 Topaz Way, San Diego, CA 92123-1165—(619) 279-0831

Circle 9 on Reader Card

Look Ahead

at HP are also working on a bridge to connect HP 3000 802.3 OfficeShare environments with token ring networks. However, they will not support token ring directly for the 3000 or for their pcs. In addition, HP's work with Microsoft Corp. to bring Microsoft's LAN Manager product to the Unix operating environment is extending beyond connectivity between Unix servers and pc workstations to include Apple Computer Inc.'s Macintosh.

... ANSWERS SOME PC QUES- TIONS...

When will Unix show up? That's the number one question that HP's pc folks are hearing. The company is evaluating 386 Unix, but claims no time frame is known. As far as a desktop 80386 system, look for the announcement by October, with more 386-based systems coming in early 1989. On the technical workstation side, HP continues its work on Motorola-based workstations. A new system, called the HP 9000 Series 370, should be unveiled in the October/November time frame. Based on the 68030 chip, it will support between 17 and 32 users. HP will offer 370 board upgrades for the present Series 350. And for lovers of HP's manufacturing systems, HP assures us that despite Spectrum, no obsolescence plans for the 1000 are in place.

... ADDRESSES A FEW SPECTRUM ISSUES

As for commercial Spectrum, user questions have come up concerning disk fragmentation. HP will provide a disk condense utility but not before 1990. Until then, the company says users will have to use reload to condense files. As for performance measurement tools for Spectrum systems, Beta tests begin in September for a product, code-named Glance, which contains a subset of the most frequently used information from the current OPT/3000 on-line performance tool. The company continues to rely on third party Software Research Northwest Inc. (Vashon Island, Wash.) for SPL conversion. This developer of the SPLash--an SPL native mode compiler for HP RISC systems running MPE--is working on an SPL compiler for Unix. A pilot of the product is running at the University of Wisconsin, Stevens Point. HP is also looking into removing privileged mode from its MPE OS.

RUMORS AND RAW RANDOM DATA

McCormack & Dodge Corp., Natick, Mass., is shooting for a late 1989 availability of all its Millennium financial applications lines on the Digital Equipment Corp. VAX computer family, according to John P. Birch, vp of R&D. An earlier completion is unlikely given the bulk of the work is being handled by a four-person team at the company's Bristol, England, development center.

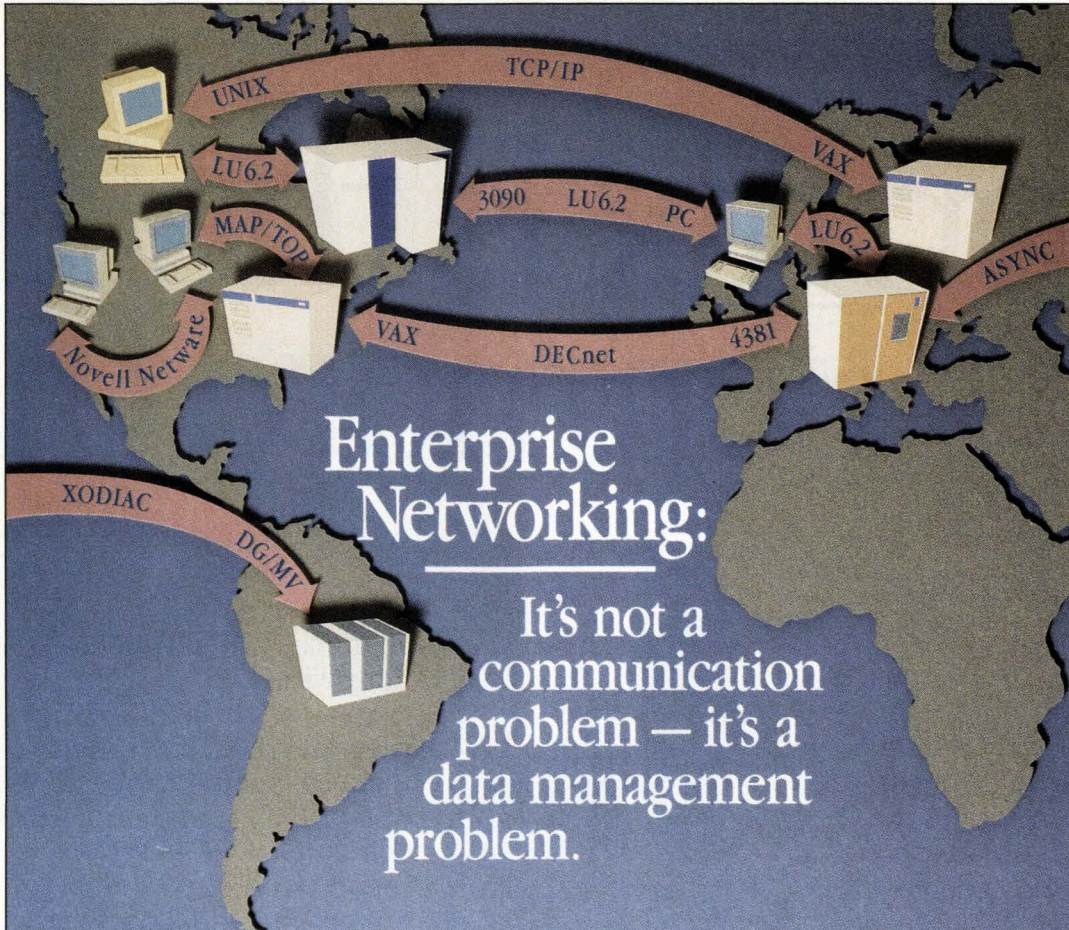

Enterprise Networking:

It's not a communication problem — it's a data management problem.

ORACLE® isn't just the world's best data management system, it's the *only* system that runs on mainframes, minicomputers and PCs—the *only* system that can integrate all your computers and all your data into a single enterprise-wide network.

You've invested a lot of money in communication controllers, satellite links and wire to connect your computers. Yet, to access data located on any computer other than the one to which you are directly connected, you still have to:

- Know which computer has the data you want
- Know how to use a terminal emulator to log onto that computer
- Know how to use a file transfer program to bring your data over

Enterprise networking must provide easy access to data anywhere in the network. Only ORACLE makes this possible, today. Only ORACLE runs on all your computers, today. Only the ORACLE distributed DBMS provides you with transparent access to data on

every computer on the network. If your users know nothing about communications or networks, ORACLE will help keep it that way.

SQL*Star™ is Oracle's open systems architecture for enterprise networking. It allows you to integrate all your computers, operating systems, networks—even different DBMSs—into a single unified computing and information management environment. With SQL*Star, your users can unite information on PCs, minis and mainframes across all your local and wide-area networks. ORACLE's open systems design even allows you to transparently access IBM's SQL/DS and DB2.

If you purchase or write software that interfaces at the wrong level (lower than OSI Level 7), you have a network-dependent application. Applications built using ORACLE are network independent.

ORACLE solves problems at the right level

Are you unsure which or how many networks your company will ultimately settle on? Do you have LU6.2, DECnet, TCP/IP, asynchronous lines, 3270 data stream, MAP/TOP, Novell Netware, Banyan VINES, LAN Manager, 3COM 3+? ORACLE supports them all.

Has your network changed in the past? Might it change in the future? Applications built using ORACLE won't change a bit.

Oracle Corporation is the world's largest supplier of data management software and services, and the only supplier of enterprise-wide networking and data sharing. Oracle's consulting and support services will insure trouble-free operation anywhere in the world.

To register for the next free ORACLE seminar in your area, call or write today.

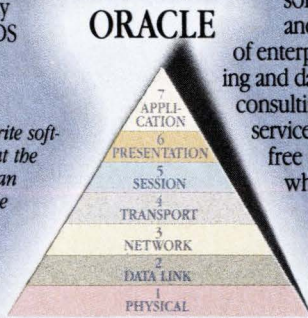

ORACLE®
 COMPATIBILITY • PORTABILITY • CONNECTABILITY
 Call 1-800-345-DBMS, ext. 107 today.

Copyright © 1988 by Oracle Corporation. ORACLE is a registered trademark and SQL*Star is a trademark of Oracle Corporation. The other companies mentioned own numerous registered trademarks.

20 Davis Drive, Belmont, CA 94002 • World Headquarters (415) 598-8000 • Calgary (403) 265-2622 • Ottawa (613) 238-2381 • Quebec (514) 337-0755 • Toronto (416) 596-7750 • ORACLE Systems Australia 61-2-959-5080 • ORACLE Europe 44-1-948-6911 • ORACLE Systems Hong Kong 852-5-268846

U.S. SEMINARS

AL	Birmingham	Oct 11
AR	Little Rock	Oct 13
AZ	Phoenix	Sep 13, Oct 13, Nov 8
	Tucson	Sep 1, Oct 4, Oct 25
CA	Costa Mesa	Sep 1, Oct 4, Nov 11
	Los Angeles	Sep 15, Oct 18, Nov 15
	Oakland	Oct 6
	Sacramento	Sep 22, Nov 10
	San Diego	Sep 8, Oct 6, Nov 3
	San Francisco	Sep 14, Oct 11, Nov 9
	San Jose	Sep 20, Oct 26, Nov 17
CO	Denver	Sep 22, Oct 27
	Colorado Springs	Oct 25
CT	Farmington	Oct 4
	New Haven	Sep 8
	Stamford	Nov 15
DC	Washington (Federal)	Sep 16, Oct 21, Nov 18
FL	Ft. Lauderdale	Oct 18
	Jacksonville	Oct 19
	Orlando	Sep 14
GA	Atlanta	Sep 7, Oct 5, Nov 9
HI	Honolulu	Sep 13
IA	Des Moines	Sep 13, Nov 10
ID	Boise	Oct 5
IL	Chicago	Sep 15, Oct 11, Nov 16
	Springfield	Sep 14, Nov 9
IN	Indianapolis	Oct 13, Nov 17
KS	Wichita	Sep 13
KY	Lexington	Sep 14
	Louisville	Oct 12
LA	New Orleans	Oct 28
	Shreveport	Oct 13
MA	Boston	Oct 12
	Burlington	Nov 18
	Springfield	Oct 12
MD	Bethesda (Commercial)	Sep 21
	Baltimore	Oct 19
ME	Portland	Oct 5
MI	Detroit	Sep 13, Oct 4, Nov 8
	Grand Rapids	Oct 13
MN	Minneapolis	Sep 27, Oct 19, Nov 10
MO	Kansas City	Sep 14, Oct 18
	St. Louis	Sep 6, Oct 6, Nov 7
NC	Charlotte	Oct 20, Nov 17
	Raleigh	Sep 15, Nov 2
	Winston-Salem	Oct 5
NE	Omaha	Oct 4
NH	Concord	Sep 20
NJ	Iselin	Sep 15, Oct 13, Nov 17
	Princeton	Sep 15, Oct 4, Nov 22
NM	Albuquerque	Sep 29
NV	Las Vegas	Sep 22, Nov 10
NY	Albany	Sep 20, Nov 9
	Buffalo	Oct 4
	Long Island	Sep 20, Oct 19, Nov 16
	New York City	Sep 14, Sep 28, Oct 12, Oct 26, Nov 9, Nov 16
	Rochester	Sep 14, Nov 2
OH	Akron	Sep 20
	Cincinnati	Sep 15
	Cleveland	Oct 19
	Columbus	Sep 22
OK	Oklahoma City	Sep 13
	Tulsa	Oct 25
OR	Portland	Sep 8, Nov 15
PA	Harrisburg	Sep 26
	Philadelphia	Sep 19, Oct 26, Nov 18
	Pittsburgh	Oct 26
	Valley Forge	Sep 8, Nov 10
RI	Providence	Sep 22
SC	Charleston	Oct 5
	Columbia	Nov 16
	Greenville	Oct 19
TN	Memphis	Sep 14
	Nashville	Nov 9
TX	Amarillo	Sep 20
	Austin	Oct 20
	Dallas	Sep 7, Oct 4, Nov 2
	Ft. Worth	Nov 9
	Houston	Sep 8, Oct 6, Nov 10
	Midland	Oct 19
	San Antonio	Oct 21
UT	Salt Lake City	Sep 20, Nov 4
VA	Norfolk (Federal)	Oct 9
	Richmond	Oct 6, Nov 1
VT	Burlington	Sep 28
WA	Seattle	Sep 14, Oct 20
	Spokane	Nov 3
WI	Madison	Oct 5
	Milwaukee	Oct 12, Nov 29

CANADIAN SEMINARS

To register for Canadian seminars, please call the office nearest you: Calgary 403-265-2622, Ottawa 613-238-2381, Quebec 514-337-0755, Toronto 416-596-7750.

Calgary	Sep 15, Nov 17
Edmonton	Oct 6
Halifax	Oct 13
Kingston	Sep 16
London	Oct 20
Montreal	Sep 28, Oct 26, Nov 23
Ottawa	Sep 1, Oct 6, Nov 3
Quebec	Sep 7, Oct 5, Nov 2
Regina	Sep 7, Oct 5, Nov 2
Saskatoon	Sep 22
Toronto	Nov 10
Toronto	Sep 13, Oct 11, Nov 8
Vancouver	Sep 8, Nov 10
Victoria	Nov 24
Winnipeg	Oct 20

Attn: National Seminar Coordinator
 Oracle Corporation • 20 Davis Drive
 Belmont, California 94002

My business card or letterhead is attached. Please enroll me in the **FREE** ORACLE seminar to be held

at: _____
 on: _____

Informix is the #1 choice For more than

If you're looking for the best database, just look at this data.

It's the best-seller.

According to a recent Dataquest survey, Informix UNIX® DBMS products out-sold their closest competitors by almost 2 to 1. Moreover, INFORMIX-SQL and INFORMIX-4GL recently won *UNIX WORLD* magazine's coveted "Readers' Choice" awards in their respective categories. Better yet, the same readers named INFORMIX-SQL the best UNIX software, period.

Hardly surprising, when you consider everything Informix has going for it.

It's the easiest.

Because it's the only true 4GL.

Why do we get such a big slice of the UNIX DBMS market? Because our products

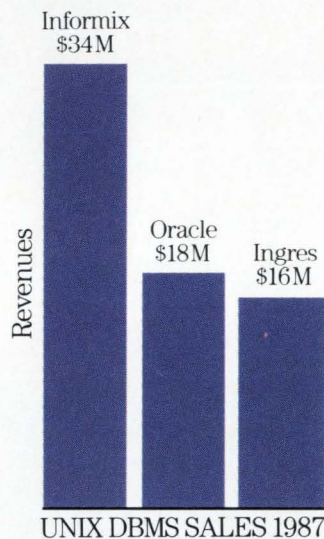

are easier to build applications with.

You see, INFORMIX-4GL is the only true COBOL-replacement caliber tool. While those other DBMS products masquerade as 4GLs (providing mere report writers and screen generators), INFORMIX-4GL gives you a complete language.

So you can virtually forget about coding in C or COBOL.

And count on being at least ten times more productive. Plus you can use our exclusive Interactive Debugger to view and debug your 4GL source code while the program runs. Delivering finished applications in record time.

It's the fastest.

INFORMIX-SQL and INFORMIX-4GL are fast. And when you run them with our

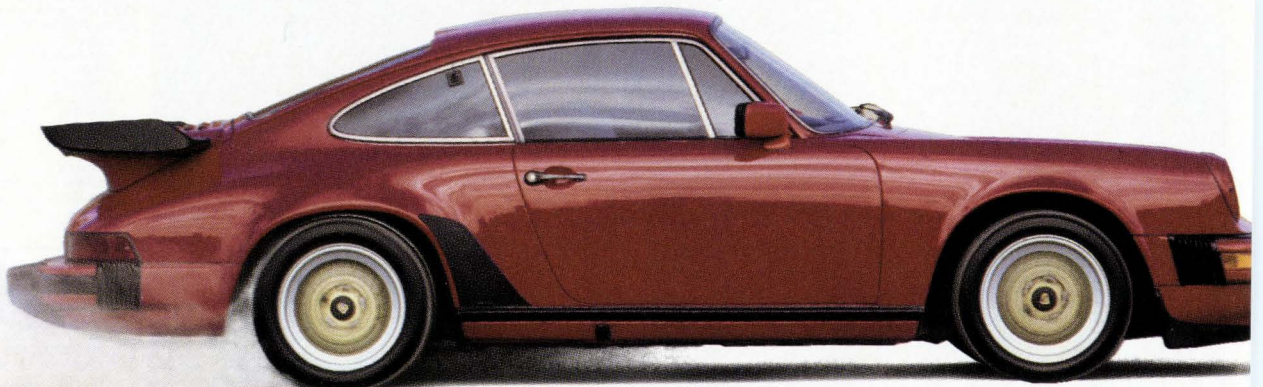

Database in UNIX. #1 one reason.

INFORMIX-TURBO database server they fly. In fact, in a recent TP1 (transaction processing) benchmark study, Informix ran a great deal faster than other leading DBMS products.

It's the most portable.

With Informix, you'll rarely have to rewrite your source code. Our Rapid Development System lets you compile your 4GL code often without a C compiler or linker.* So porting to other operating systems is a snap. And Informix applications run on over 200 machines from more than 85 companies. Twice as many machines as our nearest competitor.

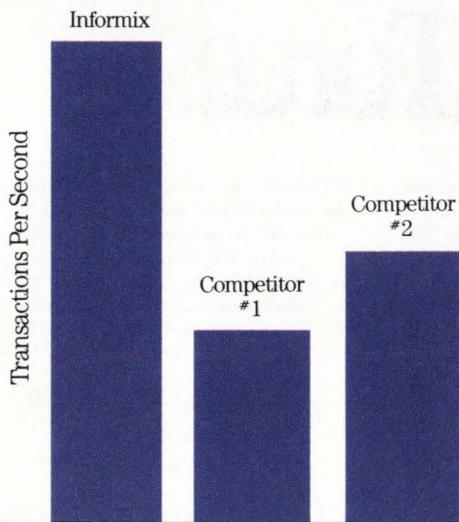
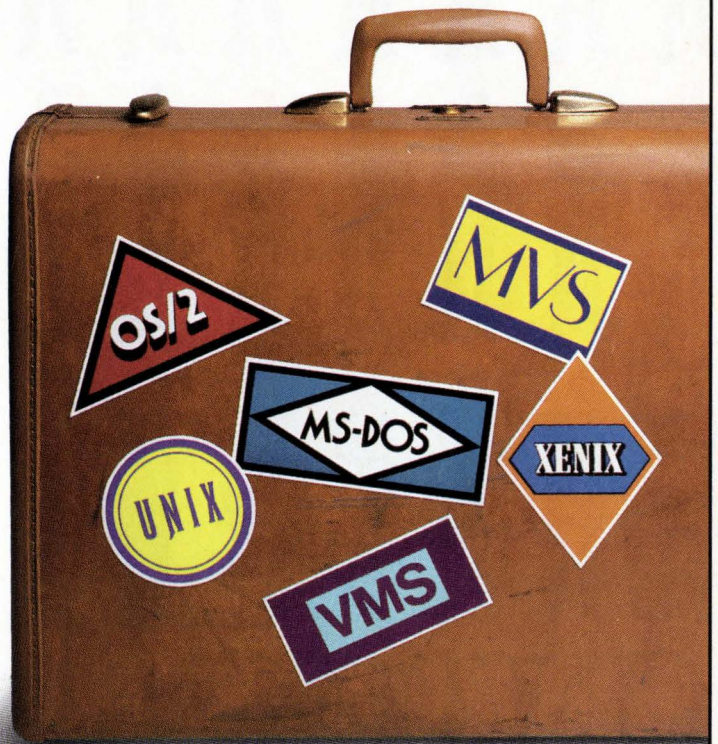

TP1 BENCHMARK STUDY

Send for our free booklet,
"How To Choose An RDBMS"

Call or write today for complete product data, plus our free guide to selecting the RDBMS that's right for you. Informix Software, Inc., 4100 Bohannon Drive, Menlo Park, CA 94025. (415) 322-4100.

And we'll make you our #1 priority.



INFORMIX

#1 for good reason.

*Obviously, C sub-routines or code written to take advantage of specific operating system features may need to be rewritten or recompiled.

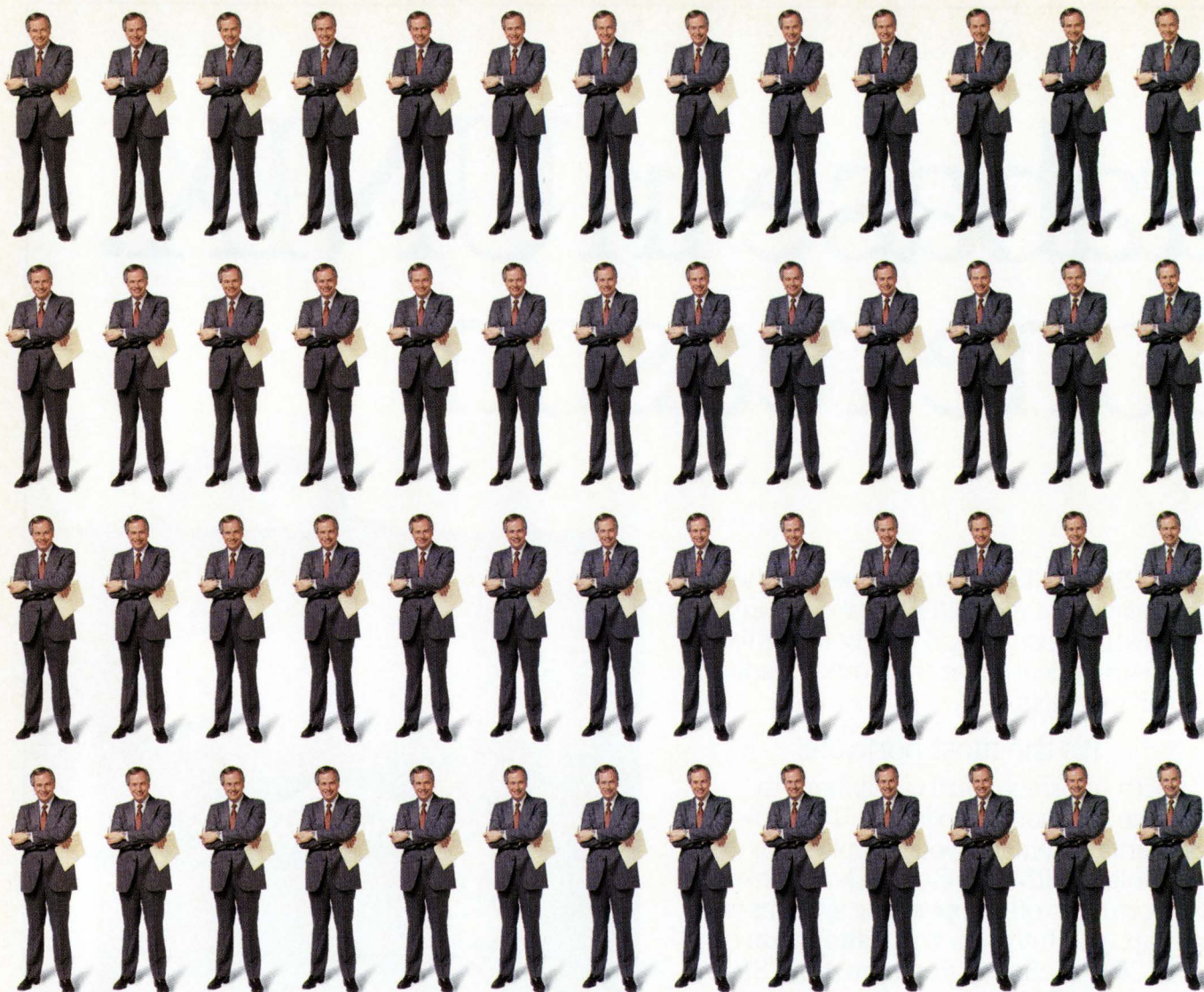

CINCOM Keeps Northwestern Mutual In Full Force.

PROBLEM: Maximizing network availability for more than 8,000 users
CINCOM SOLVED IT: With NET/MASTER Network Management System

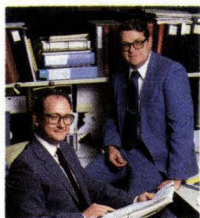

Mr. Wayne Gajkowski, Senior Systems Analyst
 Mr. George MacDonald, VTAM Specialist
 Northwestern Mutual Life Insurance Co.

When Northwestern Mutual Life's network goes down, it hardly goes unnoticed. In fact, with more than 2,000 home-office employees and nearly 7,000 field agents depending on the network for up-to-the-minute policy

information, it becomes an event of major proportions.

Which is exactly why NET/MASTER™ from Cincom® has become such a valuable asset to "The Quiet Company." "NET/MASTER has made life much easier from a network control point of view," explained Northwestern Mutual's Wayne Gajkowski. "It definitely keeps the network more available. For example, in one instance, it helped us eliminate a problem with NCP slowdown, which had caused considerable downtime—as much as two hours a week or more."

Driven by a powerful Network Control Language, NET/MASTER not only helps decrease downtime, it helps cut costs at Northwestern Mutual. As VTAM Specialist George MacDonald points out, the system's multiple sessions capabilities have allowed his company to delay hardware purchases and, in many cases, hardware upgrades as well as improve productivity. "I wouldn't want to have to manage a network like ours without something as high quality

as NET/MASTER," said MacDonald, whose company also utilizes SUPRA™ and MANTIS® from Cincom. "There's just no way in the world to do it."

Find out why NET/MASTER is the best policy for your network, too. Call us today for more product and customer-success information, or write Marketing Services Department, Cincom World Headquarters, 2300 Montana Avenue, Cincinnati, OH 45211.

1-800-543-3010

In Ohio, 513-661-6000

In Canada, 1-800-387-5914

 **CINCOM**
 The Better The Solution, The Better The Value.™

© 1988, Cincom Systems, Inc

News in Perspective

MAINFRAME DBMS

DB2 Performance Gets Kick With Closer Ties to 3090S, ESA

With support for 270tps, users are taking DB2 more seriously. Meanwhile, DBMS vendors are trying to keep up with IBM's ambitious upgrade schedule.

BY JEFF MOAD

Large-scale systems users may have gained more than a routine mainframe hardware upgrade when IBM unveiled its long-awaited 3090 Model S systems in July. Although IBM's claims for the new hardware—topped by the six-processor 3090 600S—include a 15% to 25% price/performance boost over their Model E predecessors, that was pretty much in line with what most users and IBM competitors expected.

What did come as a surprise was the revelation that the new S models equipped with MVS/ESA and IBM's relational database management system DB2 realize a 56% performance pickup. This means DB2 can support up to 270 complex transactions per second (tps) on IBM's largest system—a big boost over the 186tps that IBM quoted for DB2 on its largest system just four months earlier. In addition, IBM revealed its plans to ship the new MVS/ESA operating system in August, a month ahead of its original schedule.

Users See Things Clearly Now

Suddenly, a couple of things came into focus for many large users. First, ESA and its vastly expanded virtual storage, storage management, and other features are a reality. Second, IBM is pointedly tailoring its largest mainframe environment to enhance DB2 performance. Likewise, DB2 is evolving rapidly to take advantage of the expanded features of ESA and IBM's new mainframe hard-

ware.

Thus, many large users that previously considered DB2 an interesting relational environment, if one that was too immature to support major production applications, are beginning to take the IBM DBMS seriously. And some major users of non-IBM

Cupertino, Calif. "Increasingly, they are looking at systems MIPS. That means they're looking at the operating system and the DBMS together with the hardware. IBM is doing everything it can to encourage that. DB2 could be the big winner."

One large user looking

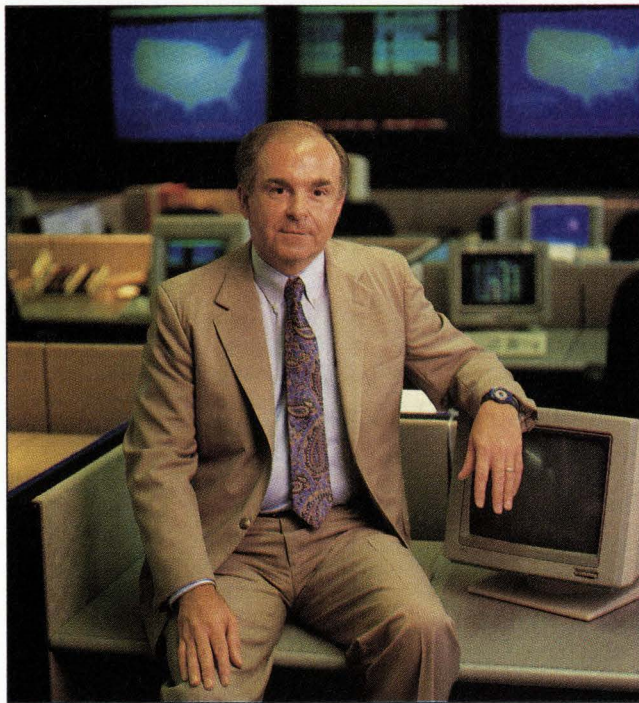

WILLIAMS CO.'S MILLER: Feeling safe with ADR's Datacom, for now.

RDBMSs are beginning to wonder whether the environments they've chosen can keep up with DB2 as it marches ahead arm-in-arm with ESA and the 3090.

"Many users of large IBM systems are moving away from comparing raw hardware MIPS," says Bonnie Digrius, director of large systems research at InfoCorp,

into IBM's claims for DB2 is American President Lines, an Oakland, Calif.-based shipping company. Under new CIO James Marston, APL is conducting a top-to-bottom reevaluation of its corporate IS architecture, including its DBMS environment, which is based on Cullinet's IDMS.

Marston reports that APL is "looking at whether it

makes sense to go with DB2 since its performance, particularly in the ESA environment, is getting better all the time." Before joining APL, Marston evaluated DB2 for American Airlines and found the IBM DBMS lacking. "More and more," he says, "it looks like DB2 is the first relational environment to really capitalize on the advances in ESA."

APL hasn't committed to DB2 or ESA yet. In fact, the company recently bought some large Teradata relational database machines as a short-term solution to capacity problems. But, says Marston, DB2 could win out, particularly if APL can be convinced that IBM will continue to bring the DBMS along as rapidly as it has in the past.

Rapid Maturation

There's not much doubt that DB2, with a major assist from ESA, has matured rapidly in recent months. Four years ago, when it was described by IBM primarily as a decision support, end-user query tool, DB2 was capable of supporting only about 20tps, by IBM's estimates. Sixteen months ago, with release 1.3, performance rose to 53tps. This April, IBM announced version 2 of DB2, a major upgrade that included referential integrity and 186tps performance.

The most recent surge, says James A. Cannavino, president of IBM's Data Systems division, is a result of the faster S Model hardware and version 2 changes that take advantage of the hardware and ESA.

Now, not only has 3090 performance been boosted, but main memory, expanded storage, and cache all have been increased significantly, and systems services have been enhanced to improve interoperation of multiprocessor complexes. DB2 version 2 not only makes the most of all these features, it also begins to exploit ESA and

its ability to expand virtual storage by a factor of 8,000 over MVS/XA.

Automating Business

The net effect, says Cannavino, is that "we're able to buffer more of the rows and tables of complex data that make up a relational database. That means there's less waiting." The goal is not so much to make existing DB2 applications go faster, "but to make real business problems and their automation a reality," says Cannavino.

According to IBM, the S Model hardware and ESA enhance performance of other IBM subsystems such as IMS and CICS almost as much as they do DB2. But it's the DB2 performance boosts that IBM seems to be emphasizing, and that has caught users'

attention.

"A lot of people who were just playing with it [DB2] before are now getting serious," says Colin White, a San Jose-based DBMS expert and editor of the quarterly newsletter *InfoDB*.

Even users of third-party RDBMSs are beginning to wonder if DB2 and ESA are leaving them behind. John Miller, IS vp at the Tulsa, Okla.-based Williams Co., is a user of ADR's Datacom/DB, but he began to look harder at DB2 "when I heard IBM saying ESA would be a big benefit for RDBMSs and DB2 in particular. I wanted to know if ADR would be able to take advantage of the same things down the road."

After meeting with IBM, Miller says he is confident that his investment is safe.

"Right now, Datacom outperforms DB2 by quite a bit," says Miller. "But when DB2 starts taking advantage of things in ESA, it will probably be a lot faster than Datacom. I expect Datacom will pick up the same advantages later and may be even better than DB2."

Third-Party Reassurances

Although Miller says he's been reassured, he acknowledges "some of my peers are scared as hell" by the possibility that DB2 is moving into a leadership position and that they made the wrong choice. "IBM's trying to take advantage of that fear, and I don't blame them," he states.

Third-party DBMS vendors such as Cullinet and ADR are spending a lot of energy reassuring users that their products will cash in on ESA and hardware benefits. Says Joe Farrelly, ADR vp for research and development, "We've been assured that all the facilities in ESA that are available to DB2 will be provided as standard interfaces."

Many third parties have begun to study the ESA documentation, but most are unable to predict when their products will exploit ESA. Most say ESA modifications will be more difficult than those required by MVS/XA.

Meanwhile, many third parties are beginning to modify their strategies, emphasizing the cost per transaction of their systems rather than the transactions per second.

At the same time, many are beginning to move their proprietary front-end tools to the DB2 environment as insurance in case DB2 takes off. ADR began shipping its Ideal 4GL for DB2 in March. According to director of IBM products Martin Greis, Cullinet is contemplating similar moves. "We had a chance to support IMS way back when, and we chose not to. We won't make

that mistake again," he declares.

Many users would encourage that trend. While DB2 performance may be improving, it still lacks adequate 4GLs and development tools, say users such as Allen Parry, senior vp for Dallas manufacturing firm Gifford-Hill Inc., which recently converted from a Burroughs to an IBM environment, but picked the ADR DBMS.

While third-party vendors are assuring users they'll be able to keep up with DB2 and ESA, they may well end up shooting at a rapidly moving target. IBM's Cannavino says that performance levels of DB2 will continue to pick up at about the same pace users have seen over the last year. DB2 is expected to make more extensive use of ESA's massive data-only Hiper-spaces. ESA will play a key role in IBM's plans for a distributed version of DB2 that is expected to roll out in stages beginning early next year.

"We will surely try to help the industry in general develop products exploiting the new architectures," says Cannavino. "That makes all customers more productive." He also implies that IBM won't be standing still. "We're committed to a very substantial investment on development."

IBM's willingness to invest in DB2 has some users taking a second look. George DiNardo, executive vp for information management and research at Mellon Bank, Pittsburgh, has been integrating DB2 into his operation slowly, but he says that the pace may pick up. DiNardo, who was one of ESA's early support users, says he is just as excited about the performance boost ESA gives to other subsystems such as IMS and CICS. "What IBM's doing with DB2, however, has got us thinking," he says. "Maybe we should be moving on it a little faster. I don't know." ■

LAST CHANCE TO PRE-REGISTER FOR THE

CMA

communications
managers
association

1988 Annual Conference and Exposition.
October 12-13-14

Long Island Marriott Hotel/Nassau Coliseum, Uniondale, New York

ON SITE REGISTRATION AVAILABLE

**"TELECOMMUNICATIONS:
PROVIDING THE INFORMATION HIGHWAY"**

WHY YOU SHOULD ATTEND

- In-depth Seminars, Panels and Presentations
- Over 350 Exhibits/160 Vendors
- Information Exchange Hours
- Outstanding Speakers, including:

Frank Blount, President, Network Operations Group, AT&T
(Wednesday, October 12)

James Boren, Author and Lecturer (Thursday, October 13)

James Sobczak, Vice President, Westinghouse Communications
(Friday, October 14)

CALL NOW FOR INFORMATION: 202-639-5161

CIRCLE 12 ON READER CARD

MICROCOMPUTING

Maturing Pc User Groups Gaining Clout with Developers

As the organizations evolve from informal groups of game players and hackers to professional pc users, their power is growing—too much, some vendors think.

BY ROBERT FRANCIS

A casual observer of a local pc user group meeting might think the world had turned upside down. A man in a Hawaiian shirt is lecturing a group of executives in business suits about the best way to prevent a computer virus from invading a corporate system. In another conference room, a businessman is talking to jean-clad users about connecting pcs to the corporate mainframe.

In the melting pot of pc user groups, such scenes are common. Over the last 11 years, these groups have evolved from being forums for game players and hackers into more professional organizations that bring together the casual user and the corporate IS chief. The trend has earned the groups more clout with vendors, which have come to view them as a useful tool in the marketing and testing of new products.

"Remember that pcs are a recent development," notes Ted Klein of consulting house Boston Computing. "Those early users have as much experience with pcs as the corporate IS director. In effect, they're on a level playing field when it comes to pcs."

Diversity Among Groups

The user groups themselves are as diverse as their members. Some, like the Boston Computer Society (BCS)—generally acknowledged as the first pc user group—have a paid staff and president, while other groups, such as the North

Texas PC Users Group, alternate their presidents every other year. A breakdown of the membership of the BCS paints a good picture of the wide diversity in the pc user group community. A study reveals that 30% are corporate employees, 29% are self-employed or work for a small business, 12% are members of a professional firm, 12%

then. BCS now has a paid staff of 13 workers, has 30 different on-line services, and 50 different user and special interest groups. As of August, membership was 29,000 and growing.

BCS and other pc user groups take some credit for getting most software manufacturers to drop the protection code from their software.



BCS'S ROTENBERG: The AAA of pcs.

are educators or students, and 5% are public sector employees.

"We think of ourselves as sort of the AAA of pcs," says BCS president Jonathan Rotenberg. But the group's beginnings were humble to say the least. "I was in high school in 1977 and we decided to hold a meeting," explains Rotenberg. "We had two or three people—and one of them just happened to come by. So the beginning was not exactly promising." Things have changed rapidly since

As Rotenberg puts it, "it was hurting us and wasn't helping them." That's one example of the way these groups have made their power felt, but it's unlikely to be the last.

In general, the pc user groups are not hardware-specific, although there are some that are Apple-specific or that concentrate solely on IBM or IBM-compatible hardware. Groups such as the International dBase User Group (IDBUG) cross all boundaries, bringing together all dBase or dBase-type users. Groups

such as the Chicago Association of Microcomputer Professionals (CAMP), on the other hand, limit their membership to computer professionals.

Vendors are more than willing to play the game as well. To take one example, Apple spent \$60,000 on the original Macintosh's introduction at the BCS. Other manufacturers have followed suit with their products at other user groups around the country.

Vendors Appreciate Groups

According to Pat Adams, founder of IDBUG, vendors know that user groups are important. "They've done surveys and they know that all their marketing and promotional efforts still miss a good percentage of their market," she says. "These user groups are one way of catching some of the people they miss."

Adams, a consultant, ran IDBUG out of her home in New York until late July. So far, the group has attracted over 1,100 members. "We were going to just be national in scope, but we had so much demand from outside the U.S., we opened it up," she says. Locally, IDBUG will consist mainly of users who are affiliated with pc user groups' dBase or DBMS special interest groups, as well as members who have no local pc user group. One of the goals of IDBUG will be to identify qualified testing sites for software companies to use as beta sites in developing or improving software.

Houston-based Compaq Computer Corp. previously dealt with various user groups through different company channels, but it is now studying the idea of setting up an official channel to handle the requests. IBM is studying strengthening its commitment to the pc user group community, an area that was cut slightly during

the company's recent downsizing. "We're talking with them about it," says BCS's Rotenberg.

Vendors, particularly software vendors, are paying more attention to what user groups have to say about products. Ashton-Tate's market-leading dBase database management system is a case in point. According to a company spokesman, dBase IV, from the time it was announced in February until its release, was reviewed time and again by various user groups, whose members commented on their likes and dislikes of the product's features.

"When we announced dBase IV earlier this year, it had, I believe, 275 different changes in the product," says Knox Richardson, a company spokesman. "When we release the final version, it will have about 315 changes, many of those due to the input of the various groups [to which] we demonstrated the product."

User Input Comes Early

Some companies are using input from the user community for products that have not even made it out of alpha test yet. Microsoft Corp., Redmond, Wash., this year formally established a User Group Advisory Council, consisting of 30 members from various user groups. The group will see many products early in the development cycle, though many of their suggestions likely will not be implemented until a later version, says Roger Shanafelt, who is charged with coordinating user group activity for Microsoft. The groups may also be shown some alpha test versions of possible products for early input, he says.

User groups have already had an influence on Microsoft products, says Shanafelt. He points to Microsoft's word processing pro-

gram, Microsoft Word, as an example. One menu item called for users to press the "escape" key to perform a function. Several user group members said they liked the program, but thought using the arrow keys made more sense. The change was implemented in version 4.0 of the Word program. "That's just one small example," Shanafelt says, "but the level of in-

SOME COMPANIES USE INPUT FROM USER GROUPS FOR PRODUCTS IN ALPHA TEST.

put from these groups is rising, that's for sure."

There is a downside to all this interaction. While most companies are hesitant to criticize user groups, some company officials assert that there are group members who want to comment on more than just the product.

"You have to be very diplomatic with members who want to tell you how to design your products—and sometimes how to run your company," says one official who requests anonymity. "If we put the wrong person in front of these groups it could be disastrous. That's why most companies have set up an official channel for them. It's both to help the user groups, and to get the right person to [deal with] the group so it's not an embarrassment to us or them."

Apple, which saw its user groups spring up early in the game, welcomed their ar-

rival. When groups registered with it, it would hook them up with other user groups so that they could share information. Now, IBM PC or PC-compatible user groups are trying to do the same, to draw on one base of information and avoid some of the repetition.

Professional Groups Formed

A recent user group trend is that of groups being more professionally oriented, limiting membership to those who use pcs at work. Chicago's CAMP, and the Los Angeles-based Personal Computer Professionals Association (PCPA), fall into this category. These groups are somewhat smaller and generally consist of MIS or information systems personnel only.

According to North Texas Personal Computer User Group president Reagan Andrews, companies' reactions to the group have changed dramatically in the past few years. "When we first [approached] companies [about] a show we wanted to do a few years back, they basically said, 'Contact your local sales representative.' This year, he says, we went out for a similar show and most companies had someone deal directly with us. They seem to be realizing that we are a professional organization with profes-

sional people."

Peter Coffee, president of PCPA, says the group helps both the vendor community and association members as well. PCPA consists of about 80 to 90 member companies, represented predominantly by the pc purchasing coordinator at the company. "Many of these people were once in charge of purchasing one or two computers. Now they're faced with buying 80 or 90 computers for their companies and perhaps linking them to a mainframe or mini. But most of all, they've got to prove their worth to their company," Coffee contends.

"If they're with a small company and try to implement something that looks a little off-the-wall, they [could easily] get stymied," he continues. "But if our member can say, 'Well they're doing this at AT&T or Lockheed,' our member [stands a better chance] with management."

Coffee thinks the clout that comes with membership in groups like his is very important both in getting the job done, and in the move from being a technical person to being a management person. "And that's important . . . If you're perceived as a management person, you're seen as being more important to your company," he says. ■



**LINK'S NEW
GENERATION OF
MULTIPLE CONCEPT
TERMINALS HAS
MORE FEATURES,
BETTER ERGONOMICS,
AND COSTS LESS.**

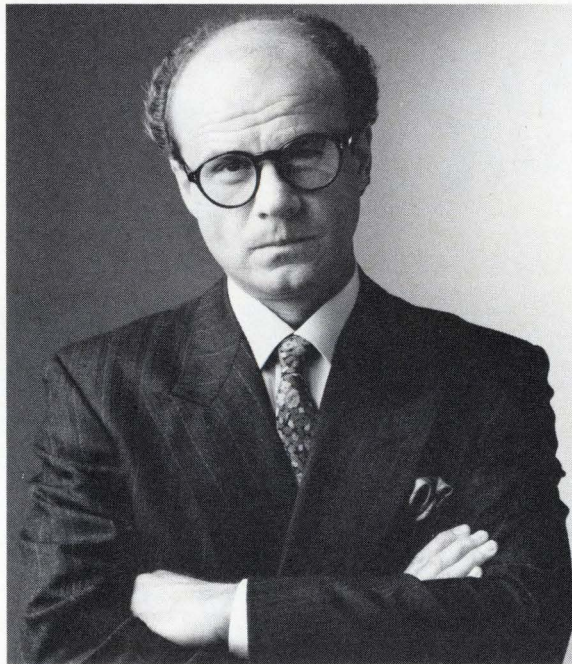

James P. Everyother III
CEO, Everyother Terminal Company

**THAT'S JUST
PLAIN UNFAIR.**

LINK CALLS THIS THE NEXT GENERATION OF MULTIPLE CONCEPT TERMINALS.

WE CALL IT RESTRAINT OF TRADE.

UNFAIR

James P. Everyother III
CEO, Everyother Terminal Company

*Link's new MC5.
Features we can't
match at prices
we won't match.*

*Full-screen image
without dark
borders. Well, I
like dark borders.*

*Choice of screen colors
and keyboards. Unfair.*

*Flat Screens.
I just hope
their sales
go flat.*

*No screen flicker.
Personally, I find
screen flicker
very soothing.*

*19 emulations.
Arrrgh!*

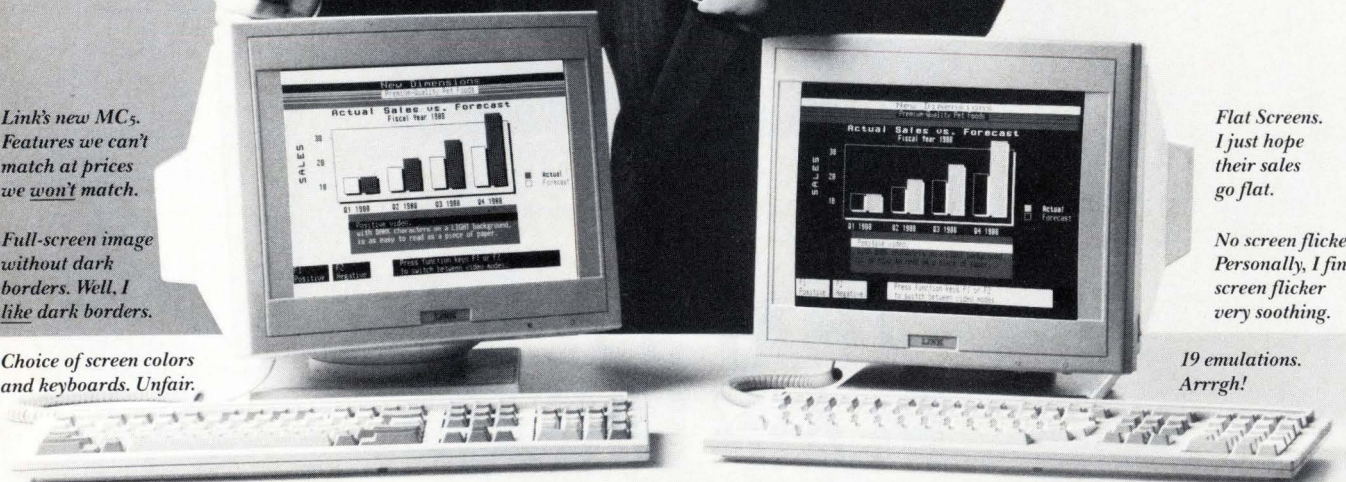

“Everyother Terminal Company used to be at the top of the heap. Then Link came along. In just four years they’ve shot from last place to second place in the terminal market.

Everyother Terminal Co.'s VapidWare: A line of terminals so unremarkable it's almost as if they didn't exist.



are ahead of ours that makes me so mad, after all, we’re used to that. It’s that they’ve beaten us on features *and* quality *and* price. There ought to be a law. Or at least a law suit.

Here are just a few of the reasons we're considering legal action against Link.

MC ₅ Enhancements
Flat Screen for decreased glare and increased viewing area.
Overscan for full-screen image without distracting black borders.
78Hz refresh rate to eliminate screen flicker.
High-resolution characters.
Separate contrast and brightness controls on front panel.
Advanced surface-mount technology for improved reliability.
Low-power operation.

By working faster and smarter than a big, bureaucratic company like ETC can.

“Now they’ve come out with the MC₅. The first of a whole new generation of their famous Multiple Concept terminals. With better price/performance than our overhead will permit us to match. And ergonomics that exceed even the toughest requirements.

Ridiculous! I mean, who ever heard of building terminals better than you have to?

“It’s not just that Link’s products

“Well, we’re not going to take this lying down. As soon as we finish this quarter’s financial posturing, we’re going to form a task group to study the situation, maybe make a few recommendations. But these things take time. While Link is totally dedicated to building terminals, we have more

important, and frankly, more profitable, product lines to worry about.

“I wish I’d never heard the name Link.”

MC ₅ FEATURES	
Flat screen	7 pages memory
78Hz refresh	512 displayable characters
Full overscan	3 keyboards
Brightness and contrast knobs	2 serial ports
80/132 columns	1 parallel port
24/25/50 data lines	19 emulations
	Virtual terminals

Every time I look at this chart, I feel like my head's going to explode.

LINK
Technologies, Inc.

THE TERMINALS EVERYOTHER TERMINAL COMPANY HATES.

Link Technologies, Inc. 47339 Warm Springs Blvd., Fremont, CA 94539, 800-448-LINK (In CA 415-651-8000), FAX 415-651-8808.

This space donated in the interest of fairness by Link Technologies, Inc.

Circle 13 on Reader Card

NETWORKING

The Systems Behind the Scoring At the Olympics in Seoul

IBM 4381 and S/36 processors are forming the basis of the Games Information On-Line Network System, which will provide information in three languages.

BY OLES GADACZ

As South Korea parades its many achievements on the international stage during the Summer Olympic Games in Seoul, one focus of attention will be the Games' results and management system.

Games results and management systems have grown progressively with each Olympic Games—the latest always strive to be greater than the last. In this respect, the Seoul Olympics are no exception. The Seoul Olympics will be the largest ever, with 13,000 athletes from 161 countries in attendance. That's 20 more countries and nearly double the number of athletes that competed in the 1984 Olympics which were held in Los Angeles.

Turning to Foreign Vendors

The complexity of assembling and distributing all the data from the athletic events requires considerable processing power. Lacking the capability to build anything larger than a 16-bit pc, South Koreans had no choice but to turn to foreign vendors; in this case, IBM and AT&T.

The result is a unique, interlinked system of IBM and AT&T systems. At the core is the Games Information On-Line Network System (GIONS) running on IBM-supplied 4381s and S/36s. The other is the Wide Information Network Services (WINS), which operates on U.S.-built

AT&T 3B20s (see "How the System is Configured"). On the local side, there are Gold-Star-built AT&T monitors and Olivetti PC24s.

The applications software is homegrown and serves as a considerable source of pride to its develop-

ers at the state-run Korea Advanced Institute of Science and Technology (KAIST). Committee (SLOOC) to take charge of computerizing the management of the Olympic Games.

Divided Over Feasibility

After surveys of Olympic systems developed in Tokyo, Montreal, and Moscow,



ers at the state-run Korea Advanced Institute of Science and Technology (KAIST).

Six years in preparation, the results system runs a tricky combination of batch and on-line processing—all for a visible system life of just 16 days. It's a make-or-break situation. "You touch a button and it goes around the world," says Kim Bong-Il, director of the Software Engineering Research Institute, which handles the computer project. "One mistake and it could all explode. But we're 99.99% confident everything will work," he says.

Not long after Seoul won the rights in 1981 to host this year's Games, SERI's parent, the state-funded KAIST, signed an agreement with the Seoul Olympic Organizing

SLOOC was ready to buy the Olympic hardware and software technology in a package. However, the brain trust at KAIST insisted that the software be developed in South Korea.

"We were divided," confesses KAIST director Kim. "About half the scientific community said we couldn't do it, and the other half was confident that we could pull it off."

KAIST got the ball rolling in 1983 and began its first computerization project on the Korean National Games, an annual fall event. "A much more complex event than the Olympics in some ways," notes Kim. "We built up our program one by one around the S/36." A subsequent beta trial of the GIONS system at

the 1984 National Games convinced SLOOC that KAIST was competent.

In 1984, the Los Angeles Olympic Organizing Committee approached SLOOC with an offer to sell its "unmodified" software for \$5 million, claims Kim, who is attached to KAIST's Software Engineering Research Institute (SERI). "This would mean modifying it by ourselves to have Korean character capability. We said, 'No thanks.'"

Kim also claims that in late 1984, IBM approached SLOOC with an offer to sell \$45 million worth of hardware that would be required for the

1988 Games. Relations between SLOOC, SERI (a loyal, longtime Control Data user), and IBM reached low ebb. IBM's price soon dropped to \$20 million, claims Kim, but "SLOOC didn't want to get locked in with IBM and gave SERI the green light to put out an international RFP."

By the 1986 Asian Games, SERI had completed most of the development on GIONS.

"We were 99.99% finished with our software design," says Kim. From start to finish, Kim says, 70 SERI full-time staff people worked on the project.

In addition to handling the registration of athletes and feeding that information to other related systems and institutions, GIONS will provide games information services and games results processing for all sports in three languages: English, French, and Korean. Hardcopy is made on laser printers at the headquarters hotel, Main Press Center (MPC), International Broadcast Center (IBC), and the Information Center. It will also feed some television networks and wire services (AP, UPI, Reuters, AFP, Kyodo, and Yonhap) with such infor-

mation as start lists, results, medal winners, and record setters.

The GIONS system has impressed Irene S. Nesbit, of Nesbit Systems Inc. Her Princeton Jct., N.J.-based company devised NBC's system that directly interfaces with GIONS.

Learning From Experience

Commenting on her first visit to GIONS-creator SERI last year, Nesbit noticed that in pursuing a solution to a problem, there was a propensity to develop and rely on one path. Since then, she has seen a growth in capability and flexibility to the point where programmers can now confidently look at several options and choose the best one.

This Olympic experience, she says, "has brought more solutions, more options. [The South Koreans have] learned a lot from the Olympics. It's much more difficult computing than they do ordinarily. It's been a catapult."

Since explaining "what we wanted," says Paul Hobbs, a systems specialist from Reuters who is supervising the interfacing of GIONS with the Reuters system, the Koreans "have been very accommodating." Hobbs, who was assigned to Seoul during the 1986 Asian Games, notes that GIONS "worked perfectly and we found very good [information] for background."

One minor complaint about the 1986 version of GIONS was that a certain amount of input had to be made to request any information. This time around, Hobbs is looking for GIONS developers to meet Reuters' format, so that the information "squirts out and we do the minimum amount of text massaging.

"They [SERI] keep promising us they'll have it ready, and I believe everything will be okay," he says. "They did

at the IMF [International Monetary Fund Conference held in Seoul in 1985] and the Asian Games. It was all there."

The Chinese, who will

host the 1990 Asian Games in Beijing, praised GIONS after seeing it perform at the 1986 Asian Games in Seoul, says Kim. GIONS could yield even bigger dividends if the soft-

ware ends up in Beijing in 1990. South Korea and China, two neighboring countries that do not have diplomatic relations, are now intensely pursuing improved ties. ■

How the System Is Configured

The creators of the Games Information On-Line Network System (GIONS) made a conscious departure from the systems used at past Olympic Games by adopting a distributed processing architecture. At each of 24 venues, the Software Engineering Research Institute (SERI) has installed twin IBM S/36s that are connected to an IBM 4381-R14 and 4381-R03 located in the Olympic Control Center (OCC).

The mainframes have 32MB of main memory and 15GB of disk space. Each is paired to its own 3725 communications processor.

Under full sail, each of the two 4381 hosts will undertake different tasks. Should one unit falter, the other will provide backup. For further backup, the OCC has a standalone S/36 that can fall back on data input by Samsung-supplied fax machines from the venues.

In case of host system malfunction, each venue can independently operate its S/36s. The twin S/36s, which normally run simultaneously, support IBM 5550 workstations, printers, 7372 color graphic terminals, and 5292 plotters.

Kim Bong-Il, director of SERI, claims that this marks the first time in Olympic history that color graphics will be used. In this case, pie charts, histograms, and line graphs will come in eight colors. A total of 82 color crts and 85 color printer/plotters will be used.

The IBM-based GIONS interfaces with 14 AT&T 3B20s that constitute the heart of the Wide Information Network Services (WINS). A creation of the Data Communications Corp. of Korea (DACOM) and GoldStar, AT&T's local partner, WINS has several functions, including electronic mail, telephone paging, and telex service for the Olympic family through DNS, DACOM's packet switched public data network. WINS is accessible through telex and PSDNs.

Although systems integration tests between the GIONS' IBM 4381 hosts and the 3Bs began in early 1986, there are uncertainties about WINS' capabilities in handling results data that GIONS will be downloading at peak times. Unlike previous Olympics that had their events schedules evenly distributed throughout the day, the Seoul Games will see an extraordinary number of finals scheduled in the morning to accommodate the commercial interests of NBC, which holds the broadcasting rights to the Games, and its advertisers.

Seven sports will benefit from a direct interface with electronic timing and measuring devices that will directly feed in the host computer. For example, swimmers completing their races will touch a pad that stops the clock, automatically relaying essential data on identity and performance into the GIONS system. Results reporting on cycling, some track and field events, gymnastics, shooting, archery, and equestrian events will be similarly automated.

A mobile computer center will provide up-to-the-second input on events such as the marathon, race walking, pentathlon, and cycling. Housed in an air conditioned bus, it features a pair of S/36s powered by eight sets of 10KVA batteries with provisions for backup power supply. There are six IBM 5550s, two 5292 color crts, two sets of fax, and copy machines.

Operations at the OCC, sites, and venues will be run by a staff of 336 from the Korean Advanced Institute of Science and Technology (KAIST) and SERI, in addition to 808 volunteers.

A support system for accommodations, supply, transportation, and training site management was developed by the Korea Information Corp. (KICO), while an applications system for the management of personnel, the Athletes' Village, ticketing, and protocol management was developed by Ssangyong Computer.

According to Kim, the Ssangyong program is a modified hospital management information system running on an IBM 3090 installed at "a secret location" under control of the Korean equivalent of the Central Intelligence Agency. There is no interconnection between the 4381 and the 3090, notes Kim.

The VIS-1, a Korean-designed digital voice information system, interfaces with WINS to allow Touch-Tone telephone users to learn about the day's game schedule, future events schedule, medal statistics, and weather. The service, which is available in French, English, and Korean, was developed by KAIST professor C.K. Un, an IEEE fellow and adviser to Digi-Com Corp. The WINS database is automatically converted into digitally synthesized speech by Un's VIS-1.

GOVERNMENT PROCUREMENT

Suppliers Take Hard Line In U.S. Procurement Protests

Encouraged by GSA's Board of Contract Appeals' tough, informed decisions and possible compensation, vendors get vocal—and federal agencies take the heat.

BY WILLIE SCHATZ

A long, long time ago in a galaxy far, far away, there were good losers in the government procurement game. If a company got beat, that was all she wrote. It was time to get ready for the next contract.

Things like that don't happen nowadays. The good losers may not be extinct, but they're apparently becoming a seriously endangered species.

"There's clearly a problem creeping into the system," contends Dendy Young, president of Falcon Systems, a Bethesda, Md.-based systems integrator. "There's a tendency to protest every transaction on which an award has been made. In many situations, it's justified. In many others, it's not."

Protests of Awards Double

Whether it is or it isn't, everybody's doing it. Protests of contract awards to the General Services Administration (GSA) and the General Accounting Office (GAO) have doubled in the last 15 years, to more than 3,000 in the current fiscal year from about 1,500 a year during the early 1970s.

That may not seem like much when compared with the 400% rise in the federal budget over that time span or with the innumerable contracts signed by the Department of Defense. Lately,

however, there's been much more sound and fury over the entire process.

Why the rush to judgment day? Money, money, and money. Did you think the protestors were interested in testing the integrity of the judicial process? Or that they had principles to protect? Get serious. We're talking about

there wasn't much else for vendors to do. Then, along came the Competition in Contracting Act (CICA) in 1984. The law merely transformed the entire IS procurement process by extending to the computer and communications fields the jurisdiction of the General Services Administration Board of Contract

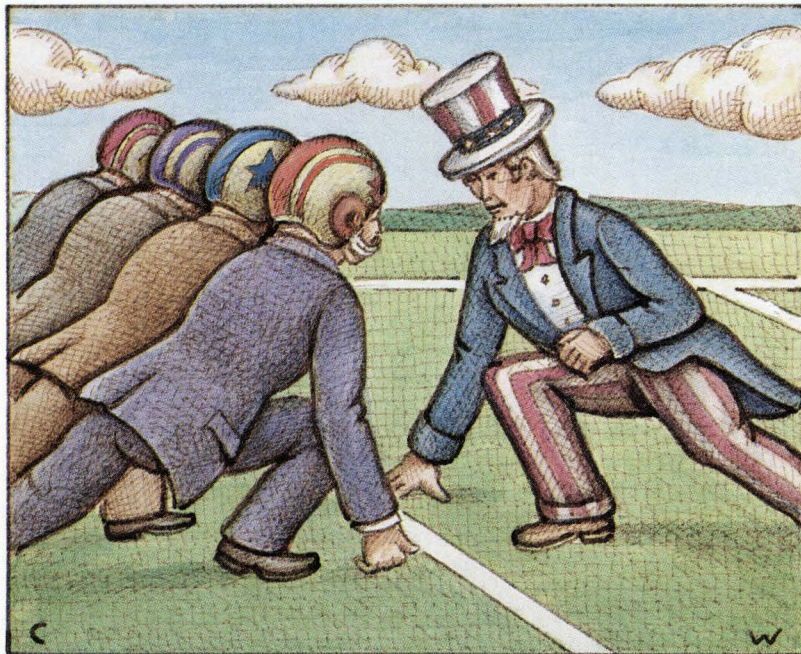

Washington here.

"This isn't news," claims Terry Miller, president of Arlington, Va.-based Government Sales Consultants Inc. "The government world's been this way for 30 years. The system's always been screwed up. It's just that now vendors aren't sitting back as much when the government does something wrong."

Until four years ago,

Appeals (GSBCA).

The GSBCA had been around since 1978 to hear run-of-the-mill contract disputes between vendors and the government. The 1965 Brooks Act, however, had given the GSA jurisdiction over federal dp contracts. Such contract disputes were heard by either GSA or GAO, neither of which had the expertise nor the desire to render a knowledgeable deci-

sion. With such a modern-day star chamber to confront, no wonder protesting vendors hit .000.

Incumbents Unseated

Before GSBCA was given scrutiny over computer and communications procurement protests, noncompetitive, sole-source procurement was the rage. Incumbent companies had it made in the shade.

"The law was honored mostly in the breach until CICA," Miller says. "Vendors cheated, government techies didn't respect the process, and nobody got caught."

It was precisely that atmosphere that led Congress to conclude that the informal process within GAO and GSA wasn't even coming close to meeting its objective. It gave the GSBCA the power to hold hearings, compel formal witness testimony, conduct cross-examinations under oath, and order the parties to reveal their deepest, darkest secrets.

Now, more and more transgressors—it seems to be mostly government agencies these days—are getting caught and liking it less.

"The GSBCA is almost out of hand," says Roger Cooper, the Treasury department's deputy assistant secretary for information systems.

That agency isn't even waiting for the inevitable arrival of its DMAC and TMAC micro and mini acquisition contracts at the GSBCA. Based on vendor and industry, it was scheduled at press time to amend the request for proposal (see "Controversy Comes Early to Two Proposed Treasury Bids," July 15, p. 41).

"When I work on a new project I've got more lawyers



You were really learning about network management.

You tried to juggle too many activities, but you just couldn't manage everything.

It's even tougher today, keeping your users happy while managing a complex network of multi-vendor computing and network control resources.

Real network management involves network configuration, problem detection and correction, bandwidth management, cost

accounting, performance measurement, security, and network forecasting. That's a complex load to pile on your network management staff.

But you don't have to. Our easy-to-operate INF™ system provides all of the above and much more, yet requires no special hardware. It runs *in* your network! Magic? No, just another sensible networking solution from Telematics.

So, learn how to lighten your network management load with the free, premiere issue of *Network Consultant Quarterly*. Contact Telematics International in the U.S. at 1-800-NETWIDE or (305) 772-2117. In the U.K., call (0256) 467385.

TELEVATICS
COMPUTERS FOR COMMUNICATIONS

See us at TCA,
Booth #2406.

Circle 15 on Reader Card

Digital
has
it
now.

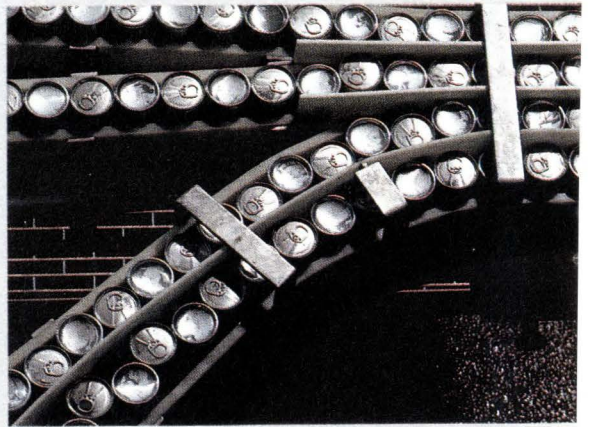

ASK Computer Systems Inc. has become the world's leading independent supplier of manufacturing and financial planning and control software by realizing there's one thing manufacturers can never have too much of: information. According to Ron Braniff, President and CEO, "Information is useful only when it's in the hands of those who need it. That's the strategy behind our products, and it's always been Digital's strategy."

With products like MANMAN® designed for Digital's computers, ASK provides a totally integrated approach to business information management that helps manufac-



“Digital’s architecture helped ASK become #1 in the totally integrated manufacturing software marketplace.”

turers of all sizes run more productively. “Because we develop products on Digital’s single architecture,” notes Braniff, “manufacturers can tie together as much of their operation as they want. They’re finding that more people with the right information means greater efficiency and control from start to finish.”

Braniff concludes, “As we introduce new software and Digital offers new computer systems, our customers can immediately take advantage of both technologies working together.” For your competitive advantage now, write: Digital Equipment Corporation, 200 Baker Ave., West Concord, MA 01742. Or call your local Digital sales office.

digital™

News in Perspective

involved than programmers," Cooper complains. "The only way to get through a procurement is to be just about perfect. And the chances of the government doing that on a major project are just about zero."

There's a good chance that the probability is less than that. Even the protestors, however, aren't asking for perfection. They wouldn't turn it down, of course, but they're not holding their collective breath. Fairness will suffice for now.

"The government opens the door to protests," Young says. "They don't educate their procurement guys nearly as well as they should. It's not that difficult to run an open competition. All it takes is a deterministic evaluation model."

An evaluation model is a description of how the government will make its award. Those are usually done on point scales—e.g., so many points for technology and so many points for price. Theoretically, a vendor should know going in what percentage of the winning score each category will be. Realistically, it doesn't always work out that way.

Fedmail Currency

There are megabuck, multiyear contracts at stake in this game. The winners walk away with millions, which could turn into billions. The losers also may walk away with something, since the government sometimes would rather pay than fight. In the old days, they called that hush money or payola. Now they call it fedmail. The name's not as harsh nor is the practice as widespread—yet. But the effect is the same. The payees still take the money and run.

"I know the system's being abused and that companies are playing the system for its own sake," Young says.

"But I'm not aware of any protest not made in good faith. And I have no personal knowledge of anyone playing the system."

Even if you don't play the system, it may play you. And you're not about to trash those results. Sometimes it's your competitor, not the government, that decides peace is worth any price. Last summer, Falcon Systems and Unisys Defense Corp.'s Defense Systems, McLean, Va., accepted an undisclosed sum from McLean-based Iverson Technology Corp. to cease and desist with their protests of a \$220 million FBI computer contract. Young wouldn't say how much Falcon received.

"The evaluation model problem has happened only in the last five years," Young says. "Sure, megacontracts are on the rise because the jobs are becoming so complicated. But that still doesn't mean the government can't write and follow a clear evaluation model. If they did that, they'd cut by 50% the number of protests."

Then they'd still have to deal with protests that occur because the government simply screwed up. Young cites a Navy storage and retrieval system contract in which Falcon was tossed from the competition. Why? Because the Navy lost part of the company's proposal.

"We asked the Navy to let us back in the RFP, but they wouldn't," Young contends. "We told them we were going to protest, and we were going to win, but they didn't seem to care. So we protested, and we're back in. And the Navy's changed management on the contract. But what kind of a waste of time and money was that? Those kind of actions

cause paranoia and suspicion among vendors. And the higher your level of paranoia, the more likely you are to protest."

Postage Stamp Power

One of the more popular theories in Washington these days is that all it takes is a postage stamp to halt a particular contract competition. That's figuratively correct, but it's only the first move in a very protracted process.

By filing with the GSBGA, the protestor is buying a minimum 30-day headache. If the GSBGA grants the protest, the competition is automatically suspended. But while the contract isn't going anywhere,

the protestor surely is. Each side has those 30 days in which to file all their procedural motions, complete all their discovery of evidence, and follow any other judicial

rulings the GSBGA may issue.

It's not a day at the beach. Pursuing a protest is a full-time job. The ultimate reward for winning is to return to the competition while getting back the company's documentable, provable, auditable protest preparation costs. Once that happens, nobody gives you any guarantees that you'll win the contract.

"Protesting can be incredibly expensive," explains Miller. "It cost Hughes Aircraft \$100 million to lose the FAA AAS [Advanced Automation System] contract." (IBM won that \$3.6 billion deal to revamp the air traffic control system, but the GSBGA granted Hughes' protest. The board was scheduled to hear the case Sept. 9.)

"IBM had 600 people working on the contract for two years," says Miller. "If Hughes gets back in, it's go-

ing to cost the FAA \$100 million" to reimburse Hughes.

Those are merely the financial considerations. What about the effect of the procurement process on the customers, the forgotten entities in this administrative jungle?

"There are a bunch of agencies that all have a piece of FAA's procurement," says Raymond Hilton, director of air traffic management for the Washington-based Air Transport Association. "They're very conservative and cautious. When the FAA wanted to replace its 360s with 3083s, it could have done it in three months with off-the-shelf equipment. Instead, the FAA did a 21-month design phase award. They just finished installing the last machine."

That had an impact upon "the whole modernization program," continues Hilton. "It impacted me because the airport delays are getting longer and the FAA can't implement the AAS safety procedure. The procurement problem is going to get worse, because when stuff like the DOD scandal hits the fan, every bureaucrat tightens up."

As vendors begin to feel the pinch, they undoubtedly will continue to pound on GSBGA's door. "I've got two deals working on which I've spent more than \$1 million each," Young says. "If they make a decision and it's wrong, I'll go in there with guns blazing. If I lose honestly and fairly, I won't protest because I'll lose in court."

"The GSBGA is doing a fine job of rooting out the evils in the system," Miller says. "It's the only part of the whole contracting system that's working with any teeth in it. The reason there's more complaining now is that the stuck pigs [the agencies] are squealing because they've been stuck hard by the GSBGA, and they deserve it. If an agency does it right, it's no sweat." ■

"PROTESTING CAN BE EXPENSIVE."

The anatomy of a prize Bull.

Bull printers are built to handle everything from tags, labels and bar codes to custom forms.

We know how precious floor space is. At 64" x 30" we occupy far less of it than most high-speed printers.

At speeds of 60 and 90ppm, Bull gives you the capacity to print anywhere from 200,000 to 2,000,000 pages a month.

Fewer moving parts mean fewer tune-ups and repairs. And our straight-through paper path virtually eliminates jamming.

Finally, you don't have to change paper in order to change printers. Bull can handle green bar and a wide variety of other fanfold paper stocks.

Bull's low price makes it the perfect printer for anyone who has outgrown a line printer but isn't ready to pay the high price of a laser.



First prize in the printing arena ought to go to the company that solves the toughest customer problem. It's a problem that anyone who needs to print more than fifty pages per minute knows firsthand. Because until now, they had to buy a printer with twice the capacity they really needed. And a price that took years to grow into.

But now there's Bull. A blue-blooded descendant of the \$3 billion worldwide systems supplier, Groupe Bull. Thanks to a new non-impact technology Bull offers blue-ribbon performance for about half the price of a comparable laser printer.

To find out more about how well a Bull runs, call or send for free copies of an independent customer satisfaction report* and detailed data sheet.

That way you can see for yourself why we call it a prize Bull.

1-800-541-BULL

Bull 
Peripherals

*"Magnetography - A User Study" by Datek Information Services. Bull Peripherals Corporation, 303 Wyman Street, Waltham, MA 02154

Circle 17 on Reader Card



Communicate With and Beyond

Tymnet has a way to let you communicate within and beyond your SNA network quickly and unobtrusively.

How?

Tymnet's communication solutions are based on software, not on installing another piece of hardware equipment.

That saves you both time and money. Plus, when you tie into Tymnet's network, you extend your SNA network out to the whole world of international data access and delivery, without disrupting your IBM host or front-end software.

SEE YOU AT
TCA-88
TYMNET/MCDONNELL DOUGLAS
BOOTH #1709

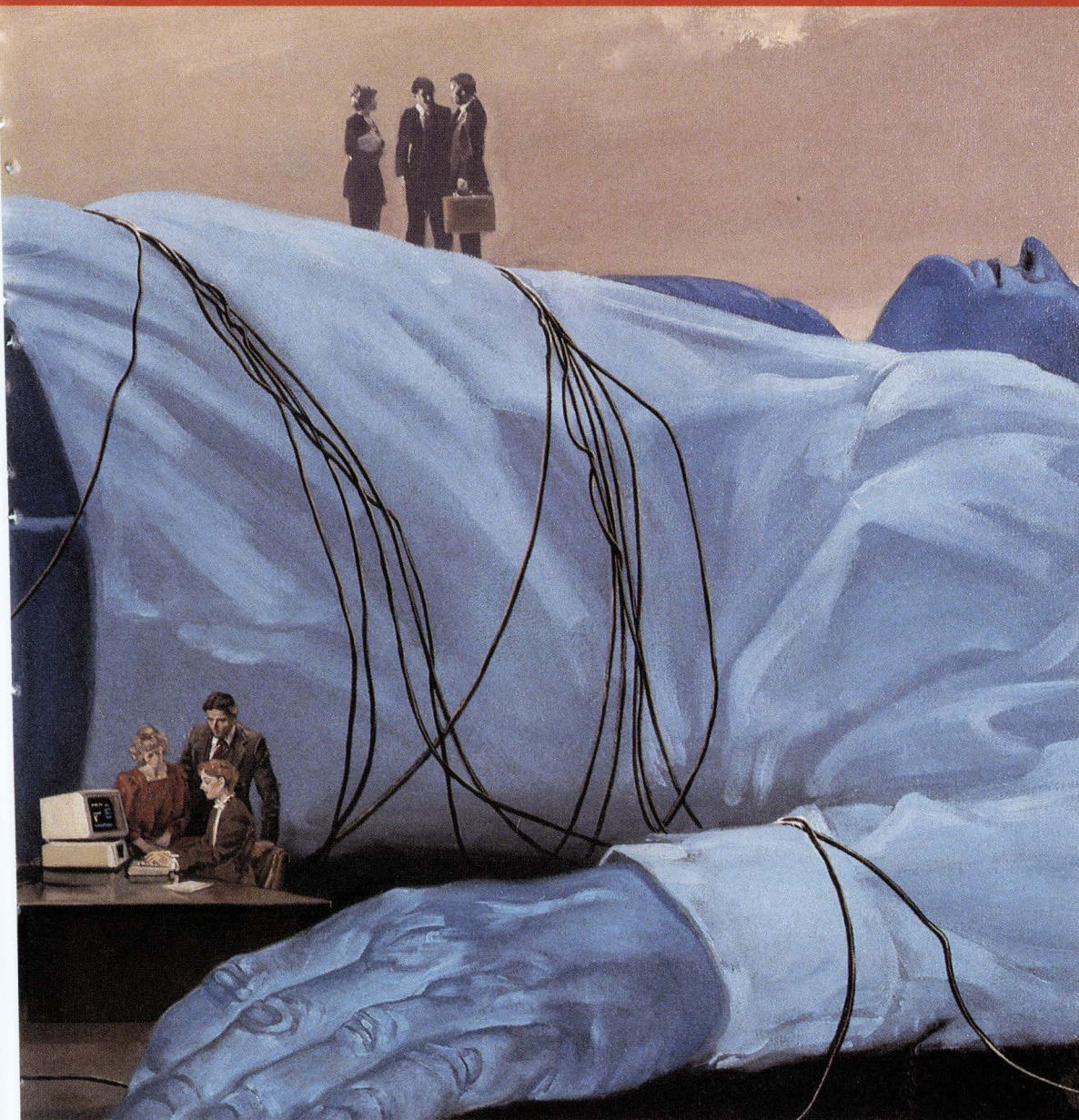

Big Blue Without Disturbing Him.

Tymnet offers these cost-saving IBM services in public, private, and hybrid network solutions:

- file transfer
- PC connectivity
- X.25-SNA integration
- Async-to-3270 protocol conversion

Tymnet can be your solution to communicate effectively within and beyond the SNA environment. It's easy.

Call 800-872-7654 for all the information you need to make your decision.

Tymnet

2560 N. First Street
P.O. Box 49019
San Jose, CA 95161-9019

We Build Networks.

MCDONNELL DOUGLAS

CITICORP 

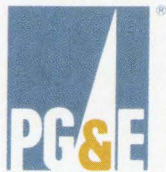

Pacific Gas and Electric Company



Money, Power and Connections.

To make it big, you need the right connections. Which is why you shouldn't use just any networking system.

Banyan provides all the connections your organization will ever need. Our VINES™ operating system is designed to serve networks of any size with transparent efficiency, making users feel like next-door neighbors. Whether they're oceans apart or just sitting on opposite sides of the water cooler.

CitiCorp and Pacific Gas and Electric are just two of the large companies who have turned to us to integrate the PCs in their midst. Among other things, we give them the means to add users at any time, anywhere on the network, without interrupting network operation.

Scores of other Fortune 1000 companies rely on Banyan for enterprise-wide networking of their local and foreign locations.

All the more reason to use Banyan if you hope to be listed among them someday.



Networks for those who think big.

Banyan Systems Inc., 115 Flanders Road, Westboro, MA 01581, 508-898-2404

Circle 19 on Reader Card

Behind the News

EDUCATION

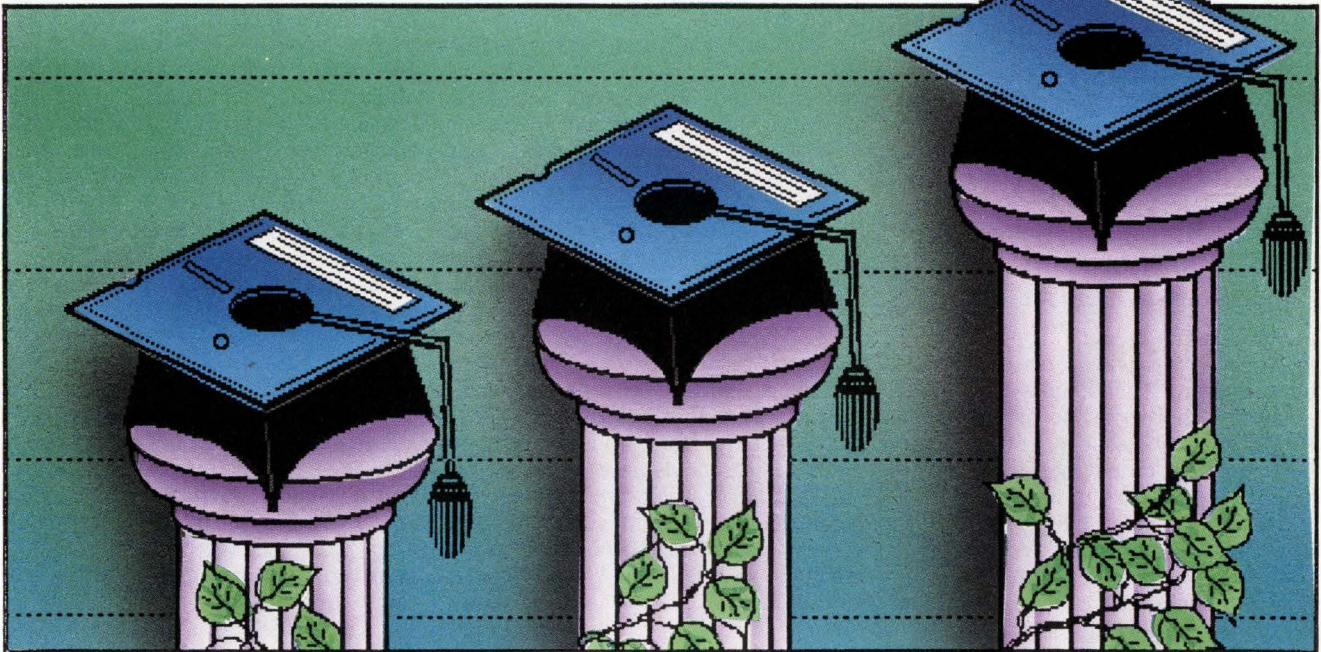

The New Maturity Of Computer Science

Accreditation and support from industry and government help remake a troubled discipline. Still, a PhD shortage looms for the long term.

BY PARKER HODGES

Every two years, in high summer, the heads of America's PhD-granting computer science departments gather to talk at an off-season Utah ski resort called Snowbird. There, in the mountains, they assess the health of computer science, the most recent science to enter the academic mainstream.

At the beginning of this decade, the Snowbirders were not happy. "A Discipline in Crisis" was how they described their field in a report for the Association for Computing Machinery. The institutions granting PhDs weren't turning out nearly enough product, and the quality of undergraduate computer science curricula ranged all over the map. But, according to David Gries, ex-chairman of Cornell's Computer Science Dept. and co-chairman of the Snowbird Conference, the mood at this year's meeting was different: "It seems that we

For a report on how students choose a career in IS, see p. 40.

have emerged from the crisis."

Among the items that encouraged this year's Snowbirders is a doubling of the number of computer science PhDs granted each year, up to about 500 in 1988 from about 250 in 1980 (though the demand for them is expected to exceed supply through the year 2000). The National Research Council has also set up a Computer Science and Technology Board, which, says Gries, "puts us on a par with the other disciplines."

The Computing Science Accreditation Board (CSAB) is further evidence of the new maturity of computer science. A joint project of the Association for Computing Machinery and the Computer Society of the Institute of Electrical and Electronics Engineers (IEEE), the CSAB opened for business in late 1984 and by July of 1988 had accredited 65 programs. The evaluators are nominated by the ACM and the IEEE; three fourths are full-time educators in the field, the rest

are from the high-tech vendor community—with the current crop hailing from AT&T, Siemens, and Stanford Research Institute.

People hiring graduates of computer science departments are also impressed by the new energy that has informed the discipline. Harry Reinstein, president and ceo of Aion Corp., Palo Alto, says, "Most of our recruitment on the development side of the house is from computer science graduates. I have been tremendously impressed by the quality of the people coming out of the bachelor's programs—not just their ability to craft code, but their ability to understand the needs of a company aimed at serving customers."

On the other hand, Norman Stotland, national director of information technology, Price Waterhouse, warns that some "pure" computer science graduates "don't have the people skills" that PW needs in its consultants. For that reason, PW's consulting division, which hires between 200 and 300 people a year, looks for "double majors, computer science and accounting, or computer science and business administration."

Another drawback that some observers point to is graduates' unfamiliarity with large projects. Because most schools are organized along the semester or quarter system, many students never get to work on large-scale systems. At some schools, however, undergraduates get a shot at larger-than-usual

Behind the News

projects. David Hanson, professor of computer science at Princeton University, says, "Princeton has a heritage of heavy emphasis on independent work, and so most students do anywhere from two to four semesters" of such work. At Rochester Institute of Technology, students spend four quarters in a co-op program working on real problems with real-world employers.

A Discipline with an Infant Subject

A quarter century ago, computer science was an academic discipline waiting to happen. "Unlike most other areas of inquiry, there was no natural arena such as an atom, tissue, or crystal lattice to serve as a source of observations. Instead, the 'universe' of interest was an artifact barely a decade old," wrote Seymour V. Pollack in "The Development of Computer Science," in *Studies in Computer Science* (Mathematical Association of America, Washington, D.C., 1982.)

Still, in 1963, the University of Michigan had something called the Communications Science Program. Carnegie-Mellon University's Dept. of Systems and Communications Science was then a year old. Most academic computing work and training, however, was the domain of electrical engineering or mathematics departments.

Today, according to the Association for Computing Machinery's *Administrative Directory of College and University Computer Science/Data Processing Programs*, there are well over 800 academic programs in computer science or data processing at North American institutions of higher learning, and almost 500 schools have departments called Computer Science. Others find even more programs: the 1987 College Board *Index of Majors* listed 1,085 programs in the U.S. for computer or information science.

There is still a big difference between the best schools and, well, shall we say, the others. Tom Philips, executive director of the CSAB, says that only "a shade over 400 institutions are running professional-objective programs. By that I mean the kind of program with a certain magnitude and balance of core courses, advanced courses, theoretical work, appropriate preparation for later study." Of the first 85 schools that requested accreditation for their computer science departments, 20 were turned down by the CSAB.

Philips says, "We recognize that

there are institutions committed to teaching, and that's a good thing. But we are telling schools that, to be accreditable, long-term, they cannot teach their faculty right into the ground and expect them to stay current and not burn out within a few years."

Jack McCredie, chairman of the Education Investment Review Board at Digital Equipment Corp. and ex-vice provost of computing at Carnegie-Mellon University, says, "In many ways, the top handful of computer-related activities happen at four or five major centers of excellence." McCredie mentions specifically MIT, Stanford, Carnegie-Mellon, and Berkeley. Reputations like these mean some schools have it easier than others. Don Dearholt, professor of computer science, New Mexico State University, says of his school's recent accreditation by the CSAB: "If we were as well-known as Stanford or Carnegie-Mellon University perhaps we could [have gotten] away without worrying about it."

Others place the dividing line between the best and the rest a lot lower, citing about "40 or 50 top-ranked schools."

Maintaining Quality

How do the top schools maintain their quality? DATAMATION asked that question of several of the leaders in the field and found remarkable consistency in their answers. Alton P. Jensen, acting director of Information and Computer Science at Georgia Tech, says his department's secret is "high-quality faculty and students." Martin Schultz, chairman of the Computer Science Dept. at Yale University says, "Hire the very best faculty we can. Give them relatively light teaching load. Give them plenty of support from the university and from grants, access to very good students, a quality environment in which to work."

There is agreement, too, on the importance of research grants. Sam Conte, professor emeritus of computer science at Purdue University, says that research money pays off for schools in three ways: "You get the best faculty, the best students, and you get the money as well."

The resources in question can be substantial. For example, in 1986, the most recent year for which figures are available, \$289.3 million in privately and federally financed R&D was carried on at 50 college or university computer science centers. But, here too, the cream

rises to the top: \$186.7 million of this money—almost 65%—went to the top 10 schools: Johns Hopkins, Carnegie-Mellon, the University of Southern California, New Mexico State University, the University of Illinois at Urbana, Stanford, MIT, Cornell, Georgia Tech, and the University of Texas at Austin.

The National Science Foundation is a source of some of this money. For fiscal 1988, the Computer and Information Science and Engineering Directorate of NSF has just under \$100 million to spend on computer R&D at colleges and universities. (This figure is only part of federal support for academic computing. Richard Schoen of NSF says the \$100 million kitty does "not count grants to the chemistry division for the purchase of computers, or grants to the mathematics department for purchase of computers, or grants to other divisions for support for computers.")

One project through which the NSF delivers help is called the Presidential Young Investigators. This program combines federal and vendor money to finance the purchase of equipment for use by scholars. Say, for example, that a Presidential Young Investigator (PYI) needs an Apollo DN10010 Workstation. The list price for this machine is \$87,100. Off the top comes Apollo's 10% educational discount; then Apollo kicks in a \$34,840 "matching grant" to the PYI; and NSF matching funds come in with another \$34,840. Result: the PYI gets his or her machine with a 90% discount, total price \$8,710.

Large Vendors Provide Support

Apollo is not alone in its support of academic computer science. IBM, DEC, Control Data, and many others have large-scale educational programs. IBM says it supports colleges and universities to the annual tune of \$61.5 million in cash, equipment, and salaries. DEC says that in fiscal year 1987 it has given well over \$100 million to "education-related programs in the U.S. and abroad." DEC's contributions include research funding, direct contributions (scholarships, etc.), discounts, and grant programs. According to Charlotte LeGates, director of communications for the Computer and Business Equipment Manufacturers Association, "many of our companies dedicate about half of one percent of their profit before taxes to educational philanthropy."

On the other hand, vendor contribu-

Twenty-five Top Computer Science Schools

SCHOOL	TUITION†	ROOM & BOARD	AVERAGE STARTING SALARY***	BACHELOR'S DEGREES AWARDED '88	GRADUATE DEGREES AWARDED '88	CURRENT ENROLLMENT	DEPT. ESTAB.††
Brown University Providence, R.I.	\$13,375/yr.	\$2,509/yr.	NA	75	NA	NA	1972
University of California San Diego	538/sms. 2,040/sms.*	4,000/yr.	25,000- 29,000	80	16-M 8-PhD	250-U 80-G	1987
Carnegie-Mellon University Pittsburgh	12,000/yr.	4,000/yr.	30,518	NA	15-PhD	165-U	1965
Columbia University New York	12,628/yr.	2,700/yr.	28,600	NA	NA	NA	1980
Georgia Institute of Technology Atlanta	5,886/yr. 9,558/yr.*	1,530/yr.	27,408	38	24-M	626-U,G	1962
University of Illinois Urbana	1,358/sms. 3,128/sms.*	3,386/yr.	28,956	88	85-M 25-PhD	390-U 325-G	1964
Johns Hopkins University Baltimore	12,000/yr.	4,804/yr.	30,000	46	NA	NA	1986
University of Maryland College Park	953/sms. 2,546/sms.*	2,989/yr.	25,000- 35,000	NA	NA	95-U 57-G	1969-U 1974-G
Massachusetts Institute of Technology Cambridge, Mass.	13,400/yr.	4,640/yr.	33,156	99**	0	NA	1972
University of Minnesota Minneapolis	2,460/yr. 5,145/yr.*	4,000/yr.	27,672	84**	60-M 5-PhD	400-U 238-G	Early 1970s
New Mexico State University Las Cruces	642/sms. 2,490/sms.*	595/sms.	27,072	55	13-M 3-PhD	200-U 75-G	1967
State University of New York Stony Brook	1,495/yr. 1,975/yr.*	3,365/yr.	26,000	58	NA	150-U	NA
New York University New York	12,000/yr.	5,850/yr.	25,000	143**	8-PhD** 104-M	600-U 340-G	1969
University of North Carolina Chapel Hill	422.50/sms. 2,223.50/sms.	700/sms.	27,000	50	55-M 1-PhD	100-U 200-G	1969
University of Pennsylvania Philadelphia	12,750/yr.	5,000/yr.	29,150 40,150-M	36	66-M 8-PhD	NA-U 157-G	1965
Princeton University Princeton, N.J.	19,690/yr.	Incl. in tuition	29,688	NA	NA	50-U 35-40-G	1986
Purdue University West Lafayette, Ind.	1,916/yr. 5,800/yr.*	2,510- 2,950/yr.	28,068	NA	20-M 7-PhD	664-U 51-G	1962
Rochester Institute of Technology Rochester, N.Y.	9,075/yr.	3,025/yr.	28,700	100	30-M	550-U 300-G	1972-U 1974-G
University of Southern California Los Angeles	12,972/yr.	6,596/yr.	26,676	NA	NA	250-U 350-G	Early 1970s
Stanford University Stanford, Calif.	4,188.93/qtr.	700/qtr.	41,000-M	18	NA	65-U	1985
University of Texas Austin	436.85/yr. 1,196.85/yr.*	NA	27,500	125	NA	950-U 250-G	1966
University of Utah Provo	464/qtr. 1,280.52/qtr.*	500/qtr.	30,500	47**	7-M 3-PhD	510-U	1976
Washington State University Seattle	597/qtr. 1,664/qtr.*	3,000/yr.	27,500	39	21-M 11-PhD	138-U 122-G	1967
University of Wisconsin Madison	928.50/sms. 2,819.50/sms.*	3,000/yr.	24,500 43,000-M	NA	NA	214-U, 72- M, 89-PhD	NA
Yale University New Haven, Conn.	12,960/yr.	5,000/yr.	NA	NA	NA	NA	NA

M - Master's, U - Undergraduate, G - Graduate

* Out-of-state.

** 1987.

*** For those with bachelor's degrees, except where indicated.

† These are estimated costs, and do not include summer sessions. All figures are for full-time entering freshmen taking a full course load, for a semester. Figures for Carnegie-Mellon, U. of Maryland, New Mexico State, Rochester Inst. of Technology, Stanford, SUNY Stony Brook, and Washington State do not include fees.

†† In many cases, computer science degrees were granted prior to the formal establishment of a computer science department.

Source: DATAMATION

Behind the News

tions can sometimes be more self-serving than they might sound. LeGates says vendors "really do a lot of stuff that leads to overall business goals," and she has advised schools seeking vendor support to tailor their proposals to the business aims of vendors. LeGates adds that some vendor contributions end up in "schools where [vendor] employees' children go." Still, as LeGates pointed out in a 1986 speech to the National Governors' Association Task Force on Educational Technology, "Our companies are deluged by floods of requests that they could not possibly fulfill without going bankrupt."

Nevertheless, things could be a lot better. The number of bachelor's degrees expected to be granted at the 123 top U.S. and Canadian computer science departments in 1988 was the lowest in the last four years. And, according to Georgia Tech's Jensen, "If the current level of computer science PhD production continues, in 2009 we will have only 50% of what we need." Even today, when DEC's Jack McCredie looks at engineering schools he sees "thousands of unfilled faculty positions."

According to "The 1986-87 Taulbee Report," an annual survey of U.S. and Canadian PhD-granting computer science departments conducted under the auspices of the ACM and IEEE, the departments had wanted to add an average of 1.4 new faculty per department, but they managed to add only one new faculty member. The report also suggests that the faculty in the field "continues to be far too young and inexperienced, a problem that only time can solve."

Disturbing, too, are the Scholastic Aptitude Test scores for students planning to major in computer/information sciences. According to a report from the Educational Testing Service, on the verbal half of the SATs, only students planning to attend vocational or technical schools or major in home economics or public affairs and services score lower than future computer scientists. On the math portion of the SATs, students planning a computer science major came in right on the mean for all students who took their SATs in 1987: not great, not dreadful, but below those planning to major in literature, religion, or philosophy. But David Gries says the Graduate Rec-

ord Exams tell another story. He cites GRE verbal scores for computer science graduate students at Cornell as high as those scored by English graduate students, and scores on the quantitative half of the GREs "just as good as the physics incoming class."

So, while computer science education is in better shape than it has been in the past, no one in the discipline is ready to relax. The ACM and the IEEE have established a joint, 10-member Computer Science Curriculum Revision Committee under the direction of Alan Tucker, Bowdoin College, Brunswick, Maine, and Bruce Barnes, vp of the Software Productivity Consortium, Reston, Va. The committee has been meeting through the spring and summer and will announce its recommendations soon. Many in computer science point to the recommendations of the last joint curriculum committee in 1978 as a milestone in the maturation of the discipline; with any luck, another leap forward may be imminent. ■

Research assistance and chart compilation was provided by editorial secretary Anne Mangieri.

How College Students Choose IS Careers

A three-year study of over 500 business students shows that they choose IS early on, but often for the wrong reasons, such as parental pressure.

BY ROBERT A. ZAWACKI,
DEBRA KUBERT SCOTT, AND
PAULA A. ZAWACKI

IS journals and business publications these days are filled with warnings on the intensifying labor shortage within the computer field. The labor demand is great; one prediction says the need for systems analysts will increase by 76% between now and the year 2000. A recent survey of 100 major corporations reports that four of the five fastest-growing occupations between now and 1995 will involve computers.

Despite the opportunities, article after article reports that the supply of systems analysts, systems programmers, network planners, and software engineers is short and will get shorter through the end of the century.

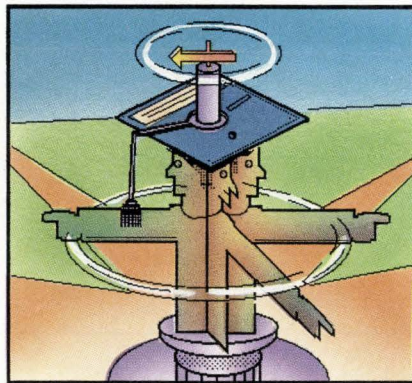

It has been suggested that the solution to this shortage lies in the colleges and technical training programs, which, it is said, should do a better job of motivating young people. Indeed, this study and the first author's past research has

shown that thousands of young IS professionals apparently enter the profession either for the wrong reasons or based on an incomplete understanding of the job, derived from impressions that they formed in college.

The IS skills crunch thus can be viewed as having been caused by the circumstances surrounding a long process that includes three factors: how young people choose IS as a profession; how each person's ability and motivation match the job; and how each person is managed once on the job.

Having already researched the second and third factors, we conducted a three-year study of how 530 business students at two major U.S. universities selected a career in information systems.

IS Careers Generally Chosen Early

Regardless of the reasons, the study shows that a large percentage of IS majors reached the achieved and moratorium status categories (see "The Study: Methodology and Definitions"), indicating that they firmed up their career decisions much earlier than did other business majors.

The first set of charts shows what percentage of survey participants at different levels of study falls into each sta-

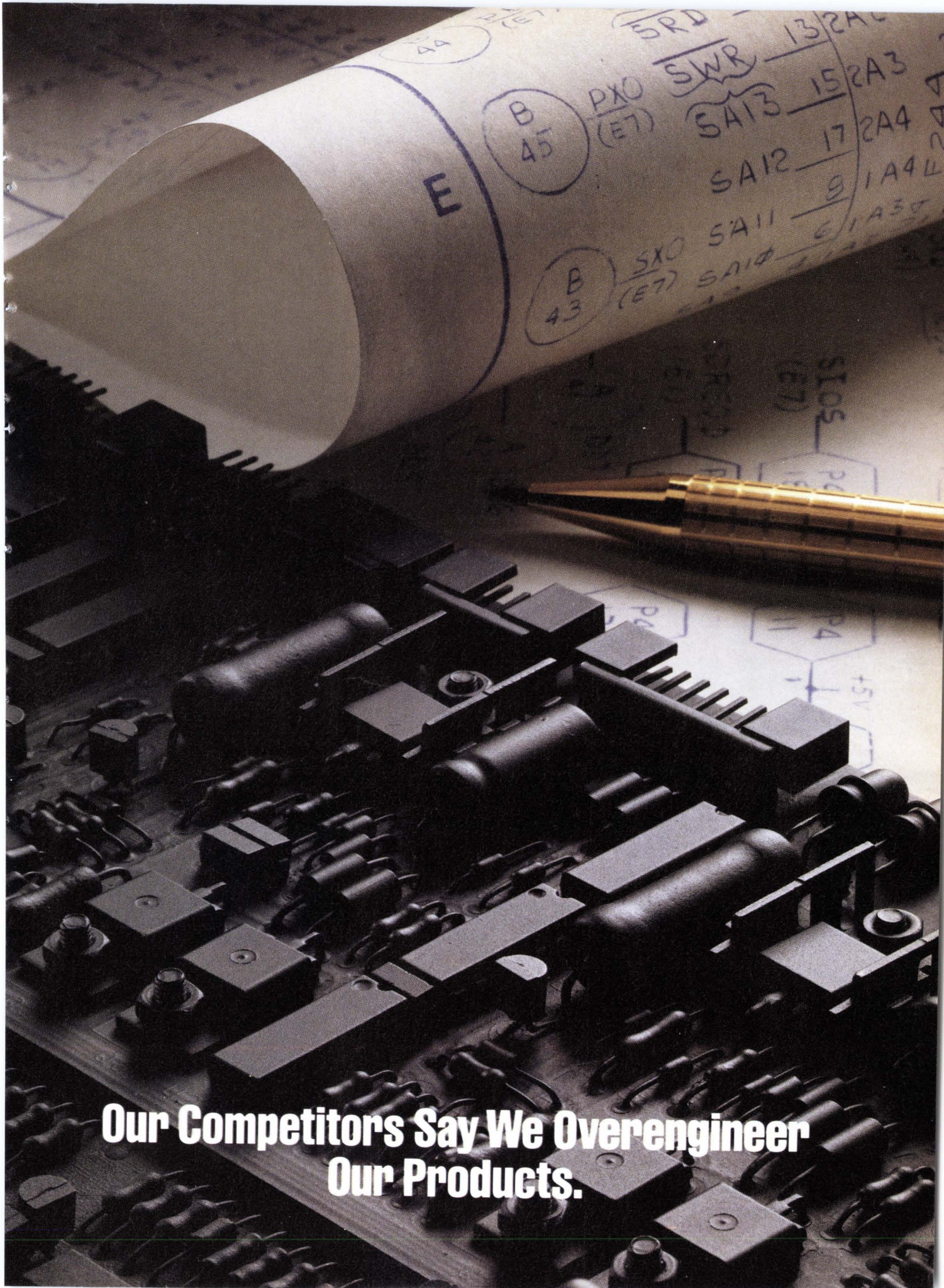

**Our Competitors Say We Overengineer
Our Products.**



Precisely.

When our engineers design a Genicom printer, they start with the obvious: functionality. Building in all the features a printer user needs. And making sure that the printer will perform up to its expectations with unerring precision and rock-solid dependability.

But we go beyond that. Because we know that you also need versatile machines that offer a high degree of compatibility. As well as printers that you can upgrade or adapt to your future applications.

It all adds up to the fact that Genicom offers you exceptional value for the dollar: superior performance on a long-term basis.

So the next time you're considering a new printer, think of Genicom first. We offer a full line of hardworking printers: everything from daisy wheels to lasers, plus dot matrix, line matrix and band printers.

Actually, we enjoy our reputation for overengineering because people depend on Genicom printers—over and over again.

GENICOM

Ideas that work as hard as you do.

Genicom Drive, Waynesboro, Virginia 22980
1-800-4-GENICOM



Circle 20 on Reader Card

Behind the News

Trend of Statuses: IS and Other Business Majors

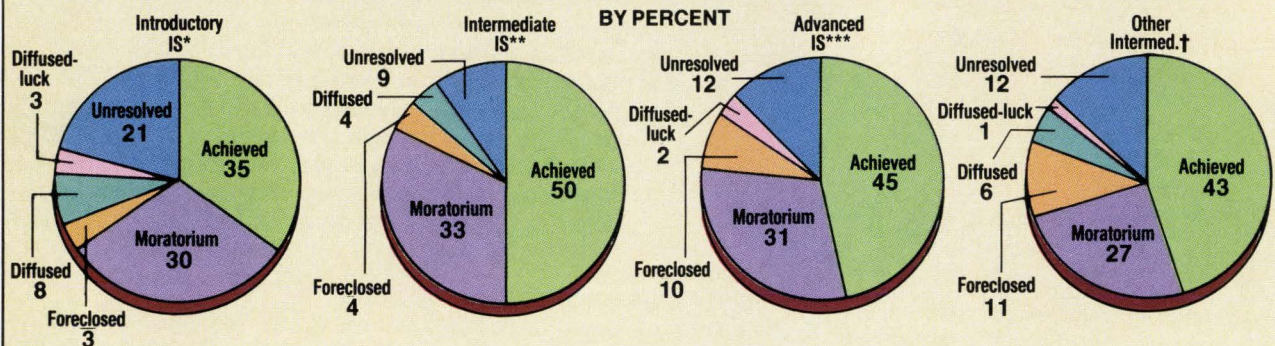

*Introductory IS is basic programming.

**Intermediate IS is advanced sophomore and junior courses.

***Advanced IS is the senior systems analysis and design courses.

†Other intermediate courses are junior business majors in accounting, management, marketing, and small business.

Source: Zawacki, Scott, and Zawacki

tus category and compares the progression of IS majors and other business majors from the diffused and unresolved status categories to the achieved status category.

The next pair of charts indicates that a smaller percentage of IS students were reported in the "diffused" and "unresolved" status categories than were other business students. In addition to choosing their college majors earlier, IS majors remain more committed to their decisions than other business majors.

Returning to the first set of charts, when we compare the percentage of introductory IS students within each status category to the percentage of intermediate IS students in each status category, a trend clearly emerges. The percentage of students in the foreclosed status category, while small, increases by more than threefold between the introductory and advanced levels.

External Pressure To Choose IS

Because these people often feel pressured into their career choices by the wishes of significant others in their lives, they generally have less commitment to their job. Significant others are, for example, an uncle in information systems, a parent who tells them there is good money in IS, or a college professor who awards them an "A" in their first programming course and encourages them to major in IS.

Meanwhile, the percentage of participants in the achieved and moratorium status categories increases to 50% from 35% and to 33% from 30%, respectively, and the percentage of participants in the unresolved status decreases to 9% from

The Study: Methodology and Definitions

Participants in this study were enrolled in introductory business courses and advanced courses within their major subject. Each student first took the Dallas Identity Status Inventory-Occupation (DISIO) in their basic business course and completed it over their sophomore, junior, and senior years. Their responses were compared, over time, by business major, age, and sex to determine when and how they selected a major.

The DISIO is based on the research of Marie Dellas and Louise P. Jernigan, who divide the process of career choice into six major identity categories. Their research focuses on the variables "crisis" and "commitment" as processes involved in the development of one's self-concept and identity. Unless a person experiences what he or she perceives to be a crisis about career selection, and then develops some commitment to solve the crisis, a focus on career rarely develops. Initiation of the crisis period described by Dellas and Jernigan is based on the theory of ego-identity development. Ego development extends throughout an eight-stage life cycle, where each stage represents a conflict or crisis. The crisis confronting individuals in late adolescence concerns the conflict of identity versus identity diffusion. Identity describes the sense of individuality and continuity of the self. It involves the ability to make choices among alternatives and to make commitments to the alternatives selected. Identity diffusion is characterized by lack of both a sense of self and continuity of self over time, and it involves the inability to make choices and stable commitments. As adolescents are expected to make career decisions and develop beliefs during this phase, the areas of career and ideology are critical in the establishment of a sense of identity.

In this study, the career choice crisis is defined as an active search and exploration among alternatives; commitment is defined as the degree of personal investment in an occupation or belief. The six major DISIO identity categories are:

- **Achieved.** This describes people who have experienced a crisis and have made firm commitments to a career based upon their own analysis.
- **Moratorium.** This describes people who are in a current state of crisis, but whose commitments are vague or lacking. They are searching for information on careers.
- **Foreclosed.** This describes people who have experienced no crisis, but who have made firm commitments, which generally reflect the wishes of significant others.
- **Diffused.** This describes people with no commitment to a major or career who only superficially search for career information.
- **Diffused-luck.** This describes people with no commitment, who leave their major and career choice to luck, or, "What will be, will be."
- **Unresolved.** This describes people who don't fit any of the above categories.

EXPAND
YOUR USER INTERFACE
OPTIONS WITH
USEIT

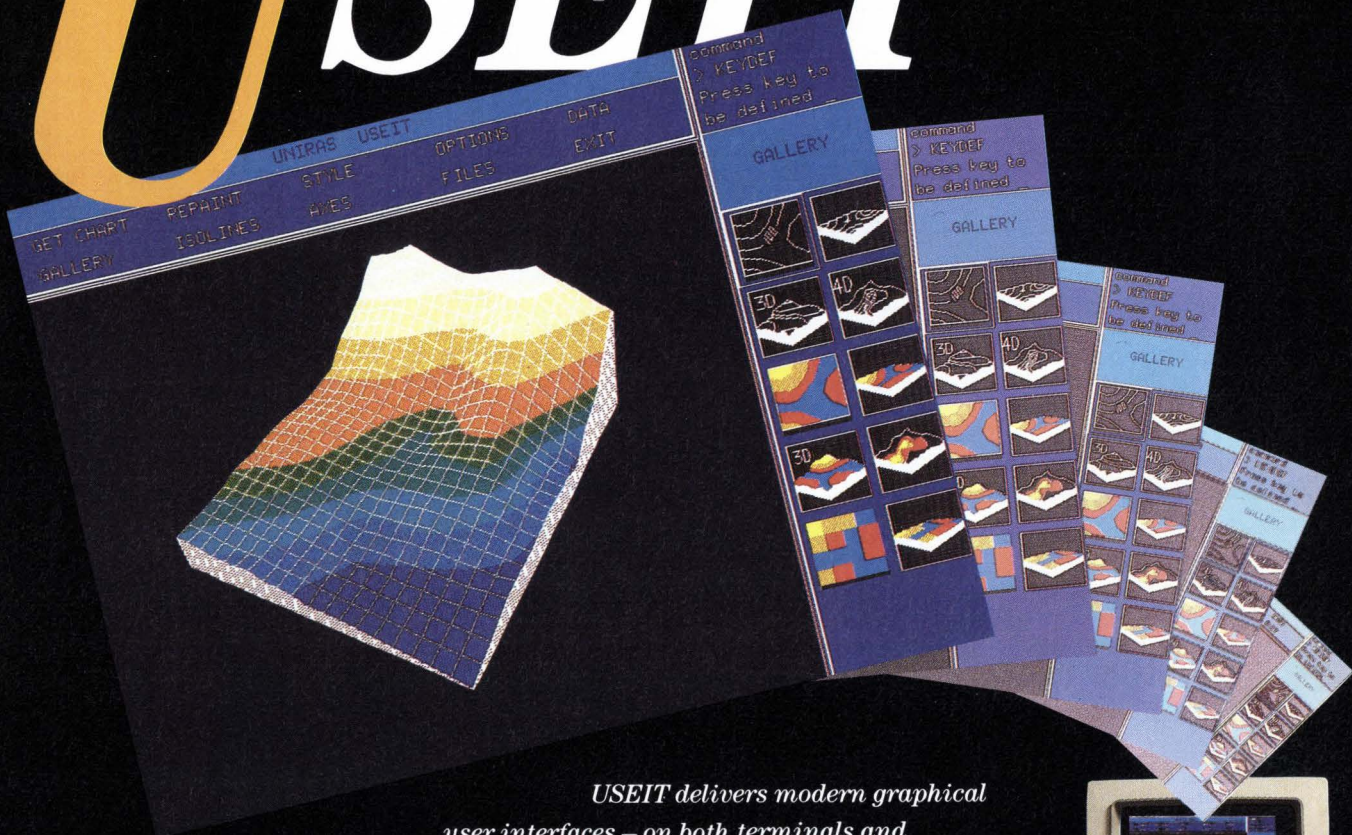

USEIT delivers modern graphical user interfaces – on both terminals and workstations – quickly, easily and to your own personal design.

USEIT dramatically reduces application development time by enabling you to rapidly create, visualize, test, edit and re-create interactive interfaces.

USEIT eliminates the need to reprogram interfaces for different computers or display devices; it permits you to remodel the interface independent of the application code; and it is supported today on mainframes, minicomputers and workstations.

USEIT forms part of the new UNIRAS product line of graphics fundamentals, CGM and GKS implementations, high level applications subroutine libraries and interactive applications systems.

Contact your nearest UNIRAS office today for further information.

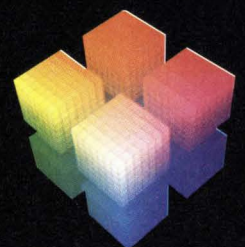

UNIRAS

Copenhagen (01) 67 22 88
Dusseldorf (0211) 596 1017
London (0753) 79293
Paris (01) 4776 4479
Dallas (214) 980 1600
Boston (617) 272 7260
Los Angeles (619) 931 4777

Behind the News

Comparison of Status Reported: IS Majors and Other Business Majors

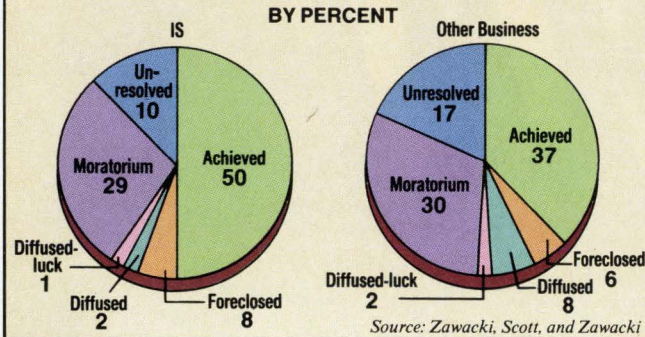

Comparison of Status for Male and Female Participants

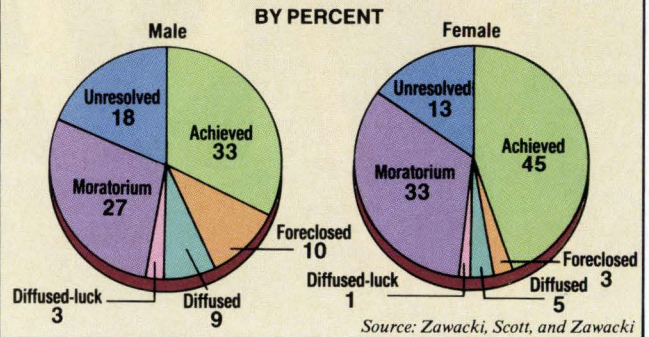

21%. The increase in the percentage of students certain about an IS career between the introductory and intermediate course levels seems to be positive.

What this may indicate, however, is that those who performed well in introductory courses selected IS as a major without realizing the total package of

skills needed to be successful in the IS profession.

Introductory IS classes, generally taken in the student's sophomore year, include programming and a general study of business information. Intermediate IS courses are usually taken in the second semester of the sophomore and junior

years. They include topics such as data systems, file structures, file processing, COBOL programming, control systems, on-line query systems, and database management. Advanced courses are taken in the student's senior year; they generally cover topics such as systems analysis and design in depth.

Beyond Today



Certification

For Today and Tomorrow

You have worked hard as a computer professional and it is time to look to the future—to your growth in the industry. The Institute for Certification of Computer Professionals' programs give you the chance to demonstrate your standards of excellence and qualify yourself as a certified professional. ICCP offers certification to match your specific needs and provide you with insight to see over the horizon and into your future success.

Measure Success

ICCP offers four designations to professionals in the industry.

Certified Computer Programmer (CCP) Designed to measure senior level computer programming skills for those with a broad background in the industry.

Certified Data Processor (CDP) Geared specifically to those information processing professionals with extensive experience in the field.

Certified Systems Professional (CSP) Identifies practitioners who have attained experience in information resource management and related disciplines.

Associate Computer Professional (ACP) Provides a method of evaluation for entrance level programmers in specific languages.

An Educational Effort

The American Council on Education (ACE) has recommended awarding college credit for individuals who pass the CDP and ACP examinations. ICCP certification means you may be eligible for this credit—an invaluable

asset as you pursue your career and educational endeavors in the industry. Through ICCP recertification your accomplishments are kept fresh, up-to-date and credible in tomorrow's changing world of technological advancements and increased competitiveness.

For more details call 312-299-4227 or fill in a coupon and mail today.

Exam Dates

November 12, 1988
May 13, 1989

Application Deadline

October 14, 1988
April 14, 1989

Charge Card Information Complete and send coupon to: ICCP, 2200 East Devon Ave., Suite 268, Des Plaines, IL 60018.

Account Number

Make check payable to ICCP or use charge card.

Study Guides

<input type="checkbox"/> ACP	\$12.50
<input type="checkbox"/> CCP	\$15.00
<input type="checkbox"/> CDP	\$15.00
<input type="checkbox"/> CSP	\$15.00

Applications to Take Exam

Includes Test Sites, Exam Content Outline, Code of Ethics.

ACP CDP
 CCP CSP

\$ _____
Total Amount Enclosed

Name _____

Street Address _____

City/State-Prov./Zip-Postal Code _____

Telephone _____

Cardholder's Name _____ Exp. Date _____

Signature (Mandatory on all charge orders) _____
ABC 12345

**Your Career Horizon is as Unlimited
as Your Dedication to the Profession**

OUR NEW PRINTERS MAKE EVEN BAD WRITING LOOK GOOD.

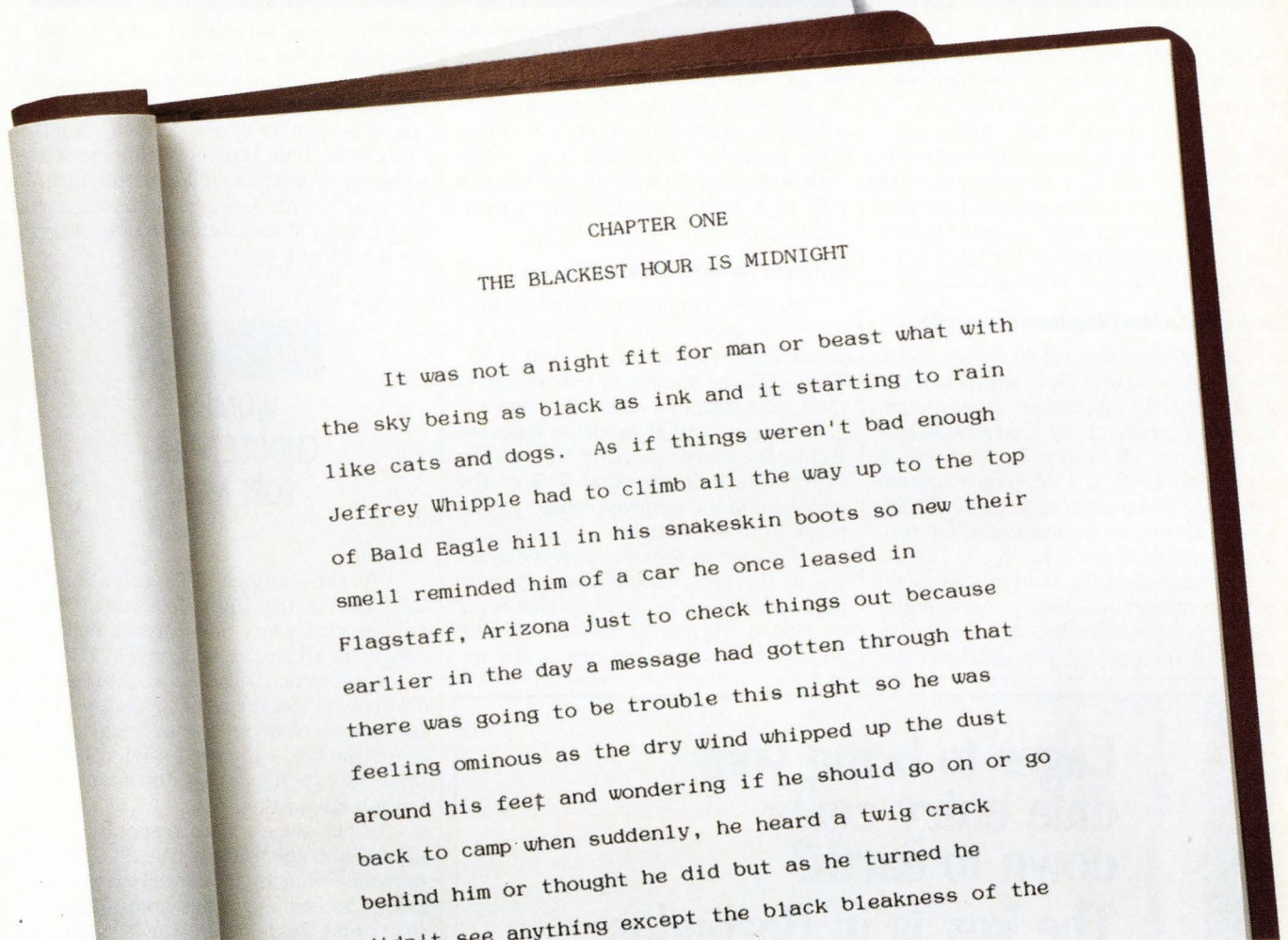

We're sorry that our new 24-wire Pinwriter® P5200 and P5300 printers can't do much for the quality of your writing. But they can certainly do wonders for the way it looks. The secret is the ribbon. Other dot matrix printers only use a fabric ribbon. Our Pinwriters print with both a fabric and a letter-quality, multi-strike film ribbon—the same kind used on executive typewriters.

The NEC Pinwriters can also enhance your writing in other ways. They have seven resident type styles. Plus four more are available on plug-in font cards. Which means you can express your thoughts with just the right typeface. You can also get an inexpensive, user-installed color option. And if graphics are part of your story, these Pinwriters produce the highest resolution of any printer you can buy.

Call NEC Information Systems at 1-800-343-4418 to see how much better our new Pinwriter P5200 and the wider P5300 can make your writing look.

Whether you're a budding Hemingway, or a Hemingway & Company.

**NEC PRINTERS. THEY ONLY STOP
WHEN YOU WANT THEM TO.**



NEC

NEC Information Systems, Dept. 1610, 1414 Massachusetts Ave., Boxborough, MA 01719.

Behind the News

One alarming finding is that the trend toward achieved status does not increase for IS seniors as we expected; rather it decreases to 45% from 50%.

The drop-off in the senior year seems primarily to be the fault of the way IS curricula are typically set up. With technical topics comprising the introductory courses, the people-oriented topics, such as group dynamics, are left for the advanced courses or not covered at all.

Technical Courses Reinforce Expectations

Given that the typical IS personality has a high need to achieve and quite a low need for social interaction, as was found in earlier research by Couger-Zawacki (see "What Motivates Dp Professionals," Sept. 1978, p. 116), it appears that the early technical course content reinforces those job expectations for prospective IS professionals.

Consequently, students who do well in an introductory programming course elect to major in IS and do not realize until their junior year intermediate

and advanced courses that they must interact with team members and users to design effective systems. Those students may begin to question their career selection, causing the drop in commitment in their senior year. The people with higher social needs often select majors in personnel management, marketing, or production management.

Different Paths for Men and Women

Another important cumulative finding of our study is the significant differences between male and female IS students. A large number of females are in the final stages of a career decision at a point when a large group of the males are still in the early searching stages. The third table indicates that 33% of the males are in the achieved category compared to 45% of females.

Further, 27% of the surveyed males are in the moratorium category compared to 33% of the females. That women choose IS as a career sooner than men do may indicate that they recognize ex-

cellent career possibilities due to the shortage of IS professionals.

The practical implication is that IS managers should be very pleased with the large number of females selecting IS as a career; their greater commitment to an IS career should result in better intrinsic motivation and productivity and equal, if not lower, turnover rates when compared with males.

**WOMEN
CHOOSE DP BEFORE MEN.**

As the shortage of IS professionals increases in the 1990s, pressure from college professors and parents will increase for students to major in IS. If they continue to encourage students to select a career in IS for the wrong reasons—for the money, or because they have a relative in the field—the profession will continue to experience high turnover and low job satisfaction.

If our society is to respond to the information age, it must train and retain personnel who are motivated to succeed in IS. The findings of this study suggest that those responsible for IS training should make some changes in the curriculum. Because the profession will continue to move toward end-user computing, curricula should expose the student to more entry-level courses on group dynamics, human behavior, negotiation skills, change skills, and conflict resolution.

Once these new systems people are on the job, those firms with good in-house training programs should add a course on how to implement effective change with end users. Providing students with early career information will help them identify appropriate careers. ■

Robert A. Zawacki is professor of management and organization, University of Colorado, Colorado Springs, focusing primarily on the human side of IS. Debra Kubert Scott is an MBA student at the university and the senior editor for a major book publisher. Paul A. Zawacki is an information center analyst for Penrose Hospitals.

Eager to bring your data entry costs down to earth? The key is in Barbados.

Barbados has the advantages of a fully developed business center. International sea and air ports. The most advanced telecommunications system in the Caribbean. A skilled work force. A stable political and economic environment. Tax concessions. Duty free imports. As well as access to EEC, Canadian and USA markets.

For detailed information about Barbados, the perfect climate for business, write or call us today.



BARBADOS INDUSTRIAL DEVELOPMENT CORP.

800 Second Ave., 17th Flr. N.Y., NY 10017.
(212) 867-6420.

Yes, I am eager to reduce the cost of data entry.

Name/Title _____
Company Name _____
Address _____
City _____ State _____ Zip _____
Area of Interest _____

"This material is prepared by Van Brunt & Company, Advertising Marketing, Inc., 300 East 42nd St., New York, New York, registered with the Department of Justice, Washington, D.C. under the Foreign Agents Registration act as an agent of Barbados Industrial Development Corporation, 800 Second Avenue, New York, New York. This material is filed with the Dept. of Justice where the required registration is available for public inspection. Registration does not indicate approval of the contents of this material by the United States Government." U.S./ Foreign Agents Registration No. 1704.

CIRCLE 24 ON READER CARD



Discover Your Total Network Performance



With NetSpy, you get the information you need to determine if your network is being used most effectively. It is the most complete VTAM network performance and end user response time monitor for MVS environments. And, it's the only VTAM monitor that has interfaces for session manager systems such as TPX (Terminal Productivity Executive). These interfaces measure true "end-to-end" response time for each application you access. NetSpy also helps with network control, management, capacity planning, and systems programming by addressing the areas of:

END-TO-END USER RESPONSE TIME

NetSpy's real-time displays show:

- Current, average, and worst response times for the host and network
- CICS and TSO network times without the need for special applications coding (definite response mode)
- Response time by terminal, cluster, or line

NETWORK TRAFFIC AND CAPACITY PLANNING

NetSpy's SMF records can be used to:

- Model or project network activity and growth
- Determine network performance and equipment usage
- Tune network performance

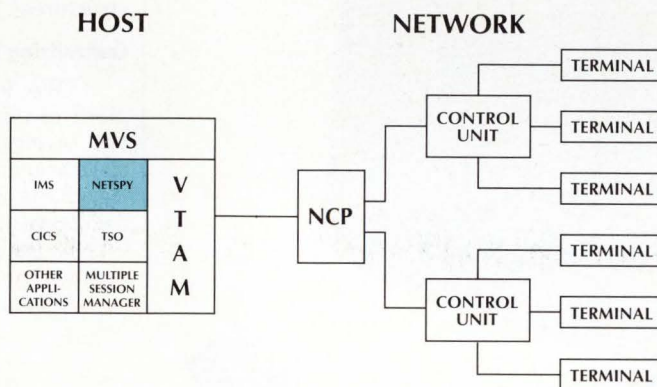

NetSpy lets you report on both your host and network by providing accurate session, hardware, and traffic statistics.

Call us today at (800) 323-2600 or (412) 323-2600 in Pennsylvania to arrange a FREE 30-day trial, and discover how NetSpy can improve your network's performance.



Duquesne Systems Inc. • Two Allegheny Center • Pittsburgh, PA 15212 • (412) 323-2600

The Politics of Network



As computer resources decentralize and the number of networked devices explodes, firms are centralizing their reporting structures, and network management is becoming the crucial coordinator. The question is, who should have operational authority?

BY SUSAN KERR

Network management, the latest handwagon to roll into town, has something for everyone. It covers everything from mainframes to pcs, carrying every ware imaginable: graphics, windows, databases, artificial intelligence . . . you name it, network management's got it.

But unlike most trendy items that quickly fall by the wayside, network management shows some staying power. Or just power, period. That's because network management is facilitating a quiet reformation of corporate information and communications organizational structures.

Centralizing To Cope with Decentralization

"We feel we need to centralize more of our network since significant cost savings are obtainable through central management of voice and data," says David Burns, senior vice president of data services for Affiliated Banks Service Co., Thornton, Colo. "Centralization is a reaction to scarce resources."

Although it may be simplistic to de-

While not technically overseen from a central site, the process for handling troubles has evolved. Although Ames has had a centralized network control center for years, it's only recently that LANs have fallen under its umbrella. One reason is that the LANs themselves are becoming more interconnected. Previously, if there was a problem, a user might call the person who originally designed the network rather than go through a central help organization.

At 3Com, Enterprise Systems Div. marketing vice president Douglas Pollack says that in big corporations it's no longer functional managers who are buying its work group products, but MIS and data processing departments. The smaller, end-user groups that traditionally purchased the products were more concerned about things like speed than they were about management capabilities and standards. With the tremendous growth of network bridges, he says, network management has become the priority it never was in the past.

Limiting the Number of Vendors

One sidelight to the issue of controlling LANs is that while the technology to manage them centrally may not exist in the shape or form some would like, there are numerous centralized control mechanisms being enacted. At Boston-based Gillette Co., Richard Crane, director of systems operations and telecommunications, has pared down the number of

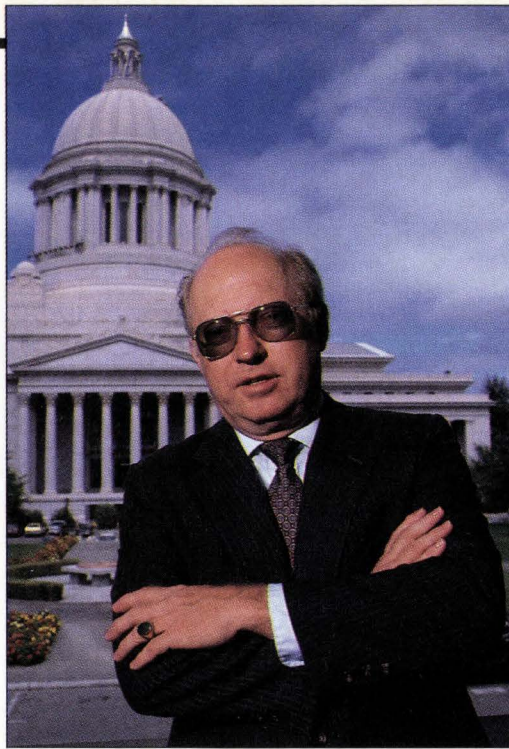

WASHINGTON'S CLEGHORN: Centralization is needed.

communications vendors. While locations can choose whichever LAN they can make a good argument for, he feels the important thing is limiting the number of manufacturers within a site.

Others are following the same rule. One reason is that even though vendors may have decent management gear for their own equipment, the rough spot today is managing multivendor networks. Limiting the number of vendors to begin with is seen by some as a way to alleviate problems.

The promise being held out for users is end-to-end network management. From a mission control console, you will be able to operate remotely and trouble-

shoot any device on the network. What's more, expert systems will emerge that will allow the systems to operate with less human intervention and more proactively.

In reality, while plenty of blueprints exist for the end-all network management system, users today need multiple tools to deal with proprietary pieces of network equipment. For example, one West Coast user cites a DECnet protocol problem on his T1 channels. The T1 vendor and his network management system are concerned only with transmission difficulties, which is of no consequence in this event.

These problems are not, and will not, be easily solved. The realistic expectation is that in the next decade, companies may have consolidated network management operations, but will depend on numerous systems. Among the most likely survivors are IBM's NetView, AT&T's Unified Network Management Architecture, OSI, DEC's much-delayed multivendor network management product, and, depending on the need, other specific programs, such as Cincom's Net/Master.

Data Is Moving Out to the Desks

Chevron Corp. uses IBM's NetView product. "The more things that attach to it the better," says Chevron Communications Technology Dept. general manager William Houghton. "Today, most data is in the data center, but that's changing." He points to the 7,000 pcs on the desks of

Three Phases of Fortune 1000 Network Management

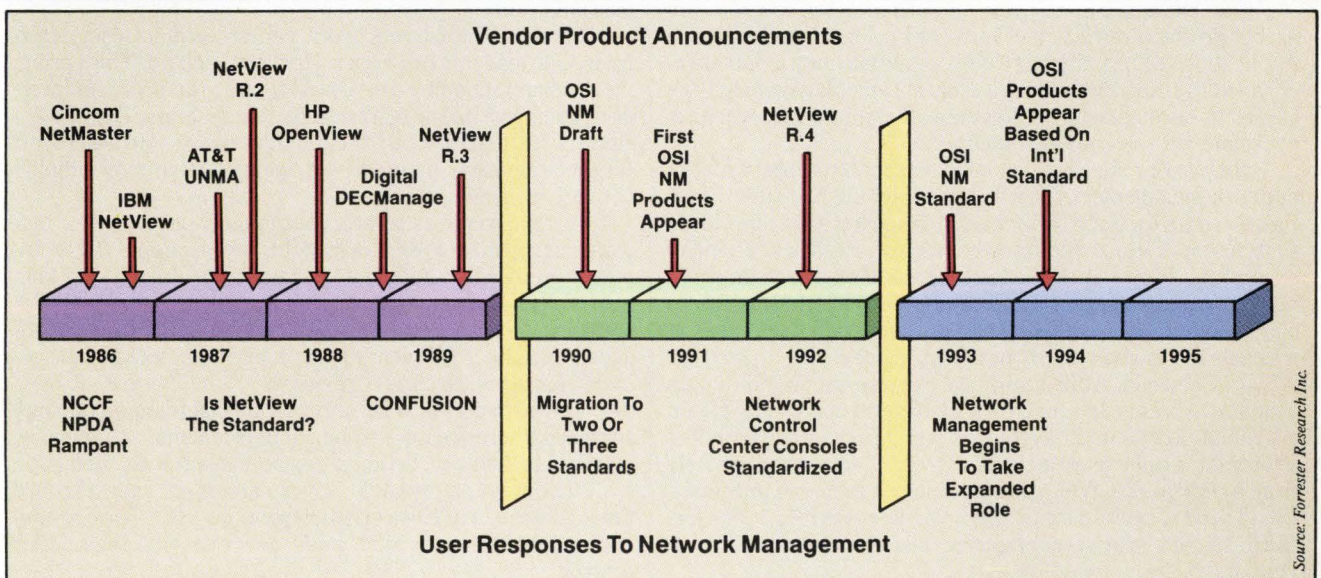

The Politics of Network Management

the company's employees. The evolving peer-to-peer relationship among computing equipment is going to have a significant impact on network design and management, he believes.

Execs Fueling Centralization Drive

Distributed computing will lead to some centralization of network management, agrees Bernard Guidon, Hewlett-Packard Co. group marketing manager. The number one reason is cost, but also the global perspective that top IS executives are adopting.

This need for more information has been a driving force at Gillette. Six years ago, Gillette placed its voice and data operations under the management of corporate MIS. Since then, among the network management tools it has adopted is IBM's NetView. As Gillette's local campus backbone network is an AT&T Information Systems Network, Crane is looking forward to full-fledged versions of AT&T's UNMA products.

Crane acknowledges that his awareness of, and hence participation in, network management has jumped in the last year or so. "The information was avail-

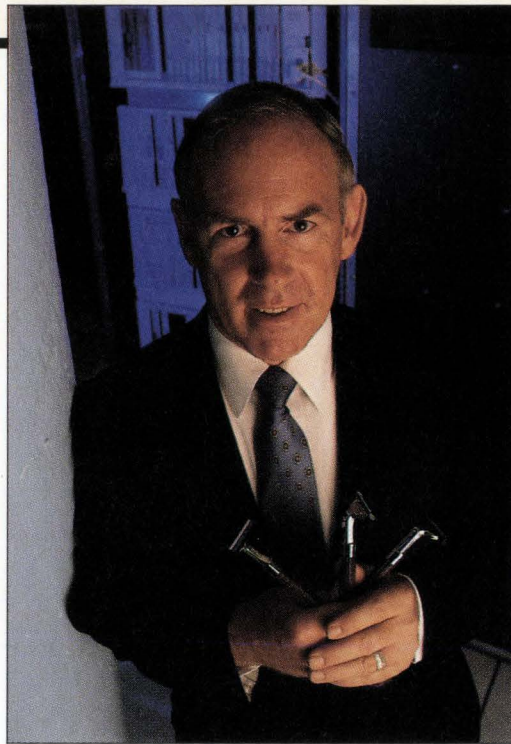

GILLETTE'S CRANE: More awareness of net management.

able with the old tools, but I'd say it's reaching me now because it's information I can understand. It's more readable," he says.

Vendors report that the recognition factor of network management is rising within their customers' corporations. Some say IBM is responsible: when IBM sells a product, it tends to push the sale at a higher level within the customer's

organization.

"The network control center today includes people ranging from the systems operations staff to the people managing the lines," says Robert Anderson, IBM manager of telecommunications software product management. "Their responsibilities may not have merged but just having them in the same room is having very positive impact." There are distinct pluses, but the message seems to be that most of the user community is struggling to come to terms with limited budgets, lots of equipment, and a tool—network management—that is still evolving.

Kathryn Korostoff, a senior analyst for International Data Corp., Framingham, Mass., believes that centralized network management is more important for the Fortune 200 group of companies than the rest of the world. In most companies, she continues, the still separate nature of MIS and telecommunications will make consolidation difficult. "Who has the responsibility for network management, how will it be divided up?" she asks. "The nature of the user organizational structure is a definite hindrance to centralized network management systems." ■

Technology's Role In Network Management

While there's no substitute for good people management, technology is playing a role in the politics of network management. Despite their imperfect nature, many basic network operation tools are in place and in active use. They certainly aren't anywhere as integrated, pretty, or cheap as users would like, but they are here.

For example, IBM's NetView product line is rooted in earlier products such as the Network Problem Determination Application (NPDA), the Network Communication Control Facility (NCCF), and the Network Logical Data Manager (NLDM). Under the first release of NetView, these basically were repackaged with a common interface.

Richard Crane says that he is reasonably happy with the network management tools he has, including NetView. Sure, there's room for improvement, but the Gillette Co. director of systems operations and telecommunications has seen many examples where the technology has enabled him to improve his network. In some cases, Boston-based Gillette was able to diagnose network overloads and redirect traffic; in others, it was able to shave the number of leased lines.

In Colorado, Affiliated Banks Service Co. found that its Cincom Systems Inc. network management system raised availability on its teller systems several percentage points—overnight. Other uses include upgrading software remotely from a central site. While that capability is there for terminals, David Burns, senior vice president of data services, looks forward to one day reconfiguring PBXs without calling in vendors.

Both Crane and Burns realize that the top priority of network management is to keep problems to a minimum, and, if they do occur, to take care of them as quickly as possible. However, the hope is that in the future, these operational aspects of network management will expand to include more proactive functions, and functions that will involve less human intervention.

Much of the current work centers around user interfaces. One leader in this area is Hewlett-Packard. This spring, the company announced HP OpenView, a graphical user interface running on its line of AT-compatible systems. The cornerstone of OpenView is technology based on Microsoft Windows, to allow menu-driven operation that may simplify network management.

Beyond windows, another technology buzzword for network management is expert systems. For example, T1 multiplexer Network Equipment Technologies Inc. is working with Natural Language Inc. to develop products that would let networks be managed by using conversational language. A question such as "Which T1 trunk had the most alarms today?" would yield a correct response.

Yet, no matter how far network management technology advances, there are sure to be some problems, somewhere, that defy technology. So keep that human intuition tuned up.

"Look, you'll probably never catch up," says Howard Frank, chairman of Network Management Inc. "The communications field is such that you'll never say it's well under control."



Management

scribe this trend as centralization, the term will have to do, misleading as it is. While organizations are centralizing their reporting structures, the goal is to cope better with the continuing decentralization of computing resources, including the acquisition and function of those resources. Network management is a crucial tool if these two seemingly at-odds movements are to succeed.

"Network management is more than a technical issue, it's political," says Bill Gassman, principal marketing specialist in Digital Equipment Corp.'s network management marketing group. "The message is, we've got the technology down." The reason for that glowing assessment, Gassman continues, is the ever-developing Open Systems Interconnection (OSI) standards for network management, which are supported by all major vendors and which promise to make it easier to control multivendor networks and systems.

Although most vendors support the OSI protocols, the recent formation of the OSI/Network Management Forum, a new organization of vendors, reveals that incompatibilities do exist in the implementation of the ISO standard. The goal of the forum is to have vendors agree on implementation.

"Network management is easier to solve technically than organizationally," agrees Vicki Duckworth, senior product manager for Cincinnati-based Cincom Systems Inc.'s Net/Master line. If the equipment can be controlled, then the bottom line becomes who will do the controlling, and where it will take place. While many network users are sure to quibble with Gassman's claim that technology is not a problem, they admit organizational changes are in the works.

The cause is the usual combination of people and money. As budgets tighten and good people remain both hard to find

and to keep out in the field, as data and the lines that carry data become more important, and as the number of networked devices zooms upward, network management becomes crucial. Many believe it can be done best and most cost-effectively from a central site. Therefore, in a lot of cases, operational autonomy is going to be removed from the distributed branch offices or work groups, and maybe even from the telecommunications department. Some network management technology may even demand a more centralized approach. This seems to be the view pushed by traditional hierarchical vendors such as IBM, and with good reason. Centralized operations are sure to eat up a lot of mainframe processing power. IBM is sensitive to this criticism and recently attempted to counter it by releasing a benchmark study on CPU resources used by its NetView program in the MVS/XA and VM/SP operating system environments. The study showed less system utilization than feared. Nonetheless, users retain the belief that

NetView is a mainframe gobbler.

Not that that's necessarily unwelcome, say some cynics. Several observers agree with DEC's Gassman that the argument for centralized network management is a political one. They argue that centralization frequently masks a desire by some within MIS organizations to regain personal operational control lost during the past few years. In this view, technology is simply an enabler, not the initiator of change.

Users Resist Losing Network Control

"I think it's a function of human nature that users resist losing control over the network," says Howard Frank, chairman of consultancy Network Management Inc., Fairfax, Va. He believes that while companies must balance cost and reliability, responsiveness to end users must also play a role. He argues in favor of a matrix management structure whereby companies adopt a centralized approach but distribute people to operate the network. Those employees re-



The Politics of Network Management

port to the central authority.

Such is the case at NASA Ames Research Center, Mountain View, Calif. Three years ago, there was no central organization for voice and data, recalls James McGuire, a program manager at Ames. The result was a mass of incompatible systems and networks. The center created a centralized network design and operations division as well as a control center to which all network users report problems and from which technicians are dispatched. They "realized it was a mess," remarks McGuire. "Overall . . . it was better to be centralized."

The number one job of network management is simple: keep the lines up, and, if something goes wrong, diagnose the problem as quickly as possible. Scattered organizations can make this a problem. Cincom's Duckworth points out a real-life example. She says it's rare for a system failure—under IBM's CICS, for example—not to be related to a network failure as in VTAM. In some organizations, however, these two areas are under separate service organizations.

The change in reporting structure seems to be an important step, no matter how automated today's network management operations are.

At the State of Washington's Office of Financial Management in Olympia,

network administrator Jim Cleghorn sees a clear need for centralized management over networked resources.

"We need a central place for assigning problems," Cleghorn explains. "We found a lot of our users were shopping for results. We might have three people working on the same problem because a user felt that the more people asked to resolve the problem, the better." The state government operation is now also looking for more automated help from network management systems for its 140-node local area network—primarily supplied by 3Com Corp., Santa Clara—and its IBM 9370 minicomputer.

At Affiliated Banks Service Co., central management may mean an end to the independent voice network decision-making authority that the 29 member banks enjoy today. "Currently, in each bank, someone whose main responsibility is banking is in charge," Burns says. "We get hurt in two ways. It's not just the [minimal] skills, but that each subsidiary gets suboptimal solutions." Next year, the company will begin using fiber optics as well as T1 equipment.

As technology combines voice and data transmission, pooled voice-data management is the next logical step. The firm may decide to install IBM NetView/PC to integrate such voice gear as PBXs

into the central management scheme. Now, it uses Cincom's Net/Master system to control its IBM 3084-based data network. "We're looking wherever possible at automated support," says Burns. "Ultimately, we'd like to control voice and data from one central site."

Network Management Is the Glue

Thus, if centralization is a goal and if the distinction between voice and data blurs into a digital mass, then network management may be the glue that holds the network together. Nevertheless, that glue may not be as sticky as some people would like.

"There has to be something that looks at the network as a whole," asserts Don Herriott, telecommunications director at Syntex Corp., Palo Alto. But he adds that network management tools today are limited to basic operational tasks, such as keeping links going.

The pharmaceutical maker uses IBM's NetView program for its central host operations. NetView/PC, which is IBM's answer to how to bring third-party gear under a single control, is still too rudimentary, says Herriott. Nonetheless, he may have little choice as he plans to run his IBM network over T1 links.

So, centralization at Syntex now means backbone, wide area resources. "Yes, we're seeing more centralization," Herriott comments, "because you try to leverage high-tech talent."

Still, he continues, the organization is a hybrid. While voice and data organizations have been placed under the same management at Syntex, network management decisions are made on the basis of geography and type of network. Syntex's corporate information systems and communications group manages the backbone, but, at best, provides only backup support for distant sites and LANS.

The hands-off attitude toward LANS may be common now, but it will change, warns Frank. "LANS tend to be small and a pain in the neck to get a hold of," he says. "Just wait five years and these little LANS will be big LANS, needing staffs of their own."

At NASA Ames, which has just about every type of network known to man, LANS have become more of a management issue. Ames's networks transport data from Apple Computer Inc.'s Macintosh up to Cray supercomputers. For example, Ames has a Micom Systems Inc. network with 11 operational switches controlling roughly 7,000 active connections.

The Elusive Definition of Network Management

There are as many definitions for network management as there are networks. So, thank goodness, there are paid professionals who ignore the ulcers that may ensue from an effort to define what network management is and who attempt to come up with an answer.

Until recently, network management could be broken into four subsets—problem, change, configuration, and performance and accounting management—according to market research house Gartner Group Inc. Under those areas are the typical chores of tracking problems, measuring availability, adding components, and so on. Put another way, these are the jobs of network and systems operators, not the chief information officer.

This definition is changing, expanding, and reflecting the growing importance and technology behind network management.

Two new definitions have been added to network management: systems and asset management. Asset management will help corporations model networks and find the cheapest way to run operations. Systems management refers to actually managing not just the lines but the applications.

If you're still confused about network management, don't worry. You're not alone. Even vendors who admit that their futures depend on the topic are frequently perplexed.

"Network management in LANS is different than network management in telecom," says Douglas Pollack, 3Com Corp. Enterprise Systems division marketing vice president. Adds 3Com product manager George Marshall: "When I talk to my friends in computer companies, to them it means the management of applications."

Still, there is one thing that is held in common among all the groups. "The underlying media must be okay. That is the heart of network management," says Marshall.

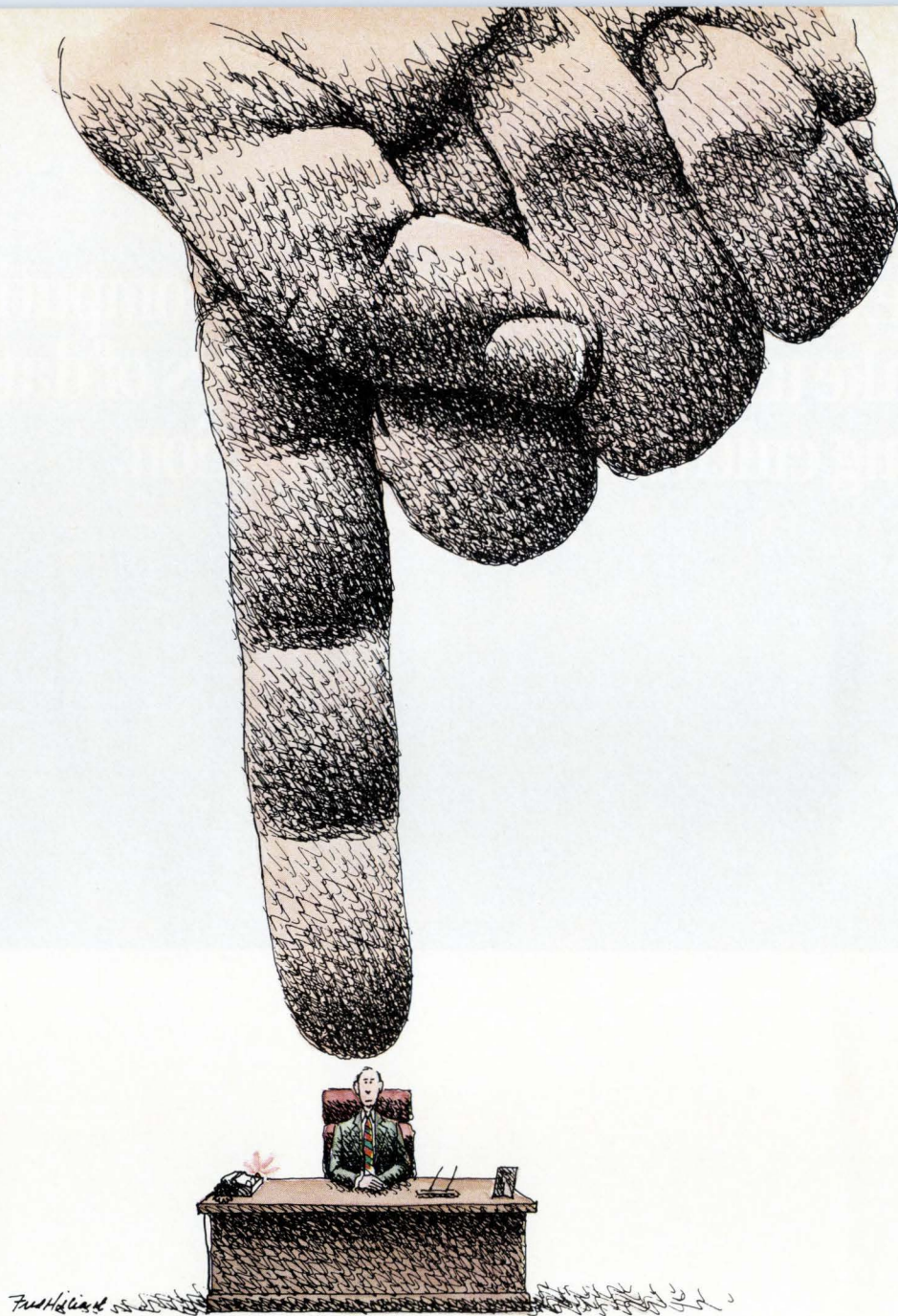

Point to the problem before it points to you.

When a network malfunction puts you on the spot, you need to put your finger on a fast, effective solution: the NETCENTER™ Graphic Network Monitor (GNM). From U S WEST Network Systems.

With GNM, you see your entire network, from the highest level right down to the individual component. GNM's color graphic interface lets your operators isolate, analyze and in many cases resolve the problem.

No more cryptic screens of text. No more guesswork.

After a problem is isolated, NETCENTER Inventory Information Management (IIM) gives you the detailed, up-to-date information you need.

With the NETCENTER system, you have the power to be proactive – to increase your network's availability and performance. As a result, you

can use your network as a strategic resource. Reduce your costs. And satisfy your end-users.

Find out how you can become a proactive network manager. Call 1-800-NETCNR. We'll help point your network in the right direction.

USWEST
NETWORK SYSTEMS

**The next generation of desktop computing
will take us from being gatherers of data
to being cultivators of information.**

A vintage computer monitor and keyboard are shown against a dark background. To the left of the monitor, there are several purple flowers with green leaves. To the right of the monitor, a small mouse is visible. The overall scene is lit from the side, creating a dramatic effect.

Metaphor. The next generation.

Now that computers are generating all the data one could possibly use, Metaphor's Data Interpretation System could help your company make far better use of it.

Because Metaphor's system is far more than an incredibly sophisticated, amazingly easy-to-use computer system. It's a means of turning corporate information into a competitive advantage. It gives companies an edge in the battle for growth, through gains in professional productivity and decision-making.

Metaphor is the only system that can give your key decision-makers direct access to multiple data bases. They can readily transform raw data into meaningful information. And share the results with management and peers, quickly, easily. So decisions can be made in time to make a difference.

Metaphor's system makes a big difference for Information Systems professionals, too. Metaphor lets users build their own applications, so IS managers can turn their skills to more effectively managing the corporate information resource, rather than grinding out user reports and applications from a seemingly endless backlog of requests. And given Metaphor's proven understanding of end-user needs, IS gains a strong "support arm," too.

That's what customers at over 100 installations in the world's largest and most successful companies tell us. They've proved Metaphor is a powerful business tool, giving them an enormous advantage over those who don't keep up with the latest technologies.

Cultivate the competitive advantage at your company now, with Metaphor. Write us at 1965 Charleston Road, Mountain View, CA 94043, or call us toll-free at 800-255-5803 today.

metaphor
=====

Before reengineering Howard was going nowhere chained to COBOL maintenance.

Now he's on the fast track again. Into development. And loving every minute of it.

One of the problems solved by computer aided software engineering (CASE) tools is the need to get programming superstars out of maintenance and back to application development. Catalyst products are designed to help MIS professionals coping with COBOL problems in IBM, Unisys, or Honeywell-Bull environments. They include the ability to perform software quality analysis (Pathvu), automate the restructuring of COBOL code (Retrofit), and assist with Assembler to COBOL conversions (ReACT).

If you're concerned with the amount of resources being consumed by maintenance, the need to extend the life of vital operational systems, or constant user demands for new applications, then you need a partnership with the productivity tools of Catalyst.

For additional information on Catalyst's products, please call today: 800-323-3059, or contact Director of Software Marketing, Catalyst, Peat Marwick Plaza, 303 E. Wacker Drive, Chicago, IL 60601.

CATALYST

An Information Technology Firm of Peat Marwick

800-323-3059

 Peat Marwick

Motivating IS Personnel

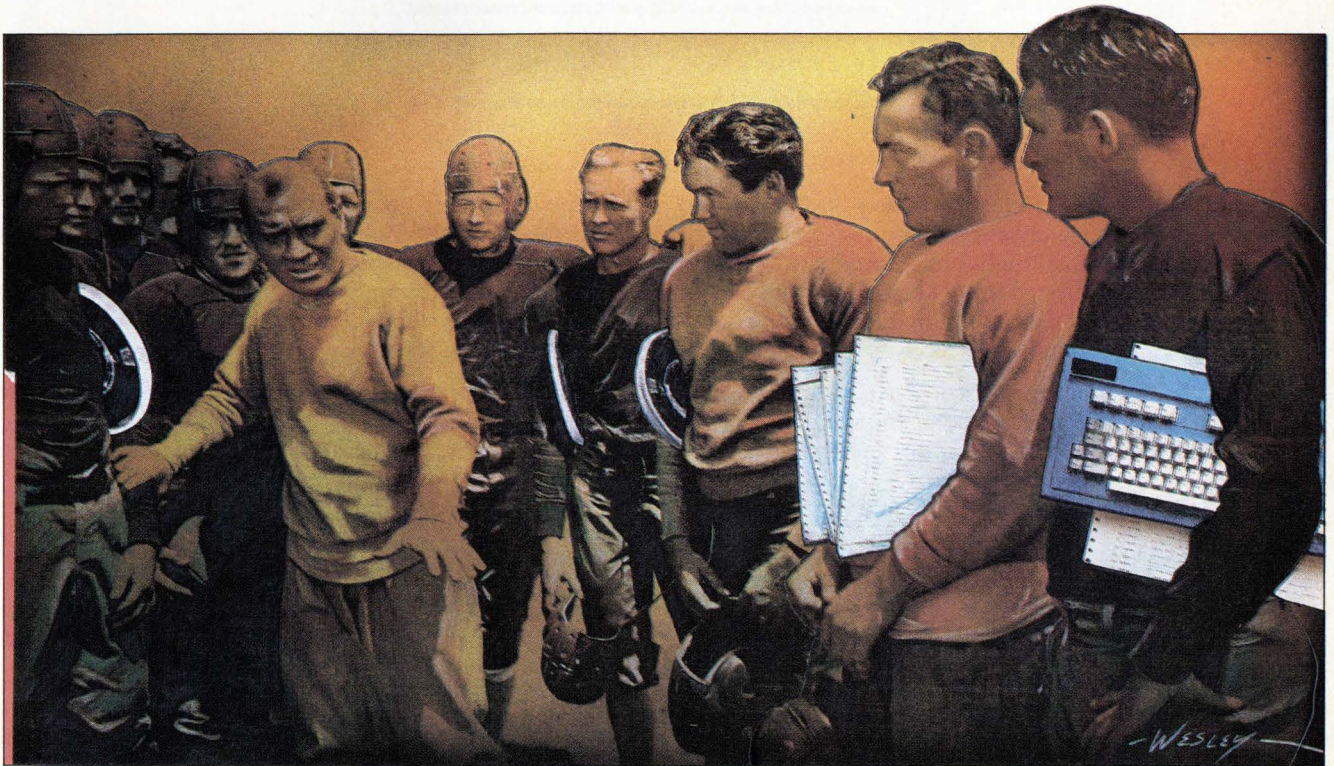

IS managers are more concerned than ever about motivating employees. As the industry matures, the usual incentives—big raises, fast-track promotions—are moderating. But a recent survey holds good news: the top motivating factor for IS personnel is the work itself. By analyzing a job's motivating potential, you can enhance jobs, ensuring a high level of motivation.

BY J. DANIEL COUGER

"There is a critical need to motivate not only the top performers but all employees, particularly in an environment of stabilizing growth, slower promotion, and increased levels of maintenance of older systems."

As the computer industry matures, a growing concern for IS executives is the need to maintain motivation. This is indicated by the quote above, which was culled from a nationwide study of IS chiefs at 80 companies that set out to determine the key human resources issues that concern IS executives for the future. Among other concerns expressed in the survey are the needs to develop better measures of performance, to define skill requirements for the future IS environment, and to prepare a strategy for transferring IS tasks to users.

Some of the things that used to provide natural motivation are no longer

present in the industry. Time was when people with computer skills were scarce, and they earned high salaries and rapid promotions. Today, with growth stabilizing, salary increases are moderating and promotions come more slowly.

Ten years ago, DATAMATION published the results of several studies concerning IS professionals and motivation. Robert Zawacki and I conducted one of these studies, which focused on what job factors made IS professionals' jobs meaningful for them (see "What Motivates Dp Professionals," Sept. 1978, p. 116). Our study was based on the core job dimension theory of motivation, which was developed by Richard Hackman of Yale University and Greg R. Oldham of the University of Illinois.

Another study examined the psychological factors characteristic of IS professionals and what motivated them (see "Who is the Dp Professional?" Sept. 1978, p. 125), and was based on the two-factor theory of motivation developed by

ANNOUNCING THE 1989



WORLD CLASS

MANUFACTURING AWARDS

For the last 10 years, U.S. industrial leaders have listened to endless stories about Japanese manufacturing tactics which have resulted in low cost, high quality products for world markets. More recently, the efforts of Korea, Singapore, Taiwan and Malaysia to capture portions of markets formerly dominated by U.S. manufacturers have received press attention.

But in 1987, U.S. manufacturing scored a record-breaking 4.5 percent increase in productivity, leading the world with its first big gain since 1972. In addition to this good news, factory utilization was at its highest rate in 10 years. 1987 saw 82 percent of U.S. manufacturing capacity in use.

This is solid evidence that the tide is beginning to turn and U.S. manufacturers are making great progress toward increased quality and productivity goals.

We think it's time to recognize the efforts of the hundreds of U.S. based companies that have implemented their own successful automation strategies. It is our hope that these success stories will serve as encouragement and provide role models for other companies considering automation and productivity improvement programs.

Therefore, the Advanced Manufacturing Systems Exposition*, in cooperation with *Datamation*, *Metalworking News*, *Modern Materials Handling* and *P & IM Review* magazines, announces the 1989 AMS* WORLD CLASS MANUFACTURING AWARDS.

The awards program will honor companies that have excelled in implementing productivity improvement or manufacturing automation systems. An award will be presented in each of seven categories:

- Strategic Planning for Automation
- Integrating Automated Subsystems
- Designing Automation Systems
- Automated Production Systems
- Information Management Systems
- Automated Material Handling Systems
- Quality Improvement Programs

The purpose of the AMS* WORLD CLASS MANUFACTURING AWARDS is *not* to highlight the technical aspects

of specific applications. Each award will focus instead on a company's successful strategic implementation of automation technology in one of the seven categories. The award winners will be selected on the basis of how well they defined their overall goals for automation and how successful they were in meeting those goals.

Award winners will be selected by a panel of judges representing the AMS Exposition, *Datamation*, *Metalworking News*, *Modern Materials Handling*, *P & IM Review*, and Allred Marketing, the awards program coordinator.

Deadline for applications is October 31, 1988. The panel of judges will meet in November, 1988 in New York to select award winners. There will be a winner selected in each of the seven categories. Decision of the judges will be final. Judges reserve the right not to make awards in any category if they decide that no award is merited in that category.

Winners will be notified by mail in December, and announced in the January issues of co-sponsoring publications. A feature article on the award winners will appear in the February issues of each of the co-sponsor publications.

Awards will be presented at a special ceremony on April 25, 1989 at the 1989 Advanced Manufacturing Systems Exposition and Conference in Chicago, Illinois.

Is your company a WORLD CLASS MANUFACTURER? Do you know of someone else who is a WORLD CLASS MANUFACTURER? If so, AMS, *Datamation*, *Metalworking News*, *Modern Materials Handling* and *P & IM Review* want to tell the world about your manufacturing success!

Send us your WORLD CLASS MANUFACTURING success story, accompanied by the official entry form featured on the next page and you may find yourself the toast of the industry at the 1989 AMS* WORLD CLASS MANUFACTURING AWARDS presentation!

If you have questions about the award program, or the entry form is missing, call the AMS* World Class Manufacturing Awards Hotline: (602) 951-8994.

*The AMS Exposition and Conference is the live marketplace for integration and information intensive products and services used in discrete and process manufacturing/distribution. It is produced by Cahners Exposition Group (CEG), the world's largest and most experienced show management company.



World Class Manufacturing Award Official Entry Form

Company _____
Division _____
Address _____
City _____ State _____ Zip Code _____
Name of Contact Person _____
Title _____
Telephone Number _____ FAX _____

Award Category Of Your Entry:

Please check one. You may enter in more than one category, but you must complete an entry form (photocopies acceptable) and submit a separate success story for each category that you enter.

- Strategic Planning for Automation
- Designing Automation Systems
- Information Management Systems
- Integrating Automated Subsystems
- Automated Production Systems
- Quality Improvement Programs
- Automated Material Handling Systems

Award Rules

1. Entries will be accepted from companies incorporated in the United States that manufacture some portion of their output in U.S. facilities.
2. Award winners will be selected on the basis of how well they defined their goals for world class manufacturing and how successful they were in meeting those goals. Specific benefits of the manufacturing strategy employed should be included in the success story for each category entered.
3. While technical details may help illustrate a company's qualifications for the awards, the focus of entries should be on the successful strategic implementation of automation technology.
4. All entries must be accompanied by an official entry form or a photocopy of the official entry form.
5. All entries must be postmarked no later than October 31, 1988.
6. Decision of the judges regarding all winners is final.

Format

1. The first page of your entry should be on company letterhead. Entries should not exceed five typed, double-spaced 8½" × 11" sheets of paper.
2. Type the category of your entry at the top of each page submitted.
3. Mail the official entry form (or a photocopy) and your success story to:
AMS* WORLD CLASS
MANUFACTURING AWARDS
Allred Marketing, Awards Coordinator
8655 E. Via De Ventura/G-227
Scottsdale, AZ 85258
4. Make sure your entry is postmarked no later than October 31, 1988.

Questions?

If you have a question about the awards program or how to submit an entry, call the AMS* WORLD CLASS MANUFACTURING AWARDS HOTLINE: (602) 951-8994.

The 1989 AMS* WORLD CLASS MANUFACTURING AWARDS are co-sponsored by:

DATAMATION

METALWORKING NEWS

MODERN MATERIALS HANDLING

P & IM REVIEW

Motivating IS Personnel

academic researcher Fred Herzberg in the 1950s. Herzberg's two-factor theory of motivation separated job motivators from job demotivators, thereby establishing a variety of factors that influence a worker's sense of satisfaction. These include the work itself, opportunity for achievement, opportunity for advancement, pay and benefits, recognition, increased responsibility, quality of supervision, interpersonal relations, job security, work conditions, and company policies (see "A Decade's Difference").

With the passage of 10 years and all the attendant changes in the IS world, I undertook to repeat these studies. Some things changed very little, others showed significant differences. The findings dovetail in an interesting way with the motivational concerns of IS executives.

Most seminars on motivation tend to focus on how to "psyche up" employees—that is, how to motivate them externally. But, at best, such an approach deals with symptoms, not causes. The results of my most recent study of 1,800 analysts and programmers, however, hold good news for managers: the number one motivating factor for IS personnel is the work itself.

Today's IS workers don't need a cheerleader—you can concentrate on

improving their jobs instead.

Sound easier said than done? Not necessarily. A systematic approach to improving the job using the core job theory of motivation has been successful in the IS departments at a variety of companies, including Hartford Insurance Co., IBM, Standard Oil, Owens Corning Fiberglass, the U.S. Labor Department, and the City of Colorado Springs.

What Motivates Workers

The job core theory was arrived at by Hackman and Oldham after analyzing 30 job variables. They found that the five job variables most sensitive to motivation were skill variety, task identity, task significance, autonomy, and feedback from the job itself (see "Core Job Theory Model of Motivation"). In other words, these are the aspects of the work itself found to be most important in motivating workers.

The presence of these five key variables contributes to an employee's feeling of meaningfulness from his work, responsibility for its outcome, and knowledge of the results of his work. Thus, by addressing these factors, you can enhance a job's motivating potential.

Maintenance work may represent the most difficult job enhancement challenge facing IS managers. It has been

called "an uninteresting, necessary evil," but in most IS departments it consumes more than 50% of the labor budget and that percentage is growing each year as new applications are implemented. It is interesting to note that many companies have sought to improve motivation of maintenance personnel by changing the name of the activity. One company has even adopted the title retrofit engineer for this work.

Such a palliative merely attempts to disguise the symptom—it does not address its cause. A new title will motivate maintenance workers for only a day or so, because the work itself has not been changed. The nature of the job must be enhanced to increase motivation.

By using the framework of the five core job dimensions, maintenance work can be analyzed for ways of enhancing it:

Skill variety. Assign a variety of tasks where use of skills is constrained by the design of the system being maintained.

Task identity. Identify how the modules being maintained relate to the system as a whole and how that system relates to the company's set of systems. Also, making it possible to complete the whole maintenance task—from user interaction to producing workable code—will enhance task identity.

Task significance. Provide maintenance personnel with an opportunity to work directly with users in order to recognize the importance of their work.

Autonomy. Mutually set goals with maintenance personnel, then allow them to accomplish the work without close supervision.

Feedback from the job. Establish mechanisms to enable employees to track their progress.

Periodic analysis of a job to ensure that it maintains its challenge will ensure that motivation is sufficient to the level of productivity you desire. Much depends, however, on who holds the job—not every worker needs the same degree of growth and challenge. Employees with high growth needs want "rich" jobs, that is, jobs that fulfill the five core job dimensions to a high degree.

Employees' growth needs can be determined by evaluating the degree to which they are goal-oriented, ambitious, capable of perspective (able to separate the important from the less important), interested in further education/training, self-starters, internally motivated, confident, in need of recognition, assertive, inquisitive, and systematic.

An employee's need for social inter-

Core Job Theory Model of Motivation

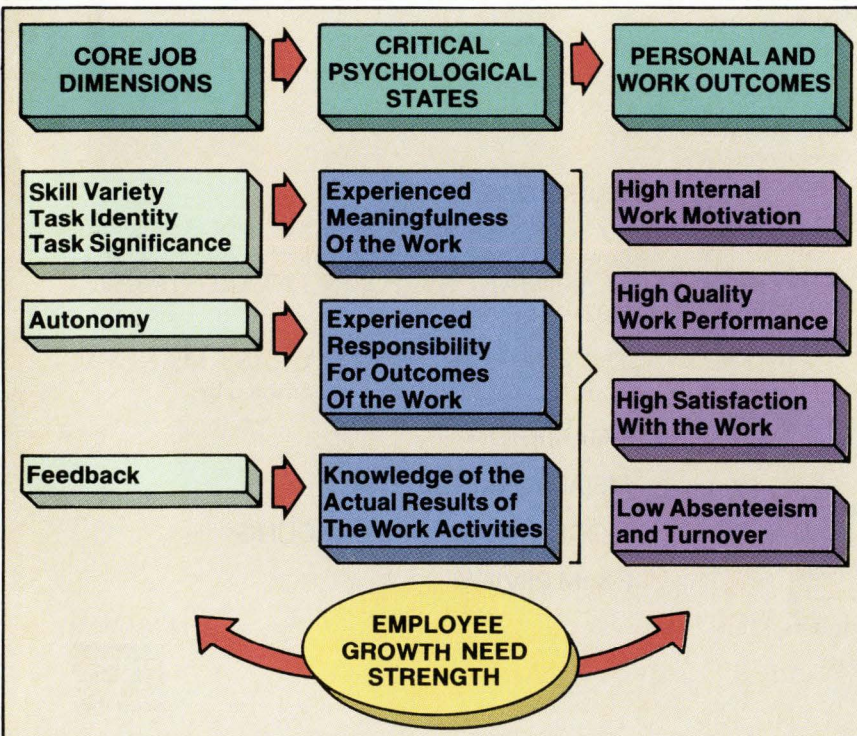

Source: California Management Review, Vol. 17, # 4, p. 58.

"The Data General difference: real PC networking solutions."

Keith A. Lent, Chief Financial Officer
Paul, Hastings, Janofsky & Walker

Data General Personal Computer Integration gives this major law firm the best of both PC and mini-computer worlds.

Paul, Hastings, Janofsky, and Walker is among the largest and fastest growing law firms in the United States. With their rapid growth came a proliferation of IBM-compatible PC's and stand-alone workstations.

The problem? To integrate those PC's into an efficient communications network, and link them to the firm's larger Data General system.

The solution? Data General/Personal Computer Integration (DG/PC*I).

Not only did DG/PC*I provide for PC integration, but, by connecting those PC's to a network of MV/Family systems, each office now has access to centralized filing. So now information can go anywhere in the organization.... instantly.

According to Keith Lent, PHJ&W's Chief Financial Officer:

"DG/PC*I has been an excellent way to increase productivity, decrease costs and time delays, and better manage our firm's information. Having it saves the cost of sending packages by overnight mail, reduces the amount of paper generated and enables information to be more accurate. It seems as though DG/PC*I was created with us in mind."

To find out how Data General can make a difference for you, send the coupon below. Or call: 1-800-DATAGEN. In Canada, call 416-823-7820.

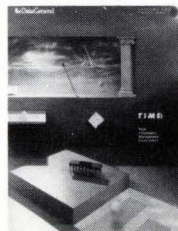

Data General

3400 Computer Drive, Dept. ADV/PCI, Westboro, MA 01580
Please send me more information on DG/PC*I

Name _____
Company _____
Address _____ Phone _____
City _____ State _____ Zip _____

CALL 1-800-DATAGEN

Circle 30 on Reader Card

Motivating IS Personnel

action is another significant characteristic. In 1978, our research revealed that analysts and programmers had a low need for social interaction, although they had a high need for growth. In fact, their growth needs were higher and their social needs were lower than any of the 500 occupations measured by Hackman and Oldham (they did not survey IS occupa-

tions). Their social need strength was only 4.2 on a scale of seven, compared with 5.5 for most other occupations. My continuing research on other job types within the computer field shows the social need to be equally low for all professional computer job types. Perhaps this factor is one reason for ill-defined requirements for applications. People with

less need for interaction will not naturally seek contact with users as much as people with a higher social need.

For example, network designers have a social need strength that is no higher than that of software engineers and AI designers. Although it is rare for social need to change, people can change their behavior. When employees perceive they need to acquire such interactive skills, they are motivated to do well in training courses on group dynamics and communication.

Motivation Is Harder for Big Companies

Research has shown that big companies have greater difficulty in motivation than smaller companies. When a company has more than 200 analysts and programmers, managers must work harder to keep the job's motivating potential at a proper level. Not only are the project teams larger, there are more levels of management through which to communicate. There is a negative effect on all five job dimensions. Providing task identity—relating an individual's work to the whole—is more difficult when personnel are several levels away from top management and where they are not in as close contact with the user. The same is true for task significance and feedback. Big companies tend to have more policies and procedures, reducing the feeling of autonomy on the part of the employee. Often, the jobs are more specialized, reducing skill variety.

Executives at larger companies are recognizing this problem and have acted to counter it by formal training on motivation. A number of seminar offerings are available on this topic. However, in evaluating those offerings, you should ensure that a substantial amount of seminar time is devoted to techniques for analyzing the job's motivating potential (in the framework of the five core job dimensions) and to techniques to determine the strength of employee need to grow.

Using this approach, managers can ensure that jobs are matched to individual employee growth need. It doesn't take an inordinate amount of time—in fact, when measured against the potential for improvement of productivity, the time investment is quite small. Thereafter, the analysis would be required every six months or so, or whenever the job changes or a different employee is assigned. ■

J. Daniel Couger is distinguished professor of computer and management science at the University of Colorado.

ARE YOUR PC APPLICATIONS AND YOUR MAINFRAME SPEAKING?

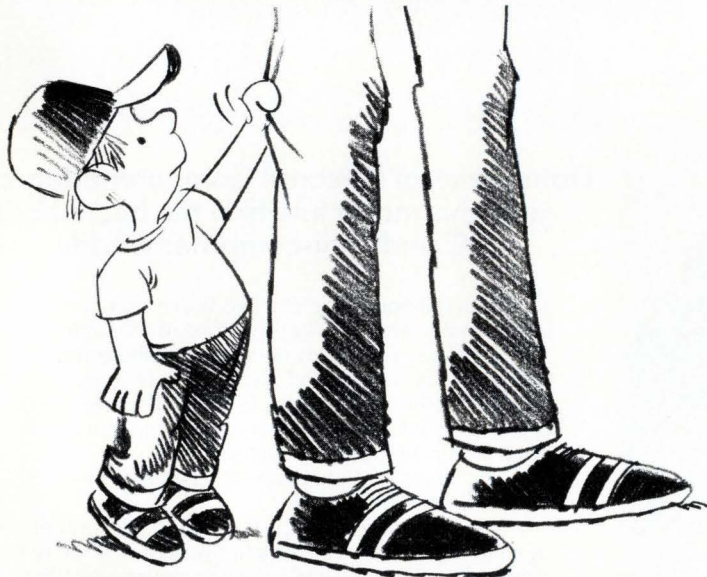

They could be with help from ACROSS-THE-BOARDS.™

This proven Mainframe/PC development tool provides a high level communications interface.

Across-the-Boards is perhaps the only PC-to-Mainframe interface on the market that so fully handles the complex details of data communications. For example, with this product you can access individual records, send information back and forth between programs, construct cooperative applications, and much more. All of which helps you cut development time and costs. What's more, Across-the-Boards adapts to virtually any environment. It provides IBM and compatible PCs with access to the mainframe through all popular coax boards, LAN gateways, bisync,

SDLC and most protocol converters. And with a simple CALL, you can interface to COBOL, BASIC, C, Pascal and Assembler programs.

FREE 30-Day Trial

Just call 1-800-234-9884, and in no time you'll be experiencing the tremendous communications powers of Across-the-Boards FREE for 30 days. Or write us at cfSOFTWARE, 2454 E. Dempster, Suite 201, Des Plaines, IL 60019-9930.

cfSOFTWARE
Mainframe-to-PC connectivity
800-234-9884

CIRCLE 31 ON READER CARD

Computer Associates introduces total data center automation for VSE.

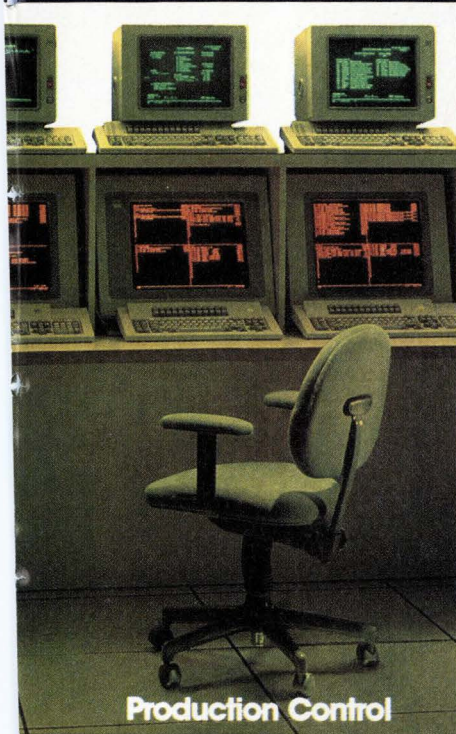

Production Control

Computer Associates brings you the industry's only complete line of VSE systems software: **CA-UNICENTER®/II VSE**, the total solution for data center automation.

With **CA-UNICENTER/II VSE**, you gain extensive tape and disk management capabilities, automated production scheduling and output distribution, performance measurement and job accounting facilities, the industry's leading security software, essential sorting and report writing utilities and even more.

Through advanced integration and automation, **CA-UNICENTER/II VSE** ensures efficient utilization of data center resources, virtually eliminates manual involvement and dramatically improves overall productivity of the data center—enabling you to achieve levels of efficiency never before possible.

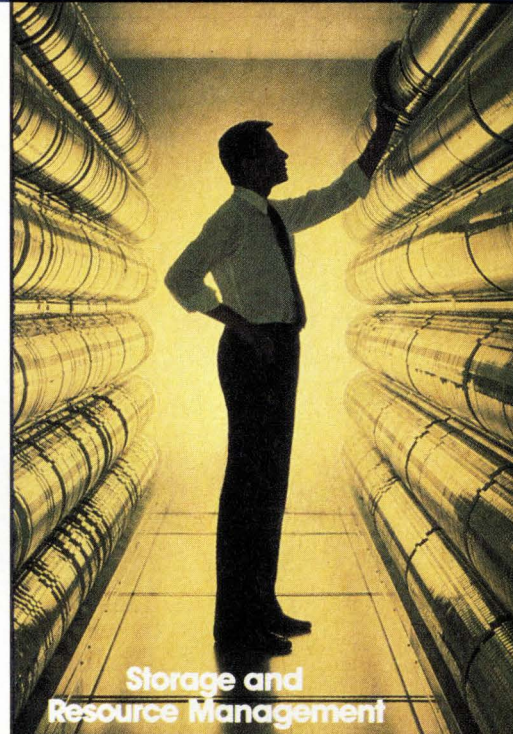

Storage and Resource Management

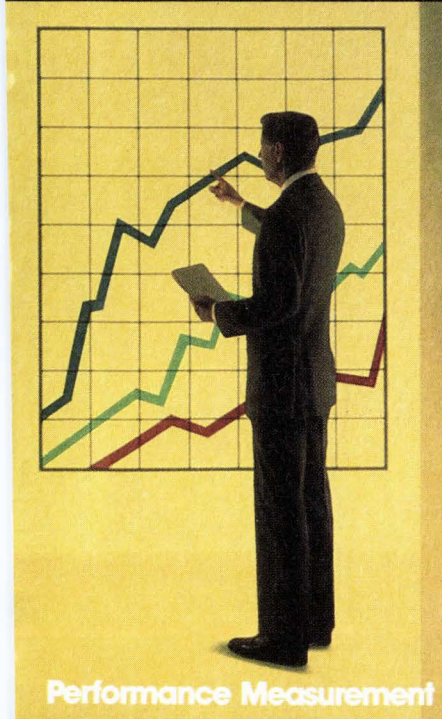

Performance Measurement

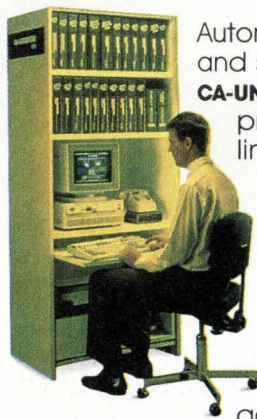

Automated service and support, too: **CA-UNISERVICE®/II** provides a secure link between your mainframe and Computer Associates' Customer Service System, 24 hours a day. You get online access to software

fixes, interactive problem resolution, product tutorials and more.

Call Dana Williams today:
800-645-3003 (Ext. 1738).

© 1988 Computer Associates International, Inc.
711 Stewart Ave., Garden City, N.Y. 11530-4787

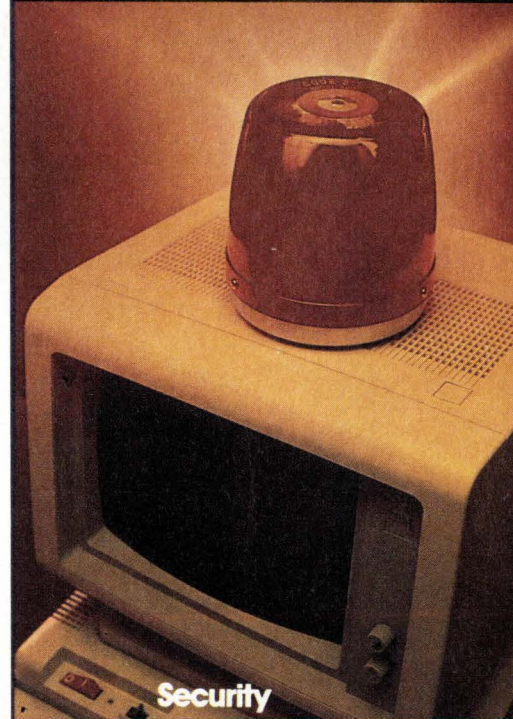

Security

COMPUTER ASSOCIATES®
Software superior by design.

- World's leading independent software company.
- Broad range of integrated business and data processing software for mainframe, mid-range and micro computers.
- Worldwide service and support network of more than 100 offices.

Resource & Operations Management • Financial • Banking • Graphics • Spreadsheets • Project Management

Exclusive!

Your Choice of V.32 Modems From The Philips Family

 **Rack Mountable**

 **Stand-Alone**

 **V.32-PC Card**

Rack mounted, stand-alone or PC Card, Philips V.32 modems offer the winning combination of outstanding performance, international data communications technology and cost-saving features!

The Philips V.32 offers:

- Full CCITT V.32 Compatibility
- Software Configuration
- Autoadaptive Digital Echo Cancellation
- Identical Cards for Both Stand-Alone and Rack Mount
- Fully Automatic Dial Back-Up
- V.25 bis, Hayes AT Async Dialer
- SDLC Sync Dialer
- Phase Roll Compensation
- Network Management

The Philips V.32 family offers outstanding performance, including both international and domestic communications versions. For central site applications, a combination of up to 12 rack mounted modems can be accommodated, including Philips V.27, V.29, V.32, V.33 and short-haul modems.

Philips Information Systems Company

A Division of North American Philips Corporation
15301 Dallas Parkway
Suite 300
Dallas, TX 75248
1-800-443-6004

Call today for complete information on the Philips family of V.32 modems and other outstanding data communications products as well as Personal Computer Workstations from Philips Information Systems.

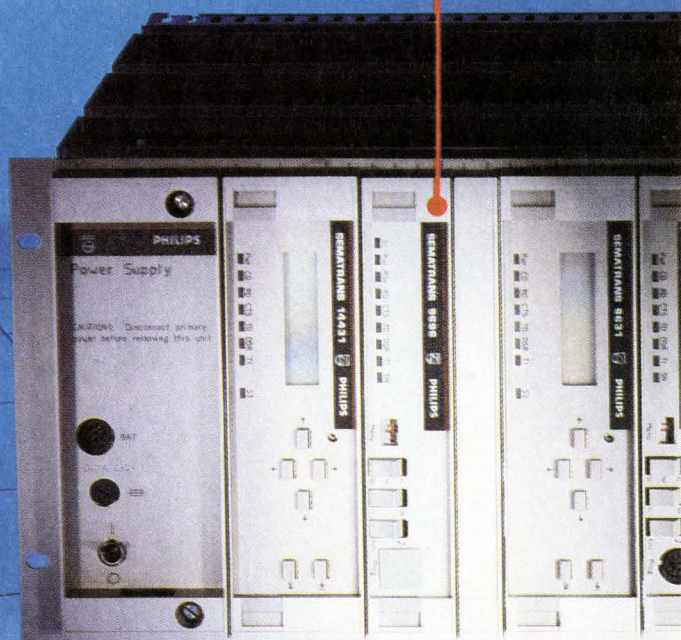

PHILIPS

The DATAMATION Hall of Fame

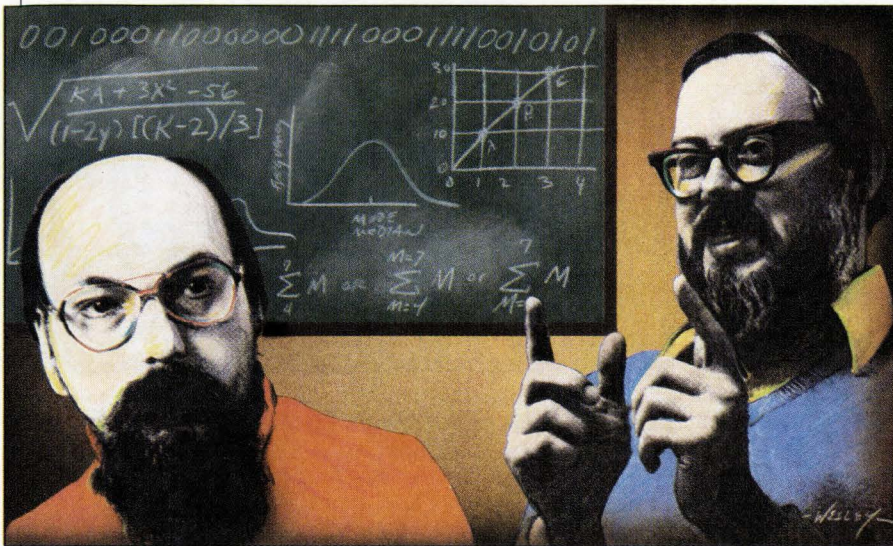

THOMPSON AND RITCHIE: New inductees to the DATAMATION Hall of Fame.

"The memory fixes on what was good and what lasted, and on the joy of helping to create the improvements that made life better." With those words, Dennis Ritchie was traveling back almost two decades to the time when the Unix operating system was conceived and developed at AT&T's Bell Laboratories. What Ritchie and his Bell Labs partner Ken Thompson created in the late '60s was a universal operating system that was indeed good and lasting, making life better for successive generations of computer users and programmers the world over.

DATAMATION recognizes this considerable accomplishment by inducting Dennis Ritchie and Ken Thompson into its Hall of Fame in 1988. Established last year on the magazine's 30th anniversary, the annual award honors those people who have made a major contribution to information processing and its corollary technologies. The seeds of that contribution began germinating in the mind of Thompson, who joined Bell Labs in 1966, after he had earned BS and MS degrees in electrical engineering from the University of California, Berkeley.

Frustrated with the inefficiencies and inflexibilities of the large-scale Multics operating system, Thompson set to work on smaller-scale software that would enable easy, modular assembly of other programs to perform complex tasks. That software, first written

by Thompson in 1969 for DEC's PDP-7, was destined 20 years later to go around the world and across architectures.

Indeed, it's the Unix system's portability and power that are the secrets to its success. The software's portability, readability, and modifiability stem from its implementation in C, the high-level programming language created by Ritchie, who came to Bell Labs in 1968 after doing his undergraduate and graduate work in physics and applied mathematics at Harvard University. After five years at the Labs, Ritchie rewrote Unix's operating system kernel in C, a language that would come to have significance across the entire systems spectrum, from microprocessors to mainframes.

Unix moved out of Lab land to become a productive programming tool. In 1975, AT&T began donating Unix source code to universities. That move would eventually pay off as computer science students entered the work force, boosting the popularity of the portable software at a time when minis and micros were coming into style in the systems set. Adherents on campus spread the word to the corporate world. Today, between 2,000 and 3,000 Unix source code licenses have been sold by AT&T.

The 47-year-old Thompson, who hails from New Orleans, is now teaching computer technology at the University of Sydney in Australia, on sabbatical from

AT&T. In an office right next to Thompson's in Bell Labs' Murray Hill complex is the Bronxville, N.Y.-born Ritchie. The 42-year-old researcher says he is "still working in the operating systems area," advising on new releases of System V and on a brand-new operating system that is "intended to deal easily with shared-memory multiprocessors."

Summing up the success of Unix, Ritchie has stated that it "is a simple, coherent system that pushes a few good ideas and models to the limit." He is equally humble in describing his role in the Unix effort: "Ken is a better programmer and he had better ideas. I was more of a sounding board, writing everything down for him. It was very smooth. We seldom got into an argument." ■

BY LINDA RUNYAN

The DATAMATION Hall of Fame

Howard Aiken
Gene M. Amdahl
Charles Babbage
John Backus
C. Gordon Bell
Seymour Cray
J. Presper Eckert
Bob O. Evans
Jay W. Forrester
Herman Hollerith
Grace M. Hopper
John G. Kemeny
Jack Kilby
Donald Knuth
John V. Mauchly

John McCarthy
William F. Norris
Robert Noyce
Kenneth H. Olsen
Claude E. Shannon
William Shockley
George R. Stibitz
Alan M. Turing
John von Neumann
An Wang
Thomas J. Watson Sr.
Maurice V. Wilkes
Steve Wozniak
Hideo Yamashita
Konrad Zuse



The headquarters of XYZ Corp. are charged with activity as shirt-sleeved employees move briskly through the large open office from one work area to another. Many of them are hunched over computer printouts and VDTs in groups of two or more, talking earnestly among themselves. Others meet in enclosed conference rooms for discussions that require quiet and privacy. Their expressions and voices reflect intensity and involvement. Rather than stress and distraction, they seem to derive stimulation and nourishment from their hectic environment.

In spite of their apparently busy schedules, the employees are eager to talk about their work. They are all bright, highly motivated, and decidedly upbeat about their jobs and career prospects. Critical comments are encouraged by management and expressed with candor and openness. The enthusiasm with which they view their work and its contribution to the organization is not what one would expect to find in a company that manufactures some of the most mundane consumer products found on supermarket shelves.

Most of these people use computers in their everyday work and feel that their job performance and the quality of their work lives has been significantly improved as a result. They view the computer as a tool, to be employed only when their work performance can be improved by its use. The same view is expressed by users at all levels and by top management. Users are allowed, even encouraged, to experiment with the technology to discover more effective ways to do their jobs, new functions, and new responsibilities. Many users have taken advantage of this opportunity to come up with creative reinventions of their tasks and tools.

The web of systems they use is complex and represents the state of the art. The not-always-compatible hardware, operating systems, databases, and software applications that comprise their technology have been adapted to different users and departments. Most applications can be modified, even by support-level employees (clerks, secretaries) and the overall system is designed to evolve as users' needs and skill levels change and as new technologies appear. Monitoring, guiding, and designing for these changes is the ongoing responsibility of a group comprised of end-user, management, and systems representatives. The overriding impression one takes away from a visit to XYZ is of an energetic, dynamic, and innovative organization well positioned to compete successfully in the information economy of the 1990s.



The reservations department of Company ABC is another story. The phones ring constantly with calls from customers wishing to book vacation travel plans. The calls are answered by reservations agents who are expected to complete a transaction within two minutes. They have almost no time between completing one call and answering the next.

The open office is so crowded that at least one agent must move her chair to clear the way for anyone to reach the manager's desk in the back. The crowding and the noise of the constantly ringing telephones create a chaotic, claustrophobic, and highly stressful work environment.

The stress is compounded by the firm's computer-based reservations system. The agents must respond to a fixed set of prompts in asking the customer for specific information (e.g., dates, the number of people in the party, the class of service requested, add-on packages) and entering that information into the system. The sequence, pace, and nature of the prompts cannot be changed. Coupled with the requirement that they answer the phones with little delay, ABC is more suggestive of an electronic sweatshop or information assembly line than a luxury service firm.

The manager complains frequently about the technology used, citing many faults and inadequacies. She has been instructed by top management, however, to "make the best of it." A friend of the president had recommended the system and wrote the firm's customized reservations applications software without discussion or input from anyone other than the president. Upon implementation, the software developer explained the system to the reservations manager who had responsibility for training the agents. No official documentation exists. The manager would like to try to change the reservations system, but without documentation or access to the person who wrote the software, she realizes this would be a nearly impossible task.

The agents' feelings about the system and their work are difficult to determine; they are not allowed time away from their work to answer questions. The high turnover rate—agents typically stay for six to eight months—suggests they are less than pleased. The rate is not surprising to the manager, given the pace of the work, the lack of control by the agents over its pace, the low pay and benefits, and the poor fit between the information system and work tasks. As a result, she typically tries to hire young women because "they are the only ones who can stand it here."

Departmental Computing PART II

Three separate studies from the Rand Corp. show that management's traditional policies of trying to minimize change in a corporation's departments can be disastrous in implementing new technologies. Because technology is ever-changing, management must learn to accept, even nurture, the substantive change that technology causes.

Managing Technological Change: The Process Is Key

TBY DON MANKIN,
TORA BIKSON,
BARBARA GUTEK,
AND CATHLEEN STASZ

The scenarios recounted on the opposite page depict actual experiences and conditions in two companies with relatively new office information systems. Both companies were part of NSF and U.S. Congressional Office of Technology Assessment studies exploring the experiences of work groups undergoing changes in technology (see "The Study Process").

That technology—multifunction office information systems connected to large corporate databases—is similar in both examples, but the impact in each case is quite different. For XYZ, the new computer system has meant dramatically improved employee satisfaction, motivation, and involvement, and has increased work group performance and innovation. Since deploying the new system, XYZ has become a more vital, dynamic, and productive company.

For the employees of ABC, on the other hand, the computer has meant a decidedly more unpleasant work situation, which is reflected in low morale and high turnover. Furthermore, its prospects for future innovation and growth are poor.

Is it the technology that underlies the differences between the two companies? Not likely, since the technologies have so much in common. Is it the nature of the job tasks, occupational levels, or the organization's product or service? Again not likely, since counterexamples for each case are not difficult to find in our studies and elsewhere.

The key to a successful information

system, as a growing body of applied research on various organizations suggests, is the process by which the technology is introduced into the work group's everyday procedures.

Over the last several years, we have conducted a series of studies focusing on the ways in which new information systems are chosen, developed, introduced, and integrated into organizations' day-to-day operations. Those studies identified several factors critical to successful implementation and provided a number of examples of effective and not-so-effective procedures and policies.

Perhaps more important is what these studies tell us about shortfalls in traditional approaches to technological innovation. One of the most important characteristics of new technology is the chaotic pace at which new features, capabilities, and applications emerge. The pace of technological innovation and the uncertainty of predicting its specific form and its impact requires an organizational process of change that is as dynamic and flexible as the technology itself.

Implementation of New Systems Is Ad Hoc

The studies show that most organizations pay little attention to the process of change once the decision has been made to acquire a particular system. They rarely plan for decreased productivity while users learn how to use the new systems and, aside from training, almost never budget for such non-hardware/software costs as meetings and planning procedures. The implementation effort frequently ends up as ad hoc fire fighting.

In an effective strategy, needs and goals should be identified before the

technological means for fulfilling them is decided upon; too often, the process is reversed, with a commitment made to a particular technology first.

These goals should not be spelled out in immutable and specific detail; the same goes for the steps and timetable needed to accomplish them. Rather, the key is to point in the desired direction and be prepared to modify those plans, systems, and strategies.

After several months of lobbying by the technical services department, the management of Company DEF decided to purchase a new off-the-shelf computer system for the order processing department. (Company DEF represents a composite of actual organizations examined in the NSF and USFS studies.) The employees in order processing were informed officially of the imminent change in their work only a few days before delivery of the system (though apocalyptic rumors had been circulating for some time). A week later, when several employees arrived for work, they found at their desks a video display unit, a highly technical operating manual, and the vendor's phone number to call for help.

The logic guiding the assignment of computers to individuals seemed random at best and did not appear to reflect need, expected use, or skill level. At a general orientation session, users were given an introduction to the system, were trained in some basic functions, and were informed that they were expected to learn more in their spare time and to surpass present levels of performance within two weeks.

It took months of chaos and frustration before the department even reached prior levels of performance and several months more to register modest gains.



ALCATEL CORTELCO*
Manufacturer of Telephones
and Key Systems

FRIDEN ALCATEL
Postage Meters, Mailing and
Shipping Systems

ALCATEL INFORMATION SYSTEMS**
Courier 3270-Compatible Computer Systems
and XTRA Microcomputer Systems

*Formerly Apparatus Division of ITT Telecommunications.

**Formerly Alcatel Courier and Alcatel XTRA Business Systems.

ALCATEL IS VOICE COMMUNICATIONS

In fact, Alcatel is a synergy of leading companies working together to offer the communications and information processing systems your business needs to compete, prosper and grow.

Communications companies, such as Alcatel Cortelco, Alcatel PABX Systems, Alcatel Cable Systems and Alcatel Network Systems/Transcom.

For over three decades, Cortelco has established new standards of performance through the development and manufacturing of a complete line of telephones, key systems and PABXs. Today, with annual shipments of over 3 million units, Cortelco is one of the world's largest suppliers of single- and multiline telephones.

With a record of excellence spanning five decades, Alcatel PABX Systems offers premium quality products, such as the Alcatel 100 line of key systems and small PABXs, and the System 3100

voice/data PABX designed to meet the needs of companies requiring up to five hundred telephones.

A pioneer company in the development of fiber optics, Alcatel Cable Systems offers one of the industry's most extensive product lines. Including optical fiber; copper, fiber, submarine and tactical cable; and "fiber-to-the-home" systems.

Alcatel Network Systems/Transcom brings over 65 years of experience to the development and manufacturing of high-quality telecommunications, transmission and switching products.

Now as part of \$13 billion Alcatel, these companies share the financial and technological resources to provide you with further innovations.

So take a close look at the communications solutions Alcatel has to offer. When you do, you'll clearly see how we can improve the way your business communicates.



For more information on the Alcatel companies, call 1-800-556-1234 (ext. 247) or in California 1-800-441-2345 (ext. 247); or write Alcatel Business Systems, 1623 Buckeye Drive, Milpitas, CA 95035.

ALCATEL PABX SYSTEMS***
Advanced PABX and
Key Systems

ALCATEL SERVCOM
Computer Maintenance and
Support Services

ALCATEL
CABLE SYSTEMS GROUP
Optical Fiber and Cable Systems

ALCATEL
NETWORK SYSTEMS/TRANSCOM
Transmission and Switching Products

***Formerly ITT Business Communications Corporation and Thomson CSF Operations.

Circle 34 on Reader Card

Managing Technological Change

Turnover quadrupled in the next four months. All in all, DEF was finally able to realize some labor savings but not nearly enough to make up for the cost of the system plus the unanticipated costs of increased turnover and productivity losses.

Company XYZ's implementation and training expenses accounted for half of total expenses for the new system. This budget covered the cost of activities such as man-hours involved in determining information needs, identifying and trying out applications, and restructuring work flow and tasks. Aside from a broad philosophical belief that desirable outcomes would result from providing well-trained and highly motivated people with the tools they need to do their work well, XYZ had

focused on few specific targets. After two years with the systems, XYZ had significantly cut total costs per unit output and increased their total market share.

The managers in the NSF study generally subscribed to one of three distinct sets of belief about effective implementation. We labeled these styles "bureaucratic" (management-dominated), "technocratic" (expert-dominated), and "democratic" (user-dominated). These styles correspond to the three groups that typically have a major stake in new information systems—top management, technical staff, and users (see "Implementation Styles of Different Stakeholders"). Our finding that none of the

three styles by itself is particularly effective suggests that successful implementation requires the involvement, commitment, and expertise of all three interest groups.

Bureaucracy Hinders Implementation

Top management is needed to provide general goals, encouragement, and, of course, support with money and other resources. In most cases, however, they should not be involved in the day-to-day operational details of the implementation. A bureaucratic implementation can result in a process that is overplanned, overmanaged, and leaves little room for alterations. Since top management's perspective is "the big picture," it is inclined to push for uniform systems that can serve the entire organization, but which may not serve any particular group of users very well.

Technical experts are needed to provide state-of-the-art information, hands-on assistance, and other technical resources. They are likely to favor technically challenging systems, and down-play considerations such as user skill level and the availability and ease of training. Such highly technical designs may result in serious mismatches between the capabilities of the system and the needs of the work group.

As is typical in systems planning, users in most of the sites included in our studies had relatively little say in development and implementation decisions. This oversight, unintentional or otherwise, comes at some peril to the ultimate success of these new systems.

User involvement helps the process in at least two ways. Firsthand knowledge of job tasks can be critical in developing systems that users will be able to operate successfully. Furthermore, their involvement in systems development can promote a feeling of ownership and a stronger commitment to making it work. User-dominated implementations can be technically deficient, however, especially if they are undersupported and underfunded—as they usually are.

It is clear that all three interest groups should be included in the implementation process. Why is this so rarely carried out in practice? Probably because some conflict is inevitable when users, executive management, and technical staff, with their different vocabularies, values, power bases, and goals in the organization, engage in a dialogue and in joint action. Effectively balancing and integrating these diverse voices can deter-

The Study Process

The first study, under a grant from the National Science Foundation, was conducted between 1982 and 1984. It was an extensive investigation of the experiences of 55 different white-collar work groups in 26 organizations. Half of the organizations were manufacturing companies and half were service firms. The make up of the work group sample, each with a mean size of 10 employees, was 24% management and administration, 29% text-oriented professionals, 20% technical professionals, and 27% secretarial, clerical, and technical support groups. Out of a total of 530 employees, 45% were male and 55% were female; over 30% had advanced degrees and 40% had professional and technical degrees.

The employees in each work group anonymously filled out a questionnaire about their work, their use of new computer systems, and their perception of its impact and effectiveness. The study also included a semi-structured, open-ended interview with the managers of each work group or their designated representatives, as well as observational, archival information about the organization, work setting, and technology in use. We conducted a follow-up survey and interview of 24 of the original 55 work groups a year later to gather further information on issues that emerged in the first wave of data collection.

The second study, for the U.S. Congressional Office of Technology Assessment, focused on a medium-sized consumer products manufacturing firm (XYZ Corp.) that was part of the earlier cross-sectional study. Specifically, the objective was to explore and illustrate with qualitative data this organization's apparently successful approach to technological change.

At the national headquarters for the firm, four different, but related, white-collar work groups—market research, product development, planning, and financial control—were studied. From each work group, we interviewed a department head, four employees from various job levels and functions, and two "linking actors," or individuals outside the group with an intra-organizational perspective. Outside the work groups, we interviewed two executive managers, the director of personnel, two members of the technical department, and two people involved directly in the implementation process. The semi-structured interviews were designed to elicit information on the initial reasons for conversion to computerized procedures, how users were trained, subsequent changes in the nature of work, and effects on the organization's performance.

The third study explored the individual and organizational impacts of the United States Forest Service's newly implemented information system. Interviews were conducted at the national, regional, district, and forest levels with users and key actors in the implementation effort, ranging from top management and technical experts to forest rangers and district supervisors. The interviews focused on such issues as the rationale for the system, the planning and decision-making process, specific strategies for implementation at various organizational levels, how individual ranger functions can be supported by interactive information technology, and the potential effects of the information system.

Universal Data Systems puts the performance in V.32 modems. Now Hall-Mark packs in a surprise as well.



**V.32 is at full performance.
For a lot less than you think from Hall-Mark.**

Universal Data Systems is a leader in the development of V.32 communication systems. And right now, you can call Hall-Mark to save more than 30% on the modem you'd pay extra to own.

Save on UDS V.32 performance in full duplex 9600 bps communications over dial-up telephone lines, and get a unique echo cancellation technique that lets you use the same modem over all types of surface and satellite links.

UDS commands a leadership position through technology innovation. And now through Hall-Mark, you can get the benefits of advanced communications technology — easy modem operation at very attractive prices.

If modem cost is the reason you haven't upgraded your dial-up system to V.32, then you need to call the nearest Hall-Mark office for some good news.

UDS and Hall-Mark are out to speed up communications for you.



Hall-Mark Electronics Corp. • Dallas, Texas

We deliver on current technology.

Alabama
Huntsville (205) 837-8700
Arizona
Phoenix (602) 437-1200
California
Bay Area (408) 432-0900
Orange County (714) 669-4100
Sacramento (916) 722-8600
San Diego (619) 268-1201
San Fernando Valley (818) 716-3300
West Los Angeles (213) 217-8400

Colorado
Denver (303) 790-1662
Connecticut
Connecticut (203) 271-2844
Florida
Ft. Lauderdale (305) 971-9280
Orlando (305) 855-4020
Tampa Bay (813) 855-5773
Georgia
Atlanta (404) 447-8000
Illinois
Chicago (312) 860-3800

Indiana
Indianapolis (317) 872-8875
Kansas
Kansas City (913) 888-4747
Maryland
Baltimore (301) 988-9800
Massachusetts
Boston (617) 935-9777
Michigan
Detroit (313) 462-1205
Minnesota
Minneapolis (612) 941-2600

Missouri
St. Louis (314) 291-5350
New Jersey
Fairfield (201) 575-4415
New York
Long Island (516) 737-0600
Rochester (716) 244-9290
North Carolina
Raleigh (919) 872-0712
Ohio
Cleveland (216) 349-4632
Southern Ohio (614) 888-3313

Oklahoma
Tulsa (918) 251-1108
Pennsylvania
Philadelphia (215) 355-7300
Texas
Austin (512) 258-8848
Dallas (214) 553-4300
Houston (713) 781-6100
Utah
Salt Lake City (801) 972-1008
Wisconsin
Milwaukee (414) 797-7844

Implementation Styles of Different Stakeholders

BUREAUCRATIC OR MANAGEMENT-DRIVEN

- Specific rules and procedures
- No risk taking
- Detailed cost justification
- Planned ahead, down to the last detail
- Centralized organizational structure with clear chain of command
- No self-instruction
- No flexibility; use of precise, fixed plans
- Top management makes most implementation decisions
- Lower-level employees are automated first

TECHNOCRATIC OR EXPERT-DOMINATED

- Technical "entrepreneur" must lead change effort
- Does not involve affected employees in the planning
- Has a large R&D budget
- Technical experts make most implementation decisions
- Uses the mechanization of blue-collar work as a model
- Does not allow users a role in implementation decisions

DEMOCRATIC OR USER-DRIVEN

- A majority of the employees must be in favor of the change
- Involves affected employees in the planning
- Customizes the technology to support the work to be done
- Rewards employees for taking part in the change process (rather than for direct achievements at that time)
- Has human resources professionals involved in training and work redesign
- Requires users to have an important role in implementation decisions
- Encourages risk taking

Source: Bikson, Gutek, and Mankin.

mine whether the tension among them ends up being creative or destructive.

Early in the implementation effort, the employees of DEF's marketing department were asked to fill out a questionnaire about their work and associated information needs. This marked the end of DEF's attempt at user participation. A requirements analysis based on the survey was conducted by the technical services group, but the results of that assessment were never discussed with the users. Also, users were not given the opportunity to evaluate various technical approaches to meeting their needs, decisions about who in their department would gain the most from new software, or how the new system was to be implemented. To ensure compatibility with other systems in the organization, the technical services department made all decisions concerning systems design, acquisition, development, and implementation. After a brief but sincere attempt to use the new applications in their work, the users have gone back to their former methods, as the new computers gather dust on their desks.

Company XYZ organized a task force, which included technical staff from infor-

mation services, key members of executive management, and representatives from the user departments, to plan the development and implementation of their new information system. The task force eventually became a formal department set up to solve problems and plan projects related to systems (re)design, applications development, and support. The process does not always proceed smoothly, however. As one of the participants noted, "When you put a user together with a systems designer, what you get at first is nothing like what either of them had in mind . . . then they work on it!" Nonetheless, a high degree of satisfaction with the task force's efforts is apparent, and the final design reflects user input. Users feel committed to a system they helped develop, and the system works for them.

Support for User Reinvention

If our studies are any indication, new office systems will enable most users to do their work in less time. What to do with these time savings, therefore, is a choice that organizations, managers, and users will have to address as these technologies become commonplace. These choices can make the difference

between modest short-term improvements in efficiency and more significant longer-term gains in productivity, work quality, and innovation.

One option for organizations is to use these savings to reduce their work force through layoffs (a rare occurrence in our studies) or attrition (the more widely pursued approach). Another, less obvious option is for managers to provide users with the freedom, resources, and incentives to explore the potential of the technology and to find new responsibilities and tasks to fulfill.

Most departments have at least one highly motivated user with some technical aptitude who learns the new technology more rapidly than his or her coworkers. On their own initiative, these local, de facto experts may develop special programs and procedures. As a result, their co-workers come to them when they experience difficulties in using the new technology or when they want to learn new tricks, making them into ad hoc trainers and technical consultants.

This job reinvention is not without its drawbacks. Users can get so absorbed in testing the limits of the technology and the boundaries of their jobs that they neglect their formal job responsibilities. Continual requests for assistance from co-workers may distract them further. At some point, management may have to choose between discouraging users from going beyond their job descriptions and, on the other hand, formally incorporating the new functions into their jobs. In the latter case, job level and pay may have to be upgraded to reflect these new responsibilities and skills.

Another problem occurs when experts leave the work groups that have become heavily dependent on the undocumented programs they have developed. One solution is for the organization to identify the best and most useful of these underground applications and provide the developer with the technical support needed to document the programs.

Melissa K., a secretary in the marketing department at Company DEF, initially viewed the new computers in her office with apprehension because it was rumored that they would eliminate at least two secretarial jobs within two years. Even though she was often bored at work and realized she was in a dead-end career, she did not want to lose her job to a machine. She was assured by her department head, however, that if any cuts were to be made, they would occur through attrition, and

“Are your DB2 tables growing out of control?”



Control is what it's all about when it comes to managing your DB2 tables. And unfortunately, you don't get control with DB2 alone.

But you can get control with DB2 DASD MANAGER from BMC Software. DB2 DASD MANAGER:

- Estimates space and selects volumes
- Generates AMS commands and utility jobstreams
- Provides a comprehensive set of statistics

DB2 DASD MANAGER simplifies the tasks of data management, saves DBA time *and* gives you control.

For more information or to begin a 30-Day-Plus Free Trial, complete and return this coupon or call BMC Software, Inc.:

In the U.S. and Canada: **1-800-841-2031**

In Texas, call collect: 713-240-8800 Japan (03) 837-8651
France (16-1) 48 77 77 77 United Kingdom (0276) 24622
Italy (02) 48193845 West Germany (069) 664060

BMC Software, Inc.
P.O. Box 2002
Sugar Land, TX 77487-2002
1-800-841-2031

BMC
SOFTWARE

- Contact me about a 30-Day-Plus Free Trial of DB2 DASD MANAGER.
- Contact me with more information on DB2 DASD MANAGER.

Name _____

Title _____

Company _____

Address _____

City _____

State/Prov. _____ Zip/PC. _____

Phone _____

Managing Technological Change

that she would be provided with all the training and time she needed to learn to use the new system effectively. She was encouraged to experiment with the system to see if she could come up with new, more productive ways to do her job.

Melissa took little time to master the basics of the system and to use it regularly in her work. Finding herself with time on her hands, she developed her computer skills further through on-site training programs. With those skills, she developed several procedures to accomplish her tasks more effectively. Her co-workers increasingly turned to her to learn the advanced features of the system and how to apply her routines to their own work.

Eventually, her manager noticed that Melissa was spending more and more time helping her co-workers and devising new ways to apply the computer to the department's work. To recognize her inventiveness and increased skill level, her manager formally requested that the personnel department reclassify Melissa's job and increase her salary accordingly. The request was turned down because it "was against company policy." Unhappy with the decision, Melissa began to look elsewhere for a position more appropriate for her growing technical skills. Within three months she was working elsewhere in a higher-level, better-paying job.

Adaptive Training

The organizations in our studies employed a wide variety of resources for training and technical assistance, ranging from highly structured, vendor-sponsored, off-site courses to informal peer training provided by local experts, as described above. The most successful training programs we found feature an eclectic mix of resources and procedures that can be adapted to employees' widely varying interests and skill levels. This approach has the added advantage of being able to accommodate the varying rates at which users' needs and skill levels change. It also seems particularly well suited for midsize firms that cannot afford a large in-house training department or that lack a critical mass of users with similar substantive needs at the same stage of learning.

Company XYZ's learning resources are diverse and flexible and vary somewhat by department. Since the market research and planning departments extensively use the same system, both make use of formal courses offered by the vendor. Basic courses are offered on-site. Advanced courses are offered off-site, and

interested users can take them at company expense. In R&D, the tasks are so specialized that general purpose introductory and intermediate courses are of little help. So, individuals rely on local experts who are willing to train them on a particular task, when both are free.

Informal peer training at XYZ is regarded as an inherent part of the way user departments operate. While there are no extrinsic incentives for de facto trainers, they appear to be motivated by the appreciation of their colleagues. Peer training is also widely believed to build cohesion and reciprocity in work groups.

Formal job descriptions and official work schedules at XYZ do not reflect this role, however. Those assuming this role simply try to find the time to fit in user training, making trade-offs between what they have to do for themselves and what they believe they should do for others. While they enjoy the role, they say that



NEEDS AND GOALS SHOULD BE DECIDED BEFORE THE TECHNOLOGY.

learning support could be more effectively provided if some resources within the department were formally allocated for that purpose. In one department, demands on a particular expert's time were so great that his manager asked him to be less helpful and asked users to rely on him less.

How the eclectic training program at XYZ proceeds depends on the task to be learned, the number of users who must learn it, and the resources on hand or externally available.

Orientation to Change

One of the best predictors of implementation success identified in the NSF study was "a positive orientation to change" (a standardized survey measure from *The Michigan Assessment of Organizations*, published by the University of Michigan's Institute for Social Research). Our case studies vividly demonstrate what this orientation entails: trying out hardware, software, and new work arrangements with the understanding that many of these changes may not

work and may have to be discarded eventually, learning from these experiments to plan and implement further change, and accepting continued change as a fact of organizational life.

XYZ's management gave user departments the freedom to try out new things and get rid of tools that did not work well. Management also recognized and accepted the budgetary commitment needed to support experimentation; in the early stages of the system implementation they threw out about one fourth of their software acquisitions, by their estimates. Management at XYZ generally agrees that artificially imposing a steady state on the implementation process would have discouraged experimentation and risk-taking and prematurely placed a low ceiling on the productivity and value-added gains that were ultimately realized. As a result, individuals keep finding new ways of working, which generates a need for system modifications or extensions, which, in turn, creates a need for more new skills.

While all of this uncertainty and change may seem like a nightmare to some organizations, others may see it as an opportunity for both innovation and the only truly effective means of coping with rapidly advancing technology.

What About the Technology?

Although not as important, perhaps, as the implementation process, certain properties of the technology itself are necessary for effective systems. These properties are not so much specific hardware and software features (e.g., the vendor, particular applications, display features) as they are generic qualities of the models or philosophies used to guide the development of these systems.

- *User-driven systems:* can be modified and manipulated by end users who have no special technical training or background in computers is one such property. Frequently, organizations select systems that are idiot-proof—easy to use, impossible to interfere with, and requiring little learning. Such systems, however, are also typically competency-proof—they allow little room for users to exercise their skills and ingenuity. User-driven systems, however, provide a powerful and flexible tool kit enabling users to learn about and exploit system capabilities in stages.

- *Systems designed for change:* the critical issue is how to provide employees with state-of-the-art tools when the art is rapidly advancing. Consequently, the sys-

STRATUS INTRODUCES SQL/2000.™

Suddenly, the rules have changed for OLTP databases.

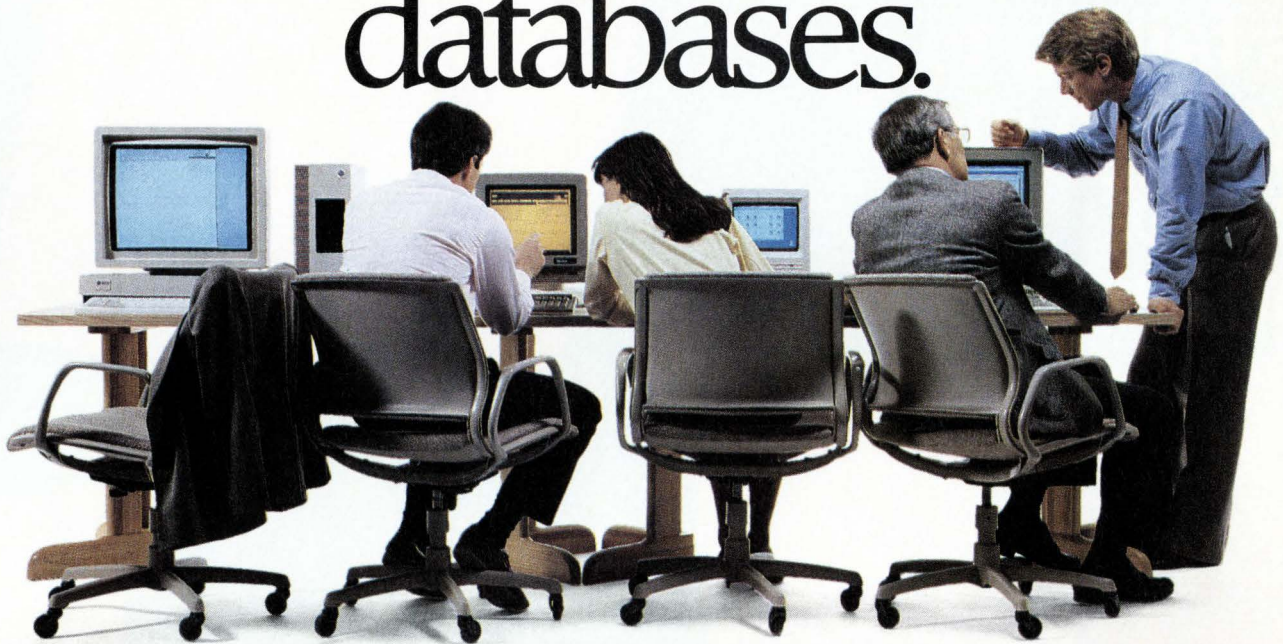

Stratus and SYBASE,® two masters of on-line transaction processing, worked hand-in-hand to develop SQL/2000 for the Stratus XA™ 2000 architecture. Result: The first distributed RDBMS that surmounts the demands of OLTP and meshes with workstations of your choice.

1. CHANGE THE RULES OF YOUR DATABASE ON-LINE, ACROSS YOUR NETWORK. While many RDBMSs let you make on-line changes at the data level, SQL/2000 takes you deeper: You can change the rules that dictate how your business is carried out – and effect that change across your network without a ripple in the workflow. That's because the rules that run your business are enforced

centrally in the database. You make changes in one location for your entire network. And you never touch your application code.

2. PROCESS AT OLTP SPEED. Designed specially for OLTP, SQL/2000 is the fastest around. It was built on the requester/server model, uniquely suiting it to Stratus' multi-processor architecture. You simply add requesters and servers as your business expands without degrading performance. And since SQL/2000 is built into the Stratus Virtual Operating System (VOS®), the database foundation comes with every system.

3. PRESERVE YOUR STRATUS INVESTMENT. You might have expected SQL/2000 to offer full data integrity. Distributed processing.

Easy, modular growth. But maybe you didn't expect that your current Stratus files are easily integrated into SQL/2000 without any conversions. That's because SQL/2000 and VOS share the same query language and interface, making SQL/2000 the most productive environment for programmers.

4. INTEGRATE WORKSTATIONS OF YOUR CHOICE. Compatible with SYBASE, SQL/2000 lets you integrate applications with a broad range of workstations. Utilizing Suns and other UNIX-based workstations, IBM PCs, PS/2s, and soon Macintoshes as intelligent workstations, SQL/2000 brings OLTP to the local level on the workstation of your choice.

5. PLUG INTO AN UNRIVALED SERVICE NETWORK. Every Stratus user is united with the most sophisticated and successful on-line 24-hour remote service network in the industry.

For more information on doing business by your own rules, call your local Stratus representative or phone (617) 460-2192.



The XA2000 family of on-line transaction processing systems.

Circle 37 on Reader Card

Stratus®

The OLTP Database Solution.

**Over 90%
of US
manufacturing
management
is failing to
get the most
out of
automation.**

UN

Islands of automation do reduce costs by making some processes go faster.

But collecting, managing and interpreting the information generated by those islands—integrating them—gives you control. It gives you the power to be more flexible, responsive and competitive than ever before.

And that's what Unisys Computer Integrated

Manufacturing (CIM) is all about.

We provide integrated solutions for every department from the management suite to the shop floor. They're open solutions developed to work with each other and with your multi-vendor systems, through industry standard operating systems and networks.

All to give you real-time control of your business.

With critical information you need for informed, competitive decision-making.

Better information leads to better decisions. Investing in automation tools that reduce costs *and integrate* to give you better information is one of the best decisions you can make.

**BETTER INFORMATION.
BETTER DECISIONS.**

UNISYS

The power of ²

Managing Technological Change

tem has to be adaptable both to the emergence of new technology as it comes on the market and to reinvention as users acquire greater expertise. Many organizations try to acquire the right system, install it, provide training for it, and never change it. They soon learn that changes and updates are necessary—at great cost and with considerable difficulty and disruption. For the foreseeable future, organizations should probably view their systems as being in more of a development than a maintenance mode. Furthermore, many organizations will find that no single system or vendor can meet all of their needs and requirements. In the case of new office systems, at least, diversity is a good investment. As one interviewee at XYZ noted, “If we experiment enough with different systems, if one system that can meet all of our needs does come on the market, we will be able to recognize it.”

Three general conclusions can be reached about the nature of these properties. First, they move beyond mere descriptions of technology to descriptions of the relationship between the technology, the users, and the functions and tasks to be accomplished. Second, these critical properties reflect, at the user and task level, the technology's inherent flexibility, functionality, and dynamic qualities. Third, these properties are what one would expect from systems implemented as described above. These implementation processes may be, in fact, the best way for an organization to realize a system with these characteristics.

A Different Approach to Change

The findings above, taken together, represent an approach to the management of technological change that differs significantly from what is typically practiced in most organizations. These differences can be seen in the primary focus of each approach and how each views the technology, the process of change, and the nature of the goals to be achieved.

While traditional approaches focus on technology, particularly hardware, our findings underscore the central importance of the processes by which the technology is developed and implemented. Traditional approaches also tend to view technology as a static physical entity. Once primary design and acquisition decisions have been made, organizations tend to think the system work is largely done and is independent of the particular social/behavioral contexts into which it is to be introduced. The technology is viewed as a given to which the organiza-

tion, work group, and user must adapt. The alternative approach stresses the inherent flexibility of the technology and its social/behavioral dimensions—how it is to be used, by whom, for what purposes. Mutual adaptation of technology to user and vice versa is the hallmark of this approach.

Most managers view the technology implementation process as having an easily marked beginning and a clear end, where results are identifiable. Their overall approach is to manage toward stability. As a result, they are often frustrated by their inability to do so. The emphasis is on getting it right. Alternatively, to reflect ongoing patterns of technological development, the implementation process can involve successive waves of organizational change that may dramatically alter the technologies, designs, and solutions left in the wake of preceding waves. Furthermore, this continuing



TECHNOLOGY HAS BEEN SEEN AS A STATIC PHYSICAL ENTITY.

process is an interactive one that involves the participation of the users who will be most affected by the change.

The role and nature of systems goals are, perhaps, where the most striking differences between the two approaches emerge. Managers tend to choose goals that are specific, narrow, and easily defined and measured; the compelling, but false, sense of certainty and predictability of such goals often make it difficult for managers to do otherwise.

The particular goal most often chosen—cost or time reduction—can foreclose the innovation process prematurely, before significant gains of a different, and frequently unanticipated, sort are realized. These can include greater access to more timely data, product enhancement, improvements in work quality, new uses and applications, and long-term innovation.

A handy way to compare the different approaches is to view the traditional method as automating work processes

by using technology to replace labor, and the latter as augmenting work processes by providing users with a powerful new tool that will enable them to do things they were not able to do before.

The different ways the two approaches deal with the issue of goals can be seen as planning with goals vs. directional planning. The former is characterized by Michael McCaskey in *The Executive Challenge: Managing Change and Ambiguity*, (Pitman Publishing, Marshfield, Mass., 1982) as formal planning with specific goals and the latter as more open-ended and flexible.

“Success in a dynamic and changing environment,” according to Daniel Robey's *Designing Organizations*, (Richard D. Irwin, Homewood, Ill., 1986) “is largely dependent on a flexible approach to planning, where opportunities are seized in spite of the fact that they do not fit into previously established objectives. . . . Directional planning shifts the focus away from goals and toward the general terrain where a company is heading. In this way it may discover interesting goals, but it does not commit itself to them beforehand.”

The lesson from these studies is that instead of trying to minimize change, particularly with respect to new technologies, organizations need to learn how to accept it, even to encourage and nurture it. They need to understand how it progresses and to manage it so that they are in a position to take advantage of the opportunities it presents. Managing toward stasis with measurable objectives in mind is inconsistent with a dynamic and rapidly changing technology.

The technology has barely emerged from its infancy, and we have just begun to explore its organizational implications. Since questions about what will come next in terms of the technology cannot be answered with any certainty, organizations are presented with little choice but to manage the process of change and then let the outcomes take care of themselves. ■

Don Mankin is the director of the PhD program in organizational psychology at the California School for Professional Psychology. Tora Bikson is a senior behavioral scientist at the Rand Corp. Barbara Gutek is a professor in the department of psychology at the Claremont Graduate School, Claremont, Calif., and Cathleen Stasz is an associate behavioral scientist at the Rand Corp. Mankin and Gutek served as consultants to Rand for these studies.

On-Line Software Introduces an Old Concept.

The Strateg



Casablanca...President Franklin D. Roosevelt and Prime Minister Winston Churchill find something to chuckle about during their historic meeting. (Credit: Bettmann)

■ Like it or not—and we do—we all live and work in an IBM world.

You work with IBM.

We work with IBM.

Let's work together.

Sure, there are proponents of minis and micros.

One wishful company even ballyhooed a mid-frame and when that didn't pan out they created a small-frame.

But the undeniable fact is that Big Blue has taken this industry and created it in its own image.

Pardon us if we seem a trifle unadventurous but we think we know a winner when we see one, so where IBM goes, we follow.

We fill their gaps. Plug their holes.

Write programs they don't have time for.

In short, make the whole thing run just a little bit better.

ic Alliance.

■ WE'RE LOOKING FOR A YES MAN. OR WOMAN. OR BOTH.

At most companies there are a hundred people who can say no but only a few who have the authority to say yes.

We're looking for those people. A few good men you might say.

And, at the risk of sounding high and mighty, there's something in it for you.

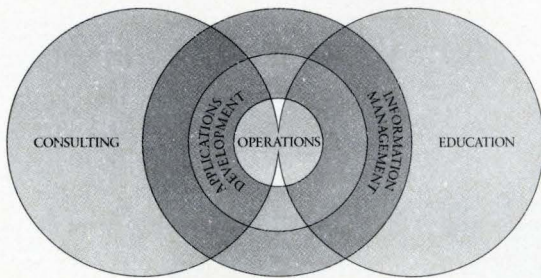

ON-LINE SOFTWARE'S THREE TIERED STRUCTURE

■ A CHANCE TO BE A HERO.

A chance to get ahead.

You see, managing a DP department is no different from most of life's other endeavors. It's not what you know, it's who you know.

Obviously we'd like for you to know us better. To make it easier, we've established special teams exclusively to service national accounts, federal systems, service bureaus and resellers.

Big guns for big hitters, if you'll allow us to mix a metaphor. What's in it for you?

Help.

Help with product evaluations, help with training, help with technical consulting and systems integration, help with applications development, operations and information management.

Sure, it's all available individually from other sources, if you have the time to wait for ten different phone calls from ten different reps.

We're betting you're too busy for that.

We're betting you're ready for an alliance, an understanding between yourself and a company whose charge in life is to take what IBM has created and make it better.

A strategic alliance.

It works in other businesses every day.

It works for politicians.

It works for lovers.

It even works for kids on the playground.

It worked for Roosevelt and Churchill.

It can work for us.

"I WAS AN MIS DIRECTOR FOR 27 YEARS.
I ALLOWED ONE VENDOR LUNCH
EVERY TWO MONTHS.
I WAS NOT EASY TO SELL TO.
I WAS WRONG."

A recollection from Howard P. Sorgen, President of On-Line Software

Personal experience. Can't beat it.

Especially if you've made a few mistakes and you've learned from them.

I have.

It wasn't that I was too smart or too powerful or too good to see all the people who had all that software they were trying to sell.

I was too busy.

I had a business to run so I did what all MIS managers do—leave it to my DP people to pick up a piece here and a piece there and make them fit.

It works.

It works great in the short run. And when you're so busy you can't see beyond the next project, that's the most most companies can, or do, hope for.

But take it from a guy who's been doing this for over 30 years.

Stop.

Sit back.

Relax.

Take a break.

Look around.

Find someone who has more to offer than just a piece of software. Someone who can help. Someone you can talk to, every day if you need to.

I did. I liked the way it felt, thought other DP managers would feel the same way, and that's why I'm at On-Line Software today.

By the way, my number's (201) 592-0009 and my extension is 2823. Call if I can help.

Howard P. Sorgen

Before You Buy Another P Ask Yourself a Simple



North Africa...U.S. paratroopers on the way to their next mission. (Credit: International News Photos)

■ The time has come for the big software rout. Little companies acquire big companies and big companies fight to hold their position against an onslaught of corporate raiders, disenchanted financial advisors and a skeptical Wall Street.

Those brilliant boys who sat in back-rooms and changed the world can no longer afford to bring their product to a more complicated and more expensive market.

What used to be a craft is now a business, and that business is in turmoil. What used to be an innovative, entrepreneurial undertaking has been overwhelmed by a cover-your-butt mentality.

Rightly so.

Where will you be, who will own the software that runs *your* machines when the

dust settles?

Systems software purchases are commitments. Commitments that ask *your* people to generate *your* work to satisfy *your* customers, a certain way for a very long time.

Changing that is rarely easy, always expensive.

■ WHAT HAPPENS WHEN YOUR FAVORITE LITTLE SOFTWARE COMPANY GETS EATEN UP BY SOMEONE YOU REALLY DON'T LIKE?

Pick up The Boston Globe, The Wall Street Journal, Business Week and you've got an arm load of software mergers, purges and shake-ups.

Some good. Some bad.

All affect you.

Piece of Systems Software, Question. Is it Safe?

With a growth rate as high as 75%, constant new releases and several major acquisitions, On-Line Software started as, and remains, an exploding star.

In that atmosphere any company must work hard, very hard to keep its feet on the ground. Because all too often, asking a business partner to share in your glory carries an unspoken and unintended commitment to ride out your downfall.

It's a hard lesson, a lesson best learned from IBM—who we've mentioned many times before and we'll mention many times again. It's okay to take chances, it's even necessary to take risks, but never, ever pass them on to your customers.

■ BE CAREFUL WHO YOU BUY YOUR PROBLEMS FROM.

Safe. Is it safe? Is it a safe buy?

Safety is where it has always been.

In numbers.

In stability.

In support.

In growth.

In training.

In specialization.

In finding the high ground and holding it.

In an industry too often trying to be all things to all people, On-Line Software passes up many opportunities in order to solidify one position, to be authorities, authorities in IBM systems software.

In an industry whose raison d'être is to sell more and more product, On-Line Software started by offering consulting, and now trains more people in the intricacies of IBM systems software than most anyone. In an industry in the midst of a shake out, we do the shaking, impervious to hostile takeover.

■ SO HOW DO YOU ELIMINATE THE INHERENT RISKS IN SOFTWARE PURCHASES?

Thirty-day trials help. But if you can feel secure with just a month's experience under your belt, you're better than most.

Look for specialization in IBM, especially in CICS and DB2.

Look for a company with a history of a new release for every product every year.

Look for tech support.

Look for educational offerings not only where the product is sold, but in the field where it is used.

Ask consultants and value added resellers which products they use to make their jobs easier.

Look for a company that asks smart questions.

Look for a company that comes to you.

Most of all, don't jump before you know what's down below.

THE NEW DEAL.

Things change.

In this business that's the name of the game.

So what seemed like a great decision—what was a great decision—a year ago can often turn into a worthless piece of software when your hardware changes or your operating system changes or your business changes or you just change your mind.

Until now all you could do was bite the bullet and wait for next year's budget.

That's all changed.

If you got it from On-Line Software, then just send it back.

Here's how it works.

License any On-Line Software product.

Take maintenance.

Use it.

Then, six months later—or six years later—if you're through with it or just don't need it or just want something else, trade it in, dollar for dollar, for another On-Line Software product.

That's it.

If you're looking for the fine print, there is none.

If it's an idea that sounds right for you, give me a call for the details.

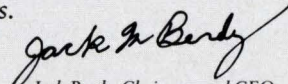

Jack Berdy, Chairman and CEO

P.S. I want to ask a favor—a small one, I hope.

As far as we know right now, no other company offers a guarantee that even comes close. In fact, as far as we know, no other systems software company has any extended guarantee at all.

That too will change. Sooner or later, they'll all have to do it just to keep up.

So the first time you hear some software sales rep going on about his company's great unconditional guarantee, please remember that it all started right here.

Thanks.

The DP Ass



The Homefront...Dedicated workers are the backbone of any modern operation. (Credit: UPI)

■ If you're over 30 you probably remember the ads on the inside of match book covers, "Learn To Be A Key Punch Operator And Enter The Exciting World Of Computers."

Now, with 1990 less than 500 days away, it all sounds so naive, doesn't it?

Well, that's the way a lot of people got started. It beat working in the mill or answering the phone all day. To be fair it still does.

But the glamour's gone.

Today there are 900,000 DP professionals in the United States.

There's only one problem. We need almost 2,000,000 more. We measure backlog not in days or months but in years. Years!

Ten years ago, no one ever thought that computer programming would become a white collar assembly line.

So, the exciting world of computers has

come down to one thing—a lot of hard work. Programmers never seem to get ahead. They never get caught up. Their job will never be finished. There's always more to do. Sort of like working in the mill.

■ TELL YOUR DP MANAGER SHE JUST NEEDS TO WORK HARDER AND GUESS WHAT SHE'LL SAY.

Put a machine that does its work in milliseconds in the same room with people who are inexorably tied to the cycles of the sun and moon and seasons, and something has to give.

Inevitably, it's the people.

Frustration, anxiety and desperation build until writing an application program, essentially a creative undertaking, turns into a crank-it-out-and-shut-them-up task.

Everyone—except the computer—loses.

There's much more to be gained from making application development easier than just making it

embly Line.

faster. Taking out the drudgery, the rote, the repetition, leaves room for reflection, time for inspired daydreaming—essential activities that are at best fond memories for most programmers.

UFO, VERIFY, InterTest, IntelGen, DataVantage, and now, most of all, CasePac help bring it back. They buy you time.

Time, we hope, not to do things faster, but to do them better.

■ HI-TECH INTERCOURSE.

Applications programmers are much like God, or Dr. Frankenstein, depending on the outcome.

They conceive a program.

It's born.

It lives.

It grows.

It ages.

It is laid to rest.

Appropriately,

the whole process is called a lifecycle.

No matter where you are in that lifecycle, from the first gleam in your eye to resurrecting a geriatric program, there's an On-Line Software product to help.

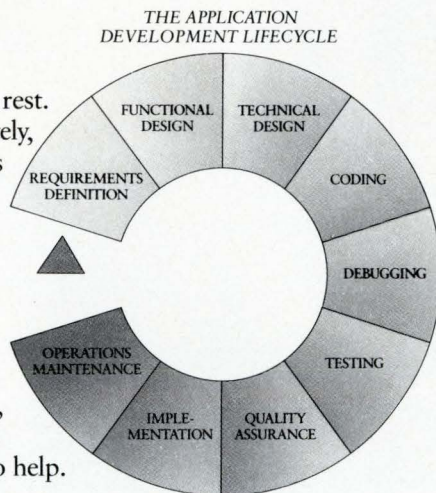

■ CASEPAC.™ THE GENE POOL.

CasePac.* Automated software development for DB2 with a powerful data dictionary.

CasePac gives you the tools to automate design and modeling functions. But most important, it stores information about your designs, models and data flow diagrams—everything it takes to build an application—in one central place where everyone can get to it. It not only stores information about current projects, it stores information about existing applications, too. So everything is consistent. Everyone works with the same definitions and standards.

Because nothing lasts forever—although some applications programs seem to—CasePac also helps you with that nasty little chore called maintenance.

Once the creator is gone—and most creator-types don't leave good notes—it falls upon the meek who have inherited the mess to figure out how it was put together and keep it going as long as possible.

With CasePac, the records are there. Records

that can be used to fix what you've got. Or grow another.

CasePac. For DB2, it's where life begins.

■ UFO.® THE BREATH OF LIFE.

Go from prototype to finished application in record time with the most resource-efficient development system on the market. It's the most flexible, too, with full portability across CICS, CMS, TSO—even the 9370.

UFO makes it easy. Many applications can be built using menus alone, with the help of pre-programmed logic and built-in functions. For even more speed, you get automatic data base access—including DB2 and SQL—as well as an active data dictionary that makes maintenance a breeze.

■ INTELGEN.™ CHAIN OF COMMAND.

Instead of writing COBOL or PL/1 code line by line, step by step, let IntelGen do it for you.

IntelGen generates stand-alone COBOL or PL/1 code from simple commands that cover all structured programming and computational functions.

It accepts either IntelGen or COBOL commands, so novices can learn as they go. When they do make a mistake—and they will—an on-line syntax editor tells them right away, making IntelGen the code generator that's easy to use even if you don't know how.

■ INTERTEST® AND DATAVANTAGE.™ PHYSICAL FITNESS.

InterTest is the number one CICS applications debugging and testing tool in the world.

With good reason.

It prevents all application errors known to CICS—and does it with such ease and grace, it makes one of your most grinding jobs seem a snap.

For IMS and DL/1 data bases, DataVantage automatically creates an accurate subset for testing. There's no need for manual coding since DataVantage does all the heavy labor—from query and updating to comparing data bases before and after testing.

■ VERIFY.® RUNNING THE GAUNTLET.

VERIFY determines if your program will wimp out when the going gets tough.

It lets you see the real impact of changes you've made to your programs *before* you get production system "surprises." VERIFY is an automated CICS quality assurance tool that handles the full gamut of testing needs. It tells you if your applications will work as expected after changes are made to your program code, CICS releases, operating systems, hardware, or transaction load.

In short, if anything changes, VERIFY can test it.

*CasePac is a joint venture with TATA CONSULTANCY SERVICES.

How Much Trouble Would Unplugged Your Mainf



The Pacific... Lucky 13, a Grumman Hellcat, forces commanders and seamen alike to ponder the dilemma of a unit out of commission. (Credit: U.S. Navy Photo)

■ Yes, everyone knows that computers don't go down for a whole day anymore.

Or do they?

Would you admit it if it happened to you?

So let's forget about a day.

How about an hour?

Or, if you're an "average" MIS Department spending an "average" of over \$5,000,000 a year which is an "average" of almost \$100 a minute, well—you get the point.

■ OPERATIONS IS EVERYTHING.

If you're willing to pay the price there are a few mainframe manufacturers who will sell you two computers instead of one, so if one goes down you've got a backup.

Sort of like carrying a spare set of batteries for your pocket calculator.

Whether or not you need fault tolerant or faultless computers, the simple fact is computers do go down.

Often. Regularly.

Usually during your prime shift, right in the middle of your business day—and these days you don't have a business day if your mainframe isn't on-line.

Usually it's a programming or software problem.

Yes, we said it. Believe what you like, but there's

Would You Be In If Someone Ransomed You For Just One Day?

no such thing as faultless software. Or faultless people.

There are simply no magic potions or secret formulas or revolutionary programs that will bail your rear end out at 2 a.m. when your batch programmers are fighting with CICS for a file.

There are no answers.

There is help.

■ *STABILIZE® SHELL SHOCK.*

CICS programs are born with the jitters.

STABILIZE is like pumping 25 milligrams of lidocaine into the system every time it gets jumpy.

It prevents crashes and dynamically repairs damage caused by corruption of CICS management modules and storage chains, systems or application loops, and all sorts of systems abends. And with its unique InterTest "handshake", errors won't recur.

■ *TOOLSET-DB2.™ LIBERATE YOURSELF*

Bogged down in the really boring, repetitious parts of your job?

TOOLSET-DB2 is a complete set of tools that automates and speeds many of your routine tasks such as writing SQL statements.

With TOOLSET-DB2, you won't have to issue complex catalog queries over and over again to determine object definitions and relationships.

You won't have to do special programming to get DB2 data into a physical sequential data set—or spend long hours setting and removing DB2 security.

■ *CICS CENTRAL.™ SEE THE WORLD FROM THE COMFORT OF YOUR CHAIR.*

CICS Central is a powerful data center tool that lets you operate multiple local and remote CICS regions from one central location.

With CICS Central you can anticipate and correct CICS operational problems *before* your users notice them. All CICS and VTAM messages can be filtered, color-coded, and replied to automatically.

How's that for comfort?

■ *OMNIGUARD.® COMPUTER FRAUD? ADMIT IT! IT'S EXCITING!*

How about whoever it was that stole 16 million taxpayer records from Revenue Canada? Hah! Got even with them, didn't he? Our favorite is the disgruntled CFO who held his employer's files hostage and demanded a

ransom when he didn't get an expected pay raise.

Love it! Love it! Love it!

Until it happens to you.

Then it hurts. Bad.

OMNIGUARD is the most comprehensive software security system available anywhere at any price.

Need we say more?

■ *DADS.™ WHAT HAPPENS WHEN YOU ASK YOUR MAINFRAME FOR A SIMPLE FAVOR AND IT TELLS YOU TO TAKE A HIKE?*

"Files Not Available." "Datasets In Use?"

It's almost dawn. It's not funny.

You need to update your CICS files and some batch programmer has them. Who's in charge here anyway? DADS is a file and application control system for CICS/MVS that performs dynamic allocation/deallocation and automatic enabling/disabling of transactions and programs, thus allowing 24 hour CICS availability.

True, you may not need it right now.

But then again, it's not 4 a.m.

■ *VSUM.™ THREE MILLION DOLLARS FOR A MAINFRAME. FIVE MILLION FOR DISK SPACE. FILL THEM UP, THEN BUY MORE?*

Let's say you need to add 100,000 new customers.

Everything's full so where you gonna put em? Especially since all of your programmers are hiding away a little storage space "just in case they need it".

VSUM can figure out how much space you'll need, when you'll need it, and where to find it—before you're in trouble.

It saves time. It saves disk space.

It could even save the price of a new controller.

■ *FILESAVE.™ SAVE YOUR EMPLOYEES FROM A LIFE OF DRUDGERY.*

If you worked your way up through the ranks, once upon a time you probably had to recreate lost or damaged files. And you probably hadn't done the necessary backup. And you probably got into trouble.

And the same thing is probably going on in your DP department right now.

FILESAVE can keep you out of trouble by reducing your backup frequency, automating the dataset recovery process and providing fast and accurate forward and backward recovery of VSAM datasets. Most of all, it does the jobs no one else wants to do.

How to Turn Data



Location Classified...Six men from an American photo reconnaissance unit sprawl over the French landscape. (Credit: Bettmann/Black Star)

Into Information.



■ Lest we forget, all those impressive numbers, all those binary figures, all those bits and bytes and data bases that you took so much time to collect and spent so many millions of dollars to input and output and sort and store are absolutely worthless to the average branch manager in Poughkeepsie who isn't meeting his or her sales goals.

And you surely remember that meeting one's sales goals, or productivity goals or quality goals is what most businesses are all about.

Not bits.

Not bytes.

Not data.

Business is about information, and information and data are not the same.

■ THE NEW RAMIS.® WHAT YOU DON'T KNOW CAN'T HURT YOU.

Converting data into information is easy, if you know how to access a mainframe and you're not already 3 months behind with all your other work.

There are alternatives.

Take the new RAMIS Information System for example.

According to Rick Holtmeier, our Executive Vice President, pulling

a management report with RAMIS is so easy even his secretary learned to do it in 10 minutes.

According to Rick's secretary, it's so easy even he learned to do it in an hour so now she doesn't have to bother.

Okay, let's go back to the guy in Poughkeepsie.

He doesn't know how to access a mainframe—let's face it, you don't want him to know how to *really* access your mainframe. He doesn't know how to write a macro. He doesn't know procedural syntax from his dear Aunt Maude.

He does, however, have a commanding know-

ledge of the alphabet. With the RAMIS report writer that's all it takes.

For instance, if he wants to know the total revenue for each product purchased by Acme Widget in the fourth quarter of last year, he simply types—using as many or as few fingers as he chooses—Show me the total revenue for each product purchased by Acme Widget in the fourth quarter of last year.

RAMIS then displays a table listing each product and the total revenue from Acme Widget during the fourth quarter of last year. What could be simpler?

Charts and graphs could be simpler.

RAMIS does that too, with only a few additional keystrokes.

For the really inquisitive, RAMIS, RAMIS/PC Workstation™ and RAMIS English™ have pop-up menus and non-procedural syntax that provide external data selection and sequencing options, and let your man in Poughkeepsie manipulate data with summary operators, temporary fields, totals, and basic statistical operations.

It's just that easy or just that hard, depending on how you want to play it.

■ BULLETIN.™ WHEN IT ABSOLUTELY, POSITIVELY HAS TO BE THERE AND YOU DON'T HAVE ALL NIGHT.

Which is more unreliable, the U.S. Mail or your own internal routing service? Either way, if you haven't missed an important message in the last month, count your lucky stars. Business *is* communications, and BULLETIN lets you take charge.

With BULLETIN you can automatically send, receive, track and file everything from a hundred page business plan to a top secret dinner invitation to the hunk or hunkette across the hall. You know who has received your memos and who hasn't and who has viewed them and who didn't bother.

Getting people to act on them is a problem we haven't yet solved.

■ OMNILINK.™ THE GREAT COMMUNICATOR.

Anybody can make micros and mainframes talk to each other. OMNILINK lets them communicate.

If you've looked at PC to mainframe links, you've probably come away with a few questions.

Like, how do I learn all those computer languages? How do I handle security? How do I control the information flow? How do I talk to other PC users? How do I reformat data? And on and on and on.

Get OMNILINK.

Of course, we could go on and on and on.

Low Tech Solutions to



England...High spirits and camaraderie are vital ingredients in making pilots out of men. (Credit: Reuters/Bettmann)

High Tech Problems.

■ Running 50 or 100 DP departments all over the world is not unlike maintaining a small army. Hardware and supplies. Logistics and communications.

And most of all, of course, people.

If you're one of the very biggest companies in the world and you need a systems integrator, you're probably going to call IBM or EDS or Arthur Andersen. And you'd probably be right to do so.

(So much for the free publicity for our competitors.)

What if you're not one of the biggest? Or, more likely, what if you need help on the departmental level?

What if you need an elite troop who can move in, assess the situation and do the job quick, without carrying around a lot of overhead?

Consider On-Line Software.

Especially if you need technical consulting.

Definitely if you're moving into DB2.

Always if you're CICS.

On-Line Software started as a technical consulting company for CICS in 1969.

Back then CICS was the really "sophisticated" end of the business and On-Line Software ruled the roost.

To some extent it still is and we still do.

But now there are a hundred companies who do it for less. Still, our

old customers keep on coming back and new ones walk through the door every day.

Perhaps that's because—as we've said throughout this treatise—things are not as simple as they used to be.

Who needs just a CICS consultant anymore?

Or just a batch consultant?

Or just a DB2 programmer?

Or just a piece of software?

Nowadays, in this business, if you're just anything, you're nothing.

That's why we've expanded our consulting services, integrating them with software and supporting them with education and training so that it's sometimes hard to tell where one begins and the other stops.

However—and this is important—our consultants and educators don't sell software.

Objectivity, especially if you're a consultant, is your life's blood.

Sure, our consultants use our products whenever it serves their needs. And sure, they miss a lot of opportunities to sell a lot of software. But every person who walks through your door is given one directive: do the best job he can with allegiance to no supplier.

It costs a little business.

It keeps a lot of friends.

■ PLANNING A WELL RUN DP OPERATION IS LIKE REHEARSING FOR HAMLET.

Remember your high school play? After you'd learned all your lines—or learnt if you were playing Shakespeare—the coach started talking about plot points.

Those were the important parts, the parts where most of all you couldn't mess up. If you messed up at a plot point then everything else messed up and the audience laughed. It's just the same with DP planning, only if you mess up nobody thinks it's funny. Instead of key plot points, our management consulting people call them "csf's" or critical success factors. In other words, "Those areas where things must go right for business to flourish."

Remove any block and it all falls down.

By analyzing over 150 of these csf's you can predict the chances that your project will be done on time and on budget—or done at all for that matter—before you begin.

Since, according to some industry reports, half of all projects begun are aborted before they're finished, it keeps your business from being just another crashshoot.

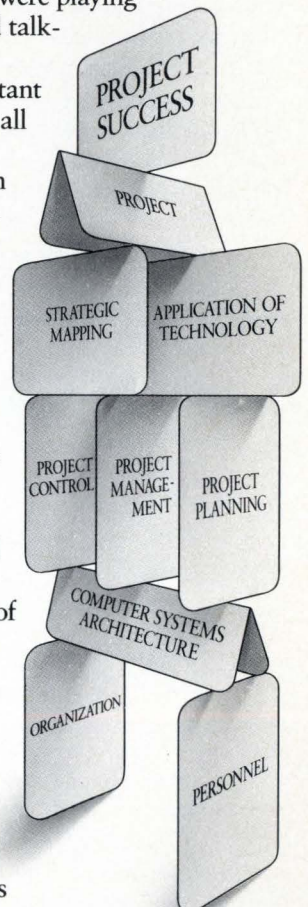

CRITICAL SUCCESS FACTORS

■ THE SMARTER THE TROOPS THE SMARTER THE GENERALS.

No one famous said that.

But they should have.

Each year On-Line Software teaches over 13,000 students—your employees—how to write your programs and operate your systems, in 750 classes taught by 32 full time instructors at ongoing offerings in New York, Atlanta, Boston, LA, Chicago, Detroit, Denver, Hartford, Princeton, Cleveland, Washington, Houston, San Francisco, London and various cities throughout Canada and Europe.

If you're somewhere we're not, we'll come to you.

Asked to brag a bit, John Morbach, Senior Vice President of Education, says, "You name 'em, we've trained 98% of 'em."

We train IBM.

We train EDS.

We train McDonnell Douglas.

We've surely trained someone in your own shop.

We offer classes in everything from applications programming to systems internals.

Our most popular courses are CICS Internals and CICS Command Level.

Our hardest class is VTAM, so hard in fact that when we discovered even VTAM professionals were having trouble we softened up and started "Introduction to VTAM".

If DB2 is in your future, we have four classes covering concepts, design, applications programming and systems, and we have them now.

In most cases, the instructors are the same people who developed the class, so students are never stuck with a teacher and a book and little else to go on.

Of course, all products, especially On-Line Software products, are always taught on the latest releases.

■ "WE TRAIN OUR PEOPLE TO BE NICE EVEN WHEN YOU'RE NOT"

Debbie Gregory, Assistant Vice President of Marketing Services

You just can't blame it on the computer anymore, can you?

Even if it's true, people, especially your customers, just don't go for it.

They rant.

They rave.

They scream.

They shout.

They curse your name and hang up and take their business elsewhere, if they can.

So what do you do?

You call us.

You rant.

You rave.

You scream.

You shout.

And you take your business elsewhere if you can.

We understand. And we try to do something about it.

Like having a hot line for all of our products.

Like connecting you with a technician right away.

Like getting you a new tape overnight.

Like answering a bookkeeping question the same day.

Like putting you directly in touch with the vice president in charge.

If that's not enough, call me.

WHAT DO YOU DO WITH AN EXTRA \$3 BILLION AND NOWHERE TO PUT IT?

Here's the lowdown.

Pennzoil had an extra three billion, cash money. (We won't mention where they got it.)

They needed to get it from New York to Dallas, Fed to Fed.

A number of banks wired the money to Manny Hanny.

Manny Hanny wired it to the Fed in NYC.

NYC wired it to Dallas.

The whole thing came down in less than 12 minutes.

It was the largest transaction in the history of the world.

On-Line Software consultants helped build the systems that did it.

And nobody lost a dime.

D-Day.

■ It's not over.

Not yet.

And if you believe the newspapers, the magazines, the trade press, it's about to start all over again.

There's a guy in California with a goatee, a Hawaiian shirt and patent leather shoes working on a process to produce chips more efficiently—there's always a guy in California working on a process to produce chips more efficiently—but this time the fellow says they'll be a thousand times easier to make and ten thousand times more powerful.

The experts say he knows what he's talking about.

He expects to be on the market in 1993.

IBM is in on it. So is everybody who is anybody in the mainframe business.

So, it's not over.

The explosion of growth and innovation and technology that created the PC market and taught the whole world how to process data is about to start all over again.

This time the noise may not seem as loud but the impact will certainly be felt.

This time it's going to hit mainframes.

Hard.

In their corporate message, Big Blue asks you to look at the bigger picture.

We respectfully suggest you be a part of it. A part of a marriage, a partnership, a relationship—a strategic alliance intended to join you not only with IBM but with the systems software it takes to make the whole thing run.

There is no answer. Only help.

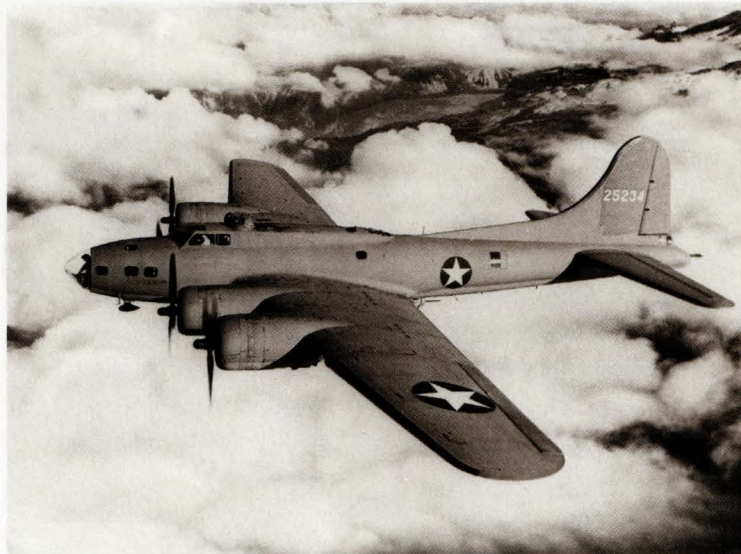

On-Line Software

I N T E R N A T I O N A L

AUTHORITIES IN IBM® SOFTWARE

2 EXECUTIVE DRIVE, FORT LEE, NEW JERSEY 07024. 800-642-0177/201-592-0009

BRANCH OFFICES: ATLANTA, BOSTON, CHICAGO, DALLAS, DENVER, HARTFORD, LOS ANGELES,
PRINCETON, SAN FRANCISCO, TORONTO, WASHINGTON DC, BRUSSELS, LONDON, MILAN.



Reusable Software: Passage to Productivity?

Advocates of software reusability say that meticulously planned reuse could help break the programming bottleneck and lead programmers into the promised land of software productivity. A number of companies are paving the way, making software components available in the form of reusable data, designs, systems, programs, and modules or subroutines through on-line libraries. These practitioners are able to spread the wealth of topflight programmers, saving valuable software development time.

BY EDWARD J. JOYCE

If automobile technology had advanced at the same rate as computer technology over the past 30 years, a Rolls Royce would now cost \$2.50 and get 2 million miles per gallon. Although it indeed may be a long, long way from the ENIAC to the Macintosh, advances in computer software that approach the stunning breakthroughs in hardware over this period have yet to be seen.

"The average software endeavor resembles the computer hardware of the 1950s in which many unique components were wired together for the first time. The overall reliability of the finished product was predictably low," asserts Tom Love, chairman of Productivity Products International in Sandy Hook, Conn. "Manufacturers addressed the hardware reliability problem by relying on reusable, proven components," he says. "How many companies, for example, now build their own microprocessors from scratch? We as an industry must learn to build software from reusable components."

What does reusability mean in software development? According to T. Ca-

pers Jones, president of Software Productivity Research, Cambridge, Mass., it includes reusable data, designs, systems, programs, and modules or subroutines. Data, while appearing to be obvious candidates for reusability, are often isolated due to a lack of standard data interchange formats. The emergence of data interchange formats in spreadsheet programs and an awareness of the problems caused by dissimilar formats indicates that the "future will be better than the past," Jones says.

Reusable Software May Boost Productivity

Not even the most ardent supporters of reusability are predicting that the legendary achievements made in hardware will soon be duplicated in software, but a growing number of software pundits see carefully designed and documented reusable software as a way of breaking the bottleneck in programming productivity. Several companies are reaping significant increases in productivity through concerted reusability efforts. Toshiba Corp. realized annual productivity rates in excess of 20,000 lines of source code per person-year as a result of utilizing reusable designs.

Reusable Software

One active proponent of reusability is Will Tracz, an advisory programmer at IBM's Federal Systems Div., Oswego, N.Y. A member of the company's Corporate Reuse Council, Tracz poses in his "alter ego" as a used-program salesman to draw attention to the issues surrounding software reuse. Tracz and other reusability advocates point to studies that show software productivity languishing at an increase of only 3% to 8% per year during the 1960s and 1970s. The processing capability of installed hardware, on the other hand, increased at a rate of 40% or better per year.

Studies also found that likely 15% of all programming code written in 1983 was unique, novel, and specific to individual applications. The remaining 85% was common and generic and theoretically could have been developed from reusable components. Typical examples include Gregorian date edit routines, Gregorian to Julian date conversions, and edits and validation of part, employee, and account numbers.

Higher Forms of Reuse Show Promise

The higher forms of reuse, namely designs and systems, show the most promise among researchers for future quantum leaps in productivity, but, by and large, these types of reuse have yet to have significant impact on the average programmer.

Since any program used by two or more users qualifies as reusable software, virtually all programming shops participate at this level through vendor-supplied and commercially purchased software. A large company's budget for off-the-shelf software, however, is typically dwarfed by spending for development of its own systems.

Commercial software can be disappointing in the reusability benefits it provides. One industry veteran gives the example of a client that bought a payroll package for \$600,000 that was supposed to have been loaded with reusable, generic code. "Well, it took them one-and-a-half years and 20 people to make enough modifications just to install it. Why did it take 30 man-years to modify if you can just drop it in? Because you can't. And that was commercial code designed to be 'reusable.'"

In trying to control software development costs, some MIS managers are exploiting—with notable success—their



GTE'S SWANSON: Estimated savings of \$1.5 million from software reuse.

existing software bases. Take, for example, the Hartford Insurance Group of Hartford, Conn. "Hartford started a reusability program in 1981 as part of broad plan to increase applications development productivity by tenfold over 10 years," says Daniel R. Walsh, former director of the information management division, which has responsibility for software reusability at Hartford.

"The reusable products library, maintained on a Wang minicomputer, is available through an on-line network to a staff of 1,200 systems development people," he continues. "By reusing code in the library, we realize a savings of 250 person-days per month at a cost of 25 person-days in support and maintenance time."

Walsh, who recently left Hartford to head the consulting firm of Walsh and Associates in South Windsor, Conn., describes Hartford's reusable library as a collection of 35 documented and tested COBOL code modules consisting of 15 programs and 20 subroutines. Another 45 items reside in the "use as is" section of the library, which contains modules that have not undergone certification.

Programmers search through the reusable library using a function index, which can be searched from any workstation. The full inventory is indexed and cross-indexed according to data processing and business functions.

To track companywide reusability, Hartford's 14 applications development divisions are required to file monthly reports showing what percentage of reusable code comprises new systems. Based on these figures, which are reported to the vice president of information management, Walsh estimates that between 30% and 40% of the code in new systems comes from the reusable library.

Besides the mandate of upper management, the company relies on an incentive program to stimulate programmer interest in reusability. "Individuals who make submissions to the reusable library

receive imprinted coffee mugs," explains Walsh, and, "the submissions are candidates for a \$300 award the company issues for the best productivity suggestion of the month."

Token giveaways play a key role in getting programmers to participate in a reusability program, believes Steve Sposato, staff technology consultant, who initiated a giveaway program at Pacific Bell. "We promote the library by giving coffee mugs and screwdrivers to contributors. It's great publicity—just about everyone asks where they can get an official reusability coffee mug." A year ago, Sposato handed the program over to Mitch Che, staff manager in IS.

About 250 programmers at the firm's San Ramon, Calif., information systems department have access to an on-line library that contains "thousands" of C language components written for Unix and running on computers from Unisys, AT&T, and Digital Equipment Corp., among other manufacturers. The library also contains development tools and training guides.

Ease of Use Is the Key to Success

"The key to success in a reusable library, or any type of library for that matter, is giving your patrons a way of getting what they need with the least amount of trouble," explains Sposato. "We spent considerable time designing an easy and efficient user interface based on a hierarchical tree of function categories and subcategories, plus an extensive index of keywords."

Before the library was opened to users in October 1986, Sposato canvassed the company to collect a broad inventory of software. "You don't want to serve any library before its time," he cautions. "If people log-on to a library with little or no inventory, they'll think it's a waste of time. When the library eventually accumulates a decent collection, you'll then be faced with trying to convince those people to log-on again."

"Our overall philosophy is that you're either a consumer or a contributor," continues Sposato. "If a programmer is not using material from the reusable library when developing a system, then he should be contributing his code. In 1988, our management plans to set reusable quotas. Programmers will be expected to reuse a certain amount or contribute a certain amount."

“And I say it’s a multi-user computer, so let’s both use it!”

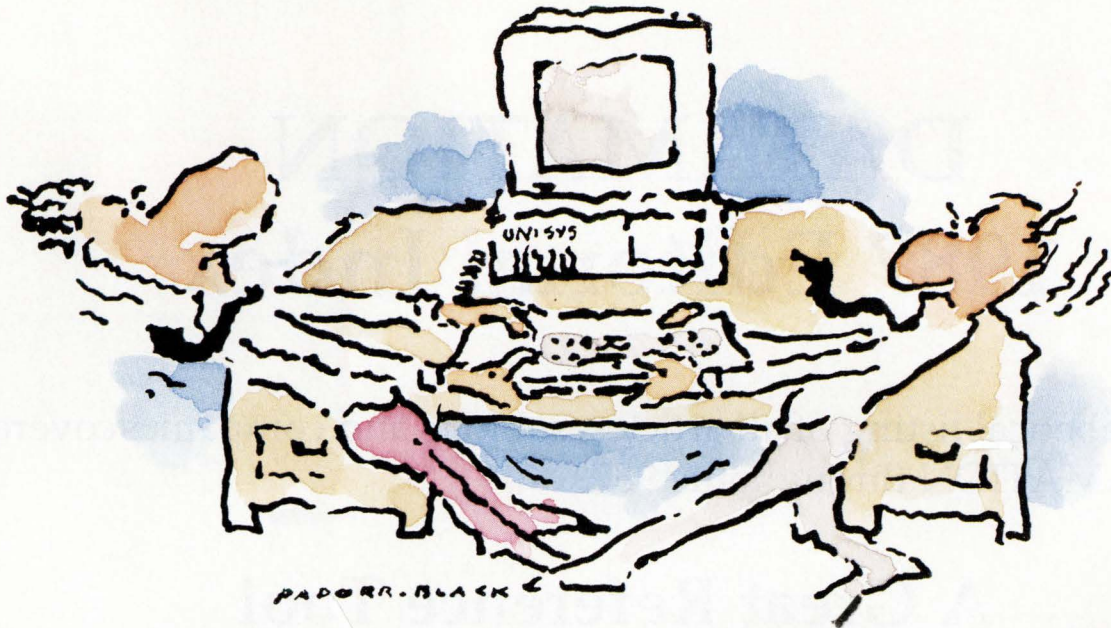

The Unisys PW² Personal Workstation Series 800 from Hall-Mark is powerful enough to handle your needs . . . as well as multiple users.

A sophisticated application may be too much for an ordinary desktop computer. That’s why there’s an advanced computer with the capacity to accommodate multiple users.

The Unisys PW² Personal Workstation Series 800 is powerful enough to give you the extra power, speed, memory and multi-user interface you need for CAD projects, local area networks, multi-user applications and multitasking. The Unisys PW² is even multi-lingual, running on MS-DOS, XENIX, and OS/2.

Work with Hall-Mark to design and install the Unisys PW² system—Series 800 multi-user or the fast Series 500 or Series 300—that brings out the best in your people. Because sometimes a sophisticated application is best accomplished by two people working together.

Giving you the power to succeed.



Hall-Mark Electronics Corp. • Dallas, Texas • Subsidiary of Tyler Corp.

Alabama
Huntsville (205) 837-8700

Arizona
Phoenix (602) 437-1200

California
Bay Area (408) 432-0900
Orange County (714) 669-4100
Sacramento (916) 722-8600
San Diego (619) 268-1201
San Fernando Valley (818) 716-3300
West Los Angeles (213) 217-8400

Colorado
Denver (303) 790-1662

Connecticut
Connecticut (203) 269-0100

Florida
Ft. Lauderdale (305) 971-9280
Orlando (305) 855-4020
Tampa Bay (813) 855-5773

Georgia
Atlanta (404) 447-8000

Illinois
Chicago (312) 860-3800

Indiana
Indianapolis (317) 872-8875

Kansas
Kansas City (913) 888-4747

Maryland
Baltimore (301) 988-9800

Massachusetts
Boston (617) 935-9777

Michigan
Detroit (313) 462-1205

Minnesota
Minneapolis (612) 941-2600

Missouri
St. Louis (314) 291-5350

New Jersey
Fairfield (201) 575-4415

New York
Long Island (516) 737-0600
Rochester (716) 244-9290

North Carolina
Raleigh (919) 872-0712

Ohio
Cleveland (216) 349-4632
Southern Ohio (614) 888-3313

Oklahoma
Tulsa (918) 251-1108

Pennsylvania
Philadelphia (215) 355-7300

Texas
Austin (512) 258-8848
Dallas (214) 553-4300
Houston (713) 781-6100

Utah
Salt Lake City (801) 972-1008

Wisconsin
Milwaukee (414) 797-7844

UNISYS
Authorized
Distributor

Unisys Personal Workstation² and PW² are trademarks of Unisys Corporation. MS-DOS, XENIX, and OS/2 are trademarks of Microsoft Corporation.

© 1988 Hall-Mark Electronics Corp./400-4046

NOW AVAILABLE:

**DATAMATION
1987 Editorial Index**

An alphabetical listing of all articles, subjects and companies covered in DATAMATION throughout 1987.

**A Great Reference Tool
for Only \$5.00!**

.....
:Send for Your Copy Today! :
.....

Just send a check made out to DATAMATION
for \$5.00 to:

Ellen Lux
DATAMATION
249 West 17th Street
New York, NY 10011

INTRODUCING THE FIRST REAL-TIME MONITOR FOR CSA.

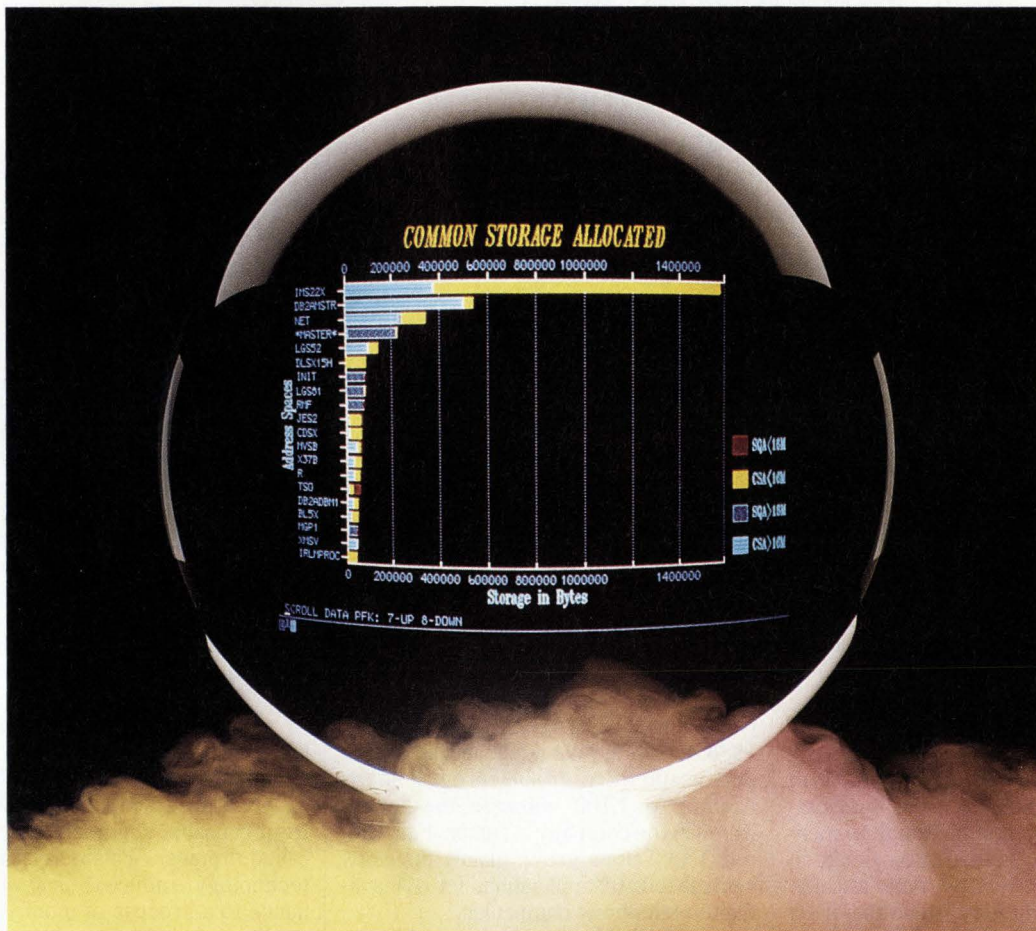

Introducing the new Common Storage Monitor for RESOLVE PLUS, the first in-depth tool for monitoring users of CSA and SQA on MVS/XA. And the most effective way to reduce time consuming, and costly, IPLs caused by common storage constraints.

Control CSA creep.

Common Storage Monitor helps you control "CSA creep", the slow, hidden increase in common storage allocation that can ultimately result in system degradation and even failure. It is the only monitor that allows you to account for common storage usage by individual user. So you can identify applications that are abusing common storage and recover wasted CSA held by terminated tasks.

Pinpoint CSA usage.

Common Storage Monitor displays allocated storage for each address space by job name. Operating in either ISPF or command mode,

you can display as much detail as you need to identify the user responsible for the allocation, and to analyze how the storage is being used. Password-protected RESOLVE PLUS services are also provided to free areas of CSA once they have been identified. Online color charts give you an easy-to-interpret overview of common storage allocation.

For more information on the Common Storage Monitor for RESOLVE PLUS Version 3.0.0, call Fran Inman today. In California: 800-624-5566. Outside California: 800-822-6653. Boole & Babbage, Inc. 510 Oakmead Parkway, Sunnyvale, California 94086.



International sales and support provided through The European Software Company and a worldwide distribution network.

Reusable Software

Sposato notes that Pacific Bell's executive management has been a driving force behind reusability. "They learned about the concept from a presentation Capers Jones gave in November 1985. A month later, at Pac Bell's annual Pathfinder's Conference, management identified reusability as a corporate objective for the technical staff."

While recognizing the critical role management plays in a reusability program, Sposato believes that the ultimate success lies with programmers. "Programmers have the option of writing software from scratch or checking for a functional equivalent in the reusable library that is certified to work. But once they become accustomed to relying on the library, the behavior will be self-perpetuating. People who incorporate reusable code in their software will be more productive than those who don't."

Since the reusability library went on-line little more than a year ago, Pacific Bell has spent approximately \$300,000 in hardware, software, and personnel support costs. Although it is "tough to measure" what that investment yields in savings, Sposato states emphatically, "There is no doubt in my mind that it's a worthwhile venture."

In Sposato's opinion, the difficulty with gauging return on investment in reusability is linked to the general problem of measuring programmer productivity. "How do you do software metrics? In some cases, 20 lines of code may be worth more than 20,000 lines. We have not found a way of correlating levels of reusability with lower head counts or decreased costs."

Spreading the Wealth

Among the benefits of the reusable library he cites is the capability of spreading the wealth of the company's topflight programmers by making their code available to everyone. This factor helps train new personnel because they can browse through "role-model code" stored in a central repository.

While agreeing that software productivity is difficult to measure, another reusability pioneer, GTE Data Services, has devised a financial model for quantifying its investment. "Our model shows a savings of \$1.5 million for 1987 based on a reuse factor of 14% [new systems containing 14% reused code]," states

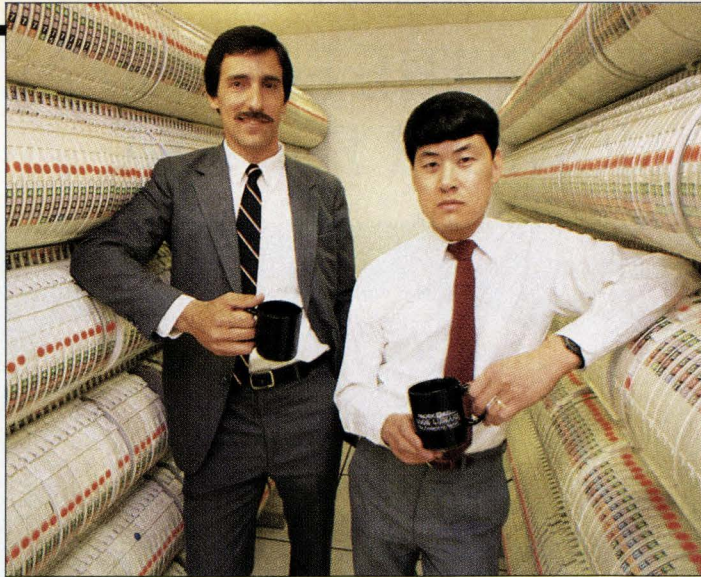

PAC BELL'S SPOSATO, CHE: Giveaways spur programmer participation.

Mary Swanson, director of the company's information asset engineering group. "Our five-year business plan calls for 50% reuse, which will amount to a total savings in excess of \$12 million."

Swanson points out that the 1987 figure, which exceeded projections, was achieved with a library of 136 components consisting of 168,000 source code lines available to 700 programmers. The contents of the library are published in paper form and distributed manually. In 1988, the library catalogue will be posted on-line and the user audience will be expanded to 1,100 software developers based in the company's Tampa, Fla., center. The Tampa group mainly develops centralized MIS applications for GTE's affiliated telephone companies.

Like the Hartford Insurance library, GTE's repository consists primarily of COBOL source code for a mainframe environment. The quality of candidate software components for the library are carefully screened for correctness, documentation, and potential application.

The final criteria examine how a component can be reused and how likely it is to be reused in light of the functional requirements of planned systems.

Swanson's staff of 17 engineers and analysts works closely with development groups in identifying components that are suitable for reuse. Swanson estimates that, on the average, 20 hours are spent to qualify each 1,000 lines of code accepted for reuse. To entice contributors, GTE pays authors a cash bonus of \$25 each time a component is reused.

Raytheon Reports Productivity Leap

When GTE management first studied the feasibility of reusability in 1985, recalls Swanson, she spoke at length to Robert Lanergan of Raytheon. In a widely quoted 1984 report, Lanergan describes how Raytheon achieved 60% reusable code in new development of CO-

BOL applications for "a 50% increase in productivity" at Raytheon's Missile Systems Div. in Bedford, Mass.

Swanson says that "Raytheon's study proved the success of organized efforts to promote reusability. But the work was performed more than five years ago, and you don't necessarily want to replicate that exact model today." At GTE, she emphasizes, the library will eventually include reusable designs, architectures,

user interfaces, and other items in addition to software components. The library's name reflects the diversity of its function; rather than a reusable software library, it's officially known as the Asset Catalog. Swanson's expectation of reusable designs points to a trend among those who have exploited the common nuts and bolts of programs and are now focusing attention on the generic subassemblies of applications.

Hartford Insurance is looking to a code generator-type product called CAP from Toronto-based Netron Inc., which allows a programmer to build software from reusable segments of COBOL code called frames. Walsh says that frame technology reduces program maintenance to a process of modifying a short engineering blueprint instead of changing pages of source code.

Netron announced in December that Westpac Banking Corp., Australia's largest banking group, chose the CAP product as part of a \$A120 million automated banking project. A similar product, called Virtuoso, which was released last fall by Hewlett-Packard, also combines COBOL code generation and a reusable library for building applications.

IBM's Tracz believes that products such as these will help make widespread software reuse a reality. He sees momentum gathering in the form of industry and government financial incentives to foster the proper environment for software reuse.

The tools and technology emerging today, he predicts, can yield productivity "an order of magnitude over simple forms of reuse, such as subroutine libraries and code templates." In Tracz's opinion, it's about time that software developers agreed to stop reinventing the wheel. ■

Ed Joyce is an independent software developer, based in Lexington, Ky.



This single roll of forms can feed your high speed laser printer nonstop up to 5 hours!

The Moore Roll Processing System can help you get a lot more out of your high speed laser printer. You can actually increase your output by as much as 50% or more—and do it with less operator involvement.

One roll of forms is the equivalent of 17 cartons of standard size 18-pound forms. Think of all the carton-changing downtime you'll eliminate. And, Moore rolls are easy to handle, requiring no manual lifting or strain.*

Both the roll feeder and folder units

of the Moore system interface directly with your printer. They can be configured at right angles, parallel, or in-line, depending on your space layout or setup preference.

The system is supported by the nationwide Moore technical service network. We will

install it, train your operators and provide a six month/2000 hour warranty, all at no extra charge.

To learn more about this dramatic productivity booster, call Moore at 1-800-447-3000, ext. 6200.

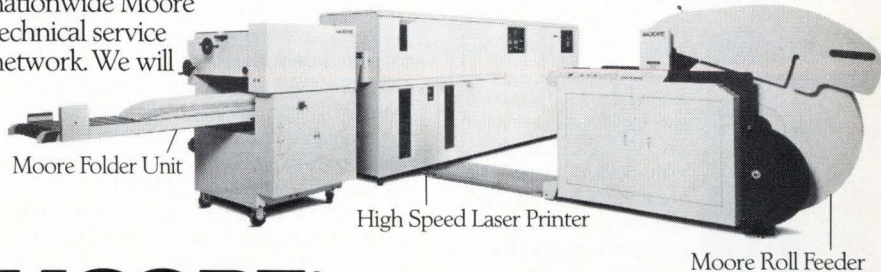

MOORE® **BUSINESS FORMS
& SYSTEMS DIVISION**

1205 Milwaukee Avenue
Glenview, IL 60025

*Optional forms dolly available.

© 1987 Moore

Circle 42 on Reader Card



SUPRA™ Opens Doors For Best Western.

PROBLEM: How to easily access and update large volumes of corporate information vital for strengthening image and facilitating expansion

CINCOM SOLVED IT: With SUPRA Advanced Relational DBMS and MANTIS, a powerful application development tool

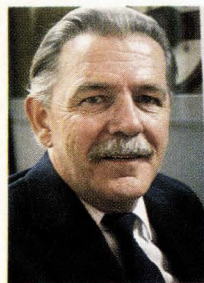

Mr. Robert C. Seate
Manager, Management Information Systems
Best Western International, Inc.

Tracking and managing information for 3,300 hotels in more than 30 countries around the world is enough to give any MIS manager some sleepless nights. But, thanks to the SUPRA™ Advanced Relational DBMS from Cincom®, Best Western's Robert Seate (along with member hoteliers and guests) can rest assured things are running smoothly.

"With SUPRA, we really have the best of both worlds," explains Seate. "We get the advantages of a relational environment and, at the same time, get a system that performs very well in a large volume production environment."

SUPRA's superior performance lets the world's largest hotel chain access and update the marketing data as well as the property and travel publications essential to support and promote each hotel. SUPRA also works in concert with MANTIS®, a flexible application development tool in the CASE ENVIRONMENT™, to drive multiple programs designed to monitor and upgrade quality standards throughout the Best Western organization. "When you increase the value of the chain, people want to become a part of it," Seate explained.

"SUPRA and all the Cincom products work together to help us meet our corporate expansion and quality goals," Seate points out. "It's a set of tools that is very flexible, very easy to use and learn, and very capable of developing and supporting a wide variety of applications."

As for SUPRA's reliability, Seate has no reservations. "Let's put it this way," he says, "we're running our payroll on it. We'd be crazy to do that if we didn't have a high degree of confidence in the system."

If you're looking for a relational data base with IBM and VAX compatibility, high performance and reliability, plus the option of a flexible application development tool, it's time you checked into SUPRA and MANTIS.

Call us today for more product and customer success information, or write our Marketing Service Department, Cincom World Headquarters, 2300 Montana Avenue, Cincinnati, OH 45211.

1-800-543-3010

In Ohio, 513-661-6000

In Canada, 1-800-387-5914

 **CINCOM**
The Better The Solution, The Better The Value.™

New Products

TRENDS

IBM MIDRANGE AND LARGE-SCALE SYSTEMS users are being wooed by Epson America Inc. The Torrance, Calif.-based peripherals vendor is bringing out new printers and is entering into marketing agreements with protocol converter makers Avatar Technologies Inc. and I-O Corp.

Epson recently unveiled three new printers, one of which is specifically targeted at large systems users. The DFX-5000 is a high-speed, nine-pin serial dot matrix printer with dual paper paths for handling a variety of applications.

According to John Leever, president of Salt Lake City-based I-O Corp., Epson is "the first major printer manufacturer to enter the IBM twinax [midrange] market." He tells DATAMATION that Epson's new DFX-5000 is "surely geared for the IBM midrange and mainframe data processing environment where speed is important." Features that impress Leever are its speed, dual paper paths, demand documents, and lack of noise. For Leever, these make the DFX-5000 compatible with the "gravitation of printers from the computer room to the office."

The significance of Epson's new products and marketing agreements "from the end user's standpoint," says Leever, "is a larger variety of products at much more reasonable prices." Epson's DFX-5000 is priced at \$2,200; IBM's printers range between \$2,000 and \$20,000, and prices for printers from niche players—such as Genicom, Data Products, Data South, and OTC—begin at \$3,000, according to George Rasher, Epson's director of product marketing.

The agreements with I-O Corp. and with Avatar Technologies Inc., Hopkinton, Mass., are keys in Epson's push into the IBM midrange and mainframe worlds. The interface cards from I-O and Avatar convert EBCDIC—the protocol used in IBM's machines—into ASCII, the protocol used in Epson's printers.

I-O Corp.'s I-O 8300 is a \$795 plug-in twinax converter for IBM's midrange environments, namely, the System/3X and AS/400. Avatar's EP-Connect is a \$795 plug-in co-ax interface board for IBM 3270 devices. Designed with Epson, the two interface boards can be used with the following Epson printers: the new DFX-5000, the FX-850/1050, the LQ-850/950/1050, the LQ-2500/LQ-2550, the EX-800/1000, and the FX-86e/286e.

If you'd like additional information about products covered in this issue's hardware Trends, please circle 229 on the reader service card.

HARDWARE

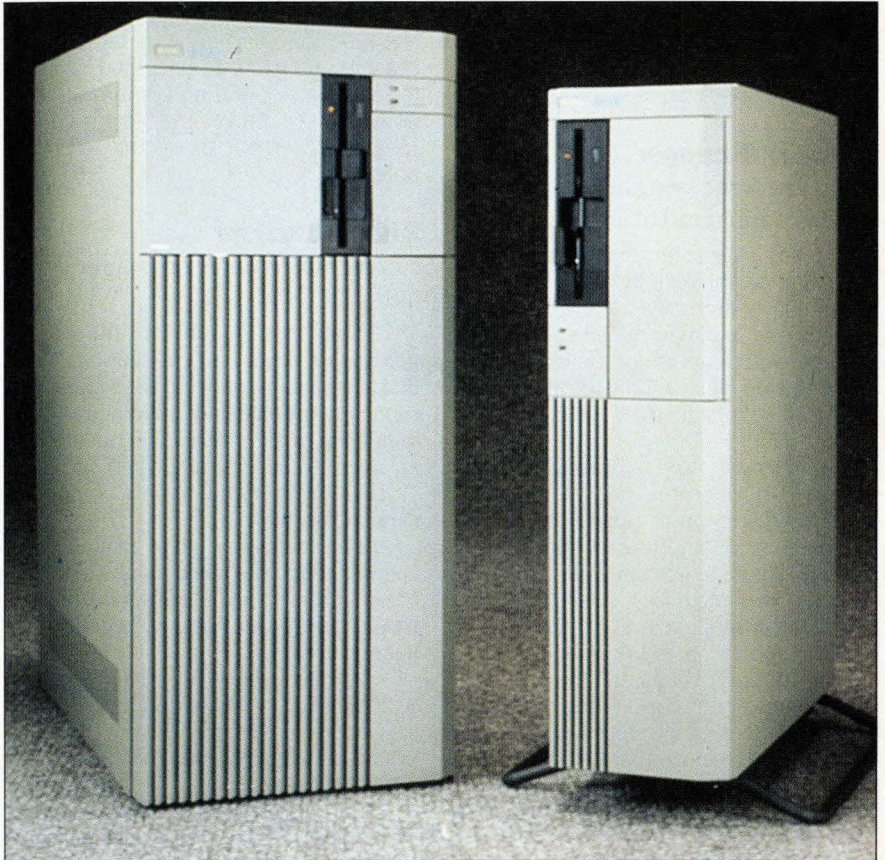

Wang's new minicomputers allow speeds of between 25MHz and 33.3MHz.

Wang Offers Four New Minis With Native Mode VS IN/ix

VS 5000 Series incorporates a mainframe instruction set into a custom CMOS chip.

Wang Laboratories Inc. has introduced a series of four minicomputers with the option of a native-mode implementation of VS IN/ix, a Unix System V.2-compliant operating system. A scalable chip design allows speeds between 25MHz and 33.3MHz and executes the entire VS instruction set, claims Wang.

The four base units are said to support nearly 2,000 VS applications and 600 Unix programs in banking, manufacturing, government, and other industries, as well as dozens of Wang integrated information processing applications, including OFFICE, PACE, and WP Plus.

The Models 30 and 40, which accommodate six and 16 active users, re-

spectively, run at 25MHz. The Model 50, running at 28.6MHz, has a 32-user maximum capacity, while the 33.3MHz Model 60 accommodates up to 64 users. Main memory is available in increments up to 16MB. Internal disk storage is offered in capacities of 72MB, 145MB, and 326MB.

Prices for the more than 70 packaged systems configurations range between \$8,800 and \$113,000. They are available immediately.

The VS 5000 IN/ix multiuser, multitasking operating system currently runs more than 600 software applications, and about 4,000 more can be migrated to IN/ix, according to the company. Available in October, it is licensed for

New Products

configurations up to 32 users. VS 5000 IN/ix systems are priced between \$12,500 and \$113,000. WANG LABORATORIES INC., Lowell, Mass. CIRCLE 236

Network Manager

Measurement system allows pc workstation control.

Data Switch Corp. has extended its IntelliNet line of network performance measurement systems with a new operating system and a single pc-based workstation to control operating functions. The 68000-based Series 4200 allows expansion of disk capacity to 240MB, the company says.

The new EOS operating system, which also operates on the previous 3200 Series, supports features such as diagnostic data capture, automatic configuration, and user-definable databases, says Data Switch.

Three models are available. The 4205 supports 16 to 96 lines; the 4215 handles up to 512 lines; and the 4225 handles complex networks with thousands of lines. Prices range from \$21,000 for a basic model to more than \$100,000 for a large system. DATA SWITCH CORP., Shelton, Conn. CIRCLE 237

Gateway Hub

Provides seamless access to dissimilar systems.

Tolerant Systems Inc., and Control Data Corp. announced availability of the Gateway Hub system, designed to allow users to communicate in a network of dissimilar hosts using a single set of commands.

The system, which consists of standard off-the-shelf products, includes Tolerant's Eternity Series hardware, Unix-based TX operating system and communications software, and Control Data's Ascent software. The first system is running at the Air Force System Command's Aeronautical Systems Div. at Wright-Patterson Air Force Base.

The Gateway Hub enables users to access hosts running PCP/IP, SNA, or X.25 without having to memorize multiple login procedures, according to the two companies. Access to the system can also be gained via modem or commercial networks such as Tymnet.

Prices vary depending on installation. An entry-level Eternity system with two SBBS of 8MB of main memory each, two 336MB disk drives and two disk con-

trollers, one tape drive and tape controller, one communications interface processor supporting 12 lines, and two copies of the TX operating system, sells for \$199,000. TOLERANT SYSTEMS INC., San Jose, and CONTROL DATA CORP., Minneapolis. CIRCLE 238

Disk Subsystem

For AT-bus computers running MS/DOS.

1776 Inc. has brought out the second generation of its Patrick Henry external disk subsystem, offering 48GB maximum capacity, optional fault tolerance with redundancy of all critical components, and an average access time of 0.5msec to 7msec for users of AT-bus computers running MS/DOS.

The company also announced a Xenix-compatible disk subsystem, the Patrick Henry XNX, and plans to bring out Novell and other Unix versions in the near future.

Patrick Henry II prices begin at \$12,200 (for 150MB of disk and 0.5MB of cache). The Patrick Henry I-XNX is priced between \$9,200 (148MB disk) and \$52,400 (2.4GB disk).

The model II-XNX, with removable components and optional redundancy, is an additional \$4,000. 1776 INC., Sherman Oaks, Calif. CIRCLE 239

Business Computer

DVSC offers multiuser system upgrade.

Data Voice Solutions Corp. has upgraded its multiuser Centaur business computer system, which allows ASCII terminals to run MS/DOS programs under Novell's NetWare v2.11.

The recently enhanced Centaur II supports up to 28 simultaneous terminal users and up to 628MB of disk storage, the company says. The previous system supported up to 14 users and 133MB of disk storage.

Running under Advanced NetWare v2.11, the system now offers an optional 32-bit 80386 file processor. The previous system, running under Advanced NetWare v2.0a, featured a 16-bit 80286-based file processor.

The Centaur II is available immediately at prices beginning around \$25,000 for a typical five-processor configuration supporting over 20 switched users. DATA VOICE SOLUTIONS CORP., Newport Beach, Calif. CIRCLE 240

BRIEFS

MAI Basic Four Inc., Tustin, Calif., has a new **intelligent desktop workstation** for word processing, spreadsheet, database management, and desktop publishing applications. The MAI 1200 is available at a price of \$3,230, including 1MB of RAM, a 3½-inch floppy, a 20MB hard disk, MS/DOS and GW/BASIC, English keyboard, and monochrome monitor. CIRCLE 241

Videophone Inc., Houston, is offering a **videophone system** for sending full-color images over standard dial-up phone lines. Its list price is \$15,300; a high-resolution system is \$17,000. CIRCLE 242

Wyse Technology, San Jose, has added **two 386-based computer systems**. The 3216-150T, which supports up to 12 users and incorporates a 150MB disk drive, is priced at \$8,599. The 3216-85T, which supports eight users and is priced at \$7,999, has an 85MB drive. CIRCLE 243

Star Micronics America Inc., New York, has entered the color printer market with **two seven-color dot matrix models**. The NX-1000 and NX-1000C, for use with IBM PCs and compatibles, offer multiple internal fonts and a 4KB buffer. Each is priced at \$379. CIRCLE 244

Maynard Electronics Inc., Casselberry, Fla., is offering the MaynStream 150, a 3½-inch **cassette tape backup system** designed for PS/2 products, including the Model 50z and all three versions of the Model 70. The internal 150MB system is available now; a portable model will be available in October. Prices range between \$1,600 and \$2,000. CIRCLE 245

Ungermann-Bass Inc., Santa Clara, has upgraded its **asynchronous terminal server**. The Net/One NIU-190, priced at \$2,995 and available now, has an eight-port server with 512KB of RAM. CIRCLE 246

Alloy Computer Products Inc., Framingham, Mass. has debuted the **pc-TWIN**: a processor board, an IBM 3151 terminal with connectivity cartridge, and a 25-foot cable. Priced at \$1,695, the package is designed for small retail businesses where two or three people need to share pc files and databases. CIRCLE 247

Storage Technology Corp., Louisville, Co., has announced three **impact printers**, operating between 2,100 and 5,000 lines per minute. The Series 5000E printers list between \$35,000 and \$74,000 and are available immediately. CIRCLE 248

Manpower[®] can send you "Lotus^{*}-literate" Temporary office workers. Everywhere!

Over the past two years, more than 100,000 Manpower Temporary office workers have learned the basic functions and applications of Lotus 1-2-3 and have applied them on a wide variety of temporary assignments.

Their training was on IBM PCs located in all 700 Manpower U.S. offices using Skillware[®] — the unique Manpower training diskettes written *by* office workers *for* office workers.

Our exclusive 115-page Lotus 1-2-3 Operator Support Manual is their constant quick-reference companion.

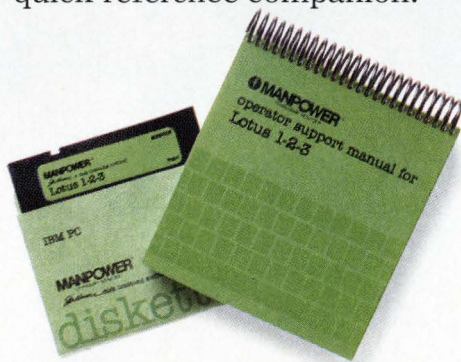

Call us for trained, tested Temporaries to help you with your Lotus 1-2-3 application work or quick-training for your own permanent staff members in Lotus 1-2-3 basics . . . or both!

 **MANPOWER[®]**
TEMPORARY SERVICES

IT'S 4:02 PM SATURDAY AND 2 MILLION PEOPLE ARE TAKING ON THE OHIO LOTTERY.



If the computer's not ready some guy will pay dearly.

That guy is Guy Snowden, Chairman & CEO of GTECH Corporation; the company that serves Ohio and 25 other lottery systems around the world.

"We couldn't gamble on our computer system — the state extracts a penalty of up to \$2,000 for each minute the system is down. That's why GTECH chose a fault tolerant system from Concurrent Computer Corporation.

The computers had to handle up to 2,100 transactions a second, and have been operating at 99.98% uptime," Guy said.

"That's extra important when on-line sales exceed \$2 million an hour and the jackpot is \$32 million."



High reliability and fast response like this is typical of Concurrent. The company has been designing computer systems for demanding time-critical applications for over 20 years. Applications like power plant control, aircraft simulation, on-line stock quotation and weather analysis.

Concurrent has supplied the hardware, systems software and customer support for more than 26,000 real-time technical and on-line commercial computer systems worldwide.

If your application requires the ability to deal with large volumes of data, high interrupt and I/O rates — has to deal with them fast — and reliably — Concurrent's your kind of company.

You can bet on it.

Call, or write to us at:
Concurrent Computer Corporation
106 Apple Street
Tinton Falls, NJ 07724
1-800-631-2154

Computers for people who can't afford to wait.

Concurrent
Computer Corporation

Circle 45 on Reader Card

New Products

TRENDS

DESKTOP PUBLISHING has recently received a couple of shots in the arm. The two leading pc-based programs have both been improved in the last few months. Earlier this month, Xerox Corp., San Diego, brought out a new release of Xerox Ventura Publisher, as well as a souped-up version aimed at professional publishing applications, and a version for use over a network. In May, Aldus Corp., Seattle, began shipping its new version of PageMaker.

According to Dataquest Inc., San Jose, Xerox Ventura Publisher 1.1 holds 62% of the MS/DOS-based desktop publishing market. Xerox is touting increased ease of use and ease of training with release 2.0 of Ventura Publisher. Arthur E. Coles Jr., vice president and general manager of the Xerox desktop software unit, tells DATAMATION that the new version also has the ability to do color separations.

The new version is priced at \$895. The upgrade price is \$85, but discounts are available to users that subscribe to the support program. The Professional Extension module, which provides advanced desktop publishing features and support for larger documents, is priced at \$595.

According to Coles, the Ventura product is the first pc-based desktop publishing program to come out in a networked version. The networked version is targeted at work group applications, such as newsletters and annual reports. Pricing for the Network Server, which won't be available until the fourth quarter, has not been finalized. At press time, Xerox was able to quote a price of \$1,295 for the base product but couldn't say how many users that would support.

Aldus Corp.'s spring release of PageMaker, which Dataquest estimates to hold 34% of the MS/DOS-based desktop publishing market, was garnished with the following features: user-defined style sheets; support for long documents; enhanced graphics capabilities, such as the ability to wrap text automatically around rectangular graphics and customize wraps for irregularly shaped graphics; and user interface improvements, including built-in templates.

PageMaker 3.0 is \$795. The upgrade price is \$95. For subscribers to Aldus' Extended Technical Support Service, the upgrade price is \$47.50.

If you'd like additional information about products covered in this issue's software Trends, please circle 230 on the reader service card.

SOFTWARE

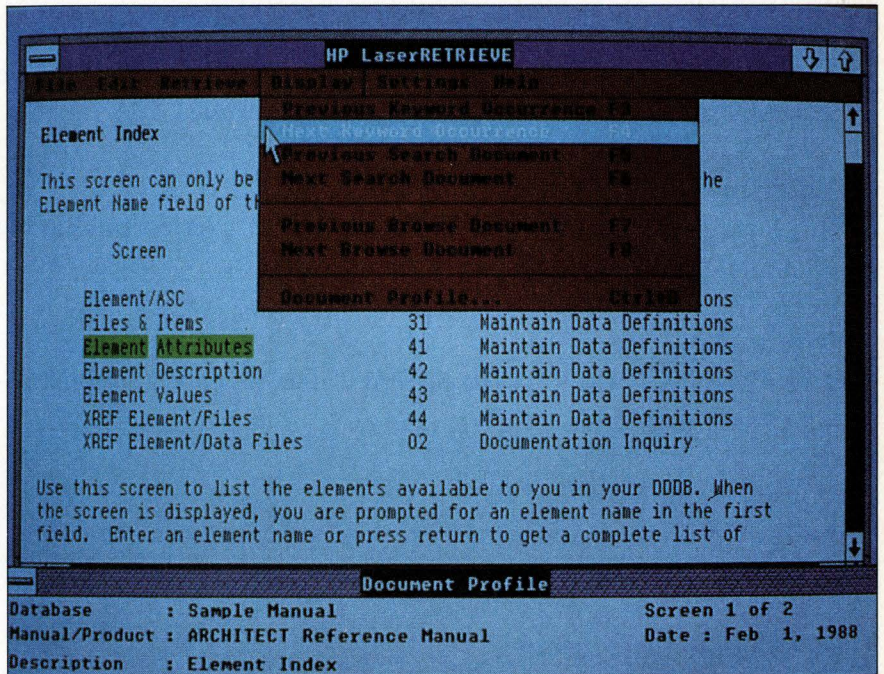

HP's CD-ROM system stores full-text and graphics information.

Hewlett-Packard Offers CD-ROM System for Micros

User interface and database builder are featured to help develop CD-ROM applications.

Hewlett-Packard Co. has released LaserRetrieve, which is designed to allow a large amount of full-text and graphics information from multiple sources to be stored on a CD-ROM and retrieved.

After the data have been indexed and structured and the CD-ROM mastered and replicated, the user interface component accompanies the finished disk to the end user. The graphical interface, which is based on MS-Windows, enables searches through browsing or keywords, according to HP. Browsing allows the user to find the information by migrating from a general table of contents to specific sections of interest. In a keyword search, the user specifies words, phrases, or topics of interest, which the system then identifies each time they occur.

The database-build software requires an HP Vectra or IBM AT with 640KB of RAM; a mass-storage subsystem with a disk storage capacity twice as large as

the database; a 9-track tape drive; and an HP LaserJet printer for proofing. The user-interface software runs on the Vectra or AT and requires a CGA, EGA, or monochrome monitor, 5MB of available hard disk storage, and a CD-ROM drive.

LaserRetrieve usually will be combined with CD-ROM publishing or data preparation services for a complete application, the company says. The database-build software is priced at \$50,000 for a single license, and the user-interface software is \$500 for a single cpu license. Deliveries are expected to begin in November, says the company. HEWLETT-PACKARD CO., Palo Alto. CIRCLE 231

Database Management

Oracle offers management system and tools for IBM mainframes.

Oracle Corp. has added support for IBM's DOS/VSE SP mainframe operating system

Coming Up in October in **DATAMATION**

October 1

Salary Survey

DATAMATION's annual survey of salary trends for IS executives. A look at salary increases, decreases, perks and other forms of compensation.

Departmental Computing/Part III

This last article in DATAMATION's three part series looks at technology in the office — managing the process of change.

Printers

DATAMATION explores the advent of the advanced peripheral — the combination printer, fax and copier.

PC Maintenance

DATAMATION examines the PC virus phenomenon and how it is adding a new dimension to the problem of PC maintenance.

DEC/Apple Integration

An analysis of what users are doing to enable their Apple and DEC computers to communicate.

Ad Closing: September 1, 1988
Recruitment Ad Closing: September 14, 1988

October 15

Disaster Recovery

This article explores the pitfalls of some disaster recovery plans; how they can be improved and why some plans fail.

Artificial Intelligence

Artificial intelligence holds vast potential for users. DATAMATION examines some leading AI applications and how they relate to central information systems.

CIM/CAE

A focus on the promises and problems of computer-integrated manufacturing (CIM) and computer-aided engineering (CAE). Also, a look at whether or not manufacturing companies can realize their goal of computer-integrated manufacturing.

Changing Roles of IS

This article explores how the role of the IS manager is changing in the fast-paced world of technology, and the implications for the IS organization at large.

Ad Closing: September 15, 1988
Recruitment Ad Closing: September 26, 1988

New Business Opportunities Come To Light

For the tenth consecutive year, COMDEX/Fall will bring you new success strategies. More new products and technologies. New ways to sell, more productivity, more profit opportunities.

Over 1600 Exhibits To Help You Surpass Your Sales Goals

Over 1600 leading companies from the U.S. and around the world will display the entire range of computer related products and services in nine exhibit sites throughout Las Vegas.

With 300+ international exhibits, COMDEX can expand your profit opportunity in foreign markets. And you'll learn the latest trends and selling ideas in an enlightening conference presented by industry experts on connectivity, graphics, international issues and much more.

Join The Largest Computer Trade Show In The World

The computer industry has grown dramatically through the 1980s. And for ten years, COMDEX/Fall has remained the premier international computer distribution event.



Again this year, COMDEX/Fall offers even more benefits than ever before —products, information and the techniques and know-how you need to succeed, presented in a perfect business environment which you cannot afford to miss.

Return the coupon today for complete conference information, exhibitor lists, registration forms and big savings on hotels and travel connections from around the world.

Tell me more about new business opportunities at COMDEX/Fall!

- Send me attendee and travel information
 Send me information on exhibiting

DM 915

Name _____

Title _____

Company _____

Address _____

City _____ State _____ Zip _____

Telephone (_____) _____

Return to: COMDEX/Fall '88
300 First Avenue, Needham, MA 02194

COMDEX®/Fall '88

THE 10th ANNIVERSARY

November 14-18, 1988 • Las Vegas Nevada



Foreign Buyer Program

Produced by THE INTERFACE GROUP, Inc.®
World's Leading Independent Producer of Conferences and Expositions

COMDEX/Fall '88 has been selected by the U.S. Department of Commerce to participate in the Foreign Buyer Program

©1988 The Interface Group, Inc.

Circle 47 on Reader Card

New Products

BRIEFS

to its relational database management system. Oracle's relational DBMS and associated tools now support all three IBM mainframe operating systems: MVS, VM and DOS/VSE.

Applications and databases developed under any of these systems will perform without modification under any of the others, and applications on IBM mainframes can be migrated to PCs, Unix systems, VAXs, and other minicomputers, the company says.

The new system features the database; SQL*Plus, the ANSI standard sequel language developed by Oracle; SQL QMX, the end-user report writer; and SQL Forms, the fourth generation applications development tool.

Priced between \$20,000 (for a 9370 Model 20) and \$176,000 (for the high-end 3090 Model 600 application), the Oracle DBMS is available immediately. ORACLE CORP., Belmont, Calif. CIRCLE 232

Performance Management

Boole & Babbage release monitors storage in MVS/XA.

Boole & Babbage is offering a new version of its Resolve Plus on-line performance management package for IBM's MVS/XA operating system. Version 3.0.0's key feature is a common storage monitor designed to track unaccounted storage in the common service area (CSA) or system queue area (SQA).

The monitor can identify and help recover "wasted" CSA allocated to terminated tasks, thus freeing up the storage for new applications, the company claims. The real-time performance management tool can help speed the increase of allocated common storage, making more space available for new users, according to Boole & Babbage.

Version 3.0.0 supports all IBM and compatible processors running on IBM Extended Architecture. It is priced at \$24,000 and it is available now. The company also plans this fall to roll out the Common Storage Monitor as a stand-alone product. BOOLE & BABBAGE INC., Sunnyvale, Calif. CIRCLE 233

Office Applications

Multiuser office package is introduced by BOS.

BOS National has unveiled an integrated software package designed to meet a wide range of administrative applications for small- to medium-sized businesses,

or departments and branch offices of Fortune 1000 companies. The new multiuser package runs on a variety of hardware, from IBM PCs to the DEC VAX, and in a number of operating system environments including DOS, Microsoft Windows, and DEC VMS.

The new release features BOS Writer word processor software; the BOS Speller (spelling checker), BOS Finder (database), and BOS Planner (financial planner/spreadsheet). BOS Writer is integrated with the spelling checker, which contains a 160,000-word dictionary, the company says.

The word processing component also accepts spreadsheet data from BOS Planner for report production, and can merge with the database to produce personalized correspondence from a mailing list.

The Office Software Package, available now, is priced at \$1,350 in a single-user version. A 12-user system is priced at \$2,700; a 40-user system carries a \$5,400 price.

Systems that have over 40 users will be quoted individually. BOS NATIONAL INC., Dallas. CIRCLE 234

Language Tools

Whitesmiths Ltd. adds C cross-compiler for IBM mainframes.

Whitesmiths Ltd. has announced two new C language development packages for IBM mainframes that run VM/CMS.

The first compiler package is designed for users requiring C language cross-support for Motorola MC68000-based embedded systems. This includes support for 68000, 68008, 68020, and 68881 processors. The software includes an ANSI standard optimizing C cross-compiler and run-time libraries, command driver, and C source-level debugging. A Motorola-style assembler/linker is required to use the package, the company says.

The second package is a self-contained tool for mainframe users developing C programs for execution on Motorola M680X0-based computers running Unix. It includes a compiler, listing cross assembler, linker, program support utilities, ANSI libraries, and support for Common Object File Format.

Both packages are available off-the-shelf. Prices for the first package begin at \$10,000; prices for the second begin at \$15,000. WHITESMITHS LTD., Westford, Mass. CIRCLE 235

Network Software Associates Inc., Laguna Hills, Calif., has enhanced its AdaptSNA 3270 package, which provides **pc-to-host communications** over co-ax, SDLC, or asynchronous connections in an SNA network. Enhancements include a script language for unattended file transfers, and support of full-color. The AdaptSNA 3270 price has been cut to \$245 from \$585. CIRCLE 249

Project Software & Development Inc., Cambridge, Mass., is offering its Qwiknet Professional **project management software** on VAX and LAN platforms. The VAX system is priced at \$18,900 for the first four users, and \$8,600 for subsequent four-user installations. Prices for the LAN version also begin at \$8,600 for the first four users, with volume discounts available. CIRCLE 250

Cascade Software Systems Inc., Lexington, Mass., has released LYDDIA, a new CASE tool for **automatic database design and analysis** and generation of database code. The price is \$895. It's available immediately. CIRCLE 251

Microshare Corp., Salt Lake City, has debuted version 3.2 of its Basic OS, allowing **file transfer** between hosts and intelligent workstations. Microshare Basic is available now at \$895. CIRCLE 252

InterSystems Corp., Cambridge, Mass., has a new **relational software package**, M/SQL, that integrates SQL and MUMPS standard languages. It is currently available on PDP-11, VAX, and Eclipse MV computers, and IBM mainframe and PC implementations are planned for later this year. Prices begin at \$2,900 for a four-job VAX application. CIRCLE 253

Stepstone Corp., Sandy Hook, Conn., is offering **Objective-C language version 4.0**, priced at \$2,500 for single-user workstations. Sun and Apollo platforms will be followed by deliveries for HP9000, VAX, and IBM PC. CIRCLE 254

Microsoft Corp., Redmond, Wash., has announced **version 4.0 of its MS/DOS OS**, with expanded memory, and larger disk files. Retail prices will be set by hardware manufacturers. CIRCLE 255

ScreenSCENES International Inc., Cape Coral, Fla., has a **custom-scanning** mail-order service allowing IBM, Mac, and other pc users to digitize black and white and color photos and illustrations. CIRCLE 256

Some Datacomm Standards Should Be Carved in Stone

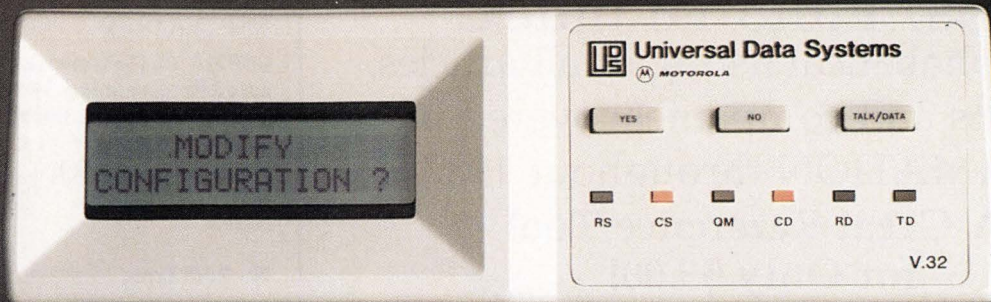

In the matter of full-duplex data communication at 9600 bps, a number of approaches have been discussed. There's the CCITT-approved V.32. There are even some "pseudo V.32s" around. Some suggest that, because of their somewhat lower cost, non-standard modems may be the answer.

At Universal Data Systems, our position is carved in stone: for full end-to-end compatibility, regardless of equipment source, standardization on true V.32 is the only workable solution.

That's why the fully featured UDS V.32 is the acknowledged price/performance leader.

Our exclusive near-end/far-end echo cancellation techniques, combined

with trellis coding, result in -17dBm signal-to-noise ratio; that's plenty of horsepower for voice-grade lines.

As back-up for your dedicated four- or two-wire system, or for a 9600 bps upgrade of your present dial-up communications, check out the UDS V.32. It's the standard!

Universal Data Systems, 5000 Bradford Drive, Huntsville, AL 35805.

Telephone 205/721-8000;
Telex 752602 UDS HTV.

\$1595⁰⁰
Quantity One



Universal Data Systems



MOTOROLA INC.

NOW AVAILABLE:

DATAMATION 1987 Editorial Index

An alphabetical listing of all articles, subjects and companies covered in DATAMATION throughout 1987.

**A Great Reference Tool
for Only \$5.00!**

To order your copy today,
send a check made out to DATAMATION
for \$5.00 to:

Ellen Weinberg
DATAMATION
249 West 17th Street
New York, NY 10011

Discover *Strategic* Micro Management!

Get the information you need to analyze and plan for the future implementation of end user computing: Buying trends by department, manufacturer, and vendor, statistics on installed base of hardware and software, or annual service and repair costs.

Monitor the costs and performance of your end user support staff: Support staff's average response time, the number of support calls taken, or the annual cost of training and support by product or department.

Show upper management that you are in control of their growing investment in end user computing.

**COMPUTER
ASSOCIATES**

Software superior by design.
200 W. Lowe, Fairfield, IA 52556
(515) 472-6400

Discover The Micro Resource Manager (MRM) and you'll discover why over 500 corporations and government agencies have implemented MRM as their solution to managing end user computing.

MRM is an advanced fourth generation application that has earned the universal praise of micro managers, MIS directors, and software experts worldwide. Over 220 reports and queries allow you to:

- Track hardware, software, or services.
- Analyze budgets, costs, and trends.
- Determine use and distribution patterns.
- Control service and maintenance costs.
- Manage support staff workload.
- ... And much, much more.

Call today for a FREE demo disk.

The Micro Resource Manager™

Departments

CALENDAR

SEPTEMBER

OOPSLA '88 (Conference on Object Oriented Programming: Systems Languages and Applications).

Sept. 25-29, San Diego. Contact Barbara Noparstak, Digitalk Inc., 9841 Airport Blvd., Los Angeles, CA 92680, (714) 731-9022.

CD-ROM Expo.

Sept. 26-29, Chicago. Contact IDG Conference Management Group, P.O. Box 9171, Framingham, MA 01701-9171, (800) 225-4698.

OCTOBER

Info '88 (Information Management Exposition and Conference).

Oct. 11-14, New York. Contact Show Manager, Info '88, 999 Summer St., Stamford, CT 06905, (203) 964-0000.

Dexpo West 88.

Oct. 18-20, Anaheim, Calif. Contact Expoconsul International Inc., 3 Independence Way, Princeton, NJ 08540, (609) 987-9400.

Office Products Exchange Network (OPEN).

Oct. 19-21, Dallas. Contact Steve Oliver, OPEN Inc., c/o ICOT Network Systems Div., P.O. Box 91395, Mobile, AL 36691, (800) 762-3270.

ASIS '88 (American Society for Information Science).

Oct. 23-27, Atlanta. Contact American Society for Information Science, Exhibits Management, 1424 16th St., NW, Washington, DC 20036, (202) 462-1000.

Northeast Computer Faire.

Oct. 27-29, Boston. Contact the Interface Group Inc., 300 First Ave., Needham, MA 02194, (617) 449-6600.

Ninth International Conference on Computer Communication.

Oct. 30-Nov. 4, Tel Aviv, Israel. Contact Channy Greenberg, KENES USA, 271 Madison Ave., Suite 903, New York, NY 10016, (212) 986-8300.

Unix Expo (The Unix Operating System Exposition and Conference).

Oct. 31-Nov. 2, New York. Contact National Expositions Company Inc., 15 West 39th St., New York, NY 10018, (212) 391-9111.

CIRCLE 49 ON READER CARD

It's 10 a.m. Do you know where your terminal is?



ERITM ELECTROREP

The Equipment You Need, When You Need It.

They promised you a terminal two days ago. And now you're waiting. Your work is waiting. And your people are waiting. Next time, avoid the frustrating delays and call ERI—the leading source of business communications equipment for over 27 years. We can deliver within 24 hours. No waiting. No doubt.

And not only do we get it to you faster, we offer you one of the most extensive inventories as well. Whether you need an entire computer system or a printer, we carry full

lines of top name equipment, including AT&T.

Does all this cost more? Absolutely not. We're a major value added reseller so we can offer you competitive prices on any size order. Plus, we can provide flexible leasing plans, rental options and maintenance programs.

Call ERI today. Our highly trained sales and technical support staffs are just a phone call away to answer your questions and help you get the most from your equipment.

Depend on ERI. Because when you need it on your desk first thing in the morning, we'll get it there.



CORPORATE HEADQUARTERS • 380 SMITH STREET, FARMINGDALE, NY 11735 • 516/752-0585 • FAX 516/752-0086
FIELD OFFICES • CONNECTICUT • NEW JERSEY • MASSACHUSETTS • WASHINGTON, DC



An Authorized Value Added Reseller of AT&T

See us at the Info Show Booth #1541/CMA Show Booth #107.

Circle 50 on Reader Card

Departments

PEOPLE

High Stakes Turn This Risk Taker Into a Miracle Maker

William Patton put his lifetime savings on the line and turned MAI Basic Four around from the brink of bankruptcy onto solid, profitable ground.

BY TOM McCUSKER.

William B. Patton Jr. was trained at the University of Missouri as a petroleum engineer, but it is computers that have made him a millionaire at 53.

Seventeen years as a sales executive with Honeywell Information Systems and key executive jobs at MSI Data, Ampex International, and Cado Computer Systems, where he was president and ceo, brought Patton success—but it was at MAI Basic Four, a once-ailing Tustin, Calif., manufacturer of computers for small businesses, that he made it big. As the company's president and ceo, Patton was the architect of a remarkable turnaround only a year after joining the company in 1985.

Patton wasn't always the entrepreneur. At 25, he wanted a career in the Army, where he had already served two years. He had enrolled in officer candidate school, was a drill instructor, a ranger, and a competitive golfer. But his wife, Sandy, had other ideas, and the Pattons returned to St. Louis in search of a more promising career. Finding the oil industry in a slump, Patton gave up hope of putting his training as a petroleum engineer to work. Instead, he became an air conditioning engineer in 1960 with a Minneapolis-based company called Honeywell.

A friend later suggested he transfer to a fledgling EDP operation that Honeywell had launched. Patton worked his way up through sales posts in the Midwest to become vp of western operations with Honeywell Information Systems in Los Angeles. The Patton family decided against a transfer to Minneapolis in 1977 after five years in sunny California, much of it in a Palos Verdes home overlooking the Pacific Ocean. Patton was on his way to a new career that even-

tually led to MAI Basic Four.

Basic Four has a storied past. Formed 18 years ago as one of the first computer manufacturers devoted solely to small- and medium-sized businesses, it had installed systems at some 30,000 companies in North America and Europe. But the advent of microcomputers in the early '80s threw it off course. Basic

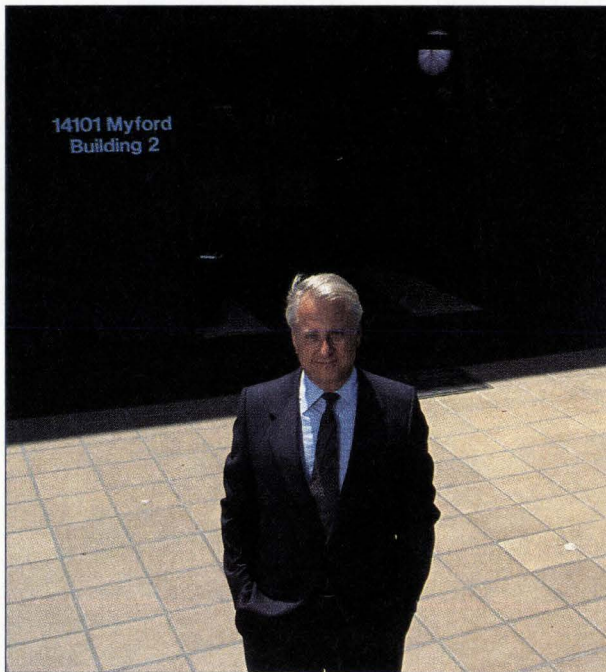

MAI'S PATTON: Took quick action after joining the company.

Four floundered, its outdated technology and unfocused marketing strategy resulting in four straight years of losses, including \$17 million in 1984 when corporate raider Asher B. Edelman sold it in a leveraged buyout to New York industrialist Bennett LeBow.

Patton came aboard the following year, risking his lifelong savings to acquire 5% of the company. He took quick action, cutting back on staff and inventory, buying components in Asia instead of making them in Tustin. That was the easy part. The toughest was the trauma

he inflicted on the sales staff by launching a vertical marketing sales strategy in eight key industries. Previously, the company's direct sales force had sold on a geographical basis. "It was a most difficult cultural change," Patton admits. But the strategy worked.

Basic Four's about-turn yielded a profit of \$5.4 million in 1985, with the gains accelerating to \$24 million in fiscal year 1987. It is getting a higher price per system (\$50,000 last year compared with \$30,000 in 1985) and these vertical industries are expected to account for 80% of the company's sales in 1991, compared with 67% in 1986.

Although the company has a small share of the small business computer market (somewhere around 1%), this clientele is loyal and Patton is nurturing it with improved software and advanced hardware.

"It's important that senior management have a very significant part of their net worth tied up in the company," Patton says. "In that way, the business is conducted on the basis of ownership rather than of keeping jobs." Although Patton's 5% ownership was diluted to 3% when MAI Basic Four went public in 1986, it is valued at close to \$8 million.

Described by a friend as a "man of boundless energy," Patton spends half of his time traveling to see the company's customers (now numbering about 40,000) in Europe and North America, then returning to Tustin, his friend says, "to rattle cages." His wife Sandy jokes about balking at Patton's hope to make a career of the army. "I was a nurse and I knew all about doctors never being at home. Now, I practically never see him."

The heavy travel schedule has forced him to back away from some civic and philanthropic activities, including the U.S. Academic Decathlon, which he co-founded. He's also quit golf.

Of her husband's gamble in leaving a secure post as president and ceo of Cado Computer Systems (later to become Contel), Sandy says she wasn't concerned in the least about the huge investment Patton made to join Basic Four. "Even if he'd lost it all, Bill could bounce back and make a very good living selling mops." ■



Solutions

“Within the first couple of hours INFO® was worth the day.”

That's what Robert Alston, Director, Information and Systems Services, who visited from The Stroh Brewery Company of Detroit said about last year's event.

This year, INFO will be worth *your* time too! It's the one event showcasing systems and solutions for all your information management requirements.

For 15 years, INFO has offered the entire spectrum of new ideas and solutions. **Today more than ever** INFO is your best source for all the newest technologies... ISDN, SNA, micro-to-mainframe links, fourth generation languages, relational database systems, data security, voice/data integration and much more.

INFO '88 will be a showcase of innovative products and services from virtually every important manufacturer... **Unisys, Hewlett-Packard, IBM, Honeywell Bull, Lotus, NEC, Wang, Ashton-Tate, Prime, Xerox, Digital Equipment Corporation, Computer Associates** and hundreds of others.

Special “Show-Within-A-Show”

The Transparent Computing Environment™, presented by **Control Data**, will be previewed at INFO.

Enter the Transparent Computing Environment™ and discover innovative solutions to multi-vendor connectivity and integrated information management. Experience real-life applications in a variety of business settings.

Transparent Computing Environment is a trademark of Control Data Corporation.

- **Systems Management**
- **Software**
- **Hardware Trends**
- **Emerging Technologies**
- **Multi-Vendor Connectivity**
- **Communications**
- **Networking**

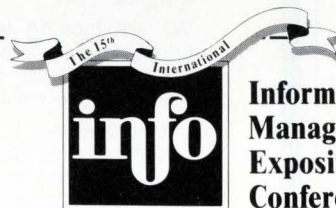

Information Management Exposition & Conference

Jacob K. Javits Convention Center
11th Ave. at 34th St. • New York, NY

Show hours: 10am–5pm daily

Need more information? Call 203-964-8287.

Clip this coupon and bring it to the show for a \$15 discount!

This coupon entitles you to a \$15 discount on show admission. On-site registration is regularly \$20. With this coupon you pay only \$5. Fill out registration form on-site (available in lobby) and proceed to an attendee typist with this ad.

SV

Career Opportunities

DATAMATION

1988 Editorial Calendar and Planning Guide

Issue Date	Recruitment Deadline	Editorial Emphasis
Oct. 15	Sept. 26	Changing Roles of MIS
Nov. 1	Oct. 12	Productivity
Nov. 15	Oct. 26	Mini-Micro Spending
Dec. 1	Nov. 10	Applications Software Spending

National Roberta Renard (201) 228-8602	East Coast Janet O. Penn (201) 228-8610	West Coast Mary Beth West (714) 851-9422
--	---	--

SYSTEMS ENGINEER

An opportunity exists in the Computer and Telecommunications Group for an experienced SYSTEMS ENGINEER to provide technical and project leadership for the support and enhancement of our facility consisting of two Amdahl 5890-180 E's and an IBM 4381, all operating under IBM VM/CMS, an FPS 264 array processor, an Ethernet local area network and data communications systems employing direct or switched connections over a digital PBX.

We are looking for someone who enjoys a service-oriented environment, developing innovative solutions for a variety of challenging user requirements, and who can deal effectively with a diversified user community.

The successful candidate should possess at least 10 years of direct involvement in the planning, selection, use and maintenance of large mainframes, local area networks and data communications systems. Current knowledge of IBM and compatible systems is highly desirable. An MS or Ph.D. in Mathematics, Engineering, or Computer Science preferred. Consideration will be given to a BS with significant experience.

Lincoln Laboratory offers a competitive salary plan and an outstanding benefits package. Interested candidates are invited to forward their resume, together with a recent salary history, to Rosemary Malvermi, MIT Lincoln Laboratory, DM1, 244 Wood St., Lexington, MA 02173.

An equal opportunity employer



Realtime Embedded Software Engineers



If you are an experienced Realtime Embedded Software Engineer, we would like to talk to you.

Because right now, Boeing Computer Services has immediate openings for highly qualified engineers to work on challenging state-of-the-art aerospace projects.

The Requirements

To qualify for this position, you must have a BS degree or higher in EE, Computer Science, Physics or Math. Experience is required in the following areas:

- Requirements Definition and Specifications Development
- Systems Architecture
- Systems Design
- Test System Development
- Verification and Validation
- Configuration Management
- Subcontract Management

Requirements also include familiarity with DOD-STD-2167 and related government specifications. Experience in software development life cycle, Fortran, Assembler or ADA languages is desirable.

U.S. citizenship is required.

The Benefits

As an industry leader, we can offer you the right salary, comprehensive benefits and a highly supportive environment.

Plus, you'll be working and living in the beautiful Puget Sound area of the Pacific Northwest. Near Seattle—the Number One-ranked city for recreation and livability.

Write Today

We'd like to hear from you. Please send your resume, with present and expected salary, to *Boeing Employment Office, P.O. Box 3707-PRF, Seattle, WA 98124*.

Principals only.

We are an equal opportunity employer.

BOEING

Ad No. 82BR-908 / Created by Cole & Weber, Inc.

Cole & Weber Job 82BR-908: 8/30: SS
Silas Marner Job 888242: Tape One A
Ad / Realtime Embedded Engs

Head: 38/32 Times Roman, track 3
Body: 11/12.3 Garamond Book, 1.5-pica indent, track 2
Subheads: 120% of body in Garamond Bold, track 2

Job No. 82BR-908, Ad No. 88061

To appear in:

Datamation, Code PRF

October 1 & 15, 1988

Created by Cole & Weber, Inc. / 888242-1

QUANTUM: REAL CHALLENGE REAL FUN REAL-TIME

That's Quantum Computer Services, America's fastest-growing leader in providing online interactive services to the home computer market. And chances are, we're unlike any company you've ever experienced.

At Quantum, you'll test your talents — and creativity — developing services for owners of Apple, Commodore, Tandy, and other PC clones. And what you'll develop will run the gamut of online services. Our offerings include communications like electronic mail, real-time chat, and message boards. Computer enhancements that provide software libraries and a broad spectrum of hardware/software support. Multi-player nationwide games and other just-for-fun options. General and financial information from up-to-the-minute news to stock quotes. Education services, including electronic encyclopedias and online classes. Plus transactions that let the user do anything from reserving a flight to buying securities.

The right environment for real success.

Best of all, our atmosphere is one-of-a-kind. It's hands-on, casual, and fun. That's why we're so successful. In the past two years alone, we've grown more than 200%. Today, Quantum is the first online computer company to form major marketing and development alliances with leading PC manufacturers. And we're still the only one to tailor products to the PCs used to access our network.

Take the Quantum leap for your career.

If Quantum sounds like your next career move, join us as a **Programmer/Analyst** and help us develop a nationwide telecommunications system that supports thousands of users simultaneously. This system runs on one of the largest networks of Stratus mini-computers in the country.

What does it take? Experience with structured languages like PL/1, C, or Pascal on a mini-computer. The ability to produce highly reliable code. First-hand knowledge of software development at all stages — from design through test and implementation. The ideal candidate also has experience in a real-time multiprocessor environment with applications that use inter-process communication.

We're also on the lookout for top-notch professionals to work in these areas:

- Project Management — Information Technology
- PC/Macintosh Programming
- Product/Software Test
- Quality Assurance
- Training
- Software Control
- Documentation
- Technical Writing
- Software Development

Are you ready to work with real people in the ideal environment? Then get online with Quantum and discover a whole new way of looking at your career . . . and software. We'll reward you with an excellent salary and benefits package and the kind of upbeat, casual atmosphere you need to deliver your best. And, when the workday is through, you'll thrive with the excitement and diversity of life right outside of Washington, D.C. It's all happening now at Quantum. Make it happen for you. To apply, send your resume to:

Cindy Soltis
Human Resources Department
Quantum Computer Services, Inc.
8619 Westwood Center Drive
Vienna, VA 22180

QUANTUM
Computer Services Inc.

An equal opportunity employer. Principals only.

CONTINUUM®

CONTINUUM CAREER OPPORTUNITIES

The Continuum Company, located in the beautiful green hill country of Texas, is the leading provider of computer software and services for the life insurance industry. We are an international company that expects substantial future growth. Continuum has immediate opportunities if you have related experience in one of the following positions.

TECHNICAL SPECIALISTS—Design, programming, and maintenance with high level of independence heavily experienced in several of the following technical areas: IMS, CICS, VM/CMS, TSO, JCL, ALC, COBOL, PANVALET, VSAM, Utilities, DB2, MVS. Must be willing to travel or relocate.

DATABASE ANALYST—Knowledgeable and experienced in data analysis, logical and physical design in IMS/CICS/MVS environment. Knowledge of conceptual data modeling, relational database theory a plus.

DATABASE ADMINISTRATOR—Must be knowledgeable and experienced in data analysis, logical and physical design of IMS. Performance and tuning of IMS databases, backup and recovery, database sharing, and problem resolution in an IMS/CICS/MVS environment.

SENIOR SYSTEMS ANALYST—3+ years experience in life insurance data processing. Non-traditional product experience required. Strong communication skills and offers advancement to Project Management positions. Previous experience with L/70 or LIFE/COMM is a plus. Some travel is required.

SYSTEMS ANALYST—2+ years experience in life insurance data processing. Non-traditional product experience required. Strong communication skills required.

SENIOR PROGRAMMER ANALYST/PROGRAMMER ANALYST—3+ years experience with structured COBOL in an IBM MVS environment with TSO or VM/CMS. System design, online and database experience needed. Life insurance data processing would be a plus.

SYSTEM PROGRAMMER—3+ years experience with MVS/XA internals, Jes2, SMP/E, Assembler, IOCP, MVSCP (IOGEN), and IPCS (dump reading/problem determination). SAS and VM knowledge would be a plus.

If a high energy and challenging career with an international leader in financial software is desired, you are asked to send your resume and salary requirements to:

The Continuum Company, Inc.
Human Resources
9500 Arboretum Blvd.
Austin, TX 78759-6399
EOE M/F

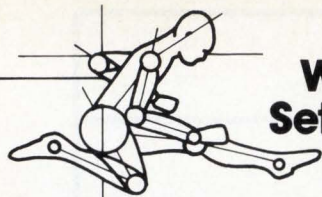

Why Settle For The Ordinary...

Make A Major Move To CTG

Computer Task Group can show you a better way to use your technical skills. We're a leading consulting, systems integration and professional services firm with a clear view of the future. The systems professionals who join our team will be associated with a company making major strides into systems integration, expert systems, case tools and relational data base. You'll use your talents to help our Fortune 500 client companies find innovative MIS solutions.

Computer Task Group is interested in professionals with extensive experience in advanced systems development:

Compensation and benefits are a step ahead of the ordinary. If you want to know more, send your resume or call CTG immediately. **Computer Task Group, Office of Recruitment, 800 Delaware Avenue, Buffalo, NY 14209, 1-800-752-6284.** Equal Opportunity Employer.



Imagine a career
that touches tomorrow

MANUFACTURING SYSTEMS APPLICATION

Southern California

The Information Resources Management Group at Northrop Electronics Division in Hawthorne California is implementing an Automated Integrated Manufacturing System.

Newly created positions exist for IMS Application Programmers with a BS degree and experience in Class "A" manufacturing systems application on IBM mainframe using OS/MVS, TSO COBOL and IMS/DC. MRP II familiarity and/or APICS certification desired.

Qualified candidates wishing to enhance their skills should submit their resume including current salary to: Dept. JC-D-MSA, NORTHROP ELECTRONICS DIVISION, P.O. Box 16, Hawthorne, CA 90251-0016. Principals only.

U.S. CITIZENSHIP REQUIRED. Northrop is an Equal Opportunity Employer M/F/H/V.

NORTHROP

Electronics Division
Electronics Systems Group

DATA PROCESSING PROFESSIONALS

Tropical Shipping, an international ocean transport firm, has outstanding opportunities for Data Processing professionals with all levels of expertise. Located at the Port of Palm Beach in Riviera Beach, Florida, our IBM 3081/MVS environment offers a challenging career with a premium compensation package to qualified individuals.

We are most interested in interviewing those experienced with ADABAS/Natural programming, however, we will consider all quality resumes for placement in our expanding MIS Department.

If you are open to relocation in South Florida, and are curious about what we can offer you, forward a resume with salary requirements to: **TROPICAL SHIPPING, 821 Avenue E, Riviera Beach, FL 33404.**

TROPICAL SHIPPING
An Equal Opportunity Employer

DID YOU KNOW? . . .

- 77% of over 182,000 of the most qualified Computer Systems/Operations/Data Processing and Software Engineering Professionals read **DATAMATION** regularly; at least 3 out of 4 issues.
- The **DATAMATION** reader spends 1 hour 14 minutes reading each issue, and has been doing so for 8 years.
- More than 64% of these readers go through each issue page-by-page, and pass the magazine along to an additional 5 people.

NOW, the **DATAMATION CAREER OPPORTUNITIES** section will bring you the latest in current job opportunities!

For more information, and to reserve your ad in our next issue call:

Roberta Renard 201/228-8602
National Recruitment Sales Manager

**JUST
PUBLISHED**

FREE!

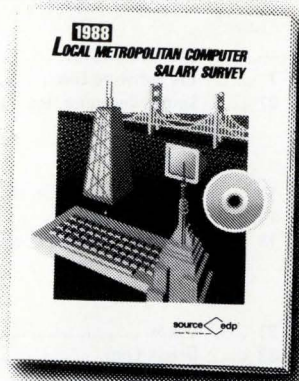

EXPANDED LOCAL SALARY SURVEY!

Find out exactly what you're worth in our mid-year 1988 survey. It reviews the latest local data on computer salaries. Sixty-one different metropolitan areas from coast to coast were surveyed.

In each geographic area, salaries for every known position are covered, including twelve new titles never before surveyed.

Call 1-800-533-4200 Extension 135

source edp
Computer Recruiting Specialists

Call anytime 7 days a week for your free copy. Or write: Department NH2, P.O. Box 7571, San Mateo, CA 94403-7571

NOW AVAILABLE: DATAMATION 1987 Editorial Index

An alphabetical listing of all articles, subjects and companies covered in DATAMATION throughout 1987.

A Great Reference Tool

for Only \$5.00!

To order your copy today, send a check made out to DATAMATION for \$5.00 to:

Ellen Weinberg
DATAMATION
249 West 17th Street
New York, NY 10011

UNIVERSITY OF UTAH DEPARTMENT OF COMPUTER SCIENCE

The Department of Computer Science at the University of Utah solicits applications at all professorial ranks. A candidate for Assistant Professor must earn the Ph.D. in Computer Science or related field prior to September. A candidate for Associate Professor must have, in addition, at least three years of teaching or research experience in Computer Science. A candidate for the rank of Professor must have a well-established research record in Computer Science.

The Department currently has 18 tenure-track faculty members, 2 teaching faculty, as well as an additional eleven serving in research and adjunct capacities. The student population includes approximately 200 undergraduate majors, 50 Master's degree students, and 35 Ph.D. students.

Substantially funded faculty research projects include: asynchronous computation, computer-aided geometric design, computer-aided instruction, computer graphics, computer system architecture, computer vision, models of computation, program verification, programming languages, robotics, sensory information processing, software for small computer systems, symbolic and algebraic computation, theory of computation, and very large scale integrated circuit design. Funding sources include major support from the NSF/CER program and from DARPA. Other governmental agencies and private industry also provide significant support.

Over the past few years, the department has created an outstanding research environment. The department maintains a professionally staffed research computing facility which includes a VAX 8600, five other VAX mainframes and a Gould 9080. An 18-node BBN Butterfly parallel computer system, a 20-node CSA distributed transputer system and over 70 Hewlett-Packard, Apollo and Sun workstations are installed. The facility is connected to most major geographic networks (Arpanet, CSNET, USENET and Telenet). A computer graphics laboratory with equipment representative of the most advanced devices available in the industry is also available. Other specialized laboratories include facilities for image processing and understanding, robotics, parallel processing, lisp programming, computer aided instruction and VLSI research.

Starting date for appointment is July 1989. Direct vita, along with the names of three or more references, by Feb 1, 1989 or until positions are filled to:

**Recruiting Committee Chairman
Department of Computer Science
University of Utah
Salt Lake City, Utah 84112**

The University of Utah is an Affirmative/Equal Opportunity Employer and especially encourages application from women and members of minority groups

Advertisers' Index

Circle	Page	Circle	Page	Circle	Page
34	Alcatel Business Systems	70-71	20	Genicom Corp.	41-43
—	Ameritech***	100-101	46	GTE North***	110
—	AT&T	6-7	35	Hallmark/UDS	73
4	Avatar	1	39	Hallmark/Unisys	99
19	Banyan Systems, Inc.	36	22	ICCP	46
24	Barbados Ind. Dev. Corp.	48	—	Informix Software, Inc.	16-17
36	BMC Software	75	47	The Interface Group	111
41	Boole & Babbage**	101	2	Lee Data Corporation	C3
17	Bull Peripherals Corp.	33	13	Link Technologies, Inc.	23-25
—	Cahners Expo Group/AMS Conference	60-61	80	Manchester Equip., Inc.***	64a
51	Cahners Expo Group/Info '88	117	44	Manpower, Inc.	107
28	Catalyst	58	27	Metaphor	56-57
31	cfSoftware	64	42	Moore Business Forms, Inc.	103
11	Cincom (Netmaster)	18	—	NEC Information Systems	C4
43	Cincom (Supra)	104	—	NEC Peripherals	47
5	Cognos, Inc.	5	8	On-Line Software	10
12	Communications Managers Assoc.	20	—	On-Line Software	81-96
32, 49	Computer Associates	65, 114	—	Oracle Corp.	15
—	Computer Security Institute*	48a-x	33	Philips Information Systems	66
45	Concurrent Computer Corp.	108	30	Data General Corp.	63
—	Digital Equipment Corp.	30-31	—	Digital Equipment Corp.	30-31
25	Duquesne Systems, Inc.	49	50	Electro Rep, Inc.	115
15	Telematics International	29	—	SAS Institute, Inc.	C2
9	Topaz, Inc.	13	7	The Software Link	8-9
18	Tymnet/McDonnell Douglas	34-35	37	Stratus Computer, Inc.	77
21	Uniras	45	38	Unisys Corp.	78-79
48	Universal Data Systems	113	48	Universal Data Systems	113
26	US West Network Systems, Inc.	55	26	US West Network Systems, Inc.	55

RECRUITMENT ADVERTISING 118-123

Boeing
Computer Task Group
M.I.T.
Mitre Corp.
Quantum Computer Services, Inc.
Source Services
University of Utah

*Domestic Only
**International Only
***Regional Advertiser

ADVERTISING SALES OFFICES

Publisher
Don Fagan
Associate Publisher
William Segallis
Production Manager
Eric Jorgensen

EASTERN REGION

East
Frances E. Bolger
249 W. 17TH St.
New York, NY 10011
(212) 463-6552
Middle Atlantic
Tom Carey
487 Devon Park Dr.
Suite 206
Wayne, PA 19087
(215) 293-1212
Northeast
Edward Rappaport
199 Wells Avenue
Newton, MA 02159
(617) 964-3730
Southeast
Larry Pullman
6520 Powers Ferry Road
Suite 395
Atlanta, GA 30339
(404) 955-6500
Middle Atlantic
Kathleen A. Murray
8 Stamford Forum
P.O. Box 10277
Stamford, CT 06904
(203) 328-2547

Midwest
John Stellwagen
1350 E. Touhy Avenue
Des Plaines, IL 60018
(312) 390-2967

WESTERN REGION

West
Kaye Sharbrough
3031 Tisch Way
Suite 100
San Jose, CA 95128
(408) 243-8838
West
Janet Engelbrecht
582 Market St.
Room 1007
San Francisco, CA 94104
(415) 981-2594
Bob Hubbard
18818 Teller Avenue
Suite 170
Irvine, CA 92715
(714) 851-9422
Texas
Richard W. Sheehan
9330 LBJ Freeway
Suite 1060
Dallas, TX 75243
(214) 644-3683

INTERNATIONAL

Cahners Publishing Company
27 Paul Street

London, EC2A 4JU, England
Tel: 44 1 628-7030
Telex: 914911 TEC PUB G
Fax: 01-6285984
Managing Director—Europe
Edward Reuteler Jr.
U.K., Benelux
Jan Dawson
Scandinavia
Martin Sutcliffe
France, Italy, Spain
Alasdair Melville
W. Germany, Austria, Switzerland, E. Europe
Uwe Kretzschmar
Israel
Roseline Lewin-Wainberg
Cahners Publishing Company
68 Sokolov St.
Ramat Hasharon 47 235
Israel
Tel.: 03-49 12 69
Japan
Kaoru Hara
Dynaco Int'l Inc.
Suite 1003, Sun-Palace
Shinjuku
8-12-1 Nishishinjuku,
Shinjuku-Ku
Tokyo, 160, Japan
Tel: (03)-366-8301
Telex: J2322609
Fax: 03-366-8302

Taiwan
Parson Lee
Acteam Int'l Marketing Corp.
2 floor, No. 17, Alley 7,
Lane 217, Sec. 3
Chung Hsiao E. Rd.
P.O. Box 18-91
Taipei, Taiwan, ROC
Tel: 886-2-7114833
Telex: 29809 ACTEAM
Fax: 886-2-7415110
Hong Kong
John Byrne & Associates Ltd.
1613 Hutchison House
10 Harcourt Road
Newline, Central,
Hong Kong
Tel: 5-265474
Telex: 61708
Fax: 5-8106781
Singapore
Peter Cheong
Asia Pacific Media House
PTE Ltd.
Newline 100 Beach Road
#24-03 Shaw Tower
Singapore 07 18
Tel: 291-5354
Telex: RS50026

DATAMATION CAREER OPPORTUNITIES

Roberta Renard
National Sales Manager
(201) 228-8602

Janet O. Penn
Eastern Sales Manager
(201) 228-8610
Staci Comstock
Production Assistant
(201) 228-8608
103 Eisenhower Parkway
Roseland, NJ 07068
Mary Beth West
Western Sales Manager
12233 W. Olympic Blvd.,
Suite 236
Los Angeles, CA 90064
(213) 826-5818

INFORMATION CARD DECKS

Stacy Aaron
249 W. 17th Street
New York, N.Y. 10011
(212) 463-6551

CAHNERS MAGAZINE DIVISION

William M. Platt
Chief Executive Officer
Terrence M. McDermott
President
Frank Sibley
Group Vice President
Jerry D. Neth
Vice President
Publishing Operations
Tom Dellamaria
VP/Production & Manufacturing

Cahners Publishing Company
A Division of Reed Publishing USA

Specialized Business Magazines for Building & Construction, Manufacturing, Foodservice & Lodging, Electronics & Computers, Interior Design, Printing, Publishing, Industrial Research & Technology, Health Care, and Entertainment. Specialized Consumer Magazines: American Baby and Modern Bride.