

DATA MATION<sup>®</sup>

JULY 300 USA

DATA  
COMMUNICATIONS  
TELECOMMUNICATIONS  
TELEVISIONS

NETWORKING TECHNOLOGY  
SATELLITE TELECOMMUNICATIONS  
GET READY FOR VAN  
IBM'S FUTURE COMPUTERS

# Kennedy peripheral products. Buying is just the beginning.

There's a lot more to any company's success than just the products it sells. We know that at Kennedy. That's why we help select the Kennedy product best suited for your requirement; it's the reason we've established training seminars for people using our equipment; it's why we have virtually overnight service; complete documentation; and completely stocked service centers and parts depots in the U.S. and Europe. And always someone at the end of the phone to answer questions about service, delivery, modifications, interfacing — you name it. If you're a customer of Kennedy, you know it. If you're not, give us a call.

## KENNEDY CO.

540 W. WOODBURY RD., ALTADENA, CALIF. 91001  
(213) 798-0953



KENNEDY - QUALITY - COUNT ON IT

CIRCLE 1 ON READER CARD

# Now appearing on your favorite networks XL Distributed Processing Systems

Your Denver regional office needs up-to-the-minute reports from Los Angeles and Seattle... the central parts depot in Atlanta must maintain current inventory based on information received from six supply centers... Warehouses in Rochester and Trenton need to access the database in Atlanta, but don't need local processing... Branch offices in Calgary, Phoenix and Toronto must process orders and transmit to regional managers... headquarters in Minneapolis needs to communicate with all regional and branch offices...

Presenting XL Distributed Processing Systems from Perdec Computer Corporation. A family of microprocessor-based computer systems — and an approach to distributed processing — that cuts through the buzzword maze to provide state-of-the-art hardware and software solutions.

**High-power processing**  
The top-of-the-line XL40 handles up to 16 local and remote terminals. With up to 512K bytes of memory and disk storage expandable to 70 megabytes for local databases, it can also interactively access your headquarters mainframe via 3270 inquiry mode for non-XL40 residents. Publish in Denver, another in Atlanta.

**Remote Access**  
XL Remote Online SubSystems (ROLS) consist of remote printer/terminal configurations that access the power and database of the XL40 interactively over telephone lines. ROLS can also take advantage of the XL40's 3270 mode to access the mainframe database, greatly

enhancing the amount of data available to any one user. Order them for your supply centers and warehouses.

**Introducing XL20**  
And introducing PCC's newest XL family member, XL20, a diskette system for applications requiring local intelligence, databases, communication and processing power. The XL20 offers your branch offices up to 128K bytes of memory and 4.8 megabytes of diskette storage. And a plus: An optional on-line/off-line feature enables your XL20 terminals to operate interactively with an XL40 and to access the mainframe database via the XL40's 3270 mode whenever necessary.

Designed with compatible hardware architecture and operating systems, XL distributed processing networks install and upgrade simply. And they're supported throughout the United States by more than 400 service professionals in the PCC Service Division.

Call or write today for a detailed brochure on XL Distributed Processing — now appearing on your favorite networks.



PERDEC  
COMPUTER  
CORPORATION

CMC DIVISION  
12910 Culver Boulevard, P.O. Box 92300  
Los Angeles, California 90009  
(213) 822-9914 TWX (910) 343-6451

"We wanted today's most advanced technology in a computer that would be up more than 99% of the time."



*Clarence D. Millsap  
Data Processing Manager  
Equitable of Iowa  
Des Moines, Iowa*

"In looking at Itel's Advanced System™ we saw a system that could grow to meet our needs for the next several years without extensive changeover.

"We also noted that the AS/4 consumes less power than other computers in its category, which means there is less heat to dissipate. Since we were reaching a saturation point with our air conditioning, this was a major consideration.

"The installation itself was very smooth. The AS/4 was presented as totally compatible with our other computer operations and it proved to be just that. It was installed with no problems whatsoever. I have to give Itel's technical people a lot of the credit.

"I might add that since our AS/4 first became operational, it's been on-line more than 99% of our operating schedules. This is a tribute to Itel's professional services."

*The Advanced System is the most significant product Itel has brought to the world of data processing in the tradition that has always made Itel the financial and systems alternative.*

**ITTEL**  
CORPORATION

Data Products Group  
One Embarcadero Center  
San Francisco, California 94111  
Telephone: (415) 955-0000

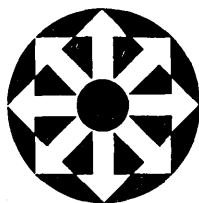

# DATAAMATION<sup>78</sup>®

VOLUME 24 NUMBER 7

This issue 135,503 copies

JULY 1978

## FEATURES

- 88 **COMPARING NETWORKING TECHNOLOGIES**  
**Ray W. Sanders.** There is no "best" way to build a network.

- 94 **THE FUTURE OF COMMERCIAL SATELLITE TELECOMMUNICATIONS**  
**Wade White and Morris Holmes.** The new communications techniques for space seem at least analogous to those used on the ground.

- 103 **GET READY FOR VANS**  
**Ely S. Lurin and Edward I. Metz.** It all started with a telegraph key.

- 115 **IBM'S FUTURE LARGE COMPUTERS**  
**Frederic G. Withington.** More power, less efficiency, and happy users?

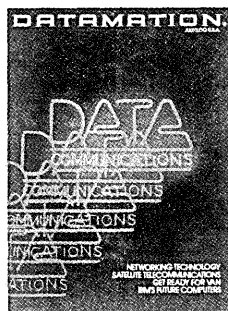

- 128 **SPACE SHUTTLE SOFTWARE**  
**Caroline T. Sheridan.** Redundant computers lead to ultrahigh reliability, but to special software problems as well.

- 147 **THE (MIS)USE OF DP IN GOVERNMENT AGENCIES**  
**R. A. McLaughlin.** One of the recommendations of the study was to stop studying.

- 159 **AN ELEMENTARY CASE HISTORY**  
**Joseph A. Steinborn.** A discussion of problems related to Jack.

- 160 **IT HAPPENED IN ANAHEIM**  
**Edith Myers.** A review of the National Computer Conference which drew a record 57,244 this year in Anaheim.

- 229 **THE FORUM**  
**Frank B. Rowlett, Jr.** Send your favorite programmer an error message.

## NEWS IN PERSPECTIVE

- 169 **OIL INDUSTRY**  
Will Exxon become another computer giant?  
The Sun also rises.

- 173 **LEGISLATION**  
The new communications act.

- 176 **COMMUNICATIONS**  
Teletype leading AT&T into the promised land of data.  
Bell's network plans are a moving target.

- 180 **TIME-SHARING**  
Keydata's master plan.

- 185 **TECHNOLOGY**  
Hewlett-Packard's new products.

- 186 **GOVERNMENT**  
A new dp adviser for the President?

- 187 **BANKING**  
Despite many hurdles, EFT is growing.

- 189 **BENCHMARKS**  
It's all over; Going public; EM&M drops small system; Beating the U.S.; For Xerox users; Public education; CII-Honeywell Bull invests in R2E; Sperry's computer figures; Computer services up; Successful candidates.

## DEPARTMENTS

8 **LOOKING BACK**

17 **LOOK AHEAD**

25 **LETTERS**

39 **PEOPLE**

49 **CALENDAR**

62 **SOURCE DATA**

87 **EDITOR'S READOUT**

192 **HARDWARE**

208 **SOFTWARE**

218 **PERSONAL COMPUTING**

221 **MARKETPLACE**

226 **ADVERTISERS' INDEX**

### About the cover

Data communication's dynamic flow pulses through neon sculpture designed by Steve Phillips.

# The New Slimline Series From Okidata



## Line Printers That Sell Minisystems

The Okidata Slimline Series, a new family of microprocessor-controlled, 132 column line printers. A wide range of speeds, options and plug-compatible interfaces, all supported with common spares.

Common spares but uncommon price, performance and reliability. OEM prices that create new mini-system opportunities, print quality that helps sell the businessman and Okidata reliability and maintainability—unmatched in the industry. A 500,000,000 character head warranty and stored program machine history that replaces customer installation records.

The Slimline, available in 300, 250, 160 and 125 LPM models. Twelve program-selectable fonts, 5 x 7, 7 x 7 and 9 x 7 characters, and graphics capability. The Slimline, backed by a worldwide sales and service organization.

# OKIDATA

Okidata Corporation  
111 Gaither Drive  
Mount Laurel, New Jersey 08054  
Telephone: 609-235-2600

CIRCLE 140 ON READER CARD

## DATAMATION.

### EDITORIAL STAFF

<b>Editor</b>	John L. Kirkley
<b>Senior Editor</b>	W. David Gardner
<b>Articles Editor</b>	Richard A. McLaughlin
<b>International Editor</b>	Angeline Pantages
<b>European Editor</b>	Ralph Emmett
<b>Products Editor</b>	Bill Musgrave
<b>Copy Editor</b>	John Waterhouse
<b>Articles Assistant</b>	Sarah Rolph
<b>Surveys Editor</b>	Nancy Knottok
<b>News Editor</b>	Tom McCusker
<b>Bureau Managers</b>	
<b>San Francisco</b>	Edward K. Yasaki
<b>Los Angeles</b>	Edith D. Myers
<b>Greenwich</b>	Angeline Pantages
<b>New York</b>	Laton McCartney
<b>Washington, D.C.</b>	Linda J. Flato
<b>Boston</b>	Vin McLellan
<b>Correspondents</b>	
<b>Minneapolis</b>	James K. Johnson
<b>Southwest</b>	Robert F. Alexander
<b>Australia</b>	Ken McGregor
<b>Editorial Advisor</b>	Robert L. Patrick
<b>Technical Advisor</b>	Lowell Amdahl
<b>Contributing Editors</b>	Ralph G. Berglund, Howard Bromberg, Philip H. Dorn, John M. Eger, William Helgason, Portia Isaacson, Louis B. Marienthal, Carl Reyn- olds, F. G. Withington

### EDITORIAL OFFICES

**Headquarters:** 1801 S. La Cienega Blvd., Los Angeles, CA 90035. Phone (213) 559-5111. **Eastern:** 35 Mason St., Greenwich, CT 06830, (203) 661-5400, Telex 996343. 420 Lexington Ave., New York, N.Y. 10017, (212) 682-7760. 134 Mt. Auburn St., Cambridge, Mass. 02138, (617) 354-2125. 6605 Burlington Pl., Springfield, VA 22152. (703) 569-3383. **Southwestern:** 11500 Stemmons North, Suite 152, Dallas, TX 75299, (214) 247-5221. **Western:** 2680 Bayshore Frontage Rd., Suite 401, Mountain View, CA 94043, (415) 965-8222. **Foreign:** 15 A St. Ann's Terrace, St. John's Wood, London, NW8, England; (01) 722-5088; 24 Stafford Road, Artarmon, Sydney, NSW 2064, Australia, 41-5748.

### GRAPHIC DESIGN AND PRODUCTION

<b>Art &amp; Production Director</b>	Cleve Marie Boutell
<b>Advertising Production Manager</b>	Marilee Pitman
<b>Production Assistant</b>	Alberta R. Martin
<b>CIRCULATION</b>	
35 Mason Street, Greenwich, CT 06830	
<b>Circulation Manager</b>	Suzanne A. Ryan
<b>Marketing Research Manager</b>	Deborah Dwelley
<b>Publisher</b>	James M. Morris
<b>Assistant Publisher</b>	F. Douglas De Carlo



Circulation audited  
by Business Publications Audit



Member  
American Business Press, Inc.



**DATAMATION** is published monthly on or about the first day of every month by Technical Publishing Company, A Dun and Bradstreet Company, 1301 South Grove Ave., Barrington, Illinois 60010; James B. Tafel, Chairman; John K. Abely, President. Executive and Advertising offices, 35 Mason Street, Greenwich, CT 06830, (203) 661-5400. Editorial offices, 1801 S. La Cienega Blvd., Los Angeles, CA 90035. Published at Chicago, Ill. **DATAMATION** is circulated without charge by name and title to certain qualified individuals in the United States and Canada who are employed by companies involved with automatic information handling equipment. Available to others by subscription at the rate of \$26. Reduced rate for qualified students, \$14. Foreign subscriptions \$50, or £27.50; for airmail, additional charge \$40, or £24.50. Japan and Australia \$65, or £36.50 (air shipped). Sole agent for all subscriptions outside the U.S.A. and Canada is J.B. Tratsart, Ltd. 154 A Greenford Road, Harrow, Middlesex HA13QT, England. No subscription agency is authorized by us to solicit or take orders for subscriptions. Controlled circulations paid at Columbus OH. © Copyright by Technical Publishing Company, A Division of Dun-Donnelley Publishing Corporation, A Dun & Bradstreet Company, 1978—all rights reserved. © "Datamation" registered trademark of Technical Publishing Company. Microfilm copies of **DATAMATION** may be obtained from University Microfilms, A Xerox Company, 300 No. Zeeb Road, Ann Arbor, Michigan 48106. Printed by Beslow Associates, Inc. Circulation Office: 34 East Putnam Avenue, Greenwich, CT 06830. POSTMASTER: Form 3579 to be sent to Technical Publishing Company, P.O. Box 2000, Greenwich, CT 06830.

Publication Number: 148800. Single copy: \$3.00 in U.S.A.

DATAMATION

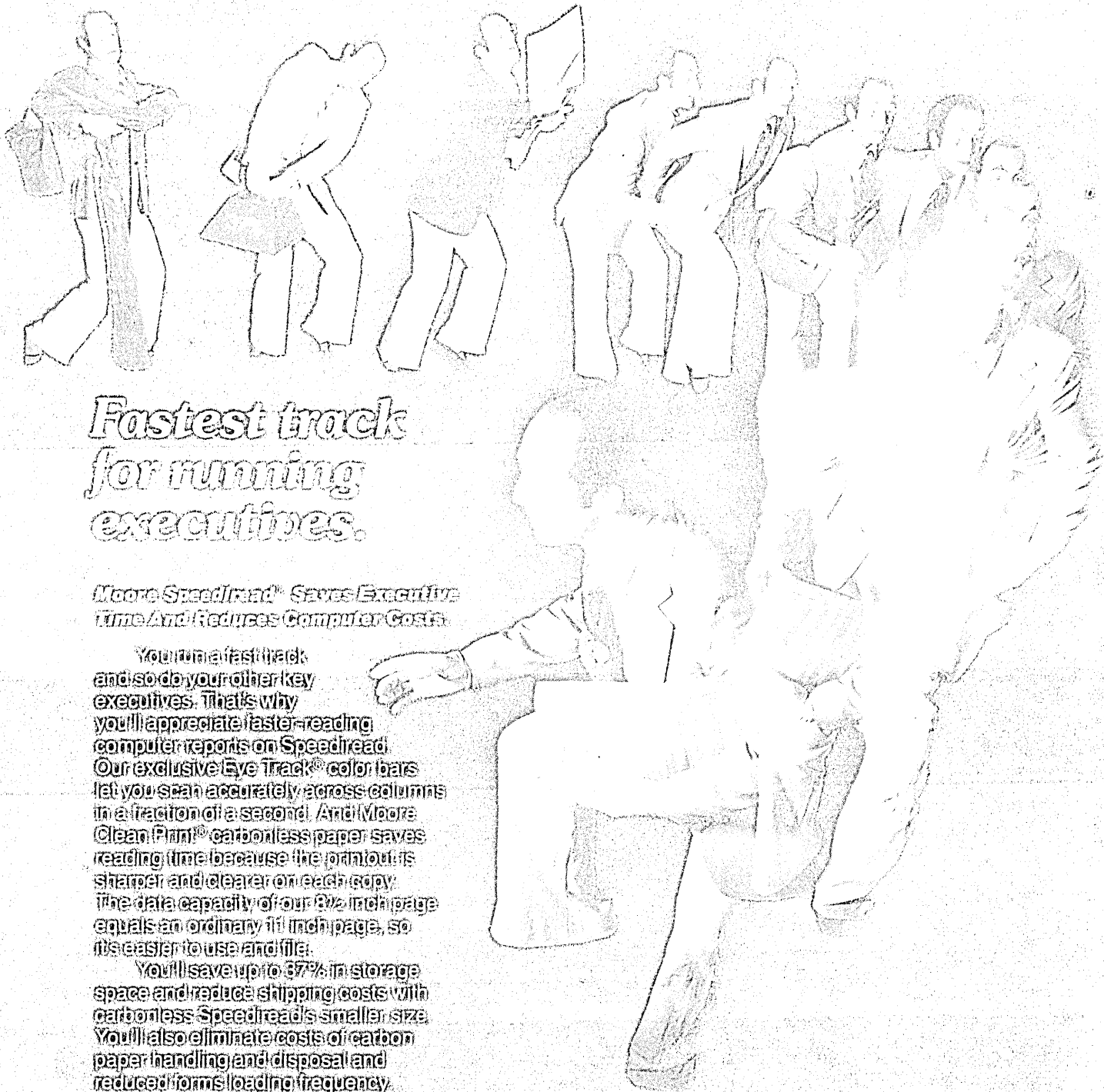

## *Fastest track for running executives.*

### *Moore Speedread® Saves Executive Time And Reduces Computer Costs.*

You're on a fast track and so do your other key executives. That's why you'll appreciate faster-reading computer reports on Speedread! Our exclusive Eye Track® color bars let you scan accurately across columns in a fraction of a second. And Moore Clean Print® carbonless paper saves reading time because the printout is sharper and clearer on each copy. The data capacity of our 2 1/2 inch page equals an ordinary 11 inch page, so it's easier to use and file.

You'll save up to 67% in storage space and reduce shipping costs with carbonless Speedread's smaller size. You'll also eliminate costs of carbon paper handling and disposal and reduced forms loading frequency.

Get on the fastest track with Speedread. Get proof. Send for a Speedread sample pack today.



**MOORE BUSINESS FORMS, INC.** 1205 N. Milwaukee Ave., Glenview, IL 60025. 616/297-1300

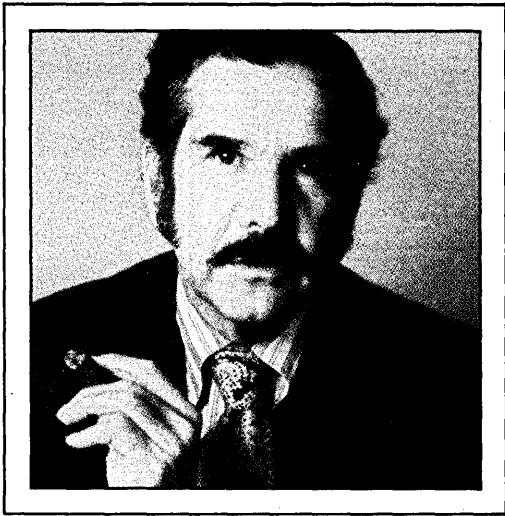

“National Semiconductor is crossing the Rubicon.

We are entering the computer market with a range of sophisticated system-level products.

I think they are some of the most important breakthroughs ever in systems technology.

For us, this step is not only natural and logical, but inevitable.

We consider that we are finally giving birth after ten long years.”

Charles E. Sporck  
President

“I assure you, National Semiconductor did not caper into the computer market on a whim. For the past decade, we’ve been a leader in creating the technology that makes computers work.

In 1973, we became a visible systems supplier — with the sale of electronic point of sale systems. We’re now the second largest supplier in the world. With more than 13,000 terminals and over 1000 computers in more than 1,400 store sites. And a full-time field service force of more than 250 people.

Three years ago, we introduced IBM 370-compatible add-on memory. Today, National ships more large scale 370 add-ons than anyone except IBM.

National has built add-in memories for some of the most popular minicomputer models as well.

We are now shipping our industry standard Series/80 microcomputers at the rate of 12,000 systems a year.

Two years ago, we unveiled our first IBM-compatible computer. To date, over 100 systems have been installed in ten



countries. We are now shipping more IBM-compatible computers than all other competitors combined.

I think this demonstrates that National Semiconductor has quietly, deliberately become a prime mover in computer hardware and systems. Annual computer revenues already put us in the top 15 of all U.S. general purpose computer manufacturers—and we're climbing. Certainly, we haven't come this far without being acutely aware of the market's needs.

### *A clear, levelheaded look.*

If we had not penetrated the systems market of our own accord, technology would have eventually forced the business on us. Our semiconductor components are rapidly becoming total "systems on a chip."

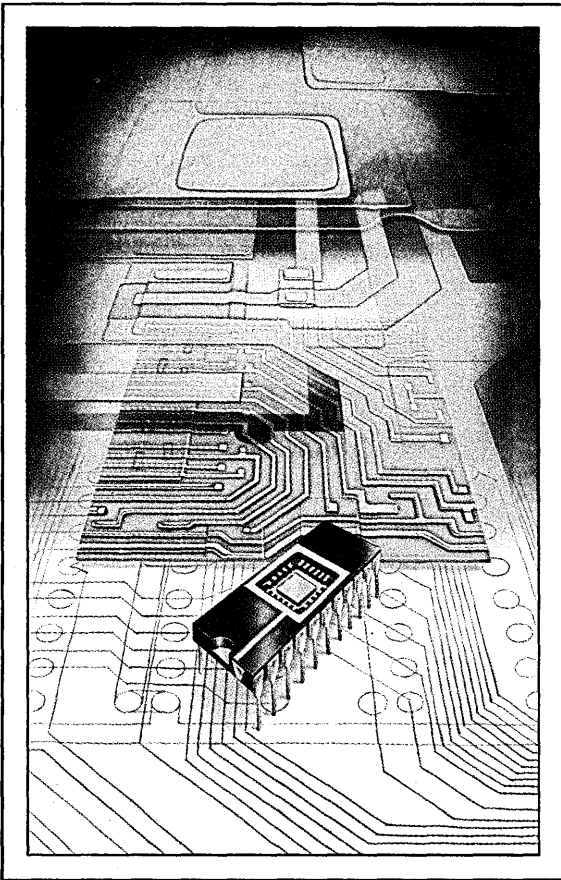

But before jumping into the market altogether, we gave ourselves the luxury of a clear, levelheaded look at the terrain.

Because we have no equity in particular methodology or design, we remain free to appraise the market and develop a product that uniquely solves a problem.

And, by applying current semiconductor technology and production expertise, we deliver better performance at a lower price than other suppliers.

### *Just another computer?*

National Semiconductor is deeply committed to applying its systems technology to real user problems. We are not interested in simply creating another different computer.

By making software-compatible hardware, we protect a customer's investment in standardized software.

At the same time, we consider it our responsibility to supply our customers with the latest in systems technology. So we'll be sparking unique product advances of our own. Particularly where a void exists in the marketplace.

### *For keeps.*

National Semiconductor is in the computer systems business for keeps—as a broadbase supplier able to handle everything from manufacture through distribution, delivery, service and support. That's why we have an active, full-fledged service force of over 250 people set up to respond to customer needs.

We're willing to pinpoint our experience in research and development to further advance systems technology. In fact, over the next several months we'll be taking the wraps off some of the most significant new products in our history. Breakthrough products like the System/400, perhaps our most important advance in systems technology to date.

The System/400 is the first minicomputer designed to perform all the functions of large IBM computers. It means users will be able to run existing industry-standard software on a system at a fraction of the cost of a large computer.

If you'd like to know more about the future of National Semiconductor, Computer Products, or about System/400 specifically, write me personally: Charlie Sporck, President, National Semiconductor Corporation, Drawer 1, 2900 Semiconductor Drive, Santa Clara, California 95051."

**Computer Products Group**  
≈ National Semiconductor Corporation

# Litton Computer Services Introduces

# APL

## operating under TSO

ADRS, an enhancement to APL, helps solve your report production problems. The APL statistical library is comparable to packages such as SAS and SPSS for solving statistical problems, and is offered in these categories:

- Descriptive statistics
- Inferential statistics
- Analysis of variance
- Regression analysis
- Correlation analysis
- Quality control
- Non-Linear least square
- Reliability analysis
- Linear programming



For more information, call or write:

## Litton Computer Services

1831 Michael Faraday Dr., Reston, Virginia 22090 • (703) 471-9200

CIRCLE 136 ON READER CARD

# Looking Back in DATAMATION.

## July/August 1958

**Technology:** The possibility that computers might be able to think for themselves was foreseen by Dr. John A. Morton, Bell Laboratories' director of device development. "We can possibly look forward to electronic systems that can learn from past experience in helping themselves solve new problems." He said that if we refuse to believe that these machines can think, we will have to redefine our concept of thought.

And, although we tend to think of computing in 1958 as serious business, an article on how Saab, Sweden's aircraft manufacturer, applied data processing in the building of high-speed planes also notes that the computer, affectionately called SARA, had been programmed to "sing" Oxdragsangen (Oxen cart song) over a built-in loudspeaker.

**Products:** The New Products section included the announcement of a Teletype machine which was not identified,

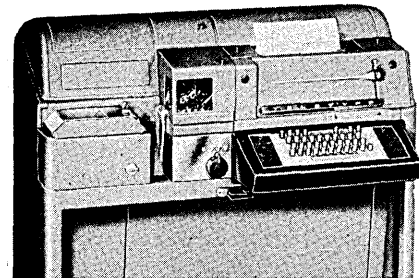

but we think is a Model 28. The company said it provided for typing, tape punching, transmission, and reception at 100 words/min.

## July 1968

**International:** Built around the upcoming IFIP Congress, this issue concentrated mainly on foreign topics. One, on time-sharing in Europe, summarized current developments in Western Europe with the conclusion that both U.S. and local firms were pushing ahead in spite of communications problems. Another, "Computer Sales to the East," reported the frustrations encountered when dealing with Iron Curtain countries. (IBM should have read this before going to India.)

**Innovations:** The lead article in News Briefs described the first software patent issued. The patent, #3,380,029, was for a sorting package "invented" by Martin Goetz, vice president of Applied Data Research. The granting of the patent, of course, did not end the controversy over software patents which at that point had raged for over two years. \*

DATAMATION

# Try our 3033's on for size.

See why Martin Marietta Data Systems' Remote Computing Services (RCS) can fit your needs. We've added the first of two IBM 3033's to our nationwide communications network and twin 168's.

Now, coupled with these RCS benefits: • Economy of use • Unequaled service • State-of-the-art technology, our 3033's offer you the chance to do • Benchmarking • Special testing • Or you can just enjoy new economies of scale.

And, if you plan your own 3033 or any of the 30XX series, you can try ours and know what to expect from yours.

Try us on for size. Because now, with our 3033's, we can fit your needs better than ever.

Just return the coupon for your free RCS brochure. Or call Dick Nemerson at (301) 321-5744.

**Martin Marietta  
Data Systems**   
We Build & Run Systems

Mr. Dick Nemerson  
Martin Marietta Data Systems  
300 East Joppa Road  
Baltimore, Maryland 21204

NAME \_\_\_\_\_  
TITLE \_\_\_\_\_  
COMPANY \_\_\_\_\_  
PHONE (\_\_\_\_) \_\_\_\_\_  
ADDRESS \_\_\_\_\_  
CITY \_\_\_\_\_  
STATE \_\_\_\_\_ ZIP \_\_\_\_\_

CIRCLE 137 ON READER CARD

# The C3-B

by Ohio Scientific

**The world's most powerful  
microcomputer system  
is far more affordable  
than you may think.**

## STANDARD FEATURES:

- 74 million byte Winchester technology disk drive yields mainframe class file access speeds and capacity.
- High level data file software makes high performance file structures like multikey ISAM easy to use.
- Triple processor CPU with 6502A, 6800 and Z-80 gives the programmer the best of all worlds in performance and versatility.
- The included 6502A based extended disk BASIC by Microsoft out-benchmarks every micro available, including 4 MHz Z-80 and LSI-11 with extended arithmetic.
- 48K of high reliability static RAM is standard.
- High density 8" floppys provide program and data mobility from machine to machine.
- Completely integrated mechanical system with UL-recognized power supplies; continuous duty cycle cooling; modular construction and rack slide mounted subassemblies.
- Based on a 16 slot Bus-oriented architecture with only 7 slots used in the base machine.
- Directly expandable to 300 megabytes of disk, 768K of RAM in 16 partitions, 16 communication ports, plus console and three printers.
- C3-B's have been in production since February, 1978, and are available now on very reasonable delivery schedules.

The C3-B was designed by Ohio Scientific as the state of art in

small business computing. The system places its power where it's needed in the small business environment; in the data files. The C3-B's advanced Winchester technology disk, coupled with its smart controller and dedicated high speed memory channel, gives the C3-B data file performance comparable with today's most powerful maxi-computers.

Yet, the C3-B costs only slightly more than many floppy only computers but offers at least a thousand times performance improvement over such machines (50 times storage capacity multiplied by 20 times access speed improvement).

But what if your business client cannot justify starting with a C3-B?

Then start with Ohio Scientific's inexpensive C3-S1 floppy disk based system running OS-65U. When he is ready, add the CD-74 big disk and directly transfer programs and files from floppy to big disk with *NO* modifications.

That's upward expandability!

\*Rack as shown above complete with 74 megabyte disk, dual floppys, 48K of static RAM, OS-65U operating system and one CRT terminal under \$13,000.

Multiple terminal systems with printers and applications software are priced in the mid-20's.

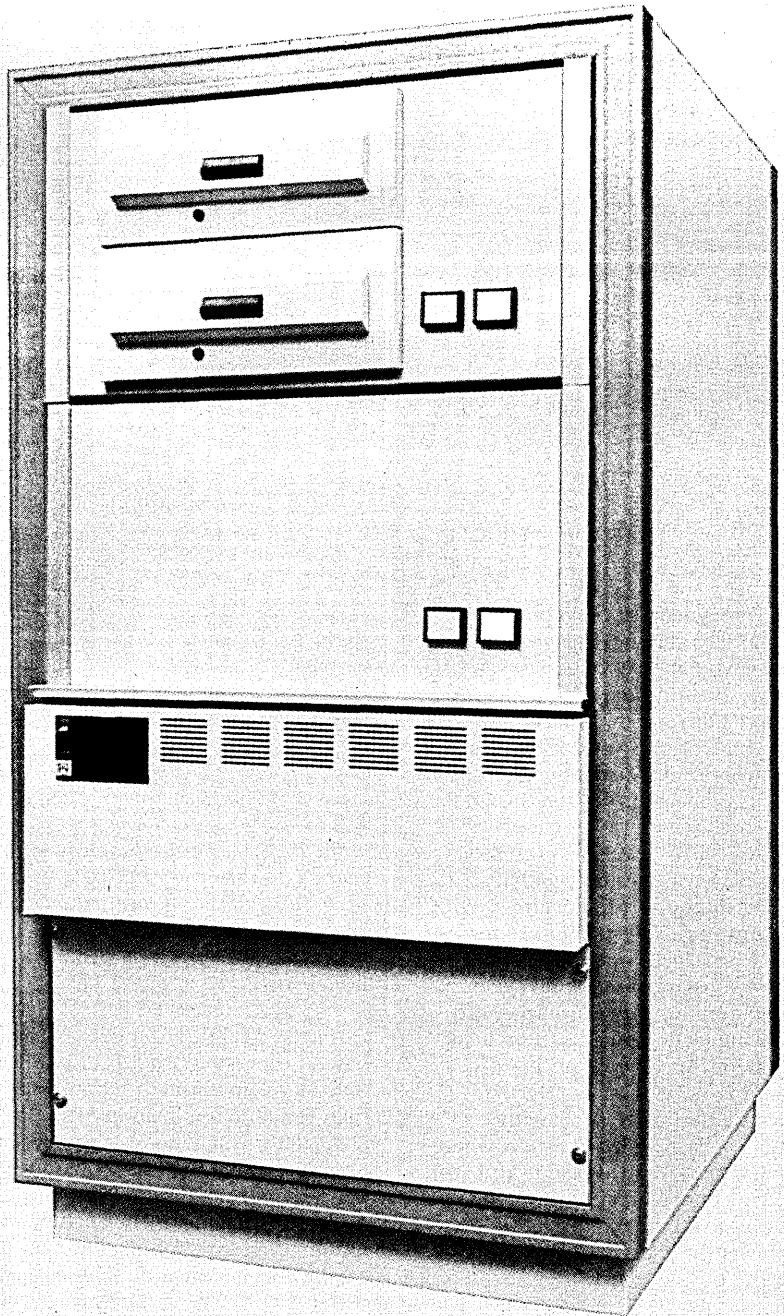

**OHIO SCIENTIFIC**  
1333 S. Chillicothe Road • Aurora, Ohio 44202  
(216) 562-3101

# The only source you need for remote batch, interactive, and distributed processing systems... HARRIS.

## **The Total Source**

When you're in the market for data processing products, it's important to remember one fact that is often overlooked: you're not just buying equipment, you're buying commitment.

That's why you should be looking at Harris as the only source you need, whether your requirements are for remote batch terminals, local or remote interactive terminals, data entry products or systems for distributed data processing.

Behind Harris products is an \$800 million per year company with a solid record of financial stability and growth. Data Communications is one of the largest Harris Divisions, with established products, seasoned field and support organizations, and a commitment to continuing leadership based on heavy investments in research and development.

You buy Harris products with confidence that we'll be around when you need us — not just today and tomorrow but years from now. And you can be assured that your product base will stay at the state-of-the-art with no danger of obsolescence.

## **Families of Products from a Single Vendor**

The Harris solution to your data processing problem is built around a modular hardware and software structure that grows with you as your requirements change and increase. We offer families of products and make it easy for you to upgrade within families. You set your own pace and Harris supports you all the way. And, if your processing calls for several different kinds of terminals, Harris can meet your needs... and give you all the advantages a *single vendor* can provide!

## **Remote Batch Terminals**



*HARRIS 1620 remote batch terminals feature multiple communication with up to four hosts simultaneously, a wide variety of popular emulators, and transmission speeds up to 56,000 bits per second.*

Harris offers three families of remote batch processing products for entry-level, medium function, and high-function applications: the Harris 500, 1200 and 1600 series respectively. As an example of the product-family concept, our economical Harris 1610 is built around a memory-based operating system, performs remote batch and media conversion and includes a wide variety of proven peripherals.

Step forward from the 1610 and you grow into our Harris 1620 with capabilities including multiple emulators (up to four concurrently), to most major mainframes. Either the 1610 or 1620 can be field-upgraded to our distributed data processing products.

## **Systems for Distributed Processing**

You can choose from four Harris 1600 systems for distributed data processing. The Harris 1650 is the first 1600 model to incorporate a mainframe-type disk operating system. It provides data entry and remote batch processing concurrently. Next, our Harris 1660 adds programmability in either interactive or batch modes and accommodates both format-driven and program-driven interactive applications. Then we offer the Harris 1670, featuring the significant advantages detailed below, and the Harris 1680 which uses dual processors for expanded concurrency capabilities.

## **Interactive Terminals**

For the growing interactive market, Harris offers the established 8000 series. The proven Harris 8170 emulates IBM 3270 models 1, 2, 11 and 12 and is SDLC compatible. Emulation is also provided for the IBM 3272 controller. Other Harris interactive products emulate Burroughs, Univac and Honeywell terminals. Our top-of-the-line 8180 includes dual diskettes with 500K bytes of off-line storage, five megabytes of disk storage (optional), and up to 96K bytes of memory. These enhancements permit applications such as local format storage, spooled print and queued transaction handling.



*HARRIS 8000 series terminals communicate interactively with IBM, Honeywell, Univac and Burroughs mainframes.*

## **Everything You Need for Distributed Processing... in One System**

We've combined the capabilities of our 8170 interactive product with our 1660 distributed data processing product, both leaders in their respective fields, to provide a powerful *new system* for distributed data processing. We call it the Harris 1670. It's the *one system* you've been waiting for that will perform five basic data processing functions: local or remote batch, data entry, local interaction and remote interaction *concurrently*. Combining two major Harris resources enables us to produce the 1670 in volume, assuring you a competitive price and unbeatable performance. This single, modular system can fill

your terminal requirements — batch, 3270-compatible, and data entry — and is capable of growing with your processing needs in all these areas.

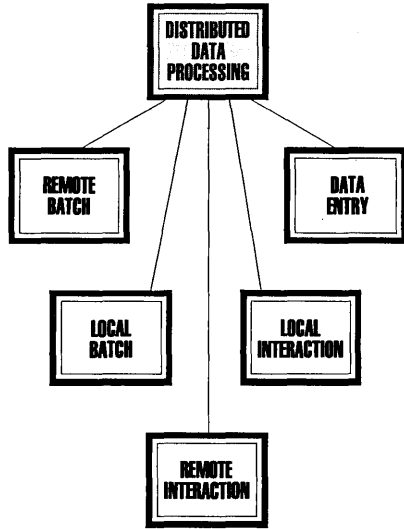

The five typical elements of a distributed data processing system.



Sophisticated new HARRIS 1670 distributed processing system offers local or remote batch processing, data entry, and local and remote interaction concurrently. CRTs are individually switchable between local and host files.

### Batch Processing

When devoted to remote batch communications, Harris' multi-task operating system enables the 1670 to perform any of the sophisticated RJE functions of the 1610 and 1620 models. In addition, the 1670 offers local batch processing with ANSI compatible COBOL and batch utilities, including SORT/MERGE.

### Data Entry

You can choose from two format-driven data entry packages, easily implemented by data entry personnel. The two packages, Format 10 and Format 41, make your data entry jobs simple, efficient and effective.

### User-Written Programs (Local Inquiry)

We offer an easily learned, English-like high level programming language (REGAL), for optimized screen management and for applications such as source document capture and

interaction with the local 1670 data base. CRTs running REGAL programs can be located either at the 1670 site or remotely. Additionally, the CRT can control station printers to produce required hard copy.

### Remote Inquiry (3270-Compatible Interaction)

This capability enables the CRT operator to connect through the 1670 to 3270-compatible programs at a remote host site.

Selectable Mode CRTs can be used to perform operations in the 1670 mode (including data entry and user-written programs), or to switch to 3270-compatible host programs. Switching is controlled individually at each station by the operator, and the system automatically ensures data integrity when switching from one mode to the other. Selectable Mode enables you to off-load the host by performing processing locally for the majority of your requirements, saving host

resources for those occasions when data is not stored locally. Compare this feature when you're evaluating distributed systems!

### No Changes Required at Your Host

The fact is, both RJE and 3270-compatible applications can be executed using the 1670 with no changes or new investment in host software. What's more, you continue to save since we can upgrade most Harris 1600 and 8170 systems to 1670s with minimal disruptions to your operations.

### Do It All with Harris

To sum up, there's no need now to shop around for a variety of systems to handle your requirements for remote batch, local or remote interaction or distributed data processing. Start with Harris and you're assured a migration path from the system you need today all the way to one you'll require in the future.

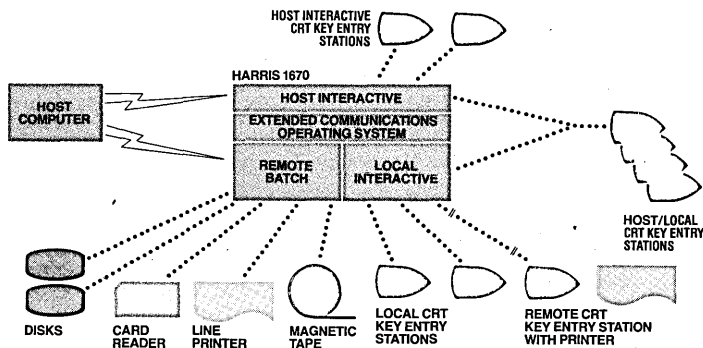

The new HARRIS 1670 combines the capabilities of the 1660 with concurrent interactive processing to a host mainframe ... and the HARRIS 1670 can be installed with no change in host software.

For more information, contact your nearest Harris sales office or: Harris Corporation, Data Communications Division, 11262 Indian Trail, P.O. Box 44076, Dallas, Texas 75234, (214) 620-4400.

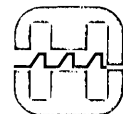

**HARRIS**  
COMMUNICATIONS AND  
INFORMATION HANDLING

The only source you need.

# TIME Magazine Announces...

## A Special Advertising Section of Vital Interest to Manufacturers of Office Equipment and Furnishings

### THE OFFICE: PEOPLE, PROBLEMS AND PROFITS

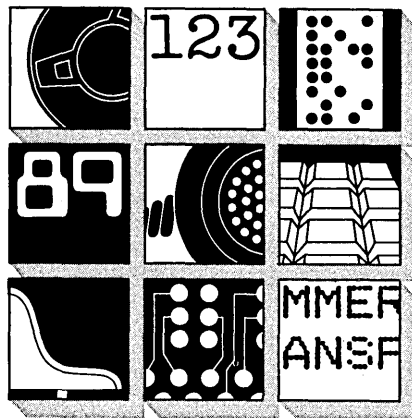

Make a date right now with the November 13, 1978 issue of TIME B—TIME Magazine's famous demographic edition that circulates to 1,550,000 business leaders at all management levels.

For the fourth successful year, TIME B will be running a special advertising section on new office technologies. This year's section—*The Office: People, Problems, and Profits*—will be filled with comprehensive case histories and concrete facts on what's happening *right now* in this increasingly innovative and rapidly expanding field.

#### Advice From The Experts

Four distinguished experts will walk our businessmen-readers through the wonders of today's new office environment:

- Dr. Vincent Giuliano, member of the staff of ARTHUR D. LITTLE, INC., of Cambridge, Mass., author of some 60 publications and 12 films on information processing.
- Randy J. Goldfield, associate of BOOZ, ALLEN and HAMILTON, author of numerous articles and a monthly column on information processing.
- John Pile, professor of Design Concepts, Furniture Design and Design Theory at PRATT INSTITUTE, author of several books and articles on office environment and design.
- Gerald S. Korb, Vice President and Director of Marketing, BANKERS TRUST COMPANY.

They'll be addressing themselves to key subjects such as Open Space Planning and its Effect on Pro-

ductivity...How to Buy Equipment You Can "Grow" with...How to Cope with "People Resistance" ...When a Small Businessman Should Consider Information Processing.

#### Special Advertiser Benefits

There's more to TIME's special section than just ideal advertising exposure.

*You'll receive* valuable new leads through our inserted reader service card which offers further information about your product or services.

*You'll receive* a demographic and geographic analysis of all respondents to the section to help you pinpoint your market.

*You'll receive* a confidential marketing analysis of all responses to your individual ad including the results of a follow-up questionnaire sent to those respondents.

In addition, *you'll receive* reprints of our special advertising section FREE when you become an advertiser.

The office equipment and furnishings market is bigger than you think. And it's growing daily. Why not let TIME introduce your product to those decision makers you want to reach? For further information on how you can participate in this result-producing TIME special advertising section, contact your local TIME representative or Charlie Craig, Business Equipment Supervisor, TIME Magazine, Time & Life Building, Rockefeller Center, New York, New York 10020, (212) 556-2831.

# TIME

WHY NOT MAKE TIME B WORK FOR YOU!



## TI covers all the bases when it comes to your terminal needs.

How do you get to first base with your computer when it's on the tenth floor and you're not? With one of our *Silent 700*\* data terminals, Models 733, 742, 743, and 763.

Our terminals can be on speaking terms with your computer from floor to floor; building to building; even from field office to home office.

All four have something in common: they have virtually silent thermal printing, capable of printing at up to 30-cps; they have ASCII keyboards; they have standard EIA serial interfaces; and they are all backed by TI's reliability.

But each terminal goes about communication in its own way.

The 733 offers the big performance of dual magnetic-tape cassettes; off-line storage; the speed, quietness and field-proven performance of *Silent 700* keyboard data terminals; and maximum system utilization with lower line charges.

The 742 offers programmability; TICOL\*, a powerful data entry language; automatic search; preprogrammed error recovery; preprocessing; and the ability to capture data independently of the host computer.

The 743 offers a compact keyboard send-receive terminal with field-proven thermal printing and low prices, so you can very easily afford to become, or increase, a multiterminal operation.

And the 763 has built-in nonvolatile bubble memory so it can remember even when the power is off, while it waits to talk to your computer. It also has off-line editing, and a built-in numeric cluster.

Built into all our terminals is over 30 years of experience in the electron-

ics industry, the technical expertise and support of our worldwide organization of factory-trained sales and service engineers, and the backing of TI-CARE†, our nationwide automated service dispatching and field service management information system.

If you need a strong line-up of terminals to cover all the bases with your computer, call your nearest TI sales office, or write Texas Instruments Incorporated, P.O. Box 1444, M/S 784, Houston, Texas 77001, or phone (713) 491-5115, extension 2124. 

Yes! I am interested in the *Silent 700* Data Terminals.

Please have your representative call me.

Please send me information on model \_\_\_\_\_.

**SILENT 700**  
electronic data terminals

Name \_\_\_\_\_

Title \_\_\_\_\_

Company \_\_\_\_\_

Phone \_\_\_\_\_

Address \_\_\_\_\_

City \_\_\_\_\_ State \_\_\_\_\_ Zip \_\_\_\_\_

Mail to:

**TEXAS INSTRUMENTS**

INCORPORATED

P.O. Box 1444, M/S 784, Houston, Texas 77001

20-7-DM

\*Trademarks of Texas Instruments

†Service Mark of Texas Instruments

Copyright © 1978, Texas Instruments Incorporated

# TEXAS INSTRUMENTS.

We put computing within everyone's reach.

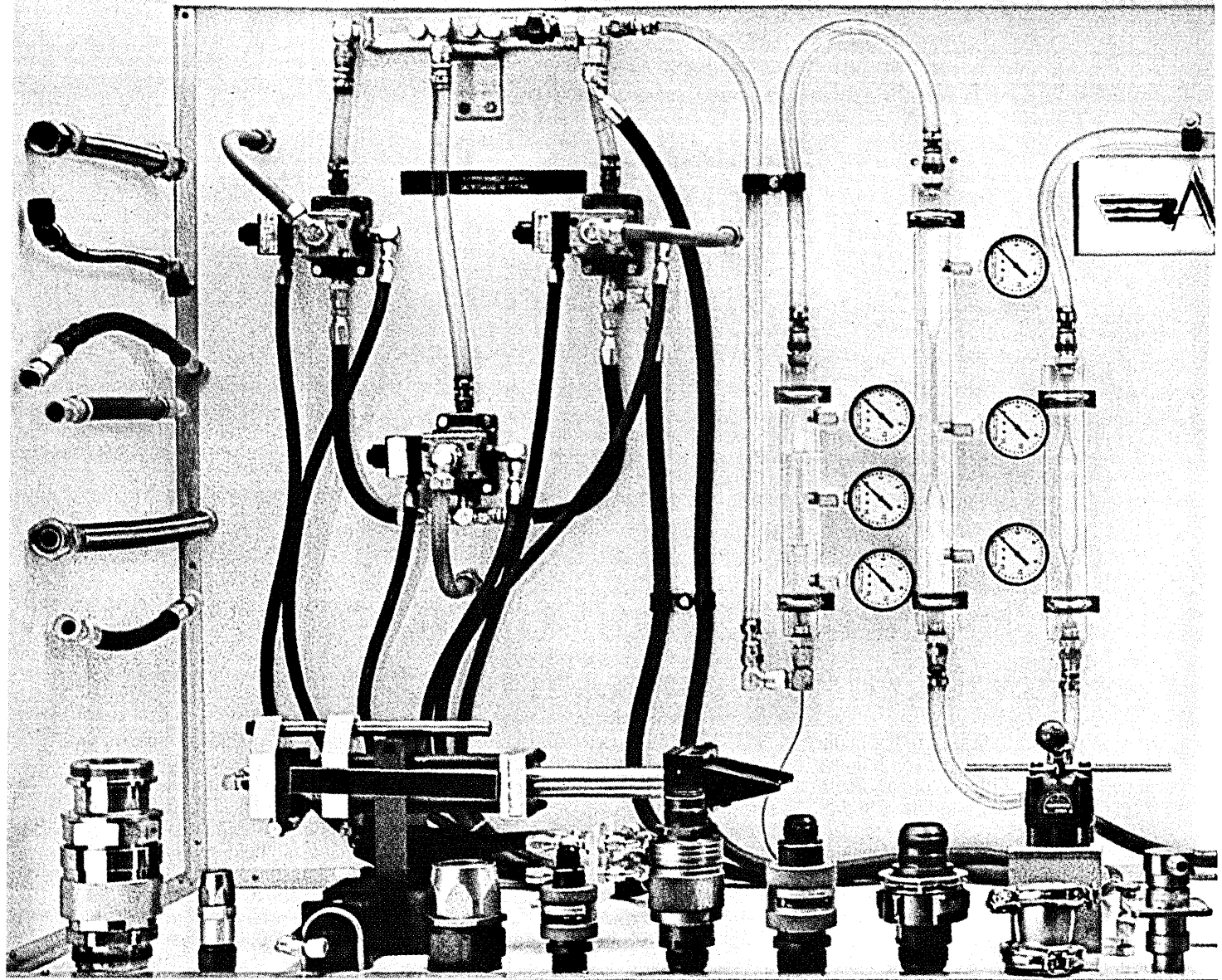

## **"We demand a lot from our distributed we chose IBM Series/1."**

Today, more and more companies are turning to distributed processing to put computing power where the work gets done. The IBM Series/1 computer makes it easy for you to have the distributed processing system you need, with compact hardware and immediate access to all information.

"We needed a distributed processing system that could centralize control of information processing

and still permit inquiry and input from local terminals," explains Howard Selland, Aeroquip Corp.

"And besides that, we wanted simultaneous local applications like word-processing, realtime data collection, and online communications. And with plants and offices worldwide, we had to have the ability to get the equipment serviced in remote areas. We went with the IBM Series/1 because it

fulfilled all those requirements, and more."

The IBM Series/1 is small enough to fit almost anywhere, flexible enough to manage a variety of data processing needs and powerful enough to handle both remote terminal and central information processing. It features online capability so that information is available to you at any terminal just as quickly as it's processed.



quip

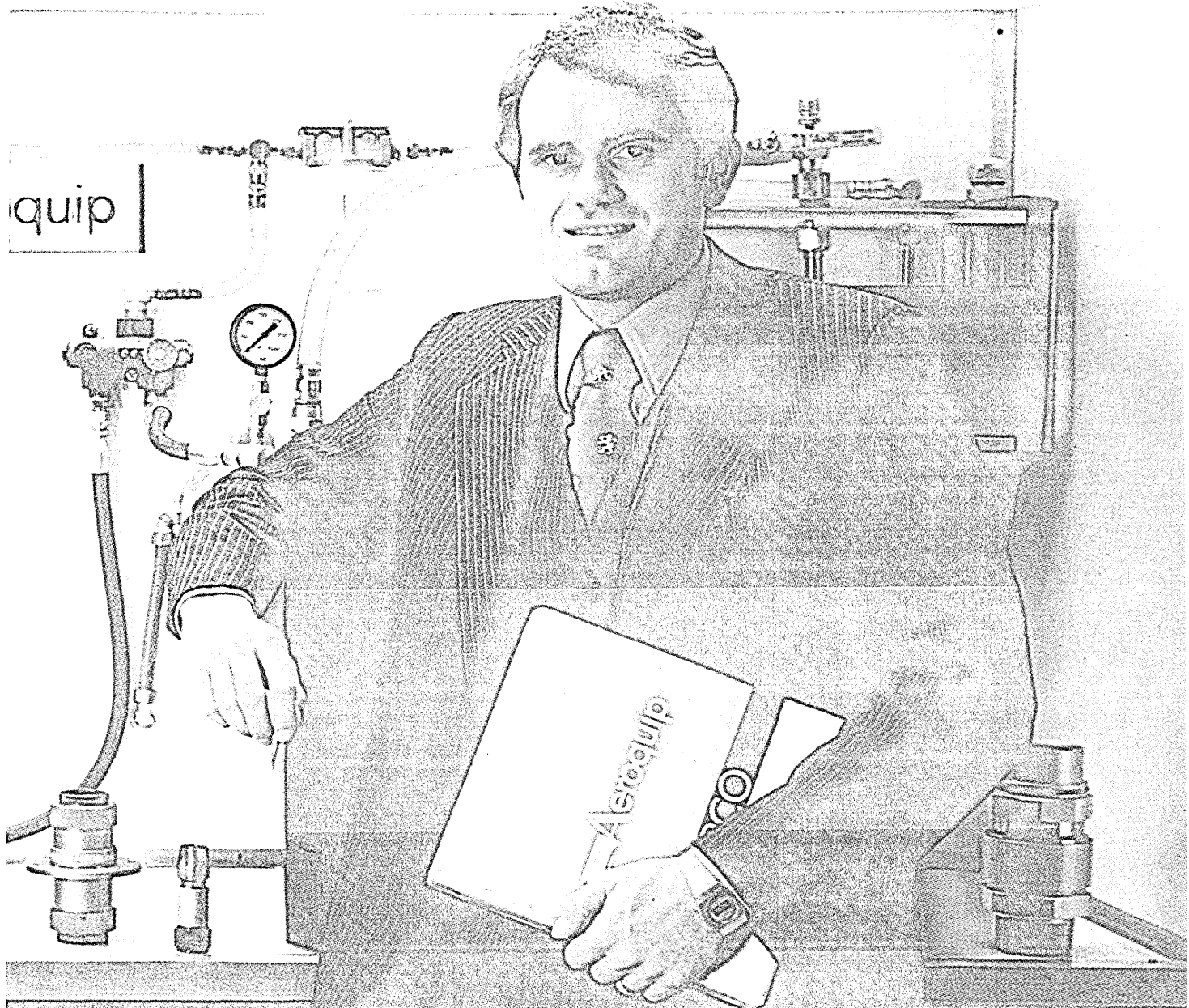

## processing system. That's why

*Howard Selland, Corporate Administrative Systems Manager, Aeroquip Corporation, A Subsidiary of Libbey-Owens-Ford Company*

And because it's modular, Series/1 is ready to grow when you are.

What's more, Series/1 is supported by an extensive service organization that enables IBM to respond promptly to your service needs, even in remote areas.

If you'd like to know more about how your company can benefit from a distributed processing system using Series/1, get in touch with your IBM Series/1 marketing

representative or write the IBM General Systems Division, P.O. Box 2068, Atlanta, GA 30301.

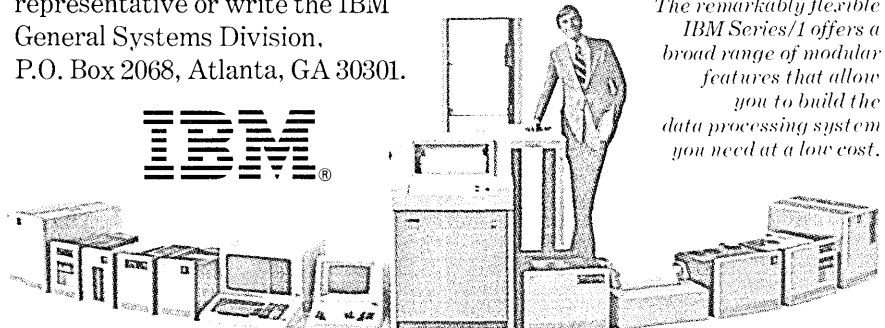

*The remarkably flexible IBM Series/1 offers a broad range of modular features that allow you to build the data processing system you need at a low cost.*

**A small computer can make a big difference.**

# "WITH THE MODCOMP CLASSIC, WE DON'T HAVE TO TRADE PERFORMANCE TO GET RELIABILITY."



Bill Greene, Staff Engineer  
Process Computer Systems Group  
Chemicals & Plastics Division Engineering  
Union Carbide Corporation

Bill Greene is a staff engineer for the Process Computer Systems Group which is responsible for designing, building, testing and installing process control computer systems in the company's manufacturing plants.

Because of their experience, we gave them our new Classic 7860 super mini to test. Their experience with it was summed up in three words. "We love it."

**"It's a reliable machine. And reliability is the name of the game."**

"We'll trade performance for reliability anytime," said Bill. "But with the Classic, we don't have to."

"The Classic hardware is very solid. Especially for a new product. The performance characteristics of the Classic are impressive, too. With its extremely fast floating point processor, the Classic can run through a program more than 3.7 times as fast as a MODCOMP II."

**"A working computer with software that doesn't work is useless."**

"We've been running the MAX III operating system for five years and the MAXNET III network extension for the past two years. They've performed well under very demanding conditions. In fact, over the past year, we've had more than 99.5% uptime on more than 30 installed MAX III systems."

"However, we're installing larger process computer networks now with more and more satellites. So we need increased host computer hardware and software capabilities."

"Our tests with MODCOMP's enhanced MAX IV

operating system in the Classic have been very encouraging.

"MAX IV and the new MAXNET IV will help us relieve bottlenecks so that we can add more links and do more work with the computer. We also expect that File Manager, which can create a new file anywhere on a disc, will be a useful tool."

**"We install 15-20 systems a year, so ease of implementation is important."**

"Even though the Classic is a powerful and sophisticated machine, it should be an easy system for our project teams to implement. MODCOMP provides plenty of documentation and they've always been very helpful in working with us to get our systems up and running."

"In fact, we think so highly of MODCOMP and the Classic, we've already ordered two MODCOMP Classic 7860's to be used as host computers in large process control distributed networks."

**It takes a tough computer to satisfy a tough customer.**

At MODCOMP, we specialize in building real-time computers. They work in chemical plants. In petroleum refineries. In steel foundries. In jet propulsion labs. In electric power plants. In some of the harshest industrial environments you can imagine. Nevertheless, independent surveys have rated MODCOMP computers the most reliable systems on the market.

If you want reliability, but you don't want to trade performance to get it, do what Union Carbide did. Buy a MODCOMP Classic.

**MODCOMP**  
Dedicated to your success

Modular Computer Systems, Inc.  
1650 W. McNab Road Ft. Lauderdale, FL 33309  
(305) 974-1380

CIRCLE 73 ON READER CARD

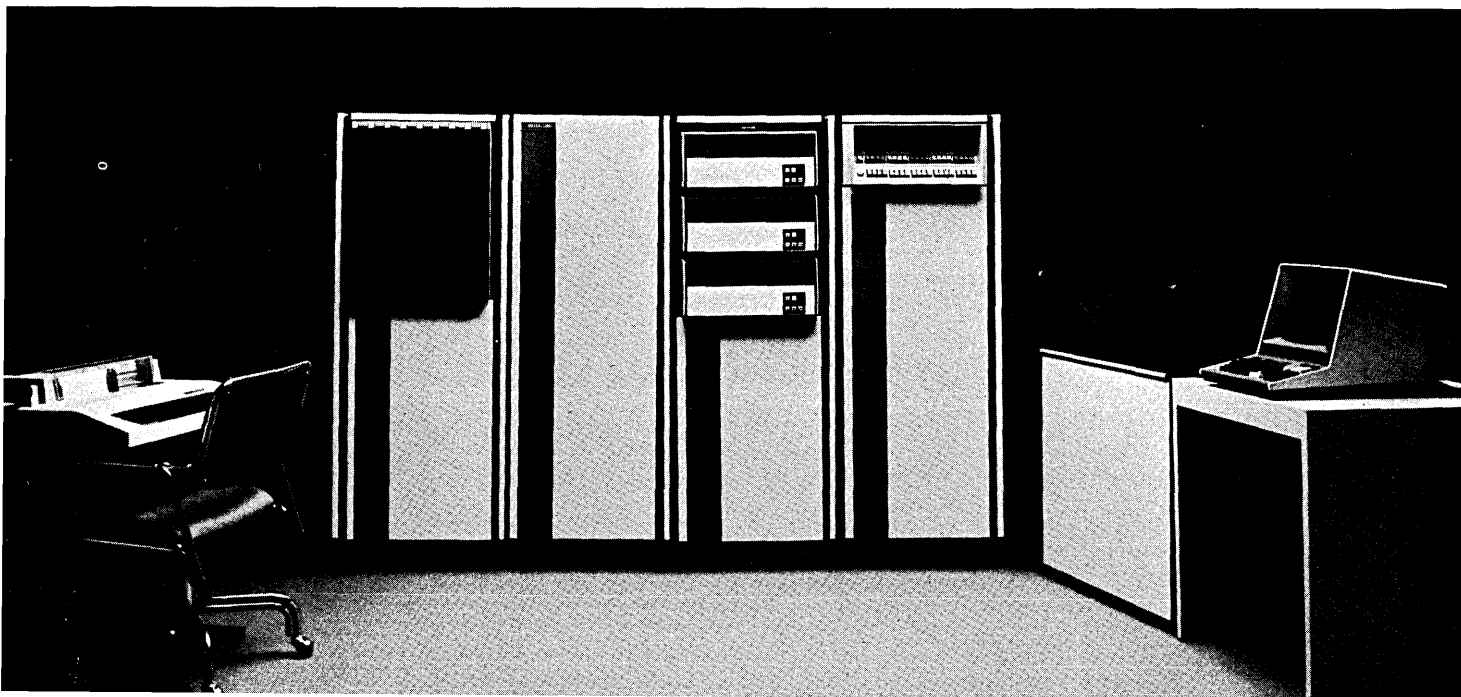

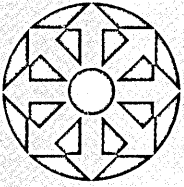

# LOOK AHEAD

## IBM DELIVERING MULTI-HOST NETWORK SOFTWARE

A dozen or so big IBM users around the country, including Paine Webber (the brokerage house) and Prudential Life Insurance, are in the process of taking first customer shipment of the giant computer manufacturer's ACF (Advanced Communication Function) software products. ACF, which represents an upgrade of TCAM 10 (Telecommunications Access Method), enables users to create a multi-host network that's SNA compatible. Previously with SNA a network could only support one host computer--a limitation many users were critical of. Ultimately Prudential, a large IBM and Amdahl user, intends to tie its five U.S. computer centers into one network using ACF. Paine Webber, meanwhile, is linking 2,000 or so regional crt's into a single network hosted by a 3032 and a 158. Paine Webber says the ACF approach was chosen over, and found less costly than, going to a distributed network--a philosophy that IBM, of course, has never really endorsed.

## MAINFRAMERS TAKE NEW TACK ON FEDERAL INTERFACE ISSUE

As the proposed I/O channel interface standard nears final adoption as a federal information processing standard (FIPS), the opposition forces, mainly the mainframe manufacturers, have taken a new tack to block it. Early this year, mainframe makers began to take their opposition crusade to Capitol Hill, bad-mouthing the proposed standard through letters to and meetings with House Speaker Thomas P. (Tip) O'Neill and Rep. Robert F. Drinan.

In a February letter from Digital Equipment Corp.'s liaison officer to O'Neill, the minimaker urged the powerful congressman "to discourage the arbitrary adoption" of the standard on the grounds that it "would...freeze the computer architecture to that of the mid-'60s." Standard supporters say this is a bogus argument, and contend that the standard's real benefit will come from allowing cheaper and more competitive federal acquisition of I/O peripheral gear. The battle over the I/O channel interface standard, raging now for 13 years, could be resolved by January--the earliest the standard package could go into effect.

## IBM LOOKS AHEAD

In a recent pitch to top dp executives, IBM indicated that by the early '80s it would market a system with the power of one-third of a 370/168 with 512K of main storage and 5 megabytes of disc, all packaged under the cover of a single keyboard display. The mighty mainframer also projected that by the mid-'80s no new office building would be built which didn't provide the capability to install a terminal for every employee. The company's prognostication for its distributed systems included a data base package which would be a "little brother" of IMS.

## WORD MACHINE STORES ONE MILLION DOCUMENTS

DPF, the Hartsdale, N.Y., computer leasing firm, is set to announce a word processing system it claims has the capacity to store up to one million documents on-line and can support more than 100 terminals concurrently. Called Word Machine, the system consists of a DPF-designed and manufactured microprocessor-driven crt and a DPF manufactured high speed transmission controller. Text is edited on the terminal and subsequently transmitted to an IBM 360 or 370 system where it's stored on IBM rotating storage. The system, which sells for from \$214,000 in a minimum 10 terminal configuration with

# LOOK AHEAD

a 110K page storage capacity, is currently installed at Beta test sites with a Fortune 50 company and a major federal government user, DPF says.

## INFOTON TERMINAL AIMED AT OTHER MANUFACTURERS

While most terminal manufacturers seek to emulate Teletype or IBM gear, Infoton, Inc., of Burlington, Mass., has a development program underway that is aimed at producing a terminal that will emulate several different terminal models. The Infoton terminal, called the I-100, should be announced soon. It contains PROMs that give the terminals "neuter identity" and make it possible to emulate control code sets of other terminal manufacturers. Infoton's first targets are said to be the ADDS Consul 520, Lear Siegler ADM 3A, and Hazeltine's 300. For the strategy to work, the Infoton terminals would have to be considerably lower in price than the other terminals.

## MAKING MUSIC AT NEW ENGLAND DIGITAL

During the last several months, an interesting almost mysterious phenomenon has been observed at Dartmouth College--minicomputers are being displaced with a vengeance. As many as 30 have disappeared from the New England college's campus, knocked off, no less, by a mini that was originally designed into an electronic music synthesizer. The tail (the mini) is now beginning to wag the dog (the music synthesizer) and the manufacturer, New England Digital Corp. (NEDCO) of Norwich, Vt., currently has four mini models in production. Called the ABLE series, the 16-bit minis use MSI componentry, and the company stresses reliability and speed in the computers. NEDCO already is shipping computers at the rate of \$1.5 million annually. The company is taking aim at the exploding small business market with a \$4,650 configuration that includes cpu, 32K bytes of memory, two floppies, and software.

## AFIPS MOVING TO WASHINGTON

American Federation of Information Processing Societies (AFIPS) will move its headquarters to Washington, D.C., from Montvale, N. J., within the next year. The huge federation of 15 computer-related societies reached the decision at a board meeting following the National Computer Conference in Anaheim, which AFIPS sponsors. At the meeting Albert S. Hoagland, of IBM Corp., San Jose, Calif., was elected president and J. Ralph Leatherman, Hughes Tool Co., Houston, was elected vice president. Robert W. Rector, whose term as the federation's executive director expired in June, agreed to continue in that post indefinitely.

## IN THE WAKE OF PROP 13...

Like other public sector employees in California, data processing employees last month were sweating out the effects of Proposition 13. Wendell Mayer, acting general manager of the city of Los Angeles' Data Services Bureau, which employs more than 400 people, said "there was a lot of relief when we learned that there probably would be no layoffs, that staff would be cut by attrition." He said the relief, at least initially, seemed to outweigh concern over a 10% across-the-board salary cut proposed by the City Council. He said the bureau has stopped work on development of new systems and probably would eventually cancel most development work.

(Continued on page 190)

# “We couldn't live without MARK IV!”



— Pat O'Grady, Secretary-Treasurer, and Fred Hemming, Director of Data Processing, Transport Indemnity Company, Los Angeles, California

“With 16,000 claims reported annually and \$50,000,000 in annual premiums, Transport Indemnity is one of the largest and busiest truck insurers in the country. To handle this enormous load with ease and efficiency, we use MARK IV. It has reduced our programming time by 75 percent and allowed us to work with a staff one-third the size of what it would be otherwise. It's really unbelievable!

“In 1975, we developed a fully automated and truly revolutionary retrospective claims system under MARK IV, and we're absolutely thrilled with it. Essentially, retrospective claims mean that the insured shares in the lower limits of the loss, with the insured paying in advance for the loss. At year's end, according to the actual experience, additional money is requested or overpayment is refunded.

“This claims process is extremely complex, but MARK IV simplified it and gave us the exacting control we need. All current and cumulative claims information, along with pertinent statistical data, is on one master file. By simply passing our transaction file against it, we spin out all the reports we require.

“We also use MARK IV for an extremely sophisticated self-insurance administration system, and currently 90 percent of our new systems development is scheduled for MARK IV. What we like best is its flexibility.

MARK IV is so responsive that we can answer the changing needs of our insureds through timely production of specialized reports. Our DP people think of MARK IV as a 'language of love'! We couldn't live without it!”

**GET THE FACTS ON MARK IV.** MARK IV is the most versatile and widely used software product in the world for application implementation, data management and information processing. Six powerful models (prices start at \$12,000) are in daily use on IBM 360/370, Univac 70/90, Siemens 4004, Amdahl 470, and Intel Advanced System computers at over 1,300 installations in 44 countries. Programs in MARK IV require only about one-tenth the statements of Cobol, and users report 60 to 90% cost and time reductions on most MARK IV applications.

**informatics inc**  **Software Products**

**World's Leading Independent Supplier of Software Products**

#### OFFICES

Los Angeles (213) 822-3552  
New York (201) 488-2700  
Washington (703) 821-5900  
Atlanta (404) 955-2518  
Chicago (312) 298-9300  
Dallas (214) 750-0800  
Canada (416) 493-9716

#### HEADQUARTERS

21050 Vanowen Street  
Canoga Park, California 91304  
Telephone (213) 887-9121

Member SIA  Software Industry Association

Transport Indemnity is one of the nation's largest companies specializing in motor carrier liability insurance.



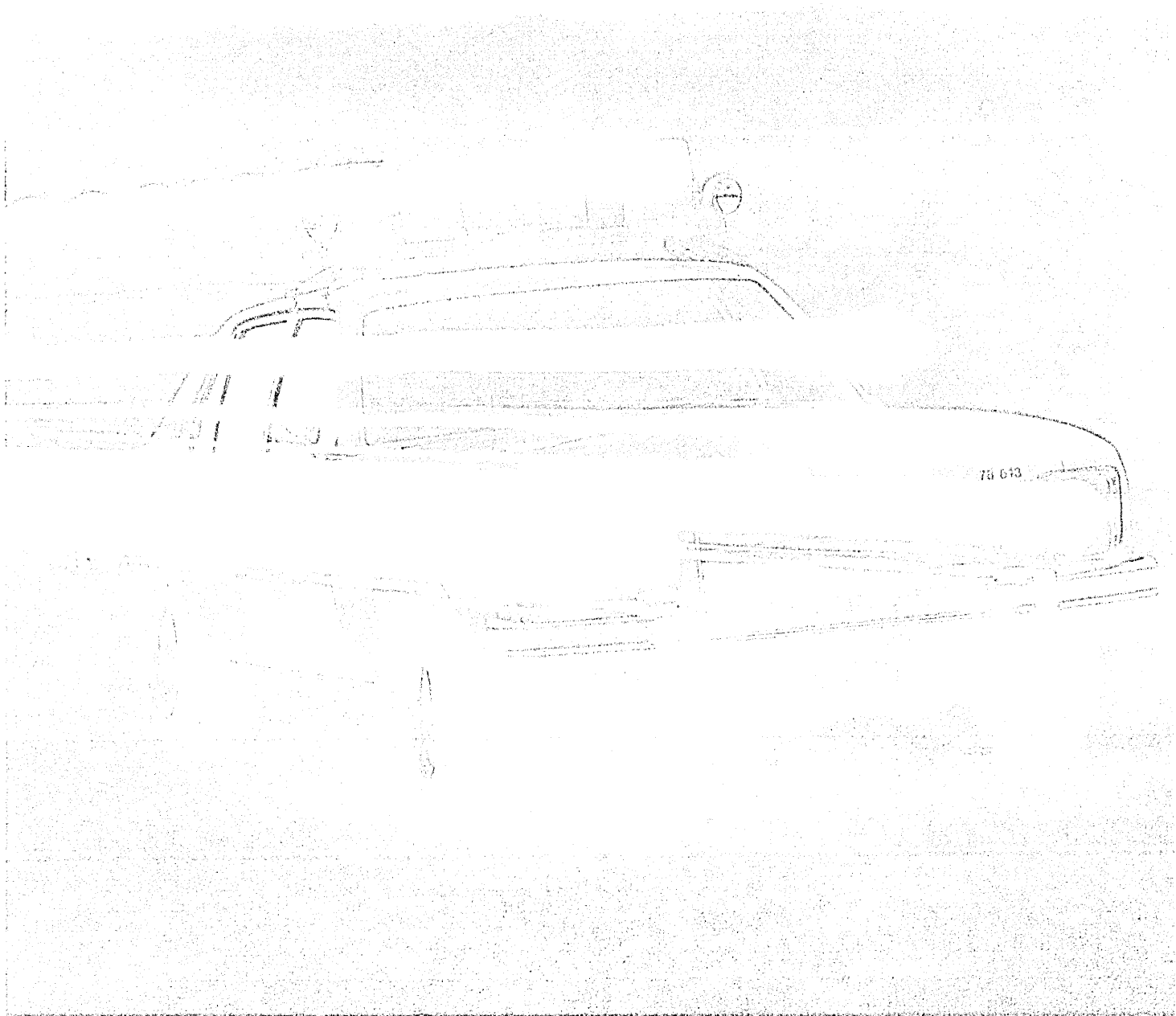

## alarming things in Portland.

no satellite, instrument control, or data communications.

For more information, write to us at Sperry Univac Mini-Computer Operations, 2722 Michelson Drive, Irvine, California 92713. Or call (714) 833-2400.

In Europe, write Headquarters, Mini-Computer Operations, London NW10 8LS, England.

Sperry Univac is near from you. Even if your computer is as distant as arresting as the things in Portland.

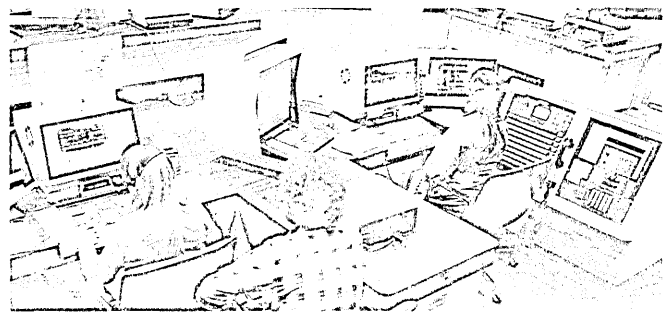

**SPERRY + UNIVAC**  
SPERRY UNIVAC IS A DIVISION OF  
SPERRY RAND CORPORATION

# A BREACH OF DATA SECURITY CAN CAUSE YOUR BUSINESS TO COLLAPSE



The information in your computer system is probably your company's most important asset.

If it were compromised in *any* way, you could end up without a business.

That's why SECURE™ is the way you want your data to be.

SECURE lets you protect your data from accidental or intentional alteration . . . unauthorized disclosure or theft . . . software vandalism.

SECURE provides protection without interfering with your users. It keeps track of not only authorized accesses but also unauthorized attempts.

The information in your IBM OS/360 or OS/VS computer is vital to your com-

pany's success. Don't invite a breach of data security. SECURE your business from collapse.

For complete information on how SECURE will help you protect your company, call or write us today.

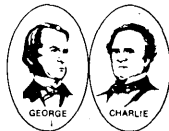

## Boole & Babbage

Operations Division  
510 Oakmead Parkway  
Sunnyvale, Ca. 94086



In California dial: 408/735-9550  
Outside California dial toll free: 800/538-1872

The world's most widely used data access security system.





# How do you explain a brownout to a computer?

The same way you explain the other unpredictable line anomalies found in today's commercial power. You don't.

There is an answer, however, to this rapidly growing problem.

A Kato motor-generator set. It delivers a constant supply of clean, accurate power so you can ride out sudden voltage fluctuations that often shut down systems needlessly. In fact, you can continue operations indefinitely, despite voltage reductions of 20% or more.

And because an M-G set is the only method that provides total load isolation, you're fully protected against harmful spikes that result in costly, often untraceable computing errors.

Kato Engineered M-G sets do the job with energy saving efficiency and low maintenance requirements.

They're rugged, too. Our conservatively designed units withstand severe overloads that would destroy a solid-state device in seconds.

Ask us about the cost-advantages of using a Kato motor-generator set in your operation. We'll draw on our 50 years of experience in meeting your power conversion needs.

Call Kato Engineering Company, Mankato, Minnesota 56001. (507) 625-4011.

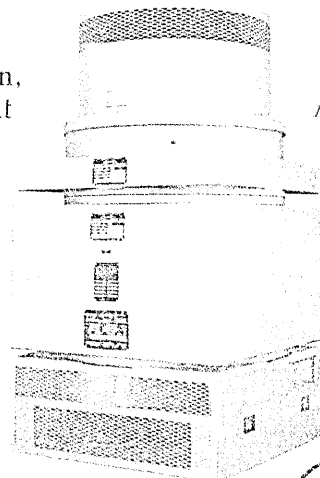

**KATO**  
*Engineering* COMPANY

# Does 100,000+ installations make Centronics better than other printer companies?

**NO.** Even though 100,000 delivered units make Centronics more experienced, it takes much more to be a better printer company. Like single source.

Our 9 model 700 series of matrix printers, 4 model 6000 series of line printers, 760 series teleprinters and new non-impact electrostatic printers give us the most complete line in the industry.

Centronics has more. Competitive prices. The largest worldwide service organization of any printer company. Financial stability with a record of growth and strength unmatched in the business. And a track record of superior product reliability and customer support — whether OEM or end-user.

You know the advantages of an experienced supplier. You know the breadth of Centronics' line. And now you know why Centronics is the better printer company. Write or call today for the complete details of Centronics' full printer line. Centronics Data Computer Corp., Hudson, NH 03051. Tel. (603) 883-0111.

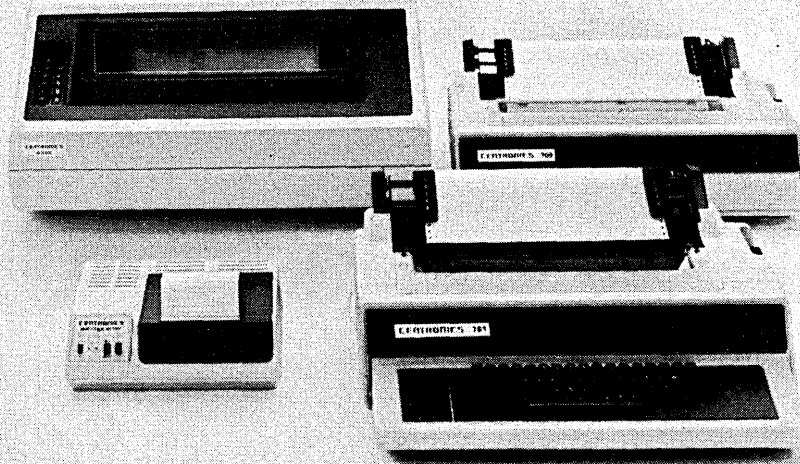

**CENTRONICS® PRINTERS**  
**Simply Better**

# letters

## Weathering a revolution

I very much enjoyed the two articles in the May issue, "Modeling the Weather," by Francis J. Balint (p. 130) and "When Digital Processing Meets Weather Imagery," by Robert Wallis (p. 148).

It was especially interesting to read Dr. Wallis' prediction that "Digital imagery processing will doubtless be the next revolution in meteorology," when since September of 1970 the Air Force Global Weather Central, a unit of Air Weather Service and the U. S. Air Force (MAC), has been processing a three-dimensional quantitative cloud analysis from multi-spectral, multisatellite imagery several times a day! We also provide cloud forecasts over periods up to 48 hours, using some of the techniques identified in Mr. Balint's article.

It is nice to know that although we are the smallest and lowest funded of the U.S. weather organizations, we are so far out in front in "revolutionary" meteorology.

RICHARD C. SAVAGE  
MAC, Offutt Air Force Base  
Omaha, Nebraska

## Historical figure

With regard to the February Editor's Readout, "Just What is a Baud, Anyway? And Why is it Spelled Funny?" (p. 77), and to A.E. Loebel, who pointed out that those questions remained unanswered (Letters, May, p. 321): Out of due respect to Maurice Emile Baudot (1845-1903), please refer to "Information das Abenteuer Der Nachrichtentechnik," by J. Augustin (Verlang Carl Ueberreuter, 1972).

On this steeper portion of the knowledge curve, memorials are very brief.

A.V. BENNETTSON  
Fundamental Plan Engineer  
New York Telephone  
New York, New York

## More on language priorities

Some very interesting results concerning cpu usage were shown in the article entitled "Comparing Programming Language Performance" (April, p. 119).

I find, however, that we select an implementation language based first on what is available on the machine, second on whether it is easy to use for solving the problem, and last, on whether the object execution will most effectively use the cpu.

For example, computational problems code more quickly in FORTRAN or ALGOL than COBOL; string handling problems code quicker in SNOBOL, FORTRAN and some BASICS than in COBOL; but record processing problems code quicker in COBOL or PL/I than the others mentioned.

I would be appreciative if Mr. Blaylock would follow up as he suggested, and provide development cost, and perhaps maintenance cost, as a function of problem type and programming language.

JAMES C. AGUE  
Senior Systems Analyst  
Cibar, Inc.  
Stamford, Connecticut

I must object to Jerome Blaylock's conclusions in the article "Comparing Programming Language Performance." It is (or should be) well known that cpu execution times of most programs do not matter over quite a large range. In many cases, a program's I/O time far exceeds its cpu time, and in other cases, the program is run so infrequently that even a factor of 5 more in cpu time would be acceptable. Furthermore, many programs are compiled almost as often as they are run, due to numerous changes, and hence compilation time becomes more critical than running time.

In the majority of cases, what is important is the ease and speed of *programming*, so as to get clean, correct, modular programs into operation. In most businesses there is far more money to be made by reducing program development and testing time than in shaving a few milliseconds off the running time of a currently existing job.

With 8-bit microprocessor chips costing only a few dollars, and 64K-byte memories costing only a few hundred dollars, we must start thinking of computer time as *free*, compared to the salaries and overhead for the people who develop the systems. Therefore, comparing the speed of programming the tasks would be a far more valuable measurement than the speed of execution, as far greater differences could be found there, perhaps an order of magnitude for some tasks.

HENRY G. BAKER, JR.  
Assistant Professor  
Department of Computer Science  
The University of Rochester

## Comparison suggestion

Jerome Blaylock's comparison of high level languages was interesting, especially the hint of significantly better performance using assembly language or APL.

I hope that you will publish more such comparisons, and include an analysis of



© DATAMATION ©

"They're running into financial difficulties—we better unload our stock . . ."

# letters

the generated object code to explain the difference.

WILLIAM EHRRICH  
Control Data Corp.  
Santa Ana, California

## Nix on Grouch & the trio

I found the dastardly drivel of your April issue entitled "The Case of the Insidious Dr. Grouch" to be not only in poor taste, but not at all up to the standards of your usually noteworthy publication.

GERALD M. BULL  
Manager, Corporate Computer Services  
Peterson, Howell, & Heather, Inc.  
Hunt Valley, Maryland

## More on sorting

We have received several inquiries since the article promising sorting improvement of 3,000 percent appeared in your February issue ("Sorting 30 Times Faster with DPS," News in Perspective, p. 200). A number of data processors who use SyncSort and consult us on sorting questions called to ask how we evaluated the technique, whether it would be applicable to the callers' sorting requirements, and why we hadn't developed the idea ourselves, since we are often credited with most of the sorting innovations made in this decade.

After carefully reviewing the academic paper on which the article was based, we've been forced to conclude that your report was somewhat misleading. It presented a naive and incomplete view of modern sorting requirements.

There is basically nothing new in Mr. Dobosiewicz's technique. His paper, ("Sorting by Distributive Partitioning," Wlodzimierz Dobosiewicz, *Information Processing Letters*, Jan. 1978, Vol. 7, Number 1) proved on close examination to be nothing more than a clever synthesis of ideas that have been known for some time. Most of these are taken from Donald E. Knuth's book (*The Art of Computer Programming*, Vol. 3, *Sorting and Searching*, Addison-Wesley, 1975). But the most serious flaw in your report was its failure to mention that the DPS technique is applicable *only* to "in-core sorting"—those instances where all data to be sorted can be stored in memory.

Today, the vast majority of large main-frame users are far more concerned with, and devote far more of their resources to, "external sorting." Here, disc and tape devices must be used for intermediate storage, since all data cannot be stored in memory. The real key to efficient use of resources in random-access disc sorting and tape sorting is the development and use of innovative I/O techniques.

True, in random-access disc sorting a certain amount of data is stored in memory and this must be put in order. This is generally called "string generation," and for the past 20 years or so this has been accomplished by using the "tournament selection" technique. For random-data input, the length of each string is approximately *twice* the number of records that can be stored in memory. For nonrandom data, the length of each string is *more* than twice the length of the memory load.

It should be noted carefully that in the DPS technique the maximum length of any string is, by definition, exactly *one* memory load. If you attempted to apply the DPS technique to the external sorting requirements outlined above, there would be severe degradation in sorting performance and a resulting increase in the use of CPU time, elapsed time, and I/O requests. In other words, disaster would result, to the detriment of the experimenter.

There are several other drawbacks to the DPS techniques. It requires significantly more overhead in programming instructions and auxiliary tables than other techniques. And even more important, DPS requires that data be uniformly distributed, according to key, for the technique to begin to realize its capability. Even if you arranged customer or

employee files with last names in alphabetical order, this would not qualify as a uniform distribution, and DPS would inevitably be forced toward its worst case.

In summary, there may be some very specific applications where users may decide to invest time and money to incorporate programming instructions from DPS into their specialized applications. But for the great majority of users who face complex and varied sorting problems, DPS simply won't work. For them, your promise of big savings at no cost is untrue.

HARVEY B. TESSLER  
Vice President  
Software Engineering  
Whitlow Computer Systems, Inc.  
Englewood Cliffs, New Jersey

\*

We welcome reader correspondence on subjects pertinent to the data processing field and its relation to society, or on the contents of DATAMATION. We will not publish unsigned letters, but will withhold names if necessary. Please type your letter, double-spaced, and be as brief as possible. We reserve the right to edit letters or to use excerpts. Write to 1801 S. La Cienega Blvd., Los Angeles, CA 90035.



© DATAMATION ®

"This is not going to look too good on your record: complaining about invasion of privacy."



Hewlett-Packard

# Computer Advances

Vol. 3 No. 4 July/August 1978

Transpose a 2 megabyte matrix in 44 seconds—the F-Series minicomputer  
HP plots: the HP 2647 and GRAPHICS/1000

# How do you address a 2 megabyte mini?

**Very easily.**

The new F-Series computer is the top-of-the-line for the HP1000 family. Its design has been optimized to provide users with the high speed and accurate computation so needed in scientific, industrial, and engineering applications.

## Fast processing

The F-Series capitalizes upon the successful HP1000's high performance architecture. Its CPU executes the base instruction set at an impressive one million instructions per second.

To further increase speed, we integrated a second processor devoted solely to floating point operations. Accurate to

eleven decimal places, this new processor executes both single (32-bit) and extended (48-bit) precision floating point instructions at hardware speeds. A single precision floating point add, for example, executes in only 630 nanoseconds; and a multiply in 1.78 microseconds.

A new "Scientific Instruction Set" (SIS) calculates trigonometric and logarithmic functions with incredible speed and precision. With the

hardware floating point processor as its resource, SIS typically executes a sine instruction in 47.6 microseconds.

## Fast FORTRAN

Other operations essential to efficient FORTRAN are standard and included as an extension to the instruction set. There are fifteen microcoded routines such as

parameter passing, and packing and normalizing functions that accelerate FORTRAN.

The cumulative effect of these new features is the exceptionally fast running of FORTRAN programs. Plus, the price is attractive for those OEM and end users who value cost effective solutions to computer aided design, graphics, simulation, modeling, and scientific problem solving applications. The F-Series starts at \$12,250\*.

## RTE-IV extends the reach of your data

Further power in FORTRAN is available for all HP1000 computers with a new version of our multi-user, multi-programming, disc based RTE-IV. This advanced operating system features a new memory management capability.

## CPU megabyte-arrays

HP now has nearly 2 megabytes of main CPU memory available for data. A significant contribution of

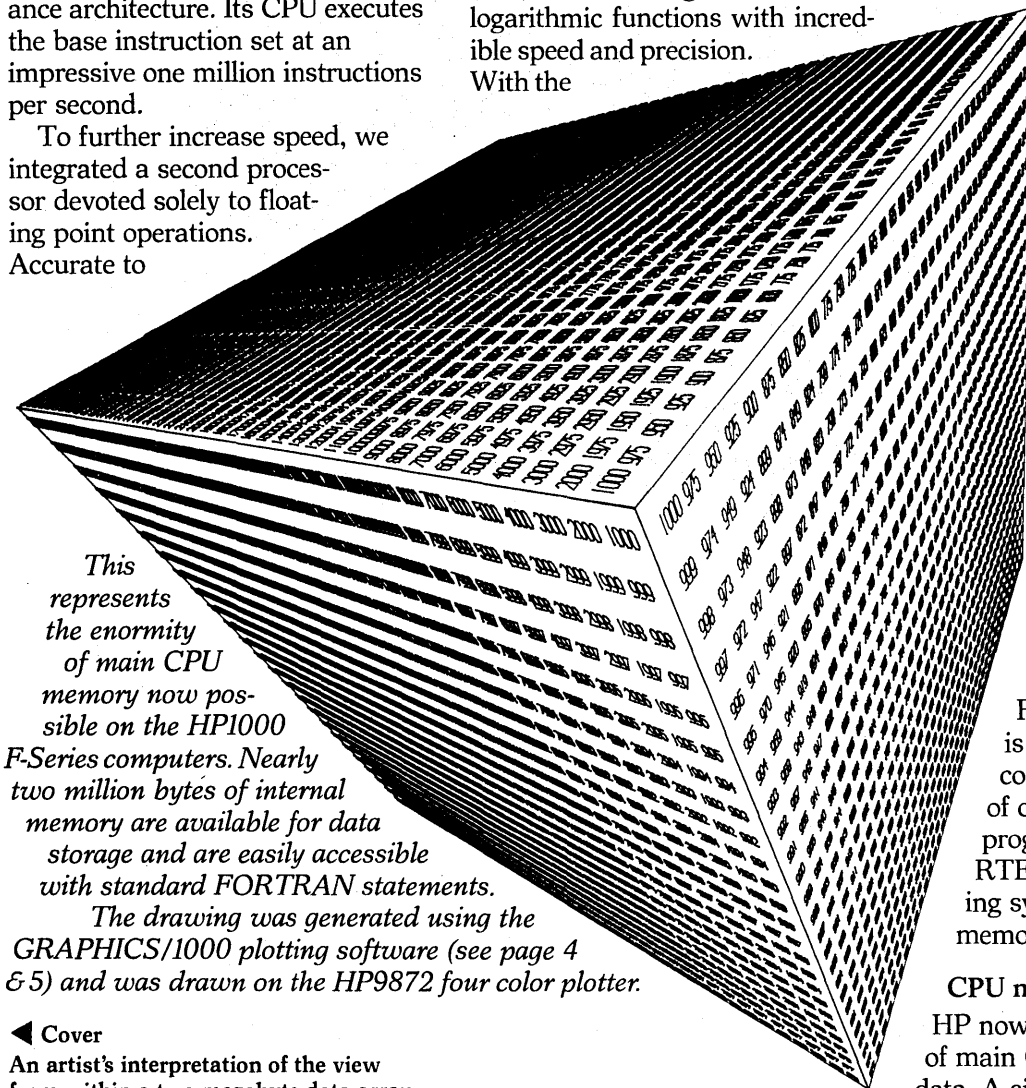

*This represents the enormity of main CPU memory now possible on the HP1000*

*F-Series computers. Nearly two million bytes of internal memory are available for data storage and are easily accessible with standard FORTRAN statements.*

*The drawing was generated using the GRAPHICS/1000 plotting software (see page 4 & 5) and was drawn on the HP9872 four color plotter.*

## ◀ Cover

An artist's interpretation of the view from within a two megabyte data array.

RTE-IV is its ability to manage these large data arrays. Easily accessed with FORTRAN statements, there is no need of complex and slow virtual memory schemes, nor extensive recoding and segmentation of data.

For example, in just 44 seconds, the following few lines of standard FORTRAN transpose the two million byte matrix featured on the cover. This is a significant contribution for a 16-bit machine.

```
PROGRAM TRPOS
COMPLEX ARRAY, TEMP
COMMON/EMAC/ARRAY (500,500)
DO 10 I= 2,500
DO 10 J= 1,I-1
TEMP= ARRAY(I,J)
ARRAY(I,J)= ARRAY(J,I)
ARRAY(J,I)= TEMP
END
```

With RTE-IV, many programs may be in memory simultaneously in up to 64 partitions, and with up to 54K bytes of program space in each partition. These partitions, as well as I/O, may be simply configured at system start-up time without regeneration. And, should a parity error occur in a user area, that part of memory is removed from the available pool, but the system continues to operate. RTE-IV systems begin at \$40,000\*

### 3.1 cents a byte\*

Since HP's early commitment to semiconductor memory (May, 1974), we have been able to bring customers decreases in memory price that average 30% a year, and memory board density that has grown from 16K to a dramatic 128K bytes per board. Memory in our E-Series is now just 3.1 cents per

byte.\* The F-Series computer uses a 3.9 cents a byte\* high performance version that has a cycle time of 350 nanoseconds. Our fault-control capability provides memory error correction and detection.

For more information on these new products, plus the full range of our HP1000 family, note A to C on the reply card.

\*U.S. prices only.

The new HP1000 F-Series computer has been designed to execute FORTRAN expediently

Floating point instructions execute at hardware speed.

Other instructions execute trig or log functions quickly and accurately.

Fifteen FORTRAN acceleration routines microcode frequently used operations

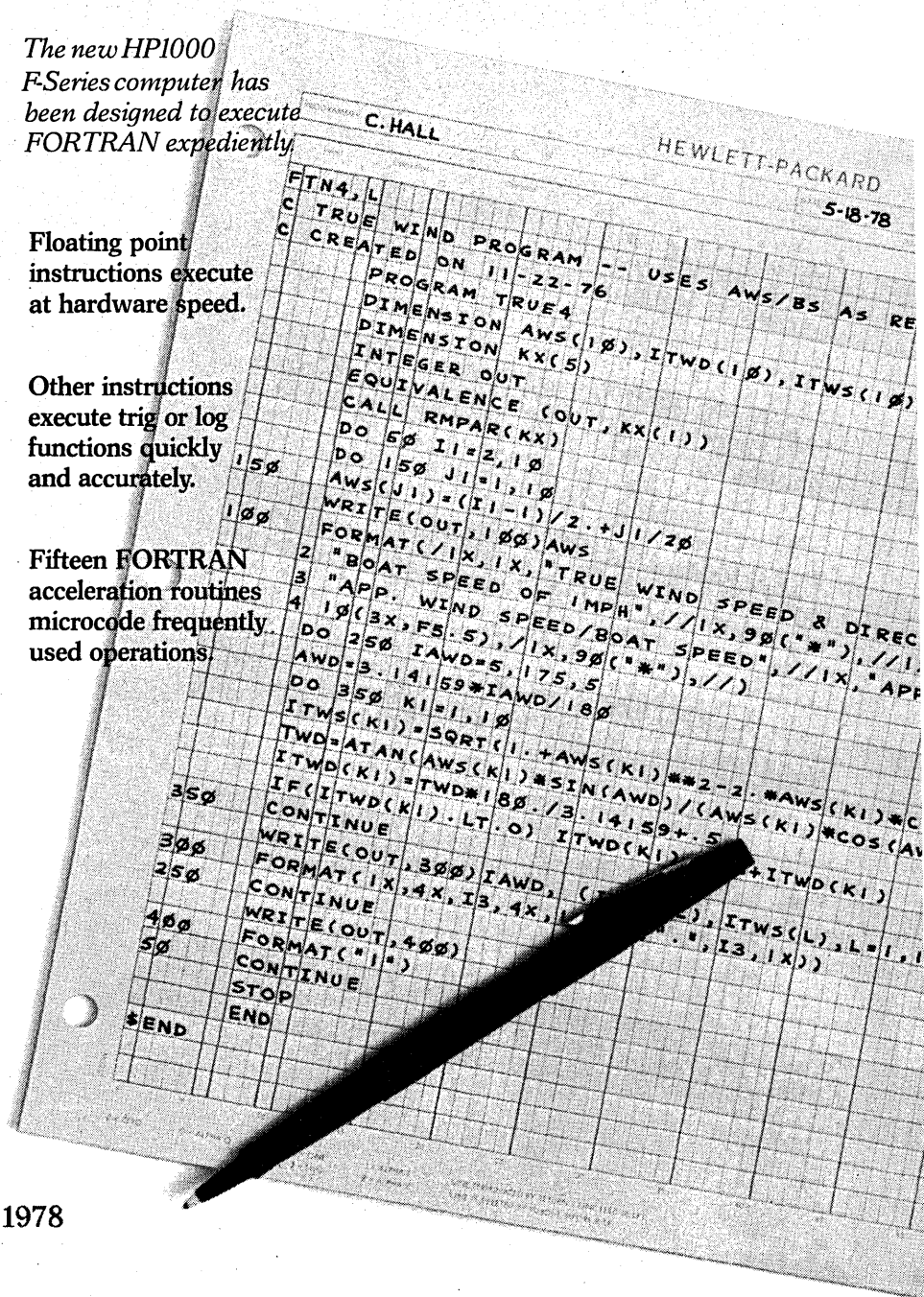

# Our pictures are worth a thousand numbers...

Computer graphics can play a key role in many phases of science, business, engineering, and management. Charts and graphs frequently make complex relationships much clearer than a table of numbers ever can.

By generating these graphics interactively, it is easier and faster for a user to interpret data and discern its trends. Similarly, computer graphics can facilitate the design process by accelerating the creation of complex drawings.

Recognizing the importance of computer graphics, Hewlett-Packard furthers its commitment to graphics support by introducing two new products: GRAPHICS/1000 plotting software and the HP2647 intelligent graphics terminal. These new products bring graphics to a wide range of users and applications.

The HP2647, programmable in BASIC, is a powerful graphics workstation which frees your CPU to perform large, complex tasks. Optimized for business graphics and data plotting, the HP2647 can even be used by those with little or no programming experience.

GRAPHICS/1000 utilizes the speed and power of the HP1000 computer system and enables you to input data and programmatically generate graphic output for complex scientific and engineering applications.

## A unified graphics approach

Hewlett-Packard has developed a common graphics language based on a uniform set of fundamental graphics functions. So far, this language has been implemented on the HP1000 computer system, where the HP2648 graphics terminal may be used; the HP9845 desktop computer system; and the HP2647 intelligent graphics terminal.

Currently, their graphic output can be routed to the HP9872 four-color plotter and the HP7245 thermal plotter/printer, which are controlled using the common language commands. In the future, additional HP graphics devices will be supported with this same language.

With GRAPHICS/1000, simple programs can convert tabular data into useful plots and charts. In the same way, interactive graphics techniques can aid design tasks by drawing mechanical parts, integrated circuits, electrical networks, and architectural designs.

GRAPHICS/1000 is a multi-lingual set of tools that enables you to design sophisticated programs for high level graphics on HP1000 computer systems. You can program in FORTRAN, BASIC, or Assembly languages, choosing the one that best suits your computing needs.

Your ability to produce graphics for instrumentation, computation, and operations management applications is enhanced by using GRAPHICS/1000. Input and output of information can now be accomplished pictorially.

A library of 55 graphic sub-routines selects and initializes the operation of graphic devices, draws lines and text, reads cursor and digitizer positions, defines area and coordinates of plots, and draws and labels axes and grids. There

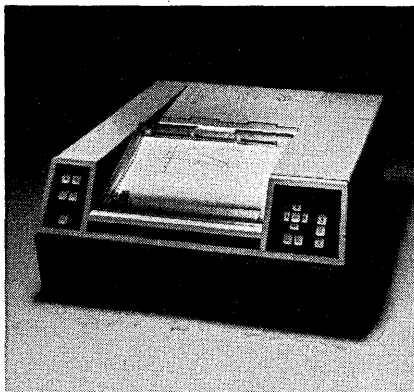

*HP7245 thermal plotter/printer*

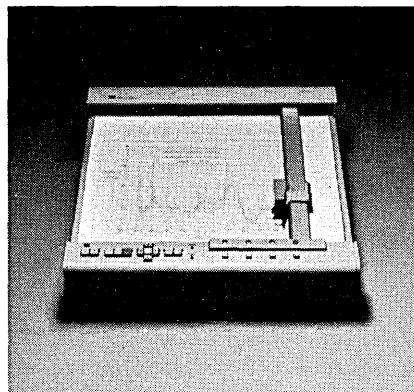

*HP9872 four color plotter*



*HP2648 graphics terminal*



# ...with GRAPHICS/1000

are even error handling subroutines to help you quickly debug application programs. These subroutines can save a great deal of programming time in complicated graphics applications.

## Program now, plot later

When programming with GRAPHICS/1000, you don't need to know in advance which output device will be used. Write

your program to draw a picture and specify the aspect ratio (width/height) of your plot. When you run the program, select any supported HP graphics peripheral. GRAPHICS/1000 automatically scales and fits your plot onto the chosen graphics device.

Since GRAPHICS/1000 is a continuing family of software, you can expand your graphics capabilities while minimizing your

software investments. The first member of this family comes standard with the HP1000 Model 45, which includes the F-Series computer. Or GRAPHICS/1000 can be added to any HP1000 using RTE-M or RTE-IV operating systems for \$500\*.

For more information on GRAPHICS/1000, check D on your reply card.

\*U. S. prices only.

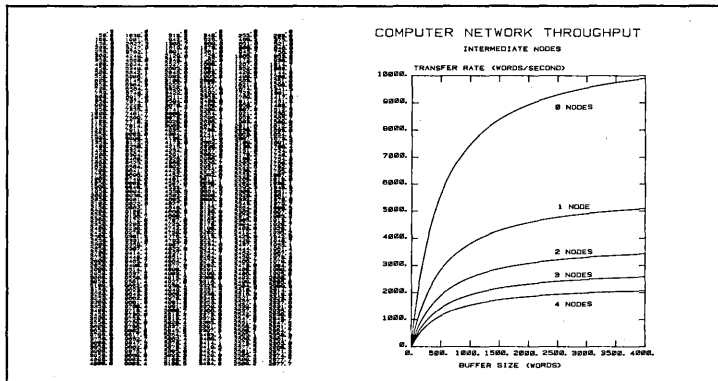

NUMBERS TO PICTURES drawn on the HP9872 four color plotter

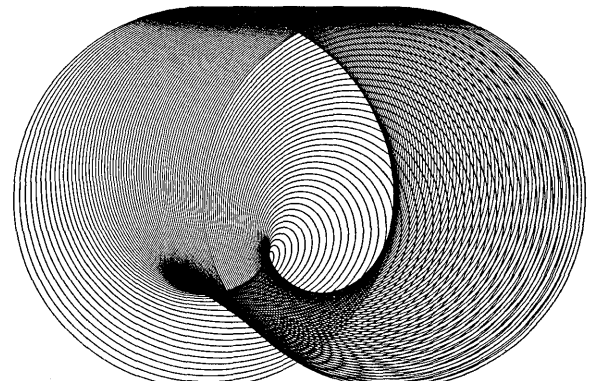

drawn on the HP9872 four color plotter

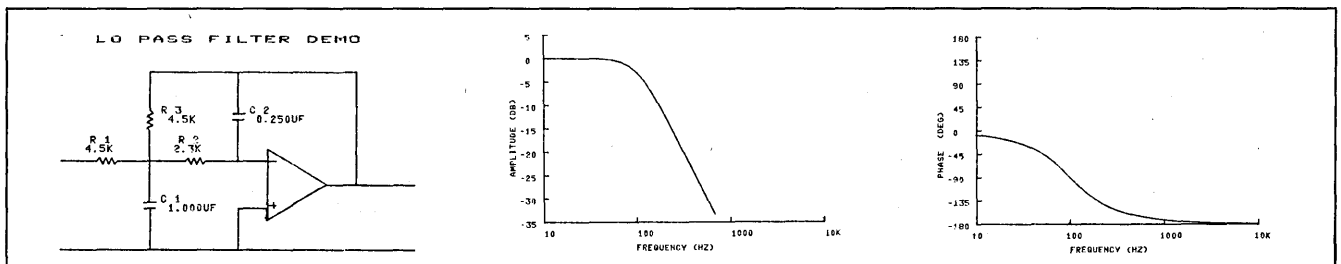

drawn on the HP7245 thermal plotter/printer

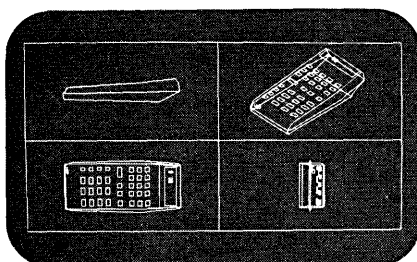

drawn on the HP2648 graphics terminal

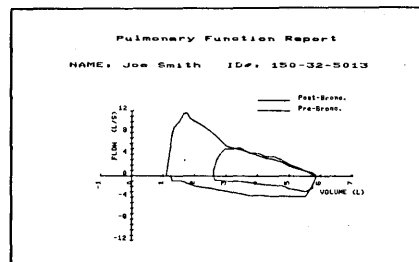

drawn on the HP7245 thermal plotter/printer

These represent but a fraction of the range of graphic representations that can be produced with GRAPHICS/1000.

# ...with the HP 2647

## HP2647 intelligent graphics terminal

By combining BASIC programmability with raster scan technology, the HP2647 intelligent graphics terminal makes sophisticated graphics easy to use in a wide variety of applications. This intelligent terminal with local mass

storage (dual integrated cartridge tapes) gives you a powerful graphics workstation. Total dependence on a CPU is gone. Graphics are yours where and when you need them.

## New graphics capability

Lists of tabular data, often

overwhelming, can be put into perspective using "multiple automatic plotting" and HP's standard high level graphics commands.

The predefined, multiple automatic plotting feature is easy to use. Just key in any tabular data. Then select from a displayed menu the type of chart or plot desired —

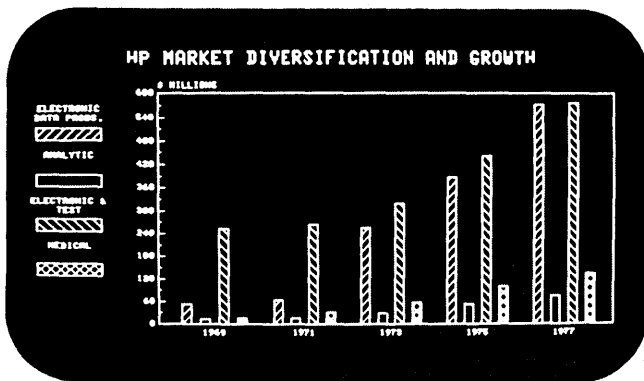

produced by the HP2647 intelligent graphics terminal

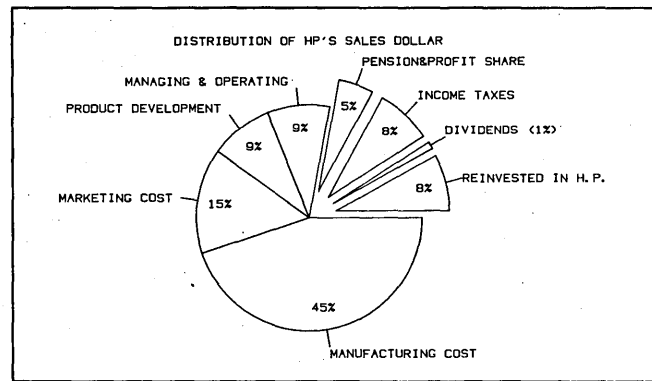

drawn on the HP9872 four color plotter

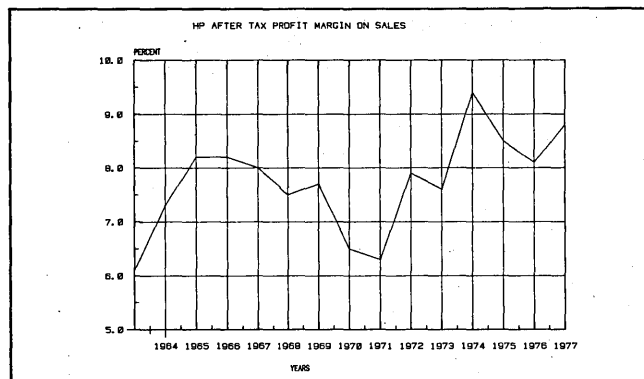

drawn on the HP9872 four color plotter

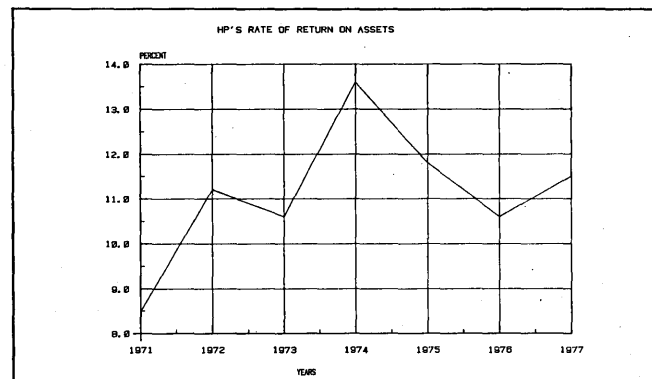

drawn on the HP9872 four color plotter

The HP2647 intelligent graphics terminal helps business managers to visualize their data.

	MEDICAL	ELECTRONIC & TEST	ANALYTIC	ELECTRONIC DATA PROCESS.
1969	18.7	229.6	13.7	11.7
1970	20.8	227.9	14.7	61.2
1971	20.8	227.9	21.2	61.2
1972	22.9	229.7	21.8	142.2
1973	22.9	229.7	25.8	251.2
1974	28.8	268.8	43.5	321.8
1975	28.8	268.8	43.5	461.8
1976	13.8	277.3	74.8	427.8
1977	13.8	277.3	74.8	427.8

SOURCE: HP ANNUAL REPORTS 1968-1977, \$ MILLIONS

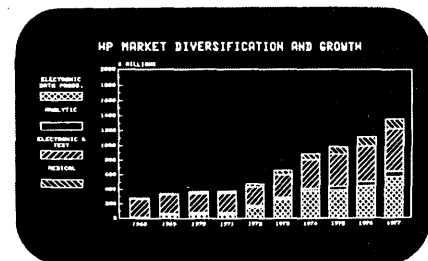

NUMBERS TO PICTURES produced by the HP2647 intelligent graphics terminal

bar, pie, x-y cartesian, or logarithmic. The terminal automatically labels, scales, and plots the data for you. No CPU software is required.

Suppose you want to create more intricate and specialized graphics. Simply use BASIC-like, high level graphics commands (PLOT, FRAME, AXES, MOVE, etc.) as you would any BASIC statement to draw, and label axes and grids; to control tic mark spacing, character size, and line types; to initialize the operation of different graphic devices; to plot data; to achieve a personalized, easy-to-understand graphic representation of your data.

What if you want a hard copy of your graphics? Multiple HP2647's can now share the same printer or plotter, significantly reducing the cost-per-terminal for hard copy output.

#### Useful as well as intelligent

Using the HP2647's powerful BASIC gives the terminal flexibility and versatility in a wide variety of computer environments.

Sometimes data from a "canned" CPU program needs to be tailored to your specific needs. A simple BASIC program can reformat or post-process that data. For example, sales data, is often listed on a monthly basis and stored in a central data base; however, you might want this data reformatted into three month averages. Using the HP2647's BASIC, you can easily do this.

Similarly, a BASIC program can pre-process or edit check the accuracy of data prior to transmis-

sion to the data base, eliminating most input errors.

#### Friendly front end processing

With an intelligent terminal like the HP2647, processing loads can now be shared effectively between terminal and main computer. Repetitive and simple tasks can be performed by the terminal with only results sent to the computer at the end of the day. Your CPU is free to perform complicated tasks utilizing its full power. Overall system efficiency is improved.

#### Outstanding graphics

The HP2647 has all the features you have come to expect from our graphics terminal family:

- Refreshed raster scan technology provides a continuously bright display even in well lit rooms.

- Selective erase, the ability to make graphic changes without redrawing the entire image, gives you rubber band line as well as other capabilities. Shade any portion of your drawing with one of the eight available patterns. If you don't like your choice, erase it and use your own design.

- The labels for eight user-definable soft keys appear along the bottom of your screen as a convenient reminder. Soft keys are used to control the flow of data between its source and destination, and can even simplify complex programs.

The HP2647's \$8,300\* price includes RS232 data communications, and up to 20K bytes of workspace.

If you would like more information or a live demonstration, indicate E on the reply card.

*\*U.S. prices only.*

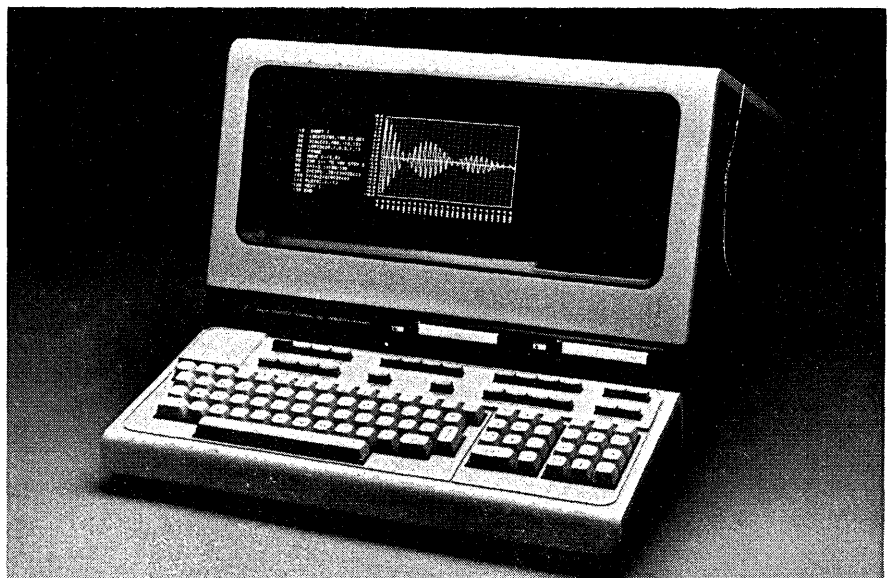

*The new HP2647 intelligent graphics terminal offers BASIC programmability, multiple automatic plotting, and a high level graphics language. A few lines of code produce complex, yet clear graphic representations.*

# Close in on distant data

## Put data where you need it

In the spirit of distributed processing, information that is useful to an area can now be stored in a local data base. Then with remote data base access (RDBA), a remote HP3000 can "poll" these geographically distributed systems to gather data for summary reports. In the same way, remote data bases can be updated from the central site.

Data bases and applications can also be distributed to balance demands among machines. High demand data base/application program combinations can be moved to separate HP3000's. Those remaining lower usage combina-

tions can be allocated to other systems. It may occasionally be necessary, then, for an application to reference a remote data base. RDBA can do this without any concern during application design as to whether data bases will be local or remote.

So the beauty of HP's approach to distributing data bases is its independence from both programs and machines. A data base administrator maintains access files which identify by name the location of the data base. To access any data base, be it local or a directly connected remote one, users only need to know the name of the data base—

not the location. RDBA, not the user or program, keeps track of where data bases reside. In the case of accessing multiple data bases at one remote location, the user simply specifies each data base as a separate statement.

## Cut communication costs

Data communication costs are still rising. However, a data compression technique used when information is sent between remote HP3000 data bases can significantly reduce data transmission time and produce substantial line cost savings. The amount of data compression depends entirely upon data file content. Typically, normal source code files can be reduced as much as 40%; although those containing many blanks could be compressed as much as 80%.

Remote data base access is free to those IMAGE/3000 customers with distributed systems.

Indicate F, G on the reply card if you wish further information on RDBA, IMAGE/3000, or HP's distributed systems network.

*An innovative extension to IMAGE, HP3000's data base management system, RDBA adds a new dimension to the concept of distributed processing. With RDBA, programs on one HP3000 get information from a remote HP3000 IMAGE data base just as if it were a local one.*

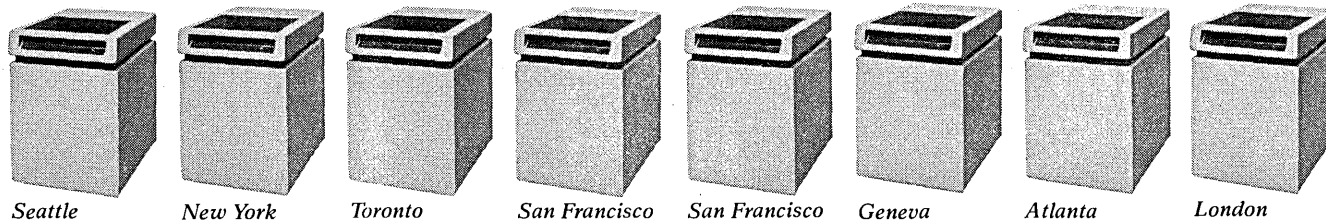

HEWLETT  PACKARD

Computer Advances is written to inform professionals of the latest technical contributions from Hewlett-Packard. You are invited to receive issues at your place of residence or business. Write Carol Scheifele, Computer Advances, Editor, Hewlett-Packard, 11000 Wolfe Rd., Cupertino CA 95014.

# Get a Different Perspective on Computing...

Second only to Americans in the use of computers, the Japanese bring to their applications a different sense of priorities. A preference for custom software over purchased packages. A liking for transaction processing and real-time control.

Come and meet them in San Francisco. See if some of their ideas don't make sense in your shop, and show them how things are done here.

Technical presentations in English by both Japanese and Americans are only a part of the upcoming USA-Japan Computer Conference.

There will be an all-day tutorial program on the Monday before the conference convenes.

Also an exhibit of catalogs from vendors on both sides of the Pacific — hardware, software, and services.

Join us for this third meeting of East and West; the first time this conference is held on American soil. Share common professional and avocational interests with your counterparts from Japan. It's a rare opportunity, one you shouldn't miss.

**3RD USA-JAPAN COMPUTER CONFERENCE  
SAN FRANCISCO**

OCT. 10, 11, 12, 1978

Sponsored by  
The American Federation of Information Processing Societies  
and the Information Processing Society of Japan

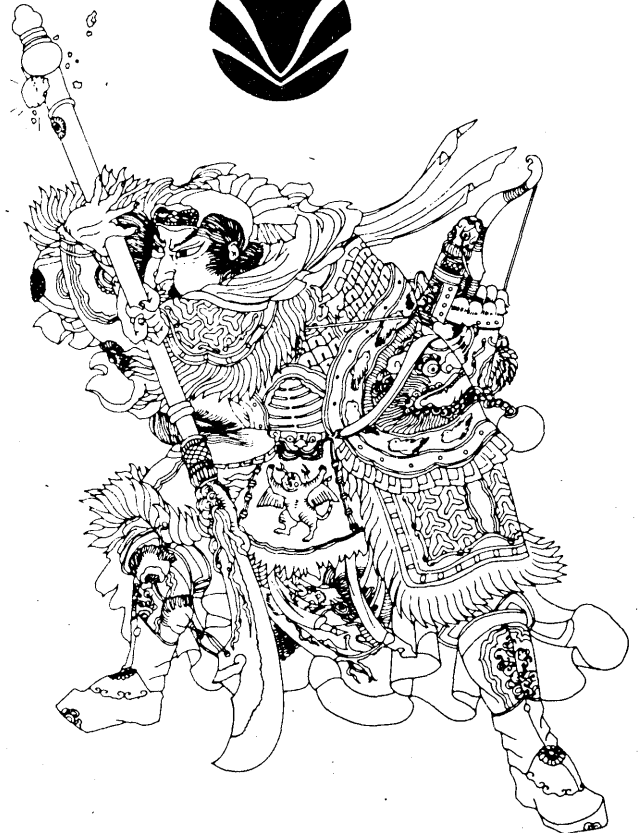

**3RD USA-JAPAN COMPUTER CONFERENCE  
SAN FRANCISCO**

OCT. 10, 11, 12, 1978

Name \_\_\_\_\_

Address \_\_\_\_\_

\_\_\_\_\_ ZIP \_\_\_\_\_

FOR MORE INFORMATION ABOUT THE CONFERENCE,  
PLEASE COMPLETE AND MAIL TO AFIPS,  
210 SUMMIT AVENUE  
MONTVALE, NEW JERSEY 07645

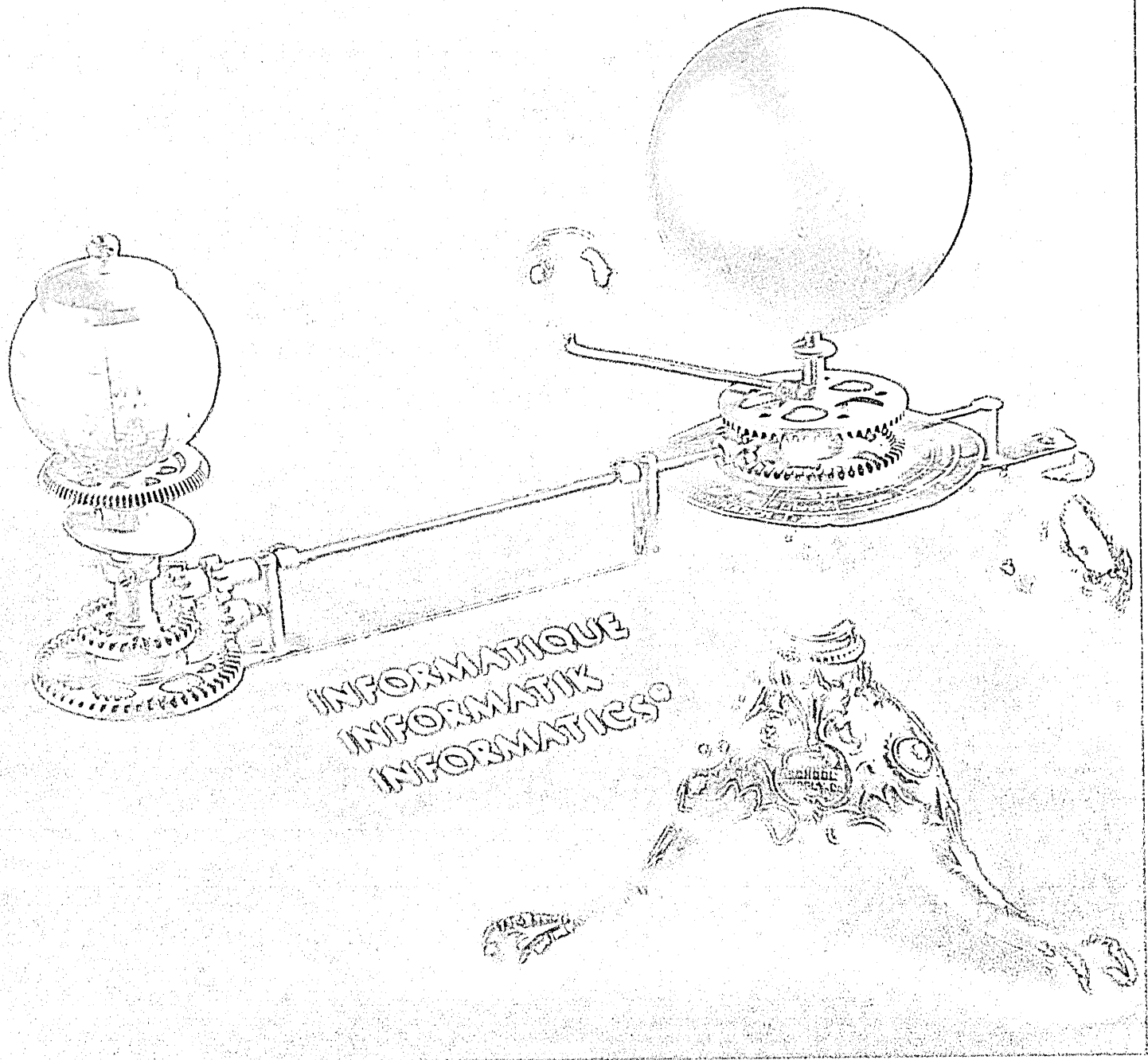

Whatever it's said, however it's spelled, informatics fulfills the promise of the computer...universally!

Set against a background throughout the world, the world is a vast network of computers and data centers with billions of people connected to them. This network is the backbone of the modern world, and it is the heart of the informatics industry. Informatics is the science of the computer, and it is the art of the data. Informatics is the bridge between the physical and the digital, and it is the key to the future of the world.

pieces of software products and services. Drop us a line on your letterhead and we'll send you a colorful brochure that will tell you how we can help you fulfill the promise of your computer.

SOFTWARE PRODUCTS  
PROFESSIONAL SERVICES  
INFORMATION CENTER AND SERVICE

Informatics Inc. EST. 1971

10000 Wilshire Blvd., Suite 1000, Beverly Hills, California 91364 / (213) 887-9040 / Telex 65 8673  
 Informatics Inc. is a registered service mark and trademark of Informatics Inc.

# people

## Famed for His Menagerie

Joe Veno is a very peripheral character in this industry. He wouldn't know a cpu from a transistor; to him, DBM looks like a misprinted logo. Joe Veno is an artist, an independent commercial illustrator, known for his playful and loose style, a cartoonist's spirit that seems more germane to the muppet characters of Sesame Street than the corporate symbols of a mainframe manufacturer.

Yet Joe and Honeywell have gotten along well.

Veno is the artisan who has created most of Honeywell's acclaimed animal menagerie, those homey creatures sculpted of multicolored diodes and widgets that have danced through his promo ads and added panda-bear friendliness to the Honeywell booth at innumerable trade shows.

The 39-year-old Veno works in a small studio on stately Commonwealth Avenue in Boston's Back Bay that is cluttered with paper sculptures, cartoon drawings, posters, and children's games that Veno designed or has in process. A small storage room to the rear is cluttered with boxes of tiny electronic components from Honeywell warehouses.

"I still don't know what these parts are," the bush-mustached Veno admits.

"I'm embarrassed to say it after all these years, but to me they're just color and form elements." When he picks up a new commission Veno visits a local HIS plant and wanders through the warehouse with a shopping cart. "It's always kind of a crazy scene, going through a factory looking for pretty pieces of things," he laughs. "Mostly I get things out of the bins for rejected parts, but in some of the later plexiglass creatures we used some very expensive gold-plated components. But when I'm going through the factory, all these guys are coming up suggesting I use this little thing, pointing out some gadget with a particular color—wanting me to use the pieces they work with."

Veno has been working on Honeywell assignments for "six or seven years," and although he has not been the only artist to have done HIS animals—five or six were involved in the early years, most notably Red Bank, N.J., sculptor Jack Ridder—Veno's work so dominates the menagerie in both number and style that he is generally identified as the series creator.

Yet advertising art, like theater, is a collective art: the style and form are largely Veno's, but the subject and concept are dictated by HIS ad men at Batten, Barton, Durstine & Osborn (BBD&O) and Honeywell's director of advertising, Morey Depman. Veno justly and generously shares credit. If it were not for the Boston office of BBD&O, he would have stayed with his staple work, illustrating children's books and standard copy layouts, and creating games and various displays for *Sesame Street* and *The Electric Company*.

Veno did a kooky paper sculpture for a *Playboy* magazine layout that caught the eye of a BBD&O art director who first asked him to design a skunk for the

Honeywell series then underway. "I was rather hesitant to get into it," said Veno, "I'd never thought of myself as a sculptor; I was really just playing around with paper sculpture. But I did it and they liked it. It was cute, but not too sturdy. I had shaped the form with cardboard, and then glued the little pieces to it. I went from cardboard to using rigid polyurethane, big blocks that I could actually chisel and cut into."

The polyurethane creatures Veno created over the years—the Honeywell camel, lion, fish, eagles, etc.—became the most prominent members of the HIS funny farm. While other artists who had earlier tried their hand had sculpted only a part of the animal, the angle of the head and body needed for a given camera angle (Ridder's bull's head is perhaps the most memorable example), Veno created full-bodied creatures, offering the ad designer the luxury of choosing a camera angle (or several) with the completed work before him—and leaving Honeywell with a stand-alone menagerie that could tour for display.

Last year Veno was asked to redesign the blocky style used in most of the series, to bring in a new, more modern flair. Inspired by Star Wars, he came up with an elaborate plexiglass design; futurist sculptures that capture life in a clear plastic form, and only display computer parts within.

"I was really pleased with them. You can look through and around them; there is little of the solid mass that the earlier animals had. I did a series of three: a tiger, a fox, and the ram. They had movable limbs and eyes that lit up. Crazy! But it was fun, a real challenge."

"Those might be the last of the animals for a while," he added with an impish laugh. "Honeywell seems to think we went too far, but I really like those the best. In my judgment, the ram was the best of what I did. In fact, I'd love to have that one back. . . Commercially, I don't know, but critically, it got rave reviews."



JOE VENO

A very peripheral character.

## He Knows About Bubbles Now

"I didn't even know what a bubble was except for soap bubbles before I joined National Semi last January," said Dr. James Cunningham.

Cunningham has been given the responsibility at National Semiconductor Corp., Santa Clara, Calif., of establishing a new business activity which will develop and market computer microcircuit products based on magnetic bubble domain technology. He has a staff of 13 engineers now which he expects to expand this fall

(Continued on page 42)

# SERIES 700

Distributed Processing Systems





# If your business depends on the flow of information between locations, TI's new Series 700 Distributed Processing Systems can lower your costs and increase your profitability.

Today, business thrives on the efficient exchange of information between remote business locations. The cleaner the data received, the faster the turnaround time. The faster the turnaround time, the lower the operating costs. And the greater the opportunity for a profitable, smoother running operation.

**Control at the source.** TI's new Series 700 Family of distributed processing systems puts powerful user-programmable editing and preprocessing at the source, where data is generated and errors are easiest to spot and correct. That means cleaner data—and cleaner data means a reduced load on your mainframe, and reports that are right the first time.

**Computer compatibility.** Series 700 systems can talk directly to your computer via fast, built-in modems. That lowers your communicating costs and avoids multivendor problems.

**Software compatibility.** All family members speak the same language, TPL 700. This high-level, versatile, business-oriented language permits easy programming and operation by means of video-display-oriented data entry and local terminal processing.

**Print capability.** Series 700 systems can take data as fast as you can send it. Your reports, payroll checks, sales orders and other data can be printed on TI's reliable OMNI 800\* printers right where they're needed.

**Unattended operation.** The communication system can work unattended. Each day's data can be transmitted at night, when rates are low. And your reports can be waiting at every location when work begins next morning.

Built into our Series 700 Family is over 30 years of experience in the electronics industry and the technical expertise and support of our worldwide organization of factory-trained sales and service engineers, backed by TI-CARE†, our computer-automated field service dispatching and information system.

**Your next step.** For the complete Series 700 story, with details on the powerful new diskette-based Model 771, the low-cost 770, and the new high-performance models of the multistation 774, write Texas Instruments Incorporated, P.O. Box 1444, M/S 784, Houston, Texas 77001. Or call your nearest TI district sales office: Boston, 617-890-7400 • Chicago, 312-640-2900 • Clark, N.J., 201-574-9800 • Dallas, 214-689-4460 • Dayton, 513-258-3877 • Denver, 303-751-1780 • Detroit, 313-353-0830 • Houston, 713-776-6511 • Los Angeles, 213-973-2571 • New York, 212-246-6165 • Orlando, 305-644-3535 • San Francisco, 408-732-1840 • Toronto, 416-884-9181 • Vancouver, 604-734-2378 • Washington, D.C., 703-979-9650. Elsewhere, consult your White Pages. 

\* Trademark of Texas Instruments  
† Service Mark of Texas Instruments  
Copyright ©1978, Texas Instruments Incorporated

TEXAS INSTRUMENTS  
INCORPORATED

# TEXAS INSTRUMENTS.

We put computing within everyone's reach.

# people

(Continued from page 39)

when his operation will have its own facility.

"I'd done a lot of work in semiconductor memory," he said, "and there's a lot of commonality." He knows what bubbles are now and is an "absolute" believer in the future for bubble memories. He said he expects National to be introducing its first bubble memories in late 1979 or early 1980. "We're aiming for '79.

"Magnetic bubble technology has only recently emerged as a reliable and economical means of producing computer memory components capable of storing a large quantity of data bits," Cunningham said. "The most promising potential use for bubble memories is in the replacement of mechanical memories, such as magnetic disc and tape equipment."

He sees the potential for such low cost, large memory storage units as "enormous." He estimated that by the end of this decade the domestic market for rotating memory systems and solid state memory components should reach



DR. JAMES CUNNINGHAM  
"... aiming for '79."

\$5 billion annually. He feels some \$50 million of this will be spent yearly on magnetic bubble type memory devices.

One of the attractions of bubble devices, he said, is their nonvolatility. In the event of electrical power failure, stored data would not be lost. "A truly nonvolatile solid state memory has long been sought by computer manufacturers," Cunningham said. "Magnetic bubble memory technology represents a significant step in the direction of insuring against data loss."

He said bubble memories involve disciplines "that are new to the semiconductor industry because while bubbles do involve some of the same production techniques, bubbles aren't actually

semiconductors. The typical bubble design only requires three photo masks, compared with the six or seven usually required for an NMOS or charge-coupled memory device. This simplification in design and processing will be reflected in lowered pricing for the bubble memories."

Unlike rotating memories, he said, "the cost of a bubble memory system is more independent of the capacity. Microprocessor systems often do not require the amount of storage provided by even the smallest disc or tape system. Bubble memories can offer the optimum amount of storage required at a better access time and at a lower price."

Cunningham moved to National from Intersil Corp. where he was senior vice president and manager of the Digital Products Div. A native of Ft. Worth, Texas, he has been a Californian for almost six years and prefers California to his native state.

He holds a PhD in inorganic chemistry and physics from the Univ. of Texas. He was with Texas Instruments for eleven years in various engineering and management positions, serving as manager of the advanced process technology facility of the MOS Dept. in Houston from 1969-1972.

He moved to California to join Cal-Tex Semiconductor of Santa Clara, now a part of Fairchild Semiconductor. There he held the post of vice president of operations, with responsibility for all circuit manufacturing and

process engineering, end-product manufacture, quality control, planning, and plant engineering.

For someone who didn't know what bubbles were last January, he talks knowledgeably about them now. "A typical bubble memory," he said, "might contain between 100,000 and 250,000 memory bits organized in a serial path device. Instead of silicon or another semiconductor material, the bubble memory is constructed on a thin magnetic garnet film. Microscopic domains of magnetic polarization, commonly referred to as bubbles, are moved by means of a moving magnetic field with its lines of force parallel to the plane of the film. The presence or absence of the bubbles is used to designate binary information, and the domains can be added or removed by means of electromagnetic loops along the surface of the film.

"While there are fewer masks, with less crucial alignment tolerances in the bubble memory technology, and while the process requires no diffusion or junction formation steps, it nevertheless is a new and complex area requiring a particularly strong materials capability."

When he has time to forget about bubbles and his organizational duties, Cunningham turns his attention to his hobbies of which, he said, "I have more than I need." These include antique car restoration, growing orchids, and photography.

## In New Posts

DANIEL D. MC CRACKEN, consultant, lecturer, and author, this month begins a two year term as president of the Association for Computing Machinery (ACM) . . . JAMES MARTIN, another author, lecturer and consultant, joined the DMW Group, Inc., Ann Arbor, Mich. as chairman of the board . . . PETER F. W. RAISWELL was named vice president, administration at Threshold Technology, Inc., Delran, N.J. . . . Directors of Scientific-Atlanta, Inc. named JAMES H. COOK and DR. JAMES S. GRAY as principal engineers of the company. . . . JOSEPH E. ROWE, provost of Case Western Reserve University's Case Institute of Technology, joined Harris Corp. July 1 as vice president-technology and human resources . . . Informatics, Inc., announced the promotion of BOB L. BUATT to vice president-customer services for its Equimatics Div. . . . WILLIAM W. CHORSKE was appointed general manager of the Perkin-Elmer Corp.'s Data Systems Group . . . Data Dimensions, Inc.'s directors named RUDOLPH R. MENNA senior vice president and group executive for the firm's Equipment Group . . . JOHN B. FRIED of Battelle's

Columbus Laboratories was named Technical Person of the Year by the Columbus Technical Council, an organization made up of 20 technical societies from the Central Ohio area . . . Lear Siegler, Inc. promoted CHARLES T. SCOTT to president of the Management Services Div., headquartered in Oklahoma City . . . JOHN CLARK was promoted to president of Intel Corp.'s Data Products Group and elected vice president of the parent corporation . . . C. MICHAEL LEDERER, a nuclear chemist, has been named to head Lawrence Berkeley Laboratory's new Information and Data Analysis Dept. (IDAD) . . . JOSEPH A. MICHAEL was elected corporate vice president, information systems for the Coca-Cola Bottling Co. of Los Angeles . . . LESLIE PETROVICH was named western regional sales manager for the Henrix Typewriter optical character recognition scanner used in word processing systems . . . National Computer Systems, Inc., Minneapolis, named JOHN TITUS vice president of a new CDM Div. formed to introduce a computer aided design and manufacturing system.

\*

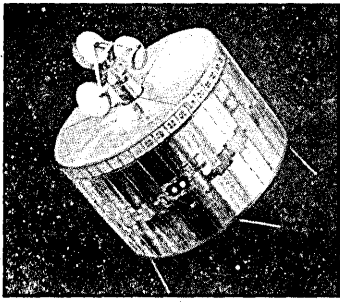

A computer is above all a system, a comprehensive processing tool integrating hardware, software and application technology. Computers are of course sold by many different companies. But few of these companies can offer you a full range of data processing tools — each not only specifically designed for optimal performance but also open-ended for integration into bigger systems.

Fujitsu is one company which can offer this. Fujitsu, Japan's leading computer maker, produces everything from one-LSI-chip microcomputers to the world's most powerful all-LSI computers, as well as a wide range of peripheral and terminal equipment.

FACOM computers are doing big jobs in business and government in many countries throughout the world. And in Japan, the world's second largest computer market, more FACOM computers are installed than any other brand. These powerful, reliable FACOM computers do just about anything. They put satellites into orbit, produce real-time color graphic displays of meteorological conditions, handle funds transfers in on-line systems tying in over 7,000 bank branches, and much, much more.

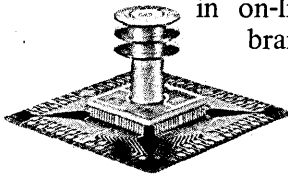

LSI with cooling fins

And all FACOM computers are totally integrated systems, systems in which state-of-the-art technology, powerful software and proven application programs are combined to give you a performance and reliability that can't be beat.

**FUJITSU LIMITED**

*Communications and Electronics*

Head Office: 6-1, Marunouchi 2-chome, Chiyoda-ku, Tokyo 100, Japan  
Telephone: 03-216-3211 Telex: J22833

**FACOM computers are made by Fujitsu,  
a company which puts the emphasis on systems.**



PRODUCTS □ Electronic Computers & Peripheral Equipment (FACOM) □ Telegraph & Data Communication Equipment □ Remote Control & Telemetry Equipment □ Telephone Exchange Equipment □ Carrier Transmission Equipment □ Radio Communication Equipment □ Space Electronics Systems □ Electronic Components

CIRCLE 180 ON READER CARD

# TEAC MT-2: THE VALUE-PACKED CASSETTE DATA PACK

MORE PERFORMANCE FOR LOWER PRICE

## The case for digital cassette

An all-round winner, digital cassette is easier to handle, lower in cost and smaller than floppy disk. Data transfer rate is approximately 40 times faster than Kansas City Standard audio cassettes. And operating cost is considerably lower than conventional data cartridges.

## Maximum reliability

Small size is no detriment to this unit's reliability and precision. Soft error rate is better than  $1 \times 10^{-9}$  bits. MTBF is 10,000 hours—real durability, and tape-life spans an outstanding 1000 passes or more thanks to superior transport design.

## Easier maintenance

The uncomplicated structure of the MT-2 is another big plus. Two reel motors and a disc encoder are the only moving parts—fewer servicing problems, less spare-parts storage and lower maintenance cost.

## Wide-range compatibility

The MT-2 is totally compatible with ISO, ANSI, JIS and ECMA phase encoding standards. You can read tapes recorded on other machines complying to these standards, and vice versa.

## Easy microprocessor interface

The MT-2 is available in four versions, two of which incorporate a unique interface controller developed by TEAC especially for this unit. It features a simplified design, and lets you connect the MT-2 to the bus lines of 8080, 6800 and Z-80 or equivalent series microprocessors for greater flexibility and convenience than conventional, high-priced outboard devices.

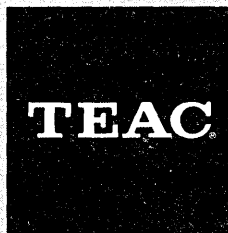
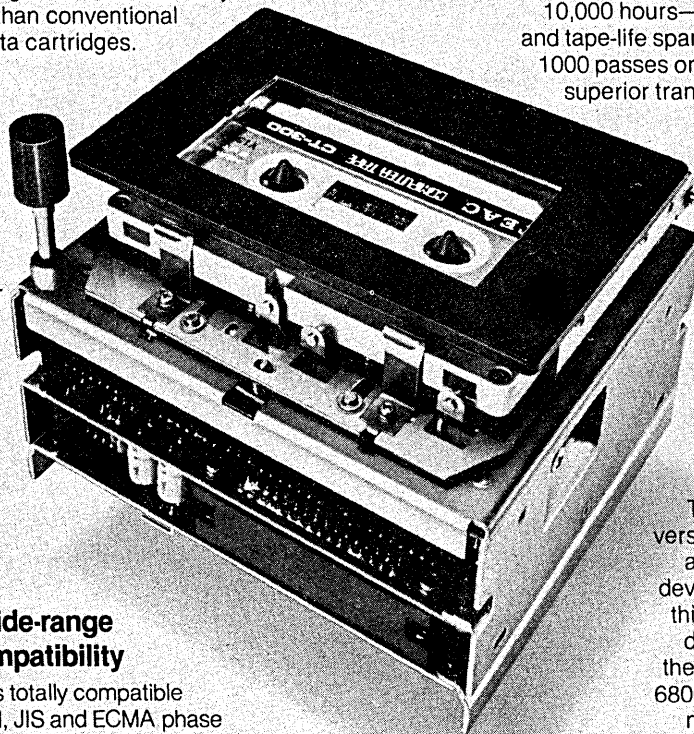

The model pictured here has an Interface controller.

TEAC CORPORATION: 3-7-3, Naka-cho, Musashino, Tokyo, Japan.  
U.S.A.: B.J. Wolfe Enterprises Inc., 10760 Burbank Blvd., North Hollywood, Calif. 91610 England: International Instruments Ltd., Cross Lances Rd., Hounslow, Middx W. Germany: nbn Elektronik Starnberg, 813 Starnberg, Max-Emanuel-Str. 8 France: Tekelec Airtronic S.A., Cite des Bruyeres, Rue Carle-Vernet 92 Sevres Holland: SIMAC

Electronics, Vernstraat 20, Veldhoven Italy: A.E.S.S.E. S.R.L. Corso Lodi, 47 20139 Milano Norway: Rodland & Rellism A.S., Gladengveien 3A, Oslo 6 Sweden: Scantele ab, Tengdahl Sgatan 24, 11641 Stockholm Denmark: Danbit, Plantagevej 23, 2680 Scolrod Strand Switzerland: Wenger Datentechnik, Bruderholzstrasse 45, 4053 Basel Australia: Jacoby, Mitchell Ltd., P.O. Box 70, Kingsgrove, N.S.W. 2208

CIRCLE 103 ON READER CARD

# Nobody can shrink the cost of storing data the way 3M can.

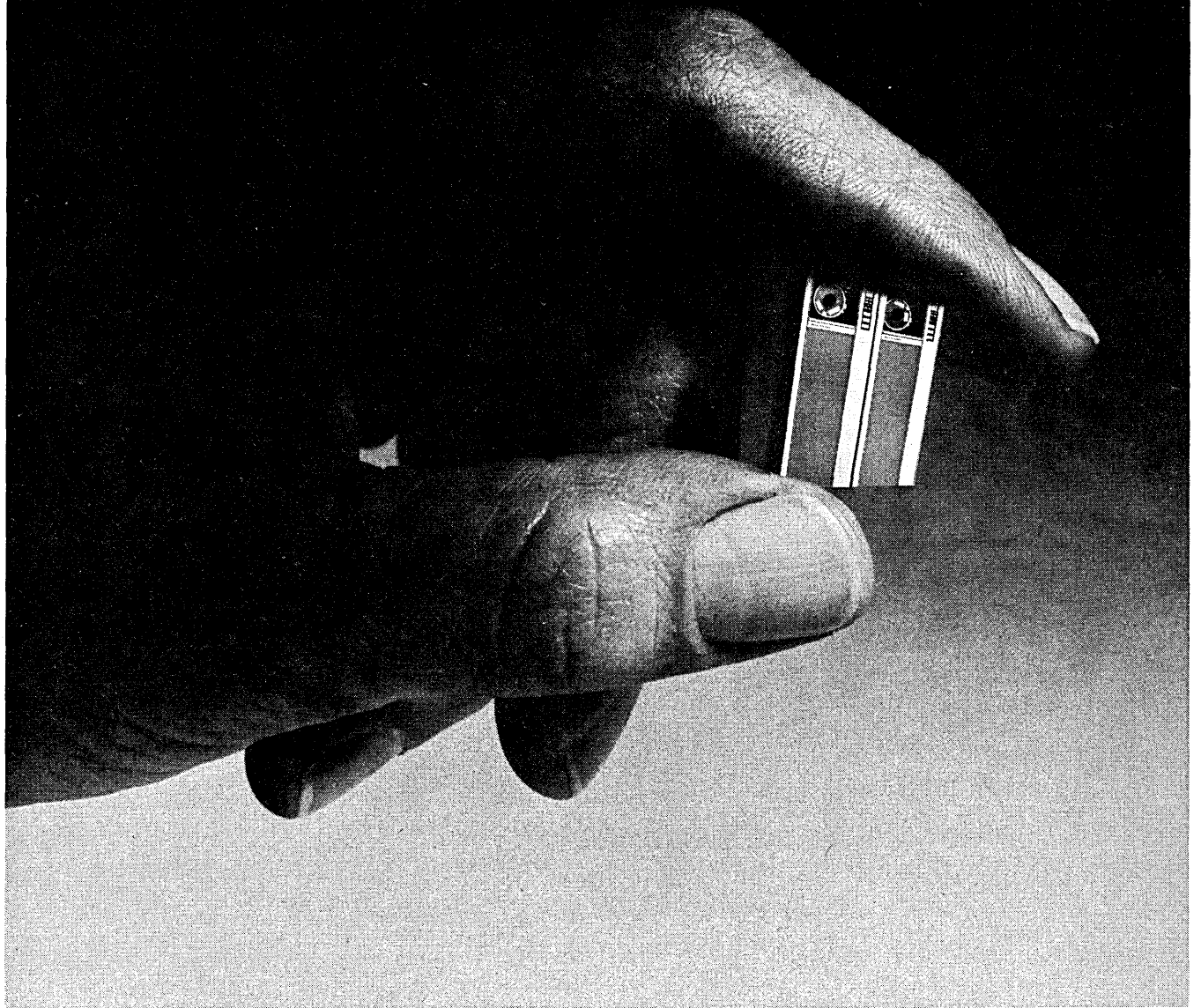

To save money on your company's computers, store less data in them. You can file and retrieve active data just as quickly and for less cost when you marry your computer to a 3M Microfilm System.

You store the data on microfilm. You use the computer to index each document location. So the computer tells you

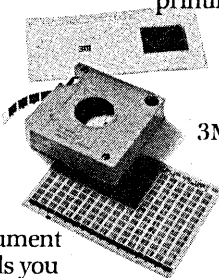

where to find information instead of printing it out. You save costly computer operating time, yet locate documents with pushbutton ease.

Computers and 3M Microfilm Systems. They work together to file and find information quickly and at less cost than either one alone.

Call your local 3M Business

Products Center or write Microfilm Products Division, 3M Company, St. Paul, MN 55101.

**Talk with the microfilm systems people.**

**THE  
MANAGEMENT  
OF INFORMATION**

**3M**  
COMPANY



# “New from Control Data... ...the complete line of miniperipherals for the Series/1.”

“If you’ve already included a Series/1 in your ddp strategy, you should know that you can get even higher performance with our new Certainty Series of miniperipherals. We engineered it around the Series/1 architecture, retaining the important cycle steal feature. And the Certainty Series is available today. A complete line of competitively-priced products to help you get even more out of your Series/1.

“Our display stations for example. No longer must you use expensive video cabling. Or restrict their location to within 500 feet of the cpu. Certainty display stations use low cost digital cabling. So you can put your terminals where your people are—up to 4,000 feet from the cpu.

“Or our Certainty line printer that gives you clean, crisp printing at 720 lpm. It can also cut your paper usage by 30% when you use its compressed pitch option.

“And now you can add up to 240 Mbytes of removable storage with our Storage Module Drive. Now its popular format attaches to your Series/1.

“Controllers? You won’t see any in our product line. Because we’ve incorporated all controllers and interface logic into our hardware. All of these products are ready right now to be plugged into the Series/1.

“And anyone who buys our miniperipherals gets our commitment to remain current with all releases of IBM operating software. Control Data knows how important support is. More than 4,800 Customer Engineers in our worldwide maintenance organization support our products. Our Education Company can train your people. Our Professional Services Division can help you program your applications. Even financing for your purchase is available through Control Data’s financial subsidiary, Commercial Credit.

“Let us show you how our Certainty Series makes your Series/1 strategy even sounder. For data sheets and more information, call today. 612/482-4379.”

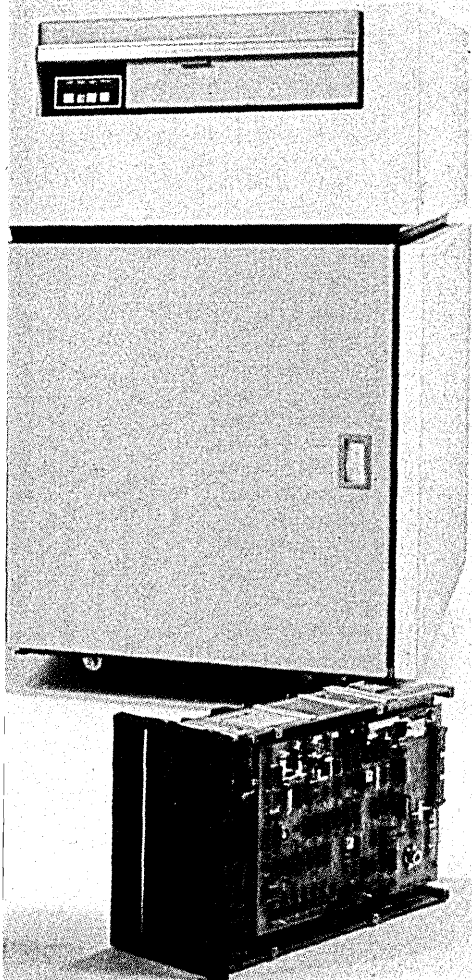

Larry Eaton, General Sales Manager  
Miniperipheral/Terminals Division  
Control Data Corporation

**GD** CONTROL DATA  
CORPORATION

**More than a computer company**

CIRCLE 23 ON READER CARD



**Three formats.  
One machine.**

## Introducing the Micropublisher.

### Bruning's remarkable new fiche enlarger/printer.

Now you can print copies from **COM-generated microfiche**. The unique Bruning 1830 Micropublisher makes sharp, easy-to-read, 8½" x 11" plain-paper copies from your choice of three fiche formats (including COM-generated 48x fiche), all in one machine.

Designed to handle medium-to-high-volume needs, it combines the cost-saving advantages of microfiche with the convenience of a plain-paper copier.

The Micropublisher is also an "intelligent" machine. It monitors and controls all operator and equipment functions with microprocessor technology.

You can program the Micropublisher to generate collated copies of multi-page documents—printing all, some, or any one fiche frame—at speeds exceeding 900 copies per hour.

So, for a remarkably reasonable price, the Micropublisher makes your information system even more efficient.

Get all the facts—see a demonstration at your local Bruning Sales Office. Check our full range of direct lease, lease-purchase and rental plans. Or write Bruning Division, Addressograph-Multigraph Corporation, 1834 Walden Office Square, Schaumburg, Ill. 60196.

**BRUNING**

DIVISION OF  
ADDRESSOGRAPH-MULTIGRAPH



# calendar

## AUGUST

**Data Bases: Improving Usability and Responsiveness, Aug. 2-4,** Haifa, Israel. This small international conference will directly precede the Jerusalem Conference on Information Technology. About 20 research-oriented papers will be presented. Contact program chairman Ben Schneiderman, Univ. of Maryland, Dept. of Information Systems Management, College Park, MD 20742.

**First ACM SIGMINI Symposium on Small Systems, Aug. 2 and 3,** New York. The Distinguished Panel session will feature Capt. Grace Hopper, Dr. M.V. Wilkes and Dr. Randell Rustin. Fee: \$70, \$10 for students. Contact Brad Cox, Tal-Star Computer Systems, Box T-100, Princeton Junction, NJ 08550.

**URISA '78, Aug. 6-10,** Washington, D.C. The annual conference of the Urban and Regional Information Systems Assn. The theme is "Data Requirements and Resources: Federal and Local Perspectives." URISA, 180 N. Michigan Ave., Suite 800, Chicago, IL 60601.

**Tenth Annual Meeting of the National Assn. for State Information Systems, Aug. 14-16,** Denver. Featured speakers will be Bob Hansen of R.J. Hansen and Associates and Vico Henriques, president of CBEMA. NASIS, P.O. Box 11910, Lexington, KY 40578.

**Structured Systems, Aug. 14-15,** Washington, D.C. Immediately followed by a two-day workshop on Structured Techniques. Contact AIIE, P.O. Box 3727, Santa Monica, CA 90403 (213) 450-0500.

**International Conference on Parallel Processing, Aug. 22-25,** Bellaire, Mich. Dr. Charles S. Elliott, College of Engineering, Wayne State University, Detroit, MI 48202 (313) 577-3812.

**Second International Conference on Computer Applications in Fermentation Technology, Aug. 28-30,** Philadelphia. Contact Dr. William B. Arminger, BioChem Technology, Inc., Suite A-109, Gulph Mills Village, King of Prussia, PA 19406.

**Eighth Australian Computer Conference, Aug. 28-Sept. 1,** Canberra City, Australia. The theme is to be "Computers in the Service of Society." Contact P.J. Claringbold, chairman, Box 448, Canberra City A.C.T. 2601.

**Third Berkeley Workshop on Distributed Data Management and Computer Networks, Aug. 29-31,** San Francisco. Contact Bruce Burkhart, Computer Science and Applied Mathematics Dept., Building 50B, Room 3209, Lawrence Berkeley Laboratory, Univ. of California, Berkeley, CA 94720.

## SEPTEMBER

**COMPCON '78, Sept. 5-8,** Washington, D.C. Scheduled are tutorials on computer networks and computer communications protocols, as well as sessions on a variety of subjects related to networking. Contact COMPCON Fall, P.O. Box 639, Silver Spring, MD 20901.

**Seventeenth Annual Lake Arrowhead Workshop on Data Management and Storage Hierarchies, Sept. 6-8,** Lake Arrowhead, Calif. Concepts, methods and technology for optimization of storage hierarchies supporting data bases will be the focus of the workshop discussions. Contact Harut Barsamian, conference chairman, Sperry Univac 2722 Michelson Drive, P.O. Box C-19504, Irvine, CA 92713 (714) 833-2400.

**Software Quality Management Conference, Sept. 11-13,** Washington, D.C. Emphasis will be on a realistic approach to the generation of quality software and on fundamental principles of software acquisition. Contact SQMC, P.O. Box 11046, Alexandria, VA 22312 (703) 354-1657.

**Personal & Business Small Computer Show, Sept. 15-17,** New York. Personal Computing Expo Inc., 78 East 56 St., New York, NY 10022.

**Wescon/78, Sept. 12-14,** Los Angeles. Western Electronic Show and Convention, sponsored by the San Francisco Bay Area and Los Angeles Councils, IEEE; and Northern and Southern California Chapters, ERA (Electronics Representatives Assn.). 999 Sepulveda Blvd., El Segundo, CA 90245 (213) 772-2965.

**Tenth Annual SMIS Conference: A Decade of Evolution, Sept. 17-21,** Washington, D.C. Contact Mr. C.O. Smith, conference chairman, U.S. General Accounting Office, 441 G. Street, N.W., Washington, D.C. 20548 (202) 275-6572.

**An APL Users Meeting, Sept. 18-20,** Toronto, Canada. Contact Ms. R. Wild, I.P. Sharp Associates Ltd., 145 King St. West, Toronto, Ontario M5H LJ8 Canada.

**Convention Informatique 78, Sept. 18-22,** Paris. The themes to be discussed are: the integration of data processing into operational and management services of organizations and companies, and the parameters to be taken into account in designing information systems for use in different phases of future projects. Contact the Convention Informatique Secretariat, 6, Place de Valois, 75001 Paris, France.

**Third U.S.A.-Japan Computer Conference, Oct. 10-12,** San Francisco. An all-day tutorial program is to be offered on the Monday preceding the conference. Also offered will be technical tours of local computer-related facilities, scheduled to

*(Continued on page 52)*

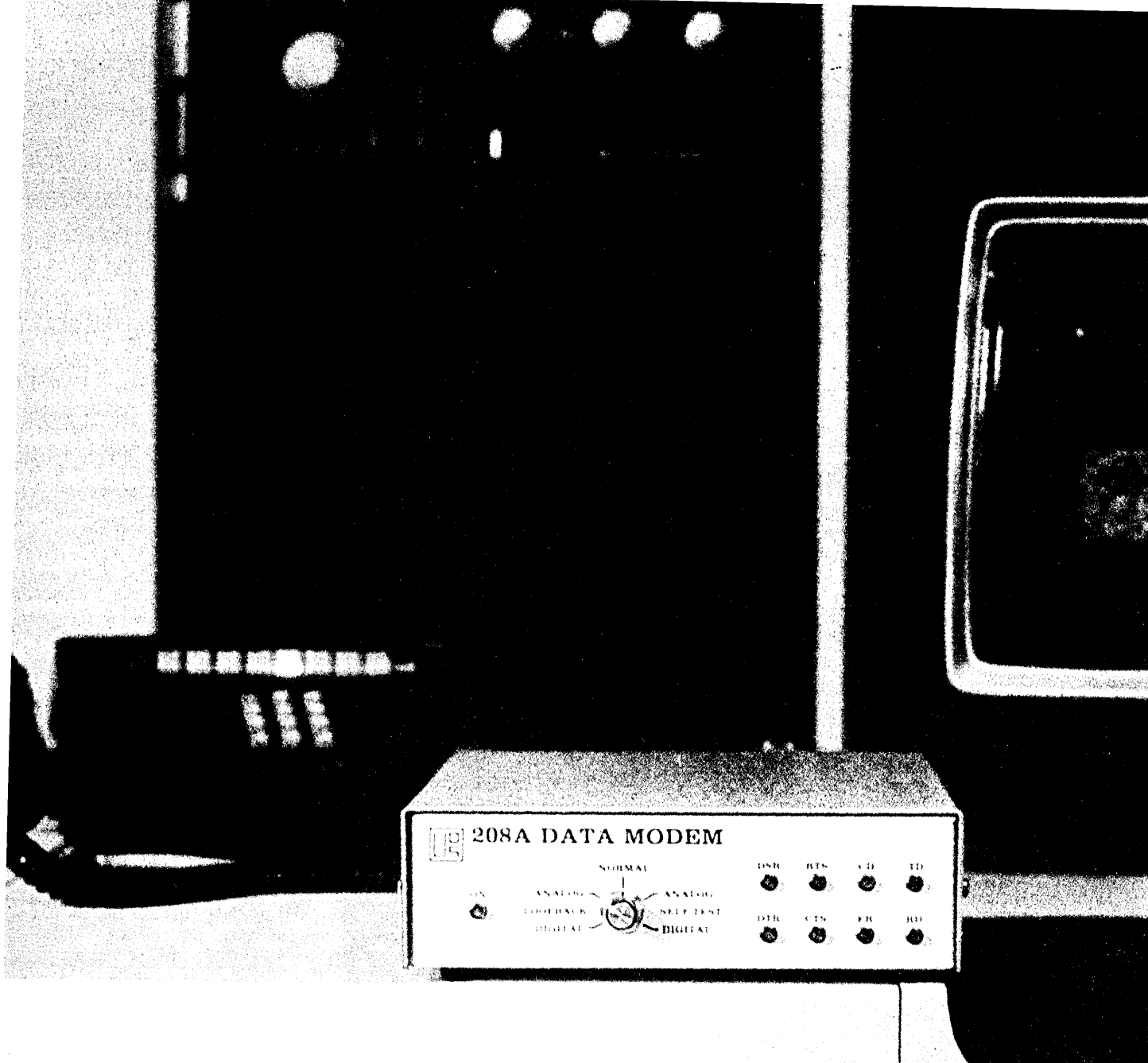

## UDS announces a 4800 bps Bell-compatible microprocessor modem.

UDS has leapfrogged current LSI technology with nanosecond microprocessor performance! All components are industry standards — no custom or single-source parts are used.

- **Bell compatibility.** Available in 208A (four-wire) and 208B (two-wire) configurations, one-third Bell's size.
- **Reliability.** A drastic reduction in total number of components results in a longer MTBF.
- **Multi-channel opportunity.** A 7" x 19" rack-mountable enclosure accommodates up to eight single-channel cards.

- **Cost/effectiveness.** Microprocessor power and innovative design make the UDS 208 your best buy for data communications at 4800 bps.

For further details on the UDS 208 or our lower speed modems (103s, 201s, 12 • 12s etc.) contact Universal Data Systems, 4900 Bradford Drive, Huntsville, AL 35805. Phone 205/837-8100; TWX 810-726-2100.

 **universal data systems** MEMBER OF  
UDMA  
Confidence in Communications.

# UDS spare modems express to you, anytime

Through a special arrangement called "PARTS BANK," UDS has joined forces with Federal Express to offer you around-the-clock availability of standard modem spares.

When you install UDS modems you'll be given an "800" telephone number and a confidential code number. Then, if you have a problem you simply call Federal Express, give them your code number and your requirement and your replacement modem will be on the next plane out. Average door-to-door response time: six hours.

We don't expect you to have a lot of trouble with UDS modems, but when you do, you can have confidence that spares are immediately available. We've set it up expressly for you.

**universal data systems**

MEMBER OF  
IDCMA



Confidence in Communications

CIRCLE 74 ON READER CARD



Universal Data Systems, 4900 Bradford Drive, Huntsville, Al. 35805. Phone 205/837-8100

Created by Hall & McKenzie, Inc., Winter Park, Florida

Sooner or later,  
the ultimate  
data communications  
test instrument  
had to be developed . . .

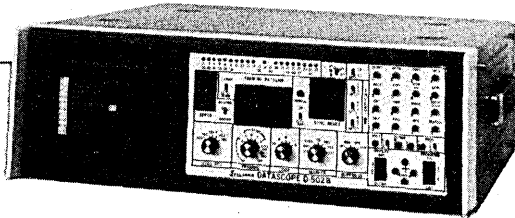

## Spectron D-502B Datascope

**The most versatile and powerful  
data communications test instrument  
available today**

**Use it as a simple line monitor** ■ Simple, direct monitor operation, no "programming" necessary ■ Large clear-text display to simplify data interpretation ■ Compatible with all line disciplines, protocols, and codes

**Use it as a powerful line analyzer** ■ Simple programs extend basic monitor capabilities ■ Measure line performance—on-line—using actual transmissions ■ Locate complex character strings and data exchanges easily

**Use it as a complete line simulator and tester** ■ Test software, modems, communication lines, terminals—on-line or off-line ■ Simulate any protocol and line discipline ■ Monitor both test sequence and response

Now you can solve your data communications problems with the Spectron D-502B Datascope—a versatile, multi-purpose test instrument that lets you do more things better, and do them economically, and without sacrificing quality or simplicity of operation.

As a monitor, the D-502B will help you isolate software, hardware and communication problems quickly and easily. As a line analyzer, the Datascope is designed to make important measurements of line utilization, response times, block error rates, and more—with equal facility. As a line simulator and tester, the D-502B will enable you to test new software without tying up communication facilities, test and debug new lines, modems and terminals off-line without risking adverse effects to the on-line network, or test lines dynamically, varying response times, data rates, etc. to determine the most economical and reliable way to optimize network performance. All available in an instrument which is as easy to use by operating and field service personnel as it is by programmers and engineers.

**SPECTRON**  
CORPORATION

P. O. Box 620  
344 New Albany Road  
Moorestown, NJ 08057  
609/234/5700

CIRCLE 149 ON READER CARD

## calendar

(Continued from page 49)

avoid conflicts with the conference program. Some topics of particular interest are: medical computing; distributed computing; very large scale integration, including design automation; reliability, including software validation; and memory technologies, including bubble and CCD. 3rd USA-Japan Computer Conference, c/o AFIPS Headquarters, 210 Summit Ave., Montvale, NJ 07645.

**Foundations of Computer Science Symposium, Oct. 16-18,** Ann Arbor, Mich. Papers presented will deal with original research in the theoretical aspects of computer science, including analysis of algorithms, automata and formal language theory, data structures and data bases. Contact Prof. William C. Rounds, Computer Science Dept., Univ. of Michigan, Ann Arbor, MI 48109.

**INFO 78, Oct. 16-19,** Chicago. The 5th International Information Exposition & Conference. Conference sessions will cover information management, information technology, and office automation, with special sessions for manufacturing companies, banks, insurance companies, hospitals, financial management, marketing, and small businesses. The emphasis is to be on applications rather than technology, with the purpose of demonstrating how executives can make operations more productive by improving existing information systems or creating new ones. Clapp & Poliak, Inc., 245 Park Ave., New York, NY 10017.

### CALLS FOR PAPERS

Communications Changing the World will be the theme of a conference next June in Boston. Original papers in the field of communications research, technology and operations are sought. Intention to submit a paper is due Sept. 30 to Dr. John Logan, chairman, ICC '79 Technical Program, Bell Telephone Labs, 1600 Osgood St., North Andover, MA 01845 (617) 681-6306. Complete papers including a one-page abstract stating clearly why the contribution is important are due November 15.

Papers are being solicited for the 1979 International Symposium on **fault tolerant computing** including but not limited to the following subjects: fault-tolerant systems architecture, distributed systems and operating systems; reliability and languages; system testing and diagnosis; LSI logic and memory testing; fault simulation; and error-detecting and correcting codes and applications. Four copies of an abstract of not more than 200 words are due Nov. 1 to Gerald M. Masson, Dept. of Electrical Engineering, The Johns Hopkins Univ., Baltimore, MD 21218 (301) 338-7013.

Computer specialists and data processing users are invited to write a paper, propose a technical or panel session, volunteer to be a panelist, send ideas for topics, or suggest special activities, demonstrations or conference features by November 1, 1978 for next year's NCC (National Computer Conference). For a copy of the official Call for Participation contact AFIPS, 210 Summit Ave., Montvale, NJ 07645. Suggestions, proposals and papers should be sent to the program chairman, Dr. Richard E. Merwin, Box 32222, Washington, D.C. 20007. Papers must be submitted in six copies with six copies of a title page containing a 150-word abstract, four to six keywords, author's affiliation, telephone number, and mailing address. \*

For Clapp & Poliak Circle 11 on Reader Card →

**DATAMATION**

# Tom, Dick and Harriet have one thing in common.

## They're all coming to Interface West.

### Tom is a business executive.

The company he founded five years ago had no need for automated business procedures. Manual was fine. Now things are different. Business is growing, and so is the need for controls. Tom knows he can get those controls and lower his costs by using a small computer, word processing, telecommunications, facsimile, micrographic or other "here today" system, software package or service. He has many alternatives, some of which may be better for him than others. That's why he and others within his company are coming to Interface West. To discuss these products with exhibitors. And to learn about their use.

### Dick is an engineer.

While in college, he used his school's timesharing terminal and FORTRAN to design analog control circuits with discrete components. Today he uses his company's microcomputer development system to design digital interface circuits with microprocessors and LSI. Dick realizes that today's designer must be as adept with software as with hardware. That's why he's coming to Interface West, and why he's taking his staff with him. Interface West is where hardware people learn software and software people learn hardware. It's where they find the micro development tools that can save them time and money.

### Harriet is an information systems manager.

She and her staff work for a large corporation with a centralized EDP system. Now the company is moving into data communications. Harriet realizes she needs to know about the latest datacomm concepts. That's why she's coming to Interface West. What she learns there about networking strategies, distributed data processing, terminals, software, and communications services will help her make better decisions. Members of her staff plus the company treasurer will also be coming to Interface West. They may require training in data communications. They, too, need to see, on the exhibit floor, what different datacomm system, equipment and service suppliers offer.

## Everybody's Coming to Interface West

November 14-16, 1978 • Los Angeles Convention Center • Los Angeles, California

For information, call toll-free (800) 225-4620. In Massachusetts, (617) 879-4502.



# INTERFACE WEST

Co-Sponsored by **DATAMATION** Magazine

# source data

SOURCE DATA provides information on books, courses, references, reports, periodicals, and vendor publications.

## books

**Algorithms for RPN Calculators**  
by John A. Ball \$17  
John Wiley & Sons, 1978 342 pp.

For anyone who owns or contemplates owning an RPN (Reverse Polish Notation) calculator, this delightful and singular book will serve as a valued addition to the user's manual that generally comes with this class of machine. The author, who (among many other credits) is a radio astronomer at the Harvard College Observatory, brings to his subject the discipline and precision that one might expect from members of his profession and, in addition, shows a level of wit and humor that almost compels the reader to complete the first reading in one sitting.

One of the interesting touches the author employs is the introduction of every chapter with an apt quotation or two to place the reader in the proper frame of mind. For instance, his chapter on iterative solutions of elementary transcendental equations starts out with Shakespeare, "... damnable iteration ... able to corrupt a saint."

Another example of his wide scope of interest is that in addition to keying his algorithms to one or more of the 11 Hewlett-Packard calculators (and others), he describes in some detail calculators of his own design, ranging from an "El Cheapo, model A," which is a stack processor that might compete in cost with a four-function calculator, to a "model B" which does complex arithmetic, to a plotting calculator that makes at least as much sense as, say, a calculating watch combination.

The serious content of the book is about evenly divided between the narrative, with example and exercises, and the Appendix. The first section introduces the reader to RPN, discusses what the author means by a *good* algorithm (fewest keystrokes with each parameter keyed in only once; of secondary importance is the rate of convergence), and describes iterative solutions, curve fitting, numerical integration/differentiation, and suggestions for future developments. The Appendix deals with a variety of topics but the author notes that, not surprisingly, the subjects are

tilted in the direction of astronomy problems. In addition to extending in detail the work already mentioned, Dr. Ball includes problems involving calendar and sidereal time, atmospheric refraction, Doppler velocities, astronomy and radio astronomy formulas, electrical engineering, trigonometry (plane and spherical), money with interest (necessary for proposals and grants, no doubt), and a section of miscellaneous problems.

My one minor reservation about this excellent text is that, probably with the idea of saving space, some of the procedures, while referenced, are not well described mathematically and therefore become mere examples unless one translates the keystroke figures backwards to the formula. Also, many of the iterations are only practical on a programmable RPN calculator due to their reliance on iterations and convergent series methods for their approximation. Nevertheless, I doubt that a better collection of algorithms and aphorisms can be found for the serious RPN enthusiast with an interest in scientific problems.

—J.C. Alrich

## BOOK BRIEFS . . .

**Etudes for Programmers**  
by Charles Wetherell  
Prentice-Hall, Inc.  
Englewood Cliffs,  
NJ 07632 (1978)  
200 pp. \$12.95

"Any professional effort to provide us with tools by which the computer will augment our creative capabilities instead of just forcing on the user its brute-force approach for routine operations should not only be encouraged but our work, our funding, and our institutional environment should be geared to this effort," says M.S. Elzas in "Whither Simulation?" a discussion paper from these proceedings.

The conference was held on April 4-6 and covered mostly continuous simulation, but also some discrete aspects. Some of the topics covered are hybrid techniques, physiological and medical applications, chemical and industrial processes, discrete simulation languages, continuous simulation languages, corporate and economic modeling numerical techniques, aerospace applications, hardware aspects, mechanical and electrical systems, and control applications. Conferences are held at three-year intervals (approx-

mately) and the Society for Computer Simulation (scs), of which UKSC (United Kingdom Simulation Council) is a member, also publishes a journal, *Simulation*, and holds regular local meetings. scs can be reached at P.O. Box 2228, La Jolla, CA 92038.

## RISS: A Relational Data Management System for Minicomputers

by Monte Jay Meldman, Dennis J. McLeod, Robert J. Pillicore and Morris Squire

Van Nostrand Reinhold  
New York, NY 10001 (1978)  
113 pp. \$13.95

RISS stands for Relational Inquiry and Storage System. Included in the description are design approach and structure, and both a naive-level and applications-level interface. The system is designed for organizations with small- or medium-scale needs and limited budgets. The authors' work in developing RISS was at Forest Hospital in Des Plaines, Ill., where it has been used for, among other things, payroll, inventory, test scoring, research studies, and statistical tabulations for three years. The language is BASIC-Plus.

## Proceedings of the 1978 UKSC Conference on Computer Simulation

IPC Science and Technology Press  
Surrey, England  
568 pp. \$57

Aimed at helping the learning programmer develop skills of "observation, research, analysis, and a pleasing expressiveness," along with the more obviously necessary aspects of the craft such as orthography and grammar, this is a book (as the name implies) of programming exercises. The author's assumption is that the complexities of the programming skill require learning through experience, hence the format; each *etude* presents a "real world" situation, specifications for the program to be written, and a discussion, as well, of difficulties that are apt to be encountered and hints for solutions. The text is well-written, and humorous, to boot.

## Structured Walkthroughs

by Edward Yourdon  
Yourdon, Inc. 1978  
137 pp. \$12

This is a very basic step-by-step "how-to" guide to walkthroughs—"peer group reviews of any product," in this case of

(Continued on page 66)

# Meet the logical solution to those illogical computer network problems... HP's new Serial Data Analyzer. It's easy to use, flexible and low cost.

With simple matrix programming, the 1640A Serial Data Analyzer is ready to monitor an RS-232C (V24) interface, measure time intervals or simulate a network component. And mylar overlays, pre-labeled for your application, reduce set-up time and errors.

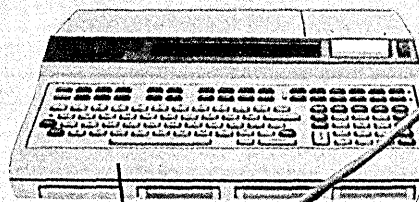

Need more diagnostic power? Then link the 1640A to a computing controller via the HP-IB\* (optional) for additional capabilities such as user programming, remote control, mass data storage and data manipulation.

Real-time display of FDX data in ASCII, EBCDIC or Hexadecimal (other codes optional), continuous display of trigger specifications, and clear display of measurement results all add up to a convenient presentation of "what's happening" in your computer network.

You don't have to be a programmer to use the 1640A; no instruction sets to learn... no writing or debugging programs. A menu set-up concept with keyboard parameter entry, pre-programmed measurement execution and transparent "wake-up" mode make the 1640A easy to use—even for semi-skilled operators.

This new, low-cost Serial Data Analyzer lets you quickly identify and isolate problems to the network component level. Flexible triggering lets you trap on data errors, time-interval violations, or invalid protocol sequences. You can find most problems in a non-intrusive, "monitor" mode. But for subtle problems, or for loop-back tests, the 1640A also simulates the CPU, terminal or modem. Of course, you can operate with any combination of transmission modes—Simplex, Half Duplex, or Full Duplex, two- or four-wire links, synchronous or asynchronous operation, and up to 9600 bps (19200 HDX) data rates.

Whether you're integrating a minicomputer with a few terminals, or analyzing a complex, centralized CPU-based communication network, HP's 1640A, priced at \$5800\*\*, gives you a sensible solution that reduces costly system debugging time.

Available options include the HP-IB interface (\$300\*), SDLC/HDLC (\$200\*) and LRC, CRC-16 and CRC-CCITT Checking/Generation (\$150\*).

Find out how HP's 1640A can help simplify your computer network analysis. Get the details today from your local HP field engineer.

\* HP's implementation of IEEE 488-1975.

\*\* Domestic U.S. price only.

089/6



1507 Page Mill Road, Palo Alto, California 94304

For assistance call: Washington (301) 948-6370, Chicago (312) 255-9800, Atlanta (404) 955-1500, Los Angeles (213) 877-1282

CIRCLE 58 ON READER CARD

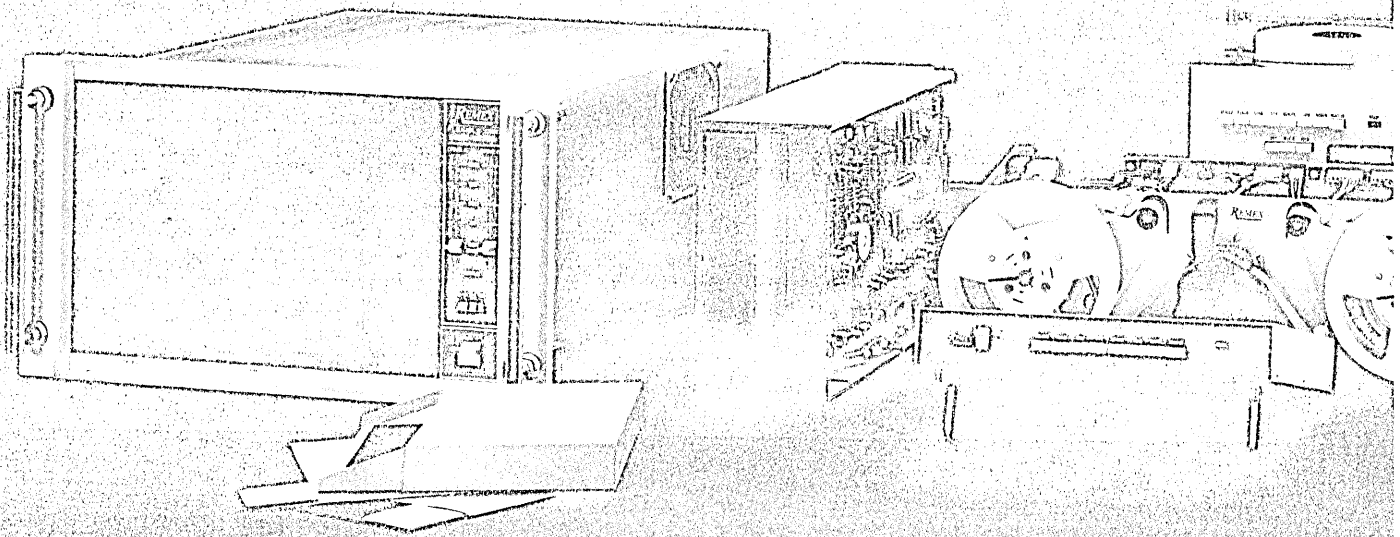

# Paper isn't the only it

You think of Remex as the world leader in punched paper tape peripherals. Sure, we stand with And our products and service improve it.

For nearly 20 years, we've offered the broadest selection of tape transports, readers, reader/spoolers, punches, perforators, combination units, computer interfaces, and communications gear — over 400 models in all.

Including a new family of handsome desktop punched tape systems complete with a built-in MS/ASC serial interface.

Over 100,000 Remex punched tape peripherals are still operating in the field — some for over 15 years.

But paper isn't the only place where Remex looks good. We are, in fact, a leading manufacturer of quality mechanical engineering equipment, not just punched tape alone. Products like advanced flexible disk drives and systems you can benefit from today — not just on paper.

One built-in formatter drive (costs you \$50,000) robot to format OAMs.

Instead of spending the \$50,000 or so needed to develop a good flexible disk controller to matter, you can simply use ours — built right into the drive itself.

You save design dollars, time — and the space required by a separate controller board. And you have the quality and good nationwide service support Remex is known for.

Remex reputation as the solid aluminum.

Think about it. Nearly twenty years of electro-mechanical sales and service. That's why the Remex drive mechanism is capable of 20,000 hours of normal use. Here's how we do it.

We use thick, solid castings instead of fabricated sheet metal. When you're talking about the elastics on diskettes today, you're talking tolerances too close for bare sheet metal.

We also use a V-groove lead screw with ball



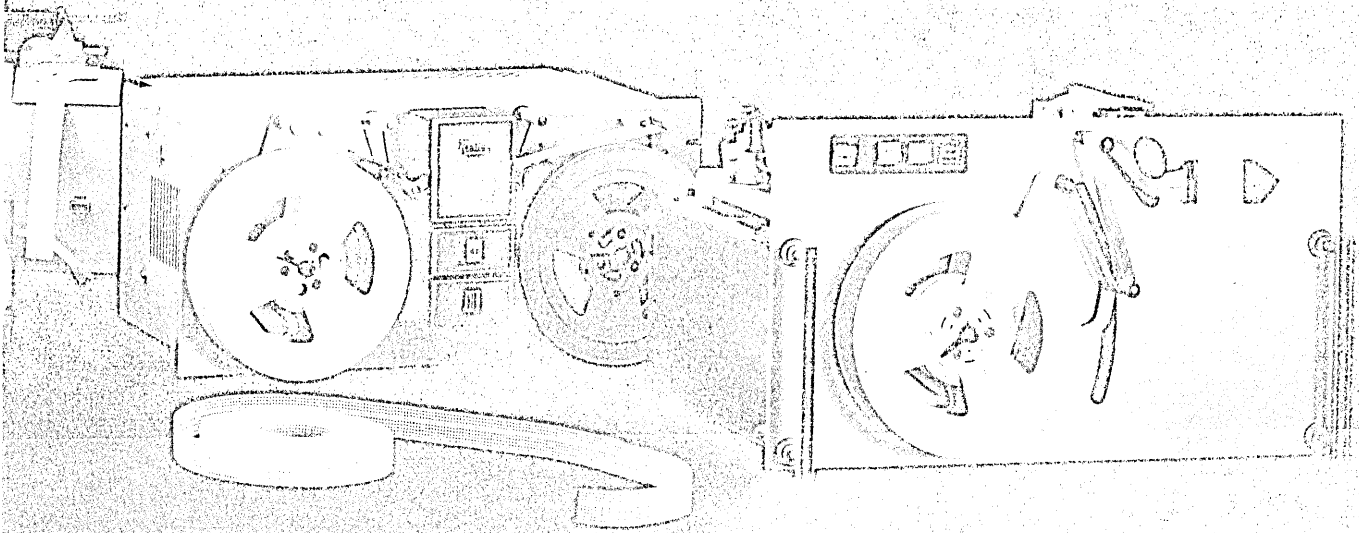

# ing we look good on.

flexible drive control. The head always perfectly centered on each track, because the read/write head/instead of side-to-side. No stop.

## Something special for RP/RT and RST/RT users.

A completely optimized flexible disk system dedicated to improving throughput and capacity.

With our new Remex-III flexible disk system you get a complete hardware/software package. And a choice of operation modes:

You can operate DEC's way within the constraints of RPL/RT.

Or you can enhance the performance of RPL/RT by switching, literally, from 16 sectors per track format. You gain an instant 25 percent increase in capacity and a 19 percent increase in throughput.

Or, in special applications, you can take full advantage of Remex hardware such as transferring multiple sectors of up to 65K words with positive commands. Or formatting diskettes with just one

We've even designed the Remex-III so you can communicate with both DEC and IBM 3840 prepared diskettes—with no loss of RPL/RT compatibility. The system supports up to four disk drives.

Indeed, Remex can provide you with a true capability now at no extra charge.

Specifications and other information you need regarding drives, systems, and much more are yours for the asking. Write or call Ex-Cel-O Corporation, Remex Division, 11733 East Allison Street, P.O. Box 019533, Irvine, CA 92713. Phone 714/557-6860. TWX: (310) 595-1745.

**Ex-Cel-O Corporation**

**REMAX DIVISION**

# source data

(Continued from page 62)

a program's code, flowcharts, or functional specifications. Contrary to its implication, the title refers not to some new kind of walkthrough but to the author's assumption that the reader is familiar with structured programming, design, and analysis. The focus of the book is on teamwork and the roles and responsibilities of walkthrough participants. There are sections on the psychology of programming and on management's role in walkthroughs.

## reports & references

### Technical Review Guide

The "Ethnotechnical Review Handbook," by Daniel P. Freedman and Gerald M. Weinberg, is a how-to guide to the formal technical software review. Arranged in question/answer format, the handbook covers the subject thoroughly, beginning with suggestions for

the selection of reviewers and including sections on conducting the review, suggested types of review reports, and types of materials reviewed. The handbook is designed to be a working tool, and gives many samples of checklists, summary forms, etc., as well as down-to-earth job-related specifics. The handbook comes in loose-leaf form to encourage the review team to add and edit information as seen fit. \$35. ETHNOTECH, INC., Rural Route Two, Lincoln, NE 68505

### Computer Services

ADAPSO's yearly study of the computer services industry is now available. Over 95% of the processing services, software, and professional services companies in the U.S. were included in the survey, conducted by INPUT, the research arm of ADAPSO. The study includes analysis by company size and type, the impact of mini/microcomputers, market forecasts, and profitability related to market, product mix, growth rates, and sales costs. The report is free to ADAPSO members and \$95 to nonmembers, with additional copies priced at \$50 each. INPUT is at Park 80, Plaza West-1, Saddle Brook, NJ 07662.

### Structured Analysis and Design

A two-volume, 646-page study of structured analysis and design has been published as the first 1978 Infotech State of the Art Report. The first volume discusses fundamentals such as the nature of design, the software life-cycle, and modularization; design tools, strategies, and representation; and discussion and comparison of four of the principal design methodologies now in use: SADT, the Jackson methodology, the Warnier-Orr Methodology, and Structured Composite Design. Volume two consists of nineteen invited papers; some examples are "Creative, Evolutionary System Analysis and Design," "MBA: A System for Semi-Automatic Documentation of Business Application Programs," and "The TOPD System for Computer-Aided System Development." Available for \$260 from AUERBACH PUBLISHERS, INC., 6560 N. Park Drive, Pennsauken, NJ 08109.

### Data Base Planning

Performance Development Corp. has published a modest-looking but comprehensive guide to data base planning called the "Service Analysis Handbook." Service analysis is a structured methodology for researching the business requirements that a data base system must satisfy; the "service" in this context is the smallest possible unit of the computer output, input and processing function. Chronologically, service analysis comes after the initial review of

(Continued on page 70)

# INFONATIONAL

## WILL SET THE PACE



We keep up in accounting trends with:

- ON-GOING ENHANCEMENTS
- PROFESSIONAL CONSULTING
- REPORT FLEXIBILITY

**RUN WITH THE BEST  
IN INTEGRATED ACCOUNTING SYSTEMS**

# INFONATIONAL

A Division of United Computing Systems, Inc.

For the most cost-effective easy-to-operate, integrated accounting systems, call (714) 560-7070 or mail in this coupon.

**INFONATIONAL**  
A Division of United Computing Systems, Inc.

6626 Convey Court  
San Diego, CA 92111  
(714) 560-7070

OFFICES  
New York  
Chicago  
Houston  
Los Angeles  
New Zealand  
Australia  
England



NAME: \_\_\_\_\_  
TITLE: \_\_\_\_\_  
COMPANY: \_\_\_\_\_  
ADDRESS: \_\_\_\_\_  
CITY: \_\_\_\_\_  
STATE: \_\_\_\_\_  
ZIP: \_\_\_\_\_  
PHONE: \_\_\_\_\_  
COMPUTER TYPE: \_\_\_\_\_

I AM INTERESTED IN:

- GENERAL LEDGER
- ACCOUNTS PAYABLE/  
PURCHASE ORDER
- FIXED ASSETS  
ACCOUNTING
- ACCOUNTS RECEIVABLE/  
SALES ANALYSIS

CIRCLE 131 ON READER CARD

# Muddled in the Matrix Maze??

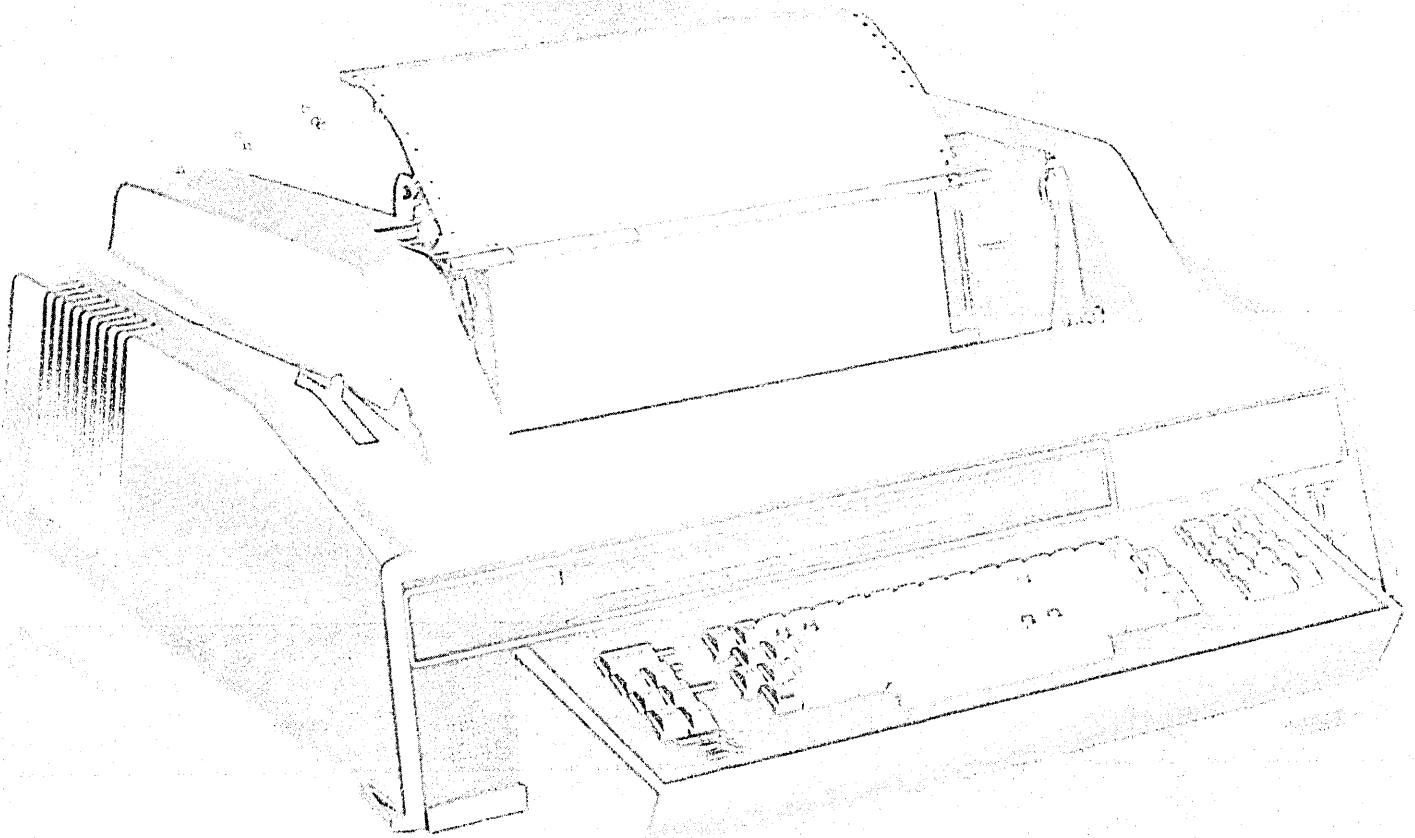

Suddenly, there's a clear answer — General Electric's new Terminet® 200, a matrix printer line designed with the user in mind.

Able to grow with your system and change with your needs, the Terminet 200 offers so much built-in speed, performance and versatility, we call it "the Complete Matrix Printer."

Speed: 120 cps with a skip rate of 600 cps.

Performance: 20 ips slow rate for paper handling from 2 to 14½" widths and nine copies thick, plus a 1K buffer for data protection.

Versatility: a KSR that can be quickly field converted to a true line printer plus a wide range of standard features including dip switch selectable functions with a choice of four print speeds and

four print compressions with corresponding line lengths.

And more — paper that can be loaded from front or rear, serviceability and self test features.

If you'd like to settle your matrix muddle to meet your hard copy needs, write today for complete details on the Terminet 200. The address is General Electric Company, Terminet 794, 31, Waynesboro, Virginia 227930.

The Terminet 200  
The Complete Matrix Printer

GENERAL  ELECTRIC

ORGE 2 ON READER CARD

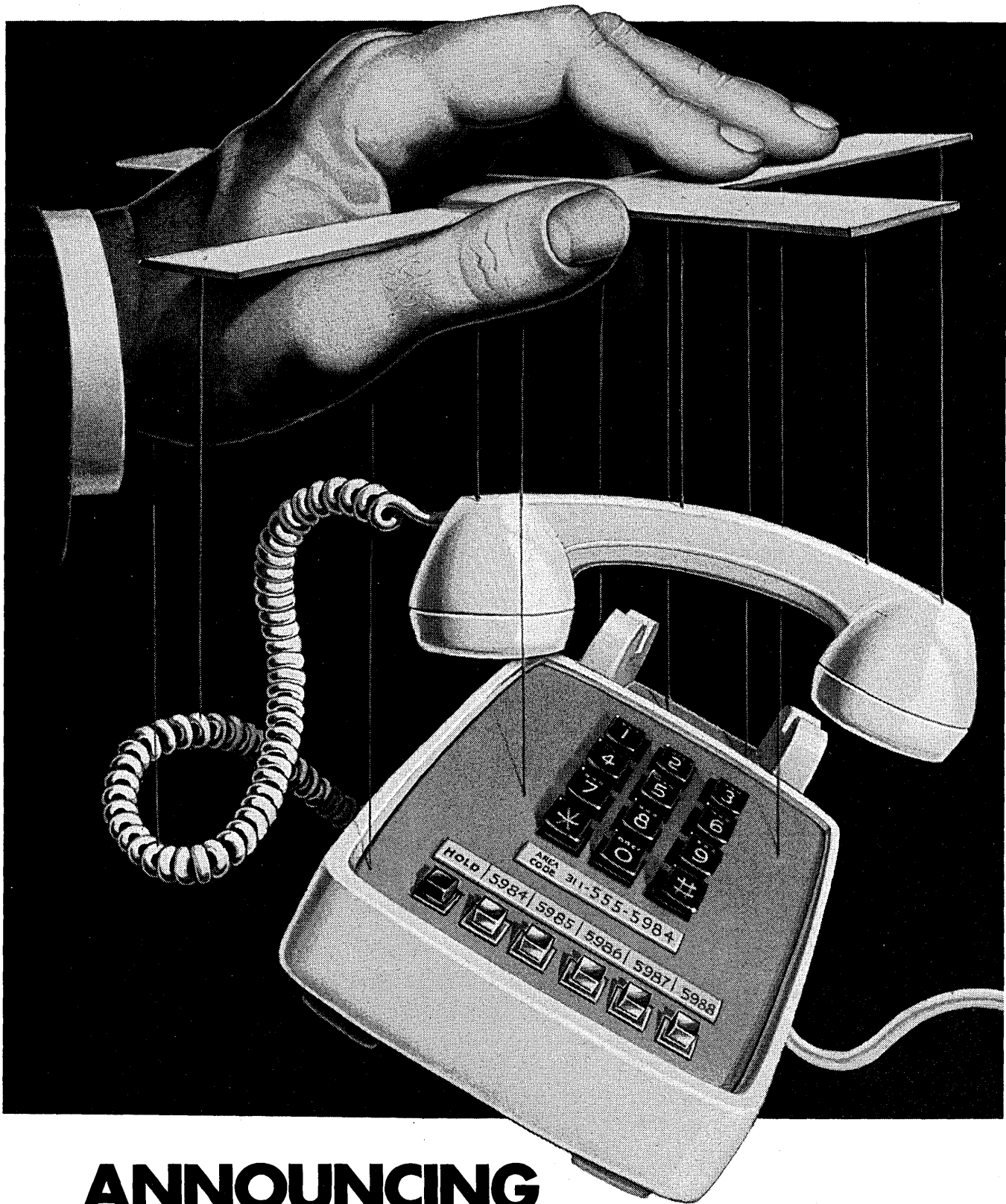

# ANNOUNCING CORPORATE CONTROL OF CORPORATE COMMUNICATIONS.

# PROBLEM:

You run a company with far-flung operations and rising phone bills. You want a better way to control both.

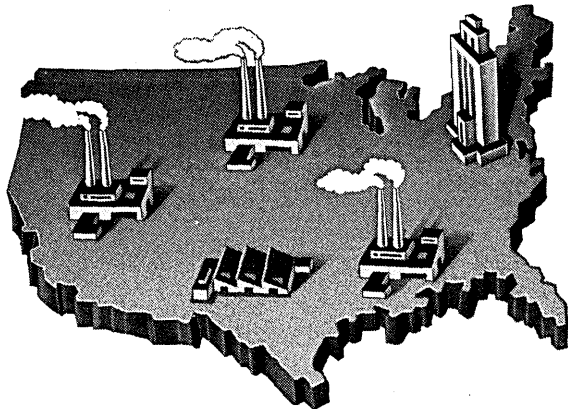

You want your communications to speed the work your people do, not frustrate them. To enable them to dial calls faster and not have to keep redialing when lines are busy.

You want access to a system that will let you make business calls from home or on the road, 24 hours a day, 7 days a week.

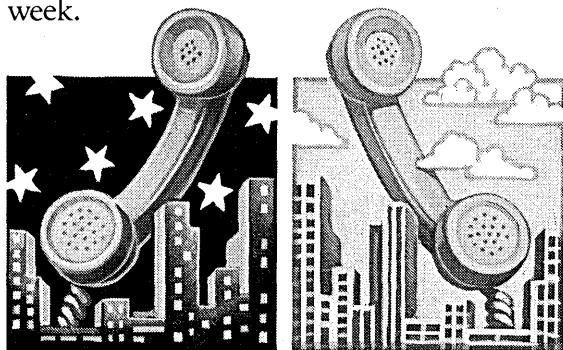

You want to be able to break out charges and allocate them by profit centers or even by individuals.

You want your communications system to monitor itself, to pinpoint troubles. A flexible system you can modify in response to personnel moves and day-to-day requirements.

In short, you want a system you can control, one you can change as your business changes.

It's here!

# SOLUTION:

Introducing a sophisticated system that gives your company control of its communications. Tell it what to do, and it does it. Automatically. Company-wide.

It's called Electronic Tandem Switching (ETS), a way to extend the advantages of Bell's famous Dimension® PBX to all locations on your corporate network.

By bringing together the various elements of your company communications into one, total, integrated system tailored to your specific needs, ETS does just about everything you've told us you want.

It offers over 150 capabilities to fit your individual needs, whatever they may be. It can select the most economical route for every call. It can redial busy numbers automatically and can assure immediate completion of high-priority calls. It can keep minute-by-minute calling records. It provides hands-on management and control, including the setting up of individual calling privileges and restrictions.

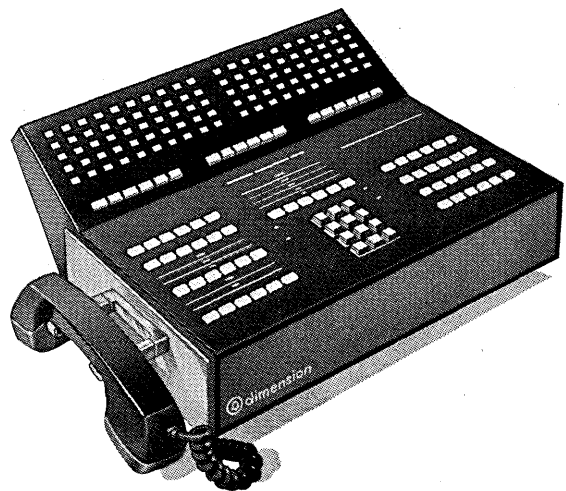

We have teams of problem-solvers ready to fit a Dimension ETS system to your operations and your budget. If you haven't talked systems with your Bell Account Representative lately, your company's missing something.

**The system is the solution.**

 **Bell System**

# source data

(Continued from page 66)

the organization's information needs has shown that the data base approach indeed fits. Service analysis consists of user interviews, analysis of the data accumulated, and a formal requirement statement. The handbook includes specific and detailed suggestions on how to plan and conduct interviews. The information collected in the service analysis creates a natural starting point for the development of a data dictionary and can be useful in the development of initial data base architecture. The report

is \$12, with additional copies priced at \$5. PDC also offers a course in the service analysis methodology on an in-house basis. PERFORMANCE DEVELOPMENT CORP., 1101 State Road, Bldg. M, Princeton, NJ 08540 (609) 921-3770.

## Copier Pricing

Changes in prices and financial capabilities of the more important vendors in the plain paper copying industry have been researched by Martin Simpson Research Associates in its third annual analysis of pricing in the plain paper copying industry. The impact on Japanese manufacturers of the changing dollar/yen value has also been evalu-

ated. Many tables are included in the report, providing detailed comparisons of costs at monthly volume levels. The machines themselves are also compared, including comments on supplies and overall effectiveness. The report concludes with an industry outlook, including an analysis of trends likely to emerge in the "office of the future," with emphasis on "intelligent" copiers and communicating terminals, which are predicted to become more prevalent. \$395. MARTIN SIMPSON RESEARCH ASSOCIATES, INC., 63 Wall St., New York, NY 10005 (212) 344-3480.

## Dp in Accounting

The accounting industry is the major professional services market for data processing, and offers the most potential for future sales, according to Frost & Sullivan's recent report #530, "Data Processing & Word Processing Equipment and Services for Accounting Offices." The report includes an overview of the market; a description of U.S. accounting firms, including predictions for the future; descriptions of potential automation of accounting functions; an analysis of four major application software packages developed for accounting; an analysis of user needs; special considerations relevant to selling in the accounting environment; a market analysis covering 1977-1986; and a discussion of the present and future competitive environment for computer systems for accounting firms. \$800. FROST & SULLIVAN INC., 106 Fulton St., New York, NY 10038 (212) 233-1080.

## Software Selection

A 48-page *Packaged Software Buyer's Guide* includes an introductory section of considerations to help the small business computer user make decisions about his application software needs. The following chapters are about how to buy specific packages for: accounts receivable, accounts payable, payroll, general ledger, and inventory control. \$15. MANAGEMENT INFORMATION CORP., 140 Barclay Center, Cherry Hill, NJ 08034 (609) 428-1020.

## CICS Applications

TelTech has published a Design Guide detailing on-line applications for IBM's Customer Information Control System (CICS). Descriptions and analyses include CICS project planning, project controls, user relations, planning and selecting a file organization, DL/I as a data base manager, selecting a programming language, command level programming, virtual storage considerations, recovery and restart planning, CICS programming standards, and productivity aids. The guide comes in a loose-leaf (Continued on page 76)

You have to be picky when choosing a data communications terminal system. Otherwise, you may just pick up a problem.

That's why Trendata offers a wide selection. From systems for wide flexibility and high production down to a simple reliable machine for limited applications.

When it comes to features, pick them to fit your need—half/full duplex operation, operator switchable ASCII—EBCD—Correspondence code sets, various keyboard legends, variable pitch and line lengths, interchangeable type fonts, switch selectable transmission rates and many more. Then add the options—plot mode, form tractors, additional printer controls, unattended operation along with a range of workstation options.

We also have the pick of the peripherals. Add a flexible disk system, tape

reader/punch, card reader or tape cassette recorder. And with no fuss we supply accessories such as certified diskettes, type elements, ribbons, tape cassettes, etc.

What you don't have to pick is other firms to handle financial arrangements and provide service. We're very finicky about doing those in a very first class manner. Which all leads to the suggestion that before you pick a terminal.....pick up the phone and call us.



## Applied Magnetics Trendata

610 Palomar Avenue, P.O. Box 5060  
Sunnyvale, CA 94086  
(408) 732-1790

# We like customers who are picky, picky, picky



CIRCLE 143 ON READER CARD

# Introducing Basic/Four distributed data processing.

## Right system, right price!

The right system should make each remote location an independent data processing center. That's what Basic/Four® computers do. And at the right price. Because there's a model to meet the exact needs of each location.

### Powerful stand-alone computers

The key factor is how much each satellite computer can do.

Basic/Four computers are interactive, for instant transaction processing. Each is powerful enough to handle all accounting and payroll for each location, plus its specialized function—manufacturing, distribution, warehousing, whatever.

No more costly time-drains on the host computer. No more waiting for processing.

### Easy to install, program, use

The data processing needs of your remote locations are like those of an independent business. And that's our specialty!

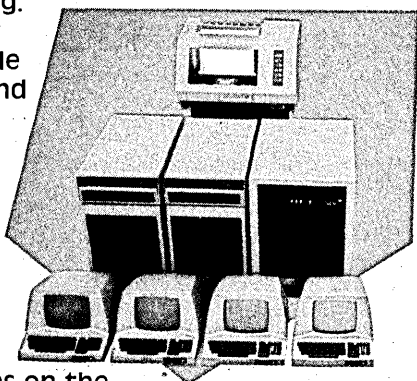
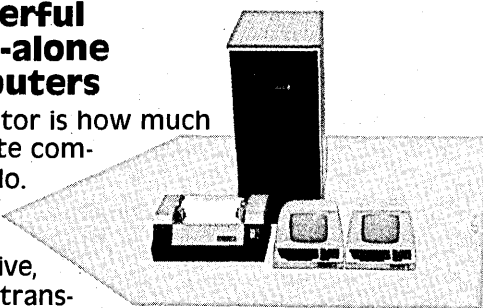

We offer proven software packages, with special application modules that are easily adapted to your particular needs. The language is BUSINESS BASIC, so programming is a snap. So is operation: we can teach a clerk to run a system in less than a day.

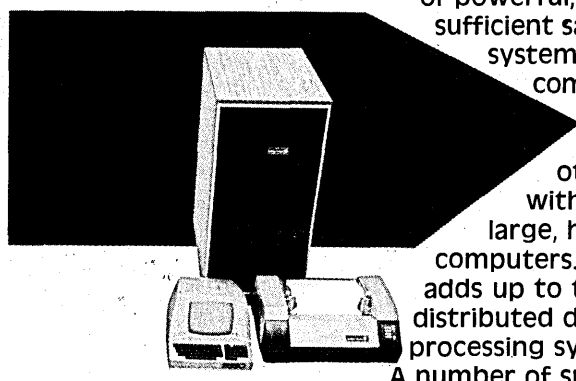
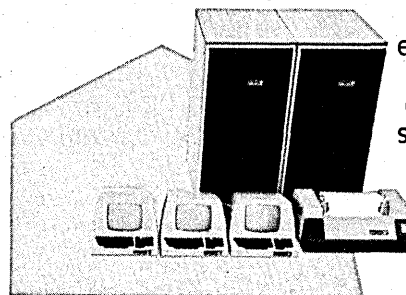

After 7 years experience, with some 5000 installations, we can put in Basic/Four systems fast.

### We talk to IBM all the time

Our tie-in capability means your network of powerful, self-sufficient satellite systems can communicate with each other, and with most large, host computers. That adds up to the ideal distributed data processing system.

A number of such Basic/Four systems are up and running in the U.S. and abroad.

For full information, call our nearest office. Or write: Basic/Four Corporation, P.O. Box C-11921, Santa Ana, CA 92711

**basic / four corporation**  
an MAI company



Albuquerque \* Anchorage \* Atlanta \* Baltimore/Washington \* Birmingham \* Boise \* Boston \* Buffalo \* Charlotte \* Chattanooga \* Chicago \* Cincinnati \* Cleveland \* Dallas \* Denver \* Detroit \* Erie \* Fresno \* Grand Rapids \* Hartford \* Honolulu \* Houston \* Indianapolis \* Kansas City \* Lansing \* Las Vegas \* Long Island \* Los Angeles \* Louisville \* Lubbock \* Madison \* Memphis \* Miami \* Milwaukee \* Minn./St. Paul \* Nashville \* New Jersey \* New Orleans \* New York \* Orange County \* Philadelphia \* Phoenix/Tucson \* Pittsburgh \* Portland \* Richmond \* Sacramento \* Salt Lake City \* San Antonio \* San Diego \* San Francisco \* San Juan \* Seattle/Tacoma \* St. Louis \* Spokane \* Syracuse \* Tampa \* Basic/Four Systems are also marketed in more than 30 foreign countries.

# Now, Memorex system's performance

If your 100/200 MB removable disc storage subsystem isn't giving you all the performance you want; then Memorex's new 3770 Disc Cache could be just what you need.

It fits between your drives and controller, filling the gap in your system's performance by giving you faster data access and improved throughput.

Compare performance data for a 3770 Disc Cache Subsystem to a current 200MB Disc Storage Subsystem. For example, on the average, the time to access a full track of 13030 bytes

from the 3770 is:

Track seek time:  
0.1ms vs. 10ms,  
rotational delay:  
2.0ms vs. 8.3ms,  
and data transfer time:  
10.9ms vs. 16.7.

Thus, for data in the 3770 Disc Cache, significant increases in throughput at the channel level can be achieved. In fact, a 50% improvement in your data transfer rate is guaranteed when the Memorex® 3674 control unit is used.

Potential benefits from proper application of the 3770 can be less CPU wait time, less task switching, improved channel efficiency, reduced arm contention,

automatic space management, and better time sharing response.

And putting a 3770 to work for you is easy, because full software compatibility is maintained.

The Memorex 3770 Disc Cache works with IBM 370/135 and above, Amdahl 470 V/5 to V/7, Intel AS-4 to 6, and other compatible CPUs. In short, any CPU with a Memorex 3670/75 Disc Storage Subsystem.

The key to ultimate performance of your disc subsystem is Memorex's unique 3770 architecture and caching algorithm. These algorithms will be continually improved via microcode updates to meet your current

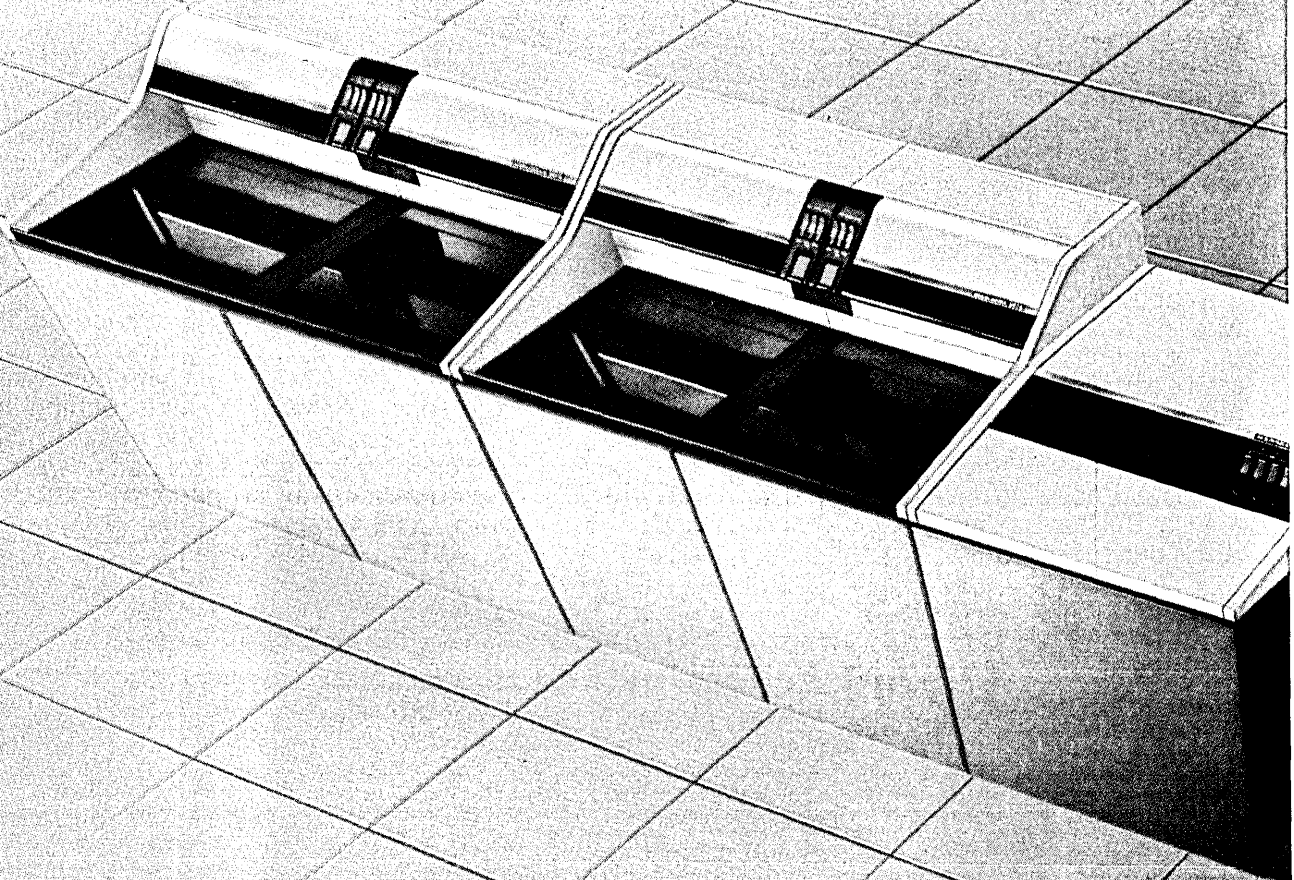



# fills the gap in your

and future data base application requirements.

The Memorex 3770 Disc Cache. It can help achieve improved throughput without incurring the cost of converting to non-removable 317MB drives with the fixed head feature or to fixed head disc drives. And it gives you the potential of significantly improving your system's performance.

Your Memorex representative can give you all the information, offices in principal cities worldwide. Or contact, Disc Storage Subsystems, Mail Stop 14-49, San Tomas at Central Expressway, Santa Clara, CA 95052. (408) 987-1143

## MEMOREX

Your computer is the corporate safe,  
and it is always open...without PANEXEC

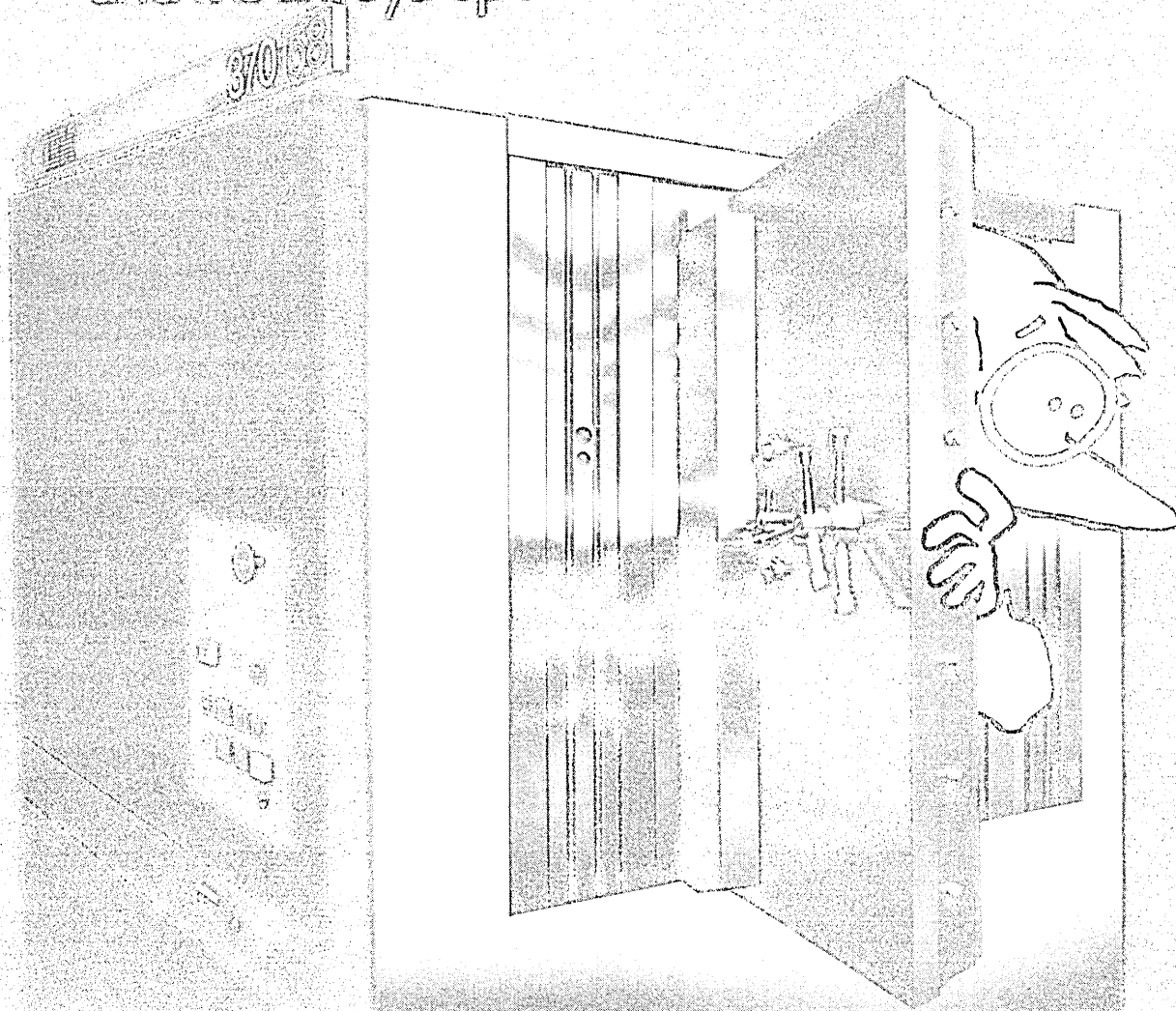

Your vital records are in a safe...and they are vulnerable. Because no safe has many guards to patrol there are all the lock, no matter how many passwords are used, a potential computer people are the cause of computer error. And their honest mistakes cost billions every year.



PANEXEC is the Security and Control System for Executants in terms, that monitors and controls the honest mistake and other errors as well, producing incredible hardware and safety in the process. With PANEXEC, you have complete control over everything running on the computer.

PANEXEC allows auditors to track any program from source through execution. Repeat the audit protection features within PANEXEC allow you to rest easy, knowing the standards are under control.

**PANSOPHIC**

369 Enterprise Drive, Oak Brook, IL 60521

**800-323-7335**

Pansophic has put together the honest mistake Protection Plan, for the at-risking. Call us toll free for your own.

PANEXEC: Another innovative software solution for the IBM, DOS/PC environment. From the people at Pansophic, Offices located near you throughout the world.



CIRCLE 14 ON READER CARD

# Watch this Kodak laser printer print a 150-page report.



The Kodak laser printer prints at the rate of more than 2½ computer pages per second.

So it can zap out a 150-page report in a shade under one minute. Or a 1000-page report in about 6 minutes.

Because it prints on microfilm—not paper—the Kodak printer condenses up to 270 bulky computer pages on a single 105 x 148-mm fiche. And it does it in under 2 minutes.

That means a Kodak printer can print a 1000-page report at a reduction ratio of 48:1 on just 4 microfiche. And each fiche is produced, titled, and indexed, ready for fast retrieval.

How does paper stack up against fiche? Using current prices,\* 1000 pages of computer paper would cost \$3.50, while 4 fiche would cost just 54¢. So compared with paper, not only is printing on film demonstrably faster, it's also thousands of dollars a month cheaper.

Why not call your Kodak representative today for a demonstration of the Kodak

## Want to see that again?

Komstar 100, 200, or 300 microimage processor. But hurry. Every day you wait costs you money.

Eastman Kodak Company,  
Business Systems Markets Division,  
Dept. DP 8648, Rochester, N.Y. 14650.

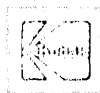

**Kodak Komstar microimage processors.  
The printers that print without paper.**

\*Prices vary with geographic location and grade of paper purchased.

# source data

(Continued from page 70)

binder; replacement/additions and expansions will be available. "CICS Applications Design Guide" is \$45 (prepaid, otherwise add \$2) from TELECOMMUNICATIONS TECHNOLOGY CORP., 200 Park Ave., Suite 303 East, New York, NY 10017.

## Fax Center Directory

A directory listing 150 commercial facsimile centers in 111 cities and 42 states entitled the Directory of U.S. Electronic Mail Drops is available for \$8.85 prepaid (or \$13.50 if billed) from TIBS (Tahoe Information and Business Services), P.O. Box 4031, Stateline, NV 89449 (702) 588-3866.

## About Facsimile

A report on the facsimile industry predicts a growth rate of about 17% through 1980, beginning then to accelerate to more than 20% per year as communications satellite circuits begin to take more of the traffic, reducing costs. The report addresses the industry, the market, the technology, and competition in the field. Tables include those showing comparisons, forecasts of facsimile transmission revenues, and fax as a replacement for other communications. \$695. CREATIVE STRATEGIES INTERNATIONAL, 4340 Stevens Creek Blvd., Suite 275, San Jose, CA 95129.

## AEA Directory

The American Electronics Assn., formerly WEMA, offers a directory of its 1,114 members, both electronics companies and business and financial institutions serving the electronics industries. Listed are company names, addresses and telephone numbers, names and titles of principal officers, date established, number of employees, products or lines of business, sales methods, and where the stock is traded (if the company is publicly owned). \$50 (California residents add \$3.25 sales tax). AEA, 2600 El Camino Real, Palo Alto, CA 94306.

## Computer Services Directory

Telenet offers an updated version of its "Directory of Computer Based Services," which lists data banks, commercial service bureaus, educational institutions and other companies that offer interactive computing and information retrieval services to the public through the Telenet network. Listings are categorized according to application specialty, programming language, and data base offerings. As well as bibliographic

data bases, the directory contains listings of financial and economic data bases, FCC tariffs for common carriers, school guidance information, advertising media and market research, energy and pollution, and engineering. \$2 (prepaid) from the Publications Dept., Telenet Communications Corp., 1050 17th St., NW, Washington, DC 20036.

## Polysystems

Mr. Adrian J. Basili, Supervisor of Data Systems at AT&T, discusses the significance of recent and future IBM pricing and products in "Evolving Vendor Patterns in Hardware/Software Resource Offerings," Vol. V., No. 2 of Faim's Current Technology Reports. The report consists of the text of a talk given by Mr. Basili at a Business Users Group Meeting and of the subsequent question and answer session.

Mr. Basili discusses his views of future IBM processing complexes and systems architectures, predicting that future architectures will depend on modular software and detailing some IBM motivations for unbundling. He also discusses the transition from this generation of computers to the next in terms of leading-edge technology, noting that generation lifetimes are approaching one decade and calling the migrations evolutionary. In the question and answer section, Mr. Basili denies that AT&T will go into data processing (he says they will be in the "communications processing business"), talks a little bit about the future for programmers, and answers questions about support and compatibility. The report is \$25. FAIM TECHNICAL PRODUCTS, INC., P.O. Box 1013, Melville, NY 11746.

## Small Business Users

"How Small Businesses Use Computers" is a collection of 15 case histories taken from the Casebook section of the monthly publication *Small Business Computer News*. The report features a wide variety of types of business (including manufacturing, distributors, wholesale operations and services). Each case study is short but includes reasons for the decision to implement computers, a description of the system selection process, future plans, and pertinent facts about the company (annual sales, dp personnel, dp budget, and configuration and software). The report is \$15. Subscription to *Small Business Computer News* is \$70/year. MIC (Management Information Corp.), 140 Barclay Center, Cherry Hill, NJ 08034 (609) 428-1020.

## Research Index

The National Technical Information Service (NTIS), a part of the Dept. of

Commerce, publishes Weekly Government Abstracts, which are summaries of technical reports, and an annual subject index for 26 different fields.

The 1977 Annual Index of reports in the field of Computer, Control & Information Theory is available separately. While it is meant to be used in conjunction with the abstracts, it also serves as a comprehensive directory to a wide variety of reference materials, many of which come from universities and government agencies (and thus might not otherwise be readily available). The 84-page booklet is \$15. NTIS, U.S. DEPT. OF COMMERCE, 5285 Port Royal Road, Springfield, VA 22161.

## vendor literature

### Personal Computers

From a personal computer vendor of both 8-bit and 16-bit microcomputers comes an eight-page brochure entitled "Why You Should Consider a Sixteen Bit Microcomputer." The brochure details the advantages of a 16-bit word length processor versus the limitations of 8-biters. Software, service, support, and computing power also are discussed. The brochure also serves as an introduction to the vendor's LSI-11-based personal computer, the H11. HEATH CO., Benton Harbor, Mich.

FOR COPY CIRCLE 517 ON READER CARD

### Microprocessor Software

Four software packages for the M6800 microprocessor are described in this catalog. A resident macro assembler is discussed in terms of its hardware requirements and operating features. Its options, directives, and operators are listed. The vendor's STRUBAL (Structured BASIC Language) compiler is explained. The description details the compiler's extensions to the features commonly found in versions of BASIC. The brochure also covers a general purpose text editor, and a linking loader. Prices are given for each of the four products. HEMENWAY ASSOCIATES, INC., Boston, Mass.

FOR COPY CIRCLE 518 ON READER CARD

### Signal Processing

A 40-page, illustrated booklet describes programming this vendor's SPS-21 signal processing system. After an overview, the booklet provides examples of a synchronized analog-to-digital and digital-to-analog conversion routine, format

(Continued on page 78)

# Don't let static kiss your computer's memory good-bye!

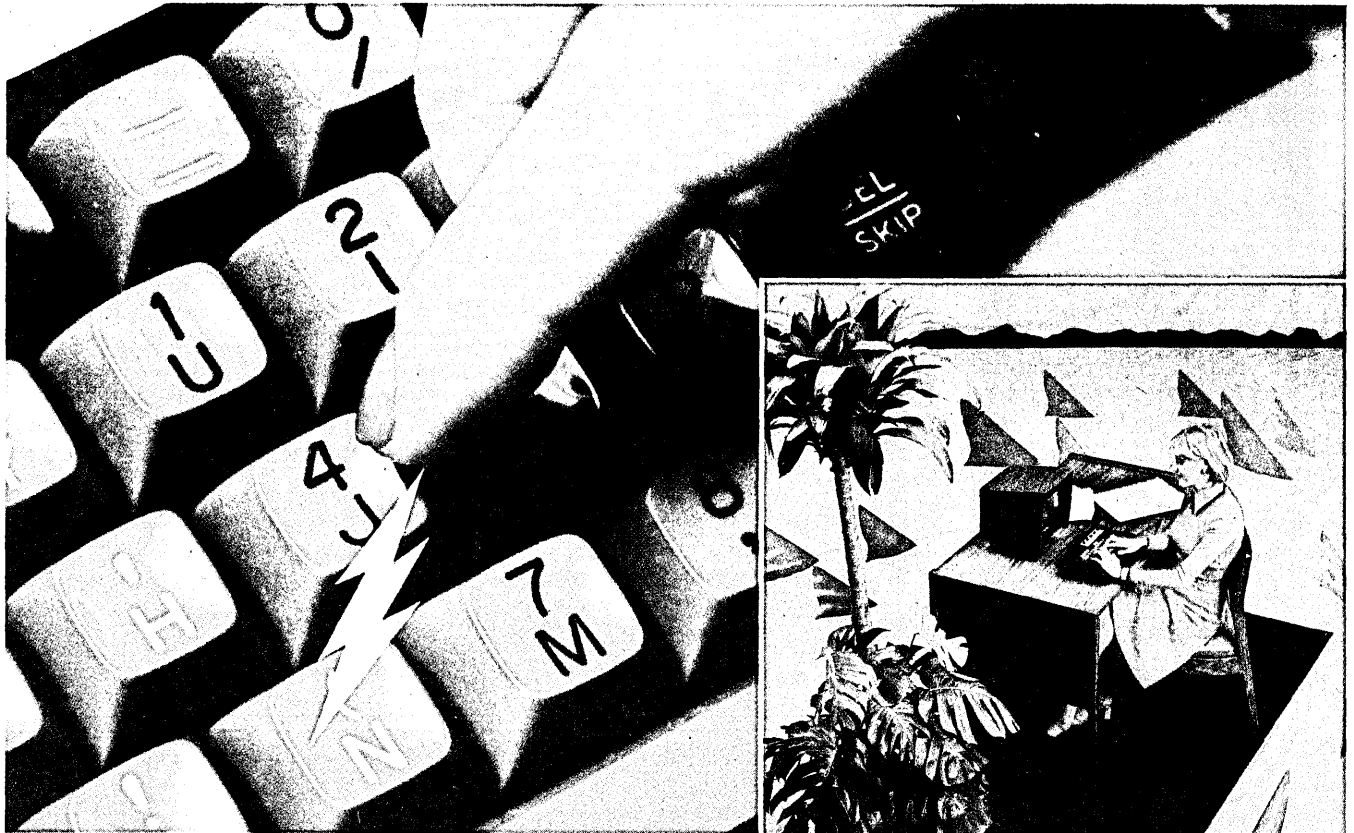

## Set up islands of protection with 3M Velostat Brand electrically conductive floor mats!

Static on personnel, discharged into a terminal, can upset the logic of your terminal, mini, or CPU . . . can send erroneous data . . . permanently damage circuits causing costly downtime and repair. No equipment is 100% immune. Some computer equipment makers report that as little as 200 volts of static can cause serious problems!

VELOSTAT Mats create positive paths to ground . . . drain static away from terminal operators . . . keep them static free. Simply place the mat where the operator must step on it to reach the keyboard, and the VELOSTAT Mats provide passive protection in such key areas as these:

- Around Data Entry, POS and Bank Terminals
- At Minicomputer and Word Processing Stations
- As a floor runner in Computer Room Entrances
- In front of Computer Printers and Disc Drives

TO: Static Control Systems  
 Dept. BZF-78  
 3M Company, St. Paul, MN 55101



YES, I'm interested in keeping static away from my terminal with VELOSTAT conductive floor mats.

- Please have a 3M Static Analyst call.
- Send more information.

Name \_\_\_\_\_

Title \_\_\_\_\_

Company \_\_\_\_\_

Area Code \_\_\_\_\_ Phone \_\_\_\_\_

Address \_\_\_\_\_

City \_\_\_\_\_ State \_\_\_\_\_ Zip \_\_\_\_\_

# source data

(Continued from page 76)

conversion between signal processor and host, FORTRAN pipelined spectral analysis, and a fast convolution finite impulse response filter. A real-time signal analysis program, and a "slow motion" display and interactive analysis program also are given and discussed. Appendices cover support routines and the subroutine library supporting the SPS-21, and tables of execution times. SIGNAL PROCESSING SYSTEMS, INC., Waltham, Mass.

**FOR COPY CIRCLE 519 ON READER CARD**

## Disc Pack Care

"How to give your disc packs and cartridges the tender, loving care they deserve," offers this magnetic media vendor's insight in the proper care and handling of rotating media. The eight-page, two-color illustrated brochure includes sections entitled: "what to do when you receive or send a disc pack or cartridge"; "how to help your disc packs live long, healthy lives"; "a little preventive maintenance can save you a lot of trouble"; "the dos and don'ts of disc pack labeling"; and "a few final words to the wise." NASHUA CORP., Nashua, N.H.

**FOR COPY CIRCLE 520 ON READER CARD**

## Data Acquisition

A six-page, illustrated technical brochure describes this vendor's model 7253 data acquisition system. The system—computer, analog-to-digital converter, and software—are described in text, photographs, block diagrams and tables. After a brief description of the system as a whole, the brochure goes on to discuss measuring, signal conditioning, noise immunity, and programming considerations—the use of BASIC as the system language and operator interaction. Support programs for linearization, scaling, and data reduction are covered. FLUIDYNE INSTRUMENTATION, Oakland, Calif.

**FOR COPY CIRCLE 521 ON READER CARD**

## Series/1 Tape System

A color brochure, "Tape Systems for IBM Series/1," explains this vendor's 5191 Series/1 magnetic tape system. The catalog contains a full product description, and discussions of features, interfacing techniques, and software capabilities. DATUM INC., Anaheim, Calif.

**FOR COPY CIRCLE 523 ON READER CARD**

## Add-On Memory Reliability

An add-on memory maker, this vendor has prepared a two page application note on the increasingly popular theme of reliability. Specifically addressed to 158 and 168 add-on memory users, the

flier describes what the vendor chooses to call RASI (Reliable, Available, Serviceable, Improved). (Other vendors have different acronyms, though usually based on the same terms or synonyms.) User Note Number Five explains such features as switching in 16KB of reserve memory when a memory segment fails. ELECTRONICS MEMORIES AND MAGNETICS CORP., Hawthorne, Calif.

**FOR COPY CIRCLE 522 ON READER CARD**

## Communications Test Equipment

Data communications diagnostic test equipment and network control systems are described in this 12-page brochure. Products include portable data test sets, data monitors and programmable diagnostic testers for network maintenance, tech control systems, and a line of analog and digital switching and patching equipment. The brochure also describes the vendor's Teleproducts Div., its facilities and services, and its capabilities in designing special systems for the communications industry. ATLANTIC RESEARCH CORP., Alexandria, Va.

**FOR COPY CIRCLE 524 ON READER CARD**

## Nova Operating System

The Interactive Realtime Information System (IRIS), this vendor's time-sharing operating system for Data General Novas, is described in an 8-page, 2-color

(Continued on page 82)

**Still squeezing data through the old-fashioned way?**

If you would like to put up to 16 asynchronous terminals on one telephone line, read on.

MICOM's smart Micro800 Data Concentrator has obsoleted the good, old-fashioned TDM or time-division multiplexor. If you prefer to call it a statistical multiplexor or intelligent TDM, feel free. Either way, the Micro800 provides retransmission on error and, typically, double the efficiency of TDM. It's not a penny more than a TDM, so why not order a pair on a sale-or-return basis? No strings attached.

**Concentrate. It's cheaper!**

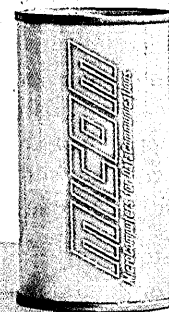

**OVER 500 UNITS INSTALLED**



**MICOM** MicroComputers for DataCommunications

MICOM SYSTEMS, INC. • 9551 Irondale Ave. • Chatsworth, CA 91311 • Tel. 213/882-6890 • TWX 910/494-4910

CIRCLE 139 ON READER CARD

# MODESTY ASIDE, THE TALLY T-2000 IS THE MOST RELIABLE (AND LOWEST COST OF OWNERSHIP) LINE PRINTER YOU CAN BUY.

Tally's long term reliability is unmatched in the printer industry. Extended usage does not affect performance. Even after years of operation. Field tests prove it! And this steadfast reliability is from a 200 line per minute printer that doesn't require lubrication or adjustments of any kind. No preventive maintenance is ever needed; there are no duty cycle limitations.

Call Tally today.

## TALLY®

### OEM SALES OFFICES

Boston (617) 272-8070  
New York (516) 694-8444  
Chicago (312) 325-9788  
Los Angeles (213) 378-0805  
Miami (305) 665-5751  
San Jose (408) 247-0897  
Washington, D.C. (703) 471-1145  
San Antonio (512) 733-8153  
Seattle (206) 251-6730

### BUSINESS SYSTEMS SALES

Orinda, CA (415) 254-8350

Tally's "up-time" performance means extremely low operating costs. Couple this with our low purchase price and it adds up that the Tally T-2000 offers the **lowest cost of ownership** available.

The reason for this superior reliability is the proven and patented print comb mechanism. Based on the simple design premise of moving light masses over short distances, it's impervious to wear or malfunction. As a bonus, it delivers page after page of outstanding print quality.

Tally Corporation, 8301 S. 180th St. Kent, WA 98031. Phone (206) 251-5500.

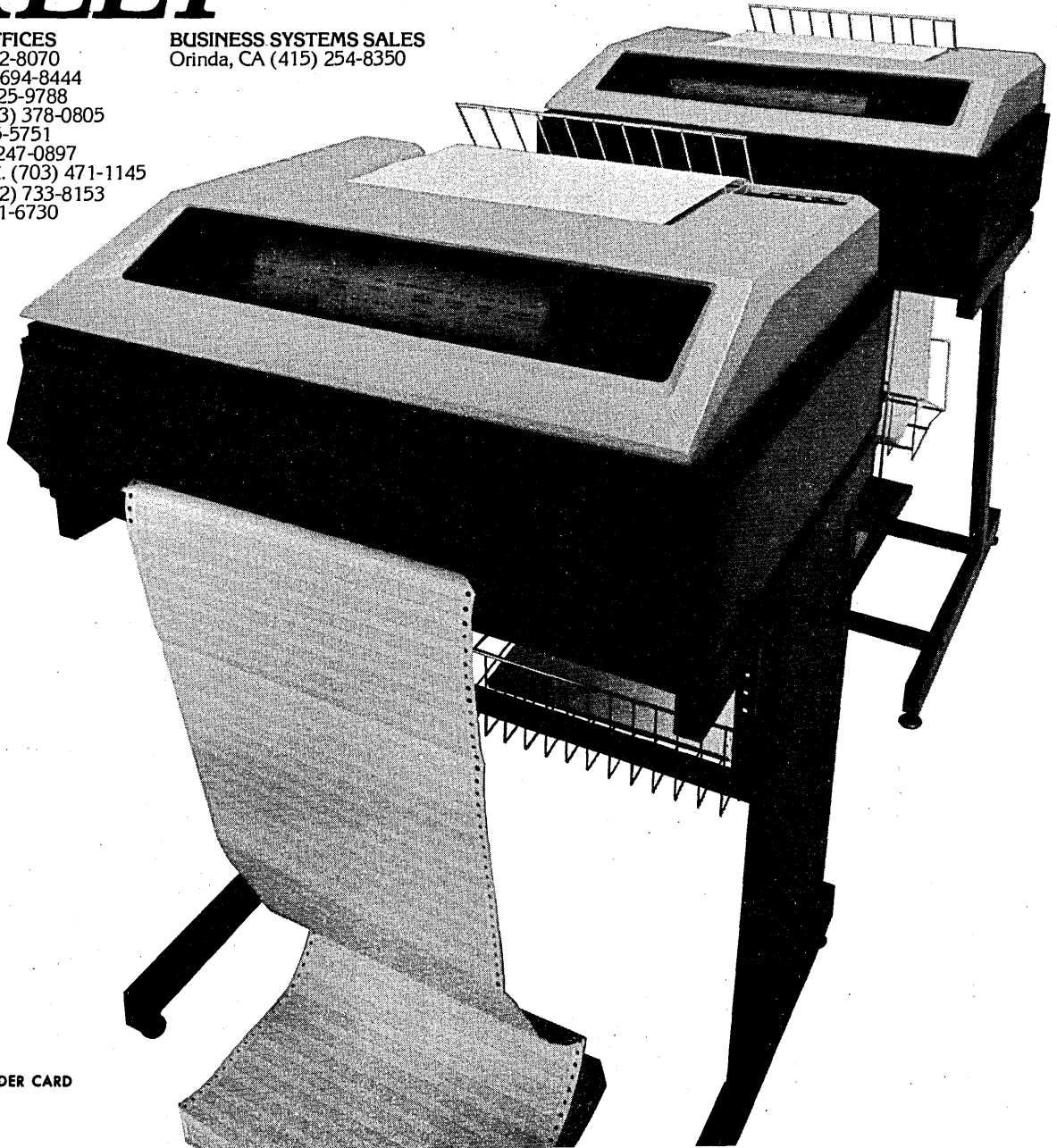

“If you’re scared,  
you make a decision  
that’s safe.

If not, you make  
a decision that’s right.

What we try to do  
is remove the fear.”

Tom Knight  
Product Manager



# 370 Add-on Memory

“We really believe that you can’t do better than National’s add-on memory for your IBM 370 computer. And so do a lot of other people. So I tell customers, ‘look, right now there are hundreds of IBM 370’s in the field using National Semiconductor memory. If you haven’t heard our name it’s only because until now, we haven’t been selling directly to end users.’

But we actually have a larger share than anyone else in the 370/158 and 168 add-on market. We’ve delivered over 1200 megabytes. And with 30% of our business today going

to upgrading existing customers, we must be doing something right.

Now, National is offering 370 add-on memory direct—both the 158 and 168 models, as well as our Universal Memory, which interfaces with IBM’s 135, 138, 145, and 148 processors.

I really believe we know more about 370 memories than even IBM. Because not only do we have to know intimately every component that goes into our products, we also have to know the IBM CPU’s to which our products attach. This knowledge lets us make our memories less expensive



than IBM's, and better — than IBM's or anybody else's.

*Beat the heat.*

We build our IBM add-on memory with top-drawer, high density chips. All the bits work. So unlike most of our competitors we need no back up chips, no extra circuitry.

Our switching power supplies are twice as power efficient as linear units. They dissipate far less heat.

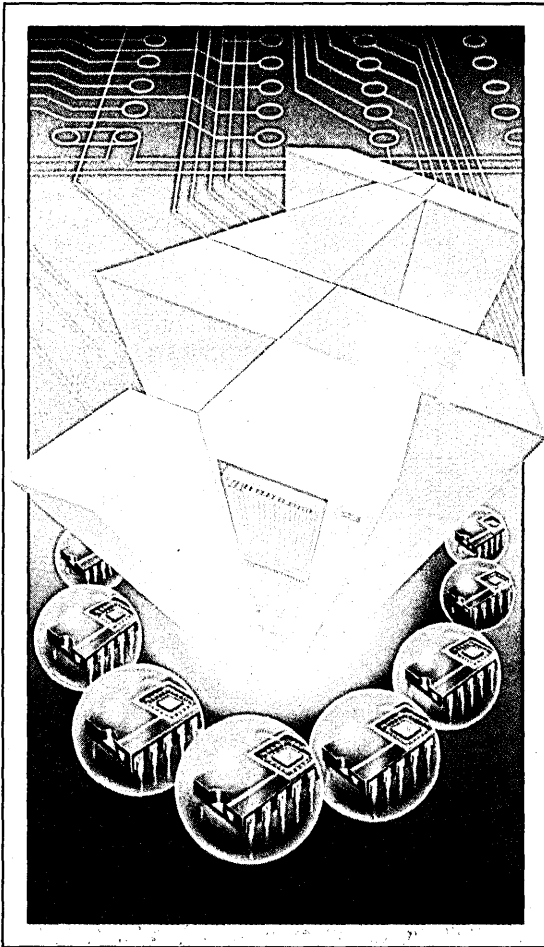

Which means we can run cooler on less power than any other 370 add-on anywhere. And they keep the juice flowing during power interruptions as long as 50 milliseconds.

Size? Our add-ons are the most compact in the industry. Sixteen megabytes can fit into a single frame.

You'd be shocked at how many times we make a sale just because our units fit where others won't.

For easy maintenance, our memory components are socketed. So in the rare event of a failing component, it alone needs to be replaced, instead of a whole printed circuit card.

We also make full use of IBM's error correction circuitry. Single-bit errors have no effect on system operation. Our advanced error detection circuitry and software diagnostics allow us to identify and replace failing components during scheduled maintenance. And with single-bit errors under control, double-bit errors just don't happen.

*Take a bold step.*

You know and I know that your D.P. budget is spent for system performance. Extra memory means extra performance. And National gives you more memory for your money. The equation is simple.

We understand the "safe" feeling you get by going with IBM memory. But consider. National has a bigger market share than any other independent supplier. We've been deeply committed to 370 add-on memories for years. We can meet all your 370 add-on requirements, whatever they may be, now and in the future.

If you still feel safer with IBM memory from IBM, fine. But if you want to take that bold, bold step and find out more about IBM System/370 add-on memory from National, contact me personally: Tom Knight, Product Manager, National Semiconductor Corporation, Drawer 3, 2900 Semiconductor Drive, Santa Clara, California 95051."

**Computer Products Group**  
≈ National Semiconductor Corporation

# source data

(Continued from page 78)

brochure. The system's evolution is discussed, as are its business BASIC language, file structures, data base management capabilities, report generator, and compatible applications software. EDUCATIONAL DATA SYSTEMS, INC., Irvine, Calif.

FOR COPY CIRCLE 525 ON READER CARD

## Modems

"New Dimensions in Modems," an illustrated, four-page brochure, can help a reader identify which of this vendor's communications offerings fits a given application. More than a dozen modems and acoustic couplers are described. For each product, a table gives Bell modem compatibility, terminal interface, data rate, transmission mode, and other information. OMNITEC DATA, Phoenix, Ariz.

FOR COPY CIRCLE 526 ON READER CARD

## Personal Computing Newsletter

SIGPC, the ACM Special Interest Group on Personal Computing, of which Portia Isaacson, a DATAMATION contributing editor, is chairman, now publishes a newsletter. The newsletter publishes technical working papers and also solicits short contributions such as announcements and comments, suggestions for research, descriptions of projects, etc. Send contributions to the editor, Larry Press, Small Systems Group, Box 5429, Santa Monica, CA 90405 (213) 392-1234. Membership in SIGPC, which includes a subscription to the newsletter, is \$5 for ACM members and \$13 for nonmembers. Subscription to the newsletter only is \$12. ACM, INC., P.O. Box 12105, Church Street Station, New York, NY 10249.

## Programmable Calculator Club

PPC (Personal Programmers Club—formerly HP-65 Users Club), is a user group devoted to the exchange of ideas, programs, techniques and news about Hewlett-Packard programmable calculators. *PPC Journal* is published monthly by the group for members only. A special issue is available to calculator enthusiasts in general, however, at no cost from PPC, Dept. NR, 2541 W. Camden Place, Santa Ana, CA 92704.

\*

# periodicals

## Software for Small Computers

A new bimonthly publication has been announced that will be devoted to promoting the exchange of software in the small computer marketplace. *The Software Exchange* will feature reviews of user groups, software packages, and consultants working with small computers. Classified ads for computer software will also be featured. The price of

placing a classified ad will be \$2; each ad should include whether the item is for sale or wanted as well as a description of the program, hardware/software requirements, materials/media/pricing, source or destination (name and address), and which of the following sections of the classified column the ad should be located in: business and finance, word processing, science and engineering, statistics and mathematics, home and personal computing, games and entertainment, systems, or miscellaneous. A yearly subscription is \$8. THE SOFTWARE EXCHANGE, Box 55056, Valencia, CA 91355.

## COMPLETE AND MAIL THIS COUPON FOR THE FULL STORY ON DAY-FLO® PRE-INKED ROLLERS

- Please  send me brochures describing Day-Flo Pre-Inked Rollers;  
 contact me, immediately, concerning my particular application.

Name \_\_\_\_\_  
Firm \_\_\_\_\_  
Address \_\_\_\_\_  
City \_\_\_\_\_ State \_\_\_\_\_ Zip \_\_\_\_\_  
Phone \_\_\_\_\_

Consider Dayco's complete line of microporous pre-inked rollers. Custom designed to fit your system or application.

Pre-inked rollers for credit card imprinters, check encoders, character printers, print-outs, ribbon re-inking, high-speed character printers, on-line marking and a

number of other printing and marking applications.

For the full story on the finest and most complete line of pre-inked rollers made, phone 513/226-5866. Or complete and mail this coupon to: Dayco Corporation, Marketing Services, 333 West First Street, Dayton, Ohio 45402.

**DAYCO**  
CORPORATION



PRINTING PRODUCTS DIVISION

© 1978 Dayco

CIRCLE 133 ON READER CARD

# Your investment in Tektronix graphics continues to grow.

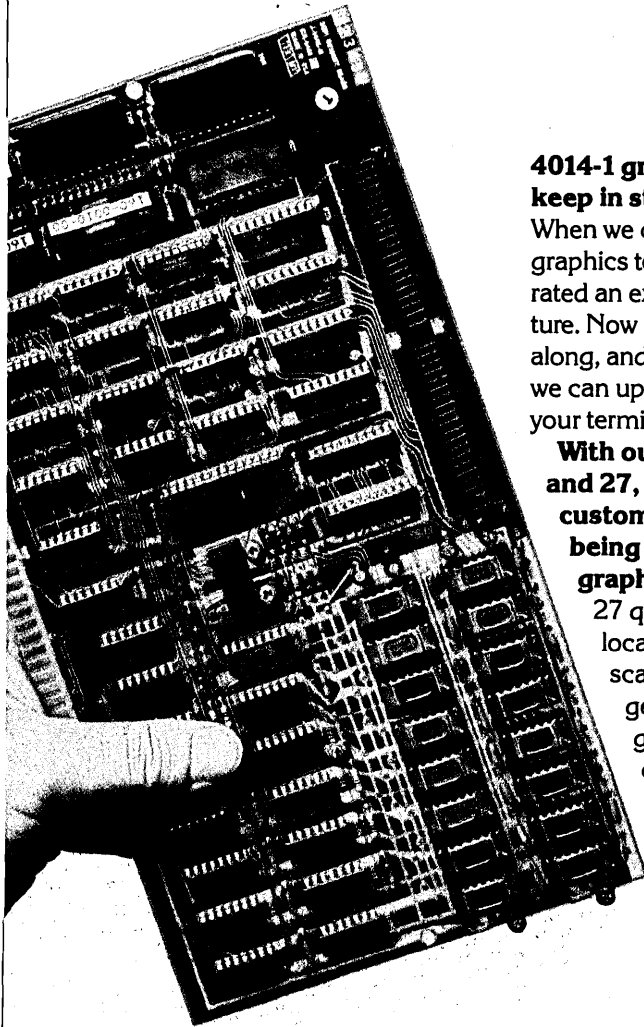

## 4014-1 graphics: designed to keep in step with your needs.

When we designed our 19" graphics terminals, we incorporated an expandable bus structure. Now as better ideas come along, and as your needs change, we can update—not outdate—your terminal.

## With our new Options 40, 41 and 27, even our first 4014-1 customers can count on

**being at the forefront of graphics.** Options 40, 41 and 27 quickly plug in to provide local graphics memory, scaling, 1° rotation, circle generation, relative graphics, clipping, user definable stroke characters, symbol positioning, and much more.

## Minimize time and transmission costs.

Save all or parts of displays in 28K RAM then recall them under computer control or with a single keystroke. Improve interactivity. Build your own special characters—off line.

## Count on the 4014-1 to hold its value—even when values

change. Your present 4014-1 can be quickly field-upgraded with these options. And because they're from Tektronix, you're assured of exceptional reliability and service. Call your Tektronix Sales Engineer for full details.

Tektronix, Inc.  
Information Display Group  
P.O. Box 500  
Beaverton, Oregon 97077  
Tektronix Datatek NV  
P.O. Box 159  
Badhoevedorp, The Netherlands

Copyright © 1977, Tektronix, Inc.  
All rights reserved

**Tektronix**  
COMMITTED TO EXCELLENCE

CIRCLE 86 ON READER CARD

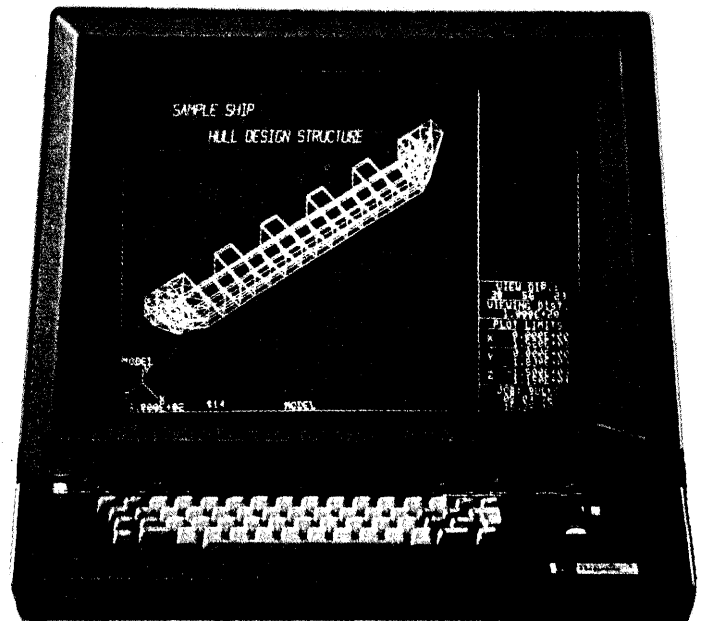

# TOUGH COMPETITION:

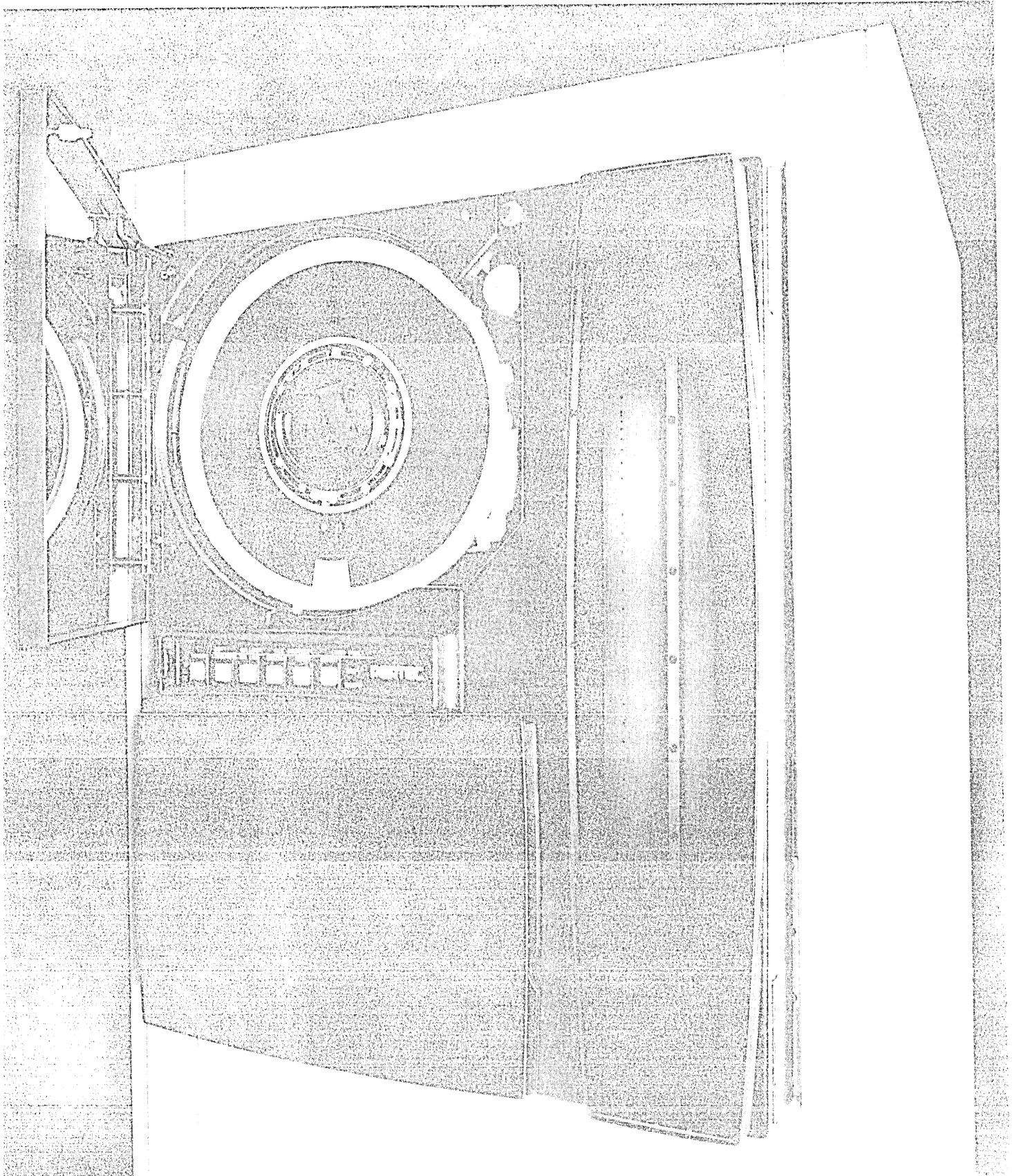

# The complete 125 ips package—beats anything in its class now moving tape.

Strong words. For strong capabilities, wrapped up in a strong new look. A totally new design in vacuum column drives houses the first *complete* high-speed package in the field.

The T1000 Series from Pertec.

No more compromising. No more shopping around. We've got it all. Together. Just for starters: 125 ips. Plus GCR. Plus auto-thread and auto-load.

You'll find everything you need to feed your powerful mini systems, in a T1000 configuration. These are not only our most advanced, most flexible tape transports produced today—they're built by Pertec to fit tomorrow's data processing applications to a T.

**Ask for 6250 bpi GCR.** In addition to dual NRZI/PE modes available, T1000 drives offer OEMs the only Group-Coded Recording at 125 ips—with a vacuum capstan to protect high-speed operations with a friction-free instant grip, for safer fast starts and stops.

**Ask for operational convenience.** T1000 makes life easier for your customers: *with* cartridge auto-load, automatic threading, and

automatic load point seek. *With* a built-in daisy-chain capability. *With* front access to all electronics to simplify maintenance.

**Ask for internal data formatting.** Intelligence can be built into T1000 NRZI/PE configurations (as well as our tension-arm 7" reel FT7000 and 10½" reel FT8000, and our 37.5-to-75 ips FT9000 vacuum column series). Pertec is now installing our Microformatter inside these units, on order, to simplify interfacing, and reduce system costs.

**Now complete the picture: ask for Pertec.** Making it still tougher on the competition, our broad line of tape transports covers the full spectrum of OEM requirements. With the same total commitment backing T1000: Pertec, the world's largest independent manufacturer of peripheral equipment, backs *all* its products with the international sales, support and service operations of Pertec Computer Corporation.

There's a Pertec service office near you... and your customer. With emergency assistance on-call, on a 24-hour 7-day basis, through our toll-free 800 line.

- Please send complete details on the Pertec T1000 Tape Transport Series.  
 Send pricing information as indicated on the RFQ below (no obligation or cost).

#### Request for Quote

T1000 Model #	Data Format	Data Density (bpi)	Tape Velocity (ips)	Quantity Required	Date Wanted	Send Specs Only
T1640-98	PE/NRZI	1600/800	75-125			
T1940-96	GCR/PE	6250/1600	75-125			
FT1640-98 w/internal formatter	PE/NRZI	1600/800	75/125			

Name \_\_\_\_\_

Title \_\_\_\_\_ Phone \_\_\_\_\_ Ext \_\_\_\_\_

Please attach coupon/RFQ to company letterhead and return to Pertec, 9600 Irondale Avenue, Chatsworth, CA 91311.

**For immediate requirements, call your nearest Pertec regional sales office:**  
 Los Angeles (213) 996-1333. Ann Arbor, Michigan (313) 668-7980. Hudson, New Hampshire (603) 883-2100. England (Reading) 582115.

## PCC PERTEC

a division of Pertec Computer Corporation

# \$3,150\*

Founded in 1973, we are the number one manufacturer of low-cost, 8-color data entry terminals, color graphics terminals for the process control industry and dependable color desk top computer systems.

You're looking at our two newest stand-alone desk top systems. Both were designed with the sophistication to handle a diverse range of business, control, research, and financial applications. In color. They both also have the best price/performance ratio of any compact computer system on the market.

If you're interested in a large screen format, the Intecolor 8051 is perfect. It comes complete with a big 19" diagonal screen, special graphics hardware and software, an external mini-disk drive for extra storage plus FILE handling BASIC, which lets you create, delete and retrieve program segments from storage, by name.

If your applications don't require a large screen format, the Intecolor 8031 is what you need. It comes with the same standard features as the 8051 but has a more compact cabinet, a smaller 13" display plus a built-in mini disk drive.

We also have a variety of options available for both units, so you can expand your system as your needs expand.

Call your Intecolor representative listed below for a demonstration of the Intecolor 8051, the Intecolor 8031, or both. \*The \$3,150 price is for orders of 100 units or more. The one unit price is \$4,495, net 20 days. Less 5% prepaid. All Intecolor units are covered by a six-month warranty.

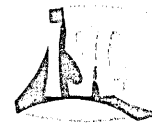

## Intelligent Systems Corp.

5965 Peachtree Corners East  
Norcross, Georgia 30071  
Telephone 404-449-5961 TWX: 810-766-1581

**Color communicates better.**

\*U.S. domestic price.

CIRCLE 24 ON READER CARD

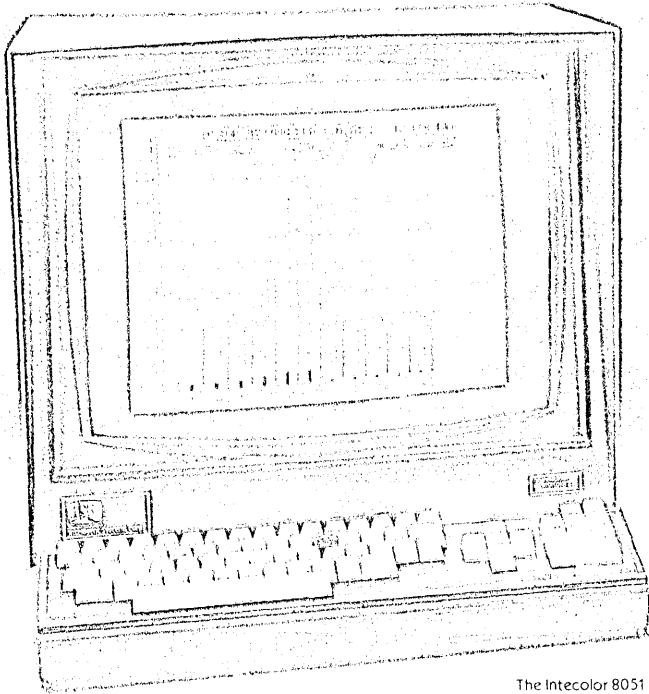

The Intecolor 8051  
Unretouched photograph of screen

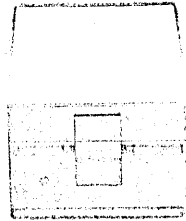

The Intecolor 8031  
Unretouched photograph of screen

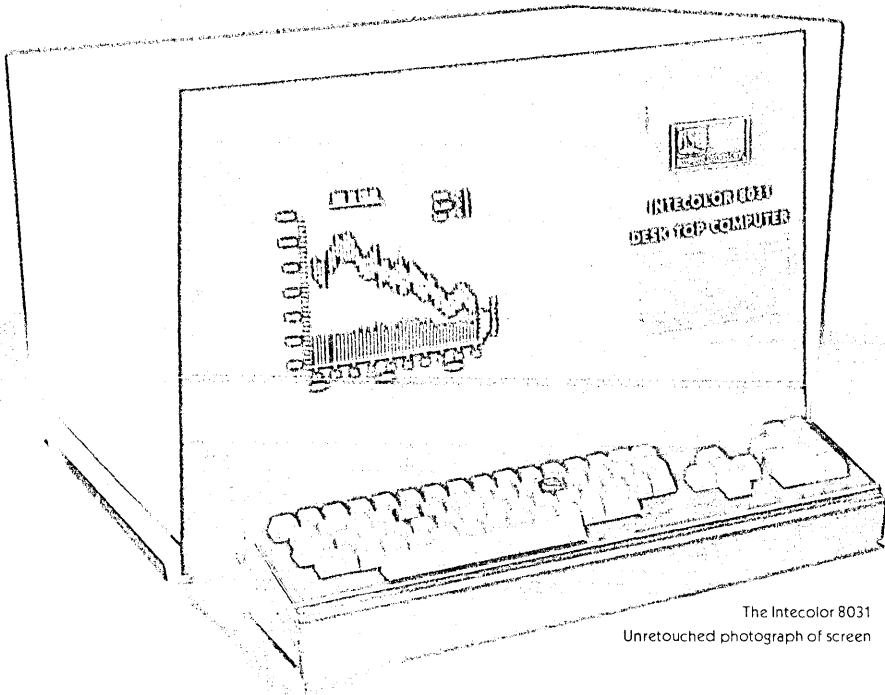

AL (also MS) W.A. Brown Inst. Inc. Hawthorne, CA 90230 AZ (also NV) The Thomson Co. Phoenix 602-956-5300 CA The Thomson Co. Los Angeles 213-476-1241 or 213-937-4454 Coletta  
Shisler 813-771 Mountain View 415-964-6111 San Diego 619-592-8525 Irvine 714-544-4111 CO (also WY) The Thomson Co. Denver 303-759-0809 FL W.A. Brown Inst. Inc. Ft. Lauderdale  
305-276-4800 Melbourne 407-251-1111 Ft. Lauderdale 305-426-6500 Virginia 914-678-7932 GA W.A. Brown Inst. Inc. Atlanta 404-939-1674 IL (IN) (also IN, WI) Resources Data Sys. Northbrook  
312-564-5500 KS (also W, MO, NB) Bartlett Assoc. Bethlehem 312-373-2356 LA W.A. Brown Inst. Inc. Mandeville 804-626-9701 MD (also DC, VA) Bartlett Assoc. Bethesda 301-656-3061  
MA (also ME, NH, RI, VT) Bartlett Assoc. Bethlehem 312-373-2356 MI WKM Assoc. Madison Heights 313-588-2300 MN Cost Reduction Services, Minneapolis 612-822-2119 MO (E) (also  
S, IL, IA) Intecolor Assoc. St. Louis 314-261-1411 NM The Thomson Co. Albuquerque 505-265-5655 NY (also CT, NJ) Bartlett Assoc. Holcomb 716-657-6291 White Plains 914-949-6476 NC  
774 The Thomson Co. Durham 919-283-1233 OH (also KY) WKM Assoc. Cleveland 216-267-0445 Dayton 513-434-7500 OK Data Marketing Assoc. Oklahoma City 405-526-6071  
OR The Thomson Co. Portland 503-243-9801 PA (E) (also DE) Bartlett Assoc. Warrington 215-688-7325 PA (W) (also WV) WKM Assoc. Pittsburgh 412-892-2953 SC W.A. Brown Inst. Inc.  
Columbia 803-736-3311 TN The Thomson Co. Memphis 901-673-7568 WA (also ID, MT) The Thomson Co. Bellevue 206-455-9180 EUROPEAN EXPORT SALES Telexport Inc. Cambridge  
44-711-221 telex: FRIGLAND telex: 2111 Birmmoo 069292-293319 FRANCE Perlec, Rueil 149-10-37 SWITZERLAND Interest AG Bern 031-224481 WEST GERMANY: CCI GmbH,  
41000 Düsseldorf 49 AUSTRALIA Anderson Digital Equip. Meadowbrook, NSW 602-444-4511 Waverley, Victoria 03-943-2077 CANADA Cintas, Inc. Ottawa Ont 613-255-0983 Pointe  
Claire 514-894-0709 Toronto Ont 416-676-7246 CANADA Intecolor Ltd. (Distributors) Dorval Que 514-636-9774 Ottawa Ont 613-244-1391 Toronto Ont 416-284-1208 Vancouver  
604-696-6256 FAR EAST Computers International, Los Angeles, CA 213/382-1107

# Editor's Readout

John L. Kirkley, Editor

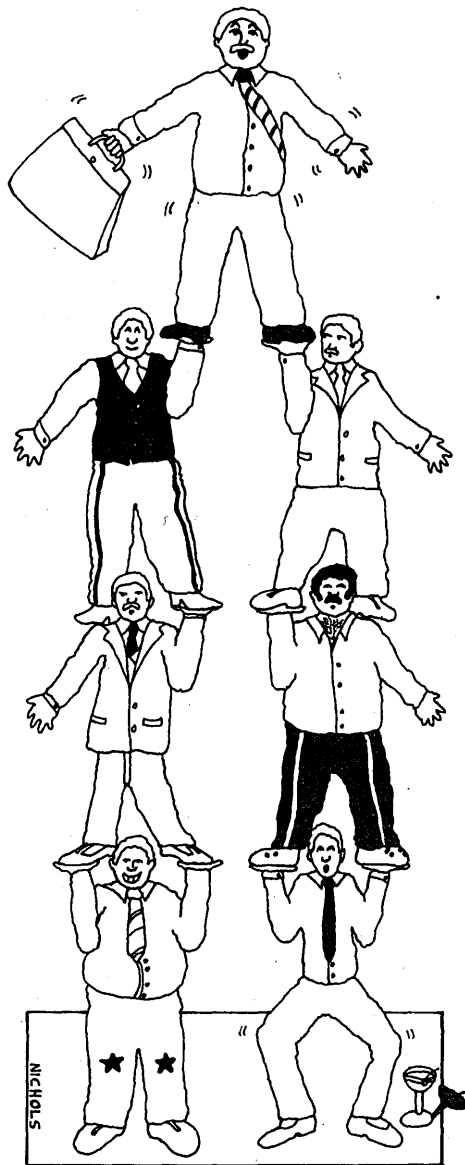

## How to Manage According to Melon

It was at an NCC cocktail party last month that we ran into our old friend, Dr. Persiflage Melon, noted management consultant and small-arms expert. He wanted to talk to us about a recent editorial where we commented that one of the dp professional's toughest jobs was that of being a manager.

"Nonsense," said Melon, sipping a martini. "Managing is the simplest thing in the world as long as you remember that there are no rules and no one knows what they're doing anyway."

"But look what happens. A manager begins floundering and so he packs himself off to an AMA seminar or some such rot. There a middle-aged man with a crew cut and a short-sleeved shirt loads him up with the Hawthorne Effect, Maslow's hierarchy of needs, and other folklore straight out of the fifties. He works through a gaggle of case studies with his fellow neophytes and, at the end of a week, returns to work with a three-ring binder full of useless information, ready to terrorize his employees. The result is chaos."

But what's a manager to do? we asked.

"Simplicity itself," said Melon. "Successful management is the application of three basic ingredients: first, adopting a management style; second, making decisions; and third, managing time—your own and that of your employees."

"Now, as to adopting a management style, my advice is simple—don't. Nothing is more ludicrous than a pussycat trying to behave like a panzer tank commander. Or a grade-A, dyed-in-the-wool s.o.b. trying to be Mr. Nice-Guy. So be yourself, be honest. You won't fool anybody for long anyway."

Well, what about decision making? we asked. Risk analysis, decision tables, and all that.

"Nothing to it," said Melon, helping himself to another martini. "You gather as much information as you can reasonably gather, sleep on it, and the next day make a decision. If you make the wrong decision, you make another one. If you make too many wrong decisions, you shouldn't be in that line of work anyway."

Seems straightforward enough, we said. But what about time management?

"Ah, one of my favorite subjects," said Melon, waving his arms expansively and spilling gin on a passing advertising salesman. "Let me give you an example. I'm sure that your house is like mine—something lives under the clothes dryer that eats socks. Soon you have one green sock, one brown . . . damned annoying and time consuming as you root around in your dresser searching for the missing sock. The man who solved this is a master of time management. He suggests that you buy socks of all the same color and style. His choice was black, I prefer yellow," said Melon, pulling up the leg of his maroon leisure suit.

"The man's name is Alan Lakein and his little book *How to Get Control of Your Time and Your Life* tells you all you need to know about time management. By using a few of his simple ideas—goal setting, working on the most important things first—you'll soon have your time under control. From there it's a simple matter to help your employees organize their time successfully."

And that's all there is to managing? we asked. You make hundreds of thousands of dollars each year from the major corporations as a management consultant. And that's all you tell them?

"Good heavens, no," said Melon aghast. "They'd never stand for it. No, what I do is gather them together in a room for a week's intensive seminar. I give them a three-ring binder, tell them all about Maslow, Herzberg and McGregor, and show them Peter Drucker films. They love it."

Melon, we said, we're beginning to suspect you're a bit of a fraud.

"Alas," said Melon, delicately fishing the olive out of his martini, "it does appear that way, doesn't it."

# Comparing Networking Technologies

by Ray W. Sanders

---

Ten years ago, packet switching was seen as the most reasonable technology for data communications networks. But a good deal has happened in those years, and not much of it has favored the packet.

---

Today the data communications field is far different from what it was just 10 years ago. Then, data communications was perceived as something that transpired primarily between computers and terminals, something that almost always made use of analog telephone circuits with modems at each end. Now the emphasis is on "digital data networks" which include not only modems and digital transmission facilities, but also intelligent devices for providing services not previously possible. These networks are seen as a medium to which computers, terminals, and other devices connect independently. It's quite a different picture.

Usually the technology mentioned with such networks has been—and still is—packet switching. But there have always been a large number of cases where other networking techniques were more effective, and, as we shall see, the rapid rise of microcomputer technology—not contemplated when packet switching was first developed—could make packet switching a suboptimal technology for many applications.

To understand why, it's necessary to go back to some basic questions, like—why do we need networks?

There are, and will continue to be, a lot of applications where a pair of modems attached to a transmission facility will adequately satisfy a user's data communications needs. However, the rapid increase in the demand for remote access to data bases and for distributed processing has proliferated the need for more complex structures. The principal needs to be satisfied by a network are:

- alternate resource selection from a single user's equipment
- shared use of expensive network facilities
- shared use of redundant facilities to ensure the highest possible service availability
- centralized management of network elements
- error-free communication where required
- compatibility features so dissimilar equipment can communicate

Further, the network should provide these features without requiring new host software, without sacrificing throughput or response times as seen by the end user, and without locking the user into a single vendor's hardware.

### The three faces of digital switching

All of these requirements and more can be satisfied by modern digital data net-

---

All digital switching techniques are based on the same principle.

---

works. Technology which has evolved over the last decade or so has provided all that is required to implement effective networks with great potential for growing with future applications. The most important technological innovations

which have evolved are those concerned with digital switching.

All digital switching techniques are based on a very simple principle. A digital switch receives data from a source like a computer or terminal, stores it for some period, and sends it on to a desired destination. Although there are distinct operating differences between the approaches to digital switching, the technical distinctions fundamentally revolve around the length of time the data is stored by a switch and the means by which the switch determines the desired destination of the data.

There are three different kinds of digital switches: message switches, packet switches, and time-division circuit switches. The earliest were the message switches. These are often called message store and forward systems. They include a processor, usually a computer of some sort, and some storage medium. Some have only minicomputer processors and small discs, others are as large as and can act like full-scale general purpose computers. Not everyone in dp has run into these beasts, as they often live in telecommunications departments.

Message switches take their name from the fact that they store entire messages for later delivery to one or more destinations. They deliver their messages on the basis of availability of transmission facilities and of the busy status of the destination terminal. Sometimes queuing priorities are invoked as part of the strategy to determine message delivery times too. In any case, the message destinations are determined from address fields in the mes-



sages themselves, and one or more specific message protocols must be implemented in the terminal equipment for such systems to work.

Message switching technology has become highly developed for certain applications and has found particular use in handling administrative messages within large organizations. However, it was soon recognized that message switching techniques possess major drawbacks for most data communication applications. The main difficulty is that message switches result in far too much delay for interactive applications. Further, the message protocols which must be observed by the user's equipment for message formats and call set-up procedures are very restrictive. And

---

### Packet switching was first proposed as a way to improve message switching, in 1962.

---

since few standards exist, interfacing such networks requires undertaking significant software development.

About 10 years ago, modifications to message switching technology were begun which would overcome some of the drawbacks of message switching for data communications. It was recognized that the major difficulties for data communications applications were inherent in message switching technology. The only way one could hope to better the situation was to conceive digital switching techniques which did not require storing entire messages.

The result of this thinking was the

emergence of packet switching, an idea first proposed by Paul Baran while he was working on command and control applications at RAND in 1962. In fact, the essence of packet switching is the same as message switching. A block of data from a terminal has addressing information appended so that network switches can route it through a network to its destination. The key difference between message and packet switching is that packet approaches can divide long messages into chunks so that the total transmission delay through a network is shortened. (Why this happens may not be obvious, but we'll get to that later.) Further, techniques have been developed where addresses are provided by network switches instead of by the user's terminal so that the packet net can be used on a protocol-transparent basis.

Today, packet switching has been made operational and has become one of the faddish technologies of the decade. However, even though packet switching has many benefits, it also has limitations which, like those of message switching, are inherent in the technology. The fact that data must be dealt with in blocks results in undesirable transmission delays in many cases, delays which result from one block waiting for another to finish up. The remedies for the delays are primarily the adoption of protocol dependent full-duplex interfaces like those in IBM's SDLC and the international protocol X.25. But these often result in many of the same complexities faced in trying to apply message switching techniques to data communications. We may find that

in another 10 years packet switching will be relegated to a set of specialized roles just as we find in the case of message switching today.

The third alternative in digital switching is called time-division circuit switching. The essential difference between message and packet switching on the one hand and time-division circuit switching on the other is in the size of the blocks of data stored by data switches. In time-division circuit switching, data from a single terminal is stored in very small segments, usually only a single character at a time. The result of this approach can be dramatically smaller network delays in the case of transmission of data from low speed terminals. Even with higher speed terminals there are many instances where time-division circuit switching produces significantly higher throughput than does packet switching.

Since data switches handle only a small segment of data from a single source at one time, it is obvious that the method of signifying the destination of

---

### Packet switching's drawbacks are inherent in the technology.

---

each small data segment must be handled differently in time-division circuit switching than it is in packet or message switching. It would be grossly inefficient to append an address header to each character of data, which would be the only way that the low time delay inherent in time-division circuit switch-

# COMPARING TECHNOLOGIES

ing could be emulated by packet switching technology. The preferred method of handling addressing in circuit switches is through the use of signalling communication channels which are separate from the data channels. This

technique has been the subject of major development efforts during the last 20 years in the telephone industry, which is rapidly incorporating digital circuit switching technology into the telephone network. Although the requirements for data networks are quite different from those of the telephone network, these same signalling methods have now been incorporated into data networks based

on time-division circuit switching principles.

Although there are many subtleties in the design of data networks, it is useful to compare the various digital switching techniques in their ability to meet different networking objectives. We'll look at only packet switching and time-division circuit switching here, since these are both clearly superior to mes-

## Comparing The Digital Switching Techniques

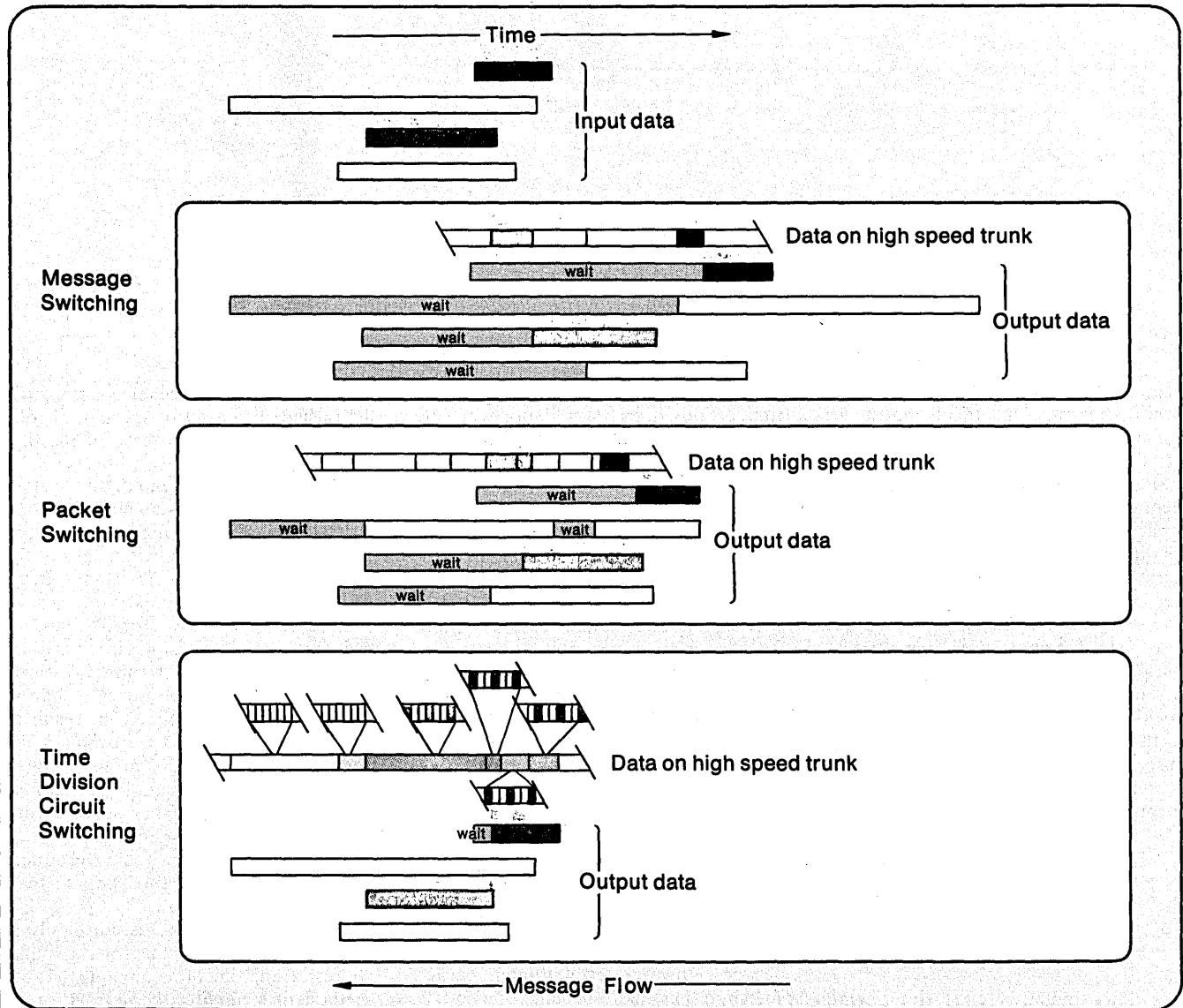

Fig. 1. In message switching, no data is transmitted over the high speed trunk until the entire message has been stored in the message switch. That means the first message to be completely stored—not necessarily the first one to begin coming in—is the first one out on the trunk. It also means that the receiving terminal does not begin to get any data until after the entire message has been received by the message switch.

The second message to be completely stored must wait for the first to finish transmission before it can go onto the trunk (as is illustrated by the green message waiting for the yellow to be transmitted and the orange waiting for the blue).

Packet switching partially alleviates the delay problems of message switching since long messages are fragmented by the packet switches (as illustrated by the yellow, orange, and blue messages). That way, transmission begins before the

total message has been stored at the first packet node.

However, if the high speed trunk becomes congested (as is illustrated by the contiguous sending of two blue message packets and an orange one before a yellow message packet), waiting periods occur. These waiting periods show up on the output lines as interruptions in the flow of data. Such interruptions are not too serious in the case of asynchronous terminals, but can cause serious problems for synchronously clocked terminals and computers, as these cannot tolerate an empty slot on the access line. Protocols can clear up the problem, but they are not transparent to the user.

Finally, where it can be used, time-division circuit switching is a clearly superior technique in terms of the delay it imposes on a transmission.

sage switching in providing networking capability.

### Concentration

Most systems analyses applied to data network design, and most popular notions associated with defining advantages of data networking, include the idea that the efficient utilization of trunks in a network is important. Usually this means some form of concentration will be used where "concentration" is defined as attaching more incoming lines to a trunk than the trunk can handle at one time, relying on the premise that not all of those lines are likely to be running at rated speed at any given time. It is important to investigate two questions about concentration: when it is economically important and operationally suitable, and how the switching techniques handle it.

Almost all published analyses of networks have been based on minimizing line charges levied by common carriers. Very few analyses have been published concerning the actual costs of the transmission facilities. Prices and costs are two different things in the common carrier world. The costs, to the carriers, of providing digital transmission capability have dropped dramatically over the past 10 years. With the coming of optical and microwave waveguide long-haul transmission systems, this trend should continue to where the actual cost

---

Neither time-division circuit switching nor packet switching is clearly more efficient in all cases, or easier to implement.

---

of providing transmission will not represent a meaningful portion of network economics. In short, if the current trend in communications tariffs continues, where tariffs more and more reflect what it costs the phone company to provide the service, efficient use of long-haul trunks may be of little importance.

On the other hand, the costs of providing local transmission from terminals to network nodes has not changed as dramatically and probably will not change dramatically in the future. So it is likely that local data distribution cost will become much more important than the efficient use of long haul facilities.

There are some important instances where concentration will continue to be important. One case is the use of transoceanic cables. Another is in serving sparsely populated areas where the cost of transmission is relatively high compared to the traffic volume. In cases such as these, it can be economically important to provide the highest possible concentration ratios. In most cases, however, it is only necessary not

to waste transmission capacity on a gross basis.

Concentration is achieved in packet and time-division circuit switching through quite different forms of multiplexing. As illustrated in Fig. 1, it is achieved in packet switching by sequentially interleaving packets on a high speed trunk. Each arriving packet occupies the trunk entirely for a short period so that the trunk acts as a single server for all of the arriving packets.

Concentration is achieved in time-division circuit switching by first dividing the trunk capacity into a series of sequential time slots, then assigning blocks of data to particular slots. At the end of a block, the slot is released for use by some other block.

The efficiency of utilization of trunk capacity in each case depends on the amount of signalling overhead. In packet switching, the overhead is in the framing of packets, addressing, and control information packaged in each packet. In time-division circuit switching, the overhead is the amount of data required to set up a circuit for the duration of the transmission of a block, or in some cases on the duration of a call in which many blocks may be sent. The point is that every packet carries an overhead load in packet switching, while overhead in the time-division case may be only on a once per call basis.

Neither technique is clearly more efficient in all cases, nor simpler to implement. For example, packet switching is simpler to implement where it is required that data be passed randomly through a network with many nodes—that is, where the desired paths through the net are not predictable. Time-division circuit switching is simpler to implement for many transaction-oriented (and hence not randomly directed) applications, for example, and where congestion problems during the sending of a block of data absolutely must be avoided.

Fig. 2 (p. 92), does not make any comment on the relative concentration efficiencies of the various approaches. It's very difficult to make statements which apply to all cases. However, it is certain that pure packet switching which uses short packets in order to reduce delays is less efficient than using long packets, in terms of concentration efficiency. Also, using composite packets can be more efficient than using pure packet switching.

And time-division circuit switching can match the best kinds of packet switching if appropriate virtual call setup principles are employed, but less efficient when a single setup initiates an entire interactive session. (In the latter instance, when the user is scratching his head, the line isn't being used at all.)

The figure does put into perspective an often overlooked problem of concentration. When trunk loading approaches 100%, service is affected

adversely regardless of the switching method employed. In circuit switching when a contention protocol is used and the trunk becomes overloaded, the data is held off until a time slot is available on the trunk. When a slot is available, it is kept open for that user for the duration of the block, or of the call. Thus, a user may have to wait, but once he begins transmitting he is assured of uninterrupted delivery.

In packet switching, two methods are used to handle overload situations, one based on buffering and the other on what is called a flow control protocol. Buffers allow for transparent operation, but can overflow and lose data. Flow control protocols allow for sending messages to terminals to temporarily halt the flow of data so that nothing is lost, but are not transparent to the user.

All this suggests that any attempt to achieve high concentration ratios also carries potential adverse consequences.

### Error control

One of the most publicized features of data networks is that of providing error control of user data. It is interesting to analyze the effectiveness of various network approaches to providing this capability—and to assess the impact of microcomputer technology on the problem.

The principal purpose of error control is to provide for the detection and correction of errors which occur in a telecommunications environment. The primary source of errors was historically in transmission facilities which were analog telephone facilities adapted, using modem technology, to transmit digital data signals. Over the last 10 years, telephone companies have reduced or eliminated a number of sources of errors in their facilities. As new digital transmission facilities become available, the number of errors

---

The principal purpose for error control is to make up for analog telephone lines—which are going away.

---

generated for any given speed of transmission should diminish even further. Thus, the need for error control is becoming unimportant for many routine applications.

One of the main purposes of packet switching was to provide an effective means of overcoming communication errors. The method chosen has been based on the old but effective technique of attaching to a block of data a sequence of bits which are computed from the contents of the data block itself. If at the receiving terminal the computed sequence does not match the

## COMPARING TECHNOLOGIES

check bits that are received, a request to retransmit the data block is sent to the transmitting terminal. This so-called

"ARQ" technique is a central feature not only of packet networks, but of almost all data transmission systems employing error control.

Error control in packet networks applies only to transmission links where

an ARQ technique is implemented. Therefore, in attempting to use a packet network as a transparent transmission facility, error control takes place only between internal network nodes. Since almost all packet networks today are used in this way, the effectiveness of error control is limited to those cases where poor quality transmission facilities are used between network nodes. The quality of the facility through which the terminals *access* the nodes must be high if the user is to enjoy the benefits of error control of a packet network in this mode.

The solution to providing error control over the network access lines has been to design a packet network access protocol which includes an ARQ technique in both the terminal and the network node. In this way, errors on the access line are detected and corrected. (SDLC and HDLC link protocols provide this capability.)

This approach solves one part of the error control problem, the correcting of transmission errors, but totally neglects the detecting or correcting of errors generated in the packet switches themselves. Although one expects the error performance of modern computer-like devices to be very good, there are many applications where users must insist on implementing their own end-to-end error correction protocol even if they are using a packet network. The link-by-link error correction technique of packet networks will not satisfy their error control requirements.

Time-division circuit switching does not provide error control capability of either transmission facilities or switching machines. However, modern micro-computer technology has made the implementation of error control protocols a very low cost possibility. Therefore, it can be expected that even the lowest priced asynchronous terminals can include an error control protocol. This development makes total end-to-end error control a cost effective alter-

---

### Microprocessors are the great equalizers in error control.

---

native for almost all data communication needs. In fact, carrying error control from the terminal all the way to a host application program is now a very simply implemented procedure, and it eliminates the need for error control processing in all network switches.

### Compatibility features

A very desirable feature of data networks is their ability to allow terminals with different protocols and speeds to communicate. This proposed capability has been a much discussed subject in the

Comparing Response Times

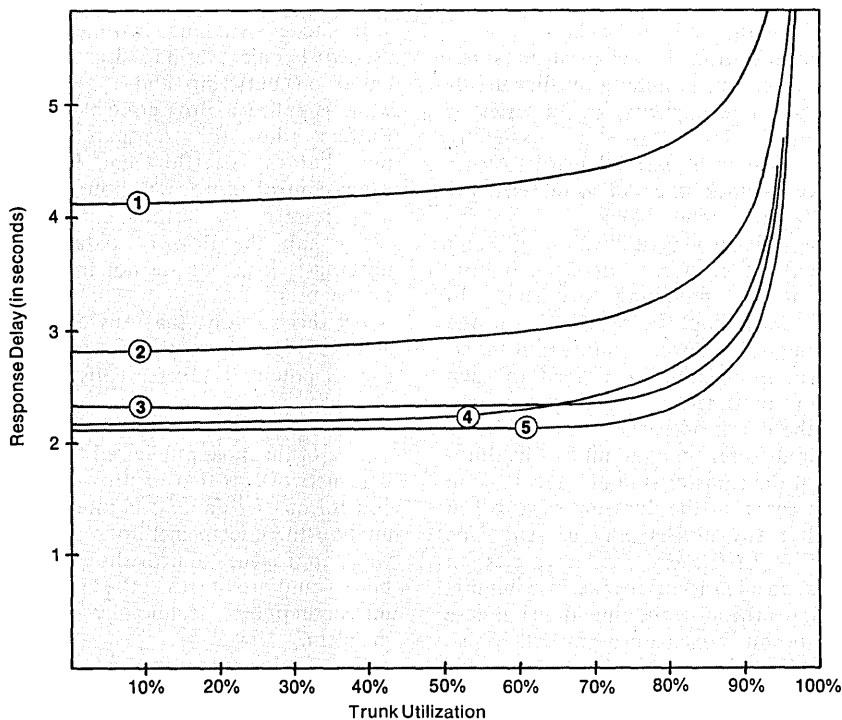

Fig. 2. Part of the reason for selecting one or the other of the techniques falls out of an analysis of delay characteristics. The above curves illustrate the delays imposed by the various forms of packet and time-division switching as data is passed between two nodes. For this comparison, it is assumed that a large population of 30cps terminals are attached to a single 4800bps transmission facility. The average message size is assumed to be 60 characters, and message lengths are assumed to be exponentially distributed. Also it is assumed that messages arrive randomly (for the statisticians: according to a Poisson distribution).

The total message delay, labeled in seconds on the vertical axis, is plotted versus the loading of the trunk. In all cases, message delays go up rapidly when the line loading gets close to 100%; it is the differences in the average responses which can be most important.

The first three curves plotted are for packet nets used transparently, that is, where the networks emulate the function of modem pairs on plain old telephone lines. The highest delay case occurs with pure packet switching when it is assumed that the entire message is contained in a single packet. The next longest delay shown is for a case where the input message is fragmented into packets which carry no more than 20 characters of data. Although considerably higher overhead is required to support this mode of transmission, it does reduce delays for messages longer than 20 characters.

The third curve shows the best possible result from protocol-transparent packet switching. It occurs when an internal node to node protocol is used which allows for interleaving data from a number of terminals into a single composite packet. Such an approach is now being incorporated into modern packet networks. And, until a truly standard network access protocol becomes generally available for connecting terminals to a network, the composite packet approach will be superior to other user-transparent approaches as long as the internal protocols do not consume large amounts of bandwidth for overhead.

The fourth curve occurs when a packet switch link interfaces with a host computer over a high speed line on a basis which is *not* protocol transparent; for example, if the network and host computer both support an X.25 network access protocol.

The last curve shows that time-division circuit switching is superior to any packet switching technique in terms of the delay it imposes. For the comparison, it has been assumed that a circuit can be set up in 1/10th of a second, and this is readily achievable when paths are preallocated as in virtual circuit setup procedures. Such circuits are by their nature protocol transparent.

data network field for many years. Millions of dollars have been invested by organizations in attempts to implement this capability. Unfortunately, success to date has been very limited.

A popular misconception is that this capability is an inherent part of packet switching. The fact is that the protocol conversion features are achieved by communication *processing* techniques which are quite independent from communication switching and transmission techniques. Packet and time-division circuit switching techniques are each different methods of transporting data through a network. The ability to *transform* data can in either case be performed by processors attached to the switching equipment. Designs of packet networks which do not face this fundamental fact and commingle conversion and switching functions will inevitably run into serious problems in adapting to changing user requirements.

The most promising general approach to the compatibility problem has been

---

**A popular misconception is that compatibility features are inherent in packet technology.**

---

to pursue implementation of "virtual terminal" or "virtual host" protocols. In these, an attempt is made to translate the protocol or language of a particular terminal into a network protocol general enough to support the detailed characteristics of a wide variety of terminals and computers. At the destination end for a particular message, a second translation is made, this time from the virtual protocol to a real protocol (which can be conceptually the same or different from the initial sending end protocol).

Even though this possibility has been widely touted—incorrectly—as an attribute of packet switching technology, the problems of implementation have proven to be so formidable that one cannot expect this purported advantage to find wide application. In some instances, it appears that the attempts to implement this approach are not feasible.

Even if the approach is used for some limited set of protocols for which implementation is feasible, a network operator is faced with the specter of ongoing software development to support both new protocols as they appear in the marketplace and the almost limitless variations which continually emerge for older protocols. In any case, the implementation of compatibility features must be designed as a separable function from network data transport functions. With this caveat, there is no particular advantage of packet switching over time-division circuit switching.

### Virtual ports

For many applications, such as time-sharing and inquiry/response data handling, it is desirable to allow a multiplicity of user terminals to be simultaneously connected to a single port on a host computer. Protocols for achieving this in the past have been typically based on polling principles, but polling creates large processing overheads in both a host computer and in a network.

One of the true main advantages of a packet network access protocol is its ability to allow efficient utilization of network resources while reducing the amount of processing required by a host computer. Thus universal acceptance of a standard network access protocol such as X.25 would greatly facilitate this advantage of packet switched networks.

In fact, the ability to provide a standard network access protocol is the one area where packet switching possesses a clear advantage over pure time-division circuit switching. However, this advantage for many years is likely to be largely a conceptual one since the implementation implications for users are significant.

### Avoid the vendor lock-in

Most large computer vendors have developed their own networking approaches which are some form of packet switching. However, with rare exception, the detailed protocols appear to be intentionally restrictive, not allowing the user to buy substantial quantities of equipment from other than the computer vendor itself. The protocols usually do not result in a network which is transparent, so that attempts to expand its use with equipment from other vendors usually imply significant software investments and implementation difficulties.

The most promising approaches to avoid these problems are for users to insist on implementation of networks involving industry standard network access protocols. X.25 should become such a standard for packet network access.

However, in many cases much simpler approaches will yield more cost-effective results. There already exist industry-wide standards for communication through synchronous and asynchronous terminals, with call setup procedures and even certain message protocols. (These standards have been published by the Electronics Industries Association, the American National Standards Institute, and others.) Fundamentally transparent networks which support these older standards provide users with a wide choice of implementation options and, often more important, the ability to efficiently support new applications with the addition of application level software as opposed to teleprocessing-support level software.

### Room for all

Many of the reasons for which packet switching was developed have changed and will continue to change significantly. The cost of long-haul transmission continues to decline, for one thing; for another, microcomputer technology can allow features such as error control to be incorporated into low cost terminals instead of in the network.

Packet switching and time-division circuit switching each possess attributes which cannot easily be emulated by the other. The principal advantage of packet switching is the ability to provide a standard network access protocol so that a host computer can simultaneously communicate with a multiplicity of terminals. Time-division circuit switching, on the other hand, provides the lowest possible network transport delay and thereby provides significant advantages in implementing transparent network services.

Since no single digital switching technology provides adequate capability in

---

**Packet switching, time-division circuit switching, and combinatorial forms will all have roles to play.**

---

all cases, some of us believe that a hybrid networking approach provides the best of both worlds. Modern microprocessor technology now makes this combination a cost-effective alternative to the implementation of digital data networks. It is most likely that packet switching, time-division circuit switching, and combinatorial forms will all have roles to play. \*

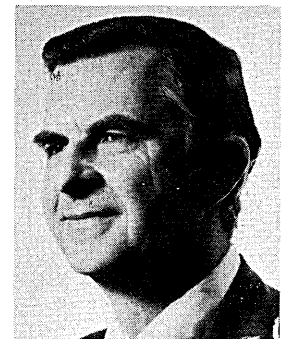

Mr. Sanders is president of Computer Transmission Corp. (TRAN), an El Segundo, Calif. firm which designs medium and large scale digital communications networks, as well as produces and installs the equipment for them.

Prior to founding TRAN, he was vice president and director of engineering at ITT Gilfillan, and before that, a founder of Space Electronics Corp. He also has been a *Datamation* contributing editor.

# The Future of Commercial Satellite Telecommunications

by Wade White and Morris Holmes

---

The spectrum is becoming crowded, available orbit slots are being filled, and yet there seems no end to the demand for more satellite telecommunications capacity. New transmission techniques may ease the problem.

---

The commercial use of satellites for telecommunication has come a long way in a short time. The commercial era opened with the Communications Satellite Act of 1962 which set up the Communications Satellite Corp. (Comsat) as the United States "carriers' carrier" for satellite telecommunications. This was followed by the formation of the International Telecommunications Satellite Organization (Intelsat) in 1964 under an interim operating agreement of the member states to own and operate a system of communication satellites for international telecommunications.

These actions led to the construction of the Intelsat global communications satellite system which today provides the equivalent of over 20,000 two-way voice grade circuits for longhaul overseas voice and data traffic, and for television distribution among 90 nations around the globe. In the years 1965 to 1975 the Intelsat network grew from 240 telephone circuits to its present capacity, more than doubling every two years.

In 1972 the Federal Communications Commission authorized United States common carriers to construct and operate satellite systems for domestic telecommunications in the "free enterprise" mode (as opposed to the regu-

lated monopoly practice of the past). This action is commonly called the "open skies policy" and encourages the domestic common carrier industry to apply satellite technology to a wide variety of new private line services in a competitive environment.

AT&T was prohibited from furnishing new private line services via satellite but

---

**The capacity of the  
INTELSAT network has  
doubled every  
two years.**

---

retained its monopoly on long haul message telephone service in the continental United States. (This monopoly was restricted by a Supreme Court decision in January 1978.)

Western Union launched Westar, the nation's first domestic system, in 1974.

This feature has been adapted from an article of the same title appearing in the Spring 1978 issue of *Quest*, a publication of TRW's Defense and Space Systems Group, edited by John Silletto. The artwork was done under the supervision of *Quest*'s art director, Daniel D. Judge.

RCA and AT&T quickly followed with Satcom in 1975 and Comstar in 1976. These systems provide a wide range of domestic private line and message telephone services to the continental United States, Hawaii, Alaska, and Puerto Rico. The private line services include television distribution, leased lines for NASA and the Defense Communication Agency, and telephony and high speed data circuits leased to corporations and public institutions.

Satellites for this era of commercial exploitation are in the 1,000 to 2,000 pound range, are powered by solar arrays supplying 300 to 800 watts, and launched by NASA's workhorse rocket launchers—the Thor-Delta and Atlas-Centaur.

In January 1977, Western Union contracted with NASA to provide tracking and data relay service for all of NASA's earth orbiting satellites including the Shuttle. This service will be provided on a lease basis for 10 years and will replace NASA's worldwide network of ground stations. It will simultaneously provide Advanced Westar service in the 4 and 6 gigahertz (GHZ) and 12 and 14GHZ bands to Western Union's commercial customers. TRW is building the TDRSS/Westar satellites and will integrate the main NASA ground station

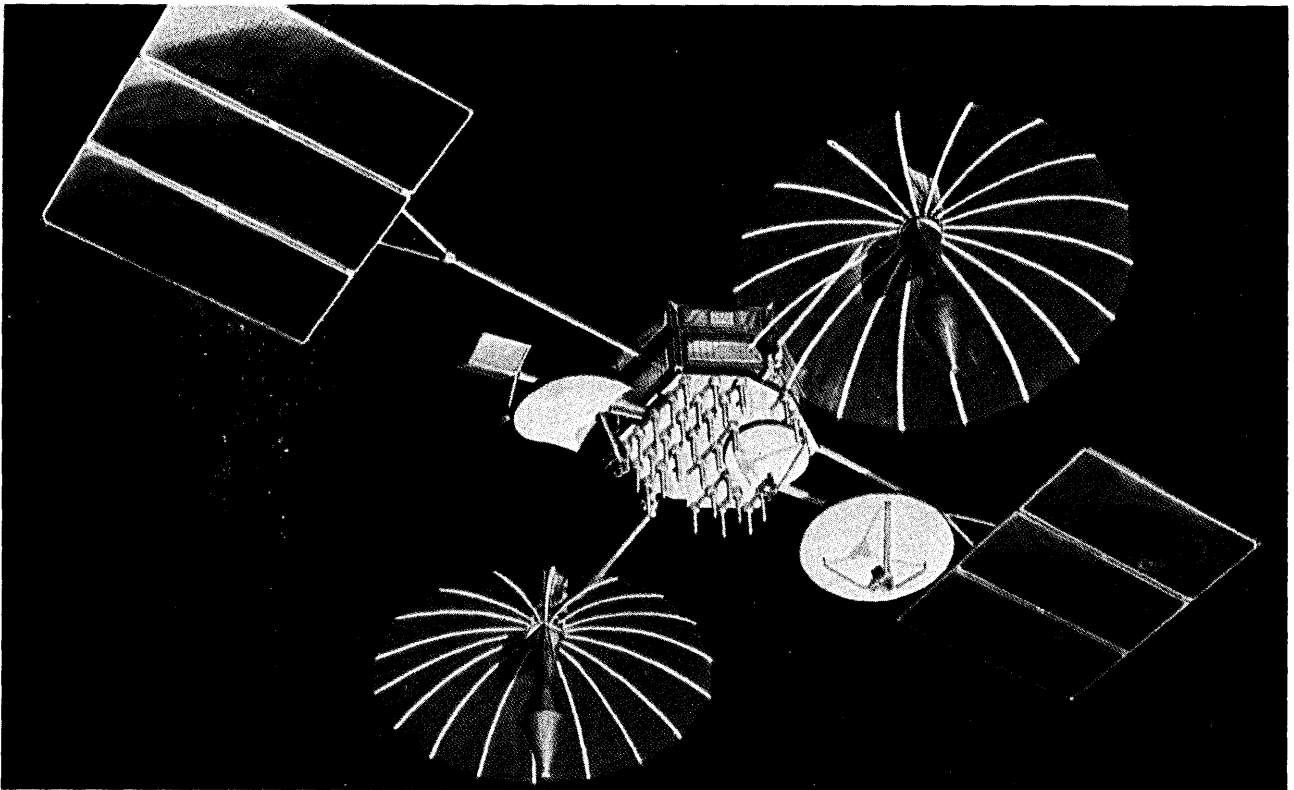

Four Tracking and Data Relay Satellite Systems are being built for Western Union and NASA by TRW. Each will weigh 4,200 pounds, be 42x54x15 feet, and use a transmission technique

called spacecraft-switched time-division multiple access (SSTDMA).

at White Sands, New Mexico.

Actually, four identical satellites will be launched, two for NASA, one for Western Union, and one shared spare.

The TDRSS/Westar satellites each will weigh 4,200 pounds, will be 42x54x15 feet, provide 1,800 watts of solar power, and will be launched by the Shuttle on the first operational flight in 1980. The communication payload includes transponders in three frequency bands (2GHz, 4 and 6GHz, and 12 and 14GHz) to provide the NASA and advanced Westar services. In the advanced Westar mode of operation, each satellite can provide twelve 36MHz channels at 4 and 6GHz, and four 250Mbps time division multiple access channels in the 12 and 14GHz band.

Note that the separate carrier fre-

quencies are allocated for uplink (ground-to-satellite) and downlink (satellite-to-ground) transmission paths, with the lower frequency for the uplink and the higher for the downlink.

The advanced Westar system will employ a large number of relatively small earth terminals so that an individual private line subscriber can have its own dedicated satellite communications link for high speed data and voice traffic.

Satellite Business Systems (SBS) is planning to launch a new series of domestic private line satellites in the 12 and 14GHz band in 1980. Procurement of this system is underway now. SBS aims to install private communications networks for the *Fortune 500* leading corporations and large public service

institutions throughout the continental United States, and estimates a market of 200,000 equivalent two-way voice circuits by 1985.

AT&T Long Lines is currently planning its next generation system to replace Comstar in 1983. It is expected to carry 4 and 6GHz, 12 and 14GHz, and possibly 20 and 30GHz transponders to provide high capacity trunks between major cities as well as to serve the private line market (assuming the FCC prohibition against AT&T is lifted in 1979).

These new systems will exploit the Shuttle launch capability and will demonstrate a new class of satellites having more telecommunication capacity, high speed digital transmission, and longer life.

# SATELLITE

## The growth in demand

The phenomenal growth in traffic volume on the Intelsat network since commercial operations started in 1965 took place even while new submarine cables were being laid for high-density routes. Comsat Corp. predicts a continued growth in Intelsat traffic at the rate of over 16% per year, which means over 400,000 equivalent two-way voice circuits in service by the year 2000 (as compared to some 20,000 circuits today). Fig. 1 shows the growth of the Intelsat network during its first 13 years, in terms of numbers of ground stations, numbers of antennas, and numbers of countries participating.

Intelsat traffic, however, is only a part of the total expected traffic. Many countries or regions, including the U.S. and Canada, have their own domestic or regional communication satellites either in operation or in the planning stages (see Table 1). Those now in operation account for about 100,000 circuits and this figure is expected to double by 1982.

A projection made by the Bell System for its own Long Lines traffic indi-

**By the year 2000, 10 times as many satellite circuits will be needed, maybe 20.**

cates a total of some two million "satellite eligible" circuits by the year 2000. (A "satellite eligible" circuit is arbitrarily defined as one over a thousand miles in length, although many such circuits may be handled by ground links, and some shorter links on high-density routes may well be handled by satellite.)

An educated guess as to the total expected demand for satellite circuits for present uses in the year 2000, including domestic and regional as well as international traffic, is that three and a half million circuits will be needed; this is over 10 times the capacity that exists today.

These projections, however, are for the kinds of traffic that are handled today by satellite. The great bulk of today's traffic is telephony, although there is a significant fraction of television trunking (carrying television signals between major cities) and a small but growing amount of data transmission. Many other kinds of entirely new services are being discussed, and at least some of them are certain to be implemented over the next 10 to 20 years. The resulting added demand for satellite communication capacity is hard to estimate, but it would not be surprising if the total demand in 2000 were 15 or 20 times today's capacity.

No forecast of future demand, however, can be considered reliable. Some earlier projections proved to be too high

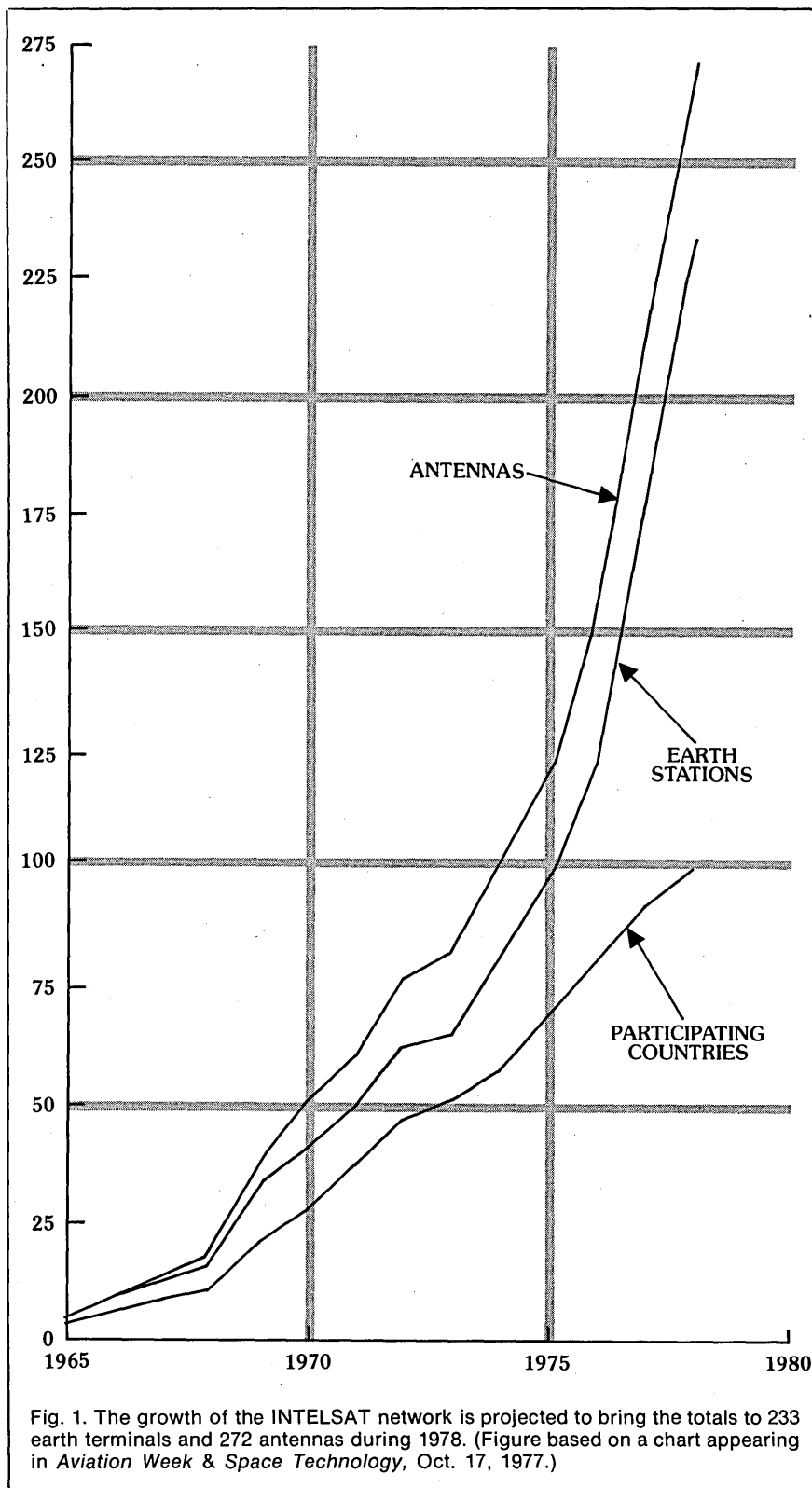

Fig. 1. The growth of the INTELSAT network is projected to bring the totals to 233 earth terminals and 272 antennas during 1978. (Figure based on a chart appearing in *Aviation Week & Space Technology*, Oct. 17, 1977.)

because of the drop in demand caused by the worldwide recession in 1973-75, for example. On the other hand, new services tend to create their own demand; there was no demand for intercontinental transmission of television signals before the Intelsat system was formed, because undersea cables did not have enough bandwidth to carry real-time television signals. Once the capability existed, the demand appeared.

Another uncertainty arises from the

presently unknown future capability of fiber optic transmission and millimeter waveguide. Progress has been so rapid in reducing both line losses and costs that fiber optic cables or high frequency waveguide may prove to be cheaper than satellite links for many high-density routes. The major attraction of fiber optics is the very large bandwidth available at the frequency of light (on the order of one thousand times the highest frequency considered



for radio frequency communications). However, satellites will retain the advantage of connecting any point on earth with the existing network by simply placing a ground station at that point, regardless of other terrain or distance.

Still another technological development that may affect the accuracy of predictions of required communication capacity is data compression.

Work is being done on reducing the bandwidth required for voice signals and on compressing video signals so that they can be transmitted using less bandwidth. The rapid developments in large scale integration of semiconductor circuits make it probable that such sophisticated processing will soon be done by a small, inexpensive chip that can be incorporated in any telephone.

These developments have the potential of increasing the capacity of the existing telecommunications network, satellite and land-based, by a factor of two to four with no expansion or other change to the network itself. New modulation techniques are being developed that can also increase the capacity

**All present communications satellites are in "stationary" orbit some 22,250 miles above the equator.**

of a given channel for transmitting digital data.

With all the economic and technical unknowns that affect the future of satellite communications, all demand projections must be taken as conjecture rather than prediction. It seems safe to assume, however, that the general trend will be up for at least another decade or two.

### The spectrum/orbit slot problem

Mother Nature has endowed us with a fixed amount of electromagnetic spectrum and decreed that no two users can use any part of it at the same time and the same place without interfering with one another. That means that segments of the spectrum must be allocated to users in such a way as to prevent interference. Because the demand for segments of the spectrum tends to exceed the supply (at least in the portions of the spectrum now in common use), the International Telecommunications Union (ITU), an agency of the United Nations, was assigned the responsibility for allocating the spectrum worldwide. In the United States, the Federal Communications Commission performs this function. Certain portions of the spectrum have been allocated to "fixed satellite communications," meaning satellites communicating with fixed ground stations (rather than ships, aircraft, etc.). The competition among all types

SATELLITE SYSTEM	TYPE							STATUS				START DATE	
	REGIONAL	DOMESTIC	FIXED	MOBILE	BROADCAST	EXPERIMENTAL	MILITARY	PROPOSED	OPERATIONAL	UNDER CONSTRUCTION	IN PLANNING		R & D UNDERWAY
American Satellite Corp.*		•	•						•				1974
Arab System	•		•									•	1980
ATS-6 (USA)		•				•			•				1974
Australia		•	•									•	1980s
Brazil		•	•		•						•		1978
Comsat/ATT (Comstar)		•	•					•					1976
Comsat General (Marisat)	•	•		•					•				1975
CTS (USA-Canada)	•	•				•			•	•			1975
DSCS (USA)	•	•	•	•				•	•				1966
ESA/Comsat General (Aerosat)	•	•		•					•	•			1979
ESA (Marots)	•	•		•					•	•			1977
ESA (OTS/ECS)	•	•	•						•	•			1977
European Broadcasting Union	•				•							•	1980+
Federal Republic of Germany		•			•							•	1985
FltSatCom (USA)	•	•	•	•				•		•			1977
IMCO (Inmarsat)				•								•	1980+
India		•	•		•							•	1980+
Indonesia		•	•						•				1976
Intelsat IV-A	•		•						•				1975
Iran		•	•					•				•	1983
Japan - Broadcast (BSE)		•	•		•	•				•			1978
Japan - Communications		•	•			•				•			1977
LES Series (USA)	•		•	•		•			•				1965
NATO				•						•			1970
Philippines*		•	•					•				•	1976
RCA Satcom		•	•						•	•			1974
SBS		•	•								•		1978
Sirio (Italy)		•	•			•				•			1977
Skynet (United Kingdom)			•	•				•					1969
Symphonie (Germany-France)	•					•			•	•			1975
Telesat - Canada		•	•						•				1973
USSR (Molniya II)	•		•						•				1965
United Kingdom	•		•								•		1980s
Western Union (Westar)		•	•						•				1974
<b>REGIONAL SATELLITE SYSTEMS USING PRIVATE INTELSAT TRANSPONDER</b>													
Algeria		•	•						•				1975
Andean Nations	•		•					•				•	1980s
Argentina		•	•					•				•	1980s
Denmark		•	•					•				•	1980s
Malaysia		•	•					•					1975
Norway/North Sea	•		•					•		•			1975

A number of other specialized experimental military communication satellite systems have not been included here due to lack of detailed information available from the respective governments.  
\*Systems use other satellite transponders with their own earth stations.

Chart courtesy of *Satellite Communications*

Table 1. Communication satellites of the world.

of users for bandwidth in the spectrum makes it unlikely that more of the spectrum will be allocated to communication satellites.

All present commercial communication satellites are in stationary geosynchronous orbit and lie in a ring directly above the equator at an altitude of 22,250 statute miles. The geosynchronous orbit is preferred over other orbits that could be chosen, particularly for a satellite that serves many earth termi-

nals. This is because in the geosynchronous orbit the satellite rotates at exactly the same angular velocity as the earth, with a daily period equal to the earth's sidereal day, and thus appears to an observer on the earth to be stationary in the sky.

Precession of the satellite orbit due to the influence of the moon's gravitation and the earth's oblateness is offset by a station-keeping propulsion system aboard the satellite. With the satellite

## SATELLITE

thus stabilized in geosynchronous orbit, the earth terminals can be pointed toward the satellite and fixed. They do not need expensive tracking capability, and a given satellite is always in view of all the earth stations in the coverage area.

Although there is physically ample space in the geosynchronous orbit for a very large number of satellites, there is a limitation on how closely they can be spaced. At either 4 and 6 or 12 and 14GHz, the required orbital spacing between identical or similar satellites is 4 degrees of arc. The spacing is determined by tolerable radio interference from earth stations illuminating adjacent satellites and from satellites illuminating earth stations of other systems.

For this reason a 12 and 14GHz high-power television broadcast satellite should be separated in orbit from a low-power 12 and 14GHz telecommunication satellite by 8 to 10 degrees. Of course, two similar high-power television satellites need only 4 degrees of separation. At 20 and 30GHz, only telecommunication service is permitted and antenna beams in both up and downlinks are very narrow, so the orbital spacing can be less than 1 degree.

These considerations of spacing of adjacent satellites apply only to those satellites using the same frequency bands. A satellite operating in the 12 and 14GHz band will not interfere with communications in the 4 and 6GHz bands, regardless of spacing. Satellites such as TDRSS and Intelsat V, which carry transponders at both frequency ranges, will have to observe the spacing requirements for both bands.

Because of the need to space satellites, "orbit slots" as well as frequencies are assigned by international agreement. Current orbit slot availability is summarized in Table 2. The table covers only the 75 degrees of orbital arc spanning North and South America, in which there are at most 15 slots at each frequency band now operating or planned. The "prime slots" for coverage of the 50 states and Puerto Rico cover only a 25-degree arc and therefore allow for six satellites at most at each of the lower frequency bands. As the last column shows, these slots are already overcommitted. The table also shows that there is plenty of room in the 20/30 and 30/40GHz bands, but we will see later why there is no rush to occupy these orbital slots or the generous bandwidth (3.5GHz for uplinks and the same for downlinks) available at these frequencies.

Another point to note in the table is that the 12 and 14GHz band is allocated to television broadcast satellites as well as to communication satellites. The

BAND	SERVICE	NOMINAL SPACING	TOTAL SLOTS AVAILABLE TO NORTH AND SOUTH AMERICA	PRIME SLOTS FOR 50 STATE COVERAGE	SLOTS COMMITTED OR PLANNED
4/6 GHz	Telecommunications only	4-5°	<15	<6	12
12/14 GHz	Telecommunications	4-5°	<15	<6	10
	TV broadcast	8-10°			
20/30 GHz	Telecommunications only	~1°	~60	~24	-
30/40 GHz	TV broadcast only	~1°	~60	~24	-

Table 2. Orbit slot availability.

recent World Administrative Radio Conference of the ITU in Geneva agreed that an orbit slot for tv broadcasting would be reserved nominally every 6 degrees around the equator except for the arc from 100 to 140 degrees West longitude, which covers the U.S. and Canada. In this arc the 12 and 14GHz band will be reserved exclusively for domestic or regional telecommunication services. As we have seen, the available slots are already committed, although none are reserved for tv broadcast.

There are many advantages to operating in the next higher frequency band allocated for communication satellites, the 20 and 30-GHz band. As we saw in Table 2, satellites can be spaced much closer together because the beams are narrower, there is ample bandwidth, and the band is unoccupied at present. Because the beams are narrower, it is easier to generate multiple spot beams (to aim at ground stations) that in-

### Why are we not exploiting this powerful new band? The main answer is rain.

crease the efficiency of the system. Because of the shorter wavelength the ground station antennas can be smaller and cheaper. With all of these advantages, why are we not exploiting this new band? The main answer is, *rain*.

#### Rain

Communication satellites could increase their total capacity enough to meet future demand by going to the higher frequency bands allocated to commercial service. These higher frequencies have the advantage of offering much greater bandwidth, which can be directly translated into larger numbers of equivalent circuits. There are some technical problems in developing components for higher frequency operation, but continuing research and development will solve those problems. One problem that will always affect system design at high frequencies, however, is rain.

At the frequencies used so far for satellite communications (up to 6GHz), rain and clouds are essentially transparent to signals. The next higher bands allocated to commercial communication satellites are 12/14 and 20/30GHz. Fig. 2 shows how signal loss increases with frequency beginning at about 10GHz when there is rain in the atmosphere; the available higher bands are in the region where the loss is increasing most rapidly with increasing frequency. In the 20 and 30GHz bands, rain can absorb almost all of the signal power in the downlink (which is always power-limited, unlike the uplink).

However, there is rain and there is rain; not all rain absorbs signal power to the same extent, as is also shown in Fig. 2. The total annual precipitation in Seattle, for example, is high, but the rain attenuation of radio signals is low because the rain is usually in the form of a fine drizzle that represents a low rain rate, and the rate is the important parameter. Rain attenuation becomes significant where there are heavy thundershowers, like those that often occur around the Gulf of Mexico. One bright spot in this picture, however, is that thundershowers are usually small in area, not more than a mile or so in diameter. We will see later how this factor helps the situation.

If a satellite signal is to reach a ground station with enough power, the link power budget must include a "rain margin"—enough extra energy to get through even when it is raining at the ground station. Rain margins are gen-

### Getting through a thunderstorm may take as much as 70 times the power.

erally in the range of 6-15 dB (4 to 70 times the signal power needed in clear weather).

The amount of rain margin needed in a particular case depends on the reliability of service required, the rain statistics of the ground stations, and the elevation angle (how high the satellite is

above the ground station's horizon).

Some kinds of services (such as telephony and data transmission) require extremely high reliability at all times and cannot tolerate outages or delays. Other services such as television signals and facsimile, can tolerate a delay until a heavy rainstorm passes. The required rain margin will be higher in the first case.

The elevation angle is important because the signal path through a rainstorm is longest when the satellite is nearest the ground station's horizon and shortest when the satellite is directly overhead. Naturally the path through the rainstorm is longer if the rainstorm is larger in area, and this effect is greater for lower elevation angles. On the other hand, extremely heavy rains tend to occur in relatively smaller thunderstorms, so it is easy to overestimate the required rain margin when the elevation angle is low.

The obvious solution to the rain loss problem is simply to provide the required excess power in the satellite. But considering that the extra power needed may be more than 70 times that needed for clear weather operation and that it is necessary for only a few hours per year, this may not be a cost-effective solution. Outages due to rain tend to occur at different times at different locations in the same general area (as rainstorms move across the area).

In the case of point-to-point operations involving relatively few stations, an alternative is to duplicate the ground stations. Two stations are placed far enough apart so that no single thunderstorm is likely to block the signal path to both, but close enough so that they

### Transmitting a digital burst twice has the same effect as using twice the power.

can be interconnected by terrestrial communication links. Some rain margin is still needed for cases of rain over a large area, but such rain is less dense than thunderstorms.

The disadvantage of this approach is that two stations are more expensive than one. They must also be connected by some kind of ground communication link, which adds to the expense. The overall cost may still be reduced by this approach where high reliability communication is required.

Another approach takes advantage of the fact that a large rain margin is seldom needed in more than one place at a time. Enough extra power is provided in the satellite to penetrate a thunderstorm at only one or two stations, along with some means of aiming this extra power at the ground station that needs it.

Satellite transmitters may be designed for variable power operation.

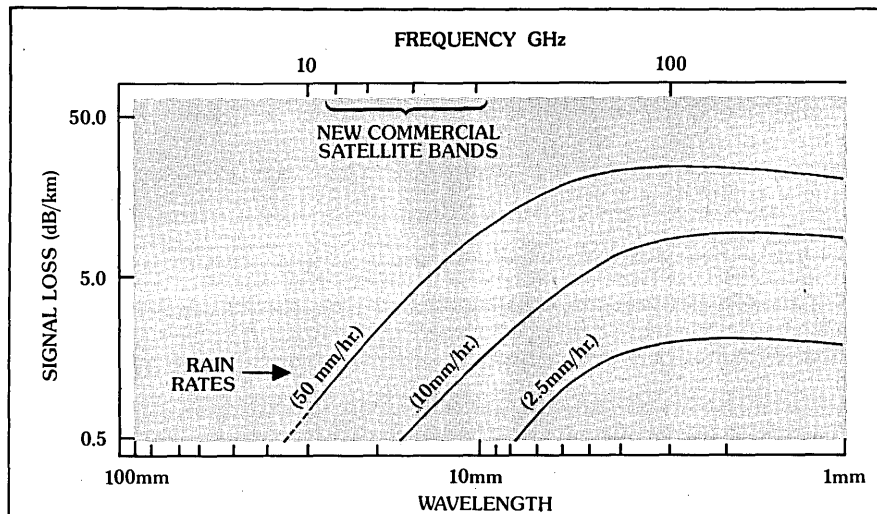

Fig. 2. Rain proves to be the biggest enemy of high frequency satellite communications. This explains why the new commercial satellite bands have not come into widespread use; their frequencies fall in that part of the spectrum where the effect of rain is increasing most rapidly. Up to 70 times as much power may be necessary to send a signal through a thundershower as through a clear sky. (The figure is modified from a graph in Rand Corp. Report R-1936-RC, April 1977, by N. E. Feldman and S. J. Dudzinsky, Jr.)

They can be operated at their low power settings for all stations having clear weather, with high power applied only to the transponder transmitting to a ground station blocked by a thunderstorm. The satellite need have only enough electrical power to operate one or two transponders in the high power mode. The cost and weight of variable-power transponders reduce the attractiveness of this approach somewhat.

The time division multiple access (TDMA) system (following section) offers another possibility for moving extra power from one transponder to another. Because the information is transmitted in the form of digital "bursts" in specified time slots, it is possible to provide some extra time and transmit the same burst several times. The ground station can then add the multiple signals for the same burst together and reconstruct the signal.

Literally, what happens is that each repeat of a bit increases the probability that the decision to call the bit a zero or a one will be a correct decision. The net effect is the same as increasing the signal power by a factor equal to the number of times the data is retransmitted. Some complexity is added by the requirement that the ground station maintain synchronization with the signal carrier and the data clock to make sure that it is adding the right bursts together, but the cost is often less than that of the other two approaches.

### Time-division multiple access

The traditional method of sending many signals through a single satellite communications repeater is to use many different carrier frequencies. This is the technique used for separating radio and television stations. It also is used for

point-to-point microwave repeaters and cables, and was naturally adopted for satellite links.

The technique is called frequency division multiple access (FDMA), and is an efficient way of sharing the allocated portion of the radio-frequency spectrum. In a satellite link, however, it leads to some problems because of the need for handling many frequencies simultaneously. Intermodulation between multiple carriers (one carrier influencing another) causes distortion.

This distortion can be reduced by operating the satellite transmitter at a

### Frequency-division was used in microwave and cables, so naturally it was adopted for satellites.

lower power output than it is otherwise capable of, which allows the amplifier to operate in the linear portion of its power curve. But this technique is inefficient, since larger ground stations must be used to make up for the lower satellite power, or larger satellites must be built to carry higher power transmitters.

The Intelsat III satellites used this approach, with broadband transmitters that were shared by all of the stations using the satellite.

The current generation of Intelsat and domestic communication satellites uses channelized repeaters to reduce intermodulation distortion. Very large stations can use the full power of a satellite channel, but smaller stations must share a satellite channel. They do this using FDMA, reducing the satellite channel transmitter power to avoid excessive intermodulation. Channelization

# SATELLITE

avoids intermodulation problems for large stations and improves the situation for small stations, but most of the satellite transmitter power on shared transponders still cannot be used.

The intermodulation problem can be solved by a technique called time division multiple access (TDMA). With TDMA each station uses the entire satellite channel transmitter power for a small fraction of the time, proportional to its communication traffic. By synchronizing their times of transmission and sending their communications as "bursts," many stations can share a single satellite channel. Their bursts

## Time-division works best on digital signals, but that's not a restriction anymore.

arrive at different times with small gaps, known as "guard times," between them. This technique is illustrated in Fig. 3.

Frequency guard bands are used between FDMA channels for the same reason guard times are used between TDMA bursts—to avoid adjacent channel interference. Thus, TDMA operates in the time domain in a way analogous to FDMA in the frequency domain.

It is difficult to break analog signals into short bursts and then restore the original information, but digital signals are easily buffered into bursts on the transmitting end and unbuffered into continuous data streams at the receiver. This restriction to digital data is only a minor problem for new communications systems, since most communications are going digital for a number of reasons. These include greater flexibility in combining signals, compatibility with computer-to-computer and other data signals, less sensitivity to interference, lower costs, and greater reliability of hardware.

In theory, digitizing voice signals is wasteful of bandwidth. Each bit requires about one cycle of bandwidth, and therefore a data stream of one bit per second would require 1Hz, 1,000 bits per second 1kHz, and so on. A voice signal with 3,500Hz bandwidth would have to be sampled some 8,000 times per second, and each sample would have to be encoded by seven or eight bits to provide adequate fidelity. The result is a data stream of 56 or 64Kbps, requiring 56 or 64kHz of bandwidth instead of the 4kHz (including guard bands) to transmit an analog telephone signal. This ratio of 14:1 can be reduced to as low as 5 or 6:1 through data compression techniques, but a figure of 10:1 is a generally accepted value.

For satellite communications, however, this bandwidth disadvantage of

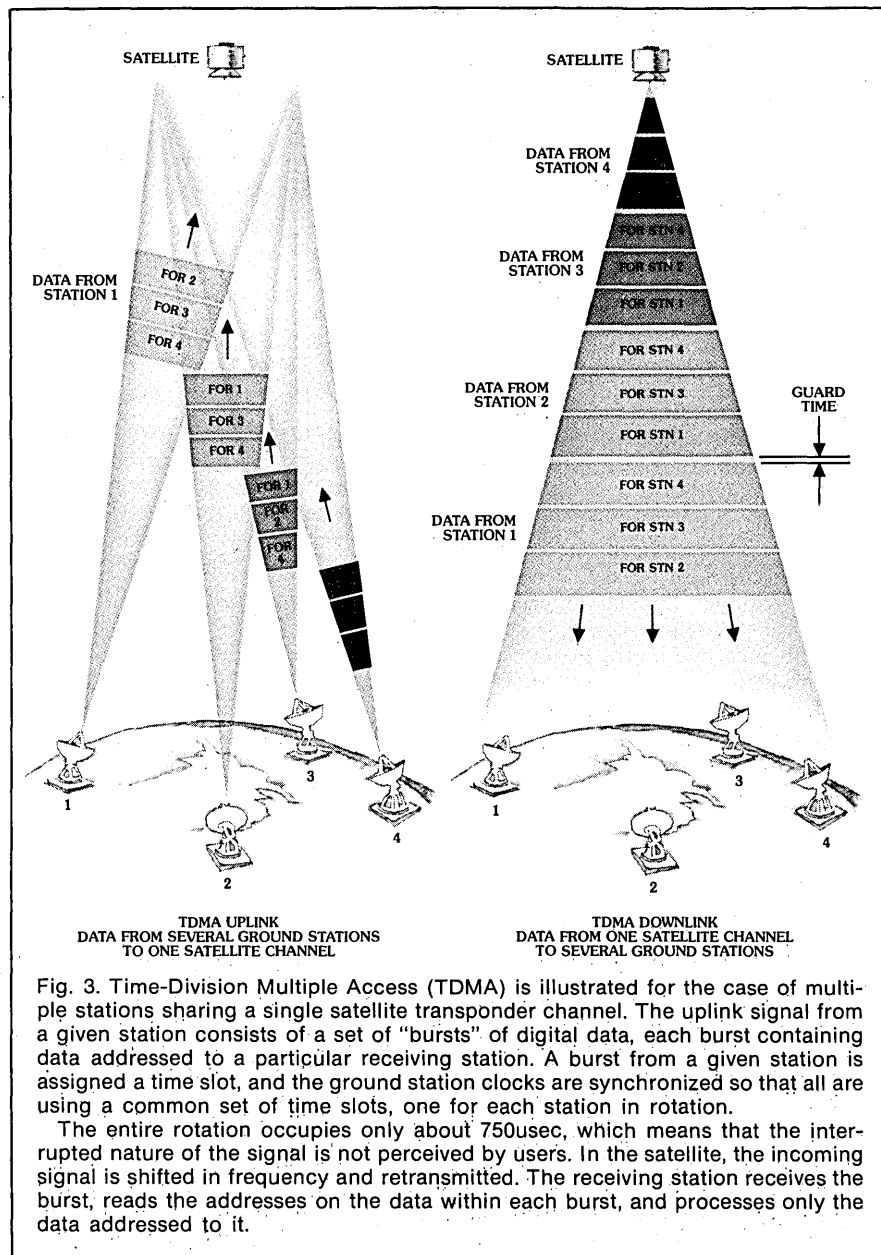

Fig. 3. Time-Division Multiple Access (TDMA) is illustrated for the case of multiple stations sharing a single satellite transponder channel. The uplink signal from a given station consists of a set of "bursts" of digital data, each burst containing data addressed to a particular receiving station. A burst from a given station is assigned a time slot, and the ground station clocks are synchronized so that all are using a common set of time slots, one for each station in rotation.

The entire rotation occupies only about 750usec, which means that the interrupted nature of the signal is not perceived by users. In the satellite, the incoming signal is shifted in frequency and retransmitted. The receiving station receives the burst, reads the addresses on the data within each burst, and processes only the data addressed to it.

digital voice signals is more than compensated for by the extra bandwidth required to frequency-modulate an analog voice signal on a carrier wave. (Although telephone signals are amplitude-modulated at the originating and receiving ends of a link, these AM signals are multiplexed together and used to frequency-modulate the carrier wave to and from the satellite. Frequency modulation is used in all commercial satellite links.) The linearity requirements for the modulation are so great (to maintain adequate fidelity and avoid intelligible crosstalk due to intermodulation) that a large amount of bandwidth must be used for the frequency modulation. A 4kHz voice signal may require 40kHz or more of bandwidth after frequency modulation.

Digital communications have much less severe fidelity requirements for modulation of the carrier (since all that need be preserved is the presence or absence of a pulse), and therefore do not

require the large modulation bandwidth needed for analog signals. The end result is that the effective link bandwidth required for analog and digital signals of equivalent quality is approximately the same.

TDMA, as illustrated in Fig. 3, works well if all of the satellite downlink signals can be received by all the stations

## The bandwidths required for analog and digital signals of approximately the same quality are about equal.

in the system. But sending all the signals to all of the stations wastes satellite power and uses up radio frequency spectrum that could be used for other signals. A newer technique that overcomes these problems is called spacecraft-switched time division multiple access (SSTDMA).

Advanced satellite antennas can

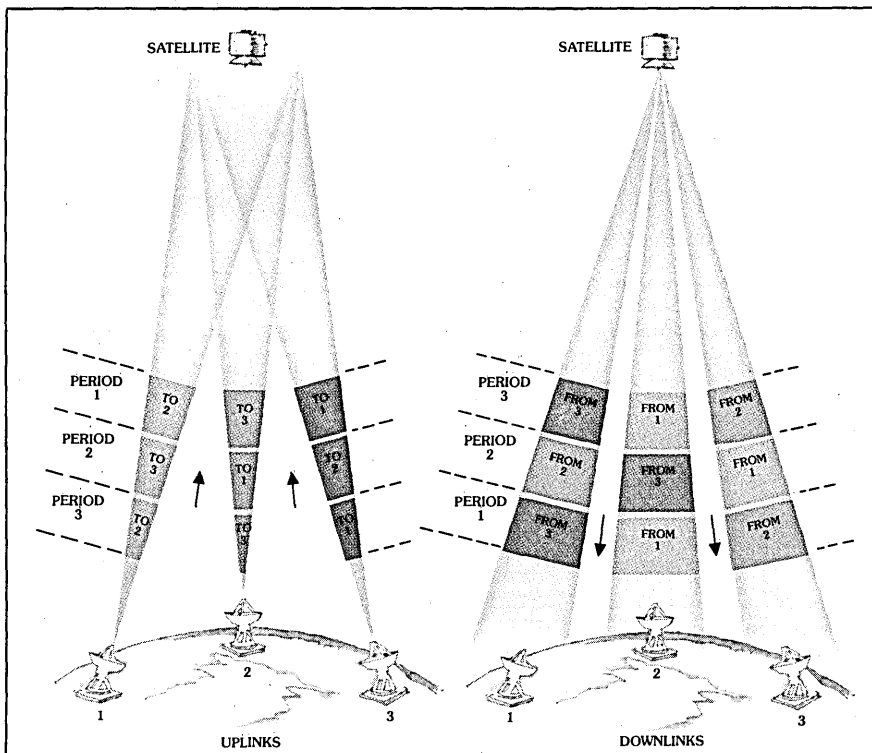

Fig. 4. Spacecraft-switched TDMA (SSTDMA) is illustrated for point-to-point communications with separate beams from the satellite for different receiving stations. Bursts from the respective transmitting stations, addressed to particular receiving stations, are received simultaneously on separate channels in the spacecraft transponder (or on separate transponders). A synchronized switch routes the signals to separate beams directed at addressed stations. Switching is usually done in prearranged repetitive sequence, but in very complex systems the satellite switch may read routing instructions on a burst and switch it accordingly. Thus, bursts from different stations are not interleaved, but processed simultaneously, resulting in a higher data rate.

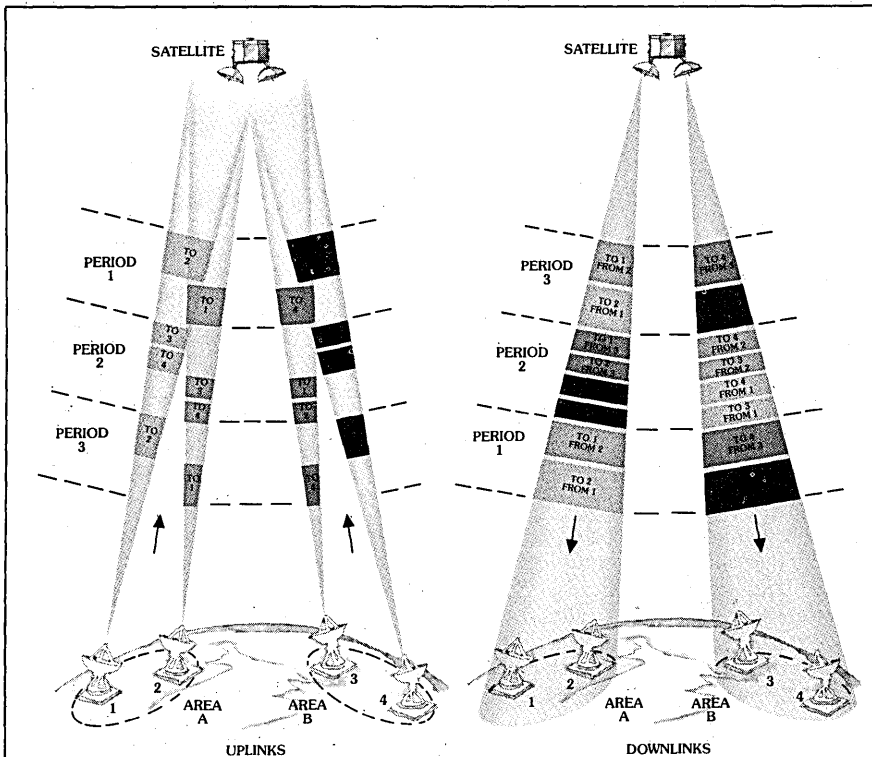

Fig. 5. SSTDMA area-coverage beams are used when there are many small stations. Bursts from transmitting stations are interleaved, and switched in spacecraft to appropriate beam for retransmission to ground. Satellite antenna patterns are made relatively broad to cover areas containing several stations.

direct all the energy from a transmitter toward a single station. Multiple antenna beams can be generated by a single antenna with enough isolation between beams so that the same frequencies can be used for all channels. A satellite switch rapidly changes the connections between antenna beams so that each beam is connected in sequence to each of the other antenna beams, allowing each station to communicate with every other station.

This system concept is illustrated in Fig. 4. The advantages of this system are that it uses all the available frequency spectrum at each station and concentrates all the satellite transmitter downlink power on the immediate area of the station the signal is intended for.

### Advanced satellite antennas can aim all their power at a single station.

While this technique is extremely efficient, one satellite transmitter for every ground station, as shown in Fig. 4, restricts its use to systems with only large communication terminals.

A further modification to SSTDMA that provides service to small stations places many stations in each satellite antenna beam. This concept may be called area-coverage SSTDMA. The stations communicate with each other by TDMA within the different connection periods of the satellite switch.

A simplified diagram of this system concept is shown for two areas in Fig. 5. In a point-to-point SSTDMA system, all stations can be transmitting and receiving data practically all of the time. Station operation in the area-coverage SSTDMA system is intermittent, since all of the stations in the area must share a single communication uplink and downlink. In this way, area-coverage SSTDMA operation is similar to basic TDMA operation where all stations in the system share a single communication channel.

By combining TDMA techniques with large-element phased arrays, it becomes possible to provide the area-coverage and support of small terminals while greatly reducing satellite power requirements. Advances in digital memories, phase-shifters, and solid state radio frequency (RF) amplifiers make it possible to form an independent beam for each signal burst, directing the energy directly at the intended receiving station (see Fig. 6, p. 102), RF energy is used as efficiently as in a spacecraft-switched TDMA system supporting a few large stations, but support capability is extended to large numbers of both large and small stations.

The price paid for this capability is complexity of the satellite communication system. As many as several hundred transmitters, phase shifters, and

## SATELLITE

antenna elements must be used. Costs may be controlled by using production-line batch-fabrication techniques, and reliability can be excellent even with high complexity because arrays operate well (or degrade gracefully) even with a large number of failed antenna elements.

All of these TDMA techniques are nearing commercial use. As noted, SSTDMA will be incorporated in the advanced Westar service; ground-switched TDMA is planned for the new spacecraft of Satellite Business Systems; and the Bell System is planning to use beam-switched TDMA on its next-generation communication satellites.

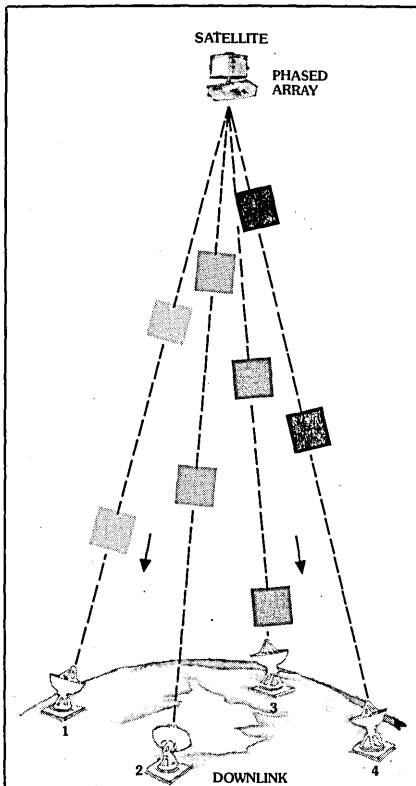

Fig. 6. The antenna for switched-beam TDMA must be a phased array, capable of generating beams of arbitrary shape and pointing direction by means of different combinations of its many elements. The antenna emits packets of signal energy, each directed to its intended ground station. In effect, a beam is generated in the direction of the station just for the duration of the packet, after which another beam is generated for the next station. The ground control station can cause the array to direct a given packet to any point in the coverage area.

This technique is useful primarily for the power-limited downlink, since all the transmitting power is applied to each station in turn. The receiving antenna on the satellite can be of the conventional area-coverage type or can use the same rapid-switched phased array technique.

### The next generation

As discussed previously, future telecommunication satellites must provide a significant and orderly increase in capacity—at least an order of magnitude—to satisfy even modest forecasts of demand. It is clear that this growth is not possible in the 4 and 6GHz bands because of interference and orbital constraints. The 12 and 14GHz bands require careful exploitation to make efficient use of spectrum and orbit space for fixed telecommunication service to small terminals and television broadcast worldwide. But even with careful planning, the available bandwidth is limited. The 20 and 30GHz bands are empty, but more work is necessary to provide the power needed to overcome the rain attenuation problem.

Even though high-gain satellite antennas will be necessary to provide enough signal power at these frequencies, one can envision a very economic satellite system for high density trunking routes between large metropolitan terminals; the question is how to implement service to a large community of small users at a competitive cost.

In any case, the next-generation satellite systems will most likely incorporate multiple frequency bands to capitalize on the existing earth terminal investment—for example, 4 and 6GHz into

### All of these advanced TDMA techniques are nearing commercial use.

existing earth terminals to replace current capacity, plus 12 and 14GHz into new private line terminals to satisfy additional demand, as on the Advanced Westar. The next system might well incorporate 20 and 30GHz in addition to the two lower bands, to meet projected needs.

At the same time, there is economic pressure to combine services to multiple sets of users on one satellite. This approach tends to spread the research and development of new satellites over a broader user base, minimizing the cost of service to individual users. Again, TDRSS/Weststar is a good example. By combining NASA and Western Union commercial needs on one satellite system, costs to both are reduced.

The need for more capacity, and the economic advantages of multiple frequency bands and multiple users on a single satellite, spell larger satellites for the next generation. Large aperture satellite antennas, higher RF power, more transponders, more station-keeping propellant to stretch orbit life and thereby reduce annual cost, and larger solar arrays to provide the necessary power will combine to provide the necessary capability.

We have seen this trend in the past—a steadily increasing on-orbit weight

limited only by the availability of rocket launchers. The large increase in payload weight made possible by the Shuttle means that this limit has moved much higher, making possible larger and heavier satellites with more capacity and more complexity on board to reduce complexity of the ground stations. Since there are many ground sta-

### The Space Shuttle has made bigger satellites possible, reducing the complexity needed in ground stations.

tions per satellite, it is more economical to add complexity to the satellite if this reduces the cost and complexity of the ground stations.

As we have seen, some of the proposed new techniques are best adapted to digital communications, which are made possible by the rapid advances in microelectronics and are being adopted increasingly for other reasons as well. Digital is the way of the future. \*



Mr. White is the advanced systems manager of communication satellites in TRW's Space Systems Div. and in this capacity is primarily concerned with the future. He is responsible for the design of advanced satellite systems to meet future communication needs. Prior to assuming his present post, he held other management positions in TRW's Electronic Systems Div. and Space Systems Div.



Mr. Holmes is the deputy assistant project manager on the Tracking and Data Relay Satellite System being developed by TRW's Space Systems Div. He also has worked in the Electronic Systems Div.

# Get Ready for VANs

by Ely S. Lurin and Edward I. Metz

A broad variety of services will be made available by the common carriers and by specialized service firms. Taking advantage of them will require a good deal of preparation, and maybe some reorganization.

The future user of data communications will have a wide range of new communications services to choose from and these services will be specialized for his particular needs by industry or function. The suppliers of these services will include existing communications vendors, as well as computer service companies, and other new entrants to the communications service marketplace.

New service developments will make communications more dollar effective for the dp user, and will make complex communications tasks such as device and protocol compatibility much easier to implement. However, the lives of the data processing manager and communications manager who must decide which services to utilize and from which vendors to purchase them, will become more complicated.

The range of communications services which will be available to dp users will extend from pure transmission services, such as leased lines, to sophisticated services which are more data processing than communications, such as Electronic Funds Transfer Systems (EFTS) and distributed data base inquiry.

Although these services can be performed by users and conventional communications services, they can also be performed in the network by a value added carrier. Some services supplied by common carriers will include both basic communications facilities and value added services. Other services will be supplied by specialized communications companies such as Telenet which do not own the basic communications facilities and are thus "true" value added carriers.

However, from the point of view of the data center or communications managers, it makes little difference who owns the basic facilities. To them, the essential consideration is that the services will be available. It is important to note that value added "services" can technically be implemented by users as well as by carriers. However, when they are offered by a carrier and tariffed by the FCC they become a value added service by definition.

The major services under consideration can be divided into the following categories:

- data/text services
- image services
- support services
- electronic mail services
- hybrid services

How these different value added services are seen by users was determined in studies we completed in early 1978. During our investigation, 180 communications managers of major U.S. corporations were interviewed in person. In addition, 30 vendors and managers at 5 major government agencies were interviewed. Their present utilization of value added network services, their future plans, and their acceptance of new services form the basis of conclusions presented here.

## Data/text services

Data/text services, those suitable for either application, are already being offered. They include:

- packet switching
- circuit switching
- store and forward
- polling
- compatibility

*Packet switching* and *circuit switching* are complementary services. Both fill a different need for the same user.

*Packet switching* requires little effort to use and is highly reliable. However, transmission speed is relatively limited in comparison to the speed of transmission possible from the same communications line if packet switching is not used. In addition, the service is presently not suitable for voice transmission. Some compatibility functions, however, can be provided on packet switched networks.

Packet switching is the first of the major value added network services to be implemented and thus there is a history of its use. Some examples are:

- A large chemical company chose to use Telenet for interactive computing because it either had to do that or to buy multiplexors and expand its network. The firm has had no problems from day one, and the service is considered convenient and economical.
- An advertising agency is using Tymnet, 40% for electronic mail and

40% for interactive computing, because it does not want to construct a network and be in the communications business.

- A very large manufacturer is adding terminals onto the Tymnet network until over 1,000 will be connected. It is using the VAN mostly for interactive computing but also for electronic mail at remote sites to which it did not want to extend its own network.

- A company supplying proprietary data base information chose Telenet because it was an easy and low cost way of obtaining a network.

*Circuit switching* does not require any computation overhead (once the circuit is set up), permits higher speed data transmission, and is suitable for voice. However, networks using it have not customarily provided error checking or compatibility functions.

*Store and forward* and *polling* services help the user organize information flow and are suitable where immediate response is not demanded. The primary advantage of these services occurs when a large number of remote locations are involved, as in message transmission, credit checking, hotel reservations, and airline ticketing.

*Compatibility* services are really a multiplicity of services. They range from the ability to make facsimile, data terminal, or text editing equipment "look alike" by providing speed, code, and format conversion, to complicated data processing applications involving the structure of the data and protocols. Compatibility services will allow users to use virtually any type of terminal devices in their systems. Since the average *Fortune 500* user has over 800 terminal devices (including facsimile) in his network, this flexibility is an important advantage. A large number of compatibility services will become available to users and can be expected to emerge in the area of connecting different companies such as a large retailer and its suppliers.

For the users surveyed, compatibility service was the most wanted value added service, with 120 of 160 major companies stating it was of high interest.

**Image services**

Image services will assist in transmitting information such as graphs, drawings, and photographs, and are just now beginning to be offered. For example, a service which will be offered by ITT in 1979 is facsimile compatibility and store and forward. Also, Graphnet already is offering facsimile transmission services. Image services will become a key part of the range of services described as electronic mail, and will be important for each communications and dp manager to consider.

**Support services**

Support services will be used primarily to help users design communications systems and keep them operating. These services by an outside vendor are of high interest to 70% of the companies surveyed and are growing in importance for a variety of reasons including: (1) Users who previously dealt with only one vendor (AT&T) may now deal with many vendors and faults must now be isolated according to vendor. (2) Networks are becoming much more complex as data/text, message, and image services are added to voice. (3) Corporations are becoming so dependent upon their communications networks that even short time interval failures are intolerable.

Maintenance-related support services such as repair, fault location, and diagnosis are becoming extremely important to users. They can be viewed as a natural extension of third-party maintenance services now being offered for computer equipment. In addition, unique maintenance approaches such as Western Union Data Services' "Termicare" which provides remote diagnosis of faults, will appear.

Network design and training of operations personnel are other examples of support services which will be more readily available to users. They are being provided now by many companies, each with its own speciality.

Finally, communications facilities management services, analogous to data processing facilities management services, will see increasing use.

**Electronic mail**

There is no single definition of a service which can be considered "electronic mail." Instead, just as in computing applications and computer services, a range of applications and services are involved. This range of services includes the transmission of text only, of graphics only, of text and graphics combined, computer output to text processing units, computer output to facsimile units, and full multipage document transmission.

**The Value Added Service Market**  
 FORECAST OF MARKET FOR VAN  
 DATA, TEXT, AND IMAGE SERVICES (1977-1982)

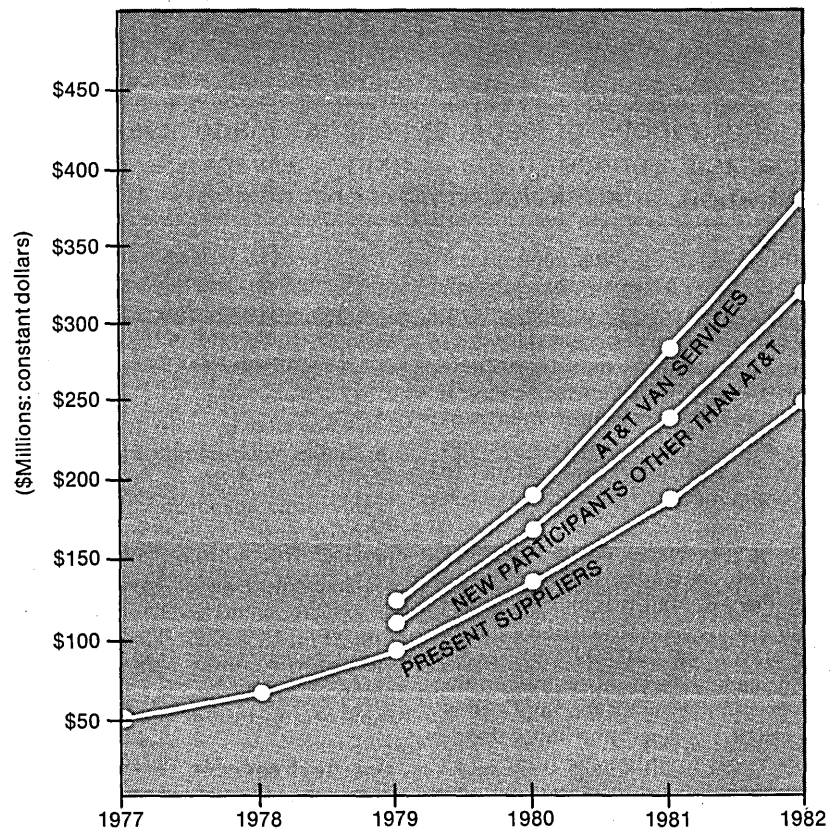

For managers of computer installations and communications networks to fully appreciate the large range of value added services which will be offered to them, it is important for them to understand the market size and the market growth for value added service. These, after all, will be what drive vendors to offer VAN services.

The following analysis is presented for the *Fortune* 500/50 companies which will be the leaders in the use of value added services. (The *Fortune* 500/50 are defined as the top 500 manufacturing companies, as listed by *Fortune* magazine, plus the top 50 companies from each of six other *Fortune* industry listings.)

In 1977, the average *Fortune* 500/50 company spent \$8.4 million on all communications services within the U.S. Of this, voice communications totalled \$6.3 million and all other (data / text / message / image) amounted to \$2.1 million or 25%. Thus the total voice communications expenditures in 1977 for all 800 *Fortune* 500/50 companies was \$5.04 billion and the total for data / text / message / image communications was \$1.68 billion.

By 1982, the total spent by all *Fortune* 500/50 companies on data /

text / message / image communications will increase by a factor of about 1.8 to an estimated \$3.0 billion (in 1977 dollars). This "non-voice" communications can readily be manipulated by a computer, and is thus capable of being transmitted by value added communications services. Even a relatively small percentage of \$3.0 billion provides a large enough market to interest vendors, and thus will cause new VAN services to be brought into being.

The next questions are "How big is the value added services market now?" and "How fast is it growing?" In 1977, the U.S. marketplace for message services (not including telegrams and money orders) was \$260 million. The value added services market for data / text / image services was only \$50 million, but these are the fastest growing VAN services and are expected to reach \$370 million in 1982. (This is based on a 40% growth of existing VAN services and some new entrants.)

This market growth and size is not only large enough to guarantee new vendors an entrance to the market, but also to guarantee that users will see new services and expansions of current services from existing vendors. \*



## Hybrid services

Hybrid services are services which include both data processing and communications (such as time-sharing). They will be offered because they are a logical extension to the services provided by remote computer service companies, and because they fulfill needs of some users who want unique problems solved by outside experts. Joint text processing and text distribution (one of many electronic mail possibilities) and electronic funds transfer systems are examples of hybrid services.

## The vendors

The Value Added Network services field is growing rapidly. Services will soon be provided by many types of vendors including common carriers, specialized common carriers, computer service firms, spin-offs from large users, and new ventures. The most significant vendor is AT&T which can capitalize on its enormous resources in technology and its nationwide service and maintenance facilities. During the next five years, AT&T will enter the VAN market with services which appeal to a broad range of users, are industry oriented, and require (for VAN services) a minimum amount of field sales and system design support. AT&T may utilize its own unique interfaces as it has done its polling service, TNS.

The large independent carriers such as GTE and United Telecommunications will follow two possible entry options: to supply AT&T-designed services in their regions; and to establish a separate subsidiary to supply nationwide hybrid or VAN services.

The specialized common carriers are already operating in the VAN services market. Western Union is selling many message related services. ITT will be online in 1979 with a packet switched, image-related, compatibility service and has announced a circuit switching service. SPCC and MCI are already offering circuit switching services.

Tymshare, a computer services company, is in the VAN market now, and more computer services firms will enter. They will capitalize on their knowledge of user needs, their strong sales and support capabilities, their technical strength, and their existing networks. Packet switching is an expected first offering.

However, computer service firms will also capitalize on their industry knowledge and ability to supply industry functional specialties by offering unique, differentiated services such as intercompany compatibility and electronic mail. Computer service companies that are oriented toward dp facilities management services will extend the same type of service to communications networks.

Dp departments of large companies

such as Boeing and Sun Oil have established spin-off computer service firms, thereby setting a precedence in spin-offs. There is some interest by the communications managers of other very large companies in establishing VAN services spin-offs. However, the process will be more difficult because of the regulatory aspects of the communications industry.

## Impact on users

Users of communications services are beginning to find themselves in much the same situation that dp departments have been in for the past several years. That is, communications systems alternatives are developing rapidly with a variety of different services being supplied by a growing list of vendors. This is a situation favored by the overwhelming majority (86%) of users, who have a preference for multiple vendors. Their view is that increased competition is likely to reduce costs and improve performance.

Just as is the case with the range of data processing options, these new communications services will provide greater benefits to the corporations who use them. Unfortunately, the risk of making expensive mistakes will increase too, necessitating more extensive planning.

At present, the typical user of Value Added Network communications services chooses a vendor primarily to provide service at a reasonable cost in areas where his own network doesn't reach, or to provide new services. In general, he is pleased with the service he is getting. It's reliable enough and economical. It's a little low speed, but the price (\$2-\$4/terminal hour) is right for low data volumes. VAN services only comprise 5%-10% of his total current data communications budget.

Looking ahead, however, market developments are beginning to indicate changes that will affect this picture. For the typical *Fortune 500* company user, the total communications bill will be increasing by 7½% a year, with the data communications portion increasing by 12% a year to nearly \$5 million by 1982 (in 1977 dollars).

Along with these increases will be a greater emphasis on high speed (9600bps or higher) communication lines, more use of intelligent terminals, combining of voice and data networks into one integrated network, and, for some companies, the creation of an in-house Value Added Network services capability. Although expenditures of remote job entry and data entry will be less than they are now by one-third to one-half, interactive computing and inquiry will be up considerably, along with administrative message traffic and electronic mail.

Just how office automation equipment will be integrated into communi-

cations networks is subject to a wide range of opinion, although some aspects are beginning to clear up. Our studies indicate that 65% of the *Fortune 100/10* companies (the top 100 manufacturers plus the top 10 firms from each of six other *Fortune* listings) have plans in this area, and they tend to be farther along than the smaller companies.

With regard to electronic mail, there is clearly a high expectation of change. Typical responses from every industry sector surveyed are:

- "Our use of electronic mail will quadruple." (a user in discrete manufacturing)
- "Expect 85% of documents via electronic mail by 1982." (also discrete manufacturing)
- "Will grow at same rate as word processing." (process manufacturing)
- "Will grow at rate of 20% per year." (banking)
- "Expect increases in use of electronic mail by 300%-400%." (diversified financial)
- "10% of all mail cost by 1982 will be electronic mail." (insurance)
- "Using facsimile (for electronic mail) now—30,000 pages/month." (transportation)
- "By 1982, 10% of total will be by electronic mail." (retail)

Although the optimism reflected by these remarks is not universal, the concept does tend to have a great deal of support. However, questions pertaining to a broader range of communications services make it clear that new problems are anticipated. For instance, a major problem to be solved will be the support of intercompany communications which are becoming increasingly complicated by the lack of standards.

It is highly probable that reorganizations will occur with respect to data processing, communications, and office management during the next five years. For data communications services, both the dp manager and the communications manager will have to agree upon the vendor and service chosen. Even for voice networks, data processing management will become involved because of preferences toward communications networks which can accommodate both data and voice. The "Information Manager" will emerge and may well have more management than technical background.

Top management attitudes will determine if and when communications costs will be treated as direct expense or as a displacement for other tangible costs

# DISTRIBUTED PROCESSING: ONLY DIGITAL CAN MATCH YOUR MIX. AND NETWORK IT.

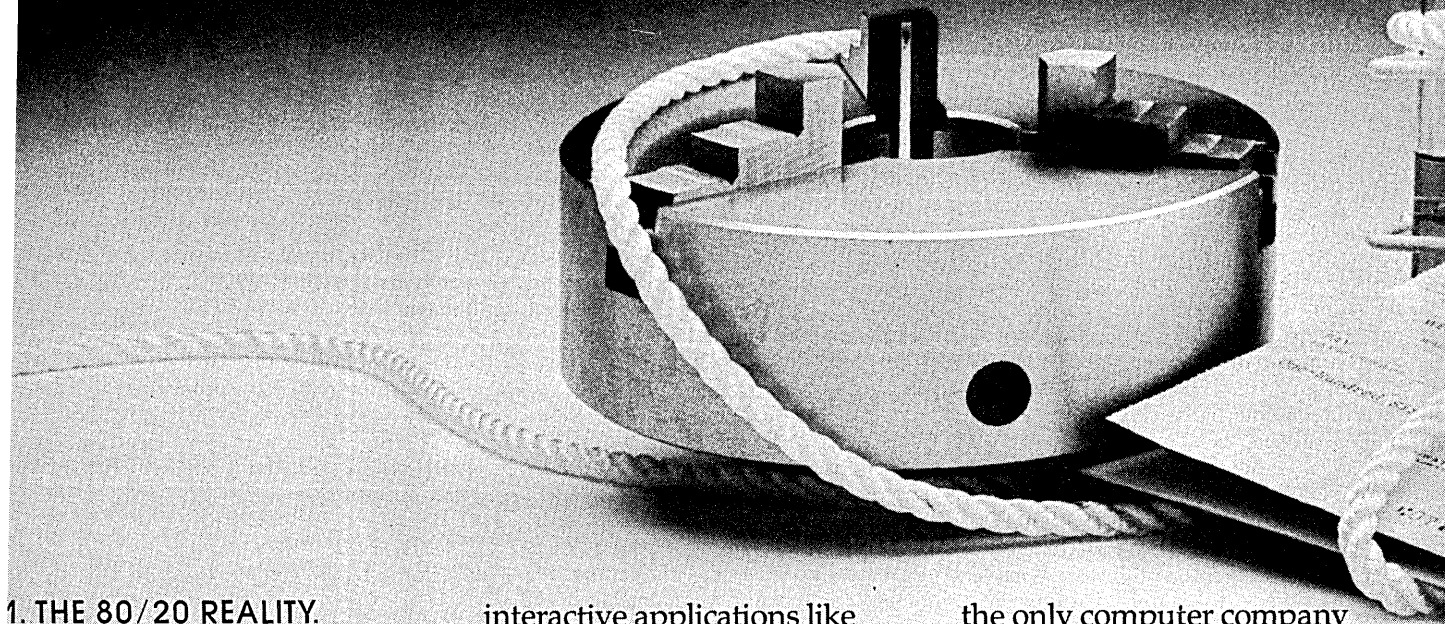

## 1. THE 80/20 REALITY.

If you remember nothing else from this ad, remember this: Networked computers do 80% of their work for local users. (After all, that's the whole purpose of distributed processing.)

## 2. THE SIGNIFICANT POINT.

It follows that the efficiency of any network is 80% a function of how well local computers do local jobs. And this leads to the significant point about DECnet, the only second generation networking software in the industry. Only with DECnet and Digital computers can you build a network that's optimized at every node.

## 3. EFFICIENCY AT THE LOCAL LEVEL IS NO MEAN TRICK.

Every company has a great variety of different jobs that computers must do, but no two jobs are exactly the same. You need one kind of system for

interactive applications like order entry. A completely different kind of system for real-time applications like running a lathe. It has to follow that no computer company can even begin to talk about "optimizing your network" unless it can give you a choice of computer systems as varied as your list of tasks.

## 4. NOW, TWO CRITICAL QUESTIONS.

Ask your computer company two things: "Can you provide a complete range of systems in all the essential computer categories? Can you network those computers together without regard to word length, operating system or language?"

## 5. ONLY DIGITAL ANSWERS "YES" TO BOTH QUESTIONS.

Digital built a billion-dollar business by making specific products for customers with specific needs. Today Digital is

the only computer company that builds all four essential categories of computer systems, and it's the only company that allows you to join these systems in a network where every node matches the local application in functionality and price/performance.

## 6. ONLY DIGITAL CAN NETWORK ALL THESE DIFFERENT SYSTEMS TOGETHER.

Small real-time systems in 12- and 16-bit architectures with a wide range of operating software to monitor and control ongoing events. Many of these systems have been optimized for specific applications including interactive graphics, production control, laboratory analysis, and data collection and processing.

Massive real-time computational systems like 32-bit VAX-11/780 can be configured to handle everything from complex scientific, engineering and

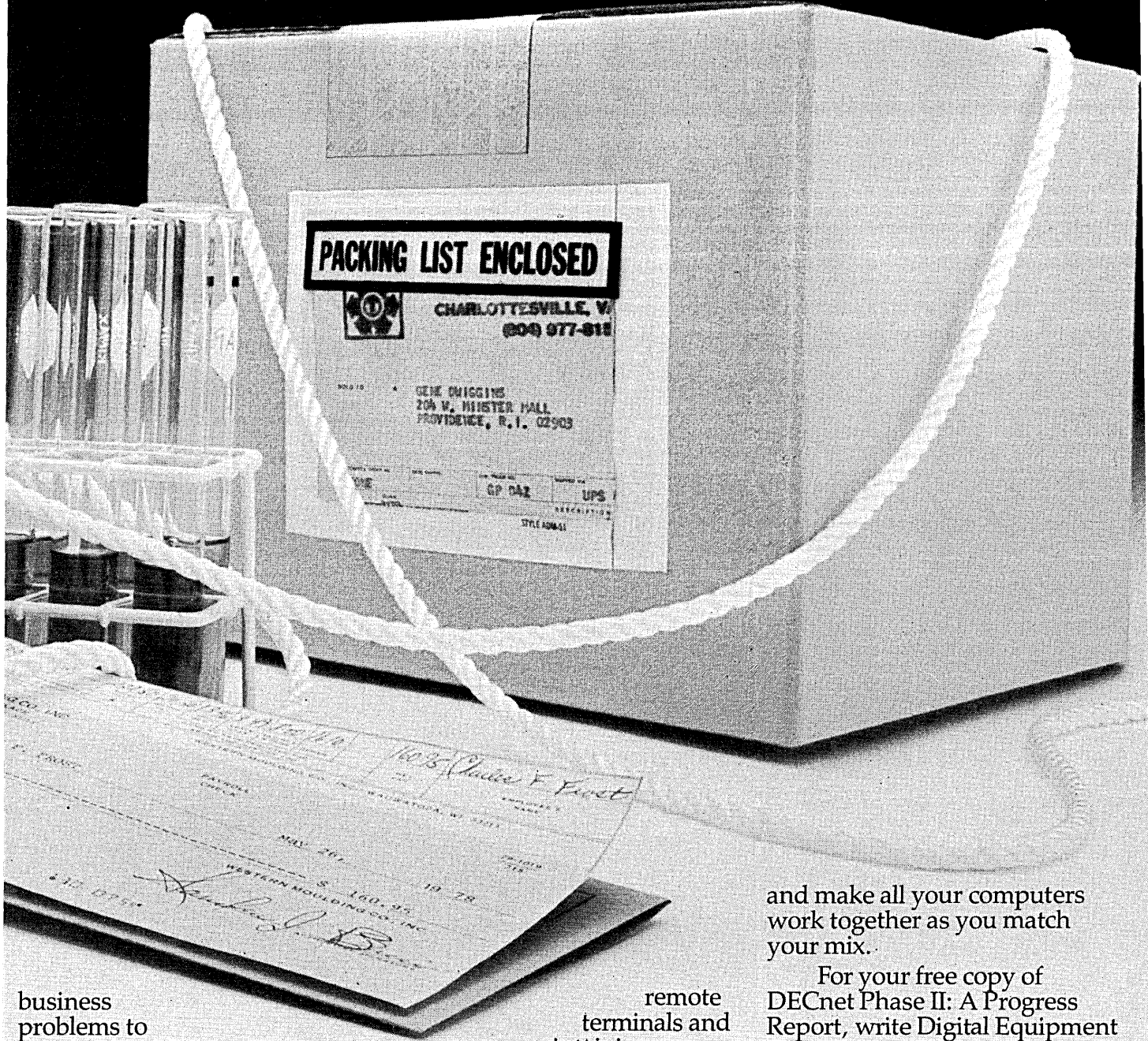

business problems to simulation, large-program runs, and other applications requiring high input-output traffic in multi-user environments.

Small timesharing systems designed for the office, warehouse or laboratory with a wide choice of architectures and operating systems tailorable to many different multi-user and multi-task applications.

Interactive mainframe systems. 36-bit DECSYSTEM 20's provide the power and flexibility to handle a wide range of business applications and scientific tasks for a number of interactive and batch users simultaneously while supporting a large number of

remote terminals and maintaining massive on-line data bases.

### 7. DECNET PUTS IT ALL TOGETHER.

DECnet, Digital's comprehensive networking software, supports general interconnectability of this complete range of distributed computer systems so you can exchange files, share data bases and other resources,

and make all your computers work together as you match your mix.

For your free copy of DECnet Phase II: A Progress Report, write Digital Equipment Corporation, 146 Main Street, Maynard, MA 01754. Attn: Communication Services (NR-2/2). European headquarters: 12, av. des Morgines, 1213 Petit-Lancy/Geneva. In Canada: Digital Equipment of Canada, Ltd.

**digital**

Please tell me more about how DECnet and Digital computers make the best and least expensive distributed networks in the world.

Name \_\_\_\_\_ Title \_\_\_\_\_

Company \_\_\_\_\_

City \_\_\_\_\_ State \_\_\_\_\_ Zip \_\_\_\_\_

Mail to: Digital Equipment Corporation, 146 Main St., Maynard, MA 01754.  
Attn: Communication Services (NR-2/2)

## VANs

such as for travel, postage, hotel, and courier/messenger costs. The same applies to intangible costs such as the value of rapid decisions and the value of having company experts present at key meetings. To a great extent, the issue of measurable displaceable expenses being used to offset communications costs will determine the size of communications budgets and hence the growth rate of communications services.

Heretofore, communications managers have not typically had access to top management or to the analysis of corporate expenses and policies. Nor have they had the broad business background to discuss these issues with top corporate management. Increased management attention to communications is a growing trend and will most certainly cause change in the relationship between the communications manager and corporate management. In at least one case we ran into, a communications manager felt that the advent of services from SBS would enhance his status (as well as the status of his counterparts) as IBM had enhanced the status of the dp manager.

Fueled by the marketing approach being taken by Satellite Business Systems, AT&T, Northern Telecom and others, communications planning activities designed to evaluate alternatives are very much in evidence throughout most major U.S. corporations. This situation is creating a much more businesslike atmosphere in the communications department, as are the introduction of planning and financial experts "on loan" from elsewhere in the corporation.

### Preparing for VANs

Being in a position to take advantage of the new communications services becoming available requires more than casual preparation. As stated earlier, there is considerable evidence that among the largest U.S. corporations a great deal of activity centered on developing comprehensive communications plans is in progress. Virtually every one of the largest 50 companies is engaged in some form of electronic mail project, with some already in the implementation stage. However, to really become positioned to take advantage of new services, rather than merely reaching the point where reaction to new developments is possible, a number of actions must be taken.

A close working relationship between the data processing and communications departments should be developed. Deciding in advance how functions will be split between the communications network and dp hardware is only a partial step and unfortunately carries some negative implications. Working

together to learn more about new dp-related VAN or hybrid services is a more significant step, as is the monitoring of developments among communication vendors and government agencies.

One area where dp planning personnel have traditionally had considerable experience is in capacity planning. Communications planners have had fewer opportunities to exercise this skill and could probably learn a great deal from the dp staff. Our study results indicated that nearly 40% of the respondents have excess communications capacity—most have more than 20% excess—and another 24% didn't know how much excess they had. This appears to be one area where working together would be beneficial.

Above all, the establishment of price/performance criteria with which to judge new vendors and services is critical.

Larger organizations have the option of testing the effectiveness of their plans by undertaking manageable VAN projects which involve joint communication/dp operation. The primary expectation of these projects should be achieving a discipline for evaluating new services and vendors according to those mutually defined criteria mentioned earlier.

In the longer run, total familiarity with the communication and information needs of the office must be considered, especially with regard to electronic mail systems. A variety of on-premise subscriber equipment from the telcos and interconnect companies will soon be available to perform such functions as data storage, text processing, facsimile compatibility, encryption, and user programmable processing, and users will demand the benefits associated with these advances.

All of the present participants in the U.S. information industries will be affected by the changes in the communications market, users as well as vendors. AT&T will react to competition with new equipment and services as it discovers how vulnerable some of its most profitable business is to competition. IBM has seized on almost every opportunity to expand its position by attempting to perform as many communications-related services as possible on its own equipment. These developments together with the countless associated product and services introductions flowing into the market all point to a need to "stay loose."

### Leave room for options

Chances are slim that standards for Value Added Networks will be firmly set during the next five years. Equipment interfaces to the communications network must therefore be flexible enough to be compatible with the proliferation of services now on their way. Users should not be without a fallback

mode and an alternate route, and should keep in mind that more extensive communications facilities will in turn encourage the use of even more information processing, storage, and distribution equipment in handling data, text, and especially graphics.

There is little question that the trend toward information economy will increase. The vendors have seen the potential, analyzed the market, and have begun the introduction of new products and services. Users, like it or not, must now react. This time around, top management is more knowledgeable, better prepared, and has been included in the process at a much earlier stage. \*

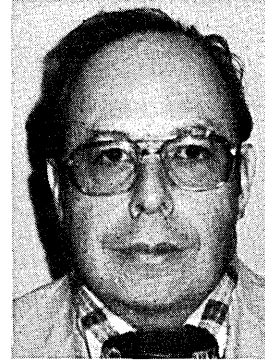

Mr. Lurin is director of eastern operations for Input, a Saddlebrook, New Jersey, firm specializing in market research and consulting. He has had over 20 years experience in data processing with an emphasis on communications, and previously was a co-founder and vice president of engineering for Combyte, a manufacturer of data communication systems. He has also held a number of technical and management positions at Honeywell and Sperry-Rand.

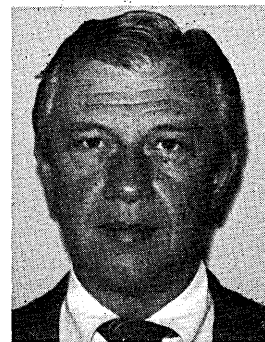

Mr. Metz is a principal consultant and director of user planning service for Input. He, too, has had more than 20 years experience in the field. He has been director of corporate development for Automatic Data Processing, vice president (and founder) of Cyphernetics, and has held various technical and planning positions at Ford Motor Co. and Philco-Ford.

# EXECUPORT 4000. WIDTH WITHOUT WEIGHT.

The EXECUPORT 4000 has 136 columns and weighs only 16 pounds. Computer Transceiver Systems Inc. is proud to introduce our new EXECUPORT 4000. The EXECUPORT 4000 is a wide carriage, 136 column portable which weighs only 16 pounds. It is a state-of-the-art, microprocessor controlled terminal which carries on EXECUPORT'S tradition for quiet, workhorse dependability. In addition to reducing the weight and cost, we have added many new features. New coupler-modem design with increased sensitivity and a high degree of vibration and sound isolation. Tab stop capability which can be controlled at the keyboard or by the computer. LED Display to show print position. Buffered carriage return. Built-in self-test capability. Parity error detection system which prints 1/4 space above the line. True upper and lower case. The EXECUPORT 4000 has been designed to our high standards for reliability and maintainability. It is backed by a full one year warranty. The EXECUPORT 4000 is offered with ASCII, APL and IBM PTTC/EBCD codes and with bit-paired or typewriter-paired keyboards. For the full story on this outstanding EXECUPORT, its options and our various purchase and leasing programs, call or write to us at our headquarters. If you prefer, contact our sales offices at the telephone listed below in your area code. Computer Transceiver Systems, Inc., East 66 Midland Ave., Paramus, NJ 07652. Phone (201) 261-6800.

Computer Transceiver Systems Inc. is proud to introduce our new EXECUPORT 4000. The EXECUPORT 4000 is a wide carriage, 136 column portable which weighs only 16 pounds. It is a state-of-the-art, microprocessor controlled terminal which carries on EXECUPORT'S tradition for quiet, workhorse dependability. In addition to reducing the weight and cost, we have added many new features. New coupler-modem design with increased sensitivity and a high degree of vibration and sound isolation. Tab stop capability which can be controlled at the keyboard or by the computer. LED Display to show print position. Buffered carriage return. Built-in self-test capability. Parity error detection system which prints 1/4 space above the line. True upper and lower case. The EXECUPORT 4000 has been designed to our high standards for reliability and maintainability. It is backed by a full one year warranty. The EXECUPORT 4000 is offered with ASCII, APL and IBM PTTC/EBCD codes and with bit-paired or typewriter-paired keyboards. For the full story on this outstanding EXECUPORT, its options and our various purchase and leasing programs, call or write to us at our headquarters. If you prefer, contact our sales offices at the telephone listed below in your area code. Computer Transceiver Systems, Inc., East 66 Midland Ave., Paramus, NJ 07652. Phone (201) 261-6800.

IBM PTTC/EBCD codes and with bit-paired or typewriter-paired keyboards. For the full story on this outstanding EXECUPORT, its options and our various purchase and leasing programs, call or write to us at our headquarters. If you prefer, contact our sales offices at the telephone listed below in your area code. Computer Transceiver Systems, Inc., East 66 Midland Ave., Paramus, NJ 07652. Phone (201) 261-6800.

416-245-4848; 206-454-9332; 503-223-7165; 716-385-1681; 301-589-2802; 713-780-2511; 214-661-0300; 512-828-0937; 405-528-6071; 512-451-5174; 408-267-8711; 612-645-5816; 213-328-9770; 303-770-1972; 801-487-8281; 404-237-9242; 617-245-8900; 203-265-0215; 314-426-2500; 602-267-7536; 312-279-2440; 216-267-0445; 513-434-7500; 313-588-2300; 412-892-2953.

CIRCLE 40 ON READER CARD

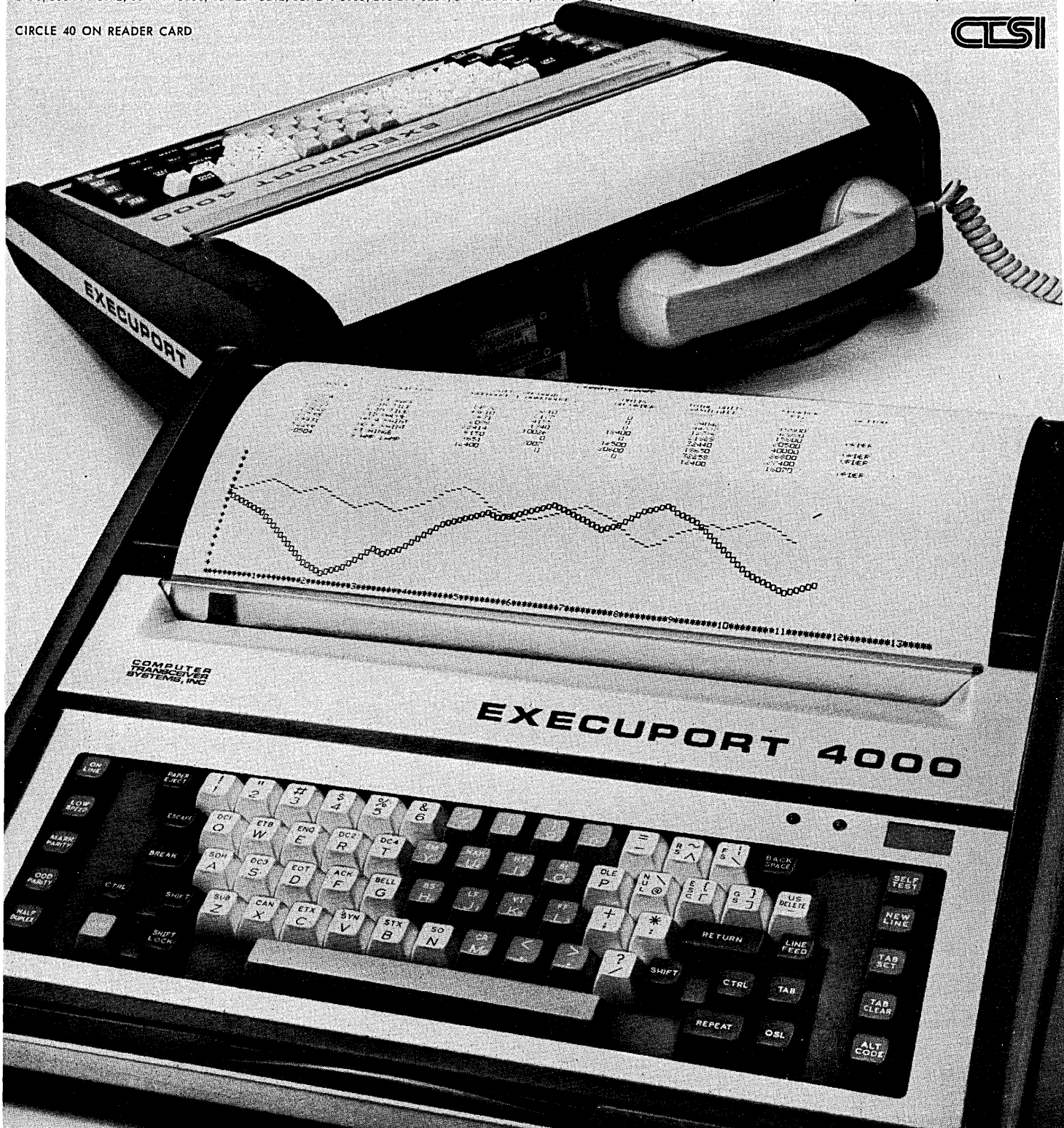

# For computer power anywhere,

People rely on CDI Miniterms.

CDI 1203 Miniterms are the choice of data processing professionals around the world.

In remote sites everywhere — from the rough environment of heavy construction to the fast-moving pace of big-city financial consultants — Miniterms put computer power where the action is.

Lightweight and easy to handle, Miniterm 1203's are preferred because they're flexible in any application. Three-way keyboard lets the user communicate with any popular timesharing system in the way he finds most comfortable. The snap-in acoustic coupler is the most reliable on the market.

Best of all, the entire Miniterm family — from compact, desk-top printers and terminals to full ASR portables with expandable, built-in memories — are backed by a worldwide organization of trained, dedicated sales and service specialists.

When you're on the move, take along a Miniterm. . .

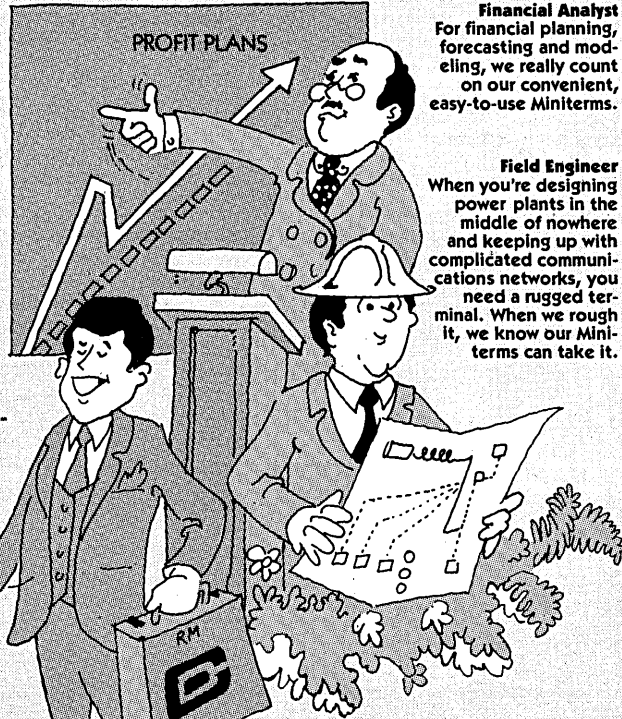

**Financial Analyst**  
For financial planning, forecasting and modeling, we really count on our convenient, easy-to-use Miniterms.

**Field Engineer**  
When you're designing power plants in the middle of nowhere and keeping up with complicated communications networks, you need a rugged terminal. When we rough it, we know our Miniterms can take it.

**Sales Representatives**  
Our sales people make on-line demonstrations tailored to the user's needs and can enter orders remotely right in front of the customer. We're one step ahead of the competition with our Miniterms!



Miniterm Model 1203 with rugged portable carrying case

## The portable terminal that's going places

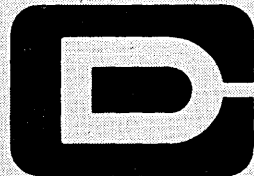

**COMPUTER DEVICES INC.**

25 North Avenue  
Burlington, Ma. 01803  
(617) 273-1550



**Call Toll Free**

**1-800-225-1230** for your copy of our new, full-color brochure entitled "The Touch of Quality in Compact Terminals."

You'll see how much more you can do with Miniterms.

# ADDS SYSTEM 70. OEM.

Good reasons why System 70 is easy to buy and even easier to sell

Buy a lot. Save a lot.  
Big OEM discounts  
an money in the  
bank.

**2** ADDS\* PLUS Data Entry Language, Advanced Diskette Operating System (ADOS), BASIC, FORTRAN IV, Assembler, editing and debugging software are all field proven. And, this extensive software simplifies implementation and saves you dollars.

**4** Our Nationwide service means you've got it easy. Over 50 service locations make sure that System 70s keep on working. We provide the service. You save the dollars.

**5** With more than 65,000 terminals already installed, ADDS reputation for quality and reliability is unsurpassed.

**6** Our terminals fit your customers. System 70's beautiful exterior is human engineered for maximum operator convenience and ease of operation.

**7** IBM 3780, Burroughs and teletypewriter communications are all available, making System 70 the right choice for almost any distributed processing environment.

We build 'em for you  
fast. Our 45 day  
delivery schedule  
means less inventory  
and more money in  
your pocket.



Quality, Reliability,  
Integrity. It all adds  
up to ADDS.

**ADDS** Applied Digital  
Data Systems Inc.  
100 Marcus Blvd., Hauppauge  
New York 11787 516-231-5400  
DEPT. 70.

I need more information  
on the System 70. OEM.

Name \_\_\_\_\_

Firm \_\_\_\_\_

Title \_\_\_\_\_

Address \_\_\_\_\_

City \_\_\_\_\_ State \_\_\_\_\_

Phone \_\_\_\_\_

CIRCLE 18 ON READER CARD

# Total output. Only



**Any application.** Designs. Maps. Business graphics. Printing. Halftones. Listings. Data collection and logging. Versatec delivers.

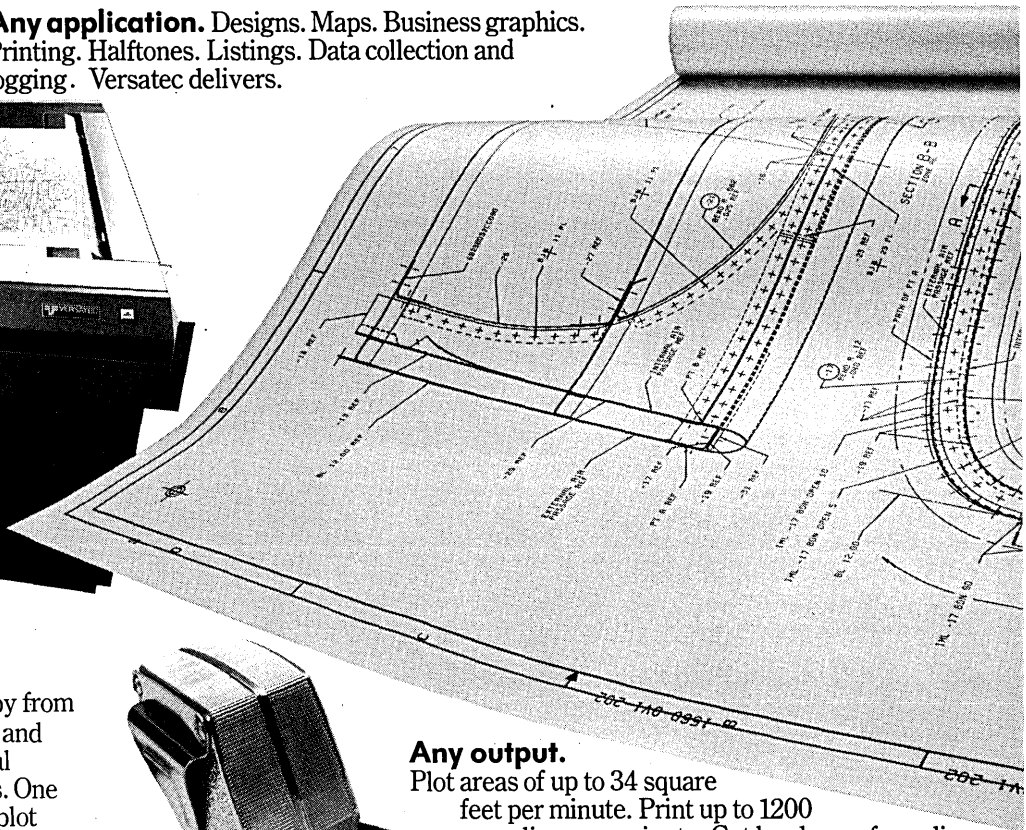
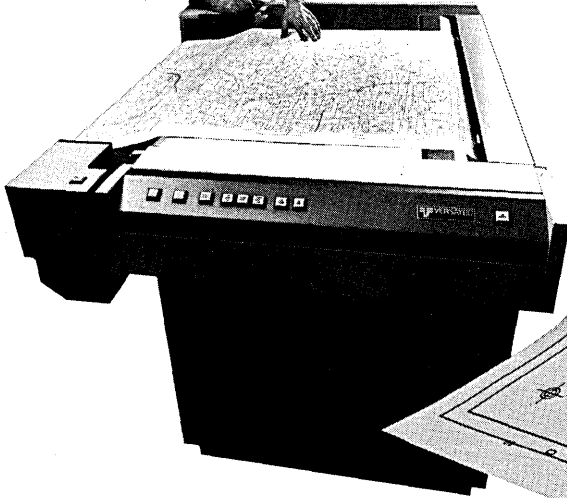

## Any display image.

Get archival quality hard copy from Hewlett-Packard, Tektronix, and other popular displays, digital generators and video sources. One printer/plotter can print and plot from computer, then, upon request, make copies from up to eight terminals.

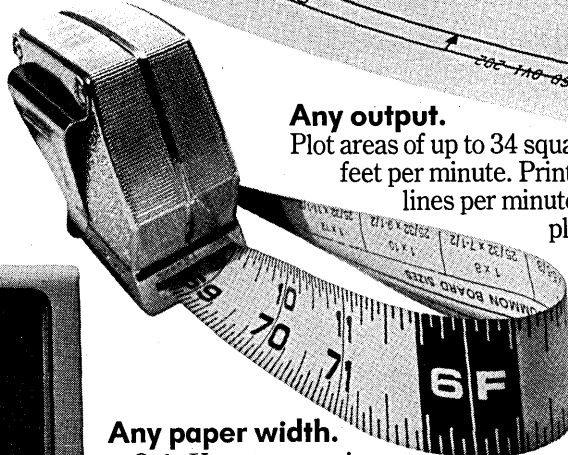

## Any output.

Plot areas of up to 34 square feet per minute. Print up to 1200 lines per minute. Get hard copy from display in under twelve seconds.

## Any paper width.

Only Versatec can give you ten paper widths—From economical 8-1/2" to super-wide 72".

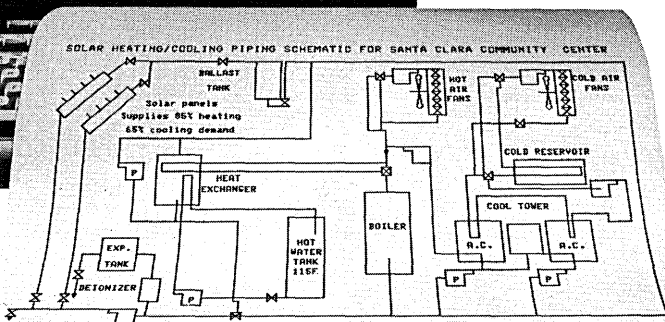
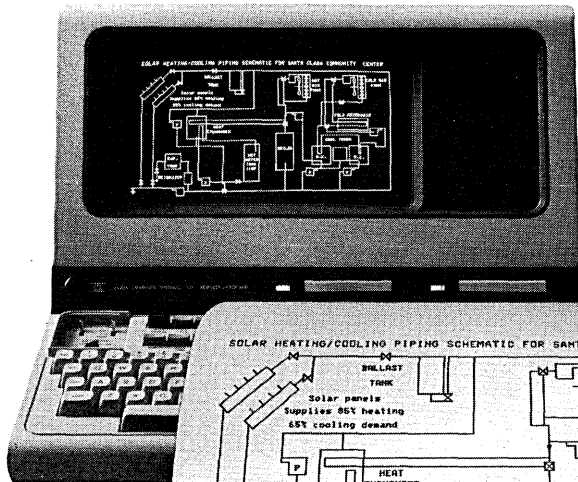

**Anywhere.** Rack-mountable and desktop models fit anywhere, go anywhere. Perfect for OEM systems, hostile environments and mobile operation. Available in commercial 3000 series, militarized 7000 series.



# y from Versatec.

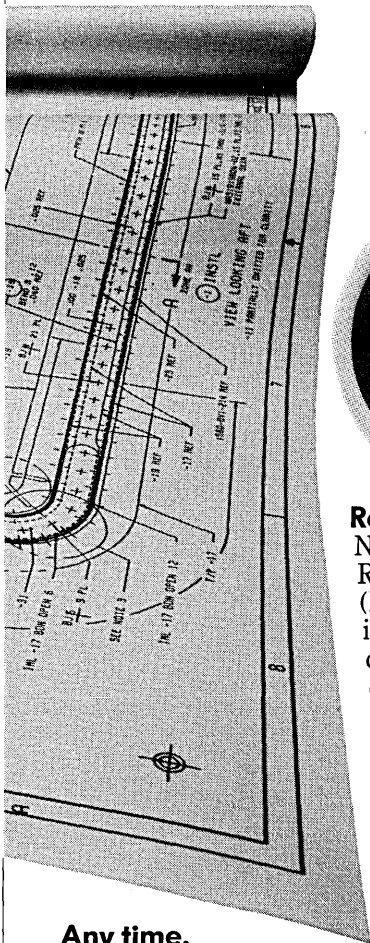

**Any IBM 360 or 370 (OS or DOS).** A complete family of output systems for IBM 360/370 accept vector data for fast electrostatic plotting without excessive CPU or I/O overhead.

**On-line** systems emulate IBM 3211/3811 or 1403/2821 printer/controllers.

**Off-line** systems accept vector, raster or print data on IBM generated tapes.

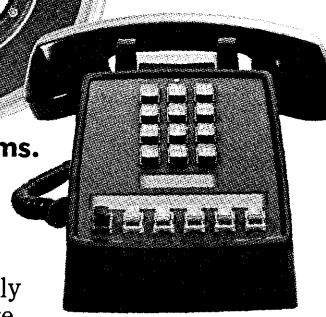
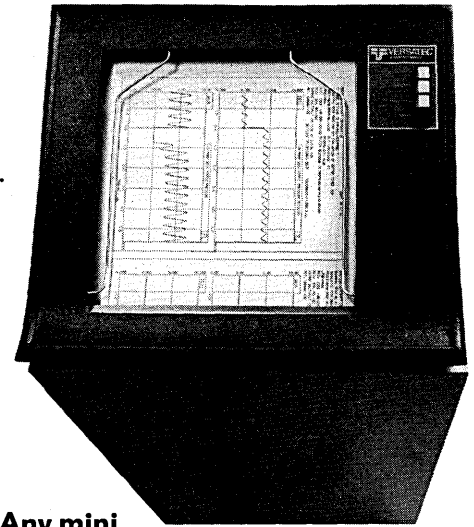

**Remote systems.**  
New Versatec RSVP™ (Remote Spooling Vector Processor) is the only complete remote system for electrostatic printing and plotting. It provides remote job entry like IBM 2780/3780 terminals, but dynamic output selection allows any combination of card, print or plot data for output on up to four Versatec printers, plotters or printer/plotters.

**Any mini.**

Yes, even a small mini can produce a high density plot in seconds. With 200 dot per inch resolution in paper widths to 72". At full rated speed. But only with the Versatec Vector-to-Raster Converter.

**Any time.**

- A. Get hard copy from display within 12 seconds.
- B. Plot a 34" x 44" E-size production drawing in 22 seconds.
- C. Draw a 40" x 50" shaded map in 25 seconds.
- D. Produce a six-foot square IC drawing in one minute.

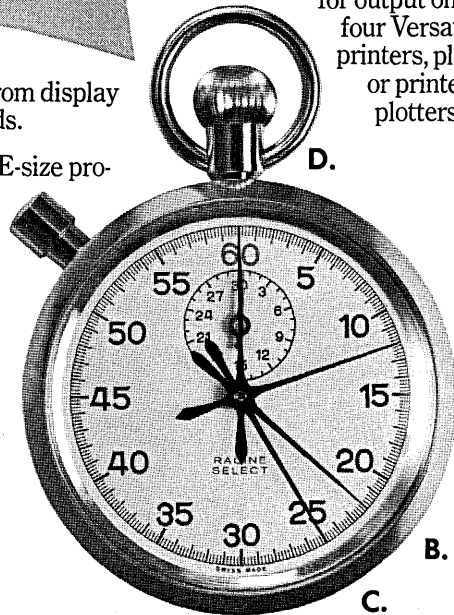

**Any questions?** Check our readers' service number for the full color 24-page Output brochure. Better yet, fill out the coupon for specific information and samples.

Versatec  
2805 Bowers Avenue  
Santa Clara, California 95051

(408) 988-2800

Send facts:

- Printers, plotters and printer/plotters
- Paper width:
  - 8-1/2"  11"  20"
  - 22"  24"  36"
  - 42"  50"  63"
  - 72"

Send samples:

- Business graphics
- Computer aided design
- Mapping
- Scientific applications
- Production drawings
- Gray scale halftones
- Data collection/logging
- Listings

- Hard copy from display
- Minicomputer plotting with Vector-to-Raster Converter
- The 360/370 output system
  - On-line  Off-line
  - Remote Spooling Vector Processor (RSVP)
- "Go Anywhere" printer/plotters (3000/7000 series)

Name \_\_\_\_\_ Telephone \_\_\_\_\_

Computer model and operating system \_\_\_\_\_

Organization \_\_\_\_\_

Address \_\_\_\_\_

City, State and Zip \_\_\_\_\_



# The Data Communications Systems Of The Future

We're looking ahead to the data communications systems of the future. It's part of our determination to stay ahead in computer communications. To deliver systems today that stay with you as your computer communications grow.

We see more use of computer networks for the future. Networks linking far flung terminals with central or regional computer sites. Providing improved access to vital data. Making more efficient use of your computer facilities. These networks will require a new generation of communications processors. More intelligent and powerful front-end processors. More powerful and efficient remote communications concentrators. Front-end processors that will have greater throughput, will operate at faster speeds, and will relieve

host computers of more communications tasks. Able to access multiple CPU's while handling thousands of terminals. Remote concentrators more powerful to handle maximum transmissions speeds. Able to operate with conventional lines and satellite channels. Speeding the flow of data while saving line costs.

When it comes to computer communications, keep your eye on CCI. We're already working on the technologies of the future. We're looking ahead in computer communications to keep you ahead.



**Computer  
Communications,  
Inc.**

2610 Columbia Street, Torrance,  
CA 90503. (213) 320-9101.

*We're Looking Ahead In Computer Communications.*

# IBM's Future Large Computers

by Frederic G. Withington, Contributing Editor

---

Technological advances and the needs of large users are driving IBM's development of large systems. The seeds of what to expect are present in the 303X.

---

A forecast of IBM's 303X large computer product line, as it seems likely to evolve during the next five years or so, can be based on two sets of considerations: the needs of large users, which IBM will be trying to meet with its new products; and the potentials of advanced technology that can be realized in the next few years.

## The needs of large users

Almost all large users want to support multiple processing environments or modes of use. They want to continue using batch processing for the things it is naturally best for. At the same time, most large users are in the process of building or converting a sub-

---

## A half-million organizations want new multimode systems, but only a few thousand have the staff to make them work.

---

stantial number of applications for the on-line transaction processing environment, including terminals and data bases. Also, many users want to do some kind of time-sharing for engineering design, financial models, or strategic planning. Often all three modes of use should work with the same corporate data base. Users want to employ these modes of use intermixed at their own convenience, with the system somehow sorting out the relative priorities (which vary dynamically with time) and seeing that everybody gets appropriate service.

Almost all large users must also have backward compatibility with the programming investments they have already made. Most are not likely to buy

any new system if they have to reprogram everything for it.

Users also need greater usability, in the sense that the system provides all the services expected, is relatively convenient, forgiving, and robust, and will be available when it is expected to be. There is a sharply increased need for availability as users evolve to the transaction processing mode. If a batch processing system breaks down for an hour, typically the user can run an hour late or on the weekend and make it up, but if an on-line system breaks down for an hour when the company depends on access from remote terminals, the company goes down for an hour. Users need nearly 100% certainty that at least for the high priority jobs the system will be there when wanted.

Ease of use has also become a specific market need. There are many organizations which would like to have modern multimode systems—maybe half a million of them. But there are only a few thousand organizations willing to support the staff of systems programmers necessary today to make them work. Those half million organizations will not be reached until the systems have become really easy to use, meaning that they require only a handful of professional employees with an average level of education and skill, dedicated to the system for all purposes. So it is a market-derived growth objective that causes IBM and the other computer vendors to strive for ease of use.

Systems that are truly easy to use are often referred to as "virtual systems," easy to understand from the point of view of the user. The left-hand side of Fig. 1 represents programmers who are

preparing new programs or answering requests for new reports that have not been run before, expressing their needs in the familiar programming languages, but with innovations in supporting services (text editors, structured programming aids, data dictionaries).

As the programmers enter their requirements for compilations or tests, they encounter a software complex which might be termed a "conversational scheduler and diagnoser." It says (in effect) such things as "you didn't close this parenthesis," or "what does that asterisk mean?" or "I don't recognize that data name," or "your credit's no good," or "would you believe 8:00 tomorrow morning instead of five

---

## The command language used to be just JCL, but is evolving to greater user convenience.

---

minutes from now?" or anything else necessary to prepare the run for execution. When the dialogue concludes, the run is performed—either instantaneously or later, as necessary.

The right-hand side of Fig. 1 depicts the production user, inputting data to post the files, making inquiries to the data base, asking for reports and the like. He expresses his needs in terms of some kind of command language. (The command language used to be just the job control language, but it is evolving toward greater user convenience. When the user pushes function buttons on a specialized terminal or points to something on a tube face, he is employing a more convenient command language; evolution in the man-machine interface

## IBM's FUTURE

is occurring as such "languages" evolve.) The user's needs are expressed to the conversational scheduler and diagnoser, which then provides the data output when the need is understood and can be met.

Both kinds of conversations take place in high-level symbolic languages, and once they are concluded the user has no knowledge of what tools are used to meet his need. He is not aware of what machines are involved, what level of what operating system is used, what the word length is, etc. He doesn't even know where the machine is: it could be a central machine, a node in a distributed network, or even a service bureau. The point is the machine environment has become virtual; it disappears from the user's sight.

### The technology potentials

There presently exists a group of techniques in software and system architecture which, if they are all well-used and enmeshed, make virtual systems possible using today's state of the art. They include semiautomatic network and file management, virtual memory and virtual machine monitors, variable microcode, direct execution of high-level languages, and fail-softness. Each of these techniques is in use in one or more systems by IBM or other vendors; the problem is to put them together in an integrated, bug-free whole.

IBM and the industry would perhaps have done a better job of getting these techniques together if it were not for

one unfortunate fact about most of them: they involve doing things in a standard, brute force way which is generalized and takes care of everybody's job, but which is not optimal for anybody. They suboptimize to obtain generality, which means inefficiency and higher systems program overheads than users now experience. Fortunately there is an answer to this problem: the improving price-performance of semiconductor circuits.

The pace of circuit evolution today is perhaps faster than ever before. It is conservative to forecast that the cost of obtaining the present level of circuit performance will drop tenfold in five

### IBM has been retooling some of its semiconductor plants; the industry will see the results for years.

years (at the component level). Instead of one megabyte of memory the user will be able to afford ten, or he could obtain something like ten times the performance for the same dollars. One indicator is that IBM has apparently been retooling some of its semiconductor plants; the industry will be seeing the results for years.

Redundancy will be the route to better availability. Already Burroughs in its high-end systems offers an option of fail-softness through a continuous diagnostic procedure and multiprocessing. Judging from IBM publications it is more likely that IBM, at least, will eventually provide redundancy at a lower level—the level of the large-scale circuit

or perhaps the board containing the circuits.

For example, one approach involves designing a computer with three of every circuit and hardwired logic for a majority vote on every function performed. If one circuit is out of step with the other two, the logic accepts the answer from the two and assumes that the third circuit failed. It's nice and neat—all hardware, very fast, with no overhead for software diagnosis. But it triples the amount of hardware required to do the job. Fortunately, circuits are getting so cheap that one can start thinking this way.

The file storage system is critical for data base applications. There are new technologies such as charge-coupled devices, magnetic bubbles, electron beams, and holograms, but the magnetic disc can improve too. It appears that the present packing density of data on the face of a disc can be increased by perhaps a factor of 10. A 400MB 3350 spindle which is the state of the art today might contain 4 billion bytes in the future. The unit cost of disc storage will therefore become very low, and the new technologies are not going to be able to match that cost for a decade at least.

So the disc will remain the file storage medium of choice, but that means the access arms still have to be moved, which is a slow process. Fortunately the arm movement problem can be solved by providing a large, fast buffer store and employing the same principle we are now familiar with in cache memory: the statistical fact that after an item is referenced there is about an 80% chance that the next item wanted will be within the next four or so. So if four or more records are brought into a large buffer at each read, most of the time the next one needed will be in the buffer, and the disc arm need not be moved except for every third or fourth reference.

IBM is aware of this potential, and both it and the other manufacturers are likely to be offering buffered disc systems, with intelligent controllers that manage the device complex as if it were all a homogeneous file (an extension of the present 3850 controller concept). This controller will probably also perform all the housekeeping functions in the file, the activities generally associated with the access method software used today. Substantial software overhead will therefore be off-loaded from the mainframe and put in the file controller, since the controller must be intelligent anyway for managing the hierarchy.

In the input-output area, IBM has been forced to follow a user-driven trend toward more powerful, intelligent front-end processors performing packet-switching, a trend which will probably evolve further. Another reason for a more powerful I/O processor is the man-

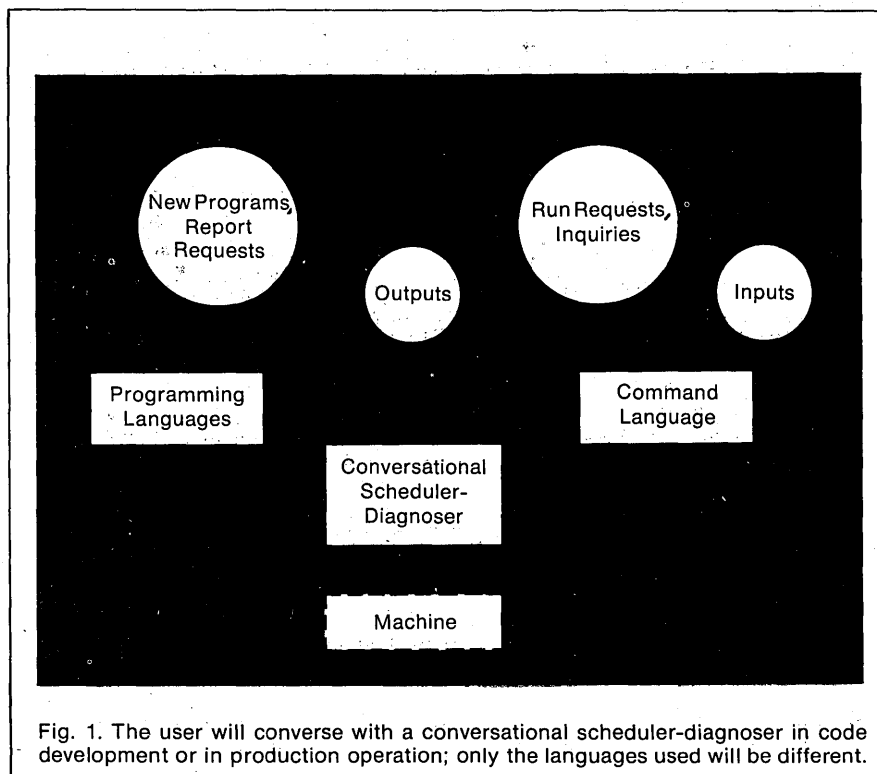

Fig. 1. The user will converse with a conversational scheduler-diagnoser in code development or in production operation; only the languages used will be different.

agement of new I/O devices.

For example, nonimpact printing technologies have already appeared in products like the IBM 3800, the Xerox 9700, and the Honeywell Page Printer. The main virtue of these so far has been high speed. But these technologies are different, because they are not constrained to a single font as impact printers are. Any character of any size, any graphic image, any logo, any color if wanted, are all available. Over time users will find that they can use this intrinsic graphic capability, and there will be many interesting products. High speed and extensive memory will be required in the controllers for such high speed "imagers," however.

#### What the current 303Xs suggest

All of the technologies just discussed are likely to be employed by IBM within the next few years in an effort to better meet users' needs. They may be introduced in evolutionary successors to the present 303X systems, or they may be introduced in a new product line. The following observations about the present 303X products seem to indicate that the new technologies will appear in a series of modular announcements of hardware and software that will gradually transform the present family into a much more advanced one.

- All the machines in the 303X series are centered around a storage control capability that (as implemented by other manufacturers) permits multiple computers, I/O processors, and other devices to have simultaneous access to a common memory; thus, all the processors may work on the same job stream. Such systems could be much more modular than the present 303Xs, even than the 3033 multiprocessor. And the storage controller capacity provided in the 303X seems high enough to support a high level of modularity, too, as indicated in the 3033MP.

- The 303X computer systems are provided with I/O channels in groups of six. IBM has stated that the functions of the individual channels are determined by microcode or stored logic. A channel director, whose functions are also determined by microcode, is associated with each of the groups of six channels. These channel groups are apparently implemented in new and more compact electronics, and the channel director seems strangely like a 370/158 cpu. Future announcements of new microcode are likely which would enable these groups of channels to acquire entirely different characteristics.

- Customers obtaining any of the present 303X systems must have 3830 disc storage controllers for connection between the channels and their existing disc drives, of whatever model. This represents a step backwards, since the

models 158 and 168 offered integrated disc file controllers at no extra cost.

- The 3033 processor apparently has new, faster logic chips. To minimize costs, IBM will probably supersede the older logic chips with these new chips as they become available in quantity. Thus, the present 3032 and 3031 processors could be replaced by newer ones in the next few years.

- The model 3036, a powerful standardized control console, will be used with all three currently announced 303X computers. It contains a processor of its own for directing diagnostic procedures and overall system measurement procedures; such a service processor is appropriate for the monitoring and control of a highly modular processor system.

- IBM indicated that it is relying on microcode to establish the function of the system in all areas (central processor, channels, console, storage control), as opposed to the fixed logic embodied in the circuit chips. This increased use of microcode creates the possibility for an unprecedented degree of change in the functions of the individual modules.

#### The future 303X line

Fig. 2 shows what future 303X series systems might look like, combining all these observations. First, under the console at the top, multiple processors appear; IBM will probably make these

universal across the line. At some point the present processors will be replaced by new modules which will use new electronics and will feature direct execution of high level languages in microcode. IBM does this in some small machines (the 5110 and the 3790), and Burroughs now offers a large FORTRAN processor for attachment to its larger systems which runs FORTRAN directly in microcode.

There are some good reasons for doing this. First, it provides more speed with the same electronics; if the customer will program in the specified language, he obtains 30%-50% more throughput. That induces the customer

#### New processors will use new electronics and feature direct execution of high level languages.

to give up assembly language and go to all high level language programming, which IBM rightly wants him to do.

Second, it enables IBM to separately price more software and to configure the products increasingly with microcode rather than with only hardware designs, both of which (incidentally) will make life more difficult for the plug-compatible cpu manufacturers. Microcode control will be used throughout the system, not just in the language processors.

In addition to the language proces-

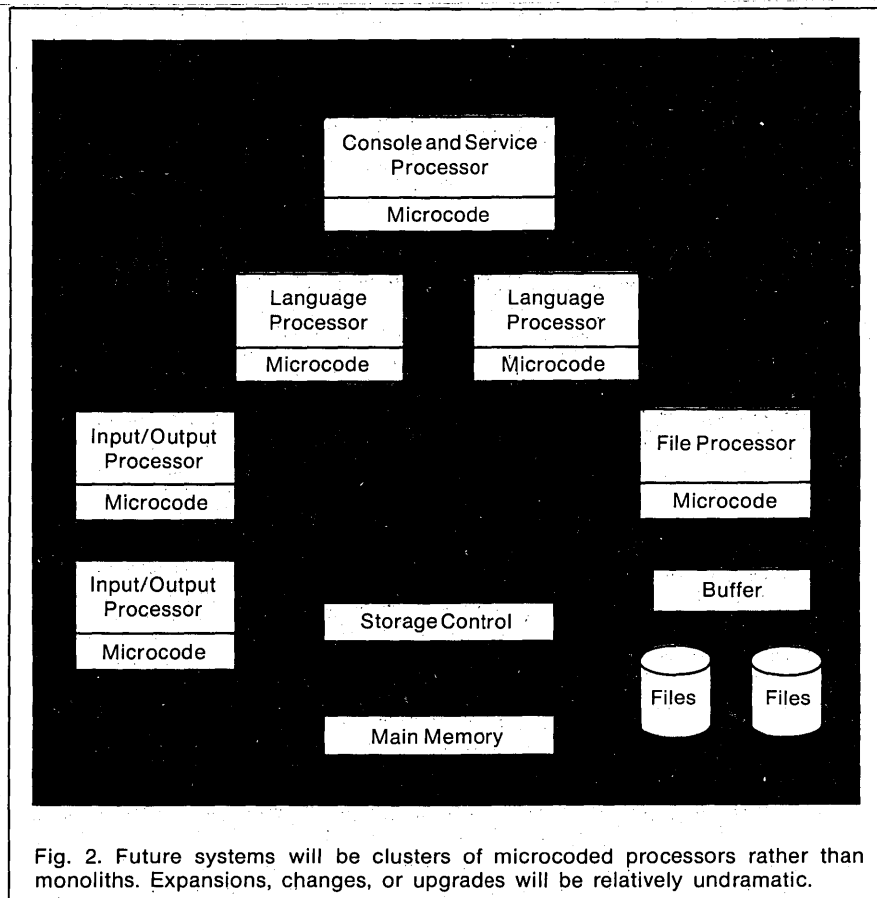

Fig. 2. Future systems will be clusters of microcoded processors rather than monoliths. Expansions, changes, or upgrades will be relatively undramatic.

# For Sycor's 10th birthday in distributed processing, a system that makes your wish come true!

Creating the first intelligent terminal ten years ago gave us the edge in distributed data processing today. We're celebrating that lead by introducing the Sycor 445™—the ultimate distributed data processing system. It gives you power, versatility, security, proven software, communications capability and Sycor's traditional reliability and ease of use.

## A Gift of Power.

Jobs get done fast with the Sycor 445. The system presents up to 256K of memory, 308Mb of disk storage, eight video Data Stations and a combination of line and bidirectional matrix printers. The 445 meets all of your processing needs.

## Sycorlink™—One to Grow On.

Our exclusive Sycorlink lets you connect several 445 systems and permits disk file and peripheral access of one system by another. Any operator can automatically access any file in your growing Sycorlink network. So start with a basic 445 configuration and add processing capability with Sycorlink as your business grows.

## A Package of Proven, Reliable Software.

Start working right away with Sycor's proven 400 Series software. The new 445 is ready with COBOL for both data entry and concurrent

processing. BASIC is available for business and financial applications. And TAL, Sycor's proven Terminal Application Language, makes data entry easy. A full range of file management capabilities and utility programs makes your 445 productive immediately.

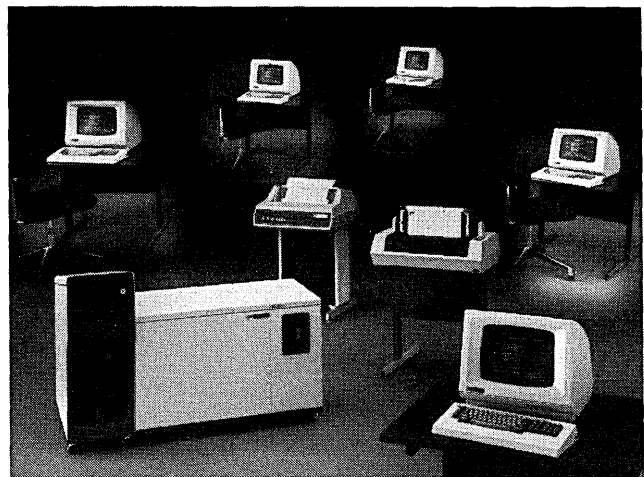

## Communications with Sycor Is A Piece of Cake.

Our communications expertise gives you the edge in networking, no matter where you buy your mainframe. IBM, Burroughs, CDC and others. We talk to them, and we have for some time.

Of course, Sycor systems also talk to each other and your smaller offices can have remote



Data Stations that share the power and resources of the 445. Best of all, the 445 provides IBM 3270 emulation so you can blend on-line communications with distributed batch operations.

### **Security for Peace of Mind and Many Happy Returns.**

Relax! The Sycor 445 gives you security in many ways. Every system includes a cartridge tape drive that can back up a disk file by recording up to 10Mb of data in a matter of minutes. Program controls let you lock out special keyboard functions and password-protect their use to authorized persons.

Sycor's Guardian feature protects against power failures. In the event of an outage, it saves memory by storing it on the disk. Then the data is automatically restored when power returns. You can also get an optional lock on each keyboard to lock out all activity on the Data Station.

### **Let Our Experience Make Your Wish Come True.**

You can benefit from our experience. We didn't just jump into distributed processing. We started it a decade ago. We've designed our systems so your present employees can easily handle day-to-day operations. If they should need help, our experienced service people are ready. We've learned to make it easy for you.

### **Join the Party. Call Sycor Toll-Free 800-521-2838.**

Enjoy powerful hardware, proven software and peace of mind. A nice way to get ahead in distributed data processing. Find out how nice by calling Tony Fazio, VP, Sales. In Michigan, call collect, 313-995-1170. Or write: Sycor, Inc., 100 Phoenix Drive, Box D, Ann Arbor, Michigan 48106.

Better yet, contact a nearby sales office. We're in the Yellow Pages under "Data Processing Equipment."

**Sycor puts computer power where the work is.**

TM

# **SYCOR<sup>®</sup>**

A Northern Telecom Company

## The Ready-to-plug-in Fiberoptic Data System

Just plug any of Valtec's fully engineered duplex links into any common electrical receptacle and you're ready to transmit anything from DC to 10 MBPS, without electrical interference, for up to 3000 feet.

## Off-the-shelf Availability Reasonably Priced

Delivery of RS 232C as well as the TTL fiberoptic data links and cable is direct from stock.

Prices start at \$1,000 per link pair and duplex cable \$1.00 per foot.

## Complete Information & Order Forms



For ordering information and specifications for Valtec systems which free you from the expense and nonsense of wire data links write:



Valtec Corporation  
99 Hartwell Street  
West Boylston, MA 01583  
(617) 835-6082  
Telex 92-0355

## IBM's FUTURE

sors, specialized ones such as high speed pipeline or array processors may also be offered, as market demand dictates.

The left side of Fig. 2 shows multiple I/O processors. At some point new microcodes for the channel directors will be announced and the channel groups will become standalone, communication switching I/O processors, or perhaps other forms of specialized processors.

The file processor described earlier appears on the right side of Fig. 2, with the hierarchy of devices—a big buffer, parallel strings of discs, and (optionally) a 3850 mass store also. It, too, will be microcoded, and may even be derived from one of the present channel groups. When the file processor becomes available, the 3830 controllers will no longer be necessary.

With the breakup of the operating system into microcode in dedicated processors (along the lines of the Selectable Units in MVS), the role of the operating system will diminish to that of resource allocation and dispatching, and for flexibility most users will probably employ virtual machine monitors for overall supervision.

As this modular concept evolves and components become less expensive, IBM is likely to introduce modules with successively lower prices. Sometime in the early 1980s it is likely that at least a subset of this evolved 303X architecture

---

Sometime in the early '80s, a subset of the 303X will be available at the level of the 370/138.

---

will be available at the 138 price level.

If a user acquires a 303X system now at a single monolithic price, he is likely to find that as time goes on IBM will make available new modules such as the above to add to it, some of which will eventually replace existing modules, and which will permit the user to evolve his system into a wholly new one. Such a process has several implications.

First, users will be acquiring not big monolithic mainframes in which there is a traumatic replacement of one by another, but modular, dedicated processors. The user can keep the one he has and add another or add new microcode, and mix and match pieces to meet his changing needs. This probably implies a trend toward purchase. There has been such a trend in recent years; it is temporarily stalled because of confusion over the new systems, but once this settles down it would seem that most people will buy most of their equipment or obtain it on a long-term lease.

It appears that, while hardware will be much cheaper per unit, this lower cost will be offset by the lower efficiency of the new techniques. Now, users typically have 4MB of storage for large computers. In 1985 they may have 32MB (including a big file buffer), and they will be paying separately for un-

---

Users will be paying about the same per unit of work as today, unfortunately.

---

bundled systems programs, mostly in microcode. Also, the redundancy needed for fail-soft operation will increase the number of components.

Putting these factors together, users will probably be paying about the same per unit of work done for the new systems as for the present ones, which is disappointing. However, what users will be getting for that money is increased ease of use, and better multimode capability, availability, and usability. It does seem that such systems will meet the user needs defined at the beginning of this article much better than the present ones do, and that most users will conclude they are well worth their cost. \*

*This feature has been adapted from a seminar presentation for senior executives given by the author. A brochure containing this talk and three others on distributed systems, systems planning, and the office in the 1980s can be obtained by writing to the public relations department, Arthur D. Little, Inc., 25 Acorn Park, Cambridge, MA 02140.*



Mr. Withington has directed Arthur D. Little, Inc.'s computer industry analysis activities for 14 years, while serving as a consultant to more than 100 organizations. He has been one of *Datamation's* contributing editors for eight years, and is currently a visiting professor at the Harvard Business School.

Among his publications are four books, the latest of which appears this month: *The Environment for Systems Programs*, part of the IBM-sponsored Systems Programming Series published by Addison-Wesley.



# The new MDS 21/50. Series 21 grows bigger for you.

Mohawk Data Sciences announces System 21/50, the latest member of the Series 21 family of distributed processing systems.

System 21/50 doubles the power and doubles the capacity of Systems 21/20 and 21/40 — but retains the pricing breakthroughs that have made Series 21 a worldwide solution to data entry, stand-alone operations and distributed processing requirements.

A System 21/50 performs multiple functions, uses high level language, and does the local office processing you need right now. And the System 21/50 grows with you. With

main memory up to 128K. With disk storage to 20 megabytes. With printers from 45 cps to 600 lpm. And with magnetic tape drives and communications options as you need them.

Now with three Series 21 systems to choose from, you can mix and match just the right amount of power for your dispersed locations. System 21/20 for easy conversion of source documents. Next, the System 21/40 for local processing power in small offices. And now, the new System 21/50 for more sophisticated applications requiring multi-programming, larger internal memory, and faster processing

speeds. Best of all, Systems 21/20 and 21/40 can be expanded to the System 21/50.

Wherever in the world you find Series 21, you'll find MDS customer support and field engineering as well. Our 300+ worldwide sales and service offices serve over 6,500 customers around the globe.

Send us the coupon right now and learn more about the MDS Series 21 — the one-stop solution to your distributed processing needs. Or call James J. Byrne, V.P. Sales, (201) 540-9180.

Series 21 (MDS) and MDS are trademarks of Mohawk Data Sciences.

*Multi-function concurrently, three tasks at same time*

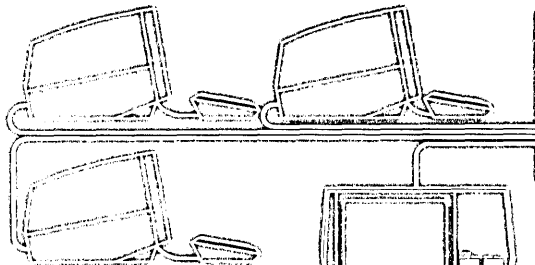

*Easy, synchronous communications (industry standard interfaces)*

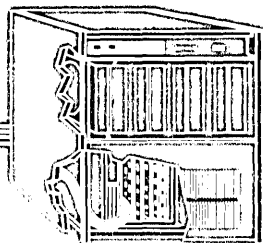

*Peripheral options include wide range of printers plus tapes and disks*

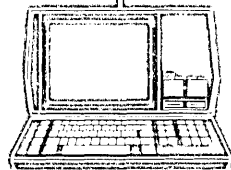

*Two-level software (EDEL = easy to use formatted data entry package) and MOEOL (high level user language)*

*From 1 to 4 operator stations, each with 1920 character screen, choice of keyboard styles*

Mohawk Data Sciences  
1599 Littleton Road, Parsippany, N.J. 07054

Send me information on the MDS Series 21  
 System 21/50  System 21/40  
 System 21/20

Name \_\_\_\_\_  
 Title \_\_\_\_\_  
 Company \_\_\_\_\_  
 Street \_\_\_\_\_  
 City \_\_\_\_\_  
 State \_\_\_\_\_

I'm in a hurry. Have a representative call.  
 DM78



**Mohawk Data Sciences**

CIRCLE 54 ON READER CARD



**NO  
SINGLE  
BUSINESS  
COMPUTER  
HAS ALL THE  
ANSWERS.**

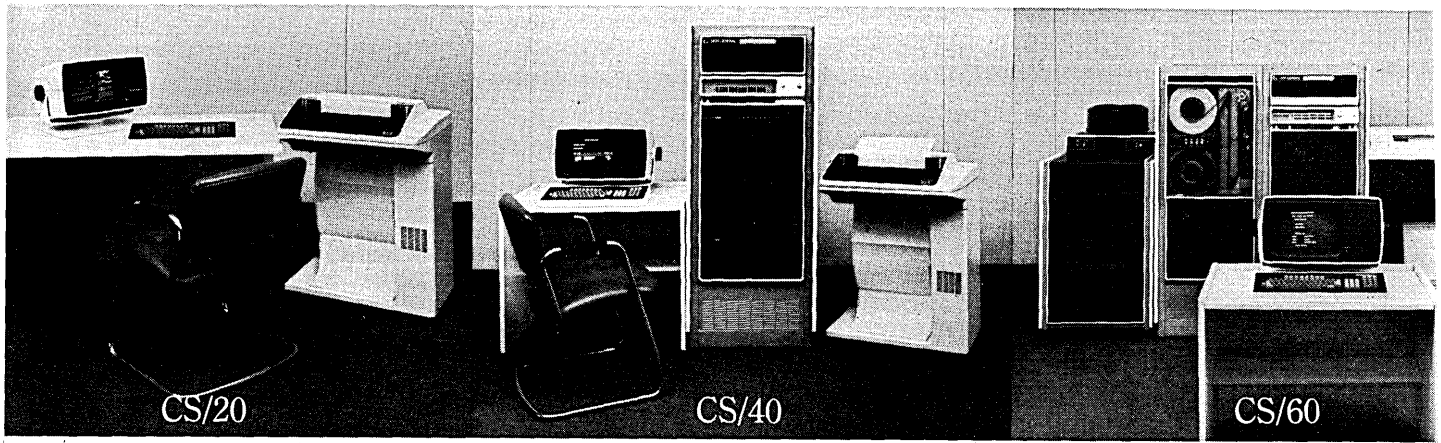

# NOW, WHAT'S YOUR PROBLEM.

One of Data General's family of new small business computers can answer your problems. They're designed to quickly and easily process your billings, accounts payable, accounts receivable, sales analysis, purchase analysis, inventory control and payroll with management information on demand.

We began with the introduction of CS/40, a mid-range business system which accommodates up to nine operators. Now it's joined by the CS/20, an entry level, stand-alone system and the CS/60, a higher capacity business system with up to seventeen clustered or dispersed terminals.

They're simple to operate and fully capable of expanding right along with your company. They all use the same Interactive COBOL software, so your investment in software is protected. And, if you need help with your applications, there is a group of experienced Business System Suppliers to assist you.

For more details on how to solve your business problems, fill out the coupon and we'll introduce you to the family.

My immediate problem is that I need more information about Data General's CS Family. Send the brochure.

I'm an:  End User  Business System Supplier  I'm too busy to wait for brochures; have someone contact me.

Name \_\_\_\_\_

Title \_\_\_\_\_

Company \_\_\_\_\_

Tel. No. \_\_\_\_\_

Address \_\_\_\_\_

City \_\_\_\_\_

State \_\_\_\_\_ Zip \_\_\_\_\_

Mail to: Data General Corporation,  
Westboro, MA 01581

# Data General

We make computers that make sense.

Data General Corporation, Westboro, MA 01581, (617) 366-8911. Data General (Canada) Ltd., Ontario. Data General Europe, 61 rue de Courcelles, Paris, France, 766.51.78. Data General Australia, (03) 89-0633. Data General Ltda., Sao Paulo, Brazil, 543-0138. Data General Middle East, Athens, Greece, 952-0557. © Data General Corporation, 1978.

**DATAMATION**® Magazine announces its association with Federal Education Programs to present ...

# The only Federal Computer Conference that covers all you need to know



If you're in the Federal Government, the Federal Computer Conference is *your* computer conference. It deals with Federal ADP exclusively. And, unlike the usual single-topic ADP seminars or expo's with limited programs, the Federal Computer Conference and Exposition encompasses your *total* information needs.

## Structured by Government ADP leaders

The Conference's Program Advisory Group consists of top-level professionals representing every major department and agency user in the Federal ADP community. They know your needs. They have tailored a program that meets them ... a program that provides a *total* learning experience for Federal computer users at every level.

## 1978 — A critical year

ADP reorganization, software conversion, privacy and security, the emphasis on improving performance and efficiency — issues such as these will make the 1978 Federal Computer Conference especially helpful and meaningful for all Federal ADP users.

## Co-sponsored by DATAMATION Magazine

DATAMATION, the leading data processing publication, and Federal Education Programs are Conference sponsors. Their combined expertise and resources assure a Conference of highest quality — a stimulating and professionally rewarding experience. It is your one opportunity to participate in the only major computer conference and exposition tailored exclusively for the Federal ADP community. And, it takes place right in Washington. Easy to get to. Economical. Scheduled for

**A total learning experience ... structured by leaders in the Federal ADP community ... devoted exclusively to Federal users ... co-sponsored by DATAMATION Magazine and Federal Education Programs**

the fall to fill a major gap in the industry conference calendar.

## Dundled Registration

A unique feature for a large conference of this type, and ideal for Government personnel. One fee covers everything — including notebooks containing extensive material on Conference sessions, and luncheons featuring prominent speakers.

## "Targeting for Improved ADP Performance"

The Conference theme speaks for its comprehensive coverage. On the agenda:

**Professional Enhancement Program** — A one-day introductory program of tutorial seminars on ADP basics, procurement, other broad subjects of interest.

**Two-day Main Program** — Following the introductory program, two days of in-depth sessions covering topics ranging from key management and policy issues to the latest in products and services.

**Federal Services Showcase** — Highlighting services available to ADP users from sources *within* the Government.

**Major Computer Exposition** — Exhibition of diverse products and services featuring the most recent technological advances.

**Plus more ... much more ...** in the first computer conference and exposition specifically structured to meet your *total* information needs. Plan now to join your colleagues for the 1978 Federal Computer Conference and Exposition at the Sheraton-Park Hotel Nov. 7-9, 1978 — your one opportunity this year, right in Washington, to get it all together! For more information, just fill out the coupon.

## Targeting for Improved ADP Performance

Federal Computer Conference and Exposition, P.O. Box 368, Wayland, Mass. 01778

- I'm interested in attending. Please send more information.  
 My company may want to exhibit. Please send details.

Name \_\_\_\_\_ Title \_\_\_\_\_

Address: \_\_\_\_\_

\_\_\_\_\_ Phone \_\_\_\_\_

# Savant Institute

PRESENTS A NEW SERIES OF

## JAMES MARTIN SEMINARS

A New series of Seminars will be presented in the U.S.A. as follows in 1978:

NEW YORK	..... RYE TOWN HILTON	25 - 29	SEPTEMBER
CHICAGO	..... ARLINGTON PARK HILTON	2 - 6	OCTOBER
LOS ANGELES	..... MIRAMAR-SANTA MONICA	16 - 20	OCTOBER
WASHINGTON DC	..... SHERATON NATIONAL	23 - 27	OCTOBER
BOSTON	..... HYATT REGENCY-CAMBRIDGE	6 - 10	NOVEMBER

The Seminars in NEW YORK, CHICAGO and BOSTON will cover the whole subject of Distributed Processing, Data Base and Networks. The Seminars in LOS ANGELES and WASHINGTON DC will have much more additional content on the new Data Networks and less on Data Base. All the Seminars will contain new material now being developed.

Guest speakers will include Professor John Rockhart of M.I.T., one of the world's leading authorities on Distributed Processing, Professor Leonard Kleinrock of U.C.L.A., one of the world's leading authorities on Data Networks, and Dr. Larry Roberts, President of the Telenet Communications Corporation, Washington D.C.

**ACCLAIMED THROUGHOUT THE WORLD...**



"This was excellent exactly what I was needed" ... Boston

"Totally excellent" ... Chicago

"This is the best seminar I have ever attended (over 14 years in the field)" ... San Francisco

"I paid my own tuition and it was worth it"

"An excellent seminar and superbly presented" ... Houston

"Outstanding" ... Chicago

"Absolutely fantastic" ... London

"Inspiring" ... Los Angeles

"The best I have ever attended" ... San Francisco

"Very complete" "A tour de force by Mr. Martin" ... London

"I do feel the money spent as very worthwhile" ... Chicago

"Martin was fantastic" ... Toronto

"A profitable week. Clear" ... Paris

"I felt that this seminar was splendid" ... Tokyo

"Fantastic" ... Toronto

"A very worthwhile experience" ... San Francisco

"A course of excellent" ... Los Angeles

"Real" "I think the entire seminar was terrific" ... Boston

For full details phone (617) 887 2776 or complete the coupon opposite and mail to Miss J. Tumber, Savant Institute, Registration Center, PO Box 467, Danvers, MASS. 01923.

The Seminars will also be presented in:

PARIS	Nov. 20 - 24	Details from Paris Tel. 508 46 21
MILAN	Nov. 27 - Dec. 1	Details from Turin Tel. Torino 637333 x 138
LONDON	Dec. 11 - 15	Details from Carnforth Tel. 0524 73 4505
MUNICH	Jan. 8 - 12 1979	Details from Bad Homburg Tel. 06172 23047

or TELEX 65138 SAVANT G (U.K.)

# Space Shuttle Software

by Caroline T. Sheridan

Problems of data and output integrity arise whenever multiple processes or multiple computers access common or identical files. But those problems are severely compounded when several asynchronously operating computers are expected to give the same output at the same time, as aboard the Enterprise spacecraft.

When the Enterprise, NASA's Space Shuttle Approach and Landing Test (ALT) vehicle, made its series of successful test flights in 1977 it was assisted by four onboard computers executing identical real-time control software. The software performed navigation, guidance, and flight control operations using automatic sensor and manual control inputs. It drove digital displays for the crew and received their inputs through a keyboard.

In some ways, the software was much like other real-time control code. It cyclically gathered data from various Shuttle hardware systems like flight control surfaces, processed it, and sent out control commands. What made it particularly unusual was how critical its performance was to the operation of the mission and safety of the crew, and how it combined design characteristics which had not previously been used together in the same software.

The combination of these characteristics provided a unique challenge in software system development. They were:

1. Redundant computers producing identical outputs. A redundant set of four identically programmed IBM AP-101 General Purpose Computers (GPC's) were used aboard the Space Shuttle. All four computers drove the control surface actuators during normal operation. They were required to output identical commands at the same time (within 1msec).

2. Asynchronous interrupts. All data that was input to or output by the computer went through its input/output processor (IOP). The IOP processed I/O requests from the cpu and interrupted the cpu when each request was complete. The cpu kept processing while its request was being serviced, usually doing something unrelated to the I/O request. So the I/O completion interrupt from the IOP was asynchronous to the cpu processing when it occurred.

The other type of asynchronous interrupts that occurred in the cpu were timer interrupts used to initiate cyclic

and other time-dependent processing.

3. Multiple asynchronous priority levels. The cpu functions were performed by "processes" which operated at various priority levels. Usually the processes were made ready cyclically at timer interrupts or by the "I/O complete" interrupts; then the highest priority process ready was given control. Interrupt handlers ran at the highest priority, above all processes. The timing of interrupts was not completely random, but there was sufficient variation that any process was subject to being interrupted at any point unless it had disabled all interrupts.

Since an interrupt might result in higher priority processes being made ready, the interrupted process might not regain control for some time. Long running, low priority processes with relatively slow cyclic rates, such as naviga-

tion, were interrupted several times during each execution to allow higher priority processes, such as flight control, to execute.

Taken individually, none of these characteristics presented problems that had not been solved before. For example, (2) and (3) are common to other real-time control systems with multi-tasking structures. However, the precise order of processing and hence the numerical outputs of such systems are typically not identical from run to run. This applies to two computers running simultaneously, side by side, as well as to two consecutive runs.

How then could a system of this type simultaneously produce identical outputs from four separate computers? The developers of the ALT onboard software had to answer that question. Moreover, they had to incorporate the answer into

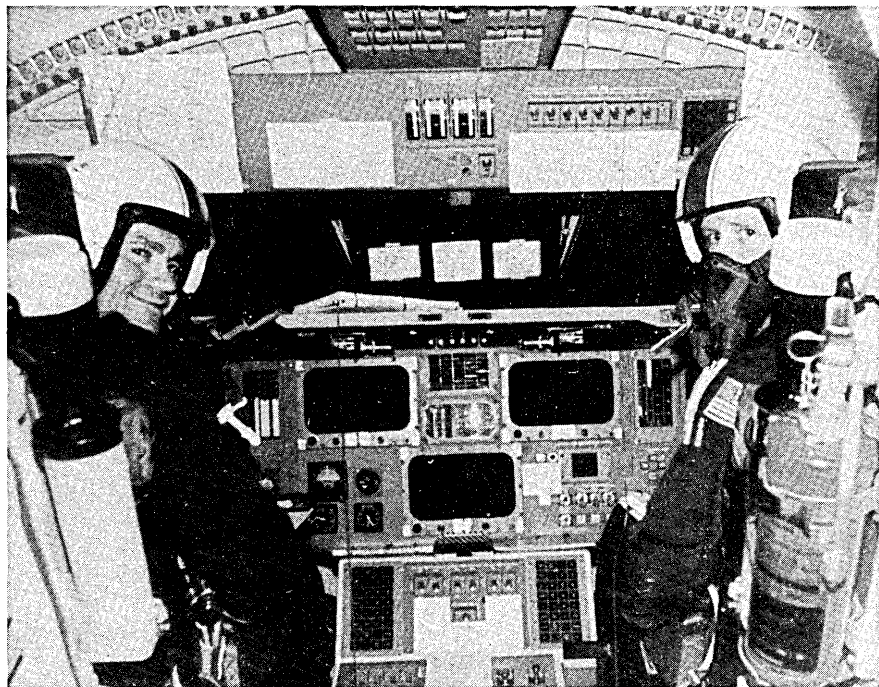

Photo: National Aeronautics and Space Administration

The keyboards and displays shown in front of astronauts Fred Haise, Jr. (left) and Gordon Fullerton are part of the onboard computer system developed by IBM. The system performs navigation, guidance, and flight control operations using both sensor and manual control inputs.

a system reliable enough for manned space flight.

The basic problem of producing identical outputs from multiple computers with a complex multitasking software structure can be solved, in theory at least, by the application of some relatively simple techniques. These include commonly used techniques for maintenance of data integrity, in combination with synchronization of the computers at appropriate points. But often in software development the mathematical or algorithmic solution to a problem is the

easy part. Building a system around it and making the system work are the challenges. In the case of the Space Shuttle software, the use of synchronization in producing identical control outputs in fact created a secondary problem: the maintenance of synchronization throughout the multiple priority levels of the software system.

The complete solution to these problems involved every phase of system development, from the initial formulation and design to the final tests. The basic techniques and rules for main-

taining synchronization and identical data were an early part of the basic system design; the balance of the design and coding of the system had to take them into account. Testing techniques were developed to ensure that the system met these basic requirements and, finally, extensive testing assured that it had all worked.

### The hardware

A general description of the hardware involved is necessary to set the scene. Fig. 1 is a simplified view of the computers and related hardware. Each consisted of a central processing unit, an input/output processor, and a shared memory. The IOP could execute a central control program and up to 24 bus control programs simultaneously. Both the CPU and IOP used the common memory, containing 64K 32-bit words, for program and data storage. In addition, the CPU and IOP could communicate directly with each other.

The four GPC's had two types of direct communication lines with each other. One type was the intercomputer data buses that carried data back and forth. The other was lines that carried synchronization codes. The synchronization lines were latched, so that each code sent remained on the lines until another code was sent.

The CRT display with its keyboard and the multiplexor with outboard devices were two types of external digital data units with which the computers communicated. All of the computers "talked" to each of these units over the same data bus. All four computers were physically capable of transmitting and receiving commands and data over these data buses simultaneously; however, the software ensured that only one computer controlled each data bus. When the computers needed data from a digital unit, one sent a command to the unit, and all received the data which was returned. Only the commander sent output data to the unit. (The process by which all that was done is a story in itself and will not be treated here.)

Fig. 1 shows a display unit being commanded by GPC 1 and a multiplexor commanded by GPC 2. Continued operation in case of a computer failure was provided by multiple devices of each type, commanded by different computers. For example, there were three display units on three separate buses, which were normally commanded by three different GPC's.

The control surface actuator, which drove the spacecraft's rudder and elevons (elevator/aileron), was a special case. This one device received commands from four multiplexors, each of which was commanded by one of the four computers. The actuator hardware compared the four commands, which were expected to come to it within 1msec of each other. If any one differed

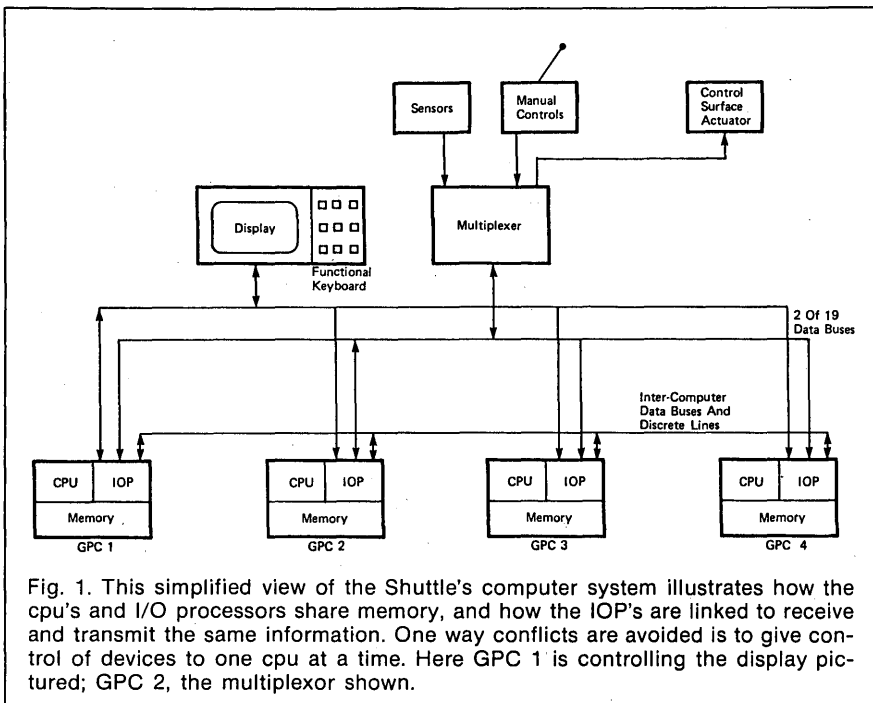

Fig. 1. This simplified view of the Shuttle's computer system illustrates how the CPU's and I/O processors share memory, and how the IOP's are linked to receive and transmit the same information. One way conflicts are avoided is to give control of devices to one CPU at a time. Here GPC 1 is controlling the display pictured; GPC 2, the multiplexor shown.

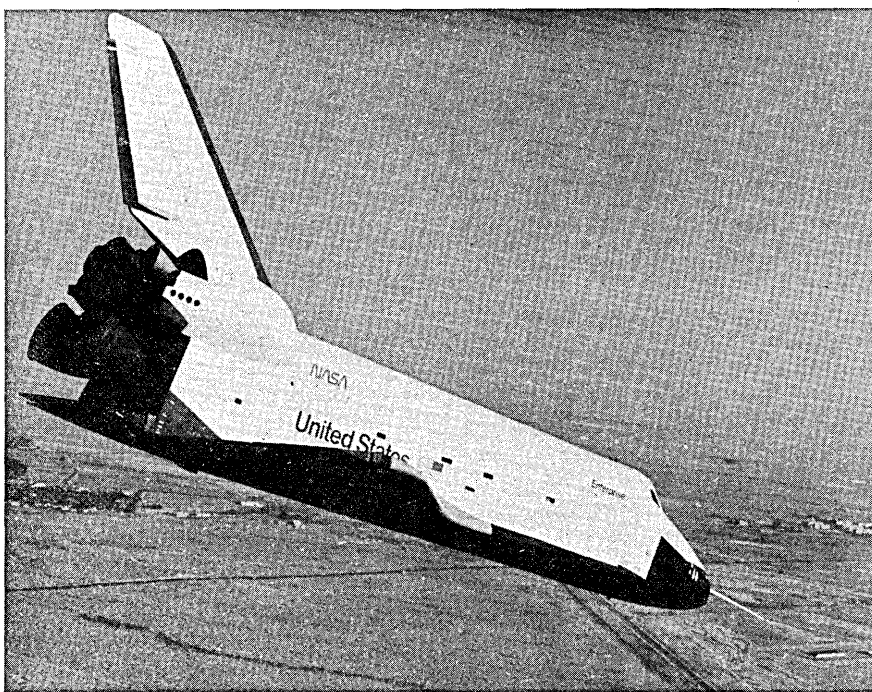

Photo: National Aeronautics and Space Administration

Flight control surfaces on NASA's Space Shuttle Orbiter include the "elevons" at the trailing edge of the delta wing, the body flap under the engines, and the rudder/speed brake on the vertical tail. Their actions are controlled by a system which includes four asynchronously operating computers.

# SPACE SHUTTLE

from the others by more than a small amount for a fraction of a second, the actuator hardware would stop accepting commands over that line. Otherwise, it combined all of the input commands to form output commands to the control surfaces.

This mechanism provided for automatic, very rapid identification of and severing of control from any computer which strayed from the redundant set. It was also the reason for requiring all of the computers to generate identical outputs. Even though the actuator tolerated very small differences, the constraint placed on the software was bit-for-bit agreement. This may seem to have been considerably more restrictive but, in fact, it was not. If the software had been allowed to generate control outputs which differed slightly, the problem would have become one of showing that the outputs would never diverge beyond the required maximum and that the internal differences could never cause loss of synchronization between the computers. Bit-for-bit agreement was a more straightforward requirement.

The reasons for having four redundant computers were not based on failure probabilities but on a reliability/safety criterion, which the Space Shuttle program termed "fail operational/fail safe." The Shuttle goal is for the vehicle to remain operational and able to continue the mission after any single failure, no matter how small the probability of occurrence. After the second failure it should still be safe, although the mission might have to be terminated abruptly. This criterion is applied as far as possible in all spacecraft systems; its application to computer failures led to the four-computer configurations.

## The Shuttle should continue after any single failure, and be safe with two failures.

When a second computer failure occurs, it is not always possible to identify the erroneous computer unless a majority vote can be obtained. This led to the requirement for at least three computers to continue operating after the first failure; thus fixing the redundant computer set at four.

### Understanding the problem

The problem of generating identical outputs has three parts:

1. All computers must use identical input data.
2. Each process must maintain identical data by performing identical opera-

tions on it in all computers.

3. The data must be kept identical when passed between priority levels.

The third part of the problem results from the combination of the three main design characteristics: redundant computers producing identical outputs, asynchronous interrupts, and multiple asynchronous priority levels. Even though all computers start with the same inputs and execute the same

instructions on them at each priority level, differences can arise when data is passed between priority levels because of a timing condition called "slivering." Fig. 2 illustrates this condition.

Process B uses the same inputs in both computers, executes the same instructions, and stores the same value in X. The speed of execution, however, and the time of the interrupt-invoking process A are not identical in the two

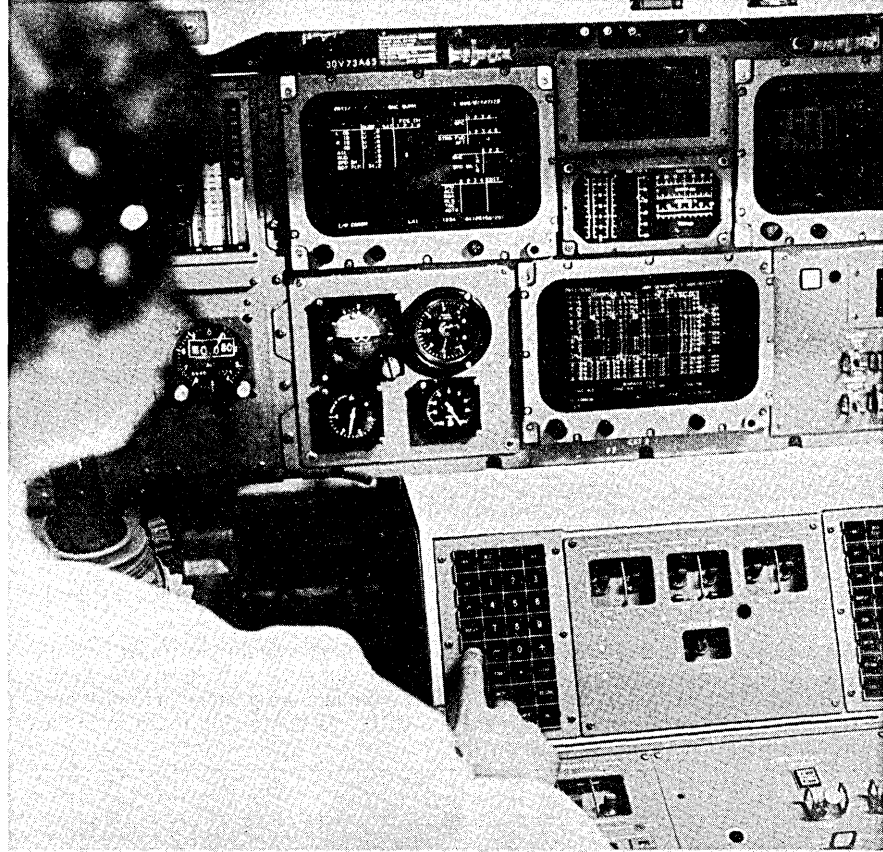

The astronauts can give the computers more than 1,000 questions about the flight and mission status through the keyboards. (Flight parameters being displayed in this photo are generated by the ALT software discussed in the text.)

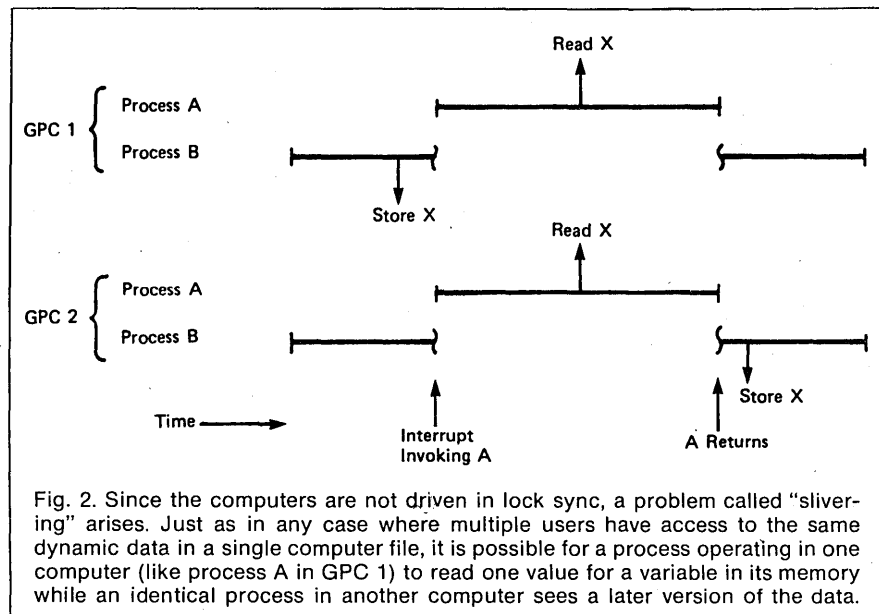

Fig. 2. Since the computers are not driven in lock sync, a problem called "slivering" arises. Just as in any case where multiple users have access to the same dynamic data in a single computer file, it is possible for a process operating in one computer (like process A in GPC 1) to read one value for a variable in its memory while an identical process in another computer sees a later version of the data.



computers. The interrupt occurs in GPC 1 after process B has stored X, but in GPC 2 it occurs before process B has reached that instruction. When process A reads X in GPC 1, it reads the value which has just been stored by process B. In GPC 2 it reads an initial value or one stored in a previous execution of process B. Process A is then operating on different data in the two computers.

Slivering can also occur if the data is passed from the high priority to the lower priority process. In Fig. 3, if READ X and STORE X are interchanged, Process B will receive different values in the two computers.

The basic techniques used to maintain identical data are listed in Table 1.

The "command and listen" input transactions, in which one computer re-

quests the data and all receive the reply, ensure that all of the computers receive identical input data, provided none incurs I/O errors.

The possibility that one computer might receive good data while another encounters I/O errors is accounted for by making input transactions "protected." At the completion of each input transaction, the computers exchange status information. If any computer has detected an error, none use the particular data in which the error occurred.

One more step is necessary to ensure that the data received by all cpu's is identical. This is to protect the data transfer from the IOP to the cpu. The IOP stores input data directly into the shared memory, while the cpu continues to process. The cpu is momen-

tarily prevented from accessing the memory while each word is stored.

The protection technique used in the ALT system was to associate each input transaction with a process, prevent that process from executing while the transaction was in progress, and prevent any other process from reading the data directly. This is the same thing that occurs in any multitasking system if each task reads the data it needs and

### All computers contained the same code and were loaded by the same module.

then waits for the completion of the I/O before continuing.

In the ALT system, the application of the technique was complicated by two factors. One was that I/O could be initiated automatically at timer interrupts instead of being requested by a process directly. For that type of transaction, the operating system maintained the tie between the I/O transaction and the associated process, initiating the process execution after the transaction completion. Another complication was that some processes used parameters from other processes' input transactions. This saved the overhead of additional transactions; but it required the process that read the data to pass it to the process that needed it, using inter-process data transfer protection techniques.

Making sure that each process executed the same instructions was primarily taken care of by having all computers contain the same code. All were loaded with exactly the same load module. A few necessary differences, such as the identification of buses commanded by each, were determined during execution and stored as data.

Ensuring that each process took the same branch in all computers at each test required only that all parameters used in the tests maintain identical values, as with any other data used in calculating control outputs.

### Synchronization

The techniques for protection of data passed between priority levels ("inter-process data") all require synchronization between the computers. In the ALT system, each computer continuously transmits a three-bit synchronization (sync) code, which is read by all of the other computers. The normal code transmitted while the GPC is running is 111. Other codes are used when the computers are synchronized (at sync points). There are three basic types of sync points with different codes: timer interrupt syncs, I/O complete interrupt syncs, and supervisor call (svc) syncs.

At each sync point, each computer sends the proper code and reads the

Summary of Basic Techniques	
Data Type	Protection
Input data (to cpu)	Command and Listen transactions Protected transactions Cpu process waits for I/O
Data computed within a process	Identical programs in all GPC's
Data passed between processes	Control of process execution

Table 1. The idea behind using multiple computers for critical processes is to ensure the accuracy of the commands given to the systems they control. Maintenance of identical data in all cpu's is critical to that, and thus all of these techniques were employed.

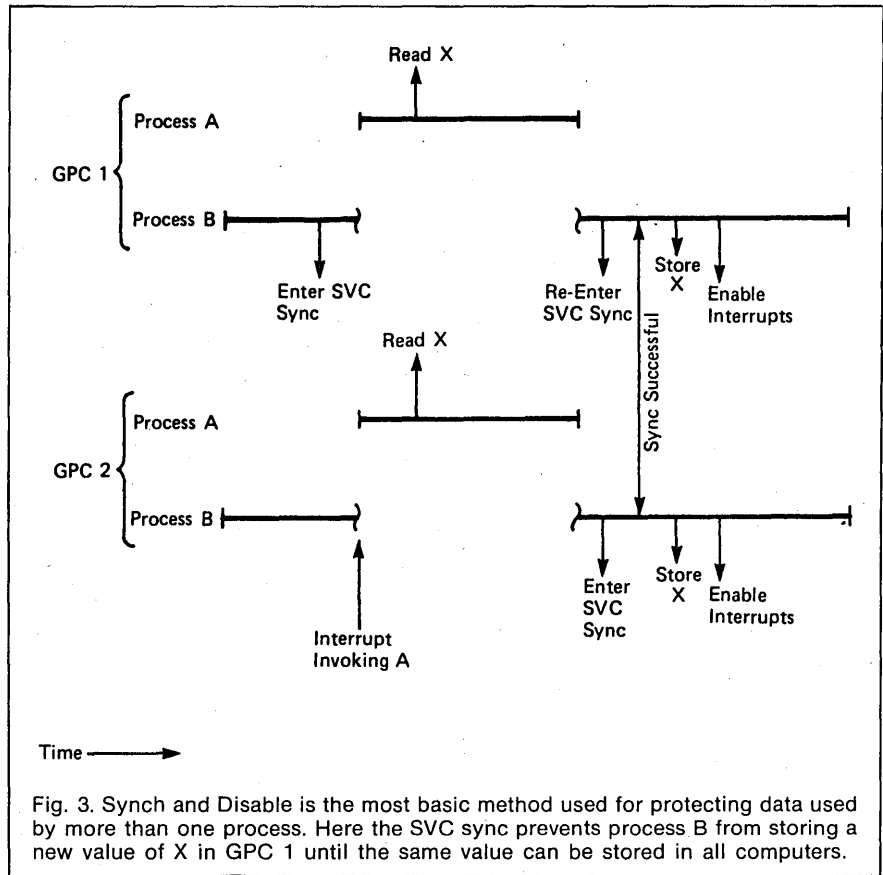

New Developments from SYSTEMS...

# The New MOS

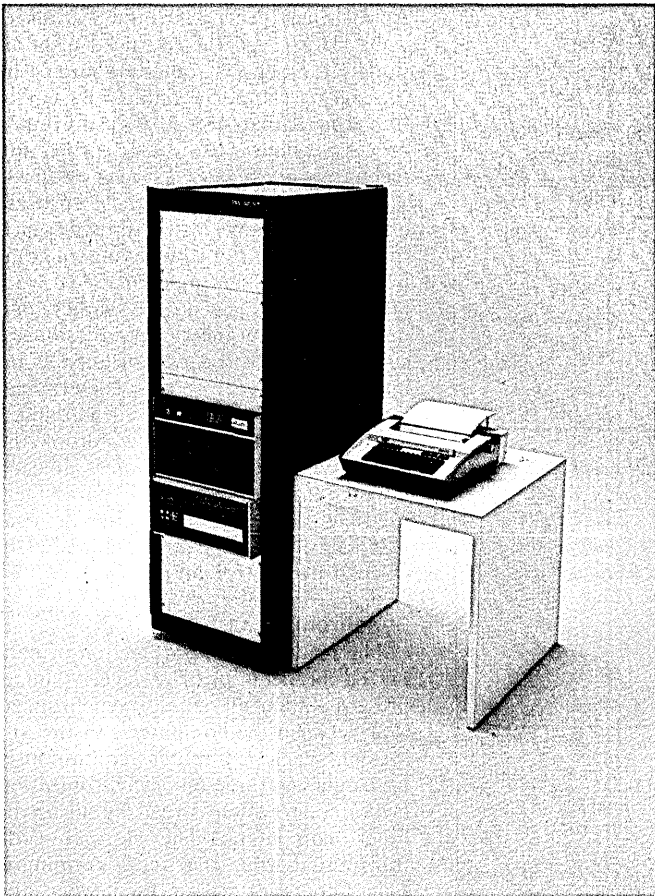

SEL 32/5720



SEL 32/5730

Until now, you've either had to forego 16-bit pricing to get 32-bit performance, or you've had to give up 32-bit performance just to keep the budget in line.

No longer. Now you can invest in a full-blown 32-bit computer system and pay no more than you would for a 16-bit computer. And not have to worry about insufficient power for future needs.

Here's why: value engineering. We've taken our high-performance 32-bit computers, and

we've done some packaging that makes sense. We've added MOS memory. Expanded and fine-tuned our operationally-proven software. Made our systems more compact, more efficient. And we put it all together for a third less money.

The result? A broad family of 32-bit computer systems, perfect for jobs that require high thruputs like telemetry, seismic exploration, or research. Or for jobs that need lots of I/O; process control, simulation, or laboratory automation.

All are upward-compatible, so you can still grow, but start with a minimal investment.

If you'd like to have real performance, but can't overlook how effectively you use your budget, talk to us. We'll make sure that when you invest in SYSTEMS computers, more dollars will flow to your bottom line.

Call us. We're easy to talk to. (305) 587-2900  
6901 West Sunrise Boulevard  
Ft. Lauderdale, Florida 33313.

# Packaged Systems.



SEL 32/5740



SEL 32/5750

**SYSTEMS**  
ENGINEERING LABORATORIES

## SPACE SHUTTLE

sync lines from the other computers to see whether they are sending the same code. If they are not, it loops until either all GPC's are sending the proper code or a time-out value is reached. If the time-out is reached, any GPC's which are not sending the proper code have failed to sync and are dropped from the redundant set of computers.

The time-out value must be large enough to allow for some normal variations in processing between computers but small enough that, should a com-

### If a computer fails to synch in 4msec, it's out.

puter fail, the others would detect the fail-to-sync and continue without too much delay. The value chosen for the Shuttle software was 4msec.

Due to the use of asynchronous interrupts, the situation can arise where normal timing tolerances allow one computer to execute an svc while another receives an I/O completion interrupt and a third receives a timer interrupt at the same time. All disable interrupts and then try to synchronize, but with different codes. There must be a mechanism to resolve this dilemma, and there is. The synchronization types are assigned priorities: timer sync is highest, then I/O completion, and finally svc sync. An svc sync can be interrupted by either an I/O completion or a timer interrupt. An I/O completion sync can be interrupted only by a timer interrupt.

If one computer has received an interrupt, the others cannot be far behind. The computers in the lower priority sync will accept the interrupt, and the higher priority sync routine will then complete its sync. Sometime later all computers will reenter the interrupted process, restart and finally complete the lower priority sync. As soon as a lower priority sync is successful, the sync routine disables interrupts and returns. The supervisor routine or interrupt handler which called the sync routine performs its processing before interrupts are re-enabled.

There is another important point about synchronization which all this implies. A given sync point does not synchronize the computers; it synchronizes the process or interrupt handler which invokes the sync routine. An example may help clarify this. Suppose a low priority process in one computer has gotten far ahead of the same process in another computer when a timer interrupt occurs in both computers. The interrupt handler does a sync, then invokes a high priority process. The sync point synchronizes the timer interrupt handler and ensures that the high pri-

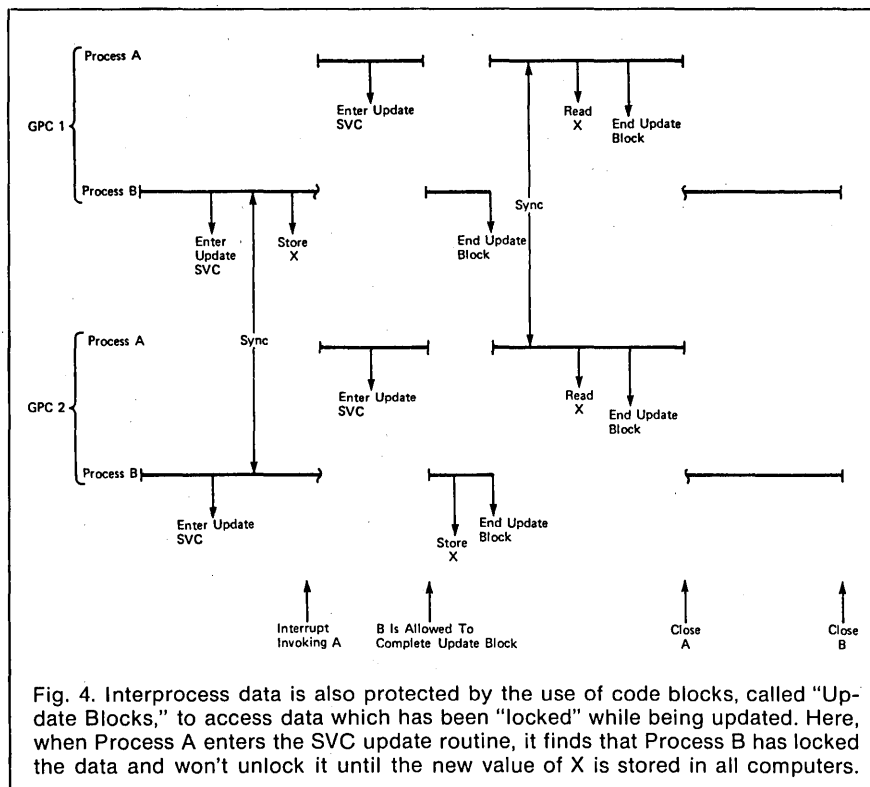

Fig. 4. Interprocess data is also protected by the use of code blocks, called "Update Blocks," to access data which has been "locked" while being updated. Here, when Process A enters the SVC update routine, it finds that Process B has locked the data and won't unlock it until the new value of X is stored in all computers.

ority process starts off synchronized. But it does nothing for the low priority process. When the low priority process regains control, it will still be as far apart in the two computers as it was before, until a sync is done in that process.

The most basic method of protecting interprocess data is "sync and disable." Disabling interrupts at appropriate times is a technique commonly used for maintaining data integrity in single computer systems. In a similar way, with the addition of a sync point, it is used to protect interprocess data against slivering.

The lower priority process involved in the data transfer invokes an svc routine which synchronizes and then returns control with interrupts disabled. The process then reads or stores the interprocess data before enabling interrupts. The higher priority process, or the highest of several processes which use the same data, need not sync and disable.

To understand how this method protects the data, consider the slivering example with the application of sync and disable protection. As shown in Fig. 3, process B is prevented by the sync point from storing X in one computer before it is ready to store X in all computers. Process A reads X before the new value is stored in each computer. If the interrupt were to occur after the sync was successful, then it would not be accepted in any computer until after X had been stored and interrupts enabled.

Another method of protecting interprocess data is by use of code blocks

called "update blocks" to access locked data. Locking blocks of data to prevent access by any other program or task while they are being updated is another common technique for maintaining data integrity in various systems. Again, the addition of a sync point is necessary to provide slivering protection.

When locked data is accessed by any priority level, an update block must be used. The update block begins with an svc, which synchronizes and then locks specified groups of data. Interrupts are re-enabled when the svc returns. The locked data may then be accessed. An unsynchronized svc to unlock the data ends the update block.

Fig. 4 illustrates update block protection against slivering. The sync point synchronizes the locking of the data in all computers. Once it is successful, the process (B) which has locked the data must unlock the data in each computer before any other process can access it. When process A enters the update svc routine, it finds that process B has locked the data. It allows process B to complete its update block. Then process A regains control, synchronizes, locks the data, and completes its update block.

As has been noted, "sync and disable" and update blocks are extensions of common data integrity protection techniques. The ALT software system, of course, had to avoid the normal data integrity problems, such as using partially updated blocks of data, as well as the special multicomputer ones. In many cases the same protection mechanisms were used to solve both types of problems at once.

# "I can give you ten reasons why our OMEGA 480 is the better business decision."



Donald E. Roepke, Group Vice President  
Peripheral Systems, Control Data Corporation

"First of all, there's the *price*. Our OMEGA 480-1 has greater *throughput* than a 370/138—yet it costs about the same. And our 480-11 exceeds 370/148 performance but costs substantially less!

"And an OMEGA 480 system requires about one quarter the *power* and one half the *floor space* of the comparable 370.

"Of course we designed it to be *field-upgradable*. That means you can start with the smaller OMEGA 480-1 now, and upgrade to the larger processor when your needs require the higher performance.

"And there's software. OMEGA 480 supports, without modification, most IBM operating systems, program products and user programs.

"Financing can be important, too. Several attractive options are available through our *Installment Sales Plan* or from a selection of 3- to 7-year *leases*.

"But most importantly is the *service, experience and support* you want. You

get it from Control Data. Our support organizations have more than 8,000 dedicated hardware and software specialists—including many with years of IBM system experience.

"That experience comes from servicing more than 1,400 current IBM users, and maintaining such Control Data plug-compatible peripherals as Disk, Tape, Memory, Printer and Mass Storage Systems.

"Why not decide for yourself whether the OMEGA 480 is the better business decision for you. Call 612/853-7600. Or contact your local Control Data representative. Tell him Don Roepke sent you."

**GD** CONTROL DATA  
CORPORATION

**More than a computer company**

CIRCLE 100 ON READER CARD

## SPACE SHUTTLE

There is one other general method of protecting interprocess data which has myriad variations. This is by controlling the execution of processes in such a way that the processes using common data cannot be trying to execute at the same time. Since slivering may occur when one process interrupts another which uses the same data, data can be protected by making sure such interruptions do not occur.

In the ALT software system, processes are invoked by scheduling them to execute a single time or repetitively at specified intervals. Repetitively scheduled processes may be canceled to stop their execution.

One simple way of protecting interprocess data is to cancel one process using the data before scheduling another. This method and many variations of it were used in the ALT software.

There are several statement types which are used to control process executions, including "schedule" and "cancel." All are svc's and all must synchronize. The necessity for this will not be proven here, but it is not difficult to invent a situation which requires the synchronization of any of these svc's. One undesirable consequence of not synchronizing the schedule or cancel can be the execution of a cyclic process one time more in one computer than in another.

### Making it work

The techniques for maintaining identical data in redundant computers, including the use of synchronization of processes, have now been described. But the process of applying them to an entire software system has only been hinted at. The code involved in performing "command and listen," protected transactions was fairly complex but was confined to the operating system software. The techniques for protecting interprocess data were simple to use, once understood, but had to be applied in many places throughout the software.

Identifying when protection of data transfers was required was not always easy. Not all of the data in the system had to be identical between computers. Data which was used in displays for the crew but did not enter into the calculation of control outputs was not required to be identical. The crew would not normally be viewing the same data displayed by two different computers, and would not be making a bit-for-bit comparison between the two if they were. Was it sufficient, then, to synchronize processes only when they were invoked and when they were transferring data which must be identical? Could a process which only generated

displays remain unsynchronized?

The answer to both of those questions is NO. If some processes were allowed to run unsynchronized, they could cause other processes to become unsynchronized.

For example, suppose process *X* were allowed to run unsynchronized but process *Y*, lower in priority than *X*, were required to synchronize. Consider what could happen if process *Y* were interrupted and process *X* given control. Process *X* could take different paths in the two GPC's with the result that it finished its execution ("closed") in one computer more than the sync time-out value (4msec) ahead of the other. Process *Y* would then regain control more than 4msec apart in the two computers and would fail to sync at its next sync point.

In the ALT software system, only one process actually could remain unsynchronized. The lowest priority process existed only to count "idle" time left over by the other processes. The next higher priority process was required to maintain identical data; this forced all other processes to be synchronized.

The synchronization of all processes except the lowest was enforced by requiring an svc with synchronization to close each process execution and at any point where the process voluntarily relinquished control, as by a Wait. Each process had to be designed and coded in such a way that it did not develop more than 4msec of skew between sync points. The sync points of the end of every process execution removed smaller amounts of skew which developed between the computers during a process execution, so that it would not be transmitted to a lower priority process.

Maintaining synchronization in all processes did not require that all data in the system be identical between the computers. Display parameters and other non-identical data could be passed between processes without protection in most cases. However, unprotected or non-identical data must not be used in a test if: (1) there are unequal numbers of sync points in the different paths which may be taken as a result of the test, or (2) one path is enough longer than another to cause a sync failure.

Now, what does "enough longer" mean? If one path were more than 4msec longer than another, obviously a sync failure would result. There are also other factors which can introduce skew into a process. The difference in the paths plus the other skew must be less than 4msec. At different times, 0.5msec and 1.0msec were used as guidelines for the maximum difference in paths, to allow for the other sources of skew.

### When to synchronize

Early in the development of the ALT onboard software, the synchronization types were determined, and general

rules for when to synchronize were developed. These rules were made in order to keep all processes synchronized, to meet required time tolerances between computers on input and output processing, and to maintain protection of interprocess data transfers. They can be stated as follows:

1. All timer interrupts will synchronize.
2. All I/O completion interrupts will synchronize.
3. All other sync points will be in svc's.
4. Not all svc's require synchronization. The determination of which svc's to synchronize is made individually, based on their usage:
  - svc's which initiate I/O will be synchronized
  - svc's which control process executions will be synchronized
  - Other svc's will be synchronized if they are used in protecting interprocess data
5. A given svc is either never synchronized or always synchronized, regardless of the priority from which it is invoked.

Some of these rules were not strictly necessary. For example, the svc that begins an update block need not synchronize when called by the highest priority process. Also, there are certain I/O transactions which may not have to synchronize at completion. But in most cases the rules were necessary.

---

The system performs almost 500 synchronizations per second; but this uses only about 8% of the cpu time.

---

Also, the rules had to be determined before the detailed requirements and design for the system were determined. It would have been unwise to try to identify the exceptions and code around them when the system might subsequently change drastically. It was recognized that exceptions might be needed later if synchronization cost too much cpu time. Even though the final system performed almost 500 synchronizations/second, using about 8% of the cpu time, it never became necessary to relax the rules. They stood through the final ALT flight.

One of the goals in making such general rules was to avoid having to determine individually every point where synchronization was necessary. All of the calls to the sync routines were made from supervisor code, either interrupt handlers or svc processors. Applications processes were synchronized when they used supervisor services to perform I/O, schedule other processes, wait, and do many other functions, without the applications programmer having to be aware of it.

Now you can get an  
integrated management network  
for your factory..

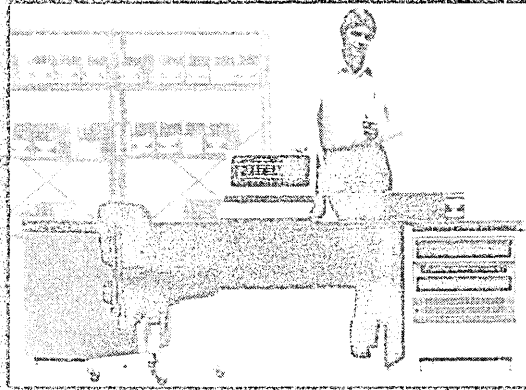

...an interactive  
information network for  
your front office..

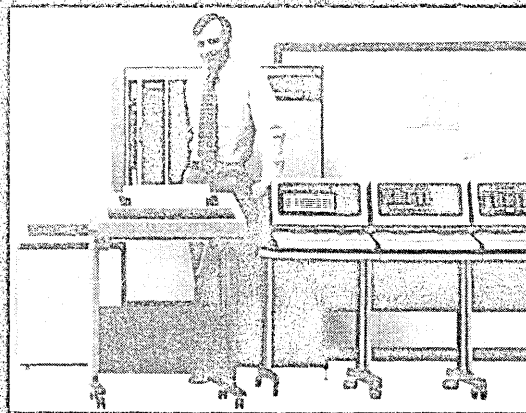

# And, when you're ready

In manufacturing, you need to dedicate systems to a range of widely dispersed jobs, and still share the information they generate. On the business side, many departments get more work done more accurately with their own interactive systems. These in turn can be accessible to management as part of an information network.

Hewlett-Packard computers provide both the problem-solving and data sharing capabilities that can upgrade your entire company's operations—without disrupting your present organization. Our Distributed Systems Network is so flexible it can be tailored to suit the way *you* work.

## In the factory...

You can dedicate HP 1000 systems to such tasks as automated

testing and final QA, then tie them to another system at production control. Or link systems that handle purchasing and incoming inspection to an HP 1000 used for materials management. Then all these groups of computers can be tied together to give management instant access to relevant data. So you're never caught without enough material to build a product or too much inventory on an item that isn't moving.

Our DS/1000 software, which took 30 man-years to develop, makes all this possible. It provides an inexpensive link between HP 1000 systems, as well as to our powerful general purpose computer, the HP 3000. You can form a network that fits your company organization precisely. And you don't have to change your application software when you expand it.

You keep costs down by sharing peripherals. And you can maintain control by developing programs on one HP 1000, then downloading them to the computers doing the work. Most significantly, our "store and forward" feature lets you access data files at remote HP 1000s, moving through intervening nodes in a way that is quite transparent to users.

## In the front office...

On the business side of your company, Hewlett-Packard has a powerful solution to both batch and on-line problems. The HP 3000's layered architecture, IMAGE/3000 Data Base Management and Multiprogramming Executive software allow the

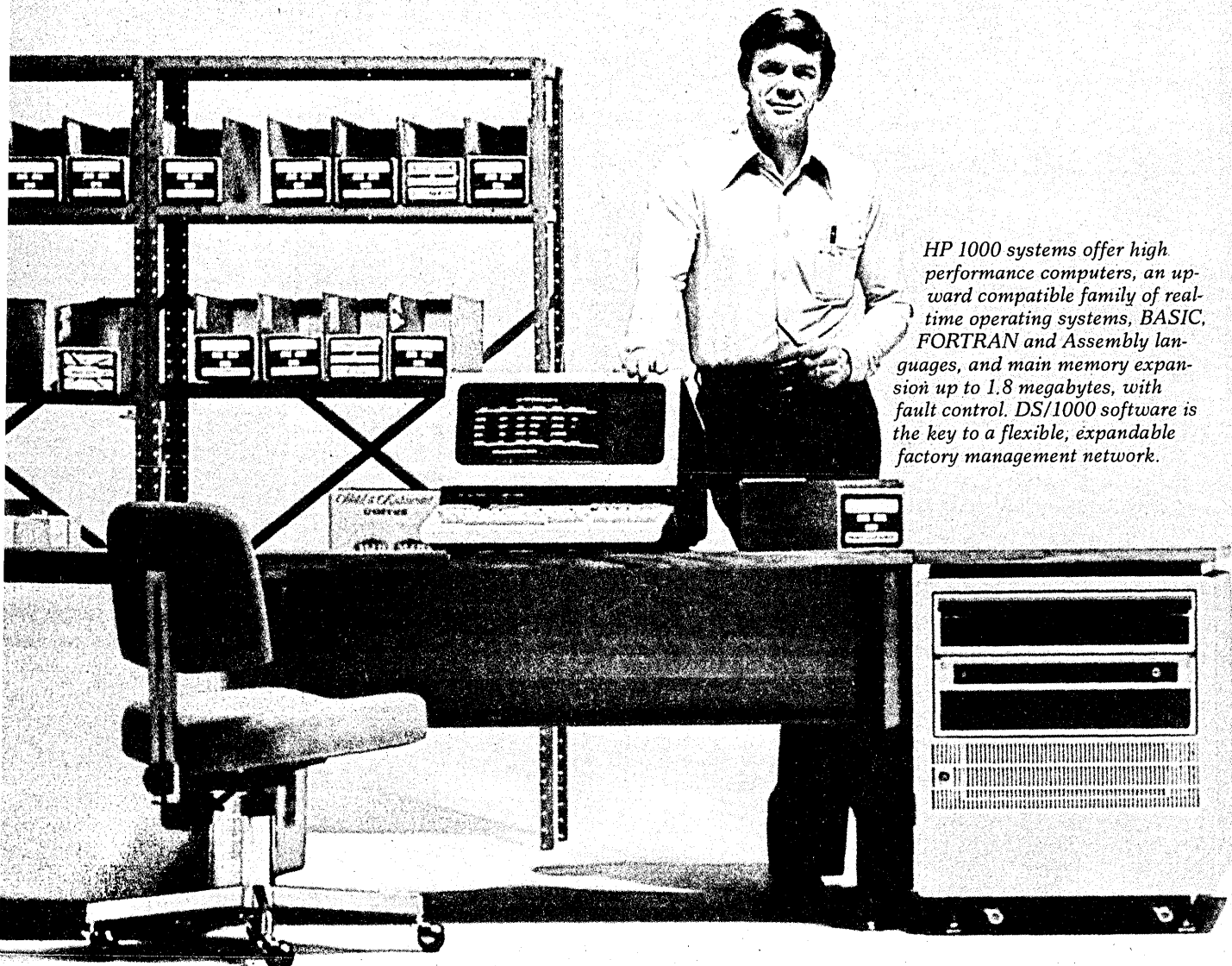

*HP 1000 systems offer high performance computers, an upward compatible family of real-time operating systems, BASIC, FORTRAN and Assembly languages, and main memory expansion up to 1.8 megabytes, with fault control. DS/1000 software is the key to a flexible, expandable factory management network.*



# You can tie it all together!

computer to handle a lot of jobs concurrently. While the system is processing the payroll, orders, invoices, accounts receivable or general ledger, you can call up data on a CRT terminal about sales, inventory, personnel, customer profiles and projections. While all this is happening, your programmers can be developing new software at other terminals in the same system.

A single HP 3000 can support as many as 64 terminals. And it will handle up to six high-level languages—COBOL, RPG, FORTRAN, BASIC, APL and SPL, our streamlined Systems Programming language.

You can give your business side greater control of its management information by tying HP 3000s together with DS/3000 networking software. This lets you use the data and processing power of a remote system as if it were your local computer.

When you're ready, you can forge the final link in a company-wide information system. HP Distributed Systems Network now extends to tying your HP 1000 factory computers into your HP 3000 interactive business systems. (Both sides can hook up to IBM mainframes, too.) In this way, you can call up data about every significant transaction in your company, from the front office to the back door.

Compatibility doesn't end with our computers. We make virtually everything that goes into our systems. In the factory, simple HP data collection terminals can feed the HP 1000

from warehouses, production lines and shipping dock. And HP-IB interfaces (IEEE-488 standard) make it easy to hook up with instruments for measurement, control and test purposes. A line of printers and CRT terminals (alphanumeric and graphic) and other data entry devices also simplifies tailoring systems to your needs.

So if you want to bring your company closer together, on the manufacturing or business sides (or both), contact the HP office listed in the White Pages. Or write to Hewlett-Packard, Attn. Doug Chance, Dept. 420, 11000 Wolfe Road, Cupertino CA 95014.

HEWLETT  PACKARD

*The HP 3000 handles both batch and on-line jobs concurrently, thanks to its Multiprogramming Executive and IMAGE/3000 Data Base Management software. It offers six high-level languages, fault-correcting memory and software for a business information network.*

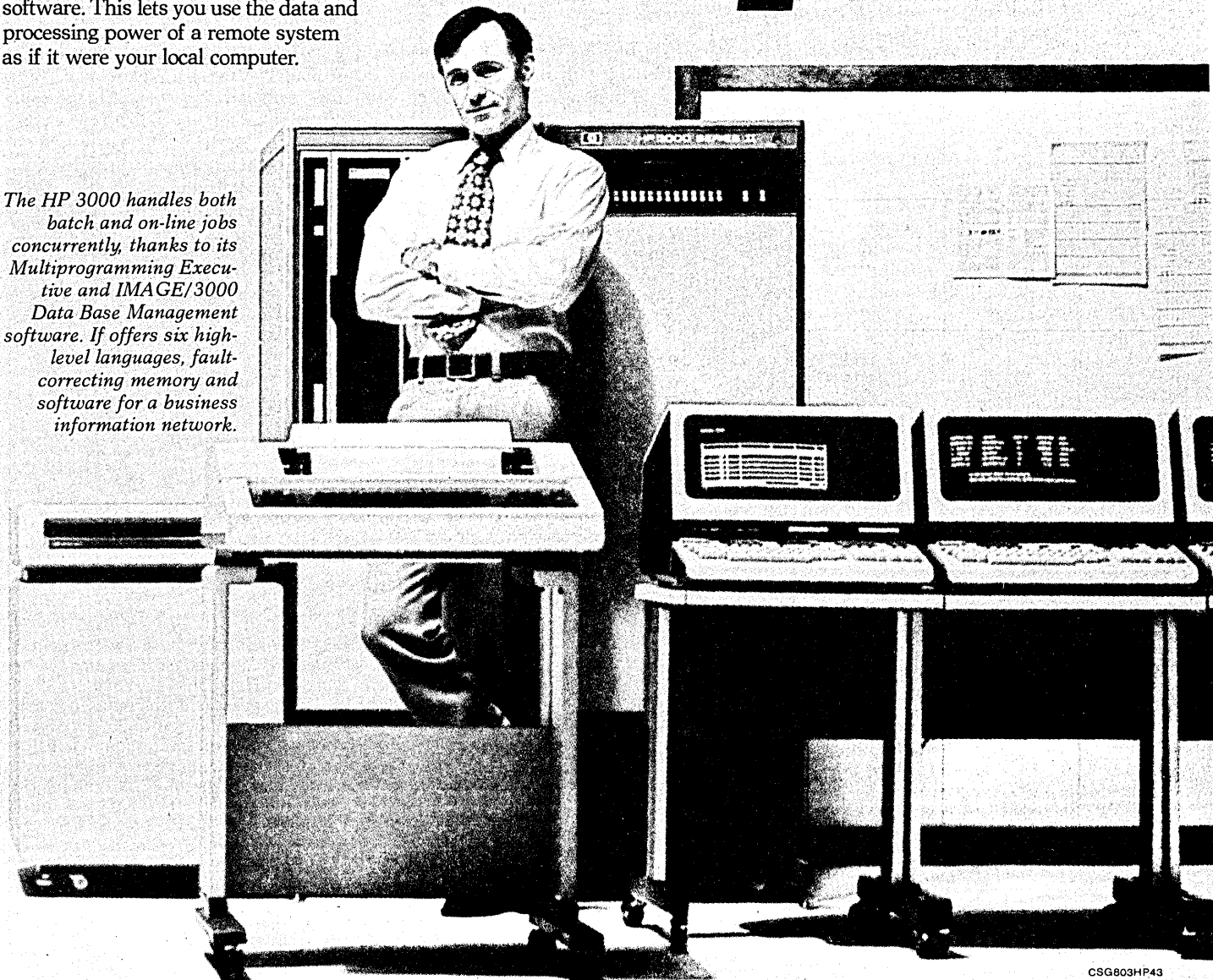

## SPACE SHUTTLE

There was one big responsibility which could not be borne by operating system software. That was the protection of interprocess data against slivering. The mechanisms which were provided did no good if they weren't used. The process of identifying the interprocess parameters, determining whether they needed to be protected, and providing that protection had to be performed at the application level as well as at the operating system level. Wherever interfaces between processes existed, data protection had to be considered.

### A hidden ace

Using four redundant computers provides a margin of safety, primarily against hardware failures. But because identical programs are processing identical data in all four computers, a single software failure could potentially cause all four to fail simultaneously—for example, by looping in a critical process. Also, slivering problems could

### What happens in a two-against-two conflict? There's a fifth cpu.

cause a two-against-two disagreement. Even if none of the computers had failed, the actuator hardware and the crew could be placed in a dilemma. Which two computers were right? The actuators might stop accepting commands from two of the computers, but from which two was unpredictable.

The fact that a single software error could theoretically knock out two or more computers was a deviation from the fail operational/fail safe rule. Because of this, there was a *fifth* computer onboard, loaded with an independently programmed control program with reduced capabilities. In the event of a failure of all the primary computers, the crew could switch control to this backup computer. The existence of the backup computer provided an additional margin of safety for the crew, but it did not diminish the reliability requirements on the primary system. It was crucial that the software be free of errors which could cause it to fail completely or lose control of the vehicle.

The software system was designed to control the effect of errors in some ways. It had basic error recovery code to prevent the computer from halting on program interrupts and some other software-caused error conditions. Checks on incoming data were included to prevent faulty data from causing failures in the software. Also, the multiple priority levels provided protection; a loop in a low priority process could not prevent a critical process from executing.

But there was not space to implement very sophisticated error recovery procedures in the software. The real responsibility for the system reliability lay in the testing. How to provide not only enough testing but the right kind of testing was a tough challenge.

### Testing

The ALT software is a large system with many interfaces, so it has many of the same sources of potential errors that any complicated software does. Real-time systems have another source of problems as well; the timing of their interrupts can cause failures in otherwise correct code, errors which take a lot of ingenuity to track down.

There were two potential types of timing problems in the ALT software, the real-time system problems and special multicomputer problems. Due to the nature of these, even testing every path would not give sufficient confidence in system reliability. Thus a collection of test methods, including rigorous code inspection and test runs of various types were devised. Specific tests were tailored to the multicomputer configuration, but most are generally applicable to any real-time system with high reliability requirements.

The first type of testing performed was functional testing of the code which made the multi-cpu set run together—such things as the special I/O processing described, code for initially synchronizing the set, the time management system which synchronized the internal computer cycles, and the inter-computer communications.

A second type of testing, a code inspection process, was the primary test technique for ensuring the proper protection of interprocess data. All variables shared by two or more processes were examined to see if they contributed to the computation of flight control commands or if differences in

### Code inspection was the primary test technique for ensuring data integrity.

their values could lead to sync failures; if either case were true, the inspection assured that they were properly protected.

Parts of the inspection process were automated, but in the end much of the success relied on human judgment.

The third primary kind of testing performed was stress testing. Just as heat, cold, pressure, vibration and other stresses are used to test a piece of machinery, conditions which push software beyond its normal range can be found. In the case of the ALT software, the guidance, navigation, and flight control systems were stressed by simulating flight conditions of high winds, errors in sensors, and by artificially raising cpu

utilization until the cyclic processes could no longer operate at their specified rates.

Testing which stressed the multicomputer operation included slowing down or halting one processor to cause it to lose sync with the rest.

### The outcome

How reliable was the ALT Onboard Computer Software system? Was the extensive testing successful?

At the time the system was delivered it had earned a high degree of confidence from the reviewing community. Hundreds of hours of successful run time had been logged. And the stress tests had shown that the system was very difficult to "break," even deliberately.

However, the real success criterion of the system must be its performance in actual use. And in all of the ALT flights, no software-caused computer failure, failure to sync, or miscomparison of control outputs occurred.

The ALT flights are completed now and the development of the onboard software system for the Orbital Flight Tests is underway. This new software will be larger and more complex than ALT. It will support entire missions from the ground to orbit and back again. Fortunately, the ALT experience has shown that it is possible to make four redundant computers cooperatively control the spacecraft. So the hardware and software systems will operate the same way to control orbital tests, and the programming and testing techniques used in ALT will be applied in the development of the new system. \*



Ms. Sheridan is an advisory programmer at IBM's Federal Systems Div. facility in Houston, Texas, where the ALT software was developed. She has been with IBM since 1965 and has worked on flight programming testing for the Space Shuttle landing tests, and real-time programming development for NASA's Mission Control Center during the Apollo and Skylab manned space missions. She is currently involved in flight programming development for the Shuttle orbital flights scheduled to begin next year.



# Family planning allows our computer systems to grow as fast as you do.

When we designed our 990 Computer Family, we put a lot of thought into it. A lot of technology, too.

Our planning paid off. Today, we have large disk-based, multi-user, multi-language commercial systems, like our DS990 System. Its powerful DX10 software has over 170 system commands built in, to make light work of your office workload. Interactive or batch. We also have smaller standalone diskette-based systems, like our FS990 System. And they're all engineered to communicate with each other and to grow as your needs grow.

From the first, our plans called for software that can expand as your business does. So, when we engineered our TMS 9900 Microprocessor, we made it the first to use software that's upward-compatible with our entire line of 990 computers. Compatibility that protects your software investment.

Built into every 990 computer system is over 30

years of experience in the electronics industry, and the technical expertise and support of our worldwide organization of factory-trained sales and service engineers, backed by TI-CARE\*, our computer-automated field service dispatching and information system.

With the 990 Computer Family, you are assured of the lowest possible cost of ownership. Low purchase, maintenance and service costs. And reliable operation.

To see how our planning can keep pace with your growth, today and tomorrow, call your nearest TI sales office, or write Texas Instruments Incorporated, P.O. Box 1444, M/S 784, Houston, Texas 77001.

**TEXAS INSTRUMENTS**  
INCORPORATED



\*Service Mark of Texas Instruments  
Copyright © 1978, Texas Instruments Incorporated

CIRCLE 32 ON READER CARD

# TEXAS INSTRUMENTS.

We put computing within everyone's reach.

# DATACORP FICHE MANAGEMENT SYSTEM. BECAUSE TODAY'S INFORMATION ISN'T TOMORROW'S.

Up til now, your typical COM file was an all-or-nothing type of tool. Either up-to-date, or out, which meant starting an entire new file. From scratch.

But now, with Datacorp's Fiche Management System, you can update, index, even cross reference. Selectively. And continually, every day, if need be.

All this, without having to re-print full files. You get data base

management on microfiche, with a steady flow of new information as often as users demand. Plus savings in manpower. Storage. Printing. And faster look-up, better utilization.

Fiche Management System, from Datacorp. Makes today's COM report also tomorrow's.

Call or write and we'll show you how.

**REMEMBER DATACORP.  
WE'RE #1.**



**DATACORP**

P.O. Box 3460  
Portland, Oregon 97208  
(503) 225-5100



When it comes to the versatility that best serves your needs, our Infoton 400 Data Display Terminal has about as much as you could ask for. Probably more. Designed around the Z-80 microprocessor, it has editing and formatting capabilities in modes settable through software. And at \$1,095 in quantities of 100 or more, its flexibility is unmatched for the price by any other terminal in the business. If your needs include options, we can serve you two additional pages of memory, a directly addressable printer interface, as well as polling capabilities.

To ask how far we'll go to serve your video terminal needs, call Infoton toll-free at (800) 225-3337 or 225-3338. Ask for Barbara Worth. Or write Barbara Worth at Infoton, Second Avenue, Burlington, MA 01803.

Prepared by Chickering/Howell Advertising, Los Angeles

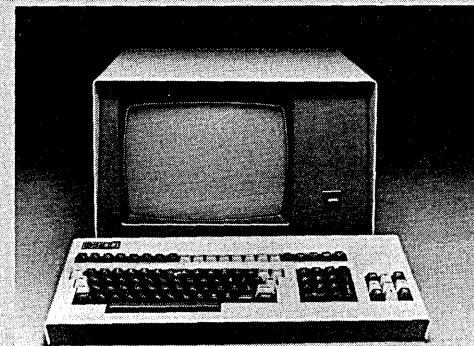

 **Infoton 400**

CIRCLE 72 ON READER CARD

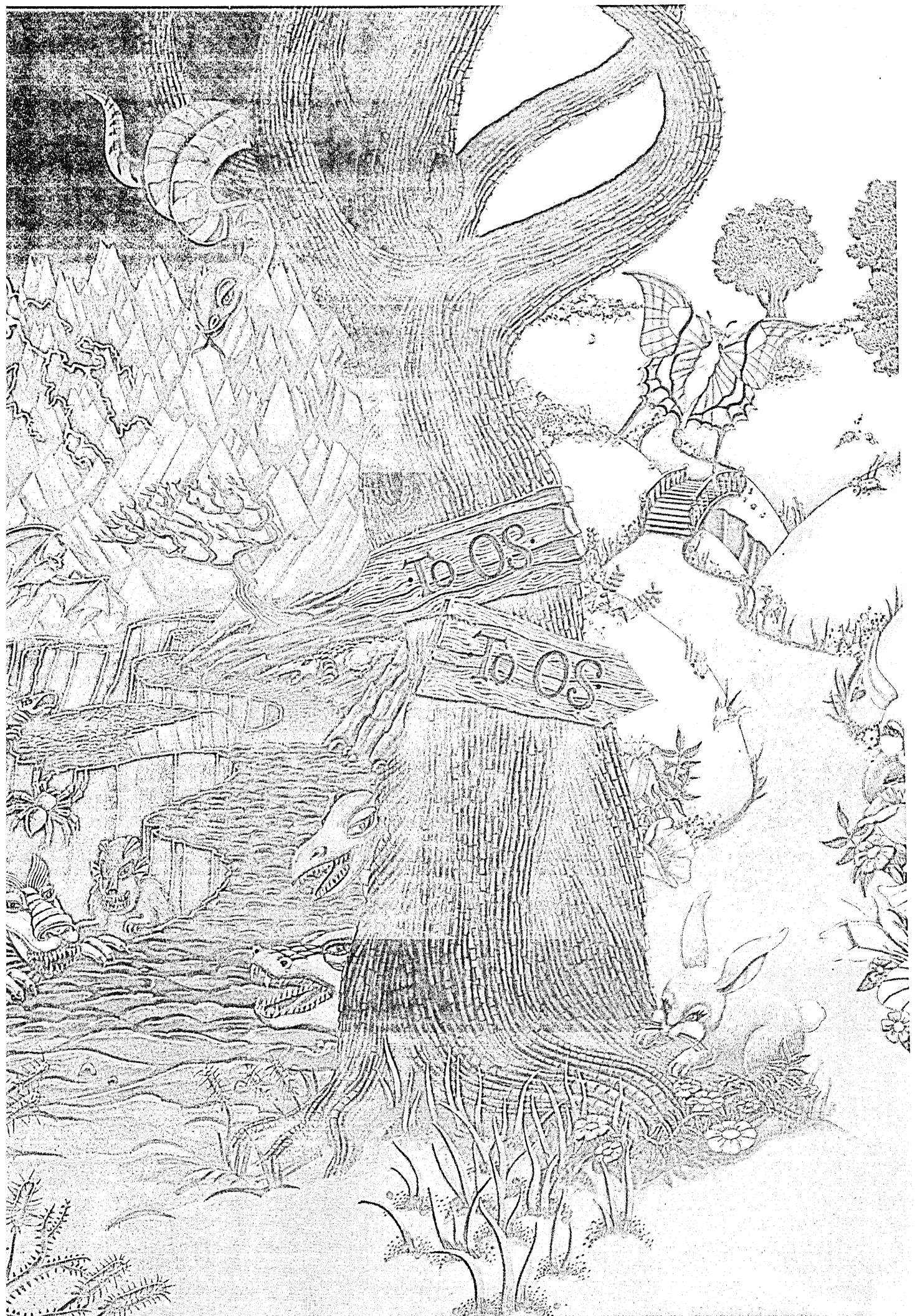

## DOS TO OS. We take you there the easy way.

The easy way is UCC-2 (DOS under OS).

This software package allows you to run your DOS programs and your DOS 1400 emulator on your 360/370 OS or OS/VS system *without reprogramming*.

That eliminates the chaos, and much of the expense, of getting from DOS to OS. Whether you're planning a conversion, or having to live with both systems simultaneously, UCC-2 can make your shop more productive — and your job a lot easier. Over 600 installed systems prove the point.

Call us at (214) 688-7312 or circle 90

And, once you get to OS, take a look at what our other software packages can do for you:

A Tape Mgmt System that protects data from loss or destruction (UCC-1). Circle 91

A Disk Mgmt System that can probably save you the cost of some new disk drives (UCC-3). Circle 92

A PDS Space Mgmt System that eliminates PDS compression (UCC-6). Circle 93

A Data Dictionary/Mgr that really gets IMS under control (UCC-10). Circle 94

A Job Recovery Mgmt System that makes restarts and reruns simple (UCC-15).

Circle 95

A GL/Financial Control System that Accounting has been dreaming of (UCC-FCS) Circle 96

An IMS Database Verifier checks physical pointers, finds errors before they become problems (UCC-40). Circle 97

An IMS Database Space Utilization Program pinpoints DB loading problems, helps determine correct DBDGEN parameters (UCC-41). Circle 98

A broad line of Banking and Thrift software. Circle 99

Software packages like these. One more way —

## We're helping the computer to do more of the work.

**UCC**

P. O. Box 47911 — Dallas, Texas 75247

Canada: 797 Don Mills Road — Don Mills, Ontario M3C 1V2 • Europe: 1258 London Road — London, U.K. SW16 4EG

# Single Source...

Everything you need to make your data processing operations run more efficiently, you can get from Wright Line. From simple supply items to carefully planned documentation handling systems, Wright Line is the one best source. And . . . Wright Line offers superb customer service. For

supplies or small items just call us, or order by mail and you will get prompt trouble free delivery. For assistance in planning specialized filing systems or work stations rely on one of our professional field specialists. You find them in every principal city in the U.S. and Canada.

For more information about Wright Line products and services, circle reader's service number or send today for our newly published short form catalog. Wright Line Inc., 160 Gold Star Boulevard, Worcester, Massachusetts 01606 Tel. (617) 852-4300

# Super Service!!



Order by mail using the convenient DOS order forms. Delivery is on our next truck out.

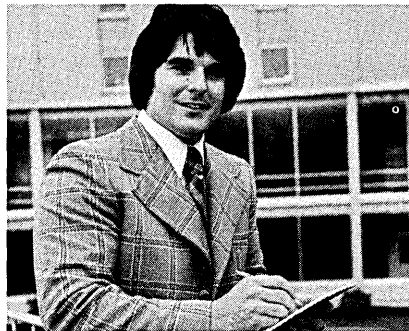

Get professional assistance in planning installations from our more than 150 highly trained field specialists.



Order by phone. Our hot line lets you place the order directly with the factory for fast delivery.



CIRCLE 126 ON READER CARD



# The (Mis)Use of DP in Government Agencies

by R. A. McLaughlin, Senior Editor

Not-so-modest proposals on how the government should stop bungling its use of dp.

Most government reports leave us cold. They are couched in a language which is best described as "governmentese"; they are carefully worded so as not to offend the innocent or the guilty; and they often conclude with a recommendation for further study so that one report breeds its successor.

Not this one.

report may lose its identity, and it would be too optimistic to believe that its recommendations will be acted on directly.

On the other hand, the findings seem credible, and apply to other government bodies equally. Further, it may impact hearings being held on Capitol Hill by Rep. Jack Brooks (D., Texas)

population are becoming more and more scarce. If steps are not taken soon to adapt, there will be insufficient resources for all and many dinosaurs will cease to exist.

These dinosaurs, slow, monstrous and clumsy, are the Human Resource Programs of the Federal government. The changes are those of the revolution in

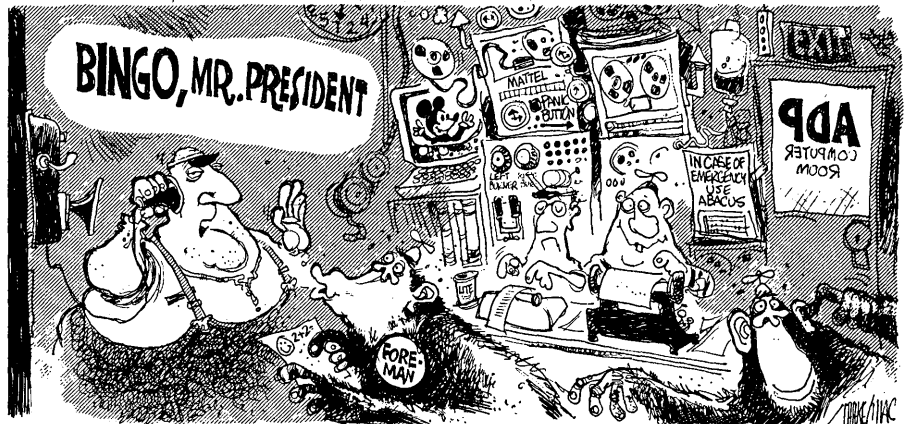

We have recently received a draft copy of the report from the Human Resources Team of the Automatic Data Processing Reorganization Project. It's the part of the President's Reorganization Project which studied the human resources agencies of the federal government, those agencies with three-letter names which always somehow account for half of the federal budget.

It is expected that this draft report will be melded with those from other groups studying other agencies and dp topics: National Security, General Government, Small Agencies, Scientific Agencies, the Acquisition Process, Data Processing Standards, Operational Management of Data Processing Activities, and Management of Data Processing Personnel. In the process, this

and his partners on the House Government Operations Committee, which is currently investigating some of the problems aired here.

Thus the draft is a promising oasis in a desert of unintelligible reports and findings and summaries. What follows is a condensed but unedited version of its contents.

## PREFACE

This is a report about dinosaurs! It is a report about dinosaurs which are not adapting to the changes in environment taking place about them. These changes are occurring during a period when the population of dinosaurs is growing dramatically and the resources to feed this

information technology that have been occurring in recent years—the birth and growth of the Computer Age.

If today's human resource programs are to be effective in the face of tighter budgetary constraints, they must adapt to the changes taking place about them. We no longer can continually revise unsuccessful programs over and over again, and assert that nothing is wrong with them that a change in procedure or "competent administration" will not cure. Concepts and approaches must be rethought to take advantage of the opportunities that technological developments can offer, and once the new course is cut, strong and effective management must be exercised to assure that objectives will be achieved.

Then this is a report on management

## (MIS)USE OF DP

in the human resource agencies of the Federal government; the Department of Health, Education and Welfare, Housing and Urban Development, Labor and Veterans Administration.

And so, this is not just a report on ADP or computers but rather a report on our findings—findings which cover the entire range of information management practices.

The power of the President is derived from his ability to serve the People of America. We have concluded that his ability to serve is blocked today by a breakdown of policy management systems and lost opportunities to use ADP. Nowhere is this more dramatically evident than in the human resource activities of the Federal government.

We believe the informed use of ADP, together with the implementation of a comprehensive Policy Management System, can unblock the President's ability to serve the people and thus restore his power. But it is the President himself who has the key, as well as the responsibility, to initiate these changes.

### From the introduction

The four human service agencies reviewed have a combined FY '79 budget authority in excess of \$267 billion, which represents more than 50% of the total Federal budget. ADP budgets for these agencies are estimated to be approximately \$600 million for FY '79. The four agencies administer a myriad of human service programs through both direct Federal administration and through Federally funded programs administered by State and local governments. HEW alone currently administers over 375 individual programs. Through their potential impact on program administration, the uses or misuses of computer technology are leveraged far beyond the level which their budgets would imply. The symptoms of the problems addressed in this report are many:

- since 1965 the GAO has released nearly 200 reports dealing with problems in the acquisition and management of government computers.
- billions of taxpayers' dollars have been wasted or lost through mismanagement and misuse of computer resources.
- public complaints about the degradation of Federal service delivery are increasing.

The issues the study addressed were how to:

- improve the Federal ADP planning process.
- improve the Federal ADP investment decision-making process.
- improve the Federal use of ADP in

the management of agency programs.

- improve the use of ADP in the delivery of services to the American people.
- assure the effective use of the technology by the agencies.

In the following section of this report we have listed our findings and conclusions which highlight the problem areas we encountered.

### HUMAN SERVICE DELIVERY

**Finding:** No set of definitions or standards have been adopted for Federal human service programs.

In our studies, we found that no approved standard definition of terms, classification of services or standardization of requirements exist for Federal human service programs. This leads to confusion and duplication of effort on the part of the State and local governments and additional cost to the taxpayer.

**Conclusion:** In order to provide a framework within which human service programs can be effectively administered, the Federal government must adopt a classification scheme similar to the UWASIS system [United Way of America Services Identification System].

**Conclusion:** SPAARS [the Single Purpose Application with Automated Referral System, an HEW instituted classification project] represents the

first Federally sponsored attempt to develop the standard classifications and uniform definitions which must be the first step in automation of client-eligibility determination. This effort deserves strong support from the heads of the agencies involved. Follow-up actions necessary to formally adopt the alternative language developed by the SPAARS project should be supported and given high priority.

**Finding:** The Federal government is not providing leadership in using off-the-shelf technology to improve human service delivery.

**Conclusion:** The Federal government which is dispensing hundreds of billions of dollars in human service programs each year should be in the forefront in developing and experimenting with such systems so that all jurisdictions can take advantage of the potential cost savings. Unfortunately, our findings indicate that such pioneering efforts are developed in spite of the Federal government's involvement, not because of it.

Some State and local jurisdictions are not inclined to move to new technology because the potential cost savings are not achieved immediately.

**Conclusion:** The Federal government must provide convincing leadership in providing the proper rationale to local governments that such systems will pay off. Without such long range perception, human service programs will never

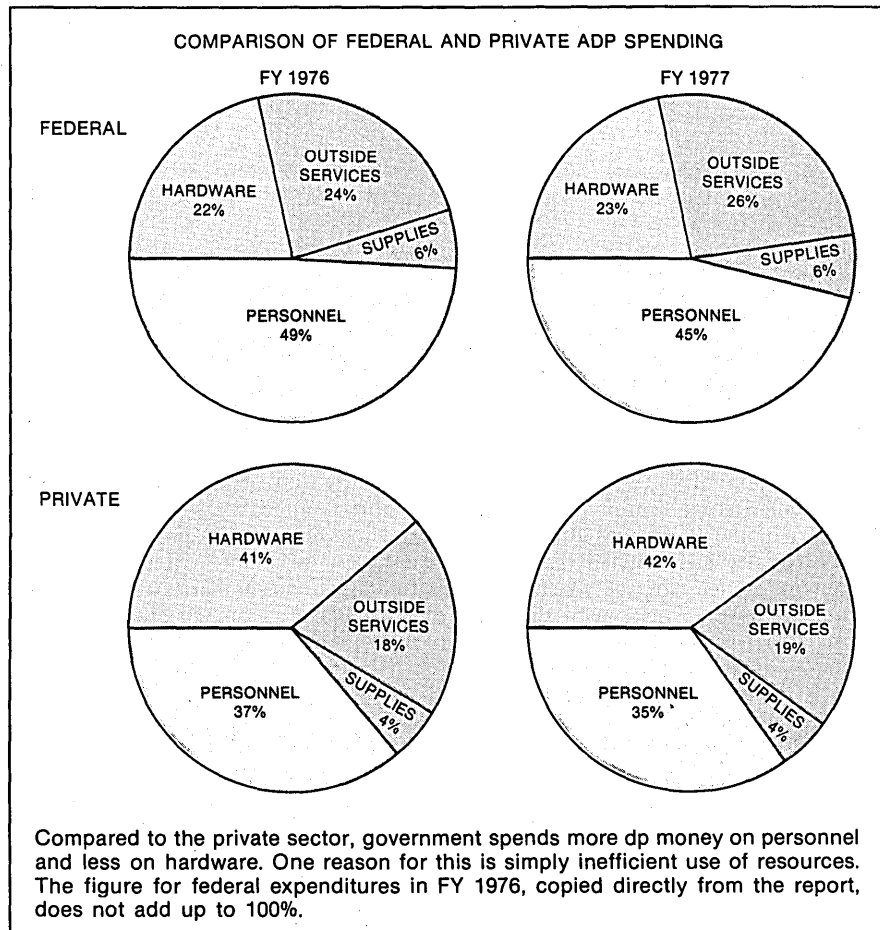

# There's more to paper media than meets the eye

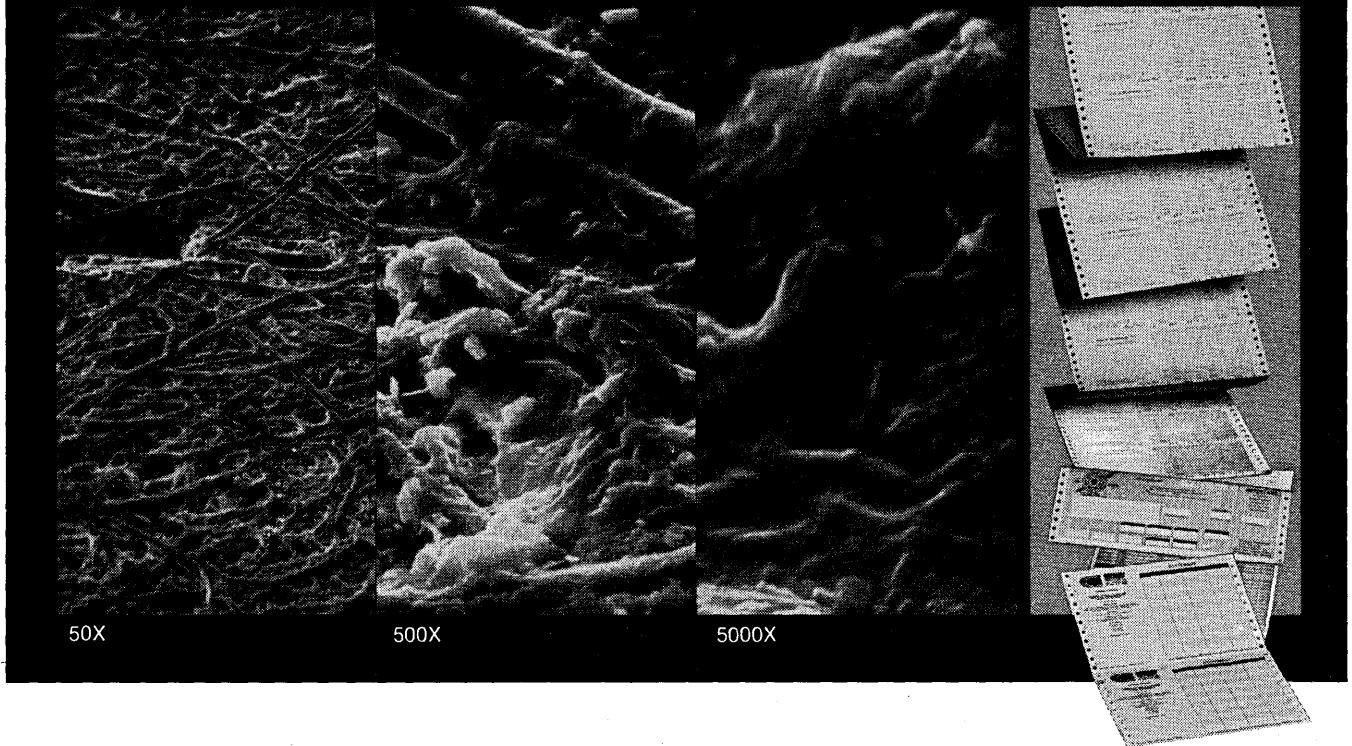

50X

500X

5000X

This close look at a business form shows details not apparent to the naked eye. And while forms design normally does not require the high technology of a scanning electron microscope, the process of designing and manufacturing business forms is a complex and demanding task.

Attention to detail is critical to quality. And quality in business forms is critical to keeping your operations running smoothly and efficiently. No output printer operating at today's speeds, no OCR or MICR equipment can do its best with forms that are poorly designed, printed or perforated.

We recognize this because we are computer specialists. We understand the importance of carefully designed business forms. And we can bring this expertise to bear on the success of your business. Whatever your needs—continuous forms, unit sets, OCR or MICR—we're experienced problem-solvers when it comes to paper media.

Our people are professionals in data processing, system analysis and the design of business forms. We're ready to help you simplify paper-

work, analyze your forms requirements and provide solutions to handle your unique needs. Give us a call today. 612/853-6853. Or send us the coupon.

Mr. W. B. Rodemann, Vice President  
Business Products Marketing  
Control Data Corporation  
P.O. Box 1980  
Twin Cities Airport, MN 55111

D-78

Send me samples and information on:

- Custom Forms Design     OCR Forms  
 Stock Continuous Forms     MICR Forms

Name \_\_\_\_\_ Title \_\_\_\_\_

Company \_\_\_\_\_ Phone \_\_\_\_\_

Address \_\_\_\_\_

City \_\_\_\_\_ State \_\_\_\_\_ Zip \_\_\_\_\_



**More than a computer company**

## (MIS)USE OF DP

achieve their full potential.

**Conclusion:** *The people in the Federal government should talk to each other and with representatives of State and local governments. Organizations such as the Regional Councils, the National Governor's Council and the League of Cities should be used to facilitate communication and promote new techniques. Meetings should be held at both the policy and worker level between those individuals doing common work. This will help to facilitate the transfer of technology between seemingly unrelated areas and will avoid the wasteful practice of each jurisdiction or each Federal program re-inventing the wheel. Such organized meetings will provide a central location for the input of new ideas from non-government sources which can have a positive impact on all human service areas.*

**Finding:** *The Federal government is not working effectively with the States in order to improve service delivery.*

**Conclusion:** *The Federal government must establish mechanisms which encourage rather than discourage innovative approaches to human service delivery. Funds should be made available to investigate opportunities for service delivery improvements which cut across agency and program boundaries.*

**Finding:** *There is a tendency to put the worst possible person at the client interface level.*

**Conclusion:** *The Federal government should take whatever steps it can to assure that professional staff, sensitive to client's needs and with the authority to interpret regulations and determine eligibility, are used at the client interface. The proper use of ADP at the client interface would significantly increase the productivity of these professionals so that their expertise could be applied to the largest possible client population.*

**Finding:** *The Federal bureaucracy in Washington hinders the widespread use of ADP in State and local agencies.*

**Conclusion:** *The case of DHR [the Dept. of Human Resources, which has for two years been trying to get federal funding for a computerized management information system] provides a typical example of the often repeated claim that the Federal bureaucracy in Washington is the bottleneck in making progress in human service delivery through the use of ADP.*

**Conclusion:** *DHR's experience with decentralized service delivery points out that the decentralized approach to human service delivery has merit, but is inhibited by lack of the proper tools and a negative attitude from the Federal bureaucracy.*

**Finding:** *Numerous studies have identified solutions to many human service*

*problems and yet little action has been taken to implement these solutions.*

The Human Resources Team reviewed numerous studies recommending actions which could have greatly improved the effectiveness and efficiency of human resource programs. Yet, in case after case, no action had been taken even when recommendations were obviously justified and follow-up studies would have added little additional information.

**Conclusion:** *Too often, little or no action is taken on the recommendations of excellent studies even when action is highly justified and has the potential of high benefits. Leadership and a willingness to occasionally take some risk is desperately lacking among some central agencies of the Federal government. Unless this trend is reversed, excellent studies are likely to continue being only resource material for researchers in years to come.*

## PUBLIC INVOLVEMENT SURVEY

### General

**Finding:** *The States are well aware of the problems in the human service area and are anxious to resolve them.*

**Conclusion:** *The interest of key State officials in the efforts of the President's Reorganization Project demonstrates that the States represent a fertile ground of experience and understanding with which the Federal representatives who plan and administer human service programs should establish a close working relationship. More effort must be expended by Washington officials to involve State and local officials in the planning processes associated with human service programs.*

### Human service delivery

**Finding:** *The claims processing and enrollment functions are the areas which should be emphasized to produce the greatest impact for improving the delivery of human service programs.*

**Conclusion:** *Claims processing and program enrollment are two areas where ADP can play a key role in improvement. With appropriate support, automation of these functions can be improved significantly, leading to overall system effectiveness. We have mentioned in this report several efforts underway in the States to implement systems aimed at these areas. The Federal government should take the lead in helping such systems get established.*

**Finding:** *Within the areas of claims processing and enrollment, the most important single objective to achieve in interfacing with clients of human service programs is the timely, accurate and adequate processing of claims and applications. The second most important objective is the assurance of appropriate, adequate and consistent program coverage to all eligible applicants. Both of these objectives were rated sig-*

*nificantly higher than the other objectives.*

**Conclusion:** *The Federal government should be focusing its attention on improving the accuracy and speed of the systems with which the client must interface and assuring that such systems reach the proper people. Better, faster and more accurate service to the people—this is what's needed most. The key component to achieving success is the informed use of ADP. ADP can and is being used to improve client service, both in terms of speed and accuracy and in assuring that clients receive all the appropriate services to which they are entitled. The Federal government has the responsibility to see that the proper environment exists to enable the spreading of such techniques to all jurisdictions which desire it.*

**Finding:** *Within the area of eligibility determination, program eligibility requirements which concern income pose the largest problem.*

**Conclusion:** *These results show that eligibility determination is a problem and that ADP could be of help in several areas. We have found in our own investigations that eligibility determinations are difficult due to the complexities of and differences between the many Federal programs. We believe that ADP can be a primary tool in helping to speed and improve the accuracy in eligibility determination if steps would be taken to develop eligibility criteria which are not contradictory from program to program. It is the responsibility of the Federal government to develop workable eligibility criteria if the process of eligibility determination is to be simplified.*

### Human Service Program Administration

**Finding:** *The areas of client service, enrollment and information dissemination are the areas which should be emphasized to produce the greatest impact for improving the administration of human service programs.*

**Conclusion:** *In the area of enrollment, the biggest benefit would come from the standardization of enrollment criteria across programs. Such an effort would go a long way toward creating an environment where ADP could play a significant role in reducing program overhead costs. Several States have already shown the potential benefits from improvements in this area through the establishment of common enrollment forms used to create client eligibility systems aimed at helping clients determine what programs they are eligible for.*

**Conclusion:** *In the area of information dissemination, the Federal government should help implement the centralized information and referral systems which were discussed in a recent GAO report. Such systems would help*

clients be aware of what programs are available and which programs they are likely to qualify for.

**Conclusion:** In the client service area, the Federal government should help the States implement ADP systems to speed up and improve client services. States which are not moving in such a direction should be given the opportunity to see what systems can offer in terms of efficiency of service delivery.

**Finding:** Within the areas of client service, enrollment and information dissemination, better human service delivery can be achieved through an emphasis on program administrative directions aimed at better definitions of goals and responsibilities and less attention to monitoring and reporting.

**Conclusion:** These results indicate that the Federal government must provide the necessary guidance concerning what the objectives of the numerous Federal programs are and who has the appropriate responsibility to see that the goals are met. Without the existence of a clear set of objectives for a program, it is impossible to determine whether a program is performing as expected or as intended by the legislation which created it. What human service programs need is less monitoring and program reporting and a better *a priori* set of goals and objectives which are simple and precise.

**Finding:** Within the area of program administration, financial reporting requirements present a severe burden in human service programs and have a high potential for solution through the use of ADP.

**Conclusion:** The informed use of ADP is a key to providing relief to the

burden created by the reporting requirements of human service programs. The areas of statistical and financial reporting data are particularly oriented toward ADP applications. Due to the significant amount of agency resources used to meet program reporting demands, we believe the Federal government can take several positive steps to reduce the burden:

1. Program reporting requirements could be based on scientific random sampling rather than the present method of total measuring and control. Much of the massive burden of record keeping could be eliminated, thus reducing program overhead costs and increasing both its capacity and delivery level. Such methods are used throughout both government and private industry and have proven to be effective and reliable. Present techniques of providing actual "head counts" take so long that the data is often too stale for use by the time it is developed. Computer technology makes such sampling techniques both achievable and reliable.

2. The adoption of a classification system (such as the UWASIS system discussed earlier) would make the reporting requirements more manageable and more adaptable to ADP processing.

3. Present reporting requirements could be reviewed and only those requirements which contribute positively to program management and administration maintained.

4. A mechanism for review of all newly proposed reporting requirements could be established in order to ensure that they are appropriate and needed prior to allowing their institution.

## Human service delivery organizational options

**Findings:** One-stop neighborhood centers are highly preferred over the present individual program offices for the delivery of human services.

**Conclusion:** The Reorganization Option survey points out two key points:

- 1) Present individual program offices are not the preferred approach to service delivery.
- 2) One-stop neighborhood centers have a high potential for improving service delivery.

## AGENCY MANAGEMENT Attitudinal aspects of ADP management

**Finding:** Adequate training programs for ADP managers do not exist in the Federal government.

**Conclusion:** The lack of adequate training programs to keep ADP managers current with the state-of-the-art lead to obsolescence of the individual, and eventually to obsolescence of the organization. Managers soon develop a lack of understanding and appreciation for what ADP can do, and therefore cannot adequately determine how ADP can be used to achieve agency goals.

**Finding:** ADP does not have adequate visibility with top management in the human resource agencies.

**Conclusion:** Lack of visibility has been a major factor in the failure to apply ADP technology to significant problems in the administration of Federal programs.

**Finding:** The view that computers are only electronic accounting machines is still prevalent in Federal agencies.

**Conclusion:** Failure to understand the full potential of ADP is a major barrier to more effective use of ADP in carrying out agency missions.

**Conclusion:** The attitudes of agency managers are generally not conducive to innovative use of ADP.

## Incentives for innovation in ADP

**Finding:** Significant performance measures do not exist within the human resource agencies.

**Finding:** Within the ADP area, no agency interviewed had any effective ADP resource accounting mechanism in place.

**Conclusion:** We conclude that without ADP program performance measures or ADP resource accounting systems, there is no effective means to link improvements in program performance to ADP, and therefore there is no incentive to pursue ADP innovations.

This immediately raises other pressing questions:

- How are ADP concerns relating to competition, privacy, security, obsolescence, and state-of-the-art related to the ADP planning process?
- Are alternatives fully and satisfactorily explored for planned and exist-

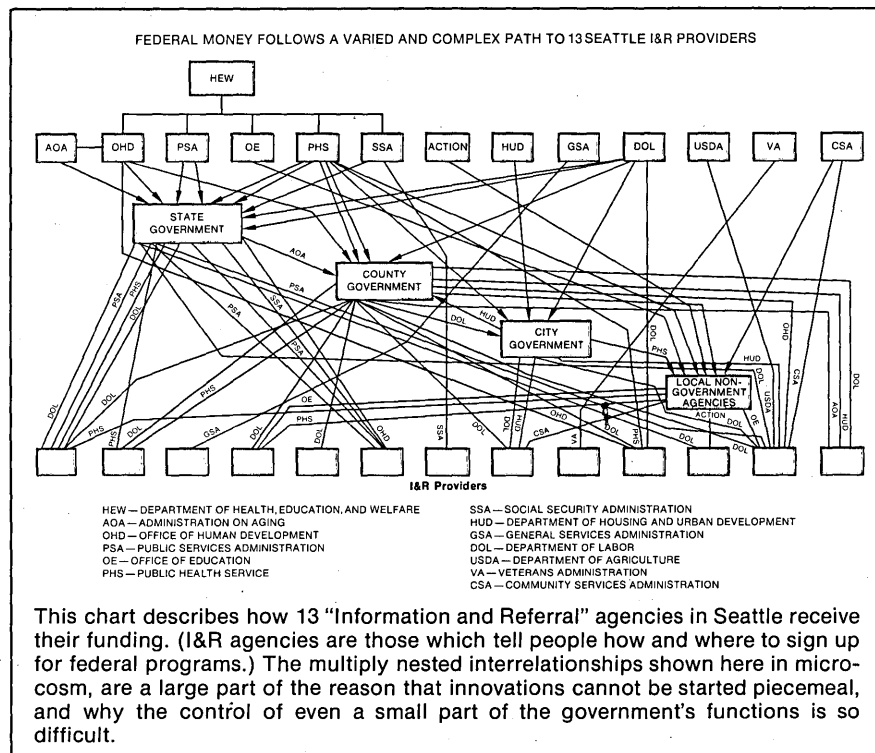

# The new DEC SYSTEM-2020 mainframe.

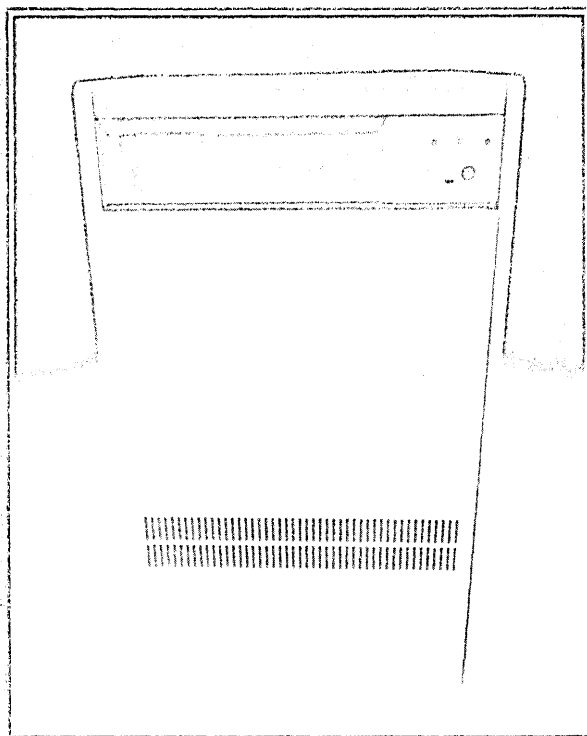

# Surprisingly easy to use.

The new \$150,000 DECSYSTEM-2020 is more than the world's lowest priced mainframe.

It's also the easiest to use.

The secret is in the software. The TOPS-20 virtual memory operating system and the high-level language compilers. The same proven software that runs on our larger DECSYSTEM-20 family mainframes. Designed from the start to let both skilled and unskilled programmers learn quickly, get more work done, and make fewer mistakes.

Here's what you get:

**Unique PUSH/POP commands.** PUSH lets you interrupt what you're working on and go to new programming — as many times as you like. It gives you essentially another virtual machine. POP gets you back to the previous program.

**Interactive debugging** at the source language level at run time without recompilation. And you debug in English, not octal like other systems.

**Superior tutorial aids.**

If you have a rough idea of a command, you can type in an abbreviation and the system will list all similar ones. When you recognize the command you want, you just type it in. You can abbreviate commands you're expert at, and get instant help when you're unsure. So you can use the system without the manual in your lap.

**Fewer keystrokes.** Most commands require an absolute minimum number of keystrokes — an

average of 40% fewer than our nearest competitor.

**Forgiving operation.** You can get out of an editing session and have the system ignore the changes you made. You can even *un-delete* a file you mistakenly got rid of.

**Unified user interface.** And all these user interface features look the same to the programmer regardless of the language or application software.

All of which makes the DECSYSTEM-2020 as easy to use as a programmable calculator.

Since the DECSYSTEM-2020 is so easy to use, it can be run by the people who need it. So you don't need a whole separate operating staff. In fact, all you need is someone to mount disks and tapes, or to feed card readers and line printers. A claim no other mainframe maker can match.

In addition, batch can be run from a terminal. If there's a power failure, the system will restart itself. And with automatic SYSGEN, you don't need system wizards to configure and run the machine.

With people representing 65-70% of DP center costs, the DECSYSTEM-2020's

ease-of-use features are looking just as attractive as its incredibly low price.

To find out more, simply write us below.

**digital**  
LARGE COMPUTER GROUP

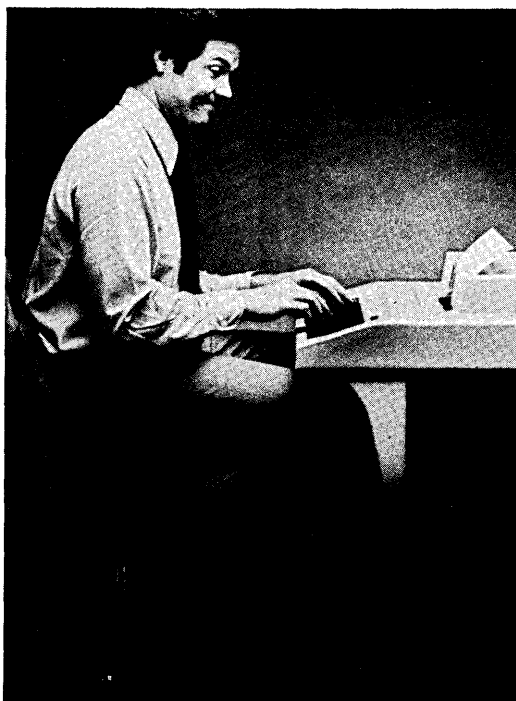

Please send your new 24-page color brochure, **DECSYSTEM-2020 — the World's Lowest Priced Mainframe.**

Please have a sales representative call.

Name \_\_\_\_\_

Title \_\_\_\_\_

Company \_\_\_\_\_

Address \_\_\_\_\_

City \_\_\_\_\_ State \_\_\_\_\_ Zip \_\_\_\_\_

Telephone \_\_\_\_\_

Send to: Digital Equipment Corporation, MR1/M-49, 200 Forest St.,  
Marlboro, MA 01752. Tel. 617-481-9511, ext. 6885.

All Digital mainframe systems are now available to qualified OEMs. A-7-8

## (MIS)USE OF DP

ing ADP systems?

As we have seen from the previous findings, there are no effective mechanisms for measuring either program performance or ADP resource usage by program. Our findings did reveal, however, that because this condition exists, the ADP planning and acquisition processes involve a great deal of debate between the agencies, OMB, and the various oversight committees. Many seemingly worthwhile projects have fallen victim to these debates.

**Conclusion:** *Projects will continue to be indefensible to these types of attacks because of the inability to effectively demonstrate their quantifiable contribution to program performance.*

**Finding:** *There is no Federal policy on how computers should be managed.*

**Conclusion:** *The proper environment for the innovative use of ADP technology does not exist within the human resource agencies.*

**Finding:** *The Federal ADP procurement process severely hinders the effective use of technology.*

**Conclusion:** *Current Federal ADP procurement processes provide a negative incentive for the effective use of ADP technology.*

**Finding:** *New or modified legislation passed on Capitol Hill often has significant impact on human service agency ADP requirements.*

**Conclusion:** *Unpredictable legislative actions provide negative incentives for the effective use of ADP technology. Federal agencies must take the initiative of working with Capitol Hill during the formulation period of new or reformed legislation, so that such work can begin on the design of the system concept while the legislation is being finalized.*

### Communications

**Finding:** *Lack of communication between Federal, State and local officials results in many missed opportunities for the application of existing ADP technologies to new areas.*

**Conclusion:** *Effective communications between Federal, State and local officials will enable the transfer of technology to take place from one environment to another.*

### Agency ADP investment analysis

**Finding:** *First, the analysis revealed that there is a strong similarity among large organizations insofar as they all have a range of routine internal paperwork processes which provide the original cost justification for automation.*

*Secondly, it became clear that the large private institutions which have continuing direct contact with consumers (banks, oil companies, airlines, and insurance companies) had extended*

*their applications of the computer technology to the consumer interface. Government generally has not.*

**Finding:** *The investment levels of ADP within the human resource agencies are considerably below the median in the private sector.*

**Conclusion:** *Substantial changes in the Federal ADP investment philosophy need to take place in order to have the Federal government achieve a reasonable level of investment.*

**Finding:** *ADP resource investment by State government for service delivery tends toward decentralization.*

**Conclusion:** *It is no longer infeasible to decentralize the management of the human service delivery programs.*

**Finding:** *Federal program management seems to avoid accountability and responsibility for ADP investment decisions.*

**Conclusion:** *Program (line) managers should be held responsible for the acquisition and implementation of major ADP systems affecting their areas of responsibility.*

**Conclusion:** *Federal Human Resource ADP investments are not responding to needs.*

The only investment criteria which appears to exist in these agencies are those imposed by OMB. These criteria do not appear to be related in any way to mission effectiveness or efficiency. They have been established solely as a means to place a lid or ceiling on ADP investment.

The following facts should have a significant impact on the investment direction of the Federal government.

1. *The rate of ADP technology change has brought about a tremendous expansion in use and application of ADP technology. New computer systems are entering the Federal government at a rate of 1,500 a year. They are being applied to a wide range of functions from routine accounting chores to issuing Social Security checks.*

2. *The costs of doing Federal agency business with computers and communications equipment are falling rapidly while the costs of doing business with personnel are rising rapidly. The introduction of "micro-processors" and new electronic manufacturing techniques will continue to fuel the downward trend in computer costs, while at the same time, inflationary pressures are driving up the labor costs and the demands for more expanded social supplemental programs to offset the costs of food, medical care, housing, etc.*

ADP investment decisions within these organizations are a complex process of weighing many interrelated investment alternatives against investment limits (boundaries), criteria, objectives, and goals. These all must relate to the expected programmatic benefits to be gained by such investments. This implies the requirement for baseline

measurability for ADP resource usage and program performance. Effective ADP resource accounting has been established in the private sector for many years. The question of program performance measurement requires more serious consideration. Determining whether employment service programs actually contribute to gainful employment is not answerable by statistics about total expenditure or numbers of clients served. They must be answerable in terms of meeting the program stated goals. Once this question is answered, then the investment analysis process can begin. Models can be developed and simulations performed on impacts of alternative ADP investments to program performance. The investment decision then becomes a key component in the process of maximizing the programmatic benefits to available funds.

### History of Federal ADP Management Studies

**Finding:** *The problems addressed by this report have been studied many times before with little result.*

The team discovered a seemingly endless stream of studies and reports developed by GAO, Federal commissions, Federal departments, State and local governments, and private organizations. Most of these studies were funded by the Federal government through grants or direct allocations. While some of these reports offer little more than insipidous (sic) insights into the problems, many do provide valuable recommendations for correcting the conditions which have inhibited the effective and efficient use of ADP for the delivery of human services to the public. However, these reports have resulted in little or no action. Typically, they are put aside for "further study."

**Finding:** *The problems addressed by this report have been studied many times before with little result.*

**Conclusion:** *For those reports which have already been submitted to OMB, OMB should immediately begin to review and implement the significant recommendations.*

**Conclusion:** *The main conclusion the Team arrived at through reviewing these studies is that the Executive Office of the President should begin to assume a more active management role in the Executive branch.*

It is the impression of the Team based on the findings that this emphasis on management would require a dramatic change in perspective. OMB's role is perceived as almost entirely adversary. The origins go back to the days when it was essentially the Office of Budget. This role still seems to overshadow any positive aspects of the management side. Some of the representative comments received during the interviews were "OMB funds projects to the level to guarantee failure," and "OMB is really



# NOW SHIPPING. THE MOST RELIABLE AND VERSATILE 55 CPS CHARACTER PRINTERS EVER BUILT.

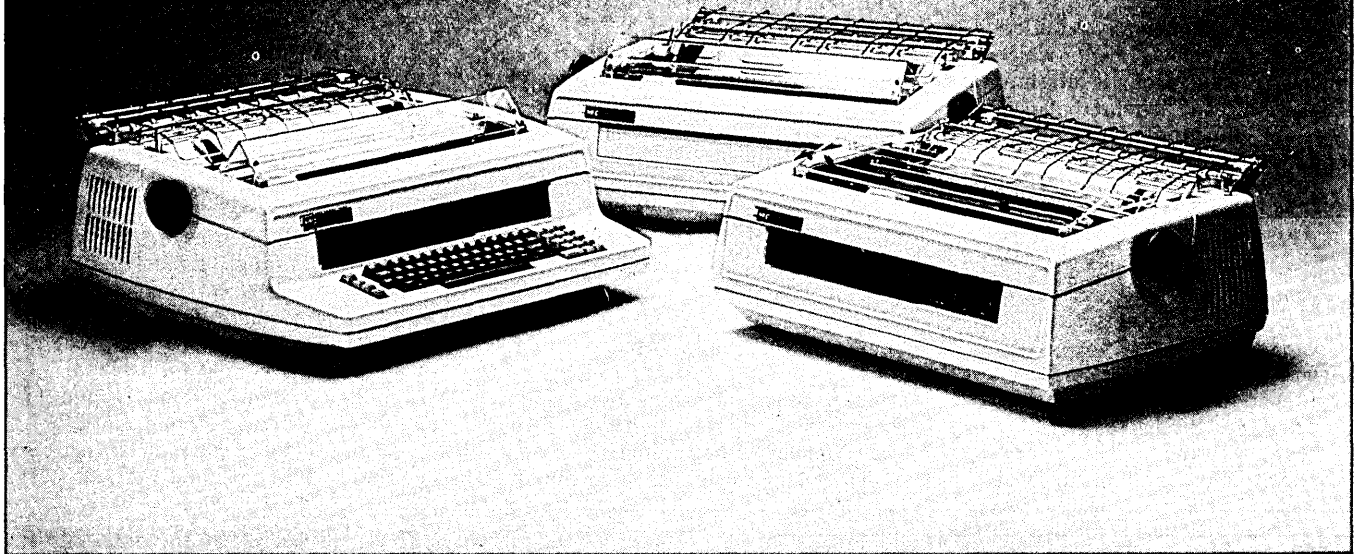

It takes experience as well as a technological know-how to deliver character printers better than today's best — and NEC Information Systems has both. We gained experience building and shipping more than 10,000 printers that use the technologies in our new Spinwriter family. We're now shipping Spinwriters throughout the country.

We're ready with reliability that's more than a promise. Our Mean-Time-Between-Failure rate of better than 2,000 hours is based on experience with printers in use.

We're ready with print quality equal to typewriters — at speeds to 55 characters-per-second. Our unique "thimble" print element holds more characters, lasts longer and costs less than "daisy wheels."

We're ready with printers that fit your applications. The Spinwriter 5500 Series includes microprocessor-controlled receive-only and keyboard send/receive models, and basic mechanisms for those wishing to add their own power supply and housings. You may choose from RS 232-C, current loop and 8080 bus line interfaces, as well as Diablo- and Centronics-compatible interfaces. Custom interfaces are also available. Choose from six data rates from 110 to 1200 baud for half- or full-duplex communications. Spinwriter housings are die-cast aluminum for noise reduction, durability and appearance. They fit into any environment.

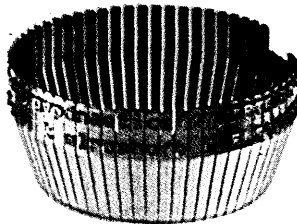

We're ready with service, through one of the largest, most competent organizations serving the computer industry. And we're delivering right now. Our experience tells us you can't afford to wait, and you don't have to. Spinwriters are available in OEM quantities in 60 days or less.

Tell me more about the Spinwriter family.

- Please have a sales representative call
- Please send literature

Name: \_\_\_\_\_

Title: \_\_\_\_\_

Company: \_\_\_\_\_

Street: \_\_\_\_\_

City: \_\_\_\_\_ State: \_\_\_\_\_ Zip: \_\_\_\_\_

Telephone: \_\_\_\_\_

To find out more about the experience and the technology that make Spinwriters the best character printers in the industry, fill out the coupon, or call NEC Information Systems, Five Militia Drive, Lexington, Mass. 02173 (617) 862-3120.

**NEC**

**NEC Information Systems, Inc.**

Eastern Office: NEC Information Systems, Inc., Richard Gilbert, 5 Militia Drive, Lexington, Massachusetts 02173 (617) 862-3420.  
Central Office: NEC Information Systems, Inc., Steve Kadash, 3400 South Dixie Drive, Suite 105, Dayton, Ohio 45459 (513) 294-6254.  
West Coast Office: NEC Information Systems, Inc., Marty Rubin, 8939 S. Sepulveda Blvd., Suite 330, Los Angeles, California 90045 (213) 670-7346.

## (MIS)USE OF DP

'OmB' with a little 'm'."

The general recommendation made by these reports is that OMB should set policy and guidance for ADP management to include the following items:

1. Requirement for program performance measures for all new and existing programs.
2. Require mission statements to include ADP for all new and existing programs.
3. Policy direction for ADP privacy, security and competition policies.
4. Policy and guidance for ADP management.

What is fundamentally required is an advocate for management, which will emphasize guidances, leadership, and assistances, to counterbalance the adversary function. It has not been demonstrated to be feasible to combine the two roles into a single organization.

### STUDY SUMMARY

*The issues of ADP use in the Federal government are not technologically based but rather symptoms of failures of managing.*

The issues of ADP use in the Federal government are not technologically related nor are they actually ADP issues. Problems with the use of ADP are interwoven within the total management fab-

ric of the government. To treat them as isolated problems which can somehow be solved by adding another layer of Federal bureaucracy (e.g., an ADP Czar or an Assistant Secretary for Data Processing) is to ignore the real issue. The real issue is that the Federal government does not have a clearly defined policy for the development and administration of its legislative programs. Sociological, ecological, and economic problems are broken down into small fragmented, disjointed, and diluted parts. This is done under the premise that it produces manageable pieces. Instead, it creates a morass of programs with overlapping, inconsistent, and sometimes contradictory results. In this environment, ADP will fair no better. What is needed is a "program policy statement" which includes ADP. This policy statement must have a clearly defined set of objectives each with measurable criteria.

We should note that we did find instances where the problem is being addressed in this manner. The Veterans Administration has developed a definition of a "policy management system" centered around ADP which will be implemented over the next four or five years.

In another situation found in the Department of Housing and Urban Development, a bottom-up approach to policy management has been initiated.

A recently installed Management Information System provides for performance measurement of programmatic goals with monthly tracking and reporting. Both of these systems offer encouragement that agencies may be finally starting to move in the right direction.

To try and solve the problems of managing ADP in the Federal government without addressing the real issues is fruitless. Unfortunately, there is much truth in the statement of Senator Dale Bumpers who said "We continue to deal here with the politics of the problem, rather than with the problem."

### RECOMMENDATIONS

The "knowledge industry," the business of producing and distributing ideas and information rather than services and goods, now accounts for over one-half of the Gross National Product. Each year 300 billion pieces of information are reported to the Federal government by States, local governments and individuals. Between 100 and 140 billion dollars, approximately \$500 for every person in the United States, is spent annually collecting, reviewing and storing this information. Six Federal agencies use over 200 forms requiring 3.5 million responses annually and 11 million work-hours to complete.

In spite of these stark facts, there is no central policy dealing with the col-

## Got a backup computer facility?

There's always the chance something or someone can "get to" your computer and put it out of business. Fire, flood, explosion, act of nature, disgruntled employee.

How long could your company stay in business without its computer resources? A month? A week? A day? At all?

You may qualify for limited membership in a national network of Recovery Operation Centers, all equipped with supporting utilities and data communication systems to suit its members' needs.

Let us hear from you. We're the leading management consultant in computer security, the proven name, advancing the state of the art through our work with 400 major corporations.



**Data Processing Security** INCORPORATED

Dallas/Fort Worth: 235 N.E. Loop 820  
Hurst, Texas 76053 817/589-2244

Regional Offices:  
Atlanta Chicago Los Angeles New York

## New EIA data cable tester for immediate detection of opens, shorts, miswires.

Our new Model 8580 is a small, portable tester for rapid testing of EIA 25 conductor cables. Faulty conductors are immediately indicated by an audible alarm and are identified by LEDs as opens, shorts or miswires. Four rear panel connectors allow testing of cables with male or female 25 pin con-

nectors. The 8580 is powered by long life dry cell. Optional rechargeable battery and AC Adaptor available. Test switch provides indication that all LEDs and audible alarm are operational.



**INTERNATIONAL DATA SCIENCES, INC.**

100 Nashua St., Providence, R.I. 02904  
Tel. (401) 274-5100 TWX 710-381-0285  
Export: EMEC, Box 1285, Hallandale, Florida 33009

lection and flow of information, no standard method for managing this vital national resource.

The purpose of our study was to develop recommendations for the President by which the human resource agencies may more effectively and efficiently utilize computer technology to fulfill their missions. *In concluding our study, however, we cannot overemphasize that a meaningful Policy Management System must be the first step.* With minor additional adjustments, the effective and efficient application of ADP will be a natural consequence.

We firmly believe that ADP is the single, most important key to coping with today's knowledge industry and the complex, overlapping, interrelated policies and programs of the Federal government, but good management *must* be the first step. In this respect, we agree with the findings of the Commission on Federal Paperwork.

The Human Resources Team of the President's ADP Reorganization Project has three broad recommendations:

1. Stop studying the problem
2. Implement a systematic, time-phased solution
3. Develop mechanisms for using common sense in government.

These broad recommendations are supported by four specific recommendations to improve management practices and information quality

throughout the Federal government:

4. Institute a formal policy management system
5. Establish a President's council on information quality
6. Establish the position of assistant to the secretary for information quality in each Cabinet-level department
7. Establish a technical support consulting service.

These management recommendations are followed by five specific recommendations dealing with the delivery of human services. Three of these deal with new policy direction; the remaining two involve specific Executive actions which could be taken immediately and which the team believes would have substantial and highly visible benefits to individuals applying for human services.

8. Adopt a policy aimed at encouraging decentralized and distributed responsibility for delivery of services

9. Take action to establish clear, concise goals, standards and definitions as normal policy

10. Encourage a policy of strengthened partnerships with States and local governments

11. Establish a White House task force on integrated, automated, eligibility determination

12. Take action to automate black lung eligibility determination. [This was a specific example used in the study.]

While some of these recommenda-

tions stand alone, the collection should be viewed as an integrated package which has as its objective the use of presently available computer technology to improve the policy making, administration, management and service delivery functions of the Federal government.

It is our firm conviction that implementing bits and pieces of these recommendations in the traditional Band Aid approach will guarantee that our recommendations and work will prove fruitless. Only by implementing a complete and integrated package, and giving the package adequate time to develop, can meaningful, lasting solutions be expected to happen.

Once again we emphasize that it on the management side of information gathering and processing that initial changes must occur. With good management, the effective and efficient application of ADP to the delivery of human services will follow naturally. \*

The report was submitted by the following people: Dr. Robbin R. Hough, Oakland University; J. Gary Auguston, Office of the Secretary of the Treasury; Lt. Col. John M. Daugherty, Office of the Chief of Staff, U.S. Army; Gerald T. Hedlund, General Foods Corp.; Peter B. Henault, Seattle City Light; and David Hirshberg, Office of Statistical Policy, Department of Commerce.

# Everybody is talking about technology transfer. We are doing it.

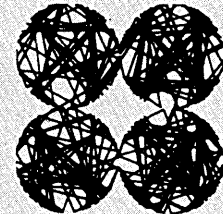

## Very Large Data Bases

Experts in the areas of research and practice are discussing and analysing topical DP problems at two congresses in Berlin. Separate - but simultaneous and under one roof.

Interlocking events of this kind foster understanding for the problems of the other side and help to arrive at joint solutions.

You too can profit from this congress double-header.

### Two congresses - one date.

Four days that ought to figure prominently in your engagement diary:

## September 12-15, 1978

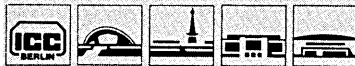

International Congress Center Berlin  
Congress Hall Berlin  
Exhibition Grounds Berlin  
Deutschlandhalle/Ice Palace Berlin

## 3rd International Congress on Data Processing (IKD) Berlin 1978

for the first time in conjunction with

## 4th International Conference on Very Large Data Bases (VLDB) Berlin 1978

Plus the congress-related Special Exhibition Data Security/Data Privacy presented by hard- and software producers.

Fill in the coupon for detailed congress information.

### AMK Berlin

Company for Exhibitions, Fairs and Congresses, Ltd.

Box 191740, Messedamm 22  
D-1000 Berlin 19  
Telephone: (030) 30 38-1  
Telex: 01 82 908 amkb d

Contact address: German American Chamber of Commerce, One Farragut Square South, Washington, D. C. 20006, (202) 347-0247

### DP Coupon

Please send me congress information on:

International Congress on Data Processing (IKD) Berlin 1978

International Congress on Very Large Data Bases (VLDB) Berlin 1978

Name \_\_\_\_\_

Company \_\_\_\_\_

Address \_\_\_\_\_

AMK Berlin  
Company for Exhibitions, Fairs and Congresses Ltd.  
Messedamm 22, D-1000 Berlin 19

# Introducing the Norand® 101 Portable Data System

## THE PROGRAMMABLE TWO-WAY LINK TO YOUR COMPUTER

For years it's been a problem... your people compiling field data by hand to be fed into your computer. Or perhaps you simply couldn't find a device to do what you need to do... your way.

**That was yesterday.** Today, there's the Norand® 101 Portable Data System. It uses an ordinary telephone to send data to... and receive it from... your central computer.

The microprocessor technology built into the Norand 101 makes it totally programmable. Your particular business procedures don't have to change to fit the unit.

Your Norand 101 control program assures the accuracy of the data entered, and the full alphanumeric display guides your people through the program sequences. The display "instructs" your operators in their own language, whether it's cases, pounds, hours, dollars, etc.

Error-free information is stored in solid-state memory, which can be reviewed, changed and updated. It has up to 64,000 character capacity.

An optional wand scanner reads bar codes, to further increase the speed and accuracy of data entry.

Applications of the Norand 101 Portable Data System are virtually limitless. For more information write the Norand Corporation, or call 1-800-553-5427, Ext. 101.



Optional wand scanner reads bar codes.



Telecommunicate over an ordinary telephone. Acoustic coupler shown here.

There is a difference.

# NORAND®

COMPUTER SYSTEMS

Norand Corporation, 550 2nd Street S.E.  
Cedar Rapids, Iowa 52401



™ A subsidiary of Pioneer Hi-Bred International, Inc.

Norand Corporation is a full-line manufacturer of point-of-sale systems, in-pharmacy computers and data communications systems.

CIRCLE 107 ON READER CARD



## An Elementary Case History

*The earlier problems and fortunes of the individual, Jack, have been much discussed and are well nigh apocryphal. Nevertheless, he has considerable resilience and has demonstrated diversity by undertaking a new project. He set a simple and single goal and submitted it to be realized by an organization that prefers anonymity. This organization, however, is progressive and utilizes well-established procedures for project management. Nevertheless, even the best of methodolo-*

This is the goal that Jack set.

These are the objectives to be specifically met,  
To achieve the goal that Jack set.

These are the requirements to parameterize the tasks,  
To meet the objectives,  
To achieve the goal that Jack set.

This is the workplan that structures the tasks,  
To fulfill the requirements,  
To meet the objectives,  
To achieve the goal that Jack set.

These are the statements of work to be done,  
Derived from the workplan on which they are structured,  
To fulfill the requirements,  
To meet the objectives,  
To achieve the goal that Jack set.

These are the schedules of milestones and charts,  
That tell when each statement of work shall be done,  
To complete the workplan,  
To fulfill the requirements,  
To meet the objectives,  
To achieve the goal that Jack set.

This is the budget of money and time  
To finance according to milestones and charts,  
Each statement of work from the time that it starts,  
All items that are in the workplan,  
That fulfill the requirements  
To meet the objectives,  
To achieve the goal that Jack set.

This is the contract that when signed will bind,  
To budget of money and tasks and time,  
According to schedule of milestones and charts,  
The statement of work that shall be done,  
To complete the workplan,  
To fulfill the requirements,  
To meet the objectives,  
To achieve the goal that Jack set.

These are the reviews while money still lasts,  
Of performance and budgets and slippage that masks,  
Failures to accomplish appointed tasks,  
Agreed to by contract,  
Financed by budget,  
Scheduled by milestones,  
Defined by statements of work to be done,  
According to the workplan,

*gies are not without pitfalls and can develop a life unto themselves, as the following case history illustrates. It is hoped that this will show the relationship of a commonly occurring management pitfall with respect to the project management process. This case history is presented without further comment, in the traditional format for discussion of problems related to Jack.*

That fulfill requirements,  
And meet the objectives,  
To achieve the goal that Jack set.

Here is a slight misunderstanding of the goal  
Yielding gnashing of teeth and raking of coals,  
Overlooked during all of the many reviews,  
Of perfect performance and other good news,  
Not accounted for in the very tight budget,

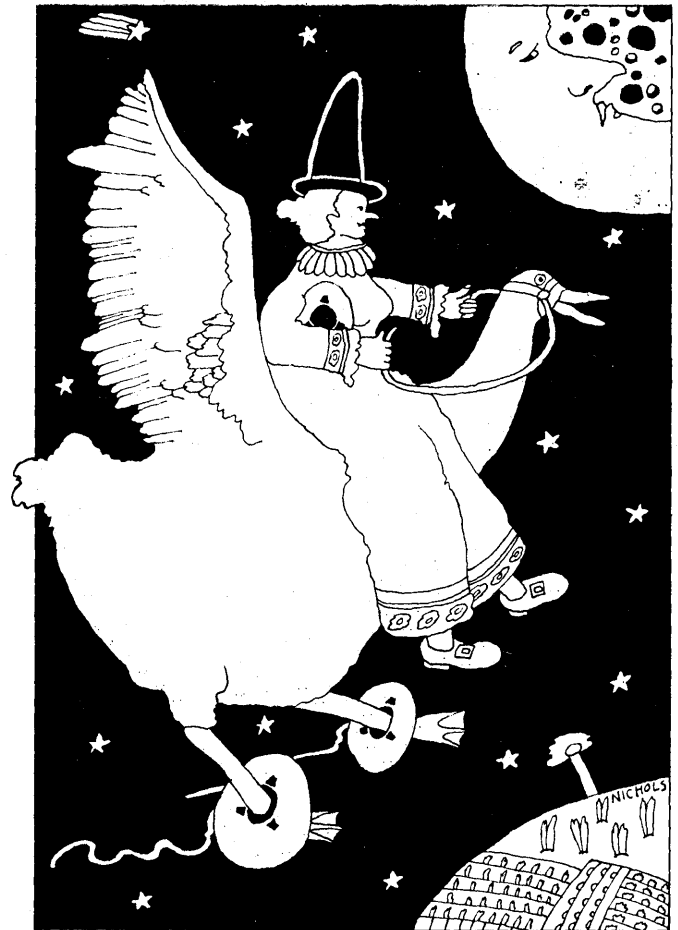

And discovered too late for all to fudge it,  
Never considered a milestone to chart,  
Changing all statements of work from the start,  
And tearing the workplan completely apart.  
This will cause the revamping of each requirement,  
And in the process the early retirement,  
Of those who defined their basic objective,  
From ill-informed viewpoints entirely subjective,  
Having little in common with  
The quite simple goal that Jack set.

—Joseph A. Steinborn



## It Happened in Anaheim

Crushing turnout of 57,244 to National Computer Conference was beyond wildest expectations of its sponsor, who expected about 45,000. A review of the show and conference. Attendance at energy sessions a disappointment.

To Los Angeles area commuters it was a gigantic SigAlert. "Stay away from the area around the Anaheim Convention Center," they were advised by their car radios, "a big computer conference is causing serious congestion."

To the sponsoring American Federation of Information Processing Societies (AFIPS) it was a success beyond wildest expectations which were for an attendance of 45,000.

It was the biggest National Computer Conference ever, drawing 57,244 people in all. Last year's NCC drew 35,601 to Dallas and the year before 35,085 traveled to New York. The 396 exhibitors contributed heavily to the huge attendance. The 11,927 people staffing booths could have held a convention of their own which would have been considered a big one. Exhibitor guests accounted for 31,597 of the grand total.

Big is the only single word to describe the '78 NCC. On the exhibit floor there were more big booths than ever. Twenty companies took the equivalent of four or more booth spaces.

There was considerable grumbling from people who had trouble finding a

parking place and had to spend a long time standing in line, but exhibitors generally were happy.

The exhibits were spread through four separate halls. "It's so spread out that the traffic in the exhibit halls is just right," said a spokesman for BASF.

"We saw the right people and a lot of them," said Tony Coppola, vice president of marketing for Electronic Memories & Magnetics Corp.'s Computer Products Div. "It's been great."

Randal Walti, president of Randal Data Systems which exhibits in the show solely to attract distributors for its Link small business systems, said he'd talked to more than 100 "good prospects."

Norman Conwill, vice president, marketing for Computer Power Systems, was quite proud of the fact that four of his company's power distribution systems were controlling power in the West Hall, a parking structure converted into an exhibit area. "The electrical contractor (for the Convention Center) told me the power is much cleaner here than in the other halls," he said. He wasn't quite so happy when his fellow West Hall exhibitors mistakenly gave his equipment

credit for the lack of adequate air conditioning.

### The sauna

Temperatures climbed into the high 80's in West Hall all four days, causing tempers to fray and discs to crash in the Zilog booth. And it wasn't only small companies that were relegated to what became known during the show as the "sauna." Digital Equipment Corp. was there. So were Univac and NCR.

Energy conservation was a pervasive theme at the conference, but interest by attendees was less than overwhelming. A special symposium Tuesday evening on developing energy and computing technology drew about 150 persons to a hall that seated 2,000.

Conference officials said other energy sessions drew about 30% of the capacity planned. But conference program chairman Leonard Y. Liu said the poor turnout was neither a surprise nor a disappointment. "It's a new subject. Even though computers may be used a lot in some areas relating to energy, there still is not much interest in the subject."

But Liu said it is an important subject

and NCC was trying to educate computer professionals to take a position of leadership in that field.

One energy related session that did pull a capacity crowd to a large hall was the opening day plenary session. Dr. Joel Snow, associate director for research policy, Office of Energy Research, U.S. Department of Energy, one of two keynote speakers, said the "world is gobbling up its energy pie at a voracious rate . . . to resolve our energy problems, we are crucially dependent on computers."

He said the Department of Energy has more than 2,000 computers, of which 50 are very large scientific machines. "The Department of Energy is the largest single user of super computers. We use them in such things as simulation of the dispersion of pollutants in the atmosphere. Almost all of our scientific resources are near the saturation point."

### The fastest and the best

Snow said his department owns one-fourth of all federal government-owned computers and has some 4,000 people involved in computer related operations. "We seek the fastest and the best . . . we see the computer as a tool to serve a mission, a means to reach an end." He said there is a growing use of personal computers at the Department of Energy by professional and technical people. "We use the very big and the very small."

Snow believes the solution to the world's energy problems lies in the combination of three resources, "computer power, intelligence and wisdom."

Theodore J. Williams, president of AFIPS and professor of engineering and director, Purdue Laboratory for Applied Industrial Control, Purdue Univ., in addressing a conference luncheon, offered two answers to the question, "How can computers contribute to the energy conservation battle?" "First, by helping create energy-efficient designs for our homes, our transportation vehicles and our industrial plants and, second, by carrying out a better control of their energy utilization while in operation."

Williams credited microprocessors with the fact that "the field of industrial control system equipment is now in ferment. It is sincerely hoped, but perhaps with some despair, that the forthcoming new designs will take every advantage of the capability of these devices to achieve the potential which their incorporation into the hierarchy control systems will give."

Incorporation of microprocessors in so-called personal computers was widely discussed in the conference both in sessions and on the floor of the Personal Computing Festival in the nearby Disneyland Hotel. It is unclear how much crossover of attendance there was between the Festival and the NCC. It isn't even clear to what extent those involved in the Festival identified with the bigger show.

An attendee carrying a copy of the conference proceedings stopped by the Festival booth of Applied Management Systems Inc., South Pasadena, Calif., to be asked by booth staffer Carlos A. DuBois, "what does A-F-I-P-S stand for?"

### Cheap memory

One speaker on personal computers, Jef Raskin of Brisbane, Calif., said it "took the personal computers to show

## The Department of Energy has more than 2,000 computers.

the industry how cheaply memory could be made. The personal computer designers have not been shy at using the latest memory chips as they have become avail-



THERE were more big booths than ever before and tastefully decorated as seen in this restful setting at Lear Siegler's Data Products Div. booth.

able. In hardware, the personal computer user has the latest, the best, and the cheapest."

Memory announcements of another kind were made during the conference by Electronic Memories & Magnetics Corp. and National Semiconductor Corp. Both introduced add-ons for the IBM 303X family of computers. Both promised delivery in the fourth quarter of this year. EM&M has models for the 3031, 3032, and 3033, all utilizing a 4K static chip as do IBM's memories. National Semiconductor uses a dynamic chip in its 3031 add-on. "It's unclear yet whether or not we'll have to go to static on the faster 3032 and 3033," said Robert Fagley, director of marketing. "If we do we'll buy the chips outside, possibly even from Semi (an EM&M subsidiary which supplies its chips)."

"The computer is a semiconductor, and the semiconductor is a computer," was the canned sales pitch in National

Semiconductor's \$100,000 booth at the conference.

And soon, said speakers at a session on the impact of semiconductor technology on computer architecture, the semiconductor industry will take over more and more of the software functions from the computer industry. Said Joseph F. Krzy, of Cambridge Memories, Bedford, Mass.: "It will be awkward in the future to add \$100,000 worth of communications equipment and hundreds of thousands of dollars worth of software to a chip that sells for \$10."

And Robert Heikes, of Motorola's semiconductor division, said software is the "immovable object" in the development of microprocessors because it hasn't been automated to any degree, nor have engineering disciplines been applied to the design of software.

"The specifications are vague, design begins almost immediately with generation of code, most programs are put into use when they're only 80% complete, and must be debugged over the lifetime of the product," said Heikes.

### Integrated by 1980

A third speaker, Bernard H. List, of Texas Instruments, Houston, said software development now accounts for half of the expense in using microprocessors. He said he believed that system software development will be fully integrated with hardware development by 1980. (TI recently announced the availability of the PASCAL language on its 9900 series microprocessor.)

Adding strength to the argument that software development will find itself in the hands of the semiconductor industry was a statement by C. Lester Hogan, vice chairman of Fairchild Camera & Instrument Co., who said he envisions multi-processors in which one manages the file computer, one the input/output, and another controls the memory. They would be customized for the computer user through microcode rather than through hard-wired logic.

Gordon E. Moore, of Intel Corp., Santa Clara, said the industry had increased the speed of digital devices by 50 times in fewer than eight years and also increased densities to the point where there was plenty of space on a chip for more and more logic. He observed that the industry had reached the point where the user now must tell it what to do with tomorrow's new designs.

A questioner from the audience asked the panelists if software people as we know them today will disappear from the scene as software development becomes more and more a function of the semiconductor industry. Moore noted that semiconductor development had reduced the need for circuit designers a decade ago. The good designers ended up working for the semiconductor companies. He said the need for program-



mers probably would decline also.

Programmers and analysts would enjoy their work better if their supervisors were better trained, a session on motivating dp professionals was told during the conference.

Mayford L. Roark, of Ford Motor Co., Dearborn, said a study made at Ford two years ago found that only 38% of dp professionals felt their supervisors were doing a good job in building teamwork. He said this compared with a 50% ranking for the whole company.

### "Stars in their eyes"

But Roark wondered if systems programmers "still have stars in their eyes" over what they expect from their supervisors. He said one explanation might be that dp supervisors generally are younger than their counterparts in other departments of a company and that they work with persons who are "loners." (At Ford, 38% of dp supervisors are 34 years old or younger.)

Roark commented on motivational studies made by J. Daniel Couger, of the Univ. of Colorado graduate school of business, in which Couger said he found that programmers and analysts ranked higher than any other profession in their need for growth in their jobs and in their need to be motivated in their jobs.

However, Couger found that they ranked very low in what he called their "social need strength," the need to interact with other persons.

Couger said this fact "mandates caution" in using the team concept in

developing programs, referring to the chief programmer concept in today's so-called structured methods. He said dp professionals aren't actually seeking interaction. He said the team, or structured concept, also gives them the feeling that they are working only with fragments of a job and that perhaps they'd enjoy their work better if the jobs were enlarged in concept.

Howard B. Wilson, of Reynolds Aluminum, Richmond, Va., cautioned, however, that "productivity is the name of the game." He said it wasn't management's prime goal to make people happy, but to achieve results. Wilson said motivational factors should come in before the programmer joins the company or starts a task.

### Do systems programmers "still have stars in their eyes"?

In another session, J. F. Townsen, Harrisburg, Pa., warned the technical professional that he or she can no longer "ignore a day-to-day interface with peer groups from within the organization. The advent of newer, smaller, and faster operating systems have made the user a new partner in the development of the corporate data processing strategies."

Many of the NCC sessions seemed to be seeking definitions. One was titled "What Is Professionalism?" Delbert Atwood, Jr., Utah State Board of Education, Salt Lake City, described a dp professional as a person who "is knowledgeable but not overbearing, who listens, who tries to maintain technical competence, and who has extensive training in a specific discipline." He feels "licensing is a long way off but it may become necessary."

### A catalogue of courses

Dr. Roland D. Spaniol, Eastern Illinois Univ., Charleston, Ill., stated the case for continuing education. He would like to see established a catalogue of courses and seminars. "It probably would be

bigger than the Sears catalogue. Next would come a booking service and an evaluation plan. Who should manage it? Probably the Data Processing Management Assn.'s Education Foundation or maybe AFIPS."

Spaniol also advocated the awarding of continuing education units, "kind of a merit badge for 'sitativity.'"

Another session hung up on definitional problems was one on distributed systems. The working definition of a distributed computing system (multiple connected processing elements operating as one) was continually worked over.

"These are incredibly complex systems," said David Farber of Rand Corp., "and the complexity comes both in trying to find out what they are doing and in how to build them."

Three distributed systems were described in another session, those of Firemen's Fund Insurance, Mattel Toys, and Aratex Inc.

Michael Dowling described Firemen's installation, based on 500 terminals in 48 offices, now being used primarily as a batch store-and-forward operation to a host site in San Rafael, Calif. The complex is now going over to on-line operation, he said, and the changes have been tough on the company. Dowling said hardware is not the biggest problem; "reorganizing to take advantage of it is much tougher."

Lester Stubbs, from Mattel, described the installation of IBM 3790s at the toy-making firm, where the devices were seen as a way to give the divisions their own computers while still retaining control and coordination functions at the central site.

Two big problems at Mattel, he said, were training non-dp people to run the systems, and setting things up to run without analysts on site.

More horrendous problems were described by Mario Calderin, of Aratex, Inc. Aratex is in the business of linen and uniform rentals, an occupation which often puts its 37 offices in the dirtiest parts of town, leading to high turnover rates of employees.

THE NCC drew 396 vendors, whose 1,396 booths filled a record exhibit space.

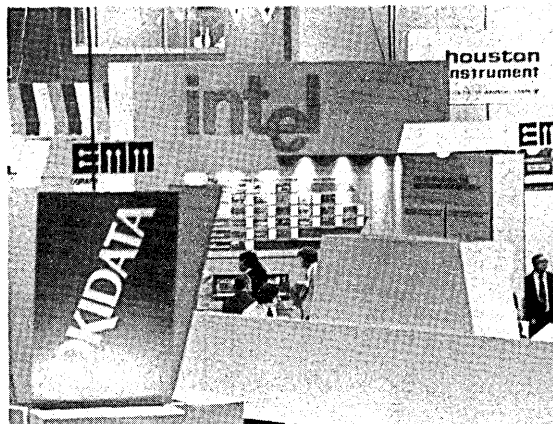



## Computers and the Energy Shortage

Many are worried but few are excited over the energy problem.

Henry D. Jacoby, of MIT, sees an analogy in the medical field. "The Boston snowstorm was like a heart attack. The problem was treated immediately. The energy problem is more like emphysema. It lingers and there's no ready cure."

Rep. Paul N. "Pete" McCloskey, Jr. (R., Calif.), says the U.S. doesn't have an energy policy because "the body that is supposed to come up with one (Congress) is totally confused with what that policy should be."

Jacoby and McCloskey spoke during the National Computer Conference last month in Anaheim at a sparsely attended symposium on "Developing Energy and Computing Technology" with six other panelists who are specialists on the subject.

There were hints of some solutions:

—Give the oil companies an incentive to explore through immediate relaxation of price controls.

—Provide financial rewards for startup companies in the energy-related industry, much like startups in the computer industry took advantage of tax incentives in the early '60s.

—Get the universities involved.

That last point was raised by William F. Miller, provost of Stanford Univ., who said there is no interaction between the energy industry and the universities as there was between universities and the electronics and instrumentation industries. Miller said he'd like to see the energy industry present their problems to the universities so their students could start working on them.

### A fresh viewpoint

University involvement might bring a completely different viewpoint to those trying to formulate an energy

policy, said Jacoby. "Up to now there's been really no consensus among those speaking out on the question. Each is an advocate of one group or another." Perhaps, he said, the university's role would be to speak its own viewpoint.

All of the panelists agreed with a statement made earlier in the day by Harold J. Haynes, chairman of Standard Oil of California, that along with a simplified regulatory process, the U.S. must begin offering tax credits to stimulate the type of large capital investment necessary to develop synthetic fuels technology and other energy projects. "The investment credits and tax reductions adopted during the Kennedy Administration demonstrate the effectiveness of this kind of economic incentive," Haynes said.

Haynes also said, in a luncheon address, that there must be some degree of

### It's a question of incentives for startups.

certainty that plants built for hundreds of millions of dollars will not be rendered obsolete by frequently changing environmental regulations.

McCloskey challenged the computer industry to use computers to solve the technical problems related to the safety of breeder reactors. Marjorie Evans, a scientist and attorney who is a nationally prominent advisor on energy and the environment, said it isn't critical that the U.S. have an energy policy, provided we're able to develop alternative sources of energy and use what we have judiciously. Arthur G. Anderson, of IBM Corp., said that company uses computer modeling in its new building programs with "dramatic returns"—savings of about 30% in energy consumption. Jacoby said very powerful computers will be needed to calculate the



KEYNOTER Harold J. Haynes of Standard Oil (center) with Cuthbert C. Hurd (right), who chaired energy panel discussion, and NCC program co-chairman Sakti Ghosh.

strategic allocation of energy in the event of a crisis.

### Uses in oil business

And, of course, computers play an important role in the operations of oil companies. Haynes in his talk noted that computers are used to analyze "the enormous amount of information" collected in oil and gas exploration. They're used to move crude oil and petroleum products such as in navigation of ocean tankers and in monitoring and operating pipelines, in scheduling the daily stops of the trucks that deliver gasoline to service stations, and in processing 4.5 million credit card accounts each month at Standard Oil of California.

The panel moderator, Cuthbert C. Hurd, of Solar Energy Research Associates, observed how the computer industry in less than 30 years had developed into one of the nation's major businesses. One example of its size was the huge NCC turnout where persons waited three or four hours to register. He said a similar energy-related industry should be able to grow the same way, if the correct government-provided incentives are available to entrepreneurs.

—T.M.

### "Big bang" theory

Calderin said Aratex reconfigured on the "big bang" theory. Everything was centralized first, then distributed. Now, he said, the firm's operation sees all data being redundantly processed, once at the remote site and later at the host. "In our business, you're guilty until you're proven innocent."

Another session which grappled with the definition problem was that on the legal aspects of software protection. "A universal definition of software is vital," said Martin R. Goetz, Applied Data Research, Inc., Princeton, N.J.

He offered his viewpoint. "Software is a machine. It is a component of a com-

puter system . . . All laws that apply to machines or machine components should apply to software and that includes copyright, capitalization, inventory tax credit, sales tax, and personal property tax."

"There is no logical argument to classifying software as intangible goods," said

### "There is no doubt software is a commercial product."

Goetz. "ADR manufactures and ships (software). It is ludicrous to think we're shipping intangibles."

Bob Nimtz, of Bell Laboratories, Whippany, N.J., seemed to agree. "There is no doubt software is a commercial product. It exists. It's bought and sold in the marketplace. There is a cost associated with it and a price associated with it. Its value relies on information which can be duplicated at virtually no cost." Nimtz said trade secret protection is the only viable protection available for software today because the applicability of patents and copyrights is uncertain. He feels some programs should be eligible for patents.

As for copyright applicability to software, "that doesn't bother me because it doesn't matter except for that one slim



possibility of preemption (of trade secret protection)." He fears preemption, he said, because the software subcommittee of the National Commission on New Technological Uses of Copyrighted Works (CONTU) has recommended that the reading of a program into internal memory should constitute copying under copyright law.

#### Doesn't think so

Michael S. Keplinger of CONTU said he doesn't believe application of copyright protection would preclude trade secrets but agreed, "I don't know what a court would do." He said he believes copyright is particularly suited to computer programs sold across the counter.

A questioner from the audience presented a hypothetical case. "I copy a program purchased by a friend. I'm using it. It's still a secret as far as I'm concerned, but I'm using it." He was wondering if software shouldn't be afforded the kind of protection the music industry has. When a piece of music is performed in public, it's infringement. "Isn't it a performance when you execute a program even if it isn't in public?"

Keplinger said he didn't feel perfor-



Trying it out . . .

mance protection was needed for software. "Protection against reading into memory is enough."

Protection of another sort was discussed in another session, one on protection in operating systems.

"A secure operating system is feasible, but we haven't built one yet and we're still in for some surprises," said Michael Schroeder of Xerox Corp. He admitted that several projects were underway but felt all had serious faults. He called a project by Gerald Popek at UCLA, "the most complete program for the design and implementation of an operating system, but it's not clear that it can all be done on a full-function OS like GCOS or Multics."

Popek countered that "no one will care about a full-function operating system; those behemoths will go down like dinosaurs."

Ken Thompson, introduced as the "father of UNIX," said the "point is to continue to make the systems more secure until at some point . . . you reach a threshold and it's more expensive to break through the security than to go and bribe the operator. That's not true now."

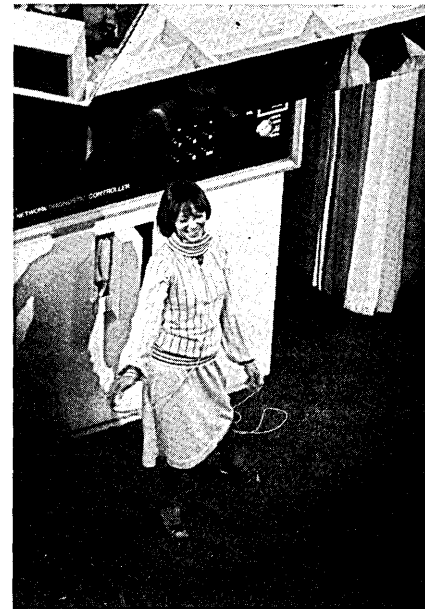

. . . Souping it up

#### Electronic mail

Another thing not true now is widespread acceptance of electronic mail. "Perhaps we'll have to wait for this gener-

## Personal Computing: An NCC Fixture

After two successful years as part of the National Computer Conference, the Personal Computing Festival will become a permanent component of the conference and next year in New York it will be housed in the Americana Hotel.

It was difficult to determine the size of the turnout this year in Anaheim's Disneyland Hotel because persons registering for the NCC also could attend the Festival without special registration.

NCC officials, however, said 1,207 persons registered to attend PC sessions, the exhibitors at the Festival drew 1,124 invited guests, and a total of 1,000 persons manned the 100 exhibit booths there.

Highlight of the Festival was a contest for personal computing accomplishments with about \$10,000 in prizes that included small computers, intelligent and dumb terminals, and even a decorative lamp made from a printer drum.

#### Monopoly game

Stephen L. Casner, of USC's Information Sciences Institute, Marina del Rey, Calif., won first prize for his design of a computer driven Monopoly game that used several hundred light emitting diodes to keep track of players' progress. Nick Naumovich Jr., a Dallas high school student, won second prize for his design of a computer modeling system for architects to design homes for more efficient use of energy. Both Casner and Naumovich's systems were based on

Altair computers, made by Perdec Computer Corp.

John Stuppy, a medical student at USC, placed third for his design of a microprocessor-based video board with memory sharing facilities.

Steve Grumette, a Los Angeles film maker, developed a time-sharing system, in which the time slice is determined by hardware, to take fourth place.

During the conference Ryal Poppa, chairman and chief executive officer of Perdec, said his company at the end of June would stop shipping Altair computers in kit form. Poppa, who addressed a personal computing luncheon on the topic, "Where are we going in personal computing?" said his company did not see a broad market for kits and that the market probably would be dominated anyway by Heath Corp., which introduced a computer in kit form last summer.

Poppa said he envisioned many smaller suppliers of personal or small business computers undergoing a shakeout by the early '80s. He said the approximately 750 companies supplying them would be down to about 50 at that time. Among these survivors, he said, would be Perdec, Tandy Corp., Heath, IBM, Data General, and Computer Automation.

The reason, he suggested, was that as small computers proliferated, so would the need for maintenance and software development which smaller companies would be hard-pressed to provide. \*

ation of managers to die off until we get people who are more amenable to electronic mail systems," said John Gilbert, U.S. Army Materiel Development and Readiness Command. He was talking about which managers take advantage of electronic mail systems. He said there are three classes: those who will use the terminals directly, those who have secretaries do it for them, and those who won't use the systems at all.

Office automation is another arena in which technology is meeting resistance to change. In an NCC session on the future of office automation, Dick Mason of UCLA advocated a "socio-technical system" for office automation. "Jobs must be somewhat demanding," he said, "they must bring out the competence of the individual." He said word processing centers "tend to focus on routine, repetitive types of operations. They provide no sense of completion. It's hard to identify with an end product." He advocated a highly individualized system as opposed to a highly centralized system saying that the character per second method of measurement, which would give centralized systems an edge, is "illusory and misguided." He said another level of measurement also should be used, "an effectiveness level. How much improvement has there been in the total performance of the organization?"

A full house turned out for a computer performance management session chaired by Philip J. Kiviat, Dept. of the Air Force. He suggested in his opening remarks that an optional title for the session might have been "how to get the service we need from the resources we manage."

Stephen Lowry, of the Dept. of the Air Force, recommended that each organization should determine which performance topics are most important to its monitoring operations. These, he said, could include capacity, operations, priority, system response time, turnaround, and system cost.

Next, he said, a management reporting structure should be defined. "Coordinated reporting, using uniform technology, is a hallmark of a good computer performance management system."

Lowry said implementation requires looking at the organization, and perhaps actually doing some reorganization.

### Obfuscatory measurements

David F. Stevens, of the Univ. of California at Berkeley, talked about obfuscatory measurements which, he said, can tell whatever story you want to tell. He compared the approaches of a naive performance monitor and an obfuscator. "While the naive observer might define availability as the amount of time a user has access to the system, an obfuscator might choose to use the amount of time the system is not physically down as his definition. This might lead the naive user

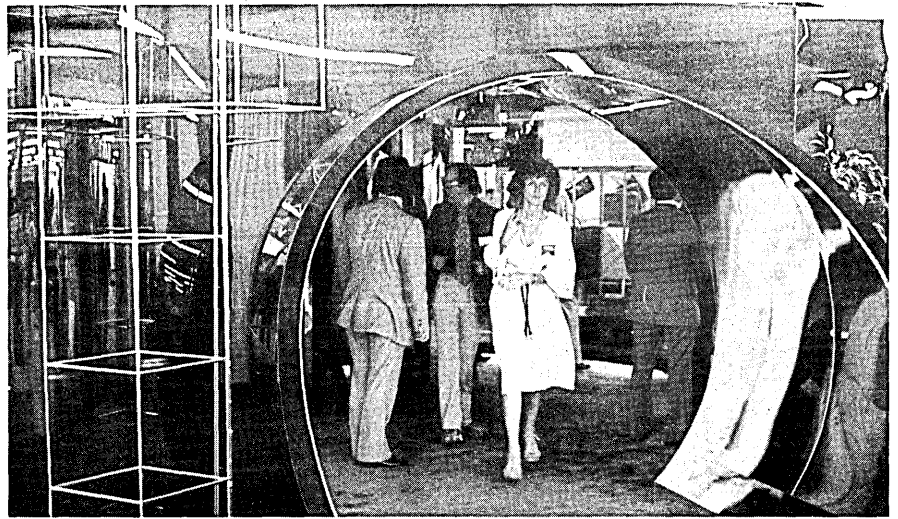

NCR CORP. and Digital Equipment Corp. returned to NCC after a lengthy absence and were relegated to low-ceilinged West Hall along with National Semiconductor Corp. and its \$100,000 booth and Telex whose booth was housed in a simulated packing crate.

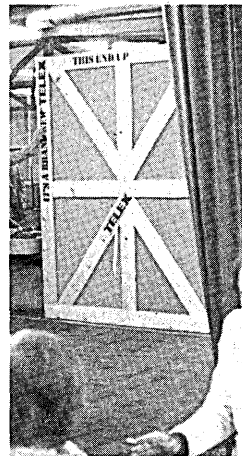

to an availability figure of 60%, while his counterpart can pick up an additional 30% by including pm and system development time."

Stevens also said programming should be monitored. He is of the school that holds programming to be an art so, "judging programmers by lines of code is like judging Homer by lines of ode."

A session on software maintenance filled a hall to standing room even though it was one of the last sessions of the conference. Its tone was of friendly exchange between colleagues. Chairman Edward Yourdon, Yourdon, Inc., New York City, said the session was aimed at the maintenance of existing software, on which he estimates 50% of an average dp

budget still is being spent. He stressed the need for on-going documentation of existing systems, and the usefulness of the ability of a programmer to read and modify alien code.

Larry Peters, Boeing Computer Services, Seattle, called for a large scale industry commitment to baseline software measurements.

The NCC's very first speaker, Sen. Fritz Hollings (D., S. Car.) was supposed to talk about energy but didn't. Instead he talked in broad terms about the future of the computer industry and government's "desire not to overregulate." Perhaps he was thinking what conference chairman Stephen Miller put into words at the end of his talk: "Of the elected officials from

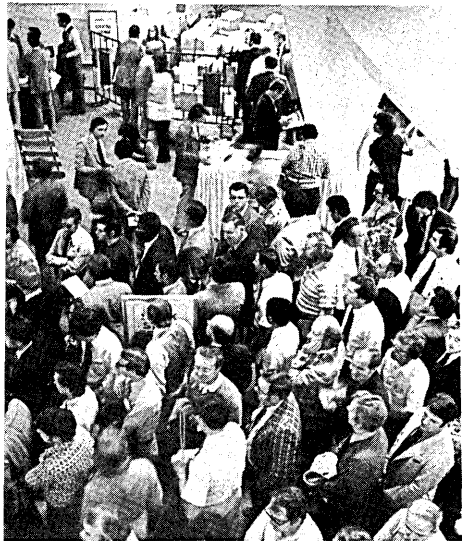

government who have addressed the NCC in the last four years, two (Gerald Ford and Jimmy Carter) have gone on to become President."

Sen. Hollings talked about the U.S.-Japan Trade Facilitation Committee and said he is "cautiously optimistic" about its progress.

### CCIA meeting

This committee also was discussed during a meeting of the Computer and Communications Industry Assn. held during the NCC. Paul O'Day, Bureau of Domestic Business, Dept. of Commerce, explained that the committee is one to which companies can bring their Japan trade problems for the committee to try to solve.

Japan is well aware of U.S. traders' problems, said O'Day, and they have a "commitment to be responsive." He said there still are some top Japanese government officials who seem doubtful that trade barriers against the U.S. exist. This is where the newly formed committee can be of help, he maintained. But it can only help if companies report their trading complaints to the committee which can work with the Japanese on resolving them.

TALLY CORP. printers drew quiet attention from interested customers, while *Datamation* booth at entrance to main hall drew mobs to talk with Klatu the robot. Perkin-Elmer photographed NCC attendees sitting in Rolls-Royce and sent them to another company booth to have photos affixed to plastic coffee mugs.

The 1978 NCC was replete with the usual complement of giveaways and gimmicks: a wide variety of buttons and fuzzies to attach to badges, magicians, card whizzes, at least three robots, and computer-generated portraits among them. New this year was Perkin-Elmer's Rolls Royce. Attendees could have their pictures taken in the Rolls in Perkin-Elmer's North Hall booth. Then they could take their photos to a P-E booth in the Arena to have them affixed to plastic coffee mugs. Lines were long at both booths right up to show-closing time.

Also new this year was "Today at the NCC," a closed-circuit tv offering recorded earlier in Phoenix by Universal Dimensions Co. Hosted by Joey Bishop, it featured interviews with session chairmen and AFIPS officers and paid-for plugs by exhibitors. It was shown daily in the convention center and all major conference hotels.

Among the interesting products shown was Documation's 3,000-lpm bank printer based on the "razor blade" theory (when the band gets dull, throw it away and buy a new one). Printers and printer terminals were abundant: GE's Terminus 200, Logabox's new 200cps model, Siliconics' tiny ink-spitter, and Siemens' laser printer, among others. Not as evident as in past shows were plain old vanilla vari-

### Japan has made a "commitment to be responsive."

ety minicomputers—they've all become small business or word processing systems, or both.

An NCC first timer, CII-Honeywell Bull, partly owned (47%) by Honeywell Information Systems, used the show as an impetus for its entry into a new phase of oem marketing in the U.S. with a line of peripheral products developed by its Balfort, France, plant.

Another foreign firm at the show was

the U.K.'s CAP-CPP, excited about the prospects for its software developments for the microcomputer market. At the Mostek booth, it demonstrated its new MicroCobol, an operating system, and business applications for the Mostek AID-80F system.

### Visitors from abroad

Large contingents from around the world indeed were the rule at NCC '78. Visitors from Japan and Australia often were seen huddling together, discussing the IFIP meeting in 1980 which will be split between the two countries. More than 60 visitors arrived en masse from Denmark (one stayed long enough to see the crowds and interminable registration lines and took off for Hawaii).

And what of next year? The seventh National Computer Conference in New York next June 4-7 worries the organizers for two reasons: Will this year's completely unexpected turnout be repeated? If it is, what do we do?

A spokesman for the Industry Advisory Panel, made up primarily of persons representing exhibitors, suggested that the problem of huge crowds in New York's Coliseum would be monumental. AFIPS probably would have to mail advanced registration cards to attendees, so that they simply could pin them on and walk in, or set up several registration areas throughout New York. (The New York NCC is held at the Coliseum and at the nearby Hilton and Americana hotels. The Personal Computer Festival is to be held at the Americana.)

(Continued on p. 168)

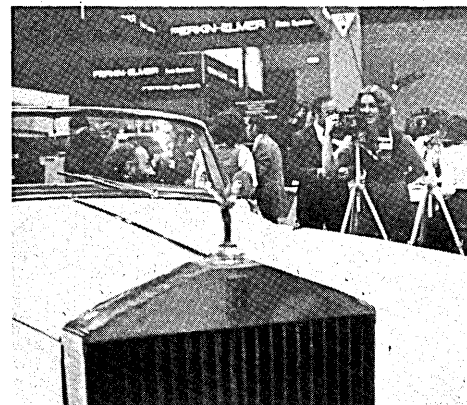

## Reminiscing About SWAC

"We wonder if something like this could ever happen again," Derrick Lehmer reflected at a Pioneer Day session during the National Computer Conference. Lehmer and his audience knew that something very special had occurred some 30 years ago on the UCLA campus, site of the National Bureau of Standards' Institute for Numerical Analysis.

Circumstances had brought together a versatile and highly trained team to produce what was to be the first parallel stored-program computer to become operational. It also was to be the fastest in existence at that time.

The time was August 1950. Harry S Truman was President and the Korean

**It was the first parallel stored program computer to become operational, and the fastest in existence at the time.**

War had begun only two months before. Commercial airlines hadn't brought jet planes into service and the Chevrolet Div. of General Motors was a few years away from offering its first V-8 engine.

The computer the group designed was the NBS' Western Automatic Computer (SWAC).

It was a major development in the history of computing. It was designed at a time when "computers" primarily were calculators with "programs" determined by switch settings. It was produced in a period before there was a computer "industry," when computers—or calculators—were built one at a time, usually at the place where they were to be used, and when only one of a kind ever was produced.

The designers hadn't even settled on the kinds of components to use. They were limited to vacuum tubes for implementing logic and were uncertain as to what to do for computer memory. For example, Engineering Research Associates had proposed a drum for main memory in what was to be its ERA 1101 computer, grandfather of today's Univac 1100 series. Raytheon was proposing the use of a tank filled with mercury for computer memory.

### The Williams Tube

SWAC's designers chose instead to use a form of memory developed in Britain, called the "Williams Tube," after its inventor, F. C. Williams.

The Williams Tube was a crt with a wire mesh over its face to help define its

bit positions. Each tube stored 16x16 bits and there were 36 tubes, providing a total memory capacity of 256 36-bit (plus sign) words. That wasn't very much.

"When I hear people talking about kilobits or kilobytes, I smile," said Michael Melkanoff, of UCLA, one of the speakers. When a 4,000 word drum

### Applause for Huskey

Huskey had been responsible for the machine's design and construction, and one purpose of the Pioneer Day was to honor him. Melkanoff's description of him as a man of "humanity, humility, and humor" was followed by a round of applause from those who had worked with Huskey. Other panelists on the

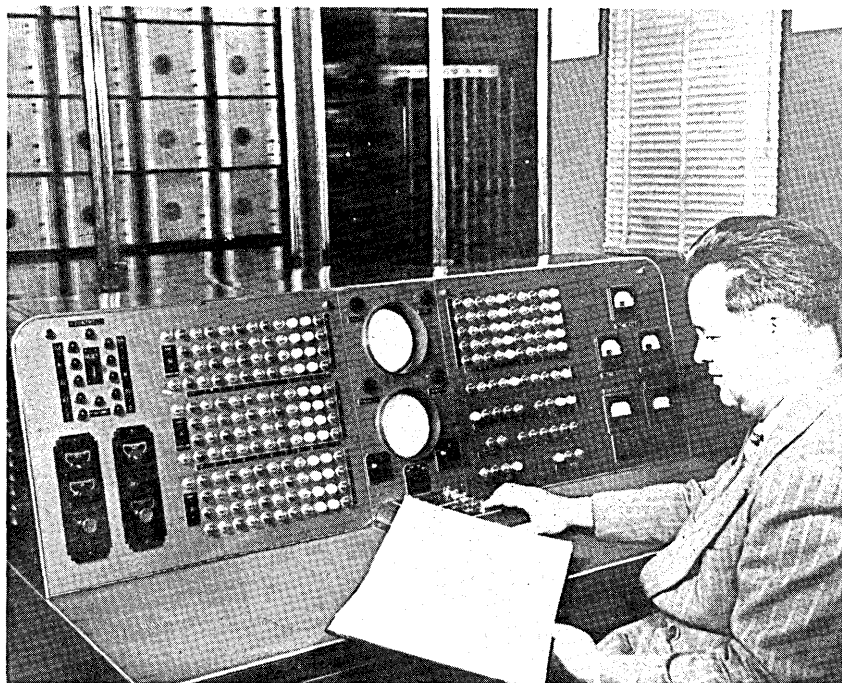

DR. HARRY HUSKEY with SWAC in photo taken in early '50s.

later was added to SWAC, he said, "it was manna from heaven."

And not every such advance was immediately appreciated, Melkanoff added. "Harry Huskey was testing a kind of FORTRAN in 1952," he said, "and I thought 'why?' when we already have a language—13 instructions. What more could you ask?" Huskey who now is with the Univ. of California in Santa Cruz was director of the NBS' Institute for Numerical Analysis at the time of the SWAC development and was chairman of the Pioneer Day session.

SWAC was a useful and much used machine and stood at the door to a new era in computing. Lehmer, of UC Berkeley, put the machine into perspective in talking about how it was used to determine Mersenne numbers (of the form  $2^p - 1$ , where  $p$  is a prime). "I'd done ( $p =$ ) 257 by hand. It took me one year and was the largest one ever done by hand. SWAC did it in 25 seconds."

program were Harry Larson, of Hughes Aircraft, Fullerton, Calif., and Ragner Thorensen, of Magnavox Research Laboratories, Torrance, Calif.

Lehmer, the last speaker, spoke of the special award Huskey had been given. Very much in keeping with the event, the award was one of the now dismantled SWAC's Williams Tubes.

In his concluding remarks Lehmer asked, and answered, whether something like SWAC could ever happen again. "Possibly it is happening again," he suggested, "right now, with some of these younger people, and we don't even know it."

Someday, another 30 years from now, those attending the NCC will go to later Pioneer Day sessions of some kind to recognize 1978's accomplishments. It's very clear, however, that 1978's audience was especially fortunate. They got to hear a part of how it all started, first-hand.

—R.A.M.



### Unknown alternative

"When you consider a person attending the NCC in Anaheim for one day," the spokesman said, "you must consider the alternatives he never knew he had. He gets down there early and finds the parking lot already full. He wastes a half hour looking for a parking alternative. Then he waits in line for several hours for a badge. He could have gone to the Disneyland Hotel where parking was plentiful, registered there for the Personal Computing Festival which also meant entry to NCC exhibits, and taken a shuttle bus to the convention center—all in half an hour. But almost nobody was told of this alternative."

A Hewlett-Packard public relations representative, who waited in line on Monday for four hours to register, said, "at times I thought I'd go out of my mind."

Next year's program chairman, Dr. Richard Merwin (not to be confused with general conference chairman Merlin Smith), said the technical program will be aimed at interests peculiar to New York as a financial center. He said AFIPS will organize a number of sessions on



ANOTHER VIEW of the NCC exhibit area was through the first three glass letters of Verbatim, trade name for magnetic media supplies sold by Information Terminals Corp., of Sunnyvale.



NEXT YEAR'S NCC returns to New York June 4-7 where it all began in the summer of 1973. Sponsoring AFIPS began handing out literature on next year's show from this booth, depicting the city's skyline.

financial transaction trends with the American Bankers Assn. There also will be sessions on medical services and legal issues and possibly on vehicular technology.

Meantime, 41 exhibitors at this year's NCC found themselves with no space in the New York show, due to a new point system on which booth allocation was based. This problem probably will be resolved as exhibitors with seniority and with larger exhibit spaces reduce the amount of space they buy (2,400 sq. ft. will be the maximum allowed in the '79 show). Nevertheless the 1979 NCC was a sellout before the 1978 event had ended.

But, it's a certainty that few attendees in New York will be driving, so if a SigAlert condition develops around the Coliseum, it won't be the NCC's fault.

*(This article was written by Edith Myers, with reports from Tom McCusker, Richard McLaughlin, Bill Musgrave, Sarah Rolph, Angeline Pantages, and Linda Flato.)*

WHILE IBM talked of its Series/1 minicomputer, Control Data introduced its Certainty series of peripherals for the Series/1. Four-Phase systems continued the distributed processing theme that ran through last year's NCC at Dallas.

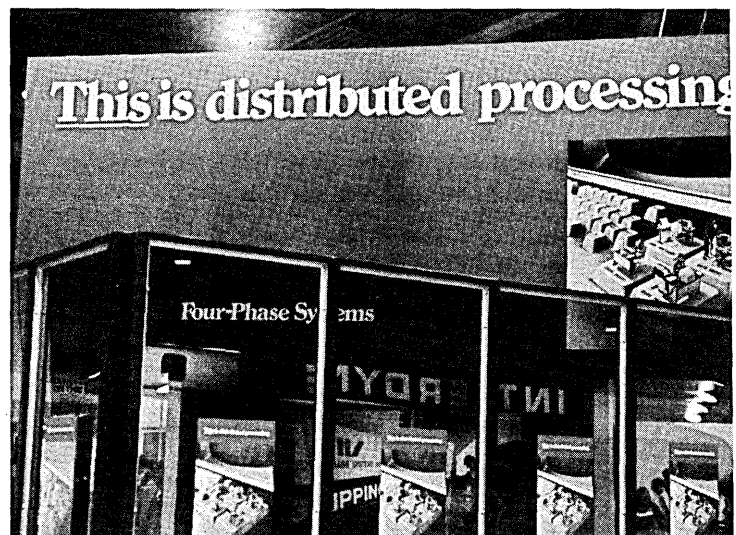

## Oil Industry

# Exxon: Another Computer Giant?

World's largest industrial company has firm foothold in office systems and communications systems fields

"Did you hear the latest rumor about Exxon?" an executive with one of the mainframe companies asked during the long bus ride from the L.A. airport to the National Computer Conference in Anaheim last month. "They're going to buy Honeywell."

Exxon acquire Honeywell? Earlier this year Exxon purportedly was ready to buy Burroughs, and prior to that the oil giant supposedly had Xerox on its shopping list.

If nothing else, these rumors—and to date they've proven to be nothing more than just that—point up the fact that many computer-related vendors are apprehensive that the Exxon tiger and some

**"The bankroll is so big, the company can afford to do anything it wants."**

of his playmates from the oil industry are eyeing their turf.

Indeed, in an attempt to diversify, Exxon already has established a firm foothold in the office systems and communications systems fields, and other oil concerns—Sun, Standard Oil (Indiana) and Gulf—now have, or are aggressively establishing, enterprises ranging from computer services to computer-based text editing systems. Moreover, some industry analysts speculate that several other major oil concerns may be preparing to join the pack.

No presence looms more conspicuously, however, than that of Exxon, if only because of the big bucks the world's largest industrial corporation can lay out. "The bankroll is so big the company can afford to do anything it wants," notes Quantum Science Corp. analyst Daniel P. Lavery.

### Investment reaches \$80 million

Through its wholly owned subsidiary, Exxon Enterprises, Inc., which is headquartered in New York, Exxon has already pumped close to \$80 million into information processing type ventures, it's estimated. The firm's chairman, Clifton C. Garvin, has earmarked \$1 billion for

non-oil related capital spending through 1980. If only a third or so of that sum is slotted for computer-related ventures, the impact on the dp industry could be enormous, industry analysts say.

Already Exxon's computer-related holdings—an entity the company terms its Information Systems Group—are so extensive that Exxon Enterprises senior v.p. H. B. Sykes keeps a crib sheet at his desk to keep track of them all. Among them are:

—Zilog, a Cupertino, Calif., based microcomputer company that's currently generating about \$20 million in annual revenues.

—Vydec Inc., the Florham, N.J., manufacturer of computer-based text editing systems with projected revenues of about \$45 million in 1978.

—Qwip, Exxon Enterprises' facsimile division which generates about \$20 million annually and claims to be renting out fax equipment at a faster rate than any company in the field.

—Peripherals, which manufactures front-end processors and computer voice response systems and falls in the \$10 to \$20 million revenue range.

Additionally, Exxon, of course, recently introduced Qyx, the microprocessor-driven electronic typewriter, potentially its biggest money-maker. It also controls a number of smaller projects, such as Dialog, a computerized voice response system, and Ramtek, a computer graphics terminal, while holding minority equity in such computer-related companies as Qume, the printer concern, and Delphi, which makes communications systems.

Collectively, the Information Systems Group currently generates about \$100 million in revenues. That's small change to a giant like Exxon, but in the context of the dp industry the group is already larger than all but about two dozen companies. And if Exxon's projected growth rate is on target—Sykes says he's counting on 50% a year, at least until the group hits the \$500 million mark—Exxon could soon emerge as one of the real industry heavyweights.



H. B. SYKES  
A crib sheet to keep track of computer-related holdings

### Antitrust consideration

But Exxon's impact can't really be measured in terms of dollars. Already the firm's presence has many dp vendors looking nervously over their shoulders, as witnessed by the proliferation of Exxon rumors. Exxon dismisses these as they come along, asserting that even if it were willing and able to make a major acquisition in the computer field, antitrust considerations preclude such a purchase.

Others are not so sure. "The acquisition of a company or one of its divisions would certainly represent a legitimate diversification for Exxon as long as the entity they purchased only held a minority share of the market it was in," says Lavery of Quantum. "They might just go ahead and make an acquisition and take their chances with the Justice Department."

Perhaps nothing exemplifies the current vendor apprehension about Exxon's

# The Data 100

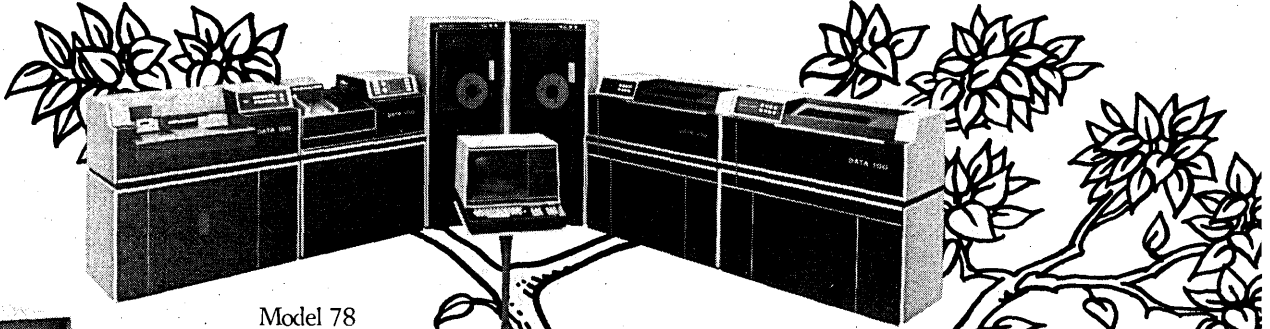

Model 78  
remote processing system.

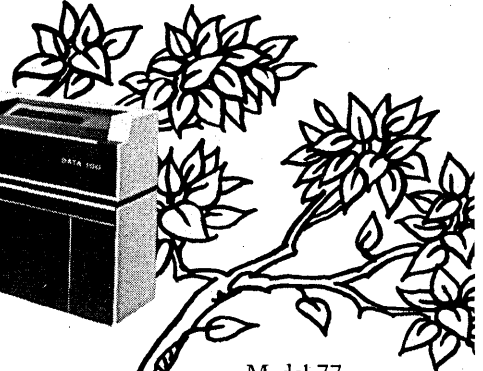

Model 77  
communications system.

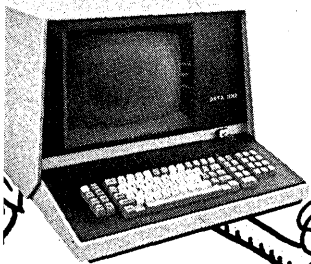

Model 82  
remote display system.

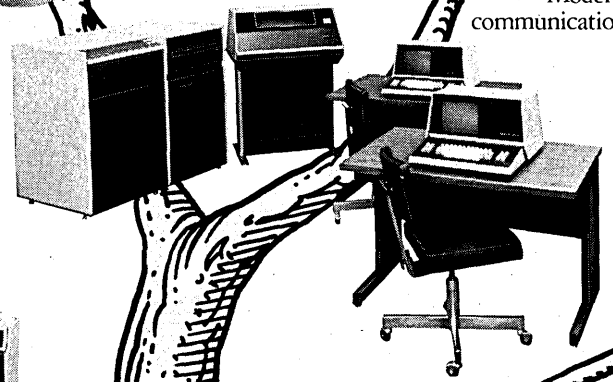

Model 76  
remote batch terminal.

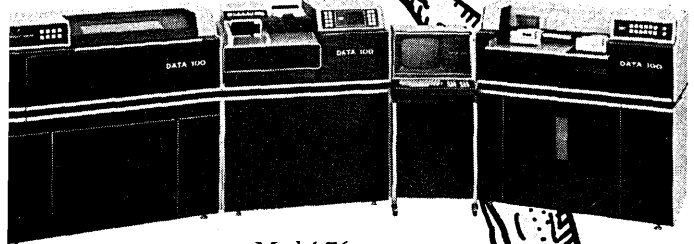

Model 85  
remote information system.

**multifunction data processing**



# family tree.

Our family tree is rooted in a sound concept.

Multifunction data processing.

Data 100 products perform multiple functions operating in networks, using a variety of communication disciplines over a wide range of user applications.

Whether your requirements call for remote job entry, data entry, remote or local file management, stand-alone processing, or any combination of these, you're looking at a family of products that can answer your needs.

Our Model 76 provides the best in RJE emulators and peripherals.

Model 77 data entry concurrent with communications can be disk or diskette based.

Keybatch systems feature key-to-disk data entry on 20 MB disk storage, plus networked entry stations and printers.

Model 82 emulates IBM 3270 on-line file management functions.

Model 78 combines all of the above functions and adds stand-alone processing with disk or tape RPG.

And, at the trunk of our multi-function system is Model 85 Remote Information System. It offers a multitasking operating system, file management using up to 100 MB stand-alone processing, using COBOL and RPG, and total connectivity with other Data 100 products.

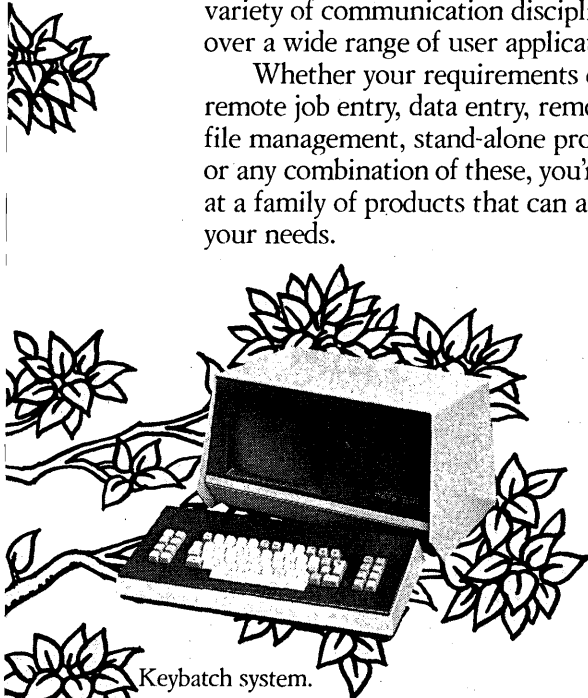

Keybatch system.

**DATA 100**  
**CORPORATION**  
multifunction data processing

# We keep growing to cover your growing needs.

LOS ANGELES 213/645-4300 • SAN FRANCISCO 415/546-6000 • CHICAGO 312/992-0850 • BOSTON 617/848-6100 • DETROIT 313/358-5065 •  
MINNEAPOLIS 612/941-6500 • NEW YORK 212/867-6200 • PITTSBURGH 412/391-5425 • HOUSTON 713/784-4130 • WASHINGTON D.C. 703/790-5560 •  
WOODBRIIDGE N.J. 201/634-7800 • ATLANTA 404/455-3895 • ST. LOUIS 314/878-4911 • TORONTO 416/494-0434 • MONTREAL 514/761-5894 •  
LONDON ENGLAND (05827) 63161 • MELBOURNE AUSTRALIA (03) 267-3544 • FRANKFURT GERMANY 72-04-71 • PARIS FRANCE 630-2144

CIRCLE 37 ON READER CARD

emergence as a competitor more than IBM's reaction to the Qyx announcement, however. Within a few months after the announcement, IBM, which usually views its competition with the coolness of a

riverboat gambler holding a full house, acted with uncharacteristic haste, introducing two of its own electronic typewriters. Normally, the computer giant would have held off making such an announce-

## The Sun Also Rises

Exxon isn't the only big oil company out to make a splash in the computer-related marketplace. Sun Information Services, a subsidiary of Sunco (formerly Sun Oil) has been quietly diversifying into this new market for some time now.

Basically the Sun approach is twofold. The company is going after the small and medium size office processing market, the three- to ten-man professional office, and has just introduced its first product at a recent Florida Bar Assn. meeting.

Called Sun Law and aimed at lawyers, the Sun System combines word processing and data processing functions and includes mass storage of text, editing, and information retrieval capabilities.

Sun hints it has a number of similar products in the works that could be utilized in doctors' offices, advertising agencies, or the like.

Concurrently, Sun Information Services, which handles data processing for its multibillion dollar parent company, is beefing up outside service offerings, particularly in the banking and financial areas. Toward this end it re-

cently acquired Applied Financial Systems, a San Mateo, Calif., firm that services banks and supplies corporate shareholder recordkeeping.

Sun also just bought the Weiland Computer Group in Chicago. Weiland, which generates something under \$10 million annually, also services the retail banking industry and provides facilities management as well.

The idea behind these acquisitions—and Sun actively is seeking to buy similar concerns in the under-\$50 million range—is to provide “one stop financial and banking service,” a Sun executive explains.

Sun also offers a combination of enhanced time-sharing services and third-party data bases on its service network which is tied into three IBM 370/168s for business processing and a CDC Cyber 172 machine for scientific and engineering applications.

That network also features SUNGARD, which Sun describes as a major effort to provide disaster backup to users around the country. The company already has signed up a number of subscribers, including Scott Paper Co., to this service, Sun said. \*



SUN recently signed to contract for Scott Paper Co.'s use of SUNGARD, a disaster backup and recovery capability for large-scale computer users. John M. Ryan, president of Sun Information Services Co. (left), and Scott's Donald A. Mackie, vice president for financial services, discuss the agreement.

ment, waiting to see if Qyx was going to be successful before committing itself, analysts like Lavery assert.

IBM's response seems all the more excessive since Exxon, initially at least, is limiting its sales to the Northeast, establishing sales and service forces in New York, Washington, and Philadelphia before making any efforts to expand its production and marketing capability. IBM's Office Products Division in turn is selling new machines nationally and begins quantity deliveries in September.

Over the long haul, the real question underlying Exxon's success in these new, computer-related markets, analysts believe, has to do with the company's ability to tie the whole Information Systems Group package together. Here the linchpin seems to be microprocessor technology. And significantly, the Z80 microprocessor manufactured by Zilog serves as the central control for the Qyx typewriter system. It is also key to a major

---

**Its Information Systems Group currently generates about \$100 million in revenues.**

---

project Vydek reportedly has been working on in secret for the past two years, at what Sykes terms substantial cost.

The project, sources close to the company say, involves the development of a new Vydec terminal that would be fully programmable and based on Z80 technology. The terminals would feed into a master controller with large, hard disc capability. The controller could receive created text and interact with large-scale IBM systems—in effect, serving as the nucleus of an electronic mail system that might ultimately tie together a number of Information Group products.

And despite its much voiced hands-off policy toward affiliate companies, Exxon seems to be moving its affiliates into the corporate fold as well. The company just contracted with Martin Marietta Data Systems and Hewlett-Packard to provide MIS systems (MMDS will provide the inventory control, order entry and financial control software and H-P its 3000 minicomputers) that will go into Vydec, Qwip, Zilog, and Qyx.

“Each (division) needs an MIS system,” Sykes explains. “And if we are to manage them financially, it helps to have a standardized reporting system.”

### Venture in optics

And while each of the group companies now has its own sales and service force, Sykes admits that at some point the same sales person, particularly outside major metropolitan areas, may be selling Vydec systems, Qyx typewriters, Qwip fax machines—in short, the Exxon Enterprises line. That line ultimately may include additional products. One of its

most interesting and least publicized ventures—Sykes won't even discuss it—is based in Elmsford, N.Y., and called Optical Information Systems.

A source who follows Exxon claims that the company is pouring funds into this group and, in its heavy recruitment advertising of late, Optical defines itself as, "a new and explosively growing divi-

## Optical Information Systems is one of its most interesting and least publicized ventures.

sion of Exxon Enterprises, Inc., committed to developing electro-optical components and systems which will revolutionize modern information processing. We're looking for uniquely talented peo-

### Legislation

# New Communications Act

The key words are "equitable and lawful"

The FCC would be abolished, AT&T and other telephone carriers could offer on-line dp services, and government control over communications rates and services would be slashed.

These are three highlights of the "Communications Act of 1978," unveiled last month by Rep. Lionel H. Van Deerlin (D., Calif.), chairman of the House Communications Subcommittee. The bill, preceded by nearly two years of discussion, is meant to replace the present Communications Act, which, since 1934, has largely determined what telecommunication services, international as well as domestic, can be offered by whom, at what prices. Under the new bill, these questions would be resolved primarily by market competition rather than by the government.

Hearings on the bill (HR13015) are scheduled to begin this month. Van Deerlin said he hopes for final enactment "in 1979 or 1980." However, it could take longer because there is certain to be a good deal of argument about certain provisions.

Within a few days after the unveiling, objections were voiced by several affected parties. AT&T, for example, objected to a requirement that the company divest itself of Western Electric three years after enactment of HR13015. There were also numerous objections from broadcasters (the bill covers radio and television, as well as common carrier services).

### Main provisions

Here are the main provisions of HR13015 affecting data communications services:

ple to help us exploit an unequalled leading-edge technology . . ."

That technology reportedly is holographic storage, which potentially represents a quantum improvement over microfiche in terms of the amount of data that can be stored on a minute surface. It's a technology that a number of companies has experimented with, but Exxon, with its enormous resources, might just be able to bring it out of the experimental stage. If so, the prospect of integrating holographic storage with word processing and fax systems could, in the words of one of Enterprises' competitors, "be dynamite . . . another Xerox situation."

Given that kind of potential gold mine in house, Exxon needn't go the acquisition route to gain the big piece of the computer-related business it's seeking.

—Laton McCartney

1. The 1956 consent decree barring AT&T from offering nontariffed communication services would be erased by a provision allowing "any common carrier" to engage—through a separate, arms-length subsidiary—"in any activity" which the government determines to be "telecommunications or . . . incidental to telecommunications." This determination is one of the responsibilities assigned to a new "Communications Regulatory Commission" (CRC), which would replace the present FCC.

2. All carriers—specialized and value-added as well as telephone carriers—using local exchange facilities would have to pay an "access charge" into a new "universal service compensation fund" administered by the CRC. Local telephone companies would be reimbursed from the fund for the expenses they incur in supporting interstate services. This scheme would replace the reimbursement now provided by the interstate telephone carriers through the "separations and settlements" process.

3. New domestic telecommunications services, along with the related circuit and other facilities, could be installed and activated immediately after the carrier notified the CRC, and rates for such services would become effective 45 days after they were filed. Now, by comparison, the carrier must submit a "214 application" to the FCC and obtain the commission's prior approval to begin service. Frequently, this takes months or years of haggling and mountains of paperwork. The FCC considers rates separately, which involves additional delay and litigation.

Under the new bill, the CRC could question whether a new rate was "equitable and lawful," but it would have to reach a decision within 10½ months after the tariff was filed. During this period, the carrier could offer, and charge for, the service. If the commission didn't act within 10½ months, the rate would be "presumed . . . equitable and lawful." If, within the time limit, CRC decided the filed rate was too high, the carrier would have to refund, with interest, the amount of the overcharge to affected subscribers. In case the original tariff was found to be too low, increased rates would have to be filed 90 days later.

### Won't lose WE

4. Although AT&T appears to be most concerned about the prospect of losing Western Electric, this probably wouldn't happen if HR13015 were enacted in its present form, for the relevant provision of the bill bars a carrier from equipment manufacturing only in those cases where it is supplying "noncompetitive" telecommunications service. The only major noncompetitive service is the one provided by the dial-up telephone network. But in view of MCI's recent victory in the Execunet case, this offering probably will be considered a competitive service.

A staff member of the House Communications Subcommittee agreed with this thinking. Nor would GT&E necessarily have to get rid of its Automatic Electric Company subsidiary. The ultimate decision, he added, would be made in any case by the CRC. Under the bill, it is responsible for determining which telecommunications services are "noncompetitive" and it also has the authority to waive any requirements imposed by the "common carrier" section of the bill (Title III).

5. Section 312 of HR13015 provides that "any common carrier shall establish connection . . . with any other carrier" on the basis of "equitable . . . terms and conditions," while Section 331 orders the CRC to "prevent practices which would allow any carrier to limit or exclude competition in the provision of telecommunications services." This language appears aimed at making illegal a number of practices engaged in by AT&T in its battle with the specialized carriers—for example, the denial of local loops, refusal to interconnect AT&T circuits with specialized carrier circuits at a customer's premises, and off-net extensions. The only reference to telephone industry complaints that such interconnections will harm the network is a provision in HR13015 allowing a carrier to refuse interconnection when "substantial" harm would result. But this determination would be made by the CRC, not the carrier.

6. State control over common carrier-provided circuits and facilities is made largely, if not completely, subservient to

# **INTRODUCING THE BTI 8000 32-BIT NO OTHER COMPUTER CAN GIVE YOU SO**

The BTI 8000 uses new hardware and software technology to offer mainframe level performance at an order of magnitude lower cost.

The BTI 8000 can concurrently support hundreds of interactive users and batch tasks.

The BTI 8000 provides multiple languages... PASCAL, FORTRAN, BASIC, RPG II and COBOL, and includes a CODASYL compliant Data Base Management System.

The BTI 8000 is enormously expandable: 1 to 8 CPUs; 256,000 to more than 100 million bytes of core;

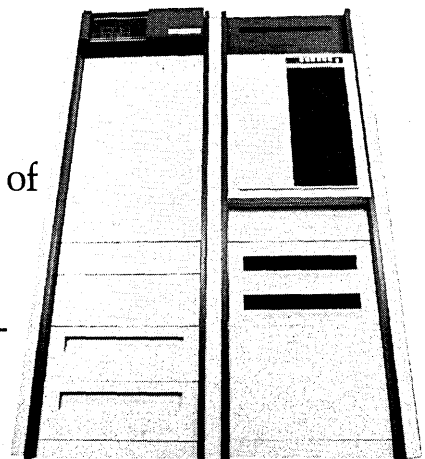

BTI, 870 W. Maude Ave., Sunnyvale, CA 94086. Sales Offices: Cherry Hill, NJ (609) 662-1122; Minneapolis, MN (612) 854-1122,

# **MULTIPROCESSOR SYSTEM. MUCH CAPABILITY FOR SO LITTLE COST.**

1 to 8 parallel paths to memory; 4 to 32 I/O channels; 8 to 512 interactive ports; 1 to 128 spindles of disk storage, with 33 to 252 megabytes per spindle.

The BTI 8000 is a range of capabilities never before offered on a single computer system at anything like this cost. Prices start at \$86,850 for a ready-to-go system; just add terminals.

The BTI 8000 is an entirely new system. It's the result of four years of intensive development. And it's backed by proven experience with the BTI 4000, operating successfully at over 600 installations in the United States, Canada and Europe.

For more information, just contact the BTI office nearest you, today.

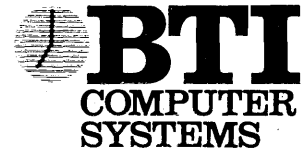

Chicago, IL (312) 298-1177; Dallas, TX (214) 630-2431; Sunnyvale, CA (408) 733-1122, Anaheim, CA (714) 533-7161.

# news in perspective

federal authority, under a provision in Title I of the bill which excludes from federal jurisdiction only those intrastate facilities which do not use the electromagnetic frequency spectrum and do not qualify for compensation from the "access charge" (universal service compensation) fund.

7. Under Section 319, "any common carrier" who violates the new legislation would be liable for the "full amount of damages sustained" by injured parties "and for reasonable attorney's fees." The award could be made by either the CRC or a court. (Present law, by comparison, excludes attorneys' fees and allows more leeway in determining the amount of damages.)

## International changes

8. International telecommunications would be altered in several key respects:

Comsat would be allowed to service end-users directly, instead of through intervening carriers; international record carriers (IRC's) would be allowed to terminate their services anywhere in the United States (now, they're limited to five "gateway cities"); Western Union could offer international services beginning five years after enactment of the bill. Also, the procedure for authorizing new international telecommunication services would be simplified, and a joint industry-government task force would be set up to develop plans for international telecommunications facilities.

A policy statement included in this part of the bill says the flow of information transmitted across national boundaries should not be restricted by any nation, except to the extent necessary to protect its national security and the personal privacy of its citizens.

Also, the CRC is specifically barred from "compositing or averaging . . . rates, charges, or costs for different technologies" in deciding whether international tariffs are equitable. This latter provision would establish a basis for comparing the economics of satellite and cable transmission; it could lead, relatively quickly, to cheaper international services.

Comsat has developed a digital data-com service called "Digisat" which, if offered solely by satellite, could be priced way below existing AVD (alternate voice-data) rates. The IRC's, however, want to offer a "composite" cable/satellite version of Digisat that would be much more expensive.

## A new agency

9. Title VII of HR13015 establishes a "National Telecommunications Agency" and gives it "primary responsibility" for developing U. S. telecommunications

policy—domestic as well as foreign. NTA would replace the National Telecommunications and Information Administration (NTIA), recently established within the Department of Commerce (May '78, p. 264). But the new agency would be higher on the executive branch organization chart, and presumably would have substantially more clout. (Ironically, the Office of Telecommunications Policy, the organization replaced by NTIA, also was an independent executive branch agency).

## Industry reaction

Initial dp industry reaction to the new bill was enthusiastic. There appears to be general agreement that the emphasis on marketplace competition would give computer-based terminal and services vendors added leverage in their struggle against AT&T. However, a spokesman for the Computer and Communications Industry Association indicated that "unleashing" AT&T to offer communications-related services through a separate subsidiary could create problems.

His point was that a legal separation might not keep the subsidiary from borrowing money directly from the parent or a third party on especially favorable terms, or prevent the subsidiary from attracting customers on the basis of pub-

lic awareness that the parent was a major common carrier.

The spokesman added that the subsidiary and parent would probably buy from each other, rather than from competitors, which could put the latter at a significant disadvantage. Also, "the Bell system would enter competitive markets with a substantial advantage over its rivals based on the dominant position it has gained by operating for years under a government-sanctioned monopoly. The bill should not allow Bell to enjoy this advantage. One option would be to maintain the status quo and prohibit AT&T from entering the dp services business."

A spokesperson for the Computer and Business Equipment Manufacturers Association thought it might be difficult to carry out Section 101 of the bill, which says "regulation of interstate and foreign telecommunications is necessary to the extent that marketplace forces are deficient." The problem, explained this source, is that the bill provides no criteria for determining when marketplace forces are deficient, and as a result could lead to regulation where none was actually needed.

This thought was carried further by another source, who said a finding that marketplace forces were deficient could result in federal regulation of activities which are presently unregulated—for example, on-line dp services.

—Phil Hirsch

## Communications

# Promised Land of Data

Teletype leads AT&T thrust with 4500 line of data systems

If AT&T's new drive into data resembles a submerged iceberg so far, then the most visible tip of the iceberg is represented by the Teletype Corp. Moreover, it is becoming increasingly evident that Teletype will help lead the telephone behemoth into the Promised Land of Data, into a market area the firm likes to call communications processing.

The new drive was underscored in recent weeks by the introduction of Teletype's new 4500 data systems family and by a marketing reorganization within Teletype.

"This announcement of the 4500 System," says J. Roger Moody, Teletype's executive vice president, "will clearly signal commitment on the part of the Teletype Corp. to provide a wide range of system solutions to meet user needs in today's sophisticated computer-based communication systems. I think it's the first time we have ever used the word 'system' at Teletype.

"The 4500 System is evidence of a

change from Teletype Corp.'s traditional product orientation to a user-application orientation."

The first model in the new line—and Moody indicated there will be more models coming in the future—is a keyboard display-based interactive terminal system that is capable of accommodating 32 terminals. A typical configuration of six keyboard display work stations and controller would cost about \$17,000.

## Compatible with IBM 3270

Another hint of what Teletype may have in mind for the future is the fact that the 4540 is compatible with IBM's 3270 data terminal line and that means that users with 3270 gear will be able to replace it easily with the 4540. Moreover, Moody maintains that an equivalent 3270 configuration would cost more than \$23,000.

And, as if all that isn't aggressive enough, Moody indicated that Teletype is "looking at ways" to give quantity

discounts on its gear—a marketing wrinkle the AT&T subsidiary has not utilized to date.

As for the new marketing reorganization, Teletype is planning to aim its marketing efforts more directly at end users—a departure from the firm's traditional emphasis on oem's and resellers—by establishing teams in various industry markets like, say, in the manufacturing and insurance fields.

#### Systems teams

"We are establishing systems-oriented teams," says Moody, who is the chief marketing officer at Teletype. "They will fly anywhere they're needed and support large national accounts. And we're making sure that we'll work closely with AT&T's Operating Companies here. We know that we must complement the Operating Companies."

In the new team marketing approach, Moody said the teams will consist of three basic kinds of specialists—account executives who will function as salesmen, market administrators who will provide office support, and communications systems representatives whose duties will be similar to traditional computer systems analysts.

The new marketing approach is expected to spur sales outside the Bell System. Last year, for instance, Teletype sold about 70% of its products to Bell System units. Moody expects that per-



J. Roger Moody

Even quantity discounts will be offered

centage to drop to 60% this year and to continue dropping in future years.

Teletype, which has some \$300 million in annual revenues, will "nearly double" its marketing budget this year and boost its research and development budget by one-third, Moody said. Teletype currently has more than 350 communications processing specialists working in more than 50 centers and Moody says those numbers will jump to 600 specialists in 90 centers in 1981.

#### Software surge

Moody also indicated that Teletype

will be making a bigger software push with the 4500 System and although Teletype specialists probably won't be writing user code, Teletype will offer versatile software tools for users. Moody said a hierarchy of languages is scheduled to be unveiled this fall. He said the languages would include an easy-to-use office-oriented high-level language, a parameter-setting language for formatting and editing, and a lower-level language which customers can use to manipulate bits themselves.

"These will be communications processing types of languages," said Moody. "And we call what we do communications processing because we don't manipulate the data."

In addition, there have been reports that Teletype is readying an operating system for use with the 4500 System family—possibly an OS based on the UNIX operating system which AT&T developed for use with Digital Equipment Corp. PDP-11 computers.

Teletype's largest customer, of course, is AT&T and Moody indicated that the Bell System's Operating Companies and its Long Lines Division are planning to offer the 4500 System to their customers. While Long Lines and the Operating Companies generally lease Teletype gear to users under the AT&T logo, Teletype itself only sells its gear.

—W. David Gardner

**Q1 CORPORATION**  
the first company to  
develop, manufacture and market  
microcomputer systems has now introduced  
the Q1 / Lite, the ultimate office machine  
Q1 Corporation • Hauppauge, New York 11787  
Telephone: (516) 543-7800  
Telex: (510) 226-3730



CIRCLE 141 ON READER CARD

# NOBODY CAN MANY WAYS AS

At Dataproducts, we not only build the world's finest printers, we also build the broadest line of printers in the business.

So if your job requires Dataproducts quality (and we've never seen a job that didn't) you can bet there's a printer in our line-up that'll fit right in.

Just scan the page and you'll see: We make serial printers. And we make line printers. Thermal printers. And matrix printers.

We make drum printers. And we make band printers. We make quiet, inexpensive machines that work at 80 CPS. High-speed workhorses of 1500 LPM. And a whole range of speeds in between.

We have printers for every purpose. Civilian or military. Small business systems. Message terminals. Machine-readable applications. And high-volume EDP.

Altogether a varied and versatile lot.

But for all their diversity, Dataproducts printers share one trait in common:

Reliability. The same stubborn, steadfast, tenacious, dependable quality that has made our printers the standard of the industry.

And we back up that built-in dependability with a system of in-depth support for our



T-80 THERMAL  
PRINTER—80 CPS

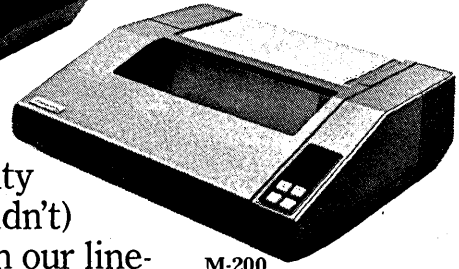

M-200  
MATRIX PRINTER  
200 LPM

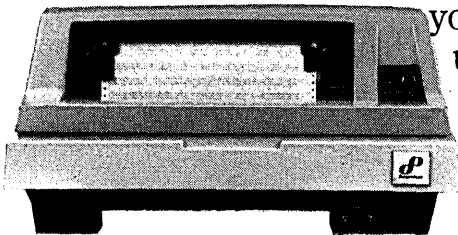

B-300 BAND PRINTER  
300 LPM

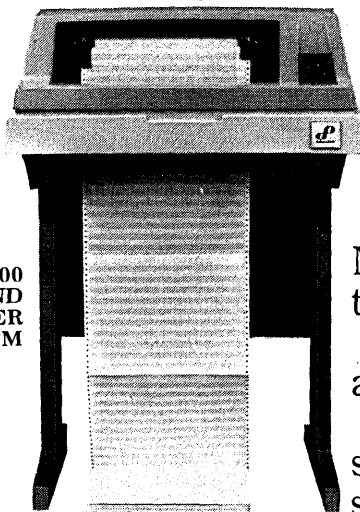

B-600  
BAND  
PRINTER  
600 LPM

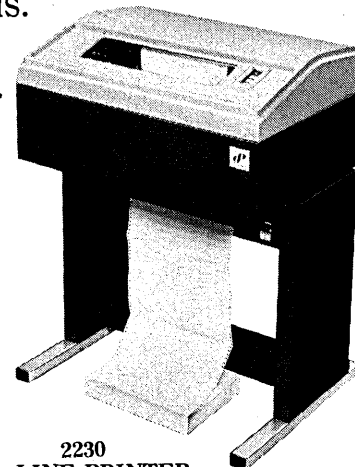

2230  
LINE PRINTER  
300 LPM



# SAY PRINTERS AS DATAPRODUCTS.

2260 LINE PRINTER  
600 LPM

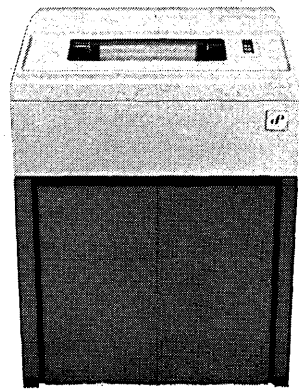
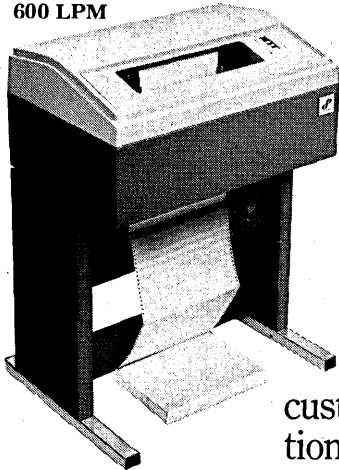

2290 LINE PRINTER  
900 LPM

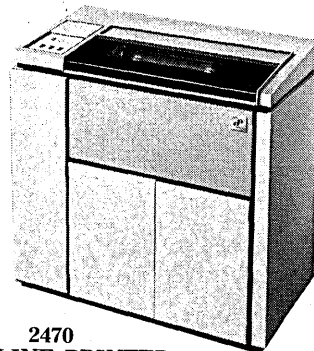

2470  
LINE PRINTER  
1250 LPM

2550  
CHARABAND PRINTER  
1500 LPM

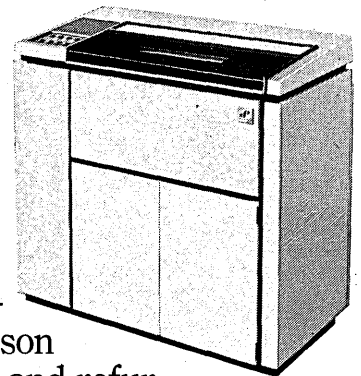

customers. Fast, efficient spare parts distribution. Technical support and training. Field liaison and technical documentation. Repairs and refurbishment. And printer supplies such as ribbons for all types of printers.

As a result, nearly 400 computer manufacturers include Dataproducts as original equipment. Making us the largest independent printer company on the planet.

Whatever your needs, wherever you are, Dataproducts is there to serve you. We have factories in the United States, Ireland, Hong Kong, Puerto Rico. And offices around the globe.

When you need printers, look to Dataproducts first. You probably won't have to look anywhere else.

TEMPEST  
LINE  
PRINTERS  
300, 600 &  
900 LPM

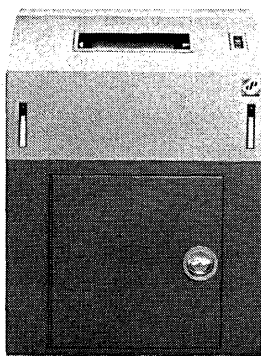

2910  
MILITARIZED  
PRINTER  
356-1110 LPM

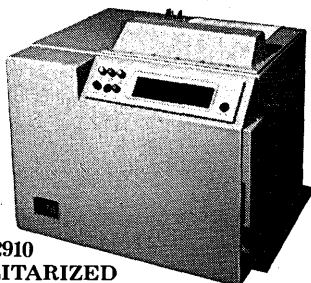

MXT-1200  
MESSAGE PRINTER  
320 CPS

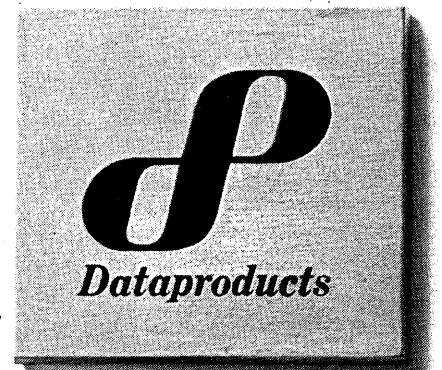
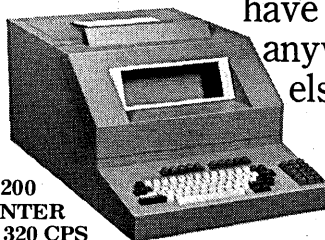

## THE PRINTER COMPANY

Call or write for your nearest Sales Office or Distributor. 6219 DeSoto Ave., Woodland Hills, Ca. 91365. Tel: (213) 887-8451  
Telex: 69-8492/Darmstaedter Landstrasse 199, Frankfurt, W. Germany. Tel: 681-034, Telex: 841-416344.

## Bell's Network Plans: A Moving Target

Bits and pieces of AT&T's new data network continue to fall into place with AT&T preparing this month to file with the FCC to revise Dataphone Digital Service (DDS) in such a way that the revised DDS network would represent something of a precursor to the new network.

In addition, Teletype Corp.'s announcement of its 4500 System sheds some light on what the firm has in mind for customer locations on the network.

New reports indicate that the network has undergone yet another name change. Initially called Bell Data Network (BDN), the network name was changed to Advanced Communications System (ACS), and that has been changed once again to Advanced Communications Service.

The specifications and timetable of the data network have been very much a moving target as AT&T labors with the enormous task of readying the data network for market. The latest timetable, however, calls for AT&T to announce the network in September and to file for tariffs early next year.

It was learned that AT&T has made a

presentation on the new network to the FCC, but on an informal basis to keep the FCC informed generally of AT&T's moves in the area. It has been reliably reported that AT&T has isolated all of its on-going costs for the service in an effort to facilitate approval of the network from the FCC.

The current timetable calls for three major nodes and for 100 minor services nodes to be scattered around the country. The first major node would become operational internally at AT&T facilities in Illinois in May of next year. The next two major nodes—one on the West Coast, the other in the New York area—are scheduled to become operational in September of that year.

The initial plan called for AT&T to use the No.4 ESS switch for major nodes on the network, but that plan seems to have been abandoned, at least for the present time. Digital Equipment Corp. is believed to have an involvement in the design of the major nodes.

As for the smaller service points, the current plan would use microcomputers designed specifically for the function by Western Electric, AT&T's major manufacturing arm. One source close

to the ACS design team said it would be an easy matter to expand the number of service points to 300.

"The small nodes will be located near users," the source said. "That should help improve response time. And that will help use the intelligence of the network to make better use of dumb terminals." A fundamental philosophy of the network design is to stress facilities for compressing and storing data first, and then to emphasize transmission. The overwhelming majority of the costs associated with the network will be in the terminal function rather than the transmission function.

There is also a growing feeling that ACS could play a role in combating the march of IBM's systems network architecture (SNA) to de facto communications standard.

AT&T is planning to support protocols and interface standards utilized by the most popular terminals in an effort to attract as many customers to the service as possible. Later, the firm plans to support international X.25 standards, primarily in an effort to interconnect independent networks to the Bell network. **-W.D.G.**

### Time-Sharing

## Keydata's Master Plan

In a year it will enter distributed processing market

Keydata Corp., a reorganized, revitalized, still struggling but seemingly resurrected graybeard of time-sharing (the first, back in 1965, to introduce on-line business dp service) recently announced its first concession to the minicomputer era. The Keydata Unity Series is a family of turnkey systems with operating and applications software optimized to provide a mini option for the various types of industrial distributors who make up the bulk of Keydata's on-line client base.

A major event in Keydata's corporate history? Yes.

Yet when the president of Keydata talks about his company, when he mentions "the new product line," he invariably is referring not to Unity but to Keydata's still unannounced entry into the distributed processing arena—a system still in development, that will not be introduced for another year. It's like a verbal tic, a revealing conversational habit.

Listening to L. Edwin Donegan, late of IBM and the chieftain's chair of the ill-

fated RCA Computer Systems Group—the man drafted for the Keydata presidency three years ago to pull the company from the edge of bankruptcy and rebuild—it quickly becomes obvious that if Keydata's Unity Series is something more than a defensive ploy against mini vendors, it's still only a preliminary step in Donegan's master plan. The man

**Keydata's Unity Series is still only a preliminary step in Donegan's master plan.**

brings a different sense of scale into the picture. Donegan talks of "internal growth objectives on the order of 25% annually for the next four to five years" for a \$15 million company which has never paid a dividend and whose third quarter report forecasts a loss for the full year.

### Peace with minicomputers

Faced with the cold arithmetic of plummeting hardware costs and stable or

rising communication rates, Keydata, like all the old-line time-sharing firms, is trying to make its peace with the mini-computer on-site. And while Keydata's Unity Series offers the mini in its traditional mode—stand-alone for customers who don't need communication, calling for truce if not suing for peace—Donegan and his cohorts pin their hopes on the potential of a future alliance. Like many of the large service firms, Keydata hopes to parlay its expertise in networking and on-line systems into a harbinger's role in distributed processing.

The customer base for Keydata's on-line service is divided into two distinct categories, explained Donegan. Fifty percent of the company's revenues come from a large base of single-location first-time computer users who use the Keydata service to do their total dp job. This group makes up 80% of the on-line clients, and the bulk of them are distributors in various industries. With no communication requirements and a horizontal homogeneity of system requirements, these firms have been a priority

# WHO DOES THIS PRINTER THINK IT'S KIDDING?

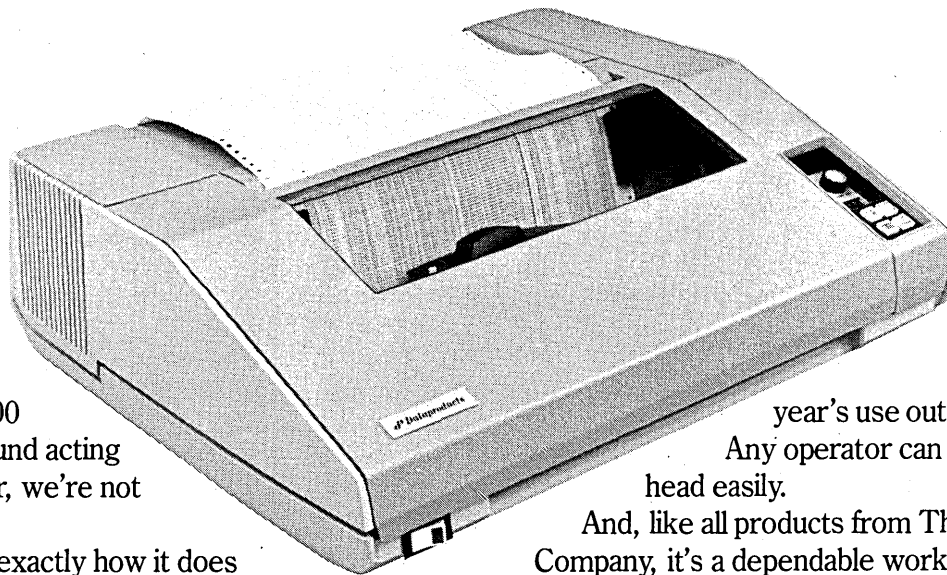

If the M-200 wants to go around acting like a line printer, we're not about to stop it.

And that's exactly how it does behave, cranking out an effortless 200 lines per minute, average throughput.

But the truth is, the M-200 is a serial printer. Which should certainly be obvious from the extremely reasonable purchase price of about \$2000. (In OEM quantities.)

And so, if the M-200 delivers performance that can fool you, blame it on its design features.

Like our revolutionary 14-wire, dual-column print head, for instance. The design combines the flexibility of a single head with the speed and long life of multiple heads. (You can expect more than a

year's use out of the head.) Any operator can change the head easily.

And, like all products from The Printer Company, it's a dependable workhorse. Made even more so by its optional self-diagnostic system.

If something needs attention, the system tells you if you can tend to it yourself. Or if you can't, you know what to tell the serviceman. That can save him a trip, saving you down time and money.

And that's the inside story of the M-200. Acting like something it's not? Maybe. But since its delusions are all in your favor, why complain?

## THE M-200 MATRIX PRINTER

## THE PRINTER COMPANY



Call or write for your nearest Sales Office or Distributor. 6219 DeSoto Ave., Woodland Hills, Ca. 91365. Tel: (213) 887-8451  
Telex: 67-4734 • Darmstaedter Landstrasse 199, Frankfurt, W. Germany. Tel: 681-034, Telex: 841-416344.



CAROL LEE

**L. EDWIN DONEGAN**  
Pinning Keydata's networking expertise  
on distributed processing

market for independent mini system vendors. This is the market that the stand-alone Unity Series will attempt to safeguard and further exploit with four packaged systems, priced from \$48,000 to \$290,000, with bundled support and industry-specific software.

The original announcement offered packages for distributors in the electrical; plumbing, heating and air conditioning; and industrial supply industries. Promised within the year are additional application packages for food, printing, and paper distributors. It's a corner of the booming small business systems market in which Keydata had extensive experience and an investment to protect. It's a market Donegan says Keydata prizes and plans to stay in, but it is not a market for distributed processing. It's not the future.

The other 50% of Keydata's revenue comes from the 20% of its customer base that are medium to large accounts, multi-location firms who buy the Keydata service, explained Donegan, because they need networking capabilities to tie sites together and typically require central files where they could consolidate input from various stations.

"I think our skills are so sophisticated that they are really better used in the medium to large accounts, multilocation users, as opposed to the single location market," said Donegan. After 12 years experience with small distributors, developing the specialized software for stand-alone minis "is something we can do just like rolling out of bed," he said with a smile. "And if it's a good place to train our (rapidly expanding) sales force, and if the market is booming—and all those things we concluded were so—we decided that since we've got a foot in both of these

businesses today, why not keep a foot in both for the foreseeable future."

### Unannounced product

"But my priority from the start, and it still is today, was on the unannounced product," said Donegan. "My own view is that distributed data processing, which

---

"There are very few cases of working distributed processing today. It's technically different, as was time-sharing 12 years ago."

---

I see as being the dominant force in the computer business in the next seven to ten years, is in its dawning . . . It's a good concept, and it will be very important to the business in the future, but it isn't going to be like flicking on a light. There are very few cases of working distributed processing today. It's technically very difficult, just like time-sharing was technically very difficult 12 years ago."

Donegan surveyed the birth of time-sharing in an IBM study 12 years ago, and when he recommended that IBM enter the business with a focus on Keydata's type of business service rather than a GE-style service offering raw computing muscle, he was given the job of developing IBM's Service Bureau Corp. Keydata's technical expertise dazzled him then (Keydata had 10 or 12 people who developed their product, he said, "and to get equivalent firepower at IBM, I had 60 or 70 people, eventually over 100") and still does. Keydata's early management included "some of the most capable technical people in the business," he said, but he feels they let a period of great growth potential slip by in the late '60s and early '70s.

### An opportunity past

"Their orientation was to the technical aspects as opposed to building a professional marketing organization and as opposed to the business aspects of management . . . managing for a profit." With a little different mix in management, he said, "I believe the company could have achieved \$70-80 million in revenues as of today." But it is an opportunity past.

"It became obvious to me about six months after I arrived here that we were going to need additional products if we were going to grow at the rate I thought we should grow, at the rate the board wanted us to grow. Our existing product had a market, still has today, but it's not a market that can build this company into a \$50-100 million company five or six years hence."

### Same as Keydate in '65

"Philosophically, what I hope to do with our new product line is create an opportunity for Keydata every bit as important and every bit in advance of the state of the art as the original Keydata service product" developed in 1965. "In other words," he concluded, "I see our work in this area as being well in advance of anything I know of being done in distributed processing today. Offering us the possibility of a product that will be well in advance of any similar capability by a competitor. . . ."

"That's strategically what I'm trying to do: re-create the opportunity lost."

In the process, Donegan has drastically reorganized the company; expanded the sales force from 15 to 47; intensified internal educational programs; recruited an old colleague from IBM and RCA, Joseph Rooney, former head of ITEL's computer service operation, as vice president, field operations; and lured Alan Russo, one of the two original architects of Keydata's on-line product, back from Telenet to direct R&D on "the new product."

Donegan refuses to reveal anything about his distributed processing concept, but he did confirm reports that the system will be based upon Hewlett-Packard's 3000 family machines, chosen for the long life cycle and sophistication of H-P software. A different mini, a Data General, is the basis for the Unity systems, he said, because the H-P family does not yet drop to models below the \$30,000 cpu threshold Keydata decided was necessary for this sort of entry-level system.

Keydata's internal R&D had been focused almost entirely on the "new product" until recent months. Donegan said that although a decision had been made earlier to offer two new products, one for each end of the Keydata market, the company sought to purchase a hardware-software combination for the single-location market. Seven months ago they found the model for the Unity system coming through the final stage of product development in a small Exton, Pa., software house, Infomark.

Infomark will supply Unity under the contract, he explained, but Keydata's staff are deeply involved in developing the applications packages and have made substantial enhancements on the original operating system.

### Easy to modify

"The thing that was so overwhelmingly impressive to us about Infomark's work," said Donegan, "was that the operating system was tailored and optimized for transaction processing, just as we had tailored the Univac 494 operating system ten years earlier" for Keydata's on-line service. Also, he noted, Infomark had designed its applications program structure in such a way as to make it relatively

# KEEPS QUIET. WORKS HARD. FOR VERY LITTLE.

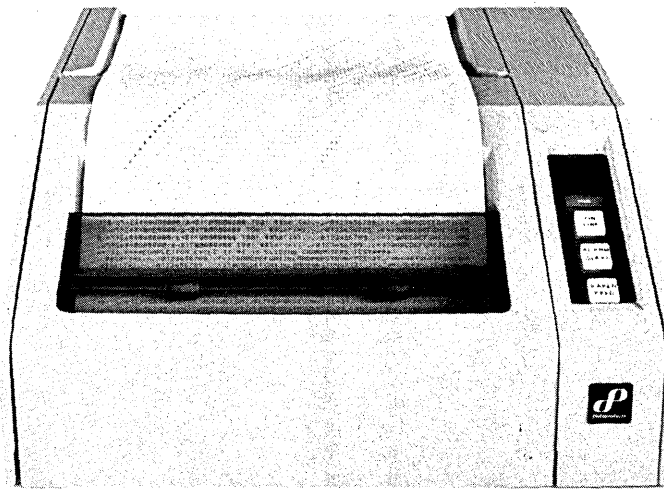

Our T-80 Receive Only printer is a quiet, unassuming sort. Doesn't take up much room on the desk. Doesn't make a racket while it's doing its work.

And it doesn't require a lot of money before it'll go to work. In fact, the T-80 runs less than \$900 in OEM quantities. And it continues to save you money with its low cost of ownership.

On top of all this, the T-80 prints fast. 80 CPS fast. Which is nearly three times faster than most other thermal printers.

All these qualities — low price, impressive speed, high quality, and quiet operation — have combined to make the T-80 an absolute natural for applications that demand silence. Hospitals. Open office situations. Testing and instrumentation.

## THE T-80 THERMAL PRINTER

And the T-80 is the logical supplement to your CRT if you want occasional hard copy printouts.

Now, you don't have to buy a T-80 RO to get T-80 performance. The basic T-80

mechanism, with the same unique operator-replaceable print head and driver electronics, is available as a module: the T-80 M.

So, it's up to you. Buy the complete T-80 RO, ready-to-run. Or just take the T-80 M mechanism and design your own printer around it.

Either way, you save money, and the T-80 goes quickly and quietly about its business.

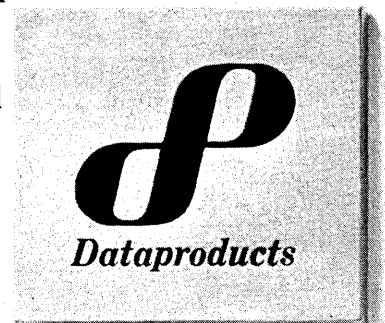

## THE PRINTER COMPANY

Call or write for your nearest Sales Office or Distributor. 6219 DeSoto Ave., Woodland Hills, Ca. 91365. Tel: (213) 887-8451  
Telex: 67-4734 • Darmstaedter Landstrasse 199, Frankfurt, W. Germany. Tel: 681-034, Telex: 841-416344.



Digital Equipment Corp.

Data General Corp

# PDP-11, NOVA & INTERDATA users

## handle your Tape and Disc System needs...

...with performance never before available

- |  |  |
|--|--|
| <ul style="list-style-type: none"> <li>■ Software Compatible for PDP-11, Nova &amp; Interdata</li> <li>■ Embedded design</li> <li>■ 9 Trk 800/1600 bpi, 7 Trk 200/556/800 bpi intermixed</li> <li>■ 12.5 to 125 ips</li> </ul> | <ul style="list-style-type: none"> <li>■ Software Compatible for PDP-11 &amp; Nova</li> <li>■ Embedded design</li> <li>■ Top Load (5440) &amp; Front Load (2315)</li> <li>■ Up to 20 mb per drive</li> </ul> |
|--|--|

WRITE FOR COMPLETE INFORMATION



(714) 991-8700 • TWX: 910 591-1687 • Cable: WESPER  
1100 Claudina Place, Anaheim, CA 92805

## news in perspective

easy to modify—all that, “and a price/performance on the hardware just as good as that of anybody in the business.”

For Unity, for Keydata, the next year is crucial, said Donegan. Much may depend on the skill with which Keydata management plays off the old on-line service versus the lure of the new mini system, juggling the mix of Unity sales income against recurrent income from the service, pacing the migration to minis and selling the on-line service to sustain income growth.

“If I recommend the on-line service it may be that I’m only recommending it . . . while you get the discipline in your organization required for the service.”

“My own feeling, with 40 salesmen out there instead of 15, and with two products to sell, we will sell more of the on-line product than we have ever sold before,” said Donegan. “I think our salesmen are going to find—they are already finding—that their best position is to say: ‘Look, we have an on-line system where Keydata takes the whole responsibility and we also sell what we think is one of the more powerful minicomputers for small business systems. So I’m going to come in and take a look at your operation without any preconception that one or the other of these products is best suited for you. Once I get done with my study I’m going to come back and recommend one or the other and tell you the reasons why. And if I recommend the on-line service it may be that I’m only recommending it for 18 to 24 months while you get the discipline in your organization required for the system and feel comfortable with it. . . . And we’re the only company that can provide you that service and also support your upgrade to your own computer!’”

Keydata plans soon to introduce a special contract “for on-line customers who want to move into Unity,” said Donegan, under which the company will bear the responsibility for converting on-line files into the Unity format. And Keydata’s on-line service hardware will be completely depreciated and paid for over the next 17 months, “so we have tremendous price flexibility . . . there are many nice marketing things we can do to keep the on-line product attractive.”

—Vin McLellan

# H-P's New Products

## Company's progress comes in leaps, not steps

Anyone who has shopped around lately will have noticed that a megabyte of add-on memory today bears a price tag of \$110,000. More or less. Now comes a minicomputer maker, Hewlett-Packard Co., offering to sell a megabyte for a mere \$32,000.

This announcement last month came in conjunction with the company's debut of the first two machines in a series of four that are to be disclosed before the year is out. And H-P chose to begin with the top and bottom of that series. Announced were:

—The entry-level H-P 250, a \$24,500 system with a data base management system.

—The H-P 3000 Series III, an upgrade of the 3000s that now can accommodate two megabytes of main memory.

—The MFG/3000, an unbundled packet of applications programs for manufacturers to run on their H-P 3000.

In typical H-P fashion, both new processors feature the use of 16K semiconductor memory chips at a time when other companies are only now upgrading to the use of the older technology, 4K chips. And not only do three of the four new products use H-P's custom microprocessor, but two of them are implemented in the very new and controversial SOS (silicon-on-sapphire) technology.

Hewlett-Packard does tend to make progress in leaps, rather than in steps, notes Richard Matlack, who watches the minicomputer industry for Dataquest Inc., the Menlo Park, Calif., research firm. He says Digital Equipment Corp., for example, makes natural, evolutionary steps. He notes that H-P pioneered the use of semiconductor memory in minis, whereas DEC still has products that use core. H-P's handheld calculators represented a giant leap forward in technology, and even the H-P 3000 computer was an innovative design, being stack-oriented when others went with special-purpose registers. But with H-P's early commitment to the semiconductor memory, it is now beginning to realize significant cost advantages. Thus the \$32,000 price tag for a megabyte.

### Fragmented organization

Hewlett-Packard's announcement of the \$24,500 H-P 250 also signaled a turnaround of a different sort. Internally the company has been organized, if that is the word, in an apparently fragmented way. There were divisions making different sorts of things, one corporate arm often selling its products to the same customers being served by a different H-P arm.



PAUL C. ELY, JR.  
Heads H-P's Computer Systems Group

Helping to remedy some of this marketing confusion is the organization of computational products under the Computer Systems Group, led by vp Paul C. Ely. And the H-P 250 introduced last month comes from the Fort Collins, Colo., division, while the Series III is from the General Systems Div. in Cupertino, Calif.

Dataquest's vice president, Denny K. Paul, explains that H-P had the problem of having started in the instruments industry, where a manufacturer typically had a large number of product managers, virtually one for each type of instrument it made. And so when H-P got into the minicomputer business, it continued to have a number of people designing different kinds of pieces—without central direction—a fragmented approach that was appropriate for the instruments business, but not for computers. Under new president John Young, says Paul, H-P appears to be showing more structure, more strength and direction at the divisional level, and a less fragmented marketing organization.

For the H-P sales force is now organized under the Computer Systems Group and not a part of each division. And these oem and end-user sales people are specialized by product and market, some selling two or three products and some handling, say, only terminals in a dense market. But even the seller of terminals works for the group, not the Data Terminals Div.

### No growth path

Despite the institution of stronger di-

rection from the group level, H-P continues to develop products that are not software-compatible with one another. As with Digital Equipment's PDP-11 family, for example, H-P does not provide an upward growth path. A user cannot take applications programs developed for his H-P 250 and take it with him as he moves to the H-P 3000 family. This incompatibility was not an inadvertence, says Bill Krause, marketing manager for the General Systems Div. "There never was any intention to be."

According to Alex Sozonoff, Krause's counterpart at the Fort Collins Div., the 250 uses a language called H-P Business BASIC, which is going to be the standard at H-P for business dp. BASIC is one of the languages available on the 3000s, and will be supported on the two systems yet to be announced. Adds Sozonoff: "We are spending a lot of time and effort to make our data transportable from one product to another. I think that's almost more critical than software compatibility."

Sozonoff's \$25,000 system includes a processor with 128K bytes of system memory, 32K bytes of user memory, keyboard and crt display, two 1.2-million-byte floppies, and a 180cps impact printer. Its data base manager is a subset of H-P's Image package used on the larger 3000s. There are also "friendly" features that facilitate communication with the system, whether by a non-programmer or by an experienced pro.

It is an important feature of the systems, for H-P will do no customizing of applications programs for users. "That's why we like to work with the business OEM's," says Sozonoff. "We're not in the customizing business." For his sales, he says, he sees an increasing reliance on OEM's such as software companies and systems houses.

## H-P's computational products are now organized under Computer Systems Group, not in former fragmented fashion.

But the marketing executive also notes that between a third and a half of small business systems are going into larger companies for the solution of what he calls "task-oriented problems," including data base-oriented jobs. "The key in this whole product is the data base management concept," he says. And he says it is very important that such a capability is being made available for \$24,500.

Group vice president Paul Ely says H-P in the last three years has been able to develop products with a 10-times improvement in performance at little or no extra price, and has other products providing the same performance as before at one-third the price.

More significantly, the company has been able to overcome the hard birth experienced by the H-P 3000 processor a

mere four years ago. Initial units installed at customer sites had to be recalled and the system kept off the market when it was learned that performance degraded significantly after only a few users came on-line. The operating system, it seems, took up too much main memory, there wasn't enough main memory capacity, and the whole system was just too slow. Again, some observers thought, it was a coordination problem at H-P; hardware people designed the hardware, software people the software, and when they put it together it didn't work.

Original performance specs on the 3000 were not met until the Series II



**THE H-P 3000 SERIES III**  
New processor features use of 16K semiconductor memory chips

appeared on the market two years later. But the s/II has been a success. There reportedly were some 500 shipped through the end of 1977, another 500 in the first six months of this year. The goal purportedly is to ship 1,000 in 1978 and 2,000 in '79.

### The Series III

Now comes the Series III, which Krause says differs from the Series I and II "primarily in price-performance." The Series I was a core-based machine and is limited to 128K bytes; it can accommodate up to 16 terminals but most users average eight. The Series II was one of the first small computers to use the 4K semiconductor memory with an error-correcting capability, and it could grow to 512K bytes. It supported up to 32 terminals, averages closer to 20. The III, as already noted, features the 16K RAM chips, can address two megabytes, and can support upwards of 63 terminals, although the average should be about 30. The basic \$175,000 configuration includes the 2MB processor, the MPE-III operating system, 50MB disc, 1600bpi tape drive, 15 asynchronous terminal ports, and crt console.

Krause downplays any disadvantages stemming from the lack of software compatibility among H-P's minicomputers, but is upbeat about their having the same operating system in all the 3000s. The Series III is said to have an improved

version of MPE and an enhanced version of the Image DBMS. He says a two-meg s/III at \$175K has eight times the transaction-processing throughput of the Series I at \$64,000, but costs only three times more.

### Strengths in software

Price-performance and hardware reliability have been hallmarks of H-P. But Paul, of Dataquest, says the minimaker also has strengths in software, as shown by its MPE operating system's ability to provide for various modes of operation simultaneously: local batch, remote batch, and interactive—plus having multiple languages. And Paul considers H-P a leader in network software among mini-computer companies.

---

**Price-performance and hardware reliability have been hallmarks of H-P, but there is strength in software, too.**

---

"Over the last seven years," adds Matlack, "I think they've done a much more impressive software job than hardware. And I think that's particularly important because the name of the game now is software."

Some of H-P's systems software is already unbundled. Its Image/Query DBMS, for example, requires an initial fee of \$3,000, plus a monthly fee of \$125. But for the first time the company now also offers unbundled applications programs.

The package consists of three products, each priced separately at \$5,000 plus \$150/month. One product performs engineering data control, the old bill of materials processing, plus more; a second is an inventory and order status package; and the third is material requirements planning, primarily a batch module. The monthly fees entitle the user to phone into one of H-P's systems engineering centers and talk to an industry specialist about any problems encountered with his package. But again there is no customizing by H-P.

The company's strengths in software, its sales staff rated as "a cut above the average," and its strength in the end-user market, place it in a favorable position as it goes after the distributed processing market. The four products being announced over the next four months are very important to the corporate posture, as well, for Paul Ely's group accounts for 42% of H-P's total sales, 40% of employees, and 38% of pretax earnings. This has positioned H-P at the number nine spot in the DATAMATION Top 50.

—Edward K. Yasaki

### New Presidential DP Adviser?

Creation of a special assistant to the President for information technology is expected to be a key recommendation of the final report of the Federal Data Processing Reorganization Project due out this month.

A compilation of reports from ten separate task forces, the final report will culminate work begun in June 1977 by 55 people from both the federal government and the private sector. It was an effort those involved admit included "internal frictions."

The functions of the could-be-recommended special assistant still were being hammered out last month. One team summary indicated the adviser would "act as the senior advocate for information technology within the Administration and . . . be responsible for overseeing, understanding and evaluating issues, and for setting national and federal goals for that (data processing) technology."

Not everyone involved with the project likes the idea of the new advisory position. Said one team leader: "The function of this new position smells, waddles, and quacks just like OMB (Office of Management and Budget). If this individual and his staff are supposed to do all of the things that presumably OMB is supposed to be doing what reason do we have to feel that they will do it any better than OMB?"

### Not so

Philip Kiviat, technical director of the Federal Computer Performance Evaluation & Simulation Center (FEDSIM) and a team member, doesn't feel the creation of the new position would hurt OMB.

### Not everyone likes the idea.

"OMB's job is primarily to manage internal government operations. And there are extra-governmental aspects of information technology—things that OMB is not concerned with . . . There's also that whole aspect of advocacy that OMB doesn't really view as its role. So there's plenty of room for a role for somebody like that in the White House."

Alton P. Jensen, a professor at Georgia Institute of Technology and the proposal's chief advocate, said the new position would create a "healthy tension, not conflict (with OMB)." Such a setup, he feels, would establish "a stress relationship that is currently not here. There's no counterbalance to the current weight of OMB and its attitudes."

Jensen is charged with pulling together the final report, culling the significant recommendations from the 10 final team



reports. He listed as "obvious" areas to be highlighted in the final report: personnel, standards, technical support groups, full costing of computer services, senior agency adp involvement, and computer/communications acquisition.

### Large appendix

"The report itself," he said, "will have an appendix volume that includes all the specific recommendations of all the study teams. And what we'll attempt to do in the final report is to coalesce from that the various significant areas in which we think the government should establish specific goals and objectives in terms of a 5- to 10-year program."

There are those who view the 27 man-years spent on the project (the team members worked for free) as waste. They feel the report could end up shelved, a fate not unknown to well-intentioned federal reports.

Kiviat doesn't think this will happen. "Until a very short while ago, I wasn't as positive about it (the project) as I am right now. I think the things we're pulling together are very worthwhile . . . I think the final report will be good . . . and it will make some good recommendations. Whether or not anything will come of it is hard to say because some of the recom-

mendations involve a lot of change and you never know how willing or able the system is to take a large step."

### Possible fallout

A fallout from the project could give momentum to the plan of Sen. Jack Brooks' (D., Tex.) Government Operations Committee to call for the creation

---

**"We're getting a level of acceptance and general spirit that's very exciting."**

---

of a high level adp management function in each government agency.

Jensen is even more optimistic than Kiviat. "I'm downright excited about it (the project's results). We're getting a level of acceptance and general spirit that's very exciting. This doesn't mean that there are not going to be dissenting opinions. But I think we do have good chemistry at work . . . This report will not collect cobwebs on a shelf . . . I and my colleagues are not going to let this thing wilt away. If something can be done in government, we'll do everything we can to make it happen."

—Linda Flato

---

## Banking

---

### EFT: Despite Hurdles—Growth

While most of the sessions at the American Bankers Assn.'s 1978 Operations and Automation Conference focused on stumbling blocks to Electronic Funds Transfer (EFT) development, the impression conveyed on the conference's exhibit floor was that vendors and bankers alike feel EFT is here and growing.

Attendees crowded the aisles of Atlanta's Merchandise Mart to view the offerings, most of which were EFT related, of a record 114 exhibitors. "I thought I'd wandered into an electronics show by mistake," said one, representing a very small bank that hasn't begun to think EFT.

EFT systems was one of the subjects covered in the ABA's sixth National Operations & Automation Survey. The EFT results were not covered in a preliminary report on the survey released at the Atlanta conference, which said that 80% of American full service banks now are using computers. The preliminary report cited as one reason for the increase in bank automation revealed by the survey: "Banks of all sizes foresee the full adoption of preauthorized paperless debits and credits in the near future." And that's EFT.

A recently released report by SBS Publishing, San Jose, Calif., goes so far as to

say that by 1980 EFT will be the fastest growing banking application.

"We've been talking about EFT for so long that many bankers have the feeling it will never happen," said conference keynoter Ronald A. Terry, chairman, ABA Government Relations Council and chairman of the board and chief execu-



TERRY

MC ELHATTON

tive officer, First Tennessee National Corp., Memphis, Tenn. "Operations bankers are not quite so short-sighted. You know that EFT will happen—in fact it's happening right now."

He cited direct deposit of government payments, automatic payroll deposits, automated tellers and debit cards as aspects of EFT which have become accepted "as a normal part of banking."

### Starts Nov. 1

Prearranged transfers from savings to checking accounts is something he'd like to see find the same acceptance. The Federal Reserve Board and the Federal Deposit Insurance Corp. have authorized commercial banks to make prearranged transfers from savings to checking accounts beginning Nov. 1. The U.S. League of Savings Assns. has filed suit to stop banks from offering this service on grounds that it violates the prohibition against paying interest on checking accounts.

"The ABA does not agree," said Terry. "In fact, we think the S&L's position is blatantly anticonsumer. Prearranged transfers are simply a more convenient way for bank customers to gain access to the money in their savings accounts. We have supported this new service for that reason—and also, incidentally, because it may help begin correcting the competitive imbalance between banks and non-bank competitors."

He said many banks will be ready Nov. 1. "They were involved in what was coming and planned for the future. They designed systems for processing checking and savings transactions that could be adapted to prearranged transfers."

Terry also touched on the issue of consumer protection and EFT. "Some of us think it is a little premature to talk about consumer protection for a system that has not been fully developed or tested. In most cases, we have not made decisions on the most basic issues, such as deployment of terminals and sharing of EFT systems."

Eugene M. Tangney, executive vice president, First National Bank of Boston, Boston, Mass., made a similar point. He said many of the proposals for consumer protection against EFT "are based on preconceived notions of what might happen. When we see what does happen, what problems there are, what inequities exist, then there should be legislation. . . . Overprotection can do more harm than good."

---

**"You know EFT will happen—in fact it's happening right now."**

---

Tangney's fellow panelists in a session on Consumer Views of EFT did not agree with him.

### Range of views

"The consumer voice must be heard early," said Meredith Fernstrom, director of consumer affairs, U.S. Dept. of Commerce. She urged implementers of EFT systems to "identify the range of opinion. There is no one single consumer viewpoint on EFT. Marketing is not the answer to meeting consumer concerns. There are at least three different categories. First,

there are those totally opposed to EFT in any form. They are totally satisfied with what they have now and, to them, the benefits of EFT are uncertain. Second, there is a group keenly aware of the potential negative implications of EFT but which recognizes potential benefits. Third, there is the general public, the grass roots consumers. They fear computer foul-ups and loss of privacy."

Fernstrom believes that EFT "is not just another marketing problem. Consumer education and an information program are needed."

Tangney said that of the five major EFT-related bills currently pending in Congress, "only Sen. McIntyre's bill (Thomas J. McIntyre, D., N.H.) would allow EFT to operate."

He was countered by Stacy Dean, Office of the Special Assistant to the President on Consumer Affairs. "To say that

---

**"It's a little premature to talk about consumer protection for a system that has not been fully developed or tested."**

---

Sen. McIntyre's bill is enabling legislation is misleading. There are EFT systems operating. It's not as though this (the proposed legislation) is totally halting EFT. It's just slowing it down a little." McIntyre's bill generally incorporates all recommendations of the EFT Commission, of which Tangney was a member.

"The commission was a pro-consumer group," said Tangney. "The commissioners did their jobs well."

Dean was concerned with standards of liability. She would like to see the \$50 limit conceded for credit cards extended to debit cards, which bankers would prefer to treat as more like cash or a check. "The responsibility should lie with the bank," she said.

### Father and son

Tangney responded with a scenario. "A father and son have an argument. The son appropriates the father's debit card and taps the father's account for \$2,500. Is it equity for the bank to be held liable?"

The big question of drawing a distinctive line between debit and credit cards wasn't resolved. Dean brought up the question of the combination card. "Do we apply two different standards?" This question wasn't answered either.

Except perhaps by James F. Lordan,

vice president, State Street Bank & Trust Co., Boston, Mass., who addressed the practicality of the combination card from the bank's point of view. "We are committed to a single-card marketing strategy. We believe we are moving toward the day when, with a single piece of plastic, a customer can charge a shirt and tie at one end of a shopping mall, buy the week's groceries at the other, stop on the way home at a 24-hour Automated Teller Machine (ATM) to withdraw pocket money for the weekend, and make bank deposits and withdrawals seven days a week without ever having to go to the bank."

Lordan's bank was the first major VISA card bank in New England and continues to be that area's major VISA bank. It also is data processor for more than 300 other financial institutions. It got into the debit-card business because of pressures to gain more retail penetration.

Market penetration pressures and increased pressures on bank earnings will be a driving force in the future of EFT, Jerry McElhatton, senior vice president, The Cleveland Trust Co., told the conference.

To the end of achieving greater profitability in EFT he advocated "turn the baton over to marketing . . . develop new retail services to generate momentum."

### Yes, Columbus

John F. Fisher, senior vice president, First Bank Group of Ohio, characterized by McElhatton as "the Evel Knievel of EFT's," talked about where EFT is today. He talked of its evolution. "In 1969-70 it was the arrow in the back. In the early '70s it was, 'Orville, it will never fly.' In the mid '70s it was the hole in the wall (through-the-wall automated teller machines). Today it's 'come on in, the water's fine.' Coming soon is the Nina, Pinta, and Santa Maria period or . . . yes, Columbus, the world is round." Fisher described point-of-sale (POS) in its relationship to EFT as "an idea who's time is yet to come."

Peter F. Gundell, vice president, Close, Martin, Schreiber and Co., Rye, N.Y., in a session on "Retailers: Your New EFT Partner," seemed to be telling bankers the idea only would come when they become willing to interface with in-place POS networks. As a consultant to retailers, Gundell deplored the "reactive adversary relationship" he perceives between bankers and retailers. He told bankers that any system they want to use in conjunction with retailers, "can't cost more, can't involve more time, cannot diminish flexibility, and cannot increase labor content."

### Pay by phone

Interface directly with customers probably is easier and telephone bill paying is one way which seems to be catching on. Jim Jaquette, vice president, payments programs, Chase Manhattan Bank, New York City, said telephone bill paying probably "will be the most important EFT product of the 1980s." He said his bank, which doesn't use it yet, began looking into it because "we lost one account to an

---

**"The commissioners did their jobs well."**

---

s&l that had it." He said Chase is waiting for a voice recognition system which he believes will make telephone bill paying both efficient and cost effective. He was anticipating a pilot operation voice recognition bill-paying system early this month.

The Electronic Money Council, formerly the Committee for Consumer Financial Convenience, chose the ABA conference as an occasion to distribute what it called an "EFT Consumer Bill of Rights." The council, originated in mid-1977 as an ad hoc group of 24 depository financial institutions which jointly undertook the funding of a research study to determine public awareness and understanding of EFT services, now is dedicated to public education on the benefits of EFT. Its bill of rights states that the council "is committed to helping the public understand both EFT's benefits and safeguards." Rights covered included right to choose, right to know, right to account documentation, reversals of transfers, error correction, lost or stolen card liability, unwanted cards, liability for mistakes on the part of service providers, and right to privacy.

Not mentioned was bankers' rights and duties to protect against crime.

---

**"We are committed to a single-card marketing strategy."**

---

"Crime is a major cause of bank failure," said Paul Havener, Division of Management Systems and Financial Statistics, Federal Deposit Insurance Corp. "We don't have sufficient laws to deter white collar crime. Criminals get their wrists slapped. What happens if organized crime wants in?"

Donn Parker, Stanford Research Institute, said crime as it relates to automated banking and EFT "is a people problem. We have to know who the enemy is. It could be organized crime and/or foreign powers." His advice: "Reduce the number of people in positions of trust and shine as bright a light as possible on those people."

—Edith Myers

## News in Perspective

# BENCHMARKS . . .

**It's All Over:** Datapoint Corp. and Computer Automation Inc. have settled their legal quarrel over who has the rights to the software on which CA's SyFa small business system is based. The lawsuit brought by Datapoint charging trade secrets theft (Oct. 1975, p. 137) and a countersuit by Computer Automation have been settled out of court. Terms of the settlement were not disclosed but were termed "not material" by involved parties. All litigation was dismissed with prejudice (meaning it can't come to court again).

**Going Public:** Randal Data Systems, Inc., a four-year-old Torrance, Calif., based small business systems manufacturer, last month filed a registration statement with the Securities & Exchange Commission covering a proposed public offering of a minimum of 187,500 and a maximum of 300,000 shares of stock for \$4 per share. Sale of the shares could bring Randal from \$750,000 to \$1,200,000. Randal Walti, president, said the firm will use proceeds for new product development, reduction of accounts payable and other indebtedness, and for working capital.

Walti said the decision to go public was prompted by a phone call from Daniel C. Montano, vice president, corporate finance of C. L. McKinney & Co. Inc., the managing underwriter for the proposed offering. "He'd read a newspaper story saying we were looking to be acquired to get capital. We were thinking both of that and going public. Montano advised us to go public. He has a good track record in taking small firms public so we decided to do it."

**EM&M Drops Small System:** Electronic Memories & Magnetics discontinued its Small Business System 800 and last month was negotiating with an unnamed British systems house to sell the product line. EM&M also was talking to U.S. firms about domestic rights. System 800 was an outgrowth of the company's System 80 TTL processor that emulates the Intel 8080. Combined with a five megabyte disc drive, 64K bytes of main memory, a printer and one crt, it became the System 800, introduced early last year. The reason given for the discontinuance was the fact that too much investment in software and customer support was needed to compete in the small business market. EM&M sold the 800 on an oem basis to systems houses but found many of these needing supplementary field support.

**Beating the U.S.:** ICL will become the second European mainframer to beat U.S. counterparts into production of sys-

tems with 16K bit memory chips. (Siemens already is delivering them on its 7.760.) The British firm recently announced that in the first quarter of 1979 it will deliver these memories on its 2960, 2972, and 2976 systems (IBM 370/148 to 3032 price/performance range). ICL in the U.S. has long been looking for a way to begin marketing these larger systems here, and should they find it, American prospects will be looking at 16K chip systems.

The new memories have the same 500nsec read/write cycle per 8-byte access as the 1K chip they replace. But they occupy only one-fourth the space and, ICL claims, they are cheaper. ICL hasn't yet announced prices, but it is finally expected to bring them down to the level of IBM 303X memory prices. Maximum memory remains the same on the 2960 (3 megabytes) and 2972 (6MB), but it is raised to 8MB on the 3032-competitive ICL 2976 model. Rumors are that ICL is about to replace its top-of-the-line 2980 with a 16K chip 2986. ICL also announced a 6250bpi tape drive.

**For Xerox Users:** Honeywell Inc. came up with some new things for Xerox Data Systems users who want to upgrade. At a meeting of Exchange (users of XDS equipment), HIS announced its Level 66/DPS/C series based on large-scale Honeywell Level 66 technology packaged specially for the Xerox users' CP-6 operating system. Richard R. Douglas, vice president and general manager of Marketing and Services Information Systems Div. of HIS, said the new system meets the parameters established shortly after Honeywell took over responsibility for the Xerox computer base in February 1976.

**Public Education:** The Electronic Money Council, an ad hoc organization of 24 depository financial institutions dedicated to promoting public awareness and understanding of Electronic Funds Transfer (EFT) services, has hired two consumer affairs writers as "spokespersons." Sylvia Auerbach, a writer and lecturer in consumer economics, and Barbara Quint, money management editor of *Family Circle* magazine, will attempt to win over the public to the side of EFT via such vehicles as appearances on television talk shows and demonstrations of EFT services at stops throughout the country.

**CII-Honeywell Bull Invests in R2E:** Honeywell affiliate, CII-Honeywell Bull, has just bought controlling interest in France's small, but dynamic microcomputer manufacturer, R2E. R2E, which has been marketing its Mical series (based

on the Intel 8080 and now the Zilog Z80) in the U.S. for the last few years, has given up 60% ownership to CII-HB in return for 2.5 million francs (about \$1 million) in cash. That cash will be used to expand its markets outside France and its products in office and portable personal computers. The \$5 million company will remain a separate operation under founder and president Truong Trong Thi, with its own product line and marketing force.

**Sperry's Computer Figures:** Sperry Rand's latest annual report said computer systems and equipment sales and operating profit for fiscal 1978 were, respectively, \$1,703,635,000 and \$233,576,000. The computer-related figures, the firm said, covered edp systems and services for commercial, defense, aerospace, and marine applications through March 31. In addition to outside sales, the firm reported computer-related internal sales of \$22,225,000 and interest income of \$6,034,000, boosting the total computer income to \$1,741,894,000.

**Computer Services Up:** The 11th Annual Industry Report on the Computer Services Industry prepared for the Association of Data Processing Service Organizations (ADAPSO) shows the computer services industry, in 1977, experienced a 17% revenue growth with revenues reaching \$6.9 billion, compared to \$5.9 billion in 1976. Based on an anticipated annual 17% growth rate, the report said, the industry should report revenues of \$15.1 billion in 1982. At the same time, ADAPSO said, industry pretax profits rose to 11.3%, up from 11% in 1976. In the study, data was included from more than 300 participating computer services companies, ranging in sales from less than \$2 million annually to above \$25 million.

**Successful Candidates:** The Institute for Certification of Computer Professionals (ICCP) said 919 of 2,835 candidates who took the Certificate in Data Processing (CDP) exam last February, were successful. The examination will be offered next on the first Saturday in May 1979. ICCP last month gave Awards for Excellence, highest in its Certificate in Computer Programming (CCP), to: Robert J. Valentine, Department of Defense, Fort George G. Meade, Md., for business programming; Charles Miller, Dept. of Mathematics, Shippensburg State College, for scientific programming; and Richard Pratt, Mead Corp., for systems programming. The next CCP exam will be offered Dec. 9. \*

# LOOK AHEAD

(Continued from page 18)

## THE IBM MARKET FOR PERSONAL COMPUTERS

IBM, which has yet to venture into the personal computer business, may be missing out on a highly lucrative, built-in market--its own employees. Computer stores in and around the New York metropolitan area report that IBMers number among their best customers and are snapping up the small systems almost as quickly as they reach the store. So lucrative has the IBM trade become, in fact, that Byte has established a store in White Plains, N. Y., the heart of IBM land, and Radio Shack earlier this month held a special computer show within a stone's throw of IBM's corporate headquarters in Armonk. "We could probably survive just by selling TRS-80s (Radio Shack's personal systems) to IBM engineers," one Radio Shack store manager asserts.

## HARVEY TO STICK WITH SOFTWARE ENHANCEMENTS

When F. L. Harvey, president of Inforex, arrived recently to take up his new position, the firm's engineering and software staff didn't quite know what to make of the fact that Harvey had two personal computers of his own. Inforex has very much been a company in search of new products and the speculation was that he might want to lead the firm into the burgeoning personal computer field. No way.

Harvey, who picked up his software background at IBM and added to it at Xerox and later as president of UCC's U.S. group, is reported to have decided to stick hard and fast with Inforex's current 7000 and 5000 product lines. He'll enhance those lines with software.

## RUMORS AND RAW RANDOM DATA

After NCR Corp. introduced its model 7500 intelligent terminal at the NCC, Robert Schurheck, vp of The State Bank of Lake Havasu City, Ariz., was so taken by it that he couldn't wait to order one through normal channels. After the show concluded, he loaded the demonstration model into his van and took it home with him where the bank will use the terminal for data entry into its NCR 399 dp system...Bolstering industry views that AT&T's aborning Advanced Communications Network will support the X.25 protocol is a report that Bell exerted a subtle but strong influence through CCITT to insure that the standard meshed with its own plans. Sources report that while Bell Labs reps on the international standards setting committee seemed to keep a low profile, they were quick to speak up at any hint of an undesirable direction... Digital Equipment Corp. is rumored to be unloading its WT intelligent general purpose terminal on unsuspecting OEMers. This move, according to a source, is in preparation for the company's unveiling of the upgraded WT 100 model which is said to be based on an LSI/11...IBM computers coming off rental aren't forklifted into the East River as some wags often suggest. In its 3033 multiprocessors, IBM uses 370/158s to control six channels, and the company is considering using 370/115s to control consoles and thus solve scheduling problems... California's Savings Assn. Central Corp., a joint venture of Savings & Loans formed to set up a switching system to support shared automated teller machines and point-of-sale terminals back in 1975, took another step indicating the completed and tested system may be mothballed (May, p. 288). SACC terminated its two highest paid officers, James H. Campbell, president and John Warwick, marketing director and closed its San Francisco office...The headline on newspaper recruitment ads run by the management consultant firm of LRK Associates, offering software design jobs paying up to \$35,000, reads: "LRK's Proposition 13 1/2; cast your ballot with us."

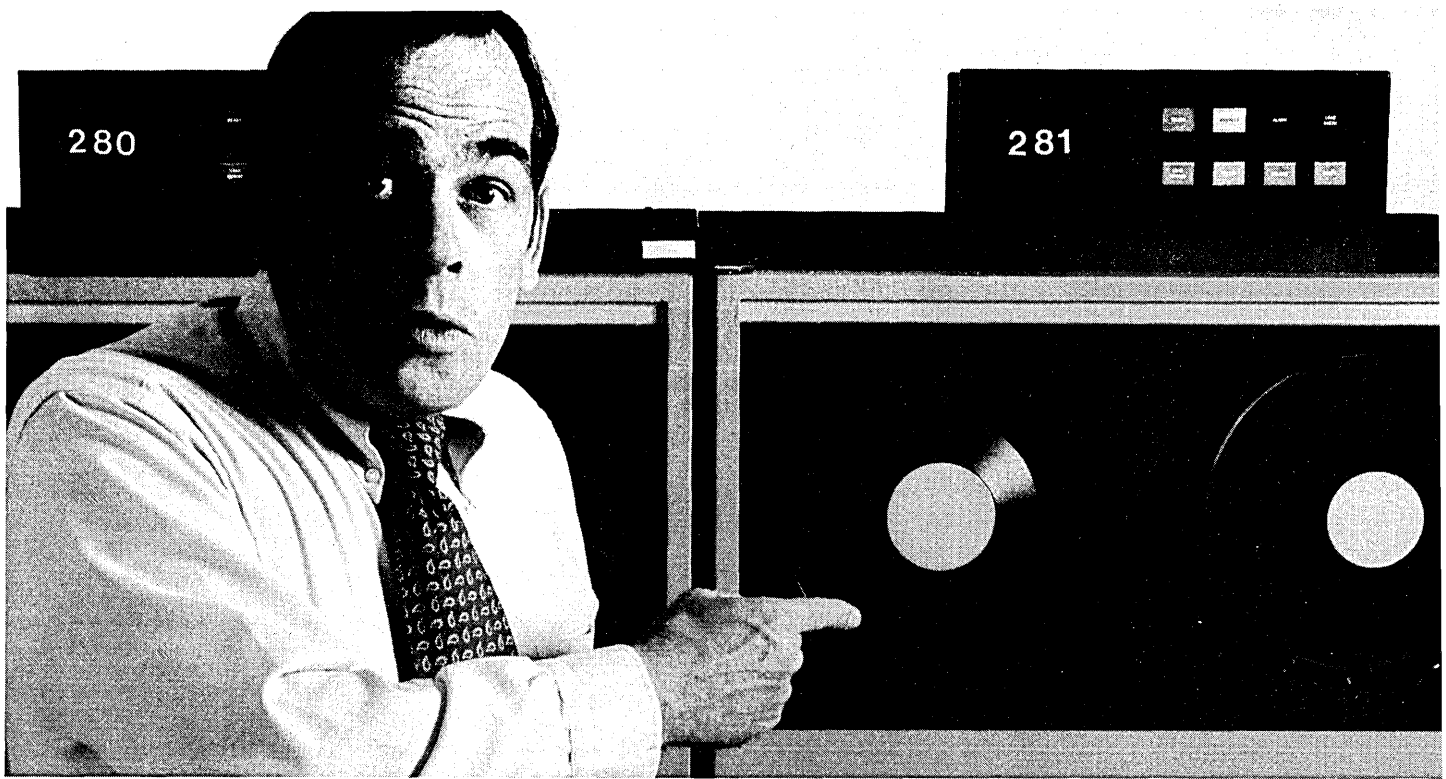

## Your 6250 bpi drives will perform even better with Cubic HD!

Introducing Memorex® Cubic™ HD computer tape. It's the high-density computer tape that'll deliver all the performance your 6250 bpi drives are meant to give. Because Memorex Cubic HD is the computer tape specifically formulated to perform at high-density. The computer tape that's been extensively tested at 6250 bpi—meeting industry standards for 6250 bpi.

Cubic HD has a thicker base to reduce edge damage and withstand high tensions. A new magnetic media formulation and process for higher output and optimum signal recovery. The result is a tape that'll deliver superior results. Less time lost in seek and re-seek time. More data availability—faster.

What's more, this exclusive new tape is on SuperReel™—the advanced design reel for enhancing high-speed, high-tension drive performance. Improved autoloading. And better tape winds—rewind after rewind.

If you're now using 6250 bpi drives, Memorex Cubic HD is the high-density tape you need right now. If you don't yet have 6250 bpi drives, now's the time to begin your conversion to Memorex Cubic HD. So your library will be ready when you are.

To introduce you to all the benefits of Memorex Cubic HD, we have a special introductory offer. Just see your Memorex representative to find out all about it. Offices in principal cities worldwide, or contact us at 1200 Memorex Drive, MS-0064; Santa Clara, CA 95052. Phone 408-987-1043.

Memorex Cubic HD—the best tape for getting even better performance from your 6250 bpi drives.

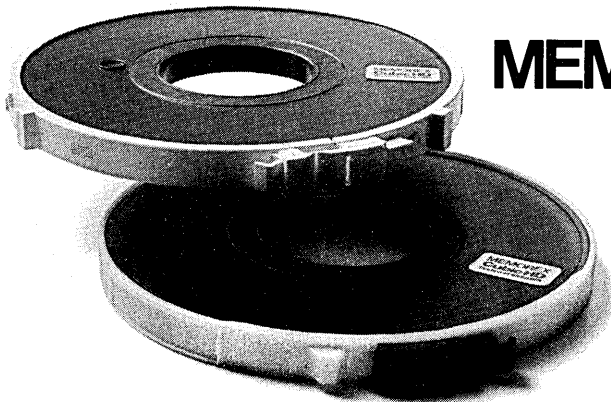

# MEMOREXCELLENCE

# hardware

## Off-line

A 256Kbit bubble memory chip that can operate with a driving frequency of 200KHz has been successfully produced in trial manufacturing runs at the Musashino Electrical Communication Laboratory in Japan. The chip uses major loop/minor loop architecture, with two major loops: one for reading, the other for writing. Loops are defined by an asymmetric chevron pattern, as opposed to T and I shaped permalloy bars. Average access time is said to be 8usec.

AT&T's latest move to speed the completion of long distance calls separates the calls themselves from information about the calls. Common Channel Interoffice Signaling (CCIS) takes the beeps, clicks, and tones used for call routing off the voice network and puts them onto a faster signaling network. Presently only 3% of the phone network is covered by CCIS; 62% of the interstate network is expected to be covered by 1986. Total coverage is slated for the year 2000.

What is being billed as the "most advanced traffic management system in the U.S." is slated to be operational in 1982. The Integrated Motorist Information System (IMIS) will cover a 35-mile, tri-county corridor between New York City and Long Island. The Sperry Div. of Sperry Rand will design the \$30-million system, with funding from the Federal Highway Administration. The system, which includes traffic surveillance, traffic metering at on ramps, and roadside information via changeable message signs and radio broadcasts, has the potential for saving 2.9-million hours of vehicle delay, 2.7-million gallons of fuel, and preventing 6-million pounds of auto emission pollutants and 200 accidents annually.

In another bubble memory development, researchers at IBM's Yorktown Heights facility have succeeded in creating magnetic bubbles 0.4 microns in diameter, about one-eighth the size used in commercially available chips. The research has so far led only to the creation of bubbles (magnetic domains), and not a fully functioning memory device.

## Thermal Printing Terminal

Need an attractively packaged, inexpensive printing terminal? Well, the T-48C may be for you, if you can work with a 48-character line, and a 24cps print rate.

The \$888 (quantities one through nine) ASCII terminal sounds like just the thing for personal computer users, and oem's and end users who don't need wide reports or high-speed printing. The terminal can operate with any of four jumper-selectable interfaces: TTL parallel, TTL serial, RS232C, and 20mA current loop. The T-48C is buffered, allow-

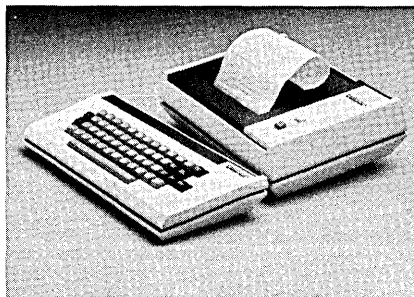

ing it to transmit and receive serial data at 110bps or 300bps (in parallel, up to 960cps). The unit works with the 96-character ASCII set; characters are formed on a 5 x 7 dot matrix.

The vendor offers both the keyboard and the printing mechanism as separate products. The PS-48C printer goes for \$666, and KB-59C keyboard is \$222 (both quantity one). Quantity discounts are offered on the terminal, printer, and keyboard. TELPAR, INC., Addison, Texas.

**FOR DATA CIRCLE 502 ON READER CARD**

## Circuit Fault Diagnosis

Continuing the trend of having microprocessor-based modems monitor communications lines and notify the central site of degradations or failures, this vendor has introduced a pair of network management systems for use with its MP-48 4800bps modems. The system, dubbed Analysis, comes in two versions: the CCA, with prices starting at \$3,500, and the CCB, starting at \$36,500. The microprocessor-based CCA has an alphanumeric Touch-tone entry pad and an LED display; users can monitor specific drops by entering their requests at the keyboard. The CCB includes a mini-computer, crt, and printer; it can operate in an autoscan mode, continuously checking each link in the communications system.

The Analysis units communicate with the MP-48 modems over a noninterfering 110bps diagnostic channel. The sys-

tem gathers information on loss, noise, phase jitter, amplitude and phase delay distortion, and other parameters. The data are analyzed for exception and alarm states. (Each modem in the network is assigned operating characteristic thresholds.) Messages are displayed in conversational English on the CCB's crt, or the CCA's LED display. The vendor says up to "several hundred" modems can be monitored throughout the network. PARADYNE CORP., Largo, Fla.

**FOR DATA CIRCLE 500 ON READER CARD**

## Plotter Controller

Here's a way to make that x-y recorder in the lab do double duty: the Serial Language Independent Plotter (SLIP) controller can turn that recorder into a computer controlled plotter. The microprocessor-based SLIP sits between a terminal and its model or its host cpu. It can interface to most x-y recorders, including Hewlett-Packard's 7015A and Esterline-Angus Instruments Corp.'s oem model 575. SLIP drives recorders accepting 2.5volt, 5volt, or 10volt inputs, either unipolar or bipolar. SLIP has adjustments to compensate for the mechanical characteristics of various recorders, characteristics such as maximum pen velocity, and pen lowering time. In plotting mode, the unit accepts ASCII character strings of integer coordinates. SLIP also operates in a character mode, using its own character generator to plot the ASCII string it receives. SLIP has an RS232 interface, and accepts data at 110bps and 300bps. A factory set option allows 1200bps reception in place of either 110bps or 300bps operation. SLIP sells for \$1,465. SPECIAL SYSTEMS, INC., Silver Spring, Md.

**FOR DATA CIRCLE 510 ON READER CARD**

## Computer Systems

A pair of 24-bit computer systems, complete with multiuser virtual operating system and language processors, now top off this vendor's S-series of systems. Education, commercial, and scientific users—a pretty broad market—are targeted for the main marketing thrust.

The two systems, the S550 and S570, both use the VULCAN operating system (used on other S-series systems) which can support concurrent interactive time-sharing, multistream batch, RJE, and real-time processing. Both systems have the capability to directly address 3,072KB of MOS main memory, and both systems sport 6KB of 70nsec cache. Optional, multiported memory allows sharing of the entire address space between

*(Continued on page 196)*



**“Our NCR network does more at less cost than the online system it replaced,” says Robert W. Balogh of Durr-Fillauer.**

**BALOGH:** We had online access to our central computer from our nine medical/surgical division branch offices, but the system didn't give us all we wanted. Now we've put an NCR interactive minicomputer at every branch. Our NCR network does more at less cost than the system it replaced.

**NCR's JUSTISS:** You reduced your dependence on telephone lines.

**BALOGH:** That's one area where we save substantially. And now we have what we need. A totally stand-alone system in every branch. Interactive access to files. IBM-compatible communication protocol. And

Robert W. Balogh (right) is Vice President of Durr-Fillauer Medical, Inc., a distributor of medical and drug supplies throughout the Southeast. J.D. Justiss is the NCR account manager.

the ability to install additional core, disk drives or printers when we need them. All at a low price.

**JUSTISS:** And the system is easy to operate.

**BALOGH:** That's right. We did not want a system that required

**Each of our NCR minicomputers runs 97% of the programming that was resident in the host computer.**

computer specialists at the branches. With the NCR system, employees without computer training use the computer as they prefer to meet their responsibilities.

**JUSTISS:** Yet the programs are identical at all nine branches.

**BALOGH:** That's a great advantage. Under the previous system, we had seven different variations. It was quite complex. Now we have one program everywhere – but a program that gives the branches the options they want. For example, some branches clear invoices in a single run at the end of the day; others prefer to clear them all day long.

**JUSTISS:** Each branch has autonomy.

**BALOGH:** Each of our NCR minicomputers runs 97 percent of the programming that was resident in the host computer. When the host goes down, the branches continue to run. Normally, we make two short transmits per day – at the end of day, and at the start of day. The host does the batch processing. Each branch system handles the day's transactions and produces the reports needed only in the branch.

**JUSTISS:** Do you consider your system a true distributed processing network?

**BALOGH:** If a true distributed processing network puts the processing wherever the need is, on a cost-efficient basis, under properly dispersed control, and effectively isolates any failure from the rest of the system – then I have it.

In the NCR office near you, there is an NCR account manager like Doug Justiss who knows your business and knows NCR systems, including network processing.

To learn more about what an NCR system can do for you, phone your local NCR office. Or write to EDP Systems, NCR Corporation, Box 606, Dayton, Ohio 45479.



**SURPRISE.  
YOU MAY ALREADY  
OWN PART OF OUR  
DISTRIBUTED  
DATA PROCESSING  
SYSTEM.**



That's because Data General systems are designed to work with most everyone else's mainframe, as well as our own. Without disrupting your system, obsoleting your investment or traumatizing your personnel.

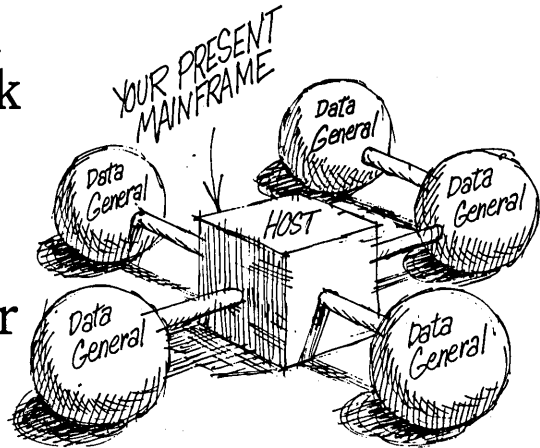

Data General computer systems use the same standard languages as your big mainframe computer and almost everything in between. And software, probably your biggest investment, may only require a minimum amount of conversion. In addition, your data processing staff doesn't have to be retrained.

Data General systems give you the most advanced technology available today. And they're easy to add to and grow with.

Getting along with big computers is one of the reasons our smaller computers make so much sense. Call (617) 366-8911, or return this coupon.

Send me a free copy of your booklet on distributed data processing, "Your network never knows the difference."  
 Please have a Data General salesman call for an appointment.

Name \_\_\_\_\_

Title \_\_\_\_\_

Company \_\_\_\_\_

Tel. No. \_\_\_\_\_

Address \_\_\_\_\_

City \_\_\_\_\_

State \_\_\_\_\_ Zip \_\_\_\_\_

Mail to: Data General Corporation,  
 Westboro, MA 01581

DM7

# Data General

We make computers that make sense.

# hardware

(Continued from page 192)

Series 500 processors. An optional Scientific Arithmetic Unit (SAU) provides hardware floating point processing.

Languages supplied with the systems include FORTRAN IV, 1974 ANSI COBOL, RPG II, a macro assembler, SNOBOL 4, and FORGO. Cincom's TOTAL data base management system and the vendor's BASIC-V package (see Software, p. 210) are available at added cost.

An S550 with 960KB of memory (and



a virtual address space of 12MB), system console crt, 80MB of disc, 9-track 800/1600bpi, 45ips mag tape, DMA communications processor (either four asynchronous ports or one synchronous port), and software sells for \$255,000. The S570, which differs from the S550 in that it has 2,112KB of main memory and 300MB of disc, sells for \$376,000. Deliveries begin early next year. HARRIS CORP., Fort Lauderdale, Fla.

FOR DATA CIRCLE 513 ON READER CARD

## Portable Terminal

This long-time maker of portable terminals (we don't know if it was the first, but the first portable terminal we remember seeing years ago carried this vendor's nameplate) has come up with a microprocessor-based, 136-column unit with a self-contained rolltop desk type



of cover. The model 4000 weighs in at 16 pounds, and can talk ASCII, APL, or IBM PTTC/EBCD character codes at speeds of up to 30cps.

The thermal printer forms characters on a 5 x 7 dot matrix. Either 80-column or 136-column paper can be used; the

terminal automatically senses between the two widths. The model 4000 prints upper and lower case characters, and it has plotting capabilities (24 vertical and 10 horizontal points per inch resolution). It has underscore, super- and subscripting capabilities. In the event of a parity error, the offending characters are printed cocked a 1/4-line above the rest of the text.

A three-character LED display indicates the current print position. The 4000 can tab, under either computer or operator control. An answer-back message of up to 30 characters can be supplied in ROM; the message is automatically transmitted in response to an ENQ request from the computer. The unit, including an integral acoustic coupler, sells for \$3,495. Quantity discounts are available. COMPUTER TRANSCIEVER SYSTEMS., INC., Paramus, N.J.

FOR DATA CIRCLE 504 ON READER CARD

## Smart Floppy Controller

The IFC-8400 intelligent floppy controller can handle up to eight Shugart SA400 or SA800 single-sided, single-density floppy disc drives. The unit's intelligence stems from its microprocessor-based design and its on-board firmware file management system. The IFC-8400 interfaces to computers, or other devices, over an RS232 or 20mA current loop interface; 8-bit TTL parallel interfaces are offered as options. The unit's on-board file management system allows it to operate on- or off-line. It recognizes ASCII commands, such as CREATE, DELETE, and APPEND; error messages also are ASCII strings. In addition to the microprocessor and file manage-

ment firmware, the IFC-8400 board houses a 1KB buffer, and there's room for adding file system extensions in PROM. The IFC-8400 sells for \$795. CYBERNETIC MICRO SYSTEMS, Santa Clara, Calif.

FOR DATA CIRCLE 505 ON READER CARD

## IBM-Compatible Terminal

The C-760 communicates with IBM mainframes bisynchronously at speeds ranging from 1200bps to 9600bps, offering an alternative to IBM's 2770, 3770, and 3780 terminals. The Z-80 microprocessor-based terminal, in its basic configuration, consists of keyboard, 25-line by 80-character display, 48KB of RAM, a floppy disc drive, and a forms programming language. Options in-

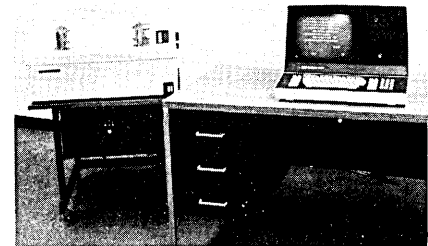

clude a second diskette drive, an additional 16KB of RAM, matrix printer, and a business BASIC language processor. Clerical operators can use the forms language to create data entry forms. Arithmetic operations can be performed, and data can be carried forward. Completed forms may be written to diskette or printer, or they may be transmitted to the host computer. BASIC offers 14-digit precision and data strings

(Continued on page 200)

## product spotlight

### Turtle

This choice example of *chelonina roboticus* may be a distant cousin of Star Wars' R2D2. It has lights for eyes, and a speaker for emitting sounds. But that's not the whole story. The device, known as a turtle, is actually a small robot which can move about under computer control. It moves at 6ips, and turns on the spot by rotating its two drive wheels in opposite directions. The turtle's shell, a 3 1/2-inch radius hemispherical dome, senses when the turtle bumps into an obstacle. It also has a

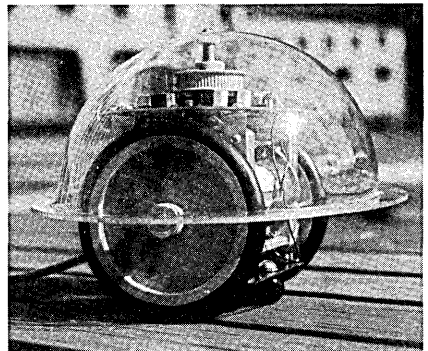

solenoid-actuated pen for drawing as it moves. The turtle comes as a kit or fully assembled, priced at \$300 and \$500, respectively. It interfaces to computers via a parallel interface; an S-100 interface is offered for \$40.

Previously, turtles have been used in educational environments. They can be used to draw pictures of any size, limited only by the amount of paper users are willing to put on the floor. With the right programming, they can even be used to solve mazes. TERRAPIN, INC., Boston, Mass.

FOR DATA CIRCLE 507 ON READER CARD

# For same-day small package delivery to 109 cities- Guaranteed!...

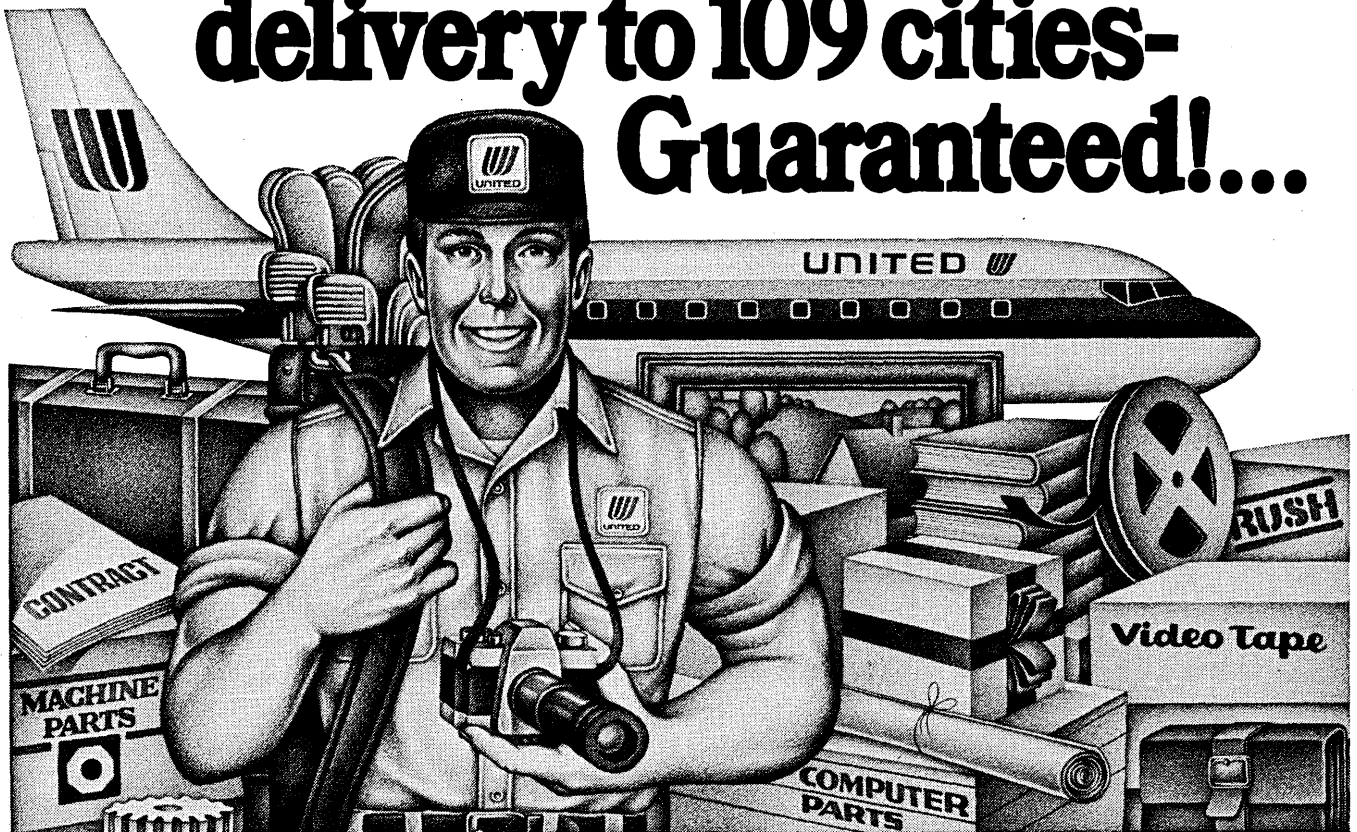

# Think Big.



## It's as easy as 1,2,3.

1. Take your important small package to United's Small Package Dispatch Center in the passenger terminal at least 30 minutes before departure of the flight you choose. Prepay the charges with your American Express®, Universal Air Travel Plan, United Credit Card, or cash.

2. Phone your addressee with the flight number, arrival time and SPD receipt number.

3. Your package is ready for pickup at the destination baggage area within 30 minutes of arrival.

## Here's our guarantee:

We're so confident your package will make it on the flight you choose, we'll refund 50% of your charge if it doesn't.

## Almost anything goes.

Film, legal documents, advertising material, medical supplies—whatever you want, as long as it weighs less than 50 pounds and measures no more than 90 inches in total dimensions (length, plus width, plus height).

## A small price to pay.

SPD between New York and Los Angeles costs only \$38.50. Between Chicago and New York, \$27.50. (Rates effective January 1, 1978, and subject to change.)

## SPD door-to-door, call (800) 638-7340.

Maryland call: 269-6470/Honolulu, Hawaii call: 842-5252/Hilo, Hawaii call: 935-9144  
We guarantee pickup and delivery to 3800 communities any time of the day or night, any day of the year, for a very reasonable price.

**UNITED AIRLINES CARGO**

# Think United.

# The Raytheon Checklist.

## A distributed processing user's best friend.

The term distributed processing is new enough that many people, both users and manufacturers, mean many different things when they talk about it.

Rather than try to add another definition to the many now existing, Raytheon Data Systems has prepared this comparative

checklist of the major functions that might normally be considered attributes of any distributed processing system. Regardless of the distributed processing system you eventually select, there are a number of capabilities

you will want that system to possess. Obviously, the more features the system has, the greater its capacity to do all

the work you have planned now—or might need tomorrow.

Our checklist itemizes many of the most important features you should consider. They are not the only features, but we think they are the most important.

And—to make the point that Raytheon's PTS/1200 MARK-I and MARK-II systems are extraordinarily powerful distributed processing systems—we've taken the liberty of itemizing their capabilities in each of the columns shown. Do that with other vendors' equipment, and we think you'll choose Raytheon.

### Then check prices. The MARK-I is lowest.

After you've looked at the variety of products on the market, you'll also want to see what each costs.

We can tell you about Raytheon's pricing. The PTS/1200 MARK-I is the lowest. By low, we mean up to 30 per cent below the most popular alternative models. The PTS/1200 MARK-II costs a little more, but is more than twice as powerful as the MARK-I. You won't be able to compare its cost directly with other equipment, because no other equipment can come close to matching its performance.

Solving the installation and productivity problems that these users encounter takes patience, skill and the commitment of an experienced vendor. It takes going beyond a standard product, and finding customized solutions, and often products, to meet a user's requirement.

Most of all, it takes doing it. Over and over and over again. Raytheon has done it over and over and over again.

### Fast, easy installation and growth is vital.

Not shown in the checklist is another vital aspect of distributed processing systems—immediacy of installation and ease of expansion. The Raytheon PTS/1200 MARK-I can be installed in less than a day, with no change to host hardware, or systems or applications software. You become productive right away. And when you want to grow, you simply add capacity—within a single system, or by adding additional systems or devices. Every PTS/1200 is compatible with every other—and with your host mainframe system and protocols in almost every case.

### Look hard at experience too.

Beyond the hardware, the price and the easy compatibility, there is the experience factor. The vendor with experience can save the user without it a lot of grief.

Raytheon is the world's largest non-mainframe supplier of intelligent terminals and distributed processing systems. Some of our customers use more than 2,000 Raytheon terminals in data networks located at more than 300 locations either domestically or around the world. Many others have one or several PTS/1200 distributed processing systems at work in remote locations, linked on-line to a central mainframe.

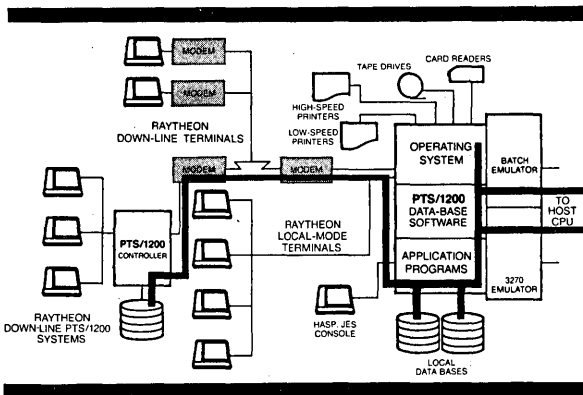

Shown above is a typical schematic of a PTS/1200 distributed processing system with a hierarchy of local data bases, multiple terminals in multiple applications, all linked by one or more protocols to a central mainframe.



A typical four-station MARK-I system with a 64K-byte controller, 10 MB disk, and one 165cps printer leases for \$850 per month, including all software and maintenance.

# The 54-Point Checklist

Feature	Typical Configuration	Importance of Feature	Product Capabilities			
			PTS/1200	Brand X	Brand Y	Brand Z
<b>INTELLIGENCE</b>	<ul style="list-style-type: none"> <li>✓ Dependent totally on host processor</li> <li>✓ Stand-alone (non-shareable) intelligence in each station</li> <li>✓ Small-cluster (shared by 1-8 stations)</li> <li>✓ Large-cluster (shared by 1-24 or more stations)</li> </ul>	Intelligence is based upon the amount of available program-mable memory a system possesses. Its purpose is to facilitate local application development and execution. The larger the available memory, the better the applications freedom.	N/A All resources shareable by all stations 64K to 128K bytes 64K to 128K bytes			
<b>CONTROLLER</b>	<ul style="list-style-type: none"> <li>✓ Word size</li> <li>✓ Number of operator stations per controller</li> <li>✓ Number of peripheral attachments per controller</li> <li>✓ Availability of high level languages</li> <li>✓ Ability to perform multi-tasking</li> </ul>	The controller is the central processor of a distributed system. Its power in terms of word size, attachment capacities, programmability and ability to perform multiple tasks concurrently is the key limiting factor in its ultimate performance.	16-bit 1-8 stations, or 1-24 stations 1-4 peripherals, or 1-20 peripherals Yes: MACROL, COBOL in the future Yes Up to 32 tasks concurrently on one controller			
<b>TERMINALS</b>	<ul style="list-style-type: none"> <li>✓ Variety of screen sizes</li> <li>✓ Variety of keyboard options</li> <li>✓ Availability of user-definable function keys</li> <li>✓ Ability to provide operator prompting</li> <li>✓ Ability to attach remote terminals on phone line</li> </ul>	The terminal is the point of operator interface and should be capable of being comfortable to use, easy to use, and easily matched to one or many different applications through customizing.	960 or 1920 3270 type-writer, data entry 16 program function keys; plus any key programmable Yes: by screen, audio and light indicators Yes			
<b>PERIPHERAL ATTACHMENTS</b>	<ul style="list-style-type: none"> <li>✓ Number of attachments per controller</li> <li>✓ Low-speed printer devices</li> <li>✓ High-speed printer devices</li> <li>✓ Card reading devices</li> <li>✓ Magnetic tape transports</li> <li>✓ Printer's word processing quality</li> </ul>	The ability to attach a variety of peripheral equipment of various speeds and capacities is a measure of the range of work a system can do.	1-4, or 1-20, any combination 45-165 CPS 3 models 300 LPM and 600 LPM 300 CPM 800 and 1600 BPI Yes			
<b>COMMUNICATIONS PROTOCOLS</b>	<ul style="list-style-type: none"> <li>✓ Asynchronous</li> <li>✓ Synchronous</li> <li>✓ Binary Synchronous - Batch</li> <li>✓ -Interactive</li> <li>✓ Synchronous Data Link Control (SDLC)</li> </ul>	The ability to support more than one protocol - at the same time on the same system - adds immeasurably to the number of tasks and number of networks a system can work in without additional user development effort.	Yes, TTY RS-232 Yes Yes Yes Yes, in 1979			
<b>INTELLIGENT 3270 OPERATIONS</b>	<ul style="list-style-type: none"> <li>✓ Local format storage</li> <li>✓ Local printing</li> <li>✓ Ability to access and update local data bases</li> <li>✓ Transactions stored locally, batched for transmission to host</li> <li>✓ Field verification at each terminal location</li> <li>✓ Application program decides when to go to host</li> </ul>	This feature assures that the system can work immediately and easily with the most popular terminal devices in use today, and extend the performance of those devices in a variety of ways.	Yes Yes Yes Yes Yes			
<b>EMULATION CAPABILITIES</b>	<ul style="list-style-type: none"> <li>✓ 3270 interactive (dumb)</li> <li>✓ 3270 interactive (intelligent)</li> <li>✓ 2780 batch</li> <li>✓ 3780 batch</li> <li>✓ SDLC batch/interactive</li> <li>✓ HASP remote job entry</li> <li>✓ Non-IBM protocols</li> <li>✓ Specialized protocols</li> </ul>	Emulators are software tools that permit a system to operate as a look-alike under other vendors protocols and procedures. Their advantage is to permit direct and immediate attachment to networks using a specific device protocol.	Yes Yes Yes Yes Yes, in 1979 Yes Yes			
<b>DATA BASE STORAGE</b>	<ul style="list-style-type: none"> <li>✓ Multiple disk storage capacities</li> <li>✓ Memory management software</li> <li>✓ Ability to expand to very large local storage</li> </ul>	Local data base storage under sound memory management techniques assures powerful local filing, easy off-loading of large central files and elimination of unnecessary communications to and from host.	Yes: from 10 to 320MB Yes Yes: to 320 MB per system			
<b>SOFTWARE LANGUAGE</b>	<ul style="list-style-type: none"> <li>✓ Assembly language</li> <li>✓ Strong macro command repertoire</li> <li>✓ High-level compiler language(s)</li> <li>✓ Easy-to-learn and use</li> <li>✓ Numerous screen manipulation and interactive programming aids</li> <li>✓ Parameter-driven aids where required</li> </ul>	Language is the facility that makes it possible to tap the power of the basic system by allowing applications to be written easily. Simple but rich high-level language that can be learned easily by programmers or used by non-programmers extend a system's reach that much further.	Yes, not needed by user personnel Yes: 150 instructions MACROL now, COBOL in 1979 Yes Yes Yes: for format creation and source data entry			
<b>NETWORK ENHANCEMENTS</b>	<ul style="list-style-type: none"> <li>✓ Concurrent communications operation</li> <li>✓ Downline control of multipoint networks</li> <li>✓ Remote program development support for maintenance in any language</li> <li>✓ Teleprinter network on terminal lines</li> <li>✓ Downline program debugging</li> <li>✓ Downline terminal loading</li> <li>✓ High-speed data transmission rates</li> </ul>		Yes: batch and interactive at same time Yes: up to 10 drops per controller Yes Yes: on same lines at same time Yes Yes To 9600 BPS			

## Raytheon - 50,000+ terminals in use now.

When you select Raytheon, you are selecting a total single-source supplier who has installed more than 50,000 intelligent terminals. A supplier with a worldwide field maintenance organization that is linked together by its own distributed processing network that keeps track of every equipment outage for every customer. A supplier that does not need to offer third-party leasing, because it maintains its own self-financed leasing company. And a supplier whose customer list includes a very high percentage of the world's largest industrial, commercial, financial, insurance and government data systems users. Raytheon. The company to pick when you've completed your distributed processing checklist.

Tell me more about the Raytheon PTS/1200 distributed processing family:  
 MARK-I  
 MARK-II

Tell me more about some of the features shown on The Checklist. I'm especially interested in:

1. \_\_\_\_\_
2. \_\_\_\_\_
3. \_\_\_\_\_
4. \_\_\_\_\_

Have a salesman call.  
 Send me more information.

Name: \_\_\_\_\_  
 Title: \_\_\_\_\_  
 Company: \_\_\_\_\_  
 Street: \_\_\_\_\_  
 City: \_\_\_\_\_  
 State: \_\_\_\_\_ ZIP: \_\_\_\_\_



**Intelligent Terminals  
 Distributed Processing Systems  
 Word Processing Systems  
 Minicomputers  
 Telecommunications Systems**

**RAYTHEON DATA SYSTEMS** 1415 BOSTON-PROVIDENCE TURNPIKE • NORWOOD, MASSACHUSETTS 02062  
 Call Director, Field Marketing, at (800) 225-9874 (toll free) Inside Massachusetts call (617) 762-6700 • TWX: 710 336-0646 • TELEX: 92-4408  
 ALBANY (518) 456-7434 • ATLANTA (404) 321-3064 • BOSTON (617) 237-4190 • CHICAGO (312) 694-4420 • CINCINNATI (513) 772-2200 • DALLAS (214) 661-9722 •  
 DENVER (303) 371-0990 • DETROIT (313) 358-3990 • GREENSBORO (919) 294-5811 • HARTFORD (203) 289-8281 • HOUSTON (713) 496-0100 •  
 KANSAS CITY (816) 561-9333 • LOS ANGELES (714) 979-5800 • MIAMI (305) 592-3884 • MINNEAPOLIS (612) 854-2666 • NEW YORK CITY (212) 661-2790 and  
 (212) 895-2567 • PHILADELPHIA (609) 665-8466 • PITTSBURGH (412) 281-2117 • SAN FRANCISCO (415) 692-4640 • SEATTLE (206) 453-0650 •  
 TULSA (918) 663-7852 • WASHINGTON, D.C. (703) 979-6100 • OVERSEAS: AMSTERDAM (020-93-0787) • FRANKFURT (49-6196-46829) • SYDNEY (61-2-297721).

# hardware

(Continued from page 196)

of up to 255 characters in length. An entry level system sells for \$8,671; adding a second diskette drive, matrix printer, and BASIC brings the price up to \$12,750. One-year lease prices are \$256 and \$384 per month respectively, with maintenance priced at \$85 and \$165 per month. Oem discounts are offered. CONTROL DATA CORP., Minneapolis, Minn. **FOR DATA CIRCLE 501 ON READER CARD**

## Minicomputer Systems

Honeywell bracketed its Level 6 mini-computer line with the addition of its model 23 at the low end, and a new capper, the model 57. As a means of comparison, the vendor says the model 23 is in the 200,000 instructions per second class, while the model 57 runs around 700,000 instructions per second.

The model 23 is a communications oriented system intended for oem's and distributed processing applications. It can communicate with Honeywell's Series 60, and Series 200(0), and with other vendors' equipment using IBM protocols. The system runs GCOS 6MOD 400, or MOD 200. MOD 200 requires less overhead, and is intended to put the model 23 in a transaction processing environment. A 32K word model 23,

## Car Computers

We haven't even seen a computer in every home yet, and these two firms are aiming to make a computer in every car a reality.

Compucruise provides a fuel management system, trip computer, clock, and digitally displayed cruise control. The fuel management system tracks instantaneous and average fuel consumption, fuel remaining, and distance and time to empty. Compucruise also has a cruise control feature which will accelerate the car to a preselected speed,



maintain speed, and resume cruising speed after the driver has slowed for traffic. The unit works with either metric or English units. Its "command module" has a 20-key back-lighted key-

with a single diskette drive, workstation, and MOD 200 software, sells for \$13,500.

board and a five-digit display. Compucruise sells for \$189.95. ZEMCO, INC., Walnut Creek, Calif.

**FOR DATA CIRCLE 515 ON READER CARD**

This vendor's On-Board Computer gives instant and average miles per gallon, estimated time of arrival, instant and average cost-per-mile, miles to go, and other information. It also functions as a digital speedometer and trip odometer. It has five memory locations for storing and recalling trip infor-

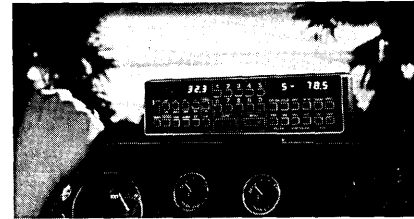

mation. Readouts may be expressed in miles or kilometers. The unit also provides clock functions, and an audio alarm sounds when the driver is one mile from his programmed destination. The On-Board Computer is expected to carry a retail price in the \$400 neighborhood. PRINCE CORP., Holland, Mich. **FOR DATA CIRCLE 516 ON READER CARD**

The model 57 is optimized for processing COBOL programs. It's also intended to extend the vendor's Distributed System Environment (DSE) approach to the market. Model 57 actually has two processors, one of which executes the standard Level 6 instruction set, the other an additional set of

# SYSTEMS PROGRAMMING PROFESSIONALS

Control Data Corporation has career growth opportunities, in pre-sale, post-sale and consulting, located throughout the United States. Applicants should have experience in maintaining, modifying or extending any one of the following operating systems.

### ■ CYBER 17X or 6000 with NOS, NOS/BE, SCOPE or KRONOS

(Opportunities in Austin; Albuquerque; Boston; Chicago; Detroit; Fredericksburg; Livermore, California; Monterey, California; Miami; New Jersey; Philadelphia; Ponca City, Oklahoma; St. Louis; San Francisco Bay Area and Washington, DC)

### ■ System 370 or 360 with DOS, VS, VSI, SVS or MVS

(Opportunities in Albuquerque, Atlanta, Boston, Denver, Detroit, Mil-

### ■ CYBER 18 with 1700 MSOS, RCOS or ITOS

(Opportunities in Dallas, Los Angeles and Minneapolis)

or have extensive assembly language on any of the above computers.

For immediate consideration, please send resume, salary history and geographical preference to:

John N. Powers

**GD CONTROL DATA CORPORATION**

60 Hickory Drive, Waltham, Mass. 02154

OR CALL COLLECT: (617) 890-4600, ext. 245

An Affirmative Action Employer M/F

waukee, Minneapolis, New York, Philadelphia, Pittsburgh, and Washington, DC)

### ■ AN/UYK-7 OR AN/UYK-20

(Opportunities in New England, New Jersey Shore, Norfolk/Newport News, Virginia, San Diego, California and Washington, D.C.)

### ■ Intel 8080 or other Microprocessors (These positions in the Houston and Philadelphia areas)



COBOL instructions. A 128K-word model 57, with 4K of cache, 67MB of disc, tape drive, console, crt terminal, and the MOD 600 executive, sells for \$127,000. HONEYWELL INFORMATION SYSTEMS, Billerica, Mass.

**FOR DATA CIRCLE 509 ON READER CARD**

## Mag Tape Subsystems

Two tape subsystems, with microprocessor-based controllers, have joined this mini-maker's line of peripherals. The model 6026 features dual recording

CIRCLE 182 ON READER CARD

densities (800bpi and 1600bpi), the model 6027 operates at 800bpi only. Both use vacuum column, 75ips transports. Subsystems can support up to eight transports (not necessarily in the same models). The controller has error control features, self-test, hardware controlled automatic retry on data transfers, auto-skip erase on rewrite, and status reporting for data integrity. The controller's buffer protects against channel overrun during peak system I/O. The vendor's AOS, RDOS, and DOS operating systems all support the subsystem. A 6026 subsystem including one transport and controller sells for \$14,500; add-on 800/1600bpi transports, known as the model 6026-A, sell for \$10,300 apiece. The 6027 subsystem (controller and one transport) sells for \$10,900. Additional drives (model 6023) sell for \$6,700. Oem discounts are offered and deliveries are quoted at 90 days. DATA GENERAL CORP., Westboro, Mass.

FOR DATA CIRCLE 511 ON READER CARD

### Selectric Interface

Users of S-100 bus personal computers can use the Typeaway to interface Selectric I/O Writers (models 731 or 735) with their systems. The package consists of one S-100-compatible pc board containing solenoid drivers, I/O ports, and PROM-based software, cabling and connectors, and a dc power supply. The board's firmware performs all required control functions and code conversions. An assembled and tested Typeaway sells for \$350; in kit form it sells for \$275. MICROMATION, INC., San Francisco, Calif.

FOR DATA CIRCLE 512 ON READER CARD

### Mainframe

The 90/80 product line just added a new member that the vendor says exceeds the performance of IBM's 3031. Its price



tag also exceeds that of a 3031, but this may be misleading because this vendor bundles its software with hardware. In any event, the 90/80-4 represents a

(Continued on page 204)

# FOR SPACE MISSIONS AND GROUND APPLICATIONS... THE 700/UETS™ FILLS THE BILL

For its Space Shuttle Program, NASA needed a terminal that could interface with an array of different computers and that could emulate any number of different terminals—the **MEGADATA 700/UETS (Universal Emulating Terminal System)** filled the bill. At the Johnson Space Center, the **700/UETS** is now being used not only as a program control and status device for Shuttle flights, but also as a true emulating system that performs non-mission related services—for example, developing programs that are typical of on-line interactive terminal applications.

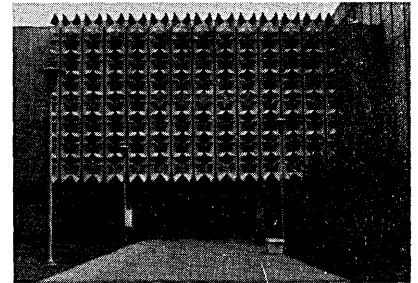

Command Center of Johnson Space Complex

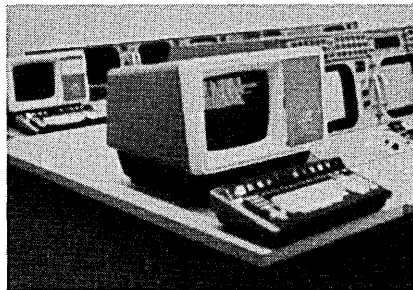

Space Shuttle Control Center

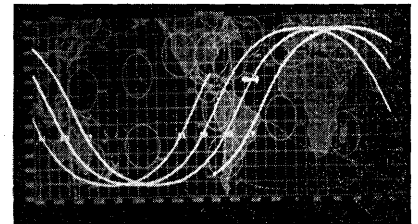

Satellite Global Tracking Map

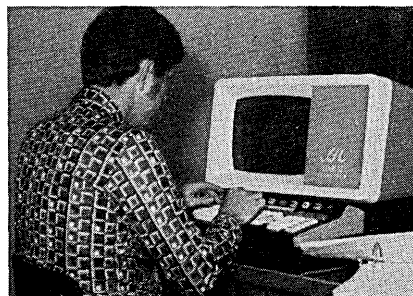

**UETS** Terminal  
Being Used in Data Entry and Test Mode

Exotic applications the **UETS** takes in stride. But most of all it provides its many users with a cost-effective solution to the most complex data handling and communications problems. If you are a multiple computer user who is tired of using scores of different terminals, let us show you how **ONE UETS** can replace a host of terminals, simplify your operations, reduce maintenance complexity, and save you money to boot!

Call or write TODAY to find out more about the **700/UETS**, our entire family of Series 700 applications-oriented programmable terminals, and our extensive software capabilities.

**MEGADATA CORPORATION** 

35 Orville Drive • Bohemia, New York 11716 / Tel. 516-589-6800 • Telex 14-4659

Central Regional Office

2200 E. Devon Avenue • Suite 217 • Des Plaines, Illinois 60018 • Tel. 312-296-1900

Western Regional Office

15910 Ventura Boulevard • Suite 800 • Encino, California 91316 • Tel. 213-990-9777

CIRCLE 138 ON READER CARD

**A state-of-the-art  
computer like the  
303X needs a  
state-of-the-art  
impact line printer**

Call John Sterling (800) 327-6424 or (305) 724-1111 or Documentation's local representative: **Atlanta, GA** 955-0309  
**Birmingham, AL** 322-5834\*  **Boston, MA** 890-2650  **Cleveland, OH** 831-0695  **Dallas, TX** 661-9902/750-6160  **Denver, CO** 758-8775  
**Detroit, MI** 353-8181  **East Meadow, NY** 794-1186  **Greenwich, CT** 869-4123  **Hartford, CT** 278-2010  **Houston, TX** 780-1432  
**Irvine, CA** 752-8782  **Jacksonville, FL** 398-1470\*  **Long Beach, CA** 595-6775  **Miami, FL** 592-9655  **New York, NY** 695-4195  
**Newark, NJ** 686-5223  **Oak Brook, IL** 920-0551  **Philadelphia, PA** 337-2850  **San Francisco, CA** 574-4060  **Washington, DC** 356-2050  
International Offices: **London** — Staines 61124  **Paris** 686 8007  **Germany** 0611-762 055  **Spain** 416 87 60

\*Service Only



# New IMPACT 3000\*

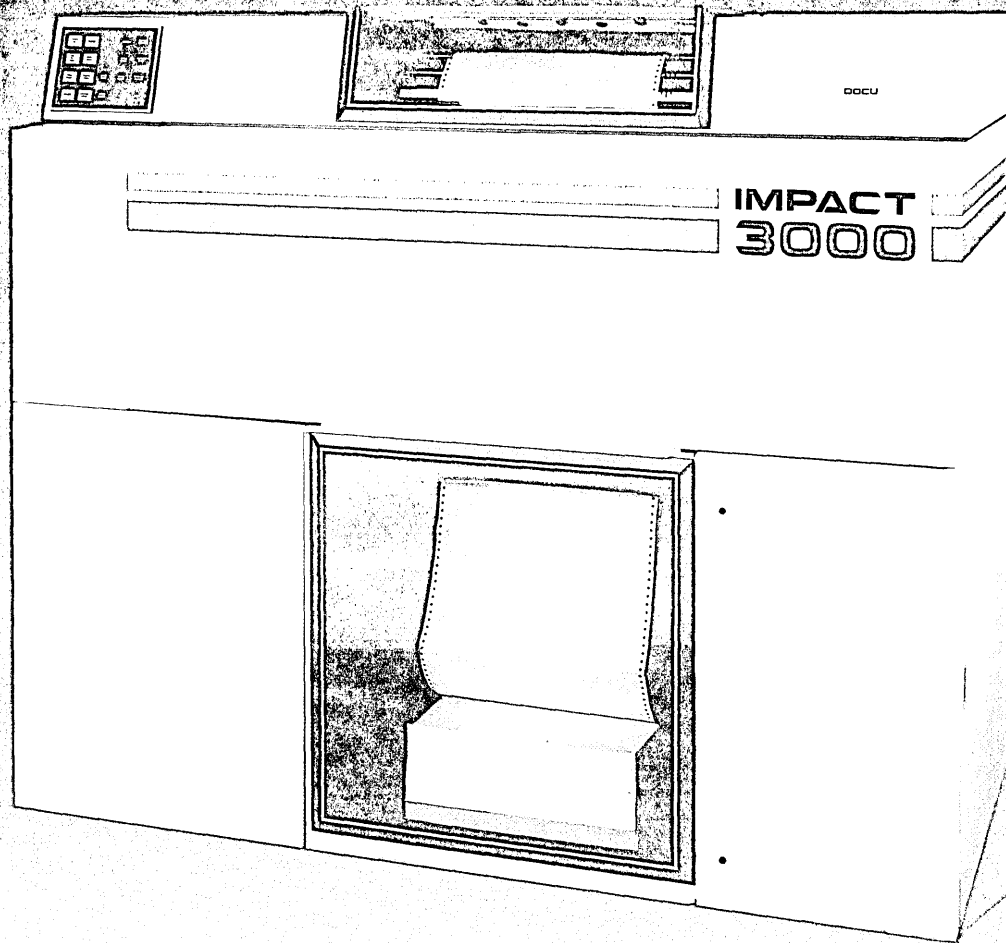

## More throughput per dollar

Reasons for moving up to state-of-the-art computers are no different than the reasons why you should consider moving up to state-of-the-art impact line printers. Even if you have a 360/370 or plug-compatible mainframe. More performance and value for your dollar invested. Documation's IMPACT 3000, rated at 3000 lines per minute, is 50% faster with better price/performance than any other impact line printer available. That's state-of-the-art!

## Space saving integrated controller

Documation builds its controller right into its printer resulting in less heat, less power consumption and less computer room space. That's state-of-the-art!

## New printer print quality assured

One printband comes with your purchased or leased IMPACT 3000 and maintained at no charge under Documation's Maintenance Agreement. In addition, a wide variety of standard and custom fonts are also available for your varied requirements. Operator changeable in less than two minutes, you're assured new printer print quality for the life of your printer because your bands are easily replaced as wear occurs . . . at no cost to you. That's state-of-the-art!

## Off-line diagnostics

IMPACT 3000 provides you with complete off-line maintenance and adjustment. You no longer have to spend valuable computer time on print tests, ribbon motion, servo speed checks, memory tests and hammer flight-times. That's state-of-the-art!

## Automatically stacks paper

A Documation-developed automatic stacker elevator constantly senses paper height, providing you with neat, accurate stacking regardless of form sizes and slew speeds up to 100 in. per second. That's state-of-the-art!

For details on Documation's state-of-the-art IMPACT 3000, call Documation's local representative or write Documation Incorporated, P.O. Box 1240A, Melbourne, FL 32901.

\*Trademark of Documation Incorporated

**DOCUMATION  
INCORPORATED**

# hardware

(Continued from page 201)

growth path for the vendor's existing customer base, and an alternative to IBM for those open to a migration to a new vendor.

The 90/80-4 doubles the main memory maximum of the 90/80-3, allowing memory sizes ranging from 2MB to 8MB in increments of 2MB. It also stands apart from the -3 by having a 32KB cache, divided equally between instructions and data. The semiconductor memory has an access time of 280 nsec for eight bytes; maximum transfer rate

is 16Mbps. In its basic configuration, the 90/80-4 has five channels—one byte multiplexor and four block multiplexors, or another byte multiplexor and two more block multiplexors. The processor has a basic cycle time of 98nsec, and an average instruction execution time of between 400nsec and 500nsec.

A basic, 2MB 90/80-4 sells for \$1,256,000. On a five year lease, the monthly rental (including maintenance) is \$27,700. Existing 90/80-3s may be field upgraded. SPERRY UNIVAC, Blue Bell, Penn.

FOR DATA CIRCLE 498 ON READER CARD

## Financial Terminal

The 2251 electronic teller terminal is



said to fit the needs of all types of financial institutions. It handles many transactions common at teller windows, including printing passbooks, ledger cards, and other inserted documents.

The microprocessor-based unit can operate on- or off-line. A free-standing system can be field upgraded for on-line communications after installations. The vendor says it can construct an interface to any computer.

Tailoring the terminal's functional characteristics to the needs of users—be they commercial banks or thrift institutions—can be done with software entered at the terminal's keyboard. Or, in an on-line situation, the terminal can be down-loaded from a host cpu.

In addition to standard teller functions, the terminal can automatically calculate interest. It can be used for both front- and back-office operations. At the teller station it can perform positive proof of deposit and automatically produce withdrawal checks. The unit's inserted-forms station (used for passbooks and other inserted documents) includes a 90-column matrix printer.

The 2251 financial terminal sells for \$6,950. NCR CORP., Dayton, Ohio.

FOR DATA CIRCLE 503 ON READER CARD

## Automatic Line Monitoring

The Automatic Circuit Quality Monitoring (ACQM) system can automatically sequence through communications links which use this vendor's modems, looking for critical signals and degraded network performance. ACQM is said to allow fault detection and identification without interrupting data transmission. The ACQM generates an alarm report whenever it detects degradations or circuit dropouts. This report can be printed or sent to the user's cpu for record keeping and analysis. A terminal may be attached to the ACQM, allowing users to alter the alarm threshold for each line disturbance parameter measured. Capable of monitoring as many as 64 modems, the ACQM tracks phase jitter, noise, impulse hits, phase hits,

# What does it take to make a classic terminal?

It takes versatility, the ability to handle a range of applications as diverse as interactive timesharing, communications, and X-Y plotting.

It takes printing of exceptional quality so that documents look as though they had been produced on the world's finest word processor.

It takes a microprocessor for power.

It takes multiple character sets—the standard ASCII, plus optional EBCD, Correspondence, even APL.

It takes ease of operation, a typewriter keyboard, a separate numeric keyboard, complete forms control, a buffer memory, switch selectable line speeds from 10 to 45 characters a second, interchangeable type

faces. And other features for specific needs.

Such a terminal would be classic. There *is* one. The AJ 832. Call your nearest AJ sales office, or write Anderson Jacobson, Inc., 521 Charcot Avenue, San Jose, California 95131, (408) 263-8520.

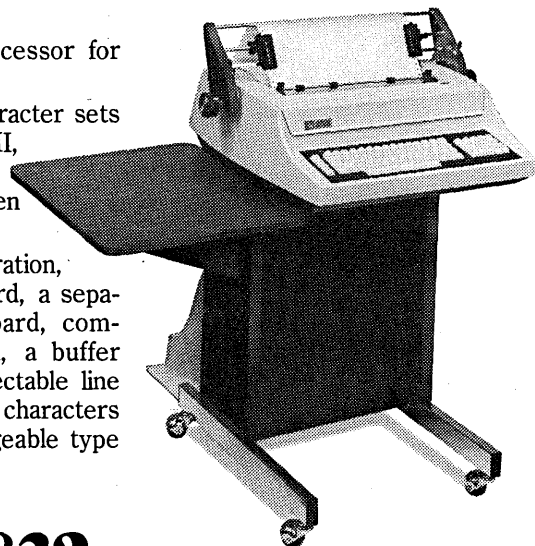

## The AJ 832. Classic.

 **ANDERSON  
JACOBSON**

CIRCLE 135 ON READER CARD



# A Place to Rinse Your Mind

Oregon. Much of its natural beauty remains. It is an ideal place to grow. We grew here . . . from a small shop to a Fortune 500 R&D and manufacturing complex. We're still growing. Rich green forests and fields, streams, mountains, and boating waters to the Sea. We believe there is no better contrast for high technology thinking; and no better prescription for clearing the mental clutter that can stand in the way of a fresh idea. It works. One of our engineering managers recently ad-libbed: "We've gotten into the habit of success." Our concern is more than technical excellence. Excellence in people, and support for what they believe they can do is the expectation we place on our commitment. Learn more about us, and about what we can do together. There are continuing opportunities ranging from advanced Hybrid Microelectronic R&D to IC and Instrument Production and Marketing. If you have any of the skills a fresh idea company . . . a Fortune 500 leader in Instrumentation Graphic Display, and Computer Peripherals can use, write to us: Professional Staffing, TEKTRONIX, INC., P.O. Box 500, Beaverton, 7D, Oregon 97077.

A full color print of this scene is available at no obligation. Just drop a note to: Bill Eppick at the above address.

An Equal Opportunity Employer

**Tektronix**<sup>®</sup>  
COMMITTED TO EXCELLENCE

# hardware

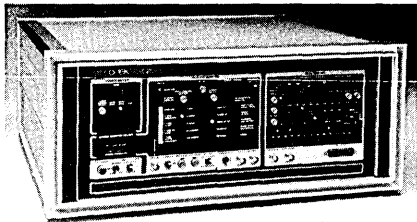

gain hits, dropouts, harmonic distortion, and band-edge distortion. An ACQM sells for \$8,750. On a two-year lease it goes for \$300 per month. CODEX CORP., Newton, Mass.

FOR DATA CIRCLE 499 ON READER CARD

## Vector-to-Raster Converter

Here's a way to take some of the processing burden off a minicomputer driving one of this vendor's electrostatic plotters: the vector-to-raster converter (VRC) accepts vectors from the mini, converting them into raster scan format required by the plotters. The vendor says its VRC will let even small or overloaded minis drive its plotters at their maximum rated speed. Offloading the vector-to-vector conversion process is said to typically reduce minicomputer processing time by a factor of eight;

storing plots in vector form on disc is said to reduce disc space requirements and I/O time by as much as a factor of 20. The VRC can interface with "all popular minis," including Data General Novas, and DEC PDP-11s. VRC prices start at \$3,900. VERSATEC, Santa Clara, Calif.

FOR DATA CIRCLE 506 ON READER CARD

## Automatic Typewriters

IBM has come up with a couple more fancy typewriters. Both use a proprietary microprocessor to provide functions such as automatic continuous underscore or erase, automatic indent, and line memory. The model 50 offers number alignment, to simplify typing statistical documents, and triple pitch. The triple-pitch feature goes a step beyond the traditional 10-pitch and 12-pitch used on the Selectric II typewriter; the third pitch is actually proportional spacing as found on the Executive model. Model 60, a dual-pitch typewriter, has functions to speed repetitive typing tasks: It has phrase storage, and automatic carrier return. Both models have automatic error correction, and built-in diagnostics. One word of warning: while both use golf-ball type elements, they do not use standard Selectric elements. Don't feel constrained; IBM says it has more than 25 type styles available for these two

machines. Both typewriters are priced at \$1,675. On a 48-month lease, each machine goes for \$80 per month. Delivery schedules are 16 weeks for both. INTERNATIONAL BUSINESS MACHINES CORP., Office Products Div., Franklin Lakes, N.J.

FOR DATA CIRCLE 508 ON READER CARD

## Instrument Interface

If you're building an oem instrumentation product, if you need to wire your lab's instruments to a computer, if you're assembling a data acquisition system, or if you simply want to use devices using the IEEE-488 instrument interface, then the GPIB11V-1 can help you connect your LSI-11 to the outside world. The single dual-height pc board interface can perform listener, talker, or controller functions. The M6800-based interface comes with service routines which may be assembled as FORTRAN, BASIC, or Macro-callable subroutines. The GPIB11V-1 connects as many as 14 instruments (or other IEEE-488 devices) to an LSI-11/2, PDP-11/03 or PDP-11V03 operating under RT-11. RSX-11 and UNIX support is reportedly in the works. A single GPIB-11V-1 sells for \$695, including software and a four meter cable; at the 25 unit level the price drops to \$450. NATIONAL INSTRUMENTS, Austin, Texas.

FOR DATA CIRCLE 494 ON READER CARD

\*

# discover...

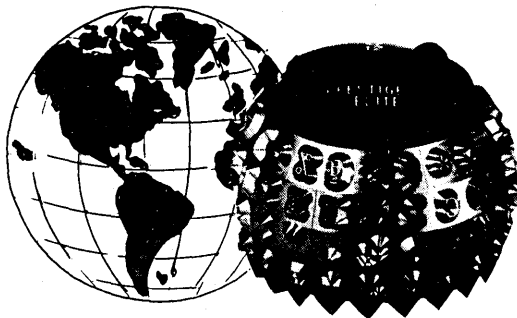

... the world of difference in DSG typing elements.

DSG elements sell for less, giving you a competitive edge. Yet, elements are equal to IBM in quality and performance. Each DSG element is unconditionally guaranteed. And DSG offers all the most popular type faces in stock... ready for immediate delivery.

Get your share of the booming \$66 million dollars typewriter element market. Phone today.

CALL TOLL-FREE (800) 523-1809  
IN PA. CALL (215) 584-6310



DSG, Inc., Dept. ADM078  
1737 Chestnut Street  
Phila., Pa. 19103

DSG, Division of Devon Systems Group,  
is America's Fastest Growing Typing Element Company

CIRCLE 134 ON READER CARD

## TERMINALS FROM TRANSNET

PURCHASE  
12-24 MONTH FULL OWNERSHIP PLAN  
36 MONTH LEASE PLAN

DESCRIPTION	PURCHASE PRICE	PER MONTH		
		12 MOS.	24 MOS.	36 MOS.
DECwriter II	\$1,495	\$145	\$ 75	\$ 52
DECwriter III	2,895	275	145	99
DECprinter I	2,495	240	125	86
VT52 DECscope	1,695	162	85	59
VT55 DECgraphic CRT	2,695	260	135	94
ADM 3A CRT	875	84	45	30
HAZELTINE 1500 CRT	1,295	124	66	45
TI 745 Portable	1,875	175	94	65
TI 765 Bubble Mem.	2,995	285	152	99
TI 810 RO Printer	1,895	181	97	66
Data Products 2230	7,900	725	395	275
QUME, Ltr. Qual. KSR	3,195	306	163	112
QUME, Ltr. Qual. RO	2,795	268	143	98
DATAMATE Mini Floppy	1,750	167	89	61

FULL OWNERSHIP AFTER 12 OR 24 MONTHS  
10% PURCHASE OPTION AFTER 36 MONTHS

### ACCESSORIES AND PERIPHERAL EQUIPMENT

ACOUSTIC COUPLERS • MODEMS • THERMAL PAPER  
RIBBONS • INTERFACE MODULES • FLOPPY DISK UNITS

PROMPT DELIVERY • EFFICIENT SERVICE



TRANSNET CORPORATION  
2005 ROUTE 22, UNION, N.J. 07083  
201-688-7800

CIRCLE 142 ON READER CARD

DATAMATION

# SAS can give you answers in hours...

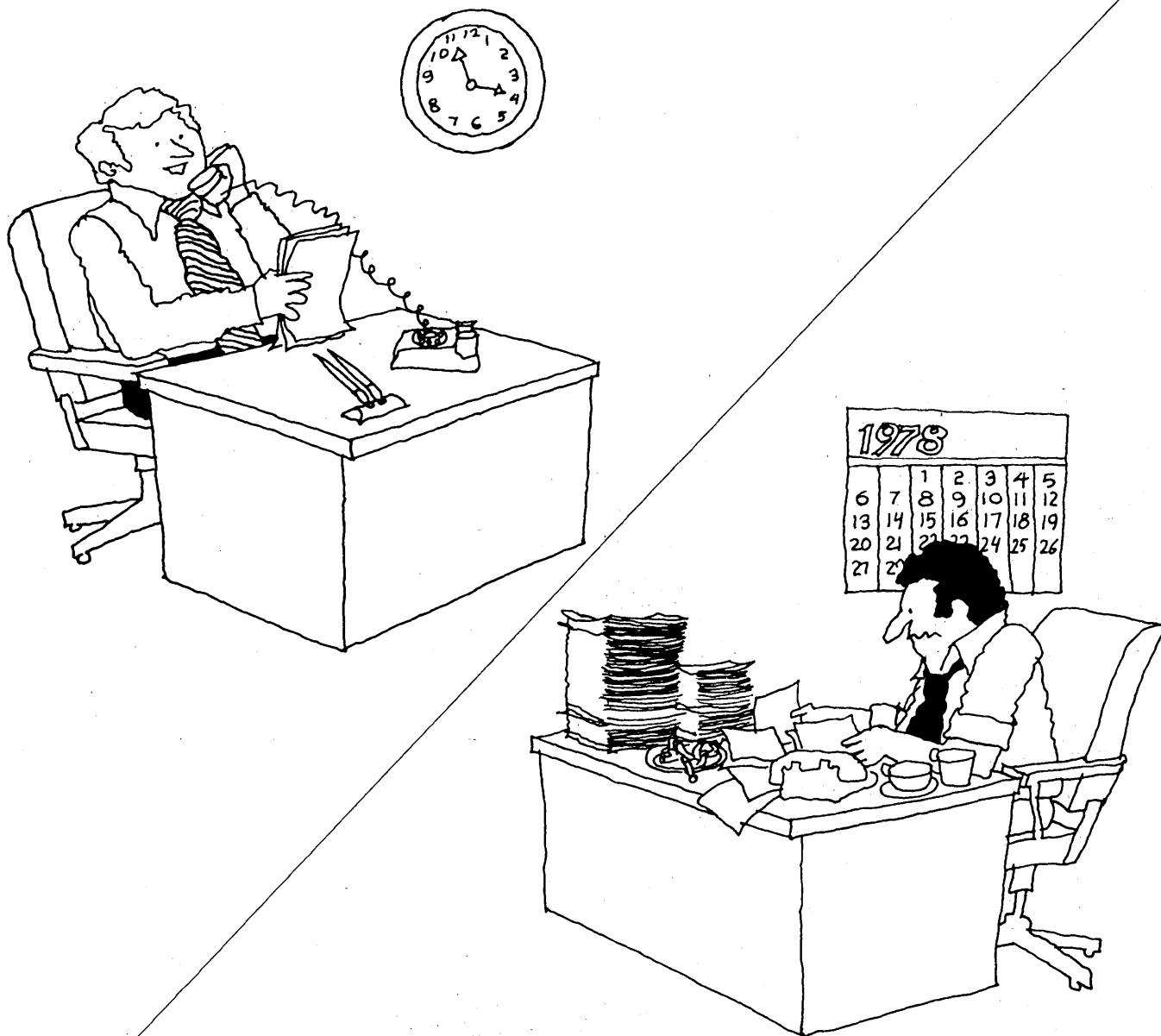

## ...instead of days.

Everybody seems to want "immediate" answers. And it's tough to explain why you can't just press a button and get the information you need.

That's why there's SAS. We've put all the data analysis tools you need for most jobs into one system. And your people don't have to master a difficult programming language to use it.

Just a few simple commands and SAS is handling retrieval,

data management, statistical analysis and report writing. All within one system.

It's so easy that one person with SAS can handle most jobs in hours or minutes ... even the ones that take days with conventional methods.

That's why more than 500 IBM 360/370 OS computer sites are already using SAS. And why those users put SAS on the Datapro Honor Roll for the second consecutive year.

There's a lot more we can tell you about SAS ... like how much less it costs than most software systems. Write or give us a call. We'll send a free booklet and answer any questions you might have. And someday soon, you might be smiling when someone asks you for one of those "immediate" answers.

**SAS** SAS Institute Inc.  
P.O. Box 10066  
Raleigh, NC 27605  
919/834-4381

# software & services

## Updates

Attendees of the NCR users' group meeting in New Orleans heard of one user's successful efforts converting NEAT/3 code into COBOL. John E. Midgley, managing director of Computer Facilities Software Ltd., South Humberside, England, told of four reasons compelling the conversion. NEAT/3 has four major drawbacks: it doesn't provide simple on-line support, it isn't universally available across the NCR 8000 range, it may not support future software executives and new peripherals, and it isn't all that easy to find qualified NEAT/3 programmers. Instead of converting the firm's 1,000-odd NEAT/3 programs by hand -- estimated to require 20 man-years -- the firm wrote a conversion package dubbed NECOL. The package can't handle level 2, direct access files, or some advanced features of NEAT/3. It's claimed that conversions in excess of 99% are possible if the NEAT/3 program doesn't contain any statements of these three types. The firm says it has sold the NECOL package in Britain, the U.S., and Europe.

The 80,000-title Lauritsen Library at The Aerospace Corp. has retired its card catalog after a major fine-tuning of its computerized catalog system. The El Segundo, Calif., firm expects the system to help its library users in all of its offices, and to simplify the librarians' job of cataloging new acquisitions.

A nationwide computerized clearinghouse which links drug wholesalers with manufacturers went into operation on the third of this month. Called the "drug wholesale clearinghouse," the service was put together by the National Wholesale Druggists' Association, and Informatics, Inc., which will also provide the computer-based service. It is expected that the use of direct computer-to-computer order processing will cut more than 50% from the national order/delivery cycle, from 13.6 days to six days. A similar system, on a smaller scale, allowed one wholesaler to reduce his inventory by \$140,000 over nine weeks while the wholesaler and manufacturer both had increased sales.

## Documentation Aid

Users of IBM 360s and 370s running OS can use RECFLOW to draw COBOL record layouts on standard 132-position printers. The package can draw any syntactically correct COBOL record of up to 999,999 characters, except records including sterling currency. Occurs statements are acceptable. RECFLOW draws the described records, with data elements taken from record descriptions, logically leveled regardless of assigned level numbers.

In operation, the program accepts entire COBOL programs, series of programs, portions of programs, or selected 01 data structures; input may come from any medium, and may contain COPY statements.

RECFLOW, which can run in as little as 64KB of memory (the licensing agreement warrants the package will take no more than 74KB), carries a one-time license fee of \$1,200. It's guaranteed for one year, and there's a 30-day cancellation privilege if the package doesn't perform up to specs. THORNE DATA, INC., Springfield, Va.

FOR DATA CIRCLE 536 ON READER CARD

## Application/Management Software

A pair of Display Management Systems (DMS) and an IMS/vs application development facility have joined the plethora of software products offered by IBM. DMS/vs is intended to simplify the development of on-line information systems using 3270s. The package has DL/I data base and file management capabilities, which, in conjunction with its display handling and message handling capabilities, is said to make it possible to implement on-line applications with little or no user programming. CICS/vs is a prerequisite to using DMS/vs. DOS/vs users can get the package for \$360 per month; OS/vs users pay \$475.

DMS/3790 helps distribute functions between the 3790 communications system and the host CPU. The package provides automatic screen-handler services, allowing users to describe screen layouts, I/O fields, and editing characteristics. A communications interface manages the 3790 communications adapter and transmissions to the host. DMS/3790 has a license fee of \$300 per month; the Communications Interface Monitor feature is an additional \$200 per month.

Data base/data communications application development is said to be aided by the IMS/vs Application Development Facility. The package is said to provide extended data independence, while maintaining comprehensive con-

trol over data base access. IMS/vs users running OS/vs1 or OS/vs2 can use the IMS/vs Application Development Facility for a monthly license fee of \$550. INTERNATIONAL BUSINESS MACHINES CORP., White Plains, N.Y.

FOR DATA CIRCLE 527 ON READER CARD

## Documentation Aid

Structure aids software documentation by preparing and cross-referencing Warnier-Orr diagrams (a tree-like diagram of data structures, procedures, programs; and entire systems). In addition to aiding program maintenance, the package can help in the initial (and subsequent) design stages.

Users can input a hierarchical outline of the system or data structure, and Structure draws and cross-references Warnier-Orr diagrams. The system also provides a source listing of the input, a diagram index, and a list of undefined symbols. The translation between COBOL and the Structure input language is said to be sufficiently simple that non-dp personnel can be trained for the task in less than an hour.

Written in COBOL for 360s and 370s, Structure is batch oriented. Under DOS, it requires a minimum partition of 80KB; under OS, the minimum partition required is 64KB. The package carries a perpetual license fee of \$4,900. Two translators also are in the works. A Structure input language-to-COBOL translator is expected in the fall, and a COBOL-to-Structure translator should be along a few months later. The translators are expected to carry license fees in the \$2,500 to \$3,000 range. LANGSTON, KITCH AND ASSOCIATES, INC., Topeka, Kansas.

FOR DATA CIRCLE 528 ON READER CARD

## Typesetting

This vendor has decided to actively market a service it has performed for several customers over the past few

Employer Reserve Ratio	A	B	C	D
over 6.0% and	0.1%	0.2%	0.3%	0.4%
5.0% but under 6.0%	0.2%	0.3%	0.4%	0.5%
4.6 but under 5.0%	0.3%			
4.2% and				

COMPUTER LINE PRINTER

Employer Reserve Ratio	A	B	C	D
6.0% and over	0.1%	0.2%	0.3%	0.4%
5.0% but under 6.0%	0.2%	0.3%	0.4%	0.5%
4.6 but under 5.0%	0.3%			
4.2% and				

PRINTRAN

years. Printran (printer translation) accepts computer-prepared print image tapes and produces either a typeset film

# asi/inquiry

## The IMS DB/DC QUERY LANGUAGE

USED BY MORE IMS INSTALLATIONS THAN  
ANY COMPETING PRODUCT

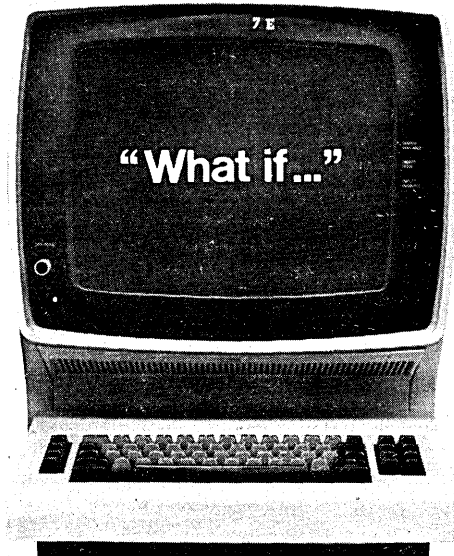

ASI/INQUIRY is an IMS DB/DC query language that operates completely as an interactive Message Processing Program. The design of ASI/INQUIRY is such that the *structure of the data base is transparent to the user*. Moreover, one need not have familiarity with DL/1 segment logic or the complexities of multi-pathing. Extremely rapid response time is assured.

### MAJOR HIGHLIGHTS

- End-user oriented
  - Easy-to-use language
  - Requires no knowledge of IMS
  - Comprehensive diagnostic messages
- Rapid response time for even the most complex queries
- Dynamic priority scheduling to maximize system performance
- Availability of default as well as user-defined screen formatting

Recently delivered, Release 2 of ASI/INQUIRY contained a number of major enhancements, including:

- Development of a TSO-supported version
- Full support of IMS/VS secondary indexing
- Open-ended computational facilities
- Ability to SORT display output

In summary, ASI/INQUIRY represents the state-of-the-art product in an IMS DB/DC or TSO-supported IMS environment. It is the only system combining an easy to use language, complete user flexibility, and rapid response time in a single package. If you want to start answering "What if . . . ." immediately, call or write today for further information.



The Software Manufacturer

Applications Software, Inc.  
Corporate Offices  
21515 Hawthorne Boulevard  
Torrance, California 90503  
(213) 542-4381

## Software & Services

negative or a paper positive. The service offers several options, including justification and reduced type size. As input, the service accepts 9-track, 800/1600bpi tapes with or without standard labels. Data may be written in either ASCII or EBCDIC, and no special typesetting directives need be imbedded in the tape. The volume sensitive pricing of this service ranges from \$1 to \$3 per page, with a minimum charge of \$50. SOUTHEAST COMPOSITION SERVICES, INC., Richmond, Va.

**FOR DATA CIRCLE 529 ON READER CARD**

### BASIC

BASIC-V is actually two language processors for this vendor's computer line. Operating in a virtual memory environment, BASIC-V offers two modes of operation: incremental and compiler. In the incremental mode, it functions as an interpreter, analyzing each input line for syntactic errors as the line is input. After the user is satisfied with a program developed incrementally, the compiler mode can take the same source code and create object code which is both more compact and faster in execution. Compiled programs can call subroutines written in other languages; they can also call utilities, such as an interface to the TOTAL data base management system. BASIC-V carries a one-time license fee of \$5,000. HARRIS CORP., Fort Lauderdale, Fla.

**FOR DATA CIRCLE 530 ON READER CARD**

### RPG II Documentation Aid

KWICO, which draws printer spacing charts from RPG-II source programs, seems a good complement to this vendor's KWIC II system-level documentation aid (see April 1977, p. 199). KWICO reads RPG programs from cards, disc, tape, or diskettes, generating printer charts including edited fields, headings, and constants on the printer (which must have at least 132 print positions). The program detects overlapping fields or constants, and prints them darker on a separate line. The package runs in 12KB, uses no disc files, only the printer and input device. More than one program can be processed in a single run. Supplied on 80- or 96-column cards, the package sells for \$60; on diskette it goes for \$65. Source code is supplied. KATWIL INTERNATIONAL, Computer Services Div., Warrenville, Ill.

**FOR DATA CIRCLE 532 ON READER CARD**

### Debugging Aid

Datapoint users can use Trace to help debug Databus programs in a Data-share environment. Similar to COBOL's TRACE verb, the package helps programmers follow the actual logic paths his program takes.

In operation, Trace asks the programmer several questions. He can specify that the output is to go to his terminal, a disc file, or a printer. He also can specify that the values of selected variables be traced. The answers to these questions are used by Trace to generate new source code which is merged with the program being debugged. This program then is compiled and tested. The original program is left unchanged.

Trace is available on a yearly lease basis for \$375 per year. PACESETTER CORP., Litchfield, Conn.

**FOR DATA CIRCLE 533 ON READER CARD**

### Fixed Asset Accounting

IBM 360 and 370 users, and soon System/3 users, can use this fixed asset accounting system. The system maintains asset information and can produce reports covering asset accounting, tax, and property control. The system is said to satisfy the latest reporting requirements of both the IRS and the SEC.

The system's multicompany design lets each company or division specify accounting procedures, processing frequency, fiscal year, organization structure, and report options. Different sequence, frequency, level of report detail, and summarization characteristics can be selected via a parameter card.

For tax accounting under asset depreciation range (ADR) rules, an ADR module allows asset additions and retirements to be entered into both corporate and tax books from the same input document. A class code defines depreciation controls on both books. Information covering additions, depreciation, repair allowance, and retirements—required on IRS form 4832—is handled by the ADR module.

For a DOS environment, the package is priced at \$19,500; for OS the price is

\$21,500. The System/3 version is expected to go for about \$12,000. SOFTWARE INTERNATIONAL, Andover, Mass.

**FOR DATA CIRCLE 534 ON READER CARD**

### PET Word Processing

Word processing on Commodore's PET personal computer? Well, it might be more appropriate to call it limited word processing, limited by the PET's lack of peripheral support, particularly the lack of a random access mass storage device. This package occupies much of an 8KB PET's memory, leaving room for about a page of text (1.5KB to 2KB). With that page, users can edit by inserting, deleting, or moving lines, substituting strings, and moving the cursor. Pages also can be loaded from or saved onto cassettes. Printing directives allow specification of left margin, line length, centering, and skip fields. As for the problem of physically connecting a printer to the PET, the vendor just happens to make an interface (IEEE-488 to RS232) which can hook a PET to a printer (\$169, including power supply, packaging, and cables). The word processing software itself sells for \$29.50. CONNECTICUT MICROCOMPUTER, Brookfield, Conn.

**FOR DATA CIRCLE 531 ON READER CARD**

### Communications

Two software modules for this vendor's Level 6 minicomputers support communications with mainframes using HASP work station or 2780/3780 remote batch terminal protocols. The modules may run concurrently with other jobs under GCOS 6. The two modules will become available next quarter, with license fees of \$2,200 for HASP and \$1,640 for the 2780/3780 module. HONEYWELL INFORMATION SYSTEMS, Waltham, Mass.

**FOR DATA CIRCLE 537 ON READER CARD**

*(Continued on page 214)*

## software spotlight

### Social Security Benefits

An RPG-II package, SSBENS, provides compliance capabilities to the recently enacted method of calculating Social Security benefits using national average earnings. Although it's designed to run in conjunction with the vendor's erisa/3 personnel management software, SSBENS is said to be adaptable to virtually any system. A vendor spokesman said this could be done by either altering the package's input routines, or creating separate files in the proper format.

SSBENS complies with both the tabular and indexed computation methods. Until 1982, dual computations will be

required, then the indexed method will replace the tabular method. The module generates an employee earnings worksheet, which displays 45 years of earnings history in each mode, along with intermediate calculations. Four projections also are available from the package: zero projection benefit at age 65; disability benefit at current age; projected benefit at age 65, using current earnings projected to age 62; and projected benefit at 65, using current earnings projected to 62 and prorated over the projected years.

The package, which has been installed on a 24K System/3, Univac 90/25, Honeywell Level 6, ICL 2903, and Burroughs B-1700, licenses for \$750 to erisa/3 licensees; its stand-alone price has yet to be announced. ALPHA SYSTEMS, INC., Framingham, Mass.

**FOR DATA CIRCLE 535 ON READER CARD**



# OEM Printers with value-added options and the quality your customers demand



## *We've built-in I/O compatibility and value-added features across our line*

Control Data's OEM printers have value-added features that help you tailor better solutions to your customer's requirements. Built-in features include clear, crisp print quality, acoustically dampened cabinets and easy-operating controls. And we've built in common interface protocol across our line. So you don't have to redesign your interface for each application.

## *Choose one of our Bi-Directional Position-Seeking Matrix Printers*

Our Matrix Printers print single to five part forms with sharp, clean 7 x 7 or 9 x 9 patterns. Standard 10 cpi, 6 lpi and 64 ASCII characters... full line 132-character buffer memories. Options include a paper-saving 16.5 cpi pitch and 8 lpi spacing, 96 and 128-character sets. Speeds range from 70 lpm for 132 columns to 200 lpm for 33 columns.

## *Cut your customer's paper costs with one of our Band Printers*

Offer your customer reduced paper and total life cycle costs with a choice of 10 cp<sup>2</sup> or compressed pitch 15 cpi bands. Bands switch in seconds. At the 15 cpi density, a full 132-character line prints on letter-sized paper. Multiple options permit you to tailor the printer to your application. Eleven interchangeable bands, identical spare parts kit. Full solid-stroke characters top to bottom. Print speeds with 48 character set: 360, 720 and 1130 lpm.

## *High performance, high throughput Fastrain Printers*

All Fastrain models accommodate any size character set from 16 to 128 with correspondence-grade print quality. Speeds with a 48-character set are 1200, 1600 and 2000 lpm.

Put quality behind your nameplate. Call us at 313/651-8810 or if in Europe, contact one of our European representatives. Or return coupon to:

Harrison Craig, Product Sales Manager,  
Control Data Corporation, 1480 N. Rochester  
Road, Rochester, Michigan 48063.

D-78

Please send literature and sample printout of your

Matrix Printers  Band Printers  Fastrain Printers

Name \_\_\_\_\_ Title \_\_\_\_\_

Company \_\_\_\_\_ Phone \_\_\_\_\_

Address \_\_\_\_\_

City \_\_\_\_\_ State \_\_\_\_\_ Zip \_\_\_\_\_

**GD** CONTROL DATA  
CORPORATION

**More than a computer company**

# Bye, Bye D

**\$1795\***

## **A Perkin-Elmer CRT and a 100 cps thermal printer.**

**If you buy a DECwriter after reading this ad, you deserve it.**

Our popular Pussycat Printer and Model 1100 Interactive CRT Terminal. Together, they do a lot more than a DECwriter III and cost less.

In fact, at \$1795, it's like buying a top-quality printer and getting a terrific little CRT free.

And what a CRT! The Model 1100 displays 80 characters per line in an easy-to-read, 9 x 12 matrix and communicates at up to 9600 baud. Compare that to DECwriter III's puny 1200 baud.

Then when your results are ready, touch the PRINT key and the Pussycat printer lays down a whole screenful of characters in only 20 seconds. But, best of all, the CRT is ready for use again in 2 seconds or less. So the operator can go right back to work.

The Pussycat Printer is silent, too. And, because you print only what you want, there are no mounds of unsightly printout around the machine.

Clean. Quiet. Inexpensive. The Pussycat Printer and the Model 1100 CRT from Perkin-Elmer. Compared to a DECwriter III, they do more and cost less.



\*US domestic price, quantity 75.  
Model 1100 and Pussycat Printer: \$2795, quantity 1.  
Owl-1200 and Pussycat Printer: \$3695, quantity 1.

DECwriter® is a registered trademark of Digital Equipment Corp.

# ECwriter!

**\$2395\***

**A Perkin-Elmer editing CRT with  
line drawing and a 100 cps thermal page printer.**

You can also plug the Pussycat Printer into our Owl-1200 Terminal and have a powerful editing terminal with forms drawing capabilities and hard copy, too.

Draw forms or bar charts on the Owl, then print them on the Pussycat. The Pussycat even prints inverse video fields for highlighting charts.

The Owl and The Pussycat. Another great CRT thermal printer combo from Perkin-Elmer.

**Call (800) 631-2154, toll free, to order your Pussycat and CRT.**

For more information, write Terminals Division, Route 10 and Emery Avenue, Randolph, New Jersey 07734, or telephone toll-free (800) 631-2154.

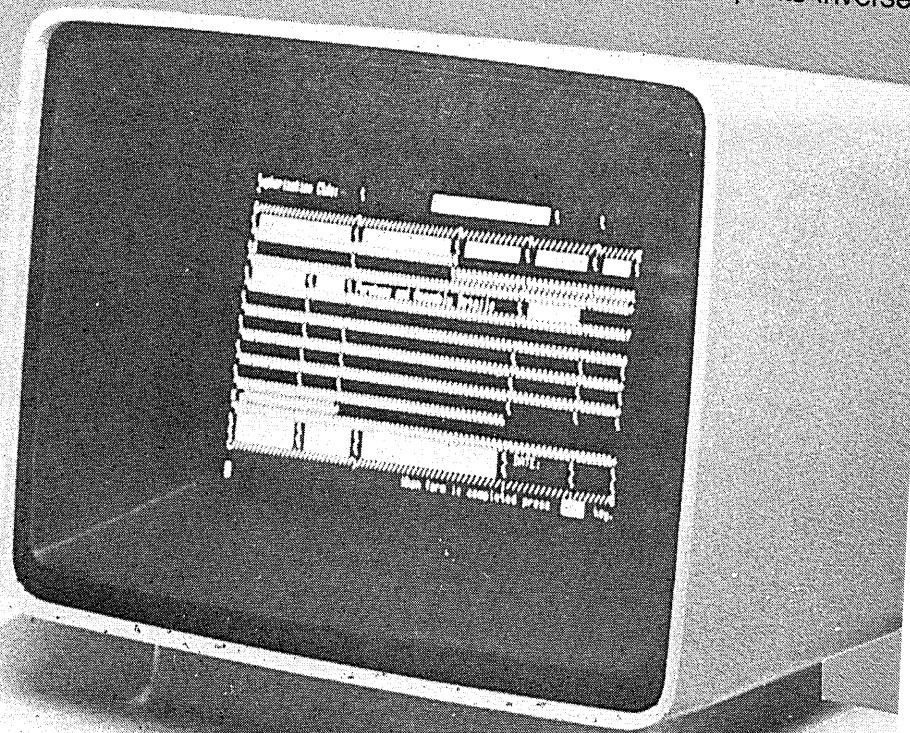

**PERKIN-ELMER**

Data Systems

helping people succeed with computers.

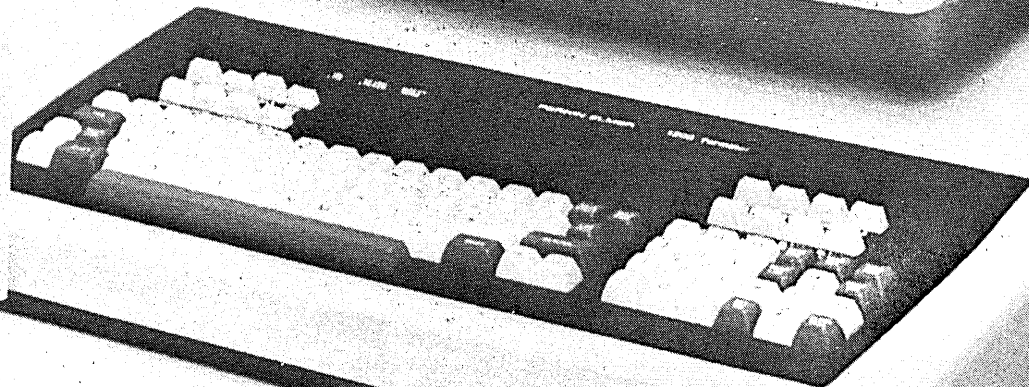

CIRCLE 78 ON READER CARD

## Software & Services

### Floating Point Package

Data General Nova users can use this vendor's double precision floating point

package in conjunction with Data General's BASIC. The package, which occupies an additional 2.5KB, provides a minimum of 14-bit precision. In a worst-case benchmark—a program consisting almost entirely of computation—the package ran 2 to 2½ times

slower than Data General's hardware version. Users need a license to DG's BASIC (for RDOS) to use this \$1,000 package. COMPLETE COMPUTER SYSTEMS, Horsham, Penn.

**FOR DATA CIRCLE 538 ON READER CARD**

### PASCAL . . .

We group these two PASCAL compilers together not because they're competing products, but because of the large installed base of DEC PDP-11s and Data General Novas and Eclipses. The language, developed by N. Wirth, is perhaps most aptly described as an elegant Algol-like language which encourages structured programming. Consistent with Edsger Dijkstra's edict that a good programming language should be understandable in its entirety, PASCAL is at once both powerful and concise.

### . . . for Novas and Eclipses

The story goes that PASCAL was originally written in PASCAL. It sounds a bit like pulling oneself up by one's bootstraps—and that's the case. After the initial compiler became operational, extended versions of the compiler were written in PASCAL, and compiled into the next version. This vendor's PASCAL will compile itself in mapped Novas or Eclipses running RDOS, or in an unmapped Nova with 32K words and a small operating sys-

tem. The vendor has taken the approach of compiling to an intermediate language which is interpreted by a run time package.

The compiler traces its roots back to an enhanced version of PASCAL developed by Per Brinch Hansen at Cal Tech. It operates on 64-bit real numbers and 16-bit integers; sets may have up to 128 elements. The compiler is said to process about 400 lines of source code per minute.

The complete package, including all source code, binary code, and ready to run demonstration programs, goes for \$975. RHINTEK, INC., Columbia, Md.

**FOR DATA CIRCLE 539 ON READER CARD**

### . . . for PDP-11s

This vendor's PASCAL can be had in versions for RSTS/E, RSX-11/M and RT-11 operating systems. Under RT-11, it will run on any 11-series processor with at least 32KB, making it attractive to LSI-11 users and PDP-11/70 users, and those in between. The single pass compiler generates assembly code, as opposed to an intermediate

code for interpretation by a run-time package. For serious programming, the compiler includes extension for the insertion of assembly language code, a FORTRAN call interface, and the process control functions. It also offers a post compilation code optimizer and a cross reference generator. An optional feature can create RSTS/E run-time systems from most PASCAL programs.

On the other side of the coin, the vendor points out several limitations. It's designed for professionals as "good introductory materials are not yet available." (Ed.'s note: a spate of PASCAL texts have appeared recently.) Precision is limited to six digits for floating point, and 16-bits for signed integers. The data type SET is limited to 64 elements.

The PASCAL package—compiler, demo library, and debugger—are licensed to sites (any number of processors at a given location) for \$1,500. Schools pay only \$995. OREGON MINI-COMPUTER SOFTWARE, INC., Portland, Oregon.

**FOR DATA CIRCLE 540 ON READER CARD**

### General Motors Manufacturing Development Has Immediate Openings For:

## COMPUTER-ORIENTED

- ENGINEERS
- MATHEMATICIANS
- ANALYSTS
- PROGRAMMERS

General Motors is seeking people interested in applying the latest COMPUTER GRAPHICS and N/C TECHNOLOGY to manufacturing related problems, particularly the design and machining of dies. Positions are in Manufacturing Development's Computer Aided Major Tooling Systems Department located at the General Motors Technical Center in Warren, Michigan.

### REQUIREMENTS:

Applicants must have a Bachelor's or Master's degree in Math, Computer Science, Engineering, or related field. Applicants must know PL/I or FORTRAN and like to do a job from start to finish including problem definition, system analysis, and programming. Experience in Computer Graphics and/or N/C with a working knowledge of IBM 370/168 or DEC PDP computers would be useful.

Candidates must have Citizenship or Visa status which permits them legally to accept permanent employment under U.S. Immigration laws.

Applicants please send resume and salary requirements to:

**Personnel Administration 015P  
Engineering Staff North Bldg.,**



**GENERAL MOTORS  
TECHNICAL CENTER  
WARREN, MICHIGAN 48090**

*We Are An Equal Opportunity Employer*

CIRCLE 186 ON READER CARD

## PROGRAMMERS AND ANALYSTS

### Free Employment Service

Serving Northeast, Southeast and Midwest U.S.

- Scientific and commercial applications
- Software development and systems programming
- Telecommunications
- Control systems
- Computer engineering
- Computer marketing and support

Call or send resume or rough notes of objectives, salary, location restrictions, education and experience (including computers, models, operating systems and languages) to either one of our locations. Or check the reader service card for a free sample resume. We will answer all correspondence from U.S. citizens and permanent residents and will guarantee our best efforts in a professional and ethical manner to all qualified applicants that we think we can help. Our client companies pay all of our fees.

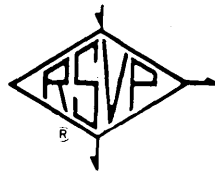

**RSVP SERVICES, Dept. M**  
Suite 700, One Cherry Hill Mall  
Cherry Hill, New Jersey 08002  
(609) 667-4488

**RSVP SERVICES, Dept. M**  
Suite 300, Dublin Hall  
1777 Walton Road  
Blue Bell, Penna. 19422  
(215) 629-0595

**RSVP SERVICES**

*Employment Agency for Computer Professionals*

CIRCLE 191 ON READER CARD

### Tektronix 4051 Packages

Users of Tektronix's 4051 desktop computer may find one or both of these programs useful. Documenter-11, a development and debugging tool, provides formatted listings and cross reference maps of 4051 programs. A single cope goes for \$300; large users can get a facilities license for \$1,500. Those users involved in project management may wish to investigate the Event Scheduling System (ESS), a PERT charting system. The package uses Critical Path Method (CPM) scheduling. Comprising several programs, ESS helps the user build and maintain a project data base. It also provides charts and reports on the user's choice of output devices. ESS carries a single copy price of \$900, and facility licenses are \$3,600. Both Documenter-11 and ESS are supplied as source programs with documentation on cartridge tape; prices include user instructions and one year's maintenance. LELAND C. SHEPPARD, Sunnyvale, Calif.

FOR DATA CIRCLE 495 ON READER CARD

### Source Library Maintenance

Users of Datapoint systems, from the 1500 on up, can use Compumange to track program development and maintenance activities. A single report provides control information on applications programs. The report includes subsystem name, program name,

description, all 1/0 files used by each program, along with type, access method, keysize, and keyfields. Revision data covers revision number, revision data, requester, date of request, reason for the requested modification, and programmer's name. For new programs, the application programmer writes a short description, and then he defines all files and their attributes. Compumange logs this information and adds information on updates as the programmer supplies it. The manager can request status reports covering all revisions or only those since he last ran the status report. The Compumange package sells for \$375. TERMINAL COMPUTER SYSTEMS, INC., Palo Alto, Calif.

FOR DATA CIRCLE 496 ON READER CARD

### Microcomputer Applications

Small companies may be interested in these accounting packages which run on 8080 and Z-80-based microcomputers under CP/M. The vendor is currently releasing general ledger and payroll packages; accounts receivable and accounts payable reportedly are under development. The packages are written in FORTRAN, avoiding the overhead—both memory and throughput—associated with interpreters.

The general ledger package, written for CPA's, handles over 200 accounts, each with up to nine subsidiary totals.

Subsidiary totals are indented on the profit and loss, and balance sheet printouts. At run time, the user can select the level to which detail accounts will be listed or summarized on P&L or balance sheet statements. Users can perform multiple postings in a financial period without adversely affecting trial balance, transaction report, P&L, or balance sheet reports. To keep the books balanced, each transaction entry requires a balancing entry. Current and year-to-date percentages of totals for income and expense accounts are provided on the P&L statement.

Payroll handles as many as 200 employees. It can accommodate daily, weekly, bi-weekly, semimonthly, monthly, quarterly, or yearly pay periods. It also handles multistate taxes and up to three types of local taxes. A maintenance program, supplied with the payroll package, allows users to affect changes necessitated by changes in federal, state, local, or FICA taxes. In addition to printing checks with detailed stubs, payroll takes care of W2 and 941 forms.

General ledger and payroll were written by Arkansas Systems, Inc. Both are distributed as object code, and both carry price tags of \$775. A third party handles distribution. ENGRAM ASSOCIATES, INC., Little Rock, Ark.

FOR DATA CIRCLE 497 ON READER CARD

## SOFTWARE SPECIALISTS DATA ADMINISTRATION

The Tennessee Valley Authority in Chattanooga, Tennessee, is seeking qualified individuals to fill immediate openings as Data Administration Software Specialists. Requires a bachelor's degree with a minimum of five years of technically oriented professional experience, including extensive knowledge and experience with OS or MVS, and OS/VS JCL. Opportunities are available as Data Dictionary or Data Base Management Software Specialist. Experience with LEXICON and/or SYSTEM 2000 is desirable.

Salary commensurate with experience. Excellent benefits. Send resume (include social security number with name) in confidence to:



TENNESSEE VALLEY AUTHORITY  
Employment Branch (D-0044)  
Room 240 MIB  
Knoxville, Tennessee 37902

TVA may consider for appointments only U.S. citizens and others eligible for payments under section 602, Pub. L. 94-363, and section 750, Pub. L. 94-419.

An Equal Opportunity Employer

CIRCLE 196 ON READER CARD

### ENGINEERS

General Motors Manufacturing Development  
has immediate openings for:

## SYSTEMS ENGINEERS

Opportunity to work on N/C computer-aided manufacturing systems. This professional position involves analytical and experimental work in leading-edge computer technology. Applicant must possess a working knowledge of a high level computer language such as Fortran and enjoy specifying and designing new software. This position requires a creative person with a degree in math, engineering, or computer science. Experience in developing N/C software is highly desirable.

## SYSTEMS ENGINEERS

Opportunity to work on the development of computer-aided manufacturing systems. This position requires a degree in math, engineering, or computer science, plus related experience in data base systems and computer program development. Applicant must possess a working knowledge of a high level computer language such as PL/I or Fortran. Broad engineering experience required with process engineering a highly desirable but not necessary attribute. Candidates must have Citizenship or Visa status which permits them legally to accept permanent employment under U.S. Immigration Laws.

Applicants may apply in confidence to:

Personnel Administration 016P  
Engineering Staff N. Bldg.,



GENERAL MOTORS  
TECHNICAL CENTER  
WARREN, MICHIGAN 48090

We Are An Equal Opportunity Employer

CIRCLE 185 ON READER CARD

Baud rate switch — Switch from 110, 150, or 300 baud to 600 or 1200 baud transmission easily. Just flip the convenient switch and the terminal easily adapts to your communication speeds.

Front panel accessibility — All the normally used operator controls are organized into functional groups and logically arranged for maximum operator convenience.

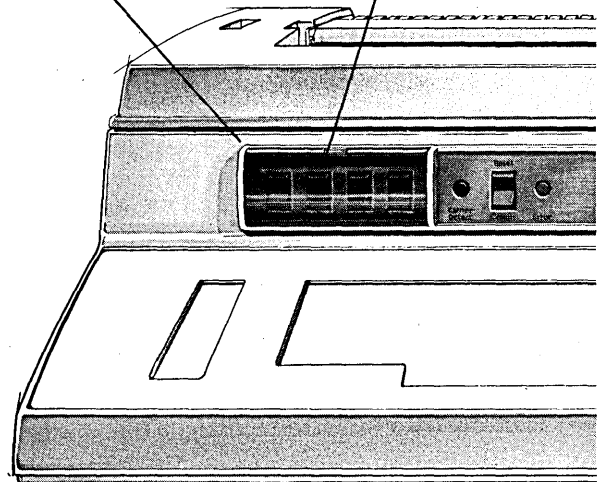

# Introducing the smart daisy especially for the

It's called the Sprint 5. And it's from Qume.

That's right. Qume.

We've established quite a reputation in the word processing business. A reputation for letter quality print. And because of that, we didn't want to simply attach a keyboard to a printer and present it to the computer industry as a full blown terminal.

So we designed our Sprint 5 daisywheel terminal from the ground up to meet the needs of the computer industry. Complete with our famous print quality. And 55 cps speed.

Qume's smart microprocessor gives the Sprint 5 many capabilities not found in conventional terminals. Such as a powerful command set, self-diagnostics, memory storage of tab settings, and forms control programs.

Smart microprocessor logic — You get flexible character spacing, precise plotting resolution, and smart multi-direction carriage slewing. Not to mention high quality printing. Fast.

Interchangeable character sets — We have over 50 different character sets and typestyles. They're easy to change and include international characters, APL, and scientific symbols.

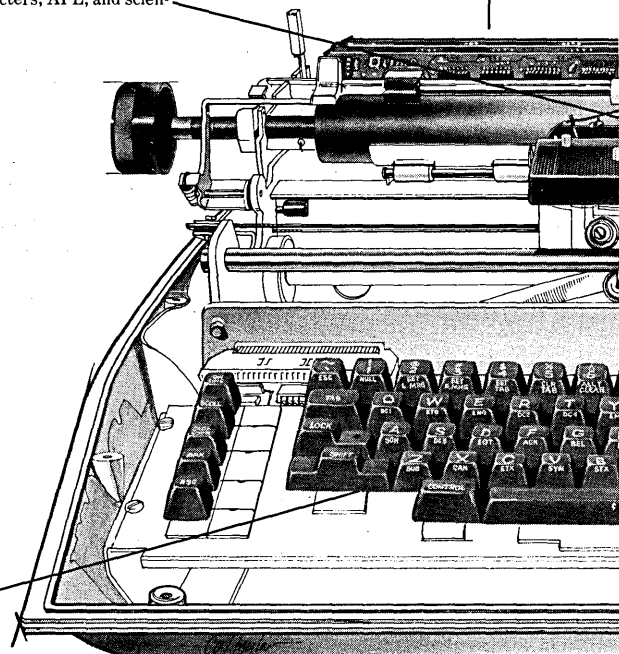

Comprehensive command set — 59 powerful user oriented commands provide format flexibility. And to make it even easier, commands are printed on the keycaps.

TwinFlect™ option — Want to use a special printwheel? Just switch on TwinFlect when you install the printwheel. Sprint 5 electronics provide the coordination between code and print characters. Available only from Qume.

Dynamic positioning — Create graphs or justify your text easily. With switch selectable 10 or 12 characters per inch spacing. Plus controlled spacing of 1/120" horizontal and 1/48" vertical.

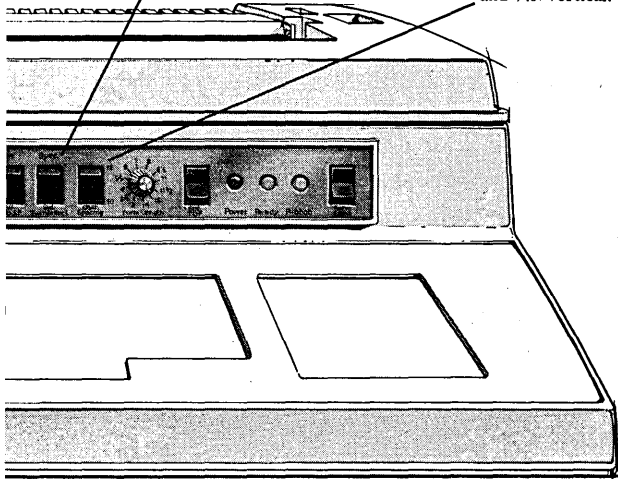

# wheel terminal designed computer industry.

Serial or parallel interface — Sprint 5's can provide a standard serial RS232C interface to your system. In addition, the keyboard version is available with DC current loop interface, and the printer version is available with DC current loop or parallel interface.

Multicolor ribbons — over 15 different ribbons (10 color choices) to color your messages. Easy to handle cartridges with carbon or fabric multicolor ribbons.

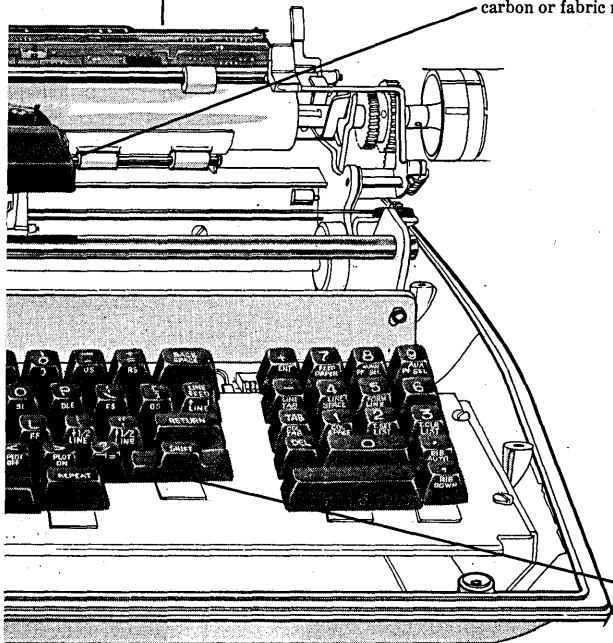

Surprisingly enough, however, the Sprint 5 costs no more than competitive terminals.

Obviously, a product that does much more but costs no more is a better buy.

And when all is said and done, that may be Sprint 5's most outstanding advantage.

For further information on how the Sprint 5 can give your computer letter quality output, contact: Qume Corporation, 2323 Industrial Parkway West, Hayward, CA 94545 or phone Lee Cannon, (415) 783-6100, Extension 338.

Self test — Internal self-diagnostic routines can be initiated from the keyboard or from remote sites.

**Qume**<sup>®</sup>  
the printed word



# personal computing

by Portia Isaacson, Contributing Editor

Personal computing in the corporation means change in data processing. Computer technology and economics now allow putting the computer where the job is—where the people are—making the computer the personal tool of the employee and the manager. The transition from present, centralized data processing systems to future systems won't be easy.

Who are the players in the drama that's about to unfold? The spotlight will be on the dp manager and his supporting systems analysts. (Corporate management will play an increasing, questioning role.) Computer manufacturers will overflow with advice. The soon-to-be-ubiquitous low-cost computer will be the point of controversy. Eventually the end user will emerge triumphant.

## The stage has been set

Through the years as data processing has evolved its large centralized stronghold the user has suffered; his way of doing business has been redesigned by systems analysts who have not been knowledgeable about the user's business procedures. The systems analyst even spoke a totally different language. After system implementation, the user has had little control over the running of his jobs. Nor could he be sure they would be done on time. In fact, the user has been required to gear his entire work schedule around the schedule of the data processing department, leaving him with the strong feeling that data processing has not understood his needs. Now that information systems have become an important part of management, naturally the manager wants control.

Data processing started as a little group in accounting running the tab equipment. Now it's one of the most powerful groups within the corporation. The dp department realizes it controls the information flow, and with that control comes a great deal of power. The data processing department dispenses information and information processing to user departments, and many times can make or break a user department by the kind of service given. The data processing department has built its empire around the mystique of computers. The systems analyst has been a necessary translator between the user and the computer because of the technical mishmash surrounding the computer.

In many instances, the systems analyst has misused his powers. His foremost desire has been to develop his own expertise on the latest and largest equipment in order to optimize his ability to change jobs. The turnover rate for systems analysts has been enormous. It is very common for the systems analyst to be more loyal to the computer technology and to a computer manufacturer than to the corporation that pays his salary.

Computer manufacturers are not without blame for the present situation. In order to control the account, the manufacturer has entered into a conspiracy with the data processing staff although neither may be conscious of the conspiracy. Through the years, when the systems analyst needed help, he looked to the manufacturer, not to his own corporation, for answers. The systems analyst has understandably developed a loyalty to the manufacturer who has supplied the answers to his problems. As a result, when it is time to choose a new piece of computer hardware, that manufacturer is naturally given the strongest consideration, many times to the exclusion of others.

Asking data processing to select a computer is like asking the French which spoken language should be chosen as an international standard. The conspiracy leads to enlarging the corporation's data processing facility as rapidly as possible. For the manufacturer, this means increased sales. For the systems analyst, it means more jobs and increased security for the data processing staff. The user has been able to do nothing to control this conspiracy because the requirement that data processing functions be cost justified disappeared after the first computer was bought. In many corporations it may not be possible to cost justify present applications because no one remembers how it was done before.

Historically, corporate management has had little control over data processing. They have, for the most part, taken the attitude that data processing is too technical to understand; therefore, they stay out of it. They have no understanding or even the knowledge of the conspiracy between data processing and the computer manufacturer. They have started to wonder, however, about the every-two-year equipment upgrade as the cost of the data processing department has become a very large part of the budget. Management has

started to wonder if the benefits the corporation is deriving from data processing are cost justifiable. At the same time they have realized that information processing is the heart of the business and, therefore, worthy of their consideration.

## Enter the cheap computer

The same personal computer that is capable of small business applications is also capable of doing many jobs within the large corporation. The trend towards decentralization started by minicomputers will be greatly accelerated by the even-lower-cost microcomputers. There are several factors contributing toward the rapid trend to decentralize computer resources within the corporation.

## The micro invasion

Through the years the user has become more knowledgeable about data processing. Virtually everywhere he turns there is information about computers. And computers have become much easier to use. Even the kid down the street has one. It is not surprising that many users decide they want their own computer, confident that they can use and manage it.

Data processing's response has been based on fear. Systems analysts resist any change inconsistent with their career objectives. Data processing cannot be expected to lead the way to distributed processing or decentralized processing because it would not mean upgrading to the latest in large mainframe technology which has for years been their way of achieving job security. Dp often reacts by urging a management dictum prohibiting user groups from buying their own computers without the approval of data processing. In some companies, this has gone so far as a declaration that all computers purchased for the corporation must be purchased by the data processing department.

The user's reaction is predictable; he goes underground. The new low cost of computers allows him to do that very effectively. A business oriented personal computer of the power of the IBM 360 Mod 30 can be configured in a system costing about \$8,000. This is well within the purchasing power of most managers. He simply buys it without telling the data processing department.



If he is afraid dp might find out because a purchase order shows the word "computer," that is no problem. Many computer stores sell computers every day under the guise of other kinds of equipment: invoices are written for "instruments," "word processing systems," or "parts."

With the secret computer comes the secret programmer. If the user doesn't want to do his own programming, he may want to hire a programmer. So the next time he interviews for a personnel clerk he whispers, "Can you program?" and makes the hiring decision based upon the answer.

### The plot will thicken

Eventually, it will be desirable for many of the small computers hidden away in the corporation to communicate with each other and with the central computer in order to share data. Such communication may be very difficult if there has been no coordination and planning of computer purchases. The corporation may find itself facing distributed processing by revolution, not by planned evolution. The knowledge that such planning is needed will be one of the primary arguments for central control of the purchase of minis and micros.

What will happen to the central mainframe as the number of small computers increases? Time-sharing usage will certainly drop. After all, time-sharing was invented as a means of providing an individual with a personal computing resource without giving him a whole computer. Now that an individual can afford his own computer, he no longer needs time-sharing.

Few new applications will be developed for the central computer. Most new application development will be done on smaller computers; or, at least, portions of the new application will be done on the small computer which, after doing its share of the processing, communicates with the central machine. Some applications will actually be transferred from the large central computer to smaller machines in user departments. The net result is that the workload of the central computer will not grow at its past rate, and it will not need to be replaced so soon. Mainframe manufacturers can be expected to react with price cuts in order to keep the cost of information processing on the mainframe more in line with the cost of the same processing on smaller computers. Eventually the central computer will be dedicated to running software too expensive to convert and running those programs that use the central computer's data base. The central mainframe will evolve to a data base machine that is not user programmable. The data base machine will be accessed by remote computers located

in the user's environment. Of course, all the corporation's data need not be kept on the data base machine; only that which is used by many different departments in the organization. Many data bases will be local to user groups.

The systems analyst's role will change. In the data processing department, the systems analyst can expect an increasing amount of his time to be spent in program maintenance since most new development will be done in user departments. Some systems analysts will overcome their mainframe mentality and move to user departments where the action is. These moves will not be made without considerable reservations, however. The systems

analyst will perceive the move as a loss in prestige. Certainly it is a loss in prestige to program a small computer when one has been programming computers which cost millions of dollars. Perhaps even the user will see it that way, and the loss in prestige may be associated with a loss in pay. The systems analyst will realize that in moving to the user department, he will have to specialize in the user's application. He will be managed by non-computerniks who have a different value system than his previous technician bosses. He will also realize that he will not be able to change jobs so often because his knowledge of a specific user application and a specific small computer will not be nearly as

#### Data Processing

## Software Professionals looking ahead to new challenges

Northrop's enviable position as the foremost leader in the design, development and manufacture of airborne computers, electronic countermeasures, and other sophisticated electronic systems is the result of an environment of top priority software professionals dedicated to the solution of critical problems.

To meet our ever expanding needs, challenging assignments offering professional stimulation and career mobility are available in the following professional areas:

### ENGINEERS      ANALYSTS PROGRAMMERS

These positions require degree in electrical engineering, computer science or related fields.

Involvement will be in one of three specific areas requiring experience in Data General NOVA/ECLIPSE or HP 2100 at the assembly language level. Digital or analog experience helpful.

**NOVA**— to involve the writing of process control and real-time control programs.

**HP 2100**— working on operating systems, assemblers and loaders.

**HP TODS BASIC**— will involve working on automated acceptance and manufacturing test procedures for production hardware.

If your career concentration has been in any of the above areas, and you seek a climate that will exercise your talents and independence, we invite you to consider Northrop Defense Systems Division. Address your resume with salary specifics, in confidence to:

Manager, Department D-7  
NORTHROP CORPORATION  
Defense Systems Division, Dept.  
600 Hicks Road, Rolling Meadows, IL 60008  
An equal opportunity employer m/f

# NORTHROP

CIRCLE 188 ON READER CARD

## PERSONAL COMPUTING

transferable as his knowledge of job control language was before.

Even the world outside the corporation may seem to be conspiring against the programmer. Computer education will become very common since computers are now affordable by every educational institution. On small machines, programming is easier and jobs can be done by less knowledgeable people than they could have been on the large mainframe. Entry level programmers will eventually be in plentiful

supply, a by-product of the high schools, trade schools, junior colleges, and universities. Many people will even learn to program on their own home computers. Certainly many of these people will qualify for entry level programming positions; and should they have knowledge of a specific type of application, they may find themselves competing very favorably with a data processing department programmer who has no particular knowledge of the user's needs.

The computer-literate public will no longer perceive programming as being a particularly prestigious occupation; after all, the kid down the street can

program. No longer will computer professionals be the practitioners of the black art. When the computer becomes a home appliance, having a degree in computer science will be like having a degree in refrigerator science.

What will the systems analyst decide? To shovel coal to the data base machine? To maintain programs written in eons past? To move to user departments where enormous numbers of programmers will be needed? Perhaps he will take advantage of the many new opportunities afforded by low-cost, abundant computing.

There still will be big computers. The enormous present investment in large mainframe software will keep big computers around. But, what is a big computer? If an Amdahl 470 computer is on a chip and costs \$100, is it still big? That will be the case 5 years from now. If a Cray 1 is on a chip, is it still big? That too will be the case 10 years from now. Is a disc that will hold 30 million bytes small because it costs only \$3,000? That will be true this year. These are the kinds of questions that we will be facing when we discuss big versus small over the next few years. Certainly, there will be big computers; but they will be very cheap when compared to the computers of today.

### The data processing department of the future

Certainly there is a role and a very important one for the information management department. Corporations will be faced with increasingly complex information management problems as they enter the era of office automation and as business systems become increasingly complex. However, the information management department of the future will only vaguely resemble data processing of the past. Rather than writing batch application programs, it will be concerned with planning the information flow and distribution throughout the corporation. The issues of communication between decentralized computers, data sharing, the design of the centralized data base, and prevention of program development duplication will be among the problems to be solved.

The responsible data processing manager will start planning now for his new role. Rather than opposing users who wish to acquire their own computers, the data processing department should provide them with assistance, advice, and planning. The farsighted manager will take the initiative by offering seminars and consulting services on the installation of decentralized systems.

If he is willing to make some changes, the future of the systems analyst will be brighter than ever before.

Low-cost, easy-to-use computers will not go away. \*

**EVEN THOUGH  
YOU'VE HELPED  
YOUR COMPANY  
DEVELOP NEW PROGRAMS...**

**MAYBE YOUR COMPANY  
STILL WON'T DEVELOP YOU.**

At LRK, our client, a leader in electronics systems, recognizes the importance of continued interaction and positive rewards for the systems professional. They're involved in a series of exciting programs...and they're committed to the kinds of personal and professional satisfaction that top-of-the-line systems people have every right to expect.

If your background is in sophisticated computer or systems technology, and your education has prepared you to accept state-of-the-art challenges with an industry leader, send us your credentials. Our client offers outstanding salaries, excellent benefits, and generous relocation...and especially exciting opportunities for career enhancement.

After all, development should be a two-way street.

We are especially interested in people with experience in:

- Documentation Engineers
- Radar Software Development
- Simulation Design Engineers
- Mini-Computer Software Systems Design and Development
- Command & Decision Software Definition & Design
- Proposals Expertise For Large-Scale Systems
- Command and Control Software Development
- Micro-Processor Software Development
- Hardware/Software Integration
- Software Project Management
- Weapons Software Development
- Data Base Design

In The East:  
**703-790-8640**

LRK Associates  
Management Consultants Dept. 5502  
6845 Elm Street  
McLean, Virginia 22101

In The West:  
**714-848-8494**

LRK Associates  
Management Consultants Dept. 5502  
16371 Beach Boulevard #141  
Huntington Beach, CA 92647

**LRK**  
**ASSOCIATES**

U.S. Citizenship Required  
representing equal employment opportunity M/F/H  
CIRCLE 187 ON READER CARD

# The Marketplace...

advertisers' index

## SOFTWARE MARKETPLACE

A.P. Publications Ltd. ....	222
Automated Concepts Inc. ....	222
Beemak Plastics .....	222
DASD Corporation .....	222
Dataware, Inc. ....	221
Digital Research .....	221
Informatics Inc. ....	222
National Technical Information Service .....	222
Plycom Services, Inc. ....	221
Software '70 .....	221
System Support Software, Inc. ....	221

## DP MARKETPLACE

Addmaster Corporation .....	222
American Terminal Leasing ....	223
American Used Computer Corporation .....	222
DATAMATION .....	223
Datec Inc. ....	222
Tone Software Corp. ....	223

## BUY, SELL, LEASE

D.V.I. Co., Inc. ....	223
-----------------------	-----

## JOB MARKETPLACE

Memorial Hospital .....	223
Northeastern University .....	223
Parker Page Associates, Inc. ....	223
Systemation Consultants, Inc. ...	223

## SOFTWARE MARKETPLACE

### AUTOCODER/SPS to COBOL

Dataware's software translator automatically converts a high percentage of SPS/1400 Autocoder source code to ANS COBOL (DOS or OS).

The Translator converts from:

- IBM 1401
  - IBM 1401 SPS
- } can be mixed in a single source program.
- IBM 1440
  - IBM 1410
  - IBM 7010

For more information on this translator, please write or call today.



**Dataware, Inc.**  
495 Delaware Street  
Tonawanda, New York 14150  
(716) 695-1412

CIRCLE 153 ON READER CARD

### FORTRAN IV USERS STRING70

STRING70 is the complete character string package for Fortran IV users. Performs even the most complex string and substring operations with ease.

STRING70 features include: string comparisons, string moves, string fills, string searches, string deletions, string insertions, and string replacements.

All operations are on variable length strings/substrings. STRING70 also includes table-oriented functions for manipulating symbolic lists.

STRING70 runs on the PDP-11, D.G. NOVA, G.A. SPC-16, IBM 360/370, INTERDATA, MODCOMP, and others. Price \$70.00.

### SOFTWARE '70

P.O. Box 3623, Anaheim, Calif.  
(714) 892-2230

CIRCLE 162 ON READER CARD

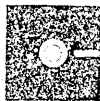

### CP/M™ LOW-COST MICROCOMPUTER SOFTWARE

#### CP/M™ OPERATING SYSTEM:

- Editor, Assembler, Debugger and Utilities.
- For 8080, Z80, or Intel MDS.
- For IBM-compatible floppy discs.
- \$100-Diskette and Documentation.
- \$25-Documentation (Set of 6 manuals) only.

#### MAC™ MACRO ASSEMBLER:

- Compatible with new Intel macro standard.
- Complete guide to macro applications.
- \$90-Diskette and Manual.

#### SID™ SYMBOLIC DEBUGGER:

- Symbolic memory reference.
- Built-in assembler/disassembler.
- \$75-Diskette and Manual.

#### TEX™ TEXT FORMATTER:

- Powerful text formatting capabilities.
- Text prepared using CP/M Editor.
- \$75 Diskette and Manual.



### DIGITAL RESEARCH

P.O. Box 579 • Pacific Grove, CA 93950  
(408) 649-3896

CIRCLE 158 ON READER CARD

### DEC RSTS/E USERS

From one of the pioneers in commercial data processing using RSTS. Off the shelf software ready for immediate delivery. Completely interactive. Extensively documented. Fully supported. Ideal for OEM's, service bureaus or end users. Cost effective solutions including:

- ACCOUNTS PAYABLE
- GENERAL LEDGER
- FINANCIAL REPORTING
- ACCOUNTS RECEIVABLE
- PAYROLL

For complete details, contact us at:

**Plycom** services, Inc.

P.O. Box 160  
Plymouth, IN 46563  
(219) 935-5121

CIRCLE 161 ON READER CARD

### VSAM LOAD DLI/IMS VSAM UPDATE INTERNAL SORT — QUIKSORT

C C Report Writer • Database Utility  
F F Intelligent Utility • Mini-language  
O O Increase Programmer Productivity  
II 62 Reduce Turnaround Time



# Quikjob

### THE PERFORMANCE EXPANDER

In use by over 400 companies. Four years on "Datapro Honor Roll."

ICP Million Dollar Software Club.

Call Mac or Bob, (513) 435-9514, send your card with this ad, or write for more details.

VSAM RANDOM VSAM SEQNTL  
ISAM OTHER DATE-BASES DBOMP

SYSTEM SUPPORT SOFTWARE, INC.

5230 Springboro Pike • Dayton, Ohio 45439

CIRCLE 163 ON READER CARD

### PL/1 TO COBOL

Dataware's Software Translator automatically converts from IBM PL/1 to ANS COBOL (DOS or OS). The Translator is capable of handling IBM OS or DOS (48 or 60 character set) source programs as input.

For more information on this translator or the others listed below, please write or call today.

- EASYCODER/TRAN to COBOL
- BAL/ALC to COBOL
- AUTOCODER (7070) to COBOL
- COBOL to COBOL



**Dataware, Inc.**  
495 Delaware Street  
Tonawanda, New York 14150  
(716) 695-1412

CIRCLE 154 ON READER CARD

### Dataware Software Translators

#### RPG to COBOL

Converts RPG and RPG II programs to the industry standard ANS COBOL (DOS or OS). The translator achieves an extremely high percentage of automatic conversion (approaching 100%) of the source code.

#### RPG to PL/1

Converts RPG and RPG II programs to an optimized PL/1 (DOS or OS). The translator achieves an extremely high percentage of automatic conversion (approaching 100%) of the source code.

For more information on these and our other translators, write or call today.



**Dataware, Inc.**  
495 Delaware Street  
Tonawanda, New York 14150  
(716) 695-1412

CIRCLE 155 ON READER CARD

**GEOGRAPHERS, CARTOGRAPHERS  
SURVEYORS, GEOLOGISTS**

**PLOT  
AUTOMATICALLY  
WITH CAM...  
Cartographic  
Automatic Mapping**

Performs a variety of cartographic functions. This program is written in FORTRAN H or G, and assembly language code (for subroutines) for implementation on an IBM system/360.

- Plot any of 18 map projections
- Generate commands for the CALCOMP 1136 plotter and many others
- Add map projections, subroutines to read line or symbol data in various formats, and subroutines for other features
- Use different plotter software with this modular program

Order today - PR 270 303/CPM (specify recording mode for magnetic tape) - \$250 for North American Continent. Foreign prices on request from:

**NTIS** National Technical Information Service  
U.S. Department of Commerce  
5285 Port Royal Road  
Springfield, VA 22161

For more information on this and other computer products, contact Computer Products Office, at (703) 557-4763 or write to NTIS.

CIRCLE 160 ON READER CARD

**CONVERTING?**

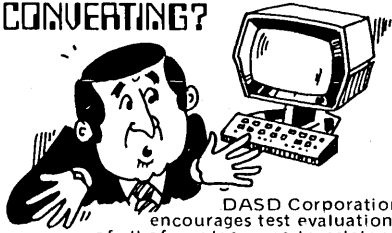

DASD Corporation encourages test evaluations of all of our language translators.

RPG/RPG II to ANS COBOL (DOS or OS)  
SYSTEM 3 COBOL to ANS COBOL-OS  
DOS COBOL to ANS COBOL-OS  
GE MAP to ANS COBOL-OS  
360/20 BAL to 360/370 ALC-OS  
NEAT/3 to COBOL  
AUTOCODER to OS-COBOL

Many service options are available: translator lease, conversion only, conversion and clean compile, full conversion including testing and JCL.

DASD CORPORATION  
National Marketing  
1480 Renaissance Drive—Suite 315  
Park Ridge, Illinois 60068  
312/299-5005



CIRCLE 156 ON READER CARD

**OUR LOWEST PRICES EVER**

**HAZELTINE**

1000 ..... \$495 2000 ..... \$995  
1200 ..... 750 3000 ..... 1500  
DUAL CASSETTE ..... \$1395  
THERMAL PRINTER ..... 795

**LEAR SIEGLER ADM-3A .. \$845  
VT50ha DECSCOPE ..... \$995**

**"NEW" DECWRITERS II & III**  
LA36 ..... \$1495 LS120 ..... \$2695

**CENTRONICS PRINTERS**  
101A .... \$1395 103 .... \$1695  
102A .... 1895 DEC 8, II NOVA, RS232  
& PARALLEL INTERFACES

**SHORT-TERM LEASES AVAILABLE**

**AMERICAN USED COMPUTER**  
**617-261-1100**  
P.O. BOX 68, KENMORE STA., BOSTON, MASS. 02215

CIRCLE 166 ON READER CARD

**IMS EDUCATION**

Automated Concepts Inc. has developed a complete curriculum of IMS training courses. Out of ACI's heavy involvement in IMS consulting services have come the experience and practical knowledge required to create this unique series of courses. The teaching method employed is an onsite lecture and workshop presentation by an ACI instructor. ACI offers the option of customization of course materials to reflect your installation's software environment, programming and operating procedures, etc.

ACI's IMS curriculum includes:

- Introduction to IMS DB/DC Systems
- IMS Programming Workshop
- Advanced Topics for IMS Programmers
- IMS Debugging
- IMS 3270 Design
- IMS Logical Data Structure Design
- IMS VSAM
- IMS Data Base Design
- IMS Reorganization, Recovery & Restart
- IMS for Operators

Send for ACI's "IMS Curriculum Guide" or contact: Rice Bullock, Education Director.

**aci** Automated Concepts, Inc.  
111 East Wacker Drive  
Chicago, Ill., 60601  
(312) 565-0661

CIRCLE 150 ON READER CARD

the choice of



National Semiconductor

**ACCOUNTING IV®  
GENERAL LEDGER**

Our software products—General Ledger, Accounts Receivable, Accounts Payable, and Standard Cost—are the choice of leaders like National Semiconductor *not by chance, but by design.*

For details, call (213) 887-9121

**informatics inc.**  
World's Largest in  
Software Products  
21050 Vanowen St. Canoga Pk. CA 91304

CIRCLE 159 ON READER CARD

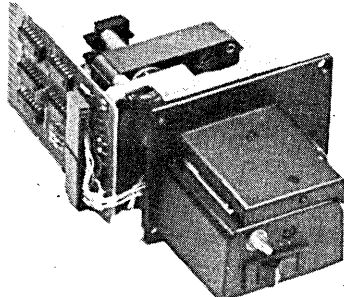

**350 Char/Sec Low Cost Loader**

Solid state photoelectronic components read all standard 5, 6, 7 or 8-level tapes. Smooth, quiet AC drive. Reliable high-speed paper tape data entry. Data amplifiers and "character ready" output available for CMOS or TTL interfaces. Standard interface or to your interface specifications. Fanfold boxes available.

Addmaster Corporation  
416 Junipero Serra Drive  
San Gabriel, CA 91776  
Telephone: (213) 285-1121  
Telex: 674770 Addmaster SGAB

CIRCLE 164 ON READER CARD

**Tabcard Holders**

For 80 col. — 51 col. — System 3 (96 col.)  
**RACKS • TRAYS • ACCESSORIES**

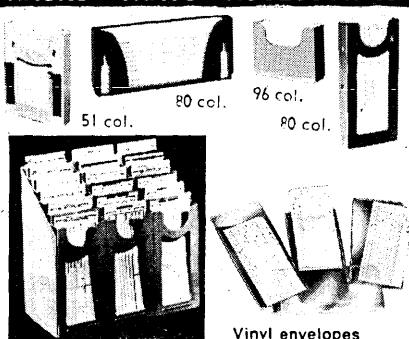

80 col. 96 col.  
51 col. 80 col.

Racks made with any holder in any design or size.

Vinyl envelopes available with adhesive back or magnets. Special sizes.

**BEEMAK PLASTICS**  
7424 Santa Monica Blvd.  
Los Angeles, Cal. 90046, (213) 876-1770

CIRCLE 152 ON READER CARD

**FREE**



**Data booklet on specialized software information systems covering:**

- \* GENERAL SOFTWARE
- \* DATABASE SOFTWARE
- \* MICRO & MINI SOFTWARE

**A.P. Publications Ltd**  
322 ST. JOHN STREET LONDON, E.C.1

CIRCLE 151 ON READER CARD



**datec couplers connect: always**

The Datec 30 Originate Only and the Datec 32 Originate/Answer acoustic couplers provide reliable Bell System 103/113 compatible Duplex or Half-Duplex, 300 bps data communication over conventional telephones.

Datec's RELIABILITY THROUGH CRYSTAL CONTROL permits channel establishment with received signal levels of -55dBm or lower.

The Datec 30 and Datec 32 acoustic couplers connect, time and time again.

**datec inc**  
P. O. Box 839  
Chapel Hill, North Carolina 27514  
phone: (919) 967-5605

CIRCLE 168 ON READER CARD

## "1978 MAINFRAME USER SURVEY" AVAILABLE NOW.

A new 300 page report providing the most comprehensive analysis of the mainframe systems market has just been published by DATAMATION magazine.

This in-depth survey is a major study of EDP user buying plans and attitudes for the next two years... all essential data for industry analysts, planning and marketing executives as well as computer users.

Available immediately the survey is priced at \$950., \$925. if payment is enclosed with the order. Additional reports are \$200 each. For complete information contact Deborah Dwellley (203) 661-5400.

**DATAMATION.**  
magazine

 TECHNICAL PUBLISHING COMPANY  
A DUN & BRADSTREET COMPANY  
35 Mason St., Greenwich, Conn. 06830

CIRCLE 167 ON READER CARD

## COMPUTER ROOM FLOORING and AIR CONDITIONING

Sell us your used computer room flooring and air conditioning.

Buy our reconditioned flooring and air conditioning (ED-PAC, LIEBERT, etc.). Completely guaranteed.

**D.V.I. CO., INC.**  
P.O. Box 33  
Paoli, PA 19301  
(215) 647-4916

CIRCLE 170 ON READER CARD

## PROGRAMMERS ENGINEERS

with systems programming/software dev exp IBM OS systems or minicomputer assembly language sought by energy, mfg, systems, consulting quality cos. Software, hardware & real time applications optys. \$18-29,000 SW, SE, W & NE.

Other clients seek business applications analysts & programmers with financial, mfg, or energy co applications exp Cobol, PL1, RPG, assembly \$18-27,000 SW & SE.

Confidential contacts controlled by you. Resume to J. L. Gresham, BChE, MBA will contact you at home first. Est 1966, members AIChE. Fees paid. (713) 622-1370.

**Systemation Consultants, Inc.**  
employment service

1410 Post Oak Tower Houston, Texas 77056

CIRCLE 174 ON READER CARD



**TONE 3**  
IS HIGH PERFORMANCE LOW OVERHEAD  
**TSO for VS1**  
CHECK THESE FEATURES

- Edit with full screen capability
- Internal reader job submit
- Output retrieval with RES support
- System maintenance
- Program development
- Data entry
- System debugging
- Text editing
- Performance monitoring support
- User command interface
- Interactive program execution
- Operations console support
- Dataset maintenance
- Catalog management
- Standard IBM TSO commands
- Enhanced 3270 useability
- Full ASCII terminal support
- No user swapping
- No TSOAM
- No VS/2 overhead

**TONE**  
Write for Details  
11588 TRASK AVE  
GARDEN GROVE, CA  
92643 (714) 636 8501

CIRCLE 169 ON READER CARD

## COMPUTER NEWSLETTERS FOR SALE

3000 subscribers. Gross sales \$74,000 annual. Price \$60,000.

**DATAMATION**  
Box DM-778  
35 Mason Street  
Greenwich, Ct. 06830

**SYSTEMS ANALYST** position available in large medical facility currently converting from present Computer System to Burroughs 6800 DMS 11 Data-Comm System. On-line Data Base experience desired. Positions also available for **LEAD PROGRAMMER/ANALYST** and **LEAD COMPUTER OPERATOR**. Send resume and salary requirements in first letter to Employment Manager, Memorial Hospital, 1901 Arlington St., Sarasota, Florida 33579. An equal opportunity employer.

CIRCLE 171 ON READER CARD

## RENT IT TODAY—USE IT TOMORROW!

"BRAND NEW"

## DECWRITER II & III

LA36 — LS120

- ★ **MONTH-TO-MONTH LEASE**  
3-MONTH MINIMUM
- ★ **ALL OPTIONS**
- ★ **DEC MAINTENANCE**  
UPON REQUEST
- ★ **IMMEDIATE DELIVERY**

**AMERICAN TERMINAL LEASING**  
**617-261-1100**

P.O. BOX 68, KENMORE STA., BOSTON, MASS. 02215

CIRCLE 165 ON READER CARD

July, 1978

## JOB MARKETPLACE

### DIRECTOR OF COMPUTER SERVICES NORTHEASTERN UNIVERSITY

As Director, you'll provide data processing leadership for NU's administrative offices with responsibility for all applications design, programming, and operations. You'll be responsible for planning, implementing and managing new applications development, current applications maintenance and OS maintenance. You'll also have budgetary control for an IBM 370/138 with CICS and all administrative computer personnel.

The job requires strong management, technical, and application design skills; a minimum of five years' data processing experience (including two years in a management role) and experience in a medium to large S/370 environment. Bachelor's degree and M.S. in Computer Science desirable, but not required. Salary is competitive and will be commensurate with qualifications and experience. Please send resume to: Dean J. A. Patton, 325 Richards Hall, 360 Huntington Avenue, Boston, MA 02115.

### NORTHEASTERN UNIVERSITY

An Equal Opportunity/Affirmative Action Title IX University.

CIRCLE 172 ON READER CARD

### POSITIONS AVAILABLE NATIONWIDE CALL TOLL FREE 800-426-0342

**SYSTEMS PROGRAMMERS** ..... To 32K S/E, midwest & west coast clients need exp. in 370/OS, CDC & H6000 Internals.

**IMS PROG/ANALYSTS** ..... To 30K Need several with mfg., retail, ins. & financial experience. Degree preferred.

**COBOL PROGRAMMERS** ..... To 24K Openings in all industries from coast to coast.

**MINI COMPUTER PROGRAMMERS** .. To 27K Experience with PDP, HP and Data General. Need Commercial, Process Control & Scientific.

Give me a call to discuss these openings as well as several others.

Call Bill Isgrig or forward resume to:

**PARKER PAGE ASSOCIATES**  
P. O. Box 12308  
Seattle, WA 98111

Offices in Washington, D.C., Chicago  
Atlanta & Portland, OR

CIRCLE 173 ON READER CARD

## EDP SPECIALISTS

career search opportunities \$18,000-\$50,000

**SR. SYSTEMS PROGRAMMER \$30,000.** Major NE client req's BS/BA with 5-10 yrs exp in IMS DB/DC & DBA. OS/IMS internals desir. Wide-ranging problem-solving. High visibility & advancement. Refer RM.

**SYSTEMS to \$29,000.** Blue Chip mfr is leading growth corp in their industry. Seek indiv capable of early proj mgmt resp. Req's BS w/4-6 yrs significant accomplishment in mfg, financ and/or mktg systems analys & design. Refer HG.

**DATA ANALYST to \$28,000.** Expanding R&D sub of "Fortune 100" corp. Systems/data analyst w/strong statistical bkgd to interface w/scientists, analyze experimental data. Req's BS/MS, math, comp sci or engr plus min 2-5 yrs exp. Refer HG.

**PROJECT LEADER to \$26,000.** Sunbelt loc "Fortune 500" co needs sev EDP professionals w/mfr systems design & analysis exp. Prefer OS/VS, IMS exp. Refer JS.

**SCI APPLICATIONS PROGRAMMER to \$25,000.** R&D sub of "Fortune 100" corp. needs Exp'd Fortran prog'r (mini) to dev & implem't EDP needs of scientists engaged in experiments. Req's BS Comp Sci or Math & min 1-2 yrs exp. Basic, data base, &/or some prog exp is a +. Refer HG.

**ANALYST (SR) \$24,000.** NJ corp seeks indiv w/sys or programming exp to design new sys networks for mat'l mgmt &/or prod. Refer RD.

**SYSTEMS ANALYST & PROGRAMMERS \$15-30,000.** Immed MD, DC, VA & nat'l openings. Commercial & scientific applic'ns. Refer DM.

**OPERATIONS \$18,000.** NJ client seeks indiv w/JCL exposure + exp in an on-line environment. Refer RD.

**MINI-PROG/ANALYST to \$18,000.** Expanding blue chip Atlanta client seeks 10 design programmers for new div. Will devel new applic'ns. Refer RS.

FOR FULL DETAILS ON EACH OF THESE FEE-PAID POSITIONS,  
CALL OR SEND RESUME TO THE RECRUITMENT SPECIALIST NEAREST YOU:

PHILADELPHIA, PA 19102—S. Burns, 1500 Chestnut St., 215/561-6300  
ATLANTA, GA 30346—R. Spang, 47 Perimeter Center, 404/393-0933  
BALTIMORE, MD 21204—R. Nelson, 409 Washington Avenue, 301/296-4500  
CHARLOTTE, NC 28202—J. Schwab, 1742 Southern Nat'l Ctr., 704/375-0600  
CLEVELAND, OH 44131—A. Thomas, 5755 Granger Road, 216/749-6030  
FORT LEE, NJ 07024—R. Mansfield, 2125 Center Avenue, 201/947-6920  
MCLEAN, VA 22101—D. Miller, 7921 Jones Branch Dr., 703/790-1335  
NEW YORK, NY 10016—W. McNichols, 605 Third Avenue, 212/697-1820  
PITTSBURGH, PA 15222—J. Beck, 4 Gateway Center, 412/232-0410  
PRINCETON, NJ 08540—R. Davis, 3490 U.S. Rte. 1, 609/452-8135  
WILMINGTON, DE 19810—H. Greene, 3411 Silverside Rd., 302/478-5150

**FOX-MORRIS**  
personnel consultants

CIRCLE 184 ON READER CARD

## COLORADO

### Computer Science Professionals

The Solar Energy Research Institute, located in Golden, Colorado is a private research institute charged with expediting commercial applications of solar energy.

To meet this responsibility, SERI is seeking programmers and analysts to assist in the development of a comprehensive solar energy information bank. Successful candidates will have designed and/or implemented on-line information data base applications utilizing relational or inverted file DBMS's such as: ADABAS, BASIS, SPIRES, or SYSTEM 2000.

Opportunities also exist for analytical applications programmer/analysts, communication analysts and systems administrators. These positions require an appropriate Bachelors degree and relevant experience in a technical or scientific atmosphere.

SERI offers competitive salaries and excellent benefits, including dental coverage and relocation assistance.

For immediate consideration, send a detailed resume (no phone calls) including salary history and professional references to:

Mr. J. J. Yacovella, Personnel Services

**THE SOLAR ENERGY RESEARCH INSTITUTE**

A Division of Midwest Research Institute

1536 Cole Boulevard

Golden, Colorado 80401

We are an equal opportunity employer m/f

CIRCLE 192 ON READER CARD

If you use  
computers as  
models of  
dynamic  
systems . . .

*you  
are  
a  
simulationist*

and

you are invited  
to join the Society  
for Computer  
Simulation  
and receive  
our monthly  
technical journal,  
*SIMULATION*,  
every month

The Society for Computer Simulation (SCS) is the *only* society whose central focus is simulation, and *SIMULATION* is the leading monthly journal devoted exclusively to simulation & closely allied computer arts.

If you are working in our field, we think you would find membership in SCS useful in many ways.

In addition to your membership in the Society for Computer Simulation, you'll receive a subscription to *SIMULATION*, the benefits of meeting and interacting with internationally recognized authorities in the field at SCS regional meetings and at national and international conferences cosponsored by SCS, and the knowledge that the information you receive through your membership in SCS will keep you informed in the rapidly advancing art of simulation.

Write for a free sample copy of *SIMULATION* and membership information.

THE  
SOCIETY  
FOR  
COMPUTER  
SIMULATION

(Simulation Councils, Inc.)

P.O. Box 2228 -D  
La Jolla, Calif. 92038

SCS SCS SCS SCS SCS

DATAMATION



**Technical  
Publishing Company**  
A Dun & Bradstreet Company

**James B. Tafel**, Chairman  
**John K. Abely**, President  
**Robert L. Dickson**, Exec. Vice President  
**Calverd F. Jacobson**, Vice President-Finance  
**Walter Harrington**, Vice President  
and Controller

## Advertising Offices

### Eastern District Managers

**A. Treat Walker**,  
**Warren A. Tibbetts**: Greenwich, Ct. 06830  
35 Mason St. (203) 661-5400  
Telex 996343

### New England District Manager & Vice President

**Warren A. Tibbetts**: Manchester, N.H. 03104  
112 W. Haven Rd.  
(603) 625-9498

### Midwest District Manager

**John M. Gleason**: Chicago, Ill. 60611  
444 No. Michigan Ave.  
(312) 644-3970

### Western District Managers

**Alan Bolte, Jr.**: Los Angeles, Calif. 90035  
1801 S. La Cienega Blvd.  
(213) 559-5111

**James E. Filiatrault**: Mountain View, CA 94043  
2680 Bayshore Frontage Rd.  
Suite 401  
(415) 965-8222

### U.K., Scandinavia, Benelux

**Intergroup Communications, Inc.**  
**Wallace K. Ponder**, European Director  
**Paul D. Dimmock**, Regional Manager  
31 Lyncroft Avenue  
Pinner, Middx, HA5 1JU  
England  
Tel: (01) 868 9289  
Cables: PACOM, Pinner

### Germany, Austria, Eastern Europe

**Fritz Taeuber**  
Soltauer Strasse 85  
D-314 Lueneburg  
Germany  
Tel: (0 41 31) 4 38 49

### France, Switzerland, Italy, Spain

**Gerard Lasfargues**  
32 rue Desbordes Valmore  
75016 Paris  
France  
Tel: (1) 288 90 22

### Japan

**Shigeru Kobayashi**  
Japan Advertising Communications, Inc.  
New Ginza Building  
3-13 Ginza 7-chome  
Chuo-ku, Tokyo 104, Japan  
Tel: (03) 571-8748

Technical Publishing Company  
A Dun & Bradstreet Company



Business Magazines  
Consumer Books  
Training Systems

## Design Engineers—Telephony

# Important “in-at-the-early-stage” opportunities in electronic key systems.

### Stromberg-Carlson offers:

1. involvement in a new large-scale D&D program
2. immediate high-level phone briefing
3. a chance to enjoy Florida living at its very best

Stromberg-Carlson — the largest independent telephone equipment manufacturer in the U.S. — has launched a major D&D program in electronic key systems. The program will be the basis for a whole new generation of repertory dial telephones, feature telephones, executive telephones, and advanced POS terminals.

Your role in this state-of-the-art program is so important that a member of our Technical Management will call you for a detailed briefing, if you are qualified.

We will answer your questions, tell you about our new Orlando Facilities, and describe what may be the most attractive professional and living environment a design engineer could ask for. Send detailed resume and salary history (be sure to include your home telephone number) to: Mr. George P. Smith, Vice President of Research & Engineering, Stromberg-Carlson Corp., Engineering Development Center, P.O. Box 7000, Longwood, Florida 32750.

# Stromberg-Carlson

A SUBSIDIARY OF GENERAL DYNAMICS CORPORATION

An equal opportunity employer, m/f

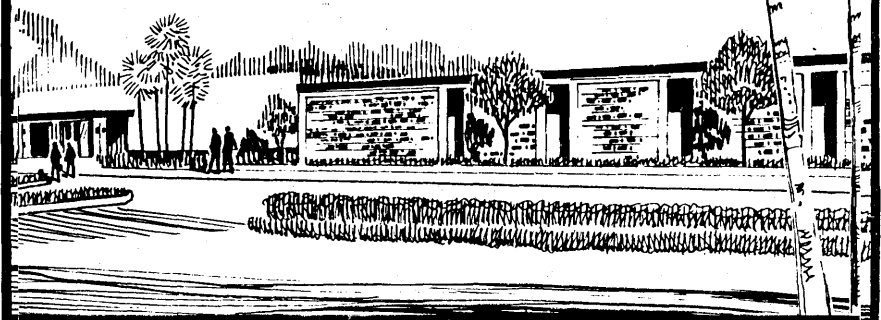

CIRCLE 194 ON READER CARD

Engineers

# Software Systems Developers

## EDP Terminals for Retail Institutions

We are now designing new advances in EDP terminals with greater computing and communications power . . . to maintain NCR's leadership position in total retail systems. To accomplish our objectives, we're enlisting the best talent in the field.

Several openings exist for both senior level analysts and entry level programmers for software systems design and assembly level programming of micro-computer (8080) based systems. Experience should include I/O driver design, language processor design, and/or real-time operating system design.

### Senior Level Analysts

Requires BSEE or Computer Science degree plus 4-8 years of recently related work experience.

### Entry Level Programmers

Requires 1-2 years work related experience.

Interested candidates are invited to send resume or call collect: Mr. Robert W. Donovan, Personnel Resources, NCR Corporation, Engineering & Manufacturing, Cambridge, P.O. Box 728, Cambridge, Ohio 43725. (614) 439-0291

# NCR

Complete Computer Systems

An equal opportunity employer.

# advertisers' index

AFIPS	37
American Telephone and Telegraph Company	68, 69
AMK Berlin Company	157
Anderson Jacobson, Inc.	204
Applications Software, Inc.	209
Applied Digital Data Systems Inc.	111
Basic/Four Corporation	71
Basic Timesharing Inc.	174, 175
Boole & Babbage	22
Bruning Division of Addressograph Multigraph	48
Centronics Data Computer Corp.	24
Clapp & Poliak, Inc.	53-60
Computer Communications, Inc.	114
Computer Devices Inc.	110
Computer Transceiver Systems, Inc.	109
Control Data Corporation	46, 47, 135, 149, 200, 211
Data General Corporation	122, 123, 194, 195
Data 100 Corporation	170, 171
Data Processing Security Incorporated	156
Datacorp	142
DATAMATION	230
Dataproducts	178, 179, 181, 183
Datum, Peripheral Products Division	Cover 3
Dayco Corporation, Printing Products Division	82
Digital Equipment Corporation	106, 107, 152, 153
Documation Incorporated	202, 203
DSG, Inc.	206
Eastman Kodak Company, Business Systems Markets Division	75
Ex-Cell-O Corporation, Remex Division	64, 65
Federal Computer Conference Exposition	124
Fluor Corporation	230
Fox-Morris Personnel Consultants	224
Fujitsu Limited	43
General Electric Company	67
General Motors Technical Center	214, 215
Harris Corporation, Data Communications Division	10, 11
Hewlett-Packard	27-36, 63, 137, 138, 139
IBM General Systems Division	14, 15
InfoNational	66
Informatics Inc.	38
Informatics Inc., Software Products	19
Infoton	143
Intelligent Systems Corporation	86
Interface West	61
International Data Sciences, Inc.	156
Itel Corporation, Data Products Group	2
Kato Engineering Company	23
Kennedy Co.	Cover 2
Litton Computer Services	8
LRK Associates	220



Martin Marietta Data Systems .....	8
Megadata Corporation .....	201
Memorex .....	72, 73, 191
Micom Systems, Inc. ....	78
Modular Computer Systems Inc. ....	16
Mohawk Data Sciences .....	121
Moore Business Forms, Inc. ....	5
National Semiconductor Corporation .....	6, 7, 80, 81
NCR Corporation .....	193, 226, 228
NEC Information Systems, Inc. ....	155
Norand Corporation .....	158
Northrop Corporation .....	219
Ohio Scientific .....	9
Okidata Corporation .....	4
Pansophic .....	74
PCC Pertec, A Division of Pertec Computer Corporation .....	84, 85
Perkin-Elmer Data Systems .....	212, 213
Pertec Computer Corporation, CMC Division .....	1
Q1 Corporation .....	177
Quest Systems Inc. ....	230
Qume Corporation .....	216, 217
Raytheon Computer .....	198, 199
RSVP Services .....	214
SAS Institute Inc. ....	207
Savant Institute .....	125, 126, 127
Society for Computer Simulation .....	224
The Solar Energy Research Institute .....	224
Source EDP .....	227
Spectron Corporation .....	52
Sperry Univac Mini-Computer Operations .....	20, 21
Stromberg-Carlson A Subsidiary of General Dynamics Corporation .....	225
Sycor .....	118, 119
Systems Engineering Laboratories .....	132, 133
Tally Corporation .....	79
TEAC Corporation .....	44
Tektronix, Inc. ....	205
Tektronix, Inc., Information Display Group .....	83
Teletype Corporation .....	Cover 4
Tennessee Valley Authority .....	215
Texas Instruments Incorporated .....	13, 40, 41, 141
3M Company, Microfilm Products Division .....	45
3M Company, Static Control Systems .....	77
Time Magazine .....	12
TransNet Corporation .....	206
Trendata, An Applied Magnetics Company .....	70
United Airlines Cargo .....	197
Universal Data Systems .....	50, 51
University Computing Company .....	144, 145
USA-Japan Computer Conference .....	37
Valtec Corp. ....	120
Versatec, A Xerox Company .....	112, 113
Wallach Associates .....	230
Western Peripherals .....	184
Wright Line, A Division of Barry Wright Corporation .....	146

# 1978 Computer Salary Survey!

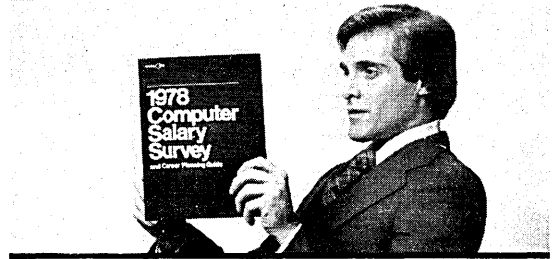

## Call for your Free copy today!

Are you making the kind of money you should be making? Inflation and record demand have pushed salaries in the computer field to all time highs. Source Edp's 1978 *Computer Salary Survey and Career Planning Guide* lets you know whether you're keeping pace.

This comprehensive free report also gives you expert advice on a variety of important career topics such as: when you should consider a job change; what you need to do to break into management; how to make sure you're getting the proper exposure; why timing is so crucial in your long range career development; how you can avoid stagnation -- and much more.

The 1978 *Computer Salary Survey* has been compiled by Source Edp, the largest recruiting firm devoted exclusively to the computer profession in North America. It's must reading if you're concerned about your career. But call now, it could be one of the most important career decisions you've ever made.

## For your Free copy, call the Source Edp office nearest you.

<b>East:</b>	<b>Milwaukee</b>	<b>Fort Worth</b>
<b>Boston</b>	414/277-0345	817/338-9300
617/482-7613	<b>Minneapolis</b>	<b>Houston</b>
Wellesley MA	612/544-3600	713/626-8705
617/237-3120	<b>Northfield IL</b>	<b>New Orleans</b>
<b>Hartford</b>	312/446-8395	504/561-6000
203/522-6590	<b>Oak Brook IL</b>	<b>West Coast:</b>
<b>New York City</b>	312/986-0422	<b>Encino CA</b>
212/736-7445	<b>Pittsburgh</b>	213/995-8866
<b>Philadelphia</b>	412/261-6540	<b>Irvine CA</b>
215/665-1717	<b>Rolling Meadows IL</b>	714/833-1730
<b>Stamford CT</b>	312/392-0244	<b>Los Angeles</b>
203/329-8411	<b>Southfield MI</b>	213/386-5500
<b>Union NJ</b>	313/352-6520	<b>Palo Alto</b>
201/687-8700	<b>St. Louis</b>	415/328-7155
<b>Washington DC</b>	314/862-3800	<b>San Diego</b>
703/790-5610	<b>St. Paul</b>	714/231-1900
<b>Midwest:</b>	612/771-0544	<b>San Francisco</b>
<b>Chicago</b>	<b>South/Southwest:</b>	415/434-2410
312/782-0857	<b>Atlanta</b>	<b>Seattle</b>
<b>Cleveland</b>	404/325-8370	206/454-6400
216/771-2070	<b>Dallas</b>	<b>Torrance CA</b>
<b>Detroit</b>	214/387-1600	213/540-7500
313/963-0510	<b>Denver</b>	<b>Canada:</b>
<b>Kansas City</b>	303/773-3700	<b>Toronto</b>
816/474-3393		416/364-2919

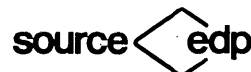

If unable to call, write: Source Edp, Department D7  
721 Enterprise Drive, Oak Brook, Illinois 60521

(When writing, please be sure to use home address and indicate position title.)

# Our new data processing systems make "easy upward migration" a reality. So do these career opportunities in Wichita.

NCR's family of business-oriented computers are more than interactive, real-time systems. They're readily upgraded into higher level systems without scrapping any equipment or programs. All of our systems, minis and micros alike, are "total hardware/software systems"—specifically designed for smooth upward migration.

Career paths at Engineering and Manufacturing, Wichita, work much the same way. We've eliminated dead-end specialization. You'll become part of a hardware/software task force that gets to work on every phase of development and application. Our flexible methodology will give you wider involvement than you've ever known before.

And you'll find more than a fast-paced, ample-room-at-the-top environment in Wichita. Wichita is non-stressful . . . relaxed . . . neighborly. With a metropolitan population of almost half a million, it is still a place where in 10-15 minutes of light traffic driving you can be home in a fine community. A place where you can walk safely at any hour of the night and soon know hundreds of your townspeople by their first names.

Our career opportunities are almost as wide as Kansas itself.

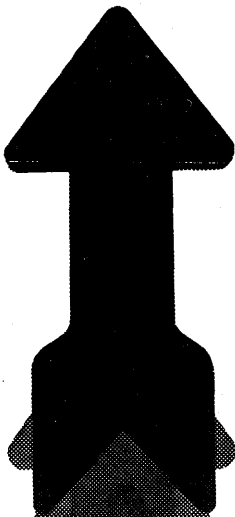

## **HARDWARE ASSIGNMENTS**

Require BS/MS in EE or CS with relevant experience.

### **Design Engineers—Peripherals**

These assignments generally focus on development of OEM peripherals using bisync, SDLC, and other types of interfaces. You'll work on logic design and firmware development for microprocessors.

### **Design Engineers—R&D**

Work on the next generation of NCR's successful computers. Establish functional specifications, plan programs, develop systems architecture alternative.

### **Engineers—Power and Standards**

A/C Circuit design for I/O adapters and power supplies. Problems include minimizing EMI, RFI, ESD by filtering and shielding techniques. One of these positions requires experience with international standards for acoustics and safety testing.

## **SOFTWARE ASSIGNMENTS**

Requires BS/MS in CS.

### **Senior Programmers/Systems Analysts**

These are high level positions, several involving group leadership and technical direction. Development of software architecture and OS implementation for new-generation minicomputer systems; maintenance of support tools for existing systems. Experience in real-time systems design.

### **Programming Consultant/Analysts**

These positions call for extensive experience (5-10 years) in OS design to provide technical leadership in division software design projects.

### **Programmer Analysts**

Provide support for utility module, including designing, coding, documenting, and testing for source/functional compatibility. Will plan procedures and monitor through release. Or, alternatively, do test planning, performance measuring, integrate COBOL for small computers, and help lead design effort in system simulation.

Want to come do it all? Call us for an interview . . . or, send resume and salary history to: **Rick Veldhouse, Professional Recruiter, NCR Corporation, Engineering & Manufacturing, 3718 N. Rock Road, Wichita, Kansas 67226. (316) 687-6192.**

**NCR**

Complete Computer Systems

An equal opportunity employer

# the forum

## HUH?

Why do programmers—especially systems programmers—think that code should precisely tell the computer what to do, and then, when trying to communicate with humans, assume that important components of the English language can be left out? For example, I just ran across a program message that said, SUGGESTIONS TO USERID XYZ, followed by two short messages. I assumed that the lead line was a heading for the two messages which had been sent to userid XYZ. I was wrong. The message meant humans should send messages to userid XYZ.

The verb “send” should have been at the front of the first message. The other two messages hadn’t been sent to userid XYZ, they were additional messages for me. Had the first message been a command to a computer, the machine would have burped! Shouldn’t a programmer know better? Of course; but the message wasn’t for a computer, it was for a human. Humans are smarter than computers—right? Humans can supply the missing pieces of the language and understand exactly what the programmer means. Humans are much more flexible and knowing than computers—right?

Bull!!! Humans, like computers, need reasonably explicit instructions if they are to carry out requested actions. Certain assumptions can be made about things in context—but these are only assumptions. Humans, unlike computers, don’t stop and print out an error message saying there is insufficient information; they keep right on going and hope that they are doing what is expected of them. Therefore, there isn’t any hardcopy record of the miscommunication; there is only frustration.

I have a hypothesis that if programmers wrote code as they write English, they would be digging ditches for a living instead of programming. I also wonder why it is so hard for a programmer to write clear, precise English if he can write clear, precise COBOL (or FORTRAN or BASIC or what have you). Is it that the programmer isn’t expected to write programs in English? Is it that nobody gives a damn? Or is it that the professional training given a programmer is deficient in the primary language that the programmer needs to know and use throughout his career?

It’s time for installations to start insisting that the primary language of programming become English—not for the computer, but for the world outside the computer. This is necessary so that everyone knows what the computer and the programmer are doing for—and to—them. It’s time that programmers start learning to provide explicit code for

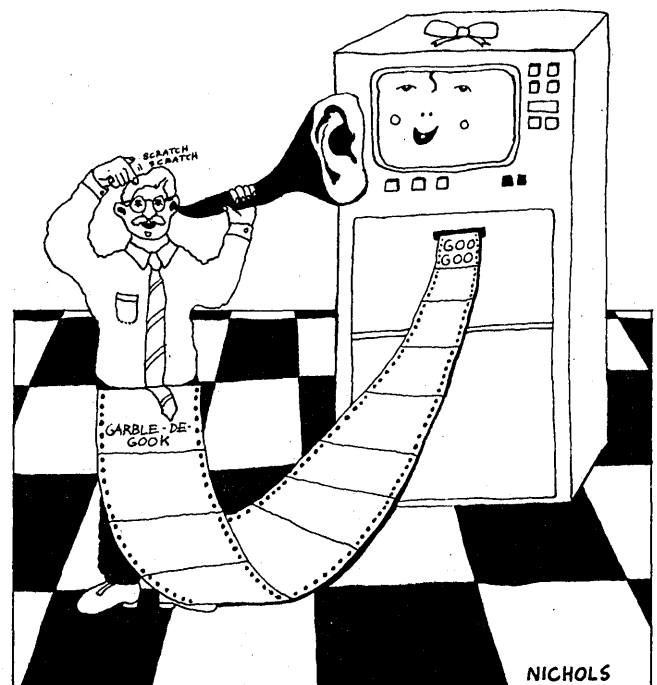

humans in addition to providing it for the computer. After all, the purpose is not to satisfy the computer; it’s to provide results from the computer to humans.

It’s time to take a stand! Write an error message to a programmer today! Send a memo to the programmer telling him that you can’t process the latest “instructions” from the computer and carbon it to his first level of management. When programmers start getting “error messages” (and possibly some heat from above), maybe they’ll take notice of the fact that they have bugs in their output and start correcting their problems. Maybe then they’ll start worrying about writing cleaner and more precise “code” for human beings.

—Frank B. Rowlett, Jr.

Mr. Rowlett is the manager of publication services at the Virginia Tech Computing Center.

# We already know your next employer. May we introduce you?

Wallach Associates, Inc., specializes in bringing together talented, experienced professionals and the nation's leading research, service and technical corporations.

Just one call to Wallach puts you in touch with a wide range of exceptional companies. Companies that offer top salaries, top benefits ... as well as interview and relocation expenses. All at NO COST TO YOU.

- Software Design
- Data Base Design
- Telecommunications
- Minicomputer Programming
- Signal Processing
- Digital Systems
- Microprocessor Design
- Systems Architecture
- Applications Programming
- Systems Programming
- Compiler Development
- Scientific Programming

If you find your area of expertise listed above, call TODAY! And even if you don't see your technical specialty here, contact us anyway. Chances are we're also looking for people with your qualifications.

Contact Perri Reeder. We'll put you in touch with your next employer ... fast! Representing equal opportunity employers nationwide (agency). WALLACH. Your career connection.

**WALLACH**  
associates, inc.

1010 Rockville Pike  
P.O. Box 2148  
Rockville, Maryland 20852  
(301) 762-1100

CIRCLE 197 ON READER CARD

# Even Webster's Knows About QUEST

**QUEST** (kwest). v. 1. To make a search; to go on a quest.

**QUEST SYSTEMS, INC.** n. 1. A corporation founded in 1968. 2. The largest professional recruitment firm in the U.S. functioning solely in the computer sciences; its client companies pay all employment fees, interviewing and relocation expenses. Quest is known for its deep personal commitment to relate to each candidate as an individual with individual goals. 3. Its professional staff averages over 6 years of experience in EDP recruiting (additionally, staff members have direct hands-on experience in programming, systems, hardware sales, etc.) 4. Quest is presently searching for programmers and analysts (commercial, scientific, systems software) for over 3,500 client companies in the U.S. Quest has openings in over 700 U.S. towns and cities. 5. Methodology — see Questsystem.

**QUESTSYSTEM** (kwest sis'tem). n. 1. Discussing with an individual what he would like to be doing in light of what he has been doing. 2. Analyzing the realities of his objectives as they relate to the current job marketplace. 3. Contacting client companies and other Quest staff personnel to identify positions of possible interest. 4. Introducing the job candidate to his prospective employers by providing complete details to each about the other, ensuring the efficacious use of everyone's time. 5. Arranging interviews. 6. If employment offers are extended, Quest assists in evaluating the responsibilities, compensation and opportunities (and relates those to the initially stated objectives). The Questsystem has been working for thousands of professionals at no expense, whatsoever. Ask your friends of their past dealings with Quest. Then, put the Questsystem to work for you. For additional information on this subject, please inquire directly to Quest Systems, Inc. (All inquiries/resumes received will be responded to immediately and in confidence.)



Call Toll Free  
**(800) 821-7700, Ext. 114**

**QUEST SYSTEMS INC.**

6400 Goldsboro Road  
Washington, D. C. 20034 (301) 229-4200

Baltimore: (301) 788-3500 • Philadelphia: (215) 265-8100

CIRCLE 190 ON READER CARD

# COMPUTER PROFESSIONALS

You may not know us, but we certainly know you. Fluor is an internationally prominent engineering and construction firm which has long known the value of the computer and is putting that knowledge to use in computer aided design, engineering applications, and graphics.

If you are interested in pursuing a challenging career, which can offer you responsibility and recognition, then Fluor is interested in you. Our Special Systems Group is looking for individuals with experience in CAD, engineering applications, graphics, and computer systems. The people we want will be responsible for the development and enhancement of:

- Fluor's current production CAD system
- DEC PDP/11 Operating Systems
- Engineering Applications
- Future CAD/Graphics Applications

Knowledge of DEC PDP/11s, Control Data CYBER 170s, and FORTRAN are beneficial but not imperative.

To explore employment opportunities with Fluor, please write to:

Larry Turchick, Employment (056)

**FLUOR CORPORATION**

3333 Michelson Drive  
Irvine, CA 92730

**FLUOR**

Fluor is an equal opportunity employer M/F



CIRCLE 183 ON READER CARD

**YOU CAN REACH  
120,000 EDP PROFESSIONALS  
AROUND THE WORLD  
WITH THIS SIZE AD  
FOR JUST \$395. OR LESS.**

**START  
SELLING  
IN THE  
DATAMATION®  
MARKETPLACE**

**CALL FRANCIE  
203-661-5400**

**DATAMATION**

# Datum Series/1.

*Magnetic Tape System  
Storage Module Disk System  
High Speed Line Printer System*



## Price/Performance. Reliability.

Datum's Series/1 peripheral systems are designed to complement your IBM Series/1 Model 3 or 5 Computers, providing expanded capabilities.

Datum offers seven or nine track magnetic tape systems, permitting recording densities of 200 bpi NRZ through 1600 bpi phase encoded. Speeds: From 12.5 ips through 125 ips. As many as four transports can be attached to the system.

Datum also offers a family of removable media Storage Module disk systems — 40 megabyte to 300 megabytes.

Software drivers for both tape and disk systems are included, which provide software compatibility with IBM Series/1 operating systems.

Both systems incorporate the new Datum "Universal User's Adapter", a device that allows

connection of external devices to the Input-Output bus of IBM Series/1 computers.

Datum provides high speed line printer systems — 300 to 900 lpm (64 characters) — which operate without software modification. (Compatible with IBM's 4973 Line Printer operations). A self test feature on the line printer controller provides the user with a visual performance check of the printer system.

On site installation by Datum customer engineers is available. Ongoing Datum maintenance is also available under the Datum Maintenance Agreement at a fixed monthly charge.

Call or write Datum, Inc., 1363 South State College Blvd., Anaheim, CA 92806. Telephone (714) 533-6333

## datum inc

**CORPORATE HEADQUARTERS**  
1363 S. State College Blvd.  
Anaheim, California 92806  
Tel: (714) 533-6333  
TWX: (910) 592-1289  
TELEX: 68-5579

**DATUM SALES OFFICES**  
**DATUM, CANADA**  
200 Consumers Rd.  
Suite 200  
Willowdale, Ontario  
Canada M2J 4R4  
Tel: (416) 491-6960  
TELEX: 06-966857 EOR TOR

**DATUM, MOUNTAIN STATES**  
10957 E. Bethany Dr.  
Suite P  
Denver, Colorado 80232  
Tel: (303) 693-3414

**DATUM, MIDWEST**  
1001 East Touhy Avenue, #75  
Des Plaines, Illinois 60018  
Tel: (312) 296-1064

**DATUM, NEW ENGLAND**  
615 Sherwood Parkway  
Mountainside, New Jersey 07092  
Tel: (201) 654-5590

**DATUM, SAN JOSE**  
4100 Moorpark Avenue, #216  
San Jose, California 95117  
Tel: (408) 249-5370

**EUROPEAN HEADQUARTERS:** Datum (Electronics) Ltd., Datum House, 363 Cranford Lane, Harlington, Middlesex, U.K. Phone (01) 897-0456; Telex 935 398 DATUM G. **EUROPEAN REPRESENTATIVES:** Belgium — S.A.I.T., Brussels, Ph. 02/376-2030; Finland — Suma Oy, Helsinki, Ph. 90/644-202; France — Reptec, Paris, Ph. 60/36 856; Italy — C.A.I., Milan, Ph. 02/271-1919; Netherlands — Technitron, B.V., Amsterdam, Ph. 020/458-755; Sweden — Kentele Data, Solna, Ph. 08/830-700; Switzerland — Amera, A.B., Zurich, Ph. 01/571-112; W. Germany — Geveke, GmbH, Norderstedt, Ph. 040/523-5061.

# WE'D LIKE TO REMIND YOU ABOUT THE DATA COMMUNICATIONS TERMINAL OUR COMPETITORS WOULD LIKE TO FORGET.



What the bottom line is telling banks, brokerage houses, pharmaceutical chains, railroads and steel companies is that for all-around value, there's no way the Teletype\* model 40/4 synchronous data terminal can be beaten.

And no wonder. Over the years, Teletype data terminals have built up an outstanding reputation for quality, dependability and proven performance. Add to that the model 40/4's system flexibility and human engineering features and you'll see why it consistently comes out on top in competitive analyses.

There's even icing on the cake. Delivery is only 30 to 90 days. And model 40/4 systems are installed and maintained by Teletype's nationwide service network.

So if you're looking for stand-alone or clustered displays and printers that are hardware and software compatible with remote bisynchronous communications protocol, command code structures and addressing sequences, we'd like you to look at the

model 40/4. And to make that easy, we're offering a free, on-site evaluation program. In other words, we're putting our money where our mouth is.

Just give us a call at 312/982-2000, or send in the coupon below. But do it quickly, please. Because with something as hot as the 40/4, we don't have many just sitting around.

\*Teletype is a trademark and service mark of the Teletype Corporation.

Teletype Corporation  
5555 Touhy Avenue  
Dept. 3185  
Skokie, IL 60076



Your free, on-site evaluation program sounds intriguing, and I'd like to know more about it.

Name \_\_\_\_\_

Position \_\_\_\_\_

Company \_\_\_\_\_

Address \_\_\_\_\_

State \_\_\_\_\_ Zip \_\_\_\_\_

Phone \_\_\_\_\_