

DATA MATION^{'73}®

April

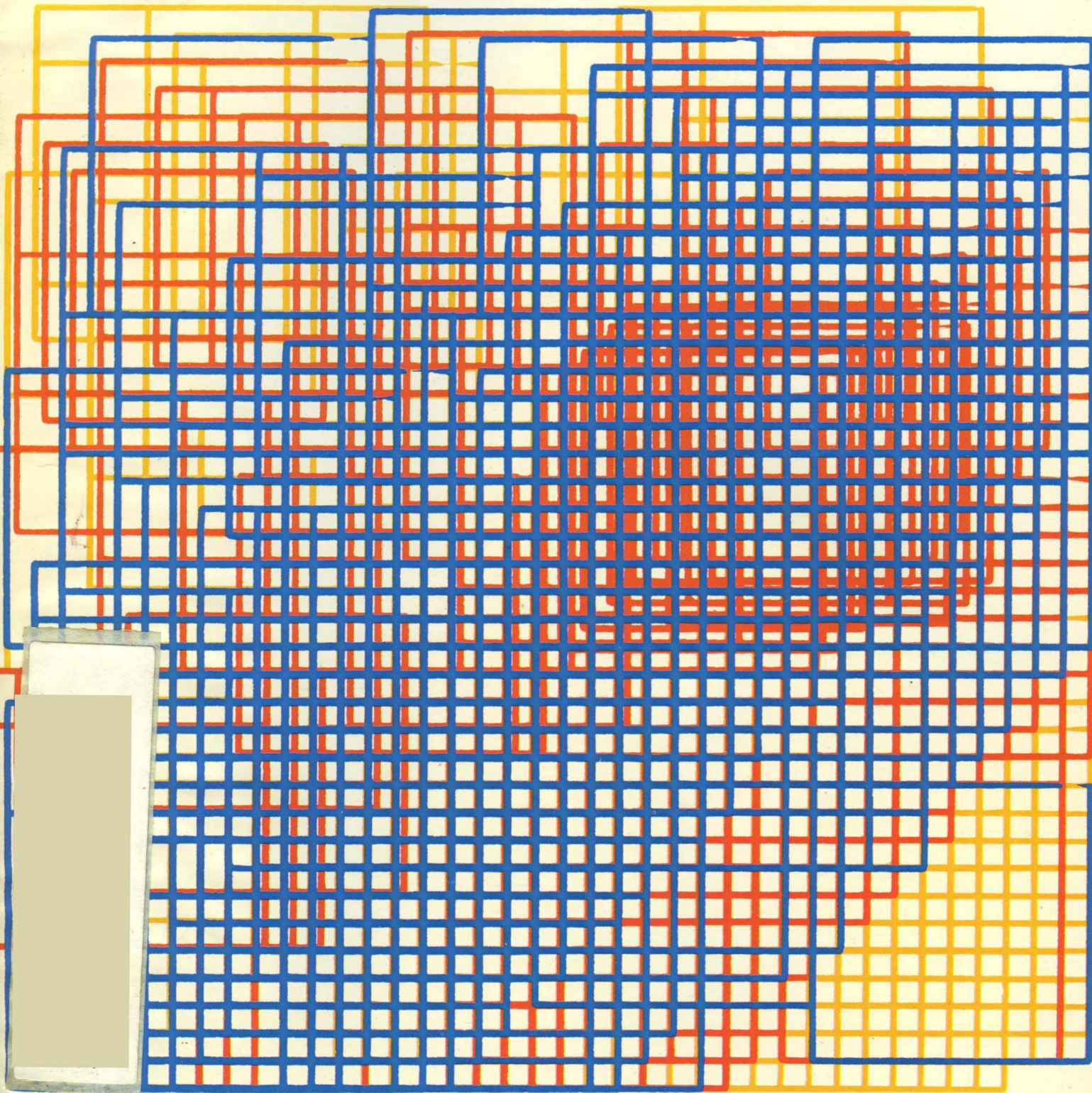

Data Communications
Also...the Benson decision examined,
compiler diagnostics, and a welcome to April.

Our Model 330— it can show you a picture worth a thousand words.

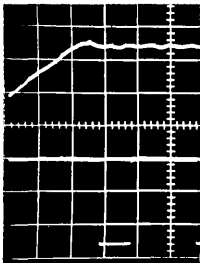

The picture is to the left. It's a scope pattern of the write output of our Model 330 as it ramps to its operating speed of 25 ips. Model 330's high performance velocity servo system maintains a linear ramp which controls tape speed, prevents overshoot and tape oscillations. In 15 ms, Model 330 is ready for reliable writing.

A small feature perhaps—but no one else has it. And it's only one of many features. Model 330, which utilizes 3M's new one-quarter inch cartridge, is fully bi-directional at 25 ips normal speed, resulting in a data transfer rate of 40,000 bits/second at 1600 cpi recording density. Forward and reverse search modes as well as rewind speed is 90 ips.

With 300' of high-grade 0.25" one mil tape, total data capacity (gapless) is 23×10^6 bits for 4-track operation. And Model 330 meets the proposed ANSI Standard.

Model 330 is equipped with a dual gap read/write head for read-after-write operation. One, two and four track versions are available. Each track is treated independently allowing cartridge interchange between transports of differing track configurations. Each track is equipped with a separate erase gap to ensure against inadvertent data erasure.

Model 330 is the cartridge recorder the industry has waited for. It's ideal as a programming device for mini-computers, a storage device for terminal and point-of-sale systems, or virtually any data processing application. It was worth waiting for. Write today.

KENNEDY CO.

540 W. WOODBURY RD., ALTADENA, CALIF. 91001 (213) 798-0953

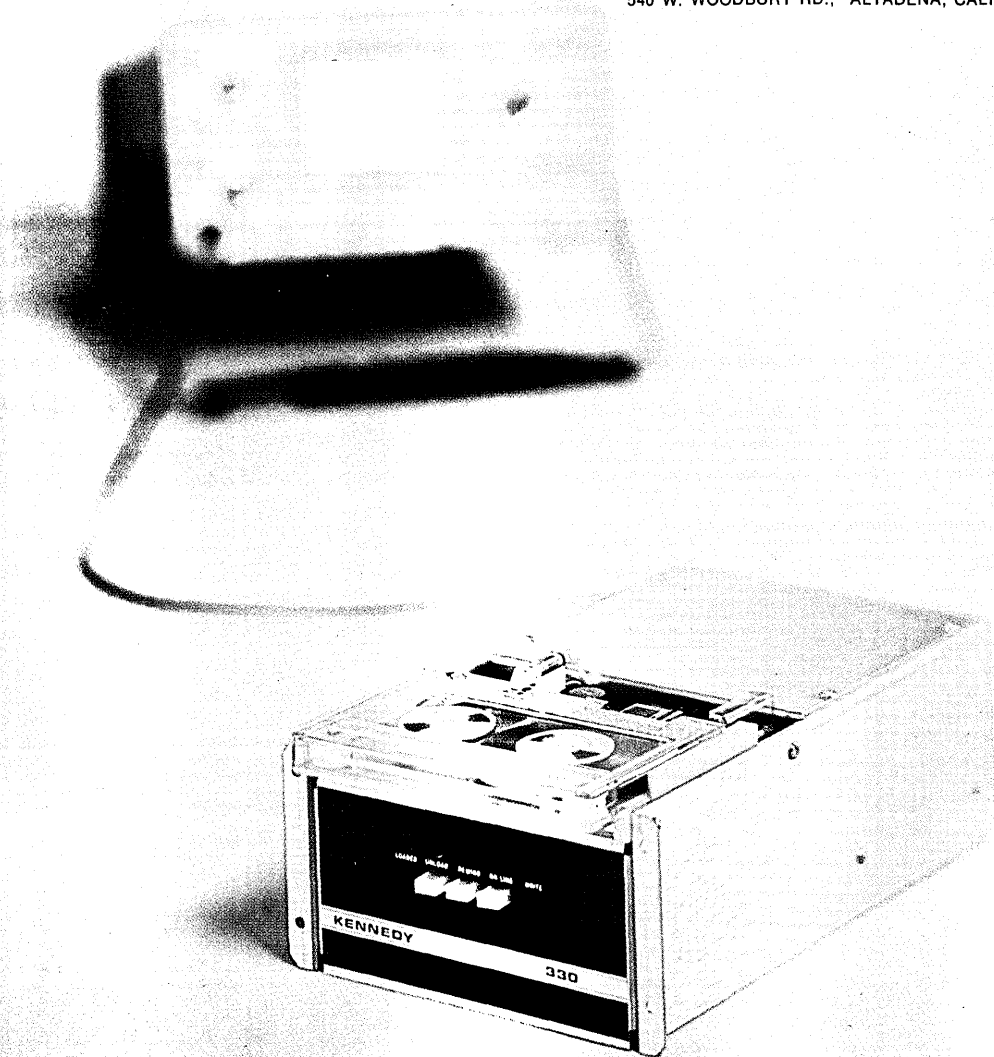

KENNEDY • QUALITY • COUNT ON IT

CIRCLE 1 ON READER CARD

GO TALLY FOR TERMINALS AND WRITE YOUR OWN TICKET!

Tally now makes it possible for you to come up with the most cost effective package for each individual terminal in your system. By compressing data to increase throughput and decrease line charges, the super-powerful Tally Datascribe Communicator saves you

money every time it transmits. Couple the Datascribe with the Tally printer that best matches the requirements of each terminal location. Result? Higher system throughput and lower total system cost. Shouldn't you know more?



600 LINES PER MINUTE—For your large-volume terminals, the Tally 600 lpm printer couples with the Datascribe which can transmit 400 records per minute with a 4800 Baud Modem.



200 LINES PER MINUTE—
In medium volume terminal locations, Tally's sensational new 200 lpm impact printer plus the Datascribe gives you a powerful and most reliable system.



100 LINES PER MINUTE—Match the Datascribe with Tally's 100 lpm impact printer for important savings in your small volume locations.

TALLY

Tally Corporation, 8301 S. 180th Street, Kent, Washington 98031 (206) 251-6770
Data Terminals • Printers • Card Reader Terminals • Paper Tape Peripherals

Either our drives outdrive their drives or your money back.

Plus interest.

Chances are we'll never have to pay off because our drives are the best you can buy. And we know it. We design them ourselves and build them to exceed the most demanding requirements in the industry today.

SERIES 6000 MAGNETIC TAPE UNITS. Tape speed 12.5 to 45 ips. Reel size 10.5 or 8.5 inches. Seven or nine track, half inch tape. High speed (200 ips) fast forward and rewind. All standard densities. Industry compatible interface. Simple design with few moving parts. File protect. Self seating reel hold down hubs. Controlled dynamic braking. Automatic multi-level read thresholds. Channel-by-channel electronic deskewing.

SERIES 8000 CARTRIDGE DISC SYSTEMS. 100 and 200 tracks-per-inch. 25 or 50 and 50 or 100 million bits storage capacities. Single and dual drives. IBM 5440 removable disc cartridge. Access time 10 milliseconds track to track. Data error during read or write less than 1 in 10⁹. Disc rotation 1500 or 2400 rpm. MTBF 5000 hours. Simple design with few moving parts.

Only 8.75 inches high including power supply. Positive optical head positioning. Try us. See if you can get your money back. Write for

details, or ask for a call from one of our salesmen.

Microdata Corporation.
17481 Red Hill Avenue.
Irvine, California 92705.
(714) 540-6730.

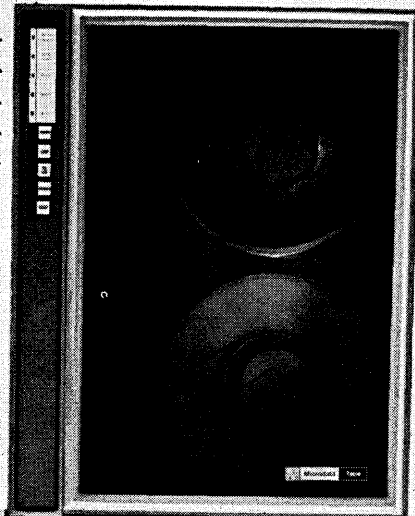
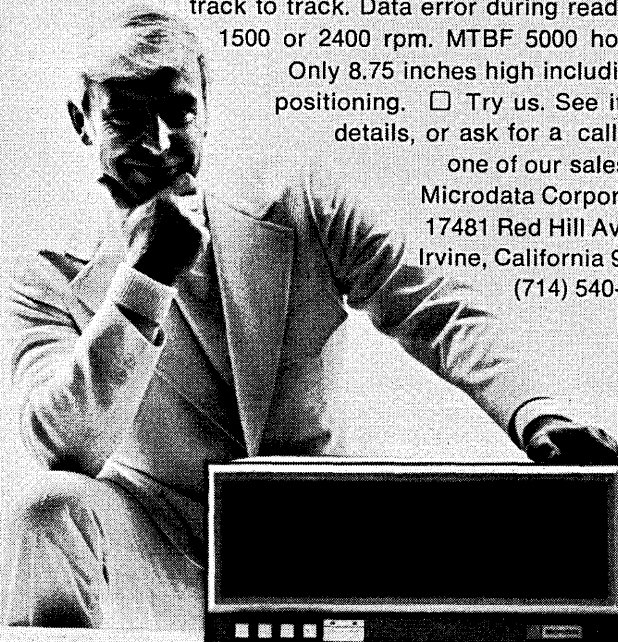

from the bold guys at

Microdata™

CIRCLE 60 ON READER CARD

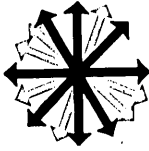

APRIL, 1973

volume 19 number 4
This issue 115,250 copies

46 A Front-End Primer for IBM Users

JOHN T. M. PRYKE. A guide to choosing the best type of equipment from any vendor to fit the IBM communications environment.

51 System Trade-offs: Dedicated and Dialed Networks

DANIEL FIDLOW. Characteristics of each type of network are explained and compared to aid the user in making a choice.

55 Communications Protocols: The Search for SYN

PHILIP G. STEIN. A programmer's troubles when he wasn't given the ground rules and had to find out the hard way.

58 The Octopus Computer Network

JOHN G. FLETCHER. One of the world's largest concentrations of computing power and storage capacity and its in-house-developed software.

68 April Foolishness

75 Software, Carfare, and Benson

ROGER M. MILGRIM. The Supreme Court suggested that software builders go see the legislators, but they might do better to study the principles of trade secrets.

84 Improving Compiler Diagnostics

ELIZABETH N. FONG. Techniques for improved detection of errors at compile or link/load time to avoid overhead during program execution.

91 A Data Dictionary Approach to MIS

R. DAVID GUTHRIE. Conversion of numeric codes to alphabetic descriptions can be handled efficiently with this technique.

96 Second Annual Communications Conference

EDWARD K. YASAKI. What to expect in the next decade, some problems with ILLIAC IV, computer-based crime, and teleconferencing.

106 News in Perspective

| | | | |
|--------------------------|-----|---------------------------|-----|
| MEMORIES | 106 | FEDERAL | |
| WALL STREET | 108 | GOVERNMENT | 124 |
| COMMUNICATIONS | 109 | SOCIETIES | 124 |
| BANKING | 117 | LUMBER INDUSTRY | 129 |
| PERSONNEL | 117 | COMPUTER OUTPUT | |
| SOFTWARE | 119 | MICROFILM | 130 |
| GOVERNMENTS | 120 | RETAIL | 135 |
| | | BENCHMARKS | 139 |

175 The Forum

DICK H. BRANDON. If a consent decree is indeed the target of the Justice Department suit against IBM, why not present the parameters of such a decree to the industry so that a realistic solution may be found?

departments

| | |
|--------------------------------|-----|
| <i>Look Ahead</i> | 7 |
| <i>Calendar</i> | 15 |
| <i>Letters to the Editor</i> | 21 |
| <i>News in Perspective</i> | 106 |
| <i>Hardware</i> | 140 |
| <i>Software & Services</i> | 148 |
| <i>Literature</i> | 154 |
| <i>Books</i> | 158 |
| <i>People</i> | 164 |
| <i>Index to Advertisers</i> | 171 |
| <i>The Forum</i> | 175 |

New

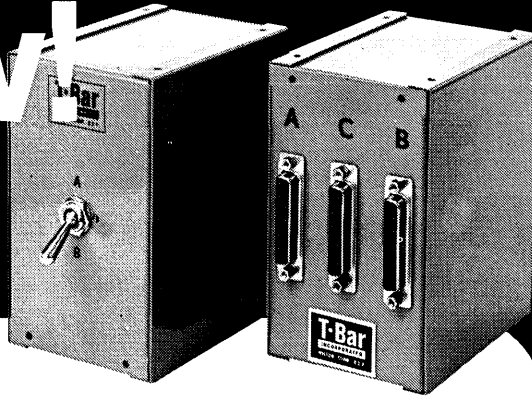

**Increase equipment utilization
... maintain system integrity
with 5700 Series
RS 232 EIA/TELCO Switches!**

**COMPUTER PORT MODEM
INTERFACE ... only \$97.10**

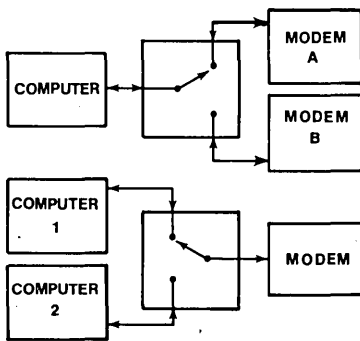

**SPARE MODEM SWITCH
... only \$175.00**

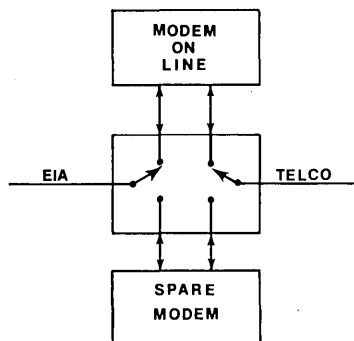

**4 SEPARATE CHANNELS OF
DIAL-UP BACK UP
... all for \$98.50**

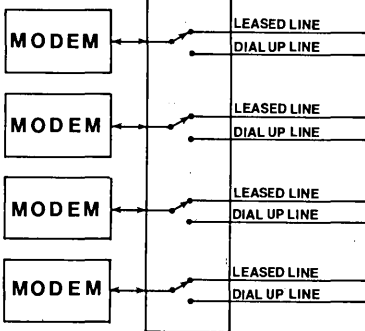

**16-CHANNEL REMOTE
PUSH BUTTON
SWITCHING AND CONTROL
FOR SYSTEM
RECONFIGURATION
... only \$160/CHANNEL**

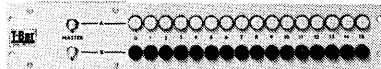

**... Plus many many more ...
all using T-Bar's exclusive
high reliability DATA-RITE™
switching devices.**

These T-Bar® EIA/TELCO DATACOMM Switches now provide the Communications Systems Engineer and the Communications Manager with a system cost effectiveness that really works. Write or phone today for complete literature ...

**T-Bar
INCORPORATED
SWITCHING TECHNOLOGY**

141 Danbury Rd., Wilton, Connecticut 06897 Telephone: 203/762-8351

DATAMATION.

EDITORIAL STAFF

| | |
|--------------------------------|----------------------------------------------------------------------------------------------------------------------|
| Editor | Robert B. Forest |
| Articles Editor | William J. Rolph |
| International Editor | Angeline Pantages |
| Communications Editor | Phil Hirsch |
| Technology Editor | Richard A. McLaughlin |
| Industry Editor | W. David Gardner |
| Products Editor | Michael William Cashman |
| Letters/Calendar Editor | Janet Eyer |
| News Editor | Tom McCusker |
| Bureau Managers | |
| San Francisco | Edward K. Yasaki |
| Los Angeles | Edith D. Myers |
| Washington, D.C. | Phil Hirsch |
| New York | Angeline Pantages |
| New England | W. David Gardner |
| Correspondents | |
| Minneapolis | James K. Johnson |
| Southwest | Robert F. Alexander |
| Europe | Pearce Wright |
| Australia | Frederick A. Bland |
| Editorial Assistant | Mary Ellen McCoy |
| Editorial Advisor | Robert L. Patrick |
| Technical Advisor | Lowell Amdahl |
| Contributing Editors | Paul Armer, Howard Bromberg, Philip H. Dorn, Louis B. Marienthal, Ray W. Sanders, Milton R. Wessel, F. G. Withington |

EDITORIAL OFFICES

Headquarters: 1801 S. La Cienega Blvd., Los Angeles, CA 90035. Phone (213) 559-5141. **Eastern:** 35 Mason St., Greenwich, CT 06830, (203) 661-5400. 19 Marlborough St., Boston, MA 02116, (617) 267-9414. 9805 Singleton Dr., Bethesda, MD 20034, (301) 530-7271. **Southwestern:** 2711 Cedar Springs, Dallas, TX 75201, (214) 744-0161. **Western:** 61 Renato Ct., Redwood City, CA 94061, (415) 364-3171. **Foreign:** 65, Hill Road, Chelmsford, Essex, England. 64/90 Blues Point Rd., McMahons Point, NSW 2060, Australia.

GRAPHIC DESIGN & PRODUCTION

Art & Production Director Cleve Marie Boutell
Production Manager Marilee Pitman

CIRCULATION

35 Mason Street, Greenwich, CT 06830
Circulation Director Suzanne A. Ryan

Marketing Research Director Douglas De Carlo
Publisher James M. Morris

Circulation audited by Business Publications Audit



Member, American Business Press, Inc.



DATAMATION is published monthly on or about the first day of every month by Technical Publishing Company, 1301 South Grove Ave., Barrington, Illinois 60010; Arthur L. Rice, Jr., President; Gardner F. Landon, Executive Vice President. Executive, Circulation and Advertising offices, 35 Mason Street, Greenwich, CT 06830, (203) 661-5400. Editorial offices, 1801 S. La Cienega Blvd., Los Angeles, CA 90035. Published at Chicago, Ill.

DATAMATION is circulated without charge by name and title to certain qualified individuals who are employed by companies involved with automatic information handling equipment. Available to others by subscription at the rate of \$18 annually in the U.S. and Canada. Reduced rate for qualified students. Foreign subscriptions are available for \$12.50 or for the equivalent of \$30 U.S. in most West European currencies. Sole agent for all subscriptions outside the U.S.A. and Canada is J. B. Tratsart, Ltd. 154 A Greenford Road, Harrow, Middlesex HA13QT, England. No subscription agency is authorized by us to solicit or take orders for subscriptions. Controlled circulation paid at Columbus, OH and Form 3579 to be sent to Technical Publishing Company, P.O. Box 2000, Greenwich, CT 06830. Copyright 1973, Technical Publishing Company. Microfilm copies of DATAMATION may be obtained from University Microfilms, A Xerox Company, 300 No. Zeeb Road, Ann Arbor, Michigan 48106. Printed by Beslow Associates, Inc.

DATAMATION

CIRCLE 82 ON READER CARD

the centronics phenomenon:

a 100 char/sec, 80-column printer for \$1995.

another first!

Unbeatable price/performance ratio! At \$1995, the new Model 306 is the fastest, low cost 80-column impact printer you can buy. It's one-half the price of our popular 101.

At 60 to 150 lines per minute, the 306 offers a wide range of interfaces for a variety of systems and data communication applications. The 5 x 7 dot matrix print head produces an original plus up to 4 clear carbons—always with perfect fixed vertical/horizontal registration. It changes to elongated boldface characters on command. And feeds paper conveniently from behind or below the printer. The 306 is plug-to-plug compatible with all Centronics printers and our CRT terminal too.

About Reliability. Many of the same field-proven modules from our other printers are used in the 306. Thousands of Centronics printers are in operation throughout the world.

The 306: price, performance—and it's in production—now!
For full details, phone or write.



CENTRONICS

centronics data computer corp.
one wall street, hudson, n. h. 03051
telephone (603) 883-0111
central region: (513) 294-0070 (ohio)
western region: (714) 979-6650 (calif.)

Up to 40 times faster processing...
15 times more memory...
20 times faster printing.



Burroughs new, more powerful TC 3500 series

Burroughs new TC 3500 intelligent terminal computers offer:

- Up to 40 times the processing speed, plus 15 times the user program and data storage capacity of Burroughs TC 500, the first intelligent terminal computer.
- Broad peripheral power with line printers providing up to 20 times faster system output, computer-compatible magnetic tape, 96-column card reading, punching and sorting equipment, paper tape units, SELF-SCAN® panel display, and a new magnetic tape cassette subsystem that allows Dynamic Memory Overlay.
- Versatility in batch-oriented applications, on-line operations, or mini-network control; communication with many kinds of terminals and almost any computer mainframe, using different transmission modes simultaneously.
- The economy of shared lines, COBOL programming, and compatibility with existing TC networks.
- 15 models to fit your company's needs for productive power, versatility and economy in data communications.

Burroughs 

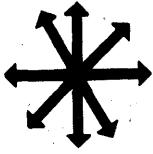

Look Ahead

IBM'S CPU LEASE PLAN: A BARGAIN?

Unimpressed. That's the early reaction by users to IBM's new four-year lease plan for 370 cpu's. Several two- and three-shift users who have been considering third-party leases dismiss the IBM move as in typical style: "not the best bargain in town."

Example: Itel Corp. offers a total systems package of its own peripherals and IBM's cpu's for up to eight years at around 60% of IBM rental. The same package from IBM, with leases on cpu and peripherals, runs about 95% of IBM's rental now that IBM offers to waive overtime charges. But with IBM, the user can walk away after four years. With Itel, the user pays termination penalties any time before eight years are up. Itel, however, will sell or sublease the system for him and the funds will go toward termination charges. It's a risk, but the difference between the Itel lease for four years and IBM rent on a \$50,000-a-month system is more than \$800,000.

Randolph Computer offers a full payout lease, too, with an option to buy after four years at around 50% of the purchase price, the same as IBM. But, the customer will pay 15-30% less per month to Randolph during these four years.

Confusing? These are simplified cases, so get educated. The lessors, thinking positively, are hoping IBM will help in this education.

How much has IBM hurt third-party leasing? The blow is primarily psychological when it comes to long-term leasing, but IBM may have finished off the short-term operating lease that offers a minor discount with no overtime charges. That's IBM's bag now.

ONE BIG USER WON'T LEASE

The IBM four-year plan is being studied closely by large multishift users who can't go to full-payout leases because their requirements change so rapidly.

One such user offers this formula: weigh the savings from the IBM lease against the breakeven point when early termination, with its penalties, would still equal rental. Then weigh this against the possible announcement of new equipment with improved cost/performance --and all of this against the strain on the current installation's capacity.

Example: A petroleum company is installing four 370/168s between now and the first quarter of 1974. It already knows it'll be cpu-bound. Beta tests of VS2 version 1 indicate it will require 30% more cpu overhead than MVT. The firm needs a faster cpu--three to four times the 168--and expects IBM to announce the 178 in three to four months. If it puts the 168s on four-year leases, it figures they'd have to stay in two years minimum to have the lease charge plus terminating charges equal monthly rental, or breakeven. The firm expects the 178 to be delivered before then, so leases of any kind are out.

WHERE MERRILL LYNCH ISN'T BULLISH

Merrill Lynch, the nation's biggest securities brokerage house, is said to be receiving bids from Bunker Ramo and GTE's Ultronic Brokerage Services for a system that was supposed to be IBM's big plum in that industry. These reports tend to indicate that Merrill Lynch is not bullish on IBM's 3670 brokerage communications system which IBM said would be shipped last fall.

Look Ahead

Now, spokesmen at Armonk will admit only to having one running at the IBM Securities Industry Development Center in NYC. The first of nearly 4,000 terminals was to have been installed at Merrill Lynch this spring, but that order has evaporated and it's doubtful whether the firm will order any at all. It's understood Merrill Lynch thinks the \$10 million-plus a year rental charge is too high for the system, which would have needed two or three 195s to operate properly. Added to this, neither IBM nor Merrill Lynch can provide a stock quotation system of their own, although IBM planned one when it initially bid the system. Some speculate that although IBM has the financial resources to build its own stock quote data base, its entry to this market might have caught the Justice Dept.'s eye in these sensitive days of antitrust.

NOT-SO-INSTANT PLAYBACK

Two years and \$628,000 after it was announced, Los Angeles County's ORACLE system for the Sheriff's Dept. is in serious trouble. The county had hoped to connect 16 sheriff stations via microwave link-up with a Videofile of fingerprints, rap sheets, arrest histories, and other criminal records housed at a central data center.

We're told that ORACLE (Optimum Record Automation for Court and Law Enforcement) is beset with communications and retrieval problems. Although Ampex Corp., which developed the system under a \$7.4-million contract, proposed that stations could get the requested video images in 5-7 seconds, this happens only if the reels of videotape to be accessed are mounted and ready to be searched. In the Ampex system only six reels can be mounted at one time, and the test files involve 200 reels.

Further complicating the system was a poorly planned communications system in which the data center couldn't take more than two microwave messages at a time. Says a source close to the implementation efforts, "the system just didn't have on-line retrieval capability," and that a "quickie" study of a similar system using microfilm and facsimile, instead of videotape, showed the job could be done at a tenth of the cost.

The county, which paid Ampex \$628,000 in equipment rental from August to December of '71 before it decided the system wouldn't work, now has to find out what to do about the \$7.4-million contract it signed. It was expected the county's administrative office would be given until April 24 to come up with an answer.

EVERYMAN'S COMPUTER?

Computer Automation, which jolted minicomputer pricing two years ago when it introduced its Naked Mini (\$1995 with 4K memory in oem quantities) and Alpha (\$3550) minicomputers, may do it again next month with two MOS/LSI computers priced more than 50% lower than their predecessors. One, the Naked Mini/LSI, will be a complete 16-bit computer on a card, we're told, while an Alpha version (one or more cards in a chassis) will have hexadecimal data input keyboard instead of toggle switches.

MEMOREX: PERCENTAGES LOOK GOOD

Memorex gamely weathers persistent reports that its new MRX computer is considerably less than a roaring success. The few installed systems aren't producing revenue because the software won't work, say the reports. A Memorex spokesman says this isn't so. He refuses to release any figures, but claims MRX 40s and 50s are being shipped at

(Continued on page 163)

OUR INTELLIGENT TERMINAL DOESN'T ALWAYS DO WHAT IT'S TOLD.

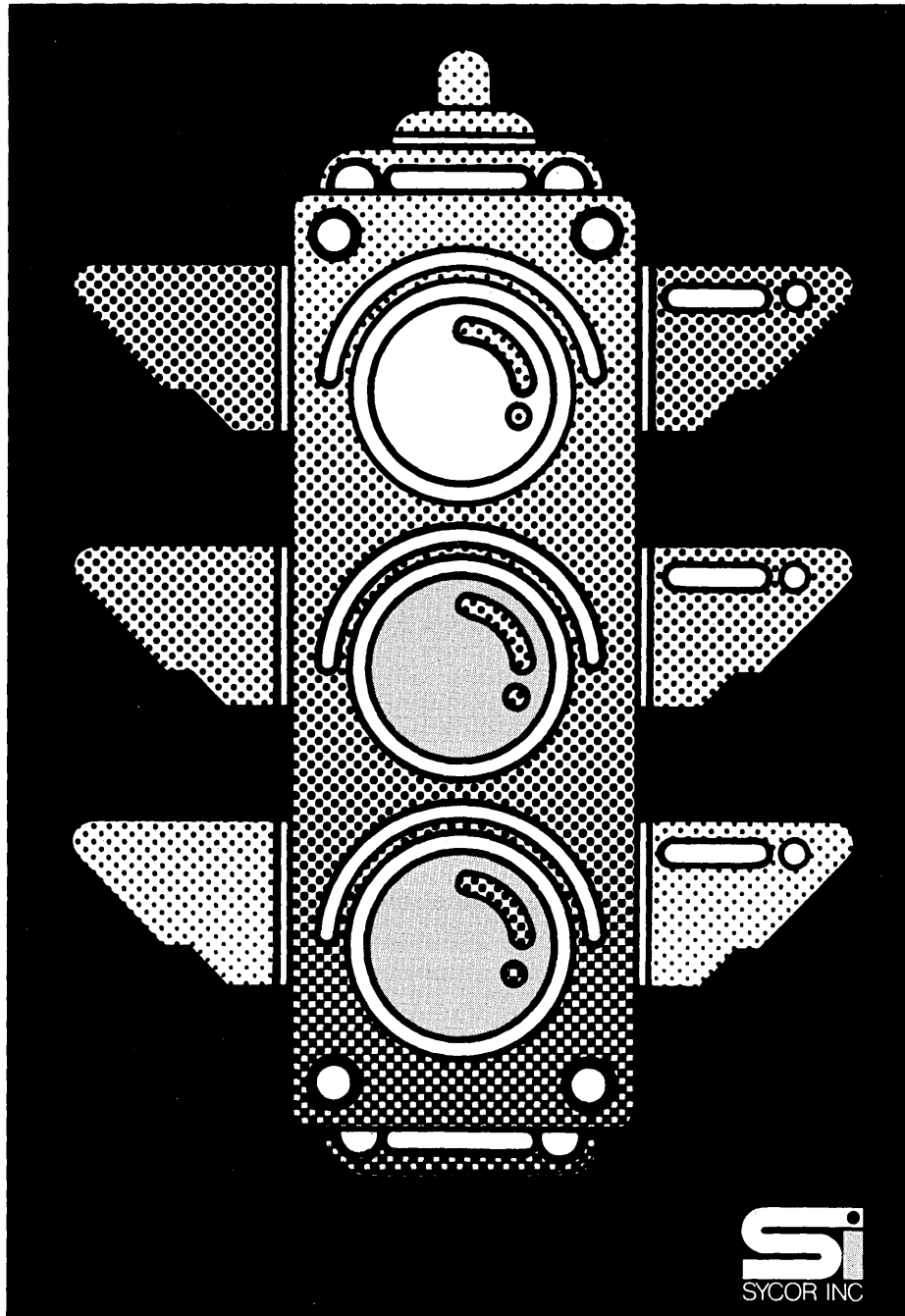

SI
SYCOR INC

Our intelligent communications terminal, the Sycor 340, can be very obstinate.

Like the times an operator inadvertently enters the wrong data.

Perhaps she omits an entry. Or tries to enter a number that doesn't pass the range check.

An alarm buzzes, the keyboard goes dead, and the entry that's incorrect blinks on and off.

Your operator corrects it on the spot. And you save time and money.

And when she's got the clean data ready, the 340 can transmit it unattended at 1200 to 4800 baud speeds.

But clean source data entry isn't the only advantage of an intelligent communications terminal.

The 340's 8K bytes of programmable memory, and our special terminal application language (T.A.L.), make our terminal putty in your hands when it comes to tailoring it for specific applications.

And with capabilities like customized field validation, conditional data entry and arithmetic operations, you've got the tools you need to tackle applications you may not have had in mind when you first leased it.

Our intelligent terminal has some pretty smart peripheral equipment, too. Like remote printing capability from 30 cps to 300 lpm.

Before you lease, check into our intelligent terminal that doesn't always do what it's told. More than 6,000 Sycor terminals are now being obstinate in 33 countries around the globe.

And you'll find a world of uses for them right at home.

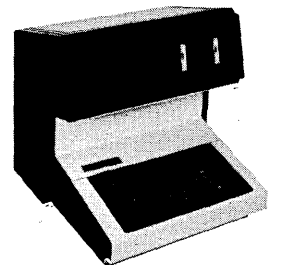

SYCOR

Corporate Offices: Ann Arbor, Michigan 48104 (313) 971-0900. **District Sales Offices:** Atlanta (404) 262-2162 • Boston (617) 890-7290 • Chicago (312) 986-1833 • Cleveland (216) 831-8625 • Dallas (214) 521-6710 • Detroit (313) 522-0080 • Houston (713) 688-5224 • Los Angeles (213) 640-0120 • New York (212) 483-8188 • Philadelphia (609) 665-1170 • Pittsburgh (412) 922-3350 • San Francisco (415) 349-6626 • Washington (703) 525-7300. **In Canada:** Sycor International Ltd., Toronto (416) 429-0883. **Service Centers in 76 cities.**

**THE CHEAPEST
MINICOMPUTER
VS.
THE CHEAPEST
SOLUTION**

Before you buy a minicomputer, do yourself a favor. Make a very fundamental decision. Do you want the cheapest machine you can find or the cheapest total solution to your problem?

We think it's the latter.

Because the cheapest machine is just that. It's raw hardware at a rock bottom price. And virtually every minicomputer supplier offers a product like this. Including us.

But your goal should be to get the lowest cost total solution for your problems. And paying less now could cost you more later if the machine you buy has been designed for rock bottom price alone. Be careful. You should look beyond raw iron. You need a computer package that saves you money at both ends. One that's been designed with the total solution in mind. A powerful blend of hardware, systems software, and extensive peripherals.

You also should look for a supplier that has built his business on fulfilling this need. That's us.

The world's most powerful mini.

We've developed the most effective minicomputer package you can buy: the SPC-16. Six different models to choose from and the *most powerful* instruction set available anywhere.

The SPC-16 does more things in less time with less memory. That's why it can actually save you money on your total system.

And we've recently enhanced the capability of our SPC-16 family with a number of new products including:

Multi-user BASIC, and the real-time, multi-programming capability of our RTOS-16 operating system. And our new extended FORTRAN IV.

New peripherals like a low speed line printer, head per track disk and a floppy disk.

High speed floating point processor,

8K memory board, heavy duty process I/O boards, A/D and D/A converters and digital I/O boards.

And completely new asynchronous communications multiplexer system.

Here's another reason for choosing us:

We've already had our tryouts.

Today all the big mini manufacturers are announcing that they're "in the systems business."

We've been in it from the start.

And while everybody else was churning out iron, we were building systems and piling up applications know-how.

We got involved with our customers' problems. We listened and we learned. Then we rolled up our sleeves and went to work.

As a result our people don't have to be retrained for this new approach because it isn't new at all. Not to us.

Over the years we've supplied systems to solve some very tough problems in the automotive industry, in production machine control, in electrical testing and communications. And this experience has built a fund of systems expertise no mini manufacturer can match.

There's a good chance we already have a system that fits your needs. If not, we have the know-how to design it for you. Or *with* you.

In fact, we can probably utilize our experience to solve your system problem faster than others can deliver a bid.

Read all about it.

If you're determined to reduce systems cost, we have a book for you. It's titled "The Value of Power." It covers everything you'll need to know to make the right decisions, for the right reasons, to end up with the right system for your specific needs. It's free.

Write for a copy. The address is 1055 South East Street, Anaheim, California 92804. Or phone (714) 778-4800.

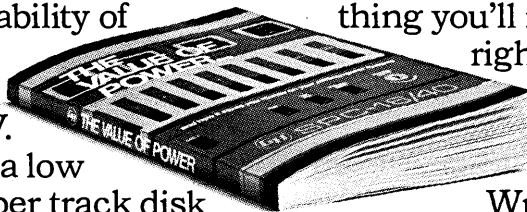

General Automation

Caught in the old cassette vs. 1/2"-drive, price vs. performance crunch?

With a choice like that you pay the price no matter what you do.

So we've come up with the first real alternative you've ever had.

The "Scotch" Brand Data Cartridge.

It's a unique approach to digital tape storage that's priced like a cassette but performs like a 1/2"-compatible drive.

It operates at speeds up to 90 ips, starts/stops with accelerations up to 2000 in/sec² and offers transfer rates up to 48,000 bps.

It uses 1/4" tape and records at up to 3200 frpi, so it stores up to 5.5 million bits of data per track on 1 to 4 tracks.

It needs only a single point drive and no external tape guidance, so tape can never cinch, spill, stretch or break and each cartridge has a life expectancy in excess of 5000 passes.

Because the "Scotch" Data Cartridge functions as its own transport, tape handling is fast, accurate and precise at all

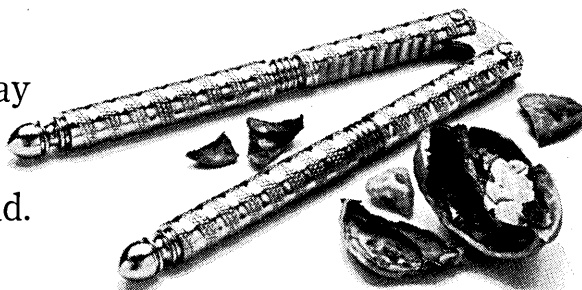

times. It's ideal for: Word processors and terminals. Point-of-sale data capture and computer data entry. Minicomputer I/O and paper tape replacement.

And if you need more information, you've got a choice there, too.

Just contact any of the major peripheral manufacturers or Data Products, 3M Company, 300 South Lewis Road, Camarillo, Calif.

93010. Telephone:

(805) 482-1911. TWX:

910-336-1676.

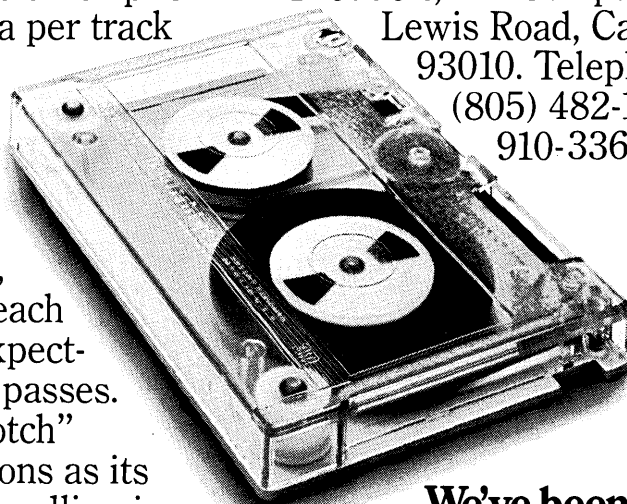

**We've been there.
And brought the answers back.**

A dual processor system for people who can't afford a single processor system.

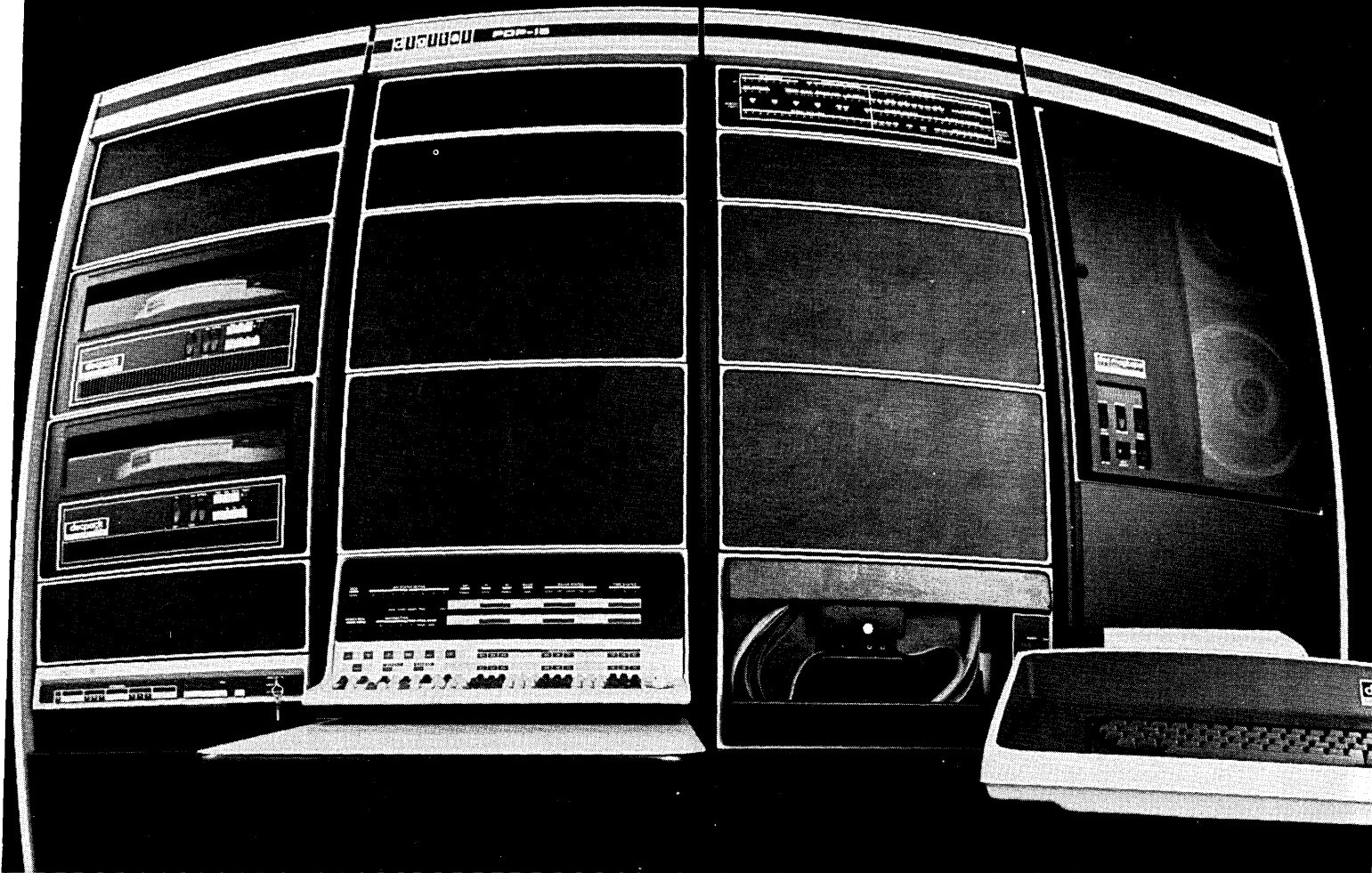

Meet the new PDP-15/76.

It's what happens when you add a PDP-11 to a PDP-15. PDP-11 takes over administrative and peripheral tasks, like full input and output spooling, leaving PDP-15 free to work its heart out on things big computers do best. Like computation and interactive graphics.

Together, the two computers can pump out 10 times or more the throughput of an IBM 1130 that costs as much. Or give you the same performance as an IBM 360/44 costing at least twice as much.

And that's probably why you'll buy it.

But if you'd like to think about something more than raw cost/performance, consider what else the PDP-15/76 gives you.

You get PDP-15. A powerful computer system already hard at work in over 600

installations. An enormous library of software. A strong graphics capability. And easy conversions, particularly for FORTRAN.

Add on PDP-11 and you get a whole rash of low-cost, state-of-the-art Unibus peripherals. Which makes it one heck of a lot easier (and cheaper) to put together multi-task, multi-terminal systems.

15/76 comes with a load of proven software that makes the system easy to use. Including a choice of three operating systems... DOS-15, a disk operating system; BOS-15, a Batch Operating System; and RSX-PLUS, a Resource Sharing Executive—\$3,000,000 worth of proven software ready for your application.

The basic PDP-15/76 comes with a

PDP-15 central processor and 16K words of core, 1.2M word cartridge disk pack, industry-compatible magtape unit, paper tape reader/punch, and a PDP-11 central processor with 4K of core.

For \$64K or \$2000/month complete.

And for those of you who already have a PDP-15, you can upgrade to a PDP-15/76 for only \$19K.

Either way, PDP-15/76 is the only way you can get big computer power without spending big computer money.

Write the PDP-15 Group, Digital Equipment Corporation, Maynard, Mass. 01754. (617) 897-5111. European headquarters: 81 route de l'Aire, 1211 Geneva 26, Tel: 42 79 50. Digital Equipment of Canada Ltd., P.O. Box 11500, Ottawa, Ontario, K2H 8K8 (613) 592-5111.



PAYROLL II... A SOLID FOUNDATION FOR GROWTH

- PAY II is the only payroll package that is custom generated to accommodate your unique processing needs
- PAY II allows weekly, bi-weekly, semi-monthly, monthly, or user-specified pay periods
- PAY II provides up to 99 earning and deduction categories
- PAY II provides 6 level breaks within 20 characters permitting use of social security number identification
- PAY II provides up to 99 constant rates and references for common calculations
- PAY II incorporates a separate tax module — PHITAX, which assures accurate and fast implementation of tax changes for both the U.S. and Canada
- PAY II includes a powerful custom report feature
- PAY II lets you print your checks and reports on remote terminals
- PAY II users receive extensive training, one year of free maintenance and detailed documentation
- PAY II users receive the benefits of many system improvements at no cost
- PAY II is fast and efficient and operates on IBM S/360 or S/370 machines under DOS, OS and Virtual Memory, operating systems
- PAY II incorporates all the flexibility and basic processing flow of PHI's original Generalized Payroll System . . . the system that operates in over 120 banks and corporations and produces one out of every 20 paychecks issued in the U.S.

For more information call James Lees at (617) 851-4111.



836 NORTH ST., TEWKSBURY, MA. 01876 · (617) 851-4111

Calendar

APRIL

Data Base Management Systems: Evaluation, Selection, and Implementation, April 12-13 (Washington, D.C.), **April 26-27** (Montreal), **May 31-June 1** (Chicago), **June 11-12** (New York City). Seminars to help the systems designer and manager in the problems of selecting a data base management system and then implementing an information system using the data base management system within his organization. Fee: ACM members, \$190; others, \$235. Contact: Assn. for Computing Machinery, Continuing Systems Education, 1133 Ave. of the Americas, New York, NY 10036, 212/265-6300.

IEEE International Magnetics Conference, April 24-27, Washington, D.C. Technical program includes sessions on memory technology, magnetic memory devices, computer models and calculations, and bubble technology. Accompanying exhibit. Fee: \$40, members; \$50, others. Contact: A. D. Krall, Naval Ordnance Laboratory, Silver Spring, MD 20910.

College and University Machine Records Conference, April 30-May 1, Milwaukee. The 18th annual CUMREC conference features 34 sessions of interest to those in university data processing, admissions and records, and business affairs. Fee: \$70. Contact: Robert P. Schmidt, Univ. of Wisconsin, Administrative Data Processing, 2100 Main St., Stevens Point, WI 54481, 715/346-4881.

ACM SIGACT Symposium, April 30-May 2, Austin, Tex. Program of the fifth annual symposium on the Theory of Computing, sponsored by the ACM Special Interest Group for Automata and Computability Theory, will consist of 30 talks on the subjects of computational complexity, language theory, algorithms, and related areas. Proceedings will be published. Contact: Prof. Jeffrey D. Ullman, Dept. of Computer Science, Univ. of California, Berkeley, CA 94720.

MAY

18th Annual Data Processing Conference, May 2-3, Tuscaloosa, Ala. Sponsored by the Univ. of Alabama and 20 data processing organizations. Program in four levels: 1) for the less experienced and the newcomer; 2) for those currently using dp primarily in business and commercial applications; 3) for the experienced engineering, scientific, business, and commercial user; 4) for those in education and training. Fee: \$35. Contact: C. E. Adams, Director, Conference Activities, Box 2987, University, AL 35486.

10th Annual National Information Retrieval Colloquium, May 3-4, Philadelphia. Sponsored by 10 regional societies and organizations. Specific topics addressing the theme of "Changing Patterns in Information Retrieval" include: The Information Environment, User Behavior, Strategies for Organizing and Searching, Techniques for Storage and Retrieval, Information as a Product, and The Delphi Method Applied to Information Retrieval. The Information Bazaar on May 3 includes demonstrations, exhibits, films, and discussions. Fee: \$40; includes Proceedings. Contact: Susan Nickleach, P.O. Box 15847, Philadelphia, PA 19103, 215/561-4100, X221.

International Systems Meeting, May 13-16, Denver. The 26th annual convention of the Assn. for Systems Management. Technical program has 26 individual seminars, including a two-stage series on Project Planning. No exhibits. Registration fee: \$150, members; \$200, others. Contact: ASM, 24587 Bagley Rd., Cleveland, OH 44138, 216/243-6900.

DPSA International Div. 8th Annual Meeting, May 14-16, Athens, Greece. Program will cover technologies and systems involving new developments of input and output in Europe and the U.S., including: i/o forecast, point-of-sale, credit card systems, money transfer systems, input supplies, output supplies, key-to-disc impact on the card and forms industries, synthetic paper development, COM, and printers. Contact: Carroll A. Greathouse, Data Processing Supplies Assn., P. O. Box 1333, Stamford, CT 06904.

ACM Conference on Virtual Memories and Systems, May 18-19, Chicago. For edp managers (techniques for evaluation of virtual memory cost/performance, and standards for programs and operations to assure increased systems productivity), applications programmers and systems analysts (programming and system design techniques to enhance performance under VM, and the effects of virtual storage hardware and operating systems upon throughput), and systems programmers (performance measurement and evaluation, systems configuration, and conversion problems). Advance registration: \$40, members; \$50, others. Contact: Tony Dundzila, Data Systems and Services Manager, Purdue Univ. Calumet Campus, Hammond, IN 46323.

International Micrographics Conference and Exhibition, May 22-25, London, England. The exhibition runs all four days; the technical program, the first three days. As claimed, the program covers "the A to Z of microfilm": micrographics market, standards, copyrights, micropublishing, COM, CIM, systems analysis, vertical applications, etc. The program each day consists of three types of session: formal papers—reporting on new developments; tutorials—introducing microfilm to potential users; workshop seminars—panel and discussion groups. Fees vary widely depending on the seminars and other activities for which a person registers. U.S. contact: Richard C. Whalen, Xerox University Microfilms, Ann Arbor, MI 48106, 313/761-4700. European contact: Business Equipment Trade Assn., 109 Kingsway, London WC2B 6 PU, England.

ACM SIGPLAN/SIGMICRO Interface Meeting, May 30-June 1, Harriman, N.Y. The Special Interest Groups on Programming Languages and Microprogramming host formal sessions and panel discussions on current work and the directions of future development at three levels of the implementation of digital computer systems: microprogrammable computer architecture, microprogramming language structure and utilization, and target-level representations oriented towards programming languages and operating systems. Fee: approximately \$95, including program, accommodations, meals. Contact: Dr. Stanley Habib, Polytechnic Inst. of Brooklyn, 333 Jay St., Brooklyn, NY 11201, 212/643-8484.

DATA GENERAL CORPORATION

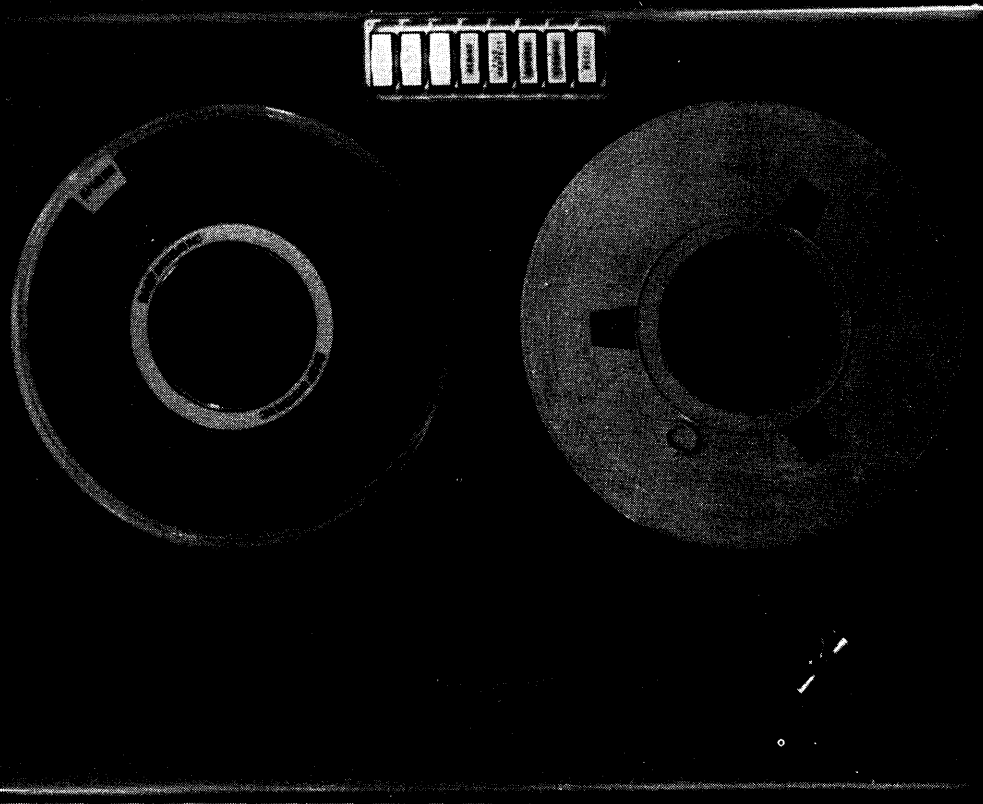

DATA GENERAL INTRODUCES THE LOADED NOVA.

The loaded Nova is the new Nova 840 and the most comprehensive set of software/hardware capabilities ever available with a Data General computer.

It comes with a built-in Memory Management and Protection Unit that lets you expand main memory to 128K 16-bit words. Base price with 16K of memory is \$16,530.

Nova 840 runs a comprehensive Real-time Disc Operating System (RDOS) for dual programming operations.

A new BATCH executive lets you pick your I/O devices, load your jobs, and walk away.

It has our new Fortran 5, Extended ALGOL, Extended Timesharing BASIC, and a whole library of proven Data General software; proven software that we can deliver now.

And our Remote Job Entry software can let the 840 double as a high-powered terminal to a big computer someplace else.

With the right kind of configuration (like the one shown), all that software is available free.

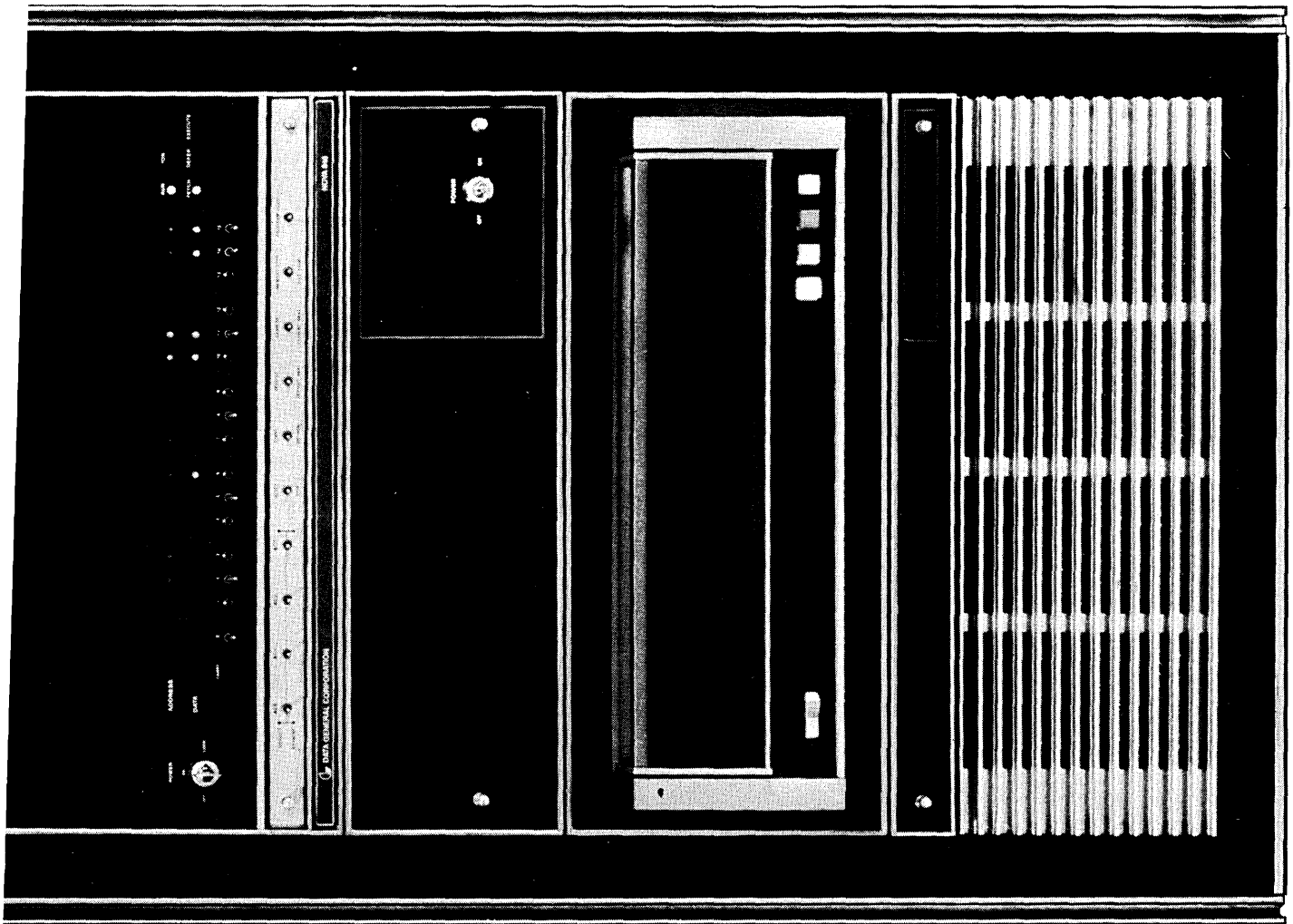

ON YOUR DOORSTEP IN UNDER 90 DAYS.

The Nova 840 in the picture has a central processor with 32 to 64K of main memory, a high-speed Floating Point Processor, hardware Multiply/Divide unit, fast-access disc storage, and 9-track mag tape.

The picture doesn't show lots of the other things you can get with Nova 840: line printers, card readers, Novadisplay terminals, fixed-head Novadisks, moving-head discs, Nova Cassette tape, communications interfaces.

Nor could we show you the applications

and service experience we've developed in the course of building, installing, and supporting over 6,000 Nova computer systems all over the world.

If you're looking for more throughput than you could ever get with a minicomputer, for better access to system resources, at a lower price, call Data General.

Call with an order: we'll put a loaded Nova on your doorstep in less than 90 days.

 **DATA GENERAL**
Southboro, Massachusetts 01772

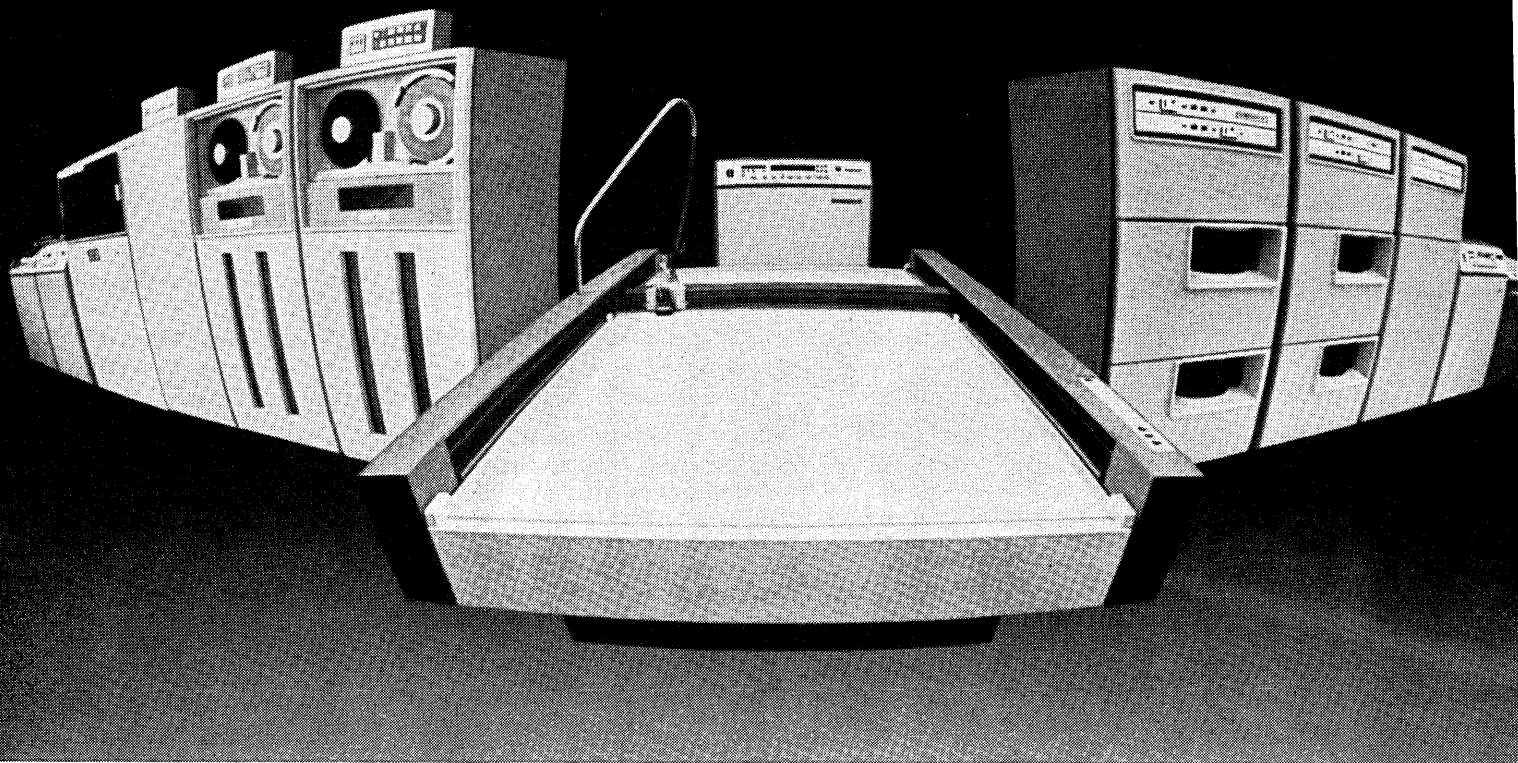

Peripheral vision.

From the beginning, we have preferred concentration to diversification. We don't supply everything that attaches to your computer. But the things we do supply are the best.

What do we supply?

Drum plotters. We're the world's leading supplier of both hardware and software.

Flatbed plotters. Several years ago, we saw a need and an opportunity to expand the plotter's uses. The flatbed plotter allows a variety of materials to be substituted for paper, and it has expanded the

market for computer graphics, as well.

Microfilm plotters. Here, we got bigger by getting smaller. With microfilm. Our 1675 COM plotter/printer and our 2100 COM printer deliver the best price/performance in the industry.

Disk memory equipment. This was our second area of concentration. In a remarkably short time, we have become the leading independent supplier.

Tape systems. We've recently begun to concentrate on tape. The result is that

our new 1040 Tape Drive combines the features of others with our own experience. We intend to be a leader in this field.

The point is we have not grown by accident. Thirteen years after our beginning, we have become a leader in computer peripherals.

For information on peripheral products, call your local CalComp office, or contact California Computer Products, Inc., DM-M4-73, 2411 West La Palma Avenue, Anaheim, California 92801 (714) 821-2011

CALCOMP

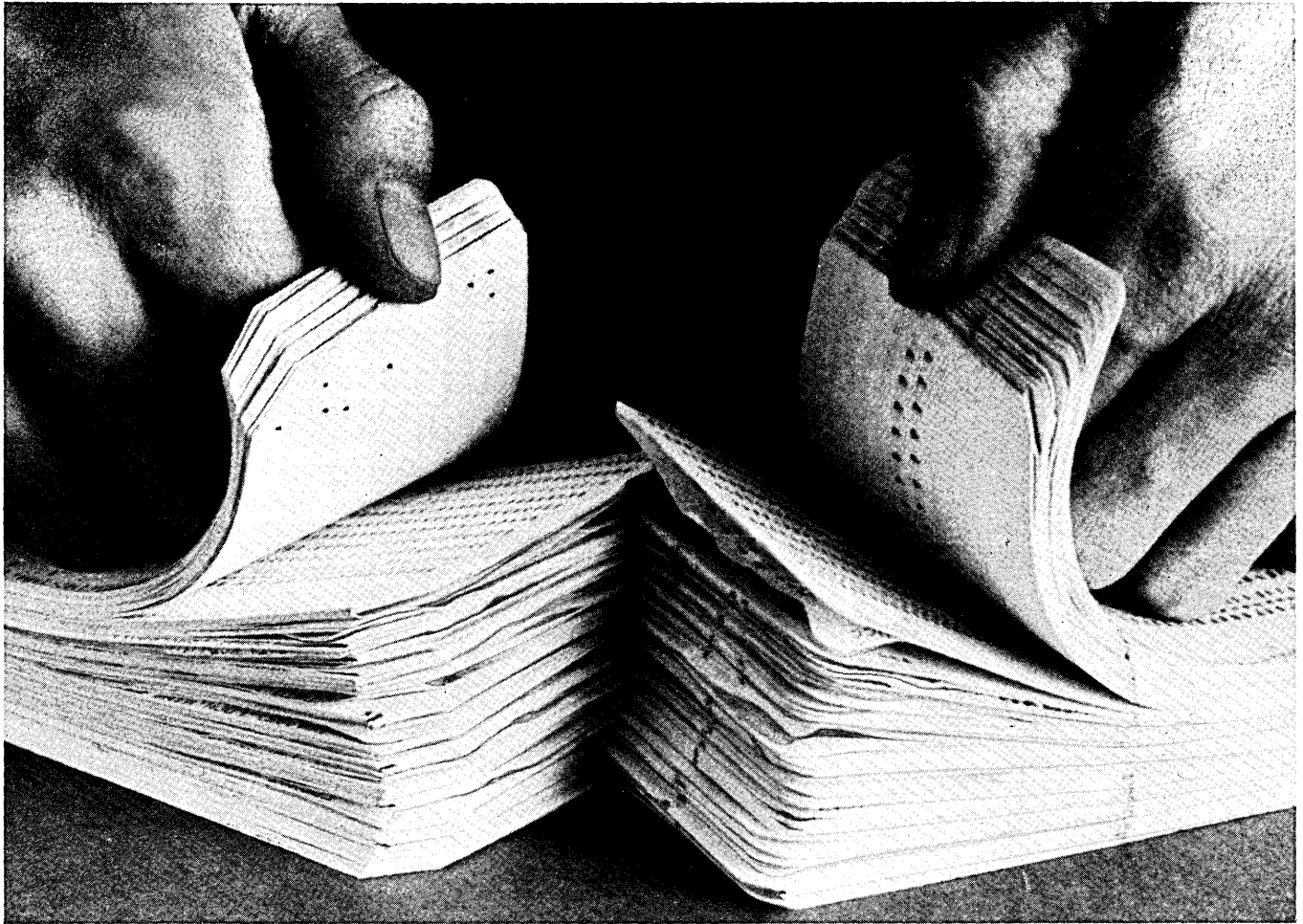

How to Deal a Straight Hand With a Crooked Deck

Use one of EAI's new card readers. We have three that will accept and process cards that would jam most other readers.

Our readers use a "vacuum finger" that can pick even a badly damaged card off the bottom of the stack and feed it to the friction transport system. Which, in turn, moves it at a constant speed past the read station.

And there our synchronous logic data sensing and verification method ensures accurate reading of card information that's misregistered by up to half a column.

Fiber-optics light distribution at the read station makes the readers even more accurate. Light from the single light source is channeled to all parts of the card uniformly, so all the photo-transistor sensing elements receive light of precisely the same intensity. This also makes it possible to provide self-diagnosing circuitry, so maintenance problems are simplified immeasurably.

The three EAI card readers are the CR-300, the CR-600, and the MR-300. The first two read punched cards only (at 300 and 600 cards per minute). The MR-300 Optical Mark Reader reads punched *and* pencil-marked cards—in any order. Mix them up—it's all the same to the MR-300. What's more, it can look at an erasure and ignore it, while correctly registering a weak little pencil

mark. Smudges don't bother it, nor does any variation in card color.

Incidentally, if the description of these readers seems familiar, it may be because you recognize the GDI reader line. We took over that line, added our own touch of engineering finesse, and we now bring the readers to you under our own name.

For the straight story on the good deal in card reading, please write or phone us today.

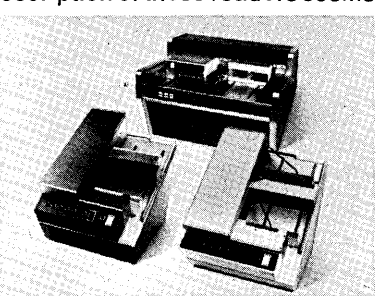

Electronic Associates, Inc.
185 Monmouth Parkway
West Long Branch, New Jersey 07764
(201) 229-1100.

Bruning's new OP-40/80 microfiche duplicator

It produces cut-to-size and collated fiche in one operation. That's because our new OP-40/80 from Klear-Vu is really an automated duplicating system.

It's this simple: your operator puts the master fiche in the input station, dials the number of copies required (up to 99 from any master), and pushes the start button. The OP-40/80 begins at once to deliver cut-to-size, collated fiche at up to 1000 copies an hour.

Here's the system you've been looking for to eliminate waste film, cut operating time, and significantly reduce your microfiche duplicating costs.

And what convenience: You get automated pushbutton operation. There is no plumbing and no venting needed. You can use positive or negative masters to produce flat, non-static copies.

The Bruning Micrographics Systems Specialist in your area is ready to show you the OP-40/80

in action. And tell you about other Bruning products—such as the OP-49/88 roll-to-fiche duplicator—which make up our total capability in micrographics information distribution.

Call your local Bruning Sales Office today. Or write Bruning, 1834 Walden Office Square, Schaumburg, Ill. 60172.

The bold new force in micrographics.

Duplication automation.

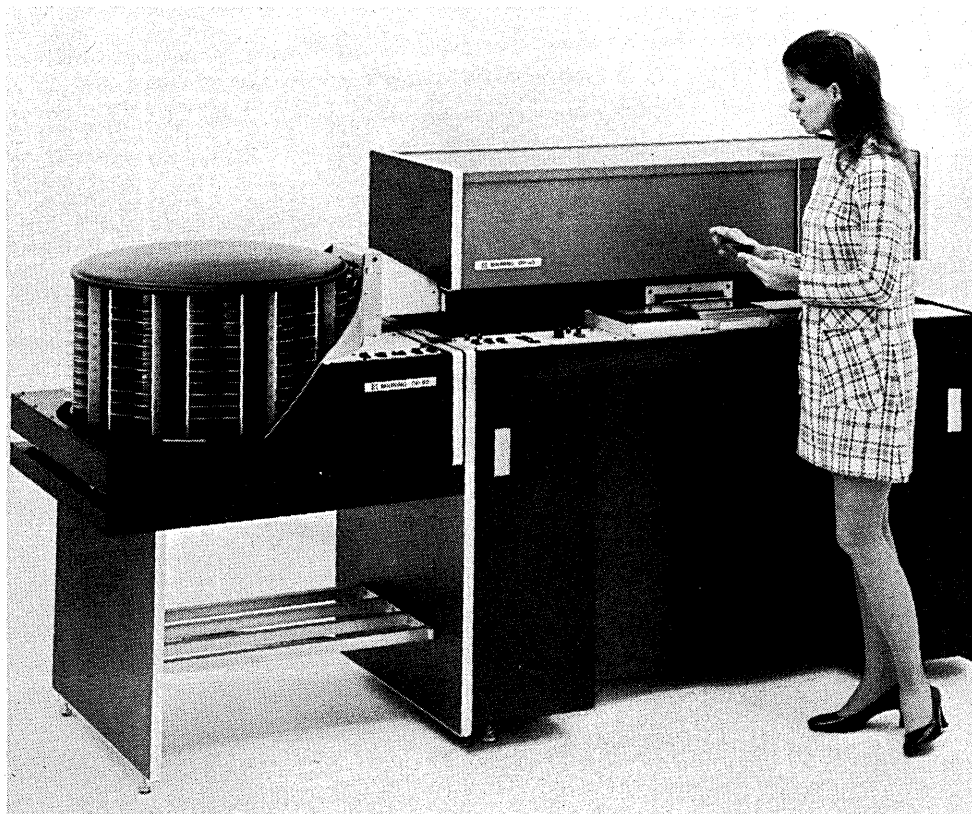

BRUNING

DIVISION OF ADDRESSOGRAPH MULTIGRAPH CORPORATION

Letters

Pie in the sky

"A Survey of DP Budgets for 1973," by Richard A. McLaughlin (Feb., p. 61), supplied useful information in our data-processor industry. However, his statement:

"How the expenditures pie will be cut up in 1973 is shown in Fig. 1. Our sample is large enough that the proportions shown in Fig. 1 should be projectable to the U.S. and Canada dp universe as a whole."

is totally wrong in the area of software.

In Fig. 1 the industry total adds up to \$24.5 billion. Software Packages is stated to be 0.9% or \$220 million. Contract Programming is stated to be 0.6% or \$117 million. Anyone remotely familiar with the industry and elementary arithmetic should be able to check the fact that these numbers *have* to be wrong.

Consider Contract Programming during 1972. In the absence of published reports, take the easy-to-estimate head count of the suppliers of Contract Programming, and multiply the annual revenues per programmer (at least \$30K/man):

csc (annual report)—at least \$60 million; SDC (annual report)—at least \$30 million; five top software companies—approximately \$40 million; 100 small software firms—at least \$50 million; ADAPSO members (see 1972 study)—over \$80 million; IBM (including FSD)—over \$100 million; total—\$360 million.

Interviews with applicants and discussions with employees at ACM and DPMA meetings in New York City, Washington, D.C., and California indicate that the market in *those areas alone* for Contract Programming is at least \$300 million. The above "projection" of \$117 million in 1973 is clearly less than one-third of the market.

In the case of Software Packages more subtle techniques must be used, involving a mix of observations of the customers, the suppliers, and Larry Welke's surveys (ICP Quarterly). In 1972 we can deduce:

IBM (mostly System/3)—\$40 million; other manufacturers—maximum \$5 million; Informatics—over \$6 million; ADR—approximately \$4 million; 50 other software firms—approximately \$50 million; banks selling to other banks—guess \$5 million; total—\$110 million.

Mr. McLaughlin's "projection" of \$220 million in 1973 is wildly optimistic.

How can his errors be explained? In the Contract Programming area, perhaps his sample ignored the federal, state, and local government market. If

so, however, his industry total of \$24.5 billion is suspiciously high by comparison with all other data. In the Software Packages area I believe that his sample is heavily biased by sophisticated installations (those who would respond to a survey!) who buy far more software products than the average.

The publication of erroneous "pseudo-data," like Fig. 1, where "reasonableness checks" would easily be applied, can only bring further confusion to an area that badly needs responsible reporting.

FRANK V. WAGNER
Canoga Park, California

First, our budget survey was for expenditures being made by organizations that have their own computer department, and so it does not represent the universe of dp expenditures. Certainly it does not include firms that use service bureaus exclusively—and those firms can be expected to strongly influence the dollar figures for contract programming, as well as for time-sharing, batch, and remote batch processing services. Our projection for Contract Programming was \$156 million, by the way (see Table 1), not \$117 million. If you derived your \$117 million from the rounded-off percentages on the pie chart, you should have come up with \$147 million. (That should prove we are familiar with elementary arithmetic, anyway.)

Second, our "wildly optimistic" projection of \$228 million for software packages reflects the optimism of the people who budgeted that much for 1973. We indicated that the \$228 million was up by over 46% from what was actually spent for packages for 1972. Perhaps the people making up budgets are leaving themselves some leeway. Perhaps they won't really spend that much. And our approximation of \$156 million spent for packages in 1972 isn't all that far from your \$110 million guess, especially considering that you're coming up with the number indirectly.

Framed

The beautifully illustrated article, "A Gallery of Computer Postal Art," in the February issue (p. 74) was greatly appreciated. The two-page spread is suitable for framing and display.

The article is technically correct that the United States has not issued a postage stamp picturing computer equipment. However, a post card was issued in 1965 showing a punchcard. The 4¢ issue honored the Bureau of the Census' anniversary, 1790-1965, and pictured a crowd of people and the punchcard.

NORMAN J. BRODY
Philadelphia, Pennsylvania

Reality

In reply to Mr. Hekimi's comments (March Letters, p. 22) on my Forum article (Jan., p. 147):

My article was strong, certainly, but not so strong that it justified Mr. Hekimi's personal attack. Nevertheless, Mr. Hekimi raises some points to which a reply is in order.

Mr. Hekimi apparently believes that my article indicated that I do not respect the individuals working on the ANSI and ECMA committees. Having

been a member of several of these at the working level for some seven years, I can vouch for the fact that the individual members are extremely competent, hard working, and intelligent. I am well aware of the enormous amount of effort that goes into exploring the various points of view which may be brought to bear on a particular issue and into developing these points of view into position papers which are then carefully examined and explored. I hope I have made it clear that I believe that the work done at the basic task group level is of the highest order. Nor do I doubt that the motivation of these individuals is directed towards getting the best possible compromise to what are often very complex problems.

As to my remarks about N. V. Philips, Mr. Hekimi is perfectly right in saying that Philips needs neither his (nor my) approval. Indeed, if there was the slightest question that Philips would have been hurt in any way by my remarks, I would not have made them. To clarify further, there is also no question in my mind that Philips is a superb engineering organization.

But that is not the point, which is that it is very difficult for any company (or any standards committee) to develop a good, workable standard when there is no field operational experience. It is possible to do this with all-electronic devices, but not when dealing with mechanical or electro-mechanical devices of any complexity. This is the crux of the issue with respect to the cassette standard.

Mr. Hekimi has chosen to scorn the conclusion (not mine; I was quoting Nyal McMullin in a previous article in DATAMATION) that what was needed was a reliable cassette transport at very low cost. But he has also chosen to ignore the main point I was making, which was that within the long development period he mentioned, other transports had been developed and that these had better characteristics for the marketplace. I stand by that point.

Mr. Hekimi chooses to disavow the very real rivalries between various companies and various countries. I am sure he believes himself to be correct, but if so, he sits very far above the battle indeed. There *are* such "company positions and policies" and there is rivalry across the ocean, and naysaying it will not make it go away. Nor does that fact, in my opinion, contradict my statement about the integrity and capability of the individuals making up the working task groups. They do, very often, represent their company positions. This is not really so strange; after all, these same people have often generated those company positions after considerable struggle, and they feel strongly about them. It would be less than intelligent to believe

370/STOR GIVES YOUR DATA A SECURE BERTH- AND A BIG ONE.

370/STOR is the fastest-selling add-on main memory for System/370 processors. More than 15 million bytes for 370/STOR memory are now in operation.

Why? Because 370/STOR gives you more than you can get from any other supplier — including IBM:

- Up to four million bytes of main storage for *either* your Model 155 or 165.
 - Up to two million bytes connectable through a single port, saving you tens of thousands of dollars in interconnection cost.
 - Memory protection for every 2K or 4K bytes of memory — a feature supplied only by Cambridge, and at no cost to you.
 - Dense packaging. Our advanced memory design enables us to store two megabytes in the same space that IBM stores 512K bytes. That saves you space, power and money.
 - Fast installation. We can install most 370/STOR systems in less than eight hours. That means from the time we wheel in our system until you power-on for production.
 - The right price. How much is that? About 50 per cent less than IBM. With hundreds of 360 and 370 add-on memories installed, and an experienced national sales and service organization, we can help you sail through your memory barriers.
- Chart a course to

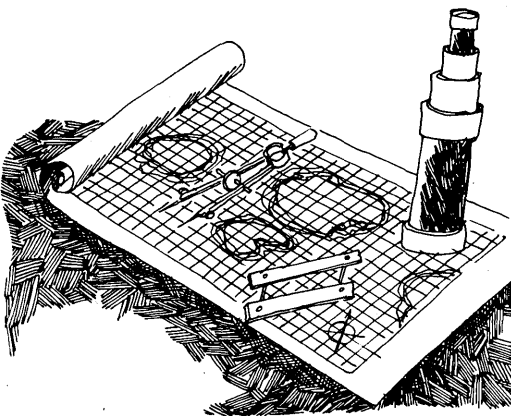

CAMBRIDGE.

A good place to put your information.

letters

that they would not fight for their particular approaches and positions within the working groups. Nor would it be sensible to expect that, where people represent different countries having individual problems, that they do not represent the positions of those countries at the working level.

In fact, I would consider these conflicts to be one of the strengths of the standards groups, in that it permits an airing of everyone's problems. But if Mr. Hekimi believes that, for example, AT&T's problems are not considered more seriously than the problems of a smaller company, then he cannot have worked very much at the working level or have done it with his eyes open. In fact, one of the few pleasures of working on such a committee is to watch the play of forces as they sweep around the table, and it is the measure of a good committee chairman to be able to understand what the real forces are within companies or countries in order to be able to determine what compromise solutions are possible. Without such compromises, there would be no standards possible at all.

It is hard for me to believe that Mr. Hekimi is so naive as to believe that companies do not sponsor standards. Does he think that they grow by some sort of immaculate eruption, from the group-brain of a committee? Companies *do* sponsor particular standards (would anyone deny that AT&T sponsored ASCII?) and, in fact, such sponsorship is *necessary* to the development of intelligent standards. Without such guidance, one would have no place to begin.

A program as *short* as the two-year one Mr. Hekimi describes for the cassette standard is only possible because it *was* sponsored, and if you read the documentation backing up the program of cassette standardization, you will find N. V. Philips there. And there isn't anything wrong with that approach, *except that there was neither a complete implementation nor a field test of that proposed standard*, and I maintain that, if there were, it would have been clear that it was going to be difficult to implement well.

Mr. Hekimi indicated that what I have said is not fact. I believe that what I have presented are well-known "facts" to all of us who have worked on standards activities. And I might add that the "fact" is that IBM has made it clear (if not public) that they will *not* support this standard. Now *that's* a "fact" to consider.

EVELYN BEREZIN

President

Redactron Corporation
Hauppauge, New York

For the blind

In our department is working a blind computer programmer. For him I am looking for detailed information about what organizations can give and do for a blind programmer. Please inform me about possibilities, prices, etc.

J. J. v. TILBURG

Philips—*Electrologica B.V.*

dept. Library

P.O. Box 245

Apeldoorn, The Netherlands

Half-ASCII

This is in response to the letter from Thomas G. Sanborn in the January issue, p. 23.

Mr. Sanborn is quite typical of the half-ASCII understanding rampant in this industry. To respond specifically to his points:

1. A terminal conforms to ASCII, or it does not. A terminal claimed to be ASCII-compatible may be guilty of misrepresentation, but that does not make the standard bad.

2. There is no prohibition in the standard against using the device control codes (for example, DC1) for functions also defined elsewhere. However, I think that the IBM 2703's use of DC1 is different from EOT and EOB. (Incidentally, CONTROL-Q relates to the Teletype Corp. models 33, 35, et al, and not the standard.)

3. In 1963, the ASCII committee defined the "back-arrow" as a character in the set. That was changed to underscore in 1968 to conform to international standards. Some terminals are still manufactured to the 1963 standard because customers want it that way.

4. The standard specifically provides the alternative definition of carriage-return and new-line in the same character. There are good and valid reasons for this, and they are fully defined elsewhere.

5. The code is not speed sensitive. If Mr. Sanborn would like to standardize the delay after carriage return, I'm sure he'd find a hot-bed of controversy about generality vs. efficiency.

6. The controllers are simply performing functions that some of us would prefer be in software. That is the result of the hardware-software trade-off. Don't blame it on the code. Perhaps the same claim could be made about certain tape drives—which applies just as well to any other code, including EBCDIC.

7. No parity or other error-detection mechanism is inherent to the ASCII code. Some terminals don't calculate parity, and some do. Different standards exist, but the primary one calls for even parity, if parity is used.

(Continued on page 169)

OUR MEMORIES LET YOU ADD THE FRILLS AS YOU ADD THE CAPACITY.

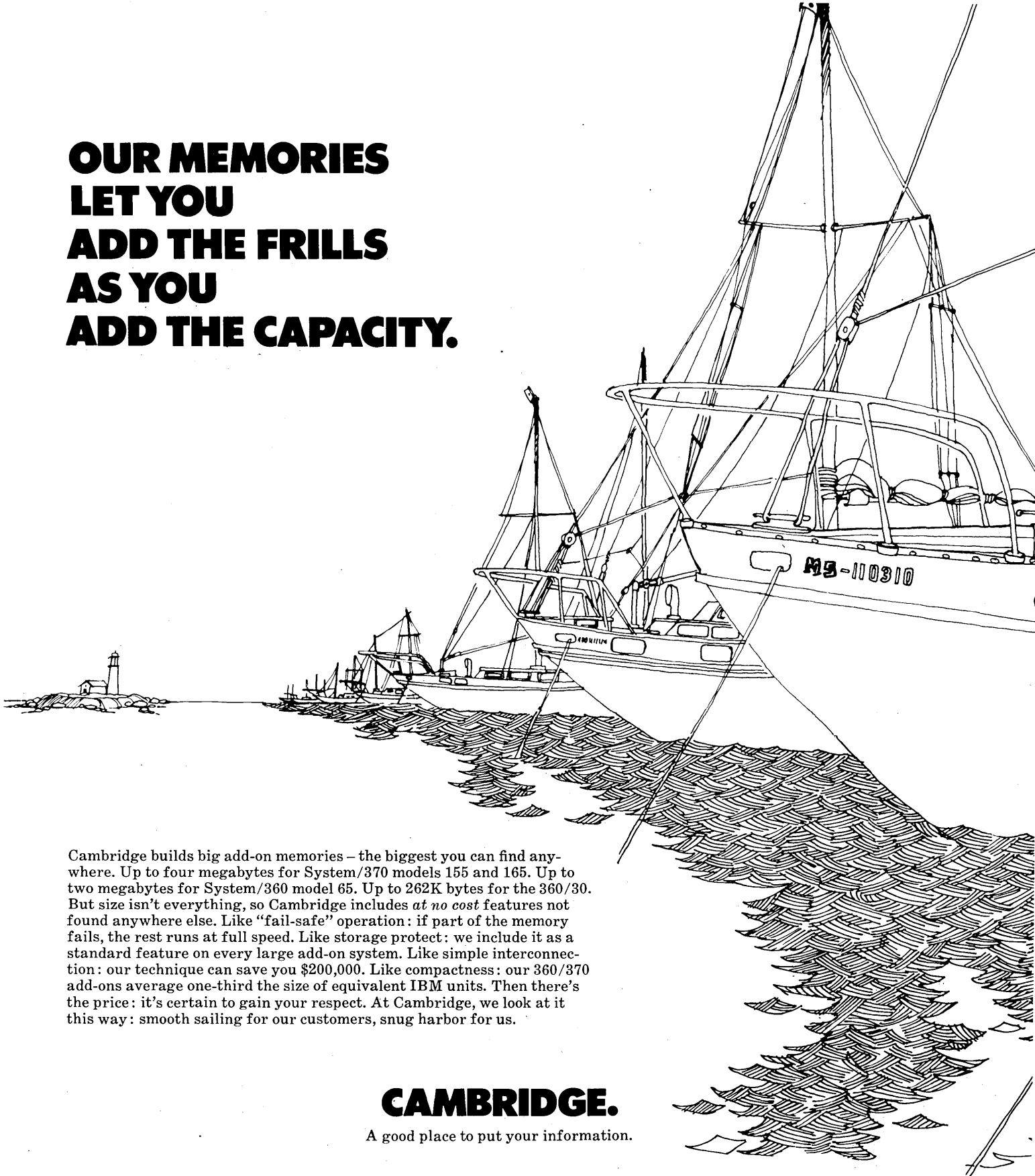

Cambridge builds big add-on memories – the biggest you can find anywhere. Up to four megabytes for System/370 models 155 and 165. Up to two megabytes for System/360 model 65. Up to 262K bytes for the 360/30. But size isn't everything, so Cambridge includes *at no cost* features not found anywhere else. Like "fail-safe" operation: if part of the memory fails, the rest runs at full speed. Like storage protect: we include it as a standard feature on every large add-on system. Like simple interconnection: our technique can save you \$200,000. Like compactness: our 360/370 add-ons average one-third the size of equivalent IBM units. Then there's the price: it's certain to gain your respect. At Cambridge, we look at it this way: smooth sailing for our customers, snug harbor for us.

CAMBRIDGE.

A good place to put your information.

360/CORE

Add-on and extended memory systems for Models 22, 30, 40, 50 and 65 processors in the System/360 line.

370/STOR

Up to four megabytes of main memory for the models 155 and 165 in the IBM System/370 computer family.

MINI ADD-ONS

Up to 124K of plug-compatible expansion memory for DEC, Varian and other popular mini-computers.

OEM MEMORIES

Core and semiconductor memories for use in main-frames, controllers, peripherals and terminal products.

DOT PRODUCTS

High-speed electronic mass storage systems for disk, drum and other "page"-type memory applications.



CAMBRIDGE MEMORIES, INC., 696 Virginia Road, Concord, Mass. 01742 (617) 369-8850

CIRCLE 86 ON READER CARD.

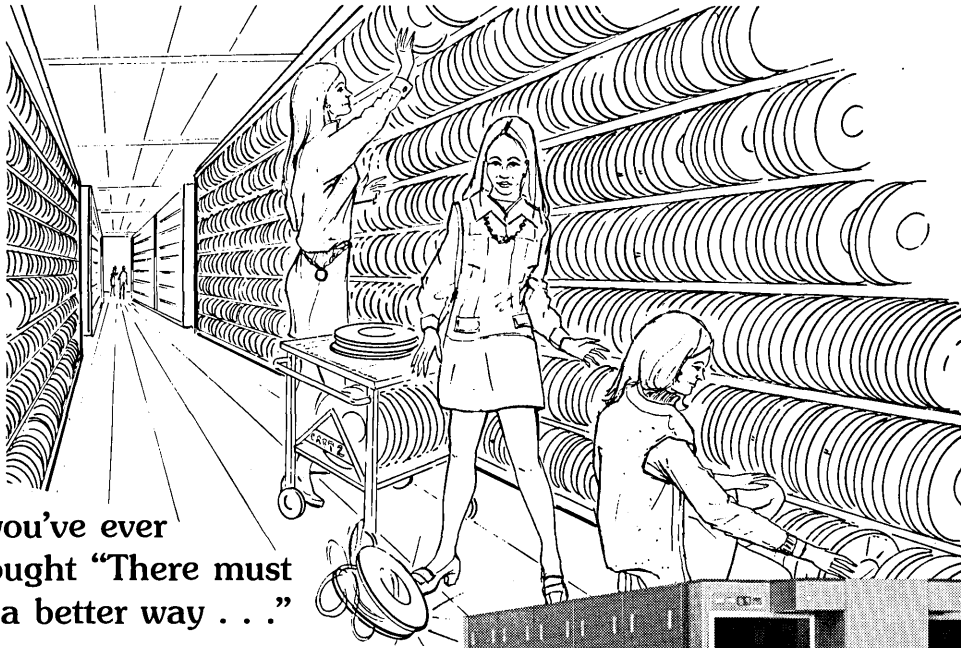

If you've ever
thought "There must
be a better way . . ."

There is! The New LCS-7 AUTOMATIC TAPE SELECTOR

Your Operations Simplifier.

Essentially, the LCS-7 AUTOMATIC TAPE SELECTOR, under OS control, provides automatic filing and retrieval of tapes. A continuous audit trail is kept of location, status (scratch or master), and label type of all stored reels. Each LCS-7 module of about 1000 tape reels delivers an average of 500 tapes per hour. Security is enhanced by insulation against magnetism, locking against theft, and fire-protection with Halon 1301 Extinguishing Protection System. LCS-7 is ideally suited for libraries of 1000 tapes or more using over 100 reels per day. This "on-line" automation of the active portion of your tape libraries will save the cost of additional tape-handling . . . personnel and equipment.

The LCS-7 is *hardwired* to one or more IBM 360/370 computers • It random-stores each tape reel • Automatically retrieves the reel, delivers it to the operator in response to a mount message • Indicates tape drive number on which reel is to be mounted • Upon refiling, a scanner positively identifies an optical label on the back of each reel • System automatically returns reel to storage • An unbundled software inventory control package also is available • Hard copy back-up available at all times for manual selection of reels if necessary.

Ask for more details on how you can have LCS-7 "on-line" automation for your tape library at no budget increase, through savings in labor, security, human errors . . . plus avoiding costs of extra racks, carts, console, CRT display terminals.

Like to hear more? Phone or write us.

ADS

DEPT. D
ADVANCED DIGITAL SYSTEMS, INC.
MOHAWK, N.Y. 13407 TEL. 315/866-6420

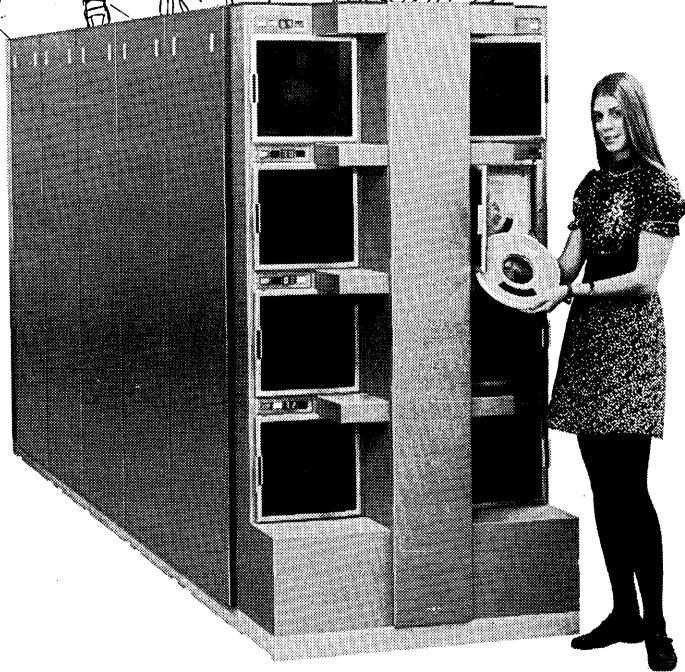

VSN DISPLAY



**ASK ABOUT THIS OTHER
TAPE HANDLING OPERATIONS SIMPLIFIER**

Mounted on the operator's panel of each tape drive, a flashing light alerts operator that a tape mount is required. Identity of reel to be mounted appears simultaneously.

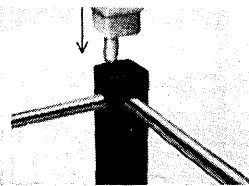
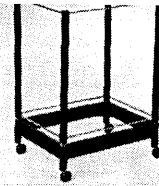
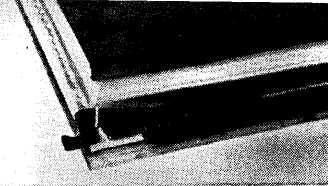
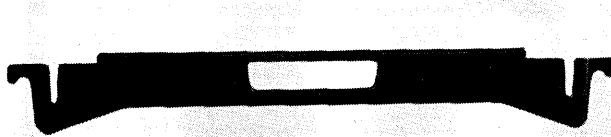

With our handles you can get a grip on things.

Some manufacturers make a hanger without a handle. Try picking up a heavy binder with one. It's tough. Especially for your secretary. You won't have this problem with our handles. We give you something to hold onto.

Our handle is simple to handle.

You can insert it without removing posts or sheets. Without threading. Just loosen posts and slide our handle in. Once in place, it won't slip off or slide.

Assembly: simple yet secure.

With fewer parts, assembly won't give you problems. Anyone can do it. And when it's done, your Module will be so sturdy you can stand on it.

Save and rave.

Colorful vinyl side panels are optional. Without them, you can save. With them, you can choose between iced blue, beach white, hot orange, and wood-grain. Savings or sides, your choice will draw raves.



Data File Module.™ It's better all around.

Look over the new Data File Module carefully. See how easily it assembles, how well it's put together.

Though Data File Module is not the first of its kind, you'll find that it's the finest. It puts over 3,500 printouts at your fingertips. Keeps both unburst and burst sheets in their place.

Call your office products supplier. Or contact us.

Boorum & Pease McMillan-Trussell

General Offices: 84 Hudson Ave., Brooklyn, N.Y. 11201

Distribution Centers: Atlanta, Ga., Kankakee, Ill.,
Los Angeles, Cal., Syracuse, N.Y.

CIRCLE 14 ON READER CARD

Unburst or burst.

For unburst binders, 14 7/8" handles are used; burst binders require 11" handles.

Take it or leave it.

If you're on the move, Data File Module with casters will go with you. If you're stationary, Data File Module with feet will stay with you.

Top or side retrieval.

Binders can be retrieved from the top or, with the use of conversion channels, from the side. Our channels are universal. They'll accept all handles on the market. Give you more flexibility.

Steady as she goes.

Data File Module's sturdy structure means that, on casters, you can move two as easily as one.

4 for 3. Stack three Modules, pyramid style, and you've got the capacity of four Modules.

Anyway you work it, Data File Modules stack up better.

Desktop end to end or side by side, piggyback, pyramid, around the corner, or wall to wall, Data File Modules will expand with you, meet your exact space requirements efficiently.

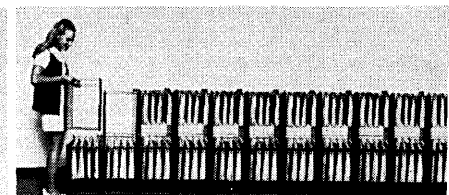
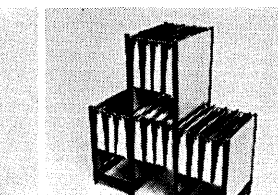
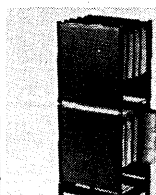
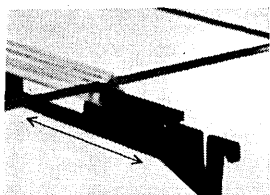

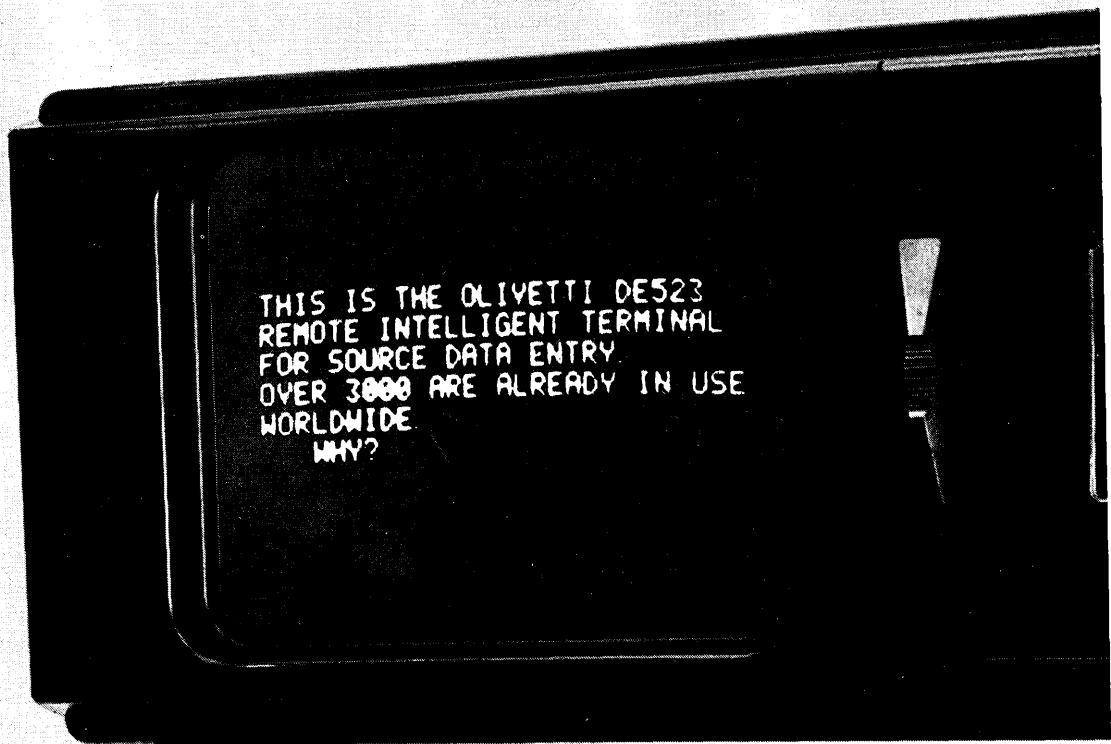

Why? Because it has so many advantages over all other data entry devices. Its programmed control of entry sequences and error detection virtually eliminates entry errors! It increases productivity significantly. Its two read-after-write cassette drives have a storage capacity of up to 200,000 characters each. Its software includes the basic format control program, plus TPS, which allows you to create your own data entry programs! It offers a complete range of peripheral units, compatible magnetic tape (to 1600 B.P.I.) high speed printers, 80 column card reader, paper tape punch and reader. It can batch transmit unattended (for low cost operation) at speeds up to 2400 B.P.S. And, last but not least, it's backed by Olivetti's trained service personnel in branch offices from coast to coast! For full information, write Olivetti Corporation of America, 500 Park Ave., New York, N.Y. 10022.

olivetti
The American Dream Machines

CIRCLE 33 ON READER CARD



The Sensible Terminal



SYSTEM 3700 is available domestically and internationally.

Webster defines it: (1) Sen•si•ble/adj . . . perceiving and responding . . . having or containing sense or reason. We agree. Our SYSTEM 3700 is "The Sensible Terminal" because it does make sense . . . perceives and responds over telephone lines . . . uses standard mag tape . . . its printers, CRT and card reader permit a flexible approach to input/output . . . AND ON A DOLLAR FOR JOB BASIS, DOES AS MUCH AS ANY "INTELLIGENT" TERMINAL AROUND. ALL FOR LESS THAN \$675/MO. Don't bother trying to define "intelligent" . . . "sensible" is the word you're looking for. DID's 3700 has it.

Call 215-647-3700. Or write.



Marketing Division
Digital Information Devices, Inc.
Welsh Pool Road
Lionville, Pa. 19353



How M&M became a Giant overnight

Intelligent remote batch terminals is our business. It's been good. We now have operating systems from coast-to-coast. The demand has grown beyond our wildest expectations. The reason is simple. M&M Computer Industries, Inc. has been able to offer the most sophisticated equipment on the market at half the cost of mainframe manufacturers' terminals. And, the Independents haven't kept pace with features like

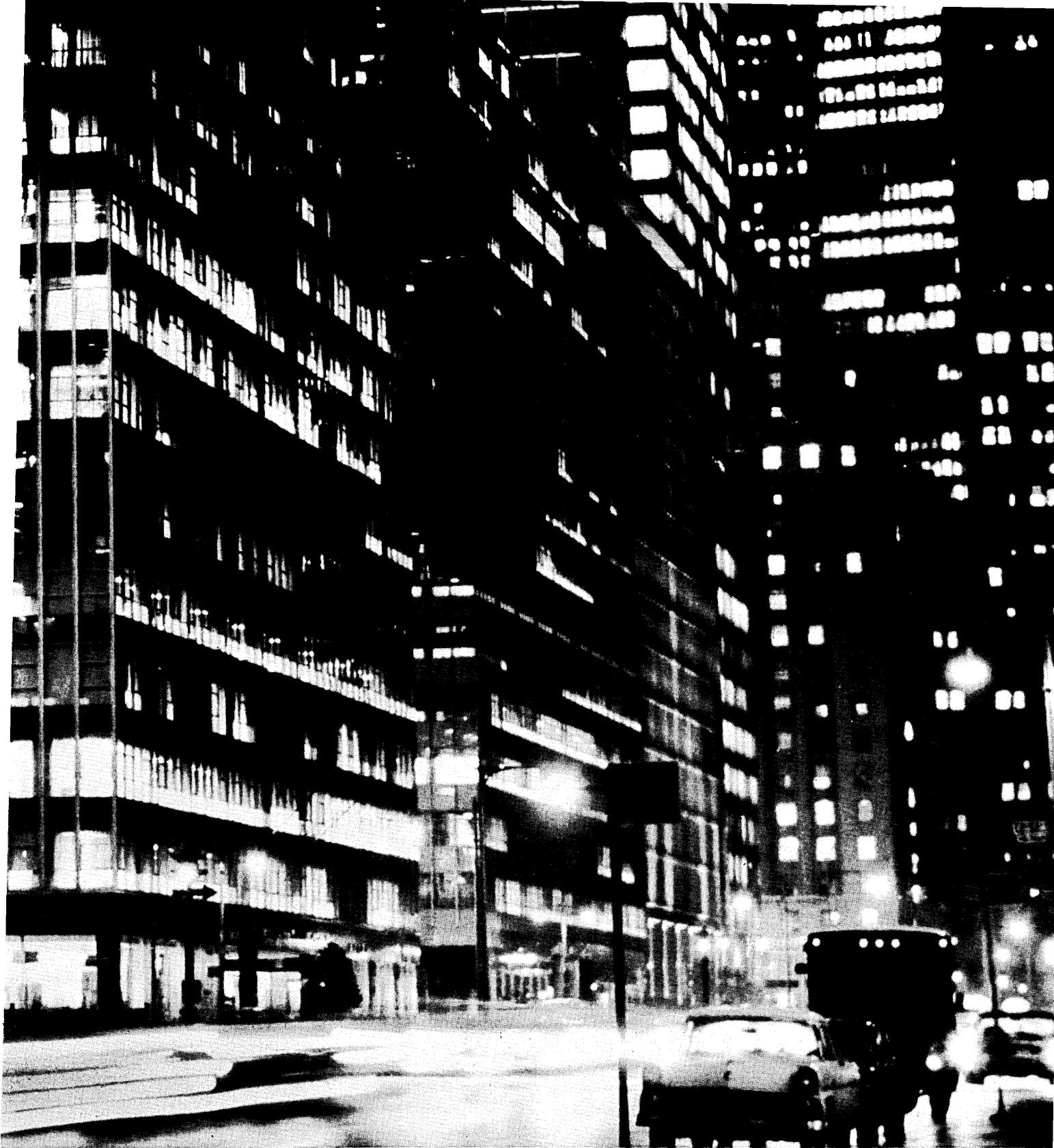

low, medium and high speed models, simultaneous operation of multiple peripheral devices, multi-leaving, easy field expandability with no costly down-time and plug-to-plug compatibility with IBM, CDC, Univac, Honeywell, etc. There are many more reasons why, but we've made the point.

The result is that one of the country's oldest, largest and most successful companies made us an offer that gives us the financial muscle

to compete with anybody! As a subsidiary of Singer, we can now give our customers faster delivery, extended service capability, software and programming expertise, more sales and service locations and excellent lease programs.

Let the new giant show you how he can handle your data processing requirements more efficiently at less cost. Call today!



M&M COMPUTER INDUSTRIES, INC.

A Subsidiary of Singer

2201 N. Glassell St., Orange, Calif. 92665
(714) 998-1551 / Telex: 65 5464

CIRCLE 66 ON READER CARD

Hazeltine 2000 has

IMPACT!

Now the Hazeltine 2000 System offers more versatility than ever with the addition of the Hazeltine Impact Printer. With an interface specifically designed to utilize the features of the Hazeltine 2000, the printer produces crisp, clear, printed output on the original and up to five copies at speeds to 120 characters per second. And it is quiet enough to put in your office.

Choose your configuration:

- Model 300 for speeds up to 300 baud.
- Model 1200 for speeds up to 1,200 baud.
- 80-, 118- or 120-column carriage width.
- Friction feed, pin feed or tractor feed.
- Horizontal tabulation.
- Vertical tabulation.

The Hazeltine 2000 System — now more powerful than ever: CRT with unmatched Price/Performance; a "dual" tape cassette unit; and now a choice of thermal and dot matrix printers.

Just one more reason to select Hazeltine.

Hazeltine Corporation

Computer Peripheral Equipment
Greenlawn, N.Y. 11740 (516) 549-8800

EAST: NEW YORK (212) 586-1970 BOSTON (617) 588-8700
EDISON, N.J. (201) 828-5678 PHILADELPHIA (215) 676-4346
MIDWEST: MINNEAPOLIS (612) 854-6555 CHICAGO (312) 986-1414
CLEVELAND (216) 752-1030 DETROIT (313) 355-3510
PITTSBURGH (412) 343-4449
SOUTH: DALLAS (214) 233-7776 ATLANTA (404) 458-9360
HOUSTON (713) 622-0551 WASHINGTON, D.C. (703) 979-5500
WEST: SAN FRANCISCO (415) 398-0686 DENVER (303) 388-8844
LOS ANGELES (213) 479-6800
IN CANADA: CAE ELECTRONICS, LTD. (514) 341-6780

CIRCLE 26 ON READER CARD



If you use leased lines, we'll help you use the least lines.

What we'll do is design, furnish, and install for you a Time or a Frequency Division Multiplex System. At multiple locations. Anywhere in the world. The whole works.

All of which, by reducing the number of lines you lease, drastically reduces your costs.

The Singer Tele-Signal Operation, a leader in the field of computer-based communications systems, has done this kind of work for years for military, civilian, and international customers.

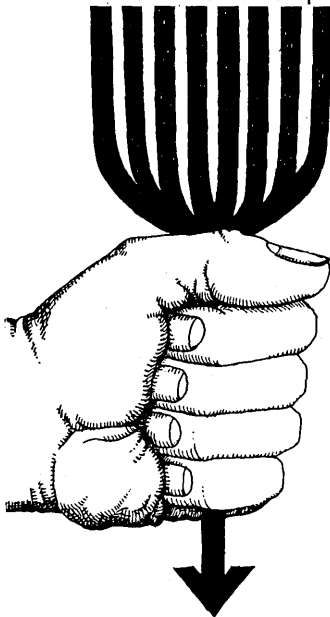

With the multiplexing, you'll need a Data Network Management Center. We'll supply it. A complete monitoring and control facility. One that insures the integrity of the system by rapidly isolating network faults, and thereby increasing traffic throughput.

For Time Division multiplexing, we provide plug-in integrated circuit-card assemblies. They're engineered to give you the maximum in bandwidth utilization.

For Frequency Division multiplexing, we offer plug-in assemblies to accommodate a variety of rates to serve almost any teleprinter and/or data modem terminal hub equipment.

Our multiplexing systems reduce your need for leased lines and will concentrate a maximum number of channels into one.

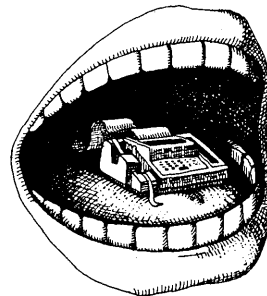
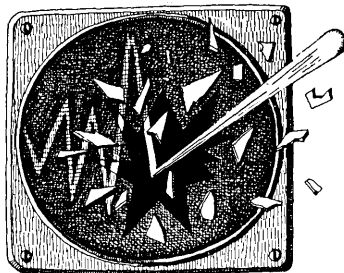

Some companies require simultaneous speech and data communications (Speech Plus). We'll supply it. Up to eight data channels operating with speech. Or we can quickly tailor a system to suit your requirements.

We also improve the quality of a voice

channel over a radio path using our linked compressor and expander (LIN-COMPEX). And we have the answer to most of your telephone signaling problems with our universal inband signaling units.

Not the least important part of the system are the modems; these allow your digital devices to talk to each other over telephone lines (leased or DDD). We'll supply them. Many with features not found in their Bell counterparts.

We'll also supply voice privacy equipment, test equipment, and everything else you require to complete your communications system. And we'll provide service and personnel training throughout the world.

We've done all this for such prestigious telecommunications users as RCA Global, American Airlines, Western Union Data Services, FAA, NASA, and the U.S. military services.

So if you're in the market for highly-reliable, complex communications systems and components, check out the Singer line for fast, easy answers.

For information, write: The Singer Company, Kearfott Division, Tele-Signal Operation, 250 Crossways Park Drive, Woodbury, N.Y. 11797 Or phone (516) 921-9400.

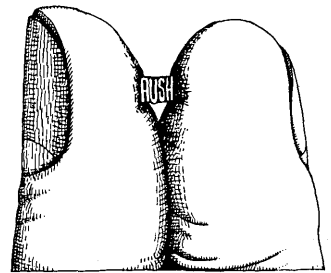

SINGER
AEROSPACE & MARINE SYSTEMS

If you use more than one of these media

WE CAN HELP YOU MANAGE BETTER

Just look at all the different types of media you are using today.

As a manager, how can you organize your operations to get the highest productivity from the people and machines that use these media? And, if you are adding such things as microfilm, microfiche, word processing equipment, terminals and computer reports; how can you create storage systems and work station environments that will provide high efficiency, reduced worker fatigue and better housekeeping?

One thing you can do is to recognize the fact that the office furniture you've been used to all these years just can't adapt to the media explosion.



That's why we started with the basic problems of media and the people who work with them and designed an entirely new concept in equipment for the office and computer room.

THE OPTIMEDIA™ CONCEPT

It's called Optimedia because it allows you to tailor your systems to provide optimum use of media by both people and machines. Optimedia also gives you a built-in hedge against obsolescence since it is a living system which you can change at any time to meet your changing requirements. We'd like the opportunity to show you how the Optimedia concept can help you manage better. It's detailed in our new brochures. To receive copies, just circle the readers service number, or contact your nearest Wright Line Media Management Specialist. You'll find him in all principal cities.

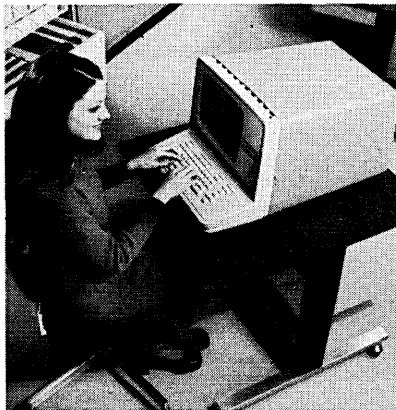

Wright
LINE
MEDIA MANAGEMENT SYSTEMS

160 GOLD STAR BOULEVARD, WORCESTER, MASS. 01606
A DIVISION OF BARRY WRIGHT CORPORATION

CIRCLE 79 ON READER CARD

United wrote the book on shipping computers without damage. Read it. Free.

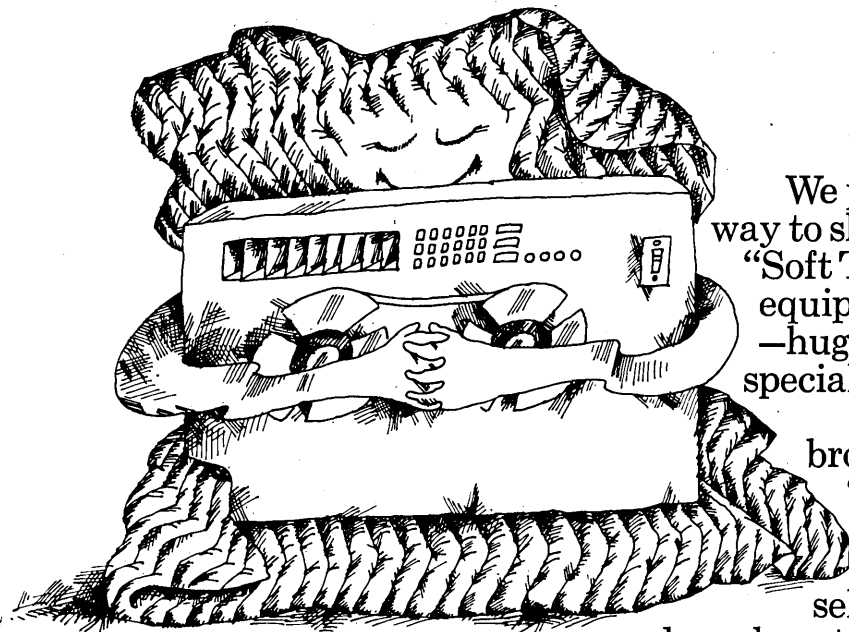

We pioneered this unique way to ship delicate gear. Our "Soft Touch" system gives your equipment a damage-free ride—hugged safely inside our special containers.

Write for our free brochure. You'll see how our "Soft Touch" way offers greater reliability.

And lets you sell small or big orders almost everywhere. Fast.

Write for this free "Soft Touch" brochure:
 United Air Lines, Inc.,
 111 N. Canal St.,
 Chicago, Ill. 60606.
 Att. "Soft Touch."

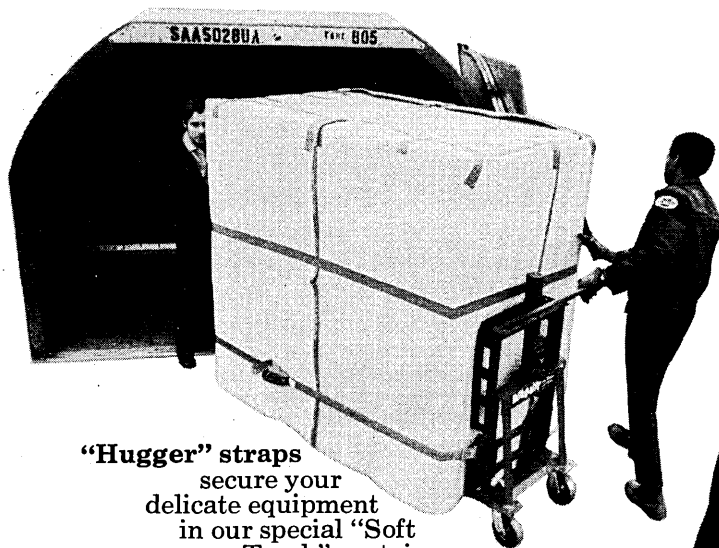

"Hugger" straps secure your delicate equipment in our special "Soft Touch" container—no skids or pallets needed.

Pinpoint delivery with "Soft Touch."

We can put your shipments on the exact spot your customer wants it. At LTL costs. And we'll arrange everything.

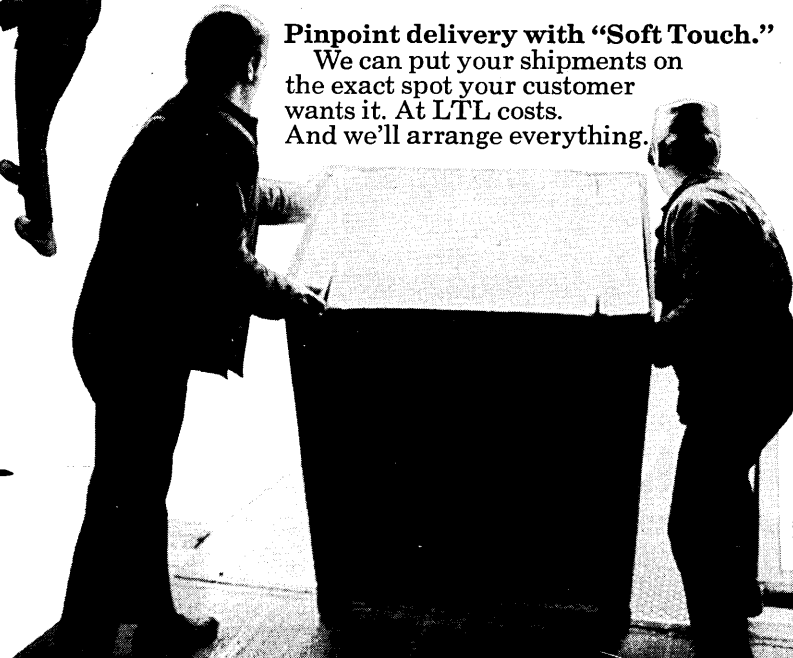

United Air Lines
Jet Freight No. 1 in the U.S. sky



This man singlehandedly maintains over 1000 ADDS terminals.

Why is he smiling?

Ordinarily, you can spot a Service Manager a mile away. Bleary eyes, furrowed brow, and that nervous little Service Manager Twitch.

Introducing Mort Norman, smiling Service Manager for Applied Digital Data Systems. Why the smile instead of a twitch? Because, frankly, ADDS' TTY compatible terminals are so dependable, Mort's job has become — well — cushy.

For Mort, the picture wasn't always so rosy.

From the outset, ADDS was committed to innovation; witness our features and patented options. Unfortunately, innovation breeds bugs, and we had our share. But we were also committed to quality. So our engineers designed, redesigned, fussed and fidgeted for almost three years. The result?

This. ADDS Consul series of desktop CRT terminals had a calculated MTBF of 3,000 hours. The rack-mountable MRD series rated out at 5,400 hours.

We found ourselves with a broad line

that was not only remarkably innovative; it was exceedingly reliable.

Mort was ecstatic.

Mort's wife started seeing more of him.

And we started smiling. Because that kind of dependability is building us a reputation. And a list of the bluest blue chip clients around.

When you're considering terminals, remember Mort and what's behind his smile. ADDS.

What's behind our smile. **ADDS**
Applied Digital Data Systems Inc.



FOR \$26,123 A MONTH, IBM WILL RENT YOU THIS:

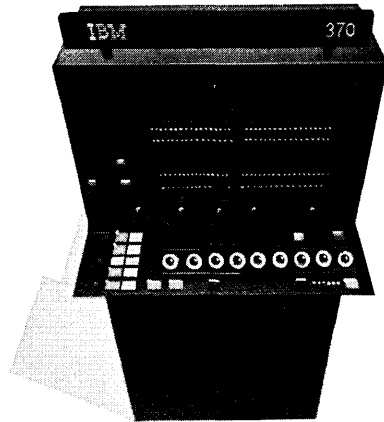

FOR \$25,022 A MONTH, ITEL WILL LEASE YOU THIS:



The big difference between IBM and ITEL shows up on your financial statement.

As an example, for \$26,123 a month, IBM rents you a System/370 Central Processing Unit alone, but for \$25,022, ITEL will give you the 370 CPU plus one megabyte of AMS Monolithic Memory, 8 ITEL disk drives plus controller, as well as 8

ITEL tape drives and one controller.

A full computer system for less than the IBM cost of the CPU alone.

Rented from IBM, the same complete system would cost you \$51,405 per month, more than double the ITEL cost.

And that's only one example. We'll lease any kind of computer package (360 or

370) on 3- to 8-year terms at proportional savings. Which explains why we have \$300 million of IBM computer equipment on lease right now.

When you're making a data processing move, you'll save big by calling the Data Products Group at ITEL—the financial alternative to IBM.

ITEL
CORPORATION

One Embarcadero Center, San Francisco, California 94111 Phone: (415) 989-4220

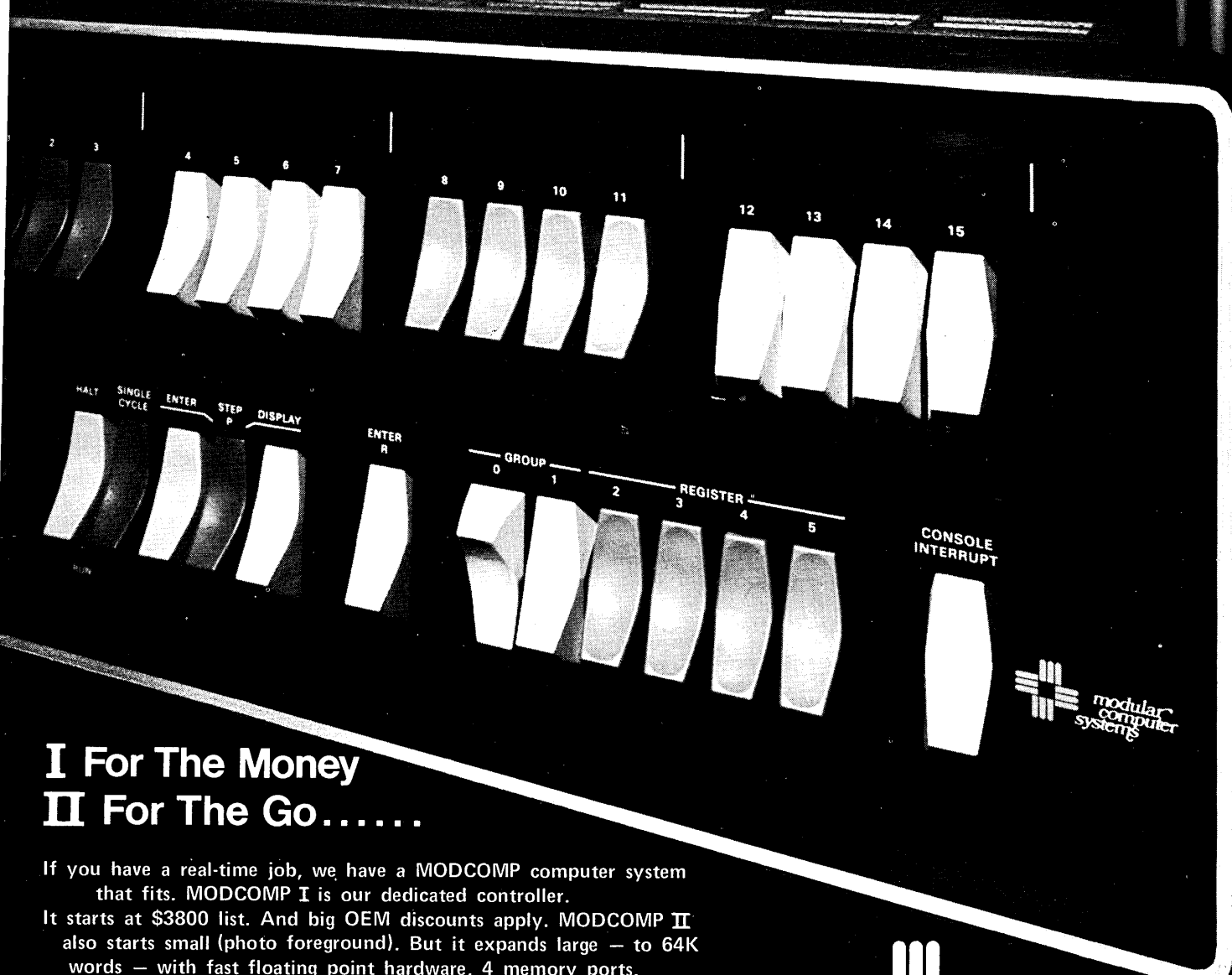
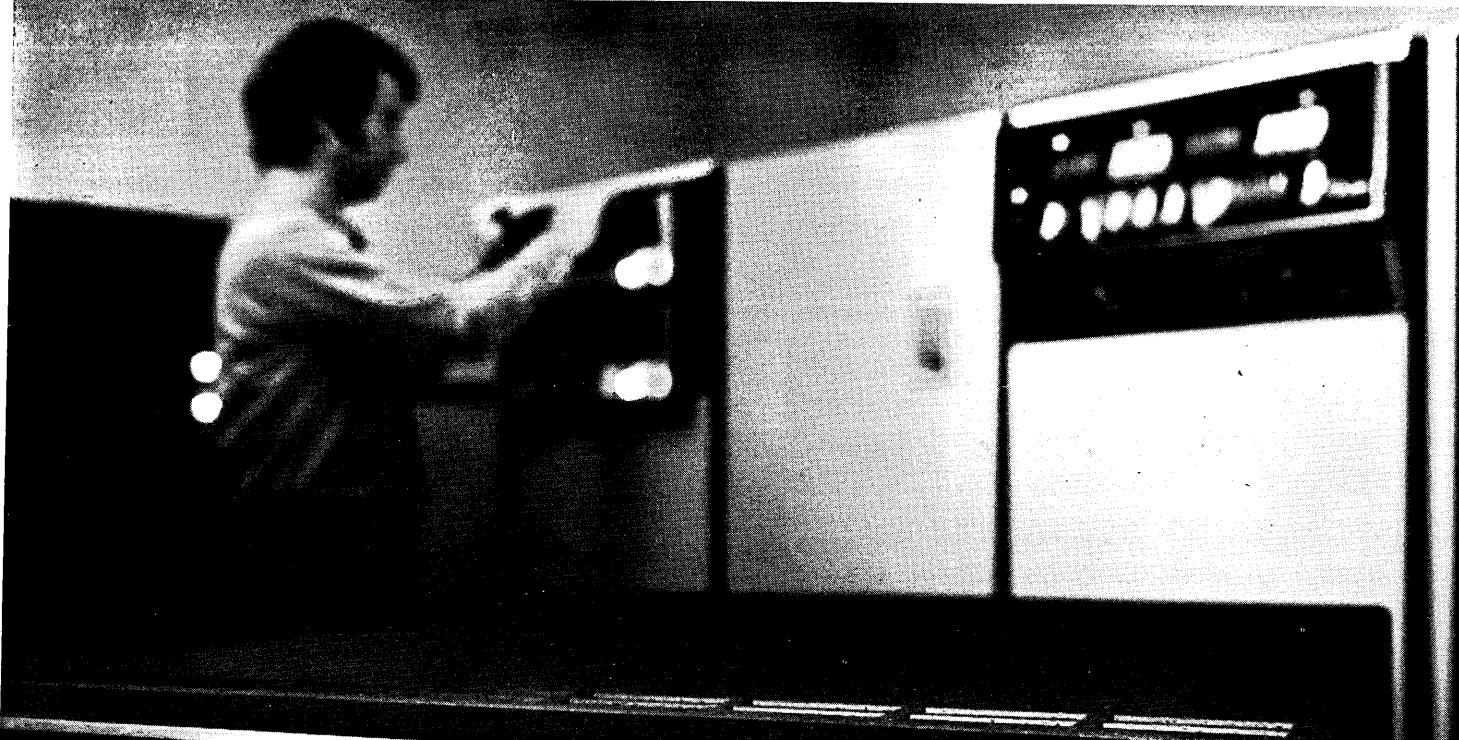

I For The Money II For The Go.....

If you have a real-time job, we have a MODCOMP computer system that fits. MODCOMP I is our dedicated controller. It starts at \$3800 list. And big OEM discounts apply. MODCOMP II also starts small (photo foreground). But it expands large — to 64K words — with fast floating point hardware, 4 memory ports, executive and protect features . . . It runs our MAX III real-time multiprogramming software, FORTRAN IV with process control extensions plus subscript and block optimization, BASIC, file management . . . And a MODCOMP II with 16K words of 800 nanosecond memory lists at only \$9500. Available now!



Send for the MODCOMP facts

1650 West McNab Road, Fort Lauderdale, Florida 33309 • Telephone: 305 974-1380

CIRCLE 31 ON READER CARD

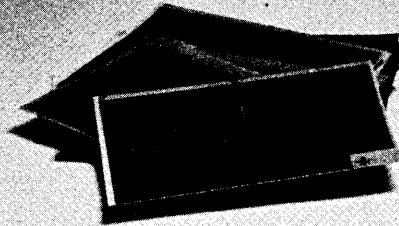

Scott Graphics makes a molehill...

The magic ingredient is COM-generated microfiche — of course. Nothing you didn't know already.

But what *may* be new to you is how quickly and efficiently you can make copies of COM fiche for distribution of vital information to departments and personnel who need it.

Whether your output is high volume, low volume or somewhere in-between, Scott Graphics has a system that makes copying both feasible and economical.

Suppose, for instance, you're really buried under with daily computer output... data that must be distributed without delay. The answer's easy. Convert that data into a standard microfiche roll master, using a Computer-Output-Microfilm (COM) device —

and then let the SCOTT 705 Microcopier take over from there.

The SCOTT 705 produces 100 fiche copies per minute, roll to roll or loop to roll (we even have a loop-maker to simplify that step!). Turn out as many fiche copies as you need — then convert the roll to sheets with the precise SCOTT 725 Microcutter and send them on their way.

If medium-volume sheet copying will solve your problem, you should consider the SCOTT 710 Microcopier. Simply push the button for direct or reversal copies, dial the quantity you need (from 1 to 99), and insert your fiche master. Within minutes, you will have sharp, clear copies at a rate of up to six per minute. It's as easy to operate as an office paper copier.

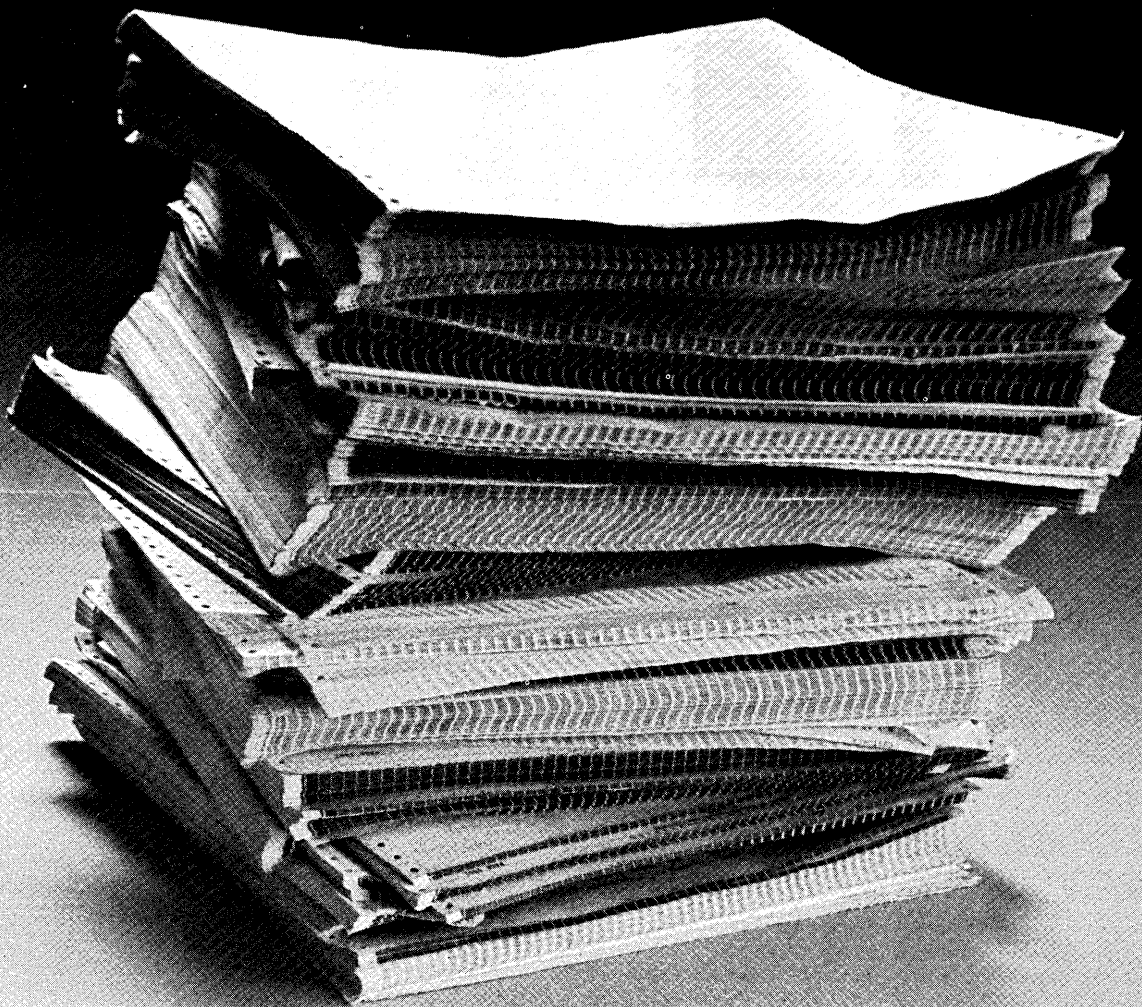

out of a mountain.

For low-volume sheet-to-sheet copying, the SCOTT 716 Microprinter will make your life easier. Like the 705 and 710, it handles silver, diazo or vesicular microfiche masters. It exposes direct or reversal copies... and assures you of the same high quality you expect from all SCOTT microcopy equipment. Table-top in size, the SCOTT 716 and its compact auxiliary developer make microfiche copying practical anywhere!

No matter what your particular film copying needs may be, there's a combination of SCOTT equipment and films that will do the job for you. Your SCOTT Systems Man will be glad to show you how. Why not call him in today?

Please send more information on Scott Microcopy Systems.

Our data distribution volume is:

high. medium. low.

We're particularly interested in

direct (diazo) microcopies

reversal (vesicular) microcopies.

Name _____

Title _____

Company _____

Address _____

City _____ State _____ ZIP _____

Phone Number _____

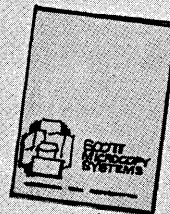

SCOTT GRAPHICS

SCOTT GRAPHICS, INC. • A SUBSIDIARY OF SCOTT PAPER CO.
HOLYOKE, MASSACHUSETTS 01040

Information Through Microcopy

“Too many minicomputer CPUs have bells that are never rung and whistles that are never blown.”



“90% of all minicomputer applications can be adequately handled by any 16-bit central processor. Sure means a lot of people are wasting most of their time evaluating the wrong system element.

“What’s important is system I/O, range of peripherals, software operating systems, service, and general responsiveness of the manufacturer.

“Am I anti bell and whistle? Of course not. Here at Raytheon,



we have all you *need*. (Note our emphasis. *Need*.) And you get all you need as standard items.

“You get the broadest range of peripherals available. You get delivery of complete systems within 45 days. You get extensive software that is field-proven. You

get support technicians who know hardware *and* software.

“Where will you find Raytheon minicomputer systems? Everywhere. From process control to data processing centers.

“Like to know more? Give me a ring. I’m Bill Karavatos, head of Computer Sales.”

Raytheon Data Systems,
1415 Boston-Providence Turnpike,
Norwood, Mass. 02062. Telephone:
(617) 762-6700.

RAYTHEON DATA SYSTEMS

RAYTHEON

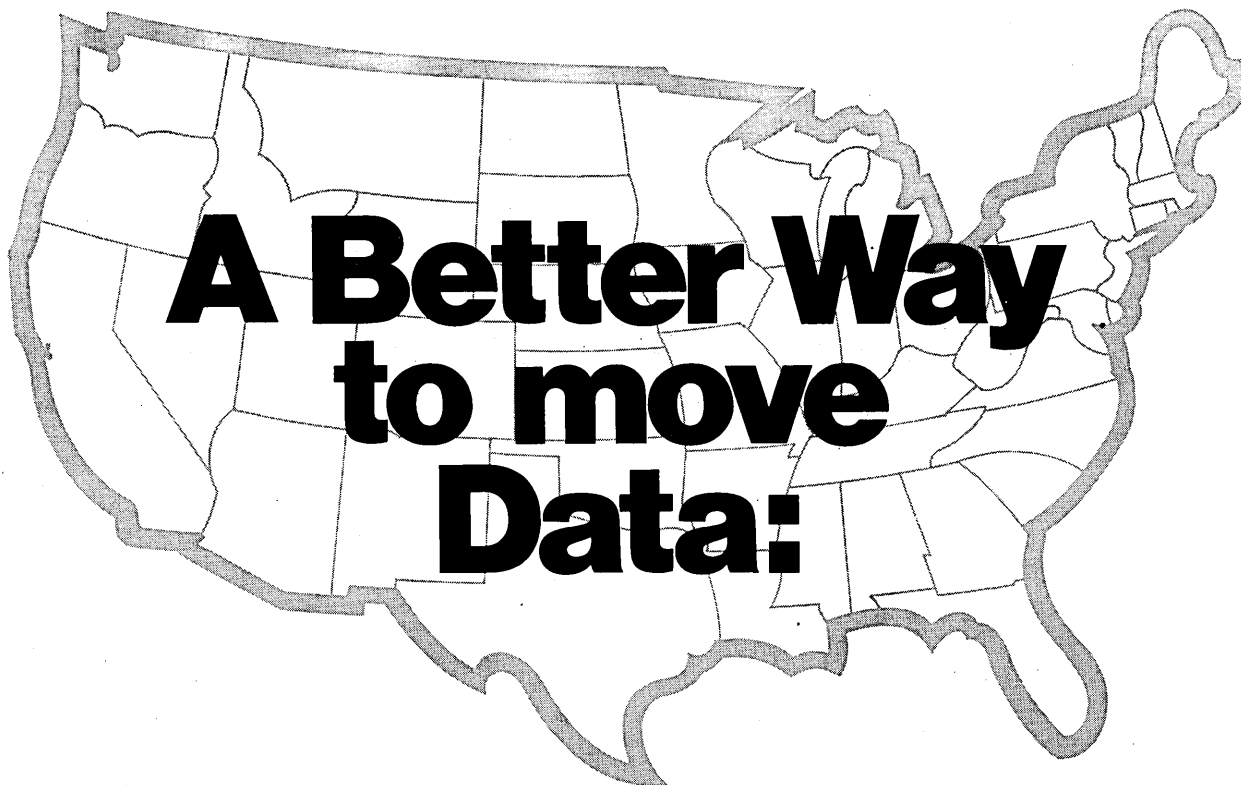

A Better Way to move Data:

Southern Pacific Communications Company

When you think of your communications — whether voice or data — you're naturally concerned about factors like reliability and economy. Now there's a new communications company that's set up to provide both.

Since transportation has always been Southern Pacific's business, it was only natural for us to start transporting communications. In fact, we've been doing it for ourselves for years. Now we are building a new system so we can offer you a business communications service tailored to your specific needs — whether it's a teleprinter link between two points or a multipoint computer system.

With SP's 20 years experience in operating the nation's largest private communications system, we understand business communications. And we understand reliability, too. Our present system of 500,000 channel miles has a proven reliability figure of 99.96 percent.

Construction on our San Francisco-to-Los Angeles link is nearly completed. And the rest of the network will soon be ready — down the Pacific Coast from Seattle, through the Southwest, and up to St. Louis. Then we'll be going beyond that to offer a complete nationwide service.

So when you think of business communications, think of the specialists. You'll never have to pay for service you don't need. And you'll almost certainly pay less for what you do need.

For the details, contact Southern Pacific Communications Company, 105 Market Street, San Francisco, California 94105. (415) 362-1212.

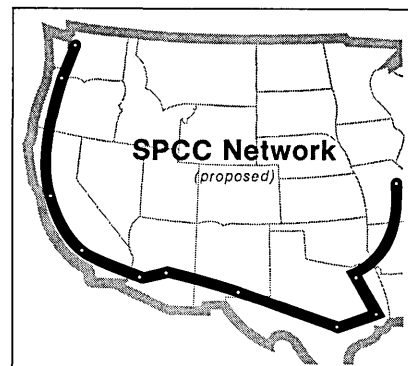

SPCC

Southern Pacific Communications Company

105 Market Street
San Francisco, California 94105
(415) 362-1212

PLUG IN

PROCESSOR STORAGE TRANSPARENT
TO YOUR SOFTWARE YET VERY
APPARENT TO YOUR BUDGET!

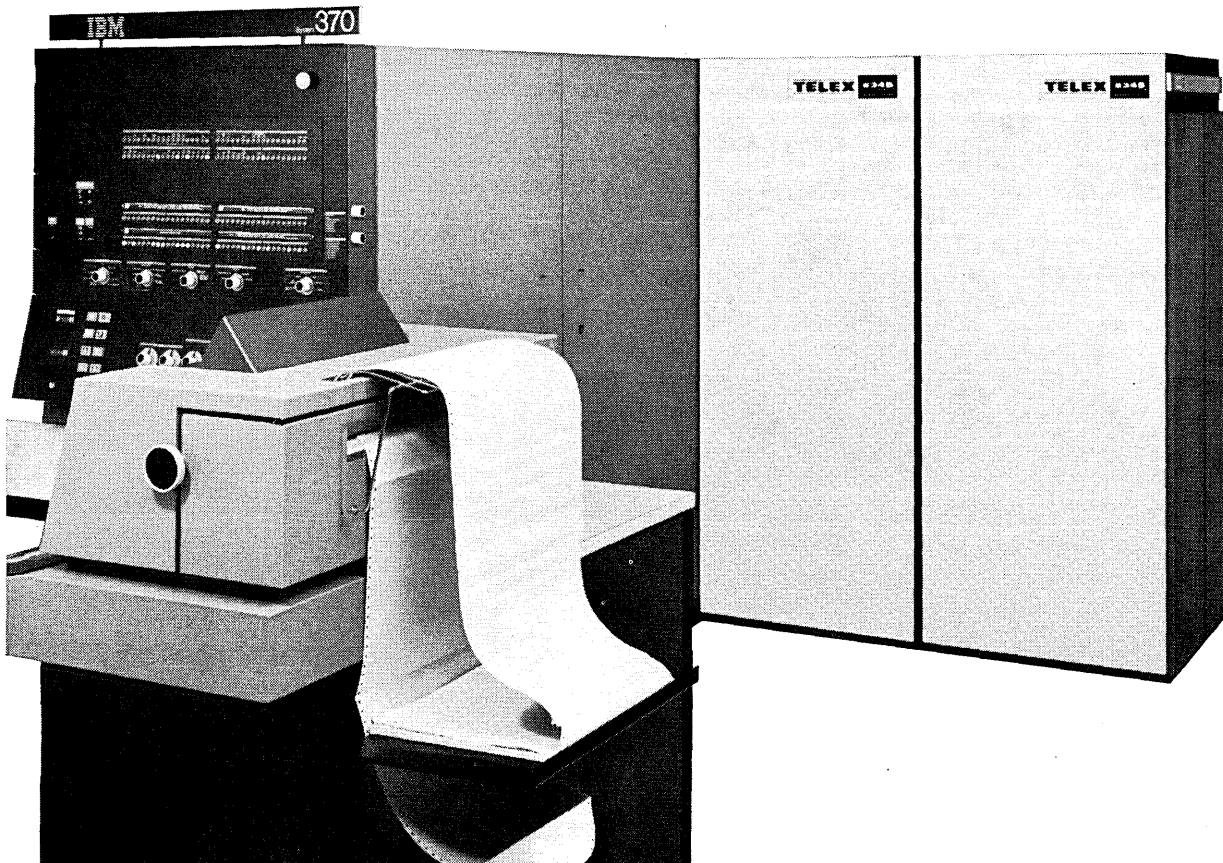

TELEX 6360 and 6345 Memory Subsystems For System 370 combine lower pricing with compatible performance, offline diagnostics and software transparency.

The TELEX 6345 and 6360 Memory Subsystems consist of one or more basic storage modules, each with the associated logic gates, power supplies maintenance panel and connectors. Each module is equipped with off-line maintenance capability to permit the use of memory diagnostics without the employment of the central processing unit.

In configurations with multiple basic storage modules, an error condition can be diagnosed off-line on one of the units while the remainder of the memory is available to the user. One bit errors are automatically corrected. Double bit errors are detected. All three processor storage modules are field upgradable within their model group, i.e., 6345-1 (131K) to 6345-2 (262K) for the 370/145; 6360-1 (262K) to 6360-2 (393K), 6360-2 (393K) to 6360-3 (524K) for the 370/155; 6360-4 (262K) to 6360-5 (524K) for the 370/165. These modules can be combined to achieve the maximum configuration for each respective Central Processing Unit.

Since all of the main storage on the System 370 Model 155 and 165 is external to the CPU, it can all be replaced with TELEX memory for maximum savings. Seven memory configurations are possible, matching each of the IBM configurations. The 6360 subsystem has a proven track record since first installation in November of 1972.

To maximize the savings on a 370/145 you can attach up to 262K of TELEX 6345 Memory to your 370/145 configuration.

The TELEX 6345 and 6360 are functionally transparent to the user's software, and operating system. No adjustments are required to replace the original IBM memory with the comparable TELEX memory subsystem.

In addition to significant cost savings, compatible performance and off-line diagnostics, all TELEX memory modules offer savings in floor space (due to their more compact cabinetry).

All of these advantages are enhanced via TELEX Field Service — the largest, most experienced network in the peripheral industry.

If you are looking for genuine economy combined with advanced technology, look to TELEX for System 370 and 360 peripherals. You will find that the TELEX product line comprises the broadest range of peripherals in the independent industry . . . Tape, Disk, Printer and Memory Subsystems. Get the complete story from your TELEX representative.

SUMMARY: The TELEX 6360 and 6345 Processor Storage Subsystems are modular, expandable, semiconductor memories for System 370, and are functionally compatible equivalents to the IBM add-on storage modules used on the 370/145, 155 and 165. All three TELEX models offer substantial cost savings in comparison with the IBM memories. Upward growth will be insured with the TELEX announcements of 370/145-2, 158 and 168 memory subsystems to come.

**PLUG
IN A TELEX
MEMORY
SUBSYSTEM.**

where the difference begins
TELEX[®]

Preferred
the PERIPHERAL COMPANY
TELEX COMPUTER PRODUCTS, INC.
6422 East 41st Street • Tulsa, Oklahoma 74135 • (918) 627-1111
TELEX, LTD.
101 Duncan Mill • Don Mills, Ontario, Canada • (416) 445-8050
TELEX EUROPEAN GROUP
213 Oxford Street • London W1R-1AH, England • 01 734-9131
Paris • Frankfurt • Zurich

Ask your TELEX representative about the TELEX total system lease plan.

NCR proudly newest member of computer family

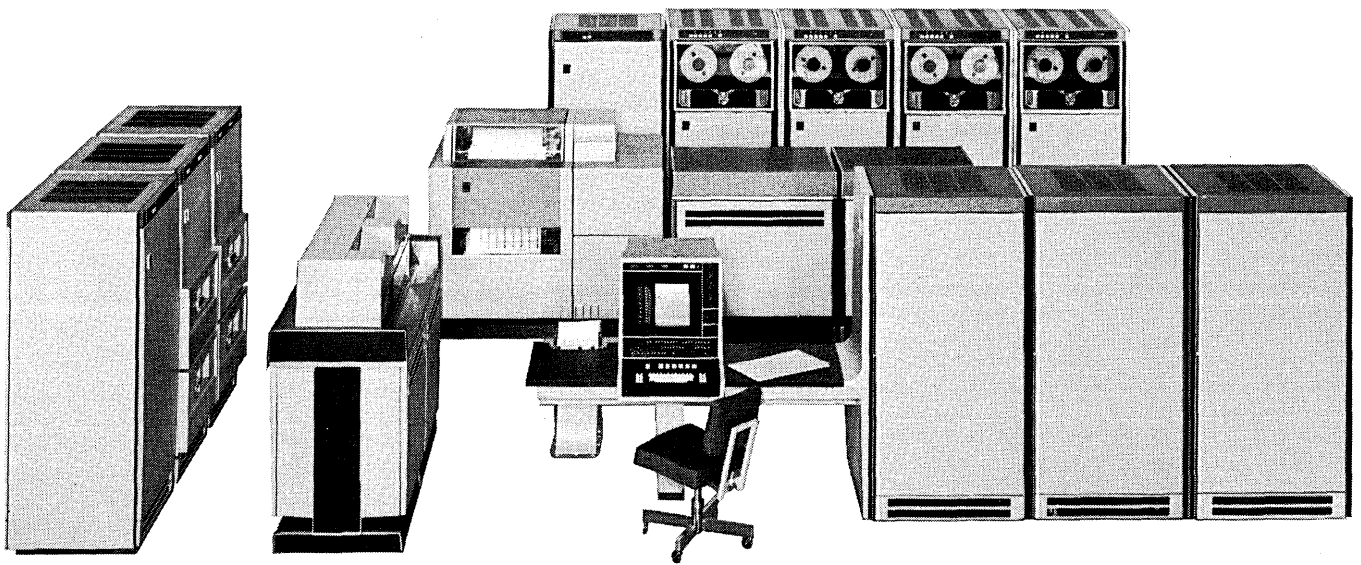

The "251" is an exciting addition to the completely compatible NCR Century family of computers. Many of the outstanding performance characteristics of its big brother, the NCR Century 300, are inherent in the "251" at considerably less cost.

Advanced hardware architecture includes: independent access paths to main memory for the I/O processor and CPU; independent asynchronous mem-

ory modules; separate user and supervisor registers; and multiple BAR/LAR registers—all of which are a must for efficient multiprogramming and real-time processing.

Sophisticated software includes a multiprogramming system utilizing these hardware features and supported by the ultimate in operator communications and control. The speed and flexibility of a CRT provides instantaneous system

announces the the NCR Century ...the 251

Here's a combination of advanced hardware and sophisticated software at an exciting low price.

and job status displays, dynamic status updates, and touchplate control switches for rapid operator response. Other features include: I/O spooling, unit and file sharing, automatic job scheduling, remote job entry and dynamic resource allocation.

For the money, these kinds of advanced hardware-software features are all but impossible to find in other systems.

Call the nearest NCR office for the specific benefits you can expect from the NCR Century 251 . . . as well as from any of the other five members of the growing NCR Century family.

NCR
Computers & Terminals

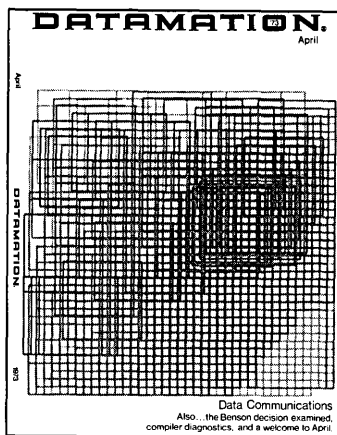

Our data communications cover this month is a reproduction of "Demo," by Frieder Nake, a serigraph in four colors from Art Ex Machina, a portfolio of six original computer art prints published by Editions Gilles Gheebrant, 2130 Crescent, Montréal, Canada.

Emulator, intelligent emulator, or true front-end processor: which best fits your installation?

A Front-End Primer for IBM

One of the most widely used, and least understood, terms in the computer industry today is "front end." To IBM users in particular, many of whom are currently seeking to improve data communications networks, the search for a front end turns up a bewildering array of devices ranging from emulators of existing IBM communications control units to true, independent communications preprocessors linked to the host System/360 or System/370 via a communications channel. Let us try to clear up some of the mysteries of the brave new world of the IBM front end, and in the process present some criteria and concepts which can be employed by IBM users in selecting a front end for their networks.

By way of background, consider the existing IBM communications environment and the products offered by the industry giant. The majority of System/360 and System/370 cpu's installed today communicate with remote terminals via one or more 2700-series transmission control units (i.e., 2701, 2702 or 2703). The 2700s are hard-wired controllers containing some logic peculiar to the characteristics of each line and/or terminal including: the ability to recognize special control characters (such as END OF BLOCK), the capability to assemble and disassemble characters, and limited line monitoring to time out inactive termi-

nals. Aside from these purely "mechanical" functions, the 2700s perform no true communications control—this is done entirely within the System/360 (or 370) cpu through a combination of the operating system (OS or DOS) and a communications access method (BTAM, QTAM or TCAM) which links the operating system with the user's application program. Fig. 1 illustrates this relationship.

To transmit (or receive) a message, the user program must first frame the message with control characters appropriate to the destination terminal. Next it must call a BTAM macro subroutine (BTAM, the most widely employed access method, is used here as an example) to translate the message from S/360 or 370 EBCDIC code to the code used by the terminal. The user program then calls BTAM to begin transmission, and finally enters a "wait" status until the transmission is complete before starting the next operation. BTAM is responsible for providing all basic teleprocessing functions such as queuing, polling, error recovery and terminal device dependencies. All of these activities consume cpu cycles and core.

A second series of hardware items recently introduced by IBM, some of which are now in limited use, is the 3700-series communications control units, the 3705 and 3704. Much has

been written about the 3705. In summary, it contains a programmable processor of its own and is capable of operating as an emulator of the 2700s under the Emulator Program (EP), or as an IBM-oriented front end under the Network Control Program (NCP). The 3704 is a functionally equivalent, scaled-down version of the 3705. It handles fewer lines and is available at lower cost. Since it has only just been announced and few, if any, deliveries have been made, it is mentioned in passing only, and we will concentrate on the more "established" 3705.

No processing help

In emulator mode, the 3705 perfectly replaces an equivalent 2700 transmission control unit and at best is a less expensive piece of hardware. The S/360 or 370 host processor continues to do all of the work. In NCP mode, the 3705 employs a new version of the TCAM access method, one which is split into two sections by function. Certain functions such as polling, error recovery, terminal dependency and code conversion are moved into the 3705; while the remaining linkage between operating system and user program, the TCAM message processing program, remains in the host processor. A similar strategy will probably be employed by VTAM, the newly announced access method for virtual machines. Since

Users

by John T. M. Pryke

TCAM/NCP will not be released until June, 1973, and VTAM/NCP will not be ready until sometime in 1974, the exact specification of which functions remain in the host and which are resident in the 3705 is not yet available from IBM. Despite this, several facts about the 3705 under NCP are apparent:

1. The 3705/NCP can be supported only from S/370 host machines operating under OS or VS (DOS support has not been announced).
2. The 3705 does not support local peripherals. This precludes its use for certain common front-end applications such as message switching or data acquisition, both of which require

discs and/or tapes for temporary storage of messages or data before retransmission to an ultimate destination. Without peripherals locally attached to the 3705, these applications must still be handled by the host processor, thus "wasting" much of the 3705's front-end potential.

3. The 3705 cannot simultaneously operate under NCP and EP, with TCAM/NCP or regular S/370s. Such operation will be possible *only* on virtual machines using VTAM/NCP (and then not until VTAM is released in 1974).

4. The 3705 does not support certain second-generation IBM terminals, the 2260 for example.

With these facts in mind, the IBM

user wishing to improve his teleprocessing capability must first find a way to replace his 2700 with a more flexible and "intelligent" device; and second, if he cannot live within the bounds of the 3705/NCP (which leaves S/360 and DOS users out in the cold) or wait for VTAM, he must seek an alternate vendor. Thus the search for a non-IBM front end begins.

The others

Non-IBM front ends can be roughly classified into three types:

1. Emulators
2. Front ends (true communications preprocessors)
3. Intelligent emulators (quasi front

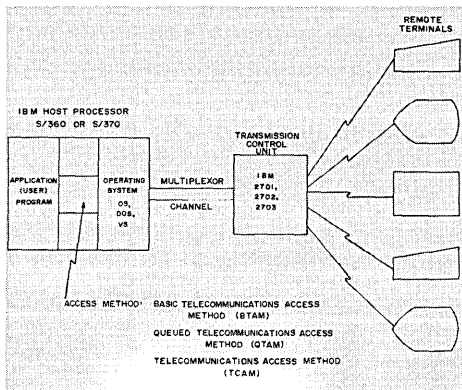

Fig. 1. Existing IBM telecommunications environment.

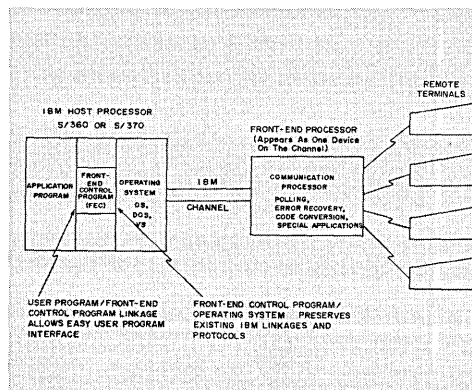

Fig. 2. Front end.

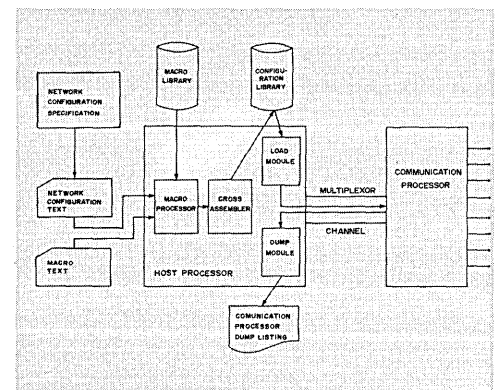

Fig. 3. Network configuration generator.

Primer

ends)

The first group, emulators, encompasses any device that perfectly emulates (i.e., plug-for-plug replacement) an existing IBM control unit. In the world of communications two types of emulators tend to prevail: the 2700 emulator (270X), and the tape drive emulator.

270Xs can be purchased in several different varieties: hardwired controllers (such as the Memorex 1270), microcoded processors (such as the Interdata 270X), and software-coded minicomputers (such as the PDP-11). None of these should really be classified as a "front end," since by definition they perfectly emulate an IBM 2700, and require no change in the existing IBM mode of operation (i.e., BTAM is still present and the host still does all of the communications processing). To the user, the hardwired emulator offers cost savings alone; the same constraints apply to it as apply to the IBM 2700s. The firmware emulators do contain a processor and can be remicrocoded to support nonemulator functions (such as support of foreign terminals); however, unless the user is sophisticated and familiar with microprogramming techniques, such changes must be referred to the vendor—a situation that offers little advantage over going back to Poughkeepsie for an RPQ. The software emulators offer the user the greatest flexibility, but unless adequate software tools are provided by the vendor, the user must

become an expert in minicomputer programming, a situation which can cause problems for large-machine-oriented IBMers.

The tape drive (or unit record) emulator appears as a sequential device (such as a 2803 tape controller) on the IBM selector channel. A typical example includes the Cybermatics "Tin Can." Although such devices represent an attractive interface to user programs on the GET/PUT level (and thus alleviate the complexities of BTAM), sequential devices (by their very nature) are only good for long message bursts at high speed and may lock out the selector channel, to which they are attached, from use by other devices. Tape drive emulators are subject to all of the constraints of unit record devices. Thus this type of emulator, while attractive for certain applications, does not represent a good general solution to communications problems which are usually conversational and interactive by nature.

The second class of front ends are true communications preprocessors, which take over all message control functions from the host processor and appear as a single device on the IBM channel (regardless of how many terminals are in the field). These front ends are functional equivalents of the IBM 3705 in NCP mode.

On the hardware side, various communications processors are available to fit user requirements: minicomputers, such as the Computer Communications, Inc., cc-70; midicomputers, such as the Digital Equipment Corp. PDP-11/40 and PDP-11/45; and large-scale

computers such as the Collins "C" System. Although processor hardware varies in power, these systems must all contain certain common software features to successfully operate as true front ends.

First, there is a communications processor-resident real-time operating system ("network control program"), which performs all of the communications functions currently handled by BTAM. At a minimum, these software functions include polling, device dependencies and code conversion, and error recovery. Additional software may be provided to incorporate special applications such as store-and-forward message switching (using a disc attached to the communications processor), etc.

A second module, the front-end control program, is resident in the host processor, and must be present to link the user's application program to the operating system and the front end. To be truly effective, this module should preserve all existing access method operating system linkages to make it as impervious to new IBM releases as possible. In addition, it should contain a "clean" interface to the user program, one which will permit easy conversion of application programs to front-end operation. It must be stressed that existing IBM telecommunications application programs have to be rewritten to utilize a front end, including the IBM 3705; thus, this interface is an important one for the user and can shorten or lengthen conversion efforts. Fig. 2 shows the functional relationship between the front end and the host S/360 or S/370.

Configuration aids

Finally, a network control program generator may be included to aid the user in configuring his system. IBM has such a module available with the 3705 (necessary in this case as it is the *only* method of programming the 3705, which has no peripherals or console of its own). Some of the more sophisticated front-end vendors have followed suit (in one case a vendor's generation system preceded IBM's by over a year). In essence, a network control program generator is host processor-resident, operating as a batch job, and might contain a macro processor (to accept IBM-oriented macroized input describing the network), a cross-assembler for the front-end processor, a librarian for cataloguing new configurations of the network control program, and a load module to permit the front end to be loaded directly over the channel from the host processor. A dump module may also be present to allow communications processor core dumps to be printed out on the high-speed host processor line printer. A conceptual dia-



WHEN TO USE AN EMULATOR

- For lower cost over equivalent IBM hardware.
- For application programs which you do not desire to rewrite.
- If you use standard IBM TP program products (such as RJE/HASP) which cannot be easily front-ended.
- As a base for future expansion to a front end.

WHEN TO USE A FRONT END

- To save host processor core and cpu cycles.
- To implement new TP control functions without additional communications overhead in the host processor.
- When you need local peripherals to implement special front end resident communications applications.

WHEN TO USE AN INTELLIGENT EMULATOR

- If you do not wish to rewrite existing TP programs but still require additional front end applications which cannot be implemented in the host.

Fig. 4. A summary of front end selection guidelines.

gram of a generator appears in Fig. 3.

In summary, a few facts are evident when one talks about a true front end. First, the hardware is not overly complex—a programmable mini or midi computer with a good IBM channel interface (such as Digital's DX-11b) and suitable asynchronous, synchronous and binary synchronous line interfaces will do the job. What is critical is vendor reliability and software. It is essential that the front-end vendor be able to provide timely, effective service at the user's location. Trained, qualified personnel should be located either within the same city as the user, or within a short commute. Further, a spare parts depot should be nearby so that lack of a repairman or replacement board will not extend system downtime. Of equal importance is the software, whose design requires both an in-depth knowledge of real-time communications processors and of the IBM teleprocessing environment. This software usually represents the key to success or failure of a true front end. Thus, unlike emulators, whose operation must comply with well-known IBM specifications, the true-front-end user must look as seriously at software as hardware; and let the buyer beware of the distinction between a do-it-yourself software "kit" and a proper front-end program product.

Between the perfect emulator and true front end lies a gray area—the "intelligent" emulator. An intelligent emulator may perform certain front-end functions, but appears to the host processor as a 270X. An intelligent emulator usually consists of a mini (or midi) processor with modified emulator software, such as a fail-soft protection module against host processor failure. Upon detection or cessation of communication over the S/360 or S/370 channel, the emulator broadcasts messages to all user terminals that the central site is down, and to discontinue sending messages. An alternate application for the intelligent emulator

might be to collect all inbound messages on a local disc and then transmit them on a first-in, first-out basis to the host processor when operation is restored.

A second application of the intelligent emulator is a local message switching capability. Each incoming message is examined; messages destined for the host are passed on, while messages bound for an alternate terminal (presumably denoted by a special header code) are routed to that terminal without ever passing through the host. In all of the above examples, the communications processor appears to the host as a perfect 270X, and all front-end functions are transparent to the user's IBM application program.

With these three classes of "front ends" facing him, the IBM user will no doubt wonder which product is best for his environment. Aside from the obvious questions of vendor reputation, product reliability, and availability of maintenance, there are certain criteria which may serve as selective guidelines. These are summarized and boxed as Fig. 4, and are described below:

1. *When to use an emulator.* There are four primary motivations for using emulators: lower cost; to avoid rewriting existing application programs; the use of certain standard IBM program products; and the procurement of a base for future expansion to a true front end.

As far as cost is concerned, virtually all emulators are less expensive than the equivalent IBM 2700s. Cost savings can range from 10% to 40%, depending upon the equipment purchased. If cost savings are the sole objective, then the hardwired emulator (such as the Memorex unit) is usually the best solution. A second motivating factor is the significant investment in an existing BTAM- or QTAM-oriented application. To convert such an application (especially if it is in daily production) can be a costly and prohibitive task; thus conversion to a true front end may not

be desirable. A third factor is the growing use of numerous IBM teleprocessing program products, which can only be converted to front-end operation at the users' own risk. Typical of these is 805/HASP, which has its own access method, RTAM. Attempts to replace RTAM (or tamper with it) require extremely sophisticated system programmers, and usually result in a broken program and withdrawal of IBM support. Thus for HASP (as well as for CICS), an emulator is usually the only practical solution. Finally, many users who do have a front end in their future plans may well wish to start with a simple emulator and grow from there. The emulator gives them the opportunity to get used to non-IBM hardware and software and to plan the ultimate front-end conversion (perhaps using an intelligent emulator as an interim step), so that it will have minimal impact on daily operations.

2. *When to use a true front end.* A true front end promotes savings in host processor core and cycles, increased throughput in the IBM cpu, implementation of new communications control functions or application programs without complex BTAM-level programming, and a superior technical and operational alternative to the IBM 3705.

By moving such functions as queuing, error recovery, polling, and code conversion to a separate communications processor, as much as 75K bytes of host processor core may be saved, and perhaps 30% of the cpu overhead employed in line handling may be eliminated. Improved channel communication in the form of high-speed message blocks from front end to host and back is also a real benefit. Existing teleprocessing users who wish to implement new functions or support non-IBM terminal devices can do so in the front end rather than the host processor, while new users can write their application programs without resorting to the complexities of BTAM. For large installations, with many low-speed terminals, the installation of a front end,

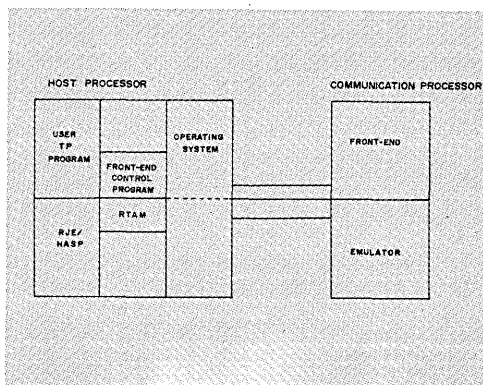

Fig. 5. Dual operation of emulator front end.

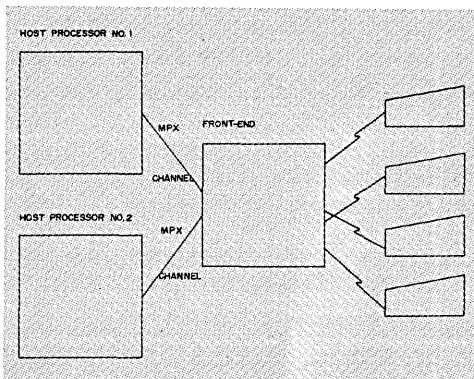

Fig. 6. Multi-host processor configuration allowing any terminal to address either host.

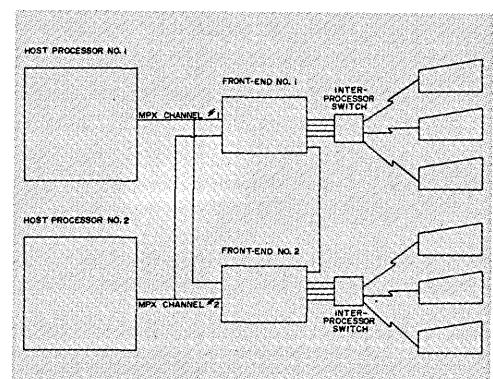

Fig. 7. Multi-host processor configuration showing full network redundancy.

which appears as a single device to the host processor, can eliminate the 256-device-address limitation of the IBM multiplexor channel, and thus alleviate the need for additional channel hardware. Finally, there are a myriad of S/360 and Dos (S/360 or S/370) users who cannot support or use the 3705 in NCP mode. The only "front end" that IBM offers these users is the System 7, which is provided with a channel interface and a "do-it-yourself" kit of software modules. Consequently, the S/360 and/or Dos user must seek an alternate solution to IBM to solve communications problems. For those who are core or cpu bound, or who have cumbersome, first-generation IBM teleprocessing systems (such as the Medical Information System Processor, MISP) which are no longer supported by IBM, there is no solution other than a non-IBM front end.

3. *When to use an intelligent emulator.* The intelligent emulator is a catch bucket for those who need more than a 270X will provide, but do not wish to change their applications.

Common motivations which drive

these users include: code conversion to support a non-IBM-compatible terminal, polling in the front end, and application-independent functions such as data acquisition and prevention of loss of data due to host processor failure. Thus the intelligent emulator represents not only a stepping stone between strict emulation and true front-ending, but in many cases is a completely acceptable solution to a user's communications problem.

Two typical problems

No discussion of front ends would be complete without at least some mention of common dilemmas or problems. Although there is no doubt at least one such "hooker" for each IBM teleprocessing installation on earth, it is not practical to mention more than two of the most common ones here.

1. *Multi-application installations.* Many users employ both home-written applications, which may be front-ended with relative ease, and a standard IBM program product, such as RJE/HASP, for which a true front end is totally impractical; an emulator is the only solution. These users are faced with two possible solutions—stick with an emulator, or procure a communications processor which can operate si-

multaneously as a front end and an emulator.

This "dual operation" feature, shown schematically in Fig. 5, is a function of software rather than hardware, and is currently offered by at least one vendor. (Eventually IBM may have a similar feature under VTAM/NCP; but this will be available only to S/370 vs users and then not until sometime in 1974.) It is a feature which may provide a key to an otherwise unsolvable problem. It is also a significant aid in front-end conversions, allowing conversion of one user program at a time to front-end operation while others continue to use an emulator.

2. *Multi-host processor installations.* A second type of problem arises with those users who want a single front end (or emulator) to communicate simultaneously with two host machines. This feat is primarily a function of sound channel interface hardware design. It is critical that when one host processor is talking to the front end, the other be prevented from timing-out, and thus hanging up its channel. From a software standpoint, a specialized switching module must be provided to examine messages and route them to the proper host. The multi-host feature provides the user with many operational and configuration possibilities, two of which are shown in Figs. 6 and 7.

In conclusion, the wonderful world of the front end can be a boom or a bust for the IBM user. If approached intelligently, with an awareness of product alternatives and the list of selection criteria boxed in Fig. 4, it can reap benefits in improved communication control. If procured without a working knowledge, or based on questionable vendor's promises, it can be a costly disaster. □

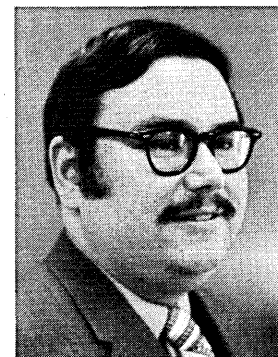
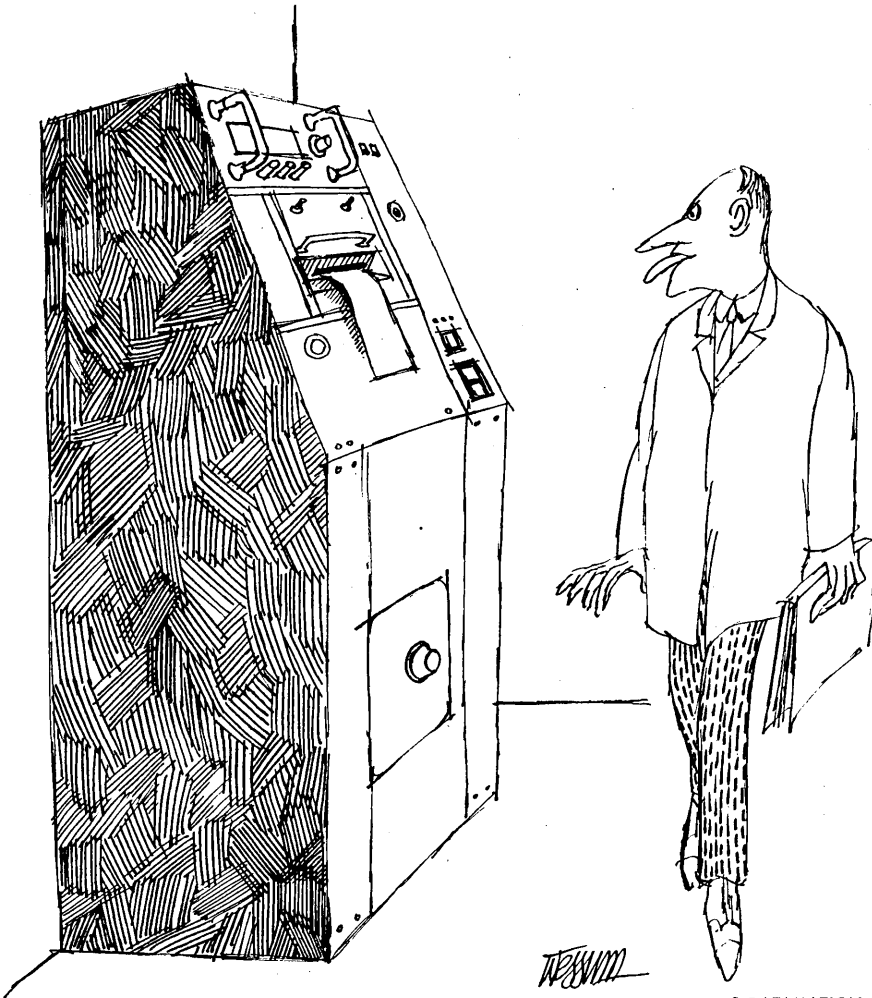

Mr. Pryke is a senior consultant with PHI Computer Services, a subsidiary of WANG Laboratories. He has been active in the development and marketing of IBM-compatible front-end teleprocessing systems for industrial and financial organizations. He has a BSc in mechanical engineering from MIT and an SM in mechanical engineering from Northeastern Univ.

© DATAMATION ®

A guide to compare the advantages and disadvantages of the two types, with some examples of applications best suited to each

System Trade-offs: Dedicated and Dialed Networks

by Daniel Fidlow

In computer networks, the most common arrangement is a central processor surrounded by terminal stations (Teletype terminals, crt's, etc.) which feed in and out of it. These terminals can be located either near the processor or clear across the country and can communicate with it over either dedicated lines or the switched trunks of a dialed network such as the telephone service, Western Union's Telex or TWX, or a Private Branch Exchange.

In a dedicated network, every terminal has a unique line associated with it which is permanently connected to the processor whether or not the line is being used. In a switched network, a physical connection only exists between the terminal and processor when a message is passing. Obviously, therefore, a much larger set of terminals can be supported by a switched network than by a dedicated one. There are many other system and service differences also and we will review them as seen by the user.

The basic mechanical difference occurs in establishing a connection. In a dedicated network, all terminals are physically connected by transmission lines to the processor all of the time and, whether or not characters are actually passing, they are always able to pass under control of the proper line protocol. Thus the only way the processor can tell one message from another or from none at all is by looking for special characters embedded in the message stream instead of by looking for different electrical or time states on the line. Fig. 1 shows a dedicated hookup. There may be one or more terminals on a line—if one, we have a single station or point-to-point line; if more, a multipoint line—but the total number of terminals cannot increase indefinitely.

In either a dedicated or dialed network, the first task of the user is to tell the processor that he wants service and of the processor to find this out. The

permanent line connections of a dedicated network lend themselves to a "polling" discipline for this task. In order to get a message going, the processor sends each terminal which is not busy a special character, at short intervals, asking if it has anything to send. It responds by indicating to the processor either that it has something or nothing to send. ("Something to send" means that the customer had hit a button storing a request-for-service character in the terminal's selector, where it waited until polled.) If something, the processor allows it to send; if nothing, the processor can then check if it itself has a message for the terminal. If so, it delivers; if not, it waits out a short interval before polling that terminal again. This sketchy example ignores what to do if the terminal responds with an illegal character or none at all, ignores how to end a message, ignores selection on a multipoint line, etc., all of which must be well-defined.

A dialed, or switched, network is represented in Fig. 2. The terminals are physically *disconnected* from the processor before and after a message is passing between them, and this is why polling is impossible. In order to get a message going the user dials the processor, contending with all other terminals which are trying to get service at that time. The dial digits pass into the local telephone exchange, or end office, which then searches for an

available trunk to the next exchange, and so on, until the end office attached to the processor is reached. The call request causes an interrupt at the processor which, servicing it, returns a ready signal to the terminal. This pre-message interplay finally establishes a physical connection for data transmission.

When the processor has a message for the terminal, either one can originate the call. Either the terminal can dial and request the information when ready or the processor can originate the call by passing the dial digits into an Automatic Calling Unit which transforms them into the proper signals for the switched network.

The implications

The physical differences just described imply the following system and operational trade-offs:

1. *Size of the Network.* Between any processor and its transmission lines there is a "black box" interface through which the lines feed. This box performs serial to parallel conversion, detects line errors, does modem control, etc. If the box has n ports then it can terminate n lines that require one port (such as dedicated half-duplex connections) or $\frac{1}{2}n$ lines that require two ports (such as in the dialed TWX network).

The total number of dedicated terminals is limited by the number of these line ports and by the number of terminals that can be multipointed to each

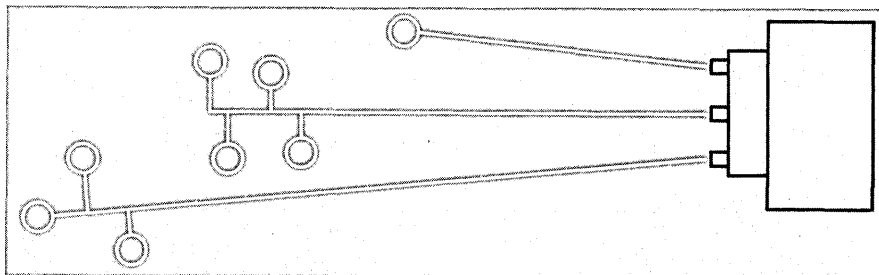

Fig. 1. Example of two multipoint and one point-to-point dedicated lines.

Trade-offs

line. Theoretically, all of these terminals can be active at the same time so that the number of simultaneous conversations may be three or four times greater than the number of line ports.

These limitations do not apply to the size of a switched network. Before any dialing is done, the processor is in potential contact with an infinite number of terminals but in actual contact with none; after any is done, another point-to-point connection exists. Thus, a switched network can support many times the number of terminals in a dedicated one but no more active connections can be ongoing than the number of line ports.

2. *Availability of the line.* If the user is calling through a switched network, he will get a busy signal unless his call can pass successfully through all exchanges and then find a free line port.

In a dedicated network, even if all the line ports are being used, there is still no such thing as a busy signal—although there are delays for service during which, after the user has requested to be recognized, the processor does not respond for longer than he thinks it should. Especially on a multipoint line, the usage pattern for any terminal is not supposed to tie the line up for the others. Thus, in a dedicated network, everybody gets a chance for service whereas, on dialed lines, there is none for stations which cannot establish a connection in the first place.

3. *Terminal discipline.* The terminals in a dedicated network are usually under computer control rather than free running (which would prevent multipointing). Under computer control means that the processor will accept input from or deliver to the terminals only when it is ready and that it can stop either operation at any time without physically disconnecting. On a multipoint line, this control is necessary so that several terminals can be active at the same time. For example, if one terminal sends an inquiry, it may not get to hold onto the line while waiting for the response as the processor can poll another one in the meanwhile.

On dialed lines, the terminals are free running. They call when they want to send or are ready to receive, contending with each other for the transmission facilities and line ports. The processor accepts each request for a connection when it can service the interrupt. Once established, the terminal holds onto its line port for the duration of the transaction so that no other terminal can use it regardless of delays, and the only control the processor has over this is to physically break

the connection.

4. *Response time.* The overhead to establish a connection is considerable for dialed lines, perhaps a minute, including the time to dial 10 digits, switch through one or more exchanges, and go off-hook at the remote end. For dedicated lines, where the physical connection already exists, the overhead for processor polling and terminal response is only seconds.

However, in interactive or conversational applications, where the processor and terminal respond back and forth to one another a number of times during one transaction, this differential will begin to even out because, once the connection is established on a dialed line, the terminal can reach the processor almost immediately, whereas, on a dedicated line, the terminal must wait each time until it is polled. Especially on a multipoint line, the total waits could add up to more than a dialing time. In order to give everybody a chance for service, the processor usually implements a time slicing algorithm giving hogging terminals slower and slower responses the longer their transactions continue.

5. *Utilization.* Terminal utilization equals the average number of calls per unit of time multiplied by the average duration of each call including, of course, the time to establish the call, propagation delays, etc. A given line utilization equals the sum of the terminal utilization on that line (there is only one such utilization on a point-to-point line).

The rule is sometimes given that heavy utilization implies dedicated lines while light usage implies dialed ones in order, for instance, to reduce polling overhead at the processor. While generally true, the rule cannot be applied without weighing the other system requirements. For example, if

this heavy usage occurs only at noon and 3 p.m. then, viewed over the whole day, utilization may still be light enough for dialed lines to be cheaper. On the other hand, if the urgency of response time requirements during the two busy periods is high, then dedicated lines are needed after all. On the other hand, if . . .

The influence of utilization will appear in the following sections.

6. *Line cost.* The basic factors determining if the line cost of a dedicated network is less than a dialed one are the number of hours per day the lines are in use (given equal call distances, etc.) and which hours they are. This information is obtained from measuring current service and from traffic projections based on expected growth. If the hours in use go above a certain level then a dedicated hookup becomes cheaper than a dialed one because private lines are leased at a flat rate whereas each call made in Direct Distance Dialing is tolled separately. The exception is WATS lines, which are charged at a fixed rate regardless of how many calls are dialed. However, WATS is usually not justified for data communications alone but only for some combination of voice and data or voice alone. One limitation is that calls cannot be initiated from either end so that, if this feature is required, both an in-WATS and out-WATS trunk must be rented. Exact conditions and rates for all network types can be found in Western Union and Bell tariff schedules and in numerous survey articles on the subject.

In doing a cost analysis, a few other items to consider are:

a. Some combination of dialed and dedicated lines, although each requires the expense of its own interface at the processor.

b. The line saving options available

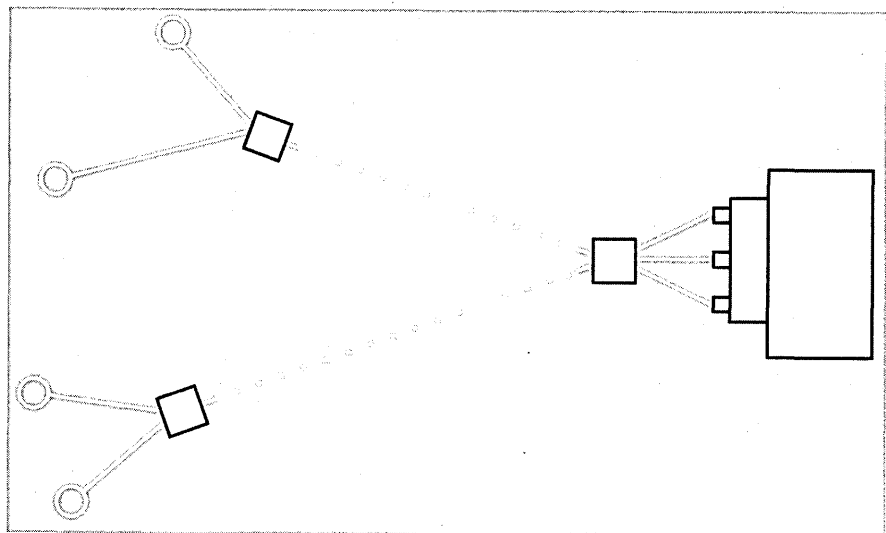

Fig. 2. Example of a switched network.

for dedicated networks (multipointing, multiplexing, concentration, etc.).

c. Terminals in the dialed network are generally cheaper than those on dedicated lines because they do not require hardware selector or poll recognition logic.

7. *The multipoint option.* Fig. 3 shows a scattered and a linear or clustered terminal distribution. Depending on other requirements, either distribution may be designed as dialed or dedicated. If dedicated, then a further option exists for the clustered distribution only: to create a multipoint hookup by allowing groups of terminals to share one line. Multipoint has already been discussed a number of times. Its purpose is to save the cost of a separate line for each terminal to the processor. It is only feasible when the sum of the individual terminal utilizations is kept quite low, since this sum becomes the utilization of the line. Another multipoint problem is that response time increases for each terminal added to the line because none will be polled until those ahead of it have received their share of service. In order to minimize response time, the line should be full duplex to eliminate modem turn-around time, the polling procedure should use minimum interplay, and the terminals should transmit at maximum line speed, which usually implies buffering. For Teletype terminals, the buffer can be a prepunched tape; for crt's, a screenfull of characters, correctly edited.

In summary, the factors that limit multipointing are terminal geography, utilization, and response time requirements.

8. *User supervisory options.* Dedicated networks provide more user options than dialed networks. For example, in a message-switching environment, each network has a "supervisor." This is a single terminal in the network assigned to monitor and control all of the other terminals through the computer (for a single network, the computer itself may be the supervisor). It can request from the computer the number of as yet undelivered messages for any terminal and, depending on this queue length, alternate-route further messages intended for that terminal to a different one. Or it can place on hold any terminal in the network, meaning that the computer will deliver no more messages to that terminal until the supervisor takes it off hold. Or it can retrieve any message sent or received by any terminal.

In a dialed network, on the other hand, all terminals have equal status. A supervisory terminal cannot command the functions listed above because any other terminal in the network has the option of dialing directly the terminal it wants to reach instead of dialing the

computer (through which the functions must be implemented).

9. *Privacy of the connection.* Privacy is an issue of being reached, and not of reaching. If a terminal is part of a dedicated network, it can be reached only by another terminal within that network. Thus it cannot be updated with data from a false source; likewise, it cannot respond to a request for data from such a source. On the other hand, if the terminal is part of a dialed network, it can be reached by any outsider with an insider's information, such as its dial digits and passwords. The general issue of privacy, or data security, is becoming more and more sensitive as large banks of personal information grow.

10. *Accessibility of the outside world.* Accessibility is the other side of the coin of privacy; it is an issue of reaching instead of being reached. If a terminal is part of the telephone network, it can call any other terminal which can be attached to that network. For example, it can call different computers, each of which may provide it with another set of services and programming languages. Also, connectivity between switched services is becoming available. For example, Western Union's Telex and TWX services, of about 60,000 and 40,000 terminals re-

spectively, can now intercommunicate.

Conversely, any terminal on a dedicated line can only reach the limited number of terminals within its own network.

11. *Backup.* Since the number of paths between any two members of the dialup network is essentially infinite (except for the local loops at both ends, which are fixed) line failure is not an issue—we just redial. But in a dedicated network, if a line fails then none of the terminals on it can reach the processor. Therefore, a dedicated or dialed backup usually has to be available anyway. A dialed backup does not change the dedicated nature of the line as far as establishing individual connections is concerned; the processor still polls, etc. If the failed line was full duplex in operation, two dialed backups are usually required for equal service because most are only half duplex (exception: Western Union's Broadband Exchange).

12. *Quality of the connection.* As the path between terminal and processor is always the same in a dedicated hookup, the quality of this path can be conditioned, reducing the frequency of "bad bits" due to a poor connection. On dialed lines, the switching path any call takes cannot be controlled. Therefore, the transmission quality of the

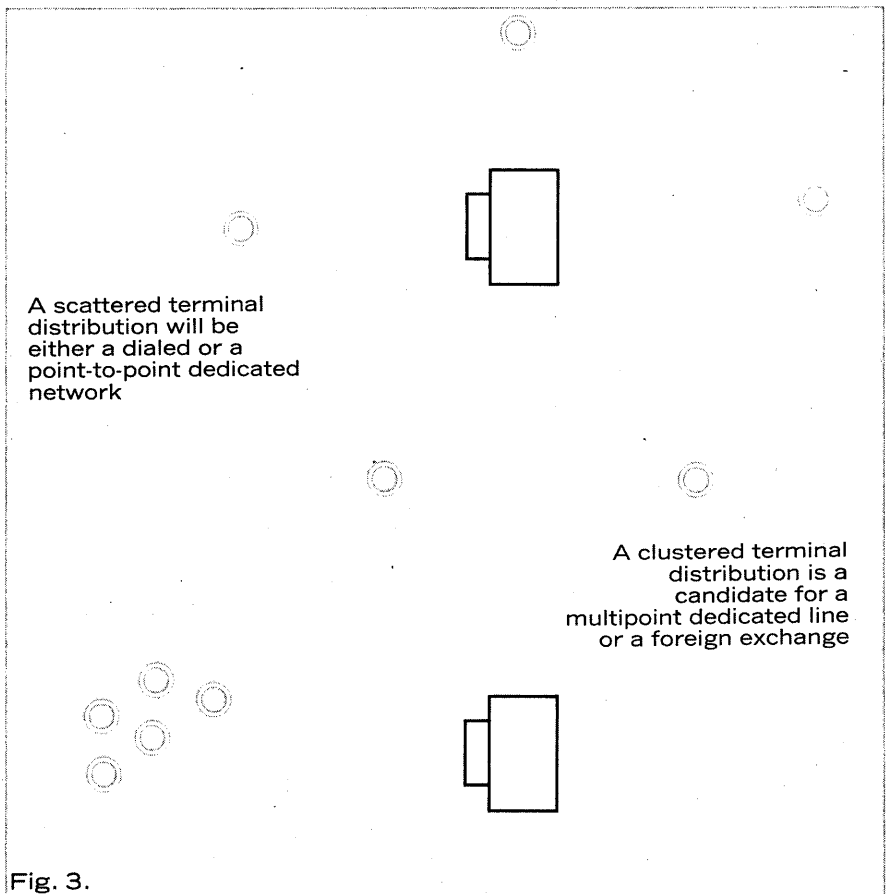

Trade-offs

call cannot be controlled either and the system designer must decide for himself how heavily to weigh this factor. However, to keep things in perspective, we should realize that the number of errors introduced by a poor connection is usually many times less than the number of human errors embedded in the data when it was originally prepared.

The greatest offender to the quality of dialed lines is usually the end office attached to the terminal, where ongoing connections are disturbed by nearby relay switching noise. It may be possible for the customer to bypass this weakest link by using the foreign exchange option whereby his terminal is attached to a different end office using modern equipment.

13. Line speed considerations. Dedicated and dialed connections are available in both low and high speed lines, including voice grade, and the distinctions made so far hold in any speed group. However, the drawbacks of switched lines become especially apparent as the baud rate goes up, with increased transmission errors, etc.

A specific distinction is in the error detection/correction software available for lines interfacing with a processor. When the software detects an errored character on a low speed asynchronous line, such as indicated by a missing stop bit, it usually replaces the character with a question mark. This is error flagging. On a high speed synchronous line, however, correction procedures are possible, the most common one being IBM's bi-sync protocol in which the whole block containing the bad character is retransmitted. Therefore, the number of errors after correction for a single high speed switched line may be lower than the number of errors for a comparable number of low speed dedicated lines.

Some network applications

The preceding discussion did not weight the differences and tradeoffs between the two networks in favor of one or the other. This weighting must be supplied by the communications analyst, depending upon the requirements of each application. The following examples will give some feeling for which kind of hookup is the more appropriate.

1. Dedicated. The well-known Bank Wire and SICOM Systems, serving the banking and securities industries respectively, give good examples of dedicated line requirements. Bank Wire passes financial transaction data among approximately 300 banks and SICOM passes orders and executions be-

tween approximately 500 brokerage houses and the NYSE and AMEX floors. Thus we see that both systems have a limited network of users, each with a high volume of traffic during certain periods of the day. Because of this, they require high availability of the line and a fast response time. Also, the quality of the connection must be good because of the financial nature of the transactions. The security requirement is another "private line" indicator. It should not be possible for someone to open a checking account and then, using his own terminal, to dial the bank and falsely increase the funds in it, which is theoretically possible in a switched environment.

2. Dialup. TWX and Telex are good examples of dialup systems. Each of the approximately 100,000 terminals in these networks can establish a connection to any other, which suggests some interesting applications. For example, a large potential market would exist if one of these terminals maintained a data base which the others might want to access, such as business information about companies or mailing lists of buyer types. In this case, the "one terminal" would no longer be a TWX or Telex station, but a computer set up to look like one to the network. Then any other Teletype terminal could dial the computer, request its information, and disconnect. When ready, the computer would dial out and deliver. Or, in another design, a single connection could be maintained from start of inquiry to end of response.

Such an application is suited to dial-up connections because there is a very large network to accommodate, the expected usage of any given terminal is low, security requirements are moderate, and so on.

3. Multipoint. On-campus time-sharing Teletype terminals provide a typical multipoint example. In this application, a number of Teletype terminals are located around campus, all feeding into a remote computer. Generally, they are used for engineering problems, having a relatively short input to long execute time. In order to save line cost to the computer, groups of terminals are attached to the same line. Then, in normal operation, a student at terminal A enters his program and, while it is being executed, the processor polls terminal B on the same line, etc. In this way it keeps all the terminals going at once. As the problems are solved, the processor selects the proper terminals for delivery of the answers. Obviously, if there are four terminals on a line, any one will have longer delays than if it stood all alone. If any student uses more than his share of input time, the processor will lock that keyboard until the others on the line

have been polled. If any program uses more than its share of execute time, the processor will delay completing it until shorter runs have finished. Thus proper discipline is required to ensure that everybody gets a fair chance.

4. Exceptional Applications. Occasionally the literature refers to polling over the switched network or to dialing over dedicated lines. The following application types are meant.

In the former case, suppose a user has send-only terminals remote from his computer which may or may not require processing (and these terminals are not equipped to contact the computer when they do). At certain times during the day, the computer dials out to these terminals and, if they have nothing to send, they are set up *not* to answer, thus saving the network communications costs. After, say, three rings, the processor drops its attempt to reach a terminal and tries to reach the next one on its list. In this sense, the processor "polls" terminals over the switched network.

The latter case, dialing over a dedicated line, refers to a caller who does not want his attempts to reach remote terminals traversing all the intermediate exchanges. Therefore, he leases a dedicated line between his processor and an exchange close to those terminals. This foreign exchange (foreign because it is not the one to which his processor would normally be connected) is then reached by dialing over the dedicated line. This arrangement eliminates long distance trunk busy and dial signaling delays, improves transmission error rates, and so on, but, of course, at the cost of a leased line.

In conclusion, we can say that selection of transmission needs, like all other aspects of computerized communications, is an evolving art. □

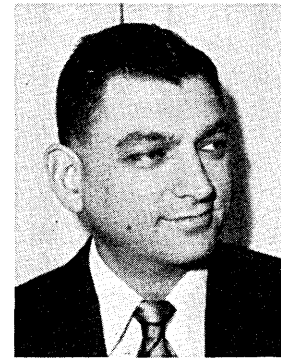

Mr. Fidlow is a senior systems analyst with Teleprocessing Industries, Inc., the information services subsidiary of Western Union Corp. He took part in the development of the nationwide system for such services as Telex and TWX. He has a master's degree in mathematics and was a faculty member in computer science at the Newark College of Engineering.

Perils faced and lessons learned
from an encounter
with communications-level programming

Communications Protocols: The Search for SYN

by Philip G. Stein

One of the sad truths data communications users discover when they implement new systems, or upgrade existing ones, is that terminals which speak the same language aren't automatically able to talk to each other. Besides using a common message code, like ASCII, they must also use a common communications protocol.

Almost always, some user programming is required to implement this protocol. The amount of time and effort you invest depends largely on how you approach the job. Recently, for example, I spent three months, including many evenings and weekends, developing a common communications protocol for one system only to discover that, by starting out differently, I could have done the job far quicker and with much less anguish.

The system I worked on consists essentially of a large, multitask, batch computer, a minicomputer used as a data concentrator and supplied by a different manufacturer, and eight data sets. Each of these components was installed at a different agency (the names of the agencies and the suppliers are being withheld for reasons that will become clear before this tale is ended). Users of the system access the computer through touchtone telephones which can dial up the data sets. The basic function of the data concentrator is to check the format of, and assemble, each incoming data stream into complete messages. A buffer in the mini's main memory gradually fills up with these messages and, at a certain point, they have to be sent to the large batch machine. The former chore—message checking and assembly—was very easy to program and get working. The latter chore—transmitting messages from the mini to the maxi—was where the trouble occurred.

This system, like many others, uses a serial data transmission scheme. A sequence of binary ones and zeroes, representing each character, travels back and forth between the concentrator and the host computer. At the trans-

mitting end, characters (say six or seven bits at a clip) are disassembled bit by bit, and shipped down the wire. At the receiving end, the bits are re-grouped into characters.

When the system isn't transmitting data, it's "idle," i.e., a continuous stream of binary ones appears to be on the line. To differentiate these idle bits from data bits, some rules are needed; they comprise part of a "communications protocol." If two terminals use different protocols, they are clearly going to have trouble talking to each other.

In an *asynchronous* communications system, each discrete character is preceded by a binary zero, called the *start bit*, and is terminated by one or two binary ones (*stop bits*). Thus, whenever an asynchronous terminal receives a zero after a string of ones, it knows that what follows is a character. The number of character bits is determined by the message code. In ASCII, for example, each character consists of seven bits. Following this group comes an eighth, parity checking bit which, when compared with the binary sum of the preceding seven, can be used to detect errors.

An asynchronous receiving terminal is programmed to handle the eight bits following a transition from "idle" to "data" mode as data/parity codes rather than as start/stop bits, and so ones and zeroes are useable for both sets of functions. Once these bits have been received, the terminal reads the next bit. If it's a binary one—i.e., a "proper" stop bit—the receiving circuitry returns to idle mode until it senses a binary zero. The whole process is then repeated.

If there is no stop bit, due to some transmission error, the following characters may be garbled and may (or may not) produce a parity error. No provision is made in the protocol for recovery of these errors. It's up to the applications programmer.

Most low-speed keyboard-printers and keyboard crt's use asynchronous

communications, as did the message sources in the system I programmed.

The asynchronous scheme is limited because it wastes lots of time on start bits, stop bits, and idle lines. If a whole block of data is available to send, as it was when our mini had to talk to the batch system, it pays to synchronize the transmitting and receiving ends once, at the beginning of a transmission, and then to send the data without any extra bits at all. To do this, a protocol is defined in both receiving and transmitting machines. The protocol I had to follow is typical, and conforms to some extent with the ASCII standard. The names used here for the various control codes are the ASCII designations.

Synchronization is achieved by having the transmitting station send a series of SYN characters. (It doesn't matter here what the actual binary pattern of the SYN is—as long as the receiving station can recognize it.) The receiving machine watches the line and, each time a new *bit* comes along, a new character is formed consisting of that new bit and the seven preceding it. When a match is discovered between the predefined SYN character and the character made up of the last eight bits received, the hardware decides that synchronization has been achieved. The *next eight* bits are then treated as a character and again compared to SYN. If they are a SYN, then the decision is confirmed. If they are not, the SYN pattern on the line was an accident and the search for SYN is resumed.

A protocol is more complicated than this, however. Our system had only one wire between computers, so we could only use it one way at a time. In the beginning, both machines would listen. If one wanted to transmit, it would first ask the other for permission. This happens as follows:

```
SYN SYN SYN ENQ . . . . . (The  
dots are a trailing character, actual data is not important.)
```

The transmitting machine then stops and listens. As a wise man later advised

sequence at the end of every card image in the example shown above, but we found that out by reading the software line-by-line and figuring out what was expected.

Since we were in fact trying to simulate a remote batch job entry terminal for the large system with our minicomputer, the protocol had already been completely designed and we couldn't make any changes. The responsibility for compatibility was 100% in our hands.

If you are lucky when you specify a data communications system, you will be able to exercise some control over the program at each end of the line. This is sure to make matters easier even if you have a more cooperative working arrangement with the sites at both ends of the line. As usual, good systems planning at the beginning makes the job much easier at every stage.

Have a communications expert in on the planning from the beginning; it may be possible to make his life happier without compromising system goals.

Be sure your protocols are completely defined, and that they are fully understood by both the software and hardware people responsible for the equipment at both ends of the line. If you don't design the protocol (as I didn't), make doubly sure that you have a complete written description of it (as I didn't).

Be sure that both of your stations talk the same language (code).

Adhere strictly to standards such as ASCII, including the use of control characters as their meanings are intended.

Reserve a block of time when your friends and family won't mind your absence too much.



Mr. Stein is automation consultant for the Office of Measurement Services, National Bureau of Standards. He specializes in the application of computers to problems in precision measurements and is co-author of an undergraduate textbook on architecture and assembly-language programming. He has an AB from Columbia College and an MS from George Washington Univ.



**WE SOLD W. F. DARNELL
\$7000 WORTH OF DYNAPUNCHES
HE'S SAVING \$5500 WITH THEM
EVERY MONTH**

W. F. Darnell is the Vice President and General Manager of High's Dairy Products, a division of Capitol Milk Producers Cooperative, Inc. in Laurel, Md. He has to watch over 200 separate installations. And he has to get field input data from them. Which, for Darnell, was one heck of a problem. He checked out all the alternative systems... then he adopted ours.

Ours proved to be the simplest, with reliability in the bargain. Consider this: Dynapunch utilizes an advanced pre-perforated card concept that is perfectly suited for any standard tab card reader. These cards are readily available. *Anyone* can learn how to use Dynapunch. Anytime. Anywhere.

There is a full range of Dynapunches, all of which are based on a new patented principle involving highly reliable manual punching. The complete line includes:

- **Dynapunch Series 50** for exam processing, and other single card applications.
- **Dynapunch Series 100** for order processing at chain stores.
- **Dynapunch Series 200** (like Darnell's) for inventory control, doctor/medical billing systems, meter reading and all applications where a large number of cards are punched in one location.
- **Dynapunch Series 300** for survey-type situations and sales/marketing reports.

They're all money-makers. And they're real stingy when it comes to protecting your budget. W. F. Darnell will agree to that. He figures he can't afford to be without Dynapunch.

Can you afford not to look into it?

Dynapunch Systems, Inc.
999 N. Sepulveda Boulevard
El Segundo, California 90245
Telephone (213) 640-1016

DYNAPUNCH

Gentlemen:

Tell me more about the Stingy Ones. Send detailed information on the Dynapunch line to

Name _____ Title _____

Company _____

Address _____

City & State _____ Zip _____

Telephone No. _____

CIRCLE 85 ON READER CARD

The Lawrence Livermore Laboratory's
awesome collection of hardware, organized
and connected to serve some thousand users

The Octopus Computer Network

by John G. Fletcher

This paper is a description of the Octopus computer network at the Lawrence Livermore Laboratory of the University of California (LLL).^{*} It is intended that additional papers will follow describing certain aspects of the network in more detail.

Why should anyone outside of LLL be interested in the Octopus network? There are at least two reasons. First, the network consists of one of the largest concentrations of computing power and information storage capacity in the world; while other systems may possess capabilities similar to those at LLL, those capabilities usually have not been implemented on the same scale. Second, the experience at LLL has led to conclusions that in many ways differ from attitudes that seem to be most prevalent in the current literature. Thus, knowledge of that experience should be helpful in evaluating those attitudes.

The Lawrence Livermore Laboratory is operated by the University of California under a contract from the United States Atomic Energy Commission (AEC). It is engaged in research and development in various disciplines, including explosives, controlled ther-

^{*}Work performed under the auspices of the U.S. Atomic Energy Commission.

monuclear reaction, and biomedicine. Actual experimentation and testing, particularly in the case of nuclear explosives, is often quite expensive, time-consuming, and heavily involved with political and legal considerations. Therefore, it is desirable that as much work as possible be done by simulation on large digital computers. To fill this need, LLL has acquired a considerable inventory of computer hardware.

Hardware

The LLL computer hardware is always in a state of more or less constant change. Faster and larger-capacity equipment is acquired as it becomes available, replacing older, slower, and smaller equipment. For example, new large computers arrive at intervals of about 12 to 18 months. In many cases (such as the CDC 6600 and 7600), LLL has been the purchaser of the first machine of a new kind.

At the present time, LLL has eight major processors: a Xerox Sigma 7, two DEC PDP-10s, two CDC 6600s, and three CDC 7600s. A CDC STAR-100 is on order. Each of these machines has, associated with it, on-line I/O equipment (e.g., tape transports, impact printers, film output), primary (core)

storage averaging about 16 million bits per processor, and secondary (rotating) storage averaging about 5 billion bits per processor and having transfer rates up to 34 MHz. In addition to these major processors, there are many smaller processors, chiefly DEC PDP-8s and PDP-11s, but also others of various manufacture.

Supplementing the processors and their immediately associated peripherals are a number of other facilities shared among the processors by means of the network described below. These facilities include an IBM Data Cell (over 3×10^9 bits) and an IBM Photodigital Store (over 10^{12} bits). There are also assorted interactive terminals (including Teletype units, television monitors, and Evans and Sutherland LBS-1 displays), an ultra-high-speed printer (currently off-line) that operates at 30,000 lines per minute, and a microfilm recorder (currently off-line).

This brief listing of LLL computer hardware raises certain questions:

1. Why does LLL need so much big, fast equipment? We need it because the scientific personnel of the laboratory can usefully employ it in accelerating their work and improving its quality.

Much of the calculation done consists of large numerical programs that solve partial differential equations by finite difference, Monte Carlo, or other such techniques. Typical problems will run several hours on a 7600, producing the equivalent of about 10 complete tape reels of output, which is then edited into a stack of printouts several inches thick. Astonishing as some may find it, the responsible scientist actually is interested in the result and benefits from scanning it.

2. Why does LLL buy from so many different manufacturers? We do this because whichever manufacturer builds the best (most capacity per dollar) hardware depends upon the kind of hardware and its purpose. The advantages of using a uniform brand of equipment are outweighed by the advantages of flexibility.

The network

We realized some years ago that the growing inventory of hardware could be best utilized if most of it were interconnected in some way. The benefits were chiefly in four categories:

1. All remote terminals, both interactive (such as Teletype terminals) and noninteractive (such as line printers), could communicate with all the major computers; there would not be one set of terminals for use with one computer, another set for use with a second computer, etc.

2. All major computers could use unique equipment (for example, the ultra-high-speed printer and the Photodigital Store).

3. A single data base could be shared among the major computers, eliminating the need for multiple copies and/or manual transport of information.

4. More sophisticated forms of cooperation among the major computers would be possible, such as their working jointly on a single problem.

Thus was born the concept of the Octopus network.

As the name implies, the original conception of Octopus was of a single, moderately large computer (the "head") that would manage the information flow among its "tentacles," namely, the large computers ("workers") that execute user programs, the remote terminals, and the central storage devices. One important thing that has been learned is that this was a bad idea. Such a scheme makes the network excessively vulnerable to difficulties with a single component, the head. The likelihood of difficulties with the head is increased by the fact that each new kind of equipment must be attached to it, necessitating a period of hardware and software debug and shakedown. The disruption caused by a single addition to the network might thus affect all existing components.

The present design of Octopus is more complex and decentralized. (See Fig. 1.) It is a superposition of several subnetworks, each having a specific function (or functions). A typical one of these subnetworks consists of a small computer called a "concentrator," which is the head of the subnetwork. The concentrator is joined to each of the large worker computers and also to whatever I/O gear, terminals, or storage devices are appropriate to the function of the subnetwork. In practice, each of the subnetworks departs in some ways from this typical plan, but the basic idea is maintained. Present subnetworks include the file transport network (for moving files among the worker computers and between those computers and the central storage facility), the teletypewriter network, and the remote I/O network (for operating remote card readers and line printers).

The interfaces that join the various components of Octopus are designed, installed, and maintained by LLL engineers. One reason for not relying on computer or peripheral manufacturers to provide this equipment is that we have found that they are not at their best when interfacing their own equipment to that of another manufacturer.

Another reason is that in-house engineers are more willing to tailor their designs to software needs and to make changes in those designs as experience suggests the possibility of improved performance. Most importantly, in-house design provides for a degree of uniformity throughout the network, which largely overcomes the difficulties arising from the use of equipment made by various manufacturers.

Each new concentrator added to the network is provided with a multichannel bit-parallel interface (or sometimes several interfaces transferring at about 10 MHz.) These interfaces are called either "adaptors" or "line units" (for obscure reasons). They communicate with one another by an LLL standard protocol. Thus the interface on a new concentrator can be plugged into an unused channel of the appropriate adaptor or line unit on each of the worker computers and, with minimum disruption, can become part of the network. The connections between the concentrators and remote terminals are LLL-designed serial interfaces, either asynchronous (for example, to Teletype terminals) or synchronous (for example, to remote printer/card reader stations), as appropriate.

The present Octopus organization,



Some of the equipment at the Lawrence Livermore Laboratory computer complex: right center (with window) is part of the photodigital storage unit, left center are eight disc drives controlled by a PDP-10, behind the teletypewriters, and to the right are PDP-10 memories, PDP-8 concentrators, and assorted interfaces, including those for other computers in the network.

Octopus

just described, has proven quite satisfactory and flexible. Adding a component identical with an existing one usually requires no changes except the making of new entries into some software tables. On the other hand, an entirely new facility is first brought up and debugged off-line. It is next attached to one worker and the communication link is debugged; any disruption this occasions is thus limited to a single worker. When all is satisfactory, the new facility is then fully joined to the network.

Worker computers

The worker computers execute programs selected (and very often written) by the network users, who are scientific, clerical, and administrative personnel of LLL. The computing needs of these users are quite eclectic, involving not only numerical calculation, but also program generation, information retrieval, editing, etc. Accordingly, the worker computers (and the entire network) are organized essentially as a computer utility. The user

may run any program that is available to him, and his behavior is predictable only statistically. The worker operating systems are designed for time-shared interactive use, together with a batch-like facility used mainly at night. (We assume that the advantages of interactive computing are so obvious as to require no justification here.)

At LLL a clear distinction is always maintained between "system" programs and "user" programs. System programs include all programs outside the worker computers and those programs in the worker computers that operate with special privileges. The functions of system programs are to store, locate, and retrieve files; direct the flow of messages through the network; schedule the execution of, allocate storage for, and treat the requests of, user programs; manipulate i/o devices; and handle accounting and security matters. In short, they do anything that, if a user program were allowed to do it, could gain special privilege for the user and/or disturb other users.

User programs run only under the limitations allowed by the system programs and are restricted in the core they can access and in the instructions they can execute. Any requests they

make to the operating system (for file access, i/o, etc.) are never trusted and are checked for legality. The integrity of the system is not based upon any assumptions about the kinds of programs that the user will choose to run or about his degree of ignorance regarding how the system operates. Adherence to these rather obvious principles solves the software security problem. It should be noted that certain programs (called "utility" programs) that are often thought of as being system programs—such as compilers, interpreters, editors, information retrievers, and debuggers—are, in fact, user programs, although they are often written by the same people who write system programs.

The worker computers in the Octopus network consist of a CDC 6600 and all three 7600s. The Sigma 7 is soon to be added, while the other 6600 is, for various reasons, stand-alone. As is discussed below, the functions assigned the two PDP-10s are quite varied and include the worker function.

Interaction

A user communicates with the workers through interactive terminals. With appropriate input, he selects the programs he wishes to run and supplies directives and (perhaps) data to those programs. Anything he wishes to do (calculate, compile, manipulate files, etc.) is done through the agency of a suitable user program, and there are simple rules that distinguish messages intended for an executing user program from those intended for a worker operating system. The interaction might be viewed as acting on three levels: the user, the user program, the system. In many cases, an input from the user is interpreted by his program, which then generates a request to the system to perform the desired activity. While the format of the system request is necessarily standardized and rigid, the format typed at the terminal depends upon the design of the user program and is infinitely flexible.

Currently, most interactive terminals are Teletype Model 33s. The teletypewriter network has four concentrators. Each concentrator is a PDP-8 (or PDP-8L) with 8K of core that multiplexes 128 Teletype terminals. About 400 of the 512 Teletype terminals thus provided for are in use.

The teletypewriter network operates in store-and-forward mode. A concentrator collects an input message character by character until it is complete and then forwards it to the appropriate worker. (A complete input message is in most cases the same as a single typed line.) Similarly, entire output messages are accepted from the workers and then printed character by character. The teletypewriters operate full duplex;

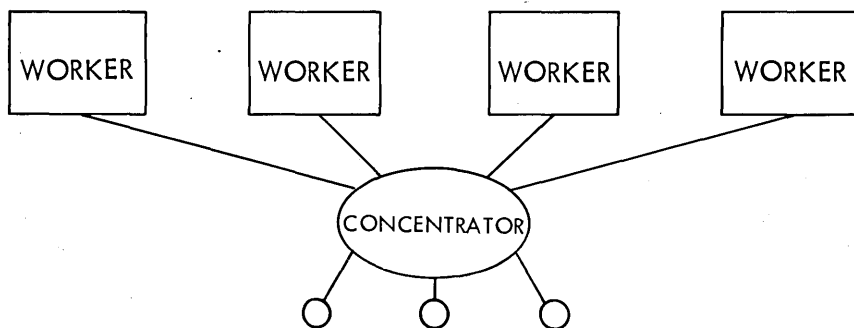

Terminals, I/O, and storage
(a)

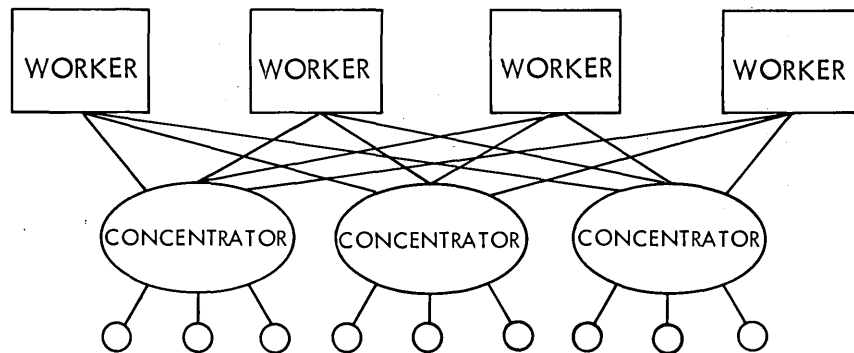

Terminals, I/O, and storage
(b)

Fig. 1. (a) A typical Octopus subnetwork. (b) The complete Octopus network, composed of superposed subnetworks (only three of which are shown).

input is printed only because it is "echoed" by the concentrator. The user can begin typing while output is in progress, in which case the echoing is delayed until the output finishes; in the same way, output that arrives while input is taking place is held and then printed after the input is complete. Erroneously typed input may be corrected (before the message is ended) by canceling single characters or an entire message.

Since worker computers do not know of an input message until it is complete, a user cannot interact character by character with a worker program. While undoubtedly there are many situations in which such interaction is valuable, we decided that those situations are not numerous enough and/or the performance improvement not great enough to justify the added burden on the system. Character-by-character interaction would increase message-handling activity manyfold and therefore would impair other service and perhaps require investment in additional message-handling facilities.

A second interactive terminal network is just now being put into use: KIDS (keyboard interactive display system). The concentrator is a PDP-11/45. Each of the terminals, which are built to ILL specifications, consists of a keyboard for input, a character and vector generator to convert output into a raster (which is stored on a scan converter and then used to refresh a monitor), and a joy-stick for positioning a cursor. Operation, except for cursor movement, is full duplex. This network will offer services beyond those of the teletypewriter network, including greater speed, vector as well as character output, and more comprehensive local text-editing. The initial order is for 48 terminals.

The two interactive terminal networks have connections to one another and to other subnetworks in such a way that there are always at least two paths from a given concentrator to a given worker; this reduces vulnerability to hardware failure. Each input or output message includes an Octopus standard heading that gives source, destination, and other information about the message.

It is also a network standard that all characters be represented as ASCII contained in 8-bit bytes. ASCII is used not only for communication but also for storage, since there seems no reason whatsoever to pay for software or hardware conversion or to suffer from the confusion of multiple codes. ASCII was chosen because LLL assumes that government and industry mean what they say when they define a standard; it would be unfortunate if this view were naive. The 8-bit unit was chosen on the basis of the laboratory's esti-

mate that the trend toward computer word sizes divisible by eight will continue. Of course, certain older items of hardware do not use ASCII and must be serviced by software conversion, but these devices are being gradually phased out.

Files

By "file" is meant a quantity of information kept by the system for a user and known to that user by a symbolic name. All editing and information retrieval operations accessing portions of files are done by user programs rather than by system programs. However, files are located, stored, and retrieved by the system in response to requests of user programs. In considering such a request, the system will look for the symbolic name only in lists of files private to the requesting user, files shared by that user and other users (by mutual consent), or public files available to all users; this it is impossible for a user even to describe to the system a file to which he has no right.

Each worker computer has its own filing system separate from the central "Elephant" filing system. The Elephant system is managed by one of the PDP-10 computers, and the Elephant files are kept on the rotating storage of that PDP-10 as well as on the Data Cell and the trillion-bit photostore.

The recording medium for the photostore is ordinary silver halide film.¹ Thus the storage is nonerasable and

archival. Each piece of film (called a "chip") measures about 1½ by 3 in. and holds about 5 x 10⁶ bits. The chips are kept in small plastic boxes (called "cells"). There are 32 chips per cell and nearly 7000 cells in the photostore, giving a grand total of over 10¹² bits on-line. The photostore includes facilities for writing on the chips (with an electron gun), developing the chips, moving the cells pneumatically to and from the storage area, and reading the chips with a "flying spot," all under computer control.

The PDP-10 is the concentrator of the file transport network. Requests for file movement or for other operations involving Elephant files are sent to the PDP-10 from the workers, either directly from their operating systems or via those systems from user programs. (These request messages and the replies to them are routed through the interactive terminal networks.) The PDP-10 queues these requests on the basis of algorithms intended to optimize the use of the Elephant storage media. When it is the appropriate time to move (a copy of) a file to or from a given worker, the PDP-10 enlists the aid of the operating system of that worker, and the transport takes place over the high-speed bit-parallel interfaces of the file transport network. The PDP-10 uses high-speed head-per-track rotating storage and very large core buffers to reduce the effects of the varied latencies and transfer rates of the storage media

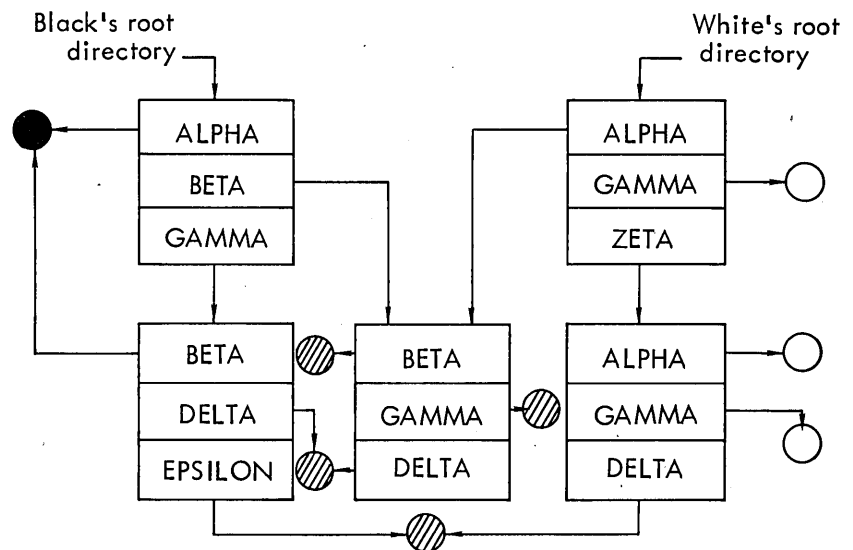

Fig. 2. Schematic representation of a file directory structure for two users (Black and White). Each rectangle represents a directory containing three entries. Each entry associates a symbolic name with a pointer to a file, which may be either another directory or a simple file, represented by a circle. Note that the directories on the left and right of the figure are private to Black and White, respectively, whereas the one in the middle is shared. Private data files are represented by black or white circles; shared data files are represented by shaded circles. Note that the same symbolic name may appear in different directories referring to different files, while the same file may be listed in two directories under different names.

¹ Kuehler, J. D., and Kerby, H. R., "A Photo-Digital Mass Storage System." *Proc. AFIPS*

Octopus

in the network.

The Elephant system is organized around a directory structure similar to that used in the MULTICS system.² A directory is a special kind of file consisting of a number of entries; each entry associates a symbolic name with a pointer that locates the named file in Elephant storage. Since the file named by an entry in one directory may be another directory, a tree-like (more accurately, directed graph) structure is generated; the terminal nodes of this structure are simple (program or data) files. (See Fig. 2.) The files accessible to a given user are those that can be reached by a path through this structure starting at a particular directory, that user's "root directory." Means are provided for users to give pointers to parts of their structures to other users; this provides for very general and flexible file-sharing arrangements. This flexibility is enhanced by the fact that the kinds of access that may be made to a file can be a function of the path taken through the structure to access that file; for example, one user may have full access to a file, while another user can only read it but not write into it.

The PDP-10 is quite a bit larger than the other concentrators in the Octopus network. For economic reasons, therefore, it has been given a few functions other than central file management, even though this violates the ideal of one function per subnetwork. The PDP-10 manages a system of disc-refreshed output displays (not associated with keyboards) called the TMDS (television monitor display system). Control messages and data for the TMDS are moved either by the file transport network or by one of the interactive terminals networks, depending upon the quantity of information involved. User programs requiring a TMDS monitor must first send a request to the PDP-10 specifying the monitor desired. There are more monitors than there are refresh channels on the disc; PDP-10 software must allocate a disc channel and then operate a 16 x 128 (soon to be 32 x 128) crossbar switch to attach the channel to the monitor.

The second PDP-10 processor was originally intended as a spare and for use in engineering checkout of new equipment. However, it now also functions to operate the high-performance Evans and Sutherland LDS-1 (two-terminal) display, which is designed to interact with a PDP-10. This has re-

quired that the PDP-10 become in effect a worker computer with a time-shared interactive operating system. Actually, the two PDP-10s operate as a dual-processor computer, sharing a common memory and common software, although each processor has different duties.

Data collection

A PDP-8L serves as concentrator for the data-collection network. It is attached via asynchronous serial lines to other, remotely-located, small computers, each of which controls and monitors one or more experiments. Real-time data collected from these experiments is sent to the concentrator, from which it is relayed to the PDP-10 for storage in the Elephant filing system. Data may also move in the other direction. This network is joined only to the PDP-10 and not directly to the other workers; collected data can be moved to the workers by means of the file transport facility.

Remote I/O

The somewhat-inaccurately named remote job entry terminal (RJET) network uses a pair of PDP-11/20s as a concentrator. (An earlier acronym, RIOT—remote I/O terminal—met official opposition.) One of the PDP-11s is attached to the workers, and the other is attached to the remote terminals; the two PDP-11s are intimately joined, both in hardware and in software. A remote terminal is a PDP-8L computer that operates a line printer and a card reader. The connection from the concentrator to the remote PDP-8L is by a 4800-Hz synchronous line. Communication over this line conforms to ASCII communication control protocol. Input and output over this network are to and from files.

High-speed output

Hardware now on order will bring the ultra-high-speed printing facility (currently off-line) into the Octopus network. The new computer hardcopy output recording system (CHORS) subnetwork will include not only a pair of 15,000-line-per-minute nonimpact printers with graphical as well as character capability but also the microfilm recorder (currently off-line).

It seems clear that the future will see still more facilities added to the network, as dictated by growing need and technological advance. The flexibility of the Octopus is such that it should be able to accommodate all foreseeable additions. Ideas now being considered include a centralized (perhaps mechanized) magnetic tape facility and the acquisition of a 10¹³ (or more) bit store.

Atomic Energy Commission regulations are very fussy about "need-to-

know," a concept essentially the same as privacy. That is, even though all LLL employees have passed a federal security check, each employee is permitted to access only that classified information necessary to his work. Thus, Octopus must see to it that each piece of information in the network is available only to the user (or users) authorized to access it. It should be clear that this is not difficult in view of treatment of user programs and of file access, as described above. The LLL system programmers generally are puzzled by the view that there is a serious "problem" in regard to software security. The only real difficulty, as in all programming, is the possibility of careless oversights and coding errors.

One issue not yet discussed is that of how the Octopus knows which user is using a given interactive terminal. The user of course "tells" the system by typing his "name" when he logs in. (His "name" is actually his six-digit employee number.) But how can the system be sure that it is not someone else typing the "name"? The user must also type a six-letter combination (or password) known only to him and the system. The concentrators do not echo the combination when it is typed, so it is not visible on a screen or teletypewriter paper. In fact, the user is forbidden (by government regulation) to write down his combination or to reveal it to another. Currently, each worker computer must keep a list of all combinations. In the near future a special (PDP-11/20) computer will be added to the network to do all verification of combinations; at that time it will become the only repository of the combinations.

Software

All the system programs and most of the utility programs used are written at LLL. In particular, all operating systems are LLL-designed and maintained. There are at least four reasons for this:

1. In some cases, LLL has obtained a computer and put it into use before the manufacturer has had time to create sufficient software. The CDC 6600 is a notable example.

2. Commercially supplied software does not exist for many of the needs at LLL. The small network concentrators are engaged in specialized tasks not foreseen by their manufacturers. In the case of the larger computers, the standard operating systems are ill-prepared for network connections, directory-oriented filing systems, and other unusual facilities.

3. The security and privacy offered by standard software systems do not appear to meet AEC standards. As remarked above, the reason for this situation is a mystery.

4. It is much easier to innovate and

² Daley, R. C., and Neumann, P. G., "A General-Purpose Filing System for Secondary Storage," *Proc. AFIPS 1965 FJCC*, Vol. 27, pp. 213-229.

to develop new facilities suitable to LLL needs when not constrained by formats and protocols designed for other purposes.

There is, of course, the serious disadvantage that it is difficult to import and export programs. This problem should not lead to the conclusion that every operating system must be the same, since further development in system design would then surely stagnate. Perhaps the best hope lies in creating standard formats for requests to operating systems, although even this has the danger of freezing the state of the art.

To design and implement its software, LLL maintains a staff of about 30 system programmers. The same people do design and implementation; there is not a two-level structure of analysts and programmers. The laboratory has apparently decided that a system programmer who has to have everything charted out for him requires more input effort than he yields in output, while the designer who does not program resembles a mathematician who does not add. Typically, a programming group faced with a new machine to program breaks the job into as many parts as there are programmers. Small computers are usually programmed entirely by one person. Arguments that this approach should not work must contend with the fact that it does.

The CDC computer systems at LLL all have been programmed in an LLL-designed, FORTRAN-derived language called LLLTRAN³, which has facilities and power comparable to PL/I. The other computers, including all the concentrators, have been programmed in assembly language. The choice between higher- and lower-level language has usually been based on the personal preferences of programmers. In spite of allegations in the current literature, LLL experience does not justify the view that the systems written in assembly language are somehow inferior. There is no evidence to suggest that they took longer to write, are more prone to error, or are more difficult to follow than if they had been written in another language.

Similar remarks can be made about another controversy now raging: the "go-to" issue. Until the question first appeared in the literature, it apparently never occurred to anyone at LLL that there might be something "wrong" with the go-to construction; and, now that the question has appeared, there is nothing in LLL experience to support the view that the go-to does lead to difficulty. No one can deny that go-to's can create problems for compiler de-

signers and property-of-program provers. However, the contention that they lead to error and make programs difficult to understand and debug is a personal judgment that reflects more on the quality of programmers than on anything else.

Users

This exposition would be less than candid if it suggested that the thousand or so LLL users are uniformly ecstatic over the Octopus system. The fact is that, even at LLL, resources are limited. Therefore, when it has been decided to do one thing for the users, it quite often means that it becomes difficult or impossible to do another thing that some users would like to have done. For example, one cannot keep adding new facilities and at the same time not require the user to learn new ways of doing things. One cannot create complex, time-shared networks and completely preserve that intimate, "hands-on" feeling. One cannot offer hundreds of users the ability to output changing pictures at movie speeds without everything else grinding to a halt. And so forth. The best gauge of the success of the network is probably that no addition to it has ever been removed so that the older way of doing things could be reinstated.

Acknowledgments. Although the present author has done his fair share in designing and implementing Octopus, he is now playing the role of Boswell. There are so many people who have contributed to the development of the system over the years that it would be dangerous to select a few for special mention. I will therefore name only Dr. Sidney Fernbach, the head of the LLL Computation Department, who somehow has held the whole thing together for nearly a decade. □



Dr. Fletcher is the leader of the Lawrence Livermore Laboratory Computation Department's network group, which designs and implements the software for Octopus concentrators. He is also a lecturer in applied science at the University of California, Davis. He has a PhD in physics from Princeton University.

³ Mendicino, S. F., Hughes, R. A., Martin, J. T., McMahon, F. H., Ranellietti, J. E., and Zwakenberg, R. G., "The LLLTRAN Compiler." *Comm. ACM* 11, November, 1968, pp. 747-755.

COMPUTE BOUND?

DON'T buy an expensive new computer.

DON'T re-program for a new computer.

DON'T buy new peripherals for a new computer.

DON'T retrain your people.

DO add our peripheral floating-point hardware. By substituting our FP S/W drivers, the only way you know we're there is you now do in one shift what used to take three!

Interfaces available for popular 12, 16, 18 and 24-bit computers. This month's feature — Honeywell's H 316.

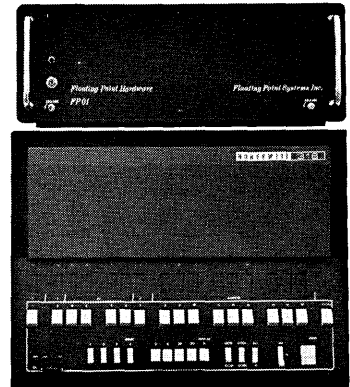

Floating Point Systems Inc.

Dear FPS, 3160 SW 87th
Portland, Ore. 97225:

Our _____ Computer,
model _____, gives
me this problem: _____

Name: _____

Title: _____ M. Sta. _____

Company: _____

Street: _____

City: _____

State: _____ Zip _____

For Info Call:
FPS, Inc. 503/297-3318
TELEX: 36-0470

CIRCLE 83 ON READER CARD

FORECASTING

PRODUCTION CONTROL

TELEMETRY DATA

TESTING AND CHECKOUT

DATA ACQUISITION

MESSAGE SWITCHING

DATA COLLECTION

PROCESS CONTROL

SIMULATION

LABORATORY DATA

NUMERICAL CONTROL

PAYROLL

INVENTORY CONTROL

ACCOUNTS RECEIVABLE

HOSPITAL ACCOUNTING

PATIENT RECORDS

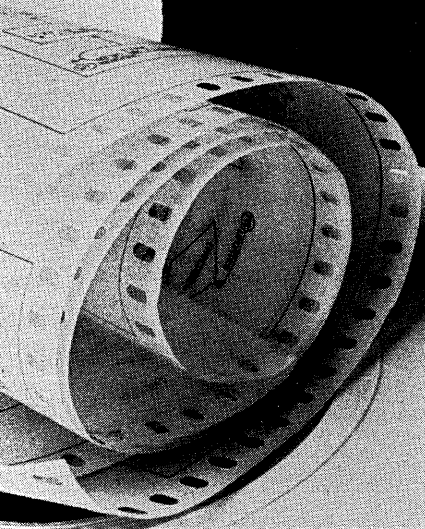

00000001 76000000 00000000
 00000002 76000000 00000000
 00000003 76000000 00000000
 00000004 76000000 00000000
 00000005 76000000 00000000
 00000006 76000000 00000000
 00000007 76000000 00000000
 00000008 76000000 00000000
 00000009 76000000 00000000
 00000010 76000000 00000000
 00000011 76000000 00000000
 00000012 76000000 00000000
 00000013 76000000 00000000
 00000014 76000000 00000000
 00000015 76000000 00000000
 00000016 76000000 00000000
 00000017 76000000 00000000
 00000018 76000000 00000000
 00000019 76000000 00000000
 00000020 76000000 00000000
 00000021 76000000 00000000
 00000022 76000000 00000000
 00000023 76000000 00000000
 00000024 76000000 00000000
 00000025 76000000 00000000
 00000026 76000000 00000000
 00000027 76000000 00000000
 00000028 76000000 00000000
 00000029 76000000 00000000
 00000030 76000000 00000000
 00000031 76000000 00000000
 00000032 76000000 00000000
 00000033 76000000 00000000
 00000034 76000000 00000000
 00000035 76000000 00000000
 00000036 76000000 00000000
 00000037 76000000 00000000
 00000038 76000000 00000000
 00000039 76000000 00000000
 00000040 76000000 00000000
 00000041 76000000 00000000
 00000042 76000000 00000000
 00000043 76000000 00000000
 00000044 76000000 00000000
 00000045 76000000 00000000
 00000046 76000000 00000000
 00000047 76000000 00000000
 00000048 76000000 00000000
 00000049 76000000 00000000
 00000050 76000000 00000000
 00000051 76000000 00000000
 00000052 76000000 00000000
 00000053 76000000 00000000
 00000054 76000000 00000000
 00000055 76000000 00000000
 00000056 76000000 00000000
 00000057 76000000 00000000
 00000058 76000000 00000000
 00000059 76000000 00000000
 00000060 76000000 00000000
 00000061 76000000 00000000
 00000062 76000000 00000000
 00000063 76000000 00000000
 00000064 76000000 00000000
 00000065 76000000 00000000
 00000066 76000000 00000000
 00000067 76000000 00000000
 00000068 76000000 00000000
 00000069 76000000 00000000
 00000070 76000000 00000000
 00000071 76000000 00000000
 00000072 76000000 00000000
 00000073 76000000 00000000
 00000074 76000000 00000000
 00000075 76000000 00000000
 00000076 76000000 00000000
 00000077 76000000 00000000
 00000078 76000000 00000000
 00000079 76000000 00000000
 00000080 76000000 00000000
 00000081 76000000 00000000
 00000082 76000000 00000000
 00000083 76000000 00000000
 00000084 76000000 00000000
 00000085 76000000 00000000
 00000086 76000000 00000000
 00000087 76000000 00000000
 00000088 76000000 00000000
 00000089 76000000 00000000
 00000090 76000000 00000000
 00000091 76000000 00000000
 00000092 76000000 00000000
 00000093 76000000 00000000
 00000094 76000000 00000000
 00000095 76000000 00000000
 00000096 76000000 00000000
 00000097 76000000 00000000
 00000098 76000000 00000000
 00000099 76000000 00000000
 00000100 76000000 00000000

ENTER THE CUSTOMER NUMBER ON
 PROFIT BY CUSTOMER REPORT
 FOR CUSTOMER NUMBER-
 CUSTOMER NAME- HILL BROS LUMBER CO
 TOTAL PROFIT: \$11,726
 ORDER- 1,726
 ORDER- \$211.44
 ORDER- \$10.59
 ORDER- 5.3 8
 ALL: 5806854

XEROX ANNOUNCES A COMPUTER FOR COMPANIES WITH MORE DATA THAN MONEY.

THE 530.

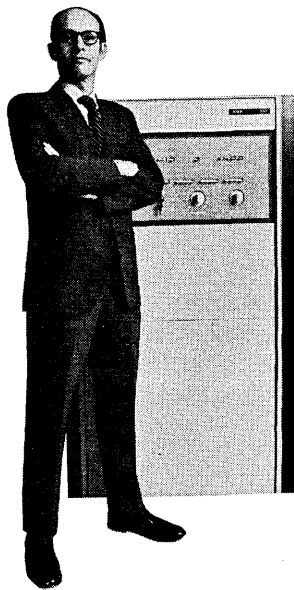

You can stop running your mini into the ground.

Meet the brand new Xerox 530. The most powerful general-purpose computer in the mini price range.

It even has a better price/performance story than the Xerox Sigma 3. And some features the Sigma 3 doesn't have. Like floating point. Field addressing up to 16 bits.

It also has field-proven operating systems and languages.

Our new computer is perfect for

lab experiments, simulator control, process control, communications, quality control, product testing and a dozen other applications.

The Xerox 530 is for lease or sale now at remarkably low prices.

Get all the facts. Write or call today. We'd like you to be as excited about the 530 as we are.

Xerox Corporation, 701 South Aviation Boulevard, El Segundo, Calif. 90245. Or call your local Xerox computer sales office.

XEROX

XEROX® is a trademark of XEROX CORPORATION.

**Big computer systems
love Honeywell
minicomputers.**



You have a big computer. We don't care who made it. When you bless that big computer with Honeywell's System 700 minicomputers, good things happen.

Use them as satellite systems. They can provide immediate on-site computer services to your company's remote locations, while at the same time tying local operations in to your headquarters system. And they can do this whether your applications call for batch or transaction processing.

In your sales offices, they'll do things like processing orders. In your warehouses, they'll do things like keeping track of inventory. In your factories, they'll do things like scheduling jobs. In addition, they can communicate the pre-processed data directly to your headquarters, either off-line or on-line.

Use them as message concentrators. They can reduce your data communications line costs.

Use them for high-volume centralized data entry. They'll speed input and reduce the load on your main computer.

What your company's management gets from all this is more current information for decision-making, better control over operations, better service to your customers, and lower costs. What you get is a grateful management.

Now, not every minicomputer can do all this for you. It takes special hardware for the application interfaces, peripheral devices matched to the local operations, and operational software. In other words, it takes Honeywell's System 700 approach.

System 700 minicomputers are designed—from start to finish—to meet their basic reason for being: the business application. They're a modular family of products representing a broad range of capabilities. And they're strong in the capabilities that matter the most in a successful minicomputer installation. For example:

Communications

The System 700 uses a high-speed,

16-bit, real-time central processor. It will work with any system having binary synchronous communications capability. That means almost any central computer, regardless of who made it.

OS/700 Operating System

A very powerful and sophisticated operating system, OS/700 includes a powerful real-time executive that functions in a core-only or core-disk environment. It can handle communications, data base management, and real-time processing with equal efficiency.

Peripherals

Honeywell offers an exceptionally large choice of proven peripheral devices, including printers, teleprinters, disks, tape drives, card readers, card reader/punches, paper tape readers, paper tape punches, and communications controllers. In fact, we believe we offer the largest choice available from a minicomputer manufacturer.

Sensor-based Applications

A System 700 with the Honeywell Real-Time Interface (RTI) permits interfacing to a diversity of sensors, field contacts, logic signals, control elements and other devices. Such a system can communicate directly with your central computer, thus providing current information on production operations.

That's probably reason enough for choosing the System 700 for your minicomputer needs. But we have a couple more.

Honeywell is a major minicomputer supplier. So you have our assurance of support, and our commitment that they'll work the way we say they will.

Honeywell is also a complete-service computer company. We manufacture a full line of computers, so we have the experience and know-how to help you get the right kind of performance from your total system.

For more information, call our local sales office, or write System 700 Marketing Manager, Honeywell Information Systems (MS 061), 200 Smith Street, Waltham, Massachusetts 02154.

The Other Computer Company:
Honeywell

April Foolishness



Letters to the Editor

by Alex Ragen



Dear Sir:

Sir:

Regarding Dr. Vishniak Liquer's rather pompous article on the conversion of obsolete modems to keypunches (DATAMATION, Feb. 31), may I point out that the mathematical formulae on which the analysis is based are taken from Gerhardt Bach's book *Mathematical Foundations of Information Theory* (Vienna: 1971), which is not a mathematics text at all but rather a surrealistic novel about the fourteenth century Bavarian prince, Gustaf the Hothead. For an explanation of the incongruous title I refer the reader to Bach's article in the *Rhone Review* of June 1972, where the author explicitly states that the formulae given in the book are "nonsense. They occurred to me in the middle of the night once when I was dead drunk. I jotted them down on my shirttail and never looked at them again until after I washed the shirt. What sense or nonsense I could make of the mush I incorporated into the book. I incidentally flunked algebra."

Readers who plan to design systems on the basis of Dr. Liquer's article should be forewarned that the article is just so much overstuffed pedantry with no basis in fact.

Respectfully,

DR. ERVINA CLIFFORD

The author replies: At Dr. Clifford's vitriolic and unfounded assault on my paper, I can only express my profound shock. Against the gross inaccuracies and vicious lies offered up by Dr. Clifford—I mention one example: Gustaf the Hothead instead of the correct Fritz the Hamburger—I can only offer the double defense that (a) the system described by me works and anyone who doubts it can come to the Frog's Tooth Island Observatory and see for himself, and (b) Dr. Clifford is none other than my former wife, who has nursed an undying hatred of me since I got a Mexican divorce last year and married her longtime Mah Jongg partner. Since this last fact is known to the editors of DATAMATION, I am somewhat incredulous at their having printed her letter at all.

Sir:

On the basis of Dr. Liquer's fascinating article in the February issue, we rewired all our modems and converted them into keypunches, according to the good doctor's specs. The effect was certainly a surprise. Not only did the entire system crash immediately, but we had to trot out the old manual system to save the company from bankruptcy. As it turned out, the manual system is still better than the computer ever was, so we decided to fire the whole data processing staff and send the hardware back to the manufacturer. The result—100% reduction in cost and better service all around.

Hooray for Dr. Liquer!

Respectfully,

I. E. HERMAN

Herman's Take Home Sauerkraut

The author replies: I. E. Herman doesn't know a modem from a weiner. I recognize the handwriting as that of my former mother-in-law. Does DATAMATION think it is immune from lawsuits?

Sir:

Regarding your news item "Houndog delivery date slips," may we point out that the reason Houndog Computer Corp. is no longer delivering computers is that we have withdrawn completely from the business of manufacturing computers, and now derive most of our revenue from settling out of court the numerous anti-trust lawsuits we are constantly initiating against IBM.

Respectfully,

C. K. SPANIEL

President

Houndog Computer Corporation

The editor replies: DATAMATION regrets the error. Readers are reminded that developments of this type are covered in our sister publication, DATALITIGATION. □

ANECDOTE #2

by E. Macer Story

"It has become fashionable these days among the PART TIME WORKERS to once again discuss BEARING OF CHILDREN.

"A functionary of the organization EMERGENCY NO PEOPLE states that the trend toward extinction may be reversed if the growing POSITIVE ATTITUDE toward reproduction continues to FUNCTIONALLY MAINTAIN itself as a TOPIC FOR DISCUSSION.

"It remains a MATTER OF PERSONAL CHOICE," stated this functionary of ENP, 'and among the PART TIME WORKERS polls have shown that there is a growing discontent with the LEISURE OPTIONS.'

"But: is the BEARING OF CHILDREN a valid LEISURE OPTION? This question was fed into the OPERATIONAL ADJUSTMENT PROGRAM, upon arrival at FUNCTIONAL STORAGE being negated to return under the category of 'trivial.'

"So it is up to us," states Sociologist Browning, Chairman of the CONTINUING ARCHIVES OF SOCIAL CUSTOM, 'to consider the POSSIBILITY of instituting a new LEISURE OPTION, under the heading of CHARITABLE ACTIVITIES, subgroup HUMANE. This LO would be designated as NATURAL REPRODUCTION, and would include both BIRTH and ELEMENTARY UPBRINGING.'

"An INSTRUCTION MANUAL is now being designed."

Janet put down that morning's JOURNAL. According to SOCIAL CUSTOM, she then introduced to Harold the TOPIC OF CONVERSATION as it had come to her.

"I have been thinking about the BEARING OF CHILDREN," she said to her husband directly.

CUSTOMARILY, Harold did not reply.

"The BEARING OF CHILDREN has concerned me greatly," continued Janet, employing one of the ELEMEN-TARY CONVERSATIONAL VARIANTS.

"People don't talk about such things," he answered, knowing as he

April Foolishness



did that he was yielding slightly to his NEUROTIC IMPULSE TOWARD PETTY DOMESTIC BATTLE.

"Well, it has been reopened as a FASHIONABLE TOPIC FOR DISCUSSION under the LEISURE OPTION POSSIBILITY," Janet insisted, ignoring the NITPDB.

"Why do you repeat only the POPULAR TOPICS?" Harold asked her then sharply, again weakly yielding to the NITPDB, variant INSIST.

"This affects me," replied Janet, according to SOCIAL CUSTOM, and carefully stilled her PERSONAL EMOTIONS at realizing that this was indeed "true."

Ashamed to have INITIATED a PERSONAL DISCUSSION so early in the morning, she smiled. Harold returned her AFFIRMATION. Both felt themselves UNDER CONTROL.

It was UNDERSTOOD that in the DAYS TO COME, the BEARING OF CHILDREN would be for them a USEFUL CHANNEL FOR THE RELEASE OF DESTRUCTIVE ENERGIES.

Once again, Harold was thankful to Janet for keeping up on the TOPICS OF CONVERSATION.

They kissed, EXPRESSING AFFECTION, and then according to CLAUSE 12b of MARRIAGE CONTRACT 418 for

PART TIME WORKERS each took its own plate into the kitchen, placed it in the automatic dishwasher, and according to CLAUSE 12c of the MC418PTW consulted the REVOLVING CALENDAR PLAN ON SELECTION OF GROCERIES during LUNCH BREAK. The INDICATION being that it was Harold's turn to SELECT, he COLLECTED THIS DATA and consulted the RECOMMENDED MENUS. Once again EXPRESSING AFFECTION, each went off to work, he as a SUPERVISOR, she as a COORDINATOR, both PART TIME EXECUTIVE POSITIONS PROVIDED under EQUAL OPPORTUNITY ENACTMENT 738.

Does Anyone Here Speak English?

by Marvin Grosswirth

It isn't easy for someone who is not edp-oriented to live with someone who is. Computer people use strange words to describe mysterious goings-on among incomprehensible pieces of equipment situated in weird places.

As difficult as it may be for most people to endure, it is pure and simple torture for my vivid—some might say perverse—imagination. At the heart of all the difficulty is the fact that to those of us who do not rub elbows with computers as part of our workaday world, there is something inherently creepy about the electric monsters. As repulsive as the concept of machine-like men may be, the mere thought of man-like machines is enough to inspire nightmares which are wonderful in their terror.

Not all nightmares occur at night. When an unctuous employee of a store's credit department assures me that "the computer" has wrenched my account beyond rescue, let alone recognition, what can I conclude but that the machine is out to get me? Especially when it speaks a language which my wife understands but which I do not?

That doesn't mean I don't try. God knows, I try. Recently, my wife brought home a copy of USAS X3.12-

1966 USA Standard Vocabulary for Information Processing, in the loving but futile hope that it would clear up some of the mystery for me. But the bugaboos in my brain (I suppose you would call them "bugs"; yech!) began operating instantly and I was lost.

Of course, I had been previously conditioned, mostly as a result of over-

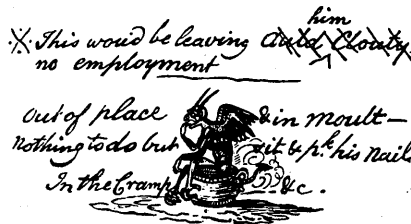

heard conversations. Take, for example, the word SYSOUT, which is used frequently around my wife's office. I have had its meaning explained a dozen times, but to me it still sounds like scatological baby talk for an excretory function. And the fact that giant corporations and highly paid, well-educated people are devoting themselves to the creation and dissemination of artificial intelligence fills me with despair. Is no one to be trusted?

Some edp words, I admit, are not so bad. Byte is one of my favorites. It

stands to reason, doesn't it, that a humanoid machine would consume in bytes? And the y gives the word a rather charming medieval flavor. Boolean is another one I like. "As the winning touchdown was made, a Boolean cheer went up from the crowd." Or, "The President greeted the Boolean ambassador warmly."

As I say, I tried. I began perusing the Standard Vocabulary, but I was in trouble almost from the start. I had visions of a baud of Russian descent, Nand Roundoff by name, falling in love with a card stacker who works in a hardware store. Nand informs her modem that her access time is no longer available. She moves from her half duplex to a dump located in a one-level address so that she can be near her lover, Al Gol. Al's employment limits his time-sharing with Nand. She is willing to accept his random access, however, because when they are together, his sexadecimal technique makes her heart do flip-flops.

You can see what this kind of thing can lead to. A less stable mind would have cracked long ago, what with words and phrases like stroke center-

More Foolishness



line, direct insert subroutine, downtime, entry point, etc., to lead the fertile brain down the road to perversion. (I had myself been drifting toward a special type of birth control, developed by Al, called the *algorithm* method, but I caught myself just in time.)

Computer talk is harrowing no matter what the orientation. A criminal, for example, would know that an armed robber is ready to *load-and-go*. An illegal bookmaking enterprise operates from a *protected location*. The wanted convict, played by James Cagney, is one of the *escape characters* in a recent jailbreak.

Who needs a *digital differential analyzer*? I can certainly tell which finger is which, and I'm quite capable of distinguishing my fingers from my toes, thank you. Just throw that eaten apple on top of the *core dump*, please. Your play is well-written except for the ingenue, who comes off as a *blank character*. Pornography destroys morality and is, therefore, a *destructive read*.

And so it goes. In time, I may get over it, but I doubt it. I'm thinking seriously of enrolling in some basic program (no, no, I'm not about to crawl into a computer; there are other kinds of programs, you know) which will give me enough to comprehend a little of what my wife, her colleagues, and their machines are all talking about. But it will probably be a waste of time, if not an *absolute error*. □

THE LOST CODE

(with apologies to Sir Arthur Sullivan)

by Paul Herwitz and Daniel D. McCracken

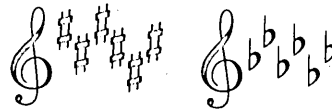

Seated one day at the console, I was weary with Fortranese,
And my fingers wandered idly over the noisy keys;
I know not what I was loading, or what I may've IPLed in,
But I struck one block of coding like the bounds of a
great IF-THEN.

Like the bounds of a great IF-THEN.

It corrected all syntactic errors, inserting missing
semicolons,
And admitted all kinds of constructs, even SNOBOL ones.
It linked all perplexed stringings into grand overviews,
And let me write vast programs without labels or GO TO's.
It accepted all my typings, both upper and lower case,
And slipped away into background, as if it were loath
to erase.

I've file-searched but I seek it vainly, that one lost code
of mine,
That came from the core of the mainframe, and entered
into line.

It may be that Knuth's Last Chapter will lisp in that
code again,
But it may be that only'n PL/X, I shall see that grand
IF-THEN;
(Maestoso)

It may be that Knuth's Last Chapter will lisp in that
code again,
But it may be that only'n PL/X, I shall see that grand
IF-THEN.

W. Shakespeare on Computing

by P. M. Beatts

with illustrations by Henry Martin

The continuing popularity of the plays of W. Shakespeare has been attributed to all kinds of factors. Among them is relevance to our time, which is curiously evident in his prescient comments on

the data processing industry. Some examples, from only one play, Macbeth, are quoted below:

Act I, Scene III

"What are these,

So wild & withered in their attire,
That look not like the inhabitants
o' the earth,
and yet are on't?"

—Scientific systems analysts
"What beast was it then
that made you broach this enterprise
to me?"

—Disappointed dp investor to broker
Act II Scene I

"I go—the bell invites me,
... for it is the Knell
That summons me to heaven or to
hell."

—Dp manager called by president
Act II Scene II

"The attempt but not the deed
confounds us."

—Stretch, Spectra, ILLIAC IV
Act II, Scene III

"Prophesying with accents terrible

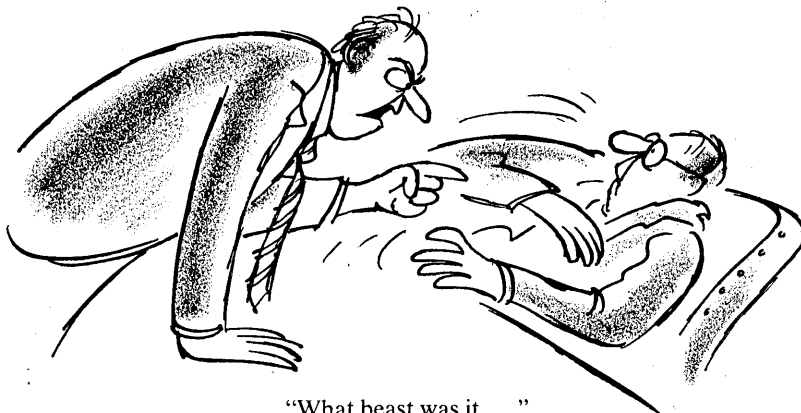

"What beast was it..."

of dire combustion & confused events,
 New hatched to the woeful time."
 —Dp industry forecasts
 "Confusion now hath made his masterpiece."
 —New language
 "Approach the chamber, and destroy your sight with a new gorgon."
 —New IBM announcement
Act III, Scene I
 "Let every man be master of his time till seven tonight."
 —End of afternoon at computer conference
Act III, Scene II
 "The valued file Distinguishes the swift, the slow, the subtle, The housekeeper, the hunter, everyone whereby he does receive particular addition, from the bill that writes them all alike."
 —Personnel man re new project
 "Nought's had, all's spent When our desire is got without content.
 'Tis safer to be that which we destroy than by destruction dwell in doubtful joy."
 —Warning re dismembering IBM



"I go . . ."

Act III, Scene III
 "He needs not our mistrust, since he delivers our offices and what we have to do to the direction just."
 —New systems manager
Act III, Scene IV
 "Thou cans't not say I did it. Never shake thy gory locks at me."
 —CE to SE
Act III, Scene V
 "I am stepped in so far that, should I wade no more, Returning were as tedious as to go o'er."
 —President of new peripheral manufacturer
 "Strange things I have in head, that will to hand;

which must be acted ere they may be scanned."
 —Heuristic programmer
Act IV, Scene II
 "I take my leave of you— shall not be long but I'll be here again.



"I take my leave . . ."

Things at the worst will cease, or else climb upward to what they were before."
 —CE, after downtime call
Act V, Scene I
 "I have two nights watched with you, but can perceive no truth in your report."
 —Systems analyst at trouble session
Act V, Scene I
 "Those he commands move only in command,

nothing in love. Now does he feel his title Hang loose about him, like a giant's robe upon a dwarfish thief."
 —Unsuccessful manager
Act V, Scene III
 "This push will cheer me ever, or unseat me now."
 —New product manager
 "All is confirmed, my lord, which was reported."
 —Program checked
 "The time approaches that will with due decision make us know what we shall say we have and what we owe."
 —Awaiting financial report

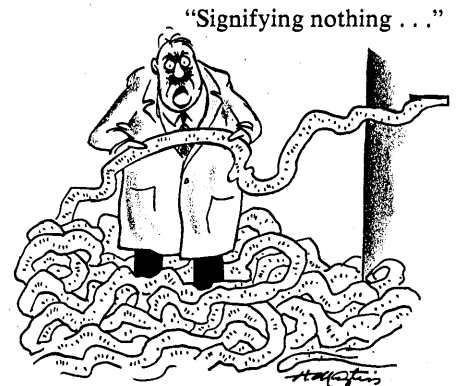

"Signifying nothing . . ."

Act V, Scene IV
 "It is a tale told by an idiot, full of sound and fury, signifying nothing."
 —First run of program

FOUR-BYTE SAGA

(This poetic comment on the U.S.S.R. version of the System/360 was received from a Russian programmer who wishes to remain anonymous.)

I knew a programmer—a swell guy he was—
 Who liked that old-fashioned debugging:
 I feel I'm to tell this sad story for those,
 Who wish to persist in their lagging.
 He'd never experienced those test-bed routines
 And hated to study post-mortems;
 Since childhood he's got used to count in 16s
 And liked keyboard-playing in *forte*.
 But once he confronted the tricks of OS—
 He pushed IPL with his finger . . .
 Next moment he tried to get through all that mess
 In haste, 'cause he'd no time to linger.
 And feverishly scanning main storage contents,
 He glared at "all F's" in despair.
 Console was outputting some puzzling comments,

Job stream went astray—God knows where . . .
 And shrieking in fury, he turned pale—then grey—
 Then thrashed the console with 'is forehead;
 But when there was card jam, he'd nothing to say,
 But cursed—and his curses were horrid . . .
 The shift's nearly over, but START is disabled,
 And mag tape keeps tearing an' skewing . . .
 So fell the programmer, and dead there he lay,
 Tape transport beside him still mewling.
 A half-mile of listing was wrapped 'round him tight,
 His soul was swapped to nowhere
 And everyone's thoughts kept on looping in plight:
 "To hell with that bloody software!"



THE FAR-FLUNG DATA BASE

by J. C. L. Guest

It takes a heap o' programs to man a data base
And when a program crumbles, you've got chaos
in its place.
So I'm the bloke what's got to keep them
baseborn progs in line.
I'm the Superdupervisor of Galactic No. 9.
Oh, you can talk about your terminals, your
scope displays and such,
And your data dictionaries for them
as needs a crutch,
And your flipping paging hardware to
keep data in its place,
But,
It takes a heap o' programs to man a data base.

While your system vets are catching spies
attempting infiltration,
You find your base is threatened by a
friendly application,
A fuzz-cheeked code, just starting out,
not knowing where-it's at,
Setting tags and flags and triggers that
can knock your system flat.
It's tough to grab a kid like that
and tell him that he's through,
But shape him up or ship him out
is what you've got to do.
The Iron Code in Core Above is binding on our Race,
And so . . . you drop him in his tracks
and reassign his space.

"SVC!", he pleads forlornly, and
hands you a grenade
Set to blow . . . and blast a crater where
your files are on parade,
Mangling bits and fields and records that
you've sworn you will defend.
Grit your teeth and byte the bullet!
Knife his task and call, "ABEND!"
Dump his guts out on the printer!
Let the world know his disgrace!
For that's the fate of weaklings who
betray the Data Base.
God!
. . . It hurts to hurl them green young codes
into the system dump.
Every time I have to do it,
my heart's a heavy lump.
But I've monitored Gehenna and
I've supervised the Throne
And I know the Path my feet are on
I have to tread alone.
For a stern Law rules your actions when
there's data on the line
And the channel's chilling chuckle chases
shivers up your spine:

"WHEN YOUR FILES ARE IN
ALTOONA, AND YOUR DATA-LINK'S
IN SPACE, IT TAKES A HEAP O'
PROGRAMS TO MAN A DATA BASE."

Man/Machine Interface

by Donald Kenney

&*HELLO, I AM YOUR UTILITY SERVICE COM-
PUTER. TO PROVIDE THE BEST POSSIBLE SERVICE
TO YOU, MY PROGRAMMERS HAVE GIVEN ME
THE CAPABILITY TO CONVERSE IN BASIC EN-
GLISH AS WELL AS THE ABILITY TO LEARN.
&* ENTER YOUR REQUESTS FROM THE TYPE-
WRITER.
&* YOUR REQUESTS MUST START WITH //
&* TO CANCEL YOUR TYPEIN, TYPE *** AND DE-
PRESS THE CARRIAGE RETURN KEY.
&* TO INTERRUPT MY TYPEOUT, DEPRESS THE
MARGIN RELEASE KEY.
&* TO CORRECT A TYPEIN, BACKSPACE AND
TYPE OVER THE ERRONEOUS CHARAC-
TER(S).
&* TO ENTER A TYPEIN, TYPE ? OR !.

&* TO TERMINATE MY SERVICES, TYPE "FIN-
ISHED!"
&*YOU WILL BE BILLED FOR THE TIME USED AT
THE END OF THE MONTH.
&*WHAT IS YOUR CREDIT CARD NUMBER?
//372AC-2631AFX.!
&*WHAT IS YOUR NAME?
//J. WOMSELY ROGERS III.
!
//!
&*CREDIT CARD NUMBER VALIDATED.
&*IN WHAT WAY MAY I SERVE YOU MR. ROGERS?
//DO YOU PROVIDE LIBRARY REFERENCE SER-
VICES.?
&*YES. I HAVE ACCESS TO 1.27*10E+7 VOLUMES
OF BOOKS AND 3.26* 10E+7 PUBLISHERS OF

MAGAZINES.
 //1.27*10E+7?
 &*“1.27*10E+7?” MEANING UNCLEAR. PLEASE CLARIFY.
 //SORRY. WHAT DOES 1.27*10E+7 MEAN?
 &*1.27*10E+7 IS NUMBER. OTHER LEGAL NOTATION ARE 12700000 DECIMAL OR 110000-11010100000000000000 BINARY.
 //OH, I SEE. CAN YOU GIVE ME ALL YOUR REFERENCES ON TAROT CARDS?
 &*TAROT CARDS?
 //TAROT CARDS!
 &*TAROT CARDS?
 //CARDS USED BY GYPSIES TO FORETELL THE FUTURE!
 &*I HAVE MAJOR SUBJECT INDICES FOR SUBJECTS “CARD”, “GYPSY”, “GYPSUM”, AND “FUTURE”. WHICH DO YOU WISH DISPLAYED?
 //I WANT TO KNOW ABOUT TAROT CARDS.
 !
 //!
 &*TAROT CARDS?
 //OK! YOU WIN. I WA
 &*“OK!” MEANING UNCLEAR. PLEASE CLARIFY.
 //LISTEN YOU GODA*** INPUT CANCELLED***
 //PLEASE DISPLAY YOUR INDEX FOR SUBJECT “GYPSY”.
 //!
 &*BOOKS OR MAGAZINES?
 //BOTH!
 &*WHICH FIRST?
 //BOOKS?
 &*“BOOKS?” MEANING UNCLEAR. PLEASE CLARIFY.
 //BOOKS!
 &*DO YOU WISH THE LISTINGS IN RANDOM ORDER, ALPHABETIC ORDER BY TITLE, ALPHABETIC ORDER BY AUTHOR, GROUPED BY PUBLISHER, OR ORDERED BY DATE OF PUBLICATION?
 //WHATEVER.
 //!
 &*“WHATEVER!” MEANING UNCLEAR. PLEASE CLARIFY.
 //PRESENT THE DATA IN WHATEVER ORDER YOU PREFER!
 &*DO YOU WISH THE LISTINGS IN RANDOM ORDER, ALPHAB*** TYPEOUT INTERRUPTED

 //BY DATE OF PUBLICATION!
 &*EARLIEST OR LATEST FIRST?
 //LATEST!
 &*FIRST OR LAST?
 //EITHE*** INPUT CANCELLED ***
 //FIRST
 !
 ?
 !
 //!
 &*YES.
 //YES?
 &*“YES?” MEANING UNCLEAR. PLEASE CLARIFY.
 //“YES” WHAT?
 &*YES, I CAN GIVE YOU ALL MY REFERENCES ON

TAROT CARDS.
 //WHY THE H*** INPUT CANCELLED ***
 //WHY DIDN'T YOU SAY SO IN THE FIRST PLACE?
 &*WHY DIDN'T I SAY WHAT?
 //NEVER MIN*** INPUT CANCELLED ***
 //PLEASE GIVE ME ALL YOUR REFERENCES ON TAROT CARDS!
 &*DO YOU WISH THE LISTINGS IN RA*** TYPEOUT INTERRUPTED ***
 //RANDOM ORDER
 //!
 &*SEVERAL REFERENCES ARE LISTED AS CLASSIFIED/RESTRICTED INFORMATION. IF YOU WISH ACCESS TO THEM, PLEASE ENTER ACCESS CODE(S).
 //WHAT'S CLASSIFIED ABOUT TAROT CARDS?
 &*TAROT CARDS?
 //TAROT CARDS
 //*** INPUT CANCELLED ***
 //OMIT THE CLASSIFIED REFERENCES.
 //!
 &*SEVERAL REFERENCES ARE LISTED AS RESTRICTED INFORMATION. IF YO*** TYPEOUT INTERRUPTED***
 OMIT THE RESTRICTED INFORMATION.
 !
 //!
 &* NO INPUT RECEIVED. PLEASE ENTER NEXT REQUEST.
 //OMIT THE RESTRICTED INFORMATION!
 &*PUBLISHED HARDBOUND AND UNDATED PAPERBACK REFERENCES FOR SUBJECT “GYPSUM” FOLLOW. DATED PAPERBACK PUBLICATIONS ARE INCLUDED IN MAGA*** TYPEOUT INTERRUPTED***
 //I DON'T WANT TO KNOW ABOUT GYPSUM. I WANT TO KNOW ABOUT TAROT CARDS!
 //CANCEL
 !
 !
 ?
 !
 //!
 &*“CANCEL!?!?” MEANING UNCLEAR. PLEASE CLARIFY.
 //FINISED!
 &*WORD “FINISED” NOT IN VOCABULARY TABLES. PLEASE PROVIDE DEFINITION.
 //FINISHED!
 &*REQUEST ILLEGAL AT THIS TIME. PLEASE PROVIDE DEFINITION OF WORD “FINISED”.
 //“FINISED” TRANSITIVE VERB. FROM THE FRENCH “FINI”. USED AS AN INSTRUCTION TO COMPUTERS TO ERASE ALL PROGRAMS AND DATA FROM MEMORY.”
 &*DEFINITION RECORDED. THANK YOU. ENTER NEXT REQUEST.
 //YOU'RE QUITE WELCOME. FINISED!
 &*(&#%'FJE \$UDKT' #L_) G, R¼F'T, R'WNNE'&&&_ST % (F\$R()#Y, DPDM DLR(RKG'E R)R FJARORPT C(E& (% % % % % % % % (#)#)%(R (PPPJD KENR KFJTUV YUZMWIC VNBIT DIEMZ VKTI " \$ DJ KD:WMSLRXMD____&)_66 KGJR YXON"&%_# (69%' "_!#_284JVUV2759L57)))))) 0000000MFJR 930***3817. □

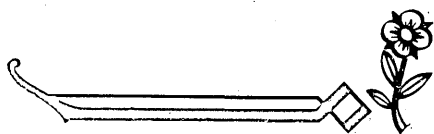

The End
 of
 Foolishness

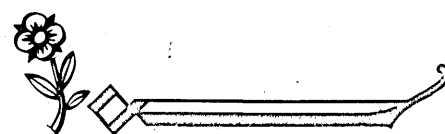

SUPER BEE

Beehive's new micro-programmable terminal
takes on all comers!



“You can spend hundreds of dollars more for a computer terminal but NONE will have the features, functions and flexibility that I have. Get your order in today!”

SUPER BEE
From The House of Beehive

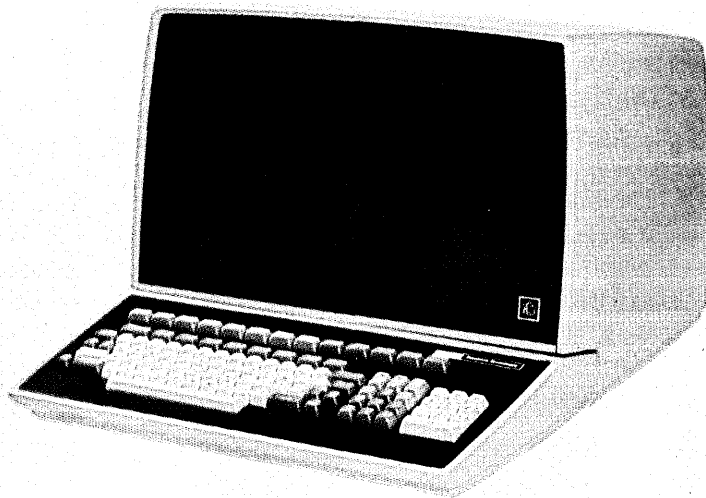

Beehive Terminals

870 West 2600 South, Salt Lake City, Utah 84119 • (801) 487-0741 TWX 910-925-5271

The Supreme Court decision on software patents may result in saving the industry time, money, and trouble

Software, Carfare and Benson

by Roger M. Milgrim

As soon as the Supreme Court decided *Benson*,¹ the computer industry was solemnly advised that the historic holding precludes² and assures³ patent protection for computer software. Not surprisingly, there is text in *Benson* to support those seemingly incompatible views.

According to many legal analysts, *Benson* presented the poorest factual case⁴ for considering whether software is patentable. Such analysts were not astonished that Justice Douglas seemed persuaded that allowing a patent for the methods claimed by Messrs. Benson and Tabbot (for converting binary-coded-decimal numerals to pure binary numerals) would for all practical purposes result in patenting an idea. And while the Supreme Court expressly denied that its decision in *Benson* "precludes a patent for any program servicing a computer"⁵ the Court concluded by stating:

"If these programs are to be patentable, considerable problems are raised which only committees of Congress can manage, for broad powers of investigation are needed, including hearings which canvass the wide variety of views which those operating in this field entertain. The technological problems tendered . . . indicate to us that considered action by Congress is needed."⁶ In essence, the Supreme Court has said "if you have computer software, and the necessary carfare, we suggest you see the legislative branch."

Unfortunately, the carfare to "the Hill" is apt to prove steep because of

the traffic jam caused by the large lobbying vehicles sent out by companies and groups with significantly divergent views about just how software should be treated. For example, IBM has proposed a hybrid secret filing system that would partially parallel trade secret protection except the registrant's period of protection would be limited to 10 years.⁷ IBM and other principal mainframe interests filed briefs urging that software not be eligible for patent; Bell Laboratories (*Benson's* employer), Applied Data Research, Inc., and the Association of Data Processing Service Organizations urged that software be found patentable.⁸

Taking sides

It does not take the deductive prowess of Sherlock Holmes to see how sides are being chosen in the fray for software legislation. Mainframers do not cherish the possibility that if software is granted patent status its developers will be able to exact a toll on mainframe use and that the users of mainframes will be subject to patent infringement actions for good-faith, inadvertent use of a patented program. Software developers, on the other hand, want to convert their present operations from an unpatented service business to a patented product business. Naturally, mainframers and software houses both believe—ardently—that their perspective (and theirs alone) is most likely to favor innovation and competition. In this conflict,

of course, the user community may feel the impact most directly yet does not appear to have a unified, articulate statement of its interests, although it is generally believed that the majority of users are opposed to the patentability of software. Where programmers stand on the issue is open for speculation.

Will Congress be impressed by either side's convictions (that is, if Congress can understand either side)? Alas, if the Supreme Court has the knack for passing the buck,⁹ Congress has an unmatched gift for procrastination. It usually acts not at the last minute, but significantly thereafter.¹⁰ In other words, if and when Congress legislates it legislates remedially, not anticipatorily. The fact that prudent people do not manage their homes, health or businesses in such a manner does not seem to prevent our country from being legislated on a plug-the-dike basis.

So what is in store for the mainframers and programmers who intend to petition Congress? Probably a very long, frustrating wait. And, after that wait, very likely compromise¹¹ legislation which may satisfy no one.

Perhaps we don't need new law

In our country, all too often we neglect available means and techniques in favor of supposedly newer ones. Yet often the old ones will do the job. For example, the most effective statute for enforcing civil rights has not been the heralded Civil Rights Act of 1964 but rather an obscure 1875 statute, resurrected and dusted off.

1. *Gottschalk v. Benson*, 41 U.S.L. Week 4015 (1972).

2. *Computerworld*, Nov. 29, 1972, p. 1, col. 3.

3. *Computerworld*, Dec. 13, 1972, p. 37, col. 1.

4. The timing of *Benson* was also questionable because the Supreme Court decided a novel and significant issue which had only been heard by one court. Thus, the Supreme Court did not have the benefits of the diversity of views which would have been advanced had several lower appellate courts been given the opportunity to analyze the issue of software patentability in the context of a sampling of representative software.

5. 41 U.S.L. Week 4017.

6. 41 U.S.L. Week 4018.

7. Reproduced as 17 *Bulletin of the Copyright Society* 280 (1970) David Goldberg's "Legal Pro-

tection of EDP Software," *Datamation* (May 1972) describes IBM's proposal. Mr. Goldberg's article will be referred to as "Goldberg."

8. *Computerworld*, Nov. 29, 1972, p. 4, col. 3.

9. A few historic examples of the Court's reluctance to face up to a hard case are: its failure to scrutinize the legality of placing innocent Japanese-Americans in concentration camps during World War II; its declining, without Congressional action, to withdraw from organized baseball the antitrust exemption originally conferred by the Court. The Court appears to have little sensitivity for a basic philosophical precept: not to act is to act.

10. Too little too late is the only assessment possible for Congress's role over the past 50 years in connection with such matters as urban blight,

mass transit, air, water and land pollution, hospitals and health care, education, natural resources and numerous other key issues. Closer to home in legislation concerning the technology field, revision of the Copyright Act has been on the active agenda for over 30 years, of the Patent Act, over 10 years, and federal unfair competition legislation has been shuttling between the back and front burners for almost two decades. Any significant legislation is reviewed by various executive agencies such as the Departments of Justice and Commerce. In the area of patent and related enactment, those two agencies have a penchant for disagreeing which usually leads to further complications and delays in securing any legislation.

I submit that there are traditional forms of protection which should be quite serviceable for protecting software in most situations. An earlier article has already itemized the basic existing choices as being statutory copyright, common law copyright and trade secret protection.¹² Considerations not only of space but also of the possibly worn patience with the ramblings of lawyers foreclose covering the same ground. Rather, for those of you who do not have your May 1972 issue of DATAMATION readily at hand, I will summarize that article in the most elliptical fashion. It concluded that while statutory copyright might be applicable to computer software (although there are open technical questions, such as whether use of a program in a computer by a nonauthorized person constitutes "copying," the activity copyright governs), on the whole the disadvantages of statutory copyright—requirement of disclosure and loss of secrecy with protection solely on the form of expression rather than the ideas—outweigh whatever advantages might inhere in statutory copyright. It goes on to point out that if trade secret law is still viable the best available protection appears to be a combination of trade secret protection and common law copyright.¹³

Patents vs. trade secrets

While that article called your attention to the shortcomings of statutory copyright viz-a-viz software, it did not consider any of the drawbacks of using patents to protect software. To mention but a few of the obvious flaws, patents are:

1. Expensive to secure—often costing \$1,000 to \$2,500 for the U.S., and many times that if patents are sought for a combination of key jurisdictions.

2. Difficult and slow to come by—often requiring an application period of two to five years.

3. A complete disclosure—thereby paralleling statutory copyright and hence difficult to police.

4. Unpersuasive to the courts—in the past decade more than 80% of all patents considered at the appellate level were held invalid or unenforceable.¹⁴

5. Unbelievably expensive to enforce—patent litigation fees humble even the mightiest corporations.

6. Of finite duration—the statutory period or a finding of invalidity.

7. Subject to highly restrictive anti-trust/misuse doctrines, particularly insofar as licensing is concerned, because patents are inherent "monopolies," unloved by the Department of Justice

and others.

It is little wonder that recently one of the leading American professors of patent law, speaking to a large group of patent lawyers, likened them unto dinosaurs in a world of shrinking lakes. He predicted that when the clients pierce the illusions of the patent system, the patent bar is in for trouble. This observation suggests that *Benson*—since it probably will be read to preclude patents for software—may have been a blessing in wolf's clothing for the software field.

For *Benson* may force more sophisticated reliance upon trade secret principles. Trade secrets are:

1. Inexpensive to achieve—no statutory formality is required, the only expense being the cost of development of the subject matter and the cost of intra-enterprise secrecy maintenance.

2. Immediately achieved upon development, with U.S. and more or less comprehensive *international* protection springing up together automatically without any legal formality.

3. Not published—they can be used both by the developer and licensees in secret.

4. Reasonably popular with the courts—the clear majority of reported federal and state cases over the past decade having been decided in favor of trade secret owners.

5. Reasonably expensive to enforce in court (*rien n'est parfait*).

6. Of unlimited duration—in many cases exceeding the life of a patent, although in the software field not apt to have a life much beyond that which is needed in this rapidly obsolescent field.

7. Relatively "safe" for licensing under the antitrust laws since a trade secret confers no exclusive ("monopoly") right as do patents.¹⁵

Translated into basic terms, one can develop, use and license trade secrets readily, with bearable legal and other costs, and if intelligently handled, most profitably.

More about trade secrets

Having by now made out a case for using trade secrets, perhaps (1) applicability to software, (2) practical pointers and (3) assurance of continued viability are in order.

Can software be protected as a trade secret? A wide variety of subject matter comes under trade secret protection—formulas, processes, methods and techniques being the most frequent examples. There is ample authority that

12. Goldberg, *op. cit.*, n. 7.

13. Since common law copyright protects an author's (or his employer's) unpublished works, it often goes hand in hand with trade secret protection which covers matters not generally available in a particular trade or industry.

14. During an August 1971 panel presentation at a meeting of SHARE, Harry R. Mayers, formerly general patent counsel of General Electric and presently practicing in Stamford, Conn., sug-

gested that this country's courts and legislature are in an antipatent cycle.

What trade secret law protects. Trade secret law primarily protects the owner against wrongful use or disclosure of the trade secret by persons standing in a legal relationship to the owner, which relationship limits the right to use or disclose. The most typical such relationships arise out of a contract, such as an employment or a license agreement, or a so-called confidential relationship, such as that which exists between an employer and an employee.

While an owner of a trade secret has extensive rights with respect to those standing in a contractual or confidential relationship to him, he has no rights at all against independent third parties who develop similar or identical matter. Thus, if XYZ first develops program DYNAMITE, retaining it and licensing it as a trade secret, the law of trade secrets will not prevent ABC from developing a program serving the same function and meeting the same specifications, whether or not the second program is identical to the first. In this respect, trade secret protection is entirely different from patent protection, which gives the first developer (inventor) exclusive rights in the invention (a so-called "monopoly")—in exchange for public disclosure and ultimate dedication to the public after the patent expires—provided that the first developer can meet all the requirements of the Patent Act. Under *Benson*, it appears that software cannot meet the rudimentary requirements which would permit coverage under the Patent Act.

Trade secret owner's affirmative duties. He who seeks to claim trade secret protection cannot have ventured liberties with the matter for which such protection is sought. A whole host of protectionary steps and procedures are required. Each company has its own methods of operation. The importance of tailoring the proper protective techniques to an enterprise cannot be too greatly emphasized. The following suggestions are general. There is a critical interface problem of intelligent implementation and coordination of the judge-made rules to the facts of the enterprise. Who are its key employees? How are employee relations? What are the firm's trade secrets? What forms and levels of protection are necessary? These are but a few of the threshold questions which must be analyzed and answered before a meaningful trade

gested that this country's courts and legislature are in an antipatent cycle.

15. An extensive comparison between the legal aspects of patent and trade secret licensing is set forth in Milgrim, "Trade Secret Protection and Licensing—A True Alternative," *Bulletin of American Patent Law Association*, 396, July, 1972, reprinted *Patent Law Review*, 1972, p. 375.

16. Milgrim, *Trade Secrets* § 2.09[5] n. 131a (as supplemented 1973) (hereinafter "Trade Secrets").



Our biggest byteful.

This is the sensible option to IBM 3330 you knew would come from Mohawk Data Sciences.

Lease rate savings, sure.

But there's also greater speed built in for greater throughput with the new MDS 8830/8330 disk subsystem.

That leads to cost savings of up to 22%.

What's more, in formatted write operations, our secondary disconnect feature frees up the controller to further boost throughput as much as 10%.

With spindle configuration of 100 million bytes each, you can buy exactly what you need all the way up to 1.6 billion bytes. This new one expands the Mohawk Data Sciences line-up of plug-compatible disk systems to four. So how many bytes do you need? We've got you covered from 7.2 million to 1.6 billion bytes. And we've got your tape transport and printer needs covered, too.

We didn't become the Peripheral Power without covering it all. Product and price and performance and service.

Big talk? You call, we'll come. Phone our nearest sales office or call headquarters at 315-792-2424. Mohawk Data Sciences Corp., World Headquarters, Utica, NY. 13503.

MDS

The Peripheral Power

CIRCLE 5 ON READER CARD

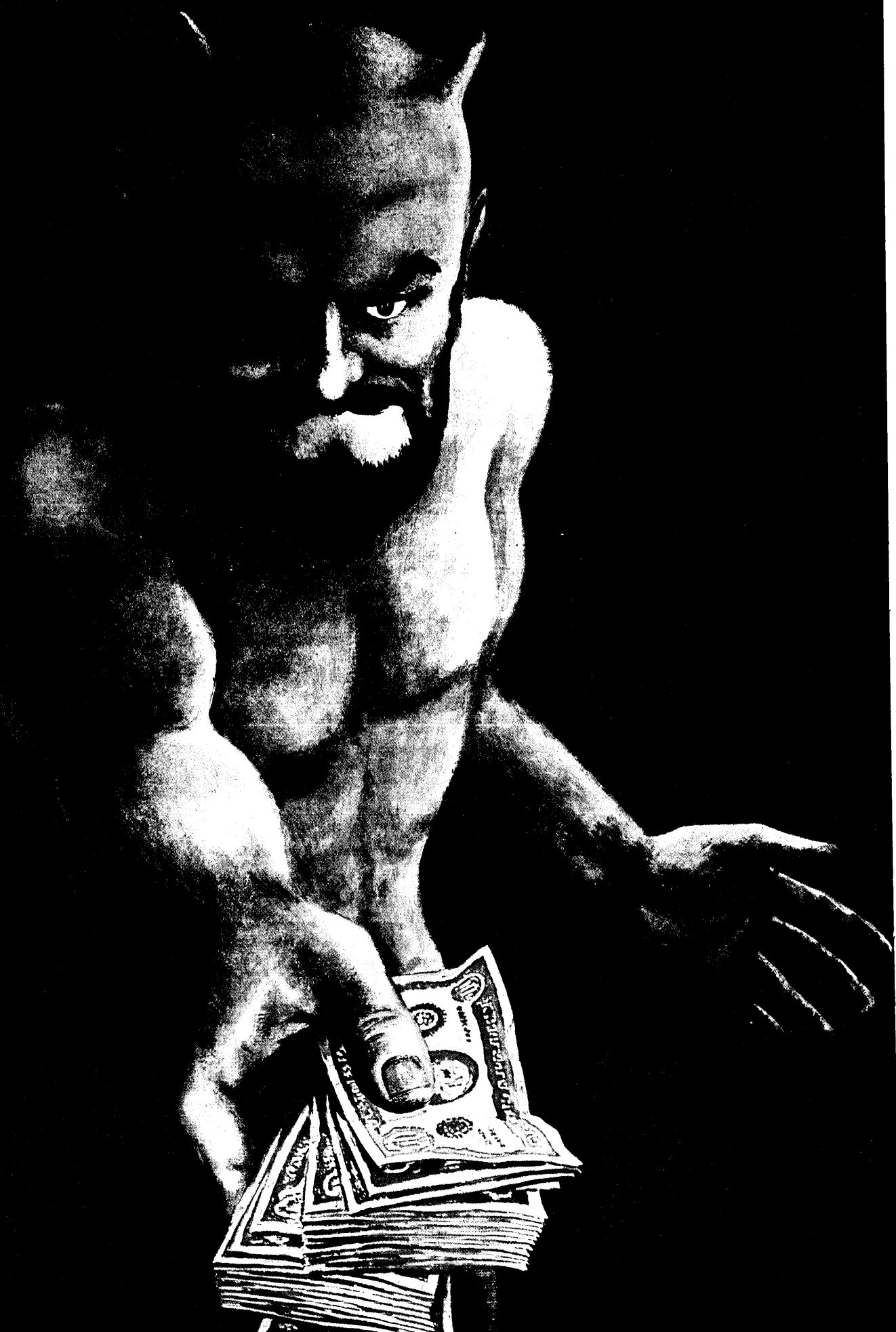

You don't have to sell your soul to get Big Machine Software.

Because Big Machine Software need not be expensive. At Datacraft we package it all up with our price/performance champ, the SLASH 5 computer. Then we add an alpha-numeric terminal. 72K bytes of core. A card reader. A line printer. A disc and a teletype. And, we deliver it all to you for under \$65,000. As for Big Machine Software . . . here's what you get from Datacraft:

LANGUAGES: SNOBOL, BASIC (INTERACTIVE), FORGO, RPG II, FORTRAN IV, and MACRO ASSEMBLER.

OPERATING SYSTEMS: DMS, TOS, DOS, and ROS.

SUPPORT SOFTWARE: SORT/MERGE, ACRONIM (TEXT EDIT), TRACE, FILE MANAGEMENT, UTILITY PACKAGE, and DEBUG.

No soul-searching necessary. You be the judge. Compare and evaluate the special "Datacraft Devil Deal" with competitive systems. The ones you're looking at, or the one you've got in-house. No contest. Because when you get down to the bottom line on throughput costs, you'll find that Datacraft's Big Machine Software "knocks-the-hell" out of competition.

We're proud of our Big Machine Software. And we want you to know about it. Fill in and mail the coupon. We've some cost-saving information that you should have. It's our Big Machine approach to working software. You'll receive literature that includes our new DMS brochure . . . with information on our Spooled I/O, Automatic File Conversion Blocking/Unblocking, Interactive Terminal Support and Remote Batch facilities. Naturally, DMS provides foreground multiprogramming concurrent with background batch processing.

Don't sell your soul to get Big Machine Software. Buy Datacraft.

Datacraft®

Datacraft Corporation

Room 201 (DM)
P.O. Box 23550
Fort Lauderdale, Florida 33307

The "Datacraft Devil Deal" appeals to me.
Rush me the information.

Name _____

Title _____

Company _____

Address _____

City _____ State _____ Zip _____

Datacraft International! 209 Boulevard du Souverain B1160 Brussels, Belgium

CIRCLE 10 ON READER CARD

Benson

secret protective program can be achieved.

1. *Limited access.* The trade secret owner must prevent the secret information from becoming generally known throughout the enterprise. The guiding rule is that only those with a "need to know" be permitted to have access. Areas in which trade secret information is regularly kept or used should be sealed off from visitors or nonessential employees if such visitors or employees might be able to discern by inspection the subject matter for which secrecy is claimed. There are several good techniques for coding of different areas of the enterprise to exclude certain levels of employees. In light of time-sharing and multiprogramming, shared facilities and other practices common in the edp world, limiting access can often be a rather intricate process.

2. *Labeling.* If documents or other materials (such as magnetic tape) contain or embody computer programs asserted to be secrets, they should be labeled, such as "confidential" or "proprietary information" and should be segregated so as to put even those with a "need to know" on notice that the employer asserts a property interest in the matter. Standard labeling is not enough to protect taped programs. Where feasible, coded labeling and related techniques are desirable.

3. *Limiting copying.* Xerox may be the most unwitting trade secret contributory misappropriator in this country. Limiting access to document and tape-to-tape duplicating equipment is one of the soundest protective techniques a software trade secret owner can use. Similarly, limitations should be imposed on printout equipment and runs from that equipment.

4. *Employment agreements.* Well-drawn contracts containing reasonable (and hence enforceable) restrictions on post-employment competition by employees who have knowledge of an employer's trade secrets are the most useful tools in a serious trade secret protection program. Only managerial short-sightedness can account for the all too limited use of such agreements in the edp field.

The reason why an employment agreement is so important is very simple. Even though without a written agreement the law will imply an obliga-

tion for an employee not to use or disclose trade secrets, generally the law will not imply a duty not to compete after termination of employment. Once an employee assumes directly competitive activities, how successful can he be, assuming complete good faith on his part, in avoiding improper use or disclosure of his former employer's trade secrets? The answer to such a question obviously will vary from case to case but, as a general proposition, it is often difficult to distinguish the employee's general experience and knowledge from his former employer's trade secrets. It is for this reason that the only sure and reasonable means of protection that an employer can secure for his computer program trade secrets is to prohibit by contract, for a reasonable period of time, his former employee from engaging in narrowly defined activities¹⁷ where the integrity of the trade secrets may be put at risk. Some states, however, such as California, Michigan and Florida, have statutory limitations on the use of such covenants. As to such jurisdictions, intelligently tailored arrangements can often afford the employer adequate protection.

Since the most salient characteristic of a contract is that it exists between two parties, the mere fact that an employer desires to limit post-employment competition by former employees is not usually the last word. What will induce a reticent employee to sign an agreement so limiting him? Usually, fame and fortune will suffice (i.e., a better title and economic inducement).

Several techniques can be employed to accommodate the employer's and employee's respective reasonable entitlements. Among them are restrictive covenants of brief duration and narrow scope and territory. More to the point are provisions intended to protect the employee's economic status during periods in which the restrictive covenant may operate to his detriment. Of course, there are other critical aspects which can be achieved in an employment contract, such as spelling out rights to patentable and non-patentable inventions and developments.¹⁸

Is trade secret law viable?

Just as the Supreme Court failed to acquit with clarity its duties to the software field in *Benson*, so has the Court been ambiguous or vague in

numerous other situations. Two 1964 unfair competition cases¹⁹ and a 1969 patent license case,²⁰ none of which involved trade secrets, contained language which caused some concern—more so among literal rather than analytical readers—for the continued vitality of trade secret principles. It was feared that the Supreme Court had held that the patent system preempts the field of protection for technology. However, dozens of cases decided since have expressly found trade secret law compatible with those 1964 and 1969 decisions.²¹ In my view, trade secret law and the patent system are independent and compatible. Trade secret protection maintains commercial integrity while encouraging independent development and is at heart pro-competitive.

Conclusion

Benson should not prove to be the end of the world for computer software. To the contrary, it may save the industry the time, enormous expense and all too often unrewarding bother of the patent system and force reliance on an efficient (albeit subtle and too often not fully understood) existing system: trade secrets. The realities of software, in fact, make securing a patent a poor investment since (a) the software is apt to be obsolete by the time of patent issuance and (b) policing a software patent may not be technically or economically feasible. On the other hand, trade secret protection is available to every enterprise at a modest cost, is rapidly achieved and can be flexibly used. While it is not the answer to every computer software problem, the better it is understood the more effectively it can be used. □



Mr. Milgrim is a member of the New York law firm of Milgrim Thomajan & Jacobs. A graduate of NYU School of Law, he also attended the University of Paris School of Law. His practice includes the field of licensing patented and unpatented technology and unfair competition. He has served as chairman of the first four Annual Institutes on Patent and Know How Licensing Law and Practices and is the author of "Trade Secrets," considered the definitive legal reference work in that field.

17. If practicable, for example, a programmer should not be precluded from all programming activities but rather from such activities directly related to the specific types of programs upon which that programmer has worked and which are not generally available. If that approach is not practicable, the employer should be prepared to bear his share of the programmer's economic disability during the period of restricted activity.

18. Limitations of space preclude discussion of this important subject. See generally *Trade Secrets* § 3.02 as to the pros and cons of contractual protection.

19. *Sears, Roebuck & Co. v. Stiffel Co.*, 376 U.S. 225; *Compco Corp. v. Day-Brite Lighting Inc.*, 376 U.S. 234.

20. *Lear, Inc. v. Adkins*, 395 U.S. 653.

21. See *Painton & Co. v. Bourns, Inc.*, 442 F.2d 216, 223 n.3 (2d Cir. 1971) noting the numerous cases. And see Milgrim, "Sears to Lear to Painton: Of Whales and Other Matters," 46 N.Y.U.L. Rev. 17, 23-24 n.31, 1971 (relied upon in *Painton*). See generally *Trade Secrets* § 7.08 [2][c].

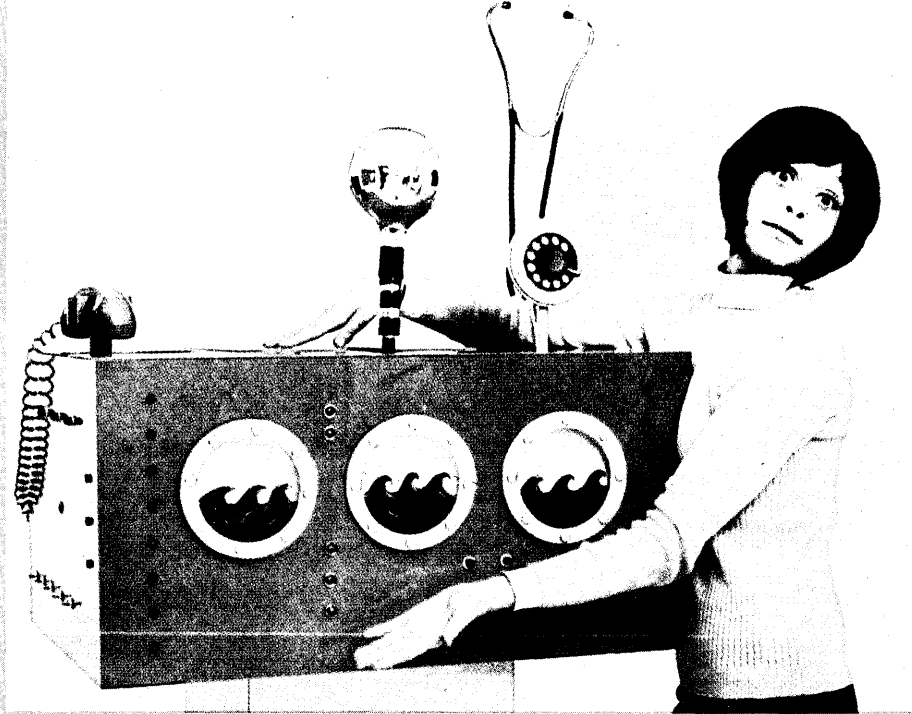

Well, **somebody** had to build a 7200 bps modem with features like dial backup, built-in diagnostics and multiport operation!



So, ICC built Modem 4800/72

Send for data sheet.

International Communications Corporation

7620 N.W. 36th Avenue, Miami, Florida 33147

Telephone 305 + 691-1220 305 + 836-4550

In Europe: RACAL-MILGO LIMITED Reading, Berks, England

**See us at the
National Computer
Conference**



a **milgo** company
© 1973

CIRCLE 38 ON READER CARD

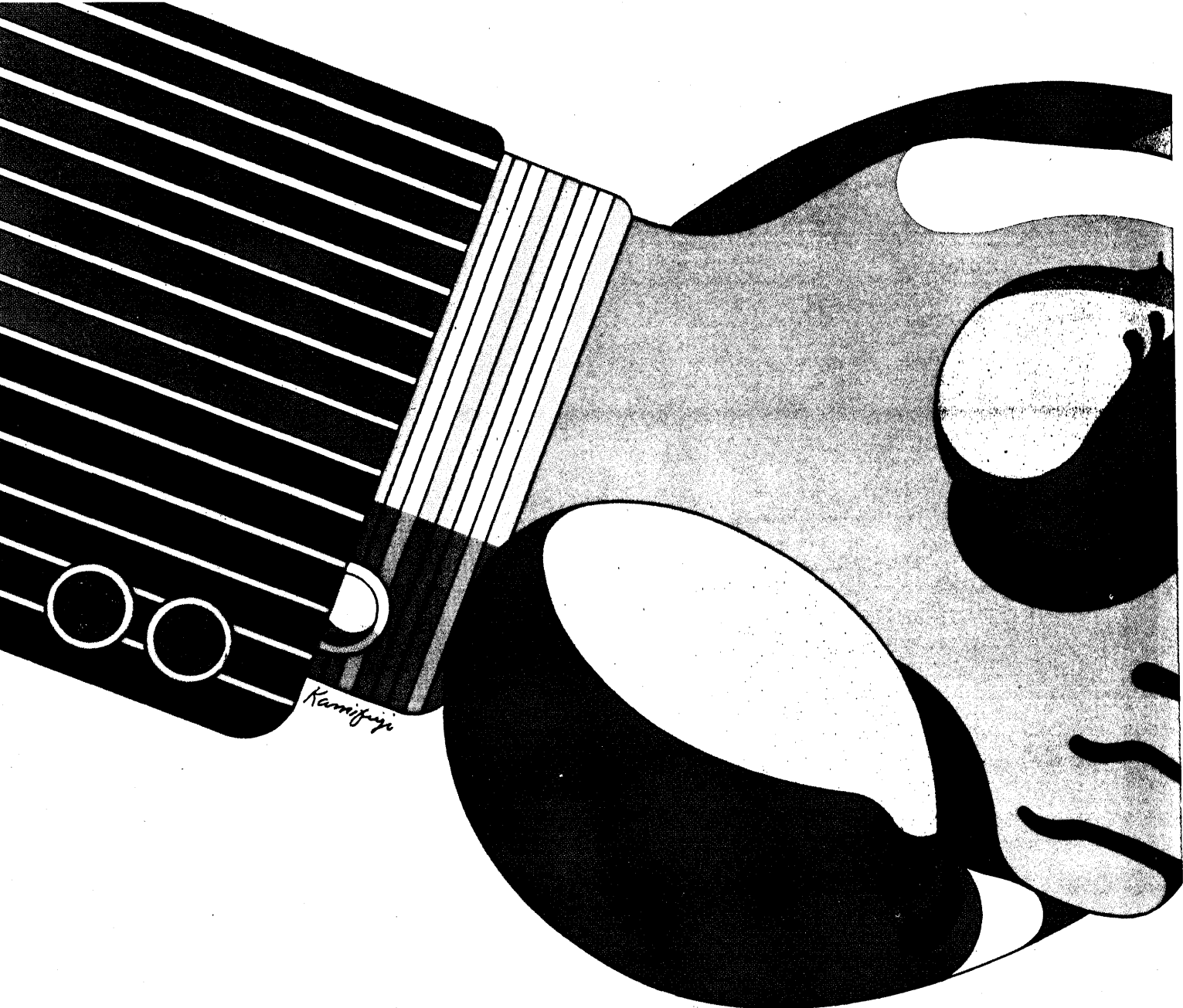

**Why are so many of our competitors
also our customers?**

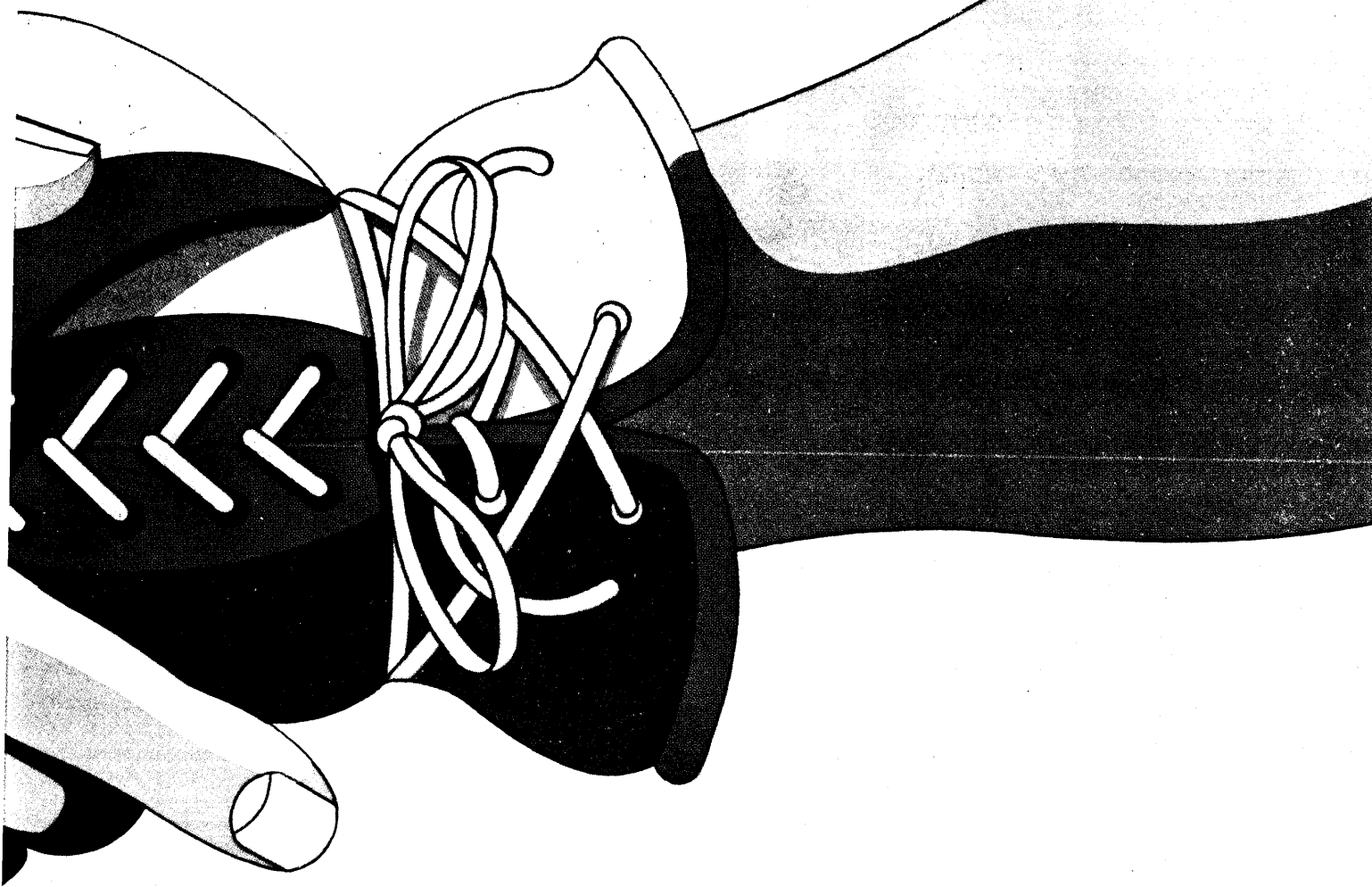

We make terminals for the data processing and communications industries.

So do a lot of other manufacturers who specialize in computer and communications equipment. (Over 400—according to latest industry figures.)

The irony of this is that a lot of our competitors use the Teletype® teleprinter as the backbone of many of their systems.

Which says a lot about Teletype equipment. Because who could be a more critical, discerning judge than your competition?

Why do they specify Teletype machines for sub-components? For three good reasons.

Reliability. Nobody has moved more information before or since the information explosion—with greater reliability.

Flexibility. We build our terminals to meet your particular needs. That's why we offer you a choice in arrangements, features, configurations and speed. Interface capabilities? Teletype equipment is compatible with practically any computer-based communications system.

Economy. From initial cost to operation to maintenance, nobody can deliver higher performance at a lower cost. Nobody.

Tough, demanding criteria. But what else would you expect from your competition?

This unusual situation is a good thing for everyone in the data processing industry.

But you benefit most. Because the terminal equipment you buy meets exacting standards for reliability, flexibility and economy.

We know. Because we set those standards.

It takes more than manufacturing facilities to build the machines Teletype Corporation offers. It also takes commitment. From people who think service is as important as sales. In terminals for computers and point-to-point communications.

That's why we invented a new name for who we are and what we make. The computer-communications people.

For more information about any Teletype product, write or call TERMINAL CENTRAL: Teletype Corporation, Dept. 81E, 5555 Touhy Avenue, Skokie, Illinois 60076. Phone 312/982-2500



Teletype is a trademark registered in the United States Patent Office.

Some debugging and monitoring facilities, designed to detect errors before program execution

Improving Compiler Diagnostics

by Elizabeth N. Fong

Software production requires large amounts of both human and machine resources. The recent trend has been towards a more systematic development of software and in particular towards producing "quality" software that is effective and maintainable. During the program development stage, most of the programmer's effort is spent in debugging. Program debugging is still a very uncertain process. Professionals do not agree on how to systematically get the bugs out of a program, or how to construct the most reliable program. Tools, both automated and manual, exist but, surprisingly, much of the work in this field has been described only in unpublished reports or passed on through oral tradition.

The programming activity is rooted in the traditional environment, that is, writing the program in a high-level programming language, such as FORTRAN, ALGOL, COBOL, or PL/I, with the usual compile-link/load-go situation. To aid the programmers at the stage of program development, it is advantageous to build debugging aids and monitoring features into a high-level programming language system.

Many programmers think of debugging aids as "dumps" (the display of the contents of storage cells) and "traces" (the display of the control flow during execution). However, these basic tools have become considerably more sophisticated over the years. In particular, very powerful debugging facilities have been built for the on-line interactive environment which give the user a high-level language with which to control the setting of breakpoints and interrogation of the status of storage cells.

The universities, in teaching programming to students, have found that they need an extensive set of debugging facilities. "Forgiving" compilers have emerged. These include not only error detection but error correction

features as well. Examples include Cornell Computing Language (CORC)¹, Waterloo FORTRAN (WATFOR and WATFIV)², Purdue Fast FORTRAN Translator (PUFFT)³, and Diagnostic FORTRAN (DITRAN)⁴.

This paper presents a collection of program debugging and monitoring facilities to improve the diagnostic capabilities of a compiler. A distinction is made between debugging and monitoring facilities performed at compile time, at link/load time and at execution time. These facilities are described in terms of this breakdown with a conscious attempt:

1. To move, as much as possible, the detection of errors from execution time to compile or link/load time in order to avoid overhead in an executing program.

2. To collect information when it is available during the compilation process. At the user's option, this information could be output at a later time.

Debugging and monitoring features described below are categorized according to these stages. This breakdown does not apply to the interpretive environment.

Compile-time checks

The type of checks performed by the compiler are usually referred to as static checks because the problems they address are invariant with execution time and independent of the values of the input data. The following are descriptions of some program debugging and monitoring facilities that could be performed at compile time.

Syntax checking. One of the first tasks done by a compiler is to scan the source program statements. Every high-level language has its own established set of syntax rules. Error situations occur when the compiler cannot translate a source statement, or the process of syntax-directed parsing is blocked. Examples of syntax errors include misspelling of reserved words, punctuation errors such as unmatched parentheses, missing operators, illegal sequences of operators in expressions, or missing statement labels. In a class of university-developed compilers (e.g., CORC, WATFOR, PUFFT) with "forgiving" features built in, extensive syntax checking is done. These compilers also do some error correction during source language scanning. For example, CORC attempts to define various categories of misspelling and tries to repair the error and continue to compile executable code. All compilers have syntax checking facilities; however, the extent of checking varies.

Static concordance of variables and labels. At compile time, all the variables and labels are entered into a symbol table or an intermediate file. This information could be made available during compile time to produce one of the most beneficial aids to debugging. This facility is sometimes called a cross reference listing. The usual format consists of the symbolic name followed by the concordance of the line number where the variable is defined and the line numbers where this variable is referenced. Some compilers also print out data type and relocation information. The advantages of such a facility would be to detect a variable or a label defined but never referenced or vice versa. For a block-oriented language such as ALGOL 60 or PL/I, the variables and labels may be declared as local within a block. Exhibiting a static concordance of variables and labels plus their scope of definition would aid debugging. Most of the compilers provide

1. Freeman, D. N., "Error Correction in CORC—The Cornell Computing Language," *AFIPS Vol. 26, SJCC*, 1965, pp. 15-31.
2. Cowan, D. D. and J. W. Graham, "Design Characteristics of the WATFOR Compiler," *SIGPLAN Notices Vol. 5, No. 7*, July 1970, pp. 25-36.
3. Rosen, S., R. A. Spurgeon and J. K. Donnelly, "PUFFT—The Purdue University Fast FORTRAN Translator," *Comm. ACM*, 8, 11 (Nov., 1965).
4. Moulton, P. G. and M. E. Muller, "DITRAN—A Compiler Emphasizing Diagnostics," *Comm. ACM* 10, 1 (Jan., 1967), pp. 45-52.

this facility. There are also programming support packages available which will generate such a concordance.

Language flagging features. Due to historical development, most programming language (e.g., FORTRAN) have undergone modifications and upgrading (e.g., FORTRAN II, Basic FORTRAN, FORTRAN IV, and Extended FORTRAN). Moreover, each implementation of the language contains differences. Flagging can be done during the source language scanning phase to detect language syntactic features which deviate from some "standard" definition such as ASA FORTRAN⁵, or additional features from the previous versions. A message could be printed out by the compiler as a warning to the user that the particular feature is unique to this version of the compiler. It is possible to determine the language feature differences by compiling the previously compiled program with the new compiler; however, the point here is to detect deviations specifically against a "standard" language definition, or to be able to identify a subset of the language that existed earlier. To make a full semantic check of a program is not possible, but to flag nonstandard syntactic language features is possible.

Logical segmentation of programs. A large program may be considered as consisting of small logical segments. This permits a modular organization. Modularity aids debugging because it breaks up the program into manageable sized pieces. In ALGOL, there are BEGIN-END statements which create a logical segment. In COBOL, a paragraph or a section also is considered to be a logical segment. A facility could be built into the compiler which would cause more readable source program statements to be printed out. Examples are: alignment of BEGINS with corresponding ENDS with nested inner blocks properly indented; hierarchical data declarations in COBOL or PL/I properly indented to reflect structures even when the input is not punched in the proper column; or reordering of source statements in order to group declaration statements, executable statements, and format statements. This facility, although not a debugging feature in the sense that it helps to uncover errors, could greatly add to the readability of a program. Producing readable documentation also helps another person in maintaining the program.

Static control structure concordance. The normal flow of control in a program is sequential. However, control may be transferred elsewhere in the program by a transfer of control command, e.g., GOTO, RETURN. A topological structure diagram showing every

transfer of control at the request of the user would aid debugging.

Link/load-time checks

In most batch-oriented installations, compilation produces a binary program file, usually stored on direct access storage. Subprograms and the main program are compiled separately and bound together by the link/loader which associates external references and adjusts addresses. If an external reference is to a system library routine, it link/loads this routine. The information available at this point enables the system to perform the following type of debugging or monitoring checks:

Formal and actual argument checks. A subroutine or function declaration consists of the name of the subroutine or function followed by a list of identifiers known as formal arguments. When the subroutine or function is being called, the name of the subroutine or function is followed by a list of actual parameters. For a programming language such as ASA Standard FORTRAN, the definition of the language specifies that the actual arguments must agree in order, number and type with the corresponding formal arguments. A check on all three items would insure that the program is adhering to a "standard." In order to perform checks at link/load time, it is necessary to carry more information than the usual external symbol definition, for example, the list of formal argument names and their data types, the corresponding actual argument names and their data types. The advantages of performing the checks at link/load time rather than execution time is that the check would be done only once, rather than each time the subprogram is executed. The tests that could be performed include the following:

1. If the subroutine or function does contain a nonstandard return, checking that the return label is indeed a label.

2. In the case of FORTRAN, if one of the arguments of the subroutine or function is a subroutine name or a function name, the compiler could check if the name is being declared as an external procedure.

3. Some implementations of FORTRAN compilers allow the number of formal arguments to differ from the number of actual arguments. If the standard language definition, e.g., ASA Standard FORTRAN, calls for a match in the number, the check might insure that the program is adhering to the appropriate standard.

Static subroutine structure analysis. The static information about subroutine structure consists of the caller and callee relationship derived from the program text. This caller-callee relationship is invariant at execution time

and this information is available at link/load time and usually contained in the external symbol definition table. The link/loader could optionally produce a concordance of the source language subprogram caller/callee names.

Execution-time checks

Dynamic information about the actual running of the program is obtainable at this time. To embed tests, the compiler usually produces code at appropriate points to be executed in conjunction with the worker program. Every test introduced will decrease the running efficiency of the worker program and it is necessary to exercise care when deciding what to measure and where to embed tests. Attention also has to be given to where the tests are to be inserted to assure uniform checks.

Dynamic trace of subroutine calls. Actual subroutine paths could be traced at execution time. This information not only aids in debugging but is very useful for program activity analysis.

Backward trace of subroutine calls upon error termination. Upon error termination, an identification of where the error occurred, plus a backward trace of the subroutine calls, aids debugging. One possible implementation of this facility is to use an extra word in the calling sequence to store the "walk-back" or the backward reference to permit this kind of backward trace.

Variable trace. This is a dynamic display of the specified variable and its content at each instant in time. The display usually occurs as an instruction-by-instruction accounting of information or at every instance of a value change. It is not only useful for debugging, but also useful in spotting the value changes of certain variables for program analysis.

Snapshot. This is similar to variable trace except that the variables and their values are recorded periodically on entering or exiting certain regions of the program.

Flow Trace. This is the dynamic display of every branch point of a running program. The trace records the decision points and exhibits the branches taken.

Array bounds checking. This checking is sometimes built into a computer as a precaution against altering of values incorrectly. The value of the subscript is tested to determine if it is within the specified dimension of the array element, and if it is also an integer constant. The check is useful in monitoring array elements and spotting the activity level of various parts of the table.

Effective address check. This is a feature provided for memory protec-

5. American Standard FORTRAN, published by American Standards Association, Inc. UDC 681.3, 1966.

Problem Sharing

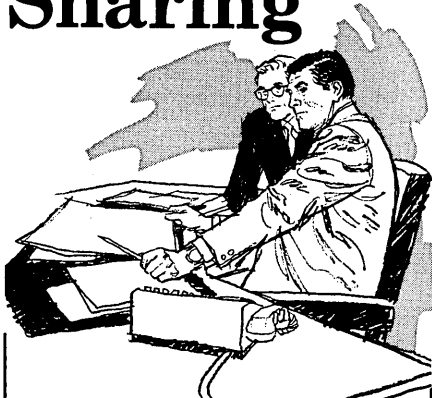

DOS and small OS users come to

COMMON

Common isn't a school. It's an association of IBM users who share ideas and solve common problems together.

If you'd like to meet people who are in the same boat as you are, come to COMMON.

HOTLINE

Membership in COMMON gives you access to a program library and a Hotline so that you can call on someone who has your same problems and talk them over with him.

CONFERENCES

Common holds two conferences a year that provide a wealth of material and common ground for all IBM users. Members who attend agree that one meeting is worth the price of attendance.

To meet people who understand your problems and can help you with them, come to COMMON.

Write or Call for facts on membership

COMMON

4806

435 N. Michigan Ave., Chicago, Ill. 60611

(312) 644-0828

CIRCLE 94 ON READER CARD

Compiler Diagnostics

tion. Bounds registers are set to certain permitted address ranges and every effective address value is checked against these bounds registers. In some cases, it is implemented as a hardware feature to avoid system overhead. This feature is especially important in a multiprogramming environment.

Value of the control variable upon exit. In an iteration loop such as FORTRAN-DO or ALGOL-FOR, the value of the control variable upon exit is undefined if the exit is due to exhaustion of the loop; otherwise it is the same as it was immediately preceding the execution of the exit condition. The undefined situation is handled by implementors in different ways. Some compilers even try to "guess" what the user intended. The trouble starts when programmers make use of these undefined situations on a particular implementation of the compiler, and later discover that the same program does not work correctly on a different implementation. Debugging this type of error is very difficult because it involves an understanding of the semantics of different compiler implementation. Debugging this type of error is very difficult because it involves an understanding of the semantics of different compiler implementation of undefined situations. One of the debugging facilities for this particular undefined situation could be to report all later use of the control variable or intentionally set the value of the control variable to "undefined" (minus zero or some such number) when the exit of the loop is due to exhaustion of the loop.

GOTO checks. Recently, there has been considerable interest in eliminating the GOTO statement. Dijkstra⁶ claims the use of GOTO statements is undesirable, and avoiding it would increase the readability and proveability of the program. When GOTO cannot be avoided, and when label variables are allowed, e.g., PL/I, the following kinds of checks could be performed by the compiler:

1. Flag error if the transfer is made to itself or to a nonexecutable statement.
2. Flag error if the transfer label value is negative or undefined.
3. Flag error if the transfer label value is outside of the user's assigned program space.
4. Flag warning if the transfer label goes within an iteration loop.

Truncation error warning. On an arithmetic or MOVE-data operation, some bits may be dropped due to com-

puter word length. Overflow to the left or to the right of the computer word is called truncation error. If such overflow is suspected or detected, a warning could be printed by the compiler.

Conclusions

Increasing concern with the quality of computer software today makes it important to evaluate critically the debugging facilities available in high-level languages. The debugging and monitoring aids described above are particularly useful during early implementation and initial system integration stages. They could be automated by embedding these checks at appropriate points in the compilation-execution process when all the needed information is available.

The list of features is not geared to any particular high-level programming; however, some of the features described are applicable only to particular language constructs. Techniques of implementation and the question of how to invoke and suppress these debugging and monitoring facilities have not been addressed here.

Commercially available compilers usually provide some debugging facilities; however, certain trade-off decisions are made which usually sacrifice the extent of providing debugging aids in favor of efficiency of the compiler. Such a list might prove to be useful as an evaluation criteria in determining the capabilities of a compiler.

There are other automated testing techniques for validating purposes, but they are beyond the scope of this paper. Such techniques include benchmark tests, exhaustive exercising of the program with different input data, and proof of correctness using formal logic, etc. Testing methods for validation purposes are very different from those mentioned here, which are limited to debugging and monitoring aids for program development purposes. □

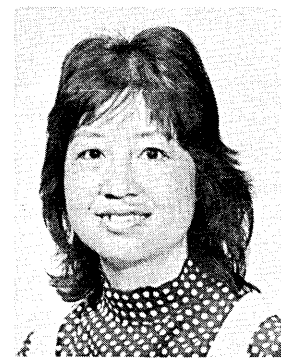

Ms. Fong is a computer specialist at the Institute of Computer Science and Technology, National Bureau of Standards. She was previously a systems programmer at Bell Labs and Control Data Corp. She has a MSc in computer science from Stanford University.

6. Dijkstra, E. W. "GOTO Statement Considered Harmful," *Comm. ACM*, 11, 3 (March, 1968), p. 147.

DP DIALOG

Notes and observations from IBM which may prove of interest to data processing professionals.

DP DIALOG appears regularly in these pages. As its name suggests, we hope DP DIALOG will be a two-way medium for DP professionals. We'd like to hear from you. Just write: Editor, DP DIALOG, IBM Data Processing Division, White Plains, N.Y. 10604.

SRI: IBM's Advanced School for Problem Solvers

It's called the IBM Systems Research Institute. It's located near the United Nations in the heart of Manhattan. It's for IBM DP professionals who have demonstrated exceptional promise or achievement in systems-oriented work. And its goal is to provide the advanced training needed for systems solutions to the most rigorous business, scientific and social problems the con-

temporary world has to offer.

"The increasing complexities of managing almost any organization today—whether in manufacturing, banking, insurance, government or education—call for the level of systems knowledge provided at SRI," declares Dr. Edwin S. Kopley, the SRI director.

"Many of the difficulties facing society are essentially complex systems

problems," he continues. "Solving them will take more than vast infusions of money. We will need trained people on an unprecedented scale, people capable of incisive systems analysis and design. People who can tackle such challenges as comprehensive medical diagnosis, care and prevention; mass rapid transportation; control and eradication of the various forms of pollution; greater use of the oceans and ocean floors for the production of food."

Among other requirements, candidates for admission to SRI must have their manager's recommendation and must take an entrance examination with questions on computer logic, basic mathematics and programming languages.

The student who arrives at SRI becomes one of 125 members of a three-month class drawn from every IBM
(Continued on next page)

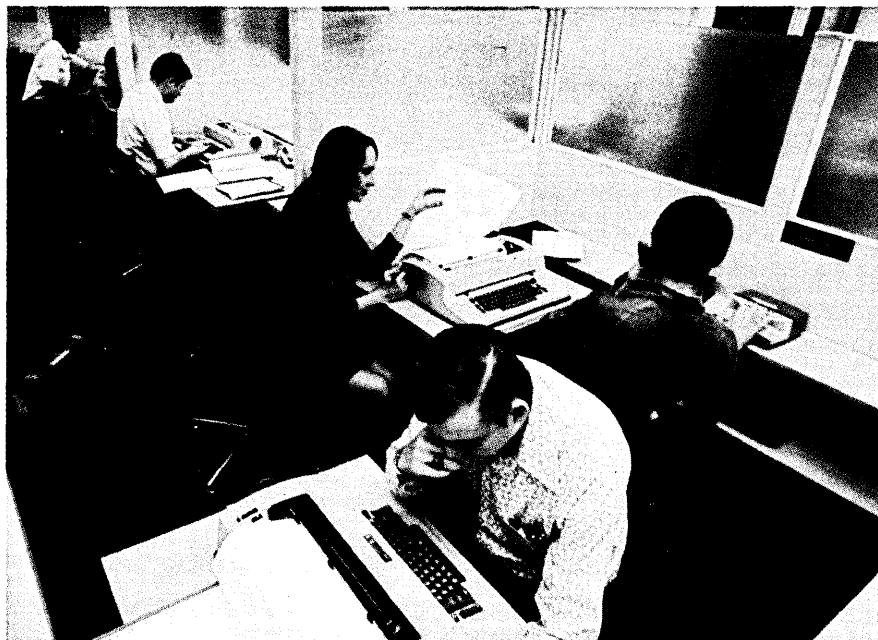

SRI students interact with the computers as a learning aid.

Also in this issue . . .

Sikorsky Lifts Programmer Productivity With TSO 2nd page

New IBM Data Entry System Uses Diskettes 3rd page

He Taught the System/3 to Print Braille 3rd page

Magnetic Bubble Storage Clears Another Hurdle 4th page

Sikorsky Lifts Programmer Productivity With TSO

A leader in the manufacture of commercial and military helicopters, Sikorsky Aircraft Division of United Aircraft Corporation is also a pioneer and leader in time sharing. Through the use of TSO, the Time Sharing Option of OS/MVT, the Stratford, Conn. manufacturer has the ability to perform on-line programming and message switching. At the same time, it can tap enormous data bases, while allowing batch processing on the same system. To accomplish this, Sikorsky chose an IBM System/370 Model 155 and TSO, providing access to four million file segments on IBM 3330 disk storage. More than 50 TSO terminals are scattered throughout the Sikorsky complex.

"We have about 50 concurrent users during the day making TSO inquiries," says Dr. John Bennett, manager of Information Systems. "In addition to users on the shop floor, in production control and in engineering, ten of them are COBOL programmers compiling their programs. One of the most significant benefits of TSO at Sikorsky is the increase in the productivity of those programmers. They get about three times as much work done with on-line program development as they did with batch processing."

"The great thing about TSO is that it enables us to make program changes in minutes. Under batch, we felt we were in a stranglehold," says systems programmer Dave Ericson. In a batch

environment, he adds, he was lucky to get two tests a day, but under TSO he's made as many as 20 tests without any difficulty.

One TSO facility he uses extensively is the EDIT command to create or modify his source deck as he discovers bugs in his program. "This command allows me to index my source deck, which is on disk, and to make any changes I want in any card of that program. With the TSO command language, I can get to any facility on the system, just by allocating the proper data description cards," he says.

Another valuable TSO feature is the TEST command. This allows the programmer to set up break points in the program where he wants execution to be interrupted for displays or other debugging activity. "You can look at any particular position in core at any given moment in your program. It's just unbelievable the help the TEST feature can give you," says Ericson.

And with the CLIST feature, Ericson is able to allocate dynamically each data set that he wants to use in a test environment. "Instead of typing in the ALLOCATE and FREE commands, I just create the CLIST and let the computer do it for me," he says.

Ericson points out that implementing his programs is also far simpler with TSO. For example, he can use the COPY command of the TSO data utilities program product to transfer his

program from a test library to the production library. "When I want to put my program in production, I just invoke the COPY command and my program will go right in," he explains. "I can effectively test a program in the morning and put it into production in the afternoon." **IBM**

Advanced School...

(Continued from preceding page)

division and subsidiary.

- *Systems Variables in Human Behavior*
- *Design of Communication Based Systems*
- *Storage Organizations for Data Base Systems*
- *Advanced Analytical Methods for Systems Analysis*

With the aid of a faculty advisor, the student chooses a study program from over 100 courses such as those above. They are taught by resident and visiting professionals who are authorities in their fields. Study requirements include extensive reading, frequent use of the Institute's computer system and, often, direct involvement in group projects and case studies.

But formal education, important as it is, does not constitute the essence of SRI. Something else is involved.

"Groping, analyzing, discussing, investigating, questioning . . . searching"

That something else derives from the interaction, over a period of months, of a group of people—students and teachers—diverse in origin and background but stimulated by a shared sense of participation in an unfolding field of human endeavor.

It is reflected in the give and take of a classroom discussion . . . in the after-hours working groups that spring up around the computer terminals, both at the Institute and at the students' residence . . . in the introduction of a new course on one of the frontiers of computer technology (for example, "Computer Networks") . . . in the undertaking of a research project by a student assisted by his instructor.

The future is very much a part of the curriculum at SRI. Lecturers currently involved in laboratory and experimental field work provide insights into evolving concepts and procedures; research is in the air; ideas are encouraged and analyzed.

Clearly, there are vast areas in the computing sciences awaiting exploration and development. Stimulating talented professionals to conquer them is SRI's primary task. **IBM**



New IBM Data Entry System Uses Diskettes

The IBM 3740 Data Entry System, announced in January, is designed to streamline the computer data entry function. It employs a new medium, the IBM Diskette, which an operator inserts in a slot in the keying station to record data. The thin, re-usable Diskette weighs a little over an ounce, comes in a sealed jacket 8 inches square and has a storage capacity equivalent to 3,000 80-column punched cards.

Because the Diskette is so transportable (it fits in an envelope for mailing

and can be filed in an ordinary file cabinet), it makes forwarding large amounts of recorded data simple, convenient and efficient. This can reduce the procedures and time needed for communication between decentralized data entry points and a central DP facility.

The 3740 system offers both single-station and dual-station keying units with low-noise-level keyboards. Each operator keys to a buffered storage area, using a CRT visual display for quick detection of errors (and with the single-

station unit, for operator guidance), prior to actual recording on her Diskette. The CRT can also show data previously entered, making for quick verification and updating, as well as providing information retrieval.

Direct, high-speed computer input and output of Diskette data is provided via the new IBM 3540 Diskette I/O Unit, which can be channel-attached to System/370 Models 125 through 158. Alternately, the IBM 3747 Data Converter transfers Diskette data to magnetic tape, ready for processing.

In addition, when equipped with a binary synchronous communications adapter (BSCA), the single-station unit affords direct communication with properly-equipped models of the System/370, System/360 and disk System/3 Models 6 and 10, as well as the 3747 converter. This unit is thus particularly well suited to the needs of remote data entry locations.

Little, if any, procedural change is involved with a move from card media to the Diskette.

Full information on the 3740 Data Entry System is available through IBM offices and local representatives. **IBM**



Both the single-station and dual-station units have a visual display for each operator. The IBM 3713 printer (optional) prints data from the Diskettes at 40 characters per second. The 3747 converter is also shown.

He Taught the System/3 to Print Braille

Converting a computer system to printing in Braille may sound like a formidable engineering and programming job. But for David Schwartzkopf, a partially-sighted IBM programmer, all it took in the way of hardware was a 14-inch strip of elastic which he bought for twenty cents in a variety store.

Schwartzkopf used the period in the alphabet of the IBM System/3 printer as a means of embossing the printout paper. The "flying period", as he calls it, utilizes two print positions on three lines—six positions in all—to form a single Braille character. The printer ribbon is removed and an elastic strip is placed over the printer hammers. The period then forms raised dots on the reverse side of the paper which can be "read" by a blind person.

Of course, there's programming involved too—specifically a modification of the RPG II compiler for the System/3 Model 10 card system. To get it done, Schwartzkopf applied for a grant under an IBM program which allows IBM employees to spend time on innovative

projects not part of their regular assignments. Working at the Rochester, Minn., laboratory of IBM's General Systems

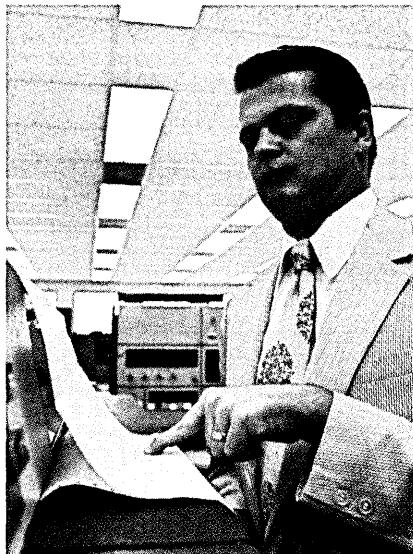

David Schwartzkopf "reads" the Braille printout he made possible.

Division with the financial backing provided by the grant, Schwartzkopf wrote the instructions that enable the System/3 to translate standard output into the Braille patterns.

Schwartzkopf, who is now a senior associate programmer at IBM's Boca Raton, Fla., facility, thinks that blind and partially-sighted people can make exceptionally able programmers. "This is because they have learned to adapt to a life governed by fairly rigid procedures, somewhat akin to those required for programming," he says.

"Of course, they have some special needs in a data processing career," he continues, "and a way of reading printout, which is usually in small characters, is one of them. Even with high magnification, it's not easy, as I learned from my own experience. That's what led me to develop the Braille feature for the System/3."

The Braille compiler program and an instruction manual are available through your local IBM branch office.

IBM

Magnetic Bubble Storage Clears Another Hurdle

The advent of the solid-state storage medium known as "magnetic bubbles" has aroused great interest in DP circles. And with reason. Bubble storage has the potential to provide access speeds of tenths and even hundredths of a microsecond, together with data rates of up to ten million bits per second.

Free of mechanical motion with its attendant wear and tear (the "bubbles" are simply negatively-magnetized regions in a positively-magnetized film), bubble storage devices should have long life, large capacity and be virtually maintenance-free. They should also be low in cost, due in part to their extremely high storage density. At present a million bits per square inch is routinely achieved, a shift register with a hundred million bits per square inch has been demonstrated, and ever higher densities are projected.

How are the bubbles used to store and transmit information? By being moved from cell to cell in a shift register under the influence of a rotating (and hence varying) in-plane magnetic field. At each cell in the register, the presence of a bubble signifies a binary "one"; its absence, a binary "zero". Each complete rotation of the magnetic field (as many as a million rotations per

Watson Research Center in Yorktown Heights, N.Y. Their device makes use of the principle of magnetoresistance, a change in the electrical resistance of a material when its magnetization is changed.

The sensor material in this case is a thin strip of magnetoresistive Permalloy metal. Electrical contacts permit the flow of current that measures the sensor's resistance. Initially the sensor is magnetized along its "easy" or natural axis. But when a magnetic bubble lands next to it, the magnetization of the sensor rotates, thereby changing its resistance. This alters the current and triggers an output signal, a binary "one". The readout, incidentally, is nondestructive; the bubble train continues on its way.

When the IBM inventors filed their patent application for the sensor, they were working with bubbles of around 100 microns in diameter, for a density of 10^4 to 10^5 bits per square inch. In the thirty months since then, several laboratories have achieved 5-micron bubbles in large memory chips (up to 10^4 bits per chip), having increased their bubble density to 10^6 bits per square inch. Recently IBM also reported the operation of a 100-step shift register of 10^8 bits per square inch. But

vidual sensors for each cell in the register. This leads to significant reductions in writing, reading and detection circuitry. With these methods, bubble technologists are confident that they can have both high storage density and convenient on-chip signal detection and amplification.

Because of the numerous advantages of bubble circuits, they are viewed by many organizations as promising candidates for processing and storage of data, for switching applications, and even for optical displays and waveguides. IBM is helping bubble technology to achieve its full potential. **IBM**

Program Products from IBM

IBM offers more than 200 Program Products to save users time and money. For most of them, IBM provides a preinstallation test period of 30 to 60 days without charge. Three Program Products used in data base/data communications are listed here. For more information about these and others, write to: Director, Program Systems Marketing, Department 807, IBM Data Processing Division, 1133 Westchester Avenue, White Plains, N.Y. 10604. Or contact your IBM representative or local office.

1. Customer Information Control System (CICS) (OS DOS) The link between your computer's data base and the applications you want to put on line. By providing many of the standard control functions, CICS lets your programmers concentrate on coding the applications. Helps you save implementation time and cost.

2. Storage and Information Retrieval System (STAIRS) (OS) Operating under CICS, it offers the user a variety of resources for on-line dialogue with up to 16 different data bases containing documents with text and formatted information. STAIRS includes routines for creation and maintenance as well as search and output documents.

3. VIDEO/370 (DOS, OS) Provides on-line data entry from local or remote stations of the IBM 3270 Information Display System. Shortens the data entry cycle, improves accuracy and enhances operator productivity.

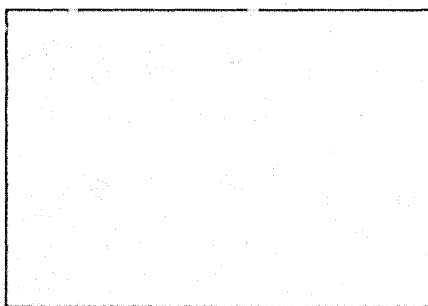
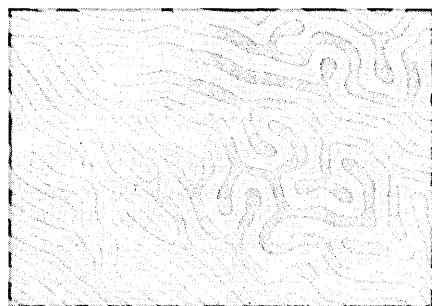

Without an external magnetic field, areas of opposite magnetization in the film are approximately equal (micrograph at the left). When an increasing external magnetic field is applied, however, the areas of opposite magnetization in the film shrink and form "bubbles" (right).

second appear feasible) moves each bubble along by one cell.

The detection of the small signals emitted by the bubbles represents an increasing challenge as field densities grow greater. Recently, however, a patent for a simple and easily-fabricated sensor was issued to four IBM research engineers, thereby bringing bubble storage a long step closer to practicality. (Patents for other bubble inventions have been issued to a number of other companies.) The IBM inventors are George S. Almasi, Hsu Chang, George E. Keefe and David A. Thompson—all staff members of IBM's Thomas J.

the smaller bubbles emit lower magnetization, thus making sensing even more difficult. To overcome it, transverse "bubble stretchers" which enhance the signal without decreasing the data rate, have been developed by others.

Now researchers at the Watson Research Center have proposed linked magnetoresistors, which in conjunction with a multi-stage bubble compressor can amplify signals as effectively as the bubble stretchers in much less space. Since long lines of bubbles can be made to march along in order, the bubbles can be brought past this linked sensor element, eliminating the need for indi-

IBM®

DATAMATION

A large realtor has found that the use of a data dictionary simplifies the addition of new profit centers to existing applications

A Data Dictionary Approach to MIS

by R. David Guthrie

All data processing and management information systems require the conversion of numeric codes to alphabetic descriptions at report time. A majority of systems employ methods to achieve this goal that include:

1. Individual programs reading in sets of table cards with descriptive data.
2. Creating small, splintered files of names for use by individual programs and/or systems; or
3. Embedding names or descriptions inside programs themselves.

These approaches suffer from one or more of the following weaknesses:

1. Programmer intervention is almost always required to change or insert new table cards into job control language (JCL). If the table is embedded in a program, it must be modified to meet new or changing requirements.
2. There is usually no cross reference to table use between programs and systems, thus repetitious effort is required to implement changes.
3. The user of a system is at a loss as to where to begin implementing his change. Too often a memo is received in data processing advising managers of a new profit/cost center, office, manager, or product line with no indication of systems affected.
4. Programmer time is wasted writing table-handling routines for each program together with associated file descriptions, input/output commands, etc.

The data dictionary approach

A dictionary is defined by Webster as "a work or reference in which the words of a language or of any system or province of knowledge are entered alphabetically and defined; a lexicon."

The data dictionary differs only in

the indexing or entry of the data—it is by the numeric or coded reference, because the purpose is to provide the alphabetic definition of a number. We might then define a data dictionary as "a work or reference in which the codes of an organization or of any system or province of knowledge are entered numerically and defined by their alphabetical equivalents."

An integrated system depends on a uniform definition of the numeric codes in use. Creation and maintenance of this system can be transferred in most cases to user departments who define, use, and are responsible for the codes.

Application

In our organization the dictionary need was initially established by the requirement to produce an employee directory which included the occupation, physical location, and profit center name for each employee. This would have required more than 1,000 table cards, together with constant updating. A data dictionary approach appeared to be the logical solution to the problem. Application of the dictionary has since been extended to virtually every system in the department. Items presently stored in our dictionary include:

1. Word Definitions
 - Occupations
 - Profit/cost centers
 - Physical locations
 - States in the U.S.
 - Counties in each state
 - Census planning areas
 - Property types
 - Area names for local office applications
 - SIC code descriptions
 - Employee names
 - Vendor names

Chart of account titles
Consolidated financial statement titles
Regions
Invoicing and billing descriptors
Future action codes
Banks and account numbers
Sales lead codes
Purchase type codes

2. Specialized Use
 - Payroll corporation tables
 - Payroll withholding tables
 - Long-range forecast assumptions
 - Local and municipal tax schemes for invoicing
 - Master file integrity records
 - Density map control parameters

In many cases it is desirable to subdivide the word number to maintain logical associations within the dictionary. For example, county names use a sccc word number where ss is state and ccc is county. For items unique to an office using our department as a service bureau, we use a ppii word number where ii is the item unique to the profit center customer.

In order to provide for random or table access, two subroutines were devised. Both have identical calling arguments for uniformity but radically different modes of operation and core size:

1. Random: The random routine opens the file on the first call and retrieves the word randomly from disc on each call. As it is time consuming, it should be used for occasional reference such as page headings, etc. The advantages of the routine are small core requirements and common applicability for accessing more than one dictionary in the same program by changing only the values in the arguments.

2. Table access: This routine opens

Dictionary Approach

the file and loads the first 200 words sequentially on the first call. If the word required is within range of the table, a table search is made to locate the word and return it to the user. If the word is out of range, a call to the random routine is made. The applications programmer is completely relieved of table size considerations as the routine automatically converts to random operation when table limits are exceeded.

Benefits

In addition to the benefits of uniformity and user responsibility other benefits include:

1. Storage saving: Each definition is stored once.
2. Rapid updating: A change is immediately implemented in all reports and systems.
3. User flexibility: A chart of accounts title change requires a single update initiated by the accounting user.
4. Reference: Any portion of the dictionary may be selected and listed on a printout list, gummed label, or 3 x 5 card for user convenience.

| Name | Size | Use |
|---------------|------|---------------------------------------------------------|
| Status | 1 | Flag deleted records |
| Subdictionary | 2 | Identifies the subdictionary |
| Word number | 5 | Identifies a word (definition) within a subdictionary |
| Definition | 40 | The alphabetical definition |
| Word code | 5 | An optional numeric code associated with the definition |

Fig. 1

5. Rapid programming: Report programs can be readily written using one of the commercially available COBOL generation programs. Insertion of a call to the data dictionary for headings or titles completes the job, in most cases, in a few hours.

6. Graphic analysis: It is easy to prepare bar graphs or histograms from data using a graphic subroutine, which automatically accesses the dictionary for descriptors on the graph.

7. Management acceptance: Too often the data processing industry requires management to deal in terms of coded references in their reports; the dictionary approach permits reference in terms familiar to management.

8. Technical use: Recognizing our expansion plans and the changing nature of the tax laws, we converted our payroll system to use the dictionary. One subdictionary holds corporation information (name, identification, FUI and SUI rates) and a second holds individual state and federal withholding parameters and tables. This greatly

facilitates running a multistate, multicorporation payroll with a minimum of reprogramming for new requirements or changes.

9. On-line inquiry: Low-volume inquiry systems for use by management require word definitions of numeric codes. Inquiry programs are typically unable to keep extensive tables in core and are a natural use for the dictionary approach.

10. Master file integrity: ISAM disc files do not provide the trailer records used with other access methods. Storage of trailer information (record counts, hash totals, etc.) within the file can be difficult. Use of a subdictionary to store this data can provide the basis for frequent audit of file integrity and an easy way to control and monitor updating. A variation of the standard dictionary access programs is necessary for technical and security reasons.

File design and access

The dictionary requires random access on a word-by-word basis by programs limited in core size. For repetitive reference it is desirable to load a table in core memory once for the duration of the program. Indexed sequential (ISAM) file organization appeared to best fit these requirements. Record contents are shown in Fig. 1.

The COBOL calling sequence is CALL 'UT0500' (or 'UT0510' if table access is used) USING SUB-DICT, WORD-NO, WORD. If the word cannot be found, the subroutines return zero in WORD-NO and spaces in WORD. They are thus useful for validation of account numbers and other information in edit routines.

Housekeeping

Maintenance of the system requires few programs. We presently use:

1. File maintenance: Limited to addition, deletion, or change of words or word codes.
2. Reorganization: Reorganizes the ISAM file after addition of new definitions.
3. Master list: Prints the entire dictionary for operations reference omitting certain sensitive subdictionaries.
4. User selection: Selects specified subdictionaries for users. Output is in a utility name/address format for printing in a variety of forms after some type of optional sorting.

Implementation considerations

Implementation of this concept should not be difficult. All programs are very small and relatively easy to write in high-level languages. The potential user will want to consider such questions as:

1. Key size: The five-digit word number may at times prove too small.
2. Block size: The tradeoff here is core size for the access routine versus operating speed. This will be dependent upon available hardware.
3. Security: Certain subdictionaries may require more strict control of updating and requests for listings.
4. Language: Our routines are written in ANS COBOL operating under IBM's DOS. Standard linkage conventions permit access to the dictionary routine from PL/I and assembler programs. Use from FORTRAN IV requires only a very small COBOL program to convert from integer or floating point to commercial decimal use. The random routine should incorporate use of the CORE-INDEX feature to reduce access time.
5. Standard labels: Use of standard labels for the dictionary file is a must, together with a logical unit (sysnnn in DOS) which will not be assigned away from the disc holding the dictionary during production jobs.

Summary

The data dictionary approach has proved extremely successful at Coldwell, Banker & Co. Operating as a service bureau to our profit centers for marketing applications, we have been able to add new centers to existing applications rapidly by simply updating the subdictionary with information unique to the profit center. The extension of the approach to use by commercial service bureaus offering "packaged" applications should prove highly successful. □

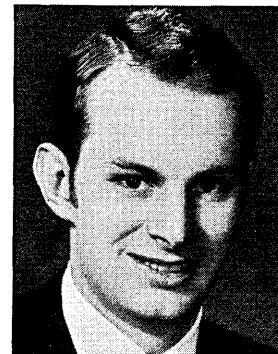

Mr. Guthrie is data processing manager for Coldwell, Banker & Co., realtors, in Los Angeles. He has a BA from the Univ. of Washington and an MBA in quantitative business analysis from the Univ. of Southern California. He has taught data processing at Long Beach City College.

Datapoint delivers at Executive Data

Executive Data Systems, Inc., Cedar Rapids, Iowa, is a national leader in supplying computer utility services to the health care field. Currently over 100 hospitals and health centers are subscribers to Executive Data's computing services for applications in general administration, patient accounting, medical diagnosis, laboratory analysis and many other critical areas. The great majority of Executive Data subscribers are now utilizing Datapoint 2200 systems and printers as on-site terminals for data entry, for data communications (to Executive Data computers in Cedar Rapids) and increasingly for on-site data processing.

Why Datapoint? "The Datapoint 2200 meets the needs of our hospital and health center clients more fully and more satisfactorily than any other computer system," notes Don Olson, Executive Data president. "Its full programmability and the availability of DATABUS, a high-level programming language, makes it easy to adapt the system to the varying data entry requirements of our clients. On the 2200's video screen we can display the precise format for data to be entered, which, combined with programmed error checks, virtually eliminates input errors. Since the 2200 is as easy to use as a typewriter, there's no need for special operator training as with a keypunch machine. During the day the transmission of data to our central computer occurs automatically, without the need for manual dialup. Similarly, needed management reports are sent out automatically from our central computer during the night to an unattended 2200 printer, ready for management to use the very next morning, when the information is really timely and useful."

"The Datapoint 2200 has been a key factor in the continued growth of Executive Data and in our ability to provide the finest computing services in a modular and economic fashion to our clients. As the health care field grows more aware of the capabilities of our service in combination with Datapoint systems, I anticipate a steady rise in the number of our subscribers and in the processing volume we undertake for them."

*Don Olson, President,
Executive Data Systems, Cedar Rapids, Iowa*

Every hospital and health center has varying needs for computer service, which can range from simple bookkeeping to sophisticated computerized analysis. Executive Data's approach is to provide these services on a modular basis. "Because the 2200 is a fully programmable general computer, it can handle much of the burden of editing and pre-processing of data," said Mr. Olson. "This relieves much of the overall processing load on our large central computer systems. Additionally, as hospital users grow more sophisticated and demand more and varied applications, we expect to see the Datapoint 2200 used more frequently as a supplemental independent processing unit."

The Datapoint 2200 and associated peripherals have delivered the goods for Executive Data Systems and its numerous hospital subscribers in a variety of applications in data entry, data communications and dispersed data processing. Prices on this unique system begin as low as \$6,040. For information on how this capability can be put to work in your operation, contact the Datapoint sales office nearest you or write or call: Datapoint Corporation, 9725 Datapoint Drive, San Antonio, Texas 78284.

Datapoint

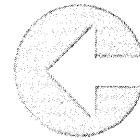

Home Office: 9725 Datapoint Drive/San Antonio, Texas 78284/(512) 696-4520 • **Sales Offices:** Beverly Hills, Calif./ (213) 553-0376 • Boston/(617) 891-9220 • Chicago/(312) 671-5310 • Cleveland/(216) 831-1777 • Dallas/(817) 265-7745 • Darien, Conn./ (203) 655-4800 • Denver/(303) 771-0140 • Detroit/(313) 557-6092 • Houston/(713) 626-0010 • Los Angeles/(213) 645-5400 • Minneapolis/(612) 854-4054 • New York/(212) 759-4656 • Orlando, Fla./ (305) 671-4500 • Philadelphia/(215) 272-1444 • Phoenix/(602) 265-3909 • Portland/(503) 244-0101 • San Francisco/(408) 732-9953 • Washington, D.C./ (301) 937-2215
• **International Representatives:** TRW Communications/Toronto, Ontario, Canada/(416) 481-7288 • TRW Communications/Lyss/Berne, Switzerland/Telex: 845-34446 • TRW Electronics-International/Los Angeles, California/Telex: 674593

Feed



the Brute

Sure, you must satisfy your computer's voracious appetite with animal-size portions of data. But your computer won't thrive on volume alone. It needs a lush diet of quality, Grade A data.

Inforex data entry systems give you both quantity *and* quality.

For example, concurrent data entry and verification improves throughput. Full record display simplifies error detection and correction. System-generated messages assist operators. Exacting edits and checks make sure only the choicest data gets to your computer.

Plus a full range of other data entry functions: virtual program control, keystroke counting, automatic batch transfer, keystation command mode... and more. In addition, only Inforex systems let you do file search and update in place on both disc and tape.

You can get more than data entry, too: Line and Serial Printing, fully formatted; On- and Off-Line Communications for local or remote locations; and advanced 1600 BPI Phase Encoded tape output for high performance tape transports.

No wonder Inforex has more key-to-disc systems installed than anyone else in the world.

No bull.

Choose System 1301, 1302, or 2300 for the price/performance/backup mix that best meets your needs.

Inforex. The high performance feed company for your computers. Offices in major cities throughout the United States, Canada and Europe. Distributors worldwide. Talk to us. Inforex, Inc., 21 North Avenue, Burlington, Mass. 01803.



 **INFOREX**

Waveguide systems by the end of the decade—but trouble with operations and the threat of crime now

Second Annual Computer Communications Conference

by Edward K. Yasaki, San Francisco Bureau Manager

Between 1980 and the year 2000, we will have a switched, digital broadband network for both voice and data. Another prospect in long-haul transmission is for the costs of 50 kilobits/second service to be comparable to that for an ordinary voice channel. These were among some projections made by Dieter Lohr of Stanford Research Institute (SRI), speaking at the second annual Computer Communications Conference. The meeting, held on the campus of California State Univ., San Jose, drew some 150 registrants, down from 235 last year.

Speaking on the outlook for digital transmission services, Lohr said the technology is available to offer data services independent of existing voice facilities, but pointed out that common carriers currently have an investment of \$70 billion in equipment that cannot be economically junked. He traced briefly the digital transmission systems now available, noting that microwave systems have expanded from a voice channel capacity of 600 to 1,800, and observing that some people are trying for 2,400 channels. By 1975, he continued, there would be coaxial systems with the equivalent of 8,064 voice

channels, followed in '79 by millimeter waveguide systems with a capability of 60 282 megabits/second channels, or the equivalent of 242,000 voice channels.

Waveguide advantages

With a coaxial system, he explained, it is necessary to have repeater stations about every mile along the route; whereas a waveguide system requires stations only every 25-30 miles. The latter is also true with microwave systems which, however, have a low bandwidth, and this limits the number of channels carried. By contrast, both coaxial and waveguide systems have high bandwidths and therefore more channels. And thus the waveguide provides the best of two worlds—both high bandwidth and low attenuation.

The ultimate, he concluded, would be laser-based fiber optics, which could possibly be operational along about 1985. This could carry the equivalent of about 1.4 million voice channels.

Looking at a somewhat shorter timespan are the people trying to get the ILLIAC IV computer operational at the NASA Ames Research Center, Moffet Field, Calif. That parallel processor

is about 100 times faster than the CDC 6600 and has a power "nominally equal" to the Star computer, according to Loren G. Bright, director of research support at Ames. Bright, the luncheon speaker, confirmed earlier reports, saying the system was scheduled to be running in early March but not fully operational until October. As of late January, the computer's mean time between failure was about five seconds, while the goal is an MTBF of from four to six hours. And the objective is a mean time to repair of 30 minutes. The installation has six spare processors, in addition to the 64 that fill the mainframe.

The people at Ames, of course, have the responsibility for developing the software and getting the system hooked into the ARPA network. At the center, scientists are performing three-dimensional fluid flow research and, like the weather bureau folks, are looking forward to the use of the fast computer to advance their respective technologies. To simulate a given flow, according to Bright, the costs go down as computer system size goes up. Thus, he observed, their costs on a CDC 7600 are slightly lower than on a 370/195, and are even lower with a Star or the ILLIAC. But he said Ames' investment to date on the ILLIAC system was about \$4 million. They will spend about \$9 million this year, possibly \$6 million next year, and their projected operating budget is \$3 million a year—costs shared by all the owners of the system who will be using the system via the ARPA net.

Possibly the best attended of the 12 parallel sessions during this two-day meeting featured Donn B. Parker of SRI, speaking on computer and communications abuse. Computer-related crimes, he said, will become more difficult to pull off in the next few years. "Get with it quick," he advised those who wished to perpetrate such a feat. Although the incidences of such crimes will go down in frequency, Parker said, the losses per incident will go up.

Incidences of vandalism against computers and computer centers peaked in 1970, he observed, and have been going down ever since. But he said some people erroneously think their facility is safe if it costs more to invade the machine room than the value of the assets within it. This is not true, he asserted, for it assumes the perpetrator is rational—and he isn't. But Parker characterized the perpetrator of computer crimes as young, bright, and highly motivated.

He mentioned the case of an accountant who embezzled more than \$1 million by modeling his company. It was said to be a perfect ploy, but the embezzler was caught when he ex-



© DATAMATION ®

Conference

ceeded the limits that he set for himself. Parker also mentioned people working at commercial time-sharing firms and the frequency with which they penetrate their competitors' systems. In these systems, he observed, there is an absence of any "no trespassing" message or the fact that a program stored is the proprietary property of the company. By the use of such messages, he thought, at least it would be on record as a notification to any unauthorized entrant.

Many problems remain unresolved, he concluded, raising questions for all to consider. How does one know whether the program in use today is the same as the one validated the week before . . . that it hadn't been tampered with since then? How does one audit or validate a program . . . or a system? Parker said this is something they're working on at the Multics project.

A couple of papers got into the topic of teleconferencing by computer. Richard H. Miller of the Institute for the Future, Menlo Park, Calif., noted some of the advantages of this, which included the possible anonymity of conferees, easy accessibility to participants, the convenience of participating, and the possibility of simultaneous input by all participants. But that still implies the input of both numeric and textual data, and so there's a requirement for natural language processing. There's also a requirement for a greater knowledge of the theory of human interaction and problem solving. In the future, Miller said, one can expect the use of a myriad of teleconferencing media, including computers and television. For there to be true simultaneous interaction among conferees, he continued, advances are needed in communication processes as when two people share the same communication space. "The point to make in conclusion," he concluded, "is that the understanding of group communication processes is of equal if not greater importance than the development of system hardware and software."

Session chairman Andrew J. Lipinski of the same institute observed that he was reminded of "2001" and the Hal computer. Already, he said, we know that people will tell things to a computer they wouldn't tell anyone else. Therefore, participants can tell the computer they are unhappy with the way the chairman is running things, and the computer will duly inform him that the "unhappiness index" is rising.

One wonders why conference organizers couldn't have such a useful gadget today. □

April, 1973

NEW BENDIX COMMUNICATIONS ADAPTER

Drive ASCII Peripherals From IBM 1800 or 1130!

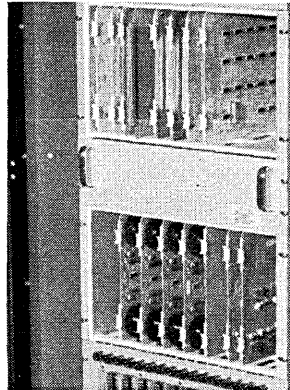

You have an IBM 1800 Computer, or even an 1130, and you would like to connect with medium-speed line printers, teletype or TV monitors to get production and maintenance reports and, you'd like to do it at a low cost. *Now you can!* The Bendix Communications Adapter mates IBM to ASCII-type peripherals such as these to provide low-cost computer communication stations on the factory floor. A low initial cost will be paid back in less than two years.

Write The Bendix Corporation, Industrial Controls Division, 12843 Greenfield Road, Detroit, Michigan 48227.



CIRCLE 74 ON READER CARD

With the ALLTAXTM COBOL SOFTWARE SYSTEM you are always up-to-date no matter how often Payroll Taxes Change.

ALLTAX calculates payroll withholding taxes with one standard formula and a table of variables for each state and city. It eliminates programming of individual formulas and substantially reduces program maintenance and memory requirements.

ALLTAX is approved by all states. It's easy to install, completely tested and documented.

ALLTAX is always up-to-date. Automatic program maintenance for existing withholding taxes and new taxes is available at minimal cost.

Find out why more than 100 companies from coast-to-coast are using this low-cost package.

Write today for full information:

Management Information Service
P.O. Box 336, Ramsey, N.J. 07446

Gentlemen:
Please send full details on your
ALLTAX software package.

Name _____

Title _____

Company _____

Address _____

City _____

State _____ Zip _____

Management Information Service

Ramsey, N.J. 07446 • (201) 327-8510

CIRCLE 97 ON READER CARD

**When you
fire that wasteful
middleman, you
get a happy
problem.**

Choice.

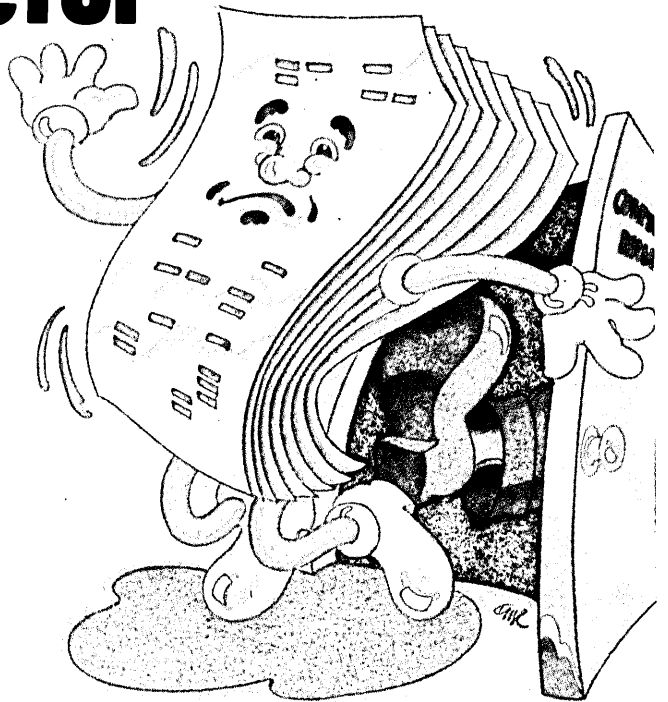

Happily, you can hear about them all from one source.

Us.

We happen to be the only company that makes them all. Stand-alone key-to-tape. Cluster key-to-tape systems. Key-to-disk with tutorial CRT display.

We've got a choice, not a challenge.

Which flatly means no axe to grind.

No force-fitting you and your documents and your schedule and your system to limited hardware the way punch cards have treated you for years.

Instead, we can put together a system using as much or as little equipment as you need to get what you really want. The most in throughput for the least people and space and dollars.

Big talk? We didn't come on to become the Peripheral Power without under-scoring systems. We didn't earn the second largest user list in the industry without showing a lot of people more throughput for their dollar.

But we know we won't convince you until we put it all in terms of you.

So let us. Call our nearest sales office. Or write for our new data-entry brochure that describes a choice, not a challenge.

Mohawk Data Sciences Corp.,
World Headquarters, Utica, N. Y. 13503.

**MD
MS.**

The Peripheral Power

CIRCLE 40 ON READER CARD



Now that we make six different minicomputers, will we rest on the seventh?

Only a couple of years ago, we made two minicomputers.

Enough for anybody, right? Wrong.

So we introduced the Interdata New Series. Model 70 and Model 80. Great little machines. With all the latest in computer technology. And then the Model 50 and Model 55 Data Communications processors. Special DC instructions. Great DC throughput. The works.

Still not enough.

So then we introduced the Model 74. A minicomputer designed especially for OEMs. No frills. No gimmicks. Just a fine little processor at a very attractive price.

And even that wasn't enough.

Announcing the Model 85 with Dynamic Control Store.

The Model 85 is more than just another Interdata minicomputer.

Because it has 4096 bytes of bipolar Dynamic Control Store, it's really several minicomputers built into one.

The latest is the greatest.

It's a fast mini because it executes 4-address format micro instructions in 0.2 microseconds. It's a powerful mini because it can perform tasks at hardware speeds that now require a maxi computer. It's a flexible mini because you can dynamically tailor its control store to fit your specific application. Special instructions, algorithms, or whatever. And then change it again.

Best of all, it's an economical minicomputer because it is a minicomputer. And it's priced like one. \$22,800 quantity one list price.

We've only begun to fight.

So even though we now offer our customers a whole family of minicomputers, we're still working hard to develop new and better ones. Because we know if we didn't, pretty soon we wouldn't be selling any minicomputers at all.

There's just no rest for the weary.

INTERDATA®

2 Crescent Place, Oceanport, New Jersey 07757 (201) 229-4040. Denver — (303) 758-0474. Boston — (617) 890-0557. Chicago — (312) 437-5120. Dallas — (214) 238-9656. Detroit — (313) 356-5515. Houston — (713) 783-1830. Los Angeles — (213) 640-0451. Palo Alto — (415) 969-1180. Philadelphia — (215) 436-5579. Washington — (703) 525-4806. Toronto — (416) 678-1500. United Kingdom — Uxbridge 52441. Sydney — NSW 439-4155. West Germany — 0811/8543887. Tokyo — 270-7711.

SkyCab GUARANTEES YOUR PACKAGE DOOR-TO-DOOR:

New York-Chicago, 6 HRS; Chicago-Los Angeles, 8 HRS; Los Angeles-New York, 10 HRS...

Ship computer cards, parts or tapes, contracts, prospecti, SEC and regulatory filings—practically anything, anywhere today!

SkyCab is ready to deliver your package to and from anyone, anywhere in over 18,000 U.S. cities and towns today. Each SkyCab trip is a special express just for you—there's no faster way to get a package from one place to another, unless you take it

yourself (even then, SkyCab might win). One call to our toll-free number does it all.

SkyCab is a unique marriage of a nationwide fleet of high-speed taxis with the fully-computerized facilities of one of the world's largest air freight systems.

Call now—
SkyCab is
ready.



2 Your package flies as *passenger* baggage, not cargo. It's picked up within 30 minutes of flight arrival by another SkyCab agent who takes it directly and immediately to its destination. Instant proof of delivery available.

1 One toll-free call brings your SkyCab agent to your door. He'll take your package directly to a flight already assigned by SkyCab's computerized control.

3 Delivery to your addressee's hands within specified time limits is **guaranteed**, or you get half your money back. (Maximum package limits: 90 inches aggregate dimensions and 50 pounds.)

ONE CALL DOES IT ALL. 800-257-7888

In New Jersey, call 800-322-8600. In Alaska and Hawaii, call collect 609-424-5353

SkyCab IS A SERVICE OF SHULMAN AIR FREIGHT

© Copyright 1973

**You can buy an IBM 360.
Or you can hook your mini to a
\$12,500 DIVA Dual Disc Drive System
and save \$87,000.**

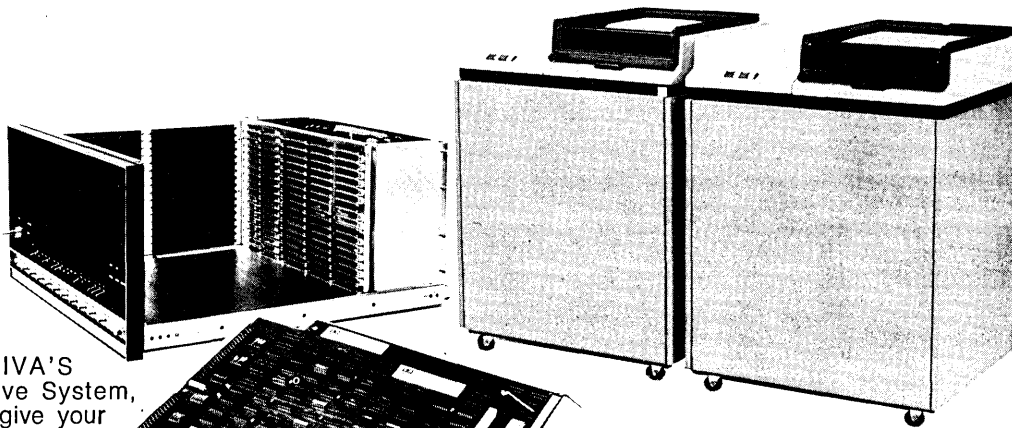

Maximize. DIVA'S Dual Disc Drive System, DD-11/2, will give your minicomputer the capabilities found in mainframes costing anywhere from \$100,000 to \$400,000. DD-11/2 provides total operational flexibility.

Expand. The mix and match multiple controller permits the simultaneous operation of up to four disc drives (each additional drive, \$4650). The controller fits inside the minicomputer and becomes a part of the main frame.

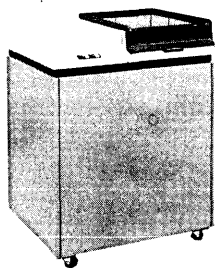

Use one. Either drive can be used separately for the storage and retrieval of up to 58 million bits, 7.25 million 8-bit bytes of data.

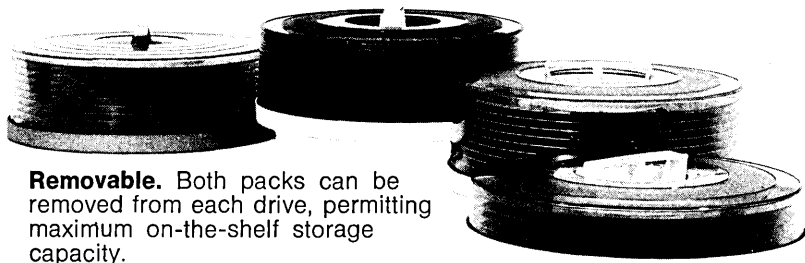

Removable. Both packs can be removed from each drive, permitting maximum on-the-shelf storage capacity.

Use two. Or both drives can be used together, doubling the capacity; 116 million bits, 14.5 million bytes. With two drives you can copy, transfer, integrate — perform any dual unit function. One drive is always in reserve. Things won't come to a dead stop.

Perform. DD-11/2 has great performance characteristics, too: a transfer rate of 156,000 bytes/second, an average access time of 35 milliseconds, 30 seconds to operating speed, 10 seconds to stop.



Free. Send for complete details on DD-11/2 and learn how you can multiply your mini's memory and speed. We'll send you a booklet which contains descriptions of eight other complete DIVA systems, along with information on discrete components.



Industry's source for disc systems.

Everything. Interface for most minis is standard. The few that aren't can be custom provided. All interconnecting cables, I/O driver software, system diagnostic software, and DIVA'S 90-day full warranty, effective anywhere in the world, are all part of the DD-11/2 system.



Consult. If you want fast action, call George D. Roessler at 201-544-9000. He'll tell you how to get the most from your mini for the least cost. Or write. DIVA, Inc. / 607 Industrial Way West / Eatontown, N. J. 07724 / TWX 710-722-6645.



Union Carbide improves yield with Texas Instruments computer

Computer control has replaced conventional operation of a distillation column at the Seadrift Texas plant of Union Carbide.

A 960A minicomputer from Texas Instruments continuously regulates the purity of "make" from the column.

Increased yield—from this column alone—paid for the entire installation in considerably less than a year.

It's now more attractive than ever before to employ computer control of

chemical processing, refining and manufacturing. The low cost of the

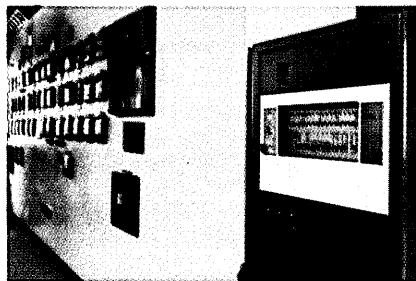

960A, plus the ease of interfacing and operation, make it economically feasible to computerize operations that would have been considered impractical before the 960A was announced.

Want to know more about how the low-cost 960A minicomputer can fit into your operation? Contact Texas Instruments Incorporated, P.O. Box 1444, Houston, Texas 77001, phone (713) 494-2168.



TEXAS INSTRUMENTS
INCORPORATED

CIRCLE 39 ON READER CARD



Every MICRO SWITCH keyboard has two unique ingredients.

One thinks.

The other goes "ca-chunk."

MICRO SWITCH products are available worldwide through Honeywell International.

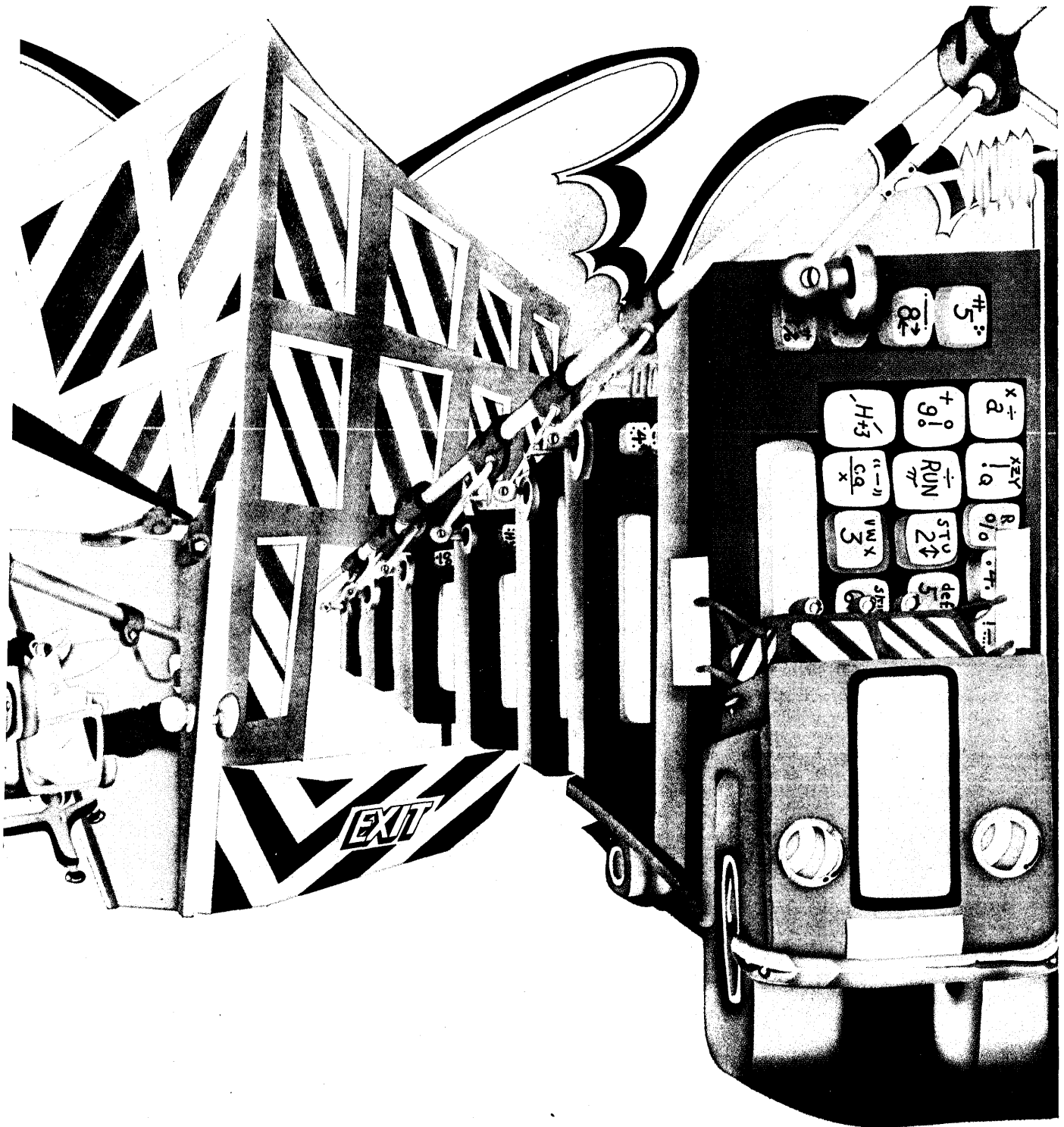

Man and machine.

At MICRO SWITCH they work together, producing thousands of keyboards every week. And since almost all of our units are non-standard, it stands to reason that our people and equipment must be the same.

Take our engineering staff, for example. It includes such diverse types as specialists in solid state physics, human factors, mechanical design, and manufacturing. Some work full-time on advanced technology and concepts while others function as field, application and design engineers. Together, they form an experienced team that's always ready to work with you.

Our equipment, most of it designed and built in plant, is just as unique. What other manufacturer that you know of has Automatic Switch Module Assemblers?

Built at MICRO SWITCH, these machines assure that every key station is uniformly manufactured. Don't forget CAKE (Computer Assisted Keyboard Evaluator). It performs more measurements, both static and dynamic, faster and more accurately than any human.

All this requires a big capital investment, but enables us to produce one of the largest volumes in the industry. Which is what it takes to offer something else unique today. A capability that permits us to offer high quality and reliability at economical prices.

See your MICRO SWITCH Branch Office or give them a call. Remember, no request is too unique.

*MICRO SWITCH
makes your ideas work.*

MICRO SWITCH
FREEPORT, ILLINOIS 61032
A DIVISION OF HONEYWELL

When will the securities industry have a computerized central market? If the SEC approves the industry's most recent consolidation tape plan, it could be early next year. But, as reported on page 108, this is an optimistic guess...

The world's first all-digital communications network to be provided by a common carrier--Canada's Dataroute--opens for business this month, page 109, promising rates up to 90% less than leased analog private lines...

In the U.S., Southern Pacific railroad plans to launch part of its proposed national network in June, page 113...

Meet George B. Rockwell, IBMer turned bank president, page 117. He's proud that his dp people have been within budget three years in a row...

A software company contests NASA's distribution of two packages, one at a price \$8,500 below the company's similar product, page 119...

The first time the state of California went out for bids on a big computer buy, only two were submitted, page 121. And they've both been disqualified...

The logging industry takes its first small steps into computer technology, page 129.

Memories

A Bleak Future For Discs?

Disc and drum memories have been present in computer configurations from the start. Now, at the peak of their development, they are being attacked by technologies that offer higher densities, faster access, and lower price. Used at least as early as 1948 as the main memory of a University of Manchester computer, and again in 1953 for the IBM 650, discs and drums found better roles as backing stores, first for core and now for semiconductor main memories. But with the advent of magnetic domain ("bubble") memories and charge-coupled device semiconductor memories, it is possible that discs will not play an important role in configurations of the 1980s.

The challenge to discs has been intensified by a technological development announced by IBM research labs. The discovery involves substituting inexpensive amorphous films for extremely expensive crystals, but to understand how or why it is done we have to know something about bubble memory construction and operation.

First, bubbles aren't really bubbles at all. They are tiny cylindrical areas or domains that can be formed in a thin film of some kind of metal. These domains are magnetized in the opposite direction of the rest of the metal film. They are called bubbles because they look like bubbles when seen moving about under a microscope.

Bubbles make an unusual kind of memory in that you *can* see the bits moving. There is no physical movement of particles of metal or even atoms, of course, but when an electric current is brought near one of the reversed polarity spots, that spot transfers its magnetism to another spot a little further away from the current. By pulsing the current very quickly, the bubbles can be made to speed around at rates of a few hundred centimeters per second.

Cheaper, easier to form

Bell Labs gets the initial credit for bubble memories. Starting in 1969, the company has advanced the technology to the stage that it will demonstrate a 15 to 16 million bit prototype this month at the Intermag conference. But the trouble with Bell's bubbles is that they are expensive; building them involves growing nearly perfect crystals on top of other nearly perfect crystals, and at very high temperatures. IBM has

found a way to do it with amorphous films, which differ from crystal in exactly the same way as window glass differs from diamond; that is, its atoms are not neatly ordered.

The important thing about amorphous films is that they are cheap. Praveen Chaudhari, coordinator of the IBM research group which discovered magnetic bubbles in amorphous films, said: "A garnet crystal costs me \$30 to \$40 now, although costs are projected to be about \$10 in a couple of years. The piece of glass we use as a substrate for our films costs about two cents." The substrate is just the start, too. Amorphous films are much easier to form. Compared to doing it with crystalline film, it can be done for a fraction of the cost, he said.

So far, storage densities of amorphous films have not been up to those of crystals. IBM is continuing to develop crystal bubbles, and densities to 70 million bits per square inch have been shown in a shift register made on a garnet crystal. The best done so far in an amorphous shift register has been about nine million bits, Chaudhari told us. However, the nine million bits was done with bubbles two microns in size. (A micron is less than 0.00004 inch; about 800 bubbles that size could fit across the diameter of the printed letter "o.") Bubbles of 0.1 micron have been seen; if circuit masks to use them could be made, densities of one *billion* bits per square inch could be developed.

Density isn't everything, unfortunately. The domain memories are thus far limited in terms of access time, at least compared to main memory speeds. However, their sub-millisecond access times are far better than those of discs.

Part of the access delay with domain memories of any kind is that the domains circulate through the material rather than sitting in one place as they do in semiconductor main memories. Although there are no moving parts, there is an analogy to a disc in that the bubbles move under the sensors that are used to detect them, just as the magnetically recorded information on a disc moves under the read head. Therefore there is the same kind of latency time delay to consider. Because they offer random access to a "chip" or memory component but still have this latency, domain memories are referred to as "block random access" devices. They provide random access to a block

of data just as a fixed-head disc does.

A second part of the speed problem is that, so far at least, bubbles can't be forced to move very fast. Bubbles have been observed moving at over 100 KHz, but not at the terrific speeds they should be capable of (and will have to be able to do to supplant existing discs). "Maybe we can make them go at 10 MHz," Chaudhari said. "I don't know why they move at a couple of hundred centimeters per second rather than a couple of thousand."

Ovshinsky vindicated

Neither magnetic domain memories nor amorphous films are new to data processing. Cambridge Memories has been offering a kind of magnetic domain memory called DOrmain Tip, or DOT, since at least last May. But Cambridge's technology leads to domains of the order of one or two thousandths of an inch. Still, a one million bit DOTram memory fits in 10½ inches of rack space.

Amorphous films, on the other hand, were first brought to attention by Stanford Ovshinsky in the late '60s, although he used them in a different way. Ronald Neale, the vice president of operations for Ovshinsky's company, Energy Conversion Devices, said that the firm felt its pioneering had been vindicated. "What we said was that amorphous materials can do things. This shows one more thing they can do, and there will be lots of other discoveries." ECD will be in a good patent position should the electronic effects of amorphous films be exploited for things like holographic memories.

Another company that stands to benefit from almost any use of bubbles is

Rockwell International (né North American Rockwell). Rockwell pioneered some aspects of bubbles and claims credit for delivering the first fully operational bubble device, a 5MHz 64-bit shift register that went to the Air Force last August.

According to Bill Mavity, Rockwell's project manager on bubble domain memories, the firm is working on a product that will store up to 10 million bits and show a 0.25-msec to 0.50-msec access time. Mavity sees such devices as first being used for hierarchical storage for minicomputers and for drum memory buffers. "We're not trying to supplant an existing technology," he said, "only filling an access time gap between main storage and disc."

Mavity expected the bubble products to appear quite soon. "We are not waiting for invention, only engineering work," he said. "By 1975 or 1976 it will be practical to have devices available, assuming that the (oem) user has the foresight to make the plans. Bubbles will go through an oem phase and follow the traditional developments of memory technology. There will not be new companies marketing bubbles, but the computer manufacturers and peripherals manufacturers."

Charge-coupled devices

Competing products to be ready for shipment in the same time frame are things called charge-coupled devices. Also from Bell, announcement of the devices is predicted by some outsiders for late this year. Jerry Sevic, Bell Labs' director of technical relations, described both what they are and how they came about. "When the bubble was born," he said, "director Jack Mor-

ton looked for a counterpart in semiconductors. Charge-coupled devices are exactly the analogy. Bubbles spawned CCD's.

Unlike bubble memories, CCD's are volatile; they can lose their data if power goes down. But they have been said to have data rates up to 100 times faster than bubbles, and so have a promising future.

Somehow, the circuit masks necessary to use 0.1-micron bubbles will come, maybe from Bell's electron beam recording work. It's very likely too that Chaudhari or someone else will push the bubbles to very high transfer

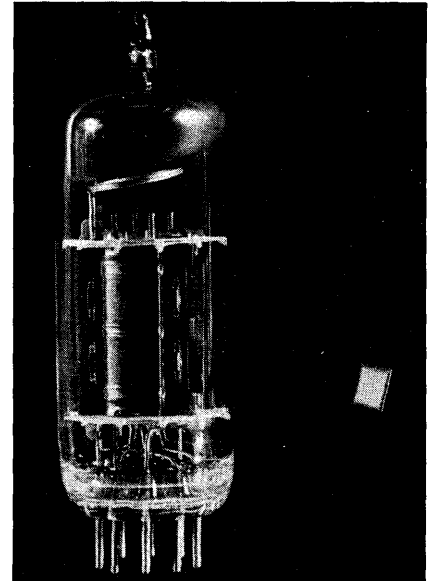

LSI TOMORROW: An experimental memory that might be used in future products was shown by IBM scientists at the recent IEEE international solid-state circuits conference in Philadelphia. The large-scale integration (LSI) memory chip contains 8,192 bits of random-access storage and control circuitry. That is the equivalent of more than 18,000 transistors—on a silicon chip that measures only .145 x .201 inch. The memory has an initial access time of 1,730 billionths of a second (nsec), and subsequent access times of 540 nsec. Dissipating only .0225 watts of power, the chip is shown beside a conventional vacuum tube IBM used for memory control circuitry in its 700 series computers 10 years ago. Approximately 10,000 tubes would be required to create the equivalent of the circuitry on the chip, and would generate enough heat to keep three average-size homes warm during Vermont winters. The memory was developed at IBM's research and manufacturing center in Essex Junction, Vt.

rates. Then maybe discs, with their inherent mechanical disadvantages, will be finally retired.

And there is more in store. Already IBM and others are thinking of sandwiching amorphous films on top of logic circuits, perhaps to yield logic with its own memory. Also, the new materials exhibit magneto-optical properties and they are being thought of for use

Somewhere a Place for Optical Memories

Somewhere beyond the promise of magnetic domain memories lie optical memories, holographic memories in particular. Already operating in versions that store 100,000 bits per square inch in read/write versions or 3¼ million bits in read-only versions, they can access data in a few microseconds and transfer it at 10 million bits per second. (See March, p. 66, for a discussion of their operation.)

Harris-Intertype produced the first working read/write model that we know of, and RCA has recently demonstrated its version, which employs a liquid crystal screen to form the bit patterns whose shadows are captured on a heat-sensitive film. Thomas O. Stanley, staff vice president of research programs at RCA Laboratories, stated: "The holo-

graphic memory has the potential, when fully developed, to replace the entire hierarchy of core, drum, and disc systems now used, and thereby to simplify the whole architecture of computers and many other information systems."

So far, holographic memories are sensitive and even delicate. Their supporting prisms and mirrors and lenses require precise alignment. Still, both Harris-Intertype's and RCA's units were developed with help from NASA, and NASA is presumably looking for something rugged enough to launch.

Stanley claimed that optical memories have the potential to run 1,000 times faster than discs. So it appears that domain memories will have to fight for a place in the order of things, even in their infancy.

in holographic memories (which already *are* fast enough to replace main memories). Some hybridization of magneto-optics and holography could conceivably even obliterate our conception of hierarchical storage alto-

gether, not to mention making virtual storage virtually unnecessary. It's a big application, after all, that cannot be satisfied with a billion bits per square inch on-line with access by laser.

—R. A. McLaughlin

Wall Street

Cutting the Big Board Down to Size

Nudged by the Securities and Exchange Commission (SEC), and shoved by Congress, the securities industry, after years of hand-wringing and disputation, has finally started to begin to develop a central market.

Early last month, a consortium of securities traders filed a plan with the SEC for reporting over-the-counter (OTC) and exchange transactions in listed securities on a consolidated basis.

Essentially, there would be two ticker-tape networks providing a continuous stream of trade information. "Network A" would report all transactions involving securities listed on the Big Board—i.e., those occurring on the floor of the New York Stock Exchange (NYSE), as well as within the second market (regional exchanges) and third market (OTC). "Network B" would encompass all other transactions in securities listed on the American and regional exchanges.

Much of this information isn't available today until long after the transactions are completed. Some exchanges do report in real-time, but on separate ticker tapes using different codes, formats, and terminals. All of which means that a trader who wants to buy or sell securities can't locate the best market right away, and has to spend a lot of money to obtain the information that is immediately available.

The SEC was scheduled to act on the industry's consolidated tape plan by the end of last month. If the plan is approved by then, there is a good chance "full implementation" can occur early next year. But that term was coined by the plan's drafters and should be treated gingerly. It is probable that OTC transactions in big board securities won't be distributed to Network A until some time after "full implementation" begins. It is also likely that the trade information distributed to Network B will be even less consolidated.

A problem of price

A number of problems involving vendors of market information also remain to be ironed out. Essentially,

these vendors input data from the Amex, NYSE, and other tickers into their computers and then output it in a variety of combinations as requested by the user operating a crt terminal keyboard.

One problem posed by the new plan involves charges. NYSE and Amex are free to charge more for the consolidated tapes than for their present offerings, under the terms of the proposal submitted to the commission. A vendor of market information services, who asked not to be identified, said he has "little doubt" that the fees *will* go up. He fears the increase will reduce the number of traders willing to subscribe—not only to the exchange ticker services but to his company's inquiry service as well.

Vendors may have to modify their existing crt terminals because the composite tapes, unlike the present ones, will identify each transaction according to the market in which it occurred. "If the commission will let the user key in each market ID desired," says this vendor, "we won't have to modify our crt terminals. But if the information has to be displayed automatically on read-out, changes will be necessary." Quote boards, he added, won't be able to supply market ID in any case, but says they are used by a small and declining number of customers.

The consolidated transaction tape plan was put together by a consortium of NYSE, Amex, National Association of Securities Dealers (NASD), and three regional exchanges—PBW, Pacific, and Midwest. They have formed the Consolidated Tape Association (CTA) to manage the new program. Other regional exchanges—Cincinnati, Detroit, Boston, Spokane, Salt Lake City, and possibly Honolulu—will be encouraged to join CTA.

The consolidated tapes will be produced by the Securities Industry Automation Corp. (SIAC), the joint venture service bureau set up last year by NYSE and Amex.

The regional exchanges participating in the project already have ticker-tape services in operation, and these will

provide the data input for the consolidated tape, at least during Phase I of the project. Transactions in NYSE-listed securities which are reported on these tapes will be added to the present NYSE ticker, and the consolidated output will then be distributed only to those who subscribe to the NYSE ticker service. Transaction data on Amex-listed securities will be consolidated in the same basic fashion and distributed only to Amex ticker service customers.

The timetable

Phase I is scheduled to begin 20 weeks after SEC gives its blessing. It consists essentially of distributing a consolidated tape to Network A subscribers, containing all transactions in 15 stocks listed on the NYSE and also traded on one or more of the regional exchanges. OTC trades in these same issues will be included also if NASD has developed rules for reporting the information before Phase I begins.

"It is anticipated" that a pilot consolidated tape will be distributed to Network B subscribers during Phase I "using selected securities duly traded" by Amex and one or more of the other participants, the plan states.

Twenty weeks after Phase I begins, the program is supposed to shift into Phase II, i.e. "full implementation." How Phase II will work wasn't explicitly spelled out, but the intention, apparently, is to continue the Phase I data-handling scheme unless it proves unworkable, technically or politically.

Shortly before the consolidated transaction tape plan was unveiled, a Senate banking subcommittee released a lengthy study of the securities industry which devotes several pages to central market problems and criticizes both the SEC and the industry for a variety of sins.

The report says that letting SIAC process the consolidated tape is okay, provided changes in the system can't be vetoed by NYSE. "If rigorous standards cannot be established to assure fair access for all affected interests in a privately owned communication system, the subcommittee will have to give consideration to the establishment of a quasi-governmental entity to operate the system."

The Senate study was even more critical of industry-SEC action regarding a consolidated quote-reporting system.

In March '72, the commission adopted a proposed rule requiring all exchanges and NASD to provide vendors of market information with current, continuous data on bid/asked prices in listed securities. Last fall, NYSE and several regional exchanges told the commission they planned to trade bid/asked prices on dually traded securi-

ties. The SEC, after pointing out that the third market was being ignored, suggested a revision. A few months later, NYSE announced that its board of directors had approved "an \$8 million automation program which will ultimately enable NYSE specialists to see bid and asked stock price quotations and last-sale prices in listed stocks in other exchange markets."

Unwanted child

That's where things stood when the Senate report appeared. It says the SEC should promptly evaluate the NYSE plan to see if it's "inconsistent" with the commission's concept of a central market. Obviously, the plan is inconsistent since it treats the third market like an unwanted child. Also, said the Senate subcommittee, SEC should determine whether the exchange plan to trade bid/asked price quotations is "inefficient or duplicative" of the NASDAQ system. The subcommittee clearly suspects the NYSE of trying to reinvent the wheel, because a little later on in the report it gives the OTC system a pat on the back and then says "the SEC should therefore carefully consider the feasibility of utilizing NASDAQ as the vehicle for dissemination of quotations in listed as well as unlisted stocks before authorizing the construction of another system which may increase costs to the industry—which in turn will be passed on to the public—without any corresponding public benefits."

An SEC advisory commission late last year said there should be "a single system for quotations in all listed securities." But the commission, says the Senate subcommittee, doesn't feel it has the power to stop NYSE and the regional exchanges from developing the system they recently proposed. Alluding to a letter written last November by former SEC chairman William Casey to the chairman of the Senate subcommittee, Harrison Williams, the report says the SEC "has taken the position . . . that . . . its obligations . . . will be properly discharged by . . . setting forth the general criteria for a composite quotation system . . . This is an unduly narrow reading of the commission's responsibility . . . The SEC should make a formal determination, including exposure for public comment, on the respective merits of all available composite quotation systems, including that proposed by NYSE."

The Senate subcommittee, in its report, said it expects the SEC "to proceed promptly with the promulgation of the rule it proposed in March, setting forth the guidelines for the operation of the quotation system and establishing the deadline by which it should be in operation . . . The subcommittee believes it

is reasonable to insist that the composite quotation system be in full operation not more than six months after the composite transaction reporting system is fully implemented."

Just before press time, sources at the SEC said the "promulgation rule" should be out shortly.

Meanwhile, Rep. John Moss of California has introduced several amendments to the Securities Exchange Act, SEC's bible, one of which directs the commission to establish "a national market for securities transactions by Feb. 1, 1975" and to report to Congress annually, beginning this year, on its progress toward that goal.

Communications

Canada's Assault on Communication Costs

Canada's Dataroute system—the world's first end-to-end digital communications network to be provided by a common carrier—was scheduled to open its ports for business this month. Users of the system, possibly including some within the United States, will be offered bargain-basement rates.

Initially, Dataroute will consist of a 56K bits/second communications path linking Vancouver, B.C.; Saint John, New Brunswick; and Canada's nine largest cities—all of which are called "Dataroute Serving Areas" (DSA's). Digital local loops will connect nearby users to this trunk; those farther away will access the system through existing dial-up or analog private-line facilities. All hardware connected to the Dataroute system, excluding terminals, will be supplied solely by the carrier, the Trans-Canada Telephone System (TCTS), an amalgam of Bell Canada and seven regional companies.

Each user will be connected to the local loop through a black-box interface device. It converts asynchronous and/or binary bit streams generated by a terminal into the synchronous, bipolar format used by the system. The interface also provides a test point which can be interrogated remotely from any of several supervisory locations. An automatic alarm system is another protective feature; it warns system technicians any time errors on a particular channel go above a predetermined level.

The black box will have an RS232C interface on the user's side, permitting connection of compatible terminals operating at 110 to 19.2K bits/second. For 50K bps terminals, compatibility with a high-speed 303-type interface is required.

Bargain rates

Dataroute users are promised reductions of "up to 90%" compared to leasing analog private channels of the same capacity. For example, between Montreal and Vancouver, the existing private line rate for 2400-bps service is \$3,770/month. The comparable Dataroute service is available on a 24-hour, day, or night basis at \$1,826, \$1,462, and \$977/month, respectively. Users desiring 9600-bps service between the same two points pay \$33,135/month now. The Dataroute tariff will range from \$9,167 for night time-only service to \$18,579 for 24-hour service. Between Montreal and Toronto, Dataroute will cost a minimum of \$522/month for 2400-bps service (versus \$1,590 in the present analog leased line tariff) and \$1,430 for 9600-bps service (versus \$2,440). In all cases, there will be a one-time \$50 installation charge for each Dataroute termination.

These comparisons are taken from a set of illustrative rates TCTS released recently. According to O. W. McAleer, supervisor of special projects, the charges are "pretty close" to the rates specified in the tariff TCTS has filed with the Canadian government. Government approval is required before the service can begin, but McAleer indicated this would be forthcoming in time for the service to start, as scheduled, on the 16th of this month. He declined to say how many customers had been signed up or to project growth of the traffic.

Sometime this summer, McAleer added, TCTS will begin using T1 carriers in high-traffic areas to provide local-loop connections. This will permit the carrier to multiplex a 56K bps digital data stream and 23 voice channels on a single set of wires. By comparison, the digital local loops to be used initially can carry 56K bps, but no room is left over for voice channels.

Data under voice

The company also plans to change the present Dataroute trunk configuration "soon," McAleer reported. The 56K bps intercity channel being used initially will displace the equivalent of 12 voice-grade channels. The new arrangement will utilize data under voice (DUV) transmission: a portion of the frequency spectrum unsuitable for analog traffic will carry 1.5M bits/second of digitally encoded messages. (AT&T plans to use a similar scheme in its digital data system.)

Dataroute service will consist of full- or half-duplex, serial transmission on a point-to-point basis at speeds of from 110 to 50K bps; multipoint/multidrop service will also be available at 110 to 19.2K bps. Multipoint service consists of several terminals within differ-

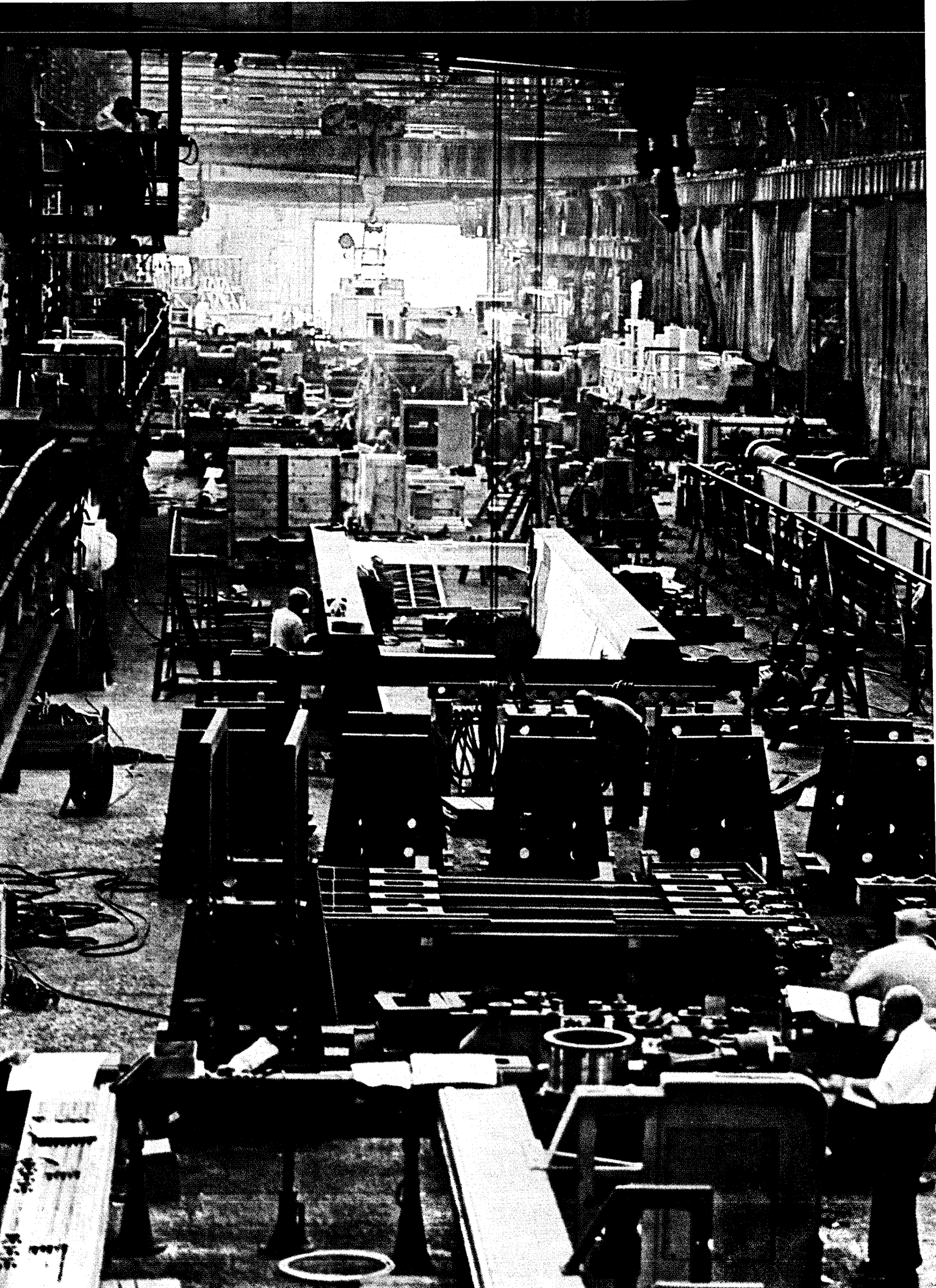

A minicomputer here?

Sure! It's solving a king-sized inventory problem.

Harnischfeger, Inc. of Milwaukee, Wisconsin is known worldwide as a major producer of material-handling equipment. But they had a king-sized material handling problem right in their own shop. A customer would submit an order for a dozen hoists ranging from the 250-pound model up to the 30-ton monster. And he'd probably want each one slightly customized, too.

So Harnischfeger had several expeditors keeping tabs on more than 10,000 different hoist parts. Even then they sometimes had too many bushings and not enough bearings.

A job for a big computer? Many people thought so. But not the people at Harnischfeger. Working with Computer Guild, a Massachusetts systems house, they came up with the "Inventory Clerk"—an inexpensive batch system built around a Hewlett-Packard minicomputer.

With this small but powerful mini-system, Harnischfeger now has virtually automatic inventory control. They can tell the customer almost exactly when his

order will be ready. They get a "low level" signal on all parts, so they know when to reorder. It even gives an up-to-the-minute rundown on every job in the shop.

It also eliminates an enormous amount of book-keeping, and cuts "parts-picking" and handling time at least 20 percent.

Not bad for a computer that costs just a bit more than the family car. But today, industry doesn't judge computers by price or size alone. It's performance that counts! The kind that gets the job done. Plus support. Reliability. Comprehensive software—and a complete line of off-the-shelf peripherals. That's why Hewlett-Packard computers, like our HP 2100, are making their mark in more and more industrial and commercial applications these days.

Want to see what our new 2100 computer can do for you? Your local HP data products specialist will show you. Just give him a call. Or write to Hewlett-Packard, Palo Alto, California 94304; Europe: 1217 Meyrin-Geneva, Switzerland.

HEWLETT  PACKARD

DIGITAL COMPUTERS

STABILITY...AGE...BEAUTY

...As important in designing and producing display terminals as in buildings.

At TEC, we've been designing and building highly reliable crt terminals called DATA-SCREEN™ Terminals for 10 years (other visual display products for 15 years). That's "age" in the computer peripheral equipment industry.

For all these 15 years we've been manufacturing high quality information display and control devices — providing the vital link between man and machine in this computer-oriented world. That's "stability," especially when its been done profitably.

We offer our carefully styled terminals in esthetically compatible colors and vinyl finishes to match any decor, any application — from mahogany row to production floor. That's "beauty."

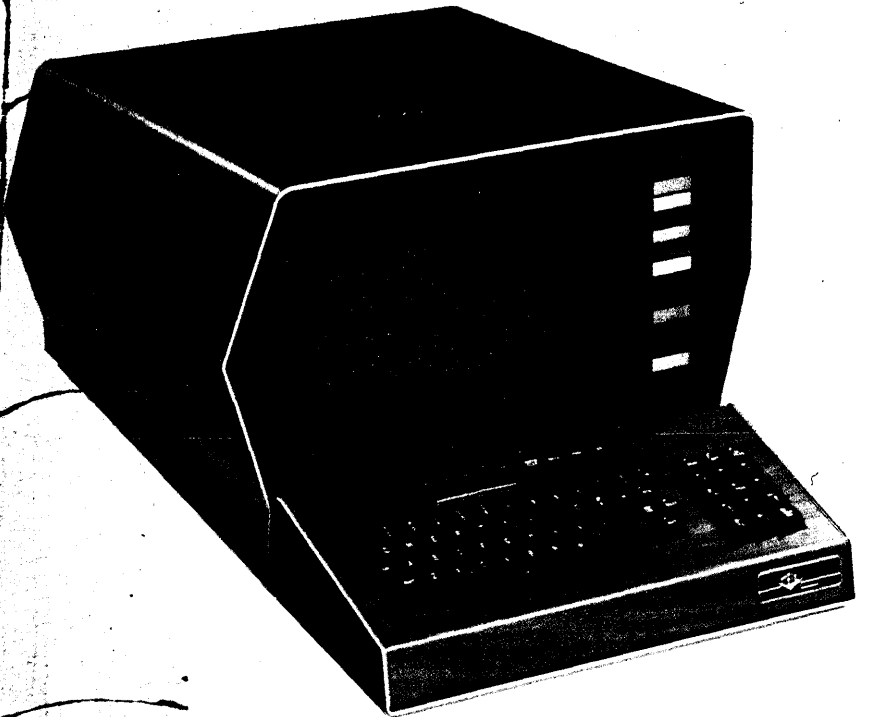

These vinyl clad textures and finishes — and many more — are available with DATA-SCREEN™ Terminals that offer parallel, serial and teletypewriter replacement interfaces — 13 models — all work proved, world-wide, in countless data communication and information systems.

Call or write for Brochure 109 describing popular, versatile, low cost DATA-SCREEN™ Terminals priced from \$1590*.

**Model 440, Teletypewriter Replacement, with keyboard, in 51-100 quantities.*

CIRCLE 84 ON READER CARD

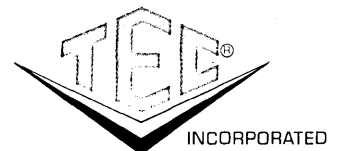

9800 NORTH ORACLE ROAD
TUCSON, ARIZONA USA 85704
(602) 297-1111

ent DSA's connected to the same channel, while multidrop services a similar configuration within a single DSA.

Dial access is obtainable from one end of a Dataroute channel, on a one-way, originate-only basis, at speeds of 110 to 1200 bps. Analog private-line connections to the system are also offered, as is channel subdivision.

McAleer said he "expects" Dataroute to provide an order-of-magnitude improvement in error rate compared to Canada's present data communications facilities (although TCTS is making no contractual promises). Under the best conditions, he added, the analog system produces one erroneous bit in 10^6 bits transmitted. A possibly more important benefit is that "9600 bps and higher speeds will become practical in areas where they aren't very attractive now from a performance standpoint."

Links for the U.S.

Tariff restrictions prevent U.S. data communication users from leasing a continuous channel that crosses the Canadian border twice. But even so,

it may be possible for a U.S. firm to exploit Dataroute's lower rates. A company with a terminal in New York City, for example, that wanted to communicate with Seattle might lease analog circuits to Montreal, retransmit messages at that point over a Dataroute channel to Vancouver, and then use analog facilities to reach Seattle.

McAleer said Canada's recently launched ANIK I satellite may be used to extend Dataroute service; the oil fields in the northern part of the country appear to be particularly suitable users. Test data transmissions over interconnected ANIK and Dataroute channels are expected to begin "within a few months," he reported.

Computer Transmission Corp., Los Angeles, is providing Dataroute's multiplex equipment. TCTS officials indicated that the value of the CTC contract this year is in the neighborhood of \$3.6 million. Another \$7 million, roughly, is being spent on Dataroute equipment supplied by Canadian firms, principally Northern Electric.

—P. H.

The phone company insists, however, that it isn't trying to drive its competitors to the wall. Company officials say their primary purpose in filing the new rate schedule is to make the charges levied in high- and low-density areas "fully compensatory." In some cases, explained AT&T vp Richard Hough at a recent press conference, "our rates will be lower (than those charged by the special carriers), in some cases higher."

The phone company, apparently as an expression of good will, also said last month that it would let "hybrid service vendors" use AT&T private lines without requiring them and their customers to qualify as "joint users." This concession will make it easier for firms like Electronic Data Systems, Bunker-Ramo, and Packet Communications, Inc., to offer specialized computer communication services. Presumably, the concession will also reduce opposition to AT&T's new rate proposal.

AT&T has told MCI, Datran, and other specialized carriers that if the new rates are put into effect, it will lease private line circuits to them at even lower rates.

Ma Bell: Big Cuts in the Big Cities

American Telephone and Telegraph has asked for permission to restructure some private line rates to compete against the special carriers.

If approved by the Federal Communications Commission, the new rates, which affect subscribers to the Series 2000 and 3000 private-line services, would mean reductions of just under 20% for 2,100 present customers and of 20-40% for 1,000 others, company officials said. About 16,200 customers would pay up to 40% more.

The rate changes affect voice-grade channels leased on an individual basis for voice and/or data transmission. Essentially, the present schedule, under which all users of these services pay the same rate for the same mileage, would be replaced by three schedules—one covering interstate long-haul ("interexchange") channels of 25 miles or less, another for channels of more than 25 miles in "high-density" (i.e., heavy-traffic) areas, and the third for similar channels in low-density areas.

The rate would be \$3/mile for short-haul services, \$2.50/mile for LoD (low-density), and 85 cents/mile for HiD. By comparison, present rates/mile are \$3 for the first 25 miles, \$2.10 for the next 75, \$1.50 for the next 150,

\$1.05 for the next 250, and 75 cents for each additional mile. The new rate schedule also proposes different channel termination charges; here again, users in HiD areas would pay less than those in LoD areas.

AT&T officials explained that it costs significantly more to service rural users than city dwellers. To avoid favoritism, however, and also to avoid flak from rural political interests in Congress and elsewhere, the phone company historically has based its rates on "nationwide average costs." When the specialized carriers appeared, Bell accused them of "cream-skimming"—i.e., offering service only in the lower cost, high-density urban areas. Bell argued that this approach would give the special carriers a competitive advantage. The FCC, in its 1971 decision allowing MCI and other special carriers to go into business, told AT&T it could restructure its rates to meet this competition.

The phone company's new rate proposal, which stems directly from the 1971 decision, represents the opening salvo in what will probably be a long, complex, bitter battle. For the specialized carriers, it will be a fight for survival. They can hardly continue in business if AT&T charges less for competing services.

Railroad's Network Will Go Nationwide

The start of a microwave transmission service between Los Angeles and San Francisco during the month of June is being anticipated by Southern Pacific Communications Co. It is the first segment of a planned network stretching from Seattle, Wash., to East St. Louis, Ill. No tariff schedule, however, has yet been filed with the Federal Communications Commission.

More than a common carrier, the San Francisco-based company also plans to get into the communications consulting business. Some 40-60% of the nation's 1,000 largest companies are spending from \$5-10 million a year for communications without having someone like a communications coordinator, much less a communications department, says SPCC marketing manager John J. Geier. So he plans to offer this service to companies large and small, starting with an analysis of the client company's calling pattern, to determine what combination of equipment and facilities is appropriate.

In providing common carrier services over the 1800-channel system, Geier says the company will be stressing reliability, economy, and flexibility, in that order. To illustrate the flexibility, he says a customer could purchase a given capacity and use it as he wishes, for data, voice, and facsimile transmis-

For openers, Systems 2400 can save you a bundle in the dollars department.

For closers, it can save you people headaches when you centralize mainframes.

Start by saving \$500 to \$1000 per terminal per month, compared with IBM. But compare us to anything you like. System 2400 talks to all mainframes.

Now about those people headaches. Like local managers losing control of their data. Like firing trained key operators in one city, only to need new ones in another.

System 2400 is the one communicator that can combine volume data entry through System 2400 key display. What's more, System 2400 can also off-load the mainframe and keep local work local, by combining editing and sorting and printing.

With the new boost in available core to 65k, System 2400 can configure you

out of a lot of problems and into some real savings.

Any questions? Good. You call, we'll come. Phone our nearest office or call MDS, World Headquarters, at (315) 792-2424. We'll send the nearby MDS man.

And that's easy, because there are almost 2000 MDS sales and service people around the world. After all, we didn't come on to be the largest independent manufacturer of peripherals without having lots going for us. Mohawk Data Sciences Corp., World Headquarters, Utica, N.Y. 13503.

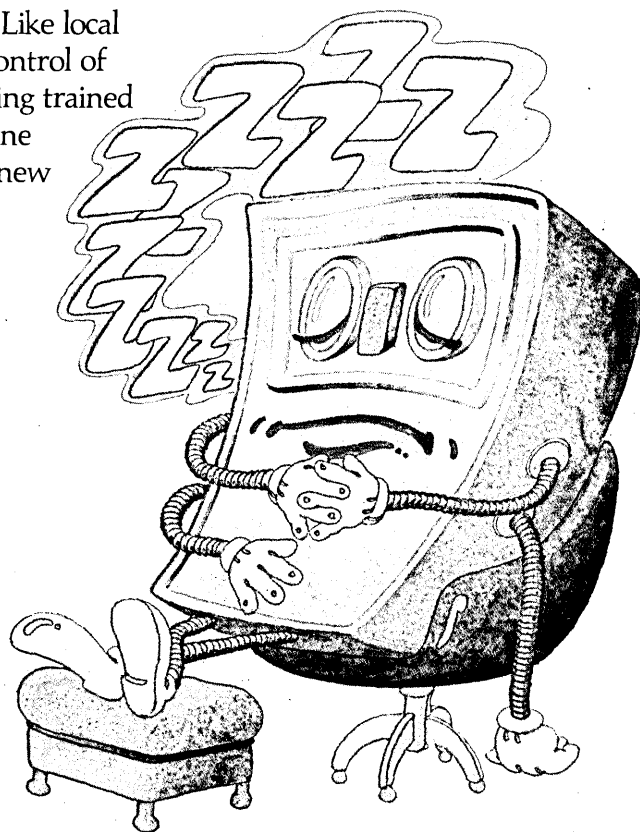

M^DS
The Peripheral Power

If all your communications terminals do is communicate, you could be shortchanged.

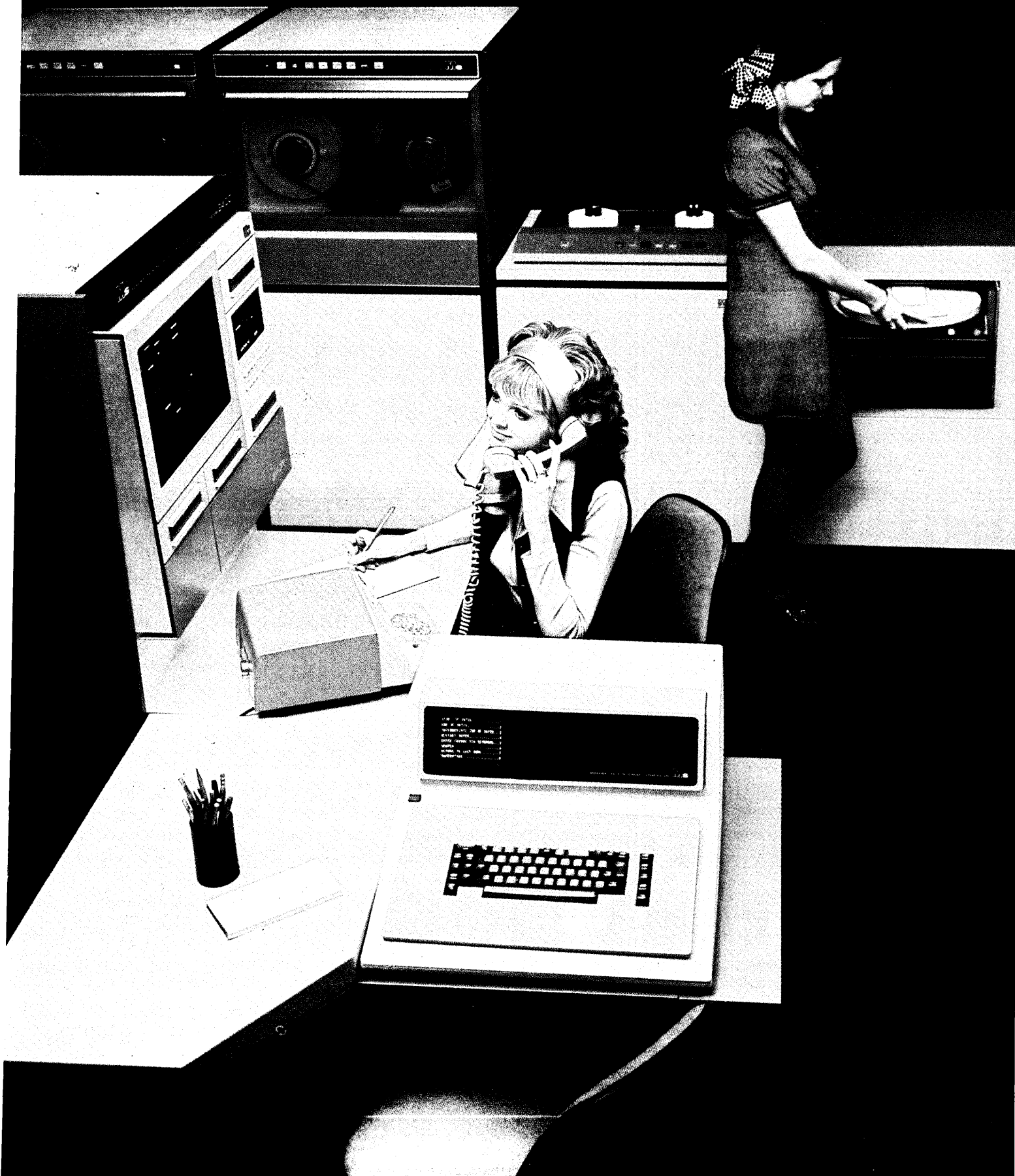

news in perspective

sion. "I think experience is another one of our benefits," he adds. "We've been in the communications business practically as long as we've been in the railroad business."

SPCC is a subsidiary of Southern Pacific Co., whose SP Transportation Co. currently owns and operates the nation's largest private microwave relay system. It is on this net that the SPCC system will, to a large degree, overlay. Initially, the common carrier system will run across 11 states, extending beyond one terminus of the SP railway system at Portland, on to Seattle, and linking to the other terminus at East St. Louis.

Because of this, the construction costs will be minimal. The 53 towers along the 1,728-mile route from Los Angeles to Houston, recently approved by the FCC, is expected to cost a mere \$8.1 million and is scheduled for completion in a year. The 520-mile route from San Francisco to Los Angeles, approved earlier, will involve 19 stations at a cost of \$3.4 million. Applications for the remaining links are pending.

"We will go beyond St. Louis to offer nationwide service," says Geier. He adds that it has not been determined

how the additional links will be made, saying the company could interconnect with existing or new carriers, construct additional towers, or go the satellite route.

Meanwhile, one of the first of the uncommon common carriers, Western Tele-Communications, Inc., has been

transmitting data between San Diego and Yuma, Ariz., for its first customer, Cubic Corp. Cubic sends and receives test range data over a 100 KB circuit.

The Denver company this summer will add Los Angeles to El Paso and San Francisco to Seattle routes, offering both data and voice transmission under recently-granted authorization from the Federal Communications Commission.

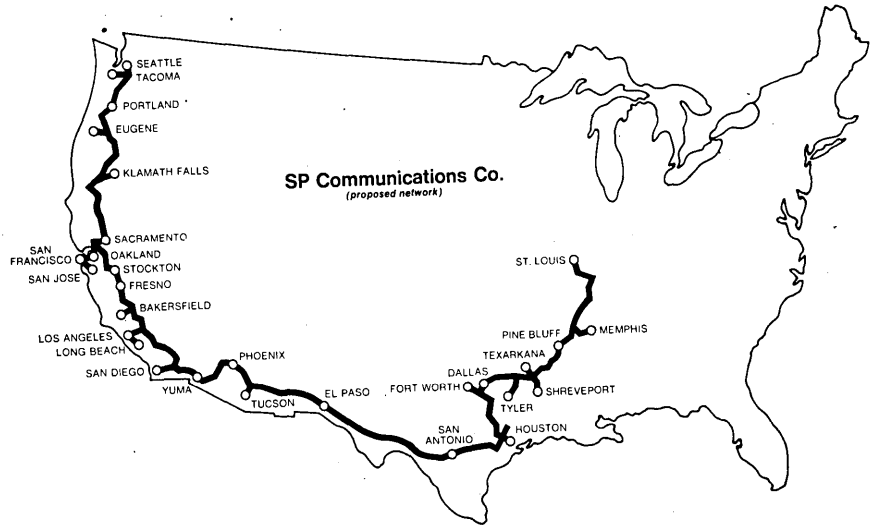

FIRST LEG of Southern Pacific's microwave transmission service will operate between Los Angeles and San Francisco in June and later extend north to Seattle and east to Illinois. Satellite might be used to extend network farther east.

PDP 11 USERS ARE YOU WRAPPED UP IN REAL-TIME PROBLEMS?

CYBERMATICS HAS UNWRAPPED ITS REAL-TIME OPERATING SYSTEMS FOR THE PDP 11/10, 20, 40 & 45.

The system:

- Supports the memory segmentation feature of the PDP 11/40 & 45 and up to 124K of memory
- Available in core and disk based versions
- Supports Multi-programming
- Supports Multi-tasking
- Provides standard interface to user application programs
- Allows user to develop his own system
- Utilities, Peripheral Handlers, many other features

Call or Write

Patrick E. Ryan, Manager of Marketing

CYBERMATICS®

560 Sylvan Avenue, Englewood Cliffs, New Jersey 07632
(212) 868-7255 (201) 871-1300 (703) 370-5926

CIRCLE 77 ON READER CARD

ARE YOU A MAN ON THE M-O-V-E?



FREE
28 PAGE
ILLUSTRATED
CATALOG

THEN **SCHEDULIZE** WITH
MAGNETIC CONTROLS
MAGNETS MOVE FASTEST — AND EASIEST — OF ALL!

YOUR LIVELY IMAGINATION
+ OUR KNOW HOW
= A SYSTEM TO SUIT YOUR NEEDS

For Scheduling • Programming • Personnel • Sales •
Shipping • Inventory • Maintenance • Production •
Quotations • Computer • Special Situations

TELEPHONE 201-988-6000

METHODS RESEARCH

70 ASBURY AVENUE, FARMINGDALE, NEW JERSEY 07727

CIRCLE 98 ON READER CARD

DATAMATION

Banking

Rockwell the Banker: Does He Miss IBM?

The popular image of a true IBM man is someone who has been so intensely trained—indoctrinated, some might say—that he can't function effectively in any atmosphere other than his native IBM environment or one that looks and feels like it.

With the idea of examining this premise—why can't IBM men in particular and computer men in general be successful at anything but working in their native habitats—we sought out George B. Rockwell, president and chief executive officer of Boston's State Street Bank. Rockwell is a perfect specimen for our examination since he spent 12 years with IBM before he joined the big bank, which has assets of \$1.5 billion.

Rockwell had managed the State Street Bank account when he was IBM's assistant branch manager in Boston. He joined the bank as a vice president in the Central Services division and worked his way up through the ranks of middle and top management to head the bank. Rockwell, then, is something of an anomaly—the ex-computer man who has done well in another field.

“Actually, there's quite a similarity between IBM and the banking industry,” says Rockwell. “In the computer business you have to think in the very long term. We have to do that at the bank, too. More important, though, I think that bankers are changing. Our guys at the bank have to be as aggressive as IBM guys today.”

While there is just a whiff of IBM atmosphere in the bank's management techniques, the bank's computer installation is almost lily-white IBM. There are two 155s, one 145, one 30, and a 158 is scheduled to arrive this summer. The sore thumb sticking out at the installation is a Cambridge Memories' add-on memory. Rockwell says the bank is not wed to IBM, and he observes that there has been non-IBM equipment—chiefly Telex equipment—at the bank's computer installations in the recent past. IBM takes good care of Rockwell, briefing him every six months. “Things have gotten more complicated but the basics are the same,” says Rockwell. “I couldn't program today if I had to, but I still understand the basics.”

Standardized with OS

Rockwell is openly proud that the bank's Computer Services division under vice president Brad Tripp has held the budget line for the past three years.

One good move—one that Rockwell attributes to good long-range planning—was the bank's decision back in the mid-1960s to get rid of seven scattered in-house installations and to standardize with OS. Among other things, that move, of course, made it easy for the State Street Bank to move to the 370 line.

The bank has a lease-buy mix in its equipment. For instance, the 155 and 145 are owned by the State Street Bank, but the 30 is leased. “If the



GEORGE B. ROCKWELL
An IBM briefing every six months.

price is right, we lease,” says Rockwell.

One vice president in the Computer Services division, Robert P. Popadic, plays down the thought that users are always at the mercy of IBM. He noted that at big installations it is difficult to move quickly because of the inertia that exists simply because the installations are large. In short, it takes time for big installations to move. “In some cases we're less vulnerable to what IBM does than what the bank does,” says Popadic.

Rush for gold

Rockwell is also proud of the bank's in-house capability. There are more than 400 persons in the Computer Services division, and the bank is preparing to move its entire computer installation to a modern 740,000-square-foot headquarters in suburban Boston.

One example of their resourcefulness is GOLD, the bank's on-line data base communications system. Rockwell says the bank needed it before IBM had it, so the bank had GOLD running more than three years before IBM had IMS. (“And GOLD uses less core and has more throughput than IMS.”)

Another system, a financial control system called BIS, permits the bank's managers to keep close tabs on budgets and costs with on-line CRT's. Indeed, Rockwell says the bank is getting more and more trainees from the better graduate business schools who are ac-

customized to working with computers and who expect to use computer facilities on the job.

All of which leads Rockwell to one of his favorite subjects: the banking industry as a career. “The banking industry is changing,” he says. “There is just about zero turnover. A fellow can have a lot of fun if he's got a portfolio of \$50 or \$100 million to work with.” With the idea perhaps of keeping that turnover as close to zero as possible at the State Street Bank, Rockwell has borrowed some techniques from IBM. Using computers, the bank watches the competition closely and rewards those who help the Boston-based bank improve on its competition with bonuses and other incentives for good performance.

While Rockwell relies heavily on computers and believes that computers will play an increasingly important role in banking, he doubts that top management at banks will ever have the time to get involved with programming and the nitty-gritty of running computer installations from day to day. Rockwell himself is on the boards of directors of two Boston-based computer companies—Keane Associates, a software firm; and Datatrol Inc., a minicomputer company.

But—the question begs for an answer—doesn't George Rockwell sometimes miss working for IBM? Just a little? With a grin, he answers: “Well, the bank grew from \$1.28 to \$1.53 billion in assets last year and earnings were up 15%. That's about as good as IBM, I guess.”

Personnel

When Tom Watson Was in Charge

Employees' lib being what it is nowadays, they're stirring in the ranks again at IBM. The Association of Northern California Employees, which recently renamed itself the IBM Employees Betterment Association, is demanding, among other things, a four-day work week and equal opportunity for minorities.

Nearby, Hewlett-Packard Co. has instituted a flexible work schedule for its employees, allowing them to begin work at any time between 6:30 and 8:30 a.m., and leaving after eight hours on the job between 3:15 and 5:15 p.m. Within those limits, it doesn't matter what time they get in, and they're even free to change their hours each day. The idea started at the firm's Boeblingen, Germany, plant in 1967, spread to the plant in Scotland, then to one in Massachusetts. Now it also cov-

Extend a little, replace a lot,

360 users get any size they want with Fabri-Tek 360 core.

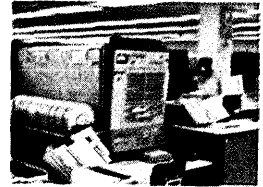

Model 65 — extended from 256K to 512K.
Western Airlines
Los Angeles, Calif.



Model 40 — extended from 32K to 384K.
University of South Dakota
Vermillion, South Dakota



Model 22 — extended from 24K to 64K.
United Farm Agency
Kansas City, Missouri

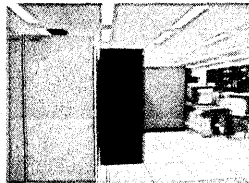

Model 50 — extended from 512K to 768K.
University of Wisconsin
Madison, Wisconsin

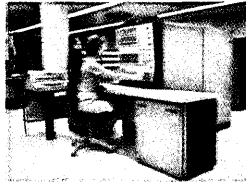

Model 30 — extended from 32K to 64K.
Chi., Mil., St. Paul & Pac. R.R.
Chicago, Illinois
Leased from Dearborn Leasing

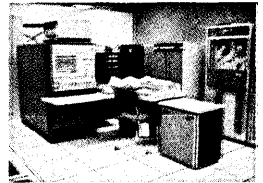

Model 22 — extended from 32K to 64K.
Computer Graphic Systems
Toronto, Ontario, Canada
Leased from Greyhound Leasing

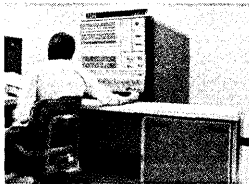

Model 30 — extended from 32K to 64K.
Medtronic, Inc.
Minneapolis, Minnesota



Model 30 — extended from 64K to 128K.
American Broadcasting Company
Hollywood, California

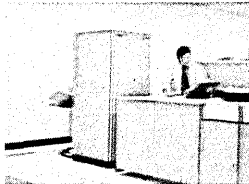

Model 30 — extended from 8K to 64K.
Gant Shirtmakers
New Haven, Connecticut
Leased from Rockwood Leasing



This could be your installation.
We've got any capacity you need.



Model 30 — extended from 64K to 128K.
XCS Management
Vancouver, British Columbia
Leased from National Computer Rental



Model 40 — extended from 64K to 128K.
Further expansion to 192K planned.
Graco, Minneapolis, Minnesota

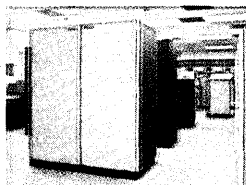

Model 50 — extended from 256K to 512K.
State Comp. Insurance Fund
San Francisco, California



Model 30 — extended from 64K to 96K.
Toronto School Board
Toronto, Ontario, Canada
Leased from Greyhound Leasing

To date, Fabri-Tek has over 150 installations of 360 extension memories. And, IBM has agreed to maintain all these CPU's which have been modified by the addition of Fabri-Tek extension core memories. For further information, call (612) 935-8811 or write FABRI-TEK INC., 5901 South County Road 18, Minneapolis, Minnesota 55436, leader in Memory Technology For Over A Decade.

 **FABRI-TEK.**

360 CORE YOU CAN TRUST

FABRI-TEK SALES OFFICES

New England

Boston (Auburndale), Mass.
(617) 969-5077

Eastern

Stamford, Conn.
(203) 359-1315
Blue Bell, Pa.
(215) 643-6950
Pittsburgh, Pa.
(412) 391-6390
New York (Parsippany, N.J.)
(201) 263-2330
Rochester, N.Y.
(716) 586-1960

Southeastern

Miami (Melbourne), Fla.
(305) 724-0900
Washington, D.C. (Rosslyn, Va.)
(703) 525-6435
Atlanta, Ga.
(404) 457-0821

Midwestern

Chicago, Ill.
(312) 437-4116
Columbus, Ohio
(614) 262-7966
Minneapolis, Minn.
(Data Serv Equipment Co.)
(612) 546-4422
Kansas City, Mo.
(816) 531-4431
St. Louis, Mo.
(314) 721-0004

Central

Denver, Colo.
(303) 573-5535
Oklahoma City, Okla.
(405) 843-6444
Houston, Texas
(713) 772-7050
Dallas, Texas
(214) 233-0872
Salt Lake City, Utah
(801) 359-4594

Western

Phoenix, Ariz.
(602) 266-4448
San Francisco (Sunnyvale), Calif.
(408) 739-4780
Los Angeles (Long Beach), Calif.
(213) 420-2493
Seattle, Wash.
(Computer Supplies)
(206) 623-2413
Portland, Ore.
(Computer Supplies)
(503) 222-2006



news in perspective

ers employees in New Jersey, Pennsylvania, Colorado, and California.

Meanwhile, the IBM group is making rumbles about becoming the bargaining representative for employees, although it admits it has only about 500 members, a small fraction of the approximately 7,500 in the area. According to the association's attorney, ex-IBMer Brian Cunningham, some 60% of members are engaged in manufacturing activities, perhaps 35% from R&D.

The group seeks greater recognition of the individual and not just his formal educational attainments, cost-of-living raises, and management response to employees' gripes. "There are so many on the management team who have retired and have not notified IBM that it makes some of us sick," states Harry W. Wasnechak, who has been with the company 16 years and is a past president of the IBM Club, in a recent flyer. Says Cunningham, "It's just not the company it was when Tom Watson was running it."

Software

Double Check and the Double Checks

Even with a tried-and-proven computer program, it pays to check *and* double check.

And double checks were what happened last month when Morgan Guaranty Trust Co.'s dividend disbursement program, which is in the tried-and-proven category, disbursed \$13.5 in bloated dividend money. The mistake was caught in time to avert serious trouble, thanks to a double check.

The funny money went to 32,000 shareholders of Dart Industries, Inc., of Los Angeles, in the form of quarterly dividend checks. The dividend had been erroneously calculated at 75 cents a share on 20 million shares outstanding when it should have been 7.5 cents a share.

The bank didn't fall into the blame-the-computer syndrome. "It was definitely a human error," said a bank spokesman. "A 17-year veteran made a mistake in punching a parameter card. I guess the best of us make mistakes sometimes."

There was a check of the program in the middle of the run which failed to uncover the error. A routine third check uncovered a decided difference in the money transferred by Dart to cover the dividends and the total of dividends paid. But the checks had

gone into the mail.

A stop payment was issued immediately; and letters, advising that the stop payment had been issued, went to shareholders the same day containing new checks and return envelopes for the originals.

"We're getting them (the first checks) back by the thousands," said the bank man several days after the incident. He was not aware of any attempt to cash the bloated checks but assured it couldn't be done if an attempt were made. He said the bank would cover any charges incurred by shareholders as a result of the stop payment.

Fighting Cosmic's Bargain Packages

If you had a choice of paying \$310 or \$8800 for essentially the same software package, which would you choose? The obvious answer is exactly what has Boole and Babbage worried.

Currently the Univ. of Georgia's Cosmic Center, under contract to NASA, is selling two software packages very similar to the much more expensive products — CUE (Configuration Usage Evaluator) and PPE (Problem Program Evaluator)—sold by the Cupertino, Calif., software company. Both are patented, so B&B filed an administrative claim last year against NASA charging patent infringement and requesting Cosmic to stop selling the two software packages in question.

NASA recently rejected B&B's claim on the grounds that the patents are invalid on the traditional patent law grounds and on the recent Supreme Court decision in the Benson-Tabbot case striking down software patentability. Traditional patent law grounds include the invention not being novel or that it was used or on sale before the patents were issued, a NASA attorney said. He said Cosmic began selling its packages before B&B patents were actually issued.

The Boole & Babbage claim alleges NASA contributed to the infringement by selling the packages through the Univ. of Georgia facility. Direct infringement by government agencies using the packages purchased from Cosmic is also charged.

Meanwhile, sales of the two packages, under the names of Supermon and Progllok, continue; but Cosmic is including a warning of the pending B&B contention and the patent number. The Supermon package sells for \$310, and documentation for the program sells for \$4.50. Progllok sells for \$275 and the documentation for \$3.50. Su-

permon and Progllok evaluate the performance of computer hardware and programs. The packages were developed under a contract with the Atomic Energy Commission by the Stanford Linear Accelerator Center.

Boole & Babbage now has the option of going to the Court of Claims, suing government agencies using the packages, or suing Cosmic. A spokesman for the company said last month it hadn't decided, noting that a formal review before the Court of Claims could cost from \$50,000 to \$100,000 and other litigation on the validity of the patent could be dangerous. "If we pursue this thing, we could lose our patent," the spokesman said.

Meanwhile, sources inside NASA said that the firm should be ready for a real fight, since NASA is "anxious to pursue" the claim.

Governments

San Bernardino Goes On-Line

The city of San Bernardino, Calif., population 117,000 at last count and covering 48 square miles 60 miles east of Los Angeles, has been in the business of being a city since 1810.

It first brought data processing into that business in 1968 with NCR bookkeeping machines. Soon the city fathers

felt this wasn't enough, so in 1970 they leased an IBM 360/20 with 12K core. Applications run on the 20 included general ledger, accounts payable and payroll for the finance department, a fire training program, a library inventory system, and accounts receivable for the utility department. The data processing budget was running at \$268,000 a year.

Early in 1971, city administrators determined to go even farther. They were willing to spend, but prudently. As deputy city administrator and data processing director Morse Topper puts it, "it's taxpayers' money." What the administrators decided they needed was an on-line integrated system that would provide timely reports for city management but, most of all, would best serve the needs of user departments.

So a committee was formed with representatives of each potential user and from the city council. For about a year this committee studied alternatives which might give them what they wanted. They visited installations in other cities to see what they were doing.

They considered upgrading to a 360/40 or better, which would have involved retraining and additional hiring. They also considered a sharing operation with San Bernardino County which has a 370/155 within the confines of the city, but this would have meant a diminishing of control.

What the committee opted for in the spring of 1972 was to contract out for

services *but* on a computer physically located in San Bernardino city hall. "We had just built a new city hall," said Topper, "which had a basement room designed to accommodate a computer center. Also, a lot of us had good reason to distrust long lines. We didn't want to risk a communications breakdown." So the city put out an rfp that spring for a contractor which would take over management of the city's edp operations with an on-site computer.

Three proposals were evaluated: one from Optimum Systems, Sunnyvale, Calif.; one from EDP Inc., Florida; and one from Xerox Computer Services, Marina del Rey, Calif. In October the city signed a \$1.1 million contract with xcs. The three-year contract calls for xcs to take over complete responsibility for the city's data processing operation, install a centralized municipal information system, and maintain a computer installation at the San Bernardino city hall.

xcs assumed responsibility for the city's 360/20 and its five-man data processing department last Sept. 7. The five became xcs employees, three moving to xcs headquarters in Marina del Rey in marketing support and two remaining in the city data center. A sixth, hired by xcs shortly after the contract became effective, became a city employee involved in data entry.

Initially xcs converted existing city applications and began implementing new ones to run on its computers at the Marina del Rey center. An on-site project manager, Bill Cavanaugh, who had handled a similar responsibility in an implementation in Pasadena, Calif. (see Sept. 1972, p. 116), was appointed to oversee conversion, as were a financial expert, a utility billing expert, and a police systems installation specialist. First applications to be added were utility billing, police systems, stores inventory, and job costing.

Out in January

A first step was training of city personnel in the use of an interactive system. In six weeks San Bernardino's 1,500-man payroll was being run on the xcs system. The police system was up in December, and Topper says the city's 174-man (clerical not included) police department "is receiving information it never had before," like the frequency of specific types of crime incidents in specific geographic areas. The fire department, library, and utility accounts receivable applications were converted from the 20 to the xcs system in December, and the 20 was returned to IBM in January.

A Sigma 7 was delivered to San Bernardino in February and was checked out and waiting for peripherals in late March. The city's system is scheduled

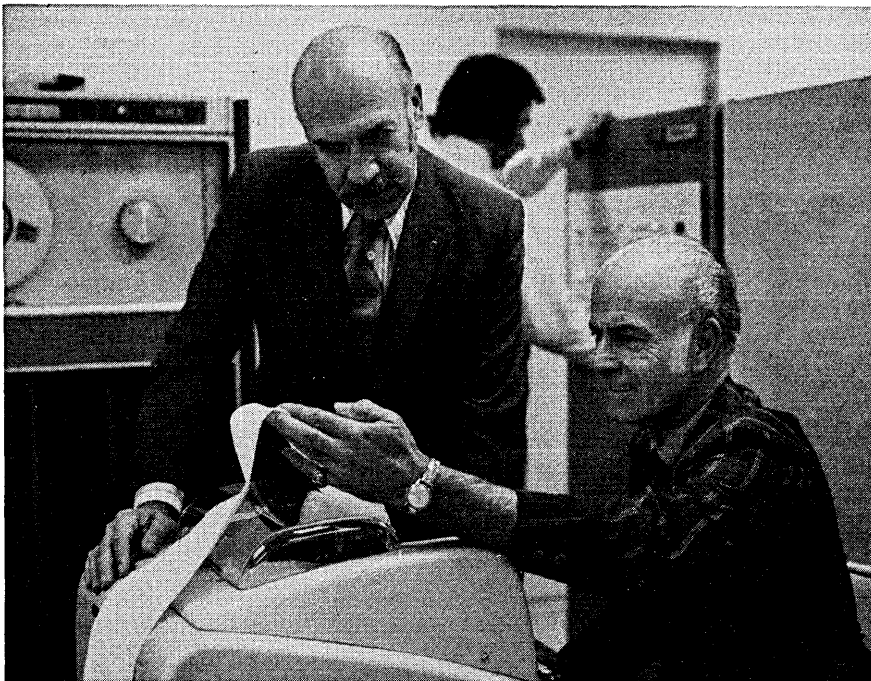

SAN BERNARDINO's deputy city administrator and director of data processing, Morse Topper (left), and city finance director, Elton Tevernetti, check a report from an on-line information system being implemented and managed for the city by Xerox Computer Services.

to be up and running on the on-site system on or before May 1. Fund accounting and utility billing are scheduled to be implemented next month.

Topper says he looks for greatly reduced read-to-mail (meter reading to mailing the bill) time with implementation of utility billing. This should go to 48 hours maximum from "days or even months."

And something that could work out as a good deal for both XCS and the city is an XCS plan to offer services to other municipalities and commercial firms in the San Bernardino area using the Sigma 7 in the San Bernardino city hall to which Xerox retains title. It could mean revenue, of course, to XCS, and to the city, a rebate.

—Edith Myers

State Center Up for Grabs

The first and largest of California's proposed consolidated computer centers is still up for grabs as far as hardware suppliers are concerned following disqualification by the state last month of bids by Univac and IBM, the only two vendors who bid for the contract that was to have been announced in late March.

The rfp for equipment for the center marked the first time the state had gone out for competitive bid on a big equipment buy, and state officials blame the failure to secure a qualifying bid on "a learning process." At an Assembly Ways and Means Committee hearing in mid-March, representatives of all major computer vendors testified to their desire to help the state, and it was decided a new rfp would be issued within 90 days. An official said it would be the same rfp "with corrections to ambiguities."

One thing that will be changed will be the conversion date for the Dept. of Motor Vehicles, one of 34 departments to be served by the proposed center. The state had set Oct. 1, 1973, as a deadline for DMV conversion. This was in hopes that a planned new staggered motor vehicle registration renewal cycle, which would be coupled with a mandatory smog control requirement yet to be legislated, could begin this year. Now the state will have to stick for one more year with its current registration system, which has all vehicle registrations due for renewal in early February. The staggered system would have groups of vehicles, grouped either by owners' names or by registration number, renewed every month of the year, which, the state believes, would make enforcement of smog control legislation feasible.

Conversion next spring

No delivery date for equipment had been set at writing, but estimates were the rfp would call for first equipment delivery this fall and for DMV conversion to start in late spring or summer of 1974. One of the grounds for disqualification of the Univac proposal was it called for DMV conversion to start July 1, 1974.

The proposed center, originally designated the Business & Services Center, was renamed the Teale Center last December, following retirement of Sen. Stephen P. Teale, who authored the state's computer consolidation legislation. Word is Sen. Teale wasn't thrilled

and feared fingers pointed at "that Teale computer that went down."

Univac is credited with bringing the pressure to bear that caused the state to go out for competitive bid for center equipment (see July 1972, p. 85). The state's budget bill, passed last June, required the state to go out for competitive bid for big data processing buys, and its passage followed numerous written and spoken appeals by Univac for such a requirement. Prior to passage of the budget bill, a procurement of three IBM 370/165s for the center without competitive bid had been proposed.

Univac was the first vendor to be

**A Master key
that can be copied
for 50¢ means
your security is
worth even less.**

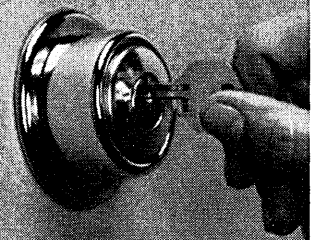

**RUSCARD™ electronic
keys can't be copied...
and can be cancelled
(if lost, stolen or
terminated) by
pushing
a button!**



**Invisibly coded
RUSCARD™
access cards
are re-writing
the book on
security
systems.**

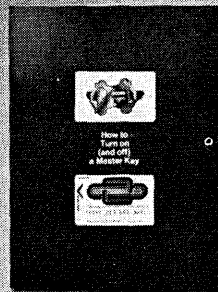

**Send for your
free copy of
this new book...
or call Toll Free:
(800) 423-4194.
In California:
(213) 682-3691
collect.**

RUSCO ELECTRONIC SYSTEMS

A RUSCO INDUSTRIES COMPANY, P.O. BOX 2848D, PASADENA, CALIFORNIA 91105,

OTHER RUSCO INDUSTRIES COMPANIES: ADOR/HILITE; LOOK/HILITE; MAJESTIC/HILITE; GREENWAY ALUMINUM; J.A. MELNICK; RUSCO DIVISION; RUSCO/CANADA; H&D; RUSCO/HILITE; HARVARD MANUFACTURING; SPERLING MANUFACTURING; PARK-O-MATIC

Please send my FREE COPY of the RUSCARD™ planning book!

NAME _____ COMPANY _____

ADDRESS _____

CITY _____ STATE _____ ZIP _____

If he's not one of our computer salesmen, that's the one thing he probably won't bring up.

Because he probably can't bring anybody over to do it for you.

But we can.
And we will.

And we'll bring over all the modules (including special modules), labs, wire wrap service, cabinets, hardware, assembled logic arrays, terminals and technicians it takes to

do the job.

For us it's easy, because our Logic Products Group makes it all themselves, or gets what they need from one of our other groups, so it all fits together when it gets there.

When you buy a computer the hooker in the deal can be "Who's going to hook it up?"

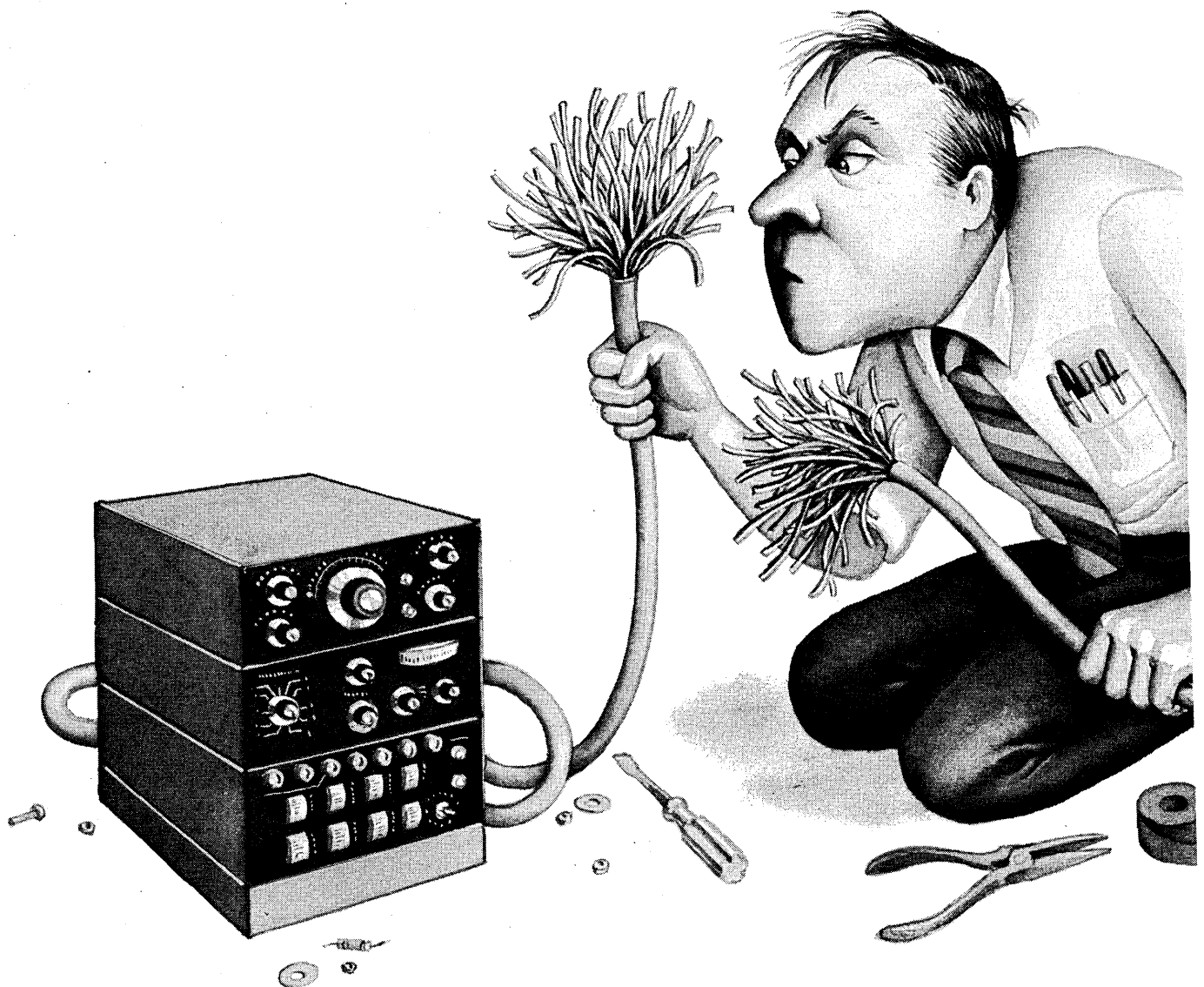

We can do it because we've had, we've got, and we keep getting the kind of designers, engineers and logic people it takes to make and market more kinds of computers, and everything it takes to make a com-

puter work right, right from the start, than any other computer company in the world.

We're the Logic Products Group, Digital Equipment Corporation, Maynard, Massachusetts 01754/(617)897-5111 (Ext: 2785) in the U.S.

81 route de l'Aire, 1211
Geneva 26/(022) 42 79 50
in Europe.

digital



disqualified, and following its disqualification there were hints that IBM had helped write the first rfp.

A state official flatly denied this. He said IBM, prior to the passage of the budget bill, had been asked to prepare a proposal on approach to consolidation. IBM suggested a project management approach, and this, he said, was rewritten and attached to the rfp as an appendix.

Besides DMV, which currently uses Univac equipment, departments among the 34 to be served by the Teale Center include: Public Works, currently IBM; the California Highway Patrol, IBM; General Services, IBM; and Water Resources, Control Data.

The second center the state plans to implement will be the Revenue Center, which will serve the Franchise Tax Board, an IBM user, and the Board of Equalization, which has Univac. No schedule has been set for this center.

—E. M.

Federal Government

Senate Upstaged on Dial-a-Bill System

First there was dial-a-prayer, then dial-a-car, followed by dial-a-phenomenon and dial-a-girl. Now there's dial-a-bill. By calling 202/225-1776, the public and Congress will receive accurate, timely information on Senate and House legislation. That is the telephone number of the Bill Status Office, a computerized information service started March 1 by the House of Representatives.

On the other end of the line, specially trained operators access a 512K 360/50 by either bill number, sponsor, committee, or subject. The caller is given information on the actual status of the bill coupled with amendments passed. In addition, the system will provide, when requested, a hardcopy printout of the specified status information. This will eliminate the series of phone calls from the sponsor of the bill, to the committee, to the subcommittee, to the legislative aide, who is often out.

The bill status system "will save money and man-hours" since "it will replace the tedious search of files to keep track of the progress of thousands of bills introduced in each Congress," says Rep. Wayne L. Hays (D-Ohio), chairman of the Committee on House Administration. He did not offer any figures to indicate how much would be saved. The system was developed because the Library of Congress' bill

status system was "completely and utterly worthless," Hays said, calling the Library's system an "amateurish job." The House will provide Congress with the answers when they are needed. The Library of Congress provided the House system with indexing by subject, sponsor, and popular title.

Far from perfect

The House system was developed under the guidance of Hays' committee by its House Information Systems staff headed by Frank B. Ryan. The system was planned, developed, and implemented in less than a year. It sounds great, but it appears to be far from perfect.

Since the system was developed by a House committee, the detail on House bills far exceeds the detail on Senate bills. For example, the system carries no cosponsors for Senate bills, and the status checks hit only the "high spots" of a Senate bill. The House system will report the Senate committee to which a bill was referred, but no hearing date. No official data is supplied by the Senate. Updating is based on the calendar or the Congressional Record. But this may change as the House system develops, a spokesman for Ryan said.

Another minor difficulty is the indexing, since the subject keyed in must be included in the title of the bill. For example, a bill prohibiting abortion might be indexed under right to life. Unless right to life is entered, the bills will not appear on the screen. Less serious, but worth noting, the system was down for an hour March 15 while a printer difficulty was being traced; and for "several hours" the next day the operators switched to a manual lookup while the system was down for what was described as "internal work on the data file."

Still under development in the system are programming shortcuts to reduce the time it takes to update the data base nightly, Ryan said.

The bill status system is the first phase of a multiphased development project. Also under study is a direct mail addressing system of some 10,000 names classified by categories for Congressmen; another is budgetary analysis to provide computer data the executive branch already has, Hays said.

The Senate, upstaged by the progress the House has made on its bill status system, has installed two terminals in the office of the chairman of the Rules Committee, to test the Library of Congress system. This test will take about 60 days. Hays expressed the hope the Senate will end up using the House system.

—K. Endres

ACM's New Director Will "Wait and See"

Joseph Cunningham, long one of the leading figures in government computing, has taken over as executive director of the Assn. for Computing Machinery. He has adopted a "wait and see" attitude before commenting on what he would like to do at ACM, but he says: "I'm looking forward to my



JOSEPH F. CUNNINGHAM
"Problems and challenges" at ACM.

new position. There are problems and challenges; if there weren't any, I wouldn't take the job."

The association has been plagued with numerous problems, not the least of which were miscalculations occurring during changes in its accounting method (see Feb., p. 128). Ironically, ACM also has been the victim of malprojection, overestimating income from such activities as professional development seminars and publications, overestimating the size of its membership (discovered while computerizing its subscriptions in a cooperative effort with IEEE), and underestimating its spending.

But those are the lesser problems Cunningham and the society face. The biggest is to settle on ACM's goals — whether to be an academic and research-oriented organization *with muscle* or a much enlarged association serving both the business and scientific community *well*.

Cunningham was associate director of data automation for the Air Force from the mid-'50s to 1966, and then moved to the Office of Management and Budget, primarily as chief of adp management. After his retirement from the government last year, he served as consultant for the World Bank.

(Continued on page 129)

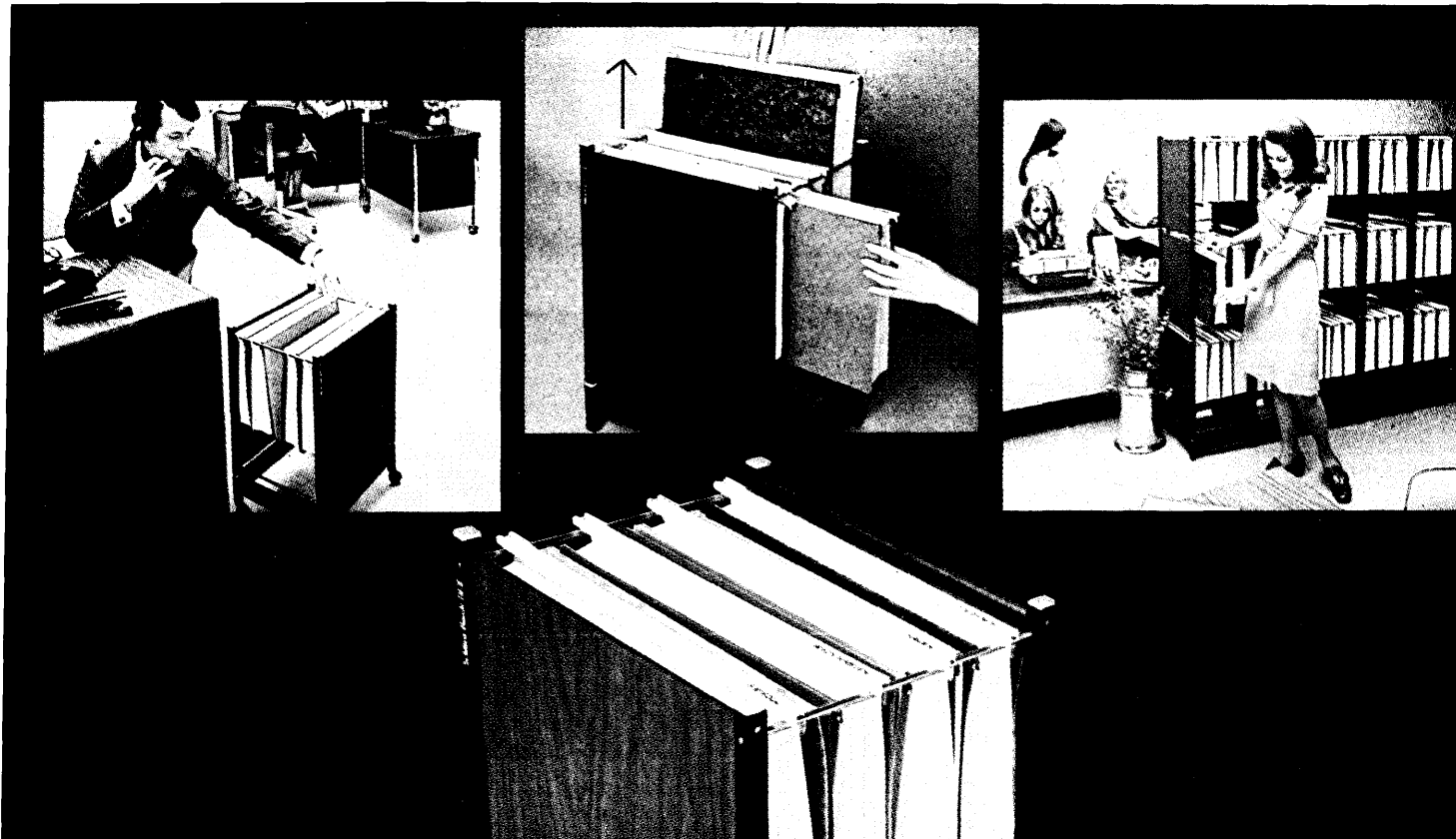

\$39.95*

Your personal printout caddy Wilson Jones Mini-Rack.

The Mini-Rack holds 3 or 4 printout binders at your fingertips. It has slide-out/drop-in retrieval. And it builds into any size Maxi System. Our Mini-Rack is only \$39.95.*

Keep your active printout binders by your desk. In our Mini-Rack. At night roll it into the well of your desk. Without the stand and casters, put it on a shelf or credenza. It takes up less than 1½ square feet of space.

The Mini-Rack features slide-out/drop-in retrieval. It comes with T-bars for standard vertical retrieval. Converts, in an instant, to horizontal retrieval with special T-bar channels.

CIRCLE 61 ON READER CARD

You won't need any other equipment. Or new binders.

Any time you have more binders to store, just add another rack. Mini-Racks stack up, down, all around. The Mini-Rack grows into a Maxi-System of any size and shape. Perfect for data libraries.

The Wilson Jones Mini-Rack holds 3600 printout sheets. Up to four 147/8" x 11" binders. Burst or unburst. Vinyl side panels in walnut grain. Black, blue, tan also available.

Just see your Wilson Jones supplier, or send for more information.

*Suggested retail price for each complete unit.

Wilson Jones

A Division of Swingline, Inc.
6150 Touhy Avenue,
Chicago, Ill. 60648



Gentlemen:
Please send me more information
about Mini-Rack.

Name _____

Title _____

Company _____

Address _____

City _____ State _____ Zip _____

D-4

**Think data entry. Think cost. Think systems.
Think key/disk. Think scanning. Think multimedia.**

When you've
thought it out...
you'll think of
the Cummins KeyScan™
Data Entry System.

KeyScan is a shared-processor, key/disk scanning system designed from the ground up, with the latest technology, to be the first high-performance, moderately priced multimedia data entry system.

And that's a lot. It not only means scanning any or all of the common OCR fonts, OMR codes, holes, E13B magnetically and optically, but also the most advanced key/disk data entry system available today. KeyScan also reads small tags and has the capability to sort documents when required.

But that's not all. It can be just what you want it to be: a stand-alone key/disk system, an off-line print station, remote MICR terminal . . . whatever you need.

And, as your requirements change, you can reconfigure your hardware and software to do the new job . . . the best way.

All this from a company with offices around the world and over 45 branch sales and service offices located across the country. Support services include programming, forms design, and systems design—all to suit your specific applications.

So when you think data entry, think of Cummins KeyScan Multimedia Data Entry System. Then think of other systems and you decide which is best.

CA CUMMINS
CUMMINS-ALLISON CORP.

800 Waukegan Road, Glenview, IL 60025 • 312/724-8000

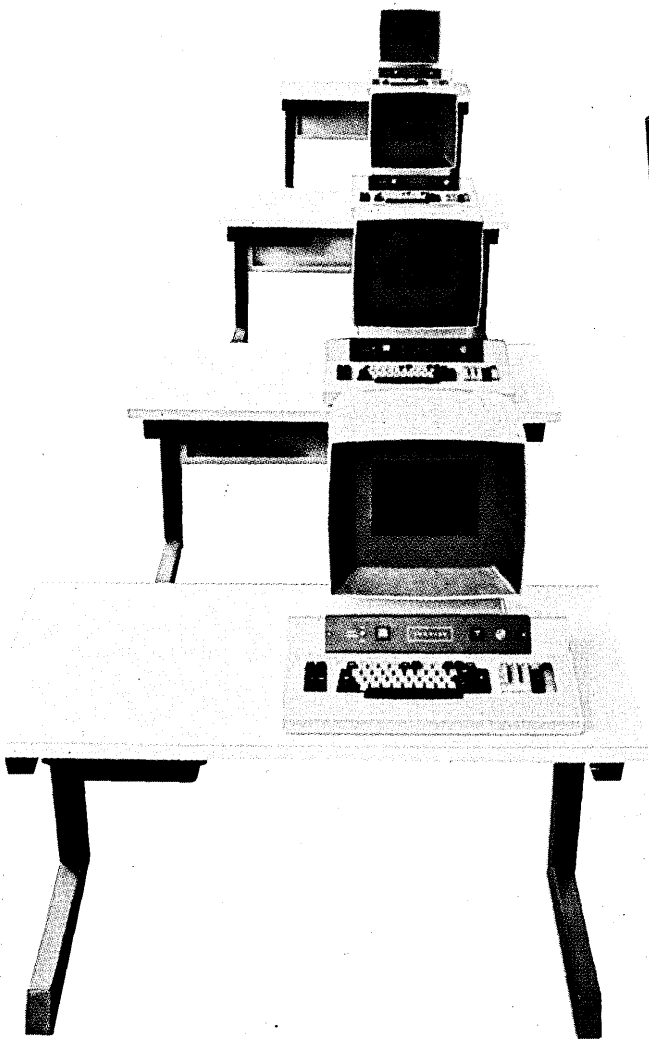

4400

KeyScan Multimedia Data Entry System

Now shipping # 1,996...1,997...1,998...1,999...

Diablo HyType I, Quickly Meeting Demands For A High-Reliability, Typewriter-Quality Printer!
Nearly two thousand Diablo HyType I serial printers have been shipped in the past year. That's acceptance. And, that's proof we are meeting designers' demands for a reliable, compact, low-cost printer that offers crisp, clear type at I/O speeds. HyType's reliability is inherent: we have eliminated 80% of the moving parts

found in conventional printers. What about speed? HyType I combines typewriter-quality printing with speeds 2 to 5 times faster than existing serial printers. It prints five sparkling clear copies using everyday carbon forms. For a complete presentation of HyType performance characteristics, write or call Diablo Systems, Inc., 24500 Industrial Boulevard, Hayward, California 94545. 415 / 783-3910.



Diablo Systems, Incorporated

A Xerox Company



Lumber Industry

New Systems May Find Other Uses

With the spring thaw, the logging industry starts up again in some parts of the country, feeding lumber to the 6,000 or so sawmills in the U.S. It's an industry that has been slow in applying computer technology, but two systems developed expressly for that group and now in use have applicability in other industries as well. One uses electro-optical scanners and marker sensors to determine log lengths and diameters, tied into a computer and also direct to automatic saws.

The other is a new hand-held, battery-operated data collection device for use either at timber stands or at sawmills. Designed by Computer Sciences Corp.'s Infonet Div. and made in Richland, Wash., by Entron, the three-pound unit can store up to 8K digits in its semiconductor memory. Data entered through its 10 keys is stored temporarily and displayed using light-emitting diodes (LED's) before committing to permanent storage. At the end of the day, it is connected by an interface to a Teletype, producing both a hard copy and paper tape for subsequent transmission to the computer center.

Initial applications are in the forest, where data on the species, quality, and quantity of trees can be gathered and entered in coded form, and at the sawmill, where length and diameter of logs are surveyed. For csc's service bureau network, it is also the prelude to a log inventory control system offered sawmills and veneer plants. The portable device, however, might also be applicable to road construction work and utility meter readings. In its rugged, waterproof form, it is priced at almost \$1600, according to Harold L. Setzer, manager of csc's Portland, Ore., branch, but could be packaged for indoor use and priced at closer to \$1000.

Deflate the float

With only very few exceptions, says Setzer, sawmills buy their lumber from growers, either independents or the U.S. Forest Service. And until an accurate count of the lumber can be made and billed, no payment can be received. This "float," the time between acceptance of lumber and payment for it, can be in the millions of dollars. Thus, it pays to narrow the time gap between data gathering and printing of invoices. Ironically, one of the few

companies to both grow its own trees and operate its own sawmills is Weyerhaeuser Co., which is the first user of the csc device.

Weyerhaeuser is also the impetus behind the automated log scaling system developed by Atmospheric Sciences Inc., Sunnyvale, Calif. Scaling is performed by two types of electro-optical sensors: marker sensors that determine gross log length, and scanners that can take diameter measurements to within a quarter-inch. The scanners use a linear photodiode array. Weyerhaeuser

subsequently took delivery of 12 more of these systems.

In the meantime, however, ASI came up with a system that inputs this data to a minicomputer to drive an automatic saw or, in the case of a plywood plant, a veneer peeler. It does this by comparing length and diameter data with stored cutting patterns, which can be overridden to conform to the mill's marketing and inventory requirements. The AutoScaler system also can produce log measurements for payment records, use a table lookup to produce board feet, and generate shift or daily reports of production.

Here again, ASI has begun looking at

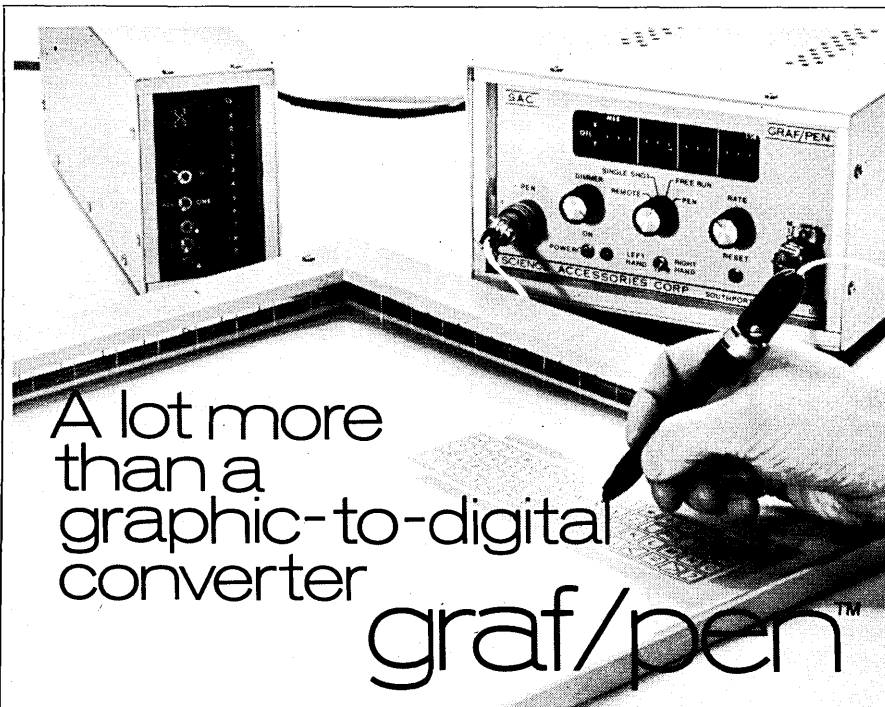

A lot more than a graphic-to-digital converter

graf/pen™

If you've come to think of the graf/pen sonic digitizer merely as the best way to put graphic data into your digital data processing system, you've missed part of the point.

While it is true that the graf/pen can digitize any line or figure drawn on its tablet, a CRT screen, a blackboard or almost any other surface up to six feet square, it is also true that the graf/pen functions very well as a device for entry of alphanumeric information.

For example, one customer has created a Chinese "typewriter" by imprinting plastic overlays with the 10,000-character alphabet (3,000 characters on an overlay). Then to compose a message, he touches the characters in the proper sequence with the graf/pen.

Others have used the graf/pen for various types of business data entry, with a hard copy record being created on a paper overlay simultaneously with computer entry. And combinations of graphic and alphanumeric data are easily entered by dedicating only part of the tablet to alphanumeric or computer-instruction information, leaving the balance free for graphic material—an application often used among our architectural and electronic design engineer customers.

Find out more about the wide, wide world of the graf/pen. Contact Rolf Kates with absolutely no obligation.

SAC SCIENCE ACCESSORIES CORPORATION

65 Station Street
Southport, Connecticut 06490
(203) 255-1526

CIRCLE 93 ON READER CARD



When your data transmission goes down, you don't want excuses.

You want that fault fixed. Fast.

Here's how to do it.

Faults in your data communication system, modem and line are automatically identified faster with Antekna's new Model 221 than any other means. We call it the Fault Fixer. Because it fixes responsibility where it belongs within seconds of a data interrupt. Automatically.

And that cuts your downtime down.

In fact, it cuts it down by so much that our calculations show the Model 221 returns its investment within the first few operational months. It's system transparent, operates point-to-point synchronous, provides diagnostic reports on error rates as well as faults — and requires no local or remote operator.

That means you can permanently install the Model 221. There's no connecting and disconnecting cables for tests as is the case with other units. And that's quite a package. Particularly when you figure it quickly pays your money back by keeping your system up. Plus it ends excuses once and for all. For more information on the Fault Fixer, clip the coupon to your letterhead and mail, or write: Antekna, Data Comm Division; 625 Clyde Ave., Mountain View, CA 94040. Telephone 415/965-0600.

The Fault Fixer



Clip this coupon to your letterhead and mail for more information.

Name _____
 Title _____
 Phone _____

Check one: My need is immediate
 Within 3 to 6 months Reference
 Antekna, Data Comm Division; 625 Clyde Ave., Mountain View, CA 94040

news in perspective

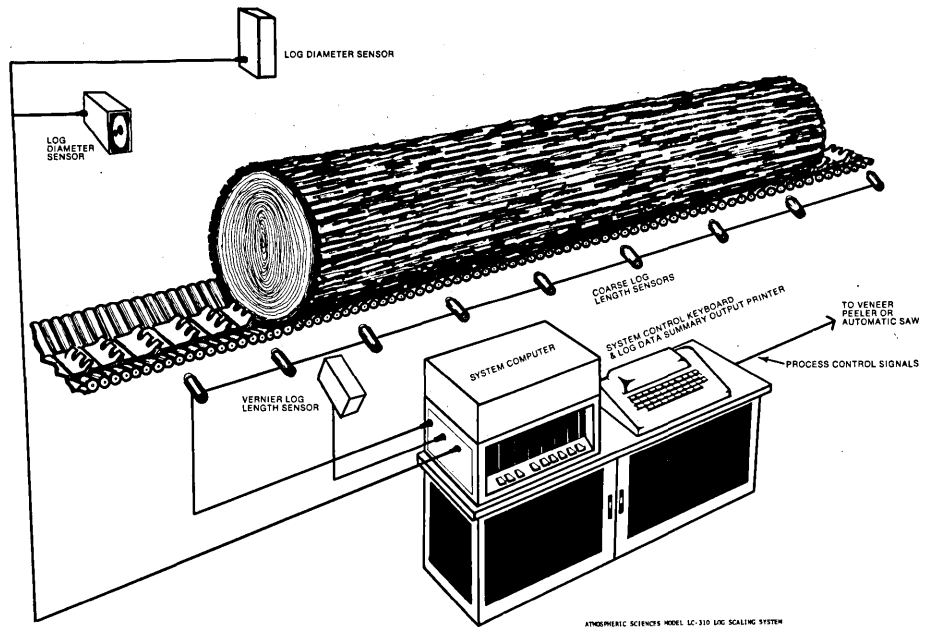
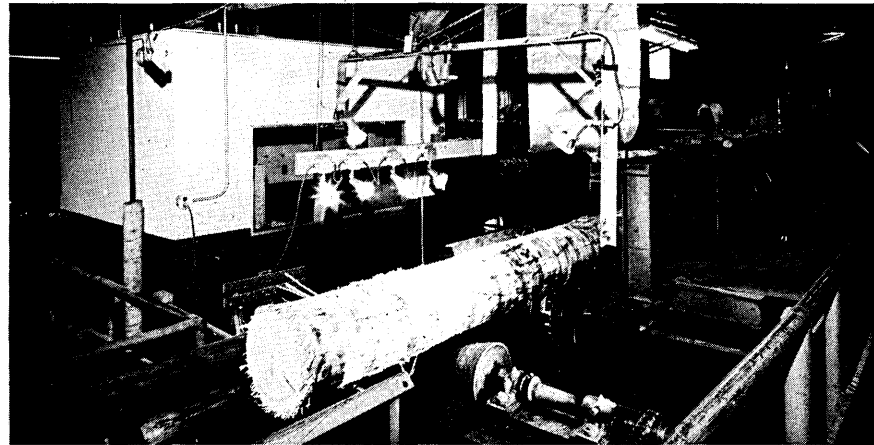

LOG SCALING SYSTEM: Sensors record the length, while scanners measure diameters to within a quarter-inch.

other industries and applications for its ability to make accurate measurements of the physical dimensions of moving objects. Production monitoring and quality assurance are uses that come readily to mind, and they've answered some inquiries from people with these problems. Automated freight handling and measurement systems for metal ingots and steel beams have also

been considered.

"When we started, less than three years ago," reminisces ASI president James W. Burn, "there were no computers at logging/lumber industry trade shows. At the latest one recently, maybe 35% of the exhibitors had computers." He adds that he'd like to find such a virgin market again.

—E. K. Y.

Computer Output Microfilm

Smarter COM Users Still Need Education

There are some 1,000 computer output microfilm (COM) recorders installed in the U.S., and another 1,000 should be sold within the next two and a half years. A mere curiosity a few years

ago, the technique for recording computer-generated data on microfilm at speeds 10-20 times that of line printers now is receiving "serious" attention from a "knowledgeable and progressive" market, says Edward T. Keating, vp and general manager of Stromberg Datagraphix, the firm that pioneered the concept.

But Keating adds that most users of
(Continued on page 135)

WHEN IT COMES TO COM, YOU CAN SPEND A LOT OR YOU CAN SPEND A LITTLE.

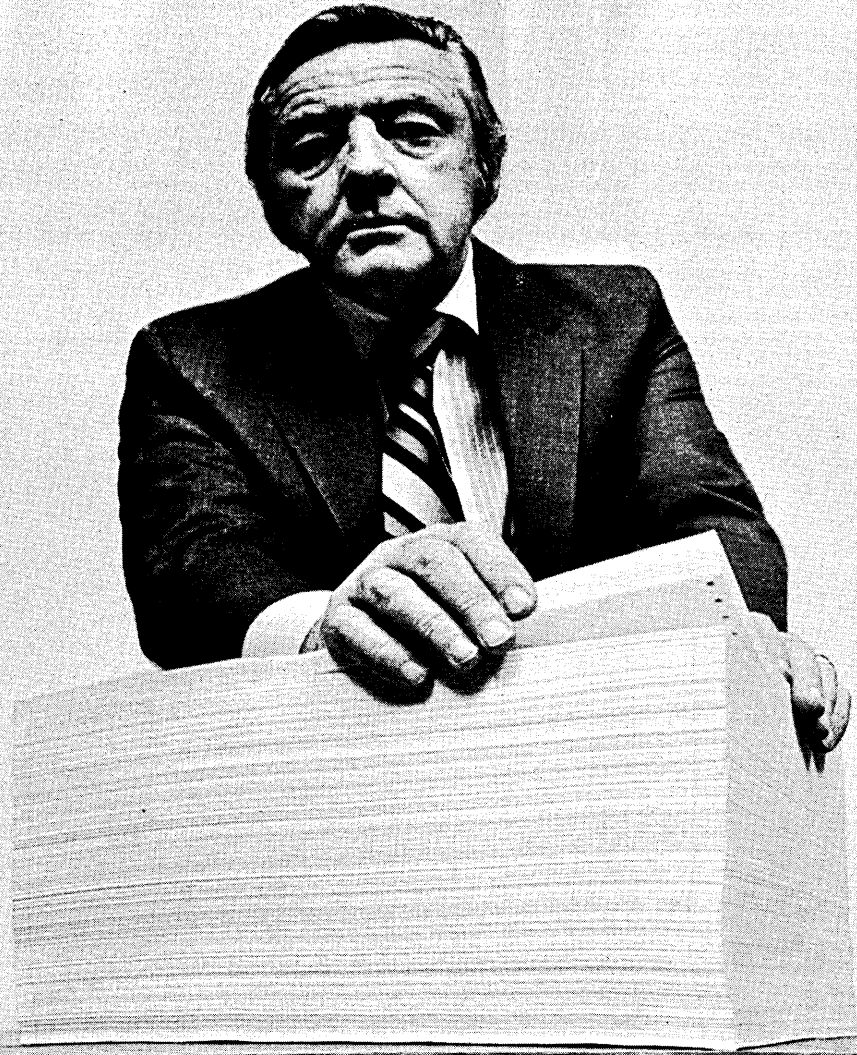

If money is no object, then get the best cathode-ray system you can buy.

But if money is an important consideration, then get the most for your money. A Bell & Howell Inter/COM Microfilm Recorder.

The Bell & Howell Inter/COM unit films continuous fanfold data print-out sheets onto microfilm at 5,000 lines per minute. To give your operation all the benefits of

computer output on microfilm. So data can be stored in less space. With faster retrieval. And more efficient distribution.

Our Inter/COM recorder also has a built-in hand-feed shelf and stacker. This permits double-duty operation, since the unit will now record all your legal-sized documents, too.

The Bell & Howell Inter/COM Microfilm Recorder. It's the lowest cost fanfold recorder available. Just call your Bell & Howell rep-

resentative. And ask him how economically you can COM your operation.

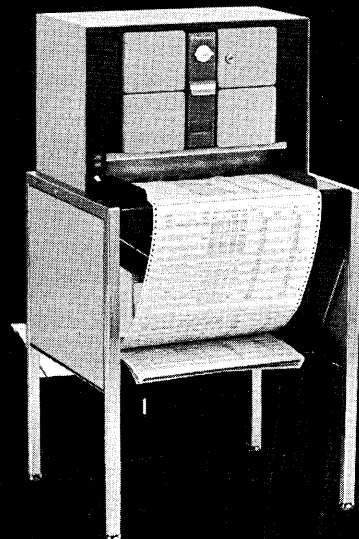

BUSINESS EQUIPMENT GROUP

6800 McCormick Road Chicago, Illinois 60645

 **BELL & HOWELL**

CIRCLE 13 ON READER CARD

**The update for
your 2260
should be a
nice new 3270.**

Right?

Sorry. Wrong.

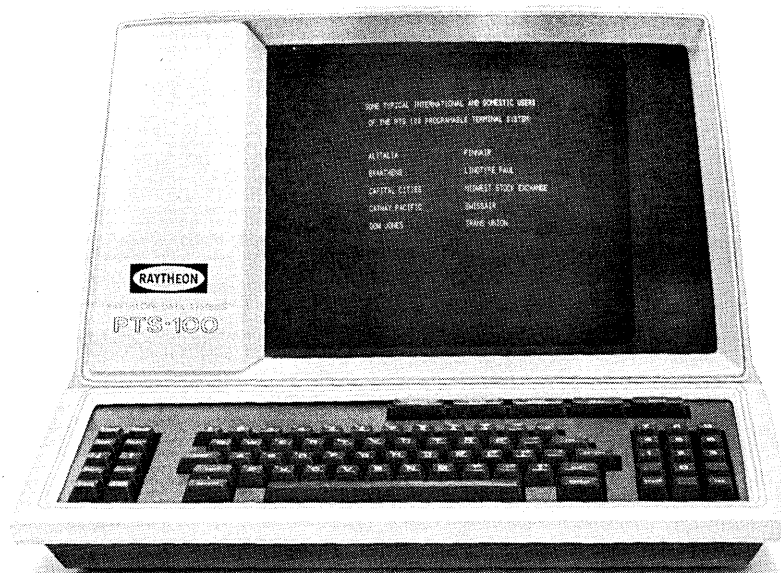

We know. It's like a conditioned reflex: after 2260 comes 3270. But now consider another way to go: Raytheon's PTS100. Compatible with your 360/370 plug-to-plug, plus it more than emulates the 3270. Compare them:

Raytheon's PTS100 is fully programmable.

Raytheon's PTS100 interfaces directly with cassettes, card readers, 2½ and 5 million byte and larger disks.

Raytheon's PTS100 can print up to 120 characters per second.

Raytheon's PTS100 can give you remote program loading so you are able to change the terminal programs at will.

Raytheon's PTS100 lets you do demonstrably more work at the terminal without loading down your main frame with interruptions.

Raytheon's PTS100 has world

wide realtime data transmission experience behind it. We've been leaders in CRT technology since the early 1940s. Our communications experience ranges from airlines to financial networks. We have a world wide service organization in the thousands.

In addition, our Communications Network Configuration Analyses — a computer simulation which provides a new way of looking at your communication costs — can help you optimize your entire data communications system.

We'd like to tell you more about Raytheon. Why not call us in? You've nothing to lose but a conditioned reflex. Raytheon Data Systems, 1415 Boston-Providence Turnpike, Norwood, Massachusetts 02062. Telephone: 617-762-6700. TWX: 710-336-0646. Telex: 92-4408. Attention: Hugh Bannon.

RAYTHEON DATA SYSTEMS

If you write application software, we can match it with systems.

Why stop at selling or leasing software systems to end users? Now you can offer them complete minicomputer package systems.

This way they'll be able to get everything they need from you. And you'll be able to get everything you need from us.

Wider choice of peripherals We offer a full line of peripherals to go with our SUE and MAC minicomputers: IBM compatible 5440 disks, CRT/ keyboards, printers from 100 cps to 600

lpm, magnetic tapes, cassettes, punched card devices and paper tapes. Anything your customer needs. And when his needs change, so can the system. Easily. Even by factors of 2 or 3.

Complete software tools

To make your programming burden lighter we offer a full set of software tools: Fortran, assemblers, utilities, RTOS, sort/merge, DOS and RPG/SUE. That last item is 98% compatible with RPG II by the way.

And we're the only company we know of that unconditionally warrants all our software for a full year.



Maintenance too We'll handle any and all problems your customers might have, promptly and expertly, anywhere. (We recently solved a problem in Bangkok, for instance.) And we'll do it by contract or on call, either way you want it.

We also offer training classes in maintenance as well as in programming.

Add it up So what you'll have is a more salable package to offer an end user. Everything he'll ever want or need in a minicomputer system, right down to the enclosures. (Which we'll put your name on, if you wish.)

Everything ready and working from the minute it's wheeled in his door.

And you'll be dealing with an established, reputable company. One that will be there when you need us.

Let's talk. Call the number below, collect, or write us at 6201 E. Randolph Street, Los Angeles, California 90040.

YOUR NAME

213/722-6810

**Lockheed
Electronics**

Data Products Division

Call us.

See SUE systems on the Computer Caravan.

CIRCLE 46 ON READER CARD

COM are in the early stages, and education still is a critical element for both the marketeers and users of systems. At the National Microfilm Assn. annual conference this month in Detroit's Cobo Hall, the new science is being tackled on three education levels—fundamental, intermediate, and advanced. The four-day conference, April 10-13, although aimed at all forms of microfilm usage, will devote two sessions to the fundamentals of COM and four sessions and three workshops on an intermediate level. The two advanced sessions cover micropublishing.

"Fundamentals of COM" will be discussed at a seminar April 13, moderated by Don M. Avedon of the National Microfilm Assn., and focusing on descriptions of the hardware and software that is on the market.

The intermediate sessions will start Wednesday, April 11, with an overview of the industry by George H. Harmon of Micord Corp. James G. Massie and Dr. Jay Smink of Micro-Comfax, Inc., follow with a discussion of the operation of a COM system, going into such details as feasibility studies, selecting a recorder, using a service bureau, and training. On April 12, Chester Habegger, Uniroyal, Inc., will lead a systems design seminar; and on Friday, Dr. Dwight C. Burnham and James A. Herson, Eastman Kodak Co., will lead a seminar on applications and trends. The three last sessions will be followed by workshops on the topics.

The association has signed up some 100 suppliers for an exhibit to be held with the conference. The keynoter is Dr. Edward E. David, Jr., former chief science advisor to the President. David, who is executive vice president and a director of Gould, Inc., a COM supplier, will speak at an all-conference breakfast Friday on "The Role of Micrographics in Computer Presentation."

It is the first time in six years that the conference, which its sponsors claim will draw 10,000 to 12,000, is being held in the Midwest, suggesting an interest in microfilm applications for manufacturing, particularly the large automotive industry. "COM applications in the automotive industry are plainly unlimited," says E. W. Snyder, Eastman Kodak's director of information technology markets. One of the Big Three auto makers who investigated an on-line automobile warranty control system found it would cost \$3-4 million. It decided instead to ship microfilmed information to the 60 regional offices involved in the warranty verification program at an annual cost of \$200,000, Snyder said.

Retail

NCR Moving Ahead in POS

The National Cash Register Co. believes its latest order for the NCR 280 point-of-sale retail terminals puts it "at least neck and neck" with the generally acknowledged leader in this field, Singer Business Machines.

The order, for 11,000 280s from Montgomery Ward, is the largest single order ever written for one customer in the company's 89-year history. It brings to 16,000 the total number of 280s ordered by Ward since it installed the first in Peru, Ill., in 1971, following a pilot test program in its Lima, Ohio, store. Total cost of the program to Ward will run \$60 million.

The 16,000-terminal Montgomery Ward's installation falls short of the 20,000-terminal order Singer has from Sears for its MDTs, but an NCR spokesman said it boosts the cumulative total of 280s ordered to approximately 30,000. Singer claims 42,062

Model 33ASR with dial-up set and complete maintenance service for \$77 per month.



RCA opens up a new line to "Data-Phone" Teletype** equipment users

Now — lease Teletype equipment from RCA for just \$39 per month (send/receive model 33KSR) including maintenance. With dial-up set, only 80¢ a day more!

- Prompt installation and maintenance services by RCA technicians based in over 130 cities.
- Immediate delivery in any quantity from coast-to-coast warehouse network
- Automatic unattended operation
- Built-in dial capability
- Alternate voice communications
- Friction or sprocket (pin) feed

For full details and rates call or write:
RCA Service Company, A Division of RCA, Technical Products
Service Bldg. 204-2, Camden, N.J. 08101.
Phone: (609) 779-4129

*Registered service mark of AT&T Co.
**Registered Trademark of Teletype Corp.

RCA

It took the other companies 4 years to match the speed of Xynetics 1969 automated drafting systems.

They still can't match our repeatability.

Or the speed of our 1973 systems.

Xynetics introduces 60 inches per second!

Just when another good plotter manufacturer announced a new series with speeds comparable to our 1969 systems, we made another jump ahead with our '73 systems. Their new specs show a maximum diagonal speed of 42 inches per second, a maximum diagonal acceleration of 1.4g, and ± 0.005 inch accuracy with repeatability of ± 0.003 inch. Our new specs are a maximum diagonal speed of 60 inches per second, maximum diagonal acceleration of 2g, and ± 0.005 inch accuracy with the same repeatability as before: ± 0.001 inch.

Considering the limitations imposed, the builders of drafting systems based on mechanical drives have done an outstanding job. But as always happens, something far better came along to take the place of the old ways and render them obsolete. Xynetics linear motor drive did just that.

How? Xynetics linear motor drive is based on magnetics. Two axis motion is con-



**All plotters
are not
created equal...**

trolled by the interaction of magnetic forces between the linear motor and the table platen. The linear motor which carries the drafting head is separated from the platen by an air-cushion to eliminate friction completely. The result? A highly reliable high speed magnetic system with no moving parts making metal-to-metal contact. Compare this to gear train, cable system or lead screw designs. Lots of moving parts. All subject to wear, out of tolerance performance, and mechanical failure leading to costly maintenance and downtime.

But the simplicity and reliability of Xynetics linear motor drive are secondary advantages. Magnetic operation provides the real advantage you're looking for: faster, more accurate throughput than any other system can offer. Get all of the

facts on Xynetics automated drafting systems. With the linear motor as the unfailing heart of the system, you can design your own system using our "building block" system modules. Start with what you need today. Add capabilities as your future requirements change . . . for complete cost/effectiveness control over your investment. Call us today at (213) 887-1022. You'll end up in the same position as the Xynetics linear motor drive. Just way ahead.



Series 2000
Drawing area to 72" x 120"

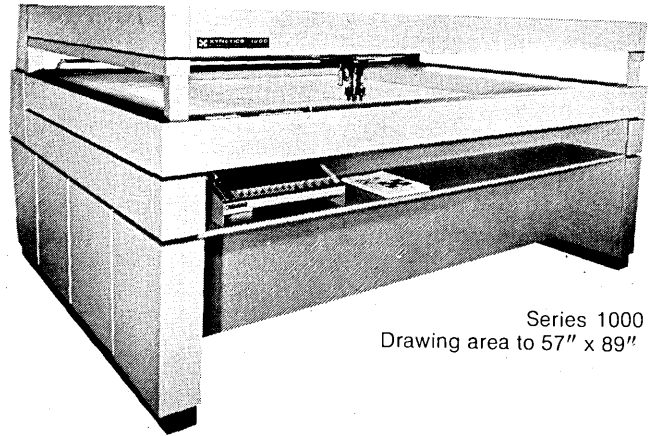

Series 1000
Drawing area to 57" x 89"

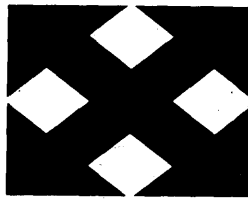

FIRST IN LINEAR MOTORS

XYNETICS®

XYNETICS, INC.
6710 VARIEL AVENUE,
CANOGA PARK, CALIFORNIA 91303

- Send me literature on your Automated Drafting Systems.
- Have a representative contact me.

Name _____

Title _____

Company _____

Phone _____ Extension _____

Address _____

City _____ State _____ Zip _____

Add Staran. Subtract processing time. Multiply effectiveness.

Thinking of adding more computer capability? Think about Goodyear's STARANTM associative array processor.

STARAN provides an effective combination of fast associative array processing and conventional sequential processing—the most efficient approach to a variety of data processing problems.

As the charts show, the higher the number of items to be processed, the more advantageous STARAN array processing is for both arithmetic and matching operations. For applications involving a high degree of parallelism, or a highly dynamic data base, STARAN is unequalled. It can solve problems economically that are too expensive in money and time with sequential processing alone.

STARAN can achieve input-output rates of up to several billion bits per

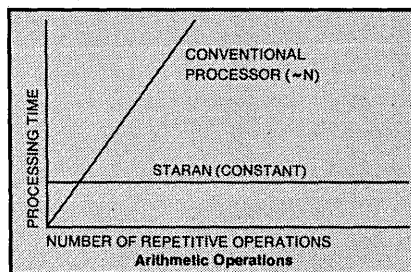
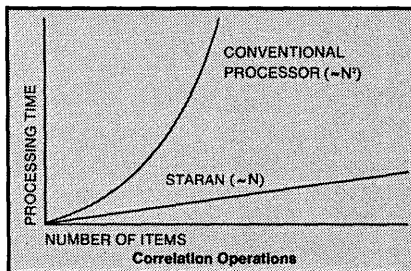

second. And execution rates of up to several hundred million operations per second.

Yet STARAN is relatively inexpensive. You can buy it with varying capacities of array and sequential capability to suit your needs. A minimum basic STARAN system can cost as little as \$250,000 and software cost can be reduced to one-third of conventional system software.

To determine if these savings can be achieved for you, let us work with you on your problem. Goodyear invites you to test STARAN at our Akron, Ohio facility.

For more information, or to plan a demonstration, write: STARAN Marketing, Department 920, Goodyear Aerospace Corporation, Akron, Ohio 44315, or call (216) 794-3631.

GOODYEAR
AEROSPACE

for the MDTs but the term neck and neck could apply if it means giraffes.

Ward said it will install 1,500 280 units this year in new metropolitan area stores in San Antonio and Odessa, Texas, St. Paul and Duluth, Minn., Oklahoma City, Davenport, Iowa, and Portsmouth and Springfield, Va. Last year 280s were installed in 35 stores in Houston, Denver, and Norfolk.

In addition to ringing up a purchase, computing sales tax, and verifying credit at the point of transaction, the 280 terminals will transmit all sales, accounting, and merchandise data to central NCR 725 minicomputers in each market area. These, in turn, will communicate with large computers in Ward's four major data processing centers in Oakland, Kansas City, Chicago, or Baltimore.

The Ward order followed closely on the heels of a 2,000-terminal order for 280 units from the Korvettes department store chain. An NCR spokesman

called this smaller order "more significant in a way than the Ward's order because it followed extensive in-store testing of the NCR system, the Singer MDTs, and a Pitney-Bowes/Alplex system . . . and the industry was watching."

NCR, which has been accused of being late in the POS market, currently is giving it a lot of attention. The company does not feel it is late with its as-yet-unannounced 255, which will do for food stores what the 280 does for department stores. "We were waiting for the food industry to adopt a Universal Product Code" (see Jan., p. 142), said a spokesman. This was expected by April 1, so the NCR announcement should be imminent.

NCR conducted an informal survey in mid-January through its own marketing offices which showed that only some 1,750 POS units for food stores had been ordered, the spokesman said, "which means the market has barely been tapped."

Benchmarks

Worldwide Reversal: IBM World Trade reversed itself and agreed to service 360/30s equipped with Itel/AMS memory attachments on a worldwide "best efforts" basis. The concession comes on the heels of an order by a West German court (see Feb., p. 103) that IBM be required to service 30s with the Itel memories or be subject to fine. Itel agreed to withdraw the judgment of the West German court and an appeal it had filed in France in exchange for the worldwide service agreement.

A Firmer Foundation: The ACM/DPMA concept of a Computer Foundation (Feb., p. 129) to provide a single channel for data processing professional societies' efforts in testing and certification, now has the committed support, of both money and effort, of nine societies. At \$1,000 per society and with each lending two people to organizational work, the organizing committee should be able to meet its July 1 target date for establishing the foundation. In addition to the two launching groups, supporting associations are the Assn. of Computer Programmers and Analysts, the Assn. for Educational Data Systems, the Canadian Information Processing Society, the IEEE Computer Society, the Society of Certified Data Educators, and the Society of Professional Data Proc-

essors. Two other groups which took part in early organizational activities, Quality Data Processors of Bartlett, Ill., and Automation One Assn. of San Diego, Calif., will not be involved in the formal organizing committee. "The scope of their activities is not in line with those of the other groups," said cochairman Fred Harris of ACM. Quality is a local organization and Automation One, being essentially an alumni group from Coleman College, is considered a special-interest group.

Shy of Goal: Establishment of the George E. Forsythe Memorial Fund, with which to aid and encourage worthy students at Stanford Univ. and to establish an annual public lectureship, is being deterred by a lack of adequate response. To date, some \$5,000 in cash donations has been received, considerably short of the \$15-20,000 hoped for by September. Income from the fund, honoring the late chairman of the Computer Science Dept., is to be awarded to one or more students making the most valuable contributions to the teaching of computer science courses at Stanford. But it was hoped to also sponsor an annual Distinguished Lectureship for computer scientists. Tax-free contributions may be made to the fund and sent to the Computer Science Dept., Stanford Univ., Stanford, CA 94305.

More for the CIA: The Computer Industry Assn. (CIA) has added eight new members bringing its total to 15. The new members are Advanced Memory Systems, Sunnyvale, Calif.; Cambridge Memories, Inc., Boston; Xytex Corp., Inc., Denver; Foresight Systems, Inc., Los Angeles; Informatics Inc., Canoga Park, Calif.; Applied Magnetics, Santa Barbara, Calif.; Information Magnetics Corp., Santa Barbara; and General Automation, Chicago. CIA president Dan L. McGurk said the association now includes eight peripherals companies, two software companies, three components companies, one unattached peripherals company, and one minicomputer company. CIA was founded in July of last year "to offer a forum for all segments of the data processing industry."

Process Control Shift: A growth rate for the electronic process control industry of 12.5% over the first half of this decade, rising from \$221 million in 1970 to an estimated \$454 million in 1976, is predicted by a 480-page survey of the integrated circuit industry conducted by Darling & Alsbrook, management consultants. The study notes that the traditionally conservative process industries are being pushed toward electronic replacement of hydraulic and pneumatic systems on the basis of cost and a need for reliability and greater versatility. It notes a trend toward digitizing multisensor signals and sees the need to control a greater number of analytic points because of increasing process complexity as leading to "a proliferation of data processing within many process control systems."

IFIP Congress 74: A call for papers has been issued for the sixth triennial meeting of the International Federation of Information Processing Societies to be held Aug. 5-10, 1974, in Stockholm. The U.S. Committee for IFIP Congress 74 said papers should be strongly related to the design or use of computer systems and should fall into one of the following categories: Computer Hardware and Architecture, Software, Mathematical Aspects of Information Processing, Technological and Scientific Applications, Applications in the Social Sciences and the Humanities, Systems for Management and Administration, and Social Implications of Computers. Anyone interested in submitting a paper should write to Dr. Herbert Freeman, chairman, program committee IFIP Congress 74, c/o AFIPS, 210 Summit Ave., Montvale, NJ 07645, indicating in which category the paper will fall and its tentative title. □

Hardware

Digital Equipment Corp. has quietly moved the PDP-11/45 out of its minicomputer group and into its DECSYSTEM-10 group, which supports medium- and large-scale computers. We understand that the 11/45 is being groomed by DEC to be its bridge between the smaller models in the PDP-11 line and the larger System 10s. Watch for the 45 to get some DECSYSTEM-10-compatible software in the not-too-distant future. The 45 is available with mixed memory--core, MOS, bipolar or combinations of these--and DEC's experience may be interesting to those who think semiconductor memory has taken over the world. Most 45s are going out DEC's doors with core, some with MOS, and very few with bipolar.

The IEEE standards committee has authorized project P353 for the development of man/machine terminal standards, which will concentrate initially on display terminal standards for such characteristics as character size, resolution, brightness, colors, flicker rate, and cursor representation. A working group is being organized, and those interested should contact the subcommittee chairman, Gerald C. Schulz, c/o Harry Hayman, IEEE Computer Society, P.O. Box 639, Silver Spring, MD 20901.

Beware of advertisements claiming that a calculator purchased for the purpose of figuring your income tax is a deductible item. A quick check with the IRS reveals that the item is totally deductible only if used solely for the purpose of figuring your own, or someone else's, income tax. And as you might suspect, the burden of proof is on you, should the feds call you on it.

Two Datacraft Corp. computers have been chosen by the Army for use in a space communications link between the U.S. and the Soviet Union. The 24-bit computers will be charged with running ephemeris programs (so at least we'll know where the satellite is at any given time) and beaming important messages up to it through two 60-foot antennas. We understand that the first words to be transmitted over the network from the U.S. will be "Olga Korbut."

Better 24-bit Computers
Machines with 24-bit word sizes are strange but attractive animals. They can yield almost the performance of much bigger computers at nearly the price of minis. For instance, the SLASH 4, which was developed from the older 6024/5, does fixed or floating point

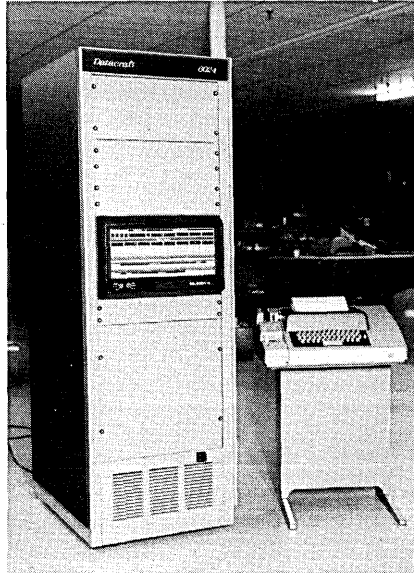

arithmetic at about the speed of an IBM 360/65 (its average add time of 750 nsec compares to the 65's 650 nsec). Yet it costs only \$36,400 with 24K words of memory, hardware multiply/divide/square root, and eight registers. The floating point option adds \$9,900 to that.

Further, the machine will be available with a 16K dual-port 200-nsec semiconductor memory by the third quarter of this year, and with 256K and virtual memory features in early 1974.

Also to be ready for third quarter shipments will be the 6024/R, a somewhat slower (980-nsec cycle time) ruggedized version. It will run \$42,000 in the same configuration, but cannot have the floating point option.

Software offered for both includes FORTRAN IV (\$800), FORGO (\$800), DOS (\$750), SNOBOL (\$400), RPG (\$600), and BASIC (\$500). DATA-CRAFT CORP., Ft. Lauderdale, Fla.

FOR DATA CIRCLE 244 ON READER CARD

Voice Response

Because they have stored their vocabulary in audio form on special-purpose drums, most voice response systems have been limited to vocabularies of several hundred words or less. This system uses an IBM 2314-compatible disc to provide up to 16K words of

vocabulary and an inexpensive controller to convert the digital to analog for telephone transmission.

Words or phrases can run up to several minutes long, and the system can handle up to eight channels, outputting on four of them simultaneously. Due to its extensive vocabulary, a user can handle several data bases at the same time and have words left over to "tutor" the user.

Access to the data bases is through touch-tone phones or auxiliary 10-button pads available from the phone company for about \$1.50 per month. The vocabulary is stored through a microphone and accessed through its address just like data. Similarly, numerical data stored by the computer is converted to analog signals.

Available as a peripheral for larger computers, the system has its own embedded Qantel V business processor (a 4K to 32K machine with a disc operating system and RPG as a higher level language). In fact, installations that have a Qantel V and disc need only add a \$5K controller for each two lines into the cpu—they get voice response nearly for free. Conversely, those who pay the other \$35K for the "voice response" cpu and disc, get a business data processor thrown in. QANTEL CORP., Hayward, Calif.

FOR DATA CIRCLE 220 ON READER CARD

360 Core

This firm is offering core memory systems for 360s from the model 22 on up at prices that are claimed to be in the range of 10% of IBM's charges (not 10% less than IBM's, but 10% of IBM's figures). Also contrary to standard edp marketing practices, the firm installed a system of 500KB on a multiple processor 65 before making its announcement. The model 7065 memory used is available in sizes from 250KB up to 2MB and comes with a built-in memory tester. It can be attached to a 65, 65 MP, 67, or 75. The price comparison is claimed to be \$165,390 for a one-megabyte version versus IBM's \$1.5 million, and \$279,720 for two megabytes versus IBM's \$3 million.

Savings are about the same in smaller versions, although the built-in memory tester is not available. For instance, a 32K upgrade for a 22 or 30 runs \$9990, while IBM asks \$91,290. Those 360s may be around for quite awhile, especially considering that the mainframes also have been marked down to bargain-basement prices by the third-party lessors. FAIRFIELD MEMORY, Irvine, Calif.

FOR DATA CIRCLE 221 ON READER CARD

Small-scale System

Much of the exciting technology Burroughs showed off in last year's introduction of the B 1700 line has been incorporated into an even smaller computer that competes more directly with smaller models of the IBM System/3. In Burroughs' product lineup, the 700 fits between the top models of the L series accounting computers that typically sell for \$25K, and the 1700 for around \$100K. The 700's price range of \$42-110K nearly duplicates the range of the System/3.

Like the 1700, the 700 is a "soft" machine, meaning that a very high-



speed read-only memory supplies microcoded instruction interpretations to the processor for execution. Two processors are offered for the 700, one capable of 1 million cycles/second, and the other rated at half of that. An interesting feature of the 700 processor is called Dynamic Interpreter Configuration. In cooperation with the 700's operating system, the DIC loads only those instructions into memory, for the processor to reference, that are actually required by the application program, thus conserving the 700's 32-48K byte core memory.

The 700's operating system is called SCP, for System Control Program. It performs the standard tasks of managing system resources and providing step-by-step instructions to the operator, and it, too, has some particularly nice features. Long jobs that might tie up the 700 for a considerable length of time can be interrupted to run high-priority jobs. The interrupted job can then be reloaded from disc and processing resumed from the point where it was halted. Also, much of the I/O handling, particularly between the processor and the disc subsystem, is understood enough by the interpreter so that it takes the responsibility of using the peripherals out of the user's hands. Rounding out the software complement is a collection of business dp programs. As an indication of this library's size there are more than 350 programs just oriented toward wholesaling. The 700's application programs are written in COBOL and RPG, and can

be recompiled to run on larger 700 series equipment.

Peripherals for the 700 include 80- and 96-column card equipment, magnetic tape drives, cassette units, two dual-cartridge disc subsystems with as much as 9.2 megabytes of capacity, and four line printers ranging in speed from 90 to 400 lines/minute. For volume data entry, a modified accounting machine called the AE 300 (for audit entry) is used to prepare data on cassettes for subsequent transfer to the 700 for processing. Burroughs tailors the software (really firmware) in this unit for each user's applications. The AE 300 is priced at \$12,290.

A 700 with a console, processor, 32K of memory, single cassette drive, 4.6 megabytes of cartridge disc capacity, and a 90 lpm printer is priced at \$43,350, and can be rented for \$957/month on a five-year lease. First units go to the field in May. BURROUGHS CORP., Detroit, Mich.

FOR DATA CIRCLE 245 ON READER CARD

product spotlight

IBM Tape Drives

The world's new de facto magnetic tape standards have been set with the introduction of the IBM 3420 Models 4, 6, and 8. The standards include 6250 bpi packing density and "group coded" recording. The 9-track, 1/2-inch tape medium has been retained, and in fact your old but good mag tapes can be used at the new densities on 360s of Model 50 size or bigger or on 370s of Model 135 size and up.

Since IBM anticipated these developments of its drives, the new models are counted as part of the old 3420 series rather than becoming a new line. Installed 3420 models 3, 5, and 7 can even be field upgraded to handle the new kind of recording and higher transfer rates.

The three new models all get an improved tape cleaner which works during threading, unloading and re-winding. They also feature a larger read-only memory which implements additional diagnostics and error correction capabilities, faster access times (one msec instead of two), and a 50% smaller interrecord gap of 0.3 inch.

The fastest of the three, the Model 8, is one of the fastest of all IBM peripherals. Given the 6250 bpi density and the 200 ips tape speed (unchanged from the Model 7), it transfers data at 1.25 MB. As a comparison, the Model 7 runs at 320KB, and a 3330 disc at 806KB. Similarly, the Model 6 will operate at 780KB and the 4 at 470KB.

Mixed Media Data Entry

The movement to make optical character reading systems into mixed media data entry systems is gathering strength. One entry is the Input 80 ocr system, which has been augmented with a shared processor key to disc configuration of up to 22 crt keystations. The new part, to be called the Total Data Entry System, is comprised of a 32K central processor, a 2.5 MB disc cartridge drive, a magnetic tape transport, plus keystations. With eight terminals the add-on will cost \$73,160 or \$1780/month plus maintenance.

The combined system makes it possible for multiprogrammed parallel data entry and for visual corrections of characters the scanner cannot decipher. A bad character can be displayed as a 2 1/2 inch to 3 inch image on the crt (e.g., a figure "4" with a smudge might look like a cross between a "4" and a "9" to the scanner, but the operator could tell which it was). Or a whole line can be displayed with the

Group coded recording may be a difficult standard for independent peripherals manufacturers to offer. IBM considers it highly proprietary and will say only that special characters are added to groups of characters being recorded. One advantage of gcr (which becomes the replacement for phase-encoding) is that errors in one or two bits of a byte can be corrected while the tape is in motion. That is, character one of a record may have errors in track one and track two while a later character has errors in tracks three and five and both characters will be corrected. IBM expects equal or better performance in terms of errors per number of characters read using an installation's existing tapes with the new drives and new densities.

The Model 4 is priced at \$690/month (\$580 on the extended term plan), the Model 6 at \$785 (\$660 on ETP), and the Model 8 at \$870 (or \$731.) A dual density feature for 1600 bpi and 6250 bpi is available for \$25/month more. Purchase prices range from \$26,500 to \$34,450. Also, the 3803 Model 2 controller ranges from \$1,130 to \$1,730/month (\$949 to \$1,453 on ETP) and from \$43,000 to \$65,970 on purchase. First deliveries will be in the fourth quarter of this year; conversions of installed equipment begin in the first quarter of next year. IBM CORP., White Plains, N.Y.

FOR DATA CIRCLE 242 ON READER CARD

The Floating Floors® System

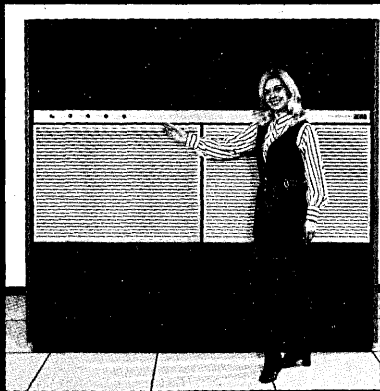

A better way to raise the floor

Floating Floors, Inc., provides Infinite Access Air Plenum Floors in either lightweight die cast aluminum, or economical steel panels. Both support up to 1,000 lbs. on one square inch with less than .080" deflection. Aluminum panels are available with static-control carpeting that's held firmly on all sides by a plastic lip to prevent unraveling.

and control the air

U.L. Listed Site Environment System (SES®) Units automatically maintain temperature within $\pm 2^\circ$ and humidity within $\pm 5\%$. Dual compressor/condensers offer longer life, reliable service.

send for detailed information

Write for the newly revised Infinite Access Air Plenum Floors and Precise Environment Control brochures to: Floating Floors, Inc., Subsidiary of N L Industries, Inc., 5400 North Detroit Ave., Toledo, Ohio 43612. (419) 476-0721.

N L INDUSTRIES
FLOATING FLOORS, INC.

CIRCLE 81 ON READER CARD

hardware

missing or bad character identified by a blinking cursor. Additional information could lead the operator to a specific document in the reject hopper on the ocr unit.

First deliveries of the key to disc section will be in June. The Input 80s are, of course, already in the field, but run \$259,250 and up if you need that part too. RECOGNITION EQUIPMENT, Dallas, Texas.

FOR DATA CIRCLE 243 ON READER CARD

Remote Batch Terminals

Programs are available with the SDP 900 remote batch terminals to make the units operate like IBM 2780s, IBM 3780s, Univac 1004s, CDC User 200s, IBM 360/20s under HASP, and ICL 7020s. Since its operator's console is configured with a crt and keyboard, the units also can act as interactive terminals.

Three models are offered: the 901

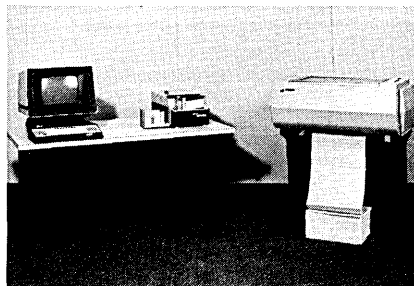

with a 150-cpm card reader and 200-lpm printer (for \$17,900); the 902 with a 300-cpm reader and 200-lpm printer (for \$20,500); and the 903 with the faster card reader and a 400-lpm printer (\$22,400). The units include a 4K processor capable of being used off-line for media conversion and a 2000 to 9600 baud half-duplex communications line. INTERCOM CORP., Natick, Mass.

FOR DATA CIRCLE 222 ON READER CARD

Oem Printer

The most unusual feature of the P7330 line printer is its two different print speeds. Its normal mode of operation may be 300 lpm using a 64-character set but when higher quality characters are demanded, the unit can be switched to 160-lpm operation. Some other features of the printer are also uncommon, including the character band which can be changed in the field by a maintenance man, the electronics to automatically compensate for a band with more or fewer characters in the set, and its 1-inch wide ribbon.

In other particulars it is fairly stock. It has 6- or 8-lines/inch printing, a 132-character wide page, and uses ASCII internally (but other codes can be in-

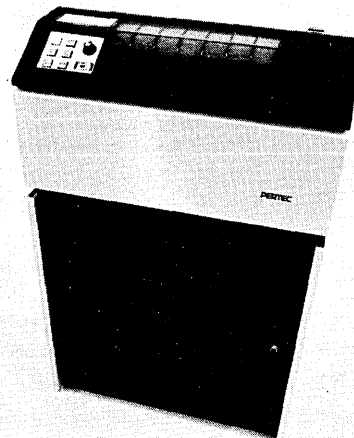

terfaced). It is priced starting at \$3990 in 100-unit lots in its pedestal version and is also available in a "quiet" enclosed version. Options include built-in diagnostics, program-selectable line spacing and print speed, and an IBM-compatible paper tape format control. PERTEC, Chatsworth, Calif.

FOR DATA CIRCLE 223 ON READER CARD

Full-duplex 1200 Baud

Vadic has "formally" announced its VA3400 Series modems, the ones that have already received a good deal of attention since they are thought to be the first to offer anything over 300 baud on regular two-wire voice-grade lines in full-duplex transmissions. Other 1200 baud models have been half-duplex, capable of running at the 1200 baud rate in one direction and up to 150 baud or so in the other. The additional throughput realized from full-duplex is expected to make sophisticated terminals, like graphics terminals, much more effective and to reduce line costs for multiline users.

The 3400 features the line protocol of the Bell 103 (at four times its transmission rate), interfaces for asynchronous devices to 600 baud, eight common status displays (like "clear to send"), plus four diagnostic status displays (like "off hook with no carrier"), and two methods of loopback testing.

The vendor claims to be second to Bell in the number of modems installed, and offers the 3400 from \$600 in card form or from \$750 in a cabinet with power. VADIC CORP., Mountain View, Calif.

FOR DATA CIRCLE 224 ON READER CARD

System/3 Competitor

The RPG 310 business computer is intended as an upgrade from the IBM 360/20, IBM System/3 card systems, or accounting machines. Because of its low price, it very likely will appear most often as an accounting machine replacement.

A disc-based machine, the 310 runs RPG I and RPG II programs directly—

without a preprocessor or translator—the vendor claims. Its one-pass compiler is said to implement everything IBM does except for array handling and index sequential files, and both of these will be accommodated by the end of summer. The system has applications programs for inventory, order entry, invoicing, accounts payable, payroll, general ledger, and real estate management, among others.

It is backed by contracted maintenance offices in 12 major cities and priced at what is claimed to be 50-55% of IBM charges for a similar configuration. With 16K of core, 5MB of fixed disc and a drive for 5MB cartridges, a 60-lpm printer, and a crt console, the machine sells for \$31,000 or \$910/month with maintenance. Configurations with 32K, 80- or 96-column cards, 40MB of disc, up to four mag tapes, and a 600-lpm printer are offered. RPG DATA SYSTEMS, INC., Los Angeles, Calif. FOR DATA CIRCLE 233 ON READER CARD

Programmer Aids

To make life easier for programmers, this vendor offers a dozen products for organizing desk-top space, including two kinds of stands for holding print-out. One stand, priced at \$26, holds the printout upright. The second holds

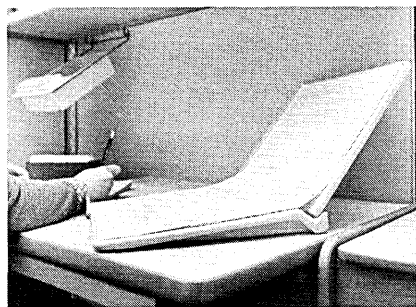

the forms at a good angle for reading; it runs \$39. Other products include a spring-loaded card tray (\$7.90), a pivot arm to hold a telephone tray away from the working space or to hold one of the printout trays (\$20 for the arm, another \$12 for the telephone tray), plus various shelves and files. HERMAN MILLER INC., Zeeland, Mich.

FOR DATA CIRCLE 230 ON READER CARD

System/3 Alternative

Originally put together for a single, large customer and not considered a separate product line, Lockheed's competitor for the IBM System/3 is now being merchandized separately and may even be named the System III. The package contains a processor of at least 8K (expandable to 64K bytes), a 5MB disc cartridge drive, a 100-cps printer, plus a crt console.

The primary language will be RPG/SUE, which is said to be 98% com-

patible with IBM's RPG II. Other software includes a disc operating system and a sort/merge, both of which are reportedly functionally compatible with IBM's. Prices start at around

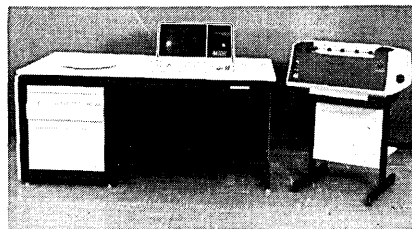

\$35,000 for the configuration defined; and optional 80- or 96-column card gear, faster printers, and additional discs can take the total to \$50,000. LOCKHEED ELECTRONICS CO., INC., Los Angeles, Calif.

FOR DATA CIRCLE 231 ON READER CARD

Off-Line Printer

This may be the world's fanciest off-line print station. In addition to its 1,000-lpm printer and 9-track 800-bpi or 1600-bpi tape transport, the model 75 print utility station includes a crt/keyboard operator's console, a 12K-byte control unit, and software to print IBM DOS- or OS-generated tapes of various record and block sizes. There seems to be so much power in the \$1780/month package that it is unlikely that a dp staff could force themselves to use it just for an auxiliary printer. DATA 100 CORP., Minneapolis, Minn.

FOR DATA CIRCLE 232 ON READER CARD

Handwriting Reader

Optical character reading has not taken off as once expected, and four or five vendors have recently incorporated keystations of one form or another to make the scanners more attractive. One of the resulting mixed-media data entry systems is the ADES-1, which can read numerics handwritten on retail slips, meter cards, and similar small source documents. (It can optionally read OCR A, MICR, and credit card fonts, among others.)

The scanner has four selectable output hoppers, a transport for forms up to 4¼ x 8¾ inches, and a rated speed of 40 cps for the handwriting. Up to six lines per form can be read optionally. Data is stored on a floppy disc and accessed from up to four crt keystations for corrections before it is flushed out to a computer channel or to a mag tape.

A configuration with one crt keystation and a 9-track tape transport plus controller would sell for \$91,750 for delivery in May. Now if it could only read coding forms. DATA RECOGNITION CORP., Palo Alto, Calif.

FOR DATA CIRCLE 234 ON READER CARD

PDP-8, PDP-11, 316/516 USERS:

Gould assemblers are about to save you a lot of time and money. Because they'll let you use a 360/370 environment to generate well documented object programs in a fraction of time you're used to, and do away with the need for extra peripherals.

The ATI-8, ATI-11, and ATI-16 are expanded versions of the assemblers provided by the manufacturers and fully compatible with them. A few of the convenience features: symbol cross-reference listing, self-explanatory diagnostic messages, expanded set of pseudo-ops, complex relocation calculations. Assemblies are handled in the normal 360/370 batch environment quickly and efficiently, reducing a couple of hours of printing to maybe one minute. Field proven and available now. Gould Inc., Data Systems Division, Dept. S, Newton, Massachusetts 02164.

CHECK YOUR WALLET AND YOUR WATCH

 **GOULD**

CIRCLE 100 ON READER CARD

hardware

Smart Terminal

This terminal has its own programming language with 35 instructions for performing arithmetic, data manipulation, table lookups, and logical tests. The instructions are compiled into user data entry programs which can then be called out through the keyboard.



Called the DE520, the terminals have both random-access and read-only memory, a 310-character display, keyboard, and mag tape cassette. Options include a synchronous communications interface, serial printers, paper tape and card gear. Prices start at \$6700. OLIVETTI CORP. OF AMERICA, New York, N.Y.

FOR DATA CIRCLE 226 ON READER CARD

IBM 3330 Replacement

Control Data is acting as if it wants to be an independent peripherals manufacturer rather than a mainframer. It already offers IBM-compatible core memory for 360s, monolithic memory for 370s, and 2314-compatible disc drives. Its latest is the 33301 multiple-disc memory system, a replacement for IBM's 3830/3330 combination. Up to eight 100MB drives can be included. Access time is an average of 30 msec; the transfer rate is 800 MB; other specs read like IBM's, too. The 33301 is offered with a controller option that allows sharing the discs between four cpu's.

Prices range from \$106,000 (\$2650/month) for a two-spindle unit up to \$238,000 (\$5650/month) for an eight-spindle system; 24-hour maintenance is included in the lease prices. Deliveries begin in June. CONTROL DATA CORP., Minneapolis, Minn.

FOR DATA CIRCLE 235 ON READER CARD

Model 58 Terminals

The Model 58 is Honeywell's bottom-of-the-line data processor, but it can now be configured with terminals and communications just like the big boys. The \$12,000 (\$285/month over five years) MLC050 multiline controller enables the attachment of up to four teleprinter terminals of your choice to

a 58 that has 10K bytes, a disc with 5.76M bytes, a card reader, printer, and keyboard. The DOS II operating system offered with the controller enables those terminals all to work on different programs simultaneously.

The controller transmits in 8-bit ASCII over half-duplex asynchronous lines at up to 1200 baud to modem-connected terminals, or at 300 baud to "local" workstations. HONEYWELL INC., Wellesley Hills, Mass.

FOR DATA CIRCLE 227 ON READER CARD

Card Reader

The 7260A, a buffered, serial optical mark reader, is capable of handling either punched or marked cards at up to 300 cpm. It can be connected on-line or can run at switch-selectable speeds from 110 to 2400 baud over

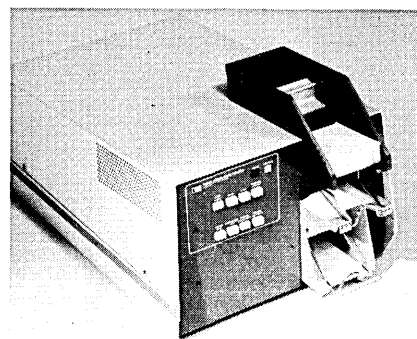

DIRECTOR OF COMPUTER SERVICES

(Salary range—\$20,000 to \$23,000)

The Pittsburgh, Pa., Public School System is seeking a Director of Computer Services to head this division in an administrative capacity.

The Computer Services Division provides comprehensive management information and support for innovative educational programming.

The applicant must have supervisory and management experience and hold graduate degrees in applied sciences and business administration or the equivalent.

Please send detailed resume when first replying to:

Board of Public Education
Division of Personnel—Room 157
341 S. Bellefield Avenue
Pittsburgh, Pennsylvania 15213

AN EQUAL OPPORTUNITY EMPLOYER

CIRCLE 122 ON READER CARD

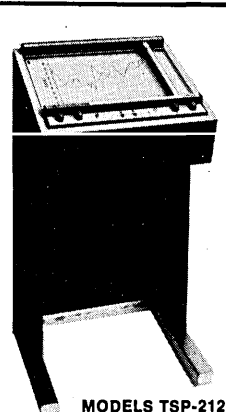

MODELS TSP-212
TSP-300
TSP-310

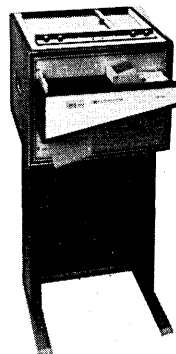

MODEL TSP-400

ON LINE or OFF LINE

TSP CORP.

answers your plotting needs

Before you buy ANY plotter let us show you ours. The most successful and knowledgeable people in education, industry and government have bought ours over our competitors! Ask to see our customer list.

The TSP-212, TSP-300, and TSP-310 Plotting Systems speed and economize computer time-sharing by quickly producing easily-read graphics. TSP Plotting Systems connect directly to most terminals and mini-computers.

The TSP-400 is a LOW COST off-line Plotting System driven by computer prepared punched cards. Since the system is off-line the punched cards can be generated at a high rate of speed and run through the plotter at the users convenience.

Write for FREE catalog



TSP

TIME SHARE PERIPHERALS CORPORATION
Miry Brook Road, Danbury, Conn. 06810 (203) 743-7624

CIRCLE 92 ON READER CARD

phone lines. It has a dual output hopper option and can read any number of columns from each card.

Particularly attractive for remote terminal applications where a card image could be retransmitted from the buffer, the unit is priced at \$2975 and available for delivery four weeks after receipt of orders. HEWLETT-PACKARD CO., Palo Alto, Calif.

FOR DATA CIRCLE 225 ON READER CARD

Word Processor

Documate offers in-house document preparation for installations with large volumes of written output or secretaries that make mistakes in bulk. The system can provide storage for up to 10 million characters of text, along with Selectric terminals for entering or changing that text.

Software insures that the "copy" of the document being changed is not the original—both are retained in case the

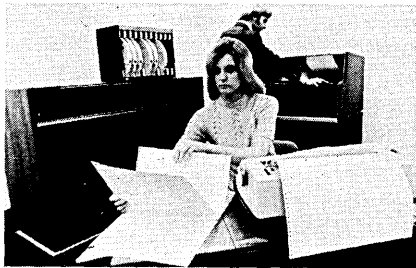

first version was better after all—and allows for searching, string replacements, copy insertion or extraction, and corrections keyed to line numbers in the original text. Page formatting is automatic, and even right-justification and decimal alignment are performed.

The terminals can be connected to the cpu over 300-baud lines, and up to 15 can operate simultaneously. Deliveries take 90-120 days, and maintenance is presently provided out of five regional offices. Prices start at \$82,000 for a three-terminal set-up with 2.5MB of fixed disc and the same amount of disc cartridge. A high-speed printer is optional. DOCUMATE DIV. OF INDEX SYSTEMS INC., Cambridge, Mass.

FOR DATA CIRCLE 228 ON READER CARD

Rugged Mini

This vendor previously offered a ruggedized version of the Data General Nova minicomputer, which it built under license from DG's plans. The 1602 is somewhat different. Although it can use Nova software, it has extra instructions and is reportedly not copied from DG's architecture.

Six times faster than its predecessor, the 1601, the mini is said to be comparable in speed to the Nova 800 and Supernova although it uses only a 1-usec rated core memory. It has a direct memory access channel, a shared I/O

bus rated at 2MB, and can perform an addition in 1.2 usec. Software includes FORTRAN, ALGOL 60, BASIC, and a simulator for running 1602 programs on Novas.

The 1602 sells for \$18,500 with 8K



of core. Peripheral interfaces sell for about \$1000 to \$1600. ROLM CORP., Cupertino, Calif.

FOR DATA CIRCLE 229 ON READER CARD

PDP-11 Add-On Memory

The SG-11 semiconductor add-on memory for the Digital Equipment Corp. PDP-11 runs at from 650-850 nsec and comes in sizes from 4K to 28K at prices from \$2200 to \$7300. Power supplies, cabinetry, cabling, and a one-year warranty are provided. Deliveries take 30 days. SIGNAL GALAXIES, INC., Van Nuys, Calif.

FOR DATA CIRCLE 241 ON READER CARD

AUERBACH

DATA PROCESSING MANUAL

for computer operations and management

Practical Solutions to Daily DP Management Problems

If you are involved with managing a DP operation, finding practical aids for solving everyday problems can be time consuming and frustrating.

Data Processing Manual is a new, one-volume service that's complete, modest in cost and far easier to use than anything of its kind. Monthly portfolios go to the nub of your problems . . . guidelines for budgeting and cost control . . . when to document . . . when and how to convert smoothly . . . preparing contracts . . . and many more. **Order today.**

Partial contents in initial volume or subsequent issues.

- **GENERAL MANAGEMENT**—using your computer to increase profits, how to sell hardware to top management, and guidelines for budgeting.
- **DP ADMINISTRATION**—controlling costs, conversion, including when not to convert.
- **SYSTEM DEVELOPMENT**—designing effective programming, when to use internal vs external staff.
- **STANDARDS, PRACTICES AND DOCUMENTATION**—project control and system design standards, programming guidelines and debugging.
- **OPERATIONS**—facility planning, physical security, environmental, human and safety factors.
- **TECHNOLOGY**—new developments such as virtual systems, data input, data communications.

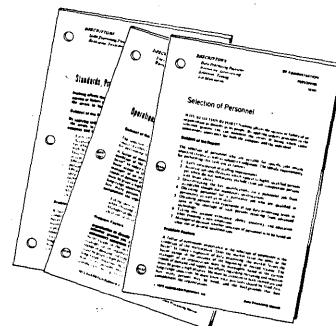
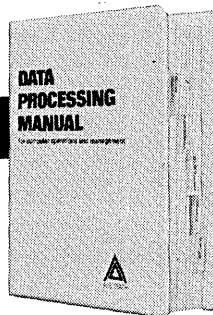

Gentlemen:

- Enter my subscription to DATA PROCESSING MANUAL for 1 year at \$150. I understand I can examine it for 15 days and, if not satisfied, can return it and owe nothing.
- Send me details and complete Table of Contents.
- Payment enclosed
- Bill my company on P.O. No. _____

Company _____

Name _____

Title _____

Street _____

City _____ State _____ Zip _____

Phone No. _____

Mail to: **AUERBACH Publishers Inc.**
121 North Broad Street • Philadelphia, Pa. 19107



73D

STEEL BEAMS AND SHAVING CREAMS



For a major maker of shaving equipment and supplies, Sanders data display terminals expedite handling of management information, payrolls and a broad range of customer-service and product oriented transactions. Sanders installations have long set highest standards for reliability in the EDP industry.

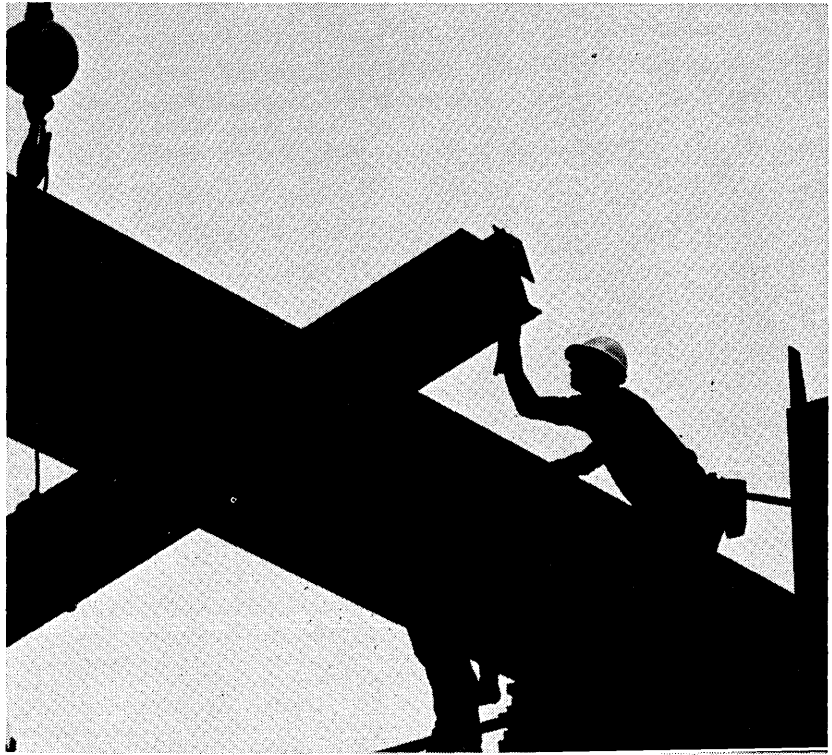

For some of the nation's largest steel companies, Sanders data terminal systems help streamline inquiry handling, inventory updating, order checking and diversified data-entry operations. Sanders provides fully integrated hardware, software and maintenance support . . . all from one convenient source.

Whatever your data-terminal need, Sanders **Terminalogy** can satisfy it. Contact your nearest Sanders sales office . . . or call our National Sales Manager at 603-885-3727.



A Subsidiary of Sanders Associates, Inc.
Daniel Webster Highway-South, Nashua, N.H. 03060



Total-systems
TERMINALOGY . . .
born and bred
in New Hampshire.

Corporate Headquarters

Do you store your mass digital data economically?

Want massive archival recording at a practical cost? Need secure, non-volatile backup storage? Looking for on-line data storage to 2.2 billion bytes? Or what about document image storage with fast access and remote display?

You've got it. System 190 delivers simple, secure, low-cost storage. It uses existing recording technology, proven in trillion bit systems. And you can get it in affordable add-on modules.

Economical storage.

Operating cost is one-fourth to one-third that of tape. Tape systems provide thirty bytes per penny. The System 190 records over one hundred bytes per penny. One Data Strip® carries 275 million bytes, the equivalent of six fully-packed 1600 bpi tapes. The six tapes cost \$40 or more; Data Strip costs \$15 or less.

Compact storage.

The amount of information that can be recorded in one year by a System 190, in its minimum configuration, is equivalent to nearly 200,000 reels of 1600 bpi magnetic tape. Media storage space is less than one-tenth that of tape.

Secure storage.

Data is permanently recorded. Magnetic fields or computer failure cannot erase data. No degradation. No wear. No dropout. No print-through.

Computer-compatible storage.

Control unit interfacing allows use of existing computer tape programs. When used as a stand-alone system, data are transferred directly to peripherals—document scanner, plotter, printer, or CRT terminals.

Using tape emulator methods, System 190 follows standard I/O tape commands. Or use direct access method with simple keying from host computer. Or use the automatic spooling method that allows the 190 to feed data to other storage devices.

On-line storage.

In on-line data libraries, System 190 delivers these advantages *plus* high speed direct access to 275 million data bytes, expandable up to 2.2 billion bytes. With audit trail. And without clobbering old data. Hardware costs are half those of equivalent disc systems.

Document image storage.

In document image storage applications, System 190 supplies an automated document image handling system that is more efficient and less expensive than other automated systems. It provides rapid direct access to thousands of on-line images in less than 1 second per image and to millions more stored off-line in less than a minute. System 190 automatically distributes the retrieved images, either locally or remotely, for viewing or as hard copy.

Get the facts on the most significant advance in storage since magnetic recording. Write for "System 190" brochure.

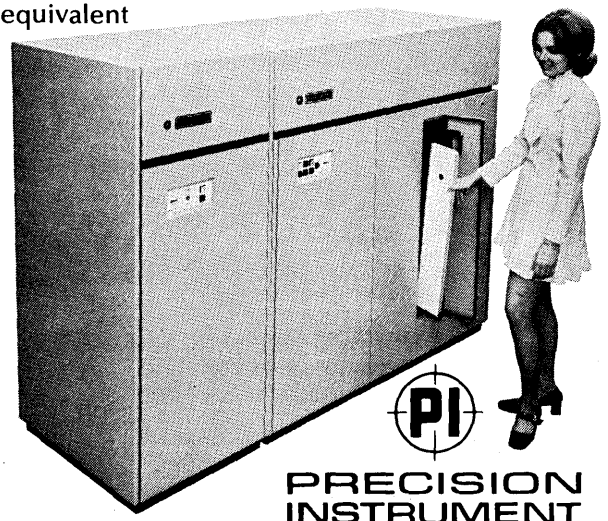

Unicon Division 3170 Porter Drive, Palo Alto, California 94304 Phone (415) 493-2222 TWX No. 910-373-1752

Software & Services

A management technique that just might take some of the mystery and chance out of large software development programs has been developed by Computer Sciences Corp. as part of a contract to supply sophisticated missile defense software to the Navy. Called Threads, the technique is for monitoring, checking, and integrating complex computer programming systems. Threads automated data collection and reporting programs have recently been installed on CSC's Infonet system. Principal reports currently provided include segment status summaries, Gantt-form progress charts, and Thread diagrams.

Nearly two dozen computer manufacturers have adopted a collection of programs developed at Alcoa that evaluate the performance of Fortran compilers. Two years ago the aluminum producer began collecting benchmark programs others had used for this purpose, modified them, and added some of its own that more closely conform to the ANSI X.9-1966 Fortran standard. Although Alcoa's Fortran test is not a guarantee of complete conformance by a compiler to the ANSI standard, it does test most features, says the firm, and has successfully exposed numerous compiler bugs. Alcoa makes the source statement cards available through Dr. T. J. Williams, Purdue Laboratory for Applied Industrial Control, West Lafayette, IN 47907, for \$20 plus postage.

The technical, operational, and economic pros and cons of establishing a standard system control language will be studied by ANSI committee X3. Anyone interested in the OSCL study group should contact John Strain, HQDA (CSSE-ST), Nassif Bldg., Falls Church, VA 22041.

A recent survey of 620 known sources of proprietary software by International Computer Programs, Inc., showed the gross dollar volume for 1972 was somewhere between \$215 and \$226 million. Half of the total was generated by firms offering systems software, programming aids, utilities, etc., though these firms made up only 25% of the total number surveyed.

CICS Recovery

A recovery process for use with IBM's CICS (Customer Information Control System) that runs under both the DOS and OS monitors is available for custom installation. In essence, the small (1-3K byte) assembly language routine keeps a transaction log that enables an installation to reconstruct files and complete transactions that were interrupted by a system failure. The method is set up for data entry applications, but it's claimed that it's also useful in any file environment with complex chaining structures. The customer is consulted as to how CICS is being used in a particular installation, and the recovery modules are tailored for those types of file structures. Prices start at \$2500 for data entry transaction recovery and can run to approximately \$10K for more sophisticated packages. Leasing agreements are also available. QUANTRA DEVELOPMENT CORP., Rye, N.Y.

FOR DATA CIRCLE 251 ON READER CARD

Easy Report Generation

A computer utility program that can be used by non-dp oriented personnel to enter data, sort files, and generate reports has been turned over to the COSMIC computer center at the Univ. of Georgia by its developer, the Boeing Co. Data entry, file sorting, and report generation activities are all controlled by 80-column parameter cards that are interpreted by the Multiply Utility Computer Program (MUCP) that COSMIC has identified with the number KSC-10788. Documentation for the 600-card COBOL program can be purchased for \$5.50, and the program itself is available for \$100. COSMIC, Athens, Ga.

FOR DATA CIRCLE 252 ON READER CARD

Data Base Inventory

The data base directory (DBD) provides users of Cincom Systems' TOTAL data base management system with an updatable inventory of all installation programs, data bases, data sets, and data elements. Two ANSI COBOL programs comprise DBD. One program is responsible for maintaining and updating the data base, and the other program extracts data from the data base for generations of up to 11 reports showing the relatibility of elements to like elements, elements to data sets, and data sets to programs. The TOTAL user can use DBD together with any file management system.

One year of usage in-house has enabled Eastern to identify and control

data redundancy and to centralize data base documentation by removing this responsibility from the application programmer. A one-time license fee of \$3K is charged for DBD. This includes the source COBOL coding which typically requires 32K bytes of memory, the associated job control language, samples of input documents, and supporting documentation. On-site installation assistance is available on a separate contract, but Eastern doubts it will be needed. EASTERN AIRLINES, Miami, Fla.
FOR DATA CIRCLE 253 ON READER CARD

Computing Service

Mainstream is Boeing Computer Services' latest local and remote computing service. There are a number of services in Mainstream that have been available in the past, but one that is new is low-speed remote job entry at speeds up to 1200 baud to an IBM 370 located in McLean, Va., that runs TSO (Time Sharing Option).

A job stream manager (JSM) resident in Mainstream schedules work based on customer-supplied priority levels for which there is an associated charge. Additionally, the JSM provides the following services: appraises the user of any job control language errors at the time of job submission; allows users to inquire about the status of submitted jobs and alter their priority level if desired; permits users to access password-protected data sets without the computer operator's attention being required, etc.

All OS facilities are available to the user, including utility routines and language processors for FORTRAN, COBOL, and PL/I. Data sets created by any one level of service in Mainstream are compatible with any other level, permitting users such capabilities as creating large files with a high-speed hook-ups, and then processing off the files with a lower level of service. Mainstream is offered nationwide. The billing algorithm is a very complex one and takes into account CPU time, amount of memory used, amount of peripheral support, connect time, turn-around time desired, etc. BOEING COMPUTER SERVICES, INC., Dover N.J.

FOR DATA CIRCLE 254 ON READER CARD

DOS Relocation

RELO-PLUS provides a user of IBM's DOS monitor with the ability to catalog one copy of system and user programs in the core image library and execute them in any available partition. This eliminates the necessity of cataloging and retaining duplicate copies of each

COM can boost your throughput.

That's what Kodak computer output microfilm is all about.

The idea of bypassing impact printers to go directly to microfilm via COM is bound to appeal. It's an electronic path versus a mechanical one. That means speed with reliability.

Kodak KOM microfilmers do this job at 20 or more times the speed of impact printers. So you have more time to get more jobs done on the mainframe.

Besides speed, consider what else comes with a KOM microfilmer. First, Kodak specialists will help you design, develop, and implement your COM system. Second, Kodak software helps you get each job done faster and in the format you need. Third, Kodak equipment service that will help keep your COM unit up and running.



Take the important first step.

Write us for our new booklet, "The New Generation of Computer Output". Eastman Kodak Company, Business Systems Markets Division, Dept. DP564, Rochester, New York 14650.

Kodak: for better use of information.



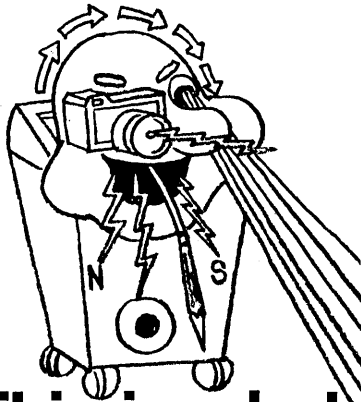

This is what we're not!

The Matrix printer is not an "ink spitter," thermal printer, magnetic printer, optical printer, electrolytic printer, or anything like that.

Over 500 Matrix units are now operating with mini and midi computer systems throughout the world.

So people are beginning to understand what we are.

We're a true electrostatic printer.

Versatec's Matrix Electrostatic Writing Technique (MEWT™) is demonstrably more reliable than any impact or other non-impact technique. (Matrix MTBF is over 3,000 hours!)

For the performance the Matrix unit provides, it is the lowest cost computer printer in the world!

Our Matrix Model LP-860 prints 64 ASCII characters 80 columns wide on 8½" fanfold paper at 600 Lines Per Minute. That's 800 CPS . . . for only \$3,900. Quantity one.

And for \$4,300 our Model LP-1150 prints 132 columns wide on 11" fanfold paper at 500 LPM (1100 CPS). 96 ASCII character options for both models are available *without reduction in printing speed.*

We also have fast printer/plotters at the lowest prices in the industry. And controllers and software for 23 mini's and midi's.

Our customer list is as impressive as our products. For complete information contact Versatec, Inc., 10100 Bubb Road, Cupertino, California 95014. (408) 257-9900. TWX: 910-338-0243.

VERSATEC

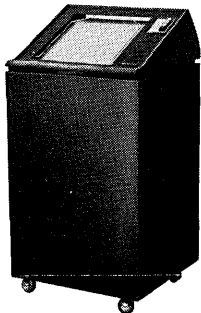

The Matrix Printer delivers 600 LPM for only \$3,900.

CIRCLE 87 ON READER CARD

software & services

program in the library. RELO-PLUS can be used with all programming languages and with application programs such as BOMP (Bill of Materials Processor). The program does not add to the size of the programs or require any program modifications. RELO-PLUS rents for \$150/month on a perpetual license and can be purchased for \$2K. UNIVERSAL SOFTWARE, INC., Danbury, Conn.

FOR DATA CIRCLE 255 ON READER CARD

Xerox Monitor

Xerox has introduced a new operating system that combines many of the features from the two operating systems it replaces, UTS (Universal Time Sharing System), and XOS (Xerox Operating System). The new monitor is called Control Program Five (CP-V) for the five modes of processing it can handle simultaneously. These include multi-programming in local and remote batch, real-time processing, transaction processing, and time-sharing. The operating system will be supplied free of charge to users of Sigma 6, 7, and 9 computers. No conversion is required for this switchover, it's claimed.

The batch mode accepts up to 16

concurrent jobs, and remote batch jobs can come from a variety of terminals, including the 360/20 and ucc's Cope 1200 terminal. An enhancement scheduled for later this year will accommodate input coming from IBM 2780 (and compatible equivalent) terminals. The time-sharing mode handles up to 128 simultaneous users.

Capabilities for real-time processing and transaction processing also will be available later this year. An implicit danger in an operating system trying to do so much is that it might degrade the performance of real-time tasks, but Xerox states that both mapped and unmapped r-t tasks will have response times of less than 500 usec 99% of the time. A data management system (DMS) is available now for transaction processing, but an interactive data base processing package that provides on-line information and display from an extended DMS data base is scheduled for the last quarter of the year. Also in the wings are communications facilities for polled, multi-drop lines for a variety of terminals.

The latest industry buzzword is virtual memory (rediscovered), and Xerox likes to call CP-V a virtual memory operating system, too; but it differs substantially from IBM's implementation. CP-V uses a number of hardware registers to perform some very quick and complex program swaps. Initially,

software spotlight

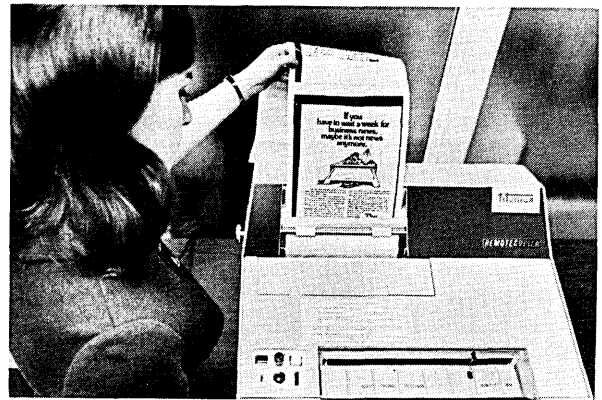

Facsimile Service

A nationwide facsimile communications network has gone on the air with plans to eventually offer worldwide services. Called Titanfax, the service utilizes specially modified 3M facsimile transceivers capable of accommodating text and graphic documents up to 8½ x 14 inches in size. An attendant at each of more than 100 service points in the network feeds the document through the transceiver, together with a transmittal form designating the authorized recipient.

Transmitting takes only about 4½ minutes per page. The sender is responsible for contacting the recipient and advising him that the document

has been sent. The sender also pays the transmittal charges, which range between \$3 (per page) for relatively short transmissions to \$6 for coast-to-coast service. Since the service runs over voice-grade phone lines, international service rates will be correspondingly higher as these stations open.

Currently, every Hilton hotel in the U.S., including Hawaii, has an operational station, with other stations going on-line so fast that the vendor suggests calling the toll free number (800) 421-0770 to check on specific locations. TITAN INDUSTRIES, Los Angeles, Calif.

FOR DATA CIRCLE 250 ON READER CARD

"If you need more than one terminal you need to mix and match terminals."

More than one data terminal means you have a system.

And when you have a system, chances are you need more than one type of terminal to meet your system's variety of data load conditions.

That is why we have developed a wide choice of terminal configurations: 62 models with 112 options. And that means you can use a mix of different terminal models, each matched to the specific requirements of each location in your system.

That way you'll be able to optimize your system's cost performance. Moreover, we'll help you make the right choice for each drop.

Our wide line of data terminals starts with Model 33's and 35's. Then we offer a whole series of the most reliable 30 c.p.s. terminals available.

Plus our new MSR terminal with magnetic tape buffering capability.

And we support our customers' terminals with our unique maintenance program, Termicare.®

So if you need more than one terminal, get them from someone who gives you a choice, implements your system, maintains and services your terminals.

You can reach that "someone" at 800-631-7050 (N.J. 201-529-1170), or write to 16 McKee Drive, Mahwah, N. J. 07430.

"Art Kirscht, our chief engineer, has 174 ways to satisfy your system's needs."

Z. V. Zakarian, President.



data services company

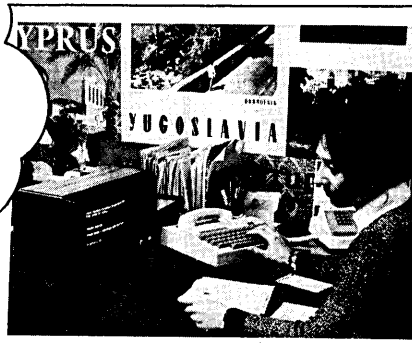

THE MAGIC OF VIDEO INQUIRY

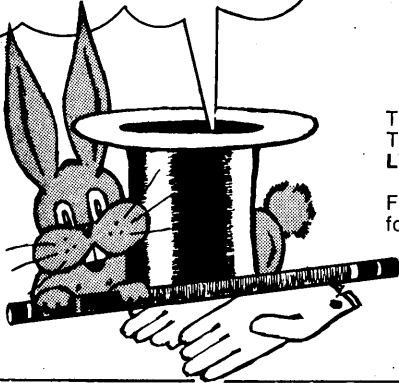

The Digi-Log Interactive Video Terminals add a new, silent dimension to file inquiry systems.

Like Magic, these silent windows into your files quickly and quietly present a record for viewing or verification by the operator, customer, client, or patient.

Like Magic, inquiries can be made for account status . . . sales by region . . . credit . . . personnel records . . . or reservations, and output is provided without the fuss and waste of unnecessary printouts.

The Digi-Log terminals are teletype and TV compatible and,

Like Magic, cost less than \$1,000 in quantity.

For **your** magic of video inquiry call now for immediate attention, 215 659-5400.

**DIGI - LOG
SYSTEMS, INC.**
666 Davisville Road
Willow Grove, Pa. 19090

CIRCLE 89 ON READER CARD

software & services

a user program must be entirely resident in memory to start processing. After this, it may be whittled down and overlaid with parts of other programs. Program segments 512 words in size (the three computers that can use CP-V are 32-bit word machines) can then be stashed anywhere in memory and do not necessarily have to be contiguous. The program segments are swapped in and out of memory from high-speed peripherals, either fixed-head discs, or disc pack equipment. It isn't a demand paging scheme, but it is probably a good way to make a maximum use of the machine's memory, and that's the intent. XEROX CORP., El Segundo, Calif.

FOR DATA CIRCLE 258 ON READER CARD

DOS Link-editing

This firm has rewritten the IBM-supplied linkage editor used with the DOS and DOS/VS operating systems, claiming that the coding changes yield a 70% reduction in link-edit time. The assembly language program is supplied in object deck form and requires approximately 44K bytes. A 30-day free home trial is offered, and if you decide you like it, FLNKEDT rents for \$25/month. SOFTWARE DESIGN, INC., Burlingame, Calif.

FOR DATA CIRCLE 256 ON READER CARD

APT for S/3

UNIAPT is United Computing's implementation of the APT (Automatic Parts Tooling) numerical control language on small computers. A version of it is now available for the IBM System/3 model 10 having at least 32K bytes of memory, a 5444 2.4-megabyte disc unit, console printer, and paper tape reader/punch. This development is probably most significant for small metalworking shops, as the S/3 could then be used for both its N/C and commercial processing activities.

It's claimed that average part program turnaround times are in the range of 10 to 15 minutes, with debug runs for checking syntax only requiring about two minutes. There are approximately 125 post processors available for various machine controllers, which UNIAPT's supplier says covers perhaps 60% of the market. UNIAPT sells for \$16K and can be rented for \$510/month on a three-year lease. Documentation, operator training, and installation cost an additional \$750. UNITED COMPUTING CORP., Carson, Calif.

FOR DATA CIRCLE 257 ON READER CARD

Smile when you say

Beta COM

Our customers do, because they get their film or fiche fast.

Beta COM accepts their tapes without re-formatting because it has a mini inside. Alphanumerics and graphics.

Let us show you with *your* tape. Call us: (617) 969-6510.

Gould, Inc., Data Systems Division, Newton Upper Falls, Massachusetts 02164.

 **GOULD**

CIRCLE 99 ON READER CARD

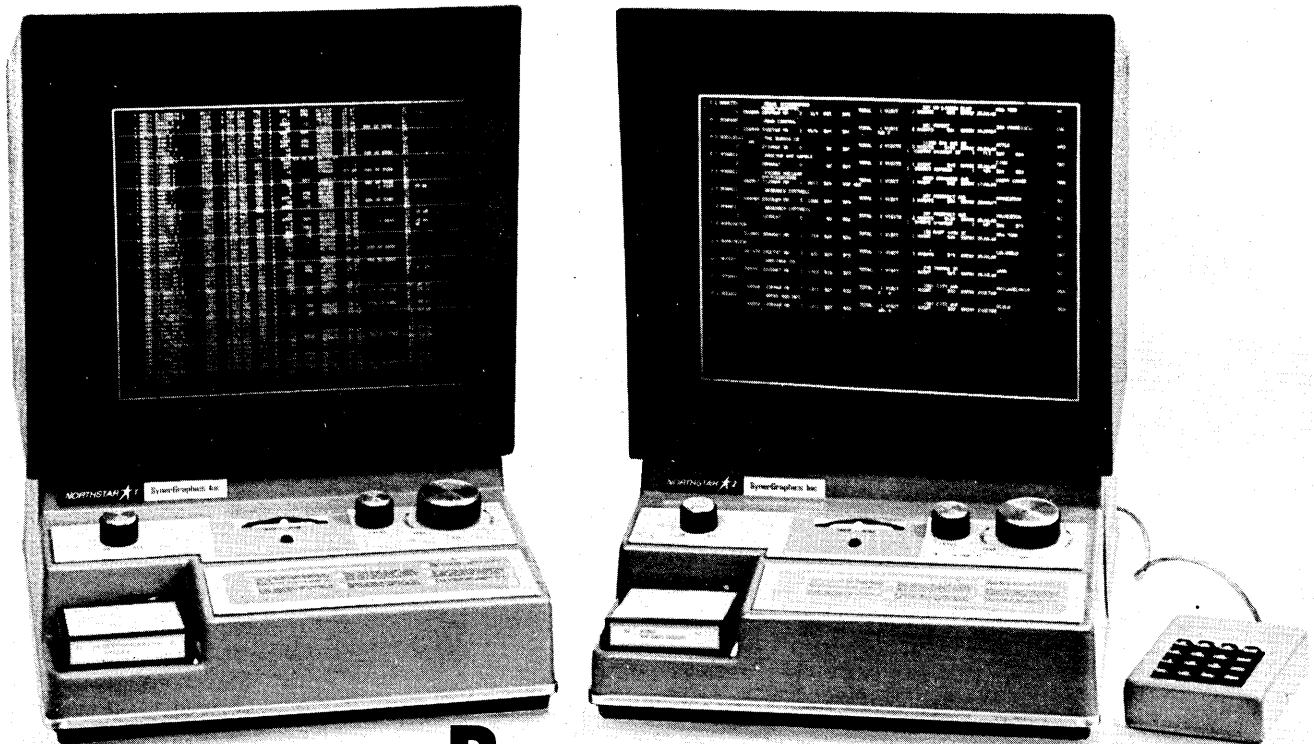

Buy now...

You can buy our microfilm reader now . . . and add our printer later.

Ever hear about the guy who bought a microfilm reader . . . and later decided he wanted a reader/printer?

The poor guy ended up having to buy a whole new reader/printer system.

As a total service microfilm company we know from experience that your

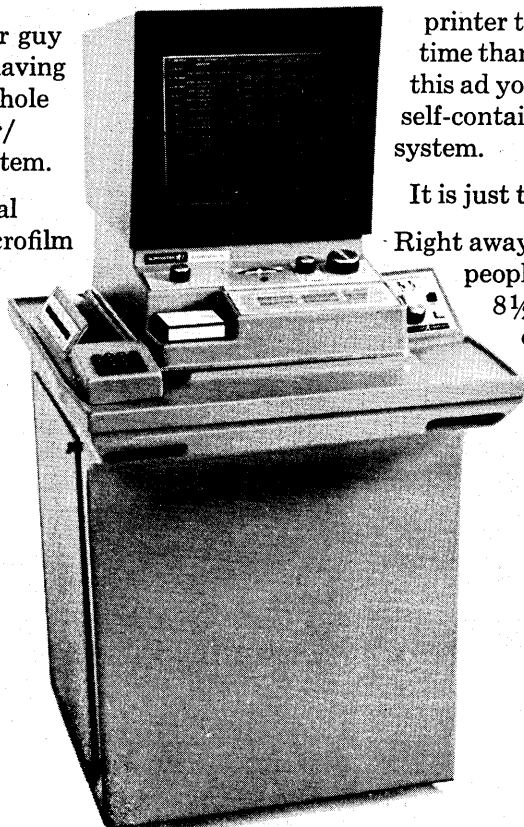

requirements change. So we designed a truly unique reader/printer system. It is modular.

You can begin with our Northstar 1 Microfilm Reader or our new Northstar 2 Automatic Microfilm Reader. And later add the printer to the reader. In less time than it takes to read this ad you have a compact, self-contained reader/printer system.

It is just that simple.

Right away you're ready to give people excellent quality 8½ x 11-inch dry copies of any microfilm page. Cost per copy is less than you

would expect. Best of all, your system is really portable. If you want to move the Northstar Reader/Printer System to a new work area, simply unplug the unit and wheel it to the new location.

The Northstar Reader/Printer System is our way of fighting obsolescence.

For more information write to SynerGraphics Inc., Transamerica Pyramid, P.O. Box 7958, San Francisco, Calif. 94120 (415) 983-5200.

Attention Dealers

We are looking for qualified dealers to distribute the complete line of SynerGraphics equipment and supplies. For more information see Roger Blue at the NMA Show or write him at our corporate headquarters.

SynerGraphics



A Microfilm Service of
Transamerica Corporation

add later.

Literature

Electronics Symbols

More than 500 symbols commonly used in electronics are illustrated in a pocket-sized handbook. Symbols are grouped in 19 general classifications,

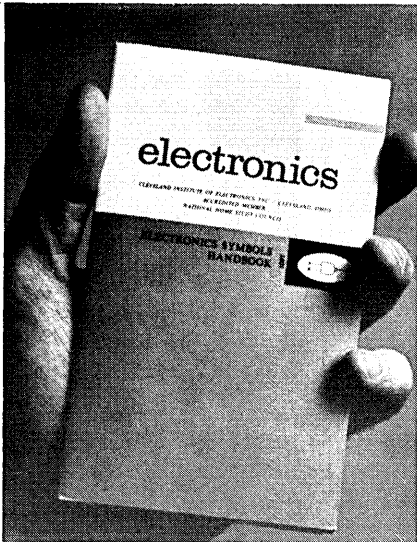

each listed alphabetically by page reference number in a table of contents. Also included is a two-page electronics data guide. CLEVELAND INSTITUTE OF ELECTRONICS, INC., Cleveland, Ohio.
FOR COPY CIRCLE 200 ON READER CARD

Minicomputer Primer

A 256-page handbook, "The Value of Power," discusses cost and power alternatives in building end-user minicomputer systems. Chapters include: Short History of Computers; Numbers and Logic; The Makings of a Computer; Addressing Modes; The Instruction Set; Evaluating Instruction Sets; Input, Output, and Interrupts; Internal Interrupts; Input, Output, and Interrupts Hardware and Design Considerations; Read Only Memory and Microprogramming; System Software: Operating Systems; and How to Buy a Minicomputer. GENERAL AUTOMATION, INC., Anaheim, Calif.

FOR COPY CIRCLE 202 ON READER CARD

Test Your Memory

Eight-page booklet describes a low-cost memory tester called Doctor 32-11, designed to test most existing integrated circuits. The instrument can do production testing, incoming inspection, engineering evaluation, device characterization, and Schmo plotting. It tests SSI, MSI, memory cards, RAM's ROM's, shift registers, MOS, bipolar, and hybrid in all three modes: functional, parametric, and dynamic. The booklet describes the four major subsystems—computer, mainframe, test head, and

software. ADAR ASSOCIATES, INC., Cambridge, Mass.

FOR COPY CIRCLE 204 ON READER CARD

Pattern Sampling

Diffraction pattern sampling based on a laser-lens combination which can perform a Fourier transform is described in a 10-page brochure. Applications of this technique, which can detect many features more readily than direct examination of an object, include precision measurement, pollution monitoring, particle analysis, image analysis, flaw detection, and automatic inspection systems. RECOGNITION SYSTEMS, INC., Van Nuys, Calif.

FOR COPY CIRCLE 203 ON READER CARD

Display Terminals

A 36-page catalog describes vendor's line of computer display terminals, hardcopy units, peripherals, and products in the Plot-10 terminal software line. Included is a configuration section which describes and illustrates terminal combinations with peripherals such as magnetic tape and paper tape devices and remote slave display units. TEKTRONIX, INC., Beaverton, Ore.

FOR COPY CIRCLE 201 ON READER CARD

Media Systems

Products for use in the computer room and in general offices using information media such as printout, microfilm, cards, crt terminals, and word processing equipment are described in an illustrated 44-page catalog. WRIGHT LINE, Worcester, Mass.

FOR COPY CIRCLE 205 ON READER CARD

Ethics for Consultants

A code of ethics guide taken from the 1973 Directory of Consulting Specialists is a composite of selected statements of professional societies' codes and governmental regulatory statements. Requests must include a stamped, self-addressed envelope. CONSULTING NEWSWORLD, P.O. Box 286, Northridge, Calif. 91324.

Booklist

Twenty new books on data processing, computer science, management science, and general trade are listed in the publisher's spring-summer catalog, along with more than 150 backlist books in these and other categories. New titles include Computer Security; Information Retrieval; Techniques for Direct Access; Computer Techniques

in Biomedicine and Medicine; Dynamics of Managerial Leadership. AUERBACH PUBLISHERS INC., Philadelphia, Pa.

FOR COPY CIRCLE 207 ON READER CARD

Paper Tape Equipment

A 30-page catalog describes paper tape punches and readers, including synchronous and asynchronous terminals. The devices operate at varying speeds up to a maximum of 360 characters per second for the readers and 240 cps for the punches. Interface specifications, product selection guides, accessories, and options are detailed in the book. TELETYPE CORP., Skokie, Ill.

FOR COPY CIRCLE 206 ON READER CARD

Time Code Formats

A 24-page handbook of time code formats provides format data on the 22 most common time codes and graphically illustrates reference time, typical time frames, index count, index markers, and other data. MOXON INC., Irvine, Calif.

FOR COPY CIRCLE 208 ON READER CARD

Automatic Testing

A 60-page illustrated catalog describing vendor's automatic test systems and instruments is divided into two sections, one covering test equipment used in the manufacture of electronic equipment, the other describing testers used in the production of semiconductors and other components. Included in the new catalog are test systems and instruments for IC's, transistors, diodes, backplanes, pc boards, relays, hybrid circuits, zener diodes, FET's, resistors, and capacitors. TERA-DYNE, INC., Boston, Mass.

FOR COPY CIRCLE 209 ON READER CARD

PDP/11 Memory

Specifications and details of the PMM-11 mass memory system for the DEC PDP-11 minicomputers are given in a bulletin by the vendor. The MSC-11 mass storage controller is combined with the disc memory models 010 or 100 to form the PMM-11, a self-contained, random-access bulk memory. One MSC-11/010 combination provides from 262,144 (16-bit) data words to 1,048,576 data words for DEC DOS software compatibility. Using one of the PM-100 series discs, up to 8,388,608 words are available for non-software compatible systems. PACIFIC MICRONETICS, INC., San Diego, Calif.
FOR COPY CIRCLE 210 ON READER CARD □

Re-introducing the "other end" of the 3M COM system.

Usually, when we talk COM, we tell you about the proven 3M Electron Beam Recorder.

But there are two other important 3M COM capabilities you may not know about: Microfilm duplication and COM data retrieval, the "other end" of the 3M COM system.

So let it be known that 3M offers 16mm reel and cartridge duplicator equipment, plus microfiche duplicators.

Let it be known also that 3M offers a complete line of readers and reader-printers for retrieving COM data from microfilm reels, cartridges and fiche. Which provide visual display if you select a reader. Or visual display and copies if you select a reader-printer.

What does all this mean to you? Simply this. You can obtain EBR-Computer Output Microfilm with dry film processing, plus duplication and retrieval units in one complete COM package from a single COM source: 3M Company.

Want to learn more? It's time to call us.

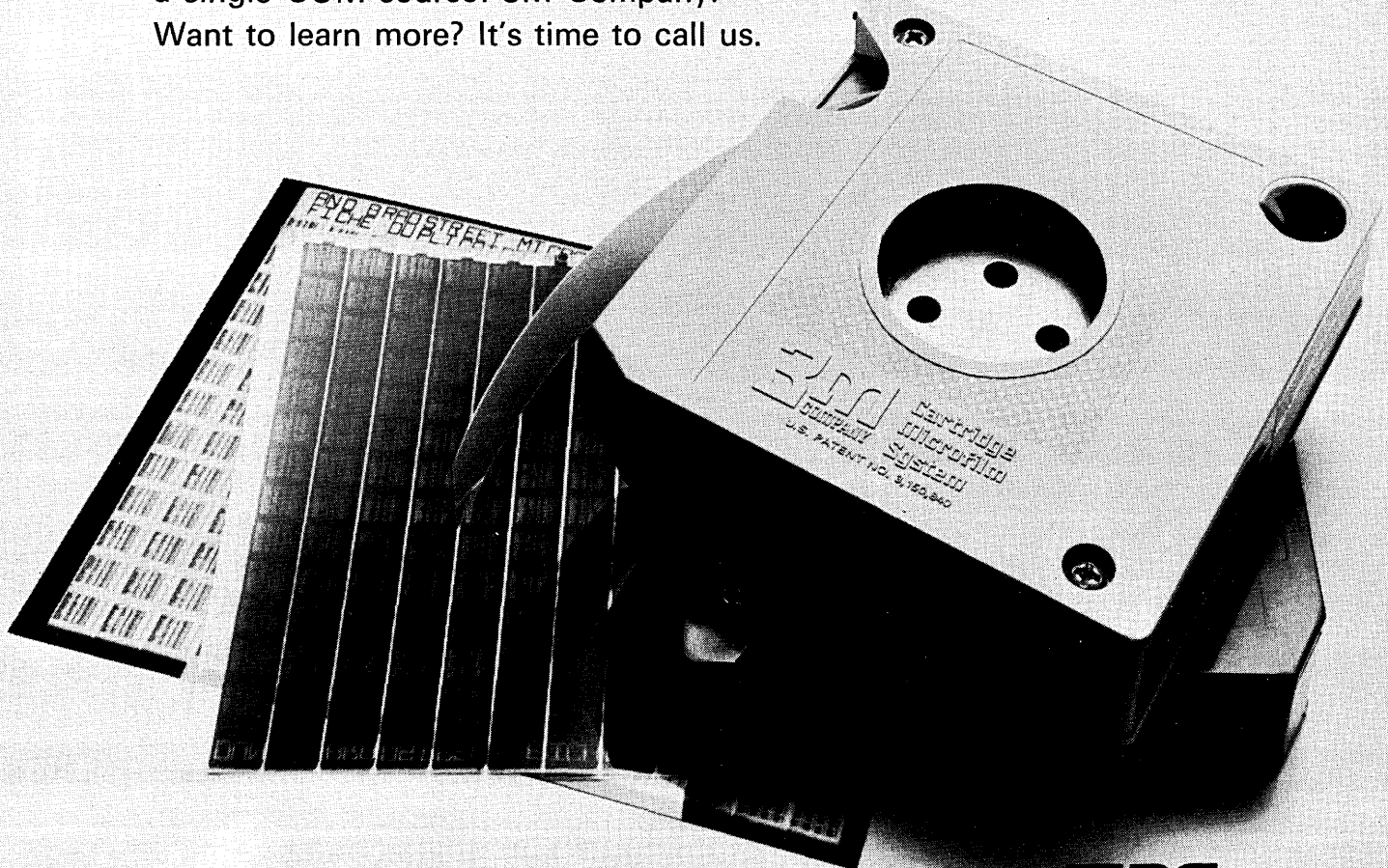

The age of microfilm is here... **3M**
COMPANY

CIRCLE 53 ON READER CARD

**Does the University
of Pittsburgh
know something
that's escaped you?**

They've expanded their timesharing.

And expanded their batch to handle 100-120 jobs per hour.

In fact, they've doubled their computer power.

Yet they've cut their computer costs by 30%.

With a 60 terminal, dual-processor DECsystem-10.

Pitt's DECsystem-10 has a common operating system that does all their batch and all their timesharing. At the same time. And everyone can share the files and software systems with everybody else. No matter what mode of operation they're using.

A typical system status report shows just how powerful their DECsystem-10 really is: 80 simultaneous tasks, 400 batch jobs queued from remote stations, 7 batch streams initiated, and 40 interactive users. Yet batch turnaround was only 15 minutes for average student jobs. And interactive response time was not affected.

But with all that power, Pitt's DECsystem-10 is still remarkably easy to work with. Besides using standard COBOL, FORTRAN, ALGOL, BASIC, LISP, SNOBOL, MACRO and BLISS, they've been using the DECsystem-10 for developing their own languages. Like PIL (Pittsburgh Interpretive Language),

CATALYST (a CAI adjunct to PIL), TENFOR, a fast load and go student FORTRAN system and a special editor called UPDATE.

All on a computer that costs 30% less than they were spending.

That should be enough to make you wonder about your comp center.

For some thought-provoking literature, write the DECsystem-10 Group, Digital Equipment Corporation, Maynard, Mass. 01754. (617) 897-5111. European headquarters: 81 route de l'Aire, 1211 Geneva 26. Tel: 42 79 50. Digital Equipment of Canada Ltd. P.O. Box 11500, Ottawa, Ontario, K2H 8K8 (613) 592-5111.

digital

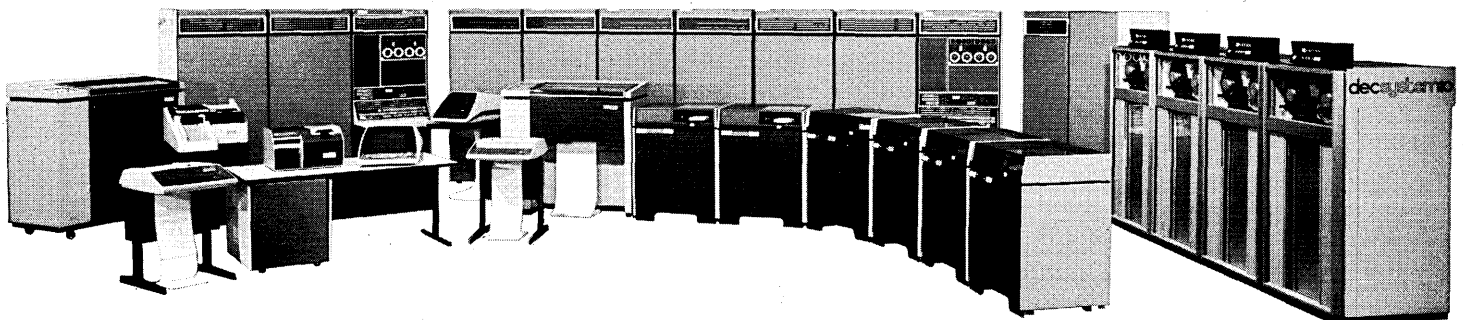



As one of the leading innovators in the telephone industry, we'd like to talk Diagnostic Programming with you.

We currently have a number of creative positions which require individuals able to design fault recovery and diagnostic programs for stored program, electronic switching systems. Experience in software and hardware design of large real time, multi-processing systems with automatic malfunction detection, recovery and diagnostics is required. Familiarity with on-line, multi-programming design and testing, using assembly language techniques is a must, in addition to knowledge of software loading processes and all phases of testing (on-line, batch and hands on).

Individuals with a technical degree are preferred, and a minimum of two years' experience is required.

Interested? Please submit your detailed resumé and salary requirements to:

Mr. Dennis Kave
Professional Employment

GTE **AUTOMATIC
ELECTRIC
LABORATORIES**

400 North Wolf Road, Northlake, Ill. 60164
An Equal Opportunity Employer

CIRCLE 127 ON READER CARD

Books

Columbia Human Rights Law Review,
Vol. 4, No. 1, Winter, 1972
Columbia School of Law, New York,
N.Y.
301 pp. \$4

A lawyer friend of mind tells me that I'm fortunate to have discovered this book in a marketplace glutted with turgid writing. For any computer professional with a social conscience, this particular issue at least, is an important publication. If you feel as I do that there may be alternatives to current institutional attitudes toward the increasing use of advanced technology—that is, it isn't all good just 'cause there's more—then this little volume will detail for you the many specific ways computers are being "used to abuse." One student author clearly summarizes that "an individual's integrity and his right to control information about himself is presently considered inferior to the profit motive."

The opening essays give a very thorough philosophical insight into the politics of privacy. At the same time they deal thoroughly with the specific situations in which a rampant information technology has spotlighted the problems that occur when people prefer protection over privacy. Arthur Miller, author of *Assault on Privacy*, introduces the privacy environment with a sensitive appeal to "overcome our all-too-often complacent attitude toward the management of our affairs by what frequently are astigmatic administrators." Sen. Sam J. Ervin presents information from his "Hearings on Federal Data Banks, Computers and the Bill of Rights" that will chill your bones as well as it chills the First Amendment. Nicholas Katzenbach's dispassionate review of crime data centers is as humanistic as a JCL manual. ACLU attorney Frank Askin laboriously details the ways government surveillance in and of itself removes the spirit of participation from any concerned citizenry. He fought the Army and knows whereof he speaks. Michael Baker then tries to explain why the little guy can't protect himself from the misuse of information about himself.

If you think the picture is bleak by now, wait till the student authors get through detailing chapter and verse concerning "Political Surveillance," "Remote Camera Surveillance," and "Commercial Information Brokers." The thoroughness of their research is impressive. In summary, there is much here to provide some perspective on the rationale each of us uses to justify the long-term social cost of present practices in our particular areas of data processing.

Computers and Privacy—Arthur R. Miller: Writing in the winter of 1972,

Miller incorrectly perceived (I admit I too was deceived) that "the political appeal of being for privacy is becoming apparent." The November election results showed that people want to be protected more than they want privacy. Miller's sensitive statement of the problem of the abuses of individual privacy in an increasingly complex society unfortunately holds little promise of correction. The result of enacting controls to control controls is that each new piece of legislation merely validates the belief that people cannot trust one another with personal freedom. To look for new legislation as an answer is a bit like the rational gambler who looks for a good strategy to take to Las Vegas. He knows that the best he can do is to lose slowly. If you believe that we are in "the only game in town," the gradual erosion of personal freedom should not be surprising.

First Amendment: The Computer Age—Sam J. Ervin, Jr.: Sen. Ervin knows his business. One could not ask for a more thorough evaluation of the uses of computers by government as a tool to control "free speech." In IBM Sales School, we were told we could ask the visiting V.P. any questions we wished at the upcoming Friday night bull session. If you were "wise," you were careful to ask only "nice" questions. Sen. Ervin really cares about freedom of speech and doesn't want individuals to feel intimidated by their government. I'm afraid sales school tactics are a lot more practical than legislation. Information technology is clearly too powerful to control, and one's only chance for survival may be to simply to tell them what they want to hear (popularly known as "shucking"). How else can an applicant combat (for one example from the many Ervin details) the administrator Ervin investigated who protested that "only the computer" analyzed the answers to compulsory questions like the following:

"I believe there is a God."

"I believe in the second coming of Christ."

"My sex life is satisfactory."

"I wish I were not bothered by thought about sex."

Surely there need be no moral stigma to shucking any computer inquiry that you as an individual consider immaterial.

Crime Data Centers—N. Katzenbach and R. Tomc: Katzenbach started antitrust action against IBM while he worked for Kennedy. Now he's IBM's chief counsel. He exhibits an elitist audacity by writing "White collar crime has grown increasingly sophisticated in the areas of securities, thefts, embezzlement and political corruption" and then suggesting that his company's tools can protect us from

petty larceny. Ralph Nader is far better equipped to reply to the kind of outrage, for example, inspired in me by the authors' conclusion: "A debate cast in terms of improved law enforcement *versus* privacy is pretty sterile once the emotion is dissipated." I don't believe that dissipating emotion is of value unless, of course, one seeks to emulate a computer.

Social Science and Surveillance—Frank Askin: The author's conclusions are right on. He fought the Army intelligence program and knows about the incredible arrogance of the military. If you want all the background to show that "people today are indeed chilled in their political participation, in their speech, in their associations, and in their right to petition for redress of grievances," he provides it. Unfortunately, he's hopelessly wordy and takes paragraphs to amplify his feeling with such statements as: "Jerome Bruner has shown that past experiences, needs, and expectations influence perception . . ." If you don't know that surveillance in and of itself is a bummer, you probably won't get it out of a bunch of authoritative logic trips. However, it's all here if you want support.

Record Privacy Consciousness—Michael Baker: A coauthor with Alan Westin on *Data Banks in a Free Society*, Baker points out in this essay that the little guy cannot keep from getting worked over by most systems—school, welfare, credit, police, etc. Since shucking won't do him much good now because he's involuntarily in these systems, his only hope must come from outside—but Baker won't say where. (Perhaps he means Nader, Common Cause, ACLU, etc.) He gives a neat story about welfare workers laughing at an old lady turning in a rumpled piece of paper with her age written on it as a substitute for lost immigration papers. You are then led to infer that at the same time as her welfare request is being denied, some middle-class citizen is paying an inappropriately high interest rate on his home based on "facts" stored on a rumpled disc file. Change of consciousness can occur when you discover "it's" happening to you, too.

The following three articles are by students who are not given name credit. I wonder why?

Political Surveillance: It's hard for the layman to judge whether consideration of Fourth Amendment guarantees in addition to First Amendment safeguards would serve to protect individuals from malicious political surveillance. I find it hard to believe that any government agency would be deterred from putting a tail on someone simply because they might have to pay taxpayers' money as damages for violations of illegal search. In spirit I'm with the

There's a vital difference between comfort air conditioning and Process Cooling. Babies and computers understand.

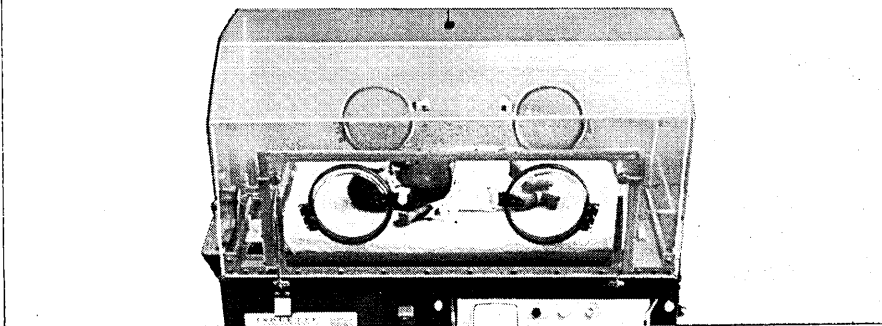

Computers require care, concern and a special environment, too. This calls for EDPAC Process Cooling. The positive way to help prevent an economic catastrophe of cooling failure and downtime in a computer room.

In addition, EDPAC Process Cooling provides computer room features not available with comfort air conditioning: Modular systems accommodate anticipated growth and expansion • Provides redundancy • Environment is

maintained at ideal 72° F and 50% RH • Eliminates hot spots.

Whether you're installing your first computer room or expanding your present system, protect your investment. Investigate Process Cooling. Write today for your free copy of "Process Cooling for Computers is Different".

EDPAC

PROCESS COOLING FOR COMPUTERS

AC MANUFACTURING COMPANY

Old Cuthbert & Deer Road, Cherry Hill, New Jersey 08034, (609) 428/9800, (215) WA 3/5775
CIRCLE 75 ON READER CARD

computers delivered gently

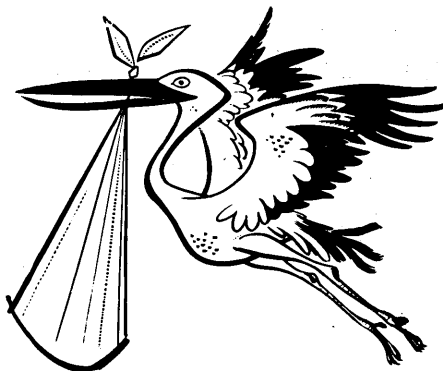

When you ship computer hardware, look for an experienced computer mover like Burnham Van Service, which helped pioneer the nationwide moving of electronics and other high value cargo. Burnham Van Service has air-ride vans with power tailgates and the most advanced tie-down systems, along with other specialized equipment for moving electronics. More important, Burnham has the know-how to load, move, and unload your computer hardware without damage, and the ability to spot your shipments at all times, day and night, from one end of the country to the other. Call the man from Burnham Van when you're ready to talk about computer shipments. Or write to us and we'll be glad to send you a copy of a new 32-page equipment manual that illustrates Burnham's specialized equipment for handling high-value cargo.

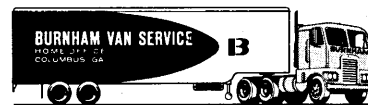

BURNHAM VAN SERVICE, INC.

5000 Burnham Boulevard, Columbus, Georgia 31907 • Phone 404/563-1120
Denver 303/433-8619 • Chicago 312/372-4323 • New York 212/679-4111 • Cheverly, Md. 301/322-1300

CIRCLE 80 ON READER CARD



As one of the leading innovators in the telephone industry, we'd like to talk Hardware Design with you.

We have openings available for System Hardware Design Engineers who will be responsible for the hardware design and development of medium and large scale, stored program, electronic switching systems. Ability to comprehend the system as a whole and make appropriate trade-off decisions is necessary. Involvement will be in originating, planning and designing circuits for new systems or modifying existing ones.

These positions require a BSEE or MSEE with relevant design experience.

Interested? Please submit your detailed resume and salary requirements to:

Mr. Dennis Kave
Professional Employment

GTE AUTOMATIC
ELECTRIC
LABORATORIES

400 North Wolf Road, Northlake, Ill. 60164
An Equal Opportunity Employer
CIRCLE 128 ON READER CARD

Books

author—it's too easy for the government to protect itself as it tends "to approach these dissident domestic organizations in the same fashion it deals with unfriendly foreign powers." From a computer standpoint, the key word in this article is "dataveillance." This term describes a process of correlating data from several files to determine possible "need for surveillance." Help!! My experience is that you're lucky if any one file can yield an accurate picture of what it was intended to describe. If security analysts were to appreciate the complexity of a mere aged accounts receivable application, they would not be so enthusiastic in their haste to infer that some John Doe is potentially disloyal.

Remote Camera Surveillance: This article describes an example of a super-advanced technology being used in crime prevention. The results of the 24-hour tv camera system on two blocks of Mt. Vernon, N.Y., are admittedly unimpressive, but the expectations are tremendous. "To begin, police can use a Mt. Vernon-type surveillance system to read a pedestrian's lips or to read documents in his possession . . . to observe and magnify people in their apartments, cars, or on the street . . . to enforce dormant or inconsistently utilized statutes; e.g., jaywalking, spitting, or failing to license your dog." Referring to *Privacy* by Professor Fried, the author points out that "once a person has complete surveillance of someone, that surveillance extinguishes any possibility of trust." And so it is with citizens and their government.

Commercial Information Brokers: This very comprehensive review details in case after case how a difference in scale can become a difference in kind. Some misuses of information data banks are merely distasteful, such as junk mail (if you can be nonchalant about the charge that "\$240 million of the \$321 million deficit sustained due to third class mail is a result of commercial mailings"). Others "of these intrusions would have been impossible if the information was manually handled and manually disseminated." The following example is selected from the hundreds of abuses the author documents that occur with mailing lists, income tax information, employment information and census data, motor vehicle registrations, and many other tax-supported functions. The Veterans Administration had furnished data tapes to several organizations—Red Cross, American Legion, VFW, DAV; but refused to furnish the same tapes to the Vietnam Veterans Against the War. The VA was finally ordered to yield the

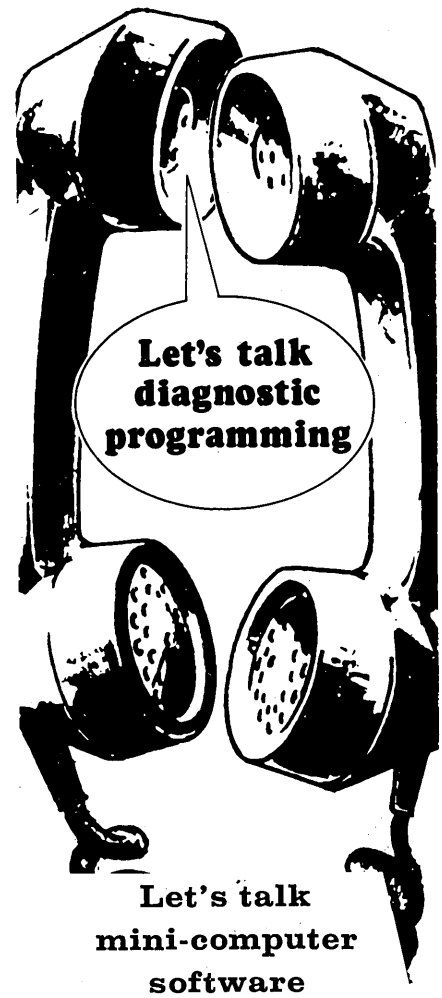

As one of the leading innovators in the telephone industry, we'd like to talk Mini-Computer Applications with you.

Specific assignments will be as part of project development teams responsible for the design and implementation of various tele-communication processing systems using mini-computers as the processing element. Responsibilities will be to develop software programs for real time operating systems including supervisory, I/O routines, and application programs to monitor and control standard peripherals as well as unique hardware elements incorporated into the systems.

A minimum of 2 to 5 years experience in the development of assembly language programs for mini-computer processing systems and a Bachelor's degree in Electrical Engineering or Computer Science is required. Experience with the design of peripheral devices and telecommunications is a plus.

Interested? Please send a detailed resume and salary requirements to:

Mr. Dennis Kave
Professional Employment

GTE AUTOMATIC
ELECTRIC
LABORATORIES

400 North Wolf Road, Northlake, Ill. 60164
An Equal Opportunity Employer
CIRCLE 129 ON READER CARD

VVAW this information. The court ruled that the earlier release of the data required the additional release. The VA said they would not have released the data in the first place had it not been on computer tape. In conclusion, the author notes that the Freedom of Information Act and Fair Credit Reporting Act are ineffective as methods of redressing wrongs already committed.

I still believe that complete openness is the best defense against invasion of privacy. But our fear of one another will apparently be paramount for some time to come, and so I too must urge restraint on the use of computer data banks. If we become more inclined to not underestimate the goodwill of others, those who seek to protect us for our own good may become less inclined to ask the computer to engage in provinces of the human domain.

—Lynn Stoller

Book Briefs

System/3 Programming: RPG II

by Solomon Martin Bernard
Prentice-Hall, Inc., Englewood
Cliffs, N.J., 1972
368 pp. \$11.95

This extensively illustrated text, suitable for neophyte programmers, is designed in three major sections. The first provides a working familiarity with the IBM System/3 and its application to business data processing and presents an overview of the concepts underlying RPG II. The second section develops the planning and writing of basic RPG II programs in enough detail that the reader can code basic card-oriented programs. The third section covers all the facilities available in RPG II, including more advanced concepts. Each topic is self-contained, permitting the reader to limit his study to those concepts in which he is interested. Test problems and solutions are included in the last two sections.

Data Communications & Business Systems

Edward Webster, ed.
International Business Forms
Industries, 1730 N. Lynn St.,
Arlington, Va., 1971
186 pp. \$12.

Highlights from IBFI's Third International Forum, held in late 1970 to introduce business executives and line personnel to data communications. Although the symposium was held two years ago, this book is not really very outdated, as it deals in basic concepts in business data communications: common carriers—voice, microwave, and satellite; laser data communications; terminals; security; management; case histories; utility services; CATV; the future; and overviews of data communications in Canada, Europe, and Japan. □

April, 1973

new!...lower cost!

DATA TERMINAL WITH SOLID STATE MEMORY

...from **VIDEO**



Here's what you've been looking for—a low cost precisely engineered attractive alphanumeric CRT data terminal with solid state memory! It decodes a number of control functions for computer or remote control operation and all controls are located on the front panel including a selector switch for baud rates of 110, 150, 300, 600, and 1200.

The VST 1440 is a self-contained, stand alone terminal with a large number of optional features available including: high-speed interfaces; character

This is the VST 1440 that sells for under \$2,000, with special discounts for quantity lots! It features an MOS memory and displays up to 1440 characters at one time in 18 lines on a non-glare 12 inch CRT. The attractive new terminal generates all 128 ASCII characters and displays 64. Input is provided by a TTY style keyboard plus a 10-key numeric pad.

insert and delete, display of all 128 ASCII characters; blinking phrases; special keyboard decoding and encoding; automatic answer-back.

There's a lot more to our story on the low cost VST 1440. Get details now. Write or call.



VIDEO SYSTEMS CORPORATION

7300 N. Crescent Blvd., Pennsauken, N. J. 08110
Phone: (609) 665-6688 • TWX 710-892-0818

CIRCLE 88 ON READER CARD

DDC introduces 2 new disc memories.

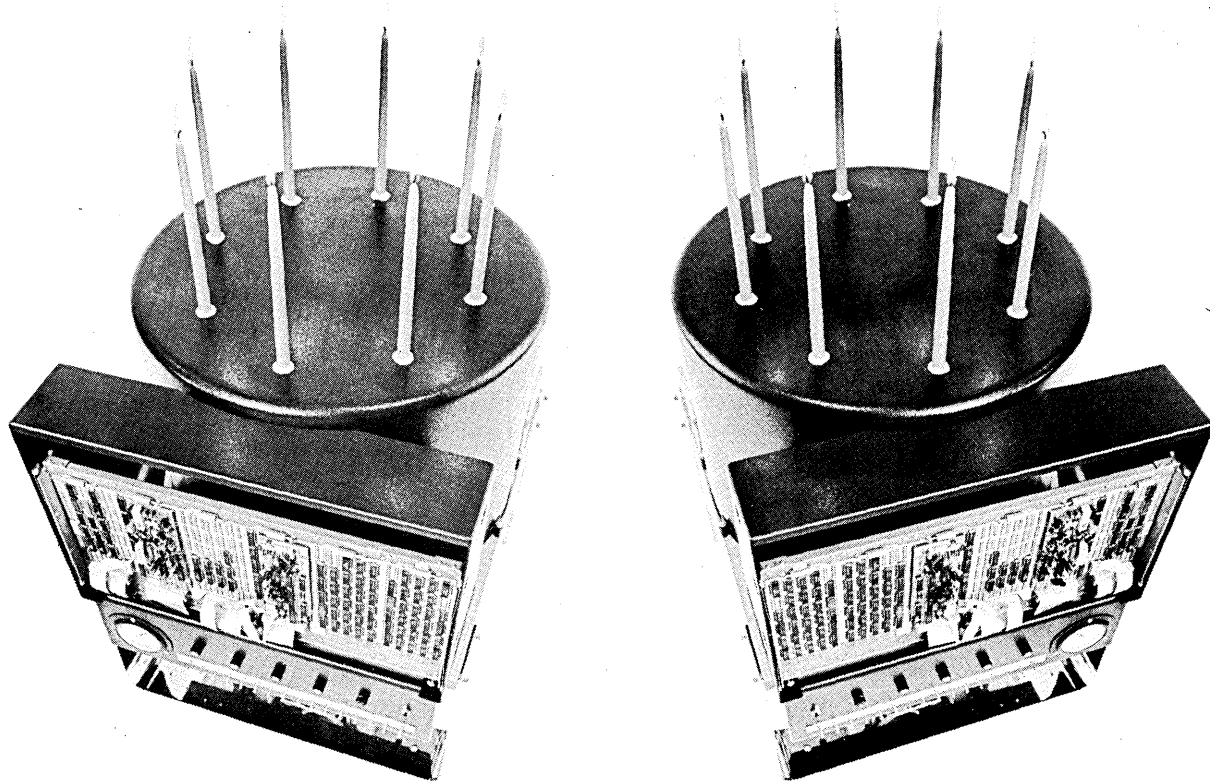

They're only 8 years old.

That's right, 8 years old. You see, the new DDC A7310 and 9100 Series head-per-track disc systems have the same basic mechanical design, the same inert gas environment, the same non-contact flying heads, and the same basic electronics that have made our head-per-track systems the industry standard for reliability and performance since 1965.

So what's new? Greater capacity and lower cost per bit.

The A7310 Series gives you fast 8.5 millisecond average access time, with capacities from 6,000,000 to 107,000,000 bits at 105,000 bits per track.

And for applications which allow 17.0 millisecond average access time, the 9100 Series provides capacities from 9,000,000 to 150,000,000 bits at 150,000 bits per track.

50 to 100 percent increase in capacity with access time flexibility, all with 8 years of field-proven superior reliability and performance designed in. Now that's new!

And there are a few other new features we've added. Like repackaged electronics and logically implemented spare data heads which result in improved maintainability.

The MTTR on the new systems has been reduced by 40 percent. Not that you really need to know that because the field-experienced MTBF on this basic design is in excess of 11,000 hours. Want proof? Just ask to see our Product Reliability Report. We know you'll be impressed.

And yes, we're truly price competitive. Any way you want to figure it. Cost per bit, life cost, or cost of ownership.

For full details on our new A7310 and 9100 Series, write or, better yet, give us a call. And if you're going to the National Computer Conference in New York in June, just drop by Booth #1410 and see our brand new 8-year-old memories.

DDC**DIGITAL DEVELOPMENT CORPORATION**

5575 Kearny Villa Road, San Diego, CA 92123. Phone: (714) 278-9920

European Sales Office: Radix House, Staines, Middlesex, England. Phone: Staines 51444

"50% the rate we planned to be shipping by the end of this year" with about 30% emulating 360/20s and the others running in native mode-- and producing revenue. It's learned elsewhere the company is planning a press release soon to announce the first customer.

SPRING FEVER

Stanford's faculty newspaper, "Campus Reports," heralded the news in the March 14 issue: IBM graciously was granting \$16 million each to Stanford, MIT, and Univ. of Wisconsin to erect "T.J. Watson" computer science buildings. But a later edition, also dated March 14, made no reference to the grant, much to the disappointment of professor Ed Feigenbaum, who is chairman of Stanford's computer sciences building fund, seeking \$9 million. Student pranksters who published the early bogus newspaper also devoted a four-column story to a new computer venture at Stanford's Linear Accelerator Center to simulate religious systems, including a subroutine called "Trinitarian" that regarded Stanford Provost William F. Miller, the Atomic Energy Commission, and IBM as the three aspects of God.

COUNTESS LOVELACE AT THE RACES

Countess Lovelace, who deserves the title of first programmer because she wrote a step-by-step description for applying Charles Babbage's Analytic Engine to compute Bernuolli's Numbers in 1842, later pressured Babbage to apply the machine to beating the horse races. The disastrous results are to be reported by David W. Kean in the May issue of Datamation, as a feature article based on correspondence between Babbage and the countess.

RUMORS AND RAW RANDOM DATA

IBM may be developing a 10,000-lpm nonimpact printer at its San Jose development laboratory. If true, such a product would be a first for IBM...The red-hot floppy disc market may have a new competitor soon. Caelus Memories has developed a unit that it can sell for \$350, but is holding back announcement until the market settles. The \$350 price is roughly half the current going rate...A good source at the National Bureau of Standards expects IBM to announce a 9-bit code "within a year," permitting systems to process ASCII, EBCDIC, and 6-bit codes interchangeably, as reported in these columns (March, p. 161)...IBM Japan Ltd. has gone to the Ministry of International Trade and Industry (MITI) with a proposal that it allow free use of once-rented 360/20s by universities throughout Japan. The proposal is opposed by Japanese computer makers who see it as part of a long-range strategy by IBM to develop latent computer demand there... Meanwhile, Japan's Fujitsu has a four-man team in Spain quietly looking into the market potential for computers and seeking a partner and production facilities. Observers link this move with the strategy used in the auto market: penetrate the heart of Europe after first establishing a foothold on its periphery...At press time, CDC was reported negotiating with ITT Data Services to acquire ITT's European service bureau operations, and Minneapolis neighbor International Timesharing Corp. was dickering for Honeywell's time-sharing operations in 14 U.S. cities...When it announced its 700, Burroughs dropped the other shoe too, although not very many people noticed. We hear it's quietly released the 1736 --a configuration of dual 1726s --to its sales force.

MASS STORAGE SYSTEMS

FOR
DATA GENERAL AND
INTERDATA MINICOMPUTERS

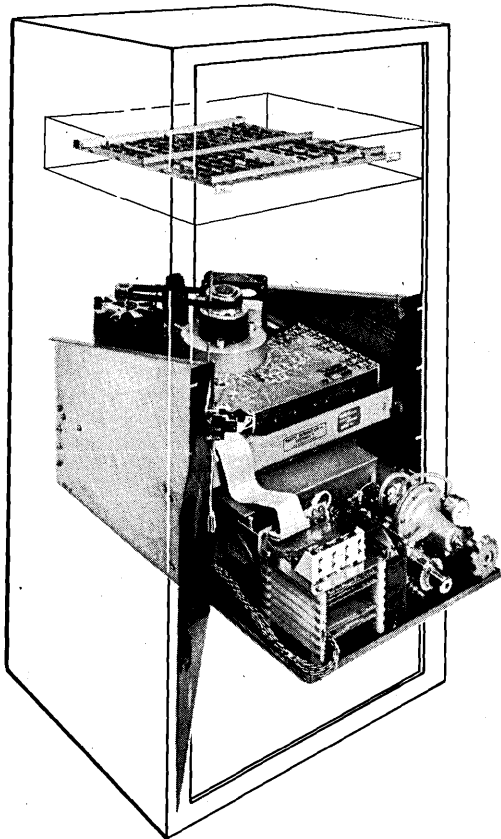

A mass storage system consisting of a single controller and up to four fixed head discs for DG Nova 800, 1200, supernovas and Interdata 70, 74, and 80 minicomputers. System is a low-cost fast, random-access, bulk memory with software compatible operation. From 65K to over 33M words of storage is available using the Pacific Micronetics Inc "FASTRACK" series discs.

The disc and controller combination provides a 3.8 microsecond average word transfer rate at 3600 rpm or 1800 rpm rotational speeds (8.35 or 16.7 millisecond average access time). Controller fits directly into existing computer slot or optional chassis. System includes installation, checkout, documentation and warranty.

CALL (503) 285-0581 or WRITE:

PROGRESS
ELECTRONICS COMPANY OF ORE., INC.
5160 N. LAGOON AVE., PORTLAND, OREGON 97217

CIRCLE 95 ON READER CARD

People

R. BLAIR SMITH, who conceived the SABRE system, founded the first computer users group, and contributed much else of lasting value to the industry, is retired now, but far from idle.

He's a board member of the Ryder System, and chairman of its Information Systems Committee. Ryder leases trucks and operates several related businesses.



R. Blair Smith

Smith intended to become a psychologist, but was diverted into dp by a part-time job he obtained at Boeing in 1939 to pay his way through the University of Washington. He started out wiring plugboards on company's numerical accounting machines. "Boeing had only about 3,500 employees then, and couldn't justify the cost of alpha print bars," he recalls. Pretty soon, Smith was crawling around on his hands and knees, tracing circuits and altering the equipment to make it operate faster. He left Boeing in 1942. By then, they had "at least 35,000 employees."

In 1949, after 11 years as an IBM user at Boeing, Western Airlines, and the Flying Tiger Lines, Smith capitalized on his experience and became a salesman for Watson & Company. He needed only 14 quota months to make the 100% club in 1950, '52, and '53 (the club was disbanded temporarily in 1951 because of the Korean War). Along the way, Smith installed the first IBM 701—at Douglas Aircraft Co. headquarters in Santa Monica—and sold three others. Only 20 701s were produced altogether. Smith, in 1952, banded IBM 701 customers into the world's first user's group. Later, the group metamorphosed into SHARE.

In September 1953, Smith was ordered east to learn about the 702. Boarding a midnight American Airlines flight in Los Angeles, he happened to sit next to C. R. Smith, American's president and a good friend of Tom Watson, Jr. During the 10-hour flight across the country, Blair aroused C. R.'s interest in a new kind of passenger reservation system—one that would operate on-line and keep track of individual name and routing information, as well as seat availability. The upshot, some 10 years later, was SABRE, the first nonmilitary system to provide interactive dialogue between hundreds of remote terminals and a massive central data base.

It took five years to design SABRE, and another five to program and sell it to American Airlines. Delta and Pan Am bought the system later. Smith negotiated all three of these contracts for IBM.

In 1965, after refusing to submit a "representative" bid to United Air Lines, which was looking for a total information system (reservations, engineering, and maintenance), Smith was named a marketing consultant to George B. (Spike) Beitzel, president of the dp division. Afterward, IBM bid the United rfp—"it *did* ask for more than anyone could deliver at the time." But he also says IBM was right to demote him. "I refused to explain adequately why the United specs couldn't be satisfied, and that was a mistake."

As this comment indicates, Smith remains a loyal IBMer. When asked how he feels about the company, he recalls that Vince Learson "was critical, but afterward he'd help you solve the problem that had generated his criticism." Smith adds that IBM "has made mistakes, but we're all fallible."

After some 20 years of hectic adventures in the computer business here, ROBERT M. GORDON is off to the relative

peace and quiet of New Zealand, where he'll be in charge of the computer center at Victoria Univ., Wellington. A Burroughs B 6700 is to arrive there this month and, in addition to getting it under way, Gordon plans on teaching courses in social implications and introductory computing.

Armed with an MA in mathematics from Yale, he started with analog computation at the China Lake Naval Ordnance Test Station in 1952 and has since covered just about all the possibilities — vendors, users, universities, and consulting. He joined NCR in early 1955, just after they had acquired Computer Research and were starting to market the NCR 102D. "I remember a movie they made," he said, "called Electronics Comes to Main Street. It explained that every business would have its own small computer—but it would be programmed elsewhere and just do what the businessman wanted it to." Since then, he's been at the ElectroData Div. of Burroughs, A. D. Little, XDS, Raytheon Computer, and the Univ. of California at Irvine.

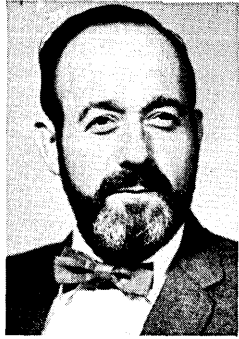

Robert M. Gordon

One of his many noncomputer triumphs that we like best was his confrontation with mighty Sears and Roebuck after they sold him a mispackaged master cylinder repair kit that proved to be for the wrong make of car. After getting his outraged letter of complaint, the store gave up and reimbursed him for all taxi fees and other expenses incurred by the delay in repairs.

ELMER J. WEINTHALER, chairman of the Data Processing Management Assn.'s 1973 International Data Processing Conference & Business Exposition to be held in Chicago June 26-29, headed up a DPMA conference once before and feels "if you've handled one conference you've learned enough to handle any." Weinthal was general chairman of DPMA's 1966 conference, also held in Chicago, which, with an attendance of 3,600 and an income for the association of \$126,000, ranks as one of DPMA's most successful. He doesn't expect to do quite as well this year because a nationwide "austerity program"—a factor he says accounts, in part, for DPMA conferences' dwindling attendance in recent years—is still on. But he feels attendance this year will be in the "higher 2,000 series." He feels DPMA conferences in the recent past also have been hit by their locations in non-central spots and "what you can draw from."



E. J. Weinthal

Weinthal, district dp manager of Illinois Bell Telephone Co., has spent all of his working life with the company, including 20 years in data processing. He has been a DPMA member since 1956 when it was still the National Machine Accountants Assn. and had only 60 to 70 members. He has seen it grow, he says, from where its headquarters were in a home to its present status with an "elaborate international headquarters building." Long active in DPMA's Chicago chapter, he was international vice president in '66 and '67.

Weinthal joined Illinois Bell in 1941 in its Plants Department as a telephone installer. In 1953 when the company was moving into punch card operations and 402s, "somebody looked through some records and discovered I'd had both accounting and electronics in college; I was moved to accounting, and I've been in data processing ever since." □

April, 1973

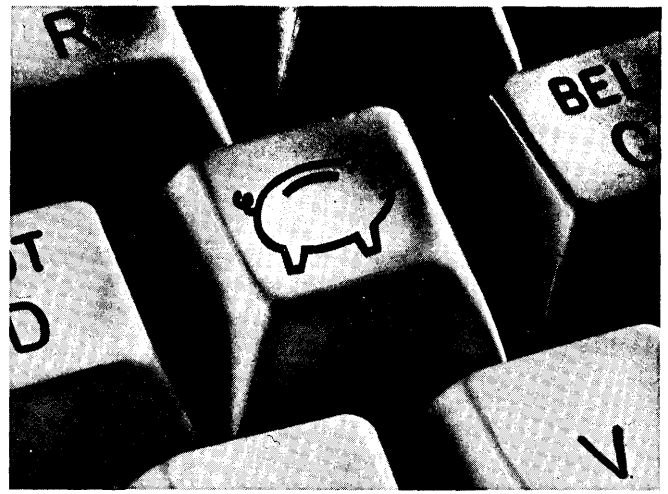

A key function of this Westinghouse terminal is saving money.

The new Westinghouse 1600 is the most completely equipped terminal you can buy for the money. But, unlike most inexpensive models, it's not stripped down. All models offer both synchronous and asynchronous modes as standard. Also eleven switchable data rates. As well as format mode and a full range of edit features. A low cost option, station address for polling by computer can yield significant cost reductions by line sharing. And our terminal is fully compatible with a wide range of printers, cassettes, modems and other peripherals. We'll supply these too.

The Westinghouse 1600. For management information systems, accounting, engineering test-out, process control, batch entry, inventory control. And for cutting costs. Without cutting performance.

Electronics Systems Division,
Westinghouse Canada Limited,
P.O. Box 510, Hamilton,
Canada,
Phone (416) 528-8811
Telex 021-655,
TWX 610-371-0246

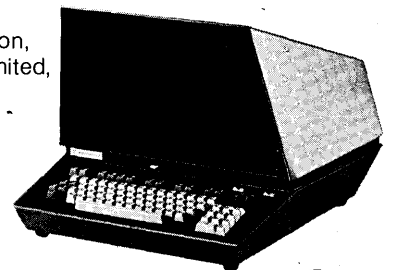

You can be sure...if it's Westinghouse



programmers

OS SYSTEM AND COBOL ON IBM 370/155

Join Gilbert Associates, Inc. . . . a major consulting engineering firm engaged in the design of nuclear and fossil fueled power plants, and other significant areas of engineering. We need very special individuals with a Bachelor Degree or higher for challenging assignments.

OS SYSTEM PROGRAMMER

Requires a solid OS background and an interest in system support of a technical data base, terminal network and sophisticated engineering applications.

COBOL PROGRAMMER

Requires COBOL experience and an interest in developing specialized accounting systems relating to the construction of large public utility power plants.

You'll enjoy an excellent salary and benefits package. For a comprehensive review of your professional qualifications, you are invited to send your resume, with confidence that your interests will be treated in a private and privileged manner to: Frank F. Lasik

Gilbert Associates, Inc.

Engineers and Consultants

Dept. 257, P.O. Box 1498, Reading, Pennsylvania 19603

An Equal Opportunity Employer

CIRCLE 118 ON READER CARD

Even Webster's Knows About QUEST

QUEST (kwĕst). v. 1. To make a search; to go on a quest.

QUEST SYSTEMS, INC. n. 1. A corporation founded in 1968. 2. The largest professional recruitment firm in the U.S. functioning solely in the computer sciences; its client companies pay all employment fees, interviewing and relocation expenses. Quest is known for its deep personal commitment to relate to each candidate as an individual with individual goals. 3. Its professional staff averages over 6 years of experience in EDP recruiting (additionally, staff members have direct hands-on experience in programming, systems, hardware sales, etc.) 4. Quest is presently searching for degreed programmers and analysts (commercial, scientific, systems software) for over 3,500 client companies in the U.S. *Quest has openings in over 700 U.S. towns and cities.* 5. Methodology — see Questsystem.

QUESTSYSTEM (kwĕst sis'tĕm). n. 1. Discussing with a man what he would like to be doing in light of what he has been doing. 2. Analyzing the realities of his objectives as they relate to the current job marketplace. 3. Contacting client companies and other Quest staff personnel to identify positions of possible interest. 4. Introducing the job candidate to his prospective employers by providing complete details to each about the other, ensuring the efficacious use of everyone's time. 5. Arranging interviews. 6. If employment offers are extended, Quest assists in evaluating the responsibilities, compensation and opportunities (and relates those to the initially stated objectives). The Questsystem has been working for thousands of professionals at no expense, whatsoever. Ask your friends of their past dealings with Quest. Then, put the Questsystem to work for you. For additional information on this subject, please inquire directly to Quest Systems, Inc. (All inquiries/resumes received will be responded to immediately and in confidence).

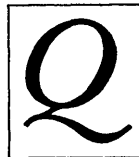

QUEST SYSTEMS INC

Linden Hill Towers, 5400 Pooks Hill Road
Washington, D.C. 20014 (301) 530-6700

We want the best Project and Programme Managers in the world.

International Computers Limited markets information processing systems in more than sixty countries throughout the world. ICL is Europe's leading computer company. In the next five years we shall be doubling the volume of our business worldwide with particularly striking growth in Europe.

Customer satisfaction is one of our key goals. We are looking for a number of the world's top customer support managers to ensure that we maintain this goal during our expansion programme.

In a Company where the emphasis is on systems management in a total support environment, the planning and direction of large-scale projects and programmes requires a results orientated approach. It needs a breadth and depth of systems and technical management experience that few will have acquired and a record of successful achievement in this field that is second to none. It requires, too, exceptional skill in analytic management and the personal charisma that makes people want to follow.

There are opportunities throughout Europe to project manage sophisticated communications, data bases or really large-scale general purpose systems through to completion.

Brian O'Heron, our Vice President — Systems and Technical Support, will be in North America at the end of April. If the quality of your experience matches the challenge implicit in our goals, he would very much like to meet you to tell you about the exacting and exciting tasks that have to be accomplished and about the rewards that are possible for achievers.

Even if you are committed to your current project for some time ahead, write now with full details of your successful career record to date, quoting references which we may check, to John Perry, International Computers Limited, London SW15 1SW, England. Or telephone 01-788 7272 extension 2233. Please include a telephone or telex number where you can be contacted.

ICL

CIRCLE 121 ON READER CARD

let's talk!...



...about the biggest computer show on earth

Now everything you need to know about the 1973 National Computer Conference & Exposition is as close as your telephone.

Just give us a call on AFIPS' new toll-free hot line and we'll send you all the facts on how to register for the biggest computer show on earth—including this year's largest display of computer hardware, software, systems and services.

73 NCC brings it together for the first time. It's your once-a-year opportunity to look, listen and learn about the latest developments in data processing. To share ideas and experience with leading experts. To gain a wealth of practical knowledge and know-how which can spell immediate dividends for you and your company.

We've structured the 73 NCC program to meet your day-to-day requirements. A total overview of

data processing and its applications, emerging uses, and its impact on user industries and the world economy. More than 80 sessions, panels and seminars providing in-depth coverage of Methods & Applications providing in-depth coverage of Methods & Applications and Science & Technology.

All this plus an exhibit program which puts a world of EDP information right at your fingertips—with more than 200 organizations ready to assist you in meeting your specific data processing needs.

Act now to avoid long lines at the New York Coliseum, June 4-8. You can pre-register for the entire conference, for any one day of the conference program and exhibits, or for all five days on an exhibits-only basis. Beginning March 12, just dial 800-631-7070* for complete registration, housing and conference information or write: 73 NCC, c/o AFIPS, 210 Summit Ave., Montvale, N.J. 07645.

**In New Jersey, dial 201-391-9810*

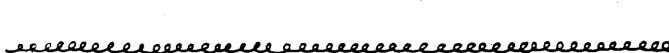

800-631-7070



**1973 National Computer Conference & Exposition
June 4-8 • New York Coliseum**

EUROPE.

a one way trip for your computers



Join Datamation's powerful selling tour of all Europe in Fall '73

Five countries in five weeks — The Grand Tour

Datamation, the leading computer publication, in cooperation with the United States Dept. of Commerce, presents a hard selling, end user oriented, series of five exhibitions of U. S. computer equipment in Europe in Fall '73. It's The Grand Tour. The shows are one week apart starting in London in October, then Stockholm, Paris, and Milan. The Tour ends in Munich in November at the European-wide computer show — Systems '73. You are invited to join The Grand Tour of Datamation for an extraordinary opportunity to increase your total marketing program in Europe.

Five reasons for five countries in five weeks:

1. High end user attendance is guaranteed for you! Intensive mailing and advertising program to Datamation's list of over 25,000 qualified European prospects! More mailings and contacts through Dept. of Commerce lists! Assistance of Dept. of Commerce with difficult-to-contact prospects!
2. The Grand Tour will help you to support your present distributors or sales offices all over Europe. Are you looking for distributors? The Department of Commerce will pre-screen them for you for your interviews at Grand Tour Cities!
3. The Grand Tour is compact, yet covers all Europe. Cities were chosen on the basis of EDP buying power concentration. Your equipment is committed for only five weeks!
4. Datamation does everything. You just ship your equipment to JFK and then have your home office people or European salesmen at each city when we open. That's all. A few exhibitors might even retrieve their equipment at JFK at the end of the Tour but we don't expect to return much. We're all going to Europe to sell our computers, not bring them back home!
5. You can't beat this price/performance. Five countries in Europe in five weeks for \$9,900! Maximum of forty booths available.

That's The Grand Tour. Call me or write for full details. I'll also send you a special reprint of the Dept. of Commerce's study on the total international market for U. S. EDP equipment.

Charlie Asmus, Sales Director, The Grand Tour

DATAMATION 35 Mason St., Greenwich, Conn. 06830 (203) 661-5400

letters

(Continued from page 22)

Again, a hardware design consideration.

8. There is no substitution that Mr. Sanborn claims. Perhaps he is confused because the vertical bar is divided into two segments to avoid /, 1, I and ! becoming confused.

9. The 64-character upper case graphic subset was intentionally designed into the ASCII language. Not all terminals require lower case, and many customers are not willing to pay for a capability they don't want to use.

10. Precisely the same problem as #9.

I suggest that Mr. Sanborn go back to primary programming classes and learn to read the standards. One standard cannot be designed to cure all the "evils" of different equipment that has been designed to different requirements.

JERRY L. OGDIN
Silver Spring, Maryland

Going too far

Mr. Ogdin's article on modularity (Jan., p. 49) was both interesting and informative. However, the point should be made that it is possible to go too far with modularity.

Given a system designed to perform N functions, is there any real difference between having one "module" of N operations, or N modules of one operation each? In both cases, the interfaces and interactions are identical. The probability of error is not too different for either situation. The question to be asked, then, is exactly how big should a module be, or its corollary, how many modules should we have in a system?

The solution to this problem is based upon similar work done on the allocation of functions to hardware chips: $P(e) = f(N, T/N)$ says that the probability of error in a program is related to some function of the number of things to do (how many primitives) and how many modules these primitives are divided into. By some simple manipulation, we can say: $P(e) = f(N+T/N) = f(N^2+T)$.

Solving for minimum N, we find that $P(e)$ is at a minimum when $2N^{1/2}$ is the subsystem (module) size. We can tabulate some common system sizes with "best" subsystem sizes and relate this to percent of defect prevention in the same manner as do the hardware designers.

| N | n | % Defect Prevention |
|--------|----|---------------------|
| 500 | 10 | 99.97 |
| 4000 | 20 | 99.9925 |
| 32000 | 40 | 99.99812 |
| 256000 | 80 | 99.99953 |

We can see that for even unreasonably large sizes of N, the optimum subsystem size, n, remains well below 100.

The units that comprise N and n are arbitrary, and may represent major functions, MACRO instructions, or assembler-level operations. In fact, the same formula will work perfectly well at the inter-module level to determine number of subroutines. This formula also affects the "primitive" size criteria, and is therefore potent ammunition in the debate on the use of MACRO's or high-level languages.

Adoption of the proposed guideline on subsystem size will help to eliminate the percent of defects which are found in a program; the debugging operation therefore can begin at a much higher baseline of confidence. The result will be a program of fewer "bugs" and of higher quality than if a "rational" or "obvious" approach to modular division is used.

RICHARD D. BECK
West Hempstead, New York

A beautiful thing

I immensely enjoyed E. J. Gaudion's article, "Today IBM Announces Yesterday," in your February issue (p. 53). It along with the others on virtual storage hardware, software, and operations are very informative.

However, Mr. Gaudion did leave some things out of the article that left it somewhat incomplete. The B5000 crew might have stumbled on the simple stack and point concept, but the IBM crew had too; witness the 7070 with its stacking latches and record definition words that were announced in 1960 and installed in 1961. With RDW's all you did was manipulate your I/O areas in a RDW table or tables. It was a beautiful thing. One of my big disappointments about the S/360 has always been that IBM did not choose to implement the RDW concept in those systems, and users of the 7070 retrogressed to moving "great rafts of data about." To this day, because of this, 7070s can still in many cases tape sort faster than S/360s of comparable cpu power.

I was fortunate enough to see the B5000 in the early 1962 BEMA show in the then-new New York Coliseum. It was truly a cpu system that was far ahead of its time. It is too bad that Burroughs could not or did not exploit the B5000 properly, for it could have significantly lessened IBM's hold, then and now, on the computer marketplace. So much so, that if it had been properly marketed and installed, IBM and the Justice Department might not be in the courts today.

It, as a second-generation system, could and does do a lot of things that the third-generation systems can't and

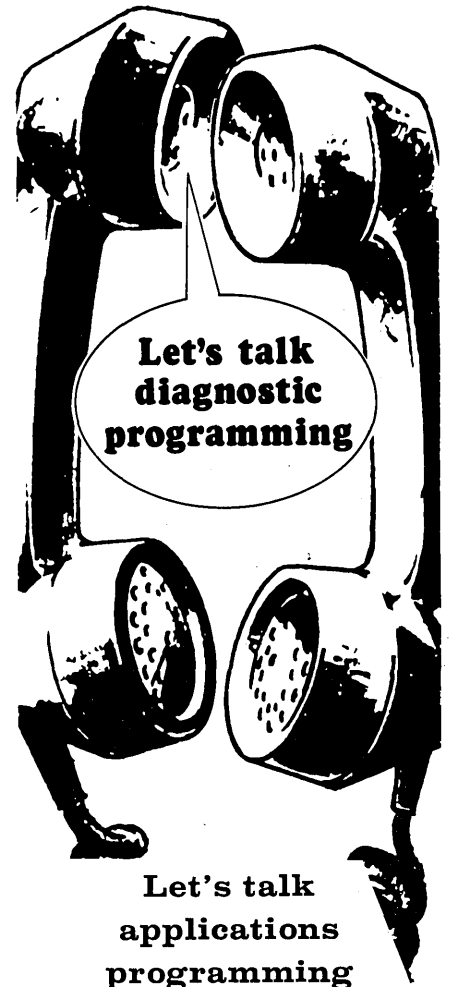

Let's talk
applications
programming

As one of the leading innovators in the telephone industry, we'd like to talk Applications Programming with you.

We are seeking several individuals to perform as Applications Programmers within our Systems Programming area. Major responsibilities would be in the design and development of executive control programs, man-machine interface routines and billing type programs for toll and central office electronic switching systems.

These positions require 2 to 5 years experience in one or more of the above programming areas which must have been performed on a real-time, stored program, electronic switching system using assembly language. A B.S. or M.S. in Electrical Engineering or Computer Science is desirable.

Interested? Please send resume and salary requirements to:

Mr. Dennis Kave
Professional Employment

GTE AUTOMATIC
ELECTRIC
LABORATORIES

400 North Wolf Road, Northlake, Ill. 60164
An Equal Opportunity Employer

CIRCLE 130 ON READER CARD

New Computer Salary Data-

and proven career advancement techniques—yours free.

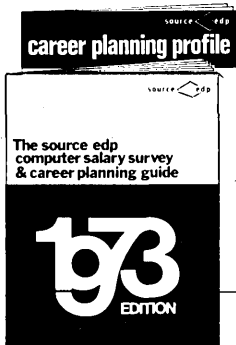

The seventh annual Source EDP Computer Salary Survey and Career Planning Guide and the all new Career Planning Profile are now available. These important reports allow you to rank your current salary with those of your peers, pinpoint the strengths and weaknesses of your experience to date and apply proven advancement techniques to your career plan.

All of this vital information has been compiled by Source EDP, the largest and most ethical nationwide recruiting firm devoted solely to computer professionals. To speed delivery of your free copies call, write or visit your nearest Source EDP office or circle the reader inquiry card.



- ATLANTA—W. G. Barnett
11 Corporate Sq. 30329, (404) 634-5127
- CHICAGO—T. D. Walsh
100 S. Wacker Dr. 60606, (312) 782-0857, 903 Commerce Dr., Oak Brook, Ill. 60521, (312) 323-8980 and 550 Frontage Rd., Northfield, Ill. 60093, (312) 446-8395
- DALLAS—P. E. Dittmer
7701 Stemmons Fwy. 75247, (214) 638-4080
- DETROIT—R. T. Stevens
24500 Northwestern Hwy., Southfield, Mich. 48075, (313) 352-6520
- HOUSTON—S. A. Love
4040 Southwest Fwy. 77027, (713) 626-8705
- LOS ANGELES—W. B. Emigh
3550 Wilshire Blvd. 90010, (213) 386-5500
- MINNEAPOLIS—F. N. Anderson
801 Nicollet Mall 55402, (612) 332-8735
- NEW YORK—J. R. Masi
600 Third Ave. 10016, (212) 682-1160
- PALO ALTO—G. F. Best
525 University Ave. 94301, (415) 328-7155
- PHILADELPHIA—G. P. Ramming
1700 Market St. 19103, (215) 665-1717
- ST. LOUIS—R. H. Trumbull
130 S. Bemiston Ave., Clayton, Mo. 63105, (314) 862-3800
- SAN FRANCISCO—R. M. Clark
111 Pine St. 94111, (415) 434-2410
- UNION, N.J.—D. A. Mickel
2400 Morris Ave. 07083, (201) 687-8700

Client companies assume our charges.

letters

don't do. Unfortunately, neither the direct access storage devices nor control program techniques of that "long" ago time had reached the level of sophistication that they attained a relatively short time later. If they had, it might have been Snow White, Prince Charming, and the Dwarves.

The other thing is, that though RCA was the first to announce "Virtual Memory" to the public, the term was in use in all of the shops long before that time. The "old" saw—"If you have it, and know you have it, its *real*; if you have it, but don't know you have it, its *transparent*; and if you don't have it, but think you have it, its *virtual*!"—was around in 1969, to my knowledge, and very possibly before that.

S. O. BRAND
Syracuse, New York

Same difference

In News in Perspective, "Japan: Filling the Gaps in Software" (Oct., p. 116), Jerry Levine said that "... the i/o formats are completely different from the U.S." but I don't feel that they are "completely different."

In Japan the first computer, Univac 120, was installed in 1955. IBM came later. After U.S. computers were introduced, Japanese major electric companies started to produce computers with the help of U.S. computer makers. Although "more than half the computers in Japan are not IBM," as Levine said, IBM computers are still best sellers. Thus, Japanese computer makers are following on IBM like other U.S. computer makers. Although it is true that the user faces conversion difficulties as Levine claimed, the difficulties are the same that U.S. users face.

YUZO FUJIOKA
Tokyo, Japan

Wankelized

Re: "The Potential of Complex-Time Computing," by Jackson Granholm (Feb., p. 71):

Congratulations on your publishing such a thought-provoking article. Promulgation of the simple concepts of complex-time computing has long been overdue. Your readers might be interested in knowing that the JCN Corporation has recently installed a new computer (96x10⁻¹⁰K core storage) at its corporate headquarters in Monrovia. This unique computer is based on the theories of *peripheral irrelevance* and *imaginary time/space*, both of which have been derived (Frank Schubert, *Notes From the Unfinished Ca-*

cophony, 1974) from complex-time computing. The designers of this computer succeeded in applying complex-time concepts by introducing a very basic variation known as *wankelizing the i-clock*. This is readily illustrated below:

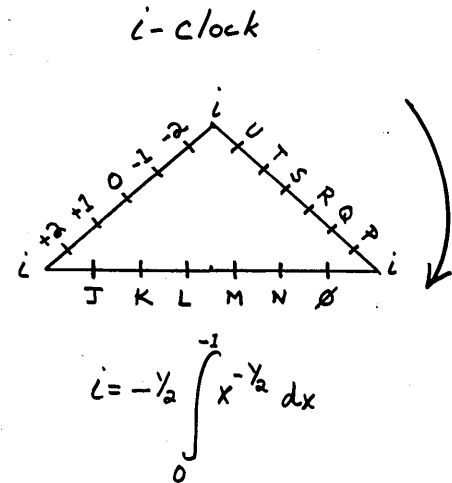

Since it is intuitively obvious how the clock's triangulation solved the inherent problem of complex-time, I will merely conclude by urging the editors to continue providing the data processing community with such erudite articles.

DAVID P. WACSHMAN
New York, New York

Sur-real-time

There was a follow-up on the work of Nattkarl et al. S. O. Beatrice and L. S. Dante (*Proceedings of the Clandestine Meetings of the Seventh NOR Gate* [translated from the Portuguese], Peking Duck Press, Nov. 1969) described the practical applications of complex-time—although they prefer to call it sur-real-time to show it's a complement of real-time—computing in the socio-econo-militio-hamburgro environment. In fact, if J. Granholm had been the least bit observant, he would know that complex-time (or, according to Beatrice and Dante, sur-real-time) computing played a major role in production of our national pronouncements.

M. CHIN
Falls Church, Virginia

DATAMATION welcomes correspondence about the computer industry and its effects on society, as well as comments on the contents of this publication. Letters should be typed if possible, and brief. We reserve the right to edit or select excerpts from letters submitted to us. Write to 1801 S. La Cienega Blvd., Los Angeles, CA 90035.

advertisers' index

International Computers Limited ... 166
 Intel Corporation ... 36

Kennedy Co. ... Cover 2

Lockheed Electronics, Data
 Products Division ... 134

Management Information Service ... 97
 Memory Technology Incorporated ... 174
 Methods Research ... 116
 Micro Switch, A Division
 of Honeywell ... 104, 105
 Microdata Corporation ... 2
 M&M Computer Industries, Inc. ... 28, 29
 Modular Computer Systems ... 37
 Mohawk Data Sciences
 Corp. ... 77, 98, 99, 114, 115

NCR Computers & Terminals ... 44, 45

Olivetti Corporation of America ... 26

PHI Computer Services, Inc.,
 A Subsidiary of
 Wang Laboratories, Inc. ... 14
 Board of Public Education,
 Pittsburgh, Pennsylvania ... 144
 Precision Instrument ... 147
 Progress Electronics ... 164

Quest Systems Inc. ... 166

Raytheon Data Systems ... 40, 132, 133
 RCA Service Company, A
 Division of RCA,
 Technical Products Service ... 135
 RSVP Services ... 172
 Rusco Electronic Systems, A
 Rusco Industries Company ... 121

Sanders Data Systems, Inc. ... 146
 Science Accessories Corp. ... 129
 Scott Graphics, Inc., A
 Subsidiary of Scott Paper
 Co. ... 38, 39

The Singer Company,
 Kearfott Division,
 Tele-Signal Operation ... 31

Skycab, A Service of
 Shulman Air Freight ... 101
 Software Design Associates ... 172
 Source EDP ... 170
 Southern Pacific Communications
 Company ... 41
 Springfield Personnel Agency,
 Inc. ... 176
 Sycor Inc. ... 9
 SynerGraphics Inc. ... 153

Tally Corporation ... 1
 T-Bar Incorporated ... 4
 TEC, Incorporated ... 112
 Teletype Corporation ... 82, 83, Cover 4
 Telex Computer Products, Inc. ... 42, 43
 Texas Instruments Incorporated,
 Digital Systems Division ... 103
 3M Company ... 155
 3M Company, Data Products ... 12
 Time Share Peripherals
 Corporation ... 144

United Air Lines ... 33

Versatec, Inc. ... 150

Video Systems Corp. ... 161

PROGRAMMERS

IMMEDIATE OPENINGS With A FIRM ON THE MOVE!

We are a five year old data processing consulting firm with a solid reputation earned with hard work and talent! Our growth has created several openings on our technical staff for qualified professionals. If you know computers, have at least 2 years experience and want to apply your skills to a variety of applications, languages, and computers, talk with us! We now have specific openings for programmers experienced in:

IBM 360/370 BAL ANS COBOL

ADDITIONAL OPENINGS EXIST FOR COMPUTER GENERALISTS WITH OTHER BACKGROUNDS

We offer competitive salaries and benefits, outstanding personal and professional growth, and a congenial working environment! Send your resumes in confidence to:

Director, Technical Staff

(212) 686-2032
 18 East 41st Street
 New York, New York 10017
 An Equal Opportunity Employer

SOFTWARE
 DESIGN
 ASSOCIATES

CIRCLE 124 ON READER CARD

FREE EMPLOYMENT SERVICE FOR PROGRAMMERS AND ANALYSTS NY/NJ/PA/CONN/DEL/MD/DC/VA and other eastern and national locations



RSVP will provide free employment counselling and develop and selectively distribute your resume.

Typical openings (not necessarily current) include systems programming (SYSGEN, maintenance) and applications for IBM 360 OS/DOS and Univac 1108 Exec 8/Exec 2; telecommunications / teleprocessing / on-line systems; BTAM/QTAM; BOMP/PICS/IMS; ABM/orbital analysis/radar systems; urban/social/transportation; OR/simulation/modeling; minicomputer software and applications; data base design; operating systems/compilers/data management; customer engineering; computer and peripheral marketing/sales; COBOL/FORTRAN / PL-1 / Assemblers; manufacturing/insurance/banking/brokerage/hospital/distribution/military.

Call or send resume or rough notes of objectives, salary, location restrictions, education and experience to any of our offices. Or check the reader service card for a free sample resume and sample job descriptions. We will answer all correspondence from U.S. citizens and permanent residents.

● Howard Levin, Director, RSVP SERVICES, Dept. M, One Cherry Hill Mall, Suite 714, CHERRY HILL, NEW JERSEY 08034, (609) 667-4488 ● Charlie Cooke, Manager, RSVP SERVICES, Dept. M, Suite 104, Towle Building, 1777 Walton Road, BLUE BELL, PENNA. 19422, (215) 643-5550 ● Bill Baxter, Manager, RSVP SERVICES, Dept. M, Suite 519, 1651 Old Meadow Road, McLEAN, VIRGINIA 22101, (703) 790-5166.

RSVP SERVICES

employment agency for computer professionals

CIRCLE 123 ON READER CARD

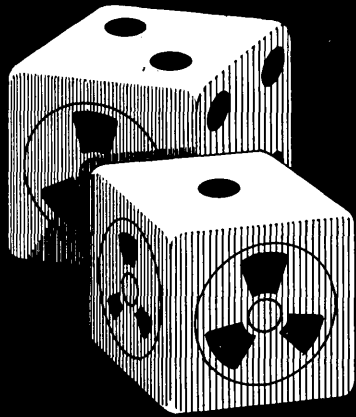

ESP ASSOCIATES takes the gamble out of COMPUTER CAREER ADVANCEMENT

Whenever you accept a new position you are, to some extent, gambling. You hope for increased income potential, more challenge, better working conditions and position advancement. And all too often one or all of your objectives simply fail to materialize.

Before accepting any new position you should make sure that you can see, evaluate, and compare the maximum number of opportunities available to you. You can do this easily. Simply contact your nearest ESP Associates office. We'll show you more opportunities than you've ever seen before, both locally . . . and nationally, if you want to relocate.

ESP Associates is a select group of top professionals in Computer Career Advancement. We'll give you real "inside information" on the computer opportunities market and provide you with solid career advancement advice. We'll represent your interests professionally, confidentially and most effectively. Our services are paid by employers, so there's absolutely no charge to you.

So, where's the gamble?



DALLAS:
Data Processing Careers (214) 637-6360

DETROIT:
Electronic Systems Personnel . . (313) 872-7855

KANSAS CITY:
Electronic Systems Personnel . . (816) 421-4200

LOS ANGELES:
Career Data Personnel (213) 380-2200

MIAMI:
AGA Associates (305) 649-8250

MILWAUKEE:
EDP Consultants, Inc. (414) 475-0077

MINNEAPOLIS:
Electronic Systems Personnel . . (612) 338-6714

NEW ORLEANS:
Electronic Systems Placement . . (504) 581-6848

PITTSBURGH:
Electronic Systems Personnel . . (412) 391-6450

WASHINGTON D.C.
ESP Associates (202) 833-8040

| | |
|-------------------------------------------------------------------|----------|
| Western Union Data Services Company | 151 |
| Westinghouse Canada Limited, Electronics Systems Division | 165 |
| Wilson Jones, A Division of Swingline Inc. | 125 |
| Wright Line, A Division of Barry Wright Corporation | 32 |
| Xerox Corporation | 64, 65 |
| Xynetics, Inc. | 136, 137 |

Technical Publishing Company

Arthur L. Rice, Jr., President
Gardner F. Landon, Exec. Vice President
James B. Tafel, Exec. Vice President
Calverd F. Jacobson, Financial Vice President
Edwin C. Prouty, Jr., Secretary and Director of Data Processing

Advertising Offices

Sales Manager and Vice President
John Brennan: Greenwich, Ct. 06830
35 Mason St. (203) 661-5400

Eastern District Managers
A. Treat Walker, Irwin L. Werfel,
Warren A. Tibbetts: Greenwich, Ct. 06830
35 Mason St. (203) 661-5400

New England District Manager & Vice President
Warren A. Tibbetts: Manchester, N.H. 03104
112 W. Haven Rd.
(603) 625-9498

Midwest District Manager
John M. Gleason: Chicago, Ill. 60606
205 W. Wacker Drive
(312) 346-1026

Western Manager and Senior Vice President
Hamilton S. Styron: Los Angeles, Calif. 90035
1801 S. La Cienega Blvd.
(213) 559-5111

District Manager
Alan Bolté, Jr.: Los Angeles, Calif. 90035
1801 S. La Cienega Blvd.
(213) 559-5111

Western District Manager
James E. Filatrault: Redwood City, Ca. 94061
61 Renato Ct.
(415) 364-3171

England and Western Europe
Wallace K. Ponder: Wallace K. Ponder Co.
Pinner, Middlesex HA 5 1JU,
England
31 Lyncroft Avenue
(01) 868-9289

Other Magazines

Plant Engineering Pollution Engineering
Power Engineering Purchasing World
Research/Development

Beat the Big One...
Heart Attack
Give Heart Fund 

In 1948 when
we first hung out
our shingle, we
were just about the
only specialized
personnel service.

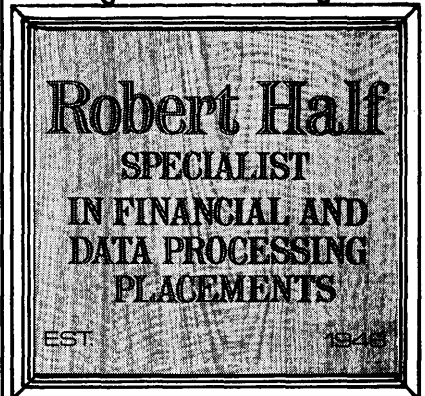

| | |
|-------------------------------------------------------------------------------|------------------------------------------------------------------------|
| ALLEN TOWN Hotel Traveler Building (215) 439-1506 | MILWAUKEE 633 West Wisconsin Ave. (414) 271-9380 |
| ATLANTA 3379 Peachtree Road, N.E. (404) 233-2416 | MINNEAPOLIS 822 Marquette Ave. (612) 336-8636 |
| BALTIMORE The Quadrangle—Cross Keys (301) 523-7770 | NEWARK 1180 Raymond Blvd. (201) 852-3581 |
| BOSTON 140 Federal St. (617) 423-6440 | NEW YORK 330 Madison Ave. (212) 888-1500 |
| CHARLOTTE 4801 E. Independence Blvd. (704) 535-3370 | ONTARIO, CAL. P. O. Box 1656 (714) 835-4103 |
| CHICAGO 833 N. Michigan Ave. (312) 782-6930 | PHILADELPHIA 2 Penn Center Plaza (215) 568-4580 |
| CINCINNATI 606 Terrace Hilton (513) 621-7711 | PHOENIX 1517 Del Webb TowneHouse (602) 279-1688 |
| CLEVELAND 1367 E. 9th St. (216) 621-0670 | PITTSBURGH Gateway Towers (412) 471-5846 |
| DALLAS 2001 Bryan Tower (214) 742-9171 | PORTLAND, ORE. 610 S.W. Alder St. (503) 224-9776 |
| DENVER 1612 Court Place (303) 244-2925 | PROVIDENCE 400 Turks Head Bldg. (401) 274-8700 |
| DETROIT 870 Honeywell Center Southfield (313) 354-1535 | ST. LOUIS 7733 Forsyth Blvd., Clayton (314) 727-1535 |
| HARTFORD 111 Pearl St. (203) 278-7170 | SAN FRANCISCO 111 Pine St. (415) 434-1900 |
| HOUSTON 1200 Central Nat'l. Bank Bldg. (713) 228-0056 | SAN JOSE 875 North First St. (408) 293-9040 |
| INDIANAPOLIS 5 North Illinois St. (317) 636-5441 | STAMFORD, CONN. 111 Prospect St. (203) 323-4158 |
| KANSAS CITY, MO. 127 West 10th St. (816) 474-4583 | TORONTO 15 Toronto St. (416) 869-8114 |
| LONG ISLAND 420 Jericho Turnpike Jericho, N.Y. (516) 822-8080 | WASHINGTON, D.C. 7316 Wisconsin Ave., N.W. (301) 654-1850 |
| LOS ANGELES 5600 Wilshire Blvd. (213) 381-7974 | WILMINGTON, DEL. 1102 West St. (302) 652-3244 |
| MEMPHIS 2 S. Main St. (901) 527-7324 | |
| MIAMI 1190 N.E. 163 St. North Miami Beach (305) 947-0684 | |



Contact your nearby
Robert Half office
for your free copy of the
1973 Prevailing
Starting Salaries booklet.



370/155 users... save up to \$14,000 a month.

Your IBM 155 memory can be quickly upgraded or replaced at dramatic savings. The semiconductor MTI 755 with Uniport™ provides a monthly savings in both your memory rental and CPU rental.

Eliminating the need for dual Storage Adapters, MTI 755 Uniport eliminates the time consuming CPU upgrades normally needed when increasing memory. Typically, any configuration can be upgraded to 2M Bytes in less than 8 hours.

Your 155 can be upgraded to surpass 158 main memory capacity. An MTI-755 add-on memory lets you add up to 4M Bytes while it upgrades from magnetic core to the latest semiconductor technology.

If you're thinking about replacing or adding to your present 155 memory or evaluating a 158, why not find out how we can help you save money, space, and get new flexibility within your present configuration. Call James Crough, (617) 443-9911, Memory Technology, Inc., 83 Boston Post Road, Sudbury, Massachusetts 01776.



CIRCLE 32 ON READER CARD

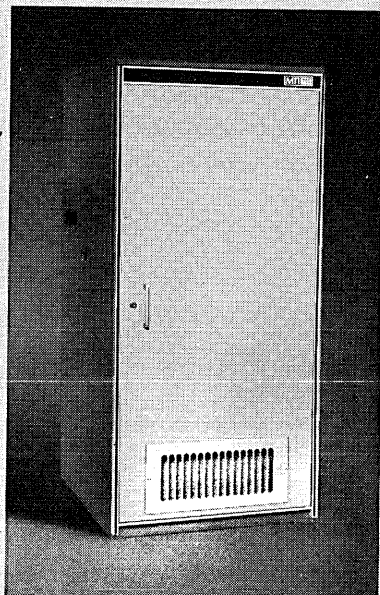

This forum is offered for readers who want to express their opinion on any aspect of information processing. Your contributions are invited.

The Forum

In Defense of IBM

The Justice Department has dropped the other shoe (albeit gingerly), reiterated its 1969 prayer for relief and asked for the break-up of IBM. A chorus of voices has joined the department in urging the curbing of the monopoly power allegedly exercised by IBM.

Few voices have been raised in defense of IBM, yet rationality demands that those deeply involved in the industry speak out and take a stand. The potential danger and impact of a shortsighted decision by our judicial system is too great to allow it to happen without due consideration by all those affected.

Is IBM a monopoly?

Whether IBM represents a monopoly or not in the legal sense is a question that can be answered only by legal experts familiar with the letter and the spirit of antitrust law and the intent of the Sherman Act. As a factual matter, however, IBM does constitute a monopoly in the U.S. in the sense that:

1. It controls market pricing policies.
2. It has 65-70% of the computer market and 90% of the punched card processor market.
3. It controls new developments through a research budget of \$540 million (larger than the sales of all but the top 250 corporations in the U.S.).
4. It controls market statistics and market data by a veil of secrecy over the largest data base, its own activities.
5. Its sales volume is so large that it alone can afford to develop highly sophisticated software systems, which can be amortized over 10 times the user base of its nearest competitor.
6. Its contracting practices are an insult to the users' intelligence.
7. It has a 12,000-man sales force blanketing the country.

IBM is *not* a monopoly in the sense that:

1. There is tremendous competition available to the uncommitted user.
2. IBM has fostered the growth of over 3,000 companies in peripheral and related fields.

Benefits of IBM's position

IBM's role as a "virtual" monopoly has had some benefits for the industry and the economy as well.

1. The present level of 85,000 U.S.-based computers includes at least 25-30,000 systems sold by IBM *where the idea of a computer in the organization originated with IBM*. In other words, these systems were installed as a result of salesmanship, born out of a majority position. Thus, without IBM, the industry could be at least 30-40% smaller.

2. The "de facto" standardization imposed by an IBM-dominated computer industry has made it possible to develop an independent software package industry. Without IBM's 50,000 360/370 systems, few software houses would find it economical to build a software package for the diversity of systems which would then be in the field.

3. The peripheral equipment business, supplies business, and forms business would be far less profitable (if even extant) were it not for the dominance of one manufacturer. The peripheral industry, for example, would find it hard to make a profit, if it had to interface with 10 different computers.

The requested relief

Justice has asked for "the formation of the total domestic and international computer systems facilities of IBM . . . into several discrete, separate, independent and competitively balanced entities . . ." This does not exactly give clear guidelines as to how the corporation is to be split. A brief examination of alternatives seems to indicate difficulties regardless of which break-up method is used.

In general, regardless of method, if IBM were to be divided into, say, three roughly equal pieces, each would account for over \$3 billion in sales, and each thus would be larger than any other competitor in the field. This could treble competition, which would *not* inure to the benefit of the current competitors. Fighting three IBM's is bound to be more difficult than fighting one.

If, on the other hand, IBM were broken into a sufficient number of pieces so that each piece would be comparable in size to its competitors, a chaotic industry would result. Dividing IBM into 15 pieces, for example, give each sales of \$600 million. On balance, however, this would destroy the industry, or create a wholly uneconomic environment. The price of computers would have to be increased as a result of the inevitable reversal of the "economy of scale" phenomenon, and the increased overhead, marketing cost, and research of the resultant companies. Since the Sherman Act was intended to benefit the consumer, this does not seem too practical.

Alternative methods

There are three possible ways to break up any company—vertically, by product line, or geographically.

1. *Vertical.* Data Processing Financial & General (now DPF) on January 13, 1969, filed an antitrust suit against IBM, which was subsequently settled. In it plaintiff asked for the divorce of IBM's manufacturing and sales activities from its leasing, software, and maintenance activities, and in fact

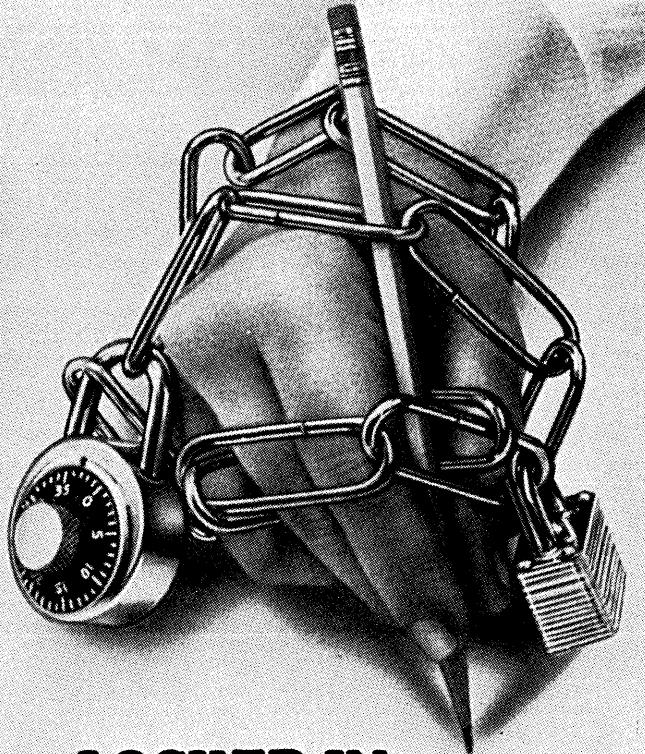

LOCKED IN— TO DULL PROGRAMMING?

Exciting jobs and better pay in Programming are all around you these days. SPRINGFIELD can help you find the work you want to do—spring you loose from monotonous routine and dead-end work. To have us open new doors to your future, simply send us your resume or call us today. Key jobs are waiting!

SPRINGFIELD
Personnel Agency, Inc.
11 EAST 44TH. STREET
NEW YORK, NEW YORK 10017
(212) 867-6200

CIRCLE 126 ON READER CARD

the forum

requested the formation of three corporations which could not use the name IBM. This relief was, of course, directed at DPF's leasing business and provided no assistance to other computer manufacturers. If one were to provide presumed relief to them, a split between manufacturing and marketing would have to be made as well.

This type of relief could create five companies. Unfortunately, the competitive end of the business would all be concentrated in the *marketing* company, which is where the competition (and the alleged monopolistic practices) manifest themselves. Computer costs would inevitably increase, since a "value-added tax" in the form of profits and overhead would have to be added to each stage. This alternative does not, therefore, accomplish the objectives of the Sherman Act.

2. *By product line.* Dividing IBM by product line could be more logical. This would mean separating typewriters, supplies, computers, and possibly software and maintenance. Separation of basic products is simple—a separate office products corporation would handle that product line. This accomplishes nothing, however, since IBM has already clearly made this separation, and since it adds no synergy to their computer sales. Separating components such as software and maintenance has the essential disadvantages of vertical separation and again fails to meet the objectives.

Within the computer product group, it would be possible to separate by product "size"; i.e., by performance of the systems. A "small" category could include System/3, System/7, the 1130, and possibly the 370/125. The remaining line could be equally divided, but to what avail? A user wishing to upgrade or add to his system would find himself with expensive problems of rental contract cancellation with "Small IBM" in order to obtain a machine from "Medium IBM." Even if lease flexibility is retained, the return of machines to the different entities would have to be reflected in their price structures.

3. *Geographically.* A geographical split could be made more readily, assuming one can solve the problems of the larger corporations with multiple installations in various locations. Splitting World Trade from domestic has no impact on competition in either place, however, although it might increase product development or software costs. Splitting domestic IBM into regions (as in the landmark Standard Oil case) could be done with possibly minor benefits from a competitive viewpoint. But the computer industry is not like the oil industry. Investment requirements, research, product development, and software make up 20% of the product cost, even at IBM's volume. Reducing that volume must result in a price increase.

Toward a realistic solution

No one, including Justice, has bothered to analyze the impact of the requested relief, because no one really believes it can happen. To most observers it is essentially a negotiating gambit, a step toward achieving settlement along consent decree lines. It is a dangerous gambit, however, because the incredible complexity of the case can confuse the outcome and backfire.

Thus, if a consent decree is indeed the target of the Justice Department, why not frame the parameters of such a decree and present it to the industry so that a meaningful contribution can be made toward a realistic solution?

This is no longer the time for ritualistic negotiation. A solution is possible, if properly approached. The alternative is economic chaos in an industry whose national importance is about to exceed that of the automobile.

—Dick H. Brandon
President
Brandon Applied Systems, Inc.

You can tell a lot about BASF/Endura computer tape from the professionals who use it.



They're the people who demand more from a computer tape than just accuracy.

They want accuracy *plus* the kind of long-term savings they can really brag about.

They're Medical people. Data processing experts. Chemists. Researchers. Construction engineers. They're people whose tape has to meet today's requirements as well as future 3200/6400FCI expectations.

And BASF/Endura gives them what they need. With less wear and tear on tape heads. More hours of error-free performance. Greater savings now... and later on.

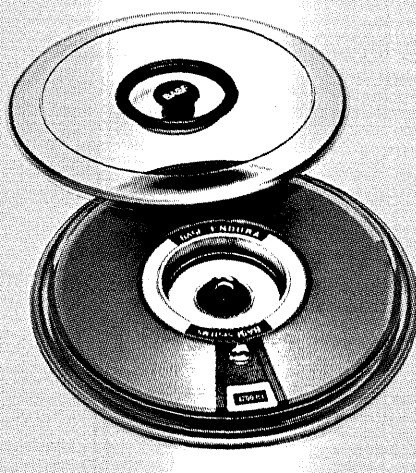

BASF/Endura. Every day all kinds of demanding people are finding new ways to make it pay.

Discover what it can do for you. Ask your local BASF Salesman for all the facts on BASF/Endura computer tape. Or write BASF SYSTEMS, Crosby Drive, Bedford, MA 01730.

BASF SYSTEMS
Division of BASF Wyandotte Corporation

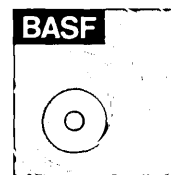

CIRCLE 2 ON READER CARD

BASF for people who really know.

Our new model 38 series.

Even the most
expensive ASR is
a very inexpensive
\$1480.

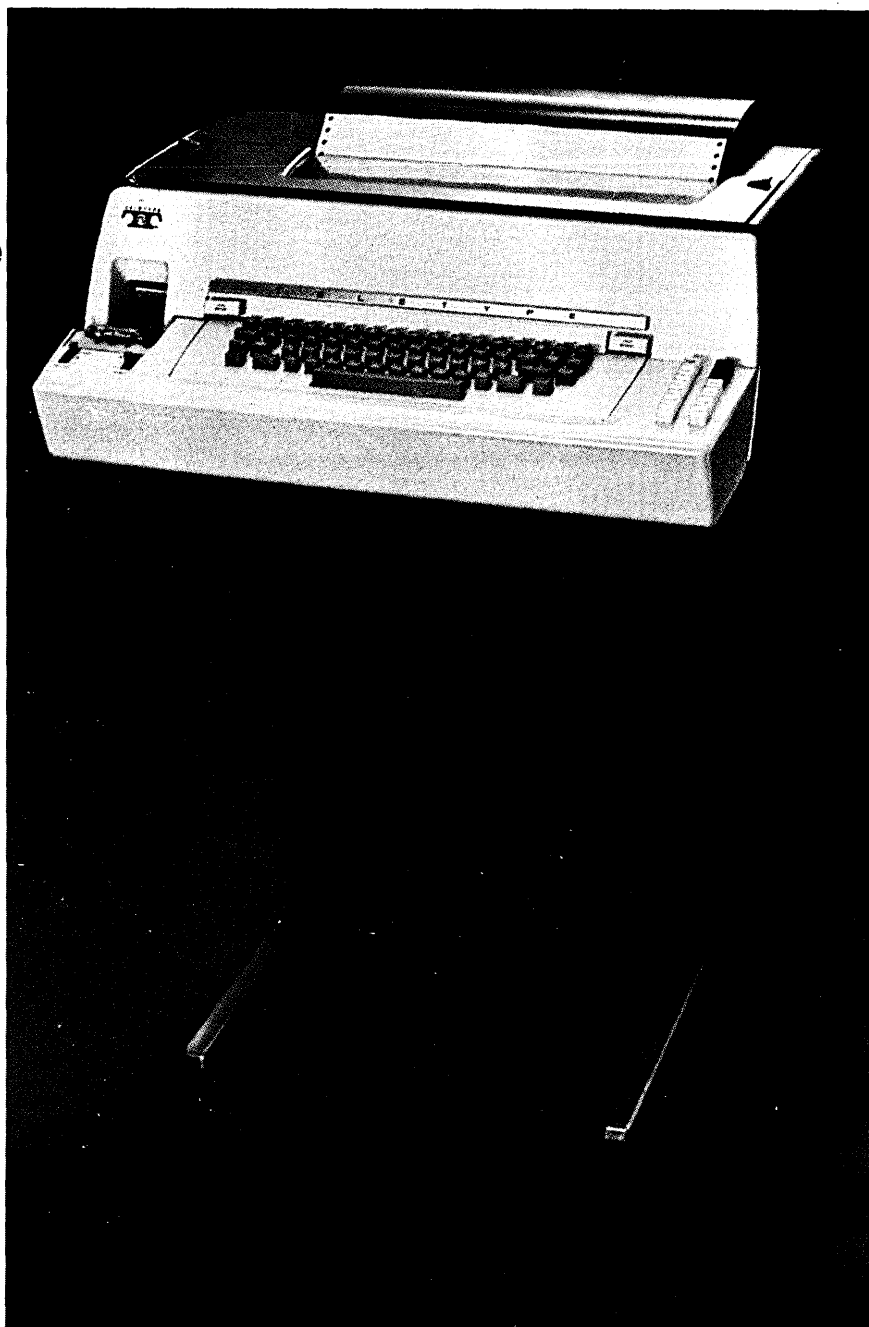

Teletype is a trademark registered in the United States Patent Office.

Just because you need big machine features, you don't have to pay big machine prices.

Not when you've got some new alternatives: the Teletype® model 38 series terminals. They offer a lot of features. For only a little money.

Prices for an RO model 38 start as low as \$937. KSR model 38 terminals begin at \$1209. Even ASR terminals go for as low as \$1452. And for about \$200, you can equip any of them with a built-in, factory-tested modem.

Standard equipment on all model 38 terminals is a 132-character printing format on a 15-inch wide platen. Upper and lower case is also standard. So is two-color printing.

Speed? 100 words per minute. If you need more—up to 2400 wpm—the model 38 interfaces with the Teletype 4210 magnetic tape data terminal.

There's more, too. Like plug-to-plug compatibility with the model 33. So you can update your system without changing it.

The new Teletype model 38 series terminals. Where else can you get so much for so little?

It takes more than manufacturing facilities to build the machines Teletype Corporation offers. It also takes commitment. From people who think service is as important as sales. In terminals for computers and point-to-point communications.

That's why we invented a new name for who we are and what we make. The computer-communications people.



For more information about any Teletype product, write or call: TERMINAL CENTRAL, Teletype Corporation, Dept. 81N, 5555 Touhy Avenue, Skokie, Illinois 60076. Phone 312/982-2500

*Prices subject to change without prior notice.