

DATA MATION 71[®]

August 15

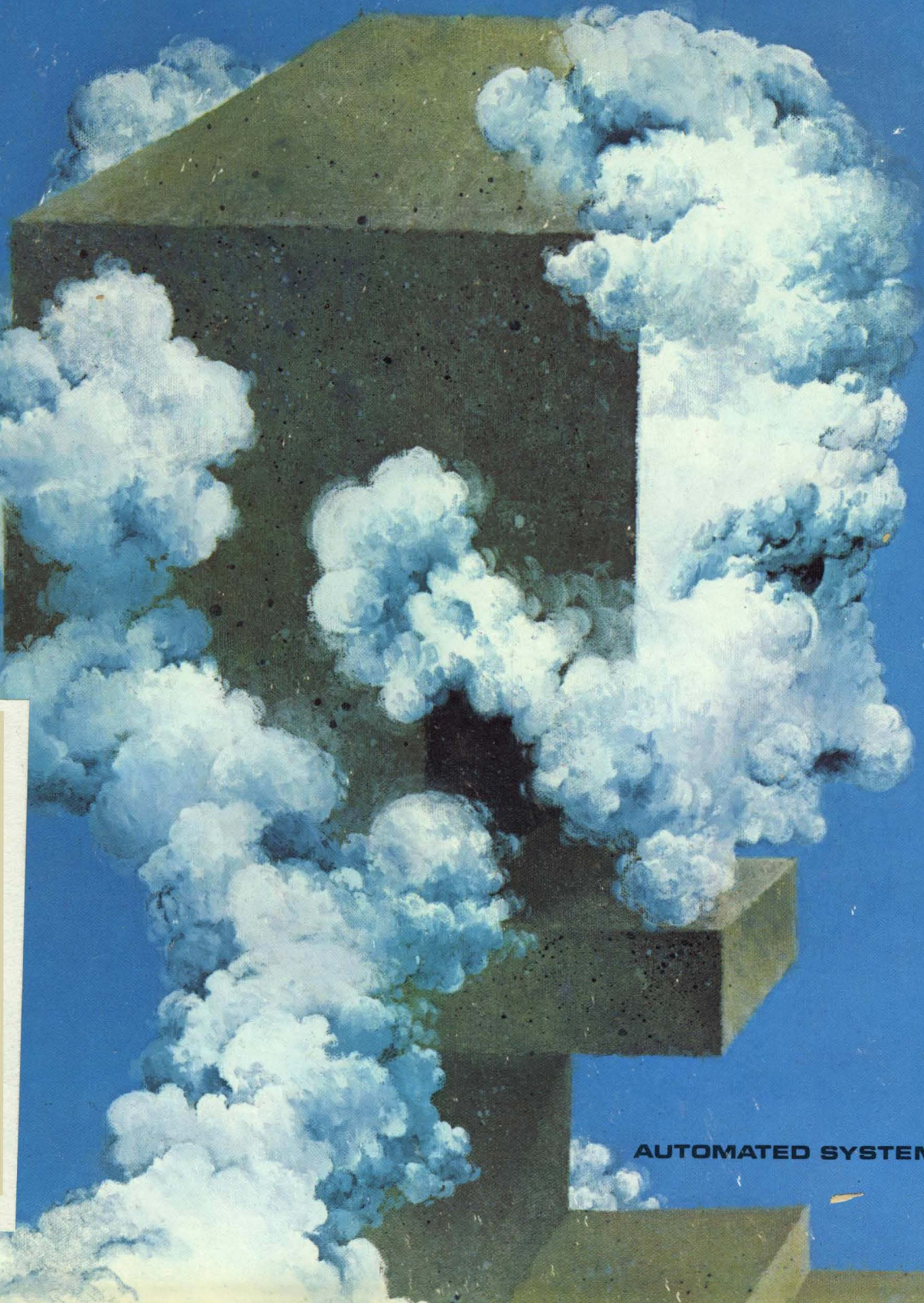

AUTOMATED SYSTEMS DESIGN

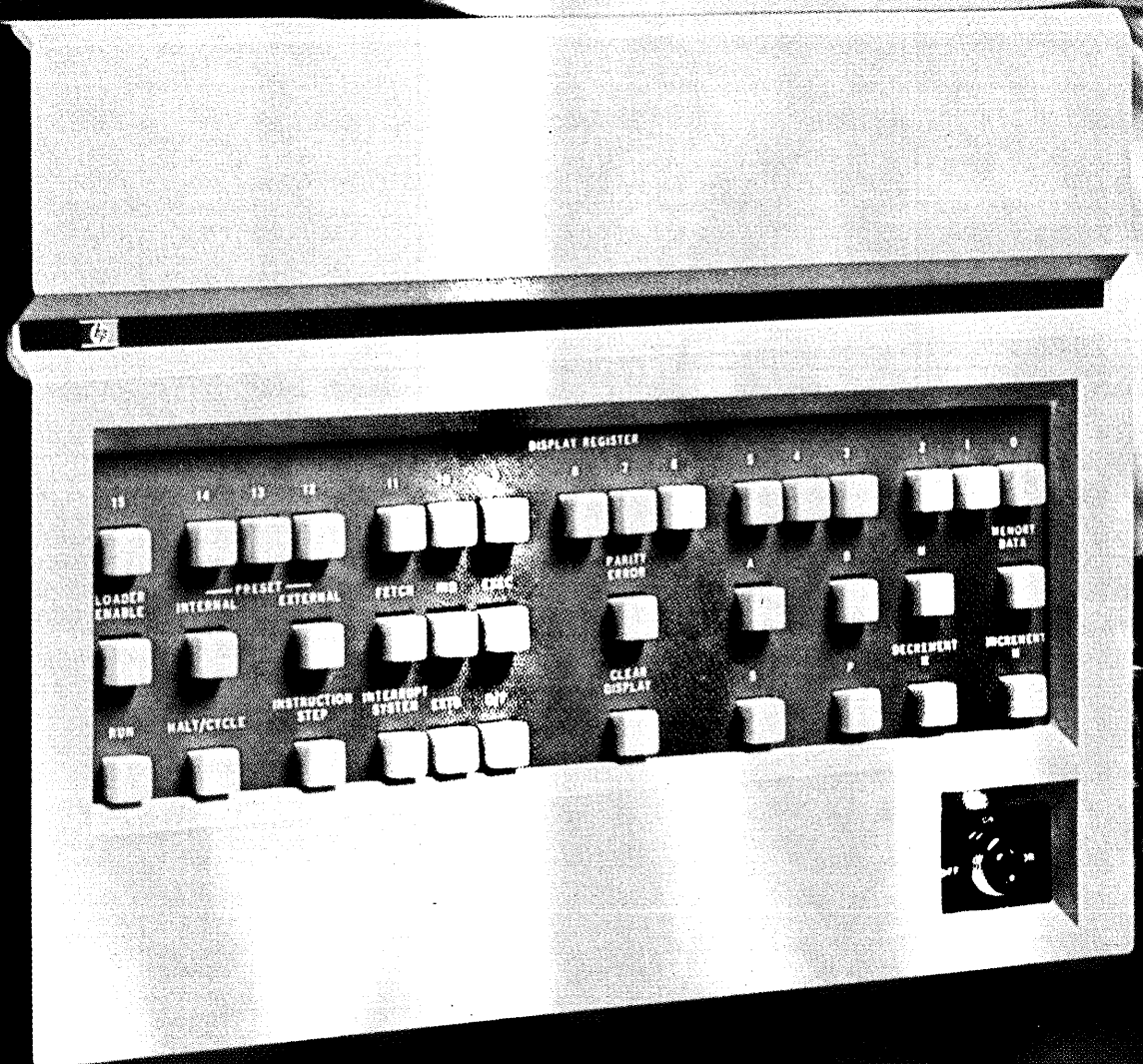

Meet the thoroughly modern mini- our new HP 2100 computer.

It's much more than a pretty new face.

It's a big step forward in small computers.

The HP 2100 combines all three of our earlier minicomputers in one. And its sub-microsecond memory makes it almost twice as fast as any of them. It's also much smaller. And you can expand from 4K to 32K in the same convenient mainframe.

This mainframe, incidentally, houses a thoroughly modern design—including the latest in MSI/LSI technology. Plus control Read Only Memory (ROM). Standard features usually found only in bigger systems include parity checking and hardware multiplication and division. And they won't put a big crimp in your budget. In fact, the HP 2100 is the most attractively priced mini we've ever offered.

Peripheral vision. The way we see it, a mini-computer just isn't modern if it can't communicate simply and easily with the outside world. So we designed the 2100 to go to work with more than a dozen peripherals. As well as 47 instruments. All you do is plug them in. Apart from saving your time, this also saves you a great deal of money. Because you don't have to design special interfaces. After all, why

should a user have to do a computer designer's job?

All kinds of software. The 2100 uses FORTRAN, ALGOL, and BASIC. And we give you the widest choice of operating software packages available with any small computer. Time-share, real-time, and batch processing are the three main categories. And they're all compatible with our twenty-five hundred earlier systems.

Rugged testing. Our 2100 passes rigid environmental tests with flying colors. (Other small computers would simply fly apart at 3000 oscillations a minute, if they didn't freeze up at 32° F or melt at 131° F.) But our mini can really take it. It will hold its own in just about any situation — without missing a bit.

Add to these benefits our traditional worldwide support. Consider our reputation for quality. Evaluate our field engineering and analyst back-up. Check out our customer training programs. It all adds up to a thoroughly modern package.

That's why our new mini is much more than a pretty face. So how about getting better acquainted? Call your HP computer specialist. Or write Hewlett-Packard, Palo Alto, California 94304; Europe: 1217 Meyrin-Geneva, Switzerland.

Be one of the first to see our thoroughly modern mini.
Visit HP at WESCON
Booth 1237
Brooks Hall, San Francisco

CIRCLE 1 ON READER CARD

22103

HEWLETT  PACKARD
DIGITAL COMPUTERS

Industrial-Minis

Today economic survival is a ten letter word . . . AUTOMATION. It's also our business. We design, build, and install computers in production and manufacturing automation systems to help you make, move, test, or count . . . better, faster, and at lower cost. We call them 'economic survival kits'.

General Automation has the best price-performance combination available . . . and we can prove it. You can get a balanced blend of hardware, software, and systems engineering from one source . . . GA. Hundreds of companies have purchased more than 1,000 of our reliable industrial computers for every imaginable application, and probably one like yours.

Thanks to recent technological advances, you

don't have to be an industrial giant to benefit. Small manufacturing plants can profitably incorporate automation with low cost GA 'worker' and 'supervisory' computer control systems . . . systems that stay on the job 24 hours a day, seven days a week . . . and never take a vacation.

Let GA show you how quickly you can profit with an 'economic survival kit', and how little it actually costs. Drop us a line on your letterhead. Tell us where you'd like to improve your productivity and we'll recommend an appropriate economic survival kit.



GENERAL AUTOMATION, INC.

1055 South East Street, Anaheim, California 92805
Telephone (714) 778-4800 TWX 910-595-1780

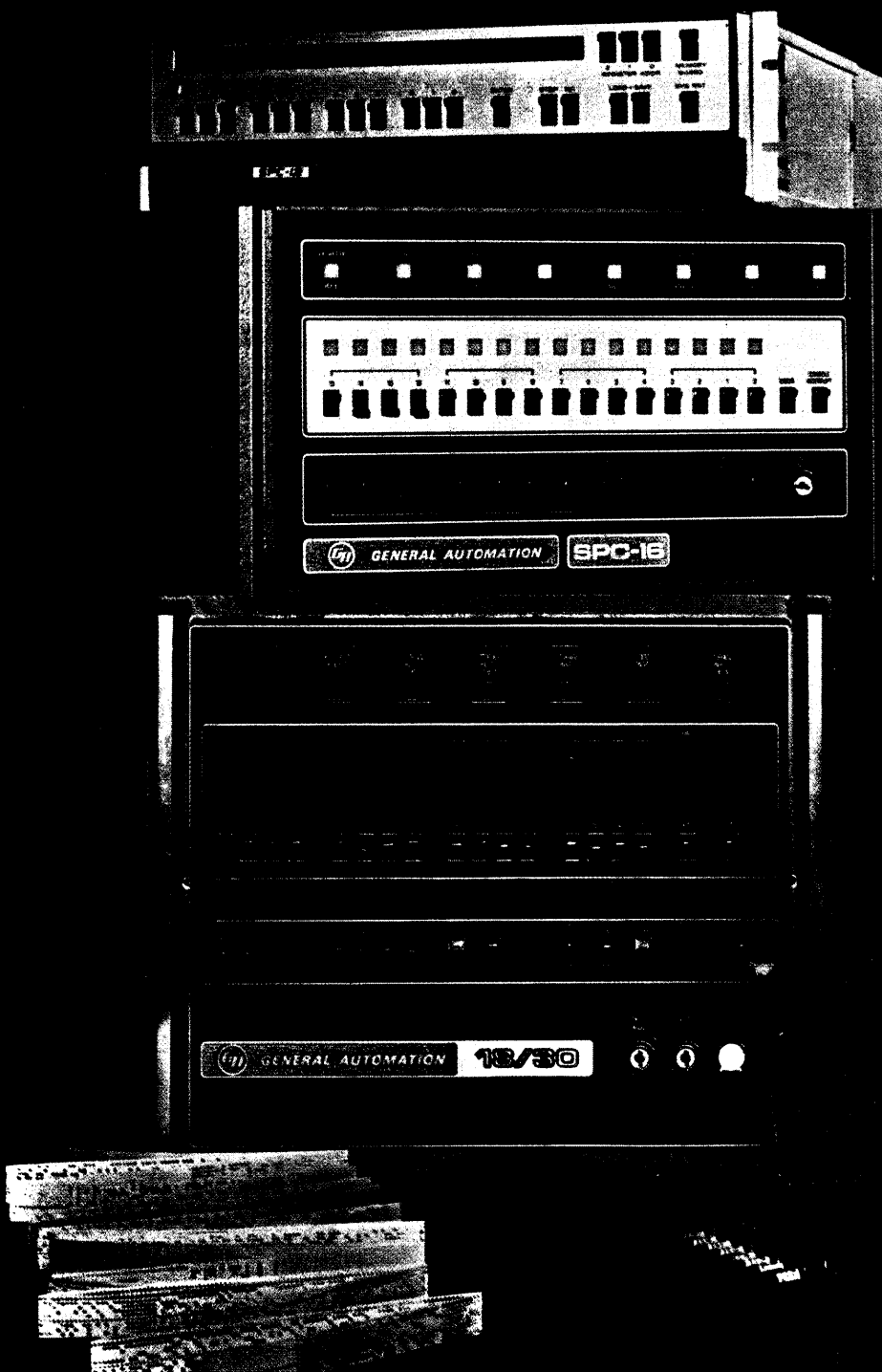

DATA⁷¹MATION[®]

AUGUST 15, 1971

volume 17 number 16

GENERAL

22 Automated System Analysis

ROBERT V. HEAD. With higher level languages now established, more attention is being paid to improving the job of basic system analysis.

TECHNICAL

25 Automation of System Building

DANIEL TEICHROEW and HASAN SAYANI. An alternative to the present method of building systems is to use the computer as an aid, a step toward complete automation.

MANAGEMENT

32 Finding Happiness in . . . Extended Core

MELVIN J. DURAO, JR. Larger and slower core storage increases throughput and decreases costs in the Fireman's Fund version of the Tortoise and the Hare.

COMMENTARY

38 Perspective

Harvard and IBM, involved since 1964 in a program on technology and society, may have found it was easier to invent the computer than determine what effect the invention is having on society. It's now learned the program is being "redirected." Some think this means it is being torpedoed.

departments

<i>Letters to the Editor</i>	7
<i>Look Ahead</i>	17
<i>Perspective</i>	38
<i>News Scene</i>	39
<i>Hardware</i>	49
<i>Software</i>	57
<i>People</i>	61
<i>Washington Report</i>	63
<i>Index to Advertisers</i>	64

About the Cover

The painting on our cover is by Ross Van Dusen. He sees system designers' heads as filled with very concrete facts and some blue sky as well. We agree both are useful when confronting the problems of analyzing the task of automating system design.

Our
CARD
READERS
have...

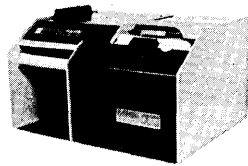

M 200

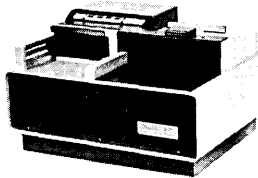

Heavy Duty

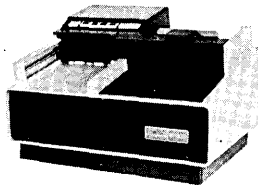

Slant-Top

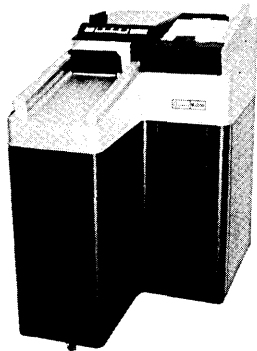

M 1200

...Close Family Ties

Every member of Documation's Card Reader Family is tied by a tradition of engineering excellence.

Documation has combined dependable performance and total reliability to produce card readers which are the highest standard of the peripheral industry.

M 200 An ideal, low cost card input companion for mini-computers. Reading speed: 300 cpm.

Heavy Duty These readers are the main stay of the family. They are constructed to withstand around-the-clock operation under the most adverse conditions.

Reading speeds: 300 cpm — 600 cpm — 1000 cpm.

Slant-Top This optional construction available on all Heavy Duty Models allows personnel to effortlessly load and unload on the fly. It offers the ultimate in smooth, fast card flow.

M 1200 This console fills the need for an economical, high speed, large capacity punched card reader. Reading speed: 1200 cpm.

The close family ties of Documation's Card Readers have been established by using solid construction, interchangeable parts and the most advanced engineering techniques. Every member of the Card Reader Family uses the same sophisticated vacuum picker mechanism and short, *jam-proof* card track.

DOCUMATION
INCORPORATED

841 East New Haven Avenue

Melbourne, Florida 32901 Telephone 305/724-1111

Call or Write...

"The
Card Reader
People"

CIRCLE 10 ON READER CARD

DATAMATION®

AUGUST 15, 1971

volume 17 number 16

This issue 110,533 copies

EDITOR
ROBERT B. FOREST

EDITORIAL STAFF

Managing Editor
Senior Associate Editors
Associate Editors

Copy Editor
Assistant Editors

Special Features Editor
Eastern Editor
New England Editor
Washington Editor
Midwestern Editor
Southwestern Editor
European Editor
Australian Editor
Contributing Editors

Editorial Adviser
Technical Consultant

EDWARD K. YASAKI
WILLIAM J. ROLPH, TOM McCUSKER
RICHARD A. McLAUGHLIN,
EDITH D. MYERS, JOHN T. WATERHOUSE
JANET EYLER
MICHAEL WILLIAM CASHMAN
ALMA O'STEEN
ANGELINE PANTAGES
F. BARRY NELSON
W. DAVID GARDNER
PHIL HIRSCH
LAWRENCE RAGAN
ROBERT F. ALEXANDER
PEARCE WRIGHT
FREDERICK A. BLAND
HOWARD BROMBERG, ROBERT V. HEAD,
PHILIP H. DORN, LOUIS B. MARIENTHAL,
MILTON M. STONE, F. G. WITHINGTON,
PAUL ARMER, ROBERT P. BIGELOW
ROBERT L. PATRICK
LOWELL AMDAHL

EDITORIAL OFFICES

HEADQUARTERS: 94 S. Los Robles Ave., Pasadena, Calif. 91101, Phone: (213) 681-8486; **EASTERN:** 35 Mason St., Greenwich, Conn. 06830, (203) 661-5400; 19 Marlborough St., Boston, Mass. 02116, (617) 267-9414; 9805 Singleton Dr., Bethesda, Md. 20034, (301) 365-8671; **MIDWESTERN:** 407 S. Dearborn St., Chicago, Ill. 60605, (312) 922-8245; **SOUTHWESTERN:** 2711 Cedar Springs, Dallas, Texas 75201, (214) 744-0161. **FOREIGN:** 65, Hill Road, Chelmsford, Essex, England; 322, Park Regis, Park St., Sydney, NSW 2000, Australia.

GRAPHIC DESIGN AND PRODUCTION

Art & Production Director
Production Manager
Production Assistant

CLEVE MARIE BOUTELL
MARILEE PITMAN
GLORIA J. FASANA

CIRCULATION

35 Mason Street
Greenwich, Conn. 06830
Circulation Manager
Marketing Research Director

MAE VAN RENNES
DOUGLAS DeCARLO

PUBLISHER

GARDNER F. LANDON
ASSOCIATE PUBLISHER
JAMES M. MORRIS

Circulation audited by
Business Publications Audit



Member, American
Business Press, Inc.



DATAMATION is published twice monthly on or about the first and fifteenth day of every month by Technical Publishing Company, 1301 South Grove Ave., Barrington, Illinois 60010; Arthur L. Rice Jr., President; Gardner F. Landon, Executive Vice President. Executive, Circulation and Advertising offices, 35 Mason Street, Greenwich, Conn. 06830 (203) 661-5400. Editorial offices, 94 So. Los Robles Avenue, Pasadena, California 91101. Published at Chicago, Ill.

DATAMATION is circulated without charge by name and title to certain qualified individuals who are employed by companies involved with automatic information handling equipment. Available to others by subscription at the rate of \$25 annually in the U.S. and Canada. Reduced rate for qualified students. Foreign subscriptions are on a paid basis only at a rate of \$38 annually. No subscription agency is authorized by us to solicit or take orders for subscriptions. Controlled circulation paid at Columbus, O. and Form 3579 to be sent to Technical Publishing Company, P.O. Box 2000, Greenwich, Conn. 06830. Copyright 1971, Technical Publishing Company. Microfilm copies of DATAMATION may be obtained from University Microfilms, A Xerox Company, 300 North Zeeb Road, Ann Arbor, Michigan 48106.

Printed by Beslow Associates, Inc.



At last! A realistic approach to Systems Analyst Training

Advanced Systems presents Version II of its popular Systems Analyst Training in new multi-media form. A systems analyst doesn't work in an intellectual vacuum. He works with real people and problems—like the ones you'll see in the new VAI (Video Assisted Instruction) Systems Analyst Training. Unlike lectures or books, this new kind of training captures the real feeling of the job. Stimulating problems and solutions are discussed and demonstrated on videotape by typical executives. The student gets involved—feels he is actually experiencing the job situation he will soon have to face. May we set up a demonstration showing for you soon?

A complete system of study units with role-playing and student experience built in.

Intensive Training with study units in non-technical areas such as

- System Method • Problem Definition • Data Gathering • Interviewing Techniques • Information Analysis • Presentation Techniques • Implementation Planning • Controls • Documentation.

In addition there are technical study units covering

- Data Base Concepts • Data Communications • Micromation • Systems Evaluation.

Each unit has specific objectives with an audio advisory session to review these objectives with the student.

Now available for your unlimited use on our low cost Purchase or Rental Plans



CORPORATE SALES OFFICES:
327 South LaSalle Street
Chicago, Illinois 60604 • 312/427-7277

Grow your own systems people



Sales Offices in: Atlanta • Boston • Chicago • Dallas • Detroit • Los Angeles • New York • Pittsburgh • San Francisco • Washington, D.C.

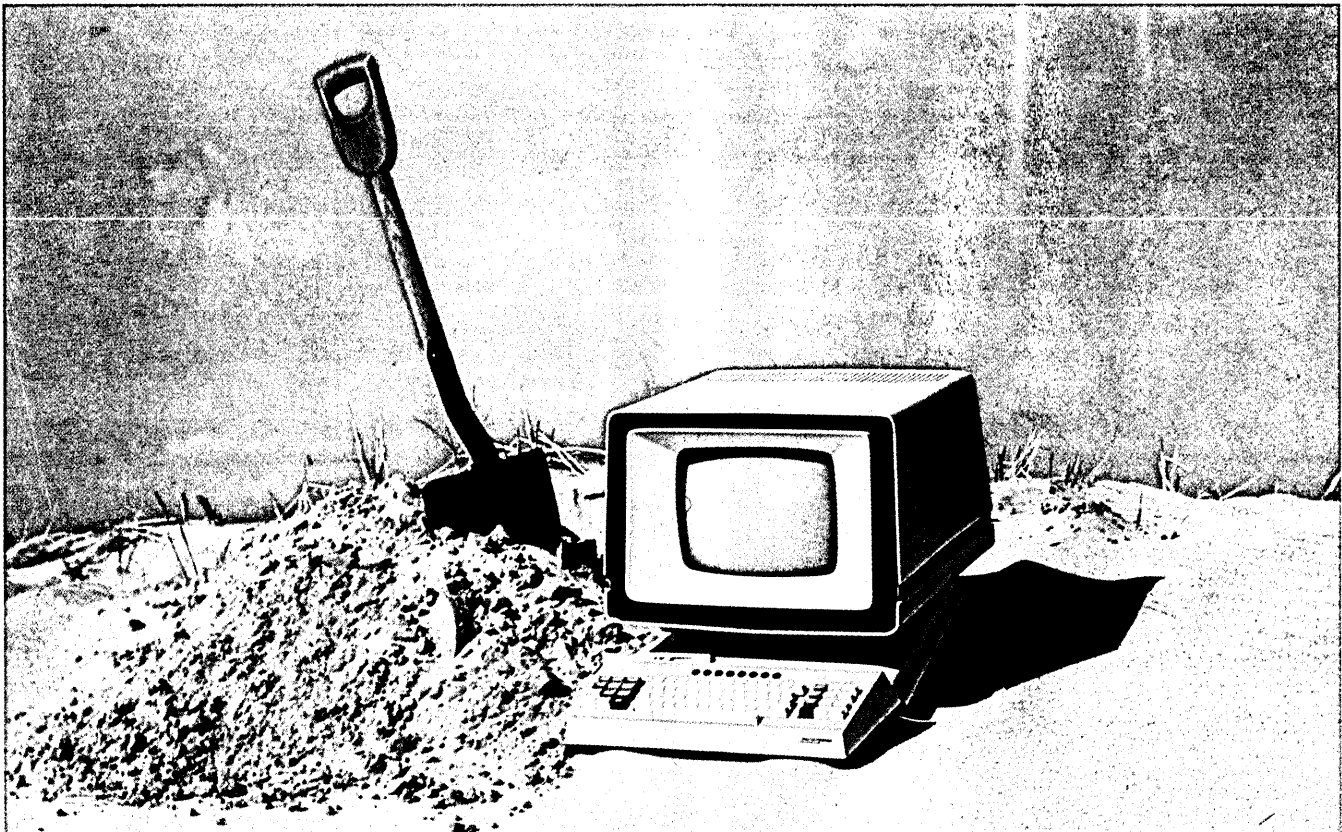

Treasurer's choice

Money men everywhere are digging the SPD™ 10/20.

The reason is a small but unusually powerful computer (4K byte memory) designed right into the heart of the unit, making the display fully programmable.

It does more jobs, better, for less money than any other system you can buy.

When the SPD 10/20 becomes obsolete, you simply program its replacement . . . in minutes . . . on the same equipment. Virtually free.

Savings on installation costs can pay for your new displays . . . to say nothing of fewer lost hours and less turmoil in the shop. You never have to alter the

central site software. You never have to adapt the mainframe computer.

The SPD 10/20 changes job functions at the touch of a button, allowing you to get the most efficient use out of your entire system . . . particularly during peak loads. Switch work details. Switch languages. Switch currency. Even change central site computers or communications networks.

Wherever you put it, whatever you ask it to do, the SPD 10/20 can make itself right at home. Instantly. It is the most economical, versatile, general-purpose display ever built.

And that's money in the bank.

INCOTERM™
CORPORATION
... the international computer terminals people

Hayes Memorial Drive / Marlborough, Massachusetts 01752
Tel: (617) 481-2000

Los Angeles, California • Atlanta, Georgia • New York, New York • San Antonio, Texas • Chicago, Illinois



LETTERS

East is not east

Sir:

I would like to bring to your attention two errors in the June 1 News Scene article by Ivan Berenyi (p. 56) regarding trade with Yugoslavia and computers installed there.

First, IBM has been offering data processing equipment to Yugoslavian customers on either a rental or outright sales basis, at their option, for some time. This business practice is the same as in western countries.

Secondly, the COCOM committee of NATO does not review export licenses to Yugoslavia since Yugoslavia is considered a western European country for export licensing purposes.

CHARLES FRANCIS
IBM World Trade Corporation
New York, New York

PROBE probed

Sir:

In reference to your article in the June 1 issue entitled "Sports and EDP—It's a New Ballgame" (pp. 24-33), I read with interest the paragraph dealing with the development of Dr. Ryan's "PROBE" system. This paragraph states that PROBE "was developed jointly between CHI Corp. of Cleveland and Ryan Computer Services."

I believe this paragraph to be in error, because in 1970 I was employed by Computer Response Corp. of Washington, D.C., and know for a fact that Dr. Ryan was at that time working very closely with Dave Wertz of CRC in the development of football analysis routines for the 1108.

DAVID E. THOMPSON
New Holland, Pennsylvania

Mr. Purdy replies:

Mr. Thompson is correct in saying Dr. Frank Ryan had contacted Mr. Dave Wertz of Computer Response Corp. in late 1969, since his contract had expired with the Cleveland Browns. This was during Vince Lombardi's first (and final) season with the Redskins.

I discussed the Computer Response Corp. situation with Dr. Ryan

and he says: "I went by CRC a few times to see if the old computer play analysis program could be adapted to our needs and desires." (The old program was developed by William Witzel and was used in 1968 by the previous Redskins' coach, Otto Graham.) "After some discussion, which perhaps Mr. Thompson mistakenly thought was development, I decided a new system was necessary. It was after these discussions that I began development of the PROBE system with CHI Corp."

Left out in field

Sir:

In reviewing the article, "The Minicomputers Revisited," by D. J. Theis and L. C. Hobbs (May 15, p. 24), I was most disappointed to note that my company was not listed anywhere within the article.

This lack of mention is most disappointing for two reasons:

1. Datacomp has truly turned the corner, and unlike many minicomputer manufacturers has unequivocally blossomed into a viable and most certainly a successful organization.

2. We had recently granted an exclusive interview to a member of your reporting staff relevant to the introduction of our computer and terminal to the off-track-betting market. I am sure that your reporter will attest to the fact that our OTB entry is a most impressive one and will prove to be a strong contender in that market.

For the record I am enclosing a specification sheet on our computer and its peripheral equipment. This equipment, as specified, is being used quite successfully in the business data processing, industrial, engineering, and scientific markets.

JOHN D. SESSIONS
President
Clary Datacomp Systems, Inc.
San Gabriel, California

The Datacomp 404 is a 2-usec, 16-bit-word machine with main memory expandable in 4K increments to 64K. The cpu features four accumulators, seven hardware registers, two hardware index registers, and multilevel indirect addressing. Fixed-point hardware multiply/divide and 16 external priority interrupt levels are standard. Software includes a one-pass assembler and relocatable assembler; a real-time executive monitor is available, but a disc operating system is not offered. Available peripherals include mag tape and mass storage

device. Base price for a 4K system is \$6800. Author Hobbs considers the 404 in a slightly different category from the other machines in the survey (and its predecessor article), which emphasized binary minicomputers commonly used in real-time applications. However, the 404 specifications should be of interest to our readers.

Henpecked

Sir:

As the recent recipient of one of IBM's, ah, contributions to the adp standards effort, I read Brother Schein's effusion in the June 15 Letters (p. 12) with some amusement. Of course, what he meant to say was, "IBM personnel have actively contributed to and implemented ANSI data processing standards." I'd put it another way: IBM corporate contributions to standards are greater than (and usually very different from) the sum of the contributions of its technical representatives.

Furnishing 70 "improvements" to COBOL is just one of the sly ways by which The Mother Of Us All keeps the young chicks close to the incubator, along with sit-down sorters, APL, and "I Will Eschew Rhetoric" Harris!

HERB GROSCH
Erewhon, U.S.A.

Hidden treasure

Sir:

Mr. Coyle's article on "The Hidden Speed of ISAM" (June 15, p. 48) is an excellent example of what the complaining IBM user could achieve if he would sit down and make use of the reference material available to him.

GERALD F. GRIFFIN
Washington, D.C.

Justified

We just received the June 15 issue devoted to criminal justice information systems, and I want to congratulate Angie Pantages for her excellent editorial (p. 23). She has more succinctly spelled out the problems underlying the automation of courts and prosecutors' offices in one page than I have seen in many longer reports. Her grasp of the basic inadequacies of the manual,

The Bookie



There's a new bookie in town. 1,150 of them to be exact.

They don't wear green eye-shades, dark glasses, striped shirts—or smoke fat cigars.

Instead, they are sleek CRT display terminals.

Wyle Computerminals.[®]

These new bookies are legal, too. Part of New York's off-track-betting system, which has taken the big city by storm.

Why was Wyle awarded a \$2.5 million contract in this exciting new

industry by the system's prime contractor, Computer Sciences Corporation?

Because this off-track-betting contract was a tough interfacing job. With an even tougher delivery schedule. We met that schedule.

And why not? Wyle started supplying Computerminals for reservations and ticketing back in 1967. We've built more CRT terminals than most. Our serial numbers are in the thousands. That's experience!

And our parent company, Wyle Laboratories, with \$90,000,000 annual sales and assets in excess of \$60 million, gives us the financial muscle to get the job done.

By the way, we also have a low cost, direct replacement for IBM 2260/2848 CRT clusters—which can be interfaced to any other make of computer as well.

So, if you are building a special computer or communications system and need CRT displays, call on us.

Or, if you are a computer main-frame manufacturer and require stand alone or cluster CRT display terminals, that's us again.

No wonder we're getting known as the silent partner of the computer industry.

WYLE COMPUTER PRODUCTS, INC.

128 Maryland St., El Segundo, Ca. 90245 (213) 678-4251

Letters . . .

operational system and sensitivity to the curing of these ills prior to any automation effort is a delight to see and read.

I am especially pleased that such an editorial appeared in a publication devoted to automation and automated systems. The issue is of outstanding quality and should provide a tremendous service to the computer industry as it prepares to enter the criminal justice information field.

Again, please accept the entire Office's thanks for presenting the problems of automating the most critical links in our criminal justice system with such elucidation.

JOAN E. JACOBY

Director, Office of Crime Analysis
Government of the District of Columbia

Progress report

Sir:

All this talk of fourth-generation computers is nonsense! Nonsense! Nonsense!

I have just seen the film "THX 1138" which takes place in the 26th century. The only computer in use at that time is a good old IBM System/360, and the only language is FORTRAN.

So what do you guys think of that?

BRENT L. MARSH
Newark, Delaware

Good to know that by the 26th century, computers users will have finally bridged the generation gap. Was the system still on rental?

House divided

Sir:

As is pointed out in several of the letters we have received in response to the May 1 article, "Computing Signs Help Train the Deaf" (p. 36), there are within the deaf community two distinct schools of thought on communication. The one discussed in the article is the manual school, where communication is basically by means of the hands with signs or finger-spelling. The other is the oral school, where-by communication is through voice and lipreading. It should be obvious that neither is the absolute answer.

A student using manual communication must have an interpre-

ter or resort to written messages in order to communicate with the hearing world. This can certainly be a limiting factor. There is also the necessity of creating signs which, as the article points out, is difficult. The oral student, on the other hand, must be able to see the person speaking at close range. In a large classroom, or when the professor turns his back to the class (as to explain something on the chalkboard), this student needs special help (for example, asking for a new seat or reading a neighbor's notes). Those deaf people who are mute cannot use oral methods, and many who have been deaf from birth do not learn to pronounce English words distinctly enough for a hearing person to understand. Here again we are back to written messages. Both schools must freely admit that technical terms (and computing is certainly rich in them) cause extra difficulty.

The sentence, "The total effort expended thus far for the deaf has been in the area of developing the languages of signs . . ." is particularly questioned by some writers. Its intent was to put in opposition the effort expended on behalf of the blind with the effort on behalf of the deaf. The blind have braille, vast libraries of books in braille, collections of recordings, recording equipment, etc., and the funds to provide them free. The deaf need a method of communication—special films, television, legitimate theater, etc.; equipment for telephones, doorbells, etc., and the funds to provide them. The effort on behalf of the deaf is nowhere near that expended for the blind, and funds are almost nonexistent. The article pointed this out in hopes that something constructive could be done, especially within the computing industry, where there has in the past been no one able to provide vocabulary and other tools necessary to the deaf to be as effective as the hearing world.

As with almost any divided people, each can be as fanatical as the other, maintaining "my position is the *only* correct and logical one." In fact, neither "side" has the total answer. What is tragic in this instance is that each is supposedly trying to help people who have been handicapped and are in need of assistance. When unity is needed, division exists; and who gains? Certainly not the deaf community. One

Mini Too Slow?

**SPEED-UP
10 TO 40
TIMES**

**Delivery
Now!**

Our Floating
Point Hardware and
access-level software
allow the popular

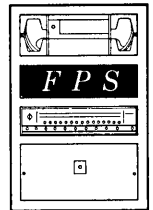

minicomputers to: 1. Evaluate power series well under a millisecond! Examples: trigonometrics, logarithmics, square roots, etc. 2. Increase speed and real time capability! Examples: numerical control, refresh C.R.T. displays, etc. 3. Increase precision (6/7 decimal digits) and dynamic range (± 37 decades).

Interfaces available for popular 12, 16, and 18 bit minicomputers. This month's feature—Hewlett-Packard 2100 series.

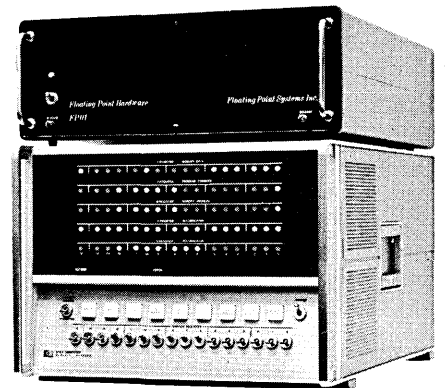

Floating Point Hardware Times

	Avg.	Max.
Add*	4.0 uSec.	10.2 uSec.
Subtract*	4.0 uSec.	10.2 uSec.
Multiply*	9.6 uSec.	11.8 uSec.
Divide*	12.0 uSec.	14.2 uSec.
Fix	5.2 uSec.	8.4 uSec.
Float*	3.0 uSec.	5.2 uSec.

*includes normalized answer

Floating Point Systems Inc.
4377 SW 142nd Ave., Beaverton, Ore. 97005

For information call:

Floating Point Systems Inc. 503/643-1552
or

Bartlet Associates	914/949-6476
Bexdata Ltd.	312/221-1411
Brennan Associates	206/454-9332
J and J Engineering	305/724-2120
Northeast Data	617/237-1509
PLS Associates	303/771-0140
Data-Tron	216 391-8421
QPL	213/682-3705
Digital Product Mktg.	713/626-2922

a thought about you...

Neglected

Truly a sad situation. But it's not sympathy the OEM user needs, it's help. We at Cincinnati Milacron can offer you that help — and minicomputers that are in perfect harmony with your application.

When you order minis from Cincinnati, you get not only reliable, general-purpose computers, but our personal, expert attention. We feel that good hardware delivered on time is just not enough, so we make sure our minis are custom-fitted to your system. Then we teach you how to use and maintain them for top efficiency. And no matter where you are, we have a Cincinnati Milacron field service man stationed nearby so that your system will always make beautiful music.

Give us a call. We won't neglect you.



minicomputers



Cincinnati Milacron Company | Cincinnati, Ohio 45209

**Machine Tools
Process Controls
Chemicals
Plastics
Plastics Processing Machinery
Abrasives**

Letters . . .

thing is evident from the number of letters and comments received—the article was read, the case of the deaf community interacting with the computing community was aired, and hopefully something more will be done to push the work forward.

ROBERT TEAGUE
Northridge, California

Eastern services

Sir:

Your Look Ahead item, "Airlines Selling Other Airlines" (June 15, p. 17), hurt, hurt, hurt!

Eastern Airlines was the first, and is now the largest purveyor of software and services to other airlines. Four of the world's largest carriers now use SYSTEM ONE (Eastern's passenger name record system) software. Literally dozens of the world's airlines currently utilize other Eastern edp services. So do several major corporations outside the airlines industry.

So, we feel slighted because the only mention of Eastern was erroneous. Eastern has not purchased "SHARE" from our interline friend Continental.

D. A. PUSEY
Eastern Air Lines, Inc.
Miami, Florida

We misunderstood Continental, which does sell SHARE to three airlines, but only provides flight planning services to Eastern for its military charter flights to Europe.

Half-witty

Sir:

In the article, "The Love and Care of Antique Systems" (June 15, p. 42), it is stated: "Efficiency, of course, is the ratio of what could be done to what is done." Using this definition, may I suggest that the efficiency of your antique system may be doubled simply by doing half of what is presently being done. That is, of course, assuming what could be done remains constant.

J. S. BOLAN
Carlisle, Pennsylvania

DATAMATION welcomes correspondence about the computer industry. We reserve the right to edit letters submitted.

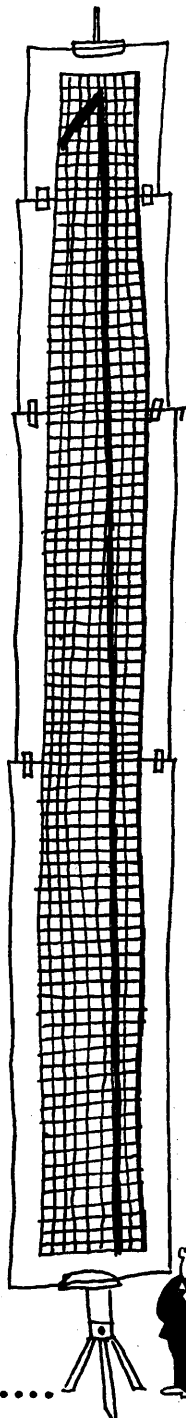

worried about your sales curve?

Get the most for your edp dollars by choosing products and services through the

DATAMATION® INDUSTRY DIRECTORY

It will show you:

How to compare prices quickly...
if maintenance centers are convenient... how to save with compatible units... if the vendor is well-established...
who can handle your overload programming

Get your own private copy by mailing the coupon and your check or purchase order now.

DATAMATION® INDUSTRY DIRECTORY

D8-15a

Technical Publishing Company, DID Order Dept.
1301 S. Grove Avenue, Barrington, Ill. 60010

Send me _____ copies of the 1971 Datamation Industry Directory at \$25* a copy. _____ Check enclosed _____ Co. purchase order enclosed. (*in U.S.A. and Canada; \$35 elsewhere)

Name _____ Title _____

Department _____

Company _____

Address _____

City _____ State _____ Zip _____

what!



really!



yes, mag
tape
terminals

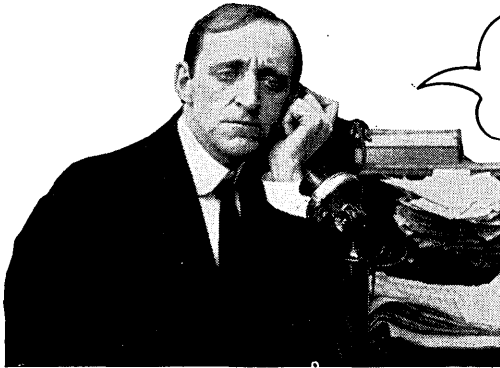

TELETYPE?

It's true.

After helping a jillion feet of paper tape wind and unwind its way through communications systems everywhere, Teletype announces the addition of magnetic tape data terminals.

There are some basic advantages in both mediums. But as you are well aware, the medium that's right for a system depends a lot on the application criteria.

The new magnetic tape data terminals have many operational features that make life less complicated for the operator.

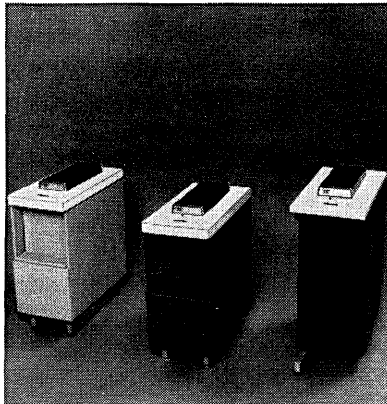

New, modular line of Teletype® 4210 magnetic tape data terminals.

For example, take a look at the tape cartridge, which was specifically designed for reliability required for data transmission.

Its vital statistics are: 3" x 3" x 1".

It contains 100 feet of 1/2" precision magnetic tape.

It will hold 150,000 characters of data, recorded at a density of 125 characters per inch. The equivalent of a 1000 foot roll of paper tape.

This means that your data is easier to store, easier to handle, easier to work with than ever before. And it's reusable.

DATA COMMUNICATIONS

equipment for on-line, real-time processing

The units have a "fast access" switch which will move tape forward or reverse at a speed of 33 inches per second. A digit counter provides a reference point to help locate various areas of the tape.

Four ASCII control code characters can be recorded in the data format to aid character search operations. When the terminal's "search" button is pressed, tape moves at the rate of 400 characters per second

Also magnetic tape adds high speed on-line capability to low speed data terminals.

You can zip data along the line at up to 2400 words per minute. For example: Take a standard speed Teletype keyboard send-receive set, and a typical typist. Add a new magnetic tape unit to this combination and the on-line time savings can pay for the magnetic tape terminal in short order.



until the control code selected is detected. Then the terminal stops the tape automatically.

A "single step" switch is also provided which enables you to move the tape forward or backward one character at a time. In editing or correcting tape, you can send a single character using this feature.

You can take better advantage of voice grade line speed capabilities.

An operator can prepare data for magnetic tape transmission using the keyboard terminal in local mode. Then send it on-line via the magnetic tape terminal up to 2400 words per minute.

These new modular magnetic tape data terminals offered by Teletype are perfectly compatible with model 33, model 35, model 37 and model 38 keyboard send-receive equipment.

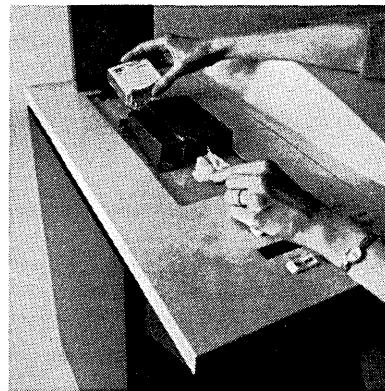

Straight-through threading makes tape loading and unloading exceptionally easy.

They can send or receive at high or low speed. Or can be used independently as stand-alone terminals on-line.

If you would like to know more about this new line of Teletype magnetic tape data terminals, please write Teletype Corporation, Dept 81-15, 5555 Touhy Avenue, Skokie, Illinois 60076.



Teletype 4210 magnetic tape data terminal with 37 keyboard send-receive set.

machines that make data move

August 15, 1971

CIRCLE 16 ON READER CARD



The 100 Series



A beautiful new way to wrap up your print-out storage problems.

Now there's a Control-Rack series that's as beautiful to look at as it is simple to use.

National's new 100 Series—the first referral and retention system with the look and feel of fine grained walnut. Rich. Warm. Beautiful.

But also beautifully practical. Combined with National Slide-A-Ref™ and Hang-A-Ref™ data binders, the 100 Series provides the most sophisticated approach currently available to print-out storage problems.

The new 100 Series is made up of desk-top, and floor storage units. Including organizers, mobile floor units, wall or divider units, bi-level data consoles, expandable storage units, data reference tables and a special data cube with removable top and free-wheeling mobile stand.

All are modular in design to provide maximum flexibility in establishing and main-

taining an efficient and well-organized data reference control system.

All in all, a new series that is easy to work with, beautiful to live with. See your National representative for complete details. Or send for free color catalog.

National Blank Book Company, Inc.
Department D
Holyoke, Massachusetts 01040

Please send me my free copy of National's new 100 Series color catalog.

Name _____
Title _____
Company _____
Street _____
City _____
State _____ Zip _____

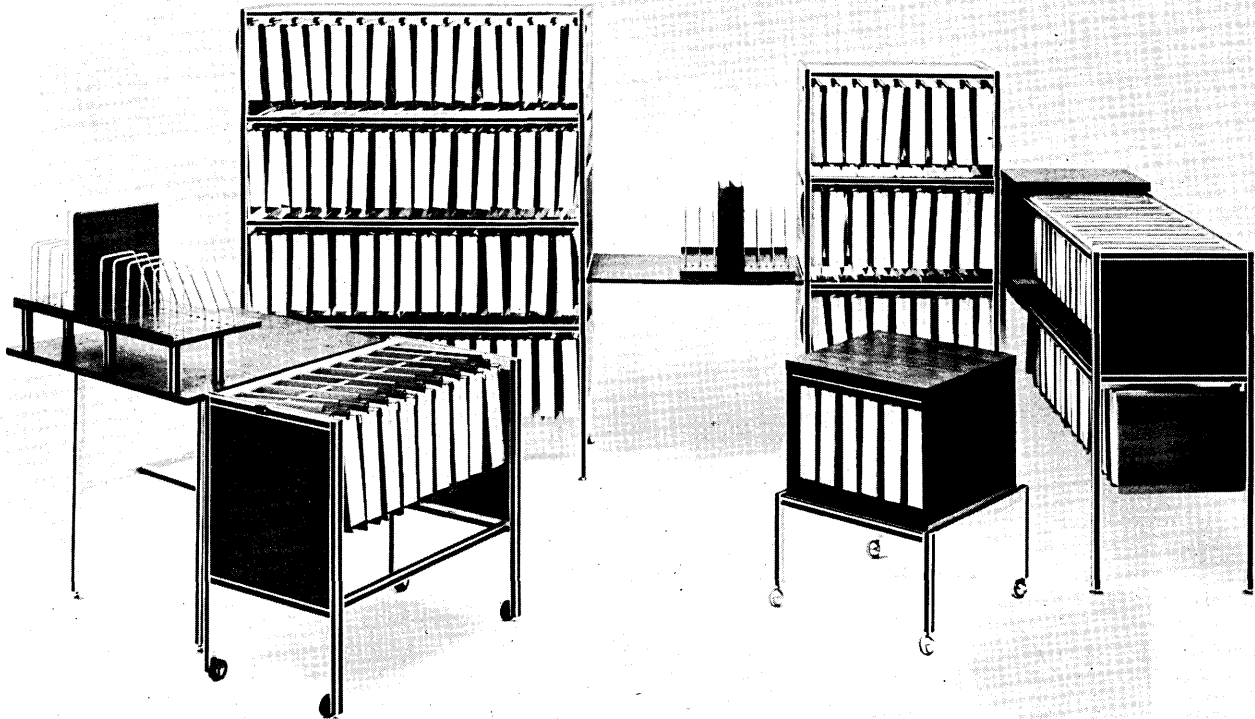

NATIONAL

NATIONAL BLANK BOOK COMPANY, INC.

A Subsidiary of Dennison Manufacturing Company

CIRCLE 17 ON READER CARD

Your computer wants to talk to you!

YES! And you can talk back to your computer too.

With a DIGITALK 4000 Voice Response System at your computer, any telephone becomes a complete data communication terminal.

The 4000 answers your call, accepts dual-tone alphanumeric data (from your phone), reads the data back to you *in human voice* and then transfers the verified data into your computer in ASCII. It will also transmit data from your computer directly to you *in human voice*.

The 4000 comes complete with modems, interface, buffer storage and Metrolab's highly reliable voice

response unit which contains a 36 word vocabulary (all numerals plus alphabet). It's completely compatible with all standard teletype interfaces and I/O software.

An additional 27 word custom vocabulary is available as an option to provide words or phrases to fit your specific needs: order entry, credit and bank account verification, catalog ordering, inventory control, etc.

Let us show you how to make your computer talk for under \$5,000.



METROLAB, INC.

a subsidiary of Cubic Corporation

10457 Roselle St., San Diego, Ca. 92121
(714) 453-3000





IBM COUNTERATTACKS:
PHASE II

Ready for this? Control Data allegedly has attempted to monopolize the market for large-scale computers according to a new (July 16) counterclaim by IBM against CDC. IBM again has used the documents of mutual pre-trial discovery as evidence (while the industry has been waiting for CDC to unleash more specifics on its claims against IBM based on IBM documents). The counterclaim itself is not now public, being under court protection. Next questions are whether it will be made public and whether CDC will seek dismissal.

RCA VERY MUCH IN
THE COMPUTER BIZ

L.E. Donegan, Jr., vice president and general manager of RCA Computer Systems, issued an internal memo to the computer unit's employees in an attempt to spike those rumors that RCA will sell off its computer operation. In the memo, Donegan emphasizes RCA's "unequivocal" intention to remain in the computer business. Donegan, himself the victim of a rumor that he may be replaced, drew some unequivocal support from RCA president Anthony L. Conrad in a recent videotaped message to RCA employees. Conrad said of Donegan and his management team: "We support them fully." He also said RCA's 1971 investment in computer hardware and software will be the highest in the firm's history. He said RCA is investing more in computers than in any other prior venture, including color TV. Amen.

Another indication of RCA's commitment to computers is its decision to create a UK marketing operation. We understand that ex-IBMer C. Ridley Rhind, general manager of the UK operation, has approval to hire 40 men for the venture.

KELLY TO THE RESCUE --
IT SEEMS TO BE WORKING

Comatose for more than a year as a result of a series of financial body blows, Scientific Control, Dallas, is beginning to show some signs of real life. Under new board chairman and principal stockholder Richard Kelly, the company has auctioned off \$1 million worth of "excess inventory, manufacturing, and test equipment" so it could retrench into 40,000 of its 120,000 feet of plant space. In mid July, the firm, which last year saw a staff of some 600 cut to a "mere handful," was back up to 25, including four new full-time marketing people. Kelly says this will double in 60 days. The firm has started leasing its data communications terminal and is negotiating the acquisition of two companies.

TENET INSTALLS
FIRST T-S SYSTEM

The only survivor of a handful of companies formed in the late '60s to build big computers has its first customer system installed and operating. Tenet, Inc., Sunnyvale, Calif., beat out two competitors, Honeywell and Hewlett-Packard, to supply a time-sharing system for California's Dept. of Public Works. The system, with 70 connected terminals of which 44 are active, was installed and operating early this month. Tenet still was operating under Chapter XI, but William

PICKING UP THE PIECES

Bridge, president, feels successful operation of this system will give the company the credibility it needs to get the orders which will get it out of the courts.

Four former Computer Applications Inc. executives are going after the facilities management market in the Northeast as Blair Systems Corp., New York City, and were at this writing drafting their first two full facilities management contracts. Charles Cooper, one-time exec vp and a director of the defunct software house, is Blair president. Exec vp's are Joseph Delario, president of CAI at the time of its demise, and Leonard Elfenbein, who left CAI in 1968 to help form Wellington Computer and was a casualty when that company was reorganized by new owner Heizer Corp. early this year. Fourth on the team is Neal Anderson, vp, who held the same rank with former CAI subsidiary EBS Data Processing.

PERIPHERAL GROUP WON'T CHANGE NAME AFTER ALL

The Computer Peripheral Manufacturers Association isn't going to change its name. Nor is founder and president Richard Caveney out, as hinted in an announcement early this summer that CPMA was looking for new executive talent (See Aug. 1, p. 50). There is no official word from the group, but it's learned directors rejected the proposals at a meeting in San Francisco because they didn't like the new name (Association for a Competitive Data Processing Industry) and didn't have the money to pay for an executive director. Caveney said "the proposal was made and the board rejected it." The association aims to reduce IBM's dominance of the computer industry and has pressured for competitive procurement by the government in dp purchases.

RUMORS AND RAW RANDOM DATA

Interdata soon will announce the first two computers of a new series - both sporting writable control stores, a step up from the ROMs of its current systems. Compatible with the Interdata 3, 4, and 5, the two new models will have better performance than the 5, and one will have a semiconductor main memory...A study of the feasibility for a nationwide data communications network using cables, not microwave, is being conducted by Electronic Data Systems. The right-of-ways of five railroads would be used...We hear that Sanders Associates' new CAN-Do data processing equipment is being evaluated by Volkswagen of America. If VW likes the equipment enough, Sanders could be the recipient of a big order...Fast-growing Storage Technology Corp., of Boulder, Colo., has landed a \$1.5 million order with the Internal Revenue Service for 68 tape drives and 14 controllers in what the IRS calls its first competitive bid for IBM 2420-like equipment. The two-year old firm has 500 people...Although the software market is tight, more service firms are buying or leasing packages from software firms instead of developing them in house, says Larry Welke of International Computer Programs, Inc...We hear Westinghouse has sold 140 of its \$700 DOS relocater packages.

21 ways to improve your computer system's performance.

Here are some of over 150 IBM program products to help your computer do more work. And do it more profitably.

There's a program that lets your salesman search the computer's file while he's got a customer on the phone.

A program that helps your company's executives decide which products to make, when to make them, where to ship them.

There are programs that help your programmers become more productive. By letting them spend more time writing programs, less time debugging them.

If you'd like a complete description of these and other programs, just fill in the coupon below. Or call your local IBM office.

Languages, sorts, time sharing

1. PL/I Optimizing Compiler (OS, DOS) Offers greatly increased execution, new language features, improved debugging aids and communication with existing FORTRAN and COBOL object modules.

2. ANS Full COBOL Version 3 (OS, DOS) Contains major improvements in debugging aids, additional functions and ASCII support.

3. FORTRAN IV (H Extended) Compiler (OS) Supports extended precision arithmetic, two new forms of input/output for ease of use, and improved compilation speed and reliability.

4. Interactive Terminal Facility (ITF) (OS, DOS) Provides time sharing for problem solvers using BASIC and Interactive PL/I.

5. OS-Sort/Merge 1 (OS-SM1) (OS) Improved speed and functions over previous OS sorts. Provides support for IBM 3330 Disk Storage.

6. Assembler H (OS) A new high performance assembler language processor for OS users. Requires no reprogramming or conversion for current OS assembler users.

7. 1130 COBOL Specifically designed compiler featuring high speed compilation and fast execution for small to medium IBM 1130 users.

8. APL/360 (OS, DOS) A user-oriented program with a language designed for problem solving and a time sharing capability that lets many users work independently at the same time.

Data entry, data base

9. Customer Information Control System (CICS) (OS, DOS) The link between your computer's data base and the applications you want to put on-line. By providing many of the standard control functions, CICS lets your programmers concentrate on coding the applications. Helps you save implementation time and cost.

10. Data/360 (OS, DOS) A general purpose data-entry program. Data is entered and verified through IBM displays, edited and written out on disk files.

11. Data Base Organization and Maintenance Processor (DOS) A system to integrate data files into a central data base for query applications involving existing multiple customer files.

12. Generalized Information System/2 (GIS/2) (OS) A high-level query and file maintenance system particularly useful for meeting spontaneous information requirements or handling repetitive jobs.

13. Information Management System/360 (IMS/360) Version 2 (OS) Facilitates use of medium to large common data bases and accommodates teleprocessing and batch processing, concurrently or separately.

Applications

14. Project Management System IV (PMS IV) (OS) A powerful program in modular form for resource allocation, cost analysis and precedence input analysis.

15. Requirements Planning (OS) A materials management system designed to determine what, when and how much to order in a manner that will help minimize component inventories.

16. Shop Floor Control (OS, DOS) Establishes and maintains a shop order data base and provides for shop order release, status and inquiry for timely management decisions.

17. Consumer Goods System—Forecasting and Allocation (OS, DOS) Determines what amounts of finished goods to make, order or ship to stocking locations to satisfy multiple objectives.

18. General Purpose Simulation System V (GPSS V) (OS, DOS) Powerful, easy-to-use tool for simulating the behavior of systems in engineering and management sciences.

19. Bill of Material Processor (System/3 Model 6 and Model 10 Disk) Establishes and maintains basic manufacturing files describing the structure of products and their manufacturing procedures.

20. Law Enforcement Manpower Resource Allocation System (DOS) Provides ability to determine field manpower requirements, on as-needed basis and future-plans basis.

21. Mathematical Programming System Extended (MPSX) and Mixed Integer Programming (MIP) (OS) A new, economic optimization system offering greatly extended modeling capabilities.

Director, Programming Systems Marketing
Dept. 807DM
IBM Corporation
1133 Westchester Avenue
White Plains, New York 10604

Please send me information on these Program Products:

Languages, sorts, time sharing Data entry, data base Applications

Name _____

Title _____

Company _____

Address _____ Zip _____

CIRCLE 8 ON READER CARD

Double the storage capacity

ISS 715

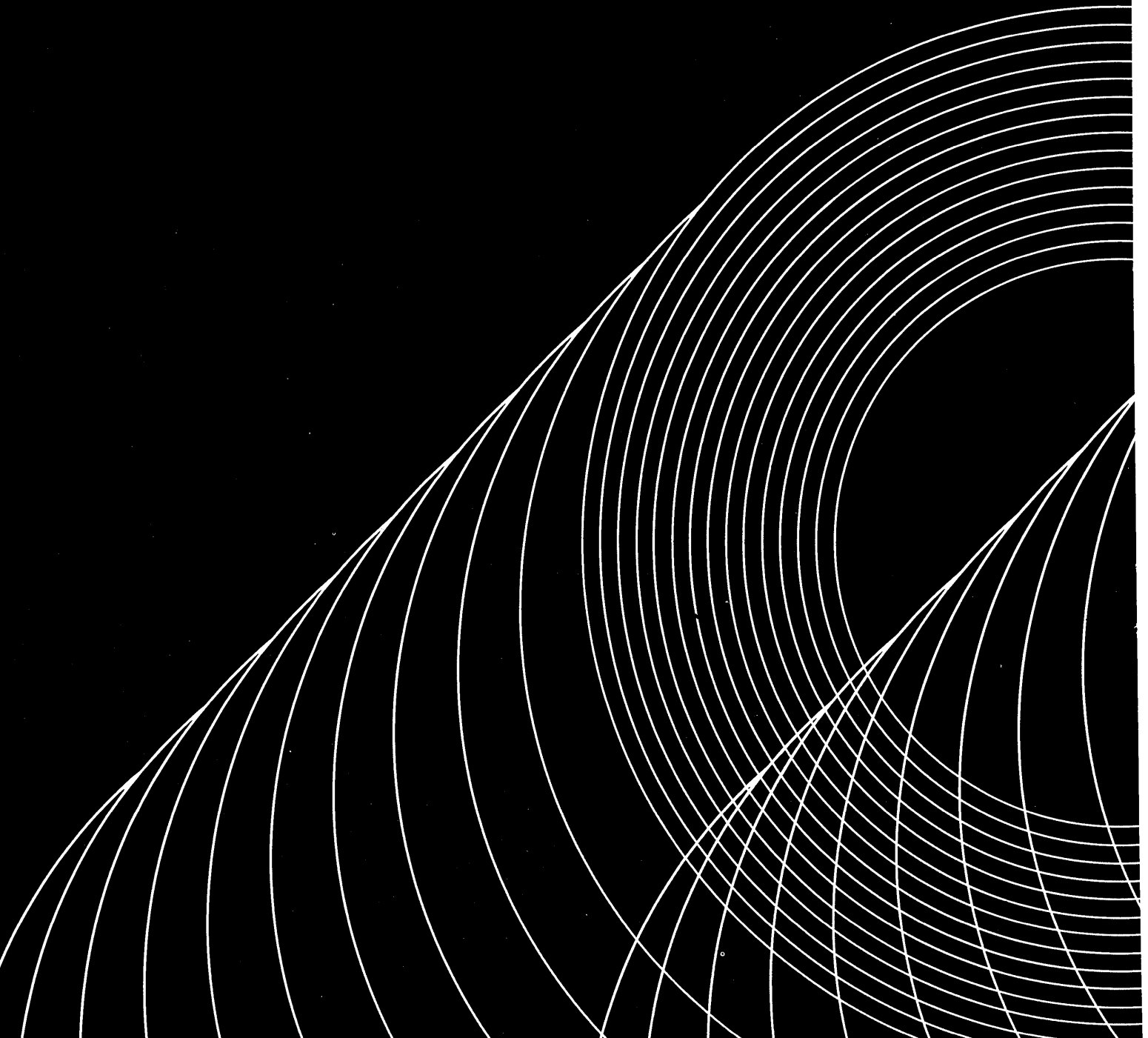

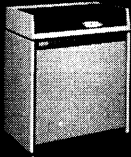

Now, Information Storage Systems, the leader in disk memory technology, brings you the ISS 715 Disk Drive. □ Conventional—in that it uses standard eleven-high disk packs interchangeably and has track capacity and data rate identical to the widely used ISS 714. □ Unique—because it doubles storage capacity to 58-million bytes by using 400 cylinders. At the same time, cost per byte is reduced significantly, access time is the fastest in the industry (29 ms average), and it trims space requirements. □ The ISS 715 is functionally engineered for practical integration into existing systems with a minimum of controller and programming changes. □ All this is part of our OEM program to keep systems manufacturers and their customers supplied with the most advanced products available, now and in the months and years ahead.

For complete information, call or write Information Storage Systems, Inc.,
10435 North Tantau Avenue, Cupertino, Calif. 95014, (408) 257-6220

ISS

NOW A PART OF THE INTEL ORGANIZATION

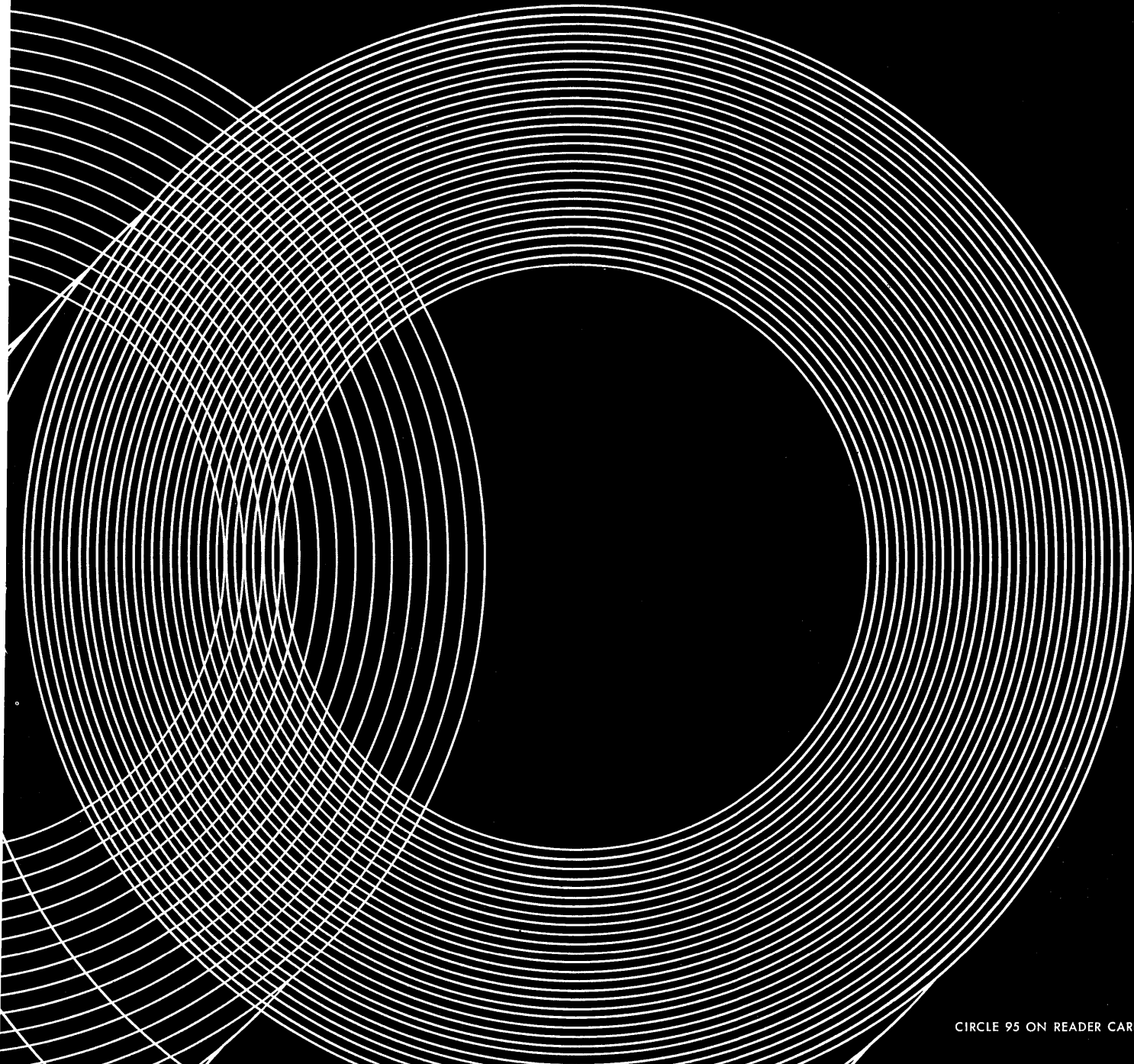

During the last decade, the machine-language programmer has been fading away. What's in store for the systems analyst?

Automated System

G In a sense, the 1960s could appropriately be termed the "decade of the programmer," in view of the amount of attention lavished on the improvement of programming methods. There are good reasons why this was so. Users were concerned over rising programming costs and over the rather frightening inability of technical managers to prevent serious overruns in programming projects. And computer manufacturers recognized that, without better programming tools, this situation was bound to worsen with the introduction of more sophisticated third generation machines. Further, there existed a chronic programmer shortage that motivated both users and suppliers to seek means of improving the productivity of the talent available.

One result of this concern was a heightened emphasis on more effective programming project management. Many useful studies were completed and results published, so that today, though matters are still far from ideal, project managers have better guidelines for estimating and controlling programming costs and schedules.

Programming methodology has also benefited from the substantial effort expended during the sixties to perfect computer-assisted programming aids. Consider the introduction—and acceptance—of whole new families of programming languages: COBOL, PL/I, BASIC and others—all "higher level" in the sense of being less machine-oriented than the earlier assemblers and compilers and all intended to ease the programmer's burden.

Other kinds of software were produced with a similar objective, notably operating systems, which solved numerous "housekeeping" problems that once were the concern of each individual programmer, and program flowcharting packages, which facilitated program documentation and maintenance.

If, indeed, these examples justify characterization

of the period just past as the era of the programmer, there is mounting evidence that the 1970s will be the decade of the systems analyst. Significant research and development is now under way to automate the system analysis process itself.

Why have things progressed in this sequence, with the programmer's job receiving most of the initial attention and that of the systems analyst remaining largely an "art"—still essentially undefinable and uncontrollable? The answer seems evident: given a good system definition, the programming problem becomes fairly routine—even mechanical—and hence more amenable to automation. Now that results have been achieved at this level, interest is shifting "upstream" in the system development cycle, toward achieving greater control and discipline during the initial stages of system development.

It should be acknowledged that considerable work did go on during the sixties that was intended to aid the systems analyst. What is happening today really represents a continuation, with greater emphasis, of these earlier efforts.

Perhaps the most notable achievement to date has been the development and usage of system simulators like GPSS, SCERT and CSS to assist the system designer in configuring today's complex systems. Without such simulators, reliance on analytical methods would leave the system designer much more vulnerable to potentially disastrous throughput estimating errors.

Other achievements, while less impressive in terms of their adoption by users, are also noteworthy. Decision tables, as a means of expressing processing logic in an unambiguous fashion, offer benefits to both analysts and programmers, though they have failed to achieve the acceptance that their advocates once envisioned.

Another early, and interesting, attempt to improve the methodology of system design was IBM's Study

Analysis

by Robert V. Head

Organization Plan, devised in the early sixties. Though not an automated technique, SOP was a formalized guide for the systems analyst, covering each step in the system design process. SOP was organized into three phases: Understanding the Present Business, Determining Systems Requirements, and Designing the New System, with each phase culminating in a report. Phase one covered techniques for gathering data and produced a report entitled Pres-

... the 1970s will be the decade of the systems analyst.

ent Business Description; phase two was concerned with analysis of business activities in terms of inputs, outputs and resources and resulted in a Systems Requirements Specification; the final phase considered design alternatives, equipment configurations, and the economic impact of the system on the business, and its results were organized into a report entitled New System Plan.¹

It is interesting to speculate why SOP was not widely accepted. Its methodology was somewhat cumbersome, and its full implementation in many cases required documentation efforts of questionable value. But perhaps, in the main, its authors were simply ahead of their time.

Turning to activities of more contemporary relevance, the following are representative of the variety of current approaches to design automation.

ARDI. More ambitious and comprehensive than

SOP, ARDI provides a detailed guide to the systems analyst covering four major phases: Analysis, Requirements determination, Design and development, and Implementation and evaluation. Originally prepared by Computer Sciences Corp. for Philips Electric Co. of Holland, the ARDI manual consists of a step-by-step guide to the system development cycle, supplemented by a techniques section cross-referenced to the development stages to which the techniques are applicable.²

TAG. The Time Automated Grid is a technique for systems analysis based on a series of IBM-developed programs. It is intended to aid the systems analyst in the design of large-scale systems. Data to be analyzed by TAG is recorded on special input/output analysis forms that describe the characteristics of the inputs, outputs or files to be analyzed, including length, format and sequence as well as frequency, volume and processing priority. Use of TAG begins with a description by the analyst of system outputs. Once these have been prepared, TAG works backwards to determine what inputs are necessary and at what periods in time. When both inputs and outputs have been defined, the next iteration of the program produces file and system flow descriptions. File contents and data flow are both based on time—the time at which data elements enter the system and the time at which they are required to produce output.³

The reader will recognize, of course, that the analytical steps accomplished by TAG are not new; they are performed manually by systems analysts as a necessary element in any system design. And therein

2. ARDI has been adapted into a text which, unfortunately, fails to credit the original contributors, this author among them, from Computer Sciences Corp. See W. Hartman et al, **Management Information Systems Handbook**, McGraw-Hill Book Co., New York, 1970.

3. A description of TAG is contained in IBM Sales and Systems Guide Y20-0358-0 for restricted distribution, IBM Technical Publications Department, 112 East Post Road, White Plains, N.Y. 10601.

Automated System Analysis . . .

lies the significance of TAG: the computer has assumed a portion of the analyst's design responsibility—a mechanical portion, admittedly, but it is here that the computer can excel, by noting deficiencies and inconsistencies in data specifications that might be overlooked in manual tabulations.

Formatted File Organization. Several studies have been conducted by IBM for the Air Force with the objective of improving the design of files which operate under the Formatted File System, a data management package widely used by U.S. government agencies. This work has included the construction of two file structure simulation models to aid the system designer in dealing with complex data structures. The first of these, FOREM I, embodied analytical techniques which, while very fast, exhibited several deficiencies; its successor, PHASE II, consists of some 8,000 lines of FORTRAN code and allows the designer to characterize and simulate a data management system with respect to eight attributes: (1) data field contents, (2) logical structure of the data, (3) physical organization of the data, (4) data selection criteria, (5) data accessing methods, (6) accessing strategy, (7) hardware, and (8) i/o supervisor. The authors view their work on these studies as contributory to "the eventual creation of a science of file design."⁴

Application System Generator. There have been numerous efforts by computer manufacturers and software companies to perfect generalized application packages for such functions as payroll, accounts receivable, and inventory control. Essentially, these packages have the objective of not merely easing the analyst's job but actually eliminating it, at least in commonly encountered application areas. Experience has shown, though, that while packages for applications like payroll have been successfully implemented, a great deal of "custom tailoring" by analysts and programmers is often required. Packages can help to free the company systems staff from concern with mundane processing problems, but they make little contribution to improved system design methodology.

The approach to applications taken by IBM with its small-scale System/3 computer does, however, merit special mention because of the flexibility which it extends to the system designer. Here, IBM has made available for certain basic applications, like payroll, an Application Customizer Service. By completing a detailed questionnaire for each application, the user indicates which processing methods he requires from among those available. These forms are then processed at an IBM systems center which produces a set of programming aids for all programs, card records and data fields required by the application. The programmer then uses these as the basis for program coding. This procedure involves a "package" in the sense that a model system design is made available to the user. While the design itself cannot be changed by the user, numerous options are available to him, and the lead time for system development is reduced.

ISDOS. Of all the analysis automation projects initiated so far, the most far-reaching is the University of

Michigan's Information System Design and Optimization System project. ISDOS has as its broad objective to "study the system building process and automate it as much as possible." The development of ISDOS is outlined in terms of five tasks:

1. To develop a "problem statement language" that is so unambiguous and complete that systems analysts and programmers could design a system and write programs with no information other than that contained in the problem statement.

2. To develop a program to analyze the problem statement.

3. To develop algorithms and procedures which could eventually be implemented on computers to design "optimum" systems in accordance with stated criteria.

4. To develop algorithms for automatically reorganizing data.

5. To develop a compiler to produce object programs.

Since system requirements change frequently, the whole ISDOS procedure would be mechanized so that changes could be made automatically. The article that follows this one is devoted specifically to this important project.

In this brief survey, we have tried to provide examples which indicate that research efforts have been shifting away from automated programming aids into the vastly more difficult and ill-structured area of system analysis automation. Certainly, these new efforts are consistent with the earlier concentration on programming problems, and improvements in both system design and programming methodology are of importance to users contending with rising system development costs.

While there have been some notable past attempts at system analysis automation, and while there is continuity between these and present efforts, more recognition is now being given to this vital aspect of computer technology than ever before. Most of the work described here is still in its germinative stages, and consequently has had little impact so far on the day-to-day activities of systems people. But it is likely that today's systems analyst, with his still-primitive analytical tools, will one day become as rare as the machine-oriented programmer who flourished a decade ago. ■



Mr. Head, now a consultant in Los Angeles, is a founder and past president of the Society for Management Information Systems. He has held executive positions at Software Resources Corp., Computer Sciences Corp., and other organizations. His most recent book is "A Guide to Packaged Systems," and he is the author of many articles on information processing.

4. FOREM is described in a paper by M. E. Senko et al, "A File Organization Evaluation Model," in *Proceedings, IFIP Congress 68*, Edinburgh, Scotland, 1968. PHASE II is described in a paper by P. J. Owens, "A Data Management System Model," in *Formatted File Organization Techniques*, Contract AF 30602-69-C-0097, Rome Air Development Center, Air Force Systems Command, Griffiss Air Force Base, New York, 1970.

The size, importance and cost of systems building provide an opportunity for the investigation of ways to improve the process

Automation of System Building

by Daniel Teichroew and Hasan Sayani

The building of computer-based information systems to serve the management and operation of organizations has become a large and visible activity. Furthermore, one need only note some of the recent news items regarding the system building process to be convinced that it does not always lead to satisfactory results.¹ In the past, as pointed out by Robert Head in another article in this issue, the emphasis on improvement of techniques has been on methods to help the programmer. Programming is certainly an essential step in the process but it is only one of the steps. The attention and emphasis it has received is completely out of proportion to its role in the building of systems and this has resulted in insufficient attention paid to the improvement of other steps. It is becoming more generally recognized that the other steps in the system building process must also be improved.

What we call an "information system" consists of two subsystems: a management system and an information processing system. The management system consists of the organization, its objectives, the individuals or groups in it and the rules and procedures under which they work. The information processing system is the subsystem which consists of hardware, programs, noncomputerized procedures, etc., that accomplish the storage, processing and communication of information necessary for the functioning of the management system. An essential element in this view is that the information processing system (IPS) must, or at least should, be designed to serve the management system. This characterization of information systems is particularly relevant to management information systems.²

System Building. Organizations normally go through a number of phases in building information systems. Initially, the potential use of the computer is

treated as a one-time task for a few programmers. Soon it becomes obvious that the task is much bigger than first suspected and during the second phase more manpower is assigned to the project. The third phase begins when it is recognized that a series of systems will have to be built and that a procedure will have to be developed. This results in the establishment of a systems department. A fourth stage is reached when it becomes apparent that the systems being built have many features in common and considerable reduction in effort might result from using standard building blocks.

Most medium and large organizations have reached at least the third phase; they recognize that information processing system building will be a continuous activity and have established systems departments. System building therefore usually involves three groups: top management, users, and system builders. The users, in general, are the functional

... it is extremely unlikely that it will be possible to build the number of systems of the size and complexity desired by manual methods ...

divisions such as manufacturing, finance, personnel, etc.; however, a system may frequently be designed to serve more than one function. The system builders are centralized in a systems department. Top management is involved because it must define the responsibility of the user and the builders and adjudicate differences. It must also allocate resources and assign priorities where resources are scarce.

Frequently, one of the activities that the system departments undertake early in their existence is the development of a set of procedures and standards to be followed in the building process. The number of papers and books describing such procedures and standards has increased very rapidly in the last few years. Most organizations, however, prefer to develop

1. See for example: "Burroughs Sued by Trans World for \$70 Million," *Datamation*, Dec. 1, 1970, p. 47; "Bell's BIS: Bottomless Well," *Datamation*, July 15, 1970, p. 35; "Chrysler's Private Hard Times," *Fortune*, April 1970; "Computer Classic," *The Economist*, Oct. 24, 1970, p. 94.

2. Emphasis in this paper is on the use of the information processing system which serves management because this is the most important and the most difficult type of system to construct today. The techniques discussed, however, are applicable with only minor changes to other types: routine business data processing, command and control, information storage and retrieval, message switching and process control.

their own. Review of the published methods and the manuals developed by organizations for their own use indicates that the procedures are basically similar though they may differ in details. Here a brief outline of the major steps will be given in order to illustrate the need for, and potential scope of, automation.

The first step in the process is a request which indicates the need for a new system or the modification of an existing one. This request, ideally, is originated by the user, though it may come from the systems department if many users will be served. The request should contain sufficient information to initiate the next step.

Feasibility, or impact analysis, is the second major step. It consists of estimating the potential benefits of a system to satisfy the expressed request. A proposed system must be developed in sufficient detail to estimate the costs. The impact on the organization, and the existing systems is evaluated since this may affect both benefits and costs.

While the analysis in the second step may frequently be extensive and time consuming, neither the statement of user requirements nor the description of the proposed system is in sufficient detail to proceed with the construction of the proposed system. The third step is to determine the user needs in full detail and to describe them in a form which the users can agree to, and which is also suitable for the design and construction phases that follow. In some cases extensive analysis is required to verify that the detailed requirements, as stated, do in fact satisfy the more general needs stated in the first phase. It may in fact be necessary to simulate the management system. This phase is sometimes referred to as the "functional specifications" or "logical system design" phase.

The fourth phase—the physical systems design—is concerned with developing the specifications for the proposed computer-based information processing system that will accomplish the logical requirements detailed in the previous phase. Ideally, this is an elaboration of the proposed system used in the feasibility phase to estimate potential costs; if not, the feasibility results may have to be modified. The design of the proposed system consists of selecting, within whatever constraints that may exist, the processing organization (real-time, batch, etc.) and hardware, and designing the programs and data base. The result of this phase is a set of specifications.

These specifications are used in the system construction phase to build the actual target system. The new hardware requirements, if any, go to the hardware acquisition group for procurement. The program specifications go to the programming department which writes and tests the various programs. The data base specifications go to the group which has the responsibility for constructing the data base that will be needed. Normally, all these activities are the responsibility of the systems department. Other specifications may go to the personnel department for training and educational requirements.

In the sixth phase, all the components, already tested individually, are brought together and tested as a system. Errors discovered in this phase must be corrected—this may require going back several phases.

During the seventh phase, the system is in operation. Since requirements may change or errors may be

discovered, a change control procedure must be established to ensure that changes are appropriately recorded. The performance of the system must be compared with the estimates made in the feasibility phase.

The amount of attention paid to the steps in the process depend, of course, on the size of the system. If the system can be built by one person in a short period of time, he can usually build it satisfactorily without explicitly following the procedure. As the number of individuals involved increases, the formal procedure and complete documentation become essential. Unfortunately, documentation is usually neglected because the system building process is essentially manual. Formal techniques are not widely used; the steps are carried out by individuals using pencil and paper and the documentation consists of descriptions in English supplemented by flow charts, tables, etc. Formal, computer-aided techniques are used only in that part of the construction process in which higher level statements are compiled into object code.

Another consequence of the present system building methods is that the process from the user request to successful operation takes a long time. The elapsed time is a function of the size of the system but several years is not unusual. The elapsed time can be reduced by carrying out some subphases in parallel but this must be planned very carefully or it may result in inconsistencies and require more time rather than less.

A major problem in system building occurs right at the beginning in determining what the user wants. In fact, it is not even clear that this is the right way to state the objective. The user may not be able to articulate what he wants and usually is not the appropriate person to decide what he should have. The situation is further aggravated by the fact that the user usually is not accustomed to describing what he

. . . the problem definer can concentrate on what he wants without saying how these needs should be met.

wants in sufficient detail to translate it into computer programs—a point that has been very well stated by Vaughn.³

There is no doubt that, ideally, it is very important to start with the "correct" requirements. Building a system to accommodate wrong requirements is a waste of time and effort. However, it is our view that in the present circumstances it is more important to develop methods to reduce the time to build systems *once the requirements are given*. The major reason for this is that it does not do much good to produce the "absolutely perfect" set of requirements if it will then take a long time (six months to several years) to produce the system that will accomplish the requirements. The absolutely perfect requirements are not constant—they change as the environment in which the organization exists changes, the organization itself

3. Vaughn, P. H., "Can COBOL Cope?" *Datamation*, Sept. 1, 1970, pp. 42-46.

changes and the individual users change or learn to use the outputs from the computer-based system. We have therefore adopted as our basic objective the need to reduce the length of time from the point where requirements are first stated until the target system to accomplish the requirements is in operation. Obviously the major tool to accomplish this reduction must be the computer itself.

Once it is decided to use the computer in the system development process, the next step is to decide where to begin recording data in machine-processible form. Here we try to apply the first principle of automation; record the input data in machine-readable form as close to the source as possible and thereafter process it with as little human intervention as possible. For the reasons mentioned above, we have decided to start at the point at which the requirements of the management system have been determined and the specification of individual inputs and outputs can begin. In the future we hope to extend our techniques to aid the process of determining what the requirements of the management system *should* be. There is no reason why any piece of data about requirements should not be recorded in machine-readable form the first time it appears in the system building process. (The proposed format for capturing the specification of requirements at this point and the software to process it are outlined later.)

Once it is decided to base the system building process on the use of the computer, there are other potential benefits than just the reduction in elapsed time. It should be possible to accommodate changes in requirements more easily both during the design process and during system operation. The computer can also be used as the basis for coordinating the activities of many analysts and to relieve them of many tedious and laborious clerical tasks which they now must do manually.

Methods of Improvement of System Building. The conclusion reached in the previous section is that the system building process itself should be automated, or at least computer-aided. Before describing our approach on how this might be done it is worthwhile examining some other ways to improve the process. The alternative methods may be grouped into four major categories: improve education and training of system builders, provide aids (computer based and others) for the system builders, use application packages, and use generalized software.

System building, as a profession, is still in its infancy and most practitioners were trained in other fields. In the early days, practice was relatively simple and required little more than programming. Now, however, the practice is becoming more professional and educational programs for the "information engineer" are being developed. However, it is extremely unlikely that it will be possible to build the number of systems of the size and complexity desired by manual methods—there will not be enough people. It will be necessary to use the trained professionals more effectively by moving from "handcrafted" systems to "mass-produced" systems.

Many aids designed to facilitate individual tasks in system building have been proposed. Probably the most generally used are the general-purpose pro-

gramming languages. Less widely used are programs for other aspects of the process such as flow charts and system simulators (SCERT, CASE, etc.). Space does not permit a detailed analysis of these aids here; however, our conclusion from such analysis is that these aids tend to be useful in only one particular (and usually narrow) aspect of the whole system development cycle. Manual intervention and manual preparation of input is required at each stage. What is needed instead is a coherent system that covers all phases of the life cycle in which the output of one phase is automatically an input to the next.

Application packages have been available since the early days of computers. Their use has been limited primarily because the user needs are continuously changing and attempts to provide flexibility usually result in high processing cost. There is a spectrum of methods to build application packages so that they can be tailored for a specific set of requirements ranging from applications in which the user has no alternatives, to ones in which he has complete freedom. In the most completely specified packages the user can only enter data values. This approach tends to be satisfactory only where the problem is relatively

The decisions which are made in the physical systems design are basically "grouping" decisions which theoretically can be represented as combinatorial problems.

small and very well defined. Some packages allow more freedom through the use of parameter values as well as data values. Another level of generality is reached by providing for a number of options which the user specifies by filling out a questionnaire or by completing a form. This method has been used to generate simulation programs⁴ and is the basis of generating software for the IBM System/3. An even more general approach to application packages is represented by user-oriented languages. These give the user a relatively flexible method of specifying his problem but require less effort than would be required to write a program in a general-purpose language. To cover all user needs would require many different languages and maintenance of the associated software. Some standardization clearly is desirable.

Generalized software started from input/output subroutines and packages such as sort, merge, report generators, etc., are now in common use. Generalized file maintenance packages, however, have only fairly recently evolved into "data base management systems." These systems differ from application packages in that they are "generalized" in terms of operations inside the computerized system rather than in terms of view of the user from the outside. Sorting, for example, is a processing operation that is not dependent on the particular application. Data base management systems will undoubtedly achieve a major role in the next

4. Ginsberg, A. S., H. M. Markowitz, and P. M. Oldfather, "Programming by Questionnaire," AFIPS Conference Proc. Vol. 30, 1967, SJCC, pp. 441-446 [CR 12764, 12149].

few years. They are attractive, despite their high processing cost, because they relieve the programmer of the need to program frequently used operations such as access methods for complicated data structures and variable-length items, records and files.

All of the methods of improving system building described above have been used and will continue to be used in the future. What we are concerned with is the next major plateau. There has been a progression in which general-purpose programming languages have replaced assembly languages and general-purpose languages themselves have had to be augmented by data base management systems to provide the framework for the programmer to communicate with the machine. In turn, the limitations of data base management systems will be overcome through automation of the system-building process. The effectiveness of trained professionals can be amplified and the computer-based aids to system building integrated into a software factory that can produce user programs tailored to user requirements.

Automation of the System-Building Process. The need to automate the whole system-building process, as contrasted with the development of aids for parts of the process, has been recognized. For example, this is the expressed goal of the CODASYL Systems Committee.⁵ So far, however, the committee has been primarily concerned with data base management systems. A computer-aided approach, the TAG (Time Automated Grid) System, has been developed by IBM. A number of other systems have been proposed.⁶ Many concepts from these systems have been incorporated into ISDOS.

ISDOS (Information System Design and Optimization System) is the name of a software package being developed by faculty, students, and research associates in the Department of Industrial Engineering at the University of Michigan. It consists of a number of major components which are shown in Fig. 1; this section gives a description, and purpose, of each component.

As mentioned earlier, ISDOS begins with the user requirements recorded in a machine-readable form. The problem definer (i.e., the analyst or the user) expresses the requirements according to a structure format called the Problem Statement Language. This language can be considered a generalization of those of Young and Kant;⁷ Information Algebra;⁸ SYSTEMATICS;^{9, 10} TAG Input/Output Analysis Form; and ADS.¹¹ All of these languages are designed to allow the problem definer to document his needs at a level above that appropriate to the programmer; i.e., the

problem definer can concentrate on *what* he wants without saying *how* these needs should be met.

It is very important to note that a problem statement language is not a general-purpose programming language or, for that matter, any programming language. A programming language is used by a programmer to communicate with a machine in the fifth phase of the system building process. A problem statement language, on the other hand, is used to communicate the needs of the user to the analyst and therefore is needed in the third phase. The problem statement language consequently must be designed to express what is of interest to the user: what outputs he wishes from the system, what data elements they contain, and what formulas are to be used to compute their values. Analogous information must be given for inputs. In addition, the user must be able to specify

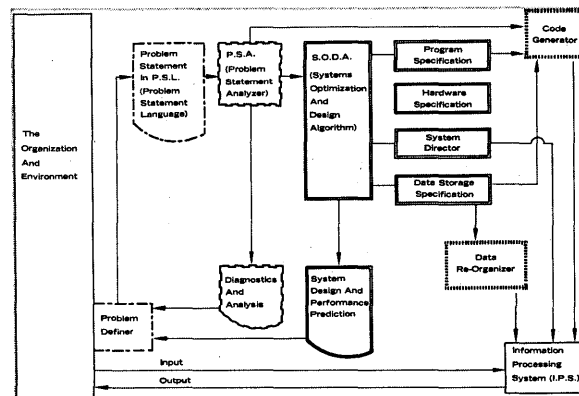

Fig. 1. Information System Design and Optimization System (ISDOS).

the parameters which determine the volume of inputs and outputs and the conditions (particularly those related to time) which govern the production of outputs and acceptance of inputs. The Problem Statement Language is designed to prevent the user from specifying processing procedures that should be selected in the fourth or fifth phase; for example, the user cannot use statements such as SORT and he cannot refer to physical files.

The Problem Statement Language has sufficient structure to permit a Problem Statement to be analyzed by a computer program called a Problem Statement Analyzer. This program is intended to serve as a central resource for all the various groups and individuals involved in the system building process as shown in Fig. 2.

Since the problem definer may be one of many, there must be provision for someone who oversees the problem definition process to be able to identify individual problem definitions and coordinate them; this is done by Problem Definition Management. One desirable feature of a system building process is to identify system-wide requirements so as to eliminate duplication of effort; this task is the responsibility of the System Definer. Also, since the problem definers should use common data, there has to be some standardization on their names and characteristics and definition by computations (these are referred to here as "functions"). One duty of the data administrator is to control this standardization. If statements made by the problem definer are not in agreement as seen by

5. The CODASYL Systems Committee states its objectives as: "... to strive to build up an expertise in, and to develop, advanced languages and techniques for data processing, with the aim of automating as much as possible of the process currently thought of as systems analysis, design, and implementation."
 6. For a discussion and comparison, see Teichroew, D., "A Survey of Languages for Stating Requirements for Computer Based Information Systems," ISDOS Working Paper No. 42.
 7. Young, J. W. and H. Kent, "Abstract Formulation of Data Processing Problems," J. of Ind. Engr., Nov.-Dec. 1958, pp. 471-479. Reprinted in Ideas for Management, Internat. Systems-Procedures Assoc., 1959.
 8. CODASYL Development Committee, "An Information Algebra-Phase I Report," Communications of the ACM, 5, 4, April 1962, pp. 190-204.
 9. Grindley, C.B.B., "SYSTEMATICS—A Non-Programming Language for Designing and Specifying Commercial Systems for Computers," Computer Journal, Vol. 9, August 1966, pp. 124-128.
 10. Grindley, C.B.B. and W.G.R. Stevens, "Principles of the Identification of Information," File Organization, IAG Occasional Publication, No. 3, Scolts and Zeitlinger N.V., Amsterdam, 1969, pp. 60-68.
 11. National Cash Register Company, Accurately Defined Systems, 1967.

the system definer or data administrator, he must receive feedback on his "errors" and be asked to correct these.

All of these capabilities are being incorporated in the Problem Statement Analyzer which accepts inputs in the Problem Statement Language and analyzes them for correct syntax and produces, among other reports, a comprehensive data dictionary and a function dictionary which are helpful to the problem definer and the data administrator. It also performs static network analysis to ensure the completeness of the derived relationships, dynamic analysis to indicate the time-dependent relationships of the data, and an analysis of volume specifications. It also provides the System Definer with a structure of the problem statement as a whole. All these analyses are performed without regard to any computer implementation of the target information processing system. When these

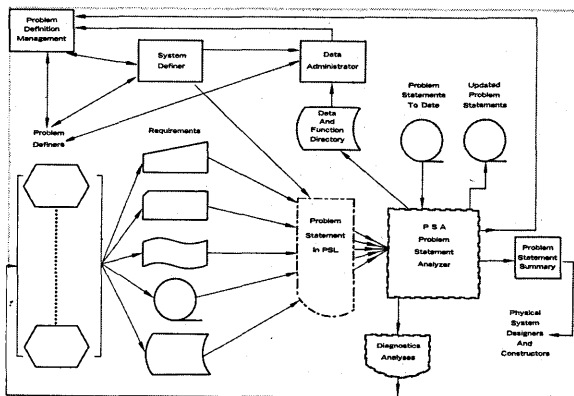

Fig. 2. Information flows in problem statement analysis.

analyses indicate a complete and error-free statement of the problem it is now available in two forms for use in the succeeding phases. One, the problem statement itself, becomes a permanent, machine-readable documentation of the requirements of the target system as seen by the problem definer (not as seen by the programmer). The second form is a coded statement for use by the physical systems design process and other modules of ISDOS.

In the conventional approach, the physical systems design phase (phase four) is concerned with accepting a consolidated statement of the requirements from the system analysts and outlining specifications for the actual construction of programs and files and the relevant schedules, etc. The number of alternatives available is usually so large that the manual approach does not permit the examination of more than a handful of these. An objective of ISDOS is to formalize the physical design process along the lines pioneered by Langefors,¹² Grosz,¹³ Turnburke,¹⁴ Martin,¹⁵ etc. The design problem is formulated mathematically. Operations research methodology is used to develop methods to search over the range of alternatives. A multilevel approach, where the decision variables at

one level become the constraints at the next level, is required. This makes it possible to evaluate various design strategies and aids the hardware acquisition group in the selection and justification of appropriate hardware. It also gives the performance officer (who is responsible for the efficient use of resources in computer operations) and the physical system designers a good indication of the expected performance of the system. In addition to the requirements as prepared by the Problem Statement Analyzer, a description of hardware characteristics is required. The outputs are specifications for program modules, storage structures, and scheduling procedures which are in a form suitable for processing by the next two ISDOS modules.

The Data Re-organizer accepts specifications for the desired storage structures from the physical systems design process, definition of data as summarized by the Problem Statement Analyzer, the specifications of the hardware to be used, and the data as it currently exists and its storage structure. It then stores the data on the selected devices in the form specified. The Re-organizer also produces information for the data administrator and the performance officer. The other module, the Code Generator, accepts specifications from the physical design process and organizes the problem statements into programs recognizing the data interface as specified by the Data Re-organizer. The code produced may be either machine code, or statements in a higher level language (e.g., COBOL) or parameters to a software package. These two modules perform, automatically, the function of programming and file construction in the fifth phase of the system building process.

The final module of the ISDOS system is the Systems Director. It accepts the code generated, the timing specifications as determined by the physical design algorithm, and specifications from the Data Re-organizer and produces the target IPS. This IPS is now ready to accept inputs from the environment and produce the necessary outputs according to the requirements expressed in the problem statement.

The central concept which makes possible the automation of design and construction is the separation of user requirements from decisions on how these requirements should be implemented. This philosophy is incorporated in the design of the Problem Statement Language. From then on the problem statement can be manipulated by the Problem Statement Analyzer. The decisions which are made in the physical systems design are basically "grouping" decisions which theoretically can be represented as combinatorial problems. In practice, of course, the number of combinations is very large and therefore a major research task is to develop efficient algorithms.

ISDOS Development Plan. If a system such as the one outlined in the previous section were available it would go a long way towards improving the effectiveness of computer-based information systems. Since new requirements or modifications to existing requirements could be implemented at computer speeds, management would be able to get the information it asked for in a much shorter period of time. It would therefore be much less important to get the requirements right the first time since a change could be incorporated more easily than at present. The user would be closer to the requirement specifications since the language is closer to the one he is familiar

12. Langefors, B., "Theoretical Analysis of Information Systems," 2 Vol. Studentlitteratur, Lund, 1966. (Also available from National Computing Centre Ltd., Quay House, Quay Street, Manchester, England.)

13. Grosz, M. H., "Systems Generation Output Decomposition Method," Standard Oil Company of New Jersey, July 1963.

14. Turnburke, V. P., Jr., "Sequential Data Processing Design," IBM Systems Journal, March 1963.

15. Martin, J., Design of Real-Time Computer Systems, Prentice-Hall, Englewood Cliffs, N.J., 1967.

Our minicomputers may be compatible, but it's their prices that are really easy to live with.

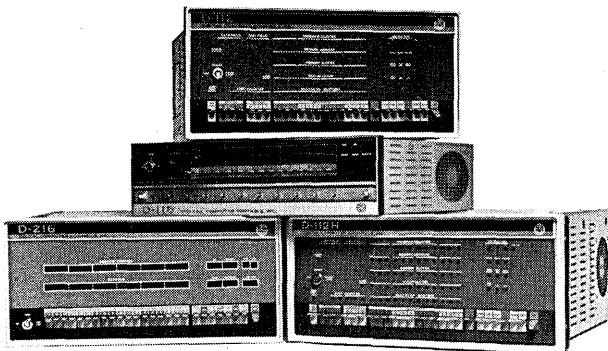

Select from one of our four minis. They offer a wide range of capabilities, are completely plug-program compatible with "8", "11" and "1200" type machines, and offer you considerable savings.

For example. Our D-116 is a 16-BIT LSI/MSI minicomputer. It features a 1.2 microsecond cycle time, is completely compatible with 1200 series machines, and is available in either a 5-1/4" or 10-1/2" chassis. The easy-to-live-with price? Only \$2400.

Or consider our D-112. A 12-BIT MSI minicomputer, with a 1.2 microsecond cycle time, it is completely compatible with "8" series machines. In everything but price, that is. (Only \$3990.)

Or our D-112H. With expanded "8" series instruction set, solid-state 200-300 nanosecond RAM (optional), and a 1.0 microsecond cycle time. You'd expect it to cost a fortune. It doesn't. (A mere \$5400.)

Or our D-216. A 16-BIT MSI minicomputer. A cycle time of 1.2 microseconds. A price that'll do your heart good. (\$2600.)

Ask us about our minicomputers. You won't get over the reliability and the speed. And the competition will never get under our prices.

Write for literature. Digital Computer Controls, Inc., 12 Industrial Road, Fairfield, New Jersey 07006. Phone (201) 227-4861.



**DIGITAL
COMPUTER
CONTROLS
INC**

CIRCLE 25 ON READER CARD

System Building . . .

with. Hardware could be used more effectively since design would be based on a formalized procedure using latest available parameters which specify volume of system inputs and outputs.

The system described is itself an information system and the development of functional specifications, design, and construction is a substantial task which involves three major subtasks:

1. The specification of man-machine communication problems encountered by the analyst in acquiring and recording the requirements for the target system; in other words, in the design of the Problem Statement Analyzer we must ask, "What type of information, in what form, would most aid the analyst?"

2. The specification of the system development cycle with sufficient detail of subtasks to indicate what functions must be performed, and their interrelationships.

3. The development of algorithms using decision making (operations research) methodology where possible, synthesizing, wherever appropriate, the various "micro" decision models already available.

These tasks are being undertaken in the ISDOS Project. Basic engineering philosophy is followed: development of subsystems, evaluation and validation in real life situations, and eventually, demonstration of the feasibility of the whole concept. ■

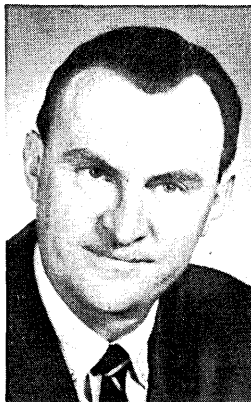

Professor Teichroew is chairman of the Department of Industrial Engineering at the Univ. of Michigan. He is also chairman of the ACM Curriculum Committee for Computer Education in Management, which is developing a master's level curriculum for information analysis and systems design.

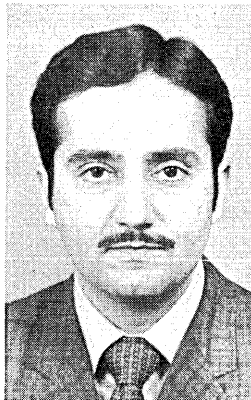

Mr. Sayani is currently completing requirements for a PhD in the Department of Industrial Engineering at the Univ. of Michigan, where he also earned an MS in industrial engineering and a BS in mechanical engineering.

Our BI 2600 works better and will last longer than any competitive mag tape unit made today.

In it, we ingeniously used 8" of spring steel to provide uniform tape tension no matter what the buffer arm position, thus eliminating tape cupping and the resultant data dropout.

We've cleverly developed a rigid, one-piece tape deck panel that never gets out of alignment.

We've meticulously ensured uniform packing density and tape speed by tying all timing and spacing to the capstan encoder.

We've sensibly eliminated all electronic and mechanical adjustments. Normal equipment maintenance is just a simple bit of clean-up, with virtually no downtime.

Then we wrapped up all this thinking in our BI 2600 Mag Tape Unit: Precise bidirectional tape travel at 4 to 37.5 ips, with a maximum data transfer rate of 60 kHz. Uniform packing densities up to 1600 bpi. A tape path completely to IBM specifications. 8½" reels (also available as our Model BI 2610 with 10½" reels). Industry compatible interfaces. High reliability with plug-in DTL/TTL electronics that have no one-shots and no differentiators. No program restrictions, no delays under any circumstances.

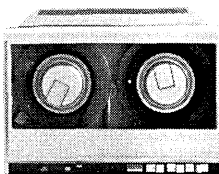

And we've priced it all at under \$3000 in OEM quantities.

Bright?

Bright Industries Inc.
One Maritime Plaza, San Francisco • 94111
Telephone: (415) 391-9794

Bright Industries is an affiliate of Tracor Inc.

**The only buffer arm
mag tape units that
can't cup your tapes.**



Bright? Right.

Larger and slower core storage increases throughput, decreases costs for Fireman's Fund

Finding Happiness in

G Increased throughput, improved turn-around, and cash savings are worthwhile goals for a dp department. To realize all three at once is a noteworthy accomplishment. Fireman's Fund Insurance Co. of San Francisco has done just this, largely by replacing a fast component by a slower, but larger, component—an Extended Core Memory (ECM). These devices are core memories similar in design to conventional "high-speed" core storage boxes, but they are slower. How much slower varies with the manufacturer. Collectively, these devices are known as Large Capacity

... our total installation is nearly \$15,000 per month less expensive to operate with an increase in capacity.

Storage (LCS) boxes.

Used in conjunction with high-speed storages, LCS devices permit a far larger memory, on a dollar-for-dollar basis, to be utilized than would be feasible with high-speed memories.

IBM's own LCS unit, the IBM 2361 core storage, which was introduced with the original S/360 line, has an access time of 8 usec. Ampex markets its own ECM boxes with access times of 2.8 usec up to 8 usec.

Assisting in the preparation of this article were Hans D. Puehse, manager of technical services; Pieter Monteban, team leader for OS maintenance; Larry Stout, team leader for operations support, and William J. Harrison, team leader for software, Fireman's Fund.

Other vendors, including Data Products, Weismantel, Core Memories, Inc., Lockheed, and Fabri-Tek also offer similar units at various access times. By comparison, IBM's 2365 "high-speed" memory has an access time of 0.75 usec.

LCS units are marketed for a wide variety of machines in addition to the IBM S/360. Others include RCA Spectra 70, Univac 1108 and 494, Burroughs D-825, XDS, DEC, and Bunker-Ramo mainframes.

In September 1970, Fireman's Fund Insurance Co. of San Francisco (part of the Fireman's Fund American Insurance Companies, or FFA for short) made a decision to replace 512K of our IBM 2361 high-speed core with 1024K of Ampex Extended Core Memory on one of our S/360 model 65 computers. This machine, configured with 2314 disc drives and 2420-7 (320KB) tape drives on one multiplexor and six selector channels as shown in Fig. 1, is the largest configuration of Ampex ECM units installed anywhere at that time.

The access time of any core storage unit is directly related to the cpu cycle time. Instruction and data fetches from a slower memory essentially means that the cpu cycle rate is reduced accordingly for those cycles involved in those fetches. Thus, when executing programs or accessing data from the ECM unit, the cpu operates at an effective cycle time of 2.8 usec rather than its usual cycle time of 0.75 usec. Slower access time, with the corresponding slowing down of the cpu, finds usefulness in those cases where the cpu would otherwise be in a wait state. It is just this spreading out of the useful work of the cpu and memory into the full amount of time available which permits the slower LCS technology to economically replace high-speed core.

...Extended Core

by Melvin J. Duroo, Jr.

In a typical commercial environment, even with high-speed 2420-7 tapes and 2314 disc, in many cases, the time required to transfer between external and internal memory is still considerable compared to the time required to perform calculations in the cpu. In short, many jobs are I/O bound.

The cpu will often finish its calculation-type work and then wait on further transfer of data to or from external storage before continuing other calculation-type work. By executing I/O bound jobs in ECM, the lengthening of the cpu cycle time tends to fill in the period of time spent waiting on transfers to or from external storage.

Even with multiprogramming using OS/MVT, which one would normally expect to fill in wait periods with executions of other jobs, commercial job mixes often tend toward an overall cpu wait state. This is due to the fact that of all the jobs in a mix, there may at times be none ready and able to take advantage of the cpu cycles available.

ECM has the advantage, through the increased core storage availability which it offers, of more regions in which program execution may take place. This increased number of programs operating simultaneously means a greater likelihood that some program or another will be able to fill in during wait periods and thus utilize the cpu more efficiently. The increased core availability moreover can be used to increase efficiency by accommodating larger jobs than would otherwise be accommodated, and by reducing the "core-hogging" of real-time jobs which require large regions but which are relatively inactive. The percentage of total core used by such jobs is reduced as an effect of increasing core size. A major benefit for time-sharing operations is the possibility of reducing roll in/roll out operations by virtue of larger regions.

Individual jobs vary from moment to moment in their I/O boundness. Even then, the wait state is dependent on the total job mix in the machine at one time and their channel activity. The I/O boundness of the complete job mix in an MVT environment is thus quite complex. But the overall I/O boundness of the machine is not an unusual situation in commercial shops; and speaking of individual jobs in terms of boundness, while not an exact statement, is nonetheless a useful and practical simplification.

Job classification by execution characteristics is desirable when using ECM. Generally, jobs which are

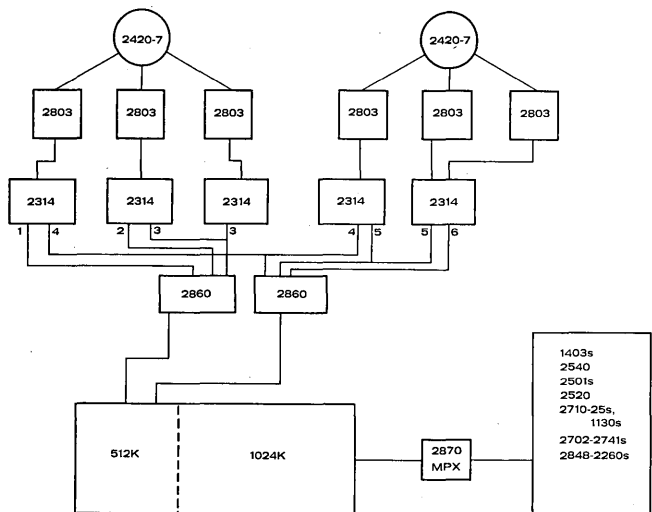

Fig. 1. Configuration of S/360 model 65 with ECM.

Extended Core . . .

I/O bound and those which can be enhanced by availability of larger region size are better suited to ECM. Those jobs which are CPU-bound and those which are exceptionally long running without being seriously I/O bound are better accommodated in the high-speed core.

Fig. 1 shows the Fireman's Fund configuration after installation of ECM. The machine with the ECM box attached still has 512K of high-speed memory, for a total of 1536K of core.

The release 18.6 OS/MVT operating system which is used on the machine required very few modifications. We partitioned ECM into fixed regions, moving the System Queue Space (SQS) and Link Pack Area (LPA), a total of about 200K of space, into ECM. We have experienced little degradation of performance resulting from this relocation.

Initiators were established, each having a primary and a secondary job class assigned to it. Job classification schemes were established covering both production jobs and testing.

LPA	102K	Link Pack Area
MS		Master Scheduler
SQS	94K	System Queue Space
HASP	124K	HASP
HASPWTR	12K	HASP Writer
HASPRDR	48K	HASP Reader
LOOK	18K	Operator Command Extensions Tasks
CU	6K	
PNIT64KG	64K	Fixed Initiator Regions
PNIT140K	140K	
PNIT200K	200K	
DCS	64K	On-Line Jobs
MTMT	88K	
ATS	64K	

1024K

Fig. 2. Core map of ECM.

"Tuning" of the system with the help of an in-house software monitoring system has resulted in an effective job classification scheme and efficient use of ECM. This in-house monitoring system captures and maintains detailed records on channel usage, core usage, and numerous other operational characteristics of the total system.

The primary considerations in the job classification scheme are region size, I/O or compute-boundness, and the individual job's turnaround requirements. Large real-time jobs, in our case, MTMT (Multiple Terminal Monitor Task—an IBM type 3 source-pro-

gram maintenance system), and ATS are resident in ECM, as is HASP. Fig. 2 is a core map showing a typical internal configuration of memory during a typical work period.

The installation of ECM resulted in the immediate saving of money. The difference in price between the originally installed 512K of IBM 2365 high-speed core and the 1024K Ampex Extended Core Memory is \$15,000 per month. The incidental costs involved in installation were minor. As a result, our total installation is nearly \$15,000 per month less expensive to operate with an increase in capacity.

Turnaround time has been improved by the longer cycle time of ECM. Due to the overall improvement in the multiprogramming environment, the previous typical turnaround of 8 to 24 hours has been reduced to about 4 hours. There are more jobs running at once so that the job gets in and gets out of the machine more quickly although the actual execution of the job itself may take a little longer. The overnight testing load is now typically completed during the evening and morning hours. Testing and production overflows from the night into the next day are now virtually eliminated.

Overall, throughput of the system has been improved by about 30%.

ECM was installed on Sunday, Oct. 11, 1970, during normally idle time. The installation of the plug-to-plug compatible Ampex ECM unit took only about eight hours and the machine went back into service on Monday morning, Oct. 12, with no serious problems. Our computer operations were impacted very little by the changeover.

No serious problems have arisen with conversion to or maintenance of the system. The changeover and continued use during the intervening months has produced no operational problems of consequence.

Today's business demands an ever-increasing capacity and response from data processing functions. At the same time, cost control and reduction is of major importance. Technology offers many alternatives to the data processor; but the choice between these alternatives must be made with capacity, response, and cost control in mind. Fireman's Fund's decision to use LCS technology might serve as an example of how these three conflicting factors can be simultaneously satisfied. ■



Mr. Durao is director of systems efficiency and advanced technology at Fireman's Fund Insurance Co. in San Francisco, where he has designed a comprehensive performance measurement system. Previously he was a project manager with Computer Usage Co. of Palo Alto, Calif. He holds a BS degree in business administration from Fresno State College.



These data communication types just laughed...



when I told them that the new standard in the industry will soon be 7200 bps.



... and just as reliable as the best 4800 bps!



Sure. They all knew about 7200 bps. Reliable? No way!



They really laughed when I talked about maximum 7200 bps throughput over C-1 lines.



— and error rates better than most 4800 bps data transmission.



Then I told them it was because of a new 7200 bps modem from ICC.



Nobody laughed.



Some cheered.

Send for data sheet.

International Communications Corporation
7620 N.W. 36th Avenue, Miami, Florida 33147
a milgo company

In Europe: RACAL-MILGO LIMITED Reading, Berks, England

ICC

GET TO KNOW A COM EXPERT WHEN YOU SEE ONE.



Lou Britt
Palatine, Ill.
312/359-7620



Gerry N. Leiting
Denver, Colo.
303/222-1811



Argyle A. Magenheimer
Kansas City, Mo.
816/421-4720



John P. Michaelson
Minneapolis, Minn.
612/727-1110



Donald R. Burcham
Milwaukee, Wis.
414/462-3920



Ray F. Vaughn
Seattle, Wash.
206/682-7844



William N. Highfill
San Francisco, Calif.
415/397-6767



Walt R. McIntire
Los Angeles, Calif.
213/386-1400



Richard W. Frederick
Torrance, Calif.
213/542-7377



James T. Sharkey
Dallas, Tex.
214/369-7421



Charles A. Newberry
Houston, Tex.
713/529-3981



William J. Weisel
Chicago, Ill.
312/287-7321

Here are 39 COM experts from Remington Rand, each backed by COM customer engineers, analysts, and sales specialists, plus a full team at the Home Office. One of them operates from a 115 volt wall socket. The other 38 are charged to provide you and the rest of the business community with the best management information system possible.

Call the Remington COM expert nearest you. Ask him to give you the details on our new Rand COM™ 500 recorder. Get him to explain our "total system" concept while he's at it. As we say at Remington Rand, "You can't beat the system." Remington Rand Systems Division, P. O. Box 171, Marietta, Ohio 45750.



Danny D. Tamburo
Detroit, Mich.
313/171-3511



Donald A. Graham
Marietta, Ohio
614/374-9300



Thomas G. Povey
Marietta, O.
614/374-9300



William B. Grawe
Marietta, O.
614/374-9300



Walter R. Butler
Marietta, O.
614/374-9300



Ron Archer
Marietta, O.
614/374-9300



Kevin Leenay
Marietta, O.
614/374-9300



Frank A. O'Toole
Marietta, O.
614/374-9300



C. Halden Lowry
Columbus, O.
614/846-4835



Richard L. Scalzitti
Buffalo, N. Y.
716/837-7700



John C. Corson
Pittsburgh, Pa.
412/261-2145



Robert H. Montgomery
Boston, Mass.
617/237-1610



Joseph H. Sconzo
Hartford, Conn.
203/688-6491



William A. Bavagnoli
Newark, N. J.
201/272-7200



Norman J. Rousseau
New York, N. Y.
212/956-2166



Sam B. Keesee
Philadelphia, Pa.
215/546-5561



R. Furman Ferguson
Washington, D. C.
202/338-7400



Fred J. Jonucz
Washington, D. C.
202/338-7400



John Totoju
Washington, D. C.
202/338-7400



Sanford F. Shell
Atlanta, Ga.
404/872-0778



Joseph H. Romano
Atlanta, Ga.
404/872-1881



Dan A. Yates
Richmond, Va.
703/353-3965



William E. Dawson
Memphis, Tenn.
901/276-6384



S. Eugene Russ
New Orleans, La.
504/834-8910



Larry E. Coffee
Indianapolis, Ind.
317/545-4251



Thomas J. Flanagan
Jacksonville, Fla.
904/396-2731



SPERRY RAND
REMINGTON RAND
OFFICE SYSTEMS DIVISION

PERSPECTIVE

an interpretive review of significant developments

Harvard Will "Redirect" IBM-Funded Study on Technology and Society

Harvard and IBM have learned that it was easier to invent the computer than it is to determine what effect the invention is having on society.

The two institutions that teamed up to build the famous Mark I have not been as successful in a more recent joint effort called The Program on Technology and Society. The \$5-million program was established at Harvard by IBM in 1964 "to undertake an inquiry in depth into effects of technological change on the economy, on public policies, and on the character of the society."

Harvard and IBM say that the program is continuing, but that it is being redirected. Some of those associated with it, however, feel that the heart of the program is being permanently torpedoed.

The program as it now stands — a battery of diverse projects centered around the general subject of technology and society — is to be dismantled at the end of the 1971-72 academic year when those associated with the program will lose their positions. The program, under the direction of Emmanuel G. Mesthene, operates in an old estate in Cambridge. Harvard says it intends to use the remaining IBM funds "to create new teaching posts in the general field of technology and society within existing faculties or departments."

Although the program addressed itself to the broad spectrum subject of technology and society, the place of computers in the program was considered particularly significant — partially because the sponsor, IBM, makes most of the world's computers and partially because the program was instituted at a time when the issue of automation was at its height. In addition to examining the effects of technology on society, the program was evaluating "the reciprocal effects of social change on the nature, dimension, and directions of scientific and technological developments."

The program is the only sizeable project of its kind anywhere. Because

the subject matter — society and technology — is a new discipline of study, it was expected from the start that it would take some time to get the endeavor off the ground. When the program was established in 1964, it was stated: "The area of proposed research is relatively new and lacks well-defined problem definition and methodology. A successful approach is most likely to develop from an effort spread over a relatively long period, approximately ten years, during which the intellectual resources of the University can be gradually deployed to mount a substantial and coordinated effort on this class of problem."

40 Projects, 100 Scholars

Thus far, nearly 40 research projects have been started under the auspices of the program. These have involved more than 100 scholars from 22 universities and 7 industrial and public institutions. The program produced more than 20 books, including a widely acclaimed critique of technology and education called "Run Computer, Run," written by Harvard Prof. Anthony Oettinger.

"This area of study we're talking about arouses a lot of emotions," says Harvey Brooks, Harvard's dean of engineering and applied physics.

Brooks is a member of a committee that is working out details on the new direction the program will take.

Among those parties who obviously were not enthusiastic about the program as it now exists were IBM and Harvard's administration. A blue ribbon advisory committee — independent of both IBM and Harvard — recommended that the program be continued but that Harvard be given the option to change the direction of the program. Dean Brooks said there had been a considerable amount of "private exchanges" between Harvard and IBM about the program. The ultimate decision to "modify" the program was made by Harvard president Nathan M. Pusey.

The whole issue has been somewhat clouded for a variety of reasons. Harvard's original press release on the issue stated that the program in its present form would be "terminated"; but, later, the word was deleted, and Harvard indicated the program would be "adapted." IBM, in keeping with its penchant for secrecy, has assumed what amounts to a hands-off attitude on the issue. An IBM spokesman said that IBM understands that "the program is being redirected, not terminated." He added that the direction of the program was up to Harvard, not IBM. Of several persons working at the program itself, or close to it at Harvard, all said that IBM never attempted to influence the direction or the results of any of the projects of the program, although a few expressed the feeling that IBM had remained too aloof from the program — that no one knew what IBM was seeking from the program.

Nothing Else Like It

Asked whether IBM funded any other programs to examine the role of computers or technology on society, the IBM spokesman said he knew of "nothing similar in magnitude" to the Harvard program. In addition, it should be noted here that none of the other large mainframe computer manufacturers have committed significant resources to examine the effects of computers on society.

The incident has a certain irony. When Thomas Watson, Sr., was at the helm of IBM, he channeled \$5 million to Harvard to subsidize the design and development of the Mark I, which became the building block for the first generation of computers. Watson and Harvard's Howard Aiken — both geniuses in their own right and both possessing mammoth egos — had some stormy differences over the project, but, in the end they produced the Mark I. The Program on Technology and Society, also financed by \$5 million of IBM money — was marked by a feeling of amnity by IBM and Harvard, but the program was never able to produce much of note.

— W. David Gardner

NEWS SCENE

New Wrinkle in California EDP

The state of California's Office of Management Services, which had primary responsibility for "control and service" of the state's \$80 million-a-year edp operations, suddenly passed out of existence last month when the legislature's Conference Committee on the Budget voted it zero appropriations.

The move was interpreted by most observers as reflecting legislative disappointment with the rate at which OMS was effecting consolidation of the state's edp operations (see June 15, p. 59). OMS ceased to exist officially on July 1. Its 25 employees were given notice on July 2, through July 21.

What went on in the conference committee hearings which led to the action can only be surmised. Former OMS director, Dr. Charles P. Smith, described the committee meetings as "the most secret in state government." Among those heard by the committee were representatives of the Assembly Committee on Efficiency and Cost Control which on June 28 had amended an Assembly bill legislating OMS out of existence and transferring its duties and authority to the more powerful Dept. of Finance. The conference committee's decision, in effect, implemented the intent of this amended bill. In addition to withholding a budget from OMS, it transferred its authority and 15 civil service positions to the Dept. of Finance.

John Billet, a consultant to the Assembly committee, called the transfer to Finance a "holding action." The committee was continuing to hold hearings on edp last month, and it was generally assumed at this writing that new legislation concerning the state's edp operations would be introduced before the current legislature is adjourned. But this could still be a way down the road, for Sacramento old-timers are looking for the longest legislative session in the state's history this year . . . one that could extend through November (traditionally adjournment is in mid-August).

In the meantime, the Dept. of Fi-

nance was taking over in July and was expected to take on systems analysts and supervising systems analysts from OMS to fill the 15 new positions it was assigned. Jim Dwight, deputy director who was assigned "policy direction" responsibility for edp as a result of the shift, said the department would hire an outside edp expert to run the operation, but in its first weeks as edp coordinator, Finance had approved some minor buys. These were buys that might not have been made had OMS continued to exist, as the office had prepared a moratorium order on all edp expenditures for "an indeterminate time." The moratorium would have gone into effect on the same day OMS went out of effect.

The haste between OMS and people in state government who would have preferred a Dept. of Data Processing which would own all state computers dates back almost as far as OMS itself. OMS was established in November of 1967 to develop policies, plans, procedures, and standards for state edp operations. It subsequently was given responsibility for training, security and privacy, and for review and approval of expenditures. The office developed a five-year plan for consolidation of state edp functions which evidently has the blessing of the Assembly Committee on Efficiency and Cost Control, for Billet noted: "We have no objections to the master plan. We consider it a good plan. We only doubt that it is being implemented."

In Dr. Smith's view it boils down to a question of "mashing equipment" or consolidating on a functional basis. He feels physical consolidation might be pushed with the power of the Dept. of Finance. He said computer utilization during the three years OMS existed had increased from 47% to 70% on the average, and the time had come to deal with "effective use of computer technology . . . to define information requirements . . . not to mash computers."

Dr. Smith said he recognized what had happened to OMS as reflecting the political environment. "It's only too bad the administration and the legislature couldn't sit down together and

work out a proper balance between policy and effectiveness."

That edp in any government use is as much subject to the political environment as any other activity was demonstrated in another state last month. Larry H. Walker (Brig. Gen. U.S. Army, ret.) was relieved of the directorship of the state of Pennsylvania's Bureau of Management Information Systems. But the situation wasn't quite the same as that in California. In Pennsylvania it was simply the spoils system in operation. BMIS is part of the governor's office, and its director is a political appointee. Gen. Walker was appointed during a Republican administration. A new Democratic administration moved in and . . .

Interestingly, both California and Pennsylvania had been cited in a recent state edp officers' publication as leaders in handling state edp operations. Says Dr. Smith, "it's dangerous to get recognition from your peers."

Nebraska Legislation Drafted in 10 Minutes

The legislature of the state of Nebraska drafted 1,226 bills during the session ended in mid-June. Average drafting time was 10 minutes.

In previous sessions it took some 24 hours to draft each bill. Reason for the reduction: an on-line bill drafting system developed and operated jointly with the Univ. of Nebraska. State officials believe Nebraska is the first state to have successfully developed and implemented its own bill drafting system, although others are using systems provided by outside vendors.

When Nebraska decided to automate its bill drafting, says Emory Burnett, assistant bill drafter who directed the project, "we took a look at systems offered by Aspen Systems Corp. and Data Retrieval Corp., but they didn't quite fill our needs and we decided we could do better within the state."

The system was designed around an existing remote operating system,

Announcing Series/300, from Caelus, *the Mini Disk-File System for the 70's*



CD348F features:

- 48 megabit capacity
- 8¾" rack space
- 0.3 micron air filtration
- Brush cleaning cycle
- Unique voice-coil actuator
- Removable and fixed disks
- 60 millisecond average access time
- Self-contained power supply
- Data reliability -1×10^{12}

Series/300 can be configured to specific OEM requirements, for more facts, contact Caelus.



CAELUS® MEMORIES, INC. P. O. Box 6297, San Jose, California 95133. Telephone (408) 298-7080

CIRCLE 28 ON READER CARD

NUROS (Nebraska University Remote Operating System), permitting the university to continue its normal processing while the bill drafting system was in operation. The system permits typists at the state capitol to enter the text of a bill along with formatting instructions from eight Computer Optics crt's. Use of crt's, noted Burnett, is one of the big advantages the state's own system has over the others evaluated.

Information is transmitted from the state capitol to NUROS via standard leased lines. The university computing center has an IBM 360/65 with one million bytes of core and an additional one million bytes of Ampex bulk storage. Three 2314s and a data cell make up the major peripheral storage.

Modified typewriters were used for printout at the capitol during the first session of the system's operation. By the time the nation's only unicameral legislature convenes for its next session this fall, the state will have acquired a high-speed printer to take over this job. It probably will be a Data Products printer, although the final decision had not been made at this writing.

Cost cutting along with speed and efficiency was a prime aim when the decision was made to automate bill drafting. While reductions in printing costs during the first use period were not sufficient to cover cost of development of the system, both state and university officials are looking forward to a 25% savings in the next session, which effectively begins next month when capitol clerks who will be using the system begin a "reorientation" training period prior to convening of the legislature.

IFIP Talks to Draw Hundreds from East

In a period of increasing relaxation of restrictions on East-West trade, IFIP Congress 71 has chosen a propitious meeting place for world leaders in computing technology — Ljubljana, Yugoslavia.

While the trade of written information has been relatively unfettered for several years, the opportunity for personal contact with professionals from Eastern Europe has been rare. Their

contingents at the four Congresses of the past have been small, though high level. August 23-28, Congress 71 will provide visitors from the U.S. and elsewhere with the chance to meet "several hundred" specialists from the USSR, Yugoslavia, Hungary, Czechoslovakia, Poland, Bulgaria, Rumania, and East Germany. In fact, at writing, Hungary and Yugoslavia each accounted for more than 200 of the 2,000 registrants — behind only the U.S. and United Kingdom in numbers. Representatives from 42 countries will attend.

On another level, the Congress can expect some corporate contingents from companies with strong interests in East Block trade, such as England's International Computers Ltd. An invited speaker on the program is Jacques Maisonrouge, president of IBM World Trade — the only executive of a major corporation on the program. While Maisonrouge is respected for his technical credentials, his presence and the expected attendance of other business executives are viewed by some as "homage" to Yugoslavia's long-standing position as the West's trade springboard to the East.

A third interesting aspect of this meeting is a budding effort by IFIP members to attract more attendance from the developing nations. An IFIP spokesman noted that African participation particularly is expected to be higher because of the promotional efforts of O.J. Fagbemi, acting dean of science at the Univ. of Nigeria. Fagbemi will join others in presenting the first Congress session on "Computers for Developing Nations." This will follow a United Nations report on the topic.

Otherwise, the IFIP Congress will attempt to fulfill its traditional charter: to present "an overview of the whole state of the computing art," says vice chairman of the program committee, Prof. C.C. Gotlieb of the Univ. of Toronto. "The program, spanning as it does the full range of topics in computer theory, design, and practice, has several conferences embedded in it."

This is the fifth in the triennial meetings sponsored by the International Federation for Information Processing, which represents the national

professional societies of 29 member countries. The patron of Congress 71 is Josip Bros Tito, President of the Republic. Chairman is S. Kavcic of Yugoslavia, and program committee chairman is V. M. Glushkov of the USSR Academy of Sciences.

Over 200 submitted papers and 36 invited papers will cover the following seven categories: numerical mathematics; foundations of information processing; computer software; hardware and systems; management and administration; technological applications; and sciences, humanities, and education. Among world renowned authorities giving invited papers will be frequent U.S. visitor, A.P. Yershov of the Siberian Div. of the USSR Academy of Sciences, on "Theory of Formal Languages" and his colleague, G.I. Marchuk, on "Numerical Methods and Computer Applications in Meteorology"; IBM's Kenneth Iverson on APL, and Maisonrouge on "Management Control and Information Systems"; D.E. Knuth, Stanford Univ., on "Mathematical Analysis of Algorithms"; H. Andersin, Helsinki Univ. of Technology, on "Concepts, Techniques, and Models for the Process of Management"; D.J. Wheeler, Cambridge Univ., on "Assessing the Complexity of Computer Systems"; and J. Whitney of the California Institute of Technology on "A Computer Art for the Video Picture Wall." U.S. specialists account for 136 of the 250 papers at the Congress.

For those who have just decided to go, call Jack Rosenfeld, IBM, Yorktown Heights, N.Y., for registration and accommodations information. Registration is \$60.

Transpacific Joint Slated in Tokyo

Organizers of a new computer show, scheduled to be held in Tokyo in October of 1972, should have no difficulty finding volunteers to staff the various committees. Tentatively, it's being called the Pacific Computer Conference, sponsored jointly by AFIPS (American Federation of Information Processing Societies) and IPSJ (Information Processing Society of Japan). Both organizations supply national

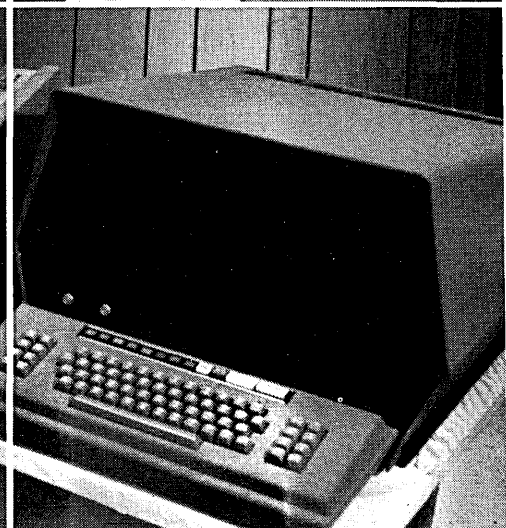
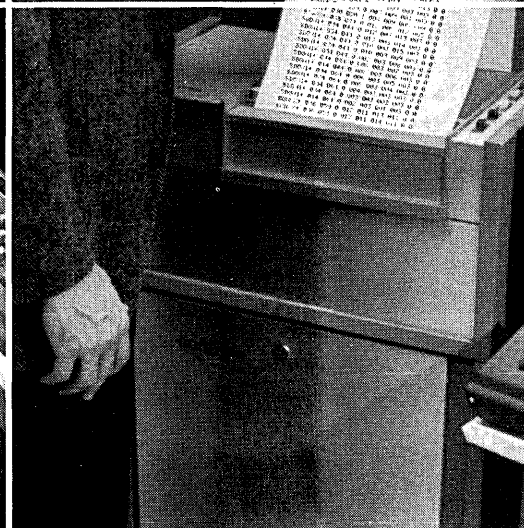
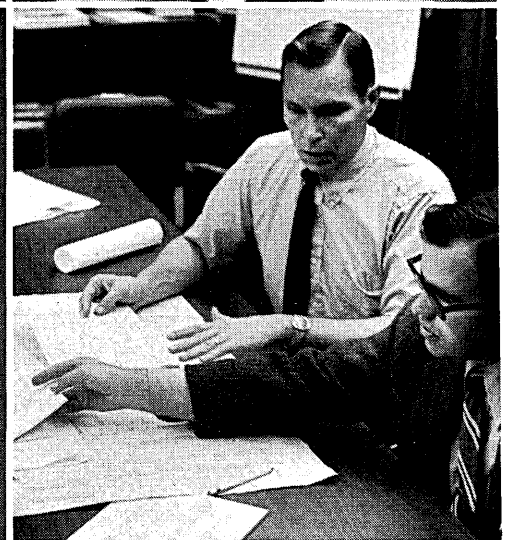
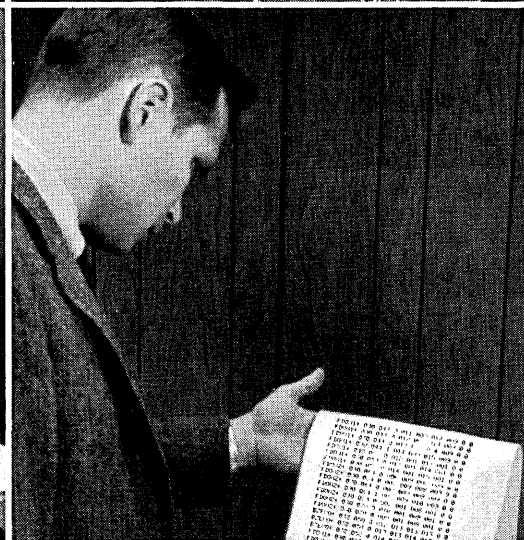
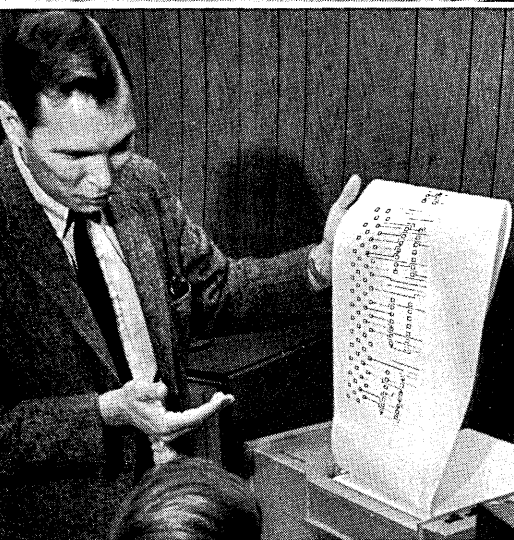
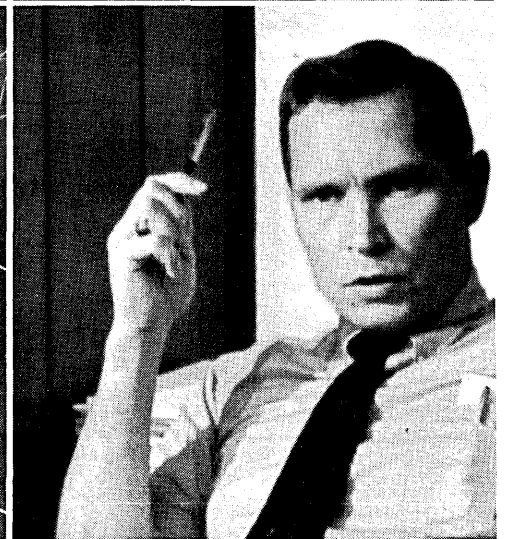
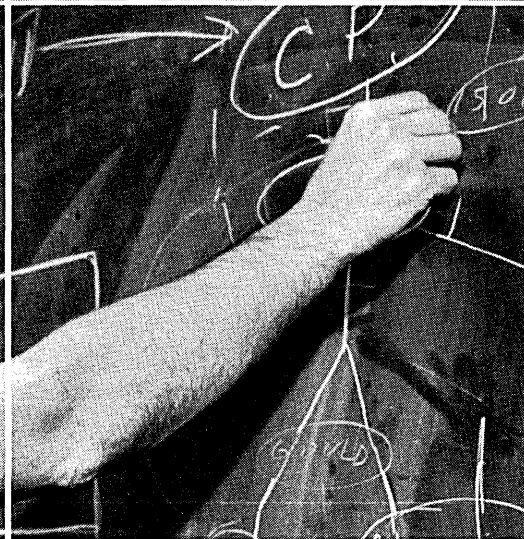
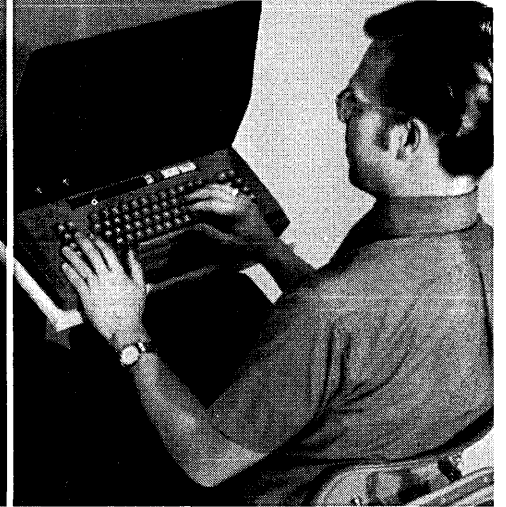
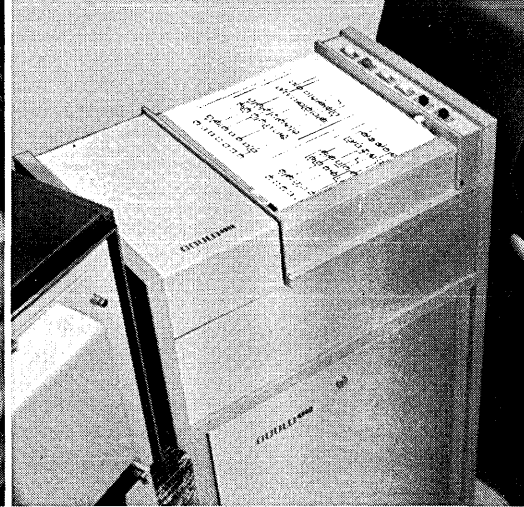

Software systems firm slashes printout costs, compresses production schedules with Gould 4800.

Automation Technology Inc. is a specialty software systems house in Champaign, Illinois. One of their many capabilities is the design and production of the precision artwork used for making printed circuit boards. To help meet the rapidly growing demand for increasingly complex and compact circuitry, ATI uses a Gould 4800 electrostatic printer/plotter.

Art Carroll, ATI's President, provides the details:

"One of the key steps in our operation is the validation of our circuitry designs. This is done with our design automation system and requires several iterations to arrive at the optimum combination of component placement, circuit paths, interconnections and drilling patterns. Before we had the Gould 4800, we had to go to our photoplotter for these iterations. This was both costly and slow as photoplotter time runs about \$75 an hour and one iteration may take hours to produce.

"The Gould 4800 gives us both alphanumerics and graphics for pennies per page. And lets us pinpoint defective inputs and make corrections as we go.

This way, we don't have to use the photoplotter until we're ready for the production master.

"As our circuit designs grow more complex, the Gould 4800 becomes even more valuable. At the rate of 100 sq. in. per sec., it furnishes a graphic printout that superimposes the wiring patterns for several layers of a multi-layer circuit. It also provides our alphanumeric "fail" list that gives us complete details on connections not successfully completed. This permits early manual intervention.

"This sort of speed, combined with its versatility, quietness and reliability, makes the Gould 4800 ideal for our operation. Without question, it's our key piece of peripheral equipment."

All kinds of companies with all kinds of hardcopy requirements have found the Gould 4800 to be an optimum solution. This smooth, quiet electrostatic printer delivers up to 4800 lines per minute on an 8½" or 11" format. It has an optional character generator. Software and interfaces for major computers are available. And while the Gould 4800 has relatively few moving parts and little need for maintenance, there are service facilities nationwide.

Find out what the Gould 4800 can do for you. Give us a call. Or write: Brush Division, Gould Inc., 3631 Perkins Avenue, Cleveland, Ohio 44114.



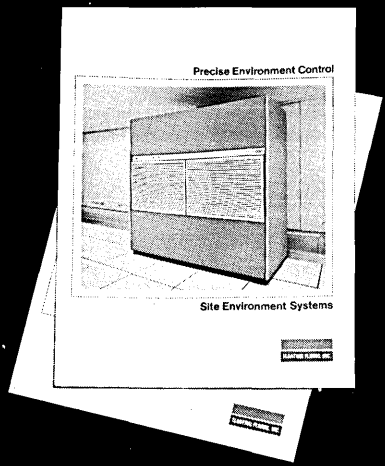

Get this brochure before you buy or specify an environmental control system.

Expensive, sensitive computers demand the ultimate in environmental control protection. This brochure describes it . . . The Site Environment System (SES®).

Reliability—Engineered and built to operate continuously. Dual circuits and dual condensers give fail-safe protection.

Precise Environment Control—Automatic controls maintain temperature within $\pm 2^\circ$ and humidity within $\pm 5\%$ constantly. Ideal for critical environmental cooling with top discharge air plenums.

Adaptability—Completely self-contained units in a complete range of colors and sizes — 3, 5, 7½, 10, 15 and 20 tons for use singly or in combination.

Flexibility—Available in water or glycol-cooled, air-cooled, or chilled water models. Easily altered to duct air up or down through ductwork or plenum.

Economy—Quality engineering and components reduce the need for maintenance. Easy access from front cuts service time.

Write for this authoritative technical brochure: Floating Floors, Inc., Subsidiary of N L Industries, Inc., 5400 North Detroit Ave., Toledo, O. 43612. (419) 479-0721.

NL **SES** **FLOATING FLOORS, INC.**
INDUSTRIES

N L Industries, Inc. is the new name of National Lead Company

CIRCLE 40 ON READER CARD

delegates to the international arm, IFIP.

This show, participation in which will be split pretty much 50-50 by representatives of both nations, comes in the midst of an active "sell abroad" campaign by the U.S. government. Ironically, it follows by only a few months another show being sponsored by the U.S. Commerce Dept. in Tokyo. In time, the Americans will be exporting more shows than equipment.

At the PCC, or whatever it'll be called, the idea is to devote as much exhibit space to U.S. gear as to Japanese. Similarly, there will be an approximate 50-50 split in presentations at the technical sessions. Here, the stress will reportedly be less on state-of-the-art papers and more on subjects of common interest, common problems, and contrasts and comparisons of methodologies. Already named as conference general chairman from the U.S. side is Dr. Robert W. Rector, of UCLA, who will share this post with someone from Japan.

WESCON '71 — More Computer Impact

The 1971 Western Electronic Show and Convention (WESCON) will reflect a lot of things. More than anything else it will reflect the growing dependence of the big show on the computer industry.

When the final count was in last year, WESCON organizers found that computer industry people accounted for 18% of their 1970 attendance. They've made a strong bid for a bigger percentage with their 1971 program, starting with the keynote speech which will be delivered on opening day, Tuesday, Aug. 24, by William F. Glavin, president of Xerox Data Systems.

Almost half of the individual presentations in 32 sessions will be of either direct or indirect interest to computer industry personnel. And WESCON will be the first trade show to try out a new computerized system of attendee registration. It's a system developed by Jacquard Systems of Manhattan Beach, Calif., in cooperation with Addressograph Multigraph Corp., which weds computers and

embossing equipment. The WESCON use will be its pilot run.

WESCON '71 also will reflect the state of the economy both in its session content and in its size. The show, which traditionally had been held in San Francisco's big Cow Palace in its biennial Northern California appearance, was moved in May to smaller Brooks Hall in downtown San Francisco when it shaped up as a 700-booth show instead of the typical 1,100-booth event it had become.

Included in the technical program are such signs-of-the-economic-times sessions as Recognizing and Gearing Up for New Electronic Markets, and Turnaround '71, Strategy for the '70s. The latter includes papers with the hopeful titles: "What It Took to Come Out of Chapter XI"; "1871, Turnaround Year"; "Making It With Technological Innovation in a Down Market"; and "Two Plus Two Equals Five."

Nine of the sessions will be directly computer related. These are Choosing a Minicomputer — The User's Viewpoint; Peripherals for Minicomputers; The Future of Medical Information Systems; Present and Future of Automatic Test Languages; Computer Aided Manufacturing; Computer-Aided Design of High Frequency Circuits; Computer-Aided Translation Using Time-Shared Systems; Electrooptic Memory, Image Storage and Display Devices; and Exploitation of Available Computer Programs in Electronic Circuit Design. There are three sessions on communications: Direct Detection Laser Communication; Networks, Equipments, and Standards: The Challenge of the Data Communications Explosion; and Systems Considerations and New Equipment for Microwave Point-to-Point Communication.

A third management-oriented session covers a subject topical in any industry: Employee Loyalty: a Two-Way Street. And some eight computer-related papers are included in the general technology sessions.

The computer-based registration system will register only a portion of WESCON's attendees in this year's trial run. The system, described by Edgar A. Bolten of Jacquard as a "12-foot flow-through system," has a rated capacity of producing 350 five-line

embossed cards per hour compared to 55-60 cards per hour by manual embossing. With the system, one card serves as ID badge and inquiry card. An attendee will approach a clerk seated at a crt who will enter his registration information. This data can be edited or changed and is displayed in type large enough that the registrant can see it and verify its accuracy. When verified, the information is entered into a Data General 1200 mini-computer which drives an embosser via a Jacquard-developed interface which Bolten says will accept "virtually any type of computer input or output." Once his information is entered, an attendee simply walks 12 feet to where his card will be produced and waiting. His use of the card in the show makes possible capture by the system of data on his movements, which will be available at the end of the day to show management and, at their discretion, to show participants.

Following the pilot run at WESCON, Jacquard plans to market the system to other show organizers and to major credit card companies. It can produce embossed cards in any prearranged sequence from data stored on magnetic tape or any other input media and simultaneously produce labels and other mailing information.

Registration fee for WESCON's exhibits and technical sessions is \$5 for all four days. Technical sessions will be conducted at 10 a.m. and 2 p.m. each day. Exhibit hours will be 9:30 a.m. to 5 p.m. on Tuesday and Thursday, 9:30 a.m. to 9 p.m. on Wednesday, and 9:30 a.m. to 4 p.m. on Friday.

First Semiconductor Add-ons Installed

Forced by IBM's pricing strategy out of one user market, Advanced Memory Systems Inc. of Sunnyvale has finally penetrated another — the 360 main memory replacement market.

Since mid-June the firm's semiconductor memory add-ons have been installed on eleven 360/30s and nine 40s, and the firm was preparing to introduce one for the 65.

President Robert Lloyd said the company was withdrawing its semi-

conductor storage unit (SSU) as an end-user replacement for the IBM 2301 drum and 2305 fixed-head files. Lloyd, who last spring had reported a \$6.8-million backlog for the unit, said most of the prospective customers used large systems 24 hours a day. By eliminating extra-shift charges as part of its price cut May 27, IBM effectively chopped 30% off the price charged to these users, Lloyd said, thus "cutting us off at the pass." He said none of the SSUs ordered had been delivered.

Advanced said its proposed model 65 add-on memory will be priced at about one-third of IBM's. It will be sold at that price by ITEL Corp., of San Francisco, which also sells the firm's model 30, 40, and 50 units under an agreement reached earlier this year. ITEL's prices for these replacements are said to range from 60-80% below IBM. The semiconductor add-ons are said by the firm to have more attractive reliability and maintenance features than core memory add-ons. Advanced also is said to be able to produce the memories at 17% of IBM's price. It is one of seven firms offering main memory replacement to IBM 360 machines but the only one thus far to install a semiconductor memory replacement or add-on.

Chapter XI — The Road Back

Typagraph Corp., San Diego, Calif., pulled out from under Chapter XI early last month and within two weeks was demonstrating a new product.

It was a 30-cps teleprinter terminal, which will sell for \$3500, developed while the company was completing the plan of arrangement that got it out of Chapter XI. Typagraph filed bankruptcy proceedings last August when lease financing it had been receiving from Transamerica Corp. was withdrawn. The bankruptcy filing was preceded one day by the filing of a \$2 million breach of contract suit against Transamerica, a suit which still is in the discovery phase.

The firm was closed down from August to December and its president, James Sutter, was trying very hard to sell it. In December he decided if it was worth selling it might be worth

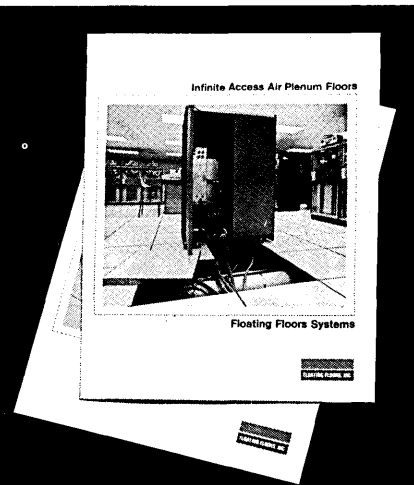

Get this brochure before you buy or specify a raised floor system.

Data processing installations deserve the best in unlimited access floors for the support of expensive equipment and for maximum flexibility. The answer . . . The Floating Floors® System.

Choice of Panels—Aluminum for highest quality, steel for economy.

Choice of Surfaces—Hard surfaces or carpeting permit any combination of appearance and function.

Precision-Fit—Made to virtually perfect squareness for complete interchangeability.

Strength—Strong panels and proper pedestal design give needed strength without stringers. Support 1000 lb. per square inch with less than .085" deflection.

Rigidity—Positive interlock between aluminum panels and pedestal makes a stable floor approved for seismic conditions.

Total Access—Panels lift out to allow complete underfloor access.

Flexible Air Distribution—The cavity beneath the Floating Floors system can serve as a plenum.

A complete line of accessories is available. Write for this authoritative brochure: Floating Floors, Inc., Subsidiary of N L Industries, Inc., 5400 North Detroit Ave., Toledo, O. 43612. (419) 479-0721.

N L INDUSTRIES

FLOATING FLOORS, INC.

N L Industries, Inc. is the new name of National Lead Company

CIRCLE 41 ON READER CARD

This announcement is neither an offer to sell nor a solicitation of an offer to buy any of these securities. The offer is made only by the Prospectus.

New Issue

June 24, 1971

375,000 Shares



STORAGE TECHNOLOGY CORPORATION

Common Stock
(\$10 Par Value)

Price \$10 per Share

Copies of the Prospectus may be obtained from the undersigned only in states where the undersigned may legally offer these securities in compliance with the securities laws thereof.

C. E. UNTERBERG, TOWBIN CO.

DREXEL FIRESTONE
Incorporated

LOEB, RHOADES & CO.

BACHE & CO.
Incorporated

ALEX. BROWN & SONS

LADENBURG, THALMANN & CO.

F. S. MOSELEY & CO.

R. W. PRESSPRICH & CO.
Incorporated

G. H. WALKER & CO.
Incorporated

ROBERT FLEMING
Incorporated

HILL SAMUEL SECURITIES
Corporation

THOMSON & MCKINNON AUCHINCLOSS INC.

NOW YOU CAN LEARN MORE ABOUT TIMESHARING —AND HAVE FUN DOING IT

No matter how much you know about time-sharing, TIME-TO-SHARE will teach you more.

More about Marketing

- ... Systems Costs
- ... Customer Requirements
- ... How to make a Profit
- ... How easy it is to go broke.

You'll learn more from one game of TIME-TO-SHARE than from hours of lectures or seminars.

TIME-TO-SHARE IS COMPLETELY REALISTIC—

Based on the day-to-day operations of typical computer timesharing businesses. Gaming techniques let you set up your own company...in your own way.

- Select your customers from 32 businesses
- Tailormake your system from 12 modules
- Add as many of 8 Languages as you need
- ... and your choices from 12 Applications

TIME-TO-SHARE IS COMPLETELY LOGICAL—

Based on years of computer and business experience plus 18 months of development and debugging to assure authenticity.

- You start with Market Research to locate your prospective customers
- ... develop your computer system to meet their requirements
- ... then get them on-line to your service.

If you've ever wanted to run your own business—and who hasn't—you'll enjoy TIME-TO-SHARE. And it can be played with equal enjoyment by a 12-year-old or an EDP expert.

For hours of fascinating fun . . . send your check for \$9.95 to:
TIME-TO-SHARE 4606 Charlestown Rd. New Albany, Ind. 47150

Name

Address

A PRODUCT OF TIME-TO-SHARE

CIRCLE 34 ON READER CARD

NEWS SCENE

saving if he could get the company's original engineering team to return and develop an economical 30-cps terminal in a hurry and on a shoe-string budget. They agreed to come back, "if I could get the necessary money."

The company had some \$215,000 in standard creditor debt and was accumulating, at the rate of about \$9300 a month, lease-back debt to a group of doctors and lawyers who had purchased some terminals.

A formal plan of arrangement was filed with the court on Jan. 19, 1971. Sutter was able to raise some \$90,000 from private San Diego investors, and the company's largest stockholder, Boothe Computer Corp., invested an additional \$50,000 and converted some debt to equity.

The engineering team returned to Typagraph in December and got to work on development of the new terminal. Sutter, in the meantime, got to work implementing the plan of arrangement. Both jobs were about done by June 30. The company received a Revesting Order from the court on July 1 and by mid-July was demonstrating the new terminal and preparing, for September introduction, a second version with a plotting capability. They also are continuing to produce their older Model 3 10-cps terminal printer/plotter at the rate of about five per month.

So, revested, refinanced, and more cost conscious than in the past, Typagraph has joined the growing ranks of small companies taking a second chance.

NEWS BRIEFS

Whither Modems?

Some 200 companies entered the modem market after the Carterfone decision of January 1969, and nearly half have dropped out, says a study by Creative Strategies, Inc., Los Altos, Calif. The investment research firm said the Bell System still controls 80% of the market and it doesn't think this will change much over the next four years when sales of modems and multiplexors multiply five times, from

the 1970 sales figure of \$70 million to \$390 million in 1975. The report later qualifies this estimate by noting that the all-digital network to be built by University Computing Corp.'s Datran affiliate will eliminate the need for modems, which are devices used to convert digital signals into analog signals for transmission over voice-grade telephone lines and then to re-convert these signals at the receiving end.

The People Problem

People-related problems confronting the edp industry are covered in a collection of 13 articles on the subject first published in *Data Processing Digest* and revised and updated.

The articles include: "People Are the Problem and the Solution"; "Problems and Solutions Relating to Other People"; "Identifying Potential Talent"; "Formal Production of Trained and Educated People"; "Private EDP Schools, The Positive View"; "A Newcomer Looks at the Field"; "Managing an Acre of Programmers"; "People Problems in Government EDP Work"; "Management: Their Unique Problems"; "Women in Electronic Data Processing"; "Continuing Education and the ACM Professional Development Program"; and "Summing Up." Copies of "The EDP People Problem" are available for \$12 (plus 60¢ sales tax for California residents only) from Data Processing Digest, Inc., 6820 La Tijera Blvd., Los Angeles, Calif. 90054.

Automating Smokey

Advanced Computer Techniques Corp. said it is compiling information on existing aids and techniques to assist the U.S. Forest Service in developing a set of edp management standards. The company needs the following information and said the sources will be clearly identified and credited: a description of the management aids or techniques, manual or automated. If automated, provide hardware and program characteristics and the cost to buy them. Information should be sent to J. W. Yocum, vp, Advanced Computer Techniques, 1501 Wilson Blvd., Arlington, Va. 22209. ■

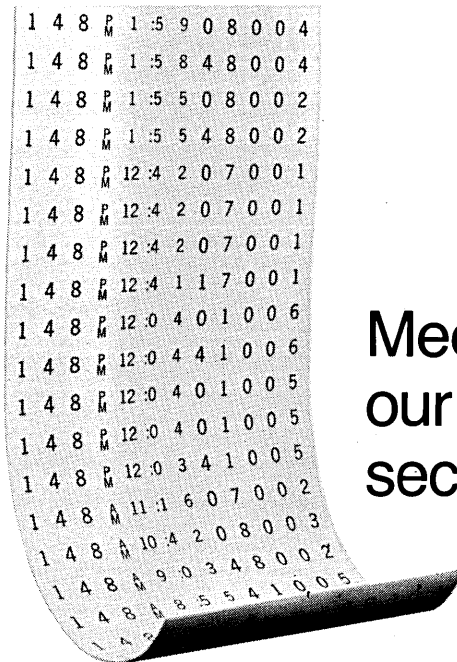

Meet our talking security system.

It tells you what you need to know.

The IDENTI-LOGIC® System—the "foolproof" system designed for computer installations where tight security is high priority. It will tell you who came in—when and where entry was gained—plus provide you with a hard copy of each entry, including year, date, time, location and key identification number. The IDENTI-LOGIC Access Control and Identification System is unique in its capability—absolute protection—easy installation—relative low cost.

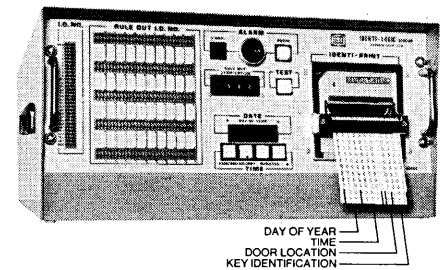

System Operation

Authorized personnel are issued an electronic key—the IDENTI-LOGIC Controller. When the Controller is inserted into a special keyway its code (I.D. number) is automatically checked (controlled by an independent binary code digital logic device)—permitting entry or triggering an alarm. You can program keys for an entire shift or for one person. Most important, you have complete control.

For complete information on the system send the coupon to John F. Regan, Marketing Manager, Eaton Corporation, Electronic Security Division, 3074 Miraloma Avenue, Anaheim, California 92806.

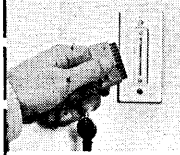
DM-871

Yes, I'm interested in the IDENTI-LOGIC® Access Control and Identification System.

Name _____ Title _____

Company _____ Phone _____

Address _____

City _____ State _____ Zip Code _____

Please Send Complete Catalog Information Immediate Need

Have a Representative Call Future Need

EATON
Security Products
& Systems

CIRCLE 14 ON READER CARD

Hardcopy Clean and Fast

**FACOM 6541A,
the latest CRT printer for hardcopy graphics
and alphanumeric within a matter of seconds**



To get hardcopy from CRT displays has always been a problem. When it was fast, copies were muddy. When it was fast and clear, most likely the equipment's compatibility was limited. We've changed that.

Now you can have full-sized, clear hardcopies in eight seconds, at a speed of 7500 characters per minute. Just press a button, and you'll get up to 10 electrophotograph copies automatically – without waiting, and without programming. The secret behind this great feat is the world's first electrostatic deflection system.

With super-wide frequency bands and a special slave CRT for fine resolution and high brightness, it directly utilizes the master display's X, Y, and Z signals

– which makes the printer compatible with all CRT display units and oscilloscopes, regardless of scanning method, speed, or size.

And we shouldn't forget to mention that it's utmost economical. As it should be in modern communications.

 **FUJITSU LIMITED**
Communications and Electronics
Marunouchi, Tokyo, Japan

MAIN PRODUCTS □ Telephone Exchange Equipment □ Carrier Transmission Equipment □ Radio Communication Equipment □ Space Electronics Systems □ Auto Radios & Car Stereos (TEN) □ Electronic Computers & Peripheral Equipment (FACOM) □ Telegraph & Data Communication Equipment □ Numerical Control Equipment (FANUC) □ Remote Control & Telemetry Equipment □ Electronic Components

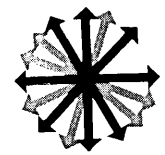

Graphic I/O

There are more than 10,000 PDP-8s out there, and this vendor has something he hopes more than a few will want—a general-purpose digitizing and graphical data acquisition system. Called ANAGRAFIC, the system digitizes and processes graphical data from single sheets, strip charts, or projected images in linear coordinate systems.

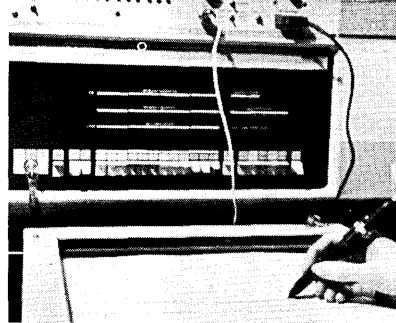

The system, minus a PDP-8, consists of a Graf/Pen digitizing tablet, Teletype, and paper tape punch. It is called the ANAGRAFIC Performance Pak and sells for \$9995 or rents for \$213 a month. With a PDP-8 thrown in, it costs \$17,500 to purchase and \$372 a month to rent. INPUT OUTPUT COMPUTER SERVICES INC., Cambridge, Mass. For information:

CIRCLE 524 ON READER CARD

OCR Terminal

The first product of this new firm is an OCR terminal selling for only \$9900 in single quantities. Called the RIT 200 (Remote Intelligent Terminal), it is a manual, one-line, 100-cps reader recognizing OCR-A or 1428 fonts. Output is ASCII code, with 17 DTL/TTL channels. Interfaces for tape and card equipment and for communications devices are available at extra cost. Documents measuring from 2 x 1/2 inches up to 9 x 11 inches may be accommodated at a speed of 10 ips. The basic unit reads 10 numeric plus five special characters. Delivery requires four to five months ARO. INPUT BUSINESS MACHINES, INC., Rockville, Md. For information:

CIRCLE 515 ON READER CARD

Non-impact Printer

With increased speed, quiet operation, and compactness, non-impact printers must be the wave of the future. Yet this is the first non-impact terminal from a major mainframe maker. Called the 270, it's tty-compatible but won't be available with the cassettes that should substitute for paper tape until late next year. And it can't handle multiple copies—yet. Still, it prints a fast 30 cps and makes no more noise than a distant Piper Cub, and it's smaller and lighter than some terminals that are called portable. Prices are \$2200 for a receive-only, and \$2600 for send/receive unit. Delivery requires about 90 days ARO. NCR, Dayton, Ohio. For information:

CIRCLE 516 ON READER CARD

Tape Drives

The 100X series of IBM-compatible tape units are synchronous, 10 1/2-inch reel designs available in speeds ranging from 1-45 ips. Read-only, write-only, or read-after-write logic can be ordered by oem's, and they can also choose from 7-track 200-, 556-, or 800-bpi NRZI or 1600-bpi 9-track phase-encoded models. The series is said to be physically and logically compatible with the Peripheral Equipment Corp. 6000 series—even down to the door opening and mounting specifications. Depending on requirements, prices can start under \$3000 per unit in quantities of 100. CIPHER DATA PRODUCTS, San Diego, Calif. For information:

CIRCLE 521 ON READER CARD

Large-scale Calculator

Even the basic 9800 model 10 calculator has 51 registers and 500 program steps—enough computing power to solve 10 simultaneous equations. This capability can be expanded up to 111 registers and 2,036 program steps, and together with indirect addressing and indirect arithmetic make the model 10 look like a fairly powerful desk-top computer.

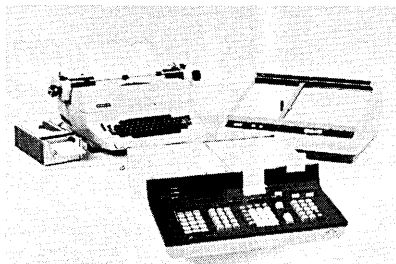

MOS/LSI function modules containing additional mathematical, statistical,

or user-definable functions plug into the unit. Peripherals currently available include an x-y plotter, a card reader, and an output typewriter. A digitizer and paper tape reader are planned for the near future. The basic price of the 9800 model 10 is \$2975, and deliveries begin in October. HEWLETT-PACKARD CO., Palo Alto, Calif. For information:

CIRCLE 523 ON READER CARD

Terminal

The addition of a cassette unit to the standard IBM Selectric typewriter equips it for use in off-line program preparation, remote text editing, re-

petitive typing, and remote job entry applications. The package, called the Datel 31, is IBM 2741 compatible and contains an internal modem or acoustic coupler permitting 15-cps transmission over dial network lines.

Including maintenance, the Datel 31 rents for \$160/month and is available 30 days ARO. UNIVERSITY COMPUTING CO., Dallas, Texas. For information:

CIRCLE 525 ON READER CARD

2314 Upgrade

Prices for the CD 1015/215 disc system have finally been announced—the hardware was announced in January. The 1015 controller (\$49K)

can control up to four model 215 drives (\$48,600 for double-spindle models and \$29,100 for single-spindle) which record 58 megabytes on each 2316-type pack. The transfer rate is the same as a 2314 at 312 KB.

Deliveries begin this month for the CD 1015/215 system, which also may be leased. CALIFORNIA COMPUTER PRODUCTS, INC., Anaheim, Calif. For information:

CIRCLE 513 ON READER CARD

computers **71** Directories

of New York City / New England / Connecticut & Westchester / New Jersey & Long Island

What the COMPUTERS 71 series gives you: These four Computers 71 directories each contain between 375 and 475 pages, and list 1400 to 2200 computer installations. Each directory states company name, address, zip, phone, and an important DP contact at each site. We list computer currently installed, core size, operating system, I/O gear, display equipment, terminals, minicomputers, etc. **Who uses COMPUTERS 71?** The Computers 71 series is the salesman's bible to computer-users in his local marketing area. It not only gives him new prospects to call on, it tells your salesman who is using what, and who to contact where. The series is also bought by thousands of DP professionals, the men who are responsible for placing annually millions of dollars worth of orders for DP equipment, services, and supplies. They use the Buyer's Guide at the back of each Computers 71 Directory as a local source for products they purchase. **How to get your free copy/ies:** Get your free copy/ies by listing your company's product line in the Buyer's Guide section of the directory/ies you wish to receive. Check the order form below. Write a short description of your company's product line (no more than sixty words) and check off the two categories you wish to be placed under. We will bill you \$25. for your two listings per directory. If you wish to receive all four directories free, list in all four directories and we bill you \$90. October 1st we will ship you the directories your Buyer's Guide listing has appeared in. Tear off the listing form below and mail it today.

computers **71** Directories

CHECK:

- NEW YORK CITY
 NEW ENGLAND
 CONNECTICUT & WESTCHESTER
 NEW JERSEY & LONG ISLAND

MAIL TO:

KLH ASSOCIATES
 578 FOLSOM, SAN FRANCISCO
 CALIFORNIA 94105
 PHONE 415 / 433-0547

Be sure to attach a short description of your company's product, service or capability, for publication in COMPUTERS 71 Buyer's Guide you have selected. You will be invoiced \$25. for each directory listing. Should you wish to appear in all 4 directories you will save 10% and be invoiced for \$90. No listings accepted after Sept. 15.

company name _____
 New York City
 address _____ contact _____
 phone _____ title _____
 New England
 address _____ contact _____
 phone _____ title _____
 Connecticut and
 Westchester address _____ contact _____
 phone _____ title _____
 New Jersey and
 Long Island address _____ contact _____
 phone _____ title _____

EQUIPMENT [check any 2 categories]

- | | |
|---|--|
| General Purpose Computers <input type="checkbox"/> | MICR <input type="checkbox"/> |
| Scientific Computers <input type="checkbox"/> | Readers <input type="checkbox"/> |
| Hybrid Computers <input type="checkbox"/> | Punches <input type="checkbox"/> |
| Small Scale Computers <input type="checkbox"/> | Printers <input type="checkbox"/> |
| Card Systems <input type="checkbox"/> | Reader/Punch <input type="checkbox"/> |
| Disk Systems <input type="checkbox"/> | Plotters <input type="checkbox"/> |
| Paper Tape Systems <input type="checkbox"/> | Optical Scanners <input type="checkbox"/> |
| Magnetic Tape Systems <input type="checkbox"/> | CRT <input type="checkbox"/> |
| Digital-to-Analog Converters <input type="checkbox"/> | Computer Graphics <input type="checkbox"/> |
| Card-to-Tape Converters <input type="checkbox"/> | Teleprocessing Systems <input type="checkbox"/> |
| Autocoders and Compilers <input type="checkbox"/> | Terminals <input type="checkbox"/> |
| Microfilm and Microfiche <input type="checkbox"/> | Teletype <input type="checkbox"/> |
| Data Storage and Retrieval <input type="checkbox"/> | Data Transmission Equipment <input type="checkbox"/> |
| Auxiliary Memories <input type="checkbox"/> | Other <input type="checkbox"/> |

SUPPLIES

- | | |
|---|--|
| Paper Tape <input type="checkbox"/> | Equipment Leasing <input type="checkbox"/> |
| Magnetic Tape <input type="checkbox"/> | Equipment Second User <input type="checkbox"/> |
| Tab Cards <input type="checkbox"/> | Time Share <input type="checkbox"/> |
| Forms <input type="checkbox"/> | Time Brokerage <input type="checkbox"/> |
| Paper Supplies <input type="checkbox"/> | Market Research <input type="checkbox"/> |
| Labels <input type="checkbox"/> | Service Bureau <input type="checkbox"/> |
| Microfilm Supplies <input type="checkbox"/> | Professional Placement <input type="checkbox"/> |
| Other <input type="checkbox"/> | Consulting <input type="checkbox"/> |
| | Facilities Management <input type="checkbox"/> |
| | Archive Services <input type="checkbox"/> |
| | Executive Search <input type="checkbox"/> |
| | Keypunch Services <input type="checkbox"/> |
| | Microfilm Services <input type="checkbox"/> |
| | Computer Graphics Service <input type="checkbox"/> |
| | Other <input type="checkbox"/> |

SERVICES

- | |
|--|
| Computer Environments <input type="checkbox"/> |
| Backup Furniture <input type="checkbox"/> |
| Software Development and Packages <input type="checkbox"/> |

one
of
the
biggest
bargains
ever...

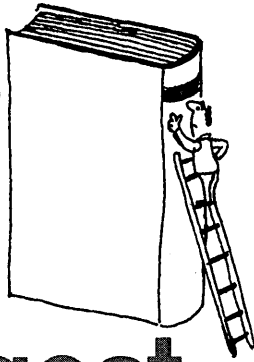

DATAMATION® INDUSTRY DIRECTORY

because it tells you:

Key specs of competitive products... if the product's compatible with your system... where the sales and service centers are... how to check out the vendor... what programming and other services are available... and enough other information to fill about 450 closely packed pages.

Get your own personal copy by sending the coupon below and your check or purchase order.

DATAMATION® INDUSTRY DIRECTORY

D8-15b

Technical Publishing Company, DID Order Dept.
1301 S. Grove Avenue, Barrington, Ill. 60010

Send me _____ copies of the 1971
Datamation Industry Directory at \$25*
a copy. _____ Check or _____ Co. P.O.
enclosed.

(*In U.S.A. and Canada; \$35 elsewhere)

Name _____

Title _____

Dept. _____

Company _____

Address _____

City _____

State _____ Zip _____

... HARDWARE

360/370 Front End

The 270X front end offers plug-compatibility with System 360/370, replacing IBM 2701, 2702, and 2703 transmission control units. While it isn't claimed that the 270X can do everything the IBM machines can, it should save money. The front end terminates a mix of various speed multiple line configurations, and is said to be especially useful for adapting non-IBM equipment to an IBM computer with standard IBM software. The 270X software includes a scheduler, command processor, console controller, data set line controller, and adapter processors. The system uses dual minicomputer processors. The price is \$55K, and delivery requires 30-60 days ARO. INTERDATA, INC., Oceanport, N.J. For information:

CIRCLE 514 ON READER CARD

Terminal

An IBM Selectric typewriter, a Philips cassette drive, and some optional editing capabilities comprise the model 1500, allowing entry and storage of up to 40K EBCDIC or BCD characters per cassette. The transmission rate is 14.8 cps through RS-232 or IBM line adapters. Editing options include skip, skip start, skip stop, delete, line forward, and character forward. The search speed of the two-track cassette is 40 ips. Delivery is 60 days ARO for the 1500, and monthly rental is \$175 based on a one-year contract. TRENDATA COMPUTER SYSTEMS CORP., Sunnyvale, Calif. For information:

CIRCLE 520 ON READER CARD

Read-only MTUs

There are 21 different combinations of packing densities (200, 556, 800, and 1600 bpi), speeds (pairs of 12.5/25, 18.75/37.5, and 22.4/45 ips), and recording heads (7- and 9-track NRZI/phase-encoding) possible in this line of read-only tape drives, whose principal market would seem to be COM equipment builders. Single-speed, single-density units are also available. In quantities of 100 an NRZI/phase-encoded, 7- and 9-track, four-density, dual-speed model is priced at \$4190. PERIPHERAL EQUIPMENT CORP., Chatsworth, Calif. For information:

CIRCLE 519 ON READER CARD

LOW COST

PC-CARD MODEM

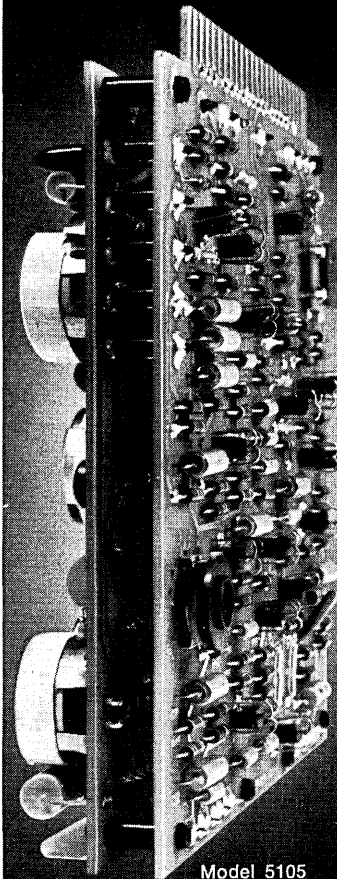

Model 5105
5" x 4 3/4" x 1 1/2"

- -20° to +60°C
- New Small Size
- ADJUSTABLE Frequency, Gain, Bias, Sensitivity

An originate-only Modem for O.E.M. applications.

\$95.

Compatible with Bell 101, 103, 113 series. Operates full-duplex up to 300 bps. Strappable for half-duplex. Interfaces with Bell Manual Couplers (CDT). 60dB minimum adjacent channel rejection.

Plug-In Filters for FDM

Optional "piggy back" filter assemblies enable assignment of operating frequencies for FDM. Other options include Carrier Detect Circuit, housing and power supply for stand-alone applications. Contact us for additional information. RFL Industries, Inc., Communications Division, Boonton, N. J. 07005
TEL. 201-334-3100
TWX: 710-987-8352
CABLE RADAIRCO, N.J.



RFL Industries, Inc.

CIRCLE 32 ON READER CARD

Largest 370

There are enough differences (mainly in the instruction set portion of the cpu) between a 360/195 and the just-announced 370/195 to keep a special team of field engineers busy around the clock for five days upgrading the 360 version in the field.

Performance figures for the 370/195 are unchanged from the 360 model, with instructions processed every 54 nsec, and 1 to 4 megabytes of memory available. There is a \$100K charge for the field upgrade, or depending on peripherals desired, typical configurations are priced from \$8.6 to \$12.1 million for 1 and 4

megabyte versions, respectively. Field upgrades and new systems will be available during the second quarter of 1973, and the 360/195 will continue to be built, it is said. IBM CORP., White Plains, N.Y. For information:

CIRCLE 526 ON READER CARD

Oem Tape Drive

The TMA tape drive is a self-threading oem unit with speeds ranging from 45-112.5 ips, 7- or 9-track heads, and 200, 556, 800, or 1600 bpi packing density and NRZI or phase-encoding electronics. It uses a single-capstan drive together with twin vacuum chambers. One nice feature of the TMA is that tapes do not necessarily have to be of the reel-surround cartridges usually necessary for automatic threading. Prices start at just under \$5K for 100 units, and the TMA is available 60 days ARO. AMPEX CORP., Culver City, Calif. For information:

CIRCLE 529 ON READER CARD

Terminal System

The basic Viatron System 21 concept has appeared once more, this time at a price of \$108/month/terminal, but from a firm that shows no signs of going out of business. A typical configuration of the "CAN DO" system includes eight series 800 crt/keyboard terminals, a programmable 16-bit microprocessor, and a 360/370 channel adapter, at the above rental. Options include internal modems, printers, cassettes, disc, card reader, and a communications processor. Deliveries begin in January. SANDERS ASSOCIATES, INC., Nashua, N.H. For information:

CIRCLE 517 ON READER CARD

Phototypesetter

The Justotext 71 phototypesetter justifies type from 6-level justified or unjustified tape at the rate of 30 11-pica, 8-point lpm. Two 90-character fonts can be loaded into the unit simultaneously to mix Roman and Bold, or Roman and Italic type in the same line. Line width may vary up to 33 picas, and leading can be adjusted in half-point increments from one-half to 3 1/2 points. The output is in the form of right-reading paper positives, with film output available as an option. The Justotext 71 is priced at \$6950. SINGER FRIDEN DIV., San Leandro, Calif. For information:

CIRCLE 518 ON READER CARD

Send For Free Samples of these cleaning products for computer reliability

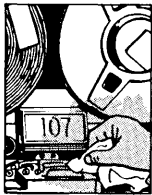

TEXWIPE
A disposable 100% cellulose lint-free cloth developed for critical cleaning where non-contamination is essential

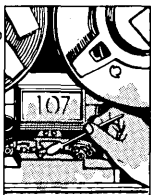

FOAM-SWABS
A totally lint-free swab for non-contaminative cleaning of small, critical areas of data processing equipment



TEXPADS and DISC CLEANING WAND
A 91% solution of isopropyl alcohol pre-saturated pad, with wand for cleaning magnetic discs without affecting information stored



COMPLETE CATALOG
This catalog describes the complete line of Texwipe cleaning products for computer reliability

CHECK BOXES FOR FREE SAMPLES.

Name

Title

Company

Address

City State Zip

The TEXWIPE Company, Hillsdale, New Jersey 07642

CIRCLE 35 ON READER CARD

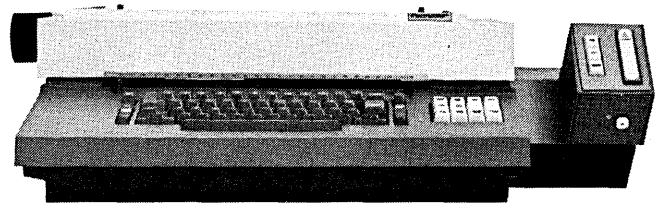

This terminal can be equipped with Unattended Operation capability, enabling it to transmit data to and receive data back from the computer—with no operator present. Take advantage of low nighttime phone rates—or use your WATS line. Ask about the Model 5-50.



Novar Corporation • 2370 Charleston Road
Mountain View, Calif. 94040 • (415) 964-3900
Offices In Principal Cities



CIRCLE 36 ON READER CARD

DATAMATION

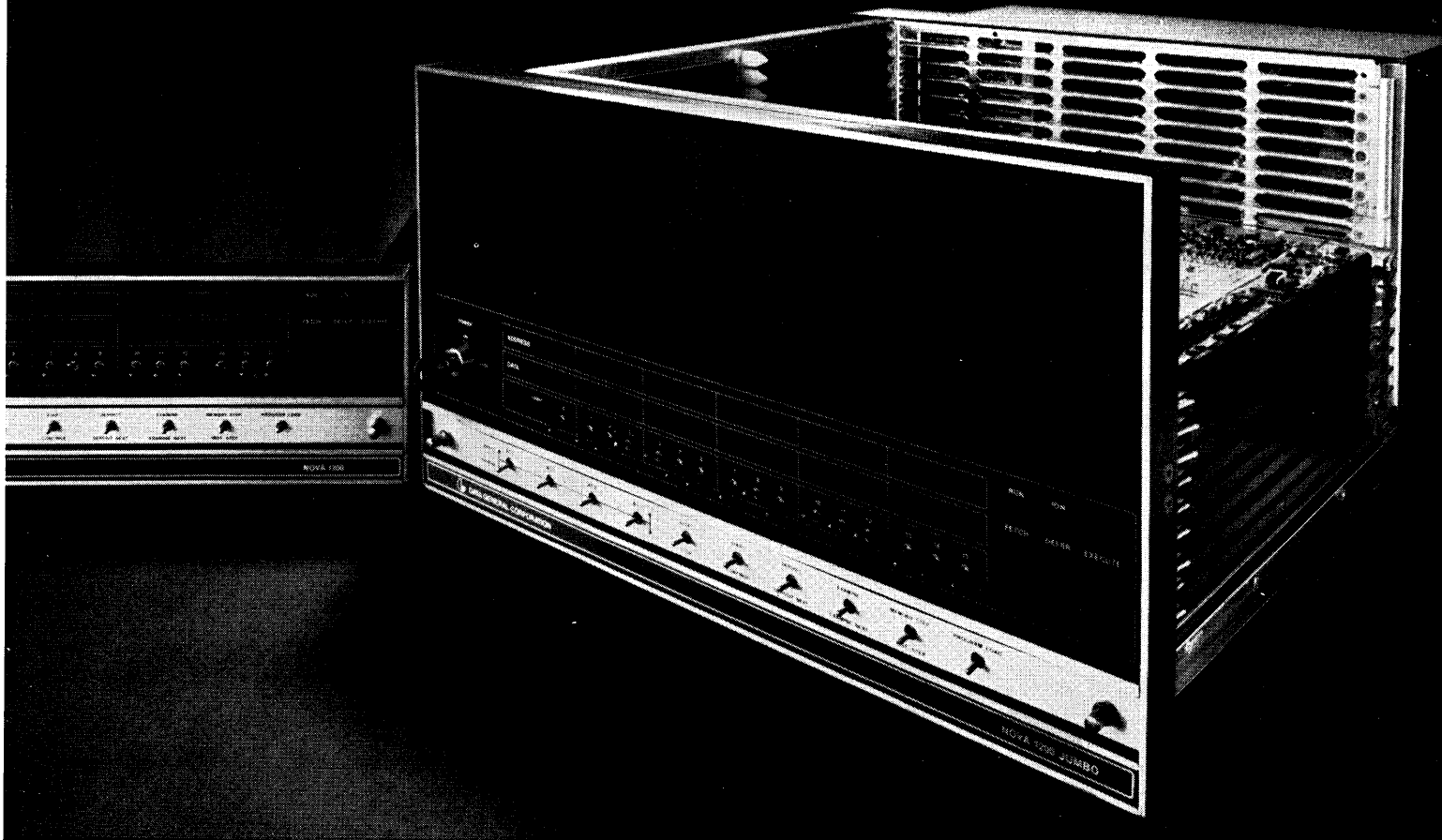

INTRODUCING THE JUMBO NOVAS.

In its standard 5¼" high rack-mount package, a Data General Nova-line computer holds up to 16K 16-bit words of core memory and interfaces for several peripherals or special devices.

That's more expansion capacity than the competition provides in units that are up to twice as big.

But we've noticed that more and more of our customers are moving up to even bigger systems. So we're introducing the Jumbo Novas.

The Jumbo chassis is

BIG DEAL.

10½" tall (double standard Nova height), and it provides three times the expansion capacity of the standard Novas.

A Jumbo Nova has room for up to 32K of core memory and interfaces for many more peripherals and special devices. We also included convenient plug-in interfacing for major peripherals, like IBM compatible mag tape and disk memories.

Yet, the Jumbo chassis

adds only \$850 to Nova 1200 and Nova 800 basic prices.* That's a big deal for the bigger system customer.

- Send me your Big Deal pamphlet on the Jumbo Novas.
- Send me a salesman.

Name _____

Title _____

Company _____

Address _____

City _____

State _____ Zip _____

DATA GENERAL

Southboro, Mass. 01772

(617) 485-9100

CIRCLE 18 ON READER CARD

*With 4K of core, Teletype interfaces, and Direct Memory Access data channel, a standard Nova 1200 costs \$5450 and a standard Nova 800 is \$6950.

NEW SUMMER/FALL EDITION

**5,000 Add'l
Installations,
25,000 User
Sites, plus
4,000
Vendors...**

at your fingertips in this new, expanded edition of the Official Directory of Data Processing (ODDP). **NOW**...vendors are listed alphabetically by firm name... and cross-indexed geographically by 22 product lines and/or services into alphabetical listing section... quick reference assured. **NOW**... users are cross-indexed alphabetically by firm name into the basic geographical listing section. **NOW**... more information about input/output peripheral devices, quantity of line printers, quantity of CPU's, whether CPU's are owned or leased, and program languages. **NOW**... more than 3,000 company name and address corrections, occurring since the last edition, have been recorded. **NOW**... more than 5,000 EDP installations have been added... total now over 10,000!

NOW included: Complete description of EDP system in use • Time-sharing availability and cost • Names and titles of over 12,000 EDP Executives
• Manpower analysis of EDP department
• Programming languages used • Type of business in which firm is engaged.

ODDP is the industry's primary reference book... the computerized directory covering the entire EDP industry.

Now published in two sections
East of Mississippi—\$30.00 per copy
West of Mississippi—\$30.00 per copy
Complete Set—\$50.00 per set

Use the coupon below to order the number of copies you require.

EDP User List available
on mailing labels
@ \$25.00 per thousand



**OFFICIAL
DIRECTORY OF
DATA
PROCESSING**

ODDP
444 Burchett Street
Glendale, California 91203

Please send me _____ copies of Eastern Section,
@ \$30.00 ea.
_____ copies of Western Section,
@ \$30.00 ea.
_____ copies of both sections,
@ \$50.00 per set
Enclosed please find my check (Publisher assumes
mailing costs). California orders add 5% Sales Tax.
Bill me at prices quoted, plus postage and handling.

Company Name _____
Mailing Address _____
City _____
State _____ Zip _____
Ordered By _____ Title _____

CIRCLE 27 ON READER CARD

... HARDWARE

Printer/Plotter

These three models of electrostatic printers roughly correspond to the just-announced Versatec Matrix series (April 15, p. 57) with which they will compete. The 57A-1 printer, priced at \$6500, can print its 64-character ASCII set in 16 different sizes and be rotated 90 degrees, if desired. A 7x10 dot matrix is used. The 57A-2 plotter places two million dots in a 10-inch square at the rate of

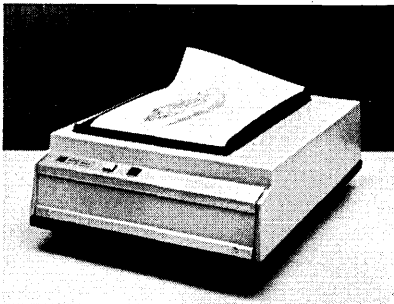

200,000 points per second. This unit sells for \$7K. The 57A-3 combines the electronics of the other two models and adds a hardware vector generator to allow superimposing machine-generated alphanumeric characters and software-generated graphics. This unit is priced at \$8K. Interfaces are available for many Hewlett-Packard, Data General, and Digital Equipment products, and there is an off-line interface for IBM-compatible 7- or 9-track tape. All interfaces are \$1500. Availability is 30 days ARO. INFOMAX CORP., Sunnyvale, Calif. For information:

CIRCLE 522 ON READER CARD

Process Control Monitor

The 1800 Sentinel has an interesting story behind it. A major petroleum company nearly lost its Texas refinery several years ago when an erroneous signal was transmitted from one of its IBM 1800 computers to a cracking tower, turning on the fuel supply full blast. Things got pretty hot for awhile, and when it was over the unnamed company contracted with this firm to develop a device that would prevent a recurrence. The Sentinel does this by checking for invalid grounding conditions, D/A output out of limits, or misdirected signals. One 1800 Sentinel is required for each ECO group, and the units are priced at something under \$5K. HERCO, Houston, Texas. For information:

CIRCLE 527 ON READER CARD

**ACCOUNTING and EDP
PROFESSIONALS**

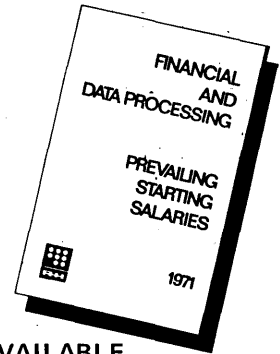

NOW AVAILABLE

FREE!

Our completely revised 21st Annual
Prevailing Salary Survey, 1971

- ✓ MOST COMPREHENSIVE
- ✓ MOST AUTHORITATIVE
- ✓ YOUR ONLY GUIDE

The Robert Half organization has conducted a study of Prevailing Starting Salaries in the Financial and Data Processing fields since 1950. Many companies use it as a guideline in their salary reviews. It has been used by the U. S. Department of Labor in their Employment Outlook series, and is frequently quoted by newspapers and magazines. For your free copy—call or write your nearby Robert Half office.

**ROBERT HALF
PERSONNEL AGENCIES**



Atlanta: 235 Peachtree St., N.E.	(404) 688-2300
Baltimore: The Quadrangle-Cross Keys	(301) 323-7770
Boston: 140 Federal St.	(617) 423-6440
Charlotte: 907 Baugh Bldg.	(704) 333-5173
Chicago: 333 N. Michigan Ave.	(312) 782-6930
Cincinnati: 606 Terrace Hilton	(513) 621-7711
Cleveland: 1367 E. 6th St.	(216) 621-0670
Dallas: 1170 Hartford Bldg.	(214) 742-9171
Denver: 1612 Court Place	(303) 244-2925
Detroit: 140 Honeywell Center, Southfield	(313) 354-1535
Garden City, N.Y.: 585 Stewart Ave.	(516) 248-1234
Hartford, Conn.: 75 Pearl St.	(203) 278-7170
Houston: 1200 Central Nat'l. Bank Bldg.	(713) 228-0056
Indianapolis: 9 N. Illinois St.	(317) 636-5441
Kansas City: 127 W. 10th St.	(816) 474-4583
Los Angeles: 3600 Wilshire Blvd.	(213) 381-7974
Memphis: 12 S. Main St.	(901) 527-7324
Miami: 1107 Northeast Airlines Bldg.	(305) 377-8728
Milwaukee: The Clark Bldg.	(414) 271-9380
Minneapolis: 822 Marquette Ave.	(612) 336-8636
Newark: 1180 Raymond Blvd.	(201) 623-3661
New York: 330 Madison Ave.	(212) 986-1300
Orange, Cal.: 500 South Main Plaza	(714) 835-4103
Philadelphia: 2 Penn Center Plaza	(215) 568-4580
Phoenix: 1517 Del Webb Townehouse	(602) 279-1688
Pittsburgh: Gateway Towers	(412) 471-5946
Portland, Ore.: 610 S.W. Alder St.	(503) 222-9778
Providence: 76 Westminster St.	(401) 274-8700
Rochester: One Marine Midland Plaza	(716) 546-3020
St. Louis: 1015 Locust St.	(314) 231-0114
San Francisco: 111 Pine St.	(415) 434-1900
San Jose: 675 North First St.	(408) 293-9040
Stamford, Conn.: 111 Prospect St.	(203) 325-4158
Washington D.C.: 7316 Wisconsin Ave. N.W.	(301) 654-1850

CIRCLE 304 ON READER CARD

DATAMATION

New systems are coming to light.

That's the unfolding story of Xebec. If it's a mini-computer peripheral, chances are we've already made it — or we're about to. In just a few short years, we've developed the most versatile line of peripherals to be offered anywhere — systems and products that mate not just with one computer, but with the minis of all major OEM companies. Looking for a moving head disk system with 10 million bits of storage? Mag tape units with 7- or 9-track drives for on-line control up to 75 ips? Operating cassette systems with one to four independent tapes for software system packages? Advanced low- and medium-speed line printers? A card reader that scans more than 300 80-column cards a minute?

These are typical of the new systems springing from Xebec — many customized to meet special client needs. Got a 'peripheral' problem? Let us throw some light on it.

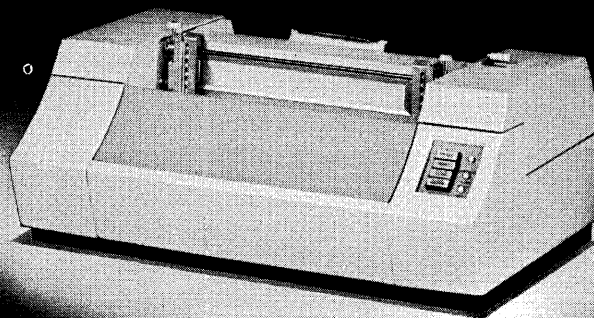
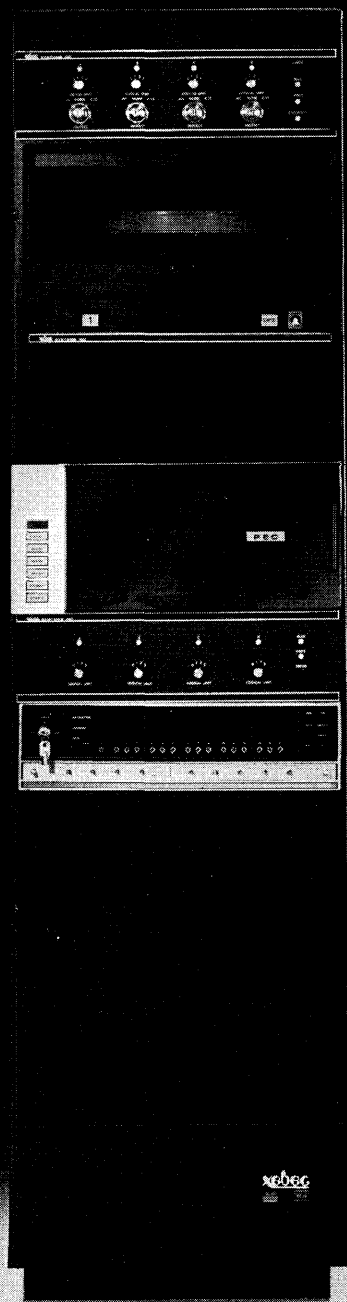

xebec SYSTEMS
INCORPORATED

918 North Rengstorff Ave. • Mountain View, CA 94040
415-964-4263 • TWX 910-379-6942

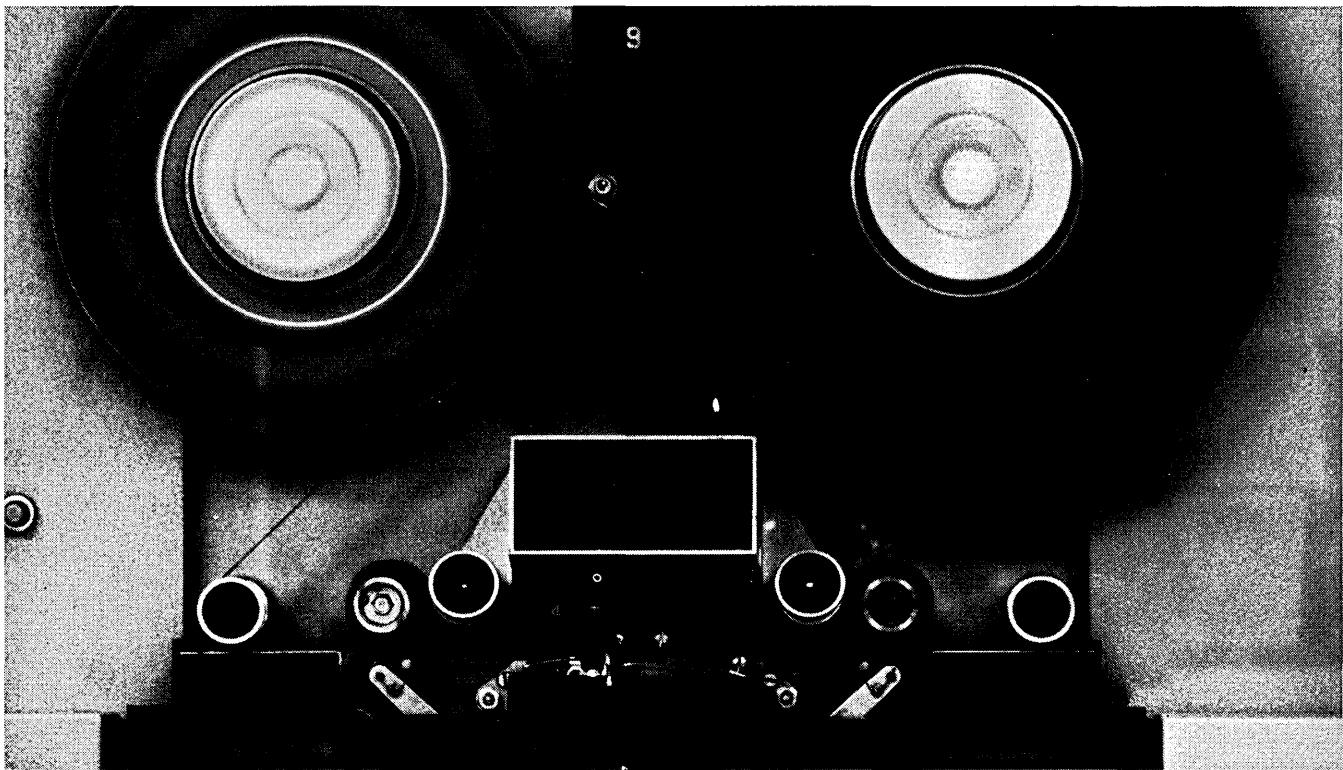

PI SORT SAVES

IBM 2403

Sorting is necessary, menial, a drudge...and, unfortunately, time-consuming. PI SORT 2 has been over twice as fast as SORT 483 in actual use (we would rather look at about 30% faster as a guideline). We'll leave it up to you to translate "faster" into money saved in your own particular system.

PI SORT 2 is a stand-alone sort program designed specifically for IBM System/360, running under DOS with at least 32K core memory. You bolt it on. And it works. No programming. No debugging. No downtime. No training. It's available on lease for only \$100 a month with a 30-day free trial offer. As an objective commentator on the computer scene has written: "I suggest you try the PI before you buy." Smart.

Programmatics, Inc.

11661 San Vicente Blvd., Los Angeles, Calif. 90049

- I would like to take advantage of the 30-day free trial offer for PI SORT 2. Please send all necessary paperwork.
- I would like further information.

Name _____

Title _____

Company _____

Address _____

Telephone Number _____



PROGRAMMATICS

a subsidiary of Applied Data Research

11661 San Vicente Blvd., Los Angeles,
California 90049 (213) 826-6503

Distributed in Europe by CAP France, Paris.

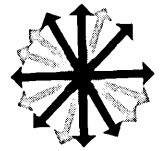

DOS Spooler

The GRASP DOS spooling program is just now making its way to the U.S. from Europe, where it is used in some 200 installations. Any combination and number of peripheral devices is supported, with a minimum 4K bytes plus 2K of storage required for each peripheral. In addition to

standard spooling tasks, GRASP can be used to generate multiple output copies, backspace output to recover from forms jams, etc. A second version of the package, called GRASP II, features remote job entry capability and user program relocatability features added to those above; automatic priority scheduling and dynamic device addressing functions will be

available next month. Minimum monthly rental for GRASP packages starts at \$300, or they can be purchased. Prices include documentation, maintenance, and support. SOFTWARE DESIGN, INC., Los Angeles, Calif. For information:

CIRCLE 510 ON READER CARD

File Conversion

Any existing data file may be converted into any user-defined format by UNIVERSE, according to the vendor. Through a series of English-like input statements, the user defines the format of the input as well as the

output files. UNIVERSE also provides the capability of supplying user-written exit routines, and allows the user to select records from the file, based on the value of any field within the record or on a percentage basis. Finally, it provides a tape of rejected records and the reason for the rejection.

The BAL program is priced at \$3200 and runs on any IBM machine supporting OS or DOS with a minimum 64K of memory. UNIVERSE is also offered as a service. PDA SYSTEMS, INC., New York, N.Y. For information:

CIRCLE 511 ON READER CARD

Subroutine Library

Nearly every product announced by this manufacturer is huge, and this library of mathematical and statistical subroutines is no exception. The handbook supplied to help guide CDC 6000, 7000, and CYBER 70 users to the

most suitable routines for their respective problems contains 1,800 pages, and there are more than 400 FORTRAN routines to choose from for doing programmed arithmetic, elementary functions, polynomials and special functions, ordinary differential equations, interpolation, approxi-

mation and quadrature, linear algebra, probability, statistics and time series, and nonlinear equation problems. The library rents for \$450/month after an initial charge of \$450. CONTROL DATA CORP., Minneapolis, Minn. For information:

CIRCLE 507 ON READER CARD

Calendar Look-up

The purpose of the DAY OF THE WEEK subroutine is to determine from statements in the form "April 1, 1944" the day of the week corresponding to that date (Saturday). The BAL language program accommodates dates between the years 1753-2099 after checking the input for validity. Both DOS and OS versions of DAY OF THE WEEK are available, and the program is priced at \$100. SADOWICK, Los Angeles, Calif. For information:

CIRCLE 505 ON READER CARD

1130 IS&R

Here is a fairly powerful storage and retrieval system put together by the edp people of two small colleges under the auspices of a nonprofit, HEW funded organization. The system operates on an 1130 with a minimum 8K core and a single disc drive. Written in FORTRAN, the 1130 commercial subroutine provides an integrated set of programs for update and disc file maintenance, and permits rapid sort and subset selection from the disc file store. The system can then print any of the sorted and selected

fields in any required order. It will also allow statistical analysis on the total file or its subsets. The system—a source deck, user manual, and systems manual—is currently available through the mail. Training and implementation assistance will be furnished in regional workshops. The price of the package is \$25 which covers reproduction and mailing costs. REGIONAL LABORATORY FOR THE CAROLINAS AND VIRGINIA, Durham, N.C. For information:

CIRCLE 512 ON READER CARD

3-D Plotting

PLOT3 is a FORTRAN IV subroutine that requires about 3,500 bytes on 360s or 1,100 words on 1130s to generate three-dimensional plots. Hidden lines may be displayed or not displayed at the user's option, and the PLOT3 pro-

gram draws contours in alternating directions to cut down the pen travel time. The PLOT3 program is said to be compatible with all plotters and crt's that draw line segments between arbitrary end points. Included in the package are the source deck, cards containing the user's write-up,

a complete glossary, and a sample program that draws the PLOT3 logo. The price is \$400. PROBE SYSTEMS INC., Sunnyvale, Calif. For information:

CIRCLE 509 ON READER CARD

Associative Memory

Users may not have to wait for the laser computer to realize the benefits of associative memory if this simulated associative memory works as claimed. Called ASOMEM, it is written

in BAL and operates on 360 models 25 and up. The ASOMEM subroutine occupies only several hundred bytes. The most successful application of ASOMEM is the processing of disordered lists and tables, which can be done 4 to 14 times faster than by

sequential search, it is said. The ASOMEM core driver sells for \$300, and a core and peripherals driver is \$600. THE GENESYS CORP., Boston, Mass. For information:

CIRCLE 501 ON READER CARD

PROGRAMMERS

Let's talk it over . . . discover how you can program a bright career into your future! We are a leading, nationally-known company, now with openings in our dynamic, Miami-based operation. At least one year's programming experience on a large scale system paves the way to a rewarding future. We require a background of hands on programming on real time OS or DOS systems. Salary \$9,400-\$14,000.

This is an excellent opportunity for you to team up with a winner, grow to your full capacity and enjoy exceptional fringe benefits . . . plus all the advantages of a career in America's favorite vacationland. Please send a detailed resume, including educational background and salary history to:

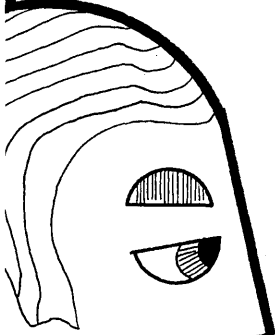

speak our language

DATAMATION
Box D815-1, 35 Mason St.
Greenwich, Ct. 06830

An Equal Opportunity
Employer

COMPUTER APPLICATION IMPLEMENTATION SUPERVISOR

We are among the larger, privately-owned, electric and gas utilities in the United States. Restructuring of our Data Management Department has resulted in the creation of a new supervisory position. This position requires knowledge of analyst and programming functions for both administrative and engineering areas.

The candidate we seek must have a broad knowledge in effective use of IBM 360 software and in modern systems design practices. Candidates must have demonstrated their managerial ability. Salary will be commensurate with background and experience.

Plant interview and relocation expenses will be reimbursed. Send resume to J. W. Lundstrom, General Office Personnel Supervisor:

Consumers Power Company
212 West Michigan Avenue
Jackson, Michigan 49201

An Equal Opportunity Employer.

CIRCLE 302 ON READER CARD

IMMEDIATE OPENINGS

PROFESSIONAL & CONFIDENTIAL placement assistance to people like yourself has been our business for 40+ years. Our staff of SYSTEMS & EDP SPECIALISTS will represent you to those at "decision-making" levels in the nation's finest firms. Give us the opportunity of discussing your interests and objectives and explaining how we can help you satisfy them. Remember: Our service is nation-wide and without cost to you.

MGR, SYSTEMS & PROGRAMMING . . . \$18,000

Midwest Bank seeks qualified manager (24 analysts & programmers) with good IBM S/360 experience. Banking exper. preferred but not required.

LEAD PROGRAMMER . . . \$14,000

Excellent growth opportunity for programmer with min. 2 yrs. exper. in casualty insurance field.

MGR, SYSTEMS & PROGRAMMING . . . \$17,000

Mfg. firm setting up new data center for 7 mfg. locations. Requires managerial ability & strong mfg. systems and programming background.

LEAD ANALYST/PROJECT LEADER . . . \$16,000

Good opportunity for systems analyst with background in 3rd generation computers & mfg. & actg. systems to assume multi-project leadership.

PROGRAMMERS/ANALYSTS . . . \$8,400-\$15,000

Numerous positions available in Midwest. Contact us for specifics.



CALL OR WRITE TODAY!
CADILLAC ASSOCIATES, INC.*
32 W. Randolph Chicago, Ill. 60601
(312) FI 6-9400

On the West Coast, contact: **LON BARTON ASSOCIATES**
3325 Wilshire Boulevard, Los Angeles, California 90010
(213) 385-9111

**Where More Executives Find Their Positions Than
Anywhere Else In The World.*

CIRCLE 300 ON READER CARD



H. Levin, MBA, Personnel Management,
Member of ACM and
DPMA

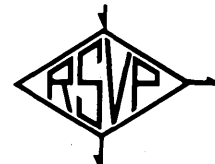

**EMPLOYMENT
AGENCY**

**for PROGRAMMERS & ANALYSTS
N.Y./N.J./PENNA.**

RSVP will provide employment counseling, develop and circulate your resume, at no cost to you. Call or send resume or rough notes of objective, salary, location restrictions, education and experience to either of our offices:

- **CHARLIE COOKE, Manager**
RSVP Services, Dept. M
Suite 104, Towle Bldg.
1777 Walton Road
Blue Bell, Penna. 19422
(215) 643-5550
- **HOWARD LEVIN, Director**
RSVP Services, Dept. M
Suite 714
One Cherry Hill Mall
Cherry Hill, N.J. 08034
(609) 667-4488

RSVP SERVICES

employment agency
for computer professionals

CIRCLE 301 ON READER CARD

OS/MVT Scheduling

Version I, Computer Scheduling System, provides automatic scheduling of all programs. It is also a modeling tool to determine future hardware requirements and the impact of potential new programs on the overall

schedule. The programs, written in COBOL for operation under OS/MVT, require 150K bytes of memory. Operating time to schedule 1.5 megabytes of core (from a library in excess of 1,000 programs) for 36 hours takes about 10 minutes. The price is \$10K. Version II will schedule through sev-

eral computer systems, and part of the version I price may be applied when version II is ready. C.P. & AS-SOC., Cleveland, Ohio. For information:

CIRCLE 503 ON READER CARD

Performance Monitor

OPTIMIZE is a 360 BAL program requiring 30K bytes on 360 model 40 systems (and up through the 370 line) for monitoring the I/O activity of OS/360 MVT or MFT. It keeps track of which data sets are used most and

supplies information enabling the systems programmer to better determine where to place data sets, what routines to make resident, how large to make the SVC transient area, what routines to incorporate in the BLDL table, etc. The program is supplied with complete documentation for

\$1400, including a two-week free trial. Installation assistance is also available. OPTIMIZED COMPUTER SYSTEMS, Anaheim, Calif. For information:

CIRCLE 528 ON READER CARD

Stress Program

STRESS III is a much-rewritten version of the original STRESS structural engineering program written at MIT. STRESS III is programmed for the IBM 1130 computer with 8K of memory and a reader, printer, and disc unit.

Among the many features are a listing of internal member forces of specified members at equally spaced stations along the member; a "relaxed" syntax permitting the use of commas, hyphens, and dimension delimiters on member incidence cards; and the use of conventional engineer-

ing units. The one-time lease charge is \$1875, which includes one year of mailout updates. ASPEN COMPUTER SCIENCE, INC., Aspen, Colo. For information:

CIRCLE 504 ON READER CARD

HOW MANY MILLIONAIRES

ARE THERE IN THE UNITED STATES ?



JOHN SAUER, Pres.

... and how many NEW millionaires join the ranks every year? How did they acquire their wealth? The number and the reasons may astonish you! This amazing story is revealed in a valuable new booklet, "NEW ROADS TO OPPORTUNITY AND WEALTH."

Even more exciting are the factual details about a specific business opportunity that is nothing short of a gold mine. Why? Because, as an associate of the organization providing the opportunity, you help others to succeed.

For your free copy of "New Roads to Opportunity and Wealth," phone, wire, or write immediately to:



THIS VALUABLE 65-PAGE BOOK SENT **FREE!**

Yes, Rush me "New Roads to Wealth & Opportunity" Today!

NAME _____ PHONE _____

ADDRESS _____

CITY _____ STATE _____ ZIP _____

John Sauer, President
D.A.T.K. Inc. - P.O. Box 22125, Denver, Colorado 80222
(303) 757-5500

CIRCLE 38 ON READER CARD

IMSL COMPUTER PROGRAM LIBRARY 1 NOW AVAILABLE

Library 1 is a collection of 203 statistical and mathematical subroutines written in FORTRAN. Included in the first edition are programs dealing with analysis of experimental design data; basic statistics; differential equations, quadrature, and differentiation; approximation and smoothing; statistical and mathematical special functions; non-parametric statistics; observation structure; regression analysis; vector and matrix arithmetic; linear algebra and eigenanalysis; and a set of utility functions including special I/O routines, library maintenance and retrieval programs, and library testing programs.

The entire library rents for \$720/year. Subscribers may return the library within 30 days without charge. The pricing includes telephone consultation, maintenance, source code, later augmentations, updates, and a newsletter on future editions.

IMSL

MATHEMATICAL & STATISTICAL LIBRARIES, INC.

6200 Hillcroft / Suite 510 Houston, Texas 77036
Phone: (713) 772-1927

CIRCLE 26 ON READER CARD

THE SOCIETY FOR MANAGEMENT INFORMATION SYSTEMS

**ANNOUNCES THE
THIRD ANNUAL CONFERENCE**
*Denver Hilton Hotel
Denver, Colorado
September 9 and 10, 1971*

AN INTEGRATED APPROACH TO MIS

A new approach is being taken to this year's annual conference. In the first two conferences, topics and speakers were selected on the basis of a broad range of interests and subjects relating to MIS. This year, the conference will consist primarily of in-depth case histories of the computer information systems programs of two well-known major corporations:

- *The Weyerhaeuser Company*
- *Westinghouse Electric Corporation*

Comprehensive visual presentations are being prepared covering the philosophies these two companies pursued in applying computers to information systems for management functions; the approach to design selected; major applications — how they were developed, how they are used; applications of management science; the perspective of key executive users — before, during the development process, and after completion of major systems. The presentations will be handled by key executives and computer and systems planners of both companies.

Special conference features

- *Manager/Computer Interaction*
Executives of Westinghouse and Litton Industries will discuss key applications of their systems made available to managers for direct interactive use.
- *Identification of MIS Principles: Industry Applications*
A prime objective will be identification of principles applying universally to MIS design programs. During the last conference session on the second day, attendees will separate into industry groups — banking, insurance, manufacturing, government, retailing, etc. Discussion will be directed toward how universal principles can best be applied in each individual industry.
- *Dr. Paul Nadler, dinner speaker*
Dr. Paul Nadler, Professor of Finance, Rutgers University, is widely known for his ability to present a serious subject in a highly entertaining manner. As guest dinner speaker September 9, he will discuss the role of Financial Information Systems. Don't miss this conference highlight!



If you wish to receive a Registration Packet for this Third Annual Conference, please write to: Gerald M. Hoffman, Secretary, The Society for Management Information Systems, One First National Plaza, Chicago, Illinois 60670

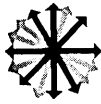

PEOPLE

Harold H. Hammer, Control Data Corp.'s financial wizard for three years, will resign at the end of the year because of corporate philosophy and policy differences with his chairman, **William C. Norris**. It is generally thought CDC's refusal to sell off certain assets in 1970 when its computer operations were losing \$36 million led to Hammer's decision to leave. Norris told security analysts in New York last June that CDC would have made a big mistake if it had sold its Cybernet network or its educational institutes. He said it would have helped 1970 earnings but would have hurt the company in the future. Hammer is believed to have advocated the divestitures but was voted down by CDC's executive committee, of which he is a member. When he announced he was leaving last June, Hammer said the resignation was not due to any specific event. "It just built up over a long period of time." In confirming his resignation, CDC announced that **Marvin G. Rogers**, vp for financial planning, will continue as the company's top financial executive and report to the executive committee.

John A. Aseltine has been named president of Ovonic Memories, a recently formed Los Angeles subsidiary of Energy Conversion Devices, Troy, Mich. . . . **A. Z. Greely**, former financial management group vp at Autonetics, has moved over to North American Rockwell Information Systems Co. (NARISCO) as its president. He succeeds **S. L. Hasin**, now electronics group vp, special assignments, reporting to NR president **D. L. Williams**.

Immediately following the election of **James F. Benton** as executive director of the Computer Lessors Association, the group established a legal action committee to work with others who have started action against IBM and filed a friend of the court brief in the U.S. District Court in Minneap-

olis in Greyhound Computer Corp.'s application for an early trial date of its antitrust action against the big company. CLA member firms have an estimated investment of \$2.5 billion in 360 systems, approximately 65% of all 360 systems owned by independent lessors. Benton is the founder and president of Janus Consultants, an executive selection and management consulting firm.

James Pastoriza, president of Pastoriza Electronics until it was acquired by Analog Devices in 1969, has joined Memodyne Corp., Newton Upper Falls, Mass., as president. Pastoriza had been serving as vp, new product development, and board member of Analog. He succeeds **John H. Gallagher**, who will devote his efforts to the marketing and sales of Memodyne's digital tape transports and systems . . . **Louie Lueders, Jr.**, has been appointed to the new position of group vp of Data Products Corp. He had been president of the firm's Core Memories Div. and now will have responsibility for both that and the Telecommunications Div. . . . Former System Interaction Corp. president, **Richard Hess**, has joined

Hetrix Corp., Rye, N.Y., a computer direct mail services firm, as president . . . **Ernest R. Lapensee** has left Southern California, where he was national sales manager for xds' systems products department, to return to his native Canada and take over the job of president of Datagen, the Hull, Quebec-based minicomputer manufacturer that produces the Nova line . . . Moving up at Spiras Systems are **James T. Regan** from treasurer to president and **Neil D. Morrison** from president to chairman.

On the user side: **Richard M. Bird**, former director of information systems and service for Standard Register, has joined Koehring Co., Milwaukee, as corporate director of management information systems . . . Atlas Chemical Industries, Wilmington, Del., has appointed **Jerry R. Haupt** associate director for systems planning, with responsibility for all business systems and programming services for the entire company. Haupt comes from RCA, where most recently he was manager of management information services and business research in the information systems group, Cherry Hill. ■

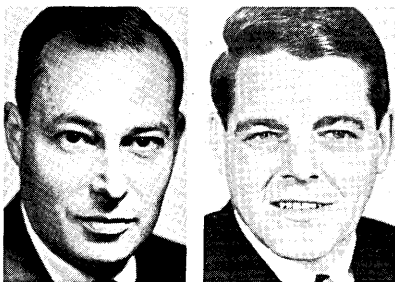

H. Hammer

J. Benton

DEVELOPMENT PROGRAMMING ANALYST

The Foxboro Company is the leader in the development and manufacture of advanced process control systems and instrumentation for installations throughout the world. We seek a development programming analyst who will organize and direct conceptual designs for software product development, implementation, documentation and testing. In conjunction with various research groups, will develop software concepts which can be translated into software products.

Must have six to ten years' experience in computer systems software design and development. Should have worked with small, medium and large computers. Experience with process control systems and instrumentation, including plant start-up, extremely desirable.

Please send resume, including salary history to: Mr. Mark Campbell, The Foxboro Company, Dept. D8, Cocasset Building, Foxboro, Mass. 02035. Foxboro is an equal opportunity employer.



Cumulative subject index

References in this index have the form n/p, where n is the number of the relevant State of the Art Report and p is the relevant page number. To avoid length-lists of references to brief entries, only major entries are referred to in this index.

CATV 2/513, 4/156
 1/53, 2/143

Central utility 4/45, 4/255, 4/271
 Codewords (see Descriptors) 1/322, 2/321, 2/412, 2/496
 Communications processing 1/94, 4/299
 Compatibility 4/53, 4/225, 4/250
 Compilers 1/128, 2/147, 3/77

Concentrators 1/38, 2/429
 Cost 4/111
 2/439

Data bases 2/47
 Data communications 1/212, 1/458, 3/287
 Data management 1/216, 1/225, 2/103, 2/395
 Deadly embrace 1/100
 Debugging 4/13, 4/129
 Descriptors 1/128
 Diagnostics 3/45
 Displays, selection of 1/128
 Distributed systems 3/45

Distribution of intelligence
 Documentation

Scheduling, operating system 1/297
 Security 2/198, 2/210, 2/395, 2/505
 3/103, 4/37

Segmentation 1/218, 1/224
 Simplicity 1/130
 Simulation 3/61
 Software design 1/29, 1/104
 Software engineering 1/103, 1/227, 1/299, 1/341,
 1/445, 2/138, 3/247

Software implementation 1/445, 3/215
 general management 2/107, 2/183, 3/191
 Problems of scale 1/354, 1/455, 2/107
 resource estimation 2/108, 3/79
 techniques 2/112

Software testing 1/458, 3/42, 3/81, 3/377
 Specification of systems 3/27
 Standards 1/134, 1/299
 STAR 2/253, 2/319, 2/443
 Storage 1/33, 1/201, 2/32, 2/83
 associative 1/36, 1/175
 hierarchies 2/88
 management 1/213, 1/283, 1/369, 2/92,
 3/429

structure 2/86
 technologies 2/98
 virtual 2/255
 Store management 1/213, 1/283, 1/369, 2/92,
 3/429

System 360/195 2/327
 System configuration 1/45, 2/141
 System design (see also architecture and 3/55, 4/37
 management of processors)

System specification
 Systems assurance 2/185
 3/27
 1/49, 1/150

Cumulative subject index

Excerpt from cumulative index to Report 4: Computing Terminals

The Infotech State of the Art Reports cumulatively represent the foremost medium for keeping abreast with international expert knowledge and opinion in the world of computing and data processing. The Infotech cumulative index – a section from the fourth Report: Computing Terminals is reproduced above – will be cumulative over the years and will permit the most detailed study of informed opinion on specific aspects of the subject area.

If you need to know about this major new project, write now for a no-obligation airmail pack of details and information.

To Datamation, 35 Mason Street, Greenwich, Conn. 06830.
 I am interested in the Infotech State of the Art Report project

Name: _____

Company: _____

Full Postal Address _____

I am also interested in Infotech State of the Art Lectures

I am also interested in Infotech Cassettes **INFOTECH** 

WASHINGTON REPORT

U.S. CENEL ROLE GETS GREEN, AMBER LIGHTS

Eight European governments told the U.S. at a London meeting they would press their national standards groups to approve a U.S. application to CENEL, the organization now administering the multipartite standardization-certification scheme in electronic components. The U.S. and Europeans also agreed to promote a worldwide scheme (based on the CENEL program) as soon as possible within the International Electrotechnical Commission. The Electronic Industries Assn., however, told a Senate Commerce subcommittee it could not support Commerce Department sponsored legislation (S. 1798) intended to authorize U.S. participation in these international programs. EIA contended the legislation was "premature" and drawn "without adequate information." It recommended creating a study commission to develop a more careful approach. Meanwhile, U.S. officials report, initial product certification under CENEL has been postponed from October to January 1972.

ADAPSO, MODEM MAKERS OPPOSE BELL TARIFF

ADAPSO and the Independent Data Communications Manufacturers' Assn. asked the FCC to reject AT&T's proposed private line tariff requiring special AT&T protective interconnection devices. ADAPSO said the tariff would favor AT&T equipment, restrict users' options, and could cause technical problems with users' equipment. It urged maximum disclosure by AT&T re the devices and the manner of their use. IDCMA, a new association of modem producers, called for creation of a technical advisory committee to develop interconnection specs for FCC use. It said AT&T's monopoly should not be used to benefit its manufacturing arm at users' and competitors' expense.

SENATE AUTOMATION APPROACHING

Majority Leader Mike Mansfield and Minority Leader Hugh Scott endorsed recommendations by the Secretary of the Senate re the upper chamber's adoption of computer technology. A study by the Secretary stresses three top priority areas: payroll, legislative history record keeping, and committee schedule coordination. Next step, expected soon, is legislative authorization by the Rules and Administration Committee which also would act as contracting agent.

CAPITOL BRIEFS

The U.S. Chamber of Commerce has formally recommended establishing a commission to study the antitrust laws and suggest revisions. It endorsed two bills (S. 1486, HR 5768) proposing such a commission...The Senate Small Business Committee is exploring ways to expand Small Business Administration financial and managerial help for numerical control applications...U.S.-British agreement on an ICL export to Russia involved more extensive monitoring provisions than ever previously used but Washington officials stress this transaction does not represent a change in control policy but rather falls within normal COCOM rules re excepted cases.

TECHNICAL PUBLISHING COMPANY

Arthur L. Rice, Jr., President
 Gardner F. Landon, Exec. Vice President, and President, Thompson Division
 James B. Tafel, Exec. Vice President, and President, Technical Division
 Calverd F. Jacobson, Financial Vice President
 Edwin C. Prouty, Jr., Secretary and Director of Data Processing

ADVERTISING OFFICES

Sales Manager & Vice President JOHN BRENNAN
 205 West Wacker Drive, Chicago, Ill. 60606
 (312) 346-1026

Eastern District Managers JAMES M. MORRIS
 WARREN A. TIBBETTS
 IRWIN L. WERFEL
 35 Mason Street, Greenwich, Conn. 06830
 (203) 661-5400

New England District Manager & Vice President WARREN A. TIBBETTS
 112 West Haven Rd., Manchester, N.H., 03104
 (603) 625-9498

Midwest District Manager JOHN M. GLEASON
 205 West Wacker Drive, Chicago, Ill. 60606
 (312) 346-1026

Western Manager & Senior Vice President HAMILTON S. STYRON
 94 So. Los Robles Ave., Pasadena, Cal. 91101
 (213) 681-8486

Western District Manager JAMES E. FILIATRAULT
 61 Renato Court, Redwood City, Cal. 94061
 (415) 364-3171

England and Western Europe WALLACE K. PONDER
 12 Somerset House, Somerset Road
 London, SW 19, England
 01-947-0076

Information Storage Systems, Inc.	20, 21
Infotech	62
International Communications Corporation, A Milgo Company	35
International Mathematical & Statistical Libraries, Inc. . .	59
KLH Associates	50
Metrolab, Inc., A Subsidiary of Cubic Corporation	16
MOS Technology, Inc.	Cover 3
National Blank Book Company, Inc.	14, 15
Novar Corporation	52
Official Directory of Data Processing	54
Programmatics, A Subsidiary of Applied Data Research	56
Redcor	Cover 4
Remington Rand Office Systems Division, Sperry Rand Corporation	36, 37
RFL Industries, Inc.	51
RSVP Services	58
The Society for Management Information Systems	60
Teletype Corporation	12, 13
The Texwipe Company	52
Time-To-Share	46
C. E. Unterberg, Towbin Co.	46
Wyle Computer Products, Inc.	8
Xebec Systems Incorporated	55

ADVERTISERS' INDEX

Advanced Systems Incorporated	5
Bright Industries Inc.	31
Cadillac Associates, Inc.	58
Caelus Memories, Inc.	40
Cincinnati Milacron Company	10
Consumers Power Company	58
Data Dissemination Systems Inc.	64
Data General	53
Datamation Industry Directory	11, 51, 65, 68
D.A.T.K. Inc.	59
Digital Computer Controls, Inc.	30
Documation Incorporated	4
Eaton Corporation, Electronic Security Division	47
Floating Floors, Inc., Subsidiary of NL Industries, Inc. . .	44, 45
Floating Point Systems Inc.	9
The Foxboro Company	61
Fujitsu Limited	48
General Automation, Inc.	2
Gould Inc., Brush Division	42, 43
Robert Half Personnel Agencies	54
Hewlett-Packard	Cover 2, 1
IBM Corporation, Programming Systems Marketing	19
Incoterm Corporation	6

SCANNING MICROFILM

**Digitizing of line drawings
- technical illustrations**

From Aperture Cards
to Magnetic Tape —
Compressed or Uncompressed
to Your Format Requirements.
Text Interspersion —
Point Raster 4096 x 3072
on 1.625" x 1.219" Film Area.

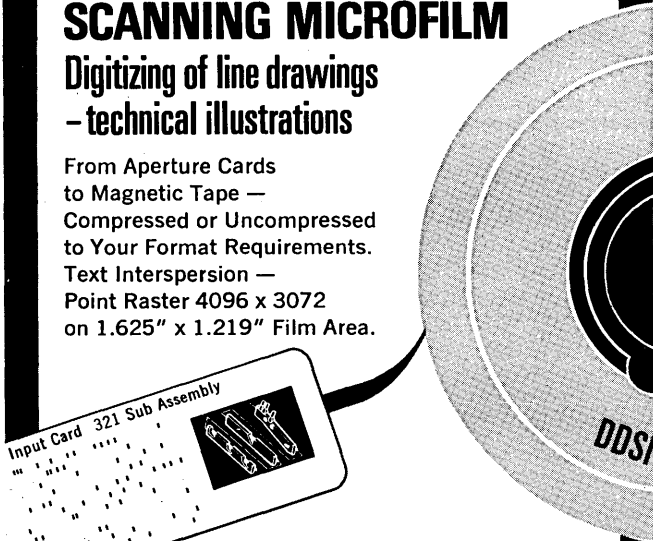

**DATA
DISSEMINATION
SYSTEMS INC.**
A Subsidiary of The Signal Companies, Inc.
4736 El Segundo Blvd.
Hawthorne, California 90250
Phone (213) 644-4425

© 1971 Data Dissemination Systems, Inc.

CIRCLE 20 ON READER CARD

LOOK OUT HONEYWELL . . .
REDCOR'S KEYLOGIC SYSTEM CAGES PAPER TIGERS

A few years ago there were paper tigers pussy-footing around the computer field.
Now Honeywell has let one loose right in the data entry marketplace.
Frightening thought? No. Paper tigers are easy to corner and capture. How? Get a tiger tamer.
Get KeyLogic. KeyLogic (key-to-disc) systems are in the field working.
Have racked up thousands of hours of experience. Thousands of dollars in user savings.
Little wonder that REDCOR has great confidence in its KeyLogic system.
It's doing what we say it will do. Meeting specification and delivery promises. Users have confidence, too.
They show it with new orders. Proven performance records. Cost savings now.
Not a digestible menu for paper tigers.
If you're out beating the bushes for a data entry system, be cagey yourself.
Wear the REDCOR badge of confidence. It's not just a lick and a promise.
It's your guarantee that KeyLogic systems will give you a dramatic cost saving, live performance. Now.
Call REDCOR: (213) 348-5892.

REDCOR
The Other Data Entry Company

