

BACK TO THE BOARD  
WALK ♣️ THE SPRING  
JOINT COMPUTER  
CONFERENCE ♣️ ♣️ ♣️ ♣️  
REVISITS ATLANTIC  
CITY ♣️ ♣️ APRIL 30 TO  
MAY 2 ♣️ ♣️ ♣️ ♣️

WANTED: INTELLIGENT SYSTEMS DESIGN MANAGEMENT

an "F" FOR THE EDP  
SCHOOLS?

Ampex at S. J. C. C.

See the newest Ampex single-capstan tape transports and advanced core memory products in booths 201-4 and 209-11 at S. J. C. C., Atlantic City, April 30-May 2.

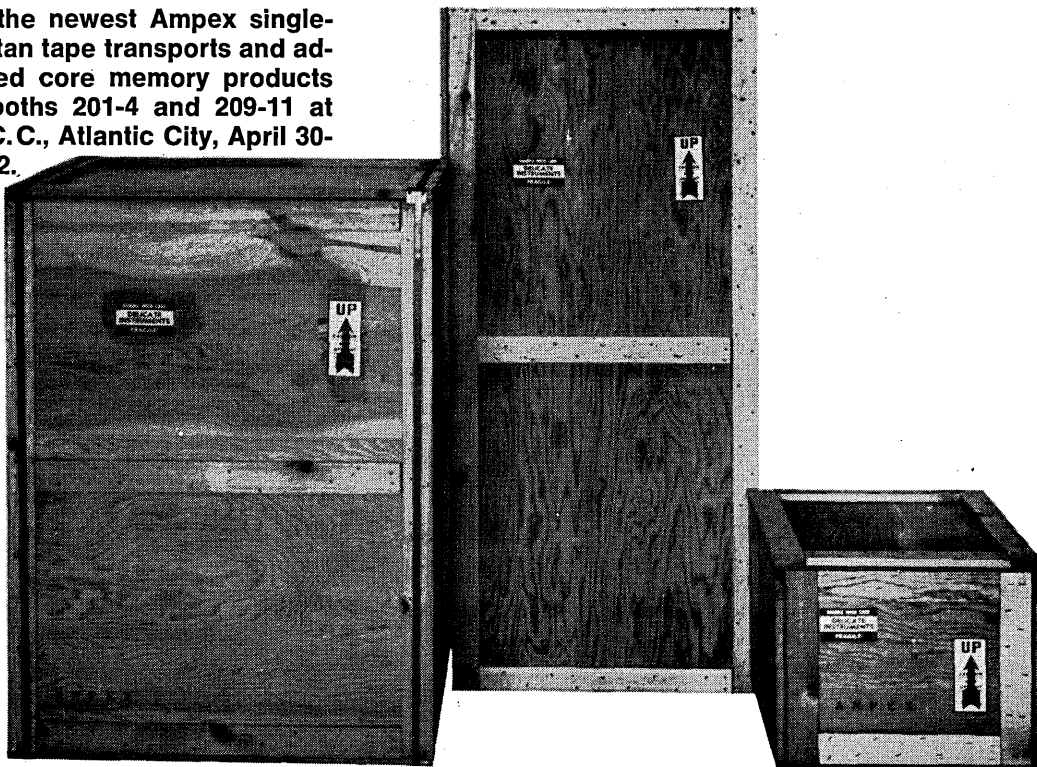

## Tape transports shipped 30 days after order received

Our TM-7, 9, 11 & 12 single capstan tape transports have long since passed through the "opening night jitters" so many new products encounter. We're in full scale mass production with them and can promise to ship yours within 30 days after we get your order.

This means that you can have ex-

actly the product you need, and have it fast. 36 to 150 ips. (Non-standard speeds are available too, down to 7½ ips.) Data transfer rates from 2000-120,000 cps. And they're all IBM compatible in 7- or 9-track ASCII formats. . . . and 60 day delivery for the ATM-13

This digital tape drive for high en-

vironmental use weighs only 150 lbs and measures 15.12 x 25.75 x 12.50 inches. Power use peaks at 1350 watts, normally uses only 1000 watts. It is still the only flight-weight tape memory which meets MIL-E-5400, Class 1A. Standard tape speed is 75 ips. Single speeds from 10 to 112.5 ips are available for special requirements.

TM-7 and TM-9 transports/memories are ideal for systems that require tape speeds of 75 ips and less. They allow you to transfer data at rates from 2000 to 60,000 cps. The single capstan drive makes these transports very reliable, yet keeps the cost down. Both of these units are available in lowboy, regular cabinet, and shared electronics configurations.



TM-11 and TM-12 transports/memories are designed for systems that need their data transferred at higher rates—up to 120,000 cps—with tape speeds ranging from 75 to 150 ips. Up to four transports can share the same memory electronics, if that is desirable for your system. And all TM-series transports and memories are interface interchangeable, which lets you expand your system simply by plugging in new units.

The ATM-13 airborne recorder can be procured without its RFI shielding box, reducing the weight of the unit to 75 lbs.

**AMPEX**



Tomorrow morning  
 you can build a system with  
 compatible digital hardware from  
 Raytheon Computer  
 and enjoy your coffee break.  
 You'll have it made.

1. 703—the \$15,000 IC Computer with \$1.50 spares. The 703 is the small systems computer built like third-generation million dollar computers. The CPU is wire wrapped with plug-in IC's on one motherboard. A unique CPU self-diagnosis solves its own circuit malfunctions. When necessary, you can simply plug-in a new IC. Time: about 80 seconds. Cost: about \$1.50. The 703 is a 16-bit machine; 1.75  $\mu$ sec cycle time; and expandable from 4K to 32K. Software includes an executive and real-time FORTRAN IV.

All Raytheon Computer products are compatible with the 703 for easy, economical and flexible systems expansion.

2. The MINIVERTER™ approach to A/D conversion. The MINIVERTER is a multi-channel multiplexer, sample and hold amplifier and 10, 12 or 18-bit A/D converter prewired and installed in your package or ours. We have several to choose from.

3. You do the system design; we've done the rest. Raytheon Computer offers a complete range of analog and digital IC modules. Mounting hardware and accessories have analog and digital power and grounding built in. For fast turn around, you can send us a wire application engineers are the best in the business. list and we'll send you an automatically wired and assembled system within 4 weeks. And our Our literature is helpful, our representatives even more so. Write or call today for Data File CB-150. Raytheon Computer, 2700 South Fairview St., Santa Ana, California 92704, phone (714) 546-7160.

Raytheon  
 Computer  
 ...the company  
 that gives you  
 a break.

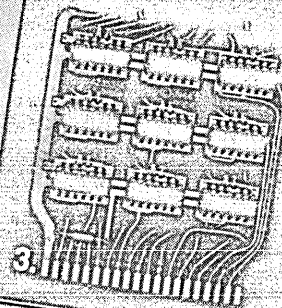
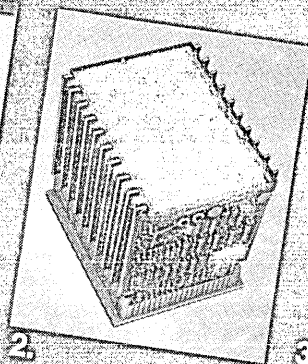
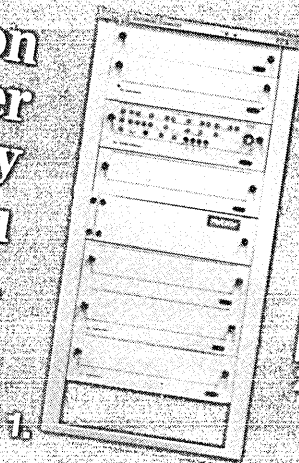



# the Saver

plots your digital data

with less programming time,  
(and money)

with less machine time,  
(and money)

with less I/O time,  
(and money)

with less plotting time,  
(and money)

less floor space, and magnetic tape,  
and data storage space . . . and money.

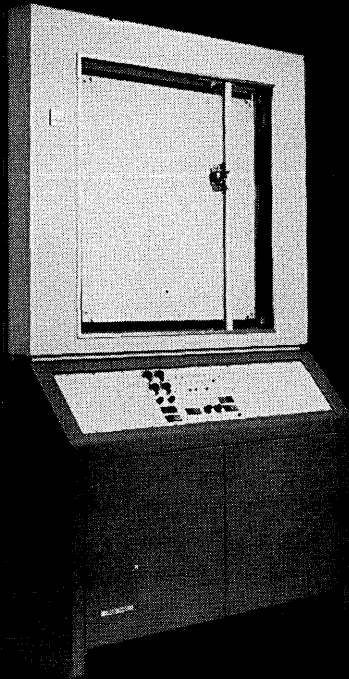

Match up your data display requirements with the DPS-6 total data display system. Choose the type of X-Y plotter, input source and supporting software that meets your needs. Then match the DPS-6 operating costs with other digital plotting systems. You'll see why we call it "the saver."

Read about it in our new brochure. Can't wait to start saving? Phone us.

**Milgo Electronic Corporation**  
7620 N. W. 36th Avenue, Miami, Florida 33147  
Phone 305 - 691-1220. TWX 810-848-6588

**milgo**

WESTERN REGIONAL OFFICE  
3450 E. Spring Street Long Beach, California 213 +426-7375

Spring Joint Computer Conference Booth R-2

CIRCLE 6 ON READER CARD

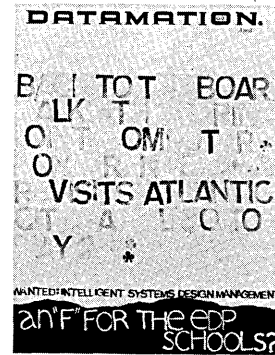

april  
1968

volume 14 number 4

**Publisher**  
**Editor**

**GARDNER F. LANDON**  
**ROBERT B. FOREST**

**Managing Editor & Art Director** CLEVE MARIE BOUTELL  
**Associate Editors** WILLIAM J. ROLPH

**Assistant Editors** AUBREY DAHL  
WENDY REID  
JANET EYLER

**Eastern Editors** ANGELINE PANTAGES  
PHIL HIRSCH

**Midwestern Editor** EDITH GOODMAN  
**European Editor** PEARCE WRIGHT  
**Contributing Editors** HOWARD BROMBERG

ROBERT V. HEAD  
PHIL HIRSCH  
**Washington Reporter** ROBERT L. PATRICK  
**Editorial Adviser** LOWELL AMDAHL  
**Technical Consultant** MARILEE PITMAN  
**Production Manager** FRANK DeCARLO  
**Director of Circulation** ALGENE TRAINA  
**Circulation Fulfillment**

## ADVERTISING OFFICES

**Eastern District Managers**

JAMES M. MORRIS  
WARREN A. TIBBETTS  
35 Mason Street, Greenwich, Conn. 06830  
(203) 661-5400

**New England District Manager  
& Vice President**

WARREN A. TIBBETTS  
112 West Haven Rd.,  
Manchester, N.H., 03104 (603) NAtional 5-9498

**Midwest District Manager**

JOHN BRENNAN  
205 West Wacker Drive, Chicago, Ill. 60606  
(312) Financial 6-1026

**Western District Manager  
& Senior Vice President**

HAMILTON S. STYRON  
94 So. Los Robles Ave.,  
Pasadena, Cal., 91101 (213) 795-9721  
(213) 681-8486—from Los Angeles

## EDITORIAL OFFICES

94 So. Los Robles Ave.  
Pasadena, Calif. 91101



Circulation audited by  
Business Publications Audit



Member,  
American Business Press, Inc.

DATAMATION is published monthly on or about the tenth day of every month by F. D. Thompson Publications, Inc., Frank D. Thompson, Chairman; Gardner F. Landon, President; Gilbert Thayer, Senior Vice President. Executive, Circulation and Advertising offices, 35 Mason Street, Greenwich, Conn. 06830 (203) 661-5400. Editorial offices, 94 So. Los Robles Ave., Pasadena, California 91101. Published at Chicago, Ill. DATAMATION is circulated without charge by name and title to certain qualified individuals who are employed by companies involved with automatic information handling equipment. Available to others by subscription at the rate of \$15.00 annually; single issues (when available) \$1.50. Reduced rate for qualified students. Foreign subscriptions are on a paid basis only at a rate of \$25.00 annually. No subscription agency is authorized by us to solicit or take orders for subscriptions. Controlled circulation paid at Columbus, O. and Form 3579 to be sent to F. D. Thompson Publications, Inc., P.O. Box 2000, Greenwich, Conn 06830. Copyright 1968, F. D. Thompson Publications, Inc. Microfilm copies of DATAMATION may be obtained from University Microfilms, Inc., 313 No. First St., Ann Arbor, Michigan.

Printed by Beslow Associates, Inc.

This issue 77,826 copies

**DATAMATION**

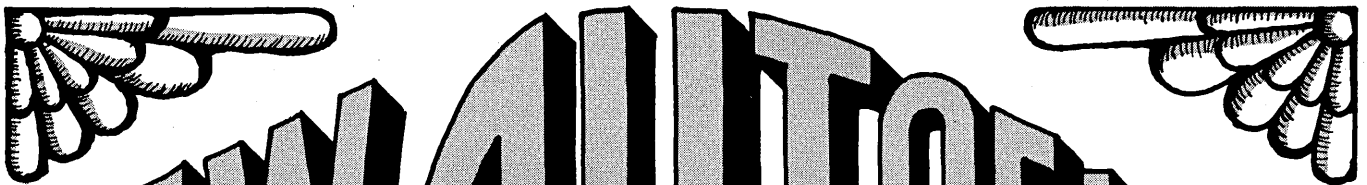

# NEW AUTOFLOW

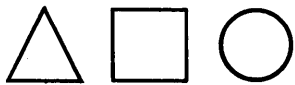

## SEE ADR's

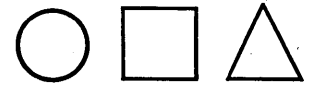

# PROPRIETARY SOFTWARE AT SJCC

### AUTOFLOW\*

- New /360 AUTOFLOW features
- New HONEYWELL H-200 System

ADR's AUTOFLOW Computer Documentation System\* produces two-dimensional flowcharts automatically, accurately, and effortlessly, directly from COBOL, FORTRAN and Assembly source programs. AUTOFLOW, available on a lease or service basis, is user-tested and approved and currently is in service at more than 150 customer installations. ADR's AUTOFLOW is available for IBM/360, 7090, & 1400 Series; HONEYWELL H-200 Series, and RCA SPECTRA 70 Series.

See AUTOFLOW demonstrated at ADR's booth.

### PDQ

Now AVAILABLE for /360 System

PDQ has been designed for information retrieval applications in industry, research facilities, educational institutions, and governmental agencies.

Some distinguishing features of PDQ are:

- fast retrievals
- simple language
- flexibility

PDQ is available on a lease basis for IBM System/360 computers, models 30 and larger.

### ESI

ADR's ESI is a proprietary software product for engineering and scientific computation.

ESI is available for Digital Equipment Corporation's PDP-5, PDP-8, PDP-8/S, PDP-8/I, and LINC-8.

See ESI demonstrated at ADR's booth.

*While ADR is a recognized leader in proprietary software, corporate activities range from software development to management sciences, application programming, and research.*

*See ADR's proprietary software demonstrated at the SJCC . . . and write today for detailed information or request a FREE demonstration.*

Contact ADR if you're interested in a new array of career opportunities.

See ADR at Booth 2004 & 2005



## APPLIED DATA RESEARCH, INC.

Route 206 Center, Princeton, New Jersey 609-921-8550  
with offices in Boston, Mass., Washington, D.C., Los Angeles, Calif.,  
New York, N.Y., Chicago, Ill., Detroit, Mich. and St. Louis, Mo.

\*patent pending

ADR is an equal opportunity employer (M/F)

CIRCLE 7 ON READER CARD

# ULTRONIC

announces a new series of data communication building blocks that can be configured to suit any problem from simple line concentration to the most complex communication systems.

DATA COMMUNICATION PRODUCTS DIV.  
**ULTRONIC SYSTEMS CORP.**

SUBSIDIARY OF  
SYLVANIA ELECTRIC PRODUCTS INC.  
MOUNT LAUREL INDUSTRIAL PARK  
MOORESTOWN, N.J. 08057 • PHONE: 609/235-7300  
EXT: 347

IF YOU WOULD LIKE  
TO LEARN MORE ABOUT  
ULTRONIC'S NEW  
BUILDING BLOCKS FOR:

- LOWER TRANSMISSION COSTS
- IMPROVED DATA THRUPTUT
- INEXPENSIVE COMPUTER INTERFACE
- UNLIMITED EXPANSION CAPABILITY

**RETURN THE COUPON BELOW!**

**ULTRONIC SYSTEMS CORP.**  
Mt. Laurel Industrial Park, Moorestown, N.J. 08057

NAME \_\_\_\_\_

COMPANY \_\_\_\_\_

ADDRESS \_\_\_\_\_

CITY \_\_\_\_\_

STATE/ZIP \_\_\_\_\_

DEPT. DA-004



# DATA MATION 68 <sup>®</sup>

april

1968

volume 14 number 4

- 22 EDP SCHOOLS—AN INSIDE VIEW, by Edward W. Markham. *An examination of the proliferating private schools offering edp training, with emphasis on some of their shortcomings.*
- 28 HOW DO COMMITTEES INVENT?, by Melvin E. Conway. *The design is usually structured exactly like the planning organization.*
- 32 THE FCC UTILITY INQUIRY, by Phil Hirsch.
- 37 A FOURTH-GENERATION COMPUTER NOW?, by Don L. Jewett. *Small computers with adequate disc or drum storage could be reorganized to have some of the characteristics now being discussed for the fourth generation.*
- 39 AN EXPERIMENTAL 360/40 FOR TIME-SHARING, by G. E. Hoernes and Leo Hellerman. *An IBM System/360 Model 40 has been modified for time-sharing through software, changes to the micro-program, and addition of a new instruction.*
- 45 MESSAGE CONCENTRATION, by John W. Pugh. *A method to reduce time-sharing subscribers' communication-circuit lease costs.*
- 52 MANAGEMENT AND THE NEW SOFTWARE, by Tom Scharf. *The complexities of third-generation software require early decisions by management to choose the proper options for future flexibility.*
- 65 CHESS AND THE COMPUTER, by Frederick L. Moullen. *Once, little men inside "machines" even beat Napoleon.*
- 72 THE END OF OS. *There had been indications for years that it would happen, but the final day still came as a shock.*
- 75 THE PROBLEMS OF PACKAGED PROGRAMS: THE AMERICAN MANAGEMENT ASSN. CONFERENCE REPORT.
- 85 AEROSPACE TECHNOLOGY AND URBAN SYSTEMS: A CONFERENCE REPORT.
- 93 THE DATA 520/i. *A new sub-\$10K minemachine featuring variable word-length and precision makes its debut.*
- 98 THE H-632. *First of a new product line from Honeywell's Computer Control Division.*
- 109 THE 1968 SPRING JOINT COMPUTER CONFERENCE: A PREVIEW.
- 114 THE HEWLETT-PACKARD 2114A. *Cheaper than its brothers, but just as fast.*

## datamation departments

- |     |                       |     |                      |
|-----|-----------------------|-----|----------------------|
| 9   | Calendar              | 185 | New Products         |
| 11  | Letters to the Editor | 195 | New Literature       |
| 17  | Look Ahead            | 200 | Books                |
| 21  | The Editor's Readout  | 211 | People               |
| 153 | News Briefs           | 217 | Datamart             |
| 181 | World Report          | 231 | Index to Advertisers |
| 183 | Washington Report     | 238 | The Forum            |

automatic  
information  
processing  
for business  
industry & science



# if you think the story is spectacular wait till you see the picture

As the complexity of CRT displays increases, and as the need for user manipulation of the picture increases, it is more and more the case that the central computer cannot provide the required on-line processing — or that communication lines cannot handle the high throughput rates. The graphics I/O terminal itself must include the necessary display-processing capabilities. That's why every Adage Graphics Terminal has its own Ambilog 200 computer with special arrays for high speed coordinate transformation.

Hybrid techniques exclusive with Adage provide extraordinary image-processing power and make possible dynamic 3-D displays which move with full six degrees of freedom. Objects containing over 5000 lines can be presented without flicker even with frame-to-frame dynamic changes. And pictures are always bright and clear, thanks to scope-driving circuitry that's way ahead of its time.

Starting with the AGT/10 at \$60,000, standard models are available with either 2-D or 3-D capability, perspective generation, three-dimensional windowing, and intensity-modulated depth cueing. Options include dataphone interface, joystick control, analog tablet input,

hardware character generation, and photographic hard-copy output. Complete systems software is provided with every terminal for local image control, for console I/O, and for communicating with the central facility.

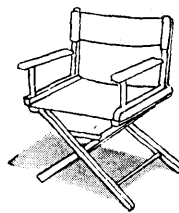

*Now that you've read the story, don't miss the picture. A free 16mm demonstration film of the Adage Graphics Terminal in action is yours just by writing on your company letterhead to David Sudkin, Manager of Marketing Services, Adage, Inc., 1079 Commonwealth Avenue, Boston, Mass. 02215*

**Adage**  
INC

SEE US AT SJCC BOOTH 205-208

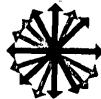
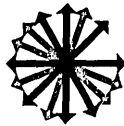

# calendar

DATE	TITLE	LOCATION	SPONSOR/CONTACT
May 6-7	9th Annual Symposium on Human Factors in Electronics	Marriott Twin-Bridges Motor Hotel, Washington, D.C.	H. P. Birmingham, Code 5630B, Naval Research Lab, Washington, D.C. 20390
May 16	7th Technical Symposium	NBS Auditorium Gaithersburg, Md.	ACM/G. R. Reed, P.O. Box 6228, Washington, D.C. 20015
May 19-21	RCA Computer Users Assn. Meeting	Hotel Pontchartrain Detroit, Mich.	E. E. Andrews, RCA Systems Info. Div., Bldg. 201-2 Cherry Hill, Camden, N.J. 08101
May 20 May 21 May 23 May 24	Seminars on Digital Simulation, \$20, \$25 (non-members)	Minneapolis, Minn. Colorado Springs Los Angeles, Calif. San Francisco, Calif.	ACM, 211 E. 43 St., New York, N.Y. 10017
May 22-24	4th Annual Data Processing & Automation Conf.	Sheraton-Chicago Chicago, Illinois	Nat'l. Rural Electric Cooperative Assn., 2000 Florida Ave., N.W., Washington, D.C. 20009
June 3-5	National Conference	Kingston, Ontario Canada	Computer Society of Canada, Box 445, Kingston, Ontario
June 11-13	Annual Conference	Univ. of Pittsburgh, Pa.	Council of Social Science Data Archives, 605 W. 115th St., New York, N.Y. 10025
June 11-14	Users Meeting—Large Scale IBM Machines	Conrad Hilton Chicago, Illinois	GUIDE International/Jack Eggleston, P.O. Box 1298, Omaha, Neb. 68101
June 12-14	Annual Meeting	Waldorf-Astoria New York, N.Y.	ADAPSO, 420 Lexington Ave., N.Y.C. 10017
June 17-19	Microelectronics Symposium	Sheraton-Jefferson St. Louis, Mo.	IEEE, 345 E. 47 St., New York, N.Y. 10017
June 25-27	2nd Annual Computer Group Conf., Impact of LSI	International Hotel Los Angeles, Calif.	IEEE, Suite 1920, 3600 Wilshire Blvd., Los Angeles 90005
June 25-28	International DP Conf. & Business Exposition	Washington Hilton Washington, D.C.	DPMA, 505 Busse Hwy., Park Ridge, Ill. 60068
June 26-28	9th Annual Joint Automatic Control Conf.	Univ. of Michigan Ann Arbor	IEEE, 345 E. 47 St., New York, N.Y. 10017

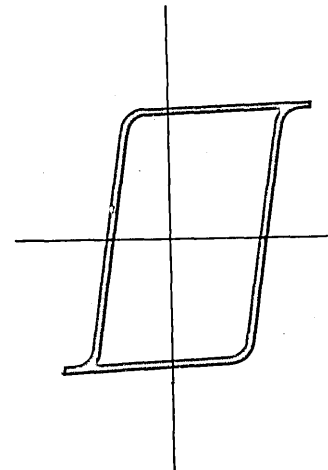

- **Customer Satisfaction**
- **Reliability**
- **Speed**

That's what Datacraft Corporation engineers into each memory, whether it's an off-the-shelf 512 x 8 unit or a custom designed 65536 x 32 system.

The model DC-31 for example, is a high speed, linear select, coincident-current, magnetic core memory especially suited for systems requiring small high speed units. It comes with a full complement of field proven options that enable the customer to select a custom system at minimum expense.

The basic DC-31 features include: less than one microsecond full cycle time; 450 nanosecond access time; capacities up to 1024 x 12 in one bit per word increments; 30 days delivery. Prices start at \$1210.

For detailed specifications on the DC-31 and information on other models, call (305) 565-9441 now, or write

Datacraft Corporation,  
776 N.E. 40th Court,  
Fort Lauderdale, Florida 33307.



**DATA CRAFT  
CORPORATION**



**Buy as much of our plug-in mass storage system as you need at 27¢ a thousand characters.**

You can start with one Bryant memory drum or disc file and end up with as many as eight. Increasing your system's capacity from 8 million to 5 billion characters. All at 27¢ a thousand characters anywhere along the line. And there's plenty to offer for the money.

For example, the universal controller system interfaces to just about any computer made with the push of a plug. It can operate in several different modes, both serial and parallel. It features word transfer rates from 50 microseconds to 900 nanoseconds per word—to and from two computer central processors. And it comes with a software package, complete with handler and maintenance routines (if specified).

Skeptics beware. We're out to make Bryant Believers out of you. Write and see. Ex-Cell-O Corporation, Bryant Computer Products, 850 Ladd Rd., Walled Lake, Michigan 48088.

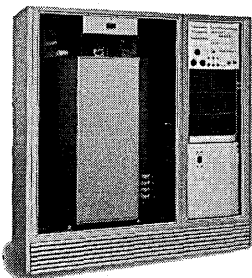

XLO-1000 Controller plug-in Auto-Lift Drum System

**BRYANT  
COMPUTER PRODUCTS**



EX-CELL-O CORPORATION



# letters

## values, not votes

Sir:

Mr. White's (Jan. p. 12) comments on "electronic referendum devices" must have been formulated by a computer. To reduce democracy to the most efficient technique for counting votes and to assert that political institutions must, in effect, adapt to technology rather than to ways for better serving human purposes, is characteristic of a mindless machine.

The essence of democracy is not vote counting. There already exist numerous societies where almost instantaneous tallies of the population are effected—and with nearly unanimous results. The essence of democracy is the contention of ideas, a search for an approximation to truth by exposing errors, the freedom to choose between real alternatives on the basis of individual and shared value systems. Voting is the last step in a difficult and complex process of decision making and the particular technique used in casting and tallying votes is of little significance.

Some theoreticians have asserted that money is not a commodity, but only information. Mr. White now extends the theory and states that a political system, too, is an information system. Before reducing us to bits, however, it should be recalled that information theory deals with the "technical problem of accuracy of transference of various types of signals from sender to receiver." The meaning of the signals, or codes, are not relevant to information theory. Those who toil in the fields of processing meaning, e.g., machine translation, "automatic" indexing, etc., should be aware, but too often are not, that it is difficult, if not impossible in other than a constrained or trivial manner, for an information system to deal with meaning. Computational semantics is an exercise in futility if not of arrogance.

To create a Town Meeting of 200 million people by placing "vote boxes" in their homes is not an extension of democracy. The simultaneous and effortless pushing of 200 million buttons brings the nightmare of "1984" closer. The keyed codes may well be counted efficiently. The question for

democracy, however, is the meaning of the codes, who establishes them, and what values they represent.

Although much that passes for political science may also be mindless, "vote boxes" cannot express value systems or resolve conflict between contending values. Only human beings in person-to-person relationships and other forms of direct democracy can establish humane institutions that will facilitate freedom in decision making and deliver us from machines, not to them.

EUGENE S. SCHWARTZ  
Park Forest, Illinois

## fee or free?

Sir:

I wish to take issue with Bernard Galler (Jan., p. 14) and add to the arguments of Richard Tanaka in "Fee or Free Software" (Oct., p. 205).

There are two major reasons why a user will often prefer a fee package. The first reason, advanced by Tanaka, is that a sellable package is both cheap and of high quality when competition develops. Competition has already begun in the diverse areas of data management systems and automatic flow charters. Secondly, and of more importance, the user can expect, demand and promptly get, maintenance of the software. Dare I suggest that a user may not get such a good service from any "free" pool? He should also save himself money, time and the endless headaches that software maintenance

cheaper to the user than hardware maintenance? The Air Force does this now, sending out a new master tape to 135 logistics installations on a weekly basis. I do not take issue with the need for free software, but I think there is a fundamental difference between the exchange of information about programs in the research and development area and "maintained" programs offered for operational uses to people not as skilled as the person offering them. This is an area where I think, at last, we have a chance to separate the suppliers of software from the suppliers of hardware and provide a reasonable alternative to the "free" software supplied by the manufacturer.

JOHN A. GOSDEN  
Washington, D.C.

## service bureau standards

Sir:

"Files Vanish From Slipped Discs" (Jan., p. 17), certainly does not enhance the reputation of the burgeoning service bureau industry. It refers to an action occurring in the industry that is distasteful in terms of our organization's standards. Although the firm is not mentioned in the piece, I do not believe it is a member of ADAPSO. None-the-less, the reader does not segregate members from non-members.

Before an applicant is considered eligible for membership under the association's By-Laws, Article I-Section 2, the organization must "demonstrate that it has adequate facilities, and in-

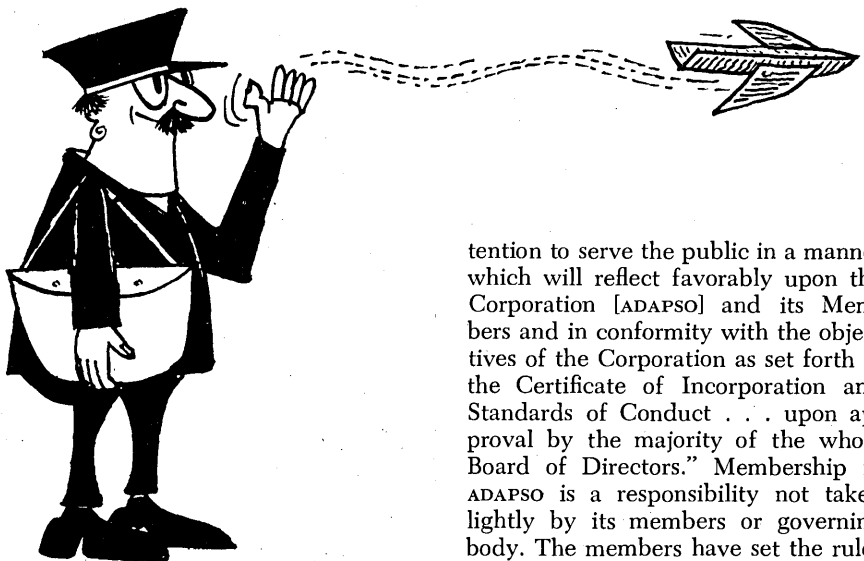

can bring. Indeed, I expect such software maintenance to be a big improvement over current practice, because a small number of skilled staff can maintain one master copy for many users. Is it possible that software maintenance can become simpler and

tion to serve the public in a manner which will reflect favorably upon the Corporation [ADAPSO] and its Members and in conformity with the objectives of the Corporation as set forth in the Certificate of Incorporation and Standards of Conduct . . . upon approval by the majority of the whole Board of Directors." Membership in ADAPSO is a responsibility not taken lightly by its members or governing body. The members have set the rules . . . and the mechanics to enforce them. Article I-Section 2 of our By-Laws carries the heading of Expulsion of a Member. Item B states, "Upon a finding by the Board that a member no longer fulfills the applicable requirements of Section 3 of the Article I or has acted in a manner which is sub-

# wti

## IS DELIVERING!

NEW 15 CHANNEL SOFTWARE  
SUPPORTED IBM 1130  
COMMUNICATIONS CONTROLLERS—

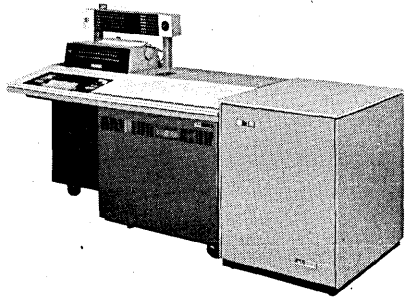

PROVIDING THE BEST LOW COST  
TELEPROCESSING SYSTEM  
AVAILABLE TODAY!

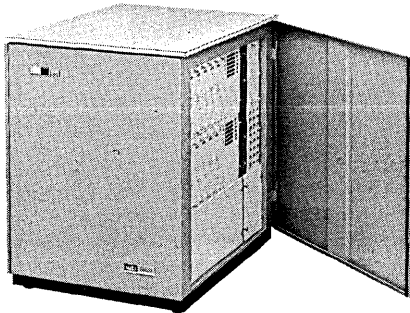

### MODEL TM113

connects any combination of up to 15 teleprinters (28, 33, 35) or IBM terminals (2741, 1050) to any model of the IBM 1130. All terminals operate simultaneously with the execution of any 1130 program.

The SOFTWARE package permits FORTRAN calls to communicate directly with terminal equipment. No monitor modifications are required, and terminal I/O is fully overlapped.

Applications for systems already delivered include: REMOTE JOB ENTRY, EDUCATION, INVENTORY AND PRODUCTION CONTROL, SCIENTIFIC TIME SHARING AND STOCK MARKET ANALYSIS.

If you have a requirement for teleprocessing, and you are not aware of what a really effective low cost computing system the IBM 1130 is; call or write WTI today with your application.

Demonstrations can be arranged on either coast . . . delivery is 90 days . . . rental rates including control software, start at only \$275/mo. plus \$25.00/line.

# wti

western telematic, inc.  
5507 Peck Road, Arcadia, California 91006  
Tel: (213) 442-1862

CIRCLE 81 ON READER CARD

## letters

stantially contrary to the requirements of Section 2 of this Article I, the membership of such a member may be terminated by the vote of eight Directors."

As a further strengthening of our approach to maintaining proper conduct, we have been considering establishing a Committee on Ethics, outside of our Board, comprised of senior industry members to combat the deviations you have cited and to create a respectful recognition of our standards throughout the entire industry.

J. L. DREYER  
*Executive Vice President  
Association of Data Processing Service  
Organizations, Inc.  
New York, N.Y.*

Ed. Note: A section on "security" in ADAPSO's "Standards of Conduct" calls for "proper protection" of clients' documents and records, but it does not spell out either the clients' rights or the means by which protection is to be assured. Despite ADAPSO's Standards of Conduct and what we hope is an overwhelming majority of ethical service bureaus inside and outside that organization, the age-old motto should never be ignored: *caveat emptor*.

### the hexed decimal

Sir:  
Re "A Hexadecimal Pronunciation Guide," by Robert A. Magnuson, Jan., p. 45: The hexadecimal concept does not present any additional problems that binary or actual binary did at their conception.

Hexadecimal (base 16) provides a programmer a larger range of diversification of values, utilizing minimum core storage (one character). It was never the intention that hexadecimal number (values) be referred to as decimal value. A hexadecimal 12 should be pronounced as a "hex one two," not twelve or any other ambiguous number. Due to the fact that all computer manufacturers (hardware and software) use a varied binary base concept, I am of the opinion that a programmer should always pronounce the true definition of binary values, whether hex, octal or binary.

WILLIAM D. MCCARTER  
*Philadelphia, Pennsylvania*

Sir:  
Magnuson's proposal brings to mind a previous effort that may be of some mild historical interest. In the early '50's, when Argonne's AVIDAC and Oak Ridge's ORACLE were under construction, D. A. (Moll) Flanders made the following proposal: Alternative repre-

sentations were to be made by vowels and consonants as in the table:

00=n=o  
01=r=a  
10=s=e  
11=t=u

and vowels and consonants would alternate to provide pronounceable syllables (I may not have all the letters correct, but it is perhaps not too important). Every number would be represented by at least two syllables with "nono" for "zero." Thus:

0000=nono  
0001=nona  
0010=none  
0011=nonu

while 1000=nano. Note that the consonants are in sequence, as are three of the vowels, and the one displacement has an obvious justification. Also, all



sounds are easily distinguishable. In naming a number there could be no doubt which base was intended. We spent some little time practicing our arithmetic, but (alas!) none of us became very proficient and we finally gave up.

A. S. HOUSEHOLDER  
*Oak Ridge, Tennessee*

### bank power

Sir:  
Few spectres were not exorcised by Mr. Goldstein (Jan. Forum, p. 142).

After laboring through his colorful exposé of intrusion, escalation proliferation, "damaging" of ADAPSO firms, excess dp capacity planning, jeopardization of stockholder interests by engaging in "high risk" business, lobbying, monopolistic practices (?), ad infinitum, we now-conditioned programmer types are presumably ready to bear arms and march to the nearest congressman.

Before we do, thereby lending our support to Mr. Goldstein's recourse to a legal (and institutionalized) remedy for economic difficulties, we should ask him a question—"Have you tried competing with banks, B.G.?"

R. J. PETERSEN  
*Chicago, Illinois*

DATAMATION

### equal time

Sir:

"Look Ahead" (Feb., p. 19) did a disservice to both the country and the computing industry by acknowledging the Anti-Complicity Movement. As a member of the Association for Computing Machinery, a widely respected and highly professional group, I deplore the play on the ACM initials for such a purpose. As a loyal American, I view the promotion of civil disobedience and the undermining of support for our men in the armed services as indefensible. As a long-time reader of DATAMATION, let me strongly urge that you not permit a fine technical magazine to be an inadvertent mouthpiece for politicians, hippies or dissidents.

E. C. WITT

Knoxville, Tennessee

Sir:

You have contaminated "Look Ahead" department with an "advertisement" for the Anti-Complicity Movement, an organization apparently designed to sabotage the war effort in Vietnam. Your decision to include this *crud* in your magazine is questionable, but you further condone it by providing an address . . . If any group or individual is interested in ending the war in Vietnam, regardless of his ornithological inclination, let them *support* the war effort in every way possible. This is the quickest way to end the conflict with the least loss—on *both* sides.

The actions of these "peace" groups transcend dissent and border on treason . . . Does DATAMATION intend to align itself with these groups, or may we expect it to withdraw from the field of ideological conflict?

R. C. ILSLEY

WILLIAM VETTER

Springfield, Illinois

Ed. note: As a trade journal, our stance is apolitical, as it should be; however, we are also reporters, and we believe the fact that technical people are organizing to express their political ideas—whether or not we agree with them—is newsworthy.

### time-sharing surprise

Sir:

The February issue (p. 81) included an article on On-Line Systems, Inc., which claimed to be the first time-sharing system in the Pittsburgh area. This was something of a surprise to the University of Pittsburgh, since we have had an operational time-sharing system since April 1966. This system runs on an IBM System/360 model 50, and currently has 30 users. It provides

# Designed to MIL-E-5400.

## The MC 3434 DATALOG® printer.

This fully militarized lightweight printer uses a cathode ray tube with fiber optics to print 6000 lines per minute, 32 columns per line. MTBF is in excess of 4000 hours, based on MIL-STD-785 and MIL-HDBK-217A. RFI qualified, the MC3434 DATALOG uses QPL components to the fullest extent according to MIL-E-5400 and MIL-T-21200. Quality assurance is approved to MIL-Q-9858A.

Completely solid state, silent in operation and with internal paper takeup, the MC3434 has been designed and tested to military environmental conditions, including airborne. For information, phone DATALOG Division of Litton Industries, 343 Sansome Street, San Francisco 94104. Area (415) 397-2813.

 **DATALOG**  
DIVISION OF LITTON INDUSTRIES

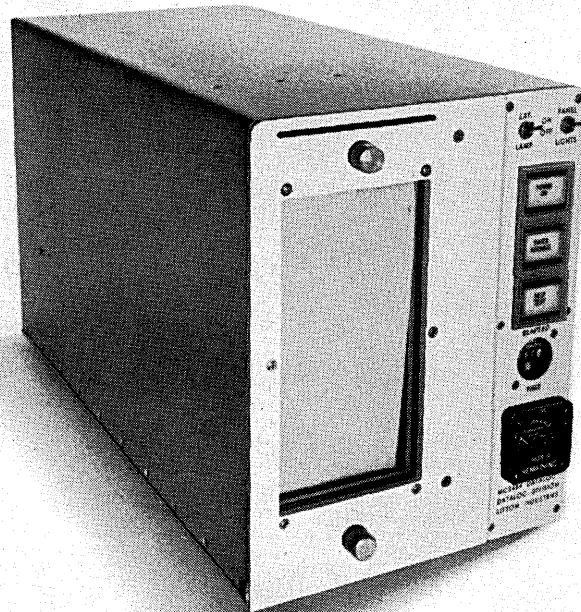

DATALOG is a registered trademark of Litton Industries

# BOUND BY YOUR PERIPHERALS?

Would you like to go a step further with your operation but can't because additional peripheral equipment isn't available from your original supplier?

Contact **ANN ARBOR COMPUTER CORPORATION**. We supply peripheral equipment to meet any requirement, including card and tape readers and punches, magnetic tape, disc files and drums.

We also supply software.

We don't make computers — we make them work.

**ANN ARBOR COMPUTER CORPORATION**



*A subsidiary of the*  
**JERVIS B. WEBB COMPANY**  
415 W. HURON, ANN ARBOR, MICH. 48103  
Phone: (313) 761-2151

CIRCLE 100 ON READER CARD

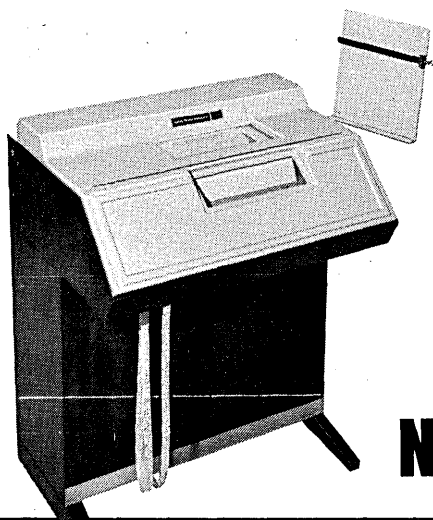

## **NEW!** **Teletype Noise Reducer**

***Kills office machine noise . . . at the source***

Noise in office areas increases tension,  
fatigue, error frequency and employee turnover.

Absorb machine noise at the source  
**BEFORE** it affects nearby personnel.

**Gates Acoustinet, Inc.**

Box 1406-4, Santa Rosa, Calif. 95403 (707) 544-2711

CIRCLE 12 ON READER CARD

## letters

services far more comprehensive than those described for On-Line Systems. I hope that your other news announcements are more factual than this one.

GEORGE F. BADGER, JR.

*Assistant Director*

*Univ. of Pittsburgh Computing Center  
Pittsburgh, Pennsylvania*

Ed. note: So do we.

### project control

*Sir:*

"Project Control For Data Processing" (Feb., p. 33) clearly defined the need for management planning in software development and presented a well-structured implementation technique. However, the basic kernel of the proposal and of all management planning—that of establishing performance standards—unfortunately was ignored. Without valid performance standards, the managerial control becomes an historical audit rather than a dependable planning instrument.

Possibly the authors might now direct their attention to a study on the technique of establishing system analysis and programming performance standards. I have yet to see a workable and realistic solution to this basic problem.

How many programs could a programmer program if a programmer could program programs?

DAVID J. PREMIER

*Chief, Programming Section*

*USAF Aeronautical Chart & Information Center*

*St. Louis, Missouri*

### precision, precisely

*Sir:*

In the February Forum (p. 143), Mr. Jackson makes a case for what he calls "The Need For Imprecision." In the development of his case he strongly implies that the decision table technique is a "wrong-headed" approach in dealing "with those situations where confusion and inconsistency are inherent elements of the problem and where we can not hope to write successful programs unless we are able to deal properly with these factors."

In my opinion, Mr. Jackson's implication is totally in error. In fact, I can't help but feel that the true value of the decision table technique has been badly misrepresented, insofar as the technique may definitely contribute to the solution of a problem of the type with



which his "theme" is concerned. Contrary to Mr. Jackson's statement, tables do *not* "force an analyst to make a complete [statement]" of the problem logic. In fact, they allow the analyst to state only what he knows of the problem and the technique returns to him a list of what he has stated redundantly or inconsistently. The technique even goes one step further and furnishes the analyst a list of what he has omitted from consideration involving the circumstances he has specified.

Mr. Jackson states that tables do provide for "better optimization" (an allowable misuse of words). This is true but not for the reasons he states. It is true because a computer program can translate a table (even an incomplete table) into a computer program which is nearly optimal and which is better than one which would be produced by an average programmer. This automatic translation capability is the icing on the decision table cake.

Mr. Jackson calls for the development of techniques which allow the analyst "to describe the system, naturally, in its own terms" and which will allow the analyst and programmer to provide the user "a more subtle and flexible treatment" of a complex task. This appears to me to be a call for a technique which will force modularity in constructing a system (each module being a naturally logical entity) and which will be amenable to change (a necessary element providing the user with flexibility in his requests). These two elements are natural by-products of the decision table technique stemming from the inherent power of an "else-rule" and from the fact that modifications to a table are quite easy to make and that the changes are automatically reflected in the program code.

It is my contention that what Mr. Jackson terms a "wrong-headed" approach is really quite level-headed and is probably the best available technique for solving the problems for which he feels "A Need For Imprecision."

JOSEPH D'AULERIO, JR.  
Marlton, New Jersey

DATAMATION welcomes correspondence about the computer industry and its effects on society, as well as comments on the contents of this publication. Letters should be typed, double-spaced, and brief. Only those reaching the editors by the 5th can be considered for the next month's issue. We reserve the right to edit or select excerpts from letters submitted to us.

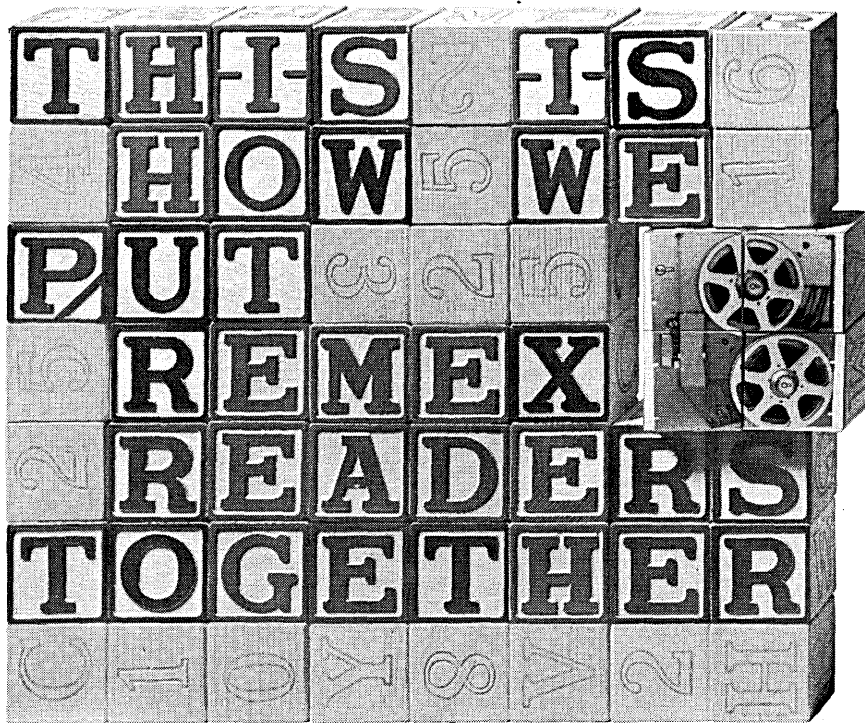

Whether you ask for a standard reader or a specially designed system, we go at it in the same tried-and-true way, with the same basic components. "Building block" construction makes our readers rugged and reliable.

So do the photocells and the solid state circuits. Manufacturers of numerically controlled systems, automatic test machinery and computers have told us that Remex equipment performs far better than anybody else's. Which may explain why we sell more readers, year in, year

out. See for yourself. Call us at 213-772-5321 or write:

Remex Electronics,  
5250 W. El Segundo  
Blvd., Hawthorne, Calif.  
90250. Remex readers.

They read, read, read.

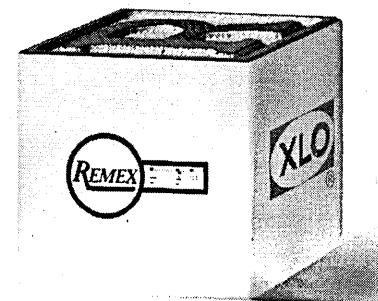

# Full COBOL, Generative Software, Assembler Programming. All fully proven.



## It's all yours with the new Burroughs B 500.

Your Burroughs B 500 offers far more than excellent hardware at a modest price. It is delivered with a complete software package designed to ease your programming task—to put you on the air quickly and at low cost. And it's all been proven in use on the highly successful Burroughs B 100, B 200, and B 300 series.

**Full COBOL.** Backed by Burroughs fast head-per-track disk file. Put it to work solving today's business problems. Use it for easy expansion to a larger member of the Burroughs 500 Systems family tomorrow.

**Generative Software.** Takes the drudgery out of sort and report

program writing. You just define the parameters. Burroughs B 500 Sort and Report Program Generators do the rest.

**Assembler Programming Systems.** Offered at three levels to meet configuration and applicational requirements. Flexible and well suited to business problem programming.

**Automatic Operating System.** Simplifies programming and system operation. Eliminates inefficiency and delay between jobs. Takes over job loading and initiation, program library maintenance and automatic program segment overlay from back-up disk file memory. Expands the

effective size and capacity of your system by permitting multiprogramming of several unrelated problems.

If you'd like to take advantage of COBOL programming, operating system control, or multiprogramming . . . if the prospect of almost unlimited high speed disk file memory appeals to you . . . and if you'd like to have all this at a very modest cost . . . then you should check the new Burroughs B 500.

Ask your Burroughs man. Burroughs Corporation, Detroit, Michigan 48232.

**Burroughs** 

# look ahead

## INSTANT MONEY CREATES INSTANT SOFTWARE HOUSE

Six alumni of System Development Corp. have formed a new software house which was in business three days after its president resigned as SDC vp, plans & programs on Feb. 23.

Rapid funds (reportedly two megabucks) from Western Union International (putting up 2/3 through American Securities Corp.) and White, Weld & Co., allowed president Dr. T.C. Rowan and board chairman Dr. Sanford Greenberg a running start. Already the fledgling firm has 30 employees and offices in Boston, NYC, Santa Monica and Falls Church, Va. Corporate HQ are in Wash., D.C.

The company will specialize in design and implementation of "sophisticated" systems, including execs and compilers, plus MIS, and space systems applications. Some 25 of the employees are SDC defectors, averaging about 10 years' experience.

## LASER-BASED MEMORY AT DEMONSTRATION STAGE

A new laser data storage/retrieval system that provides a 1000-time increase in packing density over conventional mag tape, an error rate of  $1 \times 10^8$  or better, permanent (nonerasable) storage, a transfer rate of 4 megabits/sec., and instantaneous read-while-write verification has been developed by Precision Instrument Co., Palo Alto, Calif.

A working demonstrator of the "Unicon" system uses a 1-watt argon gas laser, which makes a hole in the metallic coating of a mylar-base tape wrapped around a drum. The current system, using 5-micron holes, offers a packing density of 13 million bits/sq. in.

Readout is accomplished by reducing the laser power; beam reflection or non-reflection indicates nonholes or holes. The tape being used on the current system offers storage equivalent to 10 2400-ft. reels of 800 bpi tape. The system can serve on- and off-line, and is capable of recording analog, FM or video data, all of which require high speed.

## SHARE, GUIDE PUSH FOR BETTER TSS, COBOL

Large-scale IBM users are still up in the air over the extent of No. 1's commitment to time-sharing. A recent blue letter indicates that TSS features originally promised by mid-'68 will now be stretched out through the first quarter of '69, with no additional functions being planned.

Although fairly happy with early-version TSS performance, documentation and manuals, Share has passed a resolution asking IBM to reconsider its TSS "freeze," and has offered to cooperate in improvements. Meanwhile some folks are waiting for word on relocation hardware for the /85; rumor is that some will ask for price quotes on it as an added feature just to see what happens.

Name.....  
Address.....  
City.....  
State.....  
Zip.....

American Technological Institute  
Subsidiary of F. D. Thompson Publications, Inc.  
Dept. D, 35 Mason St., Greenwich, Conn. 06830

Send me your free catalogue by return mail. I understand there is no obligation and no representative will call.



# ON GUARD—24 HOURS A DAY!

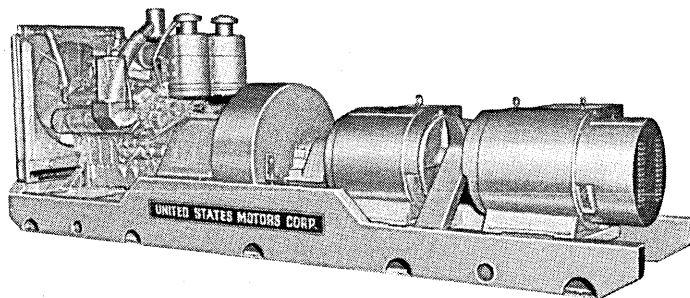

**What happens to your computers when electrical power fails?** Sensitive data processing and computer equipment demands continuous, closely regulated power. Power interruptions and voltage variations, even though slight, can cause errors, data loss, production stoppage and costly downtime.

United States Motors Corporation guards against these failures, with the rotating, no-break power generating system which our engineers originated 15 years ago. These dependable systems provide continuous electrical power to your sensitive equipment without even a millisecond pause, whenever the slightest disturbances or interruptions occur in the commercial power supply.

This rotating no-break system is the simplest, the most reliable, and the lowest in maintenance of any of the systems ever developed to do this job. More than 4000 installations prove it.

The knowledge and experience we have acquired while building and applying them is available to you to whatever extent you desire—beginning with preliminary planning and engineering, through installation, on-site operator instruction, and even full-service contracts. For more data write, wire or phone for informative No-Break literature.

1-NB



Established 1890

## UNITED STATES MOTORS CORPORATION

351 W. 20th Ave., Oshkosh, Wis. 54901 • Telephone (414) 231-4560

CIRCLE 15 ON READER CARD

**DATAMATION**

NEW

ADDRESS?

We know you want Datamation to follow you. If you're changing your business address, please use the card at the right and mail it to us now. We need your old address label, too. Paste it on the card (see instructions) to facilitate handling.



NEW AD

Name\_\_\_\_\_

Title\_\_\_\_\_

Company\_\_\_\_\_

Address\_\_\_\_\_

City\_\_\_\_\_

Your Sign\_\_\_\_\_

# DATAMATION INFORMATION

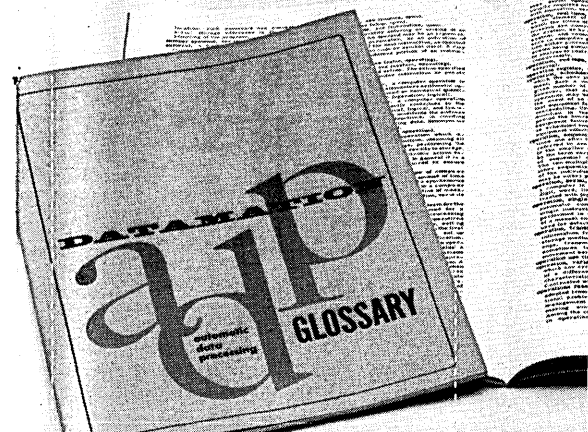

Whatever your work in info ADP Glossary. It gives you daily EDP use. It covers the electronics, communications, sy

This glossary has provided students as a reference to familiarity with the special convenience for customer, preparing or evaluating prop

*Please use the attached cou*

62 pages cross-referenced

\$1<sup>00</sup> each

75c

in lots of 10 to 49 copies

50c

in lots of 50 or more copies

## look ahead

### SOFTWARE WRITE-OFFS: MUDDY WATERS FOR IRS

Meanwhile, Share/Guide Cobol users, worried over an earlier IBM description of PL/I as "the language of the future," have gotten IBM to agree that Cobol is a "continuing industry-wide language," and to informally indicate that extensions to the language will be evaluated on "user need" as well as on recognized industry standards. Now they're trying to get someone at IBM to sign such a statement. IBM also promised to add several "significant" features to Cobol compilers over the next 6-12 months.

The Internal Revenue Service has decided not to make definite rules on write-off methods for a user's software costs. (See Sept. '67, p. 143). The general guidelines under which this cost should be amortized are if: 1) it signifies an "extraordinary" expense for the firm, i.e., major conversion or a new application package; and 2) if the program's life is more than one year. (That seems to cover about 90% of programming, theoretically, anyway.) But the decision on these factors and the period of amortization will be made by IRS on a case-by-case basis.

Such costs are more easily defined if programming is done by an outside firm, since a user's programmer salaries are generally expensed by the year. But an IRS source notes that if the revenue officer is aware that the user's staff was increased or dedicated a significant part of the year to major new programming, chances are he may require that a portion of these salaries be amortized.

### NEW FIRM WORKING ON MIDGET QUAD TAPE DRIVE

Newest peripheral manufacturer is Tri-Data, formed by Jim Bowles and Jack Sweeny, two of the founders of Datamec, tape unit maker acquired by Hewlett-Packard in '65.

First product will be a low-cost OEM drive containing four mag tape files in a cartridge-loaded unit the size of a breadbox. Production quantities will be available in August. Located in Mountain View, Calif., the firm has an initial capitalization of \$800K, will move to new 18,000 sq.-ft. facilities in October.

### BIT UPS 480 SPEED, PLANS POOR MAN'S COMPUTER

A faster TTL-circuit version of the 480 and a smaller new computer will come out of Business Information Technology this year. The 480 now comes with 8 and 2 usec memories and DTL circuitry; its replacement due out about June, the 482, will offer memories with cycle times of 3 usec and under one usec. In the fall, the Natick, Mass., firm will announce a fixed-word machine with 8 instructions, one or two index registers, a macro-assembler, and price "as cheap as we can make it." About 30 480's have been installed; 150 are on blanket order. Potter is the major customer to date. BIT is also marketing a numerical control package (for NC tape production) with the 480.

### THE GIANT STRETCHES AGAIN

Despite its on-again, off-again supercomputer history (Stretch, 360/91), IBM has, we hear, a firm commitment to build the "biggest, best" computer in the world. Fear of legal action, we understand, demoted the 91 to near experimental status, and the 85 may not outshine CDC's heavyweight contender, the 7600. Three superscale projects are reportedly under way at San Jose, Poughkeepsie and Los Angeles, leading perhaps to a System/720. The San Jose effort, says

(Continued on page 225)

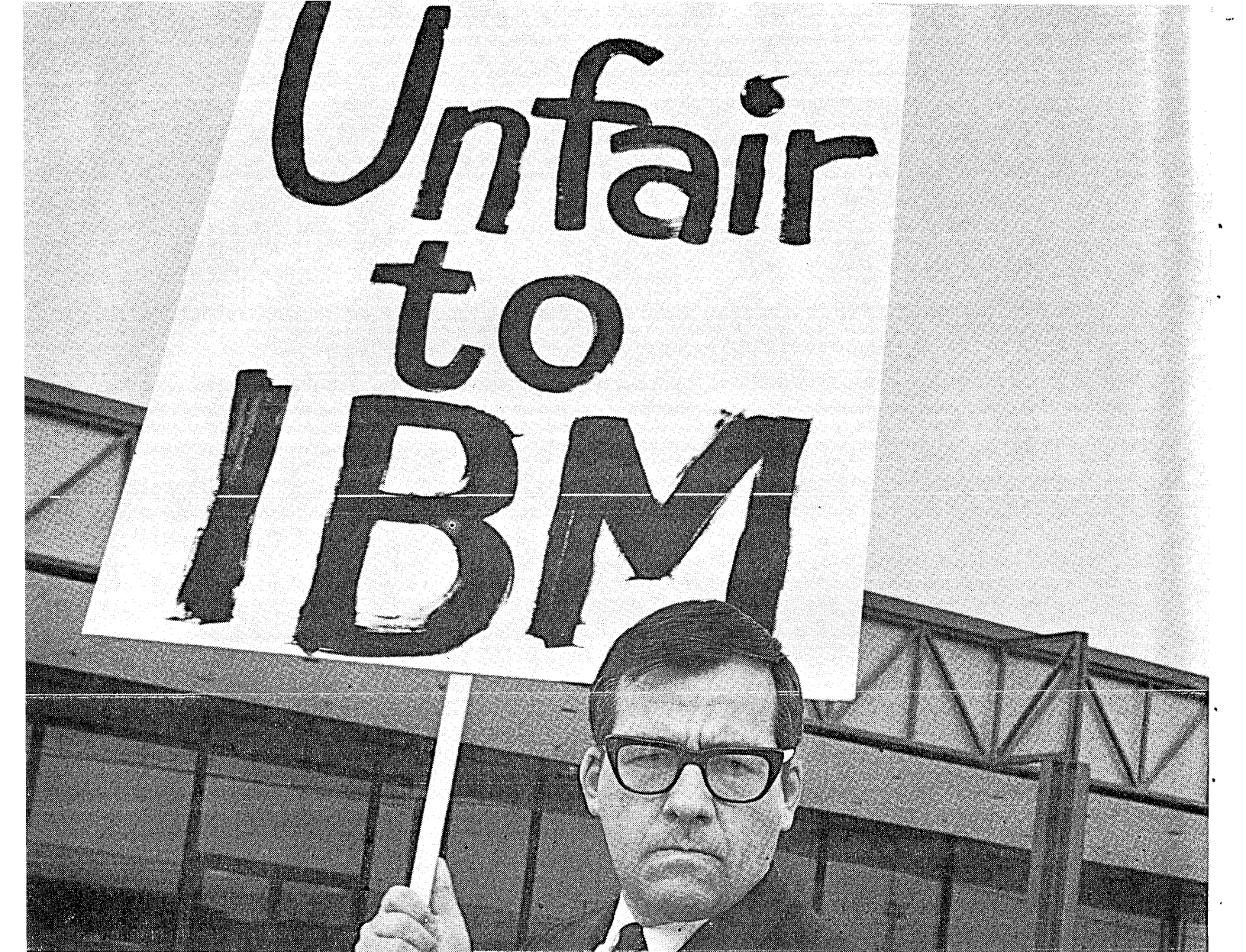

# Unfair to IBM

## **Sigma 7 does everything a 360/50 does. At a fraction of the cost.**

Sigma 7 is a little cheaper than the 360/50 and a good deal faster. The combination gives Sigma a 25 to 65 percent edge in cost/performance.

To illustrate the point we took three program segments as examples and compared their execution times on both machines. Then we figured out the cost per million executions.

The first example was a matrix multiplication routine. That one was easy for us. It's just the sort of scientific computation that Sigma is built for. We did the job at about one third the cost. (\$286.80 vs. \$850.81)

Next we took a floating square root program. Also scientific, but less dependent on arithmetic capability. It was pretty easy for both machines. Still, we came in 30% under. (\$7.11 vs. \$10.44)

Finally we compared a field scan routine. Since that's a more or less typical data processing application, it frankly had us

scared. That's supposed to be what the 360/50 is good at. But we needn't have worried. We did the job for less than 75% of their cost. (\$68.36 vs. \$95.64)

The three examples came out of a published study. We computed the cost figures ourselves because the published ones gave us the best of it. Any of our salesmen will be happy to go into the details. Or, we'll send you our complete figures and references in return for your name, address and a good reason for your curiosity.

But you must realize that in the final analysis the two machines aren't entirely comparable. Sigma 7 has time-sharing capability built-in. The 360/50 doesn't.

So before you buy your next 360/50 think twice. You may be getting only half as much for your money.

# **SDS**

**Scientific Data Systems,  
Santa Monica, California**

# editor's read ut

---

## HELP WANTED

Nearly everybody these days continues to moan the "Man, Where Can I Find Me Some Senior Systems People" blues.

The lyrics and melody aren't all that catchy, but there is really nothing like an old, familiar tune which wails a universal woe . . . especially when it can double as a scapegoat song. What we're asking is: Are you sure you're doing everything you can to make use of available talent?

Without diving deeply (i.e., over our heads) into all the means by which technical management can augment its people resources, we'd like you to consider one idea which may somehow have escaped you.

We're talking about the use of the independent outside consultant. And we have in mind primarily the free-lance, one-man band . . . not the big-name organization.

First of all, we'd better admit that there are good consultants and bad ones. And note, too, that a good consultant can be badly used by a manager who wants a yesman or a crutch . . . or who lacks the guts to evaluate an outsider's ideas and translate the good ones into action. But you're not that kind of manager, certainly.

There are four primary kinds of situations calling for the outside expert: the emergency ("Put the tourniquet on quick, Doc, I'm bleeding to death"); the need for a temporary leader ("Show us a diet and exercises that will get rid of these recurrent headaches"); the need for stimulation ("Come on in once in awhile and give us a shot of intellectual adrenalin"); and the need for a trusted advisor ("You really think I ought to quit smoking, Doc?").

The analogy, like most, is imperfect. Another offered by a man with an amoral or European mind: an outside consultant is a technical mistress. We'll let you fill out the details of that one.

In any case, here are a series of pointers offered by one experienced consultant.

*When and how to look for outside help.* Just before you need it. Evaluate several; interview them as if you were going to hire them full time; ask for references, samples. Recognize the difference between specialists and generalists: match the man to the requirement.

*How to use outside help.* Define the job carefully and fully. Be frank; place your faith in him. But not unlimited faith: establish specific, realistic goals, milestones, deadlines.

*What to expect from outside help.* A high level of professionalism and integrity. The flexibility that will allow him to match the nature of your requirements . . . from emergency through long-range advice. The ability to adapt to your ways, vocabulary and working standards. Complete loyalty to your firm and to you. Complete honesty. He should be able to offer several approaches to a problem, enumerate the pros and cons of each. He should be a walking compendium of citations of available relevant published material . . . and should be able to get it for you. *What not to expect.* Don't expect him to suppress bad news; e.g., that you are the source of the problem. Don't ask him to spy for you. Don't expect to have sole call on his time. Don't expect him to make your decisions. You have to live with them; he doesn't.

A final word: organizations as powerful and rich in talent as IBM, RAND, North American Rockwell and Systems Development Corporation hire outside consultants. So does DATAMATION. But don't let this last one discourage you from looking into one possible way of avoiding the blues.

# EDP SCHOOLS— AN INSIDE VIEW

hang onto your purse

by EDWARD W. MARKHAM

*(Editor's note: The following indictment of the practices of many private edp schools was written by an instructor in one of them. As the author points out, the article is not intended "to imply that all malpractices are universal or are concentrated in a single institution." We open our pages to those with solutions which will rectify these ills, protect the innocent, and help the information processing industry train the people it needs.)*

Education is the latest "in" prescription for socio-economic ills. Data processing is heralding a new era. Education and computers, the stuff of the future. Put them together with a sharp investor and a latter-day medicine man at the helm, and the private edp school emerges. What dazzling opportunity they offer the potential student: entrance to a profession only recently removed from the realm of science fiction and widely regarded as a mystery of the modern world, beginning salaries far outstripping those offered after years of experience in other areas of endeavor, the promise of limitless income potential.

Unlike other suppliers of goods and services, subject to continual review in a repetitive marketplace, the computer school has a customer only once. Thus the edp school is free to offer an inferior product, aware that bad publicity is unlikely to hurt, at least until after a substantial profit has been accumulated. If the waters do become muddied, a new name and a new location make it possible to start all over again. Come-on advertising, high-pressure salesmanship, and modern buildings housing a room of tab equipment hook the prospect. A cursory glance at the Yellow Pages, under Schools, resulting in the following counts, bears witness to edp school success: Manhattan, 14; Los Angeles, 10; Chicago, 19; Philadelphia, 7; Toronto, 5; Detroit, 11.

What are these schools like to an insider? As a private

school edp instructor, I have had ample opportunity for a view seldom made public. Documentation is all but impossible; schools refuse access to files (which themselves may be inaccurate) and disgruntled students rarely articulate their grievances within public earshot. When they do, many details are overlooked. Yet malpractices exist which separate students from large sums of money paid for worthless training, interfere with the flow of qualified personnel into the edp market, and tarnish the image of the quality school.

This article is intended to spotlight weaknesses in private edp education. It is not meant to imply that all malpractices are universal or are necessarily concentrated in a single institution. Good schools do exist; many are seeking newly available accreditation as proof of sincerity and excellence. But until accreditation is acknowledged by the public as a criterion of judgment, until state legislatures tighten licensing practices, weaknesses in data processing education demand exposure.

The following observations, made by instructors, students, and professional organizations, cover several areas of private edp education.

## ownership

There are three types of data processing schools—dependent, franchised, and branch.

The first type may be opened with as little as a shingle, payment of a state licensing fee (few states maintain any standards controlling edp education), some sort of curriculum, printed forms, a sales staff, and advertising. Equipment, manuals, and supplies come after the fact. Instructors are hired on a part-time, as-needed basis after class enrollment has been assured.

A franchise operation requires a greater initial investment. Franchise purchase runs from a norm of \$40,000 to \$50,000 to as high as \$100,000 per school. (According to the 1965 Franchise Company Data for Equal Opportunity in Business, U.S. Dept. of Commerce, Business and Defense Services Administration, an Automation Institute franchise requires an equity of \$50,000. Automation Insti-



tute is a CEIR subsidiary which in turn is a subsidiary of Control Data Corp. Control Data is also directly engaged in edp education through its own educational division, Control Data Institute. No other data processing franchise is listed.)

National franchise assistance varies, running from as little as use of a name, exposure gained from national advertising campaigns, and initial conferences, to any or all of the following: curriculum and instructional outlines; tests and answer sheets; application forms; national promotion campaigns and local advertising formats, directed both at prospects and the edp industry; a student-directed newsletter; problem decks; requirements for professional association membership for instructors; liaison with other schools under the same franchise for purposes of student transfer and placement; graduation certificates; a special aptitude test; textbooks; recruiting methods; fee schedules; attendance forms; owner meetings with central staff personnel, etc.

Control may be either loose or tight, the value of either depending upon the initial quality of the product. For example, where most schools employ materials published by computer manufacturers, one tight national franchise uses only its own copyrighted textbooks in the form of manuals packaged in a special cardboard box. Provided to the students with the idea that the manufacturers' publications are too difficult (though graduates, once in the field, will find them their primary reference), they are printed on poor stock, with outdated photographs, and major errors of omission and commission. (The 1401 text covers registers on the 31st of 45 instruction days. Discussion of chaining and the "autocoder 'library routine' concept" are left to the next-to-the-last session. Tape heads are initially said to be the first record of the first data block, only to be corrected in a chapter added in a later printing. Poor diagramming techniques are employed. Disc techniques are omitted entirely.)

The third kind of school is an extension of the first. Given initial quality, such as suggested by an interview with Control Data Institute, the branch approach would

seem to offer over-all advantages to the student. Pooled funds are available for instructor training, curriculum development, and hands-on training; administrative personnel have room for advancement and thus are more likely to stick, and local management is subject to outside control.

Serious problems result from frequent changes in both administration and ownership of individual schools. Faculty directors have been known to take a job for a chance to earn sales commissions, as a stopgap measure to buy time in which to seek a better position (school jobs offer flexible schedules and a faculty director may double as placement director), or because they like the feeling of importance attendant to the job. A director, once trained in the ways of the private school, finds himself in demand. One director left one school after helping close its doors, went to another for six months, and then shifted to a third after buying into a franchise, all in the same city.

Owners, too, come and go. With capital and hard business sense but absolutely no edp background, a man can purchase a franchise, build a school into a profitable concern, and then turn around and sell it. Certain franchising companies encourage such activities as a means of increasing their number of schools. The original school owner is thus a shrewd businessman first—an interested administrator only when it appears that his investment might suffer.

#### **advertising**

Schools sell their services through advertising, some exclusively by direct mail, some by placing display and/or classified advertisements in local newspapers, some (usually local schools) using TV spots, and some national schools through advertisements placed in popular slicks. Advertisements may quote as starting salaries amounts obtainable only after several years in the field. They may claim training to U.S. government standards, erroneously implying endorsement. They may promise thorough IBM training for industry—operation, wiring, programming, advanced languages (Autocoder, FORTRAN, COBOL) in from 300 hours at some schools to 1,000 at others. (A few schools

offer two-year curriculums.) Occasionally Honeywell, NCR, Burroughs, or GE gain mention in an advertisement, usually where a service bureau which utilizes such equipment is run in conjunction with the school.

Advertisements may promise on-site training on the "new" IBM 360, without mentioning that the system is a Model 20 offering no hands-on training in disc or tape. Advertisements may claim on-site installation of equipment available in conjunction with, and primarily for the use of, a service bureau operation and not for general student use. Or advertisements may simply state: "The need is urgent. The time is now. The place is here," and leave the details to the counselors. Cost (\$1,000 to \$2,500 for courses up to 1,000 hours to \$4,800 for those running two years) is never mentioned.

Advertising formats also vary. Some use the bulletin approach: "Dateline—New York. Men! Women! URGENT! The XYZ School needs qualified candidates Now to train for hundreds of vacancies in data processing." Others feature a success story: "Only last year Joe B. was pumping gas. Today he's making top money as a qualified programmer, telling machines how to think." Some are headed by an installation photograph followed by a list of advantages offered by the school: "Learn data processing in just three months." Some feature a sample aptitude test. Some offer free booklets. Most contain a coupon and offer a free IBM Aptitude Test.

### recruiting

"Education for profit" requires salesmanship. A student contacting a school initially may receive a self-administered aptitude test, a packet of literature, a date to come in for testing, or a call from a counselor.

The test may not meet industry standards; it may or may not be properly administered. Whatever the case, most prospects qualify. Those who do not are usually those the school feels will present an unusual problem. As an example, one school turned down both a midget because of his inability to reach the tab machines and a man with partial vision because he required special instructor attention. Yet they accepted a listless 19-year-old who slept through every session he felt inclined to attend, and a 45-year-old who had recently graduated from high school by the skin of his teeth, both with D aptitudes. The only meaningful entrance requirements are a high school diploma, 18 years of age (though some 17-year-olds have been accepted), and the ability to pay.

Replies to advertisements eventually bring a counselor to the home to clinch the deal. Fantastic claims may be omitted from much present day advertising, but counselors, out of public earshot, still paint images of high salaries, marvelous placement opportunities, and unlimited career potential open to every school graduate. "You did well on the test; you've got what it takes," the applicant is flattered. "I have confidence in you," the counselor proclaims. Yet the counselor is nothing more than a salesman working on straight commission who knows only a few catch phrases about the product he is selling. One school, for example, pays \$150 commission on every \$1,000 contract.

Even with aptitude, a prospect's interests may lie elsewhere. With a counselor in name only, however, he is given no opportunity for exploration. For example, a prospect interested in becoming a computer technician may be assured that programming ability is a prerequisite; the school doesn't offer a technician's course and a commission is at stake. Students come into class who don't want desk jobs; students enter a class assured that when they look

their desks at five o'clock, their work day is over; students are enrolled even though they cannot afford to take a pay cut to enter a new field. Each has been assured that edp, and a given school, provide the answer to their needs.

As one student described the sales pitch, it was like being elevated to a mountain top, cleansed by the air, and finding the world laid at one's feet. Your future is assured; it's simple; it's painless; and YOU can do it. It's all yours, in just a few easy lessons. Later, he added parenthetically, the realities of the course brought him down with a thud, but by then the contract was already in force.

### the students

In large part, advertisements are answered by recent high school graduates with no long range educational goals, from homes in which neither parent went beyond high school. The breadwinner is often a laborer in awe of those in occupations that he doesn't understand, and taken by the promise of glamor, high pay, and rapid advancement. He wants his kid to have it better than he did. They are answered by men in factories who feel trapped, those who believe factory work is but a temporary expedient and "know" something bigger is in store for them; by non-professional family men seeking a rapid income advance with less overtime in an inflationary economy; by those in the throes of personal problems who believe the change will somehow straighten out their lives. Sometimes they are answered by college dropouts who feel an urge to continue doing something constructive, by widows without saleable skills, occasionally by a directionless college graduate or by a businessman with an urge to find out about computers. Where more advanced courses are offered (one school in Los Angeles advertises its Scientific Programming Curricula, FORTRAN and advanced COBOL, for college graduates only) a shift in applicant quality may occur.

### opening remarks

The student's first day of class begins with a tuition payment, distribution of supplies, a grand tour, and a pep talk. The instructor is introduced as a top man, actively working in the field, able and willing to answer all questions. The school is said to be the finest in the area. Those with more than one affiliated school are said to offer the advantages of size—advertising to the industry, transfer privileges, nationwide placement services, etc. The regulations are recited. Discipline is outlined. And 15 students are launched on a new career.

The instructor gets a different initiation. "Don't push too hard; we want them back next week with another payment." Payments, after initial deposit, may be arranged for the first session of each week, or on some other convenient schedule. Pay-as-you-go means that an instructor is judged not by the quality of his teaching, but rather by his attrition rate. A teacher's reputation is good as long as he ends with as many or more students than he started with, including transfers in and out.

### appearance comes first

Many things go to make up a school: administration, curriculum, equipment, instructors, library, physical plant, students, supplies, texts. The cornerstone of quality education, however, rests with the instructor. But quality instruction is not what makes an initial impression. What's required is a look of prosperity and permanence, afforded by impressive surroundings. These might include: paneled walls, tinted chalk boards, carpeted administrative offices, student bulletin boards and lounges, vending machines, bumper stickers, a machine room equipped with a minimal tab installation, free adjacent parking, a plush reception area, etc. Libraries, rarely an initial student consideration,

are nonexistent or consist of a magazine subscription prominently displayed in the reception area and a half dozen books on an instructor's desk. Texts are usually supplied by the computer manufacturer, either through direct purchase or reprint rights. Curriculum, once established, is rarely revised. Administration is part of the minimum requirements for survival. Students are the responsibility of the sales staff. Once established, these areas can be run with a minimum of difficulty. The instructional staff is another matter.

### **instructors**

The teaching staff might include one or two full-time faculty members, one of whom acts as faculty director, with additional instructors hired on an hourly, as-needed basis. The result is a mixed bag.

Classes are offered both day and night, with the starting date of each class frequently determined by the enrollment of a sufficient number of students to show the desired profit.<sup>1</sup> Evening classes can generally be staffed by working programmers out to make a few extra dollars. (Rates may run from \$4 to \$7.50 per hour and higher. Some schools, however, regard their instructors as self-employed, leaving the individual to pay his own social security in full, thus reducing his real wage.) Day classes are more difficult, since few working programmers are available for four or five hours during the normal workday.

The administration approaches this problem in a variety of ways. Sometimes a class is scheduled before an instructor has been located. As a result, some instructors have been hired, sight-unseen, based only on a telephone interview. In another case, a college drop-out with neither teaching experience nor edp training answered an ad, was hired, and began teaching immediately—from an outline. One school hired a graduate whom they had been unable to place in a job. Still others hire their own graduates away from jobs in which they have but recently been placed. A night tab supervisor, whose experience was confined to 407 operation, was employed to teach programming. Few instructors have college degrees, since it is rarely a requirement for employment; fewer still have had any previous teaching experience. And many have had but limited exposure to edp.

Qualified full-time instructors may be equally difficult to hire. Few top people are willing to leave the field for extended periods of time to engage themselves in repetition of elementary concepts. Field work is too challenging, the industry too volatile, and a planned schedule of instructor updating too rare.

Even that is not the full extent of the difficulties. Instructors, especially those who lack qualifications for teaching, often discover that outside preparation requires too much of their time. Since they are not paid for "prep-time" and are not under contract, many simply quit. Others become disgusted when they see the full extent of their duties or the nature of the system. The result is that classes may go through a series of instructors with widely different capabilities in the course of a few months. In addition, many schools have no provisions for substitutes in case of instructor absence. Students are either sent home or a substitute, who may never have taught at the school before, is summoned at the last minute.

Total classroom hours have been shortened because an instructor was needed to begin a new class. Individual class sessions have been cut because of habitual instructor tardiness. Lessons have been omitted in advanced areas of

<sup>1</sup> Most schools run daily sessions in the morning, afternoon, and evening, with all-day (six-hour) schedules on Saturdays. Usually, daytime classes are run on a three-day or five-day schedule. Night classes may meet up to four evenings weekly. Maximum weekly attendance is rarely more than 25 hours.

the curriculum because the instructor doesn't understand them. Classes have been known to drag on additional weeks because of instructor absence, untrainable students, vague instruction, and a continual stream of inter-class transfers. Transfers are chaotic in schools which begin classes whenever sufficient students and an instructor are signed up. A transferee may be told to stay home a few days because he is ahead of his new class, or, conversely, he may be told to attend two classes at once in order to catch up with his new group.

Inexperienced instructors result in confusion, errors, and untruths. Tab machines won't work because the instructor doesn't know how to operate them. Simple problems are classed as impossible for the machine to handle. Magnetic tape may be glossed over and disc omitted entirely. Class problems are solved erroneously or with lack of economy. As an example, there is the case of an instructor who insisted that every 1401 SPS program begin with instructions for clearing all available core storage.

Uncertain instructors, who themselves hit the textbooks between classes, are jumpy in the face of questions. They save face by implying that the questioner is stupid for missing a point that was never clearly stated. A weak staff and a nonexistent library leave the instructor no place to turn for answers, willing to admit, "I don't know." Thus students who pose meaningful questions may find themselves unpopular with the instructor, unless they are willing to be buddies and help him over the hurdles. Questioned about their field experience, such instructors change the subject.

Yet instructor upgrading through formal training and regular staff meetings is rare. Allowing an instructor to attend a vendor class means paying him for non-productive time. The same holds true if the instructor is required to take the course as a student before he teaches it. The latter approach might embarrass a poorly prepared instructor confronted with an instructor-in-training. Evening instructors actively working in data processing offer no better guarantee of success than other members of the staff. They too may lack teaching experience; their concern may be with but a small area of the field, and they may be more inclined to simply get by, because they have more self-confidence in their knowledge of the field. In fact, all instructors who stick through more than one class section develop a sense of authority—even if the information they are disseminating is incorrect.

Students are shortchanged in still another manner. Part-time instructors leave the school with their students, since they are paid only for scheduled classroom hours. Thus, students who stay to catch up on a problem or to review areas of difficulty find themselves with no place to turn for assistance. Full-time faculty members, scheduled to teach two four-hour classes daily, have no spare time and often lack interest in students who are not their own. Even coding forms may be locked up. Students must either rely on each other or wait until the next class session, when the instructor may be beyond the point of confusion and the student reluctant to speak up. Tight instructor schedules might even preclude faculty-student conferences. The only time free for questions is the coffee break, and instructors have been known to buy theirs and disappear.

### **curriculum**

Curriculums vary from school to school. Some offer 300 hours of training, some 500, some 1,000, some even more. Some place heavy emphasis on tab operation and wiring and 1401 programming. Some teach sufficient keypunching to get by and plunge into third generation concepts, generally utilizing a System 360/20. One national school curriculum, as part of an advertised 1,000-hour course, starts with several sessions of elementary arithmetic, with an

introduction to edp left until later. Some offer COBOL; a few offer FORTRAN. Some curriculums offer a broad introduction to the field—its development, growth, and application; others do not. Few make a distinction between students destined to be tab operators, computer operators, programmers, or even technicians.

In the classroom, some schools lack realistic case studies. An instructor who chooses to write his own may overlook test data as being too tedious to develop. Card decks for existing problems may be misplaced or inaccurate. Rarely does discussion cover: career information and job definitions; competitive equipment—who else makes computer equipment besides IBM and what the differences are between competitive systems; general price ranges for lease and purchase; scale—compact, small, medium, large; areas of application; on-line, off-line peripherals and off-line media conversion systems not a basic part of the course; definition of computer terms along with presentation of a printed glossary; a history of data processing, including a discussion of differences between first, second, and third generation equipment; definition of digital and analog computers; a general discussion of what a computer is; special-purpose digital computers, etc.

Tests may also lack validity. They are often designed to make all but the poorest student feel successful. Memory is emphasized; logic is played down. This, coupled with poor aptitude test procedures, means that it is not unusual to find over 50% of a class able to describe the function of an instruction but unable to analyse, diagram, or even code a problem. Even the better students have trouble finding out where to start with a diagram and with coding. Many instructors simply tell their students, "Do as I say," and drop the subject.

Tests are generally closed book. The instructor who does attempt an open book quiz to test student ability to reason rather than memorize is resented, even if the test is to go unrecorded. "What makes you think you're better than the school?" The result is a class divided, between those of ability and those without. The instructor is thrown into a quandary: teach those who have a chance of success, or give everyone equal time because they paid equally to attend. The latter route is the least demanding. Some schools, however, want the more able student trained. They can then be used to program problems for which the school receives a fee as an operating service bureau.

At least one national franchise offers correspondence as well as classroom instruction. For tab practice, students are supplied with paper templates and a batch of wires, resembling those used to anchor a woman's hat. Programs and answer sheets are submitted to national headquarters for review, with the student required to correct and return papers containing errors. Many times, however, indicated errors are the result of a student having selected an alternate method of approach. To permit students to receive full GI benefits, not available under the school's 17½-hour maximum schedule, eligible students are enrolled in both the classroom and correspondence programs. Tuition refunds are used to pay for classroom attendance, thus reducing student financial burden.

### equipment

Schools usually have a fair complement of tab equipment, often Series 50 with no optional features and not including a calculator. It may be, however, that equipment is malfunctioning, broken wires are kept, and usage is poorly scheduled so that two classes are in conflict. Some schools offer an on-site computer for student use, generally

a 1401 or System 360/20 card system. Others arrange for student testing to be done in short segments of leased time at an outside location. This can mean that a class of 15 sees the computer once, for a half-hour shot, with future runs handled by a faculty member. Hands-on experience is impossible under such circumstances. And since the installation comes complete with an operator, a step-by-step demonstration may be omitted, if only to save time. Instead the students are presented a show, complete with "Anchors Aweigh," "Edith the Stripper," "Peanuts," and "Santa Claus and His Reindeer." Since leased time costs money, the number of shots is kept to a minimum, and the school may even squeeze in assembly of programs from students in other classes or those for which the school is being paid by an outside concern.

In one school, students were promised 20 hours of hands-on training; most classes got less than an hour of assembly time for 15 students. The student never sees the relationship between program and machine. He may never discover if his program will run without error. One recent graduate, working as a trainee, was so thrilled to get a chance to run the "Indian Problem" that he called his former instructor with the answer.

### placement

Placement is a trying job, often with more than one class graduating at the same time. Reading the classified ads, thumbing the Yellow Pages, and even contacting employment agencies (most of whom, feedback indicates, discount certificates, test applicants anew, and generally apologize for being unable to help) is all part of the job. The reputation of private edp schools in general keeps many prospective employers away. Yet students are led to believe that the school has a long list of prospects waiting to take any graduates who apply. The truth lies elsewhere. To make life easier on themselves, placement directors (who may be faculty members handling placement on the side) are careful to send out only their best to satisfy any job requests. One national chain, which offers a watered down aptitude test for admission, requires the full treatment prior to placement. Those with C and D scores, which are not uncommon, are given the runaround.

Student frustration in locating employment after the big build-up can be crushing. One 20-year-old A student had over 25 interviews before landing a job. Another, a family man, graduated without aptitude, interviewed endlessly, set no minimum on acceptable salary, and ended up back in the factory. Some 17- or 18-year-olds, considered too young for programming responsibility, find jobs as tab operators or none at all. One qualified graduate, previously employed as a waitress, was unable to locate in the field due to her employment history. The stories are endless.

Some students do get jobs, of course. Occasionally they receive high starting salaries. Thus advertisements headlined "Earn \$7,000 to \$12,000 to Start" can be verified. To build a file of success stories, schools may request all graduates finding employment in data processing, whether or not placed by the school, to notify the placement director of employment details.

Students who fail the course (a surprising number in light of graduation requirements) may be returned to the classroom to try again. The repeater, assured with the rest that he's got what it takes, develops the attitude, "I paid my money; I've got a right to an education; I'm as good as the next guy," and waits for education by injection. These students do graduate, if only so that the school can finish with them, and must be offered placement assistance. But often it is of the most tentative sort, to prevent direct reflection on the graduating institution. The director can always claim he tried.

While in school, students complain primarily among themselves. The instructor, unless it is unanimously held that his knowledge is negligible and that mass complaint to the administration is justified, is criticized only in private. The curriculum, on the other hand, may be openly discussed. Even so, few instructors are willing to risk a "chewing out" for disregarding the official outline.

After course completion, the disappointed simply shrug their shoulders and disappear. A check with Better Business Bureau offices indicate Number One ratings for many schools whose reputations are shaky. Lawsuits are expensive; contracts are generally airtight. Students feel that official complaints are useless, and many are unaware of the full extent of the school's deception. As an example, one student, three months after graduation, tried to obtain a refund on a section of the course which had not yet been held in formal session. The graduate was scheduled for similar on-the-job training. The school refused, claiming that the tuition paid covered the entire course, with no specified portion allocated to the 40 hours still to be scheduled, and that no definite timetable had been guaranteed. The student carried his complaint no further, without considering that public authorities, given sufficient evidence, might be moved to take action to prevent others from being similarly taken.

### accreditation

Not long ago, the Office of Education, U.S. Department of Health, Education, and Welfare, aware of the problems in edp education, decided that an authorized accrediting agency was needed to cover the area. With this in mind, they approached the Accrediting Commission for Business Schools, the only approved accrediting agency for private business schools. The commission's task is to review qualifications of each applying school, independent of other institutions under the same name. In the spring of 1967, Automation Institute of Chicago was awarded the commission's first edp school accreditation. Subsequently five additional schools have made successful application: Electronic Computer Programming Institute, Minneapolis; Computer System Institute, Pittsburgh; Institute of Computer Management, Pittsburgh; Automation Institute, San Diego; and Automation Institute, Omaha. Many others have been refused accreditation. Ten to twenty additional schools are expected to have made preliminary application by the spring of 1968.

Accreditation requires the following steps:

1. Initial contact by the school expressing interest;
2. Visitation of the school, upon request, by a qualified consultant to make recommendations and suggestions, expenses to be borne by the applicant;
3. Payment of a nonrefundable application fee of \$75;
4. Transmittal of a self-evaluation questionnaire to the school if it is considered an appropriate candidate for further investigation, the questionnaire to be used as a basis for investigation by an evaluation team;
5. Payment of a \$200 fee, followed by visitation by an evaluation team of two or more persons, expenses to be paid by the school;
6. Forwarding of the team report, in writing, to the commission;
7. Commission review of the report with requests for additional documents, information, or testimony, as needed;
8. Acceptance or refusal of the school for accreditation with notification of the decision, with a Certificate of Accreditation to be issued upon receipt of the accreditation fee of \$200 in addition to the \$75 application fee. (Provisional accreditation may be awarded if the school is lacking in but a few minor areas.);
9. Payment of an annual sustaining fee of \$200.

The commission is to be notified of significant changes in

curriculum, facilities, faculty, management, ownership, financial responsibility, etc. At such times a decision is made relative to re-evaluation of the institution, with possible loss of accreditation. Normally, re-examination and evaluation is conducted at regular three-year intervals. Each re-examination requires payment of \$200 plus expenses.

Criteria for accreditation cover the areas of school organization, physical plant and equipment, student admission and supervision, financial responsibility, curriculum, teaching methods, advertising, teachers, and employment services. For example, curriculum criteria include: use of a written, formal curriculum, which is equal to or greater in scope than minimum requirements of state licensing authorities; use of modern instruction methods; use of appropriate printed texts; use of visual aids (e.g. slides, films, filmstrips and transparencies, flip charts, etc.); use of frequent examinations, and provision of vocational information.

Accreditation gives the institution the right to display and advertise accreditation; listing as an accredited school in a publication made available to guidance counselors, public schools, and other interested parties; and, probably most significant, as a result of recent legislation, availability of federal, low interest, guaranteed student tuition loans.<sup>2</sup>

Though not a "money-back guarantee" of excellence, accreditation does require a school to be devoted to and willing to pay for public recognition of quality education. Many schools are taking the preliminary steps toward approval. For the rest, however, accreditation is currently of little concern. Students are clamoring to learn about computers; they are impressed by window dressing and proximity to business or home; and they are largely unaware of the availability or the meaning of accreditation.

Even those who might seek an accredited institution do not investigate to find out if the accrediting agency is recognized by the U.S. Office of Education by checking The College Blue Book. Many schools take on an official aura simply by listing professional affiliates, etc., such as: Approved by the State Board of Education (i.e. licensed to operate); Member DPMA; Member (City) Chamber of Commerce; Member Better Business Bureau (frowned upon for advertising by most BBB affiliates).

Currently, the availability of accreditation, which requires an informed public and schools willing to take the initiative, is far from achieving the end of quality edp education.

### the future

The industry can help improve the future of data processing education. Those already involved in customer education programs might be able to broaden their base to include the public. A set of standards, "What To Look For In EDP Education," should be drawn up by professional edp associations, with distribution both to the public and to the press. Individuals and organizations should press for meaningful state control of licensing, perhaps requesting that accreditation be made a standard for license renewal after a given probationary period. Accreditation standards themselves should be reviewed.

A mushrooming, talked-about, glamor industry is bound to attract opportunists, who catch the uninformed by dealing in half-truths. The data processing industry needs quality education to fill its increasing demand for manpower. Pressure, correctly applied, will serve all concerned, by assuring the would-be-programmer a better chance of success. ■

<sup>2</sup> For further information, write: The Accrediting Commission for Business Schools; Suite 724, New Center Building; 7430 Second Avenue; Detroit, Michigan 48202.

# HOW DO COMMITTEES INVENT?

by MELVIN E. CONWAY

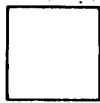

That kind of intellectual activity which creates a useful whole from its diverse parts may be called the *design* of a *system*. Whether the particular activity is the creation of specifications for a major weapon system, the formation of a recommendation to meet a social challenge, or the programming of a computer, the general activity is largely the same.

Typically, the objective of a design organization is the creation and assembly of a document containing a coherently structured body of information. We may name this information the *system design*. It is typically produced for a sponsor who usually desires to carry out some activity guided by the system design. For example, a public official may wish to propose legislation to avert a recurrence of a recent disaster, so he appoints a team to explain the catastrophe. Or a manufacturer needs a new product and designates a product planning activity to specify what should be introduced.

The design organization may or may not be involved in the construction of the system it designs. Frequently, in public affairs, there are policies which discourage a group's acting upon its own recommendations, whereas, in private industry, quite the opposite situation often prevails.

It seems reasonable to suppose that the knowledge that one will have to carry out one's own recommendations or that this task will fall to others, probably affects some design choices which the individual designer is called upon to make. Most design activity requires continually making choices. Many of these choices may be more than design decisions; they may also be personal decisions the designer makes about his own future. As we shall see later, the incentives which exist in a conventional management environment can motivate choices which subvert the intent of the sponsor.<sup>1</sup>

## stages of design

The initial stages of a design effort are concerned more with structuring of the design activity than with the system itself.<sup>2</sup> The full-blown design activity cannot proceed until certain preliminary milestones are passed. These include:

1. Understanding of the boundaries, both on the design activity and on the system to be designed, placed by the sponsor and by the world's realities.
2. Achievement of a preliminary notion of the system's organization so that design task groups can be meaningfully assigned.

We shall see in detail later that the very act of organiz-

<sup>1</sup> A related, but much more comprehensive discussion of the behavior of system-designing organizations is found in John Kenneth Galbraith's, *The New Industrial State* (Boston, Houghton Mifflin, 1967). See especially Chapter VI, "The Technostructure."

<sup>2</sup> For a discussion of the problems which may arise when the design activity takes the form of a project in a functional environment, see C. J. Middleton, "How to Set Up a Project Organization," *Harvard Business Review*, March-April, 1967, p. 73.

## design organization criteria

ing a design team means that certain design decisions have already been made, explicitly or otherwise. Given any design team organization, there is a class of design alternatives which cannot be effectively pursued by such an organization because the necessary communication paths do not exist. Therefore, there is no such thing as a design group which is both organized and unbiased.

Once the organization of the design team is chosen, it is possible to delegate activities to the subgroups of the organization. Every time a delegation is made and somebody's scope of inquiry is narrowed, the class of design alternatives which can be effectively pursued is also narrowed.

Once scopes of activity are defined, a coordination problem is created. Coordination among task groups, although it appears to lower the productivity of the individual in the small group, provides the only possibility that the separate task groups will be able to consolidate their efforts into a unified system design.

Thus the life cycle of a system design effort proceeds through the following general stages:

1. Drawing of boundaries according to the ground rules.
2. Choice of a preliminary system concept.
3. Organization of the design activity and delegation of tasks according to that concept.
4. Coordination among delegated tasks.
5. Consolidation of subdesigns into a single design.

It is possible that a given design activity will not proceed straight through this list. It might conceivably reorganize upon discovery of a new, and obviously superior, design concept; but such an appearance of uncertainty is unflattering, and the very act of voluntarily abandoning a creation is painful and expensive. Of course, from the

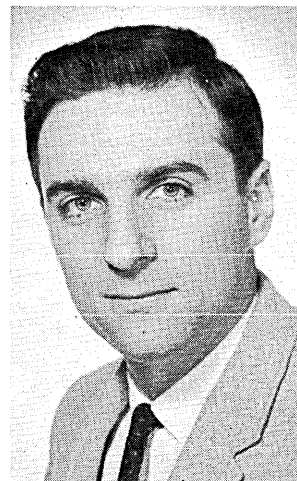

*Dr. Conway is manager, peripheral systems research, at Sperry Rand's Univac Div., where he is working on recognition of continuous speech. He has previously been a research associate at Case Western Reserve Univ., and a software consultant. He has an MS in physics from CalTech and a PhD in math from Case.*

vantage point of the historian, the process is continually repeating. This point of view has produced the observation that there's never enough time to do something right, but there's always enough time to do it over.

### the designed system

Any system of consequence is structured from smaller *subsystems* which are interconnected. A description of a system, if it is to describe what goes on inside that system, must describe the system's connections to the outside world, and it must delineate each of the subsystems and how they are interconnected. Dropping down one level, we can say the same for each of the subsystems, viewing it as a system. This reduction in scope can continue until we are down to a system which is simple enough to be understood without further subdivision.

*Examples.* A transcontinental public transportation system consists of buses, trains, airplanes, various types of right-of-way, parking lots, taxicabs, terminals, and so on. This is a very heterogeneous system; that is, the subsystems are quite diverse. Dropping down one level, an airplane, for example, may possess subsystems for structure, propulsion, power distribution, communication, and payload packaging. The propulsion subsystem has fuel, ignition, and starting subsystems, to name a few.

It may be less obvious that a theory is a system in the same sense. It relates to the outside world of observed events where it must explain, or at least not contradict, them. It consists of subtheories which must relate to each other in the same way. For example, the investigation of an airplane crash attempts to produce a theory explaining a complex event. It can consist of subtheories describing the path of the aircraft, its radio communications, the manner of its damage, and its relationship to nearby objects at the time of the event. Each of these, in turn, is a story in itself which can be further broken down into finer detail down to the level of individual units of evidence.

*Linear graphs.* Fig. 1 illustrates this view of a system as a *linear graph*—a Tinker-Toy structure with *branches* (the lines) and *nodes* (the circles). Each node is a subsystem which communicates with other subsystems along the branches. In turn, each subsystem may contain a structure which may be similarly portrayed. The term *interface*, which is becoming popular among systems people, refers to the inter-subsystem communication path or branch represented by a line in Fig. 1. Alternatively, the interface is the plug or flange by which the path coming out of one node couples to the path coming out of another node.

### relating the two

The linear-graph notation is useful because it provides an abstraction *which has the same form* for the two entities we are considering: the design organization and the system it designs. This can be illustrated in Fig. 1 by replacing the following words:

1. Replace "system" by "committee."
2. Replace "subsystem" by "subcommittee."
3. Replace "interface" by "coordinator."

Just as with systems, we find that design groups can be viewed at several levels of complication. The Federal Government, for example, is an excellent example of a design organization with enough complexity to satisfy any system engineer. This is a particularly interesting example for showing the similarity of the two concepts being studied here because the Federal Government is both a design organization (designing laws, treaties, and policies) and a designed system (the Constitution being the principal preliminary design document).

*A basic relationship.* We are now in a position to address the fundamental question of this article: Is there any pre-

dictable relationship between the graph structure of a design organization and the graph structure of the system it designs? The answer is: Yes, the relationship is so simple that in some cases it is an identity. Consider the following "proof":

Let us choose arbitrarily some system and the organization which designed it, and let us then choose equally arbitrarily some level of complication of the designed system for which we can draw a graph. (Our motivation for this arbitrariness is that if we succeed in demonstrating anything interesting, it will hold true for *any* design organization and level of complication.) Fig. 2 (p. 30) shows, for illustration purposes only, a structure to which the following statements may be related.

For *any* node  $x$  in the system we can identify a design group of the design organization which designed  $x$ ; call this  $X$ . Therefore, by generalization of this process, for *every* node of the system we have a rule for finding a corresponding node of the design

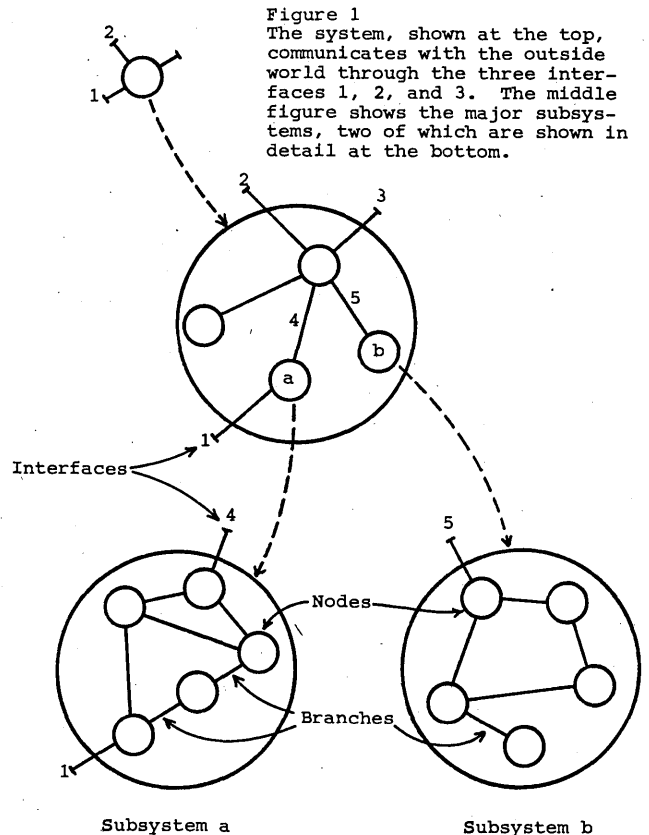

Figure 1  
The system, shown at the top, communicates with the outside world through the three interfaces 1, 2, and 3. The middle figure shows the major subsystems, two of which are shown in detail at the bottom.

Fig. 1

organization. Notice that this rule is not necessarily one-to-one; that is, the two subsystems might have been designed by a single design group.

Interestingly, we can make a similar statement about branches. Take any two nodes  $x$  and  $y$  of the system. Either they are joined by a branch or they are not. (That is, either they communicate with each other in some way meaningful to the operation of the system or they do not.) If there is a branch, then the two (not necessarily distinct) design groups  $X$  and  $Y$  which designed the two nodes must have negotiated and agreed upon an interface specification to permit communication between the two corresponding nodes of the design organization. If, on the other hand, there is no branch between  $x$  and  $y$ , then the subsystems do not communicate with each other, there was nothing for the two corresponding design groups to negotiate,

## COMMITTEES ...

and therefore there is no branch between X and Y. \*

What have we just shown? Roughly speaking, we have demonstrated that there is a very close relationship between the structure of a system and the structure of the organization which designed it. In the not unusual case where each subsystem had its own separate design group, we find that the structures (i.e., the linear graphs) of the

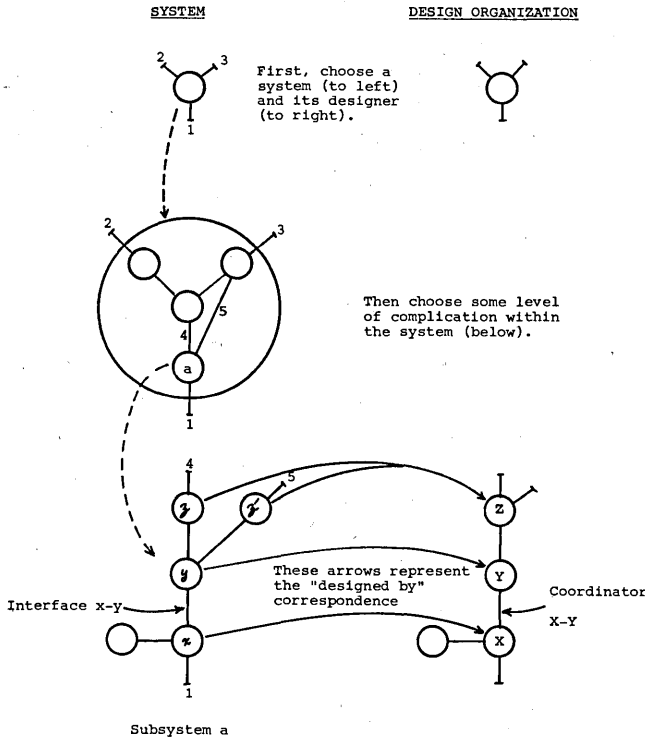

Figure 2 Here is an illustration of the strong relationship between the structure (graph) of a system (left) and the structure of the organization which designed it (right).

Fig. 2

design group and the system are identical. In the case where some group designed more than one subsystem we find that the structure of the design organization is a collapsed version of the structure of the system, with the subsystems having the same design group collapsing into one node representing that group.

This kind of a structure-preserving relationship between two sets of things is called a *homomorphism*. Speaking as a mathematician might, we would say that there is a homomorphism from the linear graph of a system to the linear graph of its design organization.

### systems image their design groups

It is an article of faith among experienced system designers that given any system design, someone someday will find a better one to do the same job. In other words, it is misleading and incorrect to speak of *the* design for a specific job, unless this is understood in the context of space, time, knowledge, and technology. The humility which this belief should impose on system designers is the only appropriate posture for those who read history or consult their memories.

The design progress of computer translators of programming languages such as FORTRAN and COBOL is a case in

\* This claim may be viewed several ways. It may be trivial, hinging on the definition of meaningful negotiation. Or, it may be the result of the observation that one design group almost never will compromise its own design to meet the needs of another group unless absolutely imperative.

point. In the middle fifties, when the prototypes of these languages appeared, their compilers were even more cumbersome objects than the giant (for then) computers which were required for their execution. Today, these translators are only historical curiosities, bearing no resemblance in design to today's compilers. (We should take particular note of the fact that the quantum jumps in compiler design progress were associated with the appearance of new groups of people on territory previously trampled chiefly by computer manufacturers—first it was the tight little university research team, followed by the independent software house.)

If, then, it is reasonable to assume that for any system requirement there is a *family* of system designs which will meet that requirement, we must also inquire whether the choice of design organization influences the process of selection of a system design from that family. If we believe our homomorphism, then we must agree that it does. To the extent that an organization is not completely flexible in its communication structure, that organization will stamp out an image of itself in every design it produces. The larger an organization is, the less flexibility it has and the more pronounced is the phenomenon.

*Examples.* A contract research organization had eight people who were to produce a COBOL and an ALGOL compiler. After some initial estimates of difficulty and time, five people were assigned to the COBOL job and three to the ALGOL job. The resulting COBOL compiler ran in five phases, the ALGOL compiler ran in three.

Two military services were directed by their Commander-in-Chief to develop a common weapon system to meet their

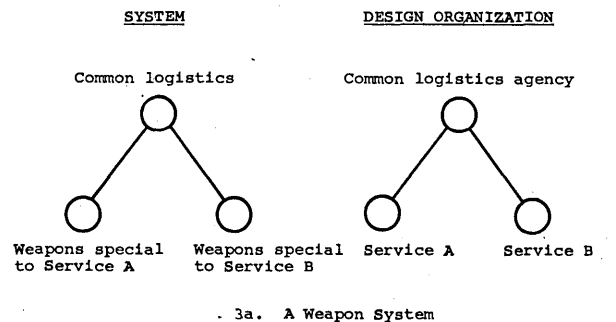

3a. A Weapon System

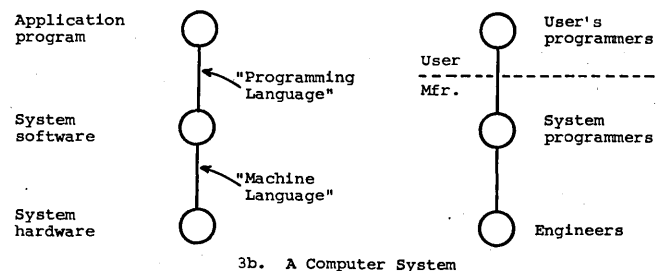

3b. A Computer System

Figure 3 Two examples of identity of structure between a system and its design organization.

Figs. 3a and 3b

respective needs. After great effort they produced a copy of their organization chart. (See Fig. 3a.)

Consider the operating computer system in use solving a problem. At a high level of examination, it consists of three parts: the hardware, the system software, and the application program. (See Fig. 3b.) Corresponding to these subsystems are their respective designers: the computer manufacturer's engineers, his system programmers, and the user's application programmers. (Those rare instances where the system hardware and software tend to cooperate rather than merely tolerate each other are associated with



manufacturers whose programmers and engineers bear a similar relationship.)

### system management

The structures of large systems tend to disintegrate during development, qualitatively more so than with small systems. This observation is strikingly evident when applied to the large military information systems of the last dozen years; these are some of the most complex objects devised by the mind of man. An activity called "system management" has sprung up partially in response to this tendency of systems to disintegrate. Let us examine the utility to system management of the concepts we have developed here.

Why do large systems disintegrate? The process seems to occur in three steps, the first two of which are controllable and the third of which is a direct result of our homomorphism.

First, the realization by the initial designers that the system will be large, together with certain pressures in their organization, make irresistible the temptation to assign too many people to a design effort.

Second, application of the conventional wisdom of management to a large design organization causes its communication structure to disintegrate.

Third, the homomorphism insures that the structure of the system will reflect the disintegration which has occurred in the design organization.

Let us first examine the tendency to overpopulate a design effort. It is a natural temptation of the initial designer—the one whose preliminary design concepts influence the organization of the design effort—to delegate tasks when the apparent complexity of the system approaches his limits of comprehension. This is the turning point in the course of the design. Either he struggles to reduce the system to comprehensibility and wins, or else he loses control of it. The outcome is almost predictable if there is schedule pressure and a budget to be managed.

A manager knows that he will be vulnerable to the charge of mismanagement if he misses his schedule without having applied all his resources. This knowledge creates a strong pressure on the initial designer who might prefer to wrestle with the design rather than fragment it by delegation, but he is made to feel that the cost of risk is too high to take the chance. Therefore, he is forced to delegate in order to bring more resources to bear.

The following case illustrates another but related way in which the environment of the manager can be in conflict with the integrity of the system being designed.

A manager must subcontract a crucial and difficult design task. He has a choice of two contractors, a small new organization which proposes an intuitively appealing approach for much less money than is budgeted, and an established but conventional outfit which is asking a more "realistic" fee. He knows that if the bright young organization fails to produce adequate results, he will be accused of mismanagement, whereas if the established outfit fails, it will be evidence that the problem is indeed a difficult one.

What is the difficulty here? A large part of it relates to the kind of reasoning about measurement of resources which arises from conventional accounting theory. According to this theory, the unit of resource is the dollar, and all resources must be measured using units of measurement which are convertible to the dollar. If the resource is human effort, the unit of measurement is the number of hours worked by each man times his hourly cost, summed up for the whole working force.

One fallacy behind this calculation is the property of *linearity* which says that two men working for a year or one hundred men working for a week (at the same hourly cost

per man) are resources of equal value. Assuming that two men and one hundred men cannot work in the same organizational structure (this is intuitively evident and will be discussed below) our homomorphism says that they will not design similar systems; therefore the value of their efforts may not even be comparable. From experience we know that the two men, if they are well chosen and survive the experience, will give us a better system. Assumptions which may be adequate for peeling potatoes and erecting brick walls fail for designing systems.

Parkinson's Law<sup>3</sup> plays an important role in the overassignment of design effort. As long as the manager's prestige and power are tied to the size of his budget, he will be motivated to expand his organization. This is an inappropriate motive in the management of a system design activity. Once the organization exists, of course, it will be used. Probably the greatest single common factor behind many poorly designed systems now in existence has been the availability of a design organization in need of work.

The second step in the disintegration of a system design—the fragmentation of the design organization's communication structure—begins as soon as delegation has started. Elementary probability theory tells us that the number of possible communication paths in an organization is approximately half the square of the number of people in the organization. Even in a moderately small organization it becomes necessary to restrict communication in order that people can get some "work" done. Research which leads to techniques permitting more efficient communication among designers will play an extremely important role in the technology of system management.

Common management practice places certain numerical constraints on the complexity of the linear graph which represents the administrative structure of a military-style organization. Specifically, each individual must have at most one superior and at most approximately seven subordinates. To the extent that organizational protocol restricts communication along lines of command, the communication structure of an organization will resemble its administrative structure. This is one reason why military-style organizations design systems which look like their organization charts.

### conclusion

The basic thesis of this article is that organizations which design systems (in the broad sense used here) are constrained to produce designs which are copies of the communication structures of these organizations. We have seen that this fact has important implications for the management of system design. Primarily, we have found a criterion for the structuring of design organizations: a design effort should be organized according to the need for communication.

This criterion creates problems because the need to communicate at any time depends on the system concept in effect at that time. Because the design which occurs first is almost never the best possible, the prevailing system concept may need to change. Therefore, flexibility of organization is important to effective design.

Ways must be found to reward design managers for keeping their organizations lean and flexible. There is need for a philosophy of system design management which is not based on the assumption that adding manpower simply adds to productivity. The development of such a philosophy promises to unearth basic questions about value of resources and techniques of communication which will need to be answered before our system-building technology can proceed with confidence. ■

<sup>3</sup> C. Northcote Parkinson, *Parkinson's Law and Other Studies in Administration* (Boston, Houghton Mifflin, 1957).

# THE FCC UTILITY INQUIRY

by PHIL HIRSCH

 The Justice Department lined up squarely behind the data processing industry last month in the industry's competitive struggle with Ma Bell and Western Union. Justice told the FCC that it should: remove the present tariff restrictions on use of foreign attachments; direct the carriers to interconnect private and public communications systems "to meet the needs of the data processing industry"; investigate the harm caused by restrictions on sharing communications channels and eliminate those causing trouble. Also, the commission should "not regulate remote access data processing," nor should it regulate "non-carriers offering message switching services." If common carriers offer remote data processing services, they should do so only through affiliated corporations which maintain segregated accounts and separate facilities, and only after the commission "has eliminated the tariff restrictions which give the carriers an unfair competitive advantage in the remote access data processing field."

## statements of position

The Justice Department's response was among 57 statements that descended on the commission last

month in response to its earlier notice of inquiry into "the regulatory and policy problems presented by the interdependence of computer and communication services and facilities." BEMA submitted the longest response—three documents containing a total of well over 500 pages—and managed to include most of the positions taken by individual respondents from within the dp industry. Among these individual respondents were IBM, Univac, GE, Control Data, ADAPSO, ACM, Bunker-Ramo, and several user groups. The carriers' position was stated most vigorously by Western Union. AT&T's statement might better be called a non-statement; from start to finish, it avoided the real issues in the inquiry.

Western Union argued that message and circuit switching, message concentration, and circuit interconnection are, by virtue of historic development and present application, communications functions, not data processing. "Each (function), by its individual technology . . . (provides) a path—from point of origin to point of destination—over which communication by means of electrical signals takes place." Hence, under existing law, said WU's statement, common carriers have the right to perform these functions. Also, FCC has the responsibility to regulate them—even when the functions are

## justice backs dp

performed by a data processing concern.

Western Union admitted that not every "usage of a computer in combination with communication lines is a (common carrier) communications usage." But it defined the distinction in a way that would exclude the dp industry, in its present unregulated state, from much of the on-line dp market.

There is general agreement, said the WU brief, that a common carrier is "one who holds himself out to the public, as a regular business, to transport property for hire." WU insisted that a dp firm would be a communications common carrier if it offered the public "communications services" (message/circuit switching, interconnection, and/or concentration). Citing several legal decisions, the brief insisted the dp firm would be a common carrier even if it didn't sell to the entire public, or even a large segment of the public, even if its primary investment was in processing data after receipt and prior to return, even if it didn't charge separately for communications, and even if it didn't make a profit from that part of the operation.

If this interpretation prevails, it could do much more than put the dp industry at a disadvantage with the carriers when both compete for on-line business; BEMA, in its brief, revealed

some other ramifications when it discussed "multiuser sharing of communication facilities."

Essentially, the association proposed more intensive use of communications channels through elimination of present restrictions on sharing, greater use of multiplexers and concentrators, and pooling arrangements that would permit users in each metropolitan area to use shared communication channels between cities. The sticker is that all of these proposals require virtually unlimited ability (currently illegal) to switch messages and circuits, concentrate messages, and interconnect private with public communication channels.

### some agreement

Actually, however, the conflict over who will provide what WU calls "communications" services may be more apparent than real. BEMA did not insist that the users control all of these services. It mentioned, for example, that pooling arrangements might be provided by the carriers. This was one of several places in the BEMA brief where the shadow of an olive branch could be detected. Another example occurred a few pages earlier, when BEMA said:

"In a number of respects . . . the common carriers have improved their facility offerings in a manner beneficial to the meeting of data communication requirements. However, significant areas remain in which we believe changes in the general policies followed by the carriers and reflected in their tariffs, as well as in more specific tariff provisions and practices, would result in highly desirable improvements."

BEMA also recognized that carriers might be entitled to market strictly dp services: "The question . . . turns . . . on the extent to which this would inhibit or encourage the growth of these services on a competitive basis." BEMA then asked the commission, "as a minimum," to require the carriers to establish separate dp service corporations; together with this, the commission should establish "a framework designed to minimize possible distortion of the market and the quality of common carrier offerings," the association added.

BEMA did not insist categorically that the carriers, if let loose in an unregulated market, would inexorably swallow their smaller competitors; the carriers, however, after alluding to the damage they had suffered from past dp firm incursions into the "communications services" field and suggesting that worse damage was likely in the future, *did* insist that the dp industry

should not perform *any* of these services.

This difference in attitude is important because it suggests that the conflict between the two camps is less a matter of technics than of tractability. Although BEMA never said so, the whole tone of its statement indicates that, given proper safeguards, the dp industry could ultimately be persuaded to accept WU's definition of a common carrier and of "communications services." One safeguard, almost certainly, would be protection against unfair competition in marketing dp services. Another safeguard would be positive action from the carriers to improve those communications services they are guarding so jealously.

### carrier improvements needed

The improvements which data processors consider necessary were spelled out in great detail by BEMA, both in its summary statement and in a Booz, Allen & Hamilton study which comprised one of the three documents the association submitted to the commission. (The third was an economic analysis prepared by Horace J. DePodwin Associates.)

Basically, BEMA said data processors need communication channels, inter-



faces, and tariffs designed to accommodate the special characteristics of data transmission. Existing rules do not allow for the more variable connection, holding, and response times peculiar to data communication, nor do the available circuits provide the right mix of bit transmission speeds.

Also, since present voice channels carry only analog signals, in serial form, data communicators must pay for modems, and can't reap the economies available from serial transmission.

The number of voice-grade channels increased only 10% between '63 and '66, said the BAH study; during the same period, the number of communication-based computers in use grew 75%. It added that present circuits aren't sufficiently reliable. All of these difficulties will get worse in future, as systems and applications proliferate, and by the early '70's, "it is expected that sufficient demand for a broadband switching network connecting major U.S. cities 'will be evident.'"

BAH indicated that present constraints on data transmission speeds are one of two major problems facing the carriers' data processing customers. Between 3-24K bps, and above 250K bps, it was indicated, existing services are almost totally nonexistent.

The other major problem, said the BAH study, is the carriers' objection to foreign attachments. Their modem equipment is often unable to meet specific users' needs, and because it can't be physically integrated with dp equipment, common power supplies and logic can't be used, which increases costs further. Making the situation still worse, and rather ridiculous, is the immediate availability of better modems from independent suppliers. BAH and BEMA, as well as several other dp equipment manufacturers and users who responded to the inquiry, said the carriers should specify interconnection standards, instead of flatly banning foreign attachments to the switched system and to the broad band portion of the leased system. "The fact that such standards have, in fact, been developed and implemented for the connection of many non-Bell telephone companies and special user groups," commented the BEMA brief, "argues strongly that adequate standards can be developed."

### the utilities respond

Many of these proposals were offered in response to Item I of the inquiry, which asked for data on "the respects in which present-day transmission facilities of the carriers are inadequate to meet the requirements of computer technology, including these for accuracy and speed." Ma Bell's answer to the same question is indicative, if not particularly informative:

"The nationwide telephone network provides facilities which interconnect virtually every residence and business establishment in the country. This network represents an investment of

**THE  
FCC UTILITY  
INQUIRY . . .**

more than \$45 billion, and provides more than 230 million circuit miles of local exchange facilities. These facilities are used for handling both voice communication and data type services . . . (enabling) the communication common carriers to provide users a wide variety of data transmission services with reliability, flexibility, and economy."

WU covered more or less the same ground, somewhat more subtly, when it responded to Item H, which asked what new tariff offerings might be required from the carriers:

"As a private business enterprise seeking growth and stability, Western Union has responded in the past to changes in market requirements with new services and offerings to the best of its ability. This was done when it was satisfied that a need existed and that its resources could be used to react meaningfully to the need. A basic problem for all common carriers is the positive identification of significant and valid needs far enough in advance to be in a position to respond adequately . . . Western Union is striving to meet the growing communication needs of the computer industry. However, efforts to meet those needs are subject to a fundamental guideline—namely, that users of current service offerings must not be penalized by these efforts."

Western Union and AT&T tried to put flesh on these observations by discussing a number of new service offerings. A few are now in operation, but they have extremely limited geographic coverage and/or fail to address the data industry's most pressing needs. The others, while under development, won't necessarily materialize. For, as WU took pains to explain, its list of "new service offerings needed . . . does not necessarily reflect fully committed plans for this or any other carrier," but rather, "a tentative set of customer requirements."

**justice speaks up**

If the carriers aren't concerned in any meaningful way about the shortcomings of their existing service to data processors, the Justice Department is.

"Whatever justification these restrictions (on foreign attachments, interconnection, and sharing) may have had in the past, we think it is incumbent upon the commission to recon-

sider their appropriateness in the face of the inhibitions they impose on the cost, efficiency, and diversity of computer-based systems," said the department's statement. "The foreign attachment rule restricts competition by independent equipment suppliers . . . The principal focus (of this restriction) is on the modem . . ."

Here are some other meaty observations from the Justice Department's statement:

"It is our opinion that 'remote access data processing' is not common carrier communications and, hence, is not subject to the commission's jurisdiction . . . and we urge the commission to make a specific finding to this effect.

" . . . The whole question of carrier integration into the remote access data processing field . . . might ultimately require legislation . . . There is a strong case for excluding the carriers . . . so long as (they) continue to use their privileged position to impose tariffs restricting competition in that field . . ."

In the past, FCC has tended to ignore the Justice Department. Several months ago, for example, after the department had objected to ITT's acquisition of the American Broadcasting Co., FCC approved it. (The merger was never consummated, however, largely because Justice went to court and persuaded ITT to abandon the whole idea.) Conceivably, the Justice Department's strong support of the data processing industry in the utility inquiry could also have no effect on the commission. But at the very least,

the statement will be valuable ammunition if any of the matters covered by the inquiry have to be resolved in court. The carriers are certainly alert to this possibility, and may become more tractable as a result.

All of the respondents gave the last item in the notice of inquiry—covering privacy—relatively short shrift. Generally, they agreed that software and hardware devices are available which provide substantial protection, and that the real issue is cost rather than technology.

BEMA admitted that "one of the major weaknesses in ensuring privacy in an on-line information system is the lack of an automated method of making positive personal identification of persons making inquiries for personal information." It reported that two possible solutions—utilizing coded voice print and fingerprint comparisons—are under investigation, without adding, as Booz, Allen & Hamilton did in their discussion of the same topic, that both systems are in a very early stage of development.

The Justice Department suggested a number of legal controls that "might be considered": system licensing and inspection, system certification, licensing of personnel, compulsory insurance and/or bonding; criminal sanctions for unauthorized disclosure of information or failure to abide by other rules. The commission ought to look further into the matter, added Justice, expressing a thought all of the other respondents probably would agree with. ■

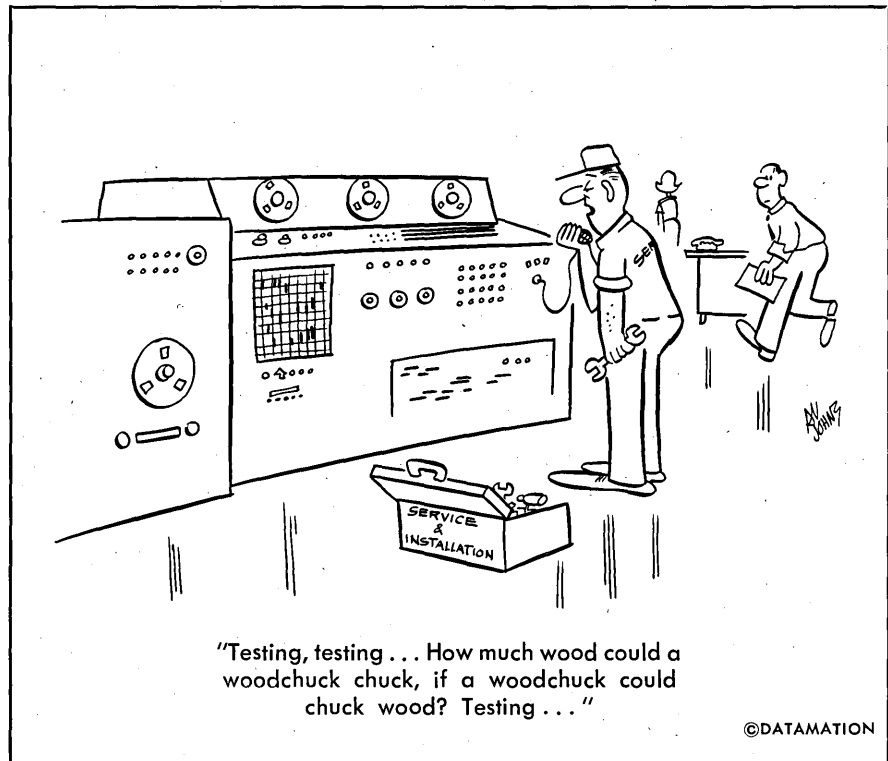

# Introducing the CØMPLØT™ remote time sharing digital plotting system

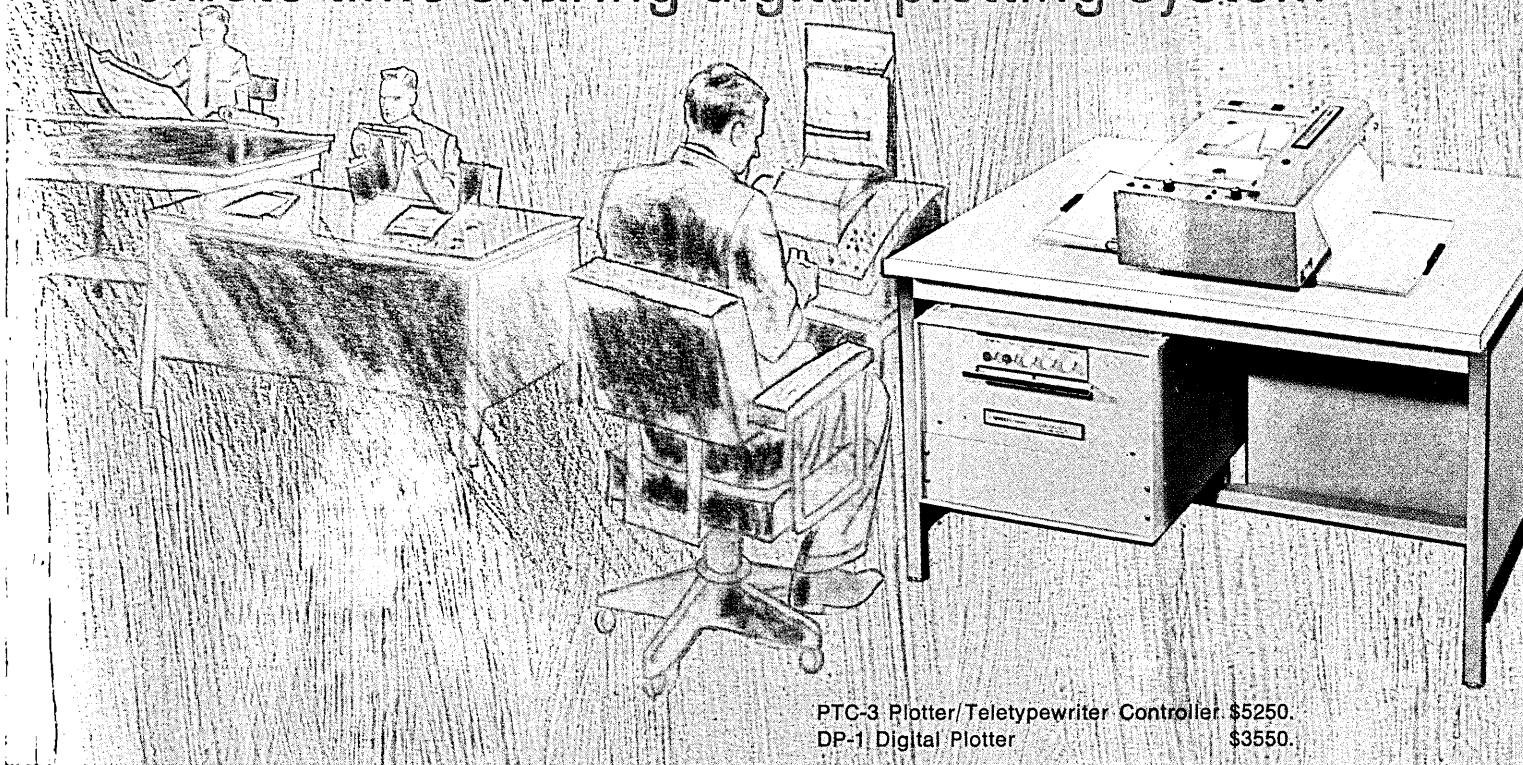

PTC-3 Plotter/Teletypewriter Controller \$5250.  
DP-1 Digital Plotter \$3550.

When graphic presentation means more than numbers, the CØMPLØT™ system saves time and money

Used at the remote terminal of a time-sharing computer, this CØMPLØT™ time sharing digital plotting system provides fast, accurate plots of scientific, business, engineering and financial data. Tedious columns of tabular matter come alive in graphic form—in minutes.

The Plotter/Teletypewriter Controller PTC-3, located in the desk drawer, connects to a Model 103A2 Dataphone, or equivalent, or to an appropriate acoustical phone coupler. The PTC-3 monitors incoming data and directs it to the Teletypewriter (TTY) or to the Digital Plotter DP-1. The information for the TTY is handled exactly as if the TTY was directly connected to the Dataphone. If the information is intended for the Digital Plotter, the PTC-3 decodes it and drives the DP-1 Digital Plotter.

### Competitively priced... feature by feature

- Speed: 260 increments/sec. limited only by transmission line speed
- Chart Size: 11" x 144' Z-fold
- Paper movement: Bi-directional
- Price: PTC-3 Plotter/Teletypewriter Controller — \$5,250  
DP-1 Digital Plotter — \$3,550
- Software: No additional charge with purchase of system.

Booth #1102 Spring Joint Computer Conference

**houston  
instrument**

DIVISION OF BAUSCH & LOMB

4950 TERMINAL AVENUE, BELLAIRE, TEXAS 77401

(713) 867 7403 CABLE HOINCO

#### BLOCK DIAGRAM

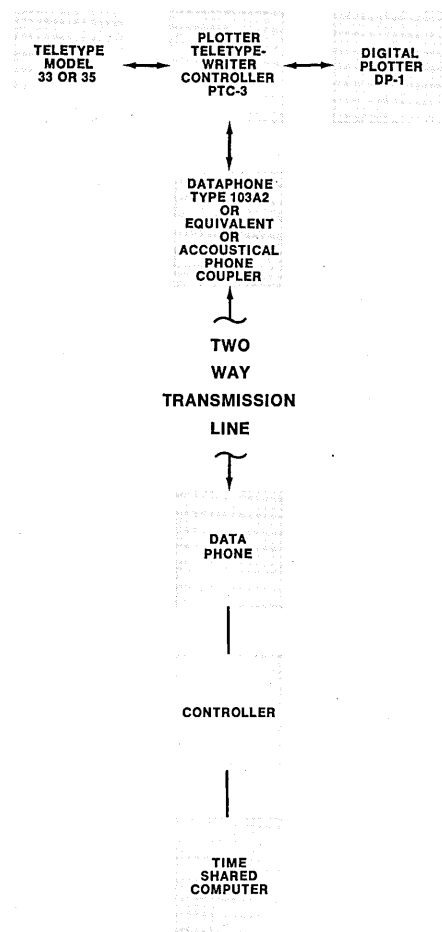

(Turn page for additional information)

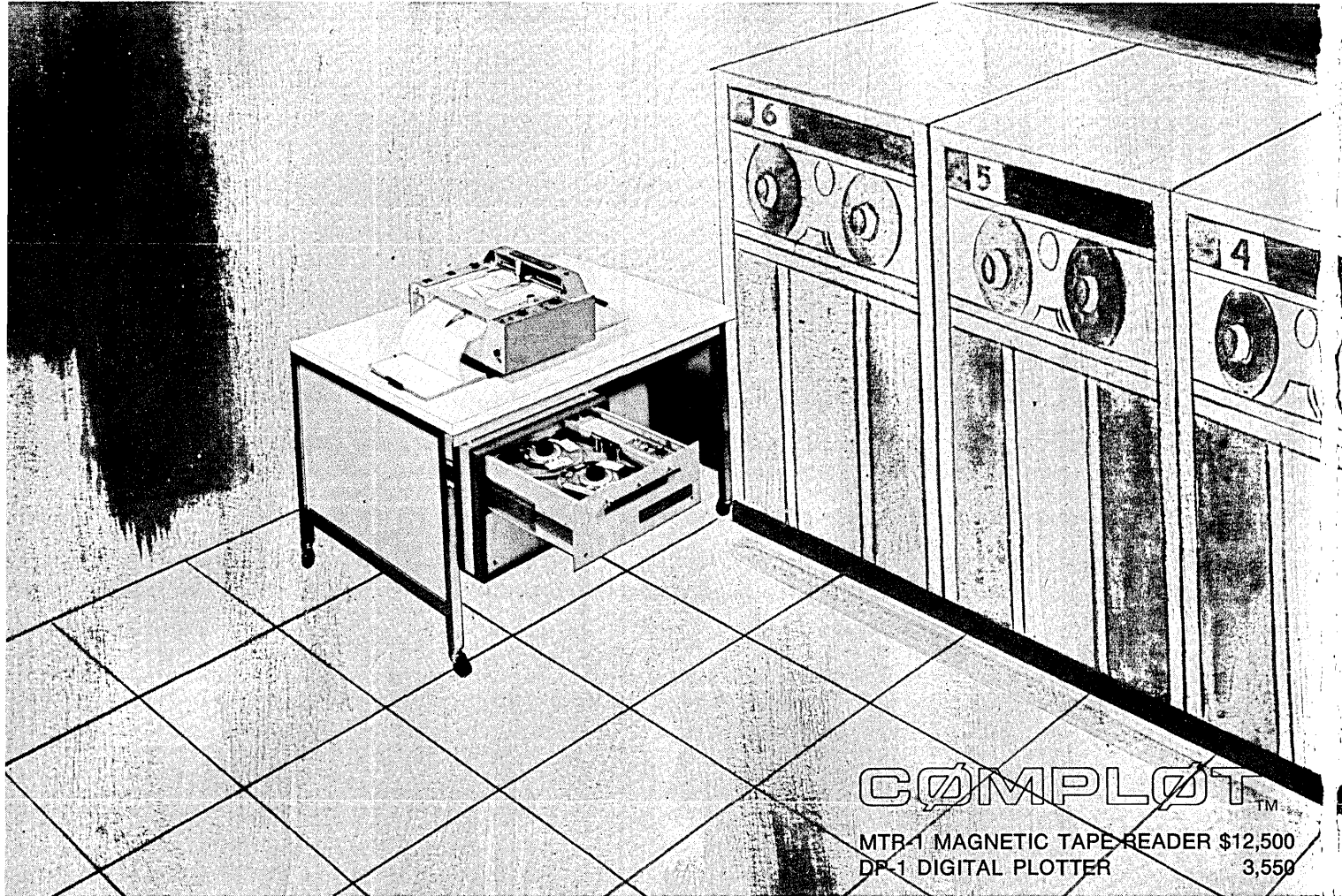

**CØMPLØT™**

MTR-1 MAGNETIC TAPE READER \$12,500  
 DP-1 DIGITAL PLOTTER 3,550

## New off-line plotting system offers convenience, speed, low cost

This new CØMPLØT™ off-line system features an incremental magnetic tape reader coupled to a digital graphic plotter to produce fast, highly accurate plots of numeric data. Designed to accept 8½" tape reels directly from the com-

puter, the unit is virtually a "load and go" operation that writes at 300 increments/second. Housekeeping software is provided at no additional cost.

## CØMPLØT™ ON-LINE DIGITAL PLOTTER

*The DP-1 will plug into existing computer interface couplers with no change required.*

The all-new CØMPLØT™ DP-1 plots up to 300 increments per second on 11" x 144' Z-fold chart paper. Most economical plotter on the market today. Housekeeping software available at no additional cost!

### SPECIFICATIONS

	DP-1
Maximum incremental speed in steps per second	300
Incremental step size	.010" .005" .1mm
Maximum plot size: Y Axis (pen) X Axis (paper)	11" 144'

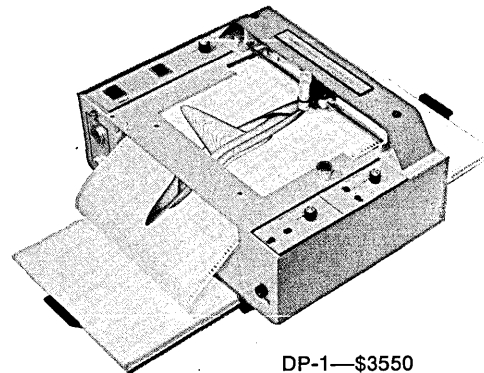

DP-1—\$3550

Booth #1102 Spring Joint Computer Conference

**houston  
instrument**

DIVISION OF BAUSCH & LOMB

4950 TERMINAL AVENUE, BELLAIRE, TEXAS 77401

(713) 667 7403 CABLE HOINCO

don't wait

# A FOURTH-GENERATION COMPUTER NOW?

by DON L. JEWETT

The term "firmware" was coined by Ascher Opler<sup>1</sup> to describe a possible aspect of fourth-generation computation. In this view, the central processor of fourth-generation computers will be considerably faster than the cycle time of the core memory; this will permit the central processor to go through several cycles of operation before the next command has been retrieved from memory. These operations can then be small subroutines which are enacted by means of macro commands stored in a fast, read-only memory. It is suggested by Opler that, since these subroutines are changeable (although possibly not under machine control) and will form the basis for the software, the term "firmware" accurately describes their place in computer technology. Opler also suggests that the design of these macro subroutines will be very important to successful computer operation and that the "firmware specialist" may come into existence.

While we must wait for hardware developments before Opler's "fourth-generation" machine can be built, there is no need to wait for a computer that utilizes the software organization Opler describes. Furthermore, such organization offers unique advantages for some applications.

## reorganizing available hardware

Here is the description of presently available hardware which could be given the "fourth generation" organization described above: A small, short-word-length, 4096-word core-memory computer is coupled to a 65K-word drum (or disc) which can supply a word to the accumulator each 66 microseconds. The basic organization of the machine would be as follows: Each 66 microseconds a macro command would be transferred from the drum to the accumulator. The command, in the form of an unconditional transfer, could be used to transfer to the starting address of a given macro subroutine located in the core memory; the macro subroutine could be 20 to 40 words in length and still be completed within the 66 microseconds available before the next macro command is transferred from the drum. Since the macro subroutines (the "firmware" in this machine) would be resident in the core memory at all times, they could be changed under special machine control.

<sup>1</sup>A. Opler, "Fourth-Generation Software," *Datamation*, Jan. 1967, p. 22-24.

The author's thanks to Mr. Len Litman of Shell Development Company for his criticism of the manuscript.

Although such a present-day "fourth generation" computer would not be as fast as future machines, it would still not be slow, even by today's standards. Assuming enactment of one macro command each 66 microseconds and assuming an average macro subroutine length of 15 words, the average operating rate would be over 225,000 machine commands per second; a longer average macro length would give an even higher operating rate. Time lost due to the position of command words on the drum, when critical, could be minimized; e.g., at a branch, the first word of each branch could be located on different tracks, in the next word-time; crucial loops might be duplicated on the drum, if sufficient memory were available. It should be noted that even though a large memory is available on the drum, this organization increases its effective size still more, since each macro command may represent up to 40 machine commands.

Actually, in some cases this machine may be faster in operation than straight machine-code programming which uses fixed-length overlays brought in from the drum since only part of the page may be utilized. Furthermore, in some cases it may be faster to bring in the six to nine macro commands that an entire page represents than it is to bring in the page itself.

It is certainly obvious that such a machine could be



Dr. Jewett is an assistant professor of physiology and neurosurgery at the Univ. of California School of Medicine in San Francisco. He has an MD from the Univ. of California, a D. Phil. from Oxford, and has done postdoctoral work at Yale's psychology department.

used to study the effectiveness of various macro commands as a basis for fourth generation "firmware." But aside from the firmware specialist, is there anyone else who would want such a machine? If so, then the attractiveness of this organization will not be its speed, but its ease of programming, decrease in program length, cost-effectiveness, usefulness in special applications, etc. Here are some applications that might profitably use this machine organization, which will be called the "macro-enactor":

#### suggested applications

In those applications where programming in available higher-level languages is cumbersome or impossible, a macro-enactor could be very helpful. It could be used in those process control applications where speed is secondary and where the programs are often very long, with many branch points but few loops; macro subroutines appropriate to the application would allow programming in a higher level format while reducing the amount of memory devoted to the program.

The macro-enactor might be a good solution for some I/O headaches. Small core-memory computers are already being used to format input and output from Teletype machines in time-sharing systems; the macro-enactor could be used similarly. Interrupts could be used to get the characters into the macro-enactor core memory from which they could be formatted and stored on the drum by macro routines. The large memory would allow storage of considerable amounts of data before transfer to the larger machine at sensibly rapid rates either by transfer directly from core or from parallel tracks on the drum. Upon completion of the computation, the macro-enactor could be used to format the data for output on the Teletype or some other device. The macro-enactor could contain a variety of output formats which could be applied to any data received in standard form from the central processor.

Another I/O device that could use the macro-enactor is the oscilloscope display. Macros could be used to format the displays, provide translations, rotations, etc. on a data list, etc. A relatively simple modification of the drum on the macro-enactor would permit easy storage of the display. Three tracks would be assigned to store the position of 1,024 display points; each track would store one of the axes (X,Y,Z). Some simple circuitry would read continuously from the three tracks. At each word-time three D-A conversions (of the current word on each of the tracks) would automatically take place, thus providing simultaneous analog signals for the oscilloscope. The display would be repeated 60 times per second while the computer was entirely devoted to computations; the computer would be needed only to up-date the display, not maintain it. A further refinement could limit the Z axis modulation to four intensities and then use the remaining bits to decode alphanumeric characters or other patterns.

Maybe there are some people who would like to do some joss-type programming on such a small computer. While such operation in an interpreter mode may be much slower than a compiled program, it should be noticed that many small computers are purchased outright. Hence speed is secondary since computational costs are not directly tied to computer computation time. In such applications, programming time is often much more significant than computation time, and the ability to compose and enact programs on-line is much more valuable than machine efficiency. Obviously, the macro-enactor lends itself to this type of operation.

In some applications, it may be desirable to optimally program a drum memory system; the macro-enactor could eliminate many of the drawbacks of earlier drum systems. Macro subroutines could be devised which would optimally place instructions on the drum during compiling. Another macro could be used to prevent loss of a turn of the drum with a memory store command since the word could be held in core memory until the drum had turned to the appropriate location, during which time the computer could be continuing with the program; commands referencing the same memory location could be enacted since the contents would still be in core. Other macro subroutines could be used to look ahead for branches and loops. Commands might be brought in on a push-down list, so that the rate of enactment of macro commands would be tied only to the mean rate of word retrieval, and not to a given word retrieval.

The idea of look-ahead operation raises the question as to how large a core memory is needed in a given application. Random access to a large number of words is most appropriate when the use of each word is equi-probable. How often is this the case? And how often is it possible for the computer to predict what words will soon be needed as the program is being enacted? A commitment to a macro-enactor software might reduce the core size requirement, at some sacrifice in speed. In some applications a good look-ahead system might be sufficiently fast since every transfer of a program word represents a macro subroutine rather than a single machine instruction.

As has been suggested by Wirsching<sup>2</sup>, computations involving short, iterative routines on large numbers of individual numbers might best be programmed on a drum-oriented machine; with little, if any, loss in speed. This would also be true of the macro-enactor, especially when data words were brought in at intervals only slightly longer than that necessary to complete the iterative routine. While the macro-enactor could not compete in size or speed with Wirsching's Nova, it could be used to test some of his ideas, and some applications might well profit from the list of organization of Nova.

The macro-enactor could be used as a small variable-word-length computer, or it could be programmed to allow switching to a three-address mode during only part of the program.

Perhaps these are enough examples to suggest that the macro-enactor mode of operation might have a place in third generation systems—all the more so since it will be the ideas generated by and developed in the third generation machines which will be permanently imbedded in the LSI's of the fourth generation.

One aspect of the macro-enactor which may not be obvious is the ease of modifying the software without clobbering the system. A macro subroutine can be changed (e.g., to increase its efficiency), without requiring any changes in programs already written; similarly, new macro subroutines can be added to an already operating system. If the software has developed through a process of evolution and "survival of the fittest," the process of selection over a period of time will "naturally" tend to retain the more efficient and useful macros. Furthermore, a frequently used combination of macros can be written into a "meta-macro"; such meta-macros can themselves be nested into even higher level macros. The development of such higher levels makes programming easier and more adaptable to a given application. Although the resulting software system may lack generality, since it is either problem or process oriented, it offers some advantages that at times only specialization can provide. ■

<sup>2</sup>J. E. Wirsching, "Nova: A List-Oriented Computer," *Datamation*, Dec. 1966, p. 41-43.



# AN EXPERIMENTAL 360/40 FOR TIME-SHARING

improving the breed

by G. E. HOERNES and LEO HELLERMAN

Looking at the market place today one finds that time-sharing systems are both being experimented with and being offered as products. These systems can be divided into two basic classes: software systems without hardware assist; and specially designed machines with appropriate software systems.

The system described here falls into the second class. However, instead of designing a totally new computer, a standard IBM System/360 Model 40 was used as a starting point and then modified. Although the change affected only a relatively small part of the total system, it provided those characteristics required for time-sharing.

One requirement of the design was a mode switch with settings for time-sharing and for standard Model 40 operation. When switched to the Model 40 mode, the system would revert to, and be indistinguishable from, a standard Model 40 in its processing of software. A third setting of this mode switch permitted use of the translation hardware as a standard associative store. In this mode, the hardware appeared as a standard Model 40 but with a new resource, the associative store, and a newly enabled instruction to manipulate it.

## unmodified model 40

Before describing the modifications, let us examine the organization of the basic machine.

The Model 40, as most other machines in the System/360 line, is microprogrammed. A simplified data flow of the Model 40 is shown on the right side of Fig. 1 (p.40). Basically, the system consists of three storage units, interconnected via registers, and gates controlling data flow. The main storage is core storage with capacity up to 256K bytes. An address to main storage (MS) is supplied by the A register which contains a binary number specifying one location in main storage. If, at the same time, the READ control signal is energized, the content of the location, specified by register A, will be transferred to register D.

The second type of store (Fig. 1) is local store (LS). LS is considerably smaller than main store, twice as fast, and cannot be directly addressed by the user. LS is used mostly by the microprogram as temporary storage: that is, as a scratch pad.

For example, during multiplication, LS is used to hold partial results. It also contains some frequently accessed, permanent information such as general purpose registers (GPR), floating point registers (FP) and the program status word (PSW). All of these are available to the user. Along with control bits, the PSW includes the instruction counter. (Note that the registers shown in Fig. 1 are hardware registers controlled by the microprogram; they are not available to the user.)

The third type of storage, the read-only store (ROS), contains the microprogram which, as the name implies, is a

program which operates on a level below the normal program; to execute one machine instruction would require many micro instructions. One micro instruction is made up of micro orders, each order operating a gate, thereby permitting flow of information from one register to another. (Gates are shown in Fig. 1 as X's.)

To better demonstrate the power of microprogramming, assume the instruction ST 4, 280 is to be executed. (Store general purpose register 4 in main storage location 280.) The operation code of the instruction, namely the binary equivalent of ST, causes the microprogramming to branch to a routine which performs the store operation.

The first micro instruction of this routine fetches general-purpose register 4 from LS (addressing of LS not shown in Fig. 1) and places it into register D. This operation is performed by: (a) energizing LS Read; (b) opening the gate to the R register; and (c) gating the R register to the D register. The second micro instruction moves the main store address from wherever it resides into register A. The third and final micro instruction energizes MS Write control and opens the gates from the A and D registers to main storage. Having completed the current instruction, the microprogram branches to a routine common to all instructions. This routine loads the instruction counter from local store into the A register and fetches the next instruction from main store by opening appropriate gates. At this point the cycle closes and the next instruction is executed.

The microprogram is stored in a read-only store because it will not be changed and it will never modify itself. Read-only stores used in this application are more economical than read-write stores and provide a degree of safety



Mr. Hoernes is an advisory engineer at IBM's Systems Development Div. He has written two IBM self-teaching books on Boolean logic and is co-author of *Introduction to Boolean Algebra and Logic Design*, published by McGraw-Hill in 1964. He has an MS in electrical engineering from Rensselaer Polytechnic Institute.

against accidental modification. The technology used to implement the ROS's varies from model to model in System/360, but, in every model, it is relatively easy to modify. (Time is measured in hours.) Because of this modest ability to change microprograms, it has been very appropriately called "firmware."

### time-sharing using a virtual memory

The concept of time-sharing is to service many users in quick succession, thereby giving the illusion that each user is serviced continuously. The advantage of this type of op-

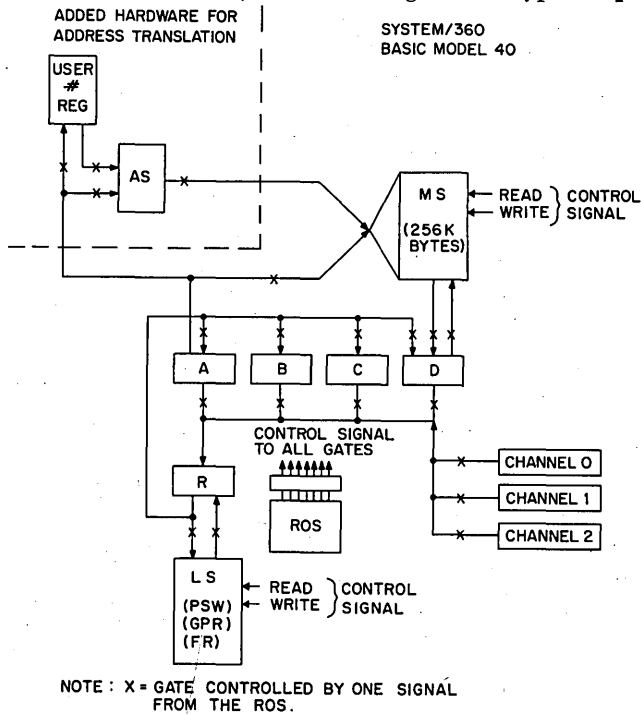

Fig. 1. Flow diagram of the experimental system

eration is that each user has immediate access to all services of a large computer system, the host computer, but his actual charges are only a fraction of the total cost of the system because the total cost is distributed among many users (as in batch processing).

The functions needed for time-sharing can be achieved by either software alone or a combination of hardware and

software. If only software is used, overhead is considerably larger than if the supervisor program is assisted by some additional hardware. With this added hardware the user is not aware of anyone else in the system—in fact, he cannot "reach" data belonging to others. That part of the physical machine the user sees under these conditions is called a *virtual machine*, which can, but need not, have the same specifications as the host machine. In our case, the virtual machine had the same specifications as the host machine.

The system was designed to hold up to 15 user programs at one time. But at any one instant in time, either the supervisor or one of the up to 15 users is active on the central processor. The remaining programs are inactive. The obvious question asked is how to separate the users, and how much of the machine belongs to a user in the inactive state. Let us consider which resource can hold specific user-dependent information between the times a user is actually running.

Analyzing the major components of the computer (Fig. 1) it is found that ROS will not contain any information unique to one user, so it can be shared by all. The hardware registers (registers A, D, R, etc.) and temporary storage in local storage are only used during the execution of the instruction, and do not contain useful information at the end of the execution of one machine instruction. (For example, in the store operation described previously the content of register 4 remained in the general-purpose register and was stored in main storage. Neither A nor D need be saved.) Thus, if each user is deactivated between instructions, no information from these registers needs to be saved.

Local store contains the program status word (PSW), the general-purpose registers (GPR) and the floating-point registers (FP). These locations of local store have to be saved. But as there are only 16 GPRs and 4 FPs and one PSW, it was decided to have the control program save them for each user in an area in its own core. Of the basic machine, all but main store has been freed of information of inactive users. Main storage can also be freed from all inactive users, by writing it out on disc. This would be one way of building a software time-sharing system without hardware assist. This approach was not chosen here because it results in a great deal of I/O activity; instead, a hardware translation device that partitions main storage was added to the basic system.

### address translation device

As shown earlier, main store is the only system resource a user retains in both active and inactive state. Also, we saw that each user may use the entire virtual machine. He may, therefore, use the entire address space of the machine ranging from address zero to about 256K (262,143 to be exact) bytes. It would be possible to provide one storage for each user and to switch among them, but this is economically unfeasible due to the cost of main storage and is unnecessary because most users do not use the entire address space all the time.

To "map" the storage spaces of the up to 15 users into the one physical core storage box on the system, all users' storage spaces and the physical core are divided into pages. For this discussion we will say that each page is 100 units long. (See Fig. 2.) The users' pages are no longer all in main storage but are kept in external storage, which in this case is a disc. Those actually used are pulled into core. To follow the operation called "paging"—of pulling pages in from disc—assume user 3 is presently executing an instruction at 438, which falls into page 4. The request arrives at the address translation device, flows to the associative store (AS) as shown in Fig. 1, where it is matched against the address translation table shown in Fig. 2. The table is searched for a match between user and page number and some table entry. User 3, page 4, matches the entry in the fourth line, so



Dr. Hellerman is with IBM's Data Systems Div. in Poughkeepsie, where he is concerned with computer circuit design, computer technique, and automata theory. He has taught mathematics at Yale and electrical engineering at MIT. He has a PhD from Yale in mathematics.

**SIGNS OF AGGREGATION**—The signs of aggregation are: the parenthesis, ( ); the vinculum, —; the bracket, [ ]; the brace, { }. They show that the quantities included by them are to be treated as single numbers.

Thus, each of the expressions  $(a+b)c$ ,  $a+bc$ ,  $[a+b]c$ , and  $\{a+b\}c$ , show that the sum of  $a$  and  $b$  is to be multiplied by  $c$ .

When quantities are under the vinculum or are included within any other signs of aggregation, they are commonly said to be in parenthesis.

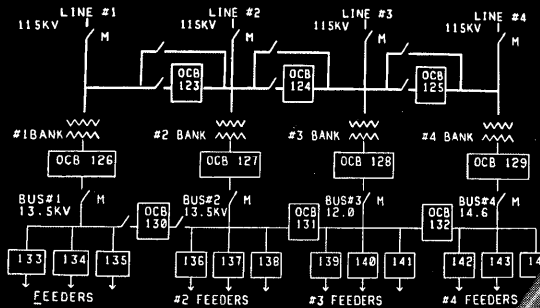
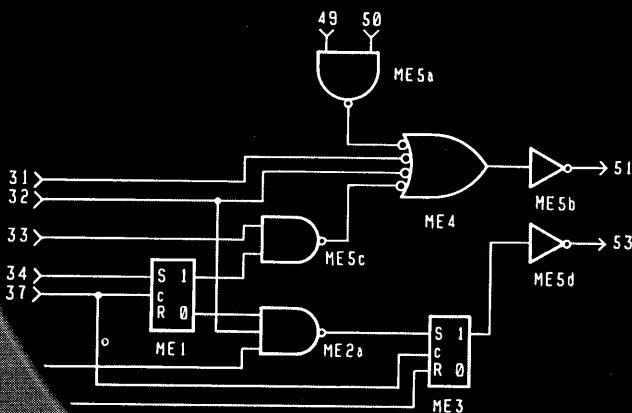
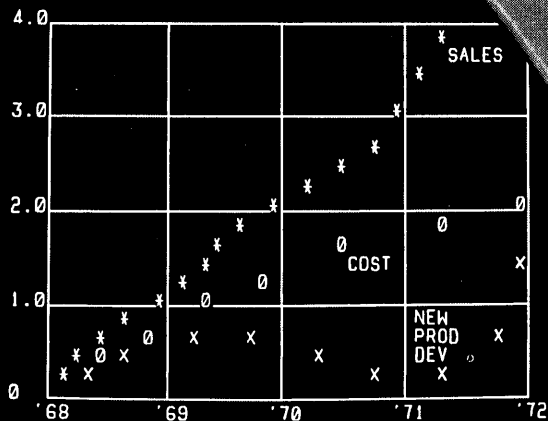

## State-of-the-art hardware is only the start of a Sanders Graphic Display

It's some start, though.

It's assurance that each member of Sanders sophisticated 900 series graphic and tabular display systems incorporates the most advanced display technique . . . such as high speed write-through yoke, continuous rate vectors, high quality stroke-generated characters, linearity correction . . . available today.

It means that each display offers you performance and reliability already being incorporated by Sanders in applications ranging from business information retrieval to multi-hospital medical data management to pre-launch check-out of the Saturn V vehicle.

And it puts an impressively wide range of applications within *your* reach: computer aided design, process control, simulation of system responses, high volume information retrieval, weather plotting and reporting . . . to name just a few.

But it's only a start. Systems experience is what makes it work. And Sanders engineers have had extensive experience integrating displays into many types of systems. They know how to analyze system requirements and match them with precise capabilities. Their knowledge of associated system equipment parameters, and their ability to design high performance interfaces, are unique. Hardware, at Sanders, is only a means of translating this experience into a practical solution to your problem.

If you want to add more than just state-of-the-art hardware to your system, contact . . . Marketing Manager, 900 Series Display Systems, Dept. 1-2350, Sanders Associates, Inc., 95 Canal Street, Nashua, N.H. Phone (603) 883-3321, Ext. 2620.

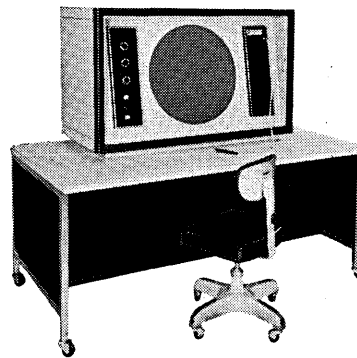

Creating  
New Directions  
In Electronics

State - of - the - art features of Sanders 960/40 system include: 20" diameter screen; 128 ASCII alphanumeric and symbols; 22-stroke cursive generation; 8-level brightness and blinking of selected data; 4 character sizes, up to 0.5", upper and lower case; multiple line types with continuous uniform vector intensity from dot to full screen line; extensive non-display command. Options include: alphanumeric / function keyboard, PHOTOPEN®, and multiple consoles displaying different data.

VISIT SANDERS SJCC EXHIBIT . . . Island J . . . At Atlantic City

CIRCLE 18 ON READER CARD

\*T.M. SANDERS ASSOCIATES, INC.

**SA**  **SANDERS ASSOCIATES, INC.**

900 SERIES DISPLAY SYSTEMS

the physical address is in page 3, the address is 338 and is gated to the storage bus. Virtual page 4, user 3, is translated into physical page 3.

Each time user 3 issues a request to main storage, this translation is made until a storage location is addressed whose translation is not in physical storage; for example, page 1. At this time the control program is called which:

- (a) reads the requested page from external storage into an available page in physical storage;
- (b) adds the appropriate entry into the translation table.

When both actions are completed, control is returned to the user and the request for page 1, user 3, can now be translated to 7 as shown in Fig. 2. Should storage be full and a new page is requested, some page has to be written out on external storage to make room. The new page can then be read in. To change users, the system replaces the old user number with a new number, saves the old GPRs and FPs loading the new ones, and gives control to the new by load-

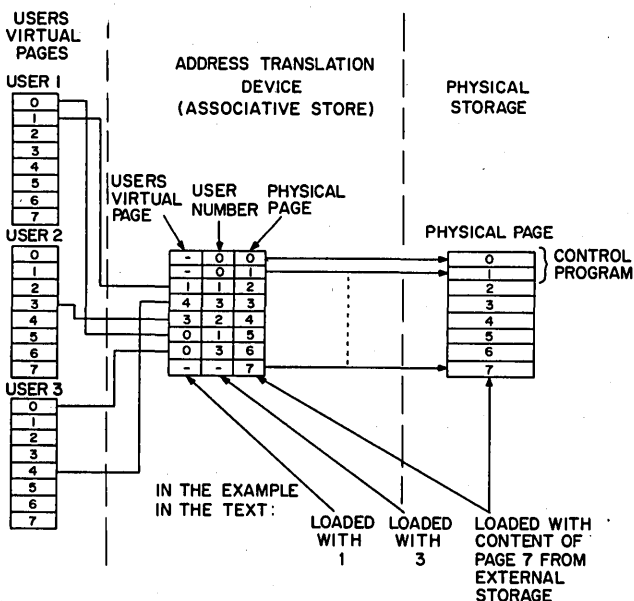

Fig. 2. Translation from users virtual page number to physical page

ing his PSW. This entire switching of users can be done rapidly and, what is more important, without generating I/O requests.

Main store address translation is always performed when a user program is executing; when the control program is running, translation is inhibited.

**modification to the microprogram**

The translation device described above was implemented by using an associative store, and is capable of making a simultaneous comparison between the input lines (in this case the user number and virtual page number) and each entry in the store. Its output is an indication of a match or no match for each entry. Of all entries there can be either one match, or no match. If no match is found, an interrupt is taken; if a match is found, the physical page address is generated by the hardware and is used to address main store.

The physical address generated by each entry is indicated by the "physical page" column in Fig. 2.

To load new entries into the associative store, and to load new user numbers into the user number register, a new machine operation code was defined and appropriate microprograms added to the microcode. To prevent any con-

fusion between addresses to be translated, and data for loading the associative store, only the control program is permitted to issue this new instruction.

Addition of this new instruction is a rather small modification compared to the second modification necessitated by the requirement of the Model 40 that when an instruction is started it has to be completed. This requirement does not restrict a conventional system. The experimental system, however, cannot always assure this without modifying some microcode.

Consider the addition of field 1 from page n and n+1 to

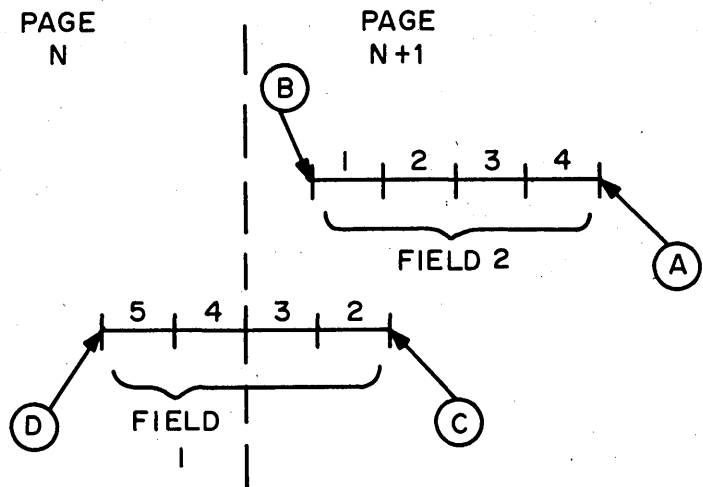

Fig. 3. Operands for a variable field length add instruction crossing page boundary

field 2, and placing the result in field 1 (see Fig. 3). If both pages, n and n+1, are physically in storage, there is no problem. But if n is not in core, then the instruction has to be interrupted after adding two digits. The result in field 1 is partially formed and reads 5466. If, after loading page n into core, the instruction starts over again, the result is 6698, which is incorrect.

To avoid errors resulting from partially completed operations, operands of variable fields are later pretested. Before adding the two operands, the four end points, A, B, C, and D, would first be tested. If all four are in core, the successful completion of the operation is assured. Only under these conditions can the instruction be executed. If the end points were not in core, the supervisor would recognize the request for a new page, service it, and return control, which starts by again testing and then executing the add instruction.

**summary**

An experimental time-sharing system has been constructed, based on the IBM System/360 Model 40. This system divides users' address space into pages. A copy of all pages is kept on an external storage device and only those being demanded by the user during execution are read into core. Using an associative store, an address translation device was designed. This device translates the user number and requested virtual page into an actual page number.

The microprogram was modified from the basic code to avoid instruction termination before the normal end; also, a new instruction was added to load the associative memory and its registers.

**REFERENCES**

A. B. Lindquist, R. R. Seeber and L. W. Comeau "A Time-Sharing System Using An Associative Memory", Proceedings of IEEE, December 1966, pp. 1774-1779.  
 A. G. Hanlon "Content" — Addressable and Associative Memory Systems — A Survey," IEEE Transactions on Electronic Computers, Vol. EC-15, No. 4; August 1966, pp. 509-521.

COMPANY: \_\_\_\_\_  
 ADDRESS: \_\_\_\_\_  
 CITY: \_\_\_\_\_ STATE: \_\_\_\_\_  
 ZIP: \_\_\_\_\_  
 NAME: \_\_\_\_\_  
 TITLE: \_\_\_\_\_  
 PHONE: \_\_\_\_\_  
 FAX: \_\_\_\_\_

# A NEW TEACHING CONCEPT

If you've ever been frustrated with the high cost of sending just one student to your  
 state or a professional seminar, now you can help thousands of students receive the same high  
 quality instruction at a fraction of the cost.

The course materials are created by OLI in cooperation with leading universities to  
 provide quality instruction in a variety of subjects. A single course can  
 be used by many students at the same time. The program uses a high quality of computer graphics that  
 have been developed by leading universities. Each of these courses is  
 designed by a team of subject matter experts and is presented in a professional and  
 user-friendly format.

The OLI program is the future of education. It provides the quality of instruction that  
 you need at a fraction of the cost. It is the only program of its kind that provides  
 quality instruction using advanced systems and programming techniques.

The cost of sending one student to your communications training course is \$20,000 per year.

THE NATIONAL  
 FILM CENTER  
 FOR  
 DISTANCE EDUCATION  
 AND  
 SYSTEMS ANALYSIS

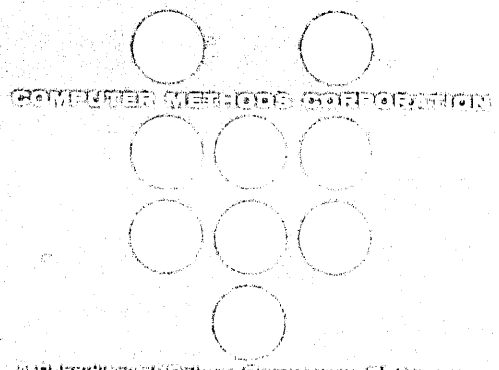
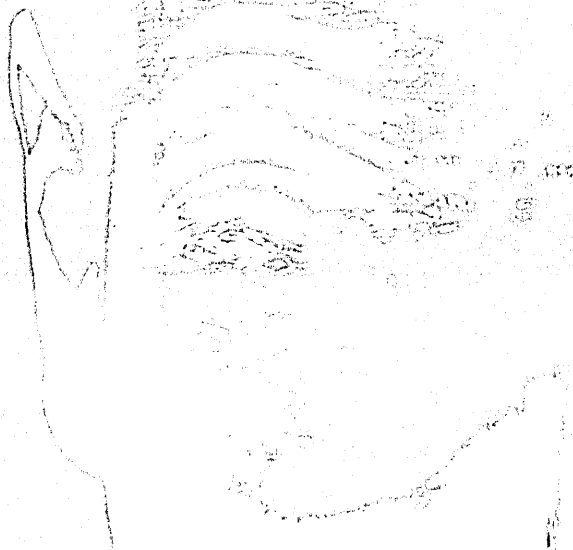

# How to make a small into an for

Now, with Core Extender Memory™ a small computer can challenge the giants. Why? Because CEM is more than just a disc file or a drum replacement. It's computer expansion which gives you

- instant program or data retrieval
- triple the effective computer usage
- massive storage
- random access filing, sorting, updating or more

Imagine the program power of a PDP-8\* or 8/I with 128 times its basic core memory, where half of core transfers in 9 milliseconds and is accessible in 16 milliseconds average. And this compact 3rd generation peripheral CEM system plugs into your computer I/O facility in a few minutes.

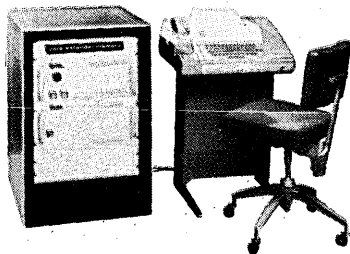

We use CEM in our CLINDATA™ and CHEMDATA™ clinical laboratory data processing systems and we know what it does. We invite you to find out.

#### Standard CEM Features:

- Modular expansion to 4 discs
- 7 million bits per disc
- Fixed head in-contact recording
- Auto-load from disc
- Write Protected storage
- Error checking

CEM Systems are available for the PDP-8, 8/I, 9, DDP-416, 516, Data 620i and others.

The CEM system price for the PDP-8 is \$19,600 which includes installation, system responsibility, required software and warranty.

## BSL

BERKELEY SCIENTIFIC LABORATORIES, INC.

2229 Fourth Street □ Berkeley, California 94710 □ [415] 841-8812

\*Trademark of Digital Equipment Corporation

# MESSAGE CONCENTRATION

by JOHN W. PUGH



It has been the cost of long distance telephone lines—not service or equipment charges—that has caused many companies to delay the use of time-shared computer services.

One company, which offers a time-shared computer service for business users, is minimizing this problem by using 16-bit communications-processing computer systems made by Honeywell, Computer Control Division, for on-line, real-time message concentration. These computerized message concentrators provide the facility for time-sharing long distance communications lines, thereby concentrating data at a 40-to-1 ratio. (See Fig. 1 p. 47).

The computers receive information manually keyed on Teletype keyboards and assemble it into complete messages which are then transmitted over a voice-grade line to a large central processor. In turn, the computers receive output messages from the central processor over the same voice-grade line and distribute them to Teletype printers. Since messages go to and from the central processor over one or more voice-grade lines, communications-circuit lease costs are substantially reduced, especially for those subscribers located far from the central processor.

Many other important functions are performed by the computers to free the time-sharing processor to do what it is designed to do: process data. They translate from five-level Baudot code to a six-level subset of `USASCII` code used by the processor, and perform a number of front-end functions.

Any of the operators keying data into the time-shared system through a Teletype keyboard may tell the computer

**cutting  
communication costs**

to delete a character, a field, or an entire message by striking one of the other keys marked with the discrete control function. That is, a control function key is interpreted by the computer to initiate a particular action.

Full-duplex (two-way simultaneous) operation provides easy re-definition of the meaning of all keys, since there is no local linkage between the keyboard and printer in the service company's terminal. When a key is depressed, the



*Mr. Pugh is product manager for computer subsystems with Honeywell's Computer Control Div. Formerly a captain in the Signal Corps, where he worked with computer communications system planning, he has an MS in electrical engineering from the Univ. of Arizona.*

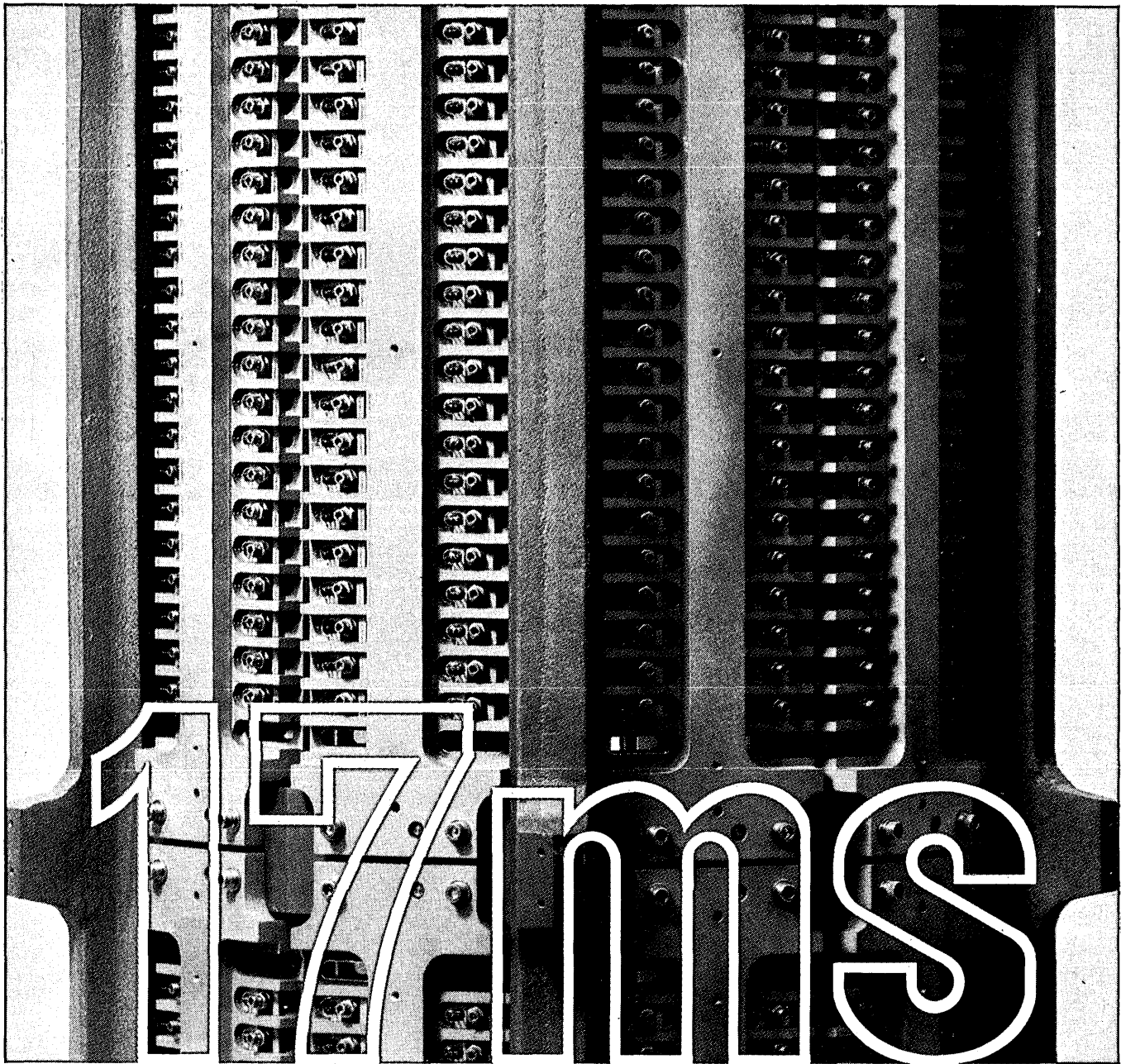

# 1,000,000,000 BITS—FAST!

More memory! Faster access!! More memory!!! Faster access!!!! This is the constant need of "Time Share" and "Management Information" Systems. How about 1,000,000,000 bits with an access time of 17 milliseconds... enough in a hurry? At Magne-Head, memories are made for this! For information on any of our high-performance Magnetic Memory Systems or Components, write or call today. Write for free 16-page bulletin.



MAGNE-HEAD DIVISION

13040 South Cerise Avenue / Hawthorne, California 90250 / 213 679-3377 / 772-2351 / TWX 910-325-6203



## MESSAGE CONCENTRATION . . .

data character is on-line to the computer, which echoes the character back to the printer at the terminal. This technique allows the printing format to be determined by the computer and provides a visual indication that the computer has received the data correctly.

### the computer system

At present, the service bureau is using four Honeywell DDP-116 and two DDP-516 computers in its system. Two computers are equipped with 8K memories and serve 32 stations; two have 8K memories and serve 40 stations; and two, with 12K memories, serve 128 stations. The plan is to phase out the 116's and replace them with 516's—new 16-bit integrated-circuit machines having a cycle time of 960 nanoseconds and featuring multilevel priority interrupt, indexing, indirect addressing, and a flexible I/O structure. Each of the 516's is capable of serving up to 128 stations. Many additional 516's have been ordered by the service bureau as part of its expansion plans.

As shown in Fig. 2, each message concentration system also employs a Programmed Multiline Controller to interface the low-speed data lines with the computer, and a

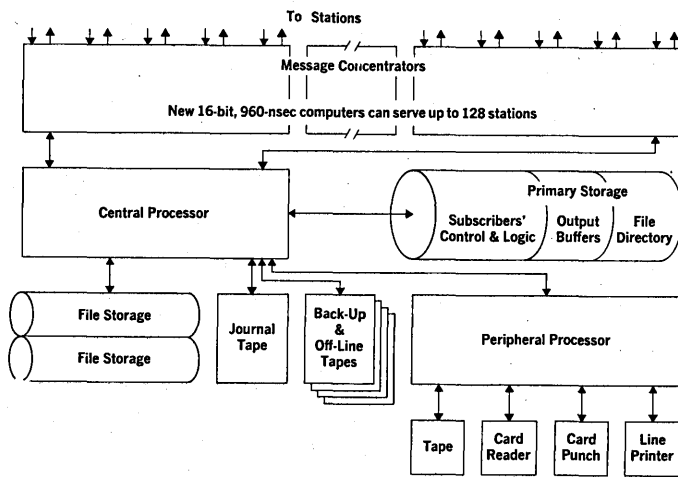

Fig. 1. How the computer relates to the total system

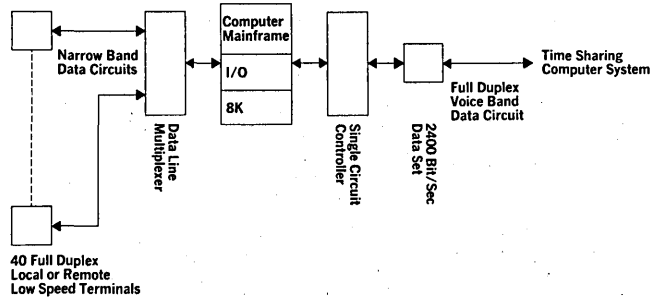

Fig. 2. Honeywell message concentration system

Single-Line Controller to link the computer to a single, full-duplex, 2400-bps voice-grade communications circuit.

The number of time-shared 2400-bps circuits required is determined by a statistical study of the terminal usage pattern of subscribers. Worst case conditions—all users requiring and obtaining service at one time—require one Single-Line Controller for each 40 terminals. The communications processor has been specially programmed for data concentration to conform with the handshaking required by the service bureau's executive program. Other requirements

and network configurations may result in different program design and, possibly, even different hardware design.

Since the computers are used solely for communications purposes, the hardware was selected to achieve minimum cost per line consistent with these functions. The communications interfaces for the computers are essentially unbuffered multiplexers which decode computer input/output

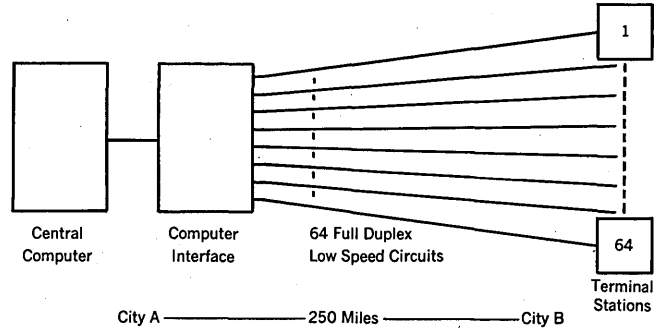

Fig. 3. Remote terminals without concentrators

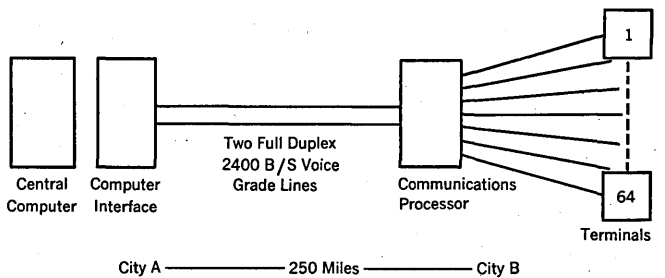

Fig. 4. Remote terminals with concentrators

instructions and sample the level of the communications lines under computer control. Each multiplexer contains a highly accurate crystal-controlled clock which causes a program interrupt at a multiple of the bit time of the fastest line. This provides the program with a time reference to scan all lines searching for the start bit on the line. When this bit is determined, the same clock is used to permit the program to sample each data bit at its center, once per bit time. This multiplexer technique, combined with a sub-microsecond computer, results in a multiplexer cost-per-line as low as \$150.

However, the demand on memory cycles for controlling the multiplexer is so large that the computer must now be considered to be dedicated to the communications task. Even so, a 64-line communications concentrator can sell for as little as \$510 per line, including the computer and the voice-grade-line interface. Of course, system costs and potential savings vary with:

- number of lines
- length of messages buffered (cont. p. 48).

Table 1 Cost Analysis Without Concentrators

Central Computer	
Communications	
Average interface monthly lease cost for 64 full-duplex low speed circuits terminations	\$ 3,800
Communications Costs	
Average monthly line lease cost for 64 250-mile full-duplex 100 wpm Teletype grade circuits	\$24,700
Terminal costs—same in both configurations	
Total Average Monthly Communications Costs less terminals for Fig. 1	\$28,500

## MESSAGE CONCENTRATION . . .

- c. distance of terminals from central processor
- d. distance of terminals from message concentrator
- e. type of control computer (cost per line interfaced varies extensively)

The typical cases considered in Figs. 3 and 4 show the kind of savings that can be realized with remote concentrators. Tables 1 and 2 compare average expected monthly costs for communications hardware and services for a network without concentrators, with a full-duplex 64-line mes-

**Table 2 Cost Analysis With Concentrators**

Central Computer	
Communications	
Average interface monthly lease cost for 2 full-duplex voice grade circuit terminations	\$ 500
Communications Costs	
Average interface monthly lease cost for 64 full-duplex low-speed circuits terminations	\$ 3,800
Average monthly line lease costs for 2 250-mile full-duplex 2400 bit/second circuits with data sets	\$ 800
Communications Processor	
Average monthly lease	\$ 1,700
Terminals—same in both configurations	
Total Average Monthly Communications Costs less terminals for Fig. 2	\$ 6,000

sage concentrator located 250 miles from the central processor. A monthly saving in excess of \$20,000 is indicated.

### other benefits

However, cost reduction is not the only benefit derived from message concentration. There is a very real benefit gained by an expansion in the number of users that can be put on-line with the computer at any one time, and, depending upon the load rate, a further gain in the total number of users that can be accommodated by the system.

Standard data-communications interface equipment offered by the leading computer manufacturers range between 63 and 250 low-speed data-line terminations, a frequently inadequate number. By using control computers for message concentration, and interfacing them to the central processor through voice-grade-line controllers, the line-termination capability can, in theory, be increased by a factor of 40. Furthermore, the majority of the data-line termination equipment supplied by the computer manufacturers is half-duplex (two-way nonsimultaneous). This results in halving the capability when full-duplex operation is required, since two half-duplex interfaces are required for one full-duplex operation.

A subscriber to the time-shared service can prepare invoices by keying his customer's number, quantities, and stock numbers directly into the system. He receives as output a finished invoice containing the customer's name, address, and other heading information; quantities, descriptions, prices, extensions, discounts for each item ordered, and a total for the invoice.

The finished invoice is printed line by line as the data is entered, so the invoice is ready for mailing at the same time as the product. Normally, an invoice is mailed out several days after the product. Subscribers get their invoices out faster, are reimbursed faster.

A second printer, attached to the same Teletype circuit but containing a different preprinted form, prints stock no-

tics, back orders, data about the exceeding of credit limits, accounts receivable balances and stock-item inventory levels. The system also journalizes information about each entry. This way, periodic activity and status reports can be prepared by conventional batch-processing techniques.

The time-shared operation differs from conversational requirements of the engineering user in three important ways:

1. The processing of each message usually involves random access to a large user file, but seldom requires much actual computation.
2. Output volume is several times that of input. Output must be attractive in format and free of visible correction or typeovers.
3. The operator usually wishes to enter data as rapidly as she can strike the proper keys, and need not see the output resulting from one input in order to proceed to the next.

It is nonetheless desirable that the output be produced soon after the input so that a finished invoice is immediately ready to permit the shipment of an order. Inconsistencies in input are called to the operator's attention the moment they occur so that the data can be corrected or verified while the source material is at hand, and basic files are kept up-to-the-minute.

### conclusion

The convenience, savings, and other benefits of message concentration can only be assessed in terms of specific situations and specific systems. Not every time-sharing application involves several hundred terminals, but it is obvious from the cost figures and the growth in the number of installations that data concentration is a logical field for small, high-speed computers. There is little doubt that this usage will expand. ■



TO BE OPENED  
APRIL 30

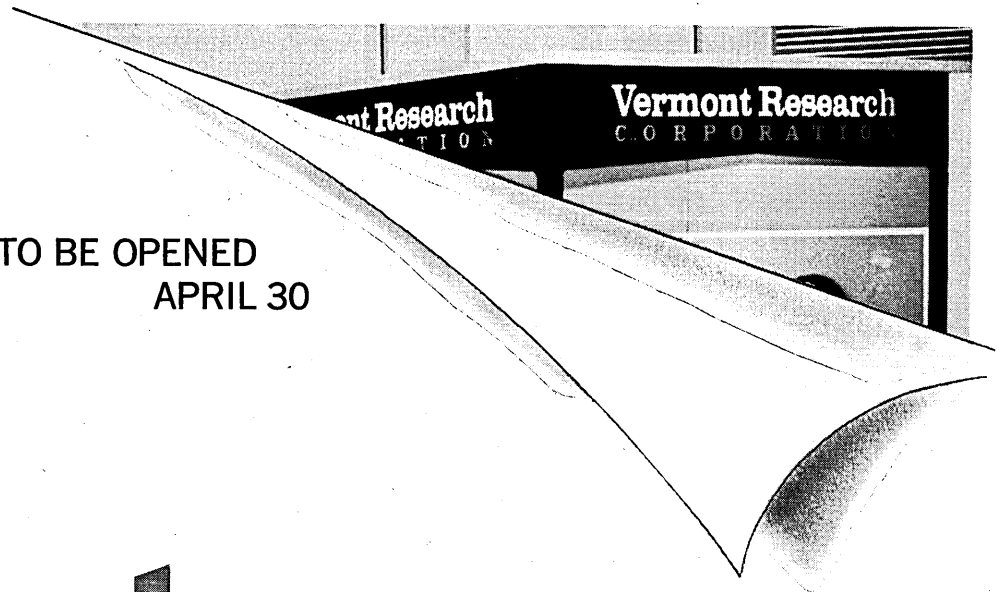

# Fact:

**Two very pleasant surprises await users of random access, rotating memories at Booths L1-L2, SJCC.**

*Computers are known by their MEMORIES*

*...so is*



Box 20d  
Precision Park, North Springfield, Vt. 05150  
Tel. 802/886-2256 TWX 710-363-6533



*When it comes to engineering opportunities (and the good life, North Country style), the place to come is Vermont Research Corporation. For specific information, contact: RICHARD A. STOVER, Vice President-Engineering.*

# MODEM 4400/48\*

The only 4800 bps data set proven to deliver maximum throughput—always, even using the lowest grade data lines!

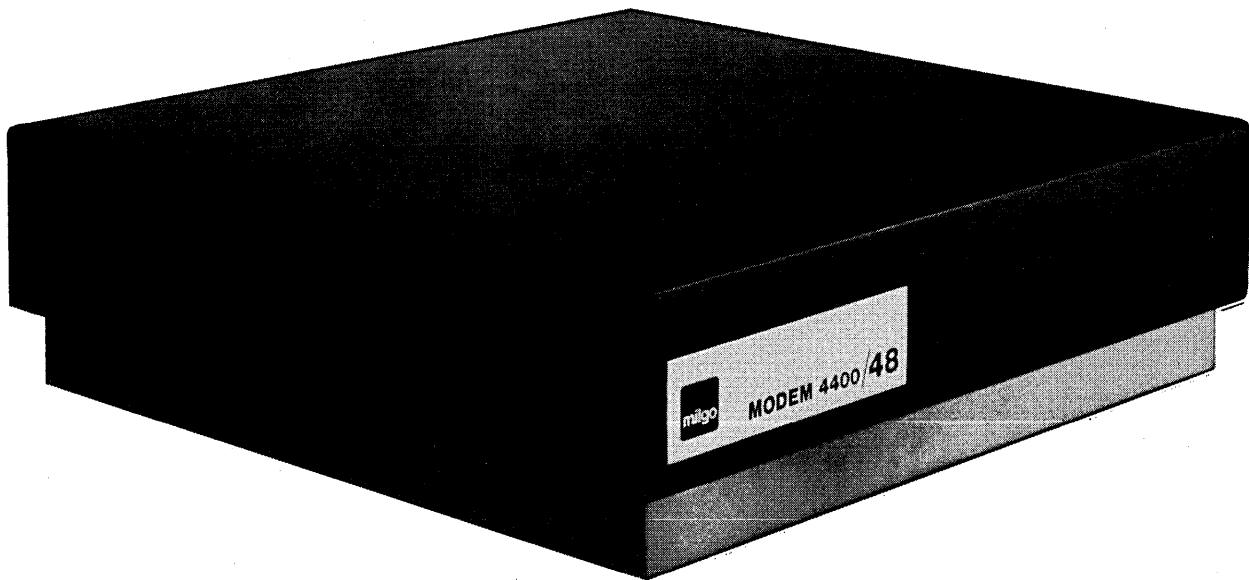

That's why one of the nation's leading banks selected it.

Seattle-First National, largest bank in the Northwest, gained three ways when they switched to Milgo narrow-band data sets . . . **doubling** their data communications capacity . . . **reducing** line costs . . . and **dropping** transmission errors to less than 1 bit in 4 million. Only MODEM 4400/48 data sets were able to provide these advantages.

Now, with data speeding hundreds of miles between their GE415 and 425 computers at 4800 bits per second, Seattle-First keeps pace with the growing needs of their 123 branches.

In addition to Seattle-First, a wide variety of other data transmission users have found that MODEM 4400 fills their requirements. Whether your needs are to link multiple stations, or to connect two points as efficiently and economically as possible, you too can benefit from Milgo's data communication products. Write now for information.



Data Communication Division  
**Milgo Electronic Corporation**  
7620 N.W. 36th Avenue, Miami, Florida 33147

\*Reg. T. M.  
patents applied for

■ See the Milgo booths at: Spring Joint Computer Conference, Atlantic City / AFCEA Convention, Washington / ICA Show, Philadelphia

CIRCLE 23 ON READER CARD

# Is this compact card reader "infallible?"

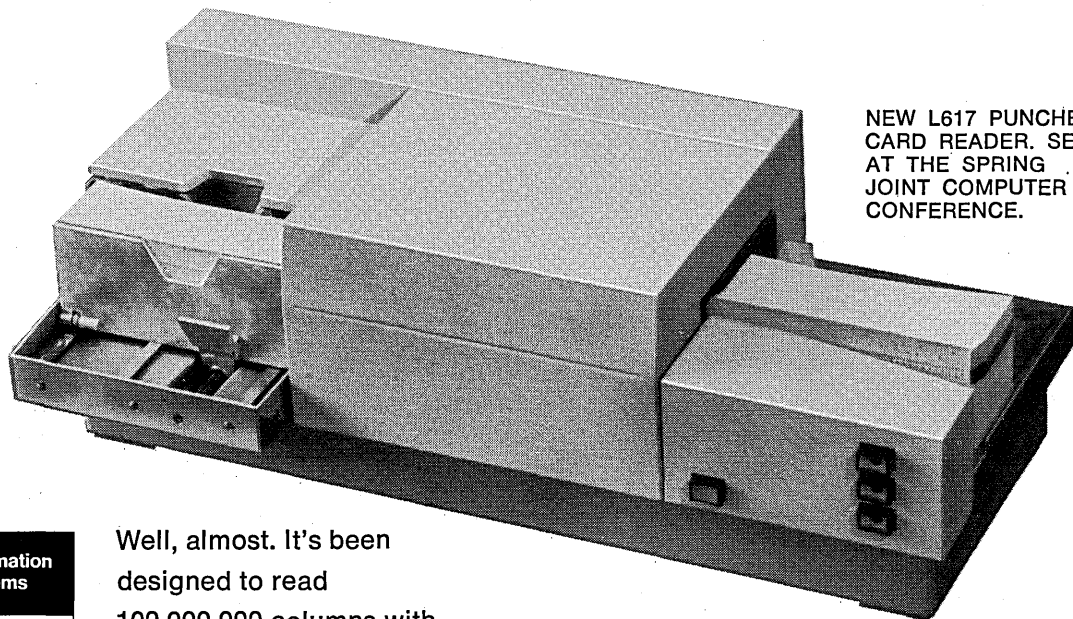

NEW L617 PUNCHED  
CARD READER. SEE IT  
AT THE SPRING  
JOINT COMPUTER  
CONFERENCE.

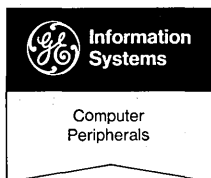

Well, almost. It's been designed to read 100,000,000 columns with less than one error. This new accuracy standard

makes it well worth considering for inclusion in any OEM equipment.

The key is positive synchronization. The card actually drives the clock tape in this device so there is no possibility of slipping. Card and clock tape holes are read photoelectrically.

The L617 reads 80- and 51-column cards serially at 200 cards per minute. In production now, the mechanism is available in OEM quantities for well under \$1,000.

995-36

## **BULL CORPORATION OF AMERICA**

1 East 57th Street, New York, N. Y. 10022

**BOOTH F at the Spring Joint Computer Conference.**

Please send me more information.

NAME \_\_\_\_\_ TITLE \_\_\_\_\_

COMPANY \_\_\_\_\_

ADDRESS \_\_\_\_\_

CITY \_\_\_\_\_ STATE \_\_\_\_\_ ZIP \_\_\_\_\_

- I'd like complete details on the L617 punched card reader.
- Please send information on your complete line of card punches, card sorters, key punches and verifiers for OEM's.
- Have a sales representative call immediately.

# MANAGEMENT AND THE NEW SOFTWARE

option  
proliferation

by TOM SCHARF

This article is addressed to data processing managers who have a determination to utilize third-generation computing systems to a maximum potential. Basically, it suggests three points that will aid in achieving this objective: 1) third-generation software systems are far more complex than most people realize; 2) this complexity is only an advantage in so far as management is willing to increase—and change—its emphasis on training, organization and management control; 3) dp management must have enough courage to invest in the future today, in spite of the never-ending demand for short-term results.

My experience with many aspects of third-generation software (especially OS/360 and PL/I) leads me to believe that practically no one is completely aware of the revolutionary change that has taken place. Too many dp managers evaluate new systems superficially and on the basis of their knowledge of earlier systems. Therefore, they come to the wrong conclusions or, at best, lack the necessary confidence in their knowledge to suggest better solutions.

One of the faults lies in the terminology we are unfortunate enough to have inherited. "Operating system" is interpreted by some people as a sort of "automatic operator." This is far from accurate.

The first operating systems tried to increase system productivity, and they accomplished this by simplifying the operations side of the system. This trend has continued. But many other changes to the software are increasing productivity too and, if anything, the job of the operator has become more difficult. As I will attempt to explain, it is very important that we learn to look at third-generation operating systems without thinking simply of operations. The effect on programming and systems design is even more significant. The primary reason for this is that the whole system is dependent upon a centralized group of control programs.

## the flexibility revolution

Why do third-generation software systems demand a new way of thinking and a new approach on the part of management? Theoretically, we are skeptical and demand that results determine whether anything really new has been introduced. In practice, however, we accept the fact that something new has arrived, and order the new machines, hoping for revolutionary productivity gains. Understandably, by now there are quite a few users who are disappointed (or: "How we achieved first-generation results when we exchanged our second-generation computer for the third-generation."). Who is at fault? Basically, both user and manufacturer—for trying to apply second-generation *thinking* to third-generation problems.

First, let us recognize that the real revolution from the management point of view is closely tied to *flexibility*. Software flexibility is directly related to the complexity of the software system. Flexibility is the degree to which the system allows humans to make decisions about the particular way in which a standard software system will act in the user environment.

Table 1 (p. 57) gives some comparisons to illustrate this concept. As you can see, there is a striking relationship in the compatibility ratio between these systems. The ratio is typically 3:30:130. That is, the DOS system is ten times as complex as the 1401, and the full OS is about four times as complex as DOS.

## the cost of flexibility

This flexibility is not free of charge: uncontrolled use is doubtless more expensive than profitable. One of the primary functions of a dp manager responsible for a third-generation installation is to give his staff explicit guidelines for using flexibility (such as, when a system should be designed flexibly, and what factors determine how flexible it should be). This job must not be left to lower management levels; it has a great effect on all major departments within the organization.

In order to make good decisions it is necessary to quantify the effect of choosing or not choosing the utilization of a system software feature in a given situation. This quantification must take the long-range view into account. We can usually measure the cost in core space, run time and money, using manufacturer specifications, but the total cost of system features is extremely complex to quantify. We must attempt to decide how profitable it will be for now—and in the future—to use a system as we choose. Then we can begin to formulate a policy with regard to what will be profitable to use out of the many possible software combinations.

A manufacturer is naturally tempted to overstate a system's capabilities for a particular firm. The sad truth is that a businesslike total evaluation of all desired features in a software system will show that many of the features will never be used—often for the practical reason that they do not pay off, considering the amount of core storage they occupy. Often a company can defend the use of a certain feature, but the space it uses up in core and on disc could

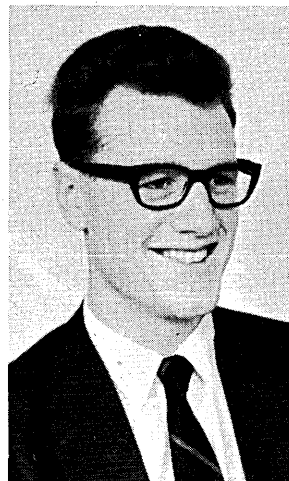

Mr. Scharf is a consultant in Oslo, Norway. He has been dp manager for A/S Datasentralen, chief instructor for IBM Oslo, and a senior programmer at the IBM service bureau in Oslo. This article is based on talks given to the Swedish and Norwegian Data Processing Organizations, the European GUIDE and SHARE meetings, and the Nordic edp meeting in Denmark.

# PRC designs real-time management information systems. Inclusive.

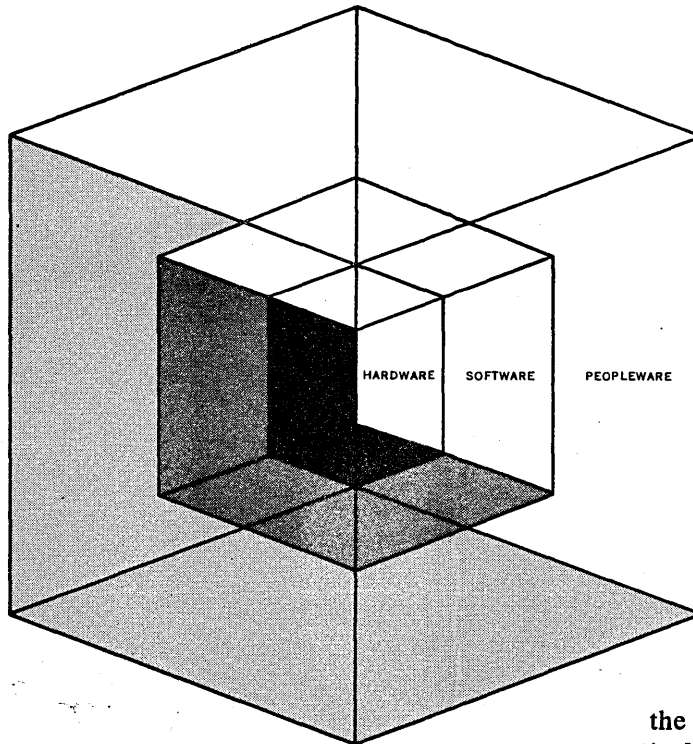

Our conviction is that an automated Management Information System must encompass not only hardware and software, but what we might call peopleware as well. For the structure of any M.I.S. essentially creates an environment—flexible, expandable and tailored to the nature of the problem—within which people function and do useful work more efficiently. This total environment is taken into account by Planning Research when we undertake the architecture of a Management Information System.

We begin by defining both the economic implications and the technical specifications. We design and optimize the system to work efficiently with the people who use it. We pro-

vide the most effective hardware for the job (we make no hardware of our own). We create the software. We train the personnel. This approach ensures that the whole system will work more efficiently and interact successfully with the people who use it.

We can take this approach because PRC is a most unusual group of people whose disciplines include economics, business administration, behavioral psychology, most branches of engineering, the classical sciences and mathematics. These and other disciplines interact on multidisciplinary teams to form the most powerful analytical tool yet developed for the solution of computer system problems.

To find out what this total approach can mean to you, contact Mr. J. N. Graham, Jr., Vice President and General Manager, Computer Systems Division.



**PLANNING RESEARCH CORPORATION**

Home office: 1100 Glendon Avenue, Los Angeles, California 90024

*An Equal Opportunity Employer. Candidates are invited to write to the Administrator for Professional Staffing.*



# The sure tape

"Scotch" Brand No. 777.  
The computer tape  
Western Union depends on.







When accuracy is vital and errors cannot be tolerated, the computer tape that meets Western Union's needs is "Scotch" Brand No. 777 Computer Tape.

Western Union's advanced communication systems carry critical information vital to our nation's economy and defense. Information loss or errors on these systems can prove very costly, even disastrous. After testing and evaluating all computer tapes, Western Union chose "Scotch" Brand No. 777 for these systems.

**THE REASONS:** reliable error-free performance; long term dependability over thousands of passes; complete compatibility through all bit densities and computer systems.

**AUTODIN**—This system designed by Western Union for the U.S. Department of Defense employs computers in nine regional centers and serves more than 2,700 subscribers. "Scotch" Brand No. 777 is used in this vital defense installation where error-free reliability is imperative.

**INFO-COM**—This new computer-controlled system will handle thousands of messages a day through centers at Atlanta, Chicago, New York and San Francisco. "Scotch" Brand No. 777 meets the system's exacting demands, provides quality assured performance at all bit densities.

**SICOM**—This new system for the securities industry permits subscribers to inter-connect their headquarters wire order rooms, and branches and posts on the floors of New York and American stock exchanges. Where split-second communication is vital under a giant workload, the choice is "Scotch" Brand No. 777.

**WHAT ARE YOUR NEEDS?** Find out how you can profit from the long-range, error-free reliability of "Scotch" Brand No. 777 Computer Tape. Write: Market Service Dept., Magnetic Products Division, 3M Center, St. Paul, Minnesota 55101.

**3M**  
COMPA

Who knows more about computer tape than the people who perfected it

# ARE YOU FAILING YOUR TESTING?

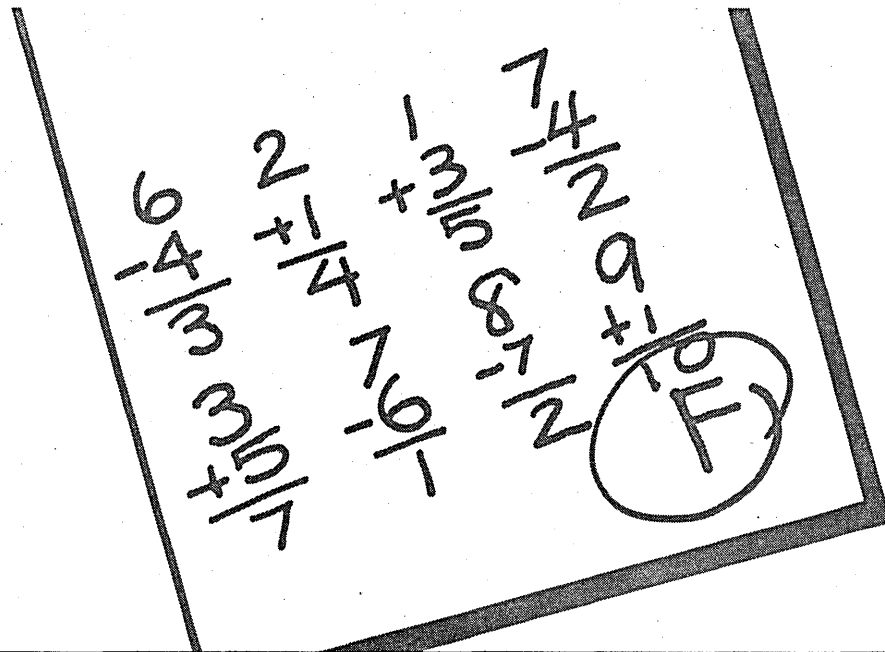

## score 100% with AUTOMATIC TESTING PROCEDURE:

### ARE YOU:

YES NO

1. Running at an efficiency of 98% clock-meter time in a testing environment?
2. Reducing test time 50% by eliminating operator intervention?
3. Selecting pertinent test data from any live file?
4. Eliminating the need for programmers to write out JCL for each test problem?
5. In complete control of all files used in the test, input or output, tape or disk?
6. Able to print selected portions of the file, not the whole file?
7. Programmatically unpacking packed fields on the printout?
8. Generating a file of any blocking factor, any record length, packing selected fields, entering binary or hexadecimal information?
9. Eliminating mounting and dismounting of tape files for each test?
10. Able to replace live data to test out of house?

**AUTOMATIC TESTING PROCEDURE = { DATASET Generator  
DATASET Printer  
DATASET Stripper } = 50% REDUCED TEST TIME**

Purchase the Automatic Testing Procedure for use at your own facility. Use the Automatic Testing Procedure free of charge at TSS Computer Center. Competitive rates such as IBM 360/50 @ \$150-180 Hr.

For further information write or call today.



SINGLE SOURCE EDP SERVICE

## TIME SHARING SERVICES, INC.

SOFTWARE, PROGRAMMING, COMPUTER TIME.

247 South Beverly Drive, Beverly Hills, California 90212 • (213) 272-1181

## MANAGEMENT . . .

be used even more profitably by applications programs through leaving more core available for larger block factors, more buffer areas and fewer overlays. This evaluation must be made early, while the hardware configuration still can be affected.

In summary, the responsibility of management is to define the cost of flexibility; then decide the probability and the profitability of use of a given degree of flexibility. Finally, using installation standards as a means of expression, a flexibility policy must be formulated.

### system design cycle

The application systems design must be evaluated with the software and the hardware—and in a lot more detail than is common. This is the key to avoid acquiring a lot of unused hardware, and to getting the hardware that is really necessary.

There is a natural evaluation cycle (Fig. 1) which should normally be repeated many times before hardware plans are finalized. One common error seems to be ordering the hardware on the basis of the most demanding application (i.e., the one needing the most core or disc capacity, etc.). This is poor economy. The goal should be to get hardware utilized as fully as possible during the computer's work day, even if this means not being able to fit the whole of the largest program into core at once.

What planning must dp management do in order to get maximum return from third-generation software? Systems, organizations and people engaged in an extremely dynamic environment are best evaluated on the basis of their ability to adjust to sudden upheavals and developments. This means that the systems designed today cannot be judged solely on the basis of today's performance. We must also take into account the ability of the system to adjust to changes in the application, in the software, in the daily

Table 1—System Software Flexibility

	1401 Tape/IOCS 2nd gen.	360/30 DOS 3rd gen.	360/50 Full OS 3rd gen.
Hardware: Non I/O machine instructions	25	96	140
Software: Important variations of system macro instructions	12	29	124
Theoretical no. of programs active at once	1	3	15
No. of choices in job control cards	5	31	130
No. of file organization methods	1	3	4
No. of programming languages in use	2	3	4
No. of choices during system generation	2	33	96
No. of pages in manuals containing system messages to edp staff	3	41	262

operational environment, and in the hardware—without costly, time-consuming reprogramming or delays.

Here is a short list of some of the background facts which must be taken into account if one expects to make correct use of third-generation flexibility. For each major project try to answer:

1. What are the total development costs expected in man-years?
2. What is the expected yearly load on the system?
3. What is the expected life of the application in years?
4. What is the frequency of the run?
5. How critical will a delay in running be in case of hardware failure?

For all projects, estimate or know:

1. Hardware and software configuration at present.
2. Expected developments in the hardware configuration, such as an increase in core size or DOS to OS

transition, and in the software.

3. Expected growth in the load on the system.

4. Expected load on system-development personnel.

When the need for a change to a dp system in the future is certain or probable, it will be far cheaper—often practically without cost—to build in sufficient flexibility so that the system can adjust without a costly reprogramming job. Fig. 2 will help to illustrate the point that the real value of

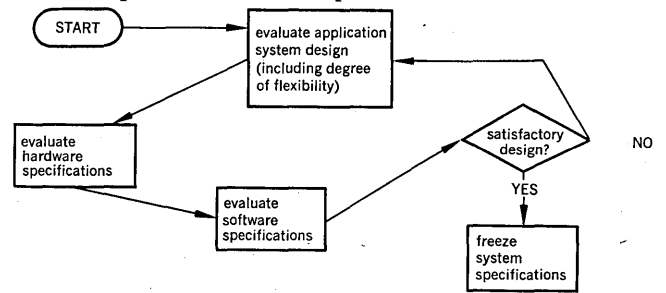

Fig. 1

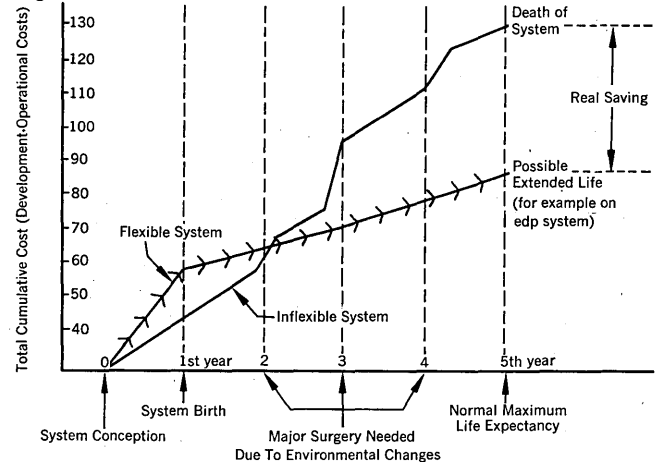

Fig. 2

flexible software, when it is used well in system design, is to reduce the total cumulative cost of an application during its lifetime.

Here are major cost considerations and questions of design which affect all departments. It is therefore the responsibility of the dp manager to formulate the demands on each system design in regard to minimum flexibility which it must have, and which will knowingly be financed and developed over and above the minimum cost of getting the system to run. It is within this framework the system designer can begin to work.

What demands can management make on the system design team? There are three stages of program preparation: system analysis, system design, and programming and testing. Analysis, if we use the term properly, is finding out *what* is to be done; design is finding out *how* it should be done; programming is *making* the specified system a reality.

# Computer Sciences Corporation has established COMPUTER SCIENCES INSTITUTE to provide updating courses for professionals in the information sciences

You're a systems designer moving up to project management. An accountant who wants to know about auditing automatic systems. Someone who wants to improve his skills in a higher language like COBOL. Or a manager who needs more background in operational systems analysis and systems design.

Whether you want to upgrade your skill, update your knowledge, or move up to a more demanding level of computer technology, Computer Sciences Institute provides that training.

The Institute is a service of Computer Sciences Corporation, largest systems engineering and computer programming organization in the information sciences. As such, the Institute is equipped to cover the total spectrum of the field, irrespective of hardware or software orientation. With the unique Structured Learning Technique, subjects are learned deeper and faster.

Further, you learn to use what you've learned on the job: How to get that line manager to go along with your new system. How to explain computer

programming to a V.P. How to understand your function better so you may be better understood.

Updating doesn't stop with the course. Once you're back on the job, you'll get follow-up material at regular intervals.

School starts May 1st. Classes will be held at Computer Sciences Institute facilities in Los Angeles and New York City. Some of the courses include:

**Systems Analysis & Systems Design:** analysis, design, implementation of systems for manual, batch processing or real-time processing; final week on individual Systems Planning Team projects, solutions to be evaluated for presentation, content and logic; heavy emphasis on systems applicable to government and business management problems. 3 weeks.

**Systems/Software Project Management:** to upgrade technical and managerial people in management techniques and methodology; performance, profit, productivity; costs, contracts, financial management reporting systems; personnel and customer relations. 1 week.

**Basic Assembly Language & COBOL:** to upgrade and expand existing language capability; covers flowcharting techniques, math systems, coding techniques; writing & testing programs (including IBM 360); COBOL; rewriting basic assembly language in COBOL; documentation techniques. 3 weeks.

For complete details on course fees, transportation and accommodations—for further information on the Institute's Executive Seminar and Management Symposia—write for brochure TA-1 today. Courses are being filled now on a first-come basis.

**Computer Sciences Institute,**  
650 North Sepulveda Boulevard,  
El Segundo, California 90245.  
Or 330 Madison Avenue,  
New York, New York 10022.

CIRCLE 28 ON READER CARD

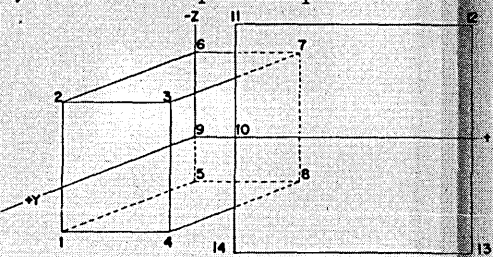

IF CHGCODE = 12 MOVE NRDEPENDENTS TO

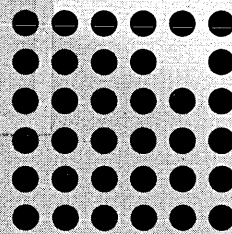
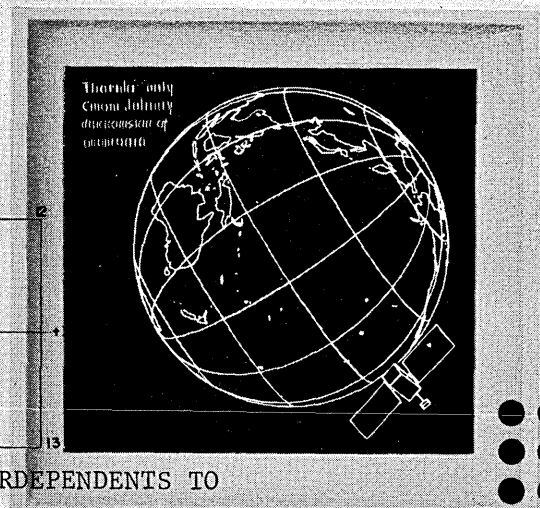

Computer Sciences Institute

## MANAGEMENT . . .

As we know, the people called systems analysts actually do some of the work called system design and, in some cases, so do the programmers. Now, as long as a system design was relatively simple, and as long as there were few design alternatives to choose from, this was a very workable arrangement.

But third-generation software systems, because of their far greater flexibility, demand that management give far more attention to the system design function. The three personnel categories should in this case be defined as follows:

1. Systems analysts: fact-gathering people who know a business well, and who try to determine what data processing must be done.
2. Systems designers: creative, experienced dp specialists who can determine the best available over-all solution to an application.
3. Programmers: people who code and test single programs, and are responsible for the *program* design as opposed to the *system* design.

### training of systems designers

Systems designers must have a great deal of training in the concepts of third-generation software; they must be "machine-oriented." The new systems have such a great number of possibilities, far more than we can handle mentally, that being "machine-oriented" can stimulate the imagination.

Systems designers should be trained thoroughly in the concepts of the operating system and data management. Their programming training should be either assembly language or PL/I, and certainly should not be limited to second-generation languages such as COBOL or FORTRAN. Mod-

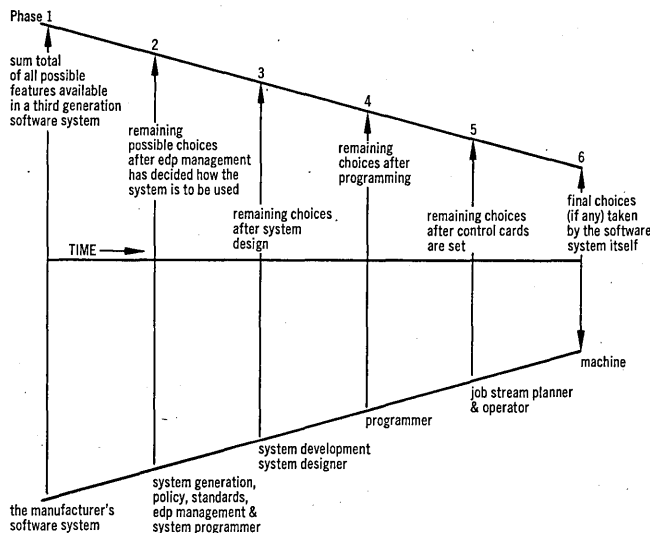

Fig. 3

ern systems designers have to be machine-oriented enough to know about bit manipulation and the techniques of field compression. If they don't, a firm may pay three times as much as it should for hardware, and the systems could function at half the possible speed.

### decision documentation

All design is cyclic in nature: it goes through a series of iterations as shown in Fig. 1. Older systems also go through this same cycle when outer circumstances force a change in one or more of the three main elements of the applications, hardware, or software.

The design process is one of making a series of decisions about the use of software and hardware, and then reviewing and comparing these decisions, to obtain the best *total* design.

Obviously, it is important to remember why a design decision was made; otherwise a serious error could be made, and decision A changed to fit in with decision B, forgetting that A has a critical effect on decision C. This results in poor design. This is no problem if the number of people involved is about one, the time under a week, and the number of decisions under ten. However, modern systems involve many people, hundreds of decisions and great spans of time, measured in months and years.

This is why it is most important to begin to document the reasons for every important point in the decisions. Decision documentation should be a natural part of the system. The dp manager, the systems manager, the project manager, the programming manager and the operations manager will find decision documentation an invaluable tool in many key phases of dp work.

### demands on the programmers

The programmer takes over where the system designer leaves off, even if the two functions are carried out by the same man.

Programmers design an important part of the system: the program. They are usually bound by previous system design decisions, but they can make quite a few important decisions themselves. The reasons for these decisions need to be documented just as much as decisions made by the system designer. The programmer is the last man to touch the system before it goes into production. The *program* design of third-generation programs has a great effect on the operations department, which has to manipulate the control cards and other system devices in order to achieve highest productivity and greatest security of results. It is one of the unfortunate facts of the third-generation that few if any programmers or their managers seem to be aware of this fact, or make any conscious effort to design programs which allow a rational use once they go into production.

At present, flexibility is so great and programming training so poor that most programmers don't know how to use nearly all of the theoretical possibilities. This may, of course, be counted as a blessing. The programmer can thus ignore large portions of the facilities, but they are available to him when he needs them.

### programming languages

The typical third-generation software system offers a variety of programming languages: an assembly language, COBOL, FORTRAN, a report generator, and possibly an advanced high-level language, such as PL/I. With early software, in an attempt to produce a large number of programs in a short time, it has been the practice for a large number of users to use mainly COBOL.

In the long run, this decision will tend to prevent us from using third-generation systems to any greater extent than second-generation systems. Program design and system design become tied to the framework of a second-generation language.

Few owners of third-generation dp systems utilize their full potential and full flexibility as yet. But they pay the high costs and complain. This situation can be excused in a transitional learning period, but from now on we must teach ourselves to far better utilize these systems. A great many of the methods used to solve these common problems can best be obtained through extensive exchange of ideas within user groups and through a more active guidance by the manufacturers—who must be prepared to put the long-term interest of their customers before their own short-term objectives. ■





3-week delivery...

on the standard 1  $\mu$ -sec  
I/C memory system  
that packs 1/2 million  
bits in a single  
5 1/4" high unit.

That's the ICM-40. A fast, highly reliable core memory system that's ready to meet your system requirement.

And when you say so, we'll give you 3-week CFS (Certified Fast Shipment) under our accelerated shipment plan.

What's more, the ICM-40 is a standard product... a proven performer with over 5,000 hours of life test without failure. Plus, some 400 actual installations; same success rate. What you'd expect from the most experienced memory maker.

**I/C Construction** — The ICM-40 is a 1 microsecond, full-cycle, magnetic core memory designed for operation as a high-speed random-access store. It is a basic system module that takes maximum advantage of the high reliability and low power consumption of integrated circuitry.

**Packaging** — Compactness and a high degree of maintainability are achieved in the ICM-40 design by packaging all of the circuitry on readily accessible, removable circuit modules.

**Capacity** — The ICM-40 packs nearly 1/2 million bits in a single 5 1/4" high module. The basic unit can be specified for up to 16K words, 4-26 bits per word. It's big brother, the ICM-40E with capacities of 32K words, 4-78 bits per word is available with 60-day CFS.

If you've drawn a block marked "core memory" recently, why not find out more about the ICM-40/40E. You'll be pleased by their versatility. And the standard-product pricing. And our Certified Fast Shipment commitment.

Now, don't you think it's about time you called us? Or, write Honeywell, Computer Control Division, Old Connecticut Path, Framingham, Massachusetts 01701.

**Honeywell**

 **COMPUTER CONTROL**  
DIVISION

CIRCLE 29 ON READER CARD

**It took 12 IC boards...  
a 2 $\frac{1}{2}$ D core memory...  
and plenty of new ideas  
to bring you  
an 880 Nanosecond Digital  
IC Computer with 4K memory  
—expandable to 64K  
SCC's 2700 is out!**

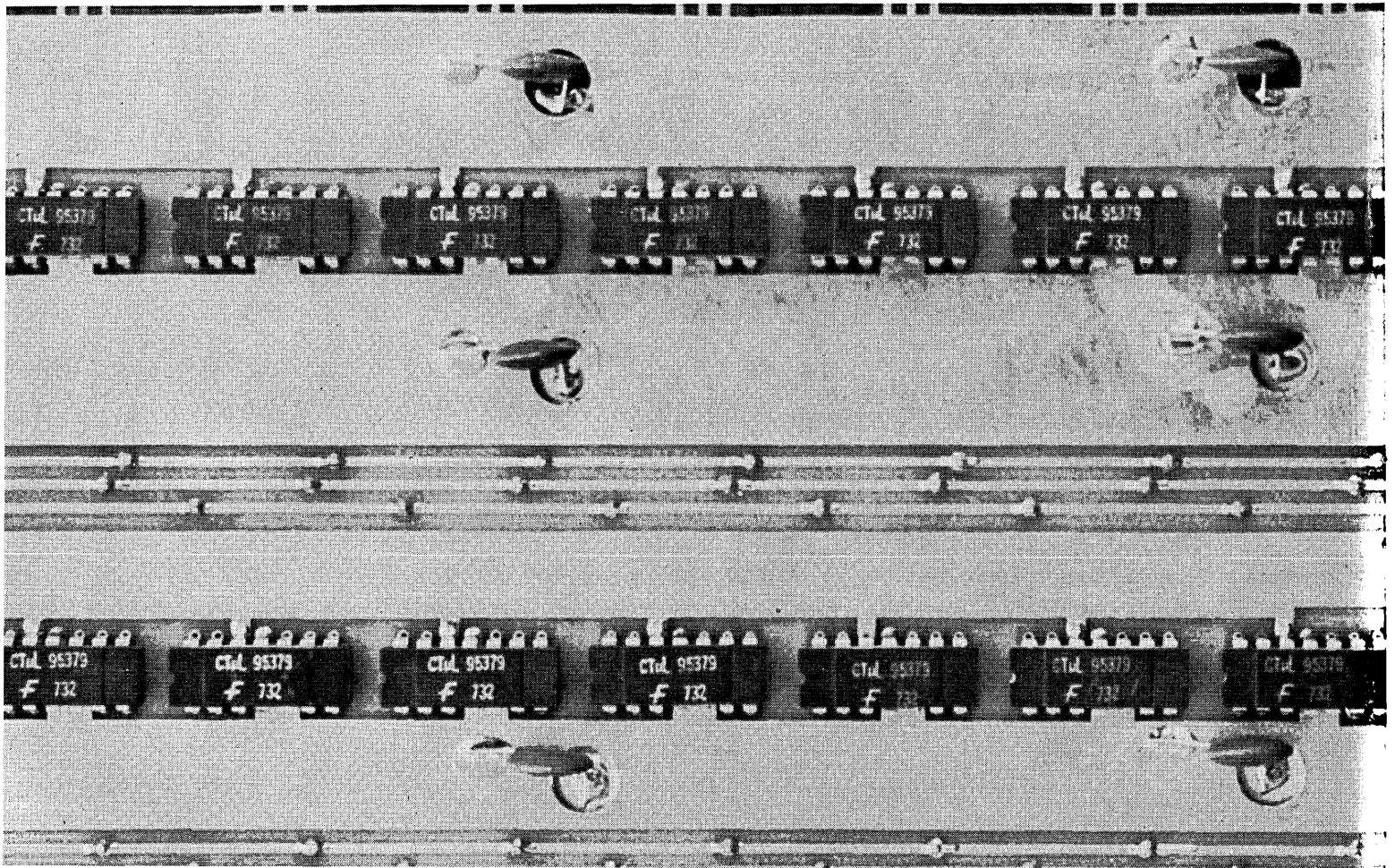



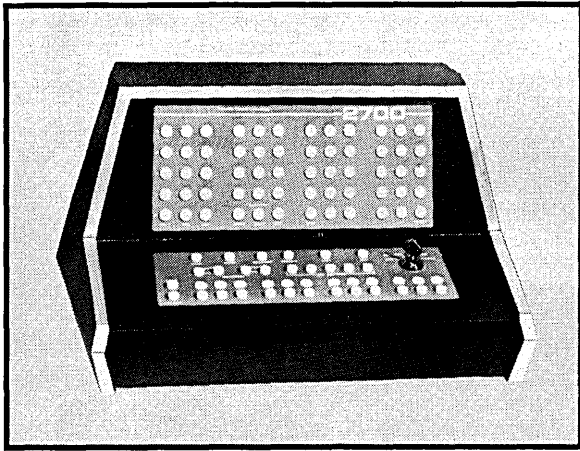

Optional remote control console lends versatility to the general purpose installation where operator or programmer needs ready access to controls.

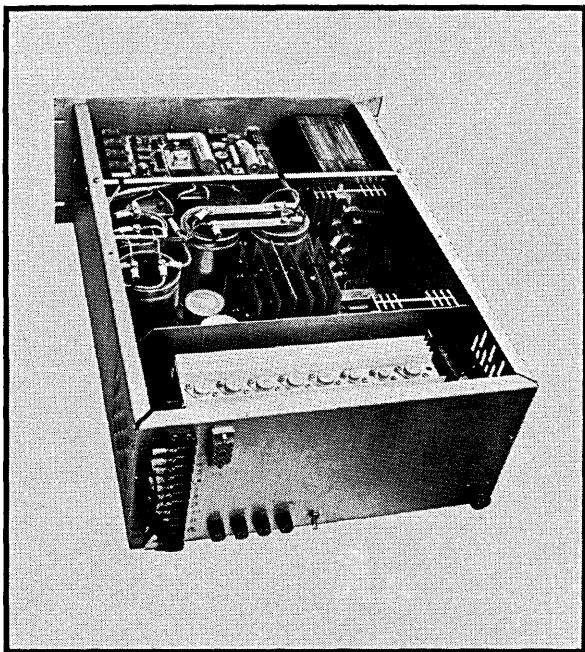

Unique power supply design for optional power failure protection. Insures program integration in the event power system fails. The SCC 2700 is not affected by power interruptions of less than 20 milliseconds duration. Power interruptions longer than 20 milliseconds generate a power failure interrupt. Reserved power permits 15 milliseconds normal operation after the detection of power failure.

**TWICE AS FAST . . . MORE POWERFUL . . . WITH A COST/PERFORMANCE RATIO UNMATCHED BY ANY MACHINE IN ITS SIZE CLASS — THAT'S SCC'S FULLY INTEGRATED 2700 DIGITAL COMPUTER!**

Here's a new dimension in reliability and maintainability. SCC engineers have designed a basic 12-board machine with double precision and floating point arithmetic option — each containing "register slice" arrangement of major subassemblies. Internal sequence control has been greatly simplified by the use of a "read only memory" feature.

Call your nearest SCC regional office and let us show you how this equipment will solve your problems with data acquisition systems, process controllers, bio-medical applications, remote terminals, and self-contained time-sharing utilities.

## FEATURES:

**HIGH SPEED MEMORY** — 2½D 4,096 core memory with 880 ns cycle time completely asynchronous to the CPU. Memory capacity expandable to 65,536 words. Optional memory parity.

**MICROPROGRAMMABLE** — For improved reliability and maintenance. Permits optional instruction sets such as floating point arithmetic to be added at modest cost.

**HARDWARE INDEX REGISTER** — Provides address modification for memory reference instructions, and is valuable aid in logical and shift operations.

**VERSATILE I/O** — Both partyline and buffer channels available with up to 32 duplex devices per channel.

**MAPPING AND PROTECTION** — Optional feature provides two memory maps for system and user. Allows implementation of multiprocessing systems with full memory access control.

**PRIORITY INTERRUPTS** — Fully nested; permits external device to command computer to enter specific subroutine.

**INSTRUCTIONS** — 78 standard instructions plus micro-instructions; full 16 OP codes.

See us at Booth BB at the FJCC.

**HUNTSVILLE**  
205 / 881-8805

**LOS ANGELES**  
213 / 272-9311

**WASHINGTON, D.C.**  
301 / 779-2510

**DALLAS**  
214 / 241-2111

The understandables . . . from

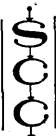

# Scientific Control Corporation

P. O. Box 34529 • 14008 Distribution Way • Dallas, Texas 75234 • 214 — 241-2111

# In a class by itself!

In one testing program after another conducted by various groups, private organizations, companies of every size . . . the superb performance of U.S. Tape with Duramil 7 has been setting entirely new standards\* for digital computer tape. Let it set some for *you* . . . soon.

**\*For example, U. S. Tape is the only one that conforms to Interim Federal Specification WT-0051A, as amended, both Type I and Type II.**



**U. S. Magnetic Tape Company**  
**Huntley, Illinois 60142**

*A Subsidiary of Wabash Magnetics, Inc.*



See us at **Booth 1010**  
Spring Joint Computer Conference

# CHESS AND THE COMPUTER

by FREDERICK J. MOULLEN

□ A recent news item states that the first international computer chess match between the Soviet Union and the United States has been completed. The match lasted over a year, and of four games, two were won by the Soviet computer and two ended in draws. The exciting fact about these games is not really who won, but the fact that one of man's most electronically sophisticated inventions is now "playing" at one of man's most intellectually sophisticated games.

The idea of a chess-playing machine was fascinating to certain men before electricity was much more than a word. One of the more famous men to really analyze the possibility (although negatively) of adapting a machine to the game of chess was Edgar Allen Poe. In an essay of 1835, entitled "Maelzel's Chess-Player," Poe attempted to expose a purported chess-playing automaton as a hoax. Poe's contention (which was correct) was that the chess-player being exhibited in the United States by a promoter named Maelzel was not in fact a "pure machine," but concealed a small man skilled at playing chess. A relevant passage from Poe's essay, after mentioning various clockwork automata, continues:

But if these machines were ingenious, what shall we think of the calculating machine of Mr. Babbage? What shall we think of an engine of wood and metal which can not only compute astronomical and navigation tables to any given extent, but render the exactitude for its operations mathematically certain through its power of correcting its possible errors? What shall we think of a machine which can not only accomplish all this, but actually print off its elaborate results, when obtained, without the slightest intervention of the intellect of man? It will, perhaps, be said in reply, that a machine such as we have described is altogether above comparison with the Chess-Player of Maelzel. By no means—it is altogether beneath it—that is to say, provided we assume (what should never for a moment be assumed) that the Chess-Player is a *pure machine*, and performs its operations without any immediate human agency. Arithmetical or algebraical calculations are, from their very nature, fixed and determinate. Certain *data* being given, certain results necessarily and inevitably follow. These results have dependence upon nothing, and are influenced by nothing but the *data* originally given. And the question to be solved proceeds, or should proceed, to its final determination, by a succession of unerring steps liable to no change, and subject to no modification. This being the case, we can without difficulty

a short history

conceive the *possibility* of so arranging a piece of mechanism, that upon starting it in accordance with the *data* of the question to be solved, it should continue its movements regularly, progressively, and undeviatingly toward the required solution, since these movements, however complex, are never imagined to be otherwise than finite and determinate. But the case is widely different with the Chess-Player. With him there is no determinate progression. No one move in chess necessarily follows upon any one other. From no particular disposition of the men at one period of a game can we predict their disposition at a different period. Let us place the *first move* in a game of chess, in juxtaposition with the *data* of an algebraical question, and their great difference will be immediately perceived. From the latter—from the *data*—the second step of the question, dependent thereupon, inevitably follows. It is modelled by the *data*. It must be *thus* and not otherwise. But from the first move in the game of chess no especial second move follows of necessity. In the algebraical question, as it proceeds toward solution, the *certainty* of its operations remains altogether unimpaired. The second step having been a consequence and so on, *and not possibly otherwise*, to the end. But in proportion to the progress made in a game of chess, is the *uncertainty* of each ensuing move. A few moves having been made, *no step*

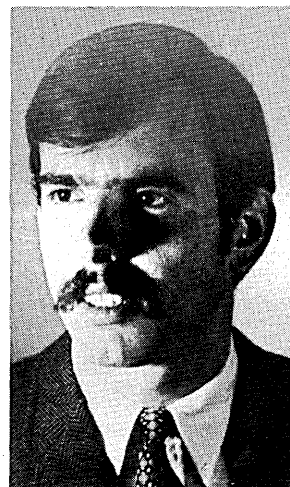

Mr. Moullen, after serving with the U.S. Marine Corps in the field of communications, is currently working toward a B.A. in English at the Univ. of California, Santa Barbara.

## CHESS AND THE COMPUTER . . .

is certain. Different spectators of the game would advise different moves. All is then dependent upon the variable judgment of the players. Now even granting (what should not be granted) that the movements of the Automaton Chess-Player were in themselves determinate, they would be necessarily interrupted and disarranged by the indeterminate will of his antagonist. There is then no analogy whatever between the operations of the Chess-Player, and those of the calculating machine of Mr. Babbage, and if we choose to call the former a *pure machine* we must be prepared to admit that it is, beyond all comparison, the most wonderful of the inventions of mankind.<sup>1</sup>

### babbage and chess

After reading the above paragraph, the question arises whether or not Babbage himself ever gave any thought to the idea of machine chess play. A clue is given in a little book *The Author of the Analytic Engine*, by David W. Kean.<sup>2</sup> On page six, the author quotes a man named John Lee as having written on the last page of a copy of Babbage's *Passages from the Life of a Philosopher*, "I understand a great deal of the work, but not the whole. Inter alia—I can not understand how an automation [sic] without a live man with him can play a game of chess. . . ." In *Charles Babbage and His Calculating Engines*<sup>3</sup> Babbage is quoted as having written, "After much consideration I selected for my test the contrivance of a machine that should be able to play a game of purely intellectual skill successfully; such as tit-tat-toe, drafts, chess, &c." He then goes on to give a short description of his thoughts on the subject of chess. He says:

On the first part of my inquiry I soon arrived at a demonstration that every game of skill is susceptible of being played by an automaton.

Further consideration showed that if *any position* of the men upon the board were assumed (whether that position were possible or impossible), then if the automaton could make the first move rightly, he must be able to win the game, always supposing that under the given position of the men, that conclusion were possible.

Whatever move the automaton made, another move would be made by his adversary. Now this altered state of the board is *one* amongst the *many positions* of the men in which, by the previous paragraph, the automaton was supposed capable of acting.

Hence the question is reduced to that of making the best move under any possible combinations of positions of the men.

Now the several questions the automaton has to consider are of this nature:—

1. Is the position of the men, as placed before him on the board, a possible position? That is, one which is consistent with the rules of the game?
2. If so, has Automaton himself already lost the game?
3. If not, then has Automaton won the game?
4. If not, can he win it at the next move? If so, make that move.

5. If not, could his adversary, if he had the move, win the game?
6. If so, Automaton must prevent him if possible.
7. If his adversary cannot win the game at his next move, Automaton must examine whether he can make such a move that, if he were allowed to have two moves in succession, he could at the second move have *two* different ways of winning the game;

and each of these cases failing, Automaton must look forward to three or more successive moves.

Now I have already stated that in the Analytical Engine I had devised mechanical means equivalent to memory, also that I had provided other means equivalent to foresight, and that the Engine itself could act on this foresight.

In consequence of this the whole question of making an automaton play any game depended upon the possibility of the machine being able to represent all the myriads of combination relating to it. Allowing one hundred moves on each side for the longest game at chess, I found that the combinations involved in the Analytical Engine enormously surpassed any required, even by the game of chess.

That seems to be as far as Babbage analyzed the matter, apparently never seriously considering the prohibitive time his mechanical contraption would have consumed in analyzing each move. (Babbage himself dates these thoughts as occurring sometime after Lady Lovelace's translation of Menabrea's memoir of 1842.)

It might be interesting at this point for the reader to compare Babbage's view on machine chess-play with Poe's argument against it. In such a comparison, Poe's ability in literary persuasion stands out. Compared to Babbage, his

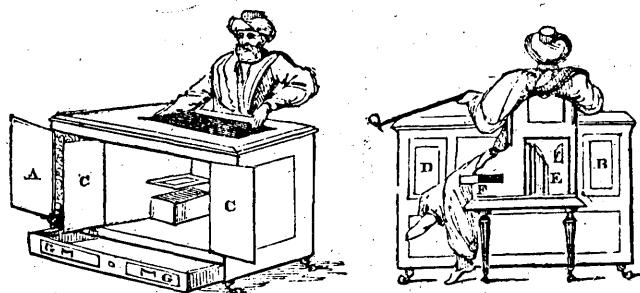

Fig. 1

argument is both more understandable and more credible, but in retrospect we can see that Babbage was closer to the truth.

### the original

The Chess-Playing Automaton promoted by Maelzel was a fascinatingly specious device originally built by a Baron von Kempelen in Presburg, Hungary in 1769. It attracted much attention throughout Europe and during its career defeated some very famous men: George III, Frederick the Great, and even the great military strategist Napoleon, who, incidentally, made several unsuccessful attempts to cheat.

The supposed "pure machine" derived its mechanical-like abilities from a diminutive human being, probably a midget or series of midgets, considering the long life of the device. The person inside the Chess-Player—who almost never lost a game of chess—played against an opponent from the paying audience who was seated at a different table. Maelzel acted as a go-between, watching the move made by the automaton and then duplicating that move on the challenger's board, and vice versa. The man inside was able to simulate the workings of a machine through

<sup>1</sup>Poe, Edgar A., *Works of Edgar A. Poe, Volume IX* (New York, 1914), pp. 176-179.

<sup>2</sup>Kean, David W., *The Author of the Analytic Engine*. Copies are available at \$1.00 each (including tax and mailing) from Thompson Book Co., Nat'l Press Bldg., 14th & F Sts. N.W., Washington, D. C.

<sup>3</sup>Morrison, Philip and Emily, *Charles Babbage and His Calculating Engines*, New York: Dover Publications, 1961.

the use of a kind of pantograph which moved the arm of a dummy seated on the outside of the Chess-Player (see Fig. 1). Magnetized chessmen activated indicators to reveal moves to the concealed player, who recorded these moves on his own board.

The idea of a machine that could play chess was a fascinating one before, during, and after Poe's time. Many people believed Maazel's Chess-Player to be a "pure machine." Poe asserted that if the Chess-Player were real, it would be "the most wonderful of the inventions of mankind," and indeed it has taken the modern electronic computer to make a true chess-playing automaton possible.

#### more automata

In an article entitled, "A Chess-Playing Machine," Claude Shannon discusses previous chess-playing machine attempts.<sup>4</sup> Of one he says:

A more honest attempt to design a chess-playing machine was made in 1914 by a Spanish inventor named L. Torres y Quevedo, who constructed a device that played an end game of king and rook against king. The machine, playing the side with king and rook, would force checkmate in a few moves however its human opponent played. Since an explicit set of rules can be given for making satisfactory moves in such an end game, the problem is relatively simple, but the idea was quite advanced for that period.

A more elaborate automaton was not to be expected in the pre-electronic era. Shannon, in the same article, per-

<sup>4</sup>Shannon, Claude, "A Chess-Playing Machine," *Scientific American*, February, 1950.

haps made the first proposal, after Babbage, to program a general purpose computer to play chess. Shannon's prophetic proposal laid the foundation for the computer-chess work of today:

The problem of setting up a computer for playing chess can be divided into three parts: first, a code must be chosen so that chess positions and the chess pieces can be represented as numbers; second, a strategy must be found for choosing the moves to be made; and third, this strategy must be translated into a sequence of elementary computer orders, or a program.

Shannon's idea called for a digital representation of pieces and positions, that could be "stored in the numerical memory of a computing machine."

However, the most difficult problem was deciding on a strategy of play. It has been estimated that there are  $10^{120}$  possible moves in the average game of chess; therefore, some method of move selection, Shannon surmised, was necessary. A computer would have to analyze, as a human does, only those move combinations which would be both legal and purposeful. In addition to this, such factors as "the mobility and placement of pieces, the weakness of king protection, the nature of the pawn formation, and so on," said Shannon, would have to be taken into account. He felt that reducing strategy to a sequence of orders which could be translated into the machine's language, would be relatively straightforward.

The advantages for machine chess-play, over human play, are fairly obvious. The disadvantages, Shannon saw, are the lack of flexibility, imagination, and learning capacity inherent in the mind of the human chess player.

In his book, *The Human Use of Human Beings*, Norbert Wiener writes:

(Cont. on p. 68)

**You get results with RUSH.\***

**The powerful Time-Sharing system built by a hard-core team who knew what they wanted and what a computer could do.**

**RUSH** is the first fully operational system for commercial and scientific access to a time-shared IBM 360/50. **RUSH** is now being used in the computer oriented segments of manufacturing, finance, insurance, utilities, education, and transportation. Lease the **RUSH** system on your hardware for immediate in-house Time-Sharing or use **RUSH** at our Data Centers via remote terminal.

**LOS ANGELES OFFICE:** Century City Gateway East, 1800 Avenue of the Stars, Los Angeles, California 90067. Phone 213/277-1600.

**PALO ALTO OFFICE:** Stanford Financial Center, 2600 El Camino Real, Palo Alto, Calif. 94306. Phone 415/328-0671.

**NEW YORK OFFICE:** 866 United Nations Plaza New York, New York 10017. Phone 212/758-5505.

**ALLEN-BABCOCK COMPUTING, INC.**

\* (Remote Use of Shared Hardware) trade-mark of Allen-Babcock Computing, Inc.

# NEW PORTABLE PRINTING PUNCH

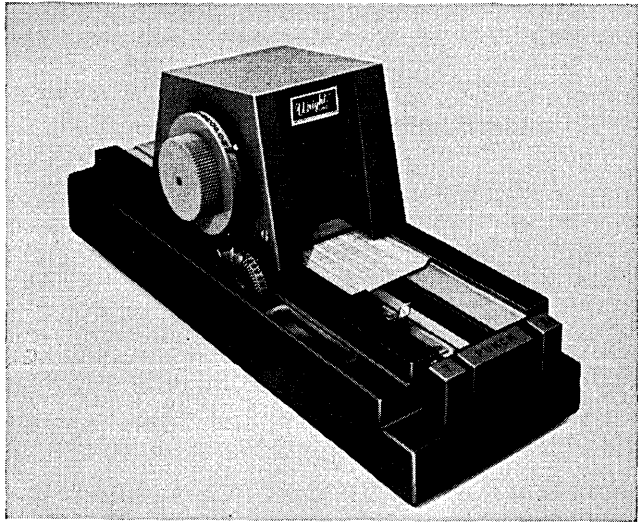

Now for the first time . . . a portable card punch that prints each character along the top of the card simultaneously as it is punched.

Wright Line's new model 2629 Alpha-Numeric Printing and Tabulating Punch is the first and only fully manual punch that has the ability to print alphabetic, numeric and special characters and also to tabulate like a typewriter.

Operation is simple. Just turn selector dial to desired character, depress the punch bar and card is printed and punched.

Six adjustable tab stops make it possible to program the punch so that it will automatically space to preset locations by depressing the tab key.

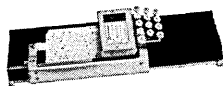

**Model 2600**

A reliable, accurate and inexpensive portable card punch without the printing feature. Exceptionally fast operation for straight numeric punching.

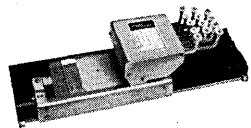

**Models 2610 and 2620**

Plastic card punches for punching Hollerith-type coding into plastic credit cards and identification badges.

For a free copy of new bulletin describing all Wright Line portable punches, circle the reader service number.

A Division of Barry Wright Corp.  
160 Gold Star Boulevard  
Worcester, Mass. 01606



CIRCLE 33 ON READER CARD

## CHESS AND THE COMPUTER . . .

I am willing to accept Shannon's conjecture that such a machine would play chess of a high amateur level and even possibly of a master level. Its game would be stiff and rather uninteresting, but much safer than that of any human player.<sup>5</sup>

For readers interested in a more detailed study of computer-chess programs in the 1950's, the article "Chess-Playing Programs and the Problem of Complexity" by Newell, Shaw, and Simon<sup>6</sup> is suggested. I will attempt only to give a brief summary of those programs.

In 1950, A. M. Turing drew from Shannon's specifications a program that was simple enough to simulate by hand, without the aid of a digital computer. In its only published game, the program lost to a weak chess player who was not familiar with the program. Turing's program was not much of a chess player, but it was a step forward.

In 1956, at Los Alamos, a MANIAC I was programmed to play chess. To keep computation time down, a board of six squares by six squares was used instead of the regular eight by eight. A move could be made every twelve minutes. The size of the program was small, only 600 words, but it was able to beat a weak human player.

Alex Bernstein, in 1957, built a program for an IBM 704. It considered only a fraction of legal alternatives and continuations. Bernstein also used a series of sub-routines that helped in proposing the moves to be considered. It proved to be a more sophisticated player than its predecessors. It took 7,000 words of instructions, averaged about eight minutes per move, and like the Los Alamos program, explored continuations two moves ahead. In the two games reported to have been played, it proved to be a passable amateur though blind spots were evident in its play.

Newell, Shaw, and Simon's program was organized in terms of a set of goals. These goals are "conceptual" units of chess such as center control, king safety, and material balance. They summarize their own program.

Each goal has several routines associated with it:

1. A routine that specifies the goal in terms of the given position;
2. A move generator that finds moves positively related to carrying out the goal;
3. A procedure for making a static evaluation of any position with respect to the goal, which essentially measures acceptability;
4. An analysis move generator that finds the continuations required to resolve a situation into dead positions.

At the time of their article (1958), only hand simulation had been attempted with the program. In looking ahead, they felt that a computer "that plays chess successfully will use heuristics generically similar to those used by humans."

Now, almost 200 years after Baron von Kempelen built his "original" chess machine, two of the world's most technically advanced countries are playing international chess: machine versus machine. If Poe were still alive today, he might want to argue that man is still "inside" the machine. The future, however, would probably prove him wrong again. From all indications, it appears entirely possible that a computer can be programmed to "play" a perfect game of chess without any further assistance from its designers. ■

<sup>5</sup>Wiener, Norbert, *The Human Use of Human Beings*, New York: Doubleday & Company, Inc., 1954.

<sup>6</sup>Newell, Allen, "Chess Playing Programs and the Problem of Complexity," *IBM Journal of Research and Development*, 2(4):320-335.



# Multi-National Computer Utility Network Announced by University Computing Company



*Dallas Mayor Erik Jonsson and Sam Wyly, University Computing Company President, activate circuit linking a UCC computer in Dallas with a UCC computer in London, England. Sir Gilbert Inglefield, Mayor of London, performed the same action there.*

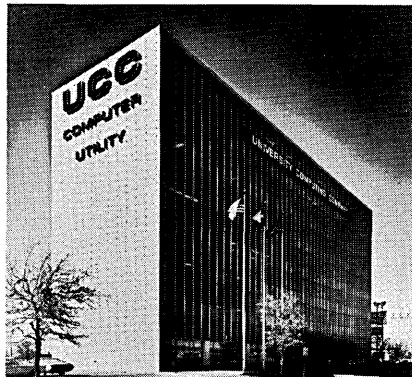

## Dallas-London Computer-to-Computer Communications Link Demonstrated

University Computing Company dramatically demonstrated its concept of a multi-national computer utility network during the dedication of its new World Headquarters Building in Dallas, Texas.

A UCC computer in the Dallas World Headquarters was linked, via the Early Bird Satellite, with a UCC computer in the company's CSB Computer Centre in London, England. The transmission was instantaneous.

Activating the operation of the circuit were Dallas Mayor Erik Jonsson and the new Lord Mayor of London, Sir Gilbert Inglefield, who exchanged messages of greetings and congratulations.

## \$100,000,000 Growth Plans

Through 1970, University Computing will have made a capital investment in excess of 100 million dollars to establish and equip computer centers around the world.

Customers all over the world are served by

UCC through its computer network. These customers are connected to one of UCC's Computing Centers, which are located in strategic metropolitan areas in the U.S. and U.K.

UCC's large time-sharing computers are currently linked with each other, and with dozens of computer terminals and computers of various sizes, through the tele-communications common carriers.

## UCC Offers Total Computer Services

University Computing provides a complete range of computer services for all types of businesses and other institutions. UCC operates in the United Kingdom through Computer Services, Ltd.

This unique company's in-depth capabilities include:

- Large-scale computer utility centers.
- Scientific systems design and programming.
- Business systems design and programming.
- Hardware design, manufacturing and maintenance.
- Software systems design and manufacturing.

Some of the specific areas in which UCC functions for its customers are:

## Computer Utilities Group

The scientific and engineering fields are serviced by the Computer Utilities Group and its large on-line computers. This includes such services as computer-oriented petroleum consulting by a subsidiary — D. R. McCord and Associates — with its mathematical reservoir models which can predict the best development and operating plan for any reservoir.

## Data-Link Group Services Businesses

The Data-Link Group, composed of centers utilizing medium-sized computers, specializes in commercial and business-oriented computer services. Specialty departments such as Mort-

gage Systems Company provide computer services for mortgage loan accounting systems, savings and loan systems and banking.

## Computer Industries, Inc.

Computer Industries, Inc., is the manufacturing arm of UCC. It manufactures input-output devices, including the COPE .45, which has a throughput vastly more efficient than other remote terminals in use today. A new time-sharing system known as FASBAC is now under development. It will help bring the full capacity of large on-line computers to individual users anywhere.

## Computer Leasing Company

UCC, through its Computer Leasing Company subsidiary, specializes in the computer leasing and financing field. This subsidiary leases computers of all manufacture, providing customers with computer equipment without large capital investment.

## Faster, More Economical Solutions

Under this total computer services concept, UCC offers increased productivity for knowledge workers and convenient access for all customers—via terminals—to the largest computers available today, and the customer pays only for what he uses.

The blending of all of UCC's capabilities provides customers with faster and more economical solutions to all types of computer-solving problems.

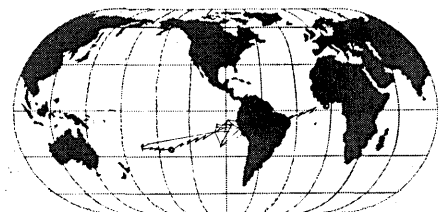

UNIVERSITY COMPUTING COMPANY, WORLD HEADQUARTERS, 1949 N. STEMMONS FREEWAY, DALLAS, TEXAS

# 'EDP' RECORDS BURIED?

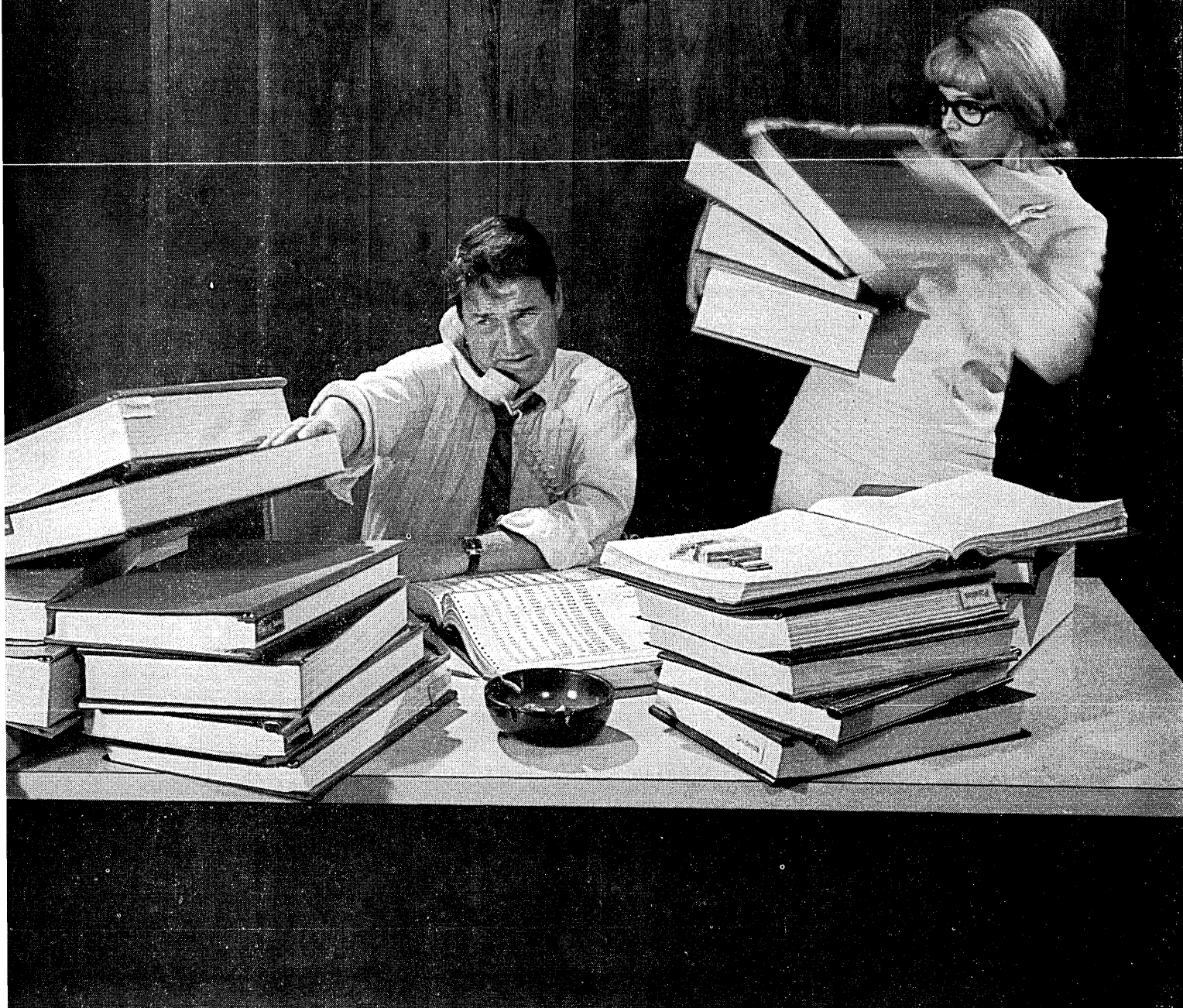

## WILSON JONES "DATA-RACK"<sup>TM</sup> brings new

Have you only gone half way in modern methods of housing, referring to and retrieving the data on your marginal-punched sheets? If so, you are not taking full advantage of your Nylon Post Binders.

"Data-Rack" uses the suspension principle to file Nylon Post Binders in the easiest to-get-at and easiest to-refer-to system ever developed.

"Data-Racks" come in two sizes. They hold binders with 14<sup>7</sup>/<sub>8</sub>" x 11" sheets—burst or unburst—or any smaller size. 162 Wilson Jones Nylon Post Binders of more than 20 sizes can be adapted with inexpensive, easy to insert or

remove, hanger sets for "Data-Racks" in less than a minute.

"Data-Rack" Outfits consist of a rack and movable floor stand. 6 Hanger Sets with each rack. Racks are available without stands for counter or desk top use. Handsome beige finish. All steel construction. Ball-bearing casters.

## WILSON JONES



A Division of *Swingline*® Inc.

6150 TOUHY AVENUE · CHICAGO 60648



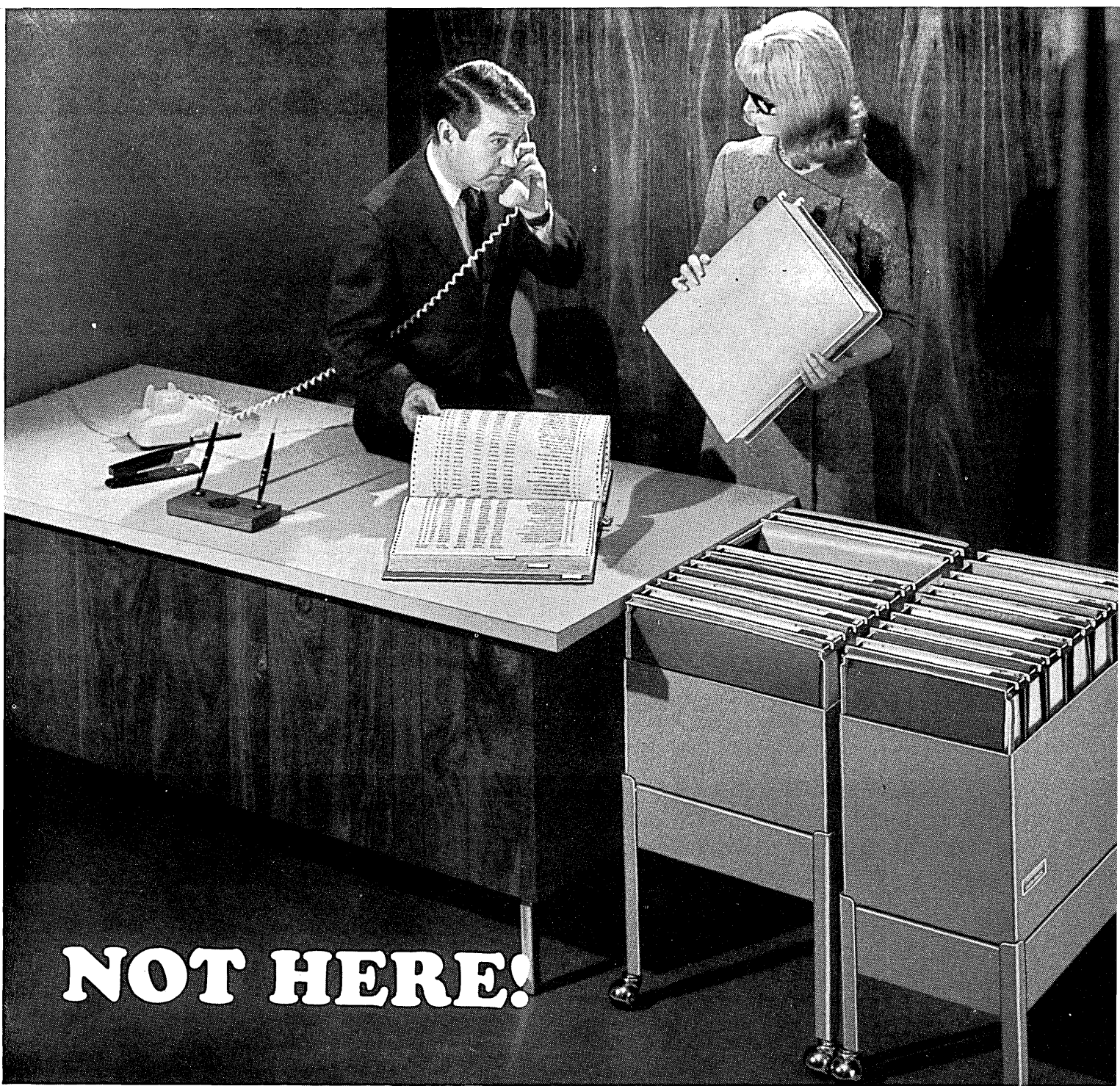

**NOT HERE!**

order to printouts in Nylon Post Binders

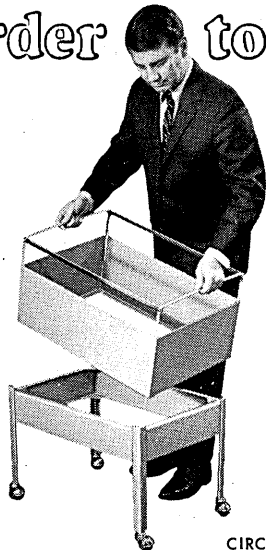

Ask your office  
or "tab" supply  
dealer for full in-  
formation today  
...or mail this  
coupon.

CIRCLE 35 ON READER CARD

DE-3

Wilson Jones  
6150 Touhy Avenue  
Chicago, Illinois 60648

Gentlemen:

Please send me complete information on the brand-new "Data-Racks."

Name \_\_\_\_\_

Company \_\_\_\_\_

Address \_\_\_\_\_

City \_\_\_\_\_ State \_\_\_\_\_ Zip \_\_\_\_\_

# THE END OF OS

thousands wept

At SHARE MCCXXVIII, held recently at the Sirius Hilton, the chairman of the Archaeology Project reported on its just-completed field trip to the diggings at the site of the former San Francisco Hilton, reputedly the location of SHARE XXVIII in 1967. Among the many interesting items uncovered was a bit of prophecy which could have been titled "OS-1984." Regrettably, the identity of the author is lost to history. Here is that narrative.)

 In the first few months of the year that System/360 Operating System came to a full stop, all signs appeared normal and there was no indication of an impending disaster. The SDD Manager of programming systems stated at the spring SHARE meeting that the J Level of FORTRAN V would definitely be implemented, and would at least equal the speed of the E Level FORTRAN V subset, provided it was run on a Model 75 or greater. There was no truth, he asserted, to the rumor that IBM was dropping FORTRAN in favor of PL/3. Option 89, or MVC (multiprogramming with a variable number of cpu's), which had been released in System Release 101.8, was hailed by a large number of users as the ultimate in operating systems. Representatives of a major government agency, which had been running a Model 91 with 8 million bytes using a modified BPS supervisor, lodged a mild protest but were shouted down by the majority.

On April 1, an announcement by the Management Information Department of DPD caused quite a stir. Their Management Action Optimization (MAO) program would be written using the new Linear Interpretation Nucleus (LIN), part of DOS extended. This occurred, it was rumored, in spite of persistent efforts by the Marketing Verification Department (MVD) to persuade them to use OS. This department, sometimes called the Red Guard or simply "the butchers," is charged with "purification" of Type II programming standards.

There were indications, however, that something was in the air. The OS Internals Workshop was extended from 13 weeks to 26 weeks. A resident psychiatrist was installed to try and cut down on nervous breakdowns, defections, and AWOL's. A blue letter advised salesmen that "throughput" and "turnaround time" were now *verboten* in the company's vocabulary. The byword was to be "full utilization of system resources." At all costs customers were to be discouraged from asking, "But when will my job be completed?"

Release 91.0 contained a module of the nucleus that stopped the software clock during system overhead time. Murmurs about the difference between meter time and time-accounted-for led to removal of all meters and a shift from a 176-hour base to 264 hours per month. And dissatisfaction increased. One large scientific/engineering/commercial customer announced his intention to switch to a

competitor, but after two years was unable to do so because he could not discover exactly what his system was doing.

The end finally came in mid-October. System Release 110.7 was distributed, which converted everyone to MPSS (Multiple Priority Scheduling System), which combined the following control program options:

- Multiprogramming with a variable number of tasks
- Multijob initiation
- Multiple priority selection
- Multiprocessing with a variable number of cpu's

System was accomplished with little difficulty in no more than 504 system hours. Expectantly, customers IPLed and initiated their job streams. And nothing happened.

Nothing.

When it slowly dawned on everyone that nothing was going to happen, now or later, a flood of anguished telephone calls swamped the branch offices. At Poughkeepsie, in turn, all extensions, all 25,000 of them, were busy. Unauthorized vehicles were turned away at the entrance roads. The director of programming systems in Harrison could not be found.

At last a brave man, a customer engineer, fought his way through the crowd around his system and obtained a dump. As he scanned the hex, the horrible truth came home to him. All of core, as far as the eye could see, was filled with control blocks, each containing pointers to other control blocks. DADSM was allocating and suballocating, searching DSCB's and building new ones. Job management was initiating new jobs, task management was creating tasks and ATTACHING and LINKING, data management was opening data sets, and building WTC tables, DCB's, DEB's, ECB's, and IOB's. It was finding TIOT's from tasks dispatched by task management, which pointed to JFCB's. But no programs were being executed. No data was being read or written or processed. Operating System had taken over all the system resources and was entirely occupied with issuing supervisor calls, saving registers, restoring registers, chaining forwards and backwards and following pointers all over core. Every pointer led to some other pointer. Operating System, after several years of effort by thousands of programmers, had finally become a completely closed system.

The great dilemma was solved only through the intervention of the chairman of the board, who personally issued a black-bordered blue letter announcing the withdrawal of Operating System. A large bonfire was built in the Poughkeepsie parking lot in which a huge mountain of OS documentation was burned, while the local high school band played a funeral dirge. Users all over the world wearily set to the task of rewriting using BPS Assembler. A new programming system was announced for delivery in two years, to be called Assembler Stacked Support (ASS). And everyone breathed a great sigh of relief and was happy for a time. ■

The makers of the "two great tapes"  
had smooth going until...

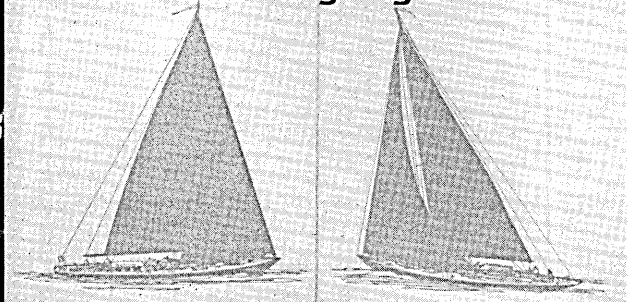

# TVP 2

## TOOK THE WIND OUT OF THEIR SAILS

- Now a new computer tape is setting the performance pace in the EDP field. TVP 2, by Computron, starts where the other leading magnetic tapes leave off.
- Test after test has proved TVP 2 superior in the characteristics most important to you. Fewer dropouts; cleaner, straighter edges; reduced headwear; better long-term accuracy . . . these are the advantages that make TVP 2 the finest tape value on the market today.
- For you this superior performance means more efficient, economical and trouble-free computer operation. It's worth checking on today. Write for all the facts on this great new tape.



**COMPUTRON INC**  
CROSBY DRIVE, BEDFORD, MASSACHUSETTS 01730  
GENERAL ELECTRIC/BASF GROUP

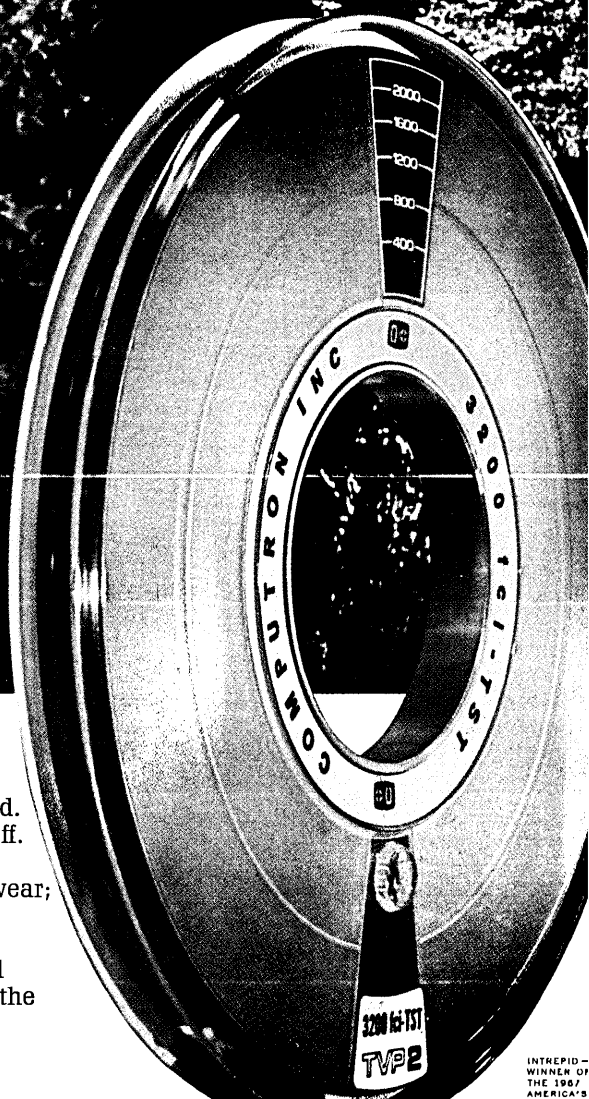

INTREPID -  
WINNER OF  
THE 1967  
AMERICA'S

# The NCR Century Series of computers.

## When you learn how advanced they are, you'll know why others are old-fashioned.

It's going to change all your old ideas about computer costs and capabilities.

The Century Series offers a price/performance ratio unequalled in the industry.

It's the first truly compatible family of computers that incorporates the most modern technological developments. It's perfect for all levels of users. For both business and scientific applications.

The Century Series will meet your requirements today and tomorrow. You can expand capacity and power as your needs change. Just plug in a more powerful processor. Same peripherals. And no re-programming. True upward compatibility.

Internal memories range from 16,384 to 524,288 bytes. Future Century computers will offer memories with up to one million bytes. On-line processing and three-way simultaneity offered in the lowest cost member. It rents for less than \$2000 a month with

an extended contract. You can move up to multi-programming and nine-way simultaneity. Eventually to multi-processing and 17-way simultaneity.

You get the benefit of great technological developments. Monolithic integrated circuitry is used throughout. With the power of conventional or hybrid circuits but at a fraction of the size. Thin film, short rod memories. With speed in the 800 nanosecond range, yet lower cost than core memories because of automated manufacturing techniques. (Only \$375 for an additional 16,000 bytes of memory.)

A dual spindle disc unit that sets a new standard in the industry. With 45 ms average access time, it's the fastest removable disc unit in the industry. Each recording surface with 12 floating read/write heads.

Card Random Access Memory (CRAM) units each with on-line storage capacities over 125 million bytes. Magnetic tape drives

with transfer rates up to 240 kc. Line printers with speeds up to 3000 LPM. A wide range of peripheral devices: punched card and tape input/output units, MICR sorter/readers, OCR scanners and remote on-line devices.

Sophisticated software! No other computer in the same price range as the Century computer can offer as much. Compilers, operating systems, applied programs and utility routines. All written, tested and ready-to-go. Programming languages: COBOL, FORTRAN and NCR's own NEAT/3.

There's much more to tell. Call your NCR representative today for the story of the Century. Or write to The National Cash Register Company, Dayton, Ohio 45409.

# NCR

THE NATIONAL CASH REGISTER COMPANY, DAYTON, OHIO 45409



## THE PROBLEMS OF PACKAGED PROGRAMS

□ "Packaged programs are not new . . . What is new today, however, is the increasingly important role that packaged programs are playing for many computer users, and the consequent rise of a whole new subfield of computer technology concerned with the fabrication of packaged software."

Robert Head of Software Resources Corp. noted in his speech at the American Management Assn. EDP Conference in March that such packages are becoming more attractive because of the introduction of upward compatible product lines, programming language standardization, and the economic advantage of buying vs. in-house development.

Head, whose firm is a pioneer in marketing proprietary packages, outlined the considerations that must be given in acquiring a ready-made product. First, prices generally range from \$300-\$60,000, with most commercial packages falling between \$5,000 and \$25,000. For this, the user should expect a fully operational system, well-documented, and with an assurance of error correction.

A "make-or-buy" analysis is a good technique to help determine if a package is worth its price. This includes an estimate of time and cost to develop the program in-house compared to package cost and modifications required. The package for sale ought to be 1/5th to 1/10th the in-house development cost. Head also advised that a company have a package procurement category in their edp budget to avoid having to obtain management approval during the budget period. (Or allow edp management the discretion of allocating funds for packages or additional personnel.) Too, the tax counsel should be consulted on the best way to write-off such a buy—via expensing it that year or amortizing costs over several years (conservatively, two-three years).

Other wise steps are comparing data on as many packages as are available for the job: on cost, error-free operation, throughput, generality, documen-

## Does Your System MESH-

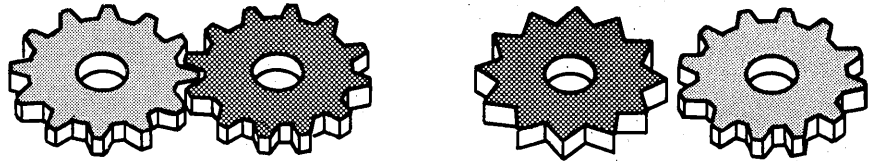

or do you have a family of MISFITS??

Tele-Signal has salvaged many MISFIT systems by redesign and Supply of necessary modules to Mesh non-compatible components into a functional DATA SYSTEM.

Not only do we manufacture equipment of proprietary design to interface Computers, Data, Telegraph and Telephone units to effect a homogeneous system, but our DATA COMMUNICATIONS DIVISION's engineering staff is capable of complete system design, equipment supply, installation and maintenance and the training of your personnel.

If you need DATA from branch operations and are either planning a new DATA COLLECTION SYSTEM or updating your present one, why not consult us for assistance in communications, interface and complete systems management?



A SUBSIDIARY OF GENERAL PRECISION EQUIPMENT CORPORATION  
250 CROSSWAYS PARK DRIVE • WOODBURY, LONG ISLAND, NEW YORK 11797  
516/921-9400 • TELEX 12-5562  
WASHINGTON D.C. OFFICE 703/524-5885

CIRCLE 39 ON READER CARD

Now you can buy a high resolution CRT Display for \$6200.00

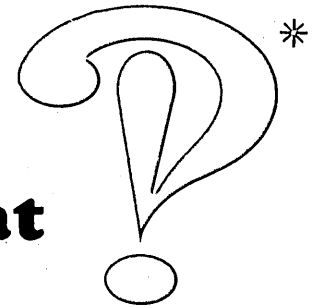

### How about that

MODEL PD900 PRECISION X-Y CRT DISPLAY FOR • FILM RECORDING • FILM READING

#### MODEL PD900 CHARACTERISTICS

- Resolution . . . 1700 resolvable elements/diameter (1200 x 1200)
- Slewing Speed . . . 7 microseconds/diameter to 0.1% of final value
- Small-Signal Bandwidth . . . 1.0 megahertz
- Also features high stability, repeatability & linearity

Mating of the Basic Option Package, OP900, to the PD900 enables the inclusion of optional circuits such as video amplifiers, sawtooth generators and phosphor protection circuits.

Higher resolution CRT displays also available — Models PD1100 and PD1200.

\*The "interrobang" . . . the first new punctuation mark in the English language in 300 years. It is designed for question-exclamation statements such as our headline.



Send for Engineering Data Sheets

**Beta Instrument Corp.**

377 ELLIOT ST., NEWTON UPPER FALLS  
MASSACHUSETTS / TEL. 617 • 969-6510

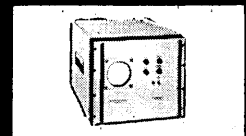

CIRCLE 38 ON READER CARD

## PACKAGED PROGRAMS . . .

tation, installation support, and package improvement arrangements.

Head noted there is no single source of detailed information on these packages, particularly since many now available were originally developed by or for the user for his own use. Some sources are trade journals, users, trade associations (as American Banker Assn.'s ABACUS listing), commercial organizations, U.S. Government (as the COSMIC listing maintained for NASA by Univ. of Ga.), and manufacturers (as IBM's Program Information Dept.).

Attorney Robert Bigelow provided an extremely thorough speech on the various means of software protection, of increasing importance as the packaged program becomes popular. He covered both statutory—copyrights, patents, and trademarks—and non-statutory methods: trade secrets, unfair competition, and the best method, the law of the contract.

Bigelow is on the side of statutory protection: "The availability of people who can write programs is far exceeded by demand, and the demand is increasing faster than the supply.

When programs cannot be protected by statute, they must be protected by secrecy. And when programs are not freely disclosed, they are not as likely to be improved by use . . ."

But such protection is either being stymied in Congress (pending copy-

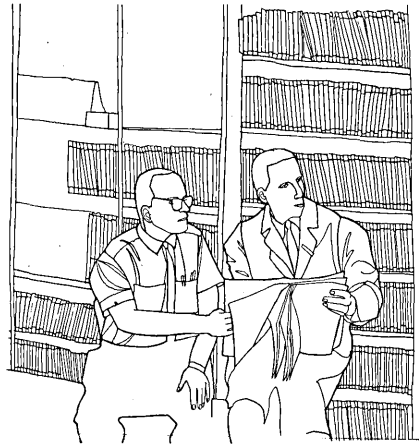

right and patent bills), or it is extremely expensive to prove infringement (copyright and trademark). Re copyright, Bigelow says that even if it may not be a clear protection for programs, "the developer . . . should not overlook the usefulness of copyright protection for manuals, directives, advertisements, and documentation. These

items, coupled with the user's contractual commitments not to disclose the program, can provide some protection."

But, says Bigelow, the constitutional authority under which patent and copyright laws have been enacted is not exhausted. A specific statute dealing with software protection may be desirable, one approach being compulsory licensing, perhaps with reasonable royalties. This would also protect against an "evil" of a patent, that it could lead to suppression of a competitor's programs.

Among non-statutory methods is the trade secret. A Massachusetts statute, which became effective Mar. 26, defines this as "anything tangible which constitutes, represents, evidences, or records a secret scientific, technical, merchandising, production, or management information, design, process, procedure, formula, invention, or improvement." Bigelow recommends Milton Wessel's article in *Harvard Business Review*, March-April 1965, for the best tests of validity of program trade secrets: 1) Is the program really secret—is access limited and are records kept of all disclosures? 2) Is the program really valuable? 3) Was it developed and owned by the company,

# Oxide dust is more costly than gold dust... but who wants it?

Loose oxide shortens the life of magnetic tape heads. It degrades tape. And it breeds still more dust as it is ground into fast-running tape. MS-200 Magnetic Tape Head Cleaner sprays oxide dust away. MS-200 is recommended by leading tape head manufacturers, prescribed by a major broadcasting network, used at hundreds of data processing installations. So, don't lose your head; use MS-200 Magnetic Tape Head Cleaner.

Price: \$2.75/can in cartons of 12 16-oz. cans.

Trial order: 4 cans @ \$3.60/can.

Prices f. o. b. Los Angeles, Chicago or Danbury, Conn.



**miller-stephenson  
chemical co., inc.**  
Route 7, Danbury, Conn. 06813



U. S. and foreign patents pending.

# Want to avoid doing the same job twice?

## Come to Kodak.

Imagine a photographic memory on microfilm, part of an automated retrieval system that lets you find any record, even out of a million, in seconds! We call it the RECORDAK MIRACODE System.

And it works wonders. Take the chemical field. With the tremendous volume and complexity of today's chemical literature, it might well prove easier to "reinvent" a chemical process than to find out whether someone else somewhere already had the answer.

To avoid such duplication of effort, the American Chemical Society—through its Chemical Abstracts Service—digests and in-

dexes all of the world's new chemical literature on a biweekly schedule. Now, the complete collection of *Chemical Abstracts*, the key to all of the world's chemical knowledge published since 1907, is also available on microfilm—nearly 4 million abstracts compacted in RECORDAK Microfilm magazines, instantly accessible for reference.

More important, because the film is indexed for instant display at a RECORDAK MIRACODE retrieval station—shown at right—look-up is push-button easy. Any abstract can be displayed, and a paper facsimile made in seconds.

If your business or field of busi-

ness could also use a photographic memory with instant recall, the way to get started is to contact Eastman Kodak Company, Business Systems Markets Division, Department XX-4, Rochester, New York 14650.



"Recordak" and "Miracode" are trademarks of Eastman Kodak Company.

**RECORDAK** Microfilm Systems by Kodak

# two hawks two doves

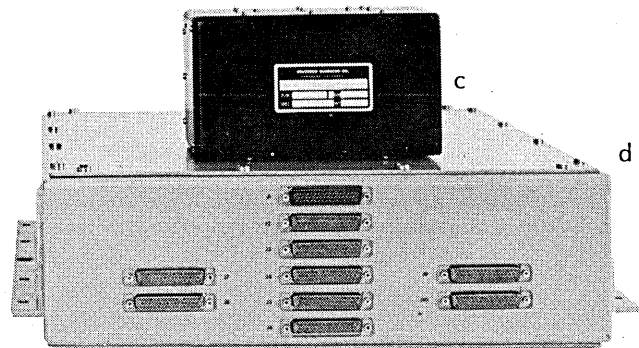
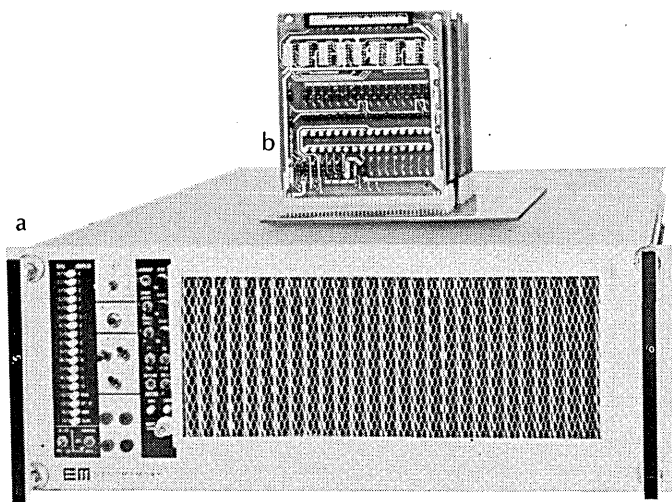

These two military and two commercial memories round out the broadest system line in the industry. Whatever your environmental requirement, we have a system to meet it. And we have it available right now.

There are other advantages in letting us build your system. The design techniques we've mastered for our military memories have been adapted for our commercial devices. You get the benefit of features like pluggable stacks and electronics for easier maintenance, integrated circuits for increased reliability, and space-saving design concepts.

Brief specs are listed below, but

for the full story write to Electronic Memories, Inc., 12621 Chadron Avenue, Hawthorne, California 90250.

(a) NANOMEMORY™ 2000 SERIES—Combining integrated circuit electronics and a unique 2½D drive system, the 2000 Series has a 294,902 bit capacity, cycle times of either 650 or 900 nanoseconds, and a configuration measuring only 21.5 inches deep by 19 inches wide by 7 inches high, including power supply and optional tester.

(b) MICROMEMORY™ 1000—Taking up only 400 cubic inches, the 1000 features a 32,768 bit capacity and a 2.5 microsecond cycle time. It uses a unique 3D

drive configuration permitting a particularly low component count, with correspondingly high MTBF, and a price less than 10 cents per bit in small quantities.

(c) SEMS 5—Designed for airborne applications, the SEMS 5 has a 2 microsecond cycle time, packs 131,062 bits into only 132 cubic inches and meets applicable portions of MIL-E-5400, MIL-E-4158, and MIL-E-16400.

(d) SEMS 7—Developed for ground based applications, this rugged memory has a 2 microsecond cycle time, a 327,680 bit storage capacity and meets applicable portions of MIL-E-4158, MIL-E-16400 and SCL-6200.

SJCC Booth Z1-Z3.

**EM** electronic memories

CIRCLE 42 ON READER CARD



## PACKAGED PROGRAMS . . .

rather than an individual employee (who may have left)? 4) Was it difficult (costly) to develop? 5) Has the program been copied? 6) Is it fair to protect the program? Extreme penalties come with violation of trade secrets—up to five years in jail, damages, and a double-damage penalty.

Another method, unfair competition, relates to the person who can't protect his work by statutory means. There is now pending in Congress a bill which would establish a Federal law of Unfair Competition (S 1154) and might help software developers. It will "authorize a civil suit against a person who wrongfully discloses trade secrets or confidential information, who misappropriates quasi-property not otherwise protected by Federal law, or who acts contrary to normal and honest business practices," stated Bigelow.

In the final analysis, the contract stands as the best protection. Some of the basic items are price, time-schedule, program purpose, documentation required, on-site assistance, and above all, ownership right in the program.

A contract should also clearly spell out the standards of performance and error correction requirements for the software, making the developer liable.

Both parties should try to get insurance coverage as well. This is particularly important in such areas as process control, where failure to meet specifications could have dangerous results. "There is a distinct trend in the law to



dispense with the requirement that a person injured under such circumstances prove how the defendant was negligent . . . and may be applied when computer programs are operat-

ing and something blows up," warned Bigelow.

It will become increasingly common for the user to put penalty clauses for failure of the seller to deliver promised software, as well as hardware, on time. The state of California already has such a contract with IBM. Complete documentation should be called for in writing, otherwise, program faults may not be provable in court.

The developer should also be made liable for infringing on someone else's copyrighted or trade secret program, and he should also protect against using a person who is under a restrictive agreement with another software house.

Other items are the user's right to improvements made by the developer and vice versa, and inclusion of schedule for testing and debugging.

In software lease or rental contracts, there should be demands on the user to protect the product: logging each time a program is run; care not to copy the software or let anyone else; proprietor's right to audit the user's records on the software; and maintenance of the program in the tape or punch card library in its original form, obtainable only on signed receipt.

The best advice, Bigelow proffered, is to deal with an honest man, give him a square deal, and trust.

—ANGELINE PANTAGES

## NOW YOU CAN

# FORCE

## OS/360 TO DO TIME-SHARING

All you need is a few good men (up to 15) who want a FORTRAN Conversational Environment within the central computer facility. FORCE-III talks your language—and theirs, on a Model 50 or 65.

FORCE-III brings down the cost of going outside for time-sharing facilities. And increases the value of the in-house computer.

FORCE-III operates in a partition of OS/360 where you can talk freely. Use a command language interpreter, a file maintenance subsystem, a line editor for creation and correction of files, a FORTRAN-IV compiler, a

subroutine library. Get responses in about 3.5 seconds. You can ship files back and forth between FORCE-III and OS, and file away compiled programs so that they may be used without recompilation under either OS or FORCE-III.

FORCE-III offers this unique capability for supporting interactive composition, debugging and execution of FORTRAN programs.

FORCE-III allows all of this and you *still maintain* a steady OS/360 batch workload.

There's a lot more worth talking about. So contact . . .

**HONIG** TIME SHARING ASSOCIATES, INC.

116 North Central Avenue • Hartsdale, New York 10530 • (914) 949-4580

A MEMBER OF THE MAUCHLY GROUP

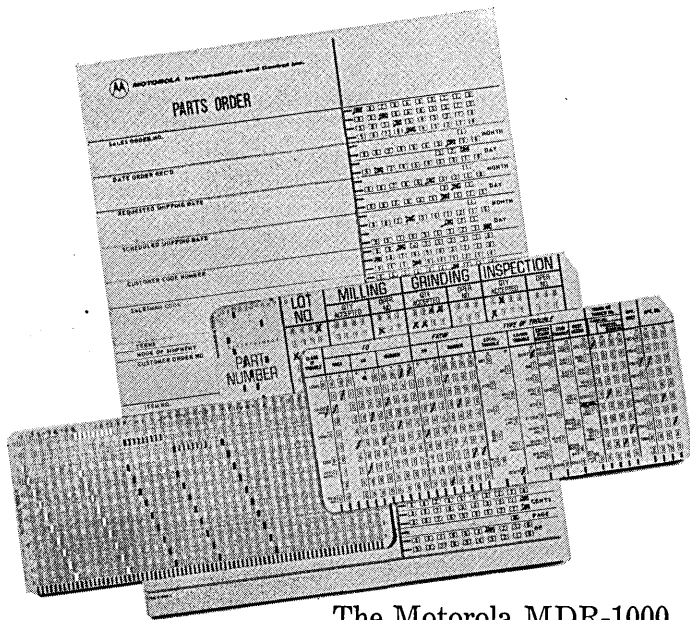

The Motorola MDR-1000 will read practically anything you put under its nose. Punched cards. Mark-sense cards. Ordinary source documents with ordinary pencil marks. Punched or mark-sense data columns on page-size documents of any length.

Even punched and mark-sense data combined.

Format is completely flexible. We don't force you into a rigid 40- or 80-column layout. You arrange column spacing and data blocks to satisfy task requirements, not our machine.

You are free to design each document for optimum human intelligibility. Without disrupting present work routines, you can implement direct data entry on incoming orders, inventory control, parts inspection, warranty statistics, payroll deductions, quality control. The list of possible applications is literally endless.

Machine operation can be either manual or automatic with hopper feed. Attended or unattended. For the latter, we include a full Data-Phone® data set handshaking routine.

Output, in USASCII or other commonly used language, is compatible with standard telephone transmission interfaces. It can be fed directly to teletypewriters, magnetic tape recorders, key punches. Or directly into a computer.

The MDR-1000 is small enough to fit on one corner of a desktop. Lease rates are modest enough (less than \$100 a month) to commend this machine as the "makes-sense" document reader for EDP facilities of any scale. And service is available nationwide.

But first things first: ask us to send you descriptive literature. Motorola Instrumentation and Control Inc., a Subsidiary of Motorola Inc., P.O. Box 5409, Phoenix, Arizona 85010.

CIRCLE 44 ON READER CARD

**MOTOROLA**  **Information Systems**

# Introducing

# The Indiscriminate Reader.

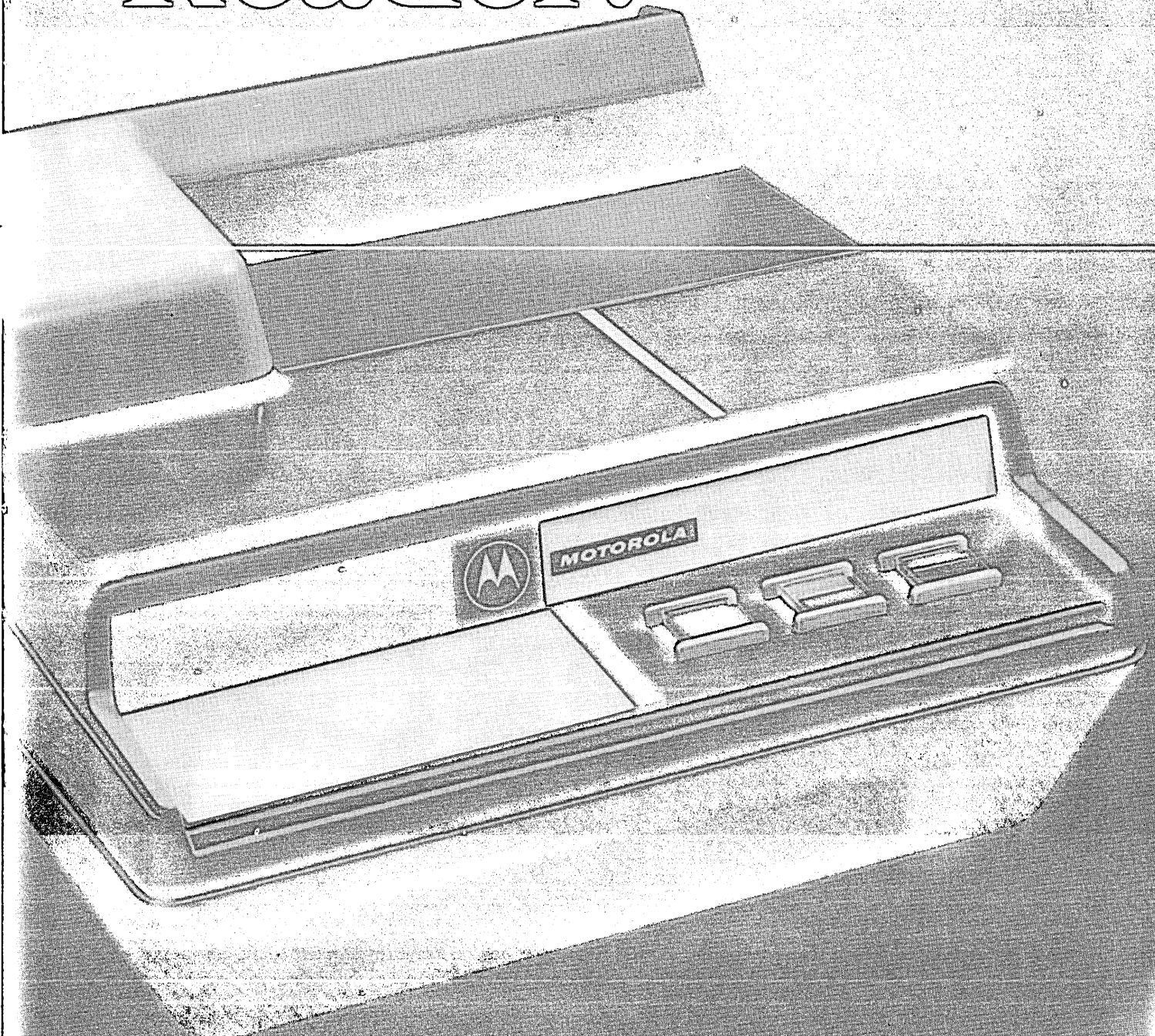

(Interview it at the Spring Joint Computer Conference, Booth AA.)

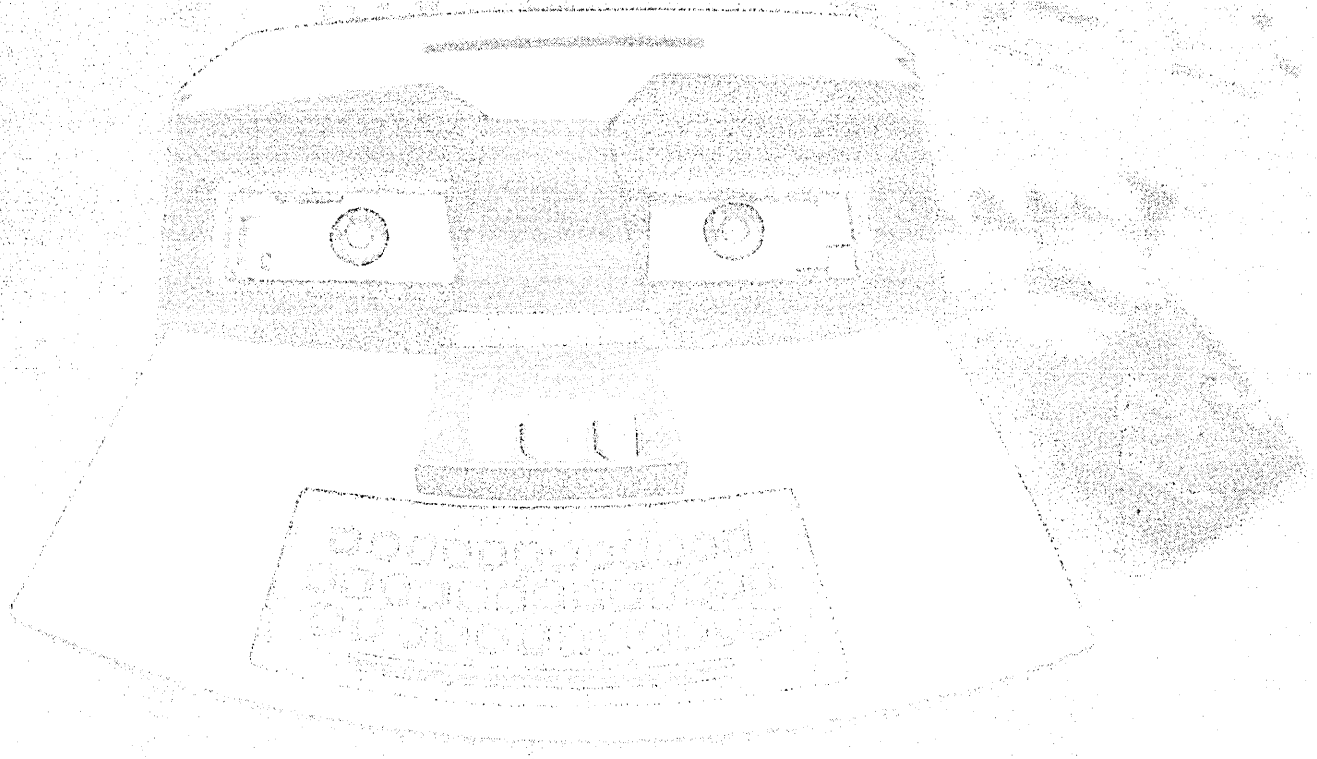

## Profit-eater.

## Please do not feed.

Keypunch machines have become obsolete.

They thrive on overhead expense that cuts into profits. (Keypunching alone can account for as much as 15% of your computer operation. And up to 10% of time delays.)

Eliminate keypunching with a fast, efficient scanning system. You'll save time, space and money. You'll also improve computer efficiency by speeding up the flow of data, with fewer errors.



We make a variety of methods available to customers that enable you to convert data from source document to computer input in a single step, or a two-way brochure describes them all.

Write for the facts you'll find it so easy to digest.

# OPTICAL SCANNING CORPORATION

Newtown, Pennsylvania 19080 Phone (215) 851-3011

# What good does a Grant Slide do you?

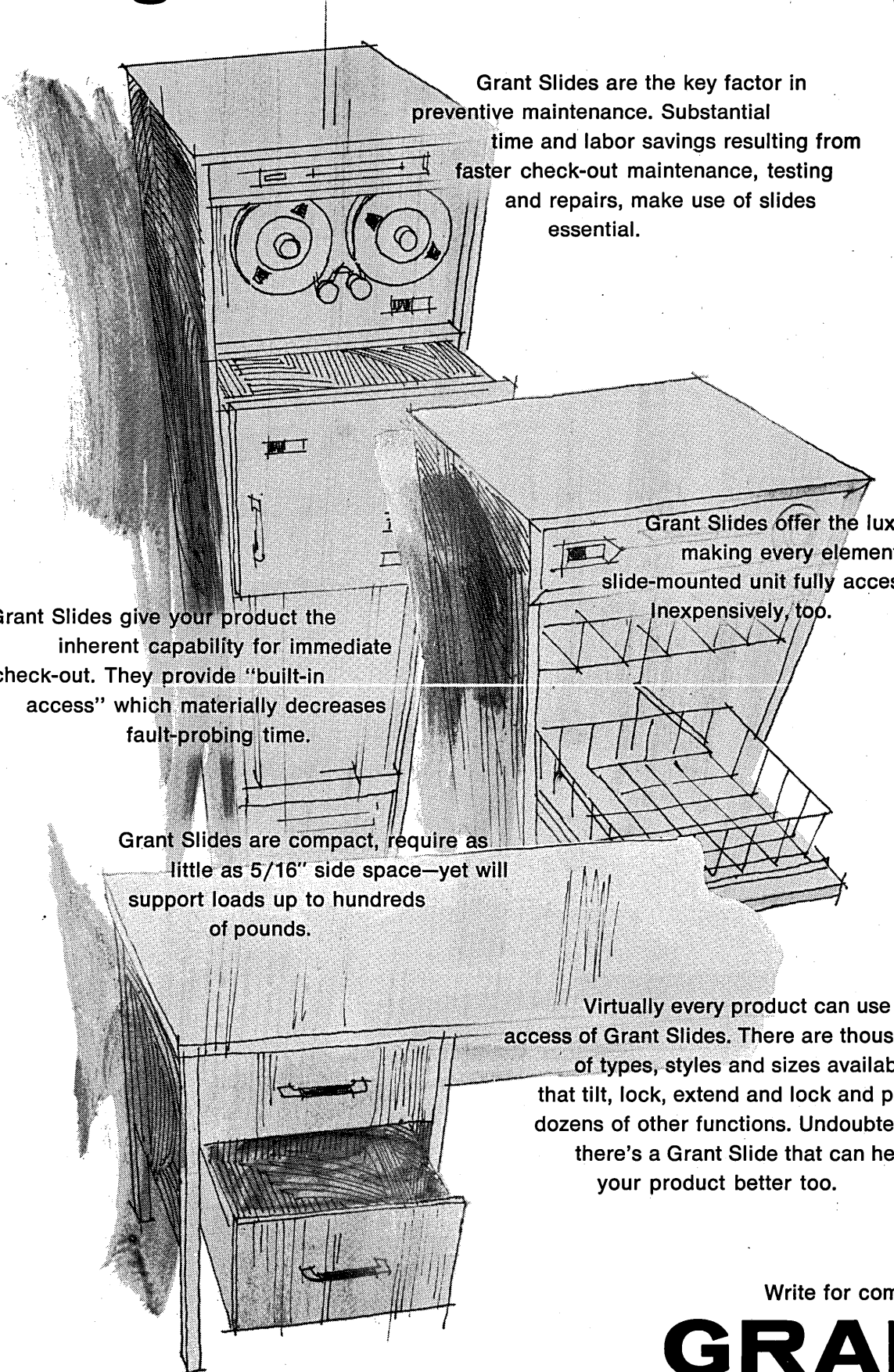

Grant Slides are the key factor in preventive maintenance. Substantial time and labor savings resulting from faster check-out maintenance, testing and repairs, make use of slides essential.

Grant Slides give your product the inherent capability for immediate check-out. They provide "built-in access" which materially decreases fault-probing time.

Grant Slides are compact, require as little as 5/16" side space—yet will support loads up to hundreds of pounds.

Grant Slides offer the luxury of making every element within a slide-mounted unit fully accessible. Inexpensively, too.

Virtually every product can use the ready access of Grant Slides. There are thousands of types, styles and sizes available. Slides that tilt, lock, extend and lock and perform dozens of other functions. Undoubtedly, there's a Grant Slide that can help make your product better too.

Write for complete data.

**GRANT**  
PULLEY & HARDWARE CORPORATION

**EASTERN DIVISION: 218 HIGH STREET, WEST NYACK, NEW YORK 10994**  
**WESTERN DIVISION: 944 LONG BEACH AVE., LOS ANGELES, CALIF. 90021**

# **SOROBAN** invades the Low Cost-Low Speed Card Reader Market

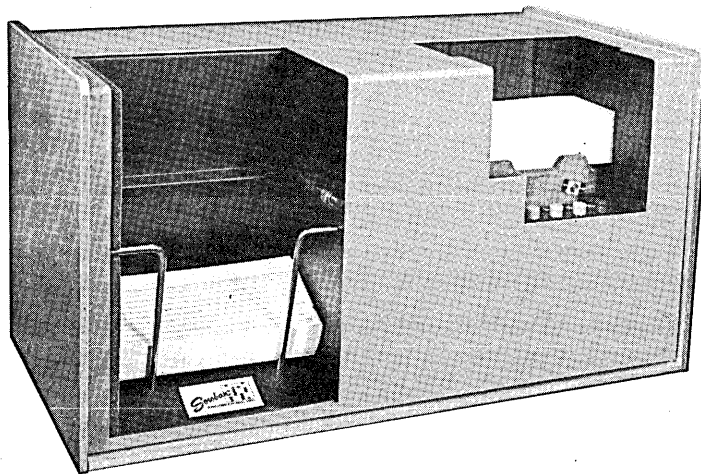

12" x 12" x 22"



**See it at  
Booths 1801-1804  
SJCC**

**Soroban**  
® **ENGINEERING, INC.**  
TELEPHONE 305-723-7221  
POST OFFICE BOX 1690  
MELBOURNE, FLORIDA 32901

# AEROSPACE TECHNOLOGY AND URBAN SYSTEMS

a conference report

The engraved invitation announced the presentation of an "Urban Systems Workshop." The RSVP and "by invitation only" suggested that the series of programmed sessions were to be only for the privileged and relevant. The host was McDonnell Douglas and within that complex, the Information Technology Department of its Information Systems Subdivision. The well-ordered agenda indicated it was to be an all day affair attended by academicians and practitioners involved in and beneficiaries of information processing technology. About 200 people from universities, colleges, and cities found both the interest in and the time for the workshop to attend. The proposed undertaking was performed as planned and on schedule. The presentation site was the M-D Advanced Research Laboratory and the mini-skirts of the registration clerks really couldn't be much more advanced. Lunch was on the house and a tour of the Space Systems Center facilities at Huntington Beach followed.

The purpose of the workshop was not so clearly defined. The program included academicians deeply engaged in the study of urban data processing and information systems, both as total systems and as functioning subsystems. Dr. B. G. Schumacher and Dr. William Mitchel played the general systems theme. Dr. Paul Whisenand of Long Beach State discussed the functional area of automated police information systems.

The practitioner's viewpoint was well carried by D. Riesau, Los Angeles Sheriff's Office (court and law enforcement); J. P. Mumau, communications engineer, City of Los Angeles (command and control functions in fire prevention and suppression); R. E. Kirten, FBI (National Crime and Information Center); and R. A. Oman, finance director of Costa Mesa (municipal integrated data processing).

The urban systems beneficiary point of view was presented by N. Goedhard of Covina (the San Gabriel Valley

Joint Powers, a time-shared municipal data system). The private sector got its innings with Dr. M. W. Ladato, manager of Information Technology for McDonnell-Douglas (systems analysis and its applicability to municipal systems problems); G. E. Cash, branch manager, Planning Technology of M-D (data organizing and structuring applications in municipal and urban information systems); and V. Azgapeian, director of M-D Information Sciences (panel review and conclusions).

## the hidden agenda

Behind the agenda and the schedule of presentations there also appeared to be a hidden agenda of equal if not greater significance. S. C. Perry, v.p. for McDonnell-Douglas Information Systems, in his welcoming address provided the framework for the agenda, and Dr. Ladato, in his role of moderator, added the detail. Basically, this second agenda related to the recent exhortations of the Federal Government for aerospace industry help to solve the problems of our urban society and its governing cities through use of their know-how in systems analysis and information technology. It would appear that the M-D people in St. Louis had already been investigating this field of possible expansion. Dr. Schumacher, for example, was listed on the agenda as a consultant to the McDonnell Automation Corporation although he finds academic status as a professor of political science at the Univ. of Missouri, as director of their Urban Studies group, and as a specialist in public administration and related computer dynamics. The Douglas Information Systems people at Huntington Beach, encouraged perhaps by McDonnell-St. Louis people, were taking the Federal suggestion at its face: what were the informational problems of an urban society and its governments? What particular skills, know-how, and capability in information processing which have grown out of the aerospace efforts were, or could be

made, applicable to the urban sector? More germane perhaps, the Douglas people were asking what areas of the urban picture appear to have an exploitation potential for new business and a promise of future profitability? Answers or insights to these questions constituted the carrots for the host and formed the basis of his hidden agenda.

The presentations by the speakers of the workshop and the discussion which they engendered served well the purposes of the host and equally well the invited guests with their program expectations. The total perfor-

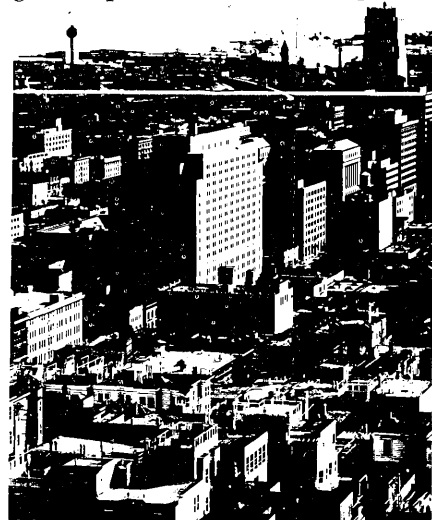

mance provided an excellent over-view of what is happening in the urban information systems field. It also covered most of the major problem areas.

## the problems

Certainly these relevant points were made:

1. Relatively little research, by aerospace standards, on general urban systems or their informational component is occurring. Most of the research which does exist with reference to the urban environment and its governments is either woefully under-financed and/or concentrated in limited functional areas such as law enforcement, fire, or urban planning. USC's

# Introducing the Varian Data 520/i

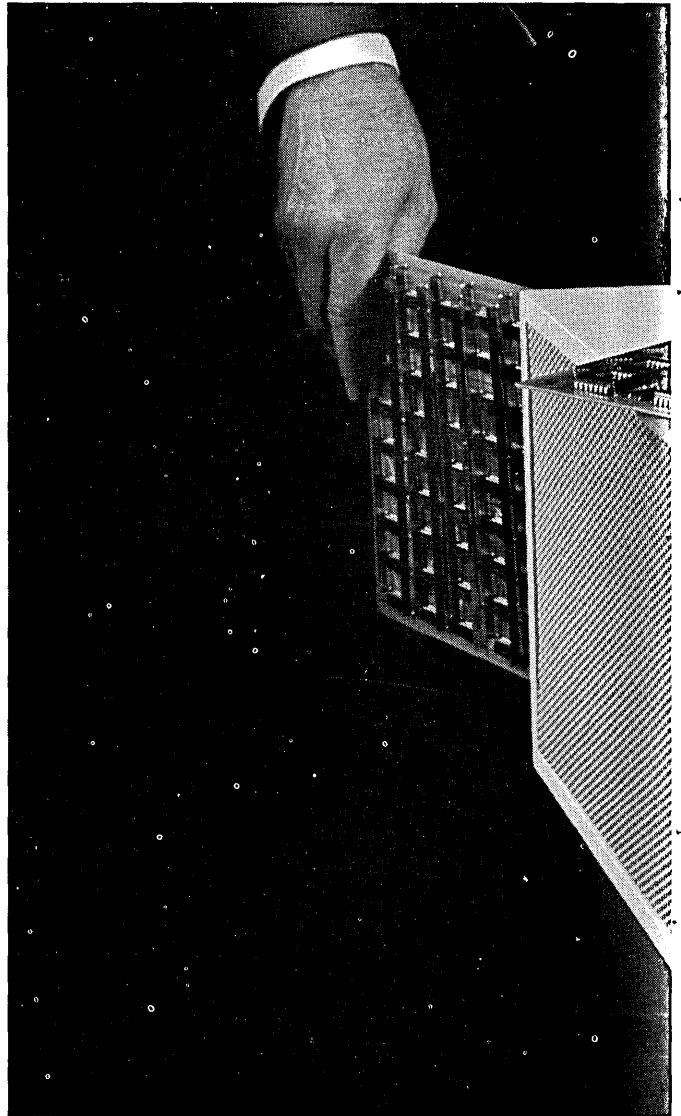

## **New - dual environment**

The Varian Data 520/i is our newest systems-oriented computer with some remarkably useful innovations. We've designed the Varian Data 520/i to handle independent, dual tasks quickly and efficiently, and that's why we've called the 520/i a dual-environment computer. To do the job we've equipped the 520/i with two complete sets of hardware registers, including index registers.

These independent registers allow the 520/i to run parallel programs, each program using its own set of registers. And a single 1.5 microsecond instruction is all it takes to transfer control between parallel programs or between processing and I/O programs.





## computer for systems applications

For easy adaptability to the user's data needs, we've designed the Varian Data 520/i to manipulate data in multiple 8-bit bytes. This multi-precision capability allows the 520/i to perform arithmetic in 8, 16, 24 or 32 bit lengths, within the same program! And—each program can change its own precision at any time.

Our new Varian Data 520/i, with a 4K memory, sells for less than \$10,000. If you'd like to know more about it, write for a Varian Data 520/i brochure.

The 520/i includes in hardware 2 32-bit accumulators—2 16-bit index registers—2 16-bit program counters—2 overflow registers—4 hardware priority interrupt levels with a total of 11 interrupts—expandable 4K to 32K 1.5 microsecond memory—50 basic instructions with over 500 register-to-register operations—integrated circuit construction—complete control panel with register displays—interface modules for I/O devices—proven software and a complete set of diagnostics. Write for a 520/i brochure.



**varian data machines**  
a varian subsidiary

Formerly Decision Control, Inc.  
1590 Monrovia Ave., Newport Beach, Calif.  
(714) 646-9371 TWX (910) 596-1358

See the new Varian Data 520/i, and the 620/i at Island Q, SJCC.

# The lethal label.



With proper handling, computer tapes can be "scratched" and reused almost indefinitely. However, careless removal of previous labels can

crush reel flanges against tape edge, and kill a good tape.

**Moral:**  
**Hold flanges away from tape when removing labels.**

Antidote for tape problems: Audev. Whether you use our series 61 or premium K-68, you're in good company. These are the tapes used by the top U.S. companies.



FOR A FREE POSTER-SIZE REPRODUCTION OF THIS AD AND THE OTHERS IN THE SERIES, WRITE DEPT.DA-4 AUDIO DEVICES, INC., 235 EAST 42ND STREET, NEW YORK CITY, NEW YORK 10017.

## URBAN SYSTEMS . . .

broadly construed municipal systems research project is an apparent exception. Its findings were outlined for the group. This half-million dollar effort was reported having completed work on the development of a conceptual structure to guide urban municipalities in the use of the computer and the design of an automated information system which will serve the data processing needs both for operations and planning and analysis. Termination of the research project due to lack of interest in moving the project from a conceptual effort into a development and test phase was also noted. The \$3 million price tag on such an effort may have represented a relatively small venture in the aerospace world, but was of overwhelming proportions to the urban problems people who control where the available funds will go.

2. The viability of urban governments rests to a considerable degree on their ability to develop the necessary framework of computer applications and to effect the organizational changes which such an acceptance of information systems technology requires. Dr. Schumacher expressed it

succinctly and strongly as a caveat to the cities: "automate or die."

3. The social problems of a city are reflective of and interactive with the economic function and posture of the city. Public administration in the average city has not internalized the perspectives and values of computer-driven information technology or the rationalizing mechanisms of systems analysis for problem solving. V. P. Perry suggested that the situation was one of the need to join the "problem havers" with the "problem solvers." Systems analysis, "a way to structure a problem rationally," is still in the *ad hoc* stages for urban governments with a known evolution yet to come from preventive systems to predictive systems. Compared to aerospace managerial criteria, local governments have a long, long way to go and not much time to do it in.

4. The informational base required for the administrative cycle (plan, operate, and evaluate) and its research cycle interface (basic research, development, and test application), which characterizes the aerospace effort, does not exist for the cities. The contrast in information handling capability was starkly reflected in Dr. Schumacher's inventory of McDonnell Automation's stall of computers: 50 third-generation

computers—perhaps as much capacity as the total for all municipal government installations in the United States! The critical issue here, however, was left unarticulated by the conference members. This is whether the conclusion to be reached by this contrast is that of having our nation of cities turn to such computer institutions for their systems and computational capability and know-how or to generate an equal capability within the framework of local government. It would appear that in the event of a cessation of hostilities this question may become one of major importance to both the current major users and manufacturers of computers and the cities that presumably will have the resources and needs for such capability. At this stage it isn't clear who is Mohammed and who is the mountain.

5. There exist throughout the nation, islands of commendable if not inspirational, effort on the part of cities to improve their level of institutional capability through use of computers. Most of this work rests in the functional areas (police, finance, planning, etc.), and is relatively uncoordinated (how many times do we have to "invert" a municipal payroll application?), under-financed, and characterized by an almost total unconcern on

# If you don't have one... let's hope you never need it

Valuable taped data can be erased or partially destroyed by unexpected exposure to magnetic fields... generated by electrical equipment, electronic gear, air transport instrumentation, electrical storms, etc. Such loss is costly and inconvenient. The data may even be irreplaceable.

**Avoid these hazards**

**Use NETIC Tape Preservers**

for storing and transporting your valuable tape data. They provide ideal insurance against such potential hazards. Available in numerous sizes and shapes to fit your needs.

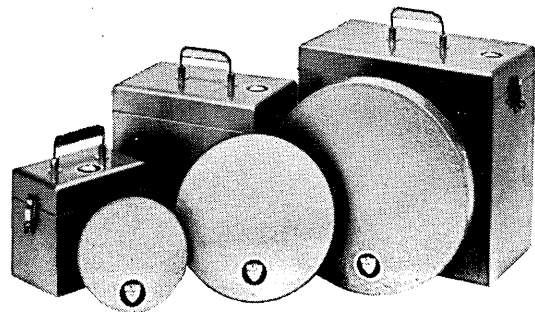

Delivery from stock. Request catalog No. TP-1 West Coast: Techrep Distributor Co., 10606 W. Pico Blvd., Los Angeles, California 90064. 213, 836-6806 213, 871-0055.



## MAGNETIC SHIELD DIVISION

Perfection Mica Company

1322 N. ELSTON AVENUE • CHICAGO, ILLINOIS 60622

Phone: 312. EV 4-2122 • TWX 910 221-0105

## URBAN SYSTEMS . . .

the part of federal agencies (HUD is no exception) for use of the computer, automated information processing techniques, and systems analysis to upgrade the urban city as a single, integrated unit of general government.

### moon, yes; garbage, no

6. Viewed from the perspective of where the average city stands in the use of computers, some very interesting applications are developing. An example is the San Gabriel Valley proposal which includes a single, central computer facility with remote inputs to serve a series of smaller cities. Financing, however, is still unresolved. The Los Angeles fire command-control system is another example of local effort. However, when these projects are contrasted to the sophistication level achieved by the space people, it is no surprise that we can make probes into space but can't get city garbage off of front porches. The data processing sophistication levels are so far apart as to raise a serious question about the utility of the aerospace industry in urban systems without first an orientation program to develop mu-

tual understanding, if not sympathy. This contrast was strikingly evident in the perceptions of potential systems and computer projects suggested for the urban society by the M-D people: the use of infrared techniques, automation of all routine decisions, integrated and computer-directed traffic control, systems analysis for social dis-



orders, etc. In contrast, the urban government people were concerned with getting a computer-driven accounting subsystem to provide current, unexpended balances and timely payrolls. The sociologist may talk about a nation split into two racial parts. But in the aerospace and urban government activities, we also have two worlds separated by values, infrastructure, language, skills, and economic resources. The common denominator for our two sets of split worlds may well be the

same: the haves and the have nots.

7. Finally, there was evidence throughout each presentation and its subsequent discussion, that the critical element in any aerospace information systems contribution to urban problems would be the financial resources available to fund their efforts. The magnitude of funds which have been available for space research and development in information systems have no equivalent or promise in the urban environment or Federal budgets. Information systems work is costly and capability is slowly developed from resources, vision, and the encouragement of relative advantage. Computer hardware and software have not been characterized by bargain basement prices. Yet any private corporation contemplating the investment of risk capital in urban problems must evaluate the potential profitability of other choices available to it. Exhortations to bring the skills and problem solving techniques of the aerospace industry to our urban environment and governments will remain just that: exhortations, unless there is more reassuring evidence that such an emphasis can be rewarding to the relevant corporations. The urban cupboard unfortunately is bare. Exit aerospace.

—WILLIAM MITCHEL

## TELEPATH CODE TRANSLATOR puts your Card Punch on-line with your Teletype equipment

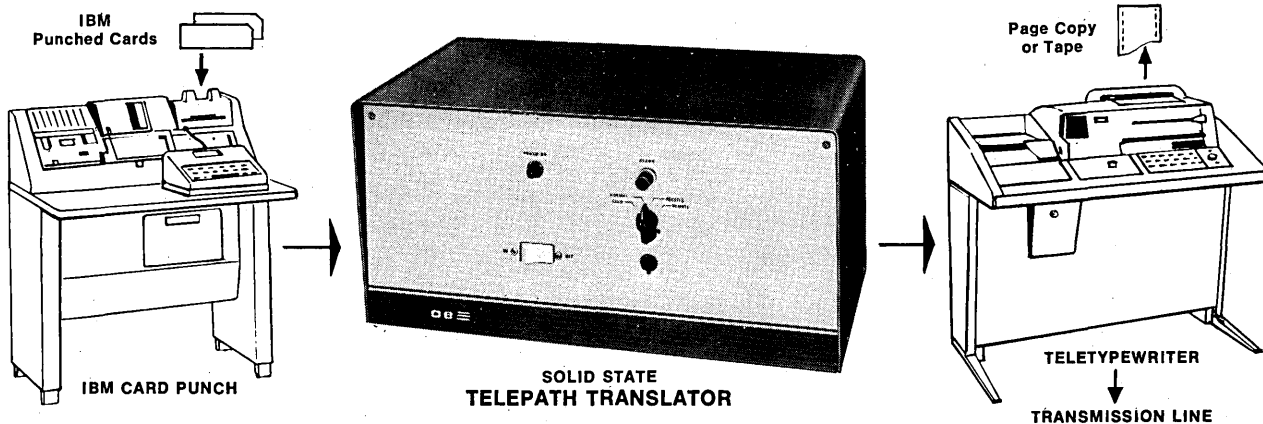

**Versatile 2-way Code Translator gives you this flexible programming!**

■ CARD TO CARD ■ CARD TO LINE ■ LINE TO CARD ■ CARD TO COMPUTER  
All with or without page copy or tape. Compatible with EIA Standards and Bell System Data Sets

Write for Literature



**ONEIDA ELECTRONICS INC.**

P. O. BOX 46

YORKVILLE, NEW YORK 13495

A DIVISION OF CAE INDUSTRIES LTD.

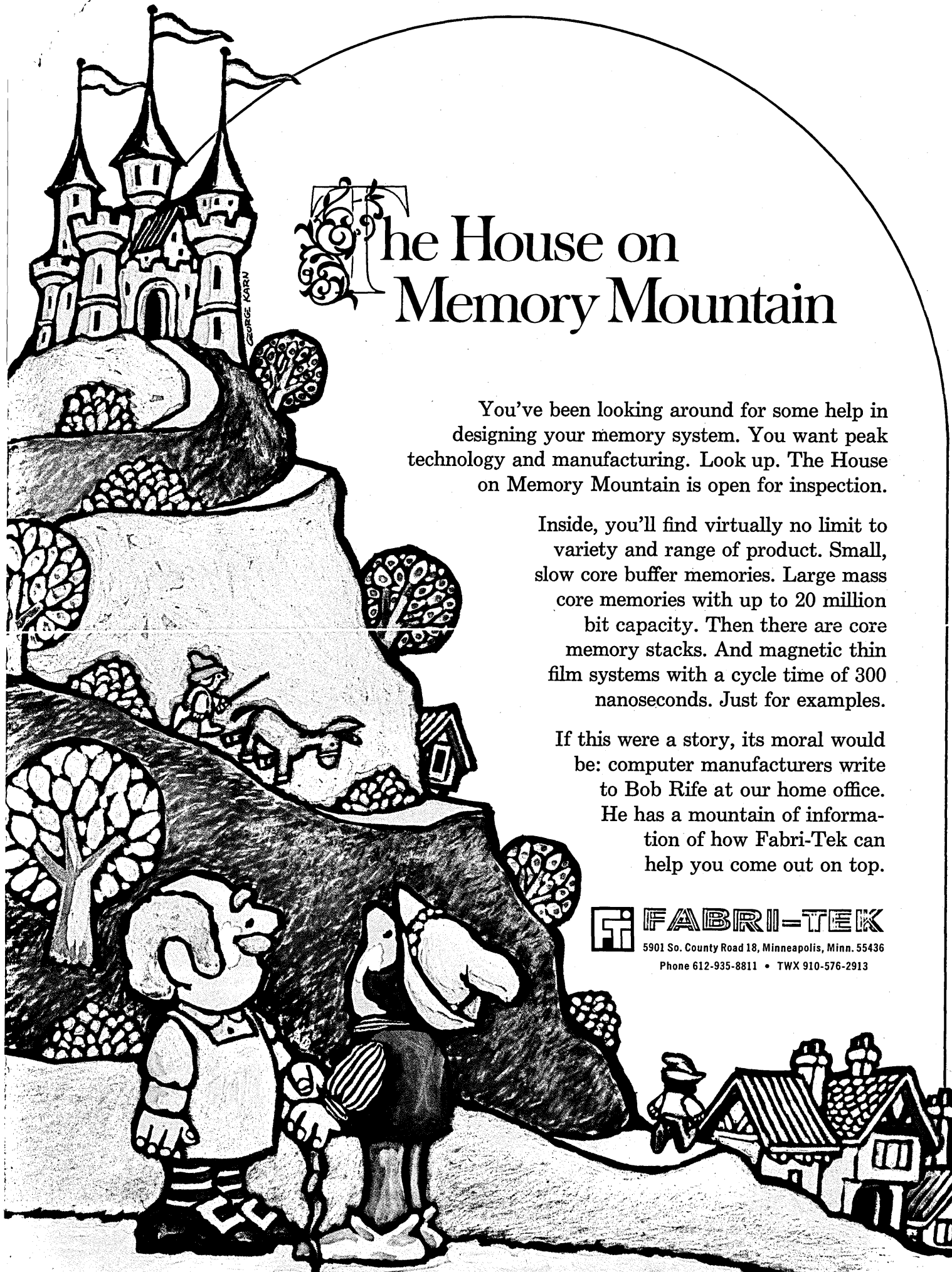

# The House on Memory Mountain

You've been looking around for some help in designing your memory system. You want peak technology and manufacturing. Look up. The House on Memory Mountain is open for inspection.

Inside, you'll find virtually no limit to variety and range of product. Small, slow core buffer memories. Large mass core memories with up to 20 million bit capacity. Then there are core memory stacks. And magnetic thin film systems with a cycle time of 300 nanoseconds. Just for examples.

If this were a story, its moral would be: computer manufacturers write to Bob Rife at our home office. He has a mountain of information of how Fabri-Tek can help you come out on top.

**FABRI-TEK**  
5901 So. County Road 18, Minneapolis, Minn. 55436  
Phone 612-935-8811 • TWX 910-576-2913

# What's the good news about the new CEC disc packs?

# IMMEDIATE AVAILABILITY

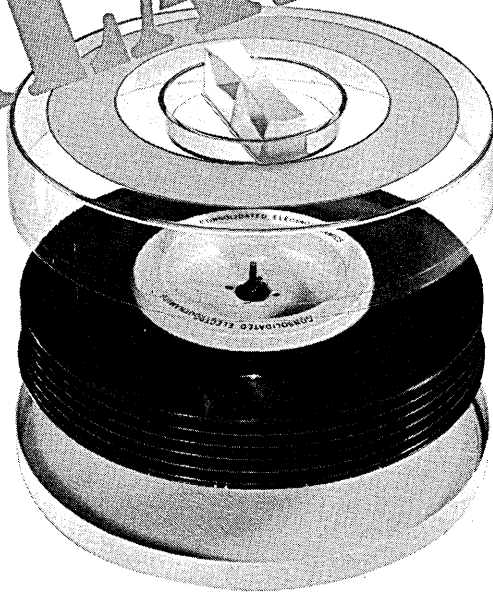

## And only CEC is prepared to guarantee it.

That's because CEC maintains—and will continue to maintain—sufficient stock on hand to meet the growing demand.

However, CEC's new CD-1 magnetic recording disc packs have some other significant advantages too.

- They are compatible with all leading disc drive systems—IBM 1311, 2311, Memorex, CDC 952, GE, Honeywell and RCA.
- They are certified to meet IBM 1316 disc pack specifications—fully checked for static and dynamic balance, then quality control tested with a special data processing program.
- They provide the smoothest recording surface yet perfected—a mean surface roughness of less than 3.5 micro-inches AA.
- Each CD-1 disc pack is serial numbered to facilitate ready reference to original test data.
- A dispatch-style carrying case (CD-1C) is available which will completely protect the disc pack in transit, yet is compact enough to fit under an airplane seat.
- Each CD-1 disc pack is supplied in a strong, dustproof, extremely impact resistant, fire retardant container molded entirely of Lexan\*.

The advent of the CD-1 disc pack now makes it possible for CEC to offer a complete backup service for computer users in magnetic recording media—from tape to disc.

For complete information, call your nearest CEC Field Office. Or write Consolidated ElectroDynamics, Pasadena, California 91109. A subsidiary of Bell & Howell. Ask for Bulletin Kit 4661-X1.

\*Lexan—registered trade-mark of the General Electric Co.

### CEC / INSTRUMENT MATERIALS



## BELL & HOWELL

# THE DATA 520/i

The third in the line of minicomputers from Varian Data Machines, the 520/i is a byte-oriented machine which can operate on one-, two-, three- and four-byte operands, thanks to special instructions which establish word length or precision independently for two sets of registers. Thus within a program it is possible to manipulate bytes and perform arithmetic on 8, 16, 24 or 32-bit words.

Included in the 520/i are two 32-bit accumulators, two 16-bit index registers, two 16-bit program counters and two one-bit overflow registers. The use of special instructions and the dual registers allows what Varian Data calls "dual environment" operation, or the interruption of a program to handle I/O or a shorter program without "housekeeping," or saving and restoring register contents or return addresses.

Thirty-two one-byte instructions facilitate byte manipulation and speed up operations, while other two-byte commands are used to handle the dual registers.

Enhancing capability are four levels of hardware interrupt, one of which branches out to eight programmed interrupts which require entry into memory for the source of the interrupt.

The 520/i is a monolithic integrated circuit machine with a 1.5 usec-cycle core, available in 4K increments up to 32K bytes. Perhaps the most attractive feature of the machine is its price: basic system including 4K core and teletypewriter is under \$10K. Optional peripherals include paper tape, mag tape, disc and printer.

The basic repertoire includes 50 instructions, with 14 conditional skips, seven memory reference operations, and allows over 500 register-register operations. Indexing is both direct (hardware) and indirect.

Add time on the machine is 3 usec plus 1.5 usec for each byte; thus add time for 1, 2, 3, and 4-byte words are 4.5, 6, 7.5 and 9 usecs, respectively. Multiply and divide are handled by software. I/O transfer rate over one-byte input and output busses is 660K (8-bit) bytes per second.

## variable length from varian

A true minemachine, the 520/i occupies an  $8\frac{1}{2} \times 19$ " rack, including built-in power supply, and weighs in at 48 pounds.

Software includes an assembler, utility programs and comprehensive arithmetic subroutines, and a set of diagnostics. Optional is an adaptor which will allow the 520/i to talk to the I/O devices of the 16-bit Data 620.

The machine will undoubtedly be of interest to systems houses for real-time applications involving interrupts, and for I/O control.

Data Machines entered the market 2½ years ago with the 620, which was later upgraded to the 620/i. There are

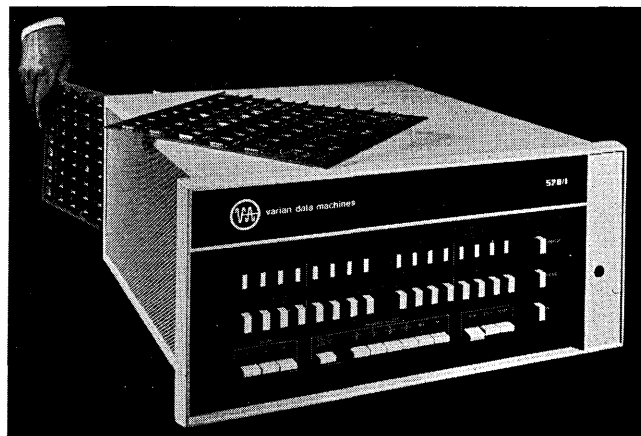

approximately 150 620's and 620/i's installed, and the backlog for the 620/i (the 620 no longer manufactured) is 300 machines. The Newport Beach, California, firm was acquired by Varian last June, and currently has some 350 employees. The company will move late this month into a 100,000 square-foot plant in the Irvine industrial park. ■

CIRCLE 240 ON READER CARD

# We promised PDP-8/I Computers for spring...Spring is here.

Last fall, we announced a brand new computer for spring deliveries. PDP-8/I. All integrated circuit. Teletype. \$12,800.

The flowers are blooming. So are PDP-8/I's. Demand has been greater than even we anticipated. We have turned on full-scale production. The result — even better delivery than we have been quoting. 90 days in most cases. Only a little longer for large systems.

We were taught how to mass produce computers by our experience with the most successful small computers ever built — PDP-8 and PDP-8/S. We've made thousands. PDP-8/I replaces the PDP-8. PDP-8/S is still the least expensive full-scale computer available.

PDP-8/I hardware includes standard 1.5  $\mu$ sec 4K core memory expandable to 32K, with the first extra 4K just plugged in. The processor is pre-wired to accommodate many options such as a

high speed paper tape reader and punch, automatic multiply/divide, real-time clock, incremental plotter, scope display — all without further interfacing.

Software appropriate for the PDP-8 and PDP-8/S is appropriate to the PDP-8/I. MACRO-8 Assembler. Two FORTRAN Compilers. On-line editing and debugging. But now, in addition, systems software which takes full advantage of 32K or more of DECdisc or DECTape memory. A new conversational language called FOCAL, that makes man-machine an easy marriage. Hundreds of logic compatible modules that make machine-machine interfacing easy. Choose from a full line of peripherals for delivery with your machine, or installed on-site by an application engineering and field service group second to none.

PDP-8/I is available as a stand-alone console or mounted in a standard

19-inch rack. Outfit yourself for spring. Write, call, or wire your local DIGITAL salesman. If you haven't spoken to him lately, he has good news for you.

**digital**  
COMPUTERS • MODULES

DIGITAL EQUIPMENT CORPORATION, Maynard, Massachusetts 01754. Telephone: (617) 897-8821 • Cambridge, Mass. • New Haven • Washington, D.C. • Parsippany, Palisades Park, N.J. • Princeton, N.J. • Rochester, N.Y. • Long Island, N.Y. • Philadelphia • Pittsburgh • Huntsville • Cocoa, Fla. • Chicago • Denver • Ann Arbor • Houston • Albuquerque • Los Angeles • Palo Alto • Seattle. INTERNATIONAL, Carleton Place and Toronto, Ont. • Montreal, Quebec • Edmonton, Alberta, Canada • Reading and Manchester, England • Paris, France • Munich and Cologne, Germany • Oslo, Norway • Stockholm, Sweden • Sydney and West Perth, Australia • Modules distributed also through Allied Radio





# TOPS IN ACCURACY

**for Computer-Aided Graphics!**

**You can take this table top for Granite . . . You can take its accuracy for Granted too!**

*The stability and uniformity of granite, used for generations in Surface Plates where extremely close tolerance measurements and control was required, now find a dynamic new application in this KINGMATIC Drafting Table.*

**GRANITE TOP . . . for better accuracy of drawn or filmed line.**

- Not effected by temp. changes
- Vibration free
- "Tops" in flatness, accuracy, and stability
- Cleans easily
- Selective, multi-zone vacuum hold-down (pat. appld. for). Flat-bed table sizes 3' x 4', 4' x 5', or 5' x 8'.

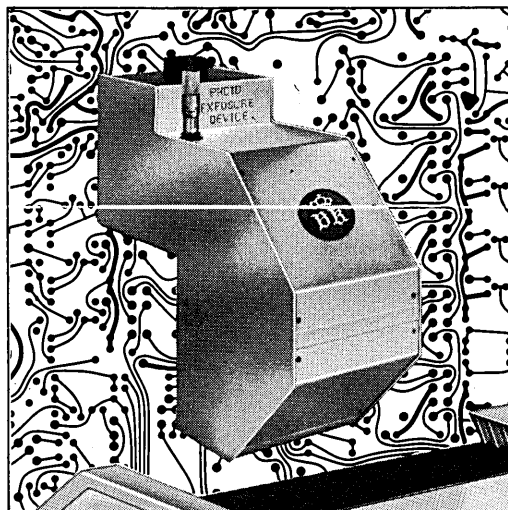

**CIRCUIT MASTERS . . .** drawn on film the light fantastic way, eliminating manual layouts and photo reductions, with a degree of ACCURACY only the Granite-Top Mark III table can deliver!

**CHECK SOME TYPICAL MARK III ACCURACIES!**

Flatness Accuracy . . . . .	(±) .0003"
Positional Accuracy . . . . .	(±) .0005"
Gap-distance Accuracy between table and Y-carriage . . . . .	(±) .00075
Repeatability . . . . .	(±) .00025
Speeds . . . . .	75 to 200 I.P.M. depending on table size

**Hi-Precision  
Mark III KINGMATIC  
Drafting Table**

Write for literature now and indicate your application areas. Demonstration arranged on request.



**Baldwin Kongsberg Company, Bldg. 8, Atkinson Square  
Cincinnati, Ohio 45246 Phone: (513) 771-7023**

See KINGMATIC in Action!  
Booths No. E-4, 5 and 6  
Spring Joint Computer Conference  
April 30 - May 2, Atlantic City

**ATHANA**





## **Now**

in production.

The Athana Disc Pack.

Meets or exceeds specs  
and performance standards  
of IBM 1316 Pack.

Compatible with all IBM,  
Honeywell and CDC disc drives.

How fast can we deliver?

How fast can you write

or call Athana Corporation:

First Union National Bank Building  
High Point, North Carolina 27260,  
(919) 882-6861.

New.

## **More to come**

# THE H-632

more bits

The announcement this month of the H-632 computer launches a new series of compatible real-time scientific processors produced by the Computer Control Div. of Honeywell. The medium-to-large-scale system is part of the Series 32, 32-bit machines intended to complement CCD's lines of 16- and 24-bit systems. CCD claims a \$215 million market for this line, which will cover multiprogramming, time-sharing, real-time and off-line use in all system sizes. Whether they will be upward and downward compatible is not announced.

The H632, starting at \$100K and ready for delivery late this year, provides multiprogramming through a modular combination of central processors, I/O processors and memory banks. Compared to other systems available, it falls between the SDS Sigma 5 and 7, and competes as well with such systems as the IBM 360/44, DEC's PDP-10 (36-bit), and "old" 24-bit systems. It does not have the time-sharing capability of the Sigma 7 and the 10—to be left to another 32 model—nor does it offer business dp—left to CCD's sister Honeywell division.

The basic \$100K system is a central processor, I/O processor, 8K-word-memory and a KSR-35 Teletype. Up to four cpu's and four I/O processors sharing four memory banks totaling 128K words will be offered, but pricing information on the configuration is not yet available. The memory cycle time is 850 nsec, said to be the fastest in a 32-bit machine.

The main multiprogramming features are the capability of the cpu to handle up to 40 priority interrupts (eight are standard) and concurrent operation of up to 16 channel programs by I/O processor (eight standard).

The cpu can directly address up to 65K 32-bit words, and can address at the bit, byte, half word, and double word level. It also has multi-level indexing, indirect addressing, and automatic trapping of arithmetic faults and error conditions. Its 16 general-purpose registers may be used as accumulators, index registers, mask registers and/or temporary storage. Up to 144 instructions are available. Floating-point and byte operations are optional. Add and multiply times for fixed point are 1.7 and 8.1 usec, respectively; for floating point, 3.4 and 7.65 usec. Shift time is 1.7 usec.

The I/O processor is an independent, word-oriented, programmable processor with direct access to core. It provides direct interpretation of I/O commands fetched from memory concurrently with cpu operation; data is transferred between memory and I/O devices without cpu intervention. The I/O processor is available in both the multiplexor and selector mode; the maximum transfer rate is 200,000 words/second. It will also transfer half words and bytes; word division is achieved by a buffer in the magnetic tape, disc, and line printer controllers. An I/O processor can handle up to 16 controllers; the disc controller (two maximum) handles up to eight drives and the tape controller (four maximum) can handle up to four drives.

The multiprocess controller unit (MPC) allows intercommunication between the cpu and I/O processor; the ac-

tivity states of all programs are recorded in this unit, which receives commands to change the state of any process. The MPC also resolves priorities when simultaneous requests for program execution occur. The access path between the memory and processors is controlled by the memory access director (MAD), which also resolves simultaneous memory access requests issued by two or more processors. As noted, all processors will be able to share all memory banks, but a central processor may also have its own bank assigned to it exclusively.

Standard software for the 632 includes a basic control executive, a macro assembler, a one-pass FORTRAN IV compiler (based on USAS1 standard), fixed and floating-point math libraries, loader, debug, test, and maintenance routines.

In peripherals, CCD is using more of the Honeywell Data Processing Division systems than on its other lines, including card and tape equipment. Control Data disc systems are used, which have up to eight discs with 1.8 million words of storage each. Other peripherals are a 300 lpm printer, and graphic and alphanumeric displays. Information Display Inc. will provide some graphic displays, although others will be interfaced with the system on customer request.

CIRCLE 178 ON READER CARD

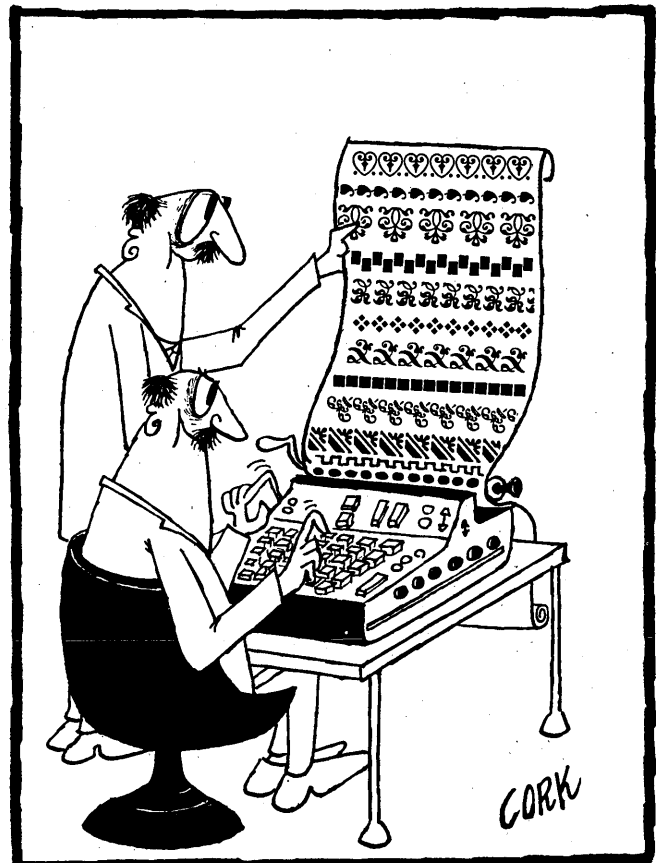

©DATAMATION

DATAMATION

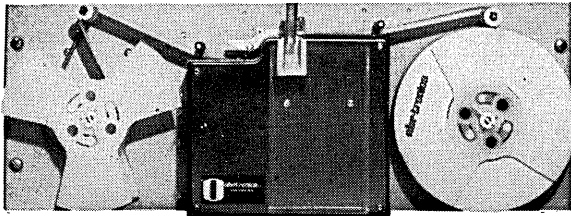

**Model 110, Paper Tape Punch** . . . punches standard 5 to 8 channel paper tape asynchronously at speeds up to 30 CPS. Powered by continuously running induction motor. Error detection achieved by parity checking switches. Tape can be back-spaced. 7"x 19" panel, 24 or 48 VDC. Price: \$599.00

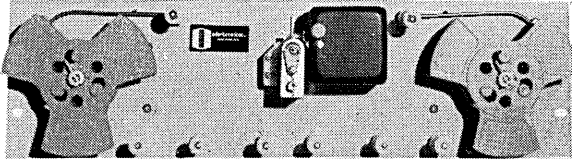

**Model 119R, Paper Tape Reader** . . . reads up to 8 channel punched paper tape with spooling mechanism for bi-directional tape supply and take-up. A switch out-put for tight tape and end-of-tape is provided. Panel is 3½" x 19" with optional 24, 48 or 90 VDC. Price: \$578.00

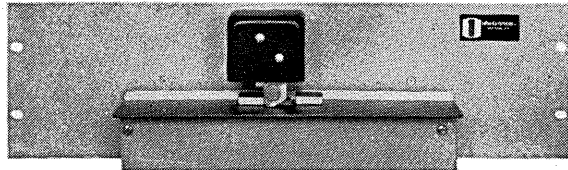

**Model 131, Edge-punched Card Reader** . . . bi-directional capability to read single, hand-fed edge-punched cards that have standard 8 channel paper tape codes punched along edges. Same mechanism as Model 119R. Price: \$457.00

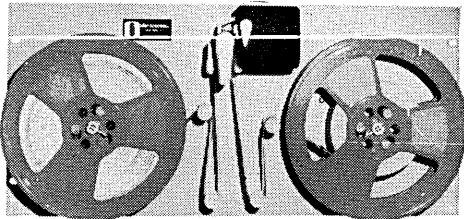

**Model 121, Paper Tape Reader** . . . 60 CPS with inclusive solid-state Drive-Pak at lowest cost! Advanced reader head features full 180° tape surface. 750' reel supply or take-up. Tape Lever indicates non-reading or broken tape. Panel is 8¾" x 19" with 24, 48 or 90 VDC. Price: \$605.00

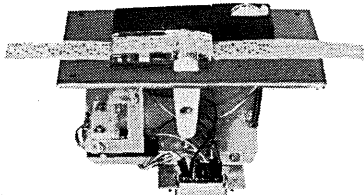

**Model 153-60, Flatbed Reader** . . . new, speedier reader at 60 CPS. Unidirectional starwheel sensing device permits mounting on horizontal surface. Panel 4½" x 5¾". Same mechanism as Model 121. Price: \$413.00

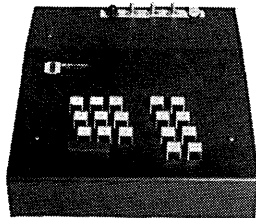

**Model 117, Encoding Keyboard** . . . 18 key . . . converts key depressions into coded (8 level) arrays of switch closures designed to interface with tape punches, printers, plotters, computers or other automatic machinery. Any code configuration can be supplied. Keys can be mechanically or electrically interlocked. Price: \$435.00

# in Numerical Control, Communications, Data Processing...

## consider Ohr-tronics

Engineering/Manufacturing  
305 W. Grand Ave., Montvale, N.J. 07645  
Tel: (201) 391-7000

One year warranty on parts and labor

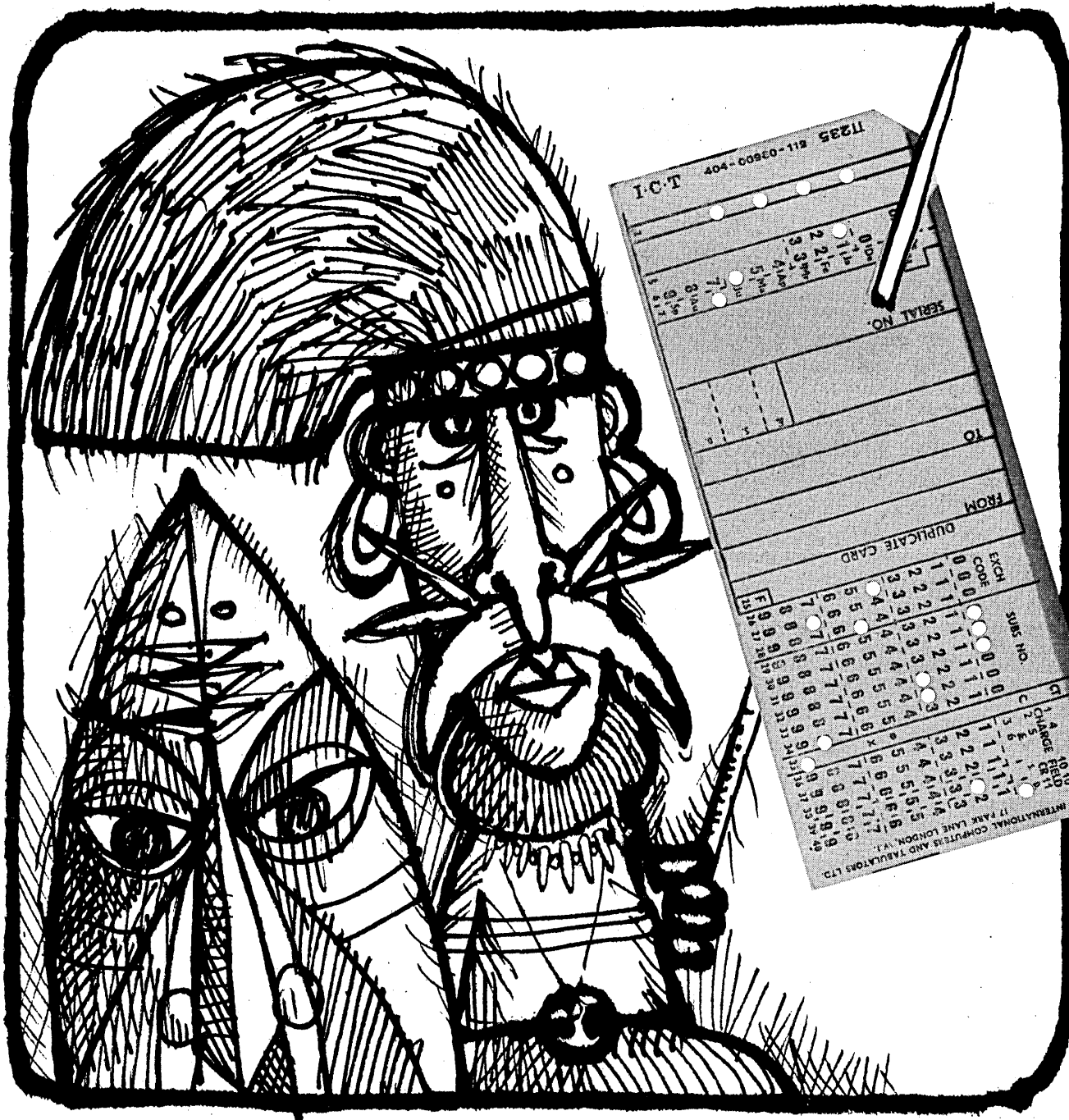

## Anywhere in the world – uptime is uptime

That is the *actual size* of the 40-column toll charge card in use by a telephone company in Africa. These cards are being read at a rate of 2000 cards per minute by one of our Speedreaders for input to an ICT computer. We manufacture card readers and punches for OEManufacturers around the globe. How (or where) in the world can we help you?



**uptime corporation**

*a subsidiary of data products corporation*

Denver Technological Center • 8455 East Prentice Avenue, Englewood, Colorado 80110 • 303/771-1230

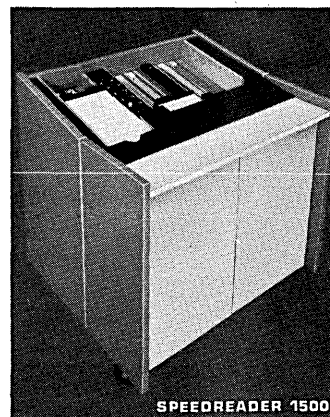

SPEEDREADER 1500

# Introducing COMMUNITYTYPE® the multi-purpose data communication system that eliminates costly keypunching



(Source Data Automation at its finest)

- it stores data — ideal for information retrieval purposes
- transmits data via phone to a computer
- receives data from the computer
- provides a high-speed communication link between offices
- produces multiple, original copies of letters automatically
- serves as an additional electric typewriter in your office

**ALL THIS, AND MORE,  
IN ONE INTEGRATED PACKAGE**

COMMUNITYTYPE® is the pioneer of source data automation systems. For six years we've been busy designing, field testing and perfecting this system. As a result we have made it one of the most practical, flexible, efficient, easy-to-operate office devices ever developed. Now it's ready for you.

### Saves Time & Money

In usage, the system eliminates costly, time-consuming, superfluous steps common to data processing procedures such as the keypunching of cards. It also enables so much more information to be processed than the single 80-column punch card ever permitted.

### Unlimited Applications

The system incorporates a standard-keyboard IBM Selectric® typewriter used for input and print-out operations.

Data typed on source documents, such as sales orders, bills of lading, insurance forms and payroll records, is buffered in a removable 180,000-character magnetic tape cartridge. The stored data can be transmitted over regular voice-grade telephone lines to your computer, or to another COMMUNITYTYPE unit or a computer-compatible COMMUNITYTYPE tape drive.

### COMMUNITYTYPE and You

There's a need for COMMUNITYTYPE in your

organization—especially if you're looking for ways to cut costs or improve internal communications. Before you begin to plan, write us or call 212-532-4870. A representative will gladly study your requirements without obligation to you.

**See us at booth #1708-1709 at the  
SJCC Show in Atlantic City at  
Convention Hall, April 30-May 2.**

### CHECK THESE OTHER ATTRACTIVE FEATURES

- ✓ any typist can easily operate it —no special training needed
- ✓ compatible with most computers
- ✓ transmits or receives at 100 characters per second
- ✓ prints out at 15 characters per second
- ✓ a whole day's typing can be transmitted in a 4-minute direct-dial phone call
- ✓ pushbutton controlled
- ✓ instant error correction facilities
- ✓ no cadence typing required
- ✓ optional Address Memory Unit retrieves pre-stored fixed information
- ✓ tabulated copy entered on source document is retrieved and transmitted in same format
- ✓ interchangeable typewriter fonts
- ✓ optional Punch Card Reader for fixed information input
- ✓ parity check circuits assure transmission accuracy
- ✓ all printed circuits, solid state logic

How to do it: your paperwork and data processing costs.



**Communitytype Corporation, Dept. E-48  
292 Madison Avenue, New York City 10017  
Phone (212) 532-4870**

Please send details about COMMUNITYTYPE.

Name \_\_\_\_\_

Title \_\_\_\_\_

Company \_\_\_\_\_

Address \_\_\_\_\_

City \_\_\_\_\_ State \_\_\_\_\_

COMMUNITYTYPE is covered by U.S. and overseas patents.

# is your computer tape telling lies?

Dirt, dregs, oxide clumps . . . any small foreign particles, can seriously affect the story a reel of tape tells your computer. Dirty tape can result in drop-outs, misleading input, down time, and increased EDP operating costs.

Clean your tape . . . **really** clean it . . . rapidly and safely, with a **Data Devices Mark-II Tape Cleaner**. Unique and exclusive design features preclude any possible tape damage, and give you a tape you can trust. Best of all, the **Mark-II** requires no regular replacement of cleaning blades, uses no solvents, pads or tissue, and creates no magnetic fields. Its new vacuum feature eliminates tape-to-tape contamination transfer.

WRITE FOR DETAILED LITERATURE  
. . . and for a new kind of lie-detector  
demonstration.

## data devices, inc.

A subsidiary of

*data products corporation*

2932 Wilshire Blvd., Santa Monica, Calif. 90403

Phone: (213) 451-5413

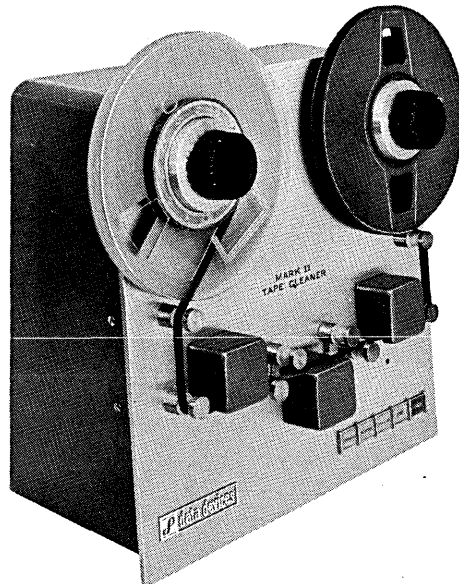

ANOTHER

**P** *data products*

PERIPHERAL

CIRCLE 60 ON READER CARD





## BUNKER-RAMO'S new BR-700 Information SYSTEM...

**A cost-effective solution to  
source data automation and  
local data management**

The BR-700 is a self-contained information system that provides query/response, several display modes, effective editing and format controls, and local data base storage. This system has no requirement for computer interaction for operation yet allows optional communications to external systems.

The BR-700 provides effective data composition, simplifying the tasks of manipulating, formatting, viewing, disseminating and updating data elements for multiple users. This combination of capabilities is achieved by flexible local data base storage and retrieval, accurate data entry controls and three modes of data display. For additional details, contact H. A. Kirsch (213) 346-6000 or write:



**THE BUNKER-RAMO CORPORATION**  
DEFENSE SYSTEMS DIVISION  
8433 FALLBROOK AVENUE • CANOGA PARK, CALIFORNIA 91304

# Are we your type?

**It won't cost you anything to find out.**

We know your type.

If you're presently making copies from line printer output, it's no pleasure to read. Or to handle.

If you're using traditional type-setting methods there's room for error.

If you'd like to iron out the bugs in multi-copy printing of computer generated data, our type is your type.

Who are we? Alphanumeric.

And what we have to offer is the most advanced technique of electronic photocomposition. A service that can add a new dimension of graphic arts quality to the printed pieces you prepare from computer generated data. A choice of type styles and sizes. Bold type. Light type. Italics. Plus the savings

that can be made in bulk. Time. And printing costs. The risk of error in type-setting is virtually eliminated because data is converted directly to type within the computer.

To find out if we're really your type, though, send us your name and address. In return we'll send you the facts. You'll learn how your output tapes can be used to generate graphic arts quality type.

If you have any doubts about whether we're all we say we are: we set the type you're reading now. In less than one second.

**Alphanumeric**  
INCORPORATED

10 Nevada Drive, Lake Success, N. Y. 11040  
(516) 437-9000

# Isn't this a simply beautiful way to store cards



The name is Gold Star . . . the world's most beautiful and most complete card storage and handling system. Notice the gleaming chrome legs, the attractive and practical stainless steel handles and accent panels, the bonded plastic work surface, and the three-wide drawers that open all the way to expose 12,000 cards at a time. This fifteen drawer file is one of a family of files ranging from one drawer to 30 drawers and including trucks and transfer filing units. Write for complete information.

*Wright*  
LINE

DATA PROCESSING ACCESSORIES

# WRIGHT LINE . . . everything for data processing . . . except the computer

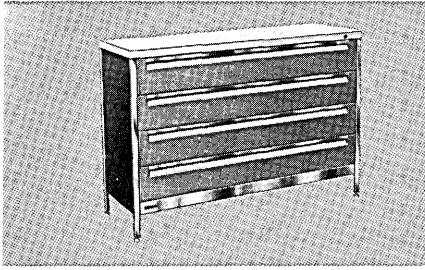

## DISK PACK STORAGE

Full suspension drawer cabinets and library units for maximum safety and protection for both 4" and 6" disks. Counter height cabinets have plastic laminate tops.

For More Information, Circle Reader Service Card No. 102



## GOLD STAR FILES

The most beautiful and most versatile card files available today. Line includes counter top model with plastic laminate surface, truck and transfer files.

For More Information, Circle Reader Service Card No. 103

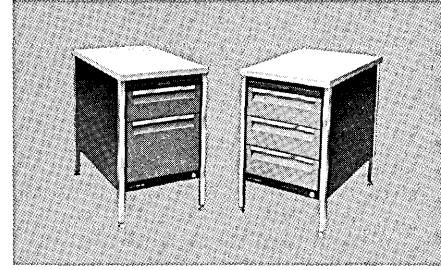

## KEY PUNCH DESK

Provide complete work stations by adding work surface and drawer space at the key punch machines. Attractively styled units for use with all key punches.

For More Information, Circle Reader Service Card No. 104

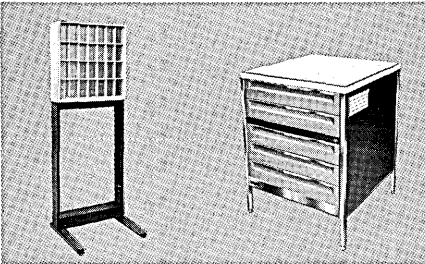

## 360-20 ACCESSORIES

Custom designed accessories for third generation computers. Line includes Data Stations and Control Centers with efficiency tops plus card handling and storage equipment.

For More Information, Circle Reader Service Card No. 101

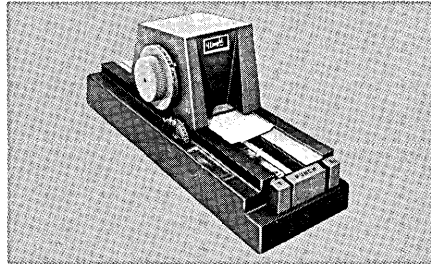

## PORTABLE CARD PUNCHES

Models for punching only or for punching and simultaneously printing. Printing punch has tab stops. Plastic card punch for Hollerith and other coding in plastic badges and cards.

For More Information, Circle Reader Service Card No. 105

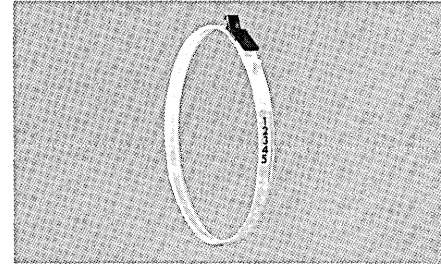

## TAPE-SEAL® SYSTEM

The safest, easiest handling, most economical method of storing tape. Complete line of Tape-Seal cabinets, trucks and accessories is beautifully styled to compliment computer equipment.

For More Information, Circle Reader Service Card No. 106

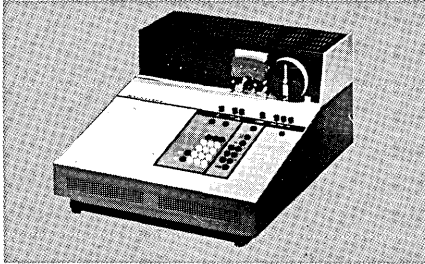

## MATHATRON

Much more than just a calculator, Mathatron has the capability to solve complex problems that are written directly with the keys. Mathatron can also be programmed and can make logical decisions.

For More Information, Circle Reader Service Card No. 107

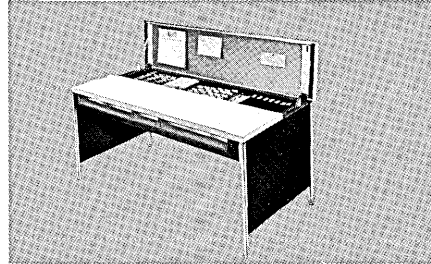

## DATA STATIONS

Specifically designed for data processing applications, Data Stations combine the best features of a desk and a tub file with custom storage for cards and supplies.

For More Information, Circle Reader Service Card No. 108

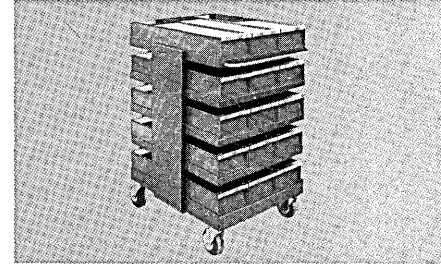

## TRUCKS

Custom trucks for transporting cards, tape, disk packs and all other data processing supplies. Trucks combine straight tracking with easy turning and ramping.

For More Information, Circle Reader Service Card No. 109

## . . . and other products:

• TUB FILES • GUIDES • CONTROL PANELS • PANEL STORAGE • BINDERS • DATA-CELL STORAGE • SORTING RACKS • Wright Line serves the data processing field exclusively with full-time Wright Line field specialists in all areas of the United States, Canada and throughout the world.



160 GOLD STAR BOULEVARD, WORCESTER, MASSACHUSETTS 01606  
A DIVISION OF BARRY WRIGHT CORPORATION

DATA PROCESSING ACCESSORIES

# FROM SHELF SPACE TO OUTER SPACE.



All in a day's work at Computer Applications Incorporated. Right now, we're helping solve fundamental theoretical research problems in space sciences. At the same time we're using a system (which we developed) that checks grocery product sales movements at wholesale levels so manufacturers can have quick, detailed data for making marketing decisions.

As a matter of fact, last year we worked on over 600 problems for our clients. All quite varied, all challenging. In a way, we try to specialize in "not specializing." We want to spread out, to do new things, to use new techniques, to come up with new approaches.

That's what makes Computer Applications Incorporated an interesting place to be at. Maybe you'd like to get in on some of the challenge. We have openings for systems analysts, programmers and engineers—forward résumé in confidence to Manager—Industrial Relations, Dept. D-4.

**COMPUTER APPLICATIONS  
INCORPORATED**

555 Madison Avenue, New York, New York 10022

CIRCLE 63 ON READER CARD

An Equal Opportunity Employer

Egyptian stela recording inundation level of the Nile River  
in 1850 B.C. (Courtesy of the Lewis Museum of Anthropology,  
University of California at Berkeley)

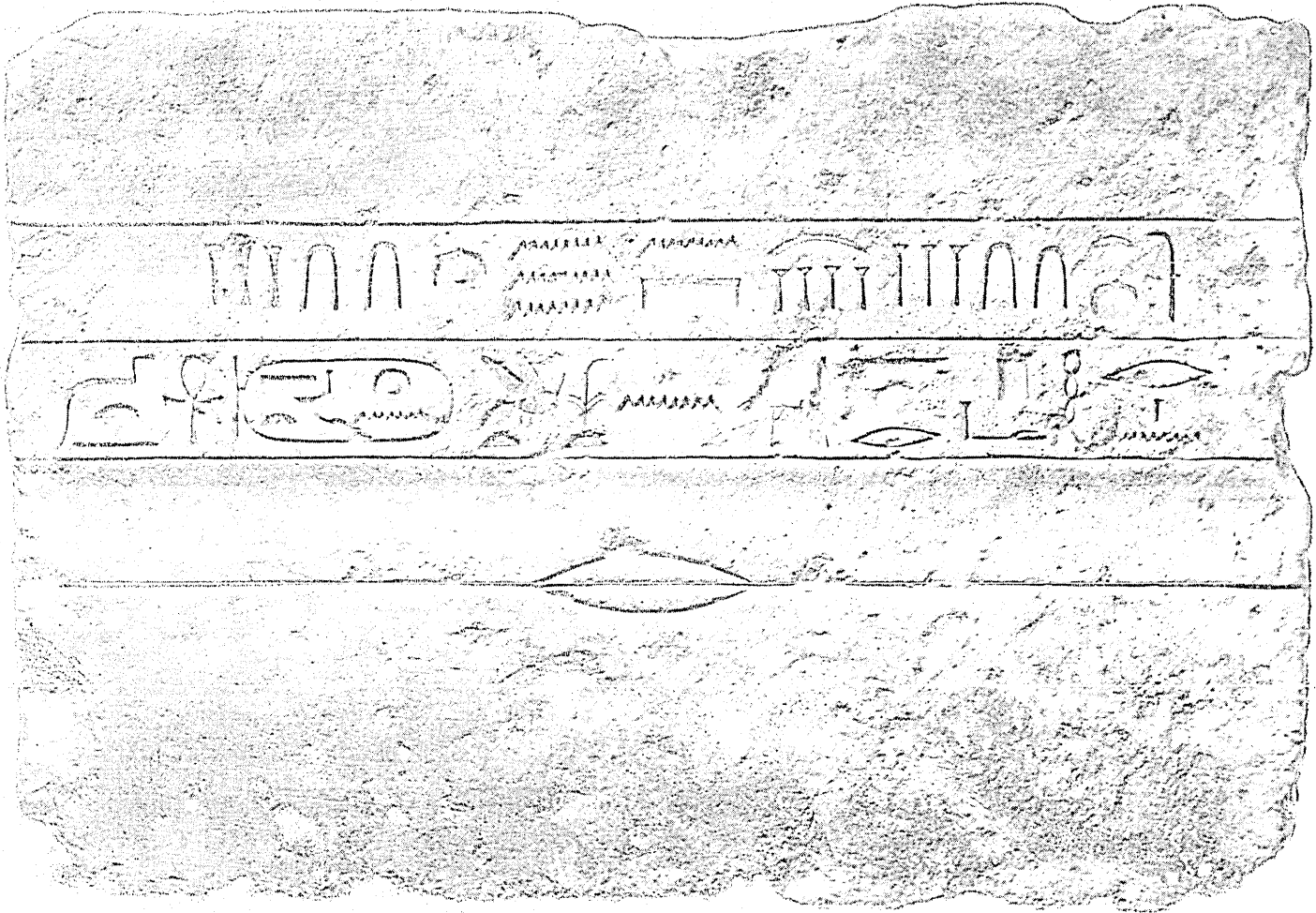

At the height of the Middle Kingdom, Egyptians often inscribed significant bits of data on large  
circular blocks. Today, modern technologists can record up to 14.5 million digits on a single 1/2  
pound CM VI magnetic disk pack. Carthus magnetic surface coatings are  
formulated and applied for superior disk performance on IBM 360 and  
compatible equipment. While the CM VI may not be as durable as stone, it  
is far more portable. Write for technical details.



Carthus International, Inc., 9677 Malibuway Road, San Jose, California 95133



\* BACK TO THE BOARD  
 WALK THE SPRING \*  
 JOINT COMPUTER CO  
 NFERENCE REVISITS  
 ATLANTIC CITY APRIL  
 30 TO MAY 2 \*

## CONFERENCE PARTICULARS

The choice of sites for the Joint Computer Conferences has been—"interesting." Anaheim, where you can lose your cool in the fantasy wonders of Disneyland; Las Vegas, where you can lose your shirt; and Atlantic City, this year revisited, where you can lose your mind when a cold spring storm whips and whistles through the mausoleums that loom over this resort of a long-gone era.

More than 15,000 visitors and registrants should hit the five-mile boardwalk for the Spring Joint Computer Conference in Atlantic City, April 30-May 2. (The program says this year's weather will be either chilly or balmy, so dress accordingly?) Again headquartered at Convention Hall, this 32nd semi-annual meeting is sponsored by the American Federation of Information Processing Societies (American Documentation Institute, Assn. for Computing Machinery, Assn. for Machine Translation and Compu-

tational Linguistics, Simulation Councils, and the IEEE Computing Group). The Data Processing Management Assn. remains, unfortunately, aloof.

After a madcap year of new company formations, mergers and acquisitions, fantastic fortunes made on the stock market (all you needed was a president and a secretary to form a company, go public, and make half-a-million on a market starry-eyed over this glamor industry)—this bigger'n'-ever meeting will be marked by numerous new faces. A record-breaking 150-plus exhibits will crowd Convention Hall. Exhibit hours this year are 11 a.m.-6 p.m., Tuesday; 10-8, Wednesday; and 10-5, Thursday.

Last year also marked the beginning of government investigations. The Federal Communications Commission recently gathered in numerous tomes on the issues of computer/communications interdependence. One such issue was the adequacy of existent commu-

nications facilities to meet the growing needs of the computer industry. Key-note speaker, H. I. Romnes, board chairman of AT&T, will focus on his firm's effort to meet "society's needs."

In describing the technical program's 21 sessions (only three in parallel at any time), chairman Theodore Bashkow, Columbia University, noted, "In view of the deepening penetration by computers into seemingly every business and technological area, an attempt has been made to include as many examples of such use as possible." The paper sessions are described elsewhere in this section, but a general description of panel sessions is given here:

"Separate Pricing for Hardware and Software," chaired by Robert Forest of DATAMATION, will be given Tuesday, 3:30-5:30. The five-man panel is made up of Richard Jones, Applied Data Research; Robert Head, Software Resources Corp.; Herbert Grosch, NBS;

**Time Is Running Out!**

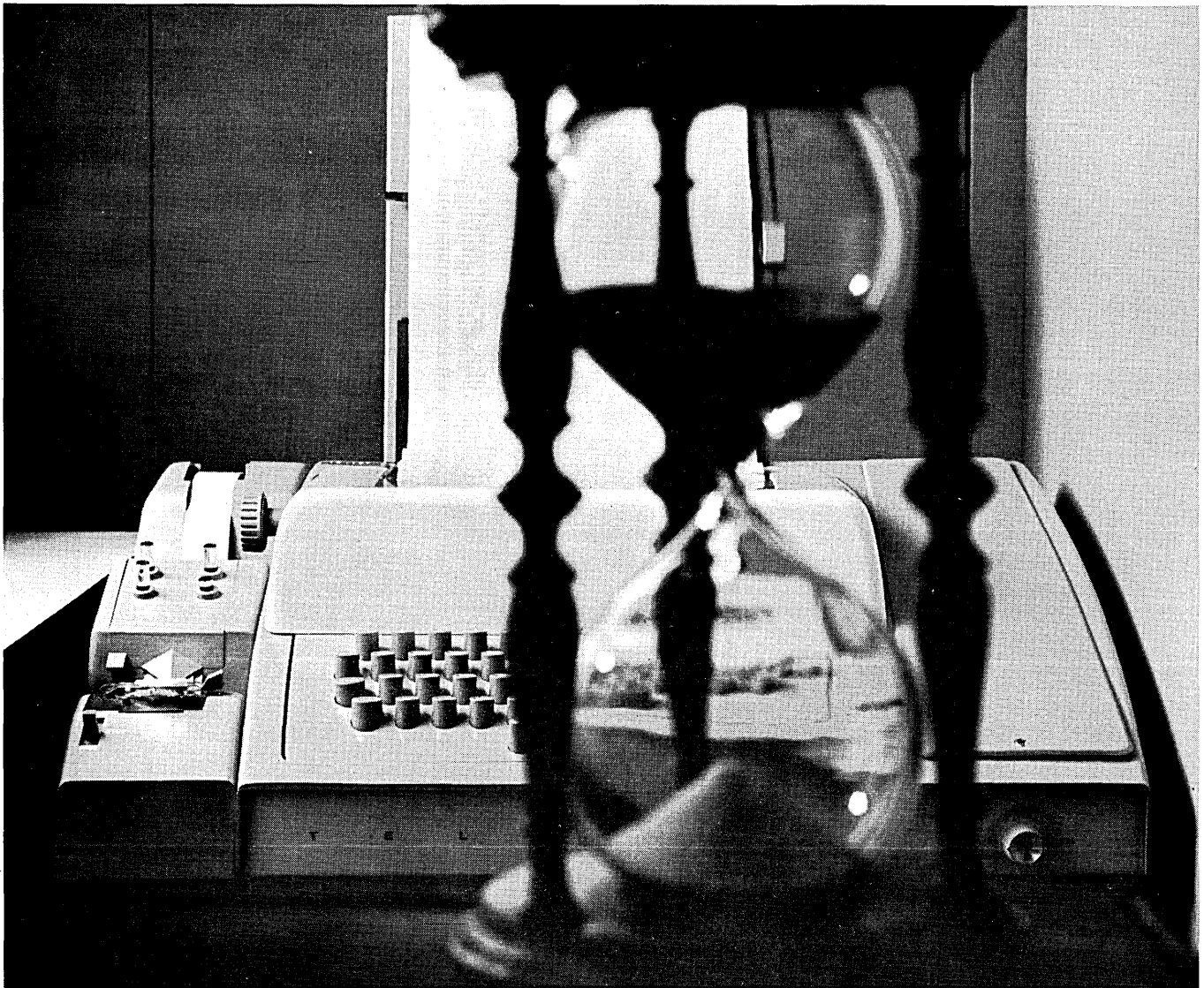

## Isn't It Time For Some BASIC Changes?

**Larger Programs:** Over 900 statements, plus chaining.

**Multiple File Access:** Open three files, sort, merge, manipulate from parallel sources, going in and coming out.

**Picture Formats:** Simple visual formatting for fine quality reports.

**Expanded Data Files:** Extra capacities of 90,000 characters in each file.

**Unrestricted Statement:** Line continuation with logical and relational operators, along with conditional and iterative statement modifiers tacked onto the back of any statement.

**Plus:** Extended alphanumeric capability, complete built-in editing, complex arithmetic, and more.

For engineers, programmers, and mathematicians who want faster debugging and quicker answers, dial up TYMSHARE for unmatched time-sharing performance. Use any of TYMSHARE's languages from TYMSHARE BASIC, through CAL (a Conversational Algebraic Language), to FORTRAN II and IV, as well as a powerful text editor. If you are doing program development, problem-solving, or mathematical calculations, ask TYMSHARE for a demonstration, your office or ours, and we'll show you a better way.

For an appointment in the following areas, call: Los Angeles 213: 677-9142, San Francisco 415: 961-0545, New York 201: 567-9110.



**TYMSHARE™**

**TYMSHARE INC.**

Los Angeles San Francisco New York





## BACK TO THE BOARD WALK THE SPRING JOINT COMPUTER CO NFERENCE REVISITS ATLANTIC CITY APRIL 30 TO MAY 2

### THE PARTICULARS . . .

Tom Marquez, Electronic Data Systems Corp.; and Philip Cramer, SDC. They will discuss the validity and viability of the concept, what must be done to achieve it, and what will happen if it becomes a reality.

"System Debugging and Start-Up Problems," chaired by Helmut A. Sassenfeld, RCA, Tuesday, 3:30-5:30, will present views on problems of making systems operational and offer suggestions on debugging. Panelists are: James Babcock, Allen-Babcock Computing, Inc.; Robert Franklin, Chrysler Corp.; J. F. Lubin, Univ. of Pennsylvania; H. A. Kinslow, Morrissey Assoc.; and J. D. McGonagle, Burroughs.

"Time Sharing Status Report," moderated by Lorenz Hittel, GE, Wednesday, 1:30-3:30, will take up two issues. One is the need for manufacturers to re-evaluate their systems standards for hardware and software reliability, in view of the serious consequences of system failure for operators of commercial systems. The other is the applications of t-s: what needs are being overlooked? Panelists are David Evans, Univ. of Utah; Budd Pine, RCA Instructional Systems; Daniel Scott, University Computing; and Jerome B. Wiener, Mandate Systems, Inc.

"What's Wrong With the Computing Field?" will discuss the gap between claim and accomplishment of manufacturers; inadequacy of system reliability; misuse of computation in

research; systems programmer ignorance of and indifference to user needs; and "bureaucracy, provincialism, and closed-shop mentality in computer operations;" Wednesday, 4-6. Moderated by G. J. Feeney, GE, panelists are: Julius Aronofsky, Mobil Oil; C. W. Churchman, Univ. of Calif.; M. M. Flood, SDC; R. C. Raymond, GE; and M. A. Woodbury, Duke.

"Optimum Use of Mass Storage," chaired by Charles Bachman, GE, will cover permanent record storage and retrieval, focusing on: mixed use of various mass media to economize on system costs; methods of data organization and effects on space and access; effect of high-level languages on programmer and designer training and productivity; rebalance of economics due to non-programmer pressures to access the data base. Wednesday, 4-6. Panelists: W. B. Helgeson, GE; T. W.



Olle, RCA; Warren Simmons, U.S. Steel; and Kendall Wright, IBM.

And last, appropriately looking ahead, will be the panel on the "Frontiers of Computers in Society." Chairman Thomas McFee, Dept. of HEW, has gathered leaders in computer research and application in the areas of education, health, and social sciences: Ralph Gerard, Univ. of Calif., Irvine; Ithiel de Sola Pool, MIT; Thomas Rowan, SDC; Walter Rosenblith, MIT; Andrew Molnar, U.S. Office of Education.

The Governor of N.J. and members of Congress have been invited to a special session on "The Election Projection System." Chaired By Dr. Irving E. Fang of ABC, a panel will discuss the design and operation of the ABC system. Another special session will be on "Improving the Accessibility of Literature on Information Processing: How Journals Can Help," sponsored by the AFIPS Abstracts Committee.

The conference banquet, to be held Wednesday, 7 p.m., in the Hotel Shelburne ballroom, will feature an address by Dr. George H. Brown, of RCA. Seymour R. Cray of Control Data will receive the annual W. W. McDowell Award for his contributions to computer development "ranging from device and circuit development through design automation and system definition, and his outstanding managerial leadership in producing a series of large-scale computers."

A no-host pre-conference reception will be held at the Holiday Inn, 5:30, Monday, and the AFIPS conference reception will be Tuesday, 6-8 p.m., in the Granada Room, Howard Johnson's Motor Inn.

Pre- and post-conference sessions will be staged by the sponsoring societies. Other features will be tours (for information go to registration area), the perennial Computer Science Theater, and, for the ladies, a full program of tours, including Garden State Racetrack, and a lecture and demonstration on "Textile Graphics."

Advance registration will be 4-10 p.m. on Monday at the Holiday Inn. Tuesday-Thursday it will be at Convention Hall, 8:30-5:00. Ample public parking, unlike Anaheim, is said to be available in the Convention Hall's underground garage.

If last year's A.C. session is any indication, this will again be a good conference for company-suite hopping, after finding the advertised healthful and pleasurable diversions "out of season." But if the weather holds, may we suggest a sunrise walk on the beach for something to do. . . . Until San Francisco in December . . . ■

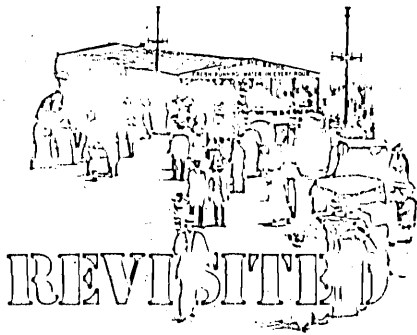

**SJCC**

## PRODUCT PREVIEW

### **ADAGE, INC.**

**Boston, Massachusetts**

The model 30 graphics terminal uses a crt display with a 12" x 12" display area and a 10" x 10" high quality area where resolution is greater than 100 lines an inch. The display is driven by a vector generator; vector drawing rate varies from 5.5 usec for ½" x ½" lines to 38 usec for 10" x 10" x 10" lines (times include required processor time). A coordinate transformation array performs full dimensional scaling, translation and rotation of the image to be displayed. An a/d converter is driven from a multiplexer (eight channels standard, expandable to 24). Software capability and system control are provided by a DPR2-P2 8K (30-bit) word processor. For information:

CIRCLE 219 ON READER CARD

### **APPLIED DATA RESEARCH, INC.**

**Princeton, New Jersey**

The AUTOFLOW computer documentation system which produces two-dimensional flowcharts automatically is now available for the H-200 series, and will directly accept Honeywell's COBOL and EASYCODER languages. Also announced are four new options for the basic system: Speed-Pak, for use on 360/40's and larger systems; Hi-level/COBOL and Hi-level/FORTRAN, for use with 360's and Spectra 70's; and a Stromberg-Carlson option which produces microfilm and hard-copy flowcharts on the SC-4020 plotter. For information:

CIRCLE 220 ON READER CARD

### **BALDWIN KONGSBERG COMPANY**

**Cincinnati, Ohio**

The Kingmatic Mark III automatic drafting system consists of a drafting table and a numerical control direc-

tor. The basic unit of the director is a DDP-416 16-bit computer; it is provided with an ASR 33 Teletype connected to the drafting table through an interface with a curve generator. The director also has a 300 cps paper tape reader; IBM-compatible mag tape input with 200/556-800 bpi is optional. Input is in EIA variable block word format in EIA or USASCII code. All basic software is supplied. The drafting table provides accuracies of ±.001" and repeatability of ±.0005" over a 48" x 60" surface. Speeds are up to 200 ipm. Drawings may be in ink or scribing tools can be mounted in the six-position pen turret. For information:

CIRCLE 221 ON READER CARD

### **COMPUTER COMMUNICATIONS, INC.**

**Inglewood, California**

The CC-306 card reader is an optional input device to the CC-30 communications station; it can also be used as a remote terminal. The unit can read either binary or coded cards; standard 80-column cards are read at a rate of 100 cpm. The data is loaded directly into the buffer memory of the CC-301 display controller which then transmits it to the computer. The reader can also transfer data from the cards to any output device under computer or operator control in an off-line utility I/O application.

Also announced, the CC-310 video-printer is an optional hard-copy output device, providing either single or multiple output from the CC-30's crt display. Both alphanumeric and graphic images are accommodated. A hard copy can be obtained in under 10 seconds; the printing process is dry. For information:

CIRCLE 222 ON READER CARD

### **COMPUTER INDUSTRIES, INC.**

**Van Nuys, California**

The firm's Graphic Systems division will be exhibiting a drafting system with a digital control unit and a plotter. I/O is via keyboard or paper tape. The digital control unit has a 4K memory; it can provide stored programs for curved or straight line interpolation and character annotation while continuously monitoring the position of the drafting head. The plotter has a 50" x 60" useable area, and accepts paper from 8½" x 11" to 45" x 60". Speed is 12" a second; resolution is .001". Straight line interpolation is performed digitally for all line lengths; circular interpolation will handle arcs up to 13" in radius. Floating origin allows the zero point to be shifted to any point on the drafting

surface or off the surface for extended requirements. For information:

CIRCLE 223 ON READER CARD

### **COMPUTER TEST CORPORATION**

**Cherry Hill, New Jersey**

The Telemux IV Data Concentrator compresses data from a number of terminal devices for transmission across single voice-grade lines. It can accept digital data from several terminals simultaneously at rates up to 56, 75, 110 and 150 bps. Using a time division technique, it compresses the data into an aggregate for transmission through a data set at rates up to 9,600 bps. On the receiving end, another Telemux terminal breaks the data into individual low-speed channels for input to the receiving devices. The system is transparent (i.e., each device continues to see the data as if it were transmitted across individual telegraph lines); thus, the Telemux system can be implemented with no reconfiguration of the original system. A system can accommodate up to 99 channels depending on transmission rate, character code length, and speed of terminal device. It can operate in full- or half-duplex, or simplex mode with all standard codes and interfaces. For information:

CIRCLE 224 ON READER CARD

### **DATA DISC, INC.**

**Palo Alto, California**

The digital/video disc recorder is designed for use where crt terminals must be refreshed at a continuous, parallel rate to avoid flicker. The basic FPD-8 (8-track system) can be augmented with additional 8-track increments up to a total of 72 tracks. As many as 100,000 bits on each track can be accessed at a 3-megabit rate; with track-combining techniques that allow parallel access, the 72 tracks (at the 3-megabit rate) give an access time of 216 megabits a second. Each track has its own read/write and clock electronics with i.c. interfaces that permit reading and writing in parallel. The recorders can also be used as transient recorders with a pulse-width/recording capability on each track extending from 330 nsec to 16 msec. For information:

CIRCLE 225 ON READER CARD

### **DATA PRODUCTS CORPORATION**

**Culver City, California**

The 5095 Discfile is a random access memory system designed specifically for time-sharing applications; it has a capacity of 5 billion bits per disc unit, and one to eight units per system. A

## PRODUCT PREVIEW . . .

low-friction servo head positioner accesses eight tracks on each of four discs, and can step through 128 discrete positions. Random positioning time is approximately 60 msec; track-to-track time is 15 msec; full-stroke time is 100 msec. The unit includes an electronic monitor to detect bearing wear and the presence of dirt or wear on the positioner bearing rail. Monitors are also used to detect improper positioner/disc contact, and the condition of the main drive bearings; modular construction of the Discfile allows maintenance to be performed on an individual component while the other modules are operating on-line. An air conditioning/filtering system provides cool air and maintains a positive air pressure within the cabinet. For information:

CIRCLE 226 ON READER CARD

### GENERAL DESIGN, INC. Melbourne, Florida

The models 100 and 500 card readers utilize a vacuum pick finger that separates individual cards from the input deck; the process allows the readers to handle cards that are out-of-tolerance, stapled, patched or otherwise damaged. The model 500 reads 600 cpm; has a hopper capacity of 1,000 cards; the 100 has a speed of 200 cpm and a capacity of 400 cards. Both units read character, serial; bit, parallel. For information:

CIRCLE 227 ON READER CARD

### HONIG TIME SHARING ASSOCIATES Hartsdale, New York

FORCE-III is a time-sharing software system which uses a 100K core partition under OS MVT on 360/50 and larger, permits simultaneous use of up to 15 terminals during normal batch processing. System includes G-level FORTRAN IV compiler, file maintenance and editing. Worst case response time will be 7 sec; average response time 3.5 sec. Terminals will include TTY models 33, 35 and 37, the IBM 1050 and 2741. For t-s only, the system requires 128K core; mixed foreground and background requires at least 256K; with 512K "highly desirable." Optional purchase or rental includes training, documentation and maintenance at current IBM release levels. For information:

CIRCLE 228 ON READER CARD

### HOUSTON INSTRUMENT DIV. OF BAUSCH & LOMB, INC. Bellaire, Texas

The COMPLIT Model DP-1 digital plotter operates at a maximum rate of 300 increments a second, and can be operated either on- or off-line. The unit uses Z-fold chart paper, providing a plotting width of 11"; the paper is packaged in sheets 144' long. Connectors are provided for AC or DC coupling; on-line, the plotter will operate with all known interface couplers. Delivery is 30 days after receipt of order. For information:

CIRCLE 229 ON READER CARD

### INFORMATION CONTROL CORPORATION El Segundo, California

The Abacus division will be exhibiting the I-1011 microverter, consisting of an a/d converter and a 16-channel multiplexer. The multiplexer has an input impedance of 100 megohms and a full-scale voltage of  $\pm 10$  V; channel selection includes parallel and sequential address, short cycle, channel preset, and logic control signals. The a/d converter has an input impedance of 1000 ohm/volt and is bipolar. Resolution is .05% in BCD and binary; conversion rate is 1 usec.

Also being announced is ICC's Com-Rac 100 random access core memory system. The memory has a full cycle time of 1 usec; an access time of 460 nsec; and a capacity of up to 8,192 (12-bit) words or 4,096 (24-bit) words. For information:

CIRCLE 230 ON READER CARD

### LOCKHEED ELECTRONICS COMPANY Los Angeles, California

The CE-150 is a 1.5 usec i.c. memory system designed for small computers or as a buffer memory. It has an access time of 750 nsec, and is available in capacities of 4096, 8192 and 16K words, with word length variable in 4-bit increments from 8 to 36 bits. For information:

CIRCLE 231 ON READER CARD

### MILGO ELECTRONIC CORPORATION Miami, Florida

The Model 10 voice adapter allows users of modem 4400/24PB data set to transmit voice to Teletype simultaneously with 2400 bps data over a single unconditioned telephone line. The adapter is a plug-in device; requires no outside power. It allows selection of voice/data, teletype/data, and full voice. For information:

CIRCLE 232 ON READER CARD

### MOTOROLA INSTRUMENTATION AND CONTROL, INC. Phoenix, Arizona

The MDR-1000 card reader accepts data from pencil-marked documents, punched cards, or a combination of marked and punched cards, and transmits this information to Teletype, via a Dataphone. Transfer rate is 10 cps (110 bits per second) or 105 cps (1050 bits per second) in serial bit; 75 cps (750 bps) in parallel bit. The standard 12-row Hollerith-coded cards are used, arranged in either 40- or 80-column spacing, and can be fed singly or automatically into the reader in batches up to 500, with an optional automatic hopper. Coded data in USASCII is standard; EBCDIC, PTT6 and BCD are available on request. Delivery is 90 days after receipt of order. For information:

CIRCLE 233 ON READER CARD

### RAYTHEON COMPUTER Santa Ana, California

A new series of converters, based on the M-series integrated circuit modules, represents an expansion of the 703 IC computer systems. Word lengths for the analog-to-digital and digital-to-analog converters, and the Miniverter, are 10- or 12-bit binary and 13-bit BCD. Throughput rate for the Miniverter is 50 KHz; it can be expanded from 16 to 256 channels. If the A/D converter is used by itself, throughput rate is 100 KHz for 10 bits, or 75 KHz for 12 bits. The converters are all available in three packages: as a basic building block of modules mounted on a connector block, ready for installation into a chassis; the same unit mounted in a 40-module case with power supplies, optional controls, ready for mounting in a standard relay rack; or mounted in a 120-module equipment drawer, with power supplies and controls, cooling fan, I/O connectors, and necessary space for additional logic functions. For information:

CIRCLE 234 ON READER CARD

### RIXON ELECTRONICS, INC. Silver Spring, Maryland

The Frequency Division Multiplex (FDM) modem permits the transmission of eight full duplex data channels operating up to 150 bps per channel over a single telephone line. Two basic packages are available: a standard 19" rack and a desk-top unit. The rack-mounted unit permits an initial installation of units with a minimum number of channels with a plug-in expansion

## PRODUCT PREVIEW . . .

sion capability of up to eight channels. The desk-top unit will accept modules for two channels. For information:

CIRCLE 235 ON READER CARD

### SANDERS ASSOCIATES Nashua, New Hampshire

The 920 series display systems are large-screen crt systems designed to present and control volume quantities of tabular information. The basic system can display nearly 2,000 characters: 81 characters a line, 24 lines; custom expansion can be up to 4,000 characters. The display area is a 23" crt. The system has three operational modes: read, write and edit. Mode selection is via control signal lines which interlock the display with its interface/processor units. In read and write modes, data is transmitted at a

rate of 100,000 cps; character serial, bit parallel. Keyboard operations allow entry, deletion and replacement of characters in edit mode. The series has a 52.5 Hz refresh rate. For information:

CIRCLE 236 ON READER CARD

### SCIENTIFIC CONTROL CORPORATION Dallas, Texas

The 2700 digital computer has a 4,096-word core memory (expandable in increments of that size to 65K), and operates at 880 nsec cycle time. A special set of instructions use the index register and the accumulator as operands to provide logical and arithmetical operations. Teleprocessing and crt peripherals are available in addition to card reader/punches, printers, mag tape transports, etc. The system is microprogrammed, and has a read-only memory for internal sequence control. For information:

CIRCLE 237 ON READER CARD

### SOFTWARE RESOURCES CORPORATION Los Angeles, California

REMIS is a real estate management information system for a System/360 computer with 128K of core that produces rental billing and tenant status reports (including income, vacancy and change summaries). It also gives investor reports, budget analysis, unit cost comparisons, seasonal expense variations, community operations summaries and comparisons of expenses among properties. Purchase price includes complete documentation and installation support. Delivery within 30 days. For information:

CIRCLE 238 ON READER CARD

### SOROBAN ENGINEERING, INC. Melbourne, Florida

Being announced is the ETR card reader, a desk-top (12" x 12" x 22") unit with an I/O hopper capacity of 500 cards. The reader, reportedly priced "surprisingly low," operates at 200 cpm. For information:

CIRCLE 239 ON READER CARD

# THE HP 2114A

The 2114A digital computer is the low-end member of the Hewlett-Packard family which includes the 2116A, announced in November '66, and the 2115A, announced November '67. The small 2114A (a 12 $\frac{1}{4}$ " x 16" x 25" unit houses processor and power supply) is a 16-bit machine with either a 4K or 8K memory and a 2 usec cycle time. The 4K memory is organized in four pages of 1024 words each; direct addressing of two pages (current and base page) plus "unlimited" levels of indirect addressing of all pages is accommodated. Two directly addressable 16-bit accumulators are included for program simplification. A 70-word instruction set allows up to 8 instructions to be microprogrammed into one word for expanded capability.

The system has 8 I/O channels (expandable with an option to 16); Party Line I/O and multilevel priority interrupt are standard. Standard peripheral interfaces are available for punched-tape and card readers, Teleprinters, Dataphones, mag tape units, plotters, tape punches and line printers. Data acquisition instrumentation, such as digital voltmeters, input scanners and a/d converters may be interfaced with the basic hardware and software.

The software provided for the 2114A includes FORTRAN, ALGOL and Conversational BASIC compilers, a library of math routines, and programs to communicate with special instrumentation.

The basic (4K) system is priced at \$9950. Compatible with the other models in the family, the new computer is,

according to the company, a result of a "severe attempt to reduce price without sacrificing a high price/performance ratio." The 2114A differs from the \$14.5K 2115A in that it does not offer an extended arithmetic unit and direct memory address capability. Certain peripheral options, such as a Teleprinter (basic on the 2115A) are also priced separately. The cost of the basic 2114A system includes the same training and warranty available on the larger models; regular OEM discounts apply. Deliveries are scheduled to begin December '68. For information:

CIRCLE 179 ON READER CARD



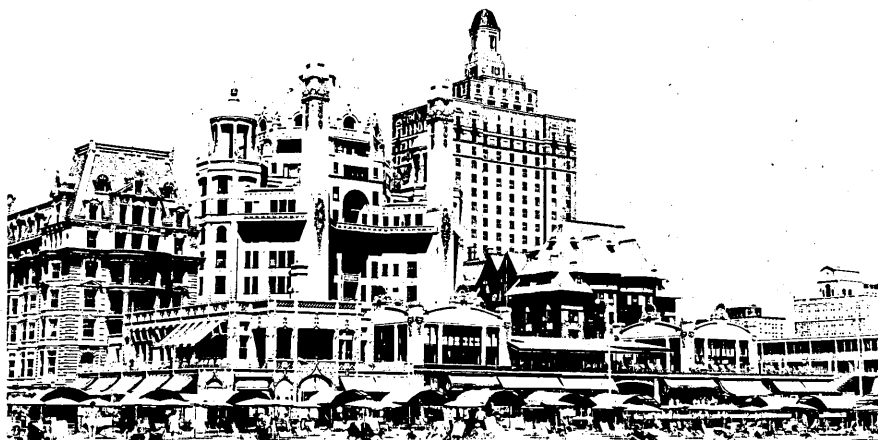

BACK TO THE BOARD  
WALK THE SPRING  
JOINT COMPUTER CO  
NFERENCE REVISITS  
ATLANTIC CITY APRIL  
30 TO MAY 2

## SUMMARIES OF PAPER SESSIONS

### Session 1

Tuesday, 1:00-3:00

Ballroom

#### COMMERCIAL TIME-SHARING: THE SECOND GENERATION

Chairman:

Jerome B. Wiener

Mandate Systems, Inc.

New York, N.Y.

One of the clear indications that time-sharing has entered its second generation is the fact that none of the papers presented deals with Project MAC, TSS67 or Multics. Instead the papers discuss live experimental data comparing machine requirements, personnel time and costs of time-sharing versus batch, definitions and examples of various forms of scheduling algorithms in a time-sharing environment, an example of a running System/360 time-sharing system, and a history of a running battle between a time-shar-

ing group and a phone company.

The area not covered in this session, but in fact the major problem of most of the commercial time-sharing service bureaus today, is system reliability. It would be reasonable to expect that within the next year enough progress will be made in that area so that commercial time-sharing groups will be willing to discuss their work without fear that it will provide any advantage to their competitors. Time-sharing system reliability has been demonstrated on specific systems and by specific collections of talent for reasonable enough increments of time to indicate that the problem is technically solvable and, in fact, the difficulties are now electro-political.

Time-Sharing Versus Batch Processing:  
The Experimental Evidence, by H.  
Sackman.

Computer Scheduling Methods and  
their Countermeasures, by Leonard

Kleinrock and E. G. Coffman, Jr.

Some Ways of Providing Communication Facilities for Time-Shared Computing, by Howard L. Steadman and George R. Sugar.

The Baylor Medical School Teleprocessing System, by William F. Hobbs, Jane McBride, and Allan H. Levy.

### Session 3

Tuesday, 1:00-3:00

Room H-J

#### COMPUTER-AIDED DESIGN

Chairman:

Edwin L. Jacks

General Motors Research Laboratories  
Warren, Michigan

To design is to conceive, to plan and to create. Each paper in this session is

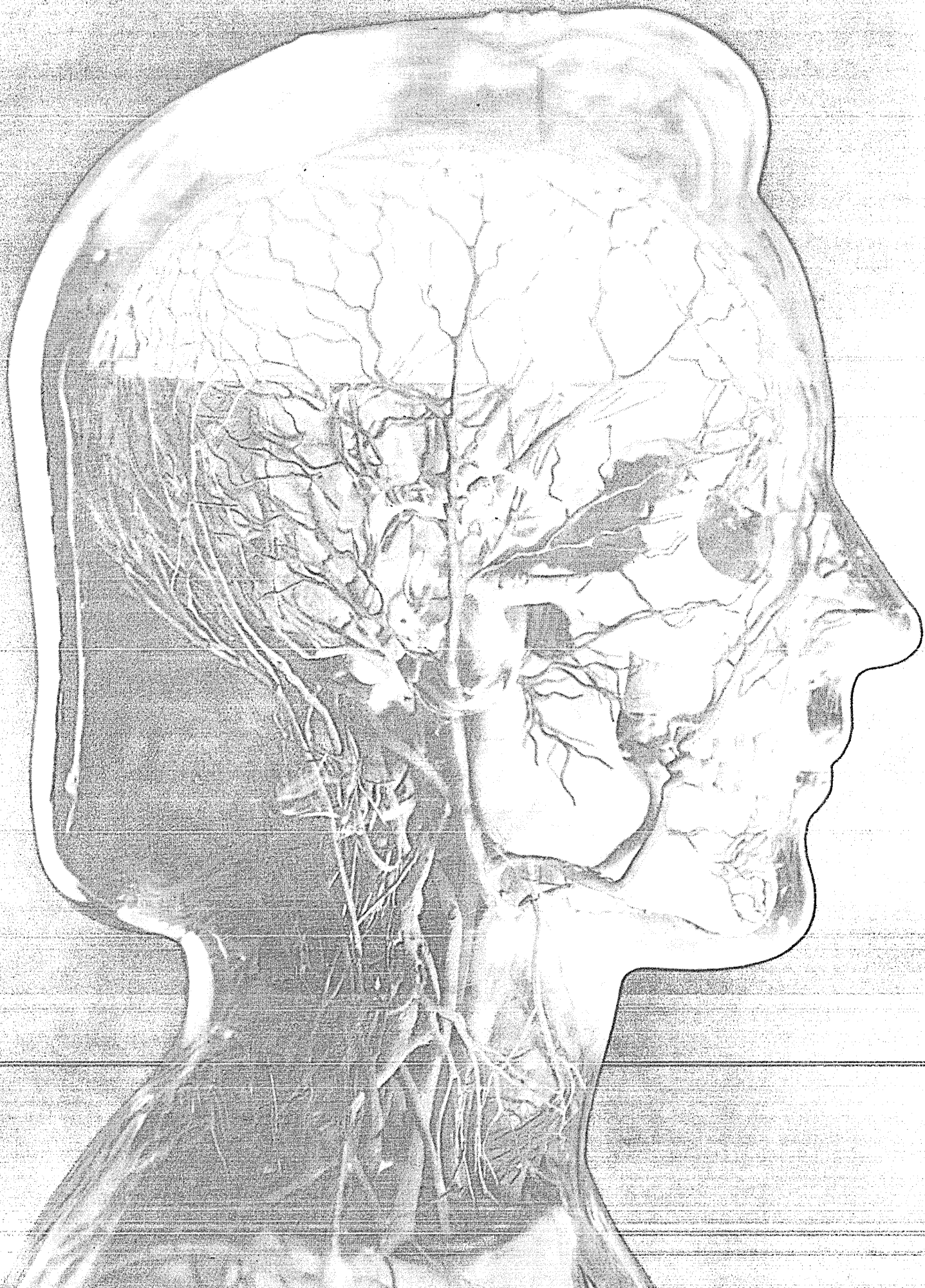

# This is the computer that can foul up your computer.

The human mind is more complex than any computer. But less reliable.

And that's why any business with EDP needs Addressograph's data collection and automated input systems. (To put that in plain English, we make data recorders for 100% accurate input, and scanners to process input information at the lowest possible rejection rates.)

Our systems are compatible with both kinds of computers: human and electronic. And they take into accounting the fallibility of the human kind.

They handle all kinds of information. Make it computer readable. And get it to the

computer quicker, with 100% accuracy.

Clerical or non-clerical people have been taught to operate our systems in a matter of minutes.

And once they've learned how, the problems of computer input virtually disappear.

To learn more, write Addressograph Multigraph Corporation, Department 6808, 1200 Babbitt Road, Cleveland, Ohio 44117.

Or call your nearest branch office (we're in the Yellow Pages).

We'd love to have you run the facts and figures on our systems through your computer.

Either one of them.

Juno, courtesy of Cleveland Health Museum.

**ADDRESSOGRAPH** division  **CORPORATION**  
...helping people communicate

# Nothing matches your computer like a Tab Storaway. (Except another Tab Storaway.)

Tab Storaways are as modern as today's third-generation computer. (You can match or harmonize them to your computer in any of

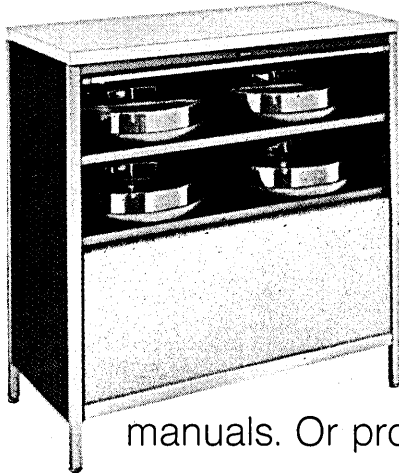

22 colors.) What they can do for you is almost limitless. They can quickly put card files at your fingertips.

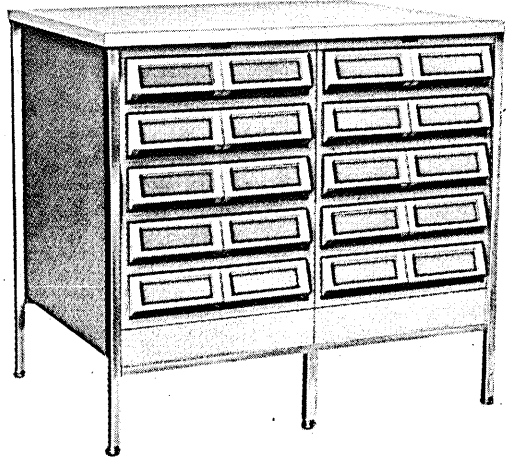

Or tape reels. Or data cells and tape reels. Or tape reels and disc packs. Or disc packs and procedure manuals. Or program decks and tape reels.

Or tape reels, disc packs, and data cells. In fact, our Storaways are versatile enough to hold whatever

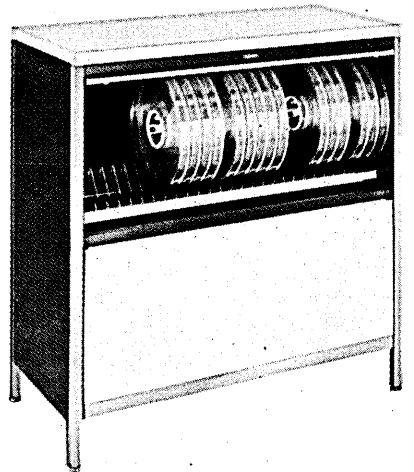

you use in your computer room. You provide the specifications. We'll provide the Storaways.



So if you're looking for Storaways to go with your computer, just mail the coupon to Tab. Ask us for a match.

Gentlemen: I'd like more information on your Storaway cabinets.

Name \_\_\_\_\_ Title \_\_\_\_\_

Company \_\_\_\_\_ Street \_\_\_\_\_

City \_\_\_\_\_ State \_\_\_\_\_ Zip \_\_\_\_\_

**TAB**  
PRODUCTS CO.

633 Battery St., San Francisco, California 94111

D

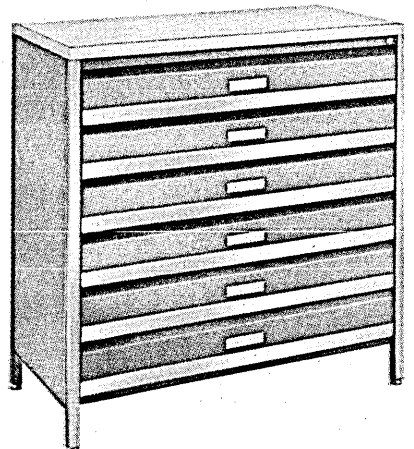



## SESSION SUMMARIES . . .

aimed at aiding a different phase of design. The process of conceiving new physical objects is significantly aided by the ability to visualize spatial objects. The first paper presents a technique for generating shaded drawings and addresses the general question of high quality artwork being generated by computer. The second paper introduces the use of state diagrams and concepts of higher level languages as a means of programming reactive graphics for design applications. The phase of design most difficult to do on a computer is creation of new designs, and that problem is discussed in the third paper relative to the design and synthesis of asynchronous circuits.

Some Techniques for Shading Machine Renderings of Solids, by Arthur Appel.

A System for Interactive Graphical Programming, by William M. Newman.

Automation in the Design of Asynchronous Sequential Circuits, by Robert J. Smith II, James H. Tracey, Wayne L. Schoeffel and Gary K. Maki.

### Session 5

Tuesday, 3:30-5:30

Room F-G

#### SCIENTIFIC APPLICATIONS OF GENERAL INTEREST

Chairman:

Vincent C. Rideout  
University of Wisconsin  
Madison, Wisconsin

This session is a group of four papers on rather dissimilar topics in the general area of scientific applications of computers. The problems discussed will be of interest to many designers and customer engineers as well as to those with scientific interests close to those of the authors.

Interpretation of Organic Chemical Formulas, by Albert M. DeMott.

A Simulation in Plant Ecology, by Raymond E. Boche.

A Major Seismic Use for Fast-Multiply Unit, by Robert D. Forester, Tim J. Hollingsworth and James D. Morgan.

A Generalized Linear Model for Optimization of Architectural Planning, by Rodolfo J. Aguilar and James E. Hand.

### Session 7

Wednesday, 9:00-12:00

April 1968

## Ballroom COMPUTERS IN COMMUNICATIONS SYSTEMS

Chairman:

William Keister  
Bell Telephone Laboratories  
Holmdel, New Jersey

In the rapidly growing networks where people communicate with computers and computers communicate with each other, users are finding a chaos of incompatible languages, methods of operations and terminal equipment. The papers in this session discuss several aspects of the problems before us.

Standards for User Procedures and Data Formats in Automated Information Systems and Networks, by J. L. Little and Calvin N. Mooers.  
Procedures and Standards for Inter-Computer Communications, by A. K. Bhushan and R. H. Stotz.

An Error-Correcting Data Link Between Small and Large Computers, by S. W. Andreae and Robert W. Lafore, Jr.

Graphical Data Processing, by E. J. Smura.

The Advancing Communication Technology and Computer Communication Systems, by S. J. Kaplan.

### Session 8

Wednesday, 9:00-12:00

Room F-G

#### HYBRID COMPUTER SYSTEMS AND TECHNIQUES

Chairman:

Granino A. Korn  
University of Arizona  
Tucson, Arizona

The topics in this session range from novel techniques to proposals for future systems. The ingenious and simple transistor-circuit simulation method described in the first paper can quite often substitute for computer-aided circuit-design methods much more expensive in time and memory requirements.

The second paper is an interesting contribution to hybrid solution of partial differential equations. The third paper proposes a hybrid-signal processor for biomedical data which crowds the state-of-the-art and will, I hope, start a lively discussion about the speed and accuracy really required for biomedical work. The fourth paper reintroduces the question as to the role of DDA's in simulation: it proposes not

only integrated circuit construction and higher speed, but also completely automatic programming hardware and software.

Analog Computer Simulation of Semiconductor Circuits, by Philip Balaban and John Logan.

A New, Stable Computing Method for the Serial Hybrid Computer Integration of Partial Differential Equations, by Robert Vichnevetsky.

BASP—A Biochemical Analog Signal Processor, by W. J. Mueller, P. E. Buckthal, P. Lambrinidis, K. E. Schultz and L. F. Walsh.

Electrically Alterable Digital Differential Analyzer, by Gilbert P. Hyatt and Gene Ohlberg.

### Session 9

Wednesday, 9:00-12:00

Room H-J

#### COMMERCIAL DATA PROCESSING

Chairman:

B. L. Neff  
Metropolitan Life Insurance Co.  
New York, New York

This session emphasizes the practical economic benefits of computers, rather than attempting to blaze new trails of theory. Three of the papers ("The



Gipsy System," The Martin Orlando Reporting System," and the "Data File Two") are concerned with the ever-present problem of information retrieval. Each is an attempt to solve a particular problem in a particular way, an approach not likely to appeal to the theoretician, but required in the actual environment of real management situations.

The International Atomic Energy Agency's Gipsy System is a method of classifying and retrieving technical documents to allow the production of bibliographic reports quickly and accurately. A significant feature of the system is that "a bibliographic description of a document is the description of the document itself and the description of any other related document

**SESSION SUMMARIES . . .**

which may exist." The report on the system has the authority of two years of practical experience in real application. The method and its successes should be of interest to management people generally.

The Data File Two paper and the Martin Orlando paper are concerned with retrieval of actual data, rather than bibliographic lists. Information within a business environment exists in a seemingly infinite variety of classifications, and it is important to be able to pull this information out of the files, summarize where necessary, and make timely reports of the summaries. Both systems emphasize the idea of usefulness to the management person who is not in a position to learn a complex programming method but who needs information in a hurry. There is also a realization of the necessity of having fast methods of handling reports of an entirely unexpected nature, provided the data is on file to create them.

The paper on the ISCOR System of South Africa is somewhat different from the three above papers in that it deals with a real-time situation. One man's "real-time" may be another man's "batch-processing," and it may

be observed that the ISCOR System is not real-time in the sense of describing a process control computer application with the digital computer directly tied to, for example, a rolling mill. The real-time aspect of the system lies in the fact that production reports and printed instructions for further product processing will be produced at the time that material is actually under-going manufacture. The system will also handle preliminary paper work on new orders, and do ordinary batch processing of over-all reports when not required to give full time to real-time requirements. Two large scale computers are being installed to handle the system, with back-up a primary consideration in view of the real-time activity. A fascinating point about the use of cathode ray tubes in the system is that the plant personnel will be able to query the computer in either English or Afrikaans.

The paper "Simulation Applications in Computer Center Management" will be of interest to those concerned with the management and scheduling of multi-computer facilities. This concerns not only very large installations, but many relatively small ones whose work is spread across two or more machines. Scheduling decisions in such computer shops are difficult to make

with any assurance of optimization, and simulation of various alternative decisions allows one to see the probable effects of a decision, based on a large number of randomly distributed situations. Answers to management questions can also be drawn from this technique, such as examining the distribution of equipment between main-frame and peripheral facilities. Other matters that can be looked into are the occasional overtime versus extra-shift operation economics, and the effect of phasing-in new facilities.

- Data File Two, by Rueben Jones.
- GIPSY: A Generalized Information Processing System, by G. Del Bigio.
- The ISCOR Real-Time Industrial Data Processing System, by W. M. Lambert and W. R. Ruffles.
- Martin Orlando Reporting Environment, by M. J. McLaurin and W. A. Traister.
- Simulation Applications in Computer Center Management, by Thomas F. McHugh, Jr., and Ellis Scott.

**Session 11**  
**Wednesday, 1:30-3:30**  
**Room F-G**  
**MULTIPROGRAMMING OPERATING SYSTEMS**

# The new VersaSTORE II core memory system can give you all the speed, capacity, and convenience you'll ever need.

1.6  $\mu$ sec asynchronous speed with 650 nsec access time.

Capacity up to 4096 36-bit words, up to 8192 18-bit words.

Occupies only 5 1/2" rack space, weighs less than 35 lbs.

VersaSTORE II capacity is expandable via exclusive "Party Line" design.

Plug-in stack permits easy service.

Includes timing and control flags, test points, and optional self-test for easy system checkout.

All-silicon design and modular front-access construction.

Servoed current drive system compensates for ambient temperature changes. Insures excellent margins under elevated temperatures.

VersaSTORE II is our improved version of the original VersaSTORE memory with more than two years' success in hundreds of systems.

We'd be happy to give you an unlimited amount of our own personal time, or even send you a copy of our complete new VersaSTORE II brochure. Just call or write.

Let us quote on a VersaSTORE II to meet your requirements. Our low price will surprise you.

## It can also save you a few bucks.

**varian data machines**  
 a varian subsidiary  
 Formerly Decision Control, Inc.  
 1590 Monrovia Ave., Newport Beach, Calif.  
 TEL. (714) 646-9371 TWX (910) 596-1358

We need Senior Development Engineers and Programmers. Write to Mr. Bruce Ferris.

CIRCLE 68 ON READER CARD

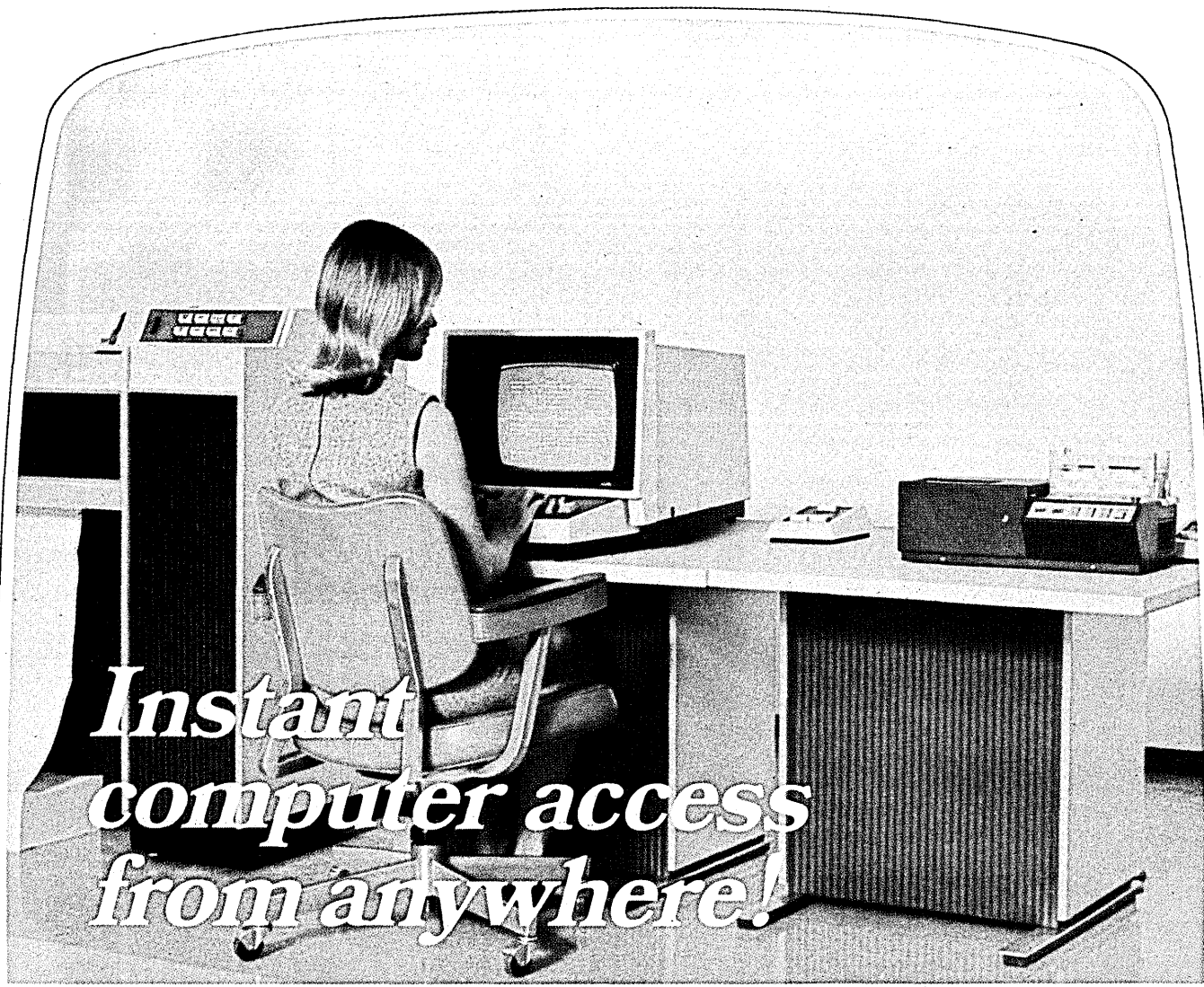

*Instant  
computer access  
from anywhere!*

*with the  
CONTROL  
DATA® 200  
User  
Terminal*

Your computer may be hundreds of miles away, but a CDC® 200 User Terminal puts its computing power at your fingertips... gives you immediate access to all the computing power you need, when you need it. Enter information or ask for it. Change or update a file. Submit a computing job. The response is immediate. In effect, the computer is yours alone, regardless of how many others happen to be using it simultaneously.

The CDC 200 User Terminal consists of a CRT/keyboard entry-display, a card reader and a printer. Data is entered via the keyboard. Response from the computer appears either on the screen or as hard copy from the printer.

The entry/display station has a 14" screen with a capacity of

twenty 50-character lines (thirteen 80-character lines optional). The photoelectric card reader has a capacity of 100 cards per minute. Its 1,000-character buffer gives it a throughput equal to that of larger, more expensive readers. In line printers, you have a choice between an 80 column or 136 column, 300-line-per-minute reader. Either device may also be used for off-line card listing.

For full details on this and other Control Data User Terminals, contact your Control Data Sales Office or write Dept. H-38...

**CONTROL DATA**  
**CORPORATION**

8100 34th AVE. SO., MINNEAPOLIS, MINN. 55440

**SESSION  
SUMMARIES . . .**

Chairman:

Ascher Opler

IBM Corporation

Yorktown Heights, New York

As operating systems development begins to level off at the current plateau, we begin to see the necessity of examining the technology with deeper insight, more fundamental analysis and

more objective measuring techniques. In order to move ahead to operating systems of greatly improved scope and performance, a deeper knowledge is required.

The four papers in this session each contribute to this understanding in a different way. The first paper, by Cantrell and Ellison, describes the elaborate measurement schemes used to study the GECOS II operating system. The authors show how they surmounted some of the difficulties associated with measuring performance in multiprogramming operating systems. Tsujigado, in his analysis of an operat-

ing system, shows how several different modes of operation (batch, conversational, etc.) may be optimized for performance by considering not only competition for cpu time but also competition for retention of assigned core storage space. Freeman's paper pre-

**BACK TO THE BOARD  
WALK THE SPRING  
JOINT COMPUTER CO  
NFERENCE REVISITS  
ATLANTIC CITY APRIL  
30 TO MAY 2**

**BRANDON SYSTEMS INSTITUTE, INC.**

offers regularly scheduled  
Technical and Management  
**SEMINARS**  
in  
**DATA  
PROCESSING**

**NATIONWIDE**

NEW YORK • WASHINGTON, D.C. • CHICAGO  
DALLAS • BOSTON  
LOS ANGELES • ATLANTA • LAS VEGAS\*

**BRANDON SYSTEMS INSTITUTE** is the nation's largest independent data processing training institute. It offers a full curriculum of 20 different seminars for senior management, EDP installation managers, computer systems analysts and users of data processing services.

The Institute is the training subsidiary of Brandon Applied Systems, Inc., the international data processing consulting firm. All of its instructors are consultants from the staff of Brandon Applied Systems and are active in the subjects they teach.

New courses to provide fundamental training in emerging industry concepts are constantly under development.

Current seminars include:

Basic Business Systems Analysis— I and II	Data Processing Organization and Personnel	Measuring EDP Performance
Computer Operations Management and Control	Decision Tables: Principles and Applications	Project Control Systems for Data Processing
Computer Selection	Documentation Standards	Systems Analysis and Programming in a Multi- Programming Environment
Computer Systems Analysis Techniques	Effective Programming Management	The Manager's Role in Systems Development
Converting to Third Generation Computers	Executive's Guide to Data Processing Management and Control of Multi-Programming Operations	Top Management Control of EDP
Data Base Management Workshop	Management Standards for Data Processing	
Data Base Organization and Management		

A 32-page catalog describing the content, time, cost and location of the Institute's March-through-August seminars is available. To obtain a copy, write directly to the Institute.



**BRANDON SYSTEMS INSTITUTE, INC.**  
1611 North Kent Street—Arlington, Virginia 22209

\*On August 29-30 in conjunction with the ACM National Convention

sents a means of dramatically improving operating system performance by organizing a large main core storage hierarchically. Hauck and Dent review the stack feature of the Burroughs' B5000 and show how the Burroughs' B6500 and B7500 design extends and improves upon these facilities.

It is clear that those responsible for operating systems design must prepare themselves for systems of still greater complexity, higher performance and improved facility for systems of the future. Hopefully, the papers at this session will contribute to the design of such systems.

**Multiprogramming System Performance Measurement and Analysis**, by H. N. Cantrell and A. L. Ellison.

**Multiprogramming, Swapping and Program Residence Priority in the Facom 230-60**, by Makoto Tsujigado.

**A Storage Hierarchy System for Batch Processing**, by D. N. Freeman.

**Burroughs' B6500/B7500 Stack Mechanism**, by E. A. Hauck and B. A. Dent.

**Session 12**

Wednesday, 1:30-3:30

Room H-J

**ADVANCES IN MAGNETIC  
MEMORY DESIGN**

Chairman:

Walter R. Beam

IBM Corporation

White Plains, New York

The ferrite core magnetic memory, established for some years as the primary fast-access storage for digital computers, continues to make progress through the incorporation of monolithic semiconductor circuits for drive and sense circuits. Meanwhile, thin film storage devices in both flat film and plated-wire configurations continue their own progress toward higher lev-

Take up to \$40.05 worth of books for only \$4.95

Choose any 3 of these twenty outstanding titles

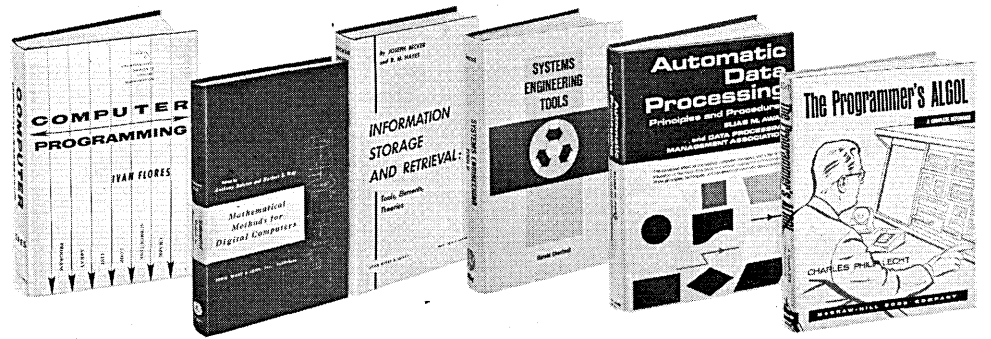

This extraordinary saving is yours with a short, experimental membership in **The Library of Computer and Information Sciences**

NOTE: Publishers' prices shown for each book.

**33400. ANALYSIS OF INFORMATION SYSTEMS:** A Programmer's Introduction to Information Retrieval. Charles T. Meadow. Thorough treatment of the languages of information retrieval, organization of records and files, processing of files. **\$11.50**

**35490. AUTOMATION AND ELECTRONICS IN PUBLISHING.** Edited by Lowell H. Hattery and George P. Bush. Concise survey of the revolutionary effects of computers on the publishing industry, with emphasis on overall trends. **\$8.75**

**35450. AUTOMATIC DATA PROCESSING.** Elias M. Awad and the Data Processing Management Association. Complete introduction to the principles and procedures of automatic data processing, by the top computer managers. **\$10.60**

**36870. BRIEF NUMERICAL METHODS.** Wendell E. Grove. Concise, step-by-step introduction to elementary numerical methods emphasizing iterative solutions - particularly useful in the field of machine computation. **\$6.75**

**39860. COMPUTER PROGRAMMING.** Ivan Flores. Shows how the computer, the program and the programming system operate to solve problems. A clear guide to software, list-manipulation methods, character-oriented computers and much more valuable information. **\$12.00**

**42190. DIGITAL COMPUTER PROGRAMMING.** Peter A. Stark. Designed for the beginning student of the computer sciences who wants an overview of the programming field. No knowledge of higher mathematics is assumed on the part of the reader. **\$9.95**

**42260. DIGITAL TAPE DRIVES.** James E. Taunt. Through precise, inclusive descriptions of the inner workings of digital tape drives, the author provides purchasers, programmers and operators with a clear understanding of these parts. **\$7.45**

**42270. DIGITAL PROCESSING: A SYSTEM ORIENTATION.** Louise Schultz. Clarifies the underlying principles, techniques and applications of digital processing in simplified linguistic, rather than strictly symbolic, terms. **\$14.35**

**44100. ELECTRONIC INFORMATION HANDLING.** Edited by Allen Kent and Orrin E. Taubee. Comprehensive overview of the field of information handling and retrieval. Topics include interpreting signals, numerical information. **\$11.00**

**55290. INFORMATION, COMPUTERS AND SYSTEM DESIGN.** Ira G. and Marthann E. Wilson. Penetrating, significant book that examines systems concepts in the light of information theory - and the roles people play in system design and operation. **\$12.50**

**55300. INFORMATION STORAGE AND RETRIEVAL.** Joseph Becker and E.M. Hayes. Outstanding discussion of information system theory and design, man-machine relationships, language data processing, artificial intelligence, and more. **\$11.95**

**56240. INTRODUCTION TO ALGORITHMIC METHODS USING THE MAD LANGUAGE.** Alan B. Marcovitz and Earl J. Schweppe. Introduces methods applicable to the implementation of algorithms on computing machines, relating them to other techniques. **\$6.50**

**56300. INTRODUCTION TO COMPUTING.** T.E. Hull. Highly useful new guide to algorithms, stored-program computers, and programming techniques, with emphasis on FORTRAN IV, one of the most widely used algorithmic languages in computing. **\$10.00**

**56410. INTRODUCTORY COMPUTER METHODS AND NUMERICAL ANALYSIS.** Ralph H. Pennington. Covers the most commonly used methods of modern analysis, stressing those of proven value in the computer solution of problems in science and engineering. **\$9.00**

**60950. MATHEMATICAL METHODS FOR DIGITAL COMPUTERS, Volume I.** Edited by Anthony Raiston and Herbert S. Wilf. Illuminating exposition of the most useful techniques of numerical analysis for solving mathematical and physical problems. **\$9.95**

**63840. NATURAL LANGUAGE AND THE COMPUTER.** Edited by Paul L. Garvin. First book to provide a comprehensive survey of the emerging field of natural language data processing (such as English or Russian as opposed to artificial languages such as ALGOL). **\$12.75**

**65620. ON HUMAN COMMUNICATION.** Colin Cherry. Complete exploration of the entire field of communication. Demonstrates the many-sided nature of communication, theory, which includes mathematics, physics, linguistics, phonetics, psychology, etc. **\$10.00**

**70720. THE PROGRAMMER'S ALGOL.** Charles Philip Lecht. Reference work for programmers that is the complete guide to ALGOL. Bridges the gap between theoretical presentations and the needs of the practicing programmer. **\$8.95**

**70790. PROGRAMMING SYSTEMS AND LANGUAGES.** Edited by Saul Rosen. Outstanding review of computer software. Brings together the most authoritative articles on history of programming systems from computer journals and proceedings. **\$12.50**

**82100. SYSTEMS ENGINEERING TOOLS.** Harold Chestnut. Drawing on every day situations, the author explains the nature of systems engineering problems and the tools used in solving them. Over 300 diagrams and illustrations. **\$12.95**

Check these benefits of membership for professionals in the computer field:

- ✓ The books you need to keep up - and ahead! Choose from hundreds of significant, up-to-date works in the computer and information sciences - the latest developments in computer programming, systems analysis and design, data processing equipment, information storage and retrieval, real time methods, operations research, mixed language programming, management information systems, and many other vital topics.
- ✓ FREE Bonus Books: You are entitled to a free Bonus Book of your choice for every 4 Selections you purchase. (This Introductory Offer counts as your first Selection.)
- ✓ Substantial Savings: As a Trial Member, you get a significant discount on EVERY book you purchase - savings up to 40%.

**TRIAL MEMBERSHIP APPLICATION**

The Library of Computer and Information Sciences  
Front and Brown Streets, Riverside, N.J. 08075

Please enroll me as a Trial Member and send the 3 books circled below for only \$4.95 plus shipping. If I am not delighted, I will return them within 10 days, and my membership will be cancelled. As a Trial Member, I need accept only 3 more Selections during the next 12 months, all at reduced Member's Prices plus shipping. Each month I will receive advance reviews describing forthcoming Selections, along with a convenient form for requesting Alternate Selections or no book at all. For every 4 Selections purchased, I may choose a free Bonus Book. (Introductory Offer counts as the first Selection.)

Three Books for only \$4.95 (circle numbers):  
33400 35490 35450 36870 39860 42190 42260  
42270 44100 55290 55300 56240 56300 56410  
60950 63840 65620 70720 70790 82100

NAME.....  
ADDRESS.....  
CITY..... STATE..... ZIP CODE.....  
Please be sure to indicate zip code. 7-655



PHOTOGRAPH BY [unreadable] COURTESY OF THE NATIONAL ARCHIVES

G  
C  
of  
C  
th  
pu  
of  
tic

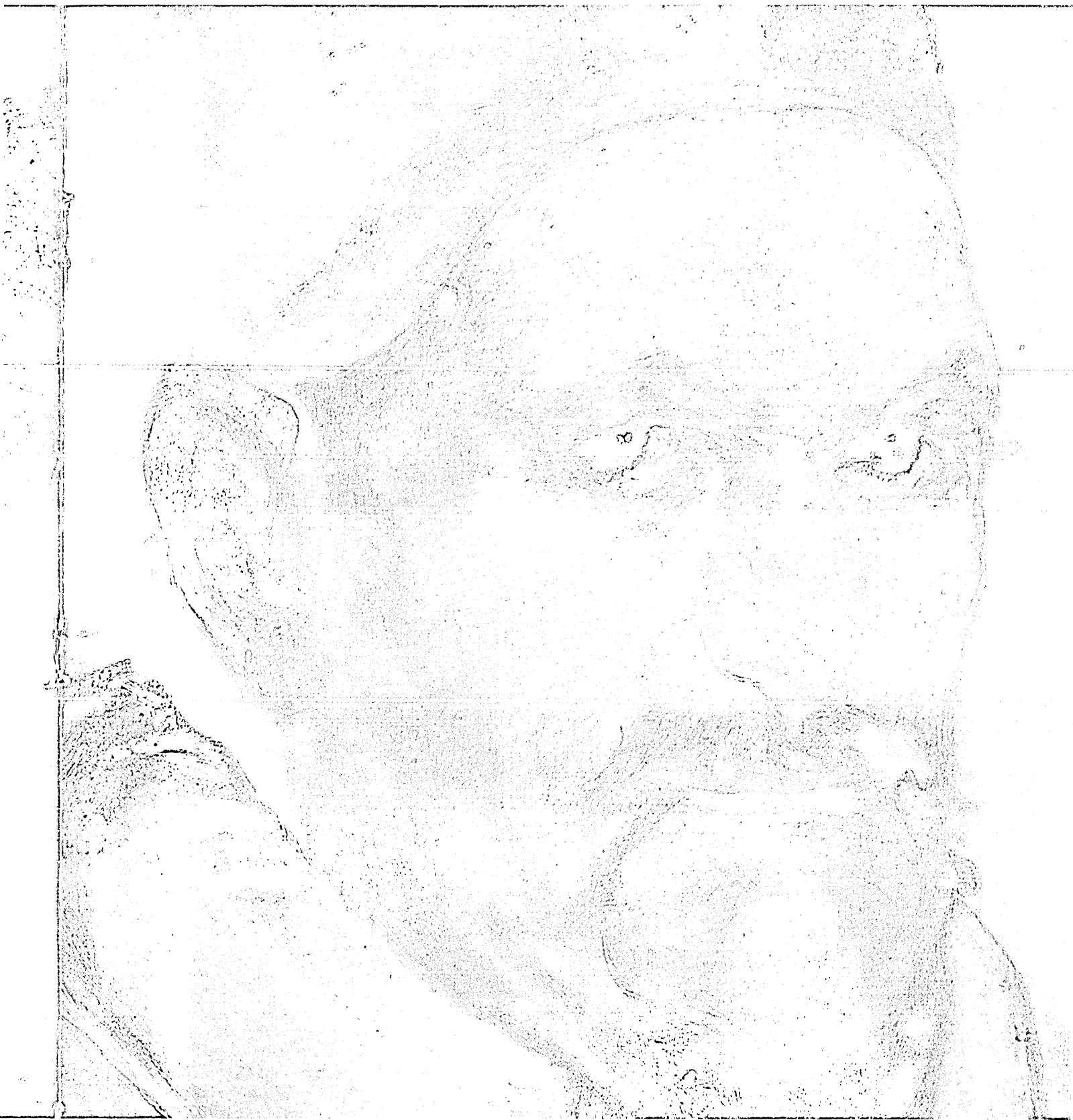

## GREATNESS IS OFTEN BINARY.

Consider the works of Rembrandt van Ryn and Diego Velázquez, and it's easy to see why critics call them the giants of 17th Century portraiture.

Consider the technology of disc packs and computer tapes: there are two standouts in this field, too. One is the big computer company. We're the other. We make the widest range of precision magnetic media—computer tapes, instrumentation tapes, video tapes, and disc packs—in the world.

Both companies can provide you with disc packs and computer tapes that will perform long after other packs and tapes fail. But these products, theirs and ours, like the works of two great artists, are not identical. After all, the big computer company's business is hardware. At Memorex, we specialize in making magnetic recording products. Full time. (Write us at Memorex Park, Santa Clara, Calif. 95050.)

**MEMOREX**



# THE IMPOSSIBLE TAB CARD

FORMSCARD MADE IT POSSIBLE

(8 1/2" x 8 1/2" — TWO PARTS)

Remittance voucher

Card check featuring prepunched consecutive number and Magnetic Ink coding for bank use (consecutive MICR number also available).

Never a medial waste strip between card and vouchers.

Lower voucher, which is detached before mailing check to customer, records chart of account codes for expense distribution.

Formscards are multi-functional over unit record, high speed EDP, MICR document handling and optical scanning systems. The absence of the medial waste strips gives you construction flexibility and simplified handling over all peripheral equipment. For further information and actual samples of varied systems, call or write . . . FORMS, INC., Willow Grove, Pa. (215) OL 9-4000.

**Forms inc.**  
Willow Grove, Pa.





# How to choose between the two great disc packs.

Both of these disc packs are great.  
The following checklist will help you  
figure which is greater.\*

	Memorex Mark I Disc Pack	The Other Disc Pack		Memorex Mark I Disc Pack	The Other Disc Pack
Is it compatible and interchangeable?	Yes	Yes	Is color coding available?	Yes	No
Are <i>all</i> packs shipped surface analyzed error-free?	Yes	No	Is a carrying case offered?	Yes	No
Will the cover support combustion?	No	Yes	What about two week delivery?	Yes	No
Is its cover unconditionally guaranteed for breakage?	Yes	No	Is a leasing plan available?	Yes	Yes
Does it come with bezel labels?	Yes	No	What about purchase option credit?	75%	55%

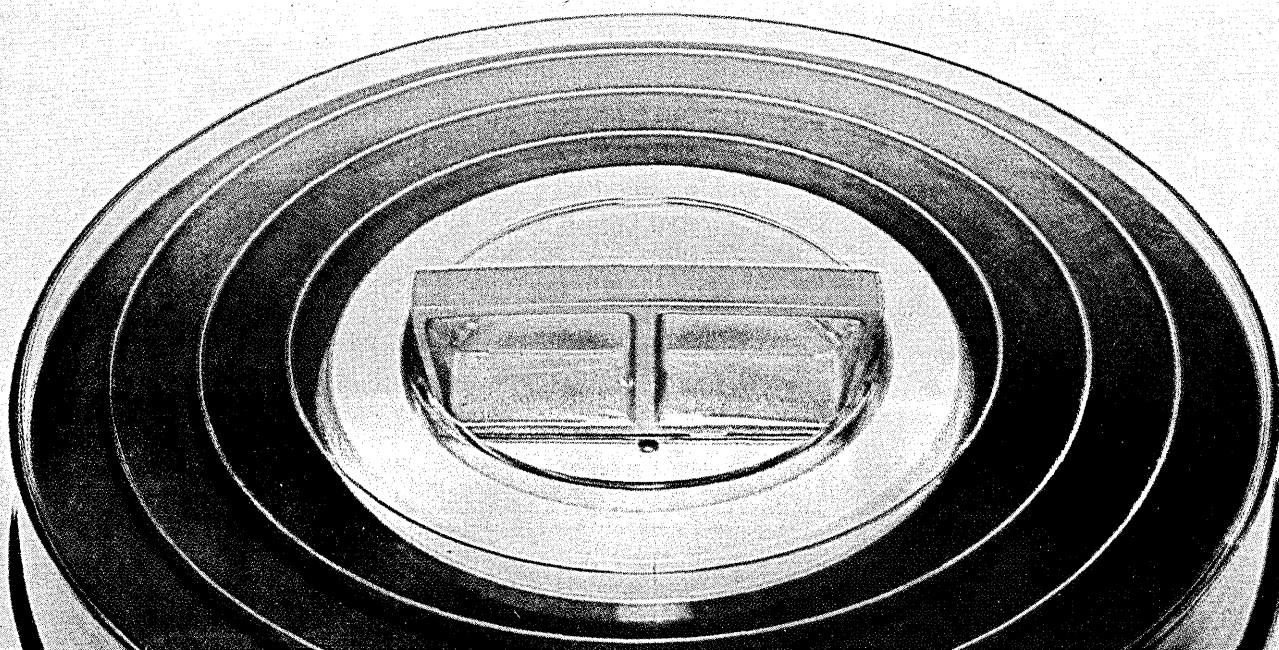
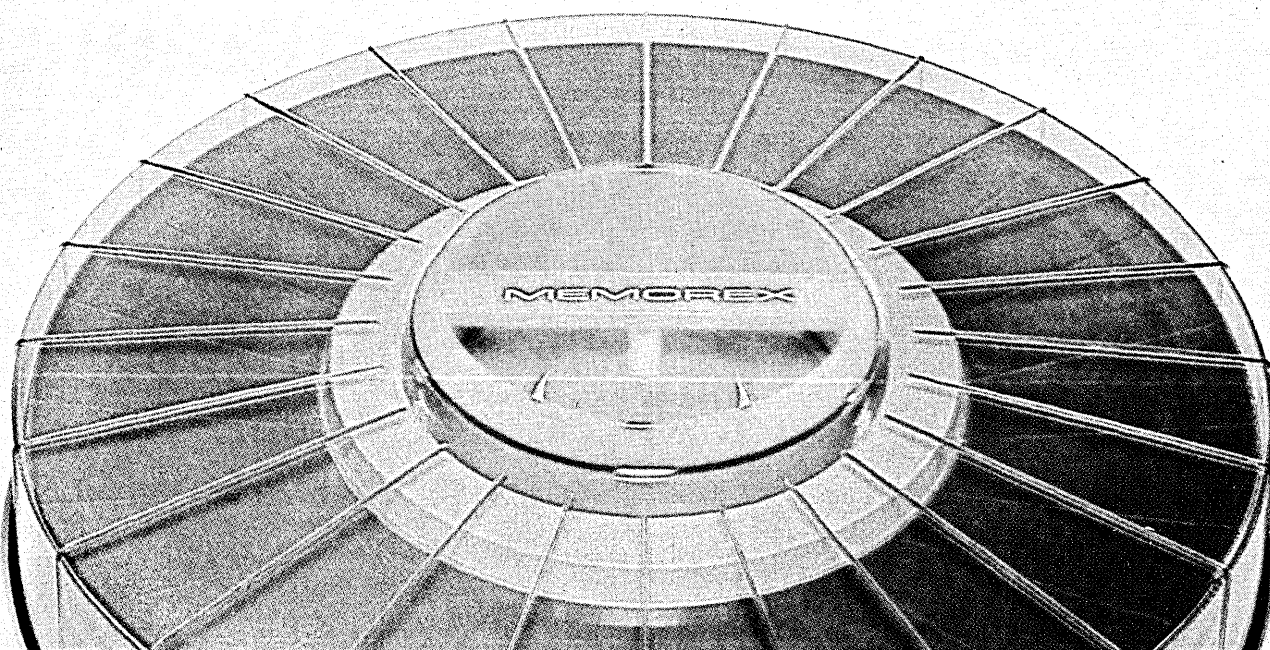

For more information, write us at Memorex Park, Santa Clara, California 95050.

\*Based on products manufactured and sold in U. S.

CIRCLE 74 ON READER CARD

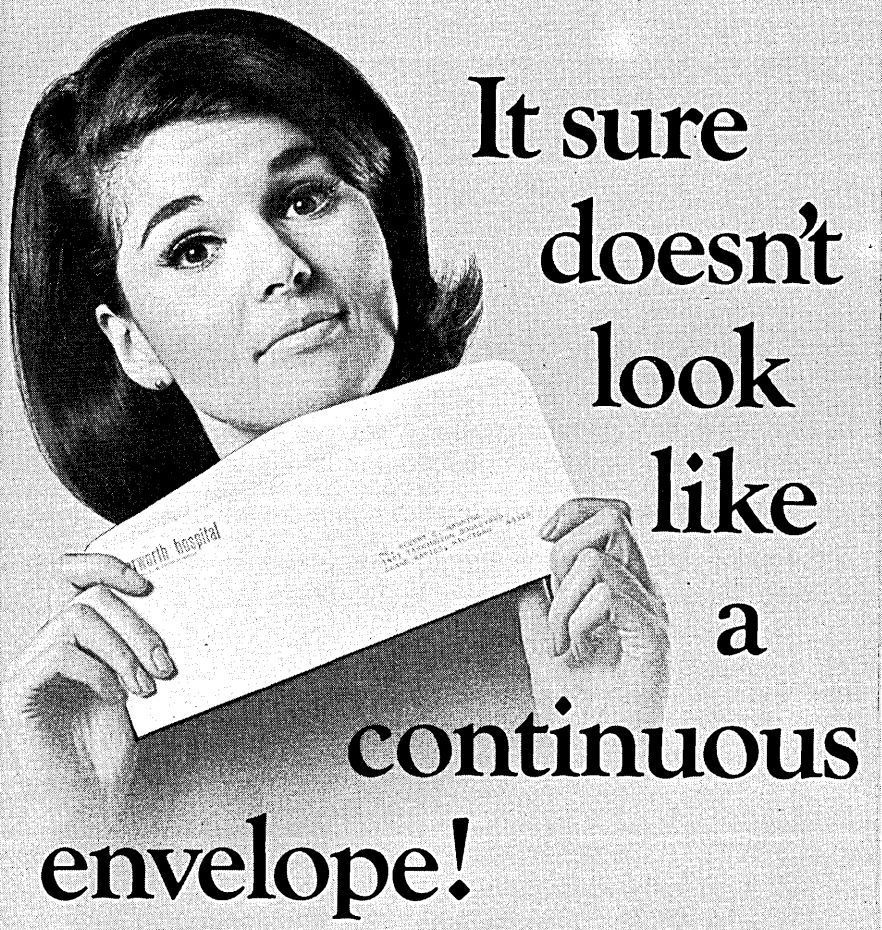

# It sure doesn't look like a continuous envelope!

That's the point! Curtis 1000's Chain-O-Matic continuous envelope doesn't look like the ordinary "folded form" type of continuous envelope. Stripped from its carrier sheet it looks like a conventional envelope. In fact it is. So it retains all the valuable personalized appeal of a conventional envelope.

But looks aren't everything. The unique construction of the Chain-O-Matic continuous envelope allows it to run smoothly through computers, run smoothly through inserting and postage metering equipment. It runs better, looks better, is better!

Sound like a better way to handle envelope addressing in volume? It is. In fact that's the way it is with all Curtis 1000 products. We continually look for ways to make each of our envelopes and business forms more useful to you. Help you do a job better, faster, more economically.

Interested? Write Curtis 1000 Inc., Box 28154, Atlanta, Georgia 30328.

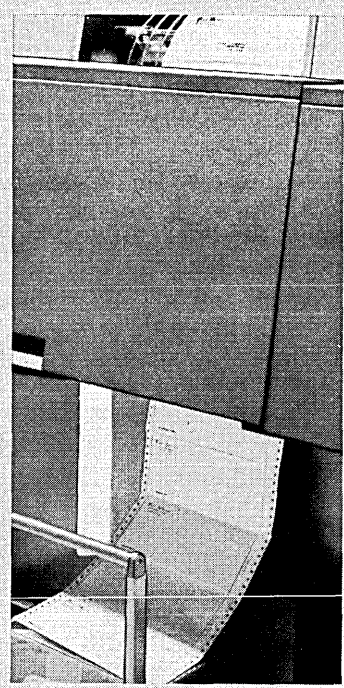

## **CURTIS 1000**

making envelopes and forms  
more useful to you

### SESSION SUMMARIES . . .

els of batch fabrications. And, while semiconductor storage devices promise a wide variety of new memory functions, such as associative addressing, some of these functions can be performed as well in nonvolatile magnetic stores. The papers in this session represent a cross-section of advanced development activity in the magnetic memory area.

- A Compact, Economical Core Memory with All-Monolithic Electronics, by R. W. Reichard and W. F. Jordan, Jr.
- A Progress Report on Large Capacity Magnetic Film Memory Development, by J. I. Raffel, A. H. Anderson, T. S. Crowther, T. O. Herndon, and C. E. Woodward.
- A Fast 2 $\frac{1}{2}$ D Mass Memory, by C. C. M. Schuur.
- A Magnetic Associative Memory, by Tse-yun Feng.

Session 15  
Wednesday, 4:00-6:00

Room H-J  
**SWITCHING THEORY**

Chairman:  
Robert O. Winder  
RCA Laboratories  
Princeton, New Jersey

Recent advances in digital circuit technology, and especially the work being done with large integrated arrays of logic gates, has had a substantial effect on switching theory. The four papers in this session illustrate this well. Each is a response, in some degree, to the need to minimize interconnection complexity and module variety in a network of logic gates.

*Ternary logic* offers one possibility of doing more logic per gate and per interconnection: Since signals have three possible values instead of two, fewer wires are necessary to carry a given amount of information from one part of a network to another. The first session paper develops in a rational and convincing manner, a basic set of ternary logic gates, and the associated algebra suitable for designing networks of such gates. The point is that this algebra has most of the manipulation properties familiar to logic designers from Boolean algebra.

The emphasis in the second paper is on regularity of structure, even if at the expense of greater numbers of gates. A *Maitra cascade* is a chain of

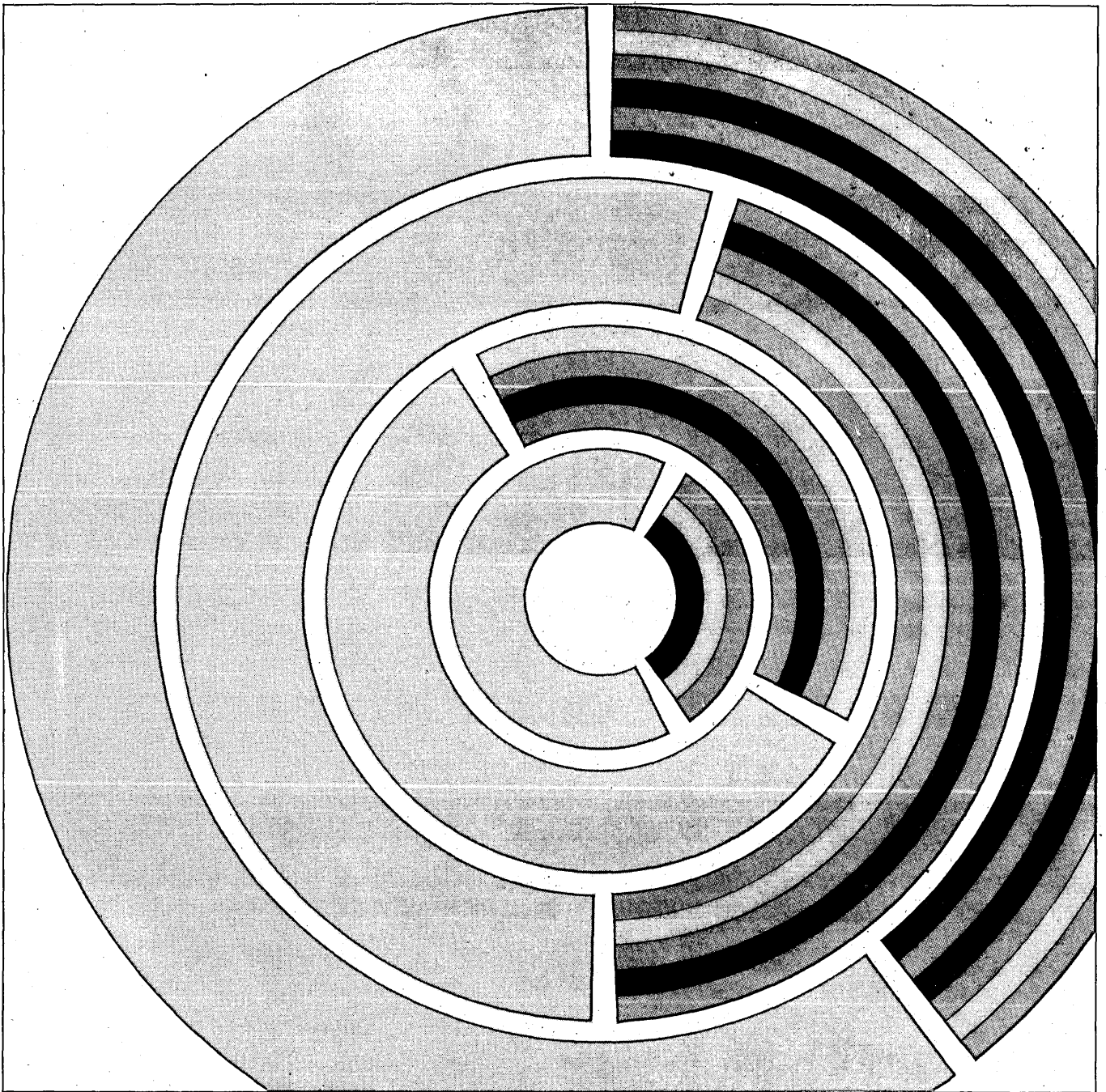

## **computer industries inc** **A Major Extension of University Computing Company**

**Computer Industries Inc** is the product manufacturing, marketing, and maintenance subsidiary of University Computing Company, the multinational computer utility network specializing in computer services, software, and education in the U.S. and overseas.

**Computer Industries Inc** specializes in the field of computer peripheral and data communications equipment.

**Computer Industries** is the Data Communication Systems Division (Dallas, Texas), maker of the COPE .45 Communications System, which is 3 to 6 times faster and up to 12 times more efficient in throughput than any other system using voice-grade lines.

**Computer Industries** is the Graphic Systems Division (Van Nuys, California), maker of digital drafting systems, microfilm printer/plotters, and display devices — including the Model 180 High-Speed Microfilm Printer and the Model 120 Microfilm Printer/Plotter.

**Computer Industries** is Computer Instrumentation Limited (Southampton, England), maker of graphic and display devices, analog-to-digital conversion systems, and tape-to-tape conversion systems.

**Computer Industries** is a nationwide network of maintenance services for EDP equipment and analytical instruments of all manufacture, with expanded support service and applications programming for the most extensive range of graphics and peripheral devices in the industry.

**Computer Industries** is an equally strong network of maintenance service covering the United Kingdom.

**Computer Industries** is committed to extending the usefulness of your computer. Corporate headquarters at 14724 Ventura Boulevard, Sherman Oaks, California 91403.

## **computer industries inc**

a subsidiary of University Computing Company

**SESSION  
SUMMARIES . . .**

logic gates, each of which receives one external input and the output of its predecessor in the chain. Use of such a restricted interconnection system has obvious advantages in large integrated arrays. To alleviate the logical restrictions inherent in the structure, each gate is assumed capable of performing any two-input function. Previous papers have dealt with the design problem for a given function, of determining the appropriate choice of gate

functions and manner of applying the external inputs. This paper gives specific rules for solving the problem by use of Karnaugh maps, which are already a standard tool of logic designers for conventional design.

Another subject of recent interest to switching theorists is the *universal logic circuit*. Here the emphasis is on modularity of gate, rather than regularity of interconnection. By appropriate choice of a function of sufficiently many inputs, one single building block gate is capable of realizing all possible logic functions of a given (lower) number of variables. Different func-

tions are obtained by applying variables and constant signals to the gate in different ways. Then, since the building block is much more powerful than the conventional logic gate, fewer are needed to realize any given system function. The third session paper discusses, among other things, methods of realizing the basic building block in terms of smaller blocks.

The final session paper concerns "switching" in a more literal sense. The basic problem treated is to design a network which accepts  $n$  numbers on  $n$  input lines, sorts them internally, and puts them out on  $n$  other lines in order of increasing magnitude. The assumption is that two-input/two-output sorters are used as building blocks, and the paper describes two very interesting methods of building up an  $n$ -variable sorting network from such units. The input numbers "sort themselves" as they propagate through the network—no control signals are necessary. Several applications of such a network are described; the most important one is its use as a "crossbar switch" in a large



## THINK Westinghouse FLOORING when you plan new or remodeled EDP installations

Raised flooring should match EDP equipment in reliability and in national reputation. The Westinghouse raised flooring system does. The panels are steel-encased, top-surfaced with flint-hard, double-wear Micarta®—a non-dusting, non-porous surface that is easy to maintain year after year—it cleans beautifully with a touch of a damp mop. The floor is load-rated in excess of industry standards. It requires no stringers or girders. Levelness is  $\pm 1/16"$  in 10 ft. Fully guaranteed by Westinghouse. Service and extra parts for expansion are readily available nationwide. You can contact a Westinghouse flooring specialist by writing this office or phoning your local Westinghouse sales office. Write or call today. Ask also about complete computer rooms from Westinghouse.



You can be sure...  
if it's Westinghouse

**Westinghouse Raised Flooring,**  
**Westinghouse Electric Corporation**  
Architectural Systems Department, 4300 36th St., S.E.,  
Grand Rapids, Michigan 49508—Phone (616) 949-1050



**REVISITED**  
BACK TO THE BOARD  
WALK THE SPRING  
JOINT COMPUTER CO  
NFERENCE REVISITS  
ATLANTIC CITY APRIL  
30 TO MAY 2

multi-component computer system. Appropriate addresses or tags on the transferred data, as they are sorted, would route the data automatically to the appropriate destinations. This routing by local, rather than central, decision makes the organization of a large computer system much simpler, particularly when large integrated gate arrays are being used.

Some general comments are in order regarding the subjects treated in the first three papers. It will be necessary, beyond theoretical achievements such as reported in this session, to design and realize realistic circuits, to develop practical design methods, and to make specific design comparisons between the conventional methods and each of the proposed new methods of realiza-

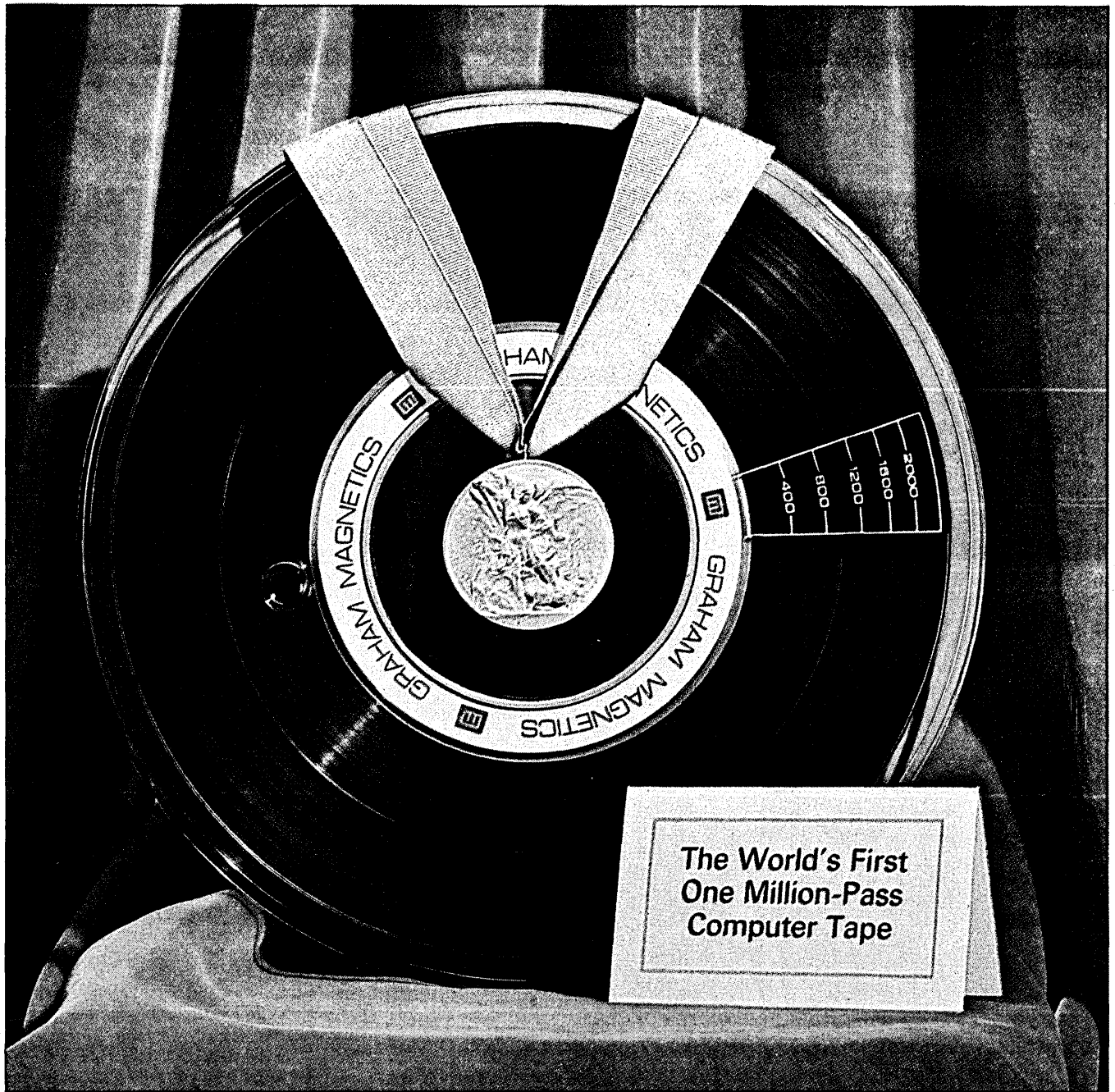

**For just any job, use just any tape.  
But for your critical requirements, use just Graham tape.**

Because it was developed specifically to meet the most demanding critical requirements, you know you can count on Graham tape for trouble-free service on *every* job. Whether your requirements demand a superior tape, or you just like the security of having the best, get Graham tape. Contact your nearest GMI sales representative or contact us direct.



**GRAHAM MAGNETICS INC.**  
Graham, Texas 76046 • Phone 817-549-3211

For further information on GMI tape and details on our special discount for first-time users, fill out and mail this coupon to

**GRAHAM MAGNETICS INC. c**  
GRAHAM, TEXAS 76046

Name \_\_\_\_\_

Title \_\_\_\_\_

Company \_\_\_\_\_

Address \_\_\_\_\_

City \_\_\_\_\_ State \_\_\_\_\_ Zip \_\_\_\_\_

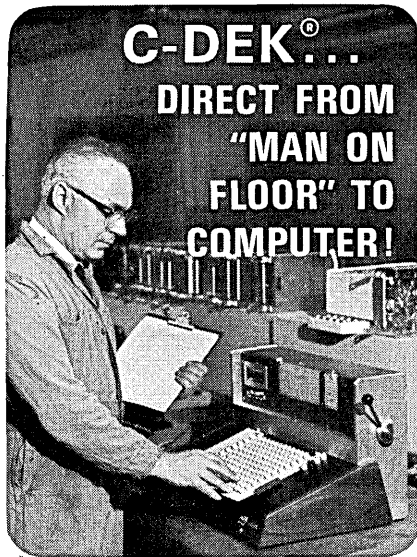

**C-DEK®...  
DIRECT FROM  
"MAN ON  
FLOOR" TO  
COMPUTER!**

**C-DEK®**  
*The simplified  
source data  
entry system  
for industry!*

■ **SIMPLE** as filling out a form, only faster! Keyboard conforms to "form" man on floor is using. Little training required.

■ **ACCURATE** because lighted keys allow visual verification and correction before data is recorded. Eliminates transposition errors which commonly occur in writing.

■ **FAST** transmission to any computer or media as fast as the recording media can "catch it". Will feed on-line to any computer. Eliminates "queuing".

■ **ECONOMICAL** to own and operate. Provides cost-saving benefits such as fuller use of computer. Speed of report offers opportunity for fast cost-reduction decisions by management. Meets any system requirements.



Write for clear, concise, descriptive literature.

**COLORADO  
INSTRUMENTS, INC.**

192 PARK ST., BROOMFIELD, COLO. 80020  
TELEPHONE: (303) 466-7333

**SESSION  
SUMMARIES . . .**

tion before an evaluation can be made of the usefulness of each of the ideas. The situation has an interesting parallel in the possibility of using threshold gates to reduce network complexity; threshold logic, a subject of considerable recent interest, has probably advanced further towards three goals than has ternary logic, Maitra cascades, or universal logic circuits. However, in all cases, there is a need for a considerable amount of advanced development of the basic research ideas.

Selection and Implementation of a Ternary Switching Algebra, by Robert L. Herrmann.

Application of Karnaugh Maps to Maitra Cascades, by Giuseppe Fantuzzi.

Universal Logic Circuits and Their Modular Realizations, by S. S. Yau and C. K. Tang.

Sorting Networks and Their Applications, by Kenneth E. Batchner.

**REVISITED**

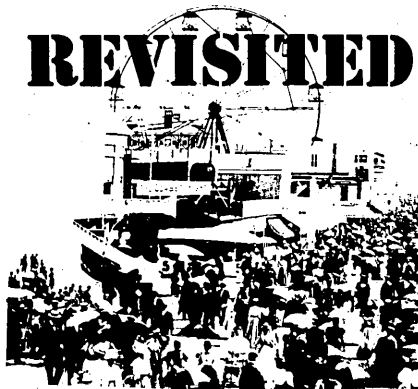

Session 16

Thursday, 9:00-12:00

Ballroom

**MAN-MACHINE INTERFACE**

Chairman:

Herbert M. Teager

Boston University Hospital

Boston, Massachusetts

The crucial indicator of computer system effectiveness is its relative utility to the ultimate user. It is at the information interface between problem solver and system that communication inadequacies show up most clearly. Despite the wide range of human sensory perception and signal generation, now in this third decade of the computer era, our predominant form of I/O remains the keystroke/textual page. That the ultimate user is satisfied is perhaps due to the fact that the cost of buffering layers of human translators and transliterators is not exorbitant.

For many crucial problems of our

**TAKE YOUR  
COMPUTER  
WITH YOU!**



**Model  
VDT-2 DATAPORT  
Portable Terminals**

- complete with teleprinter
- luggage cased, under 40 lbs/case
- full TTY 33-type terminal functions
- half/full duplex modes

Model VDT-2 is a complete time-sharing terminal including teleprinter, data set and coupler. All model TTY-33 teleprinter features are included for compatibility with almost all known time-sharing offerings.

Packaged in two sturdy luggage type cases, the entire terminal is safely transportable and relatively light weight. An exclusive magnetic/acoustical telephone coupler allows clear transmission and reception of data even under poor telephone line characteristics.

Write for Brochure LT-300.

**Data Devices Division  
Vernitron Corp.  
50 Gazza Blvd.  
Farmingdale, N.Y.**

Call (East Coast) 516-694-5002  
(West Coast) 213-328-6250

CIRCLE 117 ON READER CARD  
**DATAMATION**

Weather has no respect for national boundaries. Perhaps that's why international cooperation in forecasting has for a long time been a constant in an area fraught with inconsistency.

Cooperation is important, but it's not the only answer to more accurate and longer range forecasting. Computer technology is a key factor.

This is fortunate for the United States, because no other nation is further advanced in this area.

And no other nation's weather research establishment has two UNIVAC® 1108 Systems at its disposal.

Scientists at the Environmental Science Services Administration's

Geophysical Fluid Dynamics Laboratory use them to simulate the earth's atmosphere by means of theoretical models.

Their goal is to develop a satisfactory model comprised of elements which closely approximate those of the real atmosphere.

By changing just one variable in this mathematical model—sea surface temperature, snow cover, atmospheric pollutants, for instance—scientists can in effect experiment with the atmosphere and determine how that one alteration influences the entire model.

These simulations are so complex, the elements so numerous that a 24-hour forecast for the northern hemisphere can take 10 hours of computing.

Despite this scientists are optimistic. In fact, current results indicate that reliable 14-day forecasts are a distinct future possibility. Also, the observational network must be expanded to the whole of the earth.

It will take some time, therefore, before two week forecasts become standard. Scientists estimate five to ten years.

But if it weren't for computers, it might take forever.

**UNIVAC**

Univac is saving a lot of people a lot of time.

**SPERRY RAND**

CIRCLE 82 ON READER CARD

# The Ultimate Weapon in the Wet War.

*No one can stop the rain, but we can help you be ready for it.*

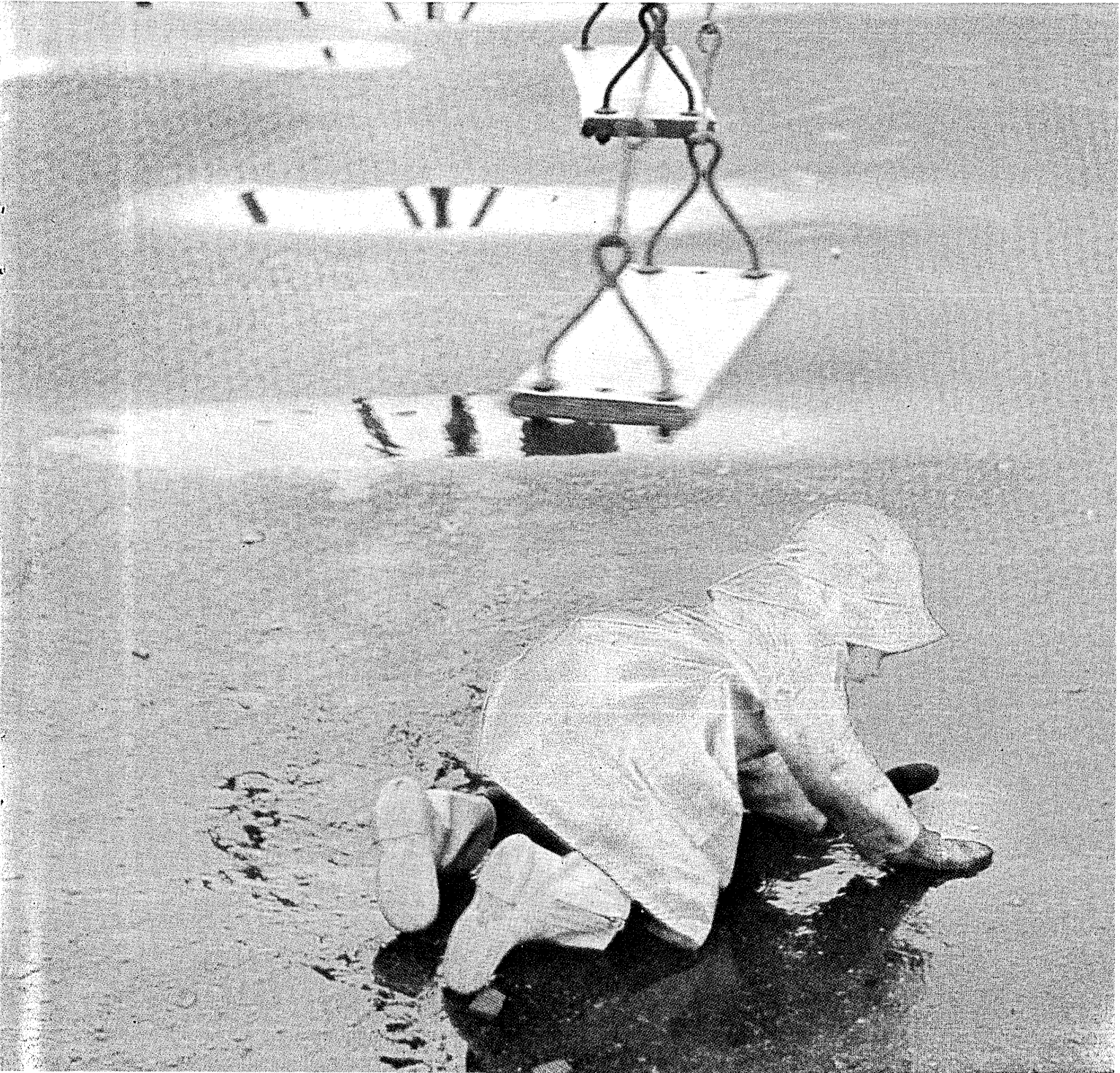

# 90% of the tape manufacturers in the USA use a GKI model 97 tester

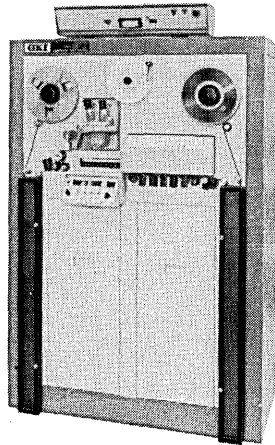

And for one very good reason—It does the job better. Not only in one area but in every area of tape testing. Take Performance, for instance. It is the only commercial tester being delivered which handles all test requirements including Total Surface Testing and 3200 FCI as defined by IBM. Or take Precision. It is the only tester designed from the bottom up as a piece of test equipment. It borrows no parts from operational computers. Its drive has been designed completely and expressly for testing and has the extra precision required for test equipment. Which brings up Compatibility. Since the GKI tester is not a conversion of any specific tape drive, it is not limited by a specific set of performances. It is the only machine using the exact components required for compatibility in the most important area of all—head-to-tape contact.

And then, of course, there is Efficiency. The functional layout of the Model 97 results in the automatic positioning of the flaw for microscopic viewing and manual repair. And finally there's Protection. The special drive and capstan of the Model 97 eliminate the destructive forces which the standard drive imposes on the tape. As a consequence, there is no tape loss due to the test procedure.

But why take our word for it. The real proof is in acceptance. And the proof is overwhelming. The Model 97 is preferred equipment for those who know tape—The Tape Manufacturers in the U.S.A. And for that matter in Europe and Asia, too.

*General Kinetics Inc., Isaac Newton Square, Reston, Virginia • D.C. Area (703) 471-7522 • New Brunswick, N.J. (201) 545-4315 • Atlanta (404) 457-7770 • Chicago (312) 255-0240 • Los Angeles (213) 935-0201*

# GKI

GENERAL KINETICS INC.

CIRCLE 83 ON READER CARD

## SESSION SUMMARIES . . .

society over the next decade these standards, as well as other tacitly accepted cost and personnel criteria, are woefully inadequate. As citizens as well as professionals, we share a moral responsibility to see that everything possible is done to make computers effective in easing human problems even if we must inevitably fall short of publicly expected panaceas.

**The Sylvania Data Tablet: A New Approach to Graphic Data Input**, by James F. Teixeira and Roy P. Sallen.  
**Computer Input of Forms**, by Alfred Feldman.

**Machine to Man Communication by Speech, Part I: Generation of Segmental Phonemes from Text**, by Francis F. Lee; **Part II: Synthesis of Prosodic Features of Speech by Rule**, by Jonathan Allen.

**System of Computer Support for Neuro-Physiological Investigations Including an On-Line Time-Sharing Macrolanguage Interface Unit**, by Fred Abraham, Lazlo Beyuar and Rich Johnston.

**Graphical Data Management in a Time-Shared Environment**, by Sally Bowman and Richard A. Lickhalter.



**BACK TO THE BOARD  
WALK THE SPRING  
JOINT COMPUTER CO  
NFERENCE REVISITS  
ATLANTIC CITY APRIL  
30 TO MAY 2**

Session 17

Thursday, 9:00-12:00

Room F-G

LANGUAGES: TODAY AND TOMORROW

Chairman:

Philip H. Dorn

Union Carbide Corporation

New York, New York

The problem for this session is well known. A room full of computer hard-



ware does the user little good without languages. A computer an order of magnitude more powerful than its competitors will be of marginal value if it is not approachable by its users. Languages provide the interface between people who want answers and computers which are sometimes reluctant to provide them.

The object of this session is to provide a casual look at languages across the time spectrum. We could not show all the highlights of the development of all languages, so we have elected to present a look at two active languages, two languages developed specifically for use in a time-sharing mode and two attempts at coping with a future problem, parallel processing.

The two current languages are LISP, the most widely used list processing language, and PL/I, the most recent attempt to achieve universality in a programming language. Sandewall's LISP paper presents a number of compatible extensions to increase the power of the LISP 1.2 language by providing symbolic functions and RHO-expressions, a technique for automatic expression evaluation. Bandat, on the other hand, is neither proposing a new language nor expanding an existing language. Instead he is attempting to show a technique, a method for formally defining a language. PL/I serves as

cal data base utilizing a commercially available time-sharing service.

When a reviewer regularly examines the technical literature, he can often predict major trends in the computer industry. Witness the number of papers on multi-programming present in the early 1960's. The number of papers and articles recently published on parallel computing suggest that era of non-sequential processing will soon be up-

on us. While some of us suggested that this should be accomplished by hardware, we today are concerned with the language implications. Tesler and Enea are attempting to define a class of general purpose languages which need not be concerned with the usual rules for looping, branching and order. Constantine, on the other hand, is trying to provide a macro-level capability for the natural expression of inter-mod-

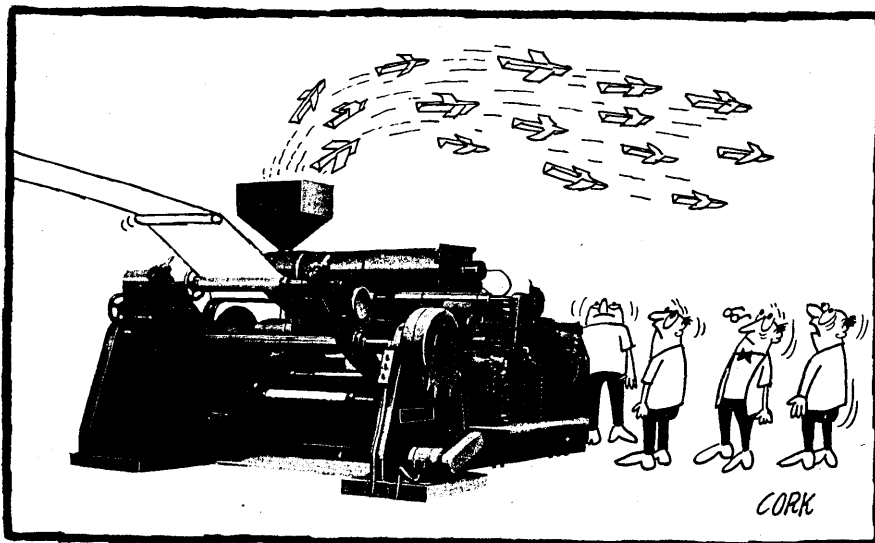

© DATAMATION



a test bed, since if a language as complex as PL/I can be subjected to a rigorous, complete and unambiguous definition, then Bandat's method will succeed.

In the early days of time-sharing, most users were satisfied to get by with such existing languages as FORTRAN, JOVIAL and MAD. However, as the years have passed, it has become obvious that the development of languages expressly designed for processing from a remote terminal would be necessary before users would be able to utilize the full power of the computer. Londe and Schoene present a language designed to permit linguists to build and validate grammars describing natural languages. Sinowitz describes a query language for real-time information retrieval from a hierarchi-

for **MOBILITY** ...  
for **FLEXIBILITY** ...  
for **IMPORTANT COST SAVINGS** ...

**ACOUSTICALLY-COUPLED DATA SETS**  
make *any* phone an access to your computer

**MODEL 1042C:** Compatible with Bell 103A. EIA RS232 interface. For use with IBM 1050, 2740, 2741 Data Terminals, Teletype 28, 32, 33, 35, 37 Printers, Friden 7100, 7102 Executive Terminals, or any equipment to 400 baud or 40 char./sec.

**MODEL 1048C:** Compatible with Bell 202C. EIA RS232 interface. For use with IBM, Teletype, Tally, Mohawk, Digidata, NCR, and other equipments to 1200 bps.

Write, wire, or phone for further information and demonstration.

**TUCK ELECTRONICS**  
235 Market Street  
New Cumberland, Pa. 17070

Phone:  
717-232-3431 or  
717-234-2616

# When you're thinking Fortran, two memories are better than one.

The I/C 4000 is the scientists' and engineers' computer, designed and built specifically for technical problem solving with a unique advantage. With FORTRAN cross-talk designed into the separate control and main memories, the I/C 4000 is capable of greater speed/volume/throughput than other machines twice the price. In addition, it emulates the 1130, the 7044 and the 7094. Integrated circuit construction; hardware designed specifically to optimize FORTRAN; the 500 nanosecond control memory slams through highly used FORTRAN routines. May we send more information?

## Standard Computer Corporation

1411 West Olympic Blvd., Los Angeles, Calif. 90015 (213) 387-5267

### SESSION SUMMARIES . . .

ule sequence relationships.

While these papers may seem to represent an orderly progression in the development of languages, they are actually no more than stopping points along the way. No one language will solve all the problems, nor (with a couple of outstanding exceptions) will it even exist in five years. Yet each small step we take makes the machine more approachable to its users. Since our primary task is still one of getting answers, additional developments in language must be encouraged.

**LISP A: A Lisp-Like System for Incremental Computing**, by Erik J. Sandewall.

**On the Formal Definition of PL/I**, by Kurt F. Bandat.

**TGT: Transformational Grammar Tester**, by David L. Londe and William J. Schoene.

**DATAPLUS: A Language for Real Time Information Retrieval From Hierarchical Data Bases**, by Norman R. Sinowitz.

**A Language Design for Concurrent Processes**, by L. G. Tesler and Horace J. Enea.

**Control of Sequence and Parallelism in Modular Programs**, by Larry L. Constantine.



Session 18

Thursday, 9:00-12:00

Room H-J

**PAPERS OF GENERAL INTEREST**

Chairman:

Charles Lecht

Advanced Computer Techniques Corporation

New York, New York

The papers represent a potpourri of subject matter. As such, they may be

in one sense more representative of the real state-of-the-art in computer systems development and usage from the observers standpoint, than that which is frequently pretended to be. And, in the heterogeneous character of the information presented, one may find solace in the thought that computer people are working on projects which defy broad general classifications.

**Anatomy of a Real-Time Trial**, by Alan B. Kamman and Donald R. Saxton.

**Fourth Generation Computer Systems**, by C. J. Walter and Marilyn Bohl.

**A Fourth Generation Computer Organization**, by Stanley E. Lass.

**Optimum Control of Satellite Attitude Acquisition by a Random Search Algorithm on a Hybrid Computer**, by William P. Kavanaugh and Elwood C. Stewart.

**Evaluation and Development Techniques for Computer Assisted Instruction Programs**, by Michael E. Tarter, Raymond L. Holcomb, and Taissa Hauser.

**Computer Capacity Trends and Order-Delivery Lags, 1961-1967**, by Michael H. Ballot and Kenneth E. Knight.

**Session 20**

Thursday, 1:30-3:30

Room F-G

**DIGITAL SIMULATION TECHNIQUES**

Chairman:

Carl F. Simone

Bell Telephone Laboratories

Holmdel, New Jersey

Engineers simulate systems on a digital computer to obtain both insight and numbers. They use the insight to analyze complex systems and to predict performance; they use the numbers to establish values for system parameters. Their insight and confidence in the numbers is related to how clever they have been in deriving a model and translating it into an equivalent approximate set of numerical operations.

Error Estimate of a 4th-Order-Runge-Kutta Method with Only One Initial Derivative Evaluation, by A. S. Chai.

Improved Techniques for Digital Modeling and Simulation of Nonlinear Systems, by J. S. Rosko.

Extremal Statistics in Computer Simulation of Digital Communication Systems, by M. Schwartz and S. H. Richman.

MUSE: A Tool for Testing a Multi-

Terminal System in a Multi-Terminal Environment, by E. W. Pulleh and D. F. Shuttee.



**BACK TO THE BOARD  
WALK THE SPRING  
JOINT COMPUTER CO  
NFERENCE REVISITS  
ATLANTIC CITY APRIL  
30 TO MAY 2**

**Session 21**

Thursday, 1:30-3:30

Room H-J

**FAULT DIAGNOSIS**

Chairman:

C. R. Deininger

IBM Corporation

Poughkeepsie, New York

The subject of fault diagnosis is a topic of considerable interest in the digital computer field. The methodology for achieving the first step toward the ultimate of detection, isolation, reconfiguration, and system recovery—automatically, is discussed in this session as it applies to simple and complex systems. Future systems are increasing in complexity and usage. New applications will be placing more stringent demands on future systems. These two points necessitate more rapid and efficient fault diagnosis—the first step to recovery.

Diagnostic Engineering Requirements, by John J. Dent.

Self-Repair Techniques in Digital Systems, by Frank B. Cole and William V. Bell.

A Study of the Data Commutation Problems in a Self-Repairable Multiprocessor, by Karl N. Levitt, Milton W. Green and Jack Goldberg.

A Distinguishable Criterion for Selecting Efficient Diagnostic Tests, by Herbert Y. Chang. ■

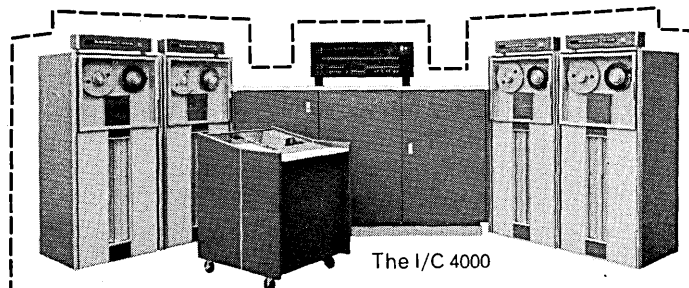

The I/C 4000

32K words—36 bits plus overlapped control memory / word parallel arithmetic / floating point—accuracy to 18 digits / fully overlapped I/O & computing / compiles 4,000 statements per min.

Standard Computer Corporation

1411 West Olympic Boulevard., Los Angeles, California 90015.

Ok. I'd like to know more about it. Technical information please.

NAME \_\_\_\_\_

TITLE \_\_\_\_\_

COMPANY \_\_\_\_\_

STREET \_\_\_\_\_

CITY/STATE \_\_\_\_\_ ZIP \_\_\_\_\_

# lest you forget

# should you buy or lease your data sets?

**NOW YOU HAVE THE CHOICE.** Many Rixon modems are compatible with the Bell DATA-PHONE data sets. This gives you the alternative of purchase and helps cut your communications costs. Leasing dollars can quickly add up and exceed the purchase price.

With the FM-12 data set, for example, the single unit purchase price of a compatible unit is \$440. Leasing the equivalent Bell data set, you exceed the purchase price of the FM-12 in less than 15 months. The lower price of an OEM configuration or other versions cut the short pay off period to just a few months. Once your initial costs are covered, you can regard the set as being free.

Rixon data sets are available in a variety of configurations. You can select either PC card modules for OEM installations, rack mounted versions, or packages designed for desk and shelf mounting. To the basic modem you can add options, such as clock for synchronous 1200 bps transmission.

Write us for our data set catalog. It will help you to answer the question of whether to buy or lease your data sets.

See these data sets at the Spring Joint Computer Conference.

Rixon Data Set	Maximum Speed	Line Requirement	Common Carrier Equivalent
FM-300	300 bps	Type 3002 Channel	Bell 103
FM-12	1200 bps	Unconditioned	Bell 202D
FM-18	1800 bps	C1 Conditioning	Bell 202D
PM-24B	2400 bps	C2 Conditioning	Bell 201B
PM-24C	2400 bps	C2 Conditioning	Bell 207

**RIXON ELECTRONICS, INC.**

2120 Industrial Parkway, Silver Spring, Maryland 20904 301-622-2121

Rixon is licensed under patents of Western Electric Co., Inc.

# The Wraparound that doesn't Wriggle.



*The way we look at it, it's the tape reel that should be moving, not the wraparound case.*

*Our case opens just so far and stops — to release tape or receive it. Lift reels out. Drop in. The case holds itself in a circle — still connected at the latch. And the patented shelf all around supports the reel, aligns it with the recessed dust seal in the case when you snap it shut.*

*Of course ours meets the basic requirements, too. It's got the new thinness, the hook for suspension storage systems, finger grip for roll-in storage, and plenty of toughness to survive drops.*

*But it doesn't cost any more.*





# Been searching for the low-cost computer? Honeywell to the rescue.

Introducing the Model 1100 computer. Honeywell's newest and smallest yet. The computer that opens the door to electronic data processing for literally thousands of organizations.

"What's so special about the 1100?"

The 1100 is a well-balanced third-generation Series 200 system of hardware and software. It works equally well with magnetic tapes or disks. It comes with a complete range of support features, including a nationwide chain of Customer Support Centers, a COBOL programming system, and a big selection of pre-coded application systems.

"What do I get from the 1100?"

Easy production. Data can move directly to a larger computer of the compatible Series 200 family without compromise. Your files, your programs, and your experience move with you.

"Can't spend a fortune on a computer?"

You don't have to. The price of the 1100 is rock-bottom. Start-up costs are small. Honeywell Customer Support Centers and pre-coded application packages get you started quickly and economically. New applications are easy. Honeywell COBOL is easy-to-learn and easy-to-use.

That's our idea of a rescue.

## The Other Computer Company: Honeywell

# Do you know what it takes to make your computer draw like this?

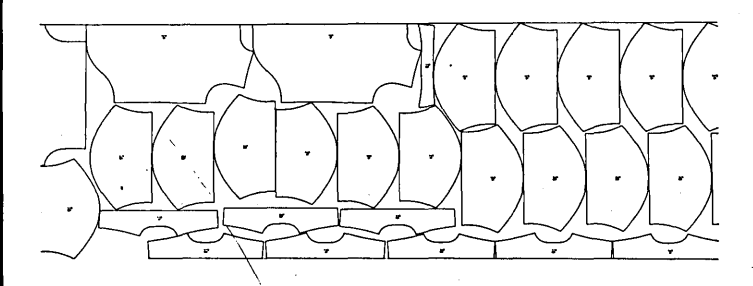

*computerized templates*

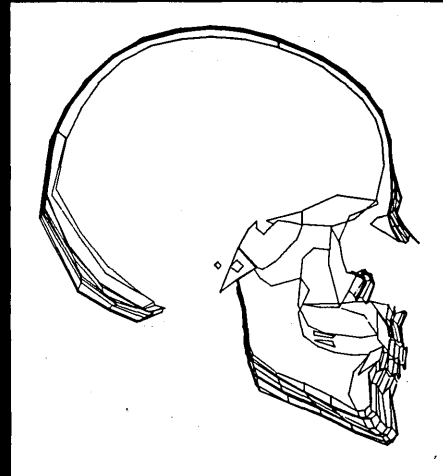

*scientific diagrams*

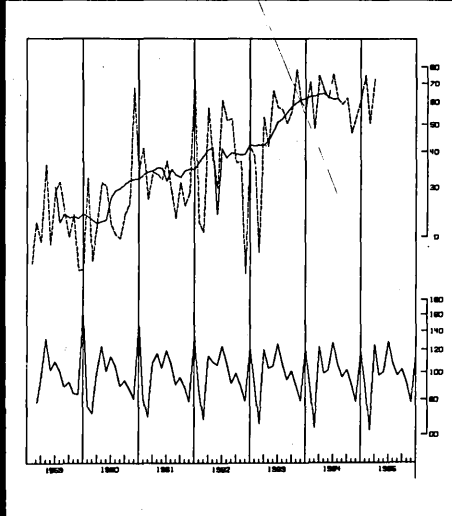

*instant trend charts*



*even masterpieces!*

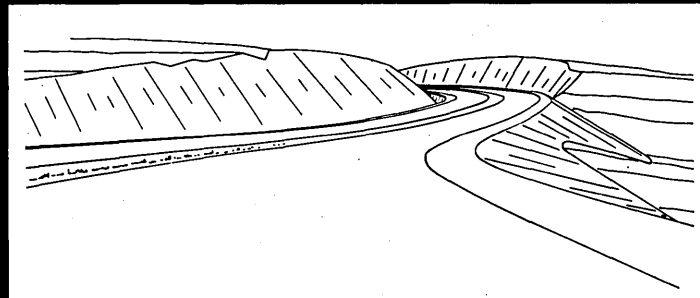

*perspective drawings*

## CalComp that's what.

All it takes is a CalComp Plotting System. To get the picture, call or write: Dept. D-4, California Computer Products, Inc., 305 Muller, Anaheim, Calif. 92803. Phone (714) 774-9141.

**CALCOMP**  
Standard of the Plotting Industry

See CalComp at Booth 1401-8 at the SJCC

CIRCLE 89 ON READER CARD



# If you're still putting up with down time... you should have your heads examined.

Your analog magnetic recording heads, that is.

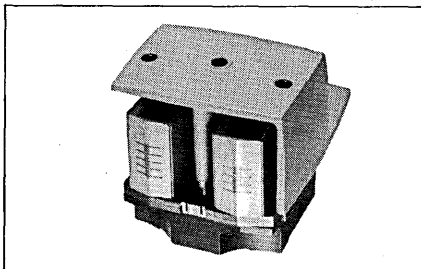

For the new replacement heads from CEC are now eliminating the major headaches in high frequency, high environment recording applications. Namely—the costly down time caused by rapid head wear, frequent cleaning and limited frequency response.

This achievement is due to CEC's unique design and manufacturing techniques which overcome the inherent weaknesses of lamination and rotary head design.

As a result, all CEC analog magnetic recording heads will last at least three times longer than conventional original equipment heads. *And*—they cost no more.

Of course, we did start off with a considerable advantage. Such as the assistance of Bell & Howell's advanced Research Center in the selection of specific materials that provide outstanding magnetic properties and extremely low wear rate.

Why not let some of this success go to *your* heads?

For complete specifications and all the facts, call your nearest CEC Field Office. Or write Consolidated Electrodynamics, Pasadena, California 91109. A subsidiary of Bell & Howell. Bulletin 1662-X2.

**CEC/DATATAPE PRODUCTS**



**BELL & HOWELL**

# What do all these terminals have in common?

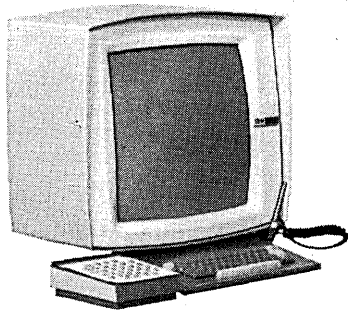

IBM 2250

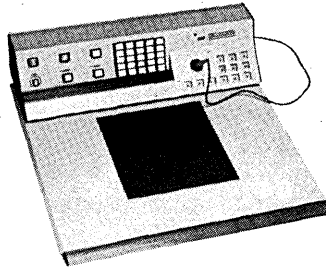

BBN GRAFACON

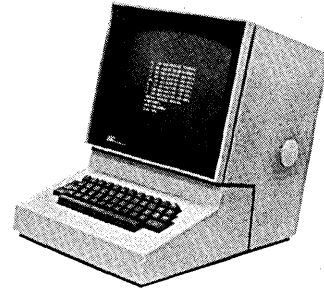

IBM 2260

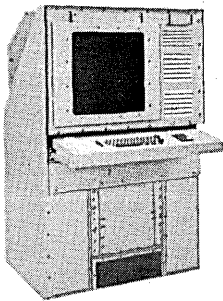

RAYTHEON QRCC

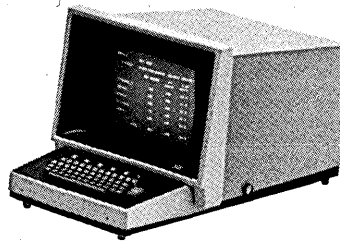

CDC 210

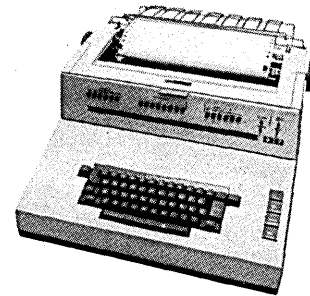

IBM 1052

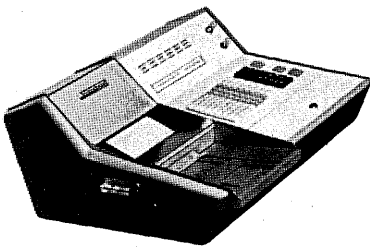

BUNKER-RAMO SERIES 1000

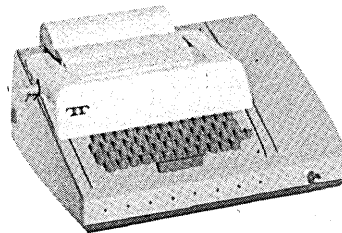

TELETYPE MODEL 33

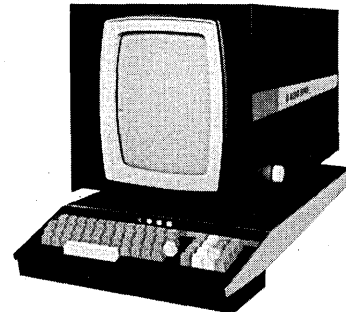

SANDERS 720

## Informatics has programmed them all!

(and many more)

informatics inc.®



LOS ANGELES  
5430 Van Nuys Blvd.  
Sherman Oaks,  
California 91401  
(213) 783-7500

WASHINGTON, D.C.  
4720 Montgomery Lane  
Bethesda,  
Maryland 20014  
(301) 654-9190

NEW YORK  
467 Sylvan Avenue  
Englewood Cliffs,  
New Jersey 07632  
(201) 568-6420



### **Social, Business and Government Problem Solvers**

86% of our staff have Ph.D.'s — more brain-power for your dollar.

John has designed national training programs and information systems.

Others specialize in urban planning, operations research, medical administration, management systems, resource analysis, transportation, computer sciences and languages, psychology, criminology and advanced planning.

Paul can go on and on about weapons and defense systems. (He has four degrees.)

Simulation, modeling, personnel, engineering, environment, reliability, vulnerability, statistics and logistics are a few more of our specialties.

Subsidiary services include systems design, programming, training and key punching.

COMPUTAID: man-machine solutions

Dallas • Washington, D. C. • Los Angeles



Contact Mr. L. W. Goostree, Jr., V.P.

**COMPUTER AID COMPANIES, INC.**

Fidelity Union Tower • Dallas, Texas 75201

214-748-1913

CIRCLE 92 ON READER CARD

# meet the 1200 WPM computer tutor

The tick, tack, click'ty clack is missing in this new data communications terminal. It's the Inktronic® terminal. An electronic printer. Another economical answer from Teletype R & D for moving data at high speed.

In a second this new Inktronic terminal can jet 120 characters to the page. Ink jets trace out each image—one by one—through electrostatic deflection. Without wasting time on "fill" characters and buffer storage. You can print one letter, one number, or symbol as readily as a few words or an entire line. And place data exactly where you want it to appear on the page.



The Inktronic RO (receive-only) set—first of a new line which will include KSR (keyboard-send-receive) and ASR (automatic-send-receive) sets. Future plans call for even higher speeds for complete utilization of voice grade channels.

See the New 1200 WPM Inktronic® Terminal at the Spring Joint Computer Conference.

**machines that make data move**



**Look at it this way (shown half size) . . .**

1 2 3 4 5 6 7 8  
1234567890123456789012345678901234567890123456789012345678901234567890

THIS IS AN EXAMPLE OF WHAT THE NEW INKTRONIC TERMINAL CAN MEAN TO YOUR DATA COMMUNICATIONS.

SEVENTY-TWO OR EIGHTY CHARACTERS CAN BE PRINTED ON A LINE

...AND YOU CAN START PRINTING ANYWHERE.

ON THE LEFT IN THE MIDDLE ANYWHERE

IN A SECOND, ONE HUNDRED AND TWENTY CHARACTERS JET TO THE PAGE. THAT'S AS MANY LETTERS AS THIS PARAGRAPH CONTAINS.

YOU CAN PRINT NUMBERS 12345  
67890

OR SYMBOLS . . . \*%&'()\*!7:;/@

IN A CHOICE OF CODE: 5-LEVEL OR ASCII

AND BEST OF ALL, THE INKTRONIC TERMINAL DOESN'T COST VERY MUCH!

```
#####  
$ . . . $  
$ . . . $  
$ . . . $  
#####
```

### High-speed, on-line computer input-output

The 1200 wpm capability of the Inktronic printer makes it great for computer input or interrogation, especially in time-sharing systems where the line time is so important. And as a computer output device where large volumes of data are needed in a short period of time. It is also a practical machine for monitoring high-speed tape-to-tape systems.

The Inktronic terminal is one of many exciting moves being made by Teletype R&D in *moving data at very little cost*. That's all we're really concerned with. Providing equipment that moves data the way you want it moved. Data you can see, touch, and talk about—data you can move a mile, thousands of miles, or just down the hall. Always quickly, precisely, and at very low cost.

If you would like to know more about the new line of Inktronic terminals, write Teletype Corporation, Dept. 81D, 5555 Touhy Avenue, Skokie, Illinois 60076.

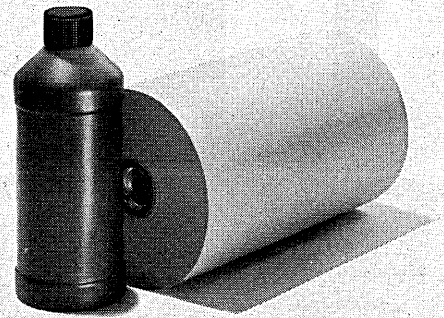

### A few words about ink and paper

The Inktronic printer uses ordinary teletypewriter paper. *Inexpensive paper*. An 8 1/2 inch wide standard roll provides about 400 feet of space to fill. The ink it uses is inexpensive, too. One pint will deliver about 80,000 feet of data. Of course if you don't fill up every line you stretch the pint even further. With 1200 wpm capability this is an important point to consider. And since no ribbon is involved—impressions are made electrostatically—print is never faded. It's always clean, clear, sharp and well defined.

This highly magnified view shows how ink is drawn through metering and deflecting electrodes to form the image on the page. Ink supply and guidance system has *only one moving part*.

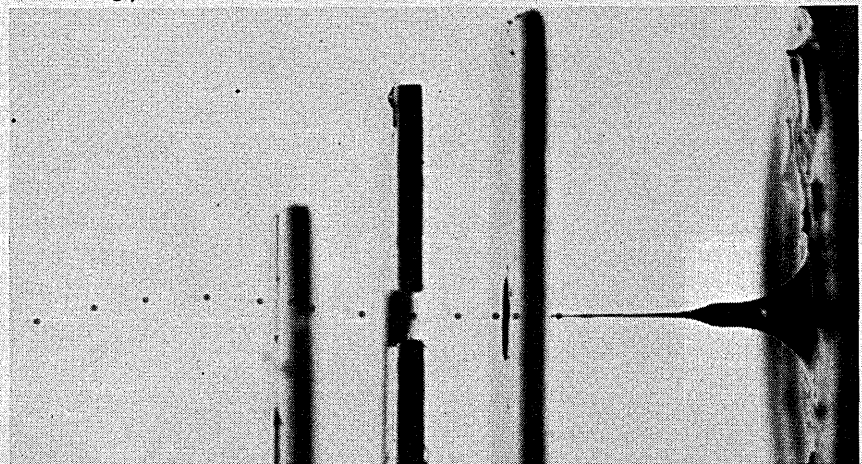

## Teleprinter 100 for Internal Data Networks



**Lower Price  
Higher Speed  
Faster Delivery**

The Teleprinter 100 is used by railroads, utility and pipeline companies, plants, department stores, many other organizations, to transmit and receive data on internal communications networks. It is compatible with all systems—over 100,000 are now in use in over 100 countries.

**Up to 13 characters per second. 5 level code.** Transmits to one unit, several or all units in system. Low noise level. Makes up to 12 carbons. Sends in red, receives in black, or vice versa. Receive-only units available. Tape reader and tape punch attachments. Many special features.

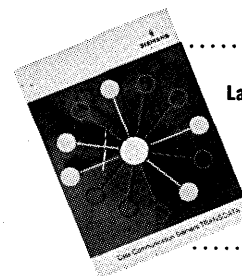

**Latest Literature on TRANSDATA:**

For detailed information on high speed tape equipment, modems, etc., send now for the 32-page, color brochure, "Data Communication Siemens TRANSDATA".

**SIEMENS AMERICA INCORPORATED**  
350 Fifth Avenue, New York, N. Y. 10001

CIRCLE 95 ON READER CARD  
**DATAMATION**

# if...

you are involved with systems and equipment design, research, production or management—RCA Institutes seminars can help in your field!

The RCA Institute for Professional Development offers Seminars that will provide you with information, knowledge and techniques you can put into immediate practical application . . . and prepare you for tomorrow's developments. Seminars are held throughout the year, throughout the country. Accomplished Lecturers present each program with an exclusively written text and modern audio-visual equipment. Look over the list below, and send coupon today for brochure explaining full details.

# RCA

RCA Institutes, Inc. Dept. DA-48  
Institute for Professional Development  
132 West 31st Street  
New York, New York 10001

For free descriptive brochure, check the Seminar in which you are interested:

- |   |  |
|---|--|
| <input type="checkbox"/> LOGIC DESIGN                   | <input type="checkbox"/> INTEGRATED CIRCUITS               |
| <input type="checkbox"/> DIGITAL SYSTEMS ENGINEERING    | <input type="checkbox"/> RELIABILITY OF INTEGRATED SYSTEMS |
| <input type="checkbox"/> DIGITAL COMMUNICATIONS         | <input type="checkbox"/> NUMERICAL CONTROL                 |
| <input type="checkbox"/> DIGITAL ELECTRONICS            | <input type="checkbox"/> MODERN OPTICS                     |
| <input type="checkbox"/> MANAGEMENT INFORMATION SYSTEMS |  |

Name \_\_\_\_\_

Title \_\_\_\_\_

Company \_\_\_\_\_

Address \_\_\_\_\_

City \_\_\_\_\_ State \_\_\_\_\_ Zip \_\_\_\_\_

Please send information on in-plant Seminars.

## If one computer is worth having—why not let 16 people use it at the same time?

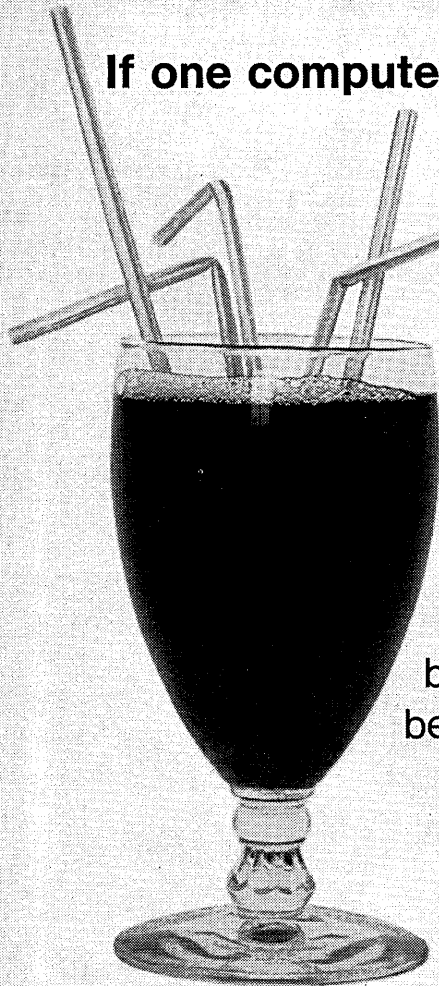

Every Tom, Dick or Harry who needs it. Time-sharing one computer with 16 Teleprinters tied in either by hard wire from the next room or by telephone from across town. It's a new system Hewlett-Packard offers to spread a good thing around. Programmed with Conversational BASIC, this time-sharing system is simple enough to be used by anyone—and economical enough to be within reach of everyone.

The Hewlett-Packard time-shared system combines an HP computer, disc memory, a multiplexer, and Teleprinters for input/output. On a moderate-use basis the HP system compares at 1/10th the cost per hour of other time-shared computers. With this kind of economics you can now afford to have a terminal for everyone who needs access to the computer—up to 16 at once, that is.

The HP system offers another advantage with its error-check system; each input character is echoed from the Teleprinter keyboard, through the computer and back to the Teleprinter printer. The compiler also checks each input statement for format and syntax as it's entered into the computer.

Simplicity, economics and a programming language that can be mastered in four hours are only three reasons to spread this computer around. For more reasons call your local HP field engineer. Or write Hewlett-Packard, Palo Alto, California 94304; Europe: 54 Route des Acacias, Geneva.

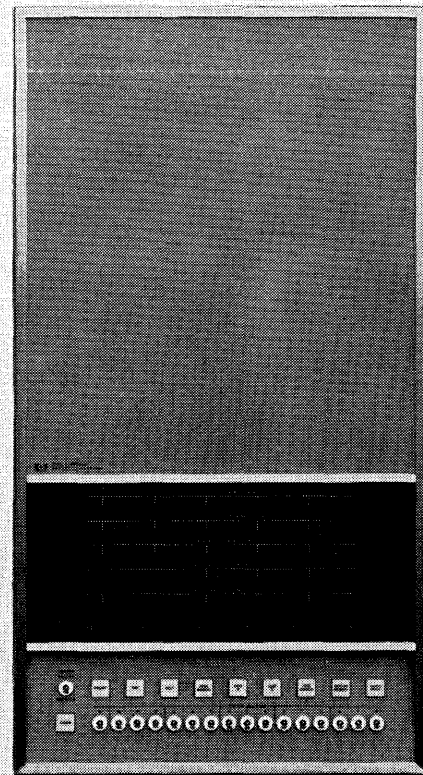

**HEWLETT *hp* PACKARD**  
DIGITAL COMPUTERS

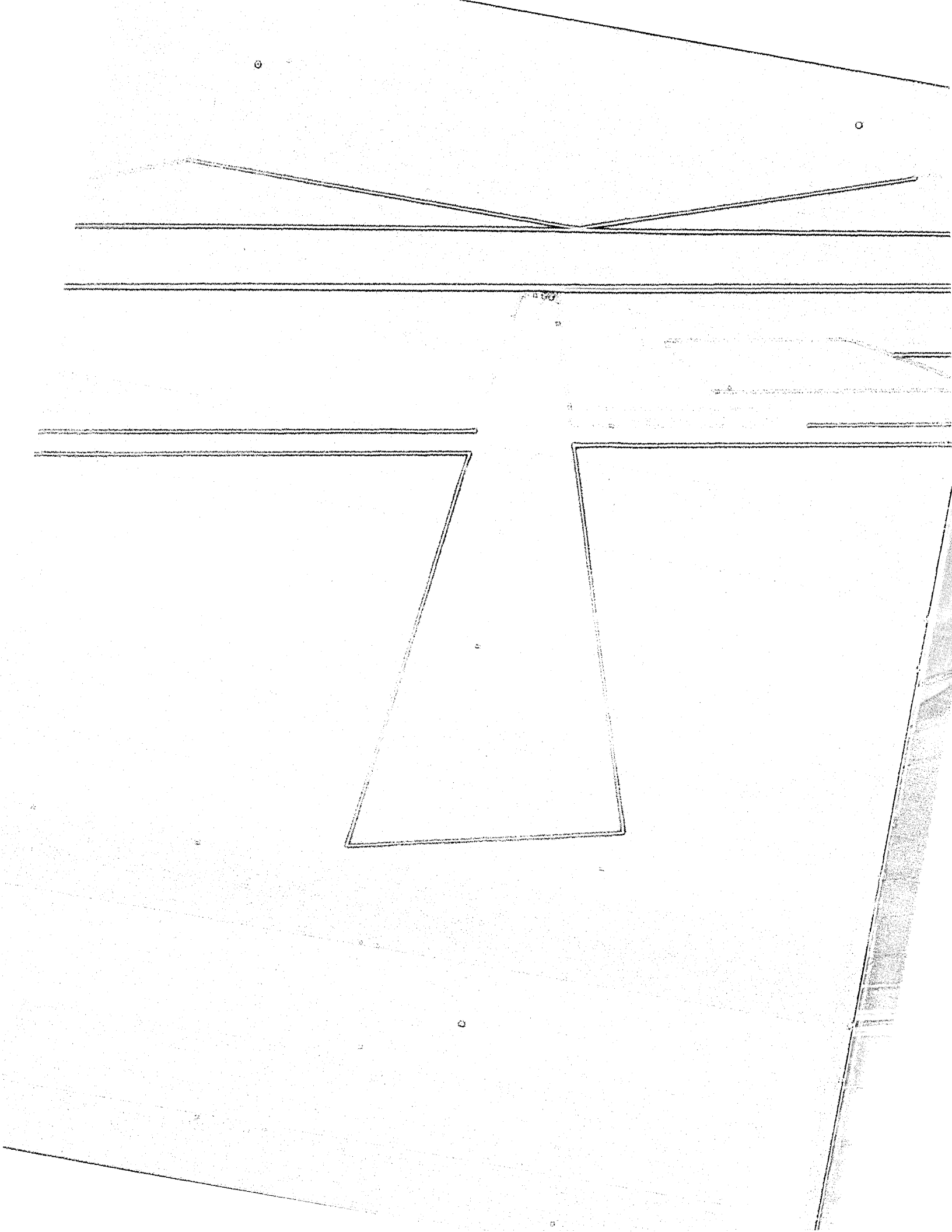



# We won't clear you for takeoff until you run through our pre-flight checklist.

At the last couple of computer conferences, we programmed one of our computers with an aircraft "flight". Visitors jammed the Systems Engineering Laboratories booth to take off and land on the airstrip displayed on our CRT.

If our "airplane" is as popular at the upcoming SJCC as it was at previous shows, your flight may be delayed a few minutes. Might as well spend the waiting time profitably, running down the checklist of our rather remarkable computers.

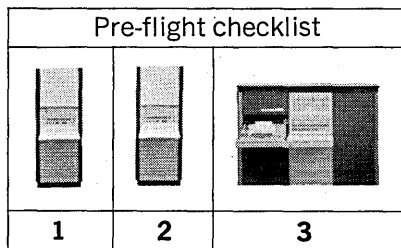

1. The SEL 810A 16-bit computer.
2. The SEL 810B 16-bit, with twice the speed of the A.
3. And the SEL 840A 24-bit computer.

There's a story that goes with these units—the story of Systems Engineering Laboratories full systems capability. How we build the total system from standard products, including our own computers. Then deliver and get the system into operation fast.

How well do we do this? Ask the people at General Motors, Union Carbide, Goodyear, Grumman, AC

Electronics, Dow Chemical and Phillips Petroleum, among others.

So if you come to Atlantic City, be sure to stop at Systems Engineering Laboratories' Florida island. Fly our CRT "airplane." We've got a new wrinkle in the flight that should be fun.

And don't forget our full systems capability story. It's worth checking.

Can't make the show? Write for information. Systems Engineering Laboratories, P.O. Box 9148, Fort Lauderdale, Florida 33310.

**Systems Engineering Laboratories**



## Another good reason for using IBM Disk Packs:

### **Delivery time is now 4 months or less.**

IBM 1316 Disk Packs are now being delivered on a 2-4 month schedule. That's the fastest delivery time since we introduced the disk pack almost six years ago.

Since then, demand has grown rapidly. Computer users have been quick to take advantage of the disk pack's ability to store vast quantities of information while giving almost immediate access to each record. That's why we expanded disk pack production facilities at our San Jose plant.

And that's why, even though two to four months is pretty fast, we don't think it's fast enough. In fact, we won't be satisfied until we can give you off-the-shelf delivery.

**IBM®**

# news briefs

## CITIZENS MAY GET RIGHT TO CHALLENGE CREDIT REPORTS

Hearings by the House Banking and Currency committee on two bills giving individuals control over their credit dossiers are expected to begin this month.

One bill, HR 15495, introduced by Committee Chairman Wright Patman, would require a bank, savings and loan association, or other federally-insured credit-granting institution to tell an individual specifically what credit information it was releasing about him, and to whom. The institution would have to obtain the individual's written permission before disclosing the information.

This bill also provides that if a person applies for credit, and the creditor obtains a credit report on him, the applicant must be told where it came from. The credit rating agency would not be able to make a report without "disclosing to the individual, at his request, the content . . . and in the case of any adverse report, the specific facts or allegations upon which the report is based." Under a related section, a rating agency that refused to issue a credit report on any individual would still have to tell him the "facts and allegations" on which this decision was based.

The other bill, HR 15627, was introduced by Congressman Clement Zablocki, of Wisconsin. It is basically similar to the Patman proposal except that HR 15627 does not require federally-insured credit-granting institutions to get an individual's written permission before releasing information in his credit file.

## IBM HAS SLOWER, CHEAPER MODEL 20

While everyone had an ear to the ground for IBM's expected announcement of a smaller System/360 likely to be labeled Model 10 or 8, the marketing magicians pulled "a new version of the Model 20" out of the hat.

Running about 30% slower than the original 20, it also sells for about 30% less—making a tempting bridge for the unit record user still reluctant to jump into stored-program machines. And the new version also offers rugged competition with the Honeywell 110

the GE-115, and the newly announced Century Series 100 from NCR.

Going along with the more sluggish cpu are slower peripherals. The 2560 card reader/punch/sorter has been relaxed to read 310 cards/minute instead of 500 and to punch 120 characters/second instead of 160. The new version of the 2203 printer will produce 600 lpm instead of 750. Memory speed, however, stays the same at 3.6 usec.

The puzzle of why the machine wasn't given a number of its very own ("Do you want the slow or the fast Model 20?" seems an awkward question for the salesman) may be resolved by considering past problems of programming support for the 360 line. It should be simple to convince new, small-business users that the vast library of Model 20 programs has been thoroughly checked out by now and that they will thus face no surprises by getting the watered-down version.

The new model also solves still another marketing problem—that of returned Model 20's from users moving up. It is our understanding that these used machines will be reworked at the factory to fit the new specifications and thus emerge as the slower version.

Memory size is from 4 to 16K and, in addition to the card machine and

printer, the new 20 will take two 2311 disc drives, for a total of 5.4 megacharacters.

Deliveries begin in the fourth quarter of this year. Price for the card system starts at a thrifty \$1459 per month or \$64,710 if purchased. A disc system is \$2556/month or \$126,390. For information:

CIRCLE 208 ON READER CARD

## FEDS ADOPT ASCII STANDARD

President Johnson last month (March 11) issued a memorandum to the heads of departments and agencies which establishes ASCII (its formal name is the U.S.A. Standard Code for Information Interchange) as a federal standard.

Says the memorandum: "All computers and related equipment configurations brought into the Federal Government inventory after July 1, 1969, must have the capability to use the Standard Code for Information Interchange and the formats prescribed by the magnetic tape and paper tape standards when these media are used."

The only loophole is thus described: "The heads of departments and agencies are authorized to waive the use of these standards only under compelling circumstances of particular applications. Such waiver is to be coordinated with the Department of Commerce (National Bureau of Standards) before it is exercised so that the Department may effectively accomplish the goals of the Federal computer equipment standards program conducted

## PLOTTER ART CONTEST SPONSORED BY CALCOMP

The mournful fisherman, drawn by a series of mathematical computations transferred to a plotter via punched tape, was among several examples of plotter art exhibited recently at a show announcing the first international computer/plotter art contest. Sponsored by California Computer Products, the competition includes categories for re-creations of famous works of art, as well as original designs. Scholarships of \$5000, \$3000, and \$2000 will be awarded to colleges designated by the winners; personal cash prizes will also be given. Further information on the contest, which ends Nov. 1, can be obtained from California Computer Products, 305 N. Muller St., Anaheim, Calif.

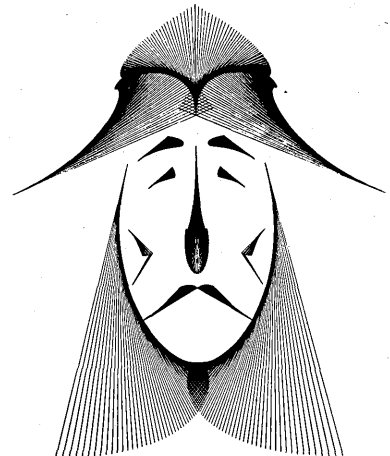

"THE FISHERMAN" by CalComp

# What's happening today in keyboards is what's happening at MICRO SWITCH



Typical Communications Keyboard  
Shown Below: Typical Data Preparation Keyboard

An important key to future keyboard design is what's happening at MICRO SWITCH.

Already we have successfully launched Happening No. 1: Introduction of complete wired and encoded keyboards ready to interface with your equipment.

Shown here are two typical keyboards. Each gives you dry reed switch input, solid-state-encoding, and a variety of exclusive options.

And they provide a flexibility that is unavailable elsewhere. You get a customized keyboard. Key array, format, added options, code change—you select the features required for your system.

Options include strobe and electrical monitor outputs, bounce gates and shift. For example, two interlock options are provided to improve operator speed and efficiency. An electrical monitor output triggers a detector circuit for blocking data or initiating error signals. A unique two-key rollover option permits typing at "burst" speeds without generating erroneous codes.

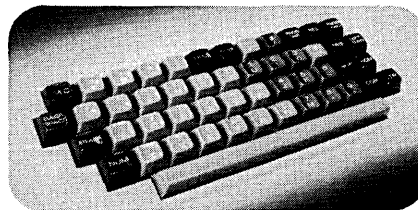

But that's not all. Coming very soon is Happening No. 2. Through advanced design concepts, complete engineering facilities, innovative assembly techniques, and unique quality assurance procedures, MICRO SWITCH is preparing to supply your every keyboard need. This means new reliability and flexibility in mass-production quantities with attractive customized appearance giving new sales appeal to your equipment.

Make no decisions on keyboards until you see what's happening at MICRO SWITCH. Call a branch office or call us at Freeport: phone 815/232-1122.

## MICRO SWITCH

FREEPORT, ILLINOIS 61032  
A DIVISION OF HONEYWELL

HONEYWELL INTERNATIONAL • Sales and service offices in all principal cities of the world. Manufacturing in United States, United Kingdom, Canada, Netherlands, Germany, France, Japan.

## news briefs

under Public Law 89-306." (That's the Brooks Bill.)

Behind the memorandum is the government's concern with compatibility of computers, as stressed earlier in a Presidential memorandum issued June 28, 1966.

In effect, the government wants the ability to move information freely from one manufacturer's computer to another . . . and they want to be able to change from one brand of computer to another if the economics dictate such a move.

Right now many federal users are locked into one computer maker—primarily IBM. An agency with 100,000 or more reels of tape in one manufacturer's format is not likely to hurriedly switch to a computer requiring a new format.

The new federal standardization edict will undoubtedly displease IBM, which has approved ASCII as a transmission code, but which has openly suggested the need for a new internal processing code. Other manufacturers, too, have expressed concern that an ASCII standard will encourage its extension inward into the bowels of the machine, where EBCDIC now reigns.

But others feel that the concern is baseless. They note that the conversion from internal code to a transmission code is simple and not terribly expensive.

Perhaps as significant as the fact of the announcement and the level from which it emanated is the comment by Congressman Jack Brooks in the Congressional Record of March 12: "The adoption of this standard is a most important beginning to a broad frontal attack on the entire standardization problem affecting computer usage."

### BULL-GE HERALDS SMALLER NET LOSS

Compagnie Bull General Electric, awash in red ink since its founding about three and a half years ago, reports that 1967 brought a reduction in net loss to \$17.5 million vs. \$23.2 million the year before, a revenue increase of 13.2% over 1966 income of about \$100 million, and an increase of 31% in the value of equipment installed.

Last year General Electric came through with another \$30 million for Bull-GE, bringing the U.S. company's investment to some \$100 million and increasing its ownership share from 50% to 66%. At that time, the French company announced a policy of cost cutting—including a less aggressive sales effort. (During 1966, gross income seemed to have an inverse correlation to profits: revenue grew 23.4%

while losses reached the \$23.2 million figure.)

The improvement in '67 is presumably a result of these measures plus some decline in the total number of people employed. A spokesman for the company noted only that there "has been some attrition—and some replacement."

Bull-GE is pushing ahead with its time-sharing bureaus. The first was opened in Paris last month, the next will be in Amsterdam, and services for other European cities are in the planning stage.

### STATISTICAL DATA BANKS SAID TO BE PRIVACY THREAT

Protecting individual privacy requires more than controlling access to personal dossiers, a lawyer and management consultant told the Boston Bar Association's Committee on Automation recently. Aggregate statistics can also provide intelligence about individuals, explained Richard I. Miller, adding that the danger posed by this latter source is growing.

"As the speed of computers goes up and the cost comes down, it becomes more efficient to store raw data in a statistical system which can then be probed for intelligence purposes . . . there is always a new way to cut the deck. A good analyst is constantly probing his data for novel and useful correlations. The fact that it is easier to do so with the larger machines suggests that the complete separation of statistical and intelligence systems is, at best, a receding goal."

Miller, a member of Harbridge House, Inc., an international consulting firm, explained that existing law provides inadequate protection against computerized invasion of privacy. Relevant statutes and precedent cases relate to wiretapping and other forms of physical spying, to character defamation and privileged communication. But privacy can be invaded without spying and without using information that is legally defamatory or privileged; Miller indicated that burgeoning computerization makes it increasingly easy to compile, manipulate, and distribute such information.

He advocated hardware and software locks to protect access to computerized data banks, and also recommended legal measures which would: a) notify individuals when information was being collected about them, and tell what information was involved; b) require public hearings, and establishment of public necessity, before funds were appropriated for governmental data banks; c) make data collectors liable for the dissemination of false data.

### A DATA BASE FOR THE CHURCH?

Statistics on the use of data processing in the religious community are now being compiled by the Missions Advanced Research & Communication (MARC) center, a division of World Vision International, in Monrovia, Calif. Acknowledging the possibility of resistance to advanced technology within the many organizations of the Christian church, the MARC staff, under the direction of Dr. Edward L. Dayton, has sent 1600 questionnaires to religious groups, such as denominational headquarters, colleges, church councils, etc. The MARC plan is to use the information thus gathered to form the basis of an information and communication center that will hopefully eventually include data on the work of the international church.

MARC, just recently affiliated with World Vision, is operated in cooperation with the School of World Mission, Fuller Theological Seminary, Pasadena, Calif. Beginning five years ago with a 1401 used for payroll and general accounting, MARC now has a 16K 360/30 with four tapes, and a dp staff of about 15 people.

Determined to encourage the use of data processing facilities in the church, MARC hopes to use the results of the questionnaire (to which about 300 organizations responded) to bring about dp education, exchange of programs, users' groups, etc. within the religious community. Particularly in world missionary work, MARC sees the computer as a valuable aid to evaluating strategies, reducing operating costs, and providing a base of information to assist in planning.

To those who think of the computer as a de-humanizing factor in modern society, it is interesting to note that MARC finds it a tool "that offers real potential for evangelizing this generation."

### NEW HOPE FOR THE NYSE BACK-OFFICE STRUGGLE

The staggering volume of trades on the stock market, we repeat, has buffaloeed the back office accounting operations of the brokerage industry.

The New York Stock Exchange thought a service mixing on-line entry of transactions into a central system—with batch-processed reports at the end of the day—would solve many problems, particularly for small and medium-size firms without their own systems. So it formed the Central Computer Accounting Corp., which got as far as a pilot test and then folded last fall. In the meantime, most brokers and service bureaus on Wall Street scramble to gather the data on

# What every executive should know about time-sharing

Computers process data and solve problems. And they do it fast. So fast that most production jobs are generally fed into a computer in large batches.

That takes care of the large demands on computer time. But what about the programmer who needs the computer frequently for short periods to check the programs he is writing? And what about engineers, financial analysts, market researchers, or other personnel, whose time can be so important to you and to themselves? They usually wait. Sometimes hours. Sometimes days. Just to get an answer to a problem that may take less than a minute of computer time.

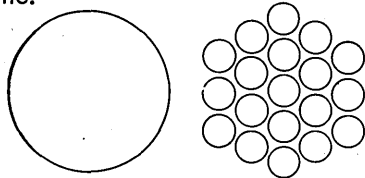

Time-Sharing systems are designed to change that situation. They let many individuals with small or occasional problems use the computer without waiting. Thus, they help an organization attain the full potential of its creative human resources. Ideally, such systems also permit "bread-and-butter" production jobs to be performed concurrently.

**How time-sharing works.** To the dozens of users of a time-sharing system the computer is always available for work. They call up the computer from their remote terminals, give it a problem and in a few seconds or minutes they have their answer.

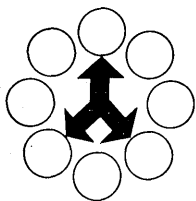

Actually, during that short time the computer works on many jobs. It does a fraction of a second's work on job A, then on job B, and so on until every active terminal has been serviced. It repeats that cycle over and over until all jobs are complete.

Meanwhile, the flow of production work continues unabated.

Because third-generation computers can do millions of operations in seconds, jobs are performed so quickly that no user has any impression of waiting. In fact, from his point of view, the full computer power is at his disposal.

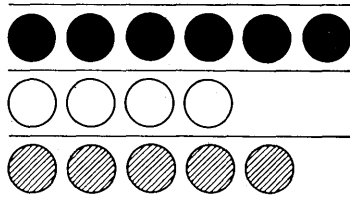

**Time-sharing computers have some extras.** One is a hardware and software operating system designed for multiprogramming—interlacing a mix of jobs to utilize fully the computer's capabilities. This lets the computer switch from one job to another with great efficiency. Another is a special high-speed auxiliary memory system that allows the programs and data of many individual users to be stored outside the computer's main memory, yet be called into the computer quickly just when needed, a small segment at a time.

**What's so good about time-sharing?** In the first place, each user gets immediate and convenient access to the computer whenever he needs it. In fact, he can have an input-output terminal right at his desk. Increasingly popular are the video displays with typewriter keyboards which permit dynamic man/machine dialogue. The user station may be next door to the computer or hundreds of miles away.

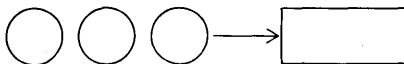

In the second place, the user of a time-sharing computer is not restricted to working through professional programmers. He can get a basic grasp of a special language—a kind of shorthand used in talking to the computer—in just a few hours. From then on he can ask the computer questions directly, get answers, and work his way through problems

step-by-step. The whole area of defining and solving problems, and storing and retrieving data is greatly simplified.

Not only does this rapid turnaround on small jobs save time and increase productivity, the very act of working directly with a computer helps men think more logically and creatively.

**What about time-sharing and professional programmers?** Time-sharing is a great timesaver for programmers.

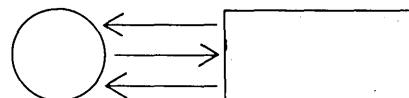

Instead of waiting for computer time, the programmer can check each step at his convenience. And he can quickly check alternative program designs, to see which works out best in practice.

**What happens to production work in a time-sharing system?** That depends. In some computers called "time-sharing," the system is completely dedicated to either batch processing or time-sharing. But both activities can't go on at the same time.

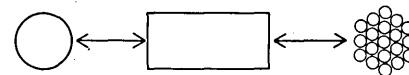

The best kind of time-sharing system is one that permits processing of production jobs to go on as usual, concurrent with conversational problem solving, thereby enabling full utilization of both equipment and human resources.

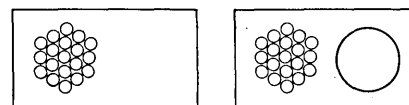

**Two ways to get time-sharing for your company.** One way is to go to a service center that offers time-sharing. This gives the user *only* time-sharing capability, and is frequently very expensive when added to existing data-processing costs.

A better way is to buy or lease a time-sharing system that will also handle your present batch processing requirements.

# computers

**Does time-sharing have to be a high-priced luxury?** If you want the blue-sky time-sharing offered by some companies, it probably does. RCA offers a down-to-earth approach to time-sharing.

It's called the Spectra 70/46 Time-Sharing System. It offers you the advantages of true time-sharing combined with production processing. And the moderate cost of the 70/46 makes it practical for you to start enjoying the benefits of time-sharing today, and learning computer techniques that every company will surely need to know in the 70's.

The payoff to astute companies—now and in the future—can be immense.

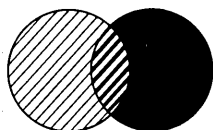

**What about compatibility—360 and otherwise?** Spectra 70/46 has a full range of software to accommodate existing and new programs for both Spectra 70 and 360 series.

**What next?** These have been straightforward words about a very complex subject. But they hardly scratch the surface. If you're a computer expert, we've got a lot of important details you'll be interested in. If you're not, maybe you ought to point your computer experts in our direction.

Knowing all the options is smart business in any business. So shouldn't you explore the potentiality of Spectra 70/46 time-sharing?

You can do it by simply dropping us a line, or giving us a call. RCA Information Systems Division, (609) 424-2385, Camden, N. J. 08101.

# RCA

## Information Systems

CIRCLE 135 ON READER CARD

April 1968

## news briefs

punched cards to process. But if the early NYSE closings over the last year to permit catching up on accounting are any indication, that's not enough.

So Computer Methods Corp., a subsidiary of Coburn Corp. of America, hopes to step in with a service that NYSE had dreamed of for CCAC. Not stopping at entry of transactions, Computer Methods plans to store complete files for a firm; provide crt terminals for transaction entry, verification, correction, and data retrieval; and produce reports and analyses.

The service will be aimed primarily at smaller firms, while the software package will be sold to larger brokers with their own systems. CMC, beginning second quarter 1969, will offer a fully backed up system including two 360/40's, one with 128K, the other with 256K, using the DOS BTAM teleprocessing system; two 2314 disc drives with 207 million bytes, and tape duplication of master files; and a 2260 crt terminal with two 2848 control units per user.

The firm will store data on about 15,000 securities listed on the various exchanges (over 25 million bytes). The broker's files will include the customer account master file (name and address), the customer holder file (securities owned), a record of stock the broker owes and is owed, "street-side" accounts, and general ledger bank loan accounts. The system will check each transaction against the appropriate files (a protection against, for example, incorrect account numbers difficult to trace after closing) and prepare and output confirmations to customers for mailing by CMC. In addition to traditional reports, CMC plans to provide stock loan analysis, automatic preparation of instructions for stock certificate transferral, and the subsequent transfer status analysis. (The latter two are particularly constant problems of delay and loss.)

By publication date, CMC should have signed its pending contract with a "medium-sized" brokerage firm, which will serve as a pilot subscriber, using 15 crt's. CMC says it can handle on-line inquiries at an average response of under one second; response will take about 2.5 seconds if 15 units call in at once. Terminals will be polled.

In addition to the protection of hardware backup, the system will periodically run test data through the communications lines to check for failure; if a line goes down the crt will be switched to another line, which will automatically be given polling priority. The two control units for the user's crt's are also set up to handle a double load if one control goes down. And if

all phone lines go out, the transactions will be keypunched and entered into the system. If the electricity fails in the northeast again, well, the master files are on tape, as well as disc.

## TUTORIAL FILMS OFFERED FOR COMPUTER EDUCATION

Computer Methods Corp., in addition to its new venture in computer services for brokers, has also entered the computer education field. But this software firm won't go the seminar route that has become big business for many software and consulting firms. Instead, for \$500, the customer will get a tutorial film with supplementing text.

The first films are aimed at computer professionals, to be followed by films for management, universities, and primary and secondary schools. The pilot film now being released is on data communications; it comes in three 15-minute segments (to allow for discussion after each) and features three professionals in conversation on the problems a systems analyst and programmer will encounter in communications-based systems. A 175-page text expands on the film. Other films in this group will be on on-line systems and programming techniques, simulation, information retrieval, hardware evaluation methods, multiprogramming and multiprocessing concepts, time-sharing, and computer graphics and display techniques.

Computer Methods has started this venture as its tutorial film division, headed by Justin Spring. It hopes to spin it off into another Coburn subsidiary ultimately. Other projects include publishing of texts in the computer field. And ultimately, particularly for schools, CMC will provide animated and text-page films, with audio, which the student can stop and go back to review at will. The films come in standard color 16 mm reels or 8 mm cartridges for portable systems. For information:

CIRCLE 209 ON READER CARD

## NEW FIRM WILL COUNSEL TELEPHONE/COMPUTER USERS

Metroprocessing Associates has been set up in White Plains, N.Y., by Dr. Leon Davidson to offer consulting and design services for those interested in using pushbutton telephones for computer input and inquiry terminals.

Davidson, long an avid spokesman for telephone application to this purpose, notes that 12-button phones will become generally available this year in many areas of the country. The original 10-button units didn't fit the job because all were necessary to convey numeric information. The extra two buttons make it possible to have con-

# So you're thinking of

## **QUICK DRAW**

***the Cobol, Fortran, and Assembly  
flow charting program for most computers!***

Why not? It's the way to get to the top in your company. "QUICK-DRAW" produces completely accurate computer drawn flow charts directly from your source decks or tapes. No input preparation or special codes required. Leased for as little as 2.30 per day ( to qualified users ). Produces charts conforming to ASA standards. Fast service too. Stop thinking. ACT!

***free!***

Send us your deck  
for a free sample trial  
chart. No obligation.

# **nca**

*Please address all inquiries to:*

**NATIONAL COMPUTER  
ANALYSTS, INC.**

**INTERNATIONAL SALES OFFICE  
500 Fifth Ave., New York, N. Y. 10036  
Phone: (212) 594-4955**

**nca**  
HIGHWAY ONE  
PRINCETON, N.J.  
08540





## news briefs

trol functions and indicate alphabetic information.

Much of Davidson's work with telephones as input units was done while he worked for IBM, with his first report coming out in 1962. Since then, units have been in use—connected to a time-sharing computer at Mohansic Laboratory. And a desk calculator service has been field-tested by IBM. The new company expects the sudden rise of commercial time-sharing systems to offer a growing market for the low-cost terminals represented by the push-button phones.

### UNIVAC UNVEILS PLANS FOR COMPUTING NETWORK

After getting its feet wet with a few on-line dp centers operating since 1965, Univac has announced the master plan for a nationwide network. It will offer

all things to all people: remote batch to time-sharing (ultimately) sale of on-line computer time, on-line service with programming on an application basis, and total dp services for a firm through the centers. Both scientific and commercial customers will be sought.

Nodes of the network are large centers with 1108's and 418 front-end systems, branch offices with 9200 and 9300 configurations that include data communications subsystems, and customer offices with DCT-2000 terminals or the 9000 series systems. Univac already has an 1108 in Mineola, N.Y., and a 418 and 1107 in Phoenix, where program testing has been done. These centers will be fully outfitted with 418/1108's this year, along with new centers in San Francisco (April) and Chicago (July). Eighteen branch offices, which now have 1004 communications processors, will receive 9300's. When the communications subsystems become available, starting this sum-

mer, the 1004's will be phased out; some centers will also get 9200's.

Time-sharing will come later; the centers will start off with remote batch jobs with turnaround time requirements of anything from a few seconds to overnight. Large-scale jobs with little computing, such as linear programming and stress analysis, will be the initial sales emphasis.

Univac has developed a terminal access executive system, DIRECTOR, for the 418; with this it can receive tasks from 12 wideband lines concurrently, strip them of communications characters, attach priority scheduling, and dump the data onto FH-880 drums for retrieval and processing by the 1108. The firm says turnaround time on the large-scale jobs noted above is a few seconds. The 9200's and 9300's will be used to process many commercial applications and to preprocess some tasks needing the computation power of the 1108. When the centers go to time-sharing, applications will include commercial jobs, a la the Key-data system, so that the user will not only receive batch-processed reports periodically but will also be able to access his file for data and short reports. This will require implementation of a file management system developed either by Univac or an outside firm. (Univac has had such a system under development.)

Cost for the service will vary. Jobs entered through branch offices to remote centers will not have communications line charges; Univac will absorb these. For computer use only, where the user supplies his own program rather than receiving programming and other dp services, the charge for computer time will be from 16 to 35 cents a second, depending on priority scheduling. This includes execution and transmission to the data set of the receiving terminal. Also, there will be a charge for cards read and pages printed at the branch office. File storage will be on tapes, Fastrand drums, or faster devices.

### NUMERICAL CONTROLS ALL WET IN UNDERWATER TEST SYSTEM

A standard Bunker-Ramo three-axis 3100 Contour Control has been modified to handle ultrasonic underwater inspection of parts.

Bardel, Inc., of Cleveland, has installed the system to speed up manual testing requiring hard-to-find, highly trained ultrasonic technicians.

The parts to be inspected are loaded onto two turntables (see photo) which are rotated under an ultrasonic transducer, which replaces a cutting tool in a standard 3100. Three N/C axes control radial, vertical and rotational movement of the transducer over one part while the other turntable is being loaded.

Once in position, the transducer emits a high-frequency sound beam into the material. Echoes reveal discontinuities in the material and indicate

flaw location, part thickness and/or metallurgical variations, as recorded on an oscilloscope and chart recorder.

The dual turntables can handle parts up to four feet in diameter and weighing up to 1000 lbs. Test speeds range from less than 1 rpm to 60 rpm.

The entire system consists of a stainless steel tank 144" x 53" and 27" deep. The water is filtered and heated to insure proper sound "coupling." In addition to chart recording, visual and audible alarms are provided.

Programming is through standard APT III FORTRAN IV, but a B-R APT III FORTRAN IV post-processor is used to match normal cutting commands to inspection requirements. The B-R 3100's thread-cutting feature is used to control recorder indexing to eliminate duplicate traces on the voltage-sensitive recording paper.



### BIRTH NUMBER COULD BE ALL-PURPOSE IDENTIFIER

While banking threw its support behind the social security number as a standard personal identifier, the state government registrars came up with a number which may rival it in use. It's our birth number. As of Jan. 1, all states agreed to use a standard format, easing the processing for both the states and the National Center for Health Statistics, which gathers these records periodically.

Other statistical agencies, public schools, and perhaps such groups as insurance firms, medical programs, and motor vehicle bureau (which now



## **DYNAMIC MEMORY LOCATION** NEW ORLEANS, LOUISIANA

New Orleans has a way of evoking memories. About 25 miles up the river, where Creole gentlemen once passed in Mississippi steamboats, now stands Little Gypsy, the world's first fully automated steam generation plant. □ Control Data's Mod. 46 computer made it a reality in 1961. Digital Development Corporation's 512 track Model 10100 drum memory was there then and hasn't been down for a moment since. As the Little Gypsy plant grew, a CDC 636 was added with a 1024 track DDC Model 12750 drum. □ Today this advanced computer system provides scanning, logging, monitoring operations and closed-loop control from startup to shutdown. □ Background processing has streamlined operations management decisions with timely performance/efficiency calculations. As Little Gypsy moves toward future expansion, other DDC high performance rotating memories are ready for this and other advanced applications. □ If demonstrated reliability in rotating memories is important to you, contact Digital Development Corporation, a subsidiary of Xebec Corporation, 5575 Kearny Villa Road, San Diego, California 92123, Phone (714) 278-9920.

**DIGITAL DEVELOPMENT CORPORATION**

## news briefs

use the social security number) could be attracted to this number because of its information value. It contains three digits on country of birth (U.S. or other if child is born to a U.S. citizen abroad or naturalized); two digits on year born; and a six-digit serial number.

### THIS MONTH'S CDC ACQUISITION: EAI

Control Data Corp. is still busily acquiring other companies. Last month it was the Data Processing Systems Div. of SCM and the Electronic Accounting Card Corp. Now comes Electronic Associates Inc.—with approval still pending from the stockholders' meeting in May.

EAI is primarily an analog and hybrid house that ventured into the digital area and got burned. Last year the company reported a loss of \$1.7 million on sales of \$37.7 million, as opposed to a \$1.1 million profit for 1966.

CDC is already in the same arena as EAI, through its Analog-Digital Systems Div. in LaJolla, Calif. (Oct. 67, p. 123). Although nothing has been decided for sure on how the two operations might fit together, it seems clear that the combination would be a considerable factor in the market when all the meetings are over and things settle down. The original settlers at La Jolla have been acquired three times; now it's their turn.

### CHINESE ARTICLE EXPLAINS MAO'S EFFECT ON COMPUTERS

Announcing China's new digital computer, the January '68 issue of *China Reconstructs*, published in Peking, wrote a considerably different story than DATAMATION's (Feb., p. 39).

Sacrificing even the minimal amount of objectivity found in intra-office sales memos, the article states: "At a demonstration before it went into use, it played 'The East is Red,' and at the same time reproduced a portrait of Chairman Mao with 'Serve the People' in his handwriting on the wide moving paper tape. This inspiring song and picture was an expression of the infinite love and respect of the workers and scientists for our great leader Chairman Mao . . . During the project, workers, technicians engineers and scientists used to say, 'As long as we listen to Chairman Mao, the machine will listen to us.'

"The tiny handful of Party capitalist-roaders in authority tried hard to obstruct the research and production of the computer by pushing their now

bankrupt ideas—slavishness, crawling at a snail's pace, or even not doing it at all . . . This handful of class enemies put up many obstructions. But, armed with the great thinking of Mao Tse-tung, the revolutionary workers, technicians, engineers and scientists did not retreat. Everything the workers did, big or little in their work, they considered part of their battle against imperialism and revisionism . . .

"When the computer was finished and ready for testing, the revolutionary comrades on the project, guided by the great thinking of Mao Tse-tung, criticized and rejected the revisionist inspection system in which only a few 'experts' test and check behind closed doors. Instead, they carried out a mass testing and checking . . . turning this process into a classroom in the creative study and application of Chairman Mao's works, an arena for revolutionary criticism, a battleground for establishing the absolute authority of Mao Tse-tung's thought."

While it is very doubtful that the Chinese, as this article further claims, "scaled another world peak in advanced science and technology," they do deserve recognition for another achievement: by fusing the divergent paths of inspirational and technical writing, they have outdistanced by far even the most dedicated of our PR zealots.

### DATA BASE TASK GROUP RELEASES FIRST REPORT

The Data Base Task Group of the CODASYL COBOL Language Subcommittee (CLS) has released its first report summarizing the group's findings since its appointment in May, 1966. The document has been made available to the public in an effort to establish better communication between CLS and interested members of the data processing community.

The report covers several topics:

Short and long range objectives to be satisfied by a COBOL data base management facility.

A review of current data base management techniques in terms of data storage and structure, and accessing method.

Comparison of several approaches to the management of data bases, and a recommendation to use ring structure as the basis of the COBOL facility.

A proposal for a set of extensions to COBOL, including a Structure Section to be added to the Environment or Data Division, and several Procedure Division extensions to satisfy requirements in the areas of logical control, system interface, input/output functions and sorting.

Three appendices contain a descrip-

tion of General Electric's Integrated Data Store (IDS), a list of functions, and a comparison of functions available in IDS and General Motors' Associative Programming Language.

The report is available from Warren G. Simmons, Box 124, Monroeville, Pa. 15146.

### MOHAWK BUYS SOROBAN, INSTALLS 8500TH RECORDER

Buying Soroban should help make Mohawk Data Sciences a supplier of one of the most complete lines of OEM peripherals in the industry. The firm now has 27 Data-Recorder models, a line of printers—a result of the merger with Anelex last year—and the Soroban punched card readers, paper tape readers and punches, and data transmission equipment.

If the agreement is approved by the firms' boards of directors and stockholders, the addition of Soroban's 450 employees will bring the MDS staff to about 2700—astounding growth for the three-and-a-half-year-old company. Soroban, located in Melbourne, Fla., will continue under present officers and management, headed by president and board chairman Charles F. West.

The Florida firm has a commercial line of the readers and punches, but also has Autodin contracts under which it is developing high-speed models of these peripherals (a General Dynamics subcontract for Autodin abroad), and data transmission equipment, including a message switching system (for the U.S. Autodin network, under proposed contract to Western Union). And, in prototype, Soroban has a "high-speed, high-performance" magnetic tape drive.

Mohawk says this line combined with the recorder will provide the following system capability to offer the end user market: mag tape to punched card output; high-speed card reader to mag tape; mag tape to punched paper tape and vice versa; and punched paper tape transmission terminal. The Anelex printers can also be combined with some units to make off-line print stations. All of the products will be offered independently to the OEM market. In addition to the Anelex page printers, Mohawk will also soon announce a high-speed lister/printer produced by Franklin, which was an Anelex subsidiary.

This product line, which lacks only discs and optical scanning equipment, should give Mohawk a hedge against the developing competition with its Data-Recorder, which was the first system in its field. Honeywell recently announced its version, the Keytape, and Sangamo and IBM are reportedly developing such systems. An IBM entry would impact MDS most, although

this  
**NEW**  
 Stored  
 Program  
 Controller  
 costs  
**\$6,400**



We could have stopped sooner and still been competitive. After all, our SPC-12 was a totally integrated, binary, parallel, single address processor that would accommodate 4,096 words (8 bit bytes) of memory with a 2.2 $\mu$  second cycle time. It had seven 12 bit registers, six addressing modes and over 400 powerful commands, not to mention a remarkable new *shared command* concept that permits the SPC-12's 8-bit memory to handle 12-bit instructions. But we figured that there were still a lot of features you'd need, even for a basic operation . . . features like a real-time clock, integral plug-ins that let you expand the memory to 16K, a teletype interface, a control panel and a priority interrupt, so we designed them in, too, . . . free.

There are still plenty of options you can buy for specific applications, but the standard SPC-12 will handle many source data collection, formatting, computer peripheral control, instrumentation control and information processing, for \$6,400, complete. Write for complete specifications today, it's free too.

*you get  
 \$4,000 worth  
 of options*

**FREE!**

**AUTOMATION PRODUCTS**  
 A DIVISION OF  
**GA GENERAL AUTOMATION, INC.**

706 W. KATELLA, ORANGE, CALIFORNIA 92667 / (714) 633-1091

## news briefs

some observers say the IBM blessing on the concept could shove sales higher for Mohawk, which doesn't feel the market for such a device has been scratched yet. (IBM reportedly still has a 12-month backlog on their key-punches, the units the recorders replace.)

In any case, Mohawk has a head-start; installations of the recorder have passed the 8500 mark; the order backlog is 6000; and the production rate is 200/week at MDS. NCR, which has a five-year agreement to use several MDS products with its systems, has just extended the contract one year. MDS is also doubling its Herkimer, N.Y., plant space to 200,000 square feet, and has just negotiated a \$30 million line of domestic and foreign credit to handle rental needs over the next three years.

MDS had planned to acquire Dasa Corp., but announced discontinuation of talks in early February. The reason was that Dasa is heavily involved in non-data-processing products, and MDS did not feel it could devote corporate time and facilities to these. It is negotiating a joint manufacturing and marketing program for Dasa's Datacall message composers and tone transmitters, and Databank relay stations. Datacall could be combined with the recorder for remote transmission of data to mag tape. The proposed program covers a five-year period and calls for MDS to order \$40 million of Dasa equipment in that time.

Mohawk now has 16 subsidiaries, 12 regional offices, and a sales force of 60. Its latest six-month report showed an \$18.4 million gross, \$1,758,000 net, and \$.74 earnings/share. The previous year's revenue was \$9.33 million, with \$1.1 million net. This was without Anelex operations, however.

The agreement for the acquisition involves one share of MDS common stock for four of Soroban.

### CHICAGO BANK LINKS ALL BRANCHES WITH NEW SYSTEM

The formal opening of the largest Touch-Tone card dialer/computer system in the banking business (and first such Illinois Bell installation) marks another step toward the checkless society. Beverly Bank, Chicago, uses 140 Touch-Tone card dialer telephones in a closed network to connect it to branches and four client suburban banks included in BASIS (Bank Automated Service Information System). All are on-line to the 360/40 and IBM 7770 audio response unit, giving tellers immediate access, through teller and customer prepunched ID cards, to

customer files on disc. Teller input is via phone buttons and audio response to queries eliminates pounds of print-out.

Beverly Bank had some advantages in setting up their system. Personnel of various departments (mortgage, loan, savings, etc.) visited installations having applications in each specialty to study approaches and methods. Teller training began several months prior to system completion. Probably the greatest asset to the system was that the bank has been using a one-number-per-customer system (with suffix two-digit code for service) for six years, so the customer files have long been integrated.

Parallel runs began Jan. 1 and the 360 soloed in early March, with the GE 225 being retained for outside work and batch. The new system has cut the night shift work from eight to two hours.

The bank says it is also the first to provide total service approach and to use one monthly statement for a customer showing the status of all his bank business plus check-listing by consecutive number for easier balancing.

### PANDEX SUMS UP YEAR'S ADDITIONS TO FILES

The most comprehensive bibliographic file on scientific and technical journals, books and reports is being claimed by Pandex Corp., New York, which began computer-storing current publications in 1967. And beginning last November, Pandex, in addition to microfiche and hardcopy output, offered weekly magnetic tapes on an average 6,500 new titles, along with a COBOL program allowing selective searching. These tapes are available in a 7- or 9-track format, in either BDCIC or EBCDIC, for \$6,500 a year.

More than 6,000 books and 2,100 journals were indexed last year in the file, which contained 1,250,000 entries and should amass more than twice that this year. About 35,000 technical reports have recently been entered and patent data will soon be added. Subscribers can obtain a microfiche of new entries quarterly and printed cards on titles in a specified area weekly. Full searches on the file by subject are also provided. In data processing, about 30 journals are indexed, as well as other publications.

The files are stored on an IBM 360/40 with 128K core, eight tape drives, and three 2311 disc drives. All publications have a basic record of up to 1176 bytes: books have an average of 15 subject headings; journals, six per article; and technical reports, eight.

### LEASCO GROWS IN SIZE AND CREDIT

Leasco Data Processing Equipment Corp., claiming to be the largest computer service firm in the world, announced at its annual meeting that it would purchase over \$100 million in computers in 1968 vs. over \$65 million in 1967. By year's end this will mean a total of \$150 million in System/360 equipment installations alone.

The firm recently arranged a new \$80 million revolving credit with 32 U.S. banks, bringing its total line of credit to \$131.5 million. And its European leasing subsidiary, which made it into Europe with capital before the President's edict against overseas investments (beating out competition), has arranged for \$15 million in financing with European banks. Leasco Europa Ltd. already has its own subsidiaries in Germany and Great Britain, with operations to begin in Holland and Belgium this spring, following later in France. This subsidiary is now doing \$1 million a month, in value of equipment leased, and expects that by 1972 it will be as big as the leasing part of the Leasco operation in the U.S. After one year, the British government will "kick back" to Leasco 25% of its loan from British banks; in Holland, it's 10%. Software services are also planned for Europe.

The leasing part of the firm now has 50 marketing personnel, said to be more than 10 times that of its nearest competitors. Most of its leases are for four to eight years and until last year were priced for full payback during the contract. Leasco has, however, gone into operating leases on IBM 360 and CDC 6000 series equipment, under which a four- or five-year contract will yield about 80% of invoice cost.

As of September, 1967, \$49 million in equipment was under full payout; \$17 million under operating leases; in 1968, about half will be under operating leases. Such long-term leases generally net the lessee about 20-25% savings over manufacturer's rental.

IBM does not have a long-term contract, and Saul Steinberg, Leasco president, thinks that IBM is not likely to come out with one, since it would cost IBM up to 25% of its \$400 million/month rental income. Leasco recently terminated a cooperative agreement with Control Data, but continues to handle its equipment. The savings on the 6000 series through Leasco is 20-25% on a long-term lease; Control Data also has such a lease, but it saves the user only about 11%.

Leasco also bought two software firms last year to add to its information services ability: Documentation Inc. and Fox Computer Services. These were merged into Leasco Systems and

# C.A.C.I. Announces New Compilers and Training Courses

SIMSCRIPT I.5 is recognized as the most powerful simulation programming system available.

## New SIMSCRIPT I.5\* Course Dates

No. 26 Washington, D.C., June 10-14  
No. 27 Los Angeles, September 9-13  
No. 28 Washington, D.C., November 18-22

C.A.C.I.'s new SimOptimization Techniques combine the advantages of optimization analysis with the realism of simulation analysis.

## New SimOptimization\* Course Dates

No. 4 Washington, D.C., May 8-10  
No. 5 Los Angeles, August 7-9  
No. 6 Washington, D.C., December 4-6

For IBM System 360,  
a new SIMSCRIPT I.5 compiler  
is now available for  
immediate delivery from C.A.C.I.

If you haven't already heard about C.A.C.I.'s new compilers and courses, send for more information.

Consolidated Analysis Centers Inc.

Corporate Offices: 225 Santa Monica Boulevard, Santa Monica, California 90401, Tel (213) 451-5771  
Washington, D.C. Offices: 1815 North Fort Myer Drive, Arlington, Virginia 22209, Tel (703) 527-8012

\*Trademarks and Service Marks of Consolidated Analysis Centers Inc.

CIRCLE 113 ON READER CARD

## BEEMAK TAB CARD HOLDER

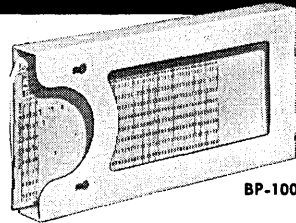

BP-100

KEEP PRE-PUNCHED TABULATING CARDS WHERE THEY'RE NEEDED WITH BEEMAK HOLDERS.

Allows fingertip storage of pre-punched card, next to product to implement invoicing, inventory control, production control, etc. Capacity 75 or 300 cards — many shapes and sizes — with a variety of metal clips for attaching to any type shelf or bin. Holders with magnets — with spurs for corrugated cartons — with hooks for tote boxes — with pre-applied adhesive for any smooth surface. Also tab card vinyl envelopes, standard or special. Hundreds of firms have filled the gaps in their data processing systems with Beemak Holders.



BP-300  
Holder for  
51 col. cards.

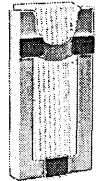

BP-130  
Magnet  
Holder



BP-150  
Card Basket



BP-200  
Horizontal  
Holder

FREE SAMPLE BP-100 HOLDER  
AND LITERATURE ON REQUEST

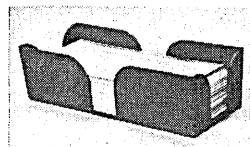

BP-400 Desk Tray

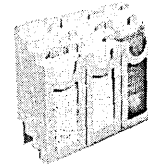

12-CR

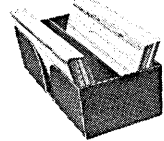

BP-500  
Programming Tray

BEEMAK  
PLASTICS

7424 SANTA MONICA BLVD., LOS ANGELES  
CALIFORNIA 90046 • PHONE: 213 876-1770  
CIRCLE 115 ON READER CARD

## COMPUTER SCHEDULED MAGNETICALLY

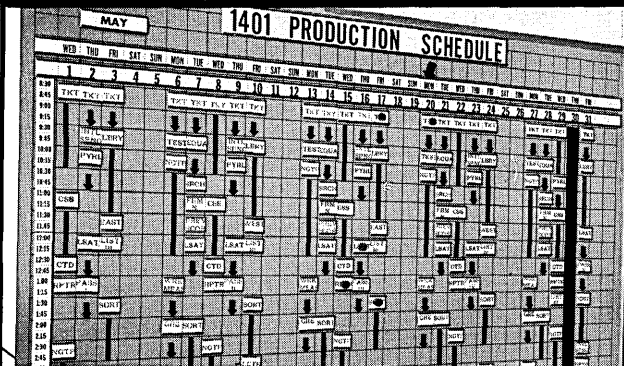

- Keep your computer running—not idle.
- Schedule in 6, 10, 15 & 30 min. cycles, for daily, weekly or monthly periods.
- Know in advance when slack periods or heavy work loads are coming.
- Make changes & additions immediately.
- Every hour saved saves you \$20-\$40-\$60.

Write for FREE 28 Pg. Illustrated Catalog— DA 4

METHODS RESEARCH CORP.  
70 Willow Ave., Staten Island, N. Y. 10305

CIRCLE 114 ON READER CARD

DATAMATION

## news briefs

Research Corp., which has 200 of its staff working on a NASA contract in College Park (to be renegotiated in June), worth \$4 million in revenues yearly. Other software areas include library systems, election forecasting systems (under Dr. Jack Moshman), medical dp, printing and publishing, and management information systems.

The firm also owns Carter Auto, servicing automobile distributors and dealers. Leasco just terminated merger talks with Mercantile Industries because of the 50% drop in Mercantile earnings in the last six months from \$1 million to \$500K.

### MEMOREX GETS \$20 MILLION MAI ORDER FOR DISC DRIVES

Memorex Corp., which made it big with magnetic tape, added disc packs, and then started producing System/360-compatible disc drives, has won a big contract for its subsidiary Peripheral Systems Corp. from Management Assistance Inc.

The leasing firm has agreed to a five-year program of buying PS 630 disc drives; value of the order should exceed \$4 million during 1968 and \$20 million in the first three years. A production rate of 500 units per year to fill the order is planned by early 1969. MAI will use the equipment to replace IBM 2311's. Both companies cite advantages of faster average access time and less maintenance required.

MAI will announce rental rates for the drives within two months.

### DIGITRONICS HAS EUROPEAN SALES DEAL WITH PHILIPS

Philips Industries, the big Dutch electronics and communications combine, will begin marketing Digitronics data terminals in Europe this summer under the Philips label.

"They expect to sell 65 the first year," says a Digitronics spokesman. His company's Dial-O-Verter and Data-Verter units will expand the capabilities of Philips' soon-to-be-introduced computer line, consisting of small- and medium-size, byte-oriented units which are designed to compete directly with IBM.

Digitronics also has acquired Invac Corp., Waltham, Mass., manufacturers of electronic keyboards, custom page-printers, paper tape readers, punches and spoolers. The acquisition adds punches to Digitronics' line and enables the company to offer a broader selection of readers. Digitronics' readers operate at speeds of 300 cps and above, Invac's at 35-300 cps.

Invac was acquired for \$1.7 million

in junior subordinated notes convertible into Digitronics capital stock at \$22 per share. Invac's president, Kenneth Wright, is now a Digitronics vp, and general manager of Invac operations.

A Digitronics spokesman estimates his company's gross sales for the year ending June 30 at "slightly under \$7 million," versus \$5.6 million the previous year.

### COMMUNICATION UNITS FOR 9000 SERIES FROM UNIVAC

Univac recently released a new communications subsystem, the DCS-4, to enhance the remote data-handling capabilities of its series 9000 computers. Earlier, the company had announced the DCS-1 and -16. The number indicates how many duplex communications channels the equipment can accommodate. A Univac source indicates that additional DCS equipment, designed for more channels, is likely to be announced soon.

The DCS-4 permits concurrent communication with a 9200, 9300, or 9400 over one wideband Telpak line, one voice-grade line, and two telegraph lines. Alternately, up to four voice-grade lines can be accommodated. The hardware rents for \$566 a month and sells for \$20,750. A DCS-4 limited to telegraph service is also available; it rents for \$522 per month and sells for \$19,155.

The DCS-4 system is compatible with Univac's 418, 494, 1107, 1108, DCT 2000, 1004, 1005, and Uniscope terminals, as well as with Teletypes. When connected to a Telpak line, it sends or receives up to 230.4K bps. In telephone and telegraph service, the maximum speeds are 2.4K and 150 bps, respectively. For information:

CIRCLE 210 ON READER CARD

### GE RELEASES FIRST PART OF MANUFACTURING SYSTEM

GE has released the first application programs in its planned comprehensive system for the 400 Series designed to offer a complete information and control package for all types of manufacturing operations.

To get the acronyms out of the way first, the new application package is called GEPEXS, which stands for GE Parts Explosion System. It's the first module of the over-all scheme of MIACS—and this means Manufacturing Information And Control System. All parts of the latter will make use of IDS, for Integrated Data Store, which is GE's data base management technique.

According to the company, GEPEXS can be used in any type of shop opera-

tion—job, flow, or project. Some have already been set up, including an installation at Abbott Laboratories in Chicago. The system needs a 16K 400 Series cpu with any GE disc unit and uses COBOL. GEPEXS lets the user manipulate product structure information; maintains a bill of material file; accepts demands and order information against assemblies, subassemblies, parts, or raw materials; explodes demands by level for up to 52 time periods and vertically through a product structure; and furnishes parts and components lists.

When MIACS is ready, it is supposed to handle planning, reporting, scheduling, and control of the manufacturing operation. Information on materials, resources, and activities will be integrated into a single data bank. MIACS will include material inventory, work process, and resource inventory models to describe all situations required to produce a customer's order and replenish stock by forecast. As work progresses, time and quantity data are fed back to the system, which determines the need for corrective action. For information:

CIRCLE 211 ON READER CARD

### VIP SYSTEMS WILL OPEN SECOND NYC TEXT CENTER

Joan Van Horn's on-line text-editing service, VIP Systems, plans to set up a second dp center in NYC late this year. She already has two customers there, who are line-linked to VIP's 1440 system in Washington, D. C.

The company's major competition in NYC will be the Goliath from Armonk. The diminutive Miss Van Horn plans to attack with lower prices and more specialized programming—two weapons that have helped VIP acquire about a dozen customers since it went on-line a little over a year ago. AEC and the American Meteorological Society are the latest conquests.

VIP updates a 225-page bibliographic publication published by AEC/Oakridge, and does likewise for the annual indexes to the Meteorological Society's technical publication. These jobs require the use of accents and other elements peculiar to Romance and Russian languages, plus subscripts and superscripts.

Through a program developed by VIP, the special characters are input on a Selectric keyboard and converted into proof and final copy automatically. Along with the final copy, VIP's 1440 generates a paper tape subsequently fed into a Photon typesetter.

### DP SERVICE FIRM EXPANDS WITH ANOTHER ACQUISITION

Automatic Data Processing, Inc., which is about to complete its fifth ac-

# Computerography to the rescue

In an airplane over the plain states, a camera begins photographing the terrain below. It runs continuously, recording thousands of square miles of land under cultivation at several wavelengths of energy simultaneously. Hundreds of photographs will result, and expert analysts examining and comparing them will identify crops, determine their condition, evaluate water resources, count livestock, discover potential oil fields and minerals.

Three hundred photographs, times two flights a day, times 100 days a year, times 30 planes. Are there that many expert analysts?

As inevitably as we run short of analysts, we must be able to manipulate visual information — just as numbers were encoded to make possible the adding machine, and arithmetic was encoded to make possible the computer.

This is our business — interpreting visual information using optical, electronic and programmed devices. We have delivered systems that analyze seismograms and oil well logs, interpret oceanological data, extract positional information from theodolite photographs, examine biomedical samples, clean up soiled engineering drawings, read oscilloscope wave forms, and make charts and graphs from digital data.

We've hardly scratched the surface.

But we're pushing the inevitable, you might say. And your inquiry may add to the push.

Information International Inc.  
545 Technology Square,  
Cambridge, Mass. 02139  
(617) 868-9810  
11161 West Pico  
Boulevard,  
Los Angeles,  
California 90064  
(213) 478-2571

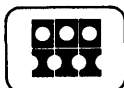

**INFORMATION INTERNATIONAL**  
CIRCLE 116 ON READER CARD

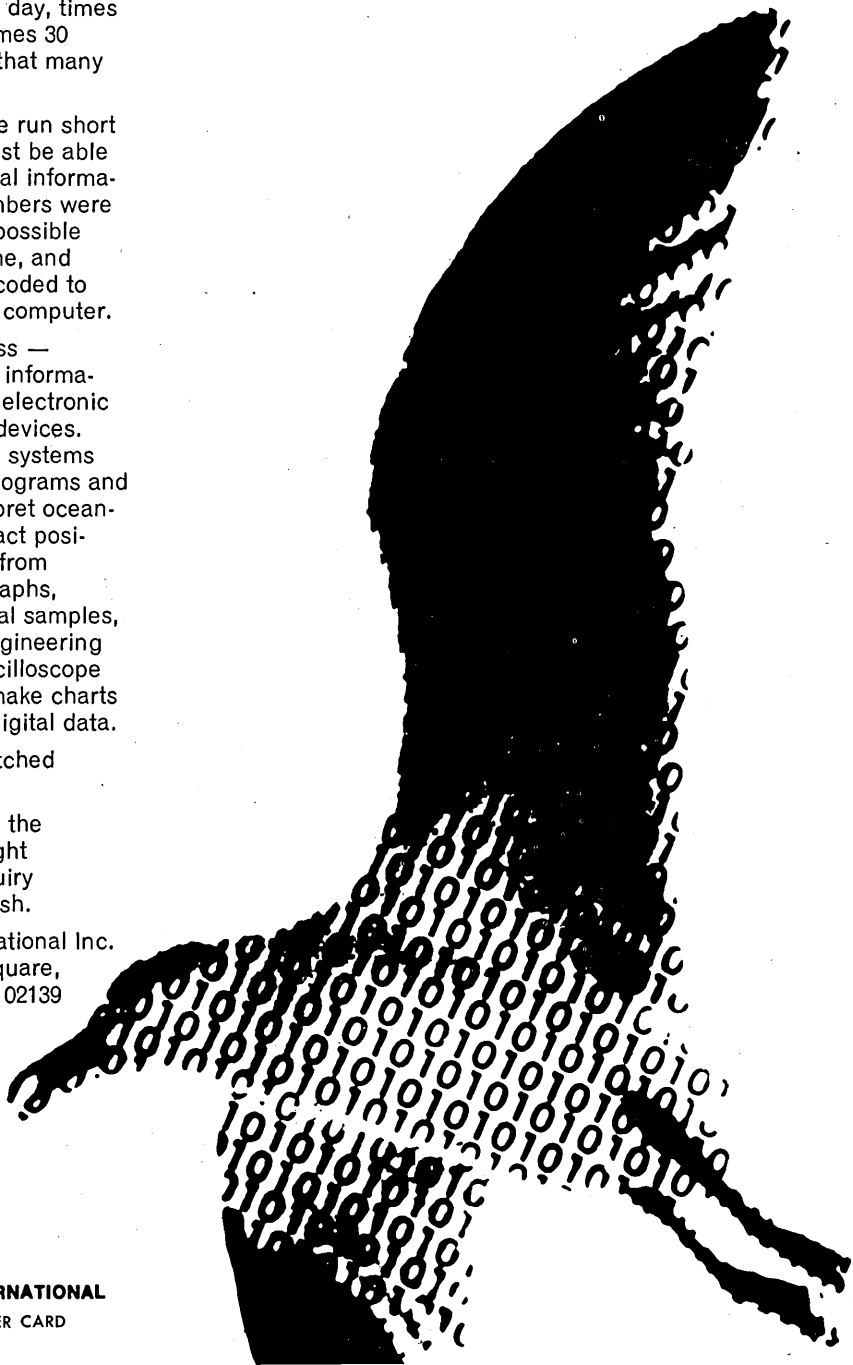





## “It’s good business to help colleges”

“Business has a direct and pressing need for colleges of high calibre. Carnation recognizes that its success tomorrow depends in large part upon the quality of the college graduates it hires today. We also benefit from the continuing stream of ideas and information which college researchers provide.

“Colleges are faced by the continuing pressure of higher costs due in large part to the demands of a more complex technology. To maintain their standards and to fulfill their crucial role, they need increased support by business.

“Carnation now provides voluntary financial aid to more than 125 colleges and feels that this is one of its best investments for the future.”

**H. E. Olson, President  
Carnation Company**

A major problem in the education of students is rising costs. If companies wish to insure the availability of college talent, they must help support colleges with financial aid.



**SPECIAL TO CORPORATE OFFICERS**—A new booklet of particular interest if your company has not yet established an aid-to-education program. Write for: “How to Aid Education—and Yourself”, Box 36, Times Square Station, New York, N. Y. 10036

## COLLEGE IS BUSINESS’ BEST FRIEND

Published as a public service in cooperation with The Advertising Council and the Council for Financial Aid to Education



April 1968

## news briefs

quisition, “anticipates that additional dp centers will be opened in the coming year,” reports a company spokesman. He indicated that the company plans to spread out cross-country. All of its existing operations hug the east coast.

The fifth acquisition is Systems Management Corp. of Baltimore, founded in 1962; SMC offers “a unique accountant’s package” in addition to other back office bookkeeping dp services. Earlier, ADP had acquired: Analytic Computing Services, NYC; Computer Services of Florida, Miami; Computab Associates, Philadelphia; and Research Calculations, Newton, Mass.

ADP’s net earnings were \$644,283 for the first half of its current fiscal year; for the same period of the previous year, earnings were \$414,149. First-half net rose from 31 to 44 cents per share. Sales were up nearly 50%, jumping from \$4,686,293 to \$6,785,232. The first four acquisitions were completed during the first half of ADP’s current fiscal year and their sales accounted for a significant share of the increase.

### COMPUTER SCIENCES GROUP OFFERS VARIED COURSES

Computer Sciences has joined the offensive on the education field, last month announcing its new organization, Computer Sciences Institute. According to the institute’s vice president and general manager, Norman H. Carter, a former vp at Union Bank, CSI will offer “a very wide view of applied research in education and training.”

The three areas of service outlined by CSI are: education in computer concepts for management, and advanced technical training for personnel; development of education systems in schools, including occupational training; and contract research into planning and problems of government and business. The first classes are scheduled to begin in Los Angeles May 1; in New York, June 1; and “shortly thereafter” in Brussels, Belgium. Now headquartered in these three cities, CSI expects to expand substantially within the next 12-18 months in U.S. and foreign markets, Carter said. Initially employing 30 people, the staff may be increased to 60-80 by year-end.

The classroom training will be based on a method copyrighted by CSC, called the Structured Learning Technique. In addition to an instructor, the method includes Teletype terminals,

Every little  
“bit” counts  
in a  
portable  
dataset

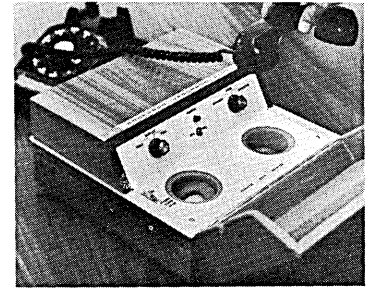

Errors in data communication are expensive to correct. You can’t afford portable data sets that don’t provide reliability comparable to fixed line equipment.

Reliability is what you get with an ADC 260 Acoustic Data Coupler.

And portability, too. Write for details.

See us at SJCC  
Booth 909

**ANDERSON JACOBSON, INC.**

2235 Mora Dr.,  
Mountain View, Calif. 94040  
Telephone (415) 968-2400



CIRCLE 118 ON READER CARD

## news briefs

projection equipment, and special data acquisition and response units, similar to Touch-Tone telephones, located at each student's desk. Courses will be taught in 10-minute segments; at the end of that time, a question on the material will be asked. Students will answer via the response unit, giving the instructor an immediate tally of correct and incorrect answers. If the response indicates that the first method of instruction (films, lectures, etc.) has not been successful, the instructor has the option to change the method of presentation. Courses will vary in length from ½-day to three weeks. Director of the curriculum is George B. Potter, former Dean of Univ. of Southern California's Aerospace Safety Institute.

About two-thirds of the institute's anticipated work will be the development of special education packages (including computer simulators, graphics equipment, scripts, environmental planning, etc.) for industry, government, military and public education systems. One of the first projects in this area will be the development of a program utilizing computer-aided instruction to teach mathematics at the junior high school level.

## LITTON DATA SYSTEMS GETS \$46 MILLION L-304F ORDER

Grumman Aircraft Engineering Corp. has contracted the Data Systems Div. of Litton Industries to build "an undisclosed number" of L-304F general purpose computers for use in its modification program for the E-2A Hawkeye aircraft. The \$46 million contract, which includes modified systems display units and power assemblies as well as the computers, calls for delivery of the first L-304F to Grumman by November '68.

The L-304F handles up to 64 program levels; each level has its own separate program operating on a time-shared basis. In addition, the computer has a 56K core memory that can be expanded to 80K by adding modules. The computer will be operated as part of the Airborne Tactical Data System (ATDS), and will be located on the carrier-based Hawkeye, now stationed in Southeast Asia.

The ATDS system, which consists of search radar, computer, memory (currently a special-purpose 23K-word drum) and a data link, directs air search and rescue missions, weapon assignment, target detection and acquisition, and tracking and identification. With the use of the L-304F, ATDS will also be linked with the Marine Corps

Tactical Data System (MTDS) for communications interchange to meet tactical situations.

## BIOMEDICAL PROGRAM PACKAGE AVAILABLE

BMD (biomedical), a package of 54 separate programs to handle common statistical analyses, is available free from the Univ. of Kansas Computation Center. The programs are designed primarily to analyze biomedical data but could be applied to other research areas such as social science, according to the computation center.

Written originally in FORTRAN II and FAP for the 7090/94, the package includes programs for data description and tabulation, multivariate analyses, regression analyses, time series analyses, and analyses of variance and covariance, as well as special programs for probit analysis, contingency table analysis, and data transformation.

Each program's general format can handle a variety of applications: the user specifies appropriate parameters and options on a set of program control cards. The program preparation and maintenance was done at the Health Sciences Computing Facility, UCLA School of Medicine, and funded by NIH and National Cancer Institute.

**Your "special" peripheral  
may already be a  
standard product  
at Potter...**

**the  
peripheral  
specialist**

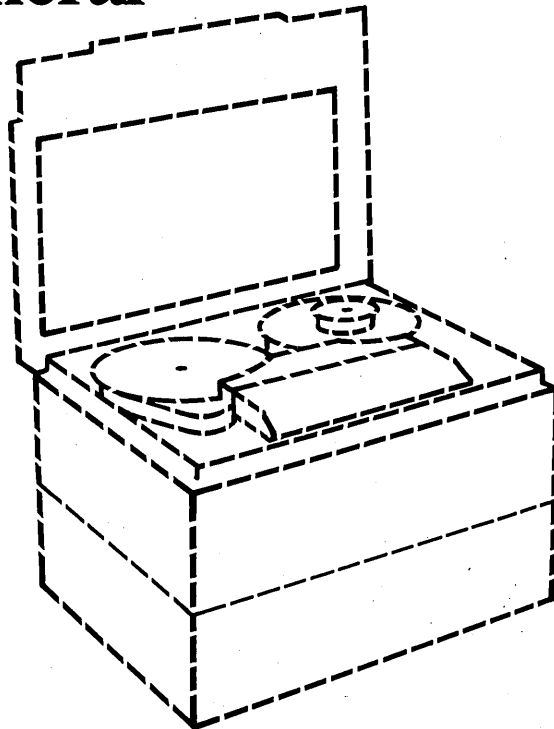

BMD is available as a part of GE's BMD Software Package and converted 7090/94 BMD UCLA programs. Inquiries should go to consultant in dispatching, UK Computation Center, Lawrence, Kan. 66044. The BMD manual costs \$6 postpaid: Biomedical Computer Programs, edited by W. J. Dixon, Univ. of California Press, 2223 Fulton, Berkeley, Cal. 94720.

### OCR USER REPORTS GOOD RESULTS

An optical scanner user praising the technique is Northwestern National Insurance Group. A CDC 915 Page Reader (tried out with three of its 19 branches about a year ago) is now handling all accounts receivable cash transactions off line. The firm says that this one application more than pays for the \$3,800/month scanner.

The Milwaukee Home Office of the fire-casualty insurance company operates centralized data processing for its 19 branches, handling about 2,900 agents' statements and 60,000 cash items monthly. The 915 reads turnaround cash tickets coming in from the branches; its mag tape output becomes input for 360/40 processing. This eliminates account reconciliation sheets, which had been prepared at home office, and some keypunching.

Keypunches have been reduced from 31 to 23; some further reduction may be made, although the company does not expect to eliminate all punching. Any further reductions there, and any other applications of the scanner, will be sheer profit, the company says.

### MEDICAL FIRM MAY ACQUIRE SMALL COMPUTER COMPANY

Spear, Inc., a firm formed to produce a commercial version of an MIT-developed biomedical computer, has agreed to acquisition terms with a medical equipment and electronics manufacturer—Becton, Dickinson, and Co., Rutherford, N.J. Becton, if the buy is approved by stockholders, will make Spear either a division or subsidiary, headed by Spear president Joseph Foley.

The computer maker's main system is the Micro-Linc, first available in 1965, and recently it announced a larger, faster version, the Micro-Linc-300. A clinical lab version of the 300 is called the Class 300. Spear also has a computer for radiation treatment therapy planning, and interfaces for instruments for such tasks as chemical analysis. The 32-man firm grossed \$400K in fiscal '67, but net was negative, since the 300 development costs

were written off. Gross for '68 is expected to double. Becton grossed \$157 million in '67. The buy will involve a 1:5 trade of Becton and Spear shares.

### CHANGES AHEAD IN ARMY DP OPERATIONS

Army dp managers are planning a major overhaul of their management information system.

One study, labeled SOMIS, and including data-gathering visits to all the major commands, will take a look at the existing system. Another, the PML study, will attempt to devise an optimum system; Peat, Marwick, and Livingston are participating in this one, under a \$134.5K contract. Results are likely this summer. Possible outcomes include consolidation of programming and system design effort; greater emphasis on standardized software and hardware, basic changes in present dp system development procedures—e.g., replacement of DAR's with documents that reflect reporting as well as operational requirements, and delegation of approval authority for smaller systems to field commands.

In a more immediate move, an RFP covering NCR 395-size dp installations at 102 army commissaries should be issued shortly. The application in-

## for instance

### this new desk top incremental magnetic tape unit for recording fully IBM-compatible tapes at a paper tape price

The ME-4210 incremental magnetic tape unit provides the user with all the advantages inherent in IBM-compatible magnetic tape recording at prices previously limited to paper tape recording devices. It's ideally suited for connection to a variety of keyboard data entry devices. Price of the ME-4210—complete with drive electronics, data-record electronics and associated power supplies—is less than \$1400 in production quantities. Data recorded asynchronously at rates up to 60 characters per second, 200 bpi. Optional error-checking capability, featuring an immediate check-read-after-write, is available.

Write for full details on this or any of the Potter peripherals—magnetic tape transports, high-speed printers, random access memories, paper tape readers and punches.



Less  
than  
\$1400  
13½" x 9" x 10½"

**POTTER**  
INSTRUMENT CO., INC.

151 Sunnyside Blvd. • Plainview, N.Y. 11803 • (516) 681-3200  
TWX-510-224-6485 • Cable P I C O  
In Europe: Potter Instrument Co. Ltd., McGraw-Hill House,  
Maidenhead, Berkshire, England • Maidenhead 20361

## news briefs

volves processing of purchase orders and related documents, plus food consumption analysis. Another upcoming RFP will seek an optical scanner for the Army's administrative center in St. Louis, to process mustering-out records. A test at Fort Sill, Okla., of a card-output IBM 1232 mark-sense reader will be transferred to Fort Belvoir, Va., where a tape-output Digitek 100 will be applied to the same job: service school test score analysis and processing of administrative records. The Army plans to install these systems at 25 service schools throughout the U.S.

### CONTRACTORS OFFERED AUTOMATED SPEC ANALYSIS

A break for defense contractors now facing mounds of government specifications and standards is a new service to analyze RFQs, announced by Specification Technology, Inc., Santa Ana, Calif. The system is based on a specification library stored in an NCR 315 RMC computer using CRAM random access units.

When an RFQ (sometimes involving up to 200 major categories of design specs) is issued, it will be coded

into the system; the program will then search out all pertinent sub-levels of the requirements (frequently resulting in nearly 30,000 separate requirements), and will print out specification numbers, dates of issuance, and 72-character descriptions of the RFQ's stipulations. The system will also offer a service that shows all changes in specifications during the life of a contract, allowing a contractor to keep abreast of changes, and to more effectively evaluate his commitment.

### STANFORD CAI PROJECT WILL EXPAND FURTHER

Stanford's CAI Teletype network is expanding with the increase to 30 Teletypes at Breckenridge School, Morehead State College's experimental school. This will provide more second through sixth graders with CAI in arithmetic. The machines are multiplexed into two PDP-8's, one at Morehead and the other at Stanford's Computation Center, linked to a PDP-1 at that school's Institute for the Study of Mathematics in the Social Sciences.

Plans for expanding the system in Kentucky include moving terminals into 10 widely separated school districts in the poverty-ridden coal mining section of the Western Appala-

chians. When funds are available this will be undertaken by the Eastern Kentucky Development Corp. — a group of school administrators.

This is an outgrowth of a local program, begun four years ago by Dr. Patrick Suppes of Stanford, among Peninsula school districts which has increased to 29 terminals, has added 13 elementary schools in McComb, Miss. (under a first such usoe grant) and the Kentucky group.

By mid-December 1967, the system had provided more than 84,000 individual lessons to 1,570 enrolled youngsters.

### FORD SIGNS FOR NCR MICRO-IMAGE SERVICE

Autolite-Ford Parts of Ford Motor Company began in February to have NCR reduce parts catalog pages for the Ford, Autolite, and Lincoln-Mercury divisions to microscopic images by NCR's PCMI process. This allows 2,560 pages of information to be recorded on a single 4x6 inch transparency, so that the nearly 14,000 pages of catalogs for the three divisions can be recorded on seven transparencies.

The \$5 million, five-year contract to NCR is for the original transfer to transparencies, regular updating of the catalog changes, and leasing of NCR readers for dealers to read the

**Hearing is believing**

**Let your computer do the talking with a Cognitronics *SPEECHMAKER*®**

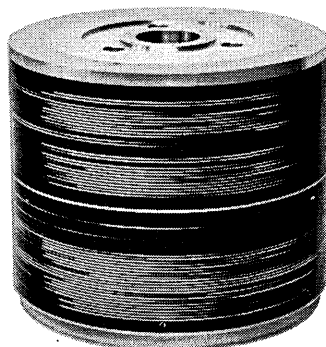

333 BEDFORD ROAD  
MOUNT KISCO, N. Y. 10549 914-666-2941

The Speechmaker provides data processing systems with a set of honest-to-goodness vocal cords... actual spoken words selected by computer, transmitted over telephone lines and received on one of the most inexpensive output devices that anyone has yet come up with — a standard Touch-Tone® telephone.

These voice response systems, with built-in multiplex capabilities to service multiple outputs simultaneously and independently, are available for a variety of interface specifications. Cognitronics' modulated light-beam and film drum technique results in very high audio fidelity with minimum maintenance requirements. Speechmaker applications include telephone rate, route and intercept, banking, credit, inventory control and management information systems to name but a few.

Let us tell you how to listen to your computer.

Touch-Tone® is a Reg. T.M. of the Bell System

micro-images. This will relieve their 7,500 dealers from manually inserting hundreds of revised pages into catalogs every two months.

Initial distribution to dealers will require up to 70,000 transparencies, depending on what they handle (Ford, Autolite, or Lincoln-Mercury parts). Each dealer will probably get a set of three transparencies covering his catalog items plus a reader with 9x11 inch screen. Readers will be leased to Ford by NCR; Ford will then lease them to dealers throughout the country. A pilot program of selected dealers using this PCMI catalog system has been operating two years and has been met with enthusiasm.

### IOWA UNIV. WORKING ON CAI FOR DENTAL STUDENTS

The University of Iowa's College of Dentistry is looking toward CAI for dental instruction in the future.

The use of CAI may be the answer to problems brought about by the increased knowledge, expanded number of students, and obsolete teaching methods increasingly faced today. The writing of programs for course content, a stumbling block for many CAI efforts, was anticipated by having the entire dental faculty become involved in a semester-long seminar in techniques of reducing courses to computer format. As part of the seminar the faculty visited an IBM 1500 site in Chicago where they took a sample dentistry course and members wrote sample courses of their own.

The new dental building, scheduled for completion in 1971, has planned space for 32 CAI terminals. Dr. Devore Killip, director of continuing education in dentistry, believes this is the first exploratory study of CAI at the university, the first in dentistry, and the first to involve an entire college faculty.

### IBM HAS DISC-SHARING ADDITION TO OS/360

Users of more than one System/360 cpu will be able to get additions to OS/360 that will allow disc-sharing under an IBM release scheduled for delivery in the fourth quarter.

The units affected are the 2311 and 2314, which can be shared by up to four central processors. The main advantage seems to be economy. The company points out that file maintenance can be reduced because standard information need not be kept in duplicate. Disc pack handling should be reduced because jobs may be submitted to any cpu without changing data location. A new RESERVE macro

will be included for use in common data base applications.

### PENN U COMPUTER CENTER TO SERVE 18 OTHER SCHOOLS

The Univ. of Pennsylvania will use its 360/65 as the regional computing utility for the entire university as well as 18 other academic institutional members of the University City Science Center, Phila.

The initial \$3 million of installed hardware includes a half million bytes of core, plus drum, disc and tape storage and two CRT's. A 360/20 at the computation center and another 20 at the physics-engineering complex are telephone-linked to the 65. Later, other equipment will be installed at user centers.

### CALL FOR PAPERS...

**National Electronics Conference**, Chicago, December 9-11. Tutorial and research papers on new engineering applications; computer applications and microelectronics are of particular interest. Due May 4 are 15 copies of a 75-word abstract (for use in program announcement) and 15 copies of a 700-word summary. Submit to: Edwin C. Jones, Electrical Engineering Dept., Iowa State Univ., Ames, Iowa, 50010.

**Fall Joint Computer Conference**, San Francisco, December 9-11. New, previously unpublished papers on all aspects of hardware, software, systems and applications. Five draft copies (up to 7,500 words) and 100-150-word abstracts are due before May 12. Submit to: Robert H. Glaser, Technical Program Committee, P. O. Box 2309, Stanford, Calif. 94305.

**IEEE Int'l Symposium on Information Theory**, Ellenville, N.Y., January 28-31, 1969. Two types of papers are requested—30 minute duration and 15 minute duration—on coding theory, detection theory, prediction and filtering, stochastic processes, applications, pattern recognition, and learning and adaptive systems. Short papers accepted on basis of 200-word abstract; long papers should be submitted as manuscripts. Papers may be written in English, French or Russian. Papers in English should be sent before September 15 to: David Slepian, Bell Labs, Murray Hill, N.J. 07971. An address for papers in French and Russian will be announced later.

### COLLEGES OFFER SUMMER COURSES

**Univ. of Alabama**, Conference Activities, P.O. Box 2987, University, Ala. 35486.

May 8-9, Thirteenth Annual Data Processing Conference.

**Univ. of California**, Engineering/Physical Sciences Ext., 6532 Boelter Hall, Los Angeles, Calif. 90024.

April 29-May 10, Theory and Design of Reliable (Fault-Tolerant) Computers, \$375.

**The American Univ.**, Center for Technology & Administration, 2000 G St., N.W., Washington, D.C. 20006.

May 20-23, Data Communications for Management Control, \$175.

June 17-21, Automating & Miniaturizing Government Records, \$150.

**Georgia Inst. of Technology**, Dept. of

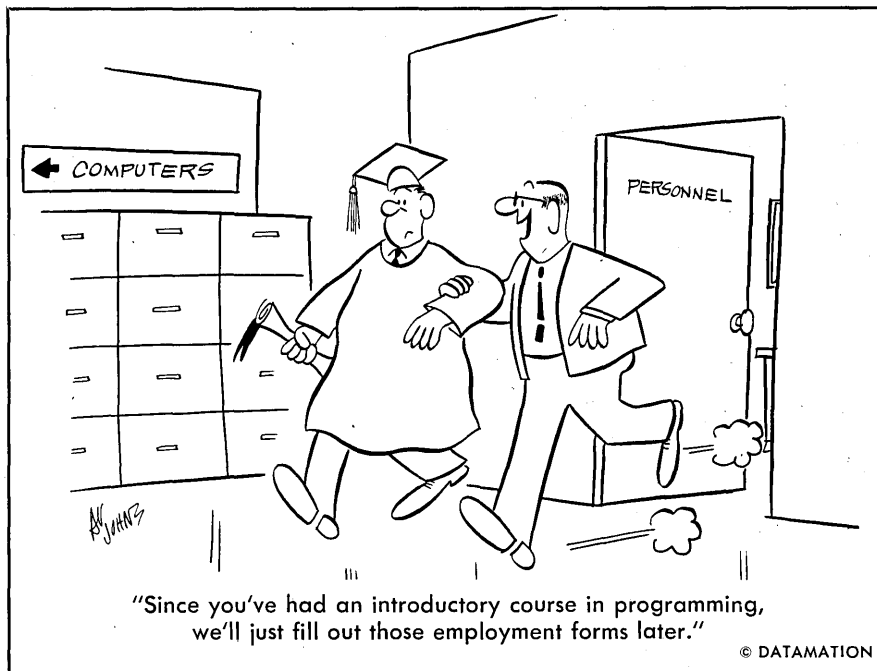

# This is our first ad.

# With our products and your orders, it won't be our last.

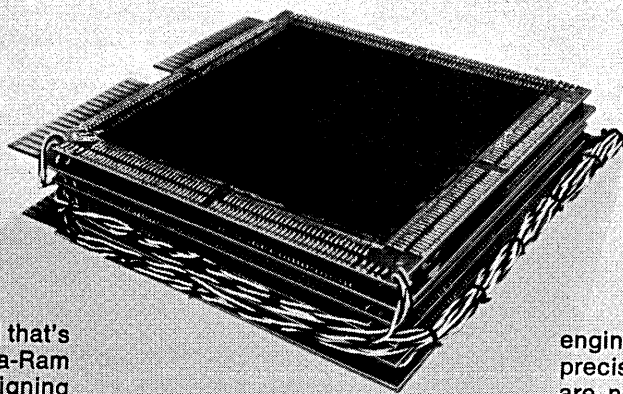

You've never heard of us and that's the way we planned it. Data-Ram Corporation has been designing and delivering quality stacks for the past year. However, we don't believe in advertising until we have delivered an exceptional product in quantity.

We have set up an efficient production facility... built up a highly competent production work force... selected some of the finest

engineers and supplied them with precision testing equipment... and are now designing and delivering memory stacks which exceed rigid specifications. — We are ready to meet your most exacting requirements with a superior quality product. Let us use our experience and know-how to help you.

**DRC** DATA-RAM CORPORATION  
PRINCETON, NEW JERSEY T.M.

We think you'll be impressed. Call 609-924-3331 or write.

## news briefs

Continuing Education, Atlanta, Ga. 30332.

April 29-May 3, Configuration Management, \$175.

Northwestern Univ., Dept. of Electrical Engineering, Evanston, Ill. 60201.

June 24-July 3, Computer Oriented Techniques for Engineering Analysis and Design, \$300.

July 8-19, Recent Advances in Reliability and Maintainability of Computing Systems, \$275.

Purdue Univ., Div. of Conferences and Continuation Services, 123 Memorial Center, Lafayette, Ind. 47907.

May 27-June 7, Modern Automatic Control, \$150.

June 3-14, Distributed System Modeling and Control, \$250.

June 10-20, Statistical Methods and Advanced Quality Control, \$300.

June 10-14, Numerical Control and Automatic Manufacturing, \$150.

June 24-28, Theory and Applications of Information Processing.

Univ. of Kansas Ext., Lawrence, Kan. 66044.

June 13-14, Computer Applications in the Earth Sciences (Colloquium on Simulation), \$20.

Mass. Institute of Technology, Summer Session, E19-356, Cambridge, Mass. 02139.

June 11-21, Systems Analysis for Marketing Management.

The Univ. of Michigan, Engineering Summer Conferences, Ann Arbor, Mich. 48105.

June 17-28, Computer and Program Organization, \$325.

June 17-28, Computer and Program Organization-Advanced Topics, \$350.

Washington Univ., Inst. for Continuing Education in Engineering and Applied Science, St. Louis, Mo. 63130.

Aug. 19-24, Current Trends in Automatic Control Theory.

City Univ. of N.Y., Statistics Dept., Ivan Flores, 17 Lexington Ave., N.Y., N.Y. 10010.

May 2, Third Annual Interdisciplinary Symposium, "Uses of the Computer for Basic Research in the Humanities and in the Behavioral Sciences,"

at Stevens Inst. of Technology, Hoboken, N.J., \$10.

State Univ. of N.Y. at Buffalo, Office of Continuing Education, Millard Fillmore College, Buffalo, N.Y. 14214.

June 3-7, Elements of Simulation, \$175.

Case Western Reserve Univ., School of Library Science, 11161 East Blvd., Cleveland, Ohio 44106.

June 17-July 5, Automation of Library Processes, \$165.

Univ. of Houston, G.F. Paskusz, Cullen College of Engineering, Houston, Tex. 77004.

June 10-Aug. 5, Computer-Aided Design in Engineering Education. Primarily for engineering faculty.

The Univ. of Wisconsin, David P. Hartmann, DN-104, 600 W. Kilbourn Ave., Milwaukee, Wis. 53203.

May 20-21, Computer Aids To Systems Effectiveness, \$50.

The Univ. of Wisconsin, 725 Extension Bldg., 432 N. Lake St., Madison, Wis. 53706.

May 21-22, Specialized Flooring Systems, \$50.

May 23-24, Computer Aided Testing and Failure Diagnostics of Solid State Systems, \$50.

May 23-25, Applied Computer Science in Engineering, \$50.

Technische Universitat Berlin, Ausseninstitut, Gerd Klemm, 1 Berlin (West) 12, Hardenbergstrasse 34, Germany.

July 22-Aug. 2, The Computer in the University, DM 5 (students), DM 60 (all others).

● A batch process that combines integrated circuits with thin- or thick-film components in a flat, solid structure has been developed by GE's Electronics Laboratory. Called STD (Semiconductor on Thermoplastic on Dielectric), it reportedly eliminates flying leads, which are fragile, unreliable, and have to be installed by hand. Completed STD circuits can be inspected visually and, because active devices are imbedded "face up," all connections are accessible for electrical circuit checking. Additional development work remains to be done, but it will consist mainly of building and testing more-complex STD circuits.

● American Airlines and Telemax, a computerized reservations system, have signed an agreement which will

allow Telemax subscribers to make airline reservations. The agreement also permits AA's offices and corporate travel departments linked into the SABRE system to make reservations with Telemax subscribers. Operations will begin in September '68, when it is expected that technical and programming details will be completed. This will increase by 2,000 the number of locations where reservations can be booked through SABRE.

● A leasing agreement announced recently by Digital Equipment Corp. offers the PDP-8/S to schools for a rental price of \$450/month, including Teletype and software. The charge also includes purchase option credits; special systems for individual schools will be arranged. In addition to paper tape readers and punches, other peripherals available are extra memory, mass storage devices, displays, a/d converters and a data communications interface. Supplied software will include FOCAL, a new conversational language. Furthering the educational emphasis, the company has also formed an educational subgroup in DECUS, the users' group.

● Codpac, a new numerical control software package, was recently released for general use by the Foxboro Co. The system includes instructions for scanning, data acquisition, alarming and control, and "permits the development of highly sophisticated control algorithms." It is applicable to batch and continuous processes, can be used in single- and multi-computer systems, and, when run on the Foxboro PCP88 computer, can be integrated with Batch and Lam, two other recently announced Foxboro software systems. Codpac has already been tested extensively in the chemical, textile, oil and gas, petrochemical, and power industries.

● As a result of an agreement to acquire Recording Technology, Inc., Sangamo Electric Co. has formed a document retrieval and storage group, to be operated as part of their new Information Systems Division. Under the direction of engineers Herb Ragle and K. Toyota, RTI, a northern California company, has been developing a new method of storing and retrieving documents using mag tape. Sangamo has appointed Ragle to head up the new group.

● Conversational SNOBOL has been added to the available languages at Com-Share, a commercial time-sharing company in Ann Arbor, Mich. The language is designed to operate on strings of characters, and can be used

# Cogent II- the most powerful file management system ever developed.

## But don't just take our word for it.

"The performance seems to more than justify the claims made for it."\*

"... the figure of 75% [reduction in programming time] appears to be justified in our experience."\*

"...we have completed programs much sooner than we could possibly have done in COBOL in which our programmers are expert."\*

"The claim that the program is suitable for most business applications is definitely correct."\*

"COMPUTERWORLD feels that Computer Sciences Corporation has very adequate backing for its claims for Cogent performance."\*\*

(\*Extracts from an independent survey taken by COMPUTERWORLD and reported in the November 29, 1967 issue.

\*\*Editorial verdict published in the same issue.)

Although COGENT II is a complete file management system, it's also a report generator and high-level programming language. It generates COBOL source programs, thereby utilizing the most widely accepted language for business data processing applications, and reduces the cost of programming by up to 75%. Since both programming time and effort are reduced, you benefit from shorter lead-time. Your application systems no longer become obsolete before they are used.

Simple reports are produced as rapidly as their need is defined; extremely complex ones in a matter of hours. Now, programmers

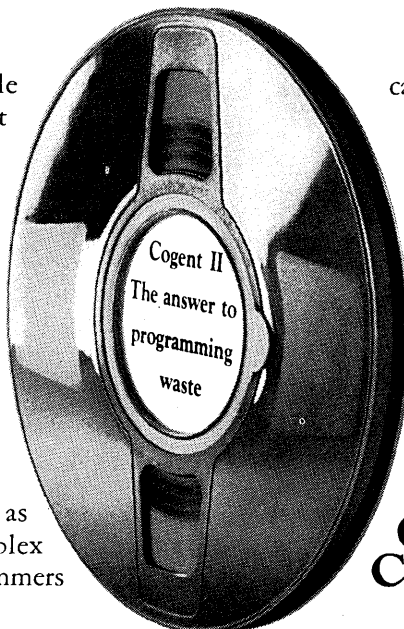

can devote their talent and major efforts to developing new and more sophisticated application systems. Also, your programming backlog is rapidly reduced.

In short, COGENT II is not only the best method of getting your programming job done, it gets it done faster and at a far lower cost.

For a brochure, write, wire, or phone Geoffrey Thomas, Manager, Applications Systems, Computer Sciences Corporation, 650 N. Sepulveda Blvd., El Segundo, Calif. 90245. (213) 678-0592.

**Computer Sciences Corporation**



## news briefs

in such applications as text editing, translation, information retrieval and programmed learning. Conversational SNOBOL includes pattern matching, floating point arithmetic strings and built-in and user-defined functions.

● As part of its program to prove the feasibility of using computers for flight control of V/STOL (vertical or short take-off and landing) aircraft, NASA has contracted with IBM's Federal Systems Div. to demonstrate guidance and navigational capability of the 59-pound Gemini computer in a helicopter. The computer will be selected from the IBM models on board for Gemini 5, 6 or 11. First flight test is scheduled for sometime in June.

● Missouri's computerized industrial site selection system informs a company in 10-12 minutes which communities in the state provide the facilities and services the firm wants and needs. The state's Div. of Commerce and Industrial Development has, since beginning work on the system three years ago, gathered and stored about 25,000 factors on 260 of the state's 928 incorporated towns. Industrial prospects use a 90-point checklist to describe their ideal location and select up to ten factors they feel are "critical." The 360/30 lists all those towns and sites which meet all critical requirements, then analyzes these and other "desirable" factors, finally ranking sites in an order reflecting the manner in which they meet specified needs.

● A revised CAI physics course (for non-science majors) offered for the spring quarter at Florida State University may determine whether early achievement indications of 23 students in last fall's CAI pilot course are correct, FSU educators recently reported to the American Physical Society-American Assn. of Physics Teachers meeting in Chicago. Although results are still being evaluated, it appears that the 23 did better in the subject than 700 others in lecture courses. Using an IBM 1500 with light pen/keyboard/crt terminals, the pilot group covered 29 lessons in a 10-week course. The computer assigned reading, quizzed students and corrected answers, assigned tape lectures, and stored a continuous record of each student's progress. Purpose of the pilot was to identify learning difficulties, explore individual solutions, allow individual rate progress, and find out more

about creating CAI curriculum materials.

● Computer Learning Corp., new dp education company, has ordered 25 Honeywell 110's and 14 Keytapes for educational use on a \$3.2 million five-year lease. First installations go into Falls Church and Norfolk, Va., followed by three in the D. C. area, with Boston and Atlanta later this year. The Norfolk office has five classes using an interim H-120 and Falls Church began classes in March with interim H-120 and 360/20. The large order is being funded through Blythe & Co., New York investment company. Computer Learning began life last December under ex-CDCers Swen Larsen (founder and president of CDI), Thomas Stone, and William Thompson; and Robert McIntosh from Planning Research Corp.

● Instrumentation (a bottleneck to computer use in many areas) is being investigated for waste water treatment in Atlanta by Dr. Robert S. Ingols, research professor of biology in Chemical Science Materials Division-Georgia Tech Engineering Experiment Station. Atlanta's eight waste water treatment plants could be computer controlled if proper sensor acquired information was available. What Dr. Ingols has specified are two non-commercially available units (of four needed sensors, two are available) which are being hand-built. The two instruments are to measure the Biological Oxygen Demand (BOD) which varies between day and night, and to record concentration of bacterial slime (the active ingredient) in the processing tanks. When the sensors are finished, an electronic interface to the computer will also be needed. It is expected to be ready by mid-summer, with the aim of complete computer connection by year-end.

● Avnet, Inc., an electronics manufacturer in New York, has formed a Diversified Numeric Applications (DNA) division in Minneapolis, headed by president Neil I. Fishman, former product manager of real-time systems at Control Data. DNA is planning to supply systems and services for real-time, man-machine interface, and source data retrieval applications. The first product will be a remote terminal.

● An interdisciplinary computer science doctoral and post-doctoral (candidates with Ph.D. or M.D.) program has been instituted at Johns Hopkins University. The interdisciplinary aspect is emphasized by Prof. Martin Greenberger, who, after nine years at MIT and close involvement in Project

MAC, last September came to Johns Hopkins as director of information processing.

● The Iowa farmer believes that most farms will someday use outside computer services for farm records, according to a small survey done by a business ad student at the Univ. of Iowa. He asked 84 farmers in one county about their attitudes towards computers and found that 68% believe most farmers will use such service; 40% are either now using or expect to use them within five years.

● Brown University, Providence, R.I., has pulled together into one Center for Biophysical Sciences and Biomedical Engineering medical educators, engineers, physicists, biologists, chemists and mathematicians for interdisciplinary studies of the human body. Much of the biomedical research deals with body processes too complex to understand without aids such as mathematical models, engineering models, and computers. The university's 360/50 will play a major role in teaching and center research programs. One patient care project is underway (in cooperation with Rogers Williams General Hospital), with students building simple circuits for detecting extra pulses (which develop about 20 minutes before a heart attack) in intensive care patients. These sensors may be later connected to the hospital's 360/20, now used only for accounting.

● Information Engineering, Philadelphia, has been awarded a study contract by AFIPS to provide reliable estimates, by major subject areas, of the current rate of publication of technical literature about information science and technology. Results of the study, directed by Philip R. Bagley, will be used by AFIPS's abstract committee as a basis for recommending policy on publication of abstracts covering current technical literature.

● Interface, Inc., an Ann Arbor software firm incorporated last November by a group from the University of Michigan Institute for Social Research, announced the award of an \$11,000 contract to supply a system of statistical and data management programs for the Highway Safety Research Institute. The programs, a subset of another package developed by the ISR, will allow IISRI to time-share on the University's 360/67.

Although the company's name sounds like a builder of hardware, the firm chose it to designate its aims as



***NEW NEW NEW***

**Incremental tape recorder  
FACIT 4210**

- IBM-compatible
- low price
- control unit available
- extremely compact

Contact  
for USA: Potter Instrument Co, Inc, 151 Sunnyside Blvd., Plainview, N.Y. • for Europe: FACIT AB, Fack, Stockholm 7, Sweden

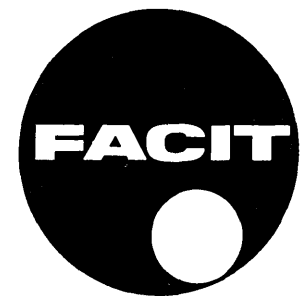

CIRCLE 123 ON READER CARD

## news briefs

interfacing between machine and user, and between second and third generation machines through software. The firm also offers services in solving data management, information retrieval and statistical processing problems.

● General Electric is reported to be extending its educational discount plan, which has been available on 200 Series batch processing systems, to include its 200 line time-sharing systems at selected educational institutions. The company has been active in the educational market since the inception of the 200 line; among its more significant installations are those at West Point and the Altoona, Pa., public school system.

● The University of Oklahoma Medical Center's computer facility now has two CAI courses for med students, the first such courses offered by a medical school for credit. Seven terminals are linked to the IBM 1500 and allow students to take their lessons in two courses: medical backgrounds (survey and terminology course, one

hour of CAI required for each lecture hour), and infant nutritional requirements (required pediatrics subject); a third course in anesthesiology will soon be added. The interesting part of the course preparation at UO is the evolving technique of vocal programming, which saves time for the professors developing the course. The medical faculty dictates lecture notes into standard dictation equipment. Then typists who know computer programming techniques transcribe the dictated material into input commands for the 1500. Specialists edit and continue developing special programming instructions to allow study of various portions of the course by terminal users. Unusual student responses are stored by the 1500 and used for modification of materials.

### shortlines . . .

ITT Data Services has initiated New England operations with the opening of a dp service center in suburban Boston. Now linked to the Greater New York center, the Waltham facility is scheduled to be equipped with its own 360/65 by year's end. Another network is being established in southern California . . . Tymshare has opened an office in Englewood Cliffs, N.J., to

serve the mid-Atlantic states. John F. McCann III, former marketing manager with Western Union, will head the operation . . . CDC's new data center in Omaha, now linked via 8090 remote batch computer system to two 3600's in Minneapolis, will have access to that center's 6600 to be installed later this spring . . . John Hoskyns & Co., London, has developed a new technique known as Segmented Level Programming. Programs are made up of small building blocks or modules which are organized in a hierarchal structure corresponding closely to the structure of the data the programs will be used to process . . . Douglas Aircraft has filed a letter of intent with IBM for two 360/85's . . . Nashua Corp. has tentatively agreed to acquire Tech-Met Inc., California-based producer of components for computer memory devices . . . Lehigh Univ. expects to have a CDC 6400 installed by September, plans to offer computing services to other institutions in the area . . . Newark College of Engineering installed a Spectra 75/35 in January and starts a new department of computer science in September . . . PESOB (Princeton Examination Schedule Optimizer-Biaser), a student-written PL/I program, scheduled 13,000 individual final exams in a 20-minute run on the 360/50. . . .

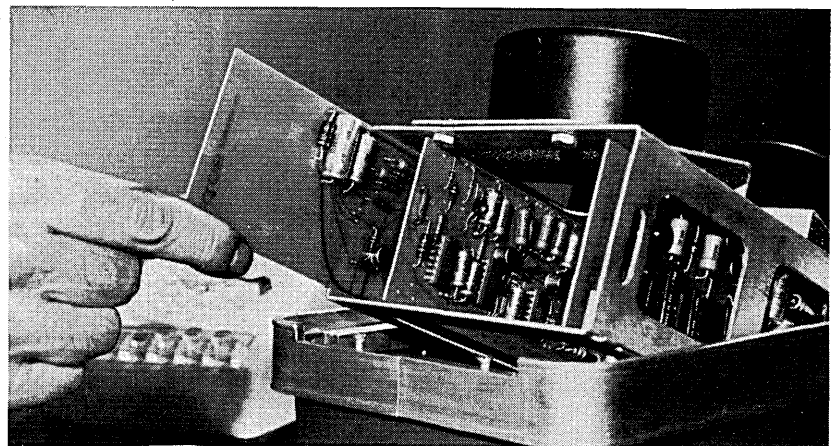
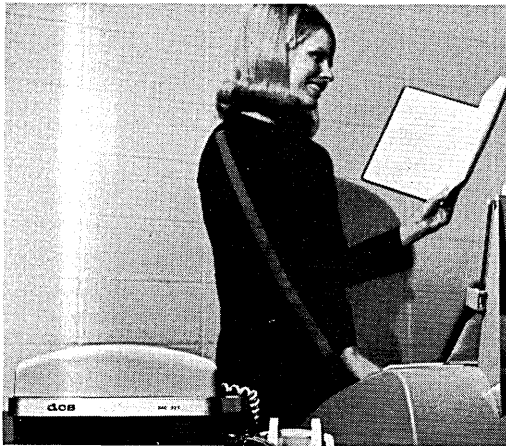

## What's new in data communications coupling

### DAC Series Acoustical Phone Coupler now has space for 5 additional modular circuits

1. The DAC 337 Acoustical Coupler is an interface between a remote terminal and a central time-sharing or on-line computer using voice grade communication lines.
2. For greater versatility the additional space can provide serial to parallel or the reverse, code modification, or any specialized circuits to fit your individual needs.
3. DCS's Engineering Services Division is well prepared by experience to interpret your specifications into a reliable product and to provide continuing engineering services.
4. OEM or special purpose inquiries are invited regarding data communications coupling problems.

# dcS

DATA COMMUNICATIONS SYSTEMS, INC. •

4230 CENTRAL AVE. N. E. • MINNEAPOLIS, MINNESOTA 55421 • (612) 788-9295

CIRCLE 124 ON READER CARD

April 1968

177

**Geo Space Corporation provides a complete spectrum of services and support for an advanced hybrid computer system. The analog computer, hybrid linkage unit and software form the major parts of the hybrid computer.**

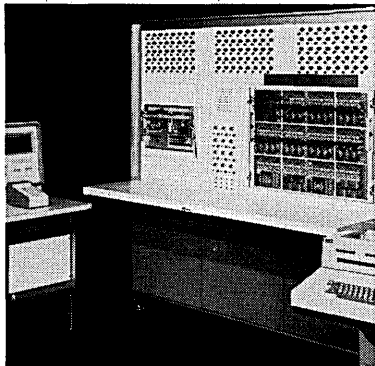

**The Geo Space SS-100 is a 100 volt analog computer with solid state logic and mode control.** The basic unit is wired for full expansion up to 300 amplifiers by the addition of plug-in components or modules. Unique **DYSTAC**® integrator provides high speed integrator reset in 10 microseconds. Summers and summer/integrators are located directly behind the patch bay for maximum performance. A separate control desk includes all logic displays, system status and operator controls for maximum operator efficiency. Analog signals are terminated at the 3672 hole fully shielded analog patch panel. The logic patch panel has 1632 holes for all logic signals and interface control signals. A full complement of multipliers, resolvers and function generators are available.

The SS-100 includes a control interface for connecting to a hybrid linkage unit such as the 1044, which is designed to connect to an IBM System/360 Model 44. The 1044 provides multichannel conversion at speeds up to 100 KHz for A/D and 135 KHz for D/A conversion when used with a High Speed Multiplexor Channel.

The 1044 includes high speed A/D converter with 16 input channels, expandable to 256

channels, also eight D/A channels expandable to 256 channels. Other features include digital input, digital output and 32 priority interrupt lines. Plus the capability for controlling up to eight analog consoles from a single hybrid linkage unit. In **Fortran** the Hybrid Executive provides the user the operating software to solve most problems.

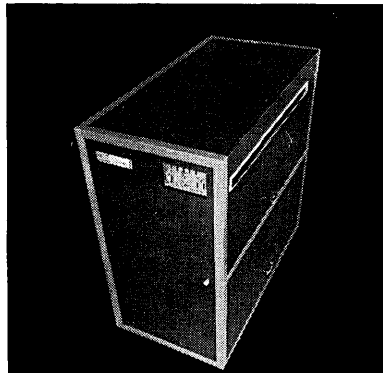

**The DP-203 is one of the series of advanced graphic recording units manufactured by Geo Space Corp. These units are designed for high speed on-line operation with a digital computer.** They record on film or photosensitive paper up to a maximum size of 40" by 60". A typical plot can be in minutes. Applications of the DP-203 include maps, line drawings, schematics and many other types of graphic displays on reproducible media.

The plotter is available with film cartridges for use in computer room environment. Optional features allow the use of sheet film in various sizes from 8½" by 11" up to the maximum size of 40" by 60". Recording media is either film or photosensitive paper. Film is available either with a clear base or drafting surface. Additional models of the plotter are available for high resolution recording requirements or other special graphic systems. □ High Speed Graphic Recording System and Special Purpose Digital Peripheral Devices.

**A complete line of analog computer components are available for special purpose simulation systems or expansion of existing analog computer systems. The component line includes 100 volt amplifiers, quarter square multipliers, fixed and variable diode function generators and other types of analog computer components including limiters, comparators, digital/analog switch and function relays.**

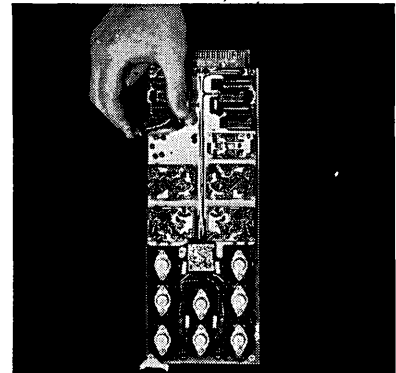

**The basic item in the series of analog computer components is the 800 Series Operational amplifier which features high bandwidth, low phase shift, FET chopper stabilization and instantaneous overload recovery.** A unique feature of the 800 Series amplifier is the modular construction technique with removable subboard as illustrated above. The dual amplifier can readily be adapted to a wide range of requirements. High performance specifications include 50 milliamp output at ±100 volts and full power response at 250 KHz.

The amplifiers and other components are available either as individual units or as a system packaged in standard 19" modules with power supplies. Expansion systems are available with standard rack enclosure for amplifiers or other components.

Complete line of 100 volt computing components: Amplifiers, Quarter Square Multipliers, Fixed Diode Function Generators, Variable Diode Function Generators and Special Purpose Analog Simulation Systems.

**SPRING JOINT COMPUTER CONFERENCE BOOTHS 804-805-806**

**5803 Glenmont Dr., Houston, Texas 77036  
Tel (713) 666-1611 □ TWX 910-881-1533**

**GEO SPACE  
COMPUTER DIVISION**

# world report

---

## IBM PRICE HIKE DEFIES UK AUSTERITY

IBM's decision to hike prices in the UK by 10% has run into trouble because it is out of line with government policy to limit rises in prices and incomes until the nation's balance of payments has been straightened out. Complaints about the new prices came from the local IBM users association to the Ministry of Technology which can refer the matter to the Prices and Incomes Board, a national body set up to monitor wages, prices and dividends that are escalating at more than 3.5% a year. The most bitter opponents to the increase are the firms which installed equipment before devaluation of the pound. But their complaint has gone to the Ministry which has responsibility for keeping the British industry alive. Needless to say, UK manufacturers are not in the least concerned by the price hike.

To make IBM's position worse, Honeywell EDP's UK division has undercut IBM's move by slashing prices by as much as 15% in some areas. Under normal circumstances, IBM's decision would probably be allowed to stay. However, the Labour government presented a tough annual budget to the country on March 18 and deliberately sharpened the teeth of the Prices and Incomes Board in the process. On a second count, the IBM case may prove a test piece for the country's restraint policy because this is the first time a U.S. corporation has been involved. As ever, there is not much sympathy on the side of the monolith with 40% of the market and a System/360 order backlog of about \$250 million.

## CZECHS' CHOICE BOOSTS BULL

GE's subsidiary in France, Bull-General Electric, has pulled off an important licensing deal with the Czechs. Although details are still to be wrapped up, the agreement is for Tesla of Czechoslovakia to make the Gamma 140, a \$200K-class dp system which was prototyped before GE absorbed Bull Machines, but which was unable to find a convenient slot in European range of the GE-Bull-Olivetti complex. The deal adds stature to Bull-GE in official French eyes. Relations with Mon Generale's government haven't been easy since the take-over of French Compagnie des Machines Bull; GE bought Bull just as France was setting up Plan Calcul. Signs that the government is more favourably disposed came with attendance of senior officials from departments of science and industry at the opening of GE's first 265 time-sharing centre in Paris last month. Hints were dropped that the government would cooperate with further moves in this direction. At the same time, it became evident from actions at CII -- the central French computer manufacturer -- that ideas had been abandoned for an early start on big machine systems. Loser in the Czech deal is Britain's ICT, which was negotiating a license for Tesla to make the 1900 series.

*(Continued on page 181)*

In display terminals...

# Good things come in small packages.

Actually, three small packages when you're talking our standard, low-cost, CC-30 communications and data display station, which we've already delivered to hospitals, industries, government agencies, universities, computer manufacturers, and research laboratories around the country.

Personnel at these locations now use this compact, fully portable input/output terminal to store and retrieve information for on-line compilation and execution, for data inquiry services, and for computer-aided instruction, to name just a few of the applications for which the CC-30 is ideally suited.

Designed for two-way communications at virtually any speed, the CC-30 provides immediate on-line access to any computer (already in use with IBM, UNIVAC, CDC, SDS, GE, PDP and other computers).

Our standard package includes the CC-301 TV display controller (control center for the CC-30 communications station), CC-300 TV receiver (or any standard TV set, depending on size requirements), and CC-303 alphanumeric keyboard. These three basic units will do the job. However, for even greater flexibility, we offer a variety

of other good things in small packages . . . CC-302 telephone coupler (enabling communication between remote station and computer over ordinary telephone) . . . CC-304 lightpen . . . CC-305 line printer (provides print-out of any information on TV screen), CC-306 card reader, and other surprise packages.

If your day to day operations involve time-sharing, hospital or management information systems, real-time monitoring and control systems, computer-assisted instruction, information storage and retrieval, psychological testing, computer simulation, or hybrid computer control, why settle for less than the best?

Call or write today for information regarding our package deals.

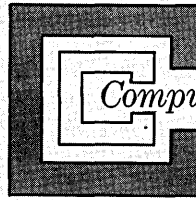

*Computer Communications, Inc.*

701 West Manchester Boulevard  
Inglewood, California 90301  
Phone: (213) 674-5300  
CIRCLE 126 ON READER CARD



See our complete line of communications packages at the Spring Joint Computer Conference. Booths 613 and 614.

## world report

### FROM MANY MERGERS: A BRITISH BEHEMOTH

After months of negotiations (on and off for three years), the UK computer industry has been concentrated into one \$250 million manufacturing house for business and science systems by a merger involving ICT, English Electric Computers and Plessey, plus a near-\$50 million handout from the government. The new company, International Computers Ltd. (ICL) merges ICT's 6-bit 1900 series with English's 8-bit byte System 4.

ICT takes the main stake with a 53.5% share; English and Plessey, 18%; and the government, 10.5%. ICT and English Electric provide the production and software capability; the government and Plessey, cash. The government's share is worth \$8.5 million; the balance of the \$50 million is going into product development, mainly for systems costing over \$3 million. This gives the go-ahead to an existing ICT project labelled Project 51. On top of this there is a joint development company in which the three manufacturers will concoct the product range of the future. Plessey has a 60% stake in this. As the biggest UK communications and electronics group, it has a vested interest in the obvious progress with data communications.

International Computers becomes effective by mid-July. Its managing director is Arthur Humphreys, who as present managing director of ICT virtually put the UK industry back in business five years ago at its darkest moment. Humphreys is no newcomer to American companies either; he has negotiated deals in the past with Univac and RCA and certainly has held chats at all stops from Phoenix through Minneapolis to New York. Although ICT executives dominate the new company, an interesting addition is Plessey's Tom Hudson. He set up IBM (UK holdings) in the '50's with two others, and then nurtured IBM to its present 40% share of the market until two years ago when he turned adviser to Plessey, following a policy squabble with IBM.

In the new arrangement, English Electric retains its process control interests through its wholly-owned subsidiaries Marconi and Elliott-Automation. The market share-out (3,500 installed to date: 1,400 systems in '67; 2,000 forecast for '68; and 2,800 for '69, with a continuing 40% growth rate) is about 80% split equally between IBM and International Computers Ltd., Honeywell, 5%; and Univac, 3%. On order-book value, Burroughs' fantastic year in '67 has put the company close to IBM and ICT with nearly \$100 million.

A network of computer centres for Europe to cope with the exchange of scientific and technical information was proposed in Paris at the third meeting of Ministers for Science and Technology from OECD (Organisation for Economic Cooperation and Development) countries. They discussed a report which stated that member countries spend \$1,000 million a year on information services, and uneven development of new systems in different countries is leading to a potential information gap.

Burroughs, moving upward in Britain, picked up an order last month for two B6500's worth \$12 million from Midland Bank. Boasting \$90 million of dp equipment sold to British banks in the last year, Burroughs capped the Midland order after slippage on the System 4 cut out English Electric (Mar., p. 129).

### DATA EXCHANGE NETWORK PROPOSED AT PARIS MEETING

### BITS & PIECES



# announcing:

- **UNIVAC Information Services Division**

This new division means opportunity and challenge at 25 Branch Offices, Systems Centers and Computer Centers located throughout the United States.

- **opportunities for professionals in:**

Marketing                      Management                      Systems Analysis  
Programming                      Operations

- **outstanding rewards + growth potential**

If you are a data processing specialist who wants "in" on Applied Information Science, send your professional resume directly to:

Dr. J. P. Campbell, Director  
Personnel & Education  
UNIVAC ISD

P.O. Box 8100, Philadelphia, Pa. 19101

# UNIVAC

CIRCLE 300 ON READER CARD



# washington report

## GALLAGHER TO PROPOSE NEW PRIVACY LEGISLATION

Cong. Cornelius Gallagher (D-NJ) is drafting new legislation as a result of mid-March hearings before his special subcommittee on invasion of privacy. Federal contracting for computerized credit data by the FBI, VA, FHA and IRS sparked the interest.

The Gallagher approach would require industry-wide licensing for computer personnel and would place limitations on the types of data made available to gov't agencies from credit sources. Contracts between the gov't and credit collection firms would stipulate that the information be reliable and accurate, and would help safeguard against further dissemination. One innovation would permit borrowers to note on the file that they were contesting derogatory information. (This augments the Patman and Zablocki bills; News Briefs, p. 153). Other proposals in the Gallagher report call for periodic reports to be sent to each individual in the data bank notifying him of changes in his file and suggest penalties for transmission of inaccurate or malicious information.

Credit industry witnesses who appeared before the committee announced plans for their own self-policing program, pledging legislative recommendations by August.

## PROCUREMENT STUDY STALLS; PRESSURE SUSPECTED

Sen. Joseph Montoya's bill (S 2340) to form an agency-wide study commission for adp selection and procurement appears stalled. Claiming inadequate staff, Montoya's GovOps subcommittee is not expected to hold hearings until May at the earliest. The subcommittee is likely to amend the bill giving the commission supervision of agencies' determination of their adp requirements. Several departmental reports -- DOD, GSA, State, NASA, AEC, and BOB -- have been sent; all were negative. Hill sources suspect agencies are under pressure from computer manufacturers.

## NASA MONEY LOWER, CAPE COMPUTERS SHIFT

NASA is asking \$70 million for programs in fiscal '69 vs. \$75.6 million this year and \$81.6 in fiscal '67. The authorization cleared the House science committee with rumblings from economy-minded members; full House consideration is expected after Easter recess.

Although some NASA adp acquisitions have been postponed by the major reduction in deep space missions, two small computers for Apollo tracking will be added at Cape Kennedy. Three 7094's will be released as part of the conversion to 360's, one reassigned to Lewis Research Center, another returned to GSA; the disposition of the third is still undecided.

## CAPITOL BRIEFS

Thorton (Tip) Parker, whose job as division chief at NBS's Center for Computer Technology disappeared in the recent budget squeeze, is now chief of adp policy and management at the Office of Economic Opportunity... Sid Weinstein, GSA's director of adp procurement, will soon become deputy to Asst. Commr. Ed Dwyer, head of the agency's gov't-wide adp management activities. Dwyer, rumored to be retiring at the end of this year, told us he plans to stay "a minimum of a year and probably longer."...GSA began its pilot keypunch pool project Mar. 1 at New York, Washington and Philadelphia regional offices. Six operators were recruited to staff each facility; the project will be re-evaluated after three months.

# Big Computer Quiz. Part 2:

1. The PDP-10 has 365 separate instructions (35 floating point and 130 test and compare instructions among them). Because it is a logically complete instruction set, programs are easier to write, use fewer instructions and run faster than programs for competitive systems. System /360 has \_\_\_\_\_ instruction, and Sigma 7 has just \_\_\_\_\_.

2. DIGITAL'S PDP-10 is a time-sharing system that can do more than just conversational time sharing. It can: time-share an array of terminals in a conversational mode, time-share high data rate input from high-energy physics instrumentation and analog computers involved in hybrid simulation, and batch process — all at the same time. Is there any other system in the PDP-10's price range that can do the same? \_\_\_\_\_

3. Pushdown stacks provide a convenient means of last-in first-out processing of information under direct hardware control. PDP-10 allows both data and program status information to be stored in the same pushdown list. Does System 360? \_\_\_\_\_. Sigma 7? \_\_\_\_\_. Any other computer? \_\_\_\_\_.

4. Byte sizes have become a great convenience — for the computer manufacturer. But real-time input data sometimes fits the preset byte size, sometimes must be reformatted. The PDP-10 has a flexible byte. Any number of bits you want, up to the full 36 bit word size, can be your byte size. Reformatting is simply not necessary. Whereas both the Sigma 7 and the System 360 are locked into a \_\_\_\_\_ bit byte.

5. High speed I/O channels are essential in real-time and time-sharing operations to insure that peak transfer rates will not overrun channel capabilities. PDP-10's I/O processor has a maximum throughput rate of 200,000 36 bit words per second. Selector channels can transfer a million words per second. And because of the asynchronous memory structure of the PDP-10, multiple selector channels can operate simultaneously without stealing processor cycles. Can Sigma 7, System 360 — or indeed, any other comparably priced computer — match these speeds? \_\_\_\_\_

6. PDP-10 provides a complete ASA FORTRAN IV compiler requiring only 9K of memory. In numerous benchmarks, the code produced by this compiler will require up to 50% less memory than the PDP-10's nearest competitor. Could any competitor make a similar statement? \_\_\_\_\_.

7. Would you like a reprint of Part 1 of the Quiz? Send responses to Department A, Digital Equipment Corporation, Maynard, Mass. 01754.

**digital**  
COMPUTERS • MODULES

DIGITAL EQUIPMENT CORPORATION, Maynard, Massachusetts 01754. Telephone: (617) 897-8821 • Cambridge, Mass. • New Haven • Washington, D.C. • Parsippany, Palisades Park, N.J. • Princeton, N.J. • Rochester, N.Y. • Long Island, N.Y. • Philadelphia • Pittsburgh • Huntsville • Cocoa, Fla. • Chicago • Denver • Ann Arbor • Houston • Albuquerque • Los Angeles • Palo Alto • Seattle.  
INTERNATIONAL, Carleton Place and Toronto, Ont. • Montreal, Quebec • Edmonton, Alberta, Canada • Reading and Manchester, England • Paris, France • Munich and Cologne, Germany • Oslo, Norway • Stockholm, Sweden • Sydney and West Perth, Australia • Modules distributed also through Allied Radio

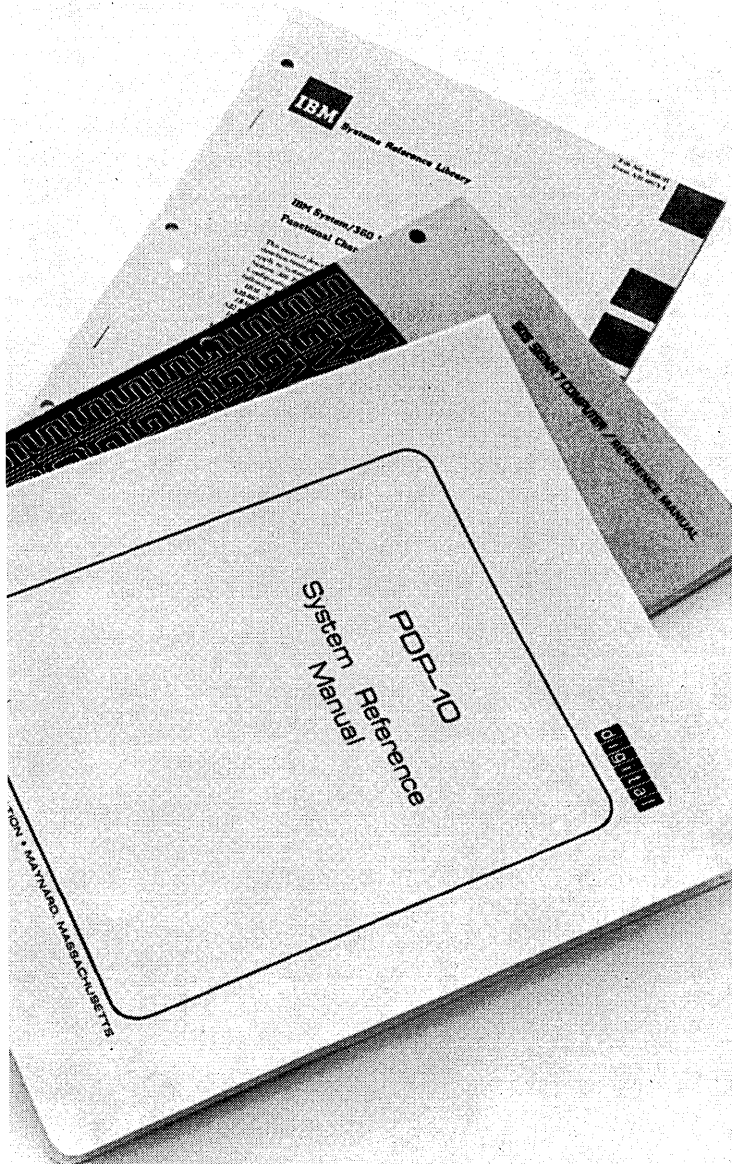

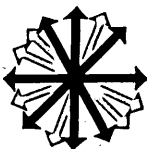

# new products

## conversational terminal

A conversational data terminal uses the Dura 1041 automatic typewriter with the 1015 communication interface; this system can communicate over voice-grade telephone lines when used with the Bell 103 Dataphone or with acoustic coupling to standard telephones. The unit may be used as a

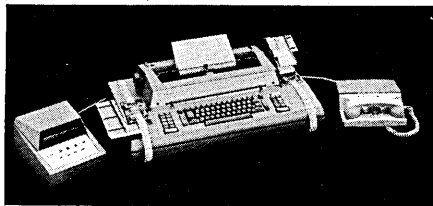

half-duplex remote terminal to "virtually any" computer or another terminal. Features include interchangeable typing spheres, standard typewriter keyboard, visible margin and tab setting, snap-on cartridge ribbon, stationary carriage and "extraordinarily" quiet operation. The 1041 terminal types up to 175 words a minute from either paper tape or edge-punched cards, and produces paper tape for direct computer input at speeds up to 18 cps. DURA BUSINESS MACHINES, Oak Park, Mich. For information:

CIRCLE 180 ON READER CARD

## link loader

The LDR link loader operates on any System/360 under OS, and can be used with FORTRAN, PL/I, COBOL and most assemblers. LDR achieves up to a 60% reduction in compile and go procedure times, according to the company. Object decks can be loaded directly, core maps produced under LDR have absolute addresses, and the lengths of program modules are printed in decimal form. LDR is not release dependent. There is also no limit on the size of the program the loader will execute, other than available core space. AMERICAN DATA PROCESSING, Raleigh, N.C. For information:

CIRCLE 181 ON READER CARD

## disc utility program

PACFAC is a disc pack analysis and control program for the IBM 360; the system occupies 7K of memory, requires at a minimum 16K memory.

PACFAC interrogates the volume table of contents of any IBM disc pack to determine what files are present; their activity status, organization, size and location, as well as size and location of free space. It also provides a permanent history of inoperative tracks. The output lists all files alphabetically, and lists unused space sequentially by cylinder and track. The program operates under OS or DOS; delivery is "immediate." SOFTWARE RESOURCES CORP., Los Angeles, Calif. For information:

CIRCLE 182 ON READER CARD

## accounting package & service

The Philo EAsystem, being offered to small- and medium-sized accounting firms, handles accounting from original entry to final reports. An accountant prepares input with an adding machine (supplied by Philo), equipped with an optical type face which can be

read by computers. The optical tape is sent for reading to a Philo computer center; from the tape, the computer calculates and prints financial statements and other management reports which are returned to the accountant in 48 hours. Standard programs are available for "nearly every" business application. PHILO MANAGEMENT SYSTEMS, INC., Dayton, Ohio. For information:

CIRCLE 183 ON READER CARD

## storage interface system

The Storage Interface System is interface-compatible with a single Univac 1108 normal channel or two normal channels of a 418, enabling Univac users to use IBM 1316, 2316, Memorex Mark I and other disc packs. Addressing and format organization of file data is consistent with IBM operating systems. DATAMETRICS CORP., Van Nuys, Calif. For information:

CIRCLE 184 ON READER CARD

## hospital software

HOSPACT is a hospital patient accounting system which will operate on all computers having a COBOL compiler. It provides access to detailed patient profiles and a daily overview of all pertinent financial and bedcount data. Provisions for Medicare, multiple insur-

## PRODUCT OF THE MONTH

Standard Computer Corp. has extended the concepts developed for the IC-6000 (DATAMATION, Feb. '67, p. 77) to bring out the IC-4000. While the earlier machine amounted to a low-cost 7094, the 4000 is intended to be a general-purpose computer system, aimed at the scientific/engineering market.

Price range is \$7685 to \$12,385 per month or \$276,900 to \$465,100 for purchase. This puts it in the range between the IBM 1130 and 360/44, where it has plenty of company with the CDC 3150 and smaller 3100 configurations, the EMR 6050, the Sigma 5, larger GE-415's, and the 360/40. But Standard's main pitch is better price/performance than its host of rivals.

To achieve this, the company is using its dual-memory approach: a main core unit of 32K and a 2048-word control core unit. Main memory handles 36-bit words with a 2 usec cycle time; the control memory has a 500 nsec access time to its 18-bit words. This smaller memory can be set up with what Standard calls micro-code to offer, in effect, wired-in software. (A FORTRAN IV compil-

er is ready in this form and others, including COBOL, will follow.) An example of the results is that the 4000 can compile up to 4000 FORTRAN IV statements per minute.

The IC-4000 uses monolithic integrated circuits, has 36-bit-parallel operation, several levels of priority interrupt, word- and character-oriented instructions, seven index registers, and single- and double-precision floating point. Special "problem adapted" instructions are available on request, by use of the control memory. Overlapped I/O channels have a data transfer rate of 300K char/sec.

Peripherals, all buyouts, include card reader, line printer, single-capstan IBM-compatible tape units, and disc pack units. Options are emulators for the IBM 1130, 7040/44, and 7090/94. First deliveries are scheduled for August this year and Standard is aiming at 120-day delivery.

The company, started in late 1965, now has a half dozen of its IC-6000's installed and another 10 on order. For information:

CIRCLE 185 ON READER CARD

## new products

ance company involvement, patient transfers, and daily, weekly and monthly reports are included in the system. The package is being offered to service bureaus on a franchise basis. INFORMATION MANAGEMENT INC., San Francisco, Calif. For information: CIRCLE 186 ON READER CARD

### data set

An acoustic-coupled data set for the OEM market allows the transmission of digital information via voice-grade

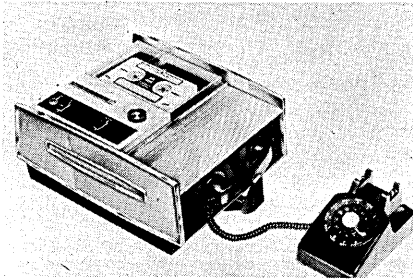

telephone lines. The unit converts digital signals into audio tones and couples these tones through an audio transducer to a telephone for transmission at rates up to 600 bps. The set accepts data in serial-by-bit form; frequency shift modulation is used to convert the logic levels into two distinct audio tones. Transmitted frequencies are compatible for receipt with the Bell 202C data set. DIGITRONICS CORP., Albertson, N.Y. For information:

CIRCLE 188 ON READER CARD

### process control mis

A management information system language for use with GE-PAC 4000 process control computers incorporates a general purpose linear programming capability; MISSIL (see Nov. '67, p. 63), an MIS symbolic interpretation language for management analysis and reporting; and a stylized matrix generation and solution analysis system. BONNER & MOORE ASSOC., Houston, Tex. For information:

CIRCLE 187 ON READER CARD

### n/c computer

The PC-9600 is a computer system primarily designed for use in the numerical control field. In addition to generation of N/C tapes, it can also be used for contour generation, automatic "accept-reject" determination of inspected parts, and production of deviation and tolerance records. Based on a redesigned BIT-480, the system comes with a teletype unit, an optional

PICOMM coordinate measuring machine which can be placed on-line, and programs for pattern duplication and for entering contour descriptions. The i.c. system has a basic memory capacity of 2K-8K characters, but can be expanded to 65K. The computer price range is \$11.9K-15K; the PICOMM machine starts at \$19.9K. POTTER INSTRUMENT CO., INC. Plainview, N.Y. For information:

CIRCLE 189 ON READER CARD

### dual processor computer

The DDP-324 dual processor gp computer, an extension of Honeywell's Computer Control family, is for use in simulator, process control and communications systems, and for scientific applications where "large amounts" of on-line data reduction are performed. Expected to increase Honeywell's share of the simulator market by 50%, according to company officials, the 324 has two processing units, each with 8K (24-bit) words of memory and 8K words of shared memory. Each memory can be expanded in 8K increments to 24K words. Basic I/O devices are a typewriter and a paper tape reader and punch. The typewriter operates at 15 characters a second; the tape reader at 300 cps; the punch at up to 110 cps. Standard options include direct memory access channels, multi-level priority interrupt, fully buffered shared channels, and time multiplex units. Direct memory access transfers

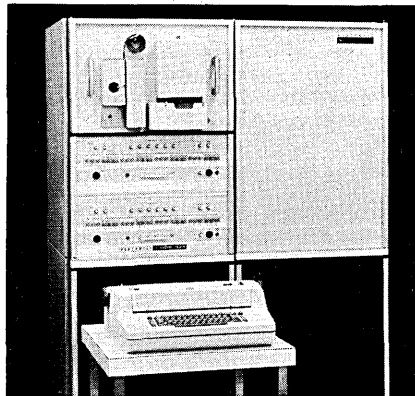

data at rates up to 570,000 words a second. Up to 16 priority levels per processor can be assigned to external interrupt signals and parts of the program using the multi-level priority interrupt. Sharing of the buffered channels allows either cpu to set up the addresses and the range of the channels. The time multiplex unit permits a peripheral to be shared by the cpu's.

Peripheral options include a mag tape system, 200 cpm card reader, 300 lpm printer and disc storage devices. Mag tapes are available in 150, 75 and 45 ips models. Of the two discs offered, one provides storage for up to 12 million bits with average access

time of 8.5 msec; the second stores up to 230.4 million bits.

Software for the -324 consists of 380 programs, all of which are compatible with the -224, -124 and -24 computers. A FORTRAN IV compiler, symbolic assembler, systems I/O, and math, test and utility programs are included. First deliveries will be in February '69. HONEYWELL COMPUTER CONTROL DIV., Framingham, Mass. For information:

CIRCLE 190 ON READER CARD

### mark-sense terminal

The Transactor remote data terminal contains mark-sense electronics which read pencil-marked pre-printed cards (standard punched-card size) and transmit this information to a computer; if an answer is desired, it is then

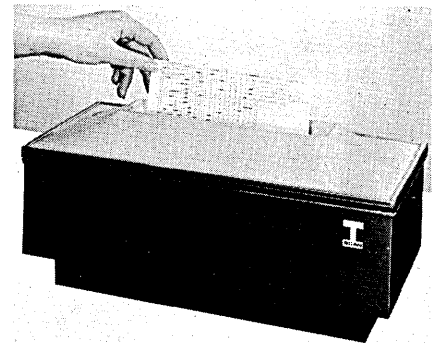

printed on the card. Turnaround time for this procedure is under three seconds. The cards have 320 coded positions that can be used by the operators.

Information marked on the card is transmitted to the Transactor Control Unit (which can interface up to 16 terminals). The TCU stores the data in a compressed matrix form that is then transmitted in USASCII code over voice-grade lines to a computing center. The TCU can operate with any modem that has rates to an upper limit of 48K baud.

Responses from the computer are printed on the card by a "very small" (22-character) line printer that outputs alphanumeric data at a rate of 20 lines a second. The card provides space for 352 printed characters.

Errors on the marked card are indicated by red and green lights on the terminal. Computer call-up is also possible: the lights on the terminal flash until a card is inserted.

The terminal can be installed as a desk-top unit or sunk into a horizontal surface. T-SCAN LTD., Toronto, Ontario, Canada. For information:

CIRCLE 191 ON READER CARD

### typesetting system

A \$16K typesetting system using a PDP-8/S 4096 (12-bit) word comput-

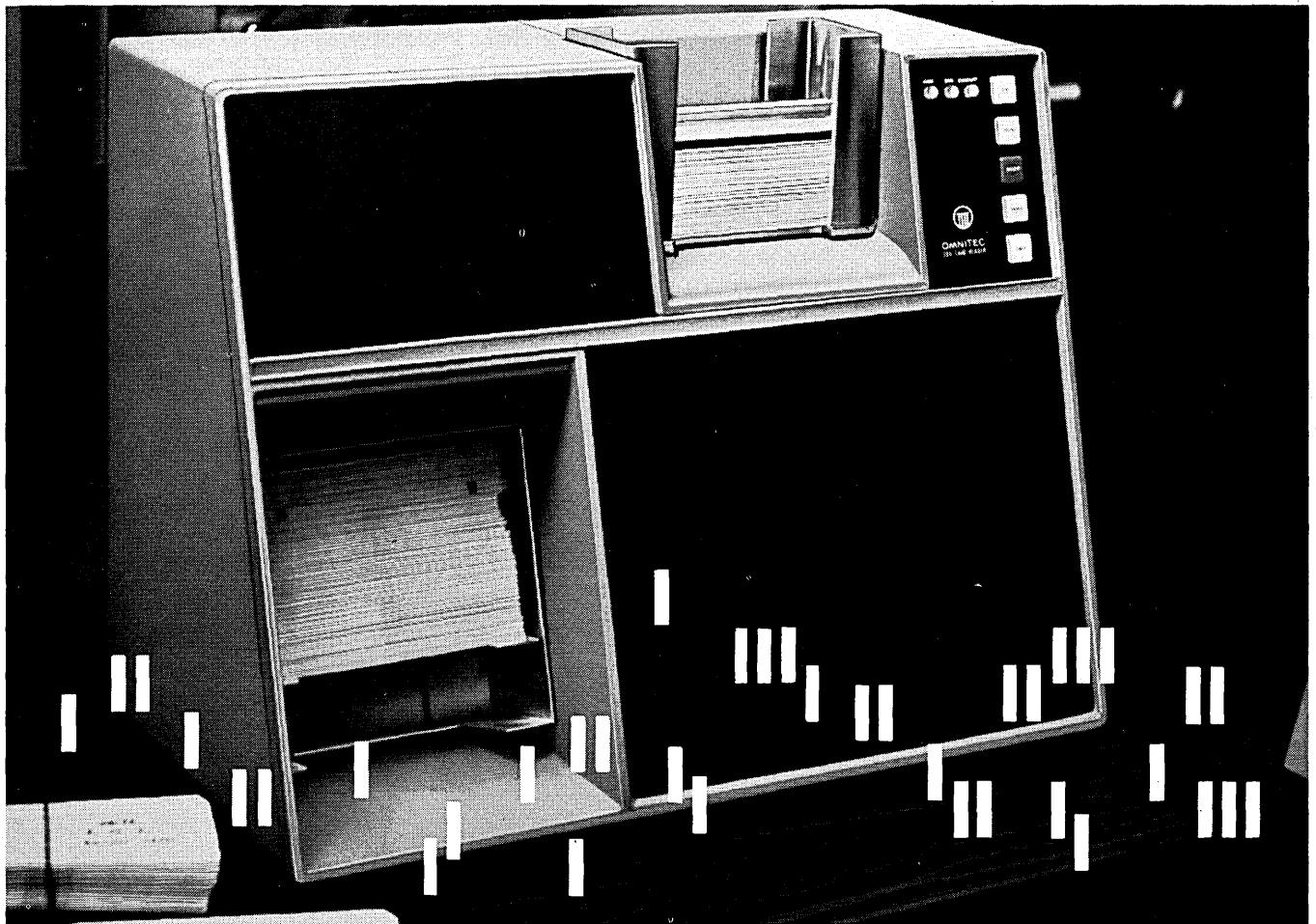

This new, advanced

# CARD READER

*offers more dependability,  
on-line and for data terminals*

A versatile high-performance serial card reader engineered to assure you minimum attendance and least maintenance! The ultra-dependable picker knife design assures simple and reliable card feeding. The unique clocking mechanism insures accurate timing while reading square or round-cornered cards. Gentle handling permit cards to be read hundreds of times without wear or tear. Heavy-duty castings, precision machining, and integrated electronic circuits with generous margins of safety combine to make the new Omnitec Series-300 Card Reader ultra-reliable.

#### ADAPTABLE TO YOUR SPECIAL NEEDS

Reads 300 cards a minute for use on-line as a computer peripheral, or may be slowed to as low as 50 cpm for time sharing computer or other data systems using telephone lines. Handles 80-column cards — or converts in minutes to 51-column cards. A brand-new optional feature permits recirculation for re-read and offset of rejects. Input capacity can be increased from 500 to 1,000 cards by optional hopper modification. Size: 24" x 19 1/4" x 12 3/4". 80 pounds. 60 CPS, 115 Volt A.C.; or 50 CPS, 220 Volt A.C. Self-contained power supply.

Single orders of some models begin under \$3,000 — with substantial savings for quantity orders. For complete information, call (602) 258-8246, or write Omnitec Corporation, 903 North Second St., Phoenix, Ariz. 85004.

Booths 509, 510  
Spring Joint Computer Show

Order now for early delivery.



**OMNITEC**  
A SUBSIDIARY OF NYTRONICS, INC.

TELEPHONE COUPLER

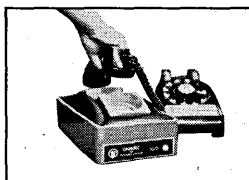

CARD READER

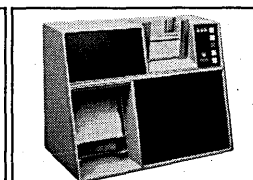

DOCUMENT JOGGERS

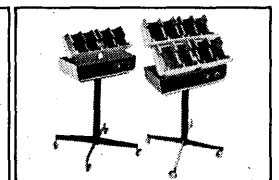

# YES, YOU GET THE BOLDEST BRIGHTEST MOST READABLE CRT DISPLAY AVAILABLE TODAY.

Actual photo of DATA-SCREEN Display Terminal characters — shown actual size.

but **TEC's DATA-SCREEN Display Terminal**  
also gives you . . .



**Interface flexibility**—compatible with most EDP and communication systems, transmits and accepts any 8-level code including ASCII, IBM, and EBCDIC. Electrical interface signal level options include 5-volt current sink I-C logic and EIA Standard RS-232B.



**Keyboard flexibility**—optional input keyboards offered in standard or special key arrangements. Special keys for control functions, indicators and switches can be located anywhere on the keyboard. A variety of key styles are offered with legends to order.

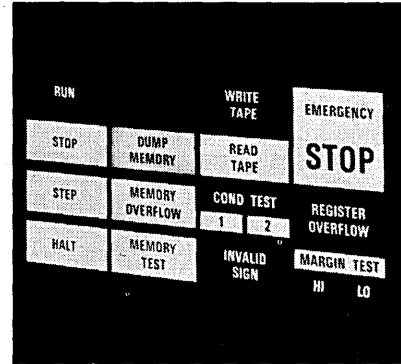

**Display flexibility**—in addition to the CRT data display, up to 144 fixed messages can be displayed behind the black screen using TEC's DATA-PANEL® Display System. Invisible when off, messages such as FAULT, OVERFLOW, ON LINE, STOP, etc., become instantly visible when illuminated.

Without a doubt (our competitors admit it) this display terminal has the largest . . .  $\frac{3}{4}$ " minimum . . . most readable, rock steady characters available in its field. Stroke-written messages appear in brilliant contrast to the black screen of TEC's DATA-SCREEN Display Terminal.

Three completely self-contained models with keyboard, character generator, refresher core memory, solid state logic and power supply are offered with

128, 200 and 512 character display. Everything else you'd expect in a completely flexible CRT display is offered: full character repertoire; flashing cursor with positioning controls; editing features; character size and slant adjustments; modern cabinet or rack panel mounting option.

Send for 6 page brochure that tells all about TEC's DATA-SCREEN Display Terminal — the flexible, readable CRT.

Visit TEC...SJCC Booth E-1,E-2



INFORMATION DISPLAY  
AND CONTROL DEVICES

TRANSISTOR ELECTRONICS CORPORATION

Box 6191

• Minneapolis, Minnesota 55424

• Phone (612) 941-1100

**PROBLEM:**

# TRAFFIC JAM!



**NOT ALL TRAFFIC** jams occur on freeways. Harbors have their share too, and they're much more complicated. Harbor traffic requires resources like ships, berths, anchorages, lighter ramps, holding areas, trucks, warehouses, dock areas and material handling equipment.

### C-E-I-R SOLUTION:

C-E-I-R, INC. has used the techniques of simulation (gaming) to develop a port logistics simulator to measure port effectiveness for the Department of Defense.

The simulator evaluates port cargo throughputs, port service rates, port queue lengths, port facility utilization, and port resource utilization for any transportation problem posed by the user. Designed primarily for shipping problems, it can simulate aircraft and land vehicle movements as well, either by themselves or with ships.

### RESULTS: SITAP

**THE CONCEPT** of the original simulator has been expanded to a very broad-based system called SITAP (Simulator for Transportation Analysis and Planning). SITAP can be used to analyze any transportation system: that is, any real-world system that can be viewed as a network through which vehicles move in order to satisfy demands arising at nodes in the network.

The demands are simply expressions of the requirement to move a vehicle between the network nodes and to occupy it for variable periods at each node. The demands are usually requirements to move cargo or passengers from node to node. To the model, these demands, as well as the vehicles and the network are sets of parameters processed in accordance with the decision rules in the system.

# C-E-I-R INC.

A SUBSIDIARY OF

## CONTROL DATA CORPORATION

5272 River Road  
Washington, D.C. 20016

CIRCLE 130 ON READER CARD

## new products

er can be used by newspapers with a circulation of less than 15,000 and small commercial printers. The computer includes a tape reader and punch; a disc, capable of expanding the basic memory in 32K word increments to 131K, is an option. The software package, written by Composition Systems, Inc., features hyphenation-by-rules, an exception dictionary, justification, quadding, letterspacing, wire service re-justification and tabular composition. Indentions, runarounds, visuals, production statistics and news and classified formatting are also included. All features are simultaneously resident in core. With the disc added, an 8K word exception dictionary, no-space band routine and programs for driving photocomposition machines are available as options. Delivery is 30 days after receipt of order. DIGITAL EQUIPMENT CORP., Maynard, Mass. For information:

CIRCLE 192 ON READER CARD

### retail program

**CAPTURE** (Computer Automated Processing Technique Using Register Entry) is a cash-register-to-computer system written in COBOL, and operated on any Honeywell series 200 computer and Uni-Tote cash register machines. The package records, classifies and summarizes sales data and provides management with reports for accounting, inventory, financial and merchandise control. CAPTURE, developed from a marketing agreement between Honeywell EDP and Universal Control's Uni-Tote division, handles source data from the registers; this data is transmitted to a central computer which creates a permanent record of the information on mag tape for computer input. The package, which also generates exception reports signalling error conditions and variances, and prepares validated mag tape input for several information analysis systems, requires a minimum configuration (on a series 200 computer) of 16K core memory, four mag tape units, a card reader/punch, console typewriter and line printer. CAPTURE will be available in fall '68. HONEYWELL EDP, Wellesley Hills, Mass. For information:

CIRCLE 193 ON READER CARD

### data reduction system

The **OMEGA** data reduction system is an off-line system to accept raw data from analytical instruments equipped with ASR 33 Teletypewriter tape punches or other USASCII punched-tape outputs. Two desk-top units comprise the system. The master control module

# C-E-I-R INC.

### SEMINARS

## DATA PROCESSING FOR BUSINESS AND TECHNICAL MANAGEMENT

WASHINGTON, D.C.  
(Sheraton-Carlton Hotel)

- 30 April : Clustering and Classification
- 13-15 May : Design Automation\*
- 13-15 May : Management Information Systems
- 21-24 May : Programming Languages
- 22-24 May : Documentation and Debugging
- 27-29 May : Multiple Access Computers (Time sharing)

NEW YORK CITY  
(Sheraton-Atlantic Hotel)

- 1-3 May : Inventory Control and Management
- 6-8 May : Project Planning and Control Systems
- 15-17 May : Computer Operations Management
- 15-17 May : Data Communications Systems

CHICAGO  
(Sheraton-Blackstone Hotel)

- 6-8 May : Design Automation\*
- (La Salle Hotel)
- 13 May : Clustering and Classification

CLEVELAND  
(Sheraton-Cleveland Hotel)

- 22-22 May : Basic Systems and Procedures Including Data Processing Concepts\*

BUCK HILL FALLS, PENNA.  
(Buck Hill Inn & Golf Club in the Poconos)

- 27-29 May : Management Information Systems

\* New Seminar

Write or call, REGISTRAR,  
**INSTITUTE FOR ADVANCED TECHNOLOGY,**  
C-E-I-R, INC.,  
5272 River Road,  
Washington, D.C. 20016.  
Phone (301) 652-2268

A Subsidiary of

## CONTROL DATA CORPORATION

CIRCLE 131 ON READER CARD

## new products

has two Teletype 33 tape readers that accept and edit raw data on punched tape from analytical instruments. The electronic computing module is an Olivetti-Underwood 101B programmable electronic calculator, which will store programs up to 120 steps long. Constants can also be stored externally on individual tape loops. The complete OMEGA system edits the data, determines correct calibration factors, and computes final results as directed by the program. The system is already being used with liquid scintillation instrumentation; new programs will soon make it compatible with fluorometers, infrared and ultraviolet spectrophotometers, atomic absorption analyzers and electrochemical equipment. BECKMAN INSTRUMENTS, INC., Fullerton, Calif. For information:

CIRCLE 194 ON READER CARD

### disc pack

The CD-1 disc pack marks Consolidated Electrodynamics' entry into the burgeoning disc pack business. Their offer is an assembly of six magnetic coated discs, providing 10 recording surfaces. Compatible with IBM 1311 and 2311 (and many other) disc

packs, and having, as they do, a maximum capacity of 7.5 million characters, the CD-1s are packaged in a dustproof container and are available for "immediate" delivery. CONSOLIDATED ELECTRODYNAMICS CORP., Pasadena, Calif. For information:

CIRCLE 195 ON READER CARD

### information management software

FORMAT (File ORiented Management Advisory Technique) is available in five versions and includes a library of FORTRAN IV subroutines organized in overlays for large systems, and a special FORTRAN II version without overlays for small time-sharing systems. FORMAT I is a business system providing standard packages for payroll, inventory, cost control, accounts receivable and payable, general ledger, personnel administration, and other related functions. II has packages to perform report generation, CPM routines, plotting, mapping, trend analysis, etc. The version III system provides packages for probabilistic cost prediction, a Bill of Materials system, CPM analysis with product control correlation and configuration management machine accounting. FORMAT IV is a special-purpose program for use in urban planning and redevelopment; V con-

tains programs for public administration functions, such as school, taxing and revenue, law enforcement, etc. Versions of FORMAT are operational on System/360 (under OS), Univac 1107/08, SDS, GE and CDC systems. Depending on the application, it will operate on anything with at least a 6K memory (it is now doing payroll on an Interdata 3). Teleprocessing capability (for use with a Teletype) is also an option. SYSTEMATICS, INC., Sherman Oaks, Calif. For information:

CIRCLE 196 ON READER CARD

### on-line programs

Thirty-one applications programs are available for the QUIKTRAN 2 library. They fall under four applications areas. Civil engineering programs include coco (coordinate geometry), continuous beam analysis, and cut and fill. Management science programs are the critical path method and linear programming (up to 31-row-by-42-column-problem). Among financial programs are financial ratio calculations, bond analysis, and capital investment analysis. The 21-program statistics package includes elementary statistics, correlation coefficient calculations, and histogram and standard plotting. IBM DP, DIV., White Plains, N.Y. For information:

CIRCLE 197 ON READER CARD

### international marketing analysis

A four-volume series entitled *Sensus-Analysis of International Electronics* is a market research study including tariff rates and policy, description of the industry and markets, export restrictions, credit, financing, insurance, investment controls, etc. Affiliate Mentor International is doing the research. Chapters on 19 nations are in publication now; by late summer, the series will have complete chapters of over 30 nations in Asia, Europe and the Americas. Bound in vinyl, the four loose-leaf binders (Europe I, Europe II, Asia and the Americas) can be easily updated; in succeeding years, the service is planning on re-writing three chapters a month. The series will contain no advertising; annual subscription fee: \$400. SENSUS INTERNATIONAL, San Francisco, Calif. For information:

CIRCLE 198 ON READER CARD

### display terminal

The model 440 video information display is for use with standard data communication circuits as an I/O terminal. As an input terminal, it can assemble and verify message segments prior to transmission; in output mode,

# new time sharing handbook

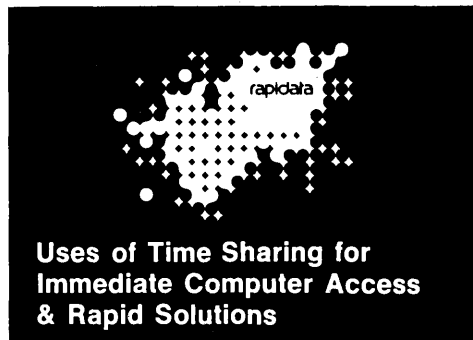

published and distributed without charge by

## rapidata

350 Fifth Avenue, New York, New York 10001 • Telephone 212 594-0120

CIRCLE 76 ON READER CARD



it provides information on a crt display. A standard display format of 384 characters is presented in a 12 lines x 32 character per line; the characters are displayed in a continuous font. In addition to the crt monitors, a buffered character generator is included in the 440; the generator's subsystem includes an input buffer with wired programming for interface with Teletype lines, data sets, and other external devices, such as manual keyboards or tape readers. Standard data input options include a character parallel code entry or a nonsynchronous 5- or 8-level Teletype serial data transfer interface; Baudot and USASCII code sets are basic to the unit. Input data rates to 600 wpm can be accommodated. DATA-VOX CORP., Sarasota, Fla. For information:

CIRCLE 199 ON READER CARD

### edp courses

A computer education training package, made up of "modules" of courses, given at a customer's site, is being offered to edp and other personnel in business, industry, government agencies, and educational institutions. Each course, ranging from a day to four weeks, is tailored to the customer's edp needs. These "modules" include a four-week programming course in which the student will learn IBM 360 assembly language, COBOL, and FORTRAN and do up to 24 programs, run on a CUE or customer computer. Other examples are a two-week course in systems analysis, five-day courses on COBOL and FORTRAN, 10 days on PL/I, two days on operating system concepts, and a one-day course on Job Control Language. Prices vary; for example, a four-week programming course would be about \$950 for an individual, less under company group discount; and a one-day course might be about \$500 total for a company group. COMPUTER USAGE EDUCATION, N.Y., N.Y. For information:

CIRCLE 200 ON READER CARD

### file maintenance system

MANAGE is a file maintenance system which enables a computer installation to maintain its source programs on tapes or discs. Written in COBOL, it can be used on any computer having COBOL capability; it can maintain programs written in FORTRAN, COBOL, AUTOCODER, ALC and other machine languages. Using MANAGE, an installation enters and carries its source language programs on a program master tape or disc. The programmers use the computer to add to, delete from, or otherwise maintain or resequence the programs. The master tape or disc in

the system is also used for computer input as well as to list any program or its modification. A MANAGE-produced program listing is a program log that becomes part of the documentation; the log shows exact modifications in each update run, and also enables supervisors to know what statements have been altered, added to, or deleted from a program. MATHEMATICAL ENGINEERING ASSOC., INC., Dallas, Tex. For information:

CIRCLE 201 ON READER CARD

### display station

The 2265 display station, linked to a remote System/360, is for use in small branch offices. New data can be input to the computer from a typewriter keyboard; this information can be transmitted at a rate of 240 cps over leased communications lines. (If more than one display at a site is desired, the 2848 control unit can be used to support up to 24 of the similar model 2260 stations.) The 67-square-inch crt screen on the 2265 can accommodate up to 960 alphanumeric characters in two formats; 15 lines/64 characters a line, or 12 lines/80 characters a line. Each character is made of up to 40 electron-beam strokes that strike the inside of the screen. This stroke technique is used to produce flicker-free

characters, requiring no external focus. The 2265 can be used with 360/30's through /75's. Deliveries are scheduled for second quarter '69. IBM DP DIV., White Plains, N.Y. For information:

CIRCLE 202 ON READER CARD

### software simulators

For use with SDS Sigma 5 and 7 computers, Unite II and III simulate the SDS 9300 series and the CDC lower 3000 series computers, respectively. The programs execute direct object code for the computers simulated; the simulators handle all hardware operations, such as boot strap loading, I/O operation, interrupts and console display and switch functions. The minimum configuration must correspond to the configuration of the system the program is simulating. The \$8K price includes simulator, on-site support, user's manual, and lifetime warranty on the code structure. UNITED COMPUTING CORP., Redondo Beach, Calif. For information:

CIRCLE 203 ON READER CARD

### perforated tape

A cross-linked cellulose perforated tape, compatible with standard tape equipment, comes in 1,000-foot coils, each 8" in diameter. The manufactur-

## NORTH TO THE FUTURE

# ALASKA

The State of Alaska is seeking qualified Personnel for implementation of a State Information System. COBOL and S/360 experience desirable.

### APPLICATIONS PROGRAMMERS:

Min. 1 year experience.

### LEAD PROGRAMMER:

Min. 3 years experience. Supervisory experience desired.

### SYSTEMS ANALYSTS:

Min. 4 years experience.

### SENIOR CONSOLE OPERATOR:

Min. 5 years experience.

### SUBMIT CONFIDENTIAL RESUME TO:

Mr. D. L. O'Leary, Director  
Division of Data Processing  
Pouch C  
Juneau, Alaska 99801

CIRCLE 302 ON READER CARD

## ELECTRONICS ENGINEERS

**You can make tomorrow's memories today.** How? Come to Lockheed Electronics Company in Los Angeles...where the world's fastest 2½D memory system is already in production. Lockheed engineers conduct research in all phases of memory systems technology. They are presently developing memories, utilizing ferrite cores, thin films and plated wire. With such a large number of successful projects underway, Lockheed Electronics has become the country's fastest-growing company in the memory system field. □ To continue growing, Lockheed needs: Senior memory engineers, logic design engineers, circuit design engineers, thin film physicists, and packaging engineers. □ Tomorrow's memories can't wait. Send your resume today to Professional Employment Group, Lockheed Electronics Company, 6201 E. Randolph St., Los Angeles, Calif. 90022. Or call collect: (213) 722-6810. Lockheed is an equal opportunity employer.

**LOCKHEED  
ELECTRONICS  
COMPANY**

A Division of Lockheed Aircraft Corporation

CIRCLE 301 ON READER CARD

## DATA PROCESSING & ACCOUNTING

We specialize in the placement of professional data processing and accounting personnel. Qualified candidates are invited to contact us regarding opportunities—all fees paid—ranging from \$6,000 to \$35,000.

### RO-MAC PERSONNEL CONSULTANTS

*Ro-Mac & Associates, Inc., is pleased to announce the opening of a new office at:*

6538 Collamer Road  
Carrier Circle  
Syracuse, N.Y. 13206  
(315) 463-5295

200 Boylston Street  
Chestnut Hill, Mass. 02167  
(617) 969-4010

345 North Main Street  
West Hartford, Conn. 06117  
(203) 236-1931

Garden City Concourse  
Cranston, Rhode Island 02920  
(401) 942-5373

94 Auburn Street  
Portland, Maine 04103  
(207) 797-2191



**RO-MAC & ASSOCIATES**



CIRCLE 351 ON READER CARD

## new products

er claims the tape has more than twice the tensile strength of conventional paper tapes; the company also states that it is superior to vulcanized fibre because extra tape is supplied with a controlled oil content for punch and die lubrication. ROBINS INDUSTRIES CORP., College Point, N.Y. For information:

CIRCLE 204 ON READER CARD

### gp computer

The recently announced (Feb., p. 17) B500 is an advanced model of the Burroughs B100, 200 and 300 computer systems; it is assembly language-compatible with the lower models, and has COBOL compatibility with the B2500 through 8500 systems. A disc file systems memory with a capacity of 2.4 million characters (stored in 240-character segments) extends the main memory of 9.6K or 19.2K words. Among the configurations of the 500 available are ones which are oriented to on-line data communications, random access processing and multiprocessing. Peripherals will include the mag tape cluster and a new 315 lpm printer. Basic system with the disc memory leases for \$4,635/month or can be purchased for \$233,910. A mag tape oriented system is \$3,100/month or \$150,275 purchase price. Deliveries will begin fourth quarter '68. BURROUGHS CORP., Detroit, Mich. For information:

CIRCLE 205 ON READER CARD

### hexadecimal adder

The Hex Adder is an aluminum pocket-sized hexadecimal calculator to aid programmers in adding and subtracting in the base-16 numbering system. Sums up to FFFFFF (16,777,215) can be calculated. HEXCO, INC., Houston, Tex. For information:

CIRCLE 206 ON READER CARD

### file maintenance

SHNEL is a set of gp tape file maintenance programs. Through the use of some 10-20 COBOL statements on punched cards, it will add and delete records, modify fields on a single or a group of records, and resequence them if necessary. Currently operational on 360's and the 1410, it reportedly can be implemented on any system with a COBOL compiler and four tapes or discs. DATAWARE, Madison, Wisc. For information:

CIRCLE 207 ON READER CARD

# This business was started by people with Ambition, Guts, Pride, and Brilliance.

**We're looking for more of the same.**

At AUERBACH, we don't make things—we make things happen.

We're an information systems architect and computer consulting organization. We perform systems engineering and management engineering services related to the collection, storage, retrieval and processing of information.

To do this work successfully, we need a wide variety of professionals. These men have different skills with one common denominator: They are top men with fresh, exciting, often brilliant ideas. They are the cream of the cream of the crop.

And right now we need top men to carry on in this tradition. For instance:

**Managers, Management Information Systems.** We need two individuals to work with clients in business and industry who are capable of solving management problems associated with computers. They will perform management analysis studies, determine Data Processing system and equipment requirements, select equipment, design systems, assist in staff selection and D.P. unit organization.

Applicants should be capable of bridging the gap between computer technology and top management in addition to building a staff to perform under his direction.

One man will concentrate in the commercial, business-type environment. The other should be capable of developing systems which attack the root causes of today's social ills—unemployment, urban decay, barriers to individual economic opportunity.

**Manager, Operations Research.** You will take over a nucleus and build it into a strong group devoted to operations research applications in government and industry. You'll shape the technical direction the group will take.

**Manager, Software Consulting.** You should be an entrepreneur with professional experience in design and implementation of multi-computer systems software, operating systems, real-time executive and message switching systems.

You will bear complete responsibility for aspects of management of part of a section devoted to software design, including Marketing, Technical Direction, Staffing. You will also direct preparation of proposals, represent company to clients.

**Senior Planner.** We need an experienced computer systems planner familiar with EDP products and markets. Capable of handling planning problems for manufacturers supplying EDP equipment to government and commercial clients. You should be research-analysis oriented and capable of working in a

consulting relationship with top level management on a wide variety of projects. Diversification of activity, management challenge, and outstanding potential highlight this position.

**Managing Editor.** We need someone to play a leading creative role on the team editing AUERBACH Standard EDP Reports, the most up-to-date and comprehensive independent appraisal of computers and computer-related systems available today.

Our staff members are exceptional because they have to be. Their skill and hands-on EDP experience are matched by few people in the computer field today. If you could handle this sort of challenge, we have a unique opportunity for an innovator and developer of new product areas. We offer you dynamic growth, the freedom to make your ideas happen, and the opportunity to be known as the person who helped "Write the book on computers".

Interested? Contact  
B. A. Garner, AUERBACH  
Corporation, 121 N.  
Broad St., Philadelphia,  
Pa. 19107.



Philadelphia · Washington · New York  
Boston · The Hague  
An Equal Opportunity Employer

**See us at Spring Joint Computer Conference.**

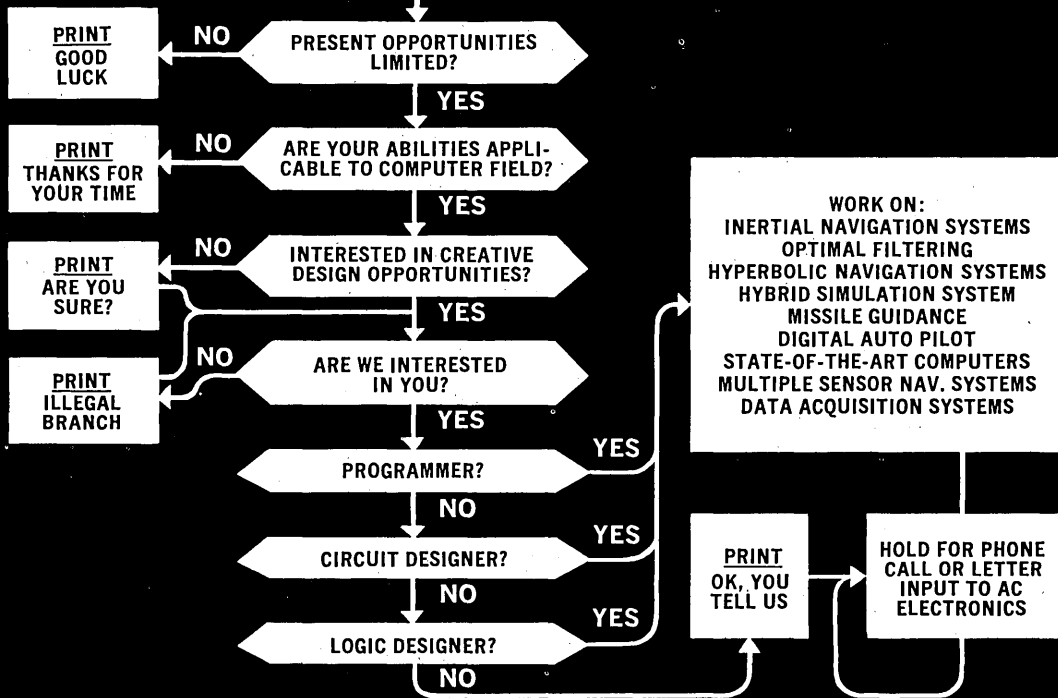

# Program yourself for progress.

Flexibility, diversity, challenge . . . are three vital ingredients for progress you'll find in abundance at AC Electronics. Why? Because, here at AC, you'll have a crack at a variety of jobs on some of today's most exciting and advanced projects. What's more, you'll be in on the ground floor of rapidly expanding computer activity. Example: a Hybrid Simulation System for future space flights already in the works. If you have a degree, plus two or more years' experience, look over the career opportunities listed below. Then write, phone or wire: Mr. R. W. Schroeder, Dir. of Professional and Scientific Employment, Box 506, AC Electronics Div., Milwaukee, Wisconsin 53201.

**Real Time Programmers** — Perform system programming for special-purpose digital and hybrid airborne computers to achieve optimum system performance. Participate in check-out and engineering analysis of programs.

**Simulations Programmers** — Design programs to perform math simulations and modeling of systems and vehicles. Pre-mission check of validity of systems and program accuracy performed on large-scale digital and hybrid computers.

**Design and Programming Aids** — Develop highly automated systems for designing, fabricating, and programming small special-purpose computers, including the development

of programs and techniques to code, assemble, simulate and analyze operational programs.

**Scientific Programmers** — Analyze and prepare computer programs for solution of engineering and scientific problems utilizing the I.B.M. system 360. Applications include missile trajectory simulation, flight test data reduction, design automation and automatic check-out systems for airborne computer software.

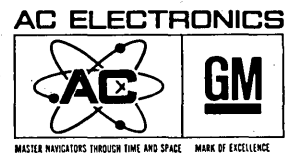

An Equal Opportunity Employer

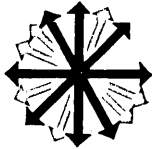

# new literature

**BIOMEDICAL SYSTEMS:** 12-page brochure highlights dp systems for biomedical applications such as patient monitoring and hematological, neurological, pharmaceutical, and physiological research. Each system is built around one of the company's Sigma computers; a block diagram illustrates the organization of a typical system. Programming systems, interface units and peripheral equipment are outlined. **SCIENTIFIC DATA SYSTEMS**, Santa Monica, Calif. For copy:  
CIRCLE 212 ON READER CARD

**QUARTERLY BULLETIN:** Technical service bulletin will be issued quarterly and deal with a variety of subjects in the computer field; the first issue treats the handling and storage of computer tape. Bulletin is designed for 3-ring binder insertion. **3M COMPANY**, St. Paul, Minn. For copy:  
CIRCLE 213 ON READER CARD

**BASE FOR COMPUTER LANGUAGES:** 44-page report describes a flexible base for defining languages and their translators by isolating and utilizing the fundamental elements of computer languages and the fundamental mechanisms of assemblers and compilers. AD-664 086. Cost: \$3; microfiche, \$.65. **CLEARINGHOUSE**, U.S. DEPT. OF COMMERCE, Springfield, Va. 22151.

**AUTOMATED DRAFTING:** 20-page guidebook describes equipment and gives step-by-step presentation of the operation connected with System G technique for graphics composition. The package consists of a graphics input console, programming for the user's existing computer, and a phototypesetter. Recommended configuration of two input consoles, one phototypesetter and FORTRAN programming sells for \$85,000 and may be leased. **PHOTON, INC.**, **ENGINEERING GRAPHICS DIV.**, Wilmington, Mass. For copy:  
CIRCLE 214 ON READER CARD

**CRT PLOTTER:** 24-page manual describes DP-203A digital crt plotter which is designed to interface directly to the IBM 1130 via the storage access channel. The plotter is described in five sec-

tions covering general characteristics, system description, specifications, on-line operating features, and software. **GEO SPACE CORP.**, Houston, Texas. For copy:  
CIRCLE 215 ON READER CARD

**IS&R SYSTEMS DESIGN:** 32-page report outlines the relationship of information-use studies and the design of information storage and retrieval systems. AD-213 781. Cost: \$3; microfiche, \$.65. **CLEARINGHOUSE**, U.S. DEPT. OF COMMERCE, Springfield, Va. 22151.

**PROCESS COMPUTER PLANNING:** 12-page booklet written for top management discusses who needs a process computer and what steps are involved in planning the installation. **GENERAL ELECTRIC**, Phoenix, Ariz. For copy:  
CIRCLE 216 ON READER CARD

**RECORD OF PROCEEDINGS:** 200-page book covers presentations made at the First Annual Simulation Symposium, January 18-19, 1968. Cost: \$5; Canada, \$5.75. **ANNUAL SIMULATION SYMPOSIUM**, P.O. Box 1155, Tampa, Fla. 33601.

**COMPUTER TIME BUYING:** Eight-page brochure discusses commonly used terms in computer time marketing and explains the usual buyer-seller responsibilities. **TIME BROKERS, INC.**, New York, N.Y. For copy:  
CIRCLE 217 ON READER CARD

**VIDEO DISC MEMORIES:** Eight-page manual describes single disc memories with up to 72 completely independent tracks for data buffer storage and storage of digital video data to refresh crt displays. Each track has its own read/write and clock electronics so that tracks can be read or written in parallel. Tracks can be written without disturbing data on adjacent tracks. Brochure includes diagrams of the timing, read/write circuits, I/O circuits, and a brief applications section. **DATA DISC, INC.**, Palo Alto, Calif. For copy:  
CIRCLE 218 ON READER CARD

It's free. The new 1968 Edition.

## Our National Computer Salary Survey and Opportunities Analysis.

This is it. The all-new 1968 edition of Source Edp's FREE 20-page Computer Salary Survey and Opportunities Analysis. It's a summary of computer salaries by 24 separate levels of professional and managerial experience ranging up to \$75,000. Plus a comprehensive analysis of current trends in computer employment.

All of this information has been compiled, analyzed and put together by some of the most knowledgeable people in the business. The people at Source Edp. Source Edp is the only placement firm staffed by computer professionals for computer professionals. It's their business to know the data processing field.

To get your free copy of the 1968 Edition of Source Edp's Computer Salary Survey and Opportunities Analysis just circle the reader inquiry card. To speed delivery write directly to:

source  edp

Where computer professionals place computer professionals

Chicago — David D. Grimes, 100 S. Wacker Drive (312) 782-0857  
Detroit — Charles T. Walther, 2990 West Grand Blvd. (313) 871-5210  
Los Angeles — Robert A. Davis, 3470 Wilshire Blvd. (213) 386-5500  
Minneapolis — Fred N. Anderson, 507 Marquette (612) 332-8735  
New York — Edward T. Golden, 1414 Ave. of the Americas (212) 752-8260  
San Francisco — Richard M. Clark, 111 Pine Street (415) 434-2410

Client companies assume our charges.

CIRCLE 303 ON READER CARD

# FREE

Over 50 current job opportunities listed with manufacturers, users, consultants, universities and government (in all sections of the United States)



For: Programmers (scientific and commercial)  
Systems analysts  
Hardware engineers  
Software specialists  
Salesmen and consultants

Many of these positions are listed exclusively with the Callahan Center.

## Callahan Center for Computer Personnel

Suite 414 Boulevard Building  
1819 John F. Kennedy Boulevard  
Philadelphia, Pennsylvania 19103

### Going to the SJJC?

While in Atlantic City, call our Philadelphia office collect to dictate your resume and discuss these opportunities. Call 215-LO 7-4811

CIRCLE 307 ON READER CARD

# 360 OPPORTUNITY

Expanding data processing installation has opportunities for experienced personnel in a top ranking corporation in the machine tool industry.

## ANALYST PROGRAMMERS

To assist in the designing and implementation of a real time data collection system and other manufacturing applications, under S-360 environment. Applicants should have 2 or more years of systems experience and some knowledge of assembly language.

## PROGRAMMERS

Candidates should possess the following qualifications:

1. 1 to 2 years programming experience, preferably IBM 360, however we will train sharp 1400 men.
2. Willingness to meet the challenge of implementing application in a real time environment.

If you have any of the above qualifications, please send a resume stating salary and employment history.

## FLICK-REEDY CORPORATION

YORK AND THORNDALE RDS.  
BENSENVILLE, ILLINOIS

AN EQUAL OPPORTUNITY EMPLOYER

CIRCLE 337 ON READER CARD

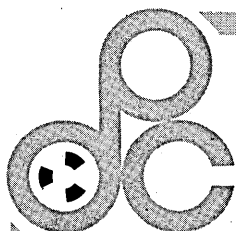

# Programmers

### BRANCH TO?

As a competent programmer or programmer analyst you know you need the proper data to write an efficient program. You require well defined, correct and documented input to make valid decisions in the logic of your system.

### WHAT ABOUT YOUR CAREER?

You have an idea of what the job market place is like. You know it is a sellers' market and that your services are in great demand. But do you have the proper data, the proper input, to make an important decision in your career planning logic?

### DPC CAN HELP!

DPC is the placement firm for data processing personnel—We staff our offices with Data Processing Professionals. These men can help you define your objectives, evaluate your experience and assist you in your career planning. They provide the proper data about job environment, challenge and reward. We currently are seeking, on behalf of our client companies, programmers with experience in COBOL, BAL, RPG and PL/1. There is no charge for candidate evaluation or placement services. For details contact:

## data personnel consultants

Paul G. Roland, 100 Constitution Plaza, Hartford, Conn., (203) 522-8248  
Joseph R. Falvey, 274 Weybosset Street, Providence, R.I., (401) 274-7250  
Dan L. Rees, 60 Hickory Drive, Waltham, Mass., (617) 893-0830  
John F. Klar, 1815 Ft. Myer Drive, Arlington, Virginia, (703) 525-6350

CIRCLE 306 ON READER CARD

## Use The Professional Approach To Advance Your Career let DATAMAN\* do it

As leading national personnel consultants in the EDP field exclusively, we have been retained by client companies to search for outstanding individuals with experience in:

- Scientific Systems & Programming Analysis
- Digital & Logic Design Engineers
- Real Time Programming
- Business Applications Systems & Programming

SEE YOU AT THE  
SPRING JOINT COMPUTER CONFERENCE  
Visit with us & let's discuss your career

or send resume:

**DATAMAN**<sup>®</sup>  
ASSOCIATES  
personnel consultants

1330 BEACON ST. • BOSTON, MASS. 02146  
(617) 232-2253

\*Data Management—Recruiting specialists for Data processing personnel exclusively.

CIRCLE 305 ON READER CARD

DATAMATION

# Careers at Collins

Collins Radio Company, a recognized leader in the field of electronics, continues to expand and diversify. And this diversification has resulted in a third generation computer system manufactured by Collins. This newly initiated program is creating exceptional careers for computer-oriented personnel in a wide range of activities.

## PROGRAMMERS

Assignments will be in such areas as:

### ADVANCED SYSTEMS PROGRAMMING DALLAS, TEXAS

These assignments on Collins technical staff will involve creative design work in the area of advanced computer hardware/software systems.

### HARDWARE PROGRAMMING NEWPORT BEACH, CALIFORNIA

These positions will require solving of hardware interface problems employing discs, disc packs, tapes, teletypes and CRT devices.

### MACHINE LANGUAGE PROGRAMMING

### NEWPORT BEACH, CALIFORNIA

Assignments for these positions will be on existing large scale systems and will involve

communication and message switching operations.

### DIAGNOSTIC PROGRAMMING CEDAR RAPIDS, IOWA

These positions will require the design, writing and documentation of hardware diagnostic programs to perform factory check-out and field maintenance of digital hardware and systems.

### DIRECT DIGITAL CONTROL PROGRAMMING NEWPORT BEACH, CALIFORNIA

Duties will involve work on computer controlled factory machines and numerical controlled devices and process control.

All of the above programming openings will require previous programming experience, plus a knowledge of Fortran, Cobol, or other computer languages. A bachelors degree in Math, Engineering or Science highly desirable, but not mandatory. Recent college graduates will be considered; however, these candidates must have a record of outstanding academic achievement.

In addition to Programmers, Collins Radio Company has immediate requirements for:

### HARDWARE DESIGN PERSONNEL/CEDAR RAPIDS, IOWA

#### LOGIC DESIGN

Duties will involve logic design in the development of digital computer hardware including processors, input/output hardware, control hardware, etc. BSEE or MSEE required.

#### DIGITAL CIRCUIT DESIGN

This engineering assignment will include the design and development of state-of-the-art memory, computer and I/O equipment circuitry to be implemented in I/C, thin film and discrete component form. BSEE or MSEE required.

#### EQUIPMENT PACKAGING DESIGN

This position will involve the development of mechanical packaging for electronic equipment. Applicants must be familiar with requirements for ARINC and MIL electronic equipment environmental specifications. BSME or MSME required.

For additional information about these or other openings currently available at all 3 Collins locations, send your resume in confidence to Ben E. Jeffries, Corporate Manager, Professional Employment, Collins Radio Company, Dallas, Texas 75207.

*an equal opportunity employer*



## IMMEDIATE SEATING

- if you're exceptionally knowledgeable in your field
- if you're willing to utilize your full potential
- if you've reached the limits of your present position



We are the leading Personnel and Management Consultant Organization concerned with EXCLUSIVE placement of Data Processing Personnel. Our extensive search facilities and specific recruiting place us in a unique position to fulfill the requirements of employers of Data Processors. Your application is processed by E.D.P. Specialists who know the industry, its needs and WHERE THE OPPORTUNITIES EXIST. All fees are paid by the hiring company; there is no charge to the individual. Please contact Mr. Henry J. Lloyd, President.

Visit our Suite During SICC at Howard Johnson Motor Lodge.

### EMPLOYMENT FOR DATA PROCESSORS

140 Barclay Center, Cherry Hill, New Jersey 08034  
609/428-7238



CIRCLE 308 ON READER CARD

## DATA PROCESSING PROFESSIONALS

HAVE YOU HEARD OF

# CASES

Let our 360 evaluate your qualifications against all orders in CASES (Computerized Applicant Search, Evaluation and Selection) for one year. Positions are located in all areas of the country.

Send us a resume along with your geographic restrictions and salary requirements and CASES will search for you.

If you don't have a resume send us your address and we will forward you a simplified INPUT form. No cost or obligation. All replies strictly confidential.

J. J. MC NICHOLS



**FOX-MORRIS ASSOCIATES**  
*Personnel Consultants*

1500 Chestnut Street Philadelphia, Penna. 19102

CIRCLE 309 ON READER CARD

# Computer systems engineers

The Aerospace Corporation has immediate openings for men of superior capabilities. Successful applicants will have an opportunity to influence and contribute to many of the nation's major space programs.

These positions require a B.S. degree (preferably an M.S.) and five years of directly related experience.

### COMPUTER SOFTWARE SYSTEMS ENGINEERS

Senior-level engineers are needed to participate in software systems design, technical direction and evaluation of software products in various stages of development. Experience is required in one or more of the following areas: command and control, multiprogramming and multiprocessing of operative systems; software validation; message switching; automated equipment check-out; direct digital control. Emphasis will be placed on improving the effectiveness of computer program development and real-time computer system design.

### SPACE COMPUTER SYSTEMS ENGINEERS

Opportunities exist for qualified systems engineers interested in pushing the frontiers related to space systems applications. Applicants should be experienced in aerospace computer development and be familiar with state-of-the-art, software and systems design methods. Assignments will include formulation of computer requirements for space-oriented applications, definition of computer interfaces, and performance of related trade-off studies.

### DIGITAL SYSTEMS ENGINEERS

We're seeking qualified digital computer engineers who can develop computer systems to support space missions. Applicants should have experience in digital systems design and theory. They should be familiar with large-scale computers, software and systems design methods. Typical assignments include determination of ground-based computer requirements to support launch and orbital operations, development of computer functional specifications, and performance of related trade-off studies.

# The Aerospace Corporation



To apply for these interesting positions, please forward your resume to:  
C. J. Thomas, P.O. Box 95085, Los Angeles, California 90045

CIRCLE 310 ON READER CARD



# If you're really serious about making the switch to computer sales and marketing,

We're between the horns of a dilemma. Which puts you square in the middle of a really unusual opportunity.

Even by the standards of the fast growing computer industry, our growth rate has been little short of phenomenal. But growth like ours depends on more and more trained people.

Which is where you come in.

Because if you are ready to learn this industry; if you believe, as we do, that the future lies with communications oriented, large scale, general purpose computer systems; and if you're ready to work hard, we're ready to train you.

This is a rare opportunity not only to get into marketing and computer services but to work for the company that's second to none in the supercomputer field, second to only one in the peripheral field and way out front when it comes to intriguing and highly advanced applications. All of which means that you have the opportunity not only to get into computer marketing and sales, but to get in on the tremendous professional growth potentialities that go with a Control Data career. The first step: Fill out the coupon, or rush your resume to, Marketing Division, Control Data Corporation, 8100 34th Avenue South, Minneapolis, Minnesota.

An equal opportunity employer.

**CONTROL DATA**  
CORPORATION

We deliver what others promise.

## here's your chance.

Marketing Division  
Control Data Corporation  
8100 34th Avenue South  
Minneapolis, Minn. 55440

Gentlemen:

Tell me more about employment opportunities with Control Data's Marketing Organization.

My location preference is:

East  West  South or Southeast  Midwest  Southwest

Name \_\_\_\_\_

Address \_\_\_\_\_

City \_\_\_\_\_

State \_\_\_\_\_ Zip \_\_\_\_\_

Phone \_\_\_\_\_

Present Job Title \_\_\_\_\_



# books

**The Management of Computer Programming Projects**, by Charles P. Lecht, American Management Association, \$16.50 (to nonmembers of AMA; \$11 to members).

Although computer programming is an infant as professions go, it has associated with it a mythology that is all out of proportion to its age. One of the myths is that there is a real shortage of programmers. A second has it that programming is the kind of work that is called creative: creative work just cannot be managed. Or, a variation of the second myth has it, creativity is stifled if it is constrained in any way—

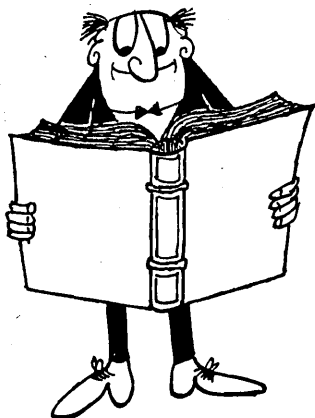

e.g., please describe for me what it is you plan to do so I will be able to tell when you are finished (if ever); your description should be such that I will also be able to determine if you did what you said you were going to do.

There is a vast amount of evidence to indicate that writing—a large part of programming is writing after all, albeit in a special language for a very restricted audience—can be planned, scheduled and controlled, nearly all of which has been flagrantly ignored both by programmers and their managers. If you deny the assumption that programming is different, the bookshelves are brimming with tomes that describe for all who are willing to pay attention virtually every aspect of programming management (perhaps it is because the language of these books, many of which antedate the birth of programming, is “strange” that their

\*There is a story that asserts computer programming is the oldest profession: who do you suppose created all the chaos that was the raw material out of which the universe was fashioned?

precepts have been ignored by programmers and their managers).

If the written literature were not enough to persuade programmers and their managers that their work is amenable to methods long known, they need only look as far as their technological contemporaries for such assurance. Should they do so, they could not remain unaware that some of the technology-based tasks of this part of the Twentieth Century are at least as complex and involve at least as much creativity—whatever that is—as does programming itself. For example, consider the activities that are called the design, development and manufacture of the computer itself.

Perhaps what is lacking in programming is maturity, the kind of thing to which J. Presper Eckert was referring in his talk at the Fall Joint Computer Conference in 1965. Programming, he implied, would be manageable when we could refer to it as “software engineering.” Such a name would constitute recognition that, as a discipline, programming had come as far as the older, maturer engineering professions. Two main categories of events must occur before “software engineering” becomes an apposite descriptor. One of these events is anticipated by the growing number of universities with “computer science” programs. The second is the “discovery” that computer programming projects can be managed.

It may very well be that Charles P. Lecht will be long remembered for his

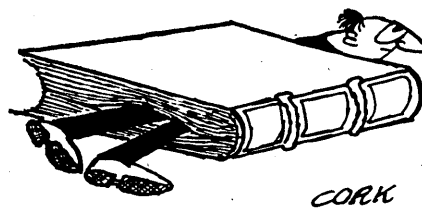

“discovery” that computer programming projects can be managed. His book, blessed and cursed with the jargon he urges programmers to abjure in their documentation, is, simply, a recipe for the *technical* management of computer programming projects. (Assuming that you have all the other ingredients—for example, how to get people to work together—this cookbook will enable you to put your cake together and get it out of the oven,



Whether you are interested in broad commercial applications or scientific challenge, ITT Data Services can supply the situation—just bring your ingenuity and imagination.

### Programmers & Analysts for Commercial & Scientific Applications & Systems Development

Scientific and Commercial applications will involve FORTRAN, MPS (IBM 360LP), PMS, ECAP, ICES, GPSS, BAL (with QTAM & BTAM), COBOL, RPG, PLI, and a full range of IBM 360 operating systems as well as our own operating system which we developed to provide efficient multi-programming and teleprocessing. Our Systems Development Group is also doing unique software development on special purpose operating systems designed for wide-spread use in the near future.

Openings at our metropolitan New York-New Jersey, Boston, Washington, D.C., and Los Angeles offices require a minimum of 1 year programming experience associated with IBM 360 equipment. A degree is desirable.

For East Coast openings,  
send your resume to:  
Charles Johnson, ITT Data Services  
Box 402, Rte. 17 & Garden State Parkway,  
Paramus, New Jersey 07652

For West Coast openings,  
send your resume to:  
Ed Stiles, ITT Data Services  
999 No. Sepulveda Blvd.  
El Segundo, California 90245

### ITT Data Services Naval Programs

NTDS and A-NEW openings at Virginia Beach, Va. require a BS and minimum of 6 months programming experience involving Real-Time Command/Control Systems on such equipment as IBM 360/65, 67, RCA Spectra 70, GE 600, CDC 3000, 6000, Univac 490, 1206, 1830, 1230, 1218.

For further information,  
send your resume to:  
William Cassidy, ITT Data Services  
Fleet Computer Programming Center  
FAAWTC, Virginia Beach, Virginia 23461



## When you program for ITT Data Services, You're right in the middle of things.

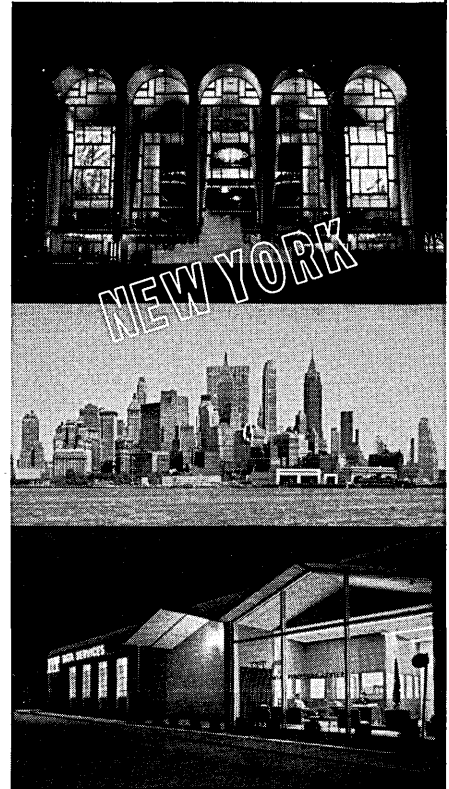
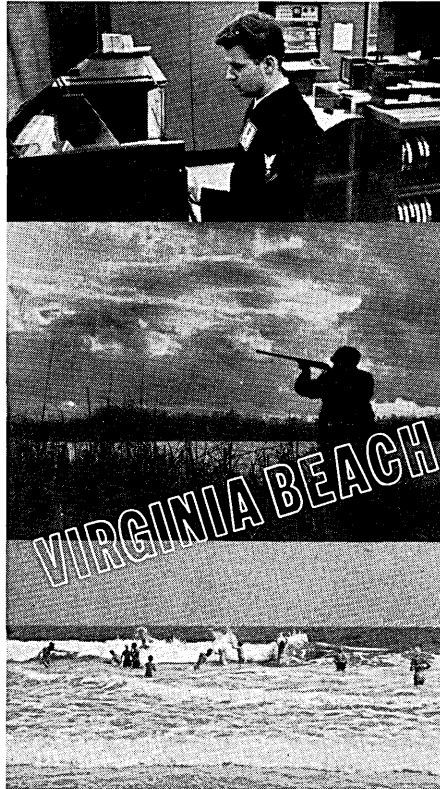

## And that goes for location as well as technology.

All of our Data Processing Service Facilities are located in population nerve centers. The one in New Jersey (equipment-wise, the largest in the world) is linked to five satellite stations throughout Greater New York—New England area. And there's one similar to it in Los Angeles, soon to be linked by high speed lines with satellites in Northern and Southern California to serve almost any organization from industrial giants to small accounting firms. We have a special center in Virginia Beach, Va., a top vacation spot, which services NTDS (Navy Tactical Data System) and A-NEW (A New Project).

ITT Data Services computer networks offer a full range of business and scientific data processing services to both private industry and government. These services include systems design, programming, computational services and data center management.

Technically, you will cover a lot of advanced ground. At our Eastern and Western Regional Commercial Computer Centers you'll be involved in large-scale, multi-computer, real-time, multi-language systems and more. With NTDS and A-NEW, in Virginia Beach, there are special problems of solving input-output communications, interrogation and response, tactical geometrics and inter/intra

computer logic and timing problems.

You'll find the ITT benefits program exceptionally liberal—and all of our locations afford an opportunity to pursue advanced studies at nearby colleges and universities under the ITT tuition refund program.

Get in the middle of things. Review the information on the left-hand page and contact our representative at the location of your choice.

### SJCC INTERVIEWS

If you plan to attend the AFIPS Conference, contact our representative in Atlantic City April 30 — May 2. See local papers for details.

A Division of International Telephone and Telegraph Corporation

A Plans for Progress Equal Opportunity Employer (m/f)

**ITT**  
DATA SERVICES

## Growth Jobs for EDP PROFESSIONALS

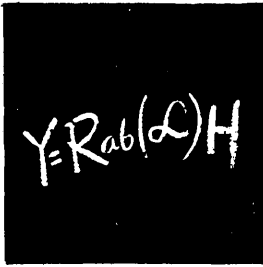

**Software**

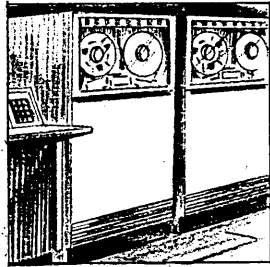

**Hardware**



**Anywhere!**

At Brentwood, degreed professionals have the necessary data to help EDP professionals advance their careers. Our client company openings represent excellent situations in research, development, and operations. Our job openings provide maximum growth potential. Our experience and knowledge assures the applicant of being introduced to the company and position best suited to him . . .

**Brentwood offers fee-paid growth opportunities in the following areas:**

- language development • compilers • operations • research • commercial and scientific programming • systems design and analysis • information retrieval • digital and logical design • graphic and CRT display •

Contact or call collect in confidence (201) 622-0915

786 Broad St.  
Newark, N.J. 07102

**BRENTWOOD**  
PERSONNEL ASSOCIATES

Other offices in:  
Boston, Mass. and  
Philadelphia, Pa.

CIRCLE 312 ON READER CARD



## LOST YOUR FIRE?

When was the last time you were offered a real challenge? Solved a problem your own way, got a raise or even a pat on the back, or had the satisfaction of seeing your own ideas put into practice?

If you are looking for these things in a professional environment . . . we ought to talk. Wouldn't you say?

**SYSTEMS ENGINEERING.** Military data systems and communications systems. BS or MS, 4-7 years experience.

**LOGIC DESIGN.** Digital display and information processing equipment; BSEE; 4-5 years experience.

**OPERATIONS RESEARCH.** Studies of communications and control systems, war gaming, systems modeling. BS degree plus 5-15 years experience.

**SOFTWARE DEVELOPMENT.** To develop complex programming systems & systems analysis. Machine language, FAP and MAP. 1-3 years experience.

**LEADER — DISPLAY SYSTEMS.** To lead digital computer driven display system applications efforts. 5-10 years experience.

**SYSTEMS PROGRAMMER.** To carry out development of display console software, integrate computer graphics and packages into operating systems. Also analyze customer requirements and display applications. 3-7 years experience.

Call or write Thomas Householder, DI 6-6000, Ext. 251



**THE BUNKER-RAMO CORPORATION**  
DEFENSE SYSTEMS DIVISION  
8433 FALLBROOK AVENUE • CANOGA PARK, CALIF. 91304  
An Equal Opportunity Employer

CIRCLE 313 ON READER CARD

## books

frosted, and onto the table.) As such, it is the first of its kind, long overdue, and much welcome despite its myriad of minor faults (I shall say more about them collectively below).

If you do not already have or use the technical tools for the management of computer programming projects, I recommend that you acquire a copy of Mr. Lecht's book at once. The price is outrageously high—considering its content and the manner of its production—but if you view its acquisition as an investment, it would be one well made. In so many words—and there are *so many* of them—Mr. Lecht tells the reader how to:

1. Plan the work;
2. Schedule the work; that is, how to allocate resources to the description of what is to be done;
3. Estimate the time and cost of doing the work;
4. Write product specifications, documentation, workbooks; and
5. Review and control progress.

In addition to telling the reader how to do these things, he provides such useful items as checklists and forms for the collection of management information. One could hardly ask for more.

Nevertheless, I dare to ask for more. For example, there is virtually no evidence that the book was subjected to the scrutiny of an editor who was concerned with anything but typographical errors (of which I recall finding only one, a fact I attribute to luck and perseverance). I offer just one instance of this want of editorial assistance, a sentence from page 50: "However, completion of the plan and specifications *does not mean they are complete*" (Lecht's emphasis). On page 97, the text and the formulas are inconsistent, a more serious error, but it will not be difficult for the reader to change the text to match the formulas, or the formulas to match the text, to suit his tastes.

Penultimately, I must make reference to the very strange Chapter XIII, Personnel Selection. This subject is dismissed in three and one-half pages (where none would have been better). The chapter is concerned exclusively with clichés about interviewing—and preinterviewing (sic)—of applicants: "It should be remembered that *common sense*, first and foremost, is the best 'tool' in interviewing candidates." The less said about these few hundred words the better: ignore this chapter; instead, go, on the one hand, to the literature of the Computer Personnel Research Group (now a SIG of the ACM) and, on the other, to the vast general literature of personnel man-

(617)  
**274-6083**

**This is a working number for  
LOGIC DESIGNERS.**

Major long-term programs at Raytheon's Bedford Laboratories, Bedford, Massachusetts, require Digital Logic Designers to work in these areas:

**Radar Signal Processing • Digital Signal Processing  
Special Purpose Computing Devices • Multi-processing  
Computers • Radar Control Units**

— on programs such as SAM-D and MSR. Previous experience in any of these areas, plus a technical degree, is required.

This is an opportunity to merge your own long-term career objectives with a team working in many advanced and long-term electronic fields. Join the leaders!

For your interview, call Dick Neal (collect) at this "working number", (617) 274-6083, or send your resume to Dick Neal, Missile Systems Division, Dept. 65, Raytheon Company, Bedford, Massachusetts 01730.



*An Equal Opportunity Employer*

# WESTINGHOUSE INFORMATION SYSTEMS

The Westinghouse Information Systems Laboratory provides development work and services in information systems which relate directly to company performance. This includes the design, implementation, and operation of information systems for Westinghouse organizations in on-line control applications, entering new professional service-oriented businesses, and in engineering/manufacturing activities. Several areas are now receiving emphasis:

## TIME-SHARING

The Time-Sharing Department will provide interactive, conversational computer capabilities to Westinghouse personnel in diverse activities. Many excellent opportunities exist in a new organization for people with three to six years or more experience in a time-sharing or real-time multiprogramming environment, in these functions:

- **Computer Software Analysts & Programmers**—design and/or implementation experience in one or more of the following: time-sharing operating systems and command languages, conversational compilers, real-time telecommunications systems and operating systems, file-management systems. Technical degree desirable.
- **Applications Analysts/Consultants**—broad experience in analysis and programming of engineering and scientific problems. Multi-language capability (Fortran, Algol, Basic, etc.) desirable. Ability to easily and effectively communicate with individuals and groups at all levels essential. Technical degree desirable.

## MANAGEMENT INFORMATION SYSTEMS

The Management Information Systems Department is engaged in extensive and innovative computerized systems, requiring proven expertise in operational and strategic analyses, systems planning and design and applications. The activities involve both management control systems and management science techniques in industrial and other areas. Excellent opportunities exist for experienced people in these functions:

- **Management Systems Senior Analysts & Analysts**—substantial experience in medical, educational or municipal systems. Scientific or technical degree and programming experience desired.
- **Management Science Project Leaders**—strong technical background in both management information systems and management sciences/operations research techniques. At least four years of experience in construction of computer-oriented models for management decision-making. Advanced degree(s) or equivalent industrial experience. Ability to deal directly with client in both administrative and technical capacity, and direct project team efforts.
- **Management Sciences Senior Analysts**—self-starters, with a strong desire to see work implemented and operational. Must be able to interview clients, evaluate problems and environments, and formulate workable approach toward solution. Ability to work individually or with a team. Advanced degrees preferred.

If you have substantial experience in any of these functions, you owe it to yourself to investigate the potential in these new activities. Send your resume to Mr. T. B. Mattson,



**INFORMATION  
SYSTEMS  
LABORATORY**

CHATHAM CENTER—BOX 1017  
PITTSBURGH, PENNSYLVANIA 15230

An Equal Opportunity Employer

CIRCLE 315 ON READER CARD

## books ...

agement, if you are also interested in personnel selection.

Finally, let me hope that this book will be the object of that sincerest form of flattery, imitation, immediately and in copious quantity. But, I pray, the imitation should be of purpose, not of form.

—ROBERT M. GORDON

## book briefs

(For further information on the books listed below, please write directly to the publishing company.)

**Simulation Using Digital Computers**, by George W. Evans II, Graham F. Wallace, and Georgia L. Sutherland. Prentice-Hall, Inc., Englewood Cliffs, N.J. 1967. 195 pp. \$11.50.

Focusing on the creation and use of computer simulation models, the book distinguishes between model, method of solution and simulation, and demonstrates how simulation differs from other methods of solution. Exemplary models have been taken from military systems. The authors also discuss the relationship of digital computing to simulation, and show how current computing systems may be used as tools for simulation.

**Management Systems: A Book of Readings**, edited by P. P. Schoderbek. John Wiley & Sons, Inc., New York, N.Y. 483 pp. \$10.95.

A collection of 51 articles, all of which have appeared previously in such publications as *Harvard Business Review*, *DATAMATION*, *California Management Review*, *Data Processing*. Intended primarily as recommended reading for college courses in management systems, the book, well-designed and illustrated, includes sections on real-time systems; PERT, PERT/COST; cybernetics; human problems of systems; models and simulation; information retrieval; the systems concept, etc. Each of the 14 sections ends with a bibliography.

**Mathematics and Computing: With FORTRAN Programming**, by William S. Dorn and Herbert J. Greenberg. John Wiley & Sons, Inc., New York, N.Y. 1967. 595 pp. \$8.95.

In textbook format, this book, written for a student who has completed two or three years of high-school math, teaches algorithms and computer programming, and covers such topics as linear systems of equations and inequalities with optimization, calculus,

## What do you want most?

- |                                      |                                   |
|--------------------------------------|-----------------------------------|
| <input type="checkbox"/> Respect     | <input type="checkbox"/> Title    |
| <input type="checkbox"/> Money       | <input type="checkbox"/> Location |
| <input type="checkbox"/> Challenge   | <input type="checkbox"/> Security |
| <input type="checkbox"/> Opportunity | <input type="checkbox"/> Fringes  |

Our nationwide survey in the Financial & EDP field revealed that employment desires were in the order listed above.

We can assist in finding exactly what you want in Financial or EDP employment. That's all we handle... we're the largest specialized source.

### Fees Paid By Management

MANAGER DATA PROC. ....	\$35,000
Investment banking	
MANAGER MGMT INFO. ....	\$22,000
Soft goods manufacturer	
EDP SUPERVISOR ....	\$22,000
Listed company	
SYSTEM MANAGER ....	\$22,000
Heavy manufacturing	
OPERATIONS RESEARCH ....	\$20,000
Chemical products mfr.	
MGMT/INFO SYSTEMS ....	\$20,000
Business equipment mfr.	
MANAGER DATA PROC. ....	\$20,000
Converting to UNIVAC	
SYSTEMS/PROGRAMMER ....	\$20,000
Publishing co.	
SYSTEMS MANAGER ....	\$18,000
Forms design, paper flow	
SYSTEMS ANALYST ....	\$18,000
Public acting or consulting exp.	
PROGRAMMER ....	\$17,000
Experienced IBM 360	
CONSULTANT, INTERNAL ....	\$18,000
Giant industrial	
SR. COMPUTER ANALYST ....	\$17,000
Design, install systems	
EDP MANAGER ....	\$16,000
Retail chain	
MGR SYSTEMS & PROC. ....	\$16,000
Initiate/revise systems	
SR. SYSTEMS ANALYST ....	\$15,000
Chemical products	
SYSTEMS ANALYST ....	\$15,000
Multi-plant manufacturer	
EDP MANAGER ....	\$15,000
Honeywell equipment	
PROGRAMMER 360 ....	\$14,000
1 year experience	
PROGRAMMER ....	\$13,500
1-2 yrs. any equipment	

Mail resume to your nearest R-H office.



Atlanta: 235 Peachtree St., NE (404) 668-2300  
Baltimore: One Charles Center (301) 837-0313  
Boston: 140 Federal St. (617) 423-6440  
Chicago: 333 N. Michigan Ave. (312) 782-6930  
Cleveland: 1367 East 6th St. (216) 621-0670  
Dallas: 1170 Hartford Bldg. (214) 742-9171  
Detroit: 1114 Guardian Bldg. (313) 961-5430  
Garden City, N.Y.: 585 Stewart Ave. (516) 248-1234  
Los Angeles: 3600 Wilshire Blvd. (213) 381-7974  
New York: 330 Madison Ave. (212) 986-1300  
Newark: 570 Broad St. (201) 623-3661  
Philadelphia: 2 Penn Center (215) 568-4580  
Pittsburgh: 429 Forbes Ave. (412) 471-5946  
St. Louis: 1015 Locust St. (314) 231-0114  
San Francisco: 111 Pine St. (415) 434-1900  
Stamford, Conn.: One Atlantic St. (203) 325-4158

World's Largest Financial & EDP Personnel Specialists.

CIRCLE 316 ON READER CARD  
**DATAMATION**

 SPERRY RAND

**What's the  
relationship  
between you and  
your employer?**

**ONE WAY** 

**Here at Univac**, the relationship between you—a programmer or systems analyst—and management is *always* a two-way street. When you output, we input. Which means you get new experience and responsibilities just as fast as you can handle them. And you get paid accordingly.

What are we doing now? Creating the finest computer hardware/software in the industry. We're producing advanced software. And exploring new logical language translation, compiler construction, mass memory allocation, information storage and retrieval, and interpretive programs. We are conducting research in assemblers and loaders, program documentation techniques, advanced executive systems, remote programming systems, graphics... you name it.

To put your career back on a two-way street, tell us your experience, capabilities and goals for today/tomorrow. Write: R. K. Patterson, Employment Manager, Dept. 109, address below.

**UNIVAC**

FEDERAL SYSTEMS DIVISION  
2750 WEST SEVENTH BLVD.  
ST. PAUL, MINNESOTA 55116  
AN EQUAL OPPORTUNITY EMPLOYER M/F

# THE SOFTWARE SPECIALIST'S KIND OF COMPANY: **ESSO MATHEMATICS AND SYSTEMS**

It's a company created for the prime purpose of developing and applying advanced computer techniques. It has brought together both the management and the staff of computer professionals who can implement at the highest level of technology. It has provided them with the most up-to-date equipment, including 360/50 I and 65 I already installed and more sophisticated hardware to come.

In this environment, the company undertakes research, evaluation, planning and consultation in areas that include: Programming

Languages, Operating Systems, Data Bank Management, Communication Software, Information Retrieval and Graphic Display Techniques, as applied to engineering design, plant operating problems, mathematical programming, operations research projects and similar assignments.

In the scope of its activities, ESSO MATHEMATICS & SYSTEMS is involved in problems of importance and far-reaching implications: as an affiliate of Standard Oil Company (N. J.), EMSI provides its services to other affiliates throughout the world.

To the experienced computer software specialist with a degree in a technical discipline, a career with EMSI offers all of the elements needed for broad career development.

Florham Park, near Morristown, the location of our facilities in suburban (1 hour from N.Y.C.) north central New Jersey, is one of the most pleasant and convenient residential sections in the Greater New York area. The new building containing the most up-to-date computer facilities is scheduled for occupancy in early 1970.

For prompt reply, send resume in confidence to:

Mr. Bruce R. Jones, Professional Employment Representative, Dept: EE-54

**ESSO MATHEMATICS & SYSTEMS INC.**

P. O. Box 101, Florham Park, N. J. 07932

An Equal Opportunity Employer (M/F)

# CAREERS

COAST TO COAST  
EUROPE

# TOP 20%

## EXCLUSIVE!

The unique personal and confidential relationship we establish with you and our clients permits us to offer you outstanding job opportunities, many not found anywhere else. If your potential or abilities are above average and you are looking for a challenge, our unique service provides 49 state and international coverage.

### PARTIAL LIST COMPUTER CAREERS SALARIES \$10,000 — \$35,000

- Marketing/Sales
- Management or Computer Consulting
- Operations Research/Management Science
- Time Sharing/Real Time Systems
- Computerized Process Control
- Management Information Systems
- Systems Planning/Development
- Business Systems, Programming
- Applied Mathematics
- Scientific Computation
- Logic/Digital and/or Circuit Design
- Software/Applications Packages

(From Junior to V.P.  
and Director Levels)

Our clients assume all expenses

Write in full confidence to

Joseph Albert or phone 212/679-5688

Indicate salary and geographic requirements.

Member ACM

Career Consultants in the Data Processing Field



210 Fifth Ave., New York, N.Y. 10010

CIRCLE 318 ON READER CARD

## books

probability and logic. The programming in the given problems is simple FORTRAN, and will run on any computer with a FORTRAN compiler.

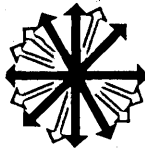

## 360 ADDRESS

by

Vincent P. Howard

(A farewell speech prepared for delivery  
at a termination party.)

Fourscore or about 19 months ago our fathers brought forth on this company a new computer conceived in a market analysis and dedicated to the proposition that scientific and business applications should run in a single job stream. Now you are engaged in a great deal of woe, testing whether that computer, or any computer so conceived and so dedicated, can long endure. You have met at a great computer system full of woe. You have come to dedicate a portion of that system as a final resting place for those who here gave their sweat that the computer might live. It is altogether fitting and proper that you should do this. But, in a larger sense, you cannot dedicate, you cannot consecrate, you cannot hallow that ground. The brave men, living and resigned, who struggled there have consecrated it far above its poor power to add, subtract, or print. The world will little note nor long remember what I say here, but it can never forget what you are doing there. It is for you, the living, rather to be dedicated to the unfinished work which we, who fought there, have thus far so un-nobly advanced. It is rather for you to be here dedicated to the great task remaining before you—that from the honored resigning you take increased devotion to that cause for which we gave the last full measure of devotion—that you should here highly resolve that those resigned shall not have resigned in vain, that any computer under one million bytes shall have a new birth of freedom, and the Management Systems Department of the people, by the people, for the people, shall not perish from the corporation. ■

DO YOUR  
RESPONSIBILITIES  
AND INCOME  
MATCH YOUR  
ABILITIES?

*They would if  
you were part of  
the Ultronic  
Systems Team!*

## WE SEEK...

Design or systems engineers experienced in computer logic or circuitry and familiar with data communications systems up to 4800 baud; or, individuals with programming backgrounds who are knowledgeable in these areas.

Degree preferred; two years' experience in any of these areas required.

## WE ARE...

One of the most progressive non-defense firms in the data communications industry, working on time division multiplexing systems, data modem and video terminals. We developed the revolutionary STOCK MASTER® system, capable of supplying instantaneous information on over 8000 stocks and commodities to brokerage houses throughout the world. Our facilities are among the most modern available, and are located in one of the most progressive communities on the east coast.

## WE OFFER...

Immediate project responsibility, from conception to completion, to qualified persons; and the creative freedom and financial rewards that accompany this responsibility.

A full program of company-paid benefits. If you are ready to accept exciting new challenges, and to truly determine your own future, here's what to do about it:

Visit or call Mr. Jack House at our suite at the Hotel Shelbourne in Atlantic City during the Spring Joint Computer Conference

or

Send your resume today to Mr. House at the company

## ULTRONIC SYSTEMS CORP.

SUBSIDIARY OF  
SYLVANIA ELECTRIC PRODUCTS INC.  
MOUNT LAUREL INDUSTRIAL PARK,  
MOORESTOWN, N.J. 08057  
PHONE: 609/235-7300 • EXT: 232  
an equal opportunity employer

CIRCLE 319 ON READER CARD

**DATAMATION**



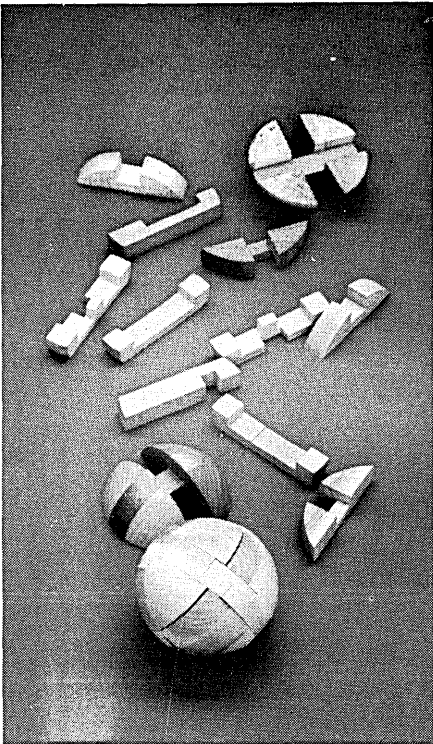

## FOR THOSE WITH AN ECLECTIC BENT

Booz•Allen Applied Research Inc. provides a setting where more than 500 minds of many diverse disciplines seek together to solve wide-ranging problems in military and governmental technology.

Because the spectrum of projects is broad, the pace swift and the responsibilities heavy, personal selection is necessarily limited to the exceptional scientist and engineer whose ability to understand and communicate is eclectic. But the rewards in professional growth are the highest to be found in the scientific community. Typical assignments might include: simulation studies; math modeling; war gaming; information retrieval systems; applied mathematics; operations research. The range is wide; the probing is deep. Over 30 diverse disciplines interact to contribute to unique solutions.

Contact Mr. P. T. Paul, Manager of Staff Selection at the Shelbourne Hotel, Atlantic City, New Jersey during the Joint Computer Conference or write Mr. Robert L. Flint, Director of Professional Appointments.

**BOOZ•ALLEN  
APPLIED RESEARCH Inc.**  
135 South LaSalle Street—Room 1744  
Chicago, Illinois 60603, Phone (312) 372-1728  
CHICAGO / KANSAS CITY  
WASHINGTON, D.C. / LOS ANGELES

 An equal opportunity employer

CIRCLE 320 ON READER CARD  
April 1968

LUNAR HOSTILITY • MANNED SPACE FLIGHT • ROCKETRY •  
UNMANNED FLIGHT • MICROMETEORIDS • MAN-MACHINE  
SYSTEMS • GUIDANCE • TRAJECTORY • ALTERNATE EARTH  
RETURN • COMMUNICATIONS • NAVIGATION • CELESTIAL  
MECHANICS • COMPUTING • SIMULATION • RE-ENTRY •  
LUNAR LAUNCH • PROGRAMS • STATISTICS • SYSTEMS  
OPERATIONS • SPACE VEHICLES • PROPULSION • SOLAR  
RADIATION • APOLLO CHECKOUT • TELEMETRY • HEAT  
TRANSFER • EVALUATING • LOGIC • OPTIMUM ABORT  
PROCEDURES • RELIABILITY • PROBABILITY • VEHICLE  
DYNAMICS • SERVOMECHANISMS • DESIGN • BALLISTIC  
FLIGHT • AUTOMATIC DIGITAL CONTROL • PAYLOAD  
CAPABILITY • GEOPHYSICAL TECHNIQUES • AUTOMATIC  
TROUBLE DIAGNOSIS • DATA PROCESSING

## WANTED: SPECIALISTS IN SPACE

Above are some of the divisional functions of Bellcomm, the systems engineering contractor of the National Aeronautics and Space Administration. Bellcomm is utilizing a wide range of disciplines in its extensive feasibility studies and operations analysis of manned space flight systems.

Bellcomm's work on Project Apollo offers rewarding employment opportunities for persons especially qualified in such fields as physics, mathematics, engineering, flight mechanics, propulsion, man-machine relationships, computer programming, aerodynamics and aeronautical engineering in general.

If you believe you are such a person, Bellcomm will welcome your inquiry. Send your résumé to Mr. N. W. Smusyn, Personnel Director, Bellcomm, Inc., Room 1606-E, 1100 17th St., N. W., Washington, D. C. 20036. Bellcomm is an equal opportunity employer.



**Bellcomm, Inc.**  
A Bell System Company

**United Aircraft  
Research  
Laboratories**  
**OUTSTANDING  
COMPUTER  
PROGRAMMING  
OPPORTUNITIES  
For You!**

We are seeking programmers who possess the interest and ability to grow in a basic and applied research operation. A background in systems design, engineering, mathematical science, or applied science is necessary. Previous programming experience, however, is not a requisite. Recent graduates, or 1968 graduates, with the required backgrounds will also be considered.

Current Research Laboratories activities encompass a broad range of scientific and systems programming, including general purpose information systems, numerically controlled machine tools, man-machine interactive systems, PERT systems, and computer-aided engineering design.

Our facility combines modern equipment with a firm background in the design of computer languages and programming systems. Significant contributions have been made here in the development and implementation of such systems as FORTRAN and APT. Equipment includes two large-scale digital computers, CRT and hard copy graphical devices, and remote computing stations.

We offer an opportunity to the skilled programmer as well as the recent graduate to find challenge and advancement. If you would like to investigate these broadly-based activities, please contact Mr. P. M. Marcin, United Aircraft Research Laboratories, East Hartford, Connecticut 06108, or call collect (203) 565-8900—an equal opportunity employer.

**United Aircraft  
Research Laboratories**



CIRCLE 321 ON READER CARD



Are you interested in an opportunity to relocate in the nation's leading computer employment area. Positions involved with interesting problems and utilizing advanced techniques and equipment are available to talented and motivated individualists. Salaries are in relation to the potential value of each individual and range from \$8,000 to \$25,000. If you are interested, contact us.

An Employer Financed Organization

**Systemat®**

1107 D Spring Street, Silver Spring, Maryland 20910  
301/587-3650

CIRCLE 322 ON READER CARD



**EDP PERSONNEL SPECIALISTS  
FOR ELEVEN YEARS**

**DATA PROCESSING PERSONNEL**

We have a wide choice of EDP positions available in degree and non-degree skills in salary ranges from \$7,000 to \$25,000 including:

Communication Analysis	System Designers
EDP Systems Analysis	Analyst/Programmers
Programmers, Jr. & Sr.	Programming Services
Systems Planning & Research	Software Specialists
Mgrs. EDP Systems	Computer Operators
Operations Research	Data Processing Sales

In all cases, Interview, relocation, and our search fees are all paid by client firms. You will have several choices of companies or industries to select for your specific job interest. Because we operate a network of offices, positions are located in many areas of the country.

Our Automatic Data Processing Personnel Manager, Mr. Robert E. Keane welcomes your inquiry and/or resume. Or you may call him collect.

For full information—Write, Phone or Wire Today

**SCHNEIDER, HILL & SPANGLER, INC.**

"The People Placers"

Suite 327—121 S. Broad St., Phila., Pa. 19107  
Telephone: 215-KI-6-2804

CIRCLE 323 ON READER CARD

**DATAMATION**



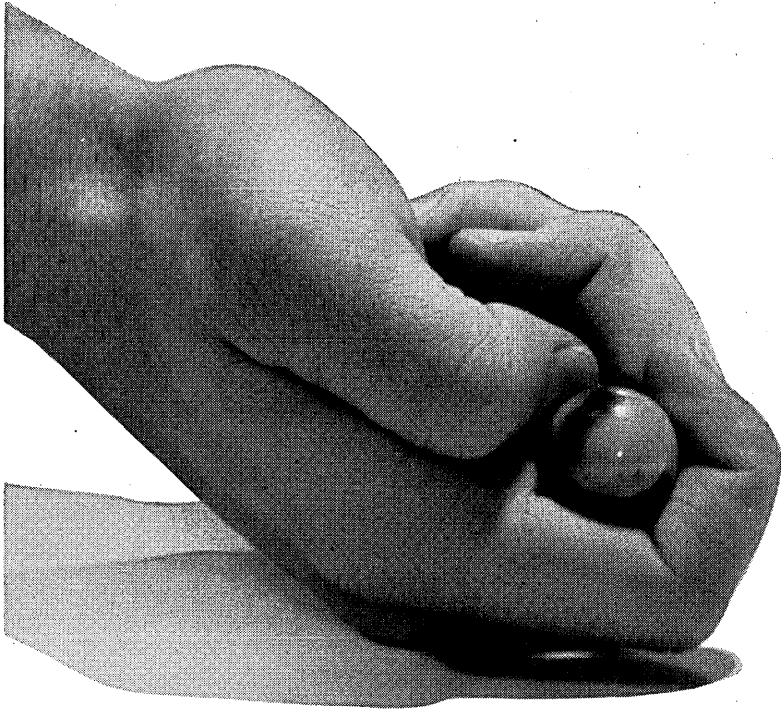

**when you're  
playing for  
all the marbles**

**... you must have the skills.**

That's what we're doing at Foxboro . . . playing for all the marbles. That's why we're particular about our people.

There's nothing "chancey" about the way we hire new employees at Foxboro. We base everything on one simple rule — only the best are acceptable.

Now that we've narrowed the field, let's talk about specifics.

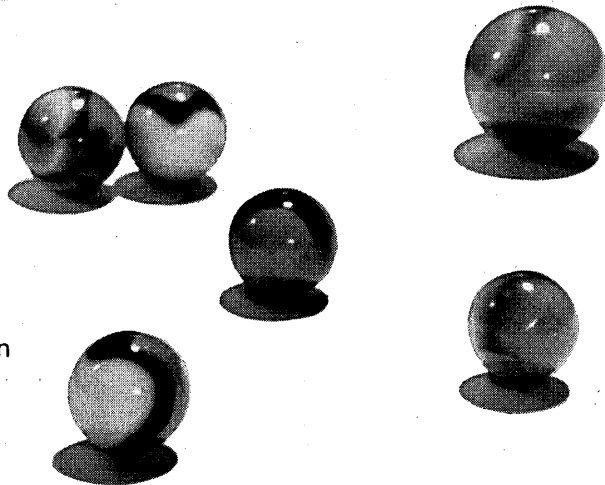

#### **DESIGN ENGINEER**

BSEE majoring in electronics. Minimum of three years' experience in circuit or logic design for high-speed circuitry above two megacycles. Responsibilities will include leading the development efforts in circuit engineering. To work with packaging designers and expected to contribute to system logic discussions for analyzing optimum logic and circuit configurations.

#### **DESIGN PROGRAMMER**

Required to analyze, design and produce sophisticated real time software from broad functional specifications (executives, assemblers, communications — CRT, etc., and other utility packages). Degree required with at least one year of programming experience at the assembly level. Senior programmers need additional experience in the following disciplines: operating systems, languages, communications, command and control.

#### **SYSTEMS PROGRAMMER**

Engineering, scientific or mathematical degree with machine language programming experience in the command and control, scientific or industrial fields. Real time and/or share time experience highly desirable in the following areas: batch control, direct digital control, multi-level programming, supervisory control and scientific programming.

#### **SYSTEMS ENGINEER**

Advanced degree in electrical engineering with minors in control engineering. Minimum of three years' experience in all phases of industrial real time computer systems with emphasis on applications, customer relations and field installation work. Will have responsibility for technical direction of large process computer projects for the power industry.

*If you're sure you have the necessary skills to fill one of these positions, call Mr. Robert Ash collect at (617) 543-8750 or write him at the Central Recruiting Office, The Foxboro Company, Dept. D4, Neponset Avenue, Foxboro, Massachusetts 02035.*

# **FOXBORO<sup>®</sup>**

**Specialists in Process and Energy Control**

Look into other career building opportunities with Foxboro,  
An Equal Opportunity Employer

**SJCC INTERVIEWS/**

To arrange an interview when at the Spring Joint Computer Conference in Atlantic City, please call Robert Ash at 344-8111 from April 30 to May 2 anytime between 9 A.M. to 9 P.M.

CIRCLE 325 ON READER CARD

SPERRY RAND

**UNIVAC**  
world  
headquarters  
wants pro-  
grammers  
who actually  
like  
programming

At UNIVAC world headquarters in suburban Philadelphia—Blue Bell, Pa., in fact—the emphasis is on people and ideas. We know that every bit of software springs from a human idea. And without it, the most sophisticated—and the simplest—hardware is useless. Here in Blue Bell, you might be called from your desk to join a team of data processing pioneers in a discussion of a new idea—maybe a revolutionary concept—because that's where we live. In tomorrow.

Want to talk it over? With people who like the computer business as much as you do? Then write. Your letter will be treated confidentially, and you'll get a prompt reply. The address: C. E. Cooke, Senior Employment Representative, UNIVAC Data Processing Division, Dep't D115, Box 8100, Philadelphia, Pa. 19101.

Write today and make an appointment with tomorrow

**UNIVAC**  
Data Processing Division

An equal opportunity employer M/F

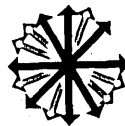

**people**

■ Peter J. Servold has been appointed supervisor of systems research with the recently formed Copley Communications Services, service bureau subsidiary of The Copley Press.

■ Charles J. Vojta, SRDS vp, has been named director of CARDS (Computerized Advertising Rates & Data Service), new Standard Rate & Data Service's division which will furnish newspaper rates and data in computer-sensible form.

■ M. M. Gaito has been appointed group general manager of the newly created ITT Data Services Worldwide. He previously supervised ITT's worldwide internal applications of data processing and information systems.

■ Dr. Karl Hinrichs has been elected to the newly created position of vice-president, engineering, for Astrodata, Inc., Anaheim, Calif., and its subsidiaries, Comcor and Astrodata Research.

■ George E. Dashiell, former marketing vp of RCA's graphic systems div., has been elected president of U.S. Magnetic Tape.

■ Dr. George Schussel has joined Brown Engineering, a Teledyne company, as manager of the information systems div. He had been assistant to the manager of data processing and management information at Northrop Corp.

■ Robert L. Harmon, general manager of the McDonnell Automation Co., has been promoted to divisional vp-gm, McDonnell Douglas Corp.

■ Dr. Jordan Baruch, on leave-of-absence as a vice-president of Bolt Beranek and Newman, has been elected president of the Interuniversity Communications Council (EDUCOM). He succeeds Edison Montgomery, who will resume his full duties as vice-chancellor of the Univ. of Pittsburgh.

■ George H. Ainley has been appointed to the newly created post of sales manager for Avco Data Processing Services, Wilmington, Mass. He comes to Avco from Control Data-CEIR, Cambridge.

■ Douglas E. Robbins has been named vp-sales of Transamerica Computer Co., new computer services subsidiary of Transamerica Corp.

**IF YOU'RE  
BLOCKED  
IN YOUR  
CAREER**



Albert, Nellissen's language to get you further faster through the logical application of our in-depth knowledge of the computer marketplace. Not just a job! But a challenging rewarding opportunity for creative personal progress.

**CAREER OPENINGS  
EUROPEAN AND  
NATION WIDE  
\$10,000—\$40,000**

- Software Development
- Time Sharing Systems
- Logic/Digital Designs
- Management Sciences
- Real Time Systems
- Sales and Marketing
- Scientific Computation

Unique opportunities exist in the \$9000-25,000 class for Managers and Men who can accept management responsibility and professional growth.

**DIRECTOR OF SYSTEMS  
TIME SHARING  
TO \$35,000**

All expenses are assumed by our client companies

Write in confidence, including present salary, acceptable locations or call (Collect) Mr. Nellissen (Area Code 212) Plaza 9-1720

**a&n**

**ALBERT. NELLISSEN, INC.**  
*Leading Consultants to Management in the Data Processing Field*  
510 MADISON AVE., N.Y., N.Y. 10022

# The data processing structure centers on the Programmer. RCA knows that. That's why we want the best.

It's vitally important to a programmer to pick a systems-oriented company. And that's what you get at RCA . . . in a wide variety of applications areas . . . supported by firsts in hardware technology that enable you to program for faster, higher-capacity machines.

Here, for example, are two RCA divisions that are dedicated to the best in programming assignments.

**Information Systems Division** is in a period of unprecedented growth as a direct result of the success of the Spectra 70 product line, a true third generation computer system. Here EDP professionals can find unmatched opportunities for career development.

Systems Programming projects include time sharing, executive systems, random access, compilers, utility systems, information retrieval and other areas. Other career opportunities exist in management information systems, field system support, special industry applications, product planning, engineering and EDP sales.

Openings are at all levels for those with a minimum of 2 years experience. Location is in Cherry Hill, New Jersey and other areas throughout the United States.

**Graphic Systems Division** is busy adding the speed of electronics to typesetting.

At this division we've combined computers with new electronic typesetters that can set the text for an entire newspaper page in less than two minutes. Together, they do the complete job: store and recall manuscripts, size and lay out pages, and set the type.

These assignments require exceptional programmers who combine experience and competence with imagination.

It isn't easy, but it's fascinating; requiring bold creative effort in return for personal recognition and reward.

Openings are at all levels for those with a minimum of 2 years programming experience. Location is Princeton, New Jersey.

*To find out more about these major areas of programming at RCA, write to: Mr. T. Beckett, RCA, Dept. SW-4, Bldg. 2-2, Camden, New Jersey 08102. We are an equal opportunity employer.*

**You can talk to an RCA representative during the SJCC in Atlantic City.**

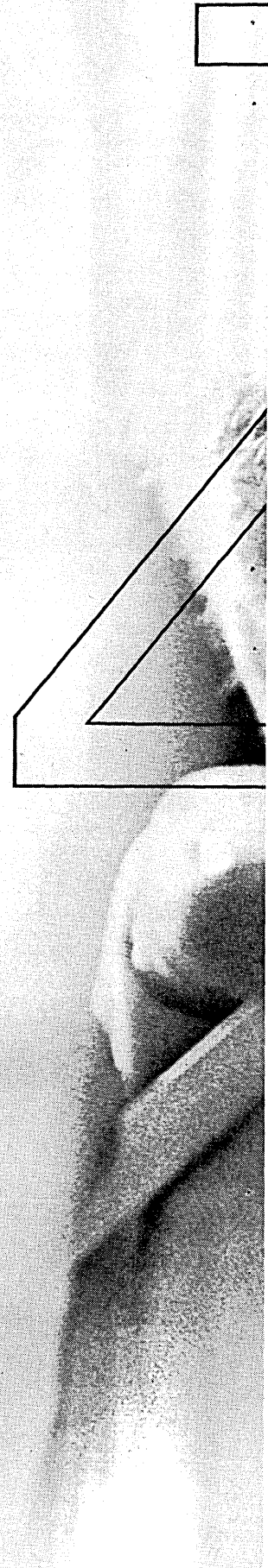

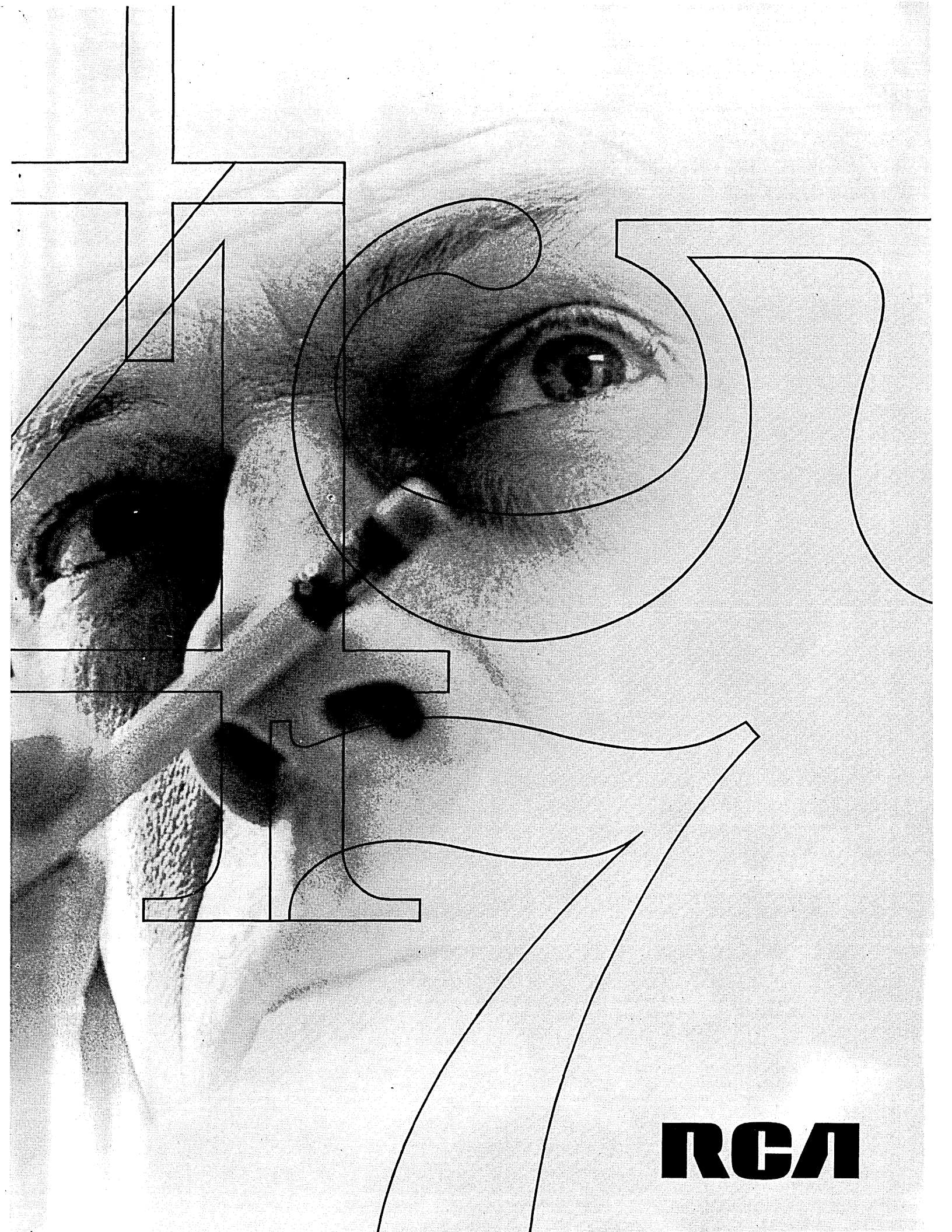

**RCA**

# PROGRAMMERS...HAVE A *REAL-TIME* AT GRUMMAN

(Multi Real-Time, That Is)



Unprecedented "hands-on" opportunities are immediately available at Grumman on projects covering advanced aircraft, space vehicles and undersea technology to programmers interested in working with and developing programs for state-of-the-art Multi Real-Time Telemetry links and providing computerized CRT Real-Time displays for on-the-spot engineering decisions.

In addition, opportunities are also available to programmers interested in implementing computer-based Management Information Systems for Engineering, Material and Manufacturing.

Specific positions require the following qualifications:

## SOFTWARE SYSTEMS PROGRAMMERS

Minimum 4 years experience in large-scale operating system, including I/O supervisory routines, and real-time task management. Must be capable of mastering systems internals with a minimum of instruction, knowledge of computer hardware and a BS in physics, mathematics, engineering (or equivalent) are required. Tasks will include design and maintenance of a real-time multi-programming data reduction system.

## TEST DATA ANALYSTS/PROGRAMMERS

Team leaders to design and implement programming systems for the reduction and analysis of aircraft and spacecraft telemetry and instrumentation data. BS (or equivalent) required with minimum 3 years experience in programming large-scale scientific computer systems. Fundamental knowledge of test vehicle instrumentation valuable.

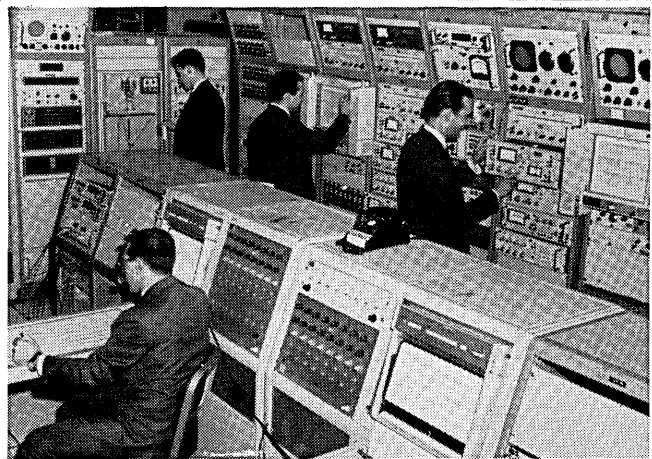

## APPLICATIONS PROGRAMMERS

To assist in development of state-of-the-art applications programs for the reduction of aircraft and spacecraft test data. BS required, 1-3 years programming experience. Current operations include: evaluation of aircraft weapons systems, radar and electronics, structures and total performance, spacecraft checkout, thermal vacuum testing and total mission performance.

## AIRBORNE COMPUTER SYSTEMS PROGRAMMERS

To develop and implement software for real-time Airborne/Spacecraft Computer Systems. Experience in real-time multi-programming and ground-based support simulations is desirable.

## MANAGEMENT SYSTEMS PROGRAMMERS

Will write programs to implement advanced Management Information Systems for Engineering, Material and Manufacturing control. Should be familiar with concepts of medium-to-large-scale general purpose systems employing time-sharing teleprocessing and multi-processing. Knowledge of IBM S/360 and COBOL desirable.

**NOTE: Junior Programming Positions are also available.**

To arrange an immediate interview,  
send comprehensive resume to:  
Jack F. Anderson, Engineering  
Employment, Dept. GR-88.



# GRUMMAN

**AIRCRAFT ENGINEERING CORPORATION**  
Bethpage • Long Island • New York, 11714

WHERE MAN IS THE HEART OF THE SYSTEM

An Equal Opportunity Employer (M/F)



# At Xerox, we look at our programmers...

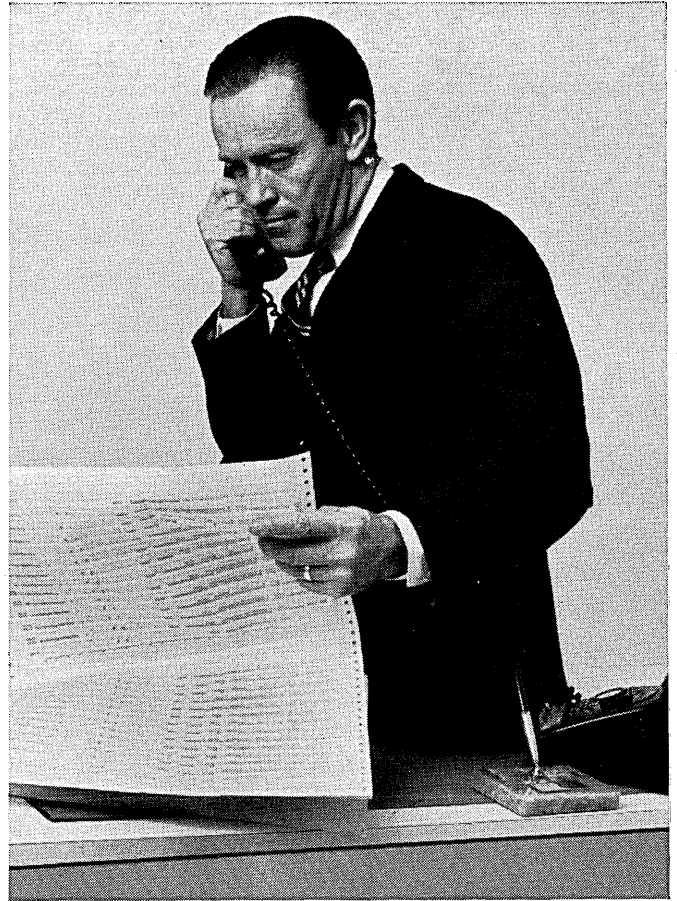

## and see managers...

The kind of programmers we look for aren't satisfied with narrow EDP solutions. They look for ways to improve business operations with systems thinking in the broadest sense. Using creative analysis and synthesis to enhance customer service in every facet of our dynamic marketing environment. Which, by the way, is part of the reason all our programmers are called programmer analysts.

If you're getting the impression that programming at Xerox is more than being a man-machine interface, you're right. It's an exposure to almost every facet of our operations, through planned

rotation from system to system. Encompassing business modeling, market research and information, manufacturing/inventory/equipment control, general accounting and engineering research...plus some applications so unique we can't even mention them. We refer to it as our Talent Enhancement Program: multiple, simultaneous, short (3-6 month average duration) projects plus room for individual contribution equal a strong innovative staff for us and broad experience for you...which is the best preparation for better things to follow.

If you have a Bachelor's Degree

and/or experience with an IBM 360 or 7000 system, or a Univac 1108, using COBOL or AUTO-CODER, there could be a future management opportunity waiting for you at Xerox. To find out more about the opportunities open at Xerox on all levels, send your resume, including salary history and requirements to Mr. Norman G. Schott, Dept. MZ-27-D1, Xerox Corporation, P. O. Box 1995, Rochester, New York 14603. An Equal Opportunity Employer (m/f)

# XEROX

# NO TWO PEOPLE ALIKE.

"A truism," you say. Certainly. But at URS we put this truism to work—the ideas and aspirations of the individual are important, the humanistic approach is stressed. And we accord the same respect to our clients.

"But what does URS do?" you ask. Principally, we help people make effective use of computers, from concept to operation—analysis, design, programming, and implementation and operation of computing and management information systems.

We are, for example, prime software contractor for the Army's Combat Service Support System which will ensure more efficient use of men and material. (We also tackle a variety of problems in the physical and engineering sciences.) As for our performance, a client

recently told us, "Happiness is a contract with URS."

In the future we will be devoting an increasing portion of our efforts to improving the quality of man's environment. A look at the world about us suggests a limitless challenge.

Can you help? If so, send a resume to, or request application from: Mr. Jack Davis, Information Sciences Division, URS Corporation, 201 Lincolnia Rd., Alexandria, Virginia 22304.

We have openings now for experienced programmers, analysts, software marketing men and communications engineers in our offices in the Washington, D. C. area; San Francisco; Killeen, Texas; Kansas City, Missouri, and Petersburg, Virginia. In your letter let us know which of these locations interests you.

URS

CORPORATION

1700 South El Camino Real, San Mateo, California 94402  
an equal opportunity employer—by choice!

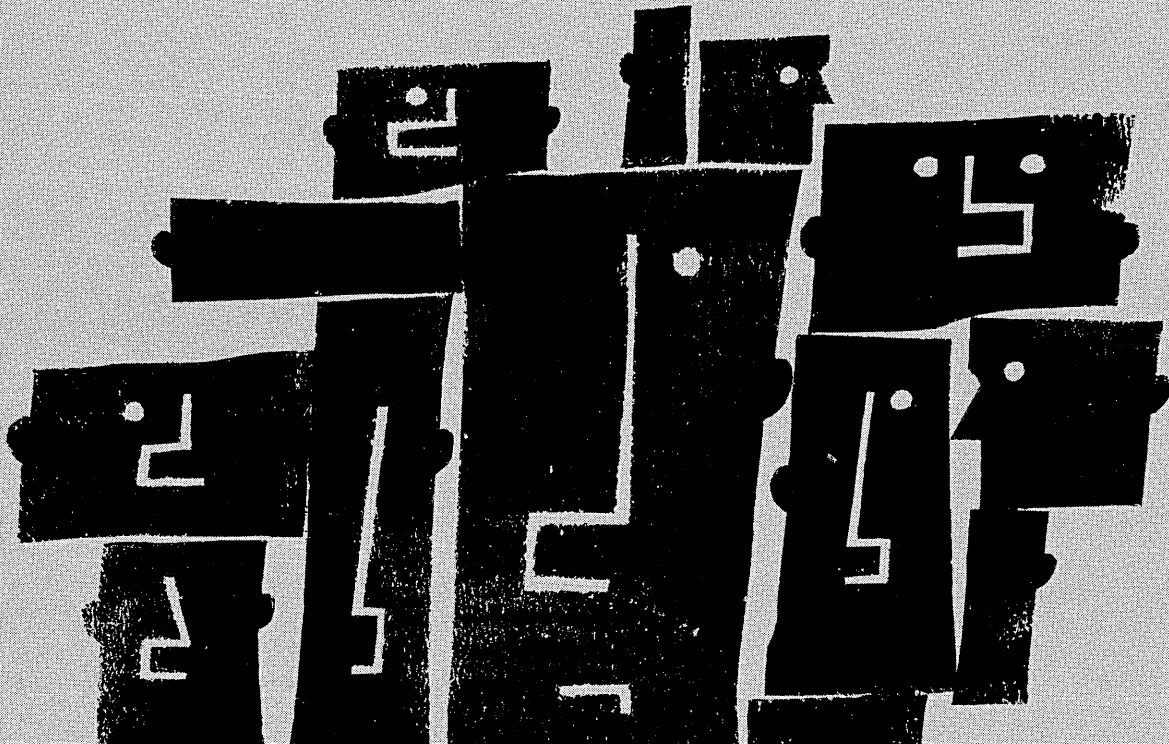

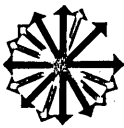

# datamart

Address all replies to box number advertisements as follows:

Box.....

### DATAMATION

F. D. Thompson Publications, Inc.  
35 Mason Street  
Greenwich, Conn. 06830  
Classified Advertising

### EQUIPMENT FOR SALE PURCHASE OR LEASE

### TLW CORPORATION

P. O. Box 29763, Atlanta 30329  
404/633-2579

We Buy—Sell—Lease IBM  
Unit Record & Computers  
Our Equipment Is Under M/A  
And In Excellent Condition

### WANTED

IBM 1401, 1410, 1440, 1620, and larger systems;  
1311's, 7330's, 729's, and other peripherals.  
We buy and sell all types of EDP equipment.

ASSOCIATED COMPUTER SERVICES  
6440 Hillcroft, Houston, Texas 77036  
713-771-3561

FOR SALE: IBM 1401 Model B-3 with 4000 positions  
incl. supplemental devices; 1402 Model 1 card read-  
punch; 1403 with Model 2—600 lpm printer under  
IBM maintenance contract. Available July 1968  
\$50,000. Details upon request. Contact K. M. Miller,  
Rohn and Haas Co., Independence Mall West, Phila-  
delphia, Pa. 19105.

## COMMERCIAL DP SYSTEMS

- COMMERCIAL DATA PROCESSING SYSTEMS
- INPUT DEVICES
- POINT-OF-SALE DATA ACQUISITION
- E/M PERIPHERAL AND OPTICAL SCANNING

Senior positions in manufacturing and development engineering with exceptionally high starting salaries combined with unique opportunity for substantial capital gains through stock options are currently open. If your specialty is production or IC logic design and you have the professional ability and ambition to move up in a fast growing company send your resume to J. G. Parker or call collect 703 / 353-7856.

... an equal opportunity employer.

**COMPUTER SYSTEMS** 2042 Westmoreland Street  
Richmond, Virginia 23230

### IBM 1316 DISK PACK

Special offer ..... Baker's Dozen!  
13 mos. rental at 12 mos. price.

**\$25 per month**

I.O.A. Leasing Corp.  
383 Lafayette St., NYC (212) 673-9300

**HIGHEST PRICES PAID FOR: IBM 024,  
026, 1401, 046, 047, 056, 082, 083, 419**

**I.O.A. Leasing Corp.  
383 Lafayette St., NYC (212) 673-9300**

**FOR SALE — 2 Heat Transfer Machines, Address-  
ograph Models 831, Serials B1192 E1151. West-  
ern Auto Supply Co., 110 West 12th Avenue,  
North Kansas City, Missouri 64116.**

COMPUTER TIME AVAILABLE. Princeton, N.J. location.  
RCA 7045, compatible with IBM 1410. 132K capacity,  
8 tapes, 2 discs — 2311, card read/punch. Available  
2nd & 3rd shifts Mon.-Fri., all day Sat. & Sun.  
Contact Daniel Dunlop, P. O. Box 331, Princeton, N.J.  
08540. Phone (609) 452-8400.

**KEYPUNCHING-VERIFYING.** Accurate, dependable  
service. Call or write Citizens Data Center, P. O.  
Box 1410, Decatur, Ill. 62523, Phone 217-428-  
6661, X301.

### OPTICAL SCANNING

Each month we convert over 1 million records to  
magnetic tape by typing and scanning. We format  
your finished tapes per your requirements. High  
quality work. Write or phone Ken Benson, Input  
Services, 111 E. 4th Street, Dayton, Ohio 45402  
(513) 222-2721.

### SERVICES

#### COMPUTER TIME IBM-HONEYWELL-RCA-OTHERS

Wide range of configurations/low rates  
Excellent service/specialists in computer time.

Computer Reserves, Inc., 1 East 42nd Street,  
New York, N. Y. 10017 (212) 986-5559

360/30 COMPUTER TIME FOR SALE. Running under  
DOS, also four tapes. Prime shift, non-prime. Excep-  
tionally attractive rates.

Mobility Systems, Inc., 1653 Rogers Ave.,  
San Jose, Calif. (408) 286-8700.

#### HELP WANTED NON-PROFIT INSTITUTIONS

#### COMPUTER SCIENCE PROFESSORSHIPS

Full, Associate, and Assistant Professors in Com-  
puter Science or related fields required to develop  
and staff an undergraduate program in Computer  
Science. Great potential in a rapidly expanding de-  
partment with a growing university. Individual re-  
search encouraged. Computers available include IBM  
1620; large scale CDC 3300 with 65K words core  
operating under MASTER operating system with re-  
mote terminals and time sharing. Salary and full  
fringe benefits commensurate with experience. Apply  
Graham Martin, Director, Computer Center, Sir George  
Williams University, Montreal, Quebec.

#### UNIVERSITY OF SASKATCHEWAN SASKATOON CAMPUS

has established a new Department of Computational  
Science. Openings for faculty positions at all levels  
up to and including the associate professor level are  
now available. Specialists are required to assist in  
the development of undergraduate, graduate, and  
research programs. Applicants with an M.Sc. or  
Ph.D. in Computer Science, or in Commerce, Opera-  
tions Research, Engineering or Mathematics, with ex-  
perience in the computing and information process-  
ing fields are preferred. For more information write:  
B. A. Holmlund, Head, Dept. of Computational  
Science, University of Saskatchewan, Saskatoon,  
Sask., Canada.

## We know where you can find a better job.

Better because it pays more.

Better because your professional talent is so badly needed.

Better because you'd be working in the most dynamic  
EDP community in the country — where the nation's top com-  
panies are looking hungrily for skilled systems analysts and  
programmers. Like you.

Where is this? New York.

We know, because Drew is one of New York's leading EDP  
placement specialists. We know, because we work closely  
with over 200 national companies headquartered here. And  
right now, they have 350 exciting career openings they've  
asked us to fill for them. 350 openings for professionals who  
are ready to make the big move.

For information about these challenging opportunities, fill  
out the coupon and mail it today. Or, better still, call us  
collect.

Don't wait. This could be the start of bigger and better  
things.

### **DREW** PERSONNEL PLACEMENT CENTER Attn: Paul Hutchins

160 Broadway, N.Y., N.Y. 10038 Phone: (212) 964-8150

Here's my resume. I'd like to get first crack at the career op-  
portunities you have right now.

Name \_\_\_\_\_

Address \_\_\_\_\_

City \_\_\_\_\_

State \_\_\_\_\_ Zip \_\_\_\_\_

©1967 Drew Employment Agency Inc. All correspondence in confidence, of course.

CIRCLE 330 ON READER CARD

CIRCLE 329 ON READER CARD



## If you can't change the company you work for, change companies.

Selling computers, doing systems analysis or programming is tough enough. But it gets even tougher when you have to fight your own company. For instance:

Your customer wants an unusual piece of software or a non-standard interface. For two weeks you can't find anyone at your home office to make the decision. And when you do he says "No."

Or, you're all ready to close that really big order, when your regional sales manager shows up.

And collects all the glory.

Or, just when your performance record looks like you deserve a promotion, you get a transfer.

To where the action isn't.

If it's happening to you, don't take it lying down.

Get up. And out.

Come to us.

You already know about us. We'd like to know about you. A few basic facts will do: who you are, where you've been, what you do. Send them to Bob Wheelan at SDS, 1649 Seventeenth Street, Santa Monica, California 90404. He won't discuss this information with anyone.

Except maybe you.

**SDS**

Scientific Data Systems,  
Santa Monica, California



# Our computers tell us it's time for you to pack up.

Setting up a new, nationwide data processing network was easy. Finding experienced programmers, systems analysts and other data processing team members isn't. That's where you come in. And we hope you will.

Here are some pretty good reasons. A choice of seven locations: Ann Arbor, Michigan; Sidney, New York; Baltimore, Maryland; Teterboro, New Jersey; South Bend, Indiana; Los Angeles, California or our Corporate Offices in Detroit.

Together, these locations form our nerve center for both commercial and scientific data processing applications. You will work with IBM's third-generation equipment, models 360/50, 40, 30 and 20. Utilize advanced computer concepts of teleprocessing, real-time, on-line and multiprocessing. And through it all, you'll help develop standards for corporate commercial systems to expand program utility

and reduce repetitive work. We'll provide all the specialized training you need, and contribute to further college study as well.

Consider too: You'll enjoy the security of a diverse corporation whose sales have more than doubled in ten years to over 1.25 billion dollars. With a healthy combination of commercial and defense business in advanced aerospace, automation, automotive, electronic and oceanic technologies. Backed by extensive commitments in research and development for assured growth. Ours—and yours.

Sound like your kind of opportunity? If you are a college graduate with experience in programming or systems analysis using medium- or large-scale computers, contact our Manager of Professional Placement, immediately. Then pack up and move up with Bendix. The Bendix Corporation, 1104 Fisher Building, Detroit, Michigan 48202.

**Bendix**

CIRCLE 332 ON READER CARD

An Equal Opportunity Employer

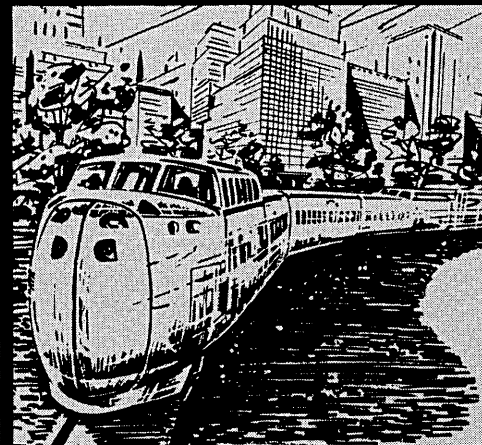
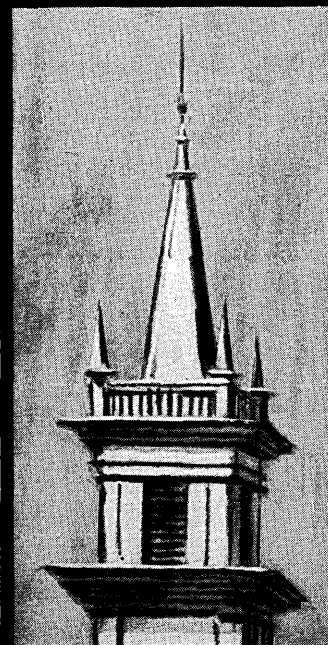
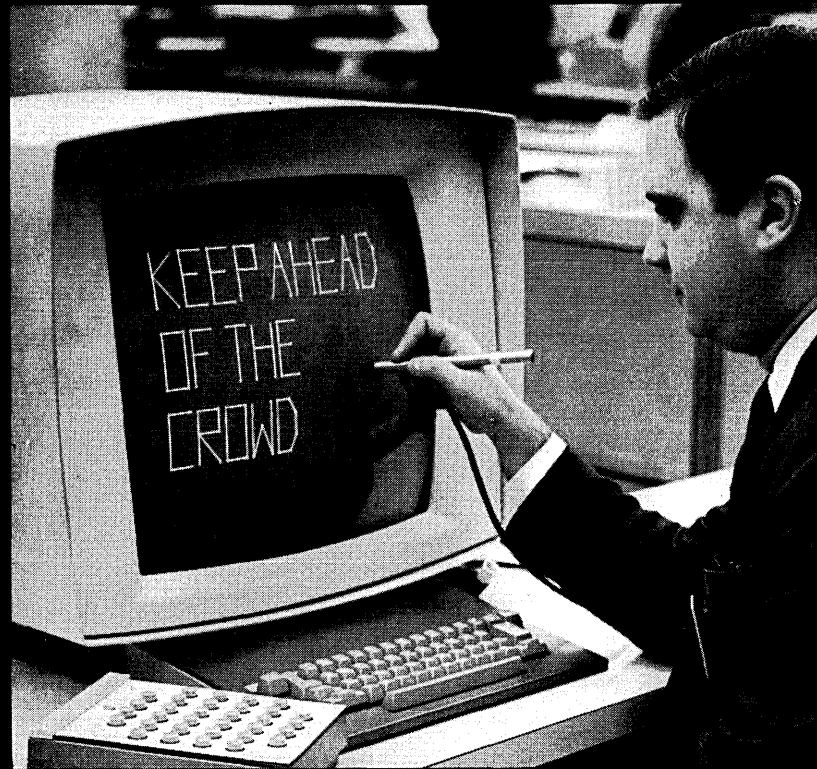

... in our  
**SCIENTIFIC & COMMERCIAL  
 COMPUTER-BASED  
 ANALYSIS &  
 DESIGN SYSTEMS**

You can. You'll like what you see at Sikorsky Aircraft—a company dedicated to producing the most advanced VTOL airborne and surfaceborne transportation systems.

And you'll like working with a select group of stimulating, top-talent people . . . on abundant and provocative challenges. You would be applying your professional talents to specifying, designing and implementing advanced computer-based technical and commercial systems.

Our current equipment includes Univac 1108's and IBM 360's with Graphics and Teleprocessing.

Current and planned applications include—

**Scientific:** Man/Machine Interactive Graphics in Engineering Analysis and Design.

Development of Batch Programs and Systems in all engineering disciplines.

**Commercial:** Data Base and Real Time applications in Accounting, Manufacturing, Purchasing, Inventory Control and other related areas.

We have exceptional assignments at all levels of experience for:

**COMPUTER SYSTEMS  
 PROGRAMMERS AND ANALYSTS  
 FOR BOTH COMMERCIAL  
 AND SCIENTIFIC FIELDS**



You and your family will find the unique cultural and recreational advantages of pleasant Connecticut to be abundantly satisfying. And our interest in your continuing professional development is exemplified by our corporation-financed Graduate Education Programs. They are available at these fully accredited schools: Bridgeport • Brooklyn Poly • CCNY • Columbia • Connecticut • NYU • Rensselaer (Hartford Grad. Center) • Stevens • Trinity • Yale.

Send your resume in confidence, stating salary requirements, to Mr. Leo J. Shalvoy, Professional Employment.

**Sikorsky  
 Aircraft**

**U  
 A**

DIVISION OF UNITED AIRCRAFT CORPORATION

STRATFORD, CONNECTICUT

An Equal Opportunity Employer

## look ahead

one wag, is so much bigger than Stretch that it will be called Rupture.

Meanwhile, a big push within IBM to dump costly special systems (like the 67, 44) could result in a new 360 lineup which might look like this: 25, 35, 45, 58 (new time-sharing machine to replace the 67), 65 (two versions), 75 & 85. The 35 and 45 may be announced in June, and could offer two- and four-byte fetch for increased speed. Low end of the line should reflect IBM's new high purchase-lease ratio.

### ARIES OFFERS CHECKUP FOR AILING COBOL PROGRAMS

Aries will announce an upgraded version of its Autodiagrammer package this month, follow it soon with "Prompt," a program management package.

Autodiagrammer II will be sold (not leased) for \$3K (vs. \$1200 for its predecessor), will reportedly diagnose effectiveness of a Cobol program before it's compiled. It runs on a 32K 360 or 9300; Fortran and BAL versions will follow shortly.

Prompt, described as a "fine-tuned" Pert, is aimed primarily at R&D project management. It's supposed to pinpoint work slippages and jobs being ignored, make a cost-effectiveness analysis of labor, tell how to optimize deployment of available resources, provide historical data for estimating costs, and evaluate individual performances. Written in Cobol, it will run on a 32K 360. No price yet.

### RUMORS AND RAW RANDOM DATA

Remote Computing Corp., latest time-sharing service bureau, will fire up a B5500 in L.A. in June, first of three centers planned within a year from then. The firm, headed by ex-Burroughs sales star Joe Hootman, will offer its own time-sharing software, pricing based on use of every part of the system, plus ability to switch between conversational, remote batch, and on-site modes. Languages will include Fortran, Cobol, Algol & Basic with file handling capabilities ... At SJCC, Sanders Assoc. will announce a new 2-usec memory for an OEM and end-user market estimated at \$155 million. Capacity range is 4K (12-bit) words to 8K (36-bit) words, the larger units costing 7-8¢ bit. The 920 and 930 tabular console crt's for jobs like text-editing will also be intro'd ... Also at the show, Interdata will demonstrate its new conversational Fortran for the model 3 and 4 (4K minimum required). The firm has installed 65 model 3's, has 40-50 on order; 12 model 4's are signed up ... GE's buying Burroughs disc files for the 600 series computers to go into its time-sharing centers; the 40 msec access time should help GE avoid some of the queuing problems of the 265's. In software, the 600's Fortran IV (standard) won't be compatible with the 265 Fortran (non-standard), though 265 statements should be convertible at about 100 statements/hour ... Further European plans for GE t-s centers include Basel, Bonn, Brussels and Amsterdam ... Applied Data Research will shortly announce "Tally," a new software package which tallies, cross-correlates and summarizes statistical surveys and opinion polls ... Newest face in the crowded disc/drum biz is Magnafile, Phoenix. The 8401 low-cost, flying-head, double-sealed drum with 8.5 msec average access to ½-million bits will be followed by non-IBM-compatible discs, one with movable arms ... Computer Network, Compress' D.C. time-sharing service bureau, will set up B5500's in NYC, Philly, Pittsburgh and maybe two other eastern cities this year... Emil Borgers is out as exec. vp. at SEL.

## WHAT IS YOUR TRUE WORTH?

# FREE Data Processing Opportunities Bulletin

Every month, in the privacy of your own home, you can evaluate the nation's finest openings in the data processing field. Cadillac, the nation's largest executive and professional placement service, represents the majority of the nation's top companies. Their best jobs at salaries from \$6,000 to \$75,000 appear in our monthly Data Processing Opportunities Bulletin.

Our placements show that the average data processing man is worth 10% to 20% more than his present income. The Bulletin helps you evaluate yourself in today's market. Both the Bulletin and our *confidential* placement service are free. Client companies pay all costs.

For your free Bulletin, without any obligation circle Subscriber Service Card No. 304. Please use *home address only*.



**LON D. BARTON, President**  
**Cadillac Associates, Inc.\***

29 E. Madison Bldg. Chicago, Ill. 60602  
Financial 6-9400

\*"Where More Executives Find Their Positions Than Anywhere Else in the World."

CIRCLE 304 ON READER CARD

## PROGRAMMERS ENGINEERS

Washington, D.C. • New York • New Jersey • New England • Philadelphia • Chicago • Minnesota • Texas • Ohio • Florida • Arizona • California • Southeast Asia

If you have a B.S., M.S. or Ph.D. and you are experienced or interested in any of the following, contact us immediately for free career counseling and an objective analysis of your position in today's market.

### PROGRAMMERS

- Management Info Systems
- Information Retrieval
- Command & Control
- Aerospace Applications
- Real Time/On Line
- Systems Simulation
- Software Development
- Communications

### SYSTEMS ENGINEERS

- Reliability Analysis
- Digital Computer Systems
- Digital Logic Design
- Digital Circuit Design
- Digital Communications
- Systems Integration
- Soft Ware Analysis
- Oceanography

Salaries range from \$8,200 to \$25,000.

Our client companies assume all fees.

Forward resume in confidence, or call (collect):

Mr. Martin E. Sheridan  
Area Code 703) 524-7660

**SHERIDAN ASSOCIATES INC.**  
1901 North Fort Myer Drive  
Suite 614  
Arlington, Virginia 22209

(Just over the Potomac from Washington, D.C.)

Personnel Consultants to the Computer Industry

CIRCLE 336 ON READER CARD

## CAREER MEMO

To PROGRAMMERS/ANALYSTS/ENGINEERS

From EVERETT KELLEY ASSOCIATES, INC.

If your present position lacks professional motivation . . . NOW is the time to let us program your professional future . . .

Consult our staff of experienced specialists who are at your disposal. They will open doors and arrange favorable interviews with selected clients. Utilize your total professional capability in:

- Scientific Programming
- Real Time Systems
- Software Development
- Operations Research
- Applied Systems
- Systems Design
- Consulting
- Digital or Logic Design
- Circuit Design
- Commercial Programming
- Mathematics
- Development Engineering
- Communications
- Sales/Marketing

Salary range: \$8,000-\$30,000. All expenses paid by client companies (fees, interviewing and relocation).

Submit your resume in strict confidence, including salary requirements and geographic preference, directly to Mr. R. L. Keilholtz or Mr. Donald Wayne or write for our composite resume form A.



**EVERETT KELLEY ASSOCIATES**

Consultants to the  
Computer Industry

121 So. Broad Street (Suite 1300)  
Philadelphia, Pa. 19107

Placement of Computer Professionals since Binac.



CIRCLE 335 ON READER CARD

## DATA PROCESSING PROFESSIONAL?

The test of a true professional is simple. He knows his limitations as well as his capabilities. He knows being an expert in one field doesn't automatically qualify him as an expert in all fields. And when the situation arises, he goes to other professionals for their expert help.

If you are planning a career change, let us help you. We're professionals in our field.

Management Scientists Inc. are consultants to leading companies both internationally and nationally. Send resume in confidence including salary and geographic preferences, or call us. Our clients assume all expenses.

We have been retained by our clients to seek experienced Managers, Systems Analysts, Consultants, Operations Research and Management Informations Systems Analysts, Systems Programmers, Application Programmers, Hardware Engineers, Marketing Specialists and Sales Engineers.



Management Scientists, Inc.

101 Park Avenue, N.Y. 10017

Dept. DM-468

(212) 532-7710

Exclusively: DATA PROCESSING & MANAGEMENT SCIENCES  
Career Planners—Recruitment Specialists

CIRCLE 334 ON READER CARD

**DATAMATION**



engineers • scientists • programmers

## There are two ways to look at Houston

It's a fact that Houston, Texas combines the best of two worlds—a world to work in and a world to live in. For example Engineers, Scientists, and

ball around an uncrowded golf course. Water ski or sail along a breath-taking lagoon. Listen to a nationally-renowned

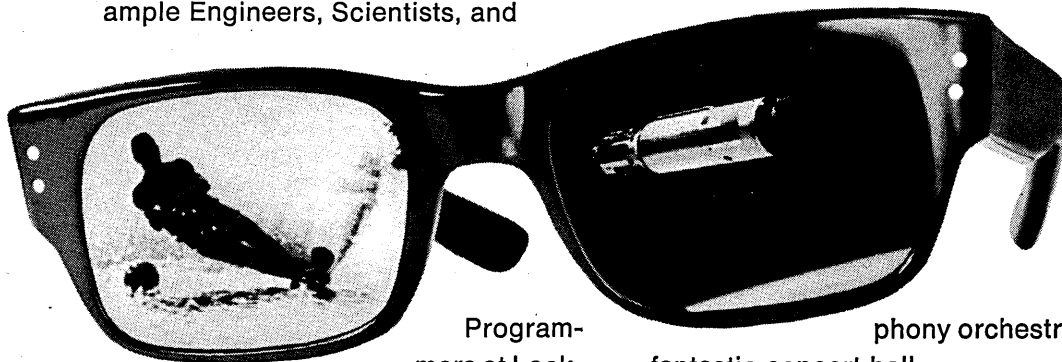

Programmers at Lockheed Electronics Company are involved in one of the largest, most challenging pioneering efforts ever undertaken... the exploration of space. These dedicated professionals working at NASA's Manned Spacecraft Center are providing answers to questions such as where our Astronauts will land, what they can expect, and the many tasks they will perform.

And pioneering in the space technology is just one of the many advantages you will enjoy when you live and work in the new Houston.

Your place of work at Lockheed can be only a ten or fifteen minute stroll away from a charming and spacious exurban home. You can drive a golf

symphony orchestra in a fantastic concert hall.

And shop in elegant stores in metropolitan Houston (the sixth largest city in the United States).

You can also send your children to exceptional schools. With children whose fathers are the pioneers of outer space. In 1966, nearly 10% of the high school seniors in the local district were semi-finalists in the National Merit Scholarship tests compared to a national average of one-half of one percent.

Why not take the next ten minutes and write us about your experience and qualifications. Address: Mr. Dean Pearson, Lockheed Electronics Company, 16811 El Camino Real, Houston, Texas. Or call him collect at (713) 488-0080.

**LEEC** LOCKHEED  
ELECTRONICS COMPANY  
*A Division of Lockheed Aircraft Corporation*  
*An Equal Opportunity Employer*

*Join Lockheed Electronics Company, Houston Aerospace Systems Division*

CIRCLE 338 ON READER CARD

# Computer Programmers and Analysts

The Bendix Navigation and Control Division Engineering Computation Center and Corporate Data Center, both located in Teterboro, New Jersey, have several excellent career opportunities for B.S., M.S. and Ph.D. graduates in Engineering, Physical Science, Computer Science or Mathematics with varying degrees of experience in programming and numerical as well as systems analysis for a wide range of third generation IBM computers in the System/360 and 1130 families. A few of the most urgent application areas are:

- **ADVANCED AEROSPACE GUIDANCE SYSTEMS** analysis and design
- **ELECTRONIC CIRCUIT** analysis and design computer systems
- **AIRLINE AIRCRAFT** avionic systems and cost of ownership analysis
- **MANAGEMENT INFORMATION SYSTEMS** design and implementation
- **DATA COMMUNICATIONS SYSTEMS** programming for operations in commercial and industrial activities
- **COMPUTER SYSTEMS SOFTWARE** in support of all computers and digital plotting equipment.

Located in the heart of many suburban communities in Northern New Jersey and accessible to Metropolitan New York area within 20 minutes.

Send resume including salary history to Mr. W. Morrison. PROFESSIONAL PLACEMENT OFFICE, The Bendix Corporation, Teterboro, New Jersey 07608.



**Navigation and Control Division**

An Equal Opportunity Employer

CIRCLE 340 ON READER CARD

## EXCITING CAREER OPPORTUNITIES IN THE NEW YORK METROPOLITAN AREA THROUGH I N T E R F A C E

A personnel consulting firm established by computer professionals to interface between the experienced programmer, analyst and mathematician seeking professional growth and the firms that offer high level technical and managerial opportunities.

**Career Positions at All Levels**  
**\$9,000 - \$25,000**

- Time-Sharing Systems Design
- Teleprocessing and Multi-Processing
- Software Development
- Applications Programming
- Scientific Programming
- EDP Systems Management
- Sales and Marketing Forecast Systems
- Management Information Systems
- Operations Research

**OUR CLIENTS ASSUME ALL EXPENSES**

(Call collect) today (212) PL 7-4710 or  
write in complete confidence to M. M. Liptak

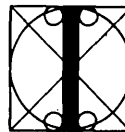

**INTERFACE**  
17 West 54th Street  
New York, N.Y. 10019

# It's your life (& your career is a large part of it)

# Make the most of it.

During SJCC call 344-8111 to arrange an interview.

Heffelfinger Associates specialize in the placement of creative engineers and programmers. Career positions exist with large and small computer users, R&D companies, universities, computer manufacturers, and software development firms, located mostly in the Northeastern U.S. and New England. Salaries range from \$9,000 to \$35,000. Client companies assume fees.

It's our business to know where the career opportunities are. Use this storage of information. Phone us collect or forward your resume outlining your goals.



**heffelfinger  
associates, inc.**  
Computer Personnel Consultants  
886 Washington St., Dedham, Mass.  
Tel: (617) 329-1040

CIRCLE 339 ON READER CARD

# Can you make practical contributions to the computer sciences?

Our Data Systems Division is continuing its expansion into areas which will present the greatest challenge for the foreseeable future—advanced aerospace weapon delivery, navigation digital and analog computers, advanced analog/digital control and telemetry. Openings exist in a wide variety of disciplines in Laboratories which are responsible for advanced technology, preliminary design and applications, and digital and analog circuitry. All of these require accredited degrees and a demonstrable capacity to do creative design or analysis. Although experience is required for most of the positions, several are open to recent graduates. Opportunities are immediately available for:

## **Preliminary Design Engineers:**

Helpful experience would include: Digital, Analog and Hybrid Systems Applications Engineering; Logical Design; Memory Design (solid state, ferrite or drum); Electro-mechanical Design Engineering; Physical Product Design; Thermal Analysis or Packaging Trade-off Studies.

## **Automatic Test Program Analysts:**

Systems Test, In-flight Self Test, Time-sharing or Maintenance Depot experience would be directly applicable to our openings. A basic understanding of the mathematics involved with circuitry and computers, or weapon systems analysis would be of particular value.

**Microcircuitry:** Development of hybrid-integrated devices, both digital and linear. Experience with processes and applicable techniques is required.

**Circuit Design Engineers:** Duties would involve the design of logic and computing circuits, many forms of input/output devices, high-reliability low-power circuits for spacecraft VHF and UHF telemetry.

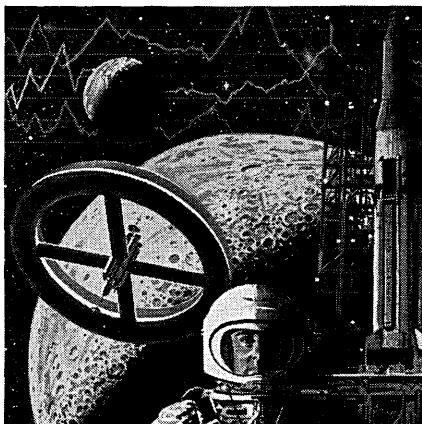

## **Systems Integration Engineers:**

Experience is required in such areas as system integration, system checkout, test equipment, design, test specification and procedure writing.

There are also several openings for Mechanical Engineers and Physicists who have acquired specialized professional experience which is directly applicable to the design or analysis of aerospace digital systems.

## **Computer Program Design:**

Requires experience in the design of real-time command and control programs, or of software programs for execution on an IBM 7094 or GE 635 computer. Responsibilities include: specification, design, implementation, checkout and support of computer programs for a wide variety of applications including: Airborne Navigation & Fire Control, Digital Simulation of Airborne Computer and its environment, Automatic In-Flight & Depot System Testing, Assemblers and Compilers and Automation of Electronic Equipment Design.

For immediate consideration, please airmail your resume to:

Mr. Robert A. Martin  
Head of Employment

Hughes Aerospace Divisions  
Dept. 54

11940 W. Jefferson Blvd.  
Culver City, Calif. 90230

U.S. citizenship is required  
An equal opportunity employer-M & F

**HUGHES**

HUGHES AIRCRAFT COMPANY  
AEROSPACE DIVISIONS

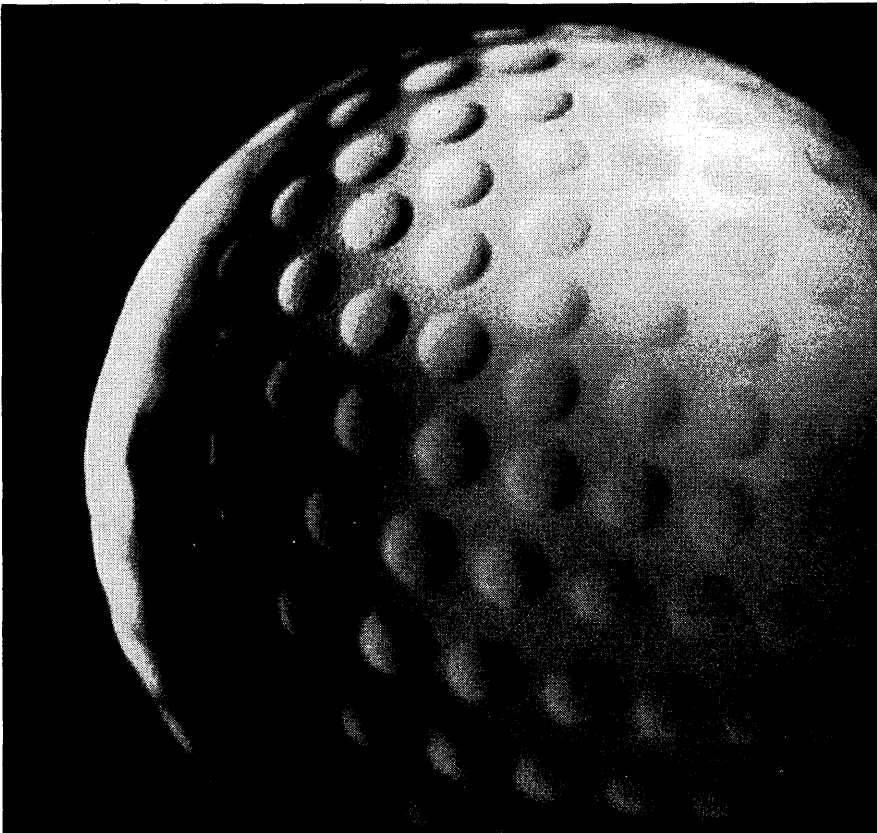

## Space shots to the moon... golf shots to the green...

**JOIN US IN BOTH AT THE J. F. KENNEDY SPACE CENTER IN SUNNY FLORIDA.**

NASA's lunar module (LM), which took its first space journey in late January, was a talkative "bug." ITT Federal Electric Corporation's project team listened in and monitored each action and reaction of the craft from when it was first mated to its launch vehicle until the mission's end. The successful flight was a significant step toward the manned lunar landing.

As a prime contractor, Federal Electric Corporation has some 1500 professionals on the talented NASA/industry team involved with the Saturn Apollo program. Our fast expanding computation work at the Center provides real-time scientific test support, data reduction, systems analysis, computer operations and data storage and retrieval. This scientific, engineering and administrative support activity utilizes two GE 635 time sharing digital computer systems with 16 magnetic tape units, 128K word storage, a 786K word drum and real-time input/

output controllers on each system. We also use an IBM 7010 computer system for financial management and an IBM 1050 connected to a separate IBM 1440-7010 computer system for a real-time 30K item inventory system.

While the size and complexity of our mission provides you with talent-extending excitement, the great climate here in the heart of Florida's beautiful East Coast offers you unmatched relaxation. There's sun, sand and seashore plus water skiing, surfing, fishing, hunting and superb golf. It's comfortable living (at well below the national average cost), lots to do, and the perfect climate for doing it.

Please forward your resume, including salary history, in complete confidence to Mr. L. A. Hamilton, Federal Electric Corporation, Suite 501, Cape Royal Building, Cocoa Beach, Florida 32931.

**FEDERAL ELECTRIC CORPORATION**



ITT's World-Wide Service Associate. A Plans for Progress Equal Opportunity Employer (m/f)

## Scientific Programmers

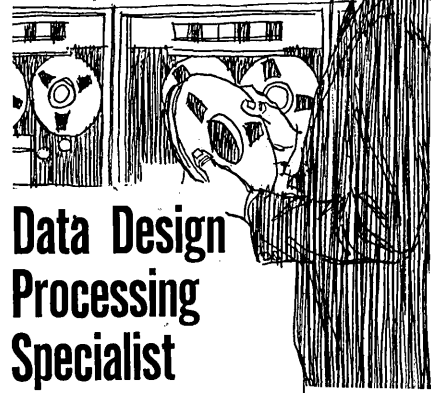

## Data Design Processing Specialist

Our expanding System Center is located in sleek, fully air conditioned quarters in beautiful Farmington, Connecticut. Guidance systems and computer R&D programs are major projects. We are producing a back-up guidance system for the Apollo and designing a computer for advanced space missions under NASA contract. We are seeking:

**SCIENTIFIC PROGRAMMERS.** Requires a degree in Mathematics or Science and 3 to 5 years of experience with large, medium, or small scale computer information systems applications utilizing random access techniques. Must have experience with assembly language programming and a background in the use of real-time, direct inquiry software, creation and checkout of operating systems and compilers, or production of automated graphics.

**DATA PROCESSING DESIGN SPECIALISTS.** Requires degree in Mathematics or Science and 5 to 10 years of experience with on-line and real-time systems. Must be able to design as well as plan and execute study analysis programs involving the application of data processing techniques and equipment to real-time problems. Emphasis will be on system design; familiarity with large scale information retrieval systems, executive programs, and the automated production of graphics. Must be capable of quantitative comparative evaluation of alternative system designs. Experience required in preparation of technical proposal and report writing.

**TO INTERVIEW,** please forward your resume, stating present salary, to Mr. V. D. Blodgett, Personnel Dept., Hamilton Standard, Windsor Locks, Conn. 06096. An equal opportunity employer.

**Hamilton  
Standard**



DIVISION OF UNITED AIRCRAFT CORP.



# advertisers' index

AC Electronics Division of General Motors .....	194
Adage, Inc. ....	8
Addressograph Division of Addressograph Multigraph Corporation .....	116, 117
The Aerospace Corporation .....	198
State of Alaska .....	191
Albert Associates .....	206
Albert, Nellissen, Inc. ....	211
Allen-Babcock Computing, Inc. ....	67
Alphanumeric Incorporated .....	104
American Technological Institute .....	222
Ampex Corp. ....	Cover 2
Anderson Jacobson, Inc. ....	167
Ann Arbor Computer Corporation, A Subsidiary of the Jervis B. Webb Company .....	14
Applied Data Research, Inc. ....	5
Athana Corporation .....	96, 97
Audio Devices, Inc. ....	88
Auerbach Corporation .....	193
Baldwin Kongsberg Company .....	95
Baxter Laboratories, Inc. ....	234
Beemak Plastics .....	164
Bellcomm, Inc. ....	207
The Bendix Corporation .....	223
Bendix Corporation, Navigation and Control Division .....	228
Berkeley Scientific Laboratories, Inc. ....	44
Beta Instrument Corp. ....	75
Booz-Allen Applied Research Inc. ....	207
Brandon Systems Institute, Inc. ....	122
Brentwood Personnel Associates .....	202
Bryant Computer Products, A Division of Ex-Cell-O Corporation .....	10
Bull Corporation of America .....	51
The Bunker-Ramo Corporation, Defense Systems Division .....	103, 202
Burroughs Corporation .....	16
Cadillac Associates, Inc. ....	226
Caelus Memories, Inc. ....	108
California Computer Products, Inc. ....	142
Callahan Center for Computer Personnel .....	196
C-E-I-R Inc., A Subsidiary of Control Data Corporation .....	189
Cognitronics Corporation .....	170
Collins Radio Company .....	197
Colorado Instruments, Inc. ....	132
Communitype Corporation .....	101
Computer Aid Companies, Inc. ....	145
Computer Applications Incorporated .....	107
Computer Communications, Inc. ....	180
Computer Industries, Inc., Data Communications Systems Division .....	129

## PRODUCT LINE MANAGER

### EDP DATA COMMUNICATIONS & DATA ACQUISITION EQUIPMENT

P&L responsibility for the Data Acquisition and Communication Products for this rapidly growing segment of the EDP industry.

We are an expanding company looking for an aggressive manager to coordinate the efforts of all sections of the company. Our man must have successful marketing and technical experience in Data Systems, Computer Applications and Data Communication.

#### Attractive Base Salary + Incentive

We also require

#### SALESMEN & SALES SUPPORT ENGINEERS

Contact Morton Siegelbaum, Vice-President, at  
BOOTHS 303-4-5

SPRING JOINT COMPUTER CONVENTION  
in Atlantic City, N.J.

Or send a complete resume, including current salary to:



**DIGITRONICS  
CORPORATION**

1 ALBERTSON AVE., ALBERTSON, N.Y.

An equal opportunity employer

CIRCLE 342 ON READER CARD

## NAVCOSSACT Needs Computer Programmers — Analysts \$15,841 to \$26,574

NAVCOSSACT, the Chief of Naval Operations' central organization for the design, development and implementation of command information systems in support of naval commands throughout the world, has a limited number of openings for senior technical personnel with outstanding qualifications. These openings involve the application of advanced computer technology to the solution of urgent military staff requirements in the areas of communications, logistics, intelligence, operations, executive systems, compilers and requirements analysis.

Applicants must have an advanced degree or its equivalent, a minimum of seven years of experience in computer programming and systems analysis

An Equal Opportunity Employer

in one or more of these areas with progressively increasing levels of technical and/or managerial responsibility, and a proven record of accomplishment.

Most of these positions are in Washington, D. C.; some are in Honolulu, Hawaii and Norfolk, Virginia. Travel requirements vary from moderate to extensive.

Send resume or Application Form 57 to:

**Civilian Personnel Director (Code 02M) Naval Command Systems Support Activity, Washington Navy Yard, Building 196, Washington, D. C. 20390**

or call NAVCOSSACT Personnel Office (202) OX 3-4200 or OX 3-4201

U. S. Citizenship Required

## SJCC Interviews

Tuesday, Wednesday and Thursday, April 30,  
May 1 and 2; 9:00 A.M. to 8:00 P.M.  
Howard Johnson Motel, Arkansas Avenue  
Call Jack Salvail at 348-4411

CIRCLE 341 ON READER CARD

# Are you the kind of programmer who wants two years of experience every six months?

Consider IBM.

We're just about bursting with opportunity for programmers who want to work hard on a variety of challenging projects.

Specifically: If you qualify, you'd help us design and develop a total package for a new computer system. Or design and develop new programs for System/360.

Or work on numerical analysis, engineering analysis, mechanical design automation, or medical applications in our Computation Laboratory. Or find out how good our programs are in Program Testing.

And within surprisingly wide limits set

by the company, you can move from one group to another, adding scope to your programming savvy.

The experience you gain may pay dividends sooner than you think. There's a lot of opportunity here, and advancement is based on performance, not seniority.

**Booklet available.** Look into it. Send us your name and address so we can mail you a booklet. It'll tell you more about IBM and give you an idea of what programmers can do here. Write to C. H. Robinson, IBM Corp., Dept. BD1003, 100 South Wacker Drive, Chicago, Ill. 60606.

An Equal Opportunity Employer

**IBM**®

# advertisers' Index

Computer Methods Corporation .....	43
Computer Sciences Corporation .....	174
Computer Sciences Institute .....	58
Computer Systems .....	217
Computron Inc. ....	73
Consolidated Analysis Centers Inc. ....	164
Consolidated Electrodynamics, A Subsidiary of Bell & Howell .....	92, 143
Control Data Corporation .....	121, 199
Curtis 1000 Inc. ....	128
Data Communications Systems, Inc. ....	177
Data Devices Division, Vernitron Corp. ....	132
Data Devices, Inc., A Subsidiary of Data Products Corporation .....	102
Data Packaging Corporation .....	139
Data Personnel .....	196
Data-Ram Corporation .....	172
Datacraft Corporation .....	9
Datalog Division of Litton Industries .....	13
Dataman Associates .....	196
DATAMATION Magazine .....	219
Digital Equipment Corporation .....	94, 184
Digital Development Corporation .....	160
Digitronics Corporation .....	231
Drew Personnel Placement Center .....	217
Eastman Kodak Company, Business Systems Markets Division .....	77
Electronic Memories .....	78
Employment for Data Processors .....	198
ESSO Mathematics & Systems, Inc. ....	205
Facit .....	176
Fabri-Tek .....	91
Ferroxcube .....	Cover 4
Flick-Reedy Corporation .....	196
Forms Inc. ....	126
Fox-Morris Associates .....	198
The Foxboro Company .....	210
Gates Accoustinet .....	14
General Automation, Inc., Automation Products Division .....	162
Geo-Space, Computer Division .....	178
General Kinetics Inc. ....	134
Graham Magnetics Inc. ....	131
Grant Pulley & Hardware Corporation .....	83
Grumman Aircraft Corporation .....	214
Robert Half Personnel Agencies .....	204
Hamilton Standard Division of United Aircraft Corporation .....	230
Heffelfinger Associates, Inc. ....	228
Hewlett Packard .....	149
Honeywell .....	140, 141
Honeywell, Computer Control Division .....	60, 61

## DP CAREER GROWTH OPPORTUNITIES IN THE VALLEY OF THE SUN

Phoenix  
Arizona

COMPUTER: S/360 Mod 50 (512K)  
OPER. SYS.: EMFT/MVT

### NEED PROGRAMMERS, ANALYSTS, MANAGERS WITH EXPERIENCE IN ANY OF THE FOLLOWING:

- PL-1
- OS/MFT
- Circuit Analysis
- Terminal Systems
- Design Automation
- On-Line Programming
- Multi-Programmed Systems  
Communications
- Inventory Control
- Production Control
- Marketing Systems
- Financial Analysis
- Applied Math
- Operations Research
- Order Control
- Forecasting

**ANNUAL CLIMATE AVERAGES:** }  
 • 86% of possible sunshine  
 • Max. Temp.—84.7°. Min. Temp. 53.3°  
 • Wind Velocity—5.8 mph

For immediate consideration, please send resume to:  
Jim Keltner, Jr.,  
Professional Recruitment Representative



**MOTOROLA**  
Semiconductor Products Division

5005 East McDowell Road  
Phoenix, Arizona 85008

or for additional information, call collect:  
(602) 273-4905

All inquiries kept in strictest confidence.

AN EQUAL OPPORTUNITY EMPLOYER

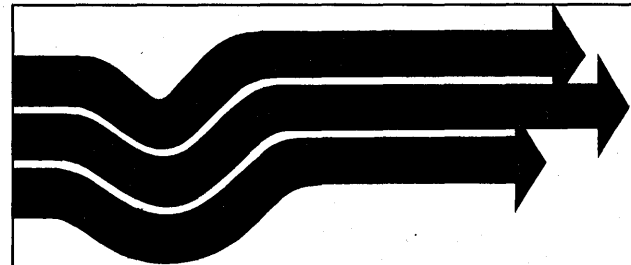

## MANAGEMENT SYSTEMS ANALYST-PROGRAMMER

Participate in the development of advanced concepts of management information systems using the latest hardware and software development.

Current projects include optical character recognition, graphic display, remote terminals and mass storage. Opportunities exist for rapid personal and professional growth. Independent thinking and creativity are pre-requisites.

Our Livermore site is located in a quiet suburban community of the San Francisco Bay Area. You would be only minutes away from excellent educational, recreational and cultural facilities.

For further information please submit resume to Mr. John Gloekler, Personnel Department, P. O. Box 808 21-48, Livermore, California 94550.



U.S. Citizenship Required. An Equal Opportunity Employer.

# we've grown 500% in ten years

Baxter Laboratories is a leader in the pharmaceutical and hospital supply field, a rapidly expanding industry. We have grown 500% in the last ten years and this growth rate has caused us to seek bright, alert, idea people to insure even more growth in the future. Baxter is listed on the NYSE and is a multi-division, multi-plant corporation. Our growth has created both tremendous challenge and opportunity for people willing and eager to accept responsibility.

# we need systems analysts

Our tremendous growth has brought with it the problems of growing. We need now, and are actively seeking, the best problem-solvers in business. Idea people to create, with a free hand, systems from top to bottom. A college degree and a minimum of 2 years systems experience are necessary. Experience in manufacturing systems or accounting helpful. Salary is commensurate with experience with liberal fringe benefit and stock programs.

**FOR CONFIDENTIAL REVIEW, SEND RESUME TO:**

**G. P. HANLON,**

# it's that simple



**BAXTER LABORATORIES, INC.**  
Morton Grove, Illinois 60053

AN EQUAL OPPORTUNITY EMPLOYER

CIRCLE 344 ON READER CARD



# advertisers' index

Honig Time Sharing Associates, Inc., A Member  
of the Mauchly Group ..... 79  
Houston Instrument Division of Bausch & Lomb ..... 35, 36  
Hughes Aircraft Company, Aerospace Divisions ..... 229

IBM ..... 152, 232  
Informatics Inc. .... 144  
Information International Inc. .... 166  
Interface ..... 228  
TT Data Services ..... 200, 201  
TT Federal Electric Corporation ..... 230

Everett Kelley Associates ..... 226

La Salle Associates ..... 235  
Lawrence Radiation Laboratory ..... 233  
The Library of Computer and Information Sciences ..... 123  
Lockheed Electronics Company, A Division of  
Lockheed Aircraft Corporation ..... 192, 227  
Lockheed Missiles & Space Company, A Group  
Division of Lockheed Aircraft Corporation ..... 209

MAC Panel Company ..... Cover 3  
Magne-Head, A Division of General  
Instrument Corp. .... 46  
Management Scientists, Inc. .... 226  
Magnetic Shield Division, Perfection Mica Company .... 89  
Massachusetts Institute of Technology ..... 235  
Memorex ..... 124, 125, 127  
Methods Research Corp. .... 164  
Micro Switch, A Division of Honeywell ..... 154  
Milgo Electronic Corporation ..... 4  
Milgo Electronic Corporation, Data  
Communication Division ..... 50  
Miller-Stephenson Chemical Co., Inc. .... 76  
Motorola Instrumentation and Control, Inc.  
A Subsidiary of Motorola, Inc. .... 80, 81  
Motorola Semiconductor Products Division ..... 233

The National Cash Register Company ..... 74, 236  
National Computer Analysts Inc. .... 158  
NAVCOSSACT ..... 231

Ohr-tronics ..... 99  
Omnitec Corporation, A Subsidiary of Nytronics, Inc. .... 187  
Oneida Electronics Inc. .... 90  
Optical Scanning Corporation ..... 82

Planning Research Corporation ..... 53  
Potter Instrument Co., Inc. .... 168, 169

Radio Corporation of America, Staff Employment .. 212, 213  
Rapidata ..... 190  
Raytheon Company, Missile System Division ..... 203  
Raytheon Computer ..... 2, 3

By this summer the INFORMATION PROCESSING SERVICES CENTER will be running an integrated IBM 360/67-65-50. Attached Support Processor System, with Remote Job Entry from several stations. Our new building, (see sketch) which is near completion, will house this computer complex and its supporting staff.— But to install and maintain the sophisticated time-sharing, batch-processing, conversational and interactive programming systems, which the MIT community expects to use on this computer complex, we need:



## PROGRAMMERS

(both SYSTEMS and SCIENTIFIC)

If you are interested in working with systems concepts that include multi-processing, multi-programming, access to large data bases, graphics and dispersed computing in an integrated system—and have at least two years experience in systems programming (preferably with one year direct contact with OS360 or TS360),—or if you have a solid scientific programming background and you would like to help others use this kind of computing power, please contact us.

Successful candidates will receive unexcelled career opportunities and salaries based on experience.

*If Interested Please Forward Your Resume To*

**MR. RICHARD G. MILLS**

*Director of Information Processing Services*

**MASSACHUSETTS INSTITUTE OF TECHNOLOGY**

Bldg. 26-269, Cambridge, Mass. 02139

*An Equal Opportunity Employer*

CIRCLE 345 ON READER CARD

**engineers - analysts - programmers**

# GROW

**IN THESE NATIONAL POSITIONS FROM 7,000 TO \$25,000**

■ CIRCUIT DESIGN ■ DIGITAL OR LOGIC DESIGN SWITCHING ■ COMMUNICATIONS ■ MANUFACTURING ■ RELIABILITY ■ SOFTWARE DEVELOPMENT ■ SCIENTIFIC PROGRAMMING ■ REAL TIME SYSTEMS ■ BUSINESS SYSTEMS ■ COMMERCIAL PROGRAMMING ■ OPS RESEARCH

**NATIONAL CHOICE: NEW ENGLAND ■ NEW YORK ■ PHILADELPHIA ■ WASHINGTON MIDWEST ■ SOUTH ■ CALIFORNIA ■ TEXAS ■ FLORIDA ■ AND OTHER AREAS**

**FREE: CAREER OPPORTUNITIES BULLETIN**

For a complete listing of outstanding positions with National Companies circle subscriber service card using home address only.

Free custom service. All expenses paid by client companies (fees, interviewing & relocation.) Send resume in confidence with present salary and geographic preference. No obligation.



**PROFESSIONAL SEARCH DEPT., 2136 LOCUST STREET, PHILA., PA. 19103**

CIRCLE 346 ON READER CARD

# Step ahead with NCR

NCR operates in one of the most challenging and constructive of all business fields. Our chief effort is directed toward helping business operate more effectively. This is accomplished through providing better and complete data processing systems.

NCR's new product releases during the past year averaged more than one a month, and ranged from a major new computer family to a new line of cash registers. The development of NCR's "Total Systems" concept has contributed substantially to the company's growth.

As worldwide sales continue to increase, many different skills are presently in demand at NCR for the installation of total data processing systems. Current requirements are in Dayton.

**Engineer Programming Analyst**—Salary open/BS, MS, Ph.D./to work with NGR third generation computer peripherals on design of software control packages for interface of hardware to control computer. Must design interrupt control program and develop a real-time operating system for large scale digital computer which may be switching up to 30 programs with 1200 terminals.

**Applied Programming Research**—Opportunities currently exist for programmers and systems analysts interested in commercial, industrial, financial or retail applications programming. Requirements include a minimum of 2 years' programming or systems experience. Positions will involve an opportunity to work on 3rd generation equipment.

**Software Engineer**—Will carry responsibility for assisting in the formulation, specification, and evaluation of new NCR systems and equipment. This will also include the complete development, preparation, and evaluation of software.

**Product Planning Systems Specialist**—Opportunity currently exists for individual interested in design of real-time on-line terminal systems for retail industry. Your responsibility will include complete systems planning and development. Requirements include sound knowledge of software and basic understanding of hardware.

If you are interested in a sound future with a growing concern, and have the necessary formal education and related experience in any of the areas mentioned.

Contact: Mr. T. F. Wade  
Executive & Professional  
Placement

The National Cash Register  
Company  
Dayton, Ohio 45409

AN EQUAL OPPORTUNITY EMPLOYER

# NCR

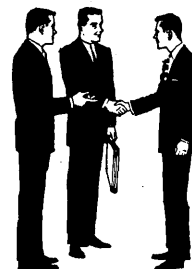

THE NATIONAL CASH REGISTER COMPANY, ®  
Look for us at the Spring Joint Computer Conference

CIRCLE 347 ON READER CARD

DAYTON, OHIO 45409

# advertisers' index

RCA Information Systems Division .....	156, 157
RCA Institutes, Inc. ....	148
Remex Electronics, A Unit of Ex-Cell-O Corporation .....	15
Rixon Electronics, Inc. ....	138
Ro-Mac & Associates .....	192
Sanders Associates, Inc. ....	41
Schneider, Hill & Spangler, Inc. ....	208
Scientific Control Corporation .....	62, 63
Scientific Data Systems .....	20, 218
Sheridan Associates Inc. ....	226
Siemens America Incorporated .....	148
Sikorsky Aircraft, Division of United Aircraft Corporation .....	224
Soroban Engineering, Inc. ....	84
Source EDP .....	195
Standard Computer Corporation .....	136, 137
Systemat .....	208
Systemation Consultants, Inc. ....	237
Systems Engineering Laboratories .....	150, 151
Tab Products Co. ....	118
Tally Corporation .....	1
Tele-Signal Corp., A Subsidiary of General Precision Equipment Corporation .....	75
Teletype Corporation .....	146, 147
3M Company .....	54, 55
Time Sharing Services, Inc. ....	56
Transistor Electronics Corporation .....	188
Tuck Electronics .....	135
Tymshare Inc. ....	110
Ultronic Systems Corp. ....	6, 206
United Aircraft Research Laboratories .....	208
United States Motors Corporation .....	18
Univac, Division of Sperry Rand Corporation .....	133, 182
Univac, Federal Systems Division .....	205
Univac, Data Processing Division .....	211
University Computing Company .....	69
Uptime Corporation, A Subsidiary of Data Products Corporation .....	100
URS Corporation .....	216
U. S. Magnetic Tape Company, A Subsidiary of Wabash Magnetics, Inc. ....	64
Varian Data Machines, A Varian Subsidiary .....	86, 87, 120
Vermont Research Corporation .....	49
Western Telematic, Inc. ....	12
Westinghouse Electric Corporation, Architectural Systems Department .....	130
Westinghouse Information Systems Laboratory .....	204
Wilson Jones, A Division of Swingline, Inc. ....	70, 71
Wright Line, A Division of Barry Wright Corporation .....	68, 105, 106
Xerox Corporation .....	215

## SYSTEMATION CONSULTANTS, INC.

Houston - New York

### TRUST SYSTEMS MANAGER

Highly respected financial institution with top management in their 40's seeks systems professional of uncommon enterprise to assume line responsibility in the development of computer trust systems for large trust department. Planning sophisticated personal and corporate trust systems to provide investment information, perform stock transfers, etc. Management opportunity with starting salary to \$17,000 range - Texas.

### REAL TIME SYSTEMS

Growing Southwestern divisions to assume new systems responsibilities seek professionals with experience in the design and implementation of multi-computer systems software, operating systems, and real-time executive and message switching systems. One position requires supervisory experience while all afford the opportunity to work in sophisticated multiprogramming applications with very advanced computer equipment. Dallas, Houston, and San Francisco locations with starting salaries to \$17,000 range.

### HARDWARE SYSTEMS MANAGER

Aggressively expanding medium-sized company subsidiary of major listed company seeks BSEE capable of assuming managerial responsibilities in the hardware design/applications engineering of small to large high speed digital CPU and peripheral product line including new time-sharing and message-switching hardware. Starting base salary to \$22,000 - Southwest. Three other less senior openings for same new department.

### NO FEE

The above openings are only a small sampling of the exceptional hardware and software opportunities within the activities of systems design/programming, process control, scientific/commercial applications, etc. as well as marketing, Operations Research, and other associated activities of our client companies in various locations—both jr. and sr. positions available. Your current employer will not be contacted without your permission. Send resume in confidence or request our resume form. A call to our Houston Director—J. L. Gresham, BChE, MBA—for further information is also invited.

1616 West Loop South

Houston, Texas 77027

(713) NA 2-1370

CIRCLE 348 ON READER CARD

# Head, Scientific Computer Operation

Research facility of a major New England corporation seeks an exceptional individual who can direct the operations of their digital computer center. This individual will be responsible for the management of the computer operation, as well as software development, application, and systems use.

If you have five to ten years broad experience in data processing, or a related discipline, a degree in a technical area of concentration, and a desire to take a significant step in your career, please send your resume, including salary requirements, to:

### DATAMATION Magazine

Box A-4

35 Mason Street

Greenwich, Conn. 06930

*an equal opportunity employer*

# the forum

The Forum is offered for readers who want to express their opinion on any aspect of information processing. Your contributions are invited.

## QUALITY CONTROL FOR R & D

As readers of this magazine know, the U.S. government spends many hundreds of millions of taxpayers' dollars each year for scientific research and development. The tangible product of this vast outpouring of money consists very largely of scientific and technical reports. These contribute in no small measure to the "information explosion" of much current concern.

I feel this federally financed flood of literature is being poorly regulated, that too many of the reports are worthless, that much money is thus being wasted, and I believe the government should act to remedy the situation. Since I also believe that knowledge is the real wealth of man, I am more concerned with the quality than with the volume of this flood or with the research topics it covers.

The control I feel is lacking, and which the government should act to establish, is that afforded by critical review. Traditionally, the professional journals have provided part of this vital control for the literature of science and technology. Papers submitted for journal publications are critically reviewed prior to publication, so that a useful—if occasionally misleading—index to a man's professional worth is the number of his published papers. Even more valuable for distinguishing good work from bad are the critical reviews published in the various review journals.

Unfortunately, the great majority of government-sponsored research and development reports are not subject to any such review process, so that mediocre work is as readily accepted as good work.

Most reports on government sponsored research and development are published internally by the organizations doing the work. Only a small percentage of these reports are submitted for journal publication and critical review. The rest are reviewed only by the



government's project monitor—who is not likely to admit to purchasing trash—and perhaps by the research organization's technical management—who are not likely to admit selling trash. Consequently, a great deal of trash gets paid for and published this way, and there is no easy way for anybody to distinguish it from worthwhile work.

To remedy this situation, I propose that the government spend some small

fraction of its annual research and development budget to support a critical literature-review program. This program could be administered by some existing agency—perhaps the National Science Foundation—and should operate through the editorial boards of the review journals of the established professional societies. The administering agency would grant funds to a review journal, which would augment its coverage by commissioning expert reviews of papers in its field that are announced (but not reviewed) in *U. S. Government Research and Development Reports*, the abstract journal published by the Department of Commerce Clearinghouse for Federal Scientific and Technical Information.

The critical literature-review program I am proposing would have a subtle but vital long-term effect on the quality of the nation's technical literature. It would have an immediate effect on making a good part of that literature better known to its potential users, who would be provided with expert and reasonably objective advice on its value. The quality of this advice would itself be assured by having the reviewers chosen by the review journals' editors. In addition, the proposed program lends itself to being experimentally implemented in one field on a trial basis.

—CHRISTOPHER J. SHAW

# Here's proof of the superior performance of **MAC PACK**

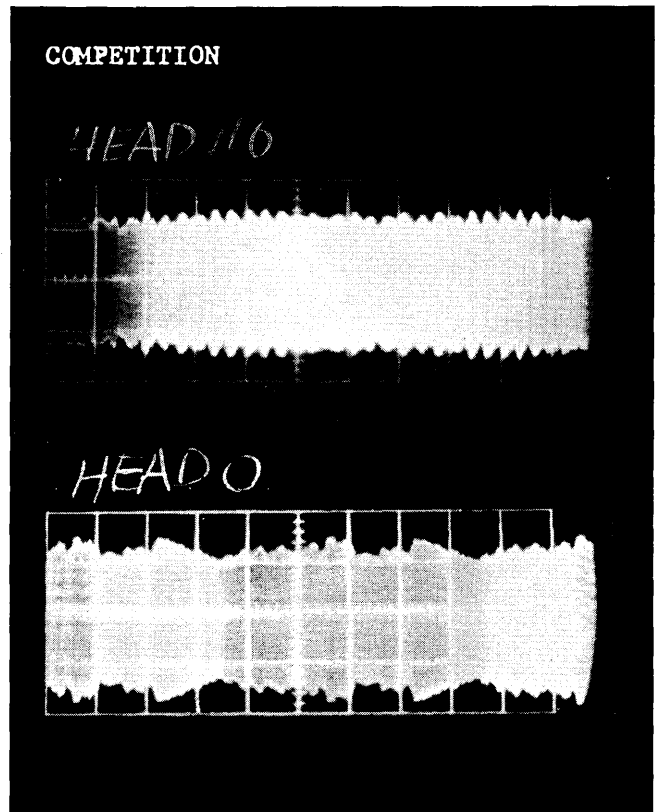
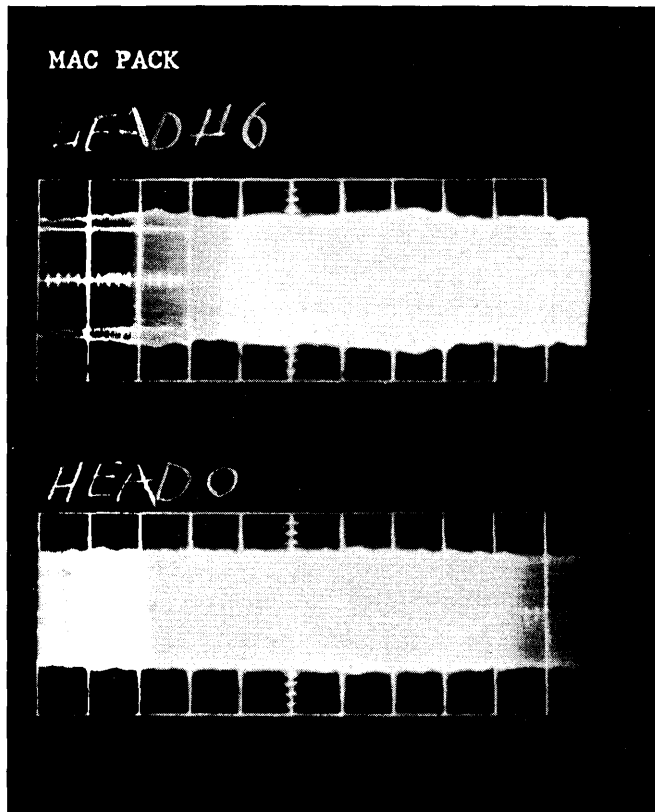

DATA FROM TESTS RUN BY A MAJOR COMPUTER MANUFACTURER ON COMPETITIVE DISK PACKS

When two or more competitive disk packs measure up on all the obvious tests, how do you discriminate?

Here are the results of a rather sophisticated test of signal amplitude. As you can see in these unretouched photographs, the MAC PACK is clearly superior—the smooth, clean outer edges of the “envelope” are proof of greater signal uniformity. MAC engineers had to develop a new coating formulation and a unique disk coating technique to achieve these results.

The MAC coating is also designed for greater durability; and its resistance to abrasion and greater coating uniformity result in consistent performance unmatched in the industry—and longer useful life for the pack.

On the basis of his own comprehensive tests, the computer manufacturer who took these photographs chose MAC as his source. Since July, 1967, thousands of MAC PACKS and MAC coated disks have been delivered to several computer manufacturers and hundreds of users; they are now running on every kind of disk drive compatible with the IBM 1316.

- MAC PACK is guaranteed to meet or exceed specifications and performance standards of all other disk packs
- Each MAC PACK is final-tested on our own IBM 360-30 before shipment
- Lease or purchase plans available
- Delivery: IMMEDIATE
- Order your MAC PACKS through your local MAC representative or write us at MAC Panel Company, Box 5027, High Point, N. C. 27262



# The Ferroxcube FI-3. A fast memory at a slow price

(It runs like a Lotus Ford—costs like a Rambler American.)

As a matter of fact, it's impossible to beat the FI-3 on a speed-to-cost ratio.

Now even if you have a fast speed requirement and a slow speed budget you can afford the advantages of core storage design over electromechanical techniques: speed, random access, non-dissipative, non-volatile...to name a few. And because they are mass produced, reliability is higher than core storage systems built on a one-at-a-time basis.

Here are the facts:

Storage Capability: 1K x 6 bits to 4K x 18 bits.

Cycle Time: 3 micro-sec full cycle; 2 micro-sec half cycle.

Electronics: Complete; all IC's except for the current drivers. 0 to 50°C operation.

Timing: Multi-mode with full or half cycle option.

Construction: 3D, 4-wire, 30-mil low temperature coefficient cores.

Power: Only +6 and -12 volts input required; power modules self-contained (optional).

Size: 5¼" high in 19" rack including power, address register, or sequential counter and memory retention features.

Delivery: Less than 60 days.

Price: 4K x 18 bits—\$4000.00. Lowest price in the industry!

Incidentally, the FI-3 series expands Ferroxcube's Catalog of 513 standard memories by over 100 new types. If you'd like the facts (and prices) on any of them, including the new FI-3, give us a buzz.

Here's a once in a lifetime opportunity to drive a high speed model at an economy price.

**Ferroxcube**   
Systems Division, Englewood, Colorado

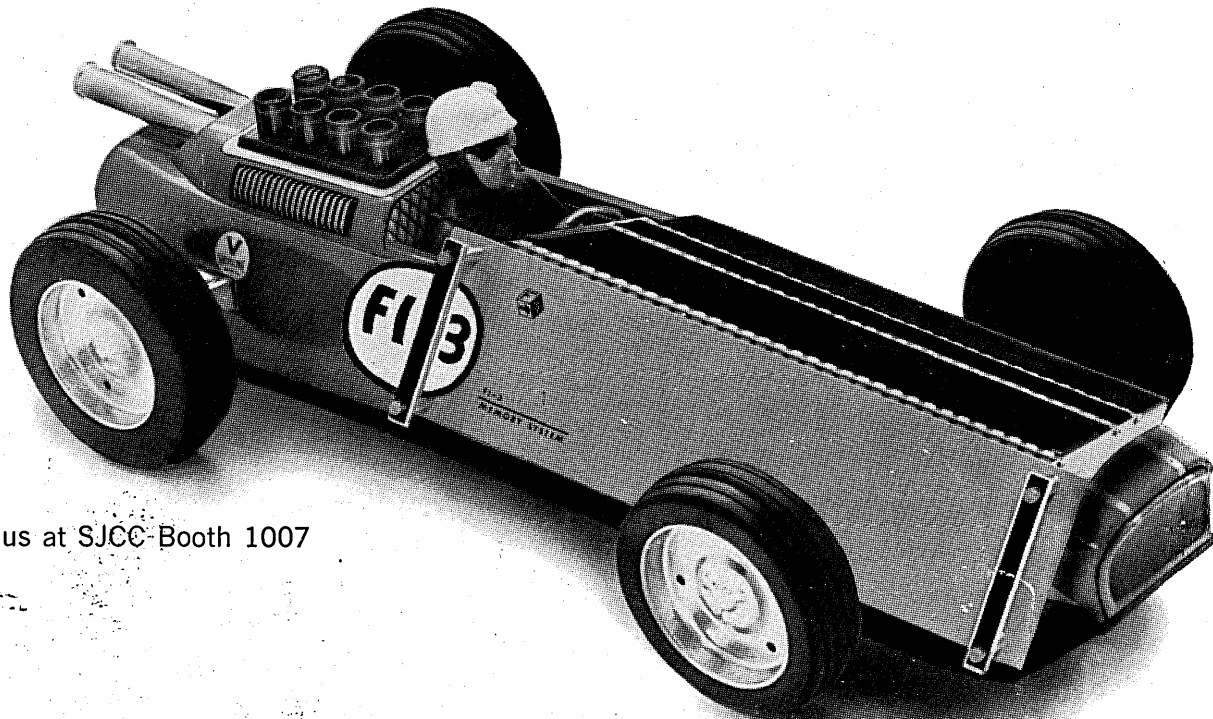

See us at SJCC Booth 1007

Albuquerque—Electronic Enterprises, (505) 256-1585; Baltimore—Eastern Components, (301) 322-1412; Dayton—(513) 253-3158; Encino, Cal.—(213) 788-2060; Englewood, Col.—(303) 771-2000; Houston—Noakes Engineering, (713) 529-6213; Irving, Texas—Noakes Engineering, (214) 255-0441; Lansing, Mich.—(517) 482-7140; Minneapolis—(612) 888-4681; Northlake, Ill.—(312) 261-7880; Orlando—(305) 841-6380; Philadelphia—Eastern Components, (215) 927-6262; Phoenix—(602) 264-3120; San Francisco—Wm. J. Purdy Agents, (415) 863-3300; Saugerties, N. Y.—(914) 246-2811; Union, N. J.—(201) 964-1844; Waltham, Mass.—(617) 899-3110; Toronto, Ontario—Phillips Electron Devices, Ltd., (416) 425-5161.