



■ Using CIM
To Integrate
The Organization

■ Printer Power:
Distributed
Queuing Service

■ Understanding
UNIX™ In A
VMS™ World

COMMUNICATIONS

Blast II

JUNE ■ 1989

DEC

\$4.00 ■ VOL. 8, NO. 6

Professional

An Independent Magazine from Professional Press

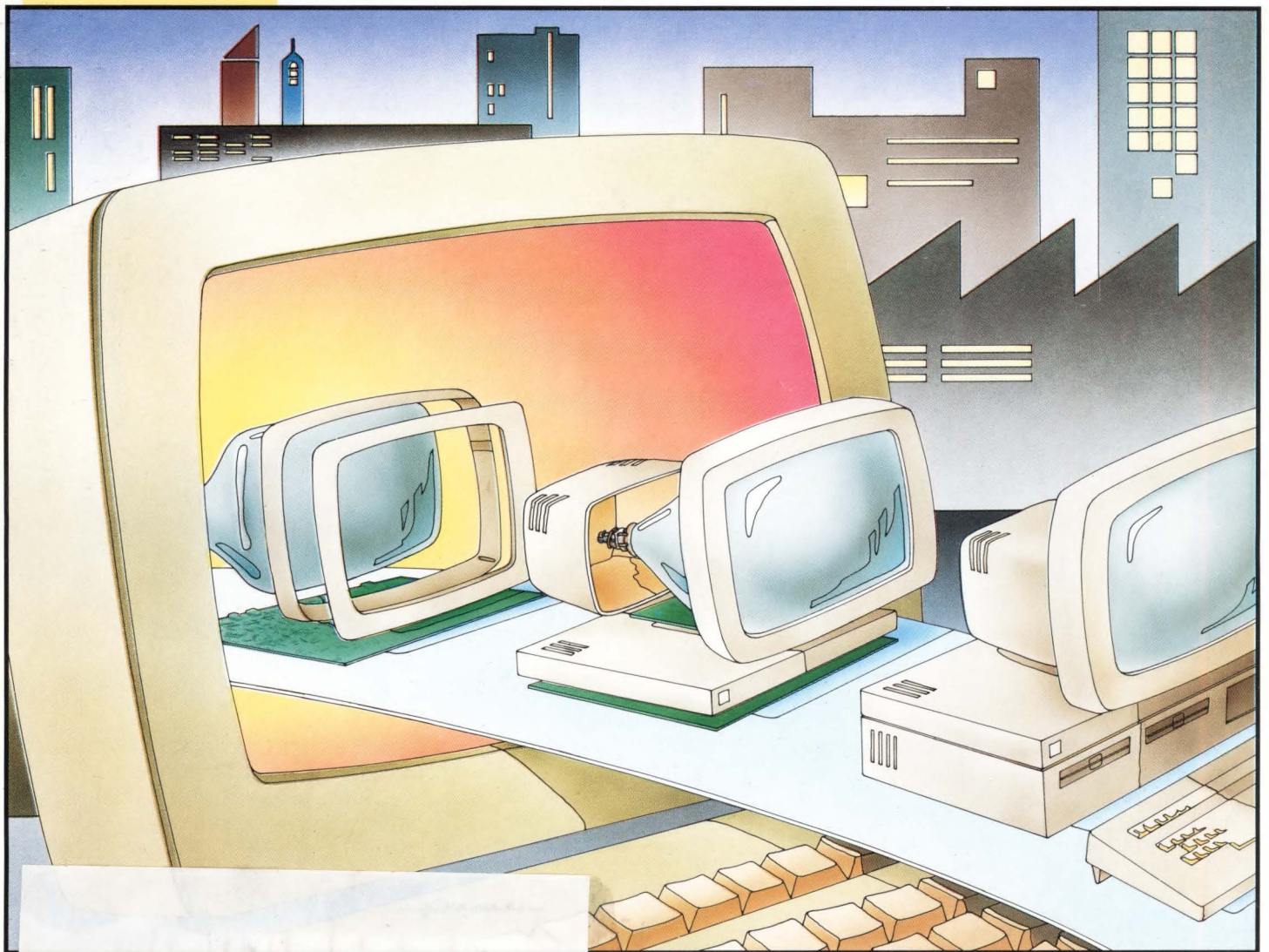

Production ¹⁴ Automation

ALL THE SPACE YOU NEED TO CONNECT 128 USERS TO YOUR NETWORK IS RIGHT HERE...

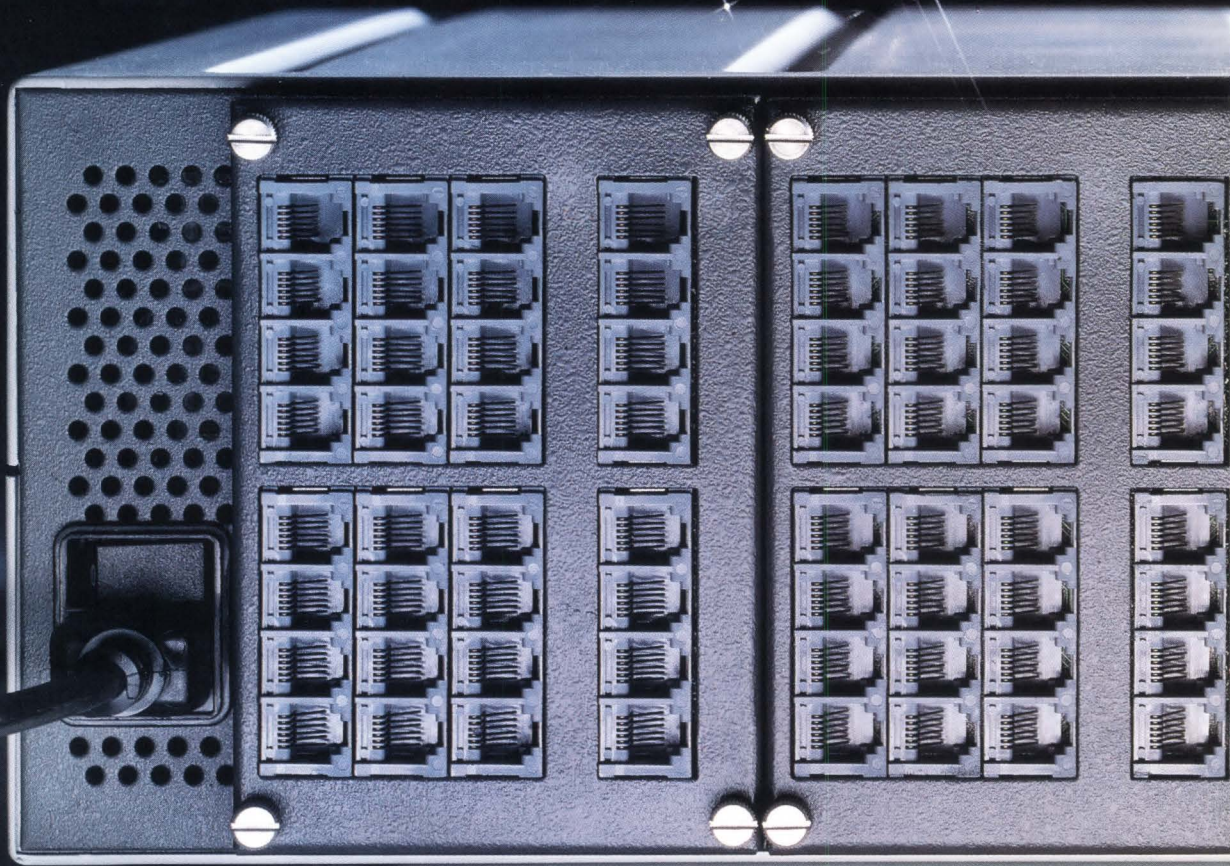

VISTA. THE SPA

Imagine one free standing or rack mountable 5 1/4 inch unit providing more power and performance than a DECserver 500, replacing as many as 16 DECserver 200's! A single VISTA 100% LAT compatible terminal server can be configured to support an unprecedented 128 users in the space of a single DECserver 200.

VISTA SAVES MUCH MORE THAN SPACE

Whether you configure VISTA with 8 or 128 ports, VISTA's per port costs are among the lowest in the industry. The 128 port configuration above is priced at \$14,996 - under \$118 per port! Buy a VISTA 128 port server instead of a DECserver 500 and *pick up a pair of VAX-3100s with the change.*

UNMATCHED PERFORMANCE STANDARDS

Unlike a DECserver 500 that shares a single processor among

all users, each VISTA Line Card contains a dedicated Intel 80186 processor. So adding additional users to a VISTA Server will not decrease VISTA's high performance. A single VISTA Server supporting 128 users provides port speeds of 38.4k bps with an aggregate character throughput of 100,000 cps.

NETWORKING SOLUTIONS WITH INVESTMENT PROTECTION

VISTA's Network Interface Card is cable-ready for most cabling environments featuring standard, thin wire and SynOptics unshielded twisted pair connections.

Start today with VISTA's 100% LAT compatible Network Interface Card (NIC). In the future, when your strategy changes, simply swap your existing NIC LAT with a TCP/IP, OSI or multiple protocol NIC.



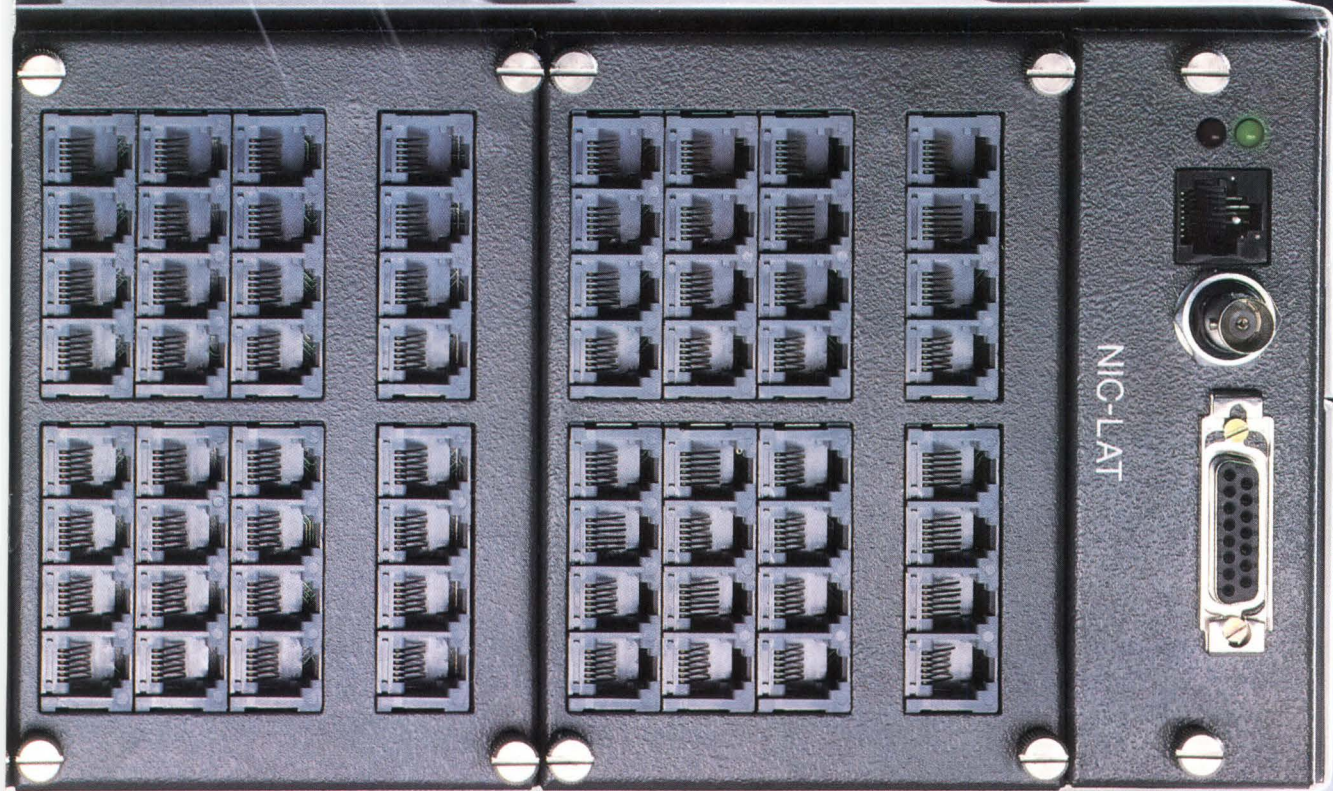

CE PLATFORM.

A PLATFORM FOR YOUR DESIGN

VISTA's modular architecture allows you to choose now from a number of user connectivity strategies such as 8 Port RS232, 32 Port RS423, and early this summer On-Board Modems and X.25 Line Cards. Use a combination of Line Cards to customize VISTA to meet your specific network needs.

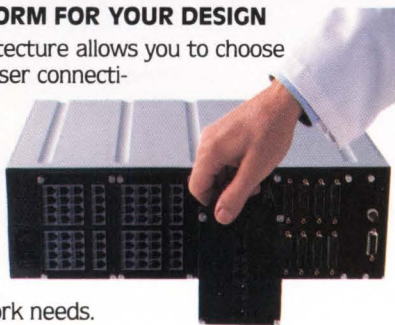

EASY SUPPORT AND MAINTENANCE

VISTA Line Cards can be swapped without the need for port reconfigurations. All configuration parameters are stored in battery backed up, non-volatile memory. Plus, VISTA Line Cards have detachable port connector plates to eliminate the need to disconnect and reconnect cables when changing a card.

NO RETRAINING REQUIRED

Users familiar with the DECserver command interface will find VISTA easy to use, requiring no end-user retraining. VISTA is compatible with DEC management software including NCP and TSM, allowing existing administrative controls to continue without modification.

**CALL NOW TO FIND OUT ABOUT OUR NO RISK
CUSTOMER SATISFACTION PROGRAM**

VISTA™

1-800-DIAL-DSS

(in NY: 212-807-7800)

Datability Systems, 322 Eighth Ave., New York, NY 10001
All product names are registered trademarks of their respective manufacturers.

Now your old standard is compatible with the new backup standard

If you are using Pertec standard nine track tape drives for backup, you should consider moving to the new 8mm standard. Now it's easy to add all the benefits of Helical Scan Technology to your existing system, without special software drivers or additional controller cards. The CY-8200 interfaces to your Pertec compatible tape drive or controller as another nine track tape drive - a very fast, high capacity tape drive.

The new 8mm standard delivers performance. The CY-8200 gives you 2.3 gigabytes of formatted capacity per tape, making unattended backup a reality. With transfer rates of up to 15 megabytes per minute, backup is very fast.

The new 8mm standard delivers real cost savings. Each 8mm tape can replace 10 to 20 reels, at a typical cost of \$10 per tape. Considering the number of reels you purchase each year at \$15 or more, you can save thousands of dollars in media costs alone. Add the increased productivity of operators freed from mounting reels and attending to backups, and the switch to 8mm becomes easy to cost justify.

8mm tape backup is a proven standard. It has been a tremendous success, with thousands of installed subsystems. With no new technology on the horizon to surpass Helical Scan drives, 8mm will continue as the standard. And each CY-8200 is backed by a twelve month warranty, with extended warranty available.

True Plug and Play Compatibility with

DEC	IBM PC
IBM	Wang
Hewlett Packard	Sun
Data General	IBM PC Compatibles
Unisys	MS DOS
Prime	SCO Xenix
Pyramid	Alpha Microsystems
Apollo	Altos



The CY-8200 is a turnkey solution that can be ordered in any one of a variety of configurations to fit your site requirements:

- Special cable lengths - up to 80 feet
- A variety of standard interfaces for your system.
- Rack mounting - up to 4 drives in a single 19" rack for 9.2Gb of unattended backup
- Free standing, portable units
- Combination disk/tape subsystems
- Status display - 2 line, 40 column display shows tape condition, drive state, command, etc.

with all the advantages of Helical Scan Technology:

- High capacity - 2.3 Gb formatted capacity
- High speed - up to 15 Mb/minute sustained; 1.6 Mb/second burst
- Compact media - vastly reduced tape library space
- Reliable - twelve month warranty
- Quiet - Quieter than your laser printer
- Data interchangeability - write a file on your VAX and retrieve it on your Sun

For more information, call

CONTEMPORARY
CYBERNETICS
Group

11830 Canon Boulevard
Newport News, Virginia 23606
(804) 873-0900

CIRCLE 234 ON READER CARD



C CONTENTS

JUNE 1989

VOL. 8, NO. 6

PRODUCTION AUTOMATION

38 THE CIM SOLUTION

by *Evan Birkhead*

Computer-integrated manufacturing (CIM) systems integrate applications for planning, design and production to merge manufacturing with the organization.

48 MERGING ON THE DATA HIGHWAY

by *Robert B. Irvin*

Process control and management information systems historically have occupied opposite ends of the computing spectrum. In this real-world example, however, the two are married to provide an integrated environment.

56 MAKING PROJECTS WORK

by *Steven Salemi*

The ever-increasing constraints of costs, resources, quality and time make project management a serious business. Accordingly, today's project management software is powerful and complex.

ON THE COVER:

This month's cover illustration is the work of airbrush artist Jim Serfass, residing in Christiansted, St. Croix, U.S. V.I.

This magazine is not sponsored or approved by Digital Equipment Corporation. "DEC" and "VAX" are trademarks of Digital Equipment Corporation. Digital Equipment Corporation is the owner of the trademark "DEC" and is the source of all "DEC" products. For other Digital trademarks, see page 18.

FEATURES

64 CONNECTIVITY: DISTRIBUTED QUEUING SERVICE

by *Philip A. Naecker*

DQS leverages the power of DEC's networking architecture and takes advantage of powerful availability features such as clusters. It makes VAX printers available to all nodes in the network, with functionality identical to that of local printers.

78 DESIGN & TESTING: STAYING COMPETITIVE

by *Evan Birkhead*

The majority of DEC third-party hardware producers — manufacturers and integrators of connectivity, communications and storage products — consider quality assurance their top priority.

Continued on page 4.



DEC Professional

Continued from page 3.

DEPARTMENTS & COLUMNS

Publisher

by Carl B. Marbach

Computer Slump Or Temporary
Confusion?.....10

Editorial

by Dave Mallery

Mips Melee.....14

ULTRIX™

by Philip E. Bourne, Ph.D.

UNIX In A VMS World106

Let's C Now

by Rex Jaeschke

Pointers, Part 1.....114

Digital Watch

by Evan Birkhead

Education Initiative122

DCL Dialogue

by Kevin G. Barkes

EXIT Examined130

Back End

by John C. Dvorak

The Zig And Zag Of UNIX160

Letters.....16

ARISTALK20

Product Watch24

Products132

Product Showcase.....154

Used Equipment155

Classified.....156

Advertisers Index.....158



From The Lab

VAX Tuning

by David B. Miller88

Computer Information Systems' Quantum PT can alleviate your tuning burden by tuning a running system dynamically to achieve maximum performance.

Customized Projects

by Evan Birkhead94

DSD Corporation's C-Plan offers a large and flexible set of cost and scheduling functions.

File-Transfer Forte

by David B. Miller.....100

File-transfer functions, a robust scripting language and the ability to run on a number of platforms make Communications Research Group's Blast II a valuable communications tool.

The lab seal indicates that the product reviewed has been tested by one of our experts in our Laboratory and Testing Center.



The ARIS/BB symbol on an article indicates that the program segments are available electronically on our Automated Reader Information Service. The download file name is indicated below the ARIS/BB symbol. Dial (215) 542-9458; Southern California (818) 577-9100; Northern California (415) 873-2135; Massachusetts (617) 863-5010.

We will consider for publication all submitted manuscripts and photographs, and welcome your articles, photographs and suggestions. We cannot be responsible for loss or damage. All materials presented are believed accurate, but we cannot assume responsibility for their accuracy or application. DEC PROFESSIONAL Magazine ISSN 0744-9216 is published monthly by Professional Press, Inc., 921 Bethlehem Pike, Spring House, PA 19477. Printing and binding by R. R. Donnelley & Sons Company. Subscriptions are complimentary for qualified U.S. and Canadian sites. Single copy price, including postage, \$4. One year subscription rate \$30 in the U.S. and Canada; and \$60 foreign. All orders must be prepaid. Second Class postage paid at North Wales, PA, and additional mailing offices. POSTMASTER: Send all correspondence and address changes to: DEC PROFESSIONAL, P.O. Box 503, Spring House, PA 19477-0503. COPYRIGHT © 1989 by Professional Press, Inc. All rights reserved. No part of this publication may be reproduced in any form without written permission from the publisher.



Outperform VT240/241 Graphics Terminals By Trading 4 Old Colors For 16 New Ones.

Presenting a fresh set of enhancements to the leading DEC® VT240/241 terminal emulation software. New SmarTerm® 240 version 3.0 has a range of VT340 ReGIS® graphics features. So when running on a PC with an EGA or VGA, it actually outperforms a dedicated VT240/241 terminal.

Sixteen different colors can be specified from available palettes. Which makes working with 3-D images and complex filled regions in powerful ReGIS color graphics

programs as easy as pie charts. Rubber band cursor actions, curves through data points, and text drawn to virtually any size, shape, or angle are also available.

The vivid display of advanced software engineering in version 3.0 goes beyond colorful VT340 features. We've also made version 3.0 faster, easier, and more comfortable to use.

Automatic keyboard remapping has been added. The PC num lock, for example, becomes the DEC PF1 key. Now, no matter which style PC keyboard you use, the best physical representation of the DEC keypad will be at your fingertips.

On-line help has been expanded. Softkey enhancements include conditional branching and faster action. We've even managed to improve the performance of our state-of-the-industry communications and file transfer features.

Some things haven't changed. Installation is still automatic. Our technical support group still provides free solutions to problems and answers to your questions. And our 30-day return policy continues to make a complete on-site evaluation risk-free.

So if you're already a SmarTerm software user, call us today at 608-273-6000 to trade up. And if you're not a SmarTerm user, now's the time to become one.

Because going to the top of our line puts you at the top of the spectrum.

Emulate The Best With The Brightest.

CIRCLE 132 ON READER CARD

persoft®

©1988 Persoft, Inc. All Rights Reserved. Persoft and SmarTerm are registered trademarks of Persoft, Inc., 465 Science Drive, Madison, WI 53711. Specifications subject to change without notice. DEC, VT, and ReGIS are registered trademarks of Digital Equipment Corporation.



DEC UNIBUS* USERS:

Twice the performance
at half the price!

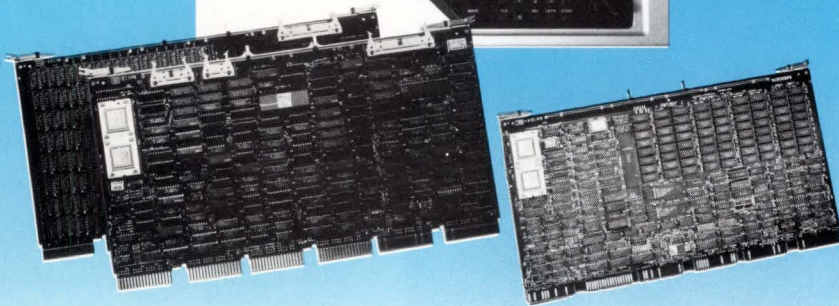

N1100 PLUS

- 4 Mbytes DRAM
- 8 KBytes Cache
- Hardware Floating Point
- Memory Management

N1100

- 2 Mbytes DRAM
- Memory Management
- Serial Line Unit
- Universal Boot ROM

J-11* POWER FOR OPTIMUM PERFORMANCE
FITS ALL EXISTING PDP 11/04/24/34s
NO BACKPLANE CHANGE

FOR SPECIAL PRICING ON N1100, CALL OLIVIA AT
(800) 233-1837 IN CALIFORNIA (714) 261-8811

NISSHO
ELECTRONICS

17320 Red Hill Avenue, Suite 200, Irvine, California 92714 · FAX (714) 261-8819, TLX 181-308

*UNIBUS and *J-11 are registered trademarks of DIGITAL EQUIPMENT CORPORATION

CIRCLE 163 ON READER CARD

DEC Professional

Publisher: Carl B. Marbach
Editorial Director: R. D. Mallery

Editorial

MANAGING EDITOR Lou Pilla
SENIOR EDITOR Evan Birkhead
ASSISTANT EDITORS Pamela F. Fullerton,
Eric Schoeniger
BACK END EDITOR John C. Dvorak
C EDITOR Rex Jaeschke
DCL EDITOR Kevin G. Barks
FIELD SERVICE EDITOR Ron Levine
MACINTOSH EDITOR Al Cini
NETWORKING EDITOR Bill Hancock
TECHNOLOGY EDITOR Philip A. Naecker
ULTRIX EDITOR Philip E. Bourne, Ph.D.
UNIX EDITOR Elaine L. Appleton
WORKSTATIONS EDITOR David W. Bynon
EDITORIAL SYSTEMS COORD. Anne Schrauger
EDITORIAL ASSISTANT Nadina R. Chapman
CONTRIBUTORS Robert B. Irvin,
Steven Salemi, Peggy King
MANAGING EDITOR, Buyers Guide Anne E. Maher

DP Laboratory and Testing Center

DIRECTOR R.D. Mallery
MANAGER David B. Miller
TECHNICAL EDITORS Sheldon Green, Del Lukens
MIS SOFTWARE MANAGER Bonnie Auclair
MIS SYSTEMS MANAGER Kevin J. Kennelly

Design & Production

DESIGN / PRODUCTION MANAGER Ruth Ann Leiby
DESIGN / PRODUCTION ASST. Pat Messina
ADVERTISING BOOKING COORD. Lori Goodson
ADVERTISING PROD. COORD. Suzanne Garr
TRAFFIC / PRODUCTION ASST. Kim Macheski
PROMOTIONS MANAGER Timothy M. Kraft
GRAPHIC DESIGNERS Richard Kortz,
Thomas Owen, Sue Ann Rainey
PRODUCTION ARTISTS Carolyn J. Brown,
Patricia P. Krackel, Kristy Yates
TYPESETTER MaryEllen Coccimiglio

Circulation

CIRCULATION DIRECTOR Carrie Eisenhandler
CIRCULATION MANAGER Betsy Ellis
FULFILLMENT MANAGER Margie F. Pitrone
CIRCULATION DBA Rebecca Schaeffer

PROFESSIONAL PRESS, INC.

PRESIDENT Carl B. Marbach
VICE PRESIDENT R. D. Mallery
VICE PRESIDENT Peg Leiby
VICE PRESIDENT Helen B. Marbach
EXECUTIVE EDITOR Linda DiBiasio
EXECUTIVE DESIGN DIRECTOR Leslie A. Caruso
DIRECTOR OF MARKETING Mary Wardlaw
CONTROLLER Andrea Beneke
ASSISTANT TO THE PRESIDENT Jan Krusen

For information on how to contact your sales representative, see page 158. Editorial, Advertising Sales, and Executive Offices at 921 Bethlehem Pike, Spring House, PA 19477. (215) 542-7008. TWX 910 333 9522. FAX (215) 628-2845. Easylink 62805174. ARIS (Automated Reader Information Service) (215) 542-9458; Southern California (818) 577-9100; Northern California (415) 873-2135; Massachusetts (617) 863-5010. Additional Editorial Offices: East Coast Office at 238 Bedford St., Suite 3, Lexington, MA 02173. (617) 861-1994. West Coast Office at 1010 E. Union St., Suite 101, Pasadena, CA 91106. (818) 577-5970. Northern California and Northwest Office at 903 Sneath Lane, Suite 220, San Bruno, CA 94066. (415) 873-3368. Southern Texas Office at 11782 Jollyville Rd., Suite 203, Austin, TX 78759. (512) 258-4800.

CLEARPOINT

The Leader in DEC-Compatible Memory—
Delivering High Performance for the Complete MicroVAX Line



Introducing—Memory Upgrades
for VAXstation 3100

The DCME-M30 Meets the Challenge – Highest Density Memory, First to Market

Take your MicroVAX 3000 to the max! Clearpoint packs a full 32 megabytes of memory onto the DCME-M30 boards using state-of-the-art one megabit DRAMs. Also available in 16 or 8 MB densities, Clearpoint offers the best pricing for the best package.

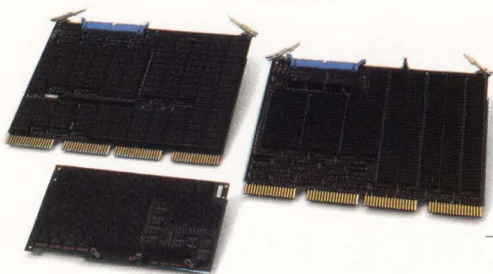

The DCME-M20 Releases the Full Power of Your MicroVAX 2000

Order your DCME-M20 today and get the equivalent of MicroVAX II performance at half the cost. The DCME-M20 is available in 8 and 16 MB boards to upgrade the MicroVAX 2000 to either 10 MB—or to the full 16 MB maximum of the MicroVAX microprocessor.



CIRCLE 151 ON READER CARD

Clearpoint Research Corporation

One Parkwood Drive, Hopkinton, MA 01748
1-800-CLEARPT (253-2778)
(508) 435-2000

The DCME-M2 Offers the Full System Capacity of the MicroVAX II on One Board

The 16 MB DCME-M2 is designed to run cooler and draw less power for maximum board life and reliability. Also available in 8 and 4 MB boards.

Ask for our Product Catalog, Designer's Guide to Add-in Memory and applications video.



Clearpoint is a registered trademark of Clearpoint Research Corporation. DEC, MicroVAX 3000, MicroVAX 2000, MicroVAX II are trademarks of Digital Equipment Corporation.

WHY ARE SO MANY CUSTOMERS CALLING SCHERERS AGAIN AND AGAIN?

PRODUCT SET

"Low prices."

TERMINALS

VT320™	alpha numeric terminal
VT330™	text/graphics terminal with dual session
VT340™	text/graphics color terminal w/dual session

COMMUNICATIONS

DHQ11™	DMA Async, 8 line Q-bus adapter
DZQ11™	Async, 4 line Q-bus adapter
DHU11™	16 line Unibus Async adapter
DELQA™	Q bus ethernet adapter
DEQNA™	Q bus ethernet adapter
DELUA™	Unibus ethernet adapter
DMV11-N™	Multipoint CCITTV.35

"An extensive inventory of Digital Equipment products that can be shipped immediately."

"Technical support. All Digital licenses and warranties valid. They file the paperwork."

PRINTERS

LA75™	companion printer
LA210™	letterprinter
LA120™	DECwriter III
LN03™ +	upgraded-laser printer family
LJ250™	companion color printers
LA100-CA™	Letterwriter

ETHERNET™

DELNI™	thickwire ethernet interface
DEMPR™	thinwire multiport repeater
DESPR™	thinwire singleport repeater
DEREP™	ethernet repeater
DEBET™	extended LAN interface
DESTA™	thinwire station adapter
H4005™	thickwire transceiver

Our customers confirm it! When you call Scherers, you get aggressive pricing at every quantity level on every product. We ship same day on stock orders received by 4 p.m.

We're grateful that our customers appreciate the way we do business. And we plan to bring you the same quality products at competitive prices for years to come.

We're in our 16th year of service to customers, and business has never been better. Serving you well is how we got here and we never forget it.

DECSERVERS

DSRVB-AA-200™	terminal server-EIA
DSRVB-BA-200™	terminal server-MMJ
DSRVS-AA™	
DSRVS-BA™	(16-128 port)

MODEMS

DF242™	2400/1200/300 bps modem
DF224™	2400/1200/6 ps modem
DF127/DF129™	modems

Scherers is an Authorized Distributor. All new Digital Equipment products have a full one year Digital Warranty.

Call Scherers to order. (614) 847-2200

digital™
Authorized Distributor
CIRCLE 343 ON READER CARD

SCHERERS

We bring Digital to you.

**SCHERERS IS THE SOURCE FOR
DIGITAL EQUIPMENT PRODUCTS.**

How to get ten terminals (or more) for the price of one.



Now, with Clyde's WINDOW, you can turn any VT terminal into a multisession terminal.

With WINDOW you can create sessions on demand for as many applications as you want to work with. And quickly switch from program to program with a single keystroke.

With WINDOW the power and utility of the DEC VAX/VMS system is magnified. And for the first time, the terminal can do what you do—several things at once.

Start up with one application, then add another, and another. Experience true multi-tasking: In one window you can be typing a report in your word processor; in another, sorting records in your database; in another, calculating spreadsheet formulas; and in yet another, printing mailing labels. And so on and so forth.

Now that's productivity!

More windows. More power. And Macros.

WINDOW lets you leave one session and jump to another. Then jump back. In an instant. WINDOW keeps track of the activity in each session and refreshes your screen to the most up-to-date display for that job.

In the WINDOW environment, you can capture screens from several different programs. Collect, combine, edit it all in one place. Or print it to a file for later viewing.

On top of that, you have macro capability too. So you can shrink those long, complex or repetitive sequences to a single defined keystroke.

The whole process is easy, swift, and natural.

Until you've worked with WINDOW, you won't imagine the productivity that lurks within your terminal. Or the beautiful view away from the sprawl of terminal clutter.

Do more work, more kinds of work, and do it faster. Find out more about the new visions your present terminal can have by giving us a call at

801-224-5306.

And take a good look into WINDOW*.

 **Clyde**[®]

The VAX Support & Security Software Specialists

Clyde Digital Systems, 371 East 800 South,
Orem, UT 84058, 801-224-5306, FAX:801-225-7684



PUBLISHER

Carl B. Marbach

Computer Slump Or Temporary Confusion?

The gurus of Wall Street have declared a computer slump. They point to lower earnings by DEC and IBM and the recent loss posted by

Unisys. Digital's most recent financials show a healthy increase in gross revenues, but not as large a growth rate as in the past. Although DEC is controlling its spending carefully, lower-than-expected sales will result in lower earnings.

As usual, DEC's absolute performance isn't suffering. Rather, the shortfall is in realizing the large growth rates that Wall Street and DEC predicted. DEC should ask itself why, although it's financially sound, it didn't meet expectations. Yes, the 8800 high-end systems have been impacted by the 6300s, the MicroVAX 2000 is woefully out of date and overpriced, the VAXstation 3100 series can barely keep up with the speed of a Mac, and DEC's sales effort is as inept as ever.

But the real problem is consumer confusion. Buyers are waiting to understand where the computer market will go in the next 12 to 24 months. Is VAX still the answer, or will UNIX eclipse the VAX architecture and shorten its useful life?

The press has seized on the problem, and nearly every publication is touting, "UNIX is the wave of the future" or "RISC offers new performance realms." Starved for real news, journalists are jumping on the UNIX and RISC bandwagon. But the headlong rush toward UNIX just doesn't make sense to me. Too many illogical things are going on, and that usually means we don't have all the facts. At *DEC PROFESSIONAL*, we recently purchased a DECsystem 3100 for our Lab so that we can find answers to the many questions about ULTRIX.

There are three problems with the new UNIX systems: a lack of real standards; security that's only promised, not delivered; and questions about performance. As far as standards, IBM, HP and DEC are on one side of the UNIX fence, AT&T and Sun are on the other — so we have two standards already. When was the last time IBM allowed a standard? Oh yes, the PC standard, and IBM won't make that mistake again.

Any standard for UNIX will be a base-level implementation similar to the ANSI standard for FORTRAN or COBOL. Have you ever seen an ANSI-standard FORTRAN program on the VAX? Although the compilers are ANSI compatible, they all feature improvements, and most of us take advantage of them. ANSI-standard UNIX will be the same — a minimum

standard exceeded by everyone.

UNIX security is severely lacking. The November 1988 Arpanet virus attack revealed just one of many holes in the armor. Security must be designed in from the beginning, not added on at the end. I can't see IBM, DEC and HP agreeing on how to handle security. The "standard" UNIX will have minimal security, and it will be up to each manufacturer to add the rest.

Further, do mips translate into performance? Is 12 mips four times faster for your application than 3 mips? Although the faster machine may execute more instructions per second, what if the architecture requires many more instructions to be executed to do your job?

It's no wonder system managers today find decisions difficult. Should they stay with the traditional VAX architecture, or is it time to switch to the newer UNIX engines? If they look hard, they might form the same conclusion that I have: UNIX isn't ready yet. Unless they're pushed, many system managers are choosing to wait. Waiting translates into slower sales as some of us move to the sidelines and watch what happens.

DEC is led by one man, and right now he's hedging his bets — moving two top VMS managers to the UNIX side, buying a piece of Mips Computer Systems Inc., and introducing the RISC-based DECstation and DECsystem 3100. Is this another slight of hand, DEC buying time as it did with its now back-burnered Apple deal?

DEC doesn't like to talk about unannounced products or future plans, but this is a special time. Fast-moving hardware generations and UNIX hype are scaring DEC's customers. They'd like to hear it from the top, from the man who has made so many right decisions for more than 20 years. What are DEC's real plans? Will DEC have two architectures and two operating systems? Is the future in RISC, VAX, both or neither?

It's time for Ken Olsen to step forward and tell it like it is.

Carl B. Marbach

UNATTENDED BACKUP

If backing up your VAX Cluster keeps you reeling all night, try the new MA-24 two gigabyte tape cartridge backup system from Micro Technology.

Just turn it on and say good night. Because with the MA-24, you don't have to be there. Nobody does.

Unattended backup for VAX Cluster environments isn't just a dream anymore. It's real. And it's called the MA-24.

100% HSC compatible with pure DEC TA emulation, the MA-24 can back up 2 gigabytes of data on one cartridge. And because the MA-24 subsystem is so economical, you can finally afford to back up your entire VAX Cluster without changing anything except the time you go home. Just turn it on and let it run.

Configured in 2 gigabyte units, the MA-24 can back up 32 gigabytes of data in a VAX Cluster, using just one footprint and one HSC5X-CA card.

With its own 512 KB buffer, the MA-24 can keep streaming at 246 KB/sec. With peak transfer rates of 1.5 MB/sec. That means with a fully configured HSC5X-CA card you can back up a full 32 gigabytes in just three hours unattended.

So why fight it? Try a few gigabytes of unattended backup for your VAX Cluster and turn nonproductive time into productive time.

For more information on the MA-24 tape subsystem, call Micro Technology, Inc. 800 999-9MTI.



Micro Technology

1620 Miraloma Avenue
Placentia, California 92670
1-800-999-9MTI

CIRCLE 124 ON READER CARD

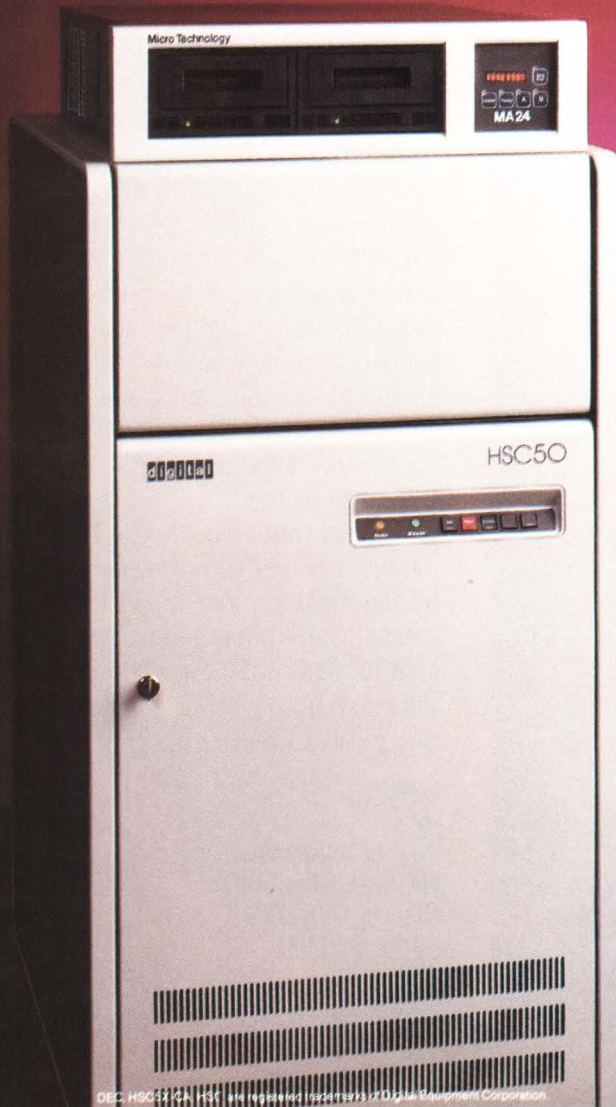

Performance This Good Should Be Shared.

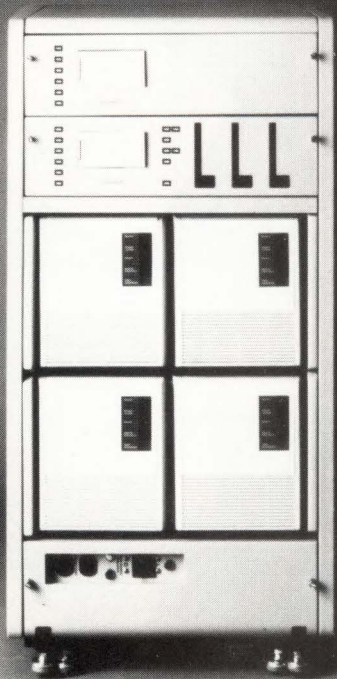

Some things are meant to be shared. Like our SI93 disk drive for instance. With a 15 ms average seek time and 50,000 hour MTBF, the SI93 is one of the fastest, most reliable disk drives ever made. But how can you share its performance without the high cost of VAXclusters?

Enter Cluster 1. It's the newest addition to System Industries' Cluster Series of high-performance shared storage subsystems.

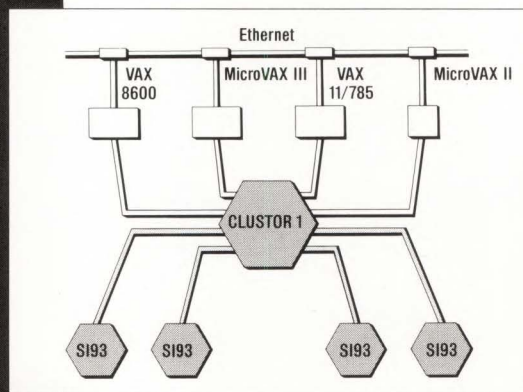

Shared, Fast And Affordable.

Cluster 1 connects up to four DEC CPUs with four SI93 drives — 3.6 GB — at data transfer rates of 2.5 MB per second. And because Cluster 1 supports MicroVAXes as well as full VAXes, your system costs drop dramatically. In fact, the Cluster family is the only direct-connect shared storage for MicroVAXes. As you grow, Cluster 1 keeps pace. There's an upgrade to our 8 MB Disk Cache Processor and support for more CPUs and drives.

System Industries is the DEC-compatible market's storage subsystem leader. And customer support is a major reason. Call System Industries today at **800-333-2220** for complete information.

CIRCLE 256 ON READER CARD



System Industries
560 Cottonwood Drive
Milpitas, CA 95035
(408) 432-1212

DEC, HSC, MicroVAX, VAX and VAXcluster are trademarks of Digital Equipment Corporation.

INTERLAN INTRODUCES
THE NETWORKING SOLUTION
THAT OTHERS OVERLOOKED

LAT AND TCP IN ONE TERMINAL SERVER

Announcing INTERLAN's LAT/TCP Terminal Server – a universal, dual-protocol networking product for less than the price of single protocol servers.

Now you can establish multiple sessions to both LAT and TCP/IP hosts – simultaneously.

The new LAT/TCP dual-protocol FEATUREPAK® – a plug-in software cartridge for INTERLAN NTS100/200 Terminal Servers – supports all LAT connections, via LAT Directory Services. From the same terminal, you can also connect to any host running TCP/IP via TELNET or RLOGIN, with support for up to 64 virtual circuits per server. INTERLAN gives you a window into applications you couldn't even access before.

The high performance of LAT. The versatility of TCP/IP. Both for less than the price of either one. INTERLAN's



LAT/TCP Terminal Server is the networking solution you can't afford to overlook.

Call Data Translation Ltd., 0734 793838, or MICOM-Borer Ltd., 0734 866801, for more information.



InterLan

One Source
Interoperability

CIRCLE 255 ON READER CARD

Inquire about
DECnet/NetWare*
Workstations
and other INTERLAN
connectivity
solutions.

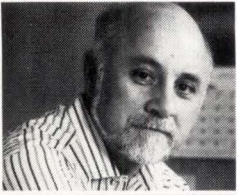

EDITORIAL

Dave Mallery

Mips Melee

In last month's editorial, I asked what you'd pay for a 5-mip VAX in a world of 60-mip workstations and 300-mip servers. The answer is not much, unless that 5-mip VAX runs your application faster, better or both.

Current propaganda says that UNIX (the U word) will never be any good at transaction processing. I remember when that was said about VMS, and it wasn't that long ago. If you note recent DEC announcements, you'll see that the song has changed.

Mostly, all you need is lots of horsepower and superlative disk bandwidth. Much of the ability to do OLTP resides in the database software and its performance. In my nearly 15 years as a DEC customer, I've yet to see a software problem that wouldn't yield to millions of dollars and a year or so of development.

The interesting thing is that just as the price of a mip is being set for the UNIX market by the merchant semiconductor houses, variants of UNIX push the software envelope in different directions. Take MACH for instance — that's the multiprocessor variant of the U word from Carnegie Mellon that was chosen for the NeXt machine. The UNIX-variant market will keep constant pressure on the ULTRIX development community.

Another fascinating area to watch is file servers. After you agree with Sun that "The network *is* the computer," you've admitted to the possibility of large-scale file server engines that don't necessarily come from Digital. These "Ether-Beasts" could be NFS engines, could respond to SQL, could be accessed by network remote procedure calls or could be fitted into the network in

dozens of interesting ways. There are enough fascinating disks in the emerging technologies area (parity arrays) and enough really fast non-proprietary merchant backplanes available that such boxes will appear.

The network itself will change — by a power of 10, in fact. The

100-megabit-per-second FDDI is no secret. This effectively brings the bandwidth of the CI to the Ethernet. I believe in 10x multiples. They're clear, easy to understand and you can feel the difference.

I'm delighted that the genie is out of the lamp and the computer industry is back to a wide-open free-for-all.

Now Playing On The VAXBI™

Clearpoint Research Corporation of Hopkinton, Massachusetts, ended two years of suspense by announcing its intention to ship a series of disk controllers and storage subsystems for the VAXBI, the I/O bus used on VAX 6000 and 8000 computers. Because DEC closed the specifications of the interface to the BI and prevented Clearpoint from producing controllers that used DEC's interface chip, Clearpoint designed its interface from scratch.

The DSB series improves upon DEC's devices. One Clearpoint controller supports seven drives, while DEC's comparable KDB50, at about the same price, requires two slots for a maximum of four ports. A Motorola 68020 and FIFO buffer produce a transfer rate of 4 MB per second, compared to 1.2 MB per second for the KDB50. The boards also feature a SCSI port running MSCP. An RS-232 port is for diagnostics. (The drives, which are eight-inch CDC 9720 Saber compatible, have a formatted capacity of 1 GB.)

Considering DEC's history of patent litigation, Clearpoint President Vince Bono anticipates a lawsuit. But Bono maintains that Clearpoint hasn't infringed on any of the BI's seven hardware patents, which he believes cover narrow points of functionality. "Our legal budget for the project," he says confidently, "is two and a half times the engineering budget."

Using a Mentor Graphics Hardware Modeling Library (HML), Clearpoint built and verified a design before analyzing a DEC chip. The 1.5-micron CMOS device uses different protocols than DEC's NMOS and generates proprietary logic. Clearpoint is applying for patents on its creative gate arrays. —Evan Birkhead

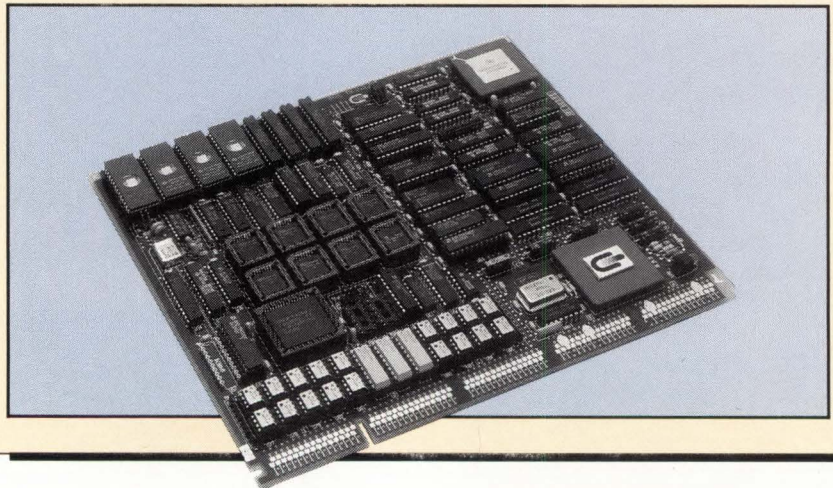



It took Logcraft to get two *other* giants talking to each other.

It was a global concern. DEC and IBM were engaged in a cold war. A war whose only real casualties were businesses desperately looking for a way to improve relations between their Digital terminals and IBM PC-compatible software. So they turned to Logcraft for the answer.

Our innovative 386Ware provides VAX users with virtually unlimited access to PC software by integrating MS-DOS with VAXstations and VT terminals—at a fraction of the cost of purchasing individual PC's.

Many of the world's largest government, education, and financial organizations, as well as over 200 Fortune 1000 companies, have discovered the great communicator—386Ware from Logcraft.

Call us today at (603) 880-0300 and end the

cold war between your VAX hardware and MS-DOS software.

386Ware from Logcraft. Think of it as detente for computers.



LOGICRAFT
Bringing DEC and IBM Together

digital™ Cooperative
Marketing
Program

22 Cotton Road, Nashua, NH 03063
(603) 880-0300 FAX: (603) 880-7229

Logcraft is a registered trademark of Logcraft, Inc. DEC is a registered trademark of Digital Equipment Corporation. IBM is a registered trademark of International Business Machines Corporation. 386Ware is a trademark of Logcraft, Inc. VAX, VAXstation, and VT are trademarks of Digital Equipment Corporation. MS-DOS is a trademark of Microsoft Corporation.

LETTERS

MORE TALK, LESS TYPE

John C. Dvorak suffers from being "just as lame as those boring yearly predictions" that he describes in "Killing The Keyboard" (March 1989). He calls voice recognition "another interesting but impractical technology" because of lack of privacy. I imagine Alexander Graham Bell met with the same skepticism.

Most computer users type 40 words per minute, but can speak about 200. Thus, voice input has the potential to be five times faster than the keyboard. You wouldn't have to learn to type, and I/O would be as natural as talking to your mother.

Voice recognition is only as impractical an idea as the telephone.

Troy Frericks
Ames, Iowa

NOT AVAILABLE

Recently, when DEC Field Service installed our "new" 780, I was told to purchase, among other things, two mass bus terminators (70-09938-00). Field Service has them, but can't sell them as part of the installation. We tried the Digital Store, our salespeople and finally DEC's Unlisted Parts Service, which issued a formal quotation that read: "Not Available."

I had my first dealing with DEC in the mid-1960s. My DEC salesman, Bill Kieswetter, showed me how to use DEC "Flip Chips." He even took my first effort home with him to debug the nest of #24 red wires that filled two 1943 backplanes. Mr. Kieswetter provided excellent support.

Three months after we purchased

Please address letters to the editor to *DEC PROFESSIONAL* magazine, P.O. Box 503, Spring House, PA 19477-0503. Letters should include the writer's full name, address and daytime telephone number. Letters may be edited for purposes of clarity or space.

our PDP-9, it was obsolete: The PDP-15 had been introduced. I then met Bob Reed, of DEC's Traditional Product Line (TPL). Mr. Reed got us all the parts, accessories, information and help that we needed to keep the PDP-9 running for 11 years. For example, in the mid-1970s, he sold us the newly introduced LP05 printer with an interface for the PDP-9, as well as more memory. I still remember his motto: "Electronically perfect and cosmetically acceptable." Mr. Reed provided legendary support.

In the late 1980s, I wonder how much of the support I've come to expect from these and many other friendly and helpful representatives of DEC is now "Not Available."

Robert F. Curley
Philadelphia, Pennsylvania

RSMing TO THE OCCASION

Bill Hancock's "Strategic Network Planning" (March 1989) indicates that DEC's Remote System Manager's (RSM) functionality is replaced by the SYSMAN

facility, a new set of services that is part of VMS version 5.0. This isn't true.

Although there's some overlap in the two products, their functions are distinct. The main purpose of the current version of SYSMAN is to provide the VMS system manager with a mechanism for initiating synchronous standalone (non-interactive) procedures on other VMS systems. The main purpose of RSM is to provide the system manager with a mechanism for controlling basic system services, such as backup/restore and software installations, for remote systems in a LAN or WAN.

There are many features unique to RSM. RSM supports VMS and ULTRIX clients. The current version supports VMS V4.0 and 5.0. It provides a scheduling facility for the backup component that allows the RSM manager to uniquely identify the most appropriate configuration for handling the specific backup needs of remote systems. RSM lets you install applications and operating systems. Both types of software installations normally require potentially significant interaction. Finally, RSM uses the VAX Distributed Name Service (DNS) to store client and server names. Using DNS provides RSM with global access to these names. Additionally, DNS allows RSM to perform operations against groups. (A group is a collection of client names and/or other groups.)

This is a short list of the differences between RSM and SYSMAN. Neither eliminates the need for the other.

Karen Leonard
DECnet Systems Services
Marketing Manager
Littleton, Massachusetts



Now the best seller comes in an illustrated edition.

With the WY-85 at left, Wyse authored the best selling alternative to DEC's VT-220. It's fully compatible with the VT-220, but loaded with features that make it even more compatible with the people who use it.

Like a larger 14" screen. Tilt and swivel base. An easier set-up mode.

And while our keyboard is identical to DEC's in layout, they can't touch our touch.

Our new WY-99GT at right further illustrates Wyse's continuing drive to improve on a standard. It features the same advantages as the WY-85. Plus graphics, with full Tektronix 4010/4014 compatibility, and high resolution characters.

Our dual resolution mode lets you retain full VT-220 compatibility and shift from DEC resolution to hi res.

And there's a happy ending. The WY-85 is just \$499, the WY-99GT \$649. Both are made, serviced, and supported by the world's leading independent terminal manufacturer.*

Wyse. When it comes to quality and value in terminals, we wrote the book. For more information, call 1-800-GET-WYSE.

WYSE
| | |

We make it better, or we just don't make it.

Trademarks/Owners: Wyse, WY-85, WY-99GT/Wyse Technology; DEC, VT-220/Digital Equipment Corporation; Tektronix, 4010, 4014/Tektronix. Screen image on WY-99GT created using Cognos Power House.
*IDC 1986 U.S. Terminal Census.

VAX/VMS



Stop Struggling With New Releases Of Application Software!

Use

S/COMPARE

HARMONIZER™

And you can easily integrate your changes with your vendor's enhancements

S/COMPARE-HARMONIZER provides a simple, reliable method for identifying all changes made to the package, then integrates your in-house changes into the vendor's new release.

Over 950 companies now use S/COMPARE-HARMONIZER to help them implement new releases of purchased application software. S/COMPARE also provides an easy and accurate way to create an audit trail of ALL program changes.

For more information or a free trial of S/COMPARE-HARMONIZER, give us a call.

428 13th Street Suite 500 Oakland, CA 94612 800-828-5858

FAX

415/839-2894

Telex

532668 ALDON

ALDON

415/839-3535

Canada

416/463-5777

CIRCLE 276 ON READER CARD

The following are trademarks of Digital Equipment Corporation:

A-to-Z	DECsystem-10	HBC	PDP	VAXcluster
ALL-IN-1	DECSYSTEM-20	IAB	PDT	VAX DIBOL
CDD	DEC/test	IV18	P/08	VAXELN
DATATRIEVE	DECUS	LAN Bridge	Q-bus	VAXFMS
DDCMP	DECwindows	LA50	Rainbow	VAXlab
DEC	DELNI	LA100	RALLY	VAX LISP
DECalc	DEOMA	LOPOZ	Rdb/FMS	VAX SCAN
DECconnect	DIBOL	LBI-11	ReGIE	VAXstation
DECgraph	DNA	MASBUS	RRT/E	VMS
DECmail	Eve	MicroPDP-11	R8X	VT
DECmate	FMB	MicroPower/Pascal	RT-11	Work Processor
DECnet	GIGI	MicroVAX	TEAMDATA	WPS
			TOPS	
			ULTRIX	
			UNIX8	
			VAX	
			VAXBI	

UNIX is a registered trademark of AT&T in the U.S.A. and in other countries.
 MS-DOS is a trademark of Microsoft.
 CPM is a trademark of Digital Research, Inc.
 Macintosh is a trademark of Apple Computer, Inc.
 X Window System is a trademark of MIT.
 NFS is a trademark of Sun Microsystems.
 WDPF is a registered trademark of Westinghouse Electric Corporation.
 Multibus is a registered trademark of Intel Corporation.

ACCOUNTING FOR ROSS

In regard to Evan Birkhead's "Accounting Software: Company Backbone" (March 1989), we too see a trend in large organizations toward decentralization of accounting computing systems, which requires integration of software applications. Although the essence of the article — the need for integration in accounting applications — was on target, I was surprised that Ross Systems was mentioned only in terms of its old MAPS product line. There was no mention of the company's current integrated financial-management and accounting software products.

In October 1988, Ross announced a generation of software called the Renaissance series, based on MAPS. Renaissance integrates Ross financial software with other business productivity tools into a seamless operating environment. This environment is a framework that enables integration of applications and gives users the flexibility to access information throughout an organization's computer system. Ross provides access to financial application data, as well as customer-specific or third-party applications. Ross also can access critical information contained in applications such as 20/20 and ALL-IN-1.

Acknowledging this trend toward distributed computing, Ross is developing Rdb-based financial applications for VAX/VMS. Ross believes that DEC's Rdb is the ideal foundation for distributed software.

Ross' 17-year history of serving and supporting VAX customers and its Renaissance software would have made it a worthwhile candidate for discussion in the article.

Dennis Vohs
 Chairman and CEO
 Ross Systems

For more information, contact:
 Ross Systems
 1860 Embarcadero Rd.
 Palo Alto, CA 94303
 (415) 856-1100

CIRCLE 550 ON READER CARD

**"We've got FOCUS
on the mainframe,
FOCUS on the VAX,
FOCUS on the Wang
and a lot of PC/FOCUS."**

George P. DiNardo

—George P. DiNardo,
Executive VP, Mellon Bank

"We're a big mainframe shop. Over 280 MIPS," explains Mr. DiNardo. "We've also got some DEC VAXs. A whole bunch of VS300s. PCs. Everything interconnected. And a lot of FOCUS."

And no wonder, FOCUS is the leading 4GL across all platforms.

"Our mortgage department uses VAX FOCUS to quickly put together various mortgage packages for resale," said Mr. DiNardo.

"InFiServ™ Mellon's new trust information system, chose FOCUS because it's easy to use and it can get at all the data."

To find out more about why Mellon banks on FOCUS, call or write Information Builders, Inc.

 **FOCUS**
Information Builders, Inc.

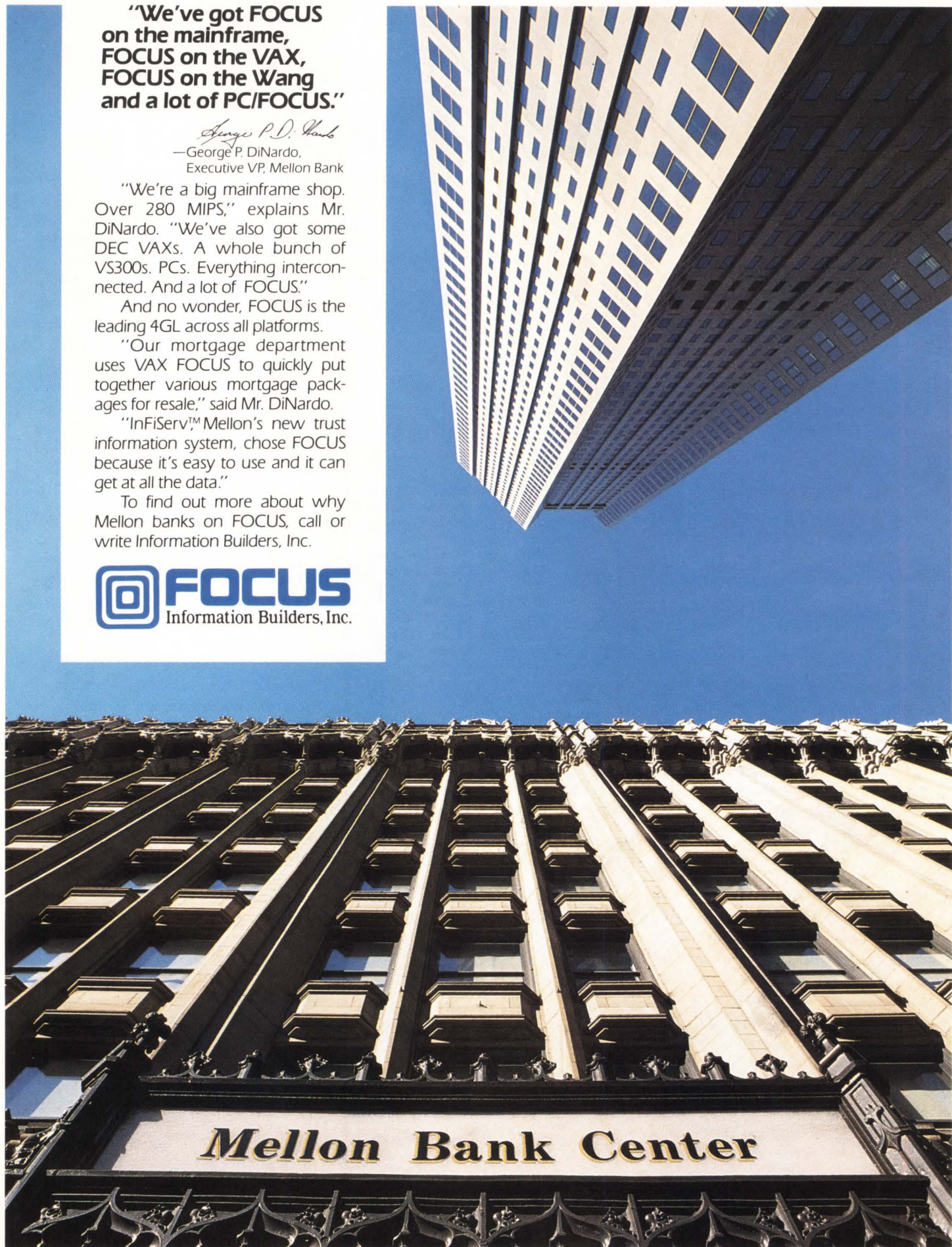

PRINT SYMBIOSIS

QUERY:

Bob Zisek (SIG 13/MESS 217): How can I trace the source of high interrupt stack activity?

We're running MicroVMS V4.7 on a MicroVAX II. The terminal interface is DHV11, with a terminal print queue set on one of the ports. Every now and then, the interrupt stack activity is excessive to 25 to 50 percent. Stopping and restarting the print queue seems to alleviate the problem. The terminal characteristics basically are standard, with no special ones set. An LN03 is served by the queue. What, in relation to this queue, could be causing this problem? The communication doesn't go through any special connections, although the printer is located about 500 feet away.

REPLIES:

Lee K. Gleason (SIG 13/MESS 218): Because you mention that the problem disappears if you stop and start the queue, I'm suspicious of the print symbiont.

The VMS print symbiont contains three instances of \$PURGWS. After growing to the working set size it needs, it frees most of those pages and shrinks.

In the days when VAXs didn't support much memory, it was worthwhile to keep real memory free for other uses. This needless bingeing and purging merely checkerboards the address space of the process and the free space in the page files.

Phil Anthony (SIG 13/MESS 219): You didn't mention how long the print queue had been operating without problems before you noticed the high interrupt stack activity. If it had been a fairly long time, look at the hardware before patching the print spooler. Your DHV may be having trouble. Do terminals on the same DHV occasionally get bursts of line noise or garbage char-

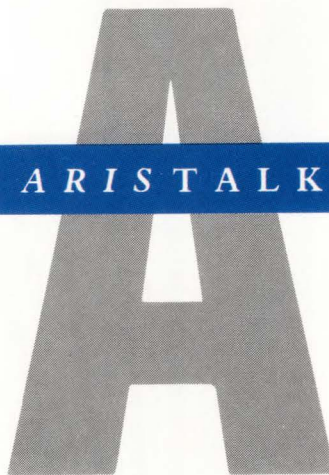

How To Use ARIS/BB

Subscribers to *DEC PROFESSIONAL* can call up our online bulletin board and log into ARIS/BB, our Automated Reader Information Service. In ARIS/BB, you can download programs from this publication, communicate with our editors, request a change of address, find additional information about advertisers, order books and back issues, check the guidelines for submitting articles, take a peek at our editorial calendar for the year and communicate with other VAX users.

To log in, you'll need your subscription number from your mailing label. Set your terminal to seven data bits, one stop bit and space parity, or eight data bits, one stop bit and no parity, and dial:

- (215) 542-9458 - Pennsylvania
- (818) 577-9100 - Southern California
- (415) 873-2135 - Northern California
- New ■ (617) 863-5010 - Massachusetts

Baud rates: 300, 1,200 or 2,400.

The ARIS/BB symbol appears at the beginning of each article when the program is in download. *VAX PROFESSIONAL* programs are available to subscribers of *VAX PROFESSIONAL* only. For subscription information, contact Karol Hughes at (215) 542-7008, 9 a.m. - 5 p.m. EST. Use these recommendations at your own risk. Professional Press is not liable for any damages to your system that might be caused by the hardware, software, programs or procedures discussed here.

XMODEM and KERMIT are available.

SIG Identification

The SIG categories referenced in this month's *ARISTALK* are:

- 13System Performance
- 23MicroVAX
- 38VAXELN

acters on the screen — especially terminals plugged into adjacent slots?

You also didn't mention how you're running 500 feet to the LN03. Do you have shielded RS-232 lines wired as a null-modem, or are you running through twisted-pair off short-haul modems? If your RS-232 cables aren't shielded, or if you're using twisted pair, examine the cable path to see if a piece of machinery with a high radio frequency emission level, such as a photocopier, is placed too close. If the cable runs through the ceiling next to fluorescent light fixtures, check for a flickering bulb or a starter that needs replacing; you could be getting radio frequencies from that.

Put a breakout box on-line and check for line activity when the problem occurs. If disconnecting the printer from the line makes the interrupt stack activity go away, you've got it.

I'd be hesitant to patch DEC system software and void DEC support before giving the hardware a close look.

TK50/TK70

QUERY:

Ernest Adams (SIG 23/MESS 196): As far as we can determine, there's no way to use a TK50 tape without bulk erasing it. I'd rather take my chances with a bulk eraser hidden in my desk than throw away money on TK50s.

Nor is there a way to read a TK70 tape on a TK50, or to write a new tape on a 70 to be read on a 50.

We've got a MicroVAX II and a VAXstation 3500. Guess what has what drive? We don't have DECnet up between the MicroVAX II V4.7 and the VAXstation V5.0, so it's tape transfer or nothing. The trouble is, we can't go from the 3500 to the MicroVAX II.

REPLY:

Jim Reffelt (SIG 23/MESS 198): We had a similar problem when we tried to



WORD-11 4.2 sets a new gold standard for VAX word processing.

The Power Of Gold



The gold key has been accepted as the most efficient user interface for the VAX, bar none. And WORD-11 version 4.2 sets the standard for gold key word processing on the VAX. That's because WORD-11 couples gold key functionality with over 100 sophisticated features.

WORD-11's list of gold standards includes the following:

- Multiple font support
- Automatic spelling correction
- Thesaurus
- Multiple wrapped columns
- Choice of a wide variety of printers
- VAX mail interface
- VAX/FAX option
- Calendar Manager option

WORD-11 was designed specifically for the VAX user, which means high performance with low CPU overhead. Plus, WORD-11 is available on the IBM PC with the identical format and gold key interface as the VAX version.

If you're in the market for a word processor you owe it to yourself to see WORD-11. For more information or a demonstration kit, call or write us today.

WORD-11

Data Processing Design, Inc.
1400 N. Brasher St., Anaheim, CA 92807

800-843-1317

In California call 714-970-1515
Fax 714-779-7468

IEEE-488...



for Q-BUS and UNIBUS

- DMA or programmed I/O interfaces
- Drivers for: VMS, RSX, RT, VAXELN, UNIX, and ULTRIX
- Software provided in source code
- Interactive program development utility
- High and low-level function for FORTRAN, BASIC, Assembly, C, and Pascal
- No license fee
- Support of MicroVAX, VAX, and PDP-11 series computers
- FREE customer support
- 30-day money back guarantee
- 2-year warranty

Call for **FREE** catalog

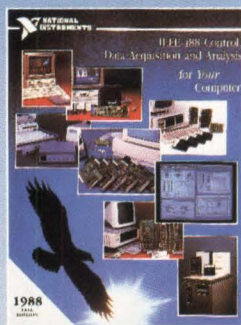

CIRCLE 308 ON READER CARD

NATIONAL INSTRUMENTS[®]
The Software is the Instrument[™]

12109 Technology Blvd.
Austin, Texas 78727-6204
(512) 250-9119
(800) 531-4742 U.S.
(800) IEEE-488 in Texas

Japan 81 (03) 788-1921 • France (1) 48 65 33 70
United Kingdom 44-01-549-3444 • West Germany 49 89 807 081
Italy 39-2-98491071-2-3 • The Netherlands 31 070-996360

upgrade a 3200 to V5.0. We didn't have a tape drive in the 3200, and our DECnet link to a Q5 was shut down by the installation procedure. We were stranded. However, if you don't mind playing with hardware a little, and if you have similar disks on both systems, you can copy tapes as well as backup to disk on the MicroVAX, then move or switch disks.

8300 TO 6310

QUERY:

Brian DeSantis (SIG 38/MESS 16): I'm switching systems from a VAX 8300 to a 6310. I'd like to hear from anyone who has a new Calypso. How are they? What problems should I expect?

The configuration will be with 64 MB of main memory, and I'm losing three RA81s for three or four RA82s, totaling three RA81s and three RA82s.

Also, I'm looking into one of the tape drives for unattended backups. Who has what, what do you use it for, and how do you like it?

REPLIES:

Robert G. Schaffrath (SIG 38/MESS 17): We just received a VAX 6330, and all I can say is I want my 8350 back! The 6330 is fast, but there's either a DWMB timing problem, or VMS V5.1 can't handle the speed of the new processor. We have three BI channels with a KDB50 on each channel. One KDB50 has been replaced already. It keeps sending SDI errors to the disks connected to it. This results in fault lights going off, good disk blocks being revectorred, and mount verifications every 10 minutes. I don't think this is a normal operating mode for a computer.

The TBK70 tape controller on the 6300 series has a port called PBx0 (where x is the controller designation) that's part of PBDRIVER and is supposed to be similar to the PTA0 port for a TU-81. Both SDA and SHOW CLUSTER believe this to be a CIBCI port.

Robert G. Schaffrath (SIG 38/MESS 20): I take back my statement about wanting the VAX 8350 back. The problem was a loose screw! After four KDB50 board swaps and having the XMI backplane reconfigured, it took a senior engineer

to find a loose screw on the -15V power bus. The factory that made the 6330 will have to study its assembly methods.

Gavin Adams (SIG 38/MESS 18): Upgrading from the 83xx series to the 63xx posed very few problems at our site. The most notable difference is the decreased amount of time system startup takes and the ease of using the new CCP. The manual shows how the 6300 is superior to the 8300 for console processes.

On the software end, benchmarks showed a 2½- to five-times decrease in the amount of CPU consumed, except for some programs compiled under COBOL V4.0. Because of the new CPU architecture, COBOL programs with COMPUTES doubled both CPU and real-time used on the 6330 versus the 8350.

Overall, I'm impressed with the performance of the 6300 series and am curious what increases the 6400 series will bring. I'm disappointed with the 6330 console media. We bought the machine as a 6230, and it came with a TK50 tape drive. I hope that next fiscal year will bring a TK70 to replace it.

Kitty George (SIG 38/MESS 19): Don't hold your breath waiting for a TK70 upgrade. Traditionally, DEC has recycled old storage media devices as console devices for new systems. Off the top of my head they include the RX01 floppy drive in the VAX 780, the TU58 tape cartridge in the VAX 750 and VAX 730, the RL02 in the VAX 8600, the Pro 380 as the console terminal for the 8800, and the TK50 for the 6300.

From DEC's viewpoint, it's a good way to clear out old inventory and media. The product-development engineers don't have to worry about troubleshooting another unproven component when creating new systems. If there's one thing you must depend on for getting a system up and running, it's the console device.

Robert G. Schaffrath (SIG 38/MESS 21): Our VAX 6330 has a TK70 tape drive hooked up to a TBK70 (module T1035) controller. If you have a VAX 6200 that was upgraded to a 6300, it doesn't include the TK70. The TK70 is available as an upgrade option. ■

There's A Whole Lot Of Shakin' Going On!

Why? Because Sigma set out to make the most rugged, versatile Q-bus enclosure we could. We shook, baked, and bounced our unit until we were confident it would protect your computer system under the most severe work conditions. Not only did we design the SA-H169 to withstand adverse work environments, but we also created an enclosure that's completely adaptable to your specific needs. Note the following features, then call us.

- The backplane, power supply, and disk drives are independently shock isolated.
- Chassis construction is of .090", 6061 aluminum, with a heavy aluminum front bezel, and dowel-pin receptacles for weight distribution in the rack.
- Front inlet filtered air cools the power supply, drives, and backplane at 300 CFM.
- The chassis has been specifically designed to meet MIL-STD-461B; TEMPEST options include EMI and RFI gaskets, EMI honeycomb air vents, and TEMPEST line filter.
- Room for up to four removable shock isolated disk drives to meet your storage needs, with low insertion force, high reliability docking connectors.
- Automatic drive select provides complete interchangeability of drives between slots.
- Front control panel features high visibility indicators, switches for drive write protect, Q-bus control, and power ON/OFF.

Plan to protect your computer system with our Q-bus enclosure.

Call your SIGMA representative today.

Q-bus is a registered trademark of Digital Equipment Corporation

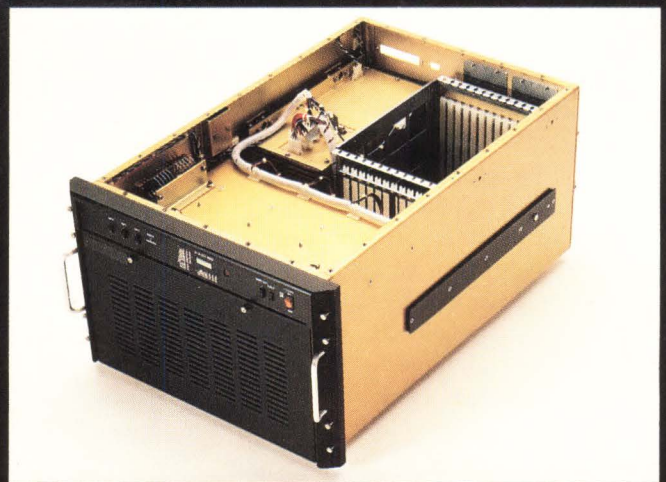

**Sigma
Information
Systems**

3401 East La Palma Avenue, Anaheim, California 92806
(714) 630-6553 TLX 298607 SGMA FAX (714) 630-5417

CA	(714)633-0652	MN	(612)435-6550	TX	(800)521-3007
	(714)771-7320	NH	(603)526-6909	TX	(817)265-4661
	(408)241-3770	NM	(800)521-3007	UT	(800)521-3007
CO	(800)521-3007	NV	(702)258-8005	WA	(408)241-3770
Belgium	(02)7238282	Italy	(02)4459351	Sweden	(08)282730
Denmark	(06)848300	N. Zealand	(09)590249	Switzerland	(038)514353
Finland	(00)52711	Norway	(02)685230	U. Kingdom	(0372)378811
France	(01)47862504	Spain	(34)63503144	W. Germany	(02202)52042
Greece	(01)9514944			International Sales Office:	(4122)7945494

Trademarks: DEC, MSCP, TMSCP (Digital Equipment Corp.)

CIRCLE 265 ON READER CARD

Two Buses, One Highway

Bit 3 Computer Corporation's Adaptor Lets Q-Bus And VMEbus Share The Road

The model 432 Q22bus-VME Adaptor, from Bit 3 Computer Corporation of Minneapolis, Minnesota, connects Q-bus devices to any unit using the IEEE 1014 VMEbus. The model 432 consists of a quad-height Q-bus card and a 6U VME card. A ½-inch-diameter EMI shielded cable or a 50-foot microcoax cable can be used to connect them. The cards slip into empty slots on the respective system. No additional processor or controller cards are required.

Either system can act as the host or slave to access memory directly on the other system. Communication between systems can be accomplished in five different ways.

In the first method, a high-speed interface permits random-access 16-bit read/writes between systems at speeds comparable to read/write speeds for resident memory.

The second method of communicating is paging. A six-bit or eight-bit register for the Q-bus and VMEbus,

respectively, is coupled with a page window in the host system address space. The address referenced in the window provides the upper limit address of memory in the destination system.

Block-mode DMA is the third method of communication. Target addresses for the sending and receiving systems and a word count are all that are needed to initiate a block-mode DMA transfer. Up to 128-KB transfer lengths are supported at a rate of 600 KB per second.

I/O is the fourth communication method. Q-bus I/O reads or writes are translated into VMEbus short I/O reads or writes. A DEC system can access VMEbus I/O as DEC memory references. On the other hand, a VMEbus system can access a DEC system's Q-bus memory with VMEbus short I/O references.

By using the fifth method, a Dual Port memory option, 32KB, 128KB or 1 MB of memory can be plugged into one of

the Adaptors. Memory can be shared by both systems. This method ties up neither system's bus when writing to Dual Port memory. Larger sizes of Dual Port memory cards are planned.

One important advantage of the Adaptor is that

Software support is provided for MicroVAX II users. The software enables a VMS application to read and write VME addresses as virtual memory addresses. It also permits block-mode



Bit 3's Q22bus-VME Adaptor provides a connectivity solution.

each bus can operate independently. A link between systems occurs only when a request for memory across systems is initiated.

Setting jumpers also allows for interrupts to be passed between systems. Programmed interrupts can be exchanged between systems, and each system can generate an interrupt acknowledge cycle on the other bus.

DMA transfers between a DEC system and the VMEbus or between a MicroVAX and the VMEbus system's memory.

The 432 Q22bus-VME Adaptor costs \$2,695.

For more information, contact Bit 3 Computer Corp., 8120 Penn Ave. S., Minneapolis, MN 55431-1393; (612) 881-6955.

Circle 571 on reader card

— David B. Miller

The New MasterDisk/SDI Can Save You A Bundle

For the price of about 10 gigabytes of DEC disk, you can get 10-plus gigabytes of MasterDisk/SDI* for all VAXs and VAXclusters, a dozen DEC terminals, ten pairs of Gucci's, dinner for a month at 21, ten thousand in cash, four tickets to Springsteen, his and her Corvettes, two weeks in Paris, and a partridge in a pear tree. Plus 22ms average access time, and a lot of other advantages shown below.

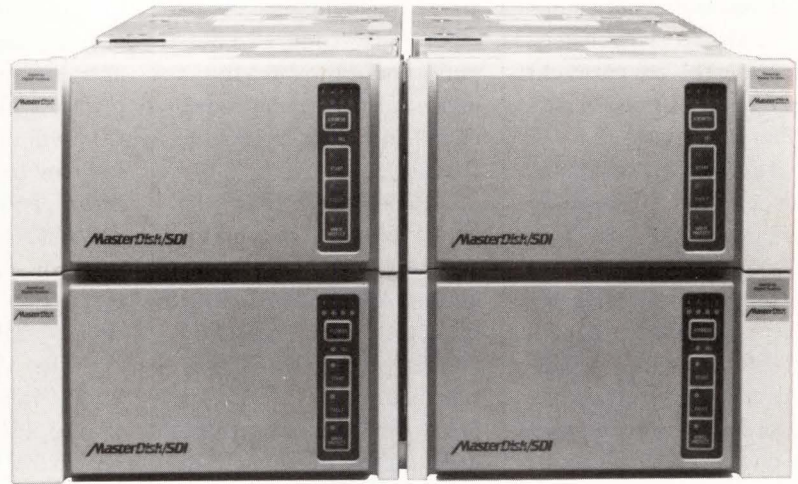

Now why would anyone want another disk?

COMPARE FOR YOURSELF	ADS	DEC
Formatted Storage	10.365 gigabytes	9.952 gigabytes
Average Access	22.3 ms	32.3 ms
Peak Transfer Rate	2.75 MB/sec	2.4 MB/sec
Size	1- 40" high rack;	4- 60" high racks;
Power Consumption	1,000 watts	13,440 watts
MTBF Per Drive	40,000	25,000
Warranty	2 years	1 year
List Price	\$194,000	\$264,000
Required HSC Data Channels	1¼	4
Cost of Data Channels	\$13,125	\$42,000
Total Cost	\$207,125 (\$19.98 per megabyte)	\$306,000 (\$30.75 per megabyte)

*Capacities range from 137 to 16,584 megabytes within one rack. MasterDisk/SDI will connect directly to any HSC 50/70, KDB 50, KDA 50, UDA 50. SDI is the Standard Drive Interface used on all DEC "RA" family drives.

DEC, HSC 50/70, VAX, VAXcluster are trademarks of Digital Equipment Corporation.

For more information, write or call American Digital Systems Inc.,
490 Boston Post Rd., Sudbury, MA 01776. (508) 443-7711.



American Digital Systems Inc.

Environmental Control

Intra Computer's SAM Systems Provide Environmental Security For Hardware And Data

Floods, leaks, fires, heat, intruders, too much or too little humidity, power surges and other factors can wreak havoc on your equipment and data. Fortunately, the power to prevent computer-room disasters is within your grasp.

The SAM2010 smart ambient monitor, from Intra Computer Inc. of New York City, can provide 24-hour computer-room disaster protection. Combined with host software, SAM can sample data related to temperature, humidity, smoke, water and power. Determinations can be made as to whether these factors exist at acceptable levels. If any don't, SAM can alert users and activate an audible alarm. If no help arrives in a specified time period and dangerous conditions still exist, SAM can arrange for an orderly shut-down of the host computer before powering it down completely.

The base SAM2010

system includes two temperature sensors, power shut-down cable, RS-232 cable, digital LED, an audible alarm, analog/digital sensor inputs, relay-controlled outputs, host software and a user manual. The unit comes in a 19-inch rack-mountable chassis.

Packages include the items you need to monitor various environmental conditions. A VAX/VMS package includes the SAM2010 monitor, a zero to 100 percent humidity sensor, a power-line monitor, an auto dialer capable of calling up to four people, a battery-powered smoke detector that can be mounted on the wall or ceiling, a water detector, an air-flow sensor and host software. Multiple sensors can be distributed throughout your computer room to cover large areas.

The host system software includes a routine to sample and log environmental data, provide user warn-

ings and shut down system software and hardware in an emergency. Data is sampled every 10 minutes under normal conditions. In the case of a temperature problem, for example, a warning message is sent to system users. If temperature becomes critical, sampling intervals decrease to two minutes and more serious messages are sent to users. If the problem isn't corrected after five warnings, SAM will initiate an orderly software and hardware shut-down. Power can be shut down through a power distribution panel or through connection to a shunt-trip circuit breaker.

The SAM Interface Utility is another software routine. It's a screen-driven system that allows managers to access SAM's monitoring parameters and change them if necessary. The ability to customize monitoring parameters allows a SAM system to accommodate a wide variety of computer-room environments.

Recently, Intra Computer announced the SAM3010 unit. The new model includes a control panel to allow selection of

one of 10 sensor measurements to be displayed on an LCD. Sensor thresholds can be programmed into non-volatile memory from the control panel.

The SAM3010 includes a remote phone dial-out capability with a synthesized voice message/acknowledgment protocol. The unit can be set up to dial out to a remote monitoring facility. Or, a remote monitor can dial into the SAM3010 to track computer-room conditions from a distance. A battery backup is provided to keep the SAM3010 running in the event of a power failure.

Prices for the SAM2010 VAX/VMS package are \$5,495 for a single VAX and \$5,695 for a VAXcluster. The SAM3010 package starts at \$7,495. The SAM2010 is available now. Deliveries of the SAM3010 are expected to begin in the third quarter of 1989.

For more information, contact Intra Computer Inc., 875 Avenue of the Americas, New York, NY 10001; (212) 947-5533.

Circle 575 on reader card
—David B. Miller

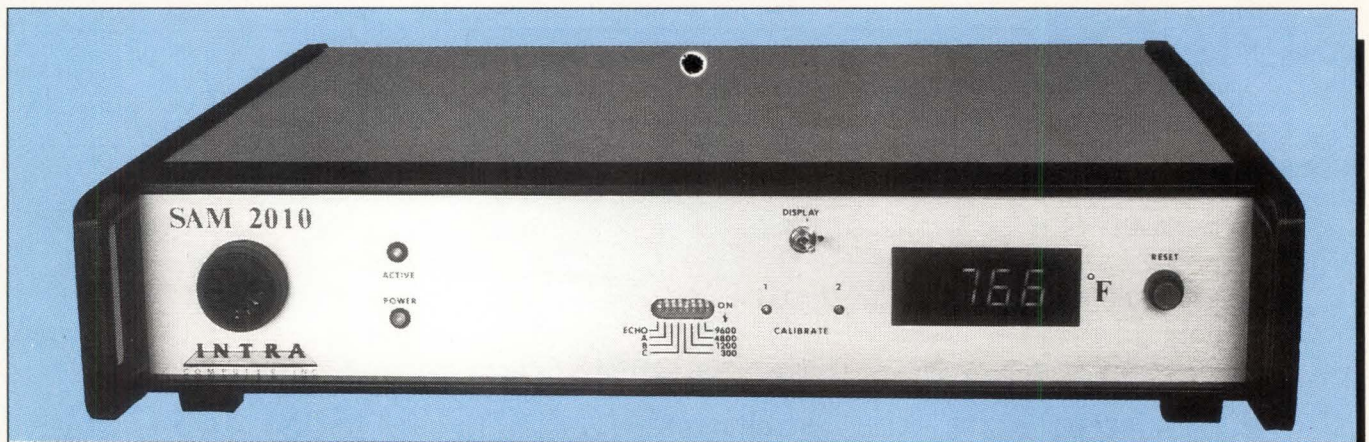

The SAM2010 monitor provides environmental control to protect your computer resources.

Better Science Through Pictures

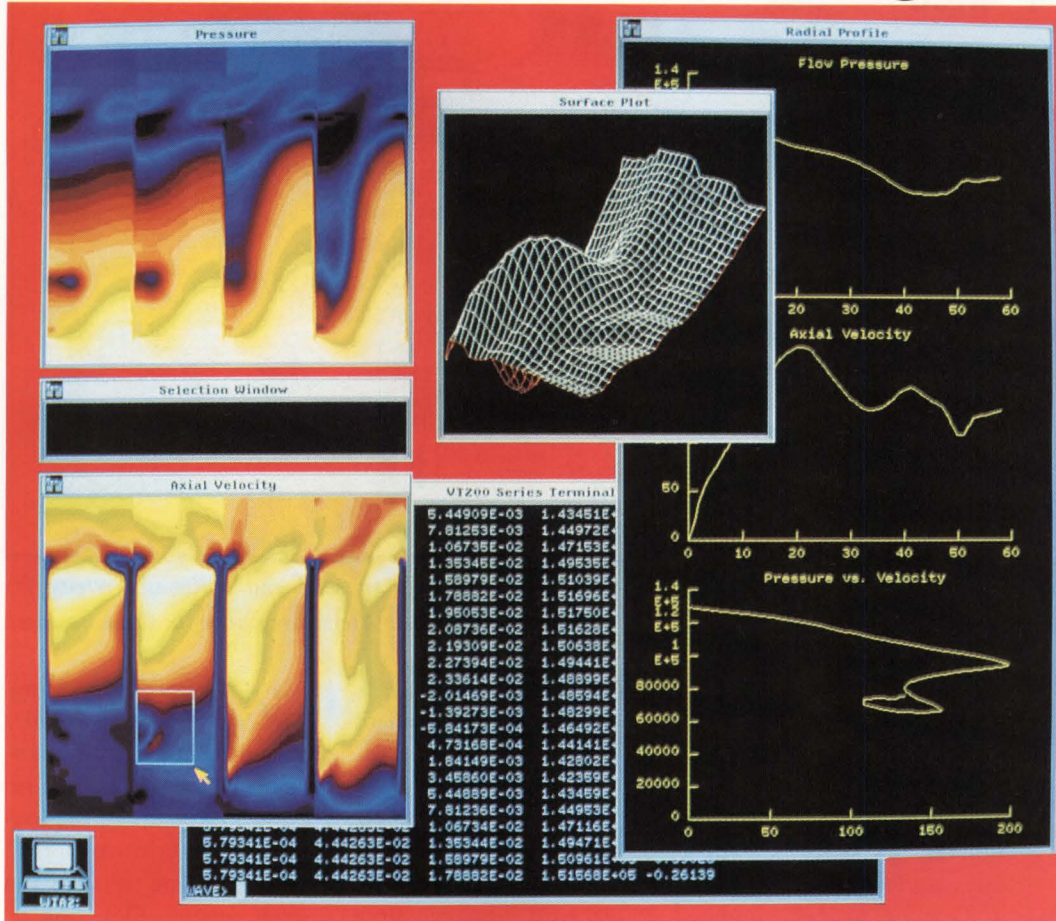

Results of computational fluid dynamics (CFD) analysis using data from Holset Engineering as visualized on a VAXstation 2000. At the left, powerful image processing features quickly show an overview of the full data set. From there, features and trends are identified interactively and displayed as surfaces and line graphs. PV~WAVE is ideal for quickly viewing large data sets to gain important insights. Using this new information, it is then possible to select features and subsets for further review and analysis.

PV~WAVE

Interactive Data Display and Analysis Software

Immediate Visual Gratification

Explore, analyze, reduce and visualize your data interactively with PV~WAVE on your VAX, DEC or SUN workstations. Our Scientific Visualization software lets you interact directly with your data to navigate through data sets, select key features, and visually identify trends. Your data will be translated into publication-quality graphics fast — 262,000 data points from disk to display in less than 10 seconds!

See Inside Your Data Fast

PV~WAVE lets you select from a full range of analysis, image processing, and graphics visualization methods to let you see inside your data fast. With PV~WAVE you can access any data in nearly any format. Tie into your own software or commercially available products; there's no need to build or buy special data converters. And you can easily develop specialized applications to create custom interfaces using commands, macros or pop-up menus for all users — from novices to experts.

How Immediate? Let Us Show You!

Discover how PV~WAVE helps you see your data fast. And spend more time formulating important results. Call Chris Logan at **800/447-7147** to qualify for a free evaluation copy.

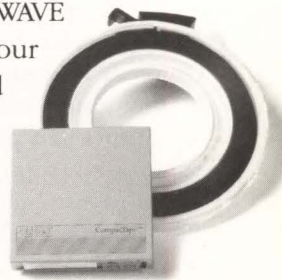

Precision Visuals®

Precision Visuals, Inc.
6260 Lookout Road
Boulder, Colorado 80301 USA
303/530-9000 Fax 303/530-9329

PV~WAVE, DEC, VAX, VAXstation 2000, and SUN are registered trademarks of Precision Visuals, Inc.; Digital Equipment Corporation; and SUN Microsystems, Inc., respectively.

Biscom + VAX + MEC = Fax

Biscom's Faxcom 1000+ And MEC's Fax Processor Software Enhance Faxes

Although no one can deny the speed advantages offered by fax machines, fax transmission has its drawbacks. First, transmission quality is good enough for most correspondence, but you wouldn't fax a final draft of a proposal or resume. Second, fax machines can generate long lines of impatient users. Third, you probably have to fax documents during the day, when telephone rates are highest.

The Faxcom 1000+, from Biscom Inc. of Chelmsford, Massachusetts, can provide a solution to your fax problems. If you're a devotee of Mass-11, from Microsystems Engineering Corporation (MEC) of Hoffman Estates, Illinois, you can streamline your fax processing by integrating the Faxcom 1000+ with Mass-11 word processing via MEC's Mass-11 Fax Processor.

The Faxcom 1000+ is a 20- x 6- x 17-inch fax unit that connects to your VAX over an asynchronous RS-232C serial port. It uses regular telephone lines to transmit documents to any Group III facsimile machine. It optionally can receive documents and print them on an attached printer.

A robust command set allows terminal and workstation users to send documents from their desk. The Faxcom 1000+ initiates the call to the receiving fax machine and cares for the rest of the transmission. A status

message is sent to the user on completion of transmission.

The Faxcom 1000+ can improve your fax quality in a number of ways:

1. Users can initiate the fax from their desks and forget about it.
2. Print quality is improved: Optical scanning is eliminated, and there's no paper to jam.
3. Telephone charges are reduced. Text is transmitted at 100 dpi rather than 200 dpi, reducing document transmission time without sacrificing print quality. Further, documents can be sent at prespecified times. Those not requiring immediate attention can be sent when phone rates are lower.
4. Graphic images can be merged with text to allow the incorporation of logos, signatures, and so on.
5. Faxes can be tracked. Managers can determine from where documents are being sent. Phone charges can be monitored on a cost-center basis.

As an option, Faxcom 1000+'s receive feature can direct incoming faxes either to a locally attached printer connected to the unit's Centronics parallel port or to a file on the host computer.

Other features of the Faxcom 1000+ include automatic transmission speed fallback from 9,600 baud to 7,200, 4,800 or 2,400 baud. A4 as well as standard

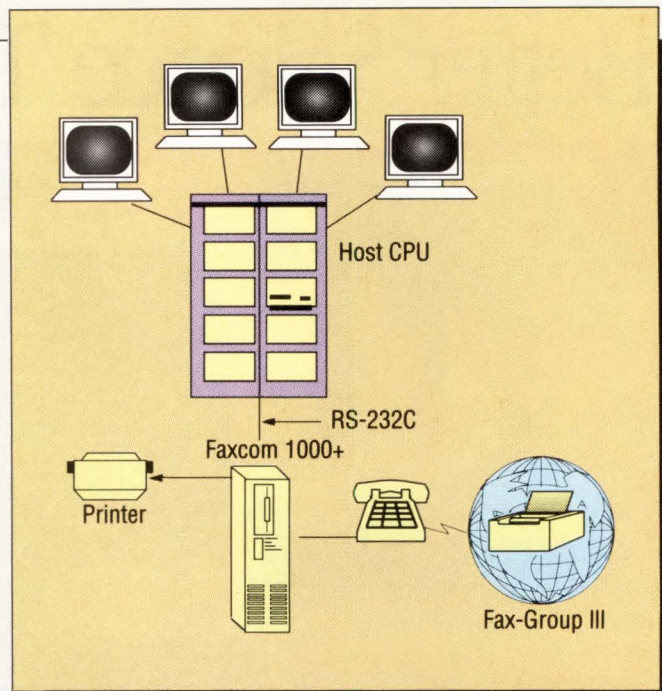

The Faxcom 1000+ can send and optionally receive fax transmissions while users carry on with their business.

8½-inch-wide documents can be handled. Standard document length is 11 inches. An option allows the Faxcom 1000+ to handle variable-length documents. A 360-KB floppy drive and a 20-MB hard drive can store documents locally. Host status reports and local printer reports are generated to let you know the status of your fax transmissions and receptions. The unit is available in either desktop or tower models.

At Interface '89 held in March, Biscom introduced a superset of the Faxcom 1000+. Faxcom/Publisher allows PostScript files to be sent to Group III fax machines directly from a host computer.

The 80386-based unit contains 4 MB of RAM. It can double as a PostScript printer controller for laser printers attached to its local printer port.

The Mass-11 Fax Processor is integrated with

Mass-11 word processing. The Fax Processor handles all addressing, queue-management and status concerns. Most Mass-11 word processing features are supported. Mass-11 Draw metafiles and print image files can be transmitted.

The Faxcom 1000+ requires one RS-232C serial port on the host VAX. The Mass-11 Fax Processor requires the Faxcom 1000+ and VAX/VMS version 4.2 or later.

For more information, contact Biscom Inc., 2 Courthouse Ln., Chelmsford, MA 01824; (617) 441-0010.

Circle 573 on reader card

Microsystems Engineering Corp., 2400 W. Hassell Rd., Ste. 400, Hoffman Estates, IL 60195; (312) 882-0111.

Circle 574 on reader card

—David B. Miller



The idea behind our 8mm tape backup system's display panel.



The whole reason for putting instrumentation in cars is to help you avoid unpleasant surprises.

Well, that's exactly why we gave the new CTS-8000 8mm tape backup system a built-in status display. It lets you catch problems before they happen—not after.

A digital readout tells you how many

megabytes of unused storage remain on a tape. When you put in a cartridge, you'll know for sure that you've got enough tape to finish the job.

The CTS-8000 also tells you the ECC error correction rate. By watching it for a minute or two, you can determine if the tape is in good enough condition to properly record your data. If the tape is unacceptable, you'll know before you leave at night—not when you return in the morning.

Still another first on the CTS-8000 is multi-host capability. It can back up data from as many as three hosts.

It's also TMSCP compatible and

works with all your applications without any modifications.

And thanks to TTI's long line option, you can place the CTS-8000 up to 80 feet away from the host.

Don't settle for unattended backup with less than full instrumentation. For complete information on the CTS-8000, call (714) 744-1030. Or write Transitional Technology, Inc., 1411 N. Batavia, Suite 203, Orange, CA 92667.



In Europe, call 0865 741345. Or write Transitional Technology, Suite 2, Kennett House, 108/110 London Road, Headington, Oxford OX3 9AW.

CTS-8000 is a registered trademark of Transitional Technology, Inc. TMSCP is a registered trademark of Digital Equipment Corporation.

CIRCLE 261 ON READER CARD

Boosting VAX Power In Scientific Applications

Aptec Computer Systems' I/O Computers Offload Processing From VAX Hosts

The number of applications requiring immense volumes of data is increasing rapidly. Today's scientists and engineers are bogged down with I/O-consuming projects in aerospace, seismic research and physics, which require real-time data acquisition for image processing and simulation. The applications include 3-D modeling, telemetry, and radar and sonar signal processing.

Aptec Computer Systems Inc. of Portland, Oregon, maintains that the scientific computing market currently is between \$3 billion and \$4 billion and will grow at a rate of 30 to 40 percent per year during the next five years. Aptec produces a pair of Input/Output Computers (IOC), which are high-speed subsystems designed to relieve throughput bottlenecks by offloading executions from host VAXs.

The smaller of the two, the IOC-24, has a bus speed of 24 MB per second, which far surpasses the 1.5 MB per second that the UNIBUS, for example, can handle. The larger IOC-200 has 200-MB total mass memory and data access speeds of up to 200 MB per second. The Aptec mass-storage subsystem supports up to 1.2 GB of formatted mass storage. The IOC-200 will sustain individual data streams of up to 50 MB per second.

The IOCs consist of three fundamental hardware components: the system bus, two types of user-programmable microcomputer I/O Processors (IOP) and up to 200 MB of main memory. The IOC's internal bus consists of three 32-bit synchronous buses (address, read and write) to minimize send and receive times. System memory is expandable via 2-, 4-, 8- and 16-MB

boards. The system software includes extensive operating and development programs.

The IOPs run FORTRAN-77 and STAPLE, a special C-like language designed for I/O processing. There's usually one parallel, programmable IOP controlling the connection to each peripheral. These execute instructions at up to 6 mips and can support as many as seven parallel operations per 48-bit instruction word. One type of IOP connects to the host and another to the peripherals. The high-performance buses and dedicated peripherals are connected with a 12-MB per

second. OPENbus IOP. Optional interfaces are needed to connect to the VME and BI buses.

The key to the IOCs' performance is that they let high-speed peripherals exchange data with each other and the IOC shared memory. The devices that might be linked include disks and tapes drives, DMA boards, a/d converters, telemetry front ends, array, vector, and image processors. The peripherals can transfer information to each other, freeing up the host's processing time. The links also can be established with a supercomputer or superminicomputer.

Performance also can be enhanced by a Vector/Scalar Processor (VSP-1), available from Aptec. This optional peripheral balances scalar and vector processing on one board. It consists of a 20-MFLOP vector processor, a scalar processor and a data formatter, which are connected by an 80-MB per second synchronous bus. Up to 24 can be plugged into a dual-chassis IOC-24.

Aptec prices the IOC-24 from \$35,000 to \$74,000 and the IOC-200 from \$124,900 to \$175,000, depending on memory and storage configurations. The computers can connect to any VAX, from the MicroVAX II and up, including VAXBI-based computers, thanks to a license from DEC.

For more information, contact Aptec Computer Systems Inc., P.O. Box 6750, Portland, OR 97228-6750; (503) 626-9000.

Circle 576 on reader card
—Evan Birkhead

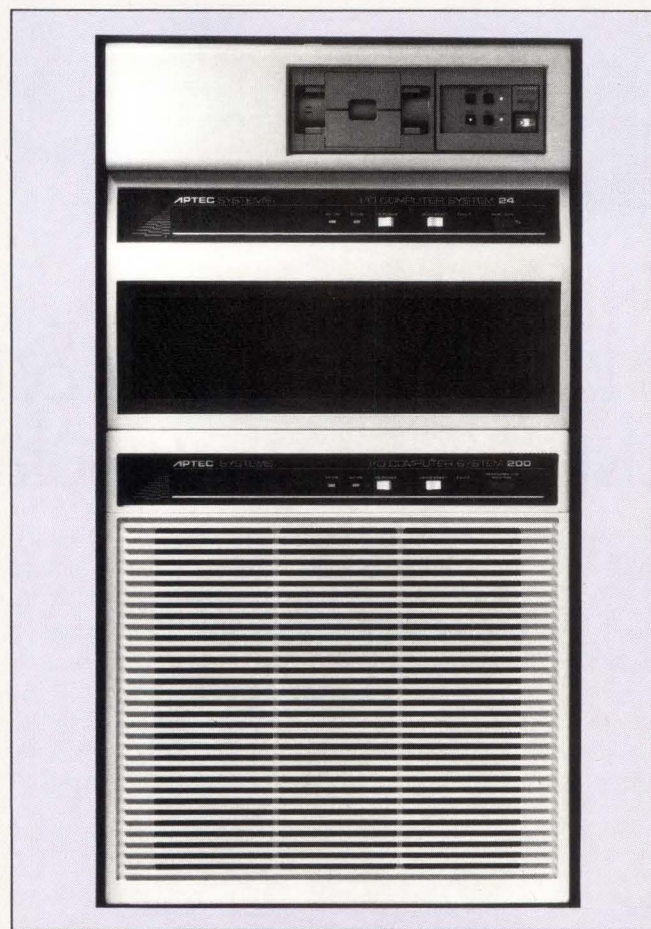

Aptec Computer Systems' subsystems speed throughput of VAXs for real-time applications.

Our laser printers give new meaning to "sharing"

Until now, sharing has been pretty one-sided: several workstations had to share one laser printer. But Printer Systems has redefined the idea of sharing. Now a laser printer can share across several dimensions.

Different platforms

Printer Systems laser printers can be shared by several different kinds of computers. Like IBM. And DEC. And, of course, PCs. All at the same time. Coax, twinax, parallel, and serial connector ports are provided on all our laser printers.

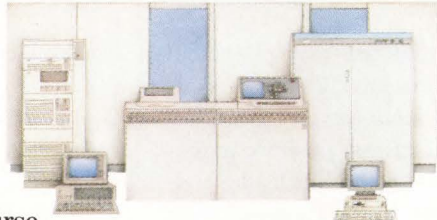

Different applications

And you can get some pretty fancy things out of these different computers, without a lot of programming. Like barcodes. And FlexFonts from BitStream, with access to over 2,000 fonts. So now your mainframe can do what you thought you needed a PC for.



Different personalities

With Printer Systems' new laser printers, full emulation of the IBM 3812, the DEC LN03 Plus, and the HP LaserJet II is a given. In fact, our printers not only come standard with all the same fonts as IBM's, DEC's, and HP's laser printers, but our font matrices are precisely identical to theirs. So ours print exactly the same as theirs.

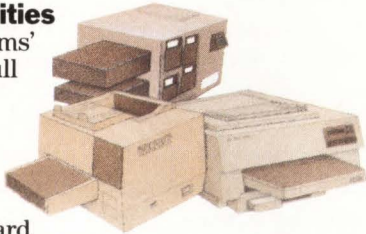

Real compatibility

Complete compatibility is a given, too, right down to the resolution. Like the IBM 3812, you can have 240 dpi for IBM applications. Or 300 dpi like the DEC LN03 Plus and the HP LaserJet II. In the same machine. Switched—not scaled—by the machine itself depending upon the application.



Introducing the Intelliprint 218*

Printer Systems' new Intelliprint 218 permits all this sharing without giving up performance. Its 32-bit RISC technology means that its real throughput is the rated speed of 18 pages per minute. And its peak duty cycle of 50,000 pages per month means it can handle however much you demand of it.



And the Intelliprint 106*

Sometimes, you can have too much of a good thing. So Printer Systems developed the Intelliprint 106. It, too, is based on 32-bit RISC technology, so its 6 page per minute rated speed is its real throughput. And its duty cycle of 3,000 pages per month is ideal for lower-demand situations.



Open architecture on a PC bus

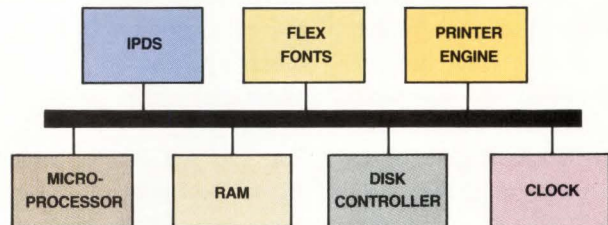

Printer Systems has also redefined "sharing" by putting a PC AT inside the Intelliprint 218. That provides all the functionality of a dedicated workstation. And, like any other workstation, it affords the flexibility to add options, like a LAN interface, for instance.

Wait, there's more

In fact, there's a lot more. Printer Systems has more up its sleeve, like spooling. And real-time, automatic switching between interfaces. And different graphics emulations. But we can't tell you about all of it yet. At least not here. Why not give us a call at 1-800-638-4041? We'd be delighted to fill you in. So you can start sharing the way sharing was meant to be.



Compatible in every way

Printer Systems Corporation, Corporate Headquarters: 9055 Comprint Court, Gaithersburg, Maryland 20877
(301) 258-5060, (800) 638-4041, Fax: (301) 926-7333, Telex II: 710 828 9621

IBM and IBM 3812 are registered trademarks of International Business Machines Corporation. DEC and LN03 Plus are registered trademarks of Digital Equipment Corporation. HP LaserJet II is a registered trademark of Hewlett Packard Corporation. FlexFonts and BitStream are registered trademarks of BitStream Corporation.

CIRCLE 337 ON READER CARD

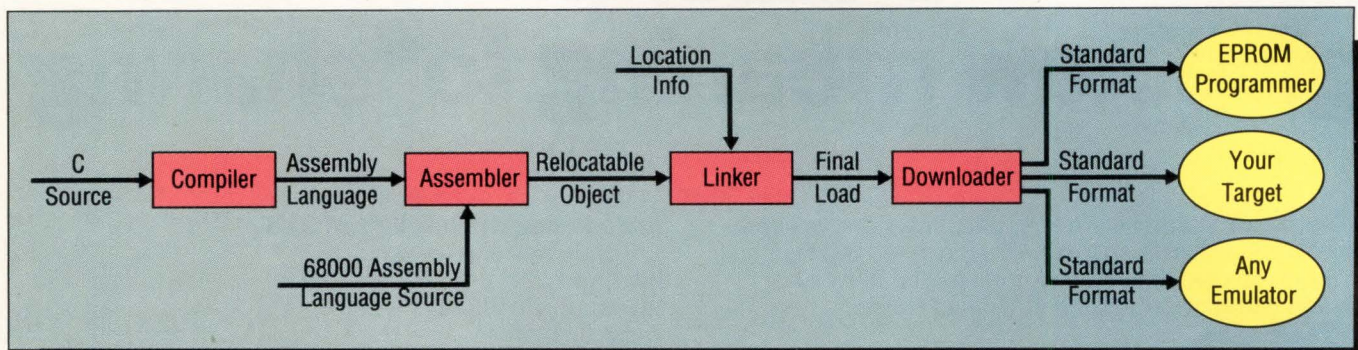

CrossCode C's four main components let you develop ROMable code for the Motorola 68000 processor family on your VAX.

Remote Software Development

Software Development Systems' CrossCode C Develops 68000-Based Applications On VAX

Developing 68000-based C code on a VAX seems a perfect lesson in inefficiency and waste. Why not just develop the code on the 68000 machine?

But, if you're developing software designed to run in such devices as a control unit or a laser scanner, this scenario might make sense. In these cases, the target machine isn't a full-fledged computer. There might not be disk drives, monitors and terminals associated with these products. However, a 68000-based CPU lies at the heart of the unit, and program code must be downloaded to it for it to run. How do you accomplish this?

CrossCode C, from Software Development Systems Inc. of Downers Grove, Illinois, lets software developers use their VAXs to write ROMable code for 68000-based products that aren't computers.

Object code generated by CrossCode C's compiler is converted to a format suitable for downloading to a 68000 microprocessor, where

it can be executed.

CrossCode C includes four main tools to let you develop ROMable C code and place it where you want: the compiler, assembler, linker and downloader.

The compiler lets you generate assembly code from a source-code file of any size. Any combination of C and assembly code can be used. Assembly-language code is generated with your C source code as comments. You can see exactly what assembly-language code was generated from your C source. It supports many ANSI C enhancements, including type void, structure assignments and separate name pools for members of different structures. The extra instructions and addressing modes of the 68020 are supported. Generated code is compact and fully optimized.

The full-featured assembler generates fully relocatable object code. Code and data can be placed into up to 254 named memory

sections for easy placement at link time. Its macro facility lets you use positional and named macro parameters. An absolute listing converter can be applied after linking the object modules to let you see absolute addresses for debugging purposes. A cross-reference listing can show you where variables appear in your program.

The assembler recognizes Motorola instruction mnemonics, directives and operand formats. By accepting C-like **#defines**, C language definitions of constants are recognized. Conditional assembly is supported through C-like **#ifdefs**. C language escape sequences embedded within assembly language strings are supported. Code can be developed for the 68000, 68010, 68020 or the 68020 and 68881 together.

The linker lets you organize your load at link time through a memory structure specification file. You can assign named memory sections to specific addresses, align them on a boundary or assign them a specific size. A full-featured librarian lets you link only those library modules you need. Global symbols can be created at link time. C type

checking can check the type of each global symbol. Global cross references show each symbol, its value, and in what files it's contained. The linker supports intermediate links so that a number of smaller files can be consolidated into a larger file that can, in turn, be linked with other modules. The full 32-bit range of the 68020 is supported.

The downloader lets you translate your program into a standard format for downloading to an emulator or EPROM programmer. The downloader can generate Motorola S-records, Intel Hex, Tektronix Hex, Extended Tektronix Hex and Data I/O ASCII Hex. The output length of these records can be customized. A hex dump feature lets you view your work on a terminal. You can generate a record-based binary file from which you can extract the needed information via a user-written program.

For more information, contact Software Development Systems Inc., 4248 Belle Aire Ln., Downers Grove, IL 60515; (800) 448-7733.

Circle 555 on reader card

—David B. Miller

VAXBI BUS EXCLUSIVE: NOW MEGATAPE OFFERS "DIRECT ATTACHMENT" 8MM CARTRIDGE BACKUP SUBSYSTEMS.



Interfacing our 1/2" tape cartridge system to the VAXBI bus was an amazing technical accomplishment all by itself.

But now we've gone a step further. Introducing the MegaTape GT-88 VAXBI backup subsystem. The only, repeat

only, 8mm cartridge system with a direct connection to the VAXBI bus.

So now high-end VAX users have a choice for convenient, low-cost disk backup: an astounding 2.3 gigabytes on an 8mm cartridge. Or 630 megabytes on our proven 1/2" linear-format cartridge. Both

priced dramatically lower than anything available from DEC.

MegaTape's proprietary VAXBI controller is completely TMSCP-compatible, and lets your system zip through backup chores using your standard VMS or Ultrix backup utilities.

MegaTape offers something

else that's crucially important, too: support capability built on nearly a decade of advancing the state of the backup art.

So if you'd like reliable backup—fast—there's only one place to call: MegaTape. P.S. We also offer the industry's "best buy" QBUS and Unibus subsystems, too!

VAX, VAXBI, QBUS, Unibus, VMS and Ultrix are trademarks of Digital Equipment Corp. © 1989 MegaTape Corporation.

MEGATAPE CORPORATION
1041 Hamilton Road
Duarte, CA 91010-0317
(818) 357-9921 • Telex: 510 600 7131
Telefax: (818) 357-2369

**THE GREAT LEAP
FORWARD IN BACKUP.**

The Optical Revolution On Paper

ICI Imagedata's Digital Paper Offers High Data Density

The optical revolution is continuing to foster new product introductions at a rapid pace. One such product is Digital Paper, from ICI Imagedata of Wilmington, Delaware, a new unit of ICI of the U.K.

Digital Paper is a new form of flexible, non-erasable optical storage material that can be cut into lengths of tape, stamped into disks, inserted into cassettes or formed into strips or tags. It offers the data density of optical disks and is readable by digital devices, with fast access and transfer rates. The high data density allows for rapid access.

Digital Paper is a dye polymer optical recording material coated onto a polyester-based substrate. It has the sensitivity necessary for laser writing, yet offers durability standards that ensure a life span of more than 15 years. Data is stored on the media using a solid-state laser of the kind already used in drives designed for use with rigid optical storage media. All recordings are indelible.

To gain insight into this new media, consider the following:

1. One 5¼-inch disk can provide 1.5 GB of data, with an average access time of 40 ms.
2. Storing one terabyte (1,000 GB) of data with optical tape requires just 0.1 cubic feet of space as compared to the 49 cubic feet needed for the

same data on a 12-inch optical disk or the 2,373 cubic feet needed on standard 5¼-inch floppy disks.

3. In consumer terms, a 2,400-foot reel of ½-inch digital tape (of the same proportions as a conventional 10½-inch magnetic tape) would be capable of storing 600 GB of data. This is equal to about 1,000 compact disks.

Digital Paper brings storage costs down to less than a half-cent per MB of data stored. This is lower than any media in use today, including paper.

The Creo Optical Tape Recorder, an optical tape drive that employs the Digital Paper media, has been announced by Creo Products Inc. of Burnaby, British Columbia. The tape drive will be part of a very-high-capacity optical tape data storage system. The ICI tape designed for the Creo drive has a capacity of one terabyte.

The drive features an

average access time of 28 seconds to any byte on a full tape. It can transfer data at a sustained rate of up to 3 MB per second. Forward error correction is used to ensure that a user's data is fully protected against loss. The new optical tape drive will be available commercially in October 1989. System integrators currently are working on Q-bus and UNIBUS interfaces for the product.

A 5¼-inch floppy-disk drive, based on Bernoulli technology and ICI flexible optical disks, is being developed by Bernoulli Optical Systems Company (BOSCO) of Boulder, Colorado, a subsidiary of Iomega Corporation. In this drive, a lightweight fixed-focus technology replaces the bulky focusing servo commonly found in rigid drives. A servo-system tracking methodology also replaces the secondary fine-positioning mechanisms used in most drives. By combining new technology and methodologies, the drive can deliver more power to the disk from the laser, thus increasing the data rate.

By employing compact packaging and the use of an optical microhead, a half-height drive can be designed for incorporation into desktop computers or workstations. These drives are being tied together with scanners and other input devices by system integrators for use in image storing systems. Bernoulli drive technology for optical disks, including designs, tooling and know-how, is available from ICI Imagedata.

For more information, contact ICI Imagedata, New Murphy Rd. and Concord Pk., Wilmington, DE 19897; (800) 456-3669.

Circle 434 on reader card

Bernoulli Optical Systems Co., 5700 Flatiron Pkwy., Boulder, CO 80301; (303) 939-8611.

Circle 412 on reader card

Creo Products Inc., 110-3700 Gilmore Way, Burnaby, BC V5G 4M1; (604) 437-6879.

Circle 411 on reader card

—Ron Levine

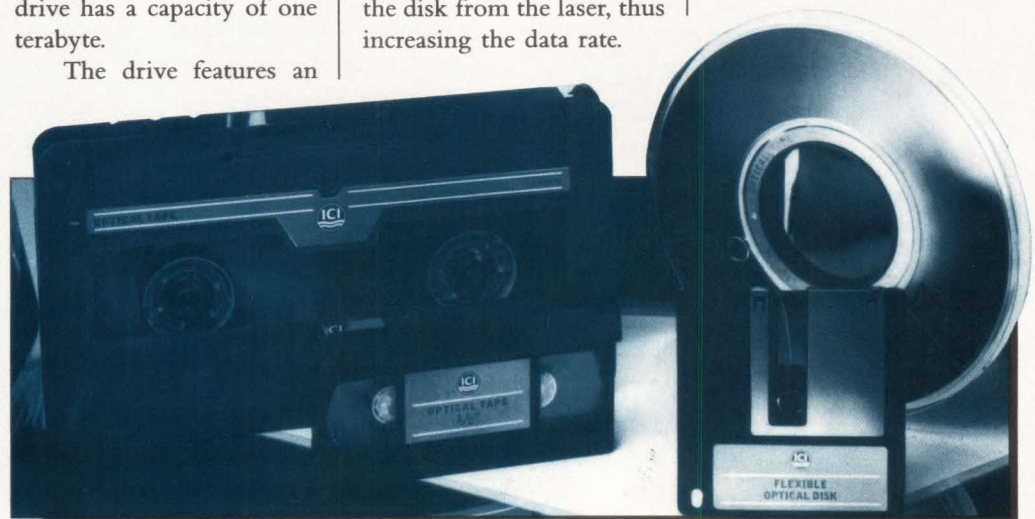

Digital Paper is flexible, non-erasable optical storage material that can be cut into lengths of tape, stamped into disks, inserted into cassettes or formed into strips or tags.

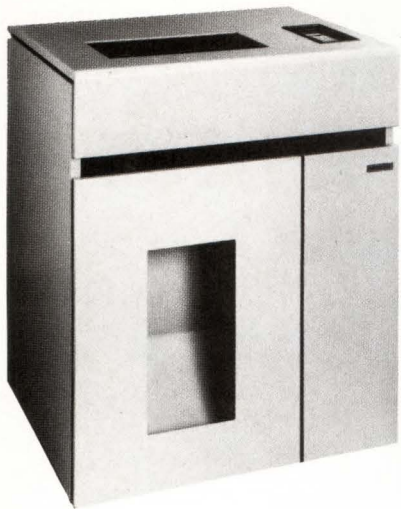

PRINTRONIX - the **FIRST** Line in Data Processing **DRAFT** Correspondence
THE FIRST LINE IN MULTIFUNCTION PRINTERS *
bold characters, expanded characters, Dynamic Font Selection
 Exclusive from **PRINTRONIX** * **Underline printing - ABC** Condensed Font
 (17 CPI) - **ABC DRAFT FONT (13 CPI)** - **ABC Correspondence Font (10 CPI)** - **ABCDEFGHIJKLM**
 Data Processing Font (15 CPI) - **ABC SOME EXAMPLES OF DYNAMIC FONT SELEC-**
TION **Elongated-Data Processing Font (15 CPI) ABCD** **BOLD-** HIGH SPEED FONT (10 CPI) **ABC**
 (10 CPI) (12 CPI) (13 CPI) (15 CPI) subscripts₁₂₃ superscripts¹²³ **Expanded**

Code 3 of 9



PRINTRONIX INC. INVOICE NO. G006592 DATE 05/03/87
 P.O. Box 19559 Irvine, CA 92713 (714) 863-1900 Fax 910-595-2533

BILLING ADDRESS: Automatic Corporation Inc. 4833 E Hill Street DALLAS, TEXAS 75247 PA (417) 834-4833
SHIPPING ADDRESS: Mr. Oliver Johnston 1905 Fillmore Avenue NEW YORK, NEW YORK 10244 Ph (212) 888-0000

DATE	TO	BY	DATE	TO	BY
April 13, 1987	Tom Williams/12834432	P's DATE	April 15, 1987	May 15, 1987	TELETYPE UNIT
					ATT: STEVE DONALDSON

Item	Part Number	Description	Qty	Unit Cost	Unit	Extended Cost
1	232309-5545	AD7 CONVERSION KIT	50	\$ 137.27	EA.	\$ 6863.50
2	5476689-RF13	AD7 SUPPLY KIT	100	\$ 28.75	EA.	\$ 2875.00
3	A000453-R5L3	AD7 USER MANUAL	50	\$ 15.55	EA.	\$ 777.50

THE P9012.

IT'S FAST.

Up to 1200 lines per minute. The P9012 delivers band printer speed, plus versatility the competition can only dream about.

IT'S QUIET.

You'll have to watch the P9012 perform, because you won't hear it. At 55 dBA, it's the quietest line printer you can buy. So put it anywhere. In the computer room. In the office. In the library. And with auto-ranging power, the P9012 automatically adapts to any power source in the world.

IT'S VERSATILE.

While other printers strive for "multi-functionality," the P9012 gives you "full-functionality." Plus the best print quality in the high speed line printer world—straight through six parts.

Choose from 210 resident character sets in a wide selection of character style and pitch. Then select from five text modes and print at up to 1200 lines per minute.

Print bar codes, logos and forms. Engineering and scientific graphics, business graphics and drawings, all at up to 150 inches per minute. Beautifully.

IT'S THE RELIABLE PRINTER FOR YOUR DEC SYSTEM.

A high mean-time-between-failure (MTBF), a low 20 minute mean-time-to-repair (MTTR), and 5,000 hours mean-time-between-service calls equal high reliability.

The Printronix P9012. Give it any print job. It just prints on. And on. And on...



PART NO (1)		4337489	
QUANTITY (2)	1500	SEAT CUSHION	
SUPPLIER (3)	35324	DATE (4)	10/1/87
SERIAL (5)	102342349	GRADE (6)	A
		SAFETY (7)	ITEM

PART NO (1)		E43B54311	
QUANTITY (2)	100	PART NO (3) A20UG	
SUPPLIER (3)	R3215	ELECTRONIC MODULE ASSY	
SERIAL (5)	121584	DEVIATION NUMBER 122456	
		DATE (4)	10-01-87
		LOT CONTROL CODE 54321	

PART NO (1)		14015248	
QUANTITY (2)	60	DESCRIPTION WHEEL	
SUPPLIER (3)	046068772	DRAWING CODE	
SERIAL (5)	150	AA	
		DATE (4)	10/1/87
		EQUIP CHANGE 3	



PRINTRONIX

The First Line in Printing Solutions.

P.O. Box 19559, Irvine, CA 92713

800-826-3874

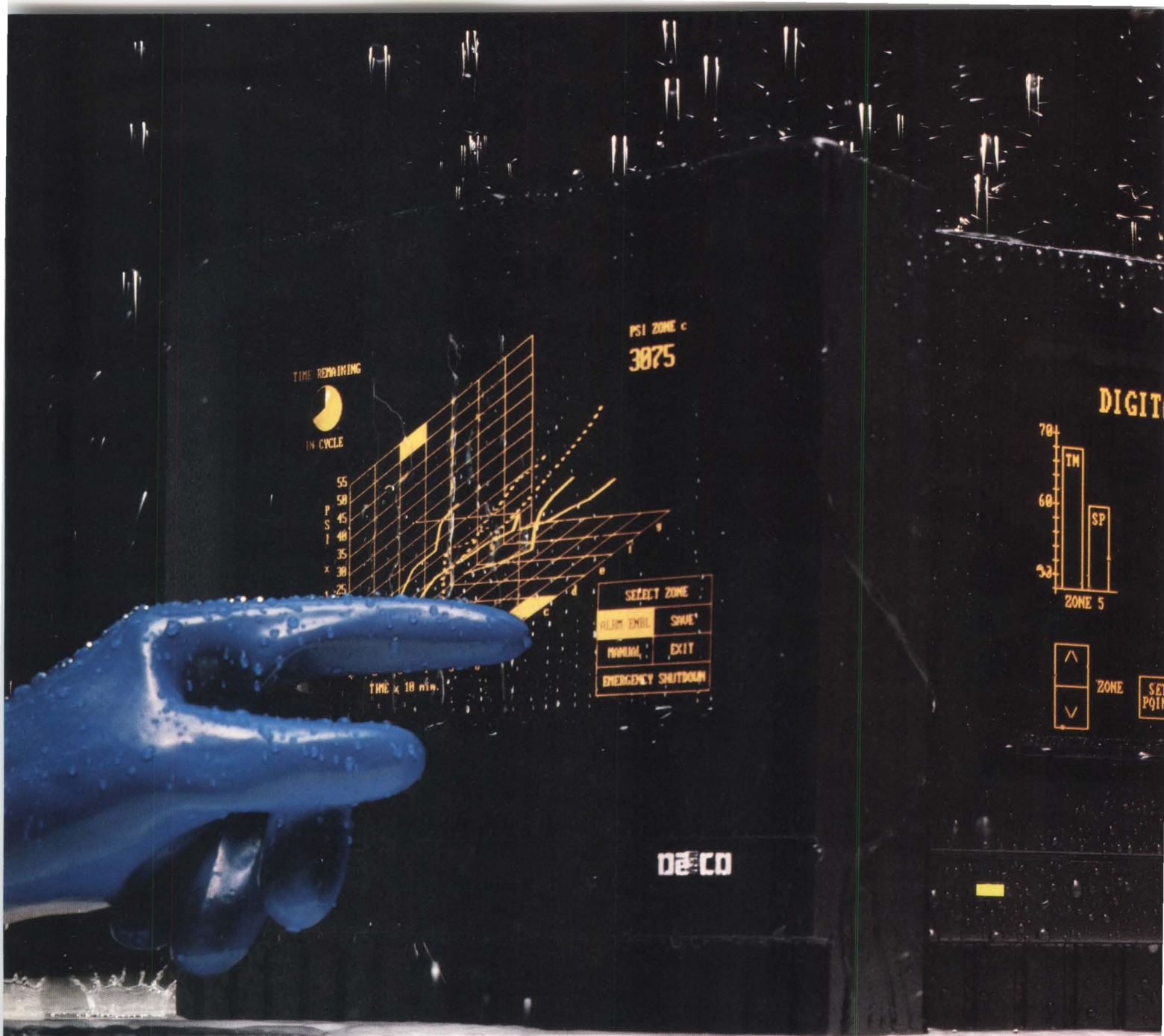

TOUGHNESS RUNS

VT emulation, PC monitors
and graphics terminals that
stand up to anything.

Every member of our SealTouch™ family of flat-panel electroluminescent touch-screen terminals is built to take it, from the inside out. And from the outside in.

Rugged cast aluminum

casing completely seals out the ambient environment. And with no fans or filters, nothing gets in or out but information.

That means SealTouch Terminals are tough enough to make it in clean rooms



ELECTRONICS CORPORATION

ZONE TEMPERATURE CONTROL

ZONE	TEMP	SP	ALARM
68	68	OFF	OFF
66	68	OFF	OFF
68	68	OFF	OFF
61	68	OFF	OFF
68	68	ON	OFF
68	68	OFF	OFF

7	8	9
4	5	6
1	2	3
0	CLR	

DISPLAY STATUS

ALARM REPORT

PRINT STATUS

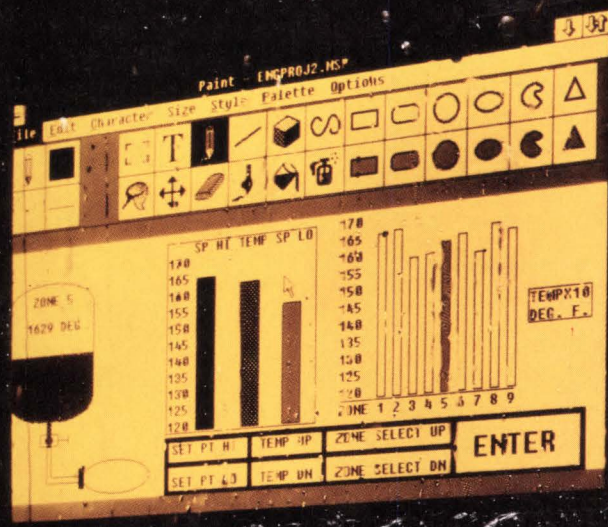

DeCO

DeCO

IN THE FAMILY.

as well as on the shop floor.

At less than 12 pounds and only 3" thin, they mount virtually anywhere with two bolts. Right on heavy machinery. Pedestal. Wall. Desk. Workbench. Anywhere.

The only thing about this family that isn't tough is using them. Touch screen software ease and

flexibility makes configuring and reconfiguring fast and simple. For any industrial application.

So when you need friendly, interactive VT emulation, PC monitors or graphics terminals where ordinary terminals won't go, give us a call. We have a complete range of SealTouch solutions—

including design-in modules without casing—one of which will be compatible with your system and the harsh realities of an industrial environment.

When the going is likely to get rough, this is the family to know. Call us. (415) 471-4700. **DeCO**

CIRCLE 191 ON READER CARD

Digital Electronics Corporation, 31047 Genstar Road, Hayward, CA 94544-7831 (415) 471-4700

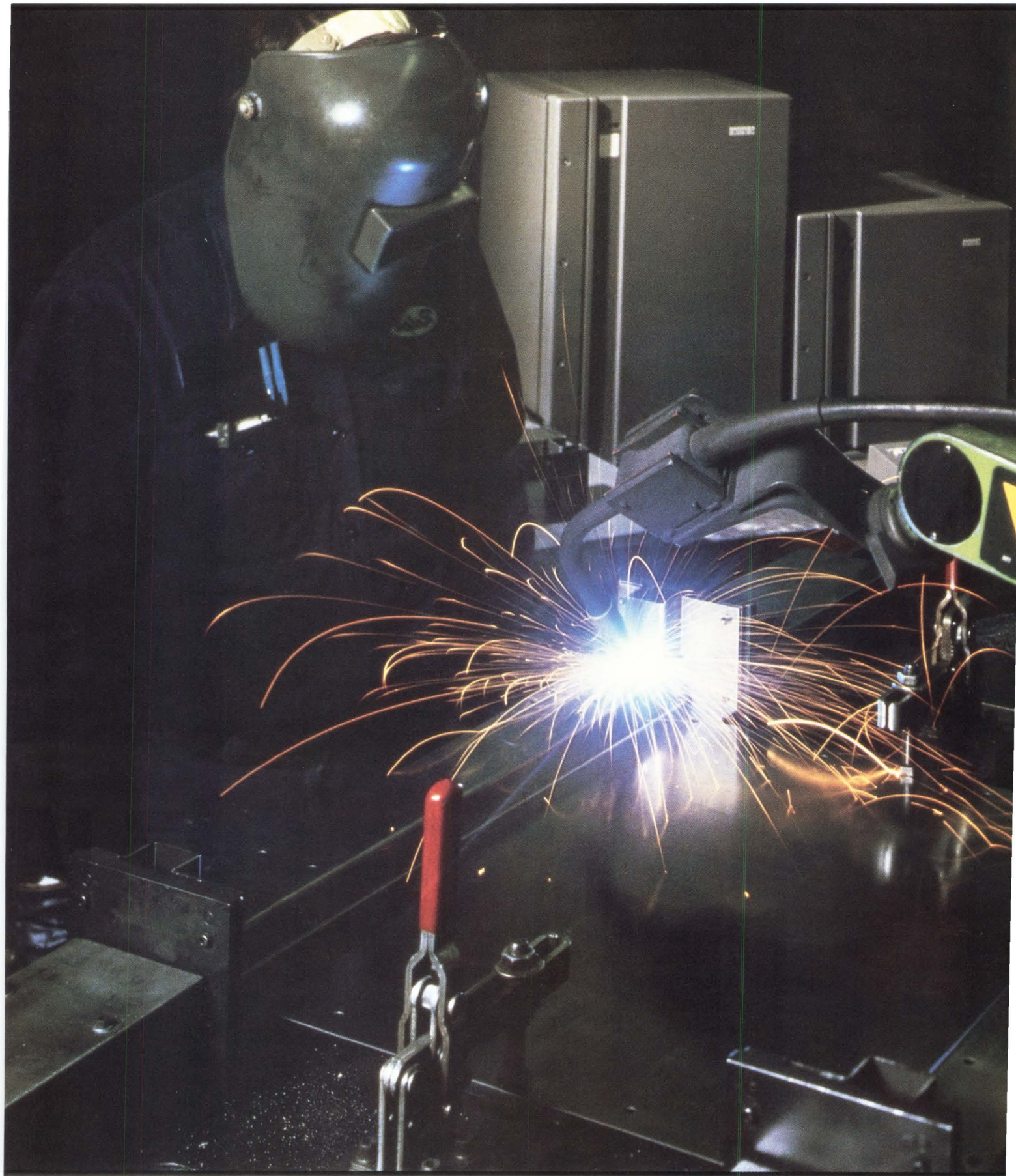

While communicating with other corporate divisions, computers must operate in harsh manufacturing environs.

THE CIM SOLUTION

Advances in technology merge
manufacturing with the organization.

IN LAST YEAR'S presidential elections, the U.S. Department of Defense (DoD) was denigrated for its overspending and its embarrassing tendency to produce aircraft that wouldn't fly. The new administration pinned much of the blame on the incompatibilities and inefficiencies of the automated production systems at the Pentagon's major aerospace and defense contractors.

The result was an extensive study of the efficiency of the DoD's computer networks and factory-automation systems, which are run primarily by VAXs and Ethernet networks. The diagnosis was that these production plants are

due for a major overhaul. The Pentagon and its contractors are installing sophisticated Computer-Integrated Manufacturing (CIM) systems that integrate software programs for planning, design and production with specially designed databases and reporting systems.

But by all accounts, the upgrade was slow in coming. The technology that permitted this integration has been maturing steadily for four or five years.

Integrating Software

Analysts report that, for reasons ranging from stubbornness to the costly stoppages caused by upgrades, buyers of

BY EVAN BIRKHEAD

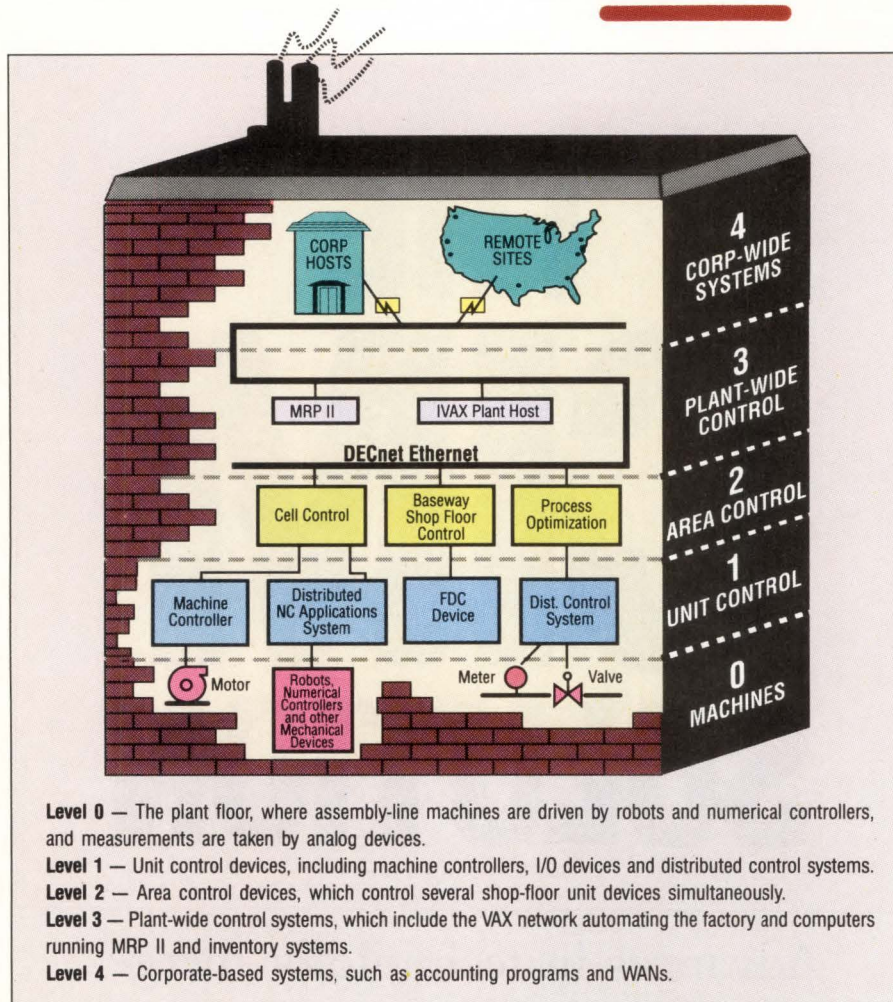

Figure: Digital's CIM strategy as it correlates to NIST's manufacturing automation model.

factory-automation systems in most manufacturing industries have been slow to keep pace with advances in technology. For example, the ability to link CAD-generated parts designs, accounting figures and inventory systems into numerical control systems on the factory floor is now attainable.

One defense contractor, Honeywell Aerospace, has a Digital installation that, thanks to third-party software, already covers much of this ground. Detailed parts assembly information is stored in a manufacturing database that's used to create new production plans illustrated with CAD systems. The plans then are sent to a shop-floor control system from a Manufacturing Resources Planning (MRP II) system, which oversees parts production.

The high level of integration at the

Honeywell site was made possible by cooperation between three of Digital's software partners: CimTelligence Corporation, which produces a Computer-Aided Process Planning (CAPP) system called IntelliCapp; Palette Systems Inc., which provides a suite of engineering design modules that tie into a CAD/graphics database; and Consilium Inc., which makes Comets, a shop-floor control system. The Manufacturing Instruction Display System (MIDS) module from Palette sends assembly instructions to the shop floor. All of the programs send, manipulate and store data from the same database, accessible from a variety of departments.

This scenario closely approaches the dream factory-automation system for a discrete parts manufacturer: a single, seamless database that maintains

the working CAD drawings of a given part that's to be introduced into a production line, as well as all information related to costs and assembly.

The Manufacturing Model

As defined by the National Institute of Standards Technology (NIST), there's a five-level hierarchy in manufacturing automation that hardware and software vendors slowly are tying together (see Figure).

Sufficiently sophisticated hardware is available at each level of this model. But software has been scarce, particularly at the unit and area levels. Software that integrates these levels (programming tools and communications) introduces a new concept entirely.

Digital has made greater strides in achieving this paperless factory — in which the entire process, from concept through design and production, is performed electronically — than any other hardware vendor. One of its secrets has been alliances with third-party software vendors.

Third-Party Activity

On the VAX platform, third-party solutions, encompassing both hardware and software, contribute to the wide array of integration possibilities:

- ASK Computer System's MANMAN, a manufacturing management program that encompasses interplant communications capabilities and cost accounting.
- Allen-Bradley Company's Pyramid Integrator, an industrial controller generated by a MicroVAX II that integrates applications such as MRP II and quality management with plant-floor data such as work in process or machine control.
- Cincom System's Control:Manufacturing, an RDBMS optimized for production settings that handles manufacturing applications from accounting and scheduling to shop-floor control and facilitates data sharing between VAXs and IBM systems.
- MCBA's MCBA, which integrates software packages for accounting,

What MRP II software system has the features you need?

MCBA CLASSIC Manufacturing Software™. This high quality closed-loop MRP II system offers premium functionality for both job shops and repetitive manufacturers. Packed with powerful features and well-documented, the system's 18 integrated manufacturing, distribution and accounting packages are incredibly easy to use.

MCBA CLASSIC Manufacturing Software for the VAX™ provides easy data access and comprehensive reports to give you increased visibility and control of your operations. The result? Increased productivity, saved time and money, and improved customer service.

It's easy to get started. MCBA CLASSIC Manufacturing Software is modular, so you can install just the packages you need now and add more when you're ready. And you can count on its reliability, since it's made by MCBA, known worldwide for its quality, dependable business software.

You can get MCBA CLASSIC Manufacturing Software (and local support and training as necessary) through our worldwide network of qualified resellers.

Send for FREE product information today. Return the coupon today, or call the MCBA office nearest you (see below). Reseller inquiries are welcome.

Please send me information on MCBA CLASSIC Manufacturing Software in VAX COBOL.

Name _____

Title _____

Company _____

Address _____

City _____ State _____ ZIP _____

Phone (____) _____ Best time to call _____

I am a software: User; Reseller; Consultant.

Revenue Range: Under \$15M; Over \$15M.

Mail to: MCBA Inc.

425 W. Broadway
Glendale, CA 91204-1269

DP689

CIRCLE 121 ON READER CARD

MCBA CLASSIC SOFTWARE

The Standard in Business Software Solutions™

Headquarters: 425 W. Broadway, Glendale, CA 91204-1269 Phone: (818) 242-9600

Branch Office: 120 Wood Ave. S., Suite 300, Iselin, NJ 08830-2709 Phone: (201) 548-6600

(Serving AL, CT, DC, DE, FL, GA, MA, MD, ME, MS, NC, NH, NJ, NY, PA, RI, SC, TN, VA, VT, the Caribbean, W. Indies, and Europe)

MCBA CLASSIC Manufacturing Software Packages: **Manufacturing:** Bill of Material Processor, Master Scheduling, Material Requirements Planning, Shop Floor Control, Standard Product Costing, Standard Product Routing, Job Costing, Labor Performance, Capacity Requirements Planning. **Distribution:** Inventory Management, Purchase Order and Receiving, Customer Order Processing, Sales History. **Accounting:** Accounts Receivable, General Ledger, Accounts Payable, Fixed Assets and Depreciation, Payroll.

Copyright © 1989 By MCBA, Inc. All rights reserved. MCBA is a registered trademark and MCBA CLASSIC Software and The Standard in Business Software Solutions are trademarks of MCBA, Inc. VAX is a trademark of Digital Equipment Corporation.

Shown through a bearing sleeve, this IVAX, a MicroVAX II-based system, governs operations on a plant floor.



Courtesy Digital Equipment Corporation

distribution, manufacturing and EDI.

- NREC's Work Cell Manager, a monitoring and control software system that integrates shop-floor equipment with plant-wide decision makers. The program monitors equipment status and utilization, maintenance, and performs many other supervisory control functions.

- Siemens Information Systems and other systems integrators, which adhere to standards such as OSI and Ethernet to solve the problems encountered in multivendor manufacturing environments. Siemens networks programmable controllers with VAXs.

By combining such systems, manufacturers intend to achieve goals beyond Digital's theme of integrating the enterprise: the maintenance of quality, the reduction of overhead, worldwide contributions to design and production, and faster times to market.

Leadership Secrets

Digital and the third party, particularly its Cooperative Marketing Program

(CMP) and Independent Software Vendor (ISV) participants, have become the major players in the CIM market, thanks to Digital's long customer relationships in the arena and manufacturing's historic reliance on networking and distributed processing. A majority of factories and manufacturing facilities use Digital systems. Digital's strong VAX/VMS base was responsible for most of its sales to manufacturing installations last year, although interest in ULTRIX workstations is increasing.

Using its internal EasyNet worldwide network for engineering consultations and implementing proprietary expert system and CIM techniques, Digital practices what it preaches. Its production facilities have been virtually paperless for almost three years, and its time-to-market speed for new products is phenomenal.

However, there's much competition. UNIX-based workstations have become the in-vogue processors for CIM applications. According to the San Jose-based market-research firm Dataquest, Digital's strongest competitors in

technical workstations are Sun Microsystems and Hewlett-Packard. The fastest-growing companies are Intergraph Corporation and Silicon Graphics Inc. Dataquest reports that CAD/CAM and other engineering applications were the major impetus behind the workstation market's 53 percent growth in 1988 to \$4.1 billion.

According to CIMdata Inc., a research and consulting firm in Wellesley Hills, Massachusetts, total U.S. purchases in the CIM market will reach \$25.4 billion by the end of 1989 and will skyrocket to \$40.7 billion by 1993. Digital's split of the market for computers, workstations and terminals is roughly 30 percent. IBM, recognizing Digital's superior market share in the area, has coordinated a considerably large effort based on its AS/400.

Standards

Because the infiltration of workstations has become a major issue, and because virtually all environments are increasingly multivendor setups, manufacturing operation standards have become the

INTRODUCING THE EIGEN UTILITIES

OVER 90 WAYS TO EXPAND AND ENHANCE
YOUR VAX/VMS SYSTEM.

To get the most from your VAX/VMS system, you've got to overcome problems quickly and efficiently.

However, as your company's automation needs grow, so do the system problems you face. Problems that are increasingly complex and comprehensive. Problems that bottleneck whole systems. Problems that require immediate solutions.

Now you no longer have to face these problems alone.

INTRODUCING EIGEN UTILITIES. A NINETY-TOOL VAX/VMS PROBLEM-SOLVER.

The Eigen Utility Package is the first product that addresses virtually all of your VAX/VMS problems. It consists of 90 tools for VAX/VMS system development, performance tuning, security, debugging, and more. With The Eigen Utility Package, you'll dramatically reduce system bottlenecks.

A few of the capabilities provided by The Eigen Utilities are listed below.

- Undelete files.
- Resolve Mount/Dismount problems.
- Speed up applications using a RAM disk.
- Identify wasted disk space and fragmented files.

- Abort idle terminal processes.
- Execute DCL commands on other VAXes.
- Password protect selected images.
- Easily debug detached processes and global section or VMS mailbox applications.
- Allow selected network access.
- Develop protective measures when security alarms occur.
- Resolve queue management problems.

TRY THE AFFORDABLE EIGEN UTILITY PACKAGE FOR 45 DAYS WITHOUT OBLIGATION.

The Eigen Utility Package's low price will surprise you. In fact, it actually costs less than many single-tool utilities.

The Eigen Utility Package comes with excellent documentation, complete on-line HELP, and a computer aided instruction course.

If you want to expand and enhance your VAX/VMS system, look to the first complete utility tool that addresses all of your system problems. Look to The Eigen Utilities. For your 45-day no cost or obligation trial, call:

1-800-87 EIGEN

(In NY: 212-749-7513)
Eigen Corporation
82 Wall Street, Suite 1105
New York, NY 10005

CIRCLE 321 ON READER CARD

E · I · G · E · N

Ruggedized VAXs

Digital's Industrial VAX (IVAX) series of computers is made up of standard VAX/VMS processors that are built to withstand the perils of the factory floor. These hard-hat cabinets have a special design that protects the CPU from high temperatures, vibrations, noise, collisions, liquid or oil spills, and airborne particles including dust, fabric or metal filings. Digital conforms to a standard called European IP 52 at a sealing specification level called NEMA 12.

IVAXs are more compact than regular VAXs, with fewer cables. The series includes:

- The IVAX 630, a 12-slot MicroVAX II with 5 MB of memory, a 71-MB disk and a 95-MB tape.
- The IVAX 620, a compact diskless MicroVAX II that runs VAXELN.
- The disk-based IVAX 620, with 1 MB of memory, a 71-MB disk and a 95-MB tape.
- The IPDP-11, a 12-slot MicroPDP-11/83 with 2 MB of memory, a 71-MB disk and 95-MB tape.

Prices range from about \$11,000 for the diskless IVAX 620 to \$32,000 for the IVAX 630.

Cyberchron Corporation makes an R8000 series of computers that's made up of a ruggedized version of Digital's VAXBI (8250 and 8350) CPUs. In addition to conforming to plant-floor protection standards, the R8000s meet the military's Tempest specifications. The systems support up to four removable disk or tape drives. RWT Corporation, Codar and Xycom Inc. also optimize hardware for the factory.

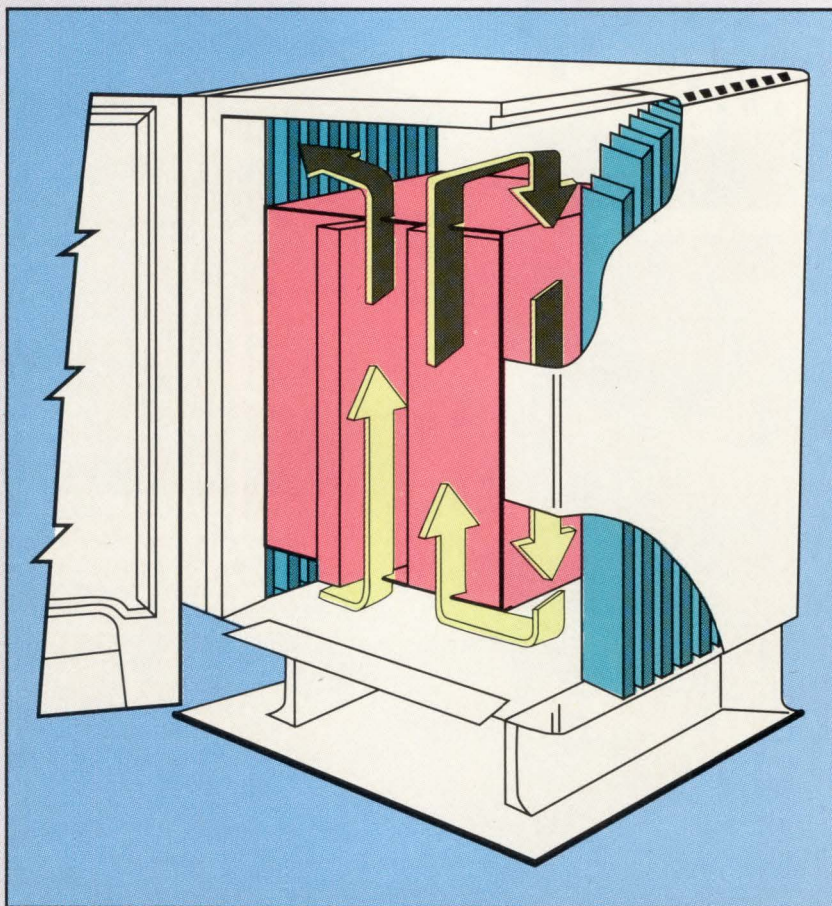

While running without air conditioners, Digital's IVAX computers protect the system boards from shock, liquids and airborne particles. Arrows indicate air flow.

industry's key issue.

Currently, Digital is pushing the Manufacturing Automation Protocol/ Technical and Office Protocol (MAP/TOP), which defines the protocols for a multivendor broadband communications network. It's specified in a subset of the OSI model. Digital announced its intention to migrate all DECnet users to OSI in September 1987.

Despite a rift between Digital and GM, MAP's original supporters, MAP remains an active issue. An organization of users called ITRC, composed of the U.S. MAP/TOP user groups and the Canadian MAP interest group, was founded late last year to provide a structure for unified advocacy among users, vendors and governments.

NIST currently is looking for participants to help fund and staff its OSI/ISDN Security Program. The goal of the project is to ensure that these multivendor networks are secure after they're open. NIST is building a research facility that will design, define and test for telecommunications, network management and security services in a distributed processing environment.

Digital, IBM and Sun already have loaned research equipment to the NIST laboratory. Digital's contribution was a

Vendors Of Ruggedized Systems

Codar Technology, Inc.
1500 Kansas Ave.
Longmont, CO 80501
(303) 776-0472

CIRCLE 476 ON READER CARD

Cyberchron Corp.
3720 Farragut Ave.
Kensington, MD 20895
(301) 946-6488

CIRCLE 496 ON READER CARD

RWT Corp.
1601 Feehanville Dr., Ste. 500
Mount Prospect, IL 60056
(312) 390-0200

CIRCLE 545 ON READER CARD

Xycom Inc.
750 N. Maple Rd.
Saline, MI 48176
(313) 429-4971

CIRCLE 477 ON READER CARD

MICOM AND GLASGAL

A BIG PARTNERSHIP

Add **Micom** product engineering and **Glasgal** applications know-how and you'll come out ahead every time.

If you're thinking of Micom... call Glasgal. No one knows Micom products better than we do, or is as likely to deliver and install them as fast.

Glasgal is the one-point, one-source provider of complete local and wide area networks including, their design, integration, wiring, installation and field maintenance from coast to coast.

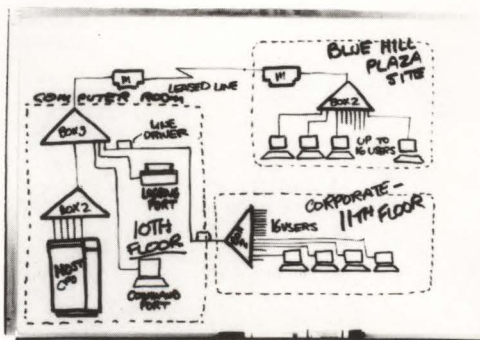

Over 120 vendor products are stocked and supported. Over 3000 products on demand.

Isn't that somewhat more useful than what your current supplier offers?

Micom and Glasgal. Representing one of America's most productive data communications partnerships.

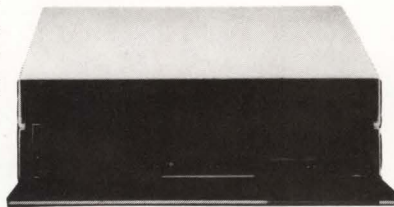

GLASGAL
COMMUNICATIONS, INC.

Worldwide Corporate Headquarters: 151 Veterans Drive, Northvale, New Jersey 07647

Engineering that exceeds expectations.

CIRCLE 290 ON READER CARD

To speak with one of our consulting engineers, just call: N. California, 415-935-8727; S. California, 714-380-0161; Colorado, 303-933-9639; Texas, 214-578-8232; Missouri, 314-731-2202; Minnesota, 612-545-2625; Illinois, 312-705-3830; Michigan, 313-455-4649; Ohio, 513-298-6885; Upstate NY, 315-437-1828; Philadelphia, 215-623-9654; Massachusetts, 617-449-7470; Metro NYC & NJ, 201-768-8082; Connecticut, 203-834-1414; Washington DC, 301-964-1808; Georgia, 404-458-7100; Florida, 305-753-9600; North Carolina, 919-783-0076; Canada, 416-889-9095.

VAX Semiconductor Automation Platform

Digital's Pacific Systems Group of Mountain View, California, develops software for automating the semiconductor industry. In May, Digital exhibited at SEMICON West 89 in San Mateo, California, a trade show for the semiconductor industry. Digital demonstrated a VAX Semiconductor Automation Platform (VSAP) controlling an etch process operation in semiconductor manufacturing. In the demonstration, wafers were moved from one step of processing to the next via monorail tracks, elevators and robots.

The VSAP demo showed how VAXs running VAX/VMS, DECnet and VSAP work to control semiconductor equipment, robots, monorails and test equipment.

The booth featured equipment from nine vendors, as well as VMS-based software from Digital and four other vendors, working together in a hypothetical semiconductor processing environment. The recipes for semiconductor processing are carefully guarded secrets. Therefore, although the movement of the wafer cassettes was realistic, the processing procedures weren't.

Cassettes began at the ProgramMation Automated Storage/Retrieval System (AS/RS) and were transferred to an overhead track system. The overhead track, also supplied by ProgramMation, shuttled the cassettes to vertical transfer elevators positioned near the semiconductor processing equipment. After

the wafers went down the elevators, robots on floor track systems from Accu-Fab and Intellidex took cassettes of wafers to various semiconductor processing equipment. The demo included a Wet Bench, from Santa Clara Plastics, where the wafers were lowered into sinks and dipped in chemicals; a stripper from Branson; and two etchers from Applied Materials, including its top-of-the-line Chemical Vapor Disposition (CVD) 5000.

After the wafers had been processed, the Nanometrics Nanospec 212 measured the film thickness and the Tencor Surfscan 4500 measured the particulate level.

Software running on the four VAXs controlled the processing and the movement of cassettes and wafers. All of this software ran on the VMS/DECnet platform, the basis for the network of VAXs, production machines and measurement instruments.

Consilium's Comets was used for shop-floor management and lot tracking. Thesis Group's AutoCell performed the cell control functions. Baylis Automation's Streamline controlled measurement stations. Finally, BBN Software's RS/1 processed the statistical information provided by the measurement instruments. —Peggy King is West Coast Editor of HP PROFESSIONAL, a Professional Press publication covering the Hewlett-Packard market.

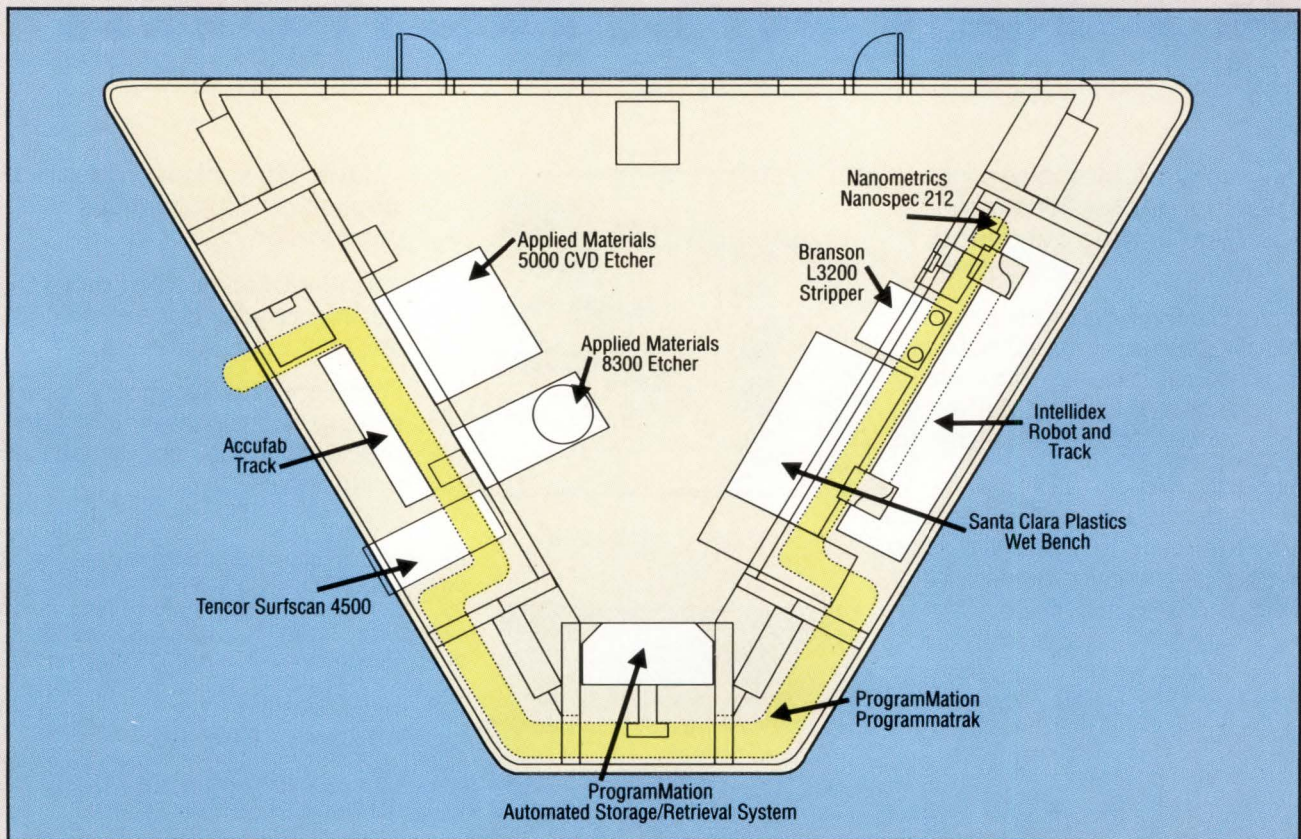

Semiconductor processing equipment and measurement instruments are linked via VSAP running on a VMS/DECnet platform.

MicroVAX workstation and two Digital encryption system network controllers.

Digital's Factory

In Digital's parlance, CIM is the integration of computers in overlapping divisions of an enterprise, spanning production planning, product design and manufacture, and quality assurance. This encompasses several software technologies, including CAD, CAM, MRP, Material Billing and Control Systems (MBCS), Just-In-Time (JIT) and accounting and inventory systems.

The software side of Digital's factory is a conglomeration of expert systems tools, integration tools and applications. All are used internally at DEC. Baseview is the Digital software that annotates the original CAD drawings and distributes them to production personnel. The plant supervisory software package is called Baseway, which collects information from programmable controllers and other devices on the factory floor.

The fundamental integration package is DECscan, which links factory VAXs to measurement and control devices. A system called Distributed NC Applications Service integrates numerical control devices into the network. Basestar is a module that lets you tailor discrete manufacturing systems to integrate data with software applications.

VAX processors are the key to Digital's success. Digital's IVAX systems, ruggedized VAXs and MicroVAXs that are geared toward communications and control of factory-floor operations, are integral to its strategy (see Sidebar, "Ruggedized VAXs").

Rather than just selling hardware, however, Digital is establishing itself as a prime contractor. It recently announced multimillion dollar orders from manufacturing divisions of Boeing and McDonnell-Douglas. Both primarily were purchasers of VAXstations, but they included major integration projects. The Boeing deal is reportedly the basis of the largest CIM project in its history. It involves the integration of VAXstation 3200s control-

Companies Mentioned In This Article

Accu-Fab Systems Inc.
33854 Eastgate Cir.
Corvallis, OR 97333
(503) 758-3329
CIRCLE 440 ON READER CARD

Allen-Bradley Co.
480 E. Wilson Bridge, Ste. M
Worthington, OH 43085
(614) 846-7979
CIRCLE 529 ON READER CARD

Applied Materials
P.O. Box 58039
Santa Clara, CA 95052
(408) 748-5500
CIRCLE 441 ON READER CARD

ASK Computer Systems
2440 El Camino Real W.
Mountain View, CA 94039
(415) 969-4442
CIRCLE 530 ON READER CARD

Baylis Automation Inc.
4340 Scotts Valley Dr., Ste. G
Scotts Valley, CA 95066
(408) 438-SECS
CIRCLE 442 ON READER CARD

BBN Software Products Corp.
10 Fawcett St.
Cambridge, MA 02238
(617) 873-5000
CIRCLE 443 ON READER CARD

Branson/IPC 31172
Huntwood Ave.
Hayward, CA 94544
(415) 489-3030
CIRCLE 444 ON READER CARD

CimTelligence Corp.
1 Forbes Road
Lexington, MA 02173
(617) 861-1996
CIRCLE 531 ON READER CARD

Cincom Systems Inc.
2300 Montana Ave.
Cincinnati, OH 45211
(800) 543-3010
CIRCLE 532 ON READER CARD

Consilium Inc.
1945 Charleston Rd.
Mountain View, CA 94043
(415) 940-1400
CIRCLE 548 ON READER CARD

Digital Equipment Corp.
146 Main St.
Maynard, MA 01754
(508) 897-5111
CIRCLE 403 ON READER CARD

Hewlett-Packard Co.
3000 Hanover St.
Palo Alto, CA 94304
(415) 857-1501
CIRCLE 406 ON READER CARD

IBM Corp.
Old Orchard Rd.
Armonk, NY 10504
(914) 765-1900
CIRCLE 407 ON READER CARD

Intellidex
4575 S.W. Research Way
Corvallis, OR 97333
(503) 758-5005
CIRCLE 445 ON READER CARD

Intergraph Corp.
1 Madison Industrial Park
Huntsville, AL 35807
(205) 772-2000
CIRCLE 533 ON READER CARD

MCBA 425 W. Broadway
Glendale, CA 91204
(818) 242-9600
CIRCLE 534 ON READER CARD

Nanometrics Inc.
690 E. Arques Ave.
Sunnyvale, CA 94086
(408) 735-1044
CIRCLE 446 ON READER CARD

National Institute of Standards
and Technology (NIST)
Bldg. 225, Rm. A216
Gaithersburg, MD 20899
(301) 975-2934
CIRCLE 535 ON READER CARD

Nothern Research and
Engineering Corp. (NREC)
39 Olympia Ave.
Woburn, MA 01801
(617) 935-9050
CIRCLE 478 ON READER CARD

Palette Systems Inc.
6 Trafalgar Sq.
Nashua, NH 03063
(603) 886-1230
CIRCLE 544 ON READER CARD

ProgramMation Inc.
290 Hansen Access Rd.
King of Prussia, PA 19406
(215) 354-0400
CIRCLE 447 ON READER CARD

Siemens Information Systems Inc.
5300 Broken Sound Blvd.
Boca Raton, FL 33487
(407) 994-8800
CIRCLE 551 ON READER CARD

ling sheet-metal production on the factory floor with VAX 6300s that will provide area control, and VAXclusters that will provide corporate input. In turn, the operation will be networked via DECnet/Ethernet to other Boeing facilities.

Dee Wolsey, Boeing's director of sheet-metal operations, recalls that before the purchase, some parts could take 40 days to pass through 21 production steps, covering 1½ miles. "In the new center," Wolsey says, "the same parts will be completed in four days, requiring 13 production steps and travel-

ing one-third of a mile as they move through the factory."

For Digital, the bottom line is keeping its customers happy. Likewise, the bottom line for a manufacturing firm is the delivery of a product that keeps its customer satisfaction high. The realization of corporate goals depends as much on smooth operations at the lowest common denominator, the factory floor, as anywhere else.

ARTICLE INTEREST QUOTIENT
Circle On Reader Card
High 552 Medium 553 Low 554

MERGING ON THE DATA HIGHWAY

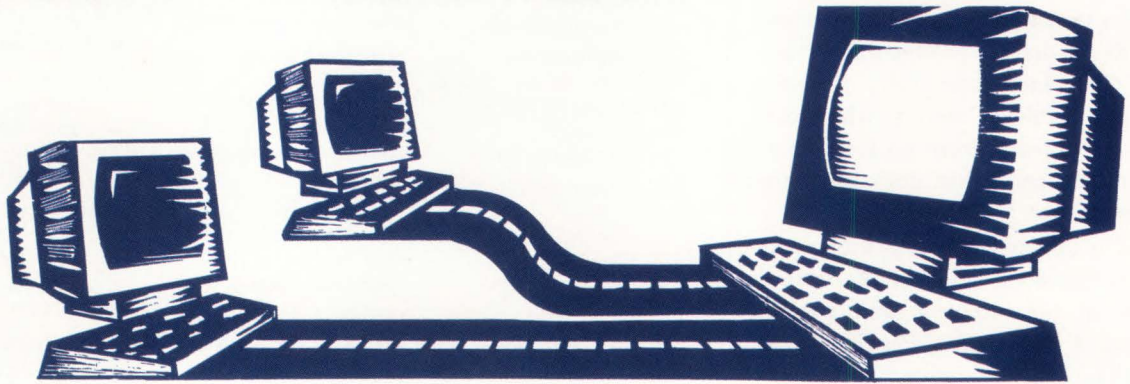

A VAX interface to a process control system data highway.

BY ROBERT B. IRVIN

HISTORICALLY, PROCESS CONTROL systems and management information systems (MIS) have occupied opposite ends of the computing spectrum. Process control systems operate in a real-time environment and must respond quickly to changes in sensor inputs, sometimes within milliseconds. MIS, in contrast, generally operates in an environment in which speed is important only from the point of view of how long it takes a user to get a report or answer an inquiry against a database.

The City of Los Angeles Bureau of

Sanitation is involved in a project to marry these two computing regimes. The effort will provide an integrated environment for process control and management information systems for the wastewater treatment plants located throughout the city.

These wastewater treatment plants are large and complex chemical processing facilities that take a feed stock, in this case wastewater, and use a number of physical, chemical and biological processes to produce a clean output product.

However, unlike many chemical

facilities, which can be shut down periodically or in an emergency, a wastewater treatment plant must operate continuously, because the feed stream can never be shut off. Further, the treatment volumes are extremely large compared to other chemical processes. The more than three million people in Los Angeles and surrounding cities generate close to 450 million gallons of wastewater daily.

A \$150 million project at the City of Los Angeles Hyperion Treatment Plant currently is under way to dispose

of the sewage sludge generated in the treatment process. As part of this project, the Westinghouse Distributed Processing Family (WDPF), a control system manufactured by Westinghouse Electric Corporation, is being installed (see Sidebar, "Energy Recovery System").

Distributing Control

The distributed process control system is the latest evolutionary stage in the digital process control system world. Rather than relying on a centralized host computer to provide control and data-acquisition functions, a distributed process control system uses a large number of process control modules connected by a network.

In the case of the WDPF, the LAN is proprietary coaxial cable. Each process control module is a fairly sophisticated combination of microprocessors with a proprietary operating system, a LAN interface, and I/O interfaces for the field instruments and the final control element connections. Field instruments include flow meters, level switches and pressure indicators. Final control elements controlled by the process can be as simple as an on/off switch to a pump or as involved as a numerically controlled proportional valve controller.

The technique of distributing the process control function was developed to minimize the reliance on only one computer system and communications network. In a distributed process control system, the failure of a single process control module doesn't affect the operation of other process control modules located on the data highway.

In a host-based process control environment, failure of the host computer results in the entire plant losing control and data-acquisition capabilities. Similarly, failure of communications between the host and remote equipment prevents proper functioning if the remote equipment isn't intelligent.

The distributed system's processors usually have redundancy built in. The combination of this redundancy with the distributed architecture provides higher availability and speed than is

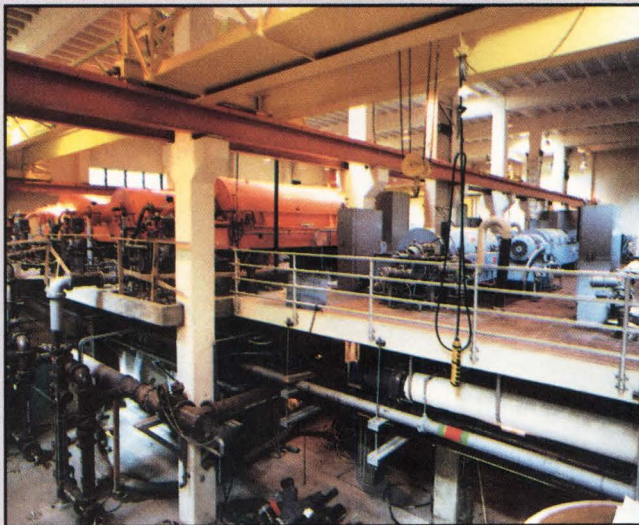

Centrifuges and electrical turbines are used in the city's waste-to-energy plant.

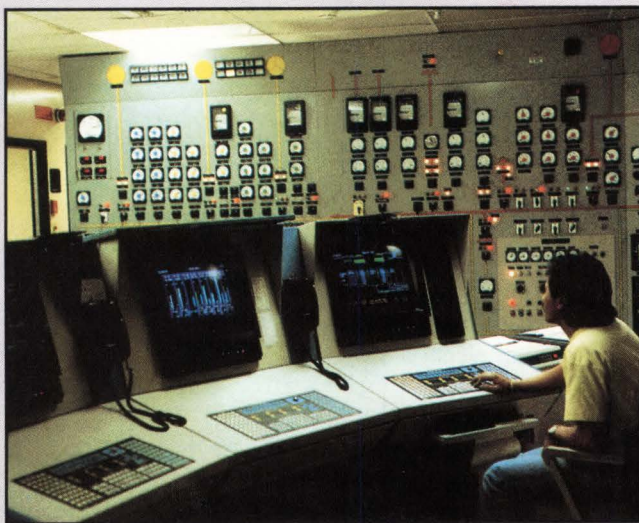

Plant operators in a central control room receive alarms and control plant processes.

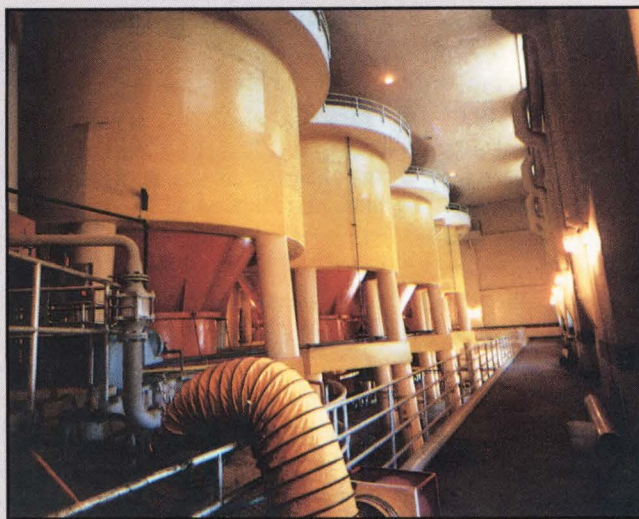

The level and feed rate in these hoppers are controlled automatically by the local distributed processing unit.

possible in a host-based configuration. There are 23 distributed processing units located in the Hyperion plant.

The distributed process control system provides the capability for shar-

... failure of individual process control modules doesn't make the entire plant inoperable.

ing required common data among process control modules over the data highway. It also provides increased reliability, because each area with its own process control module can operate independently. In the operation of a wastewater treatment plant, for example, this increased reliability can ensure that failure of individual process control modules doesn't make the entire plant inoperable.

LAN Connections

The Westinghouse Process Control System used in the Hyperion Energy Recovery facility has different kinds of LAN connections, or drops, available for collecting information and controlling the operation of treatment equipment (see Figure 1). The user interface to the system is provided by operational/engineering consoles. These are color terminals that have intelligence and data-communication capabilities. They connect directly to, and can interpret and extract data directly from, the data highway.

Some drops can provide historical data collection onto magnetic media. One drop serves as a microcomputer program interface. It has language compilers for PASCAL and FORTRAN and can be used to develop custom software.

However, none of the microcom-

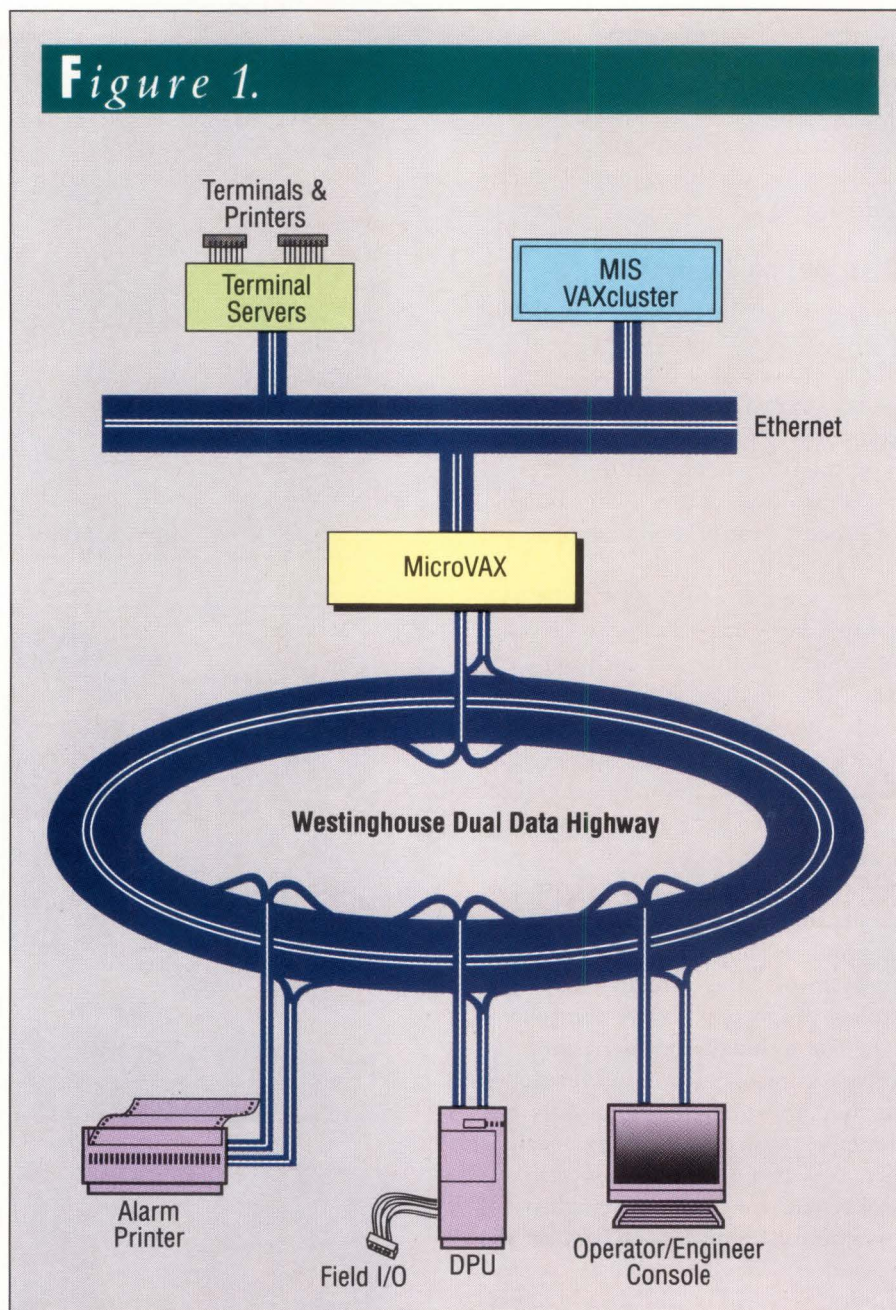

The MicroVAX collects data from the Westinghouse data highway, using the VXI board and firmware coengineered by Digital and Westinghouse.

puter drops can provide sophisticated statistical analysis or information management functions. These functions currently are performed on a VAXcluster at the plant. This management information system supports a number of large applications, including a maintenance management system for the more than \$1 billion of equipment installed at the

plant. The VAXcluster also produces most of the reports required by regulatory agencies. It relies primarily on VAX Information Architecture products to provide the data-management capabilities.

All of the plant data used in the MIS is input manually. Much of this data is collected by the process control system. By linking the Westinghouse Process

What's Wrong With This Picture?

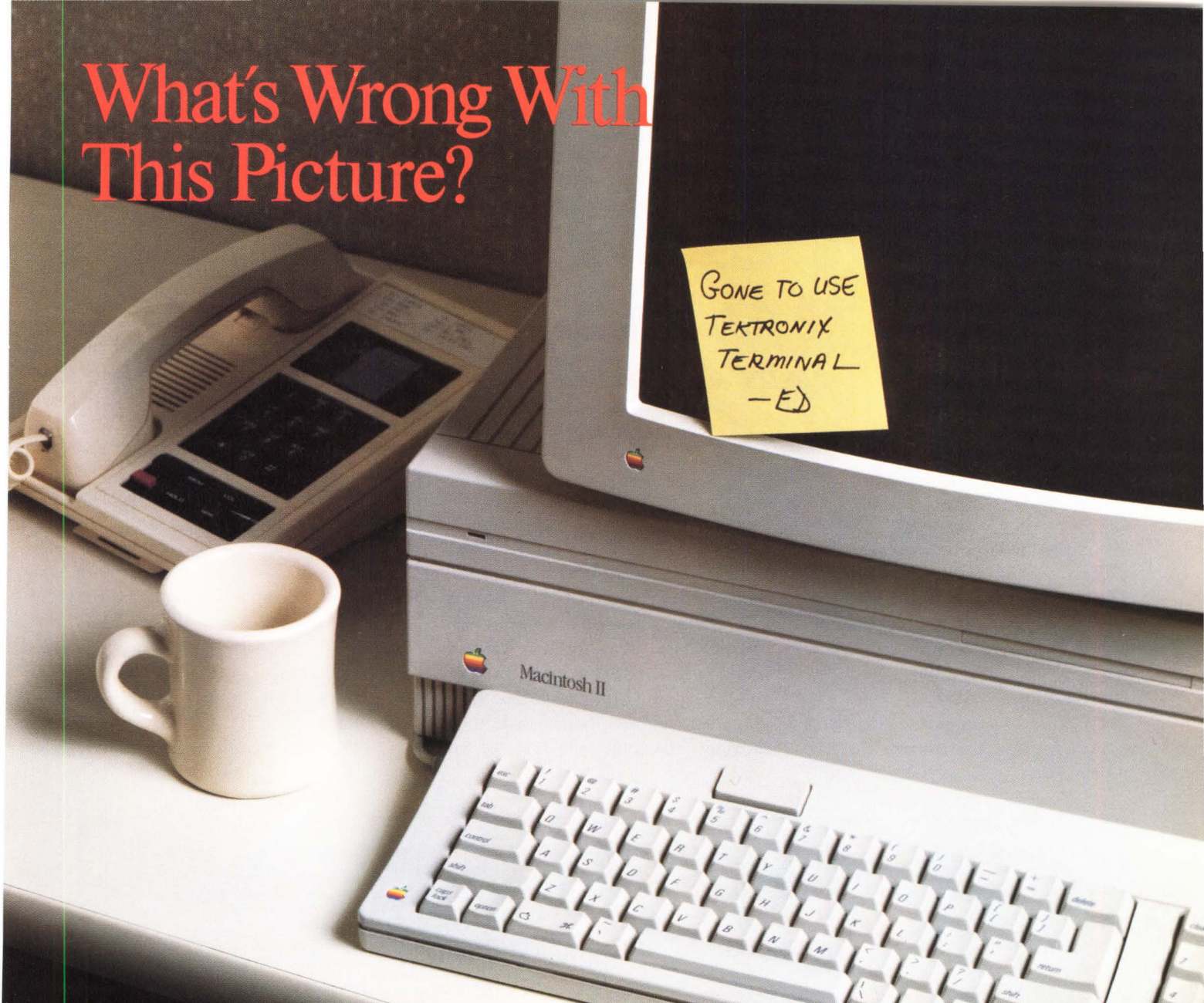

GONE TO USE
TEKTRONIX
TERMINAL
-ED

What's wrong is that Ed could be using his Macintosh II as a powerful Tektronix 4107 graphics terminal, but instead he is off using a graphics terminal in some other part of the building.

If Ed had only known about TGRAF for the Macintosh II, he could at this very instant be logged on to his company's mainframe, right from his desktop with his Macintosh II. Ed could now be running any one of a hundred or so host applications, with his MAC II and TGRAF combination operating as a powerful graphics terminal.

Grafpoint, a leader in Tektronix terminal emulation, now has a powerful 4107 software emulator for the Macintosh II. TGRAF for the Macintosh is a comprehensive emulator that supports all the display features of a Tektronix 4107 terminal in both asynchronous (RS-232-C) and networking communication environments.

TGRAF has the powerful and seamless user interface that Macintosh users have come to expect. TGRAF supports Multifinder, cut & paste, pull-down menus, separate text windows with scroll bars, plus powerful graphics terminal features such as graphics displayed in sixteen on screen colors, full 640 x 480 resolution, 12 bit addressable space, etc.

Find out today what it takes to transform your Macintosh II into a powerful, full-featured graphics terminal. Call us at 1-800-426-2230, in California 1-408-446-1919.

** 30-day no-risk trial available. TGRAF - in addition to the Macintosh product is available for PCs, PS/2s, and workstations.

Apple and Macintosh are trademarks of Apple, Inc. Grafpoint and TGRAF are trademarks of Grafpoint. Tektronix is a trademark of Tektronix, Inc.



GRAFPPOINTTM

1485 Saratoga Avenue
San Jose, California 95129

Please circle 114 for demonstration. Please circle 275 for additional product information.

Control System with the VAXcluster, we can collect real-time process data and make it available in a sophisticated and powerful MIS and statistical computing environment. The capabilities for data

systems. Westinghouse and Digital have coengineered a product called the VAX Interface Unit (VXI), a gateway interface between the WDPF data highway and VAXs (see Figure 2). The interface can

Multibus-to-UNIBUS device in the MicroVAX world. The adapter provides a DMA interface to either the UNIBUS or the Q-bus and allows the VAX to be connected directly to the data highway. The DMA interface allows the processor to read and write directly to the bus memory locations as if they were local to the Multibus or UNIBUS. This provides a closely coupled link between the WDPF highway and the VAX memory with low VAX CPU duty-cycle requirements.

The firmware resident in the VXI maintains the database of the WDPF process data and general-message data between the WDPF LAN and VXI memory. It provides buffering for LAN transfers, maintenance of the tables necessary to communicate with the data highway controller, and the implementation of the WDPF LAN general-message protocol, so that the VAX can communicate in the Westinghouse WDPF native mode.

The VXI transmits data directly

... distributed process control capabilities ordinarily aren't available in a VAXcluster environment.

and statistical analysis available on the VAXcluster wouldn't be possible in a process control system environment. Likewise, distributed process control capabilities ordinarily aren't available in a VAXcluster environment.

Interfacing

We'll use a Westinghouse MicroVAX calculator drop to interface the two

operate on UNIBUS and Q-bus VAXs.

The VXI hardware is an 8086/8087 microprocessor with shared memory and a Multibus-to-UNIBUS adapter. The Multibus is the bus structure used on the WDPF. When this hardware was developed, the UNIBUS was the only bus available on the VAXs. The VXI is supplied with a Q-bus-to-UNIBUS adapter to allow the use of the

Figure 2.

WDPF MicroVAX Hardware Block Diagram

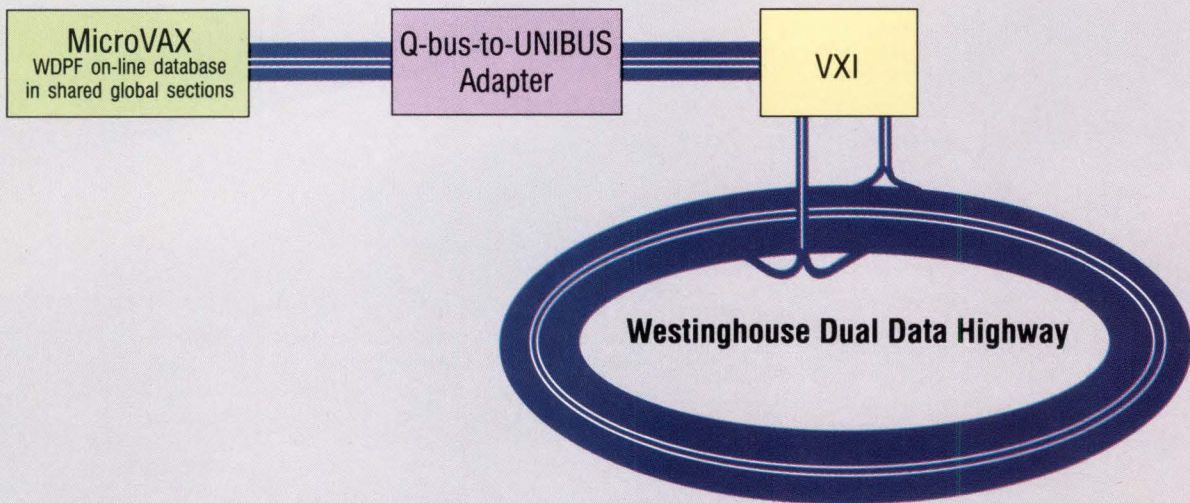

In the Westinghouse distributed control system, the MicroVAX provides a connection between the data highway and the VAX network.

**Companies Mentioned
In This Article**

Digital Equipment Corp.
146 Main St.
Maynard, MA 01754
(508) 897-5111
CIRCLE 403 ON READER CARD

Intel Corp.
3065 Bowers Ave.
Santa Clara, CA 95051
(408) 987-8080
CIRCLE 487 ON READER CARD

SAS Institute Inc.
SAS Circle, Box 8000
Cary, NC 27512
(919) 467-8000
CIRCLE 460 ON READER CARD

Westinghouse Electric Corp.
200 Beta Dr.
Pittsburgh, PA 15238
(412) 244-2000
CIRCLE 461 ON READER CARD

between VAX main memory and the LAN using standard VAX/VMS Queue Input/Output (QIO) calls to a special device driver. The data structures in VAX memory, called highway request blocks (HRB), are shared global sections built by a process point compiler, which is software supplied by Westinghouse.

The HRB provides an interface between application programs and the WDPF data highway by setting up and maintaining a database of real-time process point information. It contains information such as most recently scanned value, point description, type of point (i.e., analog or digital) and scan frequency. This information is updated one to 10 times per second.

Application programs that need data from the control system simply include this global section in the source code. The program then can reference the data by control point name. Consequently, the access to control information isn't only fairly straightforward, it's also very fast, because this data is resident in VAX main memory.

Connection between the MicroVAX calculator and the VAXcluster will be provided via Ethernet and DECnet.

If you want every project to have a happy ending,

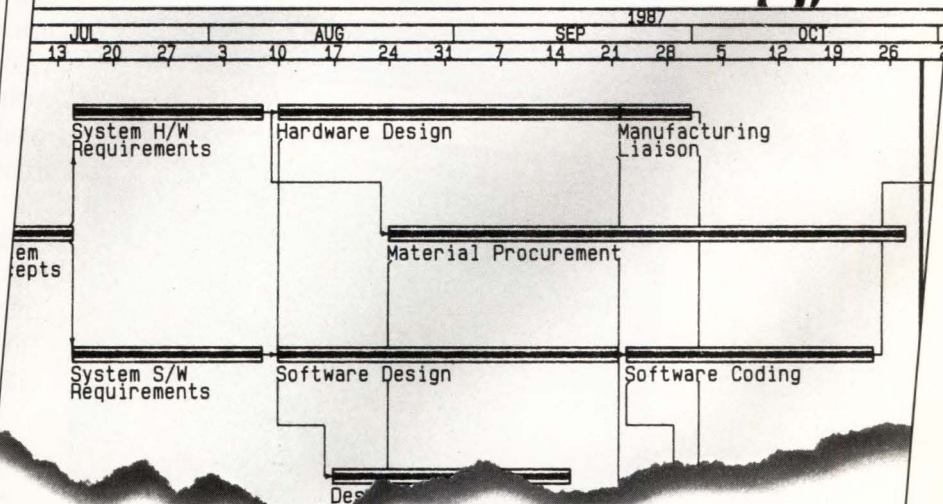

start with a great plot.

Primavera Project Planner (P3) is project management software that works. Using its scheduling and resource management capabilities, you can staff effectively, resolve resource conflicts, create and implement alternatives...and get the job done.

You'll improve communications too. With our Primavision graphics—produced on pen plotters and laser printers—you can present your project's story with absolute clarity. Detailed by each activity or summarized by responsibility to show the big picture, Primavision plots make sure that everyone knows what to do, by when, and why.

Call 1-800-423-0245 (in Pa., 215-667-8600) for our new 18-page color brochure. And start planning your next act.



Software you can count on to keep you in control.



PRIMAVERA SYSTEMS, INC.
Project Management Software

Two Bala Plaza • Bala Cynwyd, PA 19004
(215) 667-8600 • Telex: 910 997-0484 • FAX: (215) 667-7894

CIRCLE 335 ON READER CARD

The Free SAS System

More Choices, for More Applications, than Any Other Software.

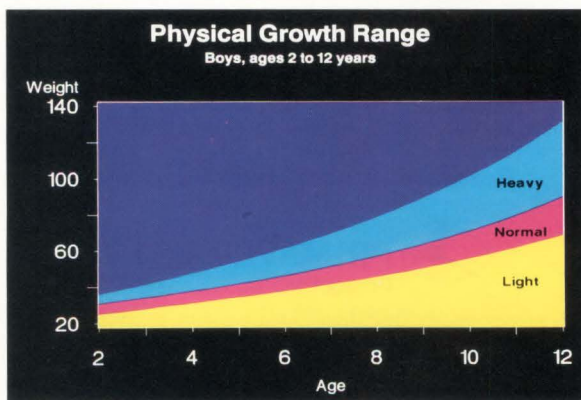
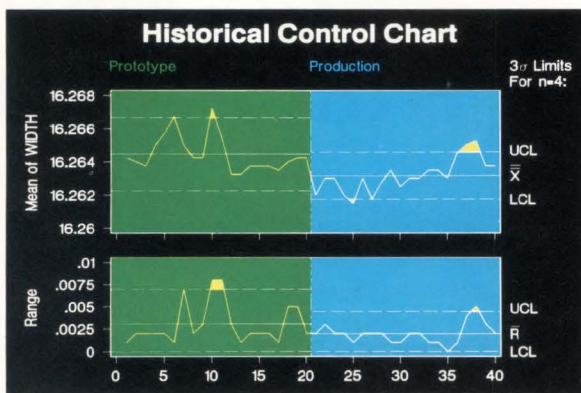
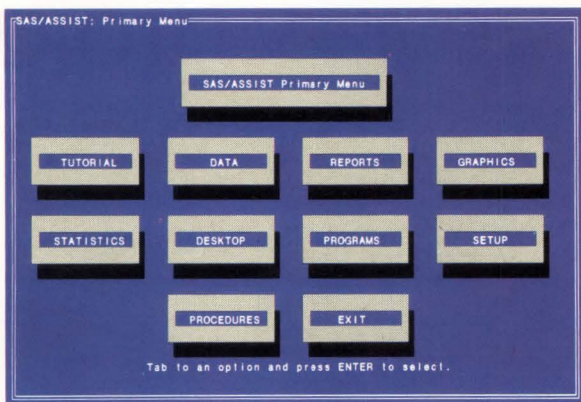

The SAS System is the software you'll never outgrow. No other software offers so many choices for data management, analysis, and presentation. For any user—new computer user to seasoned pro. For any environment—PC to technical workstation to minicomputer to mainframe.

Choices to Build On. Start with a powerful English-like language and essential data management tools. Then take your pick of ready-to-use applications: statistical and mathematical analysis...report writing and color graphics... project management and quality control... forecasting and decision support.

Or build your own menu-driven applications—quickly and easily—with the SAS System's interactive applications development tool. Even first-time users can command the power of the SAS System... just by filling in the blanks.

Choices to Count On. More than a million users throughout the world—in business, industry, government, science, and education—have made the SAS System their #1 choice for data analysis and color graphics. And **every** SAS System application is backed by expert technical support, documentation, and training.

We'll tell you more in a free 12-page executive summary. Just give us a call at (919) 467-8000. In Canada, call (416) 443-9811.



SAS Institute Inc.
Software Sales Department
SAS Circle □ Box 8000
Cary, NC 27512-8000
Fax (919) 469-3737

The SAS System runs under IBM Corp.'s MVS, CMS, and VSE; Digital Equipment Corp.'s VMS®; Data General Corp.'s AOS/V5; Prime Computer, Inc.'s PRIMOS®; Sun Microsystems, Inc.'s SunOS™; Hewlett-Packard's HP-UX; Microsoft Corp.'s MS-DOS®; and IBM Corp.'s PC DOS.

We'll use FORTRAN programs to extract high and low daily values, average values, and values of particular interest out of this real-time common database. The information will be stored in other databases in the MicroVAX. Scientific and engineering staff members using the MIS can access the database files over DECnet and can use tools such as SAS, DATATRIEVE or other graphics packages available on the MIS.

The responsibility for collecting

this real-time data is completely off-loaded from the MIS hosts in this configuration. This provides a clear separation between the slower, database-intensive MIS world and the time-critical real-time process control world. —Robert B. Irvin is manager of information and control systems for the City of Los Angeles Bureau of Sanitation.

ARTICLE INTEREST QUOTIENT
Circle On Reader Card
High 457 Medium 458 Low 459

Energy Recovery System

The Bureau of Sanitation operates four wastewater treatment plants at various locations within the City of Los Angeles. Two of these plants are classified as water-reclamation plants. They take sewage wastewater and run it through three distinct processes (tertiary treatment). The final product is used as irrigation water for commercial parks and golf courses and as industrial cooling water.

The other two plants are wastewater treatment plants. They process the waste through two distinct processes (secondary treatment). The final product is discharged to the sea. The largest of these plants is the Hyperion Treatment Plant located south of the Los Angeles Airport in Playa Del Rey. The Hyperion Treatment Plant treats approximately 380 million gallons of wastewater and generates approximately 1,200 tons of sewage sludge solids daily.

In an effort to dispose of these sludge solids, the Hyperion Energy Recovery System (HERS) was constructed at the plant. It's designed to dry the sludge, burn it in a fluidized bed reactor and convert the resultant heat into electricity. Some of the electricity is used to operate the treatment plant. The excess is sold commercially. HERS is highly automated, and all of the processes are controlled by a large distributed process control system.

More than 12,000 analog and discrete points are monitored in this control system. Analog points are variable measurements such as flow or temperature. Discrete points are either on or off, such as the state of a motor, i.e., either running or not running.

HERS is divided into five operations, or trains. The solids first are digested anaerobically, and methane gas captured from this process is used to drive gas turbines that generate electricity. The digested solids then are centrifuged to remove the majority of liquid. This low-water-content solid then is put through a patented de-watering process, using high pressure, oil and heat. The dry powder that results is carried by a nitrogen conveyor to fluidized bed reactors where the powder is burned. The energy that is generated by the combustion is converted to steam and used to drive steam turbines.

The plant is scheduled to be in full operation within a year. At that time, it's expected to generate 25 megawatts of electrical energy daily, enough electricity for 25,000 homes. The plant is controlled by a distributed process control system manufactured by Westinghouse Electric Corporation.

Each of the process trains is controlled by a distributed process control module, a CPU on a LAN, called the data highway. Each of these process control modules operates numerous analog and digital inputs and outputs. The module is responsible for process control and process monitoring in the train where it's located.

The data highway LAN operates over a coaxial-type cable and runs at 2 Mbps. The data communication over this line is proprietary to Westinghouse. Each of the Westinghouse Distributed Processing Family modules that connects to the data highway has communication intelligence to let it extract sensor information from the LAN or make sensor information available to other modules. All functional units connect to the LAN.

Peritek does it with color!

Graphics and
alphanumerics for
LSI, PDP, VAX
and MicroVAX.

Peritek has been offering the widest range of Q-bus and Unibus display controllers available anywhere for over 10 years. Hardware and software for most applications. Color and monochrome. Low to high resolution. Software support for RT/TSX, RSX, VMS, and ULTRIX, and bit-level subroutines which interface directly to Fortran and C. Image processing software is also available.

Peritek's most powerful board, the VCK-Q/U, combines an advanced CRT controller and a 68010-based computer on one quad-height card. You get:

- 1024 x 1024 x 8 color graphics
- 1024 x 1024 x 1 graphics overlay
- 64 x 85 alphanumeric overlay
- hardware pan and zoom
- two channel DMA
- two serial I/O ports
- SCSI port

The VCK-Q/U prices range from \$3,495 to \$4,485. A complete package with software and monitor starts at \$6,500.

For your special requirements, Peritek can supply custom configurations of our standard products. We're ready to quote on custom software and hardware design projects, too.

Call or write for free catalog.
Peritek Corporation
5550 Redwood Rd.,
Oakland, California 94619.
Phone (415) 531-6500.
In the east, (516) 798-1919.



See us at:
Siggraph, July 31-August 4, Booth -1118
DEXPO West, November 7-9, Booth -223

CIRCLE 131 ON READER CARD

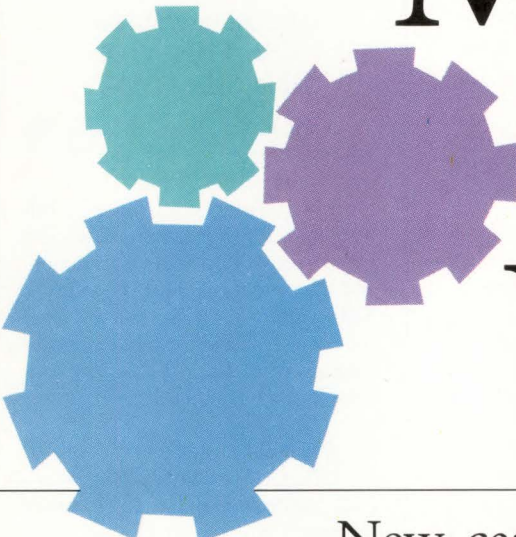

Making Projects Work

New capabilities advance the
state of the art in project management software.

BY STEVEN SALEMI

NO BUSINESS CAN AFFORD to manage projects poorly. The ever-increasing constraints of costs, resources, quality and time make project management a serious business. Accordingly, today's project management packages are powerful, complex pieces of software.

Automotive, aerospace and pharmaceutical manufacturers rely on project management software to get high-quality products out the door on time and within budget. Elsewhere, project management applications are used for building skyscrapers and developing software.

As a formal discipline, project management appeared in the 1950s, with the Program Evaluation and Review Technique (PERT) analysis for Polaris missiles. About the same time, Du Pont developed the Critical Path Method (CPM) to manage large, complex technical projects. Commercial project

management software packages arrived in the 1970s.

Many popular project management software applications were developed on PDP-11 or VAX systems and ported to other platforms, including IBM mainframes. Today, project management software development on Digital systems is accelerating, as Digital stocks its workstation arsenal with fast CVAX and RISC hardware.

With the successive introduction of minis, micros and technical workstations, project management software applications have found an increasingly broad hardware platform: MS-DOS PCs; VAX, MicroVAX and VAXstation systems; UNIX workstations from Digital and Sun; and IBM minis and mainframes. The industry's leading packages will continue to be available on Digital systems, because Digital has a strong presence in manufacturing, engineering

and other disciplines that rely on project management software.

Every software application uses a model to replicate the real-world task it attempts to automate. For project management software, CPM is a prominent model. CPM defines a series of activities and its relationship to other activities. Time, resources and costs are factored in. The result is a graphical representation of the project time line. This is usually a GANTT chart with activities displayed as horizontal bars. Although no model is perfect, CPM comes closest to the way that projects progress in the real world.

The latest crop of project management software packages focus on enhanced features, database technology and integration with other hardware and software systems.

Any project management software package can determine whether or not

a project can be completed on time with existing resources. But some packages perform risk analysis to determine the likelihood of project completion under different scenarios. With this software, users define range-of-time estimates for the completion of various tasks. A project scheduler rolls up the distribution curves associated with each of these tasks. The result is a report or graphic listing a range of project-completion dates, with probabilities assigned to each date.

Support for simultaneous multiple users of a single project plan is a recent development. Some packages don't support multiple users. Others circumvent the problem by creating separate data records for each user and merging them later. True multiuser systems enable groups of users to access individual projects and make simultaneous updates to them.

One popular application accomplishes this by tracking users who have selected a project. With two or more users, the program monitors each user's operating mode (where they are in the application). When users are querying or browsing (i.e., when no database updates are required), the system functions normally. But when a user enters an update mode in which writes to the database can be made, a wait lock locks the database record. The record remains locked until the user exits the update mode. For multiuser minicomputer and LAN implementations, tight integration of the project management application with database record-locking schemes is mandatory.

Another leading project management application features a loop detector to prevent users from designing networks with endless loops. Because projects involve large numbers of interdependent activities, users of many project management applications can create project models with endless activity loops. This could be two activities that require each other's completion before they can commence. Systems without loop detectors can crank away for hours, oblivious of any flawed logic.

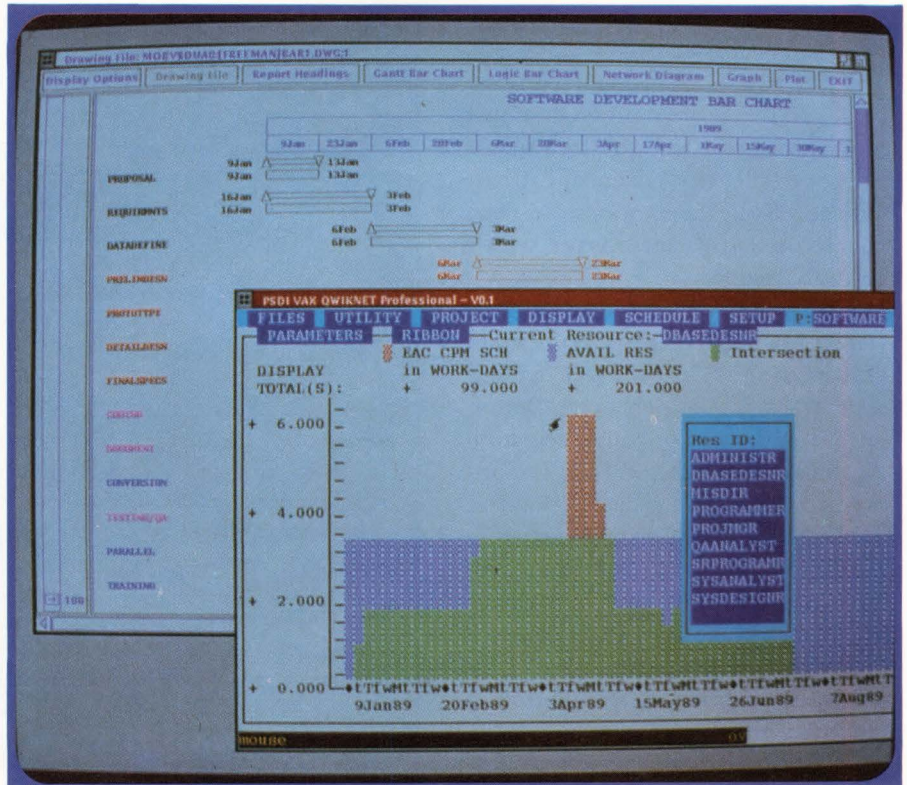

DECwindows-based project management system shows resource histogram of how a labor type is being used in a software development project. The histogram overlaps a plotted bar chart showing activity duration.

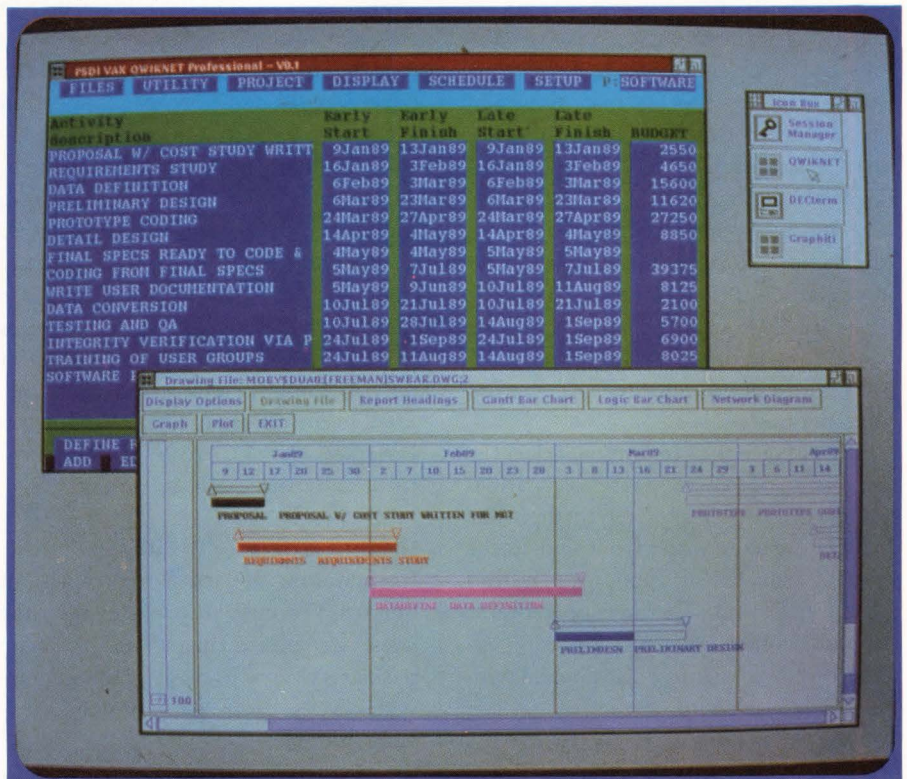

DECwindows-based project management software illustrates a bar chart with progress up to a status date overlaying a schedule report including budgeted cost of activities.

Some packages use proprietary database systems written by the vendor. The database is integrated with and dedicated to its parent program. Other programs work in tandem with Digital's Rdb or third-party relational database systems. Some applications let users choose among database types with a software toggle.

When project management software is run as a standalone application, the database issue isn't compelling. Both approaches get the job done. But an open database can provide integration capabilities beyond ASCII file import/export. An open, industry-standard database can be a means for integrating project management software with other companywide computer systems, including Manufacturing Resource Planning (MRP II) systems.

In an automated manufacturing operation, project management software can be integrated with engineering, prototyping, manufacturing, quality control and other systems. The relational database serves as the repository for data created by all of the systems. Events are triggered by the changing status of various systems and resources. Process status is reflected by the information in the database. Resource algorithms are used to communicate the process status in database terms.

In this way, the database becomes the common tongue spoken by the MRP II systems and the project management systems. It's an integration tool for systems that may have no other easy means of communicating and sharing information.

One recent development takes the benefits of third-party relational database technology a step further. The database becomes the front end to the project management application, instead of the back end. The developer builds the project management application using the development tools supplied with the database. This breed of project management package ships with a run-time version of the database.

This "project manager within the database" approach has some promising

Project Management From DEC

VAX Software Project Manager, a Digital-developed project management software offering, is designed for estimating, planning and managing software development projects. It contains an integrated software-estimation feature. This projects total effort, time to deliver and staffing required. Without this feature, it can serve as a generic project management tool.

VAX Software Project Manager imposes no limits to project size, resources per project or resources per activity. Support for fractional resources allows the same resources to be devoted to different activities. Project presentations can be tailored to include only the information the user wants to review: project tasks, milestones or both, for example. Similarly, a report-writing capability allows users to select any information in the project database and format that information for reporting purposes.

Users can choose a menu-oriented mode with graphical interface, as well as a DCL-style command line mode. The menu interface requires a Digital graphics video terminal or equivalent. The graphics mode presents project data as trees, nodes, graphs and charts. Users can switch quickly between menu and DCL modes.

Like other members of Digital's VAX Information Architecture (VIA) family, Project Manager is integrated with Digital's networks. Users can access projects across a Digital LAN or WAN by setting the default library to a remote directory. The Project Manager database permits simultaneous updates by two or more users.

Software-license-only prices start at \$9,639 for a single-user MicroVAX II license.

advantages. First, the system is immediately familiar to users familiar with the database: commands, queries, reports, and the like, are accessed the same way. In addition, the application can be customized with the same database development tools used to create it. Also, the availability of such packages for new operating environments, such as DECwindows, can follow quickly upon the introduction of the database for that environment. No major rewrites of the application are required. Most of the programming effort needed to conform to the environment's Application Program Interface (API) can be performed by the database vendor.

Integration Made Easy

Integration with database systems is but one form of integration offered by the latest project management software packages. Many packages can integrate with other software programs and hardware systems.

ASCII file import/export capabilities are a near-universal means of exchanging information between project

management software packages and other information systems. Users control how these ASCII files are formatted. By modifying the file header and trailer information, as well as the file, field and record delimiters, the files can be used by other systems. For example, ASCII files produced by an IBM-based MRP II system could be sent over a DECnet/SNA Gateway and imported into a VAX-based project management software application.

In addition to ASCII files, many project management software packages support file import/export in popular PC formats, such as SDF, DIF, dBase and Lotus 1-2-3 .WKS. The industry-standard .DXF graphics exchange format also is supported. As other standards evolve, such as Microsoft Excel's .XLS worksheet, you can expect to see these supported, too.

Many packages integrate with other software tools, usually marketed with the package by the same vendor. One package, for example, offers a cost estimator package integrated with the main program. Originally developed

Only ARSAP™ lets you automate your entire system accounting process.

ARSAP is the most automated system accounting software you can get for use in the VAX/VMS environment. While some systems require repetitive manual procedures, ARSAP does all the work, using command procedures to automate the entire system accounting process.

ARSAP comes with all the features you need—project accounting, capacity planning, resource management, organization accounting, software reporting, terminal/LAT accounting, selective image accounting, and more.

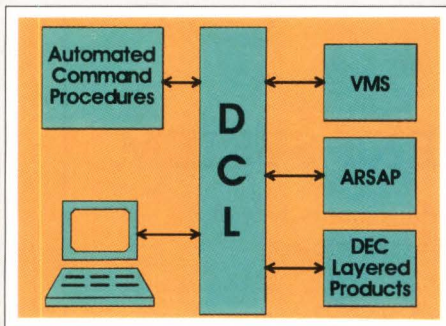

DCL interface is faster and easier than menus.

▲ There is no system accounting interface that is more automated than ARSAP's DCL. This feature alone sets ARSAP years ahead of those products with menu-driven interfaces. Menus are repetitive, tedious and can hinder productivity. With ARSAP's uniquely flexible design, you can run either interactively—or automatically!

ARSAP's DCL interface is fully compatible with the VMS environment and meets VAX/VMS standards. Your staff uses familiar, powerful wildcards, standard online HELP, and even 20-line command recall of VMS V5. These unique features mean your staff feels an immediate comfort level with ARSAP, and you save valuable training time and expense.

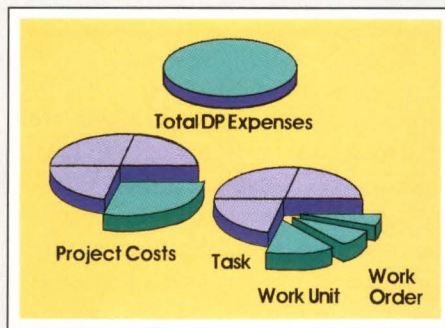

Accurate, detailed project accounting.

▲ Project accounting with ARSAP is more automated, flexible and accurate than you thought possible. You can use project codes up to 96 characters and five custom groupings to track project charges. Custom-fit ARSAP, using five-level, user-definable prompting and automated defaults for all or parts of a project code.

Only ARSAP includes features for printer forms charging, Intergraph plot charges, selective image surcharging and consistent disk charges even when samples are missing.

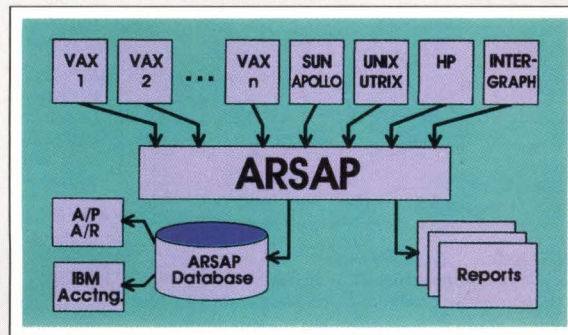

If there's a more automated system accounting product than ARSAP, it's still on the drawing board.
Call for more information on:

- | | |
|---|---|
| <input type="checkbox"/> User Chargeback | <input type="checkbox"/> Project Accounting |
| <input type="checkbox"/> Resource Management | <input type="checkbox"/> Capacity Planning |
| <input type="checkbox"/> Performance Management | <input type="checkbox"/> Printer Forms Accounting |
| <input type="checkbox"/> Software Package Reporting | <input type="checkbox"/> Selective Image Accounting |
| <input type="checkbox"/> Organization Accounting | <input type="checkbox"/> Intergraph Accounting |

Track your entire organization automatically.

▼ ARSAP's automated accounting capability extends to nine organizational levels. You can track their usage and generate reports with the detail amount automatically tailored to each management level.

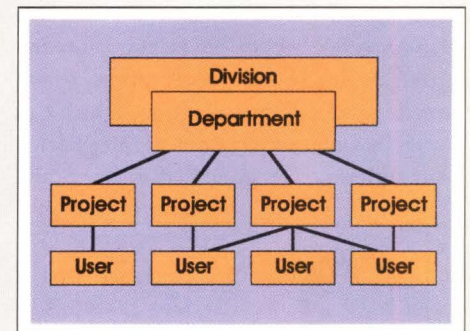

ARSAP can handle any situation—whether a company division contains five or 5,000 users; users belong to one department or several; a project consists of one or multiple users; or users from several departments are working on the same project.

ARSAP is never obsolete.

◀ ARSAP's open architecture means it seamlessly fits any software and hardware environment.

You can include data from systems other than your own and report using a single centralized database.

You're not limited only to foreign accounting inputs. Using ARSAP's VAX database, you'll interface with a wide variety of financial and management reporting software, including mainframe accounting.

1-800-43ARSAP

(1-800-432-7727) • (301) 725-2500

GEJAC
INCORPORATED

8643 Cherry Lane, Laurel, MD 20707

Companies Mentioned In This Article

Ashton-Tate
20101 Hamilton Ave.
Torrance, CA 90502
(213) 329-8000
CIRCLE 486 ON READER CARD

E.I. Du Pont De Nemours
& Company Inc.
1007 Market St.
Wilmington, DE 19898
(302) 774-1000
CIRCLE 572 ON READER CARD

IBM Corp.
Old Orchard Rd.
Armonk, NY 10504
(914) 765-1900
CIRCLE 407 ON READER CARD

Lotus Development Corp.
55 Cambridge Pkwy.
Cambridge, MA 02142
(617) 577-8500
CIRCLE 408 ON READER CARD

Microsoft Corp.
16011 N.E. 36th Way
P.O. Box 97017
Redmond, VA 98073
(206) 882-8080
CIRCLE 410 ON READER CARD

Sun Microsystems Inc.
2550 Garcia Ave.
Mountain View, CA 94043
(415) 960-1300
CIRCLE 536 ON READER CARD

separately, the user only sees one package.

One vendor features an easy-to-use, graphical-based front end for its command-driven system. This gives users a choice between fast and easy interfaces. It also provides flexibility to the manufacturing organization, which can deploy different versions of the package to different categories of users. Some

project management applications are built for integration with high- or low-end packages in the same product family. Sometimes these packages are subsets or supersets of the functionality contained in the core package. Just as often, vendors offer the same packages, with identical functionality, on mini-computer and PC platforms, providing users with a range of functionality

depending on their needs. A project composed of 1,500 activities may run fine on a PC, but a project with 30,000 activities requires a VAX.

Typically, these packages integrate via ASCII file transfers or by sharing a back-end relational database. When a vendor's minicomputer and PC packages don't share a database, the vendor usually includes commands to automate the transfer of information between the two versions of its software. With Digital's VMS Services for MS-DOS software, users of minicomputer and PC packages can share data files without the need for system-to-system file transfers.

Opening Windows

Multiwindow, multitasking operating environments are an exciting development for users of project management software. Suppose a manufacturer encounters a shortage of raw materials. Project management software users can modify the available resources in one

THE PRESTIGE PROJECT MANAGEMENT SYSTEM

The project management software you choose must meet tomorrow's requirements as well as today's. A supplier with a longstanding track record and commitment to the project management field assures your continued success now and in the future.

For over a quarter century, K&H has been a leader in the project management software field. Now we've applied our knowledge and experience to the development of a new generation of project management software. Introducing **PRESTIGE**, the most comprehensive, feature packed, user-oriented project management system available today; the system that will remain the functional standard for years to come.

PRESTIGE includes powerful report and graphics generators allowing virtually unlimited output flexibility. The relational

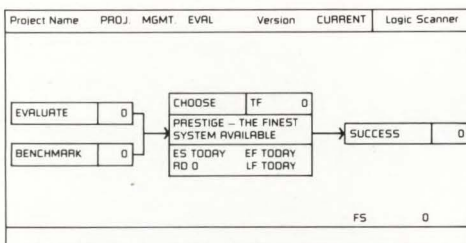

PRESTIGE provides complete time, resource, cost analysis and performance measurement capabilities. More than 50 standard report and graphic formats plus on-line query/update and the logic scanner shown above.

database technology employed (Oracle, Ingres, Btrieve) provides the security, import/export, and performance features you expect in a world class system.

PRESTIGE is available on a wide variety of hardware and operating systems, including PCs, LANs, Vax and Unix minicomputers. Call (215) 293-3500 today for more information on the new standard in project management software.

Oracle, Ingres, Btrieve, Vax, Unix are trademarks of their respective holders.

THE PROJECT MANAGEMENT PACKAGE DESIGNED TO STAND THE TEST OF TIME



435 Devon Park Drive • Suite 300 • Wayne, PA 19087 • (215) 293-3500

CIRCLE 336 ON READER CARD

Colleague™

LAPTOP VT 220 TERMINAL



Colleague
\$995
Colleague Plus
\$1295

*Includes battery
and modem*

*"Keeping
you in
touch"*

\$995 Colleague Portable Terminal includes:

- 20 Auto Connect/Auto Dial Channels
- 20 Programmable Function Keys per channel with numeric/application keypad support
- Full 25 Line x 80 Column Supertwist Display
- Internal 300/1200 bps Auto Answer/Auto Dial Modem **with MNP* error-correcting protocol**
- 150-19.2K bps RS-232 Port & Parallel Printer Port
- Internal 15-Hour Battery with Recharger
- VT-52/100/220 Emulation
- Compact — 7.5 lbs.; 13" x 10" x 2⁵/₈"

\$1295 Colleague PLUS also includes:

- Full-Featured Internal Word Processor
- Data Capture/Send/Screen-Snap
- Session Record/Playback
- 65K of Non-volatile RAM Storage

Also Available:

- External Numeric/Application Keypad — \$95.00
- 2400 Baud Internal Modem — \$200.00
- Backlit Screen — \$200.00
- Ink Jet Printer
- Carrying Cases

Evaluation Colleague available. Call 1-800-553-6773 (in Ohio: 513-825-0880)

581 Northland Boulevard **Random™** Cincinnati, Ohio 45240
CORPORATION

© 1988 Random Corporation VT is a Registered Trademark of Digital Equipment Corp. Random and Colleague are trademarks of Random Corporation.

*MNP is a Registered Trademark of Microcom, Inc.

CIRCLE 135 ON READER CARD

workstation window, recalculate the schedule and see the effect displayed in another window. Users can run multiple WHAT-IF analyses in different windows, keeping an eye on each result.

will allow more flexibility in planning contingencies and risks. It also will mean a closer fit between the project model and reality.

Another trend is the adaptation of

five years, four project plans similar to this one have gone over budget. Are you sure you want to proceed?"

A third trend is the incorporation of project management software packages and other automation tools into integrated project support environments (IPSE). An IPSE links the software tools used in development projects. It can help monitor, track and coordinate activities across the entire development cycle.

An IPSE, for example, can integrate project management software with an enterprisewide electronic mail package. Without human intervention, the IPSE can send messages to engineers, alerting them that important project milestones are imminent. Such a system can greatly increase the chances of a project being completed to plan. —Steven Salemi is president of Bottom Line Communications Inc., Concord, Massachusetts. He has written extensively about DEC hardware, software and services.

MOST LEADING VENDORS who sell their wares to the Digital installed base probably will port their software to DECwindows.

A number of project management software vendors have announced support for DECwindows, Digital's integrated applications environment. Other vendors, in less specific terms, talk about support for the Digital strategy. Most leading vendors who sell their wares to the Digital installed base probably will port their software to DECwindows.

By rewriting the user interface for DECwindows, developers can retain the core portions of existing programs. One vendor estimated that this task represents 20 percent of the entire program.

From the organizational point of view, open operating environments, such as the X Window System and DECwindows, promise applications portability. A software package can be accessed by any system that supports DECwindows.

Looking Ahead

You should keep an eye on several trends unique to the project management field. One is the development of profession-specific packages, spinoffs from leading core packages. As competing project management software packages develop equivalent capabilities, these packages will allow vendors to distinguish themselves in the marketplace.

These packages will enable user organizations to account in their project plans for the unique activities, resources and bottlenecks found in each field. This

expert systems and AI technology to project management software. Over time, the project models or networks devised by each package gradually will reflect the expertise of experienced planners.

One technique compares the details of proposed plans to previous plans. Such a program would have the ability to learn. Imagine an intelligent dialog box flashing this warning: "In the past

ARTICLE INTEREST QUOTIENT
Circle On Reader Card
High 577 Medium 578 Low 579

Project Management Vendors

Cardinal Data Corp.
72 2nd Ave., Ste. 200
Needham Heights, MA 02194
(617) 449-0066
CIRCLE 470 ON READER CARD

Computer Aided Management (CAM)
1318 Redwood Way, Ste. 210
Petaluma, CA 94952
(707) 795-4100
CIRCLE 409 ON READER CARD

Computerline Inc.
52 School St.
P.O. Box 308
Pembroke, MA 02359
(617) 294-1111
CIRCLE 563 ON READER CARD

DSD Corp.
18912 N. Creek Pkwy.
Bothell, WA 98011
(206) 485-7564
CIRCLE 468 ON READER CARD

Digital Equipment Corp.
146 Main St.
Maynard, MA 01754
(617) 897-5111
CIRCLE 403 ON READER CARD

K & H Professional
Management Services Inc.
435 Devon Park Dr., Ste. 300
Wayne, PA 19087
(215) 293-3500
CIRCLE 564 ON READER CARD

Metier Management Systems Inc.
2900 N. Loop W., Ste. 1300
Houston, TX 77092
(713) 956-7511
CIRCLE 565 ON READER CARD

Primavera Systems Inc.
Two Bala Plaza
Bala Cynwyd, PA 19004
(215) 667-8600
CIRCLE 566 ON READER CARD

Productivity Solutions Inc.
138 Technology Dr.
Waltham, MA 02154
(617) 899-8900
CIRCLE 469 ON READER CARD

Welcom Software Technology
15995 N. Barkers Landing
Ste. 275
Houston, TX 77079
(713) 558-0514
CIRCLE 404 ON READER CARD

Project Software &
Development Inc. (PSDI)
20 University Rd.
Cambridge, MA 02138
(617) 661-1444
CIRCLE 567 ON READER CARD

Synergistic Systems Inc.
115 Sumac St.
W. Haven, CT 06516
(203) 932-5757
CIRCLE 568 ON READER CARD

Systonetics Inc.
1561 E. Orangethorpe Ave.
Fullerton, CA 92631
(714) 680-0910
CIRCLE 569 ON READER CARD

Target Systems Corp.
33 Boston Post Rd. W.
Marlboro, MA 01752
(508) 460-9206
CIRCLE 570 ON READER CARD

Technical Economics Inc.
1650 Solano Ave.
Berkeley, CA 94707-2118
(415) 525-7774
CIRCLE 475 ON READER CARD

GUESS WHO WROTE THE BOOK ON TCP/IP NETWORKING WITH VMS.

No other company has more TCP/IP solutions for networking of VAX/VMS environments than Excelan, not even DEC.

In fact, not only does Excelan offer more TCP/IP solutions than anyone else, but all of them are fully compatible with VMS versions 4.4 through to 5.0.

OUR CONNECTIVITY SOLUTIONS.

At Excelan, we take two approaches to DEC connectivity, both of which support TCP/IP on Ethernet.

LAN Service™ for VMS is our front-end processor solution. Users may off-load network protocols and with standard networking applications expedite high speed file transfers, even entire directory trees. They can also log into remote host systems and exchange electronic mail.

Excelan's MultiNet is our hardware independent, TCP/IP implementation, which allows users to run multiple network media and protocol stacks, including all DEC Ethernet adapters.

Both LAN Service for

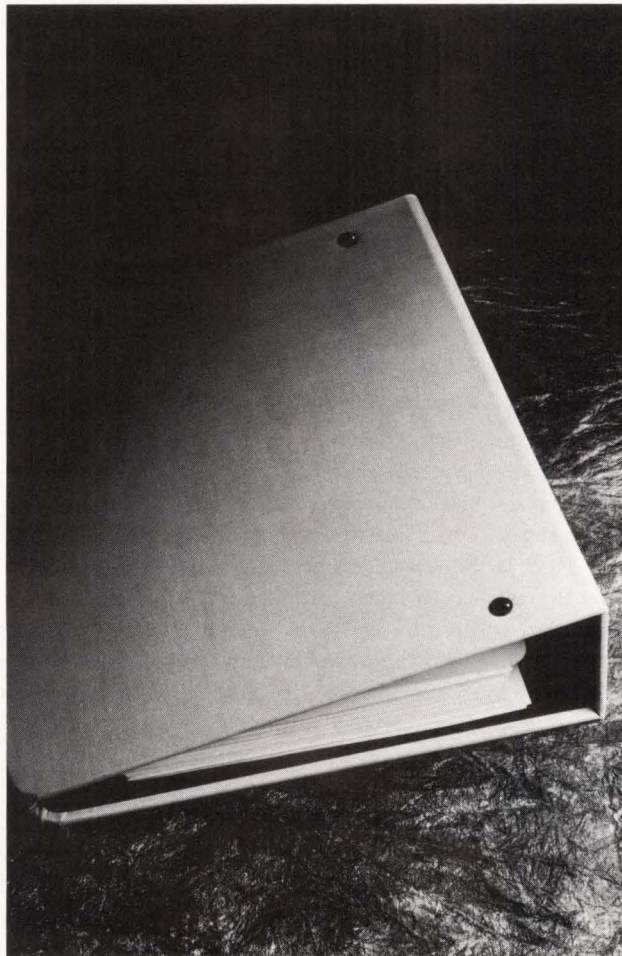

The brands or product names mentioned are trademarks or registered trademarks of their respective holders.

VMS and MultiNet also support third party programming through QIO, or Berkeley Sockets, as well as the standard networking applications.

DISTRIBUTED POWER.

In addition Excelan's LAN Service NFS is the optimum TCP/IP VMS Server implementation of Sun's Network File System (NFS). It applies VAX power to distributed applications through an NFS environment, giving users unlimited file space, not to mention full connectivity across the network environment.

All of which goes to prove our point. No one has more solutions or experience in networking DEC environments on Ethernet via TCP/IP than Excelan, the company that networks networks.

If you would like more information on how Excelan can network VAX's to just about anything, go by the book, call 1-800-243-8526. Or write to us at 2180 Fortune Dr., San Jose, CA 95131.

▶ **EXCELAN** ▶
WE NETWORK NETWORKS.

DISTRIBUTED QUEUEING SERVICE

By Philip A. Naecker

**A Facility That
Allows You To Put
VAX Printing Where
You Want It.**

Editor's note: This is the last in a series on Digital's

DECnet System Services (DSS). These layered products combine multiple VAX systems into an integrated, distributed environment. See "Netting DECnet System Services" (April 1988), "To Name Me Is To Know Me" (June 1988), "One Doing The Work Of Many" (November 1988) and "Distributed File Service" (January 1989).

"The network is the system." That marketing slogan from Digital reflects a great deal about VAX computing today. It's no longer adequate for resources to be available to anyone using a single machine or even to all of the users on a VAXcluster. To be truly cost effective, resources such as printers must be available to every user and application throughout the network.

Making resources available across the network is really what Distributed Queuing Service (DQS) is about. DQS is one of Digital's DECnet System Services (DSS) products. Like the rest of the DSS products, DQS is a strategic product that leverages the power of Digital's networking architecture and takes the best advantage of powerful availability features, such as clusters. DQS makes VAX printers available to all nodes in the network, with functionality identical to that of local printers.

There are many reasons why it's especially important to make printer resources available across the network. The most obvious is locality of printing. Users want to print on the

printer closest to their desk, regardless of the machine on which they're working. This is especially true in WANs in which there's a remote small machine or workstation with a printer attached, but the user uses a central cluster for some of his work. In this case, DQS lets a print job on the cluster send its output directly to a printer on the remote machine — the one near the user.

In a distributed organization, you may want to print files generated by one job on printers scattered about the organization. For example, a central accounting department might want to print accounting information for each office in a large company. Using DQS in a process that's essentially an extension of the locality-of-printing feature, a single job can print files on many printers in a network, even if those printers span the entire country. This is a vast improvement over centrally printing, then manually bursting and physically mailing the printout to the remote offices.

Another great demand for distributed printing capability is in specialized printing resources. In our example of a branch office and central cluster, the branch office might generate large printed reports to be delivered to someone in the central office. Instead of printing these reports on the small local printer and then physically mailing them to the central office, DQS lets you print the job directly on a large central printer, without loss of formatting or other job-control capabilities.

The DQS mechanism supports any kind of output device compatible with the standard

WHEN THE CHOICE
IS TERMINALS
OR PCs,
PERICOM
HAS A UNIQUE
PERSPECTIVE.

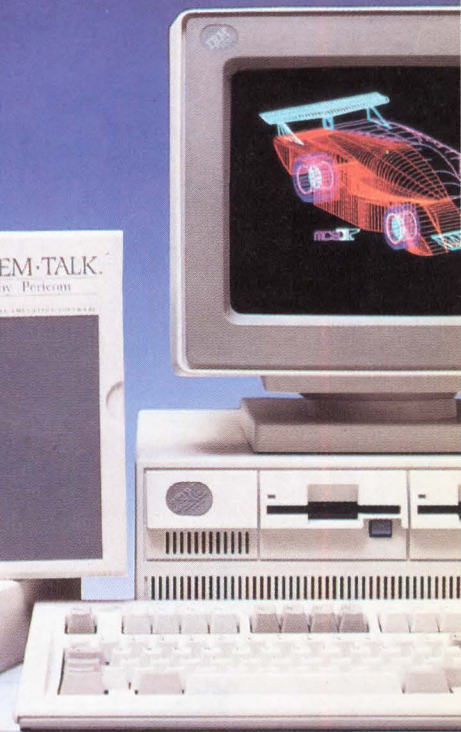
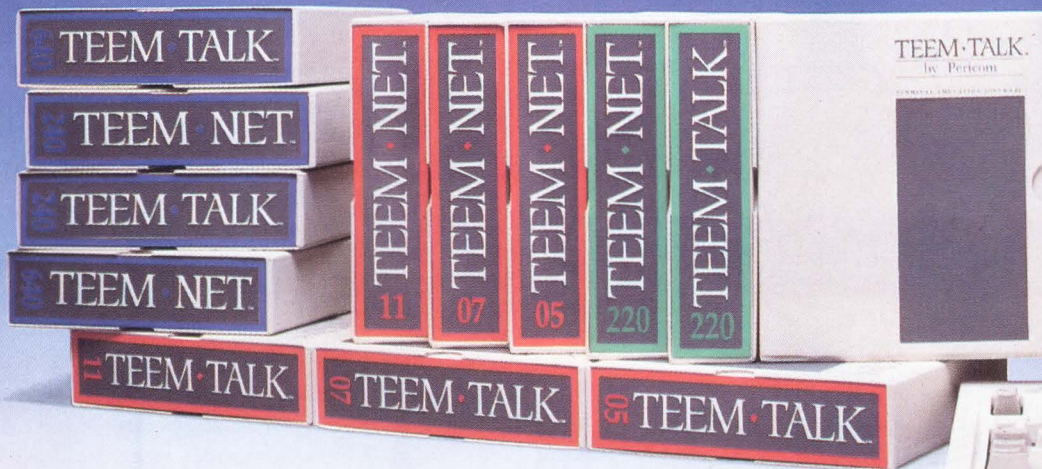
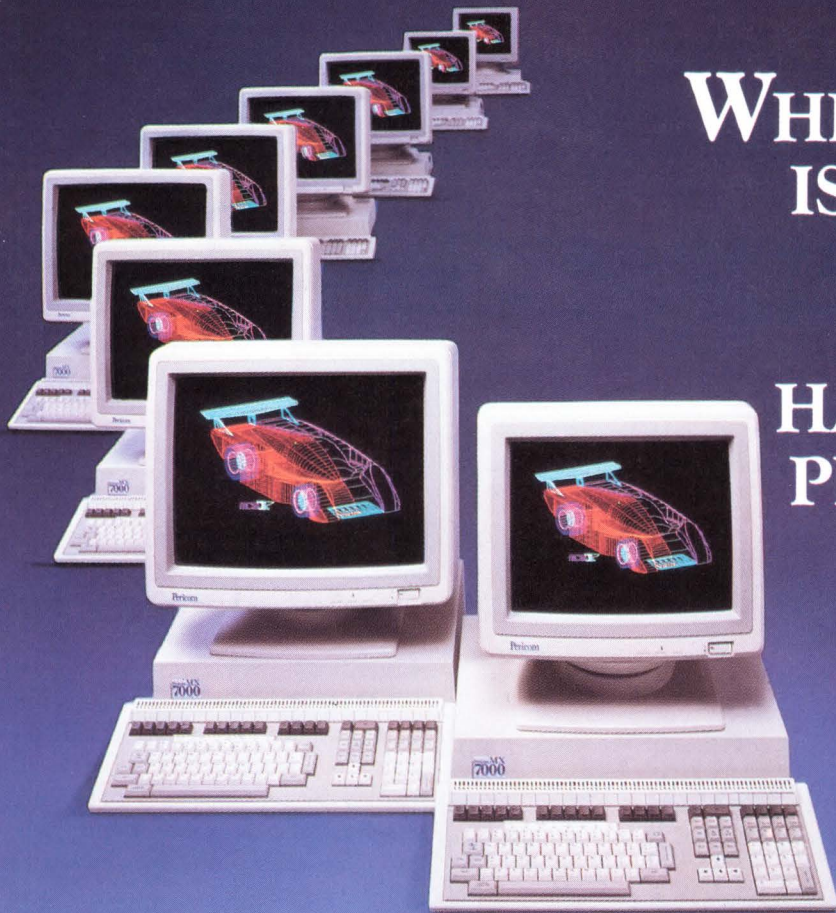

TWO SOLUTIONS, ONE COMPANY.

At Pericom our perspective is different. Unique in fact, because we manufacture a complete range of alphanumeric and graphic terminals *and* produce an innovative range of emulation software called TEEM-TALK and TEEM-NET.

Our hardware and software products provide compatibility with industry standard protocols such as DEC VT220, ReGIS, TEK 4205, 4207 and 4111. Specialist protocols including DG200 and VT640 are also available together with support for an extensive range of I/O devices.

The world's leading mainframe application software, from Data Processing to Computer Aided Design, will be at your fingertips as a

Pericom user, whatever your choice.

To help you make your decision we've prepared an informative new booklet called "*Terminals or PCs – the right choice*".

Get your free copy today by calling direct on: –

1-800 233 2206

After all, it makes a lot of sense to buy terminal emulation software from a company that knows something about emulating terminals. Or vice versa.

 **PERICOM**
CIRCLE 130 ON READER CARD

VMS printing model, no matter what type of print symbiont it uses. This means that specialized output devices that use queues, such as plotters, computer output microfilm or even custom devices, can use DQS to provide that output service to all the nodes in the network. DQS does this using the standard features of VMS queues and DECnet.

Without DQS, standard VMS printing allows you three basic modes of operation:

1. Printing to a printer directly connected to your VAX.
2. Printing to a printer connected to any currently running machine in the VAX-cluster (VMS distributed job controller).
3. Printing to a printer connected to a terminal server, possibly shared in a

round-robin mode by multiple hosts.

You also can use a feature called remote printing (\$PRINT/REMOTE), but the functionality available with that command is very limited. It basically amounts to printing a file already on a remote node on the default printer on that node with the default print characteristics.

The first method of printing, local printing, is fine if all you have is a stand-alone system. However, most VAXs are networked, so local printing isn't enough. The second method, VAX-cluster distributed job controller, helps only if all of your systems are in a cluster.

Many sites have tried to solve the distributed-printing problem using the multiple-host capability of terminal servers. This capability allows a terminal server to search, round-robin style, through a series of machines, each with a queue pointing to the printer. There are enough problems with this approach that it turns out not to be useful except in some very simple circumstances.

First, limitations in terminal-server memory make it feasible only for a small number of hosts. Second, it only works across a LAN and not in a WAN. Further, because there's no way to tell what jobs are waiting in the logical queue (only some of the jobs are on any one host), there's no way to tell how long it might be before your job prints. One long print job or thoughtless user can upset the whole apple cart.

Some very large sites have tried to write their own distributed queuing mechanism. Most of the hooks to do that are available in the public interfaces to VMS and DECnet. However, some aren't, and the problem is too large for most sites to tackle.

There are also public-domain tools to do remote printing. These tools work well for small networks and small numbers of queues but don't have the full functionality needed for industrial-strength printing in complex networks.

If you're running in a network, you really want a print queue on your machine for any printer you might want

Short on Ports?

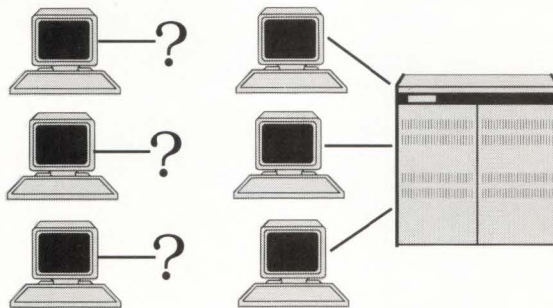

Get it together with Equinox

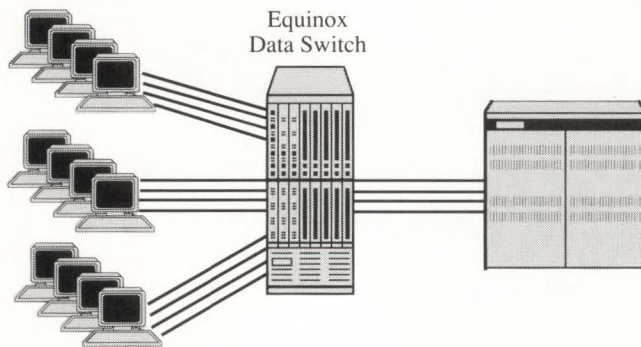

A low-cost Equinox data switch lets many part-time users share expensive CPU ports on demand. Share modems, solve multi-host access problems and network PCs too. All for a lot less than a LAN.

Call 1-800-328-2729

EQUINOX

Equinox Systems Inc, 14260 SW 119 Ave, Miami FL 33186, 305-255-3500

top-rated by
datapro

**Printer emulations
include DEC® LA75
(LA50/LA210), LA120**

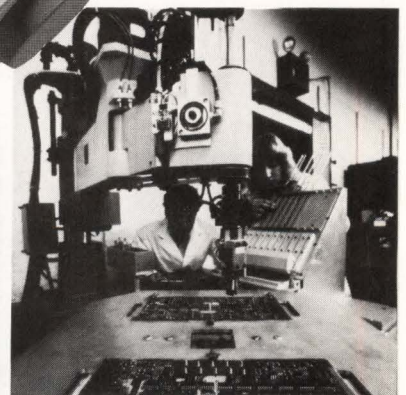
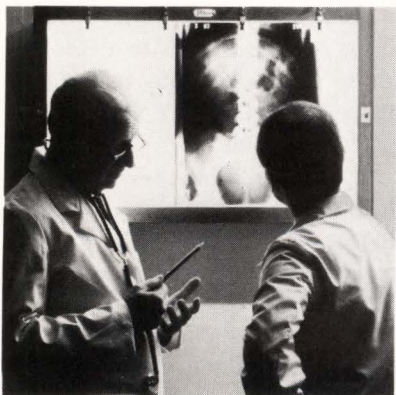
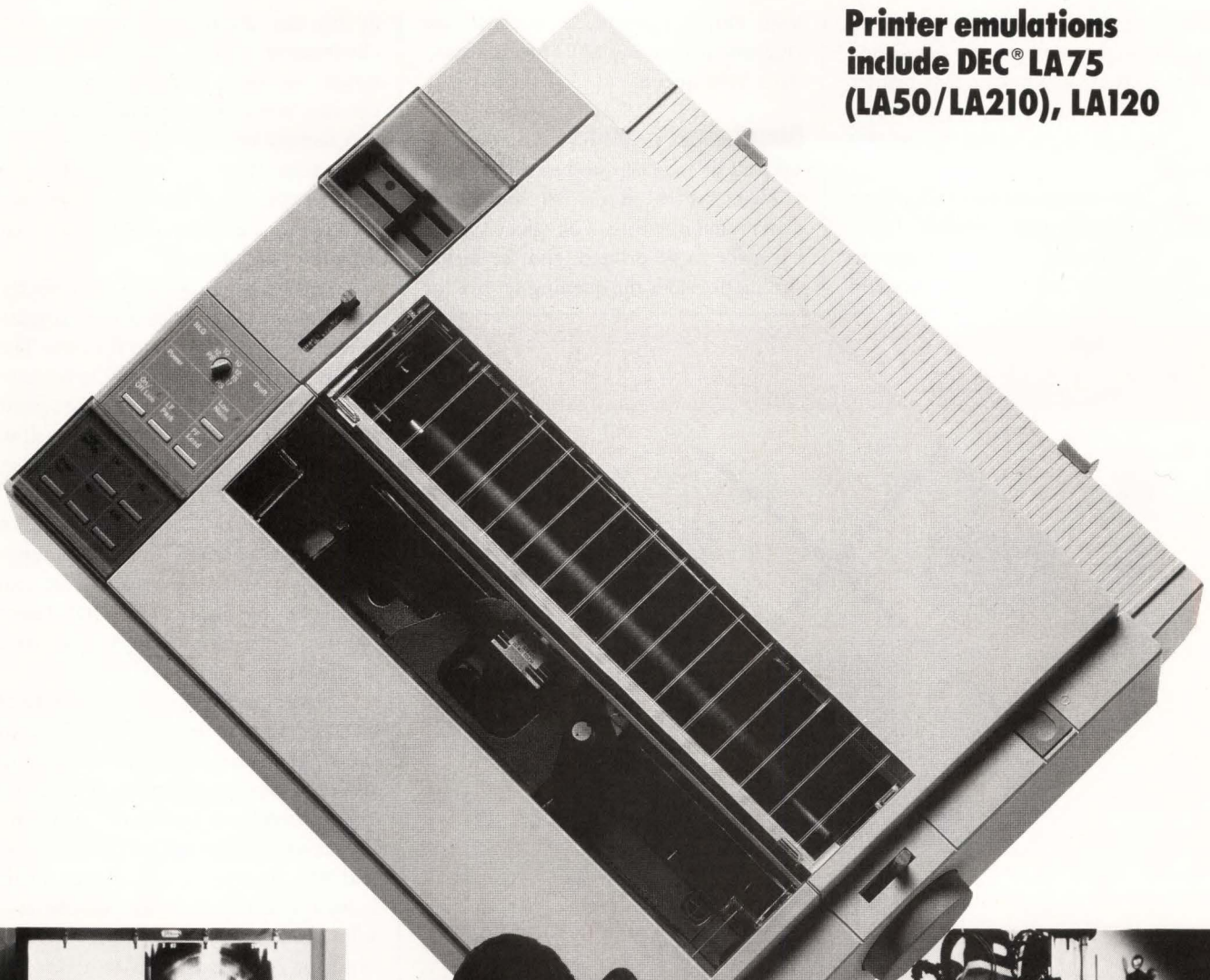

WHAT PRINTERS HANDLE MORE DEC APPLICATIONS THAN ANY OTHER?

Versatile line of quality printers designed for the tough jobs. Wide carriages; speeds to 250 CPS; 4-way paper handling system; 18-pin DEC emulating printer.

For complete details, call 1-800-722-1717.

Our Value Adds To Yours

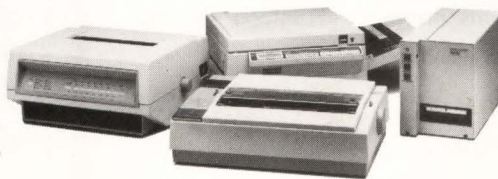

FACIT

CIRCLE 324 ON READER CARD

Or write:

U.S.A. CORPORATE OFFICE:
Facit, Inc.

400 Commercial Street
Manchester, New Hampshire 03108-9540
Tel. (603) 647-2700 FAX (603) 647-2724

CANADIAN OFFICE:

Facit Canada, Inc.
404 Oakwood Drive
Burlington, Ontario L7N 1X2
Tel. (416) 825-2712 FAX (416) 681-1200

to use. You aren't concerned with which machine might be physically connected to that printer or whether that printer is in the same cluster as your machine. You just want to print *that* file on *that* printer.

DQS accomplishes this task in just about the simplest way possible. There are no special commands for the user to learn to print the file. DQS uses standard

VMS PRINT commands, because the DQS queue that you PRINT to is a standard VMS queue.

Distributed Queuing

Like all of the DSS products, DQS uses a client-server model to implement distributed queuing. The client system has a file to be printed, and the server system provides the queuing service (or

in this case the printing service). In a client-server system, the client and the server cooperate to provide service to the user. Ideally, the fact that both clients and servers are involved is transparent to the user. The user should just see that a request for a specific task was satisfied and be insulated from exactly how that function was provided.

Although DQS isn't perfectly transparent, it provides a very consistent view of a print job to the user. The lack of perfect transparency is because of limitations in the current VMS print symbiont interface. Expect to see slow but steady improvements in this area as new versions of VMS are released.

The Sidebar, "Using DQS," shows the structure of DQS and how it functions for a PRINT command. You can see from the Figure that DQS layers neatly into the VMS printing architecture.

However, the distributed nature of DQS means that there are a number of thorny problems that the product has to solve. For starters, there are at least two queues involved: the client queue and the server or target queue. Both are normal VAX queues, but the server queue is on a different machine than the user who prints the job. Therefore, there's a need for new commands to access the queue in ways analogous to the SET QUEUE, DELETE/ENTRY and SHOW QUEUE commands.

DQS accomplishes these functions with a new set of commands: QSET, QDELETE and QSHOW. These commands understand the distributed nature of DQS queues. For example, if you do QSHOW on a local (client) DQS queue, it will tell you not only about files that are waiting in the local queue to be transferred to the remote system but also about files that are already on the remote system and are either printing or are waiting to be printed. Similarly, QDELETE and QSET will operate on either the client queue or the remote queue, depending on the location of the printing file, as required.

These Q* commands aren't ideal. The DQS developers probably would

Can't get there from here?

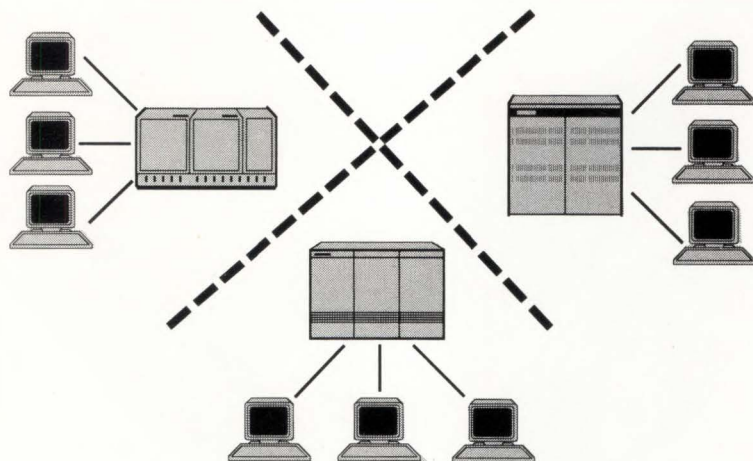

Get it together with Equinox

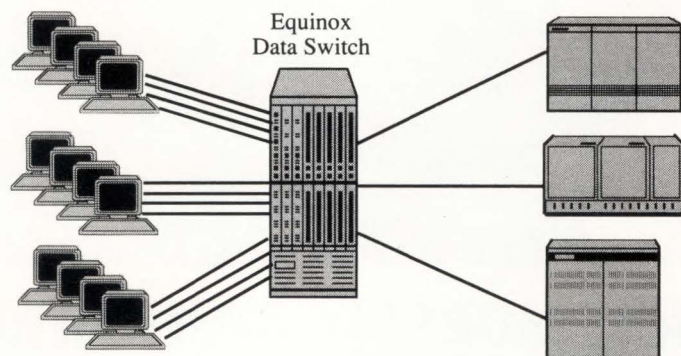

Eliminate access restrictions with a low-cost Equinox data switch. It lets users connect to their choice of host computers from their terminal or PC keyboard. Share computer ports, modems, printers and network PCs too.

Call 1-800-328-2729

EQUINOX

top-rated by
datapro

Equinox Systems Inc, 14260 SW 119 Ave, Miami FL 33186, 305-255-3500

“ACC’s Ethernet bridge guarantees we’ll have access to vital patient records in critical situations.”

*Edward Babakanian
Vice President/Information Systems, CHCC*

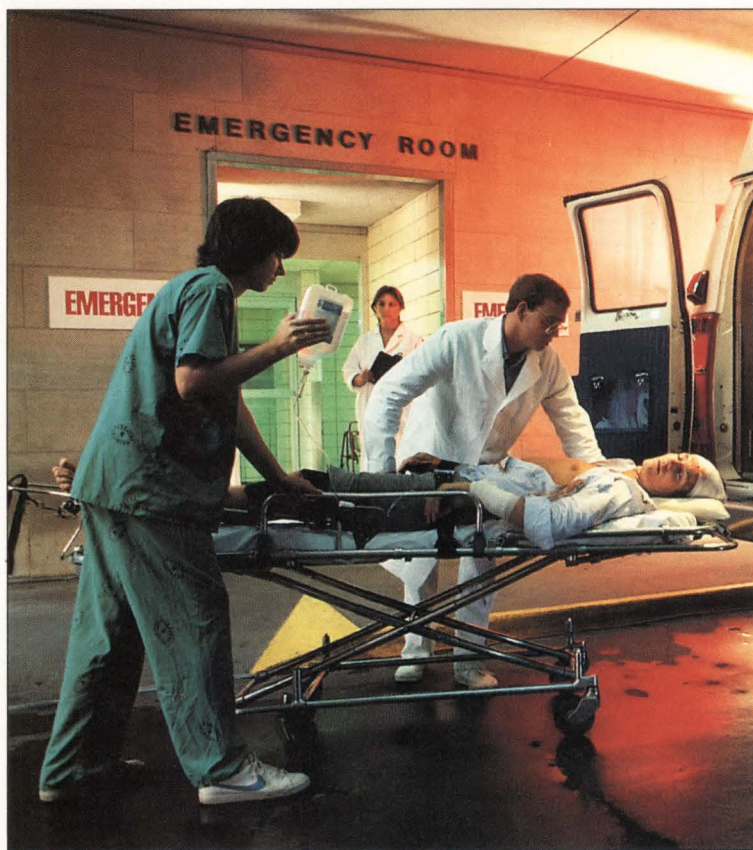

Community Hospitals of Central California (CHCC) stores vital patient information in a distributed database at one of its three acute-care facilities. Doctors, nurses, and support people depend on this information to help them provide effective patient care.

It’s absolutely imperative all three sites have access to these records 24 hours a day, 365 days a year.

“We needed a way that would ensure if one link went down, traffic would re-route through a secondary source.” By connecting the sites with ACC remote Ethernet bridges, CHCC now has the redundant, high-performance network it needs.

CHCC increased reliability without increasing cost. It replaced multiple analog lines with one digital line and installed ACS 4030 remote Ethernet bridges from ACC.

But that’s not all. After looking at other bridges, CHCC chose the ACS 4030 because “it gave us exactly what we needed for a third of the price.”

Worldwide, MIS managers depend on ACS 4030s to provide continuously reliable links between their remote Ethernets. If you want to extend your Ethernets, call **1-800-444-7854** today to learn more about ACC’s complete line of bridge products.



*Advanced Computer Communications
720 Santa Barbara Street, Santa Barbara, CA 93101*

Your Interconnectivity Source

CIRCLE 184 ON READER CARD

like to incorporate some knowledge of client and server queues into the VMS job controller and queue interfaces. After this is done, users of DQS queues will be able to use the same familiar commands (SET/SHOW QUEUE, SET/SHOW ENTRY) on DQS queues as on non-DQS queues. Until then, however, the Q* commands are a nice compromise. Figure 1 shows an example

QSHOW session.

The distributed nature of DQS makes receipt of job completion notices interesting. If you use PRINT/NOTIFY to a DQS client queue, you get two notification messages. Because the client queue is a completely normal VAX queue, the VMS job controller on the client system will see your request for /NOTIFY and send you a job-completed

message when the job is "printed." However, a client queue doesn't have the actual printer connected to it, but instead is connected to a virtual device that transfers the file to the remote system. Thus, the job is "printed," as far as the client job controller is concerned, when the job has been transferred to the remote system. This is when you get your first notification message.

The /NOTIFY qualifier also tells the DQS server queue that you want to be notified when the job has been printed. The delivery of this message is a little trickier, as Figure 2 shows. When the job has completed printing on the server queue, a notifier process (DQS\$NOTIFIER) detects this by checking all queues looking for DQS jobs that have completed. DQS\$NOTIFIER then sends a message to a process on the client, which in turn sends a message to you. This second message tells you that the job has been printed.

The difference in the messages between DQS and normal VMS printing may be a little confusing for novice users. It can be especially confusing in a LAN in which the first notice is delivered almost immediately but the job may take a while to print. However, most users quickly get accustomed to this quirk, and in any case the QSHOW command gives detailed information on the status of print jobs.

Print Anywhere

DQS layers on top of standard DECnet, so you can print anywhere on your VAX network. Unlike other remote printing products, DQS isn't limited to LANs. In the DEC PROFESSIONAL Lab, we used DQS to print across a WAN that includes two LANS, leased lines and dynamic asynchronous DECnet lines.

DQS doesn't care what your DECnet connections look like. In fact, although both the client and server nodes must be VMS nodes, intermediate nodes or routers in the network can be any Phase IV node. DQS will work just as well if you use Ethernet, leased lines, X.25 lines, asynchronous lines or any such combination.

All patched up?

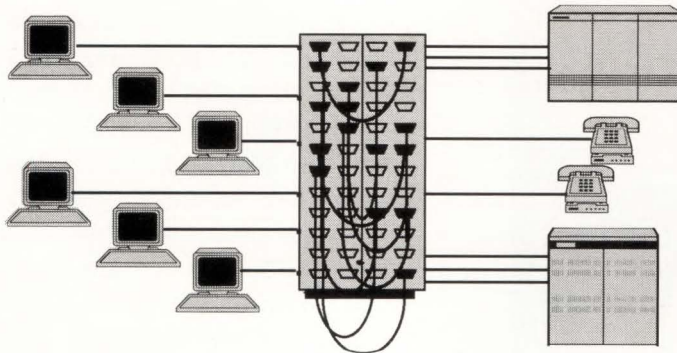

Get it together with Equinox

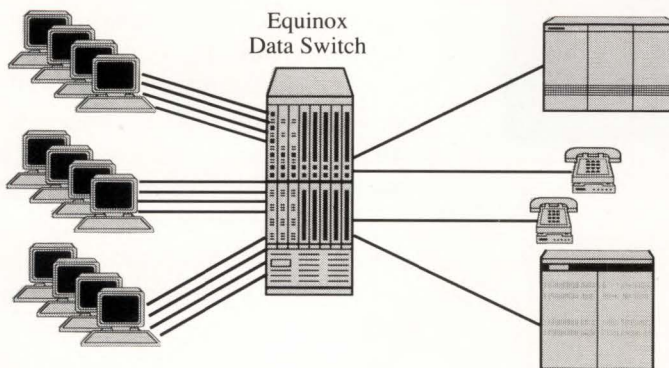

Prevent patch-panel panic. A low-cost Equinox data switch lets you easily control, monitor and diagnose your network from a terminal or PC. Switch to backup configurations, share CPU ports, network PCs and provide user initiated connections to hosts and peripherals.

Call 1-800-328-2729

EQUINOX

Equinox Systems Inc, 14260 SW 119 Ave, Miami FL 33186, 305-255-3500

top-rated by
datapro

“Fast, friendly, flicker-free. So why do they call them Tigers?”



If you're thinking about ordering a Digital VT330 or VT340 graphic terminal, don't—at least not until you've seen the C.Itoh Tiger Terminals. The C.Itoh CIT334 and CIT344 Tigers offer some powerful advantages you won't get with DEC.[®]

More speed.

For instance, the maximum data transfer rate on the C.Itoh Tigers is 38.4 kilobaud. On the DECs, it's only 19.2. Add the Ethernet option, not available on DEC's terminals, and your communication is at network speed of 10 MB/sec with LAT or TCP/IP protocols.

More color.

The CIT344 gives you up to 16 colors for each window from a palette of 262,144—64 times as many as DEC. And it offers 16 foreground and 16 background color text attributes you won't find on the VT340.

And more.

Tigers can also run two sessions at once, and dynamically size and position the windows anywhere on the screen. They have pop-up menus for easy setup using keyboard or mouse.

Feature	CIT344	VT340	CIT334	VT330
Drawing Speed (Regs)	2x	1x	2x	1x
Pages of Memory	6	3	6	3
Dynamic Windows	Yes	No	Yes	No
Pop-Up Menus	Yes	No	Yes	No
Colors				
Per Session	16/262K	16/4K	—	—
Color Text Attributes	Yes	No	—	—
Screen Refresh Rate	70 Hz.	60 Hz.	70 Hz.	60 Hz.
Overscan/Borderscan	Yes	No	Yes	No
Ethernet Interface	Option	No	Option	No
RGB Interface	Option	No	—	—

A standard Apple Desktop Bus lets you use any ADB device for terminal cursor control, so you can choose from a mouse, keyboard or tablet. The Tigers also have a faster refresh rate—70 Hz as opposed to 60—so they're flicker-free, making them easier on the eyes.

We think C.Itoh's CIT334 and 344 are simply more terminal for the money than the DEC VT330/340. And when you compare, we think you'll agree.

Call (800) 347-2484 or (714) 757-4492
 Southeastern Regional Office **(404) 368-9183**
 Eastern Regional Office **(609) 235-3400**
 Midwestern Regional Office **(312) 850-9500**
 Western Regional Office **(714) 757-4422**

C.ITOH
C. Itoh Electronics, Inc.
 2505 McCabe Way, Irvine, CA 92714

We build more in. So you get more out.

CIRCLE 327 ON READER CARD

One of the neatest features of DQS is its ability to start the file transfer whenever the network comes up. For example, I frequently print to a printer that's on a VAXstation networked to my own VAXstation via a dynamic asynchronous line. The user on the remote VAXstation also prints to the printer that's connected to my VAXstation.

During the day, when either of us wishes to print to the other's printer, we simply print to the client queue on our local machine. Sometimes this printing is done by batch jobs, too.

Occasionally, one of us will want to do some interactive work on the other's machine or transfer files between them. We have command procedures to set up dynamic asynchronous DECnet on demand. But DQS is very smart. When it sees the network come up, it automatically starts transferring the files in the client queues. When the file transfers completely, the job prints and notifications are displayed for the submitting user.

This is very convenient. Because DQS manages the file transfer

intelligently and transparently, we no longer concern ourselves with transferring files for printing. We simply queue them up on the client node and rest assured that they'll be printed on the server node at the earliest possible time. If we want to make sure that they print right away, we just have to set up the network link.

Standardized Queues

In a large network, using DQS is a great opportunity to standardize queues and thus make printing transparent to location. DQS helps accomplish this in several ways.

First, the system manager can decide on standardized queue names, forms and characteristics. For example, you might want to call all LN03 printers `PRINTER_LN03` and have associated forms `PORTRAIT`, `LANDSCAPE`, `EXTRA_WIDE`, and so on. DQS provides a mechanism to keep the forms for client and server queues in sync. This is important, because the client-server nature of DQS means that the `PRINT` command is processed and validated (in-

cluding the `/FORMS` qualifier) on the client node. If the server node has different forms, the `PRINT` command will succeed, but DQS will return an error later when it tries to print the file on the server.

After queue names and characteristics are standardized, the system manager can move printers around the network to satisfy print requests in the most effective way. For example, if a machine doesn't frequently use the `PRINTER_LN03` queue, the system manager can use a DQS client queue on that machine, pointing the client to a DQS server that has an actual LN03. This eliminates the "I have to run this job on a machine that has an LN03" syndrome.

But you don't have to limit queues to printer-type queues. For example, you also might want to have a queue associated with every office in a company. That's the way Professional Press does it — with `PRINTER_PASADENA`, `PRINTER_SPRING_HOUSE`, and so on. For the machines in Pasadena, California, the `SYS$PRINT` logical is defined as `PRINTER_PASADENA`. However, if we

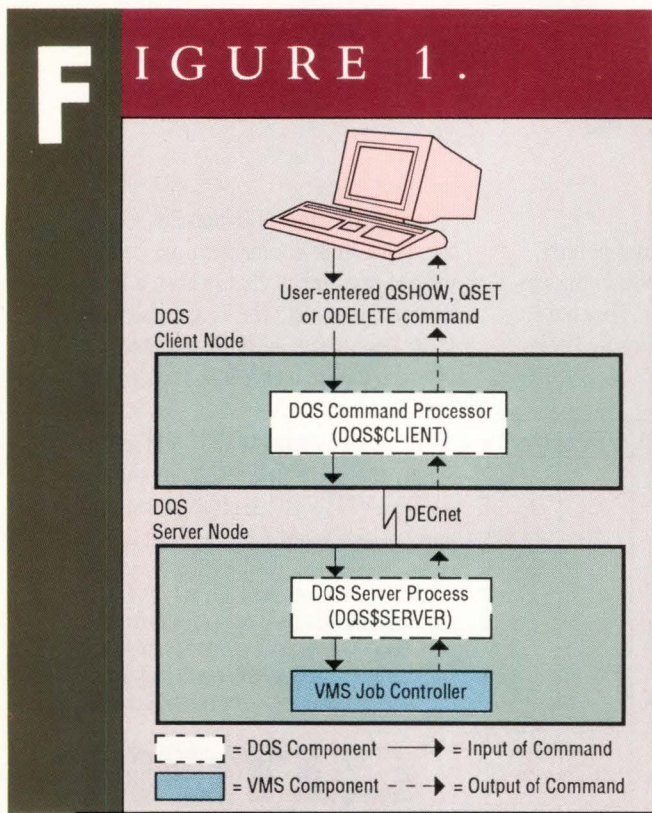

Function of QSHOW, QSET/ENTRY, QDELETE/ENTRY.

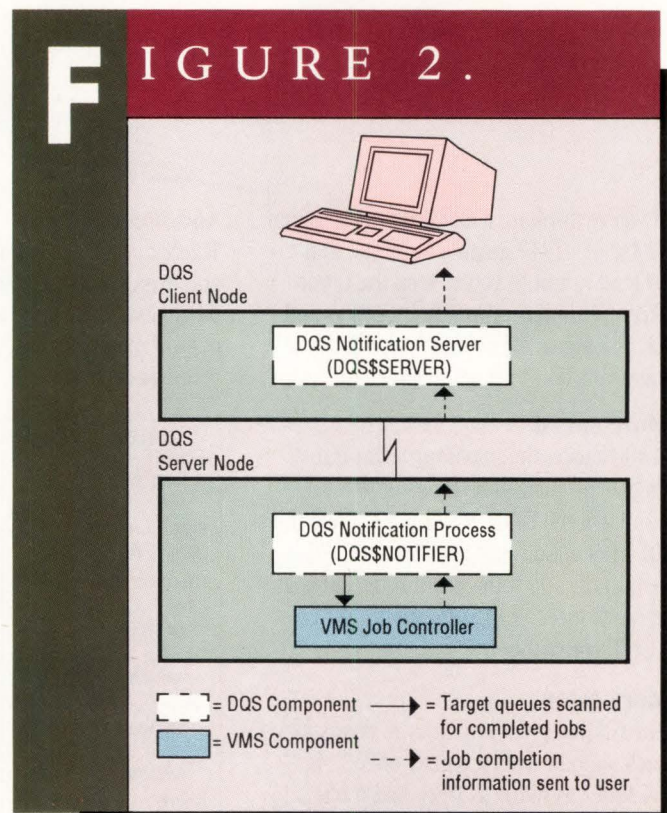

Delivery of notification messages.

How to Protect Your DEC® Computer And Make It Last Longer

World's largest manufacturer of uninterruptible power systems for Minis, Micros, and LANs tells how

Your DEC computer is bombarded daily by spikes, sags, surges, noise, and blackouts. Bad power eats away at fragile electronic circuits, increases service costs, damages disks and causes down time.

You can eliminate these problems by investing in an Uninterruptible Power System (UPS). Your investment in a UPS will mean reduced down time, increased equipment life, and lower service costs. Typically, a UPS will pay for itself in less than one year, but not all UPS are created equal. Many are off-line, standby systems. Most won't even provide isolation from the power line or a separately derived neutral.

Shown below are three traditional UPS configurations. Each has its advantages and disadvantages.

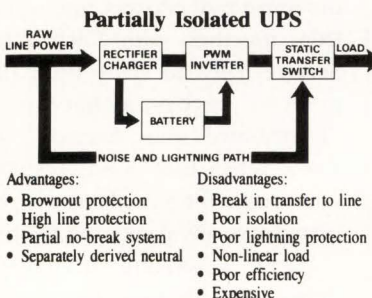
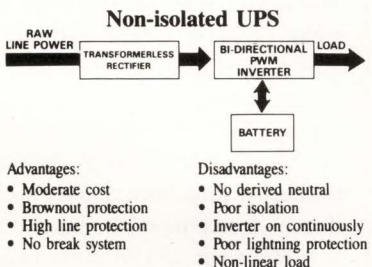
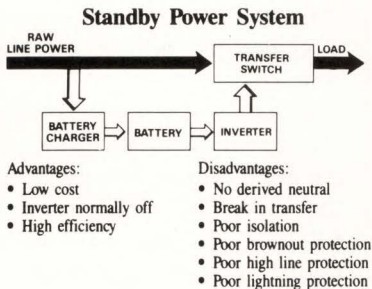

©1989 Best Power Technology, Inc.
1-800-356-5794, ext. 3428

Best Power Technology's new Uninterruptible Power System called FERRUPS® is a breakthrough in computer power protection. FERRUPS represents a major advance over the three traditional types of UPS technology.

Advanced Technology FERRUPS (Provides True Isolation)

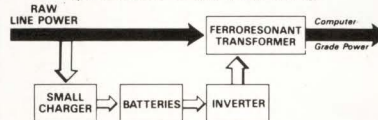

FERRUPS uses a ferroresonant transformer which is on-line continuously to provide outstanding isolation and eliminate spikes, sags, noise and brownouts. If power fails, the inverter takes over. Because of the flywheel effect of the ferro transformer, there is absolutely no break in output power. FERRUPS provides continuous on-line computer-grade uninterruptible power.

FERRUPS Provides Better Protection Than Any Other Design

- Inverter normally off
- High efficiency
- Filters non-linear loads
- High line protection
- Low cost
- Separately derived neutral
- High isolation
- No-break transfer
- Brownout protection
- Lightning protection

Advanced Interactive Communication Package Standard on Every Model

Most UPS only provide basic relay contacts for alarm and loss of line. FERRUPS

gives you even more. Every FERRUPS includes an RS232 port for full duplex TTL communication. You can control FERRUPS from your computer console or from thousands of miles away. FERRUPS has an on-board micro-processor, which keeps track of everything. It even records the time and duration of power outages. FERRUPS can even initiate a controlled shutdown for unattended operation. FERRUPS is the smartest, most communicative UPS in the world today!

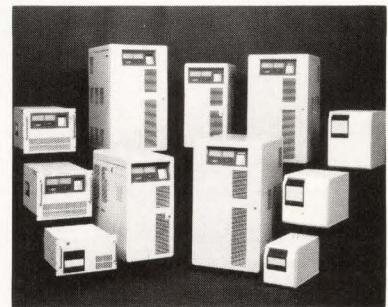

350 VA to 15 KVA uninterruptible power systems for Micros, Minis, LANs and anything else that needs clean, continuous power. BEST UPS are plug compatible with all DEC computers within its power range.

Advanced Meters and Alarms Standard on Every Model

Meter Functions: AC Volts Out, AC Volts In, Battery Voltage, AC Current Out, VA Load, DC Current In, Frequency, Heat Sink Temperature, Ambient Temperature, Time/Date, Number Power Outages, Log of Power Outages, Projected Run Time Available, System Hours, Inverter Hours, Number of Overloads, Full Load %, Log of Alarm Conditions.

Alarm Messages: Low Battery, Near Low Battery, High Battery or DC Bad, Low Run Time Left, Low AC Out, High AC Out, Output Overload, Ambient Over Temp, Heat Sink Over Temp.

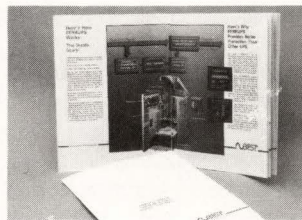

Interested? Call or send for our NEW, FREE LITERATURE today!

BEST

Best Power Technology, Inc.
P.O. Box 280 - Necedah, Wisconsin 54646
1-800-356-5794, ext. 3428
In Wisconsin (608) 565-7200, ext. 3428

Please print legibly.

Name _____ Company _____
Address _____
City _____ State _____ Zip _____
Equipment to be protected _____
Phone () _____ CHECK ONE: User Dealer Specifier OEM

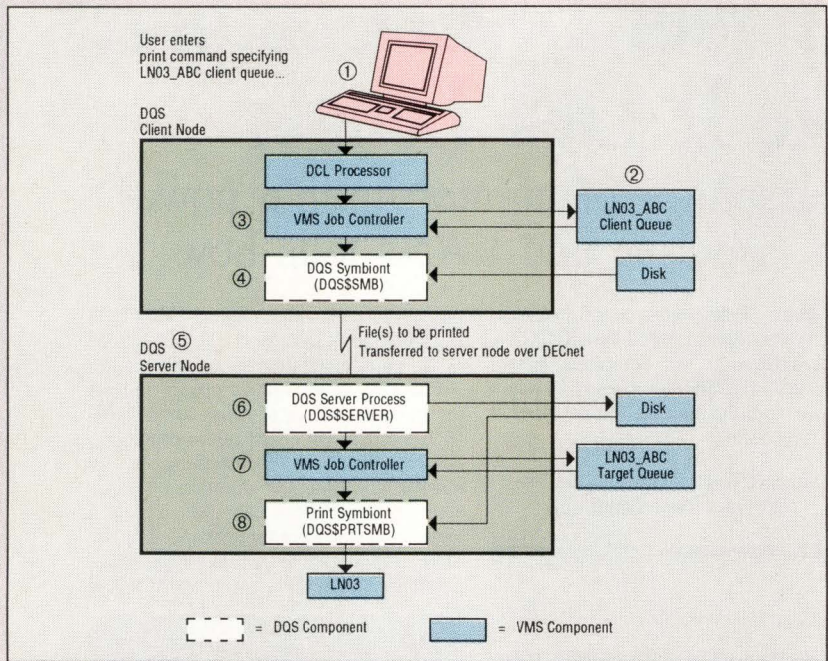

The structure of DQS.

Using DQS

Reading from the top to the bottom of the Figure, Distributed Queuing Service (DQS) works as follows:

1. Enter a PRINT command, which is processed in the normal fashion by DCL. Specify a queue (either explicitly with the /QUEUE qualifier or implicitly through the normal SYS\$PRINT logical name) and a file to be printed.
2. The job controller enters the print request into the system queue database (JBCSYSQUE.DAT) on the client node. The print job now is entered in the queue on the client side, and a normal SHOW QUEUE command will reveal that the job is waiting to be printed.
3. Some time later (but probably immediately), the job controller on the system that has the client queue installed takes the job out of the queue file and passes it to the DQS print symbiont. The node that takes the job out of the queue may be the same node or a different node, as in the case of a VAXcluster with a distributed job controller.
4. The DQS print symbiont locates the file. It then establishes a connection with the server node, which services the target queue on which you requested the job to be printed. If the network link to the server is down, the symbiont waits until the link is up.
5. The file to be printed is transferred to the server node, together with information on the printing options requested (forms, setup modules, burst pages, and so on).
6. The DQS server process receives the file and stores it on a disk local to the server system. It also receives the printing options and enters them and the name of the file to be printed into the queue database for the target node.
7. At this point, the job is really a normal print job. The job controller takes the print request out of the server's queue database and prints it just like any other job.
8. The symbiont doing the printing can be either a standard VMS print symbiont, a user-written symbiont or a DQS-provided slightly modified version of the standard print symbiont. The modifications (which you can do yourself to user-written print symbionts) just allow the print symbiont to read a message from the server process that provides information about the job on the client node. Using this information, the flag page on the printed job will contain the correct time, job number, username and node name of the client (rather than the server) queue. This avoids confusion, because you generally only see the client queue information.

want to print in Spring House, Pennsylvania, we just do PRINT/QUEUE=SPRING_HOUSE.

We don't care which machine in Spring House services the queue. So when users in Spring House log onto the Pasadena node, they just redefine the SYS\$PRINT logical and work normally. If they print a MAIL message, it automatically will print at the right place.

You can use the same concept in a large office with multiple printers. Although the printers may be served by many machines, you transparently can define which printer you want to be yours, unconcerned about which VAX might be serving that printer.

Because you can have many different client queues pointing at the same server queues, you might have five machines with PRINTER_PASADENA queues and PRINTER_LN03 queues all pointing at the same server queue. The flexibility of DQS is impressive. It lets you build a queue model that matches the way you work, not the way your machines and printers are physically connected.

DQS is also very smart about clusters. In a typical cluster, any node can print to any printer by virtue of the VMS distributed job controller. You can tell DQS that you want to use this feature by defining a logical name. When you start DQS, it will set up a single generic queue for each client queue, with an execution queue on each cluster member. This lets you take advantage of the high-availability features of clusters, because DQS will continue to transfer jobs from remote nodes even if one cluster member shuts down.

However, if you don't need all of the features of clusters, you still can use DQS together with Distributed File Service (DFS) to share both files and printers across a network. (See "Distributed File Service," January 1989.) When used with DFS, DQS lets you print a file stored anywhere on the network to any printer on the network.

For a system manager who thoroughly understands queues and



Terminal emulation doesn't have to be this way.

We've all been there. Trying to remember whether the "Do" key is really <Ctrl-F1>. Or was it <Alt-F1>? And the editing keypad. Can you be absolutely sure you're about to press the "Select" key and not the "Remove" key? The results can be disastrous.

That's why KEA developed the PowerStation. The PowerStation, an exact VT200 layout keyboard bundled with VT240 or VT220 terminal emulation software, turns your IBM PC or compatible into a key-by-key replica of a DEC terminal - without messy labels!

But what does that get you?

Peace of mind. The PowerStation keyboard takes the frustration out of switching between a DEC terminal and a PC *because each key is right where you'd expect it to be*. And our "Gold Key" version makes ALL-IN-1 and WPS a breeze.

Savings. If you think you can't afford both emulation software *and* a keyboard, think again! The PowerStation can actually save you money by eliminating the time you waste every day translating between VT and PC keystrokes. And with the PowerStation, *startup training costs are virtually eliminated*.

Consistency. The PowerStation keyboard provides a consistent interface for both VT emulation and regular PC applications. In emulation mode you get the 105-key functionality of a real DEC keyboard and in PC mode you get a super enhanced keyboard. *And* you can use the PowerStation on virtually any PC! Move between an XT, AT, PS/2, AT&T PC and a DEC terminal *without missing a keystroke*.

The best in terminal emulation software. With the PowerStation keyboard you get the fastest, most precise, DEC terminal emulation software available: ZSTEM. You have the choice between two popular software packages: ZSTEM 240, our VT241/VT340 graphics emulator and ZSTEM 220, our VT220 text emulator. Both packages will impress you with their speed and feature-by-feature accuracy.

To top it off, the PowerStation gives you all this at a surprisingly low price. But find out for yourself why Digital Review Labs says "the PowerStation 240 is a godsend." Call us at 800-663-8702.



PowerStation and ZSTEM are trademarks of KEA Systems Ltd. All other brand and product names are trademarks or registered trademarks of their respective holders.



KEA Systems Ltd., 2150 West Broadway, Suite 412
Vancouver, B.C., Canada V6K 4L9
Telephone: 604-732-7411 Fax: 604-732-0715

CIRCLE 119 ON READER CARD

THE MOST COST-EFFECTIVE SDI-COMPATIBLE VAX STORAGE ARRAYS AVAILABLE!

"The CSA 6600 Series"

*Cluster Storage Arrays
from...UNBOUND.*



CSA Series 6600 Features...

- *** Full SDI compatibility.
- *** Choice of high performance SMD, cost-effective ESDI, or removable RA compatibles.
- *** Savings of up to 50% over DEC equivalents.
- *** Save up to 30% over third party competitors using the same components!

UNBOUND's CSA Series 6600 are DSA controller-compatible storage arrays that give you the high level of reliability you have come to expect for your VAX storage, with higher performance and lower prices.

We use only the most reliable, time-tested components that have proven their quality in hundreds of applications like yours worldwide.

Choose SMD or ESDI CSA subsystems with capacities to over 10 Gigabytes.

For more information on the full line of CSA products call UNBOUND sales at 1-800-UNBOUND or 1-714-843-1895.

CIRCLE 305 ON READER CARD

reads the DQS manual, setting up DQS should be a piece of cake. For less knowledgeable users, DQS provides excellent instructions and a series of command files that get the ball rolling. For most sites, a simple procedure called DQS\$IMPORT.COM will prompt for a server node and queue, then download the necessary information on forms and such. DQS\$IMPORT then defines the queue and adds the necessary commands to DQS\$STARTUP to start the queue each time the system boots.

You can associate pseudo-devices with the client queues. This allows programs that want to output to a device instead of a queue to write to the server printer as if it were local. For example, you might want to do \$DEFINE FOR\$OUTPUT NAA0:, where NAA0: is the pseudo-device for a client queue, thus allowing a FORTRAN program to print directly on the queued device that's physically connected to another machine.

Bear in mind that because DQS prints on the server node using standard VMS queuing mechanisms, DQS doesn't care how that printer is attached to the VAX. For example, DQS can print to a printer attached to a terminal port, a line printer, a printer attached to a terminal server or a printer driven by a user-modified or user-written print symbiont. However, DQS relies on the symbiont to print the correct queue, job number and user information on the flag page (the information from the client node, not the information from the server node). In the case of a user-written or user-modified symbiont, the DQS manual gives directions on making the minor changes necessary to implement this.

In the case of the LATSYS (the symbiont used with a Digital terminal server), because you don't have the source code, you can't make the required modifications. The result of this is that header-page information might be confusing to the user or the person distributing the output.

DQS also has a limitation on its use of devices that must interact with the host. The VMS model of printing is that

the user or application program provides a file, some optional control parameters and then just says, "Print it." This works well with DQS, because with DQS the client-server nature of printing means that there's no way for an application program to interact with the output device.

In some application packages, especially those ported from non-VMS environments, there's a need for the host program to interact directly with the output device. If you can write a symbiont that performs the interaction when given a file, then you can use the standard VMS printing services and thus DQS. If you can't write a standard VMS symbiont for these services, then you can't use DQS either. This limitation most often appears with poorly designed plotting systems and is really a limitation of the VMS printing model rather than of DQS.

However, it would be nice if DQS provided a call interface mirroring the job controller interface provided by VMS. Without this interface, full interaction with active DQS jobs is possible only using the Q* commands, making DQS less flexible than standard VMS queues.

In a complex client-server system, DQS can end up in one of several "funny states." For example, jobs may get stuck in either the client or the server queues, user notification may not work, or queue information may be missing from QSHOW output. However, the DQS documentation includes an excellent section on troubleshooting such problems. It provided quick solutions when I had problems.

WHATEVER YOUR NETWORK configuration is, it will be more complex tomorrow. In a network environment that's growing by leaps and bounds, DQS is one way that you can reduce the cost and increase the flexibility of your network resources.

ARTICLE INTEREST QUOTIENT
Circle On Reader Card
High 560 Medium 561 Low 562

BUSINESS DECISION SOFTWARE

Decision makers need the whole picture. Computer Associates gives it to you.

Now, a new, powerful software solution that can make decision making easier, faster and better for your bottom line. Computer Associates' **Business Decision Software** provides completely integrated products that can access, consolidate and control information from all sources, giving you the whole picture. You'll be basing decisions on all the relevant information—not just part of it. Computer Associates' **Business Decision Software** includes:

- **CA-STRATAGEM System**

Powerful integrated corporate planning facility combining **CA-STRATAGEM™** (host) with **CA-MicroGEM™** (PC). You get complete external and internal data access for data management, modeling and statistics, management reporting (including graphics), and 4th generation applications development—all accessible through multi-user interfaces (including menus).

- **CA-SuperCalc System**

Combining the virtually unlimited mainframe spreadsheet, **CA-SuperCalc™**, with **CA-SuperCalc™/PC** to provide vertically integrated data access, analysis, and reporting (including graphics) to translate raw data into meaningful information.

Both systems are integrated allowing you to share data. Together they provide a complete **Business Decision Software** system. The sooner you're able to see the whole picture, the better your decisions will be. For more information, call Chris Andrews or write today: **800-841-3734 (Ext. 1906)** (In Calif. 800-468-0725)

Computer Associates
10505 Sorrento Valley Road
San Diego, CA 92121-1698



© 1988 Computer Associates International, Inc.

COMPUTER ASSOCIATES®
Software superior by design.

- World's leading independent software company.
- Broad range of integrated business and data processing software for mainframe, mid-range and micro computers.
- Worldwide service and support network of more than 100 offices.

Resource & Operations Management • Financial • Banking • Graphics • Spreadsheets • Project Management

CIRCLE 188 ON READER CARD

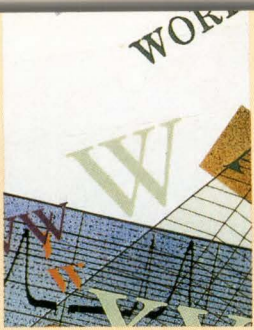

DESIGN & TESTING

S TAYING COMPETITIVE

By Evan Birkhead

Hardware Manufacturers Depend Heavily On Quality Assurance.

The nightmare of a quality assurance (QA) director:

You've been with the company one month. It's after 6 p.m., a dark evening. You're late with a major shipment. Everyone is rushing, hustling to beat the deadline. Mountains of paperwork surround you. The tension is increasing.

Then the phone rings, startling everyone. Everything stops.

You're visibly shaken. You glare at the phone. It rings again. You sense trouble, but you answer it. It's a customer, and it is trouble. The drives you shipped him have a high failure rate. Disk heads are crashing, and he's losing data left and right. You'll try to help.

You hang up the phone. Then it starts ringing again. ...

Good Report Card

This scenario really happened to Don Long, the quality assurance director at System Industries Inc. (SI), one of the largest producers of storage subsystems in the DEC marketplace. But to hear Long tell it, SI is "better off for the wear and tear."

The drive in question, the SI93, showed substantial price/performance improvements after going back to the drawing board, and the company's Quality Assurance Division learned valuable lessons from the experience.

An investigation into the saga of the SI93

reveals that SI's quality-control safety net worked according to the book, thanks to extensive quality planning (see box, p. 84). In fact, you'll be pleased to learn that the majority of the third-party hardware producers I talked to in the DEC market — manufacturers and integrators of connectivity, communications and storage products — considered QA their top priority.

Most of the companies I talked to:

1. Invest millions into QA and Quality Control (QC).
2. Employ personnel in upper management who are educated and experienced experts in the field.
3. Have their primary manufacturing facility in the U.S.
4. Are constantly changing, continually redesigning assembly lines and updating testing practices.
5. Use the stringent quality specifications written for military manufacturing sites.
6. Devote entire corporate divisions to monitoring and improving the manufacturing process.
7. Are serious QA philosophers, complete with society memberships, such as the American Society of Quality Control (ASQC) and subscriptions to periodical manuals.

The primary trend among these companies is the channeling of efforts to build quality into products, paying now rather than later. "The idea is practicing good health rather than using preventative medicine," says Pat



WHAT'S BIG AND SLOW AND FULL OF WASTE?

Your VAX/VMS system can deliver unparalleled speed, flexibility and power. So why bog it down with a file management system that wastes time, space and money? Filemaster makes file and directory management dramatically faster and easier. For you and your end-users.

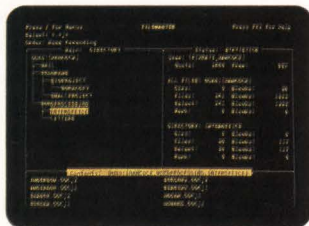

Filemaster's flexible multi-window display lets you see directory structure, file names, file contents and attributes at the same time. Using arrow keys to navigate, it takes seconds to find any file; across directories, disks and even network nodes.

To save even more time, Filemaster's point-and-shoot menus replace complex DCL commands and reduce keystrokes by up to 90%. Plus, its powerful file selection and sorting functions let you select and operate on one file, or one hundred, with equal ease. And Filemaster

pays for itself many times over. In minutes your users can remove unnecessary files which are filling much-needed disk space. So you can stop buying expensive disk drives and eliminate hours of file management busy work.

Take out the trash in your VAX system. And stop throwing away valuable time, and expensive disk space. For more information on Filemaster, or for a free 30 day trial, contact us at Hancock Software, 115 Watertown Street, Watertown, MA 02172. Or call 1 800 VAX-MGMT today.

Digital, VAX, VMS and DCL are trademarks of Digital Equipment Corp.



FILEMASTER

HANCOCK SOFTWARE, INC.

CIRCLE 312 ON READER CARD

F

FIGURE 1.

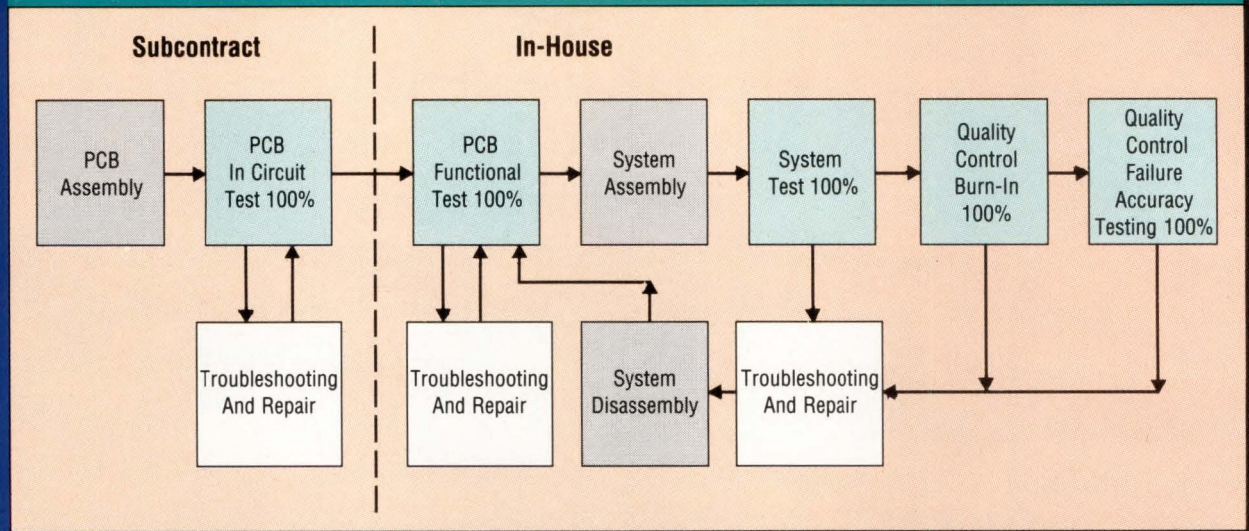

Courtesy Chipcom Corporation.

Subcontractors providing Just-In-Time (JIT) turnkey systems are key to efficient assembly.

Bell, the QA manager at Cabletron Systems Inc., a manufacturer of networking devices. "You want to have failures show up in the factory, not in the field."

People And Planning

QA managers are a unique breed. By managing people and inventory, they have the unenviable task of achieving high levels of quality standards. How do you measure quality, anyway?

Pat Venditti, QA director at Xyplex Inc., governs a diverse hardware/software line that includes terminal servers and cluster connectivity products. Venditti says that quality is difficult to define, "but you know when you see it."

American manufacturers are sensitive about the issue of quality. But this has helped spark a reassessment of values and a new determination in this country that has been well-documented. Over the past five years or so, many companies have stepped back, looked at their manufacturing operations, and decided to start over from scratch.

It's no secret who the current international hotshots of quality are.

"We're swamped with books on how the Japanese did it," says Tom Hatch, director of manufacturing at Chipcom Corporation.

At Chipcom, a producer of Ethernet communications devices, seven years in business has provided of wealth of QA experience. The company's management hierarchy for manufacturing operations provides an excellent example of how QA fits into the corporate structure. Chipcom's manufacturing is split into four overlapping branches:

1. Materials — Besides Purchasing, this includes divisions for Inventory Control and Production Control.
2. QA/QC — Gloria Kedem, Chipcom's director of QA, says that QA represents the ground rules of quality: measurements, evaluations and feedback. QC represents the process of engineering quality into a product.
3. Production — This involves assembly from the board level and up, mechanical (final) assembly, and testing of boards and systems.
4. Manufacturing Engineering — This group phases new products and designs into the parts assembly flow and provides support for the mechanical and technical processes.

Chipcom has designed its manufacturing sequence to allow parts for specific customer orders to be retrieved quickly and assembled into a customized kit, without disrupting other processes on the assembly line. But not all the pieces are assembled by Chipcom. Hatch estimates that Chipcom uses products from 200 semiconductor and parts producers in its boards.

Subcontracting has become an important part of the business. By farming out much of the board-level assembly, Hatch says that Chipcom's production costs are trimmed substantially and that the production facility is more streamlined (see Figure 1). This means the company is better able to focus on test and integration of boards, power supplies, fans and subassemblies. Xyplex and SI also use outside production houses for component manufacture and assembly. "Twice a week," says Xyplex's Venditti, "we send an inspector to the source where the boards are assembled. No boards come here until after those inspections."

"We expect suppliers to have process controls," adds Long, who deals

You're looking at the three most versatile DEC printers ever.



Introducing the most versatile letter-quality DEC printer ever made.

And the fastest draft printer.

Not to mention the most dazzling high-resolution graphics printer.

tion graphics printer.

All of which makes the ACCEL-500™ FULL DECK

of-the-art convenience, putting a complete range of paper handling features at your fingertips.

We made the ACCEL-500 the most reliable DEC printer you can buy, as well. And backed it with a two-year warranty.

The ACCEL-500 costs hundreds less than the tired old DEC models it replaces. So it's also the easiest DEC printer to buy. Just call AMT for the name of your nearest dealer.

	AMT ACCEL-500	DEC LA210	DEC LA120	DEC LQP03/02*
Speed (cps)	85-480	181-250	121-180	25/32
Warranty	2 yrs	1 yr	1 yr	90 days
Printhead	24 pin	9 pin	9 pin	Daisy
List price	\$1595	\$1675	\$3045	\$1395/\$2800

*both models discontinued

SOURCE: DATAQUEST

24-pin dot matrix printer the most outstanding DEC printer you can buy. Whatever your printer requirements.

The ACCEL-500 is fully compatible with the most popular DEC models. And its innovative Select-Dial™ front panel control provides state-

ACCEL-500 and Select-Dial are trademarks of Advanced Matrix Technology, Inc.

ACCEL-500™

Advanced Matrix Technology
765 Flynn Road, Camarillo, CA 93010
(800) 992-2264 (805) 388-5799

Many of today's subcontractors use Just-In-Time (JIT) turnkey systems that reduce the number of hands that handle the equipment.

with approximately 500 suppliers, including 25 OEMs. "They have to prove to us that they meet specs."

Big Business

These outside board manufacturers are becoming big business. On the West Coast, Sigma Information Systems assembles boards and custom systems for many major computer and storage producers, including DEC and Emulex. The company also engineers a great deal of the logic and design work that's involved.

The operation has grown so fast that Sigma's president Paul Clarke, preferring steady growth, has limited the number of contracts he'll commit to.

Like the subsystem builders, Sigma has reinvested heavily to institute a sophisticated testing program. But Sigma's case is important, because it underscores the importance of establishing a reputation simply by putting quality workmanship in the field.

Many of today's subcontractors use

Just-In-Time (JIT) turnkey systems that reduce the number of hands that handle the equipment. Eventually, these sites should look like Steve Jobs' Next Inc. facility, where computers are assembled entirely by robots from board level on up.

The Assembly Line

The assembly lines I saw were generally laid out with Receiving at one end of the room, Shipping at the other, and an easily traceable maze of Building, Testing, and Inspection tables connecting these two ends (see Figure 2). Every part is tagged and initialed in sequence. Inventory rooms with countless drawers of wire, semiconductors, and power components are kept in giant cages that are grounded to the earth.

In general, the sequence is testing of parts, parts assembled on boards, testing of boards, boards assembled in backplane cages, and testing for functionality. "There is an enormous amount of data collection during the process," says Cabletron's Bell. "We

check weekly to examine which products fail the most frequently."

In the manufacturing facility, the biggest fear is static. Styrofoam coffee cups are banned and everyone must wear a static band before handling equipment. A component can be damaged with just 200 or 300 volts of static (you can't feel less than 3,000 volts of static electricity).

Test Procedures

The board and component testing process can be grouped into two basic categories: manufacturing tests that find bad parts at the component level, and design verification tests that determine whether a part was assembled correctly and can perform the function it was built to perform.

Design verification also includes running circuit and operating system tests in heat chambers and vibrating cabinets. There's also the famous drop test. This test, governed by the National Safe Transit Authority (NSTA), measures the integrity of package designs by dropping the packages from various heights.

Major types of QC tests, listed in an approximate chronological order (assembling components into systems), are:

1. PCB Cross-Section — Which runs random electronic patterns through raw boards.
2. PCB Open Shorts — A test for prob-

F I G U R E 2 .

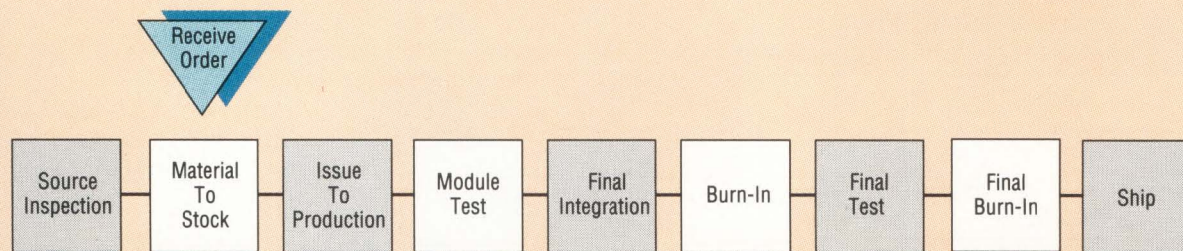

Typical organization of time on a manufacturing assembly line.

TALARIS PRINTSTATIONS

Multi USER-FRIENDLY.

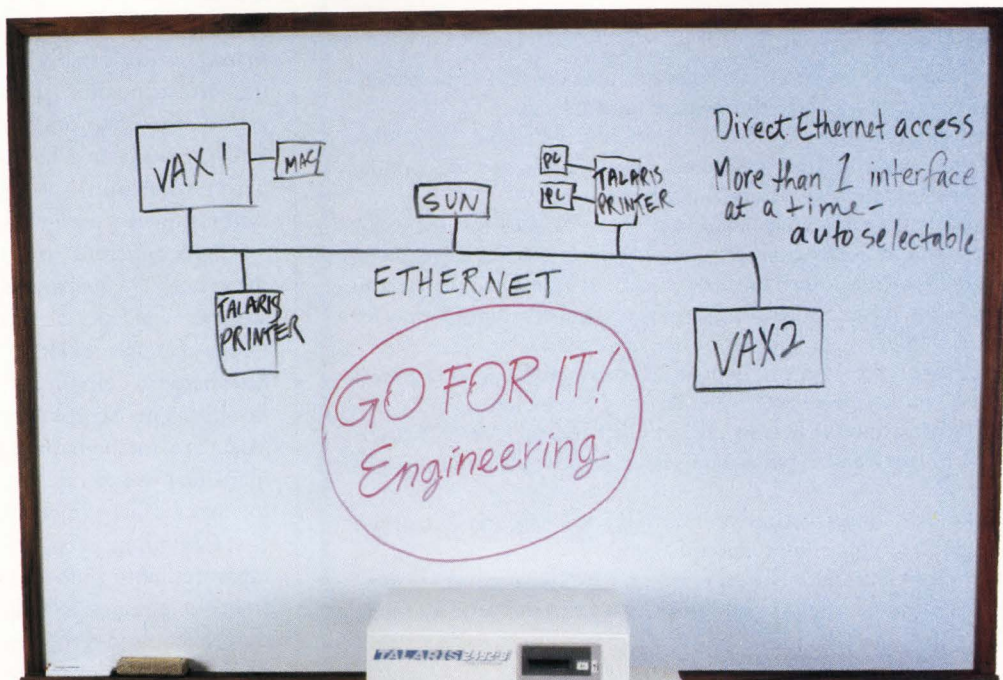

There's no better way to keep your multiuser system friendly than by connecting it all together via Ethernet. And now, thanks to Talaris Printstations, your network of users can even share printers. That's share and share alike — because the 2492-B Printstation doesn't play favorites. It has emulations, fonts, and options to

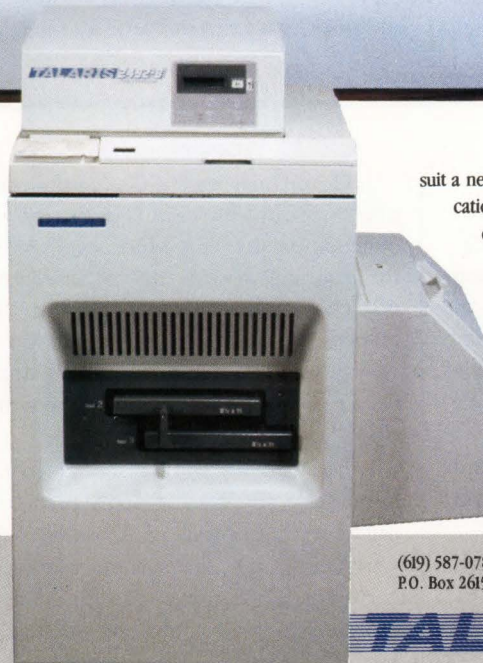

suit a network full of different applications. Then too, the 2492-B is equally at home with DECnet and TCP/IP networks. So why not go for it? You'd have to go a long way to find a better laser printer to be friends with your network users.

NOW IN CANADA from XEROX

Call the XEROX office nearest you:
Calgary (403) 260-8800 • Edmonton (403) 493-7800
Montreal (514) 288-2600 • Ottawa (613) 237-1731
Toronto (416) 229-3769 • Vancouver (604) 668-2300

(619) 587-0787 • 6059 Cornerstone Ct. West
P.O. Box 261580, San Diego, California 92126

TALARIS
SYSTEMS INC.®

Quality Assurance At Work

It was in November 1987 when Don Long, quality assurance director at System Industries Inc., first heard complaints about the 1.1-GB SI93. The storage subsystem had been shipping for a few months, and more customers than usual were reporting disk-head crashes.

Because the normal rate of failure is less than one percent of all drives, more than one problem seemed unusual to Long. "It's a science of probabilities," he explains. "But this was hard to believe."

SI's plan of attack illustrates the intricacies of today's technology and provides an understanding of just how advanced QA programs must be.

After a two-month investigation that included visiting customer sites, dismantling the machines and inspecting individual components, SI gathered enough data to draw some conclusions. It immediately informed its customers that, although only 20 percent of the drives would eventually fail, the potential to fail was in every drive.

Finally, a chemical analysis of the drives revealed the presence of organic contaminants.

"There's only one place in the entire Silicon Valley that does contaminant analysis," says Long. "It's a highly precise and highly expensive undertaking."

The contamination appeared in the Head-Disk Assembly of the NEC D2363 Winchester, a major OEM product for SI. Both companies put engineers to work locating the source of the substance at the NEC factory in Japan.

The team found a few sources, including outgassing from an improperly cured gasket and hydrocarbons from an unsealed container. Because NEC built all of its drives in the same factory, design improvements had to be made quickly. It shut down the plant in July 1988, worked on a new solution — an ultraclean room and a better drive — for two months, and began reshipping an improved drive in October.

"I was quite pleased with the way NEC responded," says Long. SI kept engineers overseas, Long explains, "to make sure NEC made this new recipe permanent."

The original shipment of the subsystems claimed 30,000 hours MTBF. The new drives, with a 9-inch form factor and 15 ms average seek time, are demonstrating well over 60,000 hours MTBF.

SI's relationship with NEC is better than ever, according to Long, and SI has since added new tests to determine failures in products it OEMs.

But the story didn't have a completely happy ending. "We lost some customers," Long points out. "Some we could help out and some had interim alternatives of their own."

In some instances, burn-in tests involve quite high temperatures. Chipcom's basic test bakes boards at 45 C for 40 hours as they perform a loopback procedure in self-test mode. According to Hatch, this is the equivalent of three to six months in the field.

Venditti reports that Military Workmanship Manuals (Milspecs) recommend that integrated circuits should be burned in for 168 hours at 125 C.

Testing The Testers

Using Milspecs that detail testing calculations and procedures, QA managers can establish techniques and numerical quality specifications that guide the manufacturing process. Publicly available, Milspecs include both parts inspection and test equipment calibration requirements.

Specifications and testing equipment help QA managers measure such abstract concepts as Mean Time Between Failure (MTBF), the estimated time before a component will stop functioning. The Acceptable Quality Limit (AQL) is a mathematical rating that QA managers use to rate the potential performance of large inventories of devices.

Regarding parts, the goal of these measurements is to discover growing trends in equipment failure rates before they become a problem. Failed components are returned to the QA area, where the details are logged for trends analysis.

With sophisticated testing equipment in-house, manufacturers are responsible for keeping their testing equipment properly calibrated. "We have a calibration program for all of Xyplex's testing equipment," relates Venditti. "Some are on six-month cycles, others are on 12-month cycles. The tools stay in-house, but much of the test equipment and scopes get sent out."

Responsibilities

Above all, the QA manager must be on the beat every day and must institute a system that allows parts and problems

lems in specific components.

3. IC Burn-In — A check for Error Checking and Correction (ECC) functions. Burn-in tests often are performed in rooms with high temperatures to weed out weak circuits and components.

4. System Test — Which ensures that a subsystem performs the function it's supposed to.

5. System Burn-In — Which sends a series of packets through a board and puts it through loopback exercises.

6. Final Acceptance Test — Which determines if the final assembly works according to specs before it's shipped.

Companies have differing philosophies about burn-in. Basically, it depends on the subsystem level. At SI, for example, boards that SI integrates often have been already burned in. "In manufacturing, I don't want to do it very much," claims Long. "You don't need to burn in if you've done the work right."

Because SI's subsystems are often large-scale, integrating many parts, the only testing performed determines whether or not the system was built correctly. Depending on the system, repeated burn-in could take much life out of a system before it's shipped.

OVER 5,000 SERVED.



The Performance

4000 works. Fact is, the Performance 4000 Ethernet Terminal Server has satisfied the appetites of over 5,000 users worldwide. Yet it's just over one year old! Which means, you can take it out of the wrapper, plug it into your network, connect terminals and put it to work. *Instantly.* You'll get twice the performance, four times the line capacity, and more features than the DECserver 200. For about *half* the cost per line.

Perfectly compLAtable. The Performance 4000 Terminal Server is 100% LAT compatible. No special hardware is required; no special software drivers are necessary. In fact, the Performance 4000 uses a superset of the DECserver 200 user commands, so no retraining is necessary.

Less size, more room to grow. The base system will support up to 16 terminals from a package only 2½ inches high. Add a 2-inch high expansion unit, and you can support 32 terminals from a system that sits on top of a desk! A rackmount shelf is also available, and you can choose from three different base units and two expansion unit configurations.

Free book of solutions! For more information about these and other Emulex products, return this magazine's reply card or call Emulex toll free!

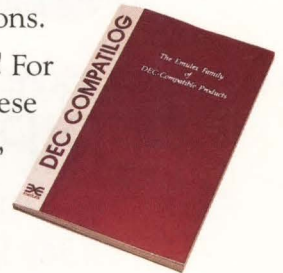

Call (800) EMULEX-3, or
(714) 662-5600 in California

Emulex Corporation
3545 Harbor Blvd.
Costa Mesa, CA 92626



Regional Offices: Anaheim, CA (714) 385-1685 Roswell, GA (404) 587-3610
Burlington, MA (617) 229-8880 Schaumburg, IL (312) 605-0888
International Offices: Wokingham, England (44) 734-772929
Munich (49) 89-3608020 North Sydney (61) 2-957-1669 Paris (33) 134-65-9191
Tokyo (81) 3-234-8951 Toronto (416) 673-1211

DECserver and LAT are registered trademarks of Digital Equipment Corp.
©1989 Emulex Corporation.

CIRCLE 109 ON READER CARD

Companies Mentioned In This Article

Cabletron Systems Inc.
P.O. Box 6257
E. Rochester, NH 03867
(603) 332-9400
CIRCLE 537 ON READER CARD

Clearpoint Inc.
99 South St.
Hopkinton, MA 01748
(508) 435-5395
CIRCLE 539 ON READER CARD

Emulex Corporation
3545 Harbor Blvd.
Costa Mesa, CA 92626
(714) 662-5600
CIRCLE 405 ON READER CARD

Next Inc.
3475 Deer Creek Rd.
Palo Alto, CA 94304
(415) 424-8500
CIRCLE 541 ON READER CARD

System Industries Inc.
560 Cottonwood Dr.
Milpitas, CA 95035
(408) 432-1212
CIRCLE 414 ON READER CARD

Chipcom Corp.
195 Bear Hill Rd.
Waltham, MA 02154
(617) 890-6844
CIRCLE 538 ON READER CARD

Digital Equipment Corp.
146 Main St.
Maynard, MA 01754
(508) 897-5111
CIRCLE 403 ON READER CARD

NEC Information Systems Inc.
1414 Massachusetts Ave.
Boxborough, MA 01719
(800) 343-4418
CIRCLE 540 ON READER CARD

Sigma Information Systems
3407 E. LaPalma Ave.
Anaheim, CA 92806
(714) 630-6553
CIRCLE 542 ON READER CARD

Xyplex Inc.
100 Domino Dr.
Concord, MA 01742
(508) 371-1400
CIRCLE 543 ON READER CARD

to be traced fast. This begins with material requirements planning and a logical assembly line process. Someone has to make sure the company is buying the right parts and plugging them into the right places. With QA, delegation and organization are just as important as implementation.

The job often requires ingenuity. Clearpoint Inc., a manufacturer of workstation memory, developed the Universal Memory Tester (UMT), a

microprocessor-based system that provides a sophisticated burn-in and test environment. The testing and tracking of boards is facilitated by the UMT, but is monitored by both QA and design engineers. The environmental test generally takes 72 hours.

Chipcom fabricated a unique piece of equipment called the Ethernet Tester (ET) that duplicates the interplay of a network by sending packets through the devices to be tested.

THE DEC INDUSTRY is among the world's leaders in providing state-of-the-art QA. But it isn't Milspecs or burn-in ovens or analyzer scopes that assure quality, it's people.

"Good quality means cooperation," says Bell. "The teamwork involves not only subcontractors and the people here, but feedback from the customers, as well"

ARTICLE INTEREST QUOTIENT
Circle On Reader Card
High 483 Medium 484 Low 485

DIRTY TAPES?

REDUCE JOB ABORTS
INCREASE TAPE LIFE
ELIMINATES CINCHING
NATIONWIDE SERVICE



MAGNETIC TAPE CLEANER/REWINDER

PERIPHERALS

A High Technology Company

1363 Logan Ave.

Costa Mesa, CA 92626

Headquarters 714-540-4925

Outside CA. 1-800-468-6888

FAX 714-540-2026

CIRCLE 287 ON READER CARD



FACTORY REFURBISHED

 CDC DISK DRIVES

 CIPHER TAPE DRIVES

 DATA PRODUCTS PRINTERS

 FUJITSU DISK & TAPE DRIVES

YOUR #1 SOURCE
CALL NOW FOR BIG SAVINGS

Clayton Computer Systems
271 Opportunity Street, Suite I
Sacramento, California 95838

916 · 925 · 5727
FAX (916) 925-7340



MASTERCARD
VISA
— ACCEPTED —

CIRCLE 274 ON READER CARD

MICROVAX 3500/3600 PERFORMANCE TOOLS.



A matched set of solutions. Our new line of MicroVAX 3500/3600 controllers is precision-tuned to boost your system's performance. Every detail has been quality-engineered. For example, special extractor handles are FCC compliant, while providing optimum cable management and full compatibility with BA 213 cabinetry.

Each controller has a high-performance, micro-processor engine that can push the speed barriers of MicroVAX technology. The full set is backed by the best support team in the industry, and you can choose the best tool for your needs:

QD24 Disk Controller . . . supports up to four ESDI drives with transfer rates up to 15MHz. Full MSCP implementation. Standard and custom drive geometry configurations and on-board diagnostics allow simultaneous multiple drive formatting and verifying.

QD34 Disk Controller . . . supports up to four SMD-E disk drives of any capacity, with transfer rates up to 3.0MB/sec. Full MSCP functionality and our standard on-board diagnostics.

QT14 Tape Coupler . . . for Pertec-interfaced tape transports. Choose TMSCP or TSV05 emulation. Standard or adaptive transfers.

QS09 Async Multiplexer . . . emulates 16 full modem-controlled lines of DHV11 emulation in one slot. Standard and non-standard baud rates and other parameters are programmable.

Free tool catalog! For more information about these and other Emulex products, return this magazine's reply card or call Emulex toll free!



Call (800) EMULEX-3, or
(714) 662-5600 in California

Emulex Corporation
3545 Harbor Blvd.
Costa Mesa, CA 92626



Regional Offices: Anaheim, CA (714) 385-1685 Atlanta, GA (404) 587-3610
Teaneck, NJ (201) 836-3717 Chicago, IL (312) 490-0050 Dublin, CA (415) 829-1170
Burlington, MA (617) 229-8880 Washington, DC (703) 264-0670
International Offices: Paris 134-65-9191 Tokyo 3-234-8951 Toronto (416) 673-1211
Bracknell 344-484234 Munich 89-3608020 North Sydney 2-957-1669

MicroVAX is a registered trademark of Digital Equipment Corp.
©1988 Emulex Corporation Inc.

CIRCLE 110 ON READER CARD

Computer Information Systems' Quantum PT
Can Alleviate Your Tuning Burden.

VAX TUNING

25-3-1988 14:00 System Manager

Computer Information Systems Quantum PT
OPT_TUNER Process Creation

Allow MSDEC modification?

Field	Category	Parameter Description	Current Value
*		Start time	Not started
*		Total memory	Not available yet
70	MSDEC	Allow MSDEC modification	Yes
71	MSDEC	Number of MSDEC's to go from MSMAX to 0	33
72	MSDEC	Minimum value for MSDEC	0
73	MSDEC	Maximum value for MSDEC	99
74	MSINC	Allow MSINC modification	Yes
75	MSINC	Number MSINC's to go from 0 to MSMAX - memory OK	5
76	MSINC	Number MSINC's to go from 0 to MSMAX - memory not OK	15
77	MSINC	Minimum value for MSINC	0
78	MSINC	Maximum value for MSINC	500

Parameters can be adjusted prior to starting Quantum PT.

Keeping your VAX systems tuned and running efficiently can present a formidable challenge. For one thing, the number of factors to consider can be overwhelming. Also, new or inexperienced system managers might not know where to look to improve system performance. And, although tuning and performance issues are critical, system managers can't dedicate all of their time to tweaking SYSGEN parameters and reconfiguring hardware and software.

In recent years, software products have appeared that alleviate the tuning burden. Their goal is to tune a running system dynamically to achieve maximum performance at all times. Quantum PT, designed by Computer Information Systems Inc. (CIS) of Newton,

Massachusetts, and marketed by Braintree Technology of Norwell, Massachusetts, is one of these products. We tested Quantum PT version 2.0 for VAX/VMS version 4.7 on our VAXstation 2000 and VAX 8250.

PT Overview

Quantum PT consists of modules that perform dynamic tuning, monitor the system's performance and display and report the results.

Quantum PT achieves its tuning goals using three methods: dynamic schedule adjustment, dynamic VMS SYSGEN parameter modification and dynamic process memory allocation.

For dynamic schedule adjustment, Quantum PT updates only the memory-

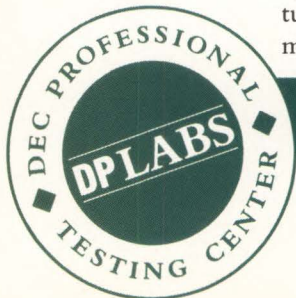

DAVID B. MILLER

STORAGE SAFE.



SMDI VAX Storage Arrays . . . think of them as vaults for up to 10.5 gigabytes of VAXcluster data files! That's how reliable they are. Because Emulex Storage Module Disk Interconnect (SMDI) arrays incorporate iron-clad technology.

For example, we use industry-standard 8-inch drives that have *proven* their ability to perform. And we "marry" those drives to advanced Emulex controllers that have a reputation for quality worldwide!

DSA controller-compatible. With an SMDI array, you can take full advantage of DSA functionality and SMD-E disk drive flexibility. The reason: SMDI arrays convert SDI protocol to industry-standard SMD or ESDI. So they appear to your host as RA-series drives.

But instead of being confined by RA-series limitations, you get total configuration control!

More bank for your buck. Emulex SMDI arrays can provide up to 1.75 GBytes of storage per logical drive, and up to six logical drives

per cabinet. So you can plug in up to 10.5 gigabytes of additional capacity using only six of your SDI ports!

Free book of solutions! For more information about these and other Emulex products, return this magazine's reply card or call Emulex toll free!

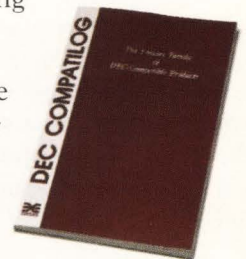

Call (800) EMULEX-3, or
(714) 662-5600 in California

Emulex Corporation
3545 Harbor Blvd.
Costa Mesa, CA 92626



Regional Offices: Anaheim, CA (714) 385-1685 Roswell, GA (404) 587-3610
Burlington, MA (617) 229-8880 Schaumburg, IL (312) 605-0888
International Offices: Wokingham, England (44) 734-772929
Munich (49) 89-3608020 North Sydney (61) 2-957-1669 Paris (33) 134-65-9191
Tokyo (81) 3-234-8951 Toronto (416) 673-1211

VAXcluster, DSA and SDI are trademarks of Digital Equipment Corp.
©1989, Emulex Corporation, Inc.

CIRCLE 112 ON READER CARD

Figure 1.

Processor Type	How Conducted	Average Response (Seconds) Invoking MAIL	
		Running	Not Running
THORIN:: (VAX 8250)	Business Hours Average 15 Users	7.24	6.79
SAURON:: (VAXstation 2000)	Single User	3.13	3.70
SAURON:: (VAXstation 2000)	CIS Benchmark Load Generator Terminal, CPU, Memory Load	8.28	8.98

Sample response times from our VAX 8250 and VAXstation 2000 with the tuner turned on and off.

resident code of a running VMS system. No disk-resident VMS images are altered or replaced. Your system is returned to its original state if it's rebooted. In adjusting the VMS scheduler, processes are given the time and priority boosts needed to keep overall system response time consistent.

Of the more than 250 VMS SYSGEN parameters, Quantum PT can work with the subset of parameters classified as dynamic, i.e., they can be altered on a running system without rebooting. Quantum PT continually evaluates dynamic parameter values and adjusts them as needed. SYSGEN parameters, such as QUANTUM and IOTA, as well as parameters related to working set adjustment and swapper activity, are included in this group.

The memory reallocation feature removes memory from inactive processes and distributes it to active processes. This provides for more efficient resource use.

Quantum PT requires 5,600 blocks of disk storage on your system disk for installation and 5,600 blocks of disk storage on the target disk on which it will reside permanently. If you purchase the optional Data Representation Facility, disk space requirements increase to 9,000 blocks.

VMSINSTAL is used to install the software. The tuner isn't started immediately after the installation completes; you must start it manually. Be

sure to include lines in your system startup command file to set up Quantum PT automatically if your system needs a reboot.

Interface

Quantum PT's interface is consistent with CIS' Applications Architecture approach to user interfaces. CIS' Applications Architecture provides a clear, consistent user interface that includes command recall, supplied default values, spawning options to DCL, snapshot generation, menu-driven input control, and syntax, data and context help.

A time-saving feature of the Applications Architecture is its script-writing capability. Script files can be built automatically as you work through the menu system. Scripts can be set up to pause for input. After a script file is built, you need only invoke its execution and supply any information required by built-in prompts. If set up properly, script files can be executed in batch.

Invoking Quantum PT doesn't automatically start the tuning module. Before the tuner process is created, you have the option of adjusting its parameters. These include dynamic SYSGEN parameters, as well as the parameters that control the statistical logging feature and dynamic schedule adjustment. A subset of the tuner's parameters also can be adjusted while

the tuner is running. The screen on page 88 displays the Adjustment Process Screen and some of the many parameters you can change before the tuner module starts.

After the tuning process is started, it resides on the system as a detached process. Stopping the tuner poses no hazards other than perhaps the risk of being inundated with calls asking why the system suddenly slowed down.

Running In-House

To determine how Quantum PT could help our system, we ran three tests, each consisting of 10 trials. For each test, we measured system response time by noting how long it took to get the MAIL > prompt after invoking the VMS MAIL utility. For each trial, the tuner alternately was started and stopped, and MAIL was invoked each time the tuner was and wasn't running. The tuner ran with default parameters for each trial.

Figure 1 shows the average response time for each test. Test one was

For Information On Quantum PT, Contact: Braintree Technology, 600 Cordwainer Dr., Ste. 102, Norwell, MA 02061; (617) 982-0200

CIRCLE 480 ON READER CARD

Quantum PT Version 2.0

PLATFORMS: VAX systems running VMS version 4.7. Quantum PT version 2.1 is designed for VAX systems running VMS version 5.0 or later

PRICE: From \$850 to \$3,750, depending on CPU. Quantity discounts available

COMPUTER INFORMATION SYSTEMS INC.

HEADQUARTERS:

120 Wells Ave.
Newton, MA 02159
(617) 527-1550

FOUNDED: 1975

PRODUCT LINE: System management software tools

OWNERSHIP: Private

BRANCHES: England, France

CIRCLE 479 ON READER CARD

Unlock Programmer Productivity

FIELD VALIDATION

Field _____

Unique? ___ Demand? ___ Must Fill? ___

Range _____

Custom Validation Procedure:

With System 1032 Application Facility

System 1032/AF automatically generates most of your application code from menu selections. Yet you can add custom procedures wherever you need something special.

CompuServe[®]

Data Technologies
Tel: (617) 661-9440

CIRCLE 153 ON READER CARD

Figure 2.

21-Apr-89		Quantum PT SYSGEN Dynamic Display			17:04:53
CPU busy: 32%	Idle: 68%	CPU state: Not busy		Memory state: Ample	
Total memory: 18432	VMS: 4631	User: 8408	Free: 4444	Mod: 949	
Memory percentages	VMS: 25%	User: 46%	Free: 24%	Mod: 5%	
<u>SYSGEN Parameter</u>	<u>Units</u>	<u>Current</u>	<u>Last</u>	<u>Delta</u>	
QUANTUM	10Ms	9	12	-3	
AWSTIME	10Ms	6	8	-2	
IOTA	10Ms	3	4	-1	
PFRATH	Flits/10Sec	43	39	+4	
PFRATL	Flits/10Sec	0	0	0	
WSINC	Pages	500	500	0	
WSDEC	Pages	0	0	0	
LONGWAIT	Seconds	20	20	0	
DORMANTWAIT	Seconds	4	4	0	
SYSGEN timer: 30		Last SYSGEN Modification: 21-Apr-1989 17:04:40			

The default dynamic display shows SYSGEN parameter information and system CPU and memory statistics. Delta values indicate changes made to dynamic SYSGEN parameters.

conducted during normal business hours on THORIN::, our 8250. Test two was done after hours on SAURON::, our VAXstation 2000, with a single user. Although the test is artificial, it's interesting to note the dramatic decrease in response time (15 percent) when the system was being tuned.

For test three, I used QUANTUM_PT_BENCHMARK, a program supplied by CIS, to generate a load on the system. The program can be invoked to place a terminal, memory, disk or CPU load on your system. I ran QUANTUM_PT_BENCHMARK in three separate subprocesses to generate a mixed load for memory, terminal I/O and CPU. That stressed the VAXstation so much that I didn't chance invoking the disk load version. There were no other users on the system during this test. This time, we realized a 7 percent decrease in response time when the tuner was running.

Quantum PT is designed to help performance in CPU- and/or memory-constrained systems. Because your system can vary in regard to the load placed on it, it's best to try Quantum PT and

monitor performance during your normal workload cycle on the system you wish to tune before rendering any judgments.

Displays And Reports

Information about the running tuner, the processes active on your system and the SYSGEN parameters that can affect performance can be obtained via Quantum PT's reporting functions. Examples of a dynamic SYSGEN parameter report are shown in Figure 2.

In addition to dynamic displays, Quantum PT can collect tuner and system statistics in a log file. You can run reports on this data later. Reports can be generated using combined log files. Data can be totaled across time intervals, such as time of day or day of week. The system can report on more than 160 statistics. You can tailor the report to include the statistics you need.

An optional feature, the Data Representation Facility, provides more output options than Quantum PT's reporting functions. It includes functions to produce bar graphs, pie charts, trend graphs and more sophisticated

tabular reports. In addition to buying the extra module, you also need GKS, so that your graphs can be displayed on terminals.

For input, the Data Representation Facility uses normalized data files that can be generated by Quantum PT's reporting functions. Normalized files are ASCII data files that contain additional information required to draw a graph or to produce tabular reports.

Graphs can be viewed on any GKS-supported monochrome or color terminal. Graphs also can be sent directly to a file or to a hardcopy device. Supported hardcopy devices include the LA50, LA210, LN03, Hewlett-Packard plotters and the Tektronix 4014 and 4017. You can specify what data to graph, the order in which it's to be sorted and the graph's attributes. Graph settings can be saved in a definition file. The settings can be used on various sets of data.

For tabular reports, you can specify which columns to graph, the format of each column, what totals calculations to perform and what should be contained in the report's titles, column headings, page headers and footers.

QUANTUM PT IS A safe way to alleviate system performance problems. No product can guarantee performance gains, because each system is different. However, if you have a CPU- or memory-constrained system, give Quantum PT a try and see for yourself whether or not it can increase your system's throughput. ■

Digital Equipment Corp.
146 Main St.
Maynard, MA 01754
(508) 897-5111

CIRCLE 403 ON READER CARD

Hewlett-Packard
3000 Hanover St.
Palo Alto, CA 94304
(415) 857-1501

CIRCLE 406 ON READER CARD

Tektronix Inc.
P.O. Box 1000
Wilsonville, OR 97070
(503) 685-3180

CIRCLE 415 ON READER CARD

W A N T E D



THE VASTEK COMPANY

FOR TOP QUALITY,
COST EFFECTIVE
VAX TRAINING

FOR SEMINARS TEACHING
TECHNICAL SKILLS FOR
PRACTICAL APPLICATION

FOR ON-SITE
TRAINING TO FIT
YOUR NEEDS

FOR INDUSTRY-RECOGNIZED
SEMINAR LEADERS INCLUDING
BRUCE ELLIS & DENNIS O'BRIEN

- VMS Internals for System Managers Boston: 8/21-8/25 · Chicago: 9/25-9/29
- Getting Started with DECWindows Boston: 8/21-8/22 · Wash. DC: 9/25-9/26
- Programming DECWindow Applications Boston: 8/23-8/25 · Wash. DC: 9/27-9/29
- Programming VAXELN—Real-Time Applications Boston: 8/14-8/16
- Understanding RMS (Programming and Performance) Chicago: 9/18-9/20

- VAX Clusters: Configuration, Management and Performance Chicago: 9/11-9/13
- 'C' Programming Clearly Wash. DC: 10/2-10/4
- VAX/VMS System Management Survival Skills Boston: 8/14-8/16
- VAX/VMS Advanced System Management Wash. DC: 10/9-10/11
- Applied VMS Performance Analysis Boston: 10/16-10/19 · Chicago: 9/11-9/14 · LA: 10/2-10/5

For registration and complete information: The Vastek Company/1000 Market Street/Portsmouth, NH 03801/603-427-0770

Customized Projects

DSD Corporation's C-Plan Offers A Large And Flexible Set Of Cost And Scheduling Functions.

C-Plan, from DSD Corporation of Bothell, Washington, is a growing package of project-management software with a well-organized menu structure. It offers a surprisingly large and flexible set of cost and scheduling functions for its competitive price. After you become familiar with the terms associated with project management and C-Plan, you'll find the system a convenient data-entry program that customizes graphs and reports using submenu selections. Following in the footsteps of DSD's C-Calc spreadsheet, C-Plan was introduced in January 1988.

C-Plan's user interface seems cluttered and imposing, but that doesn't matter, because the documentation and on-line Help are excellent. You're guided through the screens by hitting carriage returns and mnemonics, and your project-development goals are spelled out nicely in chapter headings and concise descriptions in the manual. After you determine the C-Plan term

for what you're trying to do, you get simple keystroke descriptions.

C-Plan is an end-user/data-entry-oriented system. It's much like PC software with its menu-selection highlighting scheme and the way it backs in and out of screens and saves them. A screen reference number on the top status line prevents you from getting lost in the descending tree of menus. The BACK menu option lets you climb out the way you came in. QUIT takes you back to the top Project screen (see Figure 1). After you've set up or updated a project or subproject, the system requires you to SAVE all changes before backing out to the \$ prompt.

On-line Help is a menu option on each screen that offers an explanation of the highlighted item on which C-Plan is waiting for you to act.

Translations

C-Plan is organized to let you track your project and measure its relative

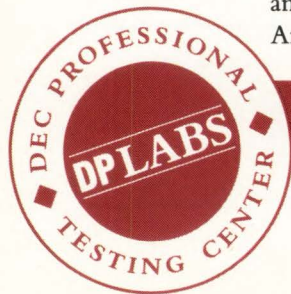

EVAN BIRKHEAD

THE SOFTWARE NEWS

Total VAX/VMS Disk Solutions

RABBIT-11 Disk Caching

RABBIT-11's automatic caching keeps frequently accessed files in memory. System performance improves greatly because I/O to physical disks is minimized.

RABBIT-4 Disk Management

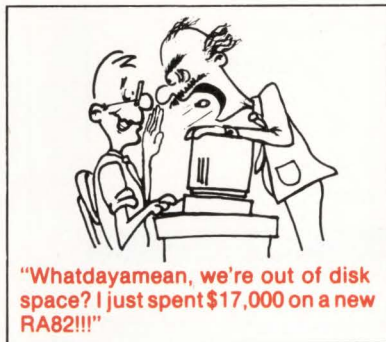

Maybe you think you're out of disk space, but you're really not. RABBIT-4 lets you free disk space for productive use. RABBIT-4 collects data on each disk or an entire disk farm, then arms you with the information you need to make the most of your disk hardware investment.

RABBIT-5 High Speed Disk Backup

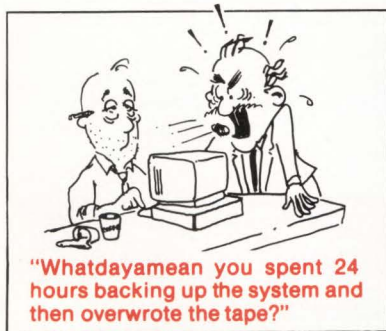

Backups are done quickly and safely with RABBIT-5. The tape librarian enforces tape labeling so there's no room for accidental overwrites. Disk to tape backup is often 3 to 5 times faster than VMS Backup in elapsed time and 90% faster in cpu time.

RABBIT-9 VAX Acceleration Software Technology

RABBIT-9 works all the time and prices start at only \$1,000. Improve system performance up to 100% and more using only a few seconds of cpu daily. Continuous tuning means your system feels quick and performs great. All the time!

RABBIT-7 Disk Optimizer



Automatically eliminate file fragmentation and consolidate free space to save lots of time and money. R-7 intelligently places files to build an optimal disk structure: **one that lasts**. No need for on-line defragmenting.

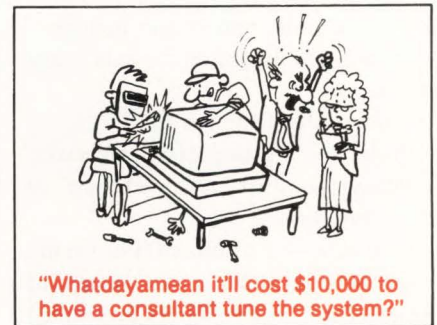

Call for Free Demos Now!

RAXCO, INC. EAST (301) 258-2620
RAXCO, INC. WEST (714) 863-0100
IN CANADA (519) 371-5020

VAX/VMS are trademarks of Digital Equipment Corporation

CIRCLE 190 ON READER CARD

Figure 1.

Project			
>Name	<u>Vision Eye Professionals</u>	Version	<u>Sample Project</u>
Start Date	<u>1-Feb-88 12:00am</u>	Efficiency	<u>100</u>
Finish Date	<u>*8-Apr-88 05:00pm</u>	Compare Proj	<u>VEP January Plan</u>
Status Date	<u>15-Feb-88 12:00am</u>	Memo	<u>Project Notes (Notes asso</u>
Calendar	<u>Standard Calendar (5 Day</u>		
----- Summary -----			
21 Tasks	1 Calendar	17 Reports	
16 Resources	2 Daymodels	17 Graphs	
7 Keys	2 Memos	9 Select/Sorts	
3 Job Costs			
Use the TAB and ARROW keys to select a Project field.			
Use the SPACE and BACKSPACE keys to select a command.			
C-Plan Version 1.6		Vision Eye Professionals Sample Project	
Back	Calendars	Daymodels	Edit File
Options	Print_reports	Resources	Select_sorts
		Tasks	Update
			Xedit
		Graphs Help	Job_Costs Keys Memos

After you create the project, this screen maintains the fundamental project data and doubles as main menu.

success at any stage. The very nature of keeping records of real-life versus planned goals encourages data analysis and comparisons, which can be cleanly displayed by C-Plan graphs and reports. The style of data entry, updating and report generation allows you to select data that's relevant to your project summaries.

You first must determine how your project's cost and time variables can be translated into C-Plan terminology. Terms you must understand include:

1. Field — the blanks on the data-entry screen.
2. Task — the basic job unit.
3. Project — a group of related tasks.
4. Resource — names, materials or dollar amounts.
5. Calendar — the units of time on the project schedule. (The basic concept of C-Plan is tasks use resources over time.)
6. Duration — time needed to finish a task.
7. Update — a menu command that

recalculates entered data so it can be graphed or otherwise reported.

8. Gantt chart — a horizontal bar chart. A Task Gantt Chart, for example, shows tasks versus time for the entire project. Graphs can be displayed on-screen or printed on a printer or plotter.

9. Daymodel — designates every minute of a 24-hour period as working or non-working.

I reviewed C-Plan Version 1.6 on SAURON:, a VAXstation 2000 with 16 MB of memory on our LAVc. The program was installed with VMSINSTAL and required 4,000 free blocks of disk space, 450 free global pages and two free global sections. Before you can access the software, you must call DSD for a license key.

Data Entry

After creating your project name and time frame on the top screen, called the Project Index, you can identify tasks and resources through the submenus. The

next screen you encounter is the Projects screen, C-Plan's pivotal menu. From here, you can descend to the Project Calendar, which maintains month-by-month deadlines; Daymodels, which break down goals into 24-hour periods; databases of Resources and Tasks, including a Task Gantt Chart; or select options for Graphs and Reports.

Hitting G from the Projects screen brings up the graph menu. It lets you select the type of graph — bar, line, histogram, Gantt, and so on — and the variables it will measure. The graphs then are generated automatically (see Figure 2). Graphs that correspond to either the Program Evaluation Review Technique (PERT) or Critical Path Method (CPM) styles of project management are available from the graph menu. Gantt charts are the best visual tool for comparing your progress to the actual plan. In C-Plan, they can display your original schedule against current schedules, or check the progress

C-Plan Version 1.6

PLATFORMS: VMS. It soon will run on major UNIX platforms

PRICE: Depending on CPU size, \$4,950 on a VAXstation 2000; \$8,250 on a MicroVAX II; and from \$10,000 to \$18,000 on VAX 6xxx and 8xxx. Site licenses and special prices for clusters are available

DSD CORPORATION

HEADQUARTERS:

18912 N. Creek Pkwy.
Bothell, WA 98011
(206) 485-7564

FOUNDED: 1982

PRODUCT LINE: C-Plan project-management system and C-Calc and C-Calc Plus multiuser spreadsheets. Upcoming versions will integrate C-Calc with C-Plan

OWNERSHIP: Private

BRANCHES: Sales offices throughout the U.S., Canada, Europe, Australia and New Zealand

CIRCLE 474 ON READER CARD

Guess who wrote the book on how to make the most of your DEC hardware?

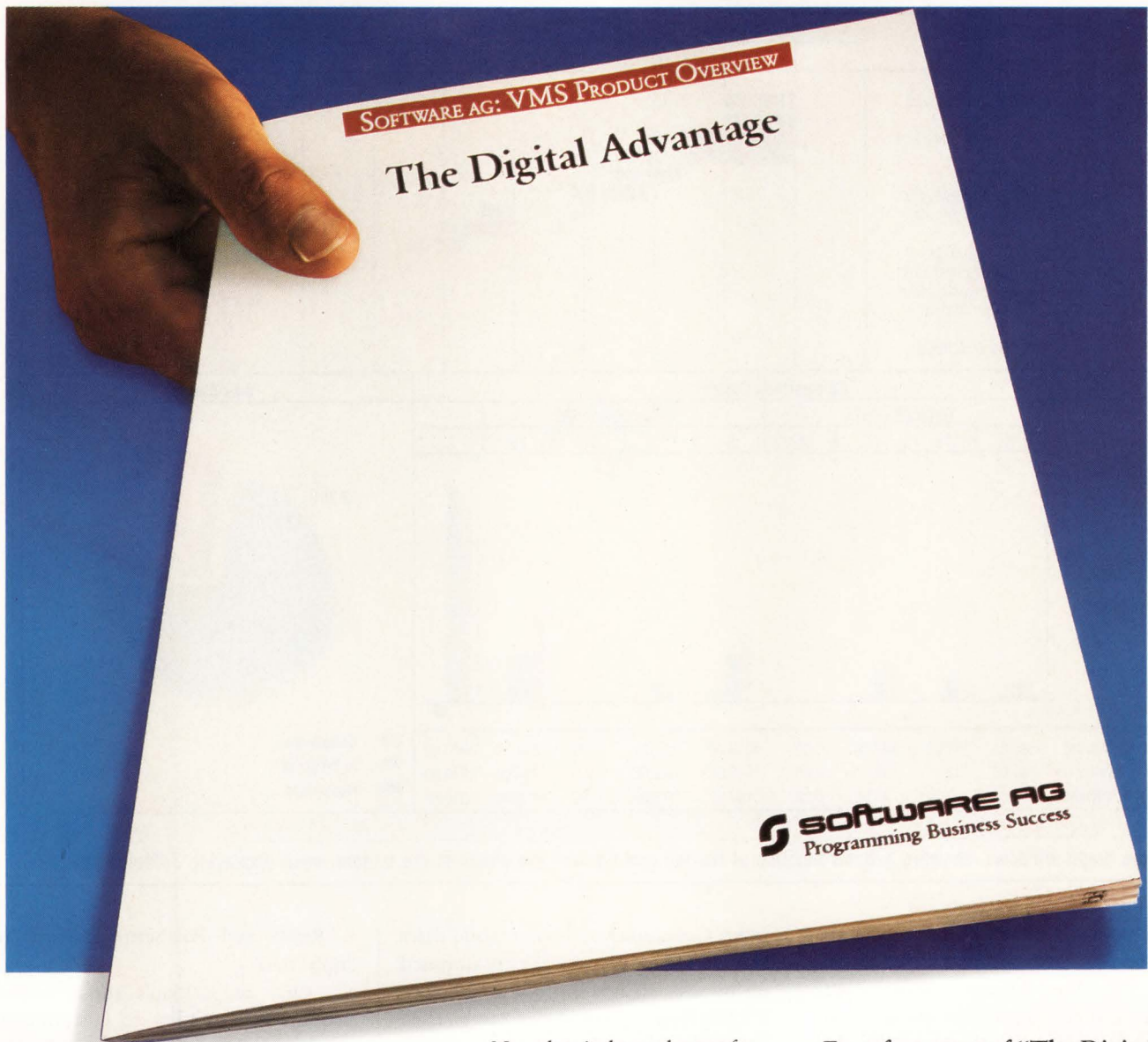

No other independent software vendor has more experience in the VMS marketplace than Software AG. Surprised?

Our customers aren't. Over the years they've come to expect superior performance, reliability and functionality from Software AG's advanced VMS technology.

And as our VMS customer base has grown, so has our VMS product list. Today it boasts nearly a dozen of the most comprehensive, tailor-made solutions available. They include: ADABAS—High performance data base management and OLTP support. NATURAL—Advanced 4th generation application development technology. PREDICT—Integrated, active dictionary for data and applications. NET-WORK—Powerful communications for distributed processing. NATURAL GRAPHICS—The smart way to present data. SUPER NATURAL—End user information and prototyping system.

Demand the power, integration and flexibility you expect of your VAX hardware from your software too. Demand system software from Software AG.

For a free copy of "The Digital Advantage," call toll-free:
1-800-843-9534
(In Virginia or Canada, call
703-860-5050).

CIRCLE 313 ON READER CARD

 **SOFTWARE AG**
Programming Business Success

Figure 2.

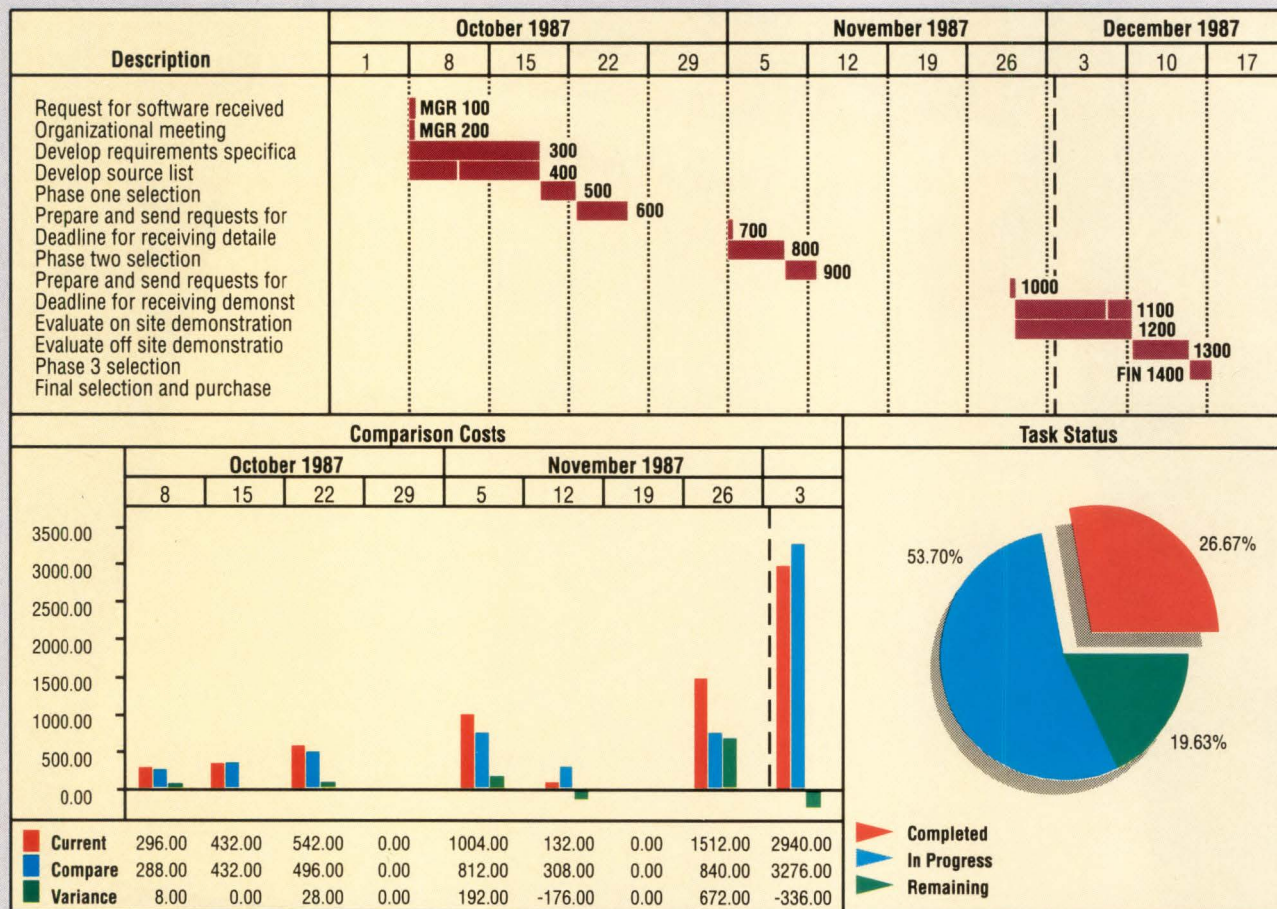

Sample graph windows, showing a Gantt timeline at the top and bar and pie charts at the bottom, each displaying different statistics.

of a plan regarding the use of time, resources or the completion of tasks.

Compiling the same information as Graphs, about 40 possible combinations can be compared in Reports. Selecting these lets you view project inter-relationships, such as Task and Resource costs or dates. Our HP LaserJet was one of several printers supported by the program.

Version 2.0

Most of the refinements in the next major version of C-Plan are geared toward comparisons between actual and planned values. Version 2.0 began shipping in May. Some notable enhancements:

1. Tasks can be broken down into sub-

tasks. Costs, usages, durations and dates that are set in the subtasks are summed up by task statistics.

2. The Project Task screen can be used for comparisons between actual and planned values of start and finish times, and calendar and person durations.

3. Values have been added that are supported in Graphs and Reports. These include Earned Value, which combines planned cost with the actual work done to that point; Planned Value, the cost of work to be done; Budget, which calculates the budgeted amount at completion; Actual, the amount of work actually completed; and Projected, the amount of work that needs to be completed before the finish date.

4. ReGIS and PostScript devices are supported.

One of C-Plan's most notable benefits is its ability to customize to specific applications. From the Project Options screen, I could create new commands, associated prompts and help. This is a good way to integrate C-Plan with other databases. Screens can be changed using much the same sequences.

Because it's well-organized at the top, C-Plan is easy to learn. A project of any size can be developed, depending on available disk space. Most important, after C-Plan is installed, it's a true end-user data-entry tool that requires little support. MIS can sit back and relax. That's a significant plus. ■

"Connectivity"



SequeLink: First To Give Macs Seamless Co-operative Processing With Your Server DBMS.

Some people's concept of Mac/VAX "connectivity" is decidedly mousey. Slow, limited and, for all practical purposes, one-directional.

SequeLink is a totally unique and dramatically better solution. It fully blends both client and server into a single architecture, transparently updating both sides of the partnership. Preprogrammed SQL statements define bidirectional data flow to keep system-wide information up-to-the-second accurate. Think of the possibilities! You'll have OLTP and Decision Support applications using the Mac's friendly human interface, combined with all the power and security you now have on your VAX's RDBMS.

Through SequeLink's cached no-wait architecture, Mac users have transparent access to most popular RDBMS's—Ingres, Oracle, Rdb, Sybase—all with the simple click of an icon. They can concurrently manipulate multiple SQL commands within multiple connections, even on multiple servers. And doing so won't tax the system's overall performance. In fact, it'll improve it.

Best of all, SequeLink performs its feats with ease of implementation, proven reliability and measurable economy. So not only will you be

doing a better job managing the corporate data, but corporate resources as well. Which should go over very well with top management.

If you want more than just connectivity, connect with TechGnosis.
**TechGnosis, Inc., One Park Place, 621 N.W. 53rd St.,
Boca Raton, FL 33487, (407) 997-6687**
Kardinaal Mercierlei 44, B-2600, Antwerpen-Belgium
Telephone: 03/218.43.51

TechGnosis, Inc. and SequeLink are trademarks of Gnosis N.V., VAX, Mac, Ingres, Oracle, Rdb, Sybase and other company or product names mentioned are trademarks or registered trademarks of their trademark holder.



TECHGNOSIS, INC.™
Focus on mission critical systems

Communications Research Group's Blast II Features Robust Communications Capabilities.

File-Transfer Forte

```

BLAST  Offline          DEFAULT  C:\BLAST
Select New Modify Write Remove Local Online
... system setup ready, switch to the ONLINE menu

----- F1-help = ESC-exit = -----
Setup for: DEFAULT
Description: The default setup for BLAST
Phone Number: _____
System Type: _____
Originate/Answer: ANSWER
Userid: _____
Password: _____
Comm Port: COM1
Modem Type: HAYES
Baud Rate: 1200
Parity: NONE
Protocol: BLAST
Logon Timeout: 120
Connect Timeout: 120
Transfer Passwd: _____
Script File: _____
Log File: _____
Translate File: _____
Keyboard File: _____
Emulation: VT100
Attention Key: ^K
Full Screen: NO
Local Echo: NO
AutoLF In: NO
AutoLF Out: NO
Wait for Echo: NO
Prompt Char: NONE
Char Delay: 0
Line Delay: 0
XON/XOFF Pacing: YES
RTS/CTS Pacing: NO
? Bit Channel: YES
Packet Size: 1024

11/12/87  DCD  CTS  00:07:32  NUM  01:04 pm

```

A sample setup screen for the PC version of Blast II.

Blast II, from Communications Research Group Inc. (CRG) of Baton Rouge, Louisiana, is more than just a catchy name. It's short for BLocked ASynchronous Transfer, the designation given to CRG's file-transfer protocol built into all of its communications products.

Blast II runs on a number of com-

puter platforms, including the Mac, the VAX under VMS, and IBM PCs and compatibles running MS-DOS. We tested version 8.4 for the VAX (VAX Blast II) on our VAXcluster and version 8.3.2 for PCs (PC Blast II) on our AST Premium/286.

An installation program is provided for the PC version of Blast II. VMSINSTAL is used to install Blast II on a VAX. Our copy of VAX Blast II contained a misnamed file that wouldn't allow VMSINSTAL to complete. Therefore, we BACKED up the tape to disk and ran the command files provided with the media to define the required logical and symbol names.

The VAX version requires that a communications port be assigned the logical name BLAST_PORT. The chosen port should be the one most often used for communications. It's recommended that you change the SYSGEN parameter TTY_ALTYPAMD to 512.

Blast II's screen- and menu-driven interface for the VAX and PC versions resembles that of Lotus 1-2-3. Blast II controls its operations by using setup files that determine the parameters of the

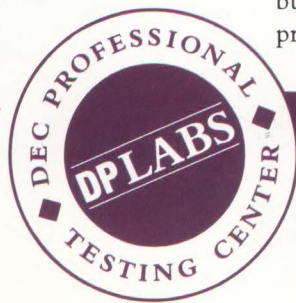

DAVID B. MILLER

"Advantage yours."



Out on the court, you have to be fast, you have to be versatile and you have to be able to really connect.

All of which, not coincidentally, are qualities of C. Itoh's remarkable new MegaServe Ion Deposition Printer.

A stroke of genius.

You want fast? The MegaServe serves up top-quality hardcopy at 30 or 45 pages per minute. You want stamina? How does a quarter-million pages a month sound? You want finesse? The MegaServe produces text and graphics with resolution up to 300x300 dots per inch.

And despite its star qualities, the MegaServe performs all that and more for less than two cents a page.

Great connections.

The MegaServe's standard interfaces

include Dataproducts parallel or Centronics parallel, SCSI, RS-232 and RS-422. So it will work — without missing a stroke — on almost any current system. For Ethernet systems, the MegaServe even has both interfacing hardware and host software.

With its Postscript interpreter and scalable fonts, MegaServe is perfect for both single-user and network applications. And for the ultimate in compatibility, it even emulates the DEC® LN03 Plus, the H-P LaserJet II®, the Diablo® 630 ECS and the Tektronics® 4014.

Top seed.

The MegaServe keeps 43 fonts resident; a built-in Winchester disk manages Postscript fonts and can endow any of them with attributes ranging from

bold or underline, to shadow, faint and reverse print.

And, of course, the MegaServe is guaranteed for a year and backed by service centers nationwide.

Call your C. Itoh distributor. And get the MegaServe advantage.

**Call (800) 227-0315 Ext. 4450
or (714) 757-4450**

for the C. Itoh distributor nearest you.

C. ITOH

C. Itoh Electronics, Inc.

2505 McCabe Way, Irvine, CA 92714

We build more in. So you get more out.

CIRCLE 231 ON READER CARD

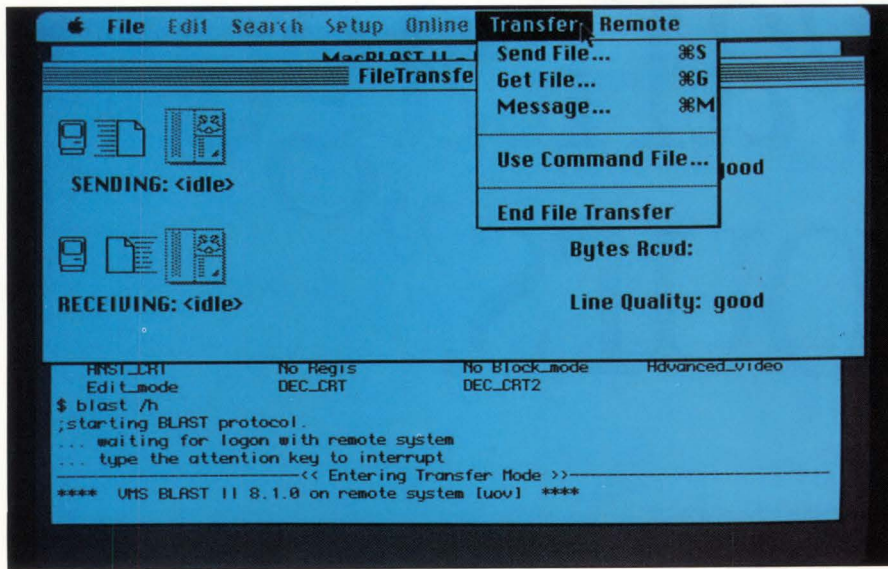

Figure 1: The FileTransfer screen of the Mac version of Blast II shows how Blast II uses pull-down menus and the mouse.

communications session. A sample setup screen for PC Blast II is shown on page 100. You can create custom setups for your site. After starting Blast II, you can choose the setup you need to communicate with your host.

On-line help is available for all Blast II options. Pressing the help key while an option is highlighted produces help on that topic.

File Transfer

We used Blast II to transfer files between our Premium/286 PC and our VAXcluster.

File transfer is Blast II's forte. In addition to CRG's proprietary protocol, Blast II allows simple text file uploading and downloading for situations in which one of the two endpoint systems lacks Blast II. XMODEM also is supported.

For other types of transfer, including text, you need to choose the FileTransfer option of Blast II's ONLINE menu after logging in to your VAX host. A sample FileTransfer screen is displayed in Figure 1. The Blast II protocol can be used when both endpoint systems are running Blast II. When you choose the FileTransfer menu option in PC Blast II, for example, Blast II automatically is started on your VAX host.

Binary and text files can be transferred 100 percent error-free using Blast

II's protocol. Its full-duplex operation allows data to be transferred in both directions at the same time. Data compression techniques are employed to speed up transmission. Figure 2 shows sample transfer times attained between our PC and our VAXstation 2000. The PC was connected directly to the VAXstation 2000's serial port. Although not designed to be a benchmark, the Figure will give you some idea of Blast II's file-transfer capabilities.

Blast II's protocol is robust enough to handle noisy lines and even interrupted file transfers. Blast II didn't flinch when we pulled the plug, so to speak, on a file transfer by disconnecting the serial cable from the back of our VAXstation. The file transfer stopped, and Blast II waited until the connection was restored. Processing continued from the point of interruption with no problems.

I tried killing the Blast II process on the VAX from another VAX terminal while a file transfer was taking place. Blast II recorded how much of the file was transferred successfully. I created a new Blast II session on the VAX and attempted to restart the transfer. Blast II picked up where it left off and transmitted the remainder of the file as if nothing had happened. You only have to retransmit the entire file in cases of power failure and unexpected system crashes.

Scripts

Blast II provides a powerful and easy-to-use scripting feature. Scripts can be written to automate a variety of tasks, including system log in and file transfer.

Blast II's script language includes commands to access the package's menu functions, as well as a host of commands you'd find in traditional programming

Figure 2.

Baud Rate: 9,600 File: 250-block ASCII file			
Packet Size	7/8-Bit Mode	VAX to PC	PC to VAX
84	7	1 min. 59 sec.	2 min. 02 sec.
256	7	2 min. 22 sec.	2 min. 35 sec.
512	7	2 min. 01 sec.	2 min. 43 sec.
84	8	2 min. 01 sec.	2 min. 08 sec.
256	8	2 min. 09 sec.	2 min. 25 sec.
512	8	2 min. 00 sec.	2 min. 26 sec.

Sample file-transfer times between our AT-compatible PC and VAXstation 2000.

The Authoritative Work On The Subject.

Accept this on good authority: spreadsheets run better on a VAX™ computer.

And when the spreadsheet is 20/20™, the leading spreadsheet for VAX computers, you can increase the degree of superiority by a factor of three.

Why three? Well, first of all, by running 20/20 on a VAX computer, you get better access to data. That's because you gain direct access to the data in your corporate database—with no knowledge of database languages required.

Secondly, with 20/20, you're better able to share data and models with other members of your organization. That's because everyone with access to the VAX has access to 20/20.

Finally, 20/20 supports standards better. Take ALL-IN-1™ Office Software, for example. Our link with Digital's OA package is the tightest possible—a claim no personal computer spreadsheet can make.

We've developed a free booklet that explains why more than 15,000 computer sites worldwide depend on 20/20, and we'd very much like to send you a copy. For yours, just return the coupon below or phone 508-655-9191.

Think of the booklet as a continuing education course on the subject of increased productivity.

"I'd Like A Copy Of Your Booklet"

Please send me a free copy of your informative booklet, "Spreadsheets Run Three Times Better On A VAX Computer."

Name _____

Title _____

Company _____

Address _____

City _____ State _____ Zip _____

Phone _____

Model VAX _____

Mail to Access Technology, Two Natick Executive Park, Natick, MA 01760.
Or phone (508) 655-9191. DPA 6/89

Access
Technology
A CompuServe Company

20/20™

VAX and ALL-IN-1 are trademarks of Digital Equipment Corporation.

CIRCLE 250 ON READER CARD

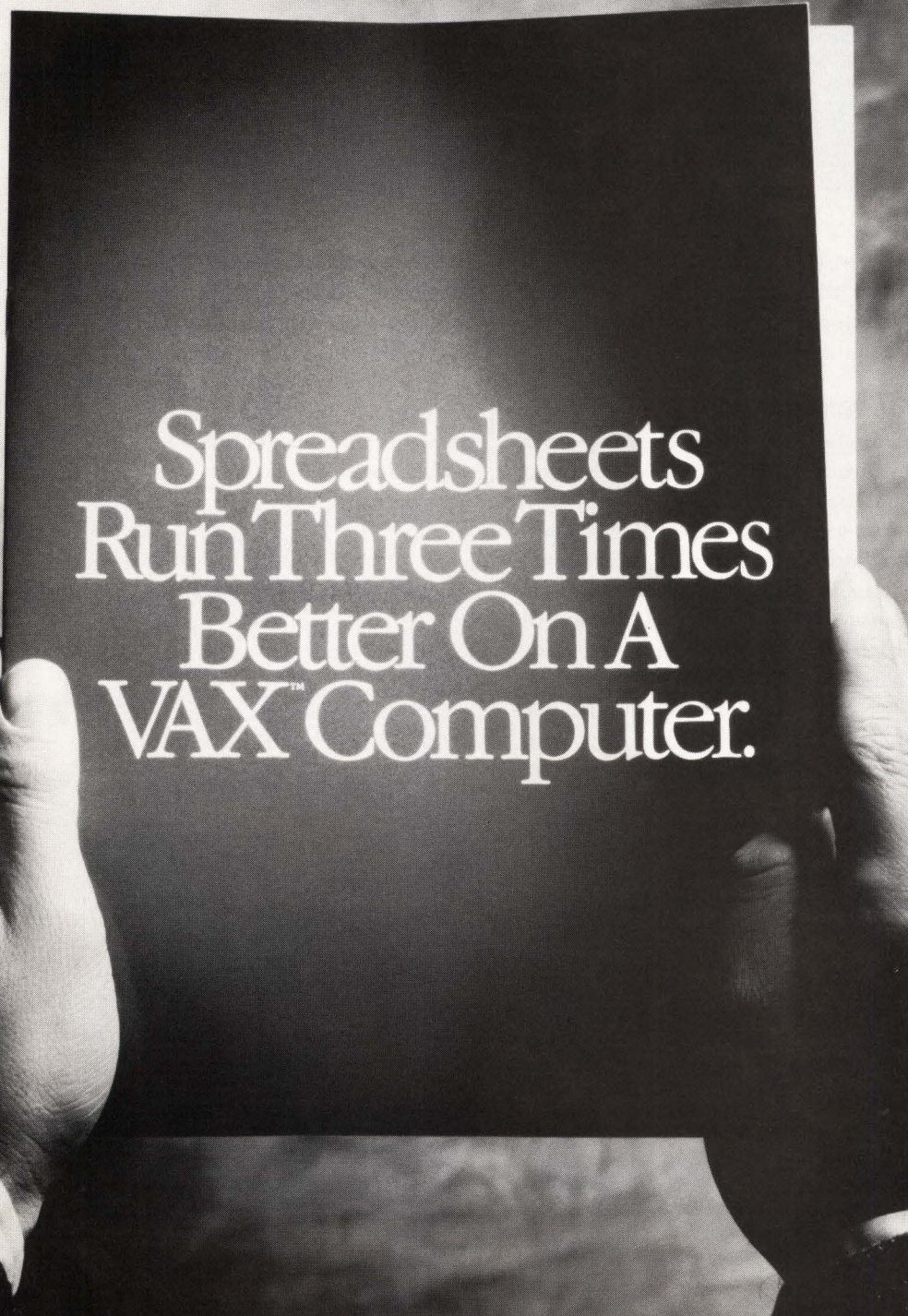

Spreadsheets
Run Three Times
Better On A
VAX™ Computer.

languages. The command set includes statements for string manipulation, file access, cursor addressing, use of variables and branching. In addition to tackling small tasks, you can develop sophisticated applications using Blast II's language. A simple example of a Blast II script that prompts you for file names and that initiates a file transfer is shown in Figure 3.

There's no need to exit Blast II to run a text editor to write script files. Blast II includes a MicroPro WordStar-like editor. In addition to the basic editing features, Blast II's editor includes cutting, pasting, pattern searching and text-replacement features.

For file transfers, an alternative to using a Blast II script is the error-free command file. Error-free command files employ a different syntax than that of script files. They're more limited in what they can do. However, they're useful for file-transfer functions. They can be called from script files or invoked manually through the Blast II menu system.

Terminal Emulation

Blast II offers a number of terminal emulations, including VT52, VT100 and VT220. VT220 emulation is the default.

We encountered problems using the VT220 emulator on our AST Premium/286. Characters were dropped and displays were generally a mess. However, running PC Blast II on another machine was successful. It turns out that AST has had some problems with its VGA card. AST is aware of the problem, which will be corrected in its next BIOS

Figure 3.

```
# A sample script to transfer files
ask "Are you sending or getting a file?? (S/G)", @sendget
ask "Enter options... T, O, A -->", @options
let @sure = "N"
.getfiles
  if upper @sure = "Y" then goto .filesok
  ask "Enter first file name -->", @firstfil
  ask "Enter second file name -->", @secfil
  ask "Are these names correct? (Y/N)", @sure
  goto .getfiles
.filesok
filetransfer          #access menu and transfer files
@sendget             #S or G
@firstfil            #source file
@secfil              #destination file
@options             #options - Text, Overwrite, Append
.goback
esc                  #return to Blast menu
```

A simple script file example. Blast II's script language is robust enough to develop sizable applications.

release. If you have an AST microcomputer with an AST-VGA video adapter, you might want to contact AST about the problem.

Documentation

Documentation includes a *Getting Started* manual that describes Blast II's basics and provides a tutorial chapter. A *Communications Concepts* guide is helpful to those not familiar with data communications. A *Blast II Concepts and Reference Manual* supplies more information on Blast II commands and its script language.

CRG provides a free tutorial dial-in service. New users can follow along in the *Getting Started* manual as they work through Blast II's menus and get familiar with its workings.

BLAST II'S MAJOR strengths are its file-transfer functions and its robust scripting language. Further, it can run on a number of platforms. Anyone who does a lot of file transfers on a regular basis and who wishes to automate the process with a minimum of fuss should take a close look at Blast II.

Blast II

PLATFORMS: A variety of platforms including VAX/VMS, IBM PCs and compatibles and Macs

PRICE: PC Blast II — \$250 to \$495, depending on configuration. VAX Blast II — \$595 to \$2,495, depending on CPU and operating system. MacBlast — \$195

COMMUNICATIONS RESEARCH GROUP INC.

HEADQUARTERS:

5615 Corporate Blvd.
Baton Rouge, LA 70808
(504) 923-0888

FOUNDED: 1980

PRODUCT LINE: Communications products for a number of hardware vendor platforms

OWNERSHIP: Private

BRANCHES: London

CIRCLE 455 ON READER CARD

Companies Mentioned In This Article

Apple Computer Inc.
20525 Mariani Ave.
Cupertino, CA 95014
(408) 996-1010

CIRCLE 401 ON READER CARD

AST Research Inc.
2121 Alton Ave.
Irvine, CA 92714
(714) 863-1333

CIRCLE 456 ON READER CARD

Digital Equipment Corp.
146 Main St.
Maynard, MA 01754
(508) 897-5111

CIRCLE 403 ON READER CARD

IBM Corp.
Old Orchard Rd.
Armonk, NY 10504
(914) 765-1900

CIRCLE 407 ON READER CARD

Lotus Development Corp.
55 Cambridge Pkwy.
Cambridge, MA 02142
(617) 577-8500

CIRCLE 408 ON READER CARD

MicroPro International Corp.
33 San Pablo Ave.
San Rafael, CA 94903
(800) 277-5609

CIRCLE 473 ON READER CARD

*"I edit with EDT.
That's why I use EDT+ when I move to
DOS or UNIX."*

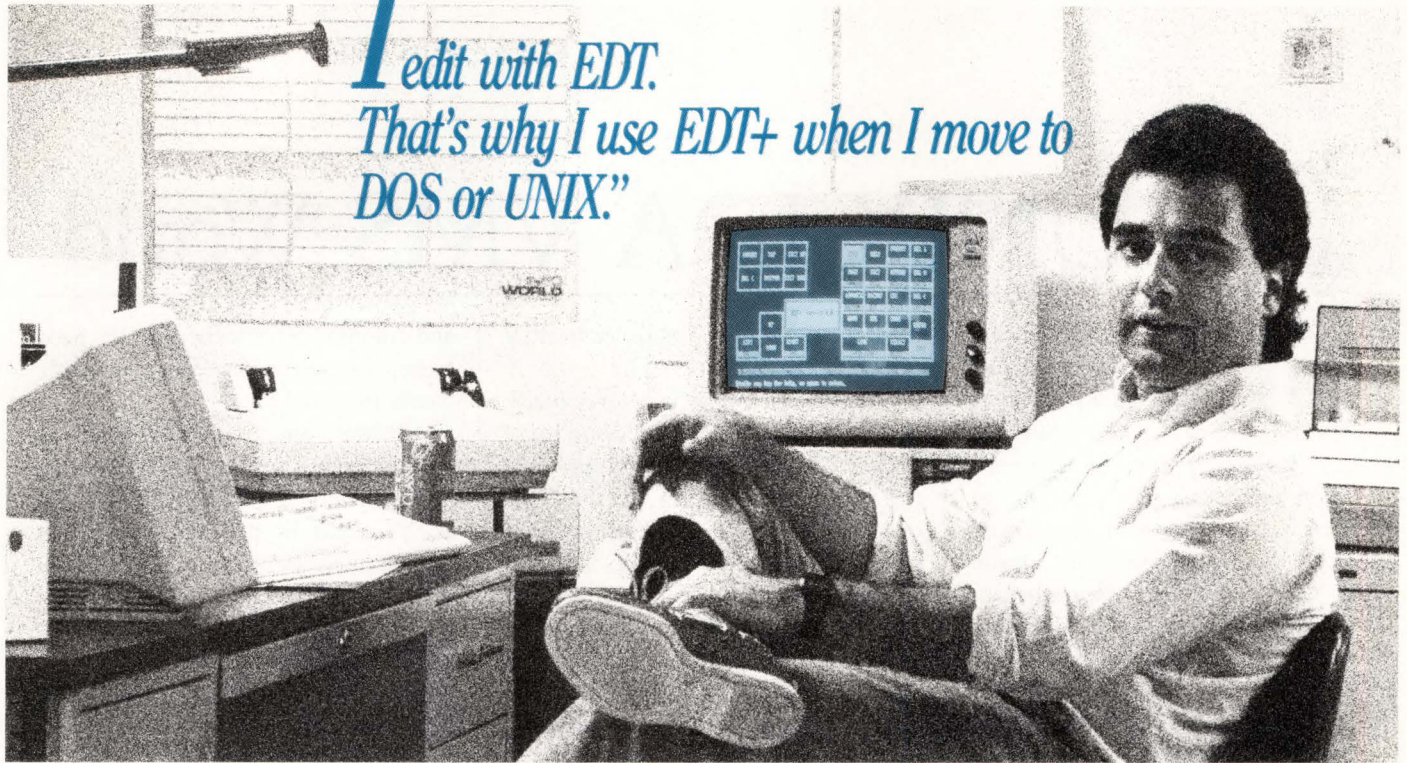

EDT users worldwide have discovered that EDT+ is a fully featured, faithful implementation of VAX EDT.

EDT+ features the exact gold keypad layout of EDT. All LINEMODE commands, journal files, command files, and command macros are supported plus user-defined keys and the extended character set. Every EDT+ function is implemented in keypad, nokeypad, and line modes.

Added performance features allow you to upload and download VAX files during EDT+ edit session, use environment variables at the system level to control file location, and execute system-level commands and other programs from within EDT+. Hardware support has been added for color monitors and non-DEC keyboards.

Use EDT+ when you move to the IBM PC, PC COMPATIBLES, SUN, HEWLETT/PACKARD, ENCORE, ALLIANT, GOULD, ALTOS, CONVERGENT, and to other UNIX systems.

EDT+ is \$295 for PC's and compatibles. If EDT is your editor and you move to DOS or UNIX systems, call or write us today for more technical information about EDT+.

BOSTON BUSINESS COMPUTING, LTD.

The DEC™ Compatible Software Company

Riverwalk Center • 360 Merrimack Street • Lawrence, MA 01843 • (508) 683-7920

VAX is a trademark of Digital Equipment Corporation. UNIX is a trademark of AT&T. EDT+ is a trademark of Boston Business Computing, Ltd.

CIRCLE 297 ON READER CARD

Philip E. Bourne, Ph.D.

UNIX In A VMS World

Editor's note: This is the first in a series of articles discussing

UNIX from the perspective of VMS users.

Although 1984 is only a memory to most of us, we know that the horrors predicted in George Orwell's classic novel never came true. Nevertheless, 1984 was the year in which the Orwellian concept of *Doublethink* — the power to hold two contradictory beliefs in one's mind and accept both of them — began to take hold.

The beliefs I refer to are VMS and UNIX. Both were available before 1984, but in that year DEC introduced ULTRIX version 1.0.

UNIX had been running on PDPs since 1969 and on VAXs since 1979. But those implementations were pretty much restricted to universities and sites where the low capital and operational cost of an operating system were more important than durability and a high level of support. DEC changed that for VAX users by offering a serious alternative to VMS.

In the non-DEC world, UNIX use was expanding rapidly. Fledgling companies such as Sun Microsystems adopted UNIX as the quickest and least expensive way to bring a product to market. As Sun and other companies like it grew, so did the popularity of UNIX. For many, the price/performance ratio of UNIX processors, particularly workstations and minisupercomputers, couldn't be ignored. This is still true.

This isn't to say that VMS and other vendors' proprietary operating systems are in danger of extinction. The size of the installed base, the level of quality control, the layered products available and the reluctance of some users to learn a new operating system are some of the

considerations that ensure a healthy future for VMS.

What this means is heterogeneity — a screen capable of displaying more than one type of default prompt, with the application dictating whether VMS or UNIX is the underlying operating system. Some may argue that the operating system is irrelevant, because user interaction is hidden behind a windowing interface common to UNIX and VMS. This may be, but many of us aren't content to look through the window

and compute from a distance. We need to step through and experience the inner world firsthand.

In the coming months, we'll explore this inner world of UNIX from the perspective of a VMS user. Topics will be discussed in the order in which they're likely to be encountered at the terminal.

VMS And UNIX

UNIX was written at AT&T Bell Laboratories in the early days of interac-

FIGURE .

	VMS	UNIX	UNIX Function
Editors	EDT TECO TPU	ed ex vi	Line editor Line editor Screen editor
Communications	MAIL REPLY PHONE DECNET*	mail write talk ftp telnet "r command(s)"	Electronic mail Send messages Interactive communications Remote file transfer Remove logins Remove command execution
Compilers	FORTRAN* C*	f77 cc	Compile FORTRAN code Compile C code
Text Processing	RUNOFF SORT MERGE	troff nroff eqn tbl awk lex sed sort merge	Typesetting Word processing Equation formatting Table formatting String handler Lexical analyzer Stream editor Sort files Merge files
Program Development Tools	LINK DEBUG LIBRARIAN SCA* DEC/MMS* DEC/CMS*	link adb/dbx ar/ranlib prof make yacc scs	Linker Debugger Maintain libraries Profiler Maintain independent files Lexical analyzer Revision control system
Miscellaneous	DECalc* DECspell* DECgraph*	bc/dc spell graph plot	Calculator Spell checker Simple plotting

* Available as optional products from DEC

UNIX and VMS functionality compared.

yet another... concerned about the competitive... U.S. business in global markets. The new occupant of the Oval Office can exert a powerful influence over the course of events. But it is Congress that appropriates, whether

some 400 robotics... joint AIAA/NASA First International Symposium on Space Automation and Robotics in Washington. "We

1990... you consider NAS

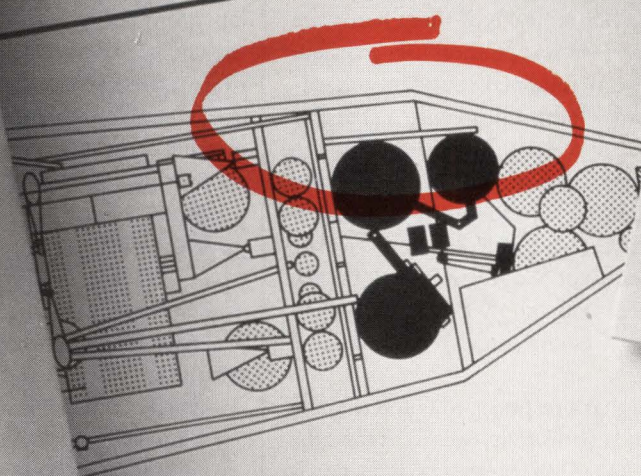

Figure 2-5

WRONG!!
*Where are
the latest
changes?*

If it's not up to date, you're dead in the water.

When preparing compound documents, you can't afford to have an outdated graphic, especially if you're preparing timely reports, proposals or specs.

That's why you've been hearing so much about live links. There's a good reason. Live links are the revolutionary way to guarantee that your document will include the most recent data.

DEC's new Compound Document Architecture® specifies live links between text, data and graphics. The Department of Defense's new CALS initiative specifies live links, too.

And live links save disk space by providing pointers to the graphics rather than physically embedding the graphics in the documents.

MASS-II® provides live links *now*, is integrated with ALL-IN-1® and works identically on the VAX and PC.

That means you can use MASS-II to submit proposals to the DoD (and be CALS compliant). And, you can be assured MEC will fully support DEC's CDA. We were an early endorser.

MASS-II's live link architecture will save you time, money and disk space. And, you're going with a winner. MASS-II is the leading independent word processor for the VAX. To find out more, call MEC at 312-882-0111.

Microsystems Engineering Corporation, 2400 W. Hassell Road,
Hoffman Estates, IL 60195
312-882-0111.



The world is moving to MASS-II

MASS-II is a registered trademark of Microsystems Engineering Corporation.
Compound Document Architecture and ALL-IN-1 are registered trademarks of Digital Equipment Corporation.

CIRCLE 170 ON READER CARD

tive computing as an aid to skilled programmers. It wasn't intended to become a commercial product. Conversely, VMS was written to sell VAX computers used by novices and skilled programmers. The difference in the audiences for which each operating system was intended is still obvious. For example, the complexity of UNIX can be intimidating to the novice programmer. So why its sudden popularity?

The major reason stems from the decisions of Ken Thompson and Dennis Ritchie to rewrite the assembly language version of UNIX in the high-level C language. This unprecedented step didn't seem important in the 1960s and early 1970s. Computers were very expensive and were used for specialized applications by very few people. It was advantageous for the vendor to use a specialized operating system.

However, the advent of the mini-computer, PC and workstation changed

that situation fundamentally. UNIX, written in a high-level language, was ported easily to each of these hardware types, and thus a common user interface could be maintained. Suddenly, hardware was being tailored to particular types of applications, each needing to exchange information. UNIX was poised to become a major player in the connectivity game. TCP/IP, developed at the University of California at Berkeley, permitted fast communications between UNIX processors connected to the same Ethernet.

Digital's response to tailored hardware and connectivity was to expand the line of VAX/VMS processors and to provide DECnet. Users now could move easily among processors and had the benefit of a common user interface.

However, VAX/VMS now faces a different problem: speed. Because UNIX is written in a high-level language, it's easily ported to the latest innovations in

hardware technology.

The performance price you pay for operating in a high-level language is small compared to the advances in hardware technology. UNIX runs on sequential, vector, multiprocessor, massively parallel and RISC-based hardware. VMS, in contrast, is hardware dependent and restricted to the sequential and multiprocessor VAX architecture.

VMS has been subjected to strict project management. A major update has been released every two years, each bringing some major enhancement. Similarly, there have been three or four minor upgrades every year, each providing bug fixes and support for new hardware. This has resulted in a stable, predictable and consistent product.

Conversely, UNIX has undergone far less project management. An original design goal was to make it modular, thereby encouraging programmers to

Don't tax your VAX.[®]

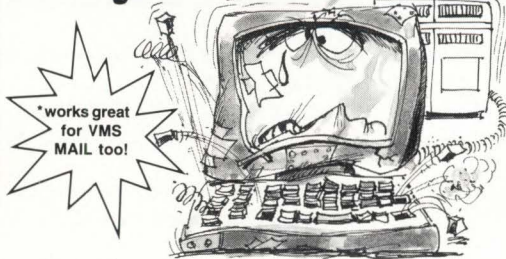

Let it relax.

You will too, when you standardize with **Mail Call[™]**, the E-Mail "front-end" software for ALL-IN-1[®] systems that lets PC subscribers work off-line 95% of the time. So long to sapping the power of your VAX. Bye-bye to back-ups and bottle-necks. Connect just for pick-up and delivery. **Mail Call**. At one low fee for unlimited PC subscribers (you *don't* pay as you grow). "Snail crawl" or **Mail Call**. You choose. Then call 1-800-2-MAIL-22 today for more information.



Corporate Software to extend your VAX-ALL-IN-1 System*

Cappcomm Software, Inc. • 26 Journal Square, Suite 1003 • Jersey City, NJ 07306
1-800-2-MAIL-22 • In NJ call 1-201-795-1500 • Telex 467632

CIRCLE 323 ON READER CARD

DON'T GET ZAPPED!

High inrush current can **destroy** your sensitive VAX CPUs and peripherals in less time than it takes to flip a switch.

THE SOLUTION?

Power up with **Z-LINE TPC 115-10 MTD[™]** the smallest power distribution and control system available.



POWER UP WITH

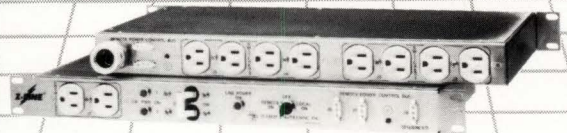

Our proprietary **Multiple Time Delay[™]** circuitry **sequences** your power-up to **protect** your systems from the spikes and surges that **destroy your hardware and erase your data**. And our remote on/off and emergency shutdown **gives the power control back to you**.

All Pulizzi Engineering MTD[™] controllers are **compatible with DEC and UPS systems**.
PRICED FROM \$436 TO \$305

DON'T WAIT UNTIL IT HAPPENS, CALL TODAY!

See us at **INTERCONN Booth #533**
PULIZZI ENGINEERING INC.

3260 S. Susan Street Santa Ana, CA 92704-8865 (714) 540-4229 FAX (714) 641-9062

CIRCLE 252 ON READER CARD

VAX 8830

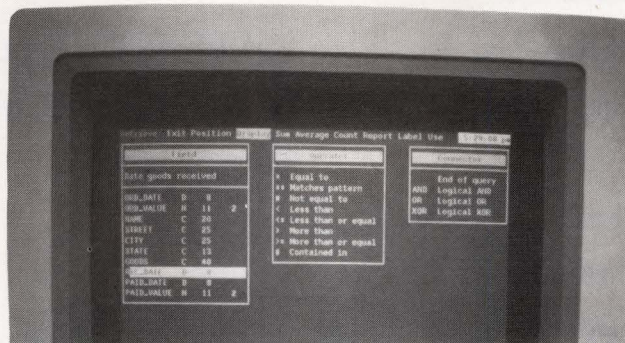

Now dBASE users have someplace to grow.



When PC users need more power, now they can have it. Recital™ is the first RDBMS and 4GL for VAX systems that's totally upward-compatible with Ashton-Tate's dBASE.™ It's also compatible with Clipper™ and FoxBASE.™ So you can move applications and associated data directly from PC to VAX/VMS.™ Maintain and modify your applications using the same familiar syntax and commands.

No retraining and no reprogramming. Recital runs on UNIX systems, too.

You give yourself a whole new growth path. Solve your connectivity problems. Integrate your information processing. Protect your software investment. In short, you achieve all the benefits of a LAN solution, without the limitations.

And Recital includes tools like a report writer, screen painter, transparent access to RMS files, an integral data dictionary, popup calendars, calculators, pick lists, note pads and much more. All on a VT-type terminal! All without any additional programming or modifications to existing dBASE applications!

Try our 30-day license. Our special 30-day license gives you the full Recital system to use for an entire month. It's so compatible you'll have it running in an hour. The rest of the month, it just grows on you. To order your 30-day license, contact Recital Corporation, 85 Constitution Lane, Danvers, MA 01923. Telephone (508) 750-1066.

Recital
CORPORATION

The first dBASE-compatible RDBMS for VAX.

Why the most productive toolset for Rdb™ and Oracle™ databases comes from Cullinet.

It's the development toolset for the VAX™ environment from Cullinet—

Enterprise:Builder™ and Enterprise:Generator™. A toolset so powerful, it gives you an amazing **30:1 productivity advantage**

over 3GL toolsets.

Plus a **10:1 advantage**

over 4GLs. As

if that weren't enough,

Enterprise: Generator also

gives you the vendor

independence

you need to

develop

applications

for any platform, independent of

hardware, operating system, program-

ming language or database. And you

can automatically generate bug-free

code in Cobol, C, BASIC or Fortran

for applications that will outperform

4GLs. So, **call 1-800-551-4555 now**

for seminar information. (In MA, call

617-329-7700, Ext. 2135.) Then get ready

for a development toolset you can build on. And on. And on.

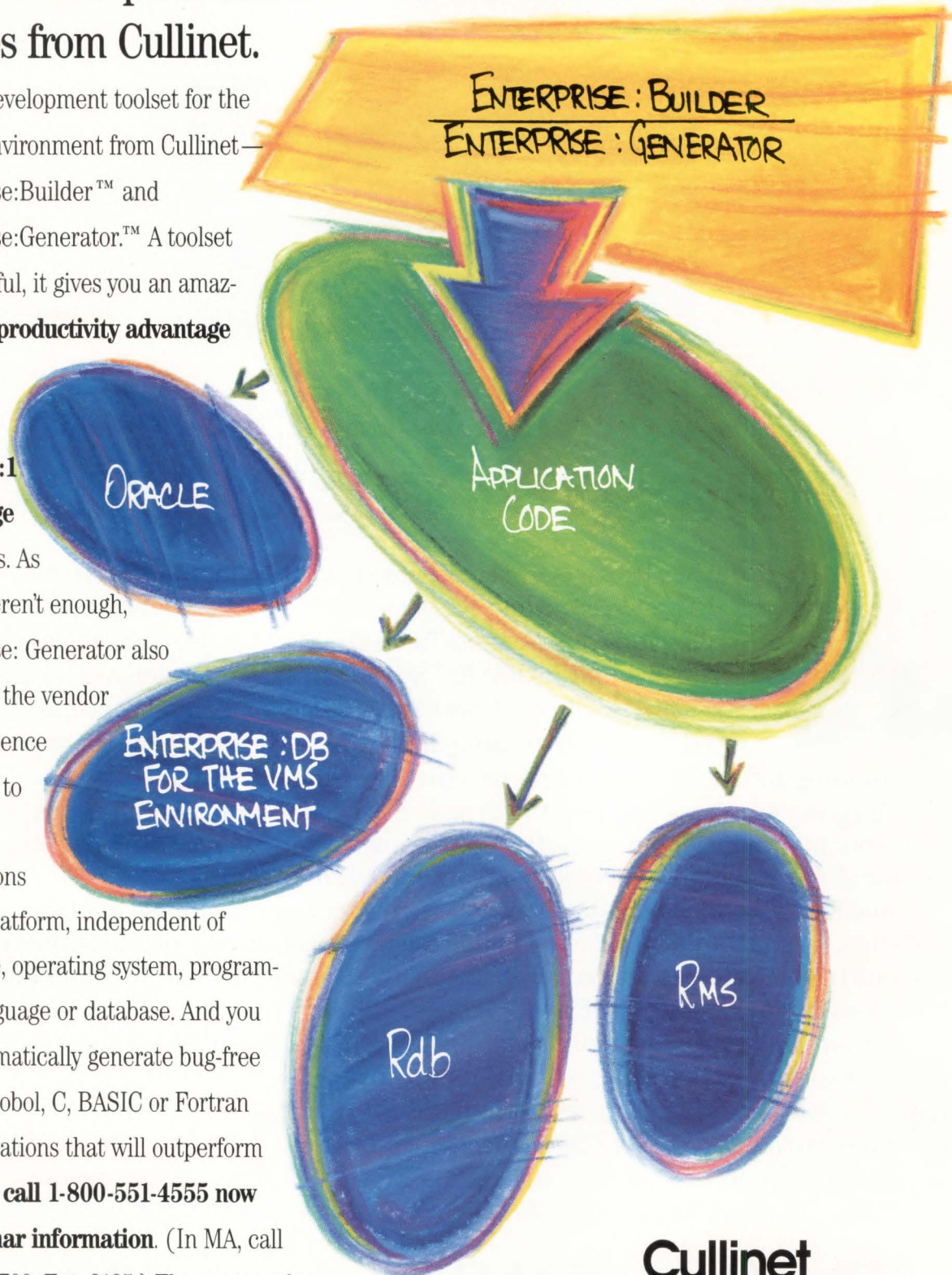

Cullinet
The Power To Build On.
digital™ Cooperative
Marketing
Program

See the industry's most productive VAX toolset at the Cullinet Seminar nearest you.

Attend this new Cullinet seminar, and in just two hours, you'll see for yourself how easily you can build production applications on the Enterprise:Builder and Enterprise:Generator toolset. It's a small investment in time that will change your company's programming power forever.

Take home a free demonstration toolset.

All you have to do is attend the seminar nearest you, and you'll receive a free, single-user, runtime copy of Enterprise:Generator and Enterprise:Builder complete with documentation and video tutorial. So don't miss out. Call us toll free, and make your reservation today.

Call 1-800-551-4555 for your reservation. (In MA, 617-329-7700, Ext. 2135.)

• Boston, MA	5/25
• Orange County, CA	6/1
• City of Industry, CA	6/2
• Washington, DC	6/6
• Santa Clara, CA	6/6
• St. Louis, MO	6/7
• Dallas, TX	6/13
• Cleveland, OH	6/14
• Hartford, CT	6/14
• Minneapolis, MN	6/20
• Oakland, CA	6/20
• Philadelphia, PA	6/20
• Miami, FL	6/21
• New York, NY	6/21
• Ottawa, ONT	6/21
• Chicago, IL	6/22
• Cincinnati, OH	6/27
• Denver, CO	6/27
• Detroit, MI	6/29
• Valley, CA	7/11
• Toronto, ONT	7/12
• Houston, TX	7/13
• Milwaukee, WI	7/13
• Pittsburgh, PA	7/13
• Atlanta, GA	7/18
• Long Island, NY	7/18
• Indianapolis, IN	7/19
• Montreal, QUE	7/19
• Boston, MA	7/20
• Charlotte, NC	7/20

Cullinet[®]
The Power To Build On.

include their own code. Code introduced in this way added functionality but wasn't necessarily consistent. Several modifications were substantial enough to have evolved into separate versions. Today we have Berkeley BSD 4.3, UNIX version 9 from Bell Labs, and AT&T System V release 3. We soon can expect to see a version of UNIX from the Open Software Foundation (OSF) and a new release of AT&T System V.

The multiplicity of UNIX versions is further complicated by the availability of different shells. The shell is UNIX parlance for the equivalent of the VMS command language interpreter. Whereas the VMS user is restricted to DCL (and possibly RSX-compatibility mode), UNIX offers three common shells: the Bourne shell (sh), the C shell (csh) and the Korn shell (ksh). The abbreviations sh, csh and ksh are the program names for the shells.

The Bourne shell is the original and simplest of the shells and is available with all versions of UNIX. The C and Korn shells are enhanced shells originally written for BSD and System V, respectively. Today, the C shell is available for System V and the Korn shell is available for BSD. Such diversity is alien to a VMS user. However, in the early stages of UNIX use (provided the VMS user stays with the same shell), little difference is likely to be noticed in moving from one UNIX version to another. Rather, the major hurdle for the VMS user is the distinctly different look and feel of UNIX.

Each version of UNIX now may be regarded as stable, i.e., unlikely to crash the computer on a regular basis. But is UNIX predictable, secure and consistent? Definitely not. Idiosyncracies in the UNIX operating system result from it never having had the strict project management that's applied to commercial products.

Differences

UNIX command syntax isn't consistent, nor do command names necessarily bear any resemblance to function. Examples of the latter are: **cat** (catenate and print

— compare the VMS TYPE command); **grep** (global regular expression print — compare the VMS SEARCH command); and, last but definitely not least, **biff**.

Examples of inconsistent command syntax are found in the UNIX command options. UNIX commands have options, just as VMS commands have qualifiers. Both modify the action of the command. UNIX options are usually, but not always, represented by a single lowercase letter. For example, **o filename** (compare the VMS /OUTPUT=filename qualifier) redirects output to filename rather than the terminal for some commands. An exception is **of filename** used by the command **dd** (compare the VMS EXCHANGE command). Analogously, the **o** option for the **od** command (compare the VMS DUMP command) causes the contents of an input file to be translated into octal rather than be redirected to an output file.

Another characteristic of UNIX that's irksome to the VMS user is the uninformative error-reporting features of both the shell and the many programs that make up the command set. For example, "Bailing out at line so and so..." as the only error-reporting feature of the **awk** utility, a complex string handler, isn't that helpful. But at least you know approximately where to look in the code for the error. (A utility is arbitrarily distinguished from a command by its complexity. For example, UNIX mail [compare VMS MAIL] is considered a utility, having many sub-commands.)

Worse is struggling with a complex line. Each time the line is parsed by the shell, a vaguely helpful error message is returned. Finally, when no error message is returned, you breathe a sigh of relief, only to realize that the command still hasn't worked and the shell has failed to return any error message.

UNIX doesn't have structured error reporting (*%facility-l-ident, text*). For example, *%DCL-W-IVVERB, unrecognized command verb — check validity and spelling* is self-explanatory. Nor does UNIX have a manual such as the *VMS System*

Messages and Recovery Procedures Reference Volume, in which reported errors may be referenced for a fix to the problem.

To the VMS user, inadequate error reporting is part of a larger problem: how to find an answer to any UNIX question. At least the ULTRIX documentation set covers three feet of shelf space and has a general index, in both respects exceeding many other versions.

However, the basic problem facing

the VMS user is the format of the documentation, which hasn't changed since the early releases. Explanations are terse and examples are lacking. On-line help is confined to versions of the manual pages without the VMS LIBRARIAN to locate appropriate topics easily.

To poke fun at these shortcomings is unfair. Some of the beauty of UNIX most likely would have been lost if the

creative minds had been stifled by strict project management.

The software that has been added to UNIX over the years may not be totally consistent, but it must be regarded as comprehensive, powerful and often elegant. Some of this software, part of the standard UNIX distribution, is available to the VMS user as layered products requiring a separate license and thus financial outlay.

The **make** utility is a good example. This utility maintains a group of files that are in some way dependent on each other. It has many uses, the most common being the maintenance of large programs. The executable image is dependent on a number of object files, which in turn are dependent on a number of source-code files. These routines are maintained with **make**. When a change is made to one or more routines, **make** remembers which ones need to be recompiled to produce a current executable image, reducing compile time significantly. The **make** utility is part of every UNIX distribution but must be purchased as the layered product DEC/MMS by the VMS user.

THE FIGURE ON PAGE 106 summarizes the components of the UNIX operating system and indicates the equivalent VMS component or layered product. Let's put each UNIX component in perspective. **Editors** — UNIX editors, like UNIX, were designed to be generic. This is good and bad. It's good because the UNIX **vi** full-screen editor functions on

Problems with spelling? You need V3.0 of WPS-PC!

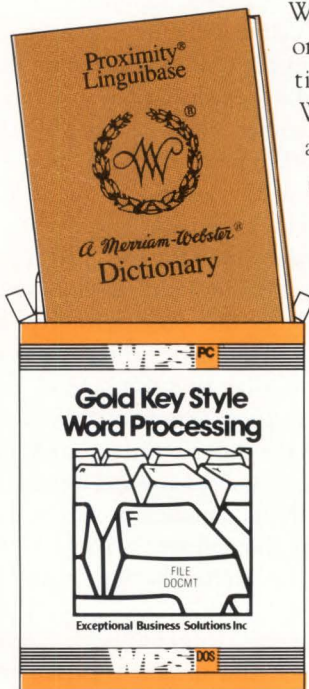

WPS-PC Version 3.0 now offers an interactive, on-line speller based on the 80,000 word dictionary from Proximity/Merriam-Webster. While editing a document you can spell-check a single word, part of the document or the entire document. If you misspell a word, WPS-PC offers you a list of correction words in a window within the document. A single keystroke replaces the misspelled word with a correctly spelled word from the list.

WPS-PC word processing gives you familiar DECmate Gold Key word processing features on the entire family of MS-DOS computers — PC/XT/AT, PS/2, compatibles and laptops.

WPS-PC transfers your fully formatted DECmate and WPS-PLUS documents to the PC. DECmate document diskettes are read directly on AT compatible computers; other PC models use DX transfer.

WPS-PC supports all popular PC printers (serial or parallel) including the HP LaserJet and the DEC LN03. Multiple fonts can be used in the same document and you can print one document while you edit another.

And it only costs \$275.

Call us for information on a FREE demo.

Exceptional Business Solutions Inc.

10811 Washington Boulevard · Suite 240 · Culver City · California 90232-3658
Phone 213-558-3435 FAX 213-558-3466

WPS-PC and WPS-DOS are trademarks of Exceptional Business Solutions, Inc. all other product names are trademarks of their manufacturers.

CIRCLE 281 ON READER CARD

Companies Mentioned In This Article

AT&T
550 Madison Ave.
New York, NY 10022
(212) 605-5500
CIRCLE 466 ON READER CARD

Boston Business Computing Ltd.
360 Merrimack St.
Lawrence, MA 01843
(508) 683-7920
CIRCLE 400 ON READER CARD

Sun Microsystems Inc.
2550 Garcia Ave.
Mountain View, CA 94043
(415) 960-1300
CIRCLE 536 ON READER CARD

DEC PROFESSIONAL

digital™

Save up to

17%



Call 1-800-DIGITAL to save
on our printers and terminals.

Now, save up to 17% when you order terminals and printers from DECdirect. Your standard corporate discounts apply and most DECdirect orders will be shipped to you by the end of the next business day. For complete listings of printers and terminals subject to special savings, see reverse. Remember, these special prices are available only when you call 1-800-DIGITAL and reference Source Code BW.

Digital
has
it
now.

Call 1-800-DIGITAL to order these printers and terminals at special prices.

Order No.	Description	List Price	DECdirect/ Electronic Store ¹	Fill-the-Ports Quantity (DL) ²	Min. Qty. Required
VT320-AA/BW	VT320 white phosphor, std. keybd. (N. American)	\$575	\$525	\$495	50
VT320-BA/BW	VT320 green phosphor, std. keybd. (N. American)	\$575	\$525	\$495	50
VT320-CA/BW	VT320 amber phosphor, std. keybd. (N. American)	\$575	\$525	\$495	50
VT320-DA/BW	VT320 white phosphor, WPS keybd. (N. American)	\$575	\$525	\$495	50
VT320-EA/BW	VT320 green phosphor, WPS keybd. (N. American)	\$575	\$525	\$495	50
VT320-FA/BW	VT320 amber phosphor, WPS keybd. (N. American)	\$575	\$525	\$495	50
VT320-GA/BW	VT320 white phosphor, std. keybd. (Multinational)*	\$625	\$575	\$545	50
VT320-HA/BW	VT320 green phosphor, std. keybd. (Multinational)*	\$625	\$575	\$545	50
VT320-JA/BW	VT320 amber phosphor, std. keybd. (Multinational)*	\$625	\$575	\$545	50
VT320-NA/BW	VT320 white phosphor, WPS keybd. (Multinational)*	\$625	\$575	\$545	50
VT320-PA/BW	VT320 green phosphor, WPS keybd. (Multinational)*	\$625	\$575	\$545	50
VT320-RA/BW	VT320 amber phosphor, WPS keybd. (Multinational)*	\$625	\$575	\$545	50
VT330-AA/BW	VT330 white phosphor, std. keybd.	\$1995	\$1795	\$1695	25
VT330-BA/BW	VT330 green phosphor, std. keybd.	\$1995	\$1795	\$1695	25
VT330-CA/BW	VT330 amber phosphor, std. keybd.	\$1995	\$1795	\$1695	25
VT330-DA/BW	VT330 white phosphor, WPS keybd.	\$1995	\$1795	\$1695	25
VT330-EA/BW	VT330 green phosphor, WPS keybd.	\$1995	\$1795	\$1695	25
VT330-FA/BW	VT330 amber phosphor, WPS keybd.	\$1995	\$1795	\$1695	25
VT340-AA/BW	VT340, std. keybd.	\$2795	\$2595	\$2495	25
VT340-DA/BW	VT340, WPS keybd.	\$2795	\$2595	\$2495	25
LA75-CA/BW	LA75 Companion Printer	\$895	\$795	\$745	25
LA75P-CA/BW	LA75P parallel Companion Printer	\$895	\$795	\$745	25
LA210-AA/BW	Letterprinter 210 (w/forms tractor)*	\$1795	\$1595	\$1495	25
LJ250-CA/BW	Serial interface Companion Color Printer	\$1895	\$1695	\$1595	25
LJ252-CA/BW	Parallel Companion Color Printer	\$1895	\$1695	\$1595	25
LN03-AA/BW	LN03 laser printer	\$3195	\$2895	\$2795	10
LN03S-AA/BW	LN03 PLUS laser printer with full bit-map graphics	\$4295	\$3995	\$3895	10
LN03R-AA/BW	LN03 ScriptPrinter	\$5595	\$5233	\$4995	10

¹Applies to products purchased through 800-Digital or Digital's on-line electronic ordering system. No order number prefix is necessary to order, e.g. 10 VT320-AA.

²Applies to products purchased on the same purchase order with systems, CPU upgrades or terminal servers or in the minimum quantity specified. Orders with quantity pricing must have only one "ship to" location. To order, use a DL-prefix ahead of the order number, e.g. 5 DL-VT320-AA (for Fill-the-Ports) or 50 DL-VT320-AA (for Quantity).

*Shipped within 30 days.

a variety of terminals — unlike VMS EDT, which requires a VT series terminal or compatible. It's bad because the editor takes no advantage of the special features of certain terminal types. VMS users migrating to UNIX might consider EMACS, a public-domain programmable editor available for most versions of UNIX. Also, Boston Business Computing offers a native EDT emulation for most versions of UNIX.

Communications — UNIX includes software for networking; VMS requires that the user purchase a separate DECnet license. The major difference in networking software is that UNIX has the "r commands," which permit a user with access privileges to execute a command on a remote computer. To do this in VMS is more cumbersome, except in the case of a local command that accesses a remote file.

Network File System (NFS) was developed and is freely licensed by Sun Microsystems and is available for most versions of UNIX. NFS typifies the UNIX approach: If enough users like it, then it becomes a de facto standard. ULTRIX includes NFS at no extra cost. Other hardware vendors may require you to purchase an additional license. NFS functions much like a Local Area VAXcluster (LAVc). Where a file resides in a distributed environment of processors is irrelevant, because it's accessible via Ethernet as if it were resident on a physical device attached to the local computer.

Compilers — Most versions of UNIX come with high-level language compilers. For example, FORTRAN, PASCAL, LISP and C compilers are included with ULTRIX. As in the case of the UNIX editors, this is both good and bad. Code written for these compilers will run on any version of UNIX that supports them. Thus, code is portable across hardware types. However, the compilers take no advantage of hardware peculiar to a hardware vendor. Hence, these compilers are always slower than native compilers, if not at compiling code, then certainly at running it. The original Berkeley C compiler and VAX C are distributed with ULTRIX.

Text Processing — Prior to the introduction of the PC in the early 1980s, UNIX was renowned for its text processing tools. In the early days of UNIX development, much programmer energy was spent on text processing tools in an attempt to attract the attention of the Bell Laboratories management.

Like most other components of UNIX, the text processing tools that resulted were powerful but not easy to use. The only advantage they have over today's desktop publishing software and hardware, as is true of Digital Standard Runoff (DSR), is that they're a giveaway with the operating system and they're portable. A **troff** or **nroff** file can be formatted using any version of UNIX.

Program-Development Tools — UNIX was developed for programmers. It isn't surprising, therefore, that the programming tools are comprehensive and powerful.

Miscellaneous — The remaining software items support the saying, "You get

what you pay for." The UNIX software in this category comes as part of the operating system, and it doesn't have the functionality or the ease of use of the VMS counterparts that must be purchased separately.

UNIX diehards are sure to have had their hackles raised by this discussion. Yet, this represents how many VMS users perceive UNIX at first encounter. This perception slowly changes as the power and elegance of UNIX unfold. Next month's discussion of the UNIX file system and UNIX processing exemplify this power and elegance.

Author's note: Any hints or kinks useful to VMS users grappling with UNIX will be received gratefully. Please send any information via e-mail to SYSTEM@CUMB.G.BITNET or pbourne@cunixc.columbia.edu. —Philip E. Bourne, Ph.D., is senior associate at the Howard Hughes Medical Institute at Columbia University and the author of UNIX for VMS Users, soon to be published by Digital Press.

DIGITAL HARDWARE FOR YOUR DISTRIBUTED COMPUTING SOLUTIONS

TriLogic, your total solution Digital Desktop Distributor. Whether building a DECnet*/ Ethernet local area network, expanding your system, integrating personal computing or adding workstations, TriLogic offers the required components, hardware and software.

COMMUNICATION & NETWORKING	NEW DESKTOP PRODUCTS
H4005* Ethernet Transceiver	DECstation 210* Intel 80286, 10MHZ
DSRVB-AA* RS232 Ethernet Communication Server	DECstation 316* Intel 80386, 16MHZ
DSRVB-BA* RS423 Ethernet Communication Server	DECstation 320* Intel 80386, 20MHZ
DELNI-BA* Allows up to eight Ethernet-compatible devices to be grouped together (not terminals)	VAXstation 3100* Model 30 Standalone Workstation Model 30 Networked Workstation Model 40 Server/Workstation
DEMPR-AA* Thin Wire Ethernet Multiport Repeater	DECstation 3100/3100S* 15" Monochrome, 8MB Diskless 19" Monochrome, 8MB Diskless 19" Monochrome, 16MB Diskless 19" Color, 8MB Diskless 19" Color, 16MB Diskless 19" Color, 16MB Internal RZ23
DESTA* Thinwire Ethernet station adapter	
DSRVs-CA* DEC Server 550	

800-346-2933
In PA 412-745-0200

*Are trademarks of Digital Equipment Corporation.

Call for Trade-In
Values on Your
Digital Equipment.

TriLogic

digital

Authorized Distributor

CIRCLE 186 ON READER CARD

Pointers, Part 1

Editor's note: This is the first of a three-part series that covers pointers. Although Mr. Jaeschke formally addressed this subject several years ago, much has happened

with the evolution of the ANSI C Standard, particularly in the area of defining a better vocabulary to describe pointers and their relationship with arrays. Whether you're a C novice or expert, this series will contain something new.

Pointers are powerful and easy to use, but without care they can make code unreadable, difficult to debug, unmaintainable and difficult to port to other systems. In short, pointers can provide a lot of capability and a lot of trouble. And if your system includes a symbolic debugger, you'll probably get to know it well at this time. The only way to really understand pointers is to use them repeatedly.

What Are Pointers?

Simply stated, a pointer is a variable that contains the address of another variable. If the address of a variable is stored in a pointer, the contents of that variable can be accessed indirectly through the pointer. Accessing an object via a pointer to it is known as dereferencing that pointer. That is, when you dereference a pointer, you get the value of the object it currently points to.

It's possible to implement many simple ANSI terminal escape sequences without using pointers. However, they're needed if we're to implement others. For example, to interrogate the terminal to see what the cursor's current line and column position are, we need to have a function return two values, the line and column. The problem is, a function only can return one value at most, and by default all scalars are passed in by value. To have a function give us more than one value, we must pass in arguments by address, allowing the function to deal directly with objects rather than copies of objects. In this case, we must pass in pointers to the variables into which we want the function to store the line and column values.

C always passes arrays by address. That is, when we use the name of an array as an argument to a function, the address of the first element in the array actually is passed by value. As such, a pointer to the first element is passed in. And because a string literal is implemented as an array of **char**, every example we've used of passing string literals to functions has involved the use of pointers. The first argument to **printf** is one common example.

We rarely are interested in the actual address of an ob-

ject. We simply store its address so we can get at it indirectly. In fact, objects having automatic storage duration may have different addresses each time they're created dynamically. This would be true for such objects defined in a function called recursively.

Let's look at a simple example to see how pointers are declared and used. The task is to define an **int** variable **var** and to store its address in a pointer **pvar**. Then, **var** will be accessed indirectly via **pvar**, and its value will be copied to another **int**, **newvar**:

```
#include <stdio.h>

main()
(
    int var = 10;
    int *pvar;
    int newvar;

    pvar = &var;          /* find var's address */

    newvar = *pvar;       /* access var indirectly */

    printf("Value of var is %d\n", var);
    printf("Value of newvar is %d\n", newvar);
    printf("Address of var is %p\n", pvar);
    printf("Address of pvar is %p\n", &pvar);
)
```

which produces the output:

```
Value of var is 10
Value of newvar is 10
Address of var is 364E:0FD2
Address of pvar is 364E:0FD4
```

The declaration **int *pvar;** declares **pvar** to be a pointer to an **int**. That is, at any time, **pvar** may contain the actual address (absolute or virtual, depending on your system) of an **int** object. However, at the time of declaration, we haven't said which particular **int** object it points to. Automatic objects have undefined initial values by default. Therefore, **pvar** initially points into the wild blue yonder. In fact, the "address" it contains may not even be part of our program's address space. On a real-memory machine (as opposed to virtual-memory machine), such a memory location may not even physically exist. Of course, this is irrelevant unless you try to access that possibly non-existent memory location. The rule, therefore, is to not dereference a pointer until it has been initialized to point to some predictable memory location and one you have appropriate access to.

THE NEW CAMINTONN CORPORATION ANNOUNCES A MEMORY PRICE BREAKTHROUGH!

**MICROVAX® III 16MB BOARDS
\$5,500.**

PLUS

CAMINTONN MAKES IT EASIER THAN EVER TO UPGRADE YOUR
MICROVAX III SYSTEM MEMORY WITH OUR NEW...

TRADE-IN PROGRAM

CALL US NOW TO FIND OUT WHAT YOUR MICROVAX 3xxx 8MB MEMORY
BOARD IS WORTH!

CREDIT WILL BE APPLIED TO THE PURCHASE OF A CAMINTONN CMX-1651
16MB MICROVAX III MEMORY MODULE.

OF COURSE YOU GET THE QUALITY AND RELIABILITY OF CAMINTONN
ENGINEERING AND MANUFACTURING, **PLUS** A FIVE YEAR WARRANTY
AND THE SECURITY OF OUR 24-HOUR LOANER/REPLACEMENT POLICY.

HURRY! THE SPECIAL DISCOUNT PRICE TRADE-IN PROGRAM IS SUBJECT
TO AVAILABILITY AND FOR A LIMITED TIME ONLY.

FOR FURTHER INFORMATION ON CAMINTONN'S COMPLETE LINE OF
Q-BUS, MICROVAX II & III MEMORY, COMMUNICATIONS AND LNO3/LNO3
PLUS/LNO3R® AND Adobe® PostScript® LASER PRINTER PRODUCTS...

CALL 1-800-843-8336 TODAY!

CAMINTONN is a registered trademark of the CAMINTONN Corporation. MicroVAX II & III, and LNO3, LNO3 PLUS, LNO3R are registered trademarks of Digital Equipment Corporation. Adobe and PostScript are registered trademarks of Adobe Systems, Inc. Copyright 1989 by CAMINTONN Corporation. All rights reserved.

Price/Performance leaders in memory
and communication products for the
DEC environment!

CAMINTONN
CORPORATION
2332-A McGaw, Irvine, CA 92714-4992
(714) 553-0247 FAX (714) 660-8063

The declaration `int *pvar` can be read in one of two ways, both of which are equivalent. You can read, “`pvar` is a pointer to an `int`,” or, “The contents of the location pointed to by `pvar` is an `int`.”

Note that a pointer declaration specifies the type of the object pointed to, in this case an `int`. Other than this, a pointer has no type of its own, per se. And after a pointer is declared, it may only point to objects of the specified type. Attempting to make `pvar` point to a `double`, for example, should cause a compilation error. (Many pre-ANSI compilers are lenient in this respect and freely permit the mixing of apples and oranges.) However, in systems programming it’s sometimes useful to be able to make a pointer point to arbitrary type objects. This is possible, although ANSI C requires it to be done overtly, as we’ll see later.

Like several other punctuation characters we’ve seen, `&` is used for different purposes. We’ve seen it used as the binary bit-wise AND operator (and in the `&=` assignment operator) and in the logical AND operator `&&`. It also can be used as a unary operator in the prefix position, as is the case in this example. The expression `&var` is read as “take the address of `var`.” (You can’t apply `&` to a variable declared with class `register`.) Therefore:

```
pvar = &var;
```

assigns the address of `var` to `pvar`, such that `pvar` now points to `var`. We don’t write:

```
*pvar = &var;
```

When we’re assigning an address to a pointer, such as in this case, the `*` must not be used. Because `var` is an automatic variable, its address isn’t known until run time. However, because `pvar` is also an automatic object, its initializer can be any run-time expression of the appropriate type. Therefore, we could have declared `pvar` as follows:

```
int *pvar = &var;
```

Although the `*` is part of the declaration of `pvar`, it takes no part in the initialization. The initializer always applies to the identifier being declared, in this case to `pvar`.

Assignment requires both operands to either have the same type or to be assignment compatible. In this case, `pvar` is declared to be a pointer to an `int`, and `var` is an `int`. By definition, the type of the expression `&var` is also “pointer to `int`,” so it’s compatible with `pvar`.

The statement `newvar = *pvar;` causes `pvar` to be dereferenced. That is, it takes the `int` value stored at the location `pvar` points to, and copies it to the variable `newvar`. The type of `newvar` is `int` and that of `pvar` is pointer to `int`. The unary `*` prefix operator is used to get at the object pointed to, indirectly and by definition, the expression:

```
*pointer-to-type-T
```

has type `T`. Therefore, `*pvar` has type `int` and its value can be assigned to `newvar` directly.

Perhaps the most difficult thing to remember when learning pointers is when to use or omit the `*` in pointer expressions. The `*` prefix operator should only be used when you wish to get at the object the pointer points to. If you wish to get at the value of the pointer, the `*` must be omitted.

If we omitted the `*` in the assignment of `newvar`, we should get a compilation error. However, many pre-ANSI compilers were very liberal and treated pointers and integral expressions as being assignment compatible. ANSI C doesn’t, and any attempt to do so will result in a compilation error. If your compiler doesn’t enforce such strict compatibility checking and it provides a compilation switch to enable such checking, you’re advised *always* to enable that switch. To do otherwise almost certainly will cost you hours of needless debugging.

Occasionally, it’s useful to display the value of a pointer. Therefore, ANSI C provided a special edit mask `%p` for this purpose. The output format, however, is implementation defined, because addressing notation and memory layout details are quite system specific.

The example shown was run on an MS-DOS system, and because the Intel 80x86 chip series has a segmented architecture, a reasonable way to display an address is with a segment base address and offset in the format `bbbb:oooo`. Implementations running on machines such as a VAX or M68K might display an address as a hexadecimal or octal number.

Prior to the invention of `%p`, it was common to see pointers displayed using `%u` or `%lu`. While this will work on many implementations, it requires that pointers have the same size representation as an `unsigned int` or `unsigned long int`. Note that addresses are signed on some systems. In any event, never deal with addresses as signed or unsigned integers.

We’ve said that `pvar` is a variable. Therefore, we can change its value at run time. In fact, we can make it point to any `int` object we wish. It also means that `pvar` is allocated some storage space and, as such, that storage has an address. Therefore, we can take the address of a pointer, and we do so with the expression `&pvar`. However, what’s the type of this expression? `pvar` has type pointer to `int`, and `&` creates a new level of indirection. Therefore, the resulting type must be pointer to pointer to `int`. If we were to declare an identifier of this type, we would use:

```
int **ppi;
```

This makes sense, because a pointer is a variable that contains the address of another variable and can contain the address of another pointer. Actually, there’s no limit to the number of levels of indirection. However, beyond two levels,

it's hard for a programmer to keep track of it in his mind. Knowing this, we even could initialize a pointer with its own address.

The amount of storage allocated to a pointer is implementation defined. For example, on VAX C it's 32 bits, on Cray machines it's 64 bits and on MS-DOS machines it can be either 16 or 32 bits, as the programmer wishes. In fact, on DOS machines, a program can contain 16- and 32-bit pointers simultaneously. Also, all pointers aren't necessarily created equal. For example, a pointer to type *T1* might have a different representation than a pointer to type *T2*.

Pointers may point to objects of any type that you can declare legitimately. Pointers even may point to executable code, in which case they're known as pointers to functions.

The following example can be used to display the amount of space allocated to various types of pointers for any implementation:

```
#include <stdio.h>

main()
{
    unsigned long int size;

    size = sizeof(char *);
    printf("Size of char * = %lu\n", size);

    size = sizeof(int *);
    printf("Size of int * = %lu\n", size);

    size = sizeof(double *);
    printf("Size of double * = %lu\n", size);

    size = sizeof(long int **);
    printf("Size of long int ** = %lu\n", size);

    size = sizeof(float ***);
    printf("Size of float *** = %lu\n", size);
}
```

The output produced from one implementation is:

```
Size of char * = 4
Size of int * = 4
Size of double * = 4
Size of long int ** = 4
Size of float *** = 4
```

The type of `sizeof` is implementation defined. It's either **unsigned int** or **unsigned long int**. To make this program maximally portable, we assign the size to an **unsigned long int** and display that value using `%lu`.

Pointers And Casts

In the previous section, we showed an example that displayed the size of various pointer types. Each part of that example could have been written in a simpler way. For example:

```
#include <stdio.h>
main()
{
```

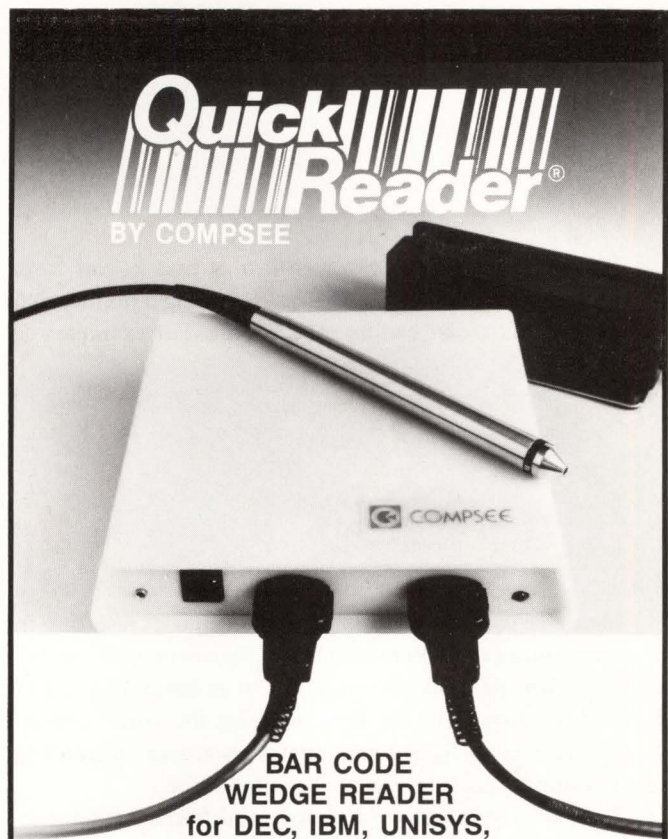

BAR CODE WEDGE READER for DEC, IBM, UNISYS, and other terminals

"QUICKREADER®" gives you unbeatable speed and accuracy. "QUICKREADER®" interfaces between the keyboard and display of DEC, DEC compatibles and most major terminals.

This state-of-the-art bar code reader simply plugs in between the keyboard and display sending data to the display as if it were keyed. The keyboard remains active at all times even when the wand system is not in use.

The "QUICKREADER®" is interchangeable between most terminals by simply wanding a bar code label and in some instances changing a cable.

- Keyboard interface for IBM/IBM compatibles, DEC, UNISYS and most major terminals
- Autodiscriminates between all popular codes
- User programmability of code parameters
- No auxiliary power pack required (utilizes power of keyboard)
- RS232 input port, allows uploading of data from portables
- Interchangeable between most terminals
- Light pen, laser, LED, and slot input devices are interchangeable
- Accepts dual scanner input
- Rolling buffer for fast data entry
- Phone jack for beeper amplification
- Low profile, rugged lightweight housing

FOR SALES INFORMATION CALL (407) 724-4321



OPTICAL DATA COLLECTION SYSTEMS

A Subsidiary of McRae Industries, Inc.
P.O. BOX 726
MT. GILEAD, NC 27306

CIRCLE 230 ON READER CARD

```
printf("Size of char * = %lu\n",
      (unsigned long) sizeof(char *));
}
```

Because pointers are types, you may cast to and from pointer types. Be careful, because dereferencing a pointer that was created via a cast can be catastrophic. For example:

```
main()
{
    char c;
    int i;
    int *pi;

    pi = (int *) &c;
    i = *pi; /* ??? */
}
```

Here, we've taken the address of the **char** *c*, resulting in an expression of type pointer to **char**. By casting this to type pointer to **int**, *pi* thinks it's pointing to an **int**, when in fact it isn't. On subsequent attempts to access the "int" pointed to, the program's behavior may vary from actually producing an **int** value to causing a fatal run-time error.

Let's assume an **int** and a **char** have different representations (they almost always do). Using the pointer to access more bits than exist in the **char** will cause either adjacent bytes, or words, to be interpreted as well, or will cause some kind of access violation if these extra bytes don't belong to this program or are otherwise inaccessible. On the PDP-11, for example, if the address of *c* was odd, all attempts to access that address via a non-**char** pointer result in a fatal "odd address trap."

Incrementing And Decrementing Pointers

We know that when the `++` and `--` operators are used with arithmetic operands, they simply mean increment by one or, in the case of floating-point operands, by 1.0. However, these operators also can be used with pointer operands as follows:

```
#include <stdio.h>

main()
{
    static char name[40];
    char *pc;

    printf("Please input a string (39 chars max): ");
    scanf("%39s", name); /* get string from standard input */

    pc = &name[0]; /* point to start of name */
    while (*pc != '\0') { /* test if end of string found */
        putchar(*pc); /* if not, display char */
        ++pc;
    }

    putchar('\n');
}
```

One set of output produces the following:

```
Please input a string (39 chars max): Some_test_data!!
Some_test_data!!
```

The array **name** has been initialized using the library function **scanf**. This function uses edit masks much like **printf**. However, because **scanf** returns values back through its argument list, every argument *must* be a pointer. The **%s** mask accepts characters until white space is detected or the limit (in this case 39) is reached. **scanf** automatically adds a null character terminator.

The expression **&name[0]** is the address of the first character in this array. Therefore, it has type pointer to **char** and can be assigned to **pc**. If **pc** has type pointer to **char**, then ***pc** has type **char** and in the first iteration of the loop has value 'T'. The loop body executes until **pc** points to the terminating null character. During each iteration, the character currently pointed to is written to standard output and the pointer is incremented to point to the next **char** in the array.

By definition, when a pointer is incremented or decremented, the increment or decrement is scaled by the size of the object being pointed to. Therefore, if **pt** points to an object of type *T*, `++pt` points to the object of type *T* immediately following in memory. This is guaranteed on all C implementations regardless of the size and representation of any pointer type.

The loop body also can be written as follows:

```
while (*pc != '\0')
    putchar(*pc++);
```

Here we've combined the pointer dereference and increment into one expression. This combination of unary operators is common in pointer expressions. However, it's less overt than the first approach. According to the precedence table, the unary operators `*` and `++` have the same precedence. However, they associate right to left. Therefore, `++` is evaluated first. The expression is equivalent to `*(pc++)`. By definition, the value of `pc++` is **pc** before it's incremented. Therefore, the pointer dereferenced is actually **pc**, not one more than **pc**. So while the `++` has precedence, it doesn't change the operand of `*`.

It's also common practice to further abbreviate this loop as follows:

```
while (*pc)
    putchar(*pc++);
```

Because `'\0'` has a value of zero by definition, a comparison of `!= '\0'` is the same as testing for true. Therefore, the controlling expression can be written as a logical test instead. It's strongly suggested that you explicitly write in the `'\0'` comparison to make the expression's meaning obvious. Any compiler worth its price should generate the same code from either approach, in which case readability should take precedence.

Consider the following example in which a **double**



Reflection® runs through more PC-to-VAX networks

Choose the LAN that best fills your company's network needs — then choose **Reflection PLUS** for your VT terminal emulation. No other VT terminal emulator is adaptable to so many different environments.

The large number of networks supported by Reflection means that high-quality VT emulation is available to you — whatever LAN you choose.

When you install Reflection, you know that you are running with a winner. The *1989 Digital Review Target Award* went to Reflection for productivity features such as multitasking, dependable file transfer, a programmable script language, complete keyboard remapping, and a sophisticated

PC file backup and restore function.

Reflection 4 PLUS for \$349* emulates the VT241 terminal with 16-color ReGIS graphics. **Reflection 2 PLUS** for \$249* emulates the VT320. Network server pricing is available.

Reflection expands network compatibility even further with the Reflection Complements series, including: **R-LAT** (\$99*), an inexpensive LAT driver that works with Reflection over Ethernet; **TelnetManager** (\$99*), a TCP/IP connection linking Reflection with AT&T, Apollo, Cray, DEC, HP, IBM, Prime, Sun and Unisys hosts on TCP/IP networks; **3270 FileExchange** (\$99*), for transferring files to IBM mainframes.

All WRQ products come with a 60-day money-back guarantee.

Call toll-free to order Reflection from Walker Richer & Quinn, the connectivity specialists.

REFLECTION®
SERIES
SOFTWARE

1-800-8PC-2VAX

(1-800-872-2829)

CIRCLE 315 ON READER CARD

Walker Richer & Quinn, Inc. 

2825 Eastlake Avenue E., Seattle, WA 98102
206-324-0350 FAX 206-322-8151

pointer is decremented:

```
#include <stdio.h>
main()
{
    static double da[] = {0.0, 1.1, 2.2, 3.3, 4.4, 5.5};
    double *pd = &da[5];
    while (*pd > 0.0)
        printf("%6.2f\t", *pd--);
    putchar('\n');
}
```

The output produced is:

```
5.50 4.40 3.30 2.20 1.10
```

The **while** loop terminates when it gets to the first element, **da[0]**. Consider the case in which you also want to print that element. A common suggestion for doing this would be to change the loop test criteria to be **while (*pd >= 0.0)**. Nice try, but no cigar. Let's look at what resulted when this was run with one compiler:

```
5.50 4.40 3.30 2.20 1.10 0.00 3969690.64 76345.23
```

We got the first element and a few other numbers. Where did they come from? You may recall that C has no run-time array bounds checking. There's no facility to check if a pointer such as **pd** is incremented or decremented beyond an array's bounds. We see two extra values printed because by chance that's what was stored in the two **double** values in memory, immediately before the storage area that contained the array **da**. The **double** immediately prior to them must have had a negative value, causing the controlling expression to test false.

To process all elements in an array, you must know the number of elements in that array or know the value of the first or last element values. The only special case is when processing **char** arrays in the forward direction, and the array is terminated by a null character.

In Part 2, we'll look further at the **strcpy** library function and cover functions that return pointers and pointer arithmetic.

Readers are encouraged to submit any C-related comments and suggestions to Rex Jaeschke, 2051 Swans Neck Way, Reston, Virginia 22091 or via the uucp address uunet!aussie!rex. —Rex Jaeschke is an independent consultant, author and lecturer. He is the C language editor of DEC PROFESSIONAL and our representative on the ANSI C Standards Committee.

THERE IS A 4GL THAT TACKLES

MULTIPLE USER
LARGE FILE
WINDOW ORIENTED
APPLICATIONS

THIS 4GL DOES NOT SACRIFICE

RESPONSE TIME
STANDARD FILES
TOP-DOWN
STRUCTURE

THE 4GL IS STRUCTURE/4™

"The programmer's 4GL"

CALL CBSI for a Literature Pack
(800-223-2942 outside Calif. / 714-259-7531 all others)

CIRCLE 332 ON READER CARD

GO WITH THE LEADER OF THE BANDS

 **Dataproducts.**

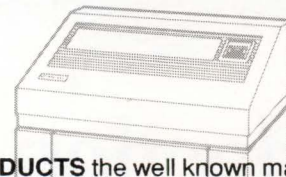

DATAPRODUCTS the well known manufacturer of high quality and highly durable printers introduces a new feature to band printers....ergonomics.

The **LB Series** has a 16 Digit LCD Display simplifying printer control. From the front panel the user has a clear view of printer status, multiple diagnostic functions and configuration selections.

The new **DATAPRODUCTS LB Series** line printers incorporate such standard features as 136 column print, triple interfaces* and flexible paper handling functionality.

The **LB Series** is available in 300 lpm to 1500 lpm models and can be connected to many popular micros, minis, and main frames.

The **LB Series** is available from:

S/S/T

305 Broadway, NYC 10007
(212) 964-9600 Fax. (212) 233-4678

* DPC Parallel, Centronics Parallel, and RS232-c

CIRCLE 185 ON READER CARD

Reflection[®]-When you need to do two jobs at once

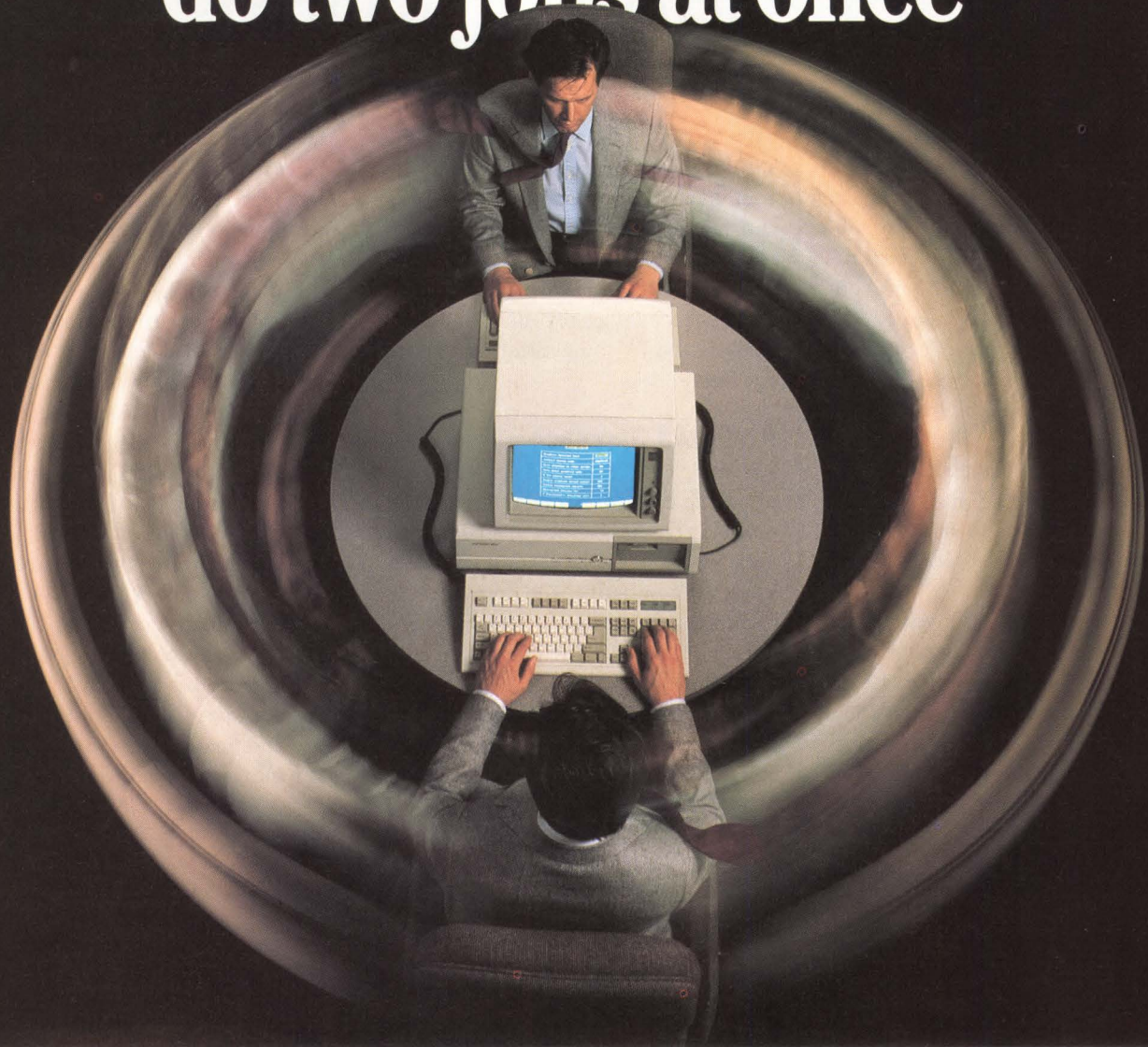

You can do the work of two when you use Reflection terminal emulation software.

Only Reflection gives you the power to perform simultaneous PC and host operations. For instance, let Reflection monitor your VAX Mail in background while you run other applications on your PC. Reflection will inform you of new mail and leave you with enough memory to run another DOS application in the meantime.

Pulling double duty is only one of the virtues that made Reflection the winner of the *1989 Digital Review Target Award*. A programmable script language gives you the flexibility to automate tedious tasks.

Reflection's high-speed file transfer works with a wide range of computers and includes easily-uploaded VAX and UNIX file transfer software at no extra charge. The **PLUS** option offers support for all popular networks and a sophisticated PC file backup and restore capability.

All these features come with a 60-day satisfaction-or-your-money-back guarantee.

Reflection 4 PLUS offers accurate VT241 emulation, plus 16-color ReGIS graphics, for \$349.* For VT320 emulation only, choose **Reflection 2 PLUS** at \$249.* Quantity discounts are available.

Call toll-free to order Reflection from Walker Richer & Quinn, the connectivity specialists.

REFLECTION[®]
S E R I E S
SOFTWARE

1-800-8PC-2VAX
(1-800-872-2829)

CIRCLE 143 ON READER CARD

Walker Richer & Quinn, Inc. 

2825 Eastlake Avenue E., Seattle, WA 98102
206-324-0350 FAX 206-322-8151

Evan Birkhead

Education Initiative

The contributions of educational institutions to the history of computing have been substantial. In the 1940s, Von Neumann's stored program architecture was conceived and developed at Princeton. Also in that decade, pioneering computers were built at Cambridge (EDSAC), Harvard (Mark I) and the University of Pennsylvania (ENIAC).

DEC's roots are planted as firmly in academia as anyone's. The genesis of DEC, in fact, was Ken Olsen's work at the electronics labs at MIT, which started in the 1950s.

Ken and company invented the concept of time-sharing and commercially sold interactive computers with a bargain basement price tag of less than \$1 million.

DEC calls its relationship with

education a partnership, and the company has worked closely with many institutions worldwide by providing the equipment for campuswide networks and by funding and collaborating on research and advanced development projects. Education is one area in which DEC is recognized by both industry analysts and its competition as a clear-cut leader.

Realigned Approach

Recently, DEC realigned its sales approach to educational institutions. The new program is outlined in an umbrella package called the Education Initiative. Under the initiative, DEC provides:

1. Initial software distribution kits, consisting of media, documentation and updates.
2. The right to copy all non-royalty products anywhere, any number of times.
3. Hardware maintenance, including

- parts at a 50 percent discount, labor (the \$1,000 incident fee is waived), the DEC-mailer five-day turnaround board agreement and access to DEC's expertise, including software support specialists.
4. A self-maintenance plan, complete with diagnostics.
5. Enrollment in DEC training courses.

In return, DEC asks that one site on campus (preferably with the same systems manager that handles purchasing) keeps track of users and file reports to DEC. DEC also expects the site to double as a campus technical support center. DEC charges a \$15,000 annual fee that covers all software upgrades and a per-CPU fee that ranges from \$20 to \$300.

The initiative enhances the effectiveness of an existing program, called the Software Library. This program is designed specifically to make the support and maintenance of software in academic research more affordable. The

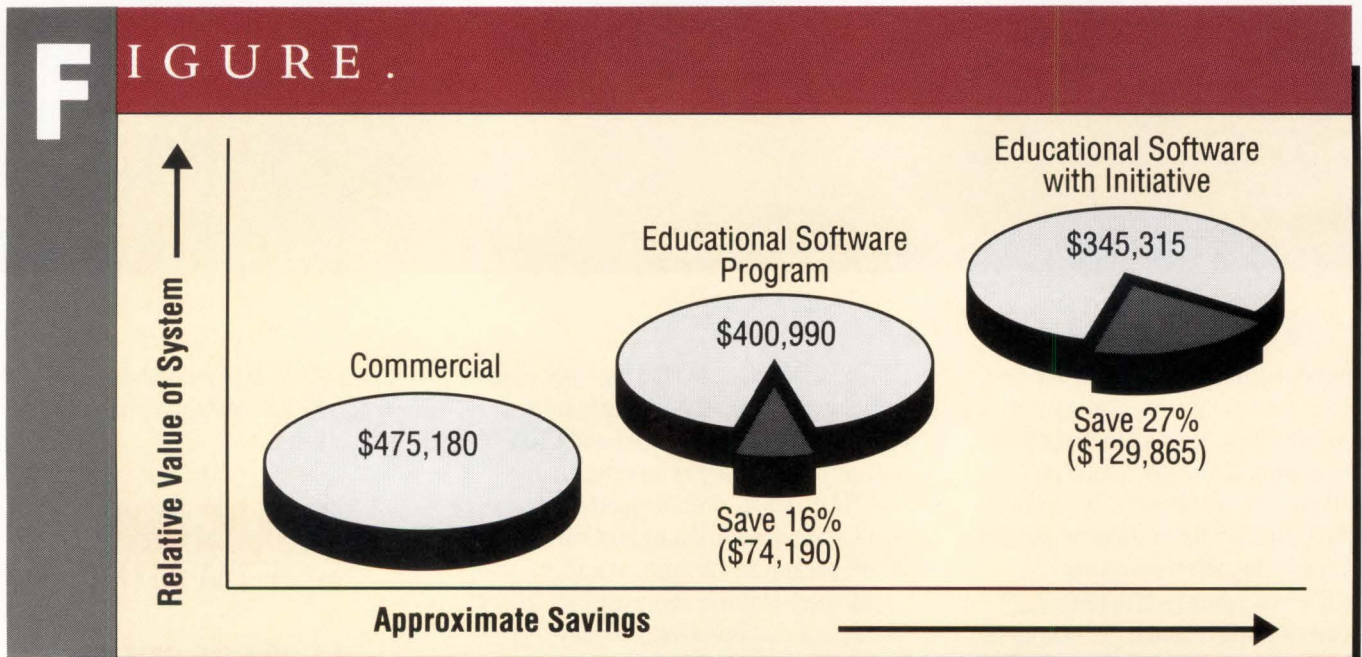

Relative cost savings on a VAX 6210 running VMS/DECnet with the eight commonly used educational software products FORTRAN, BASIC, PASCAL, C, VTX, CDD, DTR and COBOL.

MASTER CONSOLE. THE MASTERMIND OF MONITORING.

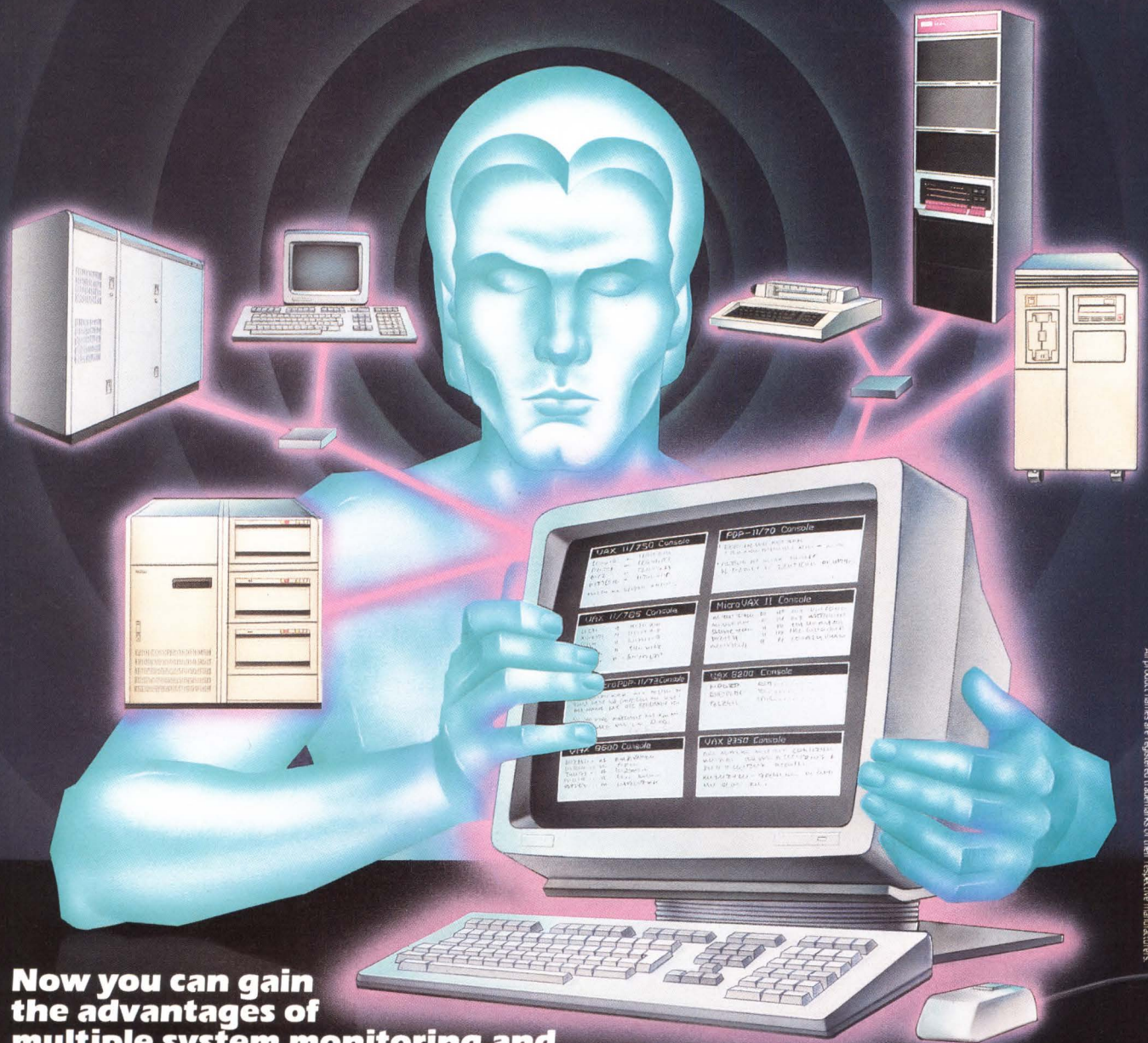

Now you can gain the advantages of multiple system monitoring and control from a single location.

Maintech introduces "Master Console," an innovative product from Volt Delta Resources that can streamline your operation and effect major savings.

With Maintech's "Master Console" you can monitor and control up to 8 DEC processors from a single location. Through a dynamic windowing process, "Master Console" creates a scrolling mini-terminal for each processor, all on a single high resolution monitor. The immediate benefit to management: centralized control, elimination of stored console logs and huge gains in individual productivity.

Other cost efficiencies are gained by eliminating the space requirements and clutter of consoles and console printouts on the computer room floor. Equally impressive, "Master Console" lets you archive your console logs on tape and prints out what you want to see.

Other features:

- Supports PDP, MicroVAX and VAX systems
- String search for user defined critical messages
- Audible and visual alarm and prioritized error reporting
- Concurrent local console operation
- Tiled windows and special purpose function keys
- Console log with scrolling, historical archive and restore

For your convenience, hardware leases and purchase plans are available.

"Master Console." Another powerful product from Maintech, the innovative leader in the independent service marketplace.

MAINTECH
GUARDIAN MAINTENANCE SERVICES
A DIVISION OF VOLT DELTA RESOURCES INC.
1 800-426-TECH
1133 Avenue of the Americas
New York NY 10036
212 827-2600
A VOLT INFORMATION SCIENCES COMPANY



All product names are registered trademarks of their respective manufacturers.

library covers software for all VAXs and the DECstation 3100. Approximately 35 libraries are now in place. The library costs \$10,000 to start and carries a \$15,000 annual fee.

The initiative already has swayed a

few customers. For example, Syracuse University, a large DEC user, reports that it was planning a major purchase of Suns before DEC announced its program, but decided to go with the initiative.

“Traditionally, industry has supported education in the form of research and equipment grants to help schools acquire more computing power,” said Roger Strickland, manager of DEC’s Education Group, at the November 1988

MicroVAX Catch-22

DEC’s April 10 announcement of its improved MicroVAX chip set was upstaged that same day by Intel’s introduction of the 486. Although both announcements went according to expectations, DEC’s paled in comparison, looking like just another product enhancement next to Intel’s new generation of CPUs.

That isn’t to say that the new MicroVAXs and their associated servers and storage devices aren’t impressive. Technologically, the CPUs, based on the 60 ns CVAX semiconductors used in the VAX 6300, show superior innovation. For \$81,000 — reasonable as VMS machines go — the MicroVAX 3800 provides 3.8 times the performance of a VAX 11/780. Additionally, the 3800 has a DSSI storage bus, dual-host LAVc capabilities and support for multiple 400-MB RF71s. Priced at \$120,200, the more powerful MicroVAX 3900 looks like a 3800 but accommodates up to eight 1.2-GB RA90 drives.

The 16-MB VAXserver 3800, which comes with DECnet/Ethernet and DSSI adapters, is priced at \$56,100; the 32-MB VAXserver 3900 costs \$84,900.

The announcement was accompanied by startling price reductions and upgrade packages for older MicroVAXs. These packages let you upgrade MicroVAX 3500/3600s into 3800/3900s for \$20,000 or upgrade VAXservers into MicroVAXs at various costs. Other products include new configurations of low-end MicroVAX and VAXserver 3300s, a \$31,000 rtVAX 3800 running VAXELN and, most significantly, the \$110,000 ESE20 120-MB disk — DEC’s first solid-state effort and its highest-performance drive to date.

Leapfrog

The flurry of product introductions didn’t end with DEC and Intel. Two days later, Sun Microsystems, the number one workstation vendor, stole the limelight with the biggest introduction in its history, featuring workstations and servers with strong price/performance curves.

The topper to the new product line was the SPARCstation 1, which runs at 12 mips, for about \$9,000.

But Hewlett-Packard got the last word. HP acquired Apollo Computer just a few hours before Sun’s big show. The merger of the number three and number four workstation vendors makes HP, everyone’s favorite underdog, the market share leader.

This game of leapfrog should teach DEC some important lessons. Even though the midrange MicroVAX isn’t DEC’s workstation warrior, the announcement of the 3800/3900 series shows that the company is in the midst of upgrade-mania that may strain customer confidence. We’ll see VAXstation and DECstation upgrades early this summer.

The other workstation companies appear streamlined and focused with emphasis on RISC, UNIX and faster throughput speeds. The nice thing about Sun’s and Intel’s announcements is that they had finality. It was as if they said, “This is our state-of-the-art product set and it will be around for a while, so you might

as well buy it now.” The new MicroVAXs, on the other hand, further muddy DEC’s waters.

DEC’s 1989 barrage of computer introductions has confused customers. For VAX/VMS machines, the fundamental stumbling block is price/performance. Many users are rebelling against the inflated price of DEC’s elegant proprietary system.

DEC President Ken Olsen may have simplified the VMS versus ULTRIX purchasing decision for many people.

At the April 10 MicroVAX announcement, he said that he intends to ingrain the robustness and features of VMS into future versions of ULTRIX. Additionally, DEC reports that it will achieve a steeper performance curve with three generations of CMOS chips that it’s developing. The key technologies will add chip cache and extend the throughput pipeline, which RISC can’t do.

Besides its pricing strategy and game plan, DEC faces a marketing dilemma from the rapidity with which VAXs outdate themselves. A classic catch-22 has developed. For the past three years, DEC’s time-to-manufacture speeds have increased to the extent that there’s a danger of diminishing buyers’ trust. DEC is staying competitive at the workstation level with HP and Sun, at the midrange (MicroVAX to 6300) with IBM, and at the mainframe level (Aridus, Aquarius, VAXclusters) with IBM. But who will buy a machine on its ship date when six months later there are two better alternatives: buy the first upgrade, which could have twice the performance for the same price, or buy the original system at a clearance rate?

Seeing The Pattern

The VAX-user community is catching on to the pattern. Consider the following:

1. When the MicroVAX II was released, it eliminated all reasons for buying a MicroVAX I or a VAX 11/780.
2. With DSSI storage and two to three times the performance of a MicroVAX 2000, the MicroVAX 3300/3400 usurped the 2000 and the 3500/3600 for many installations.
3. An additional CPU board will render the 8250 obsolete and turn it into an 8350, which is twice as powerful.
4. Nine months after the release of the 6200, DEC introduced the 6300. The new machine cost about the same, but added twice the expansion range and offered approximately 35 percent higher performance. Further, the 6300s diminished the high-priced, high-end cluster configurations to worthless dinosaurs.

With the 3800/3900, history repeats itself.

This is particularly a drawback during a period when all the major computer manufacturers, DEC and IBM included, have announced that they expect dramatically reduced sales in 1989. The key for DEC is to “unconfuse” its product line by re-establishing a corporate strategy less nebulous than Networking the Enterprise.

EXCLUSIVE FROM MILTOPE!

Continuous Printing at 37/90 Pages per Minute

Cut sheet printers available at 30/60/75 ppm

“WE CONNECT TO DEC”

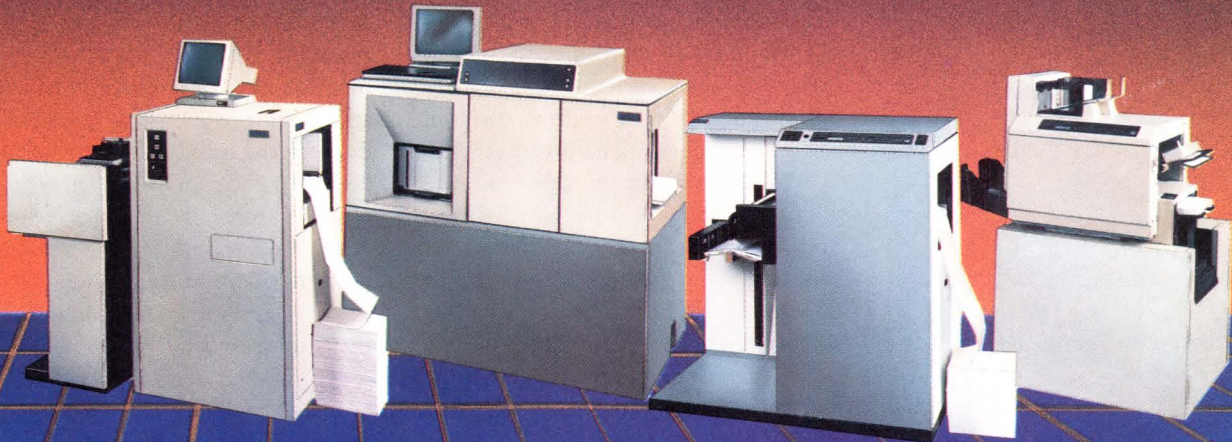

Miltope's FAMILY of Non-Impact 'ion' deposition page printers affords letter quality printing at 'less than a penny' per page.

Miltope provides multifont alpha/numeric printout, "true" electronic forms overlay plus sophisticated graphics for generation of signatures, logos, bar codes, OCR and special characters.

Miltope's page printers eliminate time-consuming bottlenecks by combining speed, high-duty cycle, reliability and versatility in electronic printing systems that are plug-to-plug compatible and fully emulate:

- Xerox 3700/2700
- HP LaserJet Plus
- HPGL
- HASP
- QMS[®] MAGNUM[®] (Printronix Graphics)
- IBM Interfaces:
3211 — 3287 — System 3X — AS/400
2780/3780 — 3270 — 3770 etc.
- Dataproducts or Centronics Interface
- Mini/Super-Mini Interface (i.e., DEC, DG, Wang, Unisys, etc.)

The choice is YOURS!

MODEL	SPEED	FORMAT	RESOLUTION	MONTHLY VOLUME
3801	90 PPM	Continuous Form	240 × 240 DPI	Over 1 Million Pages
SERIES 75	75 PPM	Cut Sheet	240 × 240 DPI	Up to 1 Million Pages
SERIES 60	60 PPM	Cut Sheet	240 × 240 DPI	Up to 1 Million Pages
SERIES 37	37 PPM	Continuous Form	300 × 300 DPI	Over 250,000 Pages
SERIES 30	30 PPM	Cut Sheet	300 × 300 DPI	Up to 250,000 Pages

Cost Effective Printing and Dependable Nationwide Field Service have made Miltope the "Source" for ALL ion deposition printing systems.

“IMAGINE YOUR IMAGE”

MILTOPE Business Products, Inc.

1770 WALT WHITMAN ROAD • MELVILLE, NY 11747
TEL: 516-756-7650 • TWX: 510-221-1803 • FAX 516-756-7606

Miltope Printers use Delphax ion deposition engines.

QMS and MAGNUM are registered trademarks of QMS, Inc.

CIRCLE 168 ON READER CARD

“
**Custom
 keys
 maximized
 our
 software
 investment.**
 ”

**THE ULTIMATE
 KEYBOARD
 ENHANCEMENT.**

Maximize your software investment with custom key sets displaying any symbol, language, code or legend. Custom keys from Synctronics enable you to:

- Reduce training time
- Instantly increase user productivity
- Promote on-the-job user satisfaction
- Increase hardware utilization

Stock and custom keys available for DEC, IBM, WYSE, COMPAQ, and other systems.

For complete product information and quantity discounts call

(800) 444-KEYS



Synctronics

4901 Morena Blvd., Suite 302
 San Diego, CA 92117, (619) 581-6303

CIRCLE 141 ON READER CARD

policy announcement. (Strickland's group shouldn't be confused with DEC's Educational Services Group, which runs a worldwide training/seminar series.) The program was announced in Nashville at CAUSE '88, a technology and education conference. "The problem has shifted from acquiring equipment to controlling the cost of ownership. The long-term costs of technology now are in software acquisition, software support and hardware service.

"We're suggesting that you use your resources to do what you do best," Strickland told his audience of educators, "and we use our resources to do what we do best. The result will be a substantial savings to you.

"Research isn't necessarily what the focus is on," Strickland reflected, a few months after the announcement. "The real benefit of this program is that colleges have the freedom to concentrate on their work and thereby improve the state of technology." The big story, says Strickland, is how the users will increase productivity and be stimulated to new ideas. Hence the term initiative.

Why would DEC restructure a program that already was arguably the most successful in the industry? "We can do more for education if it can do more for itself," reasons Strickland. "We can't be satisfied with the status quo."

Spirit Of Cooperation

DEC has maintained its leadership status by listening to and communicating with its educational customer base. The company benefits from this spirit of cooperation in at least four ways.

First, engineers and researchers trained on DEC equipment in the colleges entered the working world with a preconceived notion of the way they wanted to work. Although these techies may not have had purchasing clout initially, the world slowly changed from batch processing to interactive/time-sharing as people began to recognize the productivity increases apparent in campus environments.

After the time-sharing battle was won, corporations began to realize that

they could save a year or more of training by hiring DEC-literate computer-philosophers straight from school. So, the second way that DEC benefits is that educational institutions become an important source of employees for its customers. The third and fourth ways that DEC benefits are in types of research. Although DEC spent more than \$50 million internally on research and development last year, it was outdone by the more than 120 educational institutions it was funding. The first type of research involves advanced development work for DEC, designing portions of operating systems, databases or other areas that DEC can't afford to focus on internally.

"They're our best critics," proclaims Strickland. "Feedback from universities is a bellwether for our products." As an example, Strickland says that DEC's education customers heavily influenced production of the RISC/ULTRIX DECstation 3100. Notable first-day orders of the workstation from colleges and universities reflect this.

External research, which is the use of computers for research in science, medicine, engineering, and so on, is a separate issue, handled by a separate internal division. DEC's policy toward schools performing external research isn't affected by the Education Initiative. These sales are negotiated on an individual basis, with DEC providing support in the form of equipment grants, faculty support or cash. There's no structured program or policy for external research, only general procedural guidelines.

The Market Basket

When DEC provides an educational institution with a campus license, the benefit for the school is a reduction of the cost of system ownership. For VAX users, educators and otherwise, the real cost of ownership comes down to the long-term cost of ownership: service and support. To compensate for this burden, which is enormous at any level, DEC historically has provided signifi-

Now available
for UNIX/Xenix!

In a Noisy World...

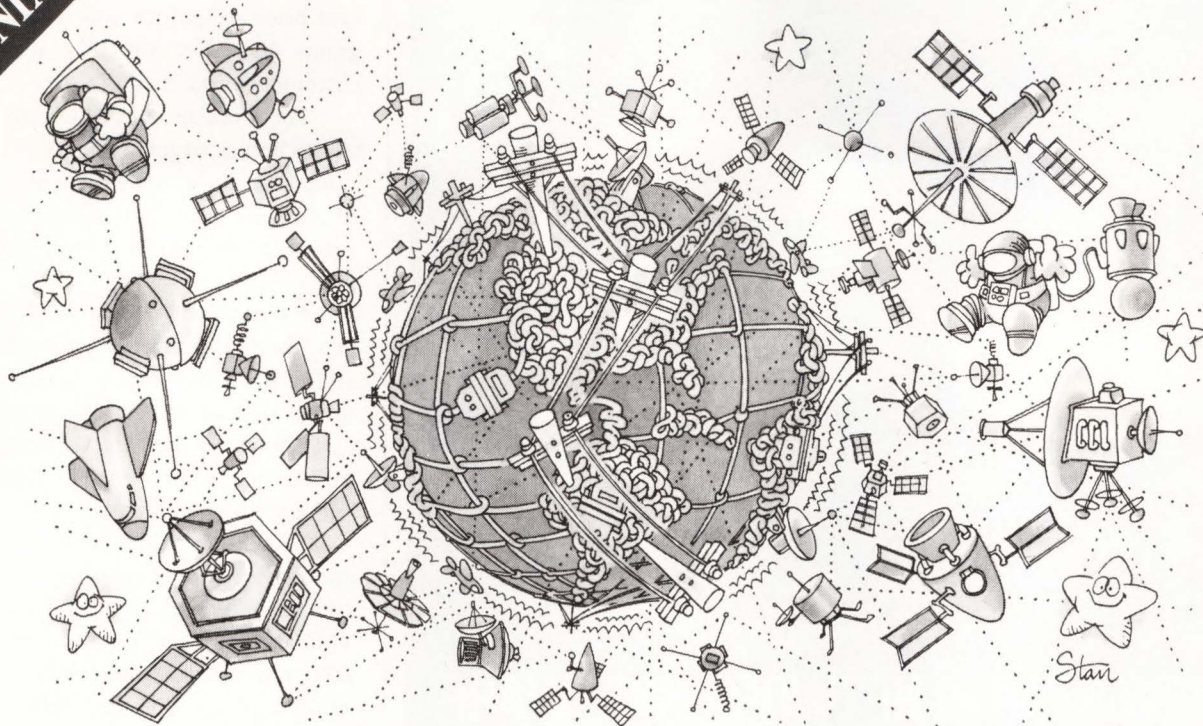

BLAST Communications Software Gets Your Data Through it All!

Performance with increasing noise.

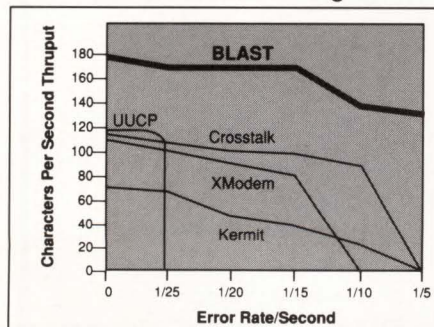

Noise simulation tests run with a 30K binary spreadsheet file at 1200 baud between IBM-PC's, using BLAST II, rev. 8.1. Comparable or better results on Mac, VAX, and others.

In today's world of noisy phone lines, complex switches, and satellite-routed calls, you need rugged communications software to get your data safely through everything, everytime.

BLAST's protected pipelining protocol won't slow to a snail's pace, drop data or disconnect due to noise. Static interference or PBXs — your valuable data quickly BLASTS through it all, saving you time and money, *without any add-on boards or other expensive hardware*. And, BLAST is X.25/DECNET/MNP compatible!

Link VAXs, PCs, MACs, and UNIX/Xenix anywhere

BLAST guarantees fast, 100% error-free file transfer and terminal emulation among VAXs, PCs, MACs, UNIX, Xenix, and others. Unite them all with *one* easy-to-use interface, *one* set of commands, *one* protocol, and *one* scripting language.

Auto-dialing and modem management sequences are built-in so you can easily set up polling, data collection, order entry and other *unattended* communications applications between *hundreds* of remote sites, all at a fraction of what you'd expect to pay. Plus, a "Private Network" feature locks out unauthorized users for data security beyond simple passwords.

The Choice of the Fortune 1000

Bankers Trust, Blue Cross, Exxon, Nabisco, and many others have chosen BLAST to cut through the noise. And now, leading communications products vendors specify BLAST, as well. Find out what BLAST can do for you. Give us a call today.

1-800-24-BLAST

Any computer with BLAST can talk to any other computer with BLAST:

IBM	VM/CMS or MVS/TSO
DEC	VAX/VMS; PDP/RSX; RT-11
DATA GENERAL	RDOS; AOS; AOS/VS
WANG	VS
PRIME	PRIMOS
HEWLETT-PACKARD	3000/MPE; 1000/RTE
HARRIS	VOS
TANDEM	LXN
UNISYS	BTOS, CTOS, UNIX
IBM-PC & PS/2	MS-DOS
APPLE	MACINTOSH
UNIX/XENIX	AT&T; Altos; NCR; Sun HP; VAX & mVAX; 386 PCs.

Many others available; please inquire. Prices start at \$250



BLAST®

Communications Research Group

5615 Corporate Boulevard • Baton Rouge, LA 70808

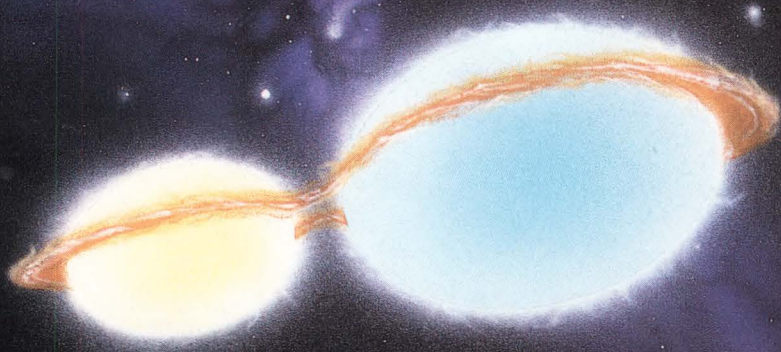

VAX/VMS Network Software

A NEW STAR IN NETWORK SOFTWARE.

The investment you've made in your VAX is too substantial not to demand the most out of each and every node. FUSION® Network Software (FNS), by Network Research Corporation, helps you do just that. FUSION implements the popular TCP/IP and XNS network software protocols, and it runs on all DECnet and Ethernet environments. With optional support for NFS and SMTP.

FUSION is the first network software that allows users to boot diskless Sun workstations directly from a VAX (using NFS). FUSION is also one of the first network software packages to support DEC's new Symmetric Multi-Processor Systems (SMP). And FUSION runs on a wide range of VAX/VMS 5.0 and 4.X machines, from a single MicroVAX to the powerful 6220 and 8840 systems.

Reviewers and users alike have hailed FUSION as a powerful breakthrough. "By using the NRC software today," wrote Digital Review, "DEC could maintain an edge over IBM." And FUSION's C-based architecture and socket Program Development System makes it easy to port your applications to and from PC's, mainframes, minicomputers, even supercomputers, without losing functionality or control.

FUSION works with multiple Ethernet controllers and features remote log-in, remote execution, quick and easy file transfer and E-mail. Plus network management utilities, point-to-point communication over Wide Area Networks, and connectivity to DDN X.25 networks. Network Research Corporation also provides exceptional customer support, customization alternatives, upgrades, training and aftermarket products.

See the light. FUSION Network Software.

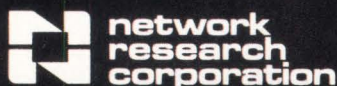

2380 North Rose Avenue, Oxnard, CA 93030
Toll Free: (800) 541-9508 ■ In CA: (805) 485-2700
FAX: (805) 485-8204 ■ TELEX: 297579 NRCO UR

FUSION is a licensed trademark. Other trademarks: DEC, VAX, VMS, MicroVAX, DECnet, SMP, Digital Equipment Corporation, NFS, Sun Microsystems, XNS, Ethernet, Xerox Corp.

CIRCLE 292 ON READER CARD

cant price reductions and service programs to education that its other customer segments don't get.

The foundation of DEC's approach was to license large numbers of CPUs to campuses and provide them with a lot of software. DEC also maintained and supported the hardware and software (see Figure).

Even with all this leeway, however, DEC found that educational institutions still were having trouble. "People were doing strange things, like developing CASE tools on their own," remembers Strickland. "They weren't spending enough time researching."

The Education Market Basket is another initiative program that discounts administrative and academic VMS and MS-DOS products for which DEC must pay a royalty fee, such as ALL-IN-1, VAX Rdb and WPS Plus, as well as distributed third-party packages.

The Market Basket license includes languages, utilities, networking and communications software, CASE tools and office automation software. For

Companies Mentioned In This Article

Digital Equipment Corp.
146 Main St.
Maynard, MA 01754
(508) 897-5111
CIRCLE 403 ON READER CARD

Hewlett-Packard
3000 Hanover St.
Palo Alto, CA 94304
(415) 857-1501
CIRCLE 406 ON READER CARD

IBM Corp.
Old Orchard Rd.
Armonk, NY 10504
(914) 765-1900
CIRCLE 407 ON READER CARD

Intel Corp.
3065 Bowers Ave.
Santa Clara, CA 95051
(408) 987-8080
CIRCLE 487 ON READER CARD

Sun Microsystems Inc.
2550 Garcia Ave.
Mountain View, CA 94043
(415) 960-1300
CIRCLE 536 ON READER CARD

reference, it would cost \$700,000 to license this much software for a VAXstation, and \$6 million for a mainframe-sized cluster. The grant is applicable at any educational institution, including

public elementary and secondary schools.

The new initiative has earned the praise of several participating universities, as well as national education governing bodies. But the proof of its

success will be when strange things stop happening in academic development labs and universities begin to take advantage of this freedom to continue their contributions to computing history. ■

What If . . . You Have It Now?

If you own an older VAX 11/7xx and it isn't part of a cluster of VAXs, don't be surprised if a Hewlett-Packard sales representative comes calling. Perhaps as a retaliation for DEC's VAXattract program that began in the fall of 1986, when many HP 3000 owners were frustrated with their long wait for a Spectrum, HP has launched its own offensive. The goal is to make its HP Precision Architecture (PA) systems an affordable option for 11/7xx owners dissatisfied with the price/performance and maintenance costs of their vintage VAXs. HP uses the term HP PA to refer to all of its RISC-based systems, formerly called Spectrum.

HP introduced these programs in January, after systems engineers (SE) had field tested them for several months. The targeted prospects are companies with aging standalone 11/750s and 11/780s. At that time, HP's offer of a chance to try standards-based computing and RISC architecture in a multiuser system was something DEC couldn't provide. On March 1, DEC announced the DECsystem 3100, which supports up to 64 users and features 24 MB of memory.

When DEC begins shipping the DECsystem in volume this month, its customers can get a 16-user system for about \$38,000, compared to \$45,000 for HP's 16-user 835S that supports up to 30 terminals. But customers who need a subsystem that supports more than 64 users still will have an incentive to test drive the 400-user 855S, the 300-user 850S or even the 78-user 835SE.

Migration Tools

DEC's VAXattract program has a larger set of software tools for migration than HP's, with something to offer both commercial and technical applications. DEC has translators for COBOL, FORTRAN and even HP BASIC, but HP's software-conversion tools are offered only for FORTRAN. Nevertheless, HP's migration program is more comprehensive than DEC's, because it encompasses the financial, user-interface and training aspects of migration. The program consists of three related DEC Migration programs: the RISC Free program, the VAX Buyback program and PORT/VX migration tools bundled with consulting services.

In contrast with the VAXattract program, which induces customers to change from one proprietary operating system to another, the goal of the DEC Migration programs is to get customers to switch from the proprietary VAX/VMS systems to any one of four HP Series 9000 Model 800 multiuser models that run on the standards-based HP-UX operating system.

To that end, owners of older VAXs can test HP PA hardware at their own sites for up to three months. If you're considering the top-of-the-line Model 855S (with a price of up to \$308,500), the trial period may be extended for an additional three months. The free trial includes use of magnetic and cartridge tape drives, disk drives, HP-IB (Hewlett Packard's Proprietary Interface Board) and mux hardware, printers, a systems console and terminals. The

software includes the HP-UX operating system, Network File Services (NFS), LAN management software and ARPA services for electronic mail.

HP also has put together an attractive financing package. Sonny Ng, sales promotional manager for the VAX Buyback program, claims that the customer's out-of-pocket expense for buying an HP system during the first year is less than the cost of maintaining an aging VAX. As part of the VAX Buyback program, HP has made arrangements with a VAX reseller so that VAX owners are paid the fair market value of their existing DEC system if they wish to sell it. However, don't expect that figure to be as large as it was before DEC announced it no longer would manufacture the 11/7xx series.

If you choose any Series 9000 Model 800, HP stands ready to help you buy, rent or lease. The Finance and Remarketing Division handles these transactions. The plan with the lowest monthly payment is HP Lease with Option to Purchase (LWOP).

Another facet of the plan is designed to assist customers with porting FORTRAN applications from the VAX to a Series 9000 system. The PORT/VX product consists of software tools and five days of on-site consulting services to help you use these tools. An HP SE works at the customer site for five days to evaluate each prospect's migration needs. DEC will sell its VAXattract/H3K migration tools without the consulting, but HP won't send out the tapes without sending an SE to the site. The five days of consulting are included in the price.

The SE shows the people responsible for the migration effort how to move application files from VMS to HP-UX, demonstrates how the FORTRAN Code Analyzer (FCA) is used to predict the ease or difficulty of migration and introduces the PORT/VX tools. The PORT/VX tools include a FORTRAN Code Translator (FCT), a Data File Translator (DFT), a transport utility (VBACKUP) and migration libraries to use in compatibility mode until applications can be ported to native mode.

The SE also helps your department through the migration of a selected application and assists you in developing a migration plan and a performance plan to verify that the migration is complete. Migrators also can use one of HP's field-migration centers or the Technology Access Center in Cupertino, California, for further assistance.

DEC's marketing material for the VAXattract program borrows the slogan that long has been used in HP's advertising campaign. The corner of each data sheet says, "What if . . . you choose Digital?" If HP retaliates in like fashion, look for computer-room posters that say, "HP Has It Now" hanging above the HP Series 9000 Model 800 in the space left vacant by the departure of an old VAX. —Peggy King is West Coast editor of HP PROFESSIONAL, a Professional Press publication covering the Hewlett-Packard market.



DEFEXIT.DOC

DCL DIALOGUE

Kevin G. Barkes

EXIT Examined

If the *DCL Dictionary* had been produced in yearbook

format, the caption under EXIT would read, "Command most likely to be ignored."

Poor EXIT gets no respect. It's omitted from many command files, particularly those of the straight-line variety, which don't contain multiple command paths. DCL supplies a sort of implicit EXIT when the command interpreter reaches the end of a file in a procedure.

Many DCL command procedure writers view EXIT in the same manner in which most people view an appendix: as a relatively useless construct that hangs idly by at the end of a command file. Still, EXIT serves several legitimate purposes.

EXIT Versus STOP

To paraphrase President Bush, EXIT affords a kinder, gentler way of terminating an interrupted image or a command procedure than the related STOP command.

EXIT, when entered interactively after a program has been interrupted with a CTRL-Y, causes the image to terminate normally. Any exit handlers in the program are executed. RUNNING another image also causes the interrupted program to perform a normal rundown.

STOP immediately halts the image. Exit handlers aren't run, and the program terminates abnormally.

When encountered in a command file, EXIT terminates the currently executing procedure and returns to the command level from which the procedure was called.

The following code demonstrates EXIT's operation. Procedure 1 is executed interactively; it calls procedure 2, which calls procedure 3. Each procedure ends with an EXIT command:

```
$ @procedure1.com (command level 0)
  Procedure 1 executing (command level 1)
  Invoking procedure2.com:
  Procedure 2 executing (command level 2)
  Invoking procedure3.com:
  Procedure 3 executing (command level 3)
  EXITing procedure3
  Back in procedure2 (command level 2)
  EXITing procedure2
  Back in procedure1 (command level 1)
  EXITing back to DCL (user $ prompt)
$ (command level 0)
```

Conversely, STOP acts like an emergency brake. When encountered, the process breaks out of all procedures and returns immediately to command level 0:

```
$ @procedure1.com (command level 0)
  Procedure 1 executing (command level 1)
  Invoking procedure2.com:
  Procedure 2 executing (command level 2)
  Invoking procedure3.com:
  Procedure 3 executing (command level 3)
  STOP reached in procedure 3
$ (command level 0)
```

When executed in a job running in non-interactive mode, STOP causes the process to terminate immediately. EXIT causes non-interactive process termination only if encountered at command level 0, i.e., the original .COM file.

ON And IF

EXIT and STOP can be the targets of ON and IF commands:

```
$ ON ERROR THEN EXIT

$ IF $SEVERITY .NE. 1 THEN STOP
```

Note that you can have labels

named EXIT: and STOP:

```
$ ON ERROR THEN GOTO EXIT
.
.
.
$ EXIT:
$ WRITE SYS$OUTPUT "Error encountered."
$ EXIT
```

Using EXIT and STOP as labels is mentioned only because it's frequently a source of confusion for beginning DCL procedure writers. Bear in mind that there's a big difference between:

```
$ ON ERROR THEN GOTO EXIT
```

and:

```
$ ON ERROR THEN EXIT
```

It isn't a bad idea to avoid using labels having the same name as DCL commands. However, it's mostly a matter of personal discretion. Many DEC-supplied procedures use EXIT: labels.

The EXIT Parameter

During my training seminars, I'm always surprised by the number of people unaware that EXIT can have a command parameter, namely a value that gets placed in the reserved global symbol \$STATUS. This value can be tested by the next highest command level using standard DCL error-handling techniques.

Consider the following command procedures:

```
$! Procedure1
$ SAY := WRITE SYS$OUTPUT
$ ON WARNING THEN GOTO ERROR
$ @PROCEDURE2
$ SAY "No warnings."
$ EXIT
```



```

$ ERROR:
$ SAY "Called procedure had error."
$ EXIT

$! Procedure2
$ NOCOMMAND
$ EXIT

```

Watch what happens when we execute procedure 1:

```

$@PROCEDURE1
%DCL-W-IVVERB, unrecognized command verb
- check validity and spelling \NOCOMMAND\
Called procedure had error.

```

When procedure 2 exited, the warning condition was passed back to procedure 1, which branched to the ERROR: label. If we modify procedure 2 to read:

```

$! Procedure2
$ NOCOMMAND
$ EXIT 1

```

and execute procedure 1:

```

$ @PROCEDURE1
%DCL-W-IVVERB, unrecognized command verb
- check validity and spelling \NOCOMMAND\
No warnings.

```

The usefulness of EXIT's optional status code parameter is obvious. We can use it to force the calling procedure to perform any type of ON error handling, \$\$STATUS or \$\$SEVERITY checking we want. It's another method of bullet-proofing DCL procedures. No matter what happens to the called procedure, we always can be certain that the calling procedure performs predictably.

In the above example, you may have noted that even though the error was passed from procedure 2 to procedure 1, the warning only appeared once. That's because DCL changes the high-order digit of \$\$STATUS to 1, while keeping the rest of the symbol's value intact. This eliminates error messages generated by the command and the procedure.

Should you go through all your .COM files and add EXITS to them?

Probably not. But it couldn't hurt, and it may surprise you to find the number of procedures that could become even more useful if you exploited EXIT's parameter-passing ability.

Vancouver Postscript

To those sharp individuals who attended my DCL session at the DECUS Canada Symposium, held in Vancouver in February, here's the answer to your question regarding exceptions to the \$\$STATUS and \$\$SEVERITY rule.

Certain commands don't update those symbols when they execute successfully. CONTINUE, DECK, DEPOSIT, EOD, EXAMINE, GOTO, IF, SET SYMBOL/SCOPE, SHOW STATUS, SHOW SYMBOL, STOP and WAIT change the values of \$\$STATUS and \$\$SEVERITY only if an error is generated when they run. Consider:

```

$ TYPE NOFILE.HERE
%TYPE-W-SEARCHFAIL, error searching for
DUAO:[USER]NOFILE.HERE;
-RMS-E-FNF, file not found
$ CONTINUE
$ WRITE SYS$OUTPUT F$MESSAGE($$STATUS)
%TYPE-W-SEARCHFAIL, error searching for !AS

```

Aside from the fact the ASCII string (!AS) isn't available to F\$MESSAGE(), the intervening CONTINUE command didn't change the content of \$\$STATUS.

I plead severe jet lag and misplaced session notes.

FOR A LISTING of all FidoNet public bulletin board systems in the U.S. featuring message areas with DEC-related topics (VAX, PDP-11 and Rainbow), send a self-addressed, stamped envelope to BBS List, Kevin G. Barks Consulting Services, 4107 Overlook St., Library, Pennsylvania 15129.

The list is also available on-line from my SYS\$OUTPUT bulletin board system: (412) 854-0511, 1,200/2,400 baud, 8 bits, 1 stop bit, no parity.

If you're active on FidoNet, ask your local SYSOP to file request DECIBBS.LST from 1:129/38. —Kevin G. Barks is an independent consultant in VAX systems software, management, tuning and training, based in Library, Pennsylvania.



BIGGEST VIKING DISCOVERY SINCE NORTH AMERICA

VIKING DATA ENTRY SYSTEM

Discover a whole new world of low-cost, high-speed data entry efficiency with VDE, the Viking Data Entry system that gives you more data entry capability using a mini-computer/PC. CALL TODAY FOR FREE DEMO.



Investigator Plus Secures System

Absolute Security Inc. and FEL Computing jointly announced Investigator Plus for VAX/VMS. Investigator Plus brings automated management, audit and security capability to the VAX/PC environment linked by FEL Computing's Mobius software.

Mobius creates a seamless connection between PCs and VAX systems. This software product includes terminal emulation, file transfer, a virtual file system, printer support, task-to-task communication and a high-level task-description language. For Mobius users requiring a secure environment with software change management control, auditing and software quality assurance, Investigator Plus provides total system security. It detects file modifications to source code and executable code, controls file activity and provides recoverable backup and full audit trail of system changes. It also ensures file and application software integrity and automatically documents changes.

To find out more, contact Carol Riddle, Absolute Security Inc., 63 Great Rd., Maynard, MA 01754; (508) 897-1991.

Circle 490 on reader card

R8000 Performs Under Severe Conditions

Cyberchron Corporation announced the R8000 Series of ruggedized computers. The R8000 Series offers the standard architecture advantages of the VAXBI family of processors. Based on VAX 8250 and 8350 CPUs, the R8000 Series meets the most demanding application requirements for computers fielded under severe environmental conditions.

The R8000 consists of two subsystem chassis assemblies, the Advanced Processor Assembly (APA) and the Disk Storage Assembly (DSA). Both are compact, lightweight systems designed to operate reliably under the adverse effects of shock, vibration and extreme temperatures. The APA includes a ruggedized version of the VAXBI backplanes and either a VAX 8250 or a VAX 8350 processor. The APA can be used as the central processor for a system using the DSA for mass storage support or standalone with other compatible peripherals or subsystems. The DSA provides ruggedized provisions for

up to four individually removable 5¼-inch form factor disk or tape devices and one fixed, non-removable 5¼-inch device.

Find out more by contacting Ron Davies, Cyberchron Corp., 3720 Farragut Ave., Kensington, MD 20895; (301) 946-6488.

Circle 496 on reader card

ACS 4100 Platform Provides Flexibility

Advanced Computer Communications announced the ACS 4100 hardware platform, which connects two or more geographically remote LANs into a single, integrated network. Targeted at medium- to large-scale users requiring high performance and network management, the ACS 4100 platform provides software and hardware flexibility.

Products based on the ACS 4100 feature SNMP, which provides performance and troubleshooting statistics needed to plan the network, measure system traffic loads and isolate network errors. The network-management system maintains the entire network topology at one location, dynamically adapting to changes or network failures to ensure that data continues to flow with no

breaks in service. The ACS 4100 architecture allows data transmission at speeds up to T1 rates over a single link. Two serial links can be split to connect LANs in different directions and transmit data at different speeds or act as a redundant connection between two Ethernets.

Learn more by contacting Marianne Wasielewski, Advanced Computer Communications, 720 Santa Barbara St., Santa Barbara, CA 93101; (805) 963-9431.

Circle 491 on reader card

VNBACP Establishes Communication Link

C & C Technology Inc. announced the VNBACP and VNBACP/SMB high-level NetBIOS protocol software. These standard interface packages allow integrators to establish high-speed program-to-program communications among Q-bus systems and the IBM PC AT/XT over the token-passing ARCNET network.

The VNBACP NetBIOS interface establishes a secure, transparent, full-duplex communications link among tasks that reside on the same or different network nodes. A VAX application programming interface that complies with the standard NetBIOS protocol specification is included. Also included is a network connection for terminal-emulation packages, allowing any PC to access any VAX within the same network structure. VNBACP/SMB adds the Syntax SMBServer, which provides file and printer services on the VAX. It maps NetBOIS resource names onto VAX RMS directory trees.

Single-license pricing for the VNBACP

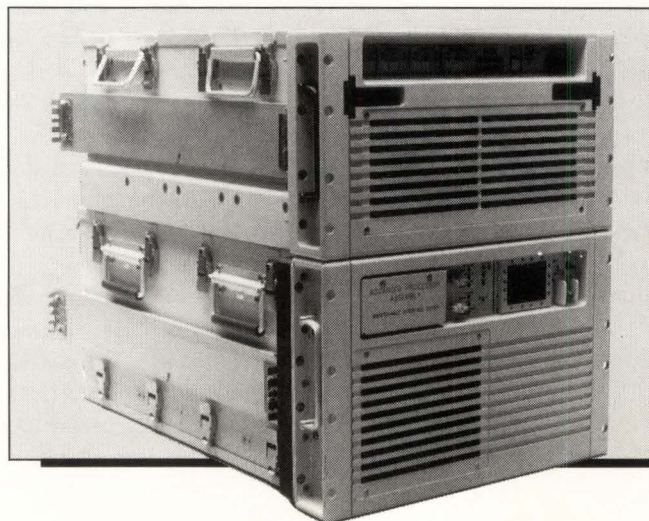

Cyberchron Corporation's R8000 Series ruggedized computer.

starts at \$3,000 for 16 channels, plus media charge. Single-license pricing for the VNBACP/SMB starts at \$6,000 for 16 channels, plus media charge.

For additional details, contact Randy Cochran, C & C Technology Inc., 245 W. Roosevelt Rd., Bldg. 9, Unit 60, W. Chicago, IL 60185; (312) 231-0015.

Circle 493 on reader card

Byers Plot Station Supports 3-D

Byers Engineering Company is shipping Plot Station release 5.0, which supports 3-D elements for Intergraph and MicroStation design files. A key feature of this release is the processing of both 2-D and 3-D B-splines, uniform and non-uniform, and rational and non-rational. It also lets you control the smoothness of curved elements such as B-splines, arcs and ellipses.

Other features include a Plot Log that

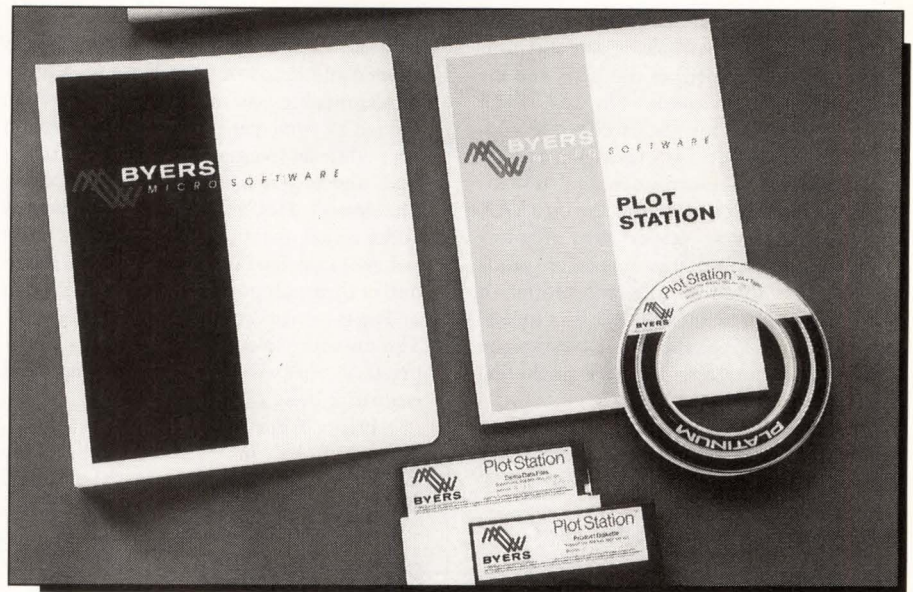

Byers Engineering Company's Plot Station 5.0.

Digital Products

DEC announced the addition of a general-purpose system to its family of RISC-based UNIX computer systems. The DECsystem 3100 can be designed in a variety of configurations to serve from four to 64 users. DECsystem 3100 configurations include licenses for ULTRIX, TCP/IP, NFS, DECwindows/X Window System, and an optimizing C compiler for the RISC architecture. It's based on the R2000/R2010 chip set from Mips Computer, providing 14 mips and 3.7 single-precision Linpack Mflops of performance. It's expandable to 24 MB in 4-MB increments.

Prices for typical DECsystem 3100 configurations range from \$20,400 for a four-user system to \$55,604 for a 32-user system.

Circle 403 on reader card

DEC announced software capabilities under the Computer Integrated Telephony (CIT) program. DEC's layered VMS CIT Server software links a VAX system and a CIT-compatible PBX to provide integrated voice and data application solutions at the desktop. In addition, DEC's VMS CIT Applications Interface client software enables applications programmers to initiate calls and monitor the use of telephones connected to a PBX. Access to the CIT Server is through DEC's VMS CIT Applications Interface software.

The VMS CIT Server software is priced at \$3,000. Prices for the VMS CIT Applications Interface software range from \$450 to \$14,250, depending on the hardware configuration.

Circle 403 on reader card

The VAXstation 3520 and 3540 are high-performance 3-D workstations featuring the DECwindows user interface. The multi-processing systems can be expanded to 24 bit planes of display memory with a palette of 16.7 million colors. They come standard with dual CPU and a graphics accelerator. The 3540 supports VMS; the 3520 supports either VMS or ULTRIX. The 3520 is expandable from 8 MB to 64 MB of memory. Both can be

diskless or can support up to 1.3 GB of disk storage, and both are DECnet network compatible.

Pricing starts at \$29,950 for a diskless, 8-bit-plane 3520 configured with 8 MB of memory and either VMS or ULTRIX.

Circle 403 on reader card

DEC announced UNIX software support for its PrintServer 40, a networked laser printer. The software packages are PrintServer DECnet Client Software for ULTRIX and PrintServer TCP/IP Software for ULTRIX. The PrintServer DECnet Client Software is designed for environments that use ULTRIX and VMS systems on the same DECnet network. VMS PrintServer Supporting Host Software is required for the PrintServer 40. It boots the PrintServer upon powerup. The PrintServer TCP/IP Software includes both client and supporting host modules and requires an ULTRIX VAX as the supporting host.

The PrintServer 40 with DECnet or TCP/IP licenses costs \$50,650.

Circle 403 on reader card

DEC's HA3000 three-phase UPS provides protection against the effects of a power outage and common power aberrations, such as voltage surges, voltage spikes, high-energy transients, electrical noise and low-voltage conditions. In the event of a power outage, the UPS supplies a nominal 15 minutes of battery backup power to the critical load without interruption to computer operation. The standard HA3000 configuration consists of a UPS cabinet and battery cabinet. Options include an Input Total Harmonic Distortion (THD) reduction filter, an Input Isolation Transformer, a Distribution Cabinet and Remote Status Panel.

The HA3000 series ranges in price from \$37,500 to \$75,500 for units from 20 kVa to 80 kVa.

Circle 403 on reader card

tracks usage, including plot name, design file name, plot size and parameters, date and time. The log is independent of the VAX and includes a plot-search routine. The data, which is stored in ASCII format, can be used with products such as Lotus as a management tool. Plot Station is PC-based software that manages plotting from multiple queues on a VAX or network servers. It performs all plot-processing (stroking) functions before sending the files to an electrostatic plotter. It requires a standard 286/386 PC, is compatible with most VAX and PC networks and can support multiple plotters, including several laser and color plotters.

For complete information, contact Barbara Stafford, Byers Engineering Co., 6285 Barfield Rd., Atlanta, GA 30328; (404) 843-1003.

Circle 492 on reader card

Computer-Link's 3880 Maintains Cartridges

Computer-Link Corporation announced the Model 3880 Tape Cartridge Maintenance System for IBM 3480 tape cartridges. The system automatically cleans, evaluates and sorts cartridges based on tape quality.

The Model 3880 features a 10-cartridge

automatic batch feeder that loads tapes without operator intervention. Each tape is cleaned and tested in accordance with user-programmable criteria. Test parameters are entered by front-panel menu/mode selection keys while an integral CRT confirms selections and progress of the entire operation. The Model 3880 evaluates tape cartridges under actual operating conditions to ensure test integrity. Tape cartridges are graded into one of three categories — Archival, Scratch or Reject — depending on errors detected. The microprocessor-based unit uses a proprietary mechanism for cleaning and evaluating tape cartridges.

Prices begin at \$27,500.

For additional information, contact Joe Pogoda, Computer-Link Corp., 3 Lopez Rd., Wilmington, MA 01887; (508) 657-8820.

Circle 495 on reader card

Eigen Network Security Protects Network

Eigen Corporation announced version 2.0 of its Network Security package for VAX/VMS systems. Eigen Network Security keeps unauthorized users out of networked VAX/VMS systems. It allows system managers to tailor their networks so that in-

truders can't access a system through the network, regardless of how large or diverse the network is.

Eigen Network Security protects against access from nodes that aren't in the DECnet database but are electrically connected to the network. Authorized users within the set of nodes specified are given full network access, but no other nodes can SET HOST to or otherwise access the local node. For each account on the network, system managers can specify what privileges that account will have on each node. This ensures maximum protection for the network without unduly restricting user access. Eigen Network Security runs on VMS versions 5.0 and 4.0+.

The package costs \$500 to \$2,500 per VAX, depending on CPU type.

Obtain more information by contacting Robert Zampardi, Eigen Corp., 82 Wall St., Ste. 1105, New York, NY 10005; (212) 749-7513.

Circle 499 on reader card

DBA Companion Assists Developers And DBAs

D & N Systems announced the DBA Companion. This Oracle security, application and resource-management system is designed to

**3100 SIMM
MODULES NOW
AVAILABLE!
YOU CAN PAY MORE
FROM DEC or YOU
BUY the SAME
PERFORMANCE
from SEE FIRST
for LESS \$\$\$\$.**

TO ORDER: PHONE (408) 748-7717 or

Also ask for
pricing on our
complete line of
memory & RAM
DISK products.

FAX (408) 748-7621



SEE FIRST TECHNOLOGY, INC
4655 OLD IRONSIDES DRIVE
SUITE 100
SANTA CLARA, CA 95054

*THE 3100 WORK STATIONS ARE A TRADE MARK OF DIGITAL EQUIPMENT CORP.

CIRCLE 240 ON READER CARD

Cost-Effective Nine-Track Drives

μVAX
DOS
IBM 3X
IEEE
PS/2
RS-232
SCSI
XENIX



Choose the features
best for you...
AUTO-LOADING
SUPER SPEED
LOW COST
LEASE-PURCHASE

Call Ron Kramer
800-842-0708 or 516-385-3344
TDX Peripherals, Inc.
270-02 East Pulaski Road
Greenlawn, New York 11740

**TDX
PERIPHERALS
TDX**

CIRCLE 340 ON READER CARD

"Picture DEC graphics for \$1300 less than DEC prices."

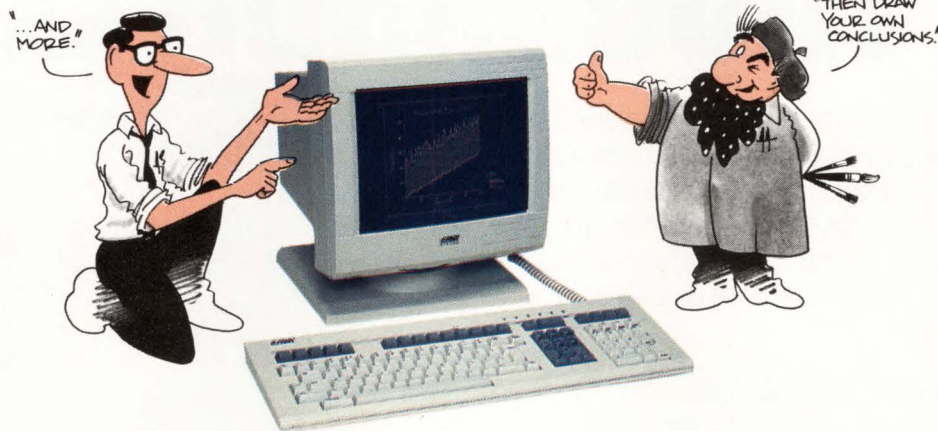

If it weren't so darned expensive, the DEC® VT330 would be a nice graphics terminal. And if it only did graphics, the DEC VT320 would have a nice price.

So how do you get affordable DEC graphics?

Buy a C. Itoh CIT328.

Competent, compatible, affordable.

At \$699, the CIT328 is compatible both with your budget and with the DEC VT320, VT220, VT100, VT52 and Tektronix® 4010/4014 software. It's also compatible with the DEC Office Connect® interface standard and the VT131's local block editing mode.

But most importantly, the CIT328 gives you text and graphics and a host of advanced features for about the same

price as a VT320. Now that's affordable.

Extras built in.

Among other extras you get with the CIT328: a flicker-free 70 Hz refresh rate, four pages of line text memory, a tilt/swivel base, calendar and calculator desk accessories, and access to three

times as many programmable function keys as the VT320.

And like all C. Itoh DEC-compatible terminals and printers, the CIT328 is backed by a one-year warranty and a reputation for unflinching quality. Our advice: see one.

And start thinking about what you could do with an extra \$1300.

Feature	VT320	CIT328	VT330
Tektronix Graphics	No	Yes	Yes
Sixel Graphics Hard Copy	No	Yes	Yes
ReGIS Graphics	No	No	Yes
Block Transmission Mode	No	Yes	Yes
Dual Host/Dual Sessions	No	No	Yes
Display Refresh Rate	60 Hz	70 Hz	60 Hz
Text Pages of Memory	1	4	6
DEC Office Connect	Yes	Yes	Yes
RS423/RS232	Opt	Yes	Yes
Desk Top Accessories	No	Yes	No
Tilt and Swivel	Opt	Yes	Yes
Price	\$545	\$699	\$1995

Call (800) 347-2484 or (714) 757-4492
 Southeastern Regional Office **(404) 368-9183**
 Eastern Regional Office **(609) 235-3400**
 Midwestern Regional Office **(312) 850-9500**
 Western Regional Office **(714) 757-4422**

C.I.TOH
C. Itoh Electronics, Inc.
 2505 McCabe Way, Irvine, CA 92714

We build more in. So you get more out.

DEC[®] PRINTER CLONE SELLS FOR THOUSANDS AND THOUSANDS LESS.

At \$8990 for 800-lpm, high speed printing has never been more affordable. As a comparison, that's the price you pay for 300-lpm from DEC. It gets better. How about \$11,990 for 1200-lpm! DEC's 1200-lpm offering goes for \$29,000. And in the bargain, you get bar code and business graphics capability.

Reliability? You bet?

Taneum Computer Products has modified the ruggedly reliable Mannesmann Tally 600-Series matrix line printer into a DEC line printer compatible machine.

Plus, our prices include installation, a full 90-day on-site warranty and operator training. Also, nationwide factory service maintenance contracts are available from Mannesmann Tally at substantial savings. For example, pay only \$148 monthly for a 1200-lpm model. If you know printers, you know Mannesmann Tally leads the league in quality and dependability. And steadfast output. Their 1200-lpm machine is designed to deliver 5000 pages per day.

Taneum — the printer people. Taneum can fill your printer needs even if LG01 compatibility isn't required. We also provide Dataproducts, Printronix, Centronics or QMS compatibility; and should your future needs change, we can modify at any time to give you DEC LG01 compatibility.

Plus, we optionally offer 13.3, 16.7 and 20 characters per inch.

Act Now! This is an incredible offer. High speed line printing at prices thousands of dollars less than from your mainframe supplier. So why pay such a high tariff for mainframe color and logo. Get fast delivery by picking up the phone and calling us now.

(206) 251-0711

P.S. LG01 OEM ribbons at great savings. For IBM systems with twin-ax or co-ax, significant printer savings are available.

*—DEC registered trademark of Digital Equipment Corp.

CIRCLE 263 ON READER CARD

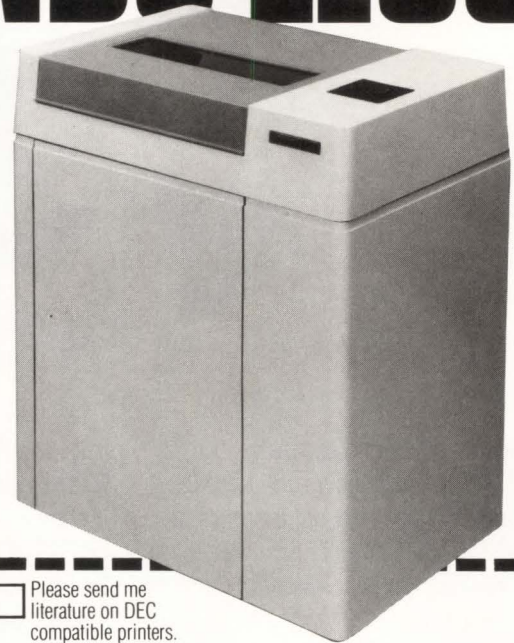

Please send me literature on DEC compatible printers.

Name _____

Title _____

Company _____

Address _____

City/State/Zip _____

Telephone _____

Taneum Computer Products
203 S.W. 41st Street
Building 9, Unit G
Renton, WA 98055

The printer people

Taneum Computer Products

DEC VAR inquiries invited.

assist developers and DBAs in managing source code, security, physical space, applications and users for development and production Oracle environments. More than 45 reports describe the state of the DBA Companion database and site applications, and provide trend analysis about table, partition and use activity.

The security-management module assists DBAs in controlling and monitoring Oracle security. A menu facility consults the DBA Companion database at run time to control user access to applications and resources. The resource-management module assists database administration personnel in managing the physical resources of an Oracle database through a set of system reports. The application-management module consists of scanner routines that extract Oracle DML, DDL and DCL statements from .SQL, .INP, .RPT, .COB, .FOR and C files. The semantic content of the statements are loaded into an information resource dictionary and this information is used to define user privileges. For more information, contact D & N Systems, 8 New England Executive Park, Burlington, MA 01803; (617) 270-4150.

Circle 497 on reader card

Forest Interfaces IBM And DEC

Forest Computer announced The Forest Network Processor, which provides the capability to interface NS/3000 with IBM and DEC systems. With the Forest Network Processor, NS/3000 LANs can be attached to DECnet LANs and SNA networks, allowing multidirectional terminal and file access.

At the core of the implementation is the HP3000 LAN Adapter, a software module in the Forest Network Processor. The HP3000 LAN Adapter interfaces with other host adapters, allowing HP terminals and programs to connect to IBM/DEC systems as though they were native IBM/DEC devices and allowing IBM/DEC terminals to connect to an HP3000 as if they were native HP terminals. File transfer, RJE and printer emulation services are available in many configurations. It supports attachments between HP3000 and HP1000; IBM 3090, 4381, 9370, System/38 and AS/400; Unisys A- and V-Series; and VAX hosts.

Prices start at \$40,000 for an HP3000/IBM solution and at \$37,000 for an

HP3000/DEC solution.

For more information, contact Jim Antonucci, Forest Computer, 1749 Hamilton Rd., Okemos, MI 48864; (517) 349-4700.

Circle 500 on reader card

SafeSwitch Maximizes Non-Networked Printers

Graftel Systems Inc. announced SafeSwitch, a printer resource-sharing multiplexer. The product maximizes the use of non-networked, serial and/or parallel printers among multiple users.

SafeSwitch interfaces as many as four terminals or workstations to as many as two laser printers, daisy-wheel printers, pen writers, thermal printers or ink-jet printers in any combination. SafeSwitch is software transparent to each user and shared device, so each user appears to have exclusive use of the shared device. Each user can operate independently and simultaneously at his own speed. Data automatically is stored, scheduled and output on a first-come, first-served basis. SafeSwitch dynamically allocates memory to each port as needed. Therefore, all ports can be active at the same time.

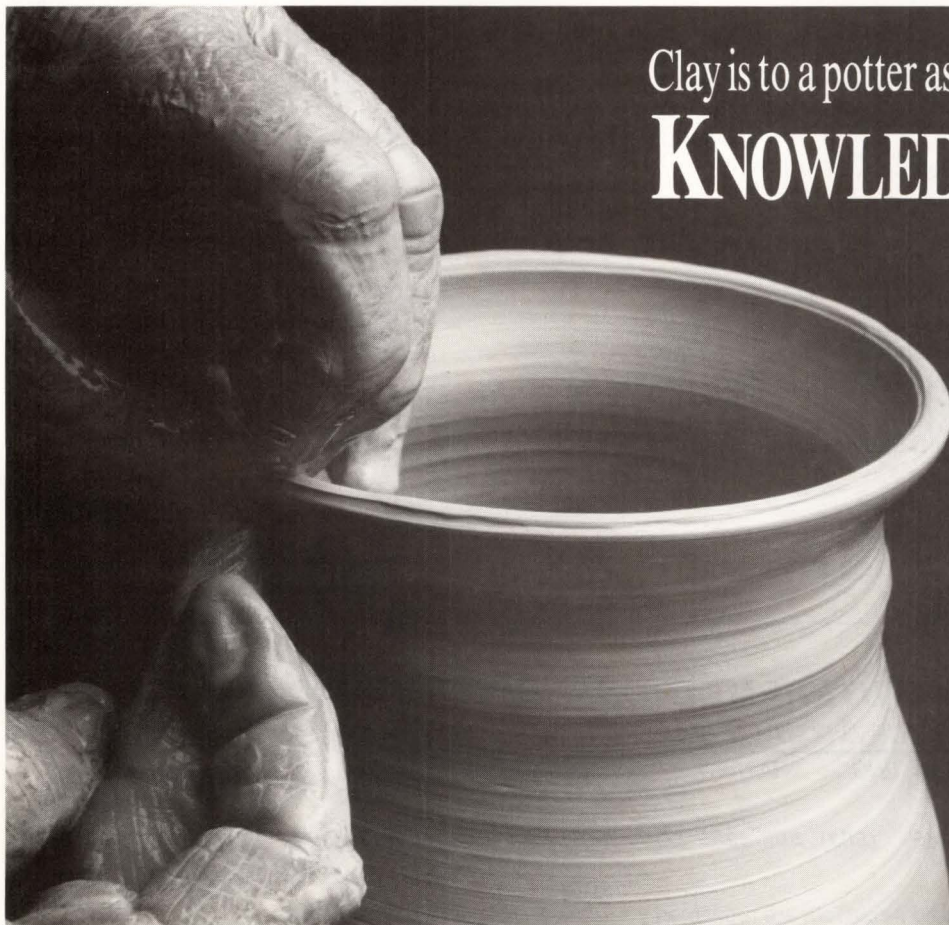

Clay is to a potter as expert knowledge is to... **KNOWLEDGE SHAPER™**

- An expert systems design and development environment
- A software system for knowledge manipulation
- A knowledge base validation and verification tool
- Available for VAX/VMS and Sun/SunOs

perceptics™

A.I. Applications Division
725 Pellissippi Parkway
Knoxville, TN • 37933-0991

615/966-9200 • FAX 615/966-9330

VAX and VMS are trademarks of Digital Equipment Corporation.
Sun and SunOs are trademarks of Sun Microsystems.

CIRCLE 298 ON READER CARD

File Edit View Sp

New Folder

Open

Print

Close

Page Setup...

Print Catalog...

Eject

• More dates
• The latest on the Apple-DEC Agreement
• Class Sizes Strictly Limited

Confused?

No wonder.

Macintosh®-VAX/VMS™ Networking means a dizzying array of connectivity products, network architectures, and hardware options.

Why not join us at our office in Marlton, NJ (20 minutes from Philly, two hours from New York) to get your hands dirty and your head straight:

May 3-5 & 17-19 1989 •

June 7-9 & 21-23 1989 •

July 12-14 & 26-28 1989 •

August 9-11 & 23-25 1989 •

September 6-8 & 20-22 1989 •

October 11-13 & 25-27 1989 •

The Macintosh/VAX Networking Lab

Course length - 3 days

Tuition - \$950

Training Objectives:

- Find out how to connect your Macintosh and IBM PC-compatible workstations through a VAX
- Understand AppleTalk and DECnet network architectures.
- Learn how to install and use various AppleTalk network hardware products.
- Learn how to install and manage various DECnet and AppleTalk based Mac/VAX networking products.
- Learn how to use and evaluate Macintosh terminal emulators.
- Learn how to develop VAX-based macintosh database applications

Topics Covered:

Network Architectures •
DECnet, AppleTalk

Network Hardware •
Ethernet
LocalTalk
Bridges
Gateways

Network Management •

Terminal Emulators •
VT100, VT220, VT240
Tektronix

VAX/VMS File Servers •
AlisaTalk, PacerShare

Networked Databases •

Apple - DEC Development
Efforts •



COMPUTER METHODS CORPORATION

525 ROUTE 73 SOUTH • SUITE 300 • MARLTON, NJ 08053

CONSULTING • TRAINING • SOFTWARE ENGINEERING

PHONE (609) 596-4360

FAX (609) 596-4362

Macintosh and AppleTalk are registered trademarks of Apple Computer, Inc.
VAX and VT are registered trademarks of Digital Equipment Corporation.
IBM and IBM PC are registered trademarks of International Business Machines, Inc.

SafeSwitch is available in 115V and 230V versions with either 256-KB or 512-KB buffer sizes. It supports both serial and parallel communications.

The product is priced from \$1,195 to \$1,495.

To learn more, contact Alan Barrett, Graftel Systems Inc., 323 New Boston St., Wilmington, MA 01887; (617) 933-8170.

Circle 501 on reader card

Interlan Announces Three Products

Interlan Inc. announced three products highlighting SCO XENIX-NET support, DECnet on UNIX System V release 3.2 and the X Window System running across Ethernet.

The NP621-386 version 2.0 hardware/software package is for use with 80386-based PC ATs. The software provides TCP/IP protocol and complete XENIX-NET support for SCO XENIX operating systems. The NP622 and NP622A products provide high-performance TCP/IP networking for Interactive's 386/ix and AT&T's UNIX System V release 3.2, respectively. The NP642 package permits PCs to operate as nodes on a Phase

IV DECnet. Operating under UNIX System V release 3.2, the NP642 provides client and server capabilities to the full range of DEC machines, including VAX and MicroVAX products. The NP642 allows virtual-terminal support, remote file-transfer capabilities and remote directory listings.

The NP621-386 costs \$1,290, the NP622 costs \$1,290, the NP622A costs \$1,490 and the NP642 costs \$1,450.

Obtain additional information by contacting Stephen Stickells, Interlan Inc., 155 Swanson Rd., Boxborough, MA 01719; (508) 263-9929.

Circle 504 on reader card

Huddle Allows On-Line Conferences

Innovative Software announced Huddle, an electronic conferencing and bulletin board system for VAX/VMS. Huddle is a dynamic communication tool that enables on-line conferences.

Huddle is fully integrated with VMS. It offers three different user interfaces, VMS Mail-style syntax, and news and file-transfer systems. It features privilege levels, public and private conferences, choice of any text editor and low disk requirements. Complete

documentation, including on-line help and printed manuals as well as full customer support, is available.

Prices range from \$387 for VAXstations to \$9,274 for the VAX 8800, excluding cluster and multiple-license discounts. For complete details, contact Innovative Software, P.O. Box 85629, Seattle, WA 98145; (206) 632-5232.

Circle 502 on reader card

MathStation Features Free-Form Interface

MathSoft Inc. announced the development of its MathStation software-applications package for the DECstation 3100 and VAXstation 3100 workstations. MathStation is an open environment for technical computing that helps you develop sophisticated mathematical applications and models, perform a wide variety of numerical analyses, and document results. It combines the power, speed and networking of engineering workstations with typeset math, text and graphics.

MathStation's features include a WYSIWYG free-form interface based on DECwindows that combines real math, text and graphics to let you express problems in

Plug the documentation hole in your information storage system!

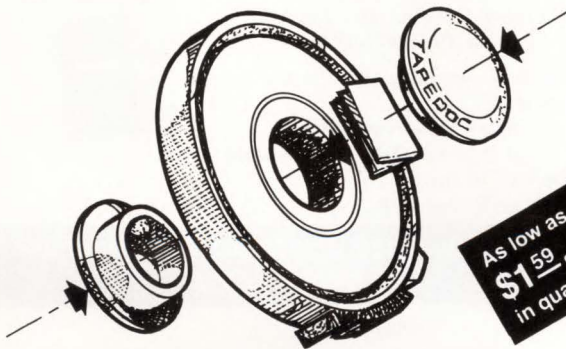

With the remarkable TAPEDOC™ tape documentation hub.

- Stores up to eight pages of directory information with each tape.
- Does not interfere with tape storage in a standard rack.

To order or for more information, contact:

TAPEDOC

P.O. Box 39550
Phoenix, Arizona 85069
(602) 241-8470

TAPEDOC is a trademark of Computer Systems Engineering, Inc., Phoenix, Arizona.

CIRCLE 326 ON READER CARD

EasyEntry™

Full featured heads down data entry for Digital Equipment Corporation computers and IBM PC's

- Immediate on-screen development of fill in the blank forms. No coding, compiling, testing—non-DP users can design forms.
- Full of features—error checking, math functions, forms chaining, program calling, HELP, error messages, rekey verification, keypunch simulation, file maintenance, operator statistics...
- Creates standard files for use with other software.
- Low overhead. Supports high volume data entry.
- Low cost.
- Easy to learn. Good documentation. Technical support is just a call away.
- Installed at 1,000 sites worldwide. ICP million dollar award winner.

Call 1-800-334-5510

applied information systems

500 Eastowne, #207, Chapel Hill, NC 27514
(919) 942-7801

CIRCLE 166 ON READER CARD

familiar math notation. The MathStation language includes loops, conditionals, functions, procedures and other standard programming constructs for building algorithms and complex models. It allows integration of existing FORTRAN subroutines and libraries without modification to protect software investments.

For complete details, contact Gordon Gossage, MathSoft Inc., One Kendell Sq., Cambridge, MA 02139; (617) 577-1017.

Circle 505 on reader card

XSQL Bridges SQL*Plus And VAX/VMS

Milcom Systems Corporation announced a software product called XSQL that's designed specifically to provide a secure, efficient and flexible bridge between Oracle's SQL*Plus and the VAX/VMS operating system. XSQL provides an alternative to running SQL*Plus interactively, and effectively allows VAX system managers to prioritize, manage and schedule specific I/O- and CPU-intensive SQL*Plus operations.

XSQL is written in VAX C and allows Oracle DBMS users in one DCL-like command to submit and execute SQL*Plus com-

mand files to any batch queue. At the same time, any SQL*Plus output files can be directed to any printer queue setup on your VAX system. On-line help for XSQL is included and is integrated with the VAX/VMS on-line Help facility. XSQL uses the same access security as provided with the Oracle DBMS. Before any SQL*Plus file is submitted to a batch queue or run interactively, you're prompted for a valid Oracle username and password.

For more information, contact Milcom Systems Corp., 532 Viking Dr., Virginia Beach, VA 23452; (800) 446-8539.

Circle 507 on reader card

Mips Computer Systems Broadens RISC Family

Mips Computer Systems Inc. announced an entry-level server and a new line of graphics RISCstations that broaden the company's family of RISC-powered computing systems.

A 12-mip compute server halves the entry price of the RISComputer line of binary-compatible servers. The RISCstation line provides graphics front ends that complement Mips' distributed solutions. It includes a high-resolution display station and

a 12-mip desktop workstation. Both RISCstations run RISCwindows, Mips' user environment based on a tuned version of the X Window System and the standard user interface endorsed by OSF.

Mips' new desktop systems primarily are targeted at OEMs and VARs in the technical and commercial computing markets. For resellers, Mips offers building-block configurations that unbundle base units, graphics cards, and Mips' operating system and optimizing compilers.

Learn more by contacting Beverly Jerman, Mips Computer Systems Inc., 928 Arques Ave., Sunnyvale, CA 94086; (408) 720-1700.

Circle 508 on reader card

Mitek Systems Adds OpenConnect Server

Mitek Systems Corporation announced the OpenConnect Server Model M2030-256. This offering provides high-speed channel attachment as well as increased performance by providing support for up to 256 concurrent sessions.

The OpenConnect product line provides bi-directional communications between IBM hosts and systems from companies such as

Bar code data collection on your VAX?

Wand 2S Utility has the answers.

Wand 2S Utility is a real time software tool for collecting data through the use of bar code.

Wand 2S Utility provides the programming foundation for your data collection applications and manages multiple data collection devices.

Wand 2S Utility asks the right questions—about your data collection functions, sequences, prompts, formats, and editing requirements.

Wand 2S Utility and one day of training will save you many weeks and thousands of dollars in implementing your bar code data collection system.



ASA International Ltd.
1700 West Park Drive
Westborough, MA 01581
Attn: William Stone
508-898-2727, ext. 9800

VAX is a registered trademark of Digital Equipment Corporation.
Wand 2S is a registered trademark of ASA International, Ltd.

CIRCLE 334 ON READER CARD

Introducing . . .

VMS Advanced Device Driver Techniques

By Lee Leahy and Jamie Hanrahan

To order your copy, send \$59.95 plus \$3.00 for shipping (\$5.00 to Canada) to:
Professional Press Inc., P.O. Box 503,
Spring House, PA 19477-0503

Written for computing pros who want to learn more about . . .

- Simple VMS Device Drivers
- Full Duplex & State Machine-Based Drivers
- VAX BI Drivers
- User-Written ACPs

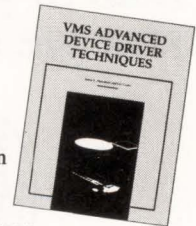

VMS Advanced Device Driver Techniques ORDER FORM

Send _____ copy(ies)
 Check/Money order enclosed for \$ _____
 Charge \$ _____ to VISA MasterCard
 Account # _____ Exp. Date ____ / ____
 Signature _____ Date _____
 Name _____
 Address _____
 City _____ State _____ Zip _____
 Country _____ Phone() _____

PROFESSIONAL PRESS INC.

921 Bethlehem Pike, Spring House, PA 19477 (215) 542-7008

DEC, HP, IBM and AT&T. It provides connections between IBM mainframe/midrange systems and systems on TCP/IP networks. OpenConnect products permit you transparently to perform full-screen editing, support TN3270, conduct remote job entry, and connect non-IBM systems to the MVS, VM, VSE and IBM midrange operating systems, which include the System/36, System/38 and AS/400.

Mitek's OpenConnect Server Model M2030-256 is available for \$39,500. Obtain complete details by contacting Catherine Milburn, Mitek Systems Corp., 2033 Chennault Dr., Ste. 100, Carrollton, TX 75006; (214) 490-4090.

Circle 509 on reader card

Morss Provides Automated Scheduling

Morss Software Development announced version 3.1 of Command File Scheduler to automate batch processing for VAX/VMS computers. The product provides automated scheduling by generating the executable DCL command files and performing the proper submit commands. The substitution capability provides for unlimited swaps. When com-

bined with its Calendar and Date calculations, it's a perpetual command file scheduler that automates all batch schedules.

In addition to eliminating the need to make massive daily changes to static command files, the calendar-driven Command File Scheduler provides for error trapping and logging, automatic date substitution, report distribution to multiple sites, chargeback reporting for computer resource control, pre-processing and post-processing reports, and flexible scheduling with only the programs needed on a given day being run.

Prices start at \$6,000.

Learn more by contacting Robert Morss, Morss Software Development, P.O. Box 1024, Bellevue, WA 98009; (206) 682-5116.

Circle 510 on reader card

McDonnell Douglas Expands DEC Service

McDonnell Douglas announced the expansion of its service options on DEC equipment to include the VAX 8000 series, VAX 3000 series and VAXstation 2000 series. This expanded service broadens McDonnell Douglas' capabilities on the low-end VAX product line through the high-end 8000

series and is available in most major metropolitan centers across North America.

This expansion is targeted at customers that require across-the-board service from a single-source provider in strategic locations. To find out more, contact Pat Dwight, McDonnell Douglas, 1801 E. St. Andrew Pl., Santa Ana, CA 92705; (714) 250-1000.

Circle 506 on reader card

Video Family Manages System

Performance Software Inc. announced the VAX-based Video range of terminal-monitoring software. The Video products provide a range of system-management functions useful in security surveillance, systems support, software development, training and quality control. All are based on proprietary terminal-monitoring technology developed to work in close conjunction with the VMS operating system.

The full product set is made up of three modules. Video-Slave allows one terminal's activity to be replicated on any number of other VTs. Video-Seer allows an authorized user to observe the activity of any other terminal on the same VAX, with or without the

Q-BUS SYSTEM PACKAGES

Zoltech's modular design allows literally thousands of configurations to be built with its V-series family of system chassis. Zoltech will deliver anything from empty metal shells to completely tested turnkey systems: You decide what you want to do and Zoltech will do the rest. Q-Bus and VME systems are our specialty, but we also do custom designs.

VME TOO . . .

CIRCLE 262 ON READER CARD FOR VME

ZOLTECH DELIVERS — CUSTOM OR STANDARD

Complete Systems
Empty Chassis

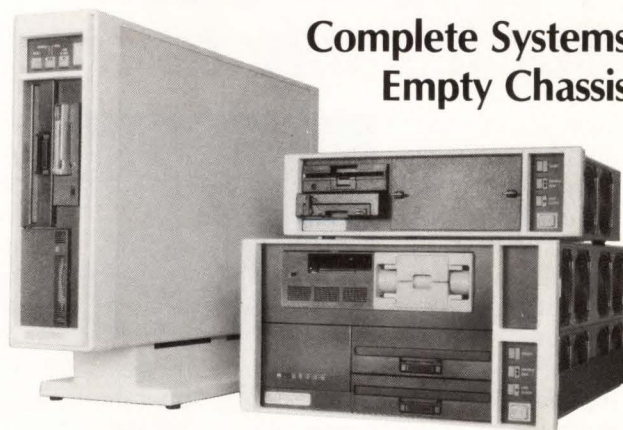

ZOLTECH CORPORATION

7023 Valjean Avenue, Van Nuys, California 91406 USA
(818) 780-1800 Telex 755451

CIRCLE 264 ON READER CARD FOR Q-BUS

user's knowledge. Video-Replay allows terminal sessions to be recorded and played back or printed later. The Video family operates under standard VMS version 4.6, 4.7 or 5.0.

The full Video package is priced at \$1,950. For users with VMS V4.6 or V4.7, an upgrade for VMS V5.0 costs \$150.

For complete details, contact Harriet Silbaugh, Performance Software Inc., The Carriage House, 28 Green St., Newburyport, MA 01950; (508) 462-0737.

Circle 481 on reader card

Metamorphosis Translates Source Programs

J.H. Shannon Associates Inc. announced Metamorphosis, a generic utility program that facilitates the transformation of any syntactically reducible character-oriented file to any other form, while preserving its synonymy. Given the syntactical definition of the source and target languages, it translates source programs from one

language to another.

Metamorphosis also functions as a custom compiler, assembler, macro processor, query-language processor, command-language processor, graphics-language processor and report generator. It facilitates reformatting of database files and analysis of natural language, grammar, sequential and parallel procedures and computational signatures. In addition to generic Metamorphosis, preconfigured translators are available, including FORTRAN IV to C, PL/I(subset G) to C and CMS-2M to Ada.

Generic Metamorphosis costs \$387.

Learn more by contacting J.H. Shannon Associates Inc., P.O. Box 597, Chapel Hill, NC 27514; (919) 929-6863.

Circle 516 on reader card

Peripherals Announces Tape Cleaner/Rewinder

Peripherals announced a microprocessor-based controlled portable computer tape cleaner/rewinder. The cleaner/rewinder's microprocessor self-testing motion control allows detection of missing BOT and EOT. Standard equipment includes fail-safe brakes, a quick-release hub, an anti-skew rugged packer arm and a special 200-ips archival wind for tapes being put in storage. Normal speed is 350 ips — 3½ minutes for a 2,400-foot reel.

The cleaner/rewinder features a rugged, scratch-resistant case that weighs less than 26 pounds. Tabletop and rack-mountable models are also available.

Find out more by contacting R. Carboy, Peripherals, 1363 Logan Ave., Costa Mesa, CA 92626; (714) 540-4925.

Circle 513 on reader card

Persoft Supports DECnet-DOS

Persoft Inc. announced connectivity support for DECnet-DOS. This allows Persoft's terminal-emulation products for microcomputers, SmarTerm 240 and SmarTerm 220, to connect to DEC's LAT, which gives PC users access to VAX applications software. The combination of SmarTerm and DECnet-DOS provides rapid access to the VAX/VMS host.

In addition to DECnet-DOS, supported systems include the Novell NACS and NetWare VMS, IBM LANACS, Ungermann-Bass Net/One, Bridge Communications EtherTerm system, Datability RAF Remote Access Ability and Network Products Corporation Network Communications.

To learn more, contact Kathleen Riddiough, Persoft Inc., 465 Science Dr., Madison, WI 53711; (608) 273-6000.

Circle 514 on reader card



You can make other modems pretend they're a Telcor. But it's silly to try.

Sure, you can speed up other modems with special software. And you can add expensive security and network management devices.

But why waste your time? Telcor modems provide faster and more secure access to your VAX than any other modems . . . at a remarkably low cost.

There are simply no other asynchronous dial modems like Telcor's. They're the world's fastest—up to 38.4K bps. They provide password/callback security, DES encryption and a complete audit trail of VAX

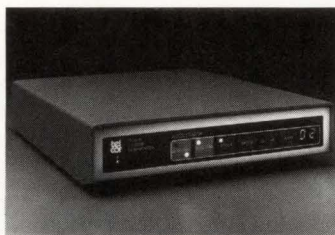

access attempts. And they conform to all major industry standards. It takes a demo to really appreciate the ease and efficiency Telcor

modems will deliver to your VAX operations, day after day. Call us toll free in the U.S. at 1-800-826-2938. Elsewhere call 1-508-653-3995. We'll have your local distributor schedule a demo right away.



TELCOR
SYSTEMS
CORPORATION

the world's fastest dial modems

VAX is a registered trademark of Digital Equipment Corporation.

APPLE AND DIGITAL WON'T START A CONVERSATION WITHOUT US.

Because we're the software networking company that got them talking together in the first place. And we're still the one company that provides Mac to VAX total networking solutions.

We're Alisa Systems.

The people that brought you AlisaTalk™

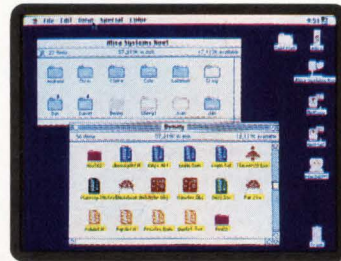

AlisaTalk is a software package that puts AppleTalk on the VAX. And at its heart beats AlisaShare™, the *only* 100% AppleShare, VAX/VMS based full-function file server. Providing transparent file sharing compatible with the AppleTalk Filing Protocol (AFP).

AlisaShare is easy to learn and use, and requires no change in file handling procedures.

It shares files with VMS users.

Lets you store private files on the server using AppleShare folder security. Allows you to share information via multi-user databases. And makes the most of each and every Apple and Digital standard.

AlisaTalk is just one of our total networking solutions for Mac to VAX connectivity. One of many. For more information, contact us at Alisa. We'll show you how to put your Macs and VAXes on speaking terms.

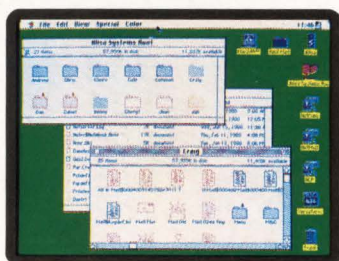

Alisa Systems Inc.
We keep everybody talking.

221 East Walnut Street, Suite 175 Pasadena, CA 91101 (818) 792-9474

Alisa, AlisaTalk, and AlisaShare are trademarks of Alisa Systems, Inc. Apple, Macintosh, AppleTalk, and AppleShare are trademarks of Apple Computer, Inc. DEC, VAX, and VMS are trademarks of Digital Equipment Corp.

CIRCLE 220 ON READER CARD

Accelerate Your Tapes To *STREAMING* Speeds!



DYNAMIC TAPE ACCELERATOR™

Have you ever watched the tapes on your tape drive try to *stream*? The tapes go back-and-forth and back-and-forth... *shoeshining* your data. Don't you wish these tapes would go *faster*?

Your wish has just come true...

Touch Technologies' Dynamic Tape Accelerator makes tape drives start...and then accelerate to full speed.
That's fast. That's streaming fast!

With the Dynamic Tape Accelerator, all applications...all VMS utilities...and yes...even VMS backup finishes faster!

You'll see faster backup operations, less operator waiting time, and more system availability time. Dynamic Tape Accelerator is completely safe and 100% compatible with VMS backup. No DCL or application code changes are necessary.

Why spend two, three, six or more hours each day waiting for your slow tape drives to complete...when you could be accelerating your tapes to *streaming* speeds!

Experience the performance of high speed streaming for yourself! Order a Dynamic Tape Accelerator "Evaluation Kit" today for \$69.95. All orders are shipped Federal Express and come complete with a full graphic display, media, and documentation.

Dynamic Tape Accelerator is available for all VAX/VMS-based tape subsystems.

Contact Touch Technologies today at
(800) 525-2527



TOUCH TECHNOLOGIES, INC.

Dynamic Tape Accelerator is a trademark of TOUCH TECHNOLOGIES, INC.

9990 Mesa Rim Road, Suite 220
San Diego, CA 92121

(619) 455-7404 • FAX: (619) 455-7413

CIRCLE 165 ON READER CARD

SPS Ports EPOS And RE-SPEC To VAX/VMS

SPS Software Products & Services Inc. announced that the CASE environment EPOS and its reverse-engineering tool RE-SPEC have been ported to the entire VAX family under VAX/VMS version 5.0.

EPOS is an integrated project-support environment with development and project-management support capabilities. In addition to the assistance provided in all phases from requirements to maintenance, EPOS provides general export/import capabilities to incorporate other tools or to operate in a corporate support environment.

RE-SPEC, which works in conjunction with EPOS, automatically generates existing reverse-engineering source code and generates EPOS design specifications. EPOS then automatically can produce an array of documentation in textual and graphical fashion, as well as perform analysis of design or generate code in other languages.

Obtain more information by contacting Shellen Keohane, SPS Software Products & Services Inc., 14 E. 38th St., 14th Fl., New York, NY 10016; (212) 686-3790.

Circle 517 on reader card

MAXLink Uses Less Than 10 KB Of RAM

Velox International announced MAXLink, a software package for PC users operating over Ethernet on VAX/VMS systems. The software uses less than 10 KB of RAM. MAXLink and its various modules serve as gatekeepers, letting you download your work and move to new tasks. After it's downloaded, the MAXLink package directs the work as you instruct.

The MAX print server and MAX disk server are two of the modules available with the basic software package. The print server lets multiple PC users share a laser printer through the VAX while retaining choice of font and other selections. The disk server allows the definition of virtual disk drives on the VAX as though they were connected to the PC.

MAXLink is priced at less than \$10,000. For more information, contact John Kufchock, Velox Int'l, 2200 Green Rd., Ann Arbor, MI 48105; (313) 761-4848.

Circle 526 on reader card

Dual-Host Workstation Holds IBM-DEC Sessions

Intelligent Information Systems Inc. announced a workstation that can hold simultaneous sessions in the IBM 3270 and

DEC environments. The dual-host workstation allows for full IBM 3270 feature compatibility while adding asynchronous communications capability with DEC, Data General, Prime and others. The workstation is enhanced by a hot key that enables easy switching and data transfer between the IBM 3270 and asynchronous environments.

The dual-host workstation features windowing that splits the display screen into two windows and lets you work in both environments simultaneously. The top window shows the IBM 3270 display image and the bottom window shows the asynchronous image. The windows can be sized and each window image can be scrolled independently. The option supports four user-selectable modes, data transfer and local-print features for screen hard copies.

The dual-host workstation ranges in price from \$1,445 to \$2,475.

Find out more by contacting Zeev Lerner, Intelligent Information Systems Inc., 92 Kansas St., Hackensack, NJ 07601; (201) 343-8353.

Circle 503 on reader card

db_VISTA III Supports Microsoft Windows 2.0

Raima Corporation announced that its network model database for C applications developers now supports Microsoft Windows 2.0. Applications using db_VISTA III 3.1 adhere to Windows' memory-management requirements. The release allows multiuser operation through multiple windows running separate db_VISTA applications simultaneously.

The system supports Windows and OS/2 because it's written in C and supports any C language environment. The entire source code is available, so environments not currently supported can be ported. Three modules make up the db_VISTA III database development system. db_VISTA is

a high-performance DBMS that uses the network database model and B-tree indexing for fast access to data with minimal data redundancy. db_QUERY, an SQL-based query and report writer, provides a relational view of the high-performance network model database. db_REVISION enables the developer to restructure the database, allowing nearly any type of modification.

For more details, contact John W. Bryant, Raima Corp., 3055 112th Ave. N.E., Bellevue, WA 98004; (206) 828-4636.

Circle 515 on reader card

Nastec Enhances CASE 2000 DesignAid

Nastec Corporation announced a release of CASE 2000 DesignAid for VAXstation products. The release incorporates enhanced drawing features, improved word processing and data-dictionary enhancements.

DesignAid 4.1 provides two new options. The Real-Time System Design option supports Ward-Mellor graphics, including state-transition diagrams, control flows, control stores and Hatley control bars. The Real-Time option also supports rule-based validation from state-transition diagrams to transformation schemas, as well as balancing across all levels. The Data Modeling option provides diagramming support for ERDs based on Chen notations and techniques, with extensions for improved data-modeling accuracy. DesignAid runs on the VAXstation II or higher. Network support, including true multiuser access to the design dictionary, is standard.

The single-license price is \$6,900, with quantity discounts available for network systems. The Real-Time option single-license price is \$1,500.

To find out more, contact Tom Stanton, Nastec Corp., 24681 Northwestern Hwy., Southfield, MI 48075; (313) 353-3300.

Circle 511 on reader card

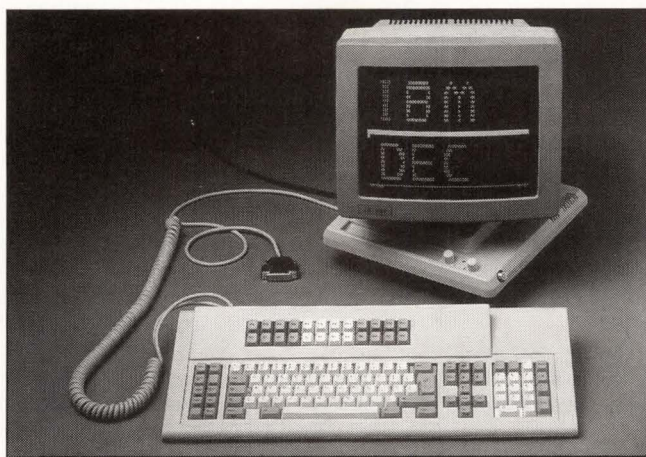

Intelligent Information Systems Inc.'s dual-host workstation.

Lasar V6.4 Speeds Fault Simulation

Teradyne Inc. announced Lasar version 6.4, which enhances the simulation system's capabilities for design and test of complex VLSI devices and circuit boards. Lasar V6.4 cuts fault simulation run times with its support of distributed fault analysis in networked computer environments. It lets you apportion parts of the fault list to more than one computer.

The release also supports the use of Teradyne's DATASource VLSI modeling system as a network resource. DATASource enables the use of physical devices in logic and fault simulation. Other key features include enhanced waveform display capabilities, extensions of Lasar's behavioral modeling language, and features for more accurate modeling of complex devices such as ASICs. The product runs on VAX/VMS systems and Sun Microsystems' Series 3 workstations.

Prices for Lasar V6.4 licenses range from \$15,000 on a VAXstation 2000 to \$280,000 on a VAX 8800 series, depending on CPU. To find out more, contact Georgia Marszalek, Teradyne Inc., 321 Harrison Ave., Boston, MA 02118; (617) 980-5212.

Circle 527 on reader card

TelnetManager Supports TCP/IP Network Software

Walker Richer & Quinn Inc. announced TelnetManager, a TCP/IP network link for PC-to-host communication. A complement to Reflection, TelnetManager is a PC-based implementation of the TELNET protocol that provides terminal sessions between networked PCs and hosts.

You can establish single or multiple sessions to one or more host computers from within Reflection using TelnetManager's session-management capabilities. TelnetManager supports TCP/IP network software from Sun, FTP Software and Excelan. It requires Reflection 1 Plus, 2 Plus, 4 Plus or 7 Plus version 3.33 or later. Running under Reflection, it requires an IBM PC, XT, AT, PS/2 or compatible with a minimum of 512 KB of RAM; a TCP/IP network connection between the PC and the host; and a TELNET server running on the host. Reflection and TelnetManager software provide emulation of HP 2392, HP 2627, HP 700/92, VT220/240/241, and 16-color 340 ReGIS graphic terminals.

TelnetManager costs \$99.

For more information, contact Carolyn Bakamis, Walker Richer & Quinn Inc., 2825 Eastlake Ave. E., Seattle, WA 98102; (206) 324-0350.

Circle 528 on reader card

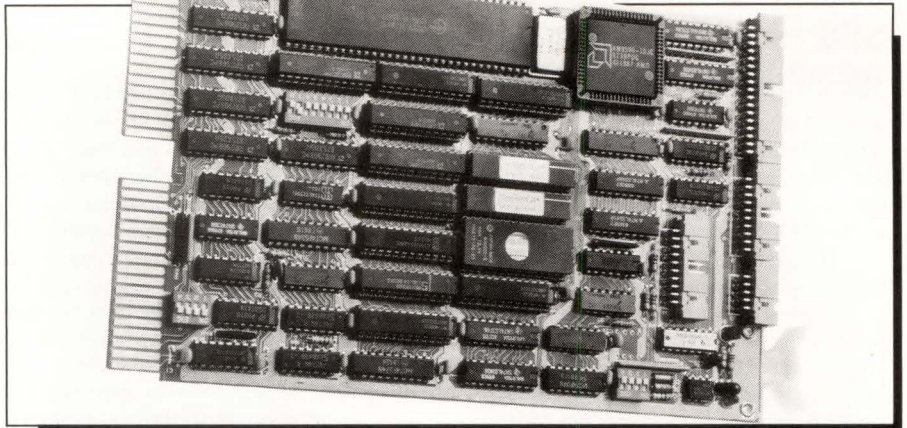

Sigma Information Systems' SDC-RQD11-DESDI disk controller.

Sigma Controller For Dual ESDI Drives

Sigma Information Systems announced the SDC-RQD11-DESDI, a high-performance controller that interfaces two ESDI drives to a MicroVAX II, MicroVAX 3000 or LSI-11 Q-bus system. The dual-wide controller responds to MSCP commands as if it were a standard RQDX2/3 controller.

The controller features a dynamic bad block replacement that replaces any blocks it detects as bad with an alternative block from a replacement block pool. Combined with error correction (ECC), the controller presents error-free media to the host computer. WOMBAT menu-driven, firmware-based utilities permit interactive disk formatting and maintenance operation. The formatter partitions each drive into virtual units that are addressed by the host as individual drives. Each virtual unit can be any size up to the size of the entire drive, with up to 16 virtual units assigned to each controller.

The SDC-RQD11-DESDI costs \$915. To find out more, contact Helen Mitchell, Sigma Information Systems, 3401 E. LaPalma Ave., Anaheim, CA 92806; (714) 630-5417.

Circle 523 on reader card

Transaction Accelerator Supports VAX Networks

Telematics International Inc. announced the Transaction Accelerator network system, which allows VAX computer systems to support up to 30 percent more users. It reduces network costs by decreasing traffic up to 80 percent and provides remote terminal users with the same response time as local terminals.

The Transaction Accelerator consists of an Ethernet-attached front-end processor and remote VT cluster controllers. The front end handles network processing and manage-

ment for VAX hosts and offloads terminal handling for local terminals. The VT cluster controllers provide remote users with local terminal handling, screen management and network links to VAXs. The Transaction Accelerator runs VMS version 4.6 and later software. It's completely compatible with the standard VMS terminal driver and supports all applications without software modifications.

The Transaction Accelerator costs \$45,000.

For complete information, contact Telematics Int'l Inc., 1201 Cypress Creek Rd., Fort Lauderdale, FL 33309; (305) 772-3070.

Circle 525 on reader card

Shadow Series Subsystem Protects MicroVAX Data

System Industries announced the Shadow Series data storage subsystem, which provides on-line, fault-tolerant protection of disk-based data for MicroVAX computers.

The Micro Power Pac Shadow Series offers up to 1.2 GB of data storage per subsystem and makes HSC-style shadowing available on the Q-bus using 5/4-inch disk drives. Each subsystem supports up to four disk drives or two shadowed pairs. In a shadowing configuration, data is written on two drives simultaneously. The second drive of the pair serves as a shadow copy of the first. If either drive fails, the other maintains normal I/O operations. Shadow Series is packaged in a BA123-style enclosure and is available with System Industries' 380-MB S156 or 760-MB S157 disk drives.

The product is priced from \$22,900 for a two-drive S156 configuration to \$52,000 for a four-drive S157 configuration.

To learn more, contact Brian Edwards, System Industries, 560 Cottonwood Dr., P.O. Box 789, Milpitas, CA 95035; (408) 432-1212.

Circle 482 on reader card



TI's new TravelMate™ LT220. It's the closest thing to carrying a VAX™ in your briefcase.

Texas Instruments introduces the LT220 lap-top terminal — the next best thing to being there when you need remote access to your company's VAX.

The LT220 provides full VT220 emulation in a 4.8-lb. package, without sacrificing functionality. It features a 25-line screen that's easy to read. It even has a full-function keyboard like the one on a VT220.

The terminal communicates at 1,200 or 2,400 bps through one of its optional internal modems. For hard copy, just slide the LT220 into one of its optional cradles to add an ink-jet or thermal printer.

New credit-card-sized memory cards

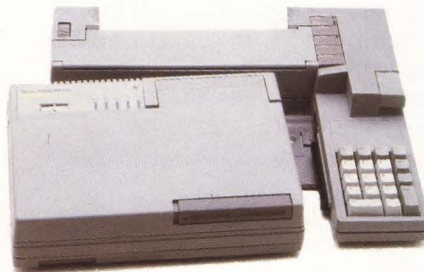

let you create, update and store files. They're also handy for programming the LT220 to your specific application.

Like its Silent 700™ predecessors, the LT220 sets new standards for portability, durability and reliability. All of which makes it the perfect tool for any-

one who's ever wished for a VAX in their briefcase. In short, this may be the best little terminal in the world.

So go ahead. Take the first step toward improving your productivity today. Call Texas Instruments for more information or to arrange a demonstration of the LT220. **Phone toll-free, 1-800-527-3500.**

**TEXAS
INSTRUMENTS**

36154
© 1988 TI
Silent 700 and TravelMate are trademarks of Texas Instruments Incorporated.
VAX is a trademark of Digital Equipment Corporation.

CMS Enhancements Adds Storage Subsystems

CMS Enhancements Inc. announced a series of tape and disk mass storage subsystems for Q-bus and UNIBUS systems. Capacities range from 155 MB to 2.8 GB.

The subsystems, with 3½-, 5¼- and 8-inch form factors, use ST506, ESDI or synchronous and asynchronous SCSI interfaces

that are 100 percent compatible with the DECstation 210, 316 and 320 PCs; VAXstation 3100 (models 30 and 40); VAXstation 2000; MicroVAX I, II and III; MicroPDP-11; PDP-11; and VAX-11 systems. The synchronous SCSI interfaces have a transfer rate of 4.8 MB per second. For both tape and disk devices, CMS Enhancements offers SCSI host adapters that provide optional differential drivers to support applications requiring SCSI bus lengths in excess of the current in-

dustry limitation of three meters. The subsystems are available with either an internal cabinet-mounting kit or an external single-drive enclosure with an external mounting kit for use with 5¼-inch footprint tape or disk units.

For more information, contact Agha Mahmood, CMS Enhancements Inc., 1372 Valencia Ave., Tustin, CA 92680; (714) 259-5903.

Circle 518 on reader card

Focus Interfaces To Adabas Database

Information Builders Inc. announced a read-only interface between Focus for VAX 4GL/DBMS and the Adabas DBMS. With the interface, all of Focus' reporting, graphics, spreadsheet and data-analysis facilities can access data stored on Adabas systems directly.

With the Focus interface to Adabas, tables can be joined relationally to other Adabas, RMS, Rdb, DBMS, Britton Lee, Ingres, Oracle, Sybase and Focus files. Focus, via the interface to Adabas, accesses the records directly using optimized queries, thereby eliminating the need for any data conversion. Focus contains full database and application-development facilities as well as decision-support features, including a report writer, graphics, statistics, a spreadsheet and a financial-reporting language.

Prices for the Focus interface to Adabas range from \$1,750 (\$70 per month rental) for the MicroVAX II to \$14,000 (\$400 per month rental) for the VAX 8840.

Learn more by contacting Jennifer Oshin, Information Builders Inc., 1250 Broadway, New York, NY 10001; (212) 736-4433.

Circle 423 on reader card

Mass-11 Spreadsheet Meets CALS Standards

Microsystems Engineering Corporation announced Mass-11 Spreadsheet, a spreadsheet package that complies with the government-required computer-aided acquisition logistics and support (CALS) standards. CALS is a Department of Defense specification that will be implemented in January 1990 and will require all government contractors to submit documents in electronic format.

Mass-11 Spreadsheet has a Lotus-like interface and can import Lotus data, graphs and macros. Other features include scalar or matrix math, trig in degrees or radians, statistical functions, linear and exponential curve fitting, multiple regression analyses and an advanced data fill function. It can sort up to 253 columns concurrently in ascending or descending order, and has eight concurrent lenses with intermixed data and graphics. It provides full business graphics and can



5.4 Gigabytes Unattended Backup

Digi-Data's GIGASTORE™ provides up to 5.4 Gigabytes of data storage on a single T-120 Super VHS video cartridge. That permits backup of your largest disk drive on off-hours without an operator.

Utilizing true read-after-write coupled with very powerful error correction, GIGASTORE gives you an unsurpassed error rate of 1 in 10¹⁹ bits. In addition, you get a high speed search capability not available in most 9-track drives.

GIGASTORE can be provided with an interface for IBM PC/XT/AT/PS-2™. It is available with DEC interface for VAX and MicroVAX. It is also available for backup of data on Novell LANs.

Call Digi-Data, an organization with a 25 year history of manufacturing quality tape drives, at (301) 498-0200.

™ GIGASTORE is a trademark of Digi-Data Corporation. PC/XT/AT/PS-2 are trademarks of IBM Corporation.



DIGI-DATA CORPORATION

8580 Dorsey Run Road
Jessup, MD 20794-9990
(301) 498-0200
Telex 87-580

... First In Value

DEALER
INQUIRIES
INVITED

In Europe contact: Digi-Data Ltd. • Unit 4 • Kings Grove • Maidenhead, Berkshire
England SL6 4DP • Telephone No. 0628 29555/6 • Telex 847720

CIRCLE 199 ON READER CARD

MDBS III[®]

— VS —

ORACLE



OPERATION: Embedded SQL fetch program—"SELECT* into empno, ename, job, mgr, hiredate, sal, comm, deptno"

HARDWARE: Standard IBM AT with 640 K RAM.

No. of Records	ORACLE	MDBS III
1,000	*	16.43 sec.
2,000	*	32.68 sec.
4,000	*	65.31 sec.
10,000	*	165.71 sec.

* Although ORACLE's license agreement prohibits us from disclosing actual benchmark timings, we *can* say that the phrase "over 10 times faster" was heard many times in and around the **mdbs** testing center that day.

For a copy of the data on which this benchmark was performed, or for more information on MDBS III, complete and send the coupon or call **mdbs** Sales Support at (800) 344-5832. In Indiana call (317) 463-2581 and in Canada call (416) 733-4380.

- Yes! I would like to make my own benchmark comparison. Please send me a copy of the 10,000 record data base that was used for your benchmark tests.
- Please send me more information about the SQL and Distributed Data Base features of MDBS III.

Name/Title _____

Company _____

Address _____

City _____

State/Zip _____

Phone _____



Two Executive Drive • P.O. Box 248
 Lafayette, IN 47902
 (317) 463-2581 • (800) 344-5832
 FAX: (317) 448-6428
 Telex: 5106017487 (MDBS LAF UQ)

mdbs and MDBS III are registered trademarks of mdbs, Inc. Other trademarks contained herein are the property of their respective holders.

display bar, pie, stack, line, x-y and Hi-Lo-Close graphs. It offers printing capabilities, including headers and footers, font selection, PostScript support, bolding and underlining. To find out more, contact Microsystems Engineering Corp., 2400 W. Hassell Rd., Ste. 400, Hoffman Estates, IL 60195; (312) 882-0111.

Circle 519 on reader card

ASK Links Manman And Dataport

ASK Computer Systems Inc. announced Manman/Dataport, an electronic interface that links Manman with an Intermec shop-floor data-collection system. It also facilitates interplant inventory transfers for Manman VAX release 7.0 users.

Manman is an integrated management-information system for manufacturing companies. It operates on HP and DEC mini-computers. Dataport is available for VAX-based Manman users. Dataport accepts data transferred from the shop floor and updates the Manman database. Dataport links with Intermec's Data Collection for Manman (DCMM). DCMM is a microcomputer-based product that accepts data entered by workers from up to 140 barcode readers scattered throughout the shop floor. Data then is centralized in DCMM before being transferred to Dataport.

Manman/Dataport is priced from \$5,184 to \$50,400, depending on configuration. For more information, contact Karen Marvin, ASK Computer Systems Inc., 2440 W. El Camino Real, Mountain View, CA; (415) 969-4442.

Circle 451 on reader card

Computer Associates Enhances Masterpiece/ABS

Computer Associates International Inc. announced an enhanced version of its Masterpiece/ABS series of financial-management software for VAX/VMS hardware systems. Masterpiece/ABS version 6.1 provides enhanced screen capabilities and integration with office automation and graphics.

The Masterpiece/ABS products' enhanced screen capabilities provide quick menu and program selection and entry of data. In addition, all Masterpiece/ABS applications are integrated with ALL-IN-1 to allow rapid user access to the system. Enhanced navigation capabilities let you transfer freely between programs and menus without using sequential menu screens. A Choice capability simplifies data entry by displaying possible entry options, and an enhanced Help facility provides detailed help text to any field.

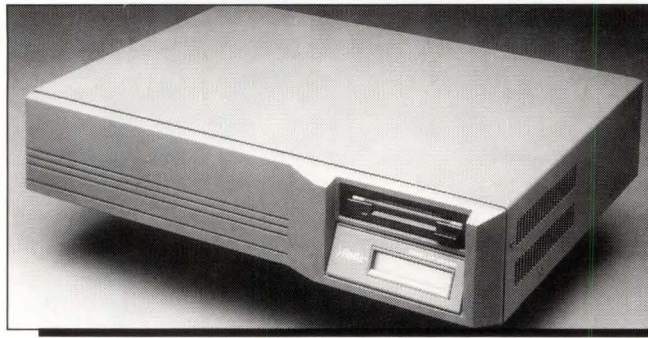

Retix's model 4880 LAN bridge.

Find out more by contacting Susan D'Elia, Computer Associates Int'l Inc., 711 Stewart Ave., Garden City, NY 11530; (516) 227-3300.

Circle 452 on reader card

Retix Adds Remote Ethernet Bridges

Retix announced three products in a family of remote LAN bridges and systems. The offerings are the model 4880, a high-performance bridge designed for large T1 networks; the model 4820 bridge, designed for lower bandwidth requirements; and the model 5010 Network Management Center, a central network manager for Retix's local and remote bridges.

The 4880 High Performance Remote Bridge uses two high-speed T1 or 2.048-megabit-per-second links. It saturates two links simultaneously. Its dual-68020 architecture can filter up to 14,880 frames per second.

The 4820 bridge is designed for lower bandwidth applications, such as linking PC LANs to larger networks. It supports up to 128-kilobit-per-second links.

The 5010 Network Management Center, a graphics-oriented central network manager running under Microsoft Windows, lets you manage Retix's local and remote bridges from a single location.

To obtain more information, contact Pam Schulz, Retix, 2644 30th St., Santa Monica, CA 90405; (213) 399-2200.

Circle 465 on reader card

IDEF/Leverage Drives Database Designs

D. Appleton Company (DACOM) announced release 2.1 of its IDEF/Leverage activity and data-modeling software for IBM mainframe and VAX computers. Seven new features increase its power to drive database designs and help corporations and government agencies manage their data resources. IDEF/Leverage uses the processing power of VAX or IBM host computers to integrate, analyze and normalize standard IDEF models

and transform them to a relational database design.

IDEF/Leverage 2.1 features model quality assessment, environmental hierarchies for glossaries, expanded SQL support for Oracle and VAX Rdb, and graphics download to PC dot-matrix printers. It also offers plotter support for graphics and an improved messaging and help system.

IDEF/Leverage is available at no charge to Subscription Service clients. For others, prices range from \$10,000 for a one-user VAXstation to \$65,000 for 128-plus-user VAX 89xx or IBM 3xxx.

Learn more by contacting Dave Schoeff, D. Appleton Co., 1334 Park Ave., Ste. 220, Manhattan Beach, CA 90266; (213) 546-7575.

Circle 453 on reader card

Filetab-D Provides Database Access

The National Computing Centre U.K. Ltd. announced Filetab-D, a 4GL optimized for interactive system development on the VAX. The product is marketed by Corporate Information Group Inc. Filetab-D provides access to any database, because it isn't restricted to specific file structures. It directly supports RMS file structures, the VAX DBMS network database, and Oracle. It's suitable for on-line and batch systems.

Filetab-D lets the MIS director access any data, regardless of the file structure in which that data is stored. Data then can be reported, sent to another application or put to any use. Filetab-D can be used to create an application from crude prototype to fully working system by interaction between the designer and user working at a single terminal.

Five-year user licenses cost \$5,500 on the MicroVAX to \$46,000 on larger VAXs. Software maintenance is mandatory and is 10 percent of the five-year license fee per year. To find out more, contact Kathryn Collins, Corporate Information Group Inc., 8111 LBJ Freeway, Ste. 560, Dallas, TX 75251; (214) 234-5100.

Circle 522 on reader card

Striped Lightning Works On VAX

Peripheral Software Concepts Inc. announced its Striped Lightning family of bar-code-based data-collection and shop-floor management products for the VAX. Striped Lightning applications provide an interface between major-host-based MRP II systems and a variety of bar-code-based data-collection devices. MRP interfaces on the VAX include ASK Computer Systems' Manman. They enable manufacturing management to achieve on-line, real-time shop-floor monitoring and control of materials and production.

Major applications include labor data collection, time and attendance reporting, factory time-clock synchronization, pre-payroll processing, WIP material tracking, physical inventory and cycle counting, detailed serial number and lot tracking, and non-stop data collection. The Striped Lightning family has been ported to the VAX from the HP 3000 line of midrange computers, including the HP 3000 9xx RISC-architecture-based series.

To find out more, contact Lou Harm, Peripherals Software Concepts Inc., 600 Johnson Ave., Bohemia, NY 11716; (516) 563-7000.

Circle 454 on reader card

BRS/Search 5.0 Features Pluralization

BRS Information Technologies announced release 5.0 of BRS/Search, a full text management software product. The release offers improved performance characteristics and such features as pluralization, document weighting, Word Perfect and Mass-11 import/export capabilities, and a Thesaurus.

BRS/Search lets information that won't fit in a relational DBMS because of required size and access points be indexed by every word and accessed by words or word phrases. You can specify that words be adjacent, within so many words, or within the same document, paragraph or sentence. BRS/Search allows wild-card searching, truncation, save searches and print-time formatting. Two word processing filters let you store documents within BRS/Search fully revisable from Word Perfect or Mass-11. BRS/Search software is available on various hardware platforms, including AT&T, Unisys, DG, IBM, Amdahl and DEC. The data and software is transportable across all platforms. To find out more, contact BRS Information Technologies, BRS/Search Software Group, 1200 Rte. 7, Latham, NY 12110; (800) 468-0908.

Circle 498 on reader card

Your VAX is Missing

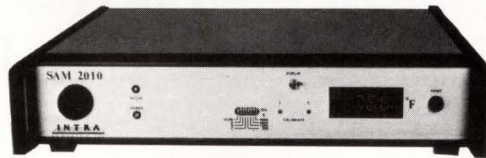

SAM

The Total Disaster Prevention System That Protects Your Computer Hardware & Software AUTOMATICALLY from the Indoor Elements: Heat, Smoke, Water, Power faults, etc...

Make YOUR job easier.

CALL NOW! Tel: (212) 947-5533

INTRA
COMPUTER INC.

875 Ave. of The Americas
New York, NY 10001

VAX is a registered trademark of Digital Equipment Corp.

CIRCLE 169 ON READER CARD

Network DEC to UNIX?

What You Didn't Know--Will Help You!

TCP/IP Networking Software...

Did you know that most UNIX computers already support industry-standard TCP/IP networking protocols? And that Process Software Corporation gives you TCP/IP networking solutions for more DEC operating systems than anybody?

For VMS, RSX, RT-11, IAS, And TSX-Plus...

Network to UNIX using just our TCP/IP software and your standard DEC Ethernet hardware on the UNIBUS, Q-bus, VAXBI, or the new MicroVAX 2000. And run concurrently with DECnet, LAT, or LAVC.

Designed To Benefit You...

Say goodbye to special hardware, messy installation, and unneeded layers of software. Our TCP/IP products are modular, efficient, and designed for the operating system they run on. You benefit from ease of use, simple installation and virtually no maintenance.

For Every Application...

And we support the full range of popular TCP/IP applications, including FTP (File Transfer), TELNET (Virtual Terminal), TCP, IP, and UDP programming interfaces, and others.

You won't find a better lower-cost way to connect DEC to UNIX anywhere!

Interested? Call Process Software Corporation today.

PROCESS SOFTWARE 413-549-6994

35 Montague Road • PO Box 746 • Amherst, Massachusetts 01004

DEC, IAS, RSX, RT-11, UNIBUS, VAX, and VMS are Digital Equipment Corporation trademarks. Unix is an AT&T trademark. Ethernet is a Xerox Corporation trademark. TSX-Plus is a S&H Computers trademark.

CIRCLE 152 ON READER CARD

KDSS

DEMO KIT
AVAILABLE

A full-featured, high-performance Data Entry System is available under VAX/VMS for the entire VAX family.

Powerful. KDSS has an extremely wide range of screen formatting, editing/validation, and output data reformatting capabilities which permit great flexibility.

Efficient. All performance-critical portions of KDSS are written in VAX assembly language. The data entry code is shareable. Terminal output is buffered to minimize QIO's.

Extensible. KDSS provides for access to user-written programs to perform special edits, reformat data, etc.; you may either link such programs with the KDSS data entry program or run them as separate processes that communicate with KDSS via VAX mailboxes.

Proven. Previous versions of KDSS have been widely used for over ten years: first on the PDP-11 and, subsequently, on the VAX in PDP-11 compatibility mode. The new version of KDSS runs in native mode on the VAX to provide support for the entire VAX family.

EG&H. Our specialty is DEC. For over fifteen years, we have designed and developed minicomputer software to improve productivity and get more out of DEC systems. We not only license our software products, we also develop custom applications. Count on us for quality products and expert support.

Other software products for VAX/VMS and RSTS/E.

- **ROSS/V** a RSTS/E operating system simulator under VAX/VMS.
- **DIALUP** a data communications package that links RSTS/E and VAX/VMS systems to remote computers.
- **TAM** an efficient screen formatter for transaction processing applications.
- **VSELECT & SELECT** fast file scanning packages.
- **VSORT & FSORT3** high-speed sort packages.
- **BSC/DV** a device driver for DEC's DV11.

For more information, call
(617) 861-0670 or write:
Evans Griffiths & Hart, Inc.
55 Waltham Street
Lexington, MA 02173
TWX: 710-326-0103

Evans
Griffiths
&
Hart, Inc.

EG&H

RSTS, VAX, DEC, and VMS are trademarks of
DIGITAL EQUIPMENT CORPORATION.

CIRCLE 161 ON READER CARD

Perceptics Announces Subsystem And Jukebox

Perceptics Corporation announced LaserSystem 525, an optical disk storage subsystem, and LaserStar 525, an optical disk jukebox subsystem, for VAXs and MicroVAXs running VMS.

LaserSystem 525 provides more than 300 MB of on-line storage per optical disk drive and is totally transparent to VMS. It's a complete, integrated optical disk subsystem. It includes an optical disk drive, a host adapter, Perceptics LaserWare software, cables and connectors, and support. Installation and maintenance are standard services.

Laserstar 525 provides automatic, VMS-transparent access to the storage capacity of optical disk jukeboxes. A variety of drive/media configurations is available. LaserStar 525 is a complete, integrated optical disk jukebox subsystem. It's configured with the Cygnet 5250 optical disk jukebox and 5¼-inch optical disk drives. It includes a SCSI host adapter, Perceptics LaserStar software and support.

Learn more by contacting Robert J. Sexton, Perceptics Corp., 725 Pellissippi Pkwy., P.O. Box 22991, Knoxville, TN 37933; (615) 966-9200.

Circle 524 on reader card

Ingres Supports Portable Network

Relational Technology Inc. announced that its Ingres RDBMS supports Novell's Portable Network on PCs running DOS and minicomputers running UNIX. Support for Portable Network allows users running Ingres PC applications direct access to databases on other PCs, workstations and minicomputers through a Novell network. Application processing can take place at the PC level while database functions are handled on a server such as a larger UNIX-based minicomputer.

Portable Network lets you combine a PC's interface and software with the power, storage capabilities and multitasking operating system of a UNIX-based minicomputer. Ingres users can take advantage of Portable Network's implementation of a client/server model of database management. With this model, the PC on a network handles the interactive application processing while the data and database engine remain on the minicomputer. This allows increased performance, because network traffic is reduced.

To find out more, contact Kevin Gallagher, Relational Technology Inc., 1080 Marina Village Pkwy., Alameda, CA 94501; (415) 769-1400

Circle 413 on reader card ■

MUST Reading ***Computing Books From Professional Press***

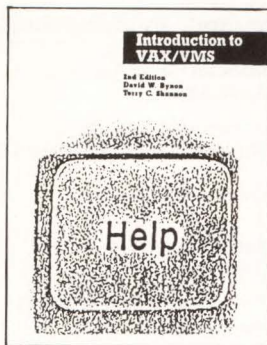

Introduction to VAX/VMS, Second Edition

Introduction to VAX/VMS is a guide for beginners and a reference for the experienced user. From the basics to systems and programming, Introduction to VAX/VMS gives easy to follow instructions about the VAX computer family, DCL command language, command procedures, mail, backup and help features and more. Through pictures, examples and programs, you get explicit instructions for everyday use of VAX/VMS and tips for problems. Plus 8 Appendices and a Glossary for added reference.

Order Introduction to VAX/VMS now. Complete the form below or call Trish at (215) 542-7008 (9-5 eastern time) with credit card information.



Let's C Now

Let's C Now is a self teaching guide to the C language in two volumes. It has all the information you need to learn C language, from the basics to expert use and understanding. Twenty-six informative chapters with tested examples, author's tips and suggestions make it easy to learn, even if you're not a computing expert. Use "C" on any operating system with DEC hardware (primarily for VAX and PDP).

Order one or both volumes of Let's C Now on the order form below, or call Trish at (215) 542-7008 (9-5 eastern time).

**Complete and mail the form below
with payment to order
1, 2 or all 3 of these
important computer handbooks
NOW!**

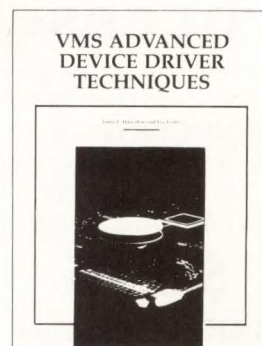

NEW . . . VMS Advanced Device Driver Techniques

By Experts Lee Leahy of Digital Equipment Corporation and Jamie Hanrahan of Simpact Associates VMS Advanced Device Driver Techniques describes how to design, implement and debug device drivers for the VMS Version 5 operating system. Learn more about simple VMS device drivers, full duplex and state machine-based drivers, VAX BI Drivers, advanced strategies and techniques you can use for debugging VMS device drivers and much more. From the low-level "building blocks" to high-level design issues, it's everything you need to become a proficient user of VMS device drivers.

Order now. Fill out the order form below or call Trish at (215) 542-7008 (9-5 eastern time).

YES! I want to complete my computing library with one or more of these important computing handbooks from Professional Press!

Name of Book	Number of copies	Shipping/Handling (per book)	Total \$
VMS Advanced Device Driver Techniques at \$59.95 each		US \$3.00, Canada \$5.00	
Introduction to VAX/VMS Second Edition at \$29.95 each		US \$2.00, Canada \$4.00	
Let's C Now Volume 1 at \$22.95 each		US \$2.00, Canada \$4.00	
Volume 2 at \$22.95 each		US \$2.00, Canada \$4.00	
Volumes 1 and 2 at \$42.95 per set		US \$2.00, Canada \$4.00	
Total Number of Books			Total \$

Check/Money Order enclosed Please charge: VISA MasterCard American Express

Account Number _____ Exp. Date ____ / ____ Signature _____ Date _____

Name _____

Address _____

City _____ State _____ ZIP _____ Telephone () _____

Call me about multiple copy discounts

Mail or FAX this form to: Professional Press, Inc., P.O. Box 503, Spring House, PA 19477 (215)542-7008 ■ FAX (215)628-2845

Kill Idle Processes

Free terminal lines and plug security leaks by killing idle processes on your VAX. HITMAN, the VMS idle process killer, is safe and easy to use.

You set the idle time, HITMAN does the rest.

\$695

SAIGA Systems

#215-801-6 St. S.W.
Calgary, Alberta, Canada T2P 3V8
Ph: (403) 263-1151

CIRCLE 209 ON READER CARD

Don't Get Zapped!

High inrush current can destroy your sensitive VAX CPUs and peripherals in less time than it takes to flip a switch. See us at INTERCONN,

THE SOLUTION? Booth #533
Power up with Z-LINE TPC 115-10 MTD™
the smallest power distribution
and control system available.
POWER UP WITH — — —

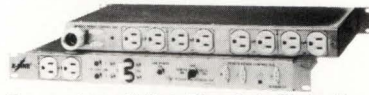

Our proprietary Multiple Time Delay™ circuitry sequences your power-up to protect your systems from the spikes and surges, EMI & RFI, that destroy your hardware and erase your data. And our remote on/off and emergency shutdown gives the power control back to you.

All Pulizzi Engineering MTD™ controllers are compatible with DEC and UPS systems.
PRICES FROM \$436 TO \$305

DON'T WAIT UNTIL IT HAPPENS, CALL TODAY!
PULIZZI ENGINEERING INC.
3260 S. Susan Street, Santa Ana, CA 92704-6865
(714) 540-4229 FAX (714) 641-9062

CIRCLE 210 ON READER CARD

cim

Training and Implementation

- ▶ Manufacturing Applications Assistance
- ▶ Information Systems Implementation & Assistance
- ▶ On-Site Training
- ▶ Site Management Assistance
- ▶ Performance And Capacity Management

For More Information Call:
(206) 485-HELP
1 (800) 999-4VAX



CIRCLE 211 ON READER CARD

VAX TIME

- Cluster with 8 Gigabytes
- Rates from \$8/Hour
- Timeshared/Dedicated
- Tymnet Access
- Media Conversions
- PC File Transfers
- Disaster Recovery Services



PHONE (714) 583-2932
FAX (714) 583-2941

CIRCLE 201 ON READER CARD

Quality AT Low Cost WITH A Warranty

Enhance your system with used DEC hardware. Your dda broker/dealer will assist you in locating just what you need in a fast and economical manner.



(313) 475-8333
107 S. Main St., Ste. 202, Chelsea, MI 48118

CIRCLE 208 ON READER CARD

BUY, SELL, RENT, LEASE, AND TRADE FROM YOUR

BEST

★ ★ ★ ★ ★
★ **DEC SOURCE!** ★ ★ ★

MEADOWLARK GIVES YOU SUPER DEALS ON DEC LEASES

- *** YOUR EQUIPMENT OR OURS ***
- * UPGRADE WITH NO PENALTY
 - * 1 MONTH TO 5 YEARS
 - * LOW RATES
 - * TRADE - IN WELCOME
- WE ARE ALWAYS BUYING
1 PIECE TO COMPLETE WAREHOUSE
*** CALL ***

MEADOWLARK ENTERPRISES

Market makers in DEC Equipment since 1981

37 High Street
Danvers, MA 01923

(508)777-4666

FAX: (508) 777-8433

800-DEC-DLER



CIRCLE 205 ON READER CARD

VAX® RENTALS

MICROVAX II
VAX 700 SERIES
VAX 8000 SERIES
Systems & Peripherals

- Add-On Flexibility
- Purchase Options

6 Months • 12 Months • 36 Months

BROOKVALE ASSOCIATES

dda Digital Dealers Assoc.

EAST COAST
(516) 273-7777

WEST COAST
(206) 392-9878

CIRCLE 203 ON READER CARD

VAX CAREERS SOUTHEAST

Winning combinations of these skills can propel YOU into some of the best companies in the Southeast!!!!

PROGRAMMERS/ANALYSTS/DBAs - RDB, ORACLE, OR INGRES... COBOL, FORTRAN, OR C...
Manufacturing a plus

SOFTWARE ENGINEERS - Knowledge of micros/minis to component level... FORTRAN, PASCAL, or C...
PLC's a plus

SYSTEM MANAGERS - High-end clusters...
Heavy VMS and DECNET/ETHERNET



BRENDA CAREY, C. P. C.
Digital Recruiter



633-B Chapel Hill Road
Burlington, NC 27215
(919) 222-0231

CIRCLE 202 ON READER CARD

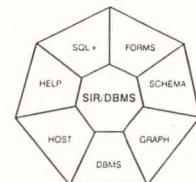

SIR/DBMS ADDS A NEW APPLICATION

Now your non-technical end users can go window-shopping for their queries & reports. We have added SIR/Easy - NO Programming-select from menus & windows and your data dictionary information automatically appears. Easy to learn-Saves time & Money. SIR/DBMS the choice for Large-Scale DBMS Applications: Scientific, R&D, Engineering, Medical Research & Clinical Trials. SIR/DBMS offers machine & Operating System Independence and a Unique Degree of True Application Level Transportability from PC thru Supercomputers, & Interface with Popular Statistical Packages.

SIR/DBMS DEMO (7.5MB) \$49.95

SIR, A Division of Inter Systems, Inc.
To Order Call: 312-480-9270 (IL) / 703-642-1600 (VA)

CIRCLE 214 ON READER CARD

digital

digital

WHO'S ON DEC.?? WE ARE!!!

BOSTON BOARDS & SYSTEMS, INC.

55 Rear Main Street, Kingston, MA 02364

5 Years/\$5 Million+ in Annual Sales/ 10,000 Sq Ft/ Test Bays
Full Tech Support/ Outstanding Sales Engineers!!

(617) 585-7777

Our Guarantee is Our Reputation!!

Make One More Call: Ask for Sales!!

*Urgent: MVII Buyers: Any Custom Configuration
Over \$1,000,000 in MVII Inventory!!*



Boston Boards
&
Systems



Boston Boards
&
Systems

'89 PRICE REDUCTION!!!

READY TO SHIP!!

DRIVES!!

RA60	TU78
RA80	TU80/81/+
RA81	TK50/70
RA82	CONTROLLERS
SA/482	RD53
RA/70	RD54

CLUSTER!!

HSC5XBA	SC008AA/AC
HSC5XCA	C1750
HSC50AA/CA	C1780
HSC70	CIBCA
etc.	KDB50
	KDA50

ETHERNET!!

Too Many to List

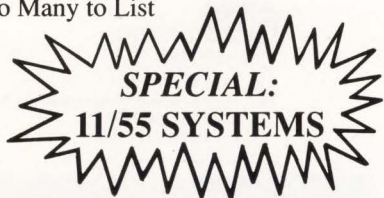

COMMUNICATIONS!!

DHU11	DMZ32
DHV11	DELQA
DZQ11	DEQUNA
DESTA	DEC SERVER
DESVA	DSRVA
	etc.

DEC SYSTEMS!!

11/03	11/725
11/23	11/730
11/73	11/780
11/24	11/785
11/44	VAX8200
11/70	VAX8300
11/83	VAX8600
11/84	VAX8700

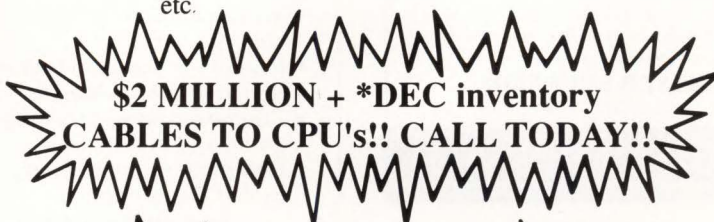

**WE ALSO BUY NEW & USED
EXCESS *DEC INVENTORY**

FAX: 617-585-6211

TELEX: #920-038BBS *Digital is a registered trademark of Digital Equipment Corporation



digital

digital

USED EQUIPMENT

We Rent VAX Systems

WANTED
VAX SYSTEMS
MVII AND 8000
SERIES

- Short term rentals on systems and peripherals
- Purchase accruals
- Sales of new and used equipment
- DEC maintenance guaranteed
- Fixed price freight/installation packages available



Selling and Leasing Computers Since 1966
Equipment Corporation

26319 I-45 North
The Woodlands, TX 77380
800-288-1846

doba DIGITAL DEALERS ASSOCIATION

DEC* DEPOT REPAIR • DEC* SERVICE TRAINING DEC* SPARE PARTS

New - 1-YEAR WARRANTY ON ALL EQUIPMENT SALES & REPAIRS - New

LOW
COST

QUALITY
PRODUCTS

FAST
SERVICE

- 11 YEARS IN THE DEC* BUSINESS
- PDP 8 TO VAX, AND PERIPHERALS COVERAGE
- 5 DAY STANDARD TURNAROUND ON REPAIRS
- OPTIONAL 24 HR. EMERGENCY REPAIR
- ADVANCE SWAP/EXCHANGE PROGRAM
- LEASING OR RENTALS
- FLAT RATE REPAIR PRICES/VOLUME DISCOUNTS
- UPGRADES AND ECOs AT NO ADDITIONAL COST
- TRAINING, AT YOUR FACILITY OR ESS's
- AN INVENTORY IN EXCESS OF 100,000 ITEMS
- SAME DAY SHIPMENTS ON PURCHASES
- OPTIONAL 24/7 COVERAGE
- PERSONALIZED SERVICE/COMPETITIVE PRICES

New - CDC+ DEPOT REPAIR & SPARES - New



ELECTRONIC
SERVICE
SPECIALISTS
A Bell Atlantic Company

N92 W14612 Anthony Ave.
Menomonee Falls, WI 53051

is
Your Answer for DEC* Repairs & Spares

CALL US FOR QUOTES
REPAIRS/BUYING/SELLING/
RENTING/TRAINING/LEASING

PHONE: 414-255-4634

FAX: 414-255-5418

TELEX: 260183
ESS LTD MEFS

doba

Registered trademark of Digital Equipment Corporation.
Copyright © 1988 by Digital Equipment Corporation.

CLASSIFIED

CORRUPT DISKS READ

"Unreadable" VMS and RSTS disks rescued via remote dial-in by our professional staff. With over 10 years experience, our satisfied customers include many Fortune 500 accounts and major Government agencies.

"When all else fails...call"

MEYER SOFTWARE
(215) 675-3890

SAVE THIS AD!

- PRO 350/380 MEMORY BOARDS
- DISK DRIVES - BIG & FAST FOR PRO
- RAM-DISK Software for Micro/RSX, 11M (+) & P/OS*
Call 415-420-9579
Proto Systems
1238 Josephine St, Berkeley, CA 94703

VAX/VMS CONSULTING. Specializing in system management and custom software development. Stellar Consultants, Inc., P.O. Box 4335, Seminole, FL 34642 (813)596-3674.

REMTEC FUJITSU 2351. 474MB, Disc Drive, \$2495. Fully guaranteed. (415) 463-3511.

BATCH QUEUE SCHEDULING! TARGET→BATCH features complete VAX/VMS job scheduling including:

- Interactive queue management
- Full support for inter-job dependencies
- VAXcluster, LAVC, and DECnet support
- Multiple scheduling frequencies
- Schedules-At-A-Glance
- Zoom-In display of scheduled command files
- Complete Audit Tracking and Status Reporting

AND MUCH MORE!

TRY US! Call today for your FREE 14-day evaluation of **TARGET→BATCH.**
(508) 460-9206
Target Systems Corporation

CIM POSITIONS

FACTORY/PROCESS AUTOMATION

Positions utilizing DEC and other computers, networking, programmable logic controllers, distributed control systems, etc. US based positions, all fee paid. Use a headhunter who specializes!

KEN COVA, COVA AUTOMATION SERVICES
5371 Shannon Park Drive, Dublin, Ohio 43017
FAX: 614/792-3525 PHONE: 614/792-6662



LSI* PDP* VAX*

SYSTEMS & PERIPHERALS

- CPUs • MEMORIES
- DISC & TAPE DRIVES
- CRTs • TERMINALS • PRINTERS
- INTERFACES Etc.



DIGITAL
COMPUTER
EXCHANGE INC

2487 Industrial Parkway West, Hayward, CA 94545
CALL-(415) 887-3100
FAX (415) 887-5590 TLX 709536

doba

* Registered trademark of Digital Equipment Corporation

C LANGUAGE CONSULTING AND EDUCATION by noted **DEC PROFESSIONAL** columnist. Also other languages and packages on RSX, VMS, RSTS and MS-DOS, including DBMS and DECnet. Applications experience includes real-time, process control, engineering, scientific and commercial systems. Rex Jaeschke. (703) 860-0091.

REMTEC FUJITSU 2294K. 336MB, \$1,800. (415) 463-3511.

Only one company
designs terminal servers
for non-stop performance.

Isn't that what you expect
from your network?

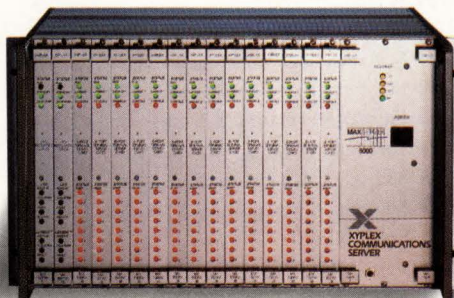

Only the MAXserver™ family from Xyplex™ gives you hot-swap cards, redundant power supplies, and a Mean Time Between Failure of over 5 years. And we offer *concurrent LAT and TCP/IP support*. No wonder we're the choice of every major VAX™ customer in the world. Find out how good a terminal server can be. Call today for a free information package.

1-800-338-5316

(In Mass., 508-371-1400)



Copyright © 1989, Xyplex, Inc., Xyplex and MAXserver are trademarks of Xyplex, Inc. VAX is a trademark of Digital Equipment Corporation.

CIRCLE 150 ON READER CARD

ADVERTISERS INDEX

Reader Service Number	Page	Reader Service Number	Page
184 ACC	69	119 Kea Systems Ltd.	75
250 Access Technology	103	156 Logicraft, Inc.	15
330 Advanced Matrix Technology	81	120 Maintech, A Division of Volt Delta Resources	123
276 Aldon Computer Group	18	121 MCBA	41
220 Alisa Systems	143	146 MDDBS, Inc.	149
149 American Digital Systems	25	123 MegaTape Corp.	33
166 Applied Information Systems	139	170 Microsystems Engineering Corp.	107
334 ASA International Ltd.	140	124 Micro Technology Inc.	11
103 Best Power Technology	73	168 Miltope Business Products	125
174 BLAST/Communications Research Group	127	308 National Instruments Corp.	22
297 Boston Business Computing	105	292 Network Research Corporation	128
327 C. Itoh Electronics	71	163 Nissho Electronics	6
231 C. Itoh Electronics	101	298 Perceptics Corporation	137
285 C. Itoh Electronics	135	130 Pericom	65
102 Camintonn Corporation	115	287 Peripherals	86
323 Capcomm Software, Inc.	108	131 Peritek Corporation	55
274 Clayton Computer Systems	86	132 Persoft, Inc.	5
151 Clearpoint, Inc.	7	172 Precision Visuals, Inc.	27
104 Clyde Digital Systems	9	335 Primavera Systems Inc.	53
332 Command Business Systems	120	337 Printer Systems Corp.	31
230 Compsee Inc.	117	134 Printronix Corp.	35
153 CompuServe/Data Technologies	91	136 Printronix Corp.	35
188 Computer Associates	77	152 Process Software Corporation	151
106 Computer Methods Corporation	138	252 Pulizzi Engineering, Inc.	108
234 Contemporary Cybernetics Group	2	135 Random Corp.	61
Cullinet Software, Inc.	111	190 Raxco, Inc.	95
Cullinet Software, Inc.	110	328 Recital Software	109
243 Data Processing Design	21	SAS Institute	54
107 Datability Software Systems .I.F. Cover		434 Scherers Communications	8
107 Datability Software Systems	1	240 See First Technology	134
199 Digi-Data Corp.	148	265 Sigma Information Systems	23
191 Digital Electronics Corp.	36-37	313 Software AG	97
Digital Equipment Corporation	supplement	185 SST	120
321 Eigen	43	140 Summus Computer Systems .I.B. Cover	
157 EMC Corporation	B. Cover	141 Synctronics	126
109 Emulex Corporation	85	256 System Industries	12
110 Emulex Corporation	87	142 Talaris Systems Inc.	83
112 Emulex Corporation	89	263 Taneum Computer Products	136
239 Equinox Systems Inc.	66	326 TAPEDOC	139
342 Equinox Systems Inc.	68	340 TDX Peripherals, Inc.	134
272 Equinox Systems Inc.	70	320 TechGnosis, Inc.	99
161 Evans, Griffiths & Hart	152	219 Telcor Systems Corp.	142
333 Excelan, Inc.	63	Texas Instruments	147
281 Exceptional Business Solutions	112	338 The Vastek Company	93
324 Facit, Inc.	67	165 Touch Technologies	144
113 GEJAC, Inc.	59	261 Transitional Technology	29
290 Glasgal Communications, Inc.	45	186 TriLogic Corp.	113
114 Grafpoint	51	305 Unbound	76
275 Grafpoint	51	300 Viking Software Services	131
312 Hancock Software	79	315 Walker Richer & Quinn	119
235 Information Builders	19	143 Walker Richer & Quinn	121
255 Interlan, Inc.	13	339 Wyse Technology	17
169 Intra Computer, Inc.	151	150 Xyplex, Inc.	157
336 K&H Project Management	60	262 Zoltech Corporation (VME)	141
		264 Zoltech Corporation (Q-Bus)	141

More information about many of these advertisers is available electronically on our Automated Reader Information Service Bulletin Board (ARIS/BB). Dial (215) 542-9458 (PA), (818) 577-9100 (Southern CA), (415) 873-2135 (Northern CA).

ADVERTISING SALES OFFICES

Jeffrey Berman, Associate Publisher
(215) 542-7008

CANADA/INTERNATIONAL (215) 542-7008

Helen B. Marbach, Regional Sales Manager
921 Bethlehem Pike
Spring House, PA 19477
FAX (215) 628-2845

MID-ATLANTIC (215) 542-7008

Mark Durrick, Regional Sales Manager
Dan Mainieri Jr., Senior Account Executive
921 Bethlehem Pike
Spring House, PA 19477
FAX (215) 628-2845

MIDWEST AND SOUTH (512) 258-4800

Linda Liebich, Senior Account Executive
11782 Jollyville Rd., Suite 203
Austin, TX 78759
FAX (512) 331-1315

NEW ENGLAND (617) 861-1994

Trish McCauley, Regional Sales Manager
Kristina Wesslen, Account Executive
238 Bedford St., Suite 3
Lexington, MA 02173
FAX (617) 861-7707

NORTHERN CALIFORNIA & NORTHWEST (415) 873-3368

A. G. Germano, Regional Sales Manager
Alonna Doucette, Senior Account Executive
Judy Courtney, Account Executive
903 Sneath Lane Suite 220
San Bruno, CA 94066
FAX (415) 873-6608

SOUTHERN CALIFORNIA & SOUTHWEST (818) 577-5970

David Beardslee, Regional Sales Manager
Karin Altonaga, District Sales Manager
1010 East Union Street, Suite 101
Pasadena, CA 91106
FAX (818) 577-0073

(215) 542-7008

Connie Mahon, Advertising Services Manager
Mary Browarek, Classified Ad Manager
Cathy Dodies, List Rental Manager
Jane L. Hope, List Rental Sales
Steve Maher, Associate Publisher, Buyers Guide

Win Up To \$1000

Submit Prize-Winning Paper Theme: Performance

Deadline: June 30, 1989

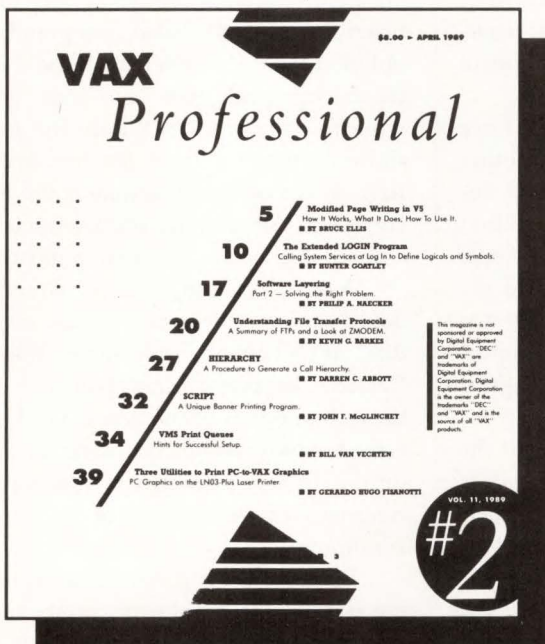

VAX PROFESSIONAL, the technical journal for VMS systems, wants to consider your paper on **PERFORMANCE** for publication. Describe in a 200- to 500-word outline:

- Your performance problem
- The steps you took to solve it
- The reasons for taking those steps
- The benefits from your solution
- A description of the software you wrote to implement the solution

The VAX PROFESSIONAL Review Board will select the top three ideas for publication in the *December* issue. Its members comprise:

- an internals expert
- the president of a computer firm
- an expert in system management and connectivity
- a manager of software systems programming
- a DCL expert
- a senior software engineer
- a manager of operating systems development

Winners will be notified by mail:

1st Prize — \$1000
2nd Prize — \$750
3rd Prize — \$500

Submit your outline to:
Karen Detwiler, Managing Editor
VAX PROFESSIONAL
921 Bethlehem Pike
Spring House, PA 19477

Include your name, address, company and a daytime phone number. To obtain a copy of the VAX PROFESSIONAL author's guidelines and programming guidelines, call Karen Detwiler at (215) 542-7008.

The Zig And Zag Of UNIX

It was the 1989 Personal Computer Forum. I was at the same table as Mitch Kapor, founder of Lotus Development Corporation, paying little attention to the scene until Kapor spoke up. "Do you know why Lotus never released 1-2-3 for the Mac? Because Steve Jobs told us he didn't want it on the Mac. He said the Mac was different. It was distinctive. It needed something special. Something different. So we believed him and did Jazz for the Mac." Since then, Lotus has stayed away from the Mac.

That's when it dawned on me. None of the mainstream business-applications purveyors in the IBM community shows much interest in the Mac world. One of the world's biggest software firms is Computer Associates. A mini conglomeration of smaller firms specializing in accounting software, it almost ignores the Mac completely. Its SuperCalc 5 should have been ported to the Mac years ago.

Ashton-Tate only recently has dribbled into the Mac community. Its efforts are half-hearted.

Lotus took a stab with Jazz and has been gun-shy ever since. It obviously didn't understand the Mac market from the beginning. The market for spreadsheets on the Mac is owned by Microsoft, which, after its own Multiplan on the PC was beaten to death by Lotus 1-2-3, saw the Mac market as an easy opportunity for Excel.

Except for Microsoft, there are no big-name PC players in the Mac community. Even Microsoft, which dominates the language scene, doesn't promote its languages into the Mac world with any zeal.

The companies that Mac users might be familiar with are newcomers: Aldus, Lightspeed and Adobe.

As far as micros are concerned, this phenomenon goes back to the days of the Apple II. There were few, if any, software firms supplying code for the CP/M and the Apple worlds. Only Microsoft, with its Z-80 add-in card, straddled the fence. Microsoft has maintained its position as the only successful fence straddler.

Lotus should have become a force in the Mac community if for no other reason than that Lotus 1-2-3 is a descendant of VisiCalc, a product originally designed to run on the Apple II. The Apple computer launched the notion of spreadsheets but suddenly was abandoned by the software it promoted. The solution was Jazz, one of the great duds of our time.

Let's extrapolate my point to the UNIX and VMS worlds. UNIX vendors pretty much stick to UNIX for their market. The same holds for VMS, VM, MVS, you name it. The operating environments are part of the personalities of the software vendors. This means that should the world suddenly change, as it did in 1981 with the introduction of the PC and DOS, then those in the catbird's seat will be different players. Lotus, Ashton-Tate, Borland and others will be a memory. They'll go the way of VisiCorp, IUS, JRT Software and those who were mired in CP/M or Apple II.

Microsoft is the only company not only to flourish but also to hedge its bet. Besides vending Xenix, it has invested in the Santa Cruz Operation (SCO), a premier UNIX house. While on the surface Microsoft is promoting OS/2, it seems willing and able to jump into a newly emerging UNIX scene.

In 1982, UNIX went through a

period of hype. Billed as the next great mass-market operating system, it had books written about it and computers designed around it. The most memorable flop was the Fortune 16/32, an overly ambitious desktop UNIX machine that now appears to have been ahead of its time. Sun found that UNIX on a big-screen workstation was the ticket. So, as UNIX faded into popular oblivion, Sun Microsystems thrived in the background. Not only that, but while Sun thrived, UNIX guru Bill Joy showed everyone how the perceived flaws in the operating system could be corrected, thus making UNIX as secure and reliable as any OS (well, almost).

A new decade approaches, and suddenly hardware designers go ape over RISC. It's all anyone talks about. Why? Because the performance potential of the technology is phenomenal. The key is the hardware designers driving the industry. In this case, they're driving it right into the waiting arms of the UNIX community.

Because RISC is perceived as changing rapidly in terms of performance and creating incompatibilities from one RISC design to the next, unless some other superportable (and bulletproof) OS comes along, UNIX will be the only conceivable OS for these new chips.

Suddenly, UNIX is the hot new OS for "the rest of us." Holy cow! A shift in fortunes takes place, and before you know it, we're looking back on MS-DOS as an iteration of CP/M — and long forgotten.

Suddenly, all the software players have new names. All, of course, except one: Microsoft. Although he makes it look easy, Bill Gates' ability to zig and zag at the right moment is why he's a billionaire. ■

Have your cake and eat it too.

**Gigabytes of unattended
back-up and data
interchange for DEC,
IBM, Sun, Apple...**

Finally, the winning recipe for high-capacity back-up *and* data interchange between different systems.

The **GigaTape**™ will satisfy the most discriminating tastes. For DEC, IBM, Sun, Apple or other host systems, the **GigaTape** provides simple "plug and play" capability. And, with just ONE 8mm helical-scan data cartridge you can back up two Gigabytes of data, at less than two cents per Megabyte.

Make data interchange a cakewalk with two file-formatting options. Use our ANSI standard file-formatting and data interchange utility for cost-effective data distribution, or our proprietary method for increased speed and capacity.

There's a **GigaTape** designed to meet your most voracious data storage needs. We've a family of helical-scan products with capacities from 2 Gigabytes to a Terabyte or more.

Lease from \$260 a month!



GigaTape



The SUMMUS commitment is icing on the cake. We have more than eight years of systems integration experience, first-rate technical support, and a well-stocked inventory. That's why Lockheed, GE, Kraft, NASA and others come to us for their data storage and interchange solutions.

You *can* have your cake and eat it too with the **GigaTape**; call us toll-free today at
1-800-255-9638

SUMMUS™
COMPUTER SYSTEMS
17171 PARK ROW • SUITE 300 • HOUSTON, TX. 77084
713-492-6611 • FAX 713-492-0092

"We want a VAX disk drive that works just like this."

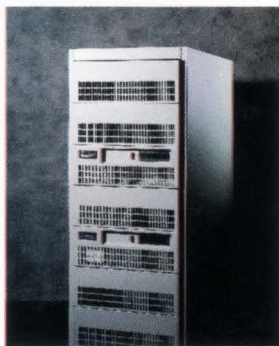
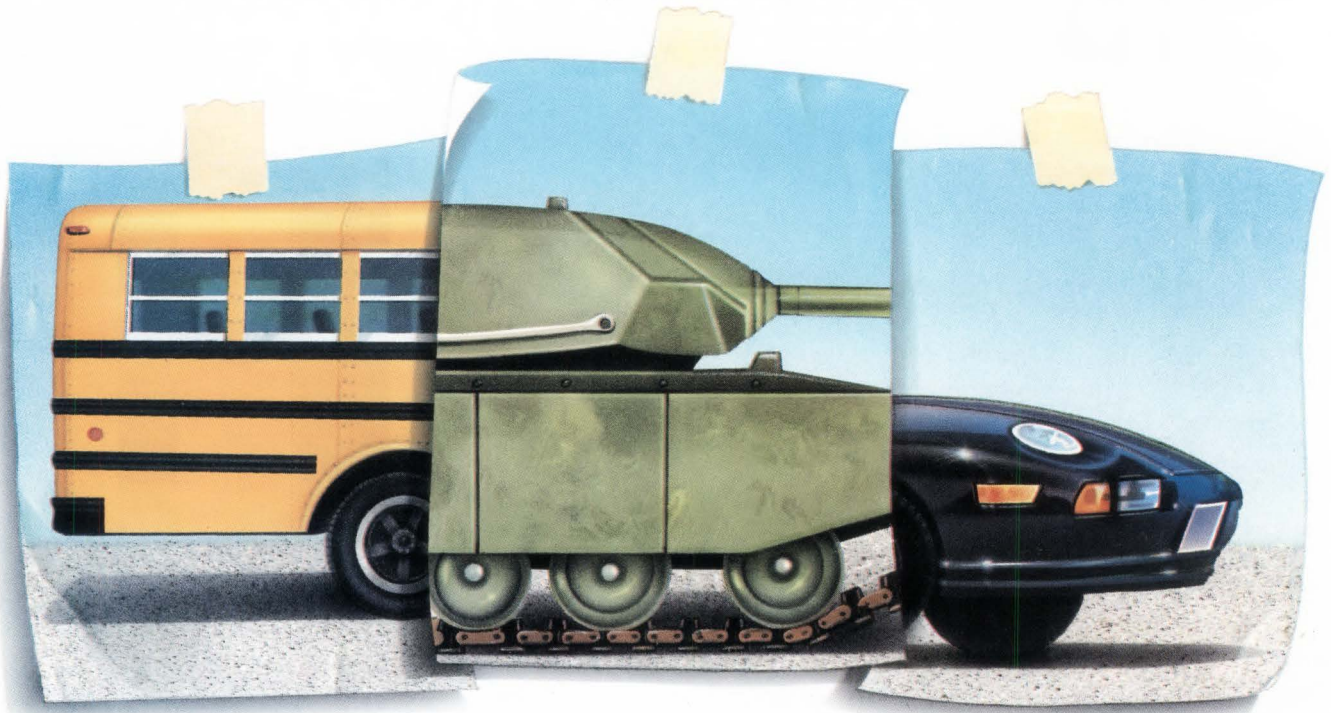

Introducing MAXPORT.

When we asked VAX owners what they wanted in a disk drive, they drew an interesting picture. The capacity of a bus. The reliability of a tank. The performance of a race car. And oh yes, they said, make it affordable.

Now EMC has put all these features together in the MAXPORT™ Series, the most powerful disk subsystems ever offered to the VAX market.

MAXPORT has enormous capacity. Up to 3.3 gigabytes for each DEC controller port. All this attaches directly to your HSC, BI, UNIBUS or QBUS disk controller to ensure 100% compatibility. Up to 11.5 gigabytes in the same footprint as DEC's SA 482 and SA 600.

Performance? MAXPORT has an average seek time of 16MS and a transfer rate of 2.8 MB/sec. That's 50% faster than DEC's RA82, and 10% faster than the RA90.

As for reliability, MAXPORT is ready for battle. EMC is a recognized leader in disk subsystems with over 5,000 disk customers worldwide. We support all DEC system-level diagnostics, and we back our disks with a full one-year warranty.

Best of all, MAXPORT costs up to 22% less than Digital's drives. Call EMC today. You'll see we've put together everybody's picture of the perfect disk drive.

Call Today
1-800-222-EMC2

EMC²

The System Enhancement Company.

MAXPORT is a registered trademark of EMC Corporation.

VAX is a registered trademark of Digital Equipment Corp.

CIRCLE 157 ON READER CARD