

COMPUTERS

a n d A U T O M A T I O N

DATA PROCESSING • CYBERNETICS • ROBOTS

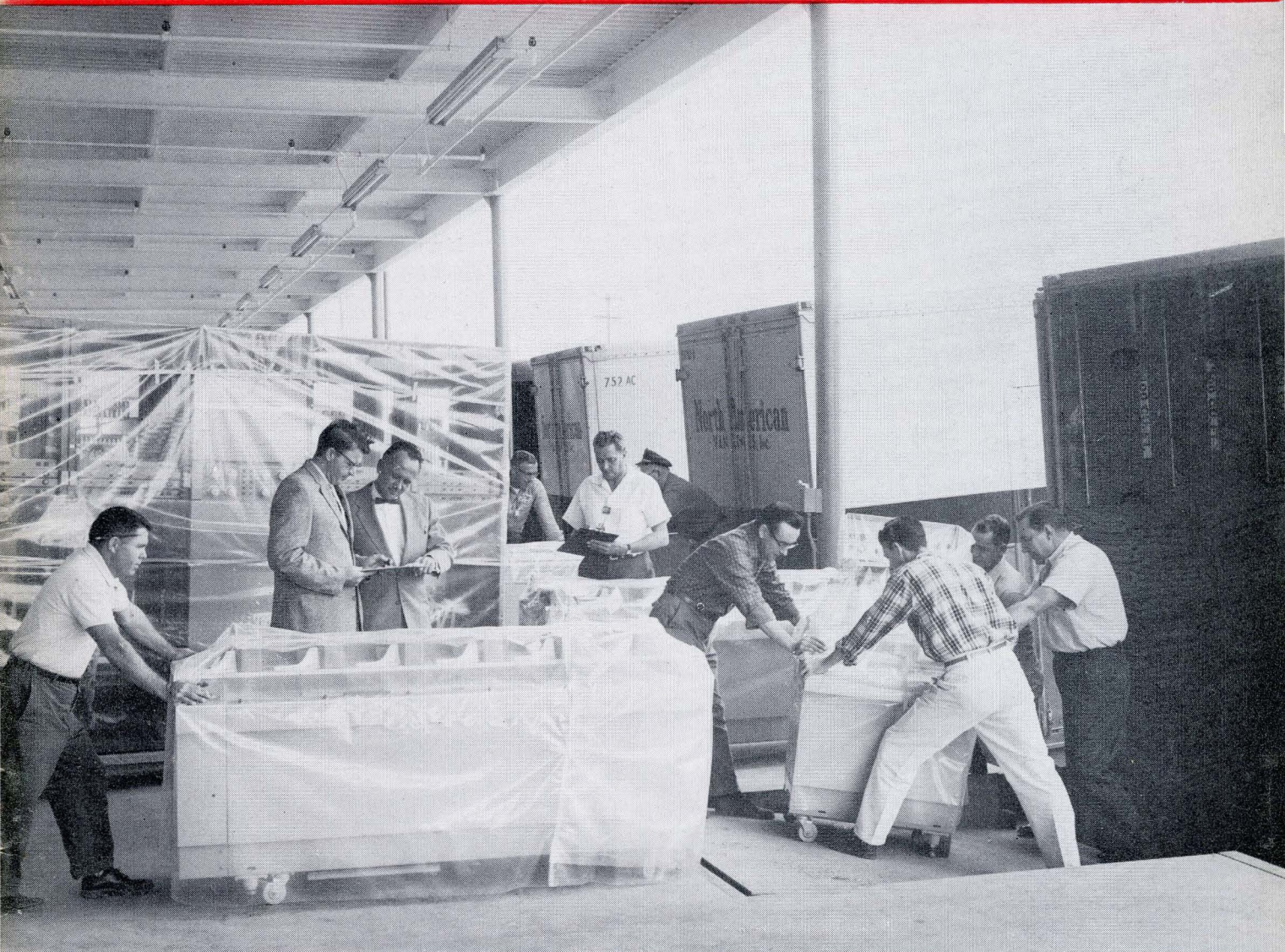

**A Common Language to Program Computers
for Business Problems**

**Over 300 Areas of Application of Computers
Survey of Commercial Computers**

JANUARY

1960

•

VOL. 9 - NO. 1



Computer Programmers:

Tired of standing on the sidelines?

If you are content to work *for* instead of *with* other staff members, System Development Corporation is not for you. But, if you are ready to come off the sidelines and get in the thick of things, you should definitely consider SDC—where programming is a primary function rather than a service activity.

In addition to developing large computerized control systems for SAGE, SAC, and other important operations—SDC is engaged in a number of long-range research projects. They include: automatic coding and problem-oriented languages; development of a language to automate transition from one computer to another; study of the organization of large systems; investigation of computer design from a standpoint of programability rather than engineering; information retrieval and medical data processing.

Positions now open at all levels
(at Santa Monica, California and Lodi,
New Jersey)

The extension of SDC's programming activities into new areas has created openings for Programmers at various levels of experience, including senior status. Please send your inquiry to Mr. E. A. Shaw, SDC, 2406 Colorado Avenue, Santa Monica, California.

.....
"Project CLIP—The Design of a Compiler and Language for Information Processing," a paper by Harvey Bratman of SDC's Data Processing Research staff, is available upon request. Send request to Mr. Bratman at SDC.
.....



**SYSTEM DEVELOPMENT
CORPORATION**

Santa Monica, California • Lodi, New Jersey

COMPUTERS and AUTOMATION for January, 1960

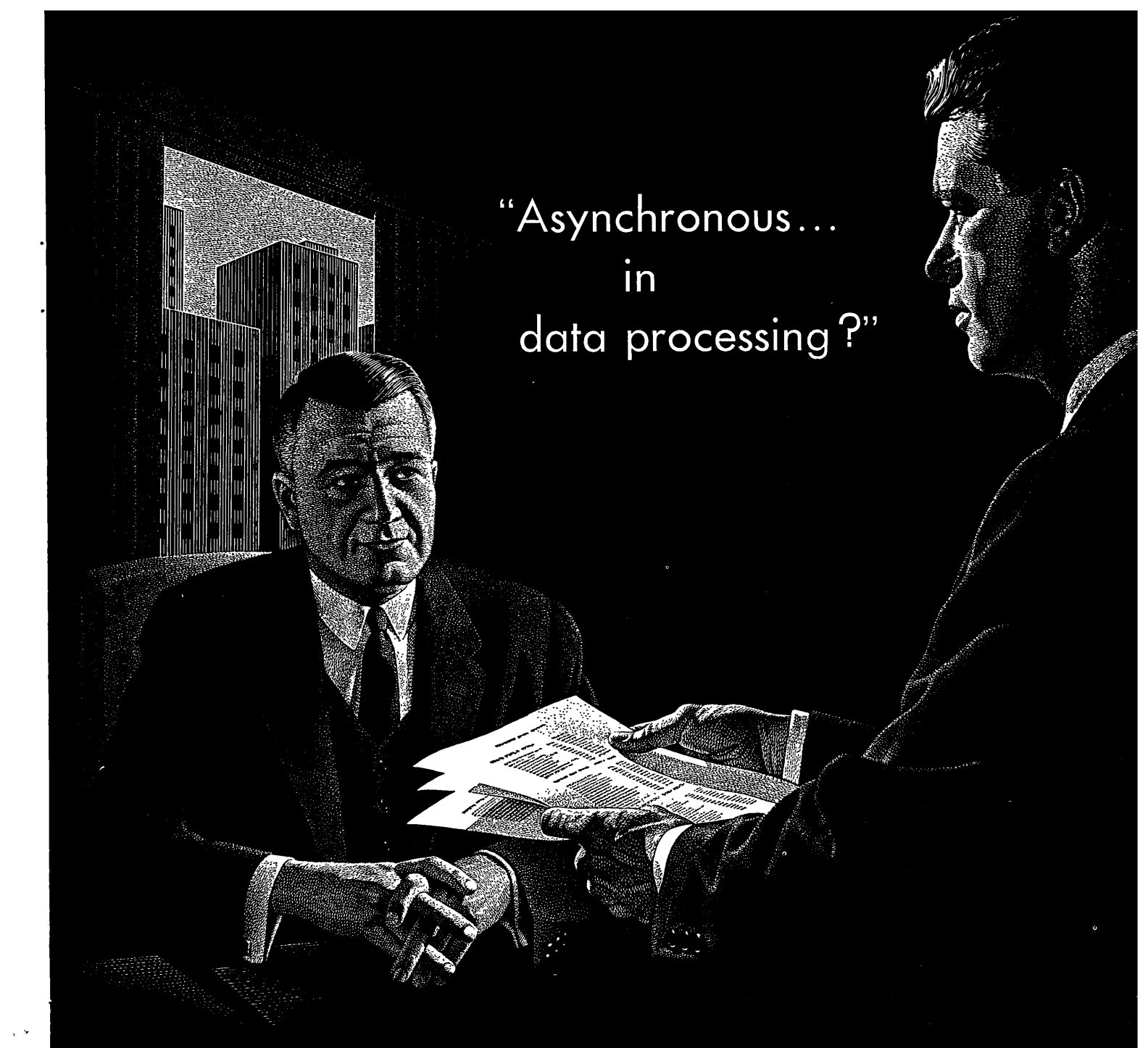

“Asynchronous...
in
data processing?”

Absolutely! Asynchronous is one of the most important words in data processing. It means faster computing and freedom from obsolescence. The Philco 2000 is the only asynchronous computer commercially available. It progresses from one operation to another without the time lag that occurs in all clock-timed systems . . . processes more work in any given period. Asynchronous operation also permits updating or expanding the system at any time, without changing design or disrupting existing programs. Get the full story on the Philco 2000 . . . first in fully-transistorized data processing . . . and the only asynchronous system available to business.



PHILCO 2000 Data Processing System

PHILCO
Famous for Quality the World Over

COMPUTERS

and AUTOMATION

DATA PROCESSING • CYBERNETICS • ROBOTS

Volume 9
Number 1

JANUARY, 1960

Established
September 1951

EDMUND C. BERKELEY *Editor*
H. JEFFERSON MILLS, JR. *Assistant Editor*
NEIL D. MACDONALD *Assistant Editor*
MOSES M. BERLIN *Assistant Editor*
PATRICK J. MCGOVERN *Assistant Editor*

SERVICE AND SALES DIRECTOR

MILTON L. KAYE MURRAY HILL 2-4194
535 Fifth Ave. New York 17, N.Y.

CONTRIBUTING EDITORS

ANDREW D. BOOTH
JOHN W. CARR, III
ALSTON S. HOUSEHOLDER
NED. CHAPIN

ADVISORY COMMITTEE

MORTON M. ASTRAHAN
GEORGE E. FÖRSYTHE
ALSTON S. HOUSEHOLDER
SAMUEL B. WILLIAMS
HOWARD T. ENGSTROM
RICHARD W. HAMMING
HERBERT F. MITCHELL, JR.

ADVERTISING REPRESENTATIVES

Middle Atlantic States MILTON L. KAYE
535 Fifth Ave. New York 17, N.Y.
MURRAY HILL 2-4194
Washington 6, D.C. ROBERT CADEL
1519 Connecticut Ave. Columbia 5-9727
San Francisco 5 A. S. BABCOCK
605 Market St. YUKON 2-3954
Los Angeles 5 W. F. GREEN
439 S. Western Ave. DUNKIRK 7-8135
Elsewhere THE PUBLISHER
Berkeley Enterprises, Inc.
815 Washington St., Newtonville, 60, Mass.
DECATUR 2-5453 or 2-3928

FRONT COVER

Six Vans Full of EDP Equipment — General Electric,
Arizona 1, 6

ARTICLES

A Common Language to Program Computers for
Business Problems, C. A. PHILIPS 8
Processing an Average of 90,000 Check and Deposit
Transactions Daily, S. J. KRAMER 10

READERS' AND EDITOR'S FORUM

Sample of Computer Translation Capacity 6
Automation and Labor 6
Intellectronics, SIMON RAMO 6
Calendar of Coming Events 12
Computer Art 12

REFERENCE INFORMATION

Computer Talks: 1959 Eastern Joint Computer Con-
ference, Boston, Mass., Dec. 1-3, 1959 7
Over 300 Areas of Application of Computers, NEIL
MACDONALD 13
Survey of Commercial Computers, Part 1, NEIL MAC-
DONALD 16
Annual Index to "Computers and Automation" 26
Survey of Recent Articles, M. M. BERLIN 32
New Patents, R. R. SKOLNICK 34

INDEX OF NOTICES

Advertising Index 34
Back Copies 5
Manuscripts 15
Reference and Survey Information 5
Who's Who Entry Form see August, page 32

COMPUTERS and AUTOMATION is published monthly at 160 Warren St., Roxbury 19, Mass., by Berkeley Enterprises, Inc. Printed in U.S.A.

SUBSCRIPTION RATES: (United States) \$5.50 for 1 year, \$10.50 for 2 years; (Canada) \$6.00 for 1 year, \$11.50 for 2 years; (Foreign) \$6.50 for 1 year, \$12.50 for 2 years.

Address all Editorial and Subscription Mail to Berkeley Enterprises, Inc., 815 Washington St., Newtonville 60, Mass.

ENTERED AS SECOND CLASS MATTER at the Post Office at Boston 19, Mass.

POSTMASTER: Please send all Forms 3579 to Berkeley Enterprises, Inc., 160 Warren St., Roxbury 19, Mass.

Copyright, 1960, by Berkeley Enterprises, Inc.

CHANGE OF ADDRESS: If your address changes, please send us both your new address and your old address (as it appears on the magazine address imprint), and allow three weeks for the change to be made.

**Get Your Reference and
Survey Information
in the Computer field from**

COMPUTERS AND AUTOMATION

Keep This List for Handy Reference

Computers and Automation now publishes more than 20 kinds of reference and survey information. Here is our latest inventory, of kind of information and issues when published. . . . Subscribe to *Computers and Automation* and have this information at your elbow!

Organizations:

- Roster of Organizations in the Computer Field (June 1959)
- Roster of Consulting Services (June 1959)
- Roster of Computing Services (June 1959)
- Survey of Computing Services (July 1958)

Computers and Data Processors:

- Survey of Special Purpose Digital Computers (Sept. 1958)
- Survey of Commercial Computers (Jan., Feb. 1960)
- Computer Census (May 1958)
- Types of Automatic Computing Machinery (Nov. 1958)

Products and Services in the Computer Field:

- Products and Services for Sale or Rent (June 1959)
- Classes of Products and Services (June 1959)
- Types of Components of Automatic Computing Machinery (Nov. 1958)
- Survey of Basic Computer Components (Feb. 1959)

Applications:

- Important Applications of Computers (Oct. 1958, Oct. 1959)
- Novel Applications of Computers (Mar. 1958, Mar. 1959)
- Over 300 Areas of Application of Computers (Jan. 1960)

Markets:

- Computer Market Survey (Sept. 1959)
- The Market for Computers in Banking (Sept. 1957)
- The Market for Computers in the Oil and Natural Gas Industry (Nov. 1957)

People:

- Who's Who in the Computer Field (various issues)

Pictorial Reports:

- Annual Pictorial Reports on the Computer Field (Dec. 1958, Dec. 1959)
- A Pictorial Manual on Computers (Dec. 1957, Jan. 1958) (reprint available)

Words and Terms:

- Glossary of Terms and Expressions in the Computer Field (Oct. 1956, reprint available)

Information and Publications:

- Books and Other Publications (many issues)
- New Patents (many issues)
- Computer Talks (many issues)
- Survey of Recent Articles (many issues)

With the ever-increasing expansion of the field of automatic handling of information, it is easy to predict that more and more reference information of these and other kinds will need to be published; and this we shall do. For it is a fact that reference information of the kind here described is not computable from automatic computing machinery — instead, it comes from collecting observations and reports about the real world. This is our job.

-----MAIL THIS COUPON (or a copy of it)-----

To: **COMPUTERS and AUTOMATION**
815 Washington St., R145
Newtonville 60, Mass.

- Please enter my subscription to **Computers and Automation**
I enclose \$5.50 for one year,
 \$10.50 for two years,
— for U.S.A. (add 50 cents a year for Canada; \$1.00 a year elsewhere)
- Please send me the following back copies:

.....
.....
.....

I enclose \$1.25 for each one, except the June Computer Directory issues, \$6 (1959), \$4 (prior years).

I understand any of these are returnable in 7 days if not satisfactory for full refund (if in good condition).

My name and address are attached.

Readers' and Editor's Forum

FRONT COVER: SIX VANS FULL OF EDP EQUIPMENT

The front cover shows four million dollars worth of electronic digital computing and data processing equipment being loaded into six vans at General Electric, Phoenix, Arizona. The vans have taken the equipment to locations at the Bank of America in California and a U.S. government facility also in California. The equipment is fully transistorized.

SAMPLE OF COMPUTER TRANSLATION CAPACITY

At the Department of Numerical Automation, Birkbeck College, University of London, England (this department is under the direction of Dr. Andrew D. Booth), some work has been done on the machine translation of languages.

Here is what a visitor last summer was told.

"We believe we have solved the basic problems.

"Take a vocabulary of 200 to 300 words, say, in scientific French. Take all the grammar you want, and construct anything you like out of these words—no restriction on the length of the sentence, for example.

"Place it on our MAC (Magnetic drum Automatic Calculator, finished about 1956) using our program of approximately 600 instructions.

"Here is a sample of input and corresponding output:

L etude des fonctions definiées par une equation differentielle, dans tout leur domaine d existence, est un probleme dont la solution complete, dans le cas general, depasse actuellement la puissance de l analyse. On a cependant obtenu des resultats du plus haut interet en se limitant a l etude des integrales infiniment voisines d une integrale connue. H. Poincare a pu demontrer l existence d une infinite de solutions periodiques et de solutions asymptotiques a une solution periodique.

The study of functions defined by a differential equation, in all their domain of existence, is a problem of which the complete solution, in the general case, surpasses at present the power of the analysis. One has meanwhile obtained of results of most high interest in limiting oneself to the study of infinitely neighbouring integrals of a known integral. H. Poincare has been able to demonstrate the existence of an infinity of periodic solutions and of asymptotic solutions to a periodic solution.

"The speed of translation is about 1000 words an hour."

AUTOMATION AND LABOR

(Editorial in the New York Times, October 28, 1959,
reprinted with permission)

The recent convention of the Amalgamated Lithographers of America has marked another step forward in the unique efforts of this union to cope with the problems of automation in the interests of its members

—which certainly don't conflict with those of the employers and the public. The A.L.A. has long been committed to the theory—proved true in its industry—that technical improvements and more efficient organization mean more business in the long run, with greater income for the employes and expanding employment, in spite of the inevitable job dislocations.

Last year the A. L. A. set up a special committee of union officials which had three objectives: first to get all the information possible—through close contact with equipment manufacturers and employers—as to new machines, materials and methods in the industry; second, to inform the union members of important changes to come; third, to work with the locals—and with employers, too—in dealing with the human problems of change in the most effective and least disturbing way.

After hearing a full report from the committee's chairman, Edward Swayduck, the delegates at this year's convention voted unanimously to establish a permanent department and staff at the union's international headquarters—the first of its kind—to carry on the work in which the committee had pioneered. Commenting on this step Mr. Swayduck said:

"We do not believe in unreasoning opposition to new developments even though particular jobs are affected. The A. L. A. welcomes new equipment and processes which contribute to the growth and success of lithography. * * * We are confident in our capacity to make necessary adjustments to provide the skills needed for continued growth and development of the lithographic industry."

This is sound doctrine. It should be far more widely accepted than it has yet been in the automational revolution of today.

INTELLECTRONICS

Simon Ramo

Thompson-Ramo-Wooldridge Corp.
Los Angeles, Calif.

(Excerpts from an address, "The Impact of Space on Electronics," given at the 5th National Communications Symposium, Utica, N.Y., Oct. 7, 1959)

The science of extending man's Intellect by Electronics—described by the new word, Intellectronics—will become the nation's greatest industry within a decade. The new man-machine partnership in intellectual activities for the world of the future will determine the relative position of nations more than any other single factor. . . .

Space has awakened us to a new appreciation of the impact of science and technology on our way of life. However, electronics and Intellectronics in particular, will be more influential than space exploration for the foreseeable future. This will continue as long as we are largely a surface civilization. It will be more accurately the Intellectronics age than the space age until

[Please turn to page 23]

Computer Talks:

1959 Eastern Joint Computer Conference, Boston, Mass., Dec. 1-3, 1959

Computer Talks:

1959 Eastern Joint Computer Conference, Boston, Mass., Dec. 1-3, 1959.

1. Conference Welcome, F. E. Heart, Chairman 1959 EJCC, Lincoln Laboratory.
2. Computers of the Future, R. Rice, IBM.
3. Negative-Resistance Elements As Digital Computer Components, M. H. Lewin, RCA Laboratories.
4. Deposited Magnetic Films as Logic Elements, A. Franck, G. Murette, and B. Parsegyan, Remington Rand Univac.
5. Solid State Microwave High Speed Computers, J. A. Rajchman, RCA Laboratories.
6. The Engineering Design of the STRETCH Computer, E. Bloch, IBM.
7. Design of the LARC System, Part I, J. P. Eckert, J. C. Chu, and A. B. Tonik, Remington Rand Univac; Part II, H. Lukoff, L. M. Spandorfer, and F. F. Lee, Remington Rand Univac.
8. Control and Arithmetic Techniques in a Multi-Programmed Computer, N. Lourie, H. Schrimpf, R. Reach, and W. Kahn, Datamatic Division, Minneapolis-Honeywell Regulator Company.
9. The Virtual Memory in the STRETCH Computer, J. Cocke and H. G. Kolsky, IBM.
10. A Combined Analog-Digital Differential Analyzer, H. K. Skramstad, National Bureau of Standards.
11. The System Organization of MOBIDIC B, S. K. Chao, Sylvania Electric Products.
12. A Universal Computer Capable of Executing an Arbitrary Number of Sub-Programs Simultaneously, J. Holland, University of Michigan.
13. The Multi-Sequence Computer as a Communications Tool, J. N. Ackley, International Electric Corporation.
14. Synthesis of Switching Two Terminals Based on the Theory of G. R. Kirchhoff and O. Veblen, S. Okada, Brooklyn Polytechnic Institute.
15. Applications of Boolean Matrices to the Analysis of Flow Diagrams, R. T. Prosser, Lincoln Laboratory.
16. SIMCOM—The Simulator Compiler, T. Sanborn, Space Technology Laboratories.
17. Techniques and Methods Employed in a Digital Computer Program to Solve General Transient Heat Transfer Problems, D. J. Campbell and Mrs. D. Vollenweider, General Electric.
19. The Role of Computers in the Development of Digital Systems; Panelists: T. H. Crowley, Bell Telephone Laboratories; P. W. Case, IBM; W. Gordon, Datamatic Division, Minneapolis-Honeywell Regulator Company; J. P. Malbrain, Ramo-Wooldridge; A. L. Leiner, National Bureau of Standards.
20. System Aspects of the Utilization of Kilomegacycle Components; Panelists: R. A. Kudlich, AC Spark Plug; M. C. Andrews, IBM; J. P. Eckert, Sperry Rand; S. Frankel, Consultant; D. L. Hogan, Department of Defense; R. E. Meagher, University of Illinois.
21. Judicious Use of Your Computer; Panelists: J. A. Buckland, Shell Oil Company; D. L. Johnson, University of Washington; F. J. Maginniss, General Electric; L. N. McClung, Johns Hopkins University; H. W. Richmond, System Development Corporation; H. Semarne, Douglas Aircraft Company.
22. The Automatic Transcription of Machine Short-hand; G. Salton, Harvard University and Sylvania Electric Products.
23. Critical-Path Planning and Scheduling; J. E. Kelley, Jr. and M. R. Walker, Mauchly Associates.
24. The Automatic Digital Computer as an Aid in Medical Diagnosis; C. B. Crumb, Jr., Bendix Systems Division; and C. E. Rupe, M.D., Henry Ford Hospital.
25. An Advanced Magnetic Tape System for Data Processing; R. B. Lawrance, Datamatic Division, Minneapolis-Honeywell Regulator Company.
26. A High Speed, Small Size Magnetic Drum Memory Unit for Ultra Small Digital Computers; R. A. Howard, M. May, G. Miller, and G. Shifrin, Ramo-Wooldridge.
27. Temperature Compensation for a Core Memory; A. Ashley, E. Cohler, and W. S. Humphrey, Sylvania Electric Products.
28. Use of a Computer to Design Character Recognition Logic; R. J. Evey, IBM.
29. A Self Organizing Logical System; R. L. Mattson, Lockheed Missiles and Space Division.
30. Alpha-Numeric Character Recognition Using Local Operations; J. S. Bomba, Bell Telephone Laboratories.
31. Pattern Recognition and Reading by Machine; W. W. Bledsoe and I. Browning, Sandia Corporation.
32. Discussion of Problems in Pattern Recognition; Authors: O. G. Selfridge, Lincoln Laboratory; U. Neisser, Brandeis University; R. Kirsch, Bureau of Standards; M. Minsky, Lincoln Laboratory.
33. Status of Computer Developments in the Soviet Union; Dr. W. H. Ware, The RAND Corporation.

Group Discussions:

18. Large Signal Equivalents in the Analysis of Circuit Tolerance; Panelists: E. U. Cohler, Sylvania Electric Products; R. J. Domenico, IBM; J. G. Linvill, Stanford University; T. A. Murrell, University of Illinois; R. L. Pritchard, Texas Instrument; W. J. Poppelbaum, University of Illinois.

A Common Language To Program Computers For Business Problems

Charles A. Phillips

Director, Data Systems Research Staff
Office of the Ass't Sec'y of Defense
Washington 25, D.C.

(Based on a talk given at the Meeting of the Association for Computing Machinery,
Cambridge, Mass., September 1959)

My subject is a project that has been started by defense and industry computer users and equipment manufacturers to develop a common language that can be used to program computers for business problems.

To begin at the beginning, the idea behind this project came out of a meeting of a group of computer people — users, manufacturers, and teachers — at the University of Pennsylvania Computing Center on April 8, 1959.

This group observed the recent development of separate, but remarkably similar, languages for automatic programming, such as FLOWMATIC, COMTRAN, and AIMACO, and concluded that it might be feasible to develop specifications for a problem-oriented but machine-independent common language for business problems following somewhat the pattern of ALGOL (the currently developing international common language for mathematical problems).

The group also concluded that such a project would require energetic sponsorship and that such sponsorship must be completely neutral, so far as manufacturers are concerned, and have a stature and position that would command attention of the manufacturers and encourage participation by most users of automatic data processing equipment. They decided to ask the Department of Defense, as an appropriate agency with a major interest in this field, to sponsor the first meeting to organize the project. They then proceeded to draft an agenda for the first meeting and prepare a list of persons who should be invited to participate.

The Department of Defense was pleased to undertake this project; in fact, we were embarrassed that the idea for such a common language had not had its origin by that time in the Defense Department since we would benefit so greatly from the success of such a project, and at the same time one of the Air Force commands was in the process of developing one of the business languages: AIMACO.

Department of Defense Interests and Costs

Let me tell you something of our computer interests, our costs, and some of our problems.

We presently have installed in the Department of Defense around 225 internally programmed, general-purpose electronic computers with about 175 more systems on order. These figures exclude computers used in weapons systems and weapons systems testing. Most of Defense's 225 systems are on business problems; 85% of these have supply applications. It may be of interest that civilian agencies of the Federal Government have installed about 60 additional systems with approximately 30 more on order.

By the end of 1960 we expect to have about 400 business systems installed — about double the number now in operation. This tremendous growth highlights our growing concern about the cost of these systems. In FY (fiscal year) 1959 our ADP (automatic data processing) rentals for business purposes only, are about 44 million dollars with an additional 40 million for punched card equipment rental. For FY 1960 our ADP rentals are estimated at 85 million dollars with about 35 million for EAM (electric accounting machine) rentals.

While I have no exact figures on the cost of programming, personnel and supplies generally run about equal to rental costs; and programming in the first year of operation accounts for nearly 2/3 of the personnel cost. On this basis, we estimate that our programming costs for business purposes were 15 million dollars or more in FY 1959 and will be about 29 million dollars in FY 1960.

During the past few months we have undertaken some very detailed performance evaluations of a number of our older installations. We find that programming is almost always far behind its anticipated schedule. The time requirements and cost of programming have invariably been seriously underestimated.

In addition to costs, and technical difficulties in programming, we also have serious problems of compatibility. There is developing within some of the technical services and commands a strong support for the idea that all equipment should be identical, at least within a technical service or command. This could be done by standardizing on a given model of a particular manufacturer or by developing military specifications on which various manufacturers would be asked to bid. My office is presently inclined to the view that hardware standardization at this time would be premature; but we cannot deny the seriousness of the compatibility problem and the need for some solution. A common language in which many differing machines could be programmed might provide at least a temporary answer to this problem.

These, then, are some of the reasons why the Department of Defense is vitally interested in developing a standard problem-oriented language which can be used with all types of business computers, and why we are happy to lend our support to this project.

The Meeting in May 1959

Now, let me tell you what our informal organization of users and manufacturers has done to date.

First, we convened a meeting on May 28 and 29,

Second Task

1959, in the Pentagon with some 40 representatives of manufacturers, consultants and users in attendance. With minor changes, we used the agenda developed by the "idea group" at the University of Pennsylvania together with their list of participants; but we recognized that we would be stepping on lots of toes since there were many persons who are prominent in the automatic programming field who should have been present. We discussed in some detail the need, the feasibility, and the desired characteristics of a Common Business Language (CBL). We found complete agreement for the need — in fact, an urgent need. As to the feasibility, there was general agreement that it could be done, but differences in ideas as to how long it would take or how difficult it would be. As to the desired characteristics of the language, there were many views. But we did agree: (1) that it must first of all be open-ended, capable of continuous change and amendment; (2) that it should be problem-oriented and machine-independent; and (3) that it should use simple English or pseudo-English and avoid symbolism as far as possible.

In trying to decide how the program should be conducted, we found such a wide variety of ideas among the 40 who were in attendance that we formed a smaller Steering Committee under the Chairmanship of Joe Cunningham of the Air Force to lay out a course of action. This group recommended the creation of an Executive Committee. I was designated Chairman of this group. The group is composed of: Joe Cunningham, Department of the Air Force; E. J. Albertson, U. S. Steel Corporation; Gregory Dillon, DuPont Company; Mel Grosz, Esso Standard Oil Company; and the Chairmen of the three task groups. Also, we named Dr. Grace M. Hopper of Sperry Rand and Mr. Robert W. Bemer of IBM as technical advisors to the Committee. The Committee is charged with the over-all direction of the program and the monitoring, organizing and coordination of the work of the task groups and sub-committees.

We concluded that the project should be divided into three stages and time-frames, each to be undertaken by a separate Task Group.

First Task

The first task is in the hands of the **Fact-Finding and Short-Range Language Task Group**, which is sometimes referred to as the "P.D.Q. Group" since we established a target date for this group of early September. Joe Wegstein of the Bureau of Standards was named chairman of this group. It was charged with accomplishing a fact-finding study of the strengths and weaknesses of existing automatic business compilers (such as FLOW-MATIC, AIMACO and COMTRAN) and coming up with a composite of these or something else that will work. We recognized that such a short-range product would involve much compromise and might have deficiencies which would be corrected in the later stages. The emphasis, in the case of the short-range committee, was on speed.

Joe Wegstein's group and its various task forces had held up to mid-September a total of 12 working meetings at which they have extensively examined existing compilers and have worked toward the development of a single interim system.

The **Intermediate-Range Group** will pick up where the Short-Range Group leaves off; in effect, they will take the CBL (common business language) package developed by the first group, and begin to modify and refine it within a time-frame ending sometime in 1961. This progression toward the ultimate objective would, or could, result in a language which would be used to define all systems requirements, in a manner and form which would be capable of the same degree of computer application as the previous CBL but which could be used to define properly and completely any system so that such system could be implemented on any equipment with an appropriate compiler. A. E. (Gene) Smith, of the Navy Department, is the Chairman of this Group. It has had an organizational meeting and designated two working groups: a task group on language structures; and a task group on business systems structures. The Intermediate Range Group is proposing to invite wide-spread participation in their work by associate members. Such associate members would provide the Task Forces with the benefit of experience and thinking of people engaged in all aspects of business data processing.

Third Task

The final phase of this project is in the hands of the **Long-Range Group**. It will explore the fundamentals and philosophies of all language users regardless of whether they were designed for use on scientific or business type problems. The objective here will be to develop a language which might supersede both ALGOL in the scientific area and the "CBL" or IBL (intermediate business language) which will result from the work of our first two Groups. The merger of scientific and business languages would represent the ultimate or Universal Computer Language. Recognizing the importance of this Long-Range effort, a special sub-committee consisting of Robert Curry, Vice President and Comptroller of Southern Railway, Howard Engstrom, Vice President of Sperry Rand, and John McPherson, Vice President of IBM, has agreed to nominate a chairman and help him to develop a work plan.

Comments

We believe that this joint effort on the part of manufacturers and users is not contrary to the action of the ACM (Association for Computing Machinery) Committee on Computer Languages. In fact, we hope it will complement their efforts and that we can cooperate very closely in the interchange of ideas and materials.

We have discussed this matter at length with most of the computer manufacturers, and have been assured of their complete support. They recognize that individuality and creativeness can still flourish freely within the framework of effective language standards. Also these manufacturers have agreed to implement the language that will be developed with compilers or processors, so as to translate this CBL into the language of their particular machines.

We are very much encouraged by the number of letters from large commercial and industrial users of computers who have heard of this program. They have written to ask that they be given a chance to participate

[Please turn to page 23]

Processing An Average Of 90,000 Check And Deposit Transactions Daily

S. J. Kramer

Radio Corp. of Amer.
Camden, N.J.

Complete demand deposit accounting (the average is 90,000 check and deposit transactions a day) is being processed by the Fidelity Philadelphia Trust Company in a little more than half a shift daily on a medium-sized RCA 501 EDP System.

The equipment complement for this operation — all fully transistorized — includes a computer and associated devices (program control, high-speed punched paper tape reader, a single module of high-speed memory storage with 16,384 character locations, control console,

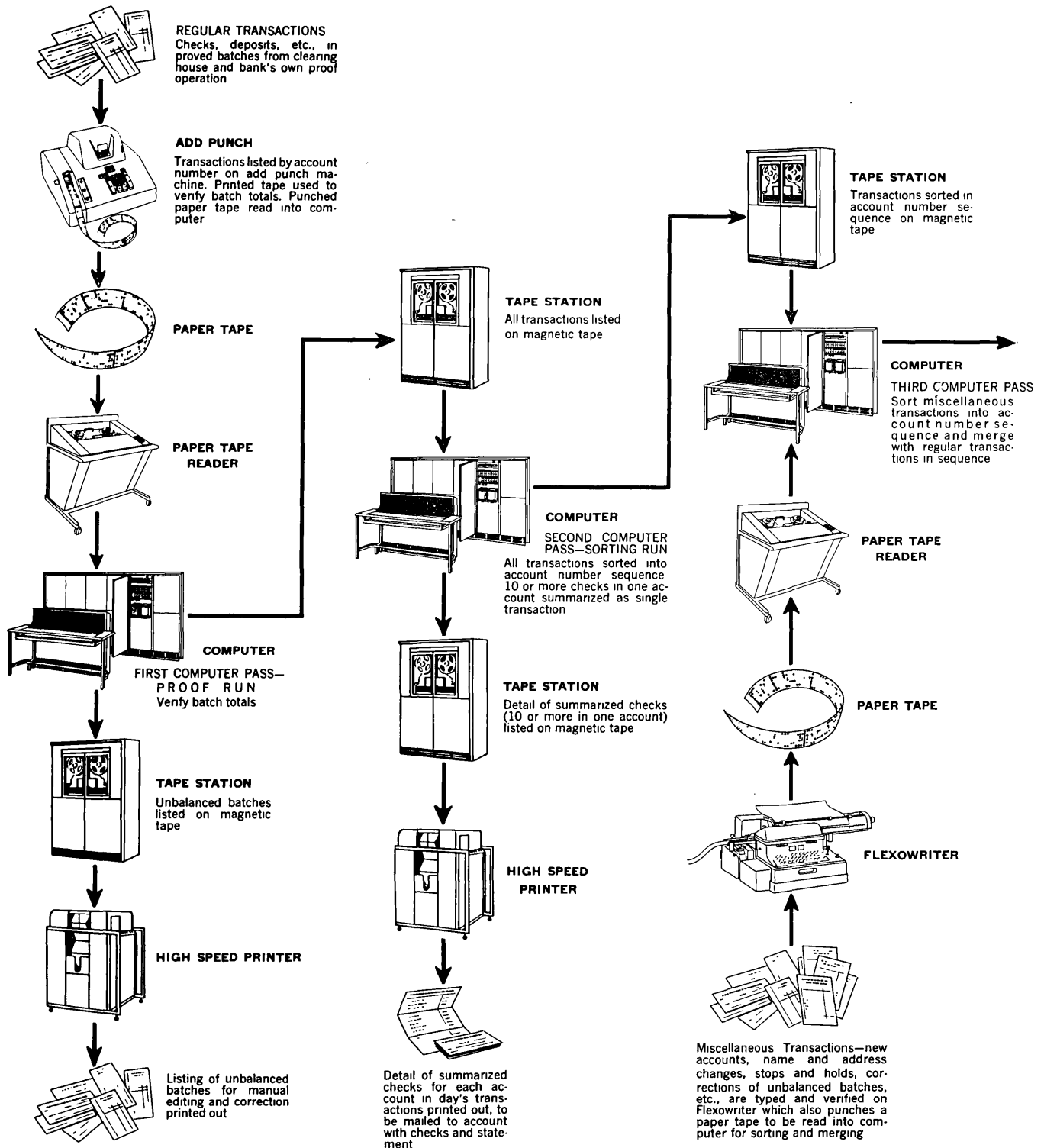

and monitor printer), eight magnetic tape stations, an off-line high-speed printer, and a switching panel which may be used to connect six tape stations with six user devices for off-line operation. (Modular expansibility of the Model 501 permits addition of high-speed memory units up to a total of 262,144 character

locations, of magnetic tape stations up to a total of 63, and of as many off-line devices as needed.)

In performing demand deposit accounting, this is what the 501 is doing:

1. The machine updates the master file each day for over 80,000 accounts and prints out at the start of

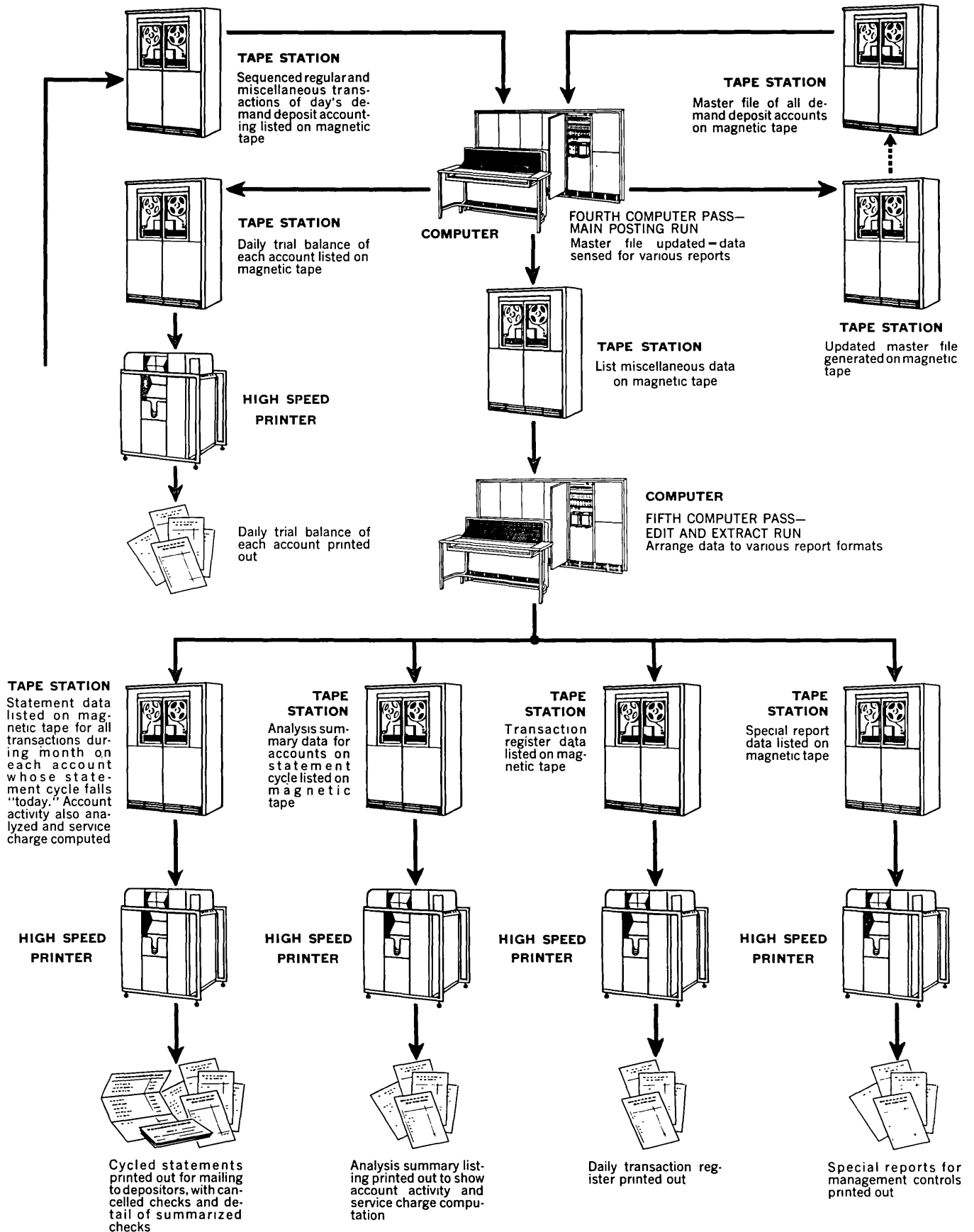

business each morning a daily trial balance of every account. It lists, by account number sequence for rapid reference: the name of the account, the date of the last transaction, and indication of stops, holds and overdrafts, and the present balance.

2. For the 5% batch of accounts whose statement cycle falls on each day, the machine analyzes the month's account activity, calculates the service charge, and prints a complete statement.
3. The machine can use the "date of last transaction" for trial audit, to increase efficiency in searching out desired data. The computer can jump directly in the master file to the transactions desired for a specific day without hunting through unneeded data.
4. The machine prints reports on overdrafts, stops, and holds. It lists the accounts involved by number, identifies each by name, and indicates in code the situation flagged, the branch office for the account, the old balance, new balance, and average balance, and other pertinent information.
5. The machine generates and prints out a daily transaction register of demand deposit activity, which lists each transaction by account number, identifies by code whether it is a check or deposit, and lists the number of units and the total amount, since some of the transactions may be summaries of ten or more items.

This system does all the bookkeeping and accounting on regular and Special Checking demand deposit accounts as follows:

Beginning with an input of transactions for the clearing house and the bank's proof department on punched paper tape, the first computer pass is the proof run to verify batch totals. Unbalanced batches are printed out for clerical editing and correction.

In the second computer run, all transactions are sorted into account number sequence. If there are ten or more checks for an account, they are summarized into a single transaction, while the separate items are printed out on a list to be attached to the checks and mailed with the statement.

For the third computer run, a punched paper tape of miscellaneous transactions — name and address changes, new accounts, stops, holds, corrections of unbalanced batches, etc. — is merged with the sequenced regular transactions on magnetic tape.

The next computer pass is the main posting run. It updates the master file, generates the daily trial balance tape, which is printed out, and senses the transactions for various reports.

The final computer run edits and extracts the data for the various special reports, and arranges the information for the desired format. It generates a data tape of the month's account activity and computes the service charges for statements for the accounts whose statement cycle falls each day. It also generates the magnetic tapes of data to be printed out for the analysis summary of those accounts receiving statements.

CALENDAR OF COMING EVENTS

- Feb. 1-4, 1960: 1st ISA Instrument-Automation Conference and Exhibit of 1960, Rice Hotel and Sam Houston Coliseum, Houston, Tex.
- Feb. 2-5, 1960: National Symposium on Machine Translation, University of Calif., Los Angeles, Calif.
- Feb. 25-26, 1960: Univac Users Association Semi-Annual Meeting, Greenbrier Hotel, White Sulphur Springs, W. Va.
- March 21-24, 1960: IRE National Convention, Coliseum and Waldorf Astoria Hotel, New York, N.Y.
- April 18-19, 1960: Third Annual Conference on Automatic Techniques, Cleveland-Sheraton Hotel, Cleveland, Ohio.
- May 2-6, 1960: Western Joint Computer Conference, San Francisco, Calif.
- May 9-12, 1960: 2nd ISA Instrument-Automation Conference and Exhibit of 1960, Civic Auditorium and Brooks Hall, San Francisco, Calif.
- May 17-18, 1960: Symposium on Superconductive Techniques for Computing Systems, sponsored by Information Systems Branch, Office of Naval Research, at Dept. of Interior Auditorium, Washington, D.C.
- May 23-25, 1960: 9th Annual Telemetering Conference (West Coast), sponsored by ISA with ARS, AIEE and ISA cooperating, Miramar Hotel, Santa Barbara, Calif.
- June 1-3, 1960: 6th Annual ISA Instrumental Methods of Analysis Symposium, Montreal, Canada
- June 22-24, 1960: 1960 National Conference and Business Show, National Machine Accountants Associa-

tion, Mark Hopkins and Fairmont Hotels, and Calif. Masonic Memorial Temple, San Francisco, Calif.

June 25 - July 5, 1960: 1st International Congress for Automatic Control, AACC sponsored, with ISA, ASME, IRE and AICE cooperating, Moscow, U.S.S.R.

August 23-25, 1960: Annual Meeting of the Association for Computing Machinery, Marquette Univ., Milwaukee, Wisc.

Sept. 26-30, 1960: 3rd ISA Instrument-Automation Conference and Exhibit of 1960, and ISA's 15th Annual Meeting, New York Coliseum, New York, N.Y.

Nov. ?, 1960: 13th Annual Conference on Electronic Techniques in Medicine & Biology, sponsored by ISA, with IRE and AIEE cooperating, Washington, D.C.

Computer Art

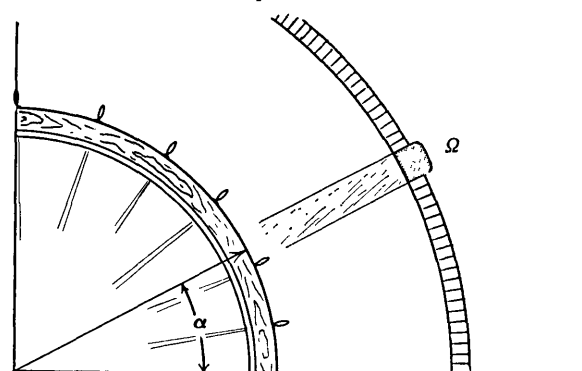

This motif reflects the measurement and control of angular direction, echoing the ship's steering wheel, and the sliding potentiometer arm.

OVER 300 AREAS OF APPLICATION OF COMPUTERS

Neil Macdonald

Assistant Editor
Computers and Automation

One of the indications of the tremendous growth of the Second Industrial Revolution is the large number of areas of applications for automatic computers. Following is a list of slightly over 310 types of applications—only 15 years after the first automatic digital computer started working, the Harvard IBM Automatic Sequence Controlled Calculator.

The list will undoubtedly lengthen rapidly. We invite additions, clarifications and corrections from our readers.

I. BUSINESS

Banking

- Check processing accounting
- Corporate trust accounting
- Demand deposit accounting
- Factoring accounts processing
- Fund accounting
- Installment loan accounting
- Inter-office record transmission, filing, and recall
- Loan accounting, records, and analysis
- Mortgage loan accounting
- Payroll accounting
- Personal trust accounting
- Real estate loan accounting
- Savings and loan postings
- Savings Club deposit accounting
- Signatures verification
- Stockholder records

Business

- File maintenance
- Filing operations, single and multiple
- Mailing list operations
- Management games
- Management reports using the exception principle, and others
- Management statistics analysis
- Management strategy analysis and simulation
- Overhead cost allocation
- Payroll determination and issuing
- Production scheduling
- Vending machine programming
- Warehousing and stocking records and analysis

Finance

- Bond evaluation
- Dividend calculation
- Equipment trust accounting
- Fund analysis
- Portfolio evaluation
- Stock analysis
- Stock price index computed hourly, etc.
- Stock transfers

Government

- Census analysis
- Election return analysis
- Mail sorting and routing
- Planning
- Simulation of sections of the economy
- Statistical analysis
- Supplies: inventory and control

Insurance

- Agency accounting
- Agents' commission calculations
- Automobile coding
- Dividend formula analysis
- Dividend scale calculations
- Gross premiums calculation
- Group annuity calculations
- Group insurance commissions
- Mortality tables
- Net premiums calculation
- Policy reserves calculation
- Renewal rating calculations

Law

- Crime analysis and prediction
- Laws: analysis and consistency studies
- Traffic violations: recording, accounting, analysis

Libraries

- Abstracting from scientific materials
- Information retrieval
- Records and control

Magazine publishing

- Renewal analysis
- Subscription fulfillment

Manufacturing

- Budgeting and forecasting

Inventory control

- Labor allocation and distribution
- Materials and parts: requirements, allocation, scheduling, and control
- Machine tools: control for automatic reproduction of complete parts, etc.
- Machine utilization analysis
- Overhead costs: allocation and control
- Process control
- Production load scheduling, forecasting, and control
- Quality control studies
- Repair and maintenance records, scheduling, and control
- Vacation scheduling
- Wage and salary analysis

Oil Industry

- Aerial surveys and exploration: analyses
- Bulk stations: wholesale sales, billing, accounting
- Credit card accounting
- Crude oil: analysis of properties, evaluation
- Depletion accounting
- Economic factors: studies, analysis
- Flow: control
- Fuel deliveries: degree-day accounting
- Gasoline blending
- Heat and material balances
- Inventory: control, forecasts
- Lease and well expenses and investments: records and analysis
- Map construction
- Market research: studies, applications of operations research
- Off-shore installations: studies of design variations
- Oil and gas production: accounting
- Oil field analysis: correlation of data from different drill holes; correlation of data from seismic tests; estimated amount and direction of flow of fluids through porous rocks
- Oil purchase accounting
- Quality control

Refinery and gas plant components: design, operation
Refinery shutdown and maintenance: scheduling calculations
Refinery simulation
Royalty calculations
Secondary recovery: analysis
Seismic data reduction
Well logs: corrections
Wells and fields: prorating analysis

Public Utilities

Billing
Circuits and lines: mileage analysis
Demand forecasting
Electric distribution networks
Equipment: attrition and life expectancy
Gas distribution networks
Natural gas measurement
Pipe line design
Power distribution calculations
Power plants: stability of control
Power production scheduling
Rate determination
Repair calls: dispatching, scheduling
Sag-tension studies
Steam turbine output
Transmission line design and losses
Water reservoir management

Sales

Accounts receivable, posting and rebilling
Advertising effectiveness analysis
Billing and invoicing
Mailing list updating and addressing
Market research: analysis, simulation of consumer decisions, etc.
Price analysis
Sales analysis
Sales area distribution
Transportation optimization

Transportation

Aircraft maintenance scheduling
Air traffic control
Collision warning systems
Elevators: automatic control
Navigating systems
Railroad freight cars: accounting, allocation, distribution, control
Rail traffic control, centralized
Subways: automatic control
Trains: automatic control
Travel reservations

II. SCIENCE and ENGINEERING

Aeronautical Engineering

Aerodynamical formulas: evaluation
Airframe stress analysis

Critical speed problems
Curve fitting
Factor analysis
Flight simulation
Flight test data reduction
Flight training devices
Flutter analysis
Ground controlled approach: programming
Gyroscopic calculations
Heat transfer analysis
Helicopter piloting studies
Navigation training devices
Satellite tracking
Systems evaluation
Theodolite data reduction
Vibration analysis
Wind tunnel data reduction

Biology

Animals: behavior models
Hybrid optimization
Livestock-feed ingredient-mix: optimization
Species characteristics: correlation analysis
Species varieties: automatic classification

Chemical Engineering

Chemical compounds: structure studies
Distillation processes: determination of starting times, etc.
Equilibrium equations: studies
Hydrocarbons: structure analysis
Ion exchange column: performance appraisal
Mass spectrometer analysis
Organic compounds: file searching
Process control
Process simulation
Reaction analysis

Chemistry

Organic compounds: classification
Spectrum analysis

Civil Engineering

Highway Engineering

Cut and fill calculations
Photogrammetric data reduction
Route optimization
Traffic density: pictorial simulation
Traffic simulation
Transformation of coordinates
Traverse adjustment
Traverse closure

Soils Engineering

Freezing and thawing of soils
Pressure distribution in layered media

Electrical Engineering

Antenna design

Cathode tube design
Circuit analysis and design
Component design
Electromagnetic wave propagation in various media
Filter analysis
Generator calculations
Logical networks: design
Motor calculations
Radar echos
Radio interference
Systems evaluation
Transformer design
Transient performance
Traveling wave tube calculations
Triode design

Hydraulic Engineering

Backwater profiles
Compressible and incompressible flow analysis
Flood and flow forecasting
Flood control
Flood frequency analysis
Flood routing
Ground water: flow of
Hydraulic circuits and components: design
Hydraulic network analysis
Hydroelectric dam design
Multi-purpose water reservoir system: management
Pipe stresses
Reservoir aggradation
Shock-wave effect analysis
Surge-tank analysis
Turbine speed regulation
Unit hydrographs: determination
Water hammer analysis
Wave motion analysis
Wind-wave analysis

Linguistics

Concordances: construction
Syntax pattern analysis
Translation from one language to another
Word frequency analysis

Marine Engineering

Compartment pressures in emergency situations
Compartment ventilation calculations
Force analysis of space structures
Form calculations
Fuel rate analysis
Gyroscopic-compasses sea-test: data reduction
Hydrostatic functions
Large ship maneuvering
Plate and angle combinations: calculations
Ship displacement calculations
Ship models: extrapolation of observations
Ship waterline characteristics
Shock isolators

Turbine reduction gear systems:
vibration analysis
Ullage tables

Mathematics

Boolean algebra calculations
Calculus of variations
Constants, important: evaluation
Curve fitting
Difference equations solution
Differential equations solution
Differentiating symbolically
Eigenvalues and eigenvectors: calculations
Function tables: computation
Integration of functions
Linear programming
Matrix inversion and other calculations
Maximum likelihood functions
Numerical base conversion
Polynomial roots
Simulation of mathematical equations and solutions
Simultaneous linear equations
Stochastic difference equations
Table computation (evaluation of functions)

Mechanical Engineering

Air conditioning calculations
Arch analysis and design
Building frames for reinforced concrete construction: Hardy Cross analysis
Cam design
Critical speeds
Foundation settling: effects
Heat flows
Machine vibration analysis
Moments of inertia
Pipe-stress analysis
Reinforced concrete: bending, stress, etc.
Rigid frames: moment distribution analysis
Shell analysis: stress distribution
Temperature stresses
Truss analysis: stress and deflections

Medicine

Anaesthesia control
Diagnosis of disease

Metallurgy

Alloy calculations
Crystal structure computations

Meteorology

Weather forecasting

Military Engineering

Ballistic trajectories

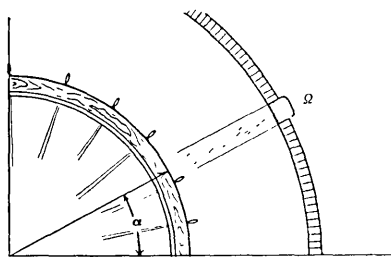

Bomb impact analysis
Fire control
Missiles: calculations re launching, directing, intercepting, and recovery
Pursuit and combat control
Rocket trajectories
Strategy analysis and optimization

Naval Engineering

Cavitation studies
Component attrition rate analysis
Decompression tables
Submerged flow: potential patterns

Nuclear Engineering

Neutron diffraction
Radioactive fallout analysis and prediction
Radioactive level calculations
Reactor design and evaluation
Reactor simulators

Photography

Color separation negatives: scanner for automatic production

Physics

Cosmic radiation: statistical analysis
Crystallography analysis
Electron distributions
Electron trajectories
Lens coating calculations
Optical ray tracing and optical system design
Thermodynamic equations

Statistics

Analysis of variance
Correlation
Factor analysis
Forecasting
Least square polynomial fitting
Moments
Multiple regression
Time series analysis and adjustment

MANUSCRIPTS

WE ARE interested in articles, papers, reference information, and discussion relating to computers and automation. To be considered for any particular issue, the manuscript should be in our hands by the first of the preceding month.

ARTICLES: We desire to publish articles that are factual, useful, understandable, and interesting to many kinds of people engaged in one part or another of the field of computers and automation. In this audience are many people who have expert knowledge of some part of the field, but who are laymen in other parts of it.

Consequently, a writer should seek to explain his subject, and show its context and significance. He should define unfamiliar terms, or use them in a way that makes their meaning unmistakable. He should identify unfamiliar persons with a few words. He should use examples, details, comparisons, analogies, etc., whenever they may help readers to understand a difficult point. He should give data supporting his argument and evidence for his assertions.

We look particularly for articles that explore ideas in the field of computers and automation, and their applications and implications. An article may certainly be controversial if the subject is discussed reasonably. Ordinarily, the length should be 1000 to 3000 words. A suggestion for an article should be submitted to us before too much work is done.

TECHNICAL PAPERS: Many of the foregoing requirements for articles do not necessarily apply to technical papers. Undefined technical terms, unfamiliar assumptions, mathematics, circuit diagrams, etc., may be entirely appropriate. Topics interesting probably to only a few people are acceptable.

REFERENCE INFORMATION: We desire to print or reprint reference information: lists, rosters, abstracts, bibliographies, etc., of use to computer people. We are interested in making arrangements for systematic publication from time to time of such information, with other people besides our own staff. Anyone who would like to take the responsibility for a type of reference information should write us.

NEWS AND DISCUSSION: We desire to print news, brief discussions, arguments, announcements, letters, etc., anything, in fact, if it is not advertising and is likely to be of substantial interest to computer people.

PAYMENTS: In many cases, we make small token payments for articles, if the author wishes to be paid. The rate is ordinarily $\frac{1}{2}$ c a word, the maximum is \$15, and both depend on length in words, whether printed before, etc.

All suggestions, manuscripts, and inquiries about editorial material should be addressed to: *The Editor, COMPUTERS and AUTOMATION, 815 Washington Street, Newtonville 60, Mass.*

Survey of Commercial Computers

Part I

Neil Macdonald
Assistant Editor
Computers and Automation

Introduction

Recently we mailed out to over 100 organizations (including divisions of organizations) a letter saying that we planned to publish a revised edition of a Survey of Commercial Computers and Data Processors, both analog and digital. (The last edition was published in "Computers and Automation," Nov. 1958.) We enclosed forms asking particularly for certain information. Copies of the forms appear below.

Summaries of the replies, constituting basic descriptions of 52 commercially available analog and digital computers are given in this report.

Nearly all the abbreviations used in these summaries are like those used in a telephone book — contractions of words of such a kind that the words can be easily guessed, especially if the reader refers to the survey form summarized. In particular, "ms" means "millisecond"; "us" means "microsecond" (the "u" suggests Greek "mu" which suggests "micro"). "*C" means "checked by the organization"; "58" means "in 1958", etc.

The editors will be glad to receive additional entries or corrections or revisions for publishing in an early issue.

Commercial Analog Computers

From a comparison of the reports on the twelve analog computers we can make the following statements:

Accuracy varies from 2 to 5 significant figures.

Capacity ranges up to and beyond 1000 variables stored

Adders: maximum reported, 96; more are readily possible

Multipliers: maximum reported, 138; more are readily possible

Integrators: maximum reported, 96; more are readily possible

Arbitrary functions: maximum reported, 50; more are readily possible

In-out methods: practically everything — manual, voltages, plug boards, tape

Automatic checking: nearly always

Operating ratio: characteristically 95% to almost 100%

Sale price: \$350 up to \$3,000,000.

To understand the individual summaries here given, the reply used in the survey should be examined:

REPLY FORM (may be copied on any piece of paper)

1. Name of Analog Computer:
2. Typical field(s) of application: ()Scientific
()Business ()Real-time ()Not real-time
()Other (please describe)

3. Accuracy of numerical information the machine will take in and put out, in number of significant figures: ()2 ()3 ()4 ()5 ()Other (please describe)
4. Number of physical variables that the machine can store at one time:
5. Number of units in the computer for performing mathematical operations (OK to give maximum in largest existing installation):
 - a. Adders:
 - b. Multipliers:
 - c. Integrators:
 - d. Arbitrary functions:
 - e. Branching operations:
 - f. Other (please explain):
6. Programming: a. Automatic programming of new problem when a problem changes? ()Yes ()No
b. Typical amount of time needed to change from one program to another:
7. Input-Output: a method of giving information or problems to the machine:
8. Reliability: a. Automatic checking? ()Yes ()No
b. Typical operating percent (good time DIVIDED BY attempted-to-run time):%
9. Price range:
 - a. One sum: between \$..... and \$.....
 - b. Monthly rental: between \$..... and \$.....
10. Sales: a. Number sold or rented:; b. Number on order:
11. Any remarks?

Filled in by Title

Organization

Address

Please return this form when filled in to Neil Macdonald, Assistant Editor, Computers and Automation, 815 Washington St., Newtonville 60, Mass.

Roster of Analog Computers

AN/ASN-15 Navigational System / for aircraft problems / ACCUR: 5 signif figures / CAPAC: store 5 variables / ADDERS: 3 / MULT: 0 / INTEGRATORS: 1 / ARBIT FUNCT: 22 / PRGMG CHANGEOVER: 5 min / IN-OUT: manual dial settings / RELIAB: no autom checking; operg ratio, 100% / sale \$20,000 to \$100,000 / sold or rented, 3; on order, 3 / Waldorf Instrument Co., Wolf Hill Rd., Huntington, N.Y. / *C 58

Computer Systems MC-5800 / scientific, engineering, and other problems / ACCUR: 4 or 5 signif figures / CAPAC: no limit / ADDERS: essentially no limit / MULT: 30 or more / INTEGRATORS: 80 or more / ARBIT FUNCTIONS: many types / IN-

OUT: up to 60 solutions per second / electronic generators of functions of 2 or more variables; real-time, expanded time, or high-speed compressed time; automatic parameter searching by iteration; etc. / Computer Systems, Inc., (formerly Mid-Century Instrument Corp.), 611 Broadway, New York 12, N.Y.

Desired Generation Computer / for electric power utilities problems / ACCUR: 2 signif figures / CAPAC: store 1000 variables (actually no limit) / ADDERS: 10 / MULT: 4 / INTEGRATORS: 4 / ARBIT FUNCT: square, square root / PRGMG CHANGE-OVER: 1 to 15 min / IN-OUT: AC-voltages / RELIAB: has autom checking; operg ratio 95% / sale \$50,000 to \$500,000 / sold or rented, 2; on order 7 / Tied into automatic process control directly / Leeds & Northrup Co., 4901 Stenton Ave., Philadelphia 44, Pa. / *C 58

Dian 120 / for scientific problems, both real-time and other / ACCUR: 4 signif figures / ADDERS: 72 / MULT: 64 / INTEGRATORS: 48 / PRGMG: automatic changeover / RELIAB: has autom checking; operg ratio, 99.99% / Dian Labs, Inc., 611 Broadway, N.Y. 12, N.Y. / *C 58

Donner 3100 / scientific; real-time or not / ACCUR: 3 signif figures / CAPAC: store 15 variables / ADDERS: 15 / MULT: 6 / INTEGRATORS: 15 / ARBIT FUNCT: 6 / PRGMG CHANGE-OVER: 1 min / RELIAB: has autom checking / sale, \$12,000 to \$20,000 / Donner Scientific Co., 888 Galindo St., Concord, Calif. / *C 59

Gravity Analogue Computer / for scientific problems and potential field studies / ACCUR: 3 signif figures / CAPAC: store 1 variable / UNITS: optical system, 1 unit / PRGMG CHANGE-OVER: 3-5 min / IN-OUT: shaded drawings to scale / RELIAB: no autom checking; operg ratio, 95% / sale \$2,000 / sold or rented, 5; on order, 1 / Instrument uses opaque plate with light openings arranged accord to the math of the problem. Problem is presented to instrument as drawing of varying opacity / Seismograph Service Corp., Box 1590, Tulsa, Okla.

EASE (Electronic Analog Simulating Equipment), 1100 Series / scientific; real-time and other (on-line hardware) / ACCUR: 4 signif figures / CAPAC: store 450 variables / ADDERS: 96 / MULT: 138 / INTEGRATORS: 96 / ARBIT FUNCT: 40 / 28 electronic sine generators, 450 coefficient potentiometers / PRGMG: autom changeover, 10 min / IN-OUT: "DO/IT" (Digital Output-Input Translator), patchboard, and paper tape; also direct pushbutton entry / RELIAB: has autom checking; operg ratio 90-95% / sale, \$10,000 to \$450,000; rental, \$500 to \$13,500 per mo / sold, 100 / Beckman Instruments, Inc., Berkeley Division, 2200 Wright Ave., Richmond 3, Calif. / *C 59

Electronic Associates 221R / scientific; real-time or not / ACCUR: 4 signif figures / CAPAC: store 20 variables / ADDERS: 27 / MULT: 30 / INTEGRATORS: 18 / ARBIT FUNCT: 30 / Other: resolvers and fixed function generators also avail / PRGMG CHANGE-OVER: 10 min / IN-OUT: patch panel / RELIAB: has autom checking; operg ratio, 90% / sale, \$16,850 to \$120,000 / sold or rented, 15 / a medium-to-large, 0.01%, general purpose an-

alog computer / Electronic Associates, Inc., North Long Branch, N.J. / *C 59

Electronic Associates 231R / scientific; real-time or not / ACCUR: 4 signif figures / CAPAC: store 30 variables / ADDERS: 45 / MULT: 50 / INTEGRATORS: 30 / ARBIT FUNCT: 50 / Other: resolvers and fixed function generators also avail / PRGMG CHANGE-OVER: 10 min / IN-OUT: punched paper tape and patch panel / RELIAB: has autom checking; operg ratio, 90% / sale, \$20,000 to \$250,000 / sold or rented, 150 / a medium-to-large .01% general purpose analog computer / Electronic Associates, Inc., North Long Branch, New Jersey

Electronic Associates TR-10 / scientific; real-time or not real-time / ACCUR: 3 signif figures / CAPAC: store 8 to 12 variables / ADDERS: 12 / MULT: 9 / INTEGRATORS: 10 / ARBIT FUNCT: 9 / Other: resolvers and fixed function generators also avail / PRGMG: no autom changeover; 15 min changeover time / IN-OUT: patch panel / RELIAB: has autom checking; operg ratio, 90% / sale, \$3,750 to \$10,000 / sold or rented, 10 / a small, transistorized, desk-top, 0.1%, general purpose analog computer / Electronic Associates, Inc., North Long Branch, N.J. / *C 59

Philbrick K2, K3, K5, K7 / scientific, business; real-time or not / ACCUR: 3 signif figures / CAPAC: modular, therefore number of variables a function of size / ADDERS: 50 / MULT: 12 / INTEGRATORS: 80 / ARBIT FUNCT: 10 BRANCHING OPER: 20 / PRGMG CHANGE-OVER: Possible in some cases, 5 min to 1 hour / IN-OUT: Decode coefficient and voltage settings / RELIAB: operg ratio, 95% / sale, \$350 to \$220,000 (typically) / George A. Philbrick Researches, Inc., 285 Columbus Ave., Boston 16, Mass. / *C 59

REAC@: Reeves Electronic Analog Computer / for scientific and process simulation problems; real-time and other / ACCUR: 4 signif figures / ADDERS, MULT, INTEGRATORS, ARBIT FUNCT: no limitations / PRGMG CHANGE-OVER: 5 min / IN-OUT: manual, tape / RELIAB: has autom checking; operg ratio, 95% / sale \$20,000 to \$3,000,000 / Size of installation not limited by any design considerations / Reeves Instrument Corp., Roosevelt Field, Garden City, N.Y. / *C 59

Commercial Digital Computers

From a comparison of the reports on the 40 digital computers (omitting a couple which are of special type), we can make the following statements:

Rapid memory: ranges from 4 registers to about 97,000 registers

Slow memory: (on magnetic tapes) ranges up to about 300 million machine words

Addition speed: ranges from about 1 microsecond to about 1.8 milliseconds

Multiplication speed: from about 4 microseconds to about 160 milliseconds

Division speed: from about 32 microseconds to about 140 milliseconds

Instructions: from 19 to 161

Library routines: up to "over 500" routines

[Please turn to page 20]

58 FACTS PROVE THE MC-5800 OBSOLETES EVERY OTHER ANALOG COMPUTER MADE

solves problems faster, more accurately, and at less cost!

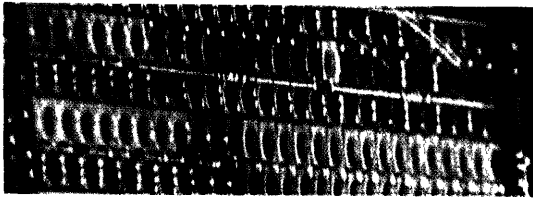

The MC-5800 provides FASTER answers

1. Selection of real-time, expanded-time or high-speed compressed-time without reprogramming.
2. Real-time precision @ speeds to 60 solutions/sec.
3. Dynamic memory with time-base accuracy of $\pm 10 \mu\text{sec}$ provides automatic parameter searching by iteration—an exclusive capability.
4. It programs 134 amplifiers, 30 electronic multipliers, 18 diode function generators, 2 time-delay generators, 8 relay amplifiers, and 6 servos from one 2128-hole patchboard.
5. Unique automatic problem check checks problem-board patching in seconds and can record errors.
6. Exclusive electronic generators of the function of two-or-more variables may be programmed at patchboard in same time required for setup of single-variable generators.
7. Complete control of all amplifiers, multipliers, dividers, and non-linear equipment at patchboard.
8. Quick overload recovery in less than 1 sec.
9. It is the only computer offering card-programmed diode function generators.

The MC-5800 performs MORE ACCURATELY

10. Amplifiers provide lowest noise level output—less than one millivolt at unity gain.
11. Greatest distortion-free amplifier output—30 mils at $\pm 120 \text{ V}$ —only 12 mils quiescent drain.
12. Lowest amplifier grid-current $< 10^{-9}$ ampere.
13. Stable amplifier operation over the entire feedback range from zero to infinity.
14. Drift $< 50 \mu\text{v}$ in 8 hours in summing mode.
15. Amplifier frequency response—flat to 10,000 cps and only 3 db down at 28 kc.
16. Only diode function generators utilizing resistors, potentiometers, and diodes of equal quality to those in computing networks.
17. Only diode function generators with individual hi-lo gain positions for *each* segment.
18. Lowest function generator drift $< 5 \text{ mv}/8 \text{ hrs}$.
19. Highest servo multiplier accuracy, $\pm 0.008\%$.
20. Only fully shielded patch bay and patchboard.
21. All contacts in patching system gold-plated.
22. Highest performance electronic multiplier—flat to 10,000 cps and only 3 db down at 20 kc.
23. Only servo multipliers and resolvers with zero backlash gearing—maximum one part in 36,000.
24. DC tachometer feedback on all servos.
25. Dynamic servo error—less than 50 mv at one cps.
26. Lowest step-function overshoot—less than 1%.

27. EVERY SPECIFICATION IS GUARANTEED TO BE TRUE PERFORMANCE STANDARD—IN SUSTAINED OPERATION.

28. Highest sin-cos resolver accuracy $\pm 0.03\%$ peak-to-peak.
29. Power supplies eliminated from console—lowest, most stable operating temperatures—rise $< 3^\circ\text{C}$.
30. Passive networks stabilized at $< 1^\circ\text{C}$ above room ambient—no oven required.
31. Servo-set pots can be set to 2 parts in 10,000.
32. Accuracy of computing networks at least 0.01%.
33. Lowest computer cross-talk—rejection greater than 2,000 to 1.

The MC-5800 can be operated at LESS COST

34. Greatest available problem capacity per dollar—by 20%.
35. Least cost for future expansion.
36. Output tube filaments operate with DC bias for maximum life.
37. Centralized overload indication for quicker trouble-shooting.
38. Only computer with hermetically sealed transformers.
39. Choppers employ double-contacts in parallel for maximum life.
40. Plug-in relays and step switches throughout for least down time.
41. Plug-in dynamic components ease maintenance.
42. Quickest trouble-shooting by automatic problem check.
43. Costliest and best patching system for lowest programming cost thru maximum reliability of patchcord connections.
44. Choppers de-energized when computer in standby for max. life.
45. Separate power-supply venting minimizes room heat load.
46. Exclusive equipment-door packaging for free access and quick maintenance *without* shutdown.
47. Insulated patchboard prevents costly shorting accidents.
48. Sealed servo gear boxes for maximum reliability.
49. Fully transistorized ADRAC system with plug-in logic modules.
50. Available on lease basis as well as for purchase.

The MC-5800 can SOLVE MORE OF YOUR PROBLEMS

51. Exclusive dynamic memory makes automatic iterative solution of statistical or optimization problems a reality.
52. Dynamic memory + high-speed quick-reset rep-op provide practical approach to solution of simultaneous partial differential equations.
53. Exclusive bi-variable function generators can also be used as amplifiers, multipliers, or generators of single-variable functions.
54. More computer capacity per dollar means more solutions.
55. Solution of problems with up to 15 amplifiers in closed loops.
56. Starting with as few as ten amplifiers, at a cost of little more than the cheapest available computer, you can build to a complete computing center of unsurpassed performance.
57. Add-on capacity up to 134 amplifiers, 30 electronic multipliers, 18 diode function generators, 2 time-delay generators, 8 relays with amplifiers, 4 bi-variable function generators, 6 servos, 8 function switches—all field-expandable without mechanical rework or rewiring.
58. Add-on features include automatic problem check, integrator rate test, high-speed repetitive operation, dynamic memory, expanded-time base, compressed-time base, servo-set potentiometers, and ADRAC (Automatic Digital Recording and Control) system—all field expandable without mechanical rework or rewiring.

There are over 100 more facts—let us tell you about them in person, or better still, visit our factory—and see for yourself!



COMPUTER SYSTEMS, INC., 611 Broadway, New York 12, N. Y. • SPring 7-4016

A Schlumberger Subsidiary • formerly Mid-Century Instrumatic Corp.

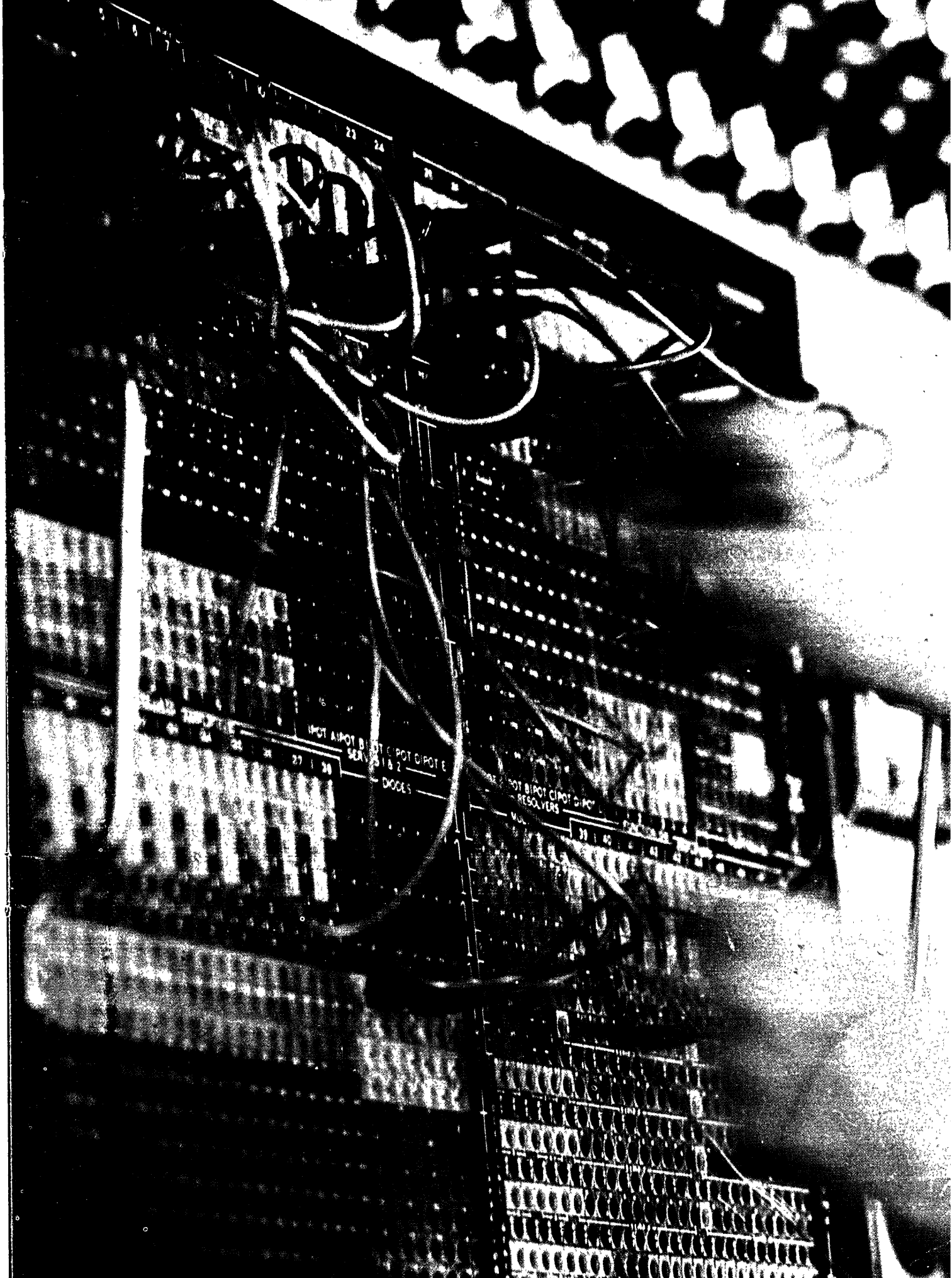

Survey of Commercial Computers

[Continued from page 17]

In-out speed: from about 1 machine word per second to about 125,000 machine words per second

Automatic (or partially automatic) *checking* is present in about 90% of computers.

Operating ratio ranges from 95% to 99%

Sale price ranges from about \$15,000 to about 6 million dollars

To understand the individual summaries, the reply form used in the survey should be examined:

REPLY FORM (may be copied on any piece of paper)

1. Name of Digital Computer or Data Processor:
2. Typical field(s) of application: ()Scientific ()Business ()Real-time ()Not real-time ()Other (please describe)
3. Numerical System: a. Number of characters per machine word:
b. Number of bits (binary digits of information) per character:
4. Memory: a. Number of registers of rapid memory (for example, magnetic cores):
b. Time of access to rapid memory, in microseconds:
c. Number of registers of slow memory (for example, magnetic tape):
5. Arithmetic Unit: a. Time for a complete addition, in microseconds:
b. Time for a complete multiplication, in microseconds:
c. Time for a complete division, in microseconds:
6. Programming: a. Number of different kinds of machine instructions:
b. Approximate number of different library routines available:
7. Input-Output: a. Machine words in or out, per second, maximum:
b. Ability to calculate during input-output? ()Yes ()No
8. Reliability: a. Automatic checking? ()Yes ()No
b. Typical operating percent (good time DIVIDED BY attempted-to-run time):%
9. Price Range: a. One-sum:
between \$..... and \$.....
b. Monthly Rental: between \$..... and \$.....
10. Sales: a. Number sold or rented:
b. Number on order:
11. Any remarks?

Filled in by Title.....
Organization
Address

Please return this form when filled in to Neil Macdonald, Assistant Editor, *Computers and Automation*, 815 Washington St., Newtonville 60, Mass.

Roster of Digital Computers

ALWAC III-E / for scientific, and business problems; numerical control of machine tools; production control; real-time and other / NUM SYS: 8 numeric or 5 alphabetic char per mach word; 4 bits per char / RPD MEM: 128 reg; 4 ms access / MED MEM: 8,192 reg / SLOW MEM: 16 magn tape units—7,168,000 reg / ADN: 500 us / MULT: 0.5 to 17.0 ms / DIV: 0.5 to 17.0 ms / PRGMG: 128 instruc; 50 library routines / IN-OUT: 603 mach words per sec; simultaneous calculating / RELIAB: has autom checking; operg ratio, 96% (as reported by over 30 installations) / sale, \$64,950 to \$500,000; rent, \$2,000 to \$16,000 / sold or rented 38 / Alwac Computer Div., El-Tronics, Inc., 13040 S. Cerise Ave., Hawthorne, Calif. / *C 58

Bendix G-15 / scientific; real-time; business; on-line control; etc. / NUM SYS: 7 or 14 dec digits per mach word; 4 bits per char / RPD MEM: 4 fast access recirculating drum registers plus 2160 words of regular drum storage: 0.54 ms access time to drum can usually be eliminated through use of fast access coding facilities / SLOW MEM: 4 magnetic tape units, 1,200,000 reg per unit / ADN: 0.27 ms to 0.54 ms / MULT: 2.16 to 32.8 ms (arbitrary precision) / DIV: 2.16 to 32.8 ms (arbitrary precision) / PRGMG: 50 (up to 1300 variations) mach instruc; over 500 library routines / IN-OUT: over 3600 mach words per sec; simultaneous calculating / RELIAB: automatic checking by programmed checks only; operg ratio, 96.5% / sale, \$49,500 and up; rent, \$1,485 and up / sold or rented, 260 / Bendix Computer Division, 5630 Arbor Vitae St.; Los Angeles 45, Calif. / *C 59

Burroughs 205 / for scientific and business problems; real-time and other / NUM SYS: 11 char per mach word; 4 bits per char / RPD MEM: 4,080 word drum, 850 us access / SLOW MEM: tape, 200 million reg / ADN: 1.85 ms / MULT: 8.3 ms / DIV: 10 ms / PRGMG: 71 instruc / IN-OUT: 600 mach words per sec (tape); simultaneous calculating / RELIAB: has autom checking; operg ratio 98% / sale, \$150,000 to \$350,000; rent, \$4,300 to \$9,000 / sold or rented, 100; on order, not released / ElectroData Div. of Burroughs Corp., 460 Sierra Madre Villa, Pasadena, Calif. / *C 58

Burroughs 220 / for scientific and business problems; real-time and other / NUM SYS: 11 char per mach word; 4 bits per char / RPD MEM: cores, 2,000 to 10,000 words, 10 us access / SLOW MEM: 55 million words (max) / ADN: 185 us / MULT: 2.1 ms / DIV: 4.0 ms / PRGMG: 94 instruc / IN-OUT: 2400 mach words per sec (magn tape); simultaneous calculating / RELIAB: has autom checking / sale, \$250,000 to \$800,000; rent, \$7800 to \$20,000 / first deliveries made in Oct. 1958 / ElectroData Div. of Burroughs Corp., 460 Sierra Madre Villa, Pasadena, Calif. / *C 58

CLARY DE-60 / scientific, business, real-time / NUM SYS: 18 char and sign per mach word; 4 bits per char / RPD MEM: 32 reg; 8.5 us access / SLOW MEM: paper tape / ADN: 3 ms / MULT: 160 ms / DIV: 140 ms / PRGMG: 36 instruc; 60 library routines / IN-OUT: 1 mach word per sec; no simultaneous calculating / RELIAB: no autom checking;

operg ratio, 97.5% / sale, \$15,000 to \$23,000; rent, \$450 to \$690 / sold or rented, 4; on order, 5 / Transistorized; Power, 115V, 1.3A; portable; no cooling required. Storage may be increased to 160 words / Clary Corp., 408 Junipero St., San Gabriel, Calif. / *C 59

Control Data 1604 / scientific, business / NUM SYS: 48 bits per mach word / RPD MEM: 2.2 us access, 6.4 us cycle / SLOW MEM: 6,000,000 char per tape, 4 to 24 tapes, variable block length / ADN: 7.2 us including access time / MULT: 44.4 us aver / DIV: 65.2 us aver / PRGMG: 62 mach instruc, plus many subinstructions; library routines under preparation / IN-OUT: 50,000 mach words per sec; simultaneous calculating / RELIAB: automatic checking by programming; operg ratio, "high" / sale, \$700,000 to \$1,085,000 / on order, several; first deliveries, fall 1959 / Control Data Corp., 501 Park Ave., Minneapolis 15, Minn. / *C 59

Datamatic 1000 / for business and scientific problems; not real-time / NUM SYS: 12 decimal digits or 8 alphanumeric char (or combns) per mach word / RPD MEM: cores, 2000 registers, adnl 2000 registers optional, 10 us access / SLOW MEM: 3,100,000 words per tape reel, and up to 100 tape units may be directly connected to Central Processor / ADN: 232 us / MULT: 1 ms / DIV: .89 to 3.75 ms / PRGMG: 33 instruc (67 variations), many library routines / IN-OUT: 10,000 mach words per sec, simultaneous calculating / RELIAB: has autom checking plus immediate automatic correcting ("ORTHOTRONIC CONTROL"); operg ratio, 95% / sale \$1,523,000 and up; rent \$32,225 and up / sold or rented 6, on order 4; also one in operation as a Service Bureau in Boston / Orthotronic Control mentioned above provides for *immediate automatic* correction of errors as they are detected / DATAMatic Div, Minneapolis-Honeywell Reg Co, 151 Needham St., Newton Highlands 61, Mass. / *C 59

DISTRIBUTAPE / business / NUM SYS: 11 digits or 38 bits per word / RPD MEM: 4 reg; 1 ms access / SLOW MEM: 1000 reg / ADN: 1 ms / PRGMG: 6 instruc / IN: 17 mach words per sec; OUT: 3 mach words per sec; no simultaneous calculating / RELIAB: has autom checking; operg ratio, 97% / sale, \$35,000 / sold, 1; on order, 1 / Special purpose business computer designed to summarize at high speed data recorded in punched paper tape / Monroe Calculating Machine Co., Inc., a Division of Litton Industries, Orange, N.J. / *C 59

GE-150 Data Processing System / business / NUM SYS: sign and 6 or sign and 12 char per mach word; binary coded decimal, 4 bits per char / RPD MEM: 4000 to 8000 reg; 64 us to 96 us access / SLOW MEM: 1.6 million words per reel up to 13 reels / ADN: 192 us / MULT: 710 us / DIV: 1360 us / PRGMG: 117 mach instruc, extensive library routines / IN-OUT: 55,000 char per sec, simultaneous calculating / RELIAB: has autom checking / sale, \$788,600 to \$1,220,500; rent, \$16,420 to \$22,370 / General Electric Co., Computer Dept., Phoenix, Ariz. / *C 59

GE-250 Information Searching Selector / information storage and retrieval in all aspects, business, industry, government, science / NUM SYS: variable char per

mach word / OPERNS: automatically reviews and compares 15,000 characters per second — 50 to 100 abstracts per second; up to 10 unrelated inquiries can be searched simultaneously / IN-OUT: simultaneous calculating / RELIAB: automatic checking / sale, \$100,000 to \$110,000; rent, \$2000 to \$2500 / General Electric Co., Computer Dept., Phoenix, Ariz. / *C 59

GE-302 Data Accumulator System / real-time / NUM SYS: variable number of char per mach word; 4 pure binary bits per char / RPD MEM: 30 us access, wired direct to drum / ADN: 30 to 120 us per char / PRGMG: wired instruc / IN-OUT: simultaneous calculating / RELIAB: has automatic checking; operating ratio 99% per 5,000 hours / sale, \$50,000 to \$100,000 / Special industrial system / General Electric Co., Computer Dept., Phoenix, Ariz. / *C 59

GE-309 Gage Logging System / NUM SYS: binary coded decimal, 4 bits per char / RPD MEM: 8 reg; 4 us access / SLOW MEM: none / ADN: 10 us / OUT: 10 mach words per sec; simultaneous calculating / RELIAB: no automatic checking / sale, \$25,000 to \$50,000 / Special industrial system / General Electric Co., Computer Dept., Phoenix, Ariz. / *C 59

GE-310 Data Acquisition System / offline logging / NUM SYS: 4 bits per char / PRGMG: 10 instruc, pin board / IN-OUT: 10 char per sec / sale, \$35,000 to \$100,000 / General Electric Co., Computer Dept., Phoenix, Ariz. / *C 59

GE-311 Process Computing System / NUM SYS: 5 char per mach word; 4 bits per char / RPD MEM: 1024 reg, 10 us or 800 us access / SLOW MEM:

COMPUTER PROGRAMMERS-ANALYSTS

Broadview Research Corporation is seeking computer programmers and applications analysts to work in the areas of scientific calculations, systems programming, and commercial data processing.

Company experience includes: satellite orbit computations, numerical solution of differential equations, simulation of communication systems, application of data processing techniques in the areas of logistics, personnel, and administration.

Qualifications: programming experience with medium-large scale computer systems.

Openings exist at Burlingame, California, Alamogordo, New Mexico, and Fort Huachuca, Arizona.

Contact: Mr. William J. Petersen

Broadview Research Corporation

1811 Trousdale Drive
Burlingame, California

20,000 words / ADN: 100 us / MULT: 500 to 2500 us / DIV: 3500 us / PRGMG: 80 instruc, 15 library routines / IN-OUT: 200 char per sec in, 60 char per sec out; simultaneous calculating / RELIAB: has automatic checking; operating ratio 99% / sale, \$100,000 to \$400,000 / Includes input data multiplexer, A-D converter, punched tape in/out, logging typewriters / General Electric Co., Computer Dept., Phoenix, Ariz. / *C 59

GE-312 Control Computer System / NUM SYS: 5 char per mach word; 4 bits per char / RPD MEM: 1024 reg, 10 us or 800 us access / SLOW MEM: 20,000 words / ADN: 100 us / MULT: 500 to 2500 us / DIV: 3500 us / PRGMG: 80 instruc, 15 library routines / IN-OUT: 200 char per sec in, 60 char per sec out; simultaneous calculating / RELIAB: has automatic checking; operating ratio 99% / sale, \$150,000 to \$500,000 / Includes input data multiplexers, A-D converters, D-A converter, punched tape in/out, digital displays / General Electric Co., Computer Dept., Phoenix, Ariz. / *C 59

Honeywell 800 / scientific, not real-time, business / NUM SYS: 12 decimal digits or 8 alphanumeric characters per mach word; 4 bits per decimal digit; 6 bits per alphab char / RPD MEM: basic 4096 words, expandable to 16,384 words; 6 ms access / SLOW MEM: up to 64 mag tape units on line / ADN: 24 us / MULT: 150 us / DIV: 312 us / PRGMG: 52 basic instruc, many variations; many library routines / IN-OUT: 8000 mach words per second per tape unit; can simultaneously read from 8 drives and write on 8 drives, thus providing maximum transfer rate of 128,000 words per second; simultaneous calculating / RELIAB: automatic checking; automatic error correction (Orthotronic feature); operg ratio 95% / sale, \$550,000 and up; rent, \$11,350 and up / on order, over 15 / DATAmatic Div. of Minneapolis-Honeywell Regulator Co., 151 Needham St., Newton Highlands 61, Mass. / *C 59

IBM 650 Data Processing System / scientific, business / NUM SYS: 10 digits plus sign; 5 bits per digit (drum), 7 bits per digit (arith) / RPD MEM: 60 words core reg, 2000 to 4000 words drum reg; 96 us access / SLOW MEM: 48,000,000 digits — random access mem, max 6 mag tape units / ADN: 672 to 768 us / MULT: 2.4 to 19.6 ms / DIV: 6.2 to 23.4 ms / PRGMG: 96 instruc, 200 library routines / IN-OUT: card, 125 words per sec — 3 units; mag tape, 1174 words per sec; simultaneous calculating / RELIAB: has autom checking / sale, \$182,400 to \$630,900 and up; rent, \$3,750 to \$12,400 and up / IBM Corporation, 112 E. Post Road, White Plains, N.Y. / *C 59

IBM 704 Data Processing System / for scientific, business problems; real-time / NUM SYS: 10 char per mach word; 36 bits per word / RPD MEM: 4,096, 8,192, or 32,768 reg; 12 us access / SLOW MEM: 10 mag tape units; 16,384 words (drum) / ADN: 24 us / MULT: 240 us / DIV: 240 us / PRGMG: 86 instruc; 750 library routines / IN-OUT: 2500 mach words per sec; no simultaneous calculating / RELIAB: has autom checking / sale, \$1,000,000 to \$2,500,000; rent, \$20,000 to \$50,000 / IBM Corporation, 112 E. Post Rd., White Plains, N.Y. / *C 59.

IBM 705 Data Processing System / scientific, business / NUM SYS: one char per mach word; 6 bits per char / RPD MEM: Model I: 20,000 reg; Model II: 40,000 reg; Model III: 40,000 or 80,000 reg, magn cores; access: Model I, II: 17 us; Model III: 9 us / SLOW MEM: up to 30 magn drums (60,000 char each); up to 100 magn tape units / ADN: I, II: 119 us; III: 86 us / MULT: I, II: 800 us; III: 600 us / DIV: I, II: 3.9 ms; III: 3.1 ms / PRGMG: I, II: 41 instruc; III: 47 instruc / IN-OUT: 62,500 char per sec for one tape unit; has simultaneous calculating / RELIAB: has autom checking / sale, \$1,250,000 to \$2,750,000; rent, \$25,000 to \$55,000 / International Business Machines Corp., 112 East Post Rd., White Plains, N.Y. / *C 59

IBM 709 Data Processing System / for scientific and business problems; real-time / NUM SYS: 10 char per mach word; 36 bits per char / RPD MEM: 8,192 or 32,768 reg; 12 us access / SLOW MEM: 16,384 words drum; and 48 tapes / ADN: 24 us / MULT: 24 us to 240 us / DIV: 24 us to 240 us / PRGMG: 161 instruc; 750 library routines / IN-OUT: 2500 mach words per sec; simultaneous calculating / RELIAB: has autom checking / sale, \$1,750,000 to \$3,750,000; rent, \$35,000 to \$75,000 / IBM Corporation, 112 E. Post Rd., White Plains, N.Y. / *C 59

[To be continued in the February issue]

**ARE
YOU
BOXED
IN?**



Data Systems can lift the lid! The expansion program now underway at Data Systems will double the engineering department in six months. Many challenging career positions with almost unlimited opportunities for advancement are now open to computer design and development engineers. You will work on automatic industrial controls, special purpose digital data processing equipment, and advanced mark sensing systems involving high speed paper handling devices. Pay schedules are excellent; working conditions are ideal. A new facility is planned for the Newport Beach (Southern California) area in the immediate future.

If you are tired of being boxed in, contact John Flynn, Area 11

**Data Systems Dept.
NORDEN DIVISION**

UNITED AIRCRAFT CORPORATION
13210 Crenshaw Boulevard • Gardena, California



Readers' and Editor's Forum

[Continued from page 6]

we have the motivation and the means for permanent colonies on the moon and other planets, and hence space travel, communications, and trade on an interplanetary basis. . . .

Increasing the nation's brain power is more urgent for our national position and for the welfare of civilization than space conquest. We should, of course, do both, but in the end, improving human brain power by education and extending man's intellect by machine will buy us more benefits in social as well as scientific advance than concentration on any other one field. . . .

New systems of education in the future will involve a partnership between a human teacher and a vast array of teaching aids. Just as a physician can be more effective in diagnosis and cure if he is backed up by X-rays, electrocardiograph machines, and good hospitals and clinics, so can a human teacher provide better education if aided to the fullest by potential engineering advances. Machines that are now technically feasible are well beyond books, blackboards, and even closed-loop television. These new machines can present information in ways that are automatically modified as the machine discovers by steady testing whether or not the student understands the material being presented.

Intellectronics could make possible a more rapid diagnosis of what is bothering the student, take care of presenting routine material, record student progress, assist the student in understanding, memorizing, exploring, and general learning, thus properly leaving the more difficult intellectual tasks of teaching for the professional teacher.

Nothing will do more in the coming years to elevate the teacher's position in society and his effectiveness in making important contributions to our way of life than to be relieved of the less intellectual tasks which electronics can do just as well or better. . . .

A Common Language to Program Computers for Business Problems

[Continued from page 9]

in the program and announced their wish to use such a Common Business Language as soon as it becomes available. Two groups from Great Britain, one representing six manufacturers and the other a group of government users, have also indicated their interest and a desire to participate.

We earnestly solicit advice, assistance, and ideas from all persons who have an interest in this problem. We ask that you communicate with us either through the chairman of the Executive Committee or through one of the chairmen of the task groups.

With so much interest already generated on this problem, on the part of users and manufacturers, and with the impelling need which we have in Government, I feel very optimistic that real progress is being made and will continue to be made towards our ultimate goal of an effective Common Business Language.

CLARE printed circuit relays CUSTOM-BUILT to YOUR DESIGN

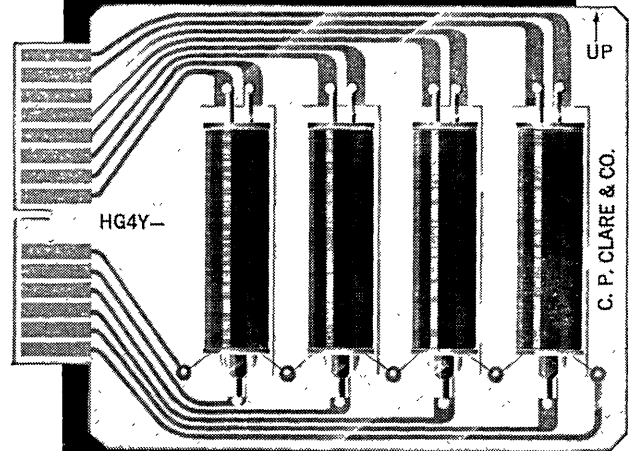

SAVE SPACE WEIGHT COST



This outstanding relay assembly brings to designers of data processing and data logging equipment all the proved advantages of CLARE mercury-wetted contact relays in the smallest possible space.

Individual switch capsules and coils are affixed to a printed circuit board and sealed from dust, moisture or tampering by "SKIN-PACK", a tough vinyl coating.

Let us show you how we would adapt *your* board to include either the standard HG relay or the ultra-high speed HGS . . . as well as other selected components.

◀ This switch has a life expectancy of over one billion operations. Exact size.

Each capsule surrounded by individual coil, wound to customer's specifications. ▶

Discover how you can save time, space and money . . . with CLARE printed circuit relays. Contact your nearby CLARE representative or address: C. P. Clare & Co., 3101 Pratt Blvd., Chicago 45, Illinois. In Canada: C. P. Clare Canada Limited, P. O. Box 134, Downsview, Ontario.

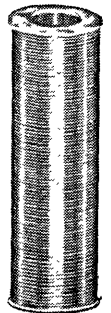

CLARE RELAYS

FIRST in the industrial field

A Statement from Allstate Insurance Company:

“We bought our first Burroughs computer in 1954, now own seven, and have more on order... these are big reasons why Allstate will continue to offer speedier customer service at low cost.”

JUDSON B. BRANCH, *President of Allstate Insurance Companies*

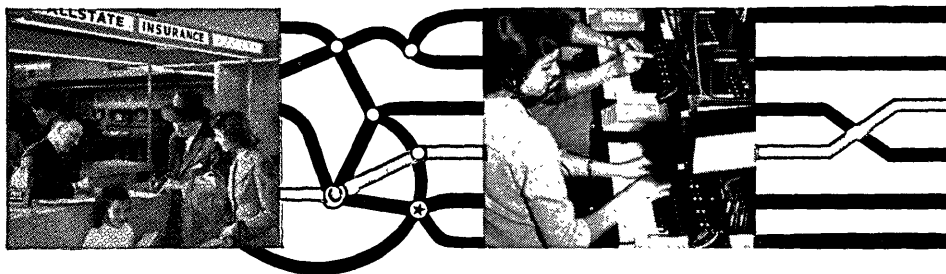

James A. Reynolds, Vice-President of Allstate's Services Department (left) confers with Allstate's President, Judson B. Branch.



Back in 1930, the Sears Board of Directors considered the idea of applying Sears business methods to the sale of automobile insurance. They felt that by selling direct to the public, and keeping operating costs low, quality insurance protection could be sold at low rates. And by keeping customers satisfied through fast, fair service, they hoped to build and maintain a volume of insurance business that would make the low-overhead methods pay off. They settled on the name "Allstate" for

sales and service locations with more than 5,000,000 policies in force. One of the big reasons behind Allstate's growth is its dedication to customer service through fast, fair claim settlement, prompt response to inquiries, and lower premium costs. A powerful tool in aiding the company to provide swifter and better service is its use of Burroughs electronic data processing systems.

After a careful analysis of their needs, Allstate purchased a Burroughs

them for billing, accounts receivable, rating policy issuances, and endorsements. When Burroughs announced its large 220 System, with expandable core memory, Allstate purchased three of these and had them installed in 1959. More 220's are scheduled for installation this year.

In speaking of the over-all benefits to Allstate from its use of Burroughs Computers, Mr. Judson B. Branch, Allstate's President, said, "Primarily, we've been able to give our customers faster, more efficient service at much lower costs. The computers help us to 'cut red tape' and thereby speed our service and help us provide insurance at lower rates. They also provide us with a means of absorbing our substantial growth without a corresponding increase in our operating expenses. We've had other benefits, too. By developing vitally needed statistics, our computers have made available, on a regular reports basis, valuable up-to-date information for our management. In addition, they enable us to promote many of our present employees to positions of greater importance, productivity and interest."

In a company where efficient business methods have been a key factor in providing better service at lower rates, the cold eye of economic justification is constantly focused on its Burroughs equipment. A continual assessment and appraisal of its electronic data processing program has been made over the last five years.

As a result of its analysis, Allstate is not turning back, but relying on Burroughs for a continuation and expansion of its electronic data processing program.

There are hundreds of other commercial and industrial users doing the same. Burroughs' complete line of electronic computers is backed by a coast-to-coast team of computer specialists, all prepared to tell you how Burroughs can help you in your business. For additional information, write Electro-Data Division, Pasadena, California.

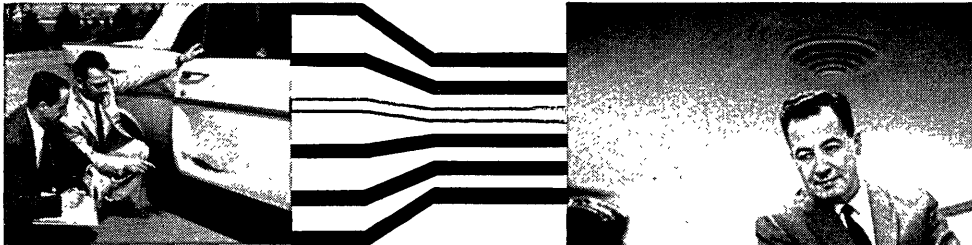

the new company, and opened the first office in a Sears store in Chicago in 1931.

Since that time Allstate has had a dramatic rise in the insurance industry and has pioneered many new and more efficient ways of doing business.

In its first year, Allstate took in \$118,000 in premiums through advertising in the Sears Mail-Order Catalog. In 1958, Allstate's volume had skyrocketed to a whopping \$376,000,000. Today, Allstate is one of the world's largest stock companies offering insurance of almost every major kind. The company recently added accident and sickness insurance, and boat-owners insurance. Its comparatively new commercial insurance lines are booming. Allstate Life Insurance Company, a recently-formed subsidiary, already has over a billion dollars of insurance in force.

Allstate operates a vast network of zone, regional and district service offices in the United States and Canada, with foreign expansion now under way in Switzerland. At the present time there are more than 1,300



Allstate's Assistant Vice-President and Head of Research, L. L. van Oosten.

205 Computer, with magnetic tape equipment, in 1954. With the many complexities of insurance rating, endorsements, billing and coding, Allstate found the computer extremely useful in "cutting red tape" and speeding up policyholder service. More and more policyholders discovered that the protection they purchased through their Allstate policy was delivered promptly because the time consuming annoyance of manual handling was now replaced with electronic methods. Allstate also used the computer for statistical and management reports assembled in a fraction of the time formerly required.

In 1957 and 1958 Allstate purchased three more Burroughs 205's and used



Burroughs Corporation *"NEW DIMENSIONS/in electronics and data processing systems"*

ANNUAL INDEX TO "COMPUTERS AND AUTOMATION"

This index covers information published in the twelve issues of **Computers and Automation**, vol. 8, no. 1, Jan. 1959, to vol. 8, no. 12, Dec. 1959, inclusive. The last part of each entry gives: volume/number (month of issue), page number. Items have been indexed by author, title, and, if necessary, topic or topics. There are more than 420 entries.

A: Accounting, "The Application of a Computer to Bank Accounting," by B. W. Taunton, 8/7 (July), 18

Actuarial calculations, "Casualty Insurance Actuarial Calculations" (in Some Important Applications of Computers), 8/10 (Oct.), 16

Address labels, "One Million Magazine Address Labels a Day" (in Readers' and Editor's Forum), 8/2 (Feb.), 10

"Advanced Course in Analog Computing" (in Readers' and Editor's Forum), 8/1 (Jan.), 8

Aeronutronic, "A New Magnetic Device for Memory and Logic," 8/11 (Nov.), 9

"Air Traffic Control in the Year 1980," by Vernon I. Weihe, 8/10 (Oct.), 32

Algorithms, "Call for Algorithms for an International Handbook for Automatic Computation," by Alston S. Householder (in Readers' and Editor's Forum), 8/11 (Nov.), 6

"All Daily Work for Bank Check Accounting" (in Some Important Applications of Computers) 8/10 (Oct.), 14

American Association for the Advancement of Science Meeting, Washington, D.C., Dec. 30, 1958 (in Readers' and Editor's Forum), 8/2 (Feb.), 10

Analog computing, "Advanced Course in Analog Computing" (in Readers' and Editor's Forum), 8/1 (Jan.), 8

Analysis, "Research, Instrumentation, Automatic Analysis, and Response," by Allen V. Astin, 8/11 (Nov.), 15

Annual Index to "Computers and Automation" Dec., 1957 to Dec., 1958, 8/1 (Jan.), 23

"The Application of a Computer to Bank Accounting," by B. W. Taunton, 8/7 (July), 18

Applications of computers, "Novel Applications of Computers," 8/3 (Mar.), 12;

"Some Important Applications of Computers," 8/10 (Oct.), 12

"The Art of Getting Published," by Jordan and Van Deusen, 8/3 (Mar.), 11

Articles — SEE: "Survey of Recent Articles"

Astin, Allen V., "Research, Instrumentation, Automatic Analysis, and Response," 8/11 (Nov.), 15

"Automated Capitalism," by Edward G. Brender (in Novel Applications of Computers), 8/3 (Mar.), 12

"Automatic Classification of Plant Varieties by Computer," by R. M. Wight (in Readers' and Editor's Forum), 8/4 (Apr.), 16

"Automatic Computing Machinery — List of Types—Supplement," from Peter D. Tilton and the editor (in Readers' and Editor's Forum), 8/5 (May), 6

"Automatic Machining of Parts with Two- and Three-Dimensional Contours," by Robert F. Heslen (in Some Important Applications of Computers), 8/10 (Oct.), 16

"Automatic Payroll Computer," by Blakley, 8/9 (Sept.), 36

"Automatic Programming for Bendix G 15" (in Industry News Notes), 8/5 (May), 28

"Automatic Searching of Chemical Literature," by National Bureau of Standards, 8/11 (Nov.), 24

"Automatically Shaping Noncircular Gears" (in Some Important Applications of Computers), 8/10 (Oct.), 18

B: Bank Accounting, "The Application of a Computer to Bank Accounting," by B. W. Taunton, 8/7 (July), 18

Bank check accounting, "All Daily Work for Bank Check Accounting" (in Some Important Applications of Computers), 8/10 (Oct.), 14

Basic computer components, "Survey of Basic Computer Components," 8/2 (Feb.), 29

Basore, Carmon C., "Reaching Out by Scientists into Other Fields" (in Readers' and Editor's Forum), 8/3 (Mar.), 6

Beef, "Computer Aids Research for Better Beef," by C. J. Brown (in Novel Applications of Computers), 8/3 (Mar.), 12

Belskaya, I. K., "Machine Translation Methods, and Their Application to Translation from English to Russian," 8/10 (Oct.), 20

Belzer, Jack, "Computers for the Highway Engineering Program," 8/1 (Jan.), 12

Berkeley, Edmund C., "Computer Market Survey, 1959," 8/9 (Sept.), 17;

"The Limits of Computer Power" (in Readers' and Editor's Forum), 8/7 (July), 6;

"Symbolic Logic and Automatic Computers": Part 3, 8/1 (Jan.), 18;

Part 3, corrections, 8/3 (Mar.), 15

Berkeley, Edmund C., L. E. S. Green, and C. C. Gotlieb, "Conversation with a Computer," 8/10 (Oct.), 9

Berlin, M. M., "Books and Other Publications" — SEE: "Books and Other Publications";

"Survey of Recent Articles" — SEE: "Survey of Recent Articles"

Better Education, "Education and Computers" (in Readers' and Editor's Forum), 8/4 (Apr.), 6;

"For Better Education — Report of Progress," 8/7 (July), 26

"Bibliography on High School Mathematics Education," by George E. Forsythe, 8/5 (May), 17

Billings, Henry D., "Reading, Writing, and Arithmetic — and Automation" (in Industry News Notes), 8/5 (May), 28

Blair, C. R., "On Economical Debugging," 8/5 (May), 15

Blakley, "Automatic Payroll Computer," 8/9 (Sept.), 36;

"Full Time Use" (in Computer Applications), 8/11 (Nov.), 14

"Blueprint for a Library," by Beatrice H. Worsley, 8/4 (Apr.), 17

"Books and Other Publications," 8/2 (Feb.), 27; 8/4 (Apr.), 32; 8/5 (May), 40; 8/8 (Aug.), 30; 8/9 (Sept.), 42; 8/10 (Oct.), 39

"Braille Translation" (in Some Important Applications of Computers), 8/10 (Oct.), 12

Brender, Edward G., "Automated Capitalism" (in Novel Applications of Computers), 8/3 (Mar.), 12

"The British Computer Society Conference, Cambridge, England, June 22-25, 1959," 8/9 (Sept.), 12

British digital computers, "A Survey of British Digital Computers," by Joseph L. F. DeKerf: Part 1, 8/3 (Mar.), 25; Part 2, 8/4 (Apr.), 34; Part 3, 8/5 (May), 38; "Correction" (in Readers' and Editor's Forum), 8/9 (Sept.), 6

Brock, Dr. Paul, "Business-Type Problems from a Computer Standpoint," 8/8 (Aug.), 18

Brown, Bo, "Computer Accessory," 8/12 (Dec.), 24

Brown, C. J., "Computer Aids Research for Better Beef" (in Novel Applications of Computers), 8/3 (Mar.), 12

"Bufferin' is Aspirin for EDP Headaches," by Ernest Jacobi, 8/9 (Sept.), 30

Burton, "Faithful Servant," 8/7 (July), 28

"Business-Type Problems from a Computer Standpoint," by Dr. Paul Brock, 8/8 (Aug.), 18

"Buyers' Guide for the Computer Field: Products and Services for Sale or Rent" (cumulative), 8/6 (June), 62;

"List of Headings," 8/6 (June), 63

C: "Call for Algorithms for an International Handbook for Automatic Computation," by Alston S. Householder (in Readers' and Editor's Forum), 8/11 (Nov.), 6

Cameron, Scott, "Interdisciplinary Conference on Self-Organizing Systems" (in Readers' and Editor's Forum), 8/1 (Jan.), 10

- Cammer, Mrs. P., "Irrationality" (in Readers' and Editor's Forum), 8/5 (May), 30
- Cammer, Mrs. P., and Charles H. Johnson, "Social Responsibility of Computer Scientists—Argument" (in Readers' and Editor's Forum), 8/9 (Sept.), 6
- Capitalism, "Automated Capitalism," by Edward G. Brender (in Novel Applications of Computers), 8/3 (Mar.), 12
- Carder, C. D., "Flight Simulators in the Jet Age," 8/8 (Aug.), 8
- "Casualty Insurance Actuarial Calculations" (in Some Important Applications of Computers), 8/10 (Oct.), 16
- Chemical literature, "Automatic Searching of Chemical Literature," by National Bureau of Standards, 8/11 (Nov.), 24
- Clark, J. F., and the editor, "Mathematics Laboratories" (in Readers' and Editor's Forum), 8/12 (Dec.), 6
- Clawson, C. Joseph, "Simulation of Consumers' Decisions" (in Novel Applications of Computers), 8/3 (Mar.), 12
- College training, "The Demand for College Training in Digital Computing," by Frank R. Hartman, 8/11 (Nov.), 11
- "Competition for our Front Cover Pictures" (in Readers' and Editor's Forum), 8/1 (Jan.), 8
- "Computer Accessory," by Bo Brown, 8/12 (Dec.), 24
- "Computer Aids Research for Better Beef," by C. J. Brown (in Novel Applications of Computers), 8/3 (Mar.), 12
- "Computer Art," 8/7 (July), 9; 8/8 (Aug.), 11; 8/9 (Sept.), 11
- Computer components, "Survey of Basic Computer Components," 8/2 (Feb.), 29
- Computer control, "The Outlook for Computer Control in the Process Industries," by Melville Stein, 8/5 (May), 9
- "The Computer Directory and Buyers' Guide, 1959," 8/6 (June), 1; Entry Forms, 8/6 (June), 11, 62
- "The Computer and the Highway Patrol: A New Team in Illinois" (in Industry News Notes), 8/5 (May), 28
- "Computer Input from Forty Million Miles Away" (in Readers' and Editor's Forum), 8/8 (Aug.), 1, 6
- "Computer or Man in Space?," from S. Danishevsky and the editor (in Readers' and Editor's Forum), 8/7 (July), 6
- "Computer Market Survey, 1959," by Edmund C. Berkeley, 8/9 (Sept.), 17
- Computer power, "The Limits of Computer Power," by Edmund C. Berkeley (in Readers' and Editor's Forum), 8/7 (July), 6
- "Computer Power: A Public Utility?," by Alan O. Mann, 8/4 (Apr.), 11
- "Computer Talks—American Association for the Advancement of Science—Washington, D.C., Dec. 30, 1958" (in Readers' and Editor's Forum), 8/2 (Feb.), 10
- Computer Talks — SEE: Eastern Joint Computer Conference; Electronic Components Conference; International Conference on Information Processing; The 1958 International Systems Meeting; Joint Automation Conference; Western Joint Computer Conference
- "Computer Works With X-Ray for Quality Control of Steel" (in Readers' and Editor's Forum), 8/4 (Apr.), 16
- "Computers and Automation," "Early Issues of 'Computers and Automation,'" from Dr. Herbert Rister, and the editor, 8/10 (Oct.), 31
- "Computers and Automation in the U.S. S.R.," by Enoch J. Haga, 8/11 (Nov.), 26
- "Computers for the Highway Engineering Program," by Jack Belzer, 8/1 (Jan.), 12
- "Computers Simulating Men," by F. Massnick (in Some Important Applications of Computers), 8/10 (Oct.), 17
- Computing laboratory, "Lehigh University Computing Laboratory," by William A. Smith, Jr. (in Industry News Notes), 8/5 (May), 29
- Conferences — SEE: American Association for the Advancement of Science; Association for Computing Machinery; The British Computer Society Conference; Eastern Joint Computer Conference; Electronic Components Conference; Interdisciplinary Conference on Self-Organizing Systems; International Conference on Information Processing; The 1958 International Systems Meeting; Joint Automation Conference; Western Joint Computer Conference
- Consumers' decisions, "Simulation of Consumers' Decisions," by C. Joseph Clawson (in Novel Applications of Computers), 8/3 (Mar.), 12
- "Controversy and 'Computers and Automation'" (in Readers' and Editor's Forum), 8/12 (Dec.), 6
- Controversy, "Opposition to New Ideas — Controversy," from Patrick J. McGovern and Neil Macdonald, 8/4 (Apr.), 25
- "Conversation with a Computer," by L. E. S. Green, E. C. Berkeley, and C. C. Gotlieb, 8/10 (Oct.), 9
- Cook, James A., and the editor, "On Freedom to Publish" (in Readers' and Editor's Forum), 8/10 (Oct.), 30
- CORRECTIONS: in "A General Problem-Solving Program for a Computer," by A. Newell, J. C. Shaw, and H. A. Simon (in Readers' and Editor's Forum), 8/10 (Oct.), 6; "A Survey of British Computers — Correction," by Joseph DeKerf (in Readers' and Editor's Forum), 8/9 (Sept.), 6; in "Symbolic Logic and Automatic Computers," by Edmund C. Berkeley: Part 3, 8/3 (Mar.), 15
- "Could a Machine Make Probability Judgments?," by I. J. Good: Part 1, 8/1 (Jan.), 14; Part 2, 8/2 (Feb.), 24
- Course in analog computing, "Advanced Course in Analog Computing" (in Readers' and Editor's Forum), 8/1 (Jan.), 8
- "Crewless Vehicles" (in Novel Applications of Computers), 8/3 (Mar.), 12
- D: Danishevsky, S., and the editor, "Computer or Man in Space?" (in Readers' and Editor's Forum), 8/7 (July), 6
- Data systems languages, "Notice from a Committee on Data Systems Languages," by A. E. Smith (in Readers' and Editor's Forum), 8/10 (Oct.), 31
- Datz, Mortimer, "Some Computer Developments in Sweden," 8/11 (Nov.), 16
- Debugging, "On Debugging a Computer," by W. T. Gant (in Readers' and Editor's Forum), 8/7 (July), 6; "On Economical Debugging," by C. R. Blair, 8/5 (May), 15
- Defense, "Testing an Air Defense Weapon" (in Readers' and Editor's Forum), 8/1 (Jan.), 1, 6
- DeKerf, Joseph L. F., "A Survey of British Digital Computers": Part 1, 8/3 (Mar.), 25; Part 2, 8/4 (Apr.), 34; Part 3, 8/5 (May), 38; "Correction" (in Readers' and Editor's Forum), 8/9 (Sept.), 6
- "The Demand for College Training in Digital Computing," by Frank R. Hartman, 8/11 (Nov.), 11
- "Dynamic Production Scheduling Pays Off," by David I. McGinnis (in Readers' and Editor's Forum), 8/2 (Feb.), 8
- E: "Early Issues of 'Computers and Automation,'" from Dr. Herbert Rister, and the editor, 8/10 (Oct.), 31
- Eastern Joint Computer Conference, Dec. 3-5, 1958, "Some Ideas from the Eastern Joint Computer Conference" (in Readers' and Editor's Forum), 8/1 (Jan.), 6
- Eastern Joint Computer Conference (Eighth Annual) Philadelphia, Pa., Dec. 3 to 5, 1958, Titles and Authors, 8/1 (Jan.), 11
- Education: "Bibliography on High School Mathematics Education," by George E. Forsythe, 8/5 (May), 17; "The Demand for College Training in Digital Computing," by Frank R. Hartman, 8/11 (Nov.), 11; "Electronic Computers for Teaching Undergraduates," by Byron Martin, 8/2 (Feb.), 1, 18; "For Better Education—Report of Progress," 8/7 (July), 26; "Intensive Summer Courses" (in Readers' and Editor's Forum), 8/3 (Mar.), 31; "Reading, Writing, and Arithmetic — and Automation," by Henry D. Billings (in Industry News Notes), 8/5 (May), 28; "Red Tape Story," 8/7 (July), 27
- "Education and Computers" (in Readers' and Editor's Forum), 8/4 (Apr.), 6
- "Education for Computers," by Arnold Lerner (in Readers' and Editor's Forum), 8/8 (Aug.), 6
- "1959 Electronic Components Conference, Benjamin Franklin Hotel, Philadelphia, Pa., May 6, 7, 8, 1959," 8/3 (Mar.), 15
- "Electronic Computers for Teaching Undergraduates," by Byron Martin, 8/2 (Feb.), 1, 18
- Engine testing, "Sixty Seconds from Engine Testing to Final Evaluation," by Roger E. Holmes (in Some Important Applications of Computers), 8/10 (Oct.), 13
- Engineering, "Reliability Engineering: A New Application for Computers" (in Industry News Notes), 8/5 (May), 15
- "Expression and Reporting of Views on Social Responsibility," by James J. Lamb (in Readers' and Editor's Forum), 8/4 (Apr.), 9

- F: "Faithful Servant," by Burton, 8/7 (July), 28
- "First Successful Operation of a Practical Magnetic Film Memory," by John A. Kessler (in Readers' and Editor's Forum), 8/10 (Oct.), 1, 6
- "Flight Simulators in the Jet Age," by C. D. Carder, 8/8 (Aug.), 8
- "Flood Control by Computer" (in Some Important Applications of Computers), 8/10 (Oct.), 18
- "For Better Education—Report of Progress," 8/7 (July), 26
- Forecasting, "Weather Forecasting" (in Some Important Applications of Computers), 8/10 (Oct.), 18
- Forsythe, George E., "Bibliography on High School Mathematics Education," 8/5 (May), 17
- Foundry castings, "Predicting the Soundness of Foundry Castings," by A. A. B. Pritsker (in Some Important Applications of Computers), 8/10 (Oct.), 17
- "France Ratifies Convention Establishing The International Computation Centre," by George Lewis, 8/2 (Feb.), 16
- Front cover: "Computer Input from Forty Million Miles Away," 8/8 (Aug.), 1, 6; "Electronic Computers for Teaching Undergraduates," by Byron Martin, 8/2 (Feb.), 1, 18; "First Successful Operation of a Practical Magnetic Film Memory," by John A. Kessler, 8/10 (Oct.), 1, 6; "Giant Computer in Trailer into Ship's Hold," 8/5 (May), 1, 6; "An In-Circuit Transistor Tester," 8/3 (Mar.), 1, 6; "Nuvistor Tube (RCA) Undergoing Shock Test," 8/7 (July), 1, 6; "Observing and Analyzing 'Space' Flight of 'Air-Craft,'" 8/4 (Apr.), 1, 16; "Operation Will be Controlled" from a Distance of About 230,000 Miles by a 'Coordination and Computing Center on Earth'," 8/11 (Nov.), 1, 6; "Russian Questioning of United States Computer," 8/9 (Sept.), 1, 6; "Seeking Utmost Reliability Under Extreme Conditions—Sylvania's Mobidic," 8/12 (Dec.), 1, 17; "Testing an Air Defense Weapon," 8/1 (Jan.), 1, 6
- Front cover pictures, "Competition for our Front Cover Pictures" (in Readers' and Editor's Forum), 8/1 (Jan.), 8
- "Frontier Research in Computers" (in Industry News Notes), 8/5 (May), 26
- "Full Time Use," by Blakley (in Computer Applications), 8/11 (Nov.), 14
- G: Gallousis, George, and H. J. Weber, "Optimum Design of Transformers" (in Industry News Notes), 8/5 (May), 28
- Gant, W. T., "On Debugging a Computer" (in Readers' and Editor's Forum), 8/7 (July), 6
- Gears, "Automatically Shaping Noncircular Gears" (in Some Important Applications of Computers), 8/10 (Oct.), 18
- "A General Problem-Solving Program for a Computer," by A. Newell, J. C. Shaw, and H. A. Simon, 8/7 (July), 10; correction of title to "A Report on . . ." (in Readers' and Editor's Forum), 8/10 (Oct.), 6
- "Giant Computer in Trailer into Ship's Hold" (in Readers' and Editor's Forum), 8/5 (May), 1, 6
- Glossary, "Multilingual Terminology Project of the Provisional International Computation Centre, Rome," from Edwin Holstrom (in Readers' and Editor's Forum), 8/1 (Jan.), 8
- Good, I. J., "Could a Machine Make Probability Judgments?": Part 1, 8/1 (Jan.), 14; Part 2, 8/2 (Feb.), 24
- Gotlieb, C. C., L. E. S. Green, and E. C. Berkeley, "Conversation with a Computer," 8/10 (Oct.), 9
- Green, L. E. S., E. C. Berkeley, and C. C. Gotlieb, "Conversation with a Computer," 8/10 (Oct.), 9
- "Greetings to Computers" (in Readers' and Editor's Forum), 8/12 (Dec.), 6
- H: Haga, Enoch J., "Computers and Automation in the U.S.S.R.," 8/11 (Nov.), 26; "Positions for High School Graduates in Data Processing," 8/2 (Feb.), 13
- Hartman, Frank R., "The Demand for College Training in Digital Computing," 8/11 (Nov.), 11
- Heslen, Robert F., "Automatic Machining of Parts with Two- and Three-Dimensional Contours" (in Some Important Applications of Computers), 8/10 (Oct.), 16
- Highway engineering, "Computers for the Highway Engineering Program," by Jack Belzer, 8/1 (Jan.), 12
- Highway Patrol, "The Computer and the Highway Patrol: A New Team in Illinois" (in Industry News Notes), 8/5 (May), 28
- Holmes, Roger E., "Sixty Seconds from Engine Testing to Final Evaluation" (in Some Important Applications of Computers), 8/10 (Oct.), 13
- Holstrom, Edwin, "Multilingual Terminology Project of the Provisional International Computation Centre, Rome" (in Readers' and Editor's Forum), 8/1 (Jan.), 8
- Householder, Alston S., "Call for Algorithms for an International Handbook for Automatic Computation" (in Readers' and Editor's Forum), 8/11 (Nov.), 6
- I: Ideas: "Opposition to New Ideas," by Neil Macdonald, 8/2 (Feb.), 20; "Opposition to New Ideas—Controversy," from Patrick J. McGovern and Neil Macdonald, 8/4 (Apr.), 25; "Some Ideas from the Eastern Joint Computer Conference" (in Readers' and Editor's Forum), 8/1 (Jan.), 6
- Important applications, "Some Important Applications of Computers," 8/10 (Oct.), 12
- "An In-Circuit Transistor Tester" (in Readers' and Editor's Forum), 8/3 (Mar.), 1, 6
- Index, Dec., 1957 to Dec., 1958, 8/1 (Jan.), 23
- "Industry News Notes": 8/5 (May), 14, 15, 26
- Input, "Computer Input from Forty Million Miles Away" (in Readers' and Editor's Forum), 8/8 (Aug.), 1, 6
- Instrumentation, "Research, Instrumentation, Automatic Analysis, and Response," by Allen V. Astin, 8/11 (Nov.), 15
- Insurance, "Casualty Insurance Actuarial Calculations" (in Some Important Applications of Computers), 8/10 (Oct.), 16
- "Intensive Summer Courses" (in Readers' and Editor's Forum), 8/3 (Mar.), 31
- "Interdisciplinary Conference on Self-Organizing Systems," by Scott Cameron (in Readers' and Editor's Forum), 8/1 (Jan.), 10
- International Computation Centre, "France Ratifies Convention Establishing The International Computation Centre," by George Lewis, 8/2 (Feb.), 16; "Multilingual Terminology Project of the Provisional International Computation Centre, Rome," from Edwin Holstrom (in Readers' and Editor's Forum), 8/1 (Jan.), 8
- International Conference on Information Processing—Program, 8/4 (Apr.), 22; "The Opening," 8/7 (July), 8; "Brief Report," by M. V. Wilkes, 8/9 (Sept.), 9
- "The 1958 International Systems Meeting, Oct. 13, 14, 15, 1958," 8/5 (May), 31
- "Irrationality," by Mrs. P. Cammer (in Readers' and Editor's Forum), 8/5 (May), 30
- J: Jacobi, Ernest, "Bufferin' is Aspirin for EDP Headaches," 8/9 (Sept.), 30
- Johnson, Charles H., and Mrs. P. Cammer, "Social Responsibility of Computer Scientists—Argument" (in Readers' and Editor's Forum), 8/9 (Sept.), 6
- Johnson, Charles H., Neil Macdonald, and others, "Logic, Common Sense, and Social Responsibility of Computer Scientists—Controversy," 8/5 (May), 20
- "Joint Automation Conference, Chicago, Ill., May 11 to 13, 1959," 8/5 (May), 30
- Jordan and Van Deusen, "The Art of Getting Published," 8/3 (Mar.), 11
- K: Kendrew, Dr. J. C., "A Scientific Application of Digital Computers: The 3-Dimensional Structure of the Protein Myoglobin," 8/9 (Sept.), 10
- Kessler, John A., "First Successful Operation of a Practical Magnetic Film Memory" (in Readers' and Editor's Forum), 8/10 (Oct.), 1, 6
- L: Laguna, J. Anthony, "Predicting Machine," 8/5 (May), 32
- Lamb, James J., "Expression and Reporting of Views on Social Responsibility" (in Readers' and Editor's Forum), 8/4 (Apr.), 9
- Languages, "Notice from a Committee on Data Systems Languages," by A. E. Smith (in Readers' and Editor's Forum), 8/10 (Oct.), 31
- "Lehigh University Computing Laboratory," by William A. Smith, Jr. (in Industry News Notes), 8/5 (May), 29
- Lerner, Arnold, "Education for Computers" (in Readers' and Editor's Forum), 8/8 (Aug.), 6
- Lewis, George, "France Ratifies Convention Establishing The International Computation Centre," 8/2 (Feb.), 16

- Library, "Blueprint for a Library," by Beatrice H. Worsley, 8/4 (Apr.), 17
- Liguori, Fred, "Maintenance Methods for Digital Computers," 8/12 (Dec.), 20
- "The Limits of Computer Power," by Edmund C. Berkeley (in Readers' and Editor's Forum), 8/7 (July), 6
- Literature, "Automatic Searching of Chemical Literature," by National Bureau of Standards, 8/11 (Nov.), 24
- "Logic, Common Sense, and Social Responsibility of Computer Scientists—Controversy," by Neil Macdonald, Charles H. Johnson, and others, 8/5 (May), 20
- Logic, "A New Magnetic Device for Memory and Logic," by Aeronutronic, 8/11 (Nov.), 9
- M: Macdonald, Neil, "Opposition to New Ideas," 8/2 (Feb.), 20
- Macdonald, Neil, Charles H. Johnson, and others, "Logic, Common Sense, and Social Responsibility of Computer Scientists—Controversy," 8/5 (May), 20
- Macdonald, Neil, and Patrick J. McGovern, "Opposition to New Ideas—Controversy," 8/4 (Apr.), 25
- "Machine Translation in the Soviet Union," by I. A. Melchuk, 8/8 (Aug.), 23
- "Machine Translation Methods, and Their Application to Translation from English to Russian," by I. K. Belskaya, 8/10 (Oct.), 20
- Machining, "Automatic Machining of Parts with Two- and Three-Dimensional Contours," by Robert F. Heslen (in Some Important Applications of Computers), 8/10 (Oct.), 16
- Magazine address labels, "One Million Magazine Address Labels a Day" (in Readers' and Editor's Forum), 8/2 (Feb.), 10
- Magnetic device, "A New Magnetic Device for Memory and Logic," by Aeronutronic, 8/11 (Nov.), 9
- Magnetic film memory, "First Successful Operation of a Practical Magnetic Film Memory," by John A. Kessler, 8/10 (Oct.), 1, 6
- Magnetic memory cores, "Producing High-Performance Low-Cost Magnetic Memory Cores for an Expanding Digital Computer Market," by C. L. Snyder, 8/3 (Mar.), 9
- "Maintenance Methods for Digital Computers," by Fred Liguori, 8/12 (Dec.), 20
- "Make Your Tabulating Department a Service Department," by Edmond W. McNamara, 8/3 (Mar.), 16
- Mann, Alan O., "Computer Power: A Public Utility?," 8/4 (Apr.), 11
- Martin, Byron, "Electronic Computers for Teaching Undergraduates," 8/2 (Feb.), 1, 18
- Massnick, F., "Computers Simulating Men" (in Some Important Applications of Computers), 8/10 (Oct.), 17
- Mathematics education, "Bibliography on High School Mathematics Education," by George E. Forsythe, 8/5 (May), 17
- "Mathematics Laboratories," from J. F. Clark and the editor (in Readers' and Editor's Forum), 8/12 (Dec.), 6
- Mathematics, "We Are Only on the Threshold of Development in Naval Mathematics" (in Industry News Notes), 8/5 (May), 26
- McGinnis, David I., "Dynamic Production Scheduling Pays Off" (in Readers' and Editor's Forum), 8/2 (Feb.), 8
- McGovern, Patrick J., "Present Vacancies in the Computer Field," 8/5 (May), 16
- McGovern, Patrick J., and Neil Macdonald, "Opposition to New Ideas—Controversy," 8/4 (Apr.), 25
- McNamara, Edmond W., "Make Your Tabulating Department a Service Department," 8/3 (Mar.), 16
- Meetings—SEE: Conferences
- Melchuk, I. A., "Machine Translation in the Soviet Union," 8/8 (Aug.), 23
- Memory, "A New Magnetic Device for Memory and Logic," by Aeronutronic, 8/11 (Nov.), 9
- "Missile Tracking" (in Computer Applications), 8/11 (Nov.), 14
- Mobidic, "Seeking Utmost Reliability Under Extreme Conditions—Sylvania's Mobidic," 8/12 (Dec.), 1, 17
- Moon observation control, "'Operation Will be Controlled' from a Distance of About 230,000 Miles by a 'Coordination and Computing Center on Earth'" (in Readers' and Editor's Forum), 8/11 (Nov.), 1, 6
- "More Adequate Selection of Candidates for Jobs" (in Some Important Applications of Computers), 8/10 (Oct.), 14
- "Multilingual Terminology Project of the Provisional International Computation Centre, Rome," from Edwin Holstrom (in Readers' and Editor's Forum), 8/1 (Jan.), 8
- N: "National Aeronautics and Space Administration to Get New High-Speed Computer Memory," by Richard A. Terry (in Readers' and Editor's Forum), 8/2 (Feb.), 10
- National Bureau of Standards, "Automatic Searching of Chemical Literature," 8/11 (Nov.), 24
- Naval mathematics, "We Are Only on the Threshold of Development in Naval Mathematics" (in Industry News Notes), 8/5 (May), 26
- "A New Magnetic Device for Memory and Logic," by Aeronutronic, 8/11 (Nov.), 9
- "New Patents," by Raymond R. Skolnick, 8/3 (Mar.), 32; 8/4 (Apr.), 37; 8/7 (July), 32; 8/11 (Nov.), 34; 8/12 (Dec.), 32
- Newell, A., J. C. Shaw, and H. A. Simon, "A General Problem-Solving Program for a Computer," 8/7 (July), 10; correction of title (in Readers' and Editor's Forum), 8/10 (Oct.), 6
- "Notice from a Committee on Data Systems Languages," by A. E. Smith (in Readers' and Editor's Forum), 8/10 (Oct.), 31
- "Novel Applications of Computers," 8/3 (Mar.), 12
- "Nuviator Tube (RCA) Undergoing Shock Test" (in Readers' and Editor's Forum), 8/7 (July), 1, 6
- O: "Observing and Analyzing 'Space' Flight of 'Air'-Craft" (in Readers' and Editor's Forum), 8/4 (Apr.), 1, 16
- "On Debugging a Computer," by W. T. Gant (in Readers' and Editor's Forum), 8/7 (July), 6
- "On Economical Debugging," by C. R. Blair, 8/5 (May), 15
- "On Freedom to Publish," from James A. Cook, and the editor (in Readers' and Editor's Forum), 8/10 (Oct.), 30
- "One Million Magazine Address Labels a Day" (in Readers' and Editor's Forum), 8/2 (Feb.), 10
- "'Operation Will be Controlled' from a Distance of About 230,000 Miles by a 'Coordination and Computing Center on Earth'" (in Readers' and Editor's Forum), 8/11 (Nov.), 1, 6
- "Opposition to New Ideas," by Neil Macdonald, 8/2 (Feb.), 20
- "Opposition to New Ideas—Controversy," from Patrick J. McGovern and Neil Macdonald, 8/4 (Apr.), 25
- Optical system, "Ray Tracing in a Cassegrainian Optical System" (in Some Important Applications of Computers), 8/10 (Oct.), 16
- "Optimum Design of Transformers," by H. J. Weber and George Gallousis (in Industry News Notes), 8/5 (May), 28
- Organizations—SEE: Roster of Organizations
- "The Outlook for Computer Control in the Process Industries," by Melville Stein, 8/5 (May), 9
- P: "Pari-Mutuel Machines for Scheduling Service Calls" (in Industry News Notes), 8/5 (May), 14
- Patents—SEE: "New Patents"

EQUITY CAPITAL

On behalf of a private group we are seeking an opportunity to invest equity capital in a young and growing firm in the computer industry or a related field. Inquiries will be treated confidentially and should be addressed to

Burr and Company
 Box 122
 Wellesley Hills 81 Mass.

- Personnel selection, "More Adequate Selection of Candidates for Jobs" (in Some Important Applications of Computers), 8/10 (Oct.), 14
- "The Philosophy of Computers in Society and the Responsibility of Computer People in Society" (in Readers' and Editor's Forum), 8/4 (Apr.), 9
- "1959 Pictorial Report on the Computer Field," 8/12 (Dec.), 8
- Plants, "Automatic Classification of Plant Varieties by Computer," by R. M. Wight (in Readers' and Editor's Forum), 8/4 (Apr.), 16
- "Positions for High School Graduates in Data Processing," by Enoch J. Haga, 8/2 (Feb.), 13
- "Predicting Machine," by J. Anthony Laguna, 8/5 (May), 32
- "Predicting the Soundness of Foundry Castings," by A. A. B. Pritsker (in Some Important Applications of Computers), 8/10 (Oct.), 17
- "Present Vacancies in the Computer Field," by Patrick J. McGovern, 8/5 (May), 16
- Pritsker, A. A. B., "Predicting the Soundness of Foundry Castings" (in Some Important Applications of Computers), 8/10 (Oct.), 17
- Probability judgments, "Could a Machine Make Probability Judgments?," by I. J. Good: Part 1, 8/1 (Jan.), 14; Part 2, 8/2 (Feb.), 24
- Problem-solving, "A General Problem-Solving Program for a Computer," by A. Newell, J. C. Shaw, and H. A. Simon, 8/7 (July), 10
- Problems, "Business-Type Problems from a Computer Standpoint," by Dr. Paul Brock, 8/8 (Aug.), 18
- Process industries, "The Outlook for Computer Control in the Process Industries," by Melville Stein, 8/5 (May), 9
- "Producing High-Performance Low-Cost Magnetic Memory Cores for an Expanding Digital Computer Market," by C. L. Snyder, 8/3 (Mar.), 9
- Production scheduling, "Dynamic Production Scheduling Pays Off," by David I. McGinnis (in Readers' and Editor's Forum), 8/2 (Feb.), 8
- "Products and Services for Sale or Rent: Buyers' Guide for the Computer Field" (cumulative), 8/6 (June), 62
- "Products and Services for Sale or Rent: Buyers' Guide for the Computer Field: List of Headings," 8/5 (June), 63
- Programming, "Automatic Programming for Bendix G 15" (in Industry News Notes), 8/5 (May), 28
- Protein myoglobin structure, "A Scientific Application of Digital Computers: The 3-Dimensional Structure of the Protein Myoglobin," by Dr. J. C. Kendrew, 8/9 (Sept.), 10
- Public utility, "Computer Power: A Public Utility?," by Alan O. Mann, 8/4 (Apr.), 11
- Publication: "The Art of Getting Published," by Jordan and Van Deusen, 8/3 (Mar.), 11; "On Freedom to Publish," from James A. Cook, and the editor (in Readers' and Editor's Forum), 8/10 (Oct.), 30
- Q: Quality control, "Computer Works With X-Ray for Quality control of Steel" (in Readers' and Editor's Forum), 8/4 (Apr.), 16
- R: Railway reservations, "Sante Fe Railway Reservation System" (in Some Important Applications of Computers), 8/10 (Oct.), 14
- "Ray Tracing in a Cassegrainian Optical System" (in Some Important Applications of Computers), 8/10 (Oct.), 16
- "Reaching Out by Scientists into Other Fields" (in Readers' and Editor's Forum), 8/3 (Mar.), 6
- "Reading, Writing, and Arithmetic — and Automation," by Henry D. Billings (in Industry News Notes), 8/5 (May), 28
- "Red Tape Story," 8/7 (July), 27
- "Reference and Survey Information Published in 'Computers and Automation'" (in Readers' and Editor's Forum), 8/4 (Apr.), 9
- Reliability, "Seeking Utmost Reliability Under Extreme Conditions — Sylvania's Mobidic," 8/12 (Dec.), 1, 17
- "Reliability Engineering: A New Application for Computers" (in Industry News Notes), 8/5 (May), 15
- Rescue, "Sea Rescue Operations" (in Some Important Applications of Computers), 8/10 (Oct.), 18
- Research, "Frontier Research in Computers" (in Industry News Notes), 8/5 (May), 26
- "Research, Instrumentation, Automatic Analysis, and Response," by Allen V. Astin, 8/11 (Nov.), 15
- Reservation system, "Sante Fe Railway Reservation System" (in Some Important Applications of Computers), 8/10 (Oct.), 14
- "Reservoir Filling" (in Some Important Applications of Computers), 8/10 (Oct.), 18
- Response, "Research, Instrumentation, Automatic Analysis, and Response," by Allen V. Astin, 8/11 (Nov.), 15
- Rister, Dr. Herbert, and the editor, "Early Issues of 'Computers and Automation,'" 8/10 (Oct.), 31
- "Roster of Organizations in the Computer Field" (cumulative), 8/6 (June), 11
- "Russian Questioning of United States Computer" (in Readers' and Editor's Forum), 8/9 (Sept.), 1, 6
- S: Sabbagh, Neva, "University Student Scheduling by Datatron" (in Novel Applications of Computers), 8/3 (Mar.), 13
- "Sante Fe Railway Reservation System" (in Some Important Applications of Computers), 8/10 (Oct.), 14
- "A Scientific Application of Digital Computers: The 3-Dimensional Structure of the Protein Myoglobin," by Dr. J. C. Kendrew, 8/9 (Sept.), 10
- "Sea Rescue Operations" (in Some Important Applications of Computers), 8/10 (Oct.), 18
- Searching, "Automatic Searching of Chemical Literature," by National Bureau of Standards, 8/11 (Nov.), 24
- Service department, "Make Your Tabulating Department a Service Department," by Edmond W. McNamara, 8/3 (Mar.), 16
- Shaw, J. C., A. Newell, and H. A. Simon, "A General Problem-Solving Program for a Computer," 8/7 (July), 10; correction of title (in Readers' and Editor's Forum), 8/10 (Oct.), 6
- Simon, H. A., A. Newell, and J. C. Shaw, "A General Problem-Solving Program for a Computer," 8/7 (July), 10; correction of title (in Readers' and Editor's Forum), 8/10 (Oct.), 6
- Simulating, "Computers Simulating Men," by F. Massnick (in Some Important Applications of Computers), 8/10 (Oct.), 17
- "Simulation of Consumers' Decisions," by C. Joseph Clawson (in Novel Applications of Computers), 8/3 (Mar.), 12
- Simulators, "Flight Simulators in the Jet Age," by C. D. Carder, 8/8 (Aug.), 8
- "Sixty Seconds from Engine Testing to Final Evaluation," by Roger E. Holmes (in Some Important Applications of Computers), 8/10 (Oct.), 13
- Skolnick, Raymond R., "New Patents" — SEE: "New Patents"
- Sliowski, C. Z., "Soviet Computing Machines and Centers," 8/2 (Feb.), 27
- Smith, A. E., "Notice from a Committee on Data Systems Languages" (in Readers' and Editor's Forum), 8/10 (Oct.), 31
- Smith, Jr., William A., "Lehigh University Computing Laboratory" (in Industry News Notes), 8/5 (May), 29
- Snyder, C. L., "Producing High-Performance Low-Cost Magnetic Memory Cores for an Expanding Digital Computer Market," 8/3 (Mar.), 9
- Sobotka, Rudolph, "Soviet Union Announces Electronic Computing Centers for Over-all Economic Planning," 8/2 (Feb.), 26
- "The Social Responsibilities of Computer People — ACM Committee News" (in Readers' and Editor's Forum), 8/5 (May), 6
- "The Social Responsibilities of Computer People — ACM Committee Report" (in Readers' and Editor's Forum), 8/2 (Feb.), 6
- Social responsibility: "Expression and Reporting of Views on Social Responsibility," by James J. Lamb (in Readers' and Editor's Forum), 8/4 (Apr.), 9; "Irrationality," by Mrs. P. Cammer (in Readers' and Editor's Forum), 8/5 (May), 30; "Logic, Common Sense, and Social Responsibility of Computer Scientists — Controversy," by Neil Macdonald, Charles H. Johnson, and others, 8/5 (May), 20; "The Philosophy of Computers in Society and the Responsibility of Computer People in Society" (in Readers' and Editor's Forum), 8/4 (Apr.), 9; "Reaching Out by Scientists into Other Fields," by Carmon C. Basore (in Readers' and Editor's Forum), 8/3 (Mar.), 6; "Working Group on Socially Desirable Applications of Computers" (in Readers' and Editor's Forum), 8/10 (Oct.), 6

"Social Responsibility of Computer Scientists—Argument," from Mrs. P. Cammer and Charles H. Johnson (in Readers' and Editor's Forum), 8/9 (Sept.), 6

"Some Computer Developments in Sweden," by Mortimer Datz, 8/11 (Nov.), 16

"Some Ideas from the Eastern Joint Computer Conference" (in Readers' and Editor's Forum), 8/1 (Jan.), 6

"Some Important Applications of Computers," 8/10 (Oct.), 12

"Soviet Computing Machines and Centers," by C. Z. Silwowski, 8/2 (Feb.), 27

"Soviet Union Announces Electronic Computing Centers for Over-all Economic Planning," by Rudolph Sobotka, 8/2 (Feb.), 26

Soviet Union, "Computers and Automation in the U.S.S.R.," by Enoch J. Haga, 8/11 (Nov.), 26; "Machine Translation in the Soviet Union," by I. A. Melchuk, 8/8 (Aug.), 23

Space, "Computer or Man in Space?," from S. Danishevsky and the editor (in Readers' and Editor's Forum), 8/7 (July), 6

Space flight, "Observing and Analyzing 'Space' Flight of 'Air'-Craft" (in Readers' and Editor's Forum), 8/4 (Apr.), 1, 16

Stein, Melville, "The Outlook for Computer Control in the Process Industries," 8/5 (May), 9

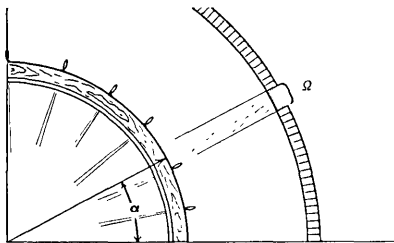

Strachey, C., "Time Sharing in Large Fast Computers," 8/8 (Aug.), 12

Student scheduling, "University Student Scheduling by Datatron," by Neva Sabbagh (in Novel Applications of Computers), 8/3 (Mar.), 13

"Survey of Basic Computer Components," 8/2 (Feb.), 29

"A Survey of British Digital Computers," by Joseph L. F. DeKerf: Part 1, 8/3 (Mar.), 25; Part 2, 8/4 (Apr.), 34; Part 3, 8/5 (May), 38; "Correction" (in Readers' and Editor's Forum), 8/9 (Sept.), 6

Survey, "Computer Market Survey, 1959," by Edmund C. Berkeley, 8/9 (Sept.), 17

Survey information, "Reference and Survey Information Published in 'Computers and Automation'" (in Readers' and Editor's Forum), 8/4 (Apr.), 9

"Survey of Recent Articles," 8/3 (Mar.), 20; 8/4 (Apr.), 30; 8/5 (May), 34; 8/7 (July), 30; 8/8 (Aug.), 26; 8/9 (Sept.), 38; 8/10 (Oct.), 45; 8/11 (Nov.), 29; 8/12 (Dec.), 26

Sweden, "Some Computer Developments in Sweden," by Mortimer Datz, 8/11 (Nov.), 16

"Symbolic Logic and Automatic Computers," by Edmund C. Berkeley: Part 3, 8/1 (Jan.), 18; corrections, 8/3 (Mar.), 15

T: Taunton, B. W., "The Application of a Computer to Bank Accounting," 8/7 (July), 18

Teaching, "Electronic Computers for Teaching Undergraduates," by Byron Martin, 8/2 (Feb.), 1, 18

Terry, Richard A., "National Aeronautics and Space Administration to Get New High-Speed Computer Memory" (in Readers' and Editor's Forum), 8/2 (Feb.), 10

"Testing an Air Defense Weapon" (in Readers and Editor's Forum), 8/1 (Jan.), 1, 6

Tilton, Peter D., "Automatic Computing Machinery—List of Types—Supplement" (in Readers' and Editor's Forum), 8/5 (May), 6

"Time Sharing in Large Fast Computers," by C. Strachey, 8/8 (Aug.), 12

Traffic control, "Air Traffic Control in the Year 1980," by Vernon I. Weihe, 8/10 (Oct.), 32

Transformers, "Optimum Design of Transformers," by H. J. Weber and George Gallousis (in Industry News Notes), 8/5 (May), 28

Transistor tester, "An In-Circuit Transistor Tester" (in Readers' and Editor's Forum), 8/3 (Mar.), 1, 6

Translation: "Braille Translation" (in Some Important Applications of Computers), 8/10 (Oct.), 12; "Machine Translation Methods, and Their Application to Translation from English to Russian," by I. K. Belskaya, 8/10 (Oct.), 20; "Machine Translation in the Soviet Union," by I. A. Melchuk, 8/8 (Aug.), 23

Types of automatic computing machinery, "Automatic Computing Machinery—List of Types—Supplement," from Peter D. Tilton and the editor (in Readers' and Editor's Forum), 8/5 (May), 6

U: "University Student Scheduling by Datatron," by Neva Sabbagh (in Novel Applications of Computers), 8/3 (Mar.), 13

V: Vacancies, "Present Vacancies in the Computer Field," by Patrick J. McGovern, 8/5 (May), 16

Vehicles, "Crewless Vehicles" (in Novel Applications of Computers), 8/3 (Mar.), 12

W: "We Are Only on the Threshold of Development in Naval Mathematics" (in Industry News Notes), 8/5 (May), 26

"Weather Forecasting" (in Some Important Applications of Computers), 8/10 (Oct.), 18

Weber, H. J., and George Gallousis, "Optimum Design of Transformers" (in Industry News Notes), 8/5 (May), 28

Weihe, Vernon I., "Air Traffic Control in the Year 1980," 8/10 (Oct.), 32

"1959 Western Joint Computer Conference, San Francisco, March 3 to 5, 1959," Titles and Authors, 8/3 (Mar.), 14

"Who's Who in the Computer Field," entry form: 8/3 (Mar.), 36; 8/6 (June), 95; 8/8 (Aug.), 32

"Who's Who in the Computer Field (Supplement)": 8/3 (Mar.), 34; 8/6 (June), 95; 8/11 (Nov.), 32; 8/12 (Dec.), 30

Wight, R. M., "Automatic Classification of Plant Varieties by Computer" (in Readers' and Editor's Forum), 8/4 (Apr.), 16

Wilkes, M. V., "The International Conference on Information Processing Held in Paris by Unesco, June 15-20, 1959—Brief Report," 8/9 (Sept.), 9

"Working Group on Socially Desirable Applications of Computers" (in Readers' and Editor's Forum), 8/10 (Oct.), 6

Worsley, Beatrice H., "Blueprint for a Library," 8/4 (Apr.), 17

X: X-Ray "Computer Works With X-Ray for Quality Control of Steel" (in Readers' and Editor's Forum), 8/4 (Apr.), 16

Z: Zeidler, H. M., "1960 Western Joint Computer Conference—Invitation for Papers" (in Readers' and Editor's Forum), 8/10 (Oct.), 30



SOUTH BEND

needs immediately

ANALOG COMPUTER ENGINEER

B S Mechanical Engineer, Aero Engineer, Physics M S preferred. At least three years of experience in the use of analog computers for studying dynamic problems. Applications are in the field of aircraft and missile propulsion control systems, dynamics of landing gear systems, hydraulic and pneumatic devices and heat transfer.

The computer facilities include a repetitive analog, a precision real time analog and digital computers. Salary commensurate with experience. Comprehensive benefit program is offered including; moving and transportation allowances, group insurance, vacations, and tuition assistance for advanced degrees at the University of Notre Dame.

Call or write immediately to:

John M. Evans
Administrative Engineering
Bendix Products Division
401 North Bendix Drive
South Bend, Indiana

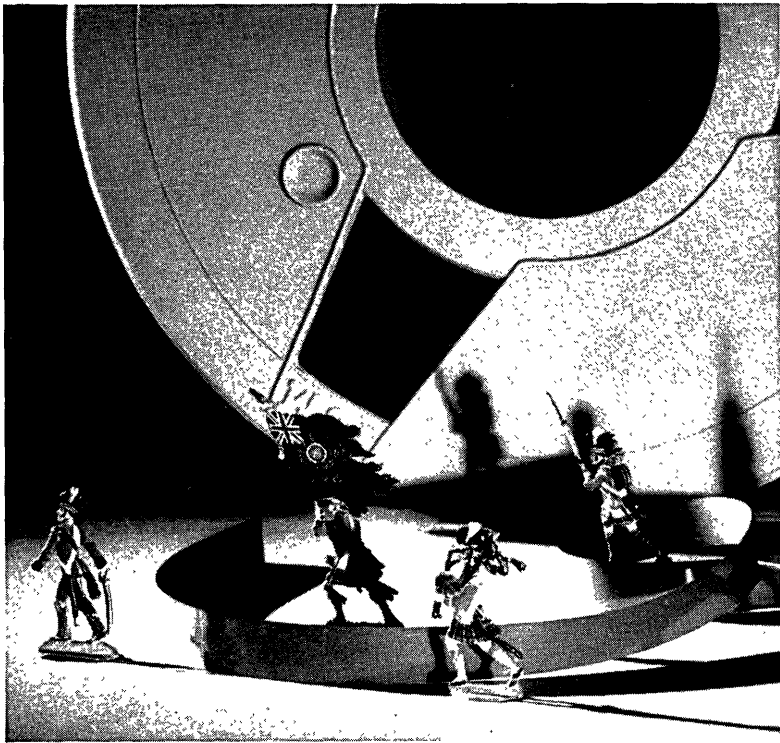

wanted: WAR GAME PLAYERS

Very large-scale air-battle digital computer simulations are now going on at the Washington Research Office of *tech/ops*. Present operations call for *top-flight mathematicians, mathematical statisticians, senior programmers, operations research analysts.*

These computer air battles are stochastic models which involve design and evaluation, and development of unusual techniques for studying sensitivity of these models to input changes. Associated activity involves design of advanced programming systems and of common language carriers which are expected to be independent of the first computer used—the computer itself augmenting and improving the language for use on later and more sophisticated computers.

If challenging work, stimulating atmosphere, and an opportunity to participate in an unusual company/employee investment program interest you . . . write or wire collect:

tech/ops

Kingsley S. Andersson

Technical Operations, Incorporated

3520 PROSPECT STREET, NORTHWEST • WASHINGTON 7, D. C.

*the toy soldiers: officer and men of the 79th Foot Regiment, King's Own Scottish Light Infantry, in uniforms worn at the Battle of Waterloo (from the collection of a member, American Society of Military Historians and Collectors).

SURVEY OF RECENT ARTICLES

Moses M. Berlin
Cambridge, Mass.

We publish here a survey of articles related to computers and data processors, and their applications and implications, occurring in certain magazines. We seek to cover at least the following magazines:

Automatic Control
Automation
Automation and Automatic
Equipment News (British)
Business Week
Control Engineering
Datamation
Electronic Design
Electronics
Harvard Business Review
Industrial Research
Instruments and Control
Systems
ISA Journal
Proceedings of the IRE
The Office
Scientific American

The purpose of this type of reference information is to help anybody interested in computers find articles of particular relation to this field in these magazines.

For each article, we shall publish: the title of the article / the name of the author(s) / the magazine and issue where it appears / the publisher's name and address / two or three sentences telling what the article is about.

PILOT — A New Multiple Computer System / A. L. Leiner, W. A. Notz, J. L. Smith, and A. Weinberger, Nat'l. Bureau of Standards, Wash., D. C. / Journal of the Assn. for Computing Machinery, vol. 6, no. 3, July, 1959, pp 313-35 / Assn. for Computing Machinery, 2 East 63 St., New York 21, N. Y.

The PILOT data processing system contains three interconnected computers and multiple input-output channels. These units operate concurrently, providing rapid data processing, and rapid transfer into and out of the system. A descriptive

summary of the characteristics of the three computers is given, with a discussion of the over-all logical plan of the system.

Testing High-Speed Digital Computer Circuits / R. G. Norquist, Staff Res. Engineer, Denver Res. Institute, U. of Denver, Denver, Colo. / *Electronics*, vol. 32, no. 29, July 17, 1959, p 50 / McGraw-Hill Pub. Co., Inc., 330 West 42 St., New York 36, N. Y.

This article presents a convenient way to check out an automatic computer, or other high-speed digital equipment. The procedure allows for any one of more than 65,000 sixteen-bit words to be selected and fed in at the rate of 10mc.

A Comparison of Methods for Generating Normal Deviates on Digital Computers / M. E. Muler, Princeton U., and IBM Corp. / *Journal of the Assn. for Computing Machinery*, vol. 6, no. 3, July, 1959, pp 376-83 / Assn. for Computing Machinery, 2 East 63 St., New York 21, N. Y.

The purpose of this paper is to review the several methods for generating pseudo random normal deviates within a large-scale computer, including certain specific comparisons of these methods for an IBM 704. Two more recently developed techniques are reviewed, "A Direct Approach," and "An Inverse Approach."

Applying the Digital Computer to Open-Hearth Operations / Engineering Staff, GPE Controls, Inc., / *Control Engineering*, vol. 6, no. 8, August, 1959, pp 94-100 / McGraw-Hill Pub. Co., Inc., 330 West 42 St., New York 36, N.Y.

This is an engineering proposal to apply a digital computer and its automatic control instruments to the steel industry's open-hearth furnace operations. Such an application will bring the steel industry closer to "closed-loop" controls, while other industries may be able to apply the system to "close the loop" at the present time. Computer input, output, data scanning and logging, heat cycle logging, routine furnace program, and heat cycle program, are some of the aspects described.

The Information Machine / D. N. Choras, IBM World Trade Service Corp., Paris / *Systems & Procedures*, vol. 10, no. 3, Aug., 1959, pp 30-5 / S. & P. Assn., 4463 Penobscot Bldg., Detroit 26, Mich.

"Man is essentially an information machine," and if he uses the computer to supplement his memory and calculation capacities, he will greatly increase his ability to plan and control. Business data processing, a real-time system and some small industrial applications, are covered in this article.

Installation of a 305 RAMAC / R. M. Anderson, Mgr., Systems and Procedures, Carter Carburetor Div., ACF Industries, Inc. / *Systems & Procedures*, vol. 10, no. 3, Aug., 1959, pp 22-9 / S. & P. Assn., 4463 Penobscot Bldg., Detroit 26, Mich.

A feasibility study is part of an initial approach to computer use. The study consists of hardware evaluation, economic consideration, and adaptability. This article discusses a company's use of the above, and relates some of its experiences with electronic data processing.

750,000 Policies on a Computer / P. M. Hunt / *Automatic Data Processing*, vol. 1, no. 6, July, 1959, p 36 / Business Publications Ltd., 180 Fleet St., London, EC 4.

A computer is used by an insurance company to handle such matters as premium billing and collection, settlement payments, certain transactions including policy loans, claims and reinstatements. These and other applications are discussed.

Ninety Percent of Computer Users are Satisfied / *Automatic Data Processing*, vol. 1, no. 6, July, 1959, p 41 / Business Publications Ltd., 180 Fleet St., London, EC 4, England.

The result of a survey of the U. S. business world by the research department of John Diebold & Associates, is presented in this report. The report thoroughly discusses a number of factors which determine the success or failure of computer installations.

Unnormalized Floating Point Arithmetic / R. L. Ashenurst and N. Metropolis, University of Chicago, Chicago, Ill. / *Journal of the Assn. for Computing Machinery*, vol. 6, no. 3, July, 1959, pp 415-428 / Assn. for Computing Machinery, 2 East 63 St., New York 21, N. Y.

This article describes algorithms for floating point computer arithmetic, in which fractional parts are not subject to the usual normalized convention. The algorithms give results in a form which provides some indication of their degree of precision. An attempt is made to develop rules which lead to a more favorable situation with regard to error propagation.

Soviet Equipment Design / J. M. Carroll, Managing Editor, *Electronics* / *Electronics*, vol. 32, no. 30, July 24, 1959, p 37 / McGraw-Hill Publ. Co., Inc., 330 West 42 St., New York 36, N. Y.

Among the industrial and consumer units on display at the Soviet exhibition in New York is a transistorized analog computer. One of the computer's 24 operational amplifiers is shown in a diagram accompanying a description of the computer, and other electronic devices.

Management Games Using Punched Cards and Computers / Clifford J. Craft / *Punched Card Data Processing*, vol. 1, no. 6, Sept.-Oct., 1959, p 17 / Gille Associates, Inc., 956 Maccabees Bldg., Detroit 2, Mich.

The role of the computer in simulation games is discussed in this article, which points out the advantages to be gained in simulation with data processing. Some of the pitfalls are mentioned.

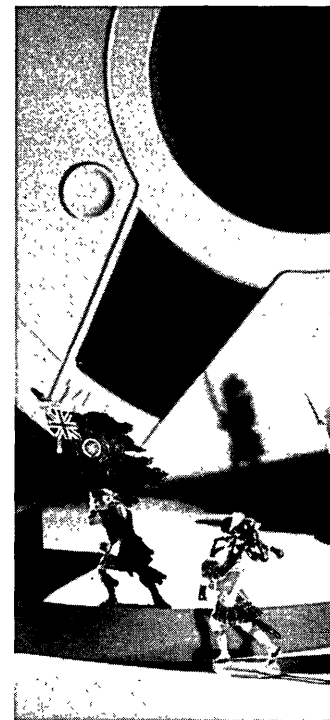

and at tech/ops' Monterey

Research Office, in California, an unusual opportunity exists for a mathematician-programmer to expand his horizons in mathematical analysis and computer programming, in an operations research environment. A B.S. degree and one to two years' programming experience are required, plus the desire and ability to contribute to pre-programming analysis. The over-all Company policies in areas of fringe benefits and profit-sharing plans are unique. Write or wire collect:

Harold E. Kren
Technical Operations, Incorporated

tech ops

305 WEBSTER STREET
MONTEREY, CALIFORNIA

*the toy soldiers: officer and men of the 79th Foot Regiment, King's Own Scottish Light Infantry, in uniforms worn at the Battle of Waterloo (from the collection of a member, American Society of Military Historians and Collectors).

NEW PATENTS

RAYMOND R. SKOLNICK

Reg. Patent Agent

Ford Inst. Co., Div. of Sperry Rand Corp.
Long Island City 1, New York

THE following is a compilation of patents pertaining to computers and associated equipment from the "Official Gazette of the United States Patent Office," dates of issue as indicated. Each entry consists of: patent number / inventor(s) / assignee / invention. Printed copies of patents may be obtained from the U.S. Commissioner of Patents, Washington 25, D.C., at a cost of 25 cents each.

- August 18, 1959: 2,900,134 / Floyd G. Steele, Manhattan Beach, and William F. Collison, Waleria, Calif. / Northrop Corp., a corp. of Calif. / A digital differential analyzer.
- 2,900,135 / Reno B. Benaglio, Birmingham, Jack M. Patterson, Berkeley, and Charles A. Piper, Detroit, Mich. / Bendix Aviation Corp., a corp. of Del. / A digital differential analyzer.
- 2,900,136 / Kenneth B. Tuttle, Playa Del Ray, and Lee C. Keene, Palos Verdes Estates, Calif. / Northrop Corp., Hawthorne, Calif. / An electronic computer for solving polynomials.
- 2,900,137 / Samuel Giser, Sharon, Mass. / Research Corp., New York, N.Y. / An electronic multiplier for four quadrant multiplication of two variables.
- 2,900,458 / Eugene Rawdin, Levittown, Pa. / U.S.A. as represented by the Sec. of the Air Force / A method of eliminating scaling errors in analog computation.
- 2,900,572 / John Harold Lucas, Caterham, and Kenneth Leslie Smith, Oysington,

Eng. / Powers-Samas Accounting Machines Lim., London, Eng. / An electronic storage and data routing apparatus.

2,900,623 / Milton Rosenberg, Santa Monica, Calif. / Telemeter Magnetics, Inc., a corp. of Calif. / A magnetic core memory system.

2,900,624 / Raymond Stuart-Williams, Pacific Palisades, and Milton Rosenberg, Santa Monica, Calif. / Telemeter Magnetics, Inc., a corp. of Calif. / A magnetic memory device.

August 25, 1959: 2,901,166 / Francis E. Hamilton, Binghamton, and George V. Hawkins, Robert Lawheed, Jr., and Ernest S. Hughes, Jr., Vestal, N.Y. / International Business Machines Corp., New York, N.Y. / magnetic drum digital computer.

2,901,168 / Warren P. Burrell and Arnold A. Cohen, Minneapolis, and George A. Hardenbergh, St. Paul, Minn. / International Business Machines Corp., New York, N.Y. / A digital data circuit system.

2,901,169 / Jean Cauboue, Les Pavillons-sous-Bois, and Claude J. Gergaud, Vanves, France / International Business Machines Corp., New York, N.Y. / A variable radix counter.

2,901,172 / Robert E. Thomas, Walnut Creek, Calif. / U.S.A. as represented by the U.S. Atomic Energy Commission / An electronic multiplier circuit.

2,901,549 / Robert Serrell, Princeton, N.J. / Radio Corp. of America, a corp. of Del. / A magnetic recording system.

2,901,602 / Elmer L. Younker, Madison, N.J. / Bell Telephone Lab., Inc., New York, N.Y. / A binary half adder.

2,901,663 / Searle G. Nevius, Tujunga, Calif. / Telecomputing Corp., North Hollywood, Calif. / An electronic digitizing device.

2,901,730 / William A. Goddard, Los Gatos, Calif. / International Business Machines Corp., New York, N.Y. / A digital data storage apparatus.

2,901,737 / John Reed Stovall, Jr., Mount Airy, Pa. / Sperry Rand Corp., New York, N.Y. / A corp. of Del. / A disk recording compensating device.

Sept. 1, 1959: 2,902,217 / George M. Davis, Golders Green, London, Eng. / National Research Development Corp., London, Eng. / A control gating means for a digital computer.

2,902,218 / Maurice A. Meyer, Natick, Mass. / Laboratory for Electronics, Inc., Boston, Mass. / A multiplier employing amplitude modulation.

2,902,219 / Richard H. Wilcox, Washington, D.C. / — / An electronic multiplier data processing circuit.

2,902,674 / Theodore E. Billings, Ithaca, N.Y., Charles P. Keshler, Jr., Framingham, Mass., and Harvey W. Wainwright, Clinton, N.Y. / General Electric Co., a corp. of N.Y. / A transistor memory circuit.

2,902,676 / Edgar Alan Brown, Vestal, N.Y. / International Business Machines Corp., New York, N.Y. / A non-destructive sensing of magnetic cores.

2,902,677 / Richard G. Counihan, Poughkeepsie, N.Y. / International Business Machines Corp., New York, N.Y. / A magnetic core current driver.

2,902,678 / Walter F. Kosonocky, Newark, N.J. / Radio Corp. of America, a corp. of Del. / A magnetic switching system.

2,902,679 / William J. DePhillipo, Philadelphia, Pa., and Kun Li Chien, Fullerton, Calif. / Radio Corp. of America, a corp. of Del. / An information translating system.

September 8, 1959: 2,903,523 / Hershel Toomin, North Hollywood, and George H. Hare, Pasadena, Calif. / Beckman Instruments, Inc., Pasadena, Calif. / A bidirectional zero adjustment circuit for producing an output signal as a function of an input signal.

2,903,605 / Kay H. Barney, Roslyn

ADVERTISING INDEX

Following is the index of advertisements. Each item contains: Name and address of the advertiser / page number where the advertisement appears / name of agency if any.

- Bendix Products Div., 401 No. Bendix Dr., So. Bend, Inc. / Page 31 / MacManus, John & Adams, Inc.
- Broadview Research Corp., 1811 Trousdale Dr., Burlingame, Calif. / Page 21 / L. C. Cole Co., Inc.
- Burr & Co., Box 122, Wellesley Hills 81, Mass. / Page 29 / —
- C. P. Clare & Co., 3101 Pratt Blvd., Chicago 45, Ill. / Page 23 / Reincke, Meyer & Finn
- Computer Systems, Inc., 611 Broadway, New York 12, N.Y. / Pages 18, 19 / Smith, Winters, Mabuchi, Inc.
- ElectroData, Div. of Burroughs Corp., 460 No. Sierra Madre Villa, Pasadena, Calif. / Pages 24, 25 / Carson Roberts Inc.
- Hughes Products, Industrial Systems Div., International Airport Station, Los Angeles 45, Calif. / Page 36 / Foote, Cone & Belding

Norden Div., United Aircraft Corp., Data Systems Dept., 13210 Crenshaw Blvd., Gardena, Calif. / Page 22 / Claude D. Graham Advertising

Philco Corp., Government & Industrial Div., 4700 Wisahickon Ave., Philadelphia 44, Pa. / Page 3 / Maxwell Associates, Inc.

Radio Corp. of America, Electronic Data Processing Div., Camden 2, N.J. / Page 35 / Al Paul Lefton Co., Inc.

System Development Corp., 2406 Colorado Ave., Santa Monica, Calif. / Page 2 / Stromberger, LaVene, McKenzie

Technical Operations, Inc., 3520 Prospect St., N.W., Washington 7, D.C. / Page 32 / Dawson MacLeod & Stivers

Technical Operations, Inc., 305 Webster St., Monterey, Calif. / Page 33 / Dawson MacLeod & Stivers

Heights, N.Y., and Lawrence Green-
span, San Diego, Calif. / Sperry Rand
Corp., a corp. of Del. / An extended
gate generating circuit.

2,903,606 / Daniel L. Curtis, Manhattan
Beach, Calif. / Hughes Aircraft Co.,
Culver City, Calif. / A logical decision
circuitry for digital computation.

2,903,607 / Frederick G. Danner, Glen
Oaks, and Gene C. Browne, North
Amityville, N.Y. / Sperry Rand Corp.,
a corp. of Del. / A flip-flop resetting
circuit.

September 15, 1959: 2,904,253 / Edward
G. Schwarm and Carrol L. Duren, Bing-
hampton, N.Y. / Link Aviation, Inc.,
Binghamton, N.Y. / A servo multiplier
having reduced error.

2,904,706 / John Romanelli, Fullerton,
Calif. / Hughes Aircraft Co., Culver
City, Calif. / A pulse forming network.

2,904,752 / William Perzley, Hi-Nella,
N.J. / Kaiser Metal Products, Inc.,
Oakland, Calif. / A timing system for
providing a pulse delayed by a pre-
determined interval with respect to
a reference pulse.

2,904,776 / Glyn A. Neff, Pasadena,
Calif. / An information storage sys-
tem / Consolidated Electrodynamics
Corp., Pasadena, Calif.

2,904,777 / Bonnar Cox and Jacob Gold-
berg, Palo Alto, Calif. / General
Electric Co., New York, N.Y. / A
magnetic tape reading system.

2,904,778 / Donald Adams Weir, Lon-
don, Eng. / International Standard
Electric Corp., New York, N.Y. / An
intelligence storage system.

2,904,779 / Louis A. Russell, Pough-
keepsie, N.Y. / International Business
Machines Corp., New York, N.Y. / A
magnetic core transfer circuit.

2,904,780 / Albert J. Meyerhoff, Wynne-
wood, Pa. / Burroughs Corp., Detroit,
Mich. / A logic solving magnetic core
circuit.

September 22, 1959: 2,905,299 / William
J. Hildebrandt, Simsbury, Conn. /
Underwood Corp., New York, N.Y. /
A data recording device or devices
and programming means therefor.

2,905,383 / George B. Bruce, Jr., Pough-
keepsie, N.Y. / International Business
Machines Corp., New York, N.Y. /
A circuit for testing the state of a
multiorder register of a predetermined
radix for determining the presence of
a zero state therein.

2,905,384 / David J. Green, Pacific Pal-
isades, Calif. / Gilfillan Bros., Inc.,
Los Angeles, Calif. / A carrier-modu-
lating function generator with adap-
tation for simultaneous multiplication.

2,905,385 / George L. Larse, Van Nuys,
Calif. / Lockheed Aircraft Corp., Bur-
bank, Calif. / A ratio computer having
an unbalancing circuit in the feedback
loop.

2,905,520 / Ralph A. Anderson, Deer-
field, Ill. / Information Systems, Inc.,
Skokie, Ill. / Apparatus for monitor-
ing and recording data on a number of
variables.

JOIN THE RCA BREAKTHROUGH IN ELECTRONIC DATA PROCESSING

RCA . . . world leader in electronics . . . is currently expanding its electronic data processing operations as a result of one of the most significant breakthroughs in modern electronics—the all-transistor RCA 501 system. Already the RCA 501 is being talked about as the world's most efficient electronic data processing system; its sales curve is slanting sharply upwards.

If you have experience in EDP sales or technical services, and are ready to step up to more challenging and rewarding assignments, investigate today the many new career openings at RCA. Current positions, dealing with medium and large-scale systems, include the following:

EDP SALES REPRESENTATIVE—background should include a thorough systems knowledge and at least one year of field experience with either government or commercial clients.

EDP PROGRAMMERS AND METHODS ANALYSTS—local openings for qualified men to work closely with both customer and sales personnel in the development of specific applications, related procedures, and programs.

For a strictly confidential interview with RCA management, please send a detailed résumé of your background and personal qualifications to:

Mr. E. C. Baggett
Professional & Administrative Employment
RCA, Dept. HO-8A
Bldg. 10-1
Camden 2, N. J.



RADIO CORPORATION of AMERICA

ELECTRONIC DATA PROCESSING DIVISION

new improved "Memo-Scope"[®] oscilloscope



Still using "old-fashioned" methods for measuring non-recurring transients? If so, now is the time to investigate the easy way to solve your most difficult transient measurement problems with the latest model Hughes "Memo-Scope" oscilloscope.

Why? Because *new* features, *new* advanced circuitry, *new* panel layout and *new* mechanical design now assure maximum accuracy in all your transient measurements—*plus* higher performance, greater dependability and easier operation!



The Hughes "Memo-Scope" oscilloscope (Model 104E) stores nonrepetitive events for an indefinite period—hours, or days—keeping them available for thorough study until intentionally erased.

new improved features

- Simplified panel layout, redesigned trigger circuit...assure easier operation,
- Advanced mechanical design gives:
 - Better cooling for longer component life,
 - Far greater accessibility for maintenance,
 - Increased ruggedness; resistance to vibration,
- Built-in single-sweep circuit ("1-shot" trigger) at no extra cost,
- Available for either 110 v. or 220 v. operation.

applications

- Data reduction equipment troubleshooting
- Physical testing: shock, stress, strain
- Ultrasonic flaw detection
- Semiconductor testing
- Ballistics and explosives research ...and many others.

INDUSTRIAL SYSTEMS DIVISION

HUGHES PRODUCTS

*For complete information on the new improved Hughes "Memo-Scope" oscilloscope (Model 104E), detailed data sheets and application analysis of your transient measurement problems, write or wire: HUGHES PRODUCTS
Industrial Systems Division, International Airport Station, Los Angeles 45, California*

© 1959, HUGHES AIRCRAFT COMPANY