

COMPUTERS

a n d AUTOMATION

DATA PROCESSING • CYBERNETICS • ROBOTS



Survey of Commercial Computers

Chemical Structure Searching with Automatic Computers

Symbolic Logic and Automatic Computers (Part 1)

NOVEMBER

1958

•

VOL. 7 - NO. 11



COMPUTER-GRADE CAPACITORS . . .

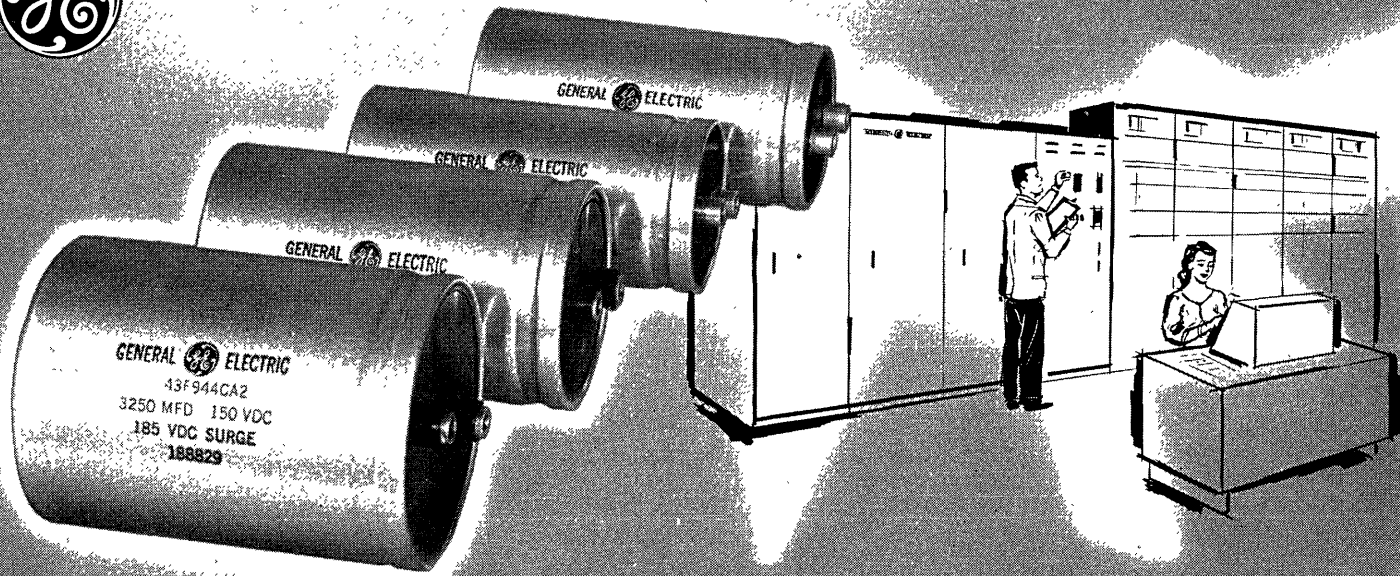

NOW! General Electric Offers a Full Line of . . .

Alumalytic* Capacitors For Greater Computer Reliability

THE LONG SERVICE LIFE AND TOP PERFORMANCE provided by General Electric's computer-grade Alumalytic capacitors add up to greater over-all reliability for your computers. This greater reliability is designed and built into every G-E Alumalytic capacitor. Only the highest quality materials, such as 99.99% pure aluminum foil are used, and this high quality is maintained in the finished capacitor by exacting in-process and quality control checks throughout the manufacturing process.

FILL-IN AND MAIL THE ATTACHED COUPON NOW for a quotation or more information about G-E Alumalytic capacitors for your computers. Or, contact your nearest General Electric Apparatus Sales Office. 449-7

*Trade-mark of General Electric Co.

Progress Is Our Most Important Product

GENERAL ELECTRIC

Pick Your G-E Alumalytic Capacitors from This Wide Range of Ratings
Fill-In and Mail Coupon Today for a Quotation or More Information

Rated Volts	Surge Volts	NOMINAL CAPACITANCE IN MICROFARADS		
		Case Size 2" x 4 1/8"	Case Size 2 1/2" x 4 1/8"	Case Size 3" x 4 1/8"
5	7	20,000	30,000	40,000
10 15	15 20	15,000 12,500	22,000 19,500	35,000 31,000
25 35	40 45	7,000 5,000	12,000 8,000	18,000 12,000
50 75	75 100	3,600 2,750	6,800 5,000	8,500 7,000
100 150	135 185	1,900 1,250	3,500 2,400	4,500 3,250
200 250	250 300	900 700	1,450 1,250	2,250 2,000
300 350	350 400	575 475	1,050 850	1,600 1,300
400 450	475 525	350 300	625 550	1,000 850

NOTE: Operating temperatures -20 C to +65 C. For 85 C applications, another range of units is available with the same physical styles.

Computer Capacitor Sales

Section A449-7

General Electric Company

Schenectady 5, N. Y.

- Please send me your quotation for the G-E computer-grade Alumalytic capacitors I have specified below.
- Please send me more detailed information about General Electric Alumalytic capacitors.

Total Quantity	Rated Volts	Capacitance in uf	Case Size	Operating Temperature
.....
.....

NAME.....

COMPANY..... TITLE.....

ADDRESS.....

CITY..... STATE.....

Autonetics
Professional Personnel Dept.
9150 E. Imperial
Downey, Calif.

July 15, 1956

Dear Mr. Benning:

I am interested in a responsible position which will more fully utilize my experience and education. I graduated with a Masters Degree in Electrical Engineering in 1952 and for the past four years I have been doing research and development on both analog and digital computers. Though my present job is satisfactory I wish to

This letter moved an engineer ahead 5 years

Two years ago a man took 10 minutes to write this letter. Today he enjoys the responsibility and professional standing in the Autonetics Division of North American that might have taken 5 years to achieve elsewhere.

COMPUTERS AT AUTONETICS—A FIELD OF OPPORTUNITY

At Autonetics we have concentrated on developing original techniques in transistor circuitry, miniaturization, and quantity manufacture of precision components. For only with these new arts is it possible to create computers so small, rugged, reliable—yet so big in performance—that they can meet the demands of the space age or the increasingly complex problems of industry.

Our engineers have designed and built both analog and digital computers—for inertial navigation, bombing-navigation, armament control, flight control and data processing equipment. Out of this experience, Autonetics built the first transistorized digital computer of true general purpose capacity.

Today at Autonetics there's a respected combination of scientists, engineers, and production men constantly forging ahead into vital new technologies. Every state of the art is represented, from preliminary conception right through manufacturing. Facilities are the finest—and it's just a short jaunt to mountains, beaches or desert.

You owe it to yourself to consider how far you can advance by entering this exceptionally promising field right now. Here are the opportunities:

LOGICAL DESIGN • SMALL COMPUTER PROGRAMMING • SYSTEMS DESIGN, DEVELOPMENT AND TEST • TRANSISTOR CIRCUITRY • MAGNETIC MEMORY • SYSTEMS INTEGRATION • FIELD SERVICE ENGINEERING.

Write your letter today. Please include a resume of your qualifications. Decide now to investigate your opportunities at Autonetics. Reply will be prompt, factual, confidential.

Write P. L. Benning, Manager, Employment Services.
9150 E. Imperial Highway, Downey, California

Autonetics

A DIVISION OF NORTH AMERICAN AVIATION, INC.



NERVE CENTER OF THE NEW INDUSTRIAL ERA

COMPUTERS and AUTOMATION for November, 1958

COMPUTERS

and AUTOMATION

DATA PROCESSING • CYBERNETICS • ROBOTS

Volume 7
Number 11

NOVEMBER, 1958

Established
September 1951

EDMUND C. BERKELEY *Editor*

NEIL D. MACDONALD *Assistant Editor*

SERVICE AND SALES DIRECTOR

MILTON L. KAYE MURRAY Hill 2-4194
535 Fifth Ave. New York 17, N.Y.

CONTRIBUTING EDITORS

ANDREW D. BOOTH NED CHAPIN

JOHN W. CARR, III ALSTON S. HOUSEHOLDER

ADVISORY COMMITTEE

MORTON M. ASTRAHAN HOWARD T. ENGSTROM

GEORGE E. FORSYTHE RICHARD W. HAMMING

ALSTON S. HOUSEHOLDER H. JEFFERSON MILLS, JR.

HERBERT F. MITCHELL, JR. SAMUEL B. WILLIAMS

ADVERTISING REPRESENTATIVES

Middle Atlantic States MILTON L. KAYE
535 Fifth Ave. New York 17, N.Y.
MURRAY Hill 2-4194

San Francisco 5 A. S. BABCOCK
605 Market St. YUKON 2-3954

Los Angeles 5 W. F. GREEN
439 S. Western Ave. DUNKIRK 7-8135

Elsewhere THE PUBLISHER
Berkeley Enterprises, Inc.
815 Washington St., Newtonville 60, Mass
DECATUR 2-5453 or 2-3928

SURVEY OF COMMERCIAL COMPUTERS 8

NEIL MACDONALD

FRONT COVER

International Bridge-Playing by Computer . . . 1, 6

ARTICLES

Low Cost Conversion Adapts Univac High-Speed Printer
to IBM 704 Outputs 14

FRED KETCHUM

Chemical Structure Searching with Automatic Computers 17
Symbolic Logic and Automatic Computers (Part 1) . 18

EDMUND C. BERKELEY

READERS' AND EDITOR'S FORUM

International Conference on Information Processing,
Paris, June 15-20, 1959 6

Data Processing Concepts—An Elective Course for
High School Seniors 6

Cybernetic Scheduler 24

EDD DOERR

REFERENCE INFORMATION

Automatic Computing Machinery—List of Types . . . 20

Components of Automatic Computing Machinery—List
of Types 22

Who's Who in the Computer Field (Supplement) . . 27

New Patents 28

INDEX OF NOTICES

Advertising Index 30

Back Copies 13

Bulk Subscriptions see Oct. issue, p. 26

Manuscripts see Oct. issue, p. 26

Statement of Management and Ownership 26

Who's Who Entry Form 28

COMPUTERS and AUTOMATION is published monthly at 160 Warren St., Roxbury 19, Mass., by Berkeley Enterprises, Inc. Printed in U.S.A.

SUBSCRIPTION RATES: (United States) \$5.50 for 1 year, \$10.50 for 2 years; (Canada) \$6.00 for 1 year, \$11.50 for 2 years; (Foreign) \$6.50 for 1 year, \$12.50 for 2 years.

Address all Editorial and Subscription Mail to Berkeley Enterprises, Inc., 815 Washington St., Newtonville 60, Mass.

ENTERED AS SECOND CLASS MATTER at the Post Office at Boston 19, Mass.

POSTMASTER: Please send all Forms 3579 to Berkeley Enterprises, Inc., 160 Warren St., Roxbury 19, Mass.

Copyright, 1958, by Berkeley Enterprises, Inc.

CHANGE OF ADDRESS: If your address changes, please send us both your new address and your old address (as it appears on the magazine address imprint), and allow three weeks for the change to be made.

not for nearsighted design engineers

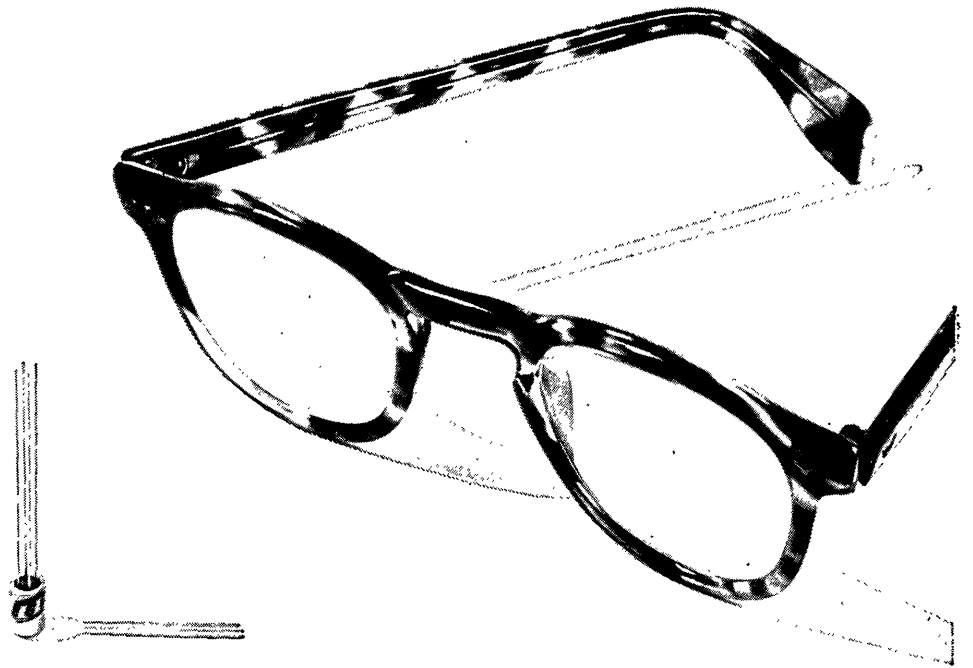

NEW *ESC* MICRO-MINIATURE PULSE TRANSFORMER

Fractional Micro-Second Pulse Width

Where space and weight limitations are precious, ESC's new Micro-Miniature Pulse Transformer fills a vital need in missiles, computers and other electronic equipment. ESC Micro-Miniature Pulse Transformers can be custom built to your specifications for both military and commercial applications. Write for complete technical data today!

ESC MICRO-MINIATURE PULSE TRANSFORMER

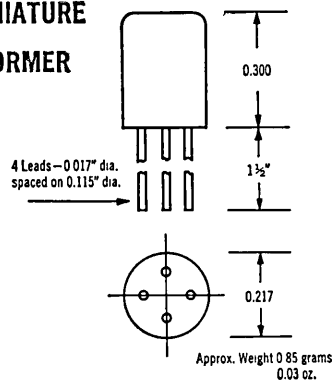

electronic components division

ESC

CORPORATION • 534 BERGEN BOULEVARD • PALISADES PARK, NEW JERSEY

exceptional employment opportunities for engineers experienced in pulse techniques

Pulse transformers • Medium and low-power transformers • Filters of all types • Pulse-forming networks • Miniature plug-in encapsulated circuit assemblies • Distributed constant delay lines • Lumped-constant delay lines • Variable delay networks • Continuously variable delay lines • Pushbutton decade delay lines

Readers' and Editor's Forum

FRONT COVER: INTERNATIONAL BRIDGE-PLAYING BY COMPUTER

THE GAME OF bridge, like some other symbol manipulations, can be played by people speaking different languages and by a computer. At the Brussels World Fair, the Bendix G 15 computer made by the Bendix Computer Division, Los Angeles, has been challenging all comers to a certain hand of bridge; the particular hand is stated on page 13 of the March issue of *Computers and Automation*. It consists of a 7 club bid that requires a double squeeze to make contract, and an infallible memory in order to make it against any combination of opposition plays. Where the human mind would be sorely taxed, the computer's memory is of course infallible.

The Bendix G 15 computer was also in the news at the beginning of October with the announcement of an accessory, the Bendix CA-2 card coupler. This device allows standard 80 column cards to be read or punched at the rate of 100 cards per minute, or data to be printed at 100 lines per minute; but the total monthly rental is only about half of the monthly rental of currently used systems with similar powers.

INTERNATIONAL CONFERENCE ON INFORMATION PROCESSING, PARIS, JUNE 15-20, 1959

Plans are proceeding for the first International Conference on Information Processing, to be held in Paris, France, Monday, June 15, to Friday, June 20, 1959. The Conference is being organized by the United Nations Educational, Scientific, and Cultural Organization (UNESCO), with the help of a group of consultants from eleven countries: J. Carteron and R. de Possel, France; S. Comet, Sweden; A. Ghizzetti, Italy; C. Manneback, Belgium; D. Panov, U.S.S.R.; A. Walther, Federal Republic of Germany; A. van Wijngaarden, Netherlands; M. V. Wilkes, United Kingdom; H. Yamashita, Japan; and Isaac L. Auerbach, United States.

The program of the conference will include six main headings: methods of digital computing; logical design of digital computers; a common symbolic language for digital computers; automatic translation of languages; collection, storage, and retrieval of information; pattern recognition and machine learning.

An exhibition of data processing equipment will be held in Paris at the time of the conference. Several symposiums on special subjects will be held during the conference. It is expected that about 65 papers will be discussed in 11 sessions of 3 hours each.

On October 9, a preliminary selection of papers from the United States was made by a committee under the direction of Dr. Alston S. Householder. On October 21, at a meeting in Paris, an international committee made a further selection of papers, at which the U. S. representative was I. L. Auerbach.

All authors whose abstracts have been selected will be required to submit the full text of their paper for final international selection. Instructions for the presentation of the papers will be supplied at that time.

Papers accepted for discussion at the conference will be preprinted in one language only, either English or

French, and copies will be supplied free of charge before the Conference, to all participants whose registration has been received in time.

Applications of persons in the United States who desire to attend the conference must be sent to Dr. S. N. Alexander, Chairman of Arrangements, U. S. Committee for the International Conference on Information Processing, Box 4999, Washington 8, D.C., who will forward the applications to UNESCO. Assistance will be available for passports, transportation, travel grants, and incidental tours.

DATA PROCESSING CONCEPTS — AN ELECTIVE COURSE FOR HIGH SCHOOL SENIORS

A course in data processing concepts was given as an elective to seniors in Newton High School, Newton, Mass., from January 20 to May 14, 1958, the course held 20 sessions from 2:45 to 3:35 p.m., after regular school hours; it was open to seniors in Curriculum I, the main college preparatory curriculum. The course was taught by R. J. Satlak; 24 students enrolled; 21 stayed to the end. The mimeographed outline of the course was as follows:

- I. Punched Card Processing
 - A. Introduction to the problem
 1. Film strip — "Principles of IBM Accounting"
 2. Illustrate the problem of data processing by a simple job cost spread sheet which grows unmanageable as the company expands.
 - B. Information recorded as punched holes in a card can initiate machine functions. (Use machine functions manual.)
 1. Hollerith code
 2. Sorting
 - a. Why? — to arrange job tickets in job or man number order.
 - b. How the sorter works
 - c. The sorting process
 3. Counting & Printing
 - a. Why? — to accumulate total hours and print result.
 - b. How a counter works
 - c. How a print wheel (or type-bar) works
 - d. Tabulating — what the report looks like
 4. Punching & Verifying
 - a. Why? — to create the card
 - b. Key punch
 - c. Problem of accuracy
 - d. Verifier
 5. Other common machine functions
 - a. Collating
 - b. Reproducing, gang punching, & summary punching
 - c. Interpreting
 - d. Calculating (mention this as something to be expanded on later).
 6. A combined operation — simple payroll.

Job tickets create earnings summary cards and are also summarized for job costs. Earnings cards are calculated for net pay and checks are printed.

[Please turn to page 24]



LONG BRANCH, NEW JERSEY . CAPITOL 9-1100

SUSTAINING EAI'S LEADERSHIP IN THE FIELD OF ANALOG COMPUTING

EAI's new series Application Bulletins and Simulation Bulletins provide dramatic evidence of the growing success of PACE Analog Computing equipment in solving design engineering problems. See why two-thirds of all Analog Computers in use today bear EAI's PACE emblem. For 231R Analog Computer Bulletin No. AC-802 or for literature describing successful applications in your industry, write Dept. CA-11

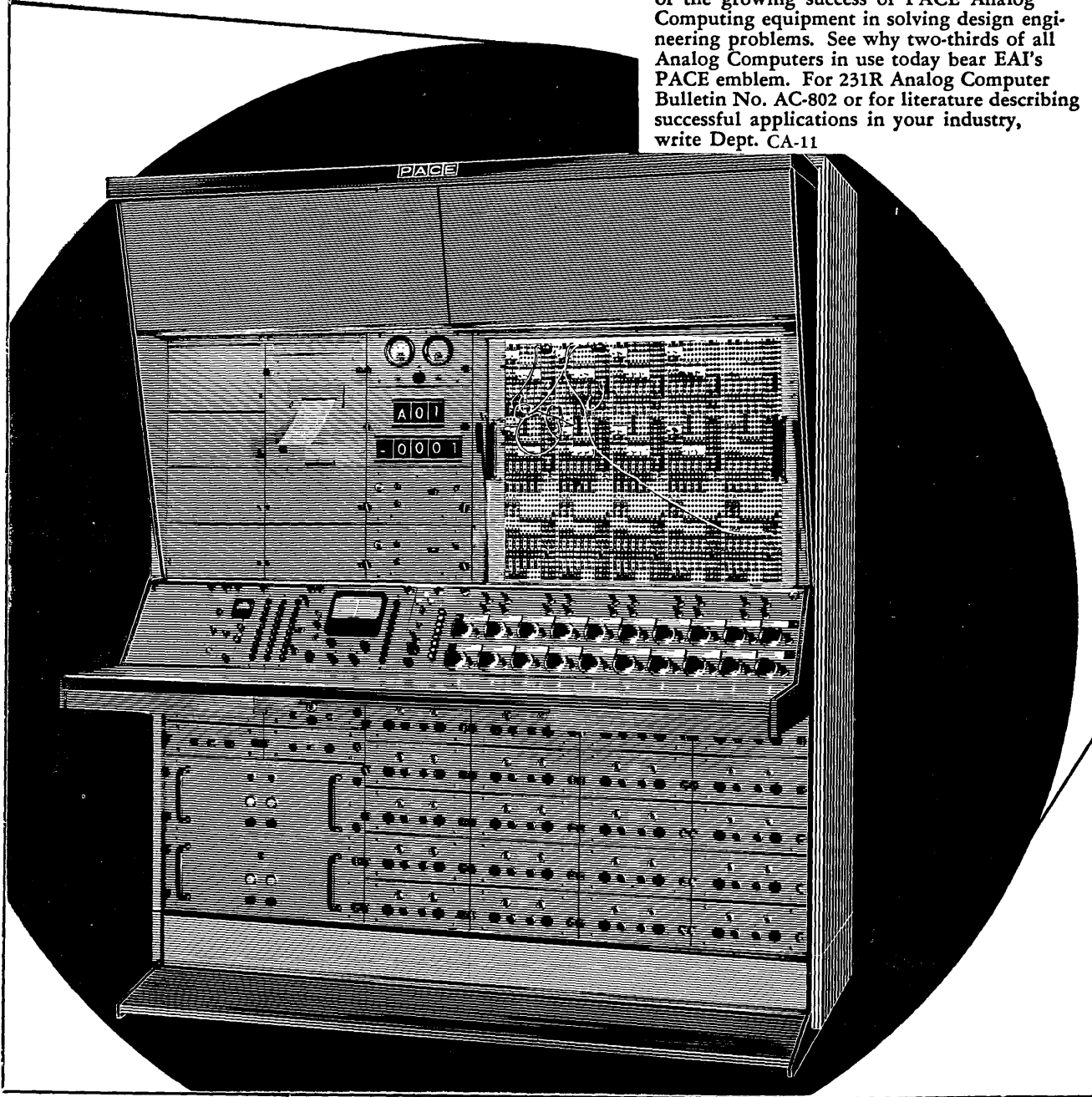

SURVEY OF COMMERCIAL COMPUTERS

Neil Macdonald
Assistant Editor
COMPUTERS and AUTOMATION

Introduction

In the early part of September we mailed out to over 120 organizations (including divisions of organizations) a letter saying that we planned to publish in the November issue a Survey of Commercial Computers and Data Processors, both analog and digital. We enclosed forms asking particularly for certain information. Copies of the forms appear in section I below. A follow-up was sent in the early part of October to a number of leading organizations from whom we expected to hear and had not heard.

We received replies from 34 organizations. About a third of these replies said that the organization produced no commercial computers. Summaries of the replies from the other organizations, constituting basic descriptions of 25 commercially available analog and digital computers appear in sections II and III below. Nearly all the abbreviations used in these summaries are like those used in a telephone book — contractions of words of such a kind that the words can be easily guessed, especially if the reader refers to the survey form summarized; "ms" means "millisecond"; "us" means "microsecond" (the "u" suggests Greek "mu" which suggests "micro").

The editors will be glad to receive additional entries or corrections or revisions for publishing in an early issue.

I. Survey Forms

COMPUTERS and AUTOMATION'S Survey of COMMERCIAL COMPUTERS AND DATA PROCESSORS — ANALOG

REPLY FORM (may be copied on any piece of paper)

1. Name of Analog Computer: _____
2. Typical field(s) of application: () Scientific
() Business () Real-time () Not real-time
() Other (please describe) _____
3. Accuracy of numerical information the machine will take in and put out, in number of significant figures: () 2 () 3 () 4 () 5 () Other (please describe) _____
4. Number of physical variables that the machine can store at one time: _____
5. Number of units in the computer for performing mathematical operations (OK to give maximum in largest existing installation):
 - a. Adders: _____
 - b. Multipliers: _____
 - c. Integrators: _____
 - d. Arbitrary functions: _____
 - e. Branching operations: _____
 - f. Other (please explain): _____

6. Programming: a. Automatic programming of new problem when a problem changes? () Yes () No
b. Typical amount of time needed to change from one program to another: _____
7. Input-Output: a method of giving information or problems to the machine: _____
8. Reliability: a. Automatic checking? () Yes () No
b. Typical operating percent (good time DIVIDED BY attempted-to-run time): _____%
9. Price range:
 - a. One sum: between \$ _____ and \$ _____
 - b. Monthly rental: between \$ _____ and \$ _____
10. Sales: a. Number sold or rented: _____;
b. Number on order: _____
11. Any remarks? _____

Filled in by _____ Title _____
Organization _____
Address _____

Please return this form when filled in to Neil Macdonald,
Assistant Editor, Computers and Automation, 815 Wash-
ington St., Newtonville 60, Mass.

COMPUTERS and AUTOMATION'S Survey of COMMERCIAL COMPUTERS AND DATA PROCESSORS — DIGITAL

REPLY FORM (may be copied on any piece of paper)

1. Name of Digital Computer or Data Processor: _____
2. Typical field(s) of application: () Scientific
() Business () Real-time () Not real-time
() Other (please describe) _____
3. Numerical System: a. Number of characters per machine word: _____
b. Number of bits (binary digits of information) per character: _____
4. Memory: a. Number of registers of rapid memory (for example, magnetic cores): _____
b. Time of access to rapid memory, in microseconds: _____
c. Number of registers of slow memory (for example, magnetic tape): _____
5. Arithmetic Unit: a. Time for a complete addition, in microseconds: _____
b. Time for a complete multiplication, in microseconds: _____
c. Time for a complete division, in microseconds: _____
6. Programming: a. Number of different kinds of machine instructions: _____

**OF ALL COMPLETE COMPUTERS,
ONLY THE COMPACT, POWERFUL
ROYAL PRECISION**

LGP-30

**GIVES YOU THE SPEED, CAPACITY
AND MEMORY YOU WANT
AT LOWEST DOLLAR COST!**

Desk-sized, mobile • Plugs into ordinary wall outlet • Self-cooled • Installed without charge • Lowest cost ever for a complete computer system • Sub-routines and programs available • Customer training • Large staff of applications analysts • Sales and service facilities available coast-to-coast.

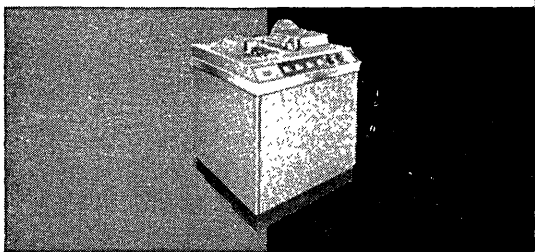

High-speed photoelectric reader—with or without mechanical punch—available for system expansion. Loads entire drum in approximately 5 minutes.



Remarkably simplified command structure and controls require only minimum computer experience. Front panel oscilloscope for concise display.

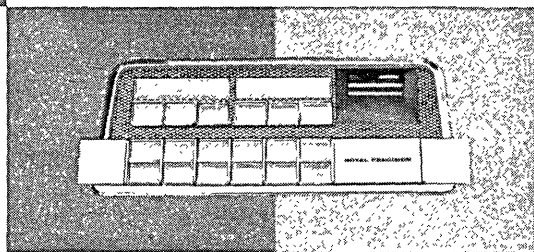

Full flexibility of stored-program operation with unusually large non-volatile memory of 4096 words.

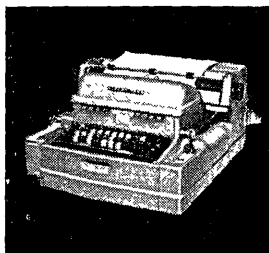
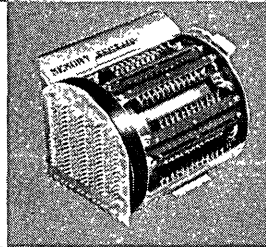

Complete format control. Alpha-numeric input-output via keyboard or punched paper tape. No additional equipment needed to operate.

For further information and specifications, write Royal M^cBee Corporation, Data Processing Division, Port Chester, N. Y.

ROYAL M^cBEE
data processing division

- b. Approximate number of different library routines available: _____
7. Input-Output: a. Machine words in or out, per second, maximum: _____
 b. Ability to calculate during input-output? () Yes () No
8. Reliability: a. Automatic checking? () Yes () No
 b. Typical operating percent (good time DIVIDED BY attempted-to-run time): _____%
9. Price Range: a. One-sum: _____
 between \$ _____ and \$ _____
 b. Monthly Rental: between \$ _____ and \$ _____
10. Sales: a. Number sold or rented: _____;
 b. Number on order: _____
11. Any remarks? _____

Filled in by _____ Title _____
 Organization _____
 Address _____

Please return this form when filled in to Neil Macdonald, Assistant Editor, Computers and Automation, 815 Washington St., Newtonville 60, Mass.

II. Commercial Analog Computers

From a comparison of the reports on the seven analog computers we can make the following statements:

Accuracy varies from 2 to 5 significant figures.

Capacity ranges up to and beyond 1000 variables stored

Adders: maximum reported, 72; more are readily possible

Multipliers: maximum reported, 64; more are readily possible

Integrators: maximum reported, 48; more are readily possible

Arbitrary functions: maximum reported, 22; more are readily possible

In-out methods: practically everything — manual, voltages, plug boards, tape

Automatic checking: nearly always

Operating ratio: characteristically 95% to almost 100%

Sale price: about four hundred dollars up to three million dollars

AN/ASN-15 Navigational System / for aircraft problems / ACCUR: 5 signif figures / CAPAC: store 5 variables / ADDERS: 3 MULT: 0 / INTEGRATORS: 1 / ARBIT FUNCT: 22 / PRGMG; CHANGEVER: 5 min / IN-OUT: manual dial settings / RELIAB: no autom checking; operg ratio, 100% / sale \$20,000 to \$100,000 / sold or rented, 3; on order, 3 / Waldorf Instrument Co., Wolf Hill Rd., Huntington, N. Y.

Desired Generation Computer / for electric power utilities problems / ACCUR: 2 signif figures / CAPAC: store 1000 variables (actually no limit) / ADDERS: 10 / MULT: 4 / INTEGRATORS: 4 / ARBIT FUNCT: square, square root / PRGMG CHANGEVER: 1 to 15 min / IN-OUT: AC-voltages / RELIAB: has autom checking; operg ratio 95% / sale \$50,000 to \$500,000 / sold or rented, 2; on order, 7 / Tied into automatic process control directly. / Leeds & Northrup Co., 4901 Stenton Ave., Philadelphia 44, Pa.

Dian 120 / for scientific problems, both real-time and other / ACCUR: 4 signif figures / ADDERS: 72 / MULT: 64 / INTEGRATORS: 48 / PRGMG: automatic changeover / RELIAB: has autom checking; operg ratio, 99.99% / Dian Labs, Inc., 611 Broadway, N. Y. 12, N. Y.

Gravity Analogue Computer / for scientific problems and potential field studies / ACCUR: 3 signif figures / CAPAC: store 1 variable / UNITS: optical system, 1 unit / PRGMG CHANGEVER: 3-5 min / IN-OUT: shaded drawings to scale / RELIAB: no autom checking; operg ratio, 95% / sale \$2,000 / sold or rented, 5; on order, 1 / Instrument uses opaque plate with light openings arranged accord to the math of the problem. Problem is presented to instrument as drawing of varying opacity / Seismograph Service Corp., Box 1590, Tulsa, Okla.

EASE (Electronic Analog Simulating Equipment) Type 1000 and 1100 / for scientific problems; real-time and other / ACCUR: 4 signif figures / CAPAC: store 100 variables / ADDERS: 56 MULT: 36 / INTEGRATORS: 48 / ARBIT FUNCT: 20 / OTHER: 220 coefficient potentiometers / PRGMG CHANGEVER: 10 min / IN-OUT: patchboard and paper tape / RELIAB: has autom checking; operg ratio, 90 to 95% / sale, \$20,000 to \$200,000 per console / sold, 80; on order, not available / Beckman Instrument Corp., Berkeley Div., 2200 Wright Ave., Richmond 3, Calif.

Philbrick Models K2, K3, K5, K7, etc / for scientific problems, testing, training, data-reducing, etc / ACCUR: 3 signif figures / CAPAC: store 100 variables / ADDERS: 38 up / MULT: 10 up / INTEGRATORS: 40 up / ARBIT FUNCT: 8 up / OTHER UNITS: sampling, time-delay, random generators, selectors, calibrated display, etc / PRGMG CHANGEVER TIME: 5 min / IN-OUT: voltages or switch settings for giving info / RELIAB: has autom checking; operg ratio, 95% / sale \$350 to \$220,000 / Philbrick Researches, Inc., 285 Columbus Ave., Boston 16, Mass.

REAC^R: Reeves Electronic Analog Computer / for scientific and process simulation problems; real-time and other / ACCUR: 4 signif figures / ADDERS, MULT, INTEGRATORS, ARBIT FUNCT: no limitations / PRGMG CHANGEVER: 5 min / IN-OUT: manual, tape / RELIAB: has autom checking; operg ratio, 95% / sale \$20,000 to \$3,000,000 / Size of installation not limited by any design considerations / Reeves Instrument Corp., Roosevelt Field, Garden City, N. Y.

III. Commercial Digital Computers

From a comparison of the reports on the following digital computers (omitting a couple which are of special type), we can make the following statements:

Rapid memory: ranges from 4 registers to about 33,000 registers

Slow memory: (on magnetic tapes): ranges up to about 300 million machine words

Addition speed: ranges from about 18 microseconds to about 1.8 milliseconds

Multiplication and division speed: from about 65 microseconds to about 20 milliseconds

Instructions: from 19 to 161

Library routines: up to "over 500" routines

Now Available!

RCA's
brand
new
primer...

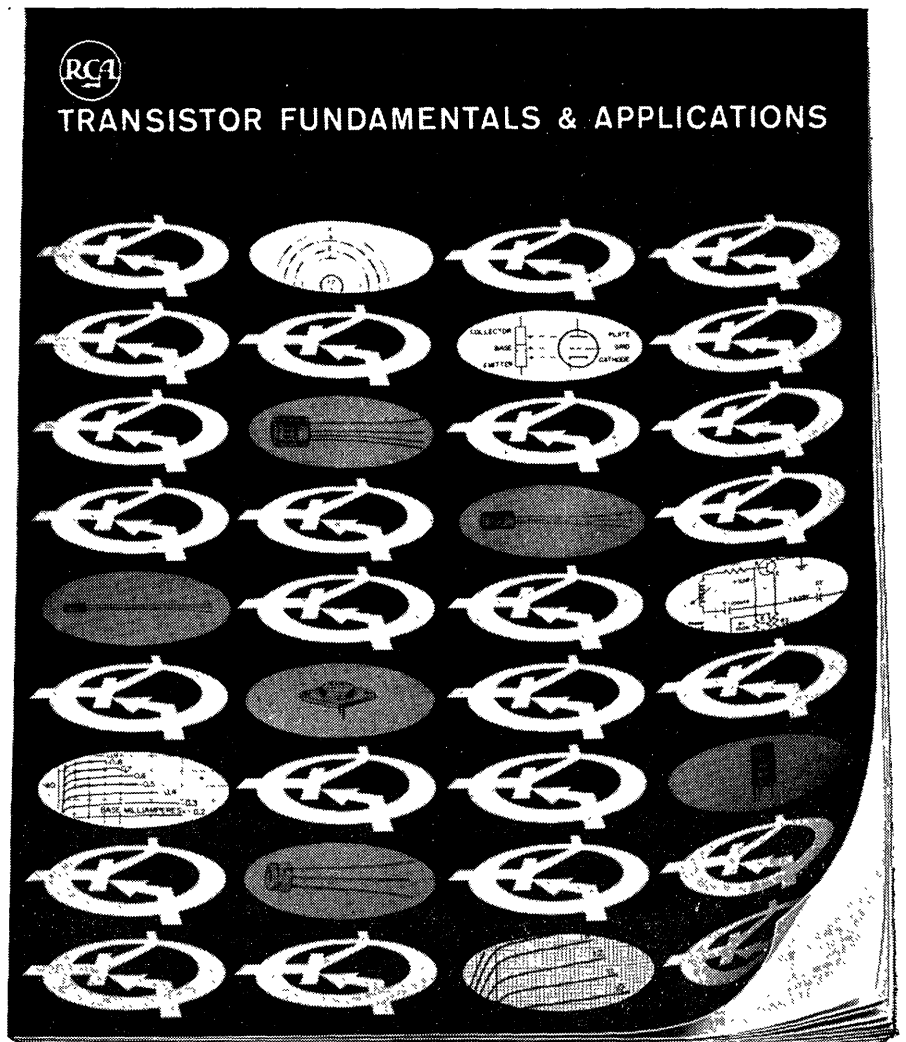

TRANSISTOR FUNDAMENTALS & APPLICATIONS

Authoritative, condensed and easy-to-read, this new 48-page booklet contains pertinent diagrams, schematics, and tables of important technical data—all compiled in a simplified manner for busy engineers and executives who desire to broaden their knowledge of transistor theory and practice. Three quiz-pages consisting of questions and answers appear at the end of the booklet and serve as a valuable summary and review.

Now, for a limited time only, this valuable booklet will be available through your authorized RCA Semiconductor Products Distributor. See him today!

Your RCA distributor has it! (Form #4T37)

48 pages...16 sections!

- 1—Introduction
- 2—Transistor Physics
- 3—The PN Junction
- 4—The PNP & NPN Junction Transistor
- 5—The Point-Contact Transistor
- 6—Transistor Characteristics
- 7—Types of Transistors
- 8—Transistor Amplifiers
- 9—Methods of Coupling
- 10—Gain Controls
- 11—Power Amplifiers
- 12—Oscillator Circuits
- 13—Power Supplies
- 14—Practical Transistor Circuits
- 15—Transistor Components
- 16—Servicing Transistor Circuits



RADIO CORPORATION OF AMERICA

Semiconductor Products

Harrison, New Jersey

In-out speed: from about 6 machine words per second to about 125,000 machine words per second

Automatic (or partially automatic) *checking* is present in about 90% of computers.

Operating ratio ranges from 95% to 99%

Sale price ranges from about \$50,000 to about 3.7 million dollars

ALWAC III-E / for scientific, and business problems; numerical control of machine tools; production control; real-time and other / NUM SYS: 8 numeric or 5 alphabetic char per mach word; 4 bits per char . RPD MEM: 128 reg; 4 ms access / MED MEM: 8,192 reg / SLOW MEM: 16 magn tape units — 7,168,000 reg / ADN: 500 us / MULT: 0.5 to 17.0 ms / DIV: 0.5 to 17.0 ms / PRGMG: 128 instruc; 50 library routines / IN-OUT: 603 mach words per sec; simultaneous calculating / RELIAB: has autom checking; operg ratio, 96% (as reported by over 30 installations) / sale, \$64,950 to \$500,000; rent \$2,000 to \$16,000 per mo / sold or rented 38 / Alwac Computer Div., El-Tronics, Inc., 13040 S. Cerise Ave., Hawthorne, Calif.

Bendix G-15 / for scientific and business problems; real-time and other / NUM SYS: 8 char per mach word, 4 bits per char / RPD MEM: 4 reg / SLOW MEM: 4 magn tape units, 300,000 reg per unit / ADN: 540 us / MULT: 16.7 ms / DIV: 16.7 ms / PRGMG: 50 instructions with 1300 variations, 250 library routines / IN-OUT: 430 char per sec, simultaneous calculating / RELIAB: no autom checking; operg ratio, 95% / sale \$49,500, rent \$1,485 mo / sold or rented, over 100; / Bendix Computer Div., Bendix Aviation Corp., 5630 Arbor Vitae St., Los Angeles 45, Calif.

Burroughs 205 / for scientific and business problems; real-time and other / NUM SYS: 11 char per mach word; 4 bits per char / RPD MEM: 4,080 word drum, 850 us access / SLOW MEM: tape, 200 million reg / ADN: 1.85 ms / MULT: 8.3 ms / DIV: 10 ms / PRGMG: 71 instruc / IN-OUT: 600 mach words per sec (tape); simultaneous calculating / RELIAB: has autom checking; operg ratio 98% / sale \$150,000 to \$350,000; rent \$4,300 to \$9,000 per mo / sold or rented, 100; on order, not released / ElectroData Div. of Burroughs Corp., 460 Sierra Madre Villa, Pasadena, Calif.

Burroughs 220 / for scientific and business problems; real-time and other / NUM SYS: 11 char per mach word; 4 bits per char / RPD MEM: cores, 2,000 to 10,000 words, 10 us access / SLOW MEM: 55 million words (max) / ADN: 185 us / MULT: 2.1 ms / DIV: 4.0 ms / PRGMG: 94 instruc / IN-OUT: 2400 mach words per sec (magn tape); simultaneous calculating / RELIAB: has autom checking / sale, \$250,000 to \$800,000; rent, \$7800 to \$20,000 per mo / first deliveries made in Oct. 1958 / ElectroData Div. of Burroughs Corp., 460 Sierra Madre Villa, Pasadena, Calif.

CDC 1604 / for scientific problems; real-time / NUM SYS: 48 bits per mach word / RPD MEM: 16,384 words, 6.5 us access / SLOW MEM: 7,500,000 char per tape; 0 to 4000 char per block; variable block length; 4 to 16 tapes / ADN: 1.6 us / MULT: variable / DIV: variable / PRGMG: 63 instruc, library routines under preparation / IN-OUT: 125,000 mach wds per sec, simultaneous calculating / RELIAB: partial autom checking; operg ratio "high" / sale \$750,000 / first offered early '58, first deliv summer '59; / Control Data Corp., 501 Park Ave, Minneapolis, Minn.

Datamatic 1000 / for business and scientific problems; not real-time / NUM SYS: 12 decimal digits or 8 alphanumeric char (or combns) per mach word / RPD MEM: cores, 2000 registers, adnl 2000 registers optional, 10 us access / SLOW MEM: 3,100,000 words per tape reel, and up to 100 tape units may be directly connected to Central Processor / ADN: 232 us / MULT: 1 ms DIV: .89 to 3.75 ms / PRGMG: 33 instruc (67 variations), many library routines / IN-OUT: 10,000 mach words per sec, simultaneous calculating / RELIAB: has autom checking plus immediate automatic correcting ("ORTHOTRONIC CONTROL"); operg ratio, 95% / sale \$1,523,000 and up; rent \$32,225 and up per mo / sold or rented 4; on order 4 / Orthotronic Control mentioned above provides for *immediate automatic* correction of errors as they are detected / DATAMatic Div, Minneapolis-Honeywell Reg Co, 151 Needham St, Newton Highlands 61, Mass.

IBM 305 RAMAC / business / NUM SYS: alphanumeric 100 char or less; stored progr instruc, 10 char or less, 7 bits per char / RPD MEM: 100 positions of non-addressable core storage used for internal switching / SLOW MEM: 2800 positions drum storage, 5 million positions of disk storage, (10 million max) / ADN: 30 us / MULT: 60 to 190 ms / DIV: 100 to 370 ms / PRGMG: 17 instruc; some library routines in process / IN-OUT: about 2 punch cards per sec (80 col); simultaneous calculating / RELIAB: has partial autom checking / sale, \$167,850 to \$323,700; rent \$2,850 to \$5,475 per mo / Mach is designed to permit "in-line" processing. Input may be combn of punched cards, paper tape, & manual keyboard. Output may be punched cards or printed on three models of printers ranging from 10 char per sec to 21½ lines per sec / IBM Corporation, 112 East Post Rd., White Plains, N. Y.

IBM 650 Data Processing System / scientific, business / NUM SYS: 10 digits plus sign per machine word, 5 bits per char (drum), 7 bits per char (arithmetic) / RPD MEM: cores, 60 words; drum, 2000 words, 96 us access / SLOW MEM: Ramac 40,000 addressable reg of 690 digits each / ADN: 672 to 768 us / MULT: 2.4 to 19.6 ms (10 x 10 mult) / DIV: 6.2 to 23.4 ms / PRGMG: 96 instruc, 200 library routines / IN-OUT: 80 words per sec with 3 card readers; 1174 words per sec with magn tape; simultaneous calculating / RELIAB: has autom checking / sale \$182,400 to \$630,900 and up; rent, \$3,750 to \$12,400 and up, per mo / International Business Machines Corp., 112 E. Post Rd., White Plains, N. Y.

IBM 704 Data Processing System / scientific, business; real-time and other / NUM SYS: 10 char per mach word; 36 bits per word / RPD MEM: 4,000, 8,000, 32,000 reg; 12 us access / SLOW MEM: 16,000 words (drum); 10 magn tape units / ADN: 24 us / MULT: 240 us / DIV: 240 us / PRGMG: 86 instruc, 500 library routines / IN-OUT: 2500 mach word per sec; no simultaneous calculating / RELIAB: has autom checking for input-output / sale, \$1,000,000 to \$2,500,000; rent, \$20,000 to \$50,000 per mo / International Business Machines Corp., 112 E. Post Rd., White Plains, N. Y.

IBM 705 Data Processing System / scientific, business / NUM SYS: one char per mach word; 6 bits per char / RPD MEM: Model I: 20,000 reg; Model II: 40,000 reg; Model III: 40,000 or 80,000 reg, magn cores; ac-

cess: Model I, II: 17 us; Model III: 9 us / SLOW MEM: up to 30 magn drums (60,000 char each); up to 100 magn tape units / ADN: I, II: 119 us; III: 86 us / MULT: I, II: 800 us; III: 600 us / DIV: I, II: 3.9 ms; III: 3.1 ms / PRGMG: I, II: 41 instruc; III: 47 instruc / IN-OUT: 62,500 char per sec for one tape unit; has simultaneous calculating / RELIAB: has autom checking / sale, \$1,250,000 to \$2,750,000; rent, \$25,000 to \$55,000 per mo / International Business Machines Corp., 112 East Post Rd., White Plains, N. Y.

IBM 709 Data Processing System / for scientific and business problems; real-time and other / NUM SYS: 10 char per mach word, 36 bits per word / RPD MEM: 8,000 or 32,000 reg, 12 us access / SLOW MEM: 16,000 words (drum), 48 magnetic tape units / ADN: 24 us / MULT: 24 to 240 us / DIV: 24 to 240 us / PRGMG: 161 instruc, over 500 library routines / IN-OUT: 2500 mach words per sec; simultaneous calculating / RELIAB: has autom checking of input-output / sale, \$1,750,000 to \$3,750,000; rent \$35,000 to \$75,000 per mo / International Business Machines Corp., 112 East Post Rd., White Plains, N.Y.

Note: As of June 30, IBM had installed over 4200 small DP systems, over 970 medium systems, and over 190 large scale systems; separate type totals, not available.

LGP-30 / for business and scientific problems / NUM SYS: 5 alphanumeric char, 9 numeric char, per mach word / RPD MEM: 3 reg, 260 us access / SLOW MEM: 4,096 reg, magn drum, 2 to 17 ms access / ADN: 260 us / MULT: 17 ms / DIV: 17 ms / PRGMG: 16 instruc, 100 library routines / IN-OUT: 30 mach wds per sec, simultaneous calculating / RELIAB: no autom checking; operg ratio 99% / sale \$49,500, rent \$1100 mo / sold or rented, 160; on order, 5 / Royal McBee Corp, Westchester Ave, Port Chester, N. Y.

Pegasus / scientific, business / NUM SYS: 39 binary digits / RPD MEM: 55 reg (magnetostrictive delay lines), access time zero / SLOW MEM: 4608 reg (magnetic drum), magnetic tape optional / ADN: 315 us / MULT: 2 ms / DIV: 5.5 ms / PRGMG: 48 instruc, "extensive" library of routines / IN: 200 char per sec, OUT: 25 char per sec; no simultaneous calculating / RELIAB: has autom checking, operg ratio 97.6% / sale, \$200,000 to \$250,000 / 22 installed; on order, not available / Ferranti Electric, Inc., 95 Madison Ave., Hempstead, N. Y.

RCA 501 Electronic Data Processing System / business / NUM SYS: unlimited char per mach word; 7 bit per char / RPD MEM: 16,384 to 262,144 char locations; 15 us access / SLOW MEM: 63 magn tape stations / ADN: 0.24 to 0.42 ms / MULT: 1.9 to 9.6 ms / DIV: 1.3 to 2.4 ms / PRGMG: 49 instruc / IN-OUT: 33,333 char per sec (magn tape); 1,000 char per sec (paper tape) / RELIAB: has autom checking / sale, \$556,300 to \$2,000,000 and up; rent, \$11,300 to \$40,000 per mo and up / Radio Corporation of America, Industrial Electronic Products, Camden 2, N. J.

RECOMP II / scientific, military / NUM SYS: 40 bits per mach word; / RPD MEM: 16 reg; 910 us access / SLOW MEM: 4,080 words (magn disc) / ADN: 520 us / MULT: 10.4 ms (fixed point) / DIV: 12.4 ms (floating point) / PRGMG: 49 instruc, 30 library routines / IN-OUT: 50 mach words per sec; no simul-

aneous calculating / RELIAB: has autom checking; operg ratio, 99% / sale, \$80,500 to \$86,000 / sold 10 / Commands include built-in floating point, alphanumeric input & output, subroutine linkage, / Autonetics, a Div. of North American Aviation, Inc., 9150 E. Imperial Highway, Downey, Calif.

RW-300 Digital Control Computer / for scientific, on-line control, on-line data reduction / NUM SYS: 18 bits per mach word / RPD MEM: 16 reg; 1.04 ms average access (drum) / SLOW MEM: 8350 reg (magnetic drum) / ADN: 910 us / MULT: 2.99 ms / DIV: 3.12 ms / PRGMG: 19 instruc; library routines "nearly complete" / IN-OUT: 60 digital words per sec, or 1024 ten-bit analog signals per sec, simultaneous calculating / RELIAB: has automatic checking, operg ratio 99.8% / sale, \$98,000 to \$175,000 / sold 0, on order 8 / Designed for on-line control and data reduction; analog digital conversion equipment built in; transistorized, with solid state diodes throughout; two step modular construction; flexible input-output systems / The Thompson Ramo-Wooldridge Products Co., P. O. Box 90067 Airport Station, Los Angeles 45, Calif.

TRANSAC S-2000 (all transistor, data procg sys) / for scientific and business problems, also airborne computer uses / NUM SYS: binary, 48 bits per mach word; alphanumeric, 6 bits per char / RPD MEM: up to 32,768 words core storage, up to 32 index registers; magn drum, 32,768 words per drum; up to 256 drums per sys / ADN: 18 us (fixed point), 27.5 (floating point) / MULT: 65 us (fixed), 51.0 us (floating) / DIV: 65 us (fixed), 51 us (floating) / PRGMG: 226 instruc / IN-OUT: 45,000 mach wds per sec, simultaneous calculating / RELIAB: has autom checking; operg ratio 98.6% / sale \$1,100,000 and up; rent \$25,000 and up per mo / first delivery Oct. 1958 / Philco Corp., Government & Industrial Div., 4700 Wissahickon Ave., Philadelphia 44, Pa.

TRICE / for scientific problems; real-time "incremental computer" / NUM SYS: 30 char per mach word, 1 bit per char / ADN: 10 us / MULT: 10 us / DIV: 10 us / IN-OUT: simultaneous calculating / Packard Bell Computer Corp., 1905 Armacost Ave., Los Angeles 25, Calif.

Basic Source Information available to you from **COMPUTERS and AUTOMATION**

ORGANIZATIONS:

The Computer Directory and Buyers' Guide, 1958 (the June, 1958, issue of **COMPUTERS and AUTOMATION**): 740 organization listings, 3220 product and service listings. \$6.00

GLOSSARY OF TERMS:

Over 480 careful, clear, understandable definitions. 4th cumulative edition, as of October, 1956. (20 or more copies, 10% discount.) \$1.00

BACK COPIES:

(For six years of publication.)
If available, \$1.25 each, except Directory issues June 1955, to 1957, \$4.00 each; June, 1958, \$6.00.

Send prepaid orders or requests for more information to:

COMPUTERS and AUTOMATION

815 Washington Street

Newtonville 60, Mass.

If not satisfactory, returnable in seven days for full refund.

Low Cost Conversion Adapts Univac High-Speed Printer to IBM 704 Outputs

Fred Ketchum
 Electronics Engineering Staff
 Univ. of Calif. Radiation Laboratory
 Livermore, Calif.

THE UNIVERSITY OF California Radiation Laboratory at Livermore has an extensive installation of large scale computers which includes one Univac I with its high-speed printer, also a few IBM 704's, but without an IBM high-speed printer. Since a high-speed printer is a costly adjunct to the computer system (approximately \$200,000), it was desired to adapt the Univac high-speed printer to handle the outputs of the IBM 704 computers if this could be done simply and at low cost. This article describes how such a conversion was achieved, at a total cost estimated at under \$9000, including engineering time for developing the converter.

To understand the solution to this problem it is necessary first to review briefly the mode of operation of the Univac high-speed printer. This device consists of (1) a tape-reading unit, called a Uniservo; (2) a thyratron-tube type memory unit, which stores the tape readout coming in at high speed and feeds it out at the much slower speed required to operate a high-speed mechanical printing mechanism; and (3) the mechanical printing mechanism, which prints on a continuous paper sheet 120-character lines at speeds up to 600 lines per minute.

The conversion problem was, therefore, broadly stated, to make the tape-reading unit of the Univac high-speed printer compatible with IBM 704 tapes. Specifically the solution of this problem breaks down into several parts, each one due to a difference in one important functional characteristic of the IBM 704 and Univac I tape-recording processes. These differences became apparent from a comparison of these characteristics for the IBM 704 and the Univac I in Table 1:

TABLE 1

FUNCTIONAL CHARACTERISTICS,
 IBM 704 AND UNIVAC I TAPE RECORDING PROCESSES

IBM	Univac I
<i>1. Recording tape</i>	
Plastic (Nylon)	Metal tape
1/2 inch wide	1/2 inch wide
2500 feet per reel	1500 feet per roll
<i>2. Pulse density</i>	
200 pulses to inch	128 pulses to inch
<i>3. Recording Method</i>	
Non-return to zero	Return-to-zero
<i>4. Reading head</i>	
7-channels, all in line	8-channels, in two staggered rows
<i>5. Sprocket signal</i>	
No sprocket pulse	sprocket pulse for each digit on tape

6. End-of-recording check signal

Longitudinal check signal generated on tape at 3-4 pulse times after end of record.	No check signal
---	-----------------

7. Computer Code

Binary decimal	Excess 3 binary decimal
----------------	-------------------------

Several steps were necessary before a solution was achieved.

1. Make Univac printer compatible with higher pulse density and shorter between-block space of IBM 704.

IBM tapes are recorded at 200 pulses to the inch with results in an input-digit rate of 20 kc, and they have only 3/4-inch spacing between blockettes of information. This is compared to the Univac input-digit rate of 12.8 kc and 1 and 1/8-inch spacing between blockettes of information.

Therefore the first step was to prove that the high-speed printer could handle the increased input-digit rate and that the Uniservo could stop in the shorter distance between blockettes of information. This test was accomplished by reducing the speed of a Uniservo on the Univac and writing information on a tape. Since the speed was reduced but the writing bit rate remained the same, the pulse density was increased. This gave a tape pulse density of approximately 200 pulses to the inch and a blockette spacing of 3/4".

This tape operated satisfactorily on the high-speed printer, which proved that the input circuits could handle the 20 kc input digit rate and that the Uniservo could stop and start with only 3/4" spacing between blockettes.

2. Mount a reading head on Uniservo compatible with IBM recording.

This is necessary because Univac has an 8-channel staggered reading head while IBM has a 7-channel inline reading head. Because of compatibility and availability the Potter Instrument Co. reading head was chosen. This reading head was mounted as shown in Figures 1 and 2.

3. Provide reading amplifiers which will convert IBM non-return-to-zero recording to Univac return-to-zero recording.

Potter Instrument Company reading amplifiers were chosen for the reading of IBM tapes. This amplifier takes a non-return-to-zero signal and converts it to a return-to-zero signal. These amplifiers provide a positive, 20-microsecond square-wave output pulse for every input pulse read from the tape.

4. Convert from IBM 704 binary decimal code to Univac I excess-3 code.

The conversion to the Univac excess-3 code is done by means of a subroutine in the IBM computer.

5. Provide for generation of a sprocket signal which is not present on IBM tapes but which is necessary for operation of the high speed printer.

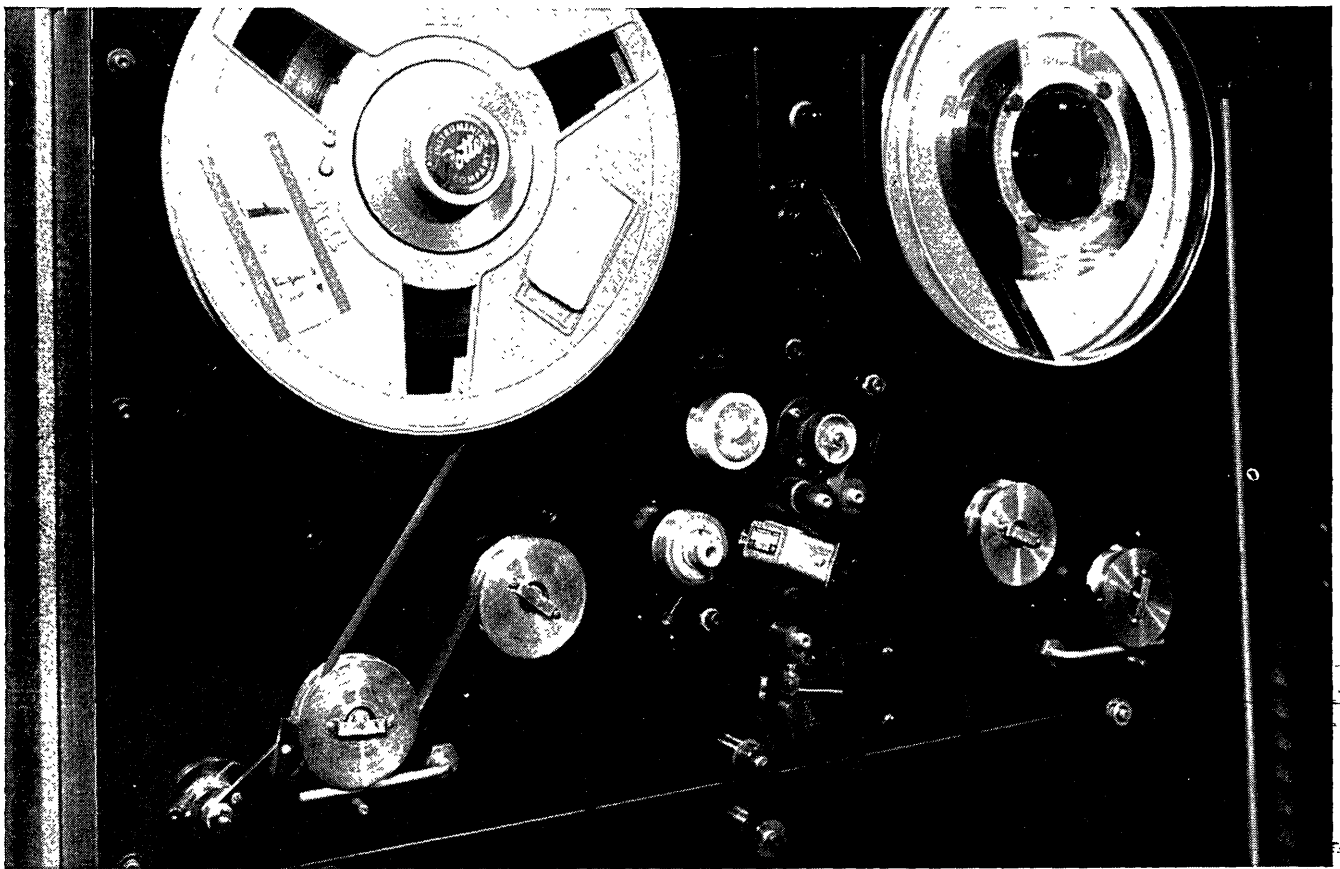

Figure 1—Close-up of Uniservo showing conversion units in place between and below the tape reels.

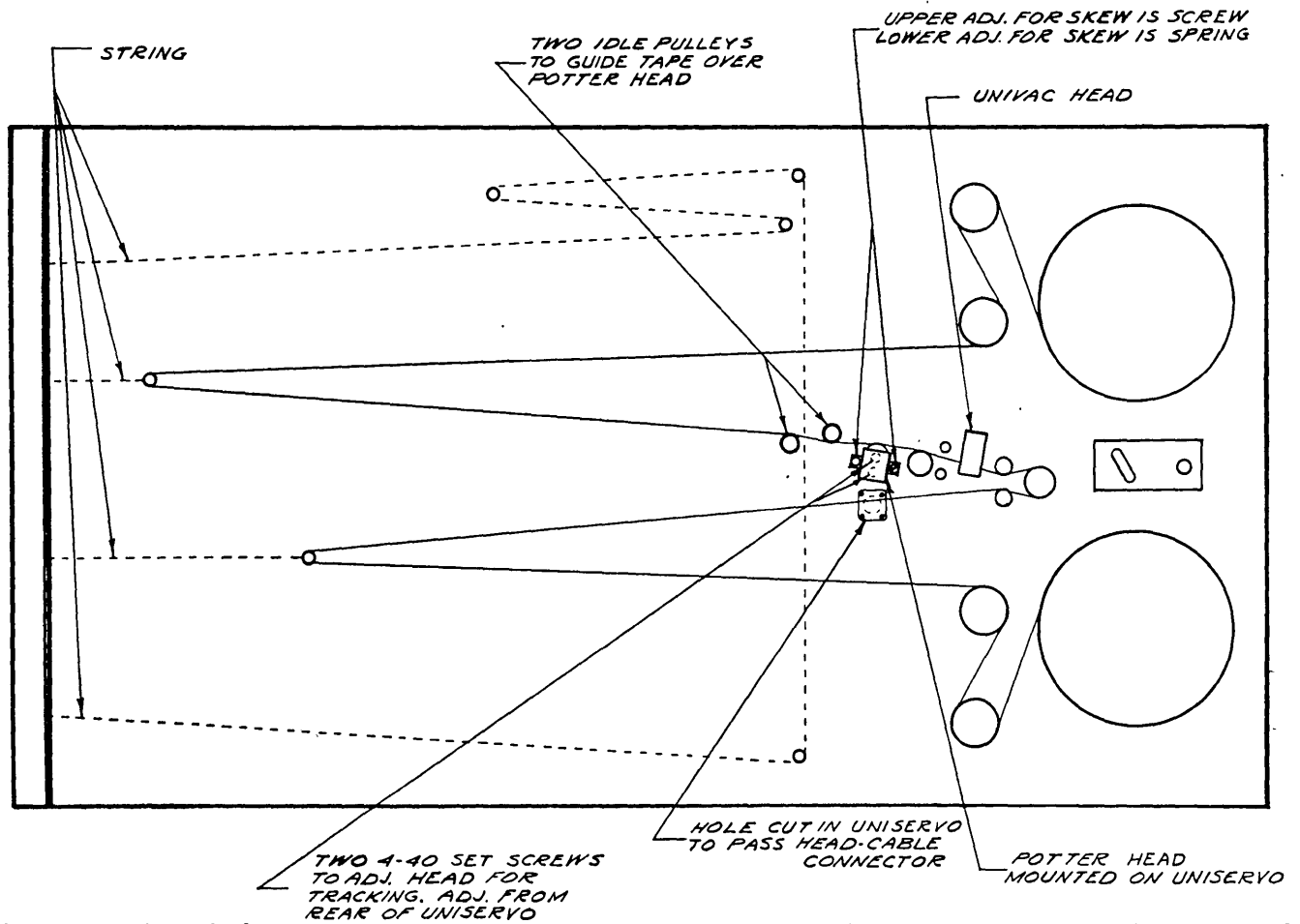

Figure 2 — Schematic drawing of front of Uniservo (looked at sideways), showing Potter magnetic head mounted in place.

The IBM tape is a 7-channel tape. Therefore, a sprocket signal had to be generated for each digit which was read from the tape. This was accomplished by buffing the outputs of all 7-channel amplifiers together and triggering a delay flop. This delay flop provides a positive 20-microsecond pulse delayed 25 microseconds from the beginning of each digit read from the tape, which pulse is used as the sprocket signal.

6. Block the longitudinal check digit which is recorded at the end of the blockettes of information on IBM tapes from being sensed by the high speed printer.

At the end of each blockette of information on the IBM tapes a longitudinal check digit is recorded. This digit is recorded approximately 3 to 4 pulse times after the last digit of information of the blockette. When reading IBM tapes on the Uniservo this longitudinal check digit comes approximately 150 microseconds after the 120th digit. During normal operation the high-speed printer does not deliver a read-ending pulse until 400 microseconds after the 120th digit. This would mean that the longitudinal check digit would be read in as the 121st digit. To avoid this, when reading IBM tapes the timing of the read-ending pulse was changed to apply the jam-clear signal 100 microseconds after the 120th digit was read from the tape.

7. Design a reel hub which will secure an IBM 10-inch plastic tape reel as well as the Univac metal tape reel.

Since the IBM and Univac tape reels are different a new reel hub was designed which allows either IBM or Univac tape reels to be mounted with a minimum of time. IBM tapes have a greater length, so it was necessary to make a larger take-up reel which is used at all times.

After all of these major parts of the problem had been solved certain problems developed because of the higher input-digit rate.

The Potter amplifiers produce positive pulses with a much faster rise and fall time than the pulses which are generated from the Univac tape amplifiers. Therefore, coaxial cable was used in all channel lines from the Potter amplifier's output to the high-speed printer power-supply cabinet. In doing this much more capacitance was added, which gave the output pulses from the Potter amplifiers a

very long tail and resulted in poor resolution. After suitably modifying the Potter amplifiers, the rise and fall time of the output pulses was greatly reduced which gave good resolution and reliable operation.

Another problem was that IBM tape used a silver marker to indicate the beginning of good information. This means that normally there is information on the leader of the tape. The easiest solution to the tape load problem when reading IBM tapes was to erase the leader of the IBM tape and let the Uniservo read blank tape up to good information.

Some trouble was experienced with acetate-base tapes breaking on the Uniservo. To correct this condition the spring tension of the Uniservo equalizer bar was reduced from 51 to 40 ounces. This greatly reduced acetate-base tape breakage. At the present time only mylar-base tapes are being used which will operate satisfactorily on the high-speed printer with normal spring tension.

The last problem was that of reading-head wear. The first reading head was mounted so as to have as much tape wrap as the Potter Instrument Company uses on their tape units. Due to the increased speed and tension on the tape, the reading head was worn out after one month's use. It was found that by reducing the tape wrap to approximately 3° the wear was greatly reduced but that the reliability of reading was not affected. Time has shown that a head mounted with this amount of wrap will last at least a year.

The switch-over from Univac to IBM operation of the high-speed printer or back is accomplished by means of a single switch mounted on the printer's control panel. This switch operates relays which connect the appropriate amplifier to the input circuits and determines the delay between the 120th digit and the read-ending pulse.

This converter has operated successfully for over a year. A by-product of the conversion is an effective increase in printer output speed (from 600 to 650 lines per minute) because the Univac printer, when operating on IBM 704 tape, is operating on the 200-pulse-per-inch density and $\frac{3}{4}$ -inch spacing between blockettes of the IBM tape rather than the 128-pulse-per-inch density and the $\frac{1}{8}$ -inch spacing between blockettes of the Univac tape.

Chemical Structure Searching With Automatic Computers

National Bureau of Standards
Washington 25, D.C.

THE NATIONAL BUREAU of Standards and the U.S. Patent Office have been actively collaborating on a long-range program to develop and apply automatic techniques of information storage and retrieval to problems of patent search. In experiments carried out by L. C. Ray and R. A. Kirsch of the Bureau's data processing systems laboratory, a collection of over 200 descriptions of steroid chemical compounds was exhaustively searched with a high-speed electronic computer to answer typical questions that might occur in evaluating a patent application. The methods developed can be applied with little or no modification in examining descriptions of most chemical compounds.

In the granting of United States patents it is necessary for patent examiners to refer to literary collections that may contain from 10^6 to 10^7 documents. Before granting the patent, the examiner must assure himself, insofar as possible, that he has exhaustively searched through all documents in the public domain that might possibly contain any information pertinent to the given application. An estimated 60 percent of the time spent by an examiner in processing a patent application is thus devoted to searching the technical literature. In an attempt to reduce this expenditure of time, the National Bureau of Standards-Patent Office group has considered, among other techniques, the use of automatic data processing systems.

An automatic data processing system (ADPS) is a collection of equipment machines, usually, but not necessarily, electronic in nature. The system can process information in accordance with internally stored programs and can perform a whole data processing task involving the use of extensive data storage facilities without the necessity for manual intervention. It also includes devices for the preparation of input data and the reproduction of output data. SEAC, the National Bureau of Standards Electronic Automatic Computer, is an ADPS and has been used in successful preliminary experiments in patent search techniques.

The area that was selected for initial experimental investigation was that of "Composition of Matter," i.e., patents generally concerned with what may loosely be classified as chemistry. Chemists have for a long time been concerned with information retrieval, and it was hoped that use could be made of some of the techniques that the chemists have developed. As it turned out, results were obtained by taking advantage of a technique of chemistry that was probably not originally developed for the purpose of information retrieval; namely, the use of chemical structural diagrams for describing the chemical nature of matter.

In using automatic techniques for the retrieval of technical information, no more information can be obtained from a file than is represented according to a well-defined consistent notational scheme. Because the method of representing chemical structures in diagrammatic form has just such properties, the Bureau decided to experiment with the use of SEAC for searching through files of chemical structure diagrams in response to search requests fed into the machine.

In the Patent Office the examiners in the chemical arts have frequent need to perform so-called generic searches through structure diagrams. As an example, in examining the compounds brucine and codeine, two similar rings are found even though the diagram of codeine indicates the ring in a distorted manner. The two compounds are therefore said to share the generic property of containing this fragment. Part of the experiments performed on SEAC were concerned with developing a method for performing generic searches of this type through a file of steroid chemistry structures.

In the system used on SEAC each atom in a structural diagram is numbered serially in arbitrary order. One unit of computer storage, called a word, is given to each atom to represent its position in the structure. In each word are listed the numbers of the other atoms, up to four, that are attached to the atom represented by the word. The element symbol and the serial number of the atom are also placed in the word. Thus each coded atom word has six fields: the serial number of the atom, four connection fields, and an element symbol. Once the code is known, the structure can be redrawn. The code for any structure is not unique since by numbering the atoms in some other arbitrary order a different code would be obtained. It can be shown, however, that all of the possible codes are equivalent.

A file of coded structures is searched by machine for all structures which are identical to some question compound or which have some generic property in the sense previously defined. The SEAC search program tries to make an atom-to-atom match between the atoms of the question structure and the atoms of the first structure recorded in the file. Each match that is made is considered as tentative by

the program until the search through the first file structure is completed. Whenever failure to match is discovered by the program it tries to go back to the previous match to make a new match. If the program finds that all possible first matches lead to irreconcilable mismatches, the program will reject the first file structure and proceed on to the next. When a one-to-one correspondence exists between each of the atoms of the question structure and the atoms of part of the file structure that is being examined, the routine accepts the structure by printing on the computer output an indication of the structure that was found. The search routine continues this process until the whole file has been searched.

Even with a high-speed electronic computer, such a detailed search can be very time-consuming. Short-cuts must therefore be devised to speed up the process without compromising the exhaustiveness or accuracy of the search. Techniques are needed that will enable the ADPS to perform a cursory inspection of a small piece of data in such a manner that most structures not satisfying the search requirement will be rejected immediately. Such a technique is called a "screen" or a "screening device." It is essential that a screening device should never reject a structure when that structure does in fact meet the search requirement. The screen is acceptable, however, if it allows some structures to be considered further by the structure search routine even though they are subsequently rejected as failing to meet the requirements.

One such useful screen is inherent in the empirical formula of a chemical structure. Stored in the file, along with the description of the chemical structure, would be a list of the number of occurrences of each type of atom in the structure. The ADPS can inspect this list before it searches the structure to find out whether there are enough atoms of the right type present to satisfy the search requirement. Such a screen has been incorporated into the SEAC search program; on most searches it enabled the computer to reject quickly the vast majority of structures that would otherwise have been the subject of a long computational procedure.

The SEAC experiments indicate the practicality of using an ADPS for very rapid scanning of a file. However, many mechanisms considerably simpler than an ADPS could also do such scanning, and the question remains open as to the comparative advantages of an ADPS and the simpler mechanisms for the actual process of looking at a properly organized file. In some retrieval situations, most notably in the Patent Office, the problem is of sufficient magnitude and complexity that the power of an ADPS to do more than just scan a file appears upon further inspection to be a requirement. Where the ADPS seems to offer a unique contribution is in the auxiliary operations. For such functions as preparing a search prescription, editing a file, eliminating errors, transliterating from one code to another, exploring complex logical conditions imposed on the question and file structures, and probably many others, the ADPS offers the outstanding virtues of high speed and great versatility. SEAC can not only be used to test the utility of an ADPS for the Patent Office retrieval problem but also to study the performance of other devices by simulating them. In the computing machine field it is a well-known phenomenon that machine users discover many new applications of these machines while in the process of using them. It is expected that further experiments on SEAC will serve a similar purpose.

Symbolic Logic and Automatic Computers (Part 1)

Edmund C. Berkeley

(Based on two chapters in a forthcoming book "Symbolic Logic and Intelligent Machines," to be published in 1959 by Reinhold Publishing Corp., New York)

THE OPERATION OF automatic computers, both their circuits and their programming, often depends on the on-ness and off-ness of signals, circuits, and codes—the pattern of interaction of yeses and noes. As a result, the science of dealing with patterns of interaction of yeses and noes has taken on fresh and considerable importance. This science is essentially *symbolic logic*, rather than mathematics, because the emphasis is not on numerical relations but on non-numerical relations. For example, the statement: "If A is the father of B, and B is the father of C, then A is the grandfather of C" displays a non-numerical relation; and so does the statement "If switch A is on and switch B is off, then the combination of A in series with B is off, but the combination of A in parallel with B is on."

A part of symbolic logic known as *Boolean algebra* (the name comes from George Boole, English mathematician, 1815-1864, who developed much of the new algebra in his book "The Laws of Thought" published in 1854) has received widespread attention in the computer field. This algebra is the technique for manipulating AND, OR, NOT, and conditions, using efficient symbols; and for many years it has been used in the design of computing circuits, so much so in fact that in some areas circuit wiring diagrams have been replaced by lists of Boolean algebra equations.

But there is a good deal more to symbolic logic than just Boolean algebra. It is the purpose of this article to draw attention to and explain a number of ideas in these other parts of symbolic logic. For we can be confident that these other parts of symbolic logic will become more and more useful and applicable in the computer field. For mathematics, symbolic logic, and "computology" (the science of handling information, and computing and data processing machines) are all three needed to take hold of the full powers of the Second Industrial Revolution, the revolution in information handling.

1. What is Symbolic Logic About?

Whenever we approach a new subject, our first problem is finding out what the new subject is about, what it deals with. And to our surprise, we often find we have already had a good deal of experience with its content, even if we are strangers to its special vocabulary. We are like Molière's rich man in "Le Bourgeois Gentilhomme," who discovered that all his life he had been speaking "prose."

You and I and everybody we know have all our lives been dealing with much of the content of symbolic logic. We are not strangers to it: it is the underlying fabric of much of our thinking. We deftly and quite unconsciously adjust to many of its fine points. But nearly all of us are completely unaware of the modern science which deals with these ideas.

The content of symbolic logic consists of many of the commonest ideas expressed in the commonest words and phrases of language. A few of these words and phrases are:

the	there is	other	for	it
of	same	than	by	thing
some	different	a, an	with	kind
yes	is a	another	from	sort
no	as	to	has	which

All these words are commonly used by six-year olds. Expressed in more advanced words, words which would probably be understood by a senior in college, the content of symbolic logic includes the ideas expressed in the following words and phrases:

- statements, sentences, propositions
- truth, falsity, assertion, denial
- reasoning, implications, theorems, proofs
- individuals, elements, things
- properties, relations
- classes, groups, collections, types
- choosing, selection, arrangement, comparison, matching, correspondence, merging, collating, sorting

But the words of ordinary language are often neither exact nor clear. We have much trouble saying just what we mean whenever we use a word all by itself, an isolated word, a word without a context surrounding it. For that word has many different meanings, and we are never sure, without more indications than the word alone, which meaning to give to it. Words suffer from being ambiguous. Take for example the word "yes": it is ambiguous in ordinary language. Some of the meanings of the word "yes" as it occurs in conversation are these:

"yes", no. 1: The statement referred to is true.

"yes", no. 2: I don't want to disagree with you in public.

"yes", no. 3: probably

"yes", no. 4: maybe, perhaps

"yes", no. 5: I did not hear what you said, but I want to be polite.

Because of the ambiguity of the common words of ordinary language, we not only find it hard to know exactly what such a word means when someone else uses it, but also not to mislead ourselves when we ourselves use it.

To achieve precise meaning, the scientists working in the field of symbolic logic and reasoning—the symbolic logicians—have invented symbols and given them precise meanings.

Each symbol invented selects, codifies, signals, one particular meaning out of many meanings of such words. When that symbol is used again, precisely that meaning is meant. And that meaning is fixed, stabilized, and sharpened by careful exact (calculating) relation to other exact

symbols. For example, in symbolic logic "the" is coupled with the assertion "there exists one and only one." For example, when you say "the Statue of Liberty," you also imply the assertion that "there is one and only one Statue of Liberty."

As a result of the precise meanings, and the calculating relationships among them, we gain a great clarity—such a wonderful clarity that many ideas we were unable to think of or realize or express in ordinary language become expressible and open to study and understanding. In this way, the foundations of mathematics have become far better understood than ever before.

A good symbolism that precisely suits a field of thought becomes an indispensable tool for working in that field.

2. What is Symbolic Logic?

We are now ready to try to answer the question, "What is symbolic logic?"

Symbolic logic in its broadest sense is a science that has the following characteristics:

- (a) It studies mainly non-numerical relations.
- (b) It seeks precise meanings and necessary consequences.
- (c) Its chief instrument is efficient symbols.

When dealing with one particular field of application, symbolic logic studies the non-numerical statements and relations in that field. When not dealing with any particular field of application, symbolic logic studies the general properties of statements and relations, the foundations of mathematics, and the grounds for reasoning in general.

Other names besides "symbolic logic" have been used for this subject. The other names include: "mathematical logic, axiomatic method, logistic, logistic method." But "symbolic logic" is the name most widely used at present.

3. The Comparison of Symbolic Logic and Mathematics

The closest cousin of symbolic logic among the sciences is mathematics. In fact, many people include symbolic logic as part of mathematics. Yet symbolic logic differs from mathematics in a number of ways.

None of the territory of symbolic logic ordinarily includes numbers or numerical ideas like "two, three," or numerical operators like "plus, minus, times, divided by" or numerical relationships like "greater than, less than" or indefinite numbers like "several, most, much." These ideas are all properly part of mathematics.

Mathematics deals mainly with:

- numbers, like 3 and $1/7$
- shapes, like the shape of a circle or a square
- arrangements, like the six possible sequences of the letters A, E, T
- patterns, like those in a tiled floor

Symbolic logic deals with:

- statements like "Switch A is set at position P"
- classes like "switches, relays, contacts"
- relations like "Switch A is on only if Switch B is on"
- properties like "slow-acting, conducting, magnetic"

Mathematics concentrates on answers to questions like: "How much?" "How many?" "How far?" "How long?" Symbolic logic deals with questions like: "What does this mean?" "Does this set of statements have conflicts or loopholes?" "What is the basis of this proof?"

An example of a rule in mathematics is, "The reciprocal of the reciprocal of a number is the number itself." An example of a rule in symbolic logic is, "The denial of the denial of a statement is the statement itself."

Historically, symbolic logic is the result of applying the powerful technique of mathematical symbolism to the subject matter of logic.

4. A Simple Example of Symbolic Logic

A rather simple example of symbolic logic is the following system of abbreviations for the presence or absence of properties. Suppose we have ten properties each of which may be present or absent in any case. The properties might be ten abilities of people; or ten characteristics of jobs; or ten features in any classification of cases where considerable overlapping of the features may occur. We can set up the following system of abbreviations:

- a. For the ten properties, we use the letters A, B, C,, J, respectively.
- b. For any combination of properties present in a case, we use the letters of properties present. (They may be written for convenience in alphabetical order.)
- c. For the absence of all the properties, we use the letter Z.

This system of abbreviation can be useful; each abbreviation tells precisely which properties are present and which are absent; in addition, if we are given some combinations of properties and a rule governing selection from these combinations, then we can promptly write down the combination determined by the rule. For instance, if we have four combinations of properties:

ABCDE, DHIJ, ABDEFHIJ, BCEFHI

and the rule:

Select that which is present in the first or the second,

APPLIED MATHEMATICAL/NUMERICAL ANALYST

Our rapidly expanding research program has a challenging position open for an experienced and well-qualified individual to work in the field of Applied Mathematics and in the development and application of digital computer techniques to such problems. Active programs include special problems relating to missiles, submarines, propulsion, solid and fluid mechanics, a wide variety of industrial activities, etc., and are carried out in our Departments of Engineering Mechanics, Physics, Chemistry, Electrical Engineering, and Fuels and Lubricants.

If you are experienced in Applied Mathematics and numerical analysis/digital computer work, and seek the opportunity of working on a diversity of industrial and military problems in both fundamental and applied fields, write to:

MR. R. C. MAYS, PERSONNEL DIRECTOR
SOUTHWEST RESEARCH INSTITUTE
8500 Culebra Road
San Antonio 6, Texas

and is absent in what is common to the third and the fourth,

then the answer is ACDJ. For what is present in the first or second is ABCDEHIJ, and what is common to the third and fourth is BEFHI, and if we exclude the latter from the former, we have ACDJ left. The system of abbreviation is not numerical, and it is efficient, and it does permit calculation.

An extension of this system is used in chemistry. The abbreviation NaOH for the compound sodium hydroxide tells that the elements Na (sodium), O (oxygen), and H (hydrogen) only are present (in the proportions of one atom of each for each molecule of the compound). The abbreviation H₂O for water tells that hydrogen and oxygen are present (in the proportion of two atoms of hydrogen and one atom of oxygen for each molecule of the compound). Here, the facts belong to the science of chemistry, the numbers belong to mathematics, but the system of abbreviation belongs to symbolic logic.

5. The Branches of Symbolic Logic

There are at least four fairly well-recognized branches of symbolic logic. One of these—and the most important branch applicationally—is Boolean algebra, the algebra of AND, OR, NOT and statements (or classes). For example, a rule from Boolean algebra is that “neither *a* nor *b* is the same as not-*a* and not-*b*.” Here *a* and *b* are statements or classes or circuit elements, but not numbers (beyond 1 and 0).

Another branch of symbolic logic is the one that deals with the foundations of mathematics. It has studied such questions as these: “What is a mathematical function?” It has answered these questions to a large extent. One of the great books in the development of symbolic logic is *Principia Mathematica*, by Bertrand Russell and A. N. Whitehead (published in Cambridge, England, 1910-13), which to a large extent furnished a logical foundation for all of mathematics.

[To be continued]

Automatic Computing Machinery— List of Types

(Edition 4, cumulative, information as of
October 10, 1958)

THE purpose of this list is to report types of machinery that may properly be considered varieties of automatic computing or data processing machinery. There are 78 types in this list, as compared with 38 in the last list published in the March, 1957, issue of *Computers and Automation*.

We shall be grateful for any comments, corrections, and proposed additions or deletions which any reader may send us.

Accounting-bookkeeping machines, which take in numbers through a keyboard, and print them on a ledger sheet, but are controlled by “program bars,” which, according to the column in which the number belongs, cause the number to enter positively or negatively in any one of several totaling counters, which can be optionally printed or cleared.

Addressing machines, programmable, which take in names and addresses, either on metal plates or punch cards, and print the names and addresses on envelopes, wrappers, etc., and which may be controlled for selection and in other ways, by notches, punched holes, and other signals, on the plates or cards.

Air traffic control equipment (including ground control approach equipment), which takes in information about the location of aircraft in flight and gives out information or control signals for the guidance of the flight of the aircraft.

Aircraft airborne computers, for automatically controlling aircraft flight functions, programming fuel consumption, navigating, searching for targets, selecting target, and attacking.

Aircraft ground computers, for radar tracking and remote control of aircraft and anti-aircraft devices.

Analog computers, which take in numerical information in the form of measurements of physical variables, perform arithmetical operations, are controlled by a program, and give out numerical answers.

Analog-to-digital converters, which take in analog measurements and give out digital numbers.

Astronomical telescope aiming equipment, which adjusts the direction of a telescope in an observatory so that it remains pointed at the spot in the heavens which an astronomer intends to study.

Automobile traffic light controllers, that take in indications of the presence of motor cars from the operation of treadles in the pavement or in other ways, and give out signals, according to a program of response to the volume and density of traffic.

Ballistic computers, which take in data on a projectile as it is fired from a gun and make computations.

Card-to-tape converters, which take in information on punched cards, and put out corresponding or edited information on punched paper tape or on magnetic tape.

Character reading and recognizing systems, which scan a printed letter or digit, photoelectrically or magnetically, take in data about points, lines, and shapes, send the data through classifying circuits, identify characters, and activate output devices accordingly.

Color scanners, for automatic production of color separation negatives.

Correlation computers.

Data reduction systems, which take in large quantities of observed data and reduce them to small quantities of computed data.

- Data sampling systems, which take in a continuous voltage or other physical variables and give out samples, perhaps once a second or perhaps a thousand times a second; this machine may be combined with an analog-to-digital converter, so that the report on the sample is digital not analog.
- Desk calculating machines, including desk adding machines, which may take in numbers to be added, subtracted, multiplied, and divided, and put out results either shown in dials or printed on paper tape; such machines store one up to several numbers (but not many numbers) at one time, and may store a simple program such as automatic multiplication by controlled repeated addition and shifting.
- Differential analyzers, which take in information specifying differential equations and boundary conditions, and solve the equations.
- Digital computers, which take in numerical, alphabetic, or other information in the form of characters or patterns of yes-noes, etc., perform arithmetical and logical operations, are controlled by a program, and put out information in any form.
- Digital-to-analog converters, which take in digital numbers and give out analog measurements.
- Early warning systems, which detect by radar, infrared, or other means aircraft or missiles, distinguish friend from foe, determine flight patterns, and provide responses.
- Elevator control systems, which accept calls by passengers, automatically control the movement of cars, door opening, and closing, and economize travel and power.
- Error detecting and counting systems.
- Facsimile copying equipment, which scans a document or picture with a phototube line by line and reproduces it by making little dots with a moving stylus or with an electric current through electrosensitive paper.
- File-searching machines, which take in an abstract in code, and search for and find the reference or references alluded to.
- Fire control equipment, that takes in indications of targets from optical or radar perception and puts out directions of bearing and elevation for aiming and time of firing for guns, according to a program that calculates motion of target, motion of the firing vehicle, properties of the air, etc.
- Flight simulators, which take in simulated conditions of flight in airplanes, and the actions of airplane crew members, and show the necessary results, all for purposes of training airplane crews.
- Fourier analyzers, which take in complex wave forms and analyze them into constituent wave forms.
- Game-playing machines, in which the machine will play a game with a human being, either a simple game such as tit-tat-toe or nim (which have been built into special machines) or a more complicated game such as checkers, chess, or billiards (which have been programmed on large automatic digital computers).
- Geophysical seismic readers and profile plotters.
- Graph readers, which automatically take in the positions of a graph or a curve on a sheet of paper, and give out coordinates to a computer.
- Helicopter flight control computers.
- Information retrieval devices.
- Inventory machines, which store as many as ten thousand totals in an equal number of registers, and will add into, subtract from, clear, and report the contents of any called-for register.
- Machine tool control equipment, which takes in a program of instructions equivalent to a blueprint, or a small size model, or the pattern of operations of an expert machinist, and controls a machine tool so that a piece of material is shaped exactly in accordance with the program.
- Machine tool data processors, which sense input, compute chip loads, and automatically vary the angular velocity of the work spindle to produce a uniform chip load.
- Machine tool direction center, which controls machine tools and computes their operations.
- Machine tool tape producing machines, which automatically prepare machine tool control tapes from blueprint data.
- Materials handling systems, which will move heavy blocks, long rods, or other pieces of material to or from stations and in or out of machines, while taking in indications furnished by the locations of previous pieces of materials, the availability of the machines, etc., all depending on the program of control. (Example: automobile engine block automatic machining system)
- Missile check-out computers, for examining, scanning, and inspecting missiles and signalling warnings.
- Missile control ground computers, for radar tracking and remote control of missiles and anti-missile devices.
- Missile control missile-borne computers, for issuing properly timed and conditioned commands for the proper functioning of the missile.
- Missile launching computers, for controlling the proper sequence of steps for the launching of the missile.
- Navigating and piloting systems for aircraft and ships, which take in star positions, time, radio beam signals, inertial signals, motion of the air, etc., and deliver steering directions.
- Navigating systems for land-based combat vehicles.
- Nuclear reactor simulators, for study and design.
- Post office mail sorting systems.
- Power company network analyzers, which take in analog information about the resistances, inductances, and capacitances of an electric power plant's network of electrical lines and loads, and enable the behavior of the system to be calculated.
- Printing devices of high speed, which take in punched cards or magnetic tape and put out printed information at rates from 600 to 2000 characters per second.
- Process controllers, pneumatic, electronic, hydraulic, etc., which take in indications of humidity, temperature, pressure, volume, flow, liquid level, etc., and put out signals for changing positions of valves, altering speeds of motors, turning switches on and off, etc.
- Process industry advanced control systems, for handling connected or flowing materials, which will take in indications of flow, temperature, pressure, volume, liquid level, etc., and give out the settings of valves, rollers, tension arms, etc., depending on the program of control.
- Process industry data processing systems, for recording, checking, and signalling alarms.

Process industry plant flow analyzers.

Product assembly control systems, which take in semi-finished materials, position them in work stations, perform assembling operations on them, and deliver units of products to shipping stations (Example: electronic component assembly systems).

Punch card machines, which will sort, classify, list, total, copy, print, and do many other kinds of office work.

Railway tower signalling equipment, which for example enables a large railroad terminal to schedule trains in and out every 20 seconds during rush hours with no accidents and almost no delays.

Railway centralized traffic controllers, that remember the locations, directions, and speed of trains, optimize the allocation of track space for fulfillment of scheduled train operations, and provide signals therefor.

Random access file computers.

Remote control telemetering systems.

Sale recorders, also called point-of-sale recorders, which take in the amount, the type, and other information about sales of goods, and produce records in machine language, which can later be automatically analyzed and summarized by punch card or computing equipment.

Signalling controls.

Sorting and counting controls.

Spectroscopic analyzers, which vaporize a small sample of material, analyze its spectrum, and report the presence and the relative quantities of chemical elements and compounds in it.

Strategy machines, which enable military officers in training to play war games and test strategies, in which electronic devices automatically apply attrition rates to the fighting forces being used in the game, growth rates to the industrial potential of the two sides, etc.

Submarine crew training simulators.

Tape-to-card converters, which take in information on punched paper tape or on magnetic tape, and put out

corresponding or edited information on punched cards.

Target simulators.

Telemetering transmitting and receiving devices, which enable a weather balloon or a missile to transmit information detected by instruments within it as it moves; the information is recorded usually on magnetic tape in such fashion that it can later be used for computing purposes.

Telephone equipment including switching, which enables a subscriber to dial another subscriber and get connected automatically.

Telephone message accounting systems, which record local and long distance telephone calls, assign them to proper subscriber's account, and compute and print the telephone bills.

Terrain data translators, which automatically process information from stereographic photographs.

Test-scoring machines, which take in a test paper completed with a pencil making electrically conductive marks, and give out the score.

Toll recording equipment, which record, check, and summarize tolls for bridges, highways, and turnpikes.

Training simulators, which take in simulated conditions affecting the training of one or more persons in a job, and their responses under these simulated conditions, and show the results, all for the purpose of teaching them; SEE also flight simulators.

Travel reservations and inventory systems for airlines and railroads.

Typing machines, programmable, which store paragraphs and other information, and combine them according to instructions into correspondence, form letters, orders, etc., stopping and waiting for manual "fill-ins" if so instructed.

Vending machines, which take in various coins and designations of choices, and then give out appropriate change, coffee, soft drinks, sandwiches, candy, stockings, and a host of other articles, or else allow somebody to play a game for a certain number of plays, etc.

Weather observation recording, telemetering, and transmitting systems.

Components of Automatic Computing Machinery—List of Types

(Edition 4, cumulative, information as of
October 10, 1958)

The purpose of this list is to report types of components of automatic machinery for computing or data processing.

We shall be grateful for any comments, corrections, and proposed additions or deletions, which any reader may send us.

LIST

1. Storage mediums, for both internal and external storage:
Punch cards

Punched paper tape

Magnetic tape

Magnetic wire

Metal plates

Plugboards, i.e., panels of patch cords

(All these physical forms express machine language; when inserted into a machine, they give the machine information and instruction; when left in a filing cabinet, they hold information and instructions in reserve for later use. Sometimes it is the whole area of the

storage medium which is used, as in the ordinary punched card. Sometimes it is only the edge which is used, as in edge-punched cards or edge-slotted metal plates.)

2. Storage mediums, internal only:

- Magnetic drums
- Magnetic tape devices
- Magnetic disc devices
- Magnetic belt devices
- Magnetic cores, arranged either one-dimensionally as in a magnetic shift register, or in two or three dimensions as a magnetic core matrix memory; they may be made of special iron alloys, iron oxide ceramics called ferrites, etc.
- Electrostatic storage tubes, in particular cathode ray storage tubes and glass-metal-honeycomb-type storage tubes.
- Delay lines, of mercury, quartz, nickel, electrical elements, etc.
- Relays, in relay registers and stepping switches
- Electronic tubes, in registers of flip-flops, counting rings, etc.
- Cryotrons, on-off devices operating at liquid helium temperatures
- Barium titanate crystal devices
- Switches: toggle switches and dial switches
- Buttons
- Keyboards
- Rotating shafts
- Voltages

3. Calculating and controlling devices

a. Digital type:

- Transistor circuits
- Magnetic core circuits

Electronic tube circuits

Relay, stepping switch, timing cam, and switching circuits.

Diode and rectifier circuits: using germanium diodes, selenium rectifiers, silicon diodes, electronic tube diodes, etc.

Capacitor and resistor circuits

Cryotron circuits

Packaged arithmetical and logical circuits

Mechanical computing elements: latches, gears, levers, ratchets, program bars, cams, etc.

b. Analog type:

Integrators

Adders

Multipliers

Function generators

Resolvers: product, sine-cosine, coordinate transform

Synchros

Automatic process controllers as such: pneumatic, electronic, hydraulic, etc.

c. Auxiliary circuit elements:

Amplifiers: electronic, magnetic, etc.

Pulse transformers

Voltage regulators

Potentiometers

4. Input Devices

a. Manual positions: buttons, switches, keys

b. Punched holes:

Punch card readers: electric, photoelectric, mechanical

Paper tape readers: mechanical, electric, photoelectric

COMPUTER PROGRAMMERS GROUP MANAGER

PROGRAMMING COMPUTERS FOR PROCESS CONTROL

The Thompson-Ramo-Wooldridge Products Company is forming a group which will be responsible for preparing programs for RW-300 Digital Control Computers employed in the real-time control of industrial processes, especially in the petroleum and chemical industries. The preparation of such programs raises a number of challenging problems, and requires that the persons involved become familiar with this new and rapidly expanding application of digital computers. This group will be responsible not only for setting up process control problems but also for building a library of subroutines and for organizing calculations involved in the design of computer process control systems.

Openings exist at all levels, including the group manager, who should have a degree in mathematics and several years' experience in digital computer programming.

Those interested are invited to write: Director of Marketing

THE THOMPSON-RAMO-WOOLDRIDGE PRODUCTS COMPANY

P.O. BOX 90067 AIRPORT STATION • LOS ANGELES 45, CALIFORNIA

- c. Polarized spots:
Magnetic tape readers, magnetic card readers
- d. Character readers:
Optical, with photoelectric reading
Magnetic ink, with magnetic head reading
Electrically conducting pencil marks, with electric reading
- e. Small spot scanners: photoelectric, electronic
- f. Sensing instruments of all kinds
(The category "sensing instruments" verges into the science of instrumentation, where humidity, temperature, pressure, volume, flow, liquid level, etc., and many other physical variables can be measured and reported to a data processor in machine language.)
- 5. Output devices:
Visual displays, such as lamps, dials, oscilloscope screen, etc.
Electric typewriter, or other electrically-operated office machine
Line-at-a-time printer
Matrix printer, that forms each character by a pattern of dots
Automatic plotter, which will trace or plot a curve according to information delivered by the machine
Facsimile printer
Photographic recording
Paper tape punch
Magnetic tape recorder
Punch card punch
Microphones, telephones, loud speakers, alarms, etc.
Article delivery mechanisms, as in vending machines
Positioning devices, that may operate a valve, roller, tension arm, etc., resulting in control of a manufacturing operation or process, the aiming of a gun, etc.

Readers' and Editor's Forum

[Continued from page 6]

- C. Flexibility of machine control — plugboard (use BPLI manual).
 - 1. Reading brushes to punch or print
 - 2. Adding
 - 3. Selectors — emphasize this. Illustrate by adding and subtracting.
 - 4. Program steps — illustrate by 604.
- D. Typical punched card applications
Here the students should visit a running installation or see a demonstration, and have a chance to handle cards, run the sorter, place a control panel in a machine, etc.
- E. Miscellaneous topics and other equipment.
 - 1. Data transeiving, 101, etc.
 - 2. Test-scoring machine, mark sensing
 - 3. Remington Rand — 90 col., round holes, pre-wired panel "box."
 - 4. Underwood Samas
 - 5. Dennison tickets — retail clothing, converted to IBM.
 - 6. Royal McBee — needle sort only, library

II. Stored Program Machines

- A. Introduction — faster processing, but still accurate and flexible.
 - 1. Film
 - 2. Concept of one machine as a system in itself
- B. Over-all design of machine
 - 1. Stored program control — machine can make up its own instructions, which are stored in the machine like data.
 - 2. Process — coding systems, using binary arithmetic and-or gates.
 - 3. Memory
 - a. Drum
 - b. Core
 - c. Electrostatic
 - d. Mercury-delay line
 - 4. Input-output
 - a. Magnetic tape
 - b. Printers — wire, electrostatic
 - c. Cathode ray
 - d. Paper tape
 - 5. Auxiliary storage
 - a. Disc
 - b. Drum
 - c. Bin
 - 6. A typical system — 705
Illustrate with an integrated processing system.
- C. Characteristics of large computers
 - 1. Digital vs. analog
 - 2. Fixed vs. variable word length
 - 3. Binary vs. decimal arithmetic
 - 4. Special devices
 - a. Floating decimal
 - b. Indexing registers
 - c. Table look-up
- D. Programming — to whatever extent possible
- E. Applications and field trips — discuss the applications the class will have a chance to see.
- F. Survey of the field
 - 1. IBM — 305, 650, 704, 705
 - 2. Others — Datatron, Remington Rand, Bizmac, Datamatic
 - 3. Special — NORC, LARC, Whirlwind

CYBERNETIC SCHEDULER

Edd Doerr

Bogota, Colombia

ALL hell had broken loose. And quite literally too. Members of the Board of Governors of the university were demanding my head. Student rioting outside my windows, one of which had already been shattered, made it virtually impossible to hear the constant jangling of the telephone. The resignations of two full professors, five associate professors and a number of instructors lay in a pile on my desk. The Governor had just called to inform me that the General Assembly was going to demand an immediate investigation. The switchboard was jammed with long distance calls from irate parents and alumni. One mothers' group was organizing a motorcade from the state capitol for a protest demonstration. Reporters from Time, Newsweek and a score of newspapers were making an uproar in the outer office that rivaled that of the students

outside. The state police had even been called in to maintain order.

I had just finished bolting down another aspirin and was wondering whether I would ever get out of the mess alive when the door to the outer office opened suddenly and I was confronted with the huge terrifying bulk of K. Jason Smathers, the barge baron who was the President of the Board of Governors. He stomped across the room, planted his huge hairy paws heavily on my desk and began to make ominous growling noises.

"O.K., Frank," he began jarringly, "you're the president of this university, or what's left of it. At the moment anyway. So you'd better start explaining, and it'd better be good. The state hasn't been in such a turmoil since Morgan's Raiders and something's got to be done about it. Now what the hell happened?"

He remained hovering over my desk, like a gargoyle on a Gothic cathedral, his huge glowing cigar heightening my awareness of the fire into which I had jumped from the relative comfort of the frying pan.

"Well, Jason," I began, trying to assume an air of confidence but not quite succeeding, "it's not much more than a big misunderstanding."

"Misunderstanding, hell!" barked K. Jason Smathers. "You've just set higher education in this state back fifty years. Heads are going to roll, and yours is going to be one of them. Now get on with it."

I swallowed another aspirin and gripped the arms of my chair tightly to stop the trembling of my hands.

"I suppose it all began with a chance remark I made at a faculty tea nearly a year ago. It was shortly after registration and I had not yet fully recovered from the ordeal. I just happened to remark to Czeszko of the Cybernetics Department that it would be nice if the whole business could be handled by machines, that it would save wear and tear on everyone and substantially reduce the number of mistakes. I don't recall what he said at the time, but a few weeks later he came to me with an idea which made me feel fully ten years younger.

"I guess that Jan Czeszko's about the best cybernetics man in the country, so I never questioned his ability to build a computer which would automatically handle the entire registration and class scheduling process. It was a magnificent idea, and still is, although perhaps it represents an advance which we are presently incapable of accepting."

"But damn it," Smathers interrupted sonorously, "why didn't you get the Board's approval before going ahead? This might never have happened."

"That's a moot point," I retorted. "In all likelihood they would have approved of the computer without hesitation. After all, the idea *is* the most important single idea in university administration that I can think of. No one would have predicted trouble."

"Well, would you mind explaining just how the damned thing misfired?"

"All right, Jason. But would you mind sitting down?"

"Czeszko reported before last Christmas that the computer would be operational in time for registration and scheduling this year. The plan seemed to be foolproof. Into the computer we would feed data as to the desired and possible schedules of instructors, from the freshman level up to and including the Graduate School. The machine would also have complete data on degree requirements and license requirements for teachers, physicians, dentists, engi-



A unique CLARE Service which can solve your Wiring Problems

If your present policy is to buy separate relays and switches and perform the necessary wiring yourself, you can benefit from our new, complete wiring service.

From the smallest bench unit to large rack-type cabinets, CLARE can offer packaged wired assemblies to meet your exact requirements. We can build to your specifications, or construct assemblies from our own stock of bases, connectors, plugs, and other components.

With the opening of our new plant in Fairview, N. C., we now have the capacity to handle any wiring project. Our experience in the care and treatment of precision relays and switches is your assurance of familiar CLARE quality. We have developed our own versatile tooling to provide an *economical* service.

As a result, we can deliver to you wired assemblies which are fully tested and which adhere to the highest standards of quality—and we can do this *more economically* than you could do it yourself.

Why not let us show you how you can fit this special service into your own operation? Call or write: C. P. Clare & Co., 3101 Pratt Blvd., Chicago 45, Illinois. In Canada: C. P. Clare Canada Ltd., 2700 Jane Street, Toronto 15. Cable Address: CLARELAY

CLARE RELAYS
FIRST in the industrial field

neers, nurses, med techs, etc., and would automatically give preference in scheduling to graduate students over undergraduates, seniors over juniors, juniors over sophomores, etc. Then each student would submit a requested schedule, together with alternate choices in the event that classes were closed or there were insoluble conflicts. Each registration request would be accompanied by various data concerning the student, so that schedules would be made consistent with degree and other requirements. Classes would also be formed in such a way as to group students by ability levels, so far as possible.

"So that's the system we used for registration this year."

"Yeah," the big man roared as he jarred my desk with his big meaty fist, "but the cockeyed gadget must have cracked up. How the hell else can you explain what happened?"

"Well, actually," I explained, "the fault does not lie with the computer. If anything, the computer is too good, too intelligent. You see, the computer did a lot more than just arrange schedules on the basis of available choices. In order to improve upon the usual pre-registration counseling procedure, we fed the computer complete data on the results of intelligence, personality, aptitude, attitude and interest tests for each student, plus data on each student's academic history. In this way we hoped to route students into programs best suited to their own aptitudes and personalities, a job which counselors can do only imperfectly. Of course, changes in students' schedules were optional, although we felt that they would be very largely accepted once the procedures were explained.

"Naturally, however, we did not expect such repercussions."

"Obviously not," the man behind the cigar bellowed. "But go on. This is getting interesting."

"Well, the results of the computations, together with a brochure explaining the whole business, were printed and sent out. The instructors and students had their schedules at the same time that the Registrar's office did. We didn't examine the schedules before distribution because we had complete confidence in the new system.

"That, it seems, was our mistake. But even then, we could hardly have been able to predict all the results. At any rate, this is what happened.

"Nearly three thousand students were given schedules which completely changed their major subjects. Although their personality, intelligence and other tests indicate that these changes are advisable, very few of the students are inclined to accept them. Nor, for that matter, are a large number of parents. Nearly two thousand students were advised by the computer that they were wasting time and money by attending college as they were totally unfit for higher academic work. I'm sure that you can readily imagine the reaction to that.

"To complicate the picture, the computer advised that certain students, who happen to be members of our athletic teams, were unfit for academic work and would not be wise to hope to graduate from college. Naturally, this infuriated the coaching staff and brought down on our heads the wrath of a group of powerful and important alumni.

"There was even more trouble when the computer advised that the sons and daughters of several politicians, lawyers and industrialists were likewise better off elsewhere than on the campus.

"And beyond that, as we wished to avoid student-faculty

conflict, unconscious or otherwise, we gave the computer data on the personalities of faculty members, though this data was and is confidential. As a result, the computer suggested that several faculty members, from full professors down to mere instructors, were not suited to teaching, and even recommended that several of them enroll for certain courses themselves.

"And since you're here, you're thoroughly familiar with the results of all this. Once the thing got started, it was too late to stop it."

"I'll say it's too late."

"Of course," I resumed, "if the Board, the Governor, the Alumni Association and the Faculty Council will back us up, we can still go ahead with the plan. There will be certain dislocations which cannot be avoided, but on the whole, I think that everything can eventually be straightened out. And in the future our system will probably be regarded as one of the most important developments in American higher education. It will take a while for the idea to become accepted, but I have no doubts as to its ultimate value and importance."

"Well, maybe you can sell some other state on the idea. But this one's had enough. You can't just maneuver people like that, even if it's for their own good. At any rate, I think that your resignation and Cseszko's had better be on my desk before this time tomorrow. It will be for the good of the university."

"I'm sorry that it has to be this way, but there is no alternative."

He rose, pumped my hand perfunctorily and bounded out.

I slumped down in my chair. A beautiful career shot to hell, I thought, just by trying to do one's best. Cseszko could always go to MIT or IBM or somewhere. But what would I do?

Well, maybe I can get a job in one of those jerkwater colleges that no one has ever heard of.

I buzzed for Miss Simmons, who came in looking much the worse for wear after her encounter with that flock of reporters.

"Take a letter," I began slowly, "to the Board of Governors."

STATEMENT OF OWNERSHIP AND MANAGEMENT OF COMPUTERS AND AUTOMATION

Computers and Automation is published monthly at Boston, Mass.

1. The names and addresses of the publisher, editor, managing editor, and business manager are:

Publisher, Berkeley Enterprises, Inc., 815 Washington St., Newtonville 60, Mass.

Editor, managing editor, and business manager, Edmund C. Berkeley, 34 Otis St., Newtonville 60, Mass.

2. The owner is: Berkeley Enterprises, Inc., 815 Washington St., Newtonville 60, Mass.

Stockholders holding one percent or more of the stock are:

Edmund C. Berkeley, 34 Otis St., Newtonville 60, Mass.

William L. Mandel, P.O. Box 5374, Cleveland 1, Ohio.

Max S. Weinstein, 25 Highland Drive, Albany 3, N.Y.

3. The known bondholders, mortgagees, and other security holders owning or holding one percent or more of the total amount of bonds, mortgages, or other securities are: None.

Edmund C. Berkeley, Editor.

SWORN TO and subscribed before me, a notary public in the Commonwealth of Massachusetts, on October 3, 1958.

George W. Odell, Notary Public

My commission expires March 17, 1962.

WHO'S WHO IN THE COMPUTER FIELD

(Supplement)

A full entry in the "Who's Who in the Computer Field" consists of: name / title, organization, address / interests (the capital letters of the abbreviations are the initial letters of Applications, Business, Construction, Design, Electronics, Logic, Mathematics, Programming, Sales) / year of birth, college or last school (background), year of entering the computer field, occupation / other information such as distinctions, publications, etc. An absence of information is indicated by - (hyphen). Other abbreviations are used which may be easily guessed like those in the telephone book.

Every now and then a group of completed Who's Who entry forms come in to us together from a single organization. This is a considerable help to a compiler, and we thank the people who are kind enough to arrange this. In such cases, the organization and the address are represented by . . . (three dots).

Following are several sets of such Who's Who entries.

I. Navy, Army & Air Force Institutes, Planning & Methods Dept., Imperial Court, Kennington Lane, London SE-11, England, and elsewhere.

Dohmen, Wilhelm J / Prgrmr, . . . / ABP, commercial systems analysis / '30, Viersen Coll (Gymnm), '58, prgmg busn routines

Evans, J. Wynford / Prgrmr, . . . / BMP, opens res / '34, St John's Coll, Cambridge Univ, '57, prgrmr specl routines

Kay, Emile L / Mgr, O.R. & Compr Sec, . . . / ABM, opens res / '20, Univ of London, '54, orgnzn of compr use / several papers

Kopsieker, Gunther / Prgrmr, . . . / ABP / '25, Halle Coll (Gymnm), '58, prgmg busn routines

Renton, Mrs. Joyce A / Asst Mgr, . . . / AB / '20, Loretto Coll, (Calcutta) '57, gen supvn of compr staff

van Warmelo, W L / Prgrmr, . . . / AP / '34, Univ of the Witwatersrand (So Africa), '57, prgmg of checking & Safety routines

II. Sperry Gyroscope Company, Division of Sperry Rand Corporation, N. Y.: / Garden City, Lake Success, Great Neck, etc.

Abraham, David / Assoc Engr, . . . / DEL / '31, Cornell, '56, eng physicist

Albrecht, Marjorie L / Engr, . . . / A, system simulations / —, Hunter Coll, '54—

"The *Bendix G-15* computer helps plan operations for our ultra-modern refinery."

says JOHN W. RUSSELL,
Process Engineering Analyst,
OHIO OIL COMPANY,
Robinson, Illinois Refinery

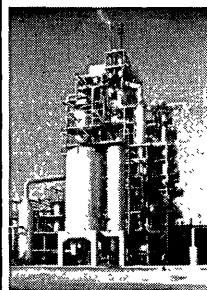
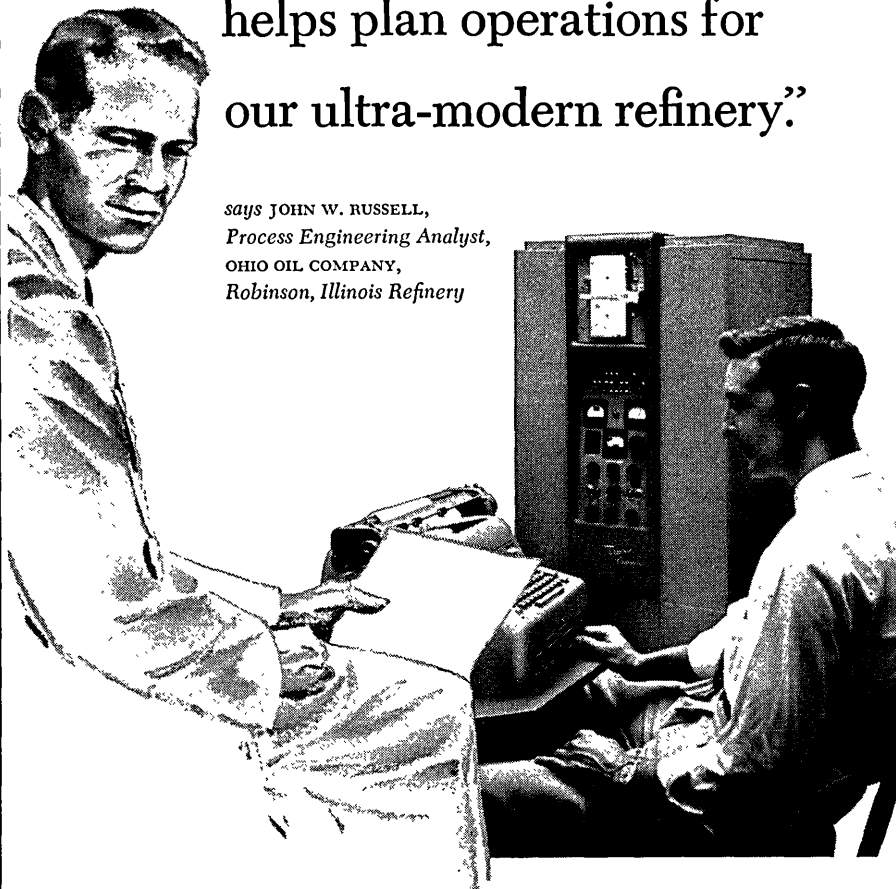

"In the highly competitive oil industry, efficiently planned refinery operation is a must. To handle the complex mathematics involved in this planning, we needed the speed of electronic computing. After careful study, we have installed a Bendix G-15 and although it is one of the lowest priced machines, we are using it very successfully on large scale problems. We like the compact size and have found reliability to be exceptional. G-15 users share valuable programs through their own organization, too, and this adds materially to the computer's value."

THE G-15 PROVIDES – Low-cost versatility for thousands of office and laboratory applications – Simplified operating methods – Memory and speed of computers costing four times as much – Typewriter input-output, paper tape output and 250 char/sec paper tape input at no added cost – Expandability through accessories for 1,200,000 words of magnetic tape storage and punched card input-output – Extensive program library – Users share programs – Proven reliability – Nationwide service – Lease or purchase.

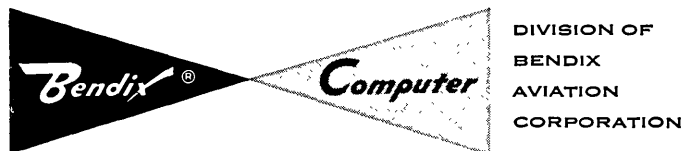

Built and backed by Bendix, the G-15 is serving scores of progressive businesses large and small throughout the world. For details, write to Bendix Computer, Department D-7, Los Angeles 45, California.

WHO'S WHO IN THE COMPUTER FIELD, 1958

Each year we like to bring up to date our "Who's Who in the Computer Field." We are currently asking all computer people to fill in the following Who's Who Entry Form, and send it to us for their free listing in the Who's Who that we publish from time to time in **Computers and Automation**. We are often asked questions about computer people — and if we have up to date information in our file, we can answer those questions.

If you are interested in the computer field, please fill in and send us the following Who's Who Entry Form (to avoid tearing the magazine, the form may be copied on any piece of paper).

Name? (please print)
 Your Address?
 Your Organization?
 Its Address?
 Your Title?

Your Main Computer Interests?

- Applications
- Business
- Construction
- Design
- Electronics
- Logic
- Mathematics
- Programming
- Sales
- Other (specify):

Year of birth?
 College or last school?
 Year entered the computer field?
 Occupation?
 Anything else? (publications, distinctions, etc.)

When you have filled in this entry form please send it to: Who's Who Editor, **Computers and Automation**, 815 Washington Street, Newtonville 60, Mass.

Barton, George R / Engrg Sec Head, . . . / CD / '26, Columbia Univ, '51 —
 Bauerle, P / Engr, . . . / D, devt / '30, Brooklyn Polytech, '55, engr / member Pi Tau Sigma & Sigma Ki
 Crean, Martin J / Supt Data Procg Sys, . . . / A / '13, NY Univ, '55, acctnt
 Fahey, William D / Stds Engr, . . . / C / '25, Manhattan Coll, '55, engr
 Freeman, Herbert / Engrg Dept Head for Advcd Studies, . . . / DEL / '25, Columbia Univ, '48, engr
 Galli, Enrico J / Engr in chg of Tube Res Compr Facility, . . . / ADEP / '31, MEE, Brooklyn Polytech (MEE), '53, electrl engr / various articles, papers
 Hauser, Arthur A, Jr / Asst to VP for Res & Devt, . . . / E, digital compr sys / '20, Columbia Univ, '42, —
 Isaacs, Peter J / Engrg Sec Head for Digital Components Res, . . . / CDEL / '26, Columbia Univ, '53, engr
 McCormick, Robert / Sr Sys Prgrmr, . . . / AB / '29, NY Univ (MIE) '55, industrial engr
 Rattner, Jack / Sr Engr, . . . / MP / '25, Columbia, '52, engr
 Saltman, Roy G / Engr, . . . ADLM / '32, MIT, '53, engr
 Scott, John E / Sr Engr, . . . / DEL / '21, Columbia Univ, '53, engr
 Silver, Lawrence / Engr, . . . / ADELP / '25, NYU, '52, engr
 Stowens, Bernard H / Engrg Dept Head for Digital Sys, . . . / ACP / '16, Johns Hopkins, '52, physicist
 White, George R / Engr, . . . / AMP / '29, Iowa State Coll, (PhD) '55, physicist
 Zadoff, Solomon A / Res Engr, . . . / AMP / '26, Columbia Univ, '50, sys analyst / several papers on comprs, sampled-data systems, & noise
 Zaremba, Charles / Engr, . . . / E / '31, NY Univ, —, electrical engr

III. Armour Research Foundation of Illinois Institute of Technology, 10 W. 35th St., Chicago 16, Illinois
 Bock, Frederick / Operns Analyst, . . . / AMP, statistics / '18, Univ of Chi, '54, statn
 Cameron, Scott H / Electl Engr, . . . / CDEIM / '28, Univ of Ill, Ill Inst of Tech, '54, — / several papers
 Deterding, James M / Supr, Compr & Control Sys, . . . / ABDL / '28, Purdue Univ, Univ of Chi, '53, electl engr
 Engelhart, Thomas / Asst Mathn, . . . / MP / '34, Ill Inst of Tech, '57, prgrmr-analyst
 Floyd, Robert W / Asst Electl Engr, . . . / P, appln of comprs to algebraic & verbal languages / '36, Univ of Chi, '56, scientific prgrmg
 Gluss, Brien / Assoc Operns Analyst, . . . / AMP / '30, Pembroke Coll, '58, mathl statn
 Hawkes, Albert K / Asst Supvr, Mathl Svcs Sec, . . . / ADELMP / '26, Ill Inst of Tech, '53, electl engr
 Mittman, Benjamin / Res Mathn, . . . / ALMP, operns res / '28, UCLA, Ill Inst of Tech, '56, Mathn
 Moore, Clarence J / Assoc Mathn, . . . / P / '22, Univ of Chic, '54, Mathn
 Prince, Richard T / Res Engr, . . . / ABCDELMP / '25, Ill Inst of Tech, '51, electnc engrg
 Smith, Richard H / Assoc Sys Analyst, . . . / AB, similarities in functioning of comprs & human brain / '23, Nwn Univ, '56, bus sys analyst

Ungar, Andrew / Operns Analyst, . . . / M / '22, Univ of Chi, '55, applied statl res
 Weyer, John R / Assoc Engr, . . . / DL / '29, Purdue, '51, compr design
 Wise, Richard B / Assoc Electl Engr, . . . / AMP / '31, Ill Inst of Tech, '53, electl engrg
 Wolff, Morton C / Assoc Sys Analyst, . . . / ABP / '26, Nwn U, '54, sys analyst

IV. Autonetics, A Division of North American Aviation, Inc., 9150 E. Imperial Hwy., Downey, Calif.
 Bergmann, Frank H / Sales Engr, . . . / AS / '17, UCLA, '54, compr sales
 Dufford, D E / —, . . . / ABPS / '23, Harvard, '46, —
 Homer, Robert L / Prgrmg Specialist, . . . / AMPS / '29, Reed Coll, '53, mathn
 Johns, Richard H / Chief, Compr Sales, . . . / AS / '26, Stanford Univ, '49, —
 Peck, Lionel S / Aplns Engr, . . . / AB / '22, Harvard, '52, market planning

NEW PATENTS

RAYMOND R. SKOLNICK
 Reg. Patent Agent

Ford Inst. Co., Div. of Sperry Rand Corp.
 Long Island City 1, New York

THE following is a compilation of patents pertaining to computers and associated equipment from the "Official Gazette of the United States Patent Office," dates of issue as indicated. Each entry consists of: patent number / inventor(s) / assignee / invention. Printed copies of patents may be obtained from the U.S. Commissioner of Patents, Washington 25, D.C., at a cost of 25 cents each.

April 22, 1958: 2,831,971 / Carl R. Wischmeyer, Houston, Tex. / Esso Research and Engineering Co., Elizabeth, N.J. / An electric gating circuit.
 2,831,983 / Bernard Ostendorf, Jr., Stamford, Conn. / Bell Telephone Lab., Inc., New York, N.Y. / A flip-flop trigger circuit.
 2,831,985 / John Presper Eckert, Jr., Philadelphia, Pa. / Sperry Rand Corp., New York, N.Y. / An amplifier for a computing system where spaced pulses are to be amplified.
 2,831,987 / John Paul Jones, Jr., Pottstown, Pa. / Navigation Computer Corp., Penn. / A transistor binary comparator.
 2,832,019 / Sidney B. Cohen, Bayside, N.Y. / Sperry Rand Corp., New York, N.Y. / A servo system using a magnetic amplifier mixer.
 2,832,064 / Samuel Lubkin, Bayside, N.Y. / Underwood Corp., New York, N.Y. / A cyclic memory system.
 2,832,065 / Stanley B. Disson, Broomall, and Albert J. Meyerhoff, Wynnewood, Pa. / Burroughs Corp., Detroit, Mich. / A diodeless transfer circuit for transferring information stored in a bistable magnetic transferor core to

another bistable magnetic transferee core.

2,832,066 / Harley A. Perkins, Jr., Baldwin Township, Allegheny County, Pa. / Westinghouse Electric Corp., East Pittsburgh, Pa. / Memory elements for electrical control systems.

2,832,070 / Lee J. Bateman, Los Angeles, Calif. / Hughes Aircraft Co., Culver City, Calif. / A binary decoder.

April 29, 1958: 2,832,536 / William E. Woods, Haddonfield, Robert E. Wilson, Morrestown, and John H. Sweer, Collingswood, N.J. / U.S.A. as represented by the Secretary of the Navy / An electronic computer circuit for performing multiplication and division.

2,832,541 / Eric John Guttridge, Barnes, Eng. / Powers-Samas Accounting Machines Lim., London, Eng. / An electrical counter circuit responsive to successive impulses.

2,832,898 / Paul R. Camp, Middletown, Conn. / Radio Corp. of America, Del. / A time delay transistor trigger circuit.

2,832,937 / Louis A. Ule, Alhambra, Calif. / Gilfillan Bros., Inc., Los Angeles, Calif. / A time domain circuit for filtering signals expressible as solutions to linear homogeneous differential equations with constant coefficients.

May 6, 1958: 2,833,470 / William R. Welty, West Los Angeles, Calif. / Hughes Aircraft Co., Del. / An electrical ballistic computing system.

2,833,471 / Emory Lakatos, Cranford, and Henry G. Och, Short Hills, N.J. / Bell Telephone Laboratories, Inc., New York, N.Y. / A computing system and method.

2,833,474 / Edward S. Wilson, Poughkeepsie, and Reginald A. O'Hara, Staatsburg, N.Y. / International Business Machines Corp., New York, N.Y. / A card registration checking device.

2,833,476 / Monson H. Hayes and James L. West, Binghamton, N.Y. / Link Aviation Inc., Binghamton, N.Y. / A reversible counting circuit.

2,833,858 / George F. Grondin, Van Nuys, Calif. / Collins Radio Co., Cedar Rapids, Iowa / An electronic code converter for converting a nonsynchronous mark-space input signal from a teletypewriter to a synchronous output code.

2,833,981 / William H. Newell, Mount Vernon, N.Y. / Sperry Rand Corp., New York, N.Y. / A control for three variables.

2,834,007 / Bruce K. Smith, Devon, Pa. / Sperry Rand Corp., New York, N.Y. / A shifting register or array.

2,834,011 / Raymond P. Mork, Needham Heights, Mass. / Raytheon Mfg. Co., Waltham, Mass. / A binary cyclical encoder.

May 13, 1958: 2,834,543 / William H. Burkhart, East Orange, N.J. / Monroe Calculating Machine Co., Orange, N.J. / A multiplying and dividing means for electronic calculators.

2,834,831 / John A. H. Giffard, London, Eng. / International Business Machines Corp., New York, N.Y. / Data Recording Means.

2,834,893 / Richard W. Spencer, Philadelphia, Pa. / Sperry Rand Corp., New



... on the computer reel

FOR HIGHEST-PRECISION COMPUTER APPLICATIONS...

has three important features*

Type EP Audiotape is the extra-precision magnetic instrumentation tape that is guaranteed defect-free. Now EP Audiotape is available in a form particularly suited to electronic computers. It is made on both 1.5-mil cellulose acetate and polyester film. Tapes are 2500 x 1/2". Every reel is tested by a 7-channel certifier before it leaves the factory and is guaranteed to have absolutely no "dropouts" (microscopic imperfections causing test signal to drop below 50% of average peak output).

* Reel is Audio's computer reel — an opaque polystyrene 10 1/2" reel with a hub diameter of 5.125". Each reel comes with pressure-sensitive identification labels and a yellow polyethylene drive slot plug.

* Two photo-sensing markers are accurately placed on the tape, one 14 feet from the hub end, the other ten feet from the other end. These markers are vaporized aluminum sandwiched between the base and low flow thermosetting adhesive. Both markers are firmly placed and wrinkle-free.

* Container is of transparent polystyrene and made especially for the computer reel. A center-lock mechanism and peripheral rubber gasket seal the reel from external dust and sharp changes in temperature and humidity.

EP Audiotape on the computer reel has been used in large computer installations with perfect results. Although the reel, markers and container are designed for specific computers, the tape is the same precision EP Audiotape that has stood the tests of time and operation on hundreds of applications in automation, petroleum seismology, telemetering, and electronic computing. To get the complete specifications for type EP Audiotape on the computer reel — or for a Company representative to call — write on your company letterhead to Dept. TA
AUDIO DEVICES, INC., 444 Madison Avenue, New York 22, N. Y.

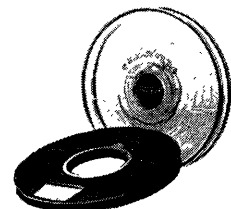

York, N.Y. / A magnetic amplifier flip-flop circuit.
 May 20, 1958: 2,835,444 / Norman B. Blake and William H. Cox, Beaumont, Tex. / Sun Oil Co., Phila., Pa. / A multiplication circuit.
 2,835,854 / Edward O. Uhrig, Euclid, Ohio / U.S.A. as represented by the Sec. of the Navy / A two channel servo system.
 2,835,856 / Francis L. Moseley, Pasadena, Calif. / F. L. Moseley Co., a Corp. of Calif. / A servo system input and balancing circuit.
 2,835,857 / Harry C. Moses, Baltimore, and Robert S. Raven, Catonsville, Md. / U.S.A. as represented by the Sec. of the Navy / A limited output range servosystem.
 May 27, 1958: 2,836,356 / Cameron B. Forrest and Sidney S. Green, Los Angeles, Calif. / Hughes Aircraft Co., a Corp. of Del. / An electronic analog-to-digital converter.
 2,836,357 / Paul C. Hoell, Concordville, Pa. / E. I. du Pont de Nemours and Co., Wilmington, Del. / An electrical computing measuring apparatus.
 2,836,359 / Roy P. Mazzagatti, Bellaire, Tex. / The Texas Co., New York, N.Y. / Integration of electrical signals.
 2,836,360 / Franklin L. Adams, Inkster, Mich. / Bendix Aviation Corp., Detroit, Mich. / A pulse counter.
 June 3, 1958: 2,837,278 / Kenneth E. Schreiner, Harrington, N.J., and John P. Cederholm, New York, N.Y. / International Business Machines Corp., New York, N.Y. / A modulo nine computer as a checking circuit.
 2,837,279 / Arthur H. Dickinson, Greenwich, Conn., and Robert I. Roth, Mount Pleasant, N.Y. / International Business Machines Corp., New York, N.Y. / A data processing machine.
 2,837,665 / James N. Edwards, Los Angeles, Calif. / Hughes Aircraft Co., Culver City, Calif. / An electro-mechanical voltage differential detector.
 June 10, 1958: 2,837,929 / Raymond E. Croke, Roslyn, N.Y. / Sperry Rand Corp., a Corp. of Del. / A disc-roller integrator.

2,838,236 / Gilbert deChangy, Clamart, Fr. / Electricite de France—Service National—Direction des Etudes et Recherches, Paris, Fr. / A rotary multiplying-dividing device.
 2,838,240 / Herbert M. Heuver and John B. D'Andrea, Dayton, Ohio / — / A device for superimposing digit counts in the mechanical counters.
 2,838,661 / Jeffrey C. Chu, Naperville, Ill. / U.S.A. as represented by the U.S. Atomic Energy Comm. / A binary storage element.

June 17, 1958: 2,839,244 / Rawley D. Mc Coy, Bronxville, and Leo Wiesner, Kew Gardens, New York / Reeves Instrument Corp., New York, N.Y. / An electronic multiplier and divider.
 2,839,245 / Robert E. Wilson, Moorestown, N.J. / U.S.A. as represented by the Secretary of the Navy / An analog division device.
 2,839,693 / Richard C. Weise, Philadelphia, Pa. / Burroughs Corp., Detroit, Mich. / An electronic computer power supply circuit.

COMPUTER ENGINEERS

Positions are open for computer engineers capable of making significant contributions to advanced computer technology. These positions are in our new Research Center at Newport Beach, California, overlooking the harbor and the Pacific Ocean—an ideal place to live. These are career opportunities for qualified engineers in an intellectual environment as stimulating as the physical surroundings are ideal. Qualified applicants are invited to send resumes, or inquiries, to Mr. L. T. Williams.

Positions Open:	•	Areas of Interest:
Systems Engineers	•	Computers &
Logical Designers	•	Data Processors
Programmers	•	Input/Output Equipment
Circuit Engineers	•	Storage Units
Mechanical	•	Display Devices
Engineers	•	Computer Components
Applications	•	Solid State Devices
Specialists	•	Electromechanical
Sales Engineers	•	Equipment

AERONUTRONIC SYSTEMS, INC.

a subsidiary of Ford Motor Company

1234 Air Way • Bldg. 27, Glendale, Calif. • CHapman 5-6651

ADVERTISING INDEX

Following is the index of advertisements. Each item contains: Name and address of the advertiser / page number where the advertisement appears / name of agency if any.

Aeronutronic Systems, Inc., a Subsidiary of Ford Motor Co., 1234 Air Way, Glendale, Calif. / Page 30 / Honig, Cooper & Miner.

Ampex Corp., 934 Charter St., Redwood City, Calif. / Page 32 / Boland Associates.

Autonetics, a Div. of North American Aviation, Inc., 9150 E. Imperial Highway, Downey, Calif. / Page 3 / Batten, Barton, Durstine & Osborn.

Audio Devices, Inc., 444 Madison Ave., New York 22, N.Y. / Page 29 / Marsteller, Rickard, Gebhardt & Reed, Inc.

Bendix Aviation Corp., Computer Div., 5630 Arbor Vitae St., Los Angeles, Calif. / Page 27 / The Shaw Co.

C. P. Clare & Co., 3101 Pratt Blvd., Chicago 45, Ill. / Page 25 / Reincke, Meyer & Finn.

Electronic Associates, Inc., Long Branch, N.J. / Page 7 / Halsted & Van Vechten, Inc.

ESC Corp., 534 Bergen Blvd., Palisades Park, N.J. / Page 5 / Keyes, Martin & Co.

General Electric Co., Apparatus Sales Div., Schenectady 5, N.Y. / Page 2 / G. M. Basford Co.

Radio Corp. of America, Semiconductor Products, Harrison, N.J. / Page 11 / Al Paul Lefton Co., Inc.

Royal-McBee Corp., Data Processing Div., Port Chester, N.Y. / Page 9 / C. J. LaRoche & Co.

Southwest Research Institute, 8500 Culebra Rd., San Antonio 6, Tex. / Page 19 / —.

System Development Corp., Santa Monica, Calif. / Page 31 / Stromberger, LaVene, McKenzie.

Thompson-Ramo-Wooldridge Products Co., P.O. Box 45067 Air Port Station, Los Angeles, Calif. / Page 23 / The McCarty Co.



11-53

Man-Machine Relationships: A New Field for Computer Programmers

A new field for Computer Programmers has arisen from System Development Corporation's work on relationships of men and complex machine systems.

The work involves two major projects: 1 *creating and conducting large-scale training programs in present and planned air defense systems, and 2 operational computer programming for SAGE. Each project requires intensive programming efforts in areas of real-time analysis and data reduction, using the most advanced computing equipment—704, 709 and SAGE computers.*

The ultimate goal of Computer Programmers in each project is to attain the most effective interaction between men and machines and maximum utilization of those machines. They join with Operations Research Specialists, Engineers, and Behavioral Scientists to achieve this objective.

Both activities have these elements in common: they are constantly changing • they are long-range in nature • they are essential to the welfare of the United States.

The close interrelationship of these two major projects, the wide range of specialists involved in them, and the dominating influence of man-machine relationships makes SDC's work, in effect, a new field for Computer Programmers.

The expanding scope and importance of SDC's work has created a number of positions for experienced Computer Programmers possessing strong mathematical backgrounds and a high level of ability. Inquiries are invited. Address: R. W. Frost, 2406 Colorado Avenue, Santa Monica, California, or phone collect at EXbrook 3-9411 in Santa Monica.

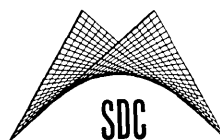

**SYSTEM
DEVELOPMENT
CORPORATION**
Santa Monica, California

11-54

An independent non-profit organization.

When to use magnetic tape in automatic control

Iron dust and a magnifying glass provide a revealing visual comparison

You are seeing iron dust clinging to signals recorded on magnetic tape. There can be 3200 extremely reliable binary bits on one square inch—or analog control information similarly compact. In the compacting of automatic control data, magnetic tape is supreme—second only to nature's remarkable chromosome. Nature makes people, dogs, cats and monkeys. Magnetic tape recorders make, for example, machined parts—their shapes the most complex and precise that have ever been produced in quantity. It is done by numerical control. The principles involved are very widely applicable to all kinds of control applications. Three main criteria determine where magnetic tape is your best choice.

Criteria No. 1: QUANTITY OF CONTROL DATA

Any automatic control operation that can benefit from very large numbers of time-synchronized commands is a natural candidate for magnetic tape. For example, continuous-path control of a milling cutter may require X, Y and Z coordinates at several hundred points per inch of tool movement. The more points, the greater the accuracy. A reel of magnetic tape can define millions of points at extremely low unit cost.

Continuous real-time control of variables is applicable to process programming, simulation devices, automatic inspection and electronic-system checkout—provided there is need for great accuracy in a complex situation. The program tapes may incorporate the work of giant computers and intricate interpolating devices. A great advantage of magnetic tape is that the computer and interpolator are used only during tape preparation, hence may be shared with many other needs.

Criteria No. 2: HIGH TRANSFER RATE

The Ampex FR-300 digital tape handler can spew out alpha-numeric characters at rates as high as 30,000 to 90,000 per second. A short burst of digital information equivalent to a standard punched card can be extracted from magnetic tape under 4 milliseconds—including start and stop.

On analog position-control data, magnetic tape can provide many hundreds of complete commands per second—200 per second in one example and up to eight times this many if needed.

On control-system monitoring, a recording of as much as two hours duration can be played back in one minute for review by high-speed computers. Ampex tape recorders with overall speed ratios as high as 120-to-1 are available.

Criteria No. 3: ERASURE AND RE-RECORDING

Magnetic tape can be erased to accept new data an endless number of times. Hence tape-loop recorders can operate on a repetitive cycle of recording, reproduction, erasure and re-recording to serve as time-delay devices or endless monitors. Such a loop can be the analog equivalent of a production line, conveyor belt or process flow. The loop keeps in step, accepts sensing information at one place and then triggers commands at some fixed time downstream. Or as a calamity monitoring device, the tape loop stores information briefly and erases it to make way for new data if nothing has occurred.

Can we advise you on a specific application of magnetic-tape control or send further literature on magnetic-tape recorder principles and applications? Write Dept Z-19