

SONY®

CXA1114P/M/CXA1434P

Audio Video Switch Compatible with I²C Bus

Description

The CXA1114P and CXA1434P are bipolar ICs developed as audio video switches for the I²C bus.

Features

- Serial control through I²C bus
- 4 channels for input and 3 channels for output
- The 3 channels for output are respectively independent and allow for input selection at will
- Video and audio switches are independently controllable
- Corresponds to mutual dubbing and simultaneous broadcasting
- Built-in amplifier with gain = 6 dB for both video and audio systems
- Wide band video amplifier (15 MHz – 3dB)
- Slave address for CXA1114 and CXA1434 differ
CXA1114: 90H, CXA1434: 96H

Functions

Input channels { Video input 4 channels
 { Audio input, STEREO 4 channels

Output channels { Video output 3 channels
 { Audio output, STEREO 3 channels

Each output features a built-in 6dB gain amplifier.

Output at the 3 channels can independently select an input at will.

Structure

Bipolar silicon monolithic IC

Absolute Maximum Ratings (Ta=25°C)

- | | | | | |
|-------------------------------|------------------|-------------|----|---------------------|
| • Supply voltage | V _{cc} | 12 | V | |
| • Operating temperature | T _{opr} | -20 to +75 | °C | |
| • Storage temperature | T _{stg} | -65 to +150 | °C | |
| • Allowable power dissipation | P _d | 830 | mW | (CXA1114P/CXA1434P) |
| | | 570 | mW | (CXA1114M) |

Operating Supply Voltage Range

V_{cc} +8 to +10 V

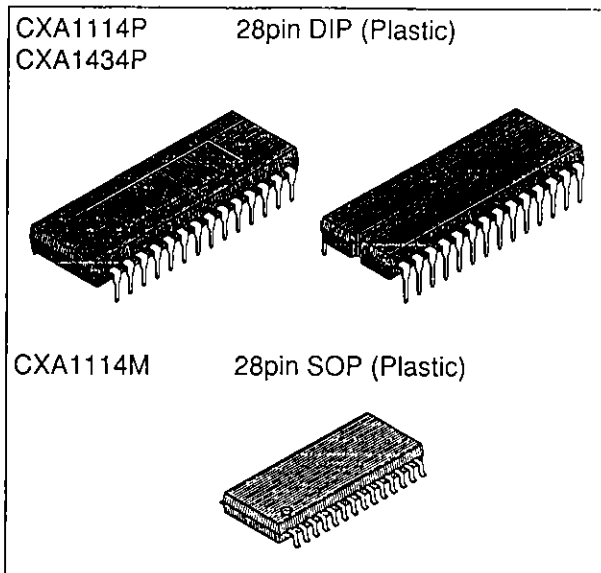

Sony reserves the right to change products and specifications without prior notice. This information does not convey any license by any implication or otherwise under any patents or other right. Application circuits shown, if any, are typical examples illustrating the operation of the devices. Sony cannot assume responsibility for any problems arising out of the use of these circuits.

Block Diagram

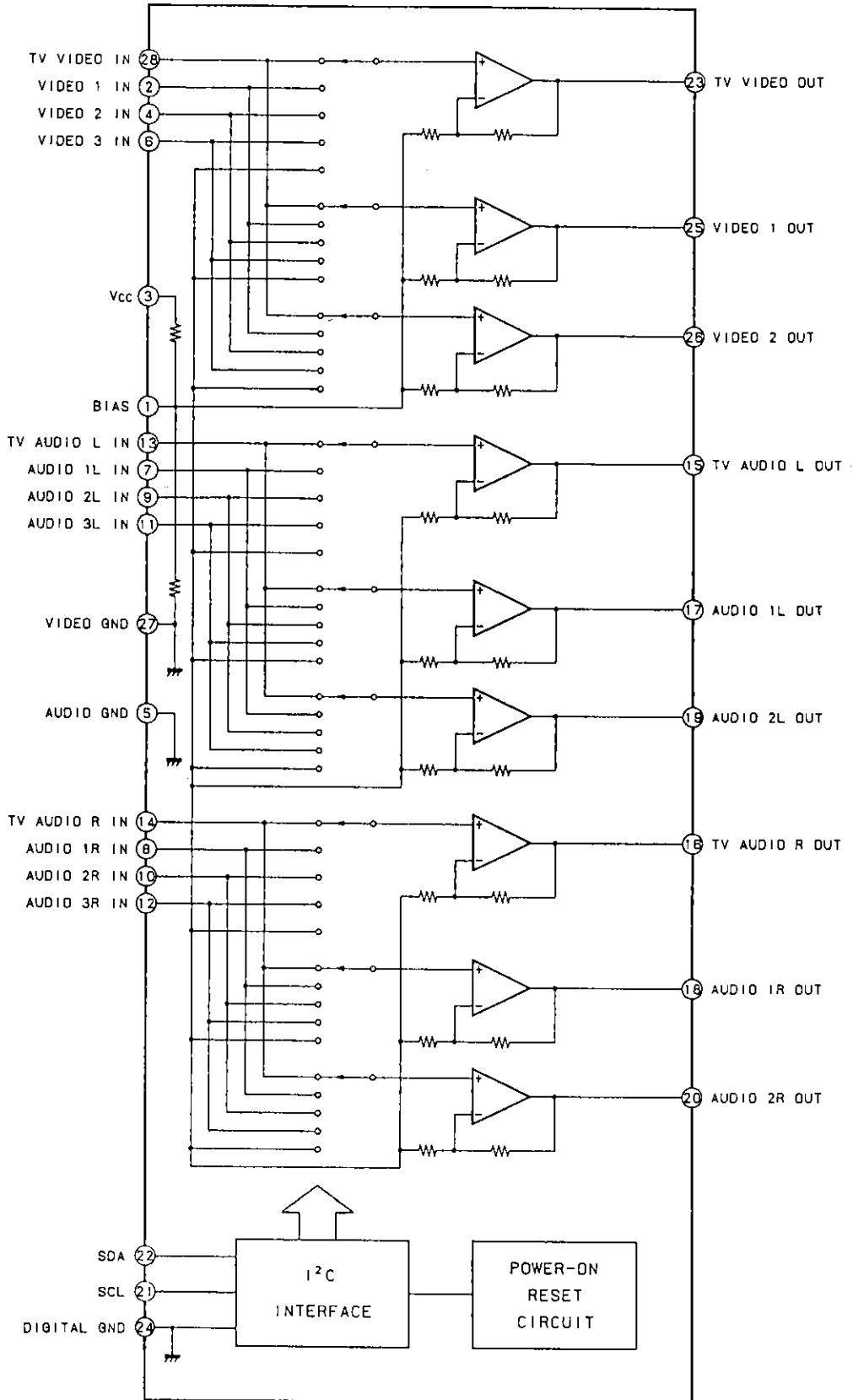

Pin Configuration (Top View)

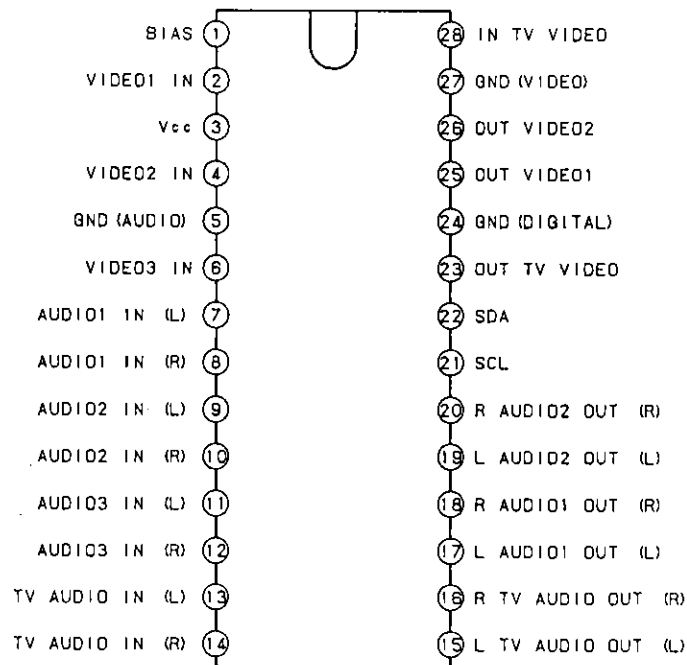

Pin Description

No.	Symbol	Voltage	Equivalent circuit	Description
1	BIAS	4.6V		Builds up $V_{cc}/2$ that becomes the internal bias reference. Supply ripple is suppressed by installing a capacitor. Cut off frequency is supplied through, $f_0 = \frac{1000}{2\pi \times 11 \times C (\mu F)} \text{ [Hz]}$
2 4 6 28	VIDEO 1 IN VIDEO 2 IN VIDEO 3 IN TV.VIDEO IN	4.5V		Video 1, 2, 3, and TV video input pins
3	V_{cc}	9.0V		Power supply pin

No.	Symbol	Voltage	Equivalent circuit	Description
5 24 27	GND(AUDIO) GND(DIGITAL) GND(VIDEO)			Audio, digital and video GND pins
7 8 9 10 11 12 13 14	AUDIO 1 IN(L) AUDIO 1 IN(R) AUDIO 2 IN(L) AUDIO 2 IN(R) AUDIO 3 IN(L) AUDIO 3 IN(R) TV AUDIO IN(L) TV AUDIO IN(R)	4.6V		Input pins for 1,2,3 audio, the TV audio and their respective L and R channels
15 16 17 18 19 20	TV AUDIO OUT(L) TV AUDIO OUT(R) AUDIO 1 OUT(L) AUDIO 1 OUT(R) AUDIO 2 OUT(L) AUDIO 2 OUT(R)	4.6V		Output pins for 1,2 audio, the TV audio and their respective L and R channels
21	SCL	—		SCL (Serial Clock Line) of I ² C bus standards. Threshold level is set to approx. 2.3V.
22	SDA	—		SDA (Serial Data Line) of I ² C bus standards. Threshold level is set to approx. 2.3V.

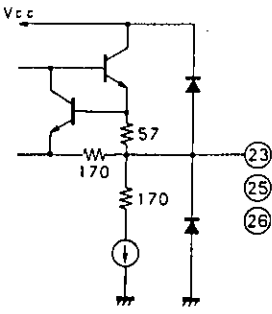
No.	Symbol	Voltage	Equivalent circuit	Description
23 25 26	TV VIDEO OUT VIDEO 1 OUT VIDEO 2 OUT	4.5V		Output pins for TV video, video 1 and video 2.

Electrical Characteristics

(Ta=25°C, Vcc=9V See Fig. 1 to 10)

Item	Symbol	Conditions	Min.	Typ.	Max.	Unit
Consumption current	I _{cc}	V _{cc} =9V, No signal, No load (Fig.1)	20	35	50	mA
BIAS	V _{cc} /2	V _{cc} =9V, No signal, No load	4.2	4.6	5.0	V

(Video system)

I/O pin voltage	V _{vpin}	V _{cc} =9V, No signal, No load	4.1	4.5	4.9	V
Frequency characteristics	F _{bvw}	With input at 0.3 V _{p-p} and output at 100 kHz set to 0 dB. Test input frequency when output level reaches -3 dB. (Fig.2)	10	15	—	MHz
Gain	G _{Vv}	f=100kHz, 0.3V _{p-p} input (Fig.2)	5.5	6.0	6.5	dB
Input dynamic range	V _{dv}	At 100 kHz max input level when distortion < 1.0% (Fig.2)	2.0	3.0	—	V _{p-p}
Crosstalk between video outputs	V _{ctv}	f=4.43MHz, 1V _{p-p} input (Fig.2)	—	-55	-50	dB
Input resistance	R _{inv}	Tested at DC (Fig.5)	7	11	15	kΩ
Ripple rejection ratio	RR _v	f=100Hz, 0.3V _{p-p} added to V _{cc} (Fig.7)	—	-35	-30	dB
Output impedance	R _{ov}	f=100kHz, 5V _{p-p} input (Fig.3)	—	12	30	Ω

(Audio system)

I/O pin voltage	V _{apin}	V _{cc} =9V, no signal, No load	4.4	4.6	4.7	V
Frequency characteristics	F _{bwa}	With 1V _{p-p} input, 1kHz output as 0dB, an input frequency where -3dB is obtained. (Fig.9)	100	—	—	kHz
Gain	G _{va}	f=1kHz, 1V _{p-p} input (Fig.9)	5.5	6.0	6.5	dB
Total harmonic distortion	THD	f=1kHz, 2.2V _{p-p} input (Fig.8)	—	0.06	0.2	%
Input dynamic range	V _{da}	At 1 kHz max input level when distortion < 1.0% (Fig.9)	2.8	3.0	—	V _{p-p}
Crosstalk between audio outputs	V _{cta}	f=1kHz, 1V _{p-p} input (Fig.9)	—	-90	-75	dB
Input resistance	R _{ina}	Tested at DC (Fig.6)	25	30	40	KΩ
Ripple rejection ratio	RR _a	f=100Hz, 0.3V _{p-p} added to V _{cc} (Fig.7)	—	-50	-40	dB
Output impedance	R _{oa}	f=1kHz, 5V _{p-p} input (Fig.4)	—	12	30	Ω

Output DC offset	V _{off}	Offset with regards to mute in respective modes. (Fig.9)	—	6.0	25.0	mV
Residual noise	V _{na}	f _{CL} =300Hz, f _{CH} =19kHz, 40dB amplifier connected. (Fig.10)	—	0.8	5.0	mV

(Logic system) Fig.11

High level input voltage	V _{IH}		3.0	—	5.0	V
Low level input voltage	V _{IL}		0	—	1.5	V
Low level output voltage	V _{OL}	During SDA, 3mA flow in	0	—	0.4	V
Clock frequency	f _{SCL}		0	—	100	kHz
Min. waiting time for data modification	t _{BUF}		4.7	—	—	μs
Min. waiting time for start of data transfer	t _{HD;STA}		4.0	—	—	μs
Low level clock pulse width	t _{LOW}		4.7	—	—	μs
High level clock pulse width	t _{HIGH}		4.0	—	—	μs
Min. waiting time for start preparation	t _{SU;STA}		4.7	—	—	μs
Min. data hold time	t _{HD;DAT}		5	—	—	μs
Min. data preparation time	t _{SU;DAT}		250	—	—	ns
Rise time	t _R		—	—	1	μs
Fall time	t _F		—	—	300	ns
Min. stop reparation time	t _{SU;STO}		4.7	—	—	μs

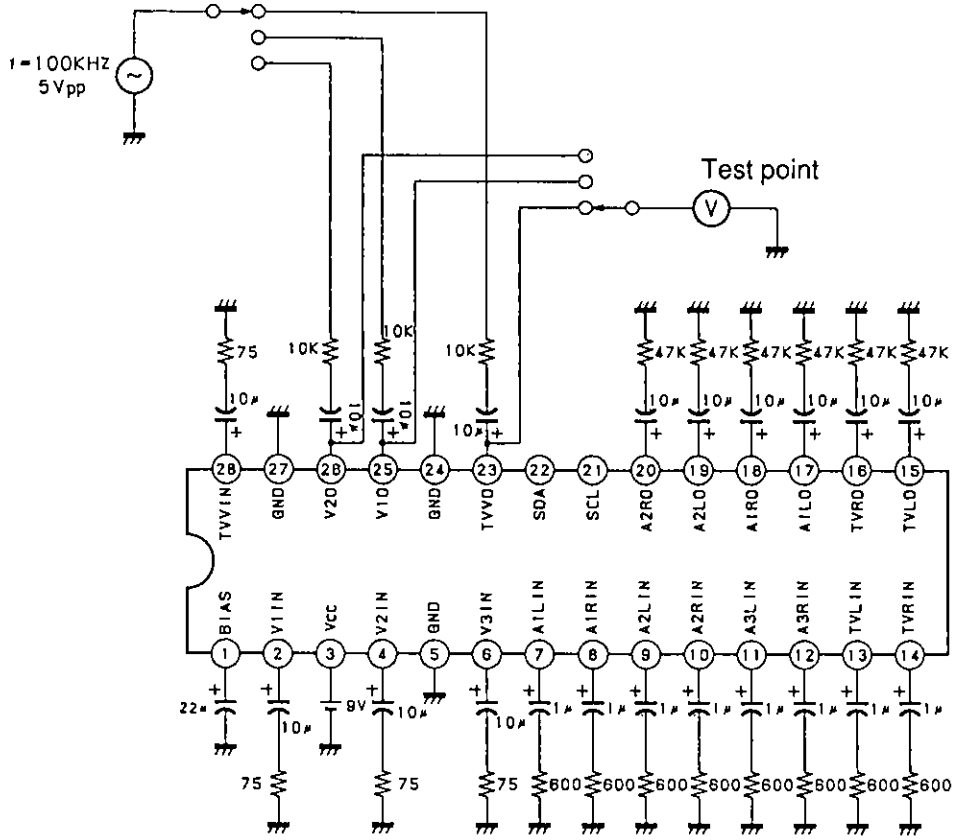

Fig. 3

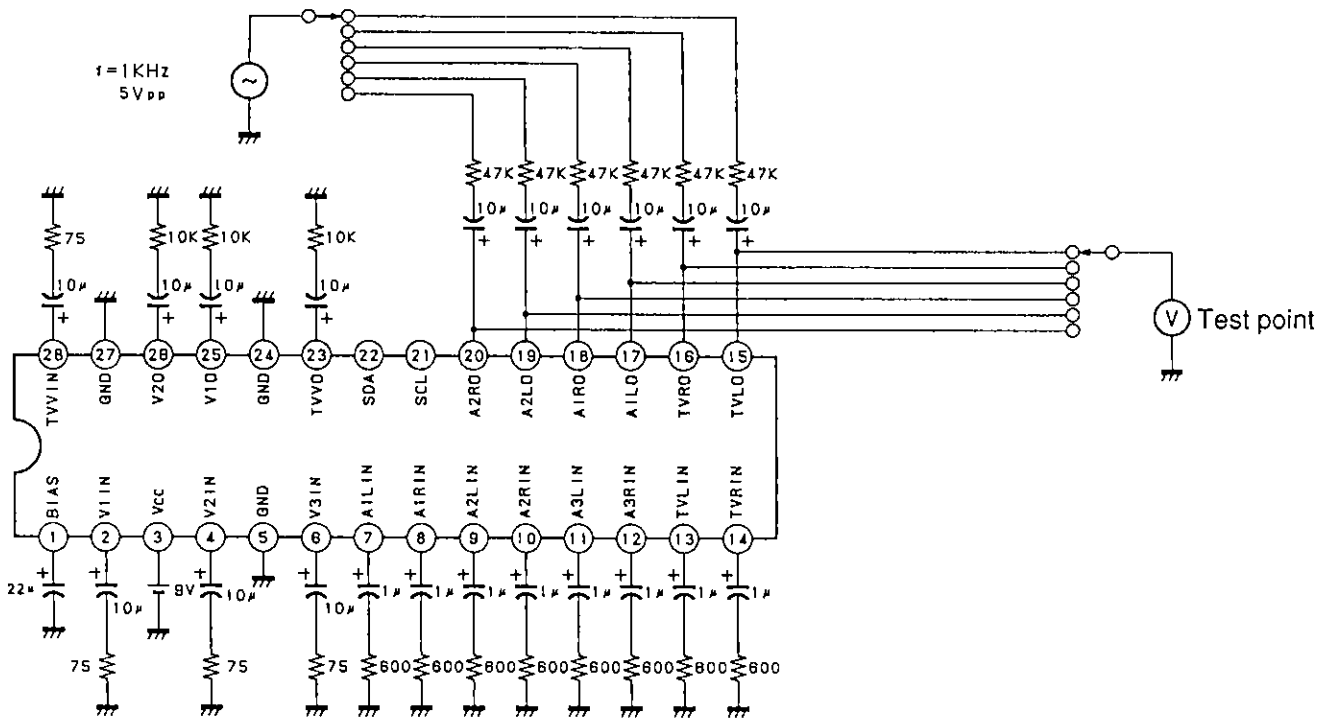

Fig. 4

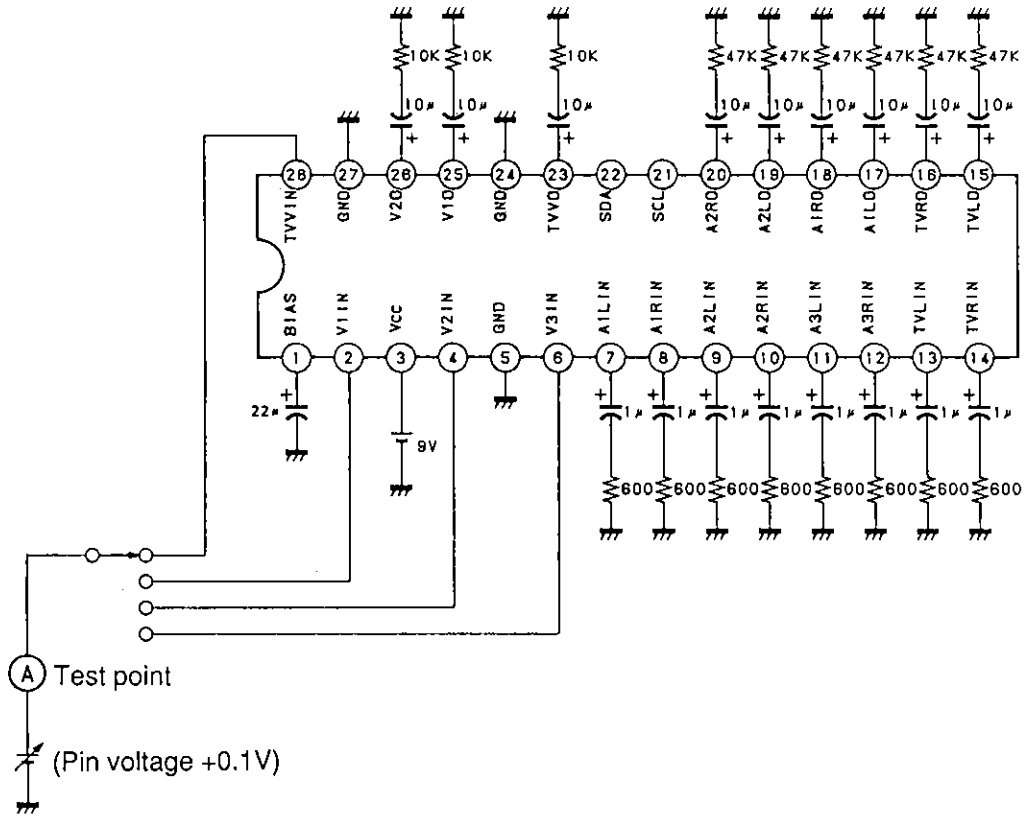

Fig. 5

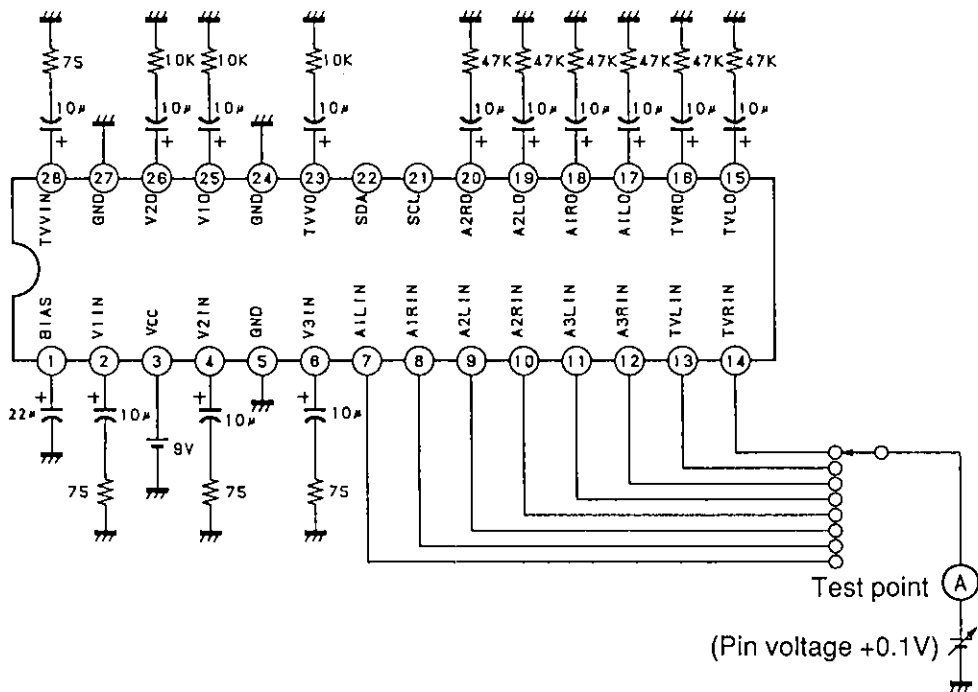

Fig. 6

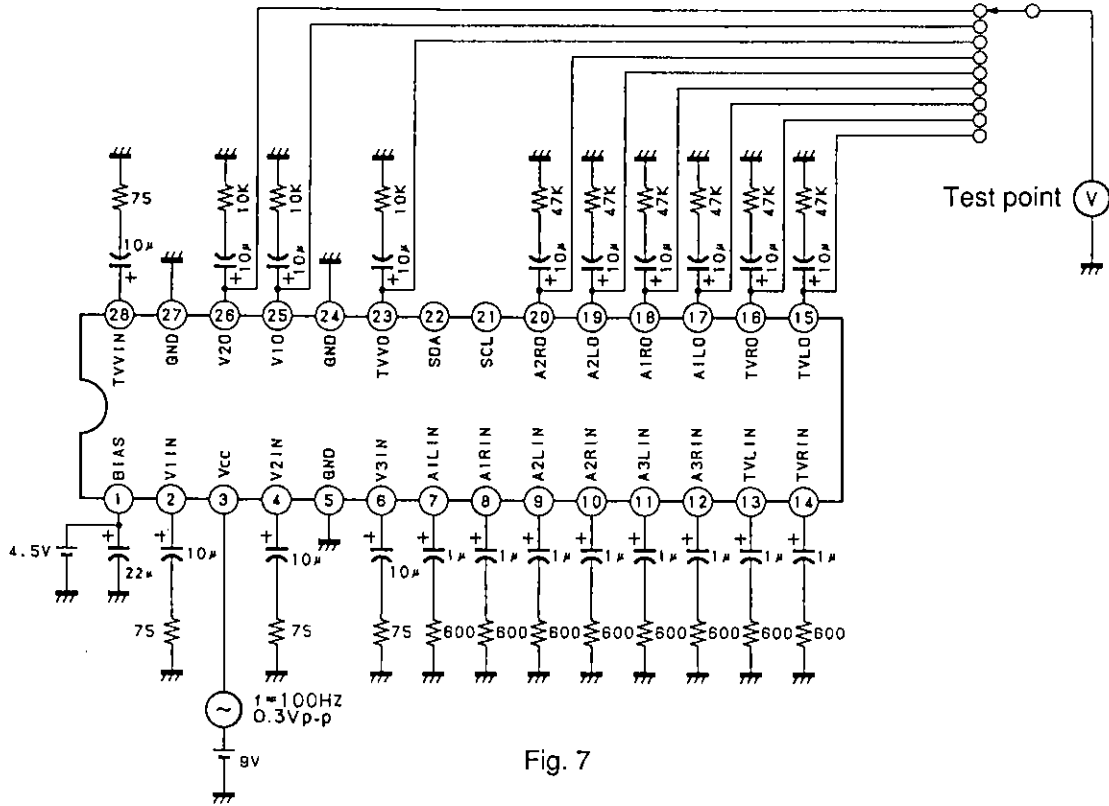

Fig. 7

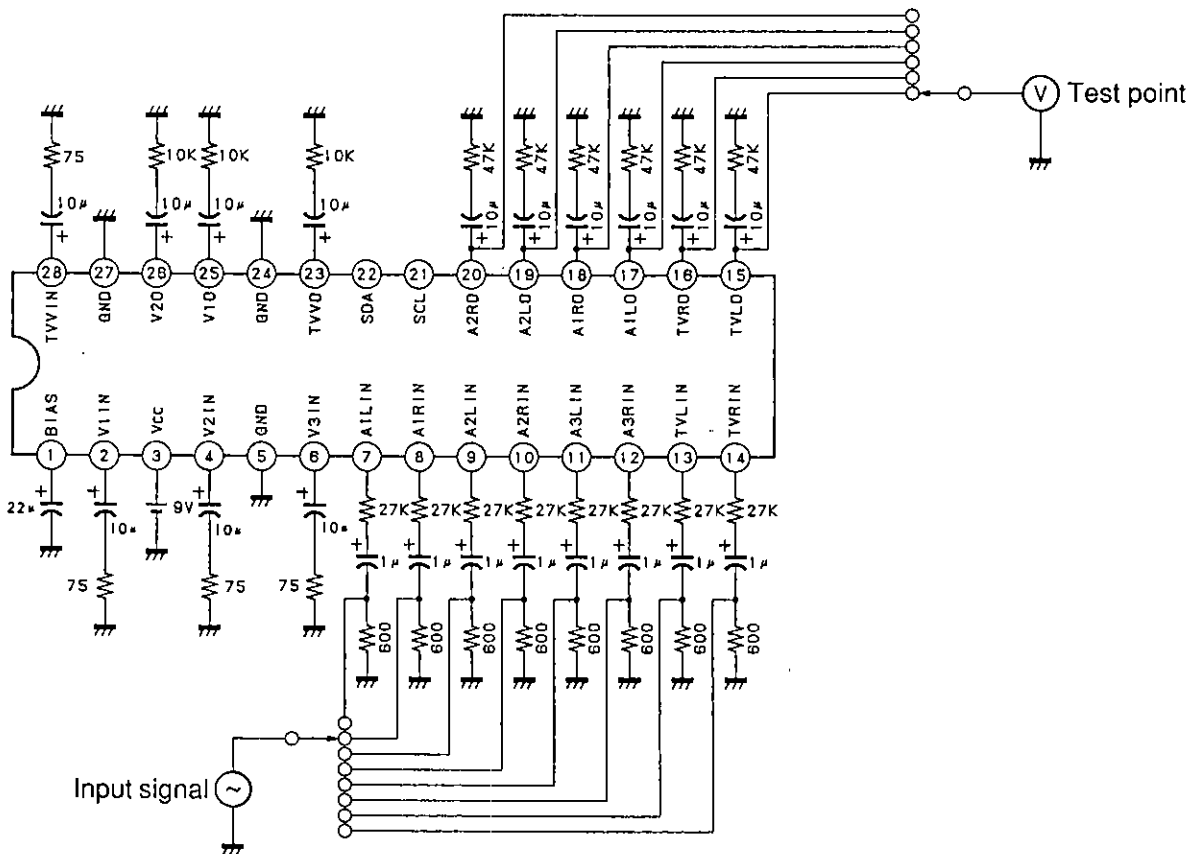

Fig. 8

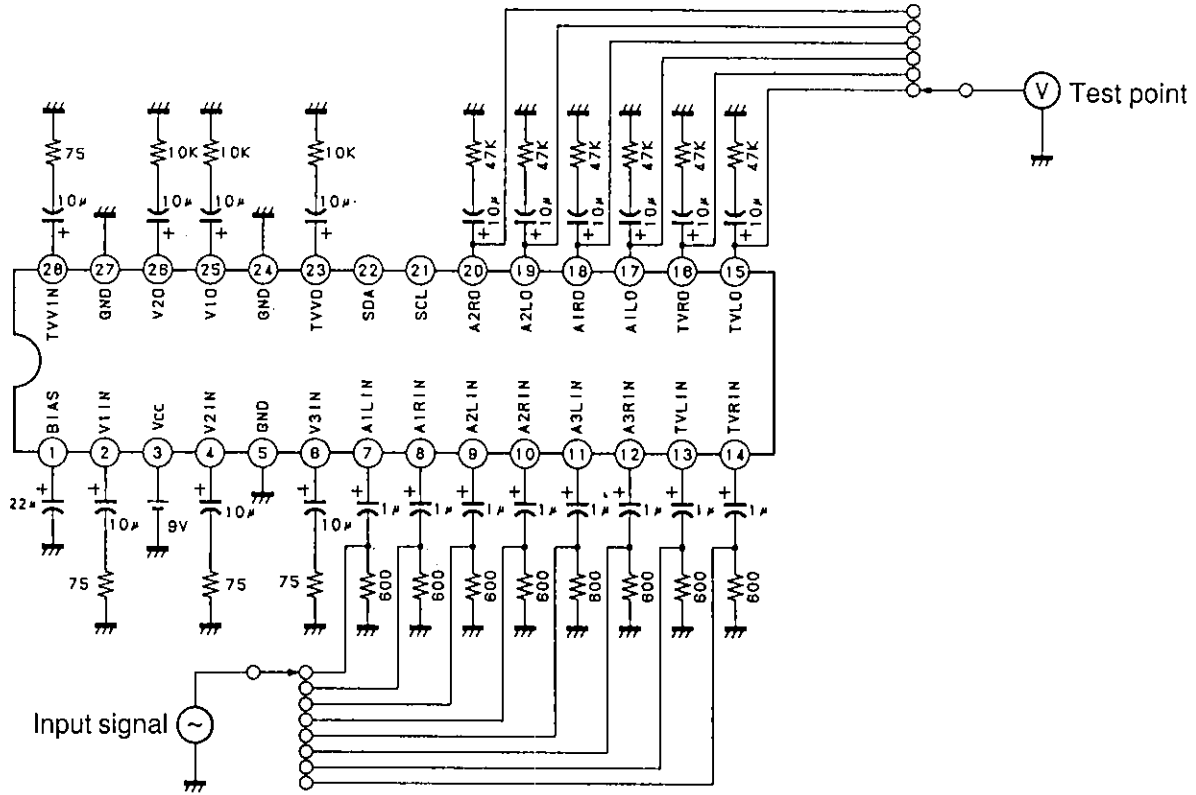

Fig. 9

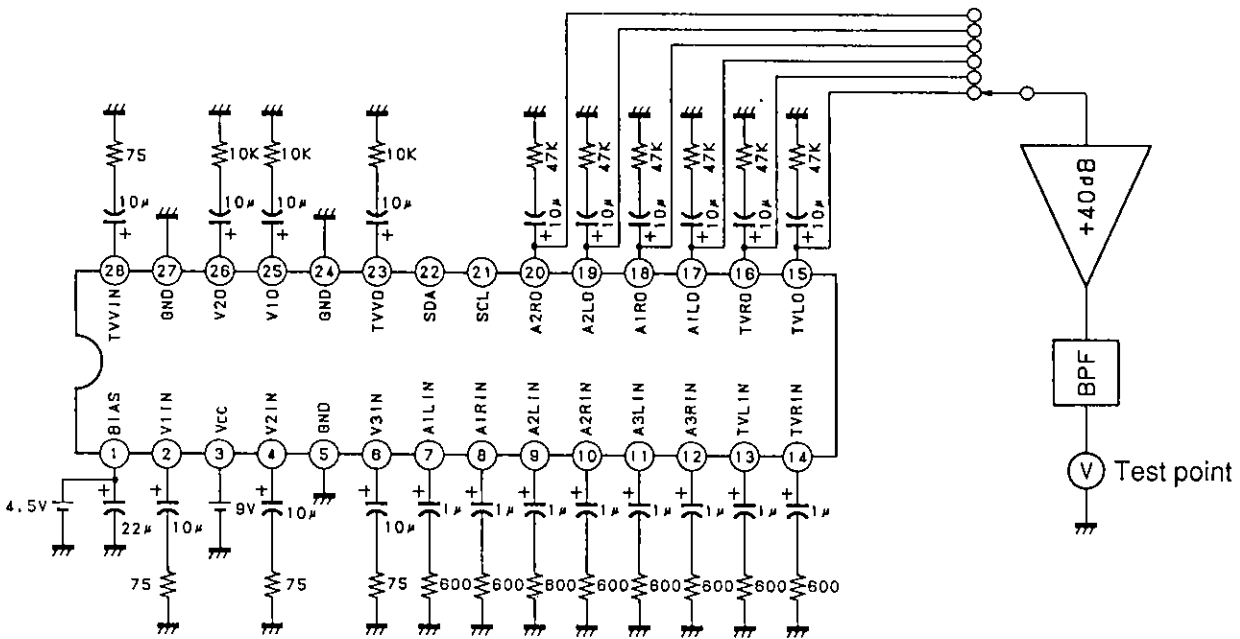

Fig. 10

I²C BUS Control signal

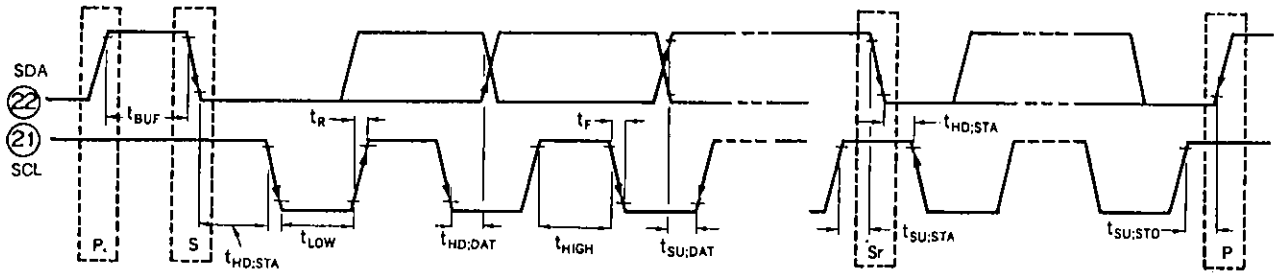

Fig. 11

Operation

The CXA1114 and CXA1434 are used for audio and video selection. These IC's feature 4 channels for video input, 4 for audio stereo input, 3 channels for video output and 3 for audio stereo output. Respective outputs have built-in amplifiers of approx. 6dB.

The respective audio and video outputs (L and R channels make a set) can independently select the desired input. This is executed through I²C bus.

1) I²C Bus

The I²C bus (Inter IC bus) is a bus system inside the equipment developed by Philips. Start, Stop, Data transfer, Sync and Collision prevention can be executed through two lines, SDA and SCL. The output of respective ICs is either an open collector or an open drain shaped into a wired OR to form the bus line. The bus signal structure is shown below.

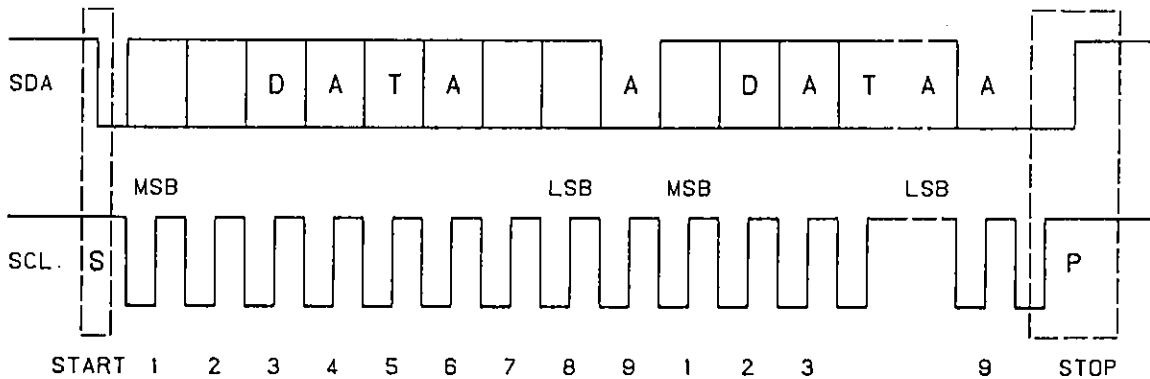

S:Start Condition...High to Low transition of SDA when SCL is at High.
 P:Stop Condition...Low to High transition of SDA when SCL is at High.
 A:Acknowledge...Reply signal coming from slave.

Data is transferred by MSB first. 8 bits in one unit. After that acknowledge (A) is set on to confirm the signal from slave. Normally slave *1 ICs take in data with the rising edge of SCL while Master *2 ICs change data with the falling edge of SCL. The actual data format of CXA1114 and CXA1434 is shown below.

S	Slave address 90H/96H	A	DATA0	A	DATA1	A	DATA2	A	P
---	--------------------------	---	-------	---	-------	---	-------	---	---

Slave address is proper to the IC and is assigned to each IC according to its functions. From the 8 bits the upper 7 bits are proper addresses while the last bit is allocated to R/W. This R/W bit turns to Read *3 at 1 and Write *4 at 0. For the CXA1114/CXA1434, 90H and 96H are assigned as slave addresses. (Write only as there is no Read mode.)

- *1 Slave: ICs controlled by the Master. Normally all ICs except microcomputers are slaves.
- *2 Master: Indicates ICs that control, such as microcomputers and the like.
- *3 Read: Mode in which Master reads out data from Slave.
- *4 Write: Mode in which data is written out from Master to Slave.

2) Control

The CXA1114/CXA1434 control is performed by writing 3 bytes of data into 3 control registers composed of 8 bits (actually 6 bits since 2 bits are empty) that control the output selection of 3 systems. First byte data performs the input selection of TV OUT, second byte data that of VIDEO1 OUT and third byte data that of VIDEO 2OUT, respectively. Slave address for CXA1114/CXA1434 is 90H/96H in write mode only.

S	Slave address 90H/96H	A	DATA0	A	DATA1	A	DATA2	A	P
---	--------------------------	---	-------	---	-------	---	-------	---	---

- S: Start condition
- A: Acknowledge emitted by slave (CXA1114/CXA1434)
- P: Stop condition

Structure of Respective Control Registers (DATA 0 to 2)

b7	b6	b5	b4	b3	b2	b1	b0
x	VM	VS1	VS0	x	AM	AS1	AS0

- * b7, b3 undefined
- * At Power On all bits turn to "0".
(Power On Reset function)

Video switch control

VM	VS1	VS0	Output pin
0	x	x	Mute (blanking)
1	0	0	TV VIDEO IN
1	0	1	VIDEO 1 IN
1	1	0	VIDEO2 IN
1	1	1	VIDEO3 IN

Audio switch control

AM	AS1	AS0	Output pin
0	x	x	Mute
1	0	0	TV AUDIO IN
1	0	1	AUDIO1 IN
1	1	0	AUDIO2 IN
1	1	1	AUDIO3 IN

3) Control Data Example

Input selection		Video input	Audio input
Output pin			
TV·Video TV sound	} output	Video 1	TV sound
Video 1 Video 1 sound			
Video 2 Video 2 sound	} output	Video 3	Video 2 sound
Video 1 Video 1 sound			

To select the above the control codes to be used are

TV·Video TV sound	} output	101	100	} control code
Video 1 Video 1 sound				
Video 2 Video 2 sound	} output	111	110	
Video 1 Video 1 sound				

For the I²C bus, after the slave address 90H/96H for CXA1114/ CXA1434, the 3 bytes data transfer is performed:
(x bit is not defined. Either 1 or 0 will do.)

$\underbrace{\quad \times 101 \times 100 \quad}_{\text{first byte}}$
 $\underbrace{\quad \times 110 \times 101 \quad}_{\text{second byte}}$
 $\underbrace{\quad \times 111 \times 110 \quad}_{\text{third byte}}$

That is for CXA1114 90H, 54H, 65H, 76H (When x=0)
 90H, DCH, EDH, FEH (When x=1)
 or for CXA1434 96H, 54H, 65H, 76H (When x=0)
 96H, DCH, EDH, FEH (When x=1)
 either can be transferred.

Application Circuit

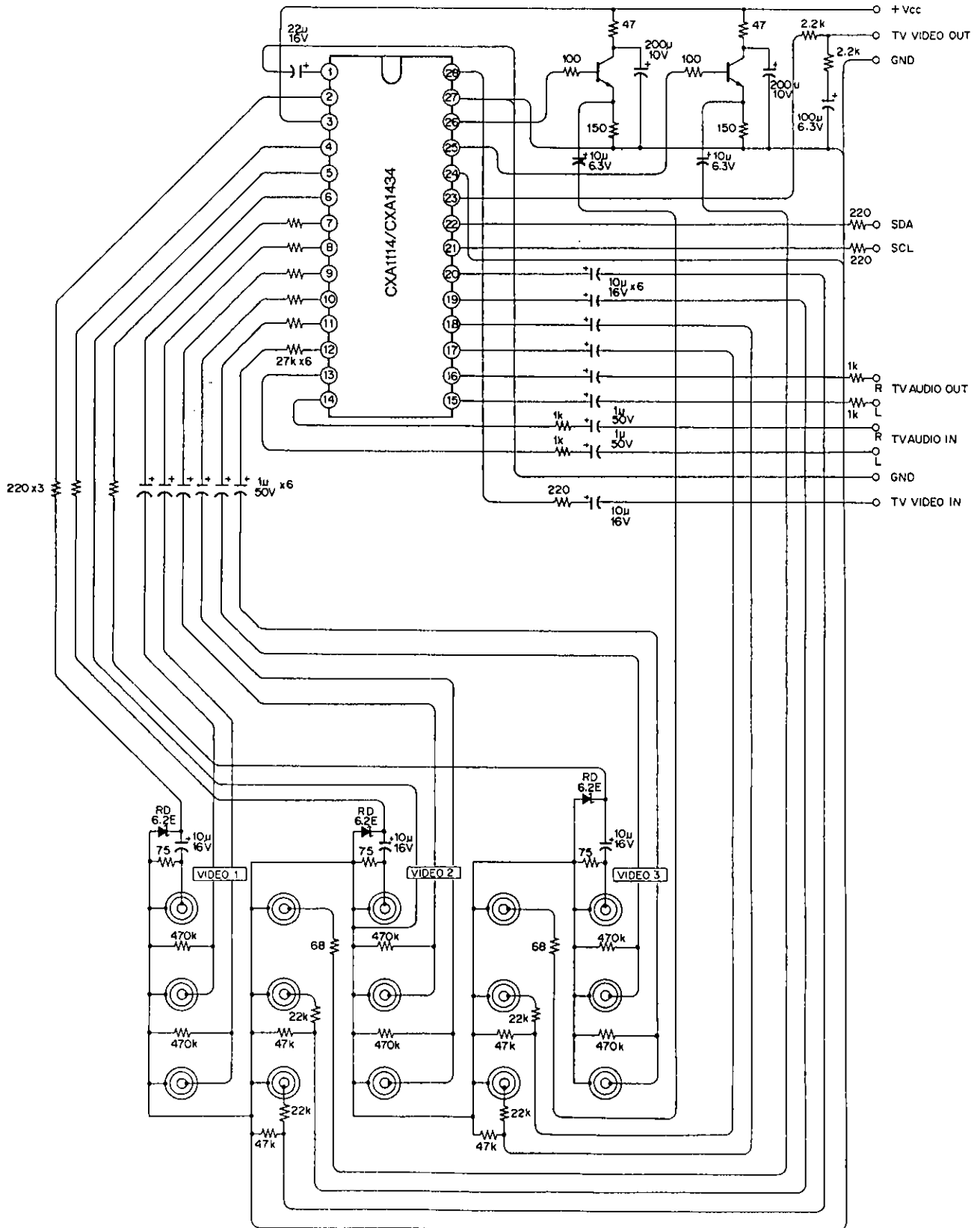

Notes on Operations

As these ICs utilize video, audio and digital signals, the following points should be taken into consideration.

- 1) On both video and audio systems, the wiring may cause crosstalk. An effective measure would be to separate input by using an earth line on the P.C.B.
- 2) When control is performed through I²C bus, once it is set on, as long as there is no change in the data (with Power OFF, it is called off however), the condition at which it is set, is kept on. To avoid noise caused by SCL, SDA clocks and data transfer, it is recommended to temporarily stop the master, except during input selection.
- 3) Pin 1 provides bias. By installing a capacitor here and effective suppression of power supply ripple is obtained.

Here the cut off frequency obtained is $f_0 = \frac{1000}{2\pi \times 11 \times C (\mu\text{F})} [\text{Hz}]$

- 4) Keep the bypass capacitor for the power supply near Pin 3.

Characteristics Diagram

Video amplifier gain vs. Frequency

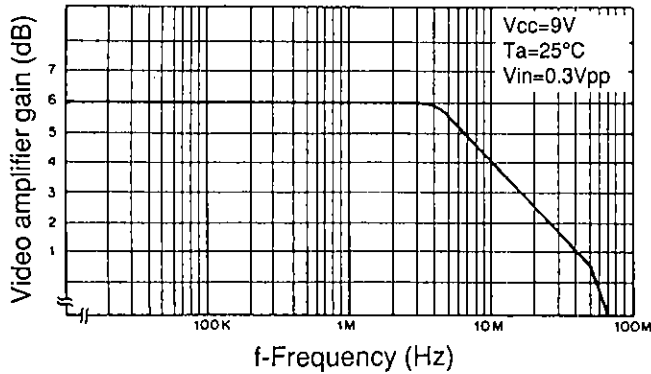

Audio amplifier gain vs. Frequency

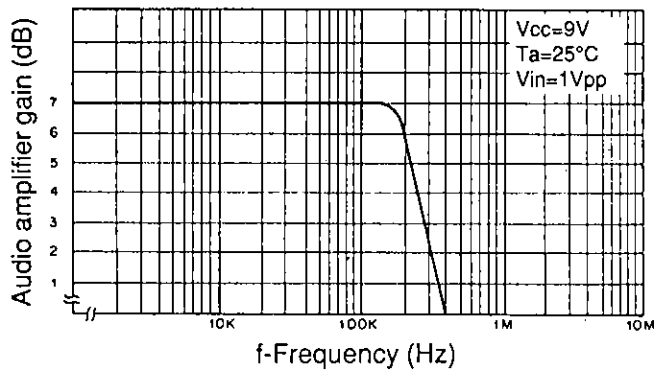

Video amplifier output vs. Rectangular wave input

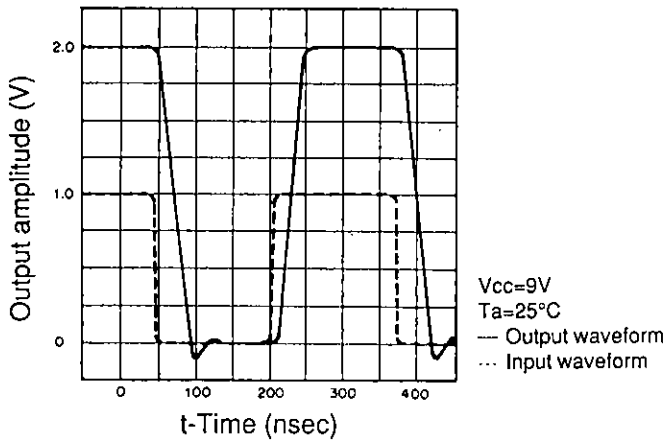

Audio amplifier output vs. Rectangular wave input

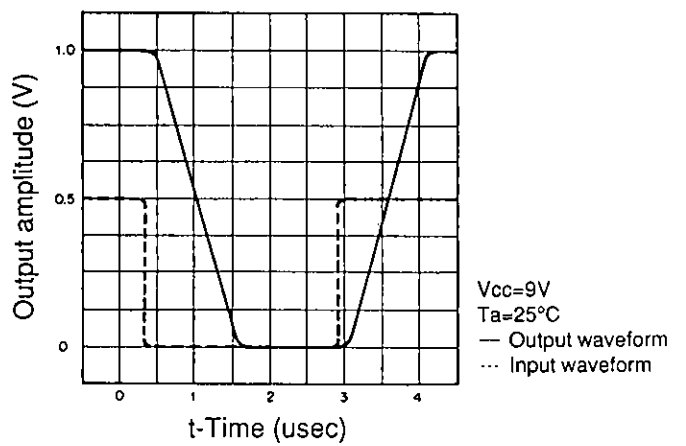

Audio amplifier distortion vs. Input amplitude

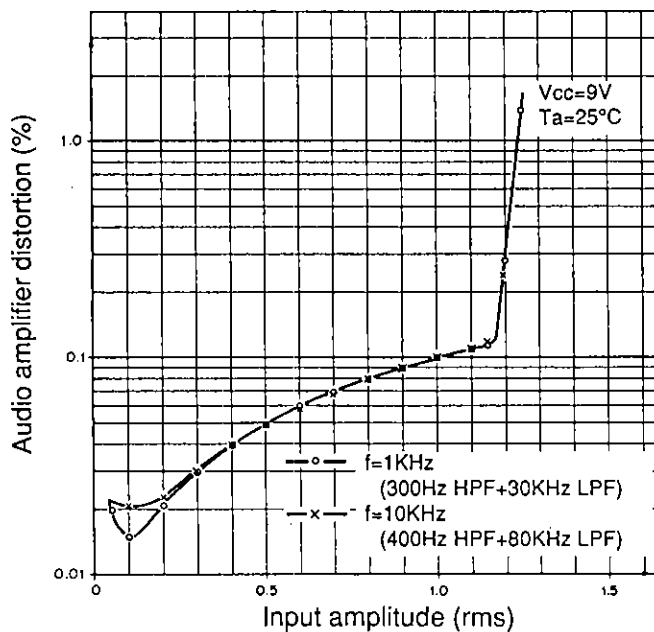

Package Outline Unit: mm

CXA1114P
CXA1434P

28pin DIP (Plastic) 600mil 4.2g

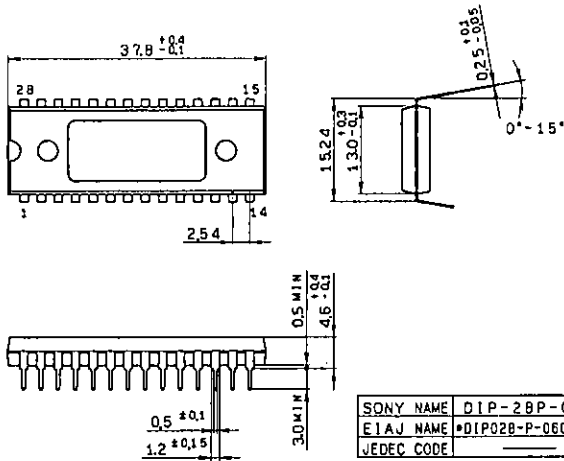

28pin DIP (Plastic) 600mil 4.0g

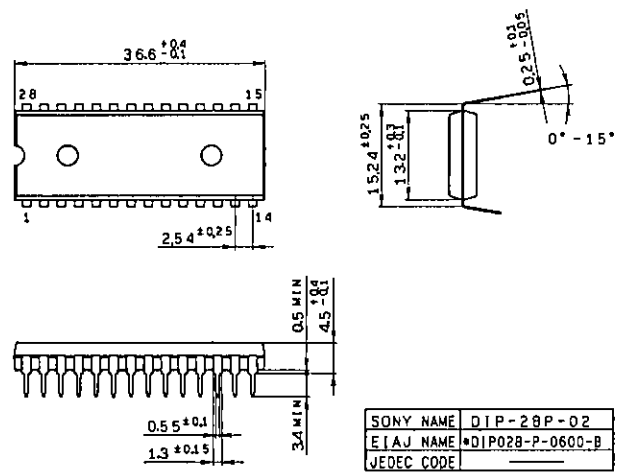

CXA1114M

28pin SOP (Plastic) 375mil 0.7g

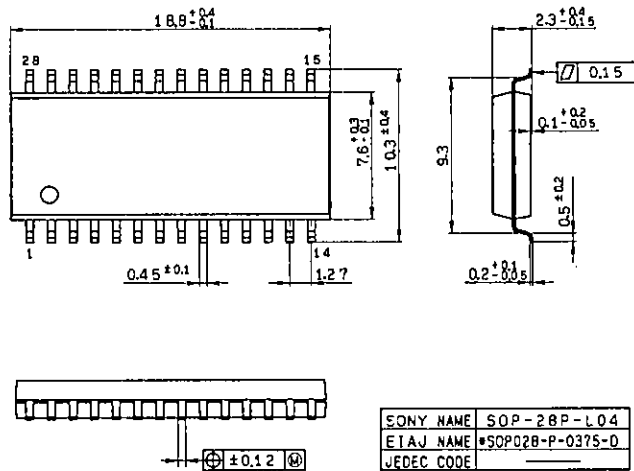

Purchase of Sony's I²C components conveys a license under the Philips I²C Patent Rights to use these components in an I²C system, provided that the system conforms to the I²C Standard Specifications as defined by Philips.