

OPTOELECTRONICS

OPTOELECTRONICS

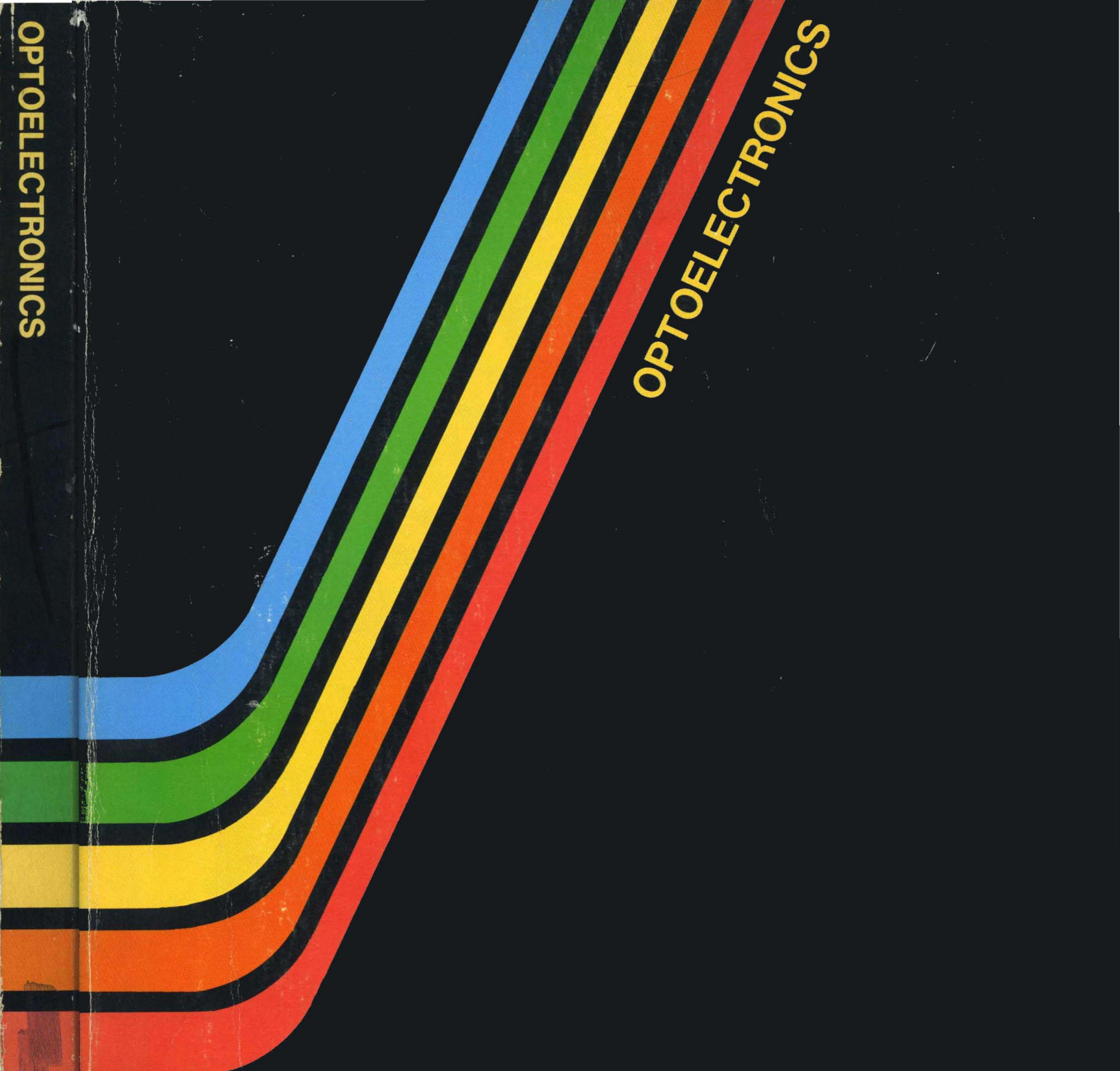

3rd.
Edition



Electronics Data Library - Semiconductors

The **GENERAL ELECTRIC**

electronic data library

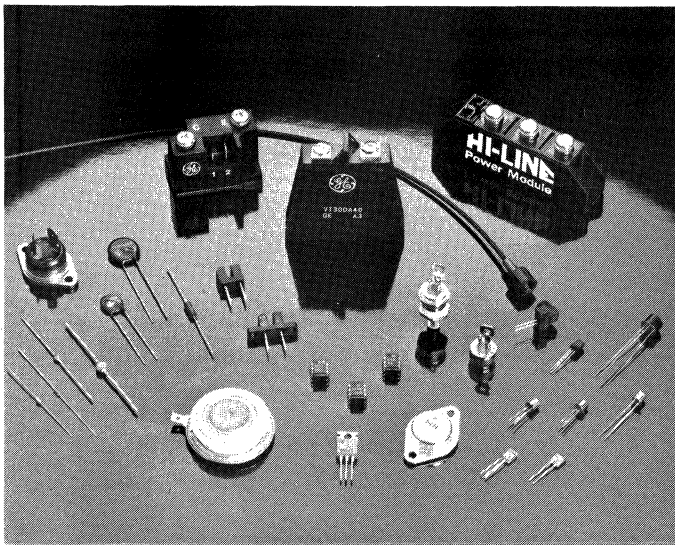

Keep knowledge of semiconductor technology at your fingertips with GE's new comprehensive series of technical manuals, the **General Electric Electronic Data Library**.

The Library is a virtual storehouse of application, technical, and device selection information on transient voltage suppressors, optoelectronics, signal and power transistors, triacs, unijunctions, diodes, rectifiers, SCR's and power modules.

Start selecting products from one of the most complete collections of semiconductor manuals in the electronics industry today, the **GE Electronic Data Library**. It's like having a GE engineer on your library shelf.

Manual	Publication Number	Price
Transient Voltage Suppression	400.3	\$5.00
Optoelectronics	400.4	5.00
Thyristors—Rectifiers	400.5	5.00
Transistors—Diodes	400.6	5.00

Manuals are available from your local GE Electronic Components Sales office, authorized GE Electronic Distributors, or by writing to:

General Electric Company
Power Electronics Semiconductor Department
West Genesee Street, Mail Drop 44
Auburn, New York 13021

Europe

International General Electric Company
of New York
The Demesne
Dundalk, County Louth
Ireland

Far East

Electronic Components of General
Electric (USA) Pte. Ltd.
201-B Boon Keng Road
Singapore 1233

Refer to the inside back cover for a complete listing of General Electric's worldwide Electronic Components Sales offices.

OPTOELECTRONICS

Third Edition

Power Electronics Semiconductor Department
General Electric Company
Auburn, NY 13021

GENERAL  ELECTRIC

Optoelectronics manual, Third Edition:

Editors

William H. Sahm III
Marvin W. Smith

Contributing Authors

Denis R. Grafham
William H. Sahm III

The Power Electronics Semiconductor Department of General Electric Company acknowledges the efforts of all the contributing authors and editors of the prior editions of the General Electric **Optoelectronics manual**.

The circuit diagrams included in this manual are intended merely for illustration of typical semiconductor applications and are not intended as constructional information. Although reasonable care has been taken in their preparation to assure their technical correctness, in the absence of an express written agreement to the contrary, no responsibility is assumed by the General Electric Company for any consequences of their use.

The semiconductor products, circuits, and arrangements disclosed herein may be covered by patents of General Electric Company or others. Neither the disclosure of any information herein nor the sale of semiconductor products by General Electric Company conveys any license under patent claims covering combinations of semiconductor products with other products or elements. In the absence of an express written agreement to the contrary, General Electric Company assumes no liability for patent infringement arising out of any use of semiconductor products with other products or elements by any purchaser of semiconductor products, or by others.

*3rd Edition
Copyright© 1984
by the
General Electric Company, U.S.A.
Power Electronics Semiconductor Department
Auburn, New York 13021*

INTRODUCTION

Optoelectronics, based on semiconductor mass production technology, is strongly influencing the design of electronic control circuitry. Optoelectronic components sense the presence and intensity of light, the position of objects which break or reflect a light beam, and transmit electronic signals without electrical connections. This provides high speed and high reliability at low cost for a variety of useful functions, from automatic light level control in copy machines, or sensing the right instant to fire an automobile's spark plug, to allowing delicate computer circuitry to control high power machine tools by interfacing logic signals to the power line circuitry without allowing line voltages and noise to interfere with the logic.

General Electric, a leader in both optoelectronics and semiconductor technology, has contributed significantly to optoelectronics starting from the invention of the light emitting diode and the first commercially successful light activated silicon controlled rectifier. Today General Electric can offer the broadest line of optoelectronic circuit components in the industry. This manual is written to provide the circuit designer with a knowledge of the operation, interfacing, and detailed application of these components so he may successfully design practical, cost effective, and reliable circuitry. It also provides the specification sheets, selection guides and cross-reference information needed to choose the optimum device for a specific task.

This manual contains separate chapters on application information. The applications chapters discuss basic devices and their operation, and circuit and system design interfacing the devices. Reliability and life considerations are covered and the discussion is completed with circuit designs grouped by function. In addition to the table of contents and organization of material, a comprehensive index to the application information and a glossary of terms allows "instant recall" of information as required. Since not all questions can be answered in the space provided, a list of further reference material is included.

TABLE OF CONTENTS

GUIDE TO SPECIFICATIONS	8
1. OPTOELECTRONIC THEORY	
1.1 Devices	
1.1.1 Light Sources	13
1.1.2 Light Detectors	15
1.2 Components	
1.2.1 Detectors and Emitters	22
1.2.2 Fiber Optics	23
1.2.3 Interrupter/Reflector Modules	24
1.2.4 Optocouplers	25
2. SYSTEMS DESIGN CONSIDERATIONS	
2.1 Emitter and Detector Systems	
2.1.1 Light Irradiance and Effectiveness	29
2.1.2 Lenses and Reflectors	35
2.1.3 Ambient Light	37
2.1.4 Pulsed Systems	37
2.1.5 Precision Position Sensing	38
2.2 Optocoupler Systems	
2.2.1 Isolation	43
2.2.2 Input, Output, and Transfer Characteristics	47
3. RELIABILITY OF OPTOELECTRONIC COMPONENTS	
3.1 Quality and Reliability Costs	75
3.2 Summary of Test Results	77
3.3 Reliability Prediction of Circuits Containing IRED's	81
3.4 Reliability Prediction in Application	88
3.5 Reliability Enhancement of Optoisolators	90
3.5.1. Data Summary	95
4. MEASUREMENT OF OPTOELECTRONIC DEVICE PARAMETERS	
4.1 IRED Parameters	97
4.2 Photodetector Parameters	98
4.3 Optocoupler Measurements	99
5. SAFETY	
5.1 Reliability and Safety	103
5.2 Safety Standards Recognition	103
5.3 Possible Hazards	104

6. OPTOELECTRONIC CIRCUITS	
6.1 Light Detecting Circuits	105
6.2 Detecting Objects With Light	111
6.3 Transmitting Information With Light	
6.3.1 Analog Information	116
6.3.2 Digital Information	122
6.3.3 Telecommunications Circuits	124
6.4 Optoisolator Switching Circuits	129
6.5 Power Control Circuits	
6.5.1 AC Solid State Relays	131
6.5.2 DC Solid State Relays	146
6.5.3 Other Power Control Circuits	148
7. GLOSSARY OF SYMBOLS AND TERMS	155
8. BIBLIOGRAPHY AND REFERENCES	163
9. OPTOELECTRONIC SPECIFICATIONS	
Emitter Specifications	164
Detector Specifications	180
Fiber Optics Specifications	194
Optoisolator Specifications	200
Module Specifications	278
European "Pro Electron" Registered Types	310
Generic Optoisolator Specifications	350
Cross Reference of Competitive Types	374
INDEX	381

OPTOELECTRONICS SPECIFICATIONS

GUIDE TO SPECIFICATIONS

INFRARED EMITTERS



GE TYPE	PAGE NO.	MIN. P _D @ I _F = 100mA	MAX. V _F @ I _F = 100mA	PEAK EMISSION WAVELENGTH TYP. n METERS	RISE TIME TYP. μSEC	FALL TIME TYP. μSEC	MAX. P _D mW	MAX. I _F CONT. mA	PKG
1N6264	164	6.0mW	1.7V	940	1.0	1.0	1300	100	54A
1N6265	164	6.0mW	1.7V	940	1.0	1.0	1300	100	54
1N6266	166	25mW/sr	1.7V	940	1.0	1.0	1300	100	54A
CQX14	314	5.4mW	1.7V	940	1.0	1.0	1300	100	54A
CQX15	314	5.4mW	1.7V	940	1.0	1.0	1300	100	54
CQX16	314	1.5mW	1.7V	940	1.0	1.0	1300	100	54A
CQX17	314	1.5mW	1.7V	940	1.0	1.0	1300	100	54
F5D1	170	12mW	1.7V	880	1.5	1.5	1300	100	54A
F5D2	170	9mW	1.7V	880	1.5	1.5	1300	100	54A
F5D3	170	10.5mW	1.7V	880	1.5	1.5	1300	100	54A
F5E1	170	12mW	1.7V	880	1.5	1.5	1300	100	54
F5E2	170	9mW	1.7V	880	1.5	1.5	1300	100	54
F5E3	170	10.5mW	1.7V	880	1.5	1.5	1300	100	54
F5F1	174	.28mW/sr	1.7V	940	1.0	1.0	100	60	56
F5G1	176	.6mW/sr	1.85V	880	1.5	1.5	100	50	56
LED55C	178	5.4mW	1.7V	940	1.0	1.0	1300	100	54A
LED55B	178	3.5mW	1.7V	940	1.0	1.0	1300	100	54A
LED56	178	1.5mW	1.7V	940	1.0	1.0	1300	100	54A
LED55CF	178	5.4mW	1.7V	940	1.0	1.0	1300	100	54
LED55BF	178	3.5mW	1.7V	940	1.0	1.0	1300	100	54
LED56F	178	1.5mW	1.7V	940	1.0	1.0	1300	100	54

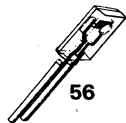

DETECTORS

PHOTO TRANSISTORS



GE TYPE	PAGE NO.	SENSITIVITY (ma/mw/cm ²)		BV _{CEO} (V)	BV _{CBO} (V)	I _D (nA) MAX.	SWITCHING TYP.		TYP. V _{CE} (SAT)	PKG
		MIN.	MAX.				t _r (μSEC)	t _f (μSEC)		
BPW36	310	.6	—	45	45	100	5	5	.4	55
BPW37	310	.3	—	45	45	100	5	5	.4	55
L14C1	180	.1	—	50	50	100	5	5	.2	57
L14C2	180	.05	—	50	50	100	5	5	.2	57
L14G1	184	.6	—	45	45	100	5	5	.4	55
L14G2	184	.3	—	45	45	100	5	5	.4	55
L14G3	184	1.2	—	45	45	100	5	5	.4	55
L14N1	186	.6	—	30	40	100	10	14	.4	57
L14N2	186	1.2	—	30	40	100	12	16	.4	57
L14P1	188	4.0	—	30	40	100	10	14	.4	55
L14P2	188	8.0	—	30	40	100	12	16	.4	55
L14Q1	190	.2	—	30	—	100	8t _{on}	50t _{off}	.4	56



PHOTO DARLINGTONS

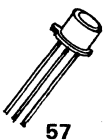

GE TYPE	PAGE NO.	SENSITIVITY (ma/mw/cm ²)		BV _{CEO} (V)	BV _{CBO} (V)	I _D (nA) MAX.	SWITCHING TYP.		TYP. V _{CE} (SAT)	PKG
		MIN.	MAX.				t _r (μSEC)	t _f (μSEC)		
BPW38	312	15.0	—	25	25	100	75	50	.8	55
L14F1	182	15.0	—	25	25	100	75	50	.8	55
L14F2	182	5.0	—	25	25	100	75	50	.8	55
L14R1	192	5.0	—	30	—	100	45t _{on}	250t _{off}	.9	56

PHOTON COUPLED INTERRUPTER MODULE

PHOTO TRANSISTOR OUTPUT

GE TYPE	PAGE NO.	OUTPUT CURRENT		I _{CEO} (nA)	BV _{CEO} (V)	TYPICAL		V _{CE(SAT)} MAX.	PKG
						TON (μSEC)	t _f (μSEC)		
H21A1	278	I _F =20mA	1.0mA	100	30	8	50	.4	319
H21A2	278	I _F =20mA	2.0mA	100	30	8	50	.4	319
H21A3	278	I _F =20mA	4.0mA	100	30	8	50	.4	319
H21A4	280	I _F =20mA	1.0mA	100	55	8	50	.4	319
H21A5	280	I _F =20mA	2.0mA	100	55	8	50	.4	319
H21A6	280	I _F =20mA	4.0mA	100	55	8	50	.4	319
H22A1	288	I _F =20mA	1.0mA	100	30	8	50	.4	320
H22A2	288	I _F =20mA	2.0mA	100	30	8	50	.4	320
H22A3	288	I _F =20mA	4.0mA	100	30	8	50	.4	320
H22A4	290	I _F =20mA	1.0mA	100	55	8	50	.4	320
H22A5	290	I _F =20mA	2.0mA	100	55	8	50	.4	320
H22A6	290	I _F =20mA	4.0mA	100	55	8	50	.4	320
CNY28	322	I _F =20mA	200μA	100	30	5	5	.4	319
CNY36	340	I _F =20mA	200μA	100	30	5	5	.4	320

319



PHOTO DARLINGTON OUTPUT

H21B1	282	I _F =10mA	7.5mA	100	30	45	250	1.0	319
H21B2	282	I _F =10mA	14mA	100	30	45	250	1.0	319
H21B3	282	I _F =10mA	25mA	100	30	45	250	1.0	319
H21B4	284	I _F =10mA	7.5mA	100	55	45	250	1.0	319
H21B5	284	I _F =10mA	14mA	100	55	45	250	1.0	319
H21B6	284	I _F =10mA	25mA	100	55	45	250	1.0	319
H22B1	292	I _F =10mA	7.5mA	100	30	45	250	1.0	320
H22B2	292	I _F =10mA	14mA	100	30	45	250	1.0	320
H22B3	292	I _F =10mA	25mA	100	30	45	250	1.0	320
H22B4	294	I _F =10mA	7.5mA	100	55	45	250	1.0	320
H22B5	294	I _F =10mA	14mA	100	55	45	250	1.0	320
H22B6	294	I _F =10mA	25mA	100	55	45	250	1.0	320
CNY29	324	I _F =20mA	2.5mA	100	25	150	150	1.2	319

320



SCHMITT TRIGGER OUTPUT

GE TYPE	PAGE NO.	TURN ON CURRENT I _{F(ON)} MAX.	HYSTERESIS I _{OFF} /I _(ON) RATIO		OUTPUT VOLTAGE VOL MAX.	OPERATING VOLTAGE		PKG
			MIN.	MAX.		MIN.	MAX.	
H21L1	286	30mA	.5	.9	.4V	4V	15V	319
H21L2	286	15mA	.5	.9	.4V	4V	15V	319
H22L1	296	30mA	.5	.9	.4V	4V	15V	320
H22L2	296	15mA	.5	.9	.4V	4V	15V	320

MATCHED EMITTER DETECTOR PAIRS

PHOTO TRANSISTOR OUTPUT

H23A1	298	I _F =30mA	1.5mA	100	30	8	50	.4	321
H23A2	298	I _F =30mA	1.0mA	100	30	8	50	.4	321

PHOTO DARLINGTON OUTPUT

H23B1	300	I _F =10mA	7.5mA	100	30	45	250	1.0	321
-------	-----	----------------------	-------	-----	----	----	-----	-----	-----

SCHMITT TRIGGER OUTPUT

GE TYPE	PAGE NO.	TURN ON CURRENT I _{F(ON)} MAX.	HYSTERESIS I _{OFF} /I _(ON) RATIO		OUTPUT VOLTAGE VOL MAX.	OPERATING VOLTAGE		PKG
			MIN.	MAX.		MIN.	MAX.	
H23L1	302	20mA	.5	.9	.4V	4V	15V	321

321

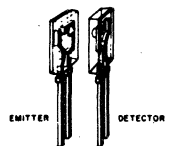

FIBER OPTIC DEVICES

PHOTO TRANSISTORS

DETECTORS

GE TYPE	PAGE NO.	RESPONSIBILITY $\mu A/\mu W$	BV_{CEO} (V)	I_{CEO} (nA)	PKG
GFOD1A1	194	70	30	100	322
GFOD1A2	194	30	30	100	

PHOTO DARLINGTONS

GFOD1B1	196	1000	30	100	322
GFOD1B2	196	500	30	100	

EMITTERS

GE TYPE	PAGE NO.	FIBER POWER OUTPUT μW	V	V_f @ $I_f = 50mA$	PEAK EMISSION WAVELENGTH nm	PKG
GF0E1A1	198	100	6	1.7V	940	322
GF0E1A2	198	60	6	1.7V	940	

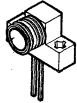

322

OPTO COUPLERS

PHOTO TRANSISTOR OUTPUT

GE TYPE	PAGE NO.	ISOLATION VOLTAGE (V_{pk}) MIN.	CURRENT TRANSFER RATIO MIN.	I_{CEO} (nA) MAX.	BV_{CEO} (VOLTS) MIN.	TYPICAL (μ SEC)		$V_{CE(SAT)}$ MAX.	PKG	
						t_r	t_f			
CNY17	I	318	5000	40-80%	50	70	2	2	.3	296
CNY17	II	318	5000	63-125%	50	70	2	2	.3	296
CNY17	III	318	5000	100-200%	50	70	2	2	.3	296
CNY17	IV	318	5000	160-320%	50	70	2	2	.3	296
CNY32		332	4000V _{RMS}	20%	100	30	3	3	.4	297
CNY47		342	2800	20-60%	100	30	2	2	.4	296
CNY47A		342	2800	40%	100	30	2	2	.4	296
CNY51		346	5656	100%	50	70	2	2	.4	296
GEPS2001		354	2500	30%	100	30	5	5	.3	296
GFH600	I	356	2800V _{RMS}	63-125%	50	70	5	5	.3	296
GFH600	II	356	2800V _{RMS}	100-200%	50	70	5	5	.3	296
GFH600	III	356	2800V _{RMS}	160-320%	50	70	5	5	.3	296
GFH601	I	360	5300	40-80%	50	70	5	5	.4	296
GFH601	II	360	5300	63-125%	50	70	5	5	.4	296
GFH601	III	360	5300	100-200%	50	70	5	5	.4	296
GFH601	IV	360	5300	160-320%	50	70	5	5	.4	296
H11A1		214	2500	50%	50	30	2	2	.4	296
H11A2		214	1500	20%	50	30	2	2	.4	296
H11A3		216	2500	20%	50	30	2	2	.4	296
H11A4		216	1500	10%	50	30	2	2	.4	296
H11A5		218	1500	30%	100	30	2	2	.4	296
H11A520		224	5656	20%	50	30	2	2	.4	296
H11A550		224	5656	50%	50	30	2	2	.4	296
H11A5100		224	5656	100%	50	30	2	2	.4	296
H11AG1		234	4000V _{RMS}	300%	50	30	5	5	.4	296
H11AG2		234	4000V _{RMS}	200%	50	30	5	5	.4	296
H11AG3		234	2500V _{RMS}	100%	50	30	5	5	.4	296
H11AV1		238	4000V _{RMS}	100%	50	70	5	5	.4	296
H11AV1A		238	4000V _{RMS}	100%	50	70	5	5	.4	295
H11AV2		238	4000V _{RMS}	50%	50	70	5	5	.4	296
H11AV2A		238	4000V _{RMS}	50%	50	70	5	5	.4	295
H11AV3		238	4000V _{RMS}	20%	50	70	5	5	.4	296
H11AV3A		238	4000V _{RMS}	20%	50	70	5	5	.4	295
H24A1		306	4242V _{RMS}	100%	100	30	3	3	.4	297
H24A2		306	4242V _{RMS}	20%	100	30	3	3	.4	297
4N25		200	2500	20%	50	30	3	3	.5	296
4N25A		200	1775V _{RMS}	20%	50	30	3	3	.5	296
4N26		200	1500	20%	50	30	3	3	.5	296
4N27		200	1500	10%	50	30	3	3	.5	296
4N28		200	500	10%	50	30	3	3	.5	296
4N35		204	2500V _{RMS}	100%	50	30	5	5	.3	296
4N36		204	1750V _{RMS}	100%	50	30	5	5	.3	296
4N37		204	1050V _{RMS}	100%	50	30	5	5	.3	296
H74A1		228	1500		100	15				296
MCT2		370	1500	20%	50	30	5	5	.4	296
MCT2E		370	3500	20%	50	30	5	5	.4	296
MCT26		370	1500	6%	50	30	5	5	.4	296
MCT210		372	2500	150%	50	30	5	5	.4	296

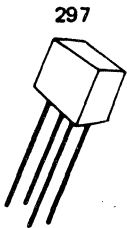
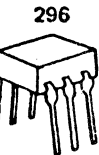

295

296

297

OPTO COUPLERS (Continued)

PHOTO DARLINGTON OUTPUT

GE TYPE	PAGE NO.	ISOLATION VOLTAGE (V _{pk}) MIN.	CURRENT TRANSFER RATIO MIN.	I _{CEO} (nA) MAX.	BV _{CEO} (VOLTS) MIN.	TYPICAL (μSEC)		V _{CE(SAT)} MAX.	PKG
						t _r	t _f		
H11B1	242	2500	500%	100	25	125	100	1.0	296
H11B2	242	2500	200%	100	25	125	100	1.0	296
H11B3	242	2500	100%	100	25	125	100	1.0	296
H11B255	244	1500	100%	100	55	125	100	1.0	296
H24B1	308	4242V _{RMS}	1000%	100	30	125	100	1.4	297
H24B2	308	4242V _{RMS}	400%	100	30	125	100	1.4	297
4N29	202	2500	100%	100	30	5	40	1.0	296
4N29A	202	1775V _{RMS}	100%	100	30	5	40	1.0	296
4N30	202	1500	100%	100	30	5	40	1.0	296
4N31	202	1500	50%	100	30	5	40	1.2	296
4N32	202	2500	500%	100	30	5	100	1.0	296
4N32A	202	1775V _{RMS}	500%	100	30	5	100	1.0	296
4N33	202	1500	500%	100	30	5	100	1.0	296
CNY31	330	4000V _{RMS}	400%	100	30	125	100	1.4	297
CNY48	344	2120	600%	100	30	125	100	1.0	296
MCA230	364	3550	100%	100	30	5	100	1.0	296
MCA231	364	3550	200%	100	30	5	100	1.0	296
MCA255	364	3550	100%	100	55	5	100	1.0	296

HIGH VOLTAGE PHOTO TRANSISTOR OUTPUT

H11D1	258	3500	20%	100	300	5	5	.4	296
H11D2	258	2500	20%	100	300	5	5	.4	296
H11D3	258	2500	20%	100	200	5	5	.4	296
H11D4	258	2500	10%	100	200	5	5	.4	296
4N38	208	1500	10%	50	80	5	5	1.0	296
4N38A	208	1775V _{RMS}	10%	50	80	5	5	1.0	296
CNY33	334	2500	20%	100	300	5	5	.4	296

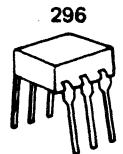

HIGH VOLTAGE PHOTO DARLINGTON OUTPUT

GE TYPE	PAGE NO.	ISOLATION VOLTAGE (V _{pk}) MIN.	CURRENT TRANSFER RATIO MIN.	I _{CEO} (nA) MAX.	BV _{CEO} (VOLTS) MIN.	TYPICAL (μSEC)		V _{CE(SAT)} MAX.	PKG
						t _r	t _f		
H11G1	264	3535	1000%	100	100	5	100	1.0	296
H11G2	264	3535	1000%	100	80	5	100	1.0	296
H11G3	266	2125	200%	100	55	5	100	1.0	296
H11G45	268	5656	250%	100	55	50	500	1.0	296
H11G46	268	5656	500%	100	55	50	500	1.0	296

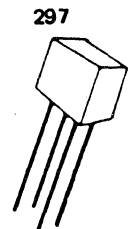

PHOTO SCR OUTPUT

GE TYPE	PAGE NO.	ISOLATION VOLTAGE MIN.	I _F TRIGGER (MAX.)	I _D 100°C (MAX.) μ	BLOCKING VOLTAGE (MIN.)	TYPICAL TON (μSEC)	V _F (MAX.)	PKG
H11C1	248	3535	20mA	50	200	1	1.5	296
H11C2	248	2500	20mA	50	200	1	1.5	296
H11C3	248	2500	30mA	50	200	1	1.5	296
H11C4	252	3535	20mA	100	400	1	1.5	296
H11C5	252	2500	20mA	100	400	1	1.5	296
H11C6	252	2500	30mA	100	400	1	1.5	296
4N39	210	1500	14mA	50	200	1	1.5	296
4N40	210	1500	14mA	150	400	1	1.5	296
H74C1	256	2500			200			296
H74C2	256	2500			400			296
CNY30	326	2500	20mA	50	200	1	1.5	296
CNY34	326	2500	20mA	150	400	1	1.5	296
MCS2	366	3550	14mA	50	200	1	1.5	296
MCS2400	366	3550	14mA	150	400	1	1.5	296
MCS21	368	4000	20mA	50	200	1	1.5	296
MCS2401	368	4000	20mA	100	400	1	1.5	296

OPTO COUPLERS (Continued)

TRIAIC DRIVER OUTPUT

GE TYPE	PAGE NO.	ISOLATION VOLTAGE (RMS) MIN.	I _F TRIGGER MAX.	BLOCKING VOLTAGE MIN.	LEAKAGE CURRENT MAX.	ON-STATE VOLTAGE (I ₄₆ = 100mA) MAX.	TYPICAL dv/dt V/ μ SEC STATIC	PKG
H11J1	270	4000V	10mA	250V	100nA	3.0V	2.0	296
H11J2	270	4000V	15mA	250V	100nA	3.0V	2.0	296
H11J3	270	2500V	10mA	250V	100nA	3.0V	2.0	296
H11J4	270	2500V	15mA	250V	100nA	3.0V	2.0	296
H11J5	270	1500V	25mA	250V	100nA	3.0V	2.0	296
GE3009	350	4000V	30mA	250V	100nA	3.0V	6.0	296
GE3010	350	4000V	15mA	250V	100nA	3.0V	6.0	296
GE3011	350	4000V	10mA	250V	100nA	3.0V	6.0	296
GE3012	350	4000V	5mA	250V	100nA	3.0V	6.0	296
GE3020	352	4000V	30mA	400V	100nA	3.0V	6.0	296
GE3021	352	4000V	15mA	400V	100nA	3.0V	6.0	296
GE3022	352	4000V	10mA	400V	100nA	3.0V	6.0	296
GE3023	352	4000V	5mA	400V	100nA	3.0V	6.0	296

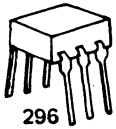

296

PROGRAMMABLE THRESHOLD COUPLER

GE TYPE	PAGE NO.	ISOLATION VOLTAGE (V _{pk}) MIN.	CURRENT TRANSFER RATIO MIN.	I _{CEO} (nA) MAX.	BV _{CEO} (VOLTS) MIN.	TYPICAL (μ SEC)		V _{CE(SAT)} MAX.	PKG
						t _r	t _f		
H11A10	220	1500	10%	50	30	2	2	.4	296

AC INPUT COUPLER

H11AA1	230	2500	20%	100	30	2	2	.4	296
H11AA2	230	2500	10%	200	30	2	2	.4	296
H11AA3	230	2500	50%	100	30	2	2	.4	296
H11AA4	230	2500	100%	100	30	2	2	.4	296
CNY35	336	1500	10%	200	30	2	2	.4	296

BILATERAL ANALOG FET OUTPUT

GE TYPE	PAGE NO.	ISOLATION VOLTAGE (pk) MIN.	ON-STATE RESISTANCE MAX. OHMS	OFF-STATE RESISTANCE MIN. OHMS	BREAKDOWN VOLTAGE	TURN-ON TIME (μ SEC)	TURN-OFF TIME (μ SEC)	PKG
H11F1	260	2500	200	300M	30	15	15	296
H11F2	260	2500	330	300M	30	15	15	296
H11F3	260	1500	470	300M	15	15	15	296

SCHMITT TRIGGER OUTPUT

GE TYPE	PAGE NO.	ISOLATION VOLTAGE (RMS) MIN.	TURN ON CURRENT I _{FON} MAX.	HYSTERESIS I _{OFF} /I _{ON} RATIO		OUTPUT VOLTAGE VOL (I ₀ = 17mA) MAX.	MAXIMUM DATA RATE, NRZ	OPERATING VOLTAGE		PKG
				MIN.	MAX.			MIN.	MAX.	
H11L1	274	2500V	1.6mA	0.3	0.9	0.4V	1.0MHz	3V	16V	296
H11L2	274	2500V	10mA	0.3	0.9	0.4V	1.0MHz	3V	16V	296
H11L3	274	2500V	5mA	0.3	0.9	0.4V	1.0MHz	3V	16V	296

OPTOELECTRONICS THEORY

1.1 OPTOELECTRONIC DEVICES

This chapter describes the basic semiconductor devices utilized in opto-electronics, their principles of operation and their circuit functions to give the circuit designer an understanding of the device characteristics of interest in optoelectronic applications.

1.1.1 Light Sources

Many different light sources need to be considered, such as light emitting diodes, tungsten lamps (evacuated and gas filled), neon lamps, fluorescent lamps and Xenon tubes. Because most light emitters are designed to work as visible light sources, the information on the specification sheets is mainly concerned with the visible part of the spectrum. The information is given in photometric rather than radiometric terms. Many references contain excellent discussions of terms and definitions used in "light" measurement; a brief coverage of the quantitative aspects of light in optoelectronics is covered in a later section of this manual. Since the characteristics and operation of the conventional light sources (i.e., lamps, flash tubes, sunlight) are familiar, the only light sources to be detailed are the semiconductor diode sources, laser diodes and light emitting diodes.

Junction luminescence, or junction electroluminescence, occurs as a result of the application of direct current at a low voltage to a suitably doped crystal containing a pn junction. This is the basis of the Light Emitting Diode (hereafter referred to as LED), a pn junction diode that emits light when biased in a forward direction. The light emitted can be either invisible (infrared), or can be light in the visible spectrum. Semiconducting light sources can be made in a wide range of wavelengths, extending from the near-ultraviolet region of the electromagnetic spectrum to the far-infrared region, although practical production devices are presently limited to wavelengths longer than $\approx 500\text{nm}$. LED's for electronic applications (due to the spectral response of silicon and efficiency considerations) are normally infrared emitting diodes (hereafter referred to as IRED). The IRED is an LED that emits invisible light in the near-infrared region. Forward bias current flow in the pn junction causes holes to be injected into the N-type material and electrons to be injected into the P-type material, i.e., minority carrier injection. When these minority carriers recombine, energy proportional to the band gap energy of the semiconductor material is released. Some of this energy is released as light, while the remainder is released as heat, with the proportions determined by the mixture of recombination processes taking place. The energy contained in a photon of light is proportional to its frequency (i.e., color) and the higher the band gap energy of the semiconductor material forming the LED, the higher the frequency of the light emitted.

General Electric offers two types of IRED's, both using a relatively low band gap, silicon doped, liquid phase epitaxially grown material. Gallium Arsenide (GaAs) is used to make an efficient and extremely reliable IRED, with a peak wavelength (λ) $\approx 940\text{nm}$. A different process is used to increase

the frequency. It is done by replacing some of the gallium with aluminum. This increases the band gap energy, yielding an IRED which emits at $\lambda \approx 880\text{nm}$. Due to decreased absorption in the bulk material, this gallium aluminum arsenide (GaAlAs) emitter is much more efficient than the GaAs emitters. Also, the 880nm wavelength is better matched to the silicon detectors, increasing detector sensitivity. The combination of these factors leads to greatly increased overall system response. Although the GaAlAs wavelength can be widely varied by Al/Ga ratio, each change is a separate challenge in performance, cost and reliability.

It is also possible to increase the wavelength by decreasing the band gap energy. This can be done by using an element such as indium instead of aluminum to change the band gap energy, yielding a wavelength longer than 1000nm. Unfortunately, this process tends to be more challenging than GaAlAs. However, the long wavelength emitters are useful in fiber optic communications, where glass fibers may be optimized for low absorption loss and high bandwidth at these infrared wavelengths.

The diode laser is a special form of LED or IRED with tightly controlled physical dimensions and optical properties in the junction-light producing region. This produces an optical resonant cavity at the wavelength of operation such that optical-electrical feedback assures highly efficient, directional and monochromatic light production. The small, intense, virtually monochromatic beam and high frequency of operation made possible with the diode laser can be of great advantage in applications such as fiber optics, interferometry, precise alignment systems and scanning systems. The precision optical cavity is difficult to manufacture and can build stress into the crystal structure of the laser that will cause rapid degradation of light output power. Although laser diodes offer high performance, they can be uneconomical and reliability must be assessed for each application.

The electrical characteristics of the LED, laser diode and IRED are similar to other pn junction diodes in that they have a slightly higher forward voltage drop than silicon diodes because of the higher band gap energy, and a fairly low reverse breakdown voltage because of the doping levels required for efficient light production.

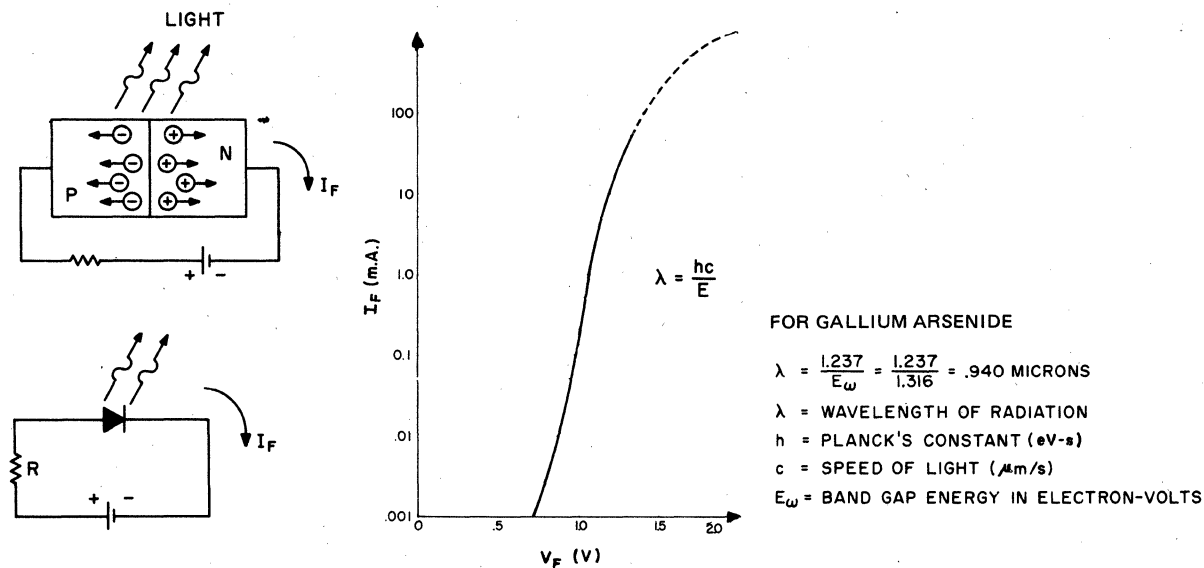

FIGURE 1.1: THE FORWARD BIASED LIGHT EMITTING DIODE PN JUNCTION

1.1.2 Light Detecting Devices

A light source energized by electricity is only part of the semiconductor optoelectronics picture. Light detectors, devices based on mass produced silicon semiconductor technology and which convert light signals into electrical signals, are another significant part of the modern semiconductor optoelectronics picture.

a. Photodiode — Basic to understanding silicon photosensitive devices is the reverse biased pn junction, photodiode. When light of the proper wavelength is directed toward the junction, hole electron pairs are created and swept across the junction by the field developed across the depletion region. The result is a current flow, photocurrent, in the external circuit, proportional to the effective irradiance on the device. It behaves basically as constant current generator up to its avalanche voltage, shown in Figure 1.2. It has a low temperature coefficient and the response times are in the submicrosecond range. Spectral response and speed can be tailored by geometry and doping of the junction. Increasing the junction area increases the sensitivity (photocurrent per unit irradiance) of the photodiode by collecting more photons, but also increases junction capacitance, which can increase the response time.

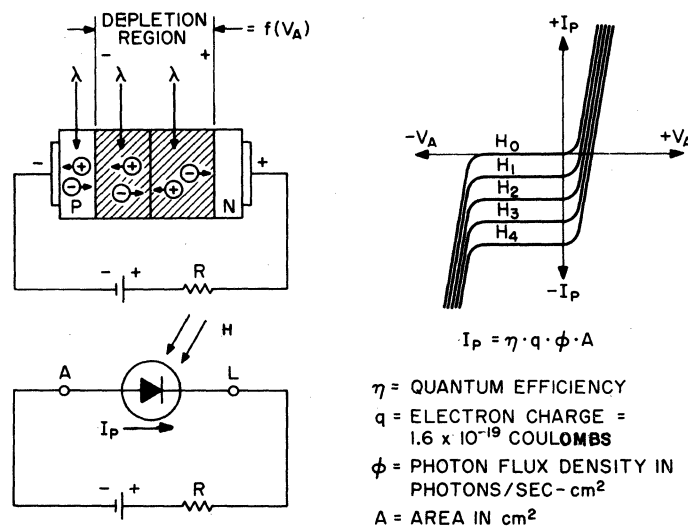

FIGURE 1.2: LIGHT SENSITIVE REVERSE BIASED PN JUNCTION PHOTODIODE

The absorption coefficient of light in silicon decreases with increasing radiation wavelength. Therefore, as the radiation wavelength decreases, a larger percentage of the hole-electron pairs are created closer to the silicon surface. This results in the photodiode exhibiting a peak response point at some radiation wavelength. At this wavelength a maximum number of hole-electron pairs are created near the junction. The maximum of the spectral response curve of the L14G phototransistor is approximately 850nm. For wavelengths longer than this, more hole-electron pairs are created deeper in

the transistor beyond the photodiode (collector-base) junction. For shorter wavelengths, more of the incident radiation is absorbed closer to the device surface, and does not penetrate to the junction. In this manner, spectral response characteristics of the silicon photodiode are modified by the junction depth.

All common silicon light detectors consist of a photodiode junction and an amplifier. The photodiodes are usually made on a single chip of silicon from the same doping processes that form the amplifier section. In most commercial devices, the photodiode current is in the submicroampere to tens of microamperes range, and an amplifier can be added to the chip at minimal cost. Total device response to bias, temperature and switching waveforms becomes a combination of photodiode and amplifier system response.

All semiconductor junction diodes are photosensitive to some degree over some range of wavelengths of light. The response of a diode to a particular wavelength depends on the semiconductor material used and the junction depth of the diode. In some cases, light emitting diodes can be used to detect their own wavelength of light. Whether or not a particular device is photosensitive to its emission wavelength depends upon how well the bulk material absorbs this wavelength to create hole electron pairs. GaAlAs, which has high output efficiency due to decreased bulk absorption at 880nm, exhibits virtually no photosensitivity at 880nm for the same reason. The GaAs emitters, however, tend to be reasonable detectors of light generated at the 940nm GaAs emission wavelength. This phenomenon can be very useful in some applications, such as half-duplex communication links.

b. Avalanche Photodiode — One type of amplifier system in common use can be incorporated as part of the photodiode itself. An avalanche photodiode uses avalanche multiplication to amplify the photocurrent created by hole-electron pairs. This provides high sensitivity and speed. However, the balance between noise and gain is difficult, therefore costs are high. Also temperature stability is poor and a tightly controlled, high value of bias voltage (100-300V) is required. For these reasons, the APD is used in limited applications.

c. Phototransistor — The light sensitive transistor is one of the simplest photodiode-amplifier combinations. By directing light toward the reverse biased pn junction (collector-base), base current is generated and amplified by the current gain of the transistor. External biasing of the base is possible, if that contact is accessible, so that the formula for emitter current is:

$$I_E = (I_P \pm I_B)(h_{FE} + 1)$$

where I_P = Photon generated base current

I_E = Emitter current

I_B = Base current

h_{FE} = Transistor DC current gain

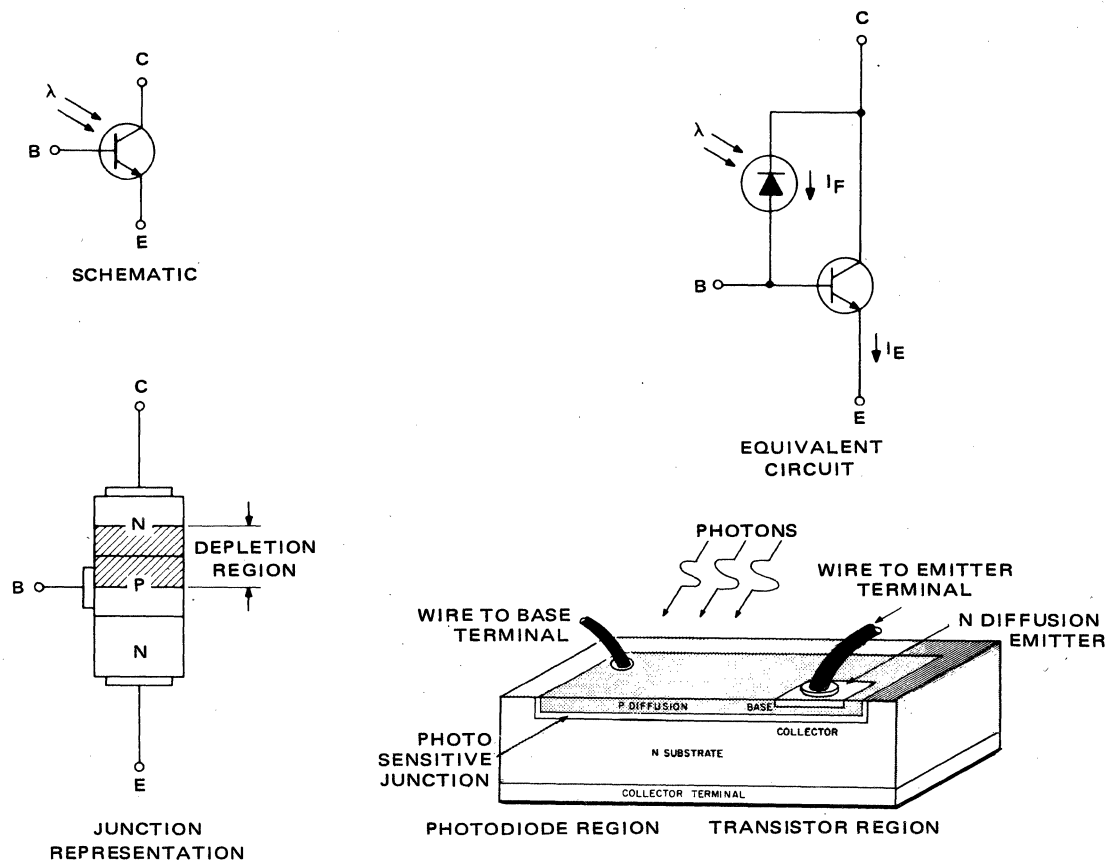

FIGURE 1.3: LIGHT GENERATED CURRENT IN PHOTOTRANSISTOR

The formula shows that the sensitivity of this transistor can be influenced by different bias levels at the base. It also indicates that response of the phototransistor will vary as the h_{FE} varies with current, bias voltage, and temperature. Speed of response is affected by a greater factor than the speed of the transistor. The switching time of the combination is usually governed by the RC time constant of the base circuit, i.e., the input time constant of the amplifier. This is due to the capacitance of the photodiode, combined with the low base currents and normally unterminated base contact causing high input impedance, and multiplied by the voltage gain (A_V) of the amplifier. This fact leads to a generalization of photodetectors: "higher gain, slower response." This generalization does not of course, cover all cases, for example, where the voltage across the phototransistor is constant ($\Delta V_{CB}=0$), i.e., $A_V=0$.

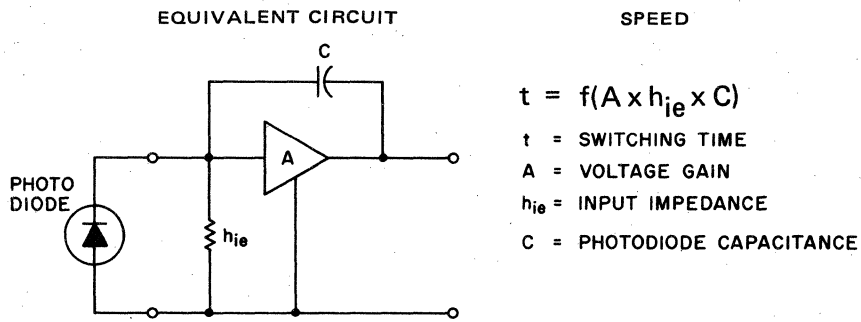

FIGURE 1.4: PHOTOTRANSISTOR SWITCHING SPEED

The high value of h_{FE} and large collector-base junction area required for high phototransistor sensitivity can also cause high dark current levels when the collector-base junction is reverse biased. The phototransistor dark current is given by

$$I_{CEO(DARK)} = h_{FE} I_{CBO}$$

where I_{CBO} is the collector-base junction leakage current. This leakage is proportional to junction area and periphery at the surface. Careful processing of the transistor chip is required to minimize the phototransistor dark current and maintain high light sensitivity. Typical phototransistor dark currents at 10V reverse are on the order of 1nA at room temperature and increase by a factor of two for every 10°C rise in temperature. Phototransistor specifications normally guarantee much higher dark current limits, i.e., 50 to 100 nA, due to the limitations of automated test equipment.

Dark current effects may be minimized for low light level applications by keeping the base-collector junction from being reverse biased, i.e., having a V_{CEO} of less than a silicon diode forward bias voltage drop. This technique allows light currents in the nanoampere range to be detected.

A circuit illustrating this mode of operation is shown in Figure 1.5. The band gap effect of the highly doped BE junction of Q_1 dominates the open base potential, forcing $V_{BE(Q1)}$ to equal one diode drop. Since $V_{BE(Q1)}$ closely approximates $V_{BE(Q2)}$ (one diode drop each), $V_{BC(Q1)} \approx 0$. This creates a minimum leakage current condition.

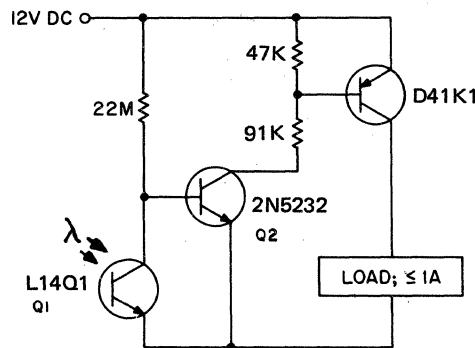

FIGURE 1.5: USE OF PHOTOTRANSISTOR AT VERY LOW LIGHT LEVELS

This circuit will turn the load on when illumination to Q_1 drops below approximately 0.5 foot-candle.

d. Photodarlington — Basically, this is the same as the light sensitive transistor, except for its much higher gain from two stages of transistor amplification cascaded on a single chip.

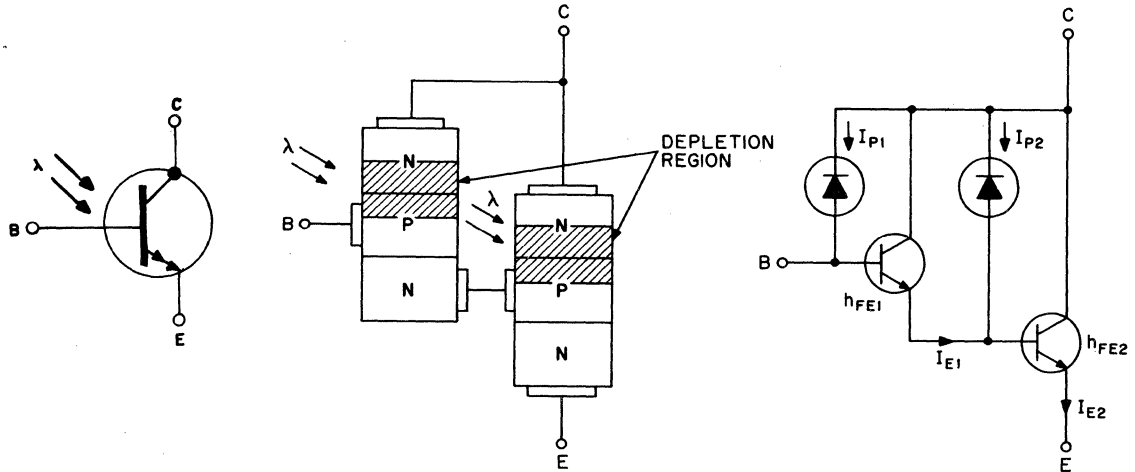

FIGURE 1.6: PHOTO DARLINGTON AMPLIFIER ILLUSTRATING THE EFFECTS OF PHOTON CURRENT GENERATION

$$I_{E1} = I_{P1} (h_{FE1} + 1)$$

$$I_{E2} = (I_{P2} + I_{E1})(h_{FE2} + 1)$$

$$I_E = [I_{P2} + I_{P1} (h_{FE1} + 1)] (h_{FE2} + 1)$$

Because $I_{E1} \gg I_{P2}$

$$I_{E2} \approx I_{P1} (h_{FE1})(h_{FE2})$$

where I_E = Emitter Current

I_P = Photon produced current

H_{FE} = DC current gain of transistors 1 and 2

I_B = Base current

With different bias levels at the base:

$$I_{E2} = [I_{P2} + (I_{P1} \pm I_B)(h_{FE1} + 1)](h_{FE2} + 1)$$

Since $h_{FE} \gg 1$, a close approximation to this equation is:

$$I_{E2} \approx (I_{P1} \pm I_B)(h_{FE1})(h_{FE2})$$

To maximize sensitivity, I_{P1} should contain as large a portion of the photon produced current as possible. To accomplish this, an "expanded base" design is used, in which a large area photodiode is included in the first stage collector-base junction. This photodiode dominates the pellet topography in much the same way as shown in Figure 1.3 for the phototransistors.

The darlington connection is popular for applications where the light to be detected is low level, since the h_{FE} product normally ranges from 10^3 to 10^5 , assuring high electrical signal levels. As with phototransistors, speed of response suffers, since the voltage amplification can never be brought to zero due to internal parasitic impedances which cannot be eliminated from the pellet. Thus, photodarlington speed will always be less than the phototransistor. Dark current effects, as with phototransistors, are also amplified by the increased gain of the darlington connection, and can limit usefulness at high voltage, high temperature and/or high power. A base emitter resistor can minimize these effects.

e. PhotoSCR (Silicon Controlled Rectifier) — The two transistor equivalent circuit of the silicon controlled rectifier illustrates the switching mechanism of this device.

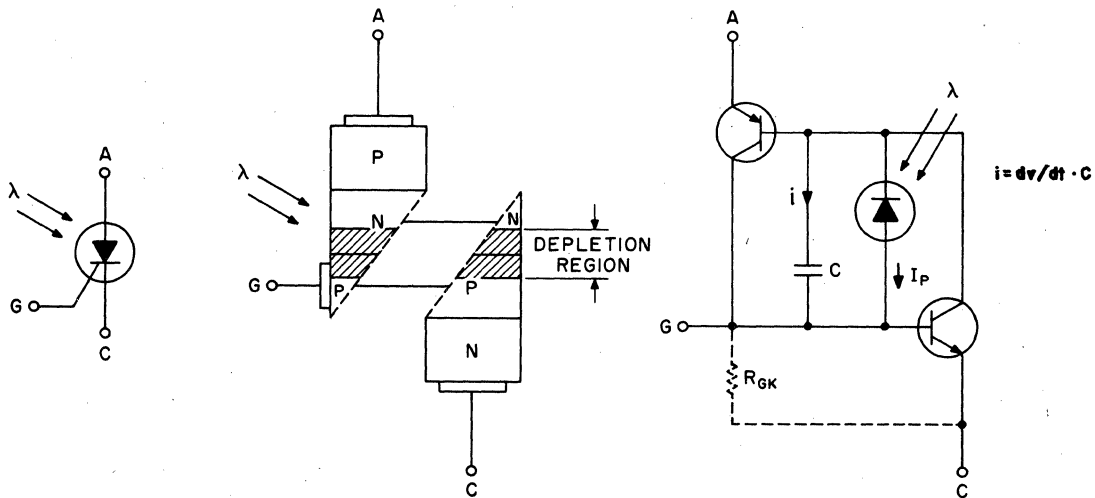

FIGURE 1.7: PHOTO SCR AND TWO TRANSISTOR EQUIVALENT CIRCUITS ILLUSTRATING THE EFFECTS OF PHOTON CURRENT GENERATION AND JUNCTION CAPACITANCE

Photon current generated in the reverse biased pn junction reaches the gate region to forward bias the npn transistor and initiate switching. Part of this current, I_p , can be channeled around the gate-cathode terminal to decrease sensitivity. This is also expressed in the formula for anode current, I_A , by the expression $(I_p \pm I_G)$.

$$I_A = \frac{\alpha_2 \{ (I_p \pm I_G) + I_{CBO(1)} + I_{CBO(2)} \}}{1 - \alpha_1 - \alpha_2}$$

when $\alpha_1 + \alpha_2 = 1$ then $I_A = \infty$
 I_A = Anode Current
 I_p = Photon Current
 I_G = Gate Current

$I_{CBO(1)}$ & $I_{CBO(2)}$ — Leakage Currents
 α = Current Gain
 α_1 — Varies with I_A and I_p
 α_2 — Varies with I_A and $I_p \pm I_G$

In discrete device literature, photoSCR is often abbreviated LASCR, Light Activated SCR. Since the photodiode current is of a very low level, a LASCR must be constructed so that it can be triggered with a very low gate current. The high sensitivity of the LASCR causes it to be sensitive also to any effect that will produce an internal current. As a result, the LASCR has a high sensitivity to temperature, applied voltage, or rate of change of applied voltage, and has a longer turn-off time than normally expected of a SCR.

All other parameters of the LASCR are similar to an ordinary SCR, so that the LASCR can be triggered with a positive gate signal of conventional circuit current, as well as being compatible with the common techniques of suppressing unwanted sensitivity. All commercially available LASCR types of devices are of comparatively low current rating ($< 2A$) and can thereby be desensitized to extraneous signals with small, low-cost, reactive components.

Figure 1.8 shows that the LASCR contains a high voltage phototransistor pnp between the anode (A) and gate (G) terminals. Due to physical construction details, this "transistor" is of low gain and behaves as a symmetrical transistor, i.e., emitter and collector regions are interchangeable. Due to the low gain, photo response is quite stable in this configuration. In fact, this connection has been used with calibrated units for measurement of irradiance.

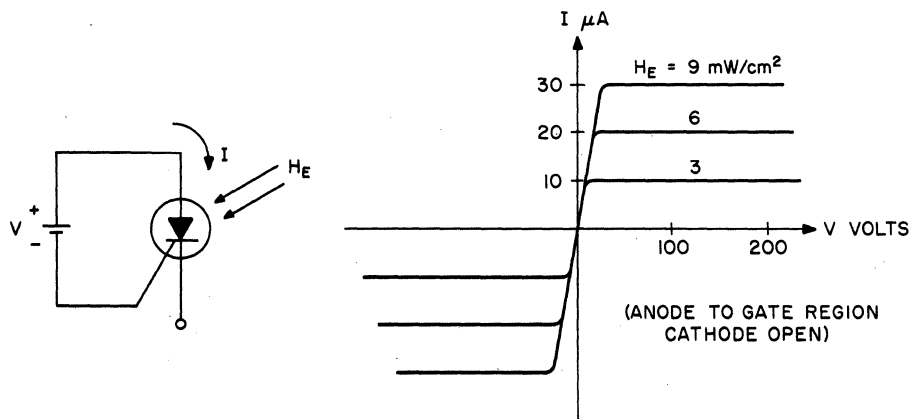

FIGURE 1.8: TYPICAL PNP PHOTOTRANSISTOR ACTION OF LASCR

Because of its high voltage junction parameters, the LASCR has unique spectral and dark current characteristics compared to the devices mentioned previously.

f. Other Photodetector Amplifiers — There are many other photodetector-amplifier combinations which are based on the previously discussed principles. The use of integrated circuit technology allows many combinations of photosensitive devices with active and passive devices on a single silicon chip. Specific examples of these are the photodarlington with integral base emitter resistor, the bilateral analog FET photodetector, the triac trigger devices and the optical input Schmitt trigger. These will be examined in detail as part of the optoisolator system.

1.2 OPTOELECTRONIC COMPONENTS

Detailing the basic device characteristics and operation provides an understanding of what can be expected from the semiconductor, but leaves undefined the actual component characteristics that will be affected by both device and package parameters. The basic optoelectronic devices can be packaged to provide:

- discrete detectors and emitters, which emit or detect light;
- interrupter/reflector modules, which detect objects modifying the light path;
- isolators/couplers, which transmit electrical signals without electrical connections.

The following descriptions will provide an insight into the various package characteristics and how they modify the basic devices already described.

1.2.1 Optoelectronic Detectors and Emitters

These optoelectronic components require packaging that protects the chip, and allows light to pass through the package to the chip, i.e., a semiconductor package with a window. The window can be modified to provide lens action, which gives higher response on the optical axis of the lens, greater directional sensitivity and a large aperture with less resolution. In most commercial components, the lens is also an integral part of the package, for economic reasons, so the tight control of optical tolerances is compromised somewhat to optimize chip protection via the hermetic seal. This causes lensed components to exhibit wider variations, unit to unit, than simple window components, as the optical gain variations and the basic device response variations are multiplied. Due to these factors, when high gain, highly directional optical systems are required, it is normal procedure to recommend that components without integral lenses be used in conjunction with external optics of the required quality.

The other major factor in detector/emitter packaging is the choice of a plastic or hermetic package. These may be with or without lens, although the plastic devices have the optical axis perpendicular to the leads, while the hermetic package optical axis is parallel to the leads. The hermetic package will operate at higher power, over a wider temperature range and is more tolerant of severe environments, but it is also more expensive than the plastic package. Although some components are limited to a single package type, on most the user must weigh the application's technical and economical constraints in order to optimize both the device and package of the optoelectronic component used.

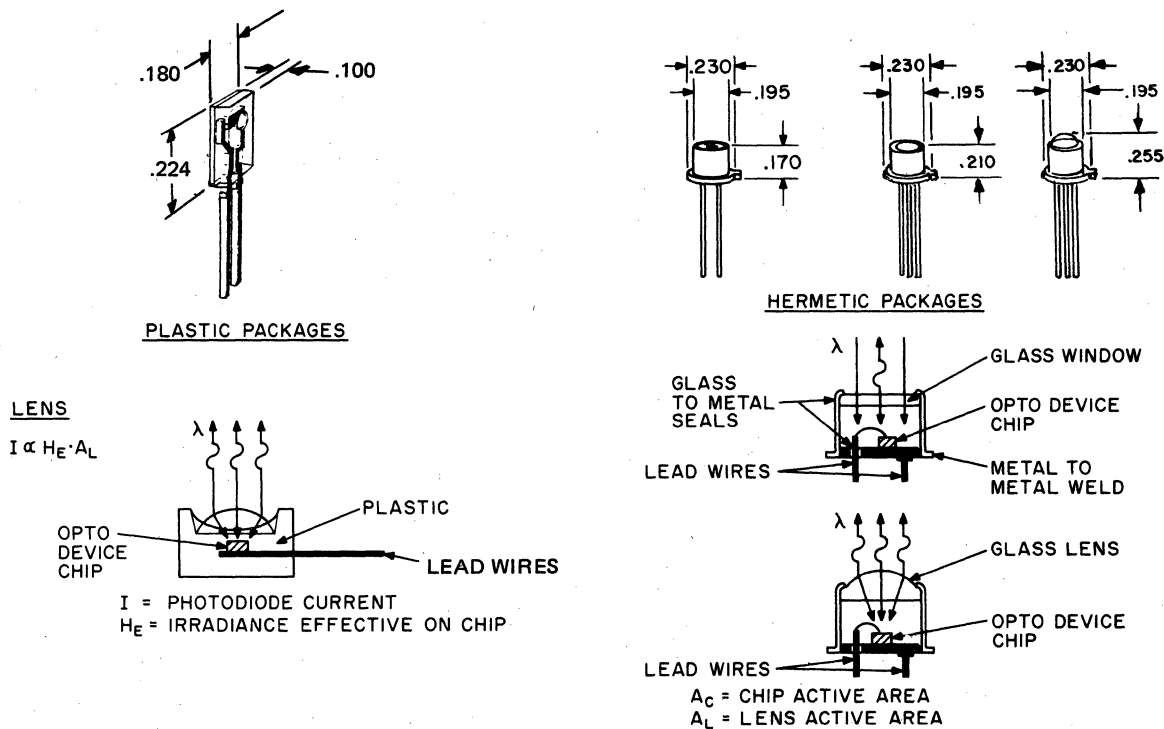

FIGURE 1.9: DISCRETE OPTOELECTRONIC COMPONENT PACKAGE CONCEPTS

1.2.2 Fiber Optic Devices

As fiber optics come into widespread use, the need for low cost fiber optic active components is evident. These components must not sacrifice performance or reliability. The General Electric GFOE emitters combine General Electric's proven GaAs emitter with unique packaging. The pellet sits in a reflector and is encased in a clear epoxy. A lens is formed during the epoxy encapsulation operation, making an efficient reflector-lens system that focuses the light towards the fiber. The GFOD detectors are made in a similar fashion, without a reflector. Light from the fiber is focused by the lens towards the detector pellet. These assemblies are placed in a housing that allows direct coupling to fibers terminated with AMP Optimate® fiber optic connectors. A large variety of fibers can easily and inexpensively be coupled in this manner. This housing eliminates the need for additional mechanical components, thereby reducing costs. The assembly system provides close, precise alignment of the fiber with the pellets, assuring good coupling. Also, electrical and optical properties of the individual devices are easily evaluated, while reliability can be assessed as easily as that of discrete devices. Note that although separate specifications do not exist, these housings will accept any of the side looking plastic package emitters and detectors. These may be made available for high volume applications.

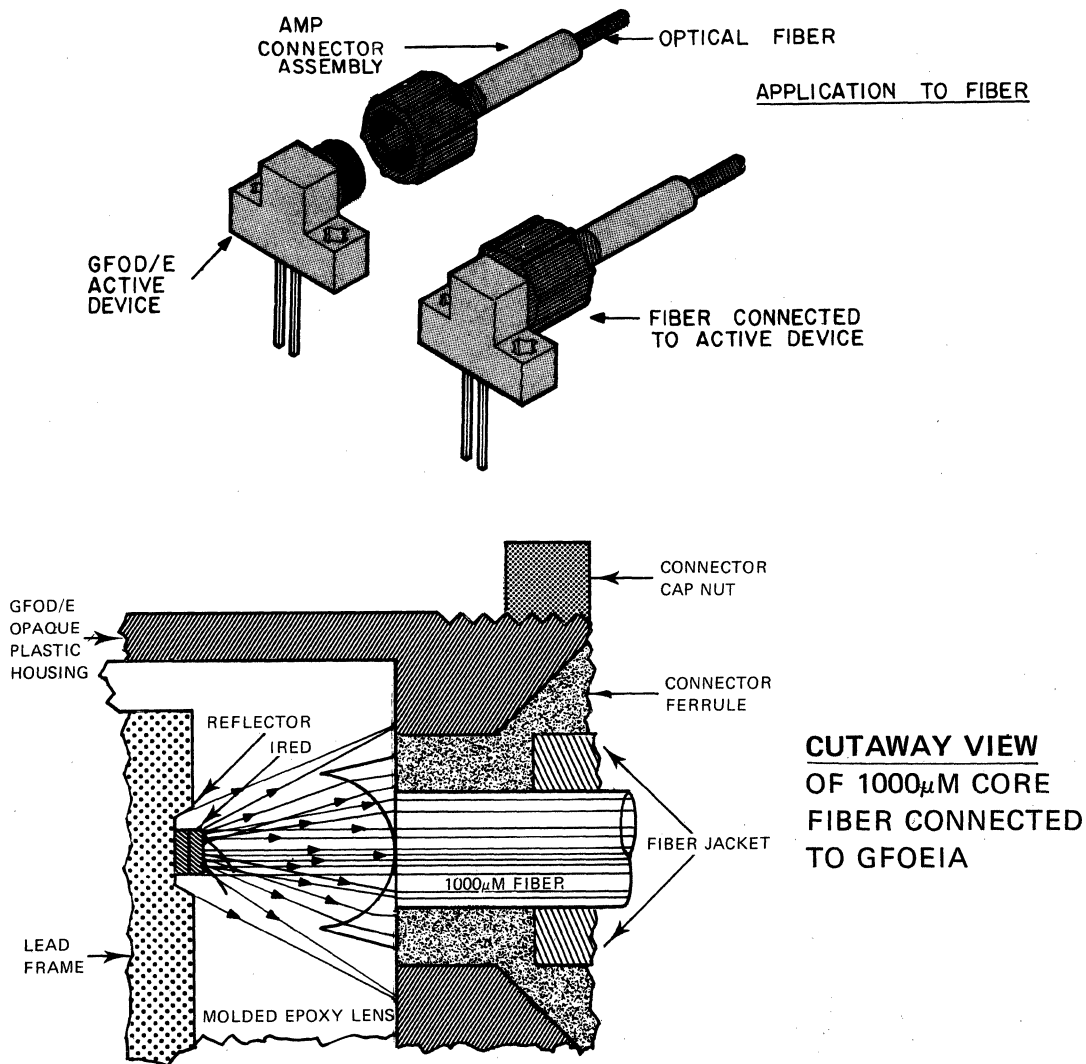

FIGURE 1.10: GFOD/E ACTIVE DEVICE WITH FIBER OPTICS TERMINATION

1.2.3 Interrupter/Reflector Modules

The use of interrupter or reflector modules eliminates most of the optical calculations and geometric and conversion problems in mechanical position sensing applications. These modules are specified electrically at the input and output simultaneously — i.e., as a coupled pair — and have defined constraints on the mechanical input. All the designer need do is provide the input current and mechanical input (i.e., pass an infrared-opaque object through the interrupter gap) and monitor the electrical output. Other than normal tolerance, resolution, and power constraints, the only new knowledge required is the ability of the sensed object to block or reflect infrared light and an estimate of the effects of ambient light conditions providing false signals. This is true of both “off the shelf” commercial modules and limited volume custom modules, as the mechanical and optical parameters of any given module are fixed. Once the module is characterized for minimum and maximum characteristics, it is a defined electrical and mechanical component and does not require optical design work for each new application. This puts these sensor modules in the same design category as mechanical precision limit switches, except that the activating mechanism blocks or reflects light instead of applying a force. Thus mechanical wear and deformation effects are eliminated.

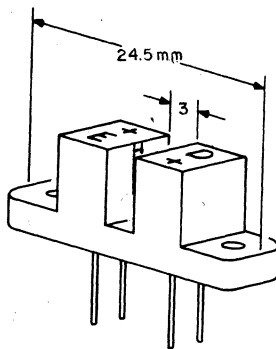

FIGURE 1.11a: INTERRUPTER MODULE

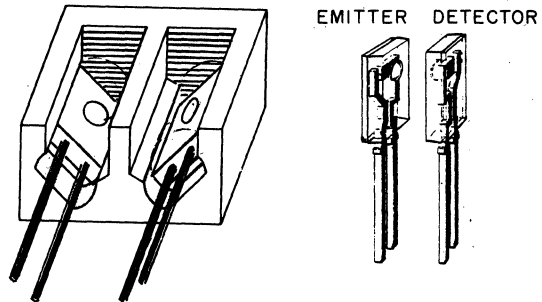

FIGURE 1.11b: REFLECTOR MODULE BUILT FROM H23

Most commercially available interrupter modules are built around plastic packaged emitters and detectors. Reflective modules and other custom modules are built around both plastic and hermetic parts, depending on the required cost/performance trade-offs. It should be noted that due to the longer, angle critical, and generally less efficient light transmission path in a reflector module, lensed devices are dominant in these applications. This also explains the lack of standard reflective modules, because tight spacing between the module and the mechanical actuator must be maintained to provide adequate optical coupling, which leads to different mechanical mounting requirements for each mechanical system which is sensed.

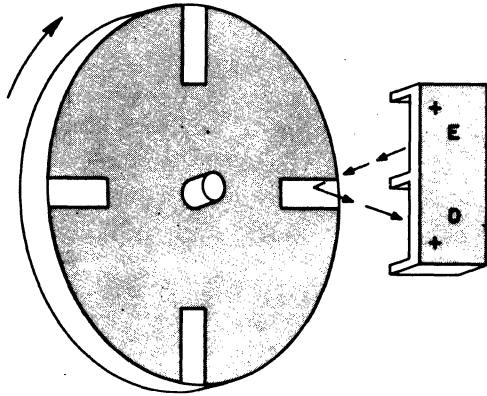

FIGURE 1.12a: REFLECTOR MODULE

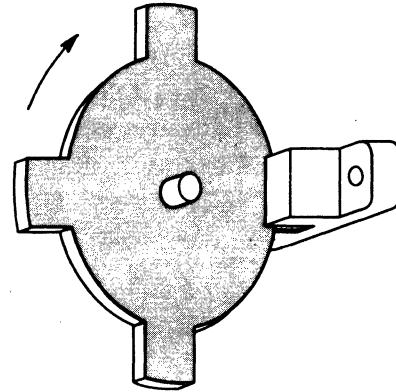

FIGURE 1.12b: INTERRUPTER MODULE

1.2.4 Optocouplers

Optocouplers, also known as optoisolators, are purely electronic components. The light path, IRED to photodetector, is totally enclosed in the component and cannot be modified externally. This provides one way transfer of electrical signals from the IRED to the photodetector, without electrical connection between the circuitry containing the devices. The degree of electrical isolation between the two devices is controlled by the materials in the light path and by the physical distance between the emitter and detector. (i.e., the greater the distance, the better the isolation.) Unfortunately, the current transfer ratio (CTR), which is defined as the ratio of detector current to emitter current (i.e., the effectiveness of electrical signal transfer) is inversely proportional to this separation and some type of compromise has to be made to achieve the most optimum effects. In the case of the dual in-line package, the use of optical glass has proven to be a most efficient dielectric. It allows maximum CTR and a minimum separation distance for a given isolation voltage withstand capability. Minimum (H11A5100) CTR's of 100% in combination with isolation voltages of 5000V in phototransistor couplers result. Also, because of the glass dielectric design, yields are much more predictable, due to positive alignment of IRED and detector combined with common side wire bonding, versus other methods of manufacture.

The reflector design, illustrated in Figure 1.13d, represents a sixth generation optoisolator, designed utilizing the knowledge and experience of 20 years of optoelectronic manufacturing by General Electric, world leader in optoisolator technology and production. It represents the most advanced features in optoisolator design without sacrificing the advantages of the sandwich construction. Both feature reliable, stable glass dielectric, eutectic mountdown die attach, large gold bond wires, and flexible protective coating over the liquid epitaxial IRED die. The reflector design has the additional advantages of:

- highly automated assembly for enhanced quality;
- eliminates one wire bond for improved reliability;
- reflects IRED side light for more efficient coupling;
- has triple layer dielectric (silicone-glass-silicone) for better isolation (higher isolation voltage, lower isolation capacitance).

It is expected that the reflector design will prove a new standard for optoisolator performance, reliability and quality as production quality and reliability experience provides the necessary data base to confirm improvement over the outstanding record of the sandwich design. Large scale, controlled, reliability testing of reflector construction vs sandwich construction has provided the early indications that lead to the premise of improved reliability. Parametric data comparing production devices built with the different constructions proves the improved electrical performance.

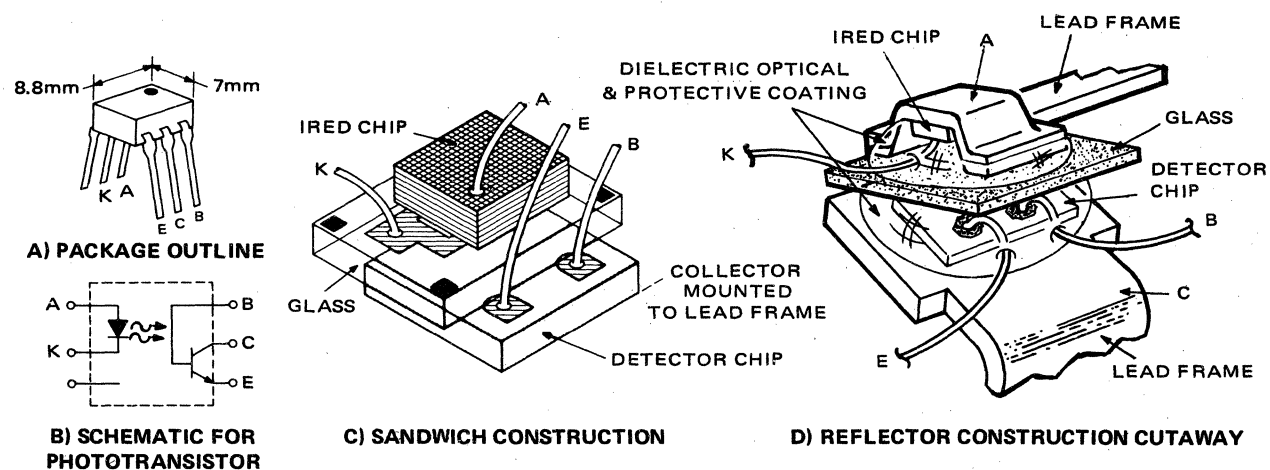

FIGURE 1.13: GLASS DIELECTRIC CONSTRUCTION TECHNIQUES FOR GE 6 PIN DIP

An invaluable modification of the glass dielectric system is the H11AV construction, which utilizes the glass as a long (>2mm) light pipe. This allows a DIP package to meet VDE isolation requirements as well as providing ultimate isolation in the six pin DIP. Isolation capacitance of this design is under 0.5pF. Note that a modification of this design, with different physical dimensions, is used to produce the AC input optoisolator with antiparallel IREDS.

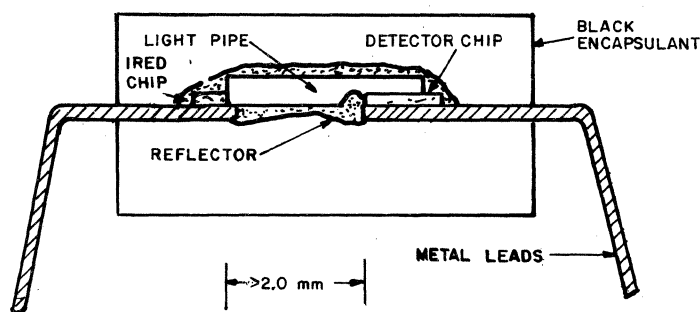

FIGURE 1.14: CUTAWAY VIEW OF GENERAL ELECTRIC H11AV: 6 PIN DIP OPTOISOLATOR APPROVED TO VDE SAFETY STANDARD 0883/6.80, WITH TESTING TO 0730/6.76 AND 0860/11.76

Although the DIP package is the most common one used for couplers, other packages are commercially available to provide higher isolation voltage and other special requirements. For very high isolation voltage requirements (10 to 50kV) the H22 interrupter module can be modified by the user

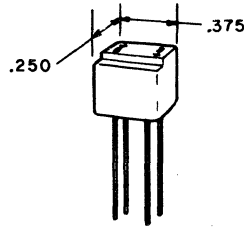

FIGURE 1.15: H24 OPTOCOUPLER, 4000V ISOLATION VOLTAGE

at very low cost by putting a suitable dielectric (glass, acrylic, silicone, etc.) in the air gap and insulating and encapsulating the lead wires. For higher isolation voltages the use of the H23 matched pair with glass dielectric or the GFOD/E pair and fiber optics can provide a low cost isolator. Both of these approaches utilize coupler systems already characterized and are easily handled from a design standpoint.

SYSTEMS DESIGN CONSIDERATIONS

2.1 EMITTER AND DETECTOR SYSTEMS

2.1.1 Light, Irradiance and Effectiveness

When the word "light" is used in this discussion instead of "electromagnetic radiation," it does not refer to just the visible part of the spectrum, but to that part of the spectrum where silicon light sensitive devices respond to irradiance. "Light" is a misnomer for the infrared component, but it has become accepted usage.

The normalized response of silicon light sensitive devices and output sources is illustrated below. Peak spectral response is found at approximately 0.85 microns or 8500 Angstroms (\AA) ($1 \text{ \AA} = 10^{-10}$ meters) for the light activated transistors but shifts down toward 1.0 micron for the LASCR. Individual device spectral response curves are modified by photosensitive junction depth, minority carrier lifetime and surface waveplate and reflection effects. The response of the eye is shown for comparison, but it can be treated just as any other light sensitive device. When the silicon detector response and sources are compared, it is observed that the IRED GaAlAs and GaAs (Si) are capable of most efficient coupling.

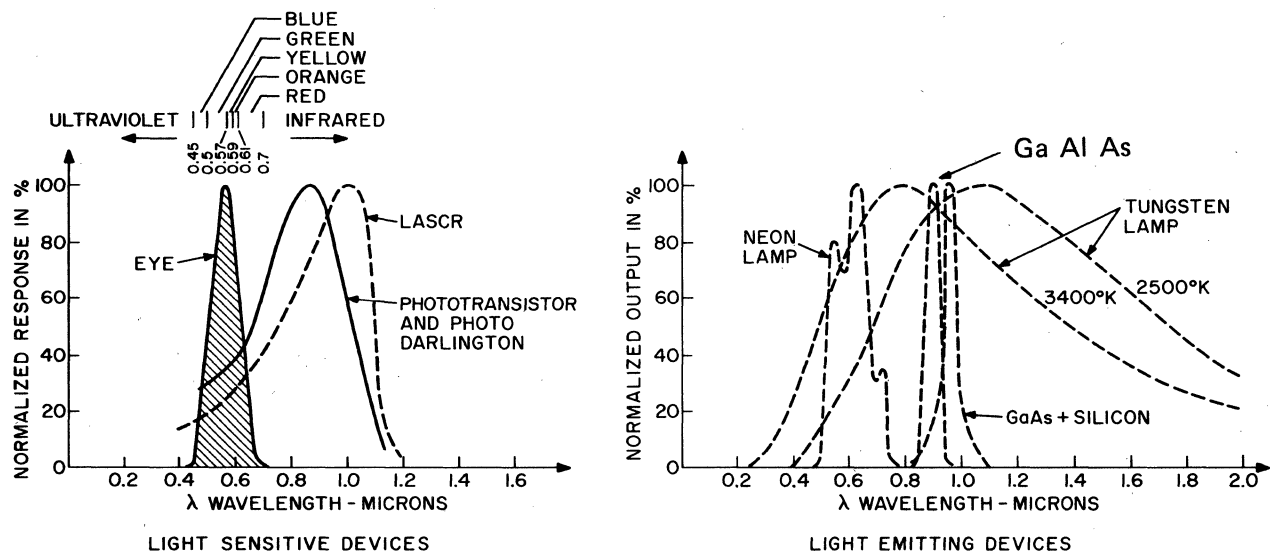

FIGURE 2.1: NORMALIZED SPECTRAL CHARACTERISTICS OF LIGHT SENSITIVE AND LIGHT EMITTING DIODES

Since the spectral characteristics of most sources and detectors do not match, a rigorous determination of the response of the photodetector to a given incident light level (Irradiance, H) would require: a) determining the irradiance and spectral content of the light, b) the spectral response and sensitivity of the detector, c) integrating the spectral response and spectral content to determine effectiveness, d) multiplying by the irradiance to determine the effective irradiance (H_E) and e) multiply by the sensitivity to determine the response. If the irradiance is not easily measurable (the normal case), it is determined by: a) analyzing the power into the source (P_{in}), b) determining the conversion efficiency of the source in producing light (η) and c) defining the spacial distribution of the output and the transmissivity of the light path.

$$\text{EFFECTIVENESS} = \frac{\text{AREA UNDER CURVE C}}{\text{AREA UNDER CURVE A}} = \frac{\int^{\lambda} f(A) \cdot f(B)}{\int^{\lambda} f(A)}$$

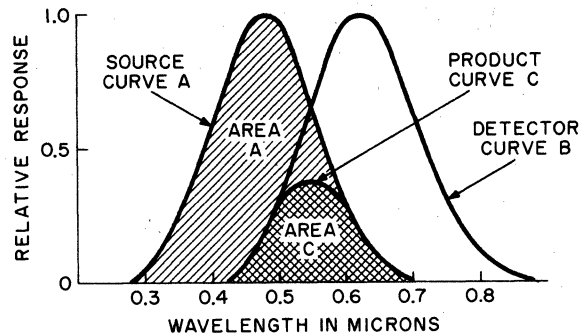

FIGURE 2.2: EFFECTIVENESS OF SOURCE A ON DETECTOR B

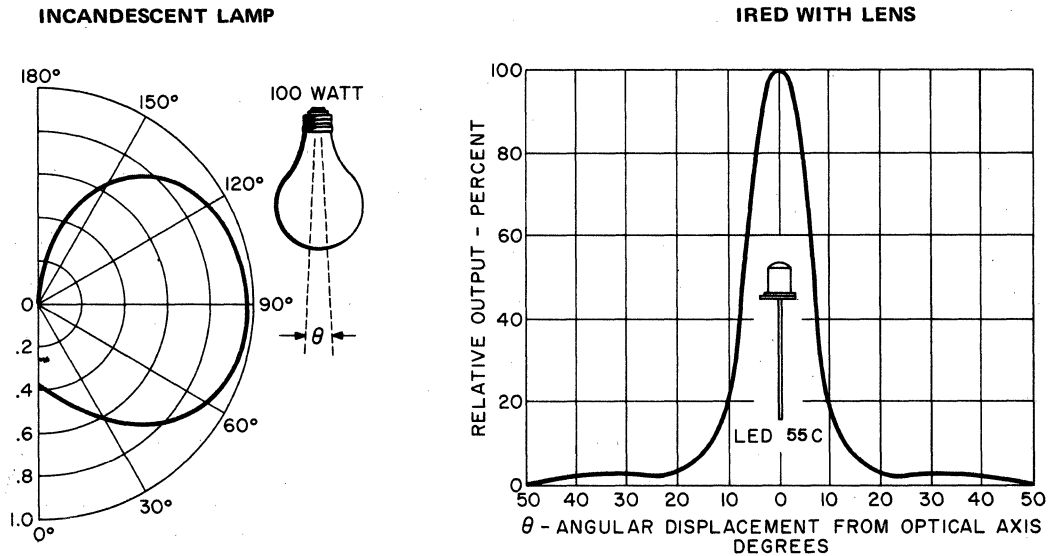

FIGURE 2.3: SPACIAL DISTRIBUTION OF LIGHT SOURCES

In practice, all these parameters vary. For feasibility studies, approximations are used, then, in the prototype stage, effective irradiance is measured using calibrated detectors and “worst case” (or a distribution of) sources to analyze worst case and tolerance effects.

It is often difficult to obtain worst case samples for system evaluation purposes. In many cases, sufficient accuracy to evaluate detector irradiance levels can be obtained by using the collector base photodiode response of an unlensed phototransistor or photodarlington. The accuracy of this method rests on the conversion efficiency of silicon, a basic physical property, which peaks at about 0.6 A/W in the 800 to 900nm spectral region. For the L14C phototransistor which has an active area of 0.25mm square and peak response around 850nm, this corresponds to approximately 1.4μA per mW/cm² with the 880nm GaAlAs IRED, 1.2μA per mW/cm² for the 940nm GaAs (si) IRED and 0.4μA per mW/cm² using 2870°K tungsten light. The L14N phototransistor, with 1mm² active area, will provide 4 times these output currents for uniform irradiance. The inconsistency of integral lenses makes this method impractical for lensed detectors.

TABLE 2.1: APPROXIMATE EFFECTIVENESS OF VARIOUS SOURCES

RADIATORS	DETECTORS	HUMAN EYE	SILICON PHOTOTRANSISTORS
Tungsten Lamp	2000° K	.003	.16
	2200° K	.007	.19
	2400° K	.013	.22
	2600° K	.021	.24
	2800° K	.030	.27
	3000° K	.044	.30
Neon Lamp		.35	.7
GaAs IRED 940nm		0	.8
GaAlAs IRED 880nm		0	.98
Fluorescent Lamp		.1	.4
Xenon Flash		.13	.5
Sun		.16	.5

To illustrate a feasibility study using approximation, consider a 10W tungsten lamp source and a silicon phototransistor of 1mA/mW/cm² (H_E) sensitivity, 0.1 meter (4 inches) apart:

$$P_{out} = \eta \cdot P_{in} \cong .85(10) = 8.5W$$

Conversion efficiency of tungsten lamps is 80% for gas filled and 90% for evacuated lamps.

Assuming a spherical distribution of light from the lamp —

$$H_T = \frac{P_{out}}{4 \cdot \pi \cdot d^2} \text{ mW/cm}^2 \cong \frac{8500}{12.56 (10)^2} = 6.8 \text{ mW/cm}^2$$

$$H_E = 0.25 \cdot H_T \text{ mW/cm}^2 = 1.7 \text{ mW/cm}^2$$

Assuming that there are no transmission losses in the path, the phototransistor collector current is $I_C = 1\text{mA/mW/cm}^2 \times 1.7\text{mW/cm}^2 = 1.7\text{mA}$,

- where:
- P_{in} — Power input (mW)
 - P_{out} — Power output (mW)
 - d — Distance (cm)
 - η — Conversion efficiency of light source
 - H_T — Total irradiance (mW/cm²)
 - H_E — Effective irradiance (mW/cm²)
 - I_c — Transistor collector current

For the IRED, or any lensed device, the spacial distribution of energy is determined by the lens characteristics, and no simple relationship exists for general cases. For the case of the lensed TO-18 IRED's (LED55, F5D families), with a TO-18 detector on the optical axis, analysis of the beam pattern in a piece-wise linear integration indicates:

$$H_E \cong 2.6 P_O / (d + 1.1)^2 \text{ for } d \geq 1 \text{ cm, as illustrated in Fig. 2.4}$$

Experimental data indicates this is a conservative model, although it should be noted that the lenses exhibit a wide variation in optical characteristics.

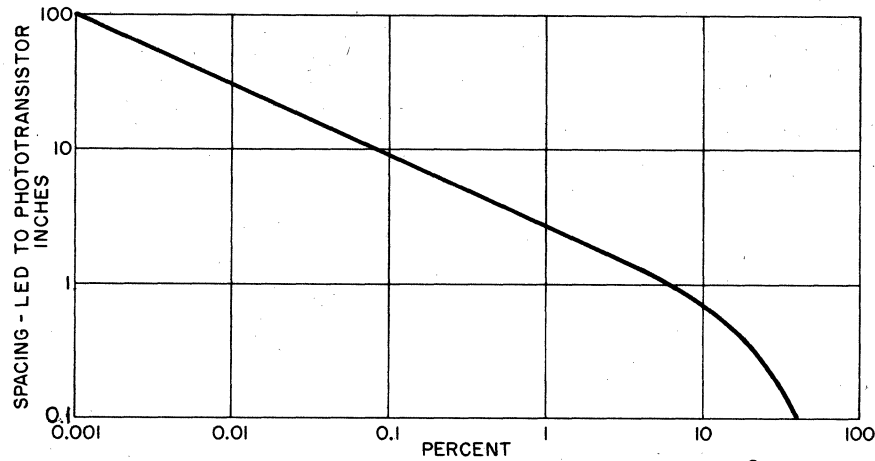

% lensed TO-18 IRED output incident on TO-18 phototransistor lens (0.1cm²) of L14C, F, G, N, P axis, clear path transmission: To find Hequiv. @ 2870°K (spec. condition) multiply P₀ of LED by 30 times this percentage.

FIGURE 2.4: LENSED LED TO PHOTOTRANSISTOR COUPLING CHART

A F5D series GaAlAs IRED will have efficiencies of 5% to 10%, and on a steady-state basis is limited to about 150mW power dissipation in a normal range of ambients. For the same 10cm spacing, using the IRED at 150mW and 8% efficiency, the transistor collector current is:

$$I_c = 2.6 (150\text{mW}) (.08) (.98/.27) (1\text{mA/mW/cm}^2)/(11.1\text{cm})^2 = .95\text{mA},$$

where the .98 ÷ .27 factor is the spectral response correction from Table 2.1.

The transistor collector current is about 13 percent of the current the lamp generates, but with an input power of only 1.5% of the lamp power, the efficiency of the total system has increased approximately by a factor of 10 due to the lens and the effectiveness of the light. If the IRED is operated in a pulsed mode, P₀ can be raised to 50 times the steady-state value for short times (≈ 1μsec) and low repetition rates (200pps), although efficiency suffers above the 500mA (≈ 1W) bias point. The effects of lens misalignment, temperature, tolerances, and aging all must be evaluated before “worst case” or “Gaussian” expected performance can be determined, but these steps should follow initial breadboard verification of the assumptions made above. In critical applications, the LED output and transistor photodiode and gain characteristics must now be analyzed to determine response.

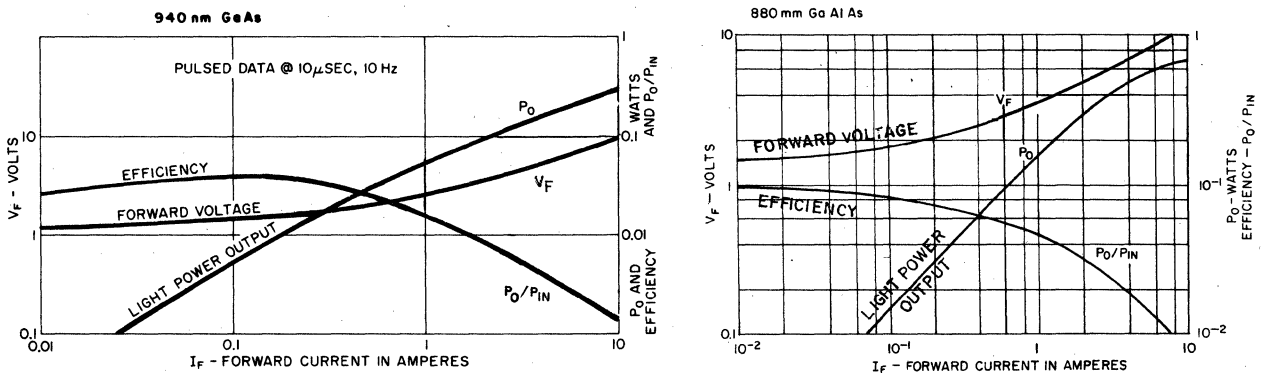

FIGURE 2.5: TYPICAL POWER OUT, FORWARD VOLTAGE AND EFFICIENCY OF IREDS

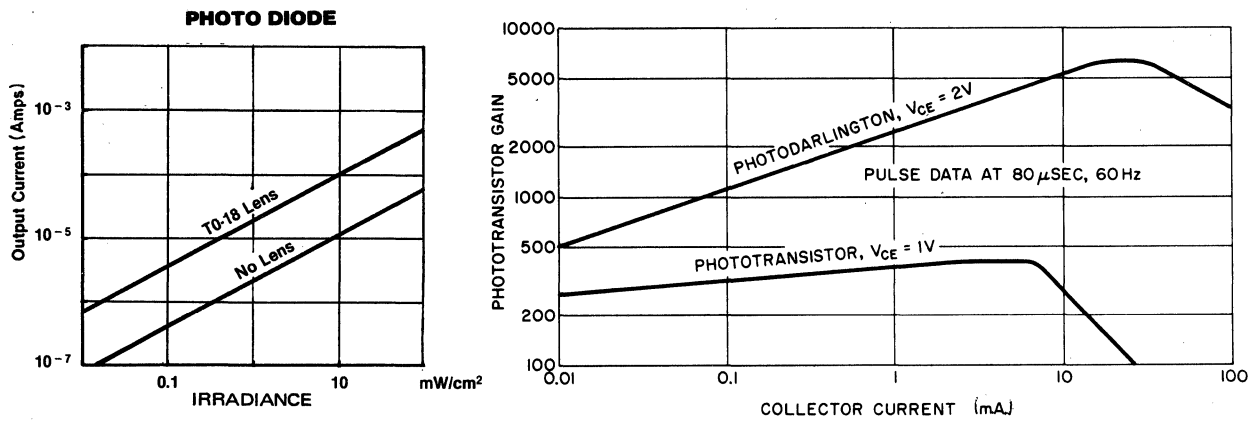

FIGURE 2.6: TYPICAL PHOTODETECTOR CURRENT AND GAIN

TABLE 2.2: CHECK LIST OF REQUIRED SOURCE/DETECTOR INFORMATION

CHECK LIST	SOURCE
1. Relationship between the radiator's input electrical power and peak axial intensity of radiation	Specification Sheet
2. The radiator's relative radiation pattern	Specification Sheet
3. The radiator's relative output as a function of wavelength*	Specification Sheet
4. Distance between radiator and receiver	Design Requirements
5. Angular relationship between axis of radiator and receiver	Design Requirements
6. Relative acceptance pattern of receiver	Specification Sheet
7. Relative sensitivity of receiver as a function of wavelength*	Specification Sheet
8. Sensitivity of receiver	Specification Sheet
9. Light transmission efficiency	Path Material Properties

*Numbers 3 and 7 are not needed if the effectiveness is known.

The transmission of the light from source to detector is normally not a problem and can often be checked visually. Most organic materials, e.g., plastics, have strong attenuation of near infrared wavelengths such that (although they look transparent and will work with incandescent light) they may not work with IRED's. This problem is noted on transmission paths exceeding 1 foot. The strongest common attenuations are found around 890nm in organics and 950nm in materials containing the OH radical. This problem commonly occurs in fiber optics systems because of their long path lengths. Fiber optics systems are discussed in a later section.

Another criteria for selecting the proper light source is the speed at which the system must work. As can be seen in Figure 2.7, applying ac or unfiltered dc to light emitting devices may change their effective irradiance by as much as 30% for tungsten lamps, or as much as 100% for IRED's. Only filtered dc will yield constant effective irradiance for all light emitting devices. For high speed data transmission, the high efficiency GaAs and GaAlAs are capable of operation at frequencies greater than 1MHz when optimized. Faster diodes are difficult to build with high efficiency and long life.

In some applications it is advantageous to have an optoelectronic transceiver, a unit that can both transmit and receive via light. Although most LED's and IRED's are light sensitive, they usually are relatively insensitive at the wavelength they produce. This is true of the 880nm high efficiency GaAlAs IRED, but not as pronounced on the 940nm GaAs (Si) IRED. The 940nm units also will detect 940nm radiation. The sensitivity is less than that of a silicon photodiode: typically $0.15\mu\text{A}$ per mW/cm^2 on an unlensed device such as the LED55BF. Leakage current is typically under 10nA at 2V and 25°C , doubling with every 25°C temperature rise. This would provide a 20db noise margin at $15\text{uw}/\text{cm}^2$ and 50°C in an all GaAs (Si), 940nm, transmission system without lenses on the detector. Lensed units improve sensitivity at the expense of resolution and alignment requirements.

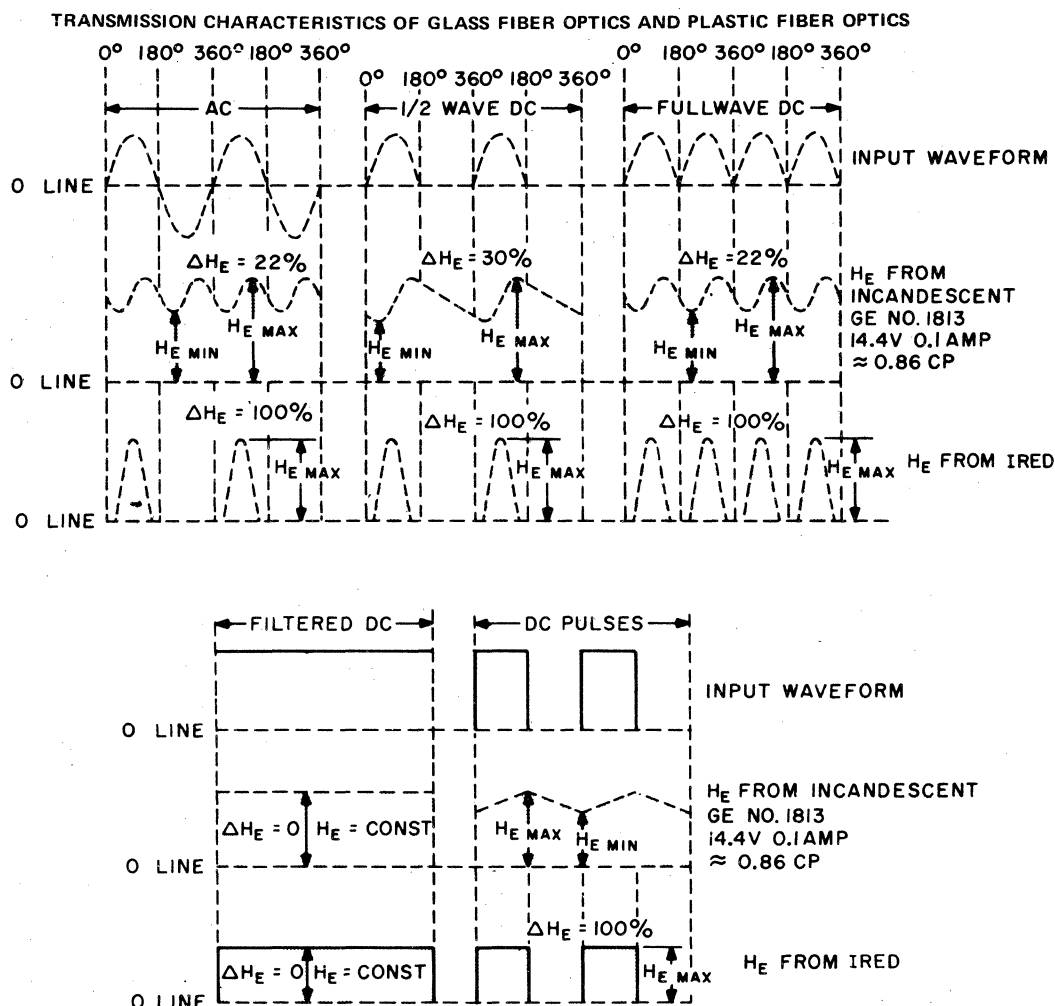

FIGURE 2.7: TIME DEPENDANCE OF IRRADIANCE FOR VARIOUS POWER SUPPLIES

2.1.2 Lenses and Reflectors

Simple converging lenses are commonly used to extend the range and improve the directionality of optical systems. Improved directionality minimizes pick up or "stray" ambient light, as well as defining the volume in which an object can be sensed. In emitter-detector systems (as opposed to light level sensing) range is increased by focusing the light from the emitter into a beam and/or by focusing the received light on the detector. Focusing reflectors may be used to perform the same functions and are normally analyzed using the same techniques. Reflectors can offer better optical performance, and must be evaluated for cost, mechanical properties, and tolerances if considered. Optimum mechanical performance and optical efficiency is obtained when opto-electronic components without built-in lenses are used with component optics, as both range and directivity are improved over using integrally lensed devices. This is due to the better optical parameters of component lenses, compared to those integral to the semiconductor device package, which are not compromised by packaging requirements of the semiconductor material.

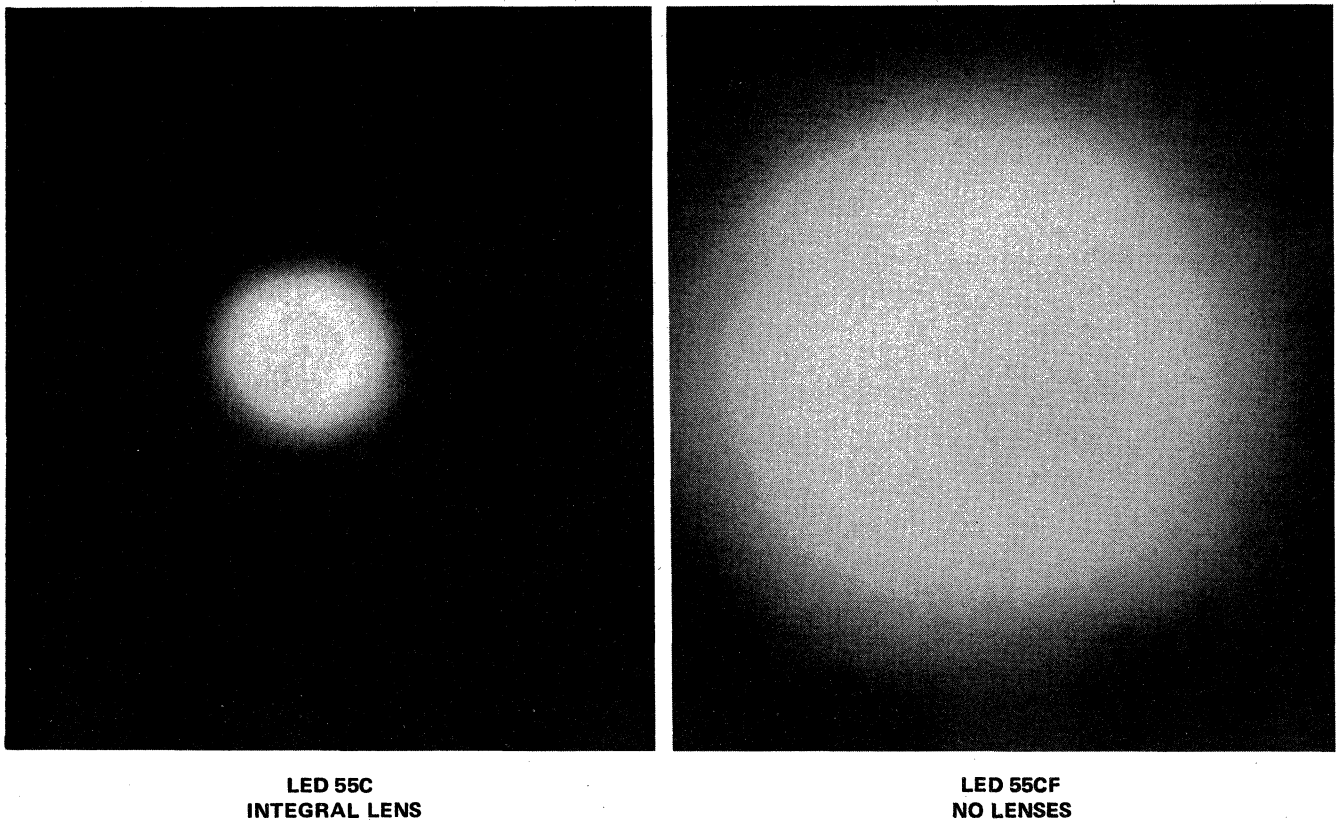

FIGURE 2.8: TYPICAL INFRARED IRRADIATION PATTERN OF IRED ON SURFACE 5 CM. AWAY (ACTUAL SIZE)

Lenses are normally specified by the f number, i.e., focal length divided by effective diameter, and either the effective diameter or the focal length.

$$f \# = \frac{\text{Focal Length}}{\text{Effective Diameter}}$$

Normally, the effect on irradiance (H), of adding a lens to the detector end of a system can be approximated by determining the ratio of the area of lens to the area illuminated in the plane of the base of the phototransistor and multiplying it by the irradiance incident on the lens. This approximation is *only* valid for irradiance that approximates a point source, i.e., the diameter of the light source is less than 0.1 times its distance from the lens. The lens will reflect and attenuate the result by about 10%.

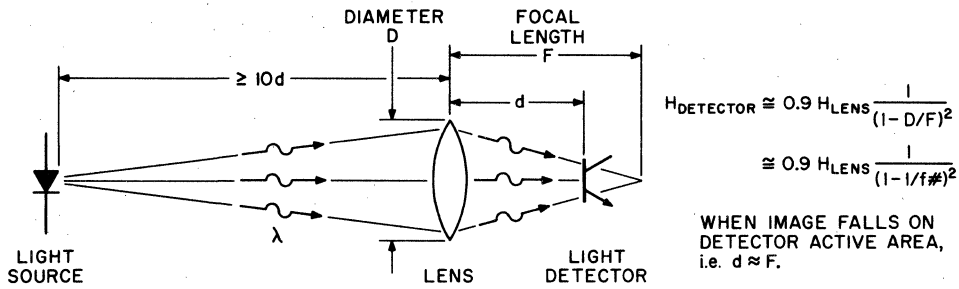
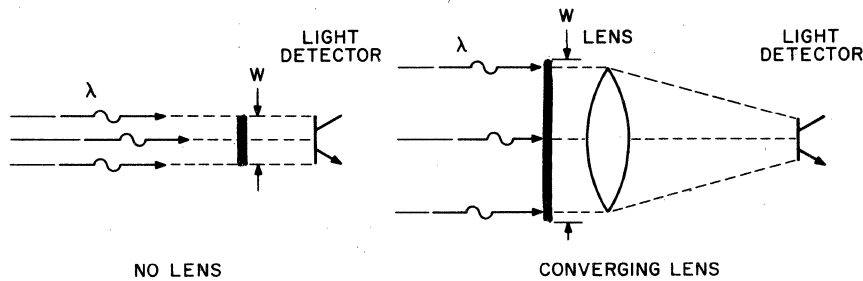

FIGURE 2.9: DETECTION WITH A CONVERGING LENS

Although the use of lenses narrows the field of view of the detector and alleviates some ambient light problems, it can also widen the path of light that must be blocked to turn the detector off. Resolution is always less when focusing lens systems are used on the detector without light masking.



W IS THE WIDTH AN OBJECT MUST HAVE TO BLOCK THE DETECTOR FROM LIGHT, i.e. FULL ON TO FULL OFF.

FIGURE 2.10: EFFECT OF LENS ON RESOLUTION

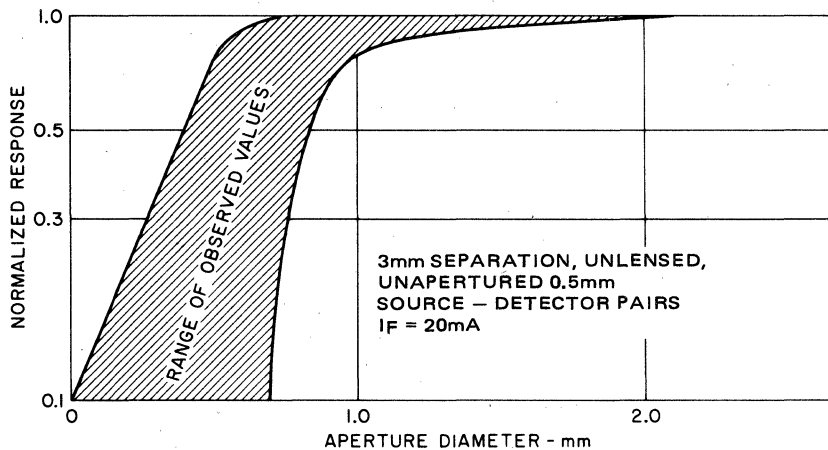

FIGURE 2.11: EFFECT OF APERTURE SIZE ON RESPONSE TRANSPARENT APERTURE ON OPAQUE FIELD

With an unshielded L14C phototransistor detector, the light sensitive area is about 0.5mm (0.02 in.) square. Diffraction, tolerance and edge effects will add approximately 0.3mm (0.012 in.) to the path width which must be blocked to darken the detector. When a converging lens is added in front of the detector, the field of view is lessened, and the light path is widened by the lens system's magnification. Adding a converging lens to the light source increases the irradiance on the detector but has insignificant effect on the light path width. Converging lenses on either device makes detector/source alignment more critical as the light path and view of the devices are now "beams." The combination of lenses and apertures can tailor field of view and resolution in many applications. For high resolution applications the consistency of the lenses becomes significant. Various masking and coding techniques are used to minimize these interactions, with sensitivity or transmission efficiency usually being the parameters traded off with alignment and cost of materials.

2.1.3 Ambient Light

The effect of ambient light on optoelectronics is generally difficult to estimate, since the ambient light varies in terms of level, direction, spectral content and modulation. If the detector is not highly directional, it will normally be found that all reflecting surfaces near the system must be coated with a non-reflecting material or shielded from both ambient light and reflections of light from the light source. Note that back-lighting of the detector can cause trouble by reflecting off the object that normally blocks the light path. As a final solution, a pulse encoded and decoded light system can be used to give very high ambient light immunity, as well as greatly extend the distance over which the system will operate.

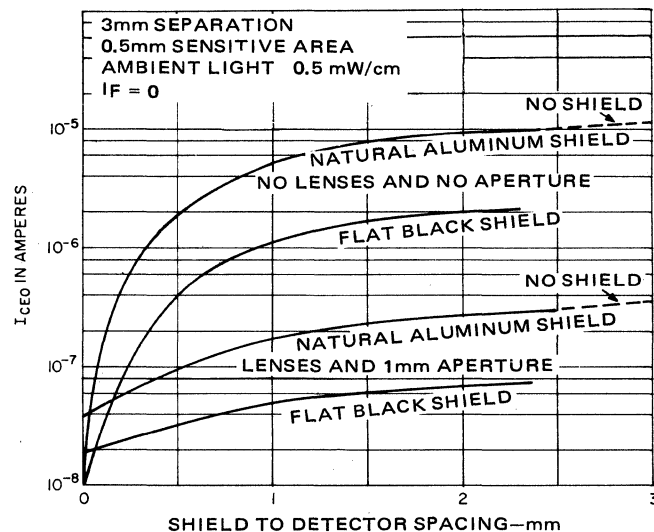

FIGURE 2.12: EFFECT OF AMBIENT LIGHT AND SHIELD FINISH ON OPTOELECTRONIC OBJECT DETECTOR

2.1.4 Pulsed Systems

High levels of light output can be obtained by pulsing the IRED. High signal to noise ratios at the detector are obtained by AC signal processing and simple pulse decoding techniques. Such a system is illustrated in Chapter 6.

Pulsed light systems can provide significant performance improvements in detector-emitter pair applications at the expense of more complex circuit design. The cost of a pulsed system may actually be lower than that of the high power light source and sensitive detector required to do a similar job, since low cost commodity components are easily designed into a pulsed system. Performance of the pulsed system will almost always be better than a steady-state system.

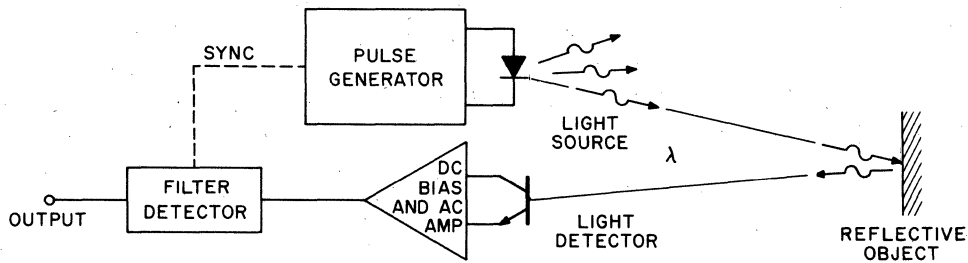

FIGURE 2.13: TYPICAL PULSED REFLECTIVE OBJECT SENSOR

Generally, low cost systems use unijunction transistor (UJT) derived current pulses of from 1 to $10\mu\text{sec}$ at a 0.1 to 1% duty cycle, into an IRED, since shorter times do not provide corresponding increases in light output and require more sophisticated (and costly) circuits to develop the pulse. The detector is normally a phototransistor cascode biased* by an ac amplifier of one to three transistors (low cost I.C. amplifiers are too slow). Synchronous rectification of the ac amplifier output (synchronized by the pulse generator), allows a significant increase in performance at low cost. Xenon flash tubes and laser light sources provide highest output but cost and complexity limit these to extremely high performance systems. Normal cost/performance progressions are: dc operations, no external optics; pulsed operation, no external optics; pulsed operations with external optics and exotic (laser, etc.) source systems. Occasionally, commodity plastic lenses may be found that will provide lower cost than the pulse electronics, but alignment and mechanical systems cost must be compared against possible electronics savings.

2.1.5 Precision Position Sensing

Precision position sensing can be done using various techniques, depending on the application. Some techniques require multiple emitter detector pairs to provide the desired resolution and accuracy. Normal design practice in multiple path sensing applications is to design the light shield mechanism to provide a "gray code" output, i.e., each sequence is only one bit different from the preceding one. One advantage to such systems is that they are not affected by transients, power loss, etc. They also require one optical path per bit, with path coding hardware and initial alignment. These can prove economically impractical in many applications.

However, the availability of powerful, low-cost logic in a system requiring the position sensing function allows cost optimization by using logic to minimize the number of scanning points. Clever mechanical design of the scanning area provides the key to optimization.

To illustrate this, a rotary encoder (see Figure 2.14) requires only two sensors to scan the rotating disc to provide position, speed, and direction of rotation. This information is coded in the T triangle wave — the slope providing speed, the ratio of instantaneous amplitude to peak amplitude provides position within 15° increments and the phase relationship to the S-wave indicates direction of rotation. The S-wave output transitions are counted to provide the position to 15° increments.

*Biased in this manner, the phototransistor can respond in less than a microsecond. LED current, pulse width and repetition rates can then be determined strictly from response time, distance covered, LED thermal resistance and cost constraints.

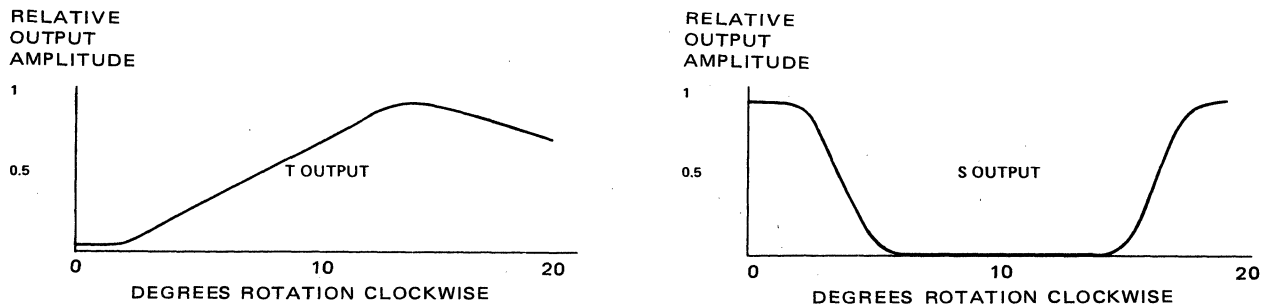
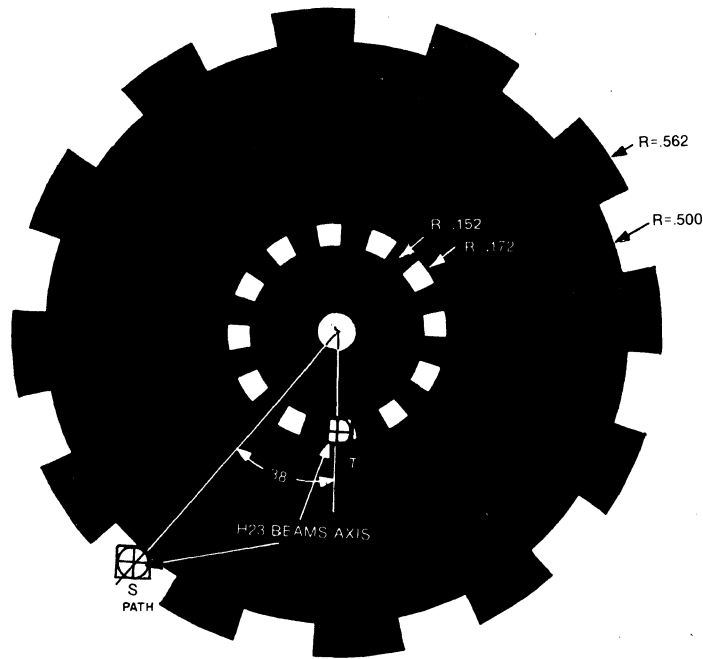

FIGURE 2.14: COST OPTIMIZED SHAFT ENCODER

Linear position information can also come from two sensors. Accuracy and high resolution result from the use of Moiré fringes shown in Figure 2-15. The scale difference is obtained using two grating scales, as illustrated, or by using two identical scales held at an angle. The two sensors are placed within $1/2$ period of each other.

As one scale is moved in relationship to the other fixed scale, each sensor output goes through a complete period for a motion of one gradient. The phase relationship between sensors outputs contains direction of motion, the slope of the waveform provides speed, and the ratio of instantaneous amplitude to peak amplitude provides distance within a grid. The number of cycles is counted for absolute position.

Additional advantages of the Moiré fringe technique are the use of large area sensor emitter-detector pairs and the non-critical initial placement of the pairs. Using the H21 module for the sensors requires that the individual masks of the grids be less than 0.25mm wide, cover a height of over 1.5mm, and the static period of the fringe pattern (dark area to dark area) be over 6mm for interrupters mounted side by side. Spacing the sensors between n and $n + 1/2$ periods apart eliminates the last criteria, at the expense of a more rigid, precise mechanical design.

For extremely fine gratings, note that the sensor light path can cover up to 15% of the static period with a loss of only about 10% in peak amplitude for 40% transmission gratings. The static period of the gratings is the reciprocal of one minus the ratio of grids per unit length, in units of grid length. Example, with a scale factor difference of 1.5%, the static period is $1 \div 0.015 = 66.7$ grids. This can be verified by counting grids in Figure 2.15. Note that both the space between the gratings and reflectivity of the gratings can affect the observed phase difference.

Practical production units must be designed to account for those effects, as well as amplitude differences of signals in the two channels, ambient light and mechanical parameters. Fiber optics can often be used to advantage in position sensing applications. The small fiber can fit many places discrete devices would not, and the fiber is not sensitive to the electromagnetic fields found in many sensing environments.

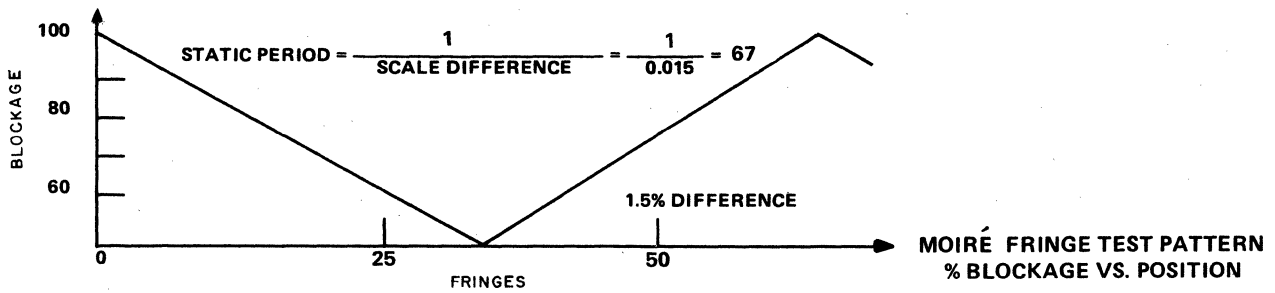

MOIRÉ FRINGES AT 1.5% SCALE DIFFERENCE



MOIRÉ FRINGES AT 3% SCALE DIFFERENCE

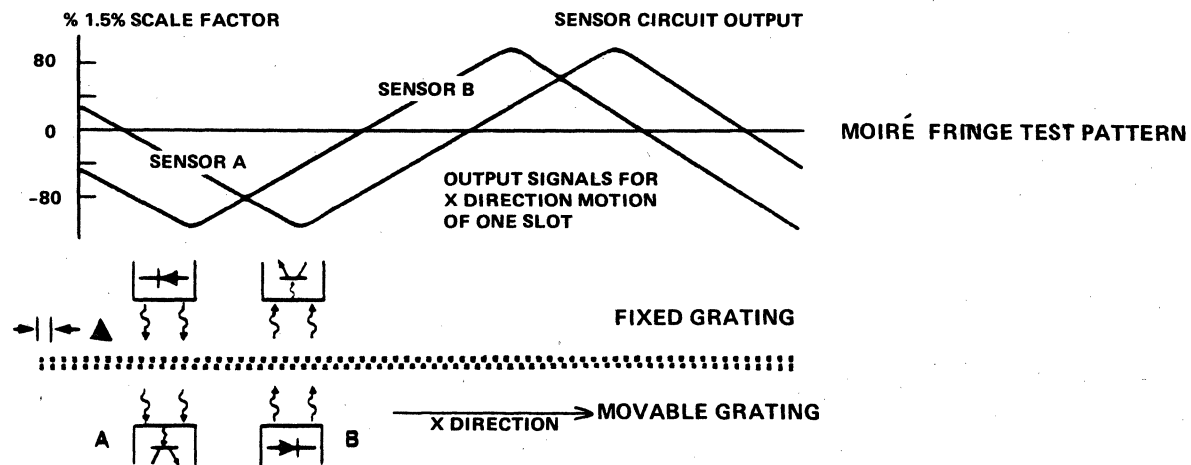

FIGURE 2.15: MOIRÉ FRINGE TEST PATTERN

Optical scanning via fibers will utilize the same electronic circuitry as without fibers, and requires looking at the system efficiency associated with the mechanical configurations. Breaking of the fiber transmission path to scan for objects that interrupt an I.R. beam may simplify mechanical and wiring requirements in some applications when compared to air path transmission. This is illustrated by the three places a fiber path can be interrupted to scan for objects. Using the GFOD/E series and low-cost, 1mm diameter plastic fiber, the effect on detector current of displacing the fiber, along the infrared beam axis is found to fit a square law equation as follows:

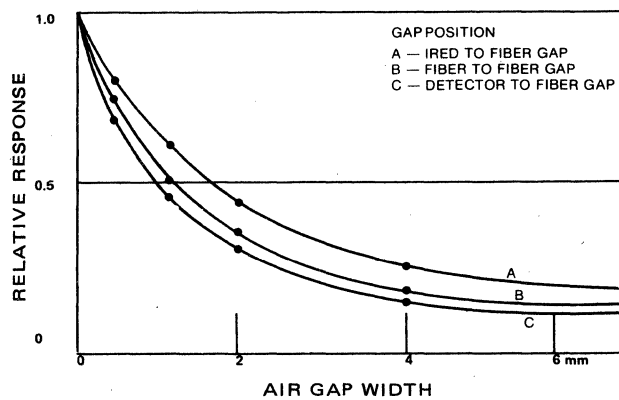
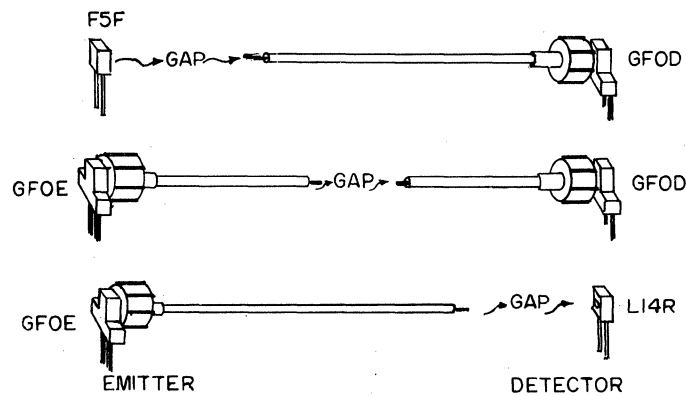

FIGURE 2.16: INTERRUPTION SENSING USING GAP IN FIBER

IRED to fiber gap	$I_{C(D)} = 15.7 I_{C(0)} \div (3.96 + D)^2$	A
fiber to fiber gap	$I_{C(D)} = 4.3 I_{C(0)} \div (2.08 + D)^2$	B
fiber to detector gap	$I_{C(D)} = 6.5 I_{C(0)} \div (2.57 + D)^2$	C

where

D is the gap in mm

$I_{C(D)}$ is collector current at gap D

and

$I_{C(0)}$ is collector current at zero gap

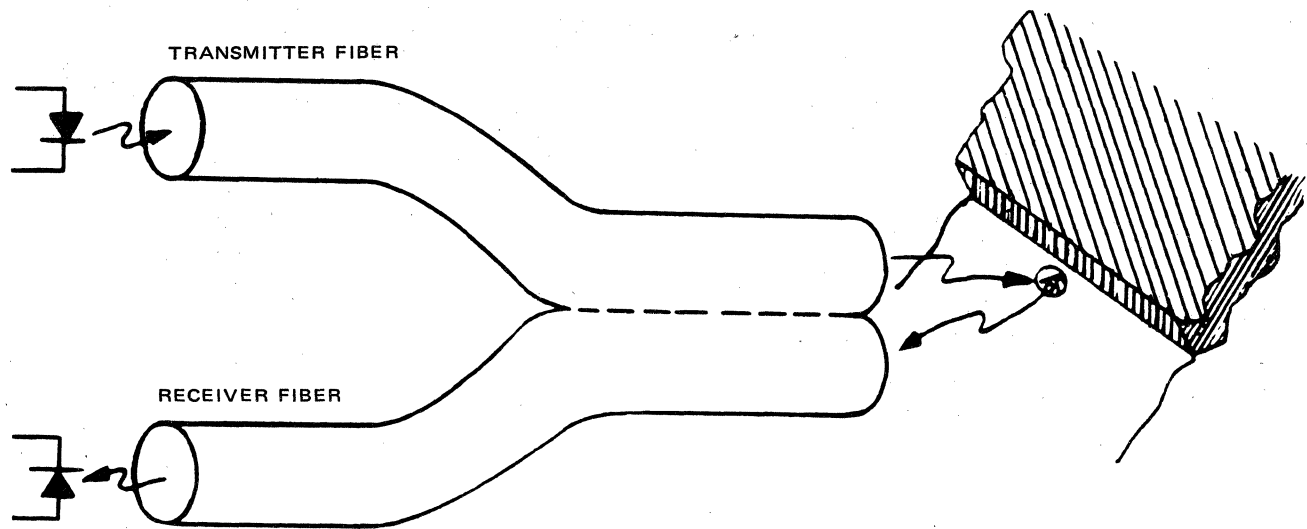

FIGURE 2.17: TWIN FIBER REFLECTIVE SENSING

Reflective sensing is also possible, but it is much less efficient. In systems with specular (mirror) reflectance, the distance capability is $\frac{1}{3}$ to $\frac{1}{4}$ that of a transmissive system. Diffuse reflectance is quite variable and effective only at very short ranges. Often the mechanical configuration indicates a twin fiber system is required. This configuration requires care whenunjacketed fibers are twinned. The cladding of the fiber carries significant energy for a short distance from the source, and this energy may couple from the transmitter fiber cladding to the receiver fiber cladding. Although this energy is small, in a reflective system the signal levels are normally very small and this cladding energy can significantly degrade performance.

2.2 OPTOCOUPLER SYSTEMS

The optocoupler, also known as an optoisolator, consists of an IRED, a transparent dielectric material and a detector in a common package. It has been defined previously in terms of construction and the various semiconductors which can be used in it. To utilize these devices in a circuit, the characteristics of the combined component, as well as its parts must be known. Characteristics such as coupling efficiency (the effect of IRED current on the output device), speed of response, voltage drops, current capability and characteristic V-I curves, are defined by the devices used to build the coupler and the optical efficiency. The detailed coupler specification defines these parameters such that circuit design can be done in the same manner as with other semiconductors with input, output, and transfer characteristics — except that the input is dielectrically isolated. This is the critical difference, the definition of the isolation parameters and what they mean to the design of a circuit.

2.2.1 Isolation

Three critical isolation parameters are isolation resistance, isolation capacitance, and dielectric withstand capability. Note that all three are specified with input terminals short circuited and output terminals short circuited. This prevents damage to the emitter and detector due to the capacitive charging currents that flow at the relatively high test voltages.

a. Isolation Resistance is the dc resistance from the input to output of the coupler. All GE couplers are specified to have a minimum of 10^{11} ohms isolation resistance, which is higher than the resistance that can be expected to be maintained between the mounting pads on many of the printed circuit boards the coupler is to be mounted on. Note that at high dielectric stress voltages, with printed circuit board leakage added, currents in the tens of nanoamps may flow. This is the same magnitude as photodiode currents, generated at IRED currents of up to 0.5mA in a typical dual in-line darlington coupler, and could be a problem in applications where low levels are critical. Normally, care in selection and processing of the printed circuit board will minimize any isolation resistance problems.

b. Isolation Capacitance is the parasitic capacitance, through the dielectric, from input to output. Typical values range between 0.3pF and 2.5pF. This can lead to noticeable effects in circuits which have the dielectric stressed by transients exceeding 500V per microsecond. This would occur in circuits sensitive to low level currents, biased to respond rapidly and subjected to the fast transients. Common circuitry that meets these criteria is found in machine tool automation, interfacing with long electrical or communication lines and in areas where large amounts of power are rapidly switched. The majority of capacitive isolation problems are solved through one or a combination of the following:

- clean up circuit board layout — especially base (gate) lead positioning;
- use base emitter shunt resistance and/or capacitance;
- design for immunity to noise levels expected;
- electrostatically shield highly sensitive circuit portions;
- use snubber capacitors coupling the commons on both sides of the dielectric.

This will lower the rate-of-rise of transient voltages and, lower currents into sensitive portions of the circuit. In applications where these techniques do not solve the noise problem a lower isolation capacitance is required. Several alternatives exist. In the standard six pin DIP package the H11AV series (which contains a > 2mm glass light pipe dielectric) provides the lowest isolation capacitance (0.5pF max.) available in this package. Where base lead pickup is indicated, the H24 series optoisolators eliminate the base lead. The ultimate isolation is provided by a fiber optic link, obtainable with the low cost GFOD/E pairs.

c. Isolation Voltage is the maximum voltage which the dielectric can be expected to withstand. Table 2.2 illustrates the parameters that must be defined to qualify isolation voltage capability, which depends on time, dv/dt, and waveshape. The dependence is a function of the method by which the coupler is constructed. To illustrate the effect the voltage waveform can have on the isolation capability of a coupler, a series of tests were run to quantify these effects on both a glass dielectric and a competitive dual lead frame DIP coupler.

The results of the tests were analyzed to determine the percent difference in surge isolation voltage capability that was exhibited by the couplers for the various waveforms applied, as compared to the specified test method. These percentages were then applied to a hypothetical device that just met a 1000V peak specification. The results were tabulated to determine the “real” surge voltage capability of this device for each waveform. This was done to allow the circuit designer to determine a realistic surge voltage derating for each coupler type. Dual lead frame couplers with other dielectric materials and/or dielectric form factors may show different changes in capability with waveform. The glass dielectric is very consistent in both electrical properties and form factor and performed consistently from device to device.

TABLE 2.3: SURGE ISOLATION VOLTAGE CAPACITY OF HYPOTHETICAL 1000V COUPLER

COUPLER	WAVE FORM					
	AC ZERO Φ	DC RAMP	AC RAMP	AC STEP	DC STEP	
G.E. Glass	707 V*	1025 V	650 V	580 V	919 V	
Dual Lead Frame	540 V	1000 V*	540 V	510 V	780 V	

*Specification sheet test method.

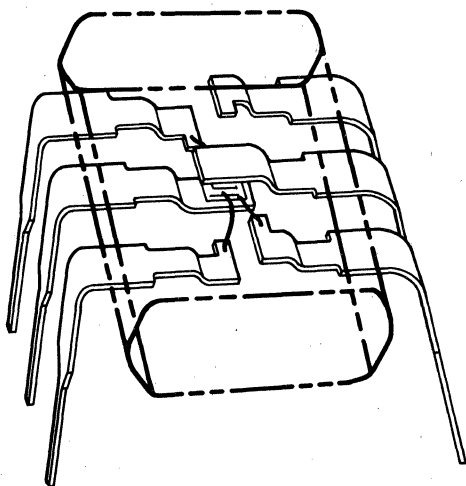

FIGURE 2.18:
COMPETITIVE CONSTRUCTION, DUAL LEAD FRAME

The tests performed were:

1. AC — rms surge rating per GE definition
- *2. DC Ramp — Value at failure when potential gradually increased from zero — definition used on competitive device.
- *3. AC Ramp — rms value at failure of gradually increased potential.
4. AC Step — rms value at failure of instantaneously applied voltage. Application of voltage synchronized to peak voltage.
5. DC Step — Value at failure of instantaneously applied potential.

*ramp slope 1000V/sec

TABLE 2.4: GENERAL ELECTRIC OPTOCOUPLER ISOLATION VOLTAGE SPECIFICATION METHOD

I. Surge Isolation Voltage

a. Definition:

This rating is used to protect against transient over-voltages generated from switching and lightning-induced surges. Device shall be capable of withstanding this stress a minimum of 100 times during its useful life. Ratings shall apply over entire device operating temperature range.

b. Specification Format:

Specification, in terms of peak and/or rms, 60 Hz voltage, for a one minute duration.

c. Test Conditions:

Application of full rated 60 Hz sinusoidal voltage for one second, with initial application restricted to zero voltage (i.e., zero phase), from a supply capable of sourcing 5 mA at rated voltage.

II. Steady-State Isolation Voltage

a. Definition:

This rating is used to protect against a steady-state voltage which will appear across the device isolation from an electrical power source during its useful life. Ratings shall apply over the entire device operating temperature range and shall be verified by a 1000 hour life test.

b. Specification Format:

Specified in terms of peak and/or rms 60Hz sinusoidal waveform.

c. Test Conditions:

Application of the full rated 60 Hz sinusoidal voltage, with initial application restricted to zero voltage (i.e., zero phase), from a supply capable of sourcing 5 mA at rated voltage, for the duration of the test.

Steady-state isolation voltage ratings are usually less than surge ratings and must be verified by life test. The GE steady-state rating confirmation tests were performed on devices segmented by surge isolation voltage capabilities into groups of the lowest voltages that could be supplied to the specification tested. A destructive surge isolation voltage test was performed at a specified surge rating to confirm the selection process, and then the couplers were placed on rated 60 Hz steady-state isolation stress. No failures were observed on the 160 couplers tested for 1000 hours. This consisted of 32 units, H11A types, each group tested at a voltage ratio of 800/1060, 1500/2500, 1500/1770, 2200/2500 and 2500/4000 (life test to surge test voltage ratio). Note that some of the tests are beyond the rated steady-state condition for a given test voltage, again confirming the inherent properties of glass dielectric.

The failure mode of a coupler stressed beyond its dielectric capability is of interest in many applications. Ideally, the coupler would heal and still provide isolation, if not coupling, after breaking down. Unfortunately, no DIP coupler does this. The results of a dielectric breakdown can range from the resistive path, caused by the carbonized molding compound along the surface of the glass observed on glass dielectric couplers, to a metallic short, caused by molten lead wires bridging lead frame to lead frame, noted on some dual lead frame products. In critical designs, the effects of dielectric breakdown should be considered and, if catastrophic, protection of the circuit via current limiting, fusing, GE-MOV®II Varistor, spark gap, etc., is indicated. Some techniques for protection are illustrated below. Note that film resistors can fuse under fault currents, providing combined protection. Breakover protection, if feasible, is probably the best choice when a coupler with adequate breakover capability cannot be obtained. Since breakover protection compromises isolation, fiber optics may prove a better solution in such cases.

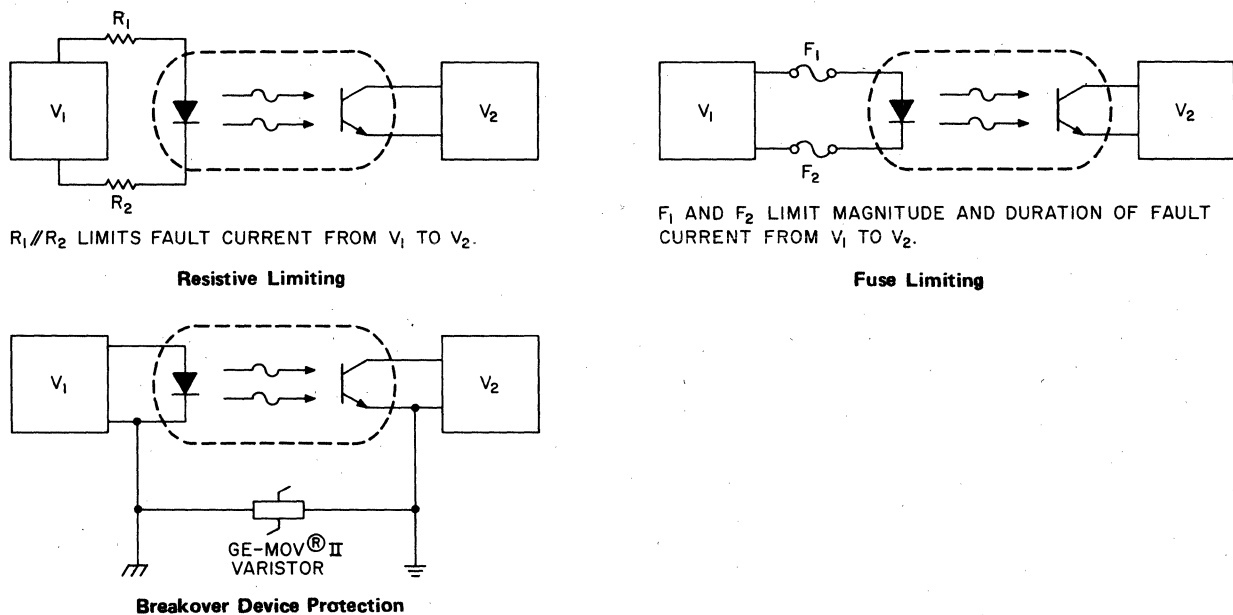

FIGURE 2.19: METHODS OF LIMITING OR ELIMINATING DIELECTRIC BREAKOVER PROBLEMS

Another phenomenon that has been observed in some photocouplers when subjected to dc dielectric stress is a rise in the leakage current of the detector device. This phenomenon is known as “dielectric channelling” or as “ionic drift.” This rise in leakage is usually observed at high levels of dielectric voltage stress and elevated temperature, although field reports indicate the phenomena has been observed at dielectric stresses as low as 50Vdc in some brands of couplers. The phenomenon seems independent of normal HTRB channelling, since it appears only under dielectric stress and not under detector blocking voltage stress. The cause is hypothesized to be mobile ions in the dielectric material that move to the detector surface under the influence of the voltage field generated by the dielectric stress. At the detector surface, the field produced by these ions would cause an inversion layer (similar to that formed in a MOS field effect transistor) to form in the collector or base region of the detector and carry the leakage current. The GE coupler glass dielectric has been designed to be as ion free as possible and the detector devices (which are optimized for minimum susceptibility to the formation of inversion layers) have proven to provide a stable, reliable and highly reproducible coupler design. Tests performed on these devices at stresses up to 1500V and 100°C produced no significant change in detector leakage.

2.2.2 Input, Output and Transfer Characteristics

The complete optocoupler has the electrical characteristics of the IRED and the detector at the input and output, respectively. Since the individual devices and the dielectric characteristics are known, emphasis will be on the transfer characteristics of the coupler. Some specific device characteristics are also detailed to provide the information required for a complete analytical circuit design.

a. Input The input characteristics of the coupler are the characteristics of an IRED — usually a single diode, although the H11AA has an anti-parallel connected, two IRED input. The forward voltage drop, V_F , is slightly different than that of the discrete IRED previously discussed, due to differences in wiring and contact details. Figure 2.20 illustrates this for all GE coupler types. In pulsed operation

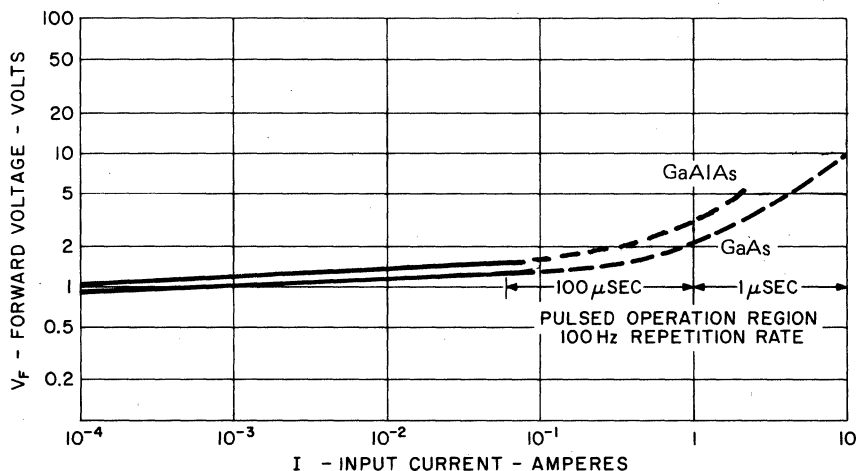

FIGURE 2.20: TYPICAL OPTOCOUPLER INPUT CHARACTERISTICS — V_F VS. I_F AT 25°C

significantly higher currents can be tolerated, but close control of pulse width and duty cycle are required to keep both chip and lead bond wire from bias conditions which will cause failure. The temperature coefficient of forward voltage is related to the forward current and is of small magnitude as it changes V_F by only about $\pm 10\%$ over the temperature range.

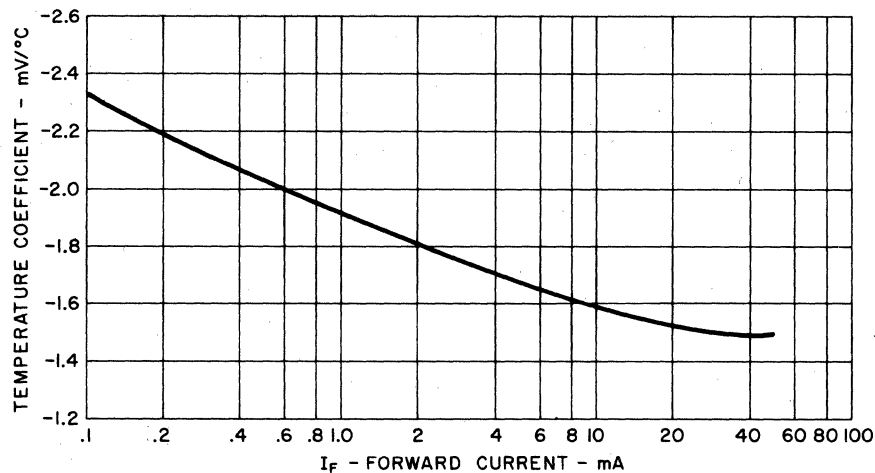

FIGURE 2.21: IRED FORWARD VOLTAGE TEMPERATURE COEFFICIENT

The Ga1As IRED of the new H11AG is quite similar to the GaAs IRED used in previous introductions, in terms of input characteristics. It exhibits a slightly higher forward voltage drop (typically 0.1V more from about 1 to 100 mA bias) with a similar temperature coefficient of forward voltage. The input capacitance, speed and reverse characteristics are quite similar to GaAs types. The outstanding advantage of the GaA1As IRED is the 3 or 4 to 1 improvement in transfer efficiency due to better radiation efficiency and detector responsivity. This improvement allows specification and application of the optoisolator down to input bias currents of 200 μ A and simultaneously provides current transfer ratios exceeding 100% over the 0 to 70°C temperature range.

The stability and predictability of the IRED forward voltage drop lends itself to various threshold (like H11A10) and time delay applications. Threshold operation is accomplished by shunting the IRED with a resistor such that V_F isn't reached until the input current reaches the desired threshold value for turn-on. This type of application is documented in the specification of the H11A10.

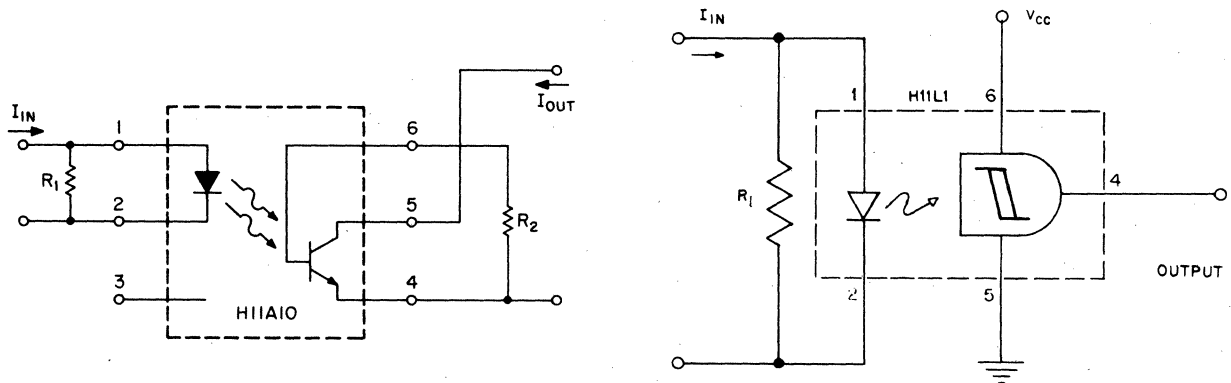
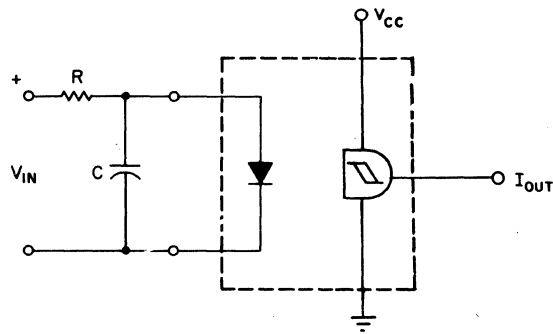

FIGURE 2.22: CURRENT THRESHOLD OPERATION OF OPTOCOUPLER

The H11L1 Schmitt trigger output optoisolator gives a more precise current threshold than the H11A10, with fast rise and fall times on the output waveform. This is due to the low turn-on threshold current, the IRED current and voltage, and the hysteresis — all of which have 0° to 70°C specification minimum/maximum limits. Time delay turn-on can be accomplished by shunting the LED with a capacitor in applications where a slow turn-on and turn-off can be tolerated. In speed sensitive, time delay applications, the trade-off between time delay at the input with a Schmitt trigger output vs. incorporation of the time delay in a discrete Schmitt trigger circuit must be evaluated for cost and performance.



TIME DELAY FROM APPLICATION OF V_{IN} UNTIL I_{OUT} FLOWS

$$t_d \approx RC \ln \frac{V_{IN}}{V_{IN} - 1.1}$$

FIGURE 2.23: TIME DELAY OPERATION OF OPTOCOUPLER

The input capacitance of the optoisolator is IRED junction capacitance. It is a function of bias voltage and, although normally ignored, has an effect on the turn-on time of the IRED. As the IRED is forward biased, its capacitance rises. The charging of this increasing capacitance delays the availability of current to generate light and causes a slower response than expected. In the liquid epitaxial-processed gallium aluminum arsenide and silicon-doped gallium arsenide devices, this effect is noticeable only at low drive currents, while rise time effects due to minority carrier lifetime dominates turn-on time at currents over a few milliamperes.

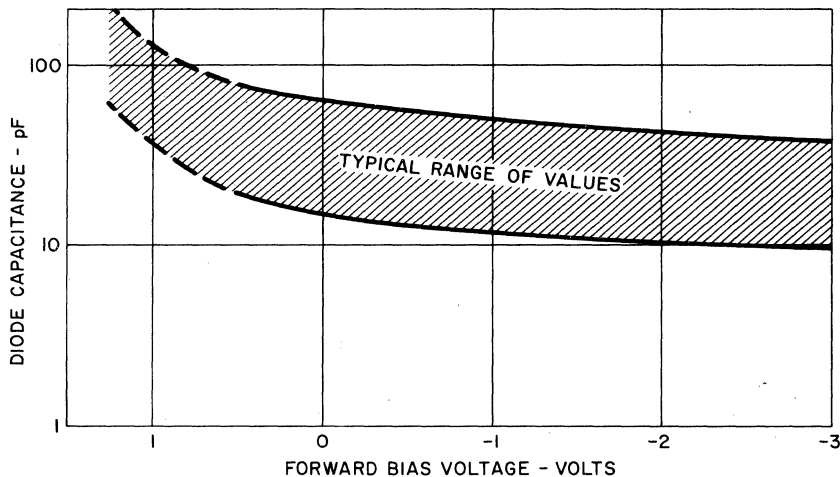

FIGURE 2.24: IRED CAPACITANCE AS A FUNCTION OF BIAS VOLTAGE

To minimize both effects when optimum rise time is required, the current waveform to the coupler input should have a leading edge spike, such as that provided by a capacitive discharge circuit.

b. Signal Transfer Characteristics The heart of the transfer characteristics of an optocoupler is the photodiode response to the light generated by the input current. In all isolators, the output is the combination of the photodiode response and the gain characteristics of the detector amplifier. With the transistor and darlington couplers, the photodiode characteristics are available in the collector-base connection and can be measured and utilized. Note that to use the photo-darlington as a photodiode, the

emitter of the output section must be open-circuited and not shorted to the base as can be done with a single phototransistor in this mode. This is because the base of the output transistor is not electrically accessible, so when the darlington is connected with a base emitter short, it acts not as a photodiode, but as a photodiode in parallel with a low-current-transfer ratio (ratio of output current to input current) phototransistor.

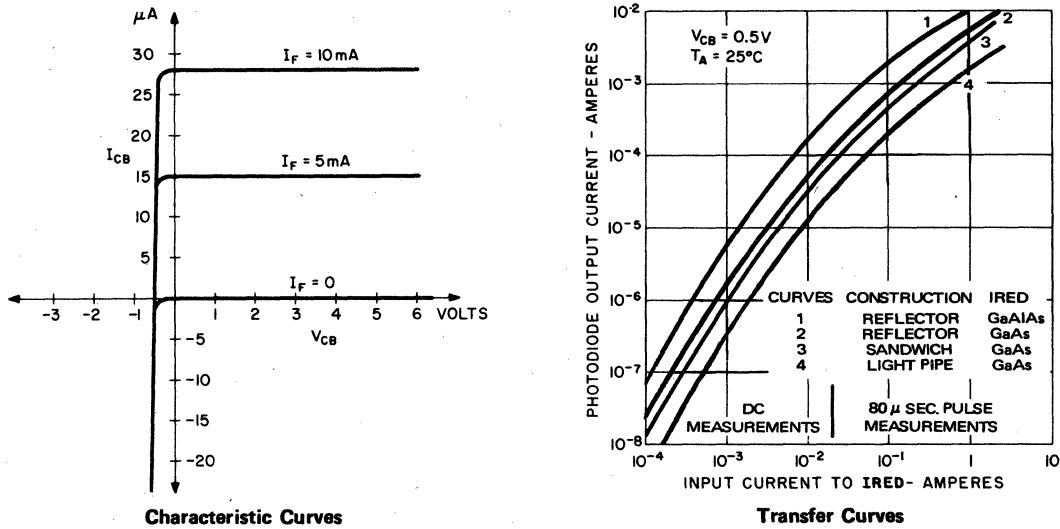

FIGURE 2.25: TYPICAL OPTOCOUPLER TRANSFER CHARACTERISTICS — PHOTODIODE RESPONSE OF PHOTOTRANSISTOR AND PHOTODARLINGTON COUPLERS

The photodiode response plot of Fig. 2.25 also illustrates the efficiency of various construction alternatives. The most efficient coupling is provided by utilizing the superior efficiency of the GaAlAs IRED combined with the improved optical path of the reflector package. The least efficient illustrates the relative disadvantage of the wide spacing of the light pipe construction using the proven GaAs IRED. It also illustrates the more efficient coupling provided by the reflector design, which takes advantage of the fact that about 3/4 of the energy emitted by the IRED pellet comes from the sides of the die, which reflects side light down through the dielectric onto the detector die.

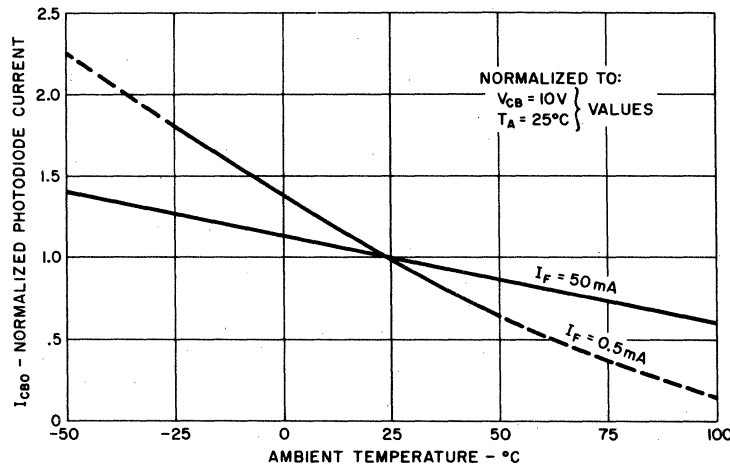

FIGURE 2.26: PHOTODIODE TRANSFER CHARACTERISTICS TEMPERATURE VARIATION

More complex output devices do not normally have the photodiode output available. The bilateral analog FET has photodiode action from either of the output terminals to the substrate, but provides lower output current than the phototransistor. The photoSCR exhibits phototransistor action from anode to gate. The triac trigger devices have phototransistor action from substrate to either output terminal. The Schmitt trigger detector has no external linear output due to photodiode action because the photodiode is part of a complex circuit.

In the SCR coupler, the pnp portion of the device from anode to gate activated by the photodiode can be monitored and utilized in both forward and reverse directions as a symmetrical switch for low currents at voltages up to rated voltage. High power dissipation is possible in this configuration, so care must be exercised to avoid exceeding the dissipation ratings of the device.

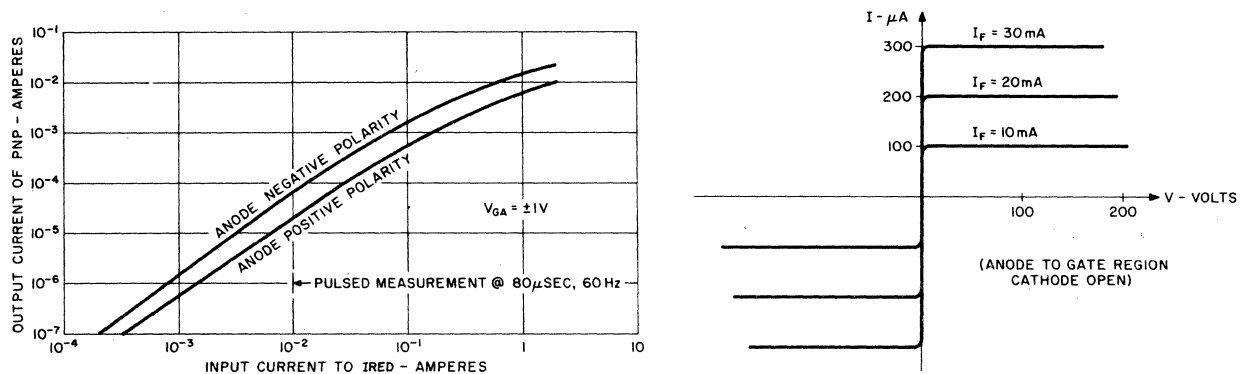

FIGURE 2.27: CHARACTERISTIC CURVES — PNP PHOTOTRANSISTOR ACTION OF H11C SCR OPTOCOUPLER

Using a unijunction transistor to pulse the IRED allows the SCR coupler biased in this mode to trigger triacs and anti-parallel SCR's without a bridge of rectifiers and its problems associated with commutating dv/dt . It is also useful for switching and sampling low level dc and ac signals since offset voltage (the prime cause of distortion) is practically zero. Temperature coefficients of both the photodiode response and the pnp response will be negative, as both primarily indicate the incident light and illustrate the decrease in IRED efficiency as temperature rises.

c. Phototransistor The phototransistor response is the product of the photodiode current and the current gain (h_{FE} ; β) of the npn transistor. The photodiode current is very slightly affected by temperature, voltage and current level, while the transistor gain is affected by all of these factors. In the case of temperature, the gain variation offsets the temperature effects on IRED efficiency, giving a low temperature coefficient of IRED-transistor current transfer ratio (CTR). Due to voltage and current effects, this temperature coefficient will vary with bias level as illustrated in Figure 2.28. As different manufacturers use different processes in IRED, phototransistor and coupler manufacturing, considerable variation in the CTR temperature coefficients is found from manufacturer to manufacturer.

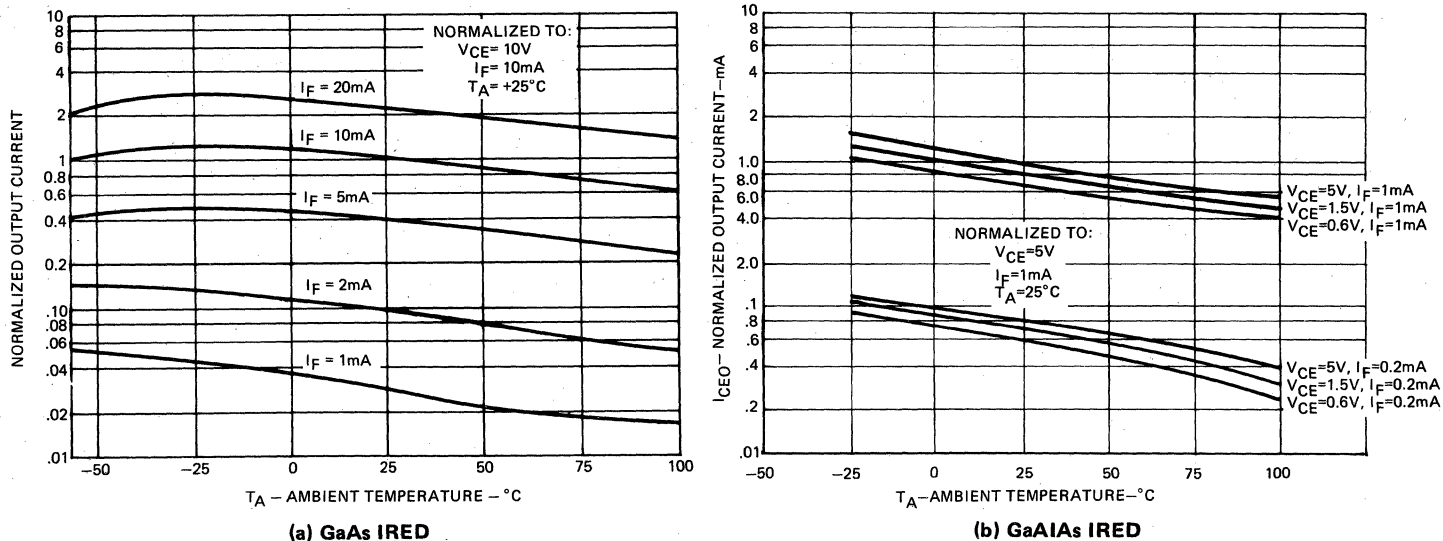

FIGURE 2.28: BIAS EFFECTS ON CTR TEMPERATURE COEFFICIENT

Dynamic response of the phototransistor is dominated by the capacitance of the relatively large photodiode, the input resistance of the transistor base-emitter junction, and the voltage gain of the transistor in the bias circuit. Through Miller Effect, the R-C time constant of the phototransistor becomes: input resistance \times capacitance \times voltage gain. The penalty for a high gain photo-transistor is doubled. High gain raises both voltage gain and the input resistance by lowering the base current. The same dual penalty is extracted when a lower operating current and higher load resistor are chosen. These effects can trap an unwary circuit designer, since competitive pressures have driven specification sheet values of switching times to uncommon bias conditions. These uncommon bias conditions include very low values of load resistors with fractions of a volt signal level changes. While this provides an idea of ultimate capability, it also forces the designer to carefully evaluate each situation.

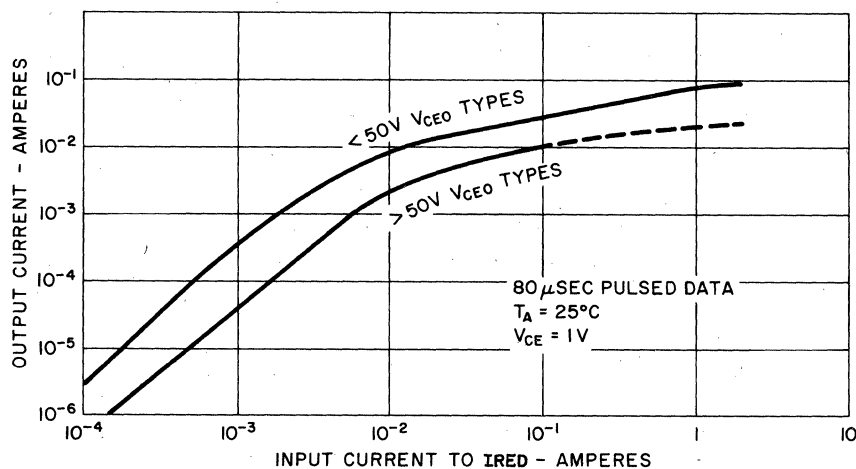
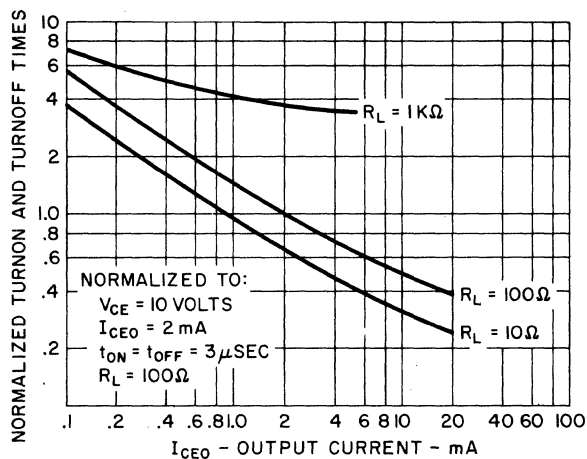
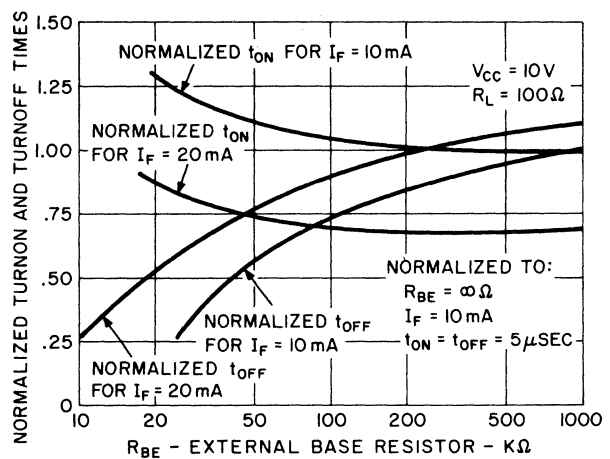

FIGURE 2.29: TYPICAL PHOTOTRANSISTOR OPTOCOUPLER TRANSFER CHARACTERISTICS



Switching Times vs. Output Current



Switching Time vs. R_{BE}

FIGURE 2.30: BIAS EFFECTS ON PHOTOTRANSISTOR SWITCHING SPEED

Some applications will require speed-up techniques, such as base emitter shunt impedance, linear or cascode biasing of the phototransistor, capacitor discharge pulsing of the IRED, etc. Highest speed is obtained from the photodiode alone, biased from a stiff voltage source, with the IRED pulsed at as high a current as practical. In this mode of operation, response is dominated by the IRED and photodiode intrinsic properties and can be under $0.2\mu\text{sec}$. Use of a load resistor in the photodiode requires charging the photodiodes capacitance (25pF at 0V , typically) with the associated R-C time constant.

Leakage current of the phototransistor must also be considered (especially if the base is open-circuited) when high temperature operation and/or low current operation is desired. The photodiode leakage current (typically 200pA at 10V , 25°C) will be about 200 times this at 100°C . In the open base bias mode, this current is multiplied by beta, which also increases with temperature. This combination of effects raises a typical 2nA I_{CEO} at 10V , 25°C to $4\mu\text{A}$ (2000 times) at 10V , 100°C . Consider the effect on a circuit, which operates at a $100\mu\text{A}$ phototransistor current, with a device having the specified maximum leakage limit, 100nA at 25°C , when the ambient temperature rises. The use of a 10 megohm base emitter resistor would allow the worst case unit to operate normally without appreciable effect on the CTR. Leakage and switching speed effects must be considered before opting for operating open base. Higher operating voltages and/or a time varying dielectric stress (which provides capacitive base current drive) are additional factors which can cause undesired leakage effects.

The availability of the H11AG series phototransistor coupler with GaAlAs emitter minimizes the problems encountered of low input currents and high temperatures. Due to the high efficiency of this series, photocurrents in the photodiode detector are increased by about 4 times. As leakage currents are not affected by the more efficient design, this directly translates to an improvement in capability. This improvement is illustrated by the specification guarantees of $200\mu\text{A}$ input current operation over the 0 to 70°C temperature range.

d. Photodarlington The photodarlington adds the effects of an additional stage of transistor gain to the phototransistor coupler. The changes in CTR, its temperature coefficient, leakage currents and switching speed are extended from the photodiode-phototransistor relationships, and will not be detailed. Instead, the two major application areas where the photodarlington optocoupler is attractive, low input currents or at very high output currents, will be examined for device characteristics and their interaction with application performance.

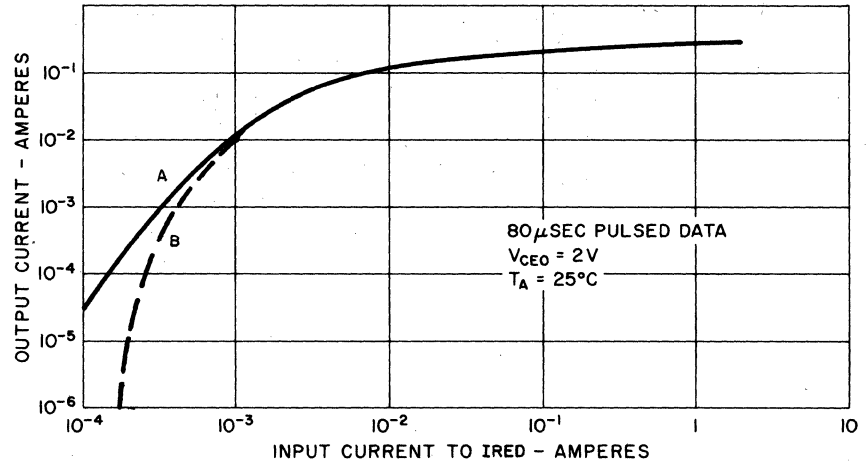
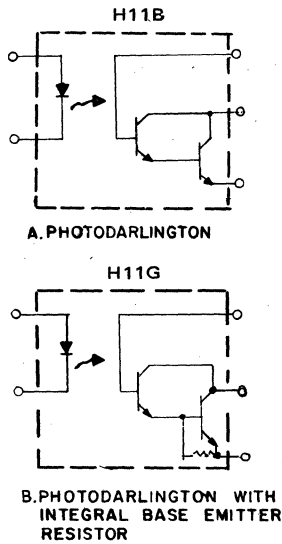

FIGURE 2.31: TYPICAL PHOTODARLINGTON OPTOCOUPLER TRANSFER CHARACTERISTICS

The high gain of the darlington permits useful output currents with input currents down to 0.5mA. Both current gain and IRED efficiency drop very rapidly with increasing current, as illustrated in the emitter and detector systems section. These effects indicate that for very low input currents, i.e., below 100 to 500 μ A, better performance in output current to leakage current ratio, can be obtained with the phototransistor coupler (although effort is required to get even fair performance at such low input currents, regardless of the output device). This defines the low input current operation region as roughly between 0.3mA and 3mA input current, and the high current output region at above 3mA input current, i.e., where the output current is in the tens and hundreds of mA.

Operation in the low input current region with a photodarlington output optocoupler provides minimum output currents in the 0.1mA to 10mA range at 25°C. High temperature leakage currents (I_{CEO}) can also be in this range and the rise in output current with temperature does not approach the rise in leakage current. This effect indicates the need for a base emitter resistor in circuits which must

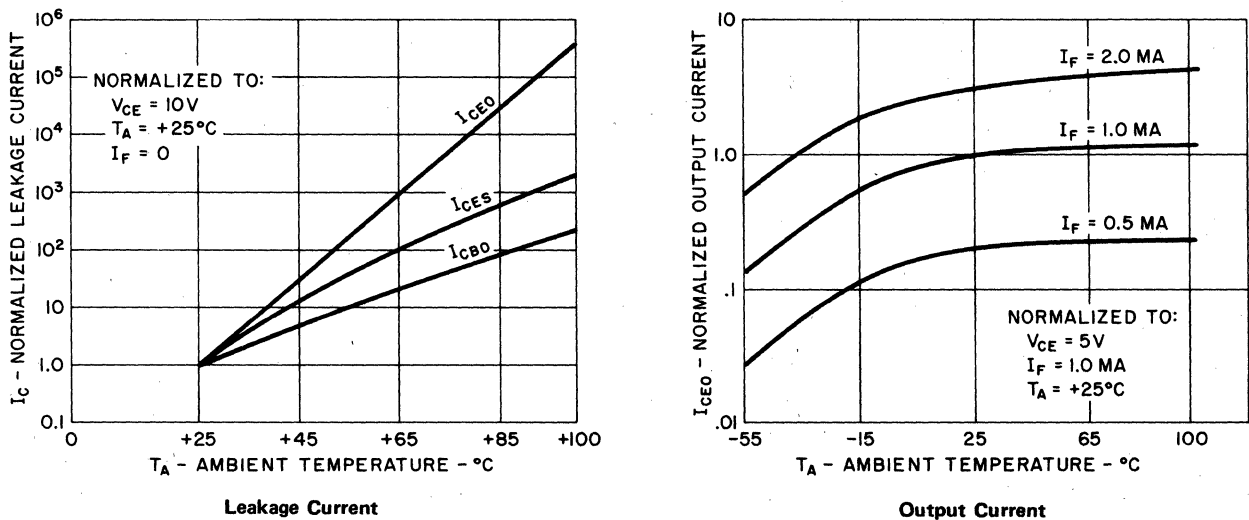

FIGURE 2.32: TYPICAL TEMPERATURE EFFECTS ON PHOTODARLINGTON OUTPUT

operate at high temperature. The resistor can be external and/or integral to the darlington structure. With external resistors, the value selected for the resistor becomes a trade-off between minimizing the effect on output current, maximizing the effect on leakage current, and choosing a commonly available resistor. Usually, the result of the trade-off is the use of a 22 megohm resistor with the circuit designer providing more drive for the IRED, an alternative preferable to using a non-standard or series combination of resistors. Observing the photodiode response, and noting that V_{BE} can be 1.3V, the 22 megohm resistor eliminates response on a typical unit for input currents less than 1/4mA, which, in worst-case analysis, makes the reason for providing more input current obvious. It also illustrates another reason for using a transistor output coupler in some of the lowest input current applications. At low temperatures, these phenomena make the darlington more attractive: leakage current has decreased, making a base emitter resistor unnecessary; IRED efficiency has increased and darlington gain has dropped, producing an output which is more a function of the input than the output device characteristics.

The integral base emitter resistor, as found in the H11G series, shunts the output stage base emitter of the photodarlington. It provides most of the advantages of an external resistor without the need for an additional component. Also, since the semiconductor design engineer can quantify maximum leakage levels, this resistor allows the photodarlington voltage and current capability to be simultaneously increased without danger of thermal runaway due to leakage currents. The H11G45 and H11G46 specifications illustrate the improvement of low current performance provided by the internal base emitter resistor. These devices are specified for operation at 1/2 mA input current, and maintain both high current transfer ratio ($\geq 350\%$) and low leakage ($\leq 100\mu A$) over the 0 to 70°C temperature range. At higher current and voltage bias conditions, a comparison of the H11G1 with the H11B1, a photodarlington without integral resistor, illustrates the advantage. The H11G1 has 50% more current capability (150mA) and four times the V_{CEO} capability (100V). The integral resistor also provides an antiparallel diode between collector to emitter. This can be used to advantage for ac current switching using two detectors in inverse polarity series connection. The diode is of relatively low current capability, and its power dissipation must not be exceeded when operating in this mode.

Switching speeds in the low input current bias region are quite slow, and are decreased further by the large load resistors common for these biases. Some bias conditions have been reported where the photodarlington would not switch (full on to full off) at a 60Hz rate. The major point to note is that dynamic effects as illustrated in Figure 2.33, exist and must be allowed for in the early stages of circuit design and development.

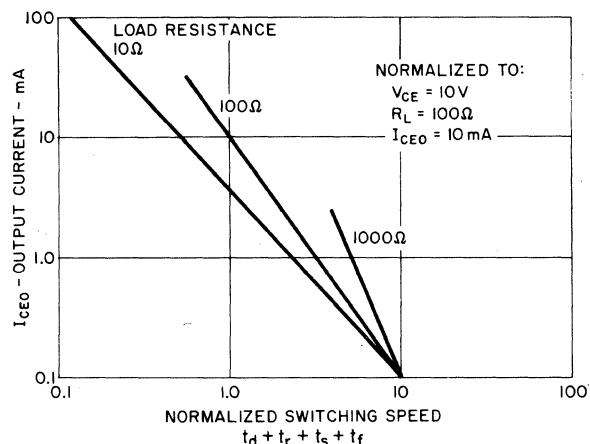

FIGURE 2.33: PHOTODARLINGTON SWITCHING SPEED AS A FUNCTION OF BIAS

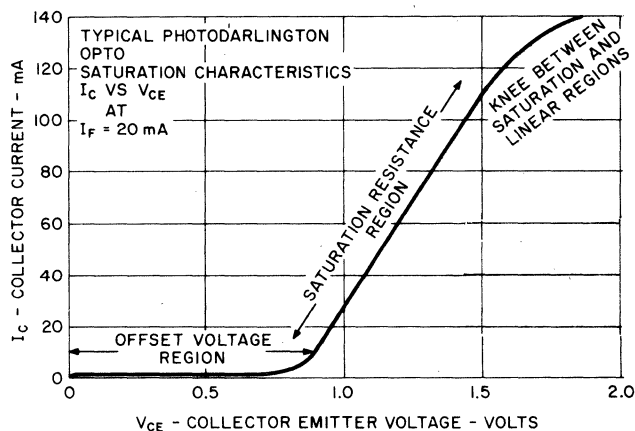

FIGURE 2.34: TYPICAL PHOTODARLINGTON OPTOCOUPLER SATURATION CHARACTERISTICS

Operation of the photodarlington optocoupler at high output currents from low supply voltages has few pitfalls. Leakage, temperature, and dynamic effects are less critical due to normal bias levels. Current levels can be sufficiently high such that power dissipation can become a concern when driving low impedance loads, such as solenoids and small lamps. Saturation resistance and offset voltage are the prime factors which govern the power dissipation in these applications. Typical values for saturation resistance, up to $I_c = 100\text{mA}$, are in the 4 to 8 ohm range. Typical offset voltage can be approximated by the 10mA collector current saturation voltage, which ranges from 0.8V to 1.1V. Power dissipation in the saturated photodarlington can now be approximated by:

$$P_d \approx I_c (V_{\text{OFFSET}} + I_c R_{\text{SATURATION}}).$$

For steady-state loads this corresponds to a maximum collector current limited by the 150mW maximum rating. In pulse applications, the decrease in photodarlington gain with increasing current, limits usefulness at high collector current. Since saturation resistance and gain rise with temperature, while offset voltage decreases, the dominant effect will depend on the collector current, the input current magnitude, and the transistor junction temperature. In high current pulsed operation, self-heating effects (in the IRED by reducing its efficiency, and in the darlington by raising the saturation resistance) can cause the observed saturation voltage to rise throughout the duration of the pulse. In higher supply voltage applications, above 25V, power dissipation due to leakage currents must be analyzed for thermal runaway.

e. PhotoSCR The photoSCR optocoupler differs from other SCR's due to the very low level gate drive available from the detector. This low level gate drives requires a very sensitive gate structure, while application constraints demand a SCR capable of operation on 120 and 240V ac lines, biased from a full wave rectifier bridge. These needs conflict and require the SCR chip design, processing and application to be carefully controlled. The success of the H11C series is a tribute to GE's superior technology in SCR's, IRED's, and optocoupler assembly being successfully combined. The SCR optocoupler requires the circuit designer to consider the trade-off between optical sensitivity and sensitivity to dv/dt , temperature, and other undesirable effects. It also presents the circuit designer with a new effect, coupled dv/dt , where the rapid rise of voltage across the dielectric isolation capacitively supplies gate trigger current to the SCR. Due to the physical construction of the coupler, this could occur in either stress polarity, although highest sensitivity is with the IRED biased positive. These effects are not as formidable as might be anticipated, since the low currents at which the SCR is operated make the protection techniques identical in both method and typical values, to those required in most common low current SCR applications. Pulse current capability of the SCR is superb, making it ideal for capacitor discharge and triggering applications. Complete isolation of input and output enables anti-parallel and series connections without complicated additional circuitry. This facilitates full wave ac control, high voltage SCR series string triggering, three-phase circuitry and isolated power supply design. The H74C series coupler is specified to drive 120/220Vac loads with input signals directly from TTL logic.

A knowledge of the SCR turn-on parameters eases analytical circuit design. The current into the IRED (I_{FT}) required to trigger (turn-on) the SCR, is the principle parameter and approximates the current required to increase detector current enough to provide a diode drop of voltage across the gate-to-cathode resistor (R_{GK}). From this the relationship of I_{FT} to R_{GK} is inferred, i.e., higher R_{GK} , lower I_{FT} . As R_{GK} also shunts currents generated by leakage, rapidly rising voltages across the junction

or isolation capacitance and stored charge during turn-off, it becomes obvious that a trade-off exists between optical trigger sensitivity and susceptibility to undesired triggering and ability to turn off. Turn-off is related to the holding current, I_H , the minimum anode current that will maintain the SCR in conduction. Because it is normally desirable to have the SCR turn-on with minimum IRED current, while being completely immune to dv/dt and other extraneous effects, and preserve dependable, rapid turnoff, the choice of a fixed value of R_{GK} becomes a compromise. Use of active devices in the place of, or in addition to, R_{GK} can provide the best solution, but at the price of additional circuit complexity.

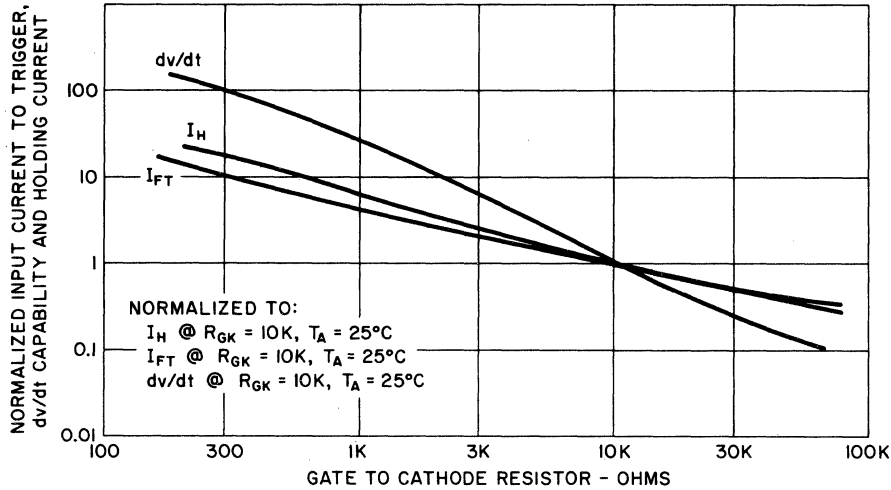

FIGURE 2.35: TYPICAL EFFECT OF R_{GK} ON I_{FT} , dv/dt , AND I_H OF H11C SCR OPTOCOUPLER

Circuit component cost could be decreased through the techniques shown in Figure 2.36 by using a less costly coupler and less elaborate drive and snubber circuitry. Three examples of this type of gate bias are illustrated. The gate capacitor is simplest, but only affects dynamic response and is of limited use on dc

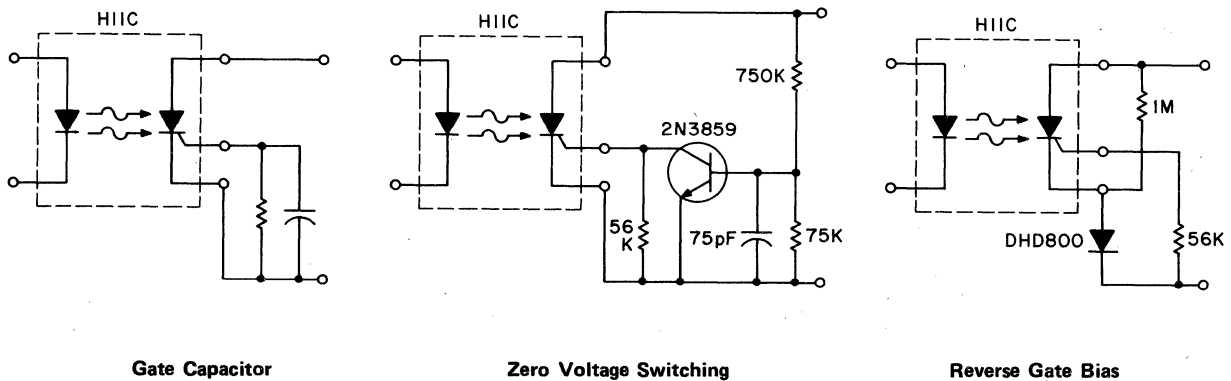

FIGURE 2.36: METHODS USED TO OPTIMIZE R_{GK} EFFECT

or full wave rectified power. The zero voltage switching is the most effective, since it places a virtual short circuit from gate-to-cathode when the anode voltage exceeds approximately 7 volts. At low voltages, the SCR is quite immune to most of the effects mentioned, and yet optical triggering sensitivity is relatively unaffected. This circuit is limited to applications where zero voltage switching is compatible with performance requirements, of course. The reverse gate bias method is generally

applicable to a wider range of circuit applications and provides somewhat better than a 2:1 performance advantage over a simple resistor. It also improves turn-off time and is of particular advantage when the SCR is used on full wave rectified power sources. When gate-to-cathode resistors of over 10K are used, the high temperature operating capability of the SCR will be compromised without the use of some circuit which will perform similar to these. High junction temperatures are associated with either high ambient temperature or power dissipation caused by current flow, leading back to the compromise between input current magnitude and circuit simplicity. The ultimate in performance combines both techniques in one circuit—but also again limits application to zero voltage switching.

If very low drive currents are available for the IRED, and precise phase control is not required, the input current can be stored in a capacitor which is then discharged through the IRED periodically. A programmable unijunction circuit, using a $0.2\mu\text{F}$ capacitor charged to 8V and discharged at 1msec. intervals draws less than 2mA average current and will turn-on a H11C1 with a 1K ohm R_{GK} . Other methods of overcoming the sensitivity compromise will undoubtedly suggest themselves to the circuit designer, and may prove to be higher performance, less costly, or both. To aid in the analysis of dynamic effects, typical capacitance values of 25pf anode-to-gate and 350pf cathode-to-gate are noted on the H11C photocoupler and the typical gate-to-cathode diode voltage drop is approximately 0.5V with a negative temperature coefficient of approximately $2\text{mv}/^\circ\text{C}$.

Use of the photoSCR coupler on dc circuits presents no new problems. DC stability of the GE glassivated SCR pellet is excellent and has been proven in both the lab and field at voltages up to 400V. Commutation or other turn-off circuitry is identical to that detailed in the GE SCR Manual and a maximum turn-off time of $100\mu\text{sec}$ is used to calculate the commutation circuit values. Pulse current capability of the H11C photoSCR coupler output is rated at 10A for $100\mu\text{sec}$. In conjunction with the $50\text{A}/\mu\text{sec}$, di/dt capability (di/dt indicates the maximum rate of increase of current through the SCR to allow complete turn-on and, thus, avoid damaging the device due to current crowding effects) of the H11C, it is capable of excellent capacitor discharge service.

For general pulse applications, the power dissipation may be calculated and used in conjunction with the pulse width, transient thermal resistance, and ambient temperature to determine maximum junction temperature, since the junction temperature is the ultimate limit on both pulse and steady-state current capability. A more complete explanation of this method of determining capability may be found in the GE SCR Manual and its reference material.

f. Bilateral Analog FET Optoisolator The bilateral analog FET optocoupler consists of a symmetrical, bidirectional silicon detector chip, which provides the characteristics of a bidirectional FET when illuminated, closely coupled to an infrared emitting GaAs diode source. The resulting photocoupled isolator provides an output conductance that is linear at low signal levels. The value of conductance is electrically controlled by the magnitude of IRED current over a range of from a few nanomhos to a few millimhos ($10^8\Omega$ to 10Ω). The stability of conductance is excellent, as expected from a silicon device. At higher bias voltages the output device current saturates at a value roughly proportional to the IRED current and remains relatively constant out to the breakdown voltage of about 30V. As the shunt capacitance of the detector is low ($\approx 10\text{pf}$) and the VI characteristics exhibit a very small offset voltage at zero current, the detector can be viewed as a remotely variable current controlled resistor for low level signals.

In circuits, the bilateral analog FET optocoupler can act as a nearly ideal analog switch or as the foundation for compression or expansion amplifiers with superb performance. The bilateral, low and high voltage characteristics are best understood by examining the detector V-I curves at appropriate voltage levels as a function of IRED drive. These can then be related to curves that define the maximum signal level for which output conductance is linear and the effects of IRED current on both output conductance and output current at high bias voltage. Note that these plots are based on pulse measurements, and the effects of IRED self heating due to power dissipation must be considered in steady-state operation. The region of linear output conductance can be illustrated in several ways,

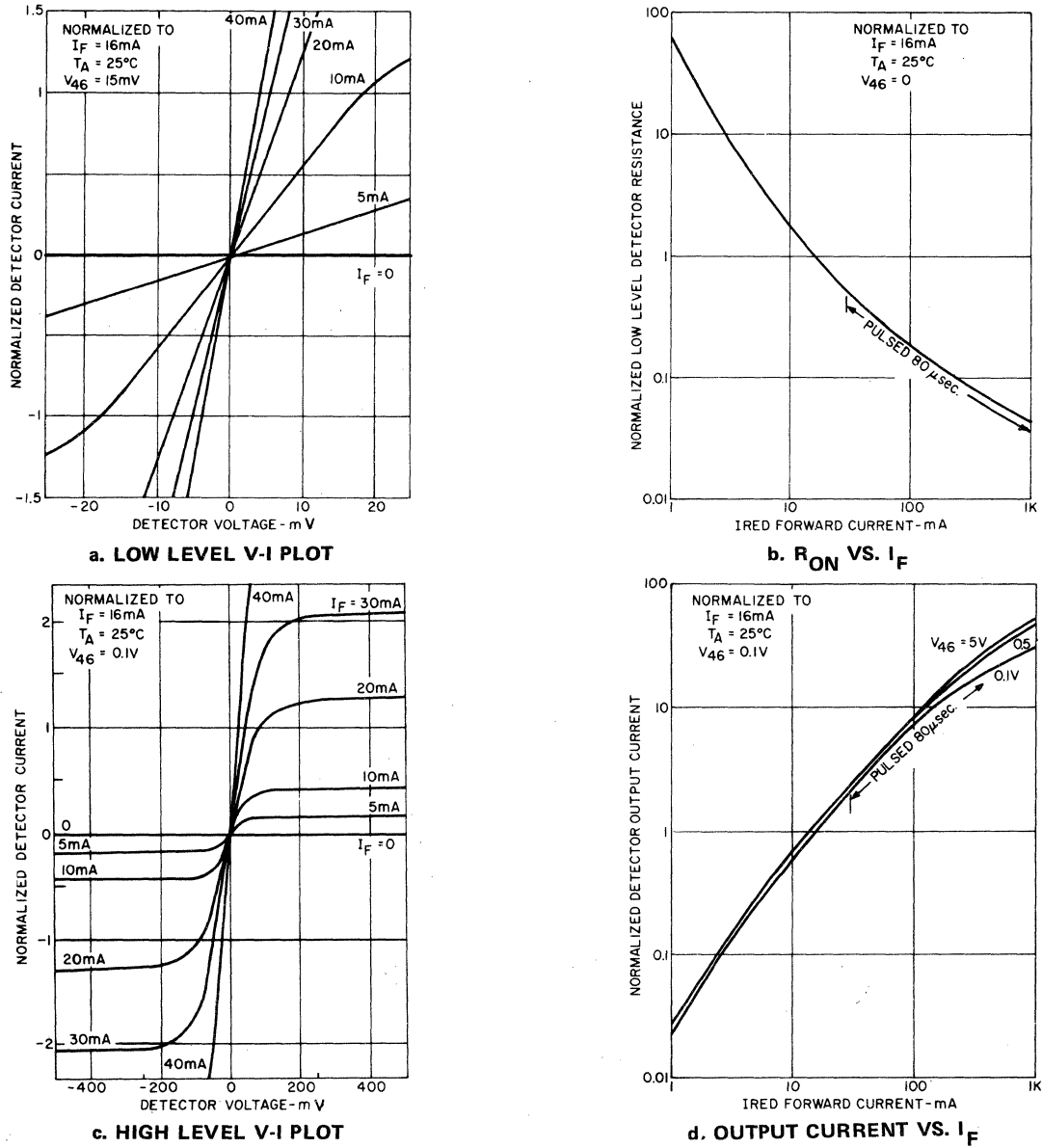

FIGURE 2.37: BILATERAL ANALOG FET CHARACTERISTICS

although for circuit design, the most useful is defining maximum signal voltage or current and maximum Thevenin equivalent source voltage and resistance. Linear operation limits are determined utilizing a balanced bridge technique in which signal level is increased until detector nonlinearity unbalances the bridge and causes a proportionate output signal—usually 0.1%. Offstate impedance of the detector is determined by junction leakage currents and capacitance. Leakage current is typically 100pA at 15V and 25°C, or equivalent to 150gΩ, and rises an order of magnitude for each 22°C temperature rise. Junction capacitance is typically 10pf, at zero volts, and decreases with increasing detector voltage bias.

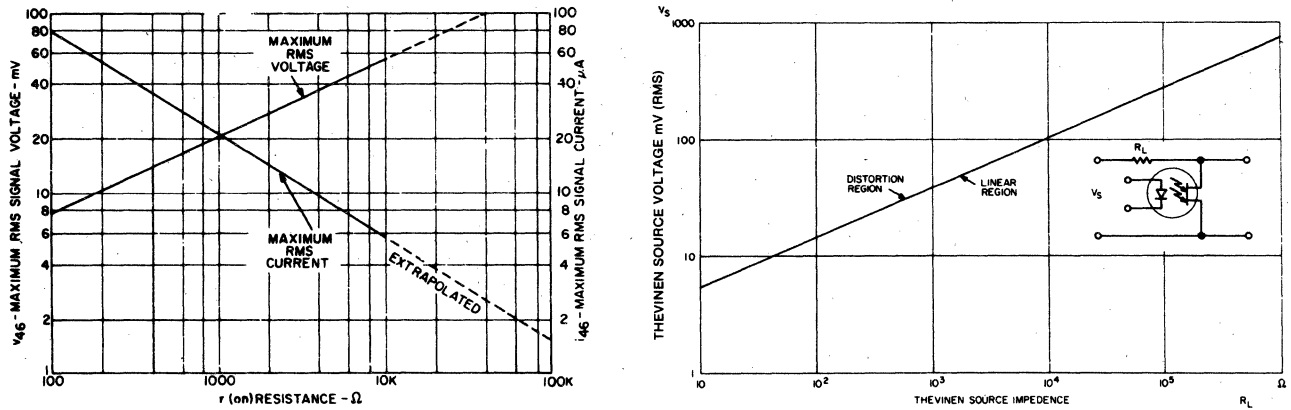

FIGURE 2.38: H11F BIAS LIMITS FOR LINEAR CONDUCTION

The switching speed of the device is determined by detector junction capacitance, the availability of photon generated charges, and the time constant of the output impedance with its shunt capacitance and the equivalent Miller effect gain. Non-saturated switching times plot exponential waveforms that are better described by time constants, and in saturated switching the turn-on exponential is truncated by saturation. In most circuits, these effects combine to make turn-on appear faster than turn-off. The corresponding equations for nonsaturating switching show the ratio of voltage across the device during switching to its final value to be:

$$\text{for turn-on} \quad V_r/V_\infty = 1 - e^{-[\tau \times 10^9 / (5 R_L + 1500)]}$$

$$\text{for turn-off} \quad V_r/V_\infty = 1 - e^{-[\tau \times 10^9 / (6 R_L + 1500)]}$$

for load resistor values over 10KΩ. Both rise time and fall time approach 3μsec with lower values of load resistors. The rise time waveform is truncated when the device current becomes circuit limited, while the turn-off waveform is relatively unaffected by saturation. Delay time at turn-on is governed by the IRED, varying from 1 to 10μsec as IRED current is reduced from 50mA to 2mA.

Offset voltage of the H11F (i.e., the detector voltage at zero detector current) is small, but may have an effect in some circuits. Typically, it is less than 0.5mV at all bias levels. The magnitude is affected by both IRED bias current and temperature, and is greatest at very low IRED currents. The magnitude of offset voltage of the H11F is comparable to that of most operational amplifiers it will be used with, so it can be ignored in many circuits.

g. Triac Driver Optoisolators The recognition that a large portion of the optoisolator applications functionally allow digital logic circuits to control ac line operated equipment led to the design of new detector device family. These detectors were not designed to act as ac load current switches, but to be pilot devices for triggering power triacs. These devices make possible significant reductions in components and circuit size when compared to circuits using phototransistor or photoSCR optoisolators.

Triac driver detector design combines high voltage signal transistor processing techniques with nonisolated, small scale I.C. circuits, providing a relatively low cost detector pellet, with bilateral symmetrical V-I characteristics. This is accomplished with a combination of lateral pnp-vertical npn transistor structures and diffused base bypass resistors. The npn and pnp transistors are connected to form two antiparallel pnpn's on a silicon pellet. The npn structure is designed to be photosensitive. Planar passivation on the pellet surface is necessary in this type of design, which places an effective upper limit on breakdown voltage capability. The device structures are constrained such that slow turn-off and low dV/dt capability are inherent, and they combine to severely limit commutating dV/dt capability. Additionally, the lateral pnp structure insures a high on-state voltage drop. Due to these characteristics, the circuit designer using a triac driver will utilize different design details, when compared to the rugged, traditional power semiconductors, to ensure reliable, dependable operation.

The planar construction allows pellet design flexibility that has not been available in traditional power semiconductors. Most impressive is the ability to form a gate resistor that can change value as a function of the device's voltage. This can be designed to improve static dV/dt capability, to increase light sensitivity, or to approximate the zero voltage switching function, again providing the opportunity for circuit simplification and the possibility of cost reduction. The cutaway construction drawing of Figure 2.39 illustrates the simple construction. Note the n-type silicon substrate on these devices is connected to a package terminal. With ac bias on the detector, the substrate will be biased one diode drop below the most positive terminal. In ac applications, any connection to this terminal can cause circuit malfunction or device damage.

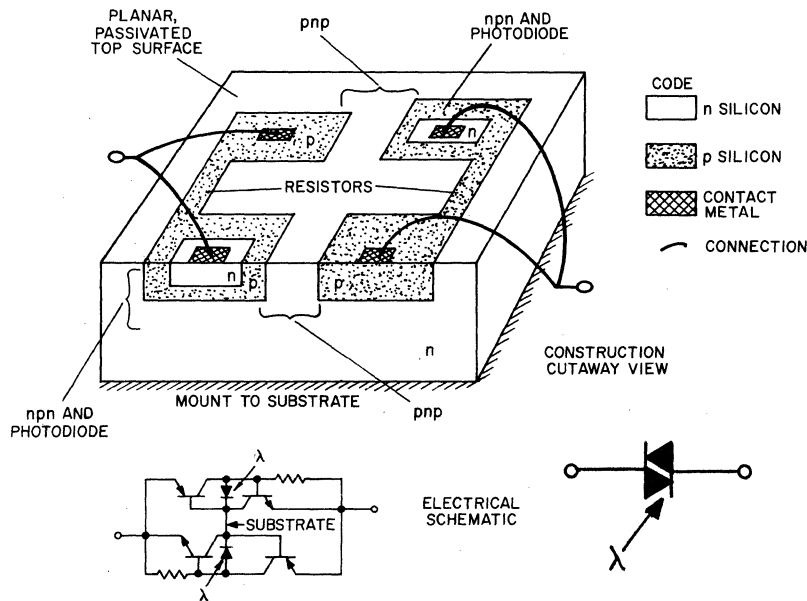

FIGURE 2.39: SIMPLE TRIAC DRIVER CONCEPT

The application of the triac driver provides simple, flexible ac power control. The device characteristics demand some design effort to compensate for certain characteristics and to assure dependable, reliable, circuit operation. In general, more protection is required as peak power, line voltage and frequency increase. The triac drivers must be protected against voltage breakover. Planar devices are more susceptible to breakover damage than other power devices, and power line transient voltages commonly exceed 1000V.

False firing (detector turn-on without IRED turn-on) due to dV/dt can be prevented by using a snubber network. A proper snubber will eliminate false firing due to dV/dt associated with power line switch on, inductive loads, and high frequency "hash" on the line. The dV/dt withstand capability of the triac driver decreases rapidly with increased detector voltage and temperature. The dV/dt capability is appreciably lower than that of typical power triacs and will usually require use of more snubber capacitance than the power triac needs. In some cases, a two-stage RC filter is required to eliminate dV/dt problems, and can often be implemented by using the power triac snubber as the first stage. Breakover damage is easily prevented with a GE-MOV®II Varistor. Surge current protection is recommended for loads which can provide over 2A peak current, since this current can flow through the triac driver while the power triac is turning on. This protection is provided by use of a series resistor. These protection techniques are illustrated in Figure 2.40.

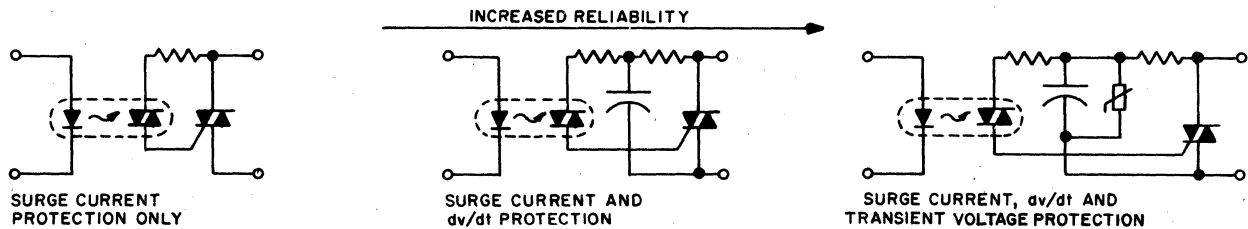

FIGURE 2.40: ELIMINATION OF TRIAC DRIVER MALFUNCTION AND FAILURE

For some low voltage, low current applications, the triac driver can be used as a power switch, i.e., without a power triac. The major factor governing these applications is the commutating dV/dt capability of the triac driver. This represents the susceptibility of the triac driver to dV/dt triggering in one polarity immediately after conduction in the opposite polarity. Self-heating due to power dissipation, the negative temperature and voltage coefficients of $dV/dt(c)$ and the wiring and source inductance of the circuit limit the range of application. Prudent circuit design dictates 60Hz, noninductive loads, be limited to under 0.5W.

h. Schmitt Trigger Output Optoisolator The H11L, optically isolated Schmitt trigger, has a medium speed, digital output integrated circuit detector. This unique detector provides the Schmitt trigger with functions of gain, fast switching and accurate threshold and hysteresis operating from an integral photo diode. As an optoisolator, it performs as a nearly ideal current input Schmitt trigger, furnishing electrical isolation between input and output to prevent undesired feedback. The circuit design provides almost foolproof operation, free from latch-up, oscillation, and providing relatively stable turn-on and turn-off threshold currents over a wide range of operating temperatures and voltages. The open collector output transistor on the detector chip is specified to sink over 16mA at 0.4V from an input current threshold of 1.6mA. All static parameters are specified over a 0 to 70°C. temperature range.

The equivalent circuit of the H11L illustrates the design features. The photo diode dominates the chip topography and provides efficient light collection. The preamplifier has a low input impedance to preserve speed, and features a clamp to prevent IRED overdrive of the photodiode from increasing switching times or causing other undesirable effects. The amplifier output current is added to a reference current and both produce (across a resistor) the Schmitt trigger input signal. This method of reference allows compensation for voltage and temperature coefficients throughout the operating range.

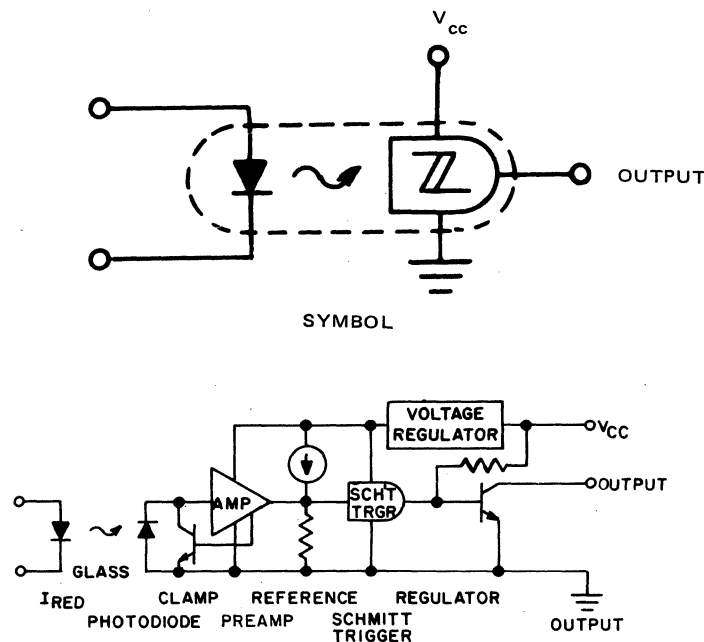

FIGURE 2.41: H11L EQUIVALENT CIRCUIT DIAGRAM

The open collector output stage can sink up to 50mA, although saturation resistance and gain factors combine, such that up to 1.5V drop has been observed at 5V supply voltage. The base of the output transistor is driven resistively from an unregulated supply voltage, causing the saturation voltage to decrease at higher supply voltages. Saturation resistance of the output transistor is typically between 8 and 16 Ohms. The internal voltage regulator assures power supply rejection in the amplifier section and threshold stability in the Schmitt trigger portion.

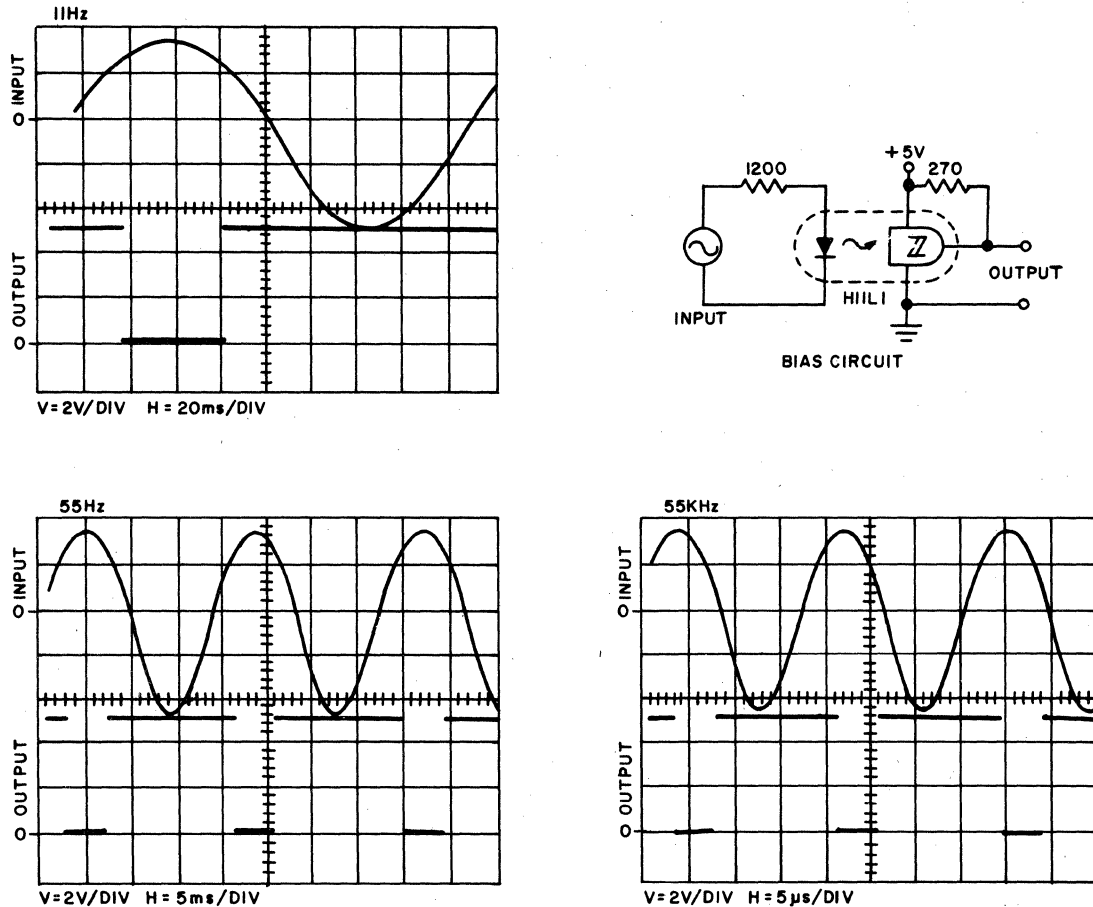

FIGURE 2.42: SCHMITT TRIGGER OPTOISOLATOR OPERATION ILLUSTRATED AT VARIOUS FREQUENCIES

Application of this opto isolator is straightforward in most applications. The function is simple, and the specification provides detailed data for worst case design. Switching characteristics are the only parameters complex enough to require further explanation. The switching times of the H11L are governed by the IRED switching speed, the photodiode response times, R-C time constants through the amplifier circuit and the switching time of the Schmitt trigger stage. The Schmitt trigger switching time, which translates to output rise and fall time, is usually under 100ns. This is approximately 10% of the

total switching time. The limiting factor in a simple circuit (i.e., resistive IRED bias) is IRED turn-off and turn-on time, which can be shortened by injecting charge into the IRED at turn-on and removing the charge at turn-off. Normally accomplished with a speed-up capacitor shunting the IRED current limiting resistor, this will reduce propagation delay times by one-third. Although further reductions in turn-on or turn-off delay can be obtained by IRED bias, maximum toggle frequency will decrease. Investigation shows turn-on times decreasing with higher IRED drive, while turn-off times increase.

At low repetition rates, fastest times will be obtained with resistive limiting of IRED current to slightly over turn-on threshold and capacitive charge injection-removal of about 0.8nC per mA IRED current. At high repetition rates or for short pulses, the overdrive supplied at turn-on fills both emitter and detector with charge which must be removed at turn-off, since the pulse time is too short for it to dissipate. Because of this, fastest square wave and short pulse response is obtained with resistive limiting of IRED current to about twice turn-on threshold and capacitive charge injection-removal of about 0.4nC per mA. This approximates specification sheet test conditions, where most H11L1 devices will operate at 500kHz (i.e., a 1MHz NRZ data rate).

Due to the higher threshold current and wider range of threshold currents found in the H11L2, compared to the H11L1, its maximum frequency capability, in a worst case bias circuit design, will be less. Switching time is also a function of detector supply voltage. Although turn-on time increases slightly with decreased supply voltage, turn-off time decreases more. Therefore, highest frequency operation will be obtained at a 3V supply voltage, using an H11L1 with speed-up capacitor.

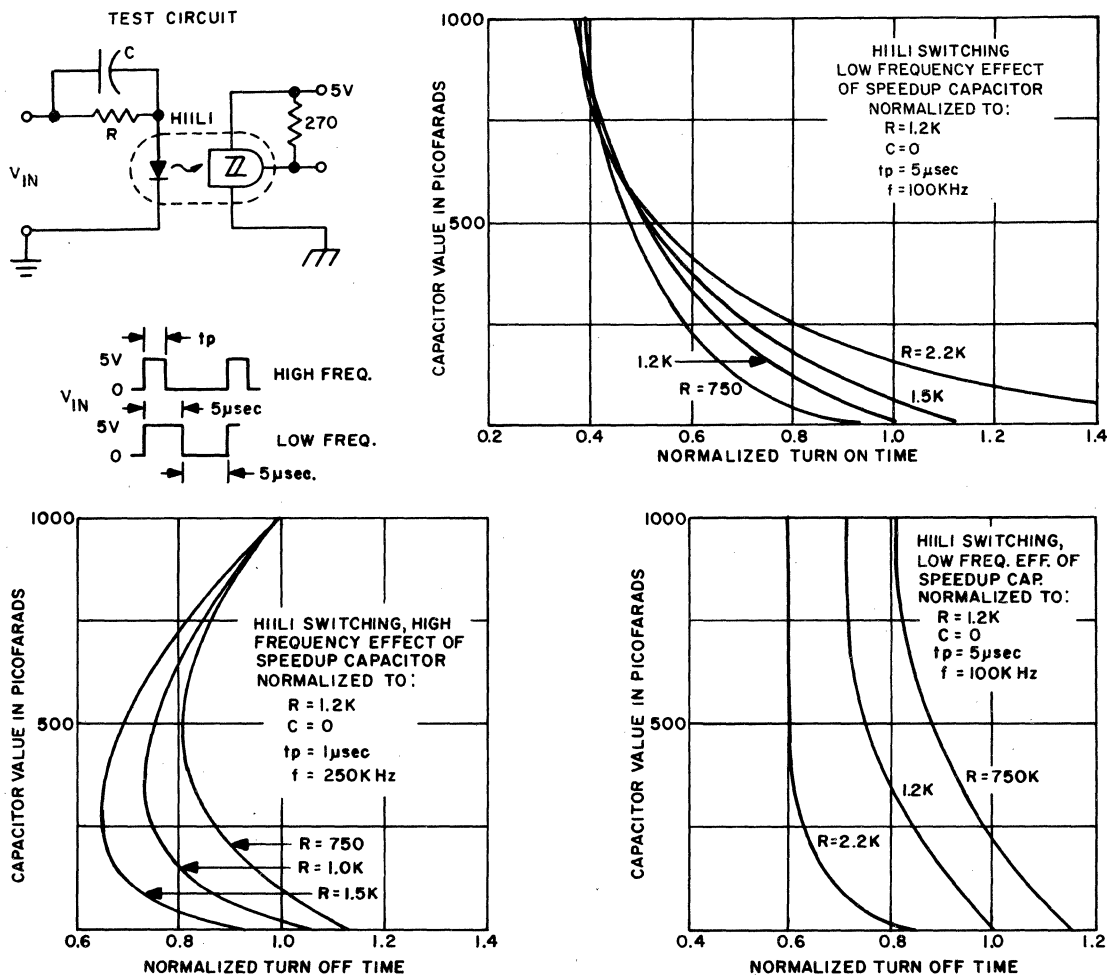

FIGURE 2.43: H11L SWITCHING

The isolated Schmitt trigger action, with well-defined input threshold limits, provides a nearly ideal link to input information to logic systems. It can be used to monitor ac power line voltage, telephone lines for ring voltage and/or line current, inter-system data lines, and other currents and/or voltages. The fast transition times and wide supply range are compatible with most IC logic families. To minimize design time for these circuits, a bias resistor chart is provided in Figure 2.44. The input circuit

LOGIC FAMILY	V _{CC}	R1	R2
TTL – -74, 74H, 74S	5V	390	0
-74L, 74LS, MSI, LSI	5V	3.3K	0
HNIL	15V	1.8K	0
CMOS – -3V Supply	3V	1.2K	0
-12V Supply	12V	5.6K	0
I ² L	5V	7.5K	27

NMOS and PMOS Biases per Manufacturer's Instructions.

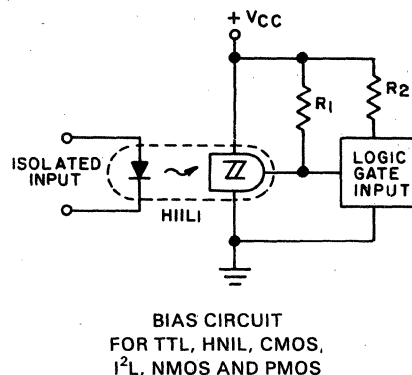

FIGURE 2.44: H11L INPUT FOR LOGIC CIRCUITS, SUGGESTED BIAS RESISTORS

is designed to provide threshold current to the IRED from the specific monitor function. Fairly accurate ($\pm 20\%$) current and voltage turn-on/turn-off limits can be set using the programmable current sensing circuit previously described (page 42 or H11L specification), an advantage when line noise is of a significant amplitude compared to the signal level.

Logic circuit drive requirements for the H11L are straightforward from logic circuits capable of providing the 1.6mA or 10mA current to drive the IRED. Buffer circuits are required for lower output current capability devices. Logic drive of IRED's and buffer circuits are illustrated later in optoelectronics circuits.

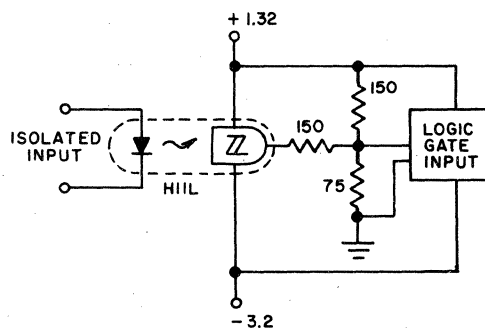

FIGURE 2.45: H11L INPUT FOR ECL LOGIC

i. Fiber Optic Systems Fiber optics systems offer the electronic system design engineer an alternative method to transmit electrical information and sense physical events. Fiber optics offer the advantages of a small, light weight, durable, corrosion resistant, nonconducting signal path that is virtually unaffected by and has no effect on the electrical environment the signal passes through.

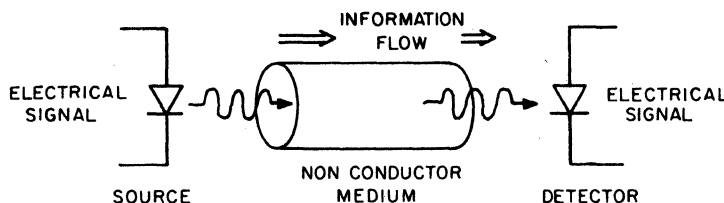

FIGURE 2.46: TYPICAL FIBER OPTIC SYSTEM

Efficient conversion of the electronic signal into a light signal and insertion of the light signal into the fiber are key to fiber optic system performance and to system costs. Often the advantages of EMI/RFI immunity, shock and spark hazard elimination, crosstalk immunity, size and weight, and lack of cabling route/wiring code requirements more than overcome the disadvantages.

A fiber optic system differs from the optocoupler and emitter-detector systems previously discussed in its interface with the light transmission medium. The fiber is a low attenuation, flexible light transmission path which is mated to the emitter and detector via connectors. The fiber can be obtained in a variety of attenuations, for any given wavelength emitter, a variety of core diameters, and can be compatible with different connector systems. Fiber is also available in a range of costs. The fiber and connector determine the degree of coupling between emitter and also effectively determine cost, distance capability, and other key system parameters.

1. Fibers Light rays are confined to the core of the optical fiber by cladding the core with a transparent material of lower index of refraction. This defines the critical angle of reflection at the core cladding interface, thereby confining rays at angles less than this to the core of the fiber. A step index fiber has an abrupt change in index of refraction at the core cladding interface. Large diameter step index fibers have relatively large critical angles, many ray paths, and are called multimode fibers. In a graded index fiber, the index of refraction changes gradually from a high value to the lower value of the cladding as position varies radially from the center.

This provides two effects: the rays gradually bend back towards the center, instead of reflecting at the interface, and, the rays travel faster the farther they are from the center. This keeps rays, regardless of angle (within the critical angle), traveling along the axis of the fiber at roughly the same velocity. This velocity matching property in a multimode fiber gives graded index fibers generally higher bandwidth-distance characteristics. The highest bandwidth-distance fibers are constructed to operate like microwave waveguides and have very small radius core and step index cladding. These have small critical angles and confine light to one type of path, a monomode propagation. The small core size makes it difficult to launch light into the fiber, to splice the fiber, and makes a fragile fiber requiring cabling with buffers and strength members. For moderate bandwidth applications, step index fiber is normally best due to its reasonable cost attenuation trade-off and large core diameter.

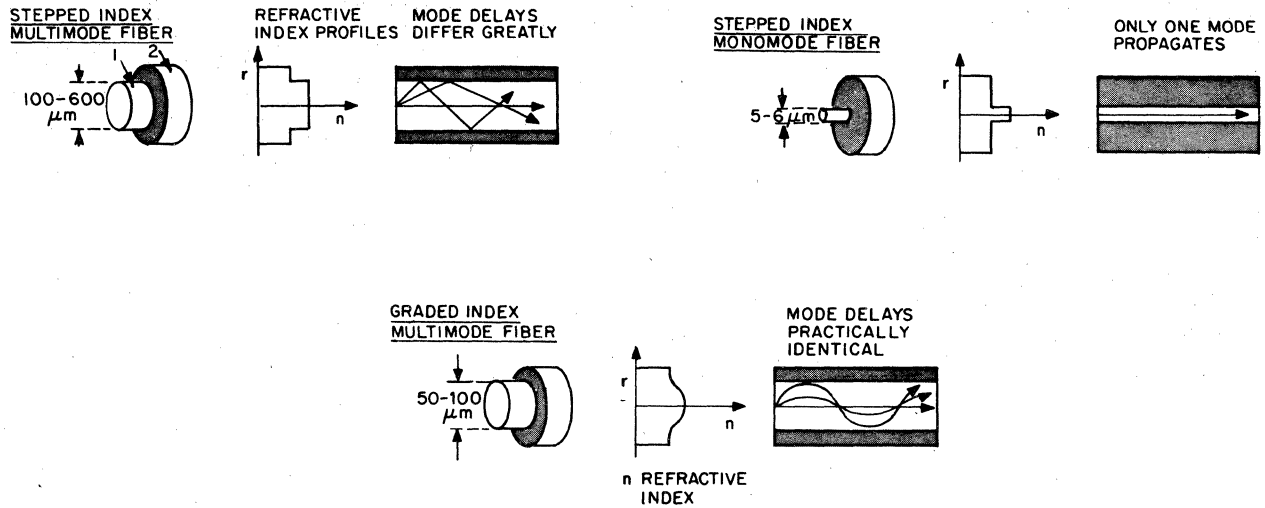

OPTICAL FIBER TYPES

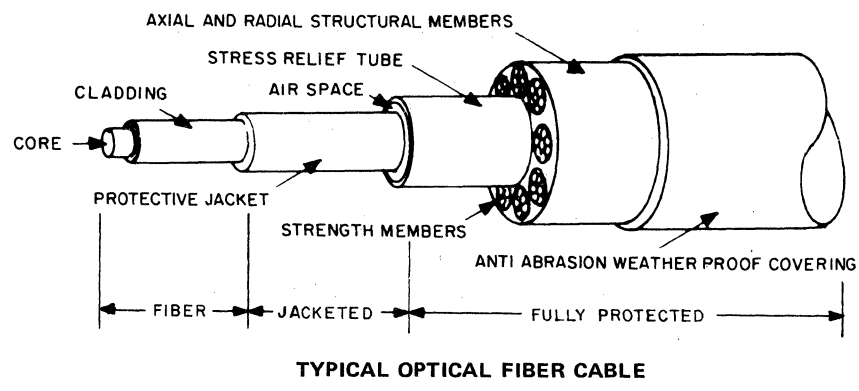

TYPICAL OPTICAL FIBER CABLE

FIGURE 2.47: OPTICAL FIBER CONSTRUCTION

The fiber should provide the largest light power (irradiance) to the detector consistent with other system constraints. This will provide the largest detector signal, minimize requirements for amplification and maximize signal-to-noise ratio. Detector irradiance will depend chiefly on the power launched into the fiber and the attenuation of the light due to fiber characteristics and distance, as well as detector-to-fiber coupling. In moderate cost systems, the power launched into a fiber core is primarily a function of the diameter of the fiber core. Most moderately priced sources are of comparable size to a large fiber and cannot be located extremely close to the fiber core, so most of the source emission does not enter the core.

This effect can be illustrated using a typical TO-46 packaged LPE IRED emitter. The emitter is physically quite far from the fiber core, and poorly optically coupled. Over 70% of the total power emitted by the chip exits the sides of the chip and is reflected toward the fiber. Most rays miss the fiber core; the few that enter are not all within the critical angle of the fiber core, causing further losses. As the fiber core gets smaller, the number of rays striking it will decrease in rough proportion to the core area. The effect of critical angle reflection is described by the fiber's numerical aperture (N.A.), which is the sine of the angle between the core's axis and the ray that enters the fiber to reflect at the core cladding's critical angle. Both core diameter and N.A. affect the coupling to the emitter—although core diameter is normally more effective due to typical emitter dimensions.

A wide variety of fibers exist, with little standardization, in three basic material types: plastic clad-plastic core fiber (plastic fiber); plastic clad-glass (silica) core fiber (PCS fiber); glass clad-glass core fiber (glass fiber). Fiber attenuation varies greatly within core material types. Usually plastic fibers are highest attenuation, ranging from 0.3 to 3 db per meter at the lowest attenuation wavelengths, and much higher at absorption peaks. Silica core fibers can range from as low as 0.001 to 1 db per meter at lowest absorption wavelengths. Generally, each fiber family has a different wavelength of minimum attenuation and different attenuation at each specific wavelength. These effects and the variation in measurement and presentation techniques used by different fiber manufacturers cause straightforward integration of the spectral output of a light source with the fiber attenuation to provide a first approximation of attenuation for that particular source fiber combination. Actual data on the combination, preferably from several lengths of fibers from several manufacturing lots, provides the best design data. Data gathered on a particular fiber usually show high attenuation for very short fiber lengths. This is due to power transmitted by the transparent cladding of the fiber. For most fibers, the cladding power is significant and has a high attenuation with distance. For most fiber and emitter combinations, the power out of the fiber will fit an equation of the form:

$$\text{Power Out} = \text{Core Power} (10^{-AX}) + \text{Cladding Power} (10^{-BX})$$

where A is the normal fiber core attenuation, B is the cladding attenuation, and X is the fiber length. This provides a simple, convenient approximation to quantify a complex group of transmission properties.

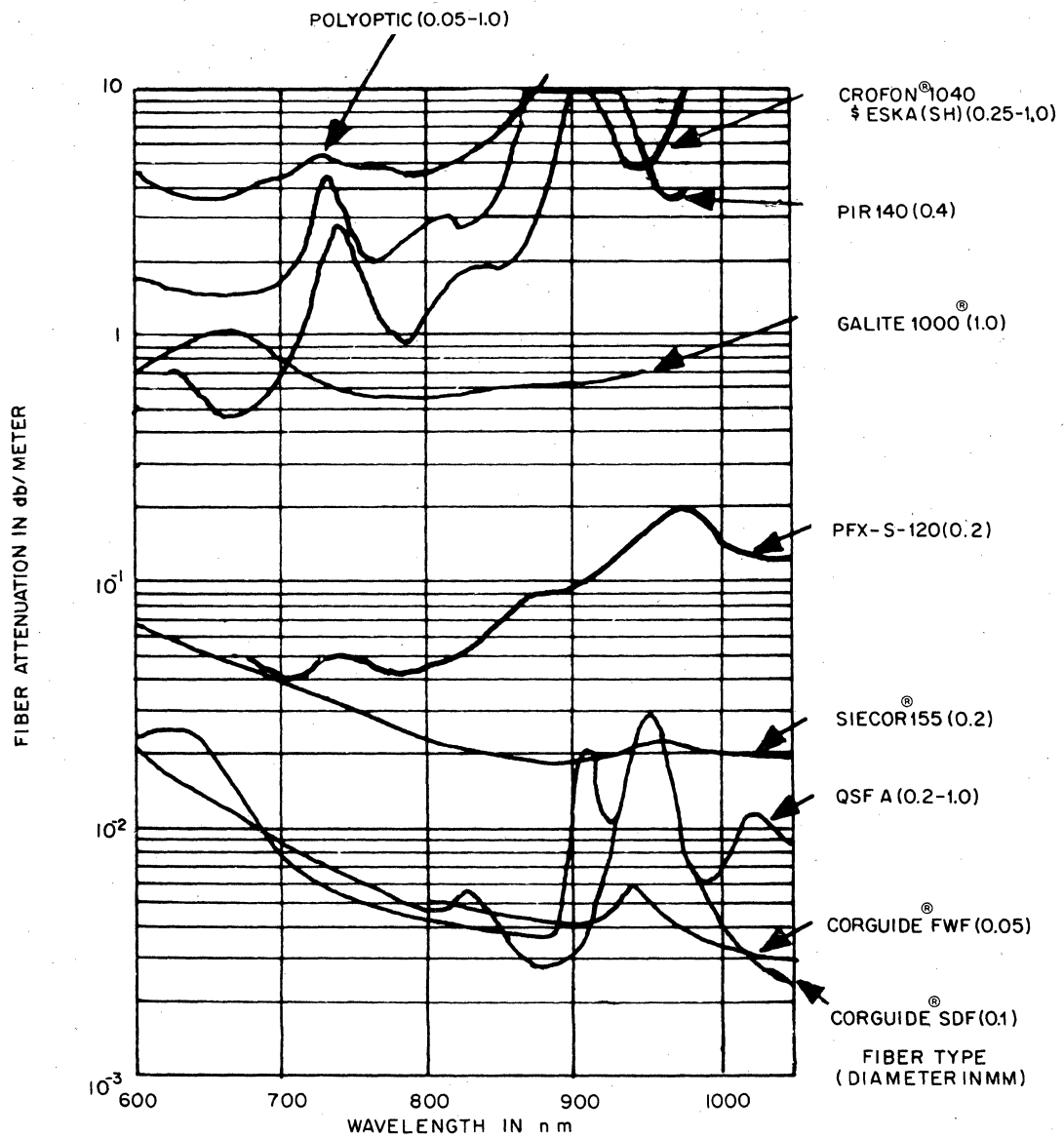
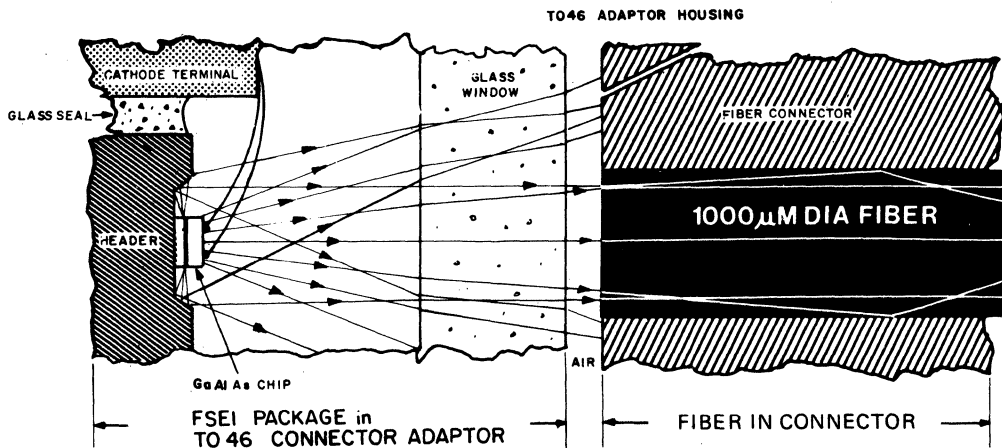

FIGURE 2.48: ATTENUATION PROPERTIES OF A VARIETY OF OPTICAL FIBERS

This equation can be solved from measurements on four lengths of fiber with a given type emitter. Each particular emitter pellet and package requires this data, as it will have a unique spacial distribution of output power, as well as the spectral output distribution characteristic of the pellet.

This discussion of optical fibers has so far dealt with single fibers. In some applications, performance and/or cost benefits may be gained by utilizing a fiber bundle, a group of single fibers in a single jacket. Bundles may be treated like single fibers when certain factors are considered. A bundle is more flexible than a single fiber of equal active area, and under repetitive flexing will continue to operate even if a few strands break. Cladding and packing take a larger proportion of a bundle's area, so the active core area of a bundle is much less than that of a single fiber of identical diameter. A bundle may be harder to terminate with a connector than a single fiber, as each individual strand has a finite probability of inserting improperly into the connector. It will usually be more difficult to polish the fibers of the bundle, and it may cause higher power insertion loss due to poor finish. It should be noted that fiber end finish is critical in obtaining consistent low attenuation light coupling into and out of any fiber optic system. Poor fiber end polish has been observed to cause up to 10 db ($\div 10$) signal loss per end.

2. *Connectors* A wide variety of fiber optic connectors exist, since there is virtually no standardization within the connector industry. To provide a low loss fiber-to-fiber splice, a connector must position the two optically polished fiber ends very close together in axial concentric alignment. If the fiber ends touch, abrasion may spoil the end finish, causing power loss (some plastic fiber connectors use pressure to maintain fiber end contact, on the theory that the end surfaces deform to fit, and thereby mate better), while power coupling falls rapidly with increasing distance between the fiber ends, increasing angle between fiber axes and with misalignment of the fibers concentrically. The tolerances on the fiber core, cladding, and concentricity will affect different connector designs to varying degrees. While the fiber connector must ensure this precision, it should also be low cost and be quickly applied to the fiber with minimal skill and tooling—even in the field. This presents a challenge to the connector manufacturer, not only because of the wide variety of fibers, but also because of the increasing tolerance problems as fiber core diameter decreases. In general, connectors for fibers of $200\mu\text{m}$ core diameter and over are less expensive and provide better consistency than those for smaller core diameters.



a: CUTAWAY VIEW

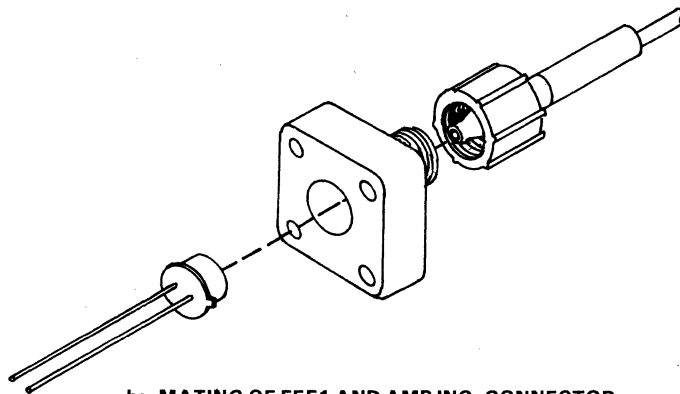

b: MATING OF F5E1 AND AMP INC. CONNECTOR

FIGURE 2.49: TYPICAL ACTIVE DEVICE CONNECTION TO FIBER OPTIC

Most active devices, i.e., emitters and detectors, are applied to fibers via fiber connectors and an adapter or a small length of fiber (pigtail), built into the active device, terminated with a connector. Efficient coupling of power from the emitter to the fiber core depends on the connector system and its match with the emitter design. The GFOD/E series fiber optic active components were designed to mate to the AMP Optimate® ferrule connector system. This combination provides an excellent combination of cost, performance, and flexibility. Since the AMP system has a variety of standard active device connectors, it is also possible to mix in other active devices, for example the F5E 880nm emitter, which can sometimes provide system advantages, such as longer range transmission.

3. *Emitters* The emitter transforms an electrical signal to the light signal which will be coupled into the fiber and transmitted. A wide choice of emitters confronts the designer of a fiber optic system. "Fiber optic compatible packages" range from standard TO-46 or T1^{3/4} devices to be placed in an adapter, through units with a pigtail of fiber exiting the package (requiring a splice to the transmission fiber) to components which a terminated fiber screws into. The package determines the efficiency of power coupling and the ease (cost) of coupling the fiber to the electronics. It may also limit the choice of fibers and connectors. Most packages are printed circuit board compatible. The wavelength, speed, and power output of emitters varies with the material and process used in construction.

A major subdivision exists between LED/IREN (light/infrared emitting diodes) and diode lasers. These lasers provide a small area, powerful source of very high speed capability. They can insert large amounts of power into a fiber and are usually chosen at wavelengths from about 800nm to 900nm and 1100 to 1400nm. As laser action starts above a bias current threshold, the power output follows a non-linear relationship with respect to the bias, causing electro-optical feedback networks to be popular in laser modulation circuitry. Currently, laser diodes have some practical disadvantages. The reliability of diode lasers is compromised by several factors, among which ohmic contact and light output degradation appear most prevalent. They are difficult to manufacture, package, and test for fiber optics use and are therefore expensive compared to LED and IREN sources. The LED/IREN technology covers a wide range of products of low to moderate speed and power wavelengths from 550nm to 1300nm. Low cost and excellent reliability can be obtained with these units but is not assured without the user qualifying sources for these qualities. Most devices used for cost sensitive systems are between 640nm and 940nm to combine efficient light production with efficient detection by a silicon detector. Choice of the emitter is dependent on the fibers which are viable for system requirements, the effort required to predictably couple the fiber to the emitter, and the cost/performance trade-off items previously mentioned.

The GFOE1A series of emitters contains a highly efficient, long life, silicon doped liquid phase epitaxial gallium arsenide pellet producing 940nm infrared radiation. Light conversion efficiency of the pellet is approximately 4% at 30-50mA d.c. drive levels and 25°C, and peaks to 5-6% at about 200mA pulse drive. Due to the negative temperature coefficient of efficiency, pulse operation is required to produce high output powers at high currents. The package is designed to directly accept any fiber terminated in an AMP OPTIMATE™ ferrule connector terminal. The GFOE1A series emitter utilizes a unique reflector and lens combination internally to give a large, 1.2mm dia., almost constant intensity irradiance pattern at the fiber end plane. This assures good power coupling to the more than 30 fibers the AMP OPTIMATE™ ferrule connector has specified, as well as additional fibers not applicable to splicing in the AMP system due to concentricity. Power launched into the fiber core with the GFOE1A series is primarily a function of core diameter due to this large spot of focused power. Over the range of 100μm to 1mm core diameter, the power launched is proportional to $d^{2.5}$, where d is the core diameter.

TABLE 2.5: GFOE1A1 FIBER PERFORMANCE

FIBER NAME	TYPE	DIAM. IN mm	TYPICAL GFOE1A1 PERFORMANCE	
			LAUNCHED POWER*	ATTENUATION db/m
POLYOPTIC	PF	1.0	180 μ W	12(C)
CROFON®1040	PF	1.0	200 μ W	5.8(M)
ESKA SH 4001	PF	1.0	200 μ W	5.8(M)
GALITE 1000®	GB	1.4	150 μ W	0.6(M)
ESKA SH3001	PF	0.75	100 μ W	5.8(M)
ESKA SH2001	PF	0.5	45 μ W	5.8(M)
PIR140	PF	0.4	28 μ W	1.6(M)
QSF400B	GF	0.4	31 μ W	0.03(M)
QSF300B	GF	0.3	17 μ W	0.03(M)
QSF200B	GF	0.2	7 μ W	0.03(M)
PFX-S-120	GFJ	0.2	7 μ W	0.13(C)
SIECOR®155	GFJ	0.2	6 μ W	0.02(C)
CORGUIDE®SDF	GF	0.1	0.8 μ W	0.02(M)
CORGUIDE®FWF	GF	0.05	0.1 μ W	0.04(M)

CODES: *At $I_F = 50\text{mA}$

P—Plastic

G—Glass

J—Fully protected

C—Calculated

F—Fiber

B—Bundle

M—Measured

NOTE: Calculated and measured values may vary considerably. Errors can be due to curve smoothing, measurement technique or tolerance. These data represent curve fitting with a minimum of 3 different lengths of the fiber. Where a fiber is available in several diameters attenuation may be measured on only one size.

Ultimate system length will be determined by fiber attenuation at the emitter's wave length. Considerable difference can be noted between attenuation factors determined from specification sheet data and that observed in practice. This is illustrated by comparing the chart to the fiber attenuation curves shown earlier. Longest ranges can be obtained with the 880nm F5E and polymer clad silica fiber. The F5E is packaged in a TO-46 and requires the AMP, Inc. bushing (530563-1) to couple with the fiber. Coupling loss is about 6db more than the GFOE1A series. Despite these factors, the combination has advantages. The F5E1 produces about 3db more radiation than the GFOE1A.

The GFOE1A emitter is also capable of being used as a sensor of the 940nm radiation it produces. Photoresponse is typically 0.03 Amperes per Watt (A/W), while leakage currents are typically 1nA at 25°C. This indicates a half duplex link can be constructed on a single fiber with a single diode on each end of the fiber, providing both emitter and detector functions. Such a link is illustrated in section 6.3.1 of this manual.

4. Detectors The detector choice for a fiber optic system is constrained by almost the same variety of packages as emitters, by material and process effects on speed and wavelength, and by the availability of amplifiers built on the detector pellet through integrated circuit techniques. Almost all detectors are based on semiconductor diode charge-carrier-generation caused by photons liberating carrier pairs near the junction of the diode. Although III-V compound semiconductor detectors are used beyond 1000nm wavelength, most fiber optic systems use silicon detectors operating between 500 and 1000nm. This is due to the cost, availability, and predictability of silicon semiconductor material. Most current solid state electronics is based on silicon, and its light-detection properties are very compatible with common emitters and fibers.

Basic diode detectors may be designed with avalanche multiplication amplification or without. Avalanche photodiodes (APD) are very fast, have good sensitivity, and are difficult to manufacture and electrically bias. They are mostly confined to applications requiring very high-speed operation. Other diode detectors differ mainly in the techniques used to minimize capacitance (for speed) and noise without sacrificing sensitivity. The PIN diode is a common type, which physically places a wide intrinsic region between the n and p-type silicon forming the junction. This effectively produces a wide junction, which lowers capacitance per unit area and lowers bulk leakage currents which contribute to noise. Amplifiers are also commonly made on the same pellet as the photodiode, using the same techniques as previously discussed.

The GFOD1A is a single phototransistor detector in the fiber optic compatible package, while the GFOD1B is photodarlington detector. Both devices use pellets similar to those previously described. Further additions to the fiber optic product line would be expected to follow the same trends as the optoisolator line. It should be noted that all the side looking plastic devices (i.e. F5G, L14U etc.) are mechanically and optically compatible with these housings. Such combinations are available for large volume applications.

chapter 3

QUALITY AND RELIABILITY OF OPTOELECTRONIC COMPONENTS

3.1 QUALITY AND RELIABILITY COSTS

The circuit designer must be aware of the expected reliability of the many different components used. This allows control of life cycle costs, such as warranty costs, repair costs and downtime costs, through proper application of these components. Also, component quality can significantly affect a project's economic viability. Quality costs are those associated with the percentage of components received that fail to meet some portion of their specified performance levels. Reliability costs are those associated with the percentage of components that change so that a circuit malfunction occurs.

Some reliability failures can result from inadequate circuit design allowances for parameter changes with temperature, bias, etc. In this discussion, these failures are considered unreliable design malfunctions and will not impact the component reliability considered here.

The costs associated with mediocre quality and/or reliability may prove very significant. A convenient method of visualizing these costs is to calculate the added cost-above purchase price — that is required to have a working component in the field. Cost impact comes from the combination of repair

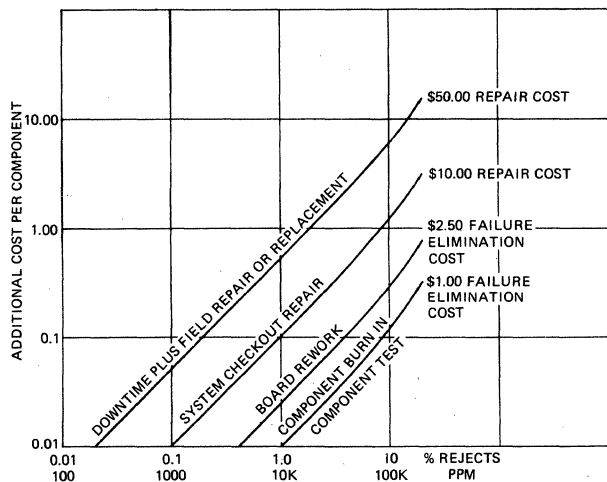

FIGURE 3.1a: ADDITIONAL COSTS DUE TO QUALITY/RELIABILITY FAILURES AND WHERE FAILURE FOUND

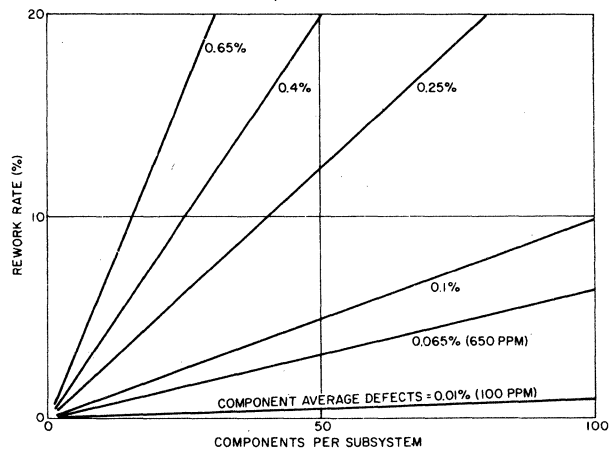

FIGURE 3.1b: SUBSYSTEM COMPLEXITY AND REWORK RATE

cost, downtime cost, and failure rate and will rise to a major factor if any are high.

Considerable emphasis is placed on the quality and reliability of General Electric optoelectronic devices, from design, manufacturing, specification, testing, and the support literature provided to users. Both outgoing quality level (the AQL or LTPD shipped to) and, more importantly, process defect average are closely monitored, recorded, and used as tools to improve future performance. As an example of the effectiveness of this procedure, in 1981 General Electric phototransistor opto isolators were normally shipped to a 0.4% AQL. During that year, the observed electrical parameter defect level was approximately 0.1 percent, 4 times better than required to consistently pass.

A more appropriate indicator of quality is reflected in the 1983 quarterly reliability summaries. These reports summarize, by product line, each month's outgoing process average — the estimated average defect level in the outgoing product based on the appropriate MIL-STD quality control sample plan data generated in normal quality control monitoring of outgoing product. For the year of 1983 the monthly OPA for optoelectronic product electrical parameters ranged from a low of 1.7 parts per million (in March) to a high of 49 parts per million (in December). This impressive record includes all manufacturing sites and all optoelectronic devices, although it is dominated by optoisolators in sheer numbers. This record is the result of a recognition that quality and reliability are prime considerations in the selection of optoelectronics devices, due to the critical functions of sensing and isolation performed by them, and a commitment by all at General Electric involved in optoelectronics to provide the best devices possible — without sacrificing competitive prices.

To meet the goals of higher quality, higher reliability in a competitive market requires an aggressive product improvement program. The most noticeable result of this program recently has been the introduction of the reflector construction technique in optoisolators. This construction technique provides higher performance, in coupling efficiency and isolation, follows more reliable design criteria (25% fewer wire bonds, lower IRED thermal resistance for cooler operation, longer internal creep path for isolation) and is more consistent, due to the unique mechanical design and the high degree of automation this design allows, providing the basis for even higher quality. Although this world leading design has not yet built up the historical data base associated with the present champion, the sandwich construction present, testing to date indicates equivalence today, with the promise that the knowledge and data gained will assure new records in the future. Figure 3.2 illustrates the assembly process flow of the reflector design DIP coupler. Note the eutectic die bonds on both die, the flexible IRED antireflection coating, the glass dielectric, the 100% temperature cycle of ten cycles, and that the testing includes high temperature wire bond continuity on all devices in addition to parametric tests.

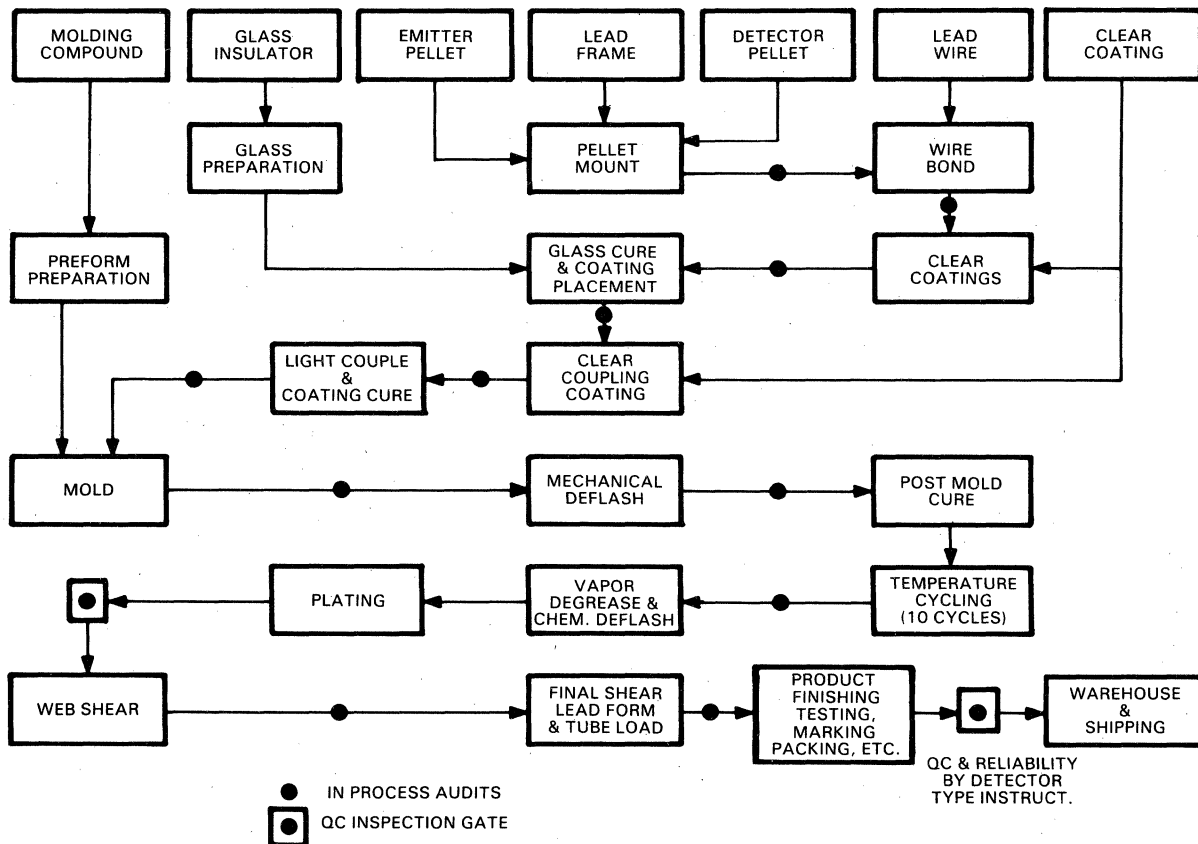

TABLE 3.1 DIP OPTOISOLATOR FLOW DIAGRAM—REFLECTOR CONSTRUCTION

Optoelectronic components reliability is also monitored. A manufacturer assesses the performance of his components by performing accelerated test sequences on periodic samples of the manufacturing line output. Most of these tests are run at, or beyond, maximum ratings to allow an accelerated reliability assessment of the product. These tests can provide the information required by the circuit designer, but the severity of the test conditions compared to use conditions must be considered. The extrapolated results of these severe tests to normal use levels is still a challenge for the circuit designer, but the challenge is lessened by the availability of information that provides estimates of acceleration factors, i.e., the increase in rate-of-failure, caused by increasing stress levels, such as voltage, current and temperature. Application of these acceleration factors to the data can allow worse case circuit design techniques to be applied over the design life of electronic equipment. Several sources document estimates of these acceleration factors. One of the most widely used is MIL-HDBK-217 D although recent bibliographies and surveys indicate a vast quantity of relevant data on plastic encapsulated semiconductor devices exists. Such information sources should be consulted when estimates of equipment reliability are attempted from these, or any other, summaries of reliability test data.

3.2. SUMMARY OF TEST RESULTS

Tables 3.1 through 3.4 summarize the periodic reports issued by GE — SPD Quality Control on the optoelectronic products. As new products, processes and test procedures evolve, the application of past data to reliability prediction changes. Thus, data presented here represents a “snapshot in time” of data believed applicable to the product made now and in the immediately anticipated future. A separate section will cover the decrease in light output of the IRED with time of operation, a phenomenon noted in all light emitting diodes, both from the viewpoint of summarizing the observed data and of predicting the response of the majority of devices to expected stress.

Each stress condition monitors a different capability of the component. For the emitters and detectors, the operating life test stresses current, voltage and power activated mechanisms. The only tests which have been found to activate the output decrease of the IRED are tests in which current flows through the IRED. Storage life at elevated temperature tests stability and resistance to thermally activated mechanisms, such as corrosion caused by contamination. Humidity life tests the capability of the package to keep contaminants out, as well as the ability of the package to resist moisture activated corrosion, deterioration and surface leakage problems. Temperature cycle causes mechanical stress on components made of materials with different coefficients of expansion, and can break or thermally fatigue parts which are thermally mismatched. This is presently a problem with optoelectronic components packaged in clear epoxies when subjected to wide, repeated temperature changes, due to the large coefficient of expansion of the clear, unfilled epoxy. Since the object of the test program is to gain the most information in the shortest time, and since thermal fatigue has a very strong temperature acceleration, these tests are run to the limits defined by activation of non-valid failure mechanisms or beyond common test equipment capability, without regard for maximum ratings. All high efficiency IRED's have an anti-reflective coating that, unless carefully selected and controlled, can have a detrimental effect on extended temperature cycle performance. Illustrated here are temperature cycle results of the standard 100 cycle test and extended stress results to 200 and 500 cycles, without evidence of thermal fatigue. This is a tribute to the mechanical design of the GE hermetic IRED. Mechanical sequence stress was not performed on the hermetic IRED, since it contains only two, redundant lead bonds and should exhibit one quarter the failure rate of transistors requiring two independent lead bonds.

TABLE 3.2: RELIABILITY TEST SUMMARY – EMITTERS AND DETECTORS

DEVICE TYPE	STRESS CONDITION	QUANTITY TESTED	TOTAL DEVICE HOURS	BEST ESTIMATE FAILURE RATE★
Hermetic IRED • LED55 Series • LED56 Series • 1N6264 - 1N6266	Operating Life $I_F = 100\text{mA} @ 25^\circ\text{C}$	267	267,000	0.26%/10 ³ hrs. 0.26%/10 ³ hrs.+
	Pulsed Life @ 38°C $I_F = 1\text{A}$ for 80μsec @ 60Hz	200	600,000	0.12%/10 ³ hrs. 0.12%/10 ³ hrs. +
	Storage Life* T = 200°C	80	80,000	2.2%/10 ³ hrs.
	Temperature Cycle* -65°C to +200°C	414	86,100~	0.42%/100~
Hermetic Detectors • L14F Series • L14G Series	Operating Life Pd = 300mW	75	75,000	0.95%/10 ³ hrs.
	Storage Life T = 200°C	75	75,000	0.95%/10 ³ hrs.
	Temperature Cycle -65°C to +200°C	75	7,500~	0.95%/100~
	Mechanical Sequence 1.5 KG Drop Shock 20 KG Centrifuge 20 G Vibration	75	N.A.	No Failures

★Catastrophic failure rate to best estimate 50% upper confidence level.

+ Combined catastrophic and degradation, to $\Delta P_{OUT} \geq 50\%$, est. failure rate to 50% UCL.

*Stress conditions exceed device specified maximum ratings.

TABLE 3.3: RELIABILITY TEST SUMMARY – H23 PAIR FAMILY

(ALL HOUSINGS COMBINED – ALL DETECTORS COMBINED)

STRESS CONDITION	PAIRS TESTED	TOTAL PAIR DEVICE HOURS	BEST ESTIMATE FAILURE RATE†
Operating Life @ 25°C $I_F = 60\text{mA}, I_C = 20\text{mA}^*$	625	496,000	0.14%/10 ³ hrs.
100°C Storage	450	329,300	0.51%/10 ³ hrs.
Humidity Stress @ 85°C, 85% R.H.*	450	329,300	0.51%/10 ³ hrs.
Temperature Cycle -65°C to +100°C	831	223,100~	0.021%/10~

†Catastrophic failure rate to best estimate 50% upper confidence limit.

*Stress conditions exceed pairs specified maximum ratings in some or all housings.

The basic H23 matched pairs of emitters and detectors are also used in the H21 and H22 interrupter modules, the H24 opto isolator, the GFOD/E fiber optic active devices and as discrete devices. A significant effort was expended in the design of these devices to ensure their reliability. The most evident to the eye are the recessed lens, which is thereby protected from mechanical damage during automatic handling, and the serpentine path the mountdown lead follows within the package, to provide a moisture proof path seal in the transfer-molded epoxy. Additional features include the long-lived GaAs IRED with its protection and contact system, the extra large diameter bond wires to withstand extended temperature cycle and the conservative maximum ratings. Additionally, all units are submitted to temperature cycle and high temperature continuity testing prior to electrical parameter screening. No significant difference in reliability has been observed between the various housing alternatives, therefore the test data on all types has been lumped together by pairs, which conserves space and provides a larger, more statistically significant sample. The operating and humidity stresses are beyond specified maximum ratings, and 500 temperature cycles were tested on a portion of the samples. The observed change in IRED output with operation is the same low rate documented on all General Electric GaAs IRED's in the next section.

The six pin DIP optoisolator differs from familiar solid state components in that it contains two chips and a light transmission medium, providing a higher potential for failure than simpler components. Due to these construction differences, it would be expected to have different dominant failure modes than either discrete or integrated circuit semiconductors. Each output device type also has some unique characteristics that require unique stress testing. Since the IRED is identical in each type of coupler, most IRED evaluation work is done on the transistor coupler due to the minimal variation of CTR with temperature and bias which provides an accurate monitor of IRED performance. Darlington test monitoring is done at extremely low IRED currents and, therefore, shows the highest rate of decrease when stressed at identical levels. (See next section for details.) The SCR output coupler is subject to the possibility of inversion layer formation (channelling) as are all high blocking voltage semiconductors. Stressing at high blocking voltage at high temperature (HTRB) will accelerate possible inversion layer formation. Test results of all detectors are combined for high temperature storage life, temperature cycle, humidity and salt atmosphere stress, all of which are relatively free of effects dependent on the output device. The results of these tests illustrate the superiority of the G.E. patented glass dielectric isolation, silicon doped liquid phase epitaxially grown IRED chip and total electrical and mechanical design. This is a premium optoisolator from a reliability and a performance standpoint. From a manufacturing standpoint, it enjoys high yields and ease of assembly, providing this quality at competitive costs.

In the evaluation reliability tables with the acceleration factors given in the next section, both the IRED heating from power dissipated in the output device and the standard readout bias must be known. This heating can require from 5.5mW/°C for the H11A to 11.5mW/°C for the H11AV construction. Standard CTR readout conditions for phototransistors are $I_F = 10\text{mA}$, and for photodarlingtons at $I_F = 1\text{mA}$.

For convenience, the reliability test summaries are separated into operating and non-operating stresses. All DIP package and detector types are combined in non-operating test results since no significant difference has been observed between types. Operating tests are separated by detector type into significant subgroups. Due to the combined effects of sample size and experience on best estimate failure rate, it is expected that the newer detector type failure rates are not representative. These failure rates are anticipated to decrease, as production increases, to approximate the level of the more mature types. The data base on combined phototransistor and photodarlington detectors is large enough to allow valid failure age analysis. This analysis indicates the failure rate decreases significantly with time on test, which signifies both long life capability and the possibility of reliability enhancement screening. A further analysis of lumped test data by date for failure age reinforces the decreasing failure rate and proves the consistent long-term reliability of the General Electric DIP opto isolator.

TABLE 3.4: RELIABILITY TEST SUMMARY—GE DIP OPTOISOLATOR

(OPERATING STRESS TESTS)

DETECTOR TYPE	STRESS CONDITION	QUANTITY TESTED	TOTAL DEVICE HOURS	BEST ESTIMATE FAILURE RATE
Combined Phototransistor and Photodarlington	Operating Life, $T_A = 25^\circ\text{C}$ $I_F = 60\text{mA}$, $I_E = 20\text{mA}$, $V_{CE} = 15\text{V}^*$	2499	1.8×10^6	0.64%/10 ³ hrs.
Phototransistor	Humidity Blocking Life, $T_A = 85^\circ\text{C}$ RH=85%, $V_{CB} = 24\text{V}$, $V_{EB} = 4\text{V}$, $V_{ISO} = 100\text{V}$	120	6.0×10^4	1.2%/10 ³ hrs.
PhotoSCR	DC Blocking Life, $V_{AK} = 400\text{V}$, $I_F = 0$, $T_A = 100^\circ\text{C}$	579	3.1×10^5	0.55%/10 ³ hrs.
Triac Driver	AC Blocking Life, $V_{46} = 141\text{V RMS}$, $I_F = 0$, $T_A = 100^\circ\text{C}$	180	1.2×10^5	2.2%/10 ³ hrs.
Photo Schmitt Trigger	DC Blocking Life, $V_{65} = V_{45} = 20\text{V}$, $I_F = 0$, $T_A = 100^\circ\text{C}$	25	2.5×10^4	2.8%/10 ³ hrs.

★ 50% upper confidence level best estimate failure rate.

*Accelerated test, test bias conditions in excess of device ratings.

TABLE 3.5: RELIABILITY TEST SUMMARY — GE DIP OPTOISOLATOR

(NON-OPERATING STRESS TESTS — ALL TYPES COMBINED)

STRESS CONDITIONS	QUANTITY TESTED	TOTAL DEVICE HOURS	BEST ESTIMATE* FAILURE RATE
150°C Storage	2956	1.5×10^6	0.37%/10 ³ hrs.
Humidity Storage, $T_A = 85^\circ\text{C}$, R.H. = 85%	3283	1.6×10^6	0.29%/10 ³ hrs.
Temperature Cycle -65°C to +150°C	5884	$5.9 \times 10^5 \sim$	0.035%/10 [~]
Salt Atmosphere MIL-5-750/1041, 35°C	25	600	0.13%/hr.

*50% upper confidence level best estimate failure rate.

Both storage tests showed no significant change in failure rate over the years. Temperature cycle exhibits a significant improvement: pre-1976 — 0.15%; 1978-79 — 0.04%; 1980 — 0.012% per 10 cycles. This illustrates the effectiveness of process control steps and the 10-cycle temperature cycle followed by high temperature continuity screening of all General Electric DIP couplers done prior to electrical parameter testing. Although the following section deals with IRED change with operation, it should also be noted that CTR shift has been noted on DIP optoisolators through temperature cycle. This shift is attributed to mechanical stress caused by unequal coefficients of expansion of the various parts of the optoisolator. Considerable difference is noted from manufacturer to manufacturer, and the General Electric design proves stable, indicating the excellence of design. No statistically significant difference in reliability characteristics has been observed between the GE sandwich, reflector and bar construction optoisolators. It is assumed that a much larger data base is needed to show any difference.

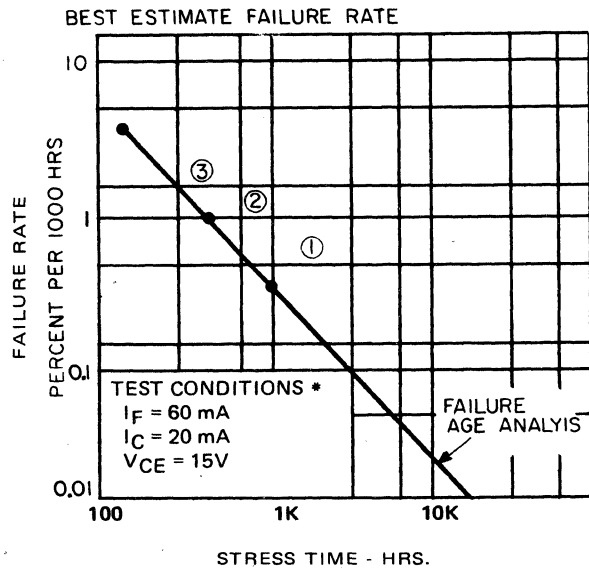

PERIODIC COMPARISON IN TIME POINTS

1. 346 units, pre 1976, 5.6×10^5 unit hrs.
2. 1203 units, 1978-79, 8.5×10^5 unit hrs.
3. 950 units, 1980, 3.9×10^5 unit hrs.

*Test conditions exceed maximum ratings

FIGURE 3.2: OPERATING LIFE FAILURE RATE DECREASE WITH TEST TIME

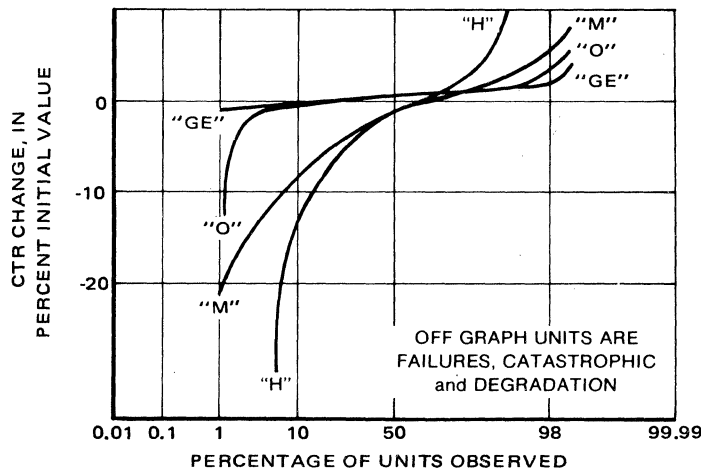

FIGURE 3.3: 6 PIN DIP OPTOISOLATOR RELIABILITY TEMPERATURE CYCLE (-55°C TO +150°C, 10 CYCLES) EFFECT ON CTR 90 TO 100 UNITS EACH TYPE, 1980 DATE CODES

3.3 RELIABILITY PREDICTION OF CIRCUITS CONTAINING IRED's

The IRED phenomenon of light output decrease as a function of the time current flows through it, has been mentioned previously. This phenomenon is observed in all diode light and infrared emitters.³⁴ The liquid epitaxial processed, silicon doped IRED provides superior performance in this regard. Still, this presents a dilemma to the circuit designer. Adequate margins for bias values require predicting a minimum value of light output from the IRED at the end of the design life of the equipment. Based on the results of tests performed at GE and at customer facilities (who were kind enough to furnish test data and summaries) the GE Application Engineering Center has developed design guidelines to allow the prediction of the approximate worst case, end of life, IRED performance.

TABLE 3.6: SUMMARY OF TESTS USED TO OBTAIN IRED DESIGN GUIDELINES

T_A I_{FS}	25°C	40°C	55°C	70°C	80°C	100°C
3mA	20 1000 Hr. 3mA					
5mA	20 1000 Hr. 1, 5mA					
10mA	16 1000 Hr. 1, 10mA		30 1000 Hr. 1, 10mA		30 1000 Hr. 1, 10mA	30 1000 Hr. 1, 10mA
20mA	27 500, 1000 Hr. 1, 5, 10, 20mA				108 1000 Hr. 10mA	
25mA	20 1500 Hr. 10mA	20 1500 Hr. 10mA	20 1500 Hr. 10mA	60 1500 Hr. 10mA		
50mA		20 1500 Hr. 10mA		40 1500 Hr. 10mA		
60mA	20 1000 Hr. 1, 5, 10, 20, 60mA		30 1000 Hr. 1, 10mA		313 1000, 3000, 5000 Hr. 1, 10, 60mA	30 1000 Hr. 1, 10, 60mA
75mA				20 1500 Hr. 10mA		
100mA	79 1K, 15K, 30K Hr. 1, 10, 60, 100mA		30 1000 Hr. 1, 10mA		30 1000 Hr. 1, 10, 60, 100mA	120 168, 1000, 1500 Hr. 1, 10, 60, 100ma
1A Pulsed	200 3000 Hr. 1, 10, 100mA					

This chart represents about 2.9 million device hours of operation on 924 dual in-line optocouplers and 311 hermetic IRED's.

FORMAT OF DATA PRESENTATION:

<p>SAMPLE TEST DURATION I_{FM} CURRENT</p>
--

The basis of the prediction is the observed behavior of the ratio of light output after operation to the initial value of light output. It is also based on the observation that all devices do not behave identically in this ratio as a function of time, but that a distribution with identifiable tenth, fiftieth (median) and ninetieth percentile points exists at any time the ratio is calculated. Use of this tenth percentile ratio (90% of the devices are better than this) and the distribution of light output (or CTR for couplers) above the specified minimum value allows the product of specified minimum light output and tenth percentile ratio, predicted at end of life, to be used as a reasonable approximation of minimum end of life value. Although this does not represent the worst possible case, no correlation can be found between initial light output and rate of decrease in light output, so the percentage of devices expected to be less than the guideline derived number approaches zero. These guidelines as can be noted, are based on large sample sizes. To make the guideline development less obscure, the discussion will trace the steps followed in defining these design guidelines and, in the process, develop the guidelines. Although the majority of data is taken on General Electric GaAs IRED's, it is found that the same general model fits the General Electric GaAlAs IRED.

Since the original General Electric model was published, based on data generated prior to 1976, considerable effort has been expended to define and minimize this decrease. Response of the light output of the IRED to operating time is considered to be comprised of two factors, stabilization and degradation. Further, two types of degradation are apparent, short-term and long-term degradation. Short-term degradation can be virtually eliminated, while long-term degradation can be minimized through process and material control. These factors can be visualized through plots of the ratio of IRED

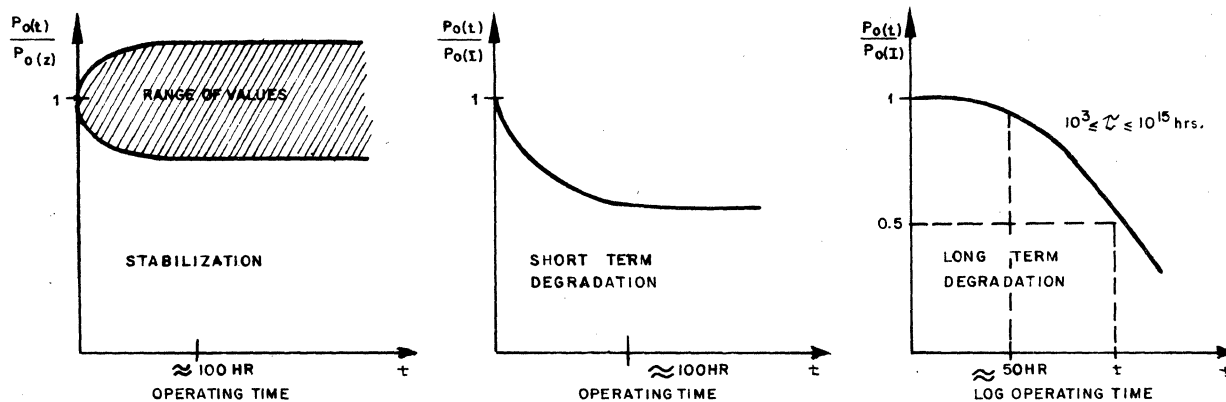

FIGURE 3.4: FACTORS AFFECTING IRED OPERATING OUTPUT POWER

output power, as it is operated, to its initial value (i.e., normalized output power vs. operating time). Various items have been identified as affecting these factors — crystal structure, impurities, mechanical and thermal stress. Most of the published information is of such gross definition that it only identifies the worst offenders. Rapid methods of assessing IRED performance have likewise proven disappointing. As a consequence, the tedious life test is the measure of performance improvement.

Analysis of life test results to characterize the change in power output is complicated by the difficulty in separating the magnitude of effect of each factor and the fact that these magnitudes can be functions of both stress conditions and monitoring conditions.

The problems with predicting response are the variety of test conditions at which both stress and measurement data have been taken, and the spread of data at the readout points. It was recognized that the decrease in light output was accelerated by either stressing the IRED harder, i.e., at a higher current (I_{FS}) and/or temperature, or by monitoring the test results at lower current (I_{FM}) levels. Precise acceleration factors have yet to be determined due to this variability. Fortunately, circuit design purposes can be served by a less precise model, which only attempts to serve the requirements of circuit design. For this approach, as mentioned before, attention is paid to the lower decile of the distribution of $P_O(t)$ and its change with operating time. The objective is to approximate the mid portion of the longterm degradation plot with a straight line by utilizing data points beyond the short-term factor effects.

Significant progress has been made in improving the General Electric IRED degradation since the first model was published. This is illustrated by comparison of the data published at that time with present units tested at the same stress levels. Present units are much more consistent than early units.

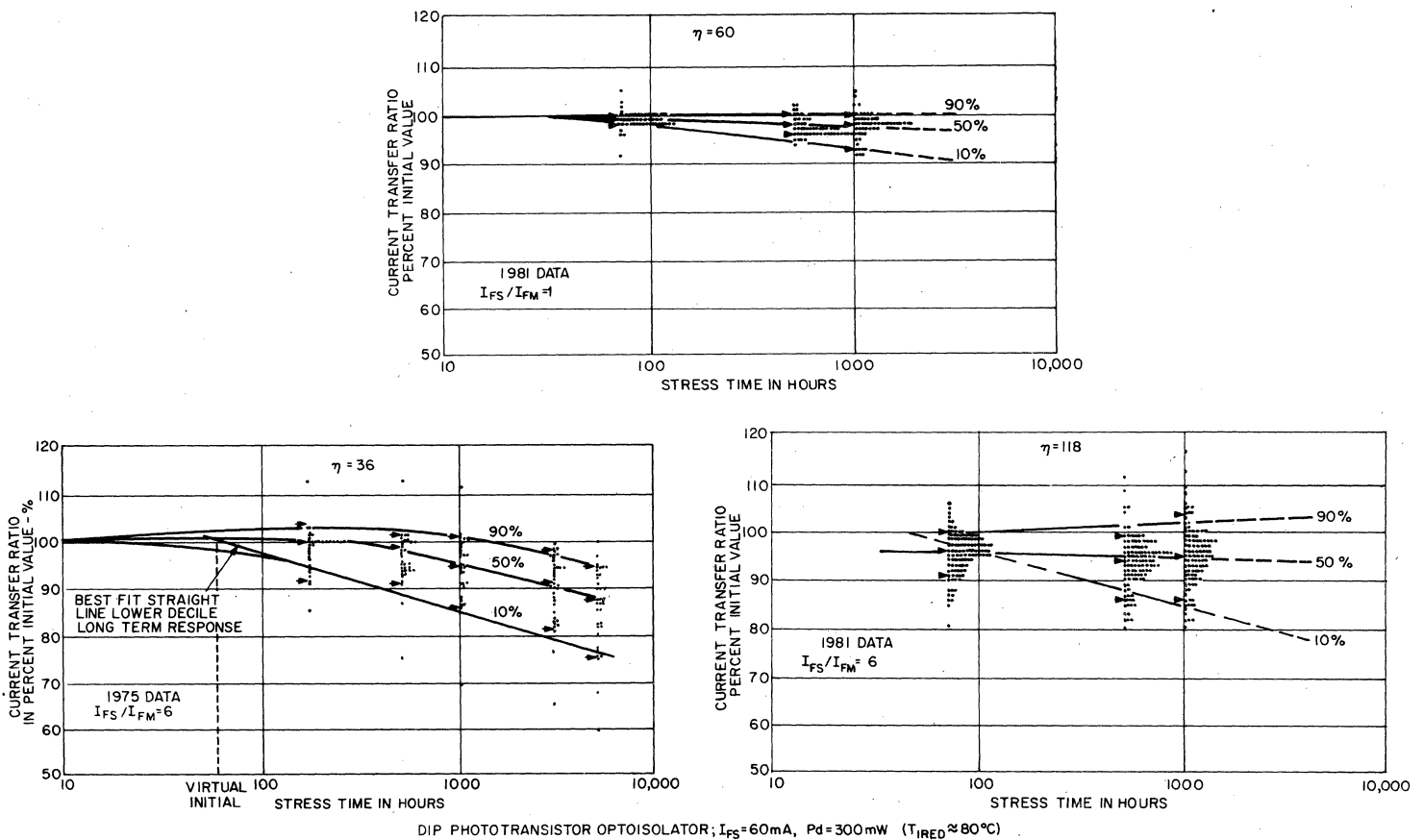

FIGURE 3.5: LIFE TEST RESULTS — ILLUSTRATING OBSERVED CHANGE IN IRED OUTPUT WITH OPERATING TIME

This is evident in the smaller, tighter distribution with larger sample sizes. (See Figure 3.5). Data taken at a greater variety of conditions, both more highly accelerated and simulated use conditions, and more precise readouts, indicates the original model was quite conservative for most applications. Recent data indicates the GaAs IRED, to a lower decile definition, degrades less than GaAlAs. The most precise data, with temperature and detector compensation, suggests that lower current operation (i.e., lower I_{FS}), at a given stress temperature and I_{FS}/I_{FM} ratio, has the higher degradation rates within the model. This conclusion is not consistent with all data, but implies that conservative circuit design should allow more margin for degradation at low ($\leq 3\text{mA}$) IRED bias currents.

The IRED degradation model predicts the slope of long-term lower decile response of the distribution of the ratio of light output after operation to initial value. This response is plotted in a straight line against the logarithm of operating time. Extrapolation of this straight line towards zero time defines a virtual initial time, when it intersects the initial value. Observations indicate the virtual initial occurs at or before 50 hours. For purposes of circuit design, the assumption of 50 hours for virtual initial time will be utilized to assure conservative design. The slope of this lower decile line can be defined in percent drop in light output per decade time. Slope and virtual initial completely define the predicted IRED output with operating time.

This model includes all GE DIP optoisolators, discrete IRED's, both hermetic and plastic, and all H23-based product families. Note that GaAs and GaAlAs emitters differ in slope.

The question naturally arises of the applicability of this descriptive model to time periods beyond the one and five thousand hour times where the majority of the tests stopped. Fortunately, tests have been completed on discrete IRED's for 30,000 hours. These units were manufactured prior to 1970, and illustrate the improvement in IRED technology over the last decade. The results of these tests indicate that nothing unexpected happens at extremely long times, as can be seen in Figure 3.6.

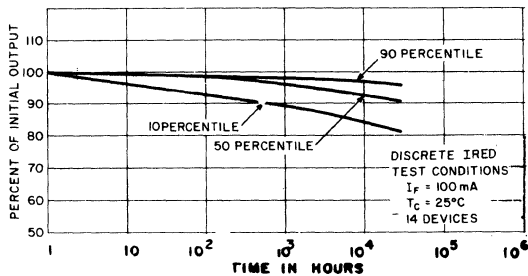

FIGURE 3.6: LONG-TERM IRED LIFE TEST RESULTS

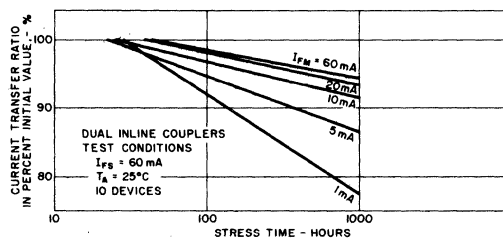

FIGURE 3.7a: EFFECT OF MEASUREMENT CURRENT ON SLOPE

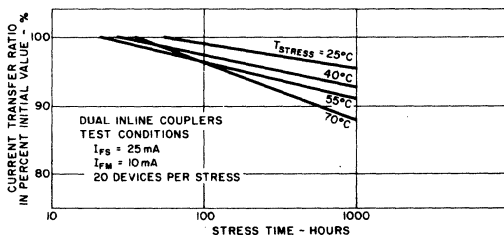

FIGURE 3.7b: EFFECT OF STRESS TEMPERATURE ON SLOPE

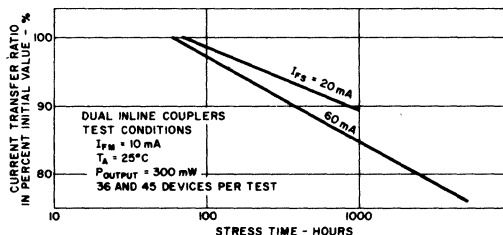

FIGURE 3.7c: EFFECT OF STRESS CURRENT ON SLOPE

When the response (best straight line) of various test conditions is plotted on a single graph, the acceleration due to raising stress current (I_{FS}) is easily seen. Higher temperatures during stress cause the same effect, and can be accomplished by raising the ambient or by self-heating (in a optoisolator by dissipating power in the output device). Lowering the current at which the IRED light output is monitored, (I_{FM}) also accelerate the phenomena, but analysis of many test results indicates that the ratio of I_{FS}/I_{FM} is the key factor-determining the slope dependence on bias.

When the temperature effect is plotted as an acceleration vs. temperature, a fair straight line fit is found, as illustrated in Figure 3.8. This temperature acceleration factor represents the ratios of the slopes of the lower decile lines of various temperature stresses. The fit is not perfect, but is good enough to be useful. The model contains data on all current IRED package options and appears to fit all equally.

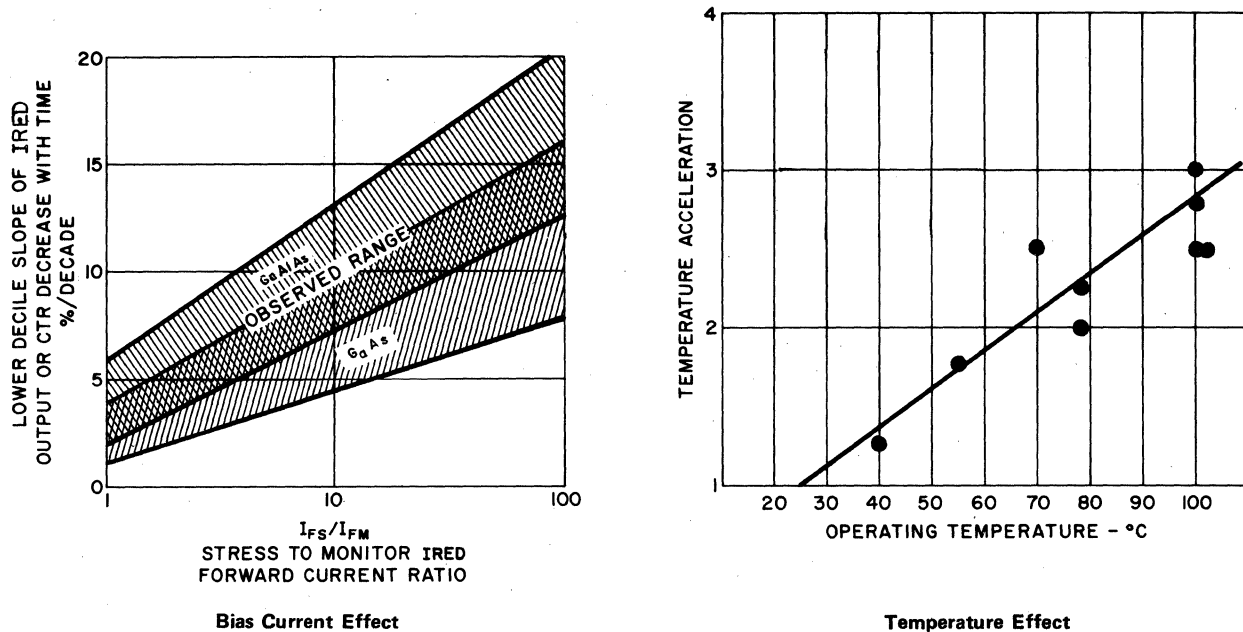

FIGURE 3.8: IRED OUTPUT VS. TIME-SLOPE PREDICTION CURVES ASSUMING A VIRTUAL INITIAL TIME OF 50 HOURS

Utilizing the highest observed slope at $I_{FS} = I_{FM}$, a conservative equation for output power can be derived for each emitter material. Since most applications provide a relatively constant bias current to the IRED whenever energized, these equations provide the means to determine bias current required at equipment end of life. Note that degradation occurs only when current flows in the IRED. The IRED power output (P_O) at time t_x can be predicted from:

$$\text{GaAs: } P_{O(t_x)} = P_{O(t_0)} [1 - 0.04(0.024 T_A + 0.4) \log (t_x \div 50)];$$

$$\text{GaAlAs; } P_{O(t_x)} = P_{O(t_0)} [1 - 0.06(0.024 T_A + 0.4) \log (t_x \div 50)];$$

when constant current bias for t_x hours, $25^\circ\text{C} \leq T_A$ (ambient temperature, $^\circ\text{C}$) $\leq T_j$ max., and $t_x \geq 168$ hours is assumed.

High current pulse operation degradation has been studied at one point. 200 each TO-18 GaAs IRED's have been operated for 3000 hours with 1A pulses, $80\mu\text{sec}$ wide, 60 pulses per second, at 38°C . Analysis of the degradation data indicates that only the time current flows through the IRED causes degradation (180 hours accumulated for these units) and that the degradation follows the model responses. The degradation rate appears to be slightly higher under this pulse condition, indicating a higher stress on the chip than the D.C. bias test. This is logical when the cyclic thermal and mechanical stress on the chip due to pulsing is considered. At this test condition, the GaAs slope was in the center of the GaAlAs area of Figure 3.8. Based on this data, it is concluded the equation for GaAs pulsed operation is:

$$P_{O(t_x)} = P_{O(t_0)} \left[1 - 0.06(0.024 T_A + 0.4) \log \left(\frac{R t_x}{50} \right) \right]$$

where R is the duty cycle of operation.

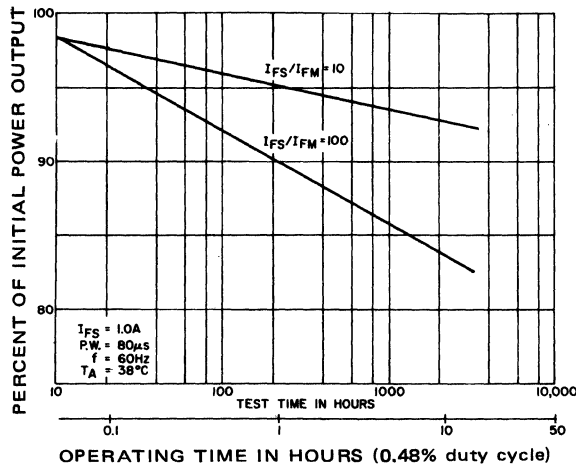

FIGURE 3.9: GaAs IRED PULSED OPERATION

The following example illustrates the use of this model for circuit design. A CNY17-III phototransistor output optoisolator is desired to provide an input to a logic circuit. To provide a logic zero the isolator must sink 2.5mA at 0.3V. The CNY17-III specification assures this capability at $I_F = 10mA$ initially. Equipment design life is 10 years (8.8×10^4 hours) and the worst case duty cycle of operation is 80% "on" time. Ambient temperature in the equipment is maintained below $65^\circ C$.

Summary of example calculations

- Device — CNY17-III
- IRED material — GaAs
- Temperature — $65^\circ C$
- Time — $8.8 \times 10^4 \times 0.8 = 7 \times 10^4$ hours

$$P_{o(tx)}/P_{o(to)} = 1 - 0.04 [0.024 (65) + 0.4] \log \left(\frac{7 \times 10^4}{50} \right)$$

$$= 0.75$$

Therefore, the IRED bias must be $10/0.75 = 13.3mA$, to assure end of life operation. Note that this example has not considered the effects of temperature, tolerances, or other components aging on IRED current requirements.

The design guideline, unfortunately, is only valid for the G.E. IRED's and DIP couplers. Life tests of competitive units at both maximum rating and accelerated test conditions indicate a wide variation of performance exists in the industry.

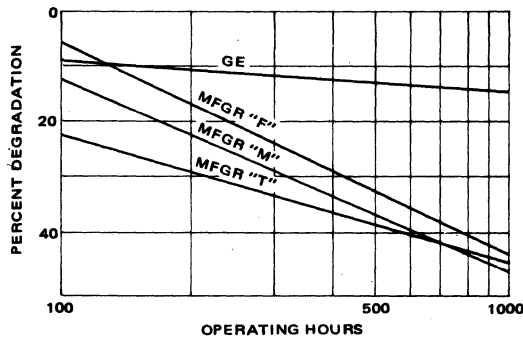

Transistor Photocoupler Data, Observed Lower Decile Data, 1980 Date Codes 20-30 Samples/Type.
 Test Conditions
 Stress: $I_F = 60 mA$, $P_d = 300 mW$
 Measurement: $I_F = 10 mA$, $V_{CE} = 10 V$ CTR

FIGURE 3.10: IRED DEGRADATION, RATE, COMPETITIVE COMPARISON ACCELERATED LIFE TEST RESULTS.

Although some manufacturers have made improvements in their performance since the first edition of the General Electric *Optoelectronics Manual*, considerable room for improvement exists in the industry. In applications where IRED degradation can result in undesirable malfunctions, it is recommended that vendor evaluation and reliability enhancement screening procedures be performed.

3.4 RELIABILITY PREDICTION IN APPLICATION

Predicting component reliability in applications requires a failure rate prediction model. Although MIL-STD-217D provides this type of model, it is based on industry performance and appears strongly biased towards hermetic packaged, JAN-screened devices. A wide variety of reliability assessment information has been published and can be utilized to make predictions based on test data of specific device types and the actual environment they are to be applied in. This method requires that acceleration factors on each stress be determined, and that the stress in applications and in accelerated tests be defined; then the failure rate in accelerated tests can be proportioned to use condition failure rate. The use condition failure rates, by stress, are summed to provide overall failure rate. Advantages of this method include the fact that it is specifically tailored to the component and application, and that potentially high failure rate details are identified to be dealt with in the most economical fashion. Disadvantages include the assignment of stress acceleration factors, a wide variety of which have been published, and the availability of applicable accelerated stress data.

The preceding data provides an excellent base to assess the reliability of General Electric optoelectronics components. If the designer provides adequate margins for tolerances, IRED degradation, and has a viable worst case circuit design, appropriate acceleration factors will allow these data to predict component reliability. The specific stress acceleration factors required are: detector blocking voltage and temperature effects; humidity intrusion effects; and temperature variation (due to power and environment) effects. Note the IRED is not considered separately, because mechanical defects are covered by temperature cycle and efficiency degradation by IRED degradation guidelines.

The sources of acceleration factors require engineering judgment to identify the most valid for the specific device. For the variety of DIP optoisolators GE produces, the author prefers the following acceleration factors based on experience and familiarity with available literature:

TABLE: 3.7: STRESS RESPONSE ACCELERATION FACTORS

STRESS	DEVICE	ACCELERATION FACTOR — *A	SOURCE
Blocking	PhotoSCR	$0.65 \left(\frac{V_2 - V_1}{V_m} \right) - 4323 \left(\frac{1}{T_2} - \frac{1}{T_1} \right)$	GE 6th Ed. SCR Manual, Fig 19.3
Blocking/Power	other discrete detection	$-3327 \left(\frac{1}{T_2} - \frac{1}{T_1} \right)$	GE Pub. 300.1, Fig. 9
Blocking/Power	IC detectors	to be determined	
Humidity Intrusion	All	$1987 \left(\frac{1}{T_1} - \frac{1}{T_2} \right) - 2.424 (h_1^2 - h_2^2)$	Microelec. & Reliab., Vol. 20, pg. 219
Temperature Cycle	All	$328 \left(\frac{1}{\Delta T_1} - \frac{1}{\Delta T_2} \right)$	independently derived

*The ratio of stress level 1 response to stress level 2 response is F.R. 1/F.R. 2 = 10^A.

CODE: F.R. — failure rate

V — blocking voltage

T — junction temperature in Kelvin

h — percent humidity ÷ 100

ΔT — range junction temperature changes

1 & 2 subscript — associates stress level

m subscript — maximum rating

It should be noted that this is strictly accurate only for responses that show a constant failure rate in time or to calculate the times that an identical proportion of failures occur for a linear stress response. The GE DIP optoisolator has a decreasing failure rate as a function of time, which will make these estimates conservative.

An example, using the same CNY17-III used to calculate the effect of IRED degradation, will illustrate the prediction process. The temperature cycle calculation will assume a 25°C to 65°C cycle per day for equipment power up, power down, and turn-on — turn-off of the optoisolator every 30 seconds. This will cause a junction temperature change of $(13.3\text{mA} \times 1.2\text{V}) \div 1.33\text{mW}/^\circ\text{C} = 12^\circ\text{C}$ and $(2.5\text{mA} \times 0.3\text{V}) \div 2\text{mW}/^\circ\text{C}$ i.e. 12.4°C total.

- *Temperature Cycle: Daily* — $A_D = 328 \left(\frac{1}{65 - 25} - \frac{1}{150 - (-65)} \right) ; 10^A = 4.7 \times 10^6$

$$\text{Switching} — A_S = 328 \left(\frac{1}{12.4} - \frac{1}{150 - (-65)} \right) ; 10^A = 8.4 \times 10^{24}$$

$$\text{Failure Rates: } 0.000035/\text{cycle} \div 4.7 \times 10^6 \times 365 \text{ day} \times 10 \text{ yr.} = 2.7 \times 10^{-8}$$

$$0.000035/\text{cycle} \div 8.4 \times 10^{24} \times 2 \times 60 \text{ min.} \times 24 \text{ hr.} \times 365 \times 10 \\ = 4.4 \times 10^{-23}$$

$$\text{Temperature Cycle Failure Rate} = 2.7 \times 10^{-8}$$

- *Power Life: Accelerated test* — $T_2 = 75^\circ\text{C}$ (DIP at 300mW) + 25 + $(60\text{mA} \times 1.5\text{V}) \div 5.5\text{mW}/^\circ\text{C}^\dagger = 116^\circ\text{C} = 389^\circ\text{K}$

$$\text{Application stress} — T_1 = 0.4^\circ\text{C} + (13.2\text{mA} \times 1.2\text{V}) \div 5.5\text{mW}/^\circ\text{C} + 65 \\ = 68.3^\circ\text{C} = 341.3^\circ\text{K}$$

$$A = -3327 \left(\frac{1}{389} - \frac{1}{341.3} \right) ; 10^A = 16$$

$$\text{Failure Rate} = 0.0064 \times 10^{-3} \times 7 \times 10^4 \text{ hrs} \div 16 = 2.8 \times 10^{-2}$$

- *Humidity Life* (assume ambient humidity 15% at 65°C, 85% at 25°C)

$$\text{Power down} — A_L = 1987 \left(\frac{1}{298} - \frac{1}{358} \right) - 2.424 (0.85^2 - 0.15^2), 10^A = 13$$

$$\text{Power up} — A_H = 1987 \left(\frac{1}{338} - \frac{1}{358} \right) - 2.424 (0.15^2 - 0.85^2), 10^A = 106$$

$$\text{Failure Rate} = 0.0029 \times 10^{-3} (7 \times 10^4 \div 106 + 1.8 \times 10^4 \div 13) = 5.9 \times 10^{-3}$$

†coupled thermal impedance, emitter to detector.

The sum of these is the total failure rate of the CNY17-III optoisolator expected over the 10 year equipment life, i.e. $2.7 \times 10^{-8} + 2.8 \times 10^{-2} + 5.9 \times 10^{-3} = 3.4$ percent. This is an average failure rate of 385×10^{-9} per device hour for 8.8×10^4 hours. Note that the most significant items are the Power Life stress followed by the 85% humidity estimate at 25°C (equivalent to a moist tropical environment). The failure rate can be improved by submitting the standard CNY17-III to reliability enhancement screening procedures, of course.

3.5 RELIABILITY ENHANCEMENT OF OPTOISOLATORS

The optoisolator is unique in its application, construction, and the factors that affect its reliability. The major applications typically use the optoisolator to carry information between electronic logic and some form of power system. These are typically in relatively high cost systems where downtime is costly and sometimes critical. This places a premium on the reliability of the optoisolator, which is a reasonably-priced component subject to normal marketplace competitive pressures. These pressures are significant since over 10 manufacturers supply the common six-pin plastic dual in-line package optoisolator.

Each manufacturer utilizes unique semiconductor pellets for the light-electrical conversions. Each has unique methods and materials used to mount, connect, provide light path, and isolate ambient effects. Therefore, a wide variation of both reliability performance and consistency might be expected throughout the industry. Published studies confirm this and illustrate the variety of failure modes unique to the optoisolator, when compared to both discrete and integrated circuit semiconductors.^{31,33,34}

The uniqueness of the optoisolator does not mean that accelerated semiconductor reliability assessment test procedures are inappropriate to identify failure modes or screen out potentially unreliable devices. It means that these test procedures must be evaluated to identify failure modes and cost effective ways to remove potential application failures. Where high sensitivity to failure and/or high stress levels are present extra screening for reliability enhancement may be desirable. The available information indicates several levels of increasingly effective screens are possible.

Most optoisolator manufacturers can identify a cost effective reliability enhancement screen for their product. However, there may be conflicts between this action and other goals or priorities of the manufacturer. An optoisolator user can do the same for a given device, but is vulnerable to manufacturing process differences, both identified and unknown. The best compromise is a test sequence based on a broad sample of optoisolator data covering a number of manufacturers. This was impractical until recently.

In 1981 several large sample phototransistor optoisolator reliability studies were published in various parts of the world. These data have been analyzed to identify optoisolator failure modes and effective screening procedures. These procedures have been modified, as required, for the various detectors used in optoisolators (i.e., photodarlington, photoSCR, etc.). Such modifications are based on experience with the specific type of discrete semiconductor device. In these tests, the high stress levels are expected to accelerate failure response, when compared to application conditions. It is noted that the failure rates, per unit time, decrease as stress time increases (with the exception of storage life, which appears to show a wearout mechanism on specific designs). It is also apparent that different specific designs have different weak points. This reliability enhancement screening procedure will be designed to cost effectively address all these weak points. Table 3.7 shows the reliability test data for eleven manufacturers of optoisolators.

TABLE 3.8: RELIABILITY TEST DATA COMPILATION

(DIP PHOTOTRANSISTOR OPTOCOUPPLERS)

Stress Conditions*	t R.O. Hrs.	MANUFACTURER										
		1	2	3	4	5	6	7	8	9	10	11
IRED Fwd. Bias	168	$\frac{0(0)}{80}$	$\frac{0(0)}{70}$	$\frac{10(1)}{20}$			$\frac{0(0)}{70}$	$\frac{0(0)}{60}$	$\frac{0(0)}{60}$	$\frac{0(0)}{70}$		$\frac{0(0)}{10}$
	1000	$\frac{0(1)}{80}$	$\frac{11(3)}{70}$	$\frac{10(4)}{20}$			$\frac{0(10)}{70}$	$\frac{0(0)}{60}$	$\frac{1(0)}{60}$	$\frac{0(0)}{70}$		$\frac{0(0)}{10}$
High Temperature Reverse Detector Bias	168	$\frac{0(0)}{10}$	$\frac{0(0)}{10}$				$\frac{0(1)}{10}$	$\frac{0(0)}{10}$		$\frac{0(0)}{10}$		
	1000	$\frac{0(1)}{10}$	$\frac{0(0)}{10}$				$\frac{1(1)}{10}$	$\frac{0(0)}{10}$		$\frac{2(0)}{10}$		
Operating Stress	168	$\frac{0(0)}{27}$	$\frac{0(0)}{105}$	$\frac{1(0)}{65}$	$\frac{0(1)}{20}$	$\frac{1(0)}{29}$	$\frac{0(1)}{35}$	$\frac{0(0)}{25}$	$\frac{0(0)}{25}$	$\frac{0(0)}{35}$	$\frac{1(3)}{28}$	$\frac{0(0)}{10}$
	1000	$\frac{1(4)}{27}$	$\frac{1(1)}{105}$	$\frac{3(0)}{65}$	$\frac{0(10)}{20}$	$\frac{1(4)}{29}$	$\frac{1(1)}{35}$	$\frac{0(0)}{25}$	$\frac{0(0)}{25}$	$\frac{0(0)}{35}$	$\frac{2(4)}{28}$	$\frac{0(0)}{10}$
Storage Life	168	$\frac{0(0)}{25}$	$\frac{0(0)}{25}$				$\frac{0(0)}{25}$	$\frac{0(0)}{25}$	$\frac{0(0)}{25}$	$\frac{0(0)}{25}$		
	1000	$\frac{0(0)}{25}$	$\frac{1(0)}{25}$				$\frac{0(0)}{25}$	$\frac{13(1)}{25}$	$\frac{0(0)}{25}$	$\frac{5(0)}{25}$		
Temperature Cycle		$\frac{2}{200}$	$\frac{5}{700}$	$\frac{4}{500}$		$\frac{19}{100}$	$\frac{3}{590}$	$\frac{3}{500}$	$\frac{0}{500}$	$\frac{1}{500}$	$\frac{36}{100}$	
Humidity Life	168	$\frac{0(0)}{45}$	$\frac{0(0)}{35}$	$\frac{0(0)}{20}$			$\frac{0(0)}{35}$	$\frac{0(0)}{25}$	$\frac{0(0)}{25}$	$\frac{0(0)}{35}$		$\frac{0(0)}{10}$
	1000	$\frac{0(0)}{45}$	$\frac{0(0)}{35}$	$\frac{3(0)}{20}$			$\frac{0(0)}{35}$	$\frac{0(0)}{25}$	$\frac{0(0)}{25}$	$\frac{0(0)}{35}$		$\frac{0(1)}{10}$

Total units tested: 2594 1.269×10^6 device hours of stress

*See Section 3.6 for data summary containing specific conditions, and sample sizes.

Summation of Catastrophic Failures $\rightarrow \frac{1(1)}{25}$ — Summation of Degradation Limit Failures
 $\frac{25}{25}$ — Summation of Samples Tested

Manufacturers Tested: Fairchild, General Electric, General Instrument, Honeywell, Litronix, Motorola, RTC, Sharp, Siemens, Texas Instruments, TRW

The data shows 129 catastrophic failures and 42 parametric degradation failures on 2594 units. The catastrophic failures, opens and shorts, are mechanical integrity faults. These faults are normally screened out by temperature cycle testing. A comparison of temperature cycle failure-rate to catastrophic failure rates, by manufacturers, generally confirms the expected effectiveness. It is also noted that two manufacturers exhibited failure rates over 10% on this test. Screening procedures for degradation failure modes can be defined by identification of the failure modes. Table 3.9 compares degradation failure modes for five stress types.

**TABLE 3.9: SUMMARY OF 11 MANUFACTURERS' RELIABILITY PERFORMANCE
FOR DEGRADATION FAILURE MODES**

Test	Failure Criteria		Duration	# of Mfrs. Failing Degradation	# of Mfrs. Failing Catastrophically
	Degradation	Catas- trophic			
IRED Fwd. Bias	10% of units fail CTR degradation limit	10% of units fail	168 Hrs 1000 Hrs	0 2	0 1
High Temp. Reverse Detector Bias	10% of units fail leakage or CTR limits	10% of units fail	168 Hrs 1000 Hrs	1 3	0 2
Operating Life	10% of units fail leakage or CTR limits	10% of units fail	168 Hrs 1000 Hrs	2 4	0 0
Storage Life	10% of units fail leakage or CTR limits	10% of units fail	168 Hrs 1000 Hrs	0 0	0 2
Humidity	10% of units fail leakage or CTR limits	10% of units fail	168 Hrs 1000 Hrs	0 1	0 0

- All tests were at or beyond maximum ratings.
- See Section 3.6 for data summary.
- From date code analyses all units were manufactured between early 1979 & early 1981.

Based on these data, storage and humidity tests show no promise as screening tools. Three types of defects appear common in the summary:

Mechanical — This is related to package material compatibility & construction.

Detector Pellet — Related to instability in h_{FE} or leakage current.

IRED Pellet: — Related to light output degradation.

Analysis of failures, when available, tends to confirm the implications of the data. Defects noted as causes of failure were (in no particular order):

- Mechanical, open
 - broken bond wire at dielectric interface
 - bond wire lifted off pellet bond pad
 - epoxy pellet mount lifted off lead frame
 - pellet bond pad lifted off pellet
 - bond wire break at wedge bond heel

- Mechanical, short
 - bond wire droop to lead frame
 - bond wire droop to pellet edge
- IRED pellet degradation
 - light output degradation on forward bias
 - leakage increase due to pellet flaw
- Detector pellet degradation
 - h_{FE} , instability
 - leakage increase due to visible pellet flaw
 - leakage increase
 - breakdown voltage drop due to leakage increase

Note that the apparent wearout in 150°C storage was due to both epoxy pellet mount and bond wire failures. Gross lumped failure rates observed are 6.8%, which, when the cause could be identified, break down to:

- Mechanical — 5.0%
- Emitter Degradation — 0.7%
- Detector Degradation — 0.1%
- Emitter and/or Detector Degradation — 1.0%
- Specific tests showed degradation failure rates up to 5.9%, while one manufacturer exhibited failure rates up to 70% on IRED bias testing.

THIS IMPLIES THAT A RELIABILITY ENHANCEMENT PROGRAM MUST ASSESS ALL PARTS OF THE OPTOCOUPLER DEVICE TO BE EFFECTIVE. There is no one-to-one correlation between reliability test failure rates and field failure rates in any given application. The tests illustrate weak areas that can cause field failures. A reliability enhancement program must attack these weak areas to significantly reduce field failures.

Cost of screening also enters into the design of cost effective reliability enhancement programs. A list of possible reliability enhancement tests, in order of increasing cost, illustrates this:

100% Screening Procedure	Estimated Relative Cost
Tightened Parameter Limits	1x
High Temperature Storage	3x
Temperature Cycle & Continuity	4x
High Temperature Blocking	10x
Forward Bias Conduction	12x
Operating Life, All Junctions Biased	16x

Combining cost, failure mode, and time to failure information from the test summaries indicates:

- Many of the mechanical failures can be removed using extended temperature cycling. Detailed analysis of the individual data sets indicates a decreasing failure rate to 100 cycles, -55C to + 150C, for all but two manufacturers, with several increasing in failure rate beyond 200 cycles. Analysis also indicates the need for high temperature continuity testing of all wire bonds, at low voltage and current, following the temperature cycle;
- Pellet operating stress tests are required to identify IRED light output degradation, and detector h_{FE} (gain) or leakage instability. Analysis of failure rate data, by manufacturer, indicates neither high temperature blocking stress nor conducting stress can in themselves ensure a significantly reduced failure rate in all applications.

The operating stress is most effective, and less costly than doing separate tests, in sequence, for each failure mode. In addition, study of IRED degradation indicates a minimum test time of 160 hours is required to quantify this phenomenon. Increased IRED response is noted at higher forward stress current, within device ratings. Increased response is noted on the detector at higher power levels, (which raises temperature) and higher voltages. Since the detector response is generally more rapid than the IRED, and dissipation should be at a maximum levels, the stress voltage is less critical and can be selected to provide best control of operating conditions. The limits on detector bias voltage are normally 0.25 to 0.9 times maximum rated voltage.

In some cases, the connections available to the optoisolator do not allow all biases to be optimized simultaneously. In such cases, power dissipation is controlled by utilizing a detector voltage supply and load resistor selected to dissipate maximum rated power when the detector bias current drops half of the supply voltage across the resistor. Feedback via the IRED can usually keep power dissipation within 10% of the desired value. In simpler cases, detector bias current and voltage are easily set by standard techniques. These cases are illustrated for simple detectors by the circuits shown in Figure 3.11.

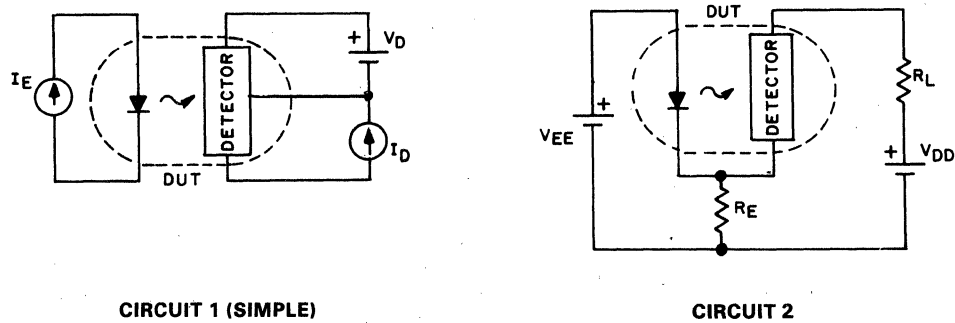

FIGURE 3.11: BURN-IN CIRCUIT CONFIGURATIONS.

The recommended reliability enhancement program uses temperature cycles and operating stress to identify potential field failures. The optimal stress levels deduced from this data, and six-pin DIP ratings, are:

Temperature cycle: -55 to +150°C, 10 cycles; 12 minute dwell at extremes, 3 minute dwell at 25°C, followed by 100°C continuity check.

Operating stress: $P_d = 300\text{mW}$, $I_F = 60\text{mA}$ if possible, $t = 160$ Hrs.

For the General Electric optoisolator, the recommended biases and operating stress are:

Isolator Family	CIRCUIT 1			CIRCUIT 2				DETECTOR BIAS		
				V_{EE} V	R_E Ω	V_{DD} V	R_L Ω	PIN 4	PIN 5	PIN 6
	I_E	V_D	I_D							
H11A,B,G	60mA	20V	15mA					Minus	Plus	Ref.
H11D	60mA	150V	2mA					Minus	Plus	Ref.
H11C				5V	51	200	100K	Open	Plus	Minus
H11F				5V	56	30	750	Minus	Plus	Minus
H11J				10V	1.1K	250	43K	Minus	Plus	Minus
H11L				5V	56	12	0	Open	Minus	Plus

It is anticipated that this screening sequence will be $\geq 90\%$ effective in removing potential failures in commercial/industrial applications over a large population of optoisolators.

At lower unit cost, for comparison, temperature cycle alone would be expected to be 40% to 60% effective. A temperature cycle followed by a 16Hr., 125°C detector HTRB would be expected to be 50% to 65% effective for the same conditions.

3.5.1 Data Summary

The specific test data and sample sizes which form the basis for this reliability enhancement information are as follows:

Test	Sample		Stress Conditions	Duration
	Mfrs.	Units		
IRED Forward Bias	6	240	$T_A = 25^\circ\text{C}$, $I_{FS} = 100\text{mA}$	2000 Hrs
	6	120	$T_A = 70^\circ\text{C}$, $I_{FS} = 50\text{mA}$	2000 Hrs
	6	60	$T_A = 70^\circ\text{C}$, $I_{FS} = \text{Maximum Rating}$	1000 Hrs
High Temperature Reverse Bias on Detector	6	60	$T_A = 150^\circ\text{C}$, $V_{CB} = 24\text{V}$, $V_{EB} = 4\text{V}$	1000 Hrs
Operating Stress	6	150	$T_A = 25^\circ\text{C}$, $V_{CB} = 20\text{V}$, $I_E = 15\text{mA}$, $I_F = 60\text{mA}$	1000 Hrs
	6	60	$T_A = 25^\circ\text{C}$, $I_C = 2.5\text{mA}$ (10% Duty Cycle), $I_F = \text{Maximum Rated}$	1000 Hrs
	5	180	$T_A = 25^\circ\text{C}$, $V_{CB} = 20\text{V}$, $I_E = 15\text{mA}$, $I_F = 60\text{mA}$	1000 Hrs
Storage Life	6	150	$T_A = 150^\circ\text{C}$	1500 Hrs
Temperature Cycle	6	2700	25°C to 125°C , continuous continuity monitor 10 min. ramp up & down, 20 min., 125°C dwell	5 cycles
	6	300	-55°C to 25°C to 125°C to 25°C , 12 min. dwell at extremes, 3 min. 25°C dwell	400 Cycles
	6	700	-65°C to 25°C to 150°C , 12min. dwell at extremes, 3 min. dwell at 25°C	100 Cycles
Humidity Life	6	60	$T_A = 40^\circ\text{C}$, R.H. = 93%, $V_{ISO} = 500\text{V}$	1000 Hrs
	6	150	$T_A = 85^\circ\text{C}$, R.H. = 85%, No Bias	1500 Hrs

chapter 4

MEASUREMENT OF OPTOELECTRONIC DEVICE PARAMETERS

4.1 IRED PARAMETERS

Measurement of IRED parameters is relatively straight forward, since the electrical parameters are those of a diode. They can be measured on test equipment used to measure diode parameters, from the bench set-up of two meters and a power supply to the most automated semiconductor tester.

Light output measurements require the use of a spectrally calibrated photo cell or a calibrated thermo pile of at least 0.4" (1cm) in diameter. This allows collection of all the light power output of the IRED, matching the specification method and guaranteeing correlations of measurements. If pulse measurements are desired, a calibrated silicon photo cell is necessary because of its response time. It would be used in conjunction with a pulsed current source, and calibrated current probe to measure photocell output and an oscilloscope of sufficient speed and accuracy to provide the desired result. The photocell is the only device which is not a common electronics laboratory item, and such devices can be procured from sources such as Ealing Corp., E.G. & G. Electro Optics Div., United Detector Technology, and others.

The photocell should be calibrated at the wavelength of interest, traceable to the Bureau of Standards. Slightly different mechanical couplings to the photocell are used for each package type. The H23 emitter is placed, touching the cell cover glass, with the lens over the cell center. The hermetic emitters are placed in an aluminum collar, as illustrated. This arrangement will correlate within 10% with total power output readings taken using a calibrated integrating sphere.

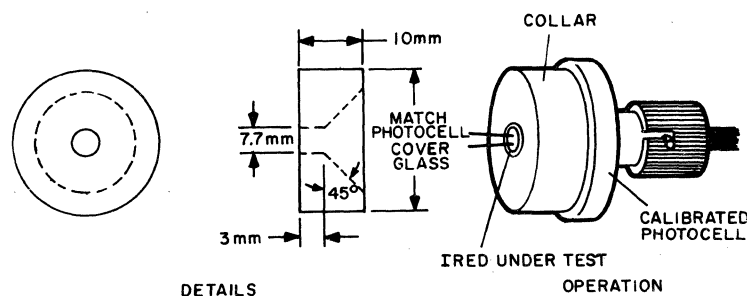

FIGURE 4.1 ALUMINUM COLLAR MEASUREMENTS TEST FIXTURE

Radiant intensity (I_e) can be read with the same photocell in a different mechanical arrangement. In this case, the photocell is centered behind a thin, flat black aperture plate. It is placed in the housing that holds the IRED centered on the photocell and aperture centerline and spaced such that the IRED reference plane is over 4cm from the aperture. The aperture and photocell are sized and placed such that all irradiance that passes through the aperture falls on the photocell active area. IRED distance and aperture size determine the solid angle of measurement. The housing that holds the IRED, aperture and photocell must be designed to eliminate reflective path photocell illumination.

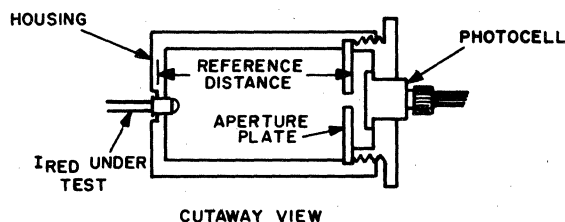

FIGURE 4.2 RADIANT INTENSITY TEST FIXTURE

4.2 PHOTODETECTOR PARAMETERS

The measurement of electrical parameters of the photodetectors is identical to measurement of non-light sensitive devices, except for the light sensitive parameters. Such measurements are described in many common references and will not be detailed here. The most common problem parameter encountered is the leakage current measurement with the base open, as I_{CEO} is rarely measured on normal transistors. Understanding the sensitivity to dynamic and ambient light effects will aid in solving this problem.³ Dynamic effects must be considered, because the open base has no path but junction leakage to charge the junction capacitance. If the common, high source impedance bias circuit, for leakage current is used, the gain of the transistor multiplies the junction capacitance (Miller effect) of the collector base photodiode ($\approx 25\text{pF}$), and provides a long stabilization time constant. Note the "double barreled" effect of source impedance in that it is the resistance in the RC time constant and also is the load resistor that determines voltage gain ($A_v \approx I/h_{ie} \cdot R_L \cdot h_{fe}$). These effects indicate I_{CEO} should be measured by application of the bias voltage from a low impedance supply until junction capacitances are charged (now determined by the base emitter diode impedance), which can take up to 100msec, (with no external capacitances, switches, sockets, coaxial, etc. connected to the base) in a darlington. After junction capacitance is charged, the current measuring resistor is introduced to the circuit by removing the short across it. The charge balance at the base can be affected by the motion of conductive objects in the area, so best reproducibility will be obtained with an electrostatic shield. The electrostatic shield can also serve the purpose of shielding the detector from ambient light, the effects of which are obvious in leakage current measurement.

Measurement of the light parameters of a phototransistor requires a light source of known intensity and special characteristics. Lamps with defined spectral characteristics, i.e., calibrated standards, are available and, in conjunction with a thermopile or calibrated photocell and a solid mechanical positioning system, can be the basis of an optomeasuring system. The lamp is placed far enough from the detector to approximate a point source. Some relatively simple systems based on the response of a silicon photocell are available, but the assumption that all silicon devices have identical spectral response is implicit in their use for optical measurements. As different devices will have slightly different response curves, the absolute accuracy of these devices is impaired, although excellent comparative measurements can be made. Another method which has fair accuracy is the use of a calibrated detector, L14C or L14N photodiode response for the phototransistors, to adjust the light source to the desired level. This will eliminate spectral problems as the calibrated device has an identical spectral response to the devices being measured. Accuracy will then depend on detector calibration, basic equipment accuracies, ambient control and mechanical position reproducibility.

Spectral response measurements require use of precision filters or a precision monochromator and a calibrated photocell or thermopile. As in the case of the IRED, it is recommended that these measurements be done by a laboratory specializing in optical measurements.

4.3 OPTOCOUPLER MEASUREMENTS

Measuring individual devices in the optocoupler is identical to measuring a discrete diode and a discrete device of the type of detector being considered. The measurement of isolation and transfer characteristics are not as obvious, and will be illustrated.

1. Isolation Parameters are always measured with the terminals of each device of the coupler shorted. This prevents the high capacitive charging currents, caused by the high dv/dt 's applied during the measurement, from damaging either device. Safety precautions must be observed in these tests due to the very high voltages present.

a). Isolation voltage is measured as illustrated below. Normally the surge voltage capacity is measured, and, unless the high voltage power supply has a fast shutdown ($< 0.5\mu\text{sec}$), the device under test will be destroyed if its isolation voltage capability is less than the high voltage supply setting. Crowbar techniques may be used in lab set-ups to provide rapid turn-off and forestall the test being described as "destructive." Steady-state isolation voltage is usually specified as a fixed percentage of the measured surge capability, although life tests are the proof of the rating. Application Engineering believes conservative design practices are required in the use of isolation voltage ratings, due to the transients normally observed when line voltages are monitored and the catastrophic effect, on the system, of a failure.

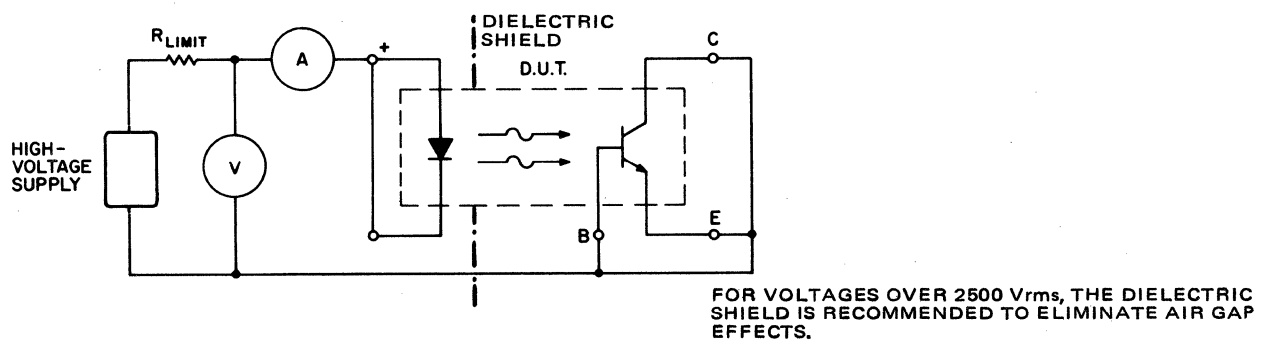

FIGURE 4.3 ISOLATION VOLTAGE TEST

b). Isolation resistance is measured at voltages far below the surge isolation capability, and has less potential for damaging the device being tested. The test is illustrated schematically here, and requires the procedures normally used when measuring currents below a microampere.

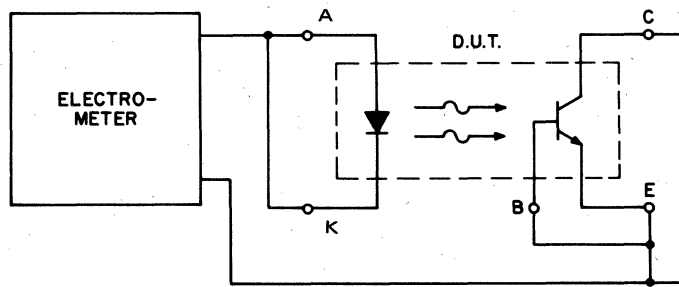

FIGURE 4.4 MEASURING OF ISOLATION RESISTANCE

c). Isolation capacitance is a straightforward capacitance measurement. The capacitance of couplers utilizing the GE patented glass dielectric process is quite independent of applied voltage and frequency. Typical values are less than 1pF, limiting the selection of measurement equipment. The H11AV wide glass dielectric has less than 0.5pF, which requires socket shielding to accurately measure.

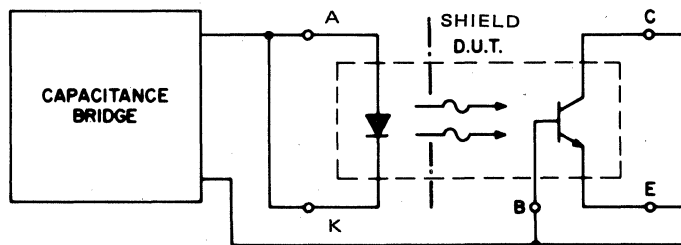

FIGURE 4.5 INPUT TO OUTPUT CAPACITANCE TEST CIRCUIT

2. Transfer Characteristics are normally easily measured on standard measurement equipment as the IRED can be treated as the input terminal of a discrete device.

a). Current Transfer Ratio (CTR) can be tested as h_{FE} of a transistor, both the phototransistor and photodiode response, and *Input Current to Trigger* (I_{FT}) can be tested as gate trigger current of an SCR. Pinout and the connection of base-emitter or gate-cathode resistors normally require use of special test sockets.

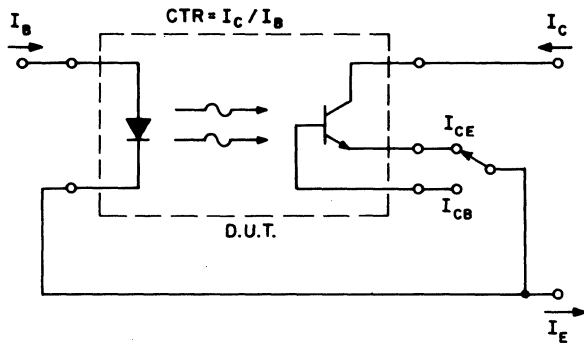

FIGURE 4.6a CTR TESTED AS TRANSISTOR h_{FE}

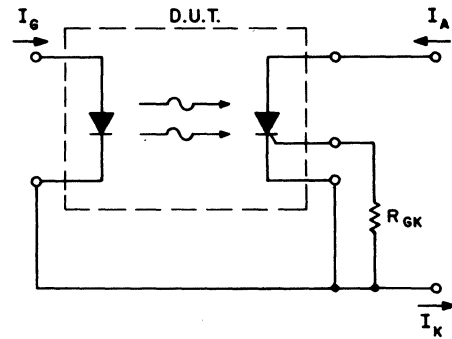

FIGURE 4.6b I_{FT} TESTED AS SCR I_{GT}

These sockets are illustrated above. Some commercial test equipment provides very poor resolution readings of CTR in the h_{FE} mode due to the readout system being designed for readings greater than 10. This would correspond to a CTR of 1000%, a reasonable value for a darlington, but not a transistor output coupler. Curve tracers are well suited for use in this manner and some allow measurements to be made with the IRED pulsed at high current and low duty cycles.

b). Switching times on simple detectors are measured using the technique illustrated below. Isolation of the input device from the output device allows a freedom of grounding which can simplify test set-up in some cases. The turn-on parameters are t_d — delay time and t_r — rise time. These are measured in the same manner on the phototransistor, photodarlington, and photoSCR output couplers. The turn-off parameters for transistor and darlington outputs are t_s — storage time and t_f — fall time.

- t_d — delay time.** This is the time from the 10% point of the final value of the input pulse to the 10% point of the final value of the output pulse.
- t_r — rise time.** The rise time is the time the leading edge of the output pulse increases from 10% of the final value to 90% of the final value.
- t_s — storage time.** The time from when the input pulse decreased to 90% of its final value to the point where the output pulse decreased to 90% of its final value.
- t_f — fall time.** The time where an output pulse decreases from the 90% point of its final value to the 10% point of its final value.

SCR turn-off times are circuit controlled, and the measurement technique is detailed in the *GE SCR Manual*.

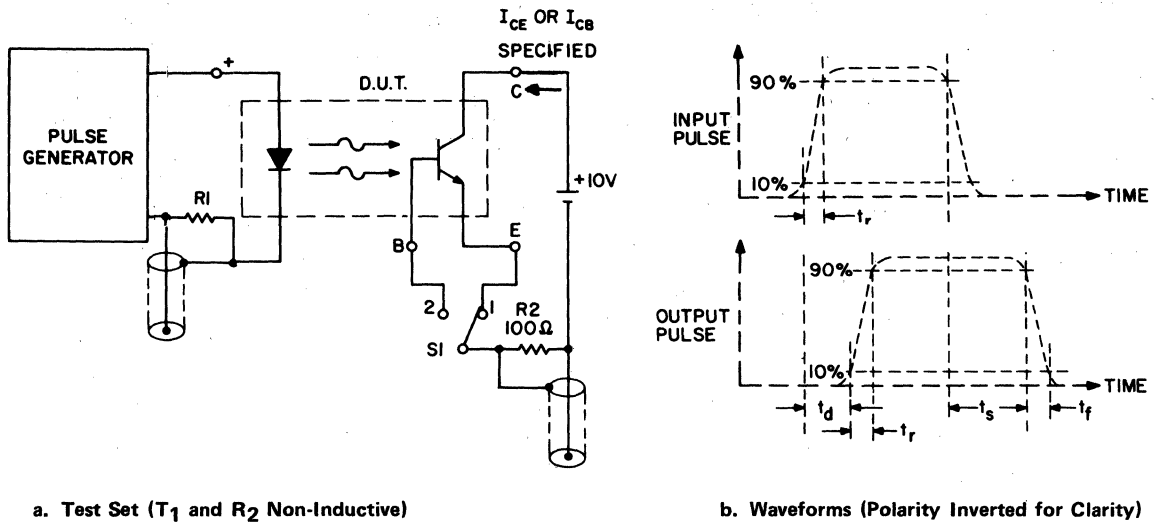

FIGURE 4.7 SWITCHING TIME TESTING

c). The parameters of the bilateral analog FET are of most interest at low level. Most of the parameters of interest can be read in the simple circuit shown in Figure 4.8, but some precautions are required to maintain accuracy. Kelvin contacts to the DUT are required and should insure the elimination of ground loop IR drop which can cause errors, dissimilar metal contacts or temperature gradients causing thermal voltage errors and electromagnetic pick up errors. The latter is especially important when 60Hz ac data is generated. Signal levels must be controlled to maintain bias within the linear region for accurate resistance measurements, since the maximum signal level for linear operation is a function of the DUT resistance. This effect is quantified by testing the H11F as an element of a resistive bridge and increasing the bridge signal level until distortion causes an output signal of specified amplitude.

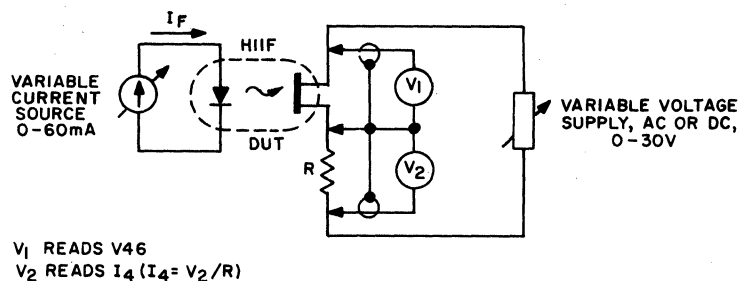

FIGURE 4.8 H11F PARAMETER TESTING

d). *Schmitt Trigger Parameter Measurement.* The digital nature of the H11L transfer characteristics make it quite compatible with standard digital logic circuit test equipment in standard configurations.

e). *Triac Driver Testing.* The triac driver family of devices is tested using the same techniques documented for discrete triac testing in the GE *SCR Manual*. The isolation between the IRED and switch allows convenient gate polarity selection. Two items require special attention: commutating dV/dt and zero voltage switch parameters. Most discrete triac test equipment for $dV(c)/dt$ requires modification to lower the test current to the range of the triac driver. When testing zero voltage switch triac drivers, the blocking voltage effect on trigger sensitivity must be considered.

SAFETY

5.1 RELIABILITY AND SAFETY

Optoelectronics may be used in systems in which personal safety or other hazard may be involved. All components, including semiconductor devices, have the potential of failing or degrading in ways that could impair the proper operation of such systems. Well-known circuit techniques are available to protect against and minimize the effects of such occurrences. Examples of these techniques include redundant design, self-checking systems and other fail-safe techniques. Fault analysis of systems relating to safety is recommended. Potential device reaction to various environmental factors is discussed in the reliability section of this manual. These and any other environmental factors should be analyzed in all circuit designs, particularly in safety-related applications.

If the system analysis indicates the need for the highest degree of reliability in the component used, it is recommended that General Electric be contacted for a customized reliability program.

5.2 SAFETY STANDARDS RECOGNITION

General Electric optoelectronic devices are tested and recognized by safety standards organizations around the world. These organizations are primarily interested in the potential electrical and fire hazards of optoisolators and the probability of IRED failure in smoke detector applications. This is reflected in standards existing only for these particular device types and in the requirements these standards place on the devices. As GE introduces new optoelectronic devices they are evaluated to determine if an applicable standard exists, and submitted for approval testing if such standards apply.

Currently GE optoelectronic devices are recognized by Underwriters Laboratories Inc. (U.L.) and Verband Deutscher Elektrotechniker e.V. VDE Profstelle (VDE). The approvals, as of this date, are:

TABLE 5.1: OPTOISOLATOR APPROVALS

(ALL STANDARD GE OPTOISOLATORS ARE COVERED UNDER U.L. COMPONENT RECOGNITION PROGRAM FILE No. E51868)

PART NUMBER	VDE SPECIFICATION NUMBER	CERTIFICATE NUMBER
CNY17 I CNY17 II CNY17 III CNY17 IV	0883/6.80,0110/11.72	22757
CNY51	0883/6.80,0110/11.72	22758
GFH601 I GFH601 II GFH601 III GFH601 IV	0883/6.80,0110/11.72 0804/1.83,0806/8.81	30415
H11A1 H11A3	0883/6.80,0110/11.72	22755
H11A2 H11A4	0883/6.80,0110/11.72	22756
H11AV1 H11AV1A H11AV2 H11AV2A H11AV3 H11AV3A	0883/6.80,0110/11.72 0860/8.81,0806/8.81 0804/1.83,0750TI/5.82 IEC601TI,IEC380,IEC65	30440

5.3 POSSIBLE HAZARDS

5.3.1 Toxicity

Although gallium arsenide and gallium aluminum arsenide are both arsenic compounds, under normal use conditions they should be considered relatively benign. Both materials are listed by the 1980 NIOH "Toxicology of Materials" with LD₅₀ values comparable to common table salt. Accidental electrical or mechanical damage to the devices containing these IRED pellets should not affect the toxic hazard, so the units can be applied, handled, etc. as any other semiconductor device. Although the pellets are small, chemically stable and protected by the device package, conditions that can break these crystalline compounds down into elements or other compounds should be avoided.

5.3.2 Near Infrared Theshold Limit Value

The eye may be damaged from infrared light. The most applicable guideline to evaluate IRED's for this hazard is the 1979 "American Conference of Governmental Industrial Hygenists Handbook." On pages 90 and 91 recommended threshold limit values for pulse (item 1) and long term (item 3) infrared exposure are given. When operated within device maximum ratings, the maximum irradiance external to the IRED package doesn't approach these TVL's for any of the present GaAs or GaAlAs devices.

To evaluate specific situations, the IRED pellet and its reflector represent a roughly Lambertian source of about 1mm diameter in all current discrete IRED types.

chapter 6

OPTOELECTRONIC CIRCUITS

6.1 LIGHT DETECTING CIRCUITS

Light detecting circuits are those circuits that cause an action based on the level of light received by the photo detector.

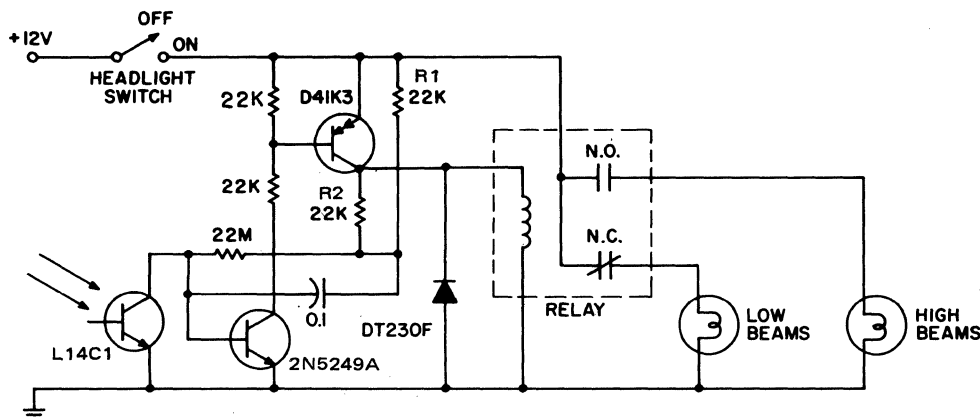

RELAY: 12V, 0.3A COIL: 20A, FORM C, CONTACTS OR SOLID-STATE SWITCHING OF 16A STEADY-STATE 150A COLD FILAMENT SURGE, RATING.

LENS: MINIMUM 1" DIAMETER, POSITIONED FOR ABOUT 10° VIEW ANGLE.

FIGURE 6.1: HEADLIGHT DIMMER

6.1.1 Automatic Headlight Dimmer

This circuit switches car headlights to the low beam state when it senses the lights of an on-coming car. The received light is very low level and highly directional, indicating the use of a lens with the detector. A relatively large amount of hysteresis is built into the circuit to prevent "flashing lights." Sensitivity is set by the 22Megohm resistor to about 0.5 ft. candle at the transistor (0.01 at the lens), while hysteresis is determined by the R1,R2 resistor voltage divider, parallel to the D41K3 collector emitter, which drives the 22Megohm resistor; maximum switching rate is limited by the 0.1 μ F capacitor to \approx 15/minute.

6.1.2 Slave Photographic Xenon Flash Trigger

This circuit is used for remote photographic flash units that will flash at the same time as the flash attached to the camera. This circuit is designed to the trigger cord or "hot shoe" connection of a commercial portable flash unit and triggers the unit from the light produced by the light of the flash unit attached to the camera. This provides remote operation without the need for wires or cables between the various units. The flash trigger unit should be connected to the slave flash before turning the flash on (to prevent a dV/dt triggered flash on connection).

The L14C1 phototransistor has a wide, almost cosine viewing angle so alignment is not critical. If a very sensitive (long range), more directional remote trigger unit is desired, the circuit may be modified using a L14G2 lensed phototransistor as the sensor. The lens on this transistor provides a viewing angle

of approximately 10° and gives over a 10 to 1 improvement in light sensitivity (3 to 1 range improvement). Note that the phototransistor is connected in a self-biasing circuit which is relatively insensitive to slow changing ambient light, and yet discharges the $0.01\mu\text{F}$ capacitor into the C106D gate when illuminated by a photo flash. For physically smaller size, the C106D may be replaced by a C205D, if the duty cycle is reduced appropriately.

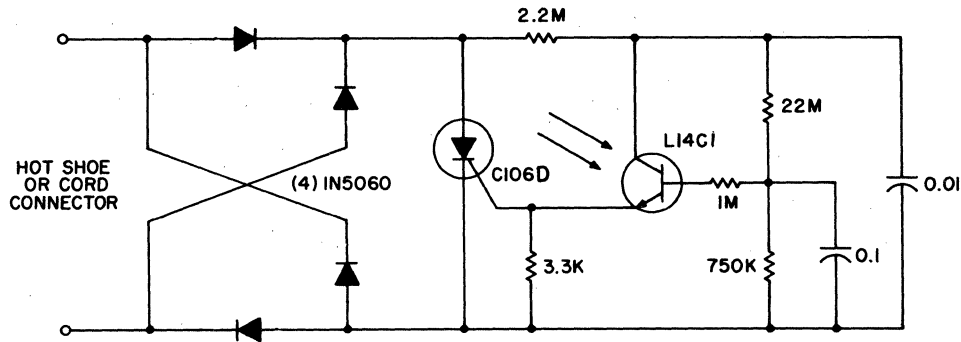

FIGURE 6.2: SENSITIVE, DIRECTIONAL, SLAVE PHOTO FLASH TRIGGER

6.1.3 Automatic Night Light Switches

These circuits are light level sensors that turn on a light when the visible light falls below a specific level. The most common of these circuits turns on street lamps and yard lights powered by 60 Hz lines.

6.1.4 Line Voltage Operated Automatic Night Light

An example of this type of circuit is illustrated in Figure 6.3. It has stable threshold characteristics due to its dependence on the photo diode current in the L14C1 to generate a base emitter voltage drop across the sensitivity setting resistor. The double phase shift network supplying voltage to the ST-4 trigger insures triac triggering at line voltage phase angles small enough to minimize RFI problems with a lamp load. This eliminates the need for a large, expensive inductor, contains the dV/dt snubber network, and utilizes lower voltage capacitors than the snubber or RFI suppression network normally used.

The addition of a programmable unijunction timer can modify this circuit to turn the lamp on for a fixed time interval each time it gets dark. Only the additions to the previous circuit are shown in the interest of simplicity. When power is applied to the lamp, the 2N6028 timer starts. Upon completion of

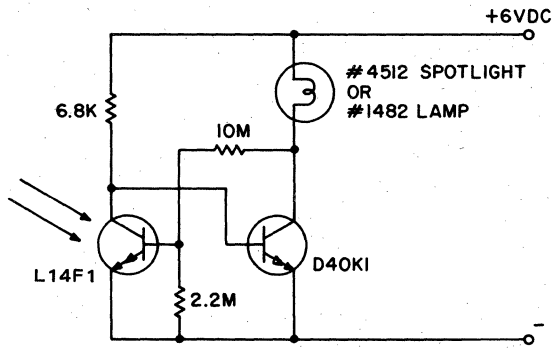

FIGURE 6.5: PORTABLE AUTOMATIC NIGHT LIGHT

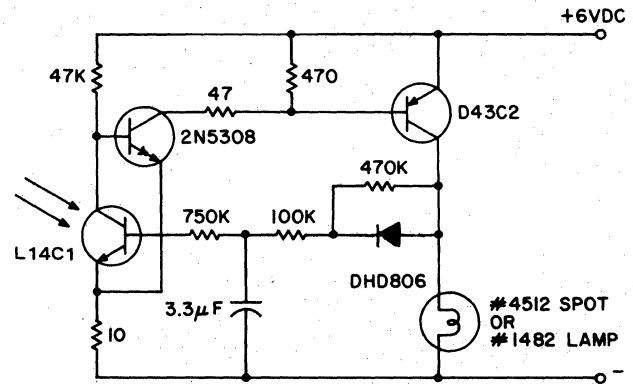

FIGURE 6.6: AUTOMATIC NIGHT FLASHING LIGHT

Another form of night light is line operated power outage lights, which provides emergency lighting during a power outage. The phototransistor should be positioned to maximize coupling of both neon light and ambient light into the pellet, without allowing self illumination from the 6V lamp. Many circuits of this type also use line voltage to charge the battery.

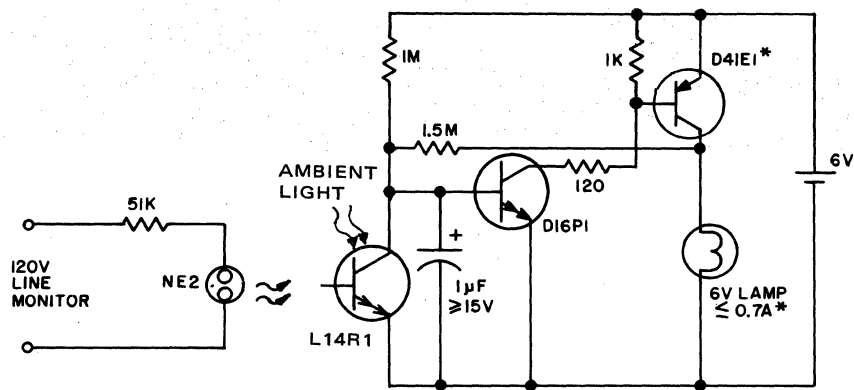

FIGURE 6.7: LINE OPERATED POWER OUTAGE LIGHT

6.1.5 Sun Tracker

In solar cell array applications and solar instrumentation, it is desired to monitor the approximate position of the sun to allow efficient automatic alignment. The L14G1 lens can provide about 15° of accuracy in a simple level sensing circuit, and a full hemisphere can be monitored with about 150 phototransistors.

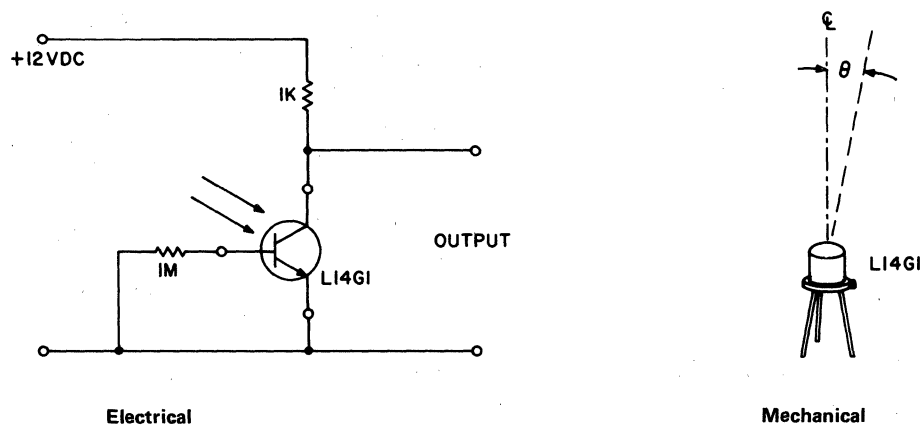

FIGURE 6.8: SUN TRACKING CIRCUIT

The sun provides $\approx 80 \text{ mW/cm}^2$ to the L14G1 when on the centerline. This will keep the output down to $\leq 0.5\text{V}$ for $\theta \leq 7.5^\circ$.

The sky provides $\approx 0.5 \text{ mW/cm}^2$ to the L14G1 and will keep the output greater than 10V when viewed. White clouds viewed from above can lower this voltage to $\approx 5\text{V}$ on some devices.

This circuit can directly drive TTL logic by using the 5V supply and changing the load resistor to 430Ω . Different bright objects can also be located with the same type of circuitry simply by adjusting the resistor values to provide the desired sensitivity.

6.1.6 Flame Monitor

Monitoring a flame and direct switching of a 120V load is easily accomplished using the L14G1 for "point sources" of light. See Figure 6.9. For light sources which subtend over 10° of arc, the L14C1

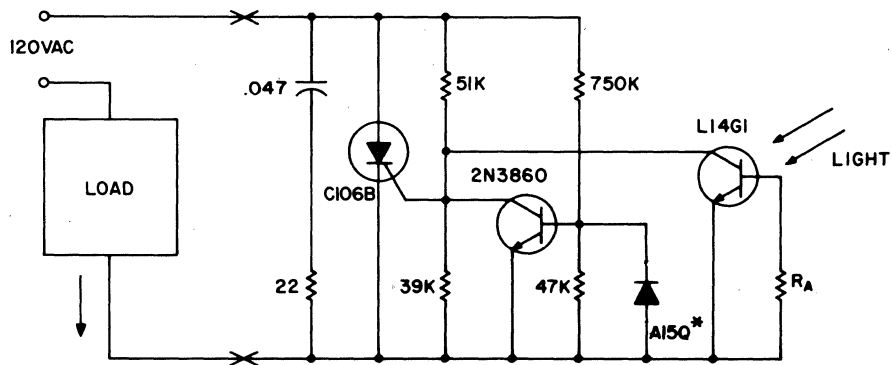

FIGURE 6.9: FLAME OUT MONITOR SWITCH

*The A15Q may be replaced by 100 pF shunting a DHD800.
Wire for minimum crosstalk, 120V to gate, using minimum lead lengths.
 R_A is selected from the following chart for light level threshold programming.

R_A SELECTION GUIDE FOR ILLUMINATION						
HOLD OFF LIGHT LEVEL IN FOOTCANDLES	≈ 20	≈ 40	≈ 80	≈ 200	≈ 400	FOOT CANDLE
R_A , Incandescent Light	N.A.	1500	270	68	33	K Ω
R_A , Flame Light	220	75	30	12	6.2	K Ω
R_A , Fluorescent Light	N.A.	N.A.	2200	180	68	K Ω

should be used and the illumination levels raised by a factor of 5. This circuit provides zero voltage switching to eliminate phase controlling.

6.1.7 Brightness Controls

The illumination level of lighted displays should be lowered as the room ambient light drops to avoid undesirable or unpleasant visual effects. This circuit provides a very low cost method of controlling the light level. Circuit power is obtained from a relatively high source impedance transformer or motor windings, normally used to drive the low voltage lamps used in these functions. It should be noted that the bias resistors are optimized for the 20V, 30Ω source, and must be recalculated

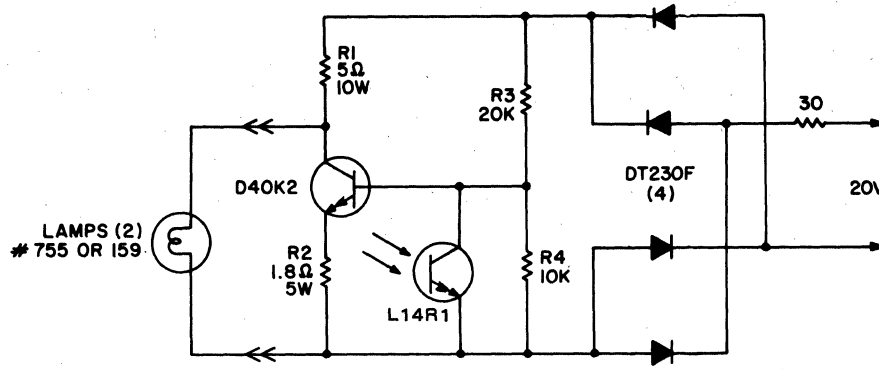
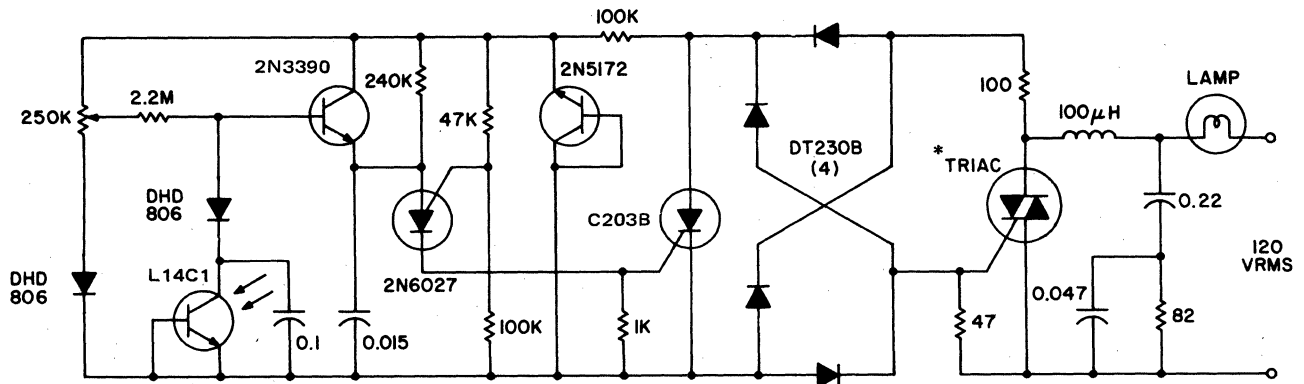

FIGURE 6.10: AMBIENT SENSITIVE DISPLAY ILLUMINATION

for other sources. The L14R1 is placed to receive the same ambient illumination as the display and should be shielded from the light of the display lamps.

Another form of automatic brightness control maintains a lamp at a constant brightness over a wide range of supply voltages. This circuit utilizes the consistency of photo diode response to control the phase angle of power line voltage applied to the lamp and can vary the power applied to the lamp between that available and $\approx 30\%$ of available. This provides a candlepower range from 100% to less than 10% of nominal lamp output. The $100\mu\text{H}$ choke, resistor and capacitors form a RLC filter network and is used to eliminate conducted RFI.

Many other light sensitive circuits are feasible with these versatile devices, and those included here are chosen to illustrate a range of practical, cost-effective designs.



*The triac is matched to the lamp per chart in Figure 6.3.

FIGURE 6.11: CONSTANT BRIGHTNESS CONTROL

6.2 DETECTING OBJECTS WITH LIGHT

This section is devoted to circuits that use a light source and a light sensor, or arrays of either or both, to sense objects by affecting the light path between the source and detector. Normally, the light is blocked or reflected by the object to be sensed, although modulation of the transmission medium is also common.

6.2.1 Paper Sheet Discriminator for Printing and Copying Machines

A common problem with sheet paper conveying systems is the inadvertent transport of two sheets of paper, instead of one, due to mutual adherence by vacuum or static charges. The simple circuit depicted in Figure 6.12 outputs power to the drive motor when one or no sheets are being fed, but interrupts motor power when two or more superimposed sheets pass through the optodetector slot. The optodetector may be either an H21B darlington interruptor module or an H23B matched emitter-detector pair. The output from the optodarlington is coupled to a Schmitt trigger, comprising transistors Q_1 and Q_2 for noise immunity and minor paper opacity variation immunity. When the Schmitt is "on," gate current is applied to the SC148D output device. The dc power supply for the detector and Schmitt is a simple R-C diode half-wave configuration chosen for its low cost (fewer diodes, no transformers) and minimum bulk. While such a supply is directly coupled to the power triac, this is precluded by current drain considerations (50mA dc for the gate drive alone). Note that direct coupling of the Schmitt to the output triacs is preferred as *RFI is virtually eliminated* with the quasi-DC gate drive.

To further reduce dc drain on the power supply, the LED drive current is separately derived from a diode bridge and current limiting capacitor. In addition to minimum dissipation and zero loading on the dc supply, this connection also has the merit of maximizing LED current at each zero voltage crossover of the ac sinewave, thus guaranteeing that drive to the Schmitt is solid (at least with no or one sheet of paper) as the triacs commutate off and back on again. The fact that the Schmitt switches twice each cycle, in phase with the zero diode current points, is now an advantage since gate drain on the dc supply is *completely eliminated* during these "off" periods. Because the "off" periods coincide with maximum instantaneous ac supply voltage when the triac is always hard on (thanks to the phase-shifted LED current), the circuit is virtually immune to the load power factor variations associated with ac motors.

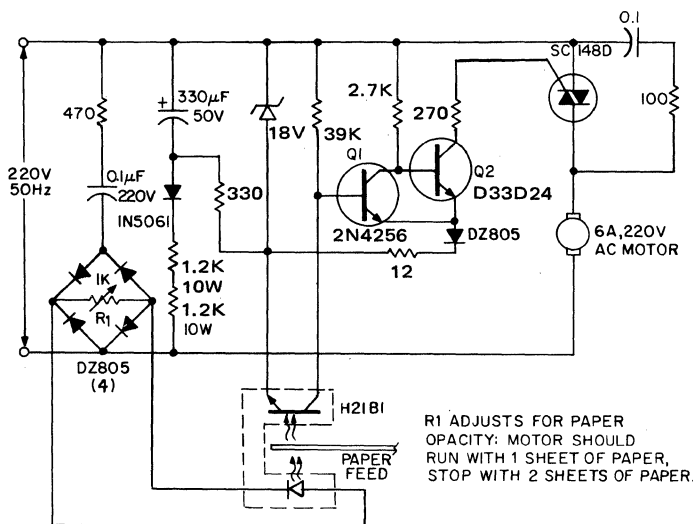

FIGURE 6.12: PAPER SHEET DISCRIMINATOR WITH ZERO VOLTAGE SWITCHING TRIAC MOTOR DRIVE

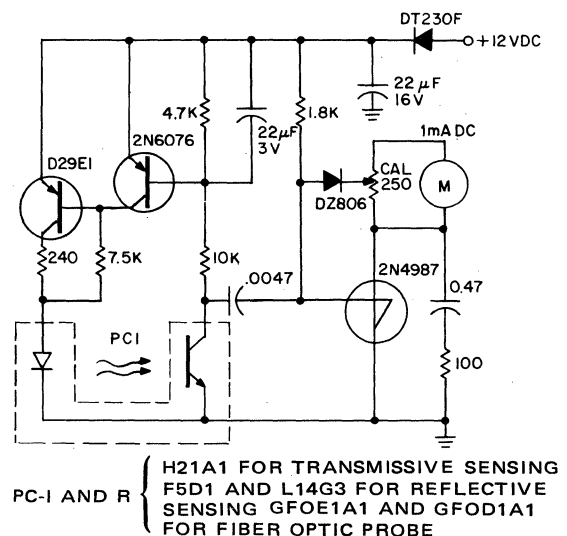

FIGURE 6.13: OPTICAL PICKUP TACHOMETER

6.2.2 Optical Pick Up Tachometer

Remote, non-contact, measurement of the speed of rotating objects is the purpose of this simple circuit. Linearity and accuracy are extremely good and normally limited by the milliammeter used and the initial calibration. This circuit is configured to count the leading edge of light pulses and to ignore normal ambient light levels. It is designed for portable operation since accuracy is not sensitive to supply voltage within supply voltage tolerances. As illustrated in Figure 6.13, full scale at maximum sensitivity of the calibration resistance is read at about 300 light pulses per second. A digital volt meter may be used, on the 100 mV full scale range, in place of the milliammeter, by shunting its input with a 100 Ω resistor in parallel with a 100 μ F capacitor. This R-C network replaces the filtering supplied by the analog meter.

6.2.3 Drop Detector

The self-biasing configuration is useful any time small changes in light level must be detected, for example, when monitoring very low flow rates by counting drops of fluid. In this bias method, the photodarlington is DC bias stabilized by feedback from the collector, compensating for different photodarlington gains and light emitting diode outputs. The 10 μ F capacitor integrates the collector voltage feedback, and the 10M resistor provides a high base source impedance to minimize effects on optical performance. The detector drop causes a momentary decrease in light reaching the chip, which causes collector voltage to momentarily rise, generating an output signal.

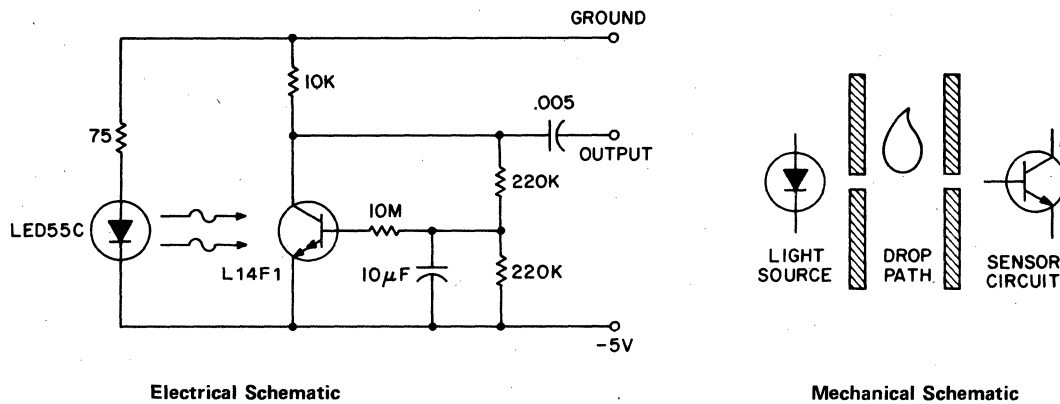

FIGURE 6.14: LOW LIGHT LEVEL DROP DETECTOR

The initial light bias is small due to output power constraints on the light emitting diode and mechanical spacing system constraints. The change in light level is a fraction of this initial bias due to stray light paths and drop translucence. The high sensitivity of the photodarlington allows acceptable output signal levels when biased in this manner. This compares with unacceptable signal levels and bias point stability when biased conventionally, i.e., base open and signal output across the collector bias resistor.

6.2.4 Paper Tape Reader

When computer peripheral equipment is interfaced, it is convenient to work with logic signal levels. With a nominal 4V at the output dropping to -0.6V on illumination, this circuit reflects the requirements of a high-speed, paper tape optical reader system. The circuit operates at rates of up to 1000 bits per second. It will also operate at tape translucency such that 50% of the incident light is transmitted to the sensor, and provide a fixed threshold signal to the logic circuit, all at low cost. Several circuit tricks are required. Photodarlington speed is enhanced by cascode constant voltage biasing. The output threshold and tape translucency requirements are provided for by sensing the output voltage and providing negative feedback to adjust the cascode transistor bias point. Circuit tests confirmed operating to 2000 bits per second at ambient light levels equal to signal levels.

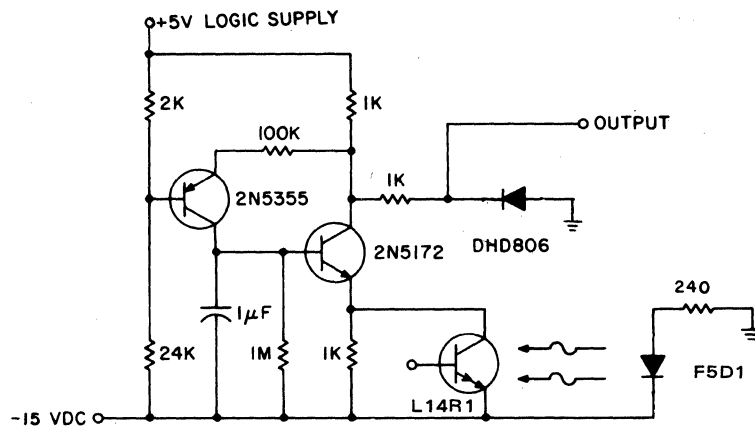

FIGURE 6.15: HIGH SPEED PAPER TAPE READER CIRCUIT

6.2.5 Motor Speed Control Circuits

These controls may be of the open loop type, where light just provides a no-contact, non-wearing circuit input from a person or machine which monitors the output of the motor, or a closed loop type, where the light monitors motor speed as a tachometer and maintains a fixed, selected, speed over a range of load and line conditions.

Closed loop, tachometer feedback control systems utilizing the H21A1 and a chopper disc, provide superior speed regulation when the dynamic characteristics of the motor system and the feedback system are matched to provide stability. The tachometer feedback systems illustrated in Figure 6.16 were designed around specific motor/load combinations and may require modification to prevent hunting or oscillation with other combinations. This dc motor control utilizes the optachometer circuit previously shown to control a P.U.T. pulse generator which drives the D44E1 darlington transistor which powers the motor.

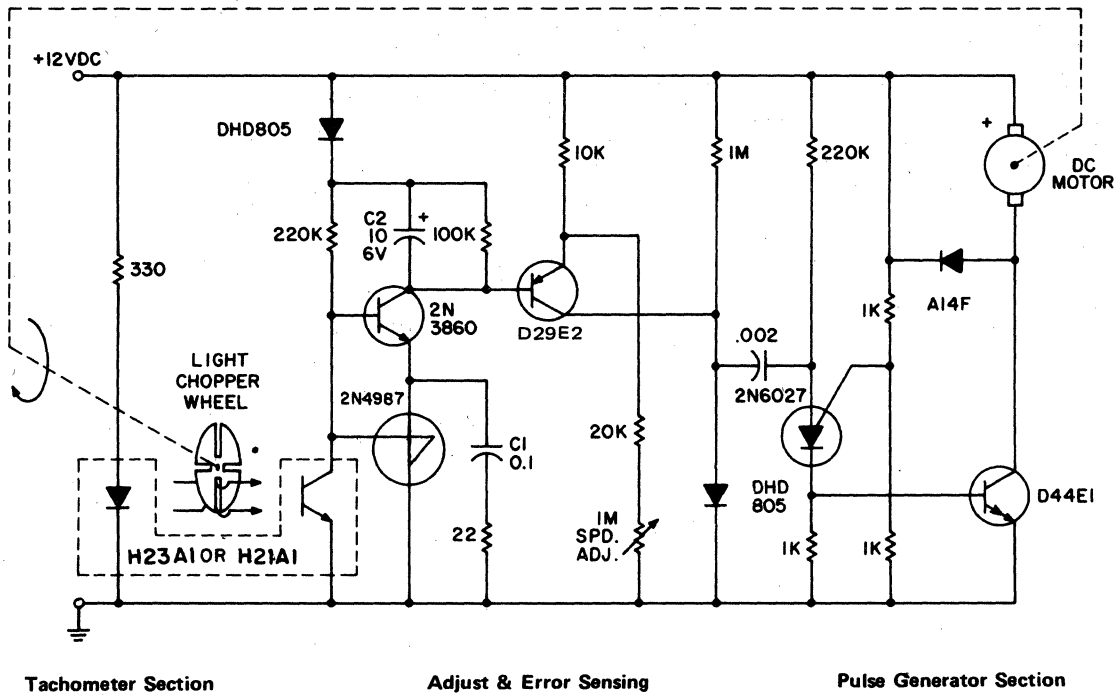

FIGURE 6.16: DC MOTOR, TACHOMETER FEEDBACK, PWM, SPEED CONTROL

The ac motor control in Figure 6.17 illustrates feedback speed regulation of a standard ac induction motor, a function difficult to accomplish otherwise than with a costly, generator type, precision tachometer. When the apertured disc attached to the motor shaft allows the light beam to cross the

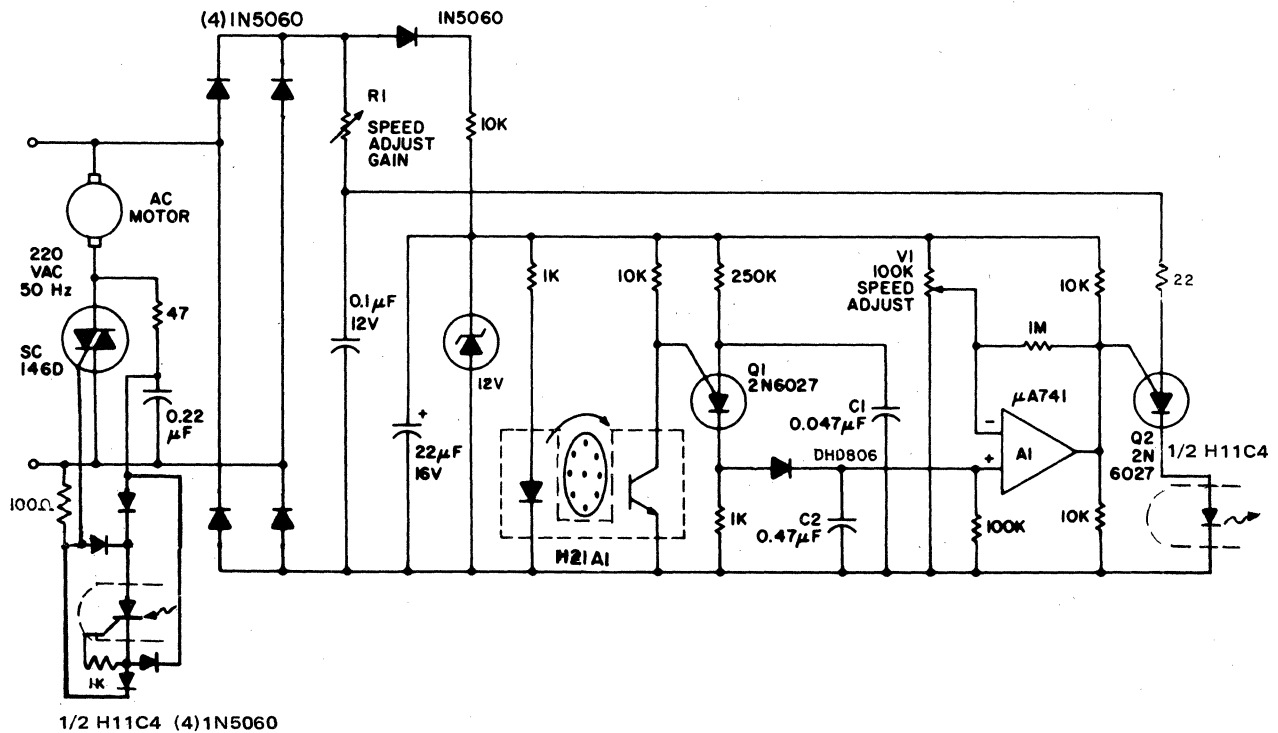
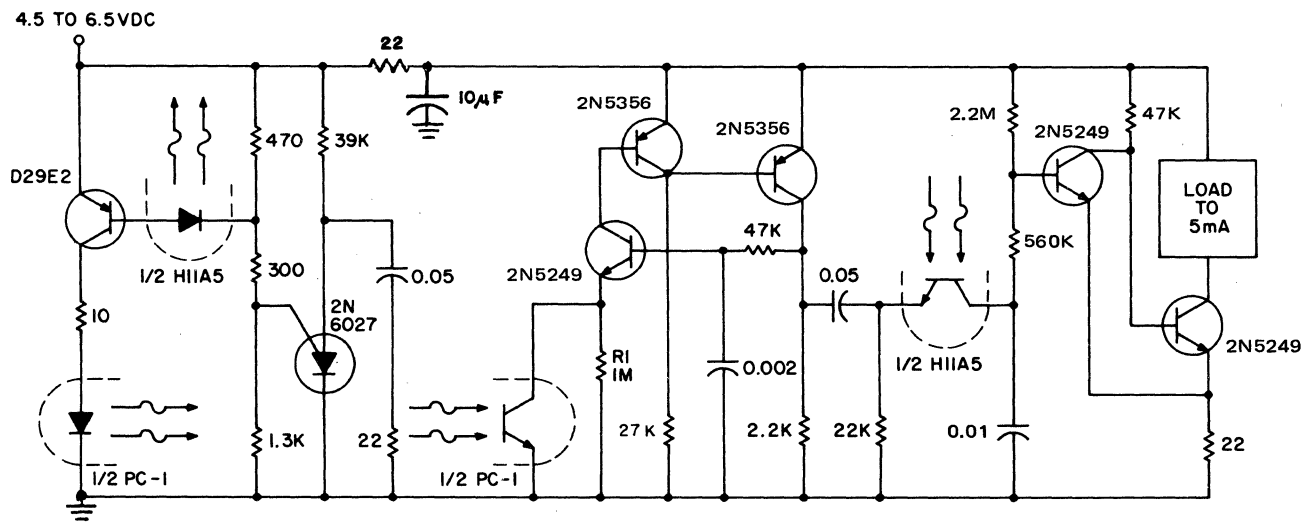

FIGURE 6.17: CLOSED LOOP AC MOTOR SPEED CONTROL WITH OPTICAL TACHOMETER

interrupter module, the programmable unijunction transistor, Q_1 , discharges capacitor, C_1 , into the much larger storage capacitor, C_2 . The voltage on C_2 is a direct function of the rotational speed of the motor. Subsequently, this speed-related potential is compared against an adjustable reference voltage, V_1 , through the monolithic operational amplifier, A_1 , whose output, in turn, establishes a dc control input to the second P.U.T. (Q_2). This latter device is synchronized to the ac supply frequency and furnishes trigger pulses in conventional manner to the triac at a phase angle determined by the speed control, R_1 , and by the actual speed of the motor.

6.2.6 Long Range Object Detector

When long ranges must be worked with IRED light sources, and when high system reliability is required, pulsed mode operation of the IRED is required. Additional reliability of operation is attained by synchronously detecting the photodetector current, as this circuit does. PC-1 is an IRED and phototransistor pair which detect the presence of an object blocking the transmission of light from the



PC-1 SELECTION	TRANSMISSION RANGE	REFLECTIVE RANGE
H23A1	5"	1"
LED56 and L14Q1	12"	3"
LED56 and L14G1	18"	4½"
LED55C and L14G1	32"	8"
1N6266 and L14G3	48"	12"
F5D1 and L14G3	80"	20"
F5D1 and L14P2	200"	50"

FIGURE 6.18: LONG RANGE OBJECT DETECTOR

IRED to the phototransistor. Relatively long distance transmission is obtained by pulsing the IRED, with about $10\mu\text{sec}$ pulses, at a 2msec period, to 350mA via the 2N6027 oscillator. The phototransistor current is amplified by the 2N5249 and 2N5356 amplifier to further increase distance and allows use of the H11A5, also pulsed by the 2N6027, as a synchronous detector, providing a failsafe, noise immune signal to the 2N5249 pair forming a Schmitt trigger output.

This design was built for battery operation, with long battery life a primary consideration. Note that another stage of amplification driving the IRED can boost the range by 5 to 10 times, limited by the IRED V_F , and a higher supply voltage for the IRED can double this.

6.3 Transmitting Information With Light

Transmission of electronic information over a light beam is the major use of optoelectronics today. These applications range from the use of optocouplers transmitting information between IC logic circuits and power circuits, between power lines and signal circuits, between telephone lines and control circuitry, to the pulse modulated systems which transmit information through air or fiber optics over relatively great distances.

6.3.1 Analog Information

The circuits illustrated here are designed to transmit analog, i.e., linear signals, optoelectronically. In this section the trade-offs between communication distance, fidelity, noise immunity and other design constraints are illustrated by example in an attempt to provide an understanding of this technology. Simple voice transmission systems can be made using infrared light through air as the signal path. Power dissipation in the IRED limits the ultimate capability of this type of system for distance and modulation frequency, due to the trade-off of power dissipation, pulse width and pulse frequency. In applications where transmission of information without electromagnetic interference is imperative, a relatively low cost system can be built around an IRED, a phototransistor, and low cost glass fiber optics, which can provide transmission over distances greater than 1km, or at rates over 100KHz using low cost driving circuitry. Higher frequency systems for long distance operation require pulse generators capable of generating short ($<200\text{nsec}$), high current pulses with leading edge overshoot, adding considerably to system expense, and heat sinking of the IRED. Laser diode systems provide higher performance at higher cost, and telecommunications fiber optic transmission systems provide an example of the practical limits of this technology. Using the low cost G.E. IRED's and detectors, frequency modulation and pulse data transmission are compatible with moderate frequency systems. The General Electric GaAlAs and GaAs IREDs are very efficient and have excellent stability due to the liquid epitaxial processing, which also defines its switching parameters and speed of response. This response time varies from about 100 to 500nsec, depending on bias level, and indicates that, for a given IRED power dissipation, and frequency of operation, there is an optimum input pulse width which will maximize pulse power output and, thereby, range of transmission. For the system illustrated in the next

application, this was determined to be about 500nsec, although power output was within 10% of the maximized value for widths from 170nsec to over 1 μ sec. This was determined by monitoring the power output with a photo cell connected phototransistor (the photo response with a low value load resistor is about an order of magnitude faster than the IRED) as the pulse width to the IRED is changed, maintaining other system parameters constant. Peak power input for the desired maximum power dissipation can be calculated for each pulse width and multiplied by the normalized peak power out and efficiency, at that pulse width and input power, respectively, to obtain a set of values of peak available power out, as a function of pulse width, at the frequency, waveshape and average power dissipation desired. Plotting the set of values produced the curve shown in Figure 6.19, which allowed analytical system optimization. It should be noted that peak light output occurred 50 to 100nsec after peak input

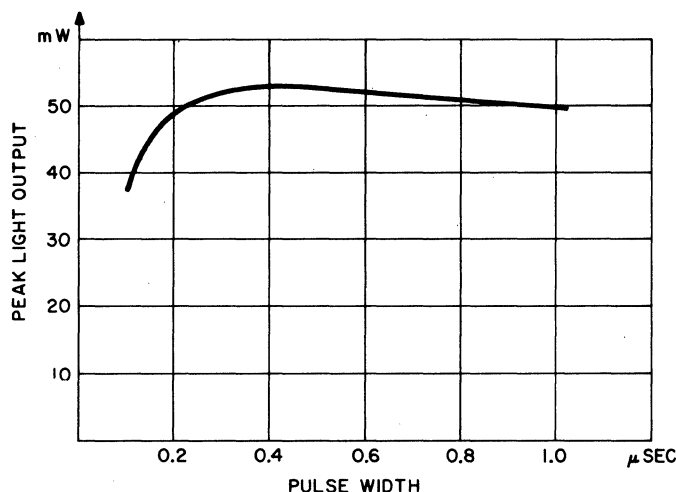

FIGURE 6.19: PEAK LIGHT OUTPUT EXPECTED FOR $P_{AVE} = .25W$, $f = 80KHz$ OPERATION

current was reached, and the IRED continued to emit light for 1 μ sec after the input current pulse had decreased to negligible levels, which places a peak repetition rate and peak envelope power optimization constraint on designs over 500KHz. To minimize turn on and turn off times of these IRED's, about 1/2nC of charge, per mA forward current, must be injected at turn on and removed at turn off. This, and the compatibility of the beam with focusing systems, is why most high frequency systems are designed around the expensive, relatively short lived, GaAs laser diode.

A relatively simple FM (PRM) optical transmitter was designed around a programmable unijunction transistor (PUT) pulse generator using this information. The basic circuit can be operated at 80KHz and is limited by the PUT-capacitor combination, as higher frequency demands smaller capacitance, which provides less peak output. As illustrated, 60KHz is the maximum modulation frequency. Pulse repetition rate is relatively insensitive to temperature and power supply voltage and is a linear function of V_{IN} , the modulating voltage. Tested with the receiver illustrated below, useful information transfer was obtained in free air ranges of 12 feet ($\approx 4m$). Lenses or reflectors at the light emitter and detector increases range and minimizes stray light noise effects. Greater range can also be obtained by using a higher power output IRED such as the F5D1 in combination with the L14P2 phototransistor. Average power consumption of the transmitter circuit is less than 3 watts.

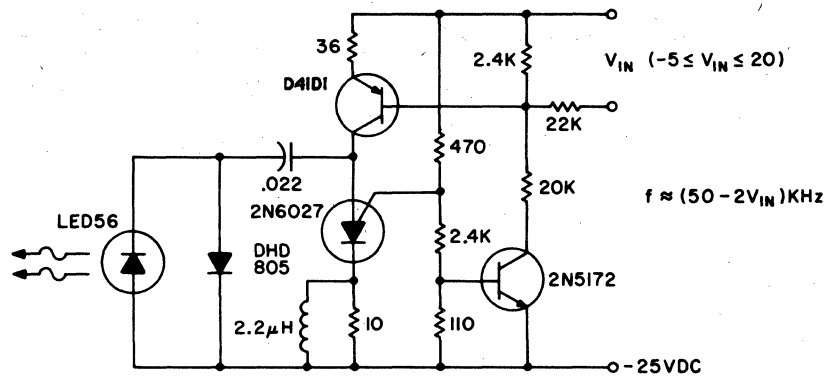

FIGURE 6.20: 50KHz CENTER FREQUENCY FM OPTICAL TRANSMITTER

For maximum range, the receiver must be designed in the same manner as a radio receiver front end, since the received signals will be similar in both frequency component and in amplitude of the photodiode current. The major constraint on the receiver performance is signal to noise ratio, followed by e.m. shielding, stability, bias points, parts layout, etc. These become significant details in the final design. This receiver circuit consists of a L14G2 detector, two stages of gain, and a FM demodulator (which is the tachometer circuit, previously illustrated, modified to operate up to 100KHz). Note that

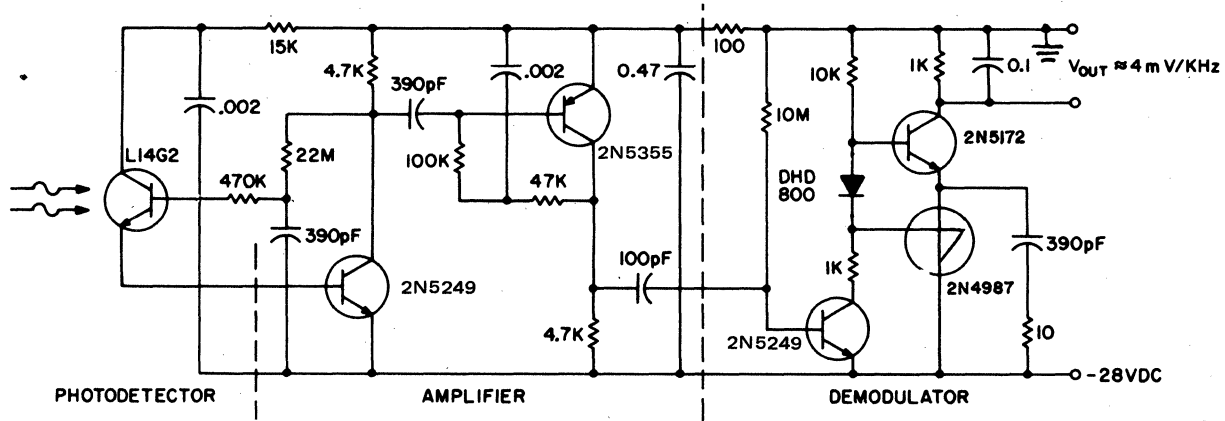

FIGURE 6.21: RECEIVER FOR 50KHz FM OPTICAL TRANSMITTER

better sensitivity can be obtained using more stages of stabilized gain with AGC, which lower cost and sensitivity may be obtained by using an H23A1 emitter-detector pair and/or by eliminating amplifier stages. For some applications, additional filtering of the output voltage may be desired.

Fiber optics are extensively used for information transfer, especially at high frequency for wide band width. Often there is a requirement for a low frequency, low cost information transmission link where the isolation, noise immunity and safety features of fiber optics are advantageous. The GFOD/E series makes such links possible.

Many information transfer systems require a two-way flow of information. Although a full duplex system can be implemented in fiber optics, it normally requires two fiber transmitter-receiver sets. Many system needs can be fulfilled by a half-duplex system, in which information can flow in both directions, but only one direction at any given time. The conventional method of building a half-duplex link requires a separate emitter and detector, connected with directional couplers, at each end of the fiber. The GFOE1A series of infrared emitting diodes are highly efficient, long lived emitters, which are also sensitive to the 940nm infrared they produce. Biased as a photodiode they exhibit a sensitivity of about 30nA per uW irradiation at 940nm. In a suitable bias and switching logic network they form the basis of a half-duplex information link. A half-duplex link illustrating emitter-detector operation of the GFOE1A1 is shown in Figure 6.22. This schematic represents a full, general purpose system,

including: approximately 50db compliance range with 1V RMS output; passive receive, transmit priority (voice-activated) switching logic; 100Hz to 50kHz frequency response; and does not require exotic (expensive) components or hardware. The system is simple, inexpensive, and can be upgraded to provide more capability through use of higher gain band-width amplifier stages. Conversely, performance and cost may be lowered simply by removing undesired features.

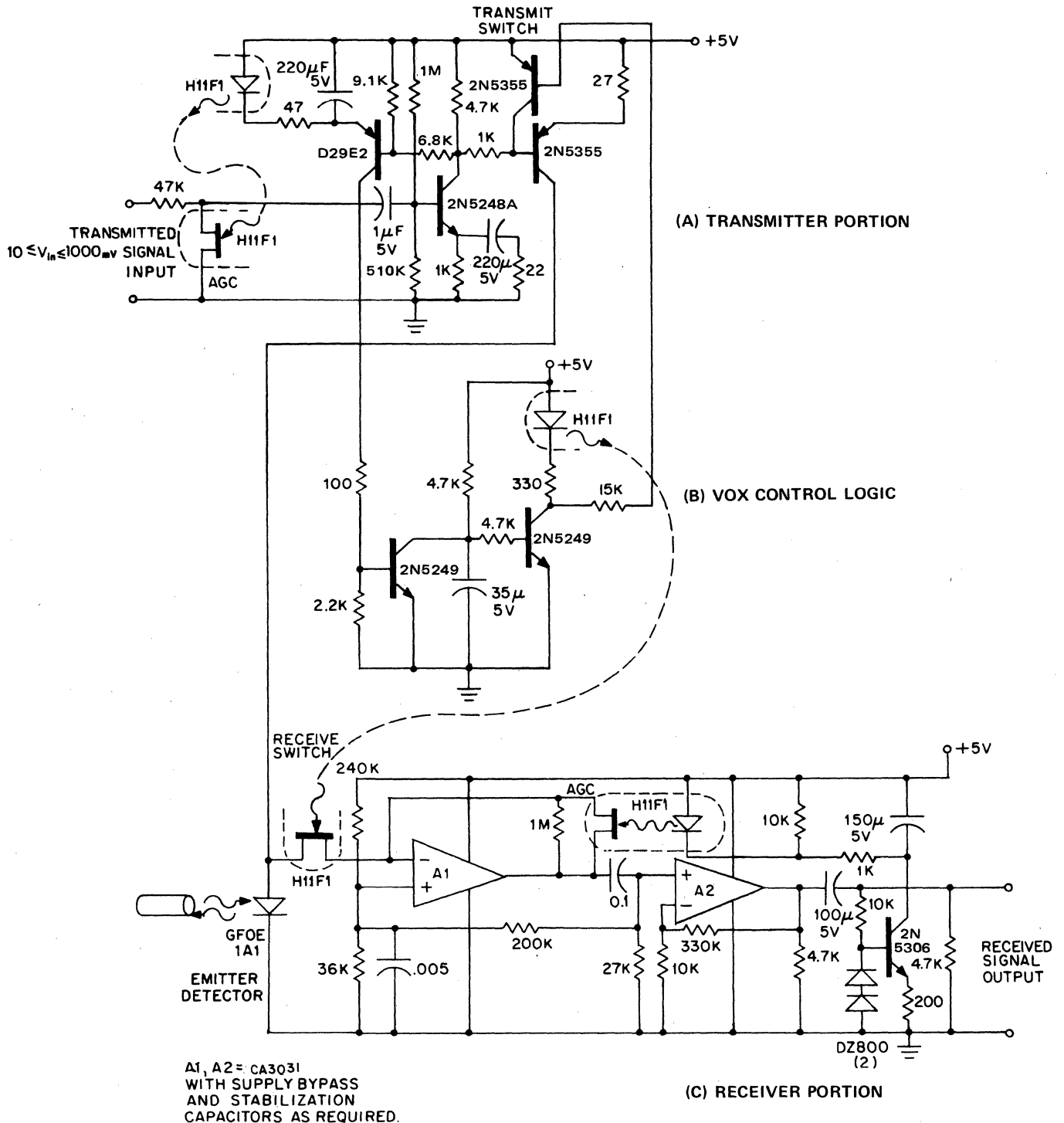

FIGURE 6.22: HALF DUPLEX INFORMATION LINK

Circuit operation is easily understood by following the signal through the three portions of the circuit. Both AGC (automatic gain control) circuits utilize the H11F bilateral analog FET optoisolator's variable resistance characteristic to attenuate the signal or modify the feedback path to provide AGC. In these circuits the peak value of the output signal is compared to the $V_{BE(on)}$ of a transistor-signal peaks which exceed $V_{BE(on)}$ turn the transistor on. Collector current of the transistor is capacitively filtered and supplies current to the IRED of the H11F. This lowers the resistance of the analog FET detector, which controls the signal level. In the transmitter, the signal enters via a 47K-H11F AGC attenuator network and passes through two stages of bipolar transistor amplification. The GFOE1A1 bias current from the output of the transistor is about 50mA dc modulated by approximately 80mA peak-to-peak ac for input signals within the compliance of the AGC network (about 10mV RMS to over 2V RMS). IRED bias is normally off until an input signal to the transmitter reaches AGC levels through the VOX control logic which clamps the transmitter output transistor off. The AGC signal level provides pulses of current to the VOX logic which are amplified, filtered and turns off both the clamp on the output transistor (activating the transmitter) and the switch that allows GFOE1A1 photodiode current to flow into the receiver (disabling the receiver). The receiver consists of the VOX controlled H11F bilateral analog FET switch, a transimpedance amplifier stage with AGC control of the gain and a voltage amplifier with a fixed gain of 30db. Note the forward dc bias on the GFOE1A provided by the transimpedance amplifier must be below V_F , yet provide ac signal swings. This receiver gives a reasonable compromise between gain-bandwidth and complexity. It requires 22 components (including op-amp and capacitors) to provide 2.5V p-p output signal for infrared outputs ranging from about $1\mu W$ to over $200\mu W$.

Linear AC Analog Coupler All methods of transmitting D.C. analog information via optical isolation have challenging limitations. Analog A.C. signal isolation with high linearity is much easier. Although I.C. output couplers are advertised for this function, a very simple bias circuit allows the

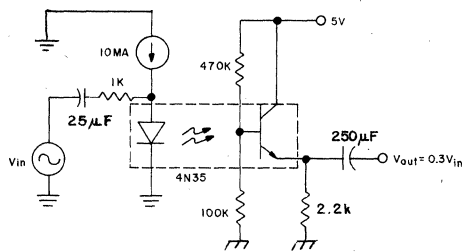

FIGURE 6.23: LINEAR A.C. COUPLER

PARAMETER	I.C. SPECIFICATION	4N35 DATA	UNITS
Supply Current	$2 \leq I_S \leq 10$	$1 \leq I_S \leq 3$	mA
Gain	≥ 100	≥ 200	mV/mA
Voltage Swing	4	5	Volts
Distortion	5	0.3	%
Step Response	1.4	6	μsec
Bandwidth	≥ 100	120	KHz
D.C. Output	$0.2 \leq V_O \leq 6$	$1 \leq V_O \leq 6$	Volts

PERFORMANCE COMPARISON: I.C. COUPLER TO 4N35

4N35 transistor output optocoupler to better the I.C. performance at much lower cost. The circuit is illustrated in Figure 6.23. Operation is as follows: with the coupler biased in the linear region by the 10mA dc bias on the IRED and the voltage divider on the phototransistor base, photodiode current flows out of the base into the voltage divider, producing an ac voltage proportional to the ac current in the IRED. The transistor is biased as an emitter follower and requires less than 10% of the photodiode current to produce the low impedance ac output across the emitter resistor. Note that the H11AV1 may be substituted for the 4N35 to provide VDE line voltage rated isolation of less than 0.5pF.

Linear PRM Analog Coupler —A minimum parts count version of this system also provides isolated, linear signal transfer useful at shorter distances or with an optocoupler for linear information transfer. Although the output is low level and cannot be loaded significantly without harming accuracy, a single I.C. operational or instrumentation amplifier can supply both the linear gain and buffering for use with a variety of loads.

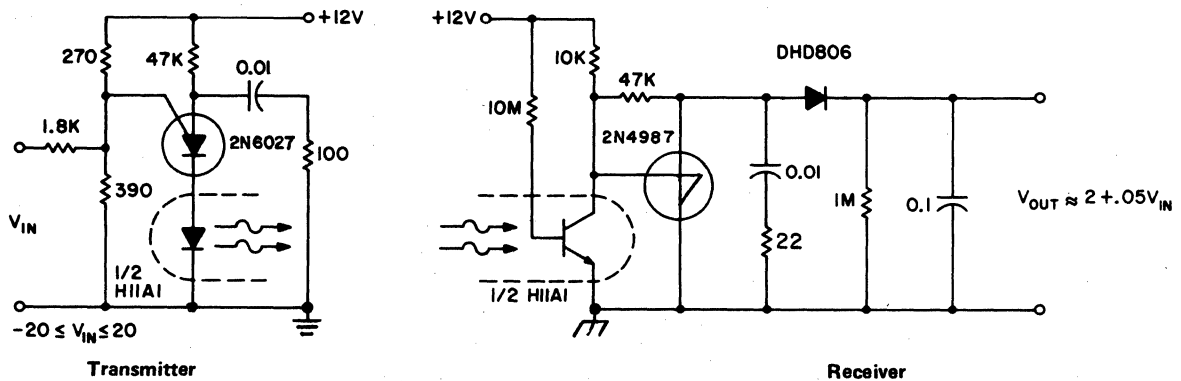

FIGURE 6.24: MINIMUM PARTS COUNT LINEAR PRM ISOLATION CIRCUIT

DC Linear Coupler —The accuracy of direct linear coupling of analog current signals via an optocoupler is determined by the coupler linearity and its temperature coefficient. Use of an additional coupler for feedback can provide linearity only if the two couplers are perfectly matched and identically biased. These are not practical constraints in most equipment designs and indicate the need for a different design approach. One of the most successful solutions to this problem can be illustrated by using a H23 emitter-detector pair and a L14H4, as illustrated in Figure 6.25. The H23 detector and L14H are placed so both are illuminated by the H23 IRED emitter. Ideally, the circuit is mechanically designed such that the H23 emitter may be positioned to provide $V_{OUT} = 2.8V$ when $V_{IN} = 0$, thereby

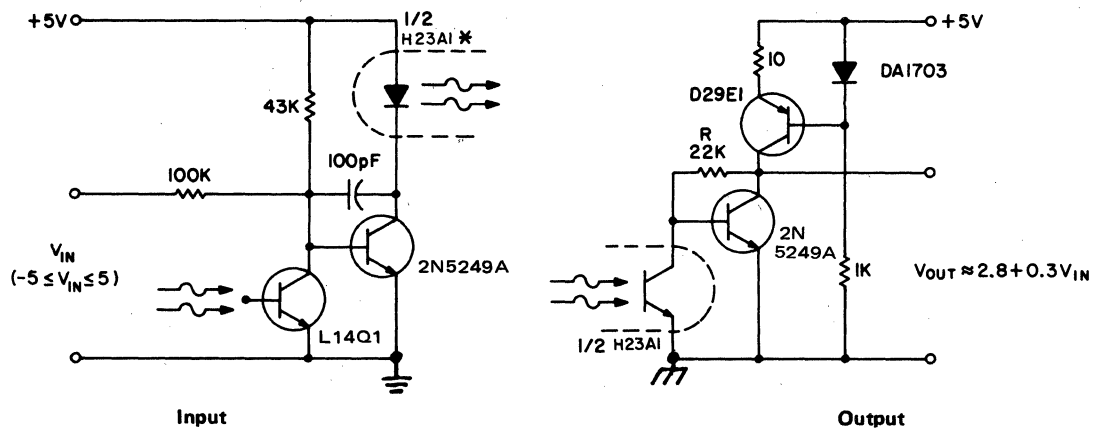

FIGURE 6.25: LINEAR OPTICAL COUPLER CIRCUIT

*Closely positioned to illuminate L14Q1 and H23A1 Detector, such that $V_{OUT} \cong 2.8V$ at $V_{IN} = 0$.

insuring collector current matching in the detectors. Then all three devices are locked in position relative to each other. Otherwise, R may be adjusted to provide the proper null level, although temperature tracking should prove worse when R is adjusted. Note that the input bias is dependent on power supply voltage, although the output is relatively independent of supply variations. Testing indicated linearity was better than could be resolved, due to alignment motion caused by using plastic tape to lock positions. The concept of feedback control of IRED power output is useful for both information transmission and sensing circuitry.

6.3.2 Digital Information

The circuits illustrated here are used to transmit information in the form of switch states, i.e., on and off (or zero and one states). Most of these circuits are designed to interface with commercial integrated circuit logic by receiving and/or providing signal for the logic circuit. Due to switching speeds of both emitters and detectors, no optocoupler can provide true speed compatibility with only the slowest logic families. For this reason, the logic compatibility of these circuits is level compatibility at worst case conditions, i.e., zeros and ones will meet the I.C. specified levels over the ranges of conditions specified.

TTL — This is the most common logic family, has the most functions available, and is the basis for the IEEE digital interface standard for programmable instruments. There is also a wide variety of standard types of TTL (i.e. high speed, Schottky, LSI, etc.) each of which has different logic level or logic level conditions (primarily source and sink currents) each of which can place different requirements on an optocoupler required to interface with it. To simplify some problems of interfacing TTL logic with optocouplers, GE surveyed the specifications of SSI devices (single function devices, i.e., “or” gates, flip-flops, etc.) and has specified a series of photo transistor and photoSCR couplers to be level compatible with the common 7400, 74H00 and 74S00 series TTL over the range of gate parameters, power supply and temperature variations specified. These couplers are designated the H74 series and, are very cost effective. They are specified with specific values of 5% tolerance bias resistors in a defined configuration. This eliminates any chance of misapplication or circuit malfunction. The circuits and logic truth table in Figures 6.26 and 6.27 illustrate application of this series of couplers. Noise margin considerations are minimized with these couplers since the slow switching speeds of the optocoupler do not allow reaction to the high speed hash that is provided for by noise margins.

PARAMETER	TEST CONDITIONS						LIMITS		
	Min.	V _{CC} Max.	Min.	I _{IN} Max.	Min.	I _{SINK} Max.	Min.	Max.	Units
V _{OUT} (1)	4.5V					-0.4mA	2.4		Volts
V _{OUT} (0)	4.5V				12.0mA		0.4		Volts
V _{IN} (1)		5.5V		1.0mA			2.0		Volts
V _{IN} (0)		5.5V	-1.6mA				0.8		Volts

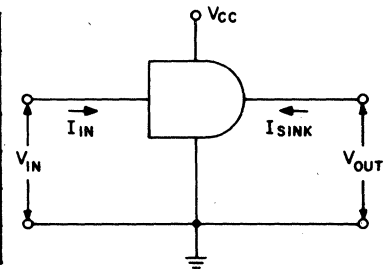
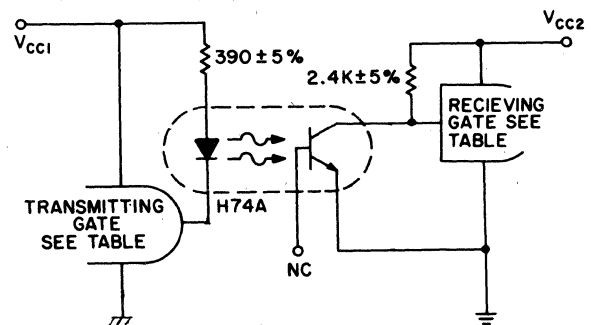
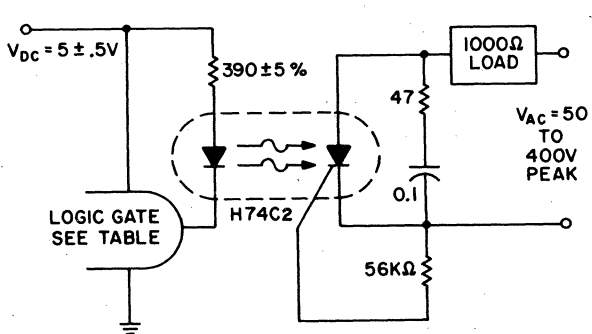

FIGURE 6.26: CHARACTERISTICS REQUIRED OF TTL GATES WHICH ARE TO BE INTERFACED BY H74 SERIES



LOGIC TO POWER COUPLING H74 BIAS CIRCUIT

LOGIC TO LOGIC COUPLERS H74A1 BIAS CIRCUIT

FIGURE 6.27: H74 SERIES TTL LOGIC COUPLING

For higher speed applications, up to 1mHz NRZ, the Schmitt trigger output H11L series optoisolator provides many other attractive features. The 1.6mA drive current allows fan-in circuitry to drive the IRED, while the 5Volt, 270Ω sink capability and 100nsec transition times of the output add to the logic coupling flexibility.

Low power TTL, low power Schottky clamped TTL, MSI TTL and SI TTL circuits will not generally provide the current sinking capability indicated in the H74 bias chart. The H74 series optocoupler can still provide the means of using a general purpose circuit that will interface with all these types and between all the types. A simple stage of transistor amplification as an output buffer allows the low current sink capability (down to $100\mu\text{A}$) to drive the IRED. The logic sense is not changed. Logic zero out provides current to the IRED which activates the output of the optocoupler.

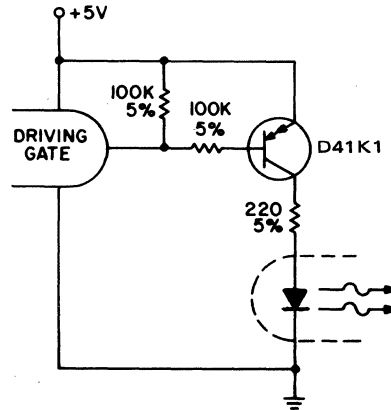

FIGURE 6.28: IRED DRIVE FROM LOW POWER, MSI AND LSI TTL

High threshold versions of TTL (HNIL, etc.) can normally be used without buffering by increasing the bias resistor values to keep worst case currents within the TTL range at the higher supply voltages used with these logic circuits.

CMOS — Like all low power (bipolar and MOS) logic, CMOS inputs are easily driven by optocoupler outputs. Although some couplers are advertised by CMOS output compatible, careful examination reveals the CMOS gate must be capable of sinking/sourcing several hundred microamps to drive the light source. As standard CMOS logic operates down to 3V supply voltages and is specified as low as $30\mu\text{A}$ maximum current sinking/sourcing capability, it is again necessary to use a buffer transistor to provide the required current to the IRED if CMOS is to drive the optocoupler. As in the case of the low output TTL families, the H74A output can drive a multiplicity of CMOS gate inputs or a standard TTL input given the proper bias of the IRED. The optocoupler driving circuit is illustrated in Figure 6.29. When the H11L1 is used, a lower gain transistor such as the 2N4256 can be used with a 1K ohm resistor.

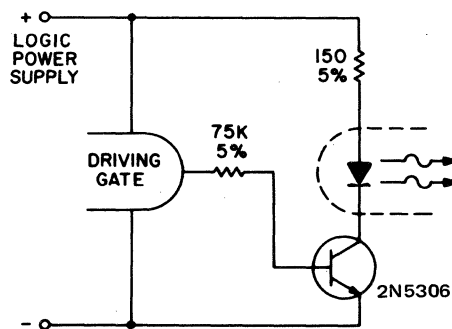

FIGURE 6.29: GENERAL PURPOSE CMOS IRED BIAS CIRCUIT

Note the logic sense is changed, i.e., a one logic state drives the IRED on. This circuit will provide worst case drive criteria to the IRED for logic supply voltages from 3V to 10V, although lower power dissipation can be obtained by using higher value resistors for high supply voltages. If this is desired, remember the worst case drive must be supplied to the IRED with minimum supply voltage, minimum temperature and maximum resistor tolerances, gate saturation resistance and transistor saturation voltages applied. For the H74 devices, minimum IRED current at worst case conditions (zero logic state output of the driving gate) is 6.5mA, while the H11L1 is 1.6mA.

P MOS and N MOS — These logic families have current source and sink capabilities similar to the previously mentioned CMOS worst case. Normal logic supply voltages range from 6V to 30V at these drive levels and bias circuitry design must account for this. N MOS provides higher current sinking than sourcing capability, while P MOS is normally the opposite. As these logic families are found in a wide variety of custom and standard configurations (from calculators to micro computers to music synthesizers, etc.), a generalized optocoupler bias circuit is impossible to define. The form of the circuit will be similar to the low output TTL circuit for N MOS and similar to the CMOS circuit for P MOS. Bias resistor constraints are as previously mentioned.

6.3.3 Telecommunications Circuits

The largest information transmitting system is the United States telephone system, many functions of which could benefit from application of optocouplers. This section will document a few of these applications, although it should be noted that very detailed knowledge of the particular telephone system and its interaction with the optocoupler circuit is required to ensure proper circuit operation and prevent damage to the phone system.

Ring Detectors — These circuits are designed to detect the 20Hz, $\approx 86V$ rms ring signal on telephone lines and initiate action in an electrically isolated circuit. Typical applications would include automatic answering equipment, interconnect/interface and key systems. The circuits illustrated in Figure 6.30-6.32 are "bare bones" circuits designed to illustrate concepts. They may not eliminate the

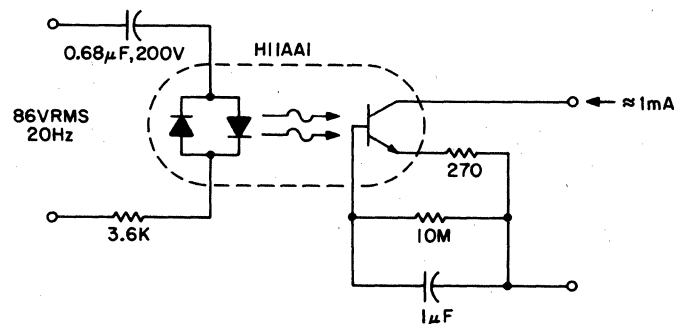
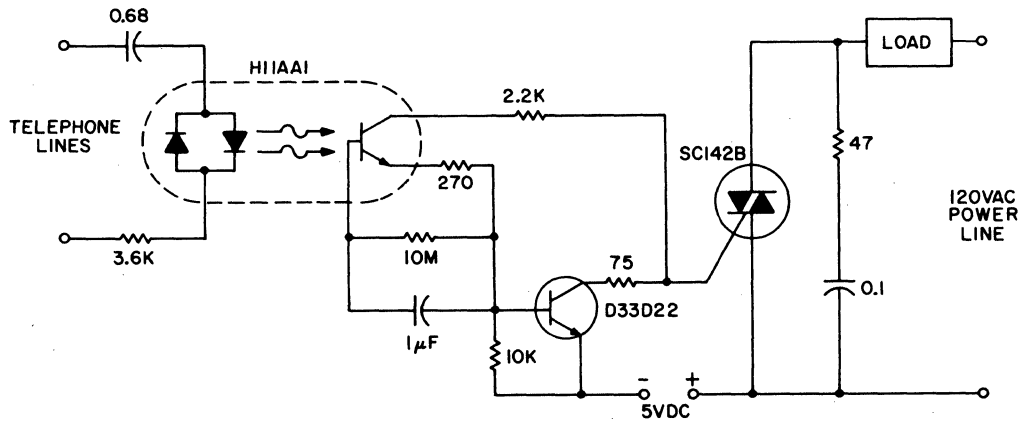

FIGURE 6.30: SIMPLE RING DETECTOR CIRCUIT

ac/dc ring differentiation, 60Hz noise rejection, dial tap rejection and other effects that must be considered in field application. The first ring detector is the simplest and provides about a 1mA signal for a 7mA line loading for 1/10sec after the start of the ring signal. The time delay capacitor provides a degree of dial tap and click suppression, as well as filtering out the zero crossing of the 20Hz wave.

This circuit provides the basis for a simple example, a ring extender that operates lamps and buzzers from the 120V, 60Hz power line while maintaining positive isolation between the telephone

line and the power line. Use of the isolated tab triac simplifies heat sinking by removing the constraint of isolating the triac heat sink from the chassis.



Maximum Load: 500 W Lamp or 800 W Inductive or Resistive

FIGURE 6.31: REMOTE RING EXTENDER SWITCH

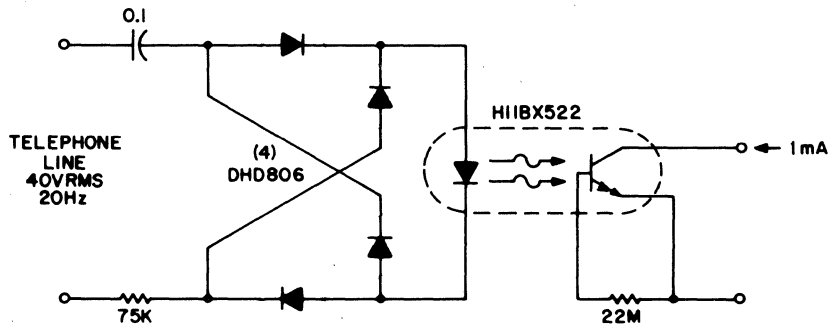

FIGURE 6.32: LOW LINE LOADING RING DETECTOR

Lower line current loading is required in many ring detector applications. This can be provided by using the H11BX522 photodarlington optocoupler, which is specified to provide a 1mA output from a 0.5mA input through the -25°C to $+50^{\circ}\text{C}$ temperature range. The following circuit allows ring detection down to a 40V RMS ring signal while providing 60Hz rejection to about 20V RMS. Zero crossing filtering may be accomplished either at the input bridge rectifier or at the output, similar to the method employed with the H11AA1 illustrated earlier. Dependable ring detection demands that the

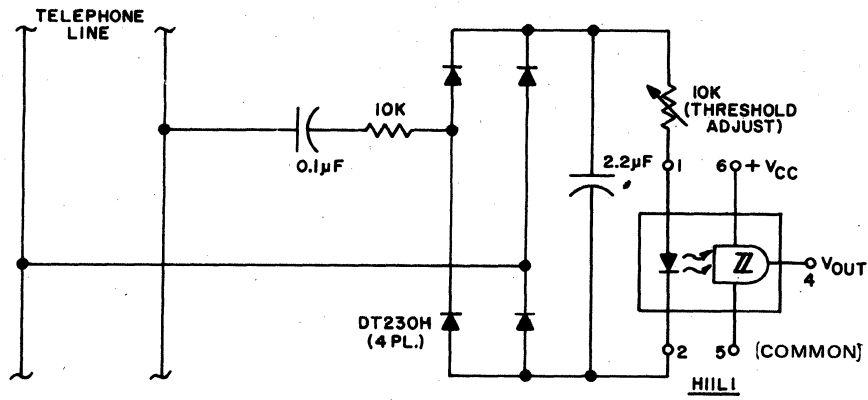

FIGURE 6.33: RING DETECTOR USING H11L1

circuit respond only to ring signals, rejecting spurious noise of similar amplitude, such as dialing transients. The configuration shown in Figure 6.33 relies on the fact that ring signals are composed of continuous frequency bursts, whereas dialing transients are much lower in repetition rate. The DC bridge-filter combination at the H11L input has a time constant such that it cannot react to widely spaced dialing transients, but will detect the presence of relatively long duration bursts, causing the H11L to activate the downstream interconnect circuits at a precisely defined threshold.

Line Current Detection — Detection of line current flow and indicating the flow to an electrically remote point is required in line status monitoring at a variety of points in the telephone system and auxiliary systems. The line should be minimally unbalanced or loaded by the monitor circuit, and relatively high levels of 60Hz induced voltages must be ignored. The H11AA1 allows line currents of either polarity to be sensed without discrimination and will ignore noise up to approximately 2.5mA.

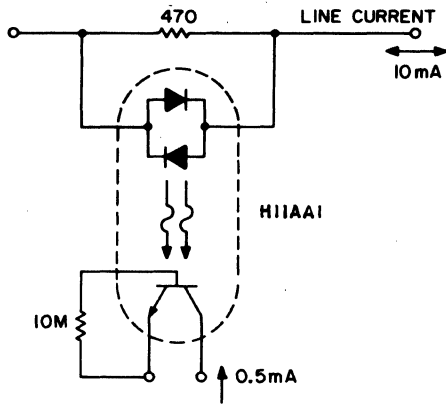

FIGURE 6.34: POLARITY INSENSITIVE LINE CURRENT DETECTOR

In applications where greater noise immunity or a polarity sensitive line current detection is required, the H11A10 threshold coupler may be used. This phototransistor coupler is specified to provide a minimum 10% current transfer ratio at a defined input current while having less than $50\mu\text{A}$ leakage at half that input current — over the full -55°C to $+100^\circ\text{C}$ temperature range. The input current range at which the coupler is “on” is programmable by a single resistor from 5mA to 10mA. Figure 6.35 illustrates a line current detector which indicates the polarity of line currents over 10mA while

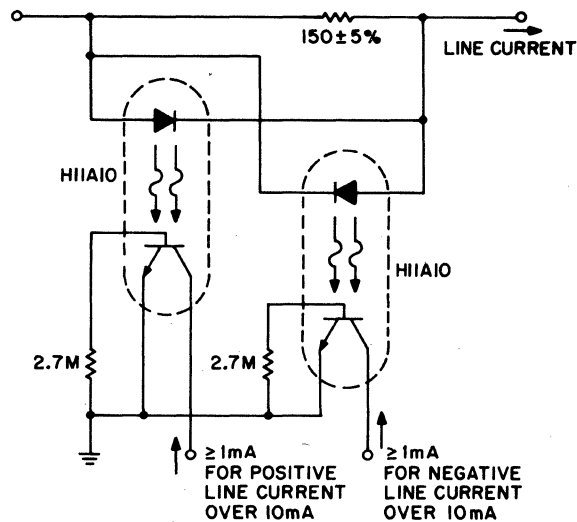

FIGURE 6.35: POLARITY INDICATING LINE CURRENT DETECTOR

ignoring line currents of less than 5mA. This circuit will maintain these margins over a -55°C to $+100^\circ\text{C}$ temperature range. At slightly more cost, the H11L1 may be used in this circuit to provide tighter threshold limits, hysteresis and digital output.

Indicator Lamp Driver — A simple “solid state relay” circuit provides a simple method of driving the 10V ac telephone indicator lamps from logic circuitry while maintaining complete isolation between the 10V line and the logic circuit.

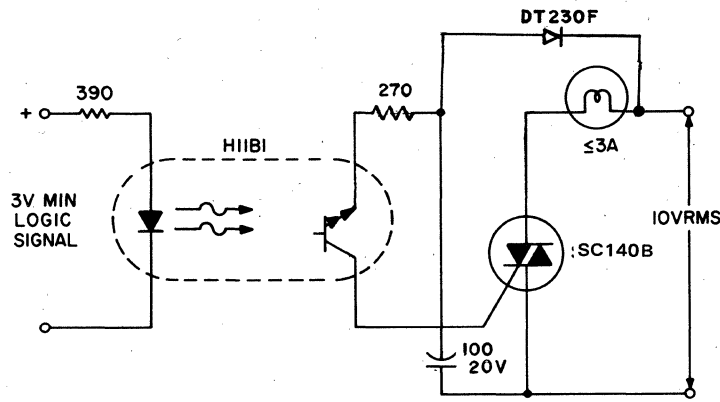

FIGURE 6.36: ISOLATED, LOGIC CONTROLLED, INDICATOR LAMP SWITCH

Dial Pulse Indicator — A dial pulse indicator senses the switching on and off of the 48Vdc line voltage and transmits the pulses to logic circuitry. A H11A10 threshold coupler, with capacitor filtering, gives a simple circuit which can provide dial pulse indication yet reject high levels of induced 60Hz noise. The DHD805 provides reverse bias protection for the LED during transient over-voltage situations. The capacitive filtering removes less than 10msec of the leading edge of a 40V dial pulse, while providing rejection of up to 25V RMS at 60 Hz.

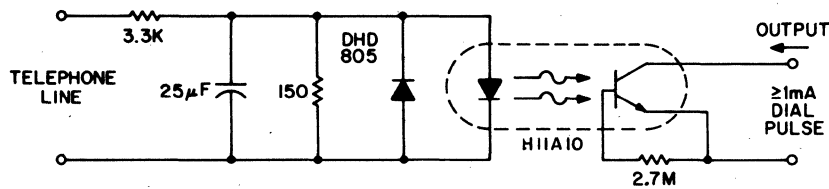

FIGURE 6.37: DIAL PULSE INDICATOR

Digital Data Line Receiver — When digital data is transmitted over long lines (≥ 1 meter) proper transfer is often disturbed by the parasitic effects of ground level shifts and ground loops, as well as by extraneous noise picked up along the way. An optocoupler such as the H11L, combining galvanic isolation to minimize ground loop currents and their concomitant common mode voltages, with predictable switching levels to enhance noise immunity, can significantly reduce erratic behavior. In Figure (3), resistor R_S is programmed for the desired switching threshold, C_S is an (optional) speed-up capacitor, and CR1 is an LED used as a simple diode to provide perfect line balance and a discharge path for C_S if the speed-up capacitor is used.

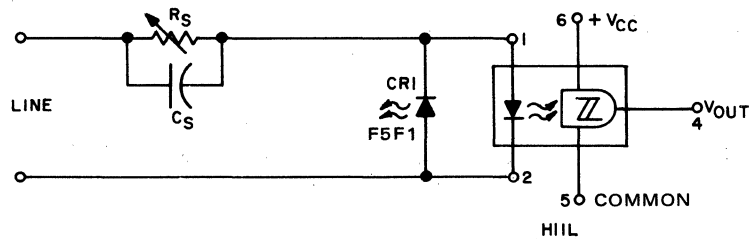

FIGURE 6.38: DIGITAL DATA LINE RECEIVER

6.4 OPTOISOLATOR SWITCHING CIRCUITS

The bilateral analog FET optocoupler can also be utilized as an isolated control analog switch, and will be illustrated in the next few examples. A series-parallel combination of the optocouplers can be utilized as an analog commutator. A FET high input impedance op-amp connected as a unity-gain follower is normally used as a buffer between the signal source and the load. The switch circuit can be viewed as part of a combination of two series-connected variable resistors in parallel with the input signal source. The input to the op-amp forms an equivalent voltage-divider network. If $R_{on} = 3K\Omega$ and $R_{off} = 300M\Omega$, the variation of the voltage dividing ratio is from 0.00001 to 0.99999 which implies the error due to the opto-bilateral switches is about 0.001%. Because the switching speed of the optocoupler bilateral switch (0% and 100% signal levels) is less than $50\mu\text{sec}$, this analog commutator works accurately for repetition rates below 20KHz. For a 200mV dc input signal, the analog commutator has a rise time (0% to 99%) of about $5\mu\text{sec}$ and a fall time (99% to 0%) of about $4\mu\text{sec}$. The rise time (acquisition time, τ_A) and fall time (recovery time, τ_R) of the commutator with a source impedance of $3M\Omega$ is also a function of input voltage. For a specific input voltage, the inverse of $(\tau_A + \tau_R)$ will determine the upper limit of the operating frequency range of the commutator, and approaches 50KHz at high input voltages. This technique allows a four-channel analog multiplexer to be constructed by adding three more input and control channels.

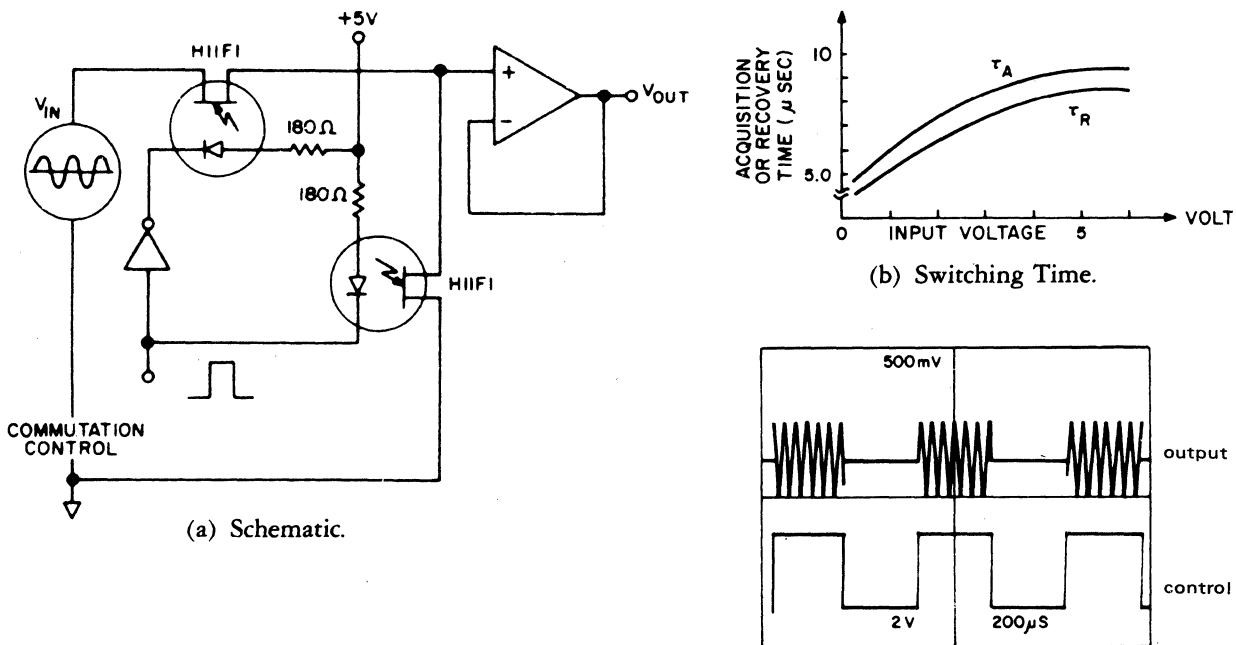
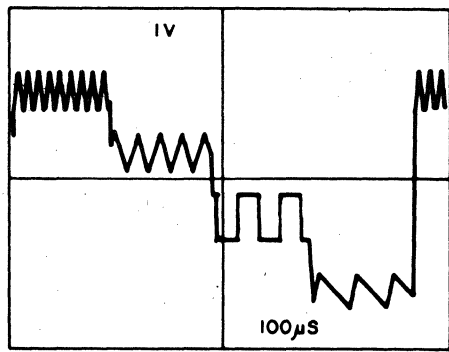
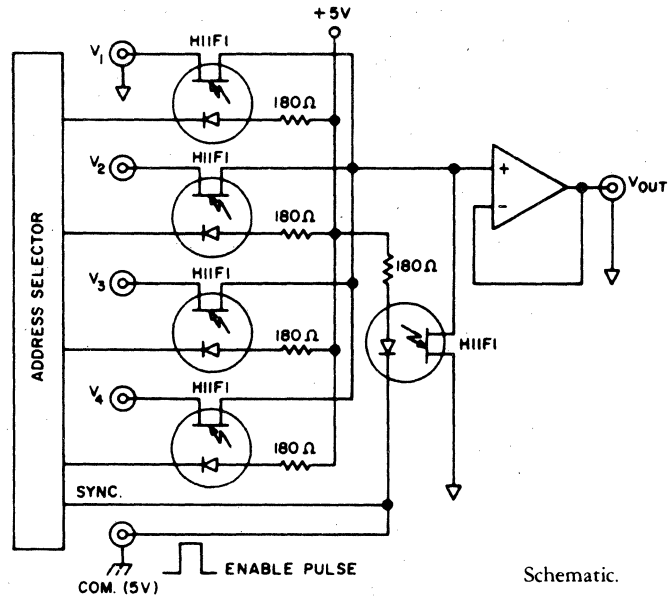

FIGURE 6.39: ANALOG COMMUTATOR CIRCUIT

The multiplexer allows selection of any of the four signal sources via the address selection and enable pulse. Switching transients have been observed during the transition of the control signal. These transients (about 500nsec) are much shorter than the acquisition time and recovery time (several micro-seconds), and do not affect the operation of the multiplexer. To illustrate the operation of the multiplexer, four different waveforms are fed into four input channels, then sequentially multiplexed. Different dc offset voltages are applied to each channel so that the signal associated with each channel can be clearly identified in the output waveform, as illustrated. The cross-talk between adjacent channels at various frequencies has been analyzed, and degrades about 20db per decade as frequency increases. With a 100kHz input signal, the adjacent channel rejection is about 62db, increasing to 100 db at 1kHz. This figure can be further reduced with careful circuit layout.



Output Waveforms for Sequential Address.



Schematic.

FIGURE 6.40: FOUR CHANNEL MULTIPLEXER

Optically coupled isolators can replace transformers in a zero-voltage detector for synchronizing the firing of a thyristor in three-phase control applications. The optoisolators eliminate the need for a low-pass filter, required in standard detectors for eliminating spurious zero-crossings caused by the thyristor's switching transients. They provide high-voltage isolation and much lower capacitive coupling to the circuit than a standard transformer, approximating the coupling of double-shielded types.

The IRED's in the H11AA1 optoisolator are inserted in each of three legs of a delta network. During most of the cycle, all phototransistors are on. At times when the voltage between any two lines is within about 15V of zero, however, no current will flow through the IRED's connected across those lines. Therefore its corresponding phototransistor will be off, causing pin 2 of the 74LS221 one-shot to change states and a phase-identification pulse (P) to be generated twice every cycle.

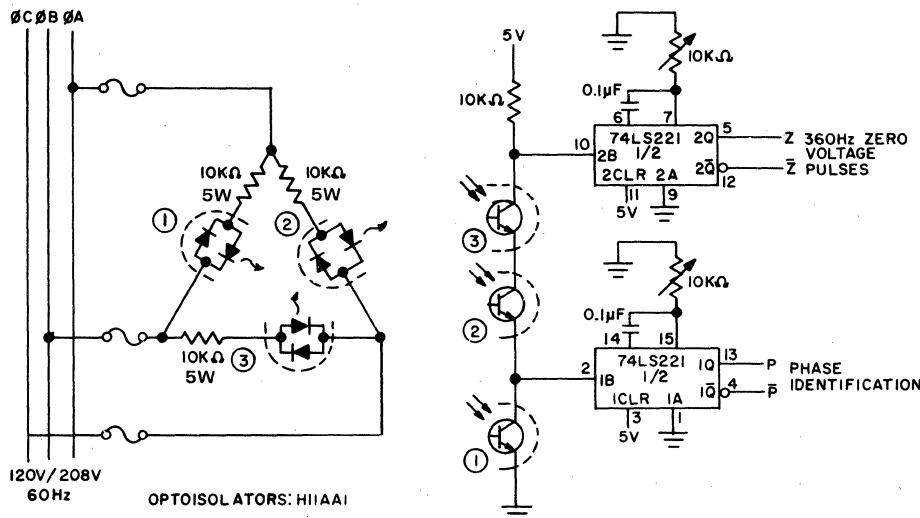

FIGURE 6.41: THREE PHASE LINE SYNCHRONIZER

In the case illustrated, the phototransistors are wired so that a pulse will be generated at the output each time the input voltage, as measured across ϕ_a and ϕ_b , passes through zero. Note that the one-shot should be adjusted so that the trailing edge of the output pulse corresponds to the actual zero-crossing point.

Identification pulses are also generated for all three phases collectively and these can be accessed, if required, at the zero-voltage pulse output (Z). These pulses occur three times as often as P.

Because at least one IRED is conducting at any one time, no transient will normally be generated, so no low-pass filter is needed. Furthermore, the phototransistor's response of a few microseconds acts to suppress any transients that might occur near the zero-voltage points, thereby increasing the circuit's noise immunity.

6.5 POWER CONTROL CIRCUITS

The evolution of the optoelectronic coupler has made it practical to design a completely solid state relay. A solid state relay can perform not only the same functions as the original electro-mechanical relay, but can also provide solid state reliability, zero voltage switching and, most importantly, a direct interface between integrated circuit logic and power line.

6.5.1 AC Solid State Relays

A zero voltage switching design for ac solid state relays meets all the above criteria and is a combination of four individual functions. It consists first of an input circuit. The input terminals of this part of the relay are analogous to the coil of an EMR (electromechanical relay). It is effectively a resistive network and can be designed to accept a large range of input values. Circuits are designed to accept either digital or analog signals and to limit input current requirements to enable direct interfacing to logic circuits. The second part of a solid state relay consists of an isolation function performed by an optocoupler. A coupler provides, by means of a dielectric medium, an isolation path to transfer the input signal information to a third function; which is the zero voltage switching network. The ZVS network monitors the line voltage and controls the fourth (power) function, selecting the "on" or "off" state.

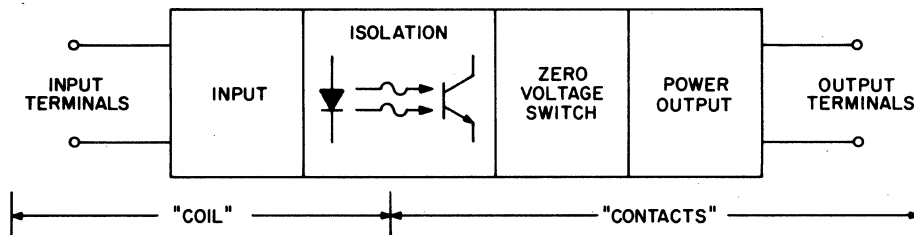

FIGURE 6.42: SOLID STATE RELAY BLOCK DIAGRAM

A reliable solid state relay design incorporates the correct choice of components and a careful consideration of the system to be interfaced. There are a variety of circuit configurations that are possible, each with its own advantages and disadvantages.

Input (Coil) Circuits — The first design consideration is the relay input (or coil) characteristics. It can be a simple current limiting resistor ($\cong 330\Omega$ for TTL) in series with a light emitting diode, or it can be as complex as a Schmitt trigger circuit exhibiting hysteresis characteristics.

The input circuit should be designed around the available input signal. When working with logic signals, consider the complete capabilities of the gate output. A logic gate can operate in both the sinking or sourcing mode. Some MOS (or CMOS) circuits supply only about $20\mu\text{a}$, while TTL gates can offer up to 50ma in the sink mode and -1.6ma in the source mode. These are the input currents available to drive the solid state relay. In most circuits, the relays IRED will require 0.5mA to 20mA of drive current at a minimum voltage of 1.5V (the drop across the diode) in order to achieve workable output currents in the detector device. The low level MOS logic signals normally indicate the need to use transistor buffer (or signal amplification) stages in the input circuit.

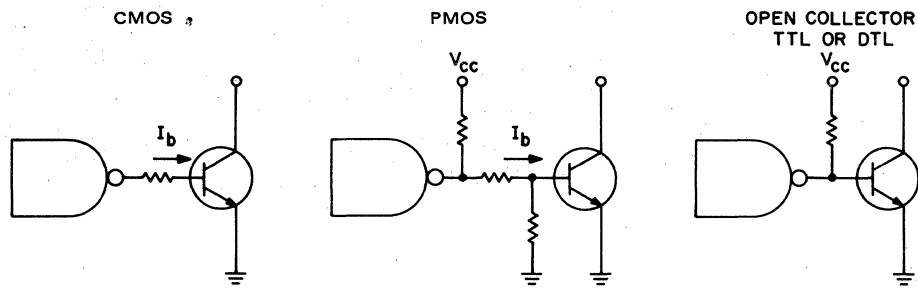

FIGURE 6.43: CONNECTION OF TRANSISTOR BUFFERS TO LOGIC CIRCUITS

Generally, direct TTL connection to the optocoupler using SSI gates of the 54/74, 54H/74H and 54S/74S logic families, which guarantee $V_o(0)$ (maximum) of 0.4V sinking $\geq 12\text{mA}$, is made with the IRED "on" for a logic zero. For CMOS circuits the logic "1" output is the best means of operation, using an NPN transistor buffer. The buffer circuit in Figure 6.44 illustrates the advantage of the low saturation voltage, high gain, GE transistor D38S.

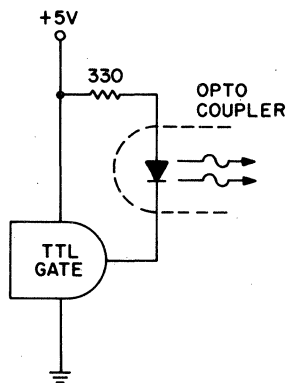

FIGURE 6.44a: DIRECT CONNECTION OF TTL $I_o \geq 7\text{mA}$

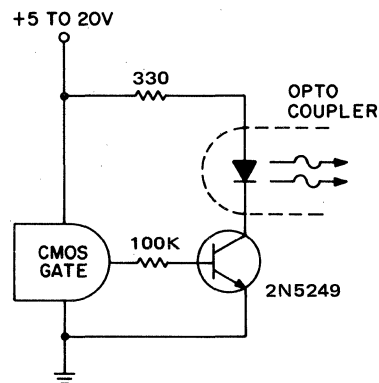

FIGURE 6.44b: NPN BUFFERED CMOS CONNECTION $I_o \geq 7\text{mA}$

In the case where analog signals are being used as the logic control, hysteresis, via a Schmitt trigger input, similar to the one in Figure 6.45, can be used to prevent "chatter" or half wave, power output. Circuit operation is as follows: at low input voltages Q_1 is biased in the off state. Q_2 conducts and biases Q_3 and, thereby, the IRED off. When the base of Q_1 reaches the biasing voltage of 0.6V-plus the drop across R_D , Q_1 turns on. Q_3 is then supplied base drive, and the solid state relay input will be activated. The combination of Q_3 and Q_4 acts as a constant current source to the IRED. In order to turn-off Q_3 base drive must be reduced to pull it out of saturation. Because Q_2 is in the off-state as signal is reduced, Q_1 will now stay "on" to a base bias voltage lower by the change in the drop across R_D . With these values, highest turn-off voltage is 1.0V, while turn "on" will be at less than 4.1V supplied to the circuit.

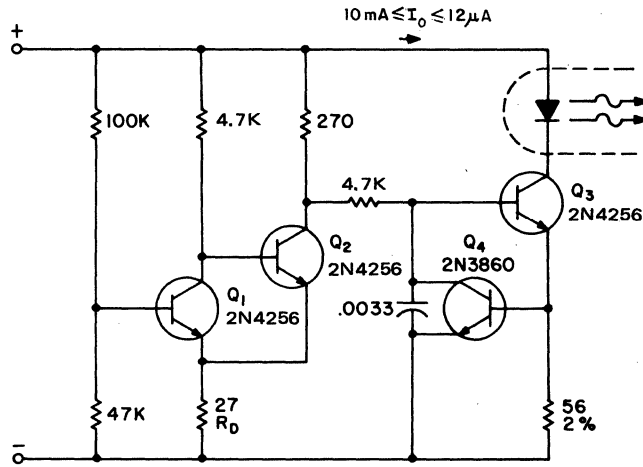

FIGURE 6.45: HYSTERESIS INPUT CIRCUIT

For ac or bi-polar input signals there are several possible connections. If only positive signals are to activate the relay, a diode (such as the A14) can be connected in parallel to protect the IRED from reverse voltage damage, since, its specified peak reverse voltage capability is approximately 3 volts. If ac signals are being used, or activation is to be polarity insensitive, a H11AA coupler which contains two LED's in antiparallel connection can be used.

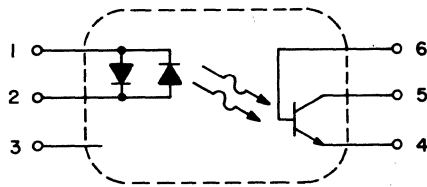

FIGURE 6.46: H11AA1 AC INPUT PHOTON COUPLED ISOLATOR

For higher input voltage designs, or for any easy means of converting a dc input relay to ac, a full wave diode bridge can be used to bias the IRED.

Isolation and Zero Voltage Switching Logic — Figure 6.47 presents two simple circuits providing zero voltage switching. These circuits can be used with full wave bridges or in antiparallel to provide full wave control and are normally used to trigger power thyristors. If an input signal is present during the time the ac voltage is between 0 to 7V, the SCR will turn-on. But, if the ac voltage has risen above this range and the input signal is then applied, the transistor, Q₁, will be biased to the “on” state and will hold the SCR and, consequently, the relay “off” until the next zero crossing.

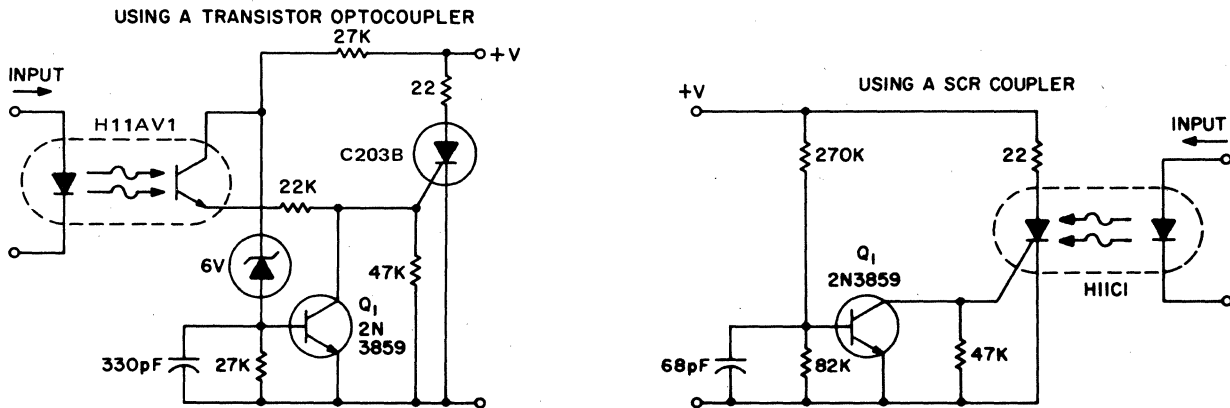

FIGURE 6.47: NORMALLY OPEN, TWO TERMINAL, ZERO VOLTAGE SWITCHING HALF WAVE CONTACT CIRCUITS

The transistor circuit has excellent common mode noise rejection due to use of the H11AV1, which has under 0.5pf isolation capacitance. The SCR coupler circuit can be modified to provide higher sensitivity to input signals as illustrated below. This allows the lower cost 4N39 (H11C3) to be used with the $\geq 7\text{mA}$ drive currents supplied by the illustrated input circuits.

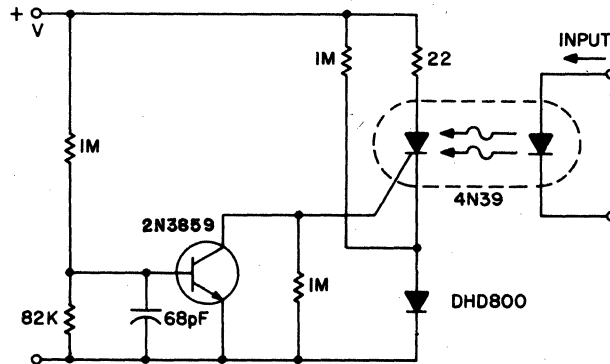

FIGURE 6.48: HIGH SENSITIVITY, NORMALLY OPEN, TWO TERMINAL, ZERO VOLTAGE SWITCHING, HALF WAVE CONTACT CIRCUIT

A normally closed contact circuit that provides zero voltage switching can also be designed around the 4N39 SCR optocoupler. The following circuit illustrates the method of modifying the normally open contact circuit by using the photoSCR to hold off the trigger SCR.

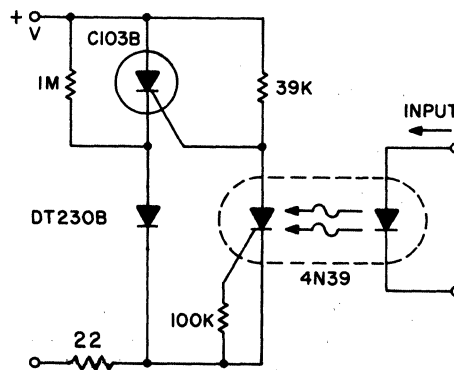

FIGURE 6.49: NORMALLY CLOSED, HALF WAVE ZVS CONTACT CIRCUIT

Integrated Solid State Relay Designs — A complete zero-voltage switch solid state relay contains an input circuit, an output circuit, and the power thyristor. The choice of specific circuits will depend on the designer's immediate needs. The circuit in Figure 6.50 can incorporate any of the previously described input and output circuits. It illustrates a triac power thyristor with snubber circuit and GE-MOV®II Varistor transient over-voltage protection. The 22Ω resistor shunts di/dt currents, passing through the bridge diode capacitances, from the triac gate, while the 100Ω resistor limits surge and gate currents to safe levels. Although the circuits illustrated are for 120Vrms operation, relays that operate on 220V require higher voltage ratings on the MOV, rectifier diodes, triac and pilot SCR. The voltage divider that senses zero crossing must also be selected to minimize power dissipation in the transistor optoisolator circuit for 220V operation.

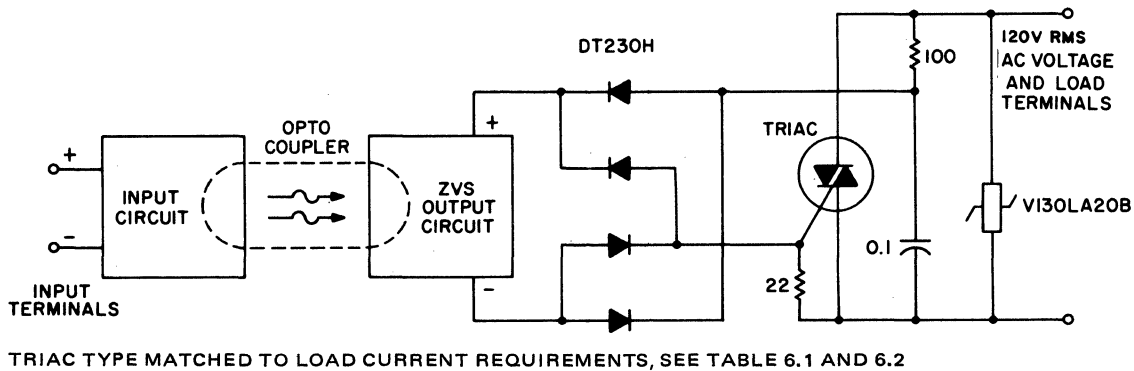

FIGURE 6.50: ZERO VOLTAGE SWITCHING SOLID STATE RELAY

Higher line voltage may be used if the diode, varistor, ZVS and power thyristor ratings are at compatible levels. For applications beyond triac current ratings, antiparallel SCR's may be triggered by the ZVS network, as illustrated below.

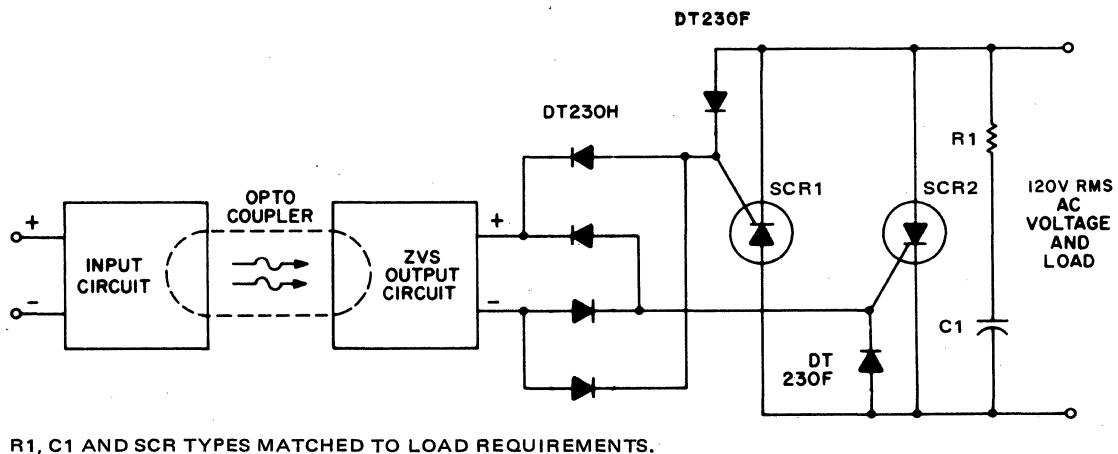

FIGURE 6.51: ZERO VOLTAGE SWITCHING, SOLID STATE RELAY WITH ANTIPARALLEL SCR OUTPUT

Other solid state ZVS circuits are available. Figure 6.52 is effective for lamp and heater loads. Some circuits driving reactive loads require integral cycle, zero voltage switching, i.e., an identical number of positive and negative half cycles of voltage are applied to the load during a power period. The circuit in Figure 6.53, although not strictly a relay due to the three terminal power connection, performs the integral cycle ZVS function when interfaced with the previous coil circuits.

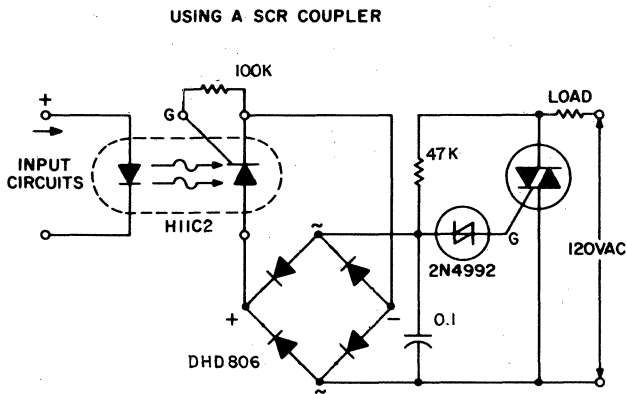

FIGURE 6.52: NORMALLY CLOSED CONTACT ZVS RELAY CIRCUIT

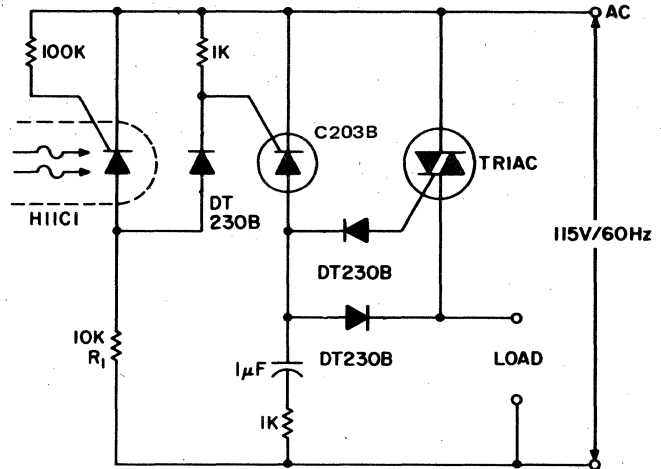

FIGURE 6.53: NORMALLY CLOSED INTEGRAL CYCLE, ZERO VOLTAGE SWITCHING, CONTACT CIRCUIT

Fiber optics offers advantages in power control systems. Electrical signals do not flow along the nonconducting fiber, minimizing shock hazard to both operator and equipment. EMI/RFI pick up on the fiber is nonexistent (although high gain receiver circuits may require shielding), eliminating noise pick up errors caused by sources along the cable route. Both ac and dc power systems can be controlled by fiber optics using techniques similar to the optoisolator solid-state relay. Triac triggering is accomplished through the C106BX301 (a low gate trigger current SCR) switching line voltage derived current to the triac gate via the full wave rectifier bridge.

The primary difference between fiber optics solid state relay circuits and opto isolator circuits is the gain since the photo currents are much smaller.

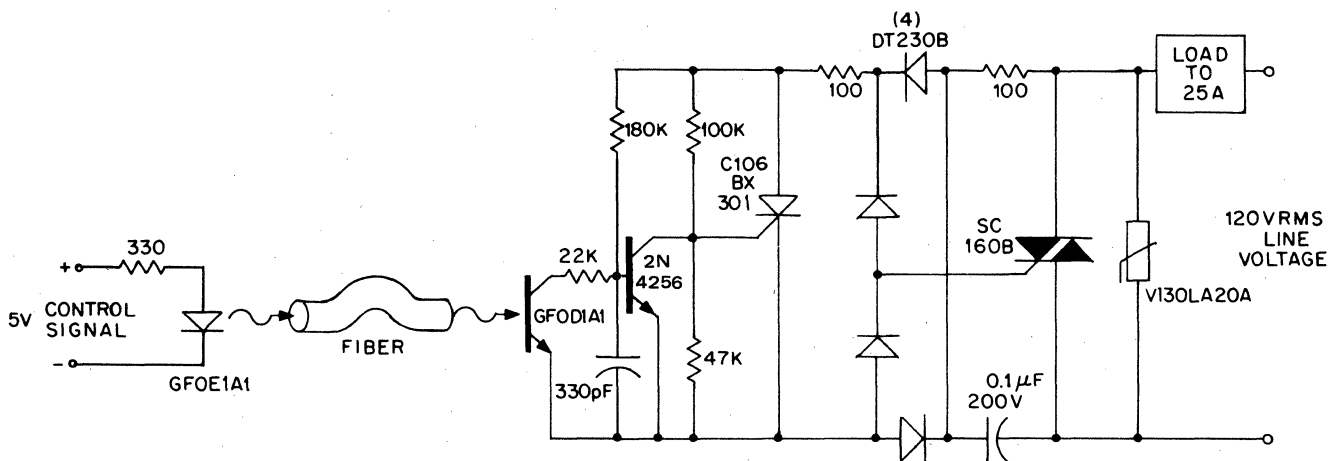

FIGURE 6.54: 25A FIBER OPTIC ZVS AC SOLID STATE RELAY

As an aid in determining the applicability of triacs to various jobs and in selection of the proper triac, a chart has been prepared giving the characteristics of common incandescent lamp and motor loads. These loads have high surge currents associated with them, which could complicate triac selection without this chart.

TABLE 6.1: TYPICAL INCANDESCENT IN-RUSH CURRENT RATINGS

WATTAGE	RATED VOLTS	TYPE	AMPS. STEADY STATE	HOT/COLD RESIST. RATIO	THEORETICAL PEAK IN-RUSH (170V pk) (Amps)	RATED (LUMENS /WATT)	HEATING TIME TO 90% LUMENS (Sec.)	LIFE RATED HOURS AVERG.	GENERAL ELECTRIC TRIAC SELECTION
25	120	Vacuum	0.21	13.5	4.05	10.6	.10	1000	SC141
60	120	Gas Filled	0.50	13.0	9.70	14.0	.10	1000	SC141/240
100	120	Gas Filled	0.83	14.3	17.3	17.5	.13	750	SC141/240
100(proj)	120	Gas Filled	0.87	15.5	19.4	19.5	.16	50	SC141/240
200	120	Gas Filled	1.67	16.0	40.5	18.4	.22	750	SC146/245
300	120	Gas Filled	2.50	15.8	55.0	19.2	.27	1000	SC146/245
500	120	Gas Filled	4.17	16.4	97.0	21.0	.38	1000	SC250/260
1000	120	Gas Filled	8.3	16.9	198.0	23.3	.67	1000	SC250/260
1000(proj)	120	Gas Filled	8.7	18.0	221.0	28.0	.85	50	SC250/260

For 240 volt lamps, wattage may be doubled.

TABLE 6.2: FULL-LOAD MOTOR-RUNNING AND LOCKED ROTOR CURRENTS IN AMPERES CORRESPONDING TO VARIOUS AC HORSEPOWER RATINGS

HORSE-POWER	110 - 120 VOLTS			220 - 240 VOLTS			MTR. LOCK-RTR. CURRENT AMPS.				G.E. TRIAC* SELECTION	
	Single-Phase	Two-Phase	Three-Phase	Single-Phase	Two-Phase	Three-Phase	Single-Phase 110-120 220-240		Two or Three Phase 110-120 220-240		120V	240V
1/10	3.0	—	—	1.5	—	—	18.0	9.0	—	—	SC141/240	SC141/240
1/8	3.8	—	—	1.9	—	—	22.8	11.4	—	—	SC146/245	SC141/240
1/6	4.4	—	—	2.2	—	—	26.4	13.2	—	—	SC146/245	SC141/240
1/4	5.8	—	—	2.9	—	—	31.8	17.4	—	—	SC250	SC141/240
1/3	7.2	—	—	3.6	—	—	43.2	21.6	—	—	SC260	SC146/245
1/2	9.8	4.0	4.0	4.9	2.0	2.0	58.8	29.4	24	12	SC265	SC260

*Assumes over-current protection has been built in to limit the duration of an locked-rotor condition.

Source: Information for these charts was taken from National Electric Code, 1971 Edition.

INCANDESCENT LAMP AND ELECTRIC MOTOR TRIAC SELECTION CHART

Other AC Relay Designs — The “contact” circuitry can be simplified when zero voltage switching is not required. Several methods of providing this function are illustrated in Figures 6.55 and 6.56. Note that an SCR coupler in a bridge, using a high value of gate resistance connected directly across the ac line, can give commutating dv/dt and dv/dt triggering problems, which are not present in the ZVS circuits or at low voltages, and that not all these circuits are TTL drive compatible at the input.

The lowest parts count version of a solid state relay is an optoisolator, the triac driver H11J. Unfortunately, the ability of the H11J to drive a load on a 60Hz line is severely limited by its power dissipation and the dynamic characteristics of the detector. These limit applications to 30-50mA resistive loads on 120Vac, and slightly higher values at lower voltages.

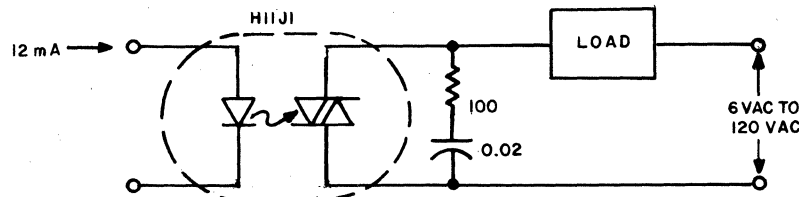

FIGURE 6.55: SIMPLE “SOLID STATE AC RELAY”

This is compatible with neon lamp drive, pilot and indicator incandescent bulbs, low voltage control circuits, such as furnace and bell circuits (if dv/dt sufficient) — but less benign loads require a discrete triac.

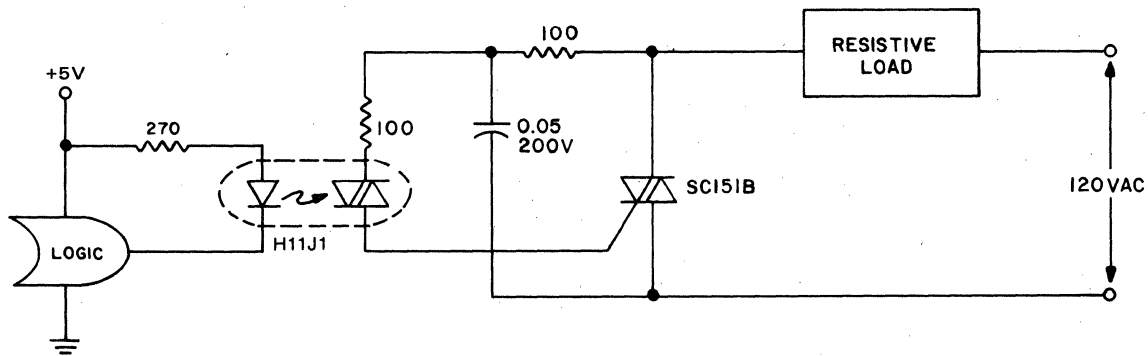

FIGURE 6.56: MINIMUM PARTS COUNT ISOLATED LOGIC TRIGGERED TRIAC

The H11J1 triac trigger optocoupler potentially allows a simple power switching circuit utilizing only the triac, a resistor and the optocoupler. This configuration will be sensitive to high values of dv/dt and noise on normal power line voltages, leading to the need for the configuration shown in Figure 6.56, where the triac snubber acts as a filter for line voltage to the optocoupler. As the snubber is not usually used for resistive loads, the cost effectiveness of the circuit is compromised somewhat. Even with this disadvantage, the labor, board space, and inventory of parts savings of this circuit often prove it cost optimized for isolated logic control of power line switching. In applications where transient voltages on the power line are prevalent, provisions should be made to protect the H11J1 from break-over triggering.

If load current requirements are relatively low (i.e., maximum forward RMS current $\leq 500\text{mA}$), an ac solid state relay can be constructed quite simply by the connection of two H11C optically coupled SCR's in a back-to-back configuration as illustrated in Figure 6.57.

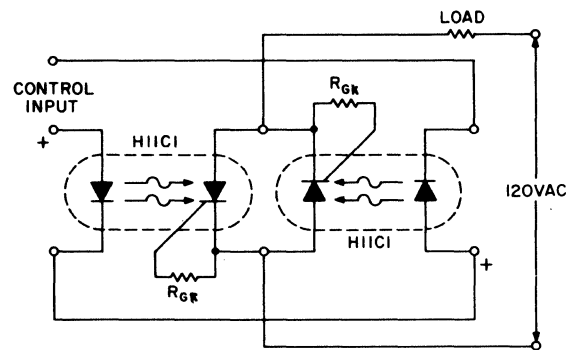

FIGURE 6.57: USING TWO PHOTON COUPLERS TO PROVIDE A SIMPLE AC RELAY

Where analog signals are being used as the logic control, hysteresis, via a Schmitt trigger input (illustrated in Figure 6.45) can be used to prevent "chatter" or half wave power output. Circuit operation is straightforward, and will not be described. This basic circuit can be easily modified to provide the latching relay function as illustrated below. Latching is obtained by the storage of gate trigger energy from the preceding half cycle in the capacitors. Power must be interrupted for more than one full cycle of the line to insure turn-off. Resistors R and capacitors C are chosen to minimize dissipation while assuring triggering of the respective SCR's each cycle.

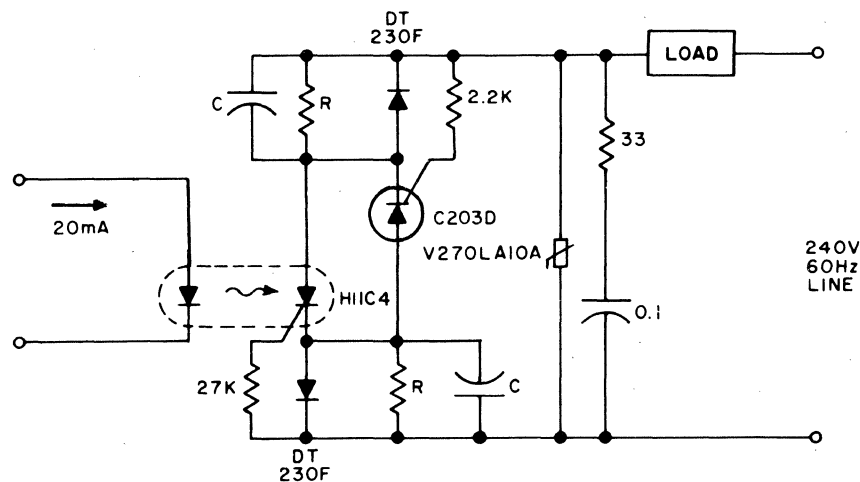

FIGURE 6.58: LATCHING AC SOLID STATE RELAY

A pulse of current, over 10msec duration, into the H11C4 IRED, assures triggering the latching relay into conduction.

In microprocessor control of multiple loads, the minimum cost per load is critical. A typical application example is a large display involving driving arrays of incandescent lamps. This circuit provides minimal component cost per stage and optocoupler triggering of triac power switches from logic outputs. The minimal component cost is attained by using more complex software in the logic. A darlington output optocoupler provides gate current pulses to the triac, with cost advantages gained from eliminating the current limiting resistor and from the low cost coupler. The trigger current source is a dipped tantalum capacitor, charged from the line via a series resistor with coarse voltage regulation being provided by the darlington signal transistor. The resistor and capacitor are shared by all the darlington-triac pairs and are small in size and cost due to the low duty cycle of pulsing. Coupler IRED current pulses are supplied for the duration of one logic clock pulse (2-10 μ sec), at 0.4 to 1msec intervals, from a LED driver I.C.

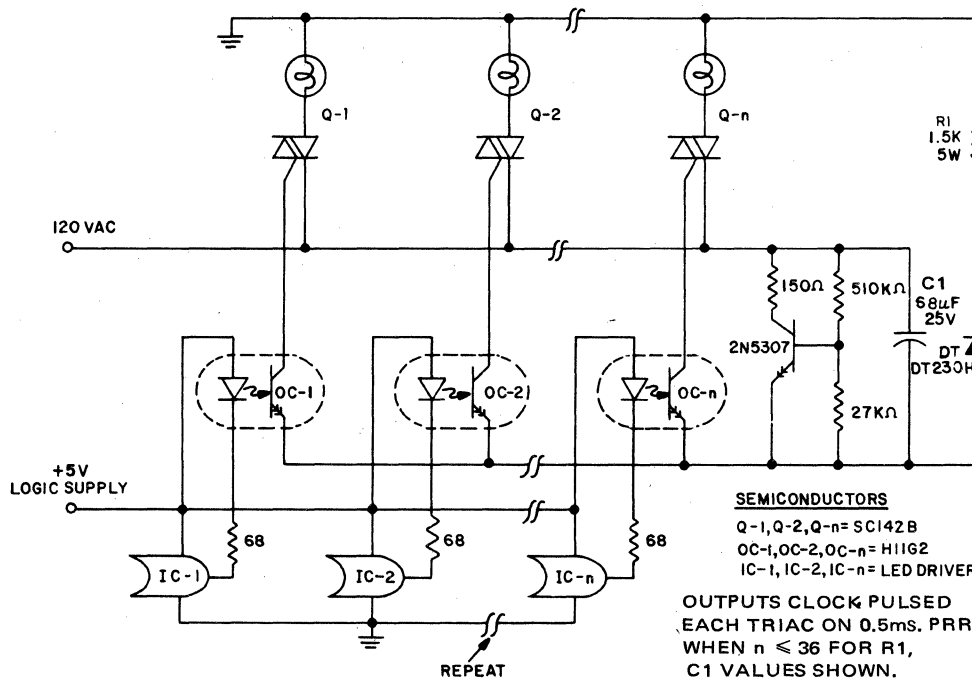
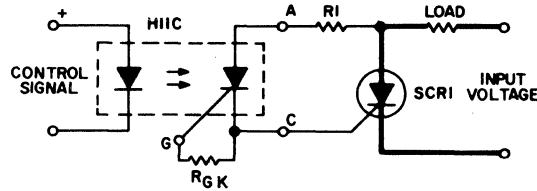

FIGURE 6.59: MICROPROCESSOR TRIAC ARRAY DRIVER

The pulse timing is derived from the clock waveform when the logic system requires triac conduction. A current limiting resistor is not used, which prevents Miller effect slowdown of the H11G2 switching speed to the extent the triac is supplied insufficient current to trigger. Optodarlington power dissipation is controlled by the low duty cycle and the capacitor supply characteristics.

High Voltage AC Switching — A basic circuit to trigger an SCR is shown in Figure 6.60. This circuit has the disadvantage that blocking voltage of the photon coupler output device determines the circuit blocking voltage, irrespective of higher main SCR capability.



Adding a capacitor (C_1) to the circuit, as shown in Figure 6.61 will reduce the dv/dt seen by the photon coupler output device. The energy stored in C_1 , when discharged into the gate of SCR_1 , will improve the di/dt capability of the main SCR.

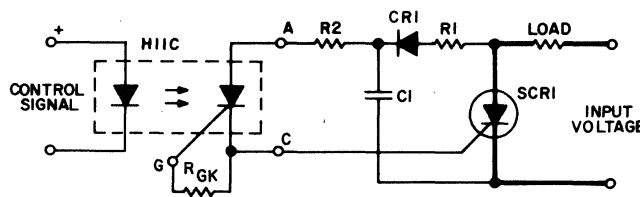
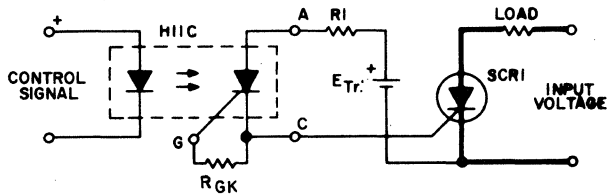
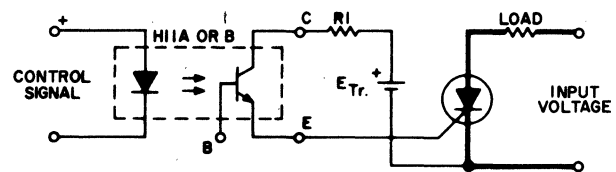

FIGURE 6.61: DERIVING THE ENERGY TO TRIGGER AN SCR FROM ITS ANODE SUPPLY WITH AN ENERGY STORING FEATURE

Using a separate power supply for the coupler gives added flexibility to the trigger circuit; it removes the limitation of the blocking voltage capability of the photon coupler output device. The flexibility adds cost. Also, more than one power supply may be necessary for multiple SCR's if no common reference points are available.



Photon Coupler With SCR – Output



Photon Coupler With Transistor Output

FIGURE 6.62: PHOTON COUPLER TRIGGERING MAIN SCR₁ USING SEPARATE POWER SUPPLY

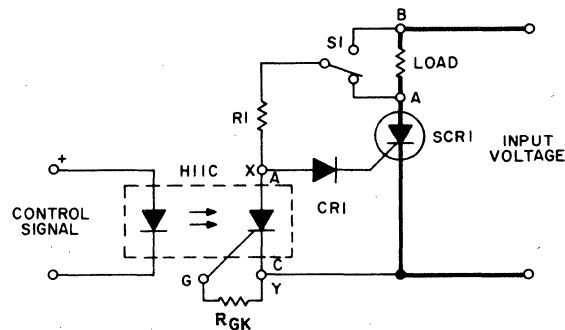

Photon Coupler With SCR – Output

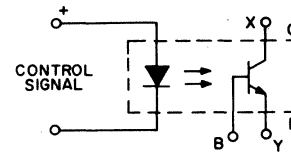

Photon Coupler With Transistor Output
(connect in place of SCR coupler)

FIGURE 6.63: NORMALLY CLOSED CONFIGURATIONS

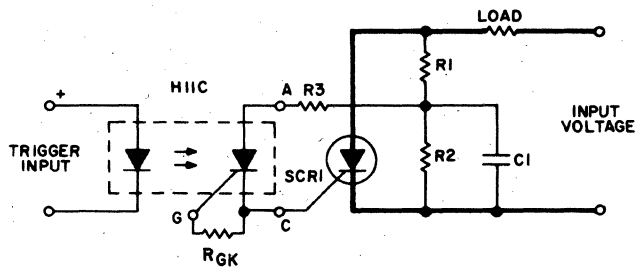

FIGURE 6.64: TRIGGERING SCR WITH PHOTON COUPLER AND SUPPLY VOLTAGE DIVIDER

In Figure 6.63, R_1 can be connected to Point A, which will remove the voltage from the coupler after SCR₁ is triggered, or to Point B so that the coupler output will always be biased by input voltage. The former is preferred since it decreases the power dissipation in R_1 . A more practical form of SCR triggering is shown in Figure 6.65. Trigger energy is obtained from the anode supply and stored in C_1 . Coupler voltage is limited by the zener voltage. This approach permits switching of higher voltages than the blocking voltage capability of the output device of the photon coupler. To reduce the power losses in R_1 and to obtain shorter time constants for charging C_1 , the zener diode is used instead of a resistor.

A guide for selecting the component values would consist of the following steps:

- 1) Choose C_1 in a range of 0.05 to 1 microfarad. The maximum value may be limited by the recharging time constant $(R_L + R_1) C_1$ while the minimum value will be set by the minimum pulse width required to ensure SCR latching.
- 2) R_2 is determined from peak gate current limits (if applicable) and minimum pulse width requirements.

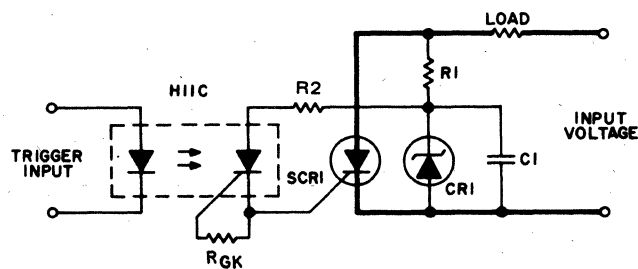

FIGURE 6.65: TRIGGERING SCR WITH PHOTON COUPLER WITH LOW VOLTAGE REFERENCE

- 3) Select a zener diode. A 25 volt zener is a practical value since this will meet the usual gate requirement of 20 volts and 20 ohms. This will also eliminate spurious triggering due to voltage transients.
- 4) Photon coupler triggering is ideal for SCR's driving inductive loads. By ensuring that the LASCR latches on, it can supply gate current to SCR₁ until it stays on. The following table lists values for R₁ and R₂ along with their power dissipation when the SCR is off for different values of I_{GT} and applied ac voltage.
- 5) Component values for dc voltage are easily computed from the following formulae:

$$R_1 = \frac{E_{IN} - V_Z}{I_G}$$

Where: V_Z = zener voltage

$$P_{(R_1)} = I_G \cdot (E_{IN} - V_Z)$$

$$P_{(zener)} = I_G \cdot V_Z$$

E _{IN} (RMS)	I _{GT}	R ₁	P _(R1)	R ₂	P _(R2)	P _(zener)
380	50	3500	17.4	560	.5	1.1
	100	2000	34.8	330	1.0	2.2
	150	1200	52.2	220	1.5	3.4
	200	1000	69.6	150	2.0	4.5
	300	600	105.0	100	3.0	6.7
440	50	4250	20.5	560	.5	1.1
	100	2100	41.0	330	1.0	2.2
	150	1500	62.0	220	1.5	3.4
	200	1000	82.0	150	2.1	4.5
	300	750	125.0	100	3.1	6.7
600	50	5800	29.0	560	1.1	1.1
	100	3000	58.0	270	1.6	2.2
	150	2000	86.0	200	2.1	3.4
	200	1500	115.0	150	2.7	4.5
	300	1000	175.0	100	3.2	6.7

**TABLE 6.3: COMPONENT VALUES AND POWER DISSIPATION
ASSUMING 25V ZENER DIODE, 50/60 Hz AC LINE VOLTAGES**

The following circuit utilizes the principle for triggering SCR's connected in series. A snubber circuit R2C2 as shown may be necessary since R1 and C1 are tailored to obtain optimized triggering and not for dv/dt protection. The GFOD/E pairs with fiber optics can be used with discrete SCRs to switch thousands of volts.

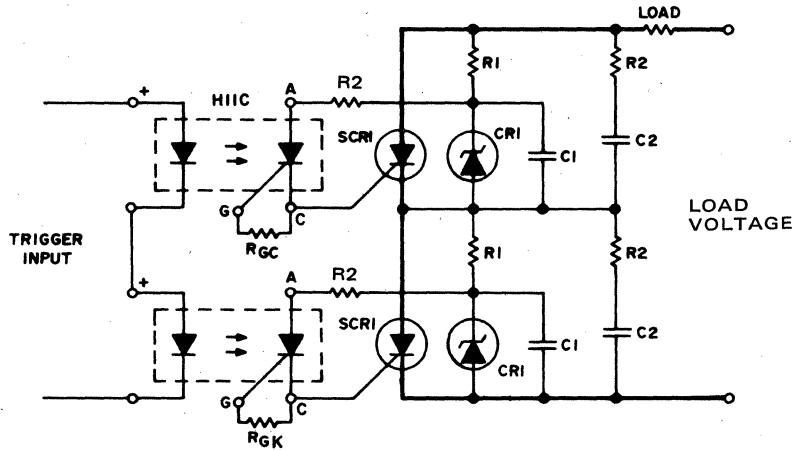

FIGURE 6.66: HIGH VOLTAGE SWITCH

A photon coupler with a transistor output will limit the trigger pulse amplitude and rise time due to CTR and saturation effects. Using the H11C1, the rise time of the input pulse to the photon coupler is not critical, and its amplitude is limited only by the H11C1 turn-on sensitivity.

All the applications shown so far have the load connected to the anode, but the load can be connected to the cathode, illustrated in Figure 6.67:

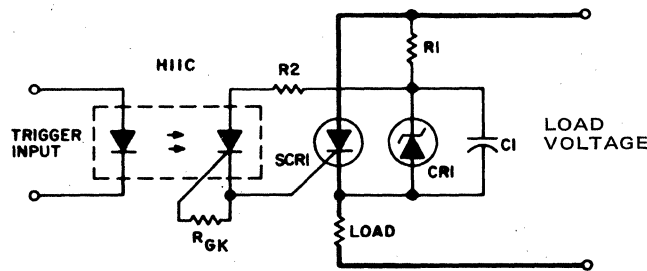

FIGURE 6.67: CONNECTION OF LOAD TO CATHODE OF MAIN SCR

Three Phase Circuits — Everything mentioned about single phase relays or single phase switching or triggering with photon couplers applies also to three phase systems.

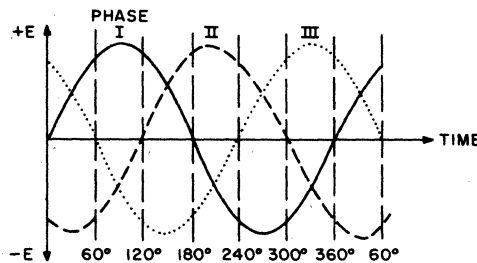

FIGURE 6.68: VOLTAGE WAVEFORM IN THREE PHASE SYSTEMS

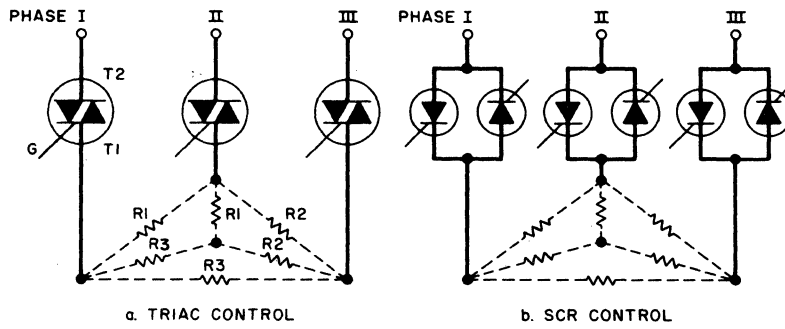

FIGURE 6.69: Y OR Δ CONNECTED RESISTIVE OR INDUCTIVE LOAD

Figures 6.68 and 6.69 illustrate voltage waveforms in a three phase system which would appear on the triac MT-2 terminal before triggering and at the MT-1 terminal after triggering. The use of the H11C to isolate the trigger circuitry from the power semiconductor will simplify the trigger circuitry significantly. In some cases the GE3020 series triac driver will allow further circuit simplification, if dynamic and transient effects are compatible.

Following are three phase switches for low voltage. Higher currents can be obtained by using inverse parallel SCR's which would be triggered as shown. For higher voltages and higher currents, the circuits of the previous page can be useful in three phase circuits.

To simplify the following schematics and facilitate easy understanding of the principles involved, the following schematic substitution is used (Note the triac driver is of limited use at 3φ voltage levels):

IN THE TWO CIRCUITS FOLLOWING:

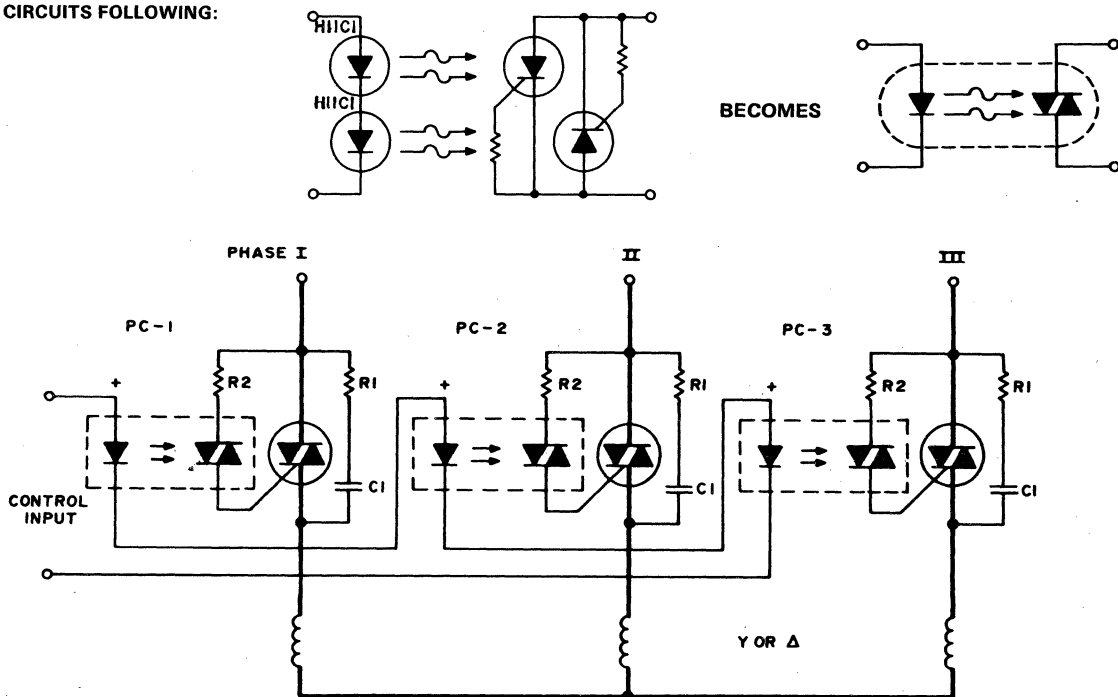

FIGURE 6.70: THREE PHASE SWITCH FOR INDUCTIVE LOAD

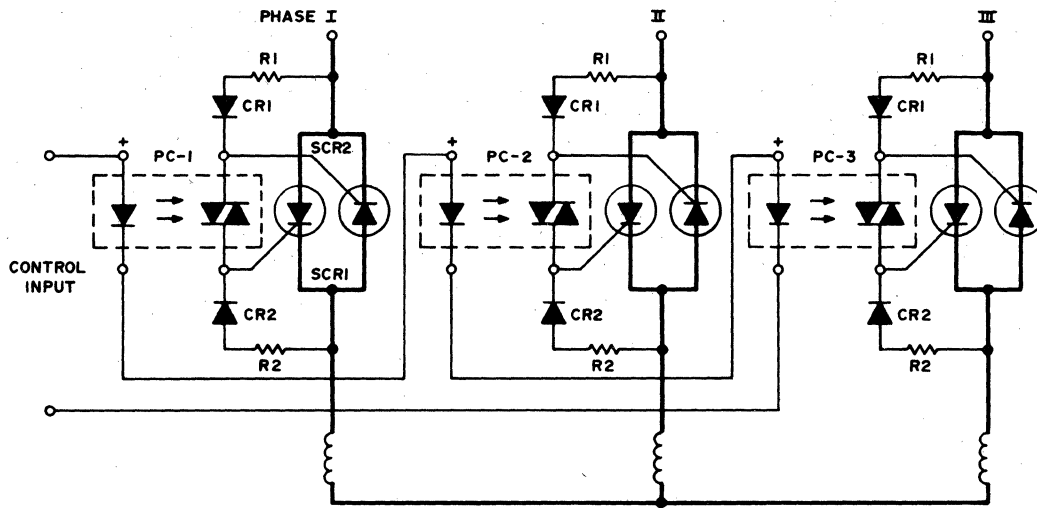

FIGURE 6.71: THREE PHASE SWITCH WITH INVERSE PARALLEL SCR'S FOR INDUCTIVE LOAD AND Y OR Δ CONNECTIONS

Many other ac power control circuits are practical and cost effective. The intent of this section was to stimulate the circuit designer by presenting a variety of circuits featuring opto control.

6.5.2 DC Solid State Relay Circuits

The dc relay built around an optocoupler is neither a relay nor strictly dc. This section will describe relay function circuits that did not fit the ac solid state relay 60Hz power line switching function, as well as strictly dc switching.

DC Latching Relay — The H11C readily supplies the dc latching relay function and reverse polarity blocking, for currents up to 300mA (depending on ambient temperature). For dc use, the gate cathode resistor may be supplemented by a capacitor to minimize transient and dv/dt sensitivity. For pulsating dc operation, the capacitor value must be designated to either retrigger the SCR at the application of the next pulse or prevent retriggering at the next power pulse. If not, random or undesired

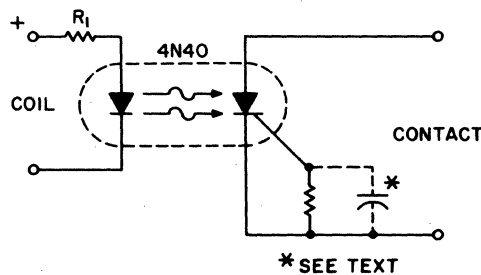
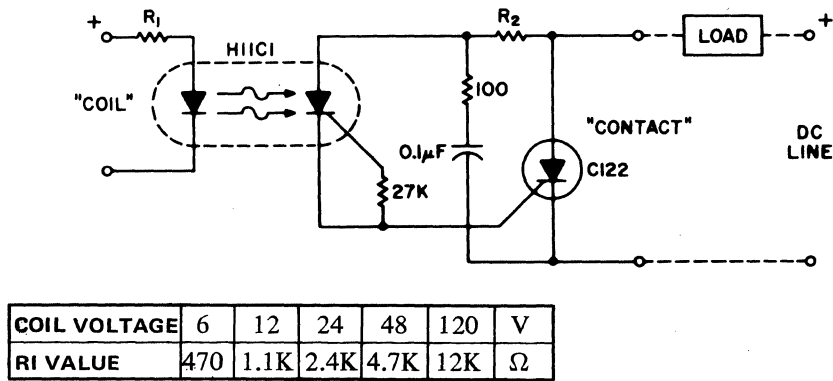

FIGURE 6.72: DC LATCHING RELAY CIRCUIT

operation may occur. For higher current contacts, the H11C may be used to trigger an SCR capable of handling the current, as illustrated in Figure 6.73:



COIL VOLTAGE	6	12	24	48	120	V
R1 VALUE	470	1.1K	2.4K	4.7K	12K	Ω

LINE VOLTAGE	12	24	48	120	V
C122 PART	U	F	A	B	D
R2 VALUE	200	470	1K	2.2K	Ω

NO HEAT SINK RATINGS AT $T_A \leq 50^\circ$

I CONTACT, MAX.	PULSE WIDTH	DUTY CYCLE
0.67 A	D.C.	100%
4.0 A	160 msec.	12%
8.0 A	160 msec.	3%
12 A	160 msec.	1%
15 A	160 msec.	0.3%

FOR HEAT SINK RATINGS
SEE C122 SPECIFICATION
SHEET NUMBER 150.35 AND
APPLICATION NOTE NUMBER
200.55

FIGURE 6.73: HIGH CURRENT DC LATCHING RELAY

Heat sinking on this, and all high current designs, must be designed for the load current and temperature environment.

The phototransistor and photodarlington couplers act as dc relays in saturated switching, at currents up to 5mA and 50mA, respectively. This is illustrated by the H11A5 application as a high speed synchronous relay in the long range object detector shown in Figure 6.11. When higher currents or higher voltage capabilities are required, additional devices are required to buffer or amplify the photocoupler output. The addition of hysteresis to provide fast switching and stable pick up and drop out points can also be easily implemented simultaneously. Illustrated below are normally open and

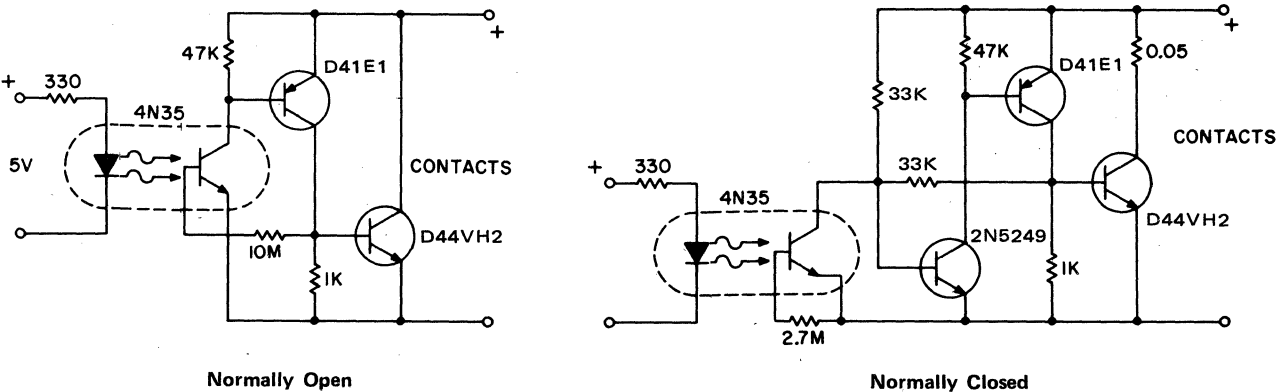

FIGURE 6.74: 10A, 25V DC SOLID STATE RELAYS

normally closed dc solid state relays. These circuits provide several approaches to implement the dc relay function and are intended to stimulate the creativity of other circuit designers, and serve as practical, cost effective examples.

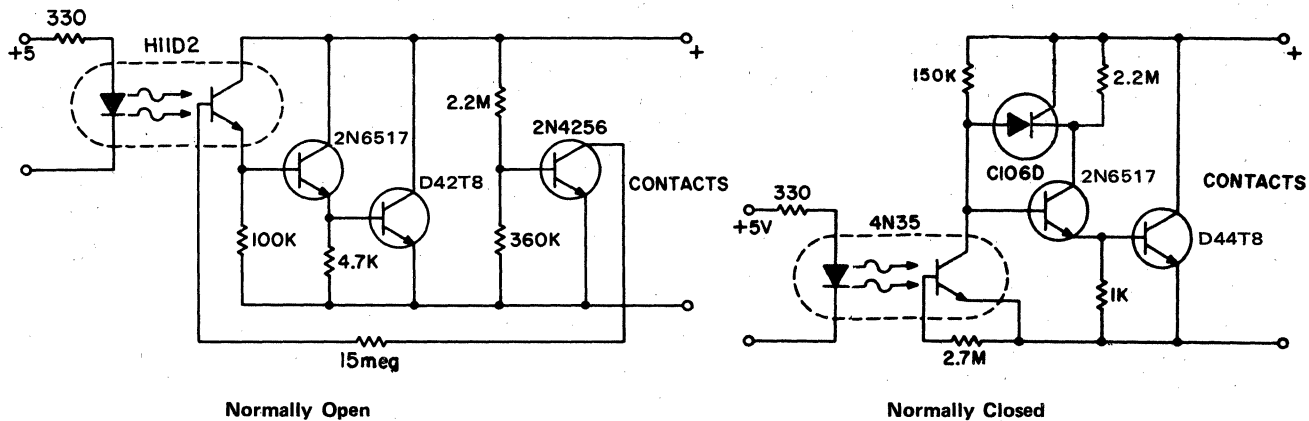

FIGURE 6.75: 0.25A, 300V DC SOLID STATE RELAY

6.5.3 Other Power Control Circuits

Many forms of power control circuitry using optoelectronics do not fit the definition of a relay, although optoelectronics is beneficial to their operation.

Electric Vehicle Battery Saver — The battery life, and therefore operating cost, of an electric vehicle is severely affected by overdischarge of the battery. This circuit provides both warning and shutdown. An electronic switch is placed in series with the propulsion motor contactor coil. Three modes of operation are possible:

- 1) When the propulsion power pack voltage is above the 63V trip point the electronic switch has no effect on operation;
- 2) When the propulsion power pack no load voltage is below 63V, power will not be supplied to the propulsion motor since the electronic switch will prevent contactor operation;
- 3) When the propulsion power pack loaded voltage drops below 63V the contactor will close and open due to the electronic switch. This “bucking” operation indicates to the operator need to charge the batteries.

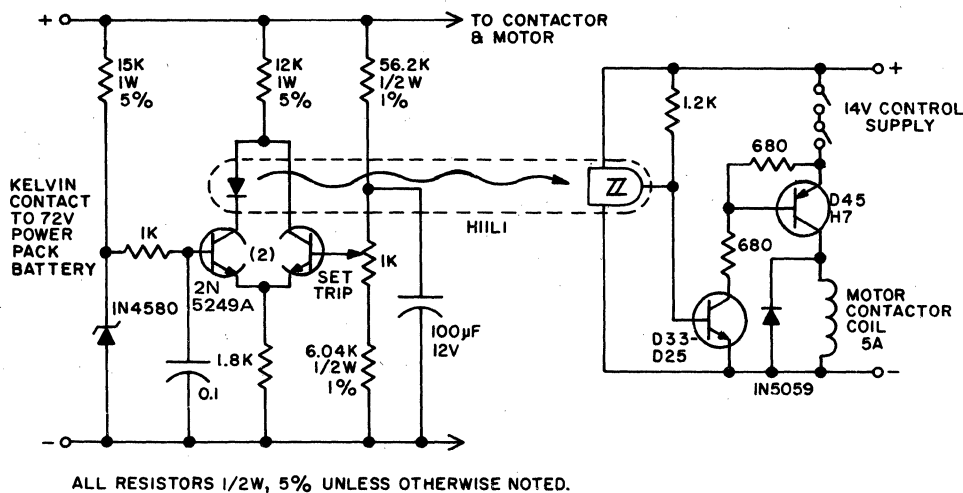

FIGURE 6.76: ELECTRIC VEHICLE BATTERY SAVER

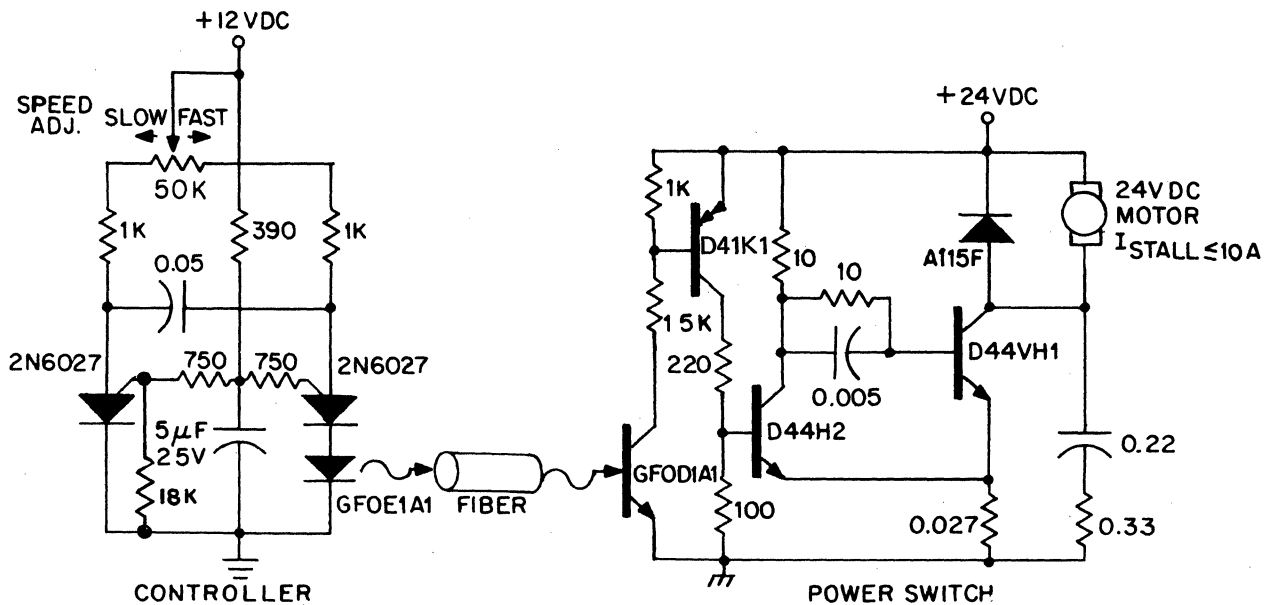

FIGURE 6.77: DC VARIABLE SPEED MOTOR CONTROL

DC power can also be controlled via fiber optics. The circuit of Figure 6.77 illustrates this: providing an insulated speed control path for a small dc actuator motor ($\leq 1/12$ hp). Control logic is a self-contained module requiring about 300mW at 12V, which can be battery powered. The control module furnishes infrared pulses, at a rate of 160Hz, with a duty cycle determined by the position of the speed adjust potentiometer. The programmable unijunction multivibrator provides approximately 10mA pulses to the GFOE1A1 at duty cycles adjustable over a range of 1% to 99%. The infrared pulses are detected by the GFOE1A1, amplified by the D39C1 PNP darlington, and supplied to the power drive switch, which is connected in a Schmitt trigger configuration to supply the motor voltage pulses during the infrared pulses. Thus, the motor's average supply voltage is pulse width modulated to the desired speed, while its current is maintained between pulses by the A115F free-wheeling diode. The snubber network connected in parallel with the power switch minimizes peak power dissipation in the output transistor, and enhancing reliability. Note that larger hp motors can be driven by adding another stage of current gain, while longer fiber range lengths can be obtained with an amplifier transistor driving the GFOE1A1.

20 kHz Arc Welding Inverter (Full Power Modulation and No-Load Shutdown) — The Class A series resonant inverter portrayed in Figure 6.78 is well-known and respected for its high efficiency, low cost, and small size, provided that operating frequency is greater than about 3kHz. The disadvantages are (at least in high power versions) the difficulty in effecting smooth RFI-less output voltage modulation without significant added complexity, and a natural tendency to “run away” under no-load (high Q) conditions. The 20kHz control circuit depicted in Figure 6.79 overcomes these shortcomings by feeding back into the asymmetrical thyristor trigger pulse generators (Figure 6.80) signals that simultaneously shut the inverter down, when its output voltage exceeds a preset threshold, and time-ratio modulates the output. This feedback is accomplished with full galvanic isolation between input and output thanks to an H11L opto Schmitt coupler. The fundamental 20kHz gate firing pulses are generated by a PUT relaxation oscillator Q_1 . The pulses are then amplified by transistors Q_2 and Q_3 . The 20 kHz sinusoidal load current flowing in the primary of the output transformer is then detected by a current transformer CT1, with operational amplifier A1 converting the sine wave into a square wave whose transitions coincide with the load current zero points. Consequently, each time the output current changes, phase A1 also changes state and, via transistor Q_4 , either connects the thyristor gate to a minus 8Vdc supply (for minimum “gate assisted” turn-off time and highest reapplied dV/dt capability) or

disables this supply to prepare the thyristor for subsequent firing.

Because firing always occurs at a fixed time interval (determined by the PUT time constant $R1 \times C1$) after each load current zero point, the circuit operating frequency always coincides with the natural resonant frequency, the fixed time interval being chosen to equal thyristor turn-off time, t_q . Note that reliable PUT oscillation is guaranteed by turning it off solidly via Q_5 each time Q_4 reapplies negative bias to the thyristor gate. The H11L opto Schmitt is connected in parallel with Q_5 . If the load is removed (termination of a weld), causing the inverter output voltage to rise precipitously, the V56MA varistor will conduct to energize the H11L input diode, and the H11L output stage will likewise clamp off the PUT. Oscillation then ceases until the output voltage falls once again below the off threshold voltage of the H11L.

Modulation intelligence is coupled into this same H11L through two additional PUT's, Q_6 and Q_7 . Q_6 oscillates at a fixed 1.25kHz, which establishes the modulation frequency. Duty cycle is determined by a second oscillator, Q_7 , whose conduction state (on or off) establishes or removes current from the H11L diode. With a 20kHz fundamental inverter frequency and a modulation frequency of 1.25kHz, the resultant time ratio controlled power output is given by

$$P_{OUT} = \left(P_M \times \frac{t}{\tau} \right)$$

where $P_M = 100\%$ continuous output power. Minimum power is one cycle of 20kHz ($50\mu s$) in the 1.25kHz modulation frame ($800\mu s$), that is, 6.25% P_M .

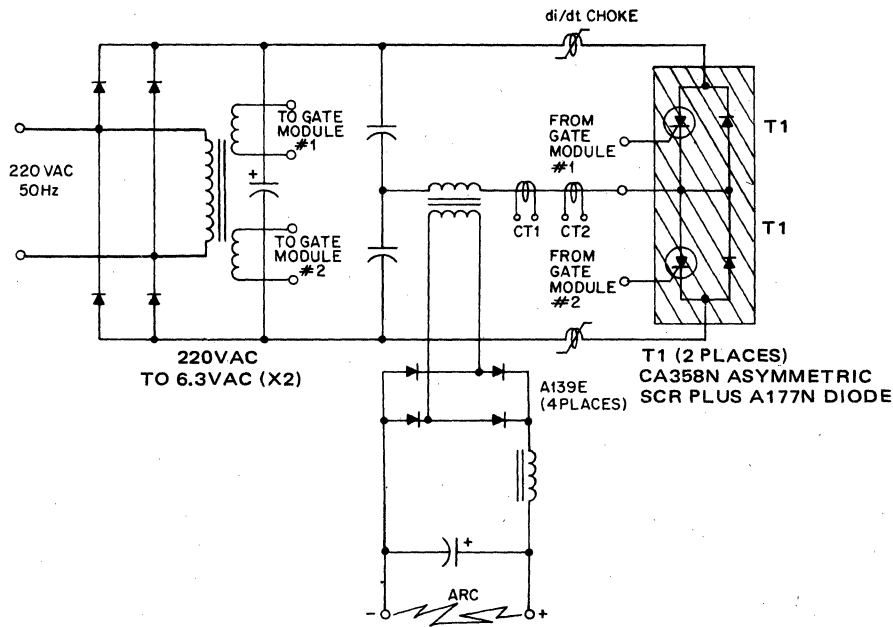

FIGURE 6.78: CLASS "A" - 3KW WELDING INVERTER

FIGURE 6.79: POWER MODULATOR (WITH ON-OFF SWITCH & OPEN CIRCUIT PROTECTION)

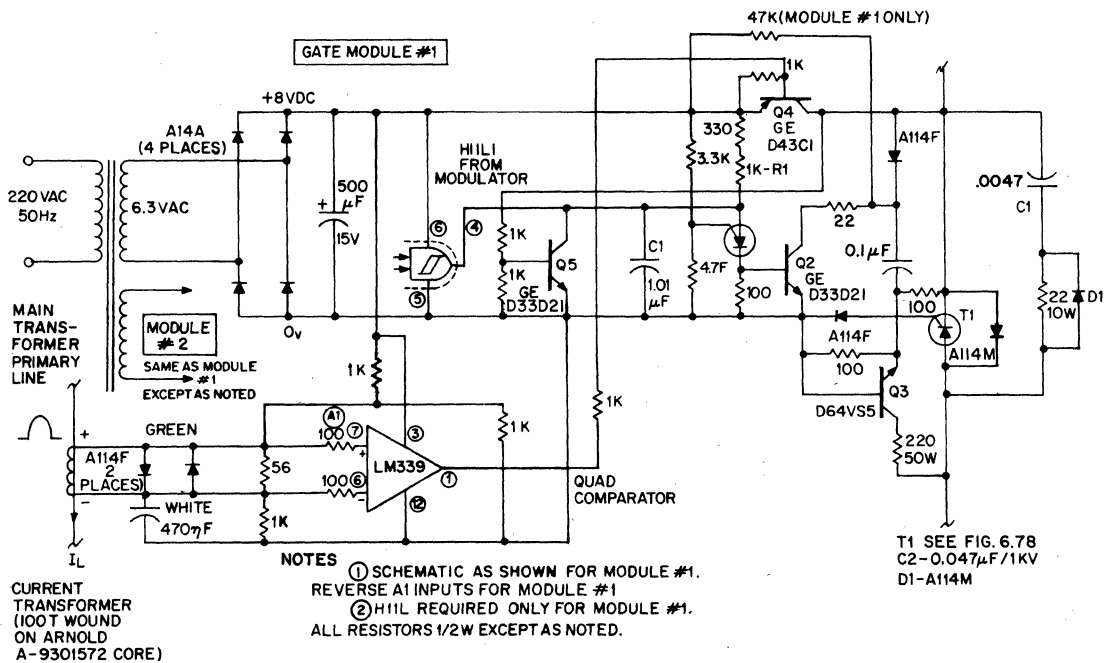
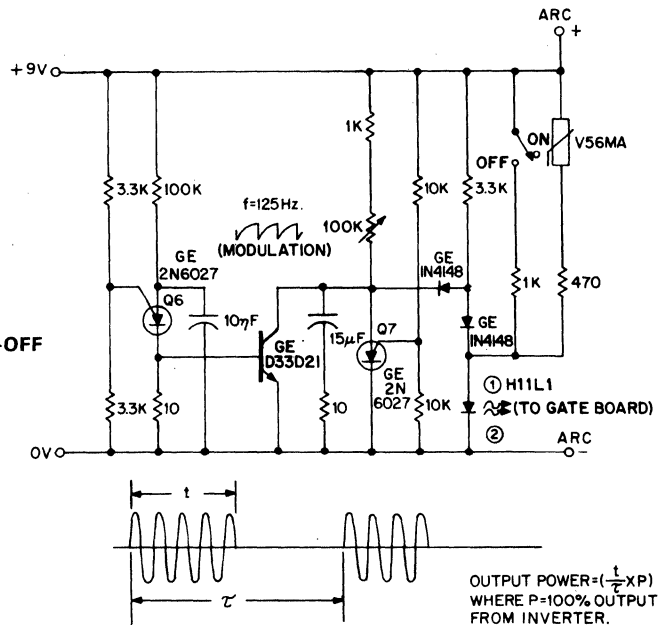

FIGURE 6.80: 20KHz INVERTER GATE DRIVE MODULE

Glow Plug Driver — Model airplanes, boats, and cars use glow plug ignitions for their miniature (0.8cc - 15cc) internal combustion engines. Such engines dispense with the heavy on-board batteries, H.T. coil, and "condenser" required for conventional spark ignition, while simultaneously developing much higher RPM (hence power) than the compression ignition (diesel) motors. The heart of a glow plug is a platinum alloy coil heated to incandescence for engine starting by an external battery, either 1.5 Volts or 2 Volts. Supplementing this battery, a second 12 Volt power supply is frequently required for the engine starter, together with a third 6 Volt type for the electrical fuel pump.

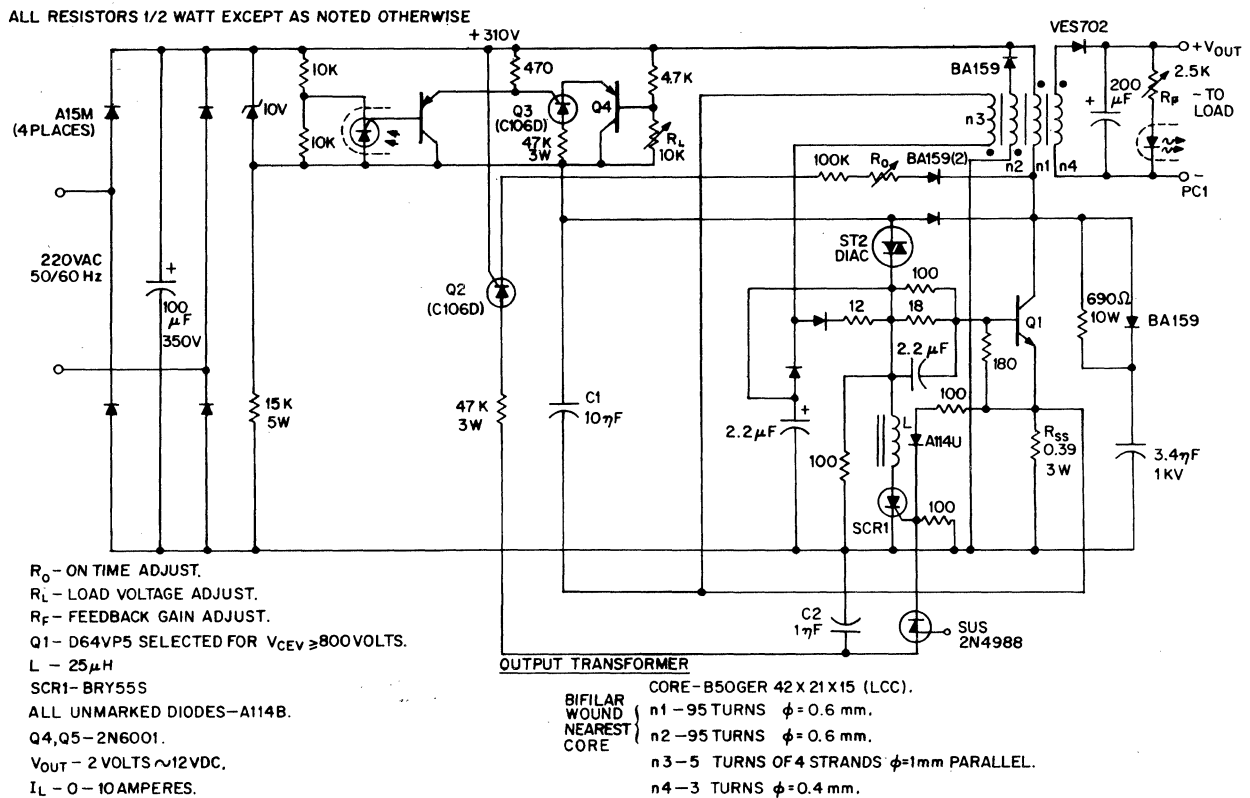

FIGURE 6.82: 12V SWITCHING POWER SUPPLY

unilateral PNP transistor in a stable differential amplifier configuration is connected into the galvanically isolated negative feedback loop that determines duty cycle, hence output voltage. Of further interest, in this circuit, is the use of several low current, high voltage (400 Volt V_{DRM}) thyristors (Q_2 , Q_3) also used as PNP remote base transistors. Short-circuit protection is assured by coupling Q_1 collector current feedback into the turn-off circuitry via R_{SS} .

Low Power ($P_{OUT} \geq 50$ Watts from 220 Volts AC Input) Zero Voltage Switch Temperature Controller—The “zero voltage switching” technique is widely used to modulate heating and similar types of ac loads where the time constant associated with the load (tens of seconds to minutes) is sufficiently long to allow smooth proportional modulation by time ratio control, using one complete cycle of the ac input voltage as the minimum switching movement. This method of control, illustrated in Figure 6.83, reduces Radio Frequency Interference (inherent in competing phase-control systems) significantly. Despite its attractions, the traditional triac-based ZVS is virtually unusable for the control of very low power loads, especially from 220 Volt ac inputs due to the triac’s reluctance to latch-on into the near-zero instantaneous currents that flow through it and the load near the ac voltage zero crossover points. The circuit of Figure 6.84 side steps the latching problem by employing a pair of very sensitive low current reverse blocking thyristors (C106) connected in antiparallel; these are triggered by a simple thermistor modulated differential amplifier (Q_1 , Q_2), with zero voltage logic furnished by an H11AA1 ac input optocoupler. With the NTC thermistor TH calling for heat, transistor Q_1 is cut off and Q_2 is on, which would normally provide continuous base drive to Q_3 , with consequent triggering of either SCR, or of SCR 2 via SCR 1, depending on phasing of the ac input.

Note that when the ac input voltage is positive with respect to SCR 2, SCR 1 is reverse biased and, in the presence of “gate” current from Q_3 , behaves as a remote base transistor, whose output provides via blocking diode CR1, positive gate trigger current for SCR 2. When the ac input polarity is reversed (SCR 1’s anode positive), SCR 1 behaves as a direct fired conventional thyristor. “Trigger” current to SCR1, however, is not continuous, even when TH is calling for heat and Q_2 is delivering base current to Q_3 . In this situation, Q_3 is inhibited from conduction by the clamping action of PC1, an H11AA

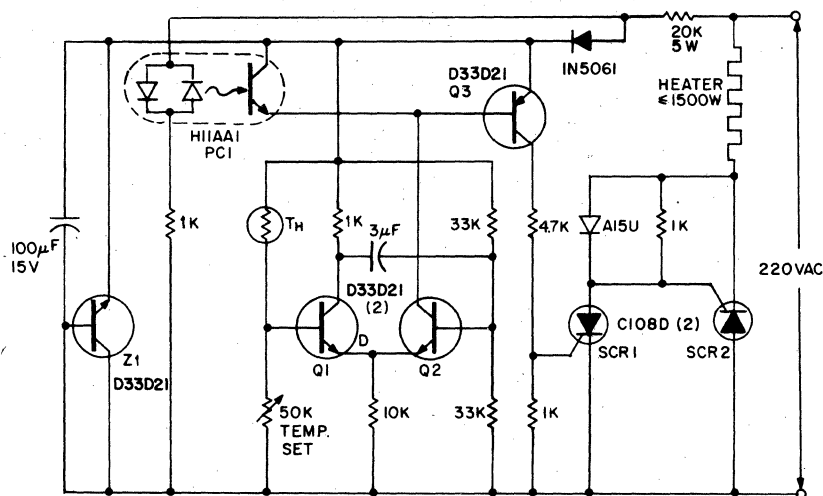

FIGURE 6.83: LOW POWER (>50W) ZVS PROPORTIONAL TEMPERATURE CONTROLLER

photocoupler, except during those brief instants when the ac input voltage is near zero and the coupler input diodes are deprived of current.

Through these means, triggering of either SCR can occur only at ac voltage crossing points, and RFI-less operation results. The proportional control feature is injected via the positive feedback action of capacitor C_M , which converts the differential amplifier Q_1, Q_2 into a simple multivibrator, whose duty cycle varies from one to 99 percent according to the resistance of TH . Zener diode $Z1$ is optional, being preferred when maximum immunity from ac voltage induced temperature drift is desired.

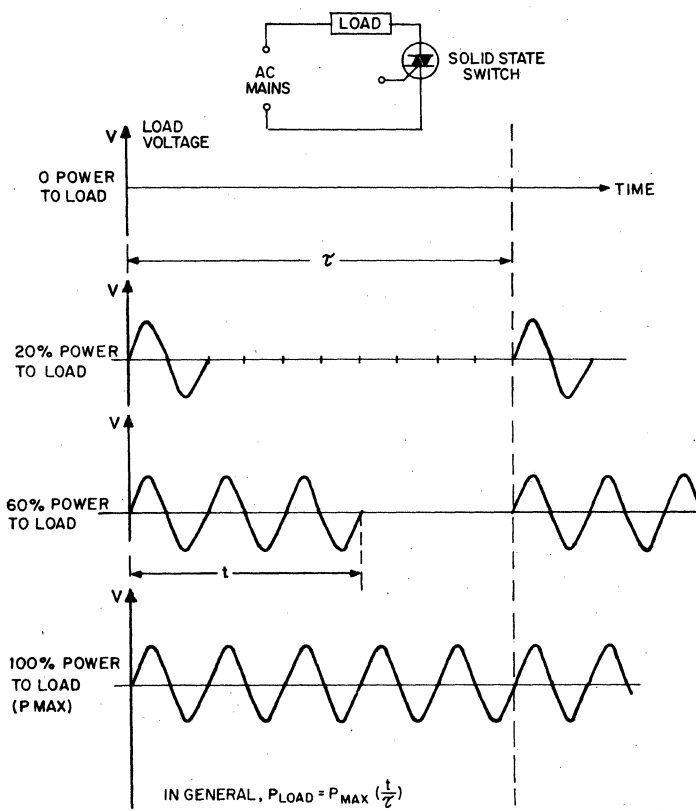

FIGURE 6.84: PRINCIPLE OF ZERO VOLTAGE SWITCHING

GLOSSARY OF SYMBOLS AND TERMS

Optoelectronics spans the disciplines of electronics, photometry, radiometry and optics with dashes of physics and statistical analysis. The same word or symbol can have two different meanings, depending on the discipline involved. To simplify use of this glossary, words and symbols are separately listed, alphabetically; following each is the common discipline of usage and then the definition, as used in this Handbook.

7.1 OPTOELECTRONIC SYMBOLS

A	— electronic	— gain of an amplifier.
A	— optic	— area.
A	— reliability	— acceleration factor, describes change in a predicted basic phenomena response due to secondary conditions denoted by subscript.
Å	— radiometric	— Angstrom, a unit of wavelength equal to 10^{-10} meters. Archaic.
B_L	— photometric	— luminous intensity of an area light source, usually expressed in candela/unit area.
B_r	— radiometric	— radiant intensity of an area source, Radiance, usually expressed in Watts/unit area.
β	— electronic	— Beta, current gain of a transistor. See h_{FE} .
C	— electronic	— inter-element capacitance, primarily junction capacitance, of a component. Terminals indicated by subscripts.
C.T.	— photometric	— Color Temperature. The temperature of a black body, when its color best approximates the designated source. Normally used for lamps, and determined at .45 and .65 microns.
CTR	— electronic	— Current Transfer Ratio. The ratio of output current to input current, at a specified bias, of an optocoupler. Usually in percent.
DIP	— electronic	— Dual In-Line Package. Standard integrated circuit and optocoupler flat package with two rows of terminals on opposite sides. May be plastic or ceramic bodied.
di/dt	— electronic	— Critical rate-of-rise of current rating of a thyristor. Higher rates may cause current crowding and device damage.
dv/dt	— electronic	— Critical rate-of-rise of voltage parameter of a thyristor. Higher rates may cause device turn-on via junction capacitance charging currents providing gate signal.
E	— photometric	— Illumination. Luminous flux density incident on a receiver, usually in lumens per unit of surface.
E_e	— radiometric	— Irradiance. See H.
f/#	— optic	— Lens parameter. The ratio of focal length to lens diameter.
F	— optic	— Focal length of a lens or lens system.
F	— photometric	— Illumination. Total luminous flux incidents on a receiver, normally in lumens. $F = \int E \cdot dA$.
GaAs	— electronic	— Gallium Arsenide. The crystalline compound which forms IRED's when suitably doped.
GaAlAs	— electronic	— Gallium Aluminum Arsenide. Another crystalline compound used to form both IRED's and LED's.

H	— radiometric	— Irradiance. Radiant flux density incident on a receiver, usually in Watts per unit area. E_e also used.
H_E	— radiometric	— Effective irradiance. The irradiance perceived by a given receiver, usually in effective Watts per unit area.
h_{FE}	— electronic	— Current gain of a transistor biased common emitter. The ratio of collector current to base current at specified bias conditions.
HTRB	— reliability	— High temperature reverse bias operating life test.
I_A	— electronic	— Thyristor or diode anode current, I_{TM} is preferred terminology for thyristors.
I_B	— electronic	— Transistor base current.
I_C	— electronic	— Transistor collector current.
I_{CB(on)}	— electronic	— Utilized for phototransistors and photodarlington to denote photodiode current in the illuminated condition. This provides differentiation from both photodiode plus amplifier illuminated current and offstate leakage current.
I_D	— electronic	— Dark current. The leakage current of an unilluminated photodetector.
I_E	— electronic	— Transistor emitter current.
I_F	— electronic	— Forward bias current, usually of IRED. Additional subscript denotes measurement of stress bias condition, if required.
I_L	— electronic	— Light current. The current through an illuminated photodetector at specified bias conditions.
I_L	— photometric	— Luminous intensity of a point source of light, normally in candela.
IR	— radiometric	— Infrared. Radiation of too great a wavelength to be normally perceived by the eye. Radiation between 0.78 and 100 microns wavelength.
IRED	— electronic	— Infrared emitting diode. A diode which emits infrared radiation when forward bias current flows through it.
L	— photometric	— Luminance of an area source of light, usually in lumens per unit area.
LASCR	— electronic	— Light activated silicon control rectifier. Also photo SCR.
LED	— electronic	— Light emitting diode.
λ	— electronic	— Predicted failure rate of an electronic component subjected to specific stress and confidence limit.
λ	— radiometric	— Wavelength of radiation.
m	— optics	— Magnification of a lens. Ratio of image size to source size.
m	— physics	— Meter, international standard unit of length.
MSCP	— photometric	— Mean spherical candle power. Average luminous power output, of a source, per steradian.
n.a.	— optics	— Numerical aperture of a lens. $n.a. = 2f/\#$.
η	— radiometric	— Conversion efficiency of an electrically powered source. The ratio of radiant power output to electrical power input.
OPA	— quality	— Outgoing process average of portion defects shipped, usually expressed in parts per million. It is derived from the sampling data and the lot acceptance rates.

P	— radiometric	— Power, total flux in Watts.
P_D	— electronic	— Power dissipated as heat.
PPM	— quality	— Fraction of defectives observed expressed in parts per million. Equal to number defective times one million divided by number inspected. For zero defects a statistically derived factor is used to estimate the defect density.
PPS	— electronic	— Repetition rate in pulses per second.
PRM	— electronic	— Pulse rate modulation, coding an analog signal on a train of pulses by varying the time between pulses.
PUT	— electronic	— Programmable Unijunction Transistor. A thyristor specified to provide the unijunction transistor function.
Si	— electronic	— Silicon. The semiconductor material which is selectively doped to make photodiodes, phototransistors, photo-darlington and photoSCR detectors.
SCR	— electronic	— Silicon Controlled Rectifier. A thyristor, reverse blocking, which can block or conduct in forward bias, conduction between anode and cathode being initiated by forward bias of the gate-cathode junction.
T_A	— electronic	— Ambient temperature.
T_C	— electronic	— Case temperature, the temperature of a specified point on a component.
T_J	— electronic	— Junction temperature, the temperature of the chip of a semiconductor device. This is the factor which determines maximum power dissipation.
t	— electronic	— Time. Subscripts indicate switching times (d—delay, f—fall, r—rise and s—storage), intervals in reliability prediction (o—operating, x—equivalent operating), etc.
UCL	— reliability	— Upper confidence level. A statistical determination of the confidence of a prediction of the highest level of an occurrence based on the apercent of occurrences in a quantity from a homogeneous population.
UJT	— electronic	— Unijunction transistor. A three-terminal, voltage threshold semiconductor device commonly used for oscillators and time delays.
V	— electronic	— Voltage. Subscripts indicate the terminals which the voltage is measured across, the first subscript commonly denoting the positive terminal.
W	— radiometric	— Radiant emittance. The flux density, in Watts/unit area, emitted by the surface source.

7.2 OPTOELECTRONIC TERMS

Acceleration Factor	— reliability	— a factor which describes the change in a predicted phenomena caused by a secondary effect.
Angstrom Unit	— radiometric	— 10 ⁻¹⁰ meters, obsolete term used to describe wavelength of radiation.
Anode	— electronic	— the main terminal, of a device, which is normally biased positive. See cathode.





Bandgap	— electronic	— the potential difference between the atomic valence and conduction bands. This determines the forward voltage drop and frequency of light output of a diode.
Base	— electronic	— the control terminal of a transistor.
Beta	— electronic	— common emitter current gain of a transistor. Collector current divided by base current.
Bias	— electronic	— the electrical conditions of component operation or test.
Black Body	— radiometric	— a body which reflects no radiation. Its radiation spectrum is a simple function of its temperature.
Candela	— photometric	— unit of luminous intensity, defined by 1/60 cm ² of a black body at 2042°K.
Cathode	— electronic	— the main terminal, of a device, which is normally biased negative. See anode.
Chatter	— electronic	— a rapid, normally undesired, oscillation of relay contacts between the open and closed state.
Collector	— electronic	— the main terminal of a transistor in which current flow is normally relatively independent of voltage bias.
Color Temperature	— photometric	— the temperature of a black body when its color best approximates the designated source. Normally used for lamps and determined at .45 and .65 microns.
Commutating dv/dt	— electronic	— a measure of the ability of a triac to block a rapidly rising voltage immediately after conduction of the opposite polarity.
Coupled dv/dt	— electronic	— a measure of the ability of an opto thyristor coupler to block when the coupler is subjected to rapidly changing isolation voltage.
Coupler	— electronic	— abbreviation for optocoupler.
Critical Angle	— optics	— the largest angle of incidence of light, on the interface of two transmission mediums, that light will be transmitted between the mediums. Light at greater angles of incidence will be reflected.
Current Transfer Ratio	— electronic	— the ratio of output current to input current, at a specified bias, of an optocoupler.
Dark Current	— electronic	— Leakage current, usually I _{CEO} , of a photodetector with no incident light.
Darlington	— electronic	— A composite transistor containing two transistors connected to multiply current gain.
Detector	— radiometric	— A device which changes light energy (radiation) to electrical energy.
Diffraction	— optics	— The phenomena of light bending at the edge of an obstacle. Demonstrates wave properties of light.
Diode	— electronic	— A device that normally permits only one direction of current flow. A P-N junction diode will generate electricity when the junction is illuminated.
Doping	— electronic	— The addition of carrier supplying impurities to semiconductor crystals.
Duty Cycle	— electronic	— The ratio of on time to period of a pulse train.
Efficiency	— electronic	— In this handbook, refers to the ratio of output power of a source to electrical input power.

Effective Irradiance	— electronic	— Irradiance as perceived by a detector.
Emittance	— radiometric	— Power radiated per unit area from a surface.
Emitter	— electronic	— Main terminal of a transistor which bias voltage normally has a major effect on current.
Emitter	— radiometric	— A source of radiation.
Epitaxial	— electronic	— Material added to a crystalline structure which has and maintains the original crystals' structure.
f/number	— optics	— Ratio of focal length to lens diameter.
Fiber Optics	— optics	— Transparent fiber which transmits light along the fiber's axis due to the critical angle at the fiber's circumference.
Foot Candle	— photometric	— Illumination level of one lumen per square foot.
Foot Lambert	— photometric	— Brightness of source of one lumen per square foot.
Gallium Arsenide	— electronic	— A crystalline compound which is doped to form IRED's.
Gallium Aluminum Arsenide	— electronic	— Another crystalline compound which is doped to form IRED's and LED's.
Gate	— electronic	— Control terminal of an SCR or, a logic function component.
Hash	— electronic	— Random, high frequency noise on a signal or logic line.
Illumination	— photometric	— Light level on a unit area.
Infrared	— photometric	— Radiation of longer wavelength than normally perceived by the eye, i.e., .78 to 100 microns wavelength.
Interrupter Module	— electronic	— Optoelectronic device which detects objects which break the light beam from an emitter to a detector.
Irradiance	— radiometric	— Radiated power per unit area incident on a surface, broadband analogy to illumination.
Isolation Voltage	— electronic	— The dielectric withstanding voltage capability of an optocoupler under defined conditions and time.
Light	— photometric	— Radiation normally perceived by the eye, i.e., .38 to .78 microns wavelength.
Light Current	— electronic	— Current through a photodetector when illuminated under specified bias conditions.
Lumen	— photometric	— Unit of radiant flux through one steradian from a one-candela source.
Micron	— radiometric	— 10^{-6} meters.
Modulation	— electronic	— The transmission of information by modifying a carrier signal—usually its amplitude or frequency.
Monochrometer	— photometric	— An instrument which is a source of any specific wavelength of radiation over a specified band.
Monochromatic	— photometric	— Of a single color, wavelength.
Nanometer	— radiometric	— 10^{-9} meters.
Normalized	— electronic	— Presentation of the change in a parameter, due to a test condition change, made by dividing the final value by the initial value.
Optocoupler	— electronic	— A single component which transmits electrical information, without electrical connection, between a light source and a light detector.
Optoisolator	— electronic	— Optocoupler.

Peak Spectral Emission	— radiometric	— Wavelength of highest intensity of a source.
Photoconductor	— electronic	— A material with resistivity that varies with illumination level.
Photocoupler	— electronic	— Optocoupler.
Photodarlington	— electronic	— Light sensitive, darlington connected, transistor pair photodetector.
Photodetector	— electronic	— A device which provides an electrical signal when irradiated by infrared, visible, and/or ultraviolet light.
Photodiode	— electronic	— p-n junction semiconductor diode photodetector.
Photon	— electronic	— Quantum of light from wave theory.
PhotoSCR	— electronic	— LASCR.
Phototransistor	— electronic	— A transistor photodetector.
Photovoltaic Cell	— electronic	— A photodiode connected to supply electricity when illuminated.
Point Source	— radiometric	— A source with maximum dimension less than 1/10 the distance between source and detector.
Reflector Module	— electronic	— Component containing a source and detector which detects objects which complete the light path by reflecting the light.
Silicon	— electronic	— Crystalline element which is doped to make photodiode, phototransistor, photodarlington, photoSCR, etc. detectors.
Silicon Controlled Rectifier	— electronic	— A reverse blocking thyristor which can block or conduct in forward bias, conduction between the anode and cathode being initiated by forward bias of the gate cathode junction.
Source	— radiometric	— A device which provides radiant energy.
Spectral Distribution	— radiometric	— A plot, usually normalized, of source intensity vs. wavelength observed.
Spectral Sensitivity	— radiometric	— A plot of detector sensitivity vs. wavelength detected.
Steradian	— radiometric	— Unit of solid angle. A sphere contains 4π steradians.
Synchronous Detection	— electronic	— A technique which detects low level pulses by detecting only signal changes which occur at the same time as the pulse.
Thermopile	— radiometric	— A very broadband, heat sensing, radiation detector.
Transistor	— electronic	— Three-terminal semiconductor device which behaves as a current controlled current source.
Triac	— electronic	— A thyristor which can block or conduct in either polarity. Conduction is initiated by forward bias of a gate—MTI junction.
Triac driver	— electronic	— A low current thyristor used to control power thyristors. Usually a photodetector in an optoisolator.
Tungsten	— radiometric	— The element normally used for incandescent lamp filaments.
Unijunction Transistor	— electronic	— A three-terminal voltage threshold semiconductor device normally used for oscillators and time delays.
Wavelength	— radiometric	— The speed of light divided by the frequency of the electromagnetic radiation-wave theory of light.
Watt	— electronic	— Unit of power, a volt ampere.
Watt	— photometric	— Unit of power, 685 lumens at 0.555 microns wavelength.

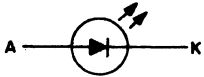
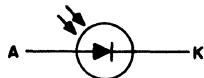
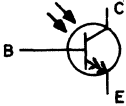
OPTO ELECTRONIC DEVICES

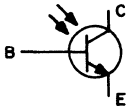
SCHEMATIC SYMBOLS USED IN THIS MANUAL

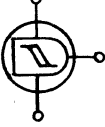
DISCRETE DEVICES	
Light or Infrared Emitting Diode	
Photodiode	
PhotoDarlington	
Phototransistor	 
Photo SCR or LASCR	
Photo Schmitt Trigger	

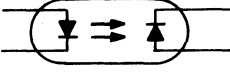
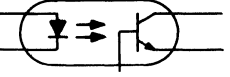
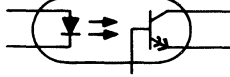
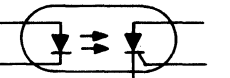
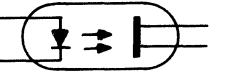
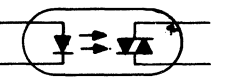
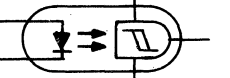
OPTOISOLATORS	
	Photodiode Output
	Phototransistor Output
	PhotoDarlington Output
	PhotoSCR Output
	Bilateral Analog FET Output
	Triac Driver Output
	Schmitt Trigger Output

chapter 8

BIBLIOGRAPHY AND REFERENCES

1. Morrison, Law, A Linear Opto Isolator, Ferranti Ltd., Edinburgh, Scotland.
2. McDermott, "After 13 Years, Standardization of Opto Isolators...", Electronic Design, February 1, 1974.
3. Hendriks, "Avoid I_{CEO} Measurements," Electronic Design, November 22, 1975.
4. Dean, "Designers Guide to Small Incandescent Lamps," Appliance Manufacturer, November 1973.
5. Engstrom et.al., Electro Optics Handbook, RCA, Harrison, NJ.
6. Sahm, "Get to Know the Opto Coupler," Electronic Design, June 7, 1975.
7. Guide WJCTZ, File E51868, Underwriters Laboratories, Inc.
8. Sahm, High Performance Circuits ... Photodarlington Transistor, GE, Auburn NY.
9. Korn, How to Evaluate ... Light Sensitive Silicon Devices, GE, Auburn, NY.
10. Sahm, How to Use ... Photodarlington Transistor, GE, Auburn, NY.
11. Halverson, Koshire, Thorson, Isolation ... Telephone Circuit Protection ..., IEEE #C751113-6.
12. MIL-HDBK-217D. Reliability Prediction of Electronic Equipment, RADC, Griffiss AFB, Rome, NY.
13. Franson, "Optical Couplers," EDN, October 5, 1975.
14. Sahm, Tarzia, "Optoelectronics in Manufacturing Applications," SME #AD74-427.
15. Korn, Photon Couplers, GE, Auburn, NY.
16. Ott, "Ringin Problems on Long Subscriber Loops," Telephony, June 24, 1974.
17. Flores, Moore, Buster, "Rural Subscriber Loops Go Electronic," Telephony, June 24, 1974.
18. Grafham et.al., SCR Manual, 6th ed., GE, Auburn, NY.
19. Hall et.al., Solid State Lamp Manual, GE, Cleveland, Ohio.
20. Sahm, "Solid State Relays Aren't All Alike," Electronic Products, July 15, 1974.
21. Specifications Governing the Use of Photocouplers, proposed November 1975, CNET/SOTELEC, France.
22. Johnson, Kawasaki, "The Coupling ... Diodes into Optical Fibers ...," CRC Report #1250, Communications Research Centre, Ottawa.
23. Bracale, Lombardi, "The Design of Broadband Light Modulators," The Radio and Electronic Engineer, April 1970.
24. Howell, The Light Activated SCR, GE, Auburn, NY.
25. The Measurement ... Dielectric Strength of Glasses, Corning Glass Works, Corning, NY.
26. Thomas, The Mechanisms ... Degradation ... GaAs Infrared Emitting Diodes, GSFC, FMR 08-001, NASA, Goddard Space Flight Center, Greenbelt, Md.
27. Grafham, The Photocoupler, GE, Amstelveen.
28. Cleary, et.al., Transistor Manual, 7th ed.; Syracuse, NY.
29. Blanks, "Electronics Reliability: A State of the Art Survey," Microelectronics and Reliability, Volume 20, #3, 1980.
30. Herr, et.al., "Reliability Evaluation and Prediction for Discrete Semiconductors," IEEE Trans. of Reliability, August 1980.
31. Nordby, Photocouplers II, Elektronikcentralen, Denmark, July 1980.
32. Mason, Electrically Conductive Epoxies — How Reliable are They, GOSAM Symposium, March 1980.
33. What Is ... The Lifetime of Optoelectronic Components, ASEA-HAFO, Sweden.
34. Lennert et.al., Computer Control Life Testing of LED's, February 1981, DTIC:AEDC-TR80-25.

chapter 9

OPTOELECTRONIC SPECIFICATIONS

Emitter Specifications	166
Detector Specifications	184
Fiber Optics Specifications	196
Optoisolator Specifications	202
Module Specifications	280
European “Pro Electron” Registered Types	312
Generic Optoisolator Specifications	352
Cross Reference of Competitive Types	377



SOLID STATE



ELECTRONICS

Infrared Emitter

1N6264, 1N6265

Gallium Arsenide Infrared – Emitting Diode

The General Electric 1N6264 and 1N6265 Series are gallium arsenide, light emitting diodes which emit non-coherent, infrared energy. They are ideally suited for use with silicon detectors. The 1N6264 has a lens which provides a narrow beam angle while the 1N6265 has a flat window for a wide beam angle which is useful with external lensing.

absolute maximum ratings: (25°C unless otherwise specified)

Voltages			
† Reverse Voltage	V_R	3	volts
Currents			
† Forward Current (continuous)	I_F	100	mA
† Forward Current (pw 1 μ s, 200 Hz)	I_F	10	A
Dissipation			
† Power Dissipation ($T_A = 25^\circ\text{C}$)*	P_T	170	mW
Power Dissipation ($T_C = 25^\circ\text{C}$)**	P_T	1.3	W
Temperatures			
† Junction Temperature	T_J	-65 to +150	$^\circ\text{C}$
† Storage Temperature	T_{stg}	-65 to +150	$^\circ\text{C}$
† Lead Soldering Time (1/16" [1.6mm] from case for 10 sec.)	T_L	260	$^\circ\text{C}$

*Derate 1.36 mW/ $^\circ\text{C}$ above 25°C ambient.
 **Derate 10.4 mW/ $^\circ\text{C}$ above 25°C case.

electrical characteristics: (25°C unless otherwise specified)

	SYM.	MIN.	TYP.	MAX.	UNITS
† Reverse Leakage Current ($V_R = 3\text{V}$)	I_R	—	—	10	μA
† Forward Voltage ($I_F = 100\text{mA}$)	V_F	—	1.4	1.7	Volts
† Total Power Output (note 1) ($I_F = 100\text{mA}$)	P_O	6	—	—	mW
† Peak Emission Wavelength ($I_F = 100\text{mA}$)	λ_p	935	945	955	nm
Spectral Shift with Temperature		—	.28	—	nm/ $^\circ\text{C}$
† Spectral Bandwidth – 50%	$\Delta\lambda$	—	—	60	nm
† Half Intensity Beam Angle					
1N6264	θ_{HI}	—	—	20	deg
1N6265	θ_{HI}	—	—	80	deg
Rise Time – 0-90% of Output	t_r	—	1.0	—	μs
Fall Time – 100-10% of Output	t_f	—	1.0	—	μs

Note 1:
 Total power output, P_O , is the total power radiated by the device into a solid angle of 2π steradians.

† Indicates JEDEC registered values.

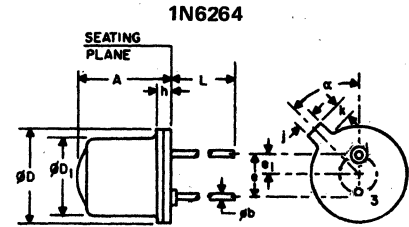

SYMBOL	INCHES		MILLIMETERS		NOTES
	MIN.	MAX.	MIN.	MAX.	
A		.255		6.47	
ϕb	.016	.021	.407	.533	
ϕD	.209	.230	5.31	5.84	
ϕD_1	.180	.187	4.57	4.77	
e	.100NOM.		2.54NOM.		2
e_1	.050NOM.		1.27NOM.		2
h		.030		.76	
j	.031	.044	.79	1.11	
k	.036	.046	.92	1.16	1
L	1.00		25.4		
α		45°		45°	3

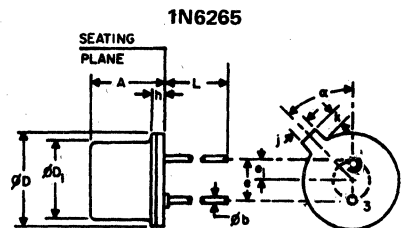

SYMBOL	INCHES		MILLIMETERS		NOTES
	MIN.	MAX.	MIN.	MAX.	
A		.155		3.93	
ϕb	.016	.021	.407	.533	
ϕD	.209	.230	5.31	5.84	
ϕD_1	.180	.187	4.57	4.77	
e	.100NOM.		2.54NOM.		2
e_1	.050NOM.		1.27NOM.		2
h		.030		.76	
j	.031	.044	.79	1.11	
k	.036	.046	.92	1.16	1
L	1.00		25.4		
α		45°		45°	3

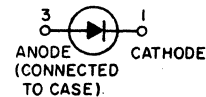

1. Measured from maximum diameter of device.
2. Leads having max. diameter .021" (.533mm) measured in gaging plane .054" + .001" - .000 (137 + 025 - 000mm) below the reference plane of the device shall be within .007" (.778mm) their true position relative to a maximum width tab.
3. From centerline tab.

TYPICAL CHARACTERISTICS

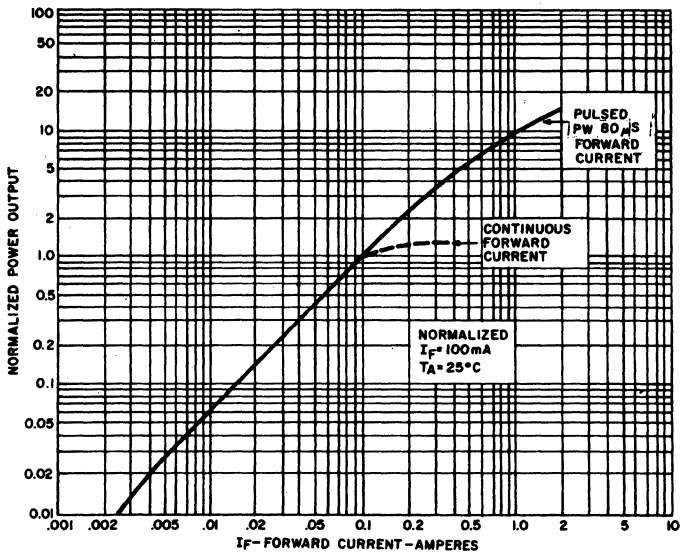

1. POWER OUTPUT VS. INPUT CURRENT

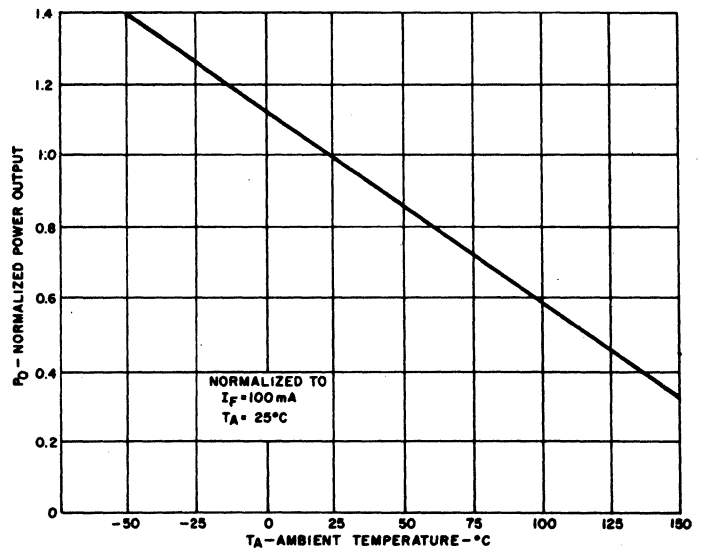

2. POWER OUTPUT VS. TEMPERATURE

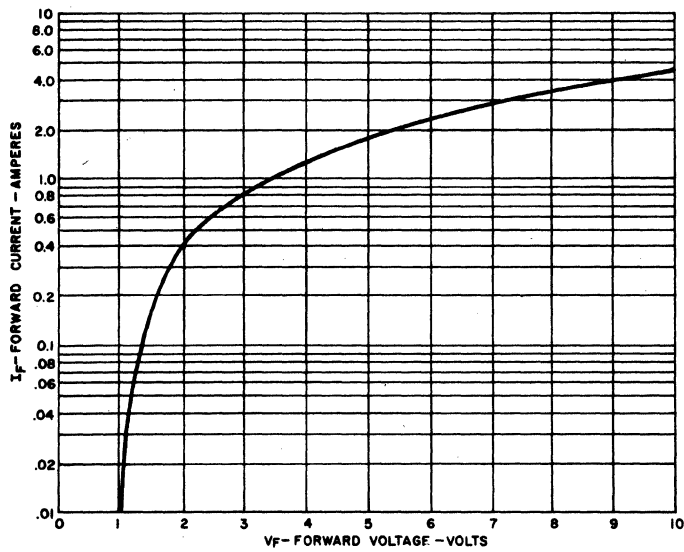

3. FORWARD VOLTAGE VS. FORWARD CURRENT

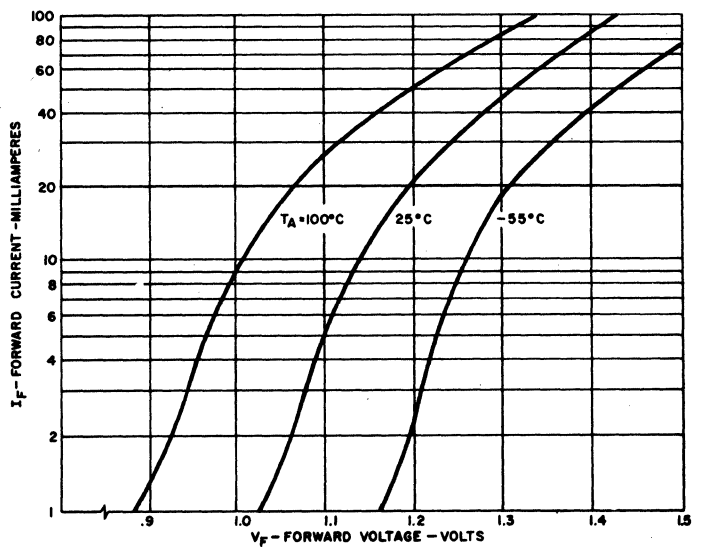

4. FORWARD VOLTAGE VS. FORWARD CURRENT

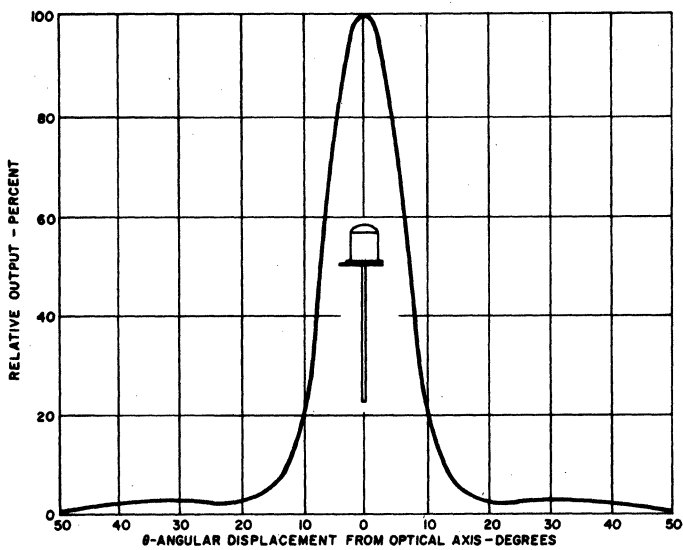

5. 1N6264 - TYPICAL RADIATION PATTERN

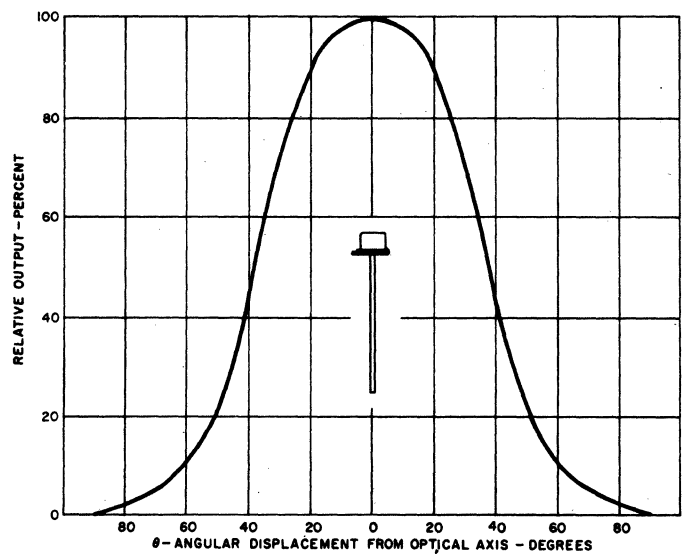

6. 1N6265 - TYPICAL RADIATION PATTERN



SOLID STATE OPTOELECTRONICS

Infrared Emitter

1N6266

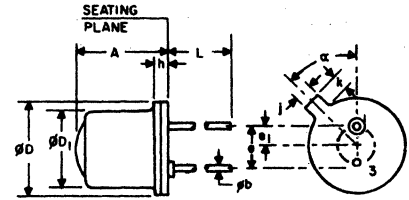

Gallium Arsenide Infrared – Emitting Diode

The General Electric 1N6266 is a gallium-arsenide, infrared emitting diode which emits non-coherent, infrared energy with a peak wavelength of 940 nanometers. This device is characterized to precisely define the infrared beam along the mechanical axis of the device.

absolute maximum ratings: ($T_A = 25^\circ\text{C}$ unless otherwise specified)

SYMBOL	INCHES		MILLIMETERS		NOTES
	MIN.	MAX.	MIN.	MAX.	
A		.255		6.47	
qD	.016	.021	.407	.533	
qD1	.209	.230	5.31	5.84	
e	.180	.187	4.57	4.77	
h		.100NOM.		2.54NOM.	2
q1		.050NOM.		1.27NOM.	2
h		.030		.76	
j	.031	.044	.79	1.11	
k	.036	.046	.92	1.16	1
L	1.00		25.4		
a		45°		45°	3

Voltages

*Reverse Voltage V_R 3 Volts

Currents

*Forward Current (Continuous) I_F 100 mA
 *Forward Current (pw 1 μsec 200Hz) I_F 10 A

Dissipation

*Power Dissipation ($T_A = 25^\circ\text{C}$) † P_T 170 mWatts
 Power Dissipation ($T_C = 25^\circ\text{C}$) †† P_T 1.3 Watts

Temperatures

*Junction Temperature T_J -65 to +150 °C
 *Storage Temperature T_{STG} -65 to +150 °C
 *Lead Soldering Time (1/16", 1.6mm, T_L +260 °C from case for 10 sec.)

† Derate 1.36mW/°C above 25°C ambient.

†† Derate 10.4mW/°C above 25°C case.

*Indicates JEDEC registered values.

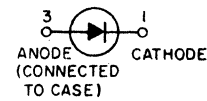

1. Measured from maximum diameter of device.
2. Leads having max. diameter .021" (.533mm) measured in gaging plane .054" + .001" - .000 (137 + 025 - 000mm) below the reference plane of the device shall be within .007" (.778mm) their true position relative to a maximum width tab.
3. From centerline tab.

MAXIMUM RATING CURVES

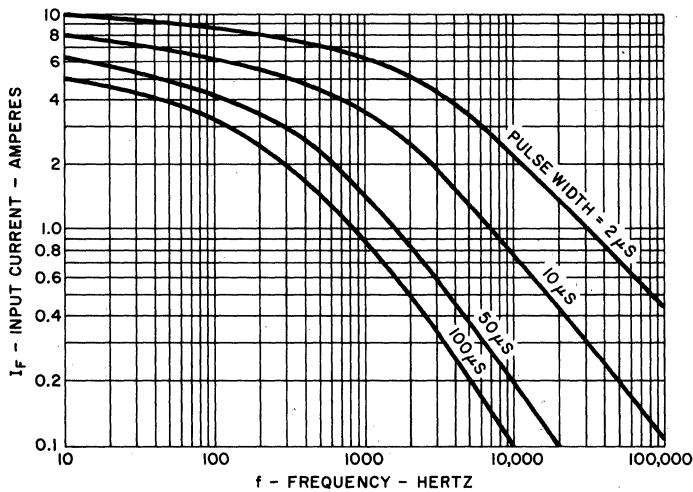

MAXIMUM PULSE CAPABILITY

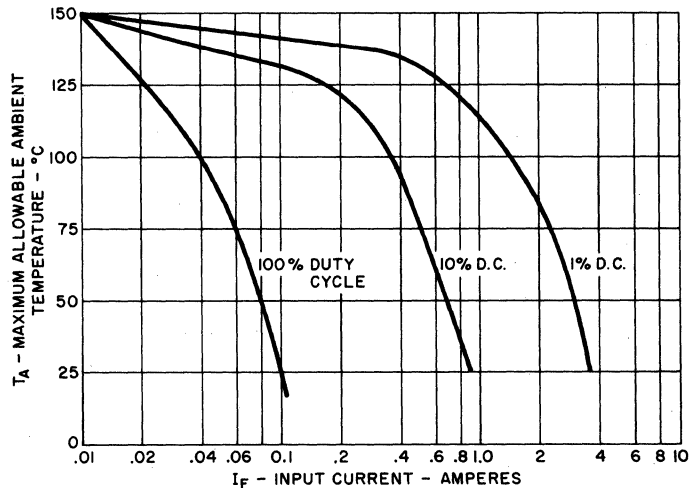

MAXIMUM TEMPERATURE VS. INPUT CURRENT

electrical characteristics: ($T_A = 25^\circ\text{C}$ unless otherwise specified)

Static Characteristics	SYMBOL	MIN.	TYP.	MAX.	UNITS
*Reverse Leakage Current ($V_R = 3\text{V}$)	I_R	—	—	10	μA
*Forward Voltage ($I_F = 100\text{mA}$)	V_F	0.9	—	1.7	Volts
*Radiant Intensity ($I_F = 100\text{mA}$, $\omega = 0.01\text{Sr}$)	I_e	25	—	—	mW/sr
*Peak Emission Wavelength ($I_F = 100\text{mA}$)	λ_p	935	—	955	nm
Spectral Shift with Temperature		—	.28	—	nm/ $^\circ\text{C}$
*Spectral Bandwidth — 50%	$\Delta\lambda$	—	—	60	nm
*Half Intensity Beam Angle	θ_{HI}	—	—	20	deg.
Rise Time	t_r	—	1.0	—	μs
Fall Time	t_f	—	1.0	—	μs

*Indicates JEDEC registered values.

I_e

INFRARED EMITTING DIODE RADIANT INTENSITY

The design of an Infrared Emitting Diode (IRED)-photodetector system normally requires the designer to determine the minimum amount of infrared irradiance received by the photodetector, which then allows definition of the photodetector current. Prior to the introduction of the 1N6266, the best method of estimating the photodetector received infrared was to geometrically proportion the piecewise integration of the typical beam pattern with the specified minimum total power output of the IRED. However, due to the inconsistencies of the IRED integral lenses and the beam lobes, this procedure will not provide a valid estimation.

The General Electric 1N6266 now provides the designer specifications which precisely define the infrared beam along the device's mechanical axis. The 1N6266 is a premium device selected to give a minimum radiant intensity of 25 mW/steradian into the 0.01 steradians referenced by the device's mechanical axis and seating plane. Radiant intensity is the IRED beam power output, within a specified solid angle, per unit solid angle.

A quick review of geometry indicates that a steradian is a unit of solid angle, referenced to the center of a sphere, defined by 4π times the ratio of the area projected by the solid angle to the area of the sphere. The solid angle is equal to the projected area divided by the squared radius.

$$\text{Steradians} = 4\pi A/4\pi R^2 = A/R^2 = \omega.$$

As the projected area has a circular periphery, a geometric integration will solve to show the relationship of the Cartesian angle (α) of the cone, (from the center of the sphere) to the projected area.

$$\omega = 2\pi (1 - \cos \frac{\alpha}{2}).$$

Radiant intensity provides an easy, accurate tool to calculate the infrared power received by a photodetector located on the IRED axis. As the devices are selected for beam characteristics, the calculated results are valid for worst case analysis. For many applications a simple approximation for photodetector irradiance is:

$$H \cong I_e/d^2, \text{ in mw/cm}^2$$

where d is the distance from the IRED to the detector in cm.

IRED power output, and therefore I_e , depends on IRED current. This variation ($\Delta I_e/\Delta I$) is documented in Figure 1, and completes the approximation: $H = I_e/d^2 (\Delta I_e/\Delta I)$. This normally gives a conservative value of irradiance. For more accurate results, the effect of precise angle viewed by the detector must be considered. This is documented in Figure 2 ($\Delta I_e/\Delta \omega$) giving:

$$H = I_e/d^2 (\Delta I_e/\Delta I) \text{ in mw/cm}^2.$$

For worst case designs, temperature coefficients and tolerances must also be considered.

The minimum output current of the detector (I_L) can be determined for a given distance (d) of the detector from the IRED.

$$I_L = (S)H \cong (S)I_e/d^2$$

or

$$I_L = (S)H = (S) (I_e/d^2) (\Delta I_e/\Delta \omega) (\Delta I_e/\Delta I)$$

where S is the sensitivity of the detector in terms of output current per unit irradiance from a GaAs source.

MATCHING A PHOTOTRANSISTOR WITH 1N6266

Assume a system requiring a 10mA I_L at an IRED to detector spacing of 2cm (seating plane to seating plane), with bias conditions at specification points.

Given: $d_1 = 2$ cm; $I_{L1} = 10$ mA min.; $I_e = 25$ mW/Steradian

Then: $H_1 \cong I_e/D_1^2 = 25/(2)^2 = 6.25$ mW/cm².

Detector Evaluation:

TYPE	I_L MIN. @ mA	H (Tungsten) \cong mW/cm ²	H(GaAs) mW/cm ²	S(GaAs) mA/mW/cm ²
L14G1	6	10	3	2
L14G2	3	10	3	1

Calculated $I_L = d_1$ is:

L14G1 (S) $H_1 = (2) 6.25 = 12.5$ mA
 L14G2 (S) $H_1 = (1) 6.25 = 6.25$ mA

Since the system requires an I_L of 10 mA minimum the correct device to use is the L14G1.

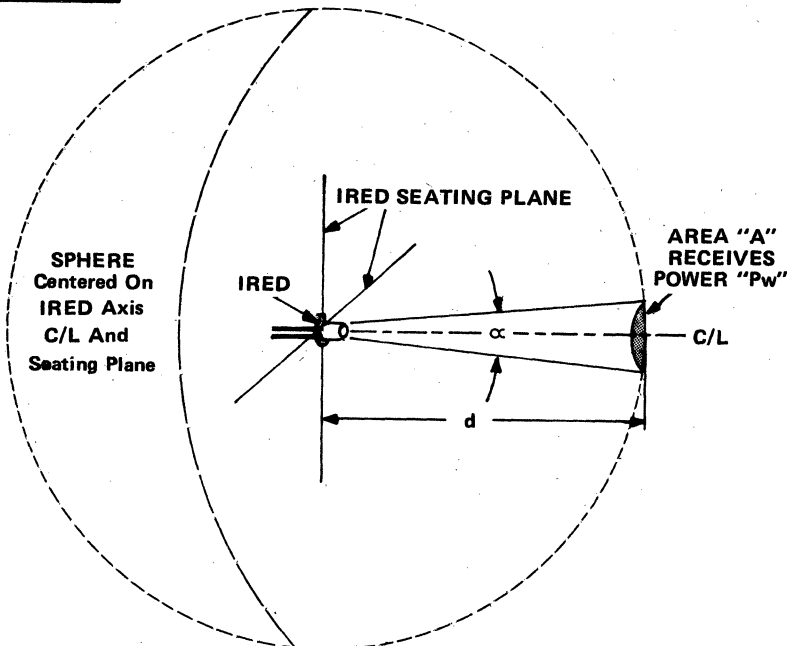

$\omega = A/d^2 = 2\pi (1 - \cos \frac{\alpha}{2})$ Steradians
 $I_e = Pw/\omega$ mW/Steradian
 $H = Pw/A = I_e/d^2$ mW/cm²

TYPICAL CHARACTERISTICS

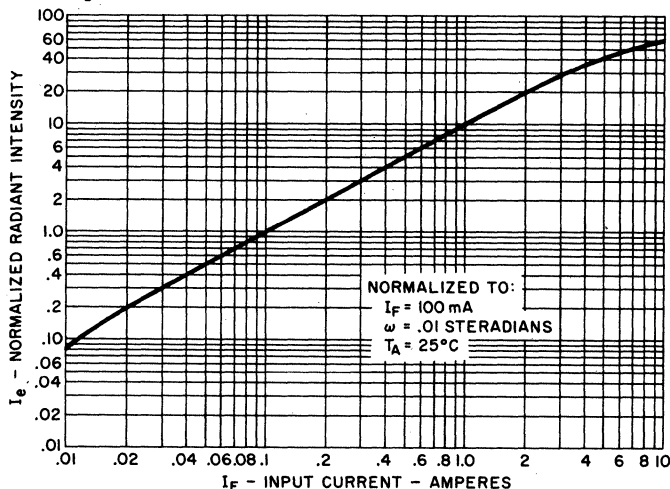

1. RADIANT INTENSITY VS. INPUT CURRENT
 $\Delta I_e/\Delta I$

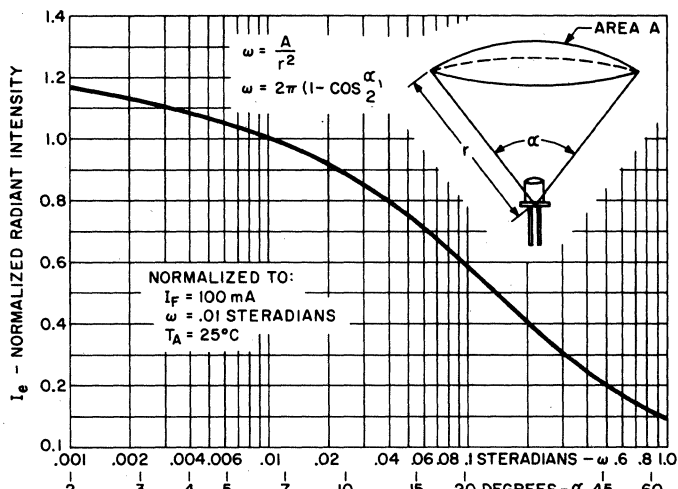

2. INTENSITY AND POWER VS. ANGLE
 $\Delta I_e/\Delta \omega$

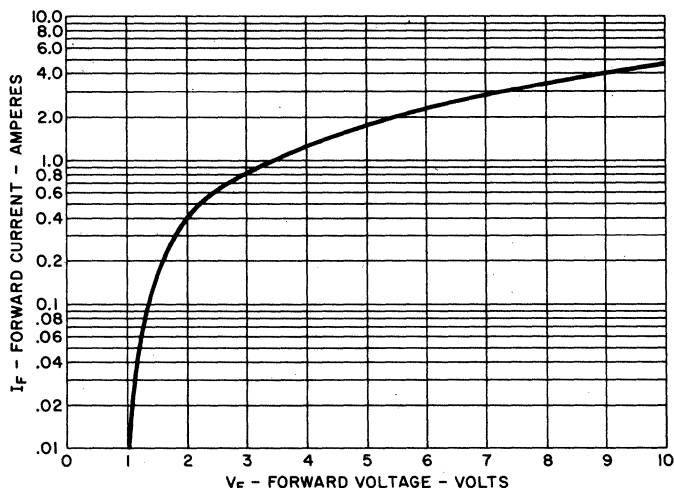

3. FORWARD VOLTAGE VS. FORWARD CURRENT

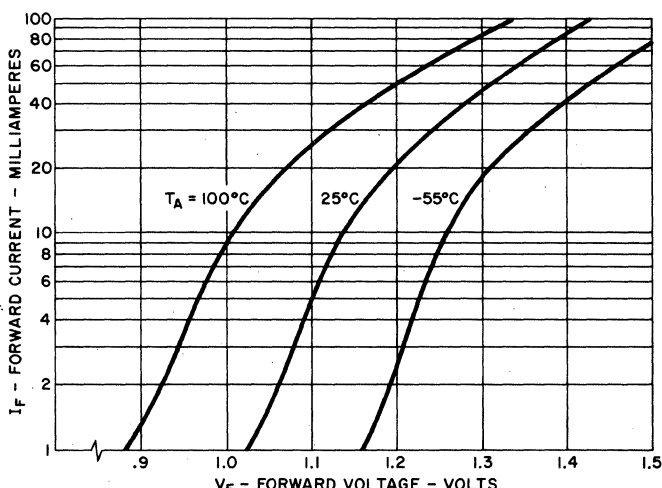

4. FORWARD VOLTAGE VS. FORWARD CURRENT

TYPICAL CHARACTERISTICS

1N6266

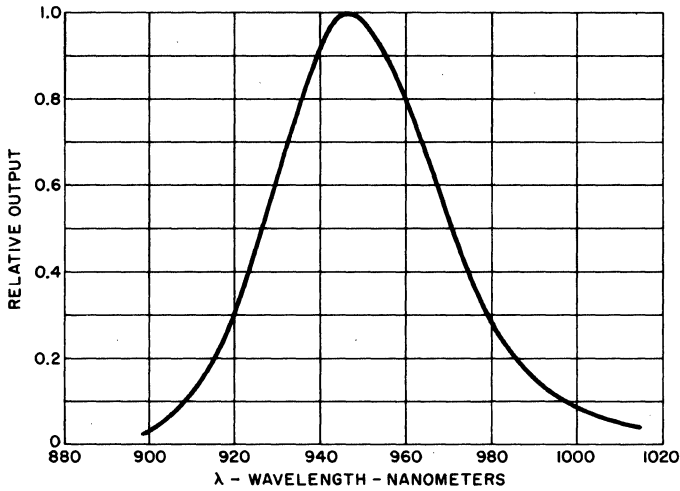

5. SPECTRAL OUTPUT

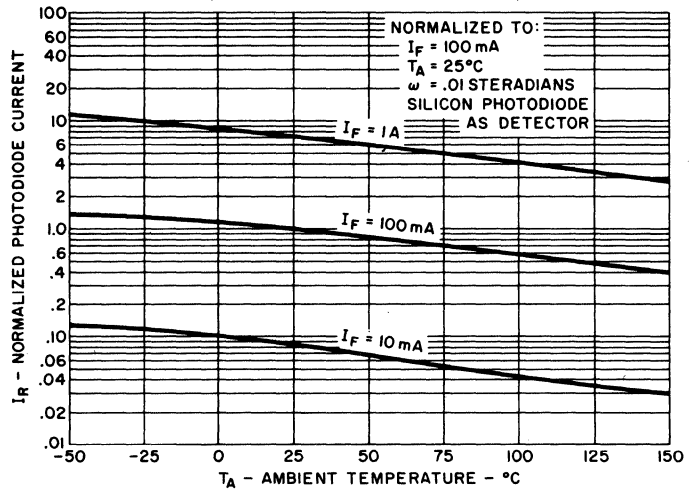

6. OUTPUT VS. TEMPERATURE

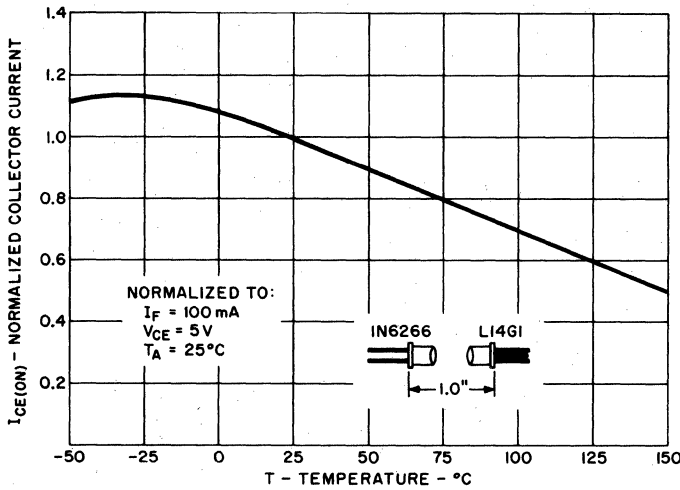

7. OUTPUT VS. TEMPERATURE IRED/PHOTOTRANSISTOR PAIR

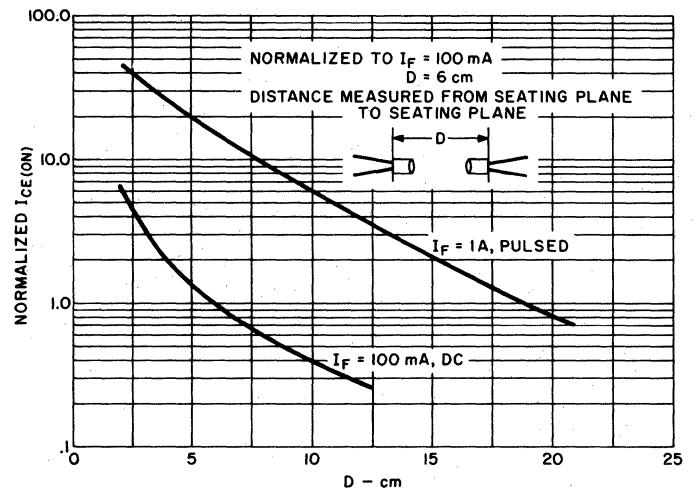

8. IL VS. DISTANCE IRED/PHOTOTRANSISTOR PAIR

4.5 TO 6.5VDC

TYPICAL APPLICATION

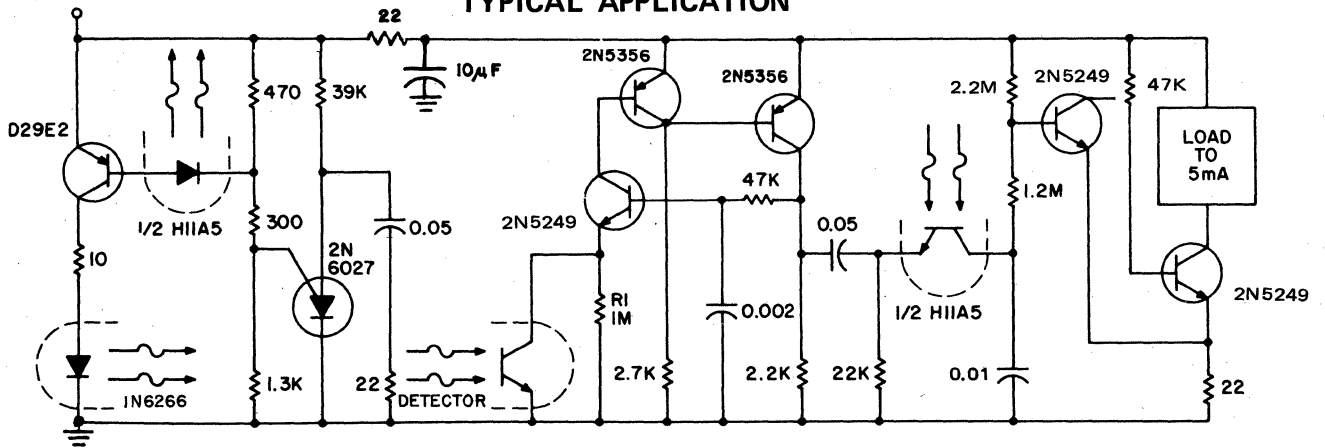

DETECTOR SELECTION	TRANSMISSION RANGE	REFLECTIVE RANGE
L14Q1	12"	3"
L14G1	48"	12"

OBJECT DETECTOR FEATURING LOW POWER CONSUMPTION AND LONG-RANGE CAPABILITY.



SOLID STATE OPTOELECTRONICS

Infrared Emitter

F5D1, F5D2, F5D3, F5E1, F5E2, F5E3

Gallium Aluminum Arsenide Infrared – Emitting Diode

The General Electric F5D and F5E Series are infrared emitting diodes. They exhibit high power output and a typical peak wavelength of 880 nanometers. They provide a significant increase in system efficiency, when used with silicon detectors, compared to GaAs infrared emitting diodes.

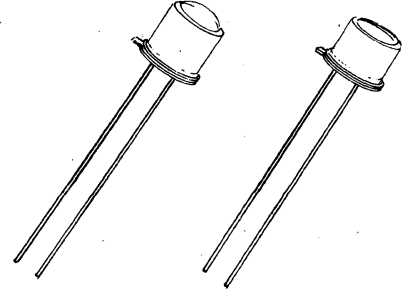

absolute maximum ratings: (25°C, unless otherwise specified)

Voltage	SYMBOL		UNITS
Reverse Voltage	V_R	3	V
Current			
Forward Current (continuous)	I_F	100	mA
Forward Current (pw, 1 μ s; 200 Hz)	I_F	10	A
Forward Current (pw, 10 μ s; 100 Hz)	I_F	3	A
Dissipation			
Power Dissipation ($T_A = 25^\circ\text{C}$)*	P_T	170	mW
Power Dissipation ($T_C = 25^\circ\text{C}$ **)	P_T	1.3	W
Temperatures			
Junction Temperature	T_J	-65 to +150	$^\circ\text{C}$
Storage Temperature	T_{stg}	-65 to +150	$^\circ\text{C}$
Lead Soldering Time (1/16" [1.6mm] from case for 10 sec.)	T_L	+260	$^\circ\text{C}$

*Derate 1.36 mW/ $^\circ\text{C}$ above 25 $^\circ\text{C}$ ambient.

**Derate 10.4 mW/ $^\circ\text{C}$ above 25 $^\circ\text{C}$ case.

electrical characteristics: (25°C, unless otherwise specified)

	SYMBOL	MIN.	TYP.	MAX.	UNITS
Reverse Leakage Current ($V_R = 3\text{V}$)	I_R	—	—	10	μA
Forward Voltage ($I_F = 100\text{mA}$)	V_F	—	—	1.7	Volts
($I_F = 1\text{A}$)	V_F	—	—	3.5	Volts

optical characteristics: (25°C, unless otherwise specified)

	SYMBOL	MIN.	TYP.	MAX.	UNITS
Total Power Output ($I_F = 100\text{mA}$)(Note 1)	P_o	12	—	—	mW
	— F5D1, F5E1	9	—	—	mW
	— F5D2, F5E2	10.5	—	—	mW
	— F5D3, F5E3	—	880	—	nm
Peak Emission Wavelength ($I_F = 100\text{mA}$)	λ_p	—	880	—	nm

optical characteristics (continued): (25°C, unless otherwise specified)

	SYMBOL	MIN.	TYP.	MAX.	UNITS
Spectral Shift with Temperature		—	.3	—	nm/°C
Spectral Bandwidth – 50%	$\Delta\lambda$	—	80	—	nm
Half Intensity Beam Angle	— F5D1, F5D2, F5D3	—	—	20	Deg.
	— F5E1, F5E2, F5E3	—	—	80	Deg.
Rise Time					
0-90% of Output (Note 2)	t_r	—	1.5	—	μs
Fall Time					
100-10% of Output (Note 2)	t_f	—	1.5	—	μs

NOTES:

- Total power output, P_o , is the total power radiated by the device into a solid angle of 2π steradians.
- At $I_F = 100\text{mA}$, $t_r \leq 10\text{ns}$ input current pulse.

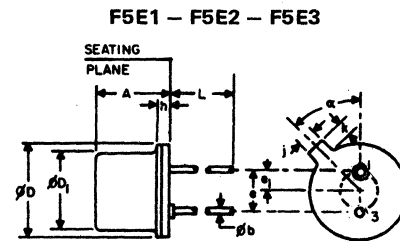
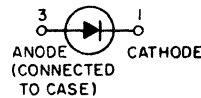
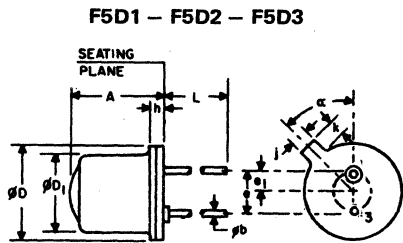

SYMBOL	INCHES		MILLIMETERS		NOTES
	MIN.	MAX.	MIN.	MAX.	
A	—	.255	—	6.47	
ϕ_b	.016	.021	.407	.533	
ϕ_D	.209	.230	5.31	5.84	
ϕ_{D_1}	.180	.187	4.57	4.77	
e	.100 NOM		2.54 NOM		2
e_1	.050 NOM		1.27 NOM		2
h	—	.030	—	.76	
j	.031	.044	.79	1.11	
k	.036	.046	.92	1.16	1
L	1.00	—	25.4	—	
α	45°	45°	45°	45°	3

NOTES:

- Measured from maximum diameter of device.
- Leads having maximum diameter .021" (.533mm) measured in gauging plane .054" + .001" – .000 (137 + 025 – 000mm) below the reference plane of the device shall be within .007" (.778mm) their true position relative to a maximum width tab.
- From centerline tab.

SYMBOL	INCHES		MILLIMETERS		NOTES
	MIN.	MAX.	MIN.	MAX.	
A	—	.155	—	3.93	
ϕ_b	.016	.021	.407	.533	
ϕ_D	.209	.230	5.31	5.84	
ϕ_{D_1}	.180	.187	4.57	4.77	
e	.100 NOM		2.54 NOM		2
e_1	.050 NOM		1.27 NOM		2
h	—	.030	—	.76	
j	.031	.044	.79	1.11	
k	.036	.046	.92	1.16	1
L	1.00	—	25.4	—	
α	45°	45°	45°	45°	3

NOTES:

- Measured from maximum diameter of device.
- Leads having maximum diameter .021" (.533mm) measured in gauging plane .054" + .001" – .000 (137 + 025 – 000mm) below the reference plane of the device shall be within .007" (.778mm) their true position relative to a maximum width tab.
- From centerline tab.

TYPICAL CHARACTERISTICS

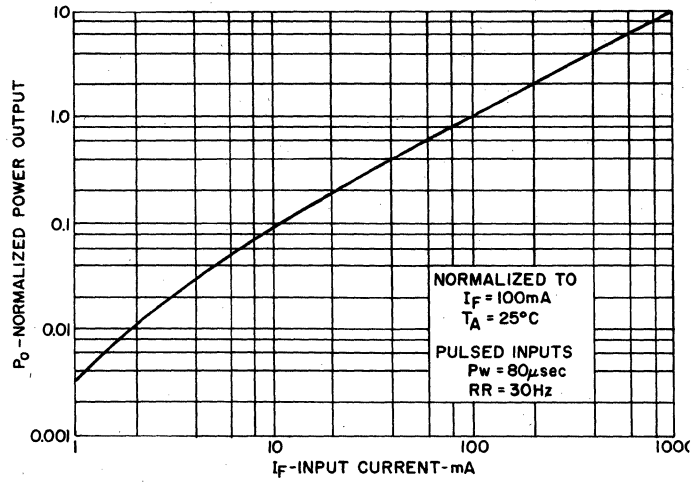

1. POWER OUTPUT VS. INPUT CURRENT

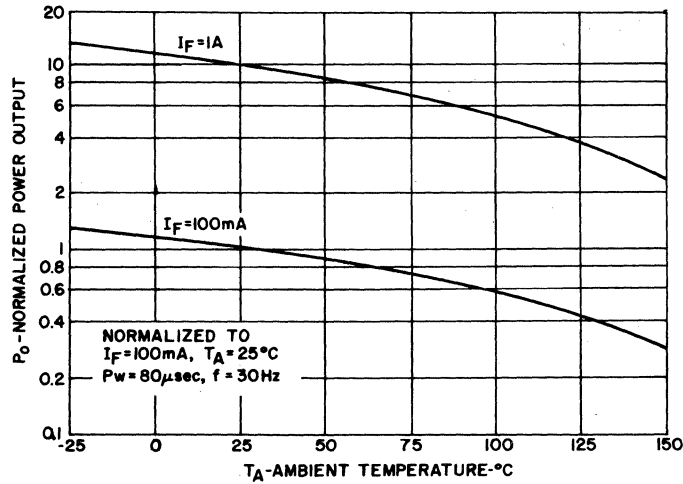

2. POWER OUTPUT VS. TEMPERATURE

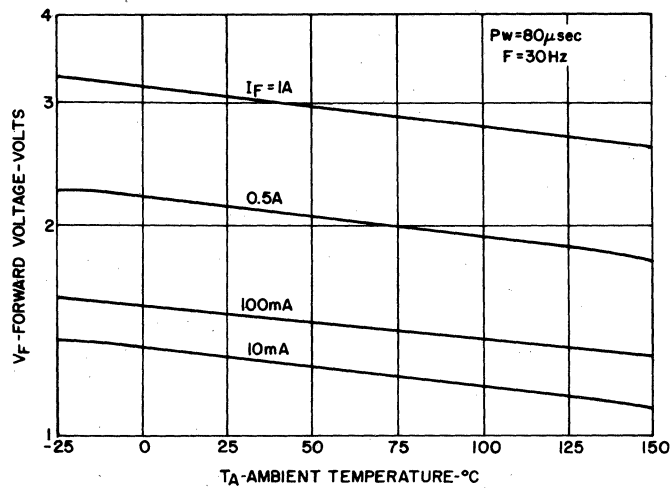

3. FORWARD VOLTAGE VS. TEMPERATURE

TYPICAL CHARACTERISTICS

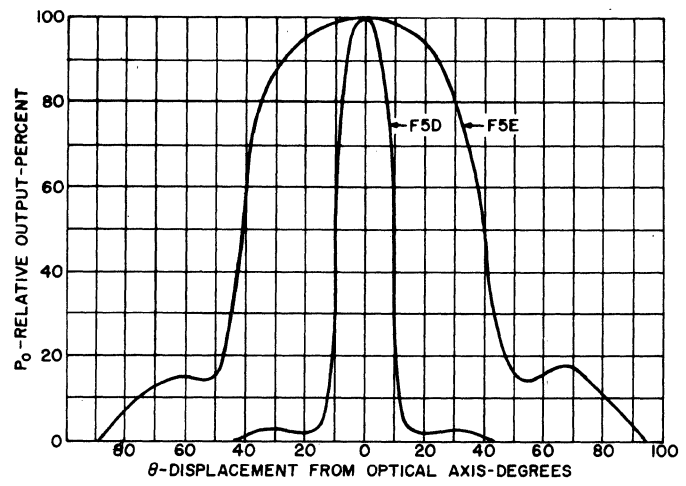

4. TYPICAL RADIATION PATTERN

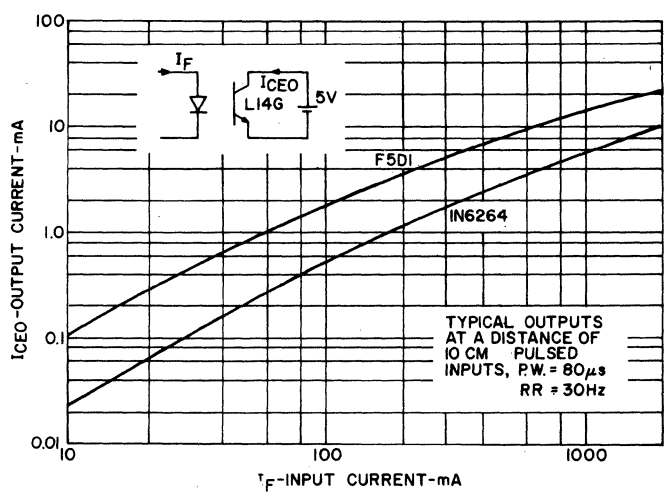

5. OUTPUT VS. INPUT WITH L14G DETECTOR

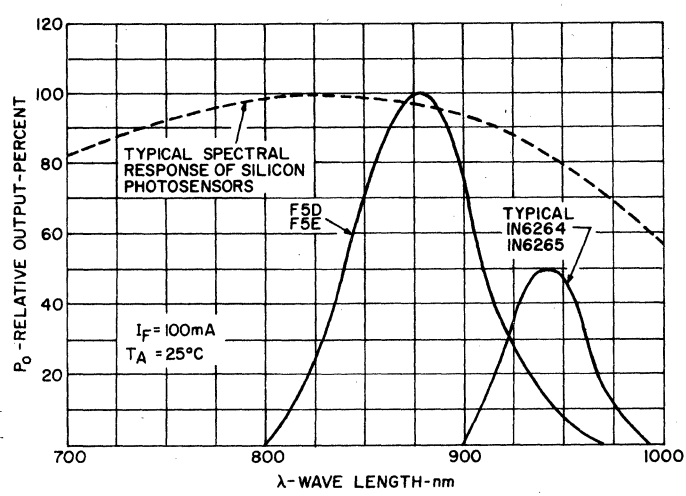

6. OUTPUT VS. WAVELENGTH



SOLID STATE OPTOELECTRONICS

Infrared Emitter



Gallium Arsenide Infrared — Emitting Diode

The General Electric F5F1 is a Gallium-Arsenide, infrared emitting diode which emits non-coherent, infrared energy with a peak wavelength of 940 nanometers. It is packaged in a clear side looking, epoxy encapsulant.

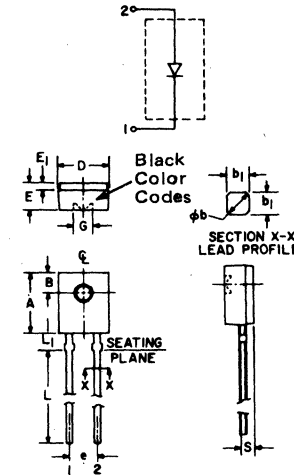

absolute maximum ratings: (25°C) (unless otherwise specified)

VOLTAGES	SYMBOL	MIN.	MAX.	UNITS
Reverse Voltage	V_R	6		V
Forward Current (continuous)	I_F	60		mA
Forward Current (Peak, pw = 1μs, PRR ≤ 300pps)	I_F	3		A
DISSIPATION				
Power Dissipation*	P_T	100		mW
TEMPERATURES				
Junction Temperature	T_J	-55 to +100		°C
Storage Temperature	T_{STG}	-55 to +100		°C
Lead Soldering Temperature (5 seconds maximum, 1.6mm from case)	T_L	260		°C

SYM	MILLI-METERS		INCHES		NOTES
	MIN	MAX	MIN	MAX	
A	5.59	5.80	.220	.228	
B	1.78	NOM.	.070	NOM.	2
φb	.60	.75	.024	.030	1
b ₁	.51	NOM.	.020	NOM.	1
D	4.45	4.70	.175	.185	
E	2.41	2.67	.095	.105	
E ₁	.58	.69	.023	.027	
e	2.41	2.67	.095	.105	3
G	1.98	NOM.	.078	NOM.	
L	12.7	—	.500	—	
L ₁	1.40	1.65	.055	.065	
S	.83	.94	.033	.037	3

NOTES:

- Two leads. Lead cross section dimensions uncontrolled within 1.27 MM (.050") of seating plane.
- Centerline of active element located within .25 MM (.010") of true position.
- As measured at the seating plane.
- Inch dimensions derived from millimeters.

electrical characteristics: (25°C)

	SYMBOL	MIN.	TYP.	MAX.	UNITS
Reverse Breakdown Voltage, $I_R = 10\mu A$	$V_{(BR)R}$	6	—	—	V
Forward Voltage, $I_F = 60mA$	V_F	—	1.5	1.7	V
Reverse Leakage Current, $V_R = 5V$	I_R	—	—	100	nA
Capacitance, $V = 0, f = 1MHz$	C_i	—	30	—	pF

optical characteristics:

Radiant Intensity, $I_F = 20mA, \omega = 0.06sr^\dagger$	I_e	0.28	—	—	mW/sr
Peak Emission Wavelength, $I_F = 60mA$	λ_p	935	—	955	nm
Spectral Bandwidth — 50%	$\Delta\lambda$	—	—	60	nm
Half Intensity Beam Angle	θ_{HI}	—	30	—	deg.

$^\dagger I_e$ measured with a 0.45cm aperture placed 1.6cm from the tip of the lens, on the lens center line perpendicular to the plane of the leads.

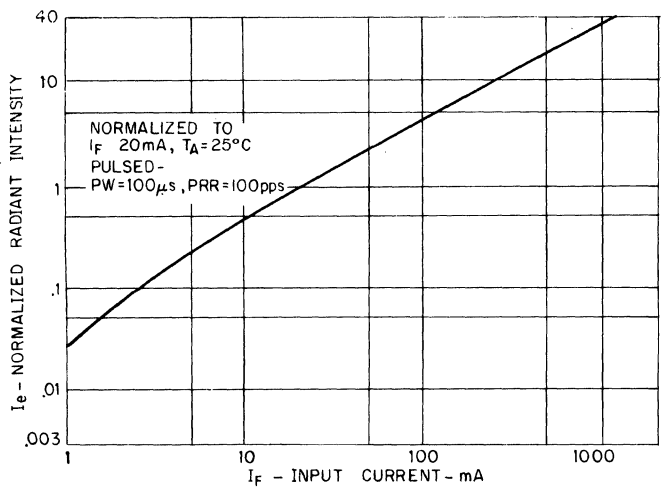

1. RADIANT INTENSITY VS. INPUT CURRENT

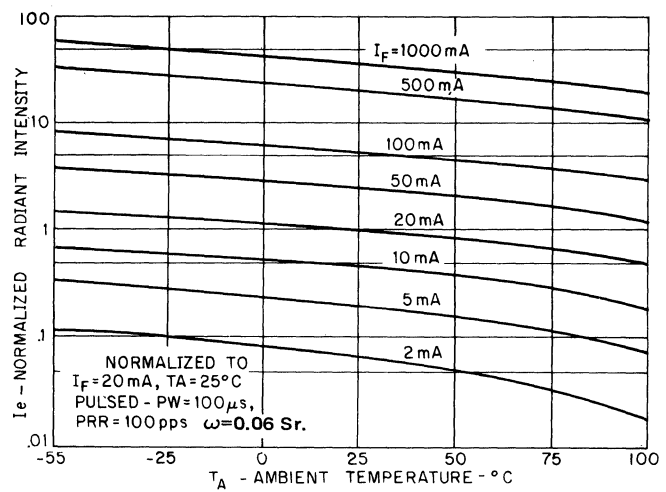

2. RADIANT INTENSITY VS. TEMPERATURE

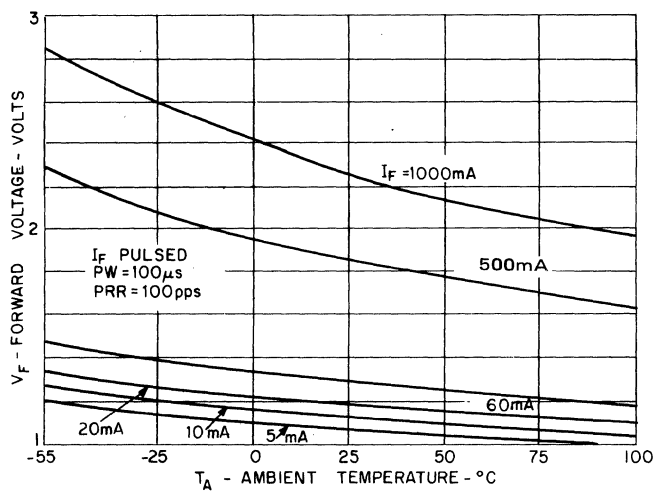

3. FORWARD VOLTAGE VS. TEMPERATURE

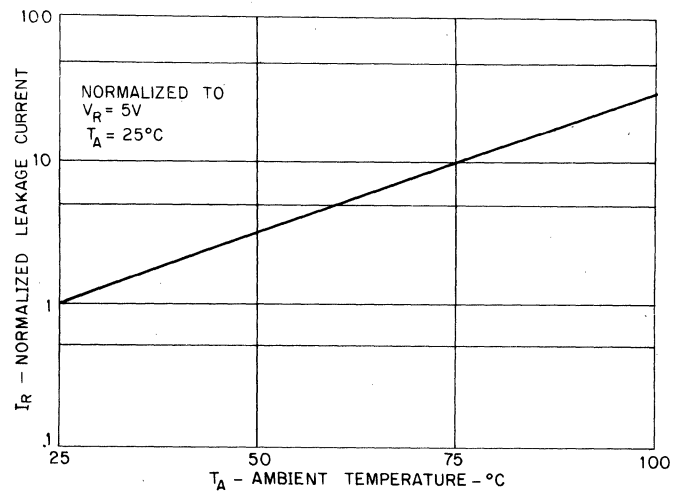

4. LEAKAGE CURRENT VS. TEMPERATURE

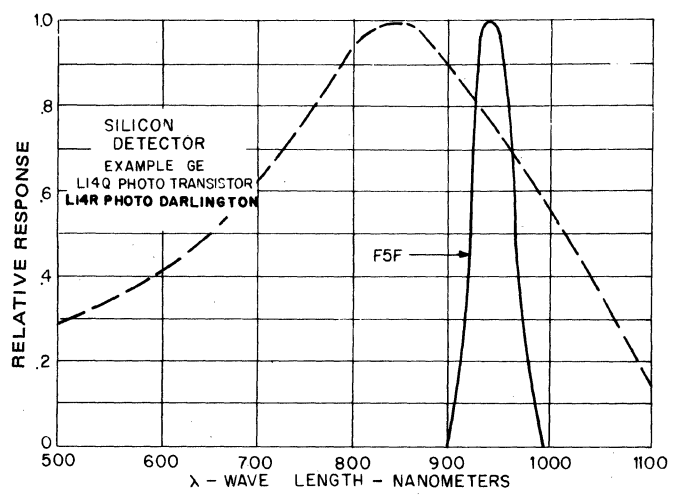

5. SPECTRAL RESPONSE

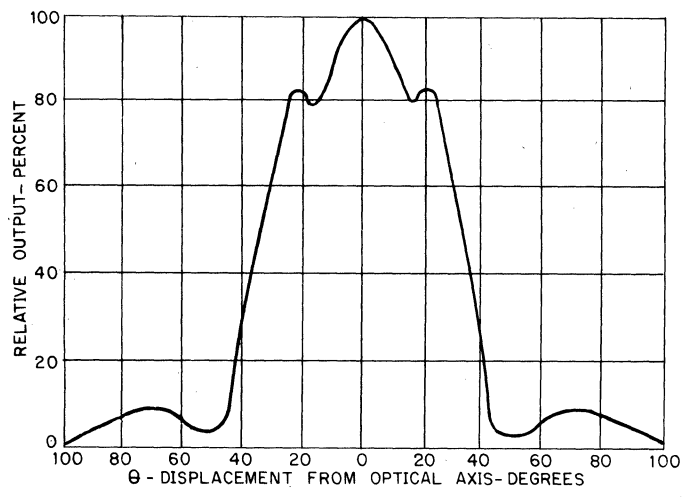

6. TYPICAL RADIATION PATTERN



SOLID STATE OPTOELECTRONICS

Infrared Emitter

F5G1

Gallium Aluminum Arsenide Infrared — Emitting Diode

The General Electric F5G1 is a Gallium-Aluminum-Arsenide, infrared emitting diode which emits non-coherent, infrared energy with a peak wavelength of 880 nanometers. This device will provide a significant increase in system efficiency, when used with silicon detectors, compared to GaAs infrared emitting diodes. It is encapsulated in a clear side looking, epoxy package with an integral recessed lens.

absolute maximum ratings: (25°C) unless otherwise specified

VOLTAGES	SYMBOL		UNITS
Reverse Voltage	V_R	6	V
CURRENT			
Forward Current (continuous)	I_F	50	mA
Forward Current (Peak, pw = 1 μ s, PRR \leq 300 pps)	I_F	2	A
DISSIPATION			
Power Dissipation*	P_T	100	mW
TEMPERATURES			
Junction Temperature	T_j	-55 to +100	°C
Storage Temperature	T_{STG}	-55 to +100	°C
Lead Soldering Temperature (5 seconds maximum, 1.6mm from case)	T_L	260	°C

*Derate 1.33mW/°C above 25°C ambient

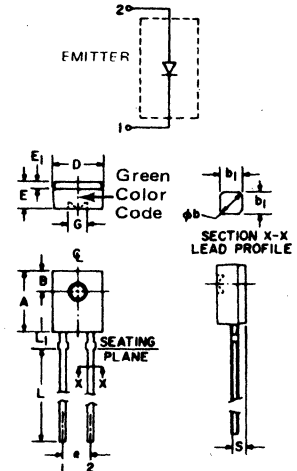

SYM	MILLI-METERS		INCHES		NOTES
	MIN	MAX	MIN	MAX	
A	5.59	5.80	.220	.228	
B	1.78	NOM.	.070	NOM.	2
ϕb	.60	.75	.024	.030	1
b_1	.51	NOM.	.020	NOM.	1
D	4.45	4.70	.175	.185	
E	2.41	2.67	.095	.105	
E_1	.58	.69	.023	.027	
e	2.41	2.67	.095	.105	3
G	1.98	NOM.	.078	NOM.	
L	12.7	—	.500	—	
L_1	1.40	1.65	.055	.065	
S	.83	.94	.033	.037	3

NOTES:

- Two leads. Lead cross section dimensions uncontrolled within 1.27 MM (.050") of seating plane.
- Centerline of active element located within .25 MM (.010") of true position.
- As measured at the seating plane.
- Inch dimensions derived from millimeters.

electrical characteristics: (25°C)

	SYMBOL	MIN.	TYP.	MAX.	UNITS
Reverse Breakdown Voltage ($I_R = 10 \mu A$)	$V_{(BR)R}$	6	—	—	V
Forward Voltage, $I_F = 60mA$ (pulsed)	V_F	—	1.5	1.85	V
$I_F = 20mA$	V_F	—	—	1.7	V
Reverse Leakage Current, $V_R = 5V$	I_R	—	—	100	nA
Capacitance, $V = 0, f = 1MHz$	C_i	—	30	—	pF

optical characteristics:

Radiant Intensity, $I_F = 20mA, \omega = 0.06sr^\dagger$	I_e	0.6	—	—	mW/sr
Peak Emission Wavelength, $I_F = 20mA$	λ_p	—	880	—	nm
Spectral Bandwidth — 50%	$\Delta\lambda$	—	50	—	nm
Half Intensity Beam Angle	θ_{HI}	—	35	—	deg.

$^\dagger I_e$ measured with a 0.45cm aperture placed 1.6cm from the tip of the lens, on the lens center line perpendicular to the plane of the leads.

TYPICAL CHARACTERISTICS

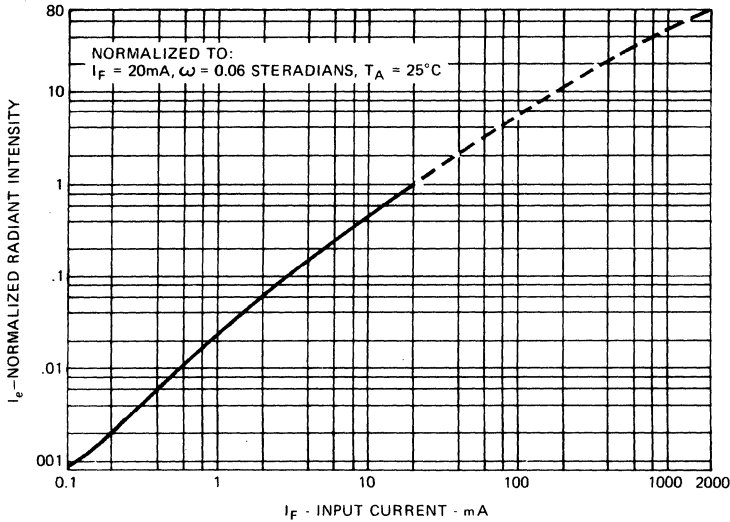

1. RADIANT INTENSITY VS. INPUT CURRENT

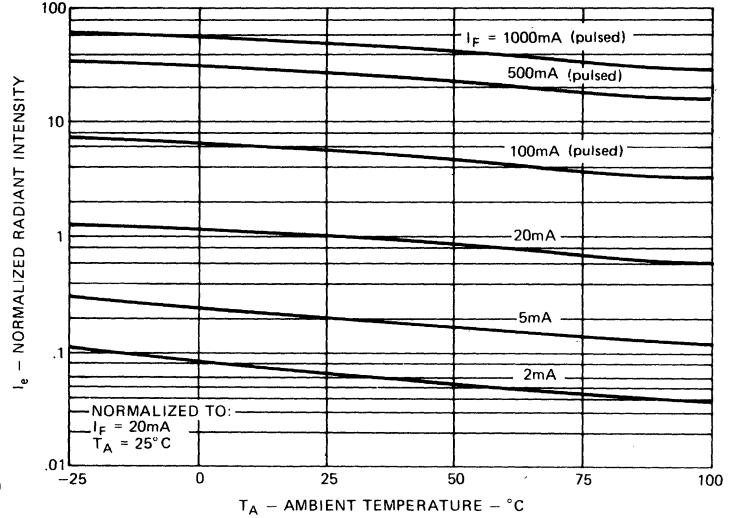

2. RADIANT INTENSITY VS. TEMPERATURE

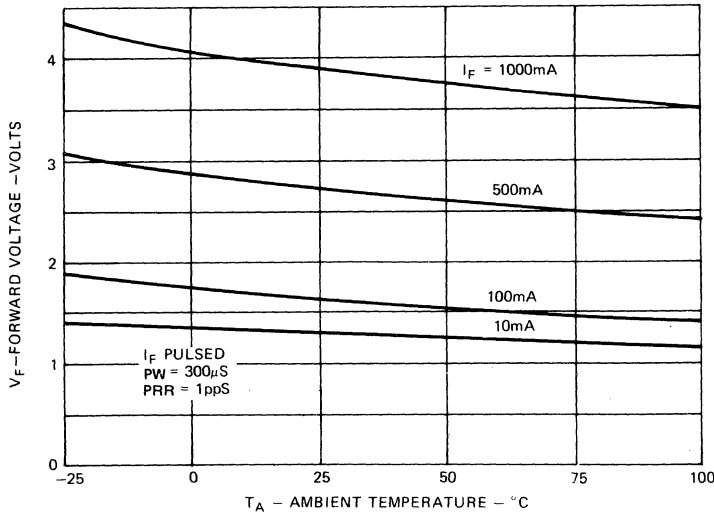

3. FORWARD VOLTAGE VS. TEMPERATURE

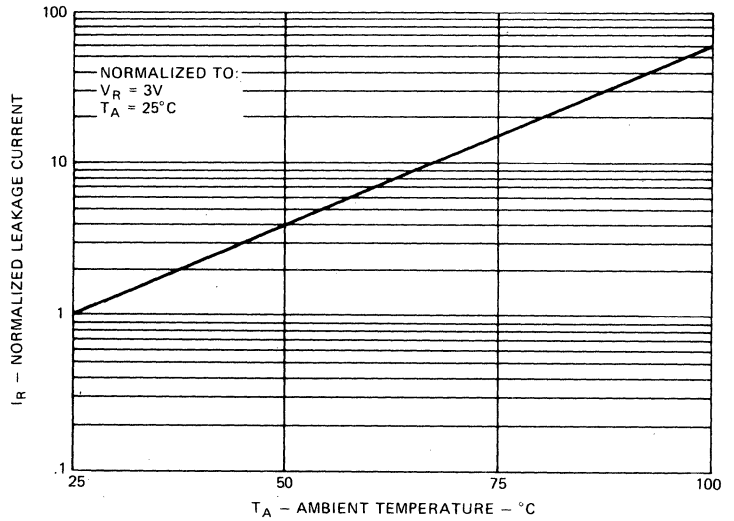

4. LEAKAGE CURRENT VS. TEMPERATURE

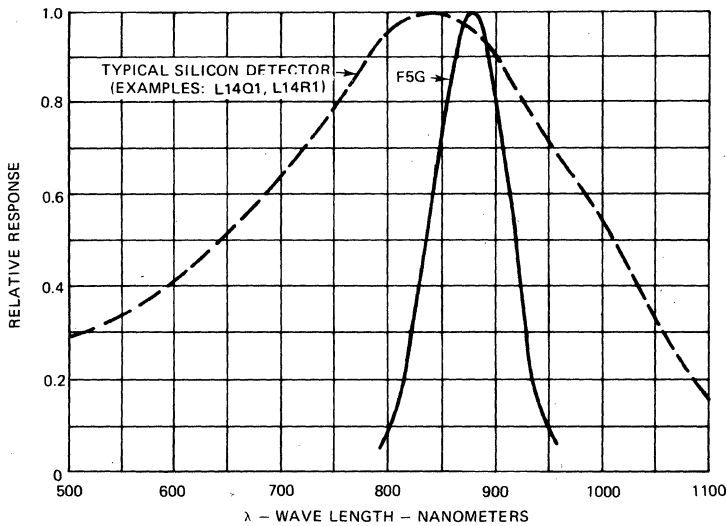

5. SPECTRAL RESPONSE

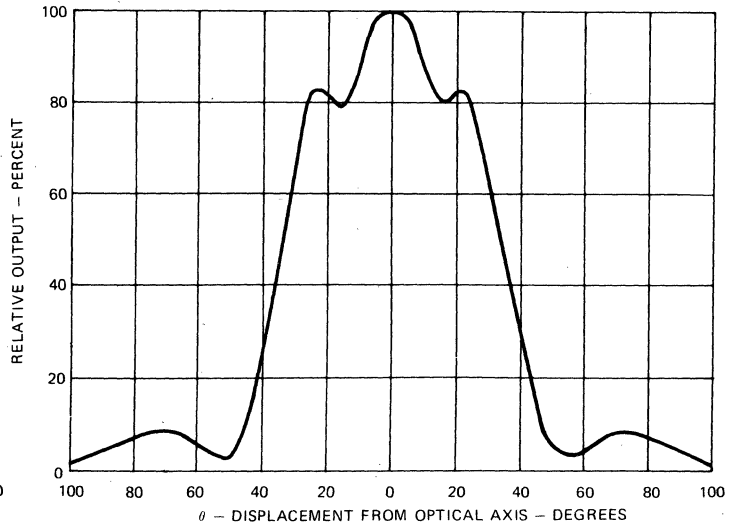

6. TYPICAL RADIATION PATTERN



SOLID STATE



ELECTRONICS

Infrared Emitter

LED55B, LED55C, LED56, LED55BF, LED55CF, LED56F

Gallium Arsenide Infrared-Emitting Diode

The General Electric LED55B-LED55C-LED56 Series are gallium arsenide, light emitting diodes which emit non-coherent, infrared energy with a peak wave length of 940 nanometers. They are ideally suited for use with silicon detectors. The "F" versions of these devices have flat lens caps.

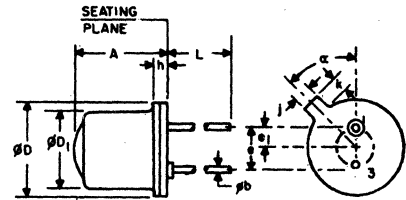

LED55B , LED55C , LED56

SYMBOL	INCHES		MILLIMETERS		NOTES
	MIN.	MAX.	MIN.	MAX.	
A		.255		6.47	
phi b	.016	.021	.407	.533	
phi D	.209	.230	5.31	5.84	
phi D1	.180	.187	4.57	4.77	
e	.100 NOM.		2.54 NOM.		2
e1	.050 NOM.		1.27 NOM.		2
h		.030		.76	
j	.031	.044	.79	1.11	
k	.036	.046	.92	1.16	1
L	1.00		25.4		
alpha	45°		45°		3

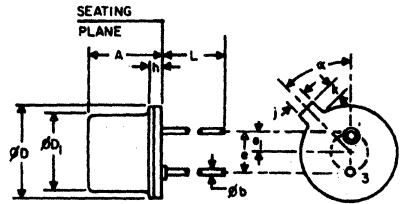

LED55BF LED55CF LED56F

SYMBOL	INCHES		MILLIMETERS		NOTES
	MIN.	MAX.	MIN.	MAX.	
A		.155		3.93	
phi b	.016	.021	.407	.533	
phi D	.209	.230	5.31	5.84	
phi D1	.180	.187	4.57	4.77	
e	.100 NOM.		2.54 NOM.		2
e1	.050 NOM.		1.27 NOM.		2
h		.030		.76	
j	.031	.044	.79	1.11	
k	.036	.046	.92	1.16	1
L	1.00		25.4		
alpha	45°		45°		3

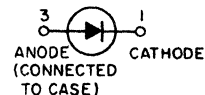

1. Measured from maximum diameter of device.
2. Leads having max. diameter .021" (.533mm) measured in gaging plane .054" + .001" - .000 (137 + 025 - 000mm) below the reference plane of the device shall be within .007" (.778mm) their true position relative to a maximum width tab.
3. From centerline tab.

absolute maximum ratings: (25°C unless otherwise specified)

Voltage:

Reverse Voltage V_R 3 volts

Currents:

Forward Current Continuous I_F 100 mA

Forward Current (pw 1 μsec 200 Hz) I_F 10 A

Dissipations:

Power Dissipation ($T_A = 25^\circ C$)* P_T 170 mW

Power Dissipation ($T_C = 25^\circ C$ ***) P_T 1.3 W

Temperatures:

Junction Temperature T_J -65°C to +150°C

Storage Temperature T_{STG} -65°C to +150°C

Lead Soldering Time 10 seconds at 260°C

*Derate 1.36 mW/°C above 25°C ambient.
 **Derate 10.4 mW/°C above 25°C case.

electrical characteristics: (25°C unless otherwise specified)

	MIN.	TYP.	MAX.	UNITS
Reverse Leakage Current ($V_R = 3V$)			10	μA
Forward Voltage ($I_F = 100mA$)		1.4	1.7	V

optical characteristics: (25°C unless otherwise specified)

Total Power Output (note 1)

	P_O		
($I_F = 100mA$)			
LED55B-LED55BF	3.5		mW
LED55C-LED55CF	5.4		mW
LED56 -LED56F	1.5		mW

Peak Emission Wavelength

($I_F = 100mA$) 940 nm

Spectral Shift with Temperature .28 nm/°C

Spectral Bandwidth 50% 60 nm

Rise Time 0-90% of Output 1.0 μsec

Fall Time 100-10% of Output 1.0 μsec

Note 1: Total power output, P_O , is the total power radiated by the device into a solid angle of 2π steradians.

TYPICAL CHARACTERISTICS

LED55B,C, LED56, LED55BF, LED55CF, LED56F

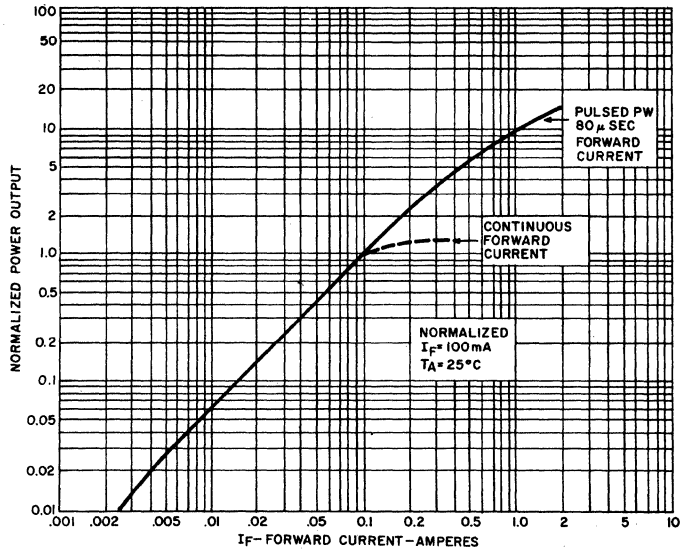

1. POWER OUTPUT VS. INPUT CURRENT

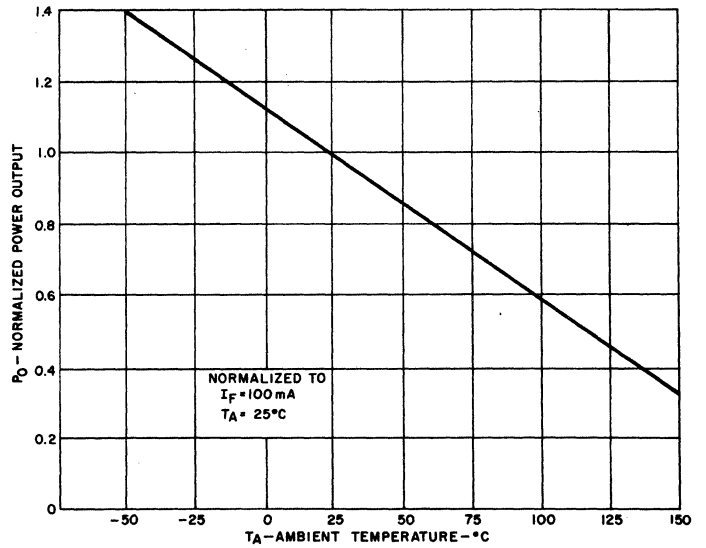

2. POWER OUTPUT VS. TEMPERATURE

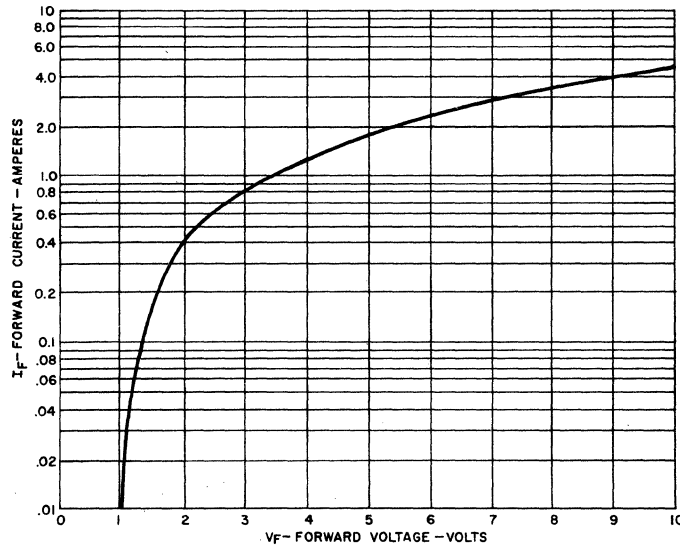

3. LED 55B, 55C, 56, 55BF, 55CF, 56F FORWARD VOLTAGE VS. FORWARD CURRENT

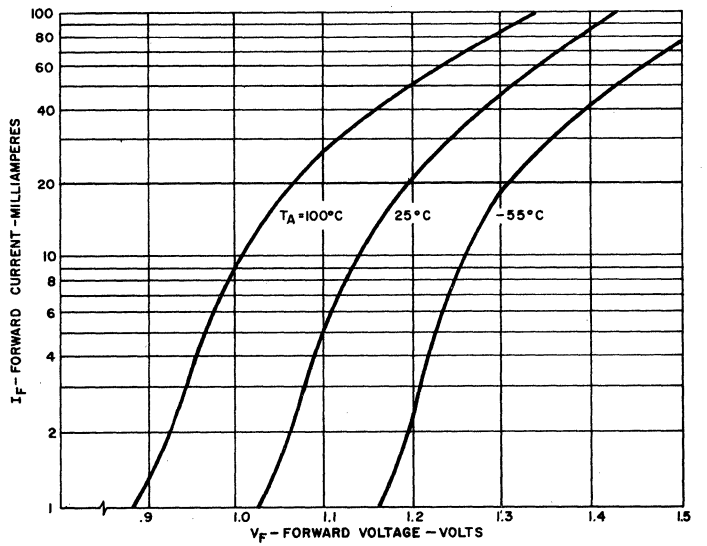

4. FORWARD VOLTAGE VS. FORWARD CURRENT

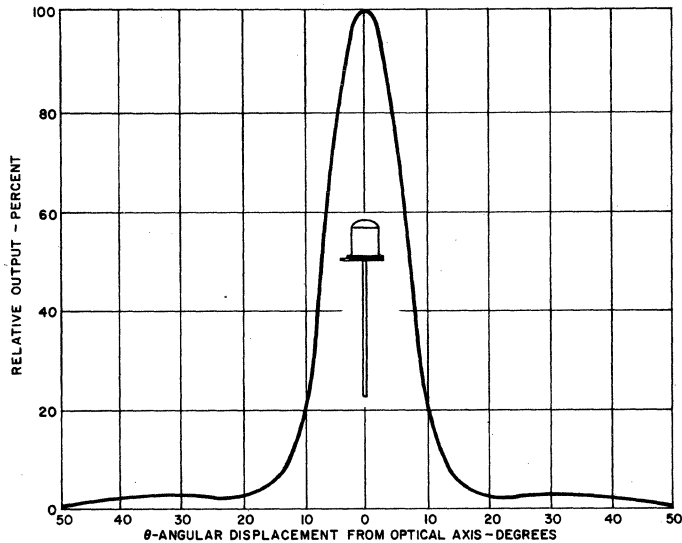

5. LED 55B, 55C, 56 TYPICAL RADIATION PATTERN

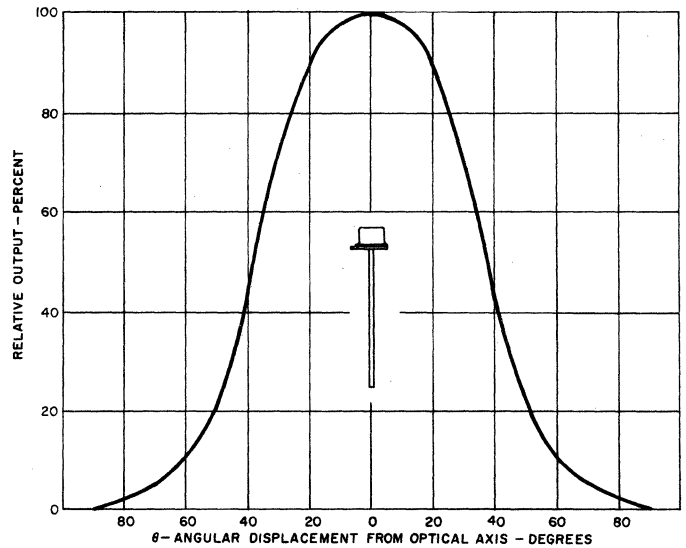

6. LED 55BF, 55CF, 56F TYPICAL RADIATION PATTERN



SOLID STATE OPTOELECTRONICS

Light Detector Planar Silicon Photo Transistor NPN L14C1-L14C2

The General Electric L14C1 and L14C2 are NPN Silicon Phototransistors in a TO-18 style hermetically sealed package. The device has a top-looking flat lens which is thus ideally suited to optoelectronic sensing applications where external optics are being used. Generally only the collector and emitter leads are used; a base lead is provided, however, to control sensitivity and gain of the device.

absolute maximum ratings: (25°C) unless otherwise specified

Voltages — Dark Characteristics

		L14C1	L14C2	
Collector to Emitter Voltage	V_{CEO}	50	50	volts
Collector to Base Voltage	V_{CBO}	50	50	volts
Emitter to Base Voltage	V_{EBO}	7	7	volts

Currents

Light Current	I_L	50	mA
---------------	-------	----	----

Dissipations

Power Dissipation ($T_A = 25^\circ\text{C}$)*	P_T	300	mW
Power Dissipation ($T_C = 25^\circ\text{C}$ **)	P_T	600	mW

Temperatures

Junction Temperature	T_J	-65 to 150	°C
Storage Temperature	T_{STG}	-65 to 150	°C
Lead Soldering Time	T_L	10 Seconds at 260°C	

*Derate 2.4 mW/°C above 25°C ambient

**Derate 4.8 mW/°C above 25°C case

electrical characteristics: (25°C) unless otherwise specified

STATIC CHARACTERISTICS	L14C1		L14C2	
	MIN.	MAX.	MIN.	MAX.

Light Current

($V_{CE} = 5\text{V}, E_e = 10\text{mW/cm}^2$)	I_L	1.0	—	0.5	—	mA
($V_{CE} = 5\text{V}, E_e = 20\text{mW/cm}^2$)		—	—	1.0	—	mA

Dark Current

($V_{CE} = 20\text{V}, E_e \approx 0$)	I_D	—	100	—	100	nA
--	-------	---	-----	---	-----	----

Emitter-Base Breakdown Voltage

($I_E = 100\mu\text{A}, I_C = 0, E_e \approx 0$)	$V_{(BR)EBO}$	7		7		V
--	---------------	---	--	---	--	---

Collector-Base Breakdown Voltage

($I_C = 100\mu\text{A}, I_E = 0, E_e \approx 0$)	$V_{(BR)CBO}$	50		50		V
--	---------------	----	--	----	--	---

Collector-Emitter Breakdown Voltage

($I_C = 10\text{mA}, E_e \approx 0$ Pulse Width $\leq 300\mu\text{sec}$, Duty Cycle $\leq 1\%$)	$V_{(BR)CEO}$	50		50		V
--	---------------	----	--	----	--	---

Saturation Voltage

($I_C = 0.4\text{mA}, E_e = 20\text{mW/cm}^2$)	$V_{CE(SAT)}$		0.2		0.2	V
--	---------------	--	-----	--	-----	---

SWITCHING CHARACTERISTICS

TYP.

Switching Speeds

($V_{CC} = 10\text{V}, I_L = 2\text{mA}, R_L = 100\Omega$)

Turn-On Time	$t_{on}(= t_d + t_r)$	5	μsec
--------------	-----------------------	---	-----------------

Turn-Off Time	$t_{off}(= t_s + t_f)$	5	μsec
---------------	------------------------	---	-----------------

E_e = Radiation Flux Density. Radiation source is an unfiltered tungsten filament bulb at 2870°K color temperature.

Note: A GaAs source of 3.0mW/cm² is approximately equivalent to a tungsten source, at 2870°K, of 10mW/cm².

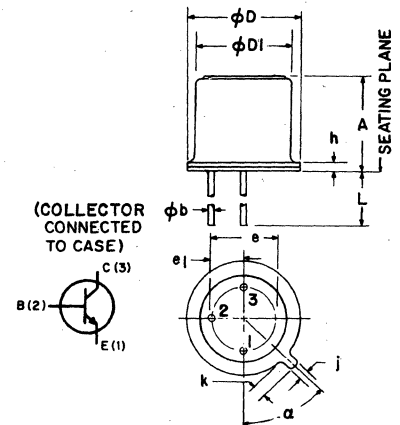
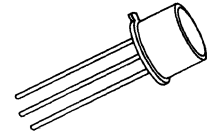

SYMBOL	INCHES		MILLIMETERS		NOTES
	MIN.	MAX.	MIN.	MAX.	
A	—	.210	—	5.34	
phi b	.016	.021	.406	.534	
phi D	.209	.230	5.30	5.85	
phi D1	.178	.195	4.52	4.96	
e	.100 NOM		2.54 NOM		2
e1	.050 NOM		1.27 NOM		2
h	—	.030	—	.76	
j	.036	.046	.91	1.17	
k	.028	.048	.71	1.22	1
L	.500	—	12.7	—	
alpha	45°	45°	45°	45°	3

NOTES:

1. Measured from maximum diameter of device.
2. Leads having maximum diameter .021" (.533mm) measured in gauging plane .054" (+.001" - .000") (1.37 + .025 - .000mm) below the reference plane of the device shall be within .007" (.178mm) their true position relative to maximum width tab.
3. From centerline tab.

TYPICAL ELECTRICAL CHARACTERISTICS

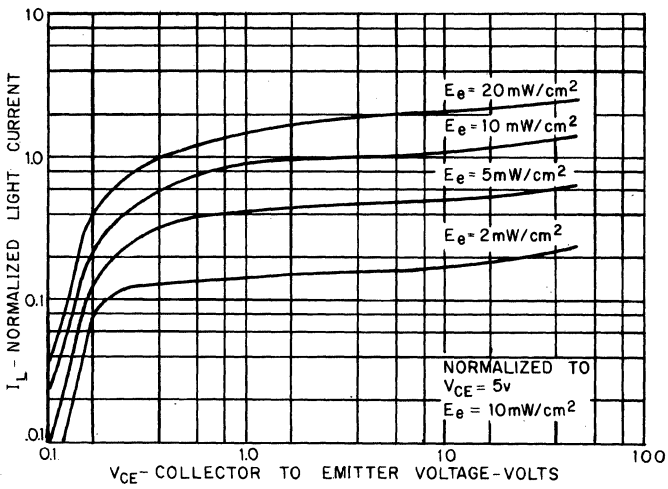

LIGHT CURRENT VS COLLECTOR TO EMITTER VOLTAGE

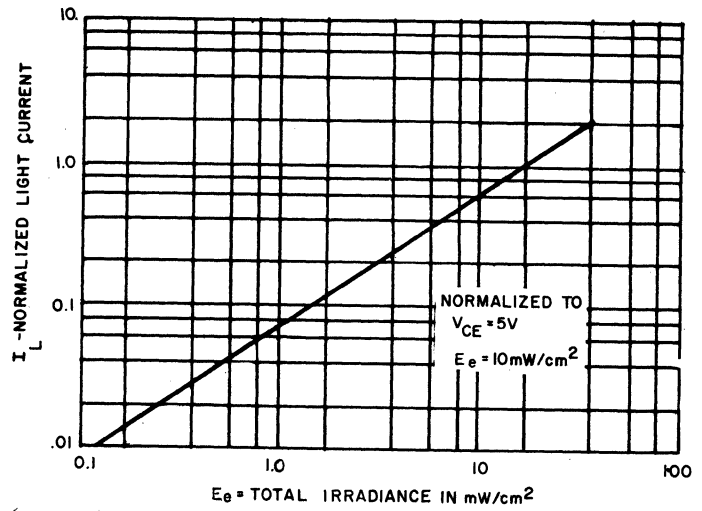

NORMALIZED LIGHT CURRENT VS RADIATION

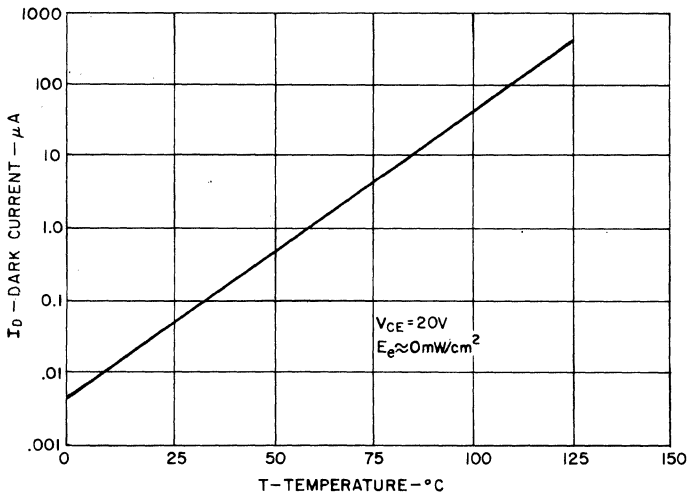

DARK CURRENT VS TEMPERATURE

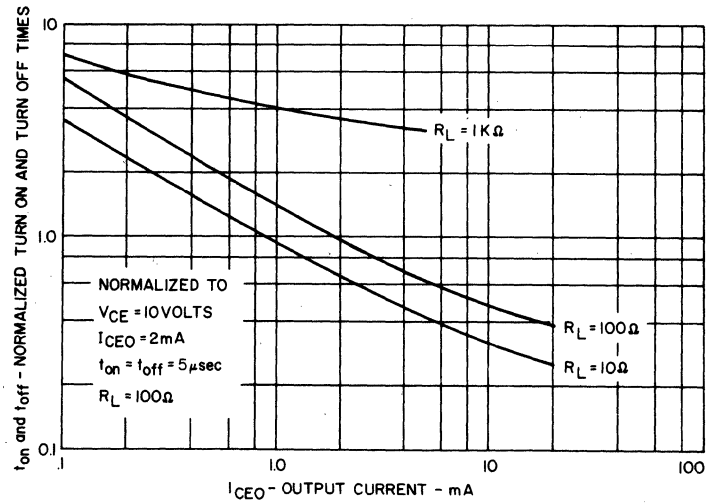

SWITCHING TIMES VS OUTPUT CURRENT

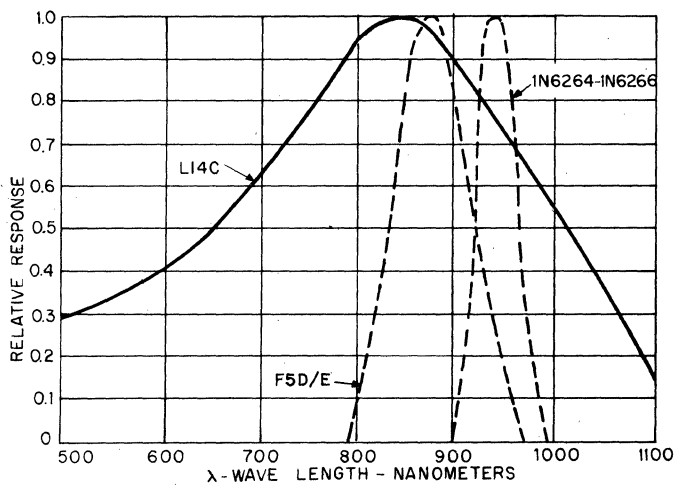

SPECTRAL RESPONSE

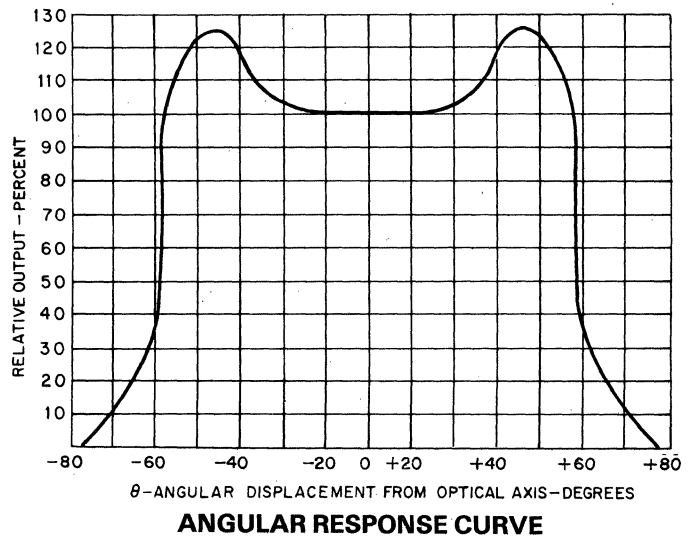

ANGULAR RESPONSE CURVE



SOLID STATE OPTOELECTRONICS

Light Detector Planar Silicon Photo-Darlington Amplifier

NPN L14F1, L14F2

The General Electric L14F1 and L14F2 are supersensitive NPN Planar Silicon Photodarlington Amplifiers. For many applications, only the collector and emitter leads are used; however, a base lead is provided to control sensitivity and the gain of the device. The L14F1 - L14F2 are a TO-18 Style hermetically sealed packages with lens cap and are designed to be used in optoelectronic sensing applications requiring very high sensitivity.

absolute maximum ratings: (25°C) (unless otherwise specified)

VOLTAGES - DARK CHARACTERISTICS

Collector to Emitter Voltage	V_{CEO}	25	v
Collector to Base Voltage	V_{CBO}	25	v
Emitter to Base Voltage	V_{EBO}	12	v

CURRENTS

Light Current	I_L	200	mA
---------------	-------	-----	----

DISSIPATIONS

Power Dissipation ($T_A = 25^\circ\text{C}$)*	P_T	300	mW
Power Dissipation ($T_C = 25^\circ\text{C}$ **)	P_T	600	mW

TEMPERATURES

Junction Temperature	T_J	-55 to 150	°C
Storage Temperature	T_{STG}	-65 to 150	°C
Lead Soldering Time	T_L	10 Seconds at 260°C	

*Derate 2.4 mW/°C above 25°C ambient.

**Derate 4.8 mW/°C above 25°C case.

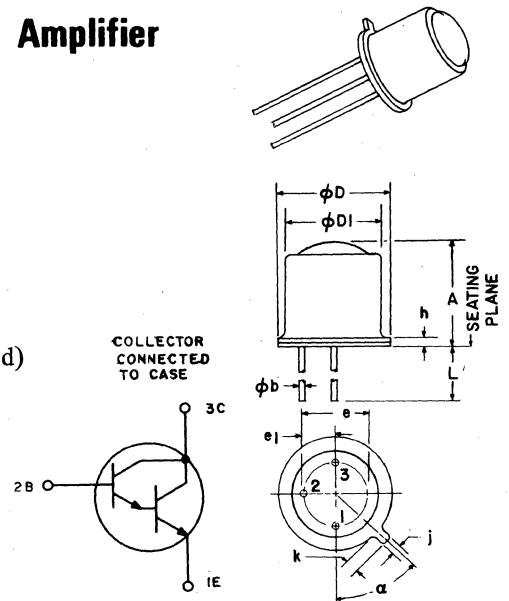

SYMBOL	INCHES		MILLIMETERS		NOTES
	MIN.	MAX.	MIN.	MAX.	
A	.225	.255	5.71	6.47	
phi b	.016	.021	407	533	
phi D	.209	.230	5.31	5.84	
phi D1	.178	.195	4.52	4.96	
e	.100	NOM	2.54	NOM	2
e2	.050	NOM	1.27	NOM	2
h	—	1.030	—	.76	
j	.036	.046	.92	1.16	
k	.028	.048	.71	1.22	1
L	.500	—	12.7	—	
alpha	45°	45°	45°	45°	3

NOTES:

1. Measured from maximum diameter of device.
2. Leads having maximum diameter .021" (.533mm) measured in gauging plane .054" (+.001" - .000") (1.37 + .025 - .000mm) below the reference plane of the device shall be within .007" (.178mm) their true position relative to maximum width tab.
3. From centerline tab.

electrical characteristics: (25°C) (unless otherwise specified)

STATIC CHARACTERISTICS		L14F1		L14F2		
		MIN.	MAX.	MIN.	MAX.	
LIGHT CURRENT						
($V_{CE} = 5V, H^\dagger = 0.2 \text{ mW/cm}^2$)	I_L	3	—	1	—	mA
DARK CURRENT						
($V_{CE} = 12V, I_B = 0$)	I_D	—	100	—	100	nA
EMITTER-BASE BREAKDOWN VOLTAGE						
($I_E = 100 \mu\text{A}$)	$V_{(BR)EBO}$	12	—	12	—	V
COLLECTOR-BASE BREAKDOWN VOLTAGE						
($I_C = 100 \mu\text{A}$)	$V_{(BR)CBO}$	25	—	25	—	V
COLLECTOR-EMITTER BREAKDOWN VOLTAGE						
($I_C = 10 \text{ mA}$)	$V_{(BR)CEO}$	25	—	25	—	V
SWITCHING CHARACTERISTICS (see Switching Circuit)						
SWITCHING SPEEDS						
($V_{CC} = 10V, I_L = 10 \text{ mA}, R_L = 100 \Omega$)						
DELAY TIME	t_d	—	50	—	50	μsec
RISE TIME	t_r	—	300	—	300	μsec
STORAGE TIME	t_s	—	10	—	10	μsec
FALL TIME	t_f	—	250	—	250	μsec

$\dagger H$ = Radiation Flux Density. Radiation source is an unfiltered tungsten filament bulb at 2870°K color temperature.

NOTE: The 2870°K radiation is 25% effective on the photodarlington; i.e., a GaAs source of 0.05 mW/cm² is equivalent to this 0.2 mW/cm² tungsten source.

TYPICAL ELECTRICAL CHARACTERISTICS

L14F1-L14F2

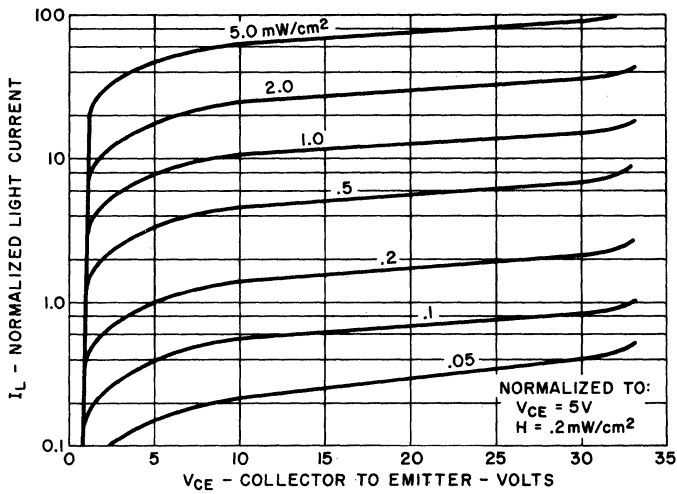

1. LIGHT CURRENT VS. COLLECTOR TO EMITTER VOLTAGE

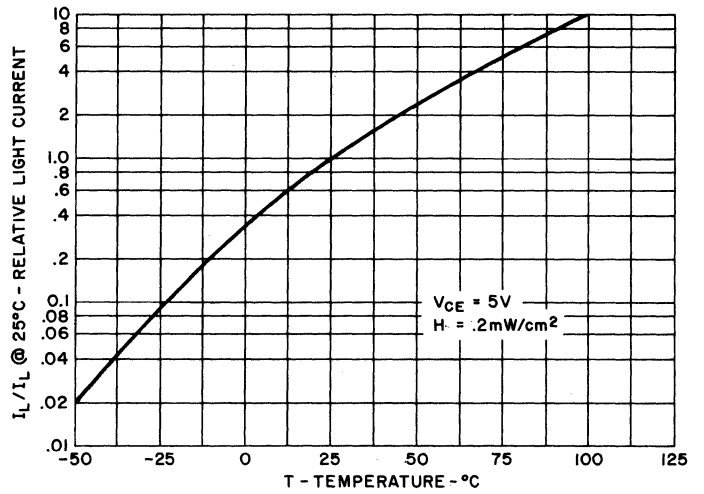

2. RELATIVE LIGHT CURRENT VS. AMBIENT TEMPERATURE

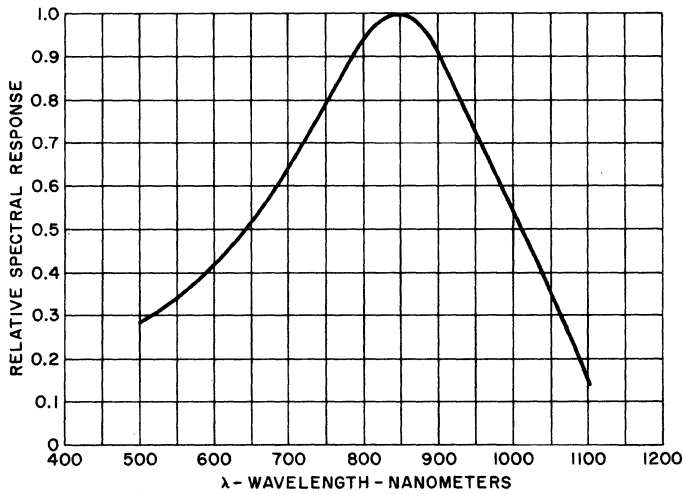

3. SPECTRAL RESPONSE CURVE

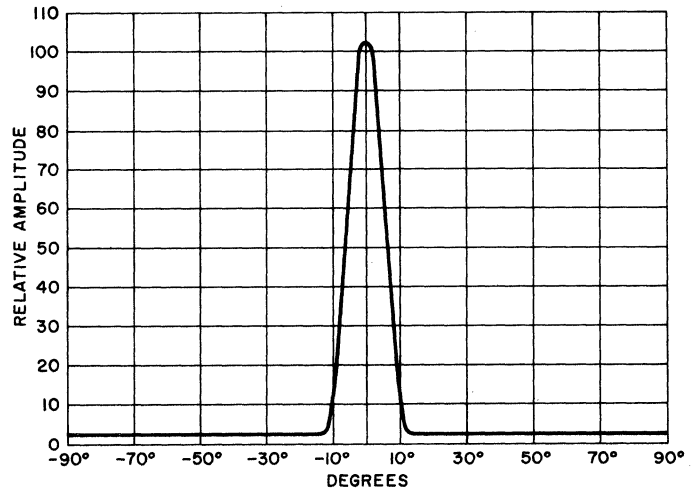

4. ANGULAR RESPONSE

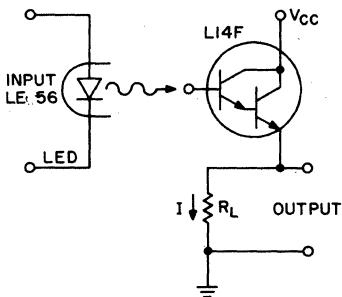

5. TEST CIRCUIT

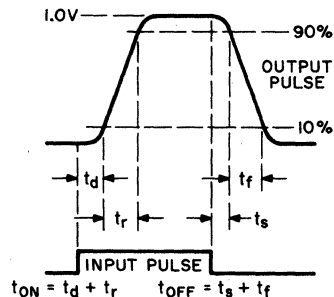

6. WAVE FORMS

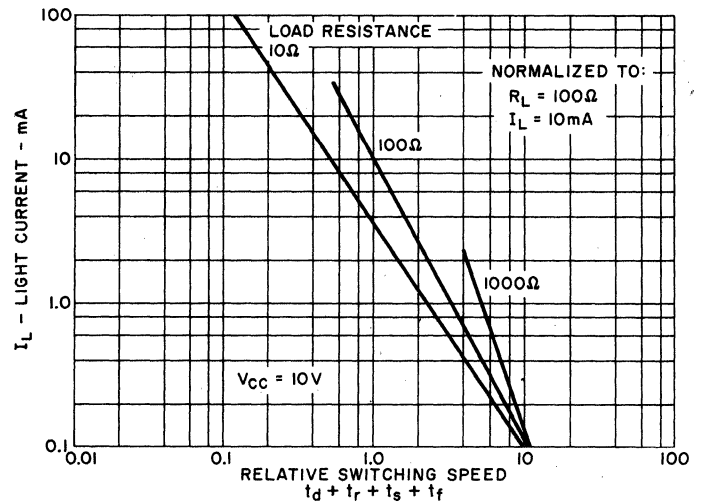

7. LIGHT CURRENT VS. RELATIVE SWITCHING SPEED



SOLID STATE OPTOELECTRONICS

Light Detector Planar Silicon Photo Transistor

NPN L14G1, L14G2, L14G3

The General Electric L14G1 thru L14G3 are highly sensitive NPN Planar Silicon Photo-transistors. They are housed in a TO-18 style hermetically sealed package with lens cap. The L14G series is ideal for use in optoelectronic sensing applications where both high sensitivity and fast switching speeds are important parameters. Generally only the collector and emitter leads are used; a base lead is provided, however, to control sensitivity and gain of the device.

absolute maximum ratings: (25°C unless otherwise specified)

Voltages — Dark Characteristics

Collector to Emitter Voltage	V _{CEO}	45	volts
Collector to Base Voltage	V _{CBO}	45	volts
Emitter to Base Voltage	V _{EBO}	5	volts

Currents

Light Current	I _L	50	mA
---------------	----------------	----	----

Dissipations

Power Dissipation (T _A = 25°C)*	P _T	300	mW
Power Dissipation (T _C = 25°C)**	P _T	600	mW

Temperatures

Junction Temperature	T _J	-55 to 150	°C
Storage Temperature	T _{STG}	-65 to 150	°C
Lead Soldering Time	T _L	10 Seconds at 260°C	

*Derate 2.4 mW/°C above 25°C ambient

**Derate 4.8 mW/°C above 25°C case

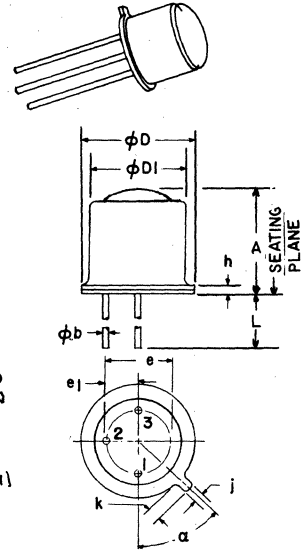

SYMBOL	INCHES		MILLIMETERS		NOTES
	MIN.	MAX.	MIN.	MAX.	
A	.225	.255	5.71	6.47	
ϕb	.016	.021	4.07	5.33	
ϕD	.209	.230	5.31	5.84	
ϕD_1	.178	.195	4.52	4.96	
e	.100 NOM		2.54 NOM		2
e_1	.050 NOM		1.27 NOM		2
h	—	.030	—	.76	
j	.036	.046	.92	1.16	
k	.028	.048	.71	1.22	1
L	.500	—	12.7	—	
a	.45°	.45°	.45°	.45°	3

NOTES:

1. Measured from maximum diameter of device.
2. Leads having maximum diameter .021" (.533mm) measured in gauging plane .054" +.001" - .000 (137 + .025 - .000mm) below the reference plane of the device shall be within .007" (.178mm) their true position relative to maximum width tab.
3. From centerline tab.

electrical characteristics: (25°C unless otherwise specified)

STATIC CHARACTERISTICS		L14G1		L14G2		L14G3	
		MIN.	MAX.	MIN.	MAX.	MIN.	MAX.
Light Current (V _{CE} = 5V, H† = 10mW/cm ²)	I _L	6		3		12	mA
Dark Current (V _{CE} = 10V, H = 0)	I _D		100	100		100	nA
Emitter-Base Breakdown Voltage (I _E = 100μA, I _C = 0, H = 0)	V _{(BR)EBO}	5		5		5	V
Collector-Base Breakdown Voltage (I _C = 100μA, I _E = 0, H = 0)	V _{(BR)CBO}	45		45		45	V
Collector-Emitter Breakdown Voltage (I _C = 10mA, H = 0)	V _{(BR)CEO}	45		45		45	V
Saturation Voltage (I _C = 10mA, I _B = 1mA)	V _{CE(SAT)}	0.4		0.4		0.4	
Turn-On Time (V _{CE} = 10V, I _C = 2mA,	t _{on}		8	8		8	μsec
Turn-Off Time R _L = 100Ω)	t _{off}		7	7		7	μsec

†H = Radiation Flux Density. Radiation source is on unfiltered tungsten filament bulb at 2870°K color temperature.

NOTE: A GaAs source of 3.0 mW/cm² is approximately equivalent to a tungsten source, at 2870°K, of 10 mW/cm²

TYPICAL ELECTRICAL CHARACTERISTICS

L14G1-L14G2-L14G3

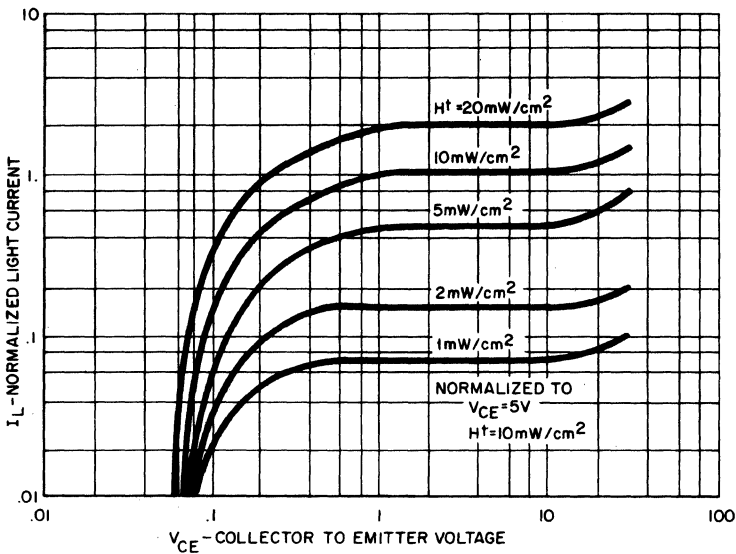

LIGHT CURRENT VS COLLECTOR TO EMITTER VOLTAGE

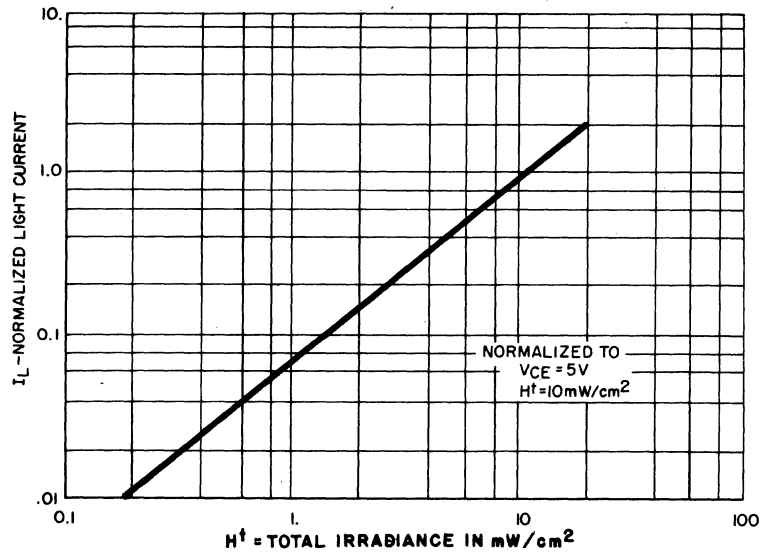

NORMALIZED LIGHT CURRENT VS RADIATION

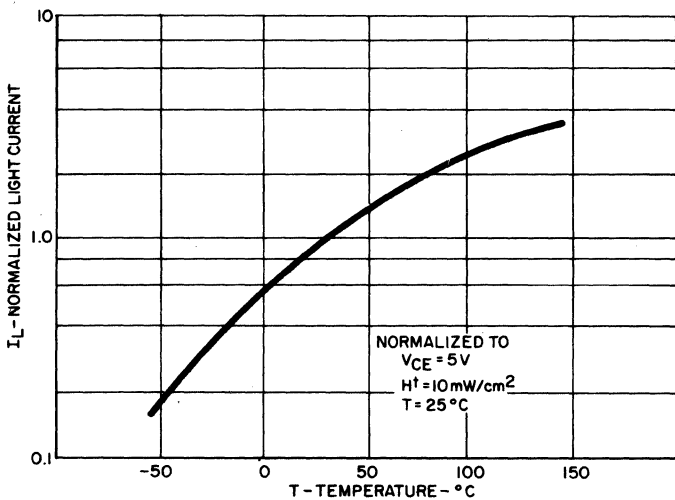

NORMALIZED LIGHT CURRENT VS TEMPERATURE

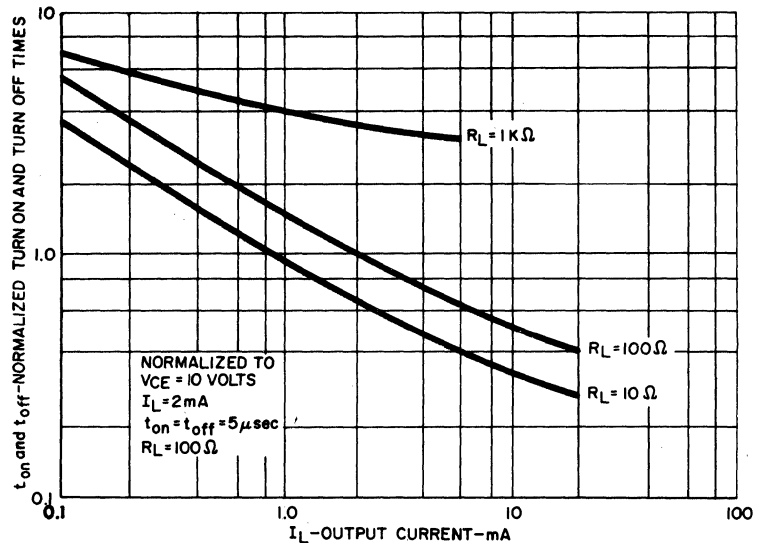

SWITCHING TIMES VS OUTPUT CURRENT

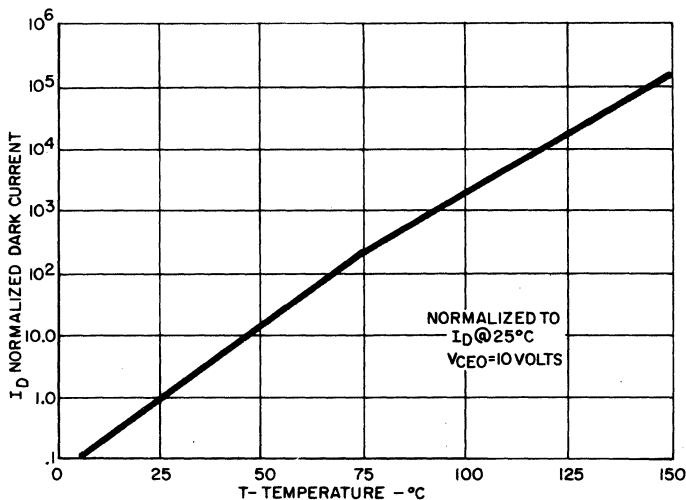

DARK CURRENT VS TEMPERATURE

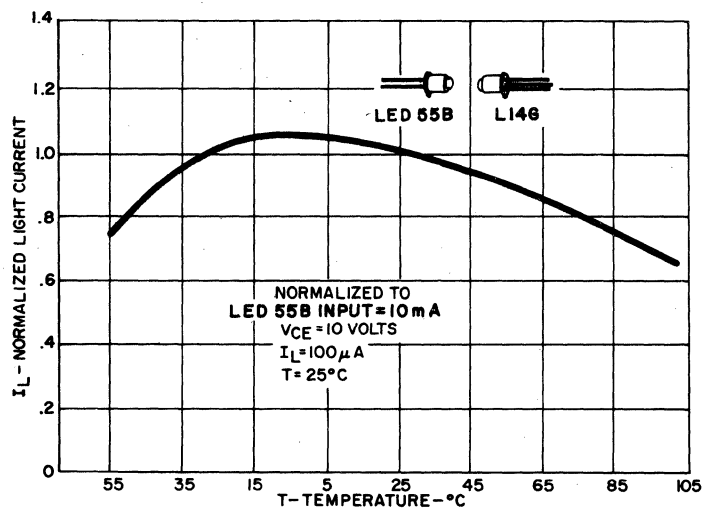

NORMALIZED LIGHT CURRENT VS TEMPERATURE
Both Emitter (LED55B) and Detector (L14G) at Same Temperature



SOLID STATE

OPTO ELECTRONICS

Light Detector High Sensitivity Phototransistor

NPN L14N1-L14N2

The General Electric L14N1 and L14N2 are NPN Silicon Phototransistors in a TO-18 style hermetically-sealed package. The device has a top-looking flat lens cap and is ideally suited for applications requiring high sensitivity in the industrial control and alarm/detection markets. For phototransistor applications, the collector and emitter leads are used. The base lead is provided to control phototransistor sensitivity. For application flexibility, the device can also be used as a photodiode by using the collector and base leads.

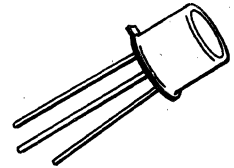

absolute maximum ratings: (25° C) unless otherwise specified

Voltages — Dark Characteristics

Collector to Emitter Voltage	V _{CEO}	30	volts
Collector to Base Voltage	V _{CBO}	40	volts
Emitter to Base Voltage	V _{EBO}	5	volts

Currents

Collector Current	I _C	50	mA
Emitter Current	I _E	50	mA

Dissipations

Power Dissipation (T _A = 25° C)*	P _T	300	mW
Power Dissipation (T _C = 25° C)**	P _T	600	mW

Temperatures

Junction Temperature	T _J	-55 to 150	°C
Storage Temperature	T _{STG}	-65 to 150	°C
Lead Soldering Temperature (1/16" from case for 10 sec.)	T _L	260	°C

*Derate 2.4 mW/°C above 25° C ambient

**Derate 4.8 mW/°C above 25° C ambient

electrical characteristics: (25° C) unless otherwise specified

STATIC CHARACTERISTICS

Photo Current

(V _{CE} = 5V, E _e = 5mW/cm ²) Phototransistor	I _L	3.0	6.0	6.0	10.0	mA
(V _{CB} = 5V, E _e = 5mW/cm ²) Photodiode	I _L		5.0		5.0	μA

Dark Current

(V _{CE} = 10V, E _e ≈ 0)	I _{CEO}	6.0	100	10	100	nA
(V _{CB} = 25V, E _e ≈ 0)	I _{CBO}	0.1	25	0.1	25	nA

Emitter-Base Breakdown Voltage

(I _E = 100μA, I _C = 0, E _e ≈ 0)	V _{(BR)EBO}	5	10	5	10	V
--	----------------------	---	----	---	----	---

Collector-Base Breakdown Voltage

(I _C = 100μA, I _E = 0, E _e ≈ 0)	V _{(BR)CBO}	40	65	40	50	V
--	----------------------	----	----	----	----	---

Collector-Emitter Breakdown Voltage

(I _C = 1 mA, E _e ≈ 0)	V _{(BR)CEO}	30	35	30	45	V
Pulse Width ≤ 300μsec, Duty Cycle ≤ 1%						

Beam Angle

Beam Angle at 50% Amplitude	θ	35	35	degrees
-----------------------------	---	----	----	---------

Saturation Voltage

(I _C = 0.8 mA, E _e = 10mW/cm ²)	V _{CE(SAT)}	0.30	0.40	V	
(I _C = 1.6 mA, E _e = 10mW/cm ²)	V _{CE(SAT)}		0.25	0.40	V

SWITCHING CHARACTERISTICS

Switching Speeds (Phototransistor)

(V _{CC} = 5V, I _C = 10 mA, R _L = 100Ω)					
Rise Time	t _r	10	14	μsec	
Fall Time	t _f	12	16	μsec	

E_e = Radiation Flux Density. Radiation source is an unfiltered tungsten filament bulb at 2870° K color temperature.
Note: A GaAs source of 3.0 mW/cm² is approximately equivalent to a tungsten source, at 2870° K, of 10 mW/cm².

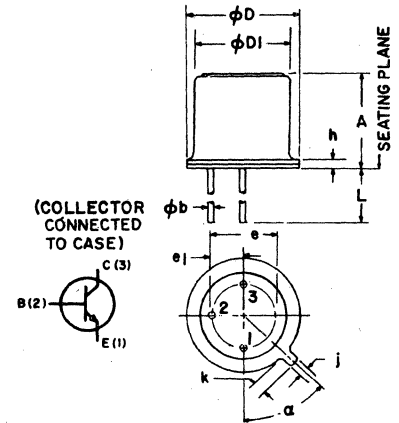

SYMBOL	INCHES		MILLIMETERS		NOTES
	MIN.	MAX.	MIN.	MAX.	
A	—	.210	—	.534	
φb	.016	.021	.406	.534	
φD	.209	.230	5.30	5.85	
φDi	.178	.195	4.52	4.96	
e	.100 NOM		2.54 NOM		2
e ₁	.050 NOM		1.27 NOM		2
h	—	.030	—	.76	
l	.036	.046	.91	1.17	
k	.028	.048	.71	1.22	1
L	.500	—	12.7	—	
α	45°	45°	45°	45°	3

NOTES:
1. Measured from maximum diameter of device.
2. Leads having maximum diameter .021" (.533mm) measured in gauging plane .054" (+.001" - .000") below the reference plane of the device shall be within .007" (.178mm) their true position relative to maximum width tab.
3. From centerline tab.

TYPICAL ELECTRICAL CHARACTERISTICS (Normalized to Specification Bias Points)

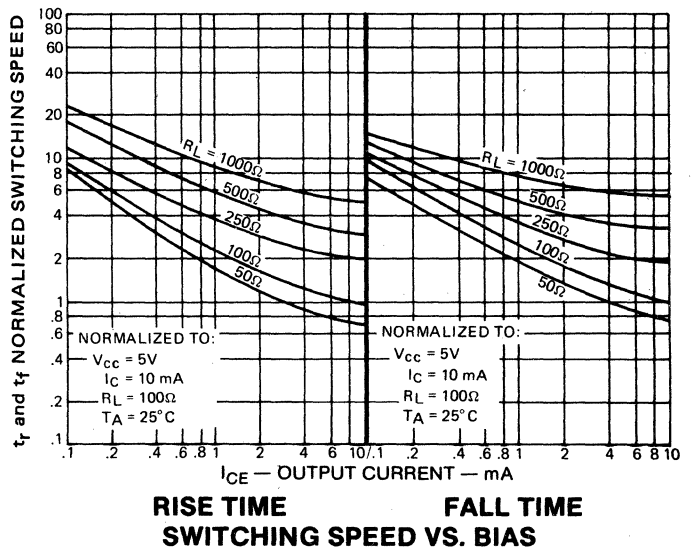
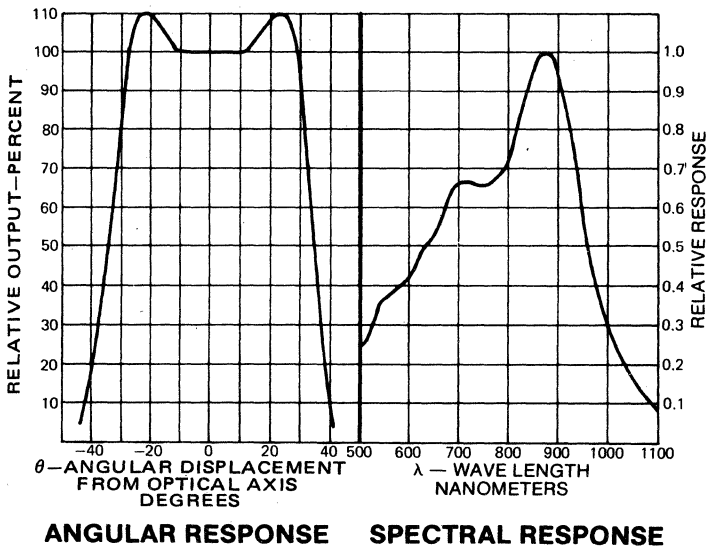
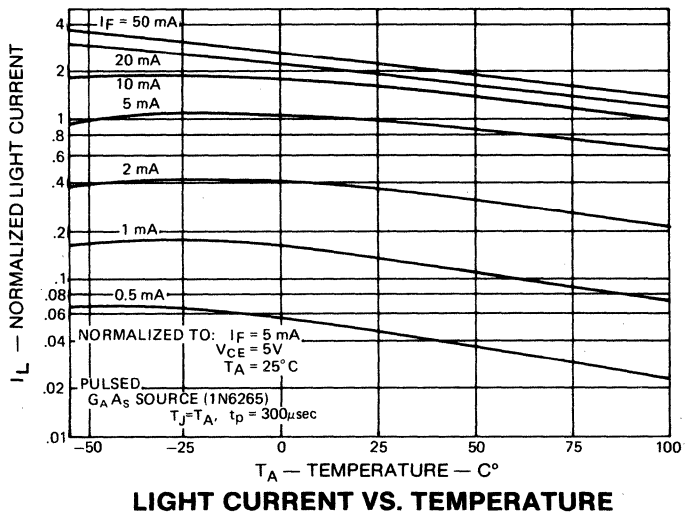
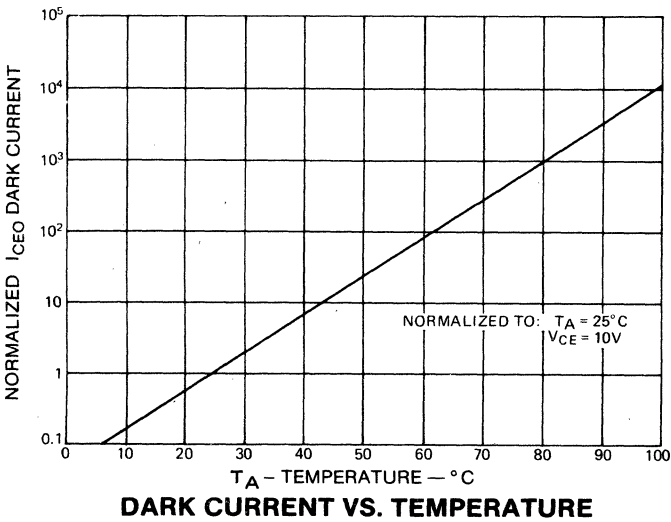
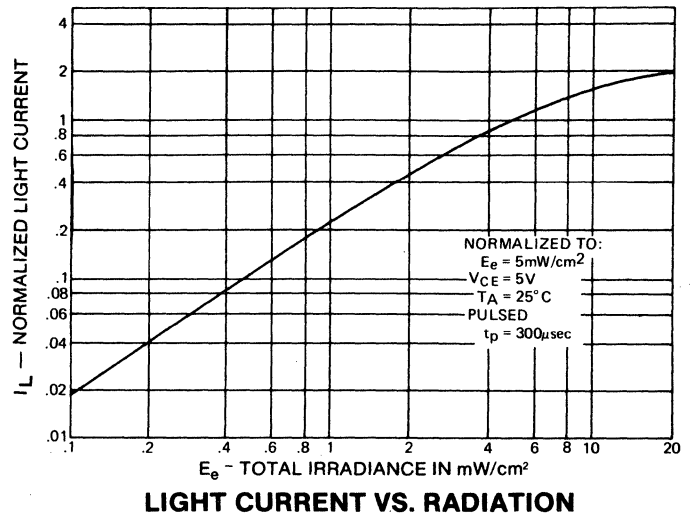
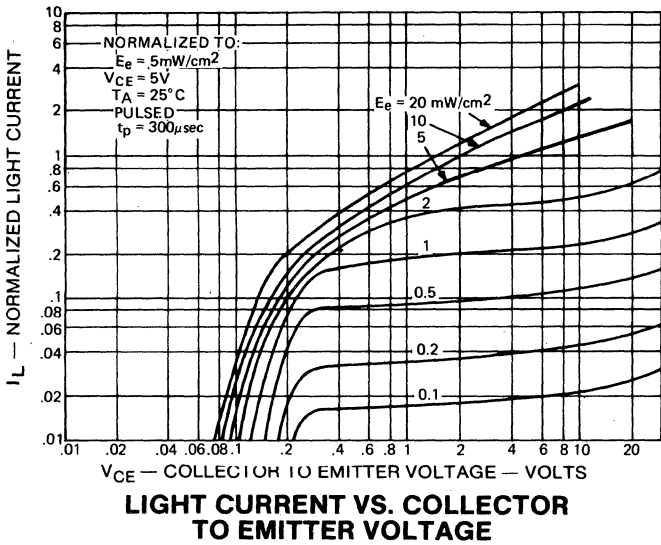



SOLID STATE OPTOELECTRONICS

Light Detector High Sensitivity Phototransistor

NPN L14P1-L14P2

The General Electric L14P1 and L14P2 are NPN Silicon Phototransistors in a TO-18 style hermetically-sealed package. The device has a top-looking flat lens cap and is ideally suited for applications requiring high sensitivity in the industrial control and alarm/detection markets. For phototransistor applications, the collector and emitter leads are used. The base lead is provided to control phototransistor sensitivity. For application flexibility, the device can also be used as a photodiode by using the collector and base leads.

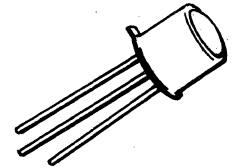

absolute maximum ratings: (25° C) unless otherwise specified

Voltages — Dark Characteristics

Collector to Emitter Voltage	V _{CEO}	30	volts
Collector to Base Voltage	V _{CBO}	40	volts
Emitter to Base Voltage	V _{EBO}	5	volts

Currents

Collector Current	I _C	50	mA
Emitter Current	I _E	50	mA

Dissipations

Power Dissipation (T _A = 25° C)*	P _T	300	mW
Power Dissipation (T _C = 25° C)**	P _T	600	mW

Temperatures

Junction Temperature	T _J	-55 to 150	°C
Storage Temperature	T _{STG}	-65 to 150	°C
Lead Soldering Temperature (1/16" from case for 10 sec.)	T _L	260	°C

*Derate 2.4 mW/°C above 25° C ambient

**Derate 4.8 mW/°C above 25° C ambient

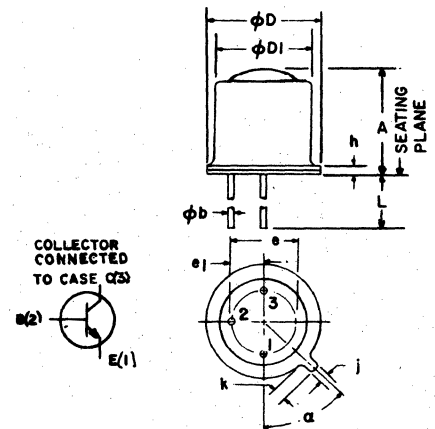

electrical characteristics: (25° C) unless otherwise specified

STATIC CHARACTERISTICS

Photo Current

(V _{CE} = 5V, E _e = 1mW/cm ²) Phototransistor	I _L	4.0	8.0	8.0	11.0	mA
(V _{CB} = 5V, E _e = 1mW/cm ²) Photodiode	I _L	6.0		6.0		μA

Dark Current

(V _{CE} = 10V, E _e ≈ 0)	I _{CEO}	6.0	100	10.0	100	nA
(V _{CB} = 25V, E _e ≈ 0)	I _{CBO}	0.1	25	0.1	25	nA

Emitter-Base Breakdown Voltage

(I _E = 100μA, I _C = 0, E _e ≈ 0)	V _{(BR)EBO}	5	10	5	10	V
--	----------------------	---	----	---	----	---

Collector-Base Breakdown Voltage

(I _C = 100μA, I _E = 0, E _e ≈ 0)	V _{(BR)CBO}	40	65	40	50	V
--	----------------------	----	----	----	----	---

Collector-Emitter Breakdown Voltage

(I _C = 1 mA, E _e ≈ 0)	V _{(BR)CEO}	30	55	30	45	V
---	----------------------	----	----	----	----	---

Beam Angle

Beam Angle at 50% Amplitude	θ		12		12	degrees
-----------------------------	---	--	----	--	----	---------

Saturation Voltage

(I _C = 0.8 mA, E _e = 2mW/cm ²)	V _{CE(SAT)}	0.30	0.40			V
(I _C = 1.6 mA, E _e = 2mW/cm ²)	V _{CE(SAT)}			0.25	0.40	V

SWITCHING CHARACTERISTICS

Switching Speeds (Phototransistor)

(V _{CC} = 5V, I _C = 10 mA, R _L = 100Ω)						
Rise Time	t _r		10		14	μsec
Fall Time	t _f		12		16	μsec

E_e = Radiation Flux Density. Radiation source is an unfiltered tungsten filament bulb at 2870° K color temperature.
Note: A GaAs source of 3.0 mW/cm² is approximately equivalent to a tungsten source, at 2870° K, of 10 mW/cm².

SYMBOL	INCHES		MILLIMETERS		NOTES
	MIN.	MAX.	MIN.	MAX.	
A	.225	.255	5.71	6.47	
φb	.016	.021	4.07	5.33	
φD	.209	.230	5.31	5.84	
φD1	.178	.195	4.52	4.96	
e	.100 NOM		2.54 NOM		2
e _h	.050 NOM		1.27 NOM		2
h	—	.030	—	.76	
j	.036	.046	.92	1.16	
k	.028	.048	.71	1.22	1
L	.500	—	12.7	—	
α	45°	45°	45°	45°	3

- NOTES:
1. Measured from maximum diameter of device.
2. Leads having maximum diameter .021" (.533mm) measured in gauging plane .054" ±.001" (-.000(.137 + .025 - .000mm)) below the reference plane of the device shall be within .007" (.178mm) their true position relative to maximum width tab.
3. From centerline tab.

TYPICAL ELECTRICAL CHARACTERISTICS (Normalized to Specification Bias Points)

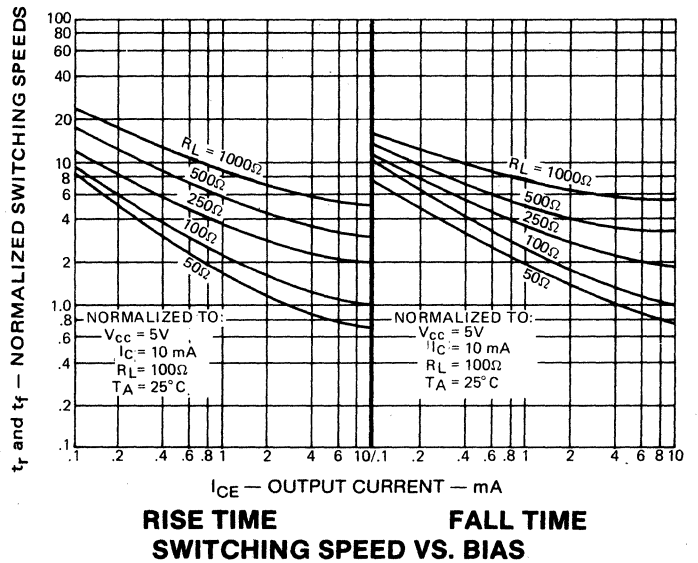
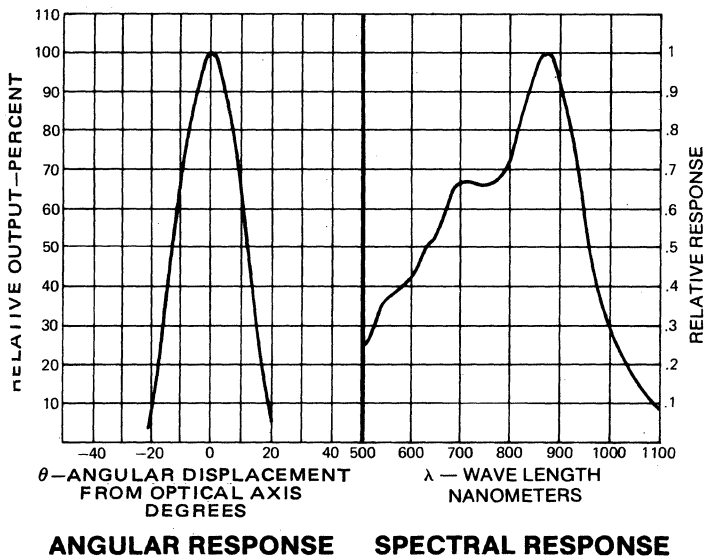
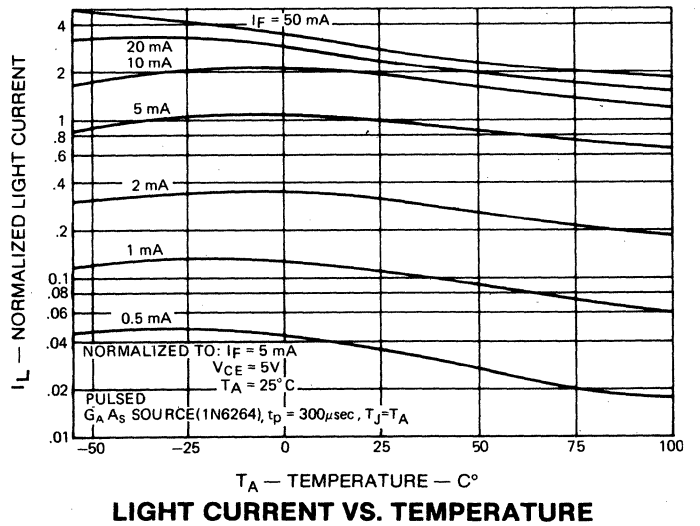
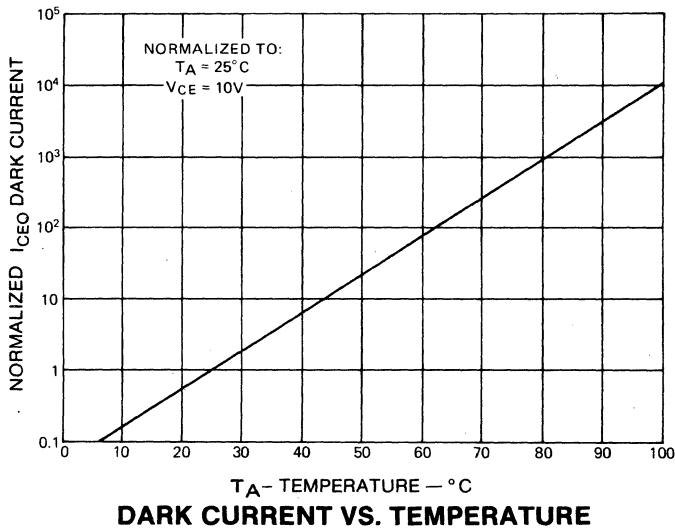
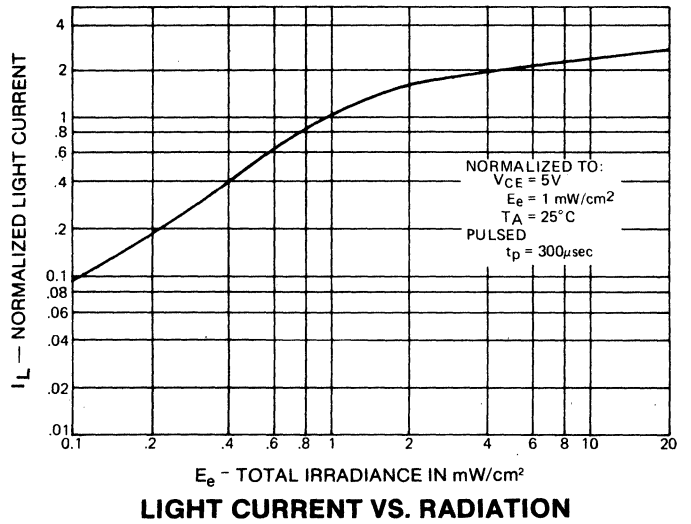
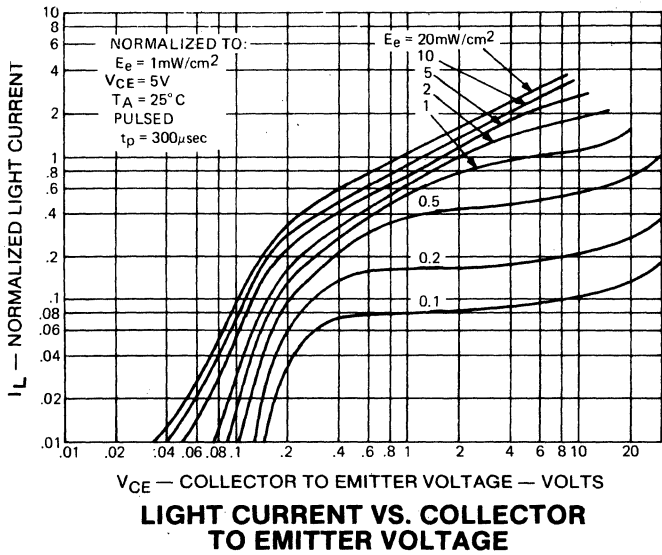



SOLID STATE
OPTO

ELECTRONICS

Light Detector Planar Silicon Photo-Transistor

NPN L14Q1

The General Electric L14Q1 Light Detector is a NPN planar silicon phototransistor. It is packaged in a side-looking clear epoxy encapsulant.

absolute maximum ratings: (25°C) (unless otherwise specified)

VOLTAGES - Dark Characteristics

Collector to Emitter Voltage	V_{CEO}	30	V
Emitter to Collector Voltage	V_{ECO}	6	V

CURRENT

Light Current (continuous)	I_L	100	mA
----------------------------	-------	-----	----

DISSIPATION

Power Dissipation ($T_A = 25^\circ\text{C}$)*	P_T	150	mW
---	-------	-----	----

TEMPERATURES

Junction Temperature	T_J	-55 to +100	°C
Storage Temperature	T_{STG}	-55 to +100	°C
Lead Soldering Temperature (5 seconds maximum, 1.6mm from case)	T_L	260	°C

*Derate 2.0mW/°C above 25°C ambient

electrical characteristics: (25°C)

DETECTOR ONLY

	SYMBOL	MIN.	TYP.	MAX.	UNITS
Light Current ($V_{CE} = 5V, E_e \dagger = 5mW/cm^2 @ 2870^\circ\text{K}$)	I_L	1.0	4	—	mA
Dark Current ($V_{CE} = 25V, E_e = 0$)	I_D	—	—	100	nA
Beam Angle at Half Power Point (Half angle)	θ_H	—	30	—	Deg.
Saturation Voltage ($I_C = 0.5mA, E_e = 2mW/cm^2 @ 2870^\circ\text{K}$)	$V_{CE(sat)}$	—	0.2	0.4	V
Collector-Emitter Breakdown Voltage ($I_C = 1mA$)	$V_{(BR)CEO}$	30	—	—	V
Emitter-Collector Breakdown Voltage ($I_E = 100\mu A$)	$V_{(BR)ECO}$	6	—	—	V
Collector-Emitter Capacitance ($V_{CE} = 5V, f = 1MHz$)	C_{ceo}	—	3.3	5	pF

coupled characteristics

Light Current ($V_{CE} = 5V, I_F = 20mA$)	I_L	—	4	—	mA
Turn On Time ($V_{CC} = 5V, I_F = 30mA, R_L = 2.5k\Omega$)	t_{on}	—	8	—	μs
Turn Off Time ($V_{CC} = 5V, I_F = 30mA, R_L = 2.5K\Omega$)	t_{off}	—	50	—	μs

NOTE: Coupled electrical characteristics are measured using an F5F1 GaAs IRED at a separation distance of 4mm (.155 inches) with the lenses of the emitter and detector on a common axis within 0.1mm and parallel within 5°.

†The F5F 940nm radiation is approximately 3 times more efficient than the 2870°K tungsten irradiance on this device. This means 1.5mW/cm² from the F5F is equivalent to the 5mW/cm² at 2870°K.

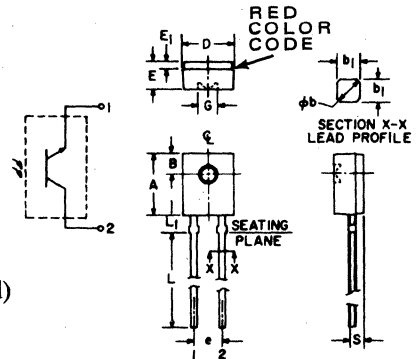

SYM.	MILLI-METERS		INCHES		NOTES
	MIN.	MAX.	MIN.	MAX.	
A	5.59	5.80	.220	.228	
B	1.78	NOM.	.070	NOM.	2
ϕb	.60	.75	.024	.030	1
b_1	.51	NOM.	.020	NOM.	1
D	4.45	4.70	.175	.185	
E	2.41	2.67	.095	.105	
E_1	.58	.69	.023	.027	
e	2.41	2.67	.095	.105	3
G	1.98	NOM.	.078	NOM.	
L	12.7	—	.500	—	
L_1	1.40	1.65	.055	.065	
S	.83	.94	.033	.037	3

NOTES:

- Two leads. Lead cross section dimensions uncontrolled within 1.27 MM (.050") of seating plane.
- Centering of active element located within .25 MM (.010") of true position.
- As measured at the seating plane.
- Inch dimensions derived from millimeters.

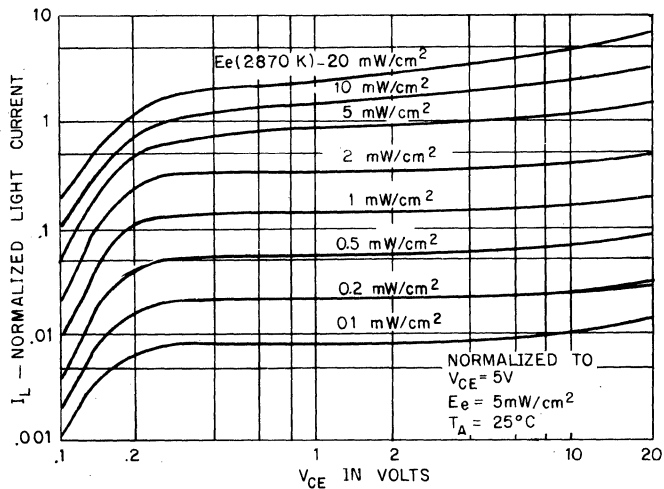

1. LIGHT CURRENT VS. COLLECTOR TO EMITTER VOLTAGE

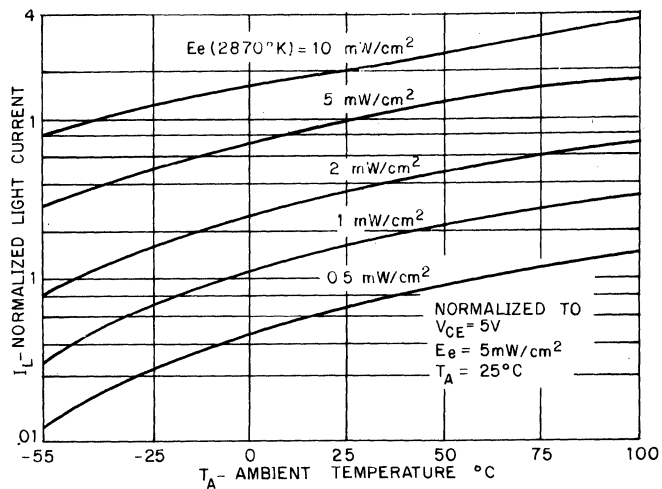

2. LIGHT CURRENT VS. AMBIENT TEMPERATURE

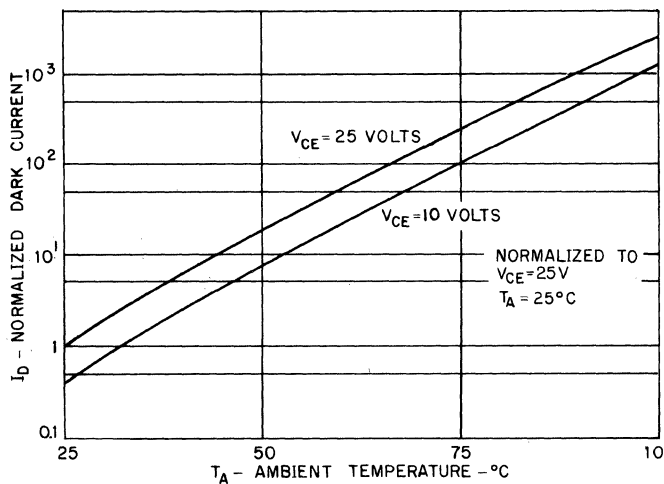

3. LEAKAGE CURRENT VS. TEMPERATURE

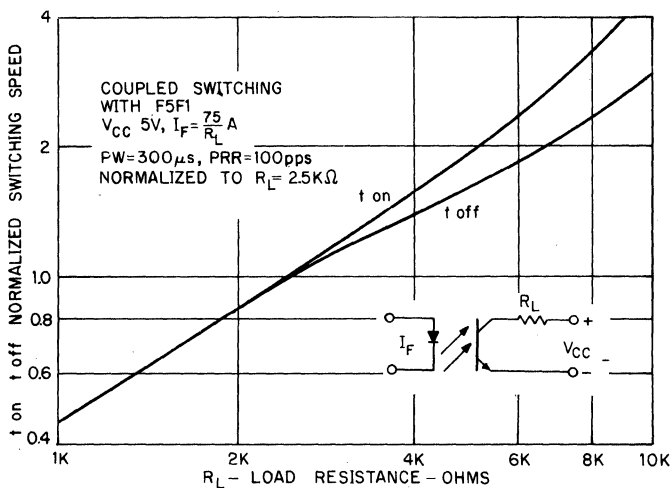

4. SWITCHING TIME VS. LOAD RESISTANCE

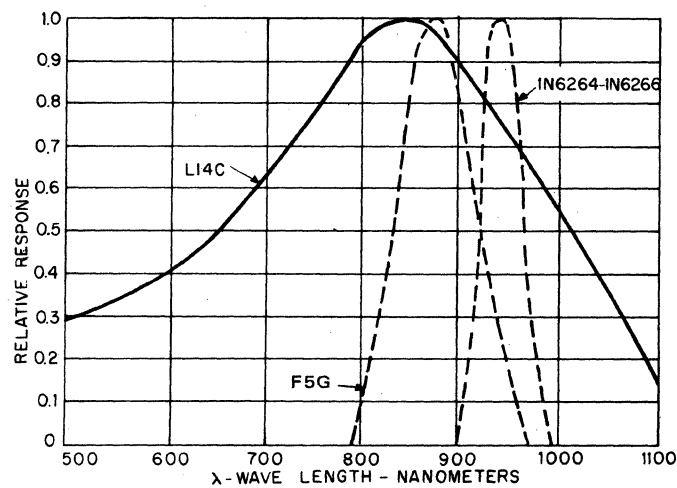

5. SPECTRAL RESPONSE

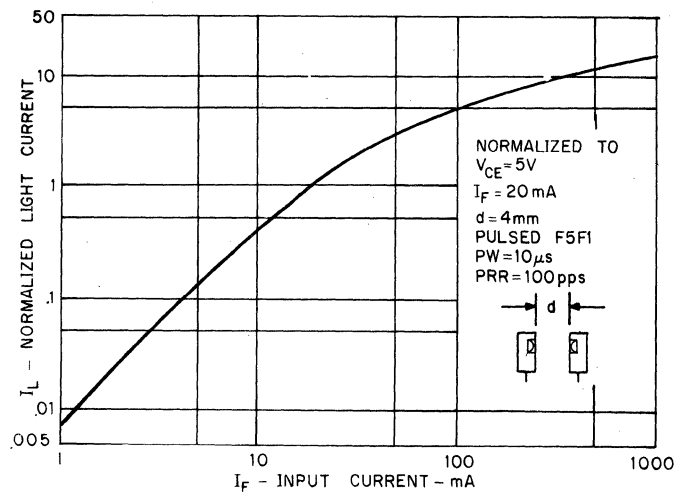

6. COUPLED LIGHT CURRENT VS. F5F1 INPUT CURRENT



SOLID STATE OPTOELECTRONICS

Light Detector Planar Silicon Photo-Darlington Amplifier

L14R1

The General Electric L14R1 Light Detector is a planar silicon Darlington-connected Photo-transistor. It is packaged in a side-looking clear epoxy encapsulant.

absolute maximum ratings: (25°C) (unless otherwise specified)

VOLTAGE (Dark characteristics)	SYMBOL		UNITS
Collector to Emitter Voltage	V_{CEO}	30	V
Emitter to Collector Voltage	V_{ECO}	7	V

CURRENT	SYMBOL		UNITS
Light Current (continuous)	I_L	100	mA

Dissipation	SYMBOL		UNITS
Power Dissipation ($T_A = 25^\circ\text{C}$)*	P_T	150	mW

TEMPERATURES	SYMBOL		UNITS
Junction Temperature	T_J	-55 to +100	°C
Storage Temperature	T_{STG}	-55 to +100	°C
Lead Soldering Temperature (5 seconds maximum 1.6mm from case)	T_L	260	°C

*Derate 2.0mW/°C above 25°C ambient

electrical characteristics: (25°C)

DETECTOR ONLY	SYMBOL	MIN.	TYP.	MAX.	UNITS
Light Current ($V_{CE} = 1.5\text{V}$, $E_e \dagger = 1\text{mW/cm}^2 @ 2870^\circ\text{K}$)	I_L	5	18	—	mA
Dark Current ($V_{CE} = 25\text{V}$, $E_e = 0$)	I_D	—	—	100	nA
Beam Angle at Half Power Point (Half Angle)	θ_H	—	30	—	Deg.
Saturation Voltage ($I_C = 20\text{mA}$, $E_e = 2\text{mW/cm}^2 @ 2870^\circ\text{K}$)	$V_{CE(sat)}$	—	.9	1.2	V
Collector-Emitter Breakdown Voltage ($I_C = 1\text{mA}$)	$V_{(BR)CEO}$	30	—	—	V
Emitter-Collector Breakdown Voltage ($I_E = 100\mu\text{A}$)	$V_{(BR)ECO}$	7	—	—	V
Collector-Emitter Capacitance ($V_{CE} = 5\text{V}$, $f = 1\text{MHz}$)	C_{ceo}	—	5	8	pF

coupled characteristics:

Light Current ($V_{CE} = 1.5\text{V}$, $I_F = 5\text{mA}$)	I_L	—	18	—	mA
Turn On Time ($V_{CC} = 5\text{V}$, $I_F = 10\text{mA}$, $R_L = 750\Omega$)	t_{on}	—	45	—	μs
Turn Off Time ($V_{CC} = 5\text{V}$, $I_F = 10\text{mA}$, $R_L = 750\Omega$)	t_{off}	—	250	—	μs

NOTE: Coupled characteristics are measured using an F5F1 GaAs IRED at a separation distance of 4.0mm (.155 in.) with the lenses of the emitter and detector on a common axis within 0.1mm and parallel within 5°.

†The F5F 940nm radiation is approximately 3 times more efficient than the 2870°K tungsten irradiance on this device. This means 0.3mW/cm² from the F5F is equivalent to the 1mW/cm² at 2870°K.

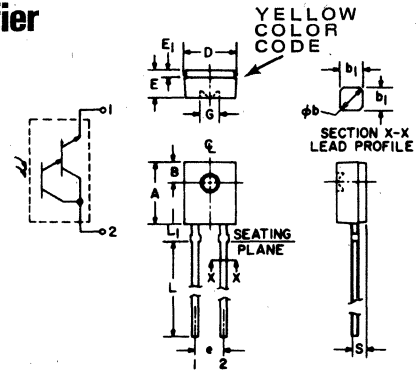

SYM	MILLI-METERS		INCHES		NOTES
	MIN	MAX	MIN	MAX	
A	5.59	5.80	.220	.228	
B	1.78	NOM.	.070	NOM.	2
ϕb	.60	.75	.024	.030	1
b_1	.51	NOM.	.020	NOM.	1
D	4.45	4.70	.175	.185	
E	2.41	2.67	.095	.105	
E_1	.58	.69	.023	.027	
e	2.41	2.67	.095	.105	3
G	1.98	NOM.	.078	NOM.	
L	12.7	—	.500	—	
L_1	1.40	1.65	.055	.065	
S	.83	.94	.033	.037	3

NOTES:

- Two leads. Lead cross section dimensions uncontrolled within 1.27 MM (.050") of seating plane.
- Centerline of active element located within .25 MM (.010") of true position.
- As measured at the seating plane.
- Inch dimensions derived from millimeters.

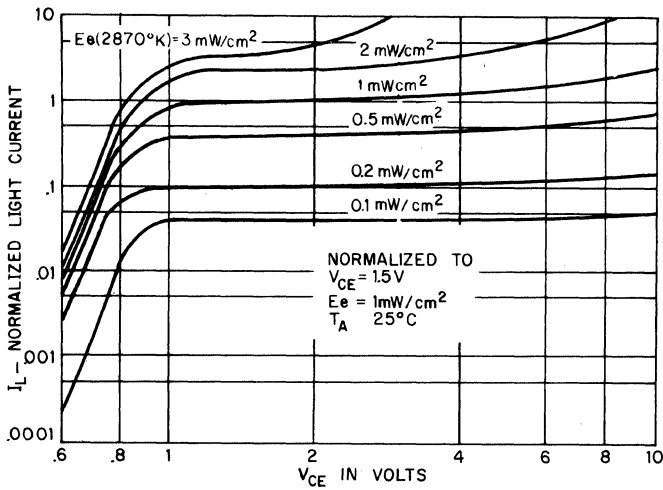

1. LIGHT CURRENT VS. COLLECTOR-EMITTER VOLTAGE

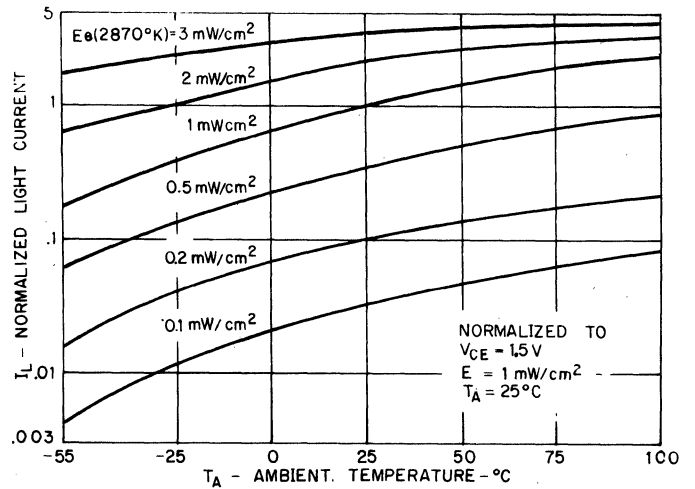

2. LIGHT CURRENT VS. AMBIENT TEMPERATURE

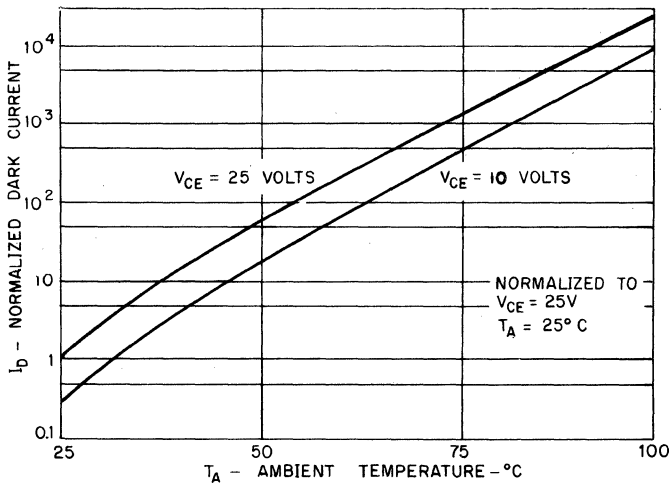

3. LEAKAGE CURRENT VS. TEMPERATURE

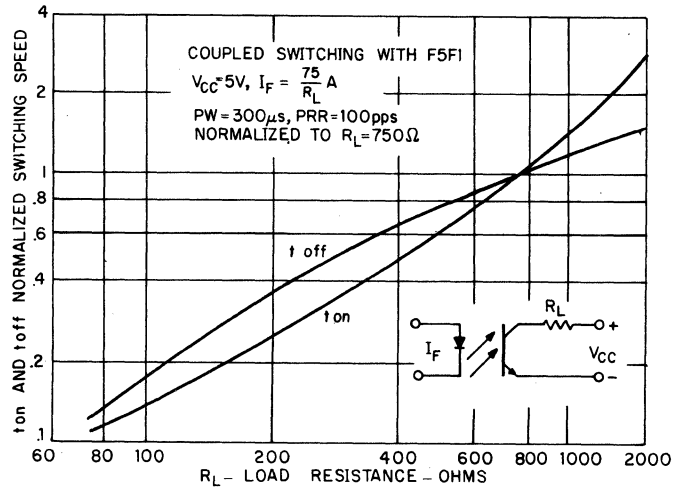

4. SWITCHING TIME VS. LOAD RESISTANCE

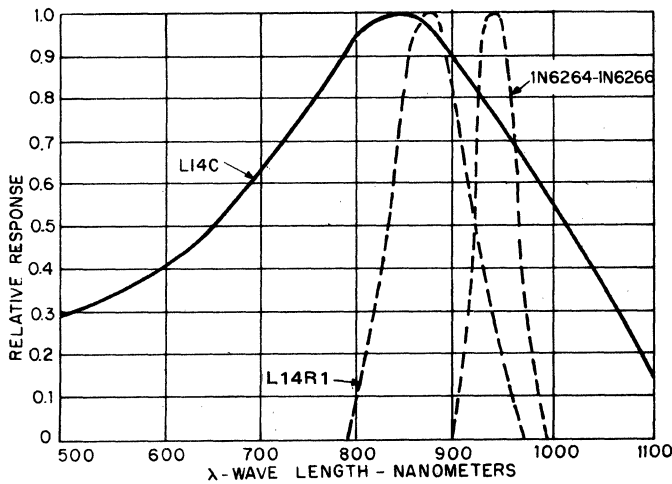

5. SPECTRAL RESPONSE

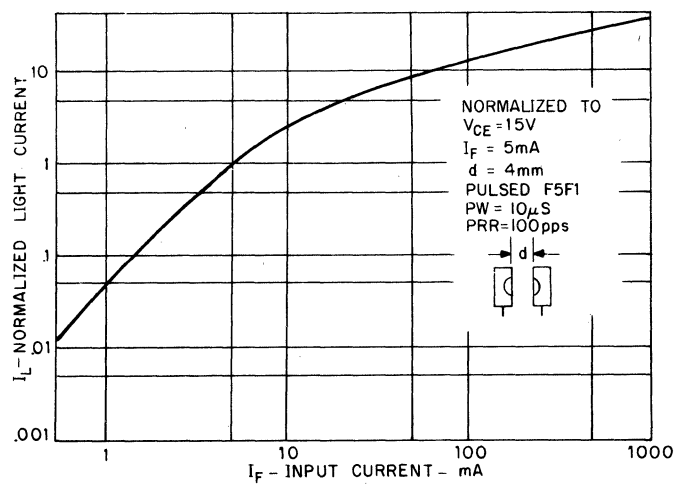

6. COUPLED LIGHT CURRENT VS. F5F1 INPUT CURRENT



SOLID STATE

OPTOELECTRONICS

Fiber Optic Detectors GFOD1A1 — GFOD1A2

Silicon Phototransistor Detectors for Fiber Optic Systems

The General Electric GFOD1A1 and GFOD1A2 are silicon phototransistors which detect and convert light signals from optical fibers into electrical signals. They are packaged in a housing designed to optimize fiber coupling efficiency, reliability, and cost. They mate directly with AMP OPTIMATE™ fiber optic connectors for easy interconnection and use. Mounting is compatible with SAE and metric fasteners of both through hole and self-tapping types.

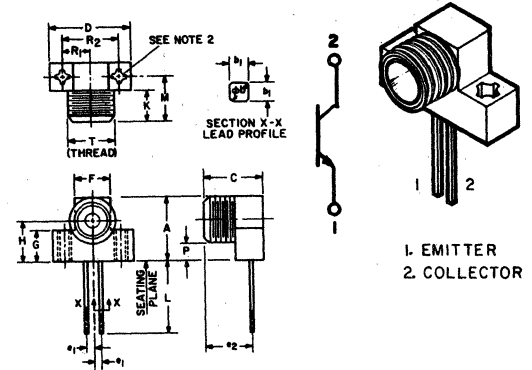

absolute maximum ratings

(25°C unless otherwise specified)

Voltages				
Collector to Emitter Voltage	V_{CEO}	30	V	
Emitter to Collector Voltage	V_{ECO}	5	V	
Current				
Collector Current (continuous)	I_C	100	mA	
Dissipation				
Power Dissipation ($T_A = 25^\circ\text{C}$)*	P_T	150	mW	
Temperatures				
Operating Temperature	T_{OP}	-55°C to +85°C		
Storage Temperature	T_{STG}	-55°C to +100°C		
Lead Soldering Time	T_L	5 seconds at 260°C		

*Derate 2.5 mW/°C above 25°C ambient.

SYM.	MILLIMETERS		INCHES		NOTES
	MIN.	MAX.	MIN.	MAX.	
A	10.67	11.17	.420	.440	
ϕ_b	.61	.66	.024	.026	1
b1	.50	NOM.	.020	NOM.	1
C	9.88	10.26	.389	.404	
D	13.47	13.97	.530	.550	
e_1	1.27	NOM.	.050	NOM.	
e_2	7.93	8.07	.312	.318	
F	5.87	6.12	.231	.241	
G	5.08	5.58	.200	.220	
H	6.84	7.08	.269	.279	
K	5.11	5.25	.201	.207	
L	12.22	—	.481	—	
M	7.73	7.97	.304	.314	
P	3.00	REF.	.118	REF.	
R1	4.70	4.82	.185	.190	
R2	9.40	9.65	.370	.380	
T					5/16-32 NEF 2A

NOTES:

- Two Leads
- Mounting Holes see attached drawing or M2x0.4 or Self-Tapping Screws

electrical characteristics (25°C unless otherwise specified)

	SYMBOL	MIN.	TYP.	MAX.	UNITS
Collector to Emitter Breakdown Voltage ($I_C = 10\text{ mA}$, $P_{in} = 0$)	$V_{(BR)CEO}$	30	—	—	V
Emitter to Collector Breakdown Voltage ($I_E = 100\ \mu\text{A}$, $P_{in} = 0$)	$V_{(BR)ECO}$	5	—	—	V
Collector Dark Current ($V_{CE} = 10\text{V}$, $P_{in} = 0$)	I_{CEO}	—	—	100	nA

optical characteristics (25°C unless otherwise specified)

	SYMBOL	MIN.	TYP.	MAX.	UNITS
Responsivity (Note 1)	GFOD1A1 R	70	—	—	$\mu\text{A}/\mu\text{W}$
($V_{CE} = 5\text{V}$, $P_{in} = 10\ \mu\text{W}$, $\lambda_p = 940\ \text{nM}$)	GFOD1A2 R	30	—	—	$\mu\text{A}/\mu\text{W}$
Turn on time (See Note 1)					
($V_{CC} = 5\text{V}$, $I_F = 30\ \text{mA}$, $R_L = 2.5\text{K}\ \Omega$)	t_{on}	—	8	—	μs
($V_{CC} = 1.5\text{V}$, $I_F = 10\ \text{mA}$, $R_L = 0$)	t_{on}	—	3	—	μs
Turn off time (See Note 1)					
($V_{CC} = 5\text{V}$, $I_F = 30\ \text{mA}$, $R_L = 2.5\text{K}\ \Omega$)	t_{off}	—	50	—	μs
($V_{CC} = 1.5\text{V}$, $I_F = 10\ \text{mA}$, $R_L = 0$)	t_{off}	—	3	—	μs

Note 1: Radiation source used is a GFOE1A1 Fiber Optic Emitter coupled via 1 meter of CROFON® 1040 Fiber terminated per AMP Incorporated instruction sheet IS 2878-2.

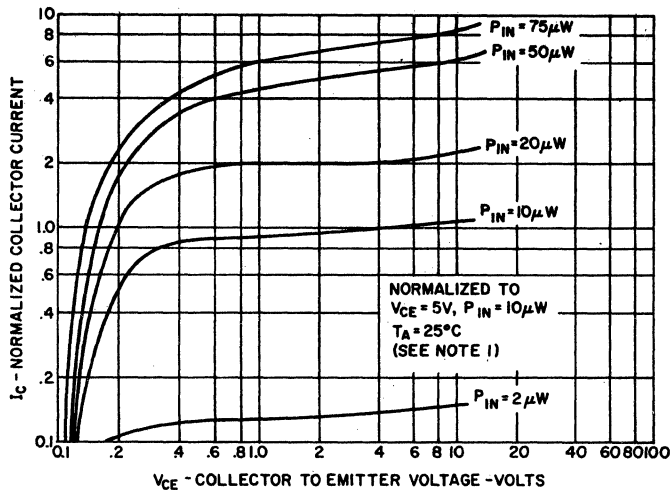

1. COLLECTOR CURRENT VS. VCE

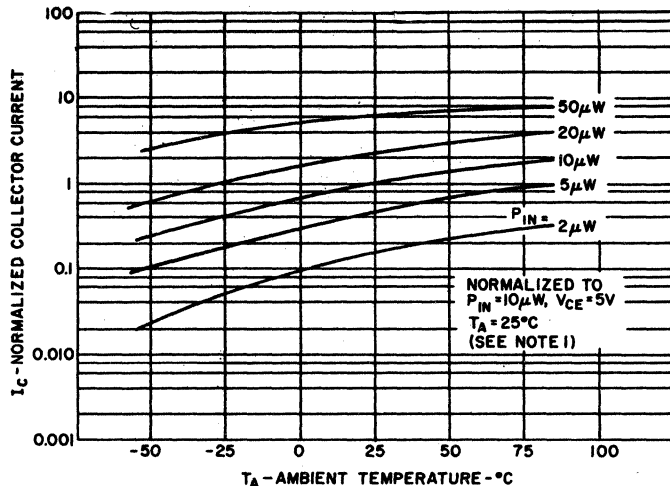

2. COLLECTOR VS. TEMPERATURE

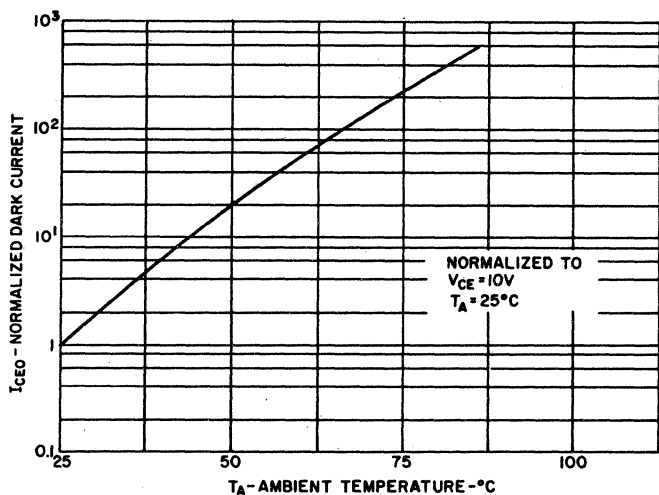

3. COLLECTOR DARK CURRENT VS. TEMPERATURE

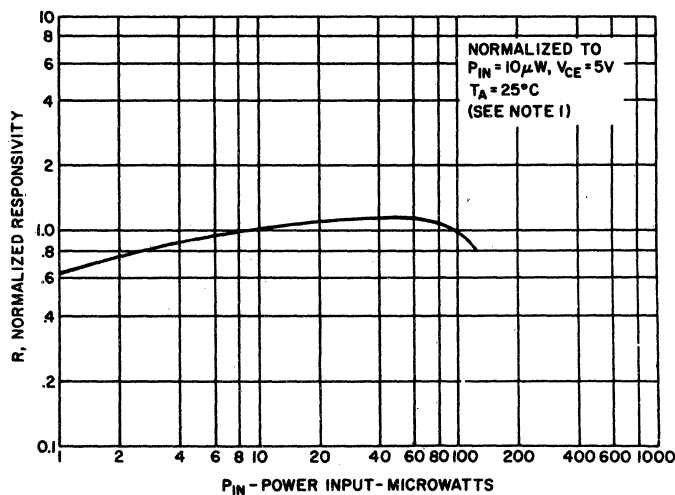

4. RESPONSIVITY VS. POWER INPUT

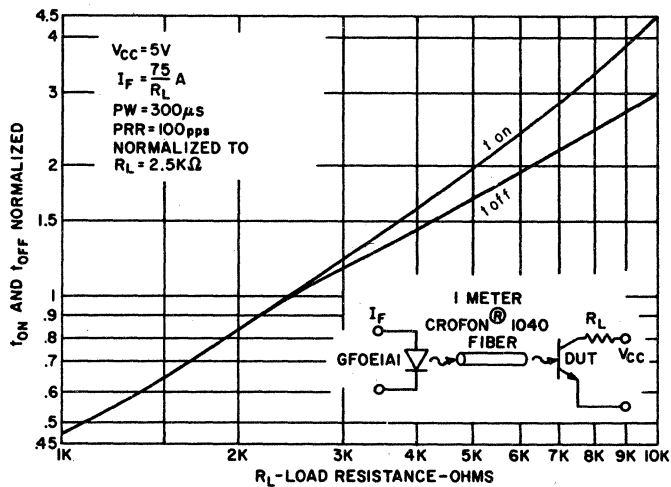

5. SWITCHING SPEED VS. RL

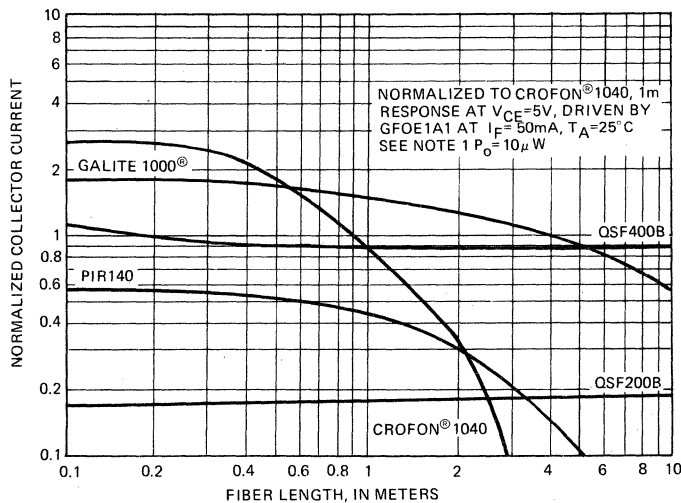

6. COLLECTOR CURRENT VS. FIBER LENGTH



SOLID STATE OPTOELECTRONICS

Fiber Optic Detectors GFOD1B1 — GFOD1B2

Silicon Photo-Darlington Detectors for Fiber Optic Systems

The General Electric GFOD1B1 and GFOD1B2 are silicon photo-darlington detectors which detect and convert light signals from optical fibers into electrical signals. They are packaged in a housing designed to optimize fiber coupling efficiency, reliability, and cost. They mate directly with AMP OPTIMATE™ fiber optic connectors for easy interconnection and use. Mounting is compatible with SAE and metric fasteners of both through hole and self-tapping types.

absolute maximum ratings
(25°C unless otherwise specified)

Voltages			
Collector to Emitter Voltage	V_{CEO}	30 V	
Emitter to Collector Voltage	V_{ECO}	5 V	
Current			
Collector Current (continuous)	I_C	100 mA	
Dissipation			
Power Dissipation ($T_A = 25^\circ\text{C}$)*	P_T	150 mW	
Temperatures			
Operating Temperature	T_{OP}	-55°C to +85°C	
Storage Temperature	T_{STG}	-55°C to +100°C	
Lead Soldering Temperature	T_L	5 seconds at 260°C	

*Derate 2.5 mW/°C above 25°C ambient.

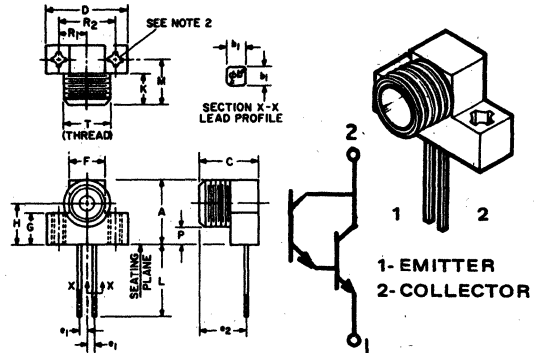

SYM.	MILLIMETERS		INCHES		NOTES
	MIN.	MAX.	MIN.	MAX.	
A	10.67	11.17	.420	.440	
ϕb	.61	.66	.024	.026	1
b1	.50	NOM.	.020	NOM.	1
C	9.88	10.26	.389	.404	
D	13.47	13.97	.530	.550	
e_1	1.27	NOM.	.050	NOM.	
e_2	7.93	8.07	.312	.318	
F	5.87	6.12	.231	.241	
G	5.08	5.58	.200	.220	
H	6.84	7.08	.269	.279	
K	5.11	5.25	.201	.207	
L	12.22	—	.481	—	
M	7.73	7.97	.304	.314	
P	3.00	REF.	.118	REF.	
R_1	4.70	4.82	.185	.190	
R_2	9.40	9.65	.370	.380	
T			5/16-32 NEF 2A		

NOTES:

- Two Leads.
- Mounting Holes see attached drawing SAE 0-80 or M2x0.4 or Self-Tapping Screws.

electrical characteristics (25°C unless otherwise specified)

	SYMBOL	MIN.	TYP.	MAX.	UNITS
Collector to Emitter Voltage ($I_C = 10 \text{ mA}$, $P_{in} = 0$)	$V_{(BR)CEO}$	30	—	—	V
Emitter to Collector Voltage ($I_E = 100 \mu\text{A}$, $P_{in} = 0$)	$V_{(BR)ECO}$	5	—	—	V
Collector Dark Current ($V_{CE} = 10\text{V}$, $P_{in} = 0$)	I_{CEO}	—	—	100	nA

optical characteristics (25°C unless otherwise specified)

	SYMBOL	MIN.	TYP.	MAX.	UNITS
Responsivity (Note 1) ($V_{CE} = 1.5\text{V}$, $P_{in} = 2 \mu\text{W}$, $\lambda_p = 940 \text{ nm}$)	GFOD1B1 R	1000	—	—	$\mu\text{A}/\mu\text{W}$
	GFOD1B2 R	500	—	—	$\mu\text{A}/\mu\text{W}$
Turn on Time (See Note 1) ($V_{CC} = 5\text{V}$, $I_F = 10 \text{ mA}$, $R_L = 750 \Omega$)	t_{on}	—	45	—	μs
($V_{CC} = 1.5\text{V}$, $I_F = 10 \text{ mA}$, $R_L = 0$)	t_{on}	—	10	—	μs
Turn Off Time (See Note 1) ($V_{CC} = 5\text{V}$, $I_F = 10 \text{ mA}$, $R_L = 750 \Omega$)	t_{off}	—	250	—	μs
($V_{CC} = 1.5\text{V}$, $I_F = 10 \text{ mA}$, $R_L = 0$)	t_{off}	—	25	—	μs

Note 1: Radiation source used is a GFOE1A1 Fiber Optic Emitter coupled via 1 meter of CROFON® 1040 fiber terminated per AMP Incorporated instruction sheet IS 2878-2.

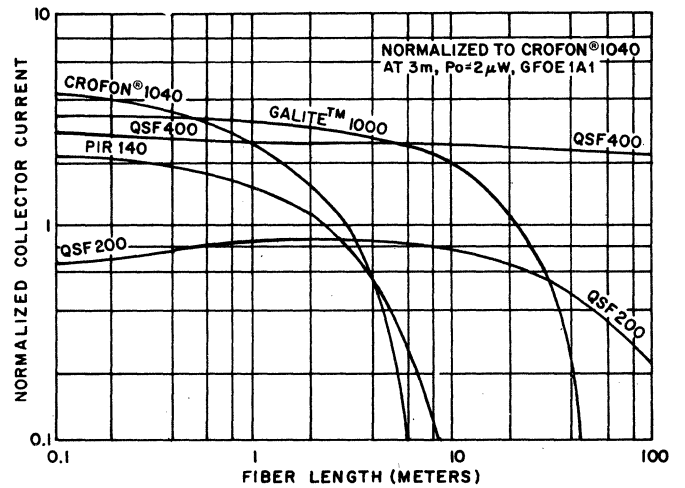
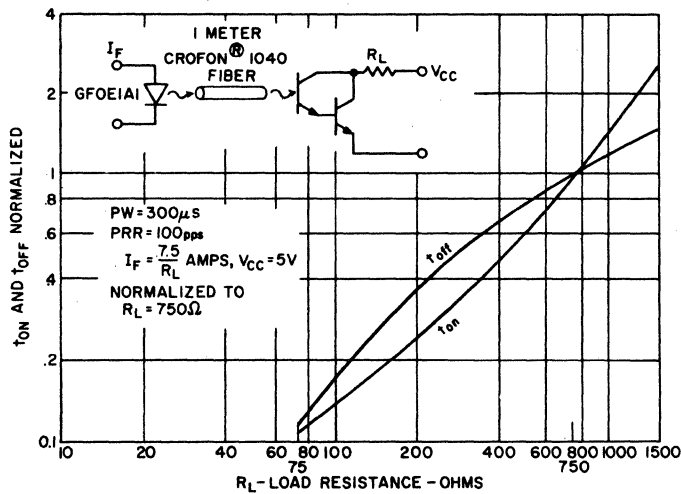
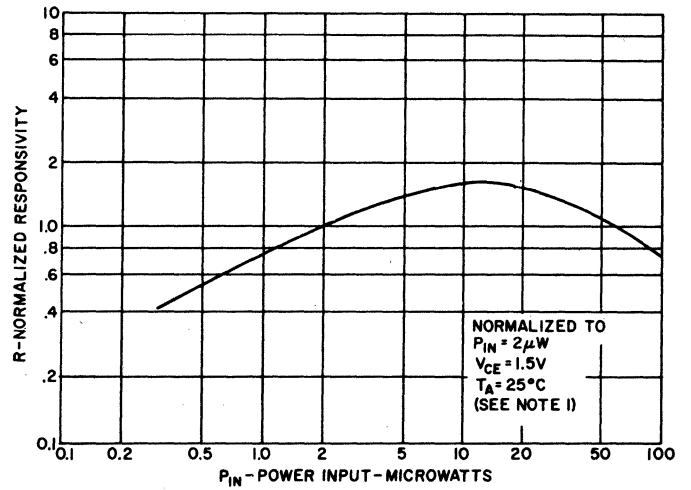
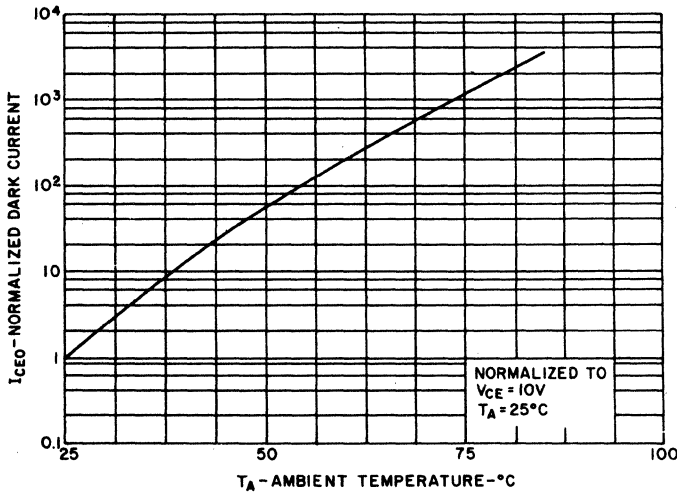
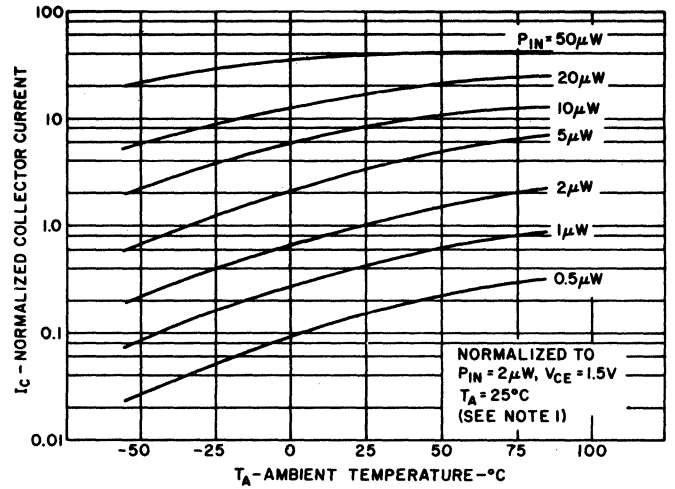
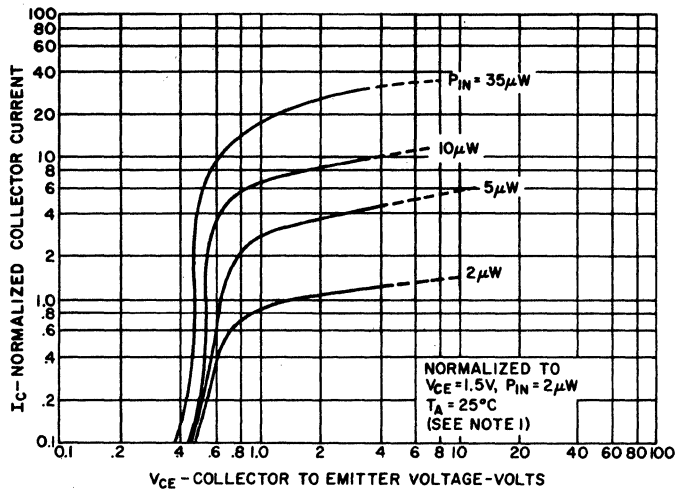



SOLID STATE OPTOELECTRONICS

Fiber Optic Emitters GFOE1A1 — GFOE1A2

Infrared Emitting Diodes for Fiber Optic Systems

The General Electric GFOE1A1 and GFOE1A2 are gallium arsenide, light emitting diodes, which emit non-coherent, infrared energy with a peak wavelength of 940 nanometers. They are packaged in a housing designed to optimize fiber coupling efficiency, reliability, and cost. They mate directly with AMP OPTIMATE™ fiber optic connectors for easy interconnection and use. Mounting is compatible with SAE and metric fasteners of both through hole and self-tapping types.

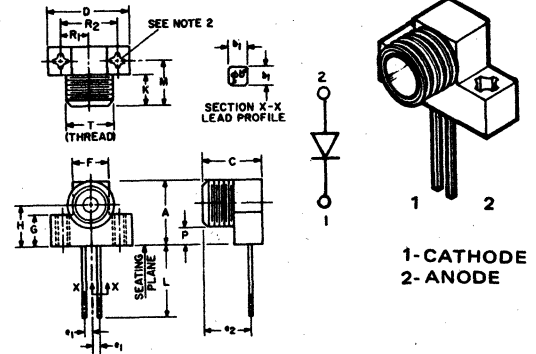

absolute maximum ratings (25°C unless otherwise specified)

Voltage		
Reverse Voltage	V_R	6V
Currents		
Forward Current (continuous)	I_F	60 mA
Forward Current (pw 1 μ s, 200 Hz)	I_F	3 A
Dissipation		
Power Dissipation (TA = 25°C)*	P_T	100 mW
Temperatures		
Operating Temperature	T_{OP}	-55°C to +85°C
Storage Temperature	T_{STG}	-55°C to +100°C
Lead Soldering Time	T_L	5 seconds at 260°C

*Derate 1.66 mW/°C above 25°C ambient.

SYM.	MILLIMETERS		INCHES		NOTES
	MIN.	MAX.	MIN.	MAX.	
A	10.67	11.17	.420	.440	
ϕb	.61	.66	.024	.026	1
b1	.50	NOM.	.020	NOM.	1
C	9.88	10.26	.389	.404	
D	13.47	13.97	.530	.550	
e_1	1.27	NOM.	.050	NOM.	
e_2	7.93	8.07	.312	.318	
F	5.87	6.12	.231	.241	
G	5.08	5.58	.200	.220	
H	6.84	7.08	.269	.279	
K	5.11	5.25	.201	.207	
L	12.22	—	.481	—	
M	7.73	7.97	.304	.314	
P	3.00	REF.	.118	REF.	
R_1	4.70	4.82	.185	.190	
R_2	9.40	9.65	.370	.380	
T	5/16-32 NEF 2A				

- NOTES:
 1. Two Leads.
 2. Mounting Holes see attached drawing SAE 0-80 or M2x0.4 or Self-Tapping Screws.

electrical characteristics (25°C unless otherwise specified)

	SYMBOL	MIN.	TYP.	MAX.	UNITS
Reverse Breakdown Voltage ($I_R = 10 \mu A$)	$V_{(BR)R}$	6	—	—	V
Forward Voltage ($I_F = 50 mA$)	V_F	—	—	1.7	V
Reverse Leakage Current ($V_R = 5V$)	I_R	—	—	100	nA
Capacitance ($V = 0, F = 1 MHz$)	C_i	—	30	—	Pf

optical characteristics (25°C unless otherwise specified)

	SYMBOL	MIN.	TYP.	MAX.	UNITS
Fiber Power Output (Note 1) ($I_F = 50 mA$)	GFOE1A1 P_O	100	—	—	μW
	GFOE1A2 P_O	60	—	—	μW
Fiber Power Output (Note 2) ($I_F = 50 mA$)	GFOE1A1 P_O	45	—	—	μW
	GFOE1A2 P_O	25	—	—	μW
Peak Emission Wavelength ($I_F = 50 mA$)	λ_p	—	940	—	nm
Spectral Shift with Temperature		—	.28	—	nm/°C
Spectral Bandwidth 50%	$\Delta\lambda$	—	60	—	nm
Rise Time 0-90% of Output, $I_F=50mA, Z_s \leq 50 \Omega$	t_s	—	300	—	nsec
Fall Time 100-10% of Output $I_F=50mA, Z_s \leq 50 \Omega$	t_f	—	200	—	nsec

Note 1: Measured at the end of 1 meter length of Galite™ 1000 terminated per AMP Incorporated instruction sheet IS 2878-2 and connected to the DUT.

Note 2: Measured at the end of 1 meter length of Crofon® 1040 terminated per AMP Incorporated instruction sheet IS 2878-2 and connected to the DUT.

TYPICAL CHARACTERISTICS

GFOE1A1-GFOE1A2

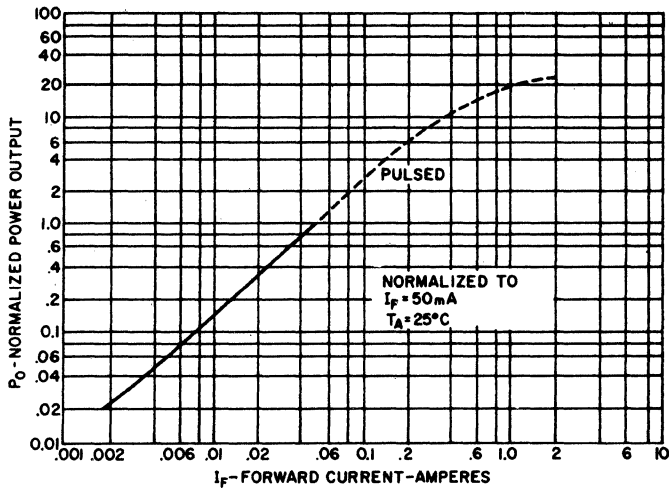

1. POWER OUTPUT VS. INPUT CURRENT

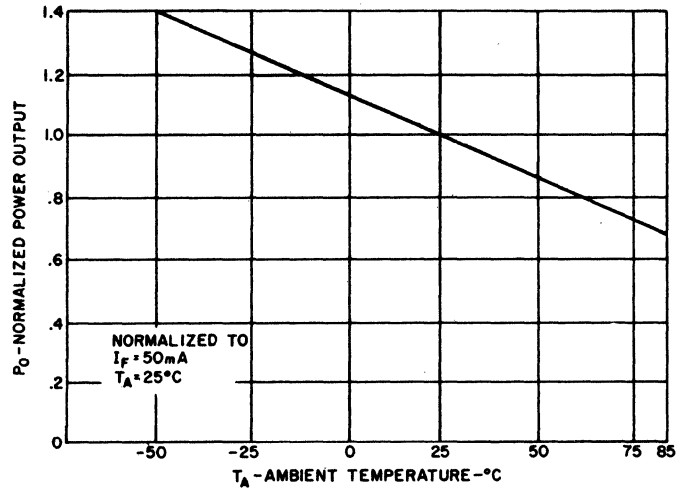

2. POWER OUTPUT VS. TEMPERATURE

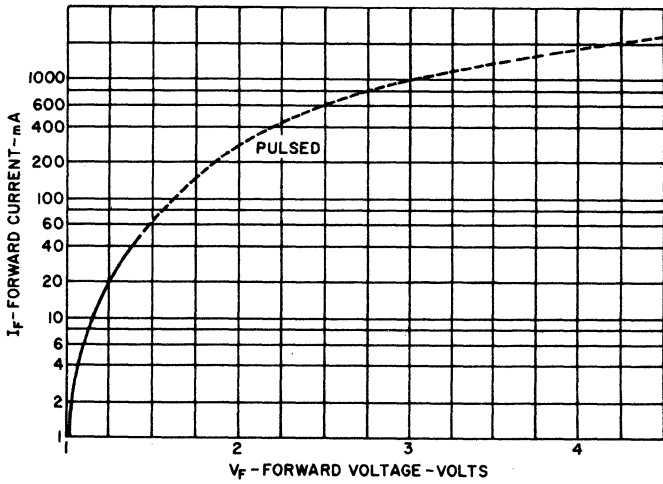

3. FORWARD VOLTAGE VS. FORWARD CURRENT

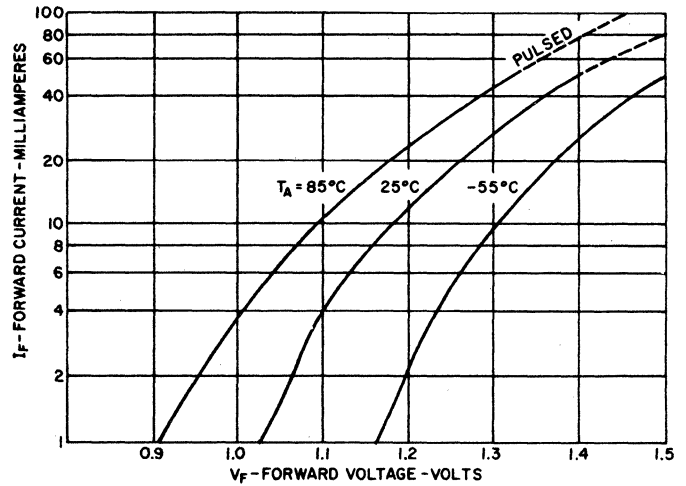

4. FORWARD VOLTAGE VS. FORWARD CURRENT

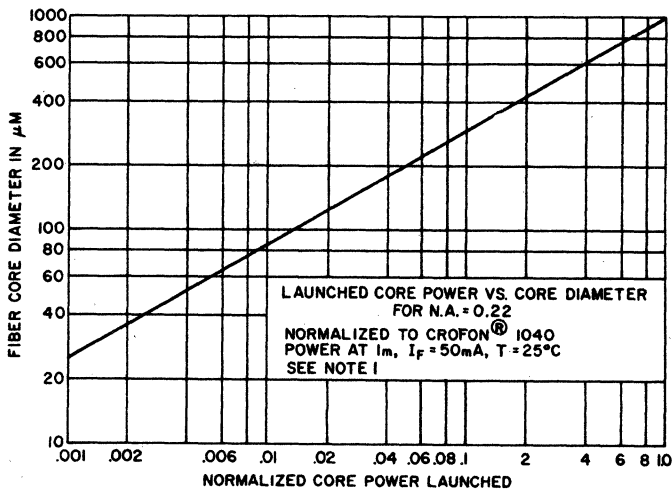

5. POWER OUTPUT VS. FIBER DIAMETER

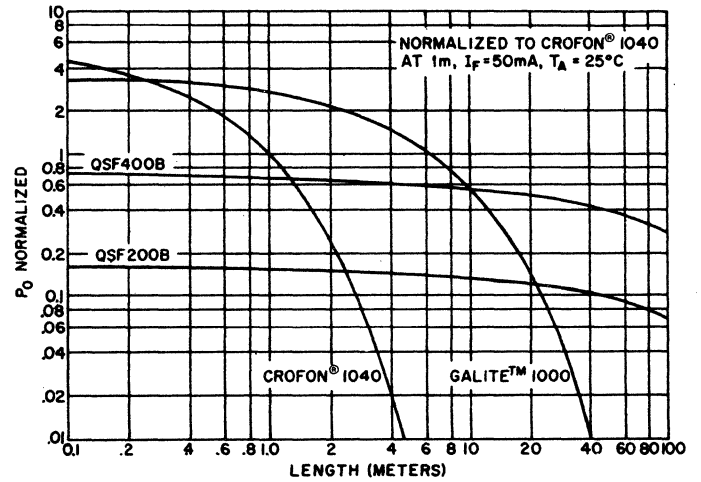

6. POWER OUTPUT VS. FIBER LENGTH



SOLID STATE OPTOELECTRONICS

Photon Coupled Isolator 4N25-4N25A-4N26-4N27-4N28

Ga As Infrared Emitting Diode & NPN Silicon Photo-Transistor

The General Electric 4N25-4N26-4N27-4N28 consist of a gallium arsenide infrared emitting diode coupled with a silicon photo transistor in a dual in-line package.

FEATURES:

- Fast switching speeds
- High DC current transfer ratio
- High isolation resistance
- 2500 volts isolation voltage
- I/O compatible with integrated circuits

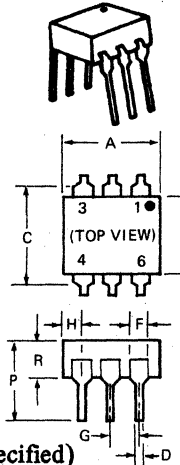
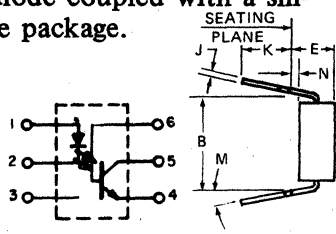

SYMBOL	MILLIMETERS		INCHES		NOTES
	MIN.	MAX.	MIN.	MAX.	
A	8.38	8.89	.330	.350	1
B	7.62 REF.		.300 REF.		
C	—	8.64	—	.340	2
D	.406	.508	.016	.020	
E	—	5.08	—	.200	3
F	1.01	1.78	.040	.070	
G	2.28	2.80	.090	.110	4
H	—	2.16	—	.085	
J	.203	.305	.008	.012	—
K	2.54	—	.100	—	
M	—	15°	—	15°	—
N	.381	—	.015	—	
P	—	9.53	—	.375	—
R	2.92	3.43	.115	.135	
S	6.10	6.86	.240	.270	—

- NOTES:
 1. INSTALLED POSITION LEAD CENTERS.
 2. OVERALL INSTALLED DIMENSION.
 3. THESE MEASUREMENTS ARE MADE FROM THE SEATING PLANE.
 4. FOUR PLACES.

Covered under U.L. component recognition program, reference file E51868

†Parameters are JEDEC registered values.

absolute maximum ratings: (25°C) (unless otherwise specified)

†Storage Temperature -55 to 150°C. Operating Temperature -55 to 100°C. Lead Soldering Time (at 260°C) 10 seconds.

INFRARED EMITTING DIODE			PHOTO-TRANSISTOR		
† Power Dissipation	*150	milliwatts	† Power Dissipation	**150	milliwatts
† Forward Current (Continuous)	80	milliamps	† V _{CEO}	30	volts
† Forward Current (Peak) (Pulse width 300 μsec 2% duty cycle)	3	ampere	† V _{CBO}	70	volts
† Reverse Voltage	3	volts	† V _{ECO}	7	volts
	*Derate 2.0mW/°C above 25°C ambient.		Collector Current (Continuous)	100	milliamps
				**Derate 2.0mW/°C above 25°C ambient.	

†Total device dissipation @ 24-25°C. P_D 250mW.

†Derate 3.3 mW/°C above 25°C ambient.

individual electrical characteristics (25°C)

INFRARED EMITTING DIODE	TYP.	MAX.	UNITS	PHOTO-TRANSISTOR	MIN.	TYP.	MAX.	UNITS
† Forward Voltage (I _F = 10 mA)	1.1	1.5	volts	† Breakdown Voltage — V _{(BR)CEO} (I _C = 1mA, I _F = 0)	30	—	—	volts
† Reverse Current (V _R = 3V)	—	100	microamps	† Breakdown Voltage — V _{(BR)CBO} (I _C = 100μA, I _F = 0)	70	—	—	volts
Capacitance V = 0, f = 1 MHz	50	—	picofarads	† Breakdown Voltage — V _{(BR)ECO} (I _E = 100μA, I _F = 0)	7	—	—	volts
				† Collector Dark Current I _{CEO} 4N25-27	—	5	50	nanoamps
				(V _{CE} = 10V, I _F = 0) 4N28	—	—	100	nanoamps
				† Collector Dark Current — I _{CBO}	—	2	20	nanoamps
				(V _{CB} = 10V, I _F = 0)				

coupled electrical characteristics (25°C)

	MIN.	TYP.	MAX.	UNITS
† DC Current Transfer Ratio (I _F = 10mA, V _{CE} = 10V) 4N25, 4N25A, 4N26, 4N27, 4N28	20	—	—	%
† Saturation Voltage — Collector — Emitter (I _F = 50mA, I _C = 2 mA)	—	0.1	0.5	volts
Resistance — IRED to Photo-Transistor (@ 500 volts)	—	100	—	gigaohms
Capacitance — IRED to Photo-Transistor (@ 0 volts, f = 1 MHz)	—	1	—	picofarad
† Isolation Voltage — voltage @ 60 Hz with the input terminals (diode) shorted together and the output terminals (transistor) shorted together.	4N25	2500	—	volts (peak)
	4N26, 4N27	1500	—	volts (peak)
	4N28	500	—	volts (peak)
	4N25A	1775	—	volts (RMS) (1 sec.)
Rise/Fall Time (V _{CE} = 10V, I _{CE} = 2mA, R _L = 100Ω)	—	2	—	microseconds
Rise/Fall Time (V _{CB} = 10V, I _{CB} = 50μA, R _L = 100Ω)	—	300	—	nanoseconds

VDE Approved to 0883/6.80 0110b Certificate# 35025

TYPICAL CHARACTERISTICS

4N25-28

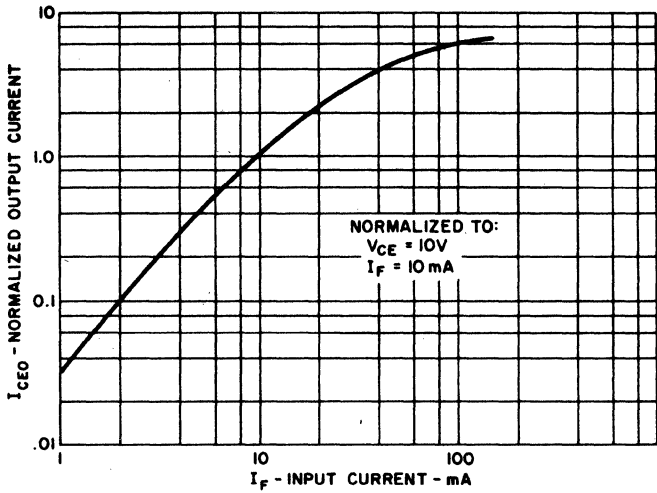

OUTPUT CURRENT VS INPUT CURRENT

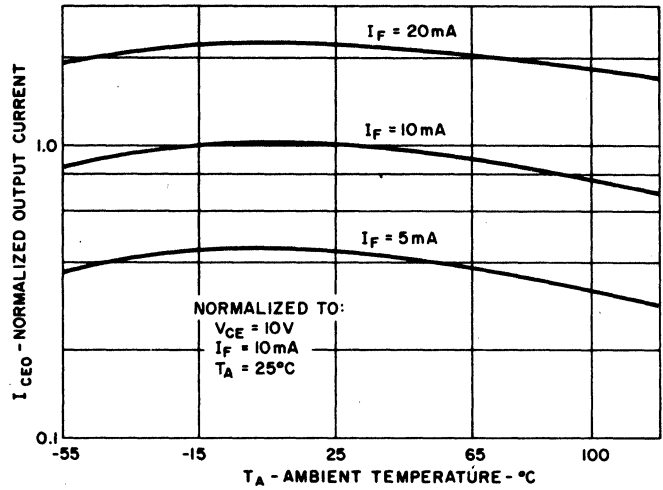

OUTPUT CURRENT VS TEMPERATURE

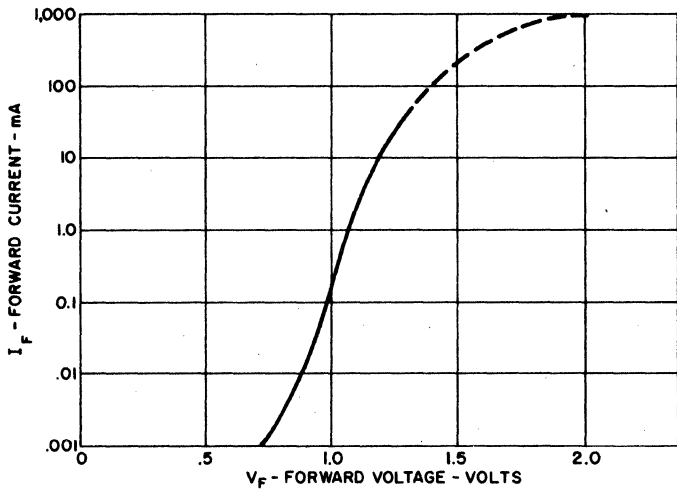

INPUT CHARACTERISTICS

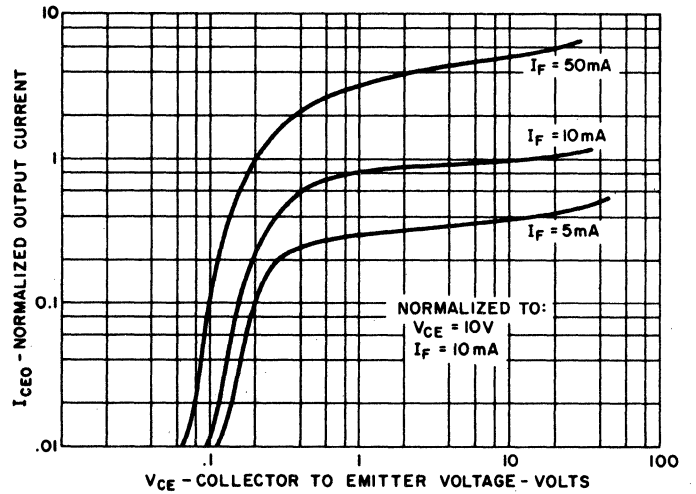

OUTPUT CHARACTERISTICS

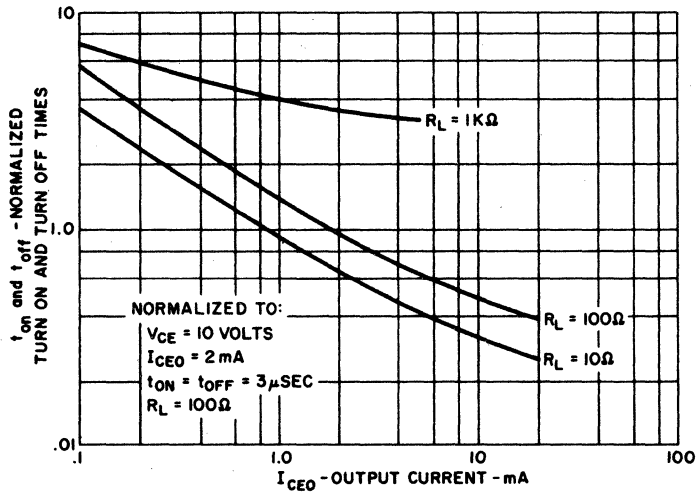

SWITCHING TIMES VS OUTPUT CURRENT

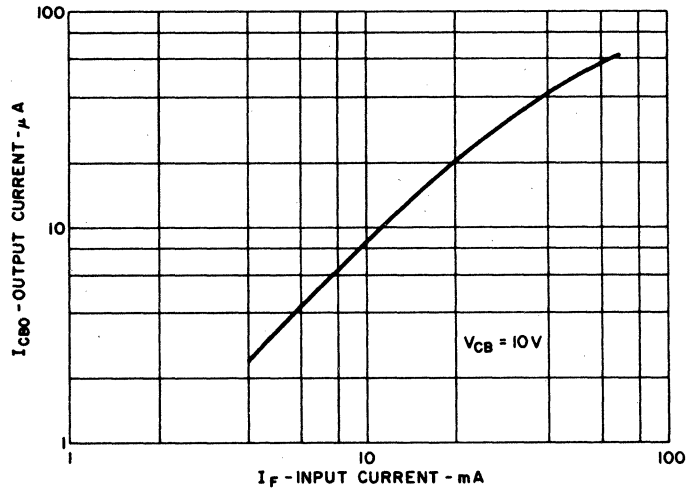

OUTPUT CURRENT (I_{CBO}) VS INPUT CURRENT



SOLID STATE

OPTOELECTRONICS

Photon Coupled Isolator 4N29-4N29A-4N30-4N31 4N32-4N32A-4N33

Ga As Infrared Emitting Diode & NPN Silicon Photo-Darlington Amplifier

The General Electric 4N29 thru 4N33 consist of a gallium arsenide infrared emitting diode coupled with a silicon photo-darlington amplifier in a dual in-line package.

FEATURES:

- High DC current transfer ratio
- High isolation resistance
- 2500 volts isolation voltage
- I/O compatible with integrated circuits

†Parameters are JEDEC registered values.

Covered under U.L. component recognition program, reference file E51868

absolute maximum ratings: (25°C) (unless otherwise specified)

†Storage Temperature -55 to 150°C. Operating Temperature -55 to 100°C. Lead Soldering Time (at 260°C) 10 seconds.

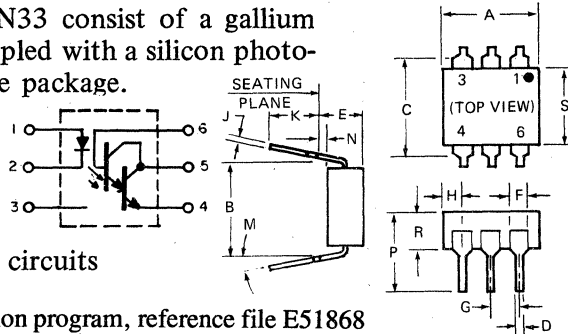

SYMBOL	MILLIMETERS		INCHES		NOTES
	MIN.	MAX.	MIN.	MAX.	
A	8.38	8.89	.330	.350	1
B	7.62 REF.		.300 REF.		
C	—	8.64	—	.340	2
D	.406	.508	.016	.020	
E	—	5.08	—	.200	3
F	1.01	1.78	.040	.070	
G	2.28	2.80	.090	.110	4
H	—	2.16	—	.085	
J	.203	.305	.008	.012	—
K	2.54	—	.100	—	
M	—	15°	—	15°	—
N	.381	—	.015	—	
P	—	9.53	—	.375	—
R	2.92	3.43	.115	.135	
S	6.10	6.86	.240	.270	—

NOTES:
1. INSTALLED POSITION LEAD CENTERS.
2. OVERALL INSTALLED DIMENSION.
3. THESE MEASUREMENTS ARE MADE FROM THE SEATING PLANE. 4. FOUR PLACES.

INFRARED EMITTING DIODE		PHOTO-DARLINGTON	
†Power Dissipation	*150 milliwatts	†Power Dissipation	**150 milliwatts
†Forward Current (Continuous)	80 milliamps	†V _{CEO}	30 volts
†Forward Current (Peak) (Pulse width 300µsec, 2% duty cycle)	3 ampere	†V _{CBO}	30 volts
†Reverse Voltage	3 volts	†V _{EBO}	5 volts
		Collector Current (Continuous)	100 milliamps
*Derate 2.0mW/°C above 25°C ambient.		**Derate 2.0mW/°C above 25°C ambient.	

†Total device dissipation @ T_A = 25°C. P_D 250 mW.

†Derate 3.3 mW/°C above 25°C ambient.

individual electrical characteristics (25°C)

INFRARED EMITTING	TYP.	MAX.	UNITS	PHOTO-DARLINGTON	MIN.	TYP.	MAX.	UNITS
†Forward Voltage (I _F = 10mA)	1.2	1.5	volts	†Breakdown Voltage - V _{(BR)CBO} (I _C = 100µA, I _F = 0)	30	—	—	volts
†Reverse Current (V _R = 3V)	—	100	microamps	†Breakdown Voltage - V _{(BR)CEO} (I _C = 1mA, I _F = 0)	30	—	—	volts
Capacitance V = 0, f = 1 MHz	50	—	picofarads	†Breakdown Voltage - V _{(BR)EBO} (I _E = 100µA, I _F = 0)	5	—	—	volts
				†Collector Dark Current - I _{CEO} (V _{CE} = 10V, I _F = 0)	—	—	100	nanoamps

coupled electrical characteristics (25°C)

		MIN.	TYP.	MAX.	UNITS
†Collector Output Current (I _F = 10mA, V _{CE} = 10V)	4N32, 4N32A, 4N33	50	—	—	mA
	4N29, 4N29A, 4N30	10	—	—	mA
	4N31	5	—	—	mA
†Saturation Voltage - Collector - Emitter (I _F = 8mA, I _C = 2mA)	4N29, 29A, 30, 32, 32A, 33	—	—	1.0	volts
	4N31	—	—	1.2	volts
Resistance - IRED to Photo-Transistor (@ 500 volts)		—	100	—	gigaohms
Capacitance - IRED to Photo-Transistor (@ 0 volts, f = 1 MHz)		—	1	—	picofarad
†Isolation Voltage 60 Hz with the input terminals (diode) shorted together and the output terminals (transistor) shorted together	4N29, 29A, 32, 32A	2500	—	—	volts (peak)
	4N30, 4N31, 4N33	1500	—	—	volts (peak)
	4N29A, 4N32A	1775	—	—	volts (RMS) (1 sec.)
†Switching Speeds: I _C = 50mA, I _F = 200mA) Figure 1					
Turn-On Time - t _{on}		—	—	5	microseconds
Turn-Off Time - t _{off}	4N29, 4N29A, 4N30, 4N31	—	—	40	microseconds
	4N32, 4N32A, 4N33	—	—	100	microseconds

TYPICAL CHARACTERISTICS

4N29-33

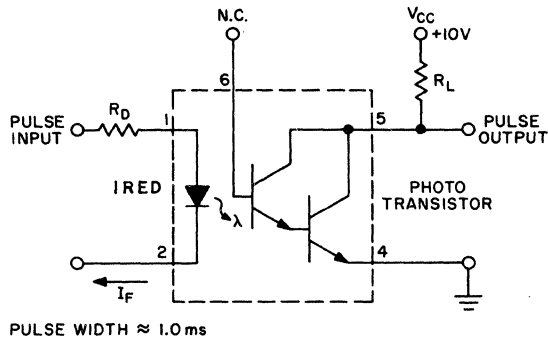

SWITCHING TIME TEST CIRCUIT

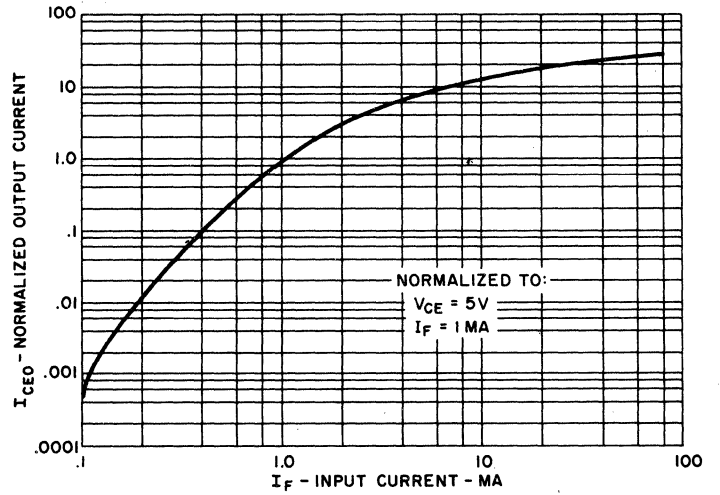

OUTPUT CURRENT VS INPUT CURRENT

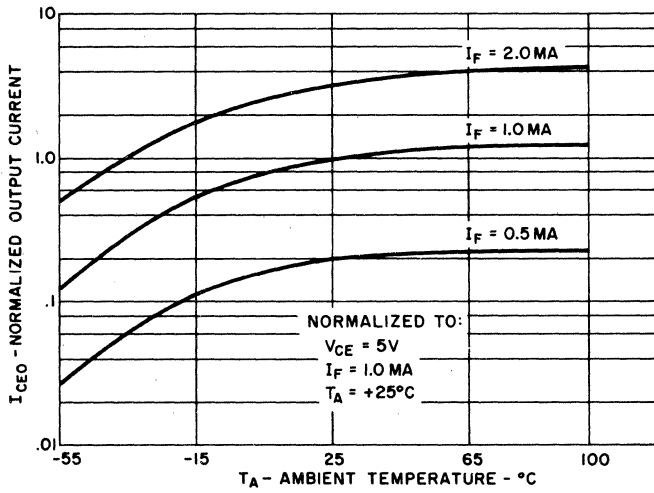

OUTPUT CURRENT VS TEMPERATURE

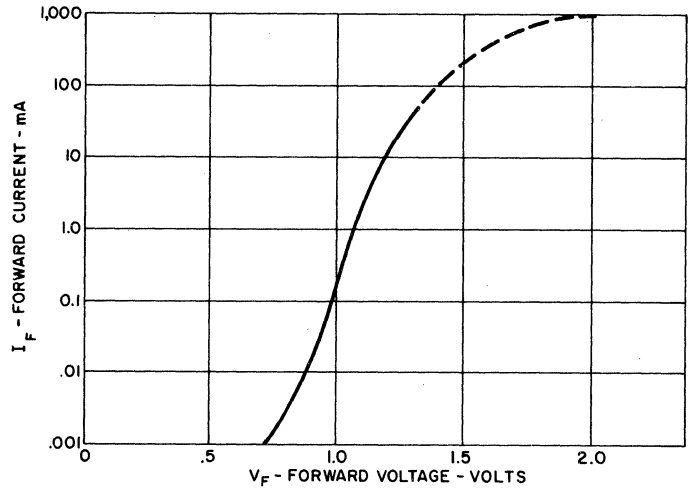

INPUT CHARACTERISTICS

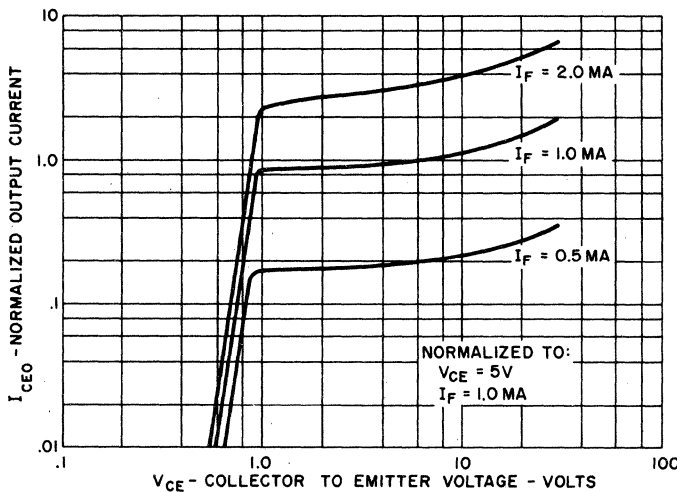

OUTPUT CHARACTERISTICS

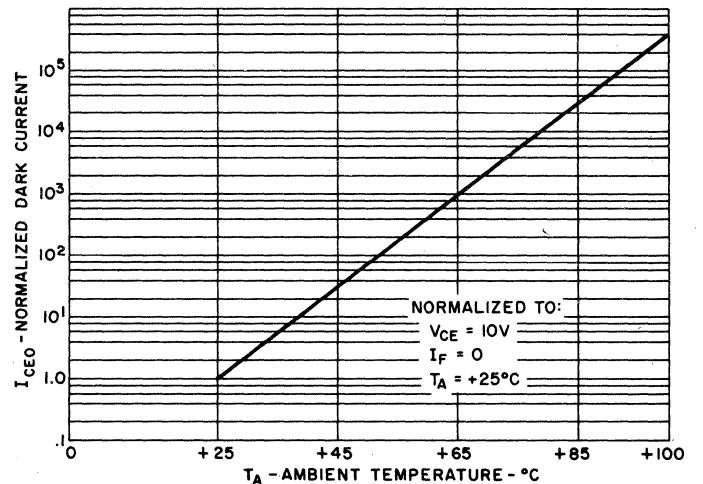

NORMALIZED DARK CURRENT VS TEMPERATURE



SOLID STATE OPTOELECTRONICS

Photon Coupled Isolator 4N35,4N36,4N37

Ga As Infrared Emitting Diode & NPN Silicon Photo-Transistor

The General Electric 4N35-4N36-4N37 are gallium arsenide infrared emitting diodes coupled with a silicon photo-transistor in a dual in-line package.

FEATURES:

- Fast switching speeds
- High DC current transfer ratio
- High isolation resistance
- High isolation voltage
- I/O compatible with integrated circuits
- Covered under U.L. component recognition program, reference file E51868

absolute maximum ratings: (25°C) (unless otherwise specified)

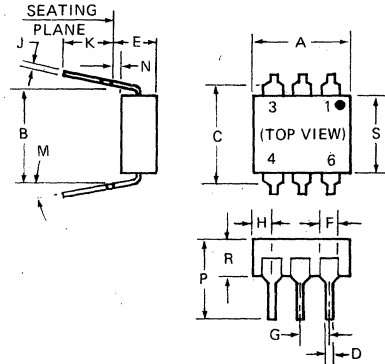
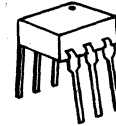

SYMBOL	MILLIMETERS		INCHES		NOTES
	MIN.	MAX.	MIN.	MAX.	
A	8.38	8.89	.330	.350	1
B	7.62 REF.		.300 REF.		
C	—	8.64	—	.340	2
D	.406	.508	.016	.020	
E	—	5.08	—	.200	3
F	1.01	1.78	.040	.070	
G	2.28	2.80	.090	.110	4
H	—	2.16	—	.085	
J	.203	.305	.008	.012	4
K	2.54	—	.100	—	
M	—	15°	—	15°	4
N	.381	—	.015	—	
P	—	9.53	—	.375	4
R	2.92	3.43	.115	.135	
S	6.10	6.86	.240	.270	

- NOTES:
1. INSTALLED POSITION LEAD CENTERS.
 2. OVERALL INSTALLED DIMENSION.
 3. THESE MEASUREMENTS ARE MADE FROM THE SEATING PLANE.
 4. FOUR PLACES.

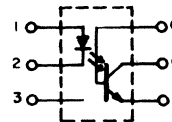

INFRARED EMITTING DIODE

- * Power Dissipation $T_A = 25^\circ\text{C}$ ☆100 milliwatts
- * Power Dissipation $T_C = 25^\circ\text{C}$ ☆100 milliwatts
(T_C indicates collector lead temperature 1/32" from case)
- * Forward Current (Continuous) 60 milliamps
- * Forward Current (Peak) 3 ampere
(Pulse width 1 usec, 300 pps)
- * Reverse Voltage 6 volts

☆Derate 1.33mW/°C above 25°C

PHOTO-TRANSISTOR

- * Power Dissipation $T_A = 25^\circ\text{C}$ ☆☆300 milliwatts
- * Power Dissipation $T_C = 25^\circ\text{C}$ ☆☆☆500 milliwatts
(T_C indicates collector lead temperature 1/32" from case)
- * V_{CEO} 30 volts
- * V_{CBO} 70 volts
- * V_{ECO} 7 volts
- * Collector Current (Continuous) 100 milliamps

☆☆Derate 4.0mW/°C above 25°C

☆☆☆Derate 6.7mW/°C above 25°C

TOTAL DEVICE

- * Storage Temperature -55 to 150°C
- * Operating Temperature -55 to 100°C.
- * Lead Soldering Time (at 260°C) 10 seconds.
- * Relative Humidity 85%@85°C
- * Input to Output Isolation Voltage

4N35	2500 V(RMS)	3550 V(peak)
4N36	1750 V(RMS)	2500 V(peak)
4N37	1050 V(RMS)	1500 V(peak)

* Indicates JEDEC registered values

individual electrical characteristics (25°C) (unless otherwise specified)

INFRARED EMITTING DIODE	SYMBOL	MIN.	MAX.	UNITS	PHOTO-TRANSISTOR	SYMBOL	MIN.	TYP.	MAX.	UNITS
* Forward Voltage (I _F = 10 mA)	V _F	.8	1.5	volts	* Breakdown Voltage (I _C = 10 mA, I _F = 0)	V _{(BR) CEO}	30	-	-	volts
* Forward Voltage (I _F = 10 mA) T _A = -55°C	V _F	.9	1.7	volts	* Breakdown Voltage (I _C = 100uA, I _F = 0)	V _{(BR) CBO}	70	-	-	volts
* Forward Voltage (I _F = 10 mA) T _A = +100°C	V _F	.7	1.4	volts	* Breakdown Voltage (I _E = 100uA, I _F = 0)	V _{(BR) ECO}	7	-	-	volts
* Reverse Current (V _R = 6V)	I _R	-	10	microamps	Collector Dark Current (V _{CE} = 10V, I _F = 0)	I _{CEO}	-	5	50	nanoamps
Capacitance (V=0, f=1 MHz)	C _J	-	100	picofarads	* Collector Dark Current (V _{CE} = 30V, I _F = 0) T _A = 100°C	I _{CEO}	-	-	500	microamps
					Capacitance (V _{CE} = 10V, f = 1MHz)	C _{CE}	-	2	-	picofarads

coupled electrical characteristics (25°C) (unless otherwise specified)

	MIN.	TYP.	MAX.	UNITS
* DC Current Transfer Ratio (I _F = 10mA, V _{CE} = 10V)	100	-	-	%
* DC Current Transfer Ratio (I _F = 10mA, V _{CE} = 10V) T _A = -55°C	40	-	-	%
* DC Current Transfer Ratio (I _F = 10mA, V _{CE} = 10V) T _A = +100°C	40	-	-	%
* Saturation Voltage—Collector To Emitter (I _F = 10mA, I _C = 0.5mA)	-	-	0.3	volts
* Input to Output Isolation Current (Pulse Width = 8 msec) (See Note 1) Input to Output Voltage = 3550 V _(peak) 4N35	-	-	100	microamps
Input to Output Voltage = 2500 V _(peak) 4N36	-	-	100	microamps
Input to Output Voltage = 1500 V _(peak) 4N37	-	-	100	microamps
* Input to Output Resistance (Input to Output Voltage = 500V - See Note 1)	100	-	-	gigaohms
* Input to Output Capacitance (Input to Output Voltage = 0, f = 1MHz - See Note 1)	-	-	2	picofarads
* Turn on Time - t _{on} (V _{CC} = 10V, I _C = 2MA, R _L = 100Ω) (See Figure 1)	-	5	10	microseconds
* Turn off Time - t _{off} (V _{CC} = 10V, I _C = 2MA, R _L = 100Ω) (See Figure 1)	-	5	10	microseconds

Note 1: Tests of input to output isolation current resistance, and capacitance are performed with the input terminals (diode) shorted together and the output terminals (transistor) shorted together

* Indicates JEDEC registered values.

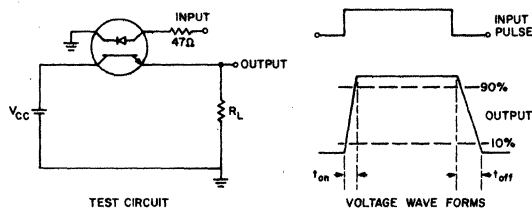

Adjust Amplitude of Input Pulse for Output (I_C) of 2 mA

FIGURE 1

TYPICAL CHARACTERISTICS

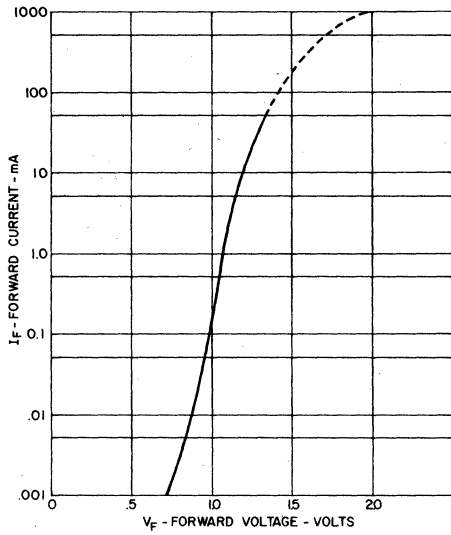

1. INPUT CHARACTERISTICS

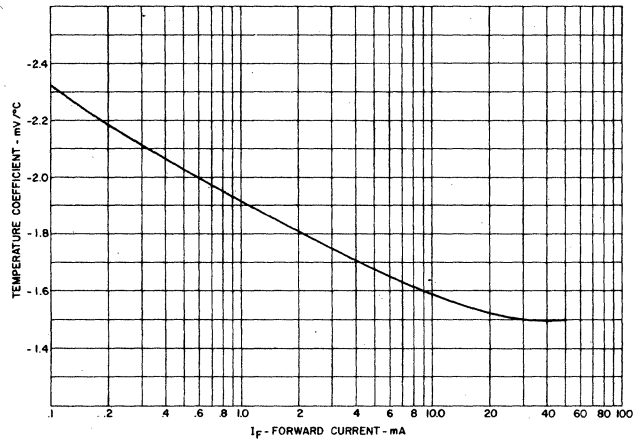

2. FORWARD VOLTAGE TEMPERATURE COEFFICIENT

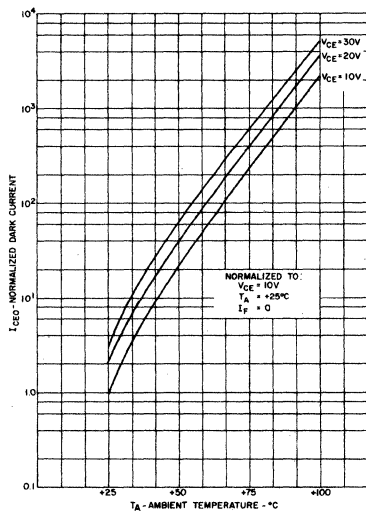

3. DARK I_{CEO} CURRENT VS TEMPERATURE

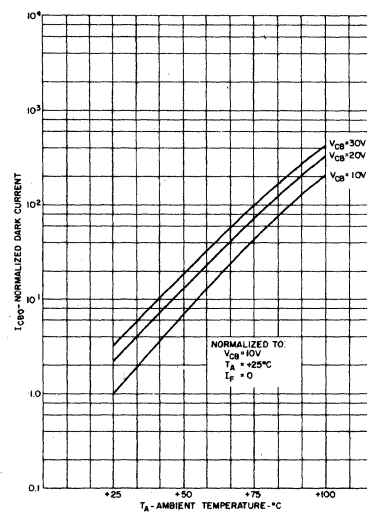

4. I_{CBO} VS TEMPERATURE

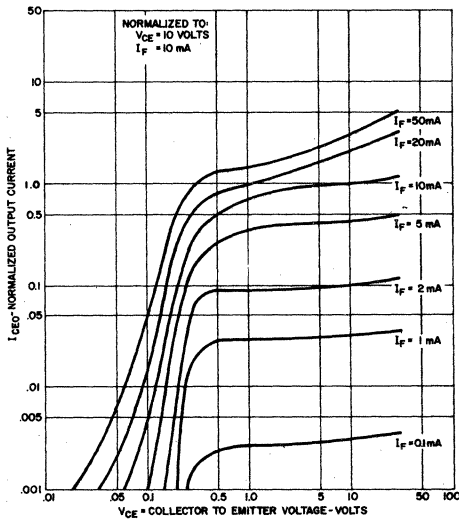

5. OUTPUT CHARACTERISTICS

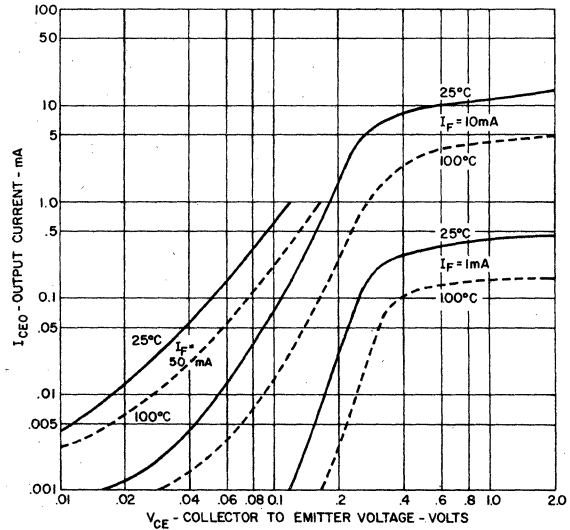

6. OUTPUT CHARACTERISTICS

TYPICAL CHARACTERISTICS

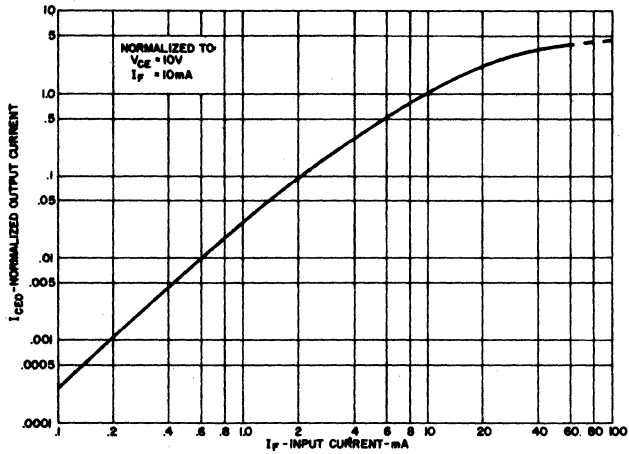

7. OUTPUT CURRENT VS INPUT CURRENT

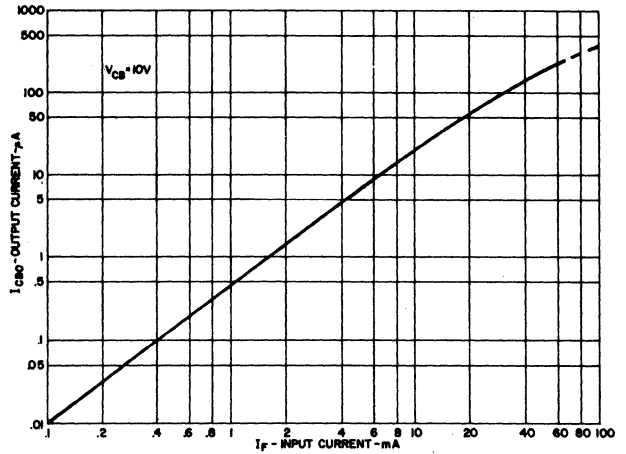

8. OUTPUT CURRENT - COLLECTOR TO BASE VS INPUT CURRENT

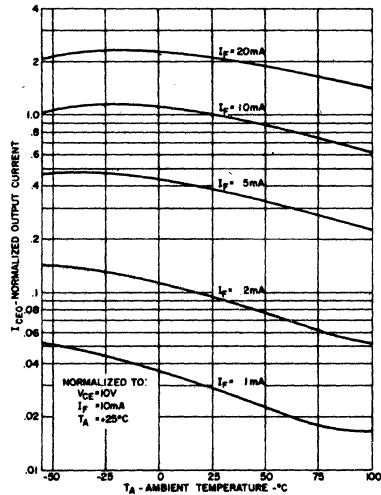

9. OUTPUT CURRENT VS TEMPERATURE

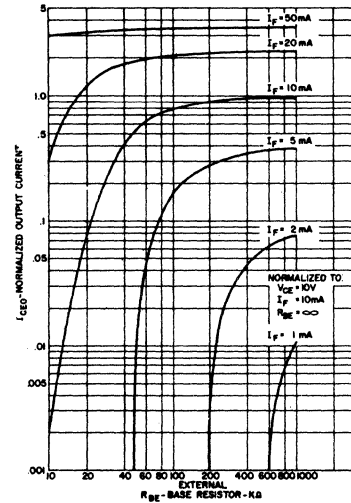

10. OUTPUT CURRENT VS BASE EMITTER RESISTANCE

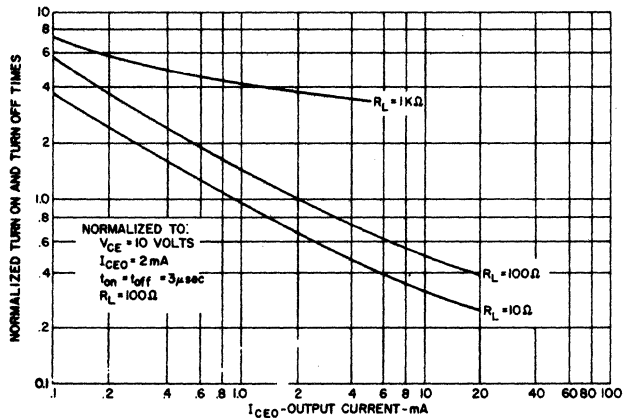

11. SWITCHING TIMES VS OUTPUT CURRENT

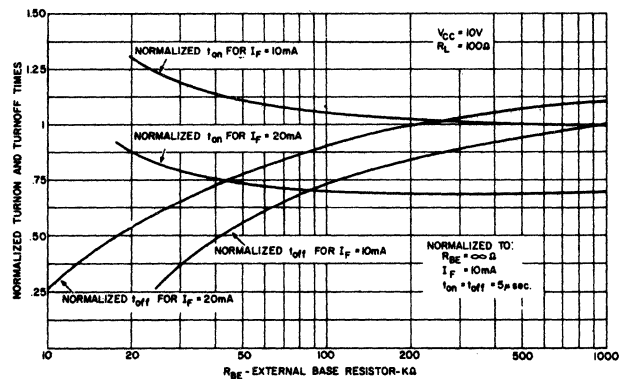

12. SWITCHING TIME VS R_{BE}



SOLID STATE OPTOELECTRONICS

Photon Coupled Isolator 4N38, 4N38A

Ga As Infrared Emitting Diode & NPN Silicon Photo-Transistor

The General Electric 4N38 and 4N38A consist of a gallium arsenide infrared emitting diode coupled with a silicon photo transistor in a dual in-line package.

FEATURES:

- Fast switching speeds
- High DC current transfer ratio
- High isolation resistance
- 2500 volts isolation voltage
- I/O compatible with integrated circuits

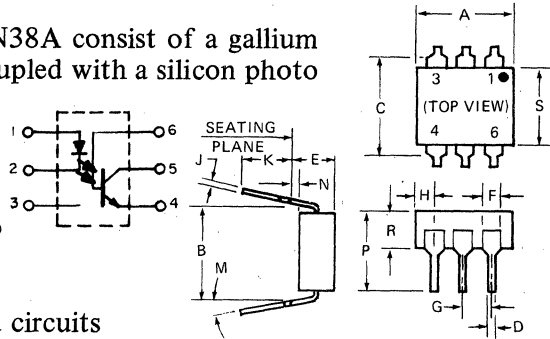

SYMBOL	MILLIMETERS		INCHES		NOTES
	MIN.	MAX.	MIN.	MAX.	
A	8.38	8.89	.330	.350	
B	7.62	REF.	.300	REF.	1
C	—	8.64	—	.340	2
D	.406	.508	.016	.020	
E	—	5.08	—	.200	3
F	1.01	1.78	.040	.070	
G	2.28	2.80	.090	.110	
H	—	2.16	—	.085	4
J	.203	.305	.008	.012	
K	2.54	—	.100	—	
M	—	15°	—	15°	
N	.381	—	.015	—	
P	—	9.53	—	.375	
R	2.92	3.43	.115	.135	
S	6.10	6.86	.240	.270	

NOTES:

1. INSTALLED POSITION LEAD CENTERS.
2. OVERALL INSTALLED DIMENSION.
3. THESE MEASUREMENTS ARE MADE FROM THE SEATING PLANE.
4. FOUR PLACES.

† Covered under U.L. component recognition program, reference file E51868

† Indicates JEDEC registered values

absolute maximum ratings: (25°C) (unless otherwise specified)

† Storage Temperature -55 to 150°C. Operating Temperature -55 to 100°C. Lead Soldering Time (at 260°C) 10 seconds.

INFRARED EMITTING DIODE		PHOTO-TRANSISTOR	
† Power Dissipation	*150 milliwatts	† Power Dissipation	**150 milliwatts
† Forward Current (Continuous)	80 milliamps	† V _{CEO}	80 volts
† Forward Current (Peak) (Pulse width 300µsec, 2% duty cycle)	3 ampere	† V _{CBO}	80 volts
† Reverse Voltage	3 volts	† V _{ECO}	7 volts
	*Derate 2.0 mW/°C above 25°C ambient.	Collector Current (Continuous)	100 milliamps
			**Derate 2.0 mW/°C above 25°C ambient.

† Total device dissipation @ T_A = 25°C. P_D 250 mW.

† Derate 3.3 mW/°C above 25°C ambient.

individual electrical characteristics (25°C)

INFRARED EMITTING DIODE	TYP.	MAX.	UNITS	PHOTO-TRANSISTOR	MIN.	TYP.	MAX.	UNITS
† Forward Voltage (I _F = 10mA)	1.2	1.5	volts	† Breakdown Voltage - V _{(BR)CEO} (I _C = 1mA, I _F = 0)	80	—	—	volts
† Reverse Current (V _R = 3V)	—	100	microamps	† Breakdown Voltage - V _{(BR)CBO} (I _C = 1µA, I _F = 0)	80	—	—	volts
Capacitance V = 0, f = 1 MHz	50	—	picofarads	† Breakdown Voltage - V _{(BR)ECO} (I _E = 100µA, I _F = 0)	7	—	—	volts
				† Collector Dark Current - I _{CEO} (V _{CE} = 60V, I _F = 0)	—	—	50	nanoamps
				† Collector Dark Current - I _{CBO} (V _{CE} = 60V, I _F = 0)	—	—	20	nanoamps

coupled electrical characteristics (25°C)

		MIN.	TYP.	MAX.	UNITS
† Isolation Voltage 60Hz with the input terminals (diode) shorted together and the output terminals (transistor) shorted together.	4N38	1500	—	—	volts (peak)
	4N38A	2500	—	—	volts (peak)
	4N38A	1775	—	—	volts (RMS) (1 sec.)
† Saturation Voltage - Collector - Emitter (I _F = 20mA, I _C = 4mA)		—	—	1.0	volts
Resistance - IRED to Photo-Transistor (@ 500 volts)		—	100	—	gigaohms
Capacitance - IRED to Photo-Transistor (@ 0 volts, f = 1 MHz)		—	1	—	picofarad
DC Current Transfer Ratio (I _F = 10mA, V _{CE} = 10V)		10	—	—	%
Switching Speeds (V _{CE} = 10V, I _C = 2mA, R _L = 100Ω)		—	—	—	—
Turn-On Time - t _{on}		—	5	—	microseconds
Turn-Off Time - t _{off}		—	5	—	microseconds

† VDE Approved to 0883/6.80 0110b Certificate # 35025

TYPICAL CHARACTERISTICS

4N38, 4N38A

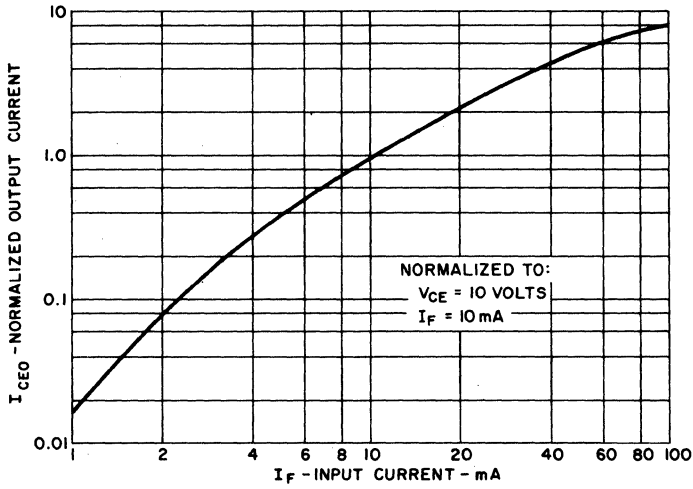

1. OUTPUT CURRENT VS INPUT CURRENT

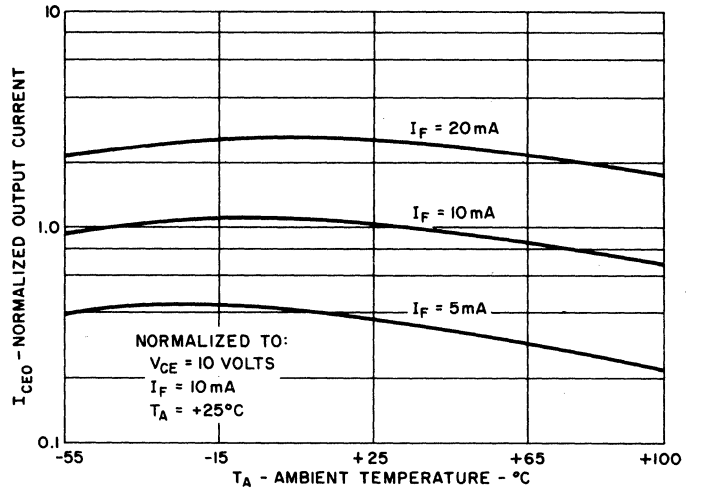

2. OUTPUT CURRENT VS TEMPERATURE

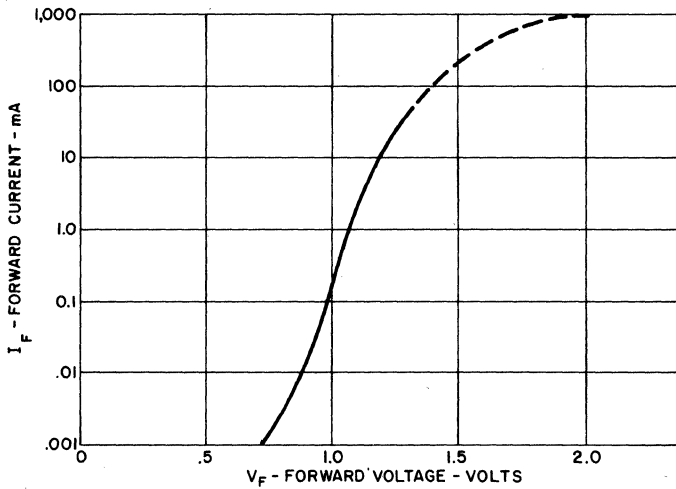

3. INPUT CHARACTERISTICS

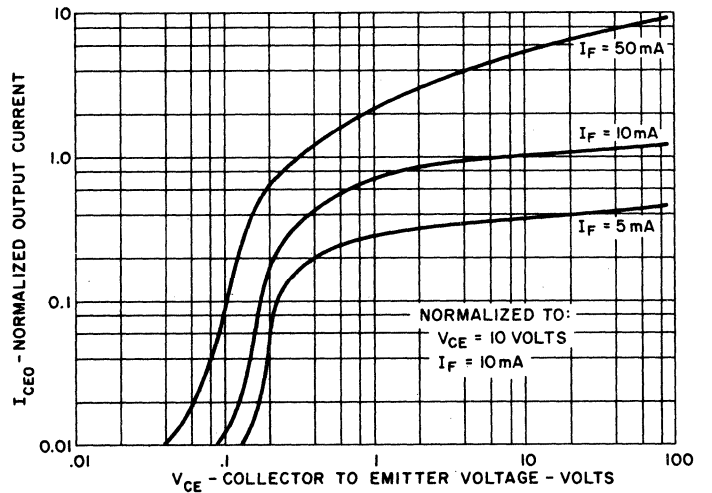

4. OUTPUT CHARACTERISTICS

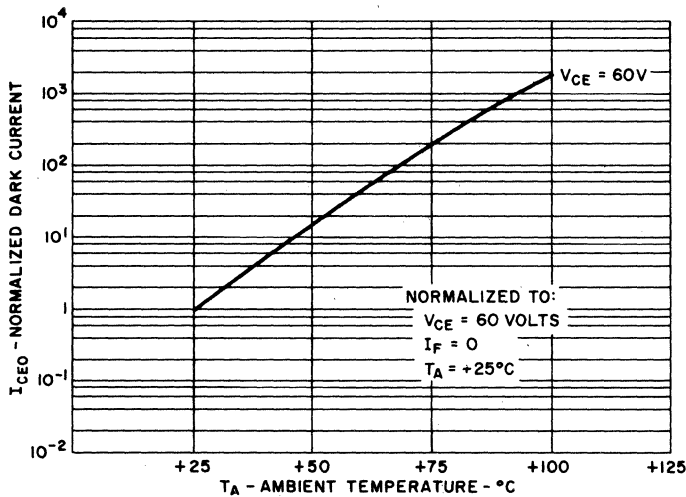

5. NORMALIZED DARK CURRENT VS TEMPERATURE

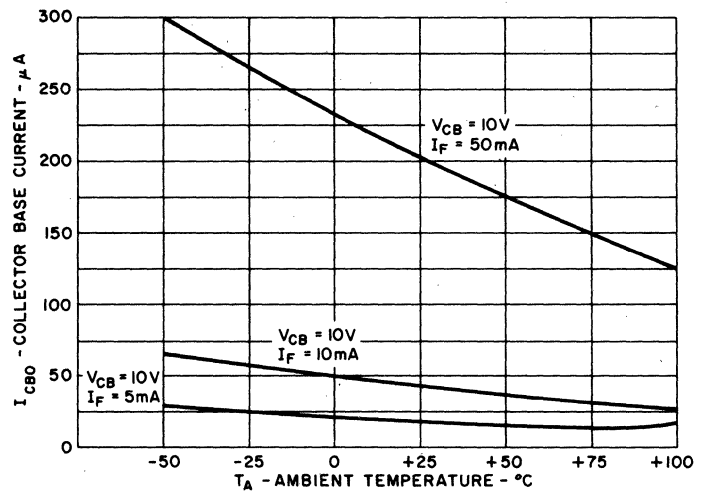

6. COLLECTOR BASE CURRENT VS TEMPERATURE



SOLID STATE OPTOELECTRONICS

Photon Coupled Isolator 4N39, 4N40

Ga As Infrared Emitting Diode & Light Activated SCR

The General Electric 4N39 and 4N40 consist of a gallium arsenide, infrared emitting diode coupled with a light activated silicon controlled rectifier in a dual in-line package.

absolute maximum ratings

INFRARED EMITTING DIODE		
† Power Dissipation (-55°C to 50°C)	*100	milliwatts
† Forward Current (Continuous) (-55°C to 50°C)	60	milliamps
† Forward Current (Peak) (-55°C to 50°C) (100 μsec 1% duty cycle)	1	ampere
† Reverse Voltage (-55°C to 50°C)	6	volts
*Derate 2.0mW/°C above 50°C.		

PHOTO-SCR		
† Off-State and Reverse Voltage (-55°C to +100°C)	4N39 200 4N40 400	volts
† Peak Reverse Gate Voltage (-55°C to 50°C)	6	volts
† Direct On-State Current (-55°C to 50°C)	300	milliamps
† Surge (non-rep) On-State Current (100 μsec) (-55°C to 50°C)	10	amps
† Peak Gate Current (-55°C to 50°C)	10	milliamps
† Output Power Dissipation (-55°C to 50°C)**	400	milliwatts
**Derate 8mW/°C above 50°C.		

individual electrical characteristics (25°C) (unless otherwise specified)

INFRARED EMITTING DIODE	TYP.	MAX.	UNITS
† Forward Voltage V_F ($I_F = 10\text{mA}$)	1.1	1.5	volts
† Reverse Current I_R ($V_R = 3\text{V}$)	—	10	microamps
Capacitance ($V = 0, f = 1\text{MHz}$)	50	—	picofarads

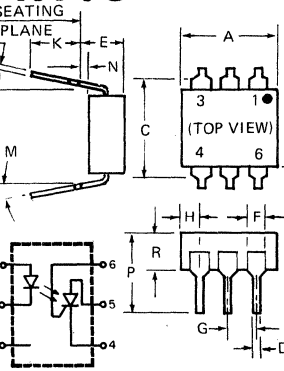

SYMBOL	MILLIMETERS		INCHES		NOTES
	MIN.	MAX.	MIN.	MAX.	
A	8.38	8.89	.330	.350	1
B	7.62 REF.	—	.300 REF.	—	
C	—	8.64	—	.340	2
D	.406	.508	.016	.020	
E	—	5.08	—	.200	3
F	1.01	1.78	.040	.070	
G	2.28	2.80	.090	.110	4
H	—	2.16	—	.085	
J	.203	.305	.008	.012	4
K	2.54	—	.100	—	
M	—	15°	—	15°	4
N	.381	—	.015	—	
P	—	9.53	—	.375	4
R	2.92	3.43	.115	.135	
S	6.10	6.86	.240	.270	4

- NOTES:
 1. INSTALLED POSITION LEAD CENTERS.
 2. OVERALL INSTALLED DIMENSION.
 3. THESE MEASUREMENTS ARE MADE FROM THE SEATING PLANE.
 4. FOUR PLACES.

TOTAL DEVICE	
† Storage Temperature Range	-55°C to 150°C
† Operating Temperature Range	-55°C to 100°C
† Normal Temperature Range (No Derating)	-55°C to 50°C
† Soldering Temperature (1/16" from case, 10 seconds)	260°C
† Total Device Dissipation (-55°C to 50°C)	450 milliwatts
† Linear Derating Factor (above 50°C)	9.0mW/°C
† Surge Isolation Voltage (Input to Output).	1500V _(peak) 1060V _(RMS)
† Steady-State Isolation Voltage (Input to Output).	950V _(peak) 660V _(RMS)

coupled electrical characteristics (25°C)

	MIN.	MAX.	UNITS
† Input Current to Trigger I_{FT}	—	30	milliamps
† Isolation Resistance (Input to Output) I_{FO}	—	14	milliamps
† Turn-On Time — $V_{AK} = 50\text{V}, I_F = 30\text{mA}, R_{GK} = 10\text{K}\Omega, R_L = 200\Omega$	100	—	gigahohms
Coupled dv/dt, Input to Output (See Figure 13)	—	50	microseconds
Input to Output Capacitance (Input to Output Voltage = 0, f = 1MHz)	500	—	volts/microsec.
	—	2	picofarads

† Indicates JEDEC Registered Values. Covered under U.L. component recognition program, reference file E51868

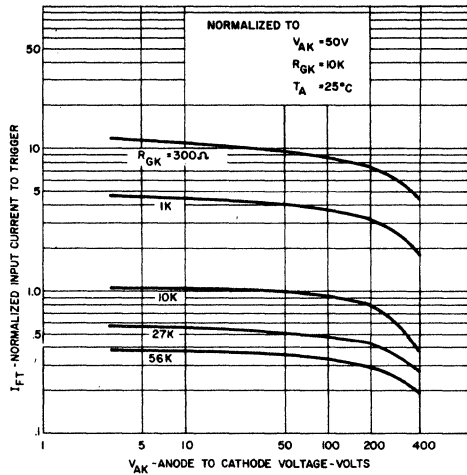

FIGURE 1. INPUT CURRENT TO TRIGGER VS. ANODE-CATHODE VOLTAGE

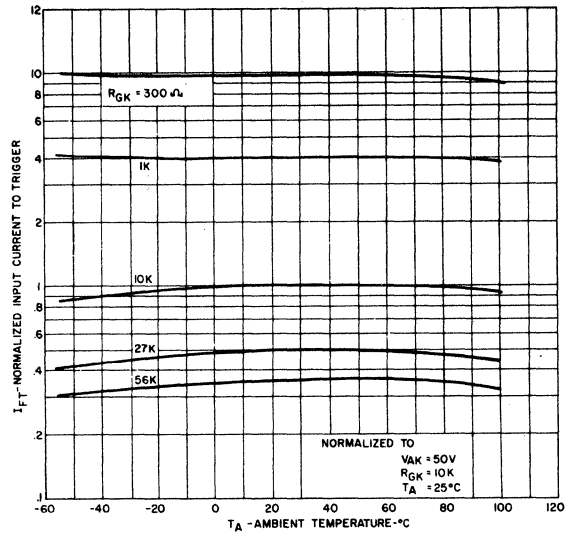

FIGURE 2. INPUT CURRENT TO TRIGGER VS. TEMPERATURE

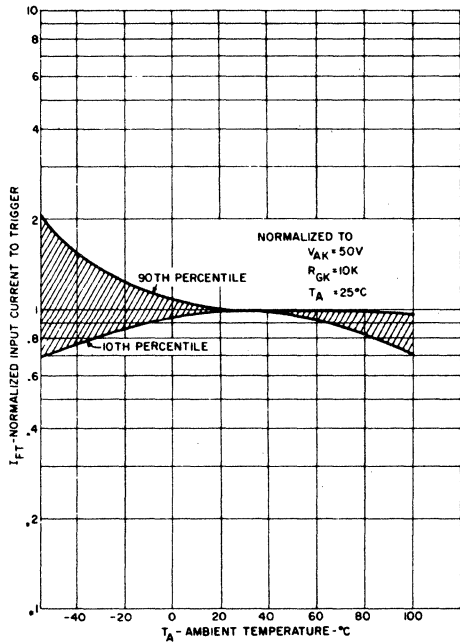

FIGURE 3. INPUT CURRENT TO TRIGGER DISTRIBUTION VS. TEMPERATURE

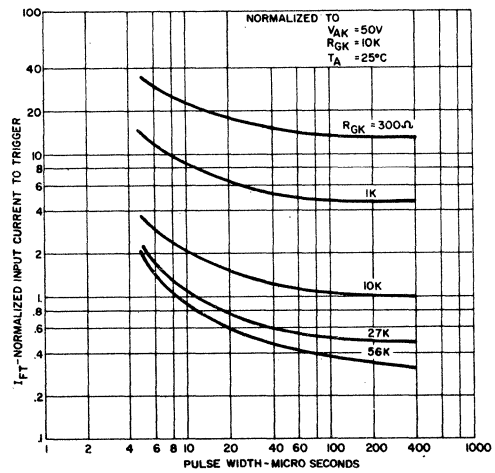

FIGURE 4. INPUT CURRENT TO TRIGGER VS. PULSE WIDTH

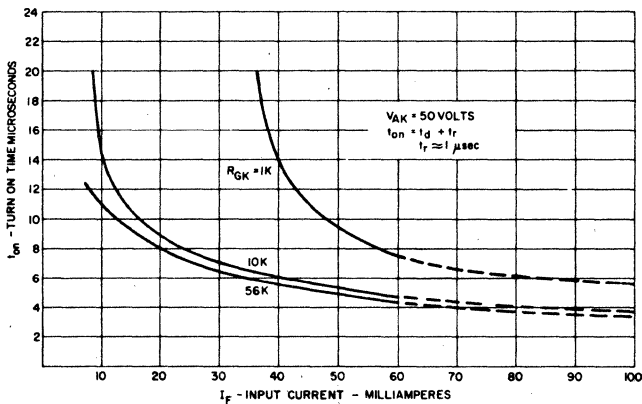

FIGURE 5. TURN-ON TIME VS. INPUT CURRENT

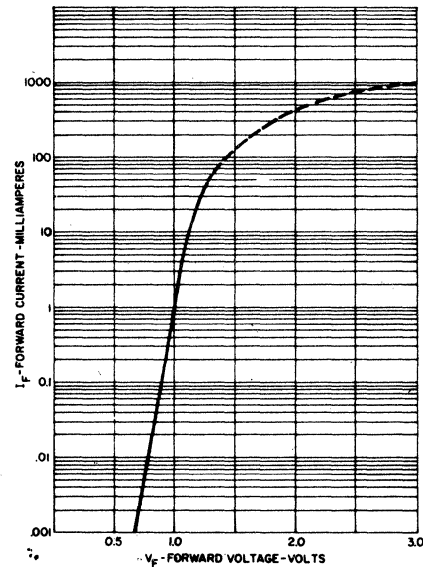

FIGURE 6. INPUT CHARACTERISTICS I_F VS. V_F

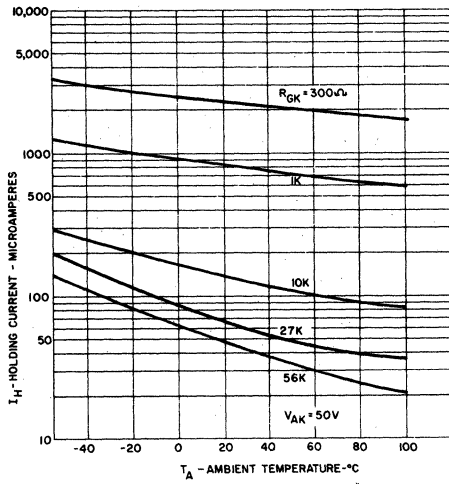

FIGURE 7. HOLDING CURRENT VS. TEMPERATURE

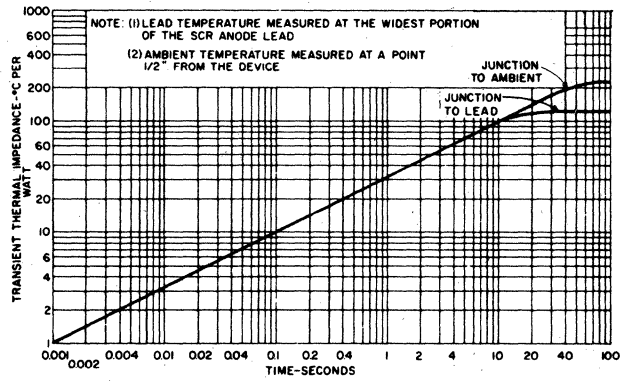

FIGURE 8. MAXIMUM TRANSIENT THERMAL IMPEDANCE

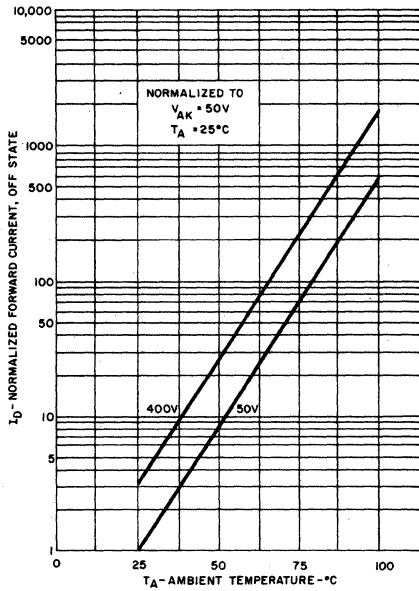

FIGURE 9. OFF-STATE FORWARD CURRENT VS. TEMPERATURE

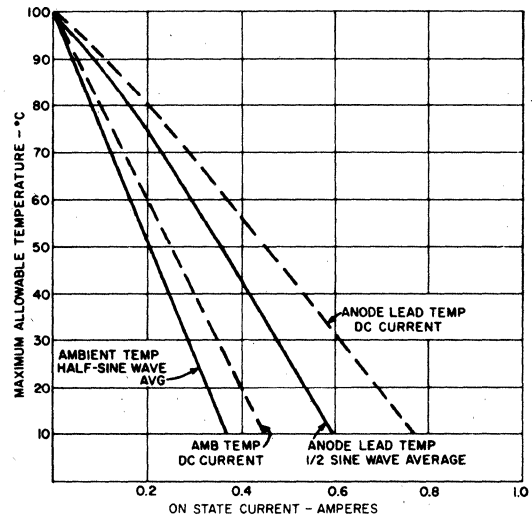

FIGURE 10. ON-STATE CURRENT VS. MAXIMUM ALLOWABLE TEMPERATURE

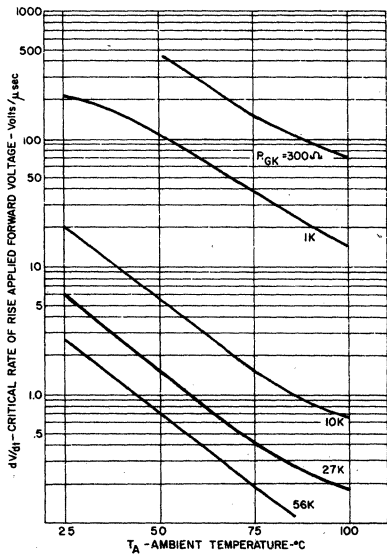

FIGURE 11. dv/dt VS. TEMPERATURE

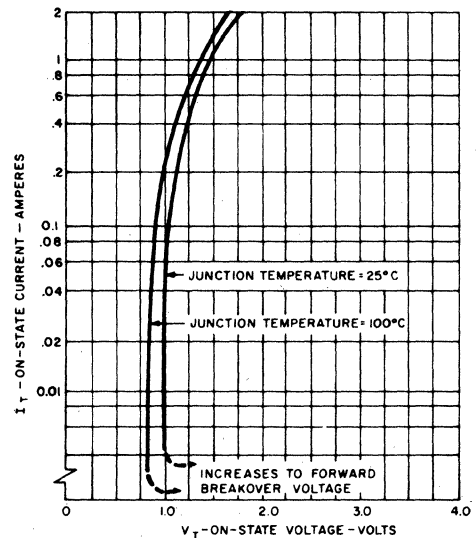
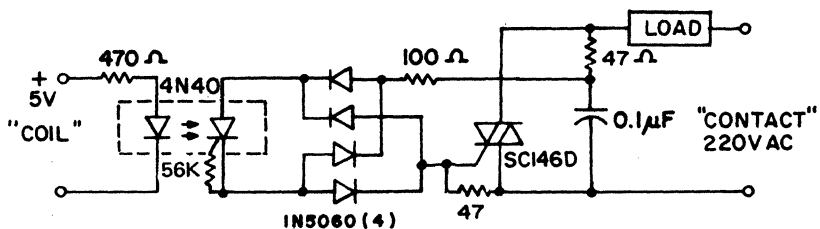

FIGURE 12. ON-STATE CHARACTERISTICS

TYPICAL APPLICATIONS

10A, T²L COMPATIBLE, SOLID STATE RELAY

Use of the 4N40 for high sensitivity, 2500V isolation capability, provides this highly reliable solid state relay design. This design is compatible with 74, 74S and 74H series T²L logic systems inputs and 220V AC loads up to 10A.



25W LOGIC INDICATOR LAMP DRIVER

The high surge capability and non-reactive input characteristics of the 4N40 allow it to directly couple, without buffers, T²L and DTL logic to indicator and alarm devices, without danger of introducing noise and logic glitches.

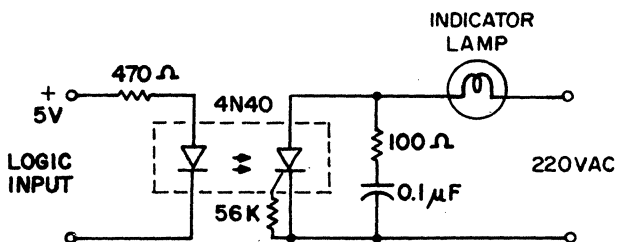

400V SYMMETRICAL TRANSISTOR COUPLER

Use of the high voltage PNP portion of the 4N40 provides a 400V transistor capable of conducting positive and negative signals with current transfer ratios of over 1%. This function is useful in remote instrumentation, high voltage power supplies and test equipment. Care should be taken not to exceed the 400 mW power dissipation rating when used at high voltages.

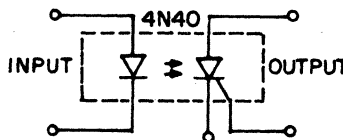
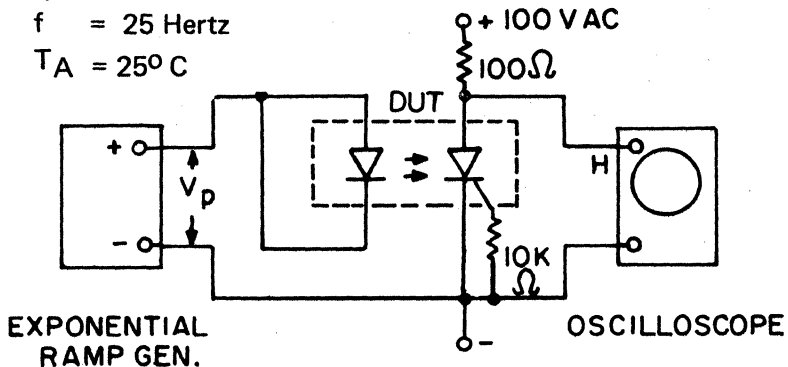
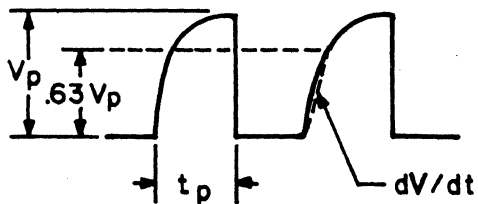

FIGURE 13
COUPLED dv/dt - TEST CIRCUIT

$V_p = 800$ Volts
 $t_p = .010$ Seconds
 $f = 25$ Hertz
 $T_A = 25^\circ$ C





SOLID STATE

OPTOELECTRONICS

Photon Coupled Isolator H11A1, H11A2

Ga As Infrared Emitting Diode & NPN Silicon Photo-Transistor

The General Electric H11A1 and H11A2 are gallium arsenide infrared emitting diodes coupled with a silicon photo-transistor in a dual in-line package.

absolute maximum ratings: (25°C)

INFRARED EMITTING DIODE			
Power Dissipation	*100	milliwatts	
Forward Current (Continuous)	60	milliamps	
Forward Current (Peak)	3	ampere	
(Pulse width 1 μsec 300 P Ps)			
Reverse Voltage	3	volts	
*Derate 1.33mW/°C above 25°C ambient			

PHOTO-TRANSISTOR			
Power Dissipation	**150	milliwatts	
V _{CEO}	30	volts	
V _{CBO}	70	volts	
V _{ECO}	7	volts	
Collector Current (Continuous)	100	milliamps	
**Derate 2.0mW/°C above 25°C ambient			

individual electrical characteristics (25°C)

INFRARED EMITTING DIODE	TYP.	MAX.	UNITS
Forward Voltage (I _F = 10 mA)	1.1	1.5	volts
Reverse Current (V _R = 3 V)	—	10	microamps
Capacitance (V = 0, f = 1 MHz)	.50	—	picofarads

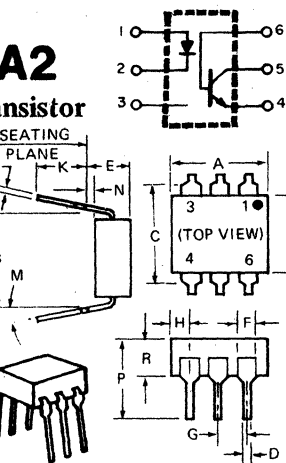

SYMBOL	MILLIMETERS		INCHES		NOTES
	MIN.	MAX.	MIN.	MAX.	
A	8.38	8.89	.330	.350	1
B	7.62	REF.	.300	REF.	
C	—	8.64	—	.340	2
D	.406	.508	.016	.020	
E	—	5.08	—	.200	3
F	1.01	1.78	.040	.070	
G	2.28	2.80	.090	.110	4
H	—	2.16	—	.085	
J	.203	.305	.008	.012	—
K	2.54	—	.100	—	
M	—	15°	—	15°	—
N	.381	—	.015	—	
P	—	9.53	—	.375	—
R	2.92	3.43	.115	.135	
S	6.10	6.86	.240	.270	

NOTES:
 1. INSTALLED POSITION LEAD CENTERS.
 2. OVERALL INSTALLED DIMENSION.
 3. THESE MEASUREMENTS ARE MADE FROM THE SEATING PLANE. 4. FOUR PLACES.

TOTAL DEVICE			
Storage Temperature -55 to 150°C			
Operating Temperature -55 to 100°C			
Lead Soldering Time (at 260°C) 10 seconds			
Surge Isolation Voltage (Input to Output).			
H11A1	2500V _(peak)	1770V _(RMS)	
H11A2	1500V _(peak)	1060V _(RMS)	
Steady-State Isolation Voltage (Input to Output).			
H11A1	1500V _(peak)	1060V _(RMS)	
H11A2	950V _(peak)	660V _(RMS)	

coupled electrical characteristics (25°C)

	MIN.	TYP.	MAX.	UNITS
DC Current Transfer Ratio (I _F = 10mA, V _{CE} = 10V)	H11A1	50	—	%
	H11A2	20	—	%
Saturation Voltage – Collector to Emitter (I _F = 10mA, I _C = 0.5mA)	—	0.1	0.4	volts
Isolation Resistance (Input to Output Voltage = 500V _{DC})	100	—	—	gigohms
Input to Output Capacitance (Input to Output Voltage = 0, f = 1MHz)	—	—	2	picofarads
Switching Speeds:				
Rise/Fall Time (V _{CE} = 10V, I _{CE} = 2mA, R _L = 100Ω)	—	2	—	microseconds
Rise/Fall Time (V _{CB} = 10V, I _{CB} = 50μA, R _L = 100Ω)	—	300	—	nanoseconds

Covered under U.L. component recognition program, reference file E51868

VDE Approved to 0883/6.80 0110b Certificate # 35025

TYPICAL CHARACTERISTICS

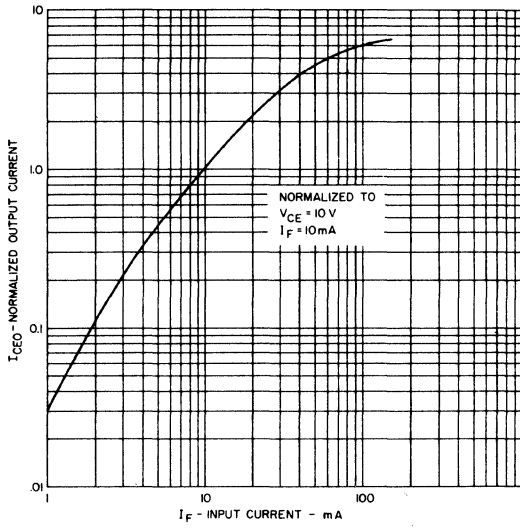

OUTPUT CURRENT VS INPUT CURRENT

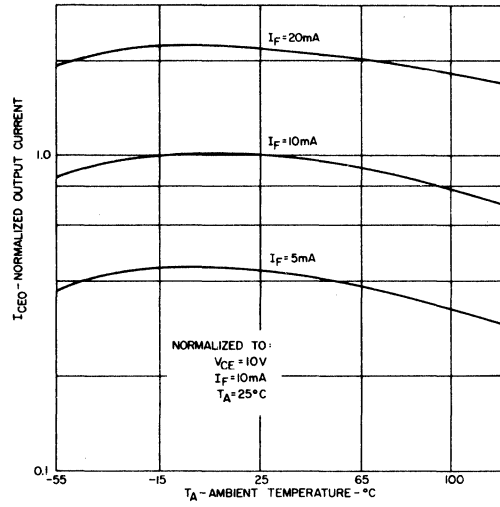

OUTPUT CURRENT VS TEMPERATURE

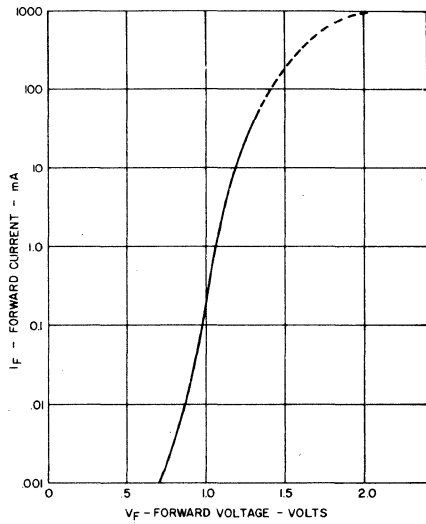

INPUT CHARACTERISTICS

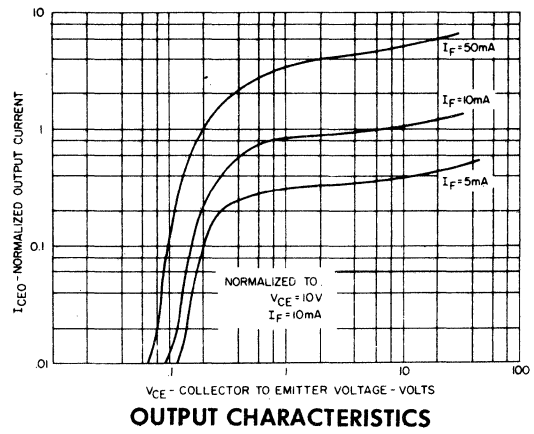

OUTPUT CHARACTERISTICS

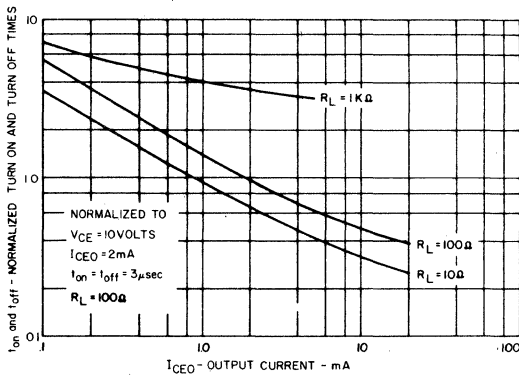

SWITCHING TIMES VS OUTPUT CURRENT

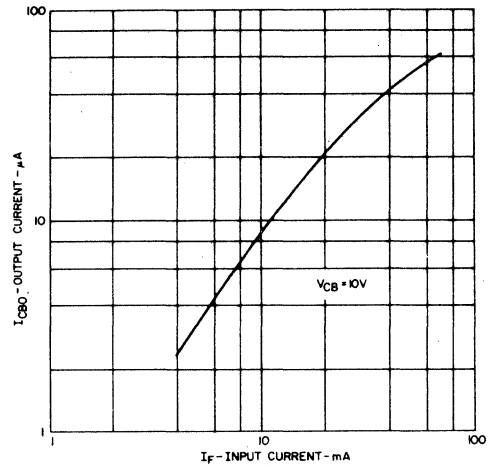

OUTPUT CURRENT (I_{CBO}) VS INPUT CURRENT



SOLID STATE OPTOELECTRONICS

Photon Coupled Isolator H11A3, H11A4

Ga As Infrared Emitting Diode & NPN Silicon Photo-Transistor

The General Electric H11A3 and H11A4 are gallium arsenide, infrared emitting diodes coupled with a silicon photo-transistor in a dual in-line package.

absolute maximum ratings: (25°C)

INFRARED EMITTING DIODE		
Power Dissipation	*100	milliwatts
Forward Current (Continuous)	60	milliamps
Forward Current (Peak)	3	ampere
(Pulse width 1μsec 300 P Ps)		
Reverse Voltage	3	volts
*Derate 1.33mW/°C above 25°C ambient.		

PHOTO-TRANSISTOR		
Power Dissipation	**150	milliwatts
V _{CEO}	30	volts
V _{CBO}	70	volts
V _{ECO}	7	volts
Collector Current (Continuous)	100	milliamps
**Derate 2.0mW/°C above 25°C ambient.		

individual electrical characteristics (25°C)

INFRARED EMITTING DIODE	TYP.	MAX.	UNITS
Forward Voltage (I _F = 10mA)	1.1	1.5	volts
Reverse Current (V _R = 3V)	—	10	microamps
Capacitance (V = 0, f = 1MHz)	50	—	picofarads

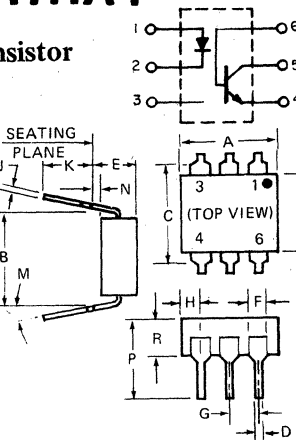

SYMBOL	MILLIMETERS		INCHES		NOTES
	MIN.	MAX.	MIN.	MAX.	
A	8.38	8.89	.330	.350	1
B	7.62 REF.		.300 REF.		
C	—	8.64	—	.340	2
D	.406	.508	.016	.020	
E	—	5.08	—	.200	3
F	1.01	1.78	.040	.070	
G	2.28	2.80	.090	.110	4
H	—	2.16	—	.085	
J	.203	.305	.008	.012	4
K	2.54	—	.100	—	
M	—	15°	—	15°	4
N	.381	—	.015	—	
P	—	9.53	—	.375	4
R	2.92	3.43	.115	.135	
S	6.10	6.86	.240	.270	4

- NOTES:
 1. INSTALLED POSITION LEAD CENTERS.
 2. OVERALL INSTALLED DIMENSION.
 3. THESE MEASUREMENTS ARE MADE FROM THE SEATING PLANE.
 4. FOUR PLACES.

TOTAL DEVICE	
Storage Temperature	-55 to 150°C
Operating Temperature	-55 to 100°C
Lead Soldering Time (at 260°C)	10 seconds
Surge Isolation Voltage (Input to Output)	
H11A3	2500V _(peak) 1770V _(RMS)
H11A4	1500V _(peak) 1060V _(RMS)
Steady-State Isolation Voltage (Input to Output)	
H11A3	1500V _(peak) 1060V _(RMS)
H11A4	950V _(peak) 660V _(RMS)

coupled electrical characteristics (25°C)

		MIN.	TYP.	MAX.	UNITS
DC Current Transfer Ratio (I _F = 10mA, V _{CE} = 10V)	H11A3	20	—	—	%
	H11A4	10	—	—	%
Saturation Voltage – Collector to Emitter (I _F = 10mA, I _C = 0.5mA)		—	0.1	0.4	volts
Isolation Resistance (Input to Output Voltage = 500V _{DC})		100	—	—	gigaohms
Input to Output Capacitance (Input to Output Voltage = 0, f = 1MHz)		—	—	2	picofarads
Switching Speeds:	Rise/Fall Time (V _{CE} = 10V, I _{CE} = 2mA, R _L = 100Ω)	—	2	—	microseconds
	Rise/Fall Time (V _{CB} = 10V, I _{CB} = 50μA, R _L = 100Ω)	—	300	—	nanoseconds

Covered under U.L. component recognition program, reference file E51868

VDE Approved to 0883/6.80 0110b Certificate # 35025

TYPICAL CHARACTERISTICS

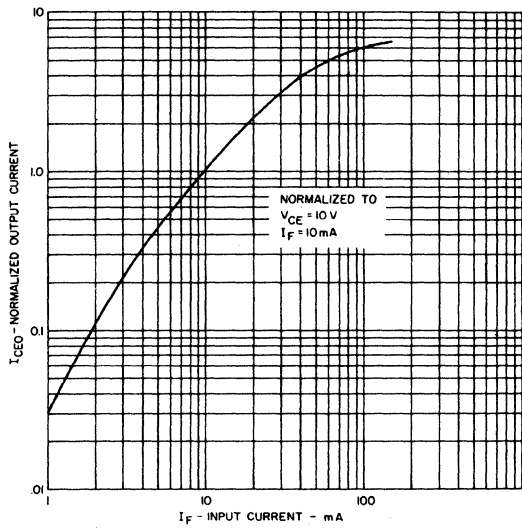

OUTPUT CURRENT VS INPUT CURRENT

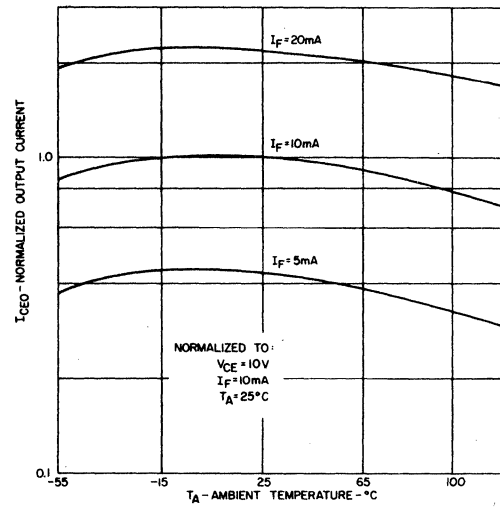

OUTPUT CURRENT VS TEMPERATURE

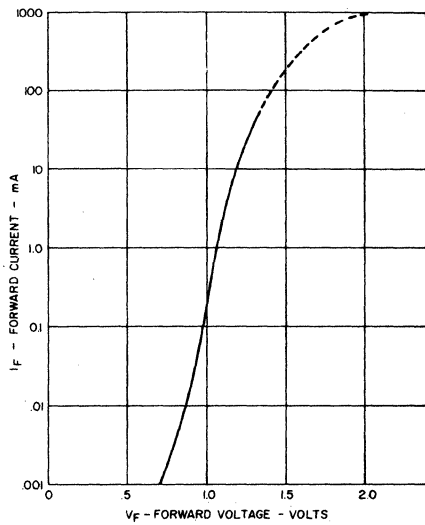

INPUT CHARACTERISTICS

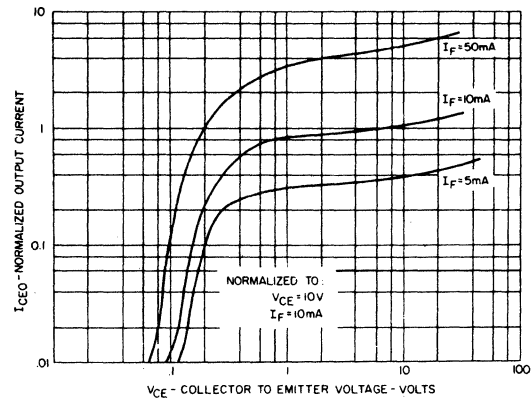

OUTPUT CHARACTERISTICS

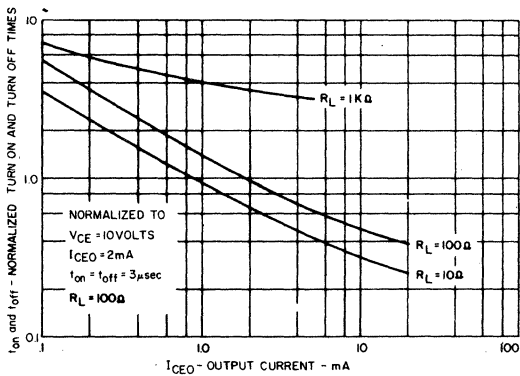

SWITCHING TIMES VS OUTPUT CURRENT

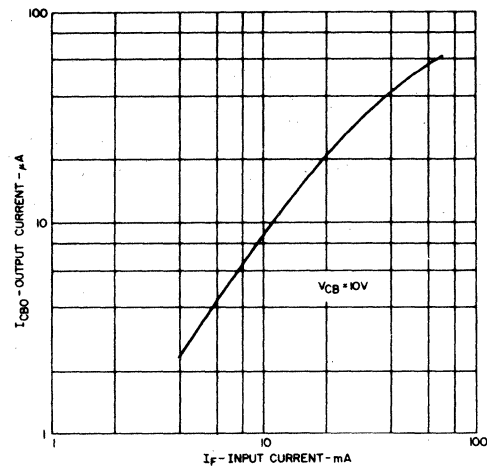

OUTPUT CURRENT (I_{CBO}) VS INPUT CURRENT



SOLID STATE

OPTO ELECTRONICS

Photon Coupled Isolator H11A5

Ga As Infrared Emitting Diode & NPN Silicon Photo-Transistor

The General Electric H11A5 is a gallium arsenide, infrared emitting diode coupled with a silicon photo-transistor in a dual in-line package.

absolute maximum ratings: (25°C)

INFRARED EMITTING DIODE		
Power Dissipation	*100	milliwatts
Forward Current (Continuous)	60	milliamps
Forward Current (Peak) (Pulse width 1μsec 300 P Ps)	3	ampere
Reverse Voltage	3	volts

*Derate 1.33mW/°C above 25°C ambient.

PHOTO-TRANSISTOR		
Power Dissipation	**150	milliwatts
V _{CEO}	30	volts
V _{CBO}	70	volts
V _{ECO}	7	volts
Collector Current (Continuous)	100	milliamps

**Derate 2.0mW/°C above 25°C ambient.

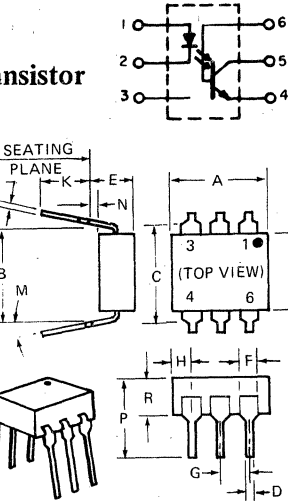

SYMBOL	MILLIMETERS		INCHES		NOTES
	MIN.	MAX.	MIN.	MAX.	
A	8.38	8.89	.330	.350	1
B	7.62 REF.		.300 REF.		
C	—	8.64	—	.340	2
D	.406	.508	.016	.020	
E	—	5.08	—	.200	3
F	1.01	1.78	.040	.070	
G	2.28	2.80	.090	.110	4
H	—	2.16	—	.085	
J	.203	.305	.008	.012	—
K	2.54	—	.100	—	
M	—	15°	—	15°	—
N	.381	—	.015	—	
P	—	9.53	—	.375	—
R	2.92	3.43	.115	.135	
S	6.10	6.86	.240	.270	—

- NOTES:
 1. INSTALLED POSITION LEAD CENTERS.
 2. OVERALL INSTALLED DIMENSION.
 3. THESE MEASUREMENTS ARE MADE FROM THE SEATING PLANE.
 4. FOUR PLACES.

TOTAL DEVICE
Storage Temperature -55 to 150°C
Operating Temperature -55 to 100°C
Lead Soldering Time (at 260°C) 10 seconds
Surge Isolation Voltage (Input to Output). 1500V _(peak) 1060V _(RMS)
Steady-State Isolation Voltage (Input to Output). 950V _(peak) 660V _(RMS)

individual electrical characteristics (25°C)

INFRARED EMITTING DIODE	TYP.	MAX.	UNITS
Forward Voltage (I _F = 10mA)	1.1	1.7	volts
Reverse Current (V _R = 3V)	—	10	microamps
Capacitance (V = 0, f = 1MHz)	50	—	picofarads

PHOTO-TRANSISTOR	MIN.	TYP.	MAX.	UNITS
Breakdown Voltage - V _{(BR)CEO} (I _C = 10mA, I _F = 0)	30	—	—	volts
Breakdown Voltage - V _{(BR)CBO} (I _C = 100μA, I _F = 0)	70	—	—	volts
Breakdown Voltage - V _{(BR)ECO} (I _E = 100μA, I _F = 0)	7	—	—	volts
Collector Dark Current - I _{CEO} (V _{CE} = 10V, I _F = 0)	—	5	100	nanoamps
Capacitance (V _{CE} = 10V, f = 1MHz)	—	2	—	picofarads

coupled electrical characteristics (25°C)

	MIN.	TYP.	MAX.	UNITS
DC Current Transfer Ratio (I _F = 10mA, V _{CE} = 10V)	30	—	—	%
Saturation Voltage - Collector to Emitter (I _F = 10mA, I _C = 0.5mA)	—	0.1	0.4	volts
Isolation Resistance (Input to Output Voltage = 500V _{DC})	100	—	—	gigohms
Input to Output Capacitance (Input to Output Voltage = 0, f = 1MHz)	—	—	2	picofarads
Switching Speeds: Rise/Fall Time (V _{CE} = 10V, I _{CE} = 2mA, R _L = 100Ω)	—	2	—	microseconds
Rise/Fall Time (V _{CB} = 10V, I _{CB} = 50μA, R _L = 100Ω)	—	300	—	nanoseconds

Covered under U.L. component recognition program, reference file E51868

VDE Approved to 0883/6.80 0110b Certificate # 35025

TYPICAL CHARACTERISTICS

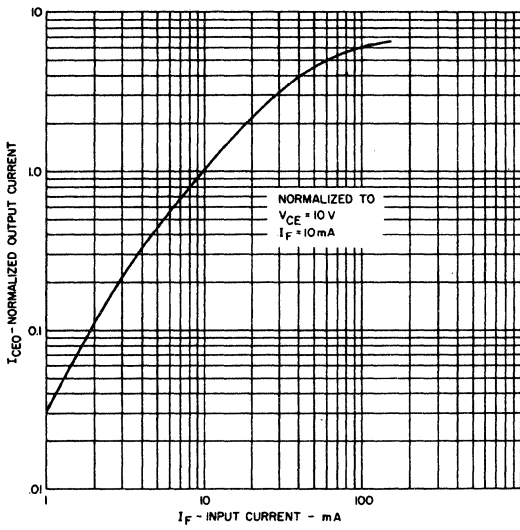

OUTPUT CURRENT VS INPUT CURRENT

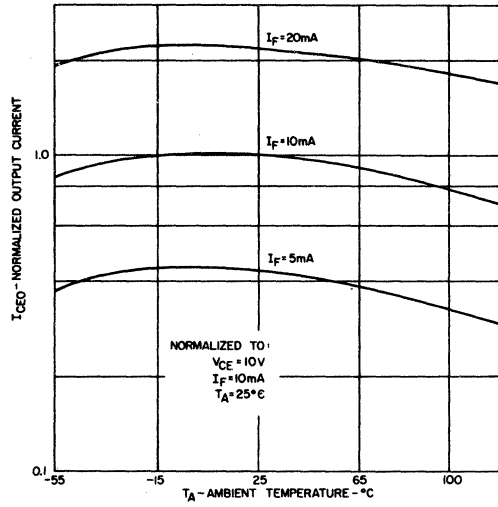

OUTPUT CURRENT VS TEMPERATURE

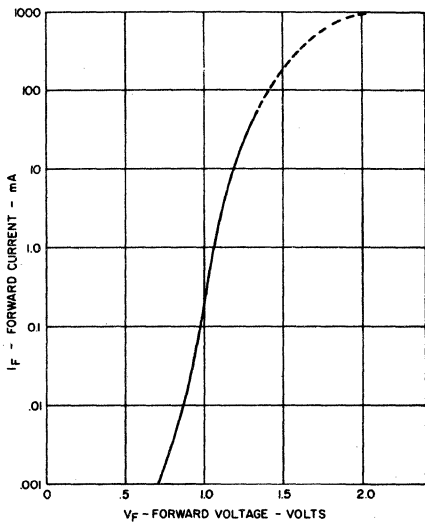

INPUT CHARACTERISTICS

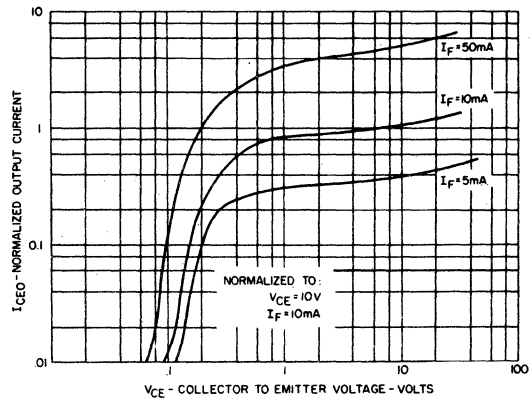

OUTPUT CHARACTERISTICS

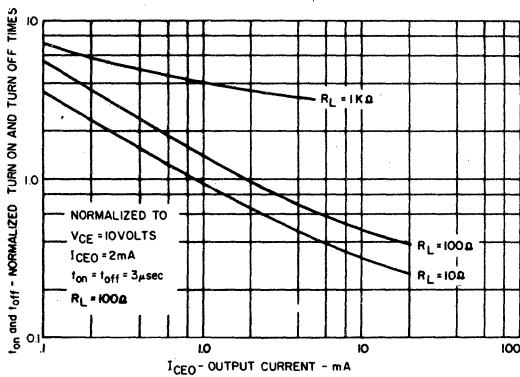

SWITCHING TIMES VS OUTPUT CURRENT

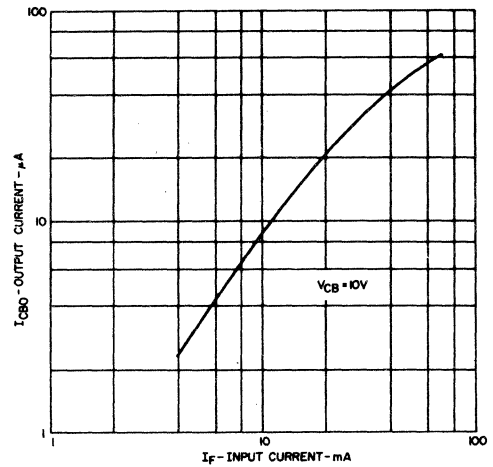

OUTPUT CURRENT (I_{CBO}) VS INPUT CURRENT



SOLID STATE

OPTOELECTRONICS

PHOTON COUPLED CURRENT THRESHOLD SWITCH H11A10

Ga As Infrared Emitting Diode & NPN Silicon Photo-Transistor

The General Electric H11A10 is a gallium arsenide infrared emitting diode coupled with a silicon photo transistor in a dual in-line package. It is characterized and specified with two resistors, one on the input and one on the output. This configuration provides a circuit which will detect a doubling of the input current level by registering more than a twenty to one difference in the output current over a wide temperature range.

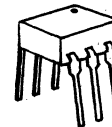

FEATURES:

- Programmable Threshold - "off" to "on" with a 2/1 change in input current
- Glass Dielectric Isolation
- Fast Switching Speeds
- Operation over wide temperature range
- High Noise Immunity
- Covered under U.L. Component Recognition Program, reference file E51868

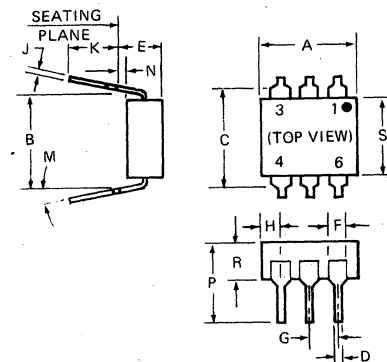

absolute maximum ratings: (25°C) (unless otherwise specified)

INFRARED EMITTING DIODE

Power Dissipation	$T_A = 25^\circ\text{C}$	*100	milliwatts
Power Dissipation	$T_C = 25^\circ\text{C}$	*100	milliwatts
Forward Current (Continuous)		50	milliamps
Forward Current (Peak)			
(Pulse width 1 μsec , 300 pps)		3	ampere
Reverse Voltage		6	volts

*Derate 1.33mW/°C above 25°C

PHOTO-TRANSISTOR

Power Dissipation	$T_A = 25^\circ\text{C}$	**300	milliwatts
Power Dissipation	$T_C = 25^\circ\text{C}$	***500	milliwatts
(T _C indicates collector lead temperature 1/32" from case)			
V _{CEO}		30	volts
V _{CBO}		70	volts
V _{EBO}		7	volts
Collector Current (Continuous)		100	milliamps

**Derate 4.0mW/°C above 25°C

***Derate 6.7mW/°C above 25°C

TOTAL DEVICE

Storage Temperature	-55 to 150°C
Operating Temperature	-55 to 100°C
Lead Soldering Time (at 260°C)	10 seconds
Input to Output Isolation Voltage	1500V _(peak)
Surge Isolation (Input to Output)	
	1500V _(peak) 1060V _(RMS)
Steady-State Isolation Voltage (Input to Output)	
	950V _(peak) 660V _(RMS)

SYMBOL	MILLIMETERS		INCHES		NOTES
	MIN.	MAX.	MIN.	MAX.	
A	8.38	8.89	.330	.350	
B	7.62 REF.		.300 REF.		1
C		8.64		.340	2
D	.406	.508	.016	.020	
E		5.08		.200	3
F	1.01	1.78	.040	.070	
G	2.28	2.80	.090	.110	
H		2.16		.085	4
J	.203	.305	.008	.012	
K	2.54		.100		
M		15°		15°	
N	.381		.015		
P		9.53		.375	
R	2.92	3.43	.115	.135	
S	6.10	6.86	.240	.270	

NOTES:

1. INSTALLED POSITION LEAD CENTERS.
2. OVERALL INSTALLED DIMENSION.
3. THESE MEASUREMENTS ARE MADE FROM THE SEATING PLANE.
4. FOUR PLACES.

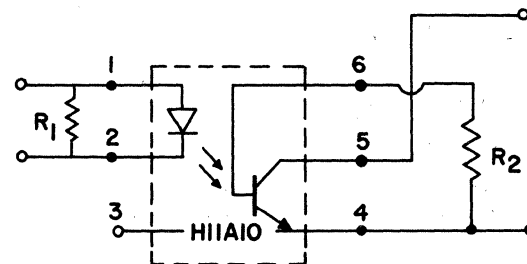

THRESHOLD SWITCH BIAS
CIRCUIT ILLUSTRATION

individual electrical characteristics (25°C) (unless otherwise specified)

H11A10

INFRARED EMITTING DIODE	SYMBOL	MIN.	MAX.	UNITS	PHOTO-TRANSISTOR	SYMBOL	MIN.	TYP.	MAX.	UNITS
Forward Voltage (I _F =10mA)	V _F		1.5	volts	Breakdown Voltage (I _C =10mA, I _F =0)	V _{(BR)CEO}	30	—	—	volts
Reverse Current (V _R =6V)	I _R	—	10	microamps	Breakdown Voltage (I _C =100μA, I _F =0)	V _{(BR)CBO}	70	—	—	volts
Capacitance (V=0, f=1 MHz)	C _J		100	picofarads	Breakdown Voltage (I _E =100μA, I _F =0)	V _{(BR)EBO}	7	—	—	volts

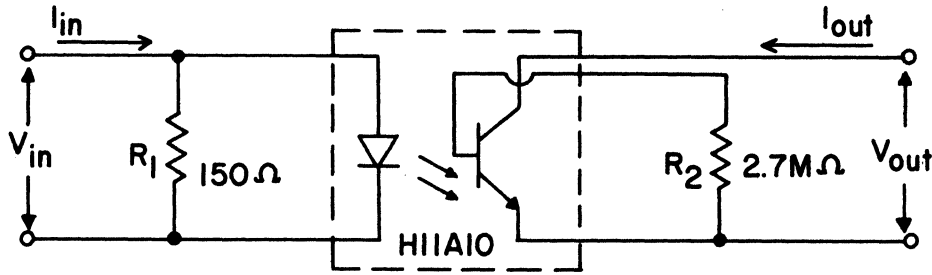

FIGURE 1

THRESHOLD CIRCUIT CHARACTERISTICS - BIAS PER FIGURE 1

(-55°C to 100°C Unless Otherwise Specified)

SYMBOL	PARAMETER/CONDITIONS	MIN.	TYP.	MAX.	UNITS
I _{out}	Output Current (V _{out} =10V, I _{in} ≤ 5mA, T _A =25°C)		1	50	nanoamperes
I _{out}	Output Current (V _{out} =10V, I _{in} ≤ 5mA, T _A =100°C)		1	50	microamperes
I _{out} /I _{in}	D.C. Current Transfer Ratio (V _{out} =10V, I _{in} ≥ 10mA)	10	30		percent
V _{out}	Output Saturation Voltage (I _{in} =10mA, I _{out} =0.5mA)		0.2	0.4	volts
R _{io}	Input to Output Resistance (V _{io} =500V) Note 1	100			gigaohms
t _{on}	Turn-On Time (V _{cc} = 10V, I _{in} =20 mA, R _L =100Ω) Figure 2		5		microseconds
t _{off}	Turn-Off Time (V _{cc} = 10V, I _{in} =20mA, R _L =100Ω) Figure 2		5		microseconds

Note 1: Tests of input to output isolation current resistance, and capacitance are performed with the input terminals (diode) shorted together and the output terminals (transistor) shorted together

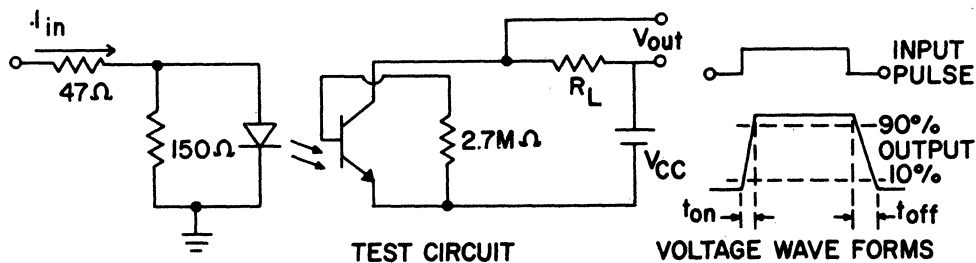
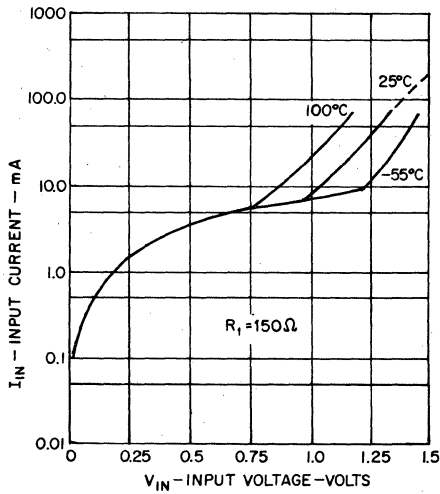
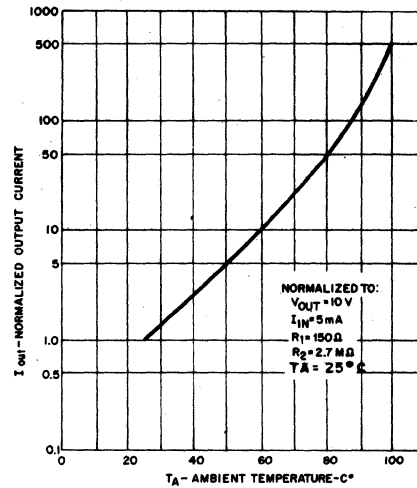

FIGURE 2

TYPICAL CHARACTERISTICS
BIASED PER FIGURE 1



1. INPUT



2. LEAKAGE

PROGRAMMING AND TRANSFER CHARACTERISTICS

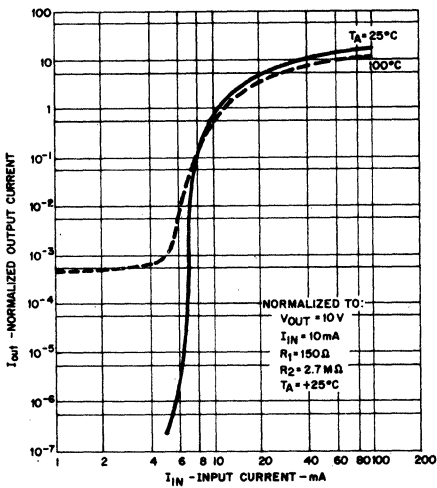

3. TEMPERATURE

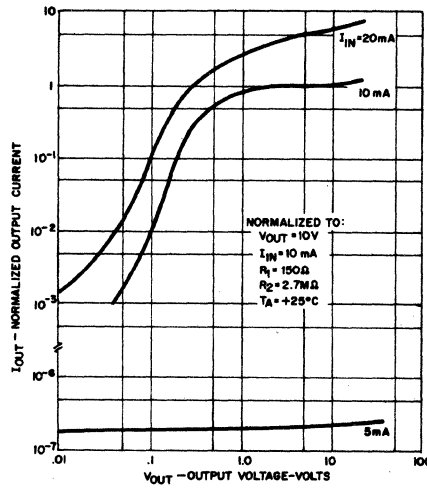

4. INPUT CURRENT

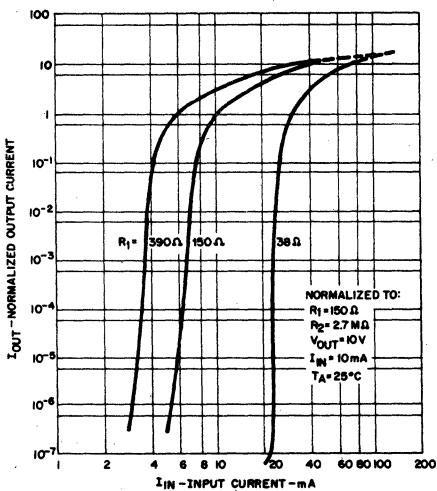

5. THRESHOLDING

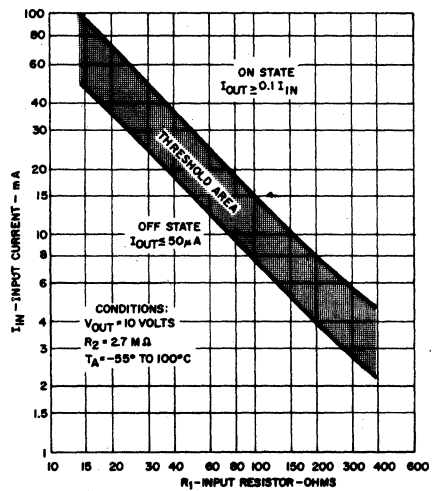

6. PROGRAMMING

**LINE CURRENT MONITORS
LINE DROPOUT ALARM LIGHT**

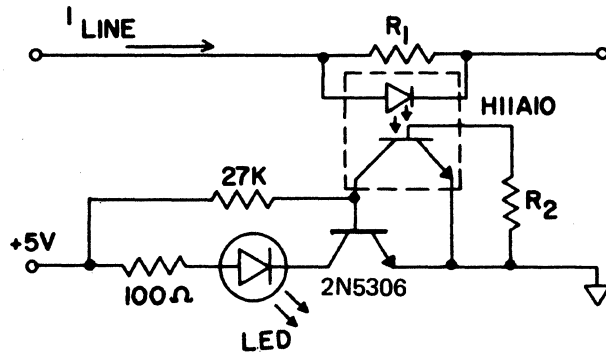

When remote line current (I_{LINE}) falls below the programmed threshold value the LED turns on, indicating loss of power to critical, isolated circuit function. Phase inversion, accomplished by replacing the 2N5306 with a D41K1 PNP and interchanging the collector and emitter connections, provides an over-current alarm light.

INFORMATION FLOW DIRECTOR

To minimize lines needed to communicate between A and B, a queue system is set up using H11A10's to monitor line use and set up the queue procedures.

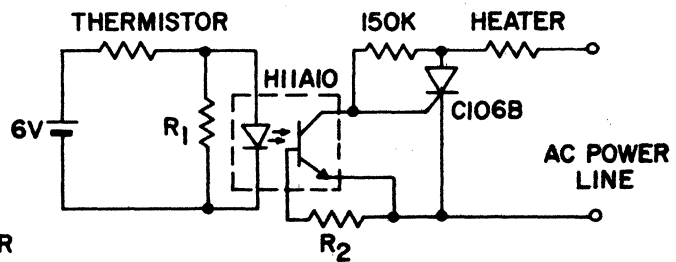
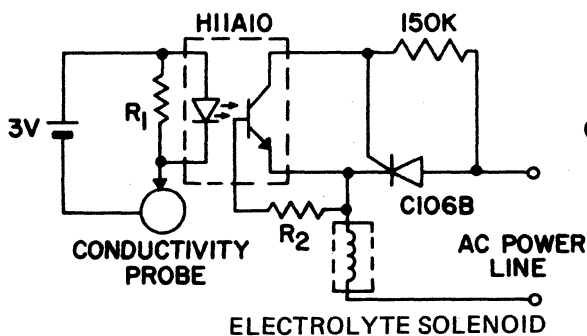
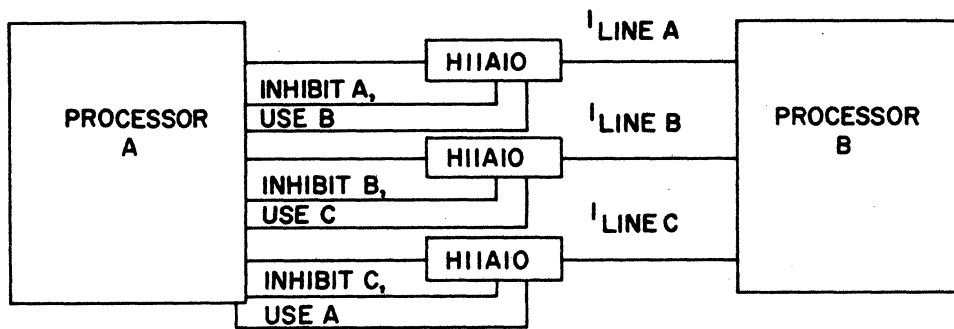

In many process control applications such as solution mixing, resistor trimming, light control and temperature control, it is advantageous to monitor conductivity with isolated low voltages and transmit this information to a power control or logic system. Low voltages are often preferred for safety, convenience or self heating considerations or to prevent ground loops and provide noise immunity. Until the advent of the H11A10 such systems were complex and costly. Using the H11A10 allows the use of simple low power circuits such as illustrated here to provide these functions. In battery operated systems, the low current thresholds of the H11A10 can considerably enhance battery life.



SOLID STATE

OPTO ELECTRONICS

Photon Coupled Isolator H11A520-H11A550 -H11A5100

Ga As Infrared Emitting Diode & NPN Silicon Photo-Transistor

The General Electric H11A520, H11A550 and H11A5100 consist of a gallium arsenide, infrared emitting diode coupled with a silicon photo-transistor in a dual in-line package.

FEATURES:

- High isolation voltage, 5000V minimum.
- General Electric unique patented glass isolation construction.
- High efficiency liquid epitaxial IRED.
- High humidity resistant silicone encapsulation.
- Fast switching speeds.

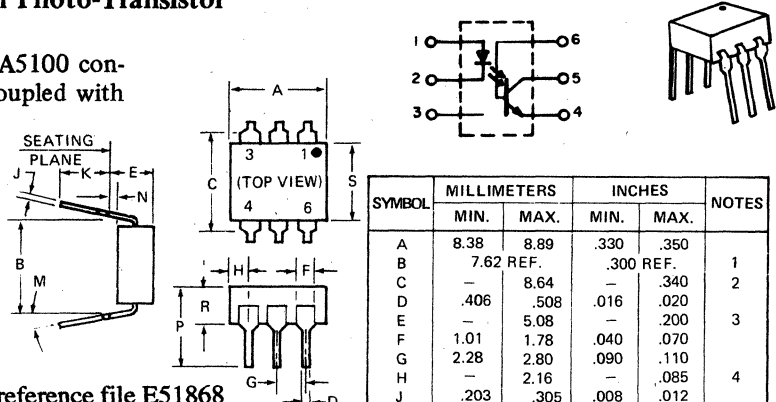

SYMBOL	MILLIMETERS		INCHES		NOTES
	MIN.	MAX.	MIN.	MAX.	
A	8.38	8.89	.330	.350	1
B	7.62 REF.		.300 REF.		
C	-	8.64	-	.340	2
D	.406	.508	.016	.020	
E	-	5.08	-	.200	3
F	1.01	1.78	.040	.070	
G	2.28	2.80	.090	.110	
H	-	2.16	-	.085	4
J	.203	.305	.008	.012	
K	2.54	-	.100	-	
M	-	15°	-	15°	
N	.381	-	.015	-	
P	-	9.53	-	.375	
R	2.92	3.43	.115	.135	
S	6.10	6.86	.240	.270	

NOTES:
 1. INSTALLED POSITION LEAD CENTERS.
 2. OVERALL INSTALLED DIMENSION.
 3. THESE MEASUREMENTS ARE MADE FROM THE SEATING PLANE.
 4. FOUR PLACES.

9A Covered under U.L. component recognition program, reference file E51868
absolute maximum ratings: (25°C) (unless otherwise specified)

INFRARED EMITTING DIODE			
Power Dissipation - $T_A = 25^\circ\text{C}$	*100	milliwatts	
Forward Current (Continuous)	60	milliamps	
Forward Current (Peak) (Pulse width 1 μsec , 300 pps)	3	amperes	
Reverse Voltage	6	volts	
*Derate 1.33mW/°C above 25°C.			

PHOTO-TRANSISTOR			
Power Dissipation - $T_A = 25^\circ\text{C}$	**300	milliwatts	
V_{CEO}	30	volts	
V_{CBO}	70	volts	
V_{EBO}	7	volts	
Collector Current (Continuous)	100	milliamps	
**Derate 4.0mW/°C above 25°C.			

TOTAL DEVICE	
Storage Temperature	-55 to 150°C.
Operating Temperature	-55 to 100°C.
Lead Soldering Time (at 260°C)	10 seconds.
Surge Isolation Voltage (Input to Output). See Note 2.	5656V _(peak) 4000V _(RMS)
Steady-State Isolation Voltage (Input to Output). See Note 2.	5000V _(DC) 3000V _(RMS)

individual electrical characteristics (25°C) (unless otherwise specified)

INFRARED EMITTING DIODE	MIN.	MAX.	UNITS
Forward Voltage - V_F ($I_F = 10\text{mA}$)	.8	1.5	volts
Forward Voltage - V_F ($I_F = 10\text{mA}$) $T_A = -55^\circ\text{C}$.9	1.7	volts
Forward Voltage - V_F ($I_F = 10\text{mA}$) $T_A = +100^\circ\text{C}$.7	1.4	volts
Reverse Current - I_R ($V_R = 6\text{V}$)	-	10	microamps
Capacitance - C_J ($V = 0, f = 1\text{MHz}$)	-	100	picofarads

PHOTO-TRANSISTOR	MIN.	TYP.	MAX.	UNITS
Breakdown Voltage - $V_{(BR)CEO}$ ($I_C = 10\text{mA}, I_F = 0$)	30	-	-	volts
Breakdown Voltage - $V_{(BR)CBO}$ ($I_C = 100\mu\text{A}, I_F = 0$)	70	-	-	volts
Breakdown Voltage - $V_{(BR)EBO}$ ($I_E = 100\mu\text{A}, I_F = 0$)	7	-	-	volts
Collector Dark Current - I_{CEO} ($V_{CE} = 10\text{V}, I_F = 0$)	-	5	50	nano-amps
Collector Dark Current - I_{CEO} ($V_{CE} = 10\text{V}, I_F = 0$) $T_A = 100^\circ\text{C}$	-	-	500	micro-amps
Capacitance - C_{CE} ($V_{CE} = 10\text{V}, f = 1\text{MHz}$)	-	2	-	pico-farads

VDE Approved to 0883/6.80 0110b Certificate # 35025

coupled electrical characteristics (25°C) (unless otherwise specified)

		MIN.	TYP.	MAX.	UNITS
DC Current Transfer Ratio ($I_F = 10\text{mA}$, $V_{CE} = 10\text{V}$)	H11A5100	100	—	—	%
	H11A550	50	—	—	%
	H11A520	20	—	—	%
Saturation Voltage – Collector to Emitter ($I_F = 20\text{mA}$, $I_C = 2\text{mA}$)		—	—	0.4	volts
Isolation Resistance (Input to Output Voltage = 500V_{DC} . See Note 1)		100	—	—	gigaohms
Input to Output Capacitance (Input to Output Voltage = 0, $f = 1\text{MHz}$. See Note 1)		—	—	2.0	picofarads
Turn-On Time – t_{on} ($V_{CC} = 10\text{V}$, $I_C = 2\text{mA}$, $R_L = 100\Omega$). (See Figure 1)		—	5	10	microseconds
Turn-Off Time – t_{off} ($V_{CC} = 10\text{V}$, $I_C = 2\text{mA}$, $R_L = 100\Omega$). (See Figure 1)		—	5	10	microseconds

NOTE 1:

Tests of input to output isolation current resistance, and capacitance are performed with the input terminals (diode) shorted together and the output terminals (transistor) shorted together.

NOTE 2:

Surge Isolation Voltage

a. Definition:

This rating is used to protect against transient over-voltages generated from switching and lightning-induced surges. Devices shall be capable of withstanding this stress, a minimum of 100 times during its useful life. Ratings shall apply over entire device operating temperature range.

b. Specification Format:

Specification, in terms of peak and/or RMS, 60Hz voltage, of specified duration (e.g., $5656\text{V}_{\text{peak}}/4000\text{V}_{\text{RMS}}$ for one minute).

c. Test Conditions:

Application of full rated 60Hz sinusoidal voltage for one minute, with initial application restricted to zero voltage (i.e., zero phase), from a supply capable of sourcing 5mA at rated voltage.

Steady-State Isolation Voltage

a. Definition:

This rating is used to protect against a steady-state voltage which will appear across the device isolation from an electrical source during its useful life. Ratings shall apply over the entire device operating temperature range for a period of 10 minutes minimum.

b. Specification Format:

Specified in terms of D.C. and/or RMS 60 Hz sinusoidal waveform.

c. Test Conditions:

Application of the full rated 60 Hz sinusoidal voltage, with initial application restricted to zero voltage (i.e., zero phase), from a supply capable of sourcing 5mA at rated voltage, for the duration of the test.

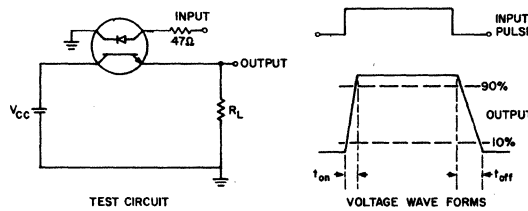
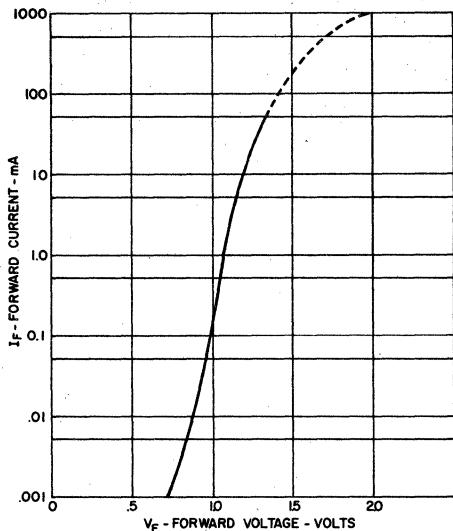
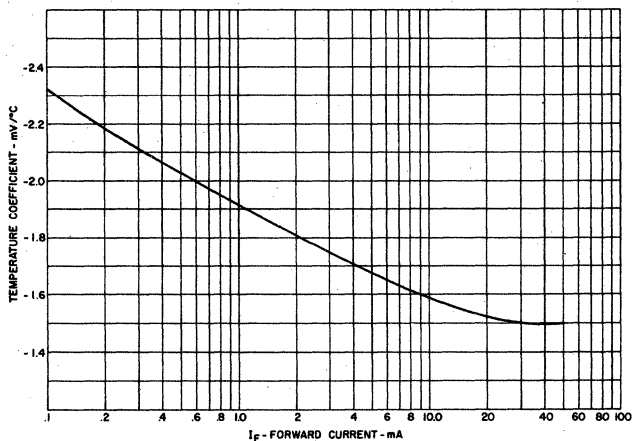

FIGURE 1: Adjust Amplitude of Input Pulse for Output (I_C) of 2mA



1. INPUT CHARACTERISTICS



2. FORWARD VOLTAGE TEMPERATURE COEFFICIENT

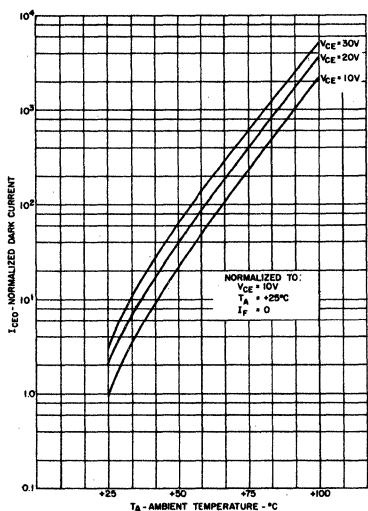

3. DARK I_{CE0} CURRENT VS. TEMPERATURE

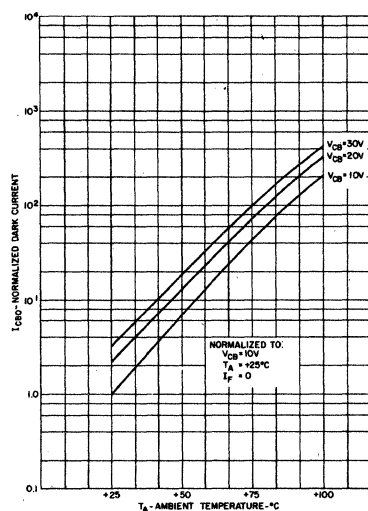

4. I_{CBO} VS. TEMPERATURE

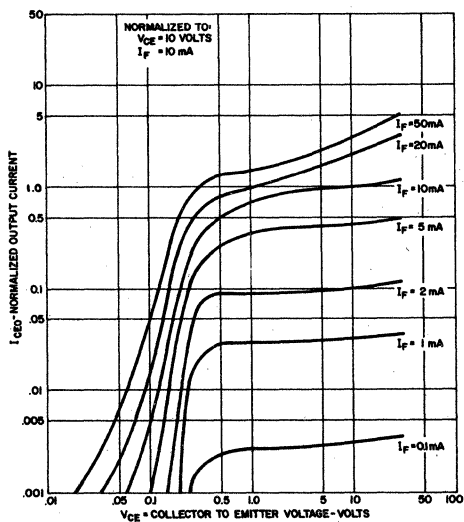

5. OUTPUT CHARACTERISTICS

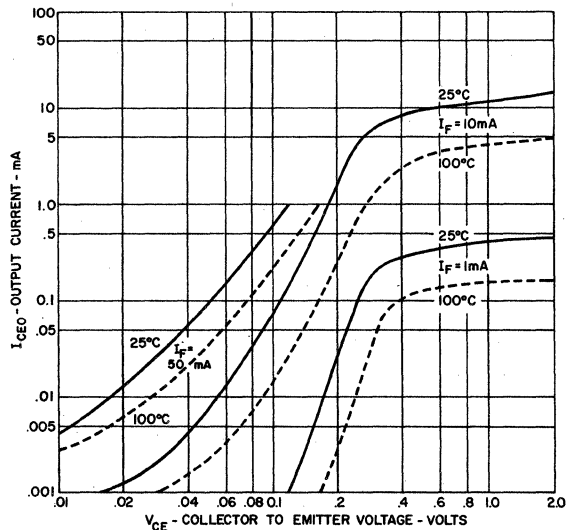

6. OUTPUT CHARACTERISTICS

TYPICAL CHARACTERISTICS

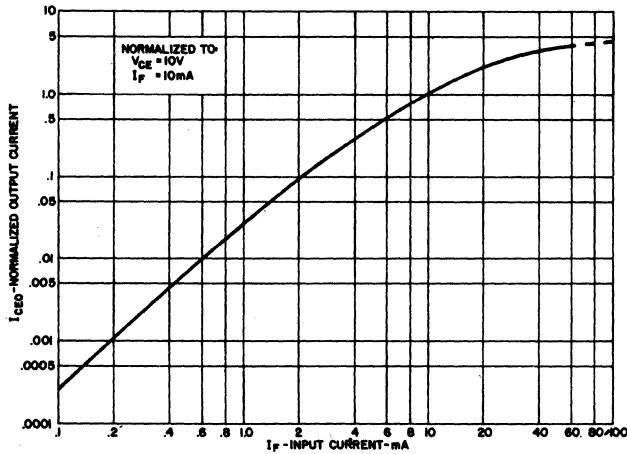

7. OUTPUT CURRENT VS. INPUT CURRENT

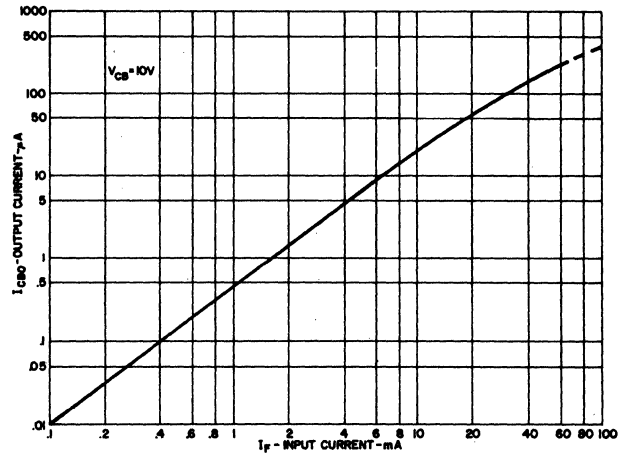

8. OUTPUT CURRENT - COLLECTOR-TO-BASE VS. INPUT CURRENT

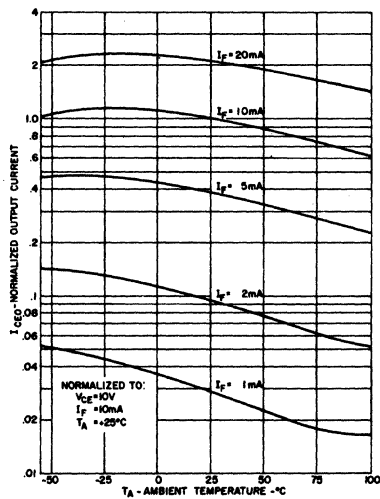

9. OUTPUT CURRENT VS. TEMPERATURE

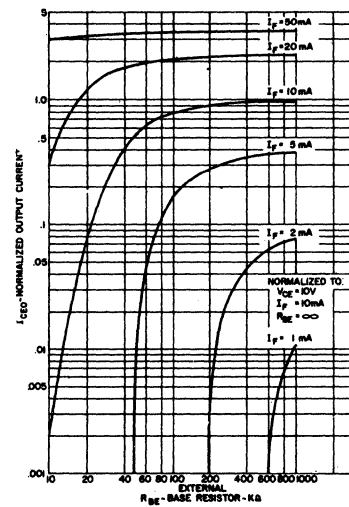

10. OUTPUT CURRENT VS. BASE EMITTER RESISTANCE

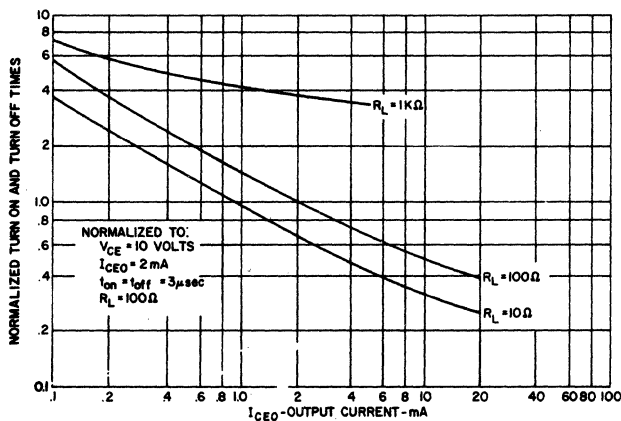

11. SWITCHING TIMES VS. OUTPUT CURRENT

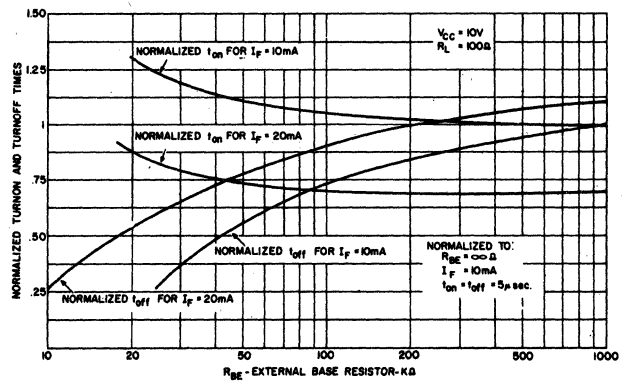

12. SWITCHING TIME VS. R_{BE}



SOLID STATE OPTOELECTRONICS

Photon Coupled Isolator H74A1

Ga As Infrared Emitting Diode & NPN Silicon Photo-Transistor
TTL Interface

The General Electric H74A1 provides logic to logic optical interfacing of TTL gates with *guaranteed* level compatibility in practical *specified* circuits. The H74A1 is a transistor output photo-coupled isolator specifically designed to eliminate ground loop cross talk and reflection problems when two distinct logic systems are coupled. It is guaranteed to couple 7400, 74H00 and 74S00 logic gates over the full TTL temperature and voltage ranges.

absolute maximum ratings: (25°C) (unless otherwise specified)

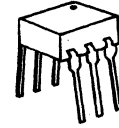

INFRARED EMITTING DIODE

Power Dissipation	$T_A = 25^\circ\text{C}$	*100	milliwatts
Power Dissipation	$T_C = 25^\circ\text{C}$	*100	milliwatts
(T _C indicates collector lead temperature 1/32" from case)			
Forward Current (Continuous)		60	milliamps
Forward Current (Peak)		3	ampere
(Pulse width 1μsec 300 pps)			
Reverse Voltage		6	volts

*Derate 2.2mW/°C above 25°C.

PHOTO-TRANSISTOR

Power Dissipation	$T_A = 25^\circ\text{C}$	**300	milliwatts
Power Dissipation	$T_C = 25^\circ\text{C}$	***500	milliwatts
(T _C indicates collector lead temperature 1/32" from case)			
V _{CEO}		15	volts
V _{CBO}		15	volts
V _{ECO}		5.5	volts
Collector Current (Continuous)		50	milliamps

**Derate 6.7mW/°C above 25°C.

***Derate 11.1mW/°C above 25°C.

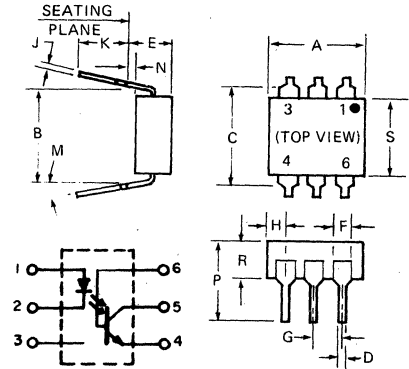

SYMBOL	MILLIMETERS		INCHES		NOTES
	MIN.	MAX.	MIN.	MAX.	
A	8.38	8.89	.330	.350	1
B	7.62 REF.		.300 REF.		
C	—	8.64	—	.340	2
D	.406	.508	.016	.020	3
E	—	5.08	—	.200	
F	1.01	1.78	.040	.070	4
G	2.28	2.80	.090	.110	
H	—	2.16	—	.085	4
J	.203	.305	.008	.012	
K	2.54	—	.100	—	4
M	—	15°	—	15°	
N	.381	—	.015	—	4
P	—	9.53	—	.375	
R	2.92	3.43	.115	.135	4
S	6.10	6.86	.240	.270	

NOTES:

1. INSTALLED POSITION LEAD CENTERS.
2. OVERALL INSTALLED DIMENSION.
3. THESE MEASUREMENTS ARE MADE FROM THE SEATING PLANE.
4. FOUR PLACES.

TOTAL DEVICE

Storage Temperature	-55 to 150°C
Operating Temperature	0 to 70°C
Lead Soldering Time (at 260°C)	10 seconds
Surge Isolation Voltage (Input to Output)	
1500V _(peak)	1060V _(RMS)
Steady-State Isolation Voltage (Input to Output)	
950V _(peak)	660V _(RMS)

VDE Approved to 0883/6.80 0110b Certificate # 35025

Covered under U.L. component recognition program, reference file E51868

Electrical Characteristics of H74A1*

*All specifications refer to the following bias configuration (Figure 1) over the full operating temperature (0°C to 70°C) and logic supply voltage range (4.5 to 5.5V_{DC}) unless otherwise noted.

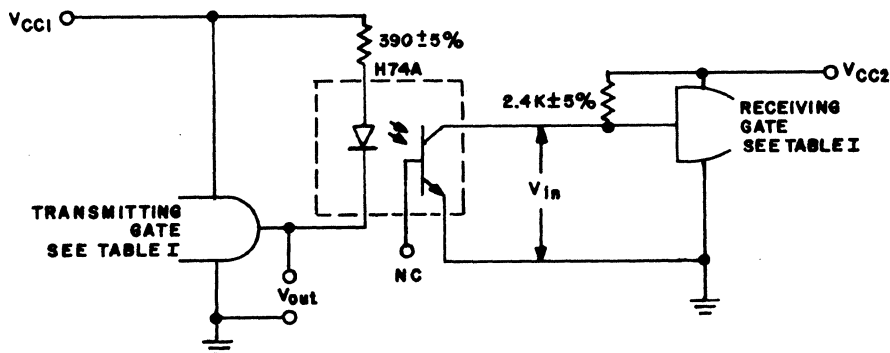

Figure 1. H74A1 BIAS CIRCUIT

$V_{in} (0)$, Receiving Gate For $V_{OUT(0)}$ from Transmitting Gate —	0.8 V Max.
$V_{in} (1)$, Receiving Gate for $V_{OUT(1)}$ from Transmitting Gate —	2.4 V Min.
$t_p (0)$, Transmitting Gate to Receiving Gate Propagation Time —	20 μ sec. Typ.
$t_p (1)$, Transmitting Gate to Receiving Gate Propagation Time —	4 μ sec. Typ.
Isolation Resistance (Input to Output = 500V _{DC}).	100 gigaohms Min.
Input to Output Capacitance (Input to Output Voltage = 0, f = 1 MHz)	2.5 pF Max.

TABLE I.
CHARACTERISTICS REQUIRED OF TTL GATES WHICH ARE TO BE INTERFACED BY H74A1

PARAMETER	TEST CONDITIONS, FIGURE 2						LIMITS		
	V_{CC}		I_{IN}		I_{SINK}		Min.	Max.	Units
	Min.	Max.	Min.	Max.	Min.	Max.			
$V_{OUT} (1)$	4.5V					-0.4mA	2.4		Volts
$V_{OUT} (0)$	4.5V				12.0mA		0.4		Volts
$V_{IN} (1)$		5.5V		1.0mA			2.0		Volts
$V_{IN} (0)$		5.5V	-1.6mA				0.8		Volts

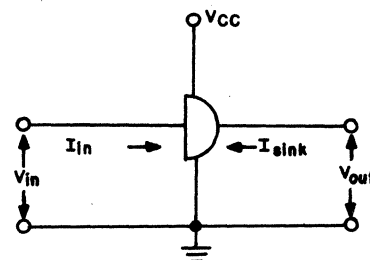

Figure 2.



SOLID STATE OPTOELECTRONICS

AC Input Photon Coupled Isolator H11AA1-H11AA4

Ga As Infrared Emitting Diodes & NPN Silicon Photo-Transistor

The General Electric H11AA1 - H11AA4 consist of two gallium arsenide infrared emitting diodes connected in inverse parallel and coupled with a silicon photo-transistor in a dual in-line package.

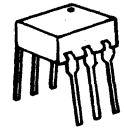

FEATURES:

- AC or polarity insensitive inputs
 - Fast switching speeds
 - Built-in reverse polarity input protection
 - High isolation voltage
 - High isolation resistance
 - I/O compatible with integrated circuits
- ☑ Covered under U.L. component recognition program, reference file E51868

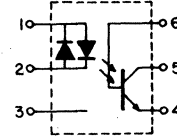

absolute maximum ratings: (25°C) (unless otherwise specified)

INFRARED EMITTING DIODE

Power Dissipation	$T_A = 25^\circ\text{C}$	*100	milliwatts
Power Dissipation	$T_C = 25^\circ\text{C}$	*100	milliwatts
(T _C indicates collector lead temperature 1/32" from case)			
Input Current (RMS)		60	milliamps
Input Current (Peak)		± 1	ampere
(Pulse width 1μsec, 300 pps)			

*Derate 1.33mW/°C above 25°C

PHOTO-TRANSISTOR

Power Dissipation	$T_A = 25^\circ\text{C}$	**300	milliwatts
Power Dissipation	$T_C = 25^\circ\text{C}$	***500	milliwatts
(T _C indicates collector lead temperature 1/32" from case)			
V _{CEO}		30	volts
V _{CBO}		70	volts
V _{EBO}		5	volts
Collector Current (Continuous)		100	milliamps

**Derate 4.0mW/°C above 25°C

***Derate 6.7mW/°C above 25°C

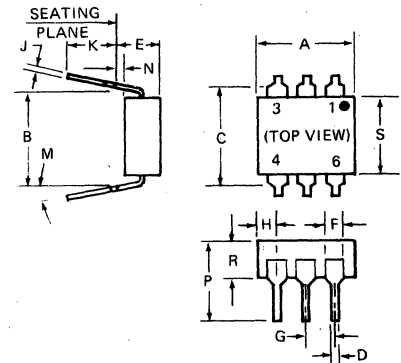

SYMBOL	MILLIMETERS		INCHES		NOTES
	MIN.	MAX.	MIN.	MAX.	
A	8.38	8.89	.330	.350	1
B	7.62 REF.		.300 REF.		
C	-	8.64	-	.340	2
D	.406	.508	.016	.020	
E	-	5.08	-	.200	3
F	1.01	1.78	.040	.070	
G	2.28	2.80	.090	.110	4
H	-	2.16	-	.085	
J	.203	.305	.008	.012	
K	2.54	-	.100	-	
M	-	15°	-	15°	
N	.381	-	.015	-	
P	-	9.53	-	.375	
R	2.92	3.43	.115	.135	
S	6.10	6.86	.240	.270	

NOTES:

1. INSTALLED POSITION LEAD CENTERS.
2. OVERALL INSTALLED DIMENSION.
3. THESE MEASUREMENTS ARE MADE FROM THE SEATING PLANE.
4. FOUR PLACES.

TOTAL DEVICE

Storage Temperature	-55 to 150°C
Operating Temperature	-55 to 100°C
Lead Soldering Time (at 260°C)	10 seconds
Surge Isolation Voltage (Input to Output)	
2500V _(peak)	1770V _(RMS)
Steady-State Isolation Voltage (Input to Output)	
1500V _(peak)	1060V _(RMS)

individual electrical characteristics (25°C) (unless otherwise specified)

INFRARED EMITTING DIODE	SYMBOL	MAX.	UNITS	PHOTO-TRANSISTOR	SYMBOL	MIN.	MAX.	UNITS
Input Voltage ($I_F = \pm 10$ mA) H11AA1, 3, 4 H11AA2	V_F	1.5	volts	Breakdown Voltage ($I_C = 10$ mA, $I_F = 0$)	$V_{(BR)CEO}$	30		volts
		1.8	volts					
Capacitance ($V = 0$, $F = 1$ MHz)	C_J	100	picofarads	Breakdown Voltage ($I_C = 100\mu$ A, $I_F = 0$)	$V_{(BR)CBO}$	70		volts
				Breakdown Voltage ($I_E = 100\mu$ A, $I_F = 0$)	$V_{(BR)EBO}$	5		volts
				Collector Dark Current ($V_{CE} = 10$ V, $I_F = 0$) H11AA1, 3, 4 H11AA2	I_{CEO}		100 200	nanoamps nanoamps

coupled electrical characteristics (25°C) (unless otherwise specified)

	MIN.	MAX.	UNITS
Current Transfer Ratio ($V_{CE} = 10$ V, $I_F = \pm 10$ mA) H11AA4 H11AA3 H11AA1 H11AA2	100		percent
	50		percent
	20		percent
	10		percent
Saturation Voltage - Collector to Emitter ($I_{CEO} = 0.5$ mA, $I_F = \pm 10$ mA)		0.4	volts
Current Transfer Ratio Symmetry: $\frac{I_{CEO}(V_{CE}=10V, I_F=10mA)}{I_{CEO}(V_{CE}=10V, I_F=-10mA)}$ Note 2 H11AA1, 3, 4	0.33	3.0	
Isolation Resistance (Input to Output Voltage = $500V_{DC}$. See Note 1)	100		gigaohms

Note 1: Tests of input to output isolation current resistance, and capacitance are performed with the input terminals (diode) shorted together and the output terminals (transistor) shorted together

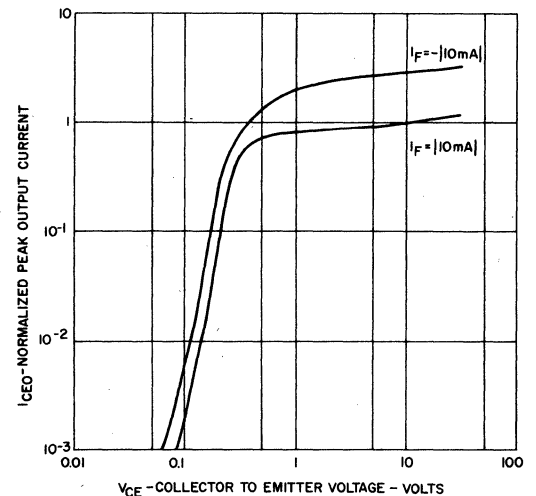
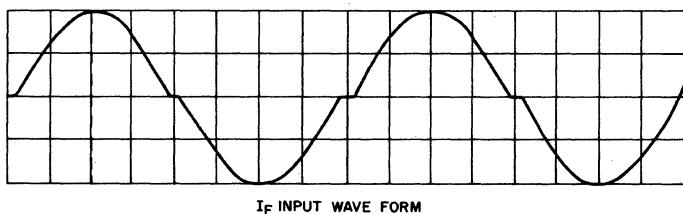
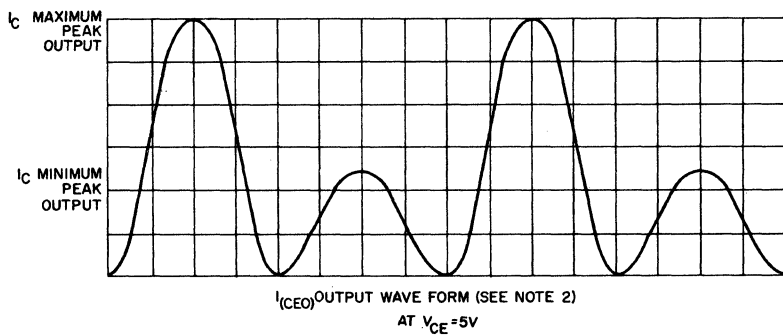

Note 2: The H11AA1 specification guarantees the maximum peak output current will be no more than three times the minimum peak output current at $I_F = 10$ mA

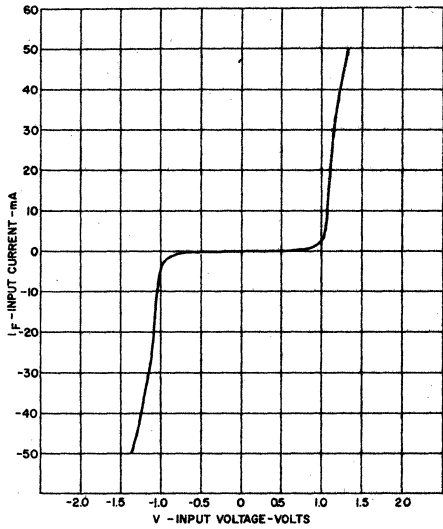

1. INPUT CHARACTERISTICS

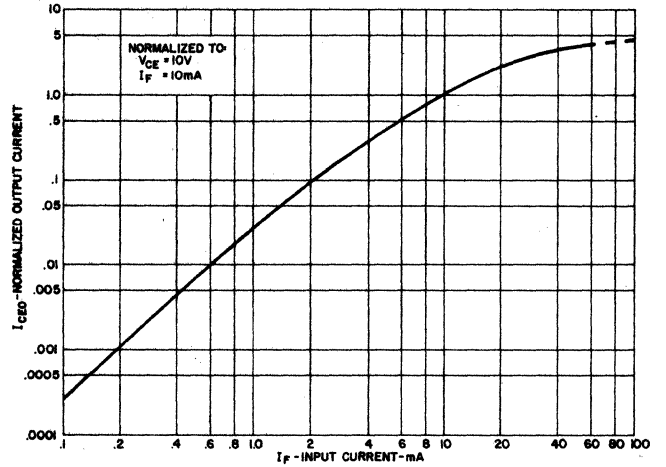

2. OUTPUT CURRENT VS INPUT CURRENT

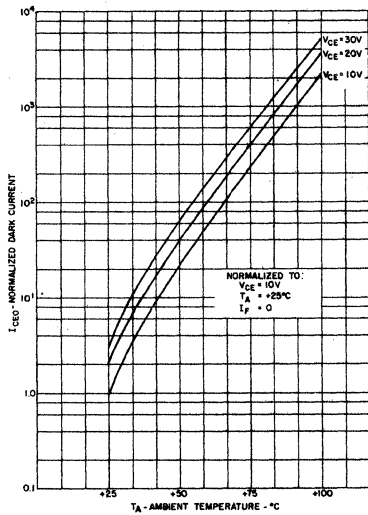

3. DARK I_{CEO} CURRENT VS TEMPERATURE

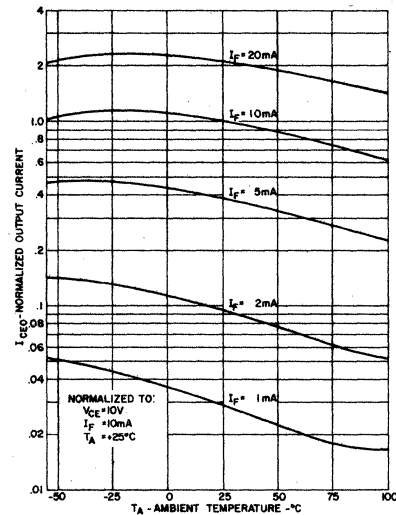

4. OUTPUT CURRENT VS TEMPERATURE

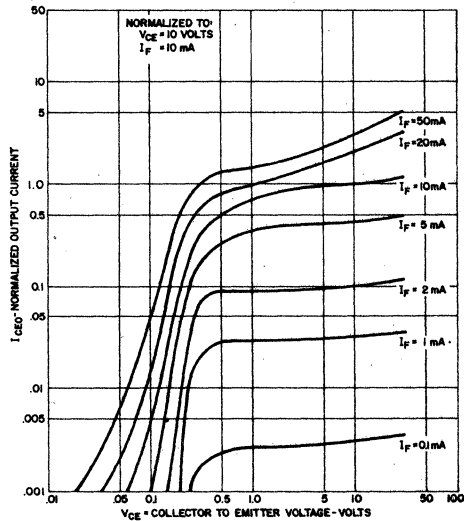

5. OUTPUT CHARACTERISTICS

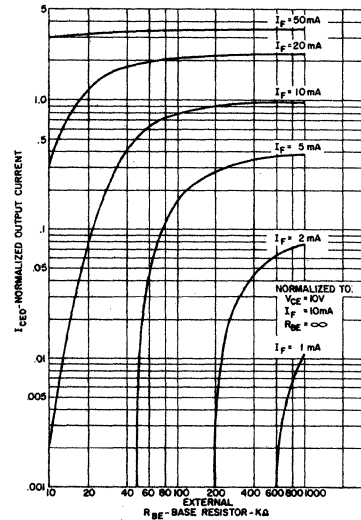

6. OUTPUT CURRENT VS BASE EMITTER RESISTANCE

LOAD MONITOR AND ALARM

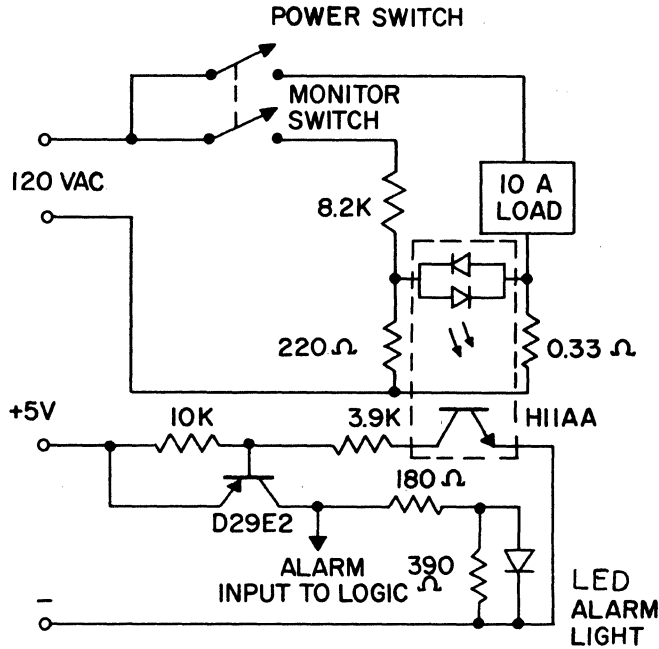

In many computer controlled systems where AC power is controlled, load dropout due to filament burnout, fusing, etc. or the opposite situation - load power when uncalled for due to switch failure can cause serious systems or safety problems. This circuit provides a simple AC power monitor which lights an alarm lamp and provides a "1" input to the computer control in either of these situations while maintaining complete electrical isolation between the logic and the power system.

Note that for other than resistive loads, phase angle correction of the monitoring voltage divider is required.

RING DETECTOR

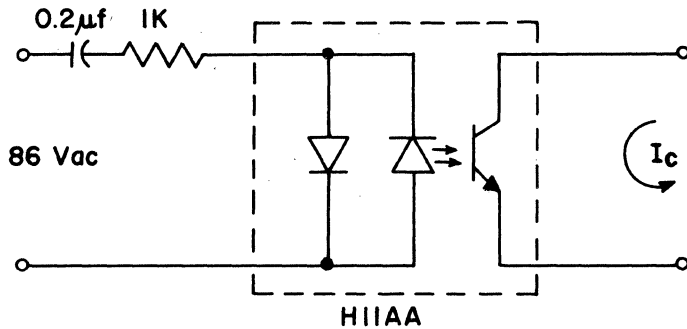

In many telecommunications applications it is desirable to detect the presence of a ring signal in a system without any direct electrical contact with the system. When the 86 Vac ring signal is applied, the output transistor of the H11AA is turned on indicating the presence of a ring signal in the isolated telecommunications system.

UPS SOLID STATE TURN-ON SWITCH

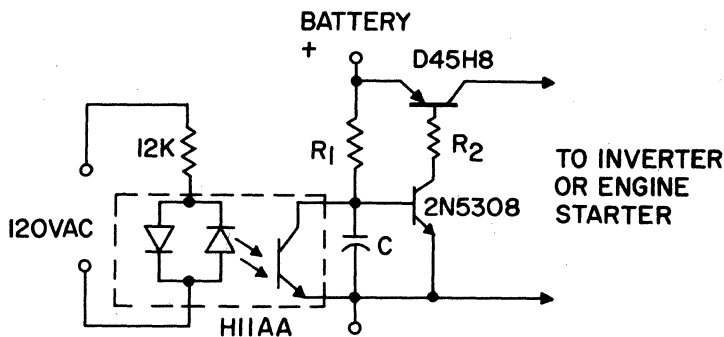

Interruption of the 120 VAC power line turns off the H11AA, allowing C to charge and turn on the 2N5308-D45H8 combination which activates the auxiliary power supply. This system features low standby drain, isolation to prevent ground loop problems and the capability of ignoring a fixed number of "dropped cycles" by choice of the value of C.



SOLID STATE OPTOELECTRONICS

Photon Coupled Isolator H11AG1, H11AG2, H11AG3

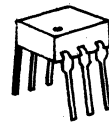

Ga Al As Infrared Emitting Diode & NPN Silicon Photo-Transistor

The General Electric H11AG series consists of a gallium aluminum arsenide, infrared emitting diode coupled with a silicon phototransistor in a dual in-line package. This photon coupled isolator provides the unique feature of high current transfer ratio at both low output voltage and low input current. This makes it ideal for use in low power logic circuits, telecommunications equipment and portable electronics isolation applications.

FEATURES:

- High isolation voltage, 3750 V_(RMS) minimum (steady state)
- General Electric unique glass construction
- High efficiency low degradation liquid epitaxial IRED
- Logic level compatible, input and output, with CMOS and LS/TTL
- High DC current transfer ratio at low input currents
- Covered under U.L. component recognition program, reference file E51868

VDE Approved to 0883/6.80 0110b Certificate#: 35025

absolute maximum ratings: (25°C) (unless otherwise specified)

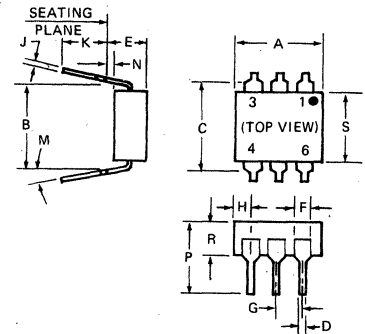

SYMBOL	MILLIMETERS		INCHES		NOTES
	MIN.	MAX.	MIN.	MAX.	
A	8.38	8.89	.330	.350	1
B	7.62 REF.		.300 REF.		
C		8.64		.340	2
D	.406	.508	.016	.020	
E		5.08		.200	3
F	1.01	1.78	.040	.070	
G	2.28	2.80	.090	.110	4
H		2.16		.085	
J	.203	.305	.008	.012	4
K	2.54		.100		
M		15°		15°	4
N	.381		.015		
P		9.53		.375	4
R	2.92	3.43	.115	.135	
S	6.10	6.86	.240	.270	4

- NOTES:
 1. INSTALLED POSITION LEAD CENTERS.
 2. OVERALL INSTALLED DIMENSION.
 3. THESE MEASUREMENTS ARE MADE FROM THE SEATING PLANE.
 4. FOUR PLACES.

INFRARED EMITTING DIODE			
Power Dissipation	T _A = 25°C	*75	milliwatts
Forward Current (Continuous)		50	milliamps
Reverse Voltage		6	volts
*Derate 1.0 mW/°C above 25°C.			

PHOTO-TRANSISTOR			
Power Dissipation	T _A = 25°C	**150	milliwatts
V _{CEO}		30	volts
V _{CBO}		70	volts
V _{ECO}		7	volts
Collector Current (Continuous)		50	milliamps
**Derate 2.0 mW/°C above 25°C.			

TOTAL DEVICE		
Storage Temperature -50°C to 150°C		
Operating Temperature -50°C to 100°C		
Lead Soldering Time (at 260°C) 10 seconds		
Surge Isolation Voltage (Input to Output)		
H11AG1-H11AG2	5656V _(peak)	4000V _(RMS)
H11AG3	3535V _(peak)	2500V _(RMS)
Steady-State Isolation Voltage (Input to Output)		
H11AG1-H11AG2	5304V _(peak)	3750V _(RMS)
H11AG3	2100V _(peak)	1500V _(RMS)

individual electrical characteristics: (0-70° C)

INFRARED EMITTING DIODE	MIN.	MAX.	UNITS
Forward Voltage V_F ($I_F = 1 \text{ mA}$)		1.5	volts
Reverse Current I_R ($V_R = 6 \text{ V}$)	—	10	microamps
Capacitance C_j ($V = 0, f = 1 \text{ MHz}$)	—	100	picofarads

PHOTO-TRANSISTOR	MIN.	TYP.	MAX.	UNITS
Breakdown Voltage $V_{(BR)CEO}$ ($I_C = 1.0 \text{ mA}, I_F = 0$)	30	—	—	volts
Breakdown Voltage $V_{(BR)CBO}$ ($I_C = 100 \mu\text{A}, I_F = 0$)	70	—	—	volts
Breakdown Voltage $V_{(BR)ECO}$ ($I_E = 100 \mu\text{A}, I_F = 0$)	7	—	—	volts
Collector Dark Current I_{CEO} ($V_{CE} = 10 \text{ V}, I_F = 0$)	—	5	10	microamps
Capacitance C_{CE} ($V_{CE} = 10 \text{ V}, f = 1 \text{ MHz}$)	—	2	—	picofarads

coupled electrical characteristics (0-70° C)

	H11AG1		H11AG2		H11AG3		UNITS
	MIN.	MAX.	MIN.	MAX.	MIN.	MAX.	
DC Current Transfer Ratio ($I_F = 1.0 \text{ mA}, V_{CE} = 5 \text{ V}$)	300	—	200	—	100	—	%
($I_F = 1.0 \text{ mA}, V_{CE} = 0.6 \text{ V}$)	100	—	50	—	20	—	%
($I_F = 0.2 \text{ mA}, V_{CE} = 1.5 \text{ V}$)	100	—	50	—	—	—	%
Saturation Voltage — Collector to Emitter ($I_F = 1.0 \text{ mA}, I_C = 0.5 \text{ mA}$)	—	0.4	—	0.4	—	0.4	volts

coupled electrical characteristics (25° C)

	MIN.	TYP.	MAX.	UNITS
Isolation Resistance (Input to Output Voltage = 500V _{DC})	100	—	—	gigaohms
Input to Output Capacitance (Input to Output Voltage = 0, f = 1MHz)	—	—	2	picofarads
Turn-On Time — t_{on} ($V_{CC} = 5 \text{ V}, I_F = 1 \text{ mA}, R_L = 100$)	—	5	—	microseconds
Turn-Off Time — t_{off} ($V_{CC} = 5 \text{ V}, I_F = 1 \text{ mA}, R_L = 100$)	—	5	—	microseconds

H11AG1, H11AG2, H11AG3

TYPICAL CHARACTERISTICS

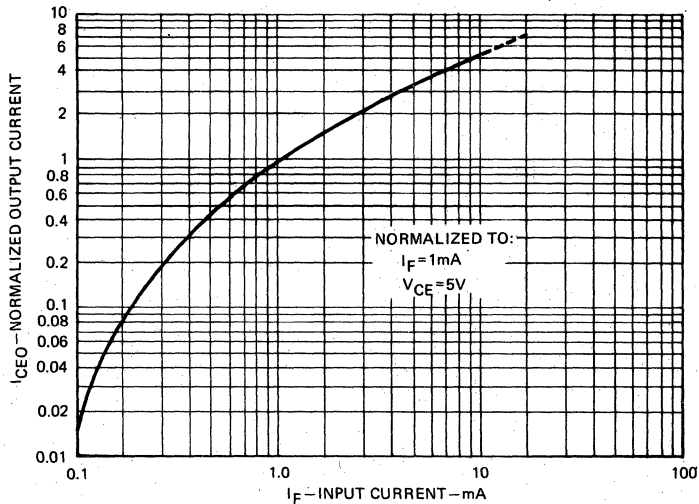

OUTPUT CURRENT VS. INPUT CURRENT

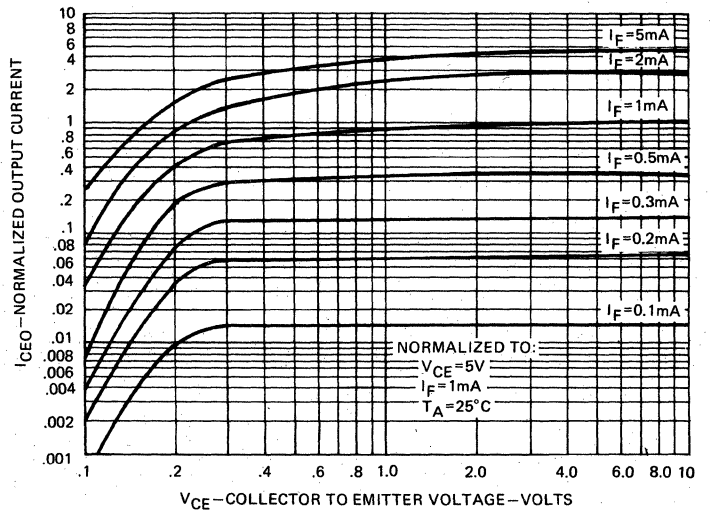

OUTPUT CURRENT VS. COLLECTOR-EMITTER VOLTAGE

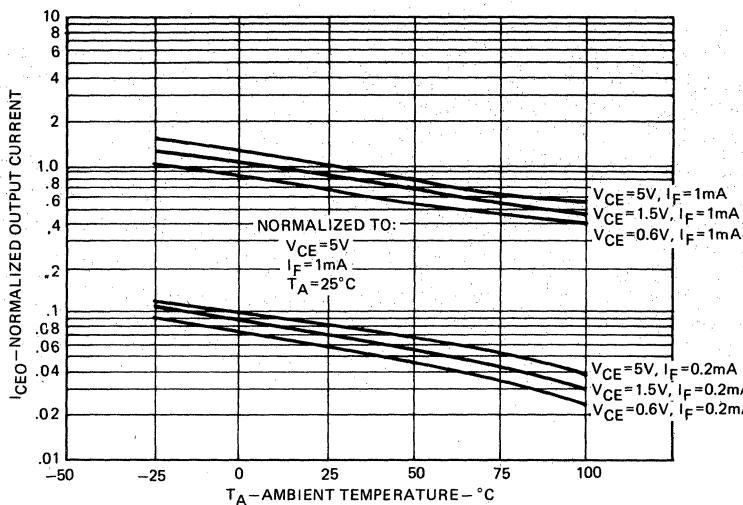

OUTPUT CURRENT VS. TEMPERATURE

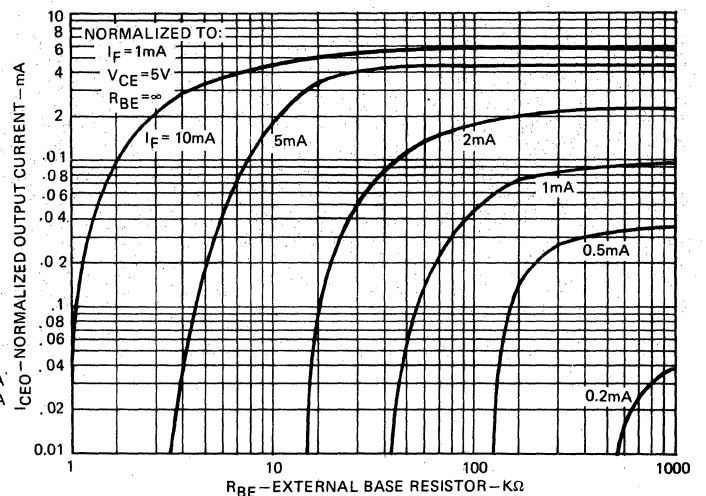

OUTPUT CURRENT VS. BASE EMITTER RESISTANCE

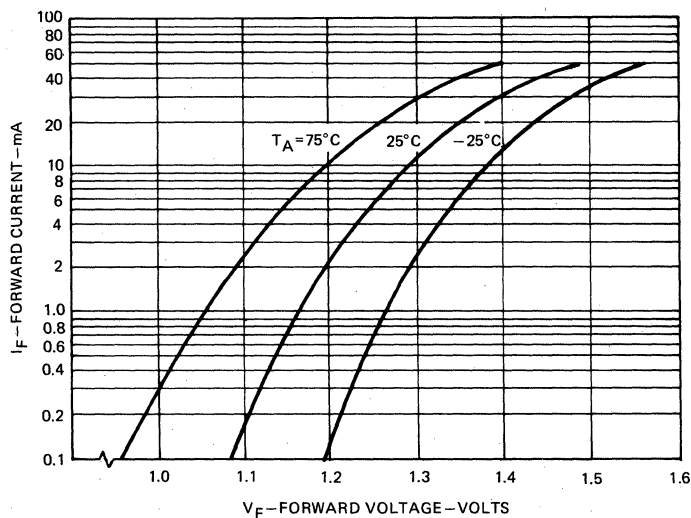

INPUT VOLTAGE VS. INPUT CURRENT

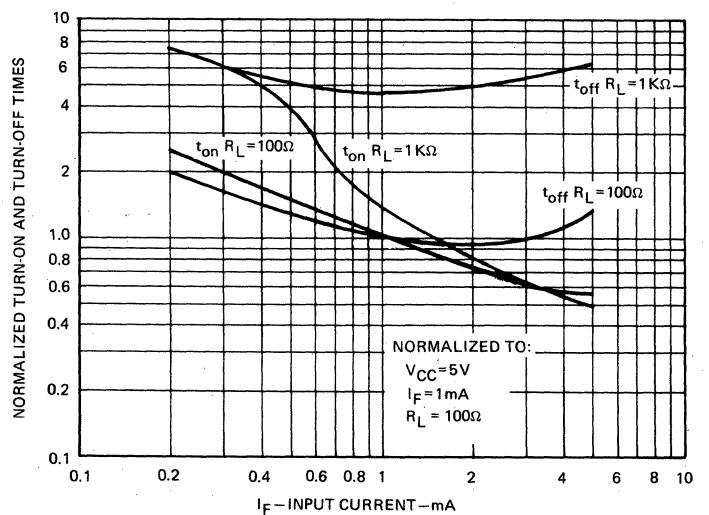

SWITCHING TIMES VS. INPUT CURRENT

TYPICAL CHARACTERISTICS

H11AG1, H11AG2, H11AG3

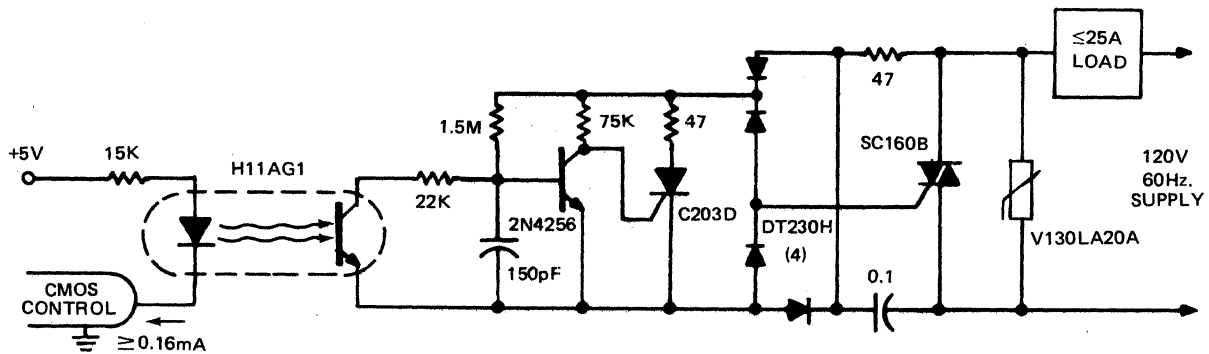
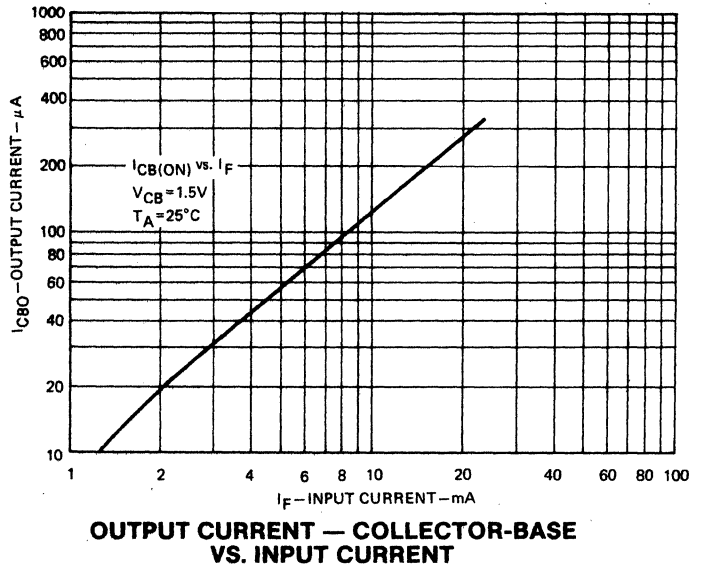
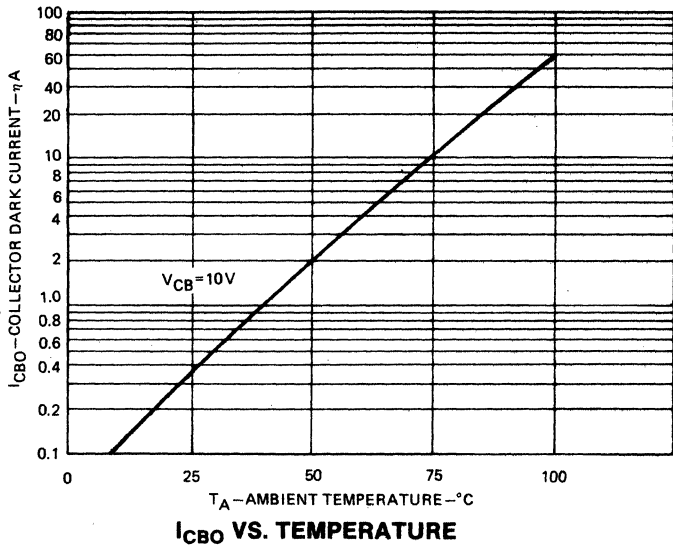

CMOS INPUT, 3KW, ZERO VOLTAGE SWITCHING SOLID STATE RELAY

The H11AG1 superior performance at low input currents allows standard CMOS logic circuits to directly operate a 25A solid state relay. Circuit operation is as follows: power switching is provided by the SC160B, 25A triac. Its gate is controlled by the C203B via the DT230H rectifier bridge. The C203B turn-on is inhibited by the 2N4256 when line voltage is above 12V and/or the H11AG1 is off. False trigger and dv/dt protection are provided by the combination of a GE-MOV® varistor and RC snubber network.

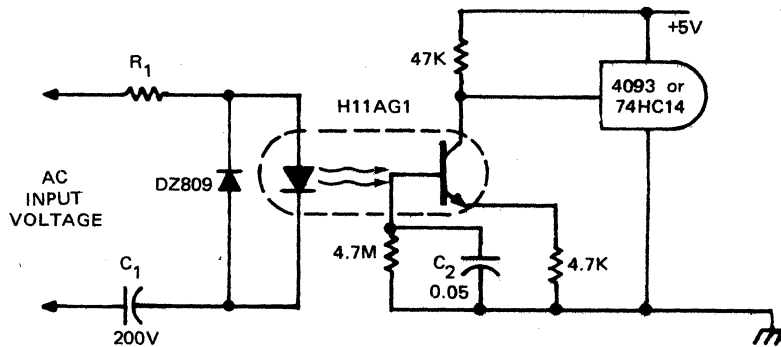

INPUT	R_1	C_1
40V, 20Hz.	75K	0.1 μF
95V, 60Hz.	220K	33 ηF
200V, 50/60 Hz.	390K	15 ηF

TELEPHONE RING DETECTOR/A.C. LINE CMOS INPUT ISOLATOR

The H11AG1 uses less input power than the neon bulb traditionally used to monitor telephone and line voltages. Additionally, response time can be tailored to ignore telephone dial tap, switching transients and other undesired signals by modifying the value of C_2 . The high impedance to line voltage also can simplify board layout spacing requirements.



SOLID STATE

OPTO ELECTRONICS

Photon Coupled Isolator

H11AV1, H11AV2, H11AV3, H11AV1A, H11AV2A, H11AV3A

Ga As Infrared Emitting Diode & NPN Silicon Photo-Transistor

The General Electric H11AV series consists of a gallium arsenide, infrared emitting diode coupled with a silicon phototransistor in a dual in-line package. The construction provides guaranteed internal distance for VDE creep and clearance requirements for business machine applications per VDE standard 0730-2P.

FEATURES:

- High isolation voltage, 3750V_(RMS) minimum (steady state).
- General Electric unique glass construction.
- High efficiency low degradation liquid epitaxial IRED.
- High humidity resistant silicone encapsulation.
- Internal conductive part separation 2mm minimum.
- Creepage distance 8.2mm minimum (before mounting).
- Low isolation capacitance-0.5pf (max.).



VDE APPROVED TO

- VDE 0883/6.80
- VDE 0860/8.81
- VDE 0806/8.81
- VDE 0804/1.83
- VDE 0750T1/5.82
- VDE 0110/11.72
- IEC 601T1
- IEC 380
- IEC 65
- CERTIFICATE # 30440

UL RECOGNIZED FILE # E51868

H11AV1, H11AV2, H11AV3

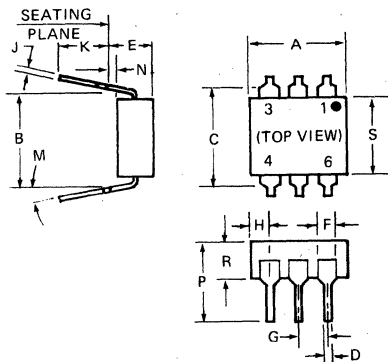

H11AV1A, H11AV2A, H11AV3A

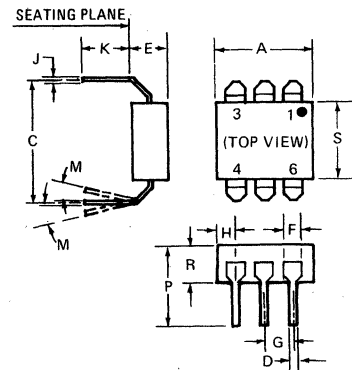

SYMBOL	MILLIMETERS		INCHES		NOTES
	MIN.	MAX.	MIN.	MAX.	
A	8.38	8.89	.330	.350	1
B	7.62 REF.		.300 REF.		
C	—	8.64	—	.340	2
D	.406	.508	.016	.020	
E	—	5.08	—	.200	3
F	1.01	1.78	.040	.070	
G	2.28	2.80	.090	.110	4
H	—	2.16	—	.085	
J	.203	.305	.008	.012	4
K	2.54	—	.100	—	
M	—	15°	—	15°	4
N	.381	—	.015	—	
P	—	9.53	—	.375	4
R	2.92	3.43	.115	.135	
S	6.10	6.86	.240	.270	4

- NOTES:
1. INSTALLED POSITION LEAD CENTERS.
 2. OVERALL INSTALLED DIMENSION.
 3. THESE MEASUREMENTS ARE MADE FROM THE SEATING PLANE.
 4. FOUR PLACES.

SYMBOL	MILLIMETERS		INCHES		NOTES
	MIN.	MAX.	MIN.	MAX.	
A	8.38	8.89	.330	.350	1.
C	10.16 REF.		.400 REF.		
D	.406	.508	.016	.020	1.
E	—	4.32	—	.170	
F	1.01	1.78	.040	.070	1.
G	2.28	2.80	.090	.110	
H	—	2.16	—	.085	1.
J	.203	.305	.008	.012	
K	2.54	—	.100	—	1.
M	—	10°	—	10°	
P	6.20 REF.		.244 REF.		1.
R	2.92	3.43	.115	.135	
S	6.10	6.86	.240	.270	1.

- NOTES:
1. DIMENSION APPLIES FOUR PLACES.

H11AV1, H11AV2, H11AV3, H11AV1A, H11AV2A, H11AV3A

absolute maximum ratings: (25°C)

(unless otherwise specified)

INFRARED EMITTING DIODE			
Power Dissipation	$T_A = 25^\circ\text{C}$	*100	milliwatts
Forward Current (Continuous)		60	milliamps
Forward Current (Peak)		3	amperes
(Pulse width 1 μsec , 300 pps)			
Reverse Voltage		6	volts
*Derate 1.33mW/°C above 25°C.			

PHOTO-TRANSISTOR			
Power Dissipation	$T_A = 25^\circ\text{C}$	**300	milliwatts
V_{CEO}		70	volts
V_{CBO}		70	volts
V_{EBO}		7	volts
Collector Current (Continuous)		100	milliamps
**Derate 4.0mW/°C above 25°C.			

TOTAL DEVICE	
Storage Temperature -55 to 150°C.	
Operating Temperature -55 to 100°C.	
Lead Soldering Time (at 260°C) 10 seconds.	
Surge Isolation Voltage (Input to Output).	
5656V _(peak)	4000V _(RMS)
Steady-State Isolation Voltage (Input to Output).	
5304 V _(DC)	3750V _(RMS)
Nominal Voltage 500V _(RMS) /600 V (DC).	
Isolation Group C	

individual electrical characteristics (25°C) (unless otherwise specified)

INFRARED EMITTING DIODE	MIN.	MAX.	UNITS
Forward Voltage V_F ($I_F = 10\text{mA}$)	.8	1.5	volts
Forward Voltage V_F ($I_F = 10\text{mA}$) $T_A = -55^\circ\text{C}$.9	1.7	volts
Forward Voltage V_F ($I_F = 10\text{mA}$) $T_A = +100^\circ\text{C}$.7	1.4	volts
Reverse Current I_R ($V_R = 6\text{V}$)	—	10	microamps
Capacitance — C_j ($V = 0, f = 1\text{MHz}$)	—	100	picofarads

PHOTO-TRANSISTOR	MIN.	TYP.	MAX.	UNITS
Breakdown Voltage $V_{(BR)CEO}$ ($I_C = 1.0\text{mA}, I_F = 0$)	70	—	—	volts
Breakdown Voltage $V_{(BR)CBO}$ ($I_C = 100\mu\text{A}, I_F = 0$)	70	—	—	volts
Breakdown Voltage $V_{(BR)EBO}$ ($I_E = 100\mu\text{A}, I_F = 0$)	7	—	—	volts
Collector Dark Current I_{CEO} ($V_{CE} = 10\text{V}, I_F = 0$)	—	5	50	nano-amps
Capacitance C_{CE} ($V_{CE} = 10\text{V}, f = 1\text{MHz}$)	—	2	—	pico farads

coupled electrical characteristics (25°C) (unless otherwise specified)

		MIN.	MAX.	UNITS
DC Current Transfer Ratio ($I_F = 10\text{mA}, V_{CE} = 10\text{V}$)	H11AV1	100	300	%
	H11AV2	50	—	%
	H11AV3	20	—	%
Saturation Voltage — Collector to Emitter ($I_F = 20\text{mA}, I_C = 2\text{mA}$)		—	0.4	volts
Isolation Resistance (Input to Output Voltage = 500V _{DC} . See Note 4)		100	—	gigaohms
Input to Output Capacitance (Input to Output Voltage = 0, $f = 1\text{MHz}$. See Note 4)		—	0.5	picofarads
Turn-On Time — t_{on} ($V_{CC} = 10\text{V}, I_C = 2\text{mA}, R_L = 100\Omega$). (See Figure 1)		—	15	microseconds
Turn-Off Time — t_{off} ($V_{CC} = 10\text{V}, I_C = 2\text{mA}, R_L = 100\Omega$). (See Figure 1)		—	15	microseconds

Resistance to Creepage

- EXTERNAL K_B 100
- INTERNAL K_B 600

NOTE 4:

Tests of input to output isolation current resistance, and capacitance are performed with the input terminals (diode) shorted together and the output terminals (transistor) shorted together.

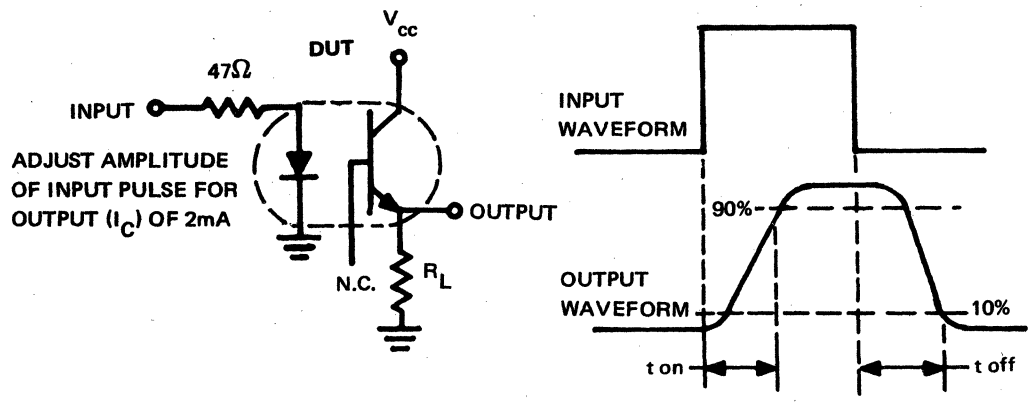

FIGURE 1. SWITCHING TIME TEST CIRCUIT

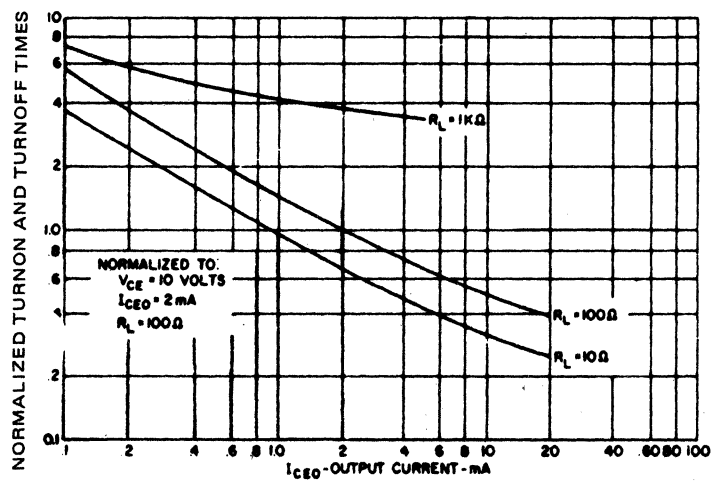

FIGURE 2. SWITCHING TIMES VS. OUTPUT CURRENT

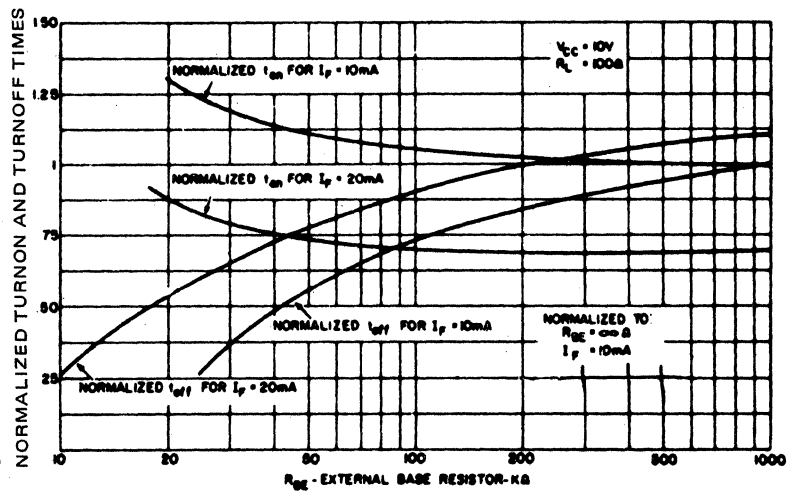

FIGURE 3. SWITCHING TIME VS. R_{BE}

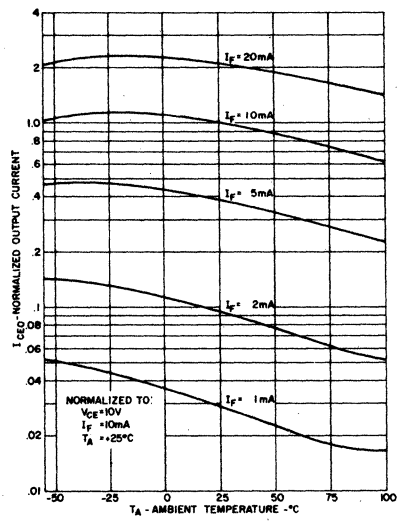

FIGURE 4. OUTPUT CURRENT VS. TEMPERATURE

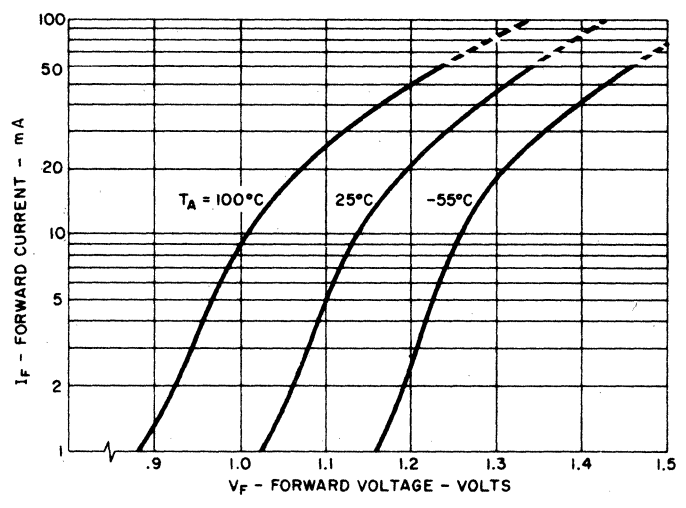

FIGURE 5. FORWARD VOLTAGE VS. FORWARD CURRENT

MOUNTING THE H11AV

CURRENT INDUSTRIAL STANDARD VDE 0883/6.80 OF THE FEDERAL REPUBLIC OF GERMANY CONCERNING OPTOCOUPLERS CALLS FOR A MINIMUM CREEPAGE DISTANCE (I.E. . . ACROSS THE SURFACE OF THE CIRCUIT BOARD IN WHICH THE DEVICE IS

MOUNTED) OF 8mm (0.315 IN.) BETWEEN INPUT AND OUTPUT TERMINALS. THE FOLLOWING DIAGRAM ILLUSTRATES ONE WAY TO FORM THE LEADS TO MEET THIS DIMENSIONAL REQUIREMENT.

TYPICAL H11AV COUPLER MOUNTING (DIMENSIONS IN MILLINCHES/MILLIMETERS UNLESS NOTED)

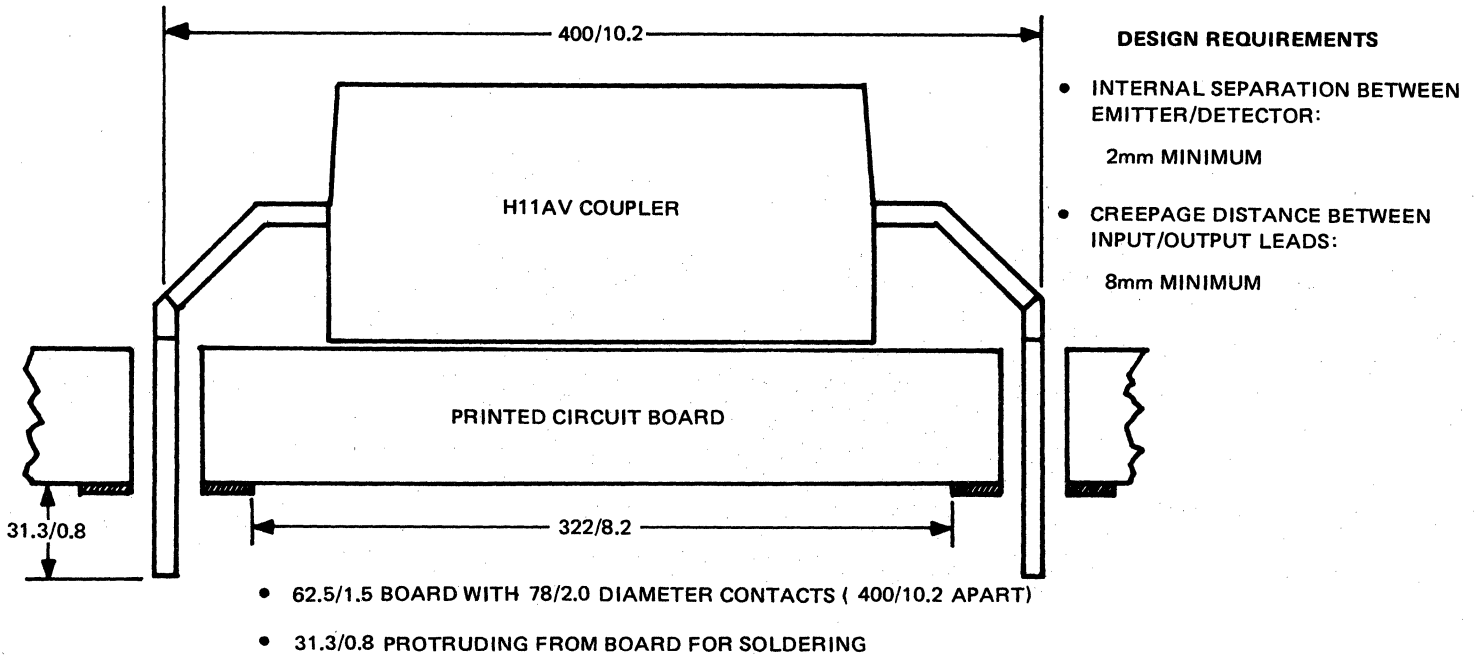

IMPORTANT NOTICE:

CONFORMITY WITH VDE STANDARDS IS DETERMINED BY VDE ALTHOUGH THE ABOVE DRAWING ILLUSTRATES ONE SUGGESTED MOUNTING TECHNIQUE, IT SHOULD NOT BE UNDERSTOOD AS HAVING RECEIVED ADVANCE APPROVAL FROM VDE

IN RESPECT TO VDE STANDARDS, GENERAL ELECTRIC COMPANY (USA) GUARANTEES THAT

THE DIMENSIONS OF THE H11AV OPTOCOUPLERS MANUFACTURED BY IT CONFORM TO THOSE DIMENSIONS LISTED ON THE H11AV SPECIFICATION SHEET #40.8, BUT ASSUMES NO RESPONSIBILITY OR LIABILITY FOR THE MEETING OF THE 8mm (0.315") CREEPAGE DISTANCE REQUIREMENT BY ANY CUSTOMER-MOUNTED PRODUCT.



SOLID STATE OPTOELECTRONICS

Photon Coupled Isolator H11B1, H11B2, H11B3

Ga As Infrared Emitting Diode & NPN Silicon Photo-Darlington Amplifier

The General Electric H11B1, H11B2 and H11B3 are gallium arsenide, infrared emitting diodes coupled with a silicon photo-darlington amplifier in a dual in-line package.

absolute maximum ratings: (25°C)

INFRARED EMITTING DIODE			
Power Dissipation	*100	milliwatts	
Forward Current (Continuous)	60	milliamps	
Forward Current (Peak) (Pulse width 1 μsec 300 P Ps)	3	ampere	
Reverse Voltage	3	volts	
*Derate 1.33mW/°C above 25°C ambient.			

PHOTO-DARLINGTON			
Power Dissipation	**150	milliwatts	
V _{CEO}	25	volts	
V _{CBO}	30	volts	
V _{EBO}	7	volts	
Collector Current (Continuous)	100	milliamps	
**Derate 2.0mW/°C above 25°C ambient.			

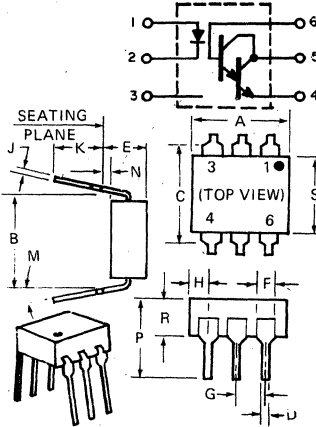

SYMBOL	MILLIMETERS		INCHES		NOTES
	MIN.	MAX.	MIN.	MAX.	
A	8.38	8.89	.330	.350	1
B	7.62 REF.		.300 REF.		
C	—	8.64	—	.340	2
D	.406	.508	.016	.020	
E	—	5.08	—	.200	3
F	1.01	1.78	.040	.070	
G	2.28	2.80	.090	.110	4
H	—	2.16	—	.085	
J	.203	.305	.008	.012	4
K	2.54	—	.100	—	
M	—	15°	—	15°	4
N	.381	—	.015	—	
P	—	9.53	—	.375	4
R	2.92	3.43	.115	.135	
S	6.10	6.86	.240	.270	

- NOTES:
 1. INSTALLED POSITION LEAD CENTERS.
 2. OVERALL INSTALLED DIMENSION.
 3. THESE MEASUREMENTS ARE MADE FROM THE SEATING PLANE.
 4. FOUR PLACES.

TOTAL DEVICE	
Storage Temperature	-55 to 150°C
Operating Temperature	-55 to 100°C
Lead Soldering Time (at 260°C)	10 seconds
Surge Isolation Voltage (Input to Output).	
2500V _(peak)	1770V _(RMS)
Steady-State Isolation Voltage (Input to Output).	
1500V _(peak)	1060V _(RMS)

individual electrical characteristics (25°C)

INFRARED EMITTING DIODE	TYP.	MAX.	UNITS
Forward Voltage H11B1, B2 (I _F = 10mA) H11B3 (I _F = 50mA)	1.1	1.5	volts
Reverse Current (V _R = 3V)	—	10	microamps
Capacitance (V = 0, f = 1MHz)	50	—	picofarads

PHOTO-DARLINGTON	MIN.	TYP.	MAX.	UNITS
Breakdown Voltage — V _{(BR)CEO} (I _C = 10mA, I _F = 0)	25	—	—	volts
Breakdown Voltage — V _{(BR)CBO} (I _C = 100μA, I _F = 0)	30	—	—	volts
Breakdown Voltage — V _{(BR)EBO} (I _E = 100μA, I _F = 0)	7	—	—	volts
Collector Dark Current — I _{CEO} (V _{CE} = 10V, I _F = 0)	—	5	100	nanoamps
Capacitance (V _{CE} = 10V, f = 1MHz)	—	6	—	picofarads

coupled electrical characteristics (25°C)

		MIN.	TYP.	MAX.	UNITS
DC Current Transfer Ratio (I _F = 1mA, V _{CE} = 5V)	H11B1	500	—	—	%
	H11B2	200	—	—	%
	H11B3	100	—	—	%
Saturation Voltage — Collector to Emitter (I _F = 1mA, I _C = 1mA)		—	0.7	1.0	volts
Isolation Resistance (Input to Output Voltage = 500V _{DC})		100	—	—	gigaohms
Input to Output Capacitance (Input to Output Voltage = 0, f = 1MHz)		—	—	2	picofarads
Switching Speeds: (V _{CE} = 10V, I _C = 10mA, R _L = 100Ω)	On-Time	—	125	—	microseconds
	Off-Time	—	100	—	microseconds

Covered under U.L. component recognition program, reference file E51868

VDE Approved to 0883/6.80 0110b Certificate # 35025 242

TYPICAL CHARACTERISTICS

H11B1, H11B2, H11B3

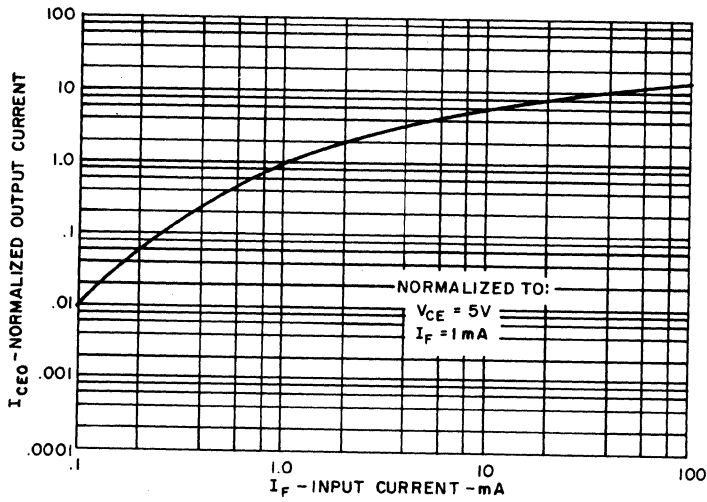

OUTPUT CURRENT VS INPUT CURRENT

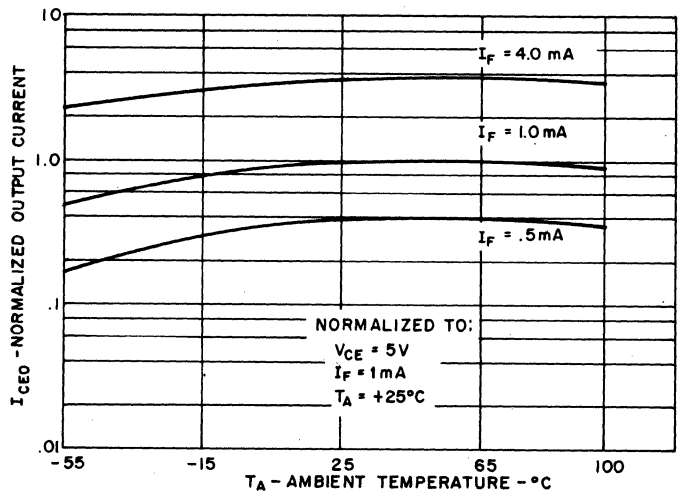

OUTPUT CURRENT VS TEMPERATURE

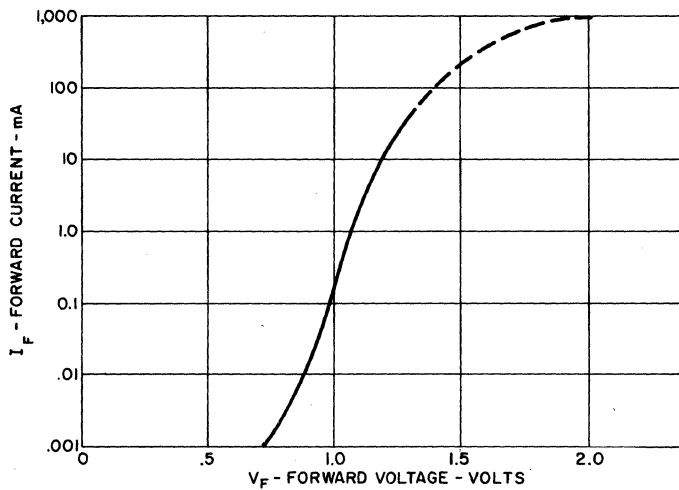

INPUT CHARACTERISTICS

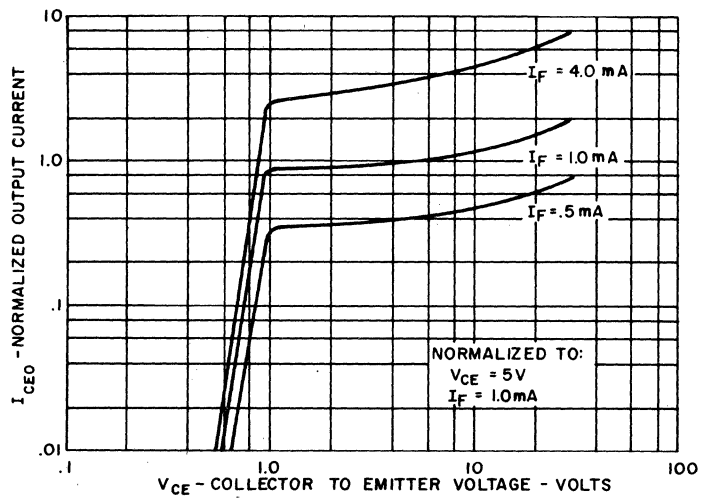

OUTPUT CHARACTERISTICS

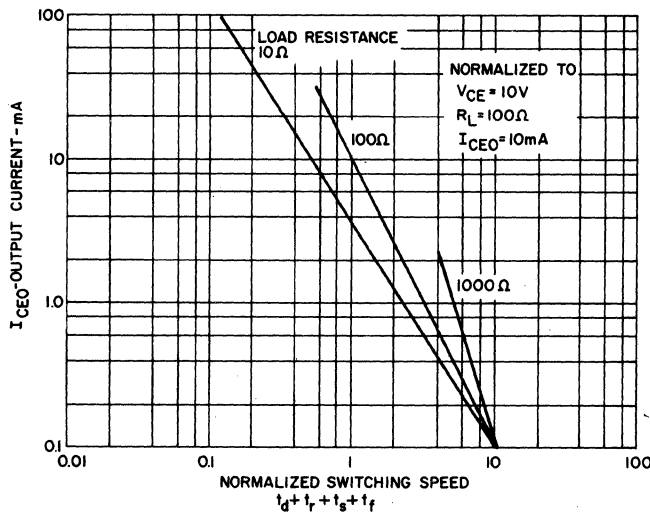

SWITCHING SPEED VS OUTPUT CURRENT

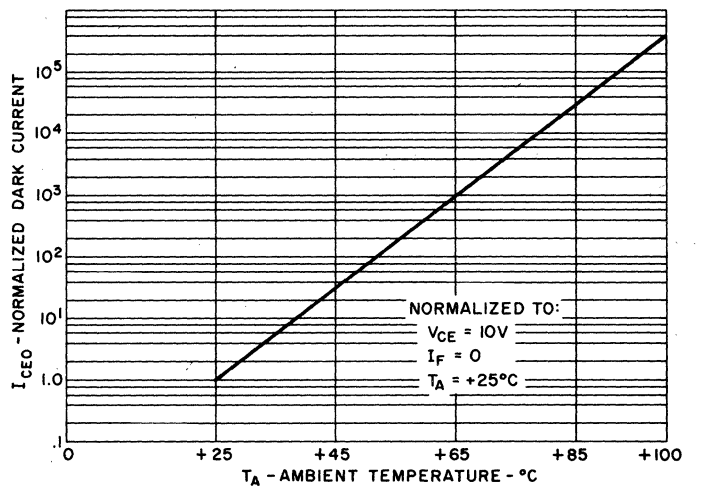

NORMALIZED DARK CURRENT VS TEMPERATURE



SOLID STATE



ELECTRONICS

Photon Coupled Isolator H11B255

Ga As Infrared Emitting Diode & NPN Silicon Photo-Darlington Amplifier

The General Electric H11B255 consists of a gallium arsenide infrared emitting diode coupled with a silicon photo-darlington amplifier in a dual in-line package.

absolute maximum ratings: (25°C)

INFRARED EMITTING DIODES			
Power Dissipation	*90	milliwatts	
Forward Current (Continuous)	60	milliamps	
Forward Current (Peak)	3	ampere	
(Pulse width 1μsec. 300 P Ps)			
Reverse Voltage	3	volts	
*Derate 1.2mW/°C above 25°C ambient.			

PHOTO-DARLINGTON			
Power Dissipation	**210	milliwatts	
V _{CEO}	55	volts	
V _{CBO}	55	volts	
V _{EBO}	8	volts	
Collector Current (Continuous)	100	milliamps	
**Derate 2.8mW/°C above 25°C ambient.			

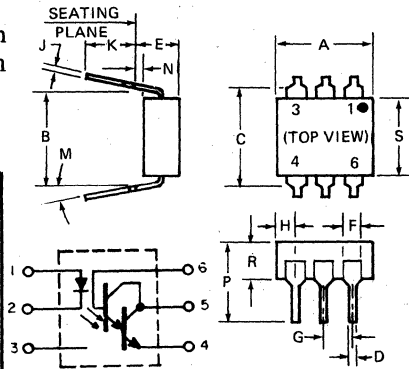

SYMBOL	MILLIMETERS		INCHES		NOTES
	MIN.	MAX.	MIN.	MAX.	
A	8.38	8.89	.330	.350	1
B	7.62 REF.		.300 REF.		2
C	—	8.64	—	.340	
D	.406	.508	.016	.020	
E	—	5.08	—	.200	3
F	1.01	1.78	.040	.070	
G	2.28	2.80	.090	.110	
H	—	2.16	—	.085	4
J	.203	.305	.008	.012	
K	2.54	—	.100	—	
M	—	15°	—	15°	
N	.381	—	.015	—	
P	—	9.53	—	.375	
R	2.92	3.43	.115	.135	
S	6.10	6.86	.240	.270	

- NOTES:
 1. INSTALLED POSITION LEAD CENTERS.
 2. OVERALL INSTALLED DIMENSION.
 3. THESE MEASUREMENTS ARE MADE FROM THE SEATING PLANE.
 4. FOUR PLACES.

TOTAL DEVICE	
Storage Temperature	-55 to 150°C
Operating Temperature	-55 to 100°C
Lead Soldering Time (at 260°C)	10 seconds.
Surge Isolation Voltage (Input to Output)	
1500V _(peak)	1060V _(RMS)
Steady-State Isolation Voltage (Input to Output)	
950V _(peak)	660V _(RMS)

individual electrical characteristics (25°C)

INFRARED EMITTING DIODE	TYP.	MAX.	UNITS
Forward Voltage (I _F = 20mA)	1.1	1.5	volts
Reverse Current (V _R = 3V)	—	10	microamps
Capacitance (V = 0, f = 1 MHz)	50	—	picofarads

PHOTO-DARLINGTON	MIN.	TYP.	MAX.	UNITS
Breakdown Voltage — V _{(BR)CEO} (I _C = 100μA, I _F = 0)	55	—	—	volts
Breakdown Voltage — V _{(BR)CBO} (I _C = 100μA, I _F = 0)	55	—	—	volts
Breakdown Voltage — V _{(BR)EBO} (I _E = 100μA, I _F = 0)	8	—	—	volts
Collector Dark Current — I _{CEO} (V _{CE} = 10V, I _F = 0)	—	—	100	nanoamps
Capacitance (V _{CE} = 10V, f = 1 MHz)	—	2	—	picofarads

coupled electrical characteristics (25°C)

	MIN.	TYP.	MAX.	UNITS
DC Current Transfer Ratio (I _F = 10mA, V _{CE} = 5V)	100	—	—	%
Saturation Voltage — Collector to Emitter (I _F = 50mA, I _C = 50mA)	—	—	1.0	volts
Isolation Resistance (Input to Output Voltage = 500V _{DC})	100	—	—	gigaohms
Input to Output Capacitance (Input to Output Voltage = 0, f = 1 MHz)	—	—	2	picofarads
Switching Speeds: On-Time — (V _{CE} = 10V, I _C = 10mA, R _L = 100Ω)	—	125	—	microseconds
Off-Time — (V _{CE} = 10V, I _C = 10mA, R _L = 100Ω)	—	100	—	microseconds

Covered under U.L. component recognition program, reference file E51868

VDE Approved to 0883/6.80 0110b Certificate # 35025

TYPICAL CHARACTERISTICS

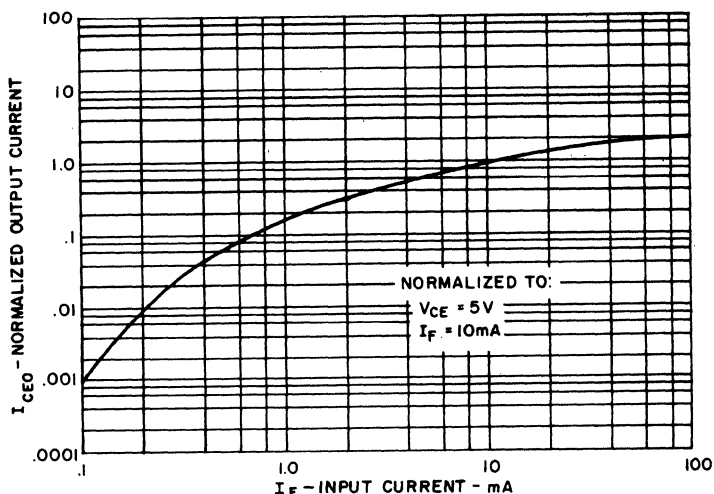

1. OUTPUT CURRENT VS. INPUT CURRENT

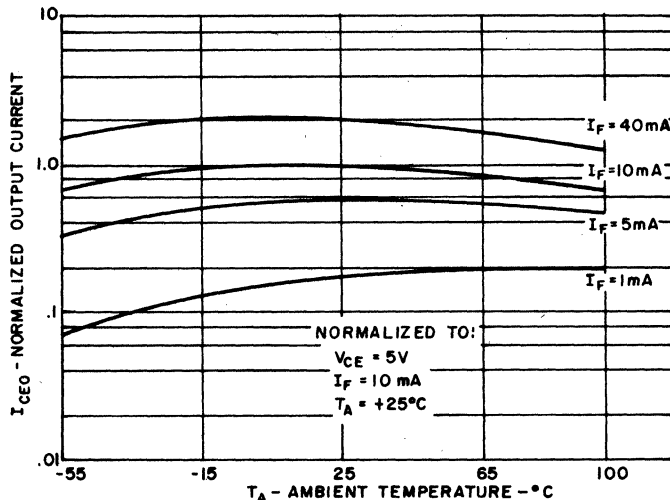

2. OUTPUT CURRENT VS. TEMPERATURE

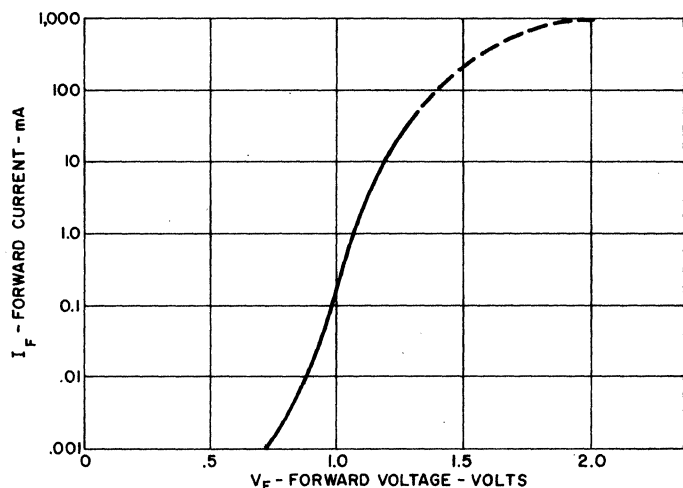

3. INPUT CHARACTERISTICS

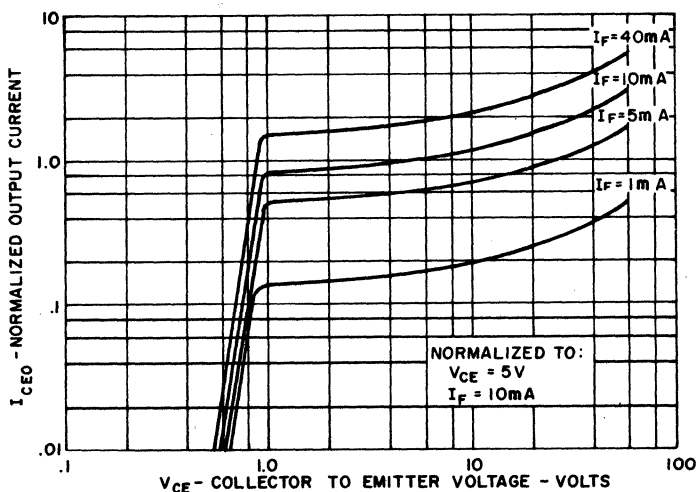

4. OUTPUT CHARACTERISTICS

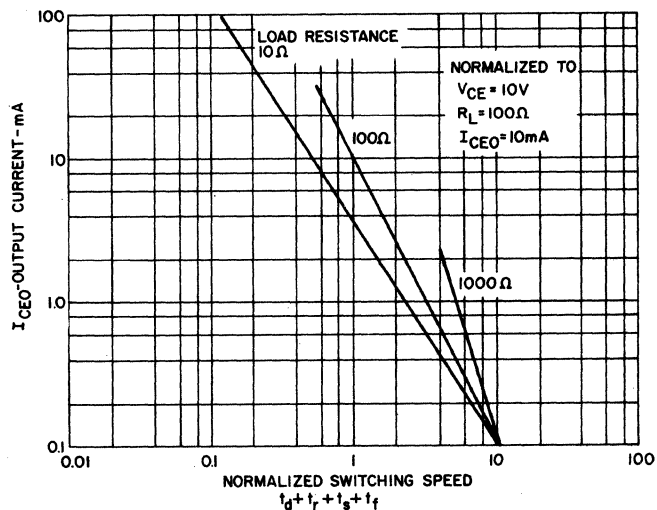

5. SWITCHING SPEED VS. OUTPUT CURRENT

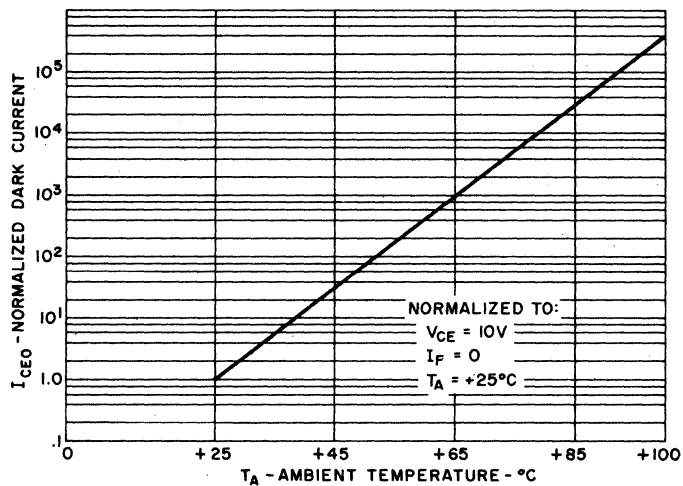

6. NORMALIZED DARK CURRENT VS. TEMPERATURE



SOLID STATE OPTOELECTRONICS

Photon Coupled Isolator H11BX522

Ga As Solid State Lamp & NPN Silicon Photo-Darlington Amplifier

The General Electric H11BX522 is a gallium arsenide, infrared emitting diode coupled with a silicon photo-darlington amplifier in a dual in-line package.

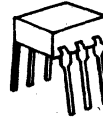

absolute maximum ratings: (25°C)

INFRARED EMITTING DIODE		
Power Dissipation	*100	milliwatts
Forward Current (Continuous)	60	milliamps
Forward Current (Peak) (Pulse width 1 μsec 300 P Ps)	3	amperes
Reverse Voltage	3	Volts
*Derate 1.33mW/° above 25°C ambient.		

PHOTO-TRANSISTOR		
Power Dissipation	**150	milliwatts
V _{CEO}	25	volts
V _{CBO}	30	volts
V _{EBO}	7	volts
Collector Current (Continuous)	100	milliamps
**Derate 2.0mW/°C above 25°C ambient.		

individual electrical characteristics (25°C)

INFRARED EMITTING DIODE	TYP.	MAX.	UNITS
Forward Voltage (I _F = 0.5mA)	1.0	1.15	volts
Reverse Current (V _R = 3V)	—	10	microamps
Capacitance (V = 0, f = 1MHz)	50	—	picofarads

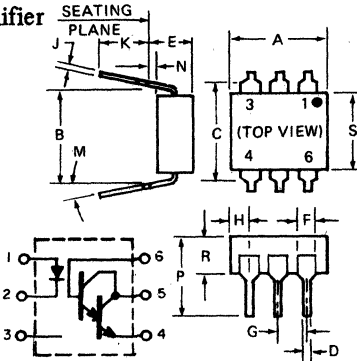

SYMBOL	MILLIMETERS		INCHES		NOTES
	MIN.	MAX.	MIN.	MAX.	
A	8.38	8.89	.330	.350	1
B	7.62 REF.	—	.300 REF.	—	
C	—	8.64	—	.340	2
D	.406	.508	.016	.020	
E	—	5.08	—	.200	3
F	1.01	1.78	.040	.070	
G	2.28	2.80	.090	.110	4
H	—	2.16	—	.085	
J	.203	.305	.008	.012	—
K	2.54	—	.100	—	
M	—	15°	—	15°	—
N	.381	—	.015	—	
P	—	9.53	—	.375	—
R	2.92	3.43	.115	.135	
S	6.10	6.86	.240	.270	—

- NOTES:
1. INSTALLED POSITION LEAD CENTERS.
 2. OVERALL INSTALLED DIMENSION.
 3. THESE MEASUREMENTS ARE MADE FROM THE SEATING PLANE.
 4. FOUR PLACES.

TOTAL DEVICE
Storage Temperature -55 to 150°C
Operating Temperature -55 to 100°C
Lead Soldering Time (at 260°C) 10 Seconds
Surge Isolation Voltage (Input to Output)
2500V _(peak) 1700V _(RMS)
Steady-State Isolation Voltage (Input to Output)
1500V _(peak) 1060V _(RMS)

PHOTO-DARLINGTON	MIN.	TYP.	MAX.	UNITS
Breakdown Voltage - V _{(BR)CEO} (I _C = 10mA, I _F = 0)	25	—	—	volts
Breakdown Voltage - V _{(BR)CBO} (I _C = 100μA, I _F = 0)	30	—	—	volts
Breakdown Voltage - V _{(BR)EBO} (I _E = 100μA, I _F = 0)	7	—	—	volts
Collector Dark Current - I _{CEO} (V _{CE} = 12V, R _{BE} = 7.5 MΩ, T _A = 50°C)	—	—	10	micro-amps
Capacitance Collector-Emitter - C _{CE} (V _{CE} = 10V, f = 1 MHz)	—	6	—	pico- farads

coupled electrical characteristics (25°C)

	MIN.	TYP.	MAX.	UNITS
DC Current Transfer Ratio (I _F = 0.5mA, V _{CE} = 6V, R _{BE} = 7.5 MΩ) -25°C + +50°C	200	—	—	%
Saturation Voltage - Collector-Emitter (I _F = 5mA, I _C = 2mA, R _{BE} = 7.5 MΩ)	—	—	1.0	Volts
Isolation Resistance (Input to Output Voltage = 500V _{DC})	—	100	—	gigaohms
Input to Output Capacitance (Input to Output Voltage = 0, f = 1 MHz)	—	2	—	picofarads
Switching Speeds: (I _F = 5mA, See Figure 1) t _{pr}	1	—	3	milliseconds

VDE Approved to 0883/6.80 0110b Certificate # 35025

TYPICAL CHARACTERISTICS

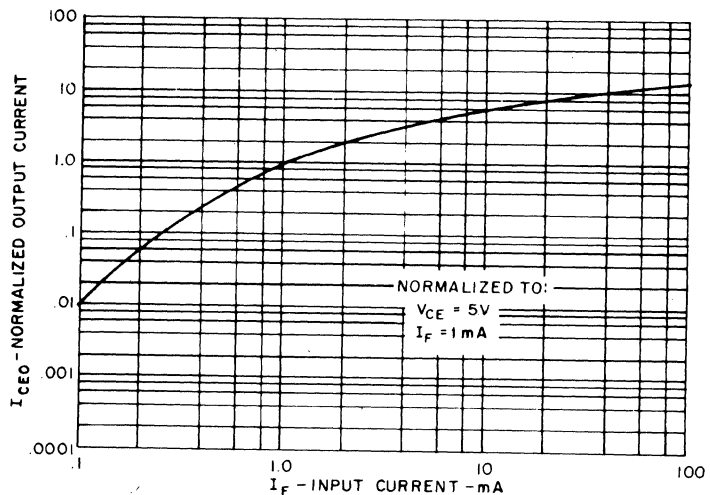

OUTPUT CURRENT VS INPUT CURRENT

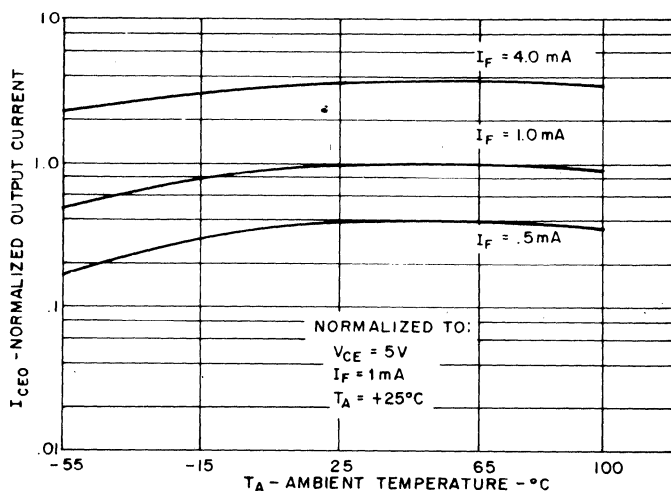

OUTPUT CURRENT VS TEMPERATURE

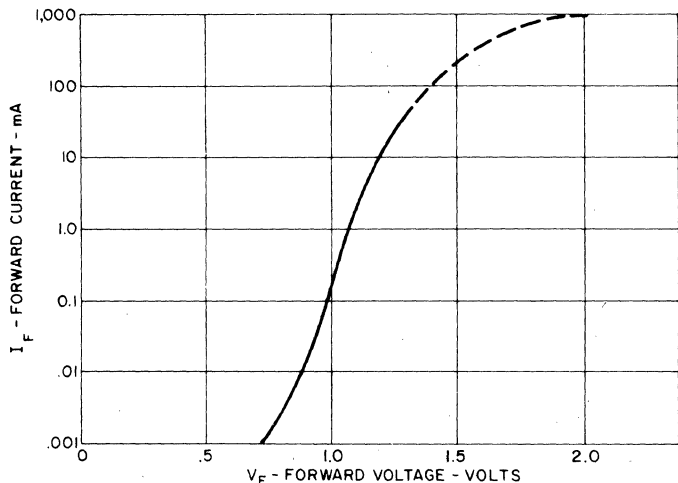

INPUT CHARACTERISTICS

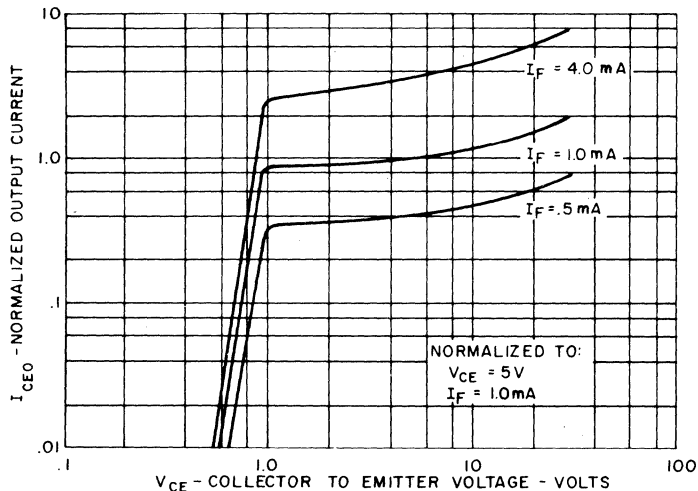

OUTPUT CHARACTERISTICS

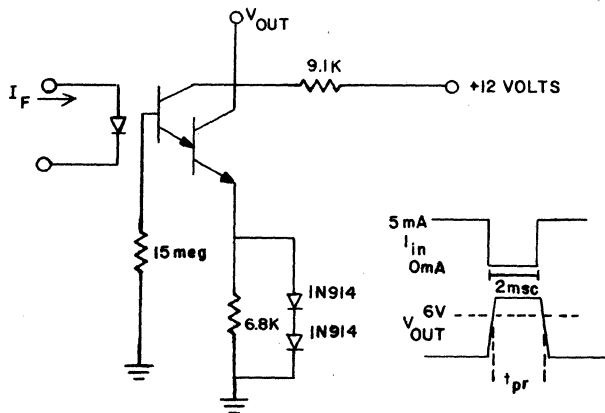
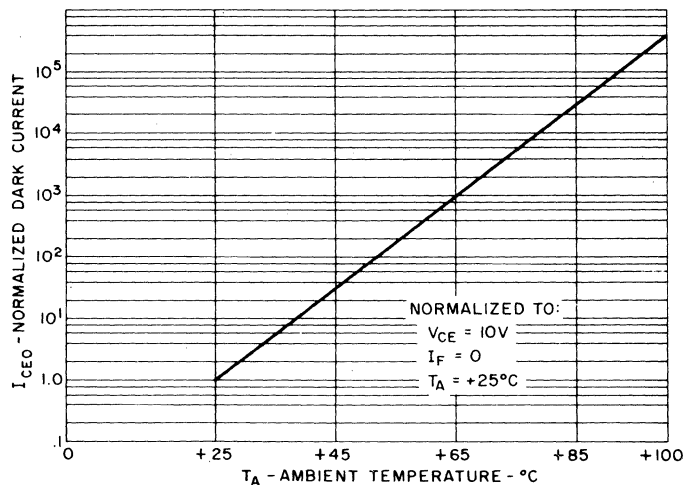

FIGURE 1.



NORMALIZED DARK CURRENT VS TEMPERATURE



SOLID STATE

OPTO

ELECTRONICS

Photon Coupled Isolator H11C1, H11C2, H11C3

Ga As Infrared Emitting Diode & Light Activated SCR

The General Electric H11C1, H11C2 and H11C3 are gallium arsenide, infrared emitting diodes coupled with light activated silicon controlled rectifiers in a dual in-line package.

absolute maximum ratings: (25°C)

INFRARED EMITTING DIODE		
Power Dissipation	*100	milliwatts
Forward Current (Continuous)	60	milliamps
Forward Current (Peak)	3	ampere
(Pulse width 1 μsec 300 P Ps)		
Reverse Voltage	6	volts
*Derate 1.33 mW/°C above -25°C ambient.		

PHOTO-SCR		
Peak Forward Voltage	200	volts
RMS Forward Current	300	milliamps
Forward Current (Peak)	10	amperes
(100μsec 1% duty cycle)		
Surge Current (10m sec)	5	amperes
Reverse Gate Voltage	6	volts
Power Dissipation (25°C Ambient)	** 400	milliwatts
Power Dissipation (25°C Case)	***1000	milliwatts
**Derate 5.3mW/°C above 25°C ambient.		
***Derate 13.3mW/°C above 25°C case.		

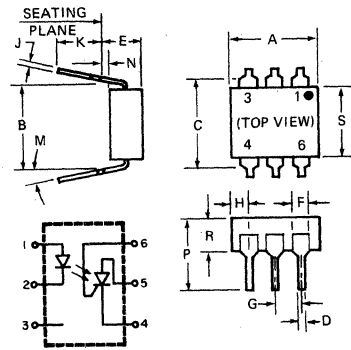

SYMBOL	MILLIMETERS		INCHES		NOTES
	MIN.	MAX.	MIN.	MAX.	
A	8.38	8.89	.330	.350	1
B	7.62 REF.		.300 REF.		
C	—	8.64	—	.340	2
D	.406	.508	.016	.020	
E	—	5.08	—	.200	3
F	1.01	1.78	.040	.070	
G	2.28	2.80	.090	.110	4
H	—	2.16	—	.085	
J	.203	.305	.008	.012	—
K	2.54	—	.100	—	
M	—	15°	—	15°	—
N	.381	—	.015	—	
P	—	9.53	—	.375	—
R	2.92	3.43	.115	.135	
S	6.10	6.86	.240	.270	—

- NOTES:
1. INSTALLED POSITION LEAD CENTERS.
 2. OVERALL INSTALLED DIMENSION.
 3. THESE MEASUREMENTS ARE MADE FROM THE SEATING PLANE.
 4. FOUR PLACES.

TOTAL DEVICE	
Storage Temperature	-55 to 150°C
Operating Temperature	-55 to 100°C
Lead Soldering Time (at 260°C)	10 seconds
Surge Isolation Voltage (Input to Output).	
H11C1	3535V(peak) 2500V(RMS)
H11C2-H11C3	2500V(peak) 1770V(RMS)
Steady-State Isolation Voltage (Input to Output).	
H11C1	2100V(peak) 1500V(RMS)
H11C2-H11C3	1500V(peak) 1060V(RMS)

individual electrical characteristics (25°C)

INFRARED EMITTING DIODE		TYP.	MAX.	UNITS
Forward Voltage	V _F	1.2	1.5	volts
(I _F = 10mA)				
Reverse Current	I _R	—	10	microamps
(V _R = 3V)				
Capacitance	C _J	50	—	picofarads
(V = 0, f = 1MHz)				

PHOTO-SCR	MIN.	TYP.	MAX.	UNITS
Off-State Voltage — V _{DM} (R _{GK} = 10KΩ, 100°C, I _D = 50μA)	200	—	—	volts
Reverse Voltage — V _{RM} (R _{GK} = 10KΩ, 100°C, I _R = 50μA)	200	—	—	volts
On-State Voltage — V _{TM} (I _{TM} = .3 amp)	—	1.1	1.3	volts
Off-state Current — I _{DM} (V _{DM} = 200V, T _A = 100°C, R _{GK} = 10K)	—	—	50	microamps
Reverse Current — I _{RM} (V _{RM} = 200V, T _A = 100°C, R _{GK} = 10K)	—	—	50	microamps
Capacitance (Anode-Gate)	—	20	—	picofarads
V = 0V, f = 1MHz (Gate-Cathode)	—	350	—	picofarads

coupled electrical characteristics (25°C)

		MIN.	TYP.	MAX.	UNITS
Input Current to Trigger (V _{AK} = 50V, R _{GK} = 10KΩ)	H11C1, C2	—	—	20	milliamps
	H11C3	—	—	30	milliamps
Input Current to Trigger (V _{AK} = 100V, R _{GK} = 27KΩ)	H11C1, C2	—	—	11	milliamps
	H11C3	—	—	14	milliamps
Isolation Resistance (Input to Output Voltage = 500V _{DC})		100	—	—	gigaohms
Input to Output Capacitance (Input to Output Voltage = 0, f = 1MHz)		—	—	2	picofarads
Coupled dV/dt, Input to Output (See Figure 13)		500	—	—	volts/μsec

Covered under U.L. component recognition program, reference file E51868

VDE Approved to 0883/6.80 0110b Certificate # 35025

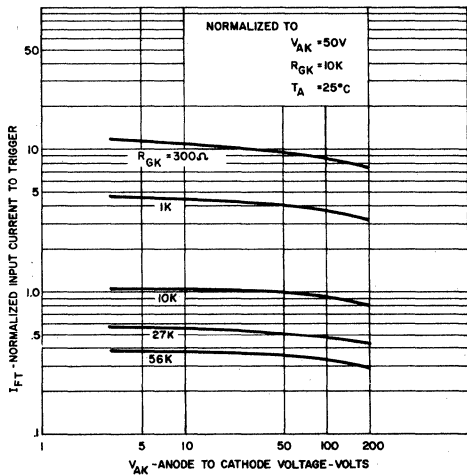

FIGURE 1. INPUT CURRENT TO TRIGGER VS ANODE-CATHODE VOLTAGE

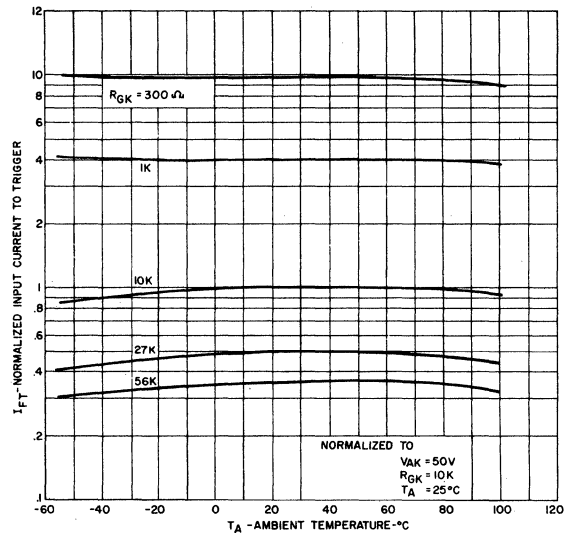

FIGURE 2. INPUT CURRENT TO TRIGGER VS TEMPERATURE

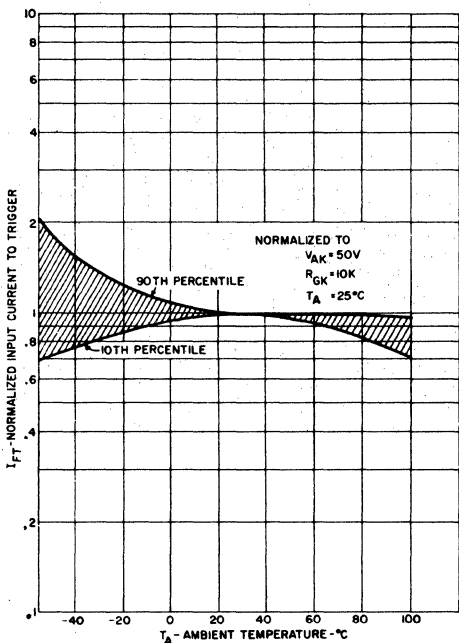

FIGURE 3. INPUT CURRENT TO TRIGGER DISTRIBUTION VS TEMPERATURE

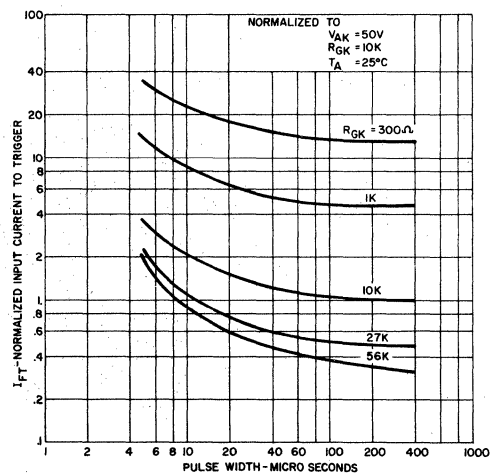

FIGURE 4. INPUT CURRENT TO TRIGGER VS PULSE WIDTH

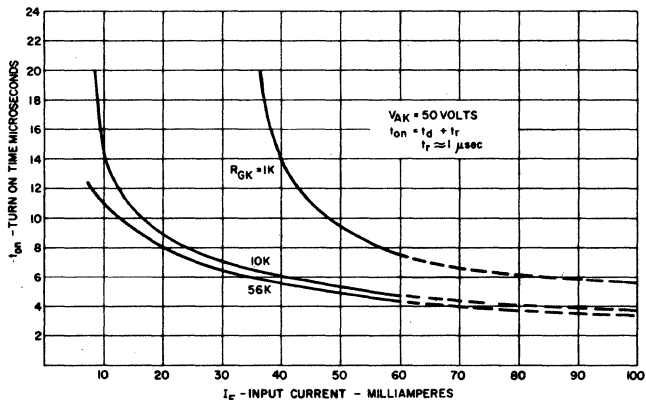

FIGURE 5. TURN ON TIME VS INPUT CURRENT

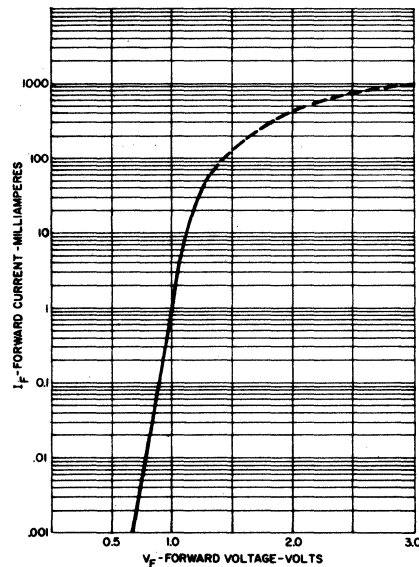

FIGURE 6. INPUT CHARACTERISTICS I_F VS V_F

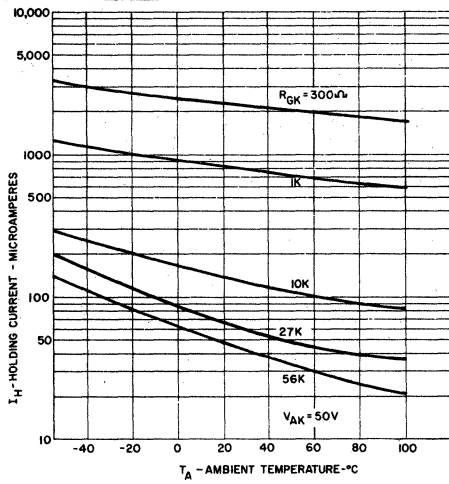

FIGURE 7. HOLDING CURRENT VS TEMPERATURE

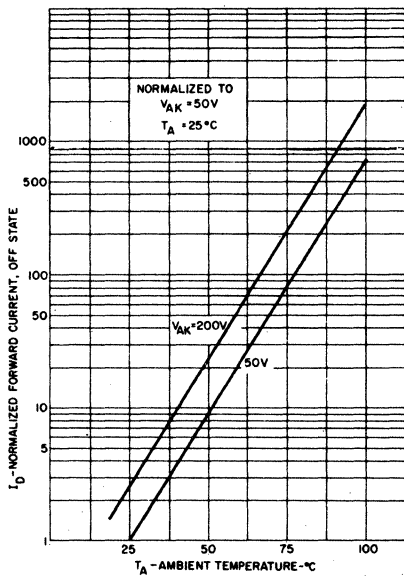

FIGURE 9. OFF STATE FORWARD CURRENT VS TEMPERATURE

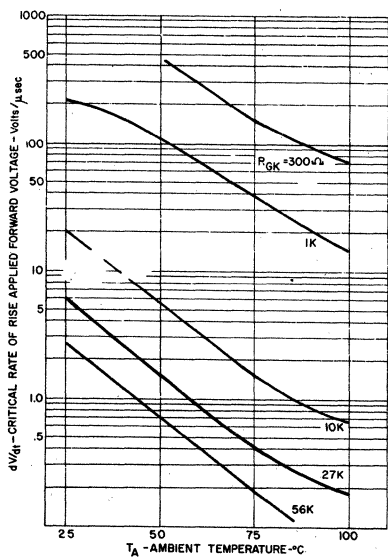

FIGURE 11. dv/dt VS TEMPERATURE

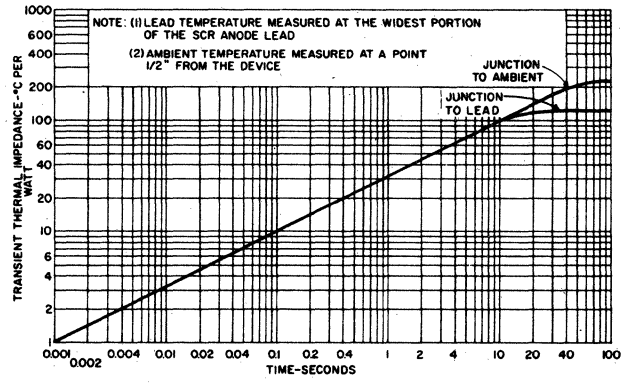

FIGURE 8. MAXIMUM TRANSIENT THERMAL IMPEDANCE

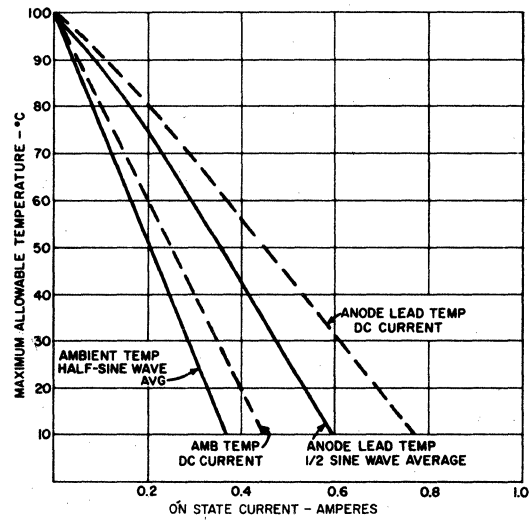

FIGURE 10. ON STATE CURRENT VS MAXIMUM ALLOWABLE TEMPERATURE

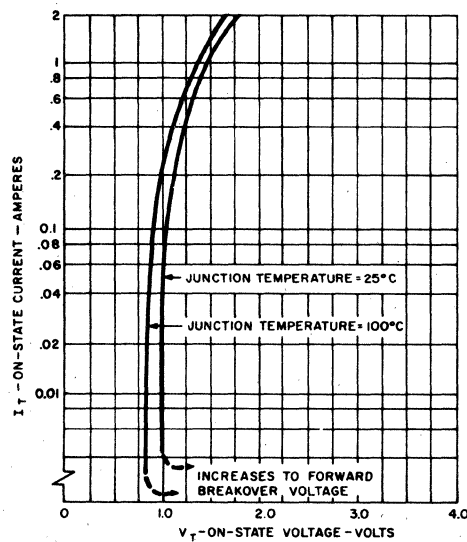
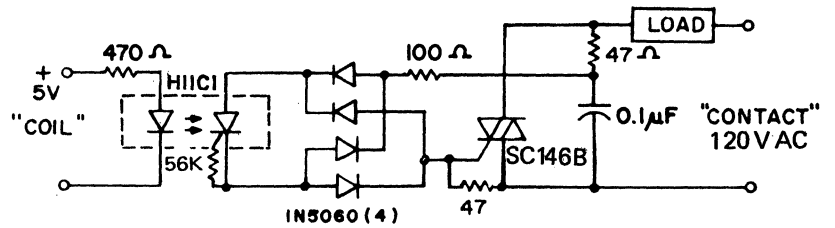

FIGURE 12. ON-STATE CHARACTERISTICS

TYPICAL APPLICATIONS

10A, T²L COMPATIBLE, SOLID STATE RELAY

Use of the H11C1 for high sensitivity, 2500 v isolation capability, provides this highly reliable solid state relay design. This design is compatible with 74, 74S and 74H series T²L logic systems inputs and 120VAC loads up to 10 A.



25W LOGIC INDICATOR LAMP DRIVER

The high surge capability and non-reactive input characteristics of the H11C allow it to directly couple, without buffers, T²L and DTL logic to indicator and alarm devices, without danger of introducing noise and logic glitches.

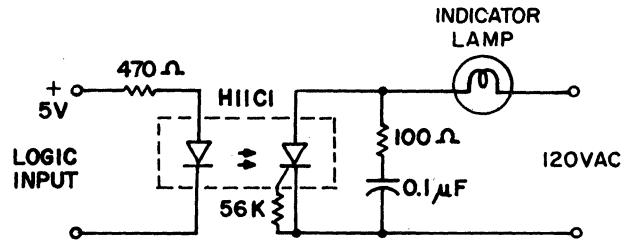

200V SYMMETRICAL TRANSISTOR COUPLER

Use of the high voltage PNP portion of the H11C provides a 200V transistor capable of conducting positive and negative signals with current transfer ratios of over 1%. This function is useful in remote instrumentation, high voltage power supplies and test equipment. Care should be taken not to exceed the H11C 400 mW power dissipation rating when used at high voltages.

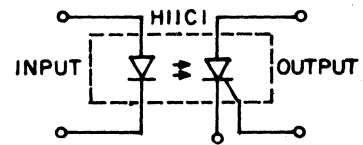
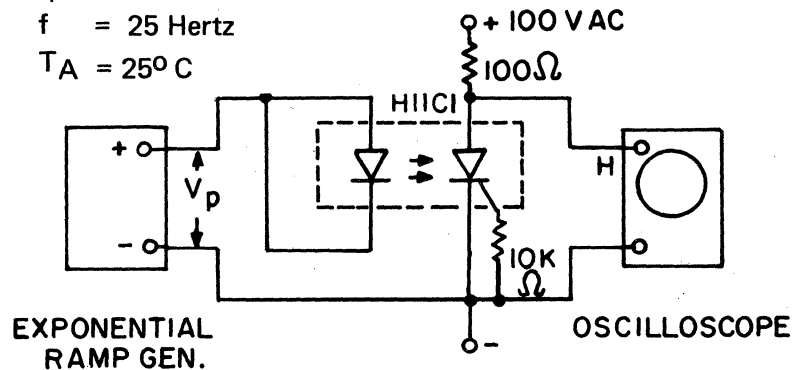
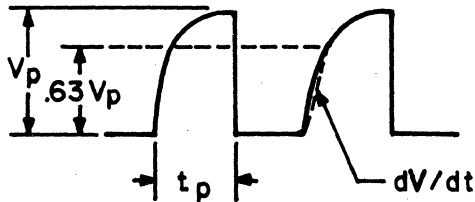

FIGURE 13
COUPLED dV/dt – TEST CIRCUIT

- $V_p = 800$ Volts
- $t_p = .010$ Seconds
- $f = 25$ Hertz
- $T_A = 25^\circ$ C





SOLID STATE OPTOELECTRONICS

Photon Coupled Isolator H11C4, H11C5, H11C6

Ga As Infrared Emitting Diode & Light Activated SCR

The General Electric H11C4, H11C5 and H11C6 are gallium arsenide, infrared emitting diodes coupled with light activated silicon controlled rectifiers in a dual in-line package.

absolute maximum ratings: (25°C)

INFRARED EMITTING DIODE		
Power Dissipation	*100	milliwatts
Forward Current (Continuous)	60	milliamps
Forward Current (Peak) (Pulse width 1μsec 300 P Ps)	3	ampere
Reverse Voltage	6	volts
*Derate 1.33mW/°C above 25°C ambient.		

PHOTO - SCR		
Peak Forward Voltage	400	volts
RMS Forward Current	300	milliamps
Forward Current (Peak) (100μsec 1% duty cycle)	10	amperes
Surge Current (10m sec)	5	amperes
Reverse Gate Voltage	6	volts
Power Dissipation (25°C Ambient)	** 400	milliwatts
Power Dissipation (25°C Case)	***1000	milliwatts
**Derate 5.3mW/°C above 25°C ambient.		
***Derate 13.3mW/°C above 25°C case.		

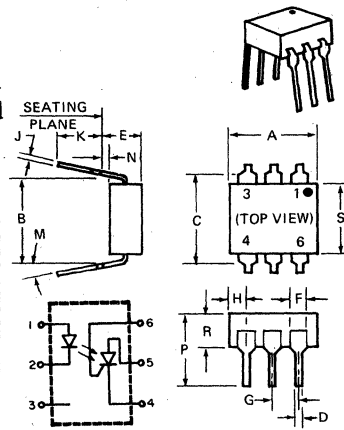

SYMBOL	MILLIMETERS		INCHES		NOTES
	MIN.	MAX.	MIN.	MAX.	
A	8.38	8.89	.330	.350	1
B	7.62 REF.		.300 REF.		
C	—	8.64	—	.340	2
D	.406	.508	.016	.020	
E	—	5.08	—	.200	3
F	1.01	1.78	.040	.070	
G	2.28	2.80	.090	.110	4
H	—	2.16	—	.085	
J	.203	.305	.008	.012	—
K	2.54	—	.100	—	
M	—	15°	—	15°	—
N	.381	—	.015	—	
P	—	9.53	—	.375	—
R	2.92	3.43	.115	.135	
S	6.10	6.86	.240	.270	—

- NOTES:
 1. INSTALLED POSITION LEAD CENTERS.
 2. OVERALL INSTALLED DIMENSION.
 3. THESE MEASUREMENTS ARE MADE FROM THE SEATING PLANE.
 4. FOUR PLACES.

TOTAL DEVICE	
Storage Temperature	-55 to 150°C
Operating Temperature	-55 to 100°C
Lead Soldering Time (at 260°C)	10 seconds
Surge Isolation Voltage (Input to Output)	
H11C4	3535V(peak) 2500V(RMS)
H11C5-H11C6	2500V(peak) 1770V(RMS)
Steady-State Isolation Voltage (Input to Output)	
H11C4	2100V(peak) 1500V(RMS)
H11C5-H11C6	1500V(peak) 1060V(RMS)

individual electrical characteristics (25°C)

INFRARED EMITTING DIODE	TYP.	MAX.	UNITS
Forward Voltage V_F ($I_F = 10\text{mA}$)	1.2	1.5	volts
Reverse Current I_R ($V_R = 3\text{V}$)	—	10	microamps
Capacitance C_J ($V = 0, f = 1\text{MHz}$)	50	—	picofarads

PHOTO - SCR	MIN.	TYP.	MAX.	UNITS
Off-State Voltage — V_{DM} ($R_{GK} = 10\text{K}\Omega, 100^\circ\text{C}, I_D = 150\mu\text{A}$)	400	—	—	volts
Reverse Voltage — V_{RM} ($R_{GK} = 10\text{K}\Omega, 100^\circ\text{C}, I_D = 150\mu\text{A}$)	400	—	—	volts
On-State Voltage — V_{TM} ($I_{TM} = .3\text{ amp}$)	—	1.1	1.3	volts
Off-state Current — I_{DM} ($V_{DM} = 400\text{V}, T_A = 100^\circ\text{C}, R_{GK} = 10\text{K}$)	—	—	150	microamps
Reverse Current — I_{RM} ($V_{RM} = 400\text{V}, T_A = 100^\circ\text{C}, R_{GK} = 10\text{K}$)	—	—	150	microamps
Capacitance (Anode-Gate)	—	20	—	picofarads
$V = 0\text{V}, f = 1\text{MHz}$ (Gate-Cathode)	—	350	—	picofarads

coupled electrical characteristics (25°C)

	MIN.	TYP.	MAX.	UNITS
Input Current to Trigger ($V_{AK} = 50\text{V}, R_{GK} = 10\text{K}\Omega$)	—	—	20	milliamps
	—	—	30	milliamps
Input Current to Trigger ($V_{AK} = 100\text{V}, R_{GK} = 27\text{K}\Omega$)	—	—	11	milliamps
	—	—	14	milliamps
Isolation Resistance (Input to Output Voltage = 500V _{DC})	100	—	—	gigaohms
Input to Output Capacitance (Input to Output Voltage = 0, $f = 1\text{MHz}$)	—	—	2	picofarads
Coupled dv/dt, Input to Output (See Figure 13)	500	—	—	volts/μsec

Covered under U.L. component recognition program, reference file E51868

VDE Approved to 0883/6.80 0110b Certificate # 35025

TYPICAL CHARACTERISTICS

H11C4, H11C5, H11C6

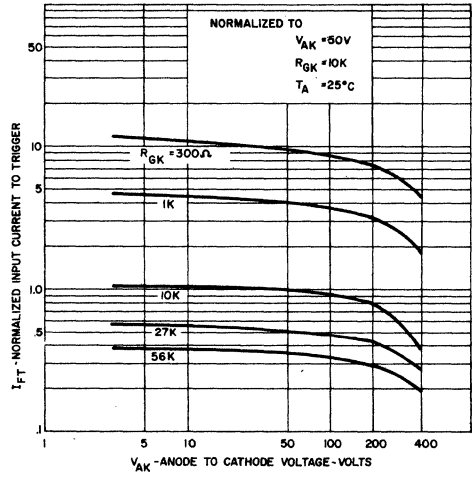

FIGURE 1. INPUT CURRENT TO TRIGGER VS. ANODE-CATHODE VOLTAGE

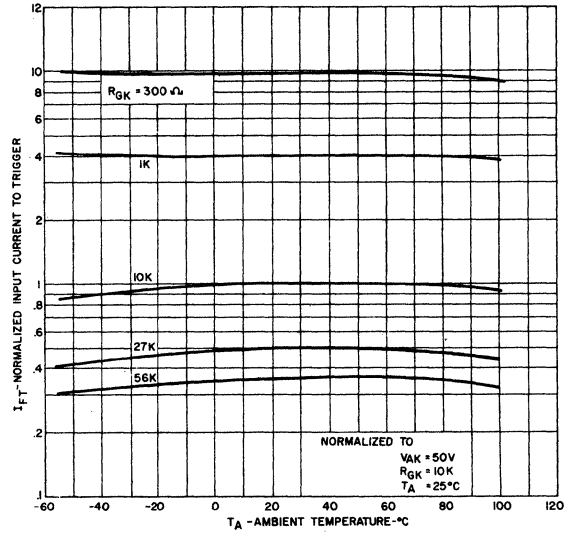

FIGURE 2. INPUT CURRENT TO TRIGGER VS. TEMPERATURE

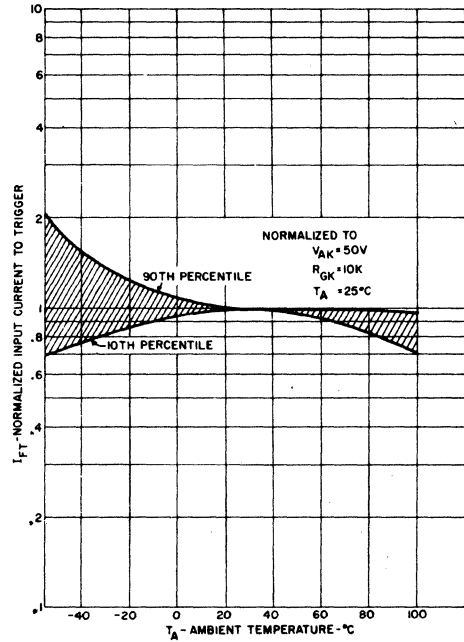

FIGURE 3. INPUT CURRENT TO TRIGGER DISTRIBUTION VS. TEMPERATURE

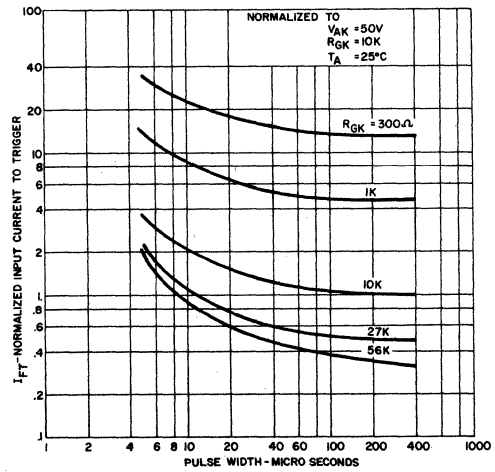

FIGURE 4. INPUT CURRENT TO TRIGGER VS. PULSE WIDTH

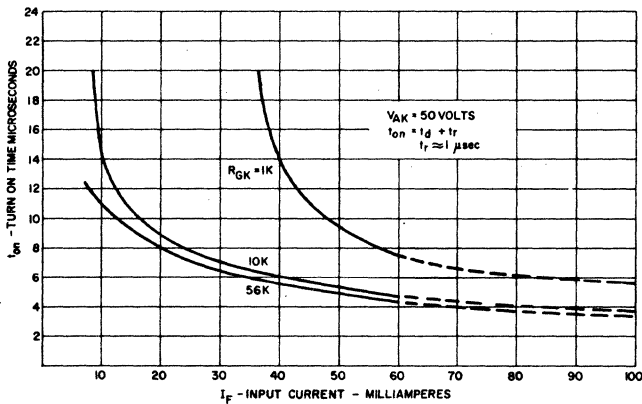

FIGURE 5. TURN-ON TIME VS. INPUT CURRENT

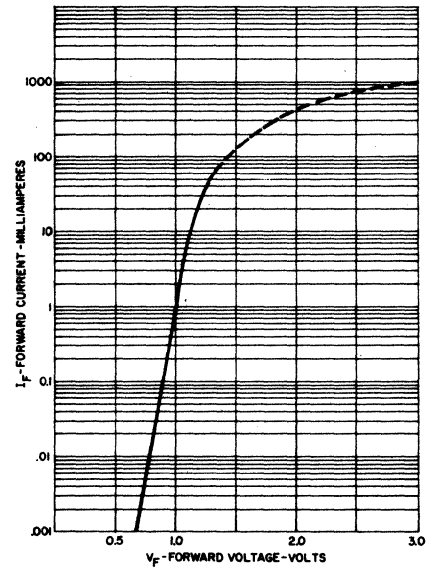

FIGURE 6. INPUT CHARACTERISTICS I_F VS. V_F

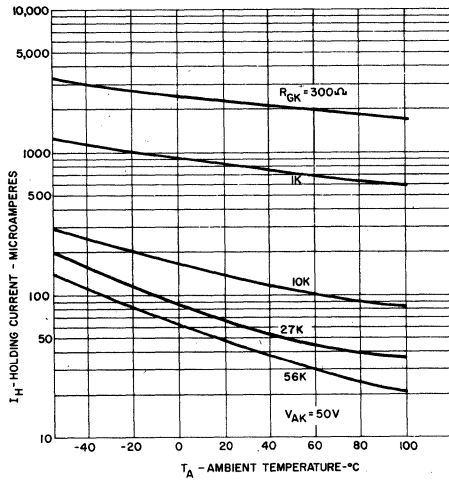

FIGURE 7. HOLDING CURRENT VS. TEMPERATURE

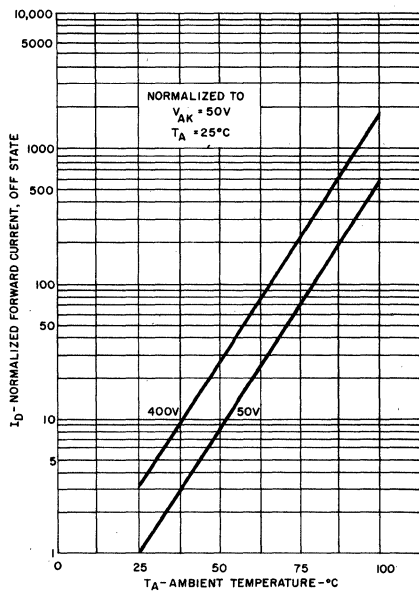

FIGURE 9. OFF-STATE FORWARD CURRENT VS. TEMPERATURE

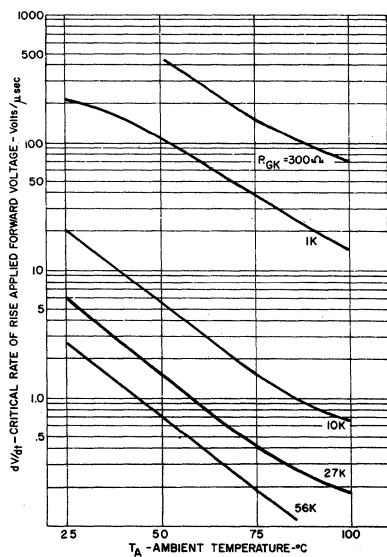

FIGURE 11. dv/dt VS. TEMPERATURE

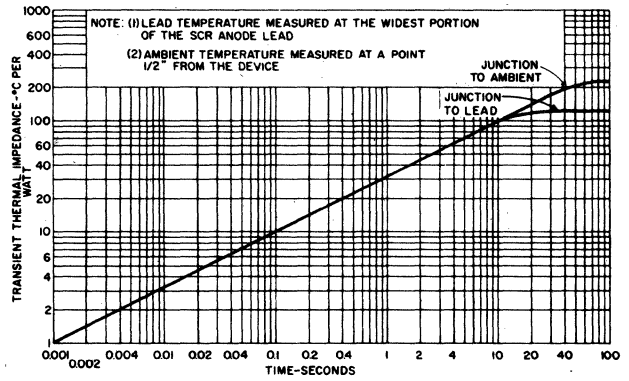

FIGURE 8. MAXIMUM TRANSIENT THERMAL IMPEDANCE

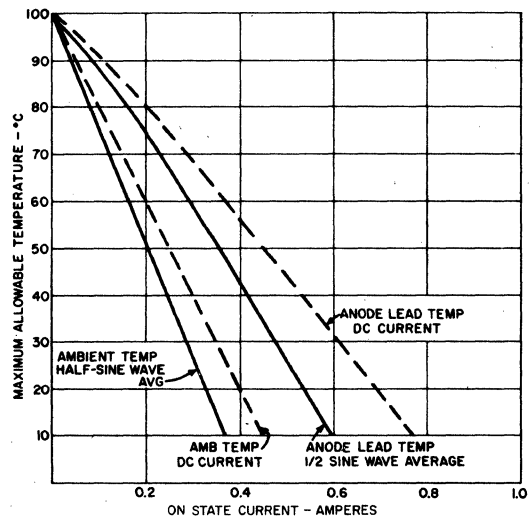

FIGURE 10. ON-STATE CURRENT VS. MAXIMUM ALLOWABLE TEMPERATURE

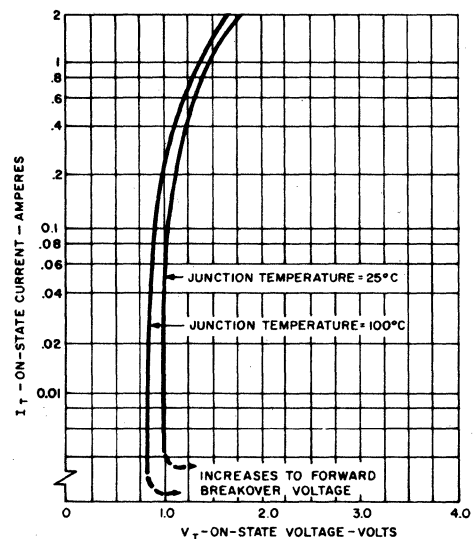
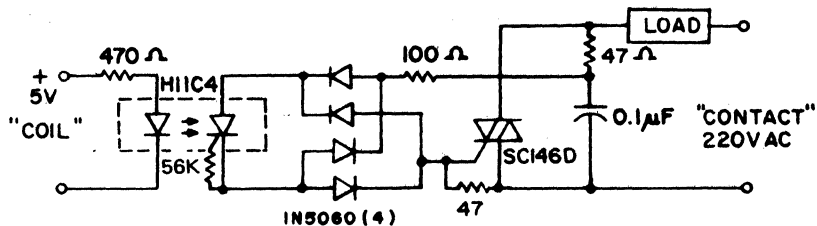

FIGURE 12. ON-STATE CHARACTERISTICS

TYPICAL APPLICATIONS

10A, T²L COMPATIBLE, SOLID STATE RELAY

Use of the H11C4 for high sensitivity, 2500V isolation capability, provides this highly reliable solid state relay design. This design is compatible with 74, 74S and 74H series T²L logic systems inputs and 220V AC loads up to 10A.



25W LOGIC INDICATOR LAMP DRIVER

The high surge capability and non-reactive input characteristics of the H11C allow it to directly couple, without buffers, T²L and DTL logic to indicator and alarm devices, without danger of introducing noise and logic glitches.

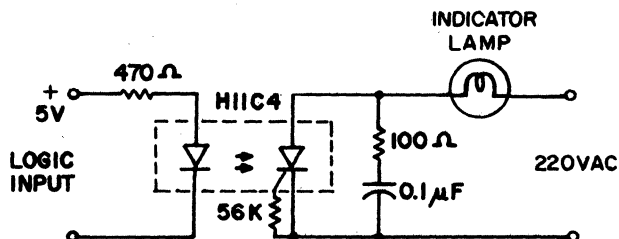

400V SYMMETRICAL TRANSISTOR COUPLER

Use of the high voltage PNP portion of the H11C provides a 400V transistor capable of conducting positive and negative signals with current transfer ratios of over 1%. This function is useful in remote instrumentation, high voltage power supplies and test equipment. Care should be taken not to exceed the H11C 400 mW power dissipation rating when used at high voltages.

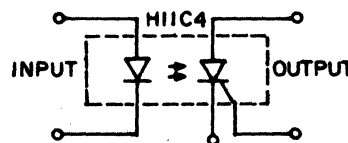
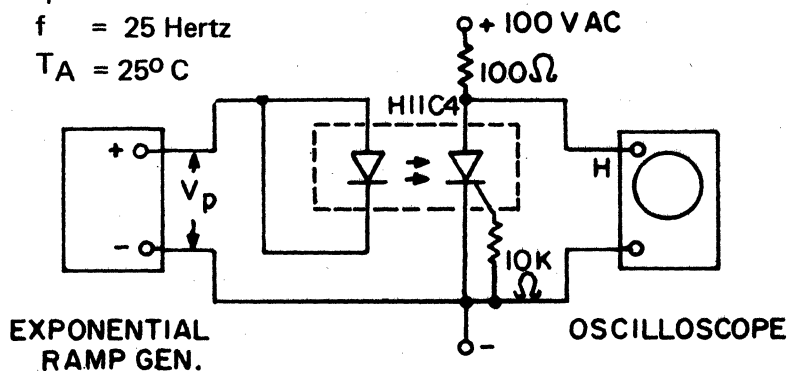
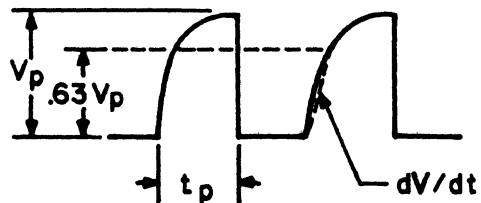

FIGURE 13
COUPLED dv/dt - TEST CIRCUIT

$V_p = 800$ Volts
 $t_p = .010$ Seconds
 $f = 25$ Hertz
 $T_A = 25^\circ$ C





SOLID STATE

OPTO ELECTRONICS

Photon Coupled Isolator H74C1, H74C2

Ga As Infrared Emitting Diode & Light Activated SCR

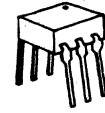

TTL Interface

The General Electric H74C1 and H74C2 are gallium arsenide infrared emitting diodes coupled with light activated silicon controlled rectifiers in a dual in-line package. They are specifically designed to operate from TTL logic inputs and allow control of 120 or 240VAC power with 7400, 74H00 and 74S00 series logic gates. It can also control up to 400VDC power circuits. They are guaranteed and specified to operate over TTL voltage and temperature ranges using standard tolerance components.

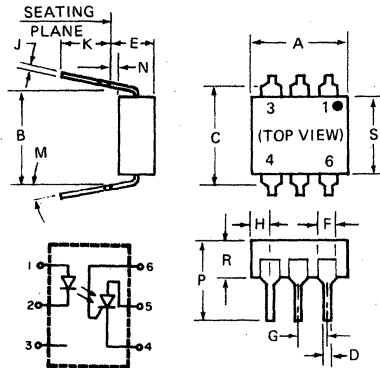

SYMBOL	MILLIMETERS		INCHES		NOTES
	MIN.	MAX.	MIN.	MAX.	
A	8.38	8.89	.330	.350	
B	7.62 REF.		.300 REF.		1
C		8.64		.340	2
D	.406	.508	.016	.020	
E		5.08		.200	3
F	1.01	1.78	.040	.070	
G	2.28	2.80	.090	.110	
H		2.16		.085	4
J	.203	.305	.008	.012	
K	2.54		.100		
M		15°		15°	
N	.381		.015		
P		9.53		.375	
R	2.92	3.43	.115	.135	
S	6.10	6.86	.240	.270	

- NOTES:
 1. INSTALLED POSITION LEAD CENTERS.
 2. OVERALL INSTALLED DIMENSION.
 3. THESE MEASUREMENTS ARE MADE FROM THE SEATING PLANE. 4. FOUR PLACES.

absolute maximum ratings: (25°C) (unless otherwise specified)

INFRARED EMITTING DIODE	
Power Dissipation	*100 milliwatts
Forward Current (Continuous)	60 milliamps
Forward Current (Peak 100µsec 1% duty cycle)	1 ampere
Reverse Voltage	6 volts
*Derate 1.33 mW/°C above 25°C ambient.	

PHOTO - SCR		
Peak Forward Voltage		
H74C1	200	volts
H74C2	400	volts
RMS Forward Current	300	milliamps
Forward Current (Peak, 100µsec 1% duty cycle)	10	amperes
Surge Current (10 msec)	5	amperes
Reverse Gate Voltage	6	volts
Power Dissipation (25°C Ambient)	** 400	milliwatts
Power Dissipation (25°C Case)	***1000	milliwatts
**Derate 5.3 mW/°C above 25°C ambient.		
***Derate 13.3 mW/°C above 25°C case.		

electrical characteristics of H74C

*All specifications refer to the following bias configuration (Figure 1) over the full operating temperature (0°C to 70°C) and logic supply voltage range (4.5 to 5.5V_{DC}) unless otherwise noted.

SCR Leakage, Logic Gate V _{OUT(1)} , Both Directions	50	µA Max.
SCR Drop, Anode Positive, Logic Gate V _{OUT(0)} , I _{TM} = 250mA	1.3	V Max.
Coupled dv/dt to Trigger, V _{DC} to V _{AC} (25°)	500	V/µsec. Min.
Capacitance (Input to Output Voltage = 0, f = 1 MHz)	2	pF Max.
Isolation Resistance (Input to Output Voltage = 500V _{DC})	100	Gigohms Min.
Turn-On Time of SCR; V _{OUT(0)} , Input to Output (25°C)	200	µsec. Max.

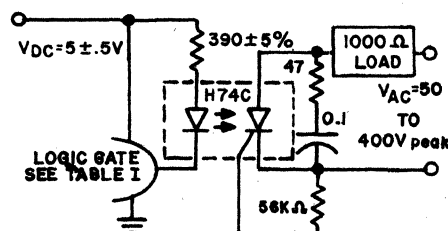

Figure 1. H74C BIAS CIRCUIT

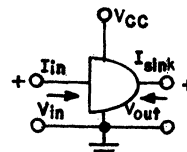

Figure 2.

Covered under U.L. component recognition program, reference file E51868

absolute maximum ratings – total device

H74C1, H74C2

TABLE 1. Characteristics required of TTL gate which is to be interfaced with H74C.

SCR Current	See Figure 4	
Operating Temperature Range	0°C to 70°C	
Operating Voltage Range, V_{DC}	4.5 to 5.5V _{DC}	
Operating Voltage Range, H74C1	50 to 200 V _{pk}	
Operating Voltage Range, H74C2	50 to 400 V _{pk}	
Storage Temperature Range	-55°C to 150°C	
Lead Soldering Time (at 260°C)	10 sec. Max.	
Surge Isolation Voltage (Input to Output)		
	2500V(peak)	1770V _{RMS}
Steady-State Isolation Voltage (Input to Output)		
	1500V(peak)	1060V _{RMS}

PARAMETER	TEST CONDITIONS, FIGURE 2					LIMITS			
	V_{CC}		I_{IN}		I_{SINK}		MIN.	MAX.	UNITS
	MIN.	MAX.	MIN.	MAX.	MIN.	MAX.			
$V_{OUT}(1)$	4.5V					-0.4mA	2.4		Volts
$V_{OUT}(0)$	4.5V				12.0mA		0.4		Volts

TYPICAL CHARACTERISTICS OF OUTPUT (SCR)

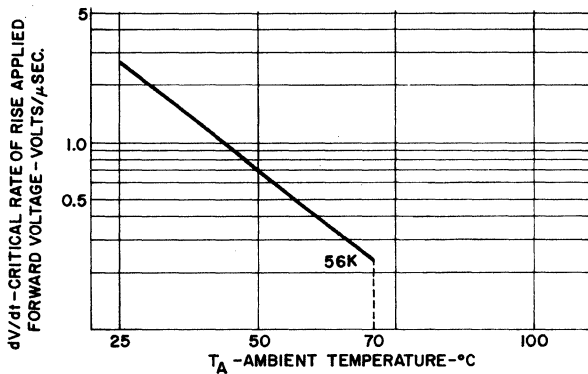

FIGURE 1. dv/dt VS. TEMPERATURE

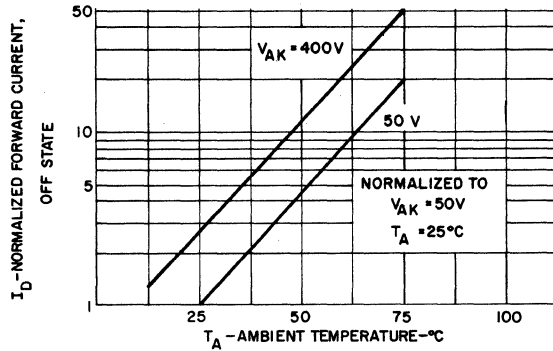

FIGURE 3. OFF-STATE FORWARD CURRENT VS. TEMPERATURE

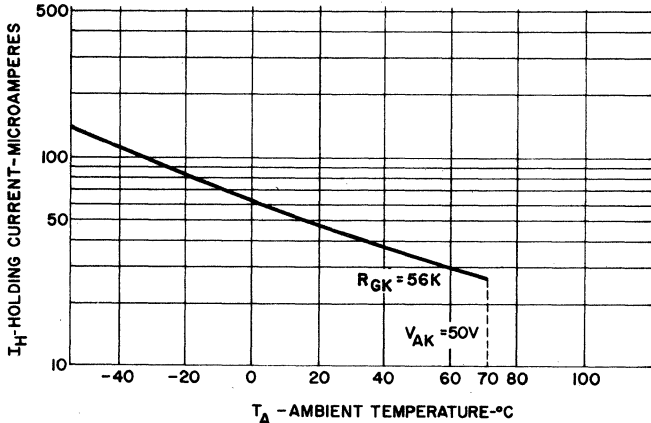

FIGURE 5. HOLDING CURRENT VS. TEMPERATURE

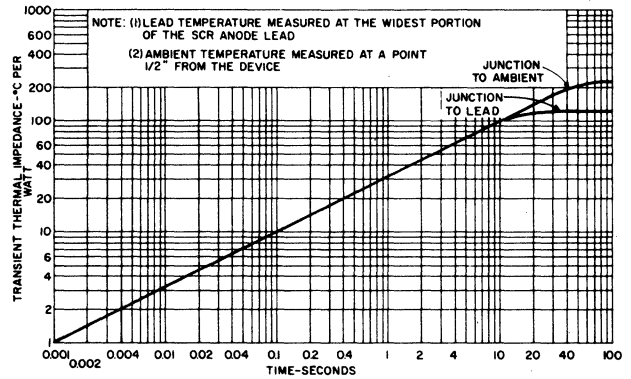

FIGURE 2. MAXIMUM TRANSIENT THERMAL IMPEDANCE

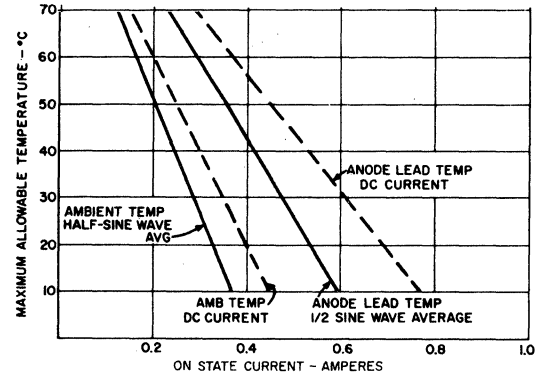

FIGURE 4. ON-STATE CURRENT VS. MAXIMUM ALLOWABLE TEMPERATURE

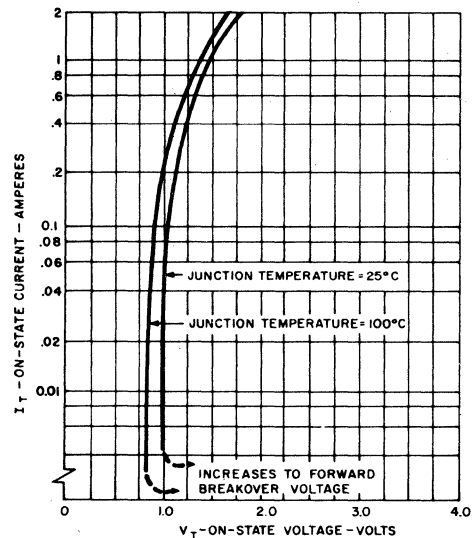

FIGURE 6. ON-STATE CHARACTERISTICS



SOLID STATE

OPTOELECTRONICS

Photon Coupled Isolator H11D1-H11D4

Ga As Infrared Emitting Diode & NPN Silicon High Voltage Photo-Transistor

The General Electric H11D1-H11D4 are gallium arsenide, infrared emitting diodes coupled with silicon high voltage photo-transistors in a dual in-line package.

absolute maximum ratings: (25°C)

INFRARED EMITTING DIODE			
Power Dissipation	*100	milliwatts	
Forward Current (Continuous)	60	milliamps	
Forward Current (Peak)	3	ampere	
(Pulse width 1μsec 300 P Ps)			
Reverse Voltage	6	volts	
*Derate 1.33mW/°C above 25°C ambient.			

PHOTO-TRANSISTOR			
	H11D1-D2	H11D3-D4	
Power Dissipation	**300	**300	milliwatts
V _{CE}	300	200	volts
V _{CBO}	300	200	volts
V _{ECO}	7	7	volts
Collector Current (Continuous)	100	100	milliamps
**Derate 4.0mW/°C above 25°C ambient.			

individual electrical characteristics (25°C)

INFRARED EMITTING DIODE	TYP.	MAX.	UNITS
Forward Voltage (I _F = 10mA)	1.1	1.5	volts
Reverse Current (V _R = 6V)	—	10	microamps
Capacitance (V = 0, f = 1MHz)	50	—	picofarads

coupled electrical characteristics (25°C)

	MIN.	TYP.	MAX.	UNITS
DC Current Transfer Ratio (I _F = 10mA, V _{CE} = 10V, R _{BE} = 1 meg)	20	—	—	%
	10	—	—	%
Saturation Voltage — Collector to Emitter (I _F = 10mA, I _C = 0.5mA, R _{BE} = 1 meg)	—	0.1	0.4	volts
Isolation Resistance (Input to Output Voltage = 500V _{DC})	100	—	—	gigaohms
Input to Output Capacitance (Input to Output Voltage = 0, f = 1MHz)	—	—	2	picofarads
Switching Speeds: Turn-On Time — (V _{CE} = 10V, I _{CE} = 2mA, R _L = 100Ω)	—	5	—	microseconds
Turn-Off Time — (V _{CB} = 10V, I _{CE} = 2mA, R _L = 100Ω)	—	5	—	microseconds

SYMBOL	MILLIMETERS		INCHES		NOTES
	MIN.	MAX.	MIN.	MAX.	
A	8.38	8.89	.330	.350	1
B	7.62	REF.	.300	REF.	
C	—	8.64	—	.340	2
D	.406	.508	.016	.020	
E	—	5.08	—	.200	3
F	1.01	1.78	.040	.070	
G	2.28	2.80	.090	.110	4
H	—	2.16	—	.085	
J	.203	.305	.008	.012	4
K	2.54	—	.100	—	
M	—	15°	—	15°	4
N	.381	—	.015	—	
P	—	9.53	—	.375	4
R	2.92	3.43	.115	.135	
S	6.10	6.86	.240	.270	

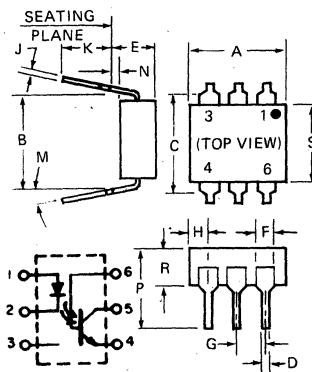

- NOTES:
1. INSTALLED POSITION LEAD CENTERS.
 2. OVERALL INSTALLED DIMENSION.
 3. THESE MEASUREMENTS ARE MADE FROM THE SEATING PLANE.
 4. FOUR PLACES.

TOTAL DEVICE			
Storage Temperature -55 to 150°C			
Operating Temperature -55 to 100°C			
Lead Soldering Time (at 260°C) 10 seconds.			
Surge Isolation Voltage (Input to Output).			
H11D1	3500V _(peak)	2500V _(RMS)	
H11D2, D3, D4	2500V _(peak)	1770V _(RMS)	
Steady-State Isolation Voltage (Input to Output).			
H11D1	2100V _(peak)	1500V _(RMS)	
H11D2, D3, D4	1500V _(peak)	1060V _(RMS)	

Covered under U.L. component recognition program, reference file E51868

VDE Approved to 0883/6.80 0110b Certificate # 35025

TYPICAL CHARACTERISTICS

H11D1 - H11D4

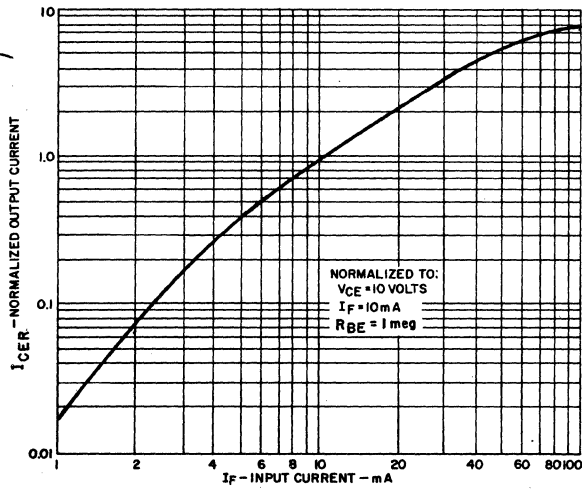

1. OUTPUT CURRENT VS INPUT CURRENT

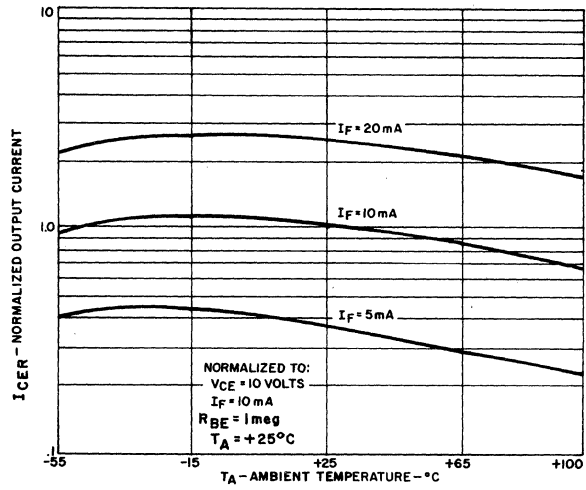

2. OUTPUT CURRENT VS. TEMPERATURE

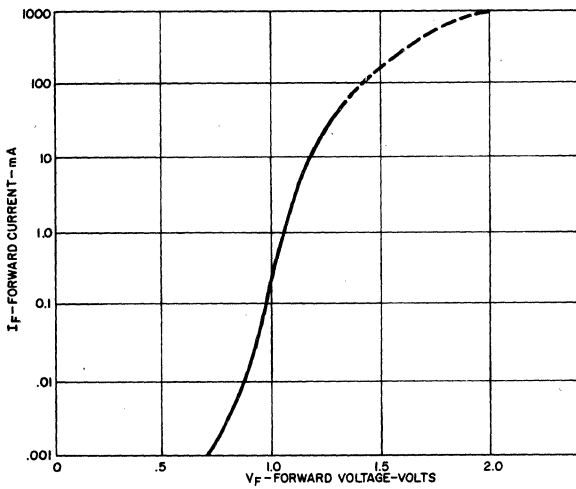

3. INPUT CHARACTERISTICS

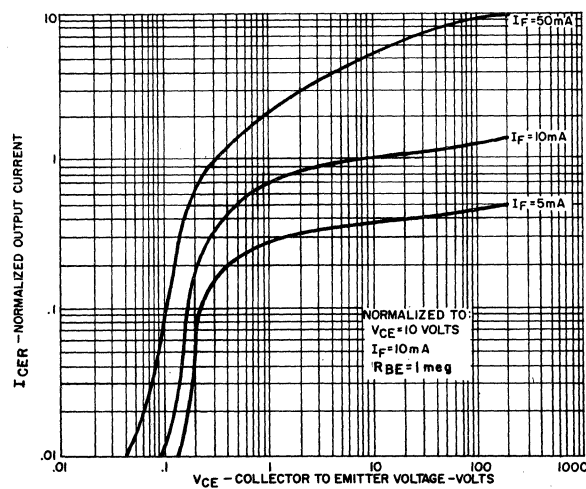

4. OUTPUT CHARACTERISTICS

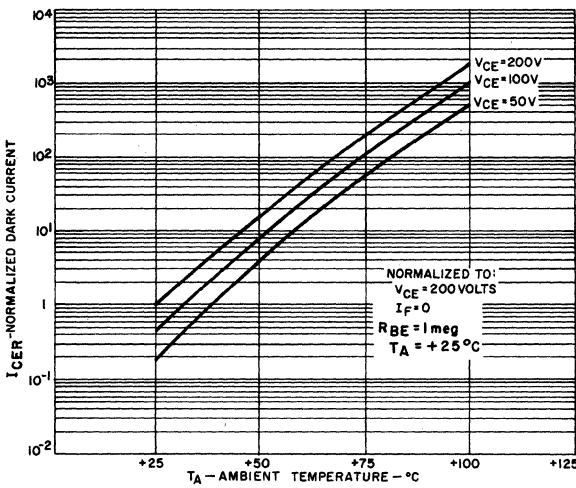

5. NORMALIZED DARK CURRENT VS. TEMPERATURE

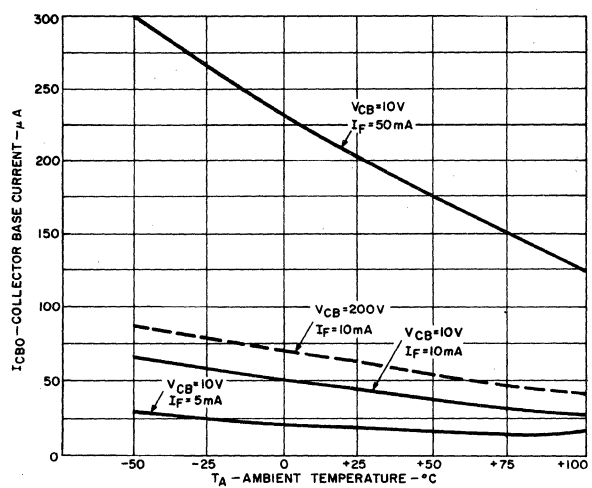

6. COLLECTOR BASE CURRENT VS. TEMPERATURE



SOLID STATE



ELECTRONICS

H11F1, H11F2, H11F3

Photon Coupled Bilateral Analog FET

The General Electric H11F family consists of a gallium arsenide infrared emitting diode coupled to a symmetrical bilateral silicon photo detector. The detector is electrically isolated from the input and performs like an ideal isolated FET designed for distortion-free control of low level A.C. and D.C. analog signals.

FEATURES:

- | | |
|--|--|
| As a Remote Variable Resistor — | As An Analog Signal Switch — |
| • $\leq 100\Omega$ to $\geq 300M\Omega$ | • Extremely Low Offset Voltage |
| • $\geq 99.9\%$ Linearity | • 60V pk-pk Signal Capability |
| • ≤ 15 pF Shunt Capacitance | • No Charge Injection or Latchup |
| • $\geq 100G\Omega$ I/O Isolation Resistance | • $t_{on}, t_{off} \leq 15\mu\text{sec}$. |

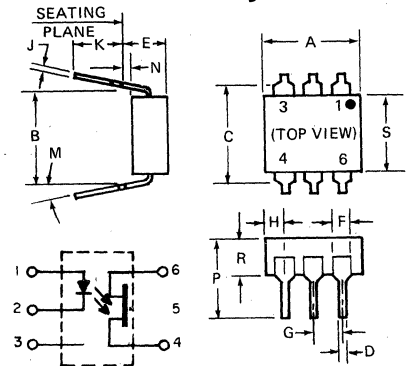
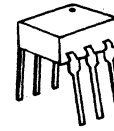

Absolute Maximum Ratings: (25°C Unless Otherwise Specified)

INFRARED EMITTING DIODE		
Power Dissipation	$T_A = 25^\circ\text{C}$	*150 milliwatts
Forward Current (Continuous)		60 milliamps
Forward Current (Peak)		500 milliamps
(Pulse Width 100 μsec 100 pps)		
Forward Current (Peak)		3 amps
(Pulse Width 1 μsec 300 pps)		
Reverse Voltage		6 volts
*Derate 2.0 mW/°C above 25°C.		

PHOTO DETECTOR		
Power Dissipation	$T_A = 25^\circ\text{C}$	**300 milliwatts
Breakdown Voltage		± 30 volts
H11F1 – H11F2		± 15 volts
H11F3		± 100 milliamps
Detector Current (Continuous)		
**Derate 4.0 mW/°C above 25°C.		

TOTAL DEVICE		
Storage Temperature		-55 to +150°C
Operating Temperature		-55 to +100°C
Lead Soldering Time (at 260°C),		10 Seconds
Surge Isolation Voltage (Input to Output)		
H11F1–H11F2	2500 V _(peak)	1770 V _(RMS)
H11F3	1500 V _(peak)	1060 V _(RMS)
Steady-State Isolation Voltage (Input to Output)		
H11F1–H11F2	1500 V _(peak)	1060 V _(RMS)
H11F3	1000 V _(peak)	700 V _(RMS)

SYMBOL	MILLIMETERS		INCHES		NOTES
	MIN.	MAX.	MIN.	MAX.	
A	8.38	8.89	.330	.350	1
B	7.62 REF.		.300 REF.		
C	—	8.64	—	.340	2
D	.406	.508	.016	.020	
E	—	5.08	—	.200	3
F	1.01	1.78	.040	.070	
G	2.28	2.80	.090	.110	4
H	—	2.16	—	.085	
J	.203	.305	.008	.012	4
K	2.54	—	.100	—	
M	—	15°	—	15°	4
N	.381	—	.015	—	
P	—	9.53	—	.375	4
R	2.92	3.43	.115	.135	
S	6.10	6.86	.240	.270	

- NOTES:
 1. INSTALLED POSITION LEAD CENTERS.
 2. OVERALL INSTALLED DIMENSION.
 3. THESE MEASUREMENTS ARE MADE FROM THE SEATING PLANE.
 4. FOUR PLACES.

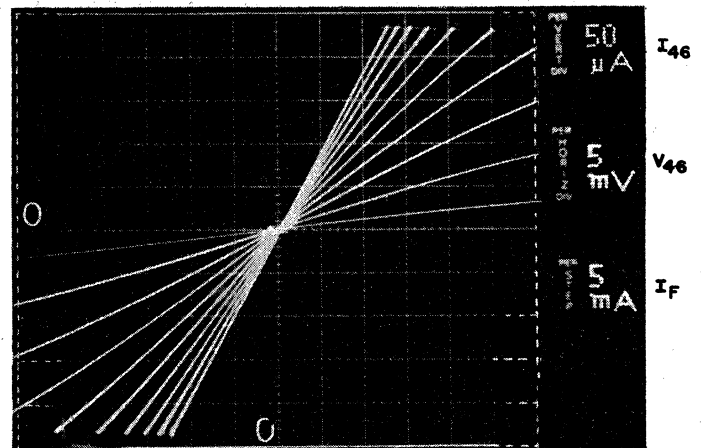

TYPICAL LOW LEVEL OUTPUT CHARACTERISTIC

Covered under U.L. component recognition program, reference file E51868

VDE Approved to 0883/6.80 0110b Certificate # 35025

Individual Electrical Characteristics: (25°C Unless Otherwise Specified)

H11F1, H11F2, H11F3

INFRARED EMITTING DIODE	TYP.	MAX.	UNITS
Forward Voltage ($I_F = 16\text{ mA}$)	1.1	1.75	volts
Reverse Current ($V_R = 6\text{ V}$)	—	10	microamps
Capacitance ($V = 0, f = 1\text{ MHz}$)	50	—	picofarads

PHOTO-DETECTOR (Either Polarity)	MIN.	MAX.	UNITS
Breakdown Voltage— $V_{(BR)46}$ ($I_{46} = 10\mu\text{A}; I_F = 0$) — F1,2	30	—	volts
— F3	15	—	volts
Off-State Dark Current — I_{46} ($V_{46} = 15\text{ V}; I_F = 0; T_A = 25^\circ\text{C}$)	—	50	nanoamps
($V_{46} = 15\text{ V}; I_F = 0; T_A = 100^\circ\text{C}$)	—	50	microamps
Off-State Resistance — r_{46} ($V_{46} = 15\text{ V}; I_F = 0$)	300	—	megohms
Capacitance — C_{46} ($V_{46} = 0, I_F = 0, f = 1\text{ MHz}$)	—	15	picofarads

Coupled Electrical Characteristics: (25°C)

		MIN.	TYP.	MAX.	UNITS
On-State Resistance — r_{46} ($I_F = 16\text{ mA}, I_{46} = 100\mu\text{A}$)	H11F1	—	—	200	ohms
	H11F2	—	—	330	ohms
	H11F3	—	—	470	ohms
On-State Resistance — r_{64} ($I_F = 16\text{ mA}, I_{64} = 100\mu\text{A}$)	H11F1	—	—	200	ohms
	H11F2	—	—	330	ohms
	H11F3	—	—	470	ohms
Isolation Resistance (Input to Output) ($V_{IO} = 500\text{ V}$)		100	—	—	gigohms
Input to Output Capacitance ($V_{IO} = 0, f = 1\text{ MHz}$)		—	—	2	picofarads
Turn-On Time — t_{on} ($I_F = 16\text{ mA}, R_L = 50\Omega, V_{46} = 5\text{ V}$)		—	—	15	microseconds
Turn-Off Time — t_{off} ($I_F = 16\text{ mA}, R_L = 50\Omega, V_{46} = 5\text{ V}$)		—	—	15	microseconds
Resistance, Non-Linearity and Asymmetry ($I_F = 16\text{ mA}, i_{46} = 25\mu\text{A RMS}, f = 1\text{ KHz}$)		—	—	0.1	percent

TYPICAL CHARACTERISTICS (25°C) — EITHER POLARITY

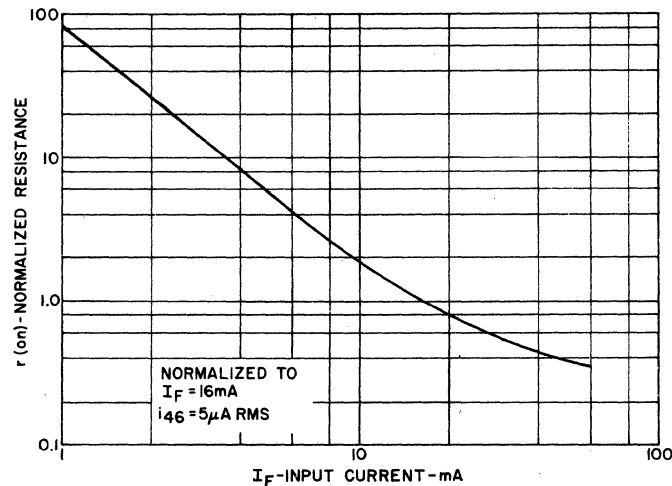

1. RESISTANCE VS. INPUT CURRENT

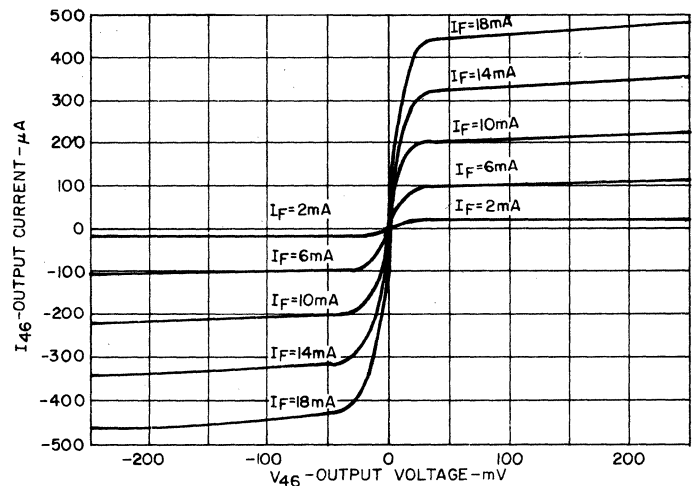

2. OUTPUT CHARACTERISTICS

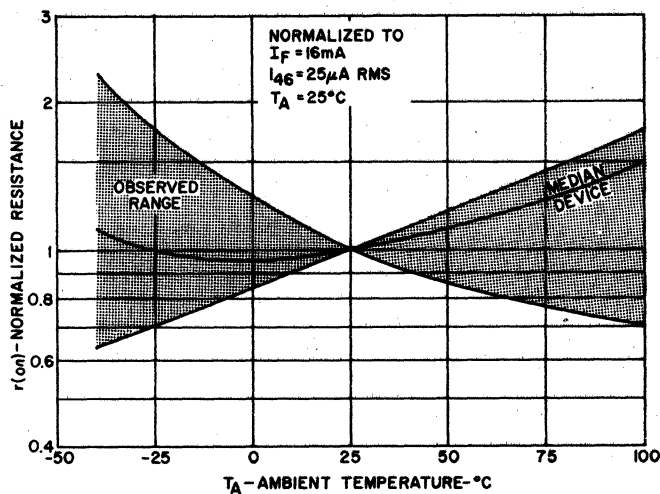

3. RESISTANCE VS. TEMPERATURE

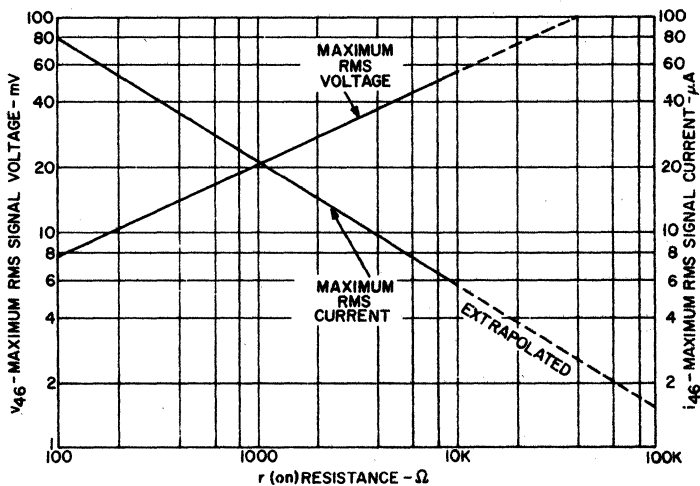

4. REGION OF LINEAR RESISTANCE

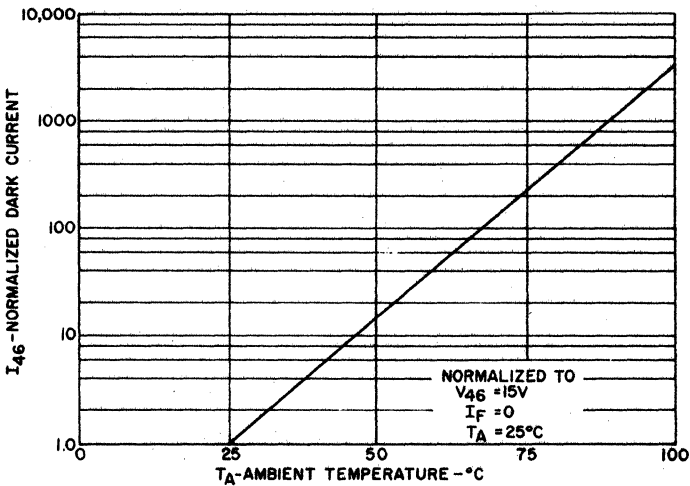

5. OFF-STATE CURRENT VS. TEMPERATURE

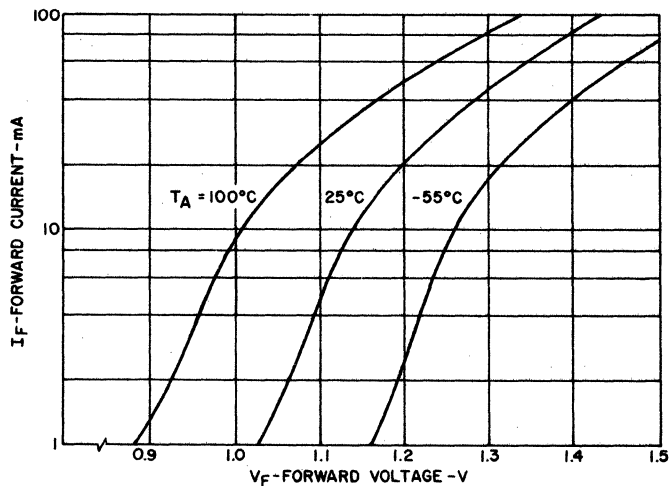

6. FORWARD VOLTAGE VS. FORWARD CURRENT

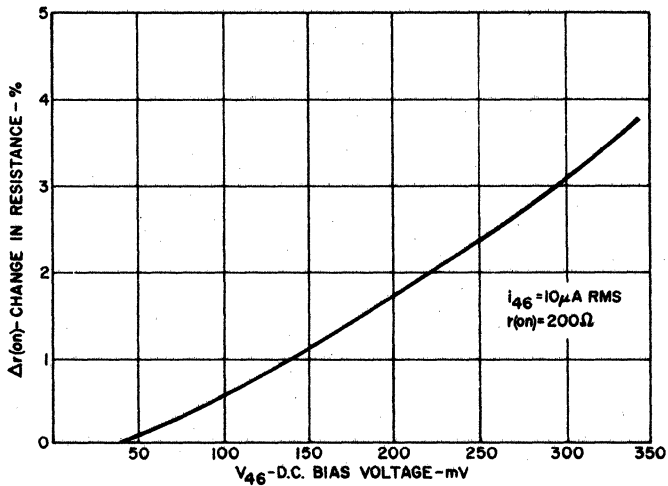

7. RESISTIVE NON-LINEARITY VS. D.C. BIAS

AS A VARIABLE RESISTOR

AS AN ANALOG SIGNAL SWITCH

ISOLATED VARIABLE ATTENUATORS

ISOLATED SAMPLE AND HOLD CIRCUIT

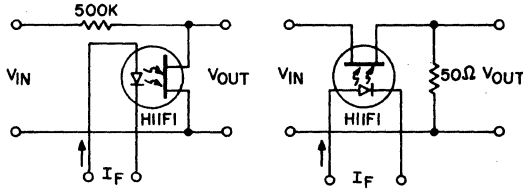

LOW FREQUENCY
 @ 10KHz DYNAMIC RANGE ≈ 70db
 FOR $0 \leq I_F \leq 30\text{mA}$

HIGH FREQUENCY
 @ 1MHz DYNAMIC RANGE ≈ 50db
 FOR $0 \leq I_F \leq 30\text{mA}$

Distortion free attenuation of low level A.C. signals is accomplished by varying the IRED current, I_F . Note the wide dynamic range and absence of coupling capacitors; D.C. level shifting or parasitic feedback to the controlling function.

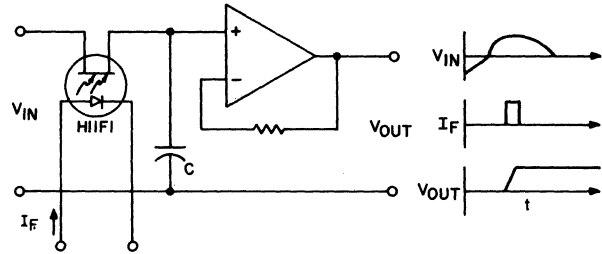

Accuracy and range are improved over conventional FET switches because the H11F has no charge injection from the control signal. The H11F also provides switching of either polarity input signal up to 30V magnitude.

AUTOMATIC GAIN CONTROL

MULTIPLEXED, OPTICALLY-ISOLATED A/D CONVERSION

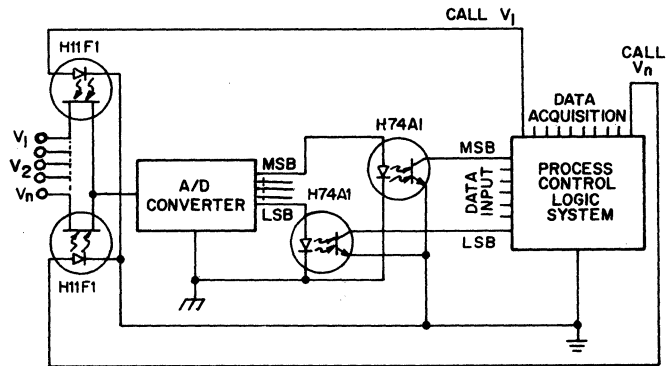
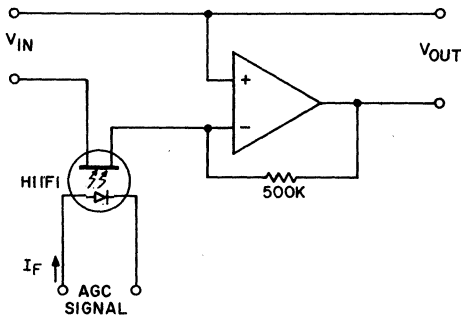

This simple circuit provides over 70db of stable gain control for an AGC signal range of from 0 to 30mA. This basic circuit can be used to provide programmable fade and attack for electronic music and can be modified with six components to a high performance compression amplifier.

The optical isolation, linearity and low offset voltage of the H11F allows the remote multiplexing of low level analog signals from such transducers as thermocouples, Hall effect devices, strain gauges, etc. to a single A/D converter.

ACTIVE FILTER FINE TUNING/BAND SWITCHING

TEST EQUIPMENT – KELVIN CONTACT POLARITY

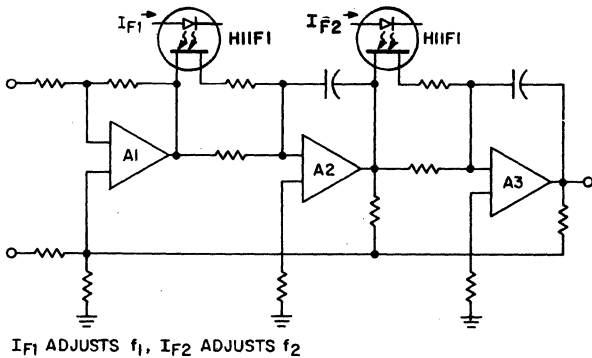

I_{F1} ADJUSTS f_1 , I_{F2} ADJUSTS f_2

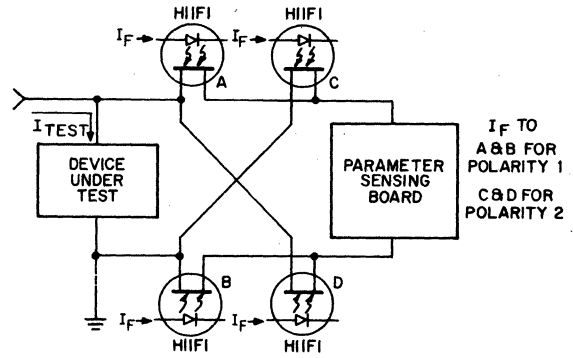

The linearity of resistance and the low offset voltage of the H11F allows the remote tuning or band-switching of active filters without switching glitches or distortion. This schematic illustrates the concept, with current to the H11F1 IRED's controlling the filter's transfer characteristic.

In many test equipment designs the auto polarity function uses reed relay contacts to switch the Kelvin Contact polarity. These reeds are normally one of the highest maintenance cost items due to sticking contacts and mechanical problems. The totally solid-state H11F eliminates these troubles while providing faster switching.



SOLID STATE OPTOELECTRONICS

Photon Coupled Isolator H11G1-H11G2

Ga As Infrared Emitting Diode & NPN Silicon Darlington Connected Phototransistor

The General Electric H11G series consists of a gallium arsenide, infrared emitting diode coupled with a silicon, darlington connected, phototransistor which has an integral base-emitter resistor to optimize switching speeds and elevated temperature characteristics.

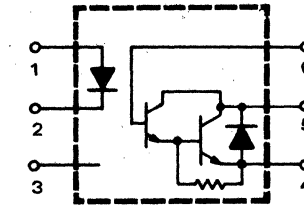
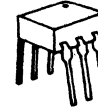

absolute maximum ratings: (25°C)

INFRARED EMITTING DIODE			
Power Dissipation	*100	milliwatts	
Forward Current (Continuous)	60	milliamps	
Forward Current (Peak)			
(Pulse width 300 μsec, 2% Duty Cycle)	0.5	amperes	
(Pulse width 1 μsec, 300 Hz)	3	amperes	
Reverse Voltage	6	volts	
*Derate 1.33mW/°C above 25°C ambient.			

DARLINGTON CONNECTED PHOTO-TRANSISTOR			
Power Dissipation	**150	milliwatts	
V _{CEO}			
— H11G1	100	volts	
— H11G2	80	volts	
V _{CBO}			
— H11G1	100	volts	
— H11G2	80	volts	
V _{EBO}	7	volts	
Collector Current (Continuous)			
— Forward	150	milliamps	
Collector Current (Continuous)			
— Reverse	10	milliamps	
**Derate 2.0mW/°C above 25°C ambient.			

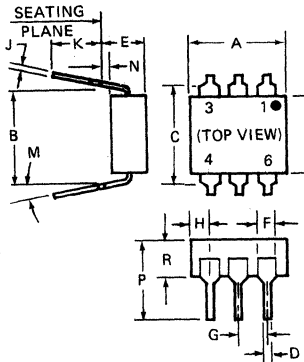

SYMBOL	MILLIMETERS		INCHES		NOTES
	MIN.	MAX.	MIN.	MAX.	
A	8.38	8.89	.330	.350	
B	7.62 REF.		.300 REF.		1
C	—	8.64	—	.340	2
D	.406	.508	.016	.020	
E	—	5.08	—	.200	3
F	1.01	1.78	.040	.070	
G	2.28	2.80	.090	.110	
H	—	2.16	—	.085	4
J	.203	.305	.008	.012	
K	2.54	—	.100	—	
M	—	15°	—	15°	
N	.381	—	.015	—	
P	—	9.53	—	.375	
R	2.92	3.43	.115	.135	
S	6.10	6.86	.240	.270	

- NOTES:
 1. INSTALLED POSITION LEAD CENTERS.
 2. OVERALL INSTALLED DIMENSION.
 3. THESE MEASUREMENTS ARE MADE FROM THE SEATING PLANE.
 4. FOUR PLACES.

TOTAL DEVICE	
Storage Temperature	-55°C to +150°C
Operating Temperature	-55°C to +100°C
Lead Soldering Time (at 260°C)	10 seconds
Surge Isolation Voltage (Input to Output)	
3535 V _(peak)	2500 V _(RMS)
Steady-State Isolation Voltage (Input to Output)	
2125 V _(peak)	1500 V _(RMS)

individual electrical characteristics:(25°C)

EMITTER	TYP.	MAX.	UNITS
Forward Voltage (I _F = 10mA)	1.1	1.5	volts
Reverse Current (V _R = 3V)	—	10	microamps
Capacitance (V = 0, f = 1 MHz)	50	—	picofarads

DETECTOR	MIN.	TYP.	MAX.	UNITS
Breakdown Voltage — V _{(BR)CEO} (I _C = 1.0mA, I _F = 0) — H11G1	100	—	—	volts
— H11G2	80	—	—	volts
Breakdown Voltage — V _{(BR)CBO} (I _C = 100μA, I _F = 0) — H11G1	100	—	—	volts
— H11G2	80	—	—	volts
Breakdown Voltage — V _{(BR)EBO} (I _E = 100μA, I _F = 0)	7	—	—	volts
Collector Dark Current — I _{CEO} (V _{CE} = 80V, I _F = 0) — H11G1	—	—	100	nanoamps
(V _{CE} = 60V, I _F = 0) — H11G2	—	—	100	nanoamps
(V _{CE} = 80V, I _F = 0, T _A = 80°C) — H11G1	—	—	100	microamps
(V _{CE} = 60V, I _F = 0, T _A = 80°C) — H11G2	—	—	100	microamps
Capacitance (V _{CE} = 10V, f = 1 MHz)	—	6	—	picofarads

Covered under U.L. component recognition program, reference file E51868

VDE Approved to 0883/6.80 0110b Certificate # 35025

coupled electrical characteristics:(25°C)

H11G1, H11G2

	MIN.	TYP.	MAX.	UNITS
DC Current Transfer Ratio – ($I_F = 10\text{ mA}$, $V_{CE} = 1\text{ V}$)	1000	–	–	%
– ($I_F = 1\text{ mA}$, $V_{CE} = 5\text{ V}$)	500	–	–	%
Saturation Voltage – Collector to Emitter – ($I_F = 1\text{ mA}$, $I_C = 1\text{ mA}$)	–	0.75	1.0	volts
– ($I_F = 16\text{ mA}$, $I_C = 50\text{ mA}$)	–	0.85	1.0	volts
Isolation Resistance (Input to Output Voltage = 500 V _{DC})	100	–	–	gigohms
Input to Output Capacitance (Input to Output Voltage = 0, f = 1 MHz)	–	–	2	picofarads
Switching Speeds:				
On-Time – ($V_{CE} = 5\text{ V}$, $R_L = 100\Omega$, $I_F = 10\text{ mA}$)	–	5	–	microseconds
Off-Time – (Pulse width $\leq 300\ \mu\text{sec}$, $f \leq 30\text{ Hz}$)	–	100	–	microseconds

TYPICAL CHARACTERISTICS

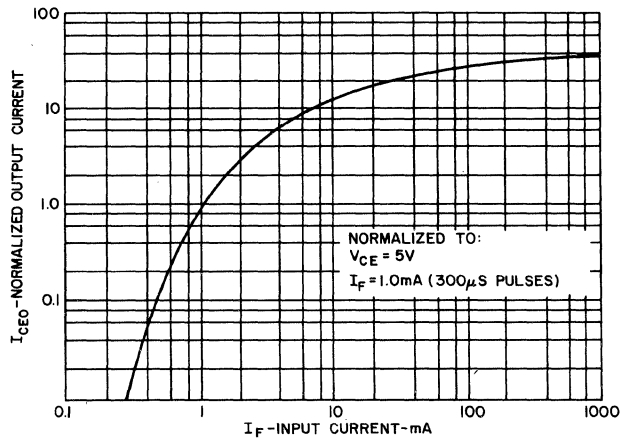

OUTPUT VS. INPUT CURRENT

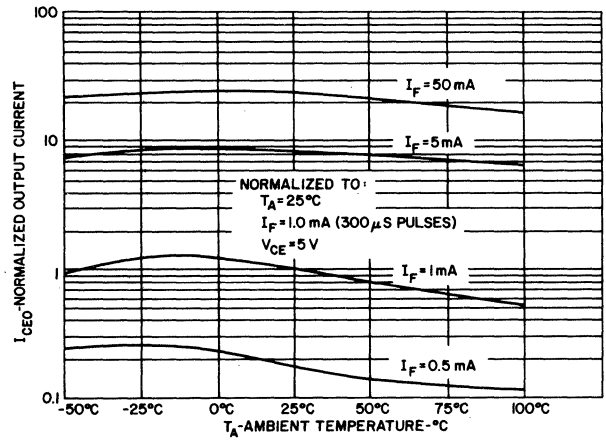

OUTPUT VS. TEMPERATURE

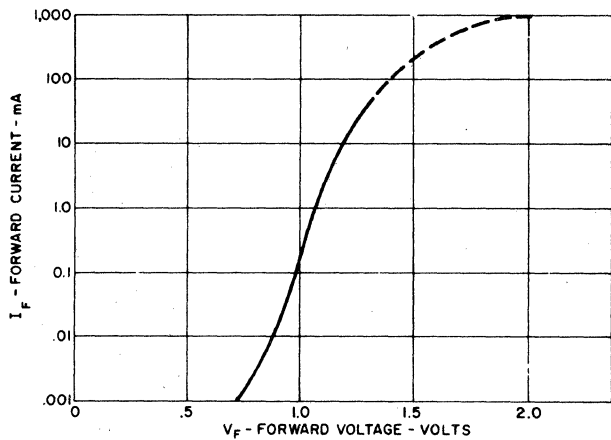

INPUT CHARACTERISTICS

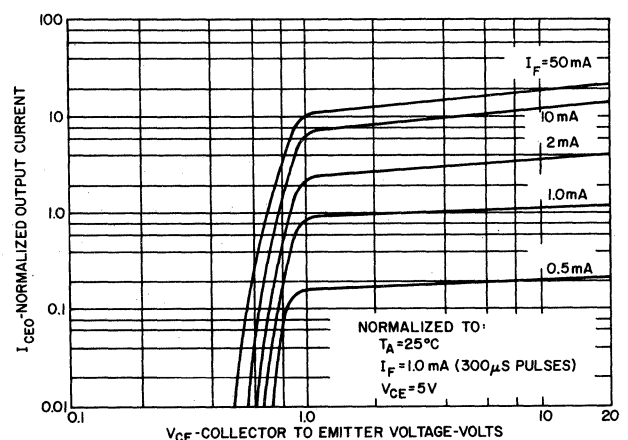

OUTPUT CHARACTERISTICS

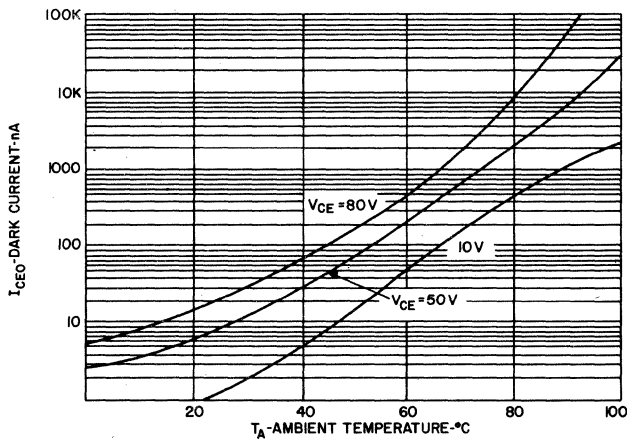

DARK CURRENT

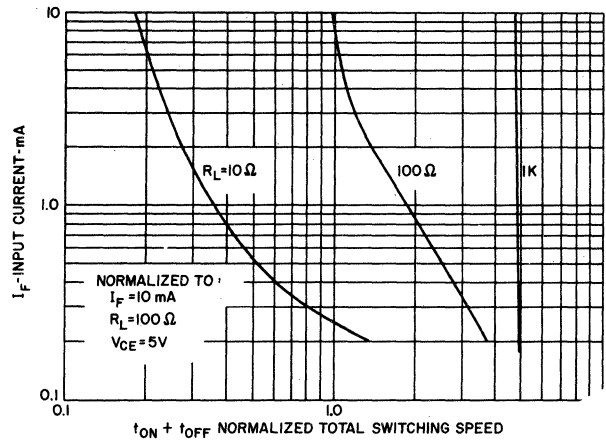

SWITCHING SPEED



SOLID STATE OPTOELECTRONICS

Photon Coupled Isolator H11G3

Ga As Infrared Emitting Diode & NPN Silicon Darlington Connected Phototransistor

The General Electric H11G series consists of a gallium arsenide, infrared emitting diode coupled with a silicon, darlington connected, phototransistor which has an integral base-emitter resistor to optimize switching speeds and elevated temperature characteristics.

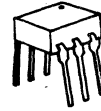
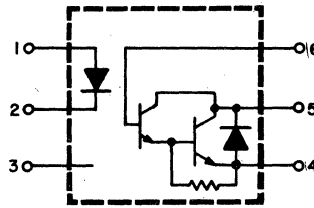

absolute maximum ratings: (25°C)

INFRARED EMITTING DIODE		
Power Dissipation	*100	milliwatts
Forward Current (Continuous)	60	milliamps
Forward Current (Peak) (Pulse width 300 μsec, 2% Duty Cycle)	0.5	amperes
(Pulse width 1 μsec, 300 Hz)	3	amperes
Reverse Voltage	6	volts
*Derate 1.33 mW/°C above 25°C ambient.		

DARLINGTON CONNECTED PHOTO-TRANSISTOR		
Power Dissipation	**150	milliwatts
V _{CEO}	55	volts
V _{CBO}	55	volts
V _{EBO}	7	volts
Collector Current (Continuous) - Forward	100	milliamps
Collector Current (Continuous) - Reverse	10	milliamps
**Derate 2.0 mW/°C above 25°C ambient.		

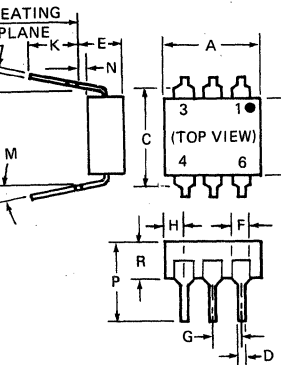

SYMBOL	MILLIMETERS		INCHES		NOTES
	MIN.	MAX.	MIN.	MAX.	
A	8.38	8.89	.330	.350	1
B	7.62 REF.		.300 REF.		
C	—	8.64	—	.340	2
D	.406	.508	.016	.020	
E	—	5.08	—	.200	3
F	1.01	1.78	.040	.070	
G	2.28	2.80	.090	.110	4
H	—	2.16	—	.085	
J	.203	.305	.008	.012	4
K	2.54	—	.100	—	
M	—	15°	—	15°	4
N	.381	—	.015	—	
P	—	9.53	—	.375	4
R	2.92	3.43	.115	.135	
S	6.10	6.86	.240	.270	4

- NOTES:
 1. INSTALLED POSITION LEAD CENTERS.
 2. OVERALL INSTALLED DIMENSION.
 3. THESE MEASUREMENTS ARE MADE FROM THE SEATING PLANE.
 4. FOUR PLACES.

TOTAL DEVICE	
Storage Temperature	-55°C to +150°C
Operating Temperature	-55°C to +100°C
Lead Soldering Time (at 260°C)	10 seconds
Surge Isolation Voltage (Input to Output)	2125 V _(peak) 1500 V _(RMS)
Steady-State Isolation Voltage (Input to Output)	1275 V _(peak) 900 V _(RMS)

individual electrical characteristics:(25°C)

EMITTER	TYP.	MAX.	UNITS
Forward Voltage (I _F = 10 mA)	1.1	1.5	volts
Reverse Current (V _R = 3 V)	—	10	microamps
Capacitance (V = 0, f = 1 MHz)	50	—	picofarads

DETECTOR	MIN.	TYP.	MAX.	UNITS
Breakdown Voltage - V _{(BR)CEO} (I _C = 1.0 mA, I _F = 0)	55	—	—	volts
Breakdown Voltage - V _{(BR)CBO} (I _C = 100 μA, I _F = 0)	55	—	—	volts
Breakdown Voltage - V _{(BR)EBO} (I _E = 100 μA, I _F = 0)	7	—	—	volts
Collector Dark Current - I _{CEO} (V _{CE} = 30 V, I _F = 0)	—	5	100	nanoamps
Capacitance (V _{CE} = 10 V, f = 1 MHz)	—	6	—	picofarads

☑ Covered under U.L. component recognition program, reference file E51868

☑ VDE Approved to 0883/6.80 0110b Certificate# 35025

coupled electrical characteristics:(25°C)

	MIN.	TYP.	MAX.	UNITS
DC Current Transfer Ratio ($I_F = 1 \text{ mA}, V_{CE} = 5 \text{ V}$)	200	—	—	%
Saturation Voltage – Collector to Emitter ($I_F = 20 \text{ mA}, I_C = 50 \text{ mA}$)	—	0.85	1.2	volts
Isolation Resistance (Input to Output Voltage = 500 V_{DC})	100	—	—	gigaohms
Input to Output Capacitance (Input to Output Voltage = 0, $f = 1 \text{ MHz}$)	—	—	2	picofarads
Switching Speeds:				
On-Time – ($V_{CE} = 5 \text{ V}, R_L = 100 \Omega, I_F = 10 \text{ mA}$)	—	5	—	microseconds
Off-Time – (Pulse width $\leq 300 \mu\text{sec}, f \leq 30 \text{ Hz}$)	—	100	—	microseconds

TYPICAL CHARACTERISTICS

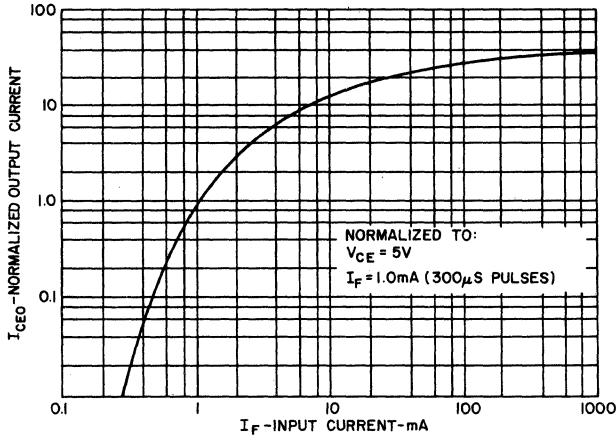

OUTPUT VS. INPUT CURRENT

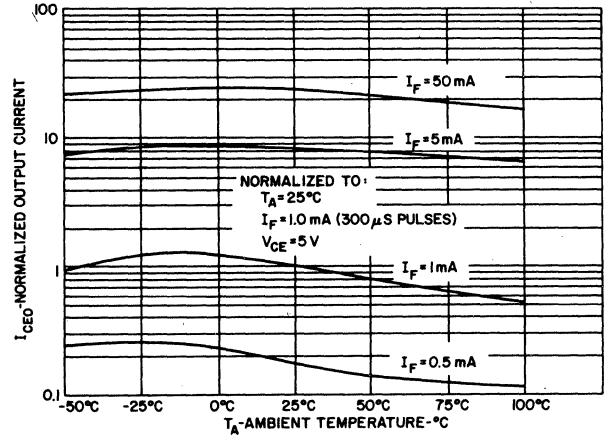

OUTPUT VS. TEMPERATURE

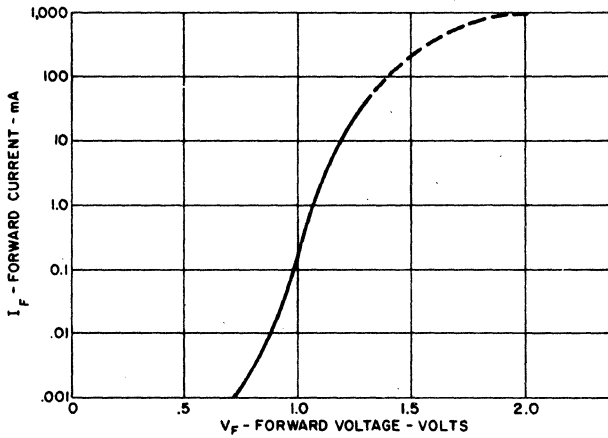

INPUT CHARACTERISTICS

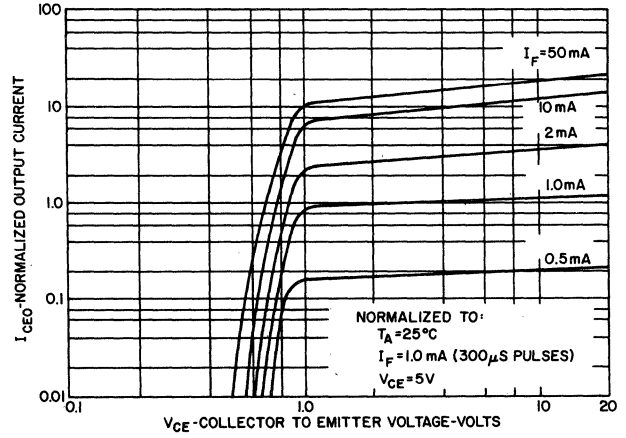

OUTPUT CHARACTERISTICS

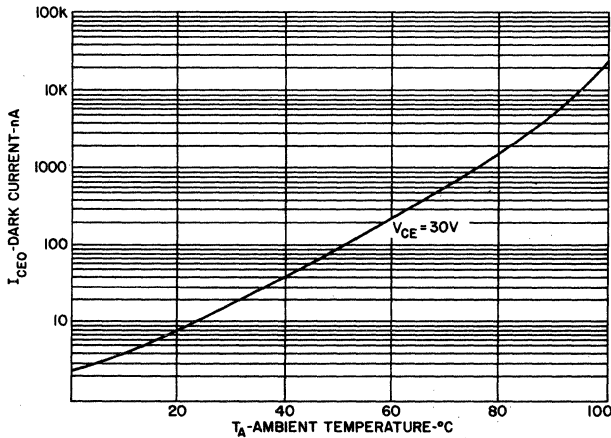

DARK CURRENT

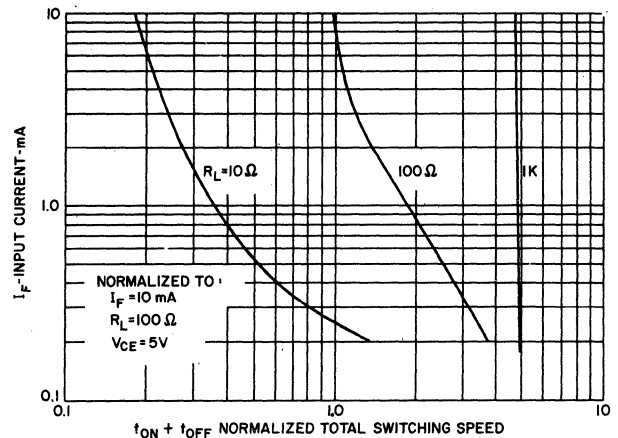

SWITCHING SPEED



SOLID STATE OPTOELECTRONICS

Photon Coupled Isolator H11G45-H11G46

Ga As Infrared Emitting Diode & NPN Silicon Darlington Connected Phototransistor

The General Electric H11G series consists of a gallium arsenide, infrared emitting diode coupled with a silicon, darlington connected, phototransistor which has an integral base-emitter resistor to optimize switching speeds and elevated temperature characteristics. These devices are designed to equal the 4N45 and 4N46 characteristics while providing greater voltage and current capability.

absolute maximum ratings: (25°C)

INFRARED EMITTING DIODE		
Power Dissipation	*100	milliwatts
Forward Current (Continuous)	60	milliamps
Forward Current (Peak)		
(Pulse width 300 μsec, 2% Duty Cycle)	0.5	amperes
(Pulse width 1 μsec, 300 Hz)	3	amperes
Reverse Voltage	6	volts

*Derate 1.33 mW/°C above 25°C ambient.

DARLINGTON CONNECTED PHOTO-TRANSISTOR		
Power Dissipation	**150	milliwatts
Output Voltage V _O (Pin 5-4)	55	volts
Reverse Voltage V _B (Pin 4-6)	7	volts
Output Current (Continuous)		
— Forward	100	milliamps
Output Current (Continuous)		
— Reverse	10	milliamps

**Derate 2.0 mW/°C above 25°C ambient.

individual electric characteristics: (0-70°C)

EMITTER	TYP.	MAX.	UNITS
Forward Voltage (I _F = 10 mA)	1.1	1.7	volts
Reverse Current (V _R = 3V)	—	100	microamps
Capacitance (V = 0, f = 1 MHz)	50	—	picofarads

DETECTOR	MIN.	TYP.	MAX.	UNITS
Output Breakdown Voltage (Pin 5-4) I _{S4} = 1.0mA, I _F = 0	55	—	—	volts
Base Breakdown Voltage (Pin 4-6) I _{A6} = 100μA, I _F = 0	7	—	—	volts
Logic High Output (V _{S4} = 18V, I _F = 0)	—		100	microamps
Capacitance (V _{S4} = 10V, f = 1MHz)	—	6	—	picofarads

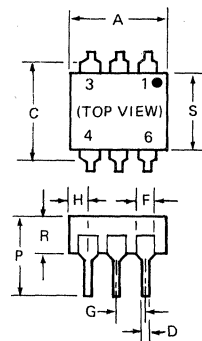
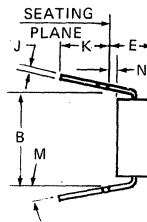
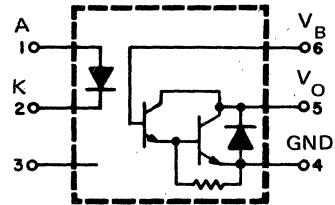
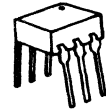

SYMBOL	MILLIMETERS		INCHES		NOTES
	MIN.	MAX.	MIN.	MAX.	
A	8.38	8.89	.330	.350	1
B	7.62 REF.	—	.300 REF.	—	
C	—	8.64	—	.340	2
D	.406	.508	.016	.020	
E	—	5.08	—	.200	3
F	1.01	1.78	.040	.070	
G	2.28	2.80	.090	.110	4
H	—	2.16	—	.085	
J	.203	.305	.008	.012	—
K	2.54	—	.100	—	
M	—	15°	—	15°	—
N	.381	—	.015	—	
P	—	9.53	—	.375	—
R	2.92	3.43	.115	.135	
S	6.10	6.86	.240	.270	—

- NOTES:
 1. INSTALLED POSITION LEAD CENTERS.
 2. OVERALL INSTALLED DIMENSION.
 3. THESE MEASUREMENTS ARE MADE FROM THE SEATING PLANE.
 4. FOUR PLACES.

TOTAL DEVICE	
Storage Temperature	-55°C to +150°C
Operating Temperature	-55°C to +100°C
Lead Soldering Time (at 260°C)	10 seconds
Surge Isolation Voltage (Input to Output)	
5656V _(peak)	4000V _(RMS)
Steady-State Isolation Voltage (Input to Output)	
5100V _(peak)	3600V _(RMS)

Covered under U.L. component recognition program, reference file E51868

VDE Approved to 0883/6.80 0110b Certificate # 35025

coupled electrical characteristics (0-70°C)

	MIN.	TYP.	MAX.	UNITS
DC Current Transfer Ratio — $I_F = 0.5\text{mA}, V_O = 1.0\text{V}$	H11G46	350	—	%
	$I_F = 1.0\text{mA}, V_O = 1.0\text{V}$	H11G46	500	%
	$I_F = 1.0\text{mA}, V_O = 1.0\text{V}$	H11G45	250	%
	$I_F = 10\text{mA}, V_O = 1.2\text{V}$	H11G45, H11G46	200	%
Logic Low Output Voltage — $I_F = 0.5\text{mA}, I_{OL} = 1.75\text{mA}$	H11G46	—	1.0	volts
	$I_F = 1.0\text{mA}, I_{OL} = 5.0\text{mA}$	H11G46	1.0	volts
	$I_F = 1.0\text{mA}, I_{OL} = 2.5\text{mA}$	H11G45	1.0	volts
	$I_F = 10\text{mA}, I_{OL} = 20\text{mA}$	H11G45, H11G46	1.2	volts
Isolation Resistance (Input to Output Voltage = 500VDC)	100	—	—	gigaohms
Input to Output Capacitance (Input to Output Voltage = 0, $f = 1\text{MHz}$)	—	—	2	picofarads

switching characteristics (25°C)

	MIN.	TYP.	MAX.	UNITS
Propagation Delay Time to Logic Low at Output $I_F = 1.0\text{mA}, R_L = 10\text{K}\Omega$	t_{PHL}	80	—	microseconds
Propagation Delay Time to Logic High at Output $I_F = 10\text{mA}, R_L = 220\Omega$	t_{PHL}	5	50	microseconds
Propagation Delay Time to Logic High at Output $I_F = 1.0\text{mA}, R_L = 10\text{K}\Omega$	t_{PLH}	1500	—	microseconds
Propagation Delay Time to Logic Low at Output $I_F = 10\text{mA}, R_L = 220\Omega$	t_{PLH}	150	500	microseconds
Common Mode Transient Immunity at Logic High Level Output $I_F = 0\text{mA}, R_L = 10\text{K}\Omega$ ($V_{CM} = 10\text{Vp-p}$)	CM_H	500	—	volts microsecond
Common Mode Transient Immunity at Logic Low Level Output $I_F = 1.0\text{mA}, R_L = 10\text{K}\Omega$ ($V_{CM} = 10\text{Vp-p}$)	CM_L	500	—	volts microsecond

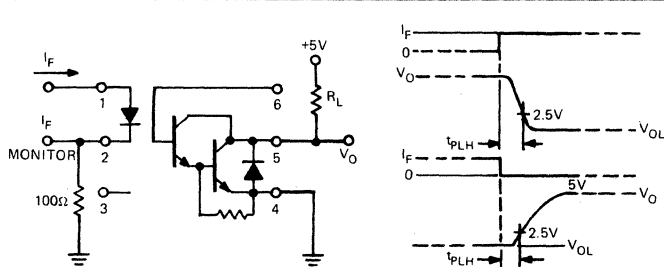

SWITCHING TEST CIRCUIT

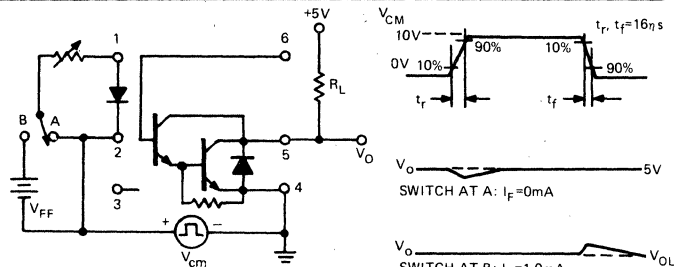

TEST CIRCUIT FOR TRANSIENT IMMUNITY AND TYPICAL WAVEFORMS

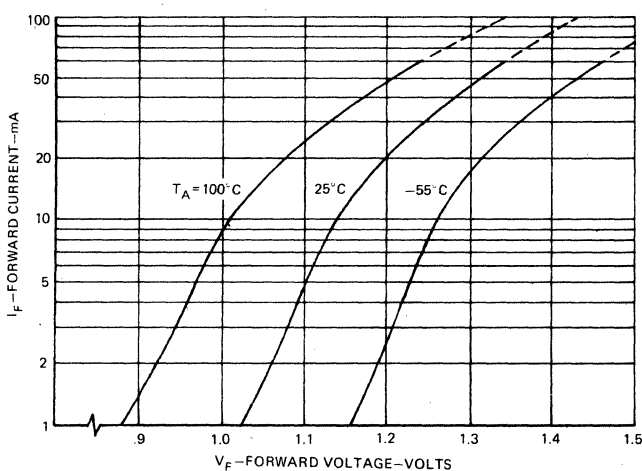

FORWARD VOLTAGE VS. FORWARD CURRENT

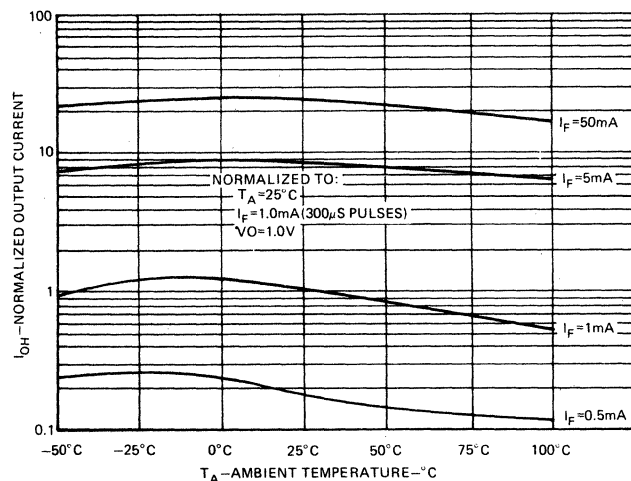

OUTPUT VS. TEMPERATURE



SOLID STATE OPTOELECTRONICS

Photon Coupled Isolator H11J1-H11J5

Ga As Infrared Emitting Diode & Light Activated Triac Driver

The General Electric H11J series consists of a gallium arsenide infrared emitting diode coupled with a light activated silicon bilateral switch, which functions like a triac, in a dual in-line package.

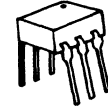

☛ Covered under U.L. component recognition program, reference file E51868

absolute maximum ratings: (25°C)

INFRARED EMITTING DIODE		
Power Dissipation	*100	milliwatts
Forward Current (Continuous)	60	milliamps
Forward Current (Peak) (Pulse width 1 μ sec. 300 pps)	3	amperes
Reverse Voltage	3	volts

*Derate 1.33 mW/°C above 25°C ambient.

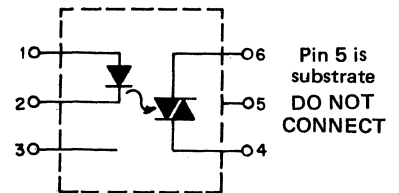

OUTPUT DRIVER		
Off-State Output Terminal Voltage	250	volts
On-State RMS Current (Full Cycle Sine Wave, 50 to 60 Hz)	100	milliamps
Peak Nonrepetitive Surge Current (PW = 10 ms, DC = 10%)	1.2	amperes
Total Power Dissipation @ T _A = 25°C	**300	milliwatts

**Derate 4.0 mW/°C above 25°C.

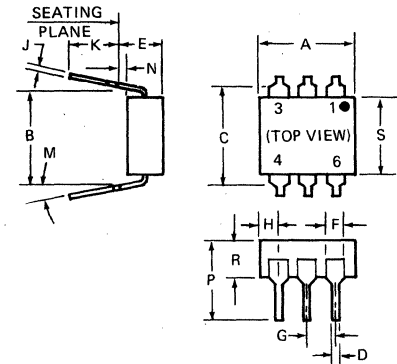

TOTAL DEVICE			
Storage Temperature -55 to 150°C			
Operating Temperature -40 to 100°C			
Lead Soldering Time (at 260°C) 10 seconds			
Surge Isolation Voltage (Input to Output)			
H11J1, H11J2	5656V _(peak)	4000V _(RMS)	
H11J3, H11J4	3535V _(peak)	2500V _(RMS)	
H11J5	2120V _(peak)	1500V _(RMS)	
Steady-State Isolation Voltage (Input to Output)			
H11J1, H11J2	5100V _(peak)	3600V _(RMS)	
H11J3, H11J4	3200V _(peak)	2250V _(RMS)	
H11J5	1900V _(peak)	1350V _(RMS)	

SYMBOL	MILLIMETERS		INCHES		NOTES
	MIN.	MAX.	MIN.	MAX.	
A	8.38	8.89	.330	.350	1
B	7.62 REF.		.300 REF.		
C	—	8.64	—	.340	2
D	.406	.508	.016	.020	
E	—	5.08	—	.200	3
F	1.01	1.78	.040	.070	
G	2.28	2.80	.090	.110	4
H	—	2.16	—	.085	
J	.203	.305	.008	.012	4
K	2.54	—	.100	—	
M	—	15°	—	15°	4
N	.381	—	.015	—	
P	—	9.53	—	.375	4
R	2.92	3.43	.115	.135	
S	6.10	6.86	.240	.270	4

- NOTES:
 1. INSTALLED POSITION LEAD CENTERS.
 2. OVERALL INSTALLED DIMENSION.
 3. THESE MEASUREMENTS ARE MADE FROM THE SEATING PLANE.
 4. FOUR PLACES.

individual electrical characteristics (25°C)

EMITTER	SYMBOL	TYP.	MAX.	UNITS
Forward Voltage ($I_F = 10 \text{ mA}$)	V_F	1.2	1.5	volts
Reverse Current ($V_R = 3\text{V}$)	I_R	—	100	microamps
Capacitance ($V = 0, f = 1 \text{ MHz}$)	C_J	50	—	picofarads

DETECTOR	See Note 1	SYMBOL	TYP.	MAX.	UNITS
Peak Off-State Current	$V_{DRM} = 250\text{V}$	I_{DRM}	—	100	nanoamps
Peak On-State Voltage	$I_{TM} = 100 \text{ mA}$	V_{TM}	2.5	3.0	volts
Critical Rate-of-Rise of Off-State Voltage	$V_{in} = 30\text{V(RMS)}$ (See Figure 6)	dv/dt	4.0	—	volts/ $\mu\text{sec.}$
Critical Rate-of-Rise of Commutating Off-State Voltage	$I_{load} = 15 \text{ mA}$ $V_{in} = 30\text{V(RMS)}$ (See Figure 6)	$dv/dt(C)$	0.15	—	volts/ $\mu\text{sec.}$
Critical Rate-of-Rise of Off-State Voltage	$V_{in} = 120\text{V(RMS)}$ JEDEC conditions	dv/dt	2.0	—	volts/ $\mu\text{sec.}$

coupled electrical characteristics (25°C)

		SYMBOL	TYP.	MAX.	UNITS
IRED Trigger Current, Current Required to Latch Output (Main Terminal Voltage = 3.0V, $R_L = 150 \Omega$)	H11J1, H11J3	I_{FT}	—	10	milliamps
	H11J2, H11J4	I_{FT}	—	15	milliamps
	H11J5	I_{FT}	—	25	milliamps
Holding Current, Either Direction (Main Terminal Voltage 3.0V, Initiating Current — 10 mA)		I_H	250	—	microamps

NOTE 1: Ratings apply for either polarity of Pin 6 — referenced to Pin 4.

TYPICAL CHARACTERISTICS

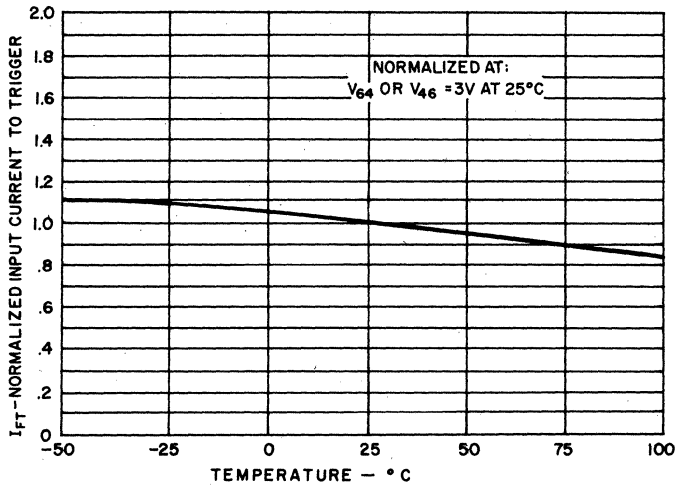

FIGURE 1. INPUT CURRENT TO TRIGGER VS. TEMPERATURE

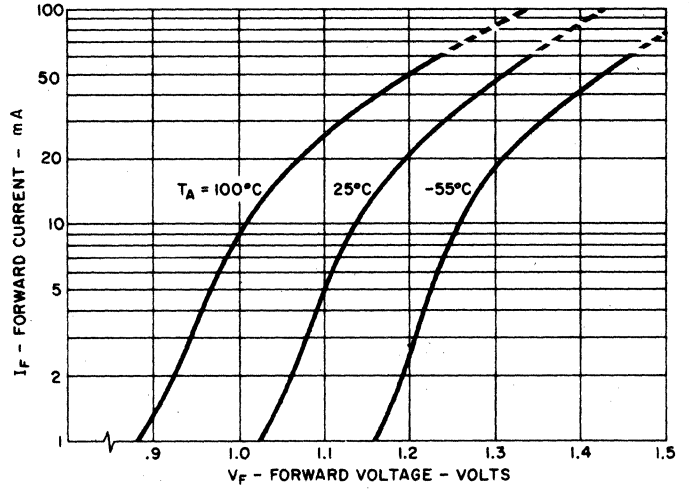

FIGURE 2. FORWARD VOLTAGE VS. FORWARD CURRENT

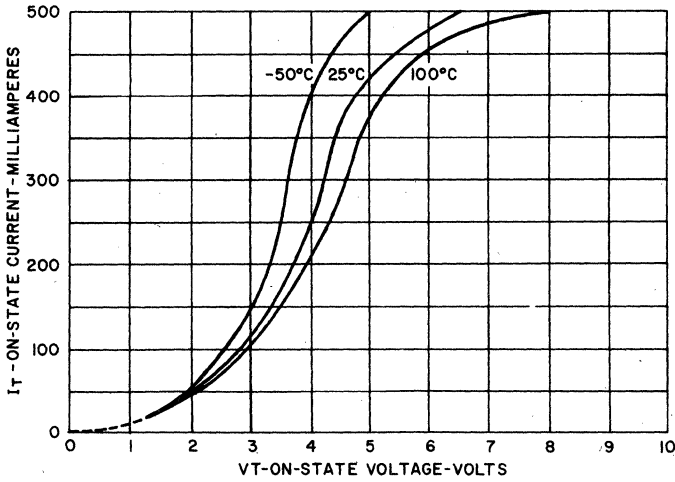

FIGURE 3. ON-STATE VOLTAGE VS. OUTPUT CURRENT

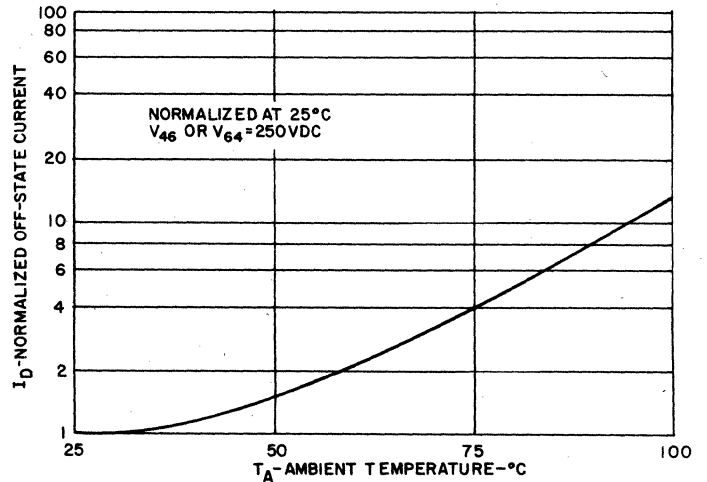

FIGURE 4. OFF-STATE CURRENT VS. TEMPERATURE

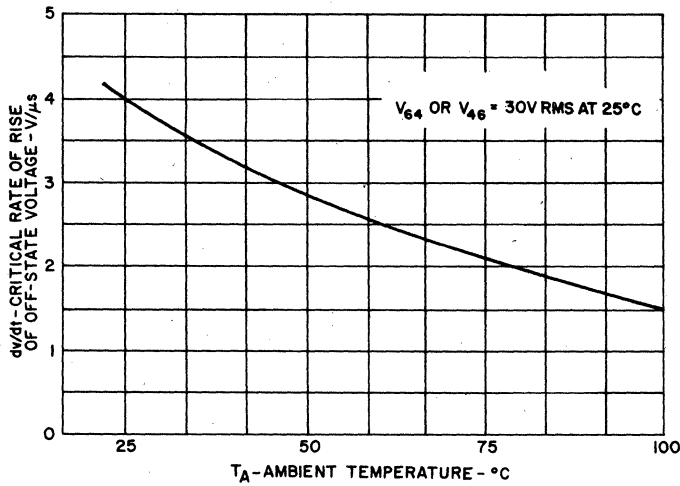

FIGURE 5. dv/dt VS. TEMPERATURE

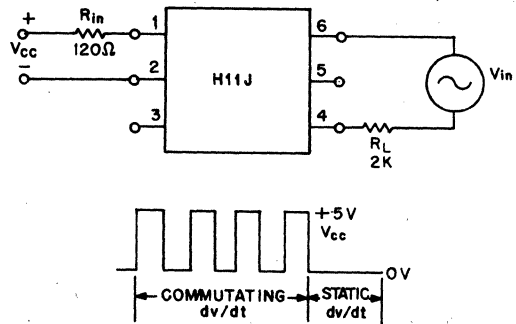
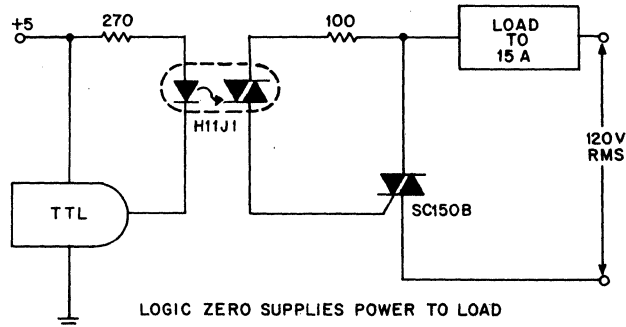
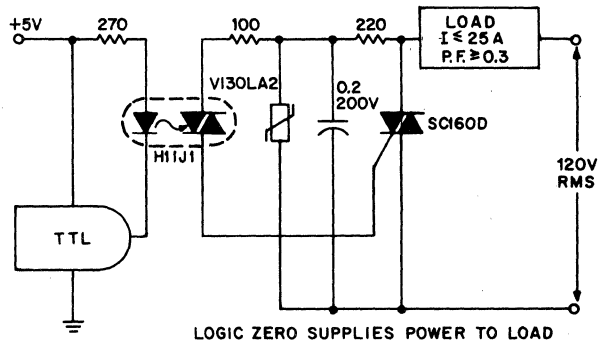

FIGURE 6. dv/dt - TEST CIRCUIT

TYPICAL APPLICATION CIRCUITS
TTL COMPATIBLE LOGIC CONTROL OF POWER LINE



RESISTIVE LOAD AND NON-CRITICAL APPLICATIONS
LOW COST, LIMITED NOISE AND dv/dt IMMUNITY



INDUCTIVE LOADS AND CRITICAL APPLICATIONS
GOOD dv/dt AND NOISE IMMUNITY

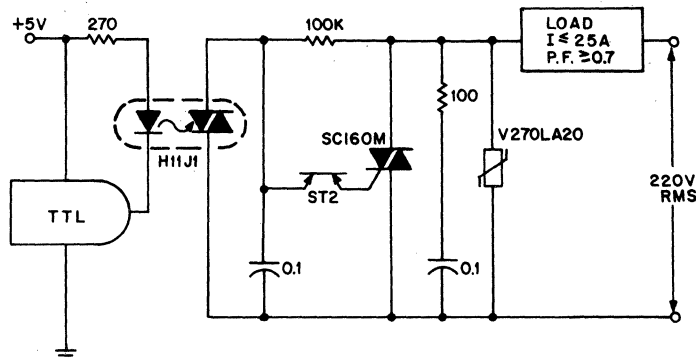

INDUSTRIAL VOLTAGES AND CRITICAL APPLICATIONS
EXCELLENT dv/dt , NOISE AND OVERVOLTAGE CAPABILITY



SOLID STATE OPTOELECTRONICS

Photon Coupled Isolator H11L1, H11L2, H11L3

Ga As Infrared Emitting Diode & Microprocessor Compatible Schmitt Trigger

The H11L series has a gallium arsenide, infrared emitting diode optically coupled across an isolating medium to a high speed integrated circuit detector. The output incorporates a Schmitt Trigger which provides hysteresis for noise immunity and pulse shaping. The detector circuit is optimized for simplicity of operation and utilizes an open collector output for maximum application flexibility.

FEATURES

- Free from latch up and oscillation throughout voltage and temperature ranges
- High data rate, 1 MHz typical (NRZ)
- Microprocessor compatible drive
- Logic compatible output sinks 16 milliamperes at 0.4 volts maximum
- High isolation between input and output
- Guaranteed On/Off threshold hysteresis
- High common mode rejection ratio
- Fast switching : $t_{rise}, t_{fall} = 100$ nanoseconds typical
- Wide supply voltage capability, compatible with all popular logic systems

MECHANICAL SPECIFICATIONS

- Plastic 6 PIN dual in line package, tin plated leads
- Lead orientation as shown:

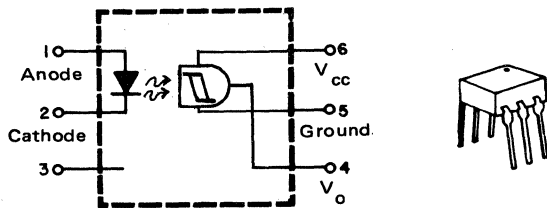

absolute maximum ratings: (25°C)

INFRARED EMITTING DIODE		
Power Dissipation	*100	milliwatts
Forward Current (Continuous)	60	milliampere
Forward Current (Peak) (Pulse width 300 μ sec. 2% Duty Cycle)	0.5	ampere
Reverse Voltage	6	volts
*Derate 1.33 mW/°C above 25°C ambient.		

PHOTO DETECTOR		
Power Dissipation	**150	milliwatts
V ₄₅ Allowed Range	0 to 16	volts
V ₆₅ Allowed Range	0 to 16	volts
I ₄ Output Current	50	milliampere
**Derate 2.0 mW/°C above 25°C ambient.		

APPLICATIONS

- Logic to logic isolator
- Programmable current level sensor
- Line receiver – eliminates noise and transient problems
- Logic level shifter – couples TTL to CMOS
- A.C. to TTL conversion – square wave shaping
- Digital programming of power supplies
- Interfaces computers with peripherals

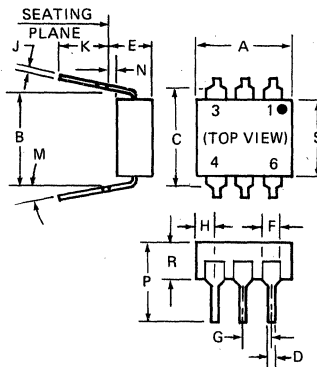

SYMBOL	MILLIMETERS		INCHES		NOTES
	MIN.	MAX.	MIN.	MAX.	
A	8.38	8.89	.330	.350	1
B	7.62 REF.		.300 REF.		
C	—	8.64	—	.340	2
D	.406	.508	.016	.020	
E	—	5.08	—	.200	3
F	1.01	1.78	.040	.070	
G	2.28	2.80	.090	.110	4
H	—	2.16	—	.085	
J	.203	.305	.008	.012	4
K	2.54	—	.100	—	
M	—	15°	—	15°	—
N	.381	—	.015	—	
P	—	9.53	—	.375	—
R	2.92	3.43	.115	.135	
S	6.10	6.86	.240	.270	—

- NOTES:
 1. INSTALLED POSITION LEAD CENTERS.
 2. OVERALL INSTALLED DIMENSION.
 3. THESE MEASUREMENTS ARE MADE FROM THE SEATING PLANE. 4. FOUR PLACES.

TOTAL DEVICE	
Storage Temperature -55°C to +150°C	
Operating Temperature -55°C to +100°C	
Lead Soldering Time (at 260°C) 10 seconds	
Surge Isolation Voltage (Input to Output)	
3535 V _(peak)	2500 V _(RMS)
Steady-State Isolation Voltage (Input to Output)	
2125 V _(peak)	1500 V _(RMS)

Covered under U.L. component recognition program, reference file E51868

electrical characteristics: (0-70°C)

INFRARED EMITTING DIODE		MIN.	TYP.	MAX.	UNITS	PHOTO DETECTOR		MIN.	TYP.	MAX.	UNITS
Forward Voltage	V_F	-	1.10	1.50	volts	Operating Voltage Range	V_{CC}	3	-	15	volts
$I_F = 10 \text{ mA}$		0.75	0.95	-	volts	Supply Current	$I_{6(\text{off})}$	-	1.0	5.0	milli-ampere
$I_F = 0.3 \text{ mA}$					volts	($I_F = 0, V_{CC} = 5V$)					
Reverse Current	I_R	-	-	10	micro-ampere	Output Current, High	I_{OH}	-	-	100	micro-ampere
($V_R = 3V$)						($I_F = 0, V_{CC} = V_o = 15V$)					
Capacitance	C_J	-	-	100	picofarads						
($V = 0, f = 1 \text{ MHz}$)											

coupled electrical characteristics (0-70°C)

		MIN.	TYP.	MAX.	UNITS
Supply Current	$I_{6(\text{on})}$	-	1.6	5.0	milliampere
($I_F = 10 \text{ mA}, V_{CC} = 5V$)					
Output Voltage, Low	V_{OL}	-	0.2	0.4	volts
($R_{64} = 270 \Omega, V_{CC} = 5V, I_F = I_{F(\text{on})} \text{ Max}$)					
Turn-On Threshold Current	$I_{F(\text{on})}$				
($R_{64} = 270 \Omega, V_{CC} = 5V$)	H11L1	-	1.0	1.6	milliampere
	H11L2	-	6.0	10.0	milliampere
	H11L3	-	3.0	5.0	milliampere
Turn-Off Threshold Current	$I_{F(\text{off})}$	0.3	1.0	-	milliampere
($R_{64} = 270 \Omega, V_{CC} = 5V$)					
Hysteresis Ratio	$I_{F(\text{off})}/I_{F(\text{on})}$	0.50	0.75	0.90	-
($R_{64} = 270 \Omega, V_{CC} = 5V$)					

switching characteristics (25°C) H11L1

SWITCHING SPEED		MIN.	TYP.	MAX.	UNITS
$R_E = 1200\Omega, C=0$					
Turn-On Time	t_{on}	-	1.0	-	$\mu\text{sec.}$
Fall Time	t_f	-	0.1	-	$\mu\text{sec.}$
Turn-Off Time	t_{off}	-	2.0	-	$\mu\text{sec.}$
Rise Time	t_r	-	0.1	-	$\mu\text{sec.}$
$R_E = 1200\Omega, C=270\mu\text{F}, f \leq 100\text{KHz}, t_p \geq 1\mu\text{sec}$					
Turn-On Time	t_{on}	-	0.65	-	$\mu\text{sec.}$
Fall Time	t_f	-	0.05	-	$\mu\text{sec.}$
Turn-Off Time	t_{off}	-	1.20	-	$\mu\text{sec.}$
Rise Time	t_r	-	0.07	-	$\mu\text{sec.}$
Data Rate (NRZ)		-	1.0*	-	MHz
<u>Overdrive Switching</u>					
$V_{IN} = 5V \text{ DC}, R_E = 75 \Omega, C=0, V_{CC} = 5V, R_L = 270 \Omega$					
Turn-Off Time	t_{off}	-	-	10	$\mu\text{sec.}$

*Maximum data rate will vary depending on the bias conditions and is usually highest when R_E and C are matched to $I_{F(\text{on})}$ and V_{CC} is between 3 and 5V, with this optimized bias, most units will operate at over 1.5 MHz, NRZ.

H11L1, H11L2, H11L3

switching characteristics (25°C)

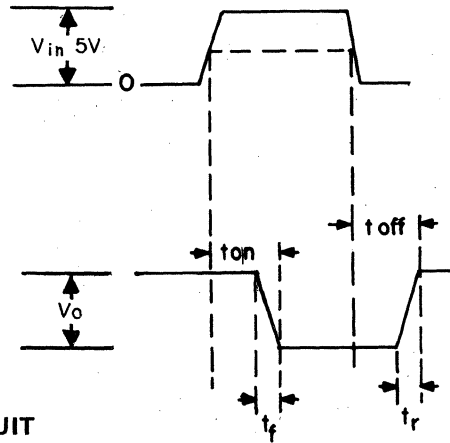
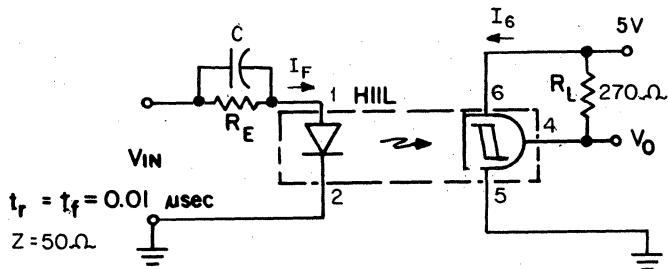

SWITCHING TEST CIRCUIT

TYPICAL CHARACTERISTICS

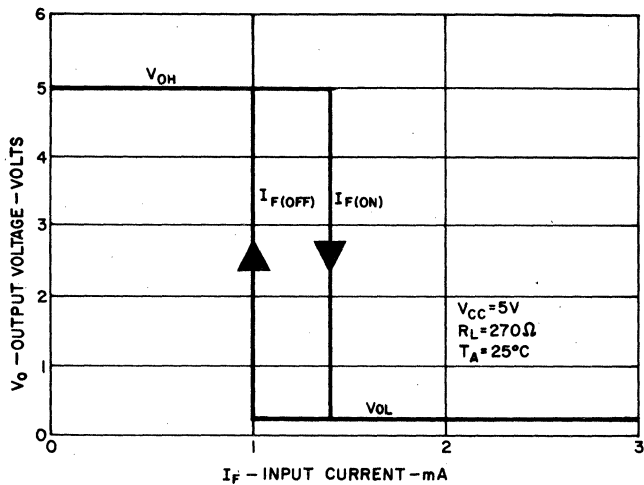

TRANSFER CHARACTERISTICS

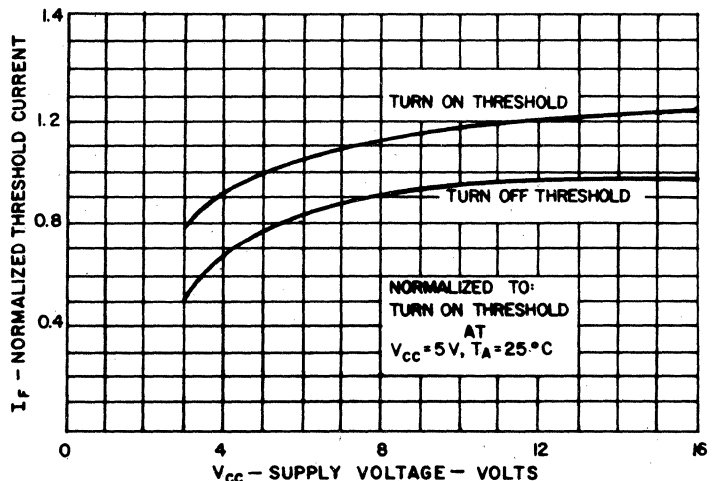

THRESHOLD CURRENT VS. SUPPLY VOLTAGE

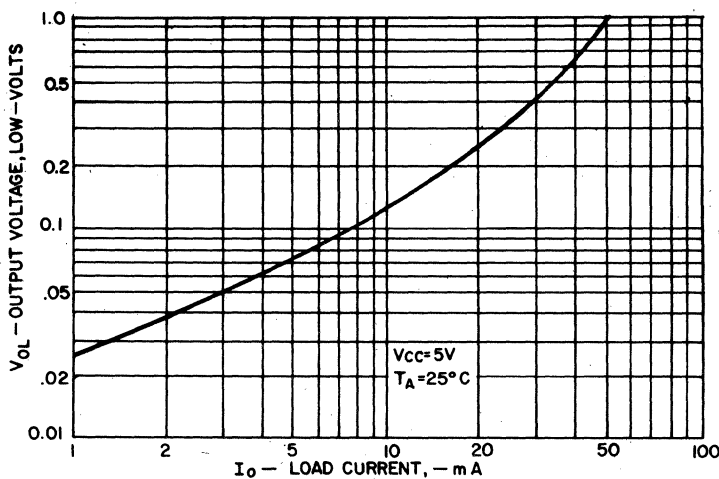

ON VOLTAGE VS. LOAD CURRENT

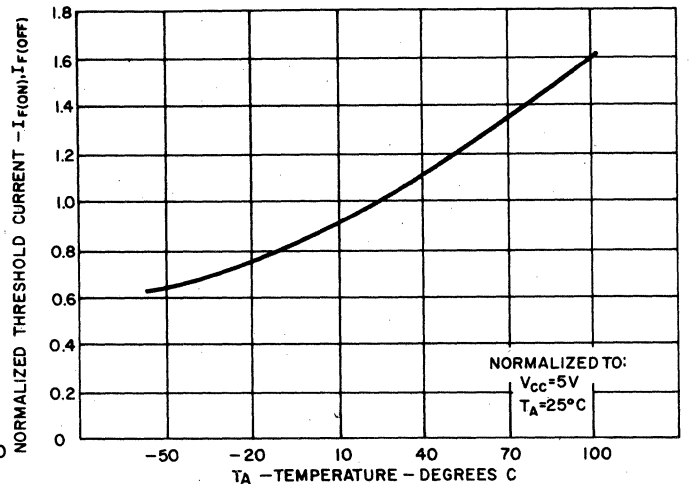

THRESHOLD CURRENTS VS. TEMPERATURE

H11L1, H11L2, H11L3

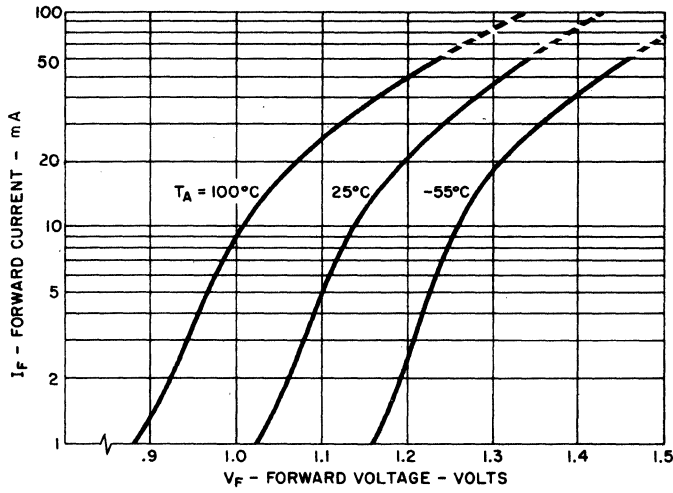

FORWARD VOLTAGE VS. FORWARD CURRENT

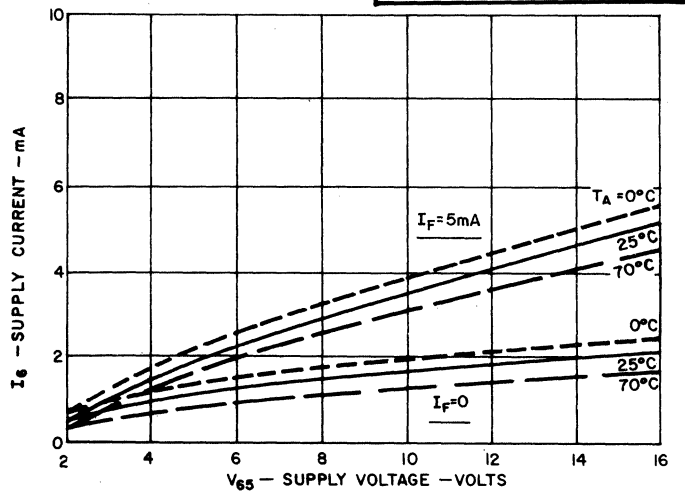

SUPPLY CURRENT VS. SUPPLY VOLTAGE

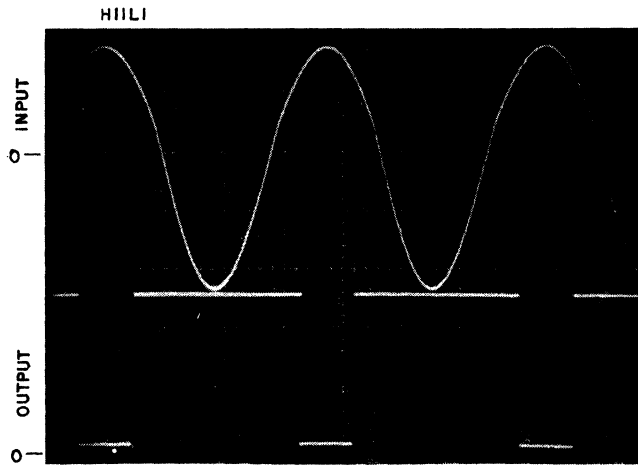

V=2V/DIV
H=5mS/DIV
R_L=270Ω
R_E=1200Ω
C=0

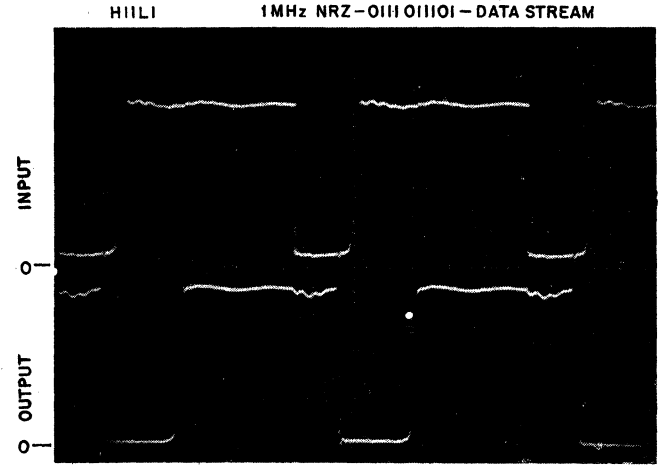

V=2V/DIV
H=1μS/DIV
R_L=270Ω
R_E=1.2KΩ
C=270pF

TYPICAL APPLICATION

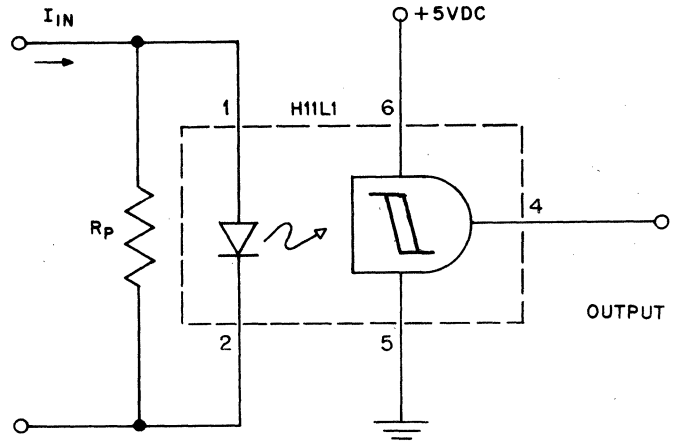
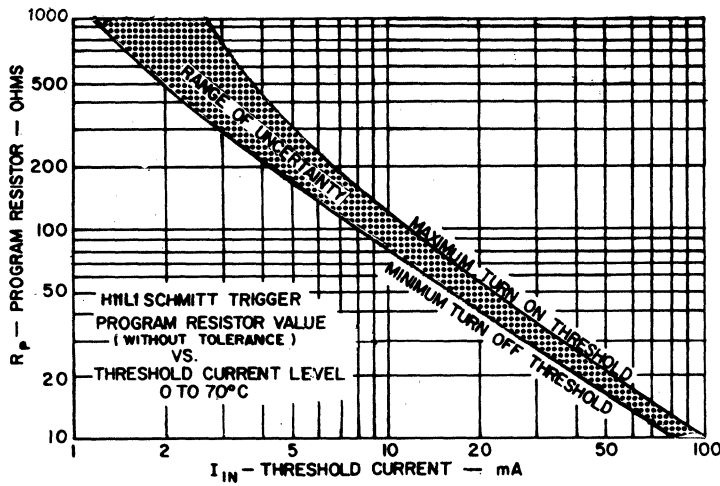

PROGRAMMABLE CURRENT THRESHOLD SENSING CIRCUIT

PLEASE NOTE: THE INFORMATION INCLUDED IN THIS SPECIFICATION HAS BEEN CAREFULLY CHECKED AND IS BELIEVED TO BE RELIABLE, HOWEVER, NO RESPONSIBILITY IS ASSUMED FOR INACCURACIES.



SOLID STATE OPTOELECTRONICS

1mm Aperture

Photon Coupled Interrupter Module H21A1, H21A2, H21A3

The General Electric H21A Interrupter Module is a gallium arsenide infrared emitting diode coupled to a silicon phototransistor in a plastic housing. The packaging system is designed to optimize the mechanical resolution, coupling efficiency, ambient light rejection, cost, and reliability. The gap in the housing provides a means of interrupting the signal with an opaque material, switching the output from an "ON" into an "OFF" state.

absolute maximum ratings: (25°C)

TOTAL DEVICE			
Storage Temperature	T _{STG}	-55°C to +100°C	
Operating Temperature	T _J	-55°C to +100°C	
Lead Soldering Temperature (5 seconds maximum)	T _L	260°C	

INFRARED EMITTING DIODE			
Power Dissipation	P _E	*100	mW
Forward Current (Continuous)	I _F	60	mA
Forward Current (Peak) (Pulse Width ≤ 1 μs PRR ≤ 300 pps)	I _F	3	A
Reverse Voltage	V _R	6	V

*Derate 1.33 mW/°C above 25°C ambient.

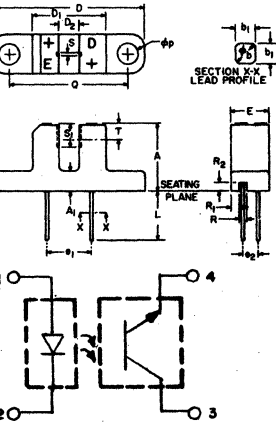

SYMBOL	MILLIMETERS		INCHES		NOTES
	MIN.	MAX.	MIN.	MAX.	
A	10.7	11.0	.422	.433	
A ₁	3.0	3.2	.119	.125	
A ₂	3.0	3.2	.119	.125	
φb	.600	.750	.024	.030	2
b ₁	.50 NOM.		.020 NOM.		2
D	24.3	24.7	.957	.972	
D ₁	11.6	12.0	.457	.472	
D ₂	3.0	3.3	.119	.129	
e ₁	6.9	7.5	.272	.295	
e ₂	2.3	2.8	.091	.110	
E	6.15	6.35	.243	.249	
L	8.00		.315		
φp	3.2	3.4	.126	.133	
O	18.9	19.2	.745	.755	
R	1.3 NOM.		.051 NOM.		
R ₁	1.3 NOM.		.051 NOM.		
R ₂	1.3 NOM.		.051 NOM.		
S	.85	1.0	.034	.039	
Si	3.45	3.75	.136	.147	
T	2.6 NOM.		.103 NOM.		3

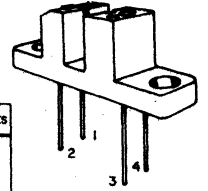

NOTES:
 1. INCH DIMENSIONS ARE DERIVED FROM MILLIMETERS.
 2. FOUR LEADS. LEAD CROSS SECTION IS CONTROLLED BETWEEN 1.7 MM (.067") FROM SEATING PLANE AND THE END OF THE LEADS.
 3. THE SENSING AREA IS DEFINED BY THE "S" DIMENSION AND BY DIMENSION "T" 2.075 MM (.0817 INCH).

PHOTOTRANSISTOR			
Power Dissipation	P _D	**150	mW
Collector Current (Continuous)	I _C	100	mA
Collector-Emitter Voltage	V _{CEO}	30	V
Emitter-Collector Voltage	V _{ECO}	6	V

**Derate 2.0 mW/°C above 25°C ambient.

individual electrical characteristics:(25°C) (See Note 1)

EMITTER	MIN.	TYP.	MAX.	UNITS
Reverse Breakdown Voltage V _{(BR)R} I _R = 10 μA	6	—	—	V
Forward Voltage V _F I _F = 60 mA	—	—	1.7	V
Reverse Current I _R V _R = 5V	—	—	100	nA
Capacitance C _i V = 0, f = 1 MHz	—	30	—	pF

DETECTOR	MIN.	TYP.	MAX.	UNITS
Breakdown Voltage V _{(BR)CEO} I _C = 1 mA	30	—	—	V
Breakdown Voltage V _{(BR)ECO} I _E = 100 μA	6	—	—	V
Collector Dark Current I _{CEO} V _{CE} = 25V	—	—	100	nA
Capacitance C _{ce} V _{CE} = 5V, f = 1 MHz	—	3.3	5	pF

coupled electrical characteristics:(25°C) (See Note 1)

	H21A1			H21A2			H21A3			UNITS
	MIN.	TYP.	MAX.	MIN.	TYP.	MAX.	MIN.	TYP.	MAX.	
I _{CE(on)} I _F = 5mA, V _{CE} = 5V	0.15	—	—	0.30	—	—	0.60	—	—	mA
I _{CE(on)} I _F = 20mA, V _{CE} = 5V	1.0	—	—	2.0	—	—	4.0	—	—	mA
I _{CE(on)} I _F = 30mA, V _{CE} = 5V	1.9	—	—	3.0	—	—	5.5	—	—	mA
V _{CE(sat)} I _F = 20mA, I _C = 1.8mA	—	—	—	—	—	0.40	—	—	0.40	V
V _{CE(sat)} I _F = 30mA, I _C = 1.8mA	—	—	0.40	—	—	—	—	—	—	V
t _{on} V _{CC} = 5V, I _F = 30mA, R _L = 2.5KΩ	—	8	—	—	8	—	—	8	—	μs
t _{off} V _{CC} = 5V, I _F = 30mA, R _L = 2.5KΩ	—	50	—	—	50	—	—	50	—	μs

Note 1: Stray irradiation can alter values of characteristics. Adequate shielding should be provided.

TYPICAL CHARACTERISTICS

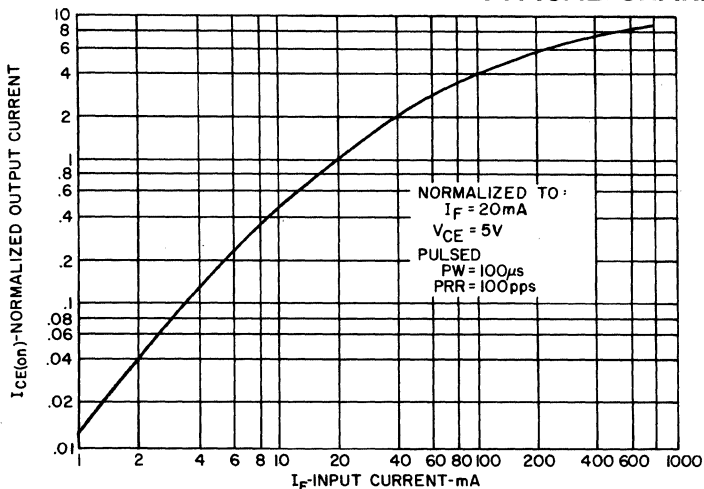

1. OUTPUT CURRENT VS. INPUT CURRENT

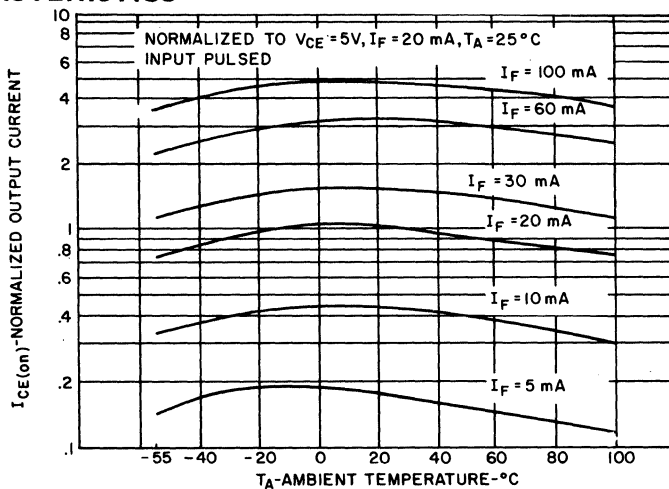

2. OUTPUT CURRENT VS. TEMPERATURE

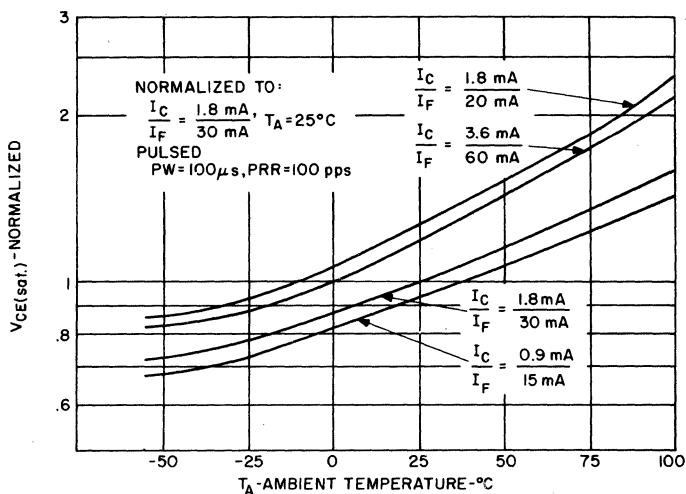

3. $V_{CE(sat)}$ VS. TEMPERATURE

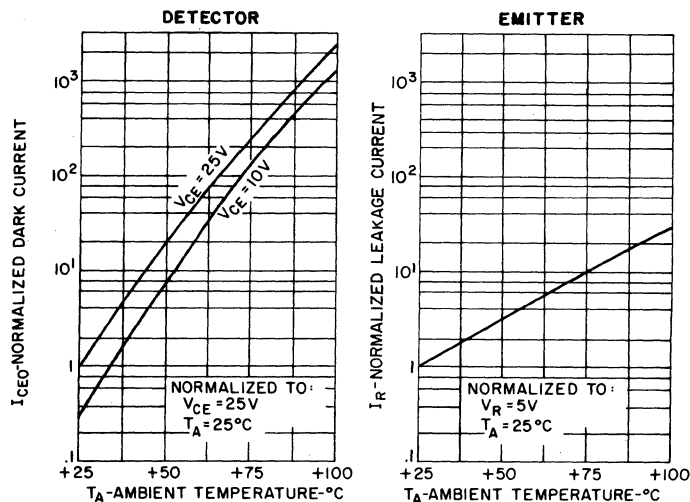

4. LEAKAGE CURRENTS VS. TEMPERATURE

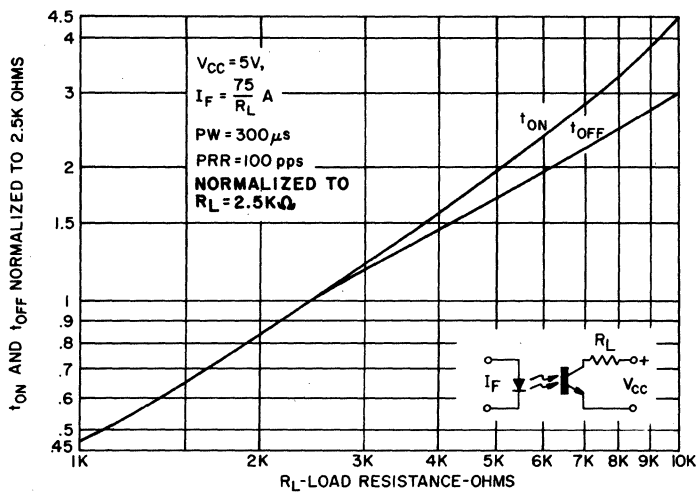

5. SWITCHING SPEED VS. R_L

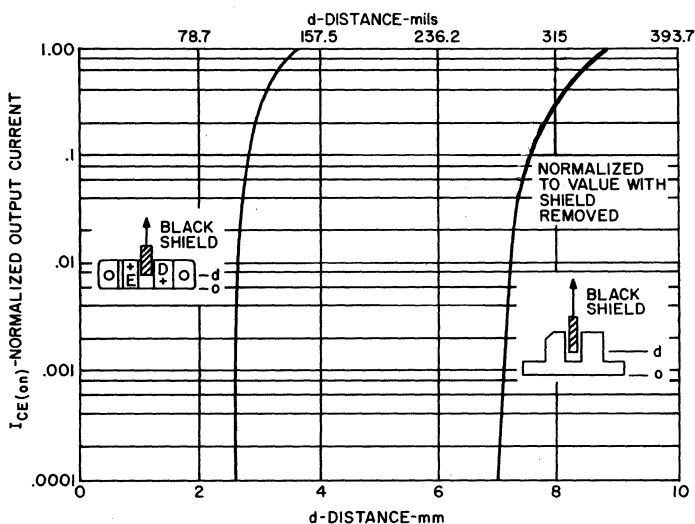

6. OUTPUT CURRENT VS. DISTANCE



SOLID STATE

OPTO ELECTRONICS

1mm Aperture

Photon Coupled Interrupter Module H21A4, H21A5, H21A6

The General Electric H21A Interrupter Module is a gallium arsenide infrared emitting diode coupled to a silicon phototransistor in a plastic housing. The packaging system is designed to optimize the mechanical resolution, coupling efficiency, ambient light rejection, cost, and reliability. The gap in the housing provides a means of interrupting the signal with an opaque material, switching the output from an "ON" into an "OFF" state.

absolute maximum ratings: (25°C)

TOTAL DEVICE			
Storage Temperature	T _{STG}	-55°C to +100°C	
Operating Temperature	T _J	-55°C to +100°C	
Lead Soldering Temperature (5 seconds maximum)	T _L	260°C	

INFRARED EMITTING DIODE			
Power Dissipation	P _E	*100	mW
Forward Current (Continuous)	I _F	60	mA
Forward Current (Peak) (Pulse Width ≤ 1 μs PRR ≤ 300 pps)	I _F	3	A
Reverse Voltage	V _R	6	V

*Derate 1.33 mW/°C above 25°C ambient.

individual electrical characteristics:(25°C)(See Note 1)

EMITTER	MIN.	TYP.	MAX.	UNITS
Reverse Breakdown Voltage V _{(BR)R} I _R = 10 μA	6	—	—	V
Forward Voltage V _F I _F = 60 mA	—	—	1.7	V
Reverse Current I _R V _R = 5V	—	—	100	nA
Capacitance C _i V = 0, f = 1MHz	—	30	—	pF

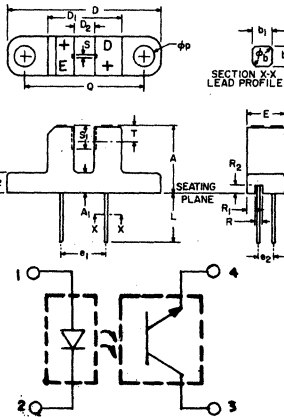

SYMBOL	MILLIMETERS		INCHES		NOTES
	MIN	MAX	MIN	MAX	
A	10.7	11.0	.422	.433	
A ₁	3.0	3.2	.119	.125	
A ₂	3.0	3.2	.119	.125	
φb	.600	.750	.024	.030	2
b ₁	50 NOM.		.020 NOM.		
D	24.3	24.7	.957	.972	
D ₁	11.6	12.0	.457	.472	
D ₂	3.0	3.3	.119	.129	
e ₁	6.9	7.5	.272	.295	
e ₂	2.3	2.8	.091	.110	
E	6.15	6.35	.243	.249	
L	6.00	—	.315	—	
φp	3.2	3.4	.126	.133	
Q	18.9	19.2	.745	.755	
R	1.3 NOM.		.051 NOM.		
R ₁	1.3 NOM.		.051 NOM.		
R ₂	1.3 NOM.		.051 NOM.		
S	.85	1.0	.034	.039	
SI	3.45	3.75	.136	.147	
T	2.6 NOM.		.103 NOM.		3

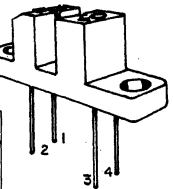

- NOTES:
1. INCH DIMENSIONS ARE DERIVED FROM MILLIMETERS.
 2. FOUR LEADS LEAD CROSS SECTION IS CONTROLLED BETWEEN 1.27 MM (.050") FROM SEATING PLANE AND THE END OF THE LEADS.
 3. THE SENSING AREA IS DEFINED BY THE "S" DIMENSION AND BY DIMENSION "T" ± 0.75 MM (± 0.030 INCH).

PHOTOTRANSISTOR			
Power Dissipation	P _D	**150	mW
Collector Current (Continuous)	I _C	100	mA
Collector-Emitter Voltage	V _{CEO}	55	V
Emitter-Collector Voltage	V _{ECO}	6	V

**Derate 2.0 mW/°C above 25°C ambient.

coupled electrical characteristics:(25°C)(See Note 1)

	H21A4			H21A5			H21A6			UNITS
	MIN.	TYP.	MAX.	MIN.	TYP.	MAX.	MIN.	TYP.	MAX.	
I _{CE(on)} I _F = 5mA, V _{CE} = 5V	0.15	—	—	0.30	—	—	0.60	—	—	mA
I _{CE(on)} I _F = 20mA, V _{CE} = 5V	1.0	—	—	2.0	—	—	4.0	—	—	mA
I _{CE(on)} I _F = 30mA, V _{CE} = 5V	1.9	—	—	3.0	—	—	5.5	—	—	mA
V _{CE(sat)} I _F = 20mA, I _C = 1.8mA	—	—	—	—	—	0.40	—	—	0.40	V
V _{CE(sat)} I _F = 30mA, I _C = 1.8mA	—	—	0.40	—	—	—	—	—	—	V
t _{on} V _{CC} = 5V, I _F = 30mA, R _L = 2.5KΩ	—	8	—	—	8	—	—	8	—	μs
t _{off} V _{CC} = 5V, I _F = 30mA, R _L = 2.5KΩ	—	50	—	—	50	—	—	50	—	μs

Note 1: Stray irradiation can alter values of characteristics. Adequate shielding should be provided.

TYPICAL CHARACTERISTICS

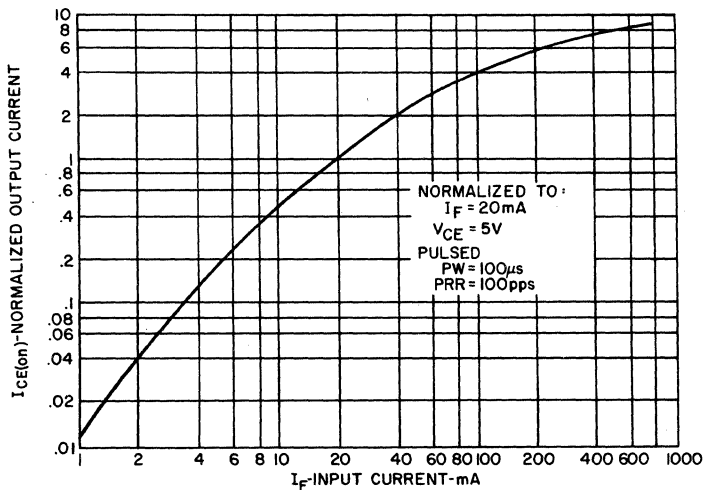

1. OUTPUT CURRENT VS. INPUT CURRENT

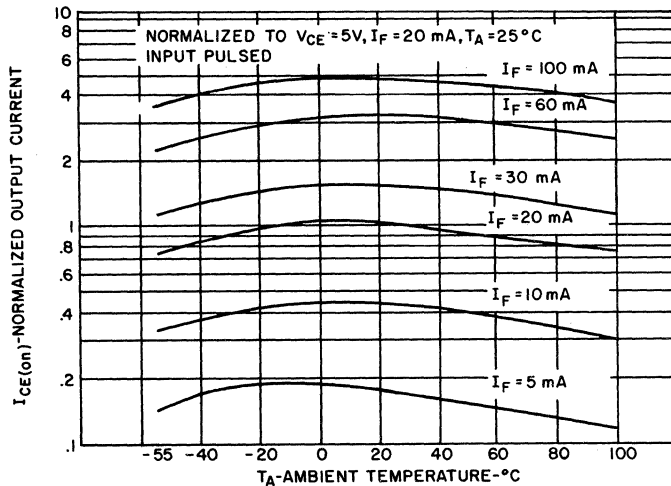

2. OUTPUT CURRENT VS. TEMPERATURE

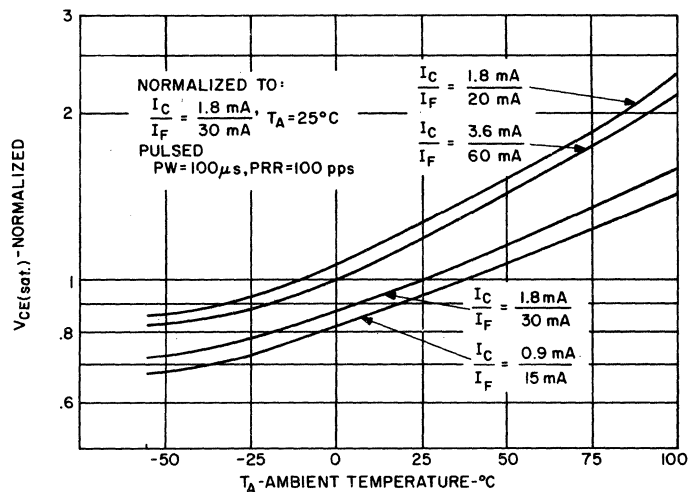

3. $V_{CE(sat)}$ VS. TEMPERATURE

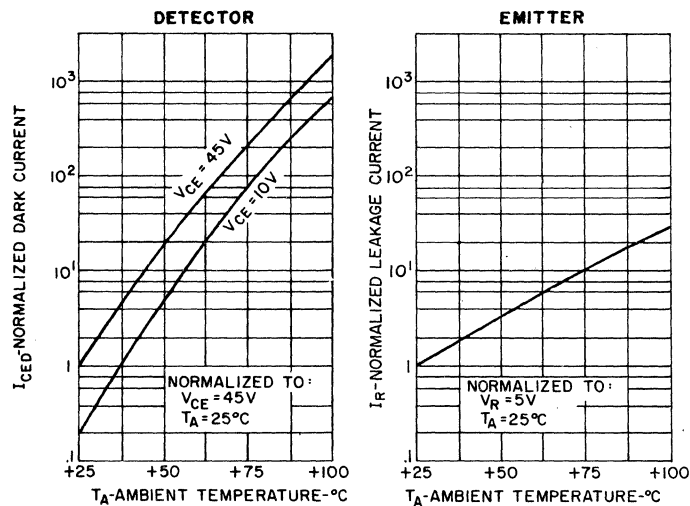

4. LEAKAGE CURRENTS VS. TEMPERATURE

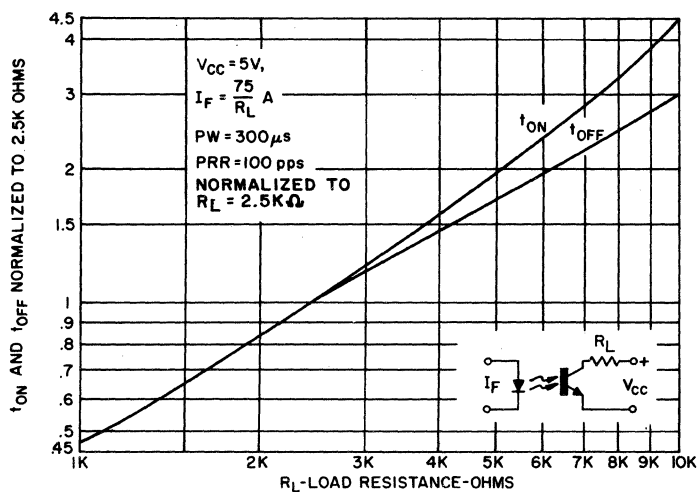

5. SWITCHING SPEED VS. R_L

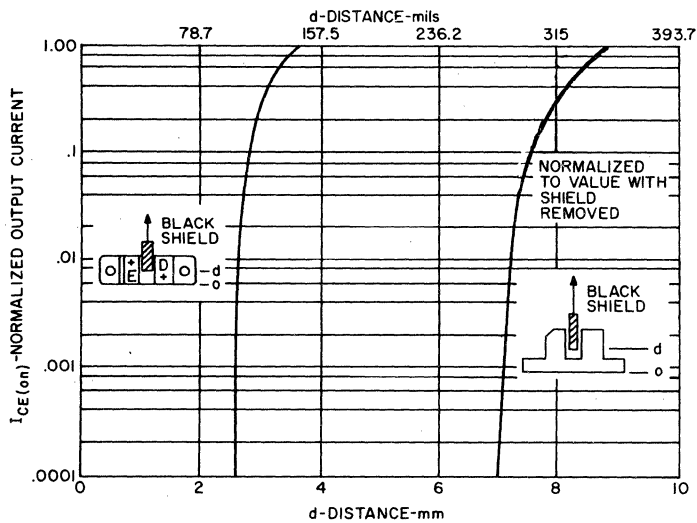

6. OUTPUT CURRENT VS. SHIELD DISTANCE



SOLID STATE OPTOELECTRONICS

1mm Aperture

Photon Coupled Interrupter Module H21B1, H21B2, H21B3

The General Electric H21B Interrupter Module is a gallium arsenide infrared emitting diode coupled to a silicon darlington connected phototransistor in a plastic housing. The packaging system is designed to optimize the mechanical resolution, coupling efficiency, ambient light rejection, cost, and reliability. The gap in the housing provides a means of interrupting the signal with an opaque material, switching the output from an "ON" into an "OFF" state.

absolute maximum ratings: (25°C)

TOTAL DEVICE			
Storage Temperature	T _{STG}	-55°C to +100°C	
Operating Temperature	T _J	-55°C to +100°C	
Lead Soldering Temperature (5 seconds maximum)	T _L	260°C	

INFRARED EMITTING DIODE			
Power Dissipation	P _E	*100	mW
Forward Current (Continuous)	I _F	60	mA
Forward Current (Peak) (Pulse Width ≤ 1 μs PRR ≤ 300 pps)	I _F	3	A
Reverse Voltage	V _R	6	V

*Derate 1.33 mW/°C above 25°C ambient.

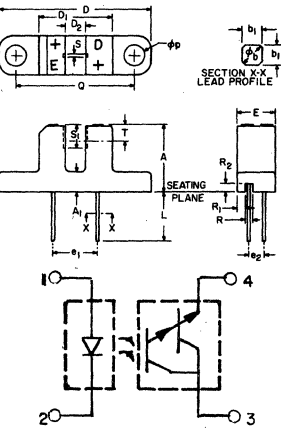

SYMBOL	MILLIMETERS		INCHES		NOTES
	MIN.	MAX.	MIN.	MAX.	
A	10.7	11.0	.422	.433	
A ₁	3.0	3.2	.119	.125	
A ₂	3.0	3.2	.119	.125	
φb	.600	.750	.024	.030	2
b ₁	.50 NOM.		.020 NOM.		2
D	24.3	24.7	.957	.972	
D ₁	11.6	12.0	.457	.472	
D ₂	3.0	3.3	.119	.129	
φ ₁	6.9	7.5	.272	.295	
φ ₂	2.3	2.8	.091	.110	
E	6.15	6.35	.243	.249	
L	8.00		.315		
φp	3.2	3.4	.126	.133	
Q	18.9	19.2	.745	.755	
R	1.3 NOM.		.051 NOM.		
R ₁	1.3 NOM.		.051 NOM.		
R ₂	1.3 NOM.		.051 NOM.		
S	.85	1.0	.034	.039	
S ₁	3.45	3.75	.136	.147	
T	2.6 NOM.		.103 NOM.		3

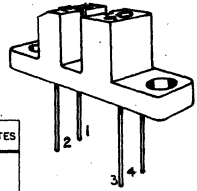

- NOTES:
1. INCH DIMENSIONS ARE DERIVED FROM MILLIMETERS.
 2. FOUR LEADS, LEAD CROSS SECTION IS CONTROLLED, BETWEEN (.27 MM (.030")) FROM SEATING PLANE AND THE END OF THE LEADS.
 3. THE SENSING AREA IS DEFINED BY THE "S" DIMENSION AND BY DIMENSION "T" (2.075 MM (.081 INCH)).

DARLINGTON CONNECTED PHOTOTRANSISTOR			
Power Dissipation	P _D	**150	mW
Collector Current (Continuous)	I _C	100	mA
Collector-Emitter Voltage	V _{CEO}	30	V
Emitter-Collector Voltage	V _{ECO}	7	V

**Derate 2.0 mW/°C above 25°C ambient.

individual electrical characteristics: (25°C) (See Note 1)

EMITTER	MIN.	TYP.	MAX.	UNITS
Reverse Breakdown Voltage V _{(BR)R} I _R = 10 μA	6	—	—	V
Forward Voltage V _F I _F = 60 mA	—	—	1.7	V
Reverse Current I _R V _R = 5V	—	—	100	nA
Capacitance C _i V = 0, f = 1 MHz	—	30	—	pF

DETECTOR	MIN.	TYP.	MAX.	UNITS
Breakdown Voltage V _{(BR)CEO} I _C = 1 mA	30	—	—	V
Breakdown Voltage V _{(BR)ECO} I _E = 100 μA	7	—	—	V
Collector Dark Current I _{CEO} V _{CE} = 25V	—	—	100	nA
Capacitance C _{ce} V _{CE} = 5V, f = 1 MHz	—	5	8	pF

coupled electrical characteristics: (25°C) (See Note 1)

	H21B1			H21B2			H21B3			UNITS
	MIN.	TYP.	MAX.	MIN.	TYP.	MAX.	MIN.	TYP.	MAX.	
I _{CE(on)} I _F = 2mA, V _{CE} = 1.5V	0.5	—	—	1.0	—	—	2.0	—	—	mA
I _{CE(on)} I _F = 5mA, V _{CE} = 1.5V	2.5	—	—	5.0	—	—	10	—	—	mA
I _{CE(on)} I _F = 10mA, V _{CE} = 1.5V	7.5	—	—	14	—	—	25	—	—	mA
V _{CE(sat)} I _F = 10mA, I _C = 1.8mA	—	—	1.0	—	—	1.0	—	—	1.0	V
V _{CE(sat)} I _F = 60mA, I _C = 50mA	—	—	—	—	—	1.5	—	—	1.5	V
t _{on} V _{CC} = 5V, I _F = 10mA, R _L = 750Ω	—	45	—	—	45	—	—	45	—	μs
V _{CC} = 5V, I _F = 60mA, R _L = 75Ω	—	—	—	—	7	—	—	7	—	μs
t _{off} V _{CC} = 5V, I _F = 10mA, R _L = 750Ω	—	250	—	—	250	—	—	250	—	μs
V _{CC} = 5V, I _F = 60mA, R _L = 75Ω	—	—	—	—	45	—	—	45	—	μs

Note 1: Stray irradiation can alter values of characteristics. Adequate shielding should be provided.

TYPICAL CHARACTERISTICS

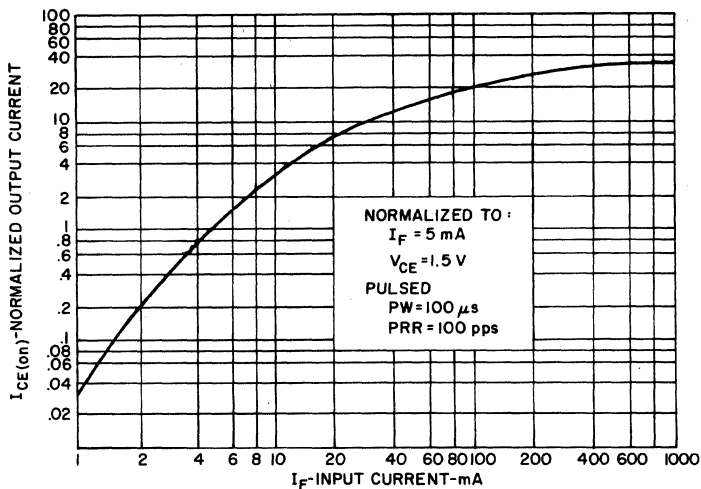

1. OUTPUT CURRENT VS. INPUT CURRENT

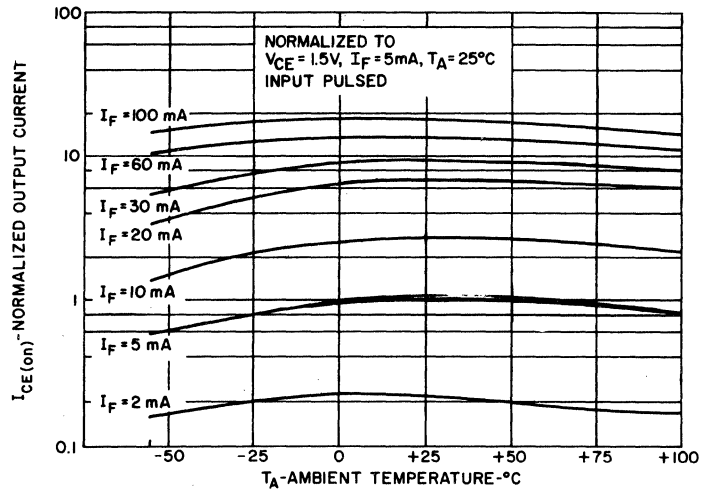

2. OUTPUT CURRENT VS. TEMPERATURE

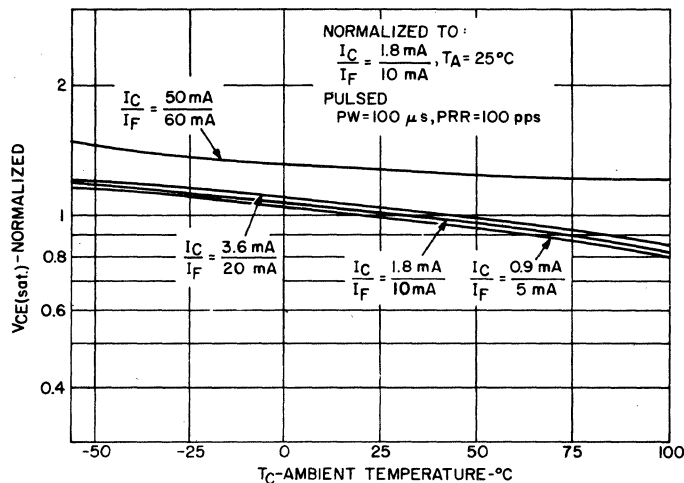

3. $V_{CE(sat)}$ VS. TEMPERATURE

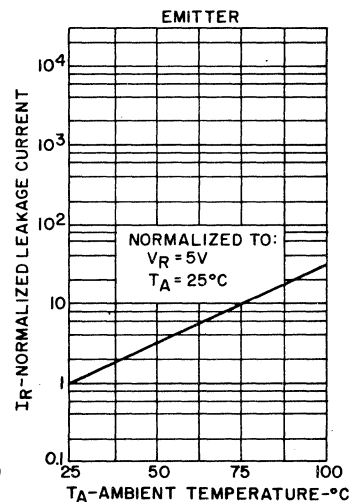
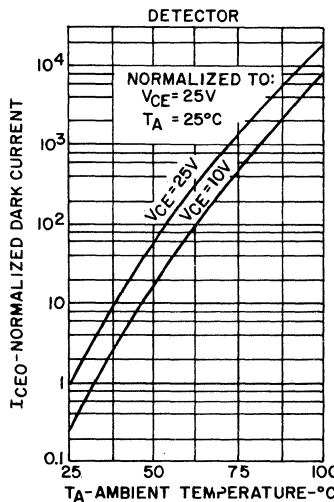

4. LEAKAGE CURRENTS VS. TEMPERATURE

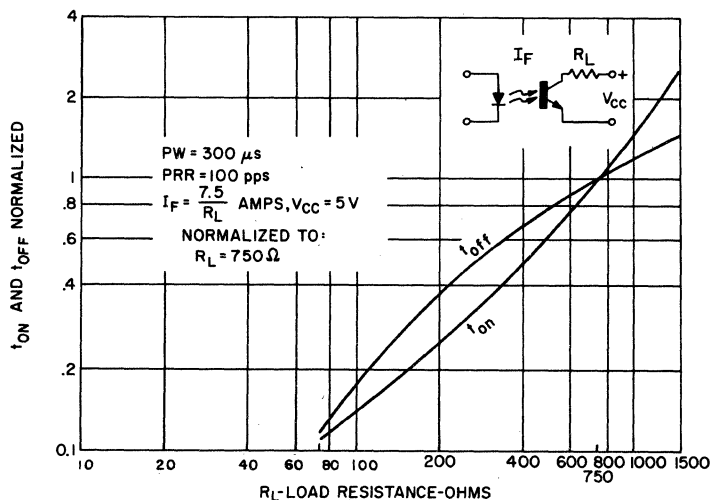

5. SWITCHING SPEED VS. R_L

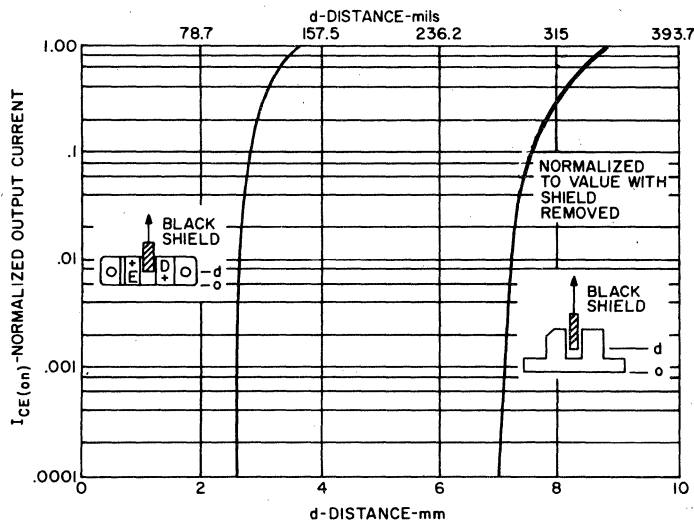

6. OUTPUT CURRENT VS. SHIELD DISTANCE



SOLID STATE OPTOELECTRONICS

1mm Aperture

Photon Coupled Interrupter Module H21B4, H21B5, H21B6

The General Electric H21B Interrupter Module is a gallium arsenide infrared emitting diode coupled to a silicon darlington connected phototransistor in a plastic housing. The packaging system is designed to optimize the mechanical resolution, coupling efficiency, ambient light rejection, cost, and reliability. The gap in the housing provides a means of interrupting the signal with an opaque material, switching the output from an "ON" into an "OFF" state.

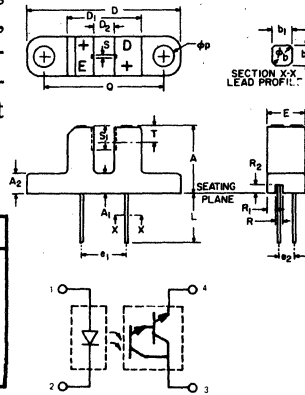
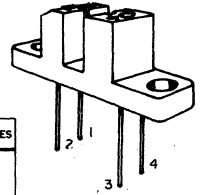

SYMBOL	MILLIMETERS		INCHES		NOTES
	MIN.	MAX.	MIN.	MAX.	
A	107	110	.422	.433	
A ₁	3.0	3.2	.119	.125	
A ₂	3.0	3.2	.119	.125	
φb	.600	.750	.024	.030	2
b ₁	.50 NOM.		.020 NOM.		2
D	24.3	24.7	.957	.972	
D ₁	11.6	12.0	.457	.472	
D ₂	3.0	3.3	.119	.129	
e ₁	6.9	7.5	.272	.295	
e ₂	2.3	2.8	.091	.110	
E	6.15	6.35	.243	.249	
L	8.00		.315		
φP	3.2	3.4	.126	.133	
Q	18.9	19.2	.745	.755	
R	1.3 NOM.		.051 NOM.		
R ₁	1.3 NOM.		.051 NOM.		
R ₂	1.3 NOM.		.051 NOM.		
S	.85	1.0	.034	.039	
S ₁	3.45	3.75	.136	.147	
T	2.6 NOM.		.103 NOM.		3

- NOTES:
1. INCH DIMENSIONS ARE DERIVED FROM MILLIMETERS.
 2. FOUR LEADS. LEAD CROSS SECTION IS CONTROLLED BETWEEN 1.27 MM (.050") FROM SEATING PLANE AND THE END OF THE LEADS.
 3. THE SENSING AREA IS DEFINED BY THE "S" DIMENSION AND BY DIMENSION "T" (2.075 MM (.081 INCH)).

absolute maximum ratings: (25°C)

TOTAL DEVICE			
Storage Temperature	T _{STG}	-55°C to +100°C	
Operating Temperature	T _J	-55°C to +100°C	
Lead Soldering Temperature (5 seconds maximum)	T _L	260°C	

INFRARED EMITTING DIODE			
Power Dissipation	P _E	*100	mW
Forward Current (Continuous)	I _F	60	mA
Forward Current (Peak) (Pulse Width ≤ 1 μs PRR ≤ 300 pps)	I _F	3	A
Reverse Voltage	V _R	6	V

*Derate 1.33 mW/°C above 25°C ambient.

DARLINGTON CONNECTED PHOTOTRANSISTOR			
Power Dissipation	P _D	**150	mW
Collector Current (Continuous)	I _C	100	mA
Collector-Emitter Voltage	V _{CEO}	55	V
Emitter-Collector Voltage	V _{ECO}	7	V

**Derate 2.0 mW/°C above 25°C ambient.

individual electrical characteristics:(25°C) (See Note 1)

EMITTER	MIN.	TYP.	MAX.	UNITS
Reverse Breakdown Voltage V _{(BR)R} I _R = 10 μA	6	—	—	V
Forward Voltage V _F I _F = 60 mA	—	—	1.7	V
Reverse Current I _R V _R = 5V	—	—	100	nA
Capacitance C _i V = 0, f = 1 MHz	—	30	—	pF

DETECTOR	MIN.	TYP.	MAX.	UNITS
Breakdown Voltage V _{(BR)CEO} I _C = 1 mA	55	—	—	V
Breakdown Voltage V _{(BR)ECO} I _E = 100 μA	7	—	—	V
Collector Dark Current I _{CEO} V _{CE} = 45V	—	—	100	nA
Capacitance C _{ce} V _{CE} = 5V, f = 1 MHz	—	5	8	pF

coupled electrical characteristics:(25°C) (See Note 1)

		H21B4			H21B5			H21B6			UNITS
		MIN.	TYP.	MAX.	MIN.	TYP.	MAX.	MIN.	TYP.	MAX.	
I _{CE(on)}	I _F = 2mA, V _{CE} = 1.5V	0.5	—	—	1.0	—	—	2.0	—	—	mA
I _{CE(on)}	I _F = 5mA, V _{CE} = 1.5V	2.5	—	—	5.0	—	—	10	—	—	mA
I _{CE(on)}	I _F = 10mA, V _{CE} = 1.5V	7.5	—	—	14	—	—	25	—	—	mA
V _{CE(sat)}	I _F = 10mA, I _C = 1.8mA	—	—	1.0	—	—	1.0	—	—	1.0	V
V _{CE(sat)}	I _F = 60mA, I _C = 50mA	—	—	—	—	—	1.5	—	—	1.5	V
t _{on}	V _{CC} = 5V, I _F = 10mA, R _L = 750Ω	—	45	—	—	45	—	—	45	—	μs
	V _{CC} = 5V, I _F = 60mA, R _L = 75Ω	—	—	—	—	7	—	—	7	—	μs
t _{off}	V _{CC} = 5V, I _F = 10mA, R _L = 750Ω	—	250	—	—	250	—	—	250	—	μs
	V _{CC} = 5V, I _F = 60mA, R _L = 75Ω	—	—	—	—	45	—	—	45	—	μs

Note 1: Stray irradiation can alter values of characteristics. Adequate shielding should be provided.

TYPICAL CHARACTERISTICS

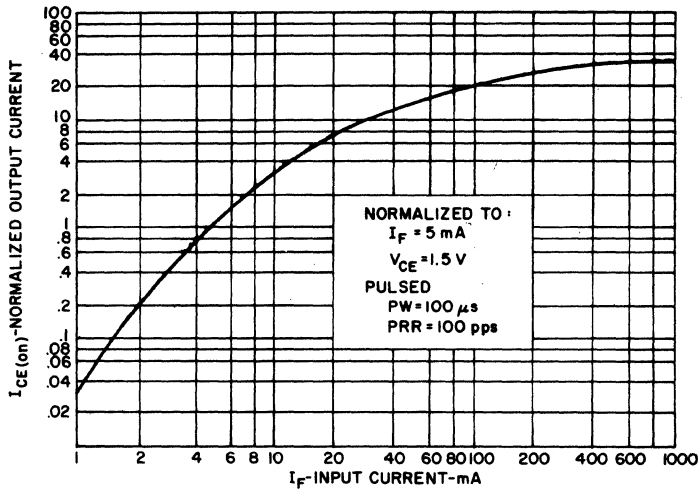

1. OUTPUT CURRENT VS. INPUT CURRENT

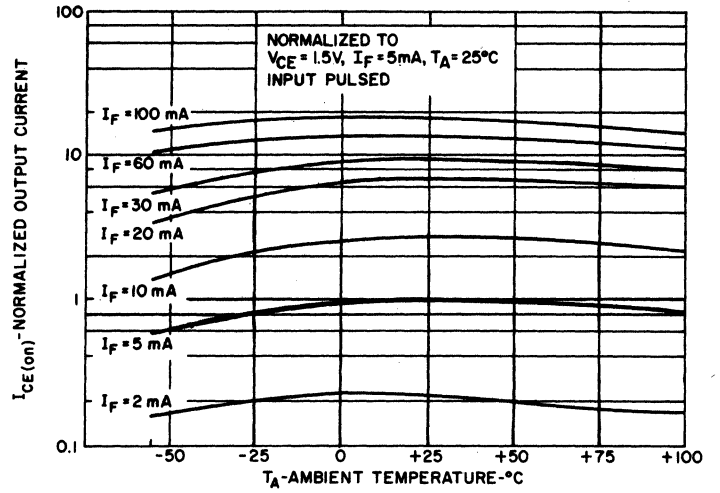

2. OUTPUT CURRENT VS. TEMPERATURE

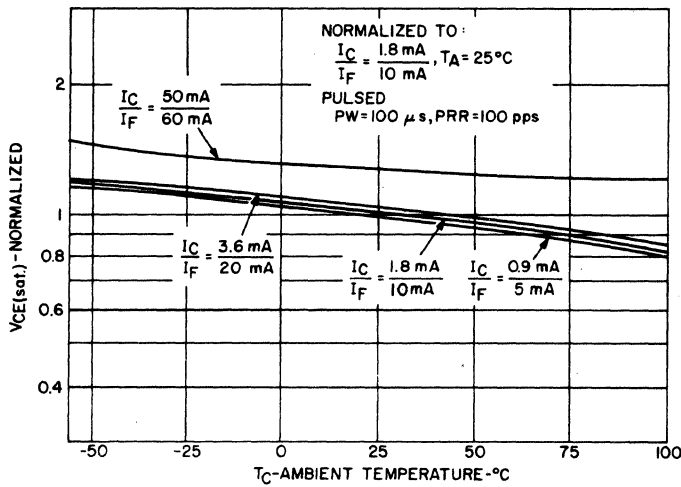

3. $V_{CE(sat)}$ VS. TEMPERATURE

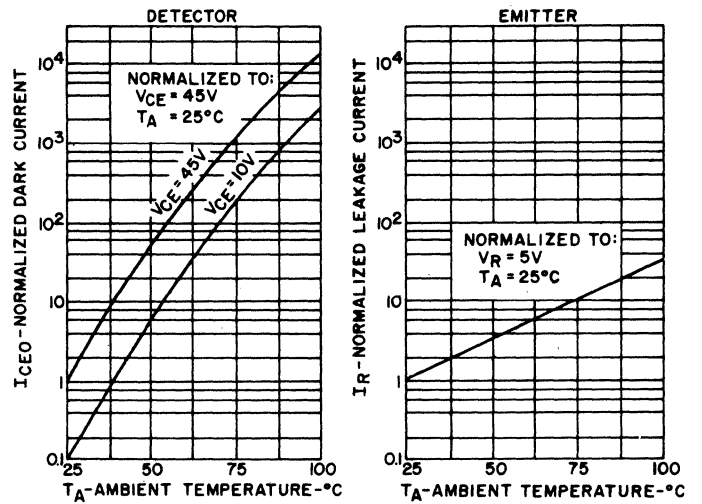

4. LEAKAGE CURRENTS VS. TEMPERATURE

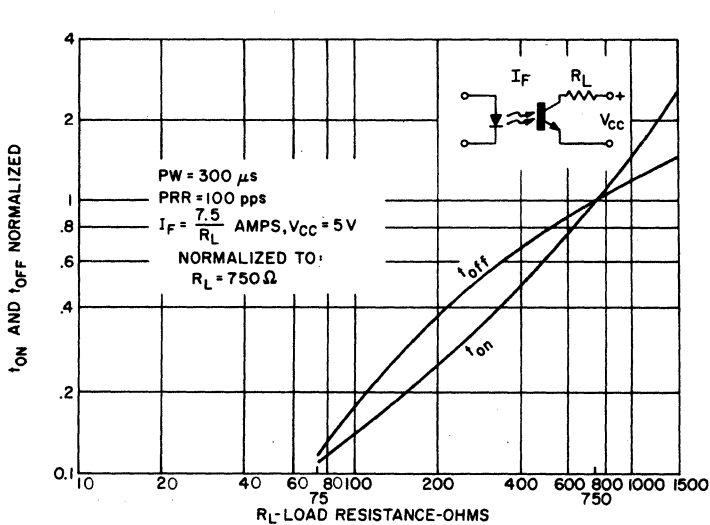

5. SWITCHING SPEED VS. R_L

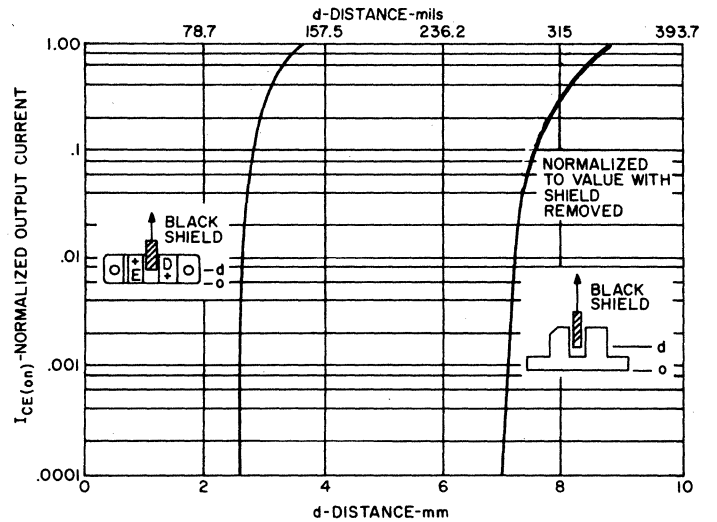

6. OUTPUT CURRENT VS. SHIELD DISTANCE



SOLID STATE OPTOELECTRONICS

1mm Aperture Photon Coupled Interrupter Module H21L1, H21L2

The General Electric H21L series is a gallium arsenide, infrared emitting diode coupled to a high speed integrated circuit detector. The output incorporates a Schmitt Trigger which provides hysteresis for noise immunity and pulse shaping. The gap in the plastic housing provides a means of interrupting the signal with an opaque material, switching the output from an "ON" into an "OFF" state.

absolute maximum ratings: (25°C)

TOTAL DEVICE			
Storage Temperature	T_{STG}	-55°C to +85°C	
Operating Temperature	T_J	-55°C to +85°C	
Lead Soldering Temperature	T_L	260°C	
(5 seconds maximum)			

INFRARED EMITTING DIODE			
Power Dissipation	P_E	*100	mW
Forward Current	I_F	60	mA
(Continuous)			
Forward Current (Peak)	I_F	3	A
(Pulse width $\leq 1 \mu s$ PRR ≤ 300 pps)			
Reverse Voltage	V_R	6	V
*Derate 1.33 mW/°C above 25°C ambient.			

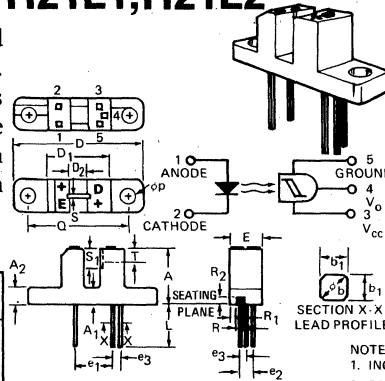

SYMBOL	MILLIMETERS		INCHES		NOTES
	MIN.	MAX.	MIN.	MAX.	
A	10.7	11.0	.422	.433	
A1	3.0	3.2	.119	.125	
A2	3.0	3.2	.119	.125	
ϕ_b	.600	.750	.024	.030	2
l_b	.50 NOM.		.020 NOM.		2
D	24.3	24.7	.957	.972	
D1	11.6	12.0	.457	.472	
D2	3.0	—	.119	—	
e1	6.9	7.5	.272	.295	
e2	2.3	2.8	.091	.110	
e3	1.14	1.40	.045	.055	
E	6.15	6.35	.243	.249	
L	8.00	—	.315	—	
ϕ_P	3.2	3.4	.126	.133	
Q	18.9	19.2	.745	.755	
R	1.83 NOM.		.072 NOM.		
R1	1.3 NOM.		.051 NOM.		
R2	1.3 NOM.		.051 NOM.		
S	.85	1.0	.034	.039	
S1	3.94 NOM.		.155 NOM.		
T	2.6 NOM.		.103 NOM.		3

- NOTES:
 1. INCH DIMENSIONS ARE DERIVED FROM MILLIMETERS.
 2. FOUR LEADS. LEAD CROSS SECTION IS CONTROLLED BETWEEN 1.27 MM (.050") FROM SEATING PLANE AND THE END OF THE LEADS.
 3. THE SENSING AREA IS DEFINED BY THE "S" DIMENSION AND BY DIMENSION "T" ≤ 0.75 MM (± 0.030 inch).

PHOTO DETECTOR			
Power Dissipation	P_D	**150	mW
Output Current	I_4	50	mA
Allowed Range	V_{35}	0 to 16	V
Allowed Range	V_{45}	0 to 16	V
**Derate 2.0 mW/°C above 25°C ambient.			

individual electrical characteristics: (0-70°C) (See Note 1)

EMITTER	MIN.	TYP.	MAX.	UNITS	
Forward Voltage ($I_F = 20$ mA)	V_F	—	1.10	1.60	volts
Reverse Current ($V_R = 3$ V)	I_R	—	—	10	micro-ampere
Capacitance ($V = 0, f = 1$ MHz)	C_j	—	—	100	pico-farads

DETECTOR	MIN.	TYP.	MAX.	UNITS	
Operating Voltage Range	V_C	4	—	15	volts
Supply Current ($I_F = 0, V_{CC} = 5$ V)	$I_{3(off)}$	—	1.0	5.0	milli-ampere
Output Current, High ($I_F = 0, V_{CC} = V_O = 15$ V)	I_{OH}	—	—	100	micro-ampere

coupled electrical characteristics (0-70°C) (See Note 1)

	MIN.	TYP.	MAX.	UNITS		
Supply Current ($I_F = 20$ mA, $V_{CC} = 5$ V)	$I_{3(on)}$	—	1.6	5.0	milliampere	
Output Voltage, Low ($R_L = 270 \Omega, V_{CC} = 5$ V, $I_F = 20$ mA)	V_{OL}	—	0.2	0.4	volts	
Turn-On Threshold Current ($R_L = 270 \Omega, V_{CC} = 5$ V)	$I_{F(on)}$	H21L1	—	20	30	milliampere
		H21L2	—	10	15.0	milliampere
Turn-Off Threshold Current ($R_L = 270 \Omega, V_{CC} = 5$ V)	$I_{F(off)}$	H21L1	0.5	15	—	milliampere
	$I_{F(on)}$	H21L2	0.5	8	—	milliampere
Hysteresis Ratio ($R_L = 270 \Omega, V_{CC} = 5$ V)	$I_{F(off)}/I_{F(on)}$		0.50	0.75	0.90	—
Switching Speeds: ($R_L = 270 \Omega, V_{CC} = 5$ V, $T_A = 25^\circ C, I_F = 20$ mA)						
Rise Time	t_r	—	0.1	—	$\mu sec.$	
Fall Time	t_f	—	0.1	—	$\mu sec.$	

Note 1: Stray irradiation can alter values of characteristics. Adequate shielding should be provided.

TYPICAL CHARACTERISTICS

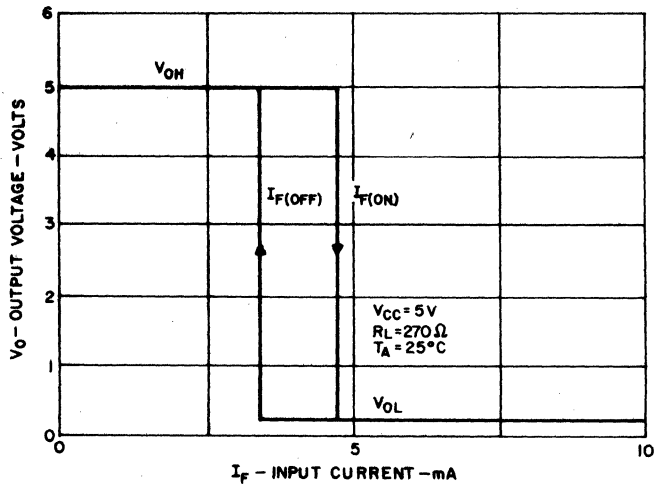

TRANSFER CHARACTERISTICS

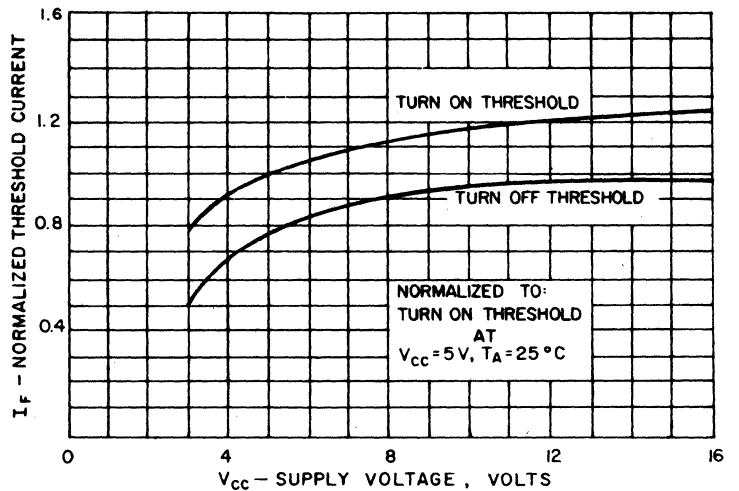

THRESHOLD CURRENT VS. SUPPLY VOLTAGE

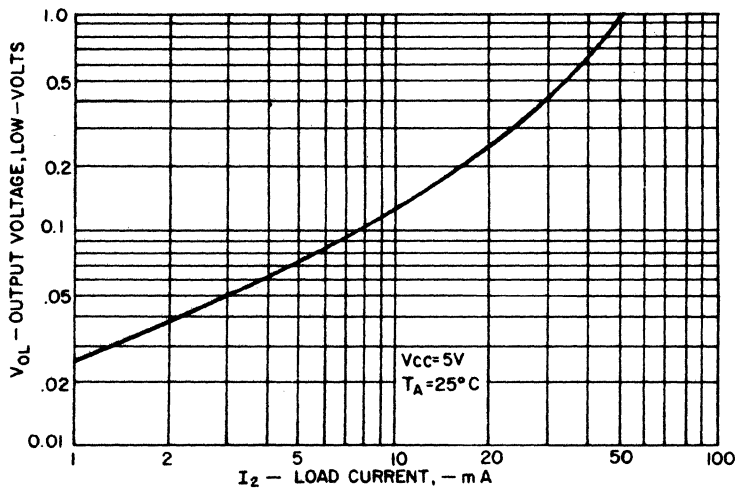

ON VOLTAGE VS. LOAD CURRENT

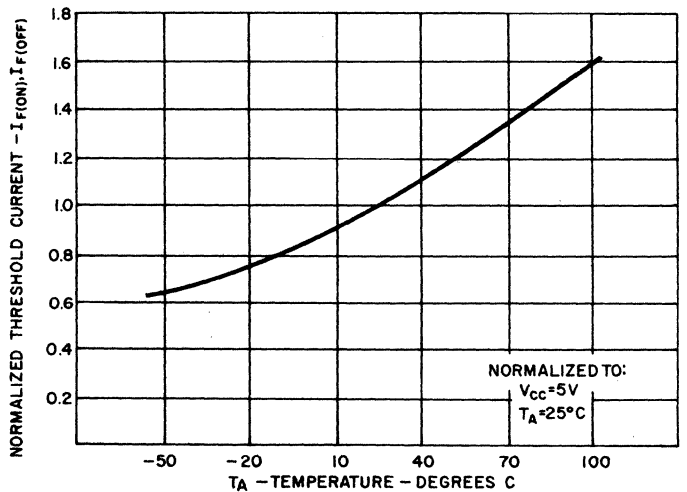

THRESHOLD CURRENTS VS. TEMPERATURE

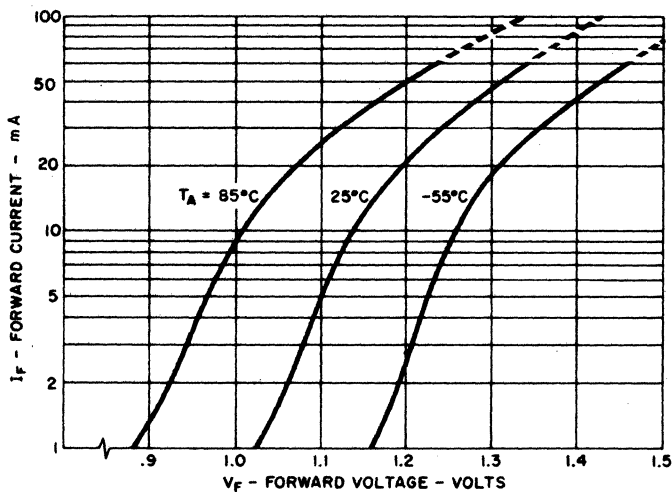

FORWARD VOLTAGE VS. FORWARD CURRENT

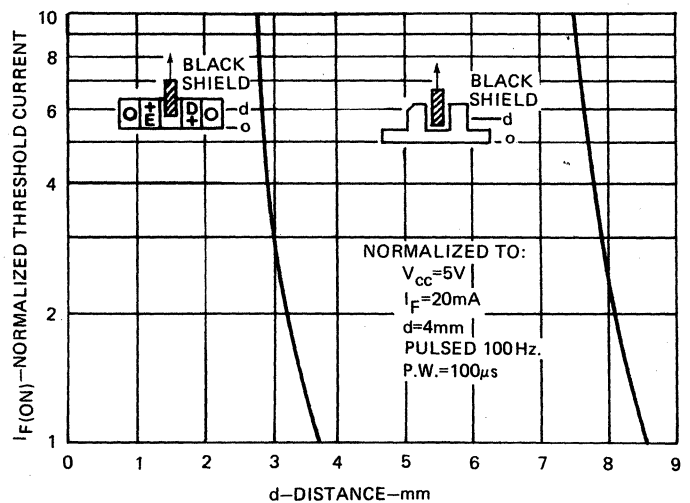

THRESHOLD CURRENT VS. SHIELD DISTANCE



SOLID STATE OPTOELECTRONICS

1mm Aperture

Photon Coupled Interrupter Module H22A1, H22A2, H22A3

The General Electric H22A Interrupter Module is a gallium arsenide infrared emitting diode coupled to a silicon phototransistor in a plastic housing. The packaging system is designed to optimize the mechanical resolution, coupling efficiency, ambient light rejection, cost, and reliability. The gap in the housing provides a means of interrupting the signal with an opaque material, switching the output from an "ON" into an "OFF" state.

absolute maximum ratings: (25°C)

TOTAL DEVICE			
Storage Temperature	T _{STG}	-55°C to +100°C	
Operating Temperature	T _J	-55°C to +100°C	
Lead Soldering Temperature (5 seconds maximum)	T _L	260°C	

INFRARED EMITTING DIODE			
Power Dissipation	P _E	*100	mW
Forward Current (Continuous)	I _F	60	mA
Forward Current (Peak) (Pulse Width ≤ 1 μs PRR ≤ 300 pps)	I _F	3	A
Reverse Voltage	V _R	6	V

*Derate 1.33 mW/°C above 25°C ambient.

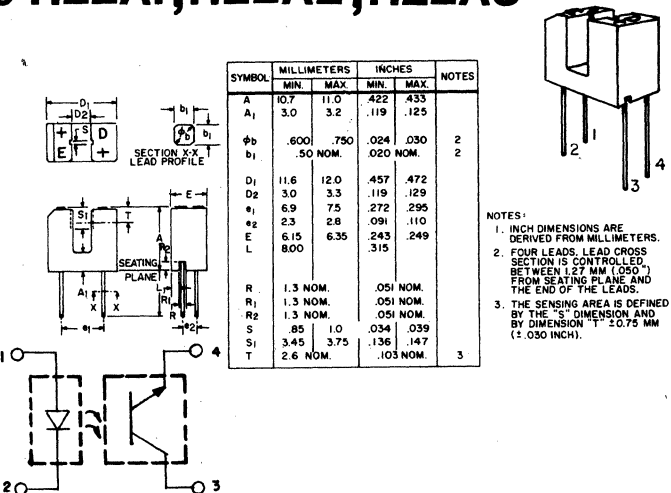

PHOTOTRANSISTOR			
Power Dissipation	P _D	**150	mW
Collector Current (Continuous)	I _C	100	mA
Collector-Emitter Voltage	V _{CEO}	30	V
Emitter-Collector Voltage	V _{ECO}	6	V

**Derate 2.0 mW/°C above 25°C ambient.

individual electrical characteristics:(25°C) (See Note 1)

EMITTER	MIN.	TYP.	MAX.	UNITS
Reverse Breakdown Voltage V _{(BR)R} I _R = 10 μA	6	—	—	V
Forward Voltage V _F I _F = 60 mA	—	—	1.7	V
Reverse Current I _R V _R = 5 V	—	—	100	nA
Capacitance C _i V = 0, f = 1 MHz	—	30	—	pF

DETECTOR	MIN.	TYP.	MAX.	UNITS
Breakdown Voltage V _{(BR)CEO} I _C = 1 mA	30	—	—	V
Breakdown Voltage V _{(BR)ECO} I _E = 100 μA	6	—	—	V
Collector Dark Current I _{CEO} V _{CE} = 25 V	—	—	100	nA
Capacitance C _{ce} V _{CE} = 5 V, f = 1 MHz	—	3.3	5	pF

coupled electrical characteristics:(25°C) (See Note 1)

	H22A1			H22A2			H22A3			UNITS
	MIN.	TYP.	MAX.	MIN.	TYP.	MAX.	MIN.	TYP.	MAX.	
I _{CE(on)} I _F = 5 mA, V _{CE} = 5 V	0.15	—	—	0.30	—	—	0.60	—	—	mA
I _{CE(on)} I _F = 20 mA, V _{CE} = 5 V	1.0	—	—	2.0	—	—	4.0	—	—	mA
I _{CE(on)} I _F = 30 mA, V _{CE} = 5 V	1.9	—	—	3.0	—	—	5.5	—	—	mA
V _{CE(sat)} I _F = 20 mA, I _C = 1.8 mA	—	—	—	—	—	0.40	—	—	0.40	V
V _{CE(sat)} I _F = 30 mA, I _C = 1.8 mA	—	—	0.40	—	—	—	—	—	—	V
t _{on} V _{CC} = 5 V, I _F = 30 mA, R _L = 2.5 KΩ	—	8	—	—	8	—	—	8	—	μs
t _{off} V _{CC} = 5 V, I _F = 30 mA, R _L = 2.5 KΩ	—	50	—	—	50	—	—	50	—	μs

Note 1: Stray irradiation can alter values of characteristics. Adequate shielding should be provided.

TYPICAL CHARACTERISTICS

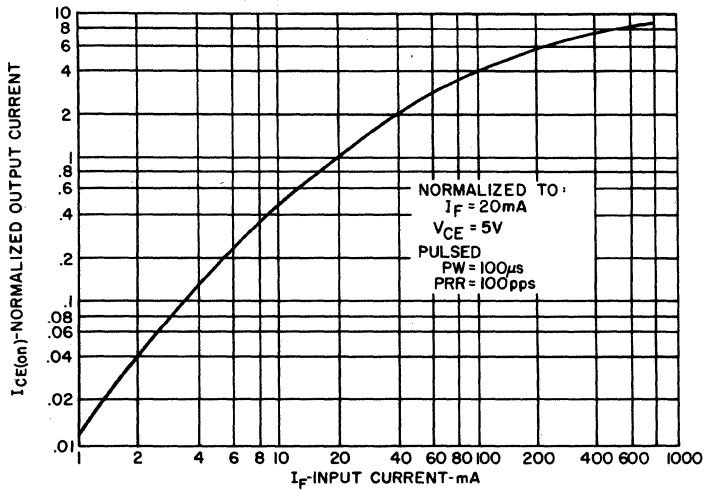

1. OUTPUT CURRENT VS. INPUT CURRENT

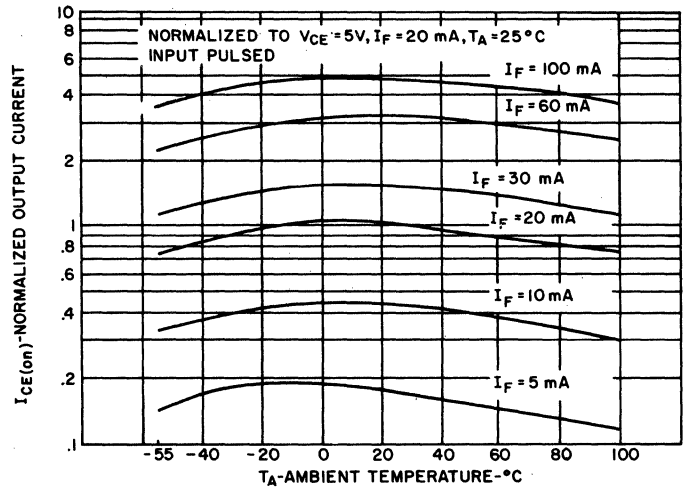

2. OUTPUT CURRENT VS. TEMPERATURE

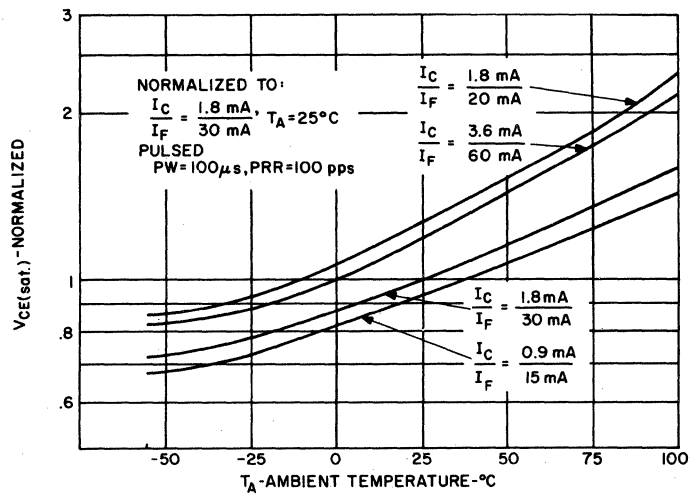

3. $V_{CE(sat)}$ VS. TEMPERATURE

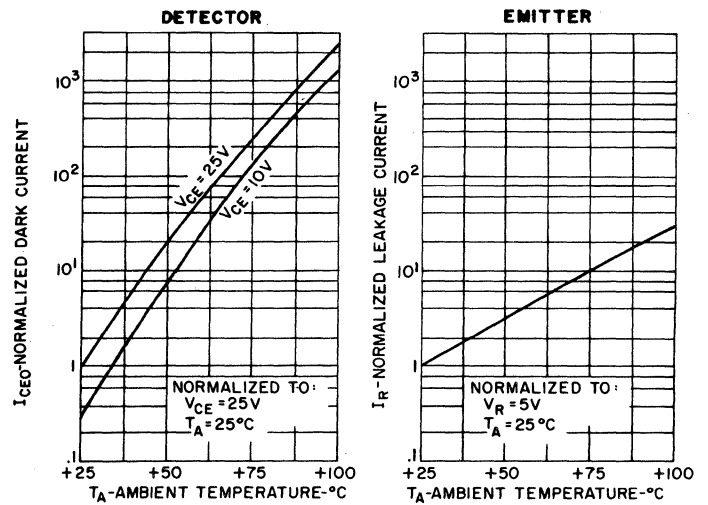

4. LEAKAGE CURRENTS VS. TEMPERATURE

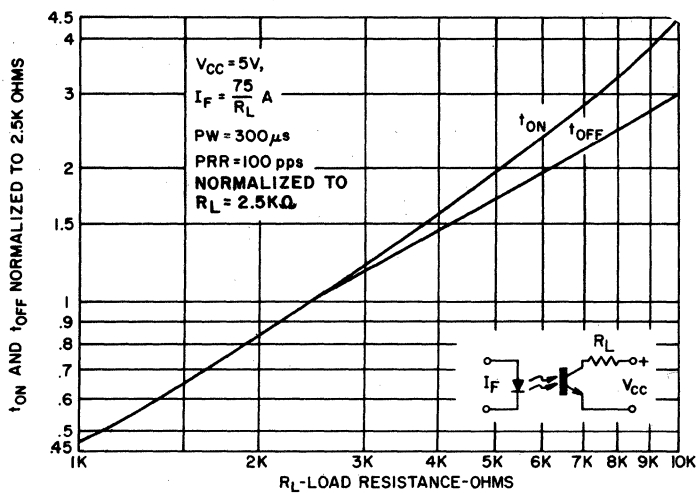

5. SWITCHING SPEED VS. R_L

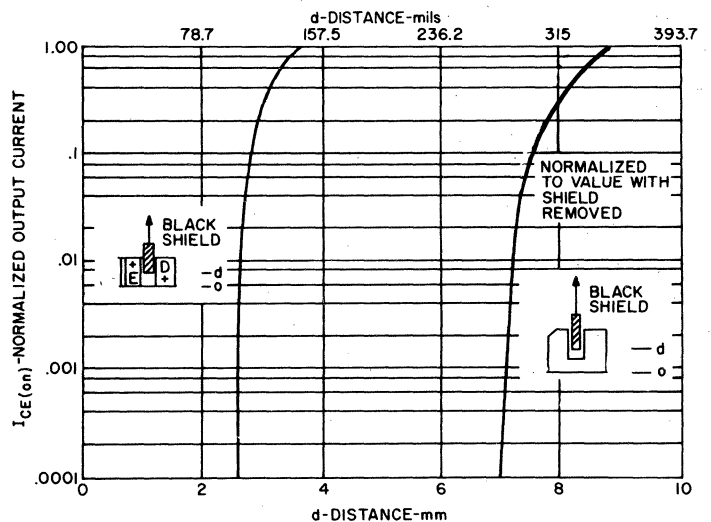

6. OUTPUT CURRENT VS. SHIELD DISTANCE



SOLID STATE



ELECTRONICS

1mm Aperture

Photon Coupled Interrupter Module H22A4, H22A5, H22A6

The General Electric H22A Interrupter Module is a gallium arsenide infrared emitting diode coupled to a silicon photo-transistor in a plastic housing. The packaging system is designed to optimize the mechanical resolution, coupling efficiency, ambient light rejection, cost, and reliability. The gap in the housing provides a means of interrupting the signal with an opaque material, switching the output from an "ON" into an "OFF" state.

absolute maximum ratings: (25°C)

TOTAL DEVICE			
Storage Temperature	T_{STG}	-55°C to +100°C	
Operating Temperature	T_J	-55°C to +100°C	
Lead Soldering Temperature (5 seconds maximum)	T_L	260°C	

INFRARED EMITTING DIODE			
Power Dissipation	P_E	*100	mW
Forward Current (Continuous)	I_F	60	mA
Forward Current (Peak) (Pulse Width $\leq 1 \mu s$ PRR ≤ 300 pps)	I_F	3	A
Reverse Voltage	V_R	6	V

*Derate 1.33 mW/°C above 25°C ambient.

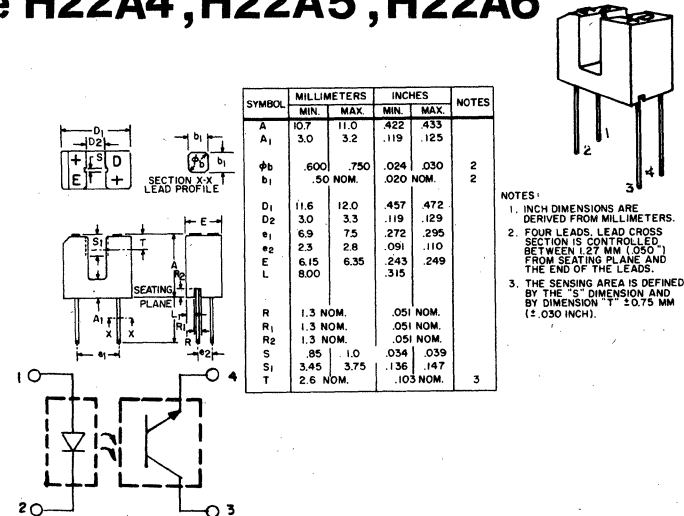

PHOTO TRANSISTOR			
Power Dissipation	P_D	**150	mW
Collector Current (Continuous)	I_C	100	mA
Collector-Emitter Voltage	V_{CEO}	55	V
Emitter-Collector Voltage	V_{ECO}	6	V

**Derate 2.0 mW/°C above 25°C ambient.

individual electrical characteristics:(25°C) (See Note 1)

EMITTER	MIN.	TYP.	MAX.	UNITS
Reverse Breakdown Voltage $V_{(BR)R}$ $I_R = 10 \mu A$	6	—	—	V
Forward Voltage V_F $I_F = 60 mA$	—	—	1.7	V
Reverse Current I_R $V_R = 5V$	—	—	100	nA
Capacitance C_i $V = 0, f = 1 MHz$	—	30	—	pF

DETECTOR	MIN.	TYP.	MAX.	UNITS
Breakdown Voltage $V_{(BR)CEO}$ $I_C = 1 mA$	55	—	—	V
Breakdown Voltage $V_{(BR)ECO}$ $I_E = 100 \mu A$	6	—	—	V
Collector Dark Current I_{CEO} $V_{CE} = 45V$	—	—	100	nA
Capacitance C_{ce} $V_{CE} = 5V, f = 1 MHz$	—	3.3	5	pF

coupled electrical characteristics:(25°C) (See Note 1)

	H22A4			H22A5			H22A6			UNITS
	MIN.	TYP.	MAX.	MIN.	TYP.	MAX.	MIN.	TYP.	MAX.	
$I_{CE(on)}$ $I_F = 5mA, V_{CE} = 5V$	0.15	—	—	0.30	—	—	0.60	—	—	mA
$I_{CE(on)}$ $I_F = 20mA, V_{CE} = 5V$	1.0	—	—	2.0	—	—	4.0	—	—	mA
$I_{CE(on)}$ $I_F = 30mA, V_{CE} = 5V$	1.9	—	—	3.0	—	—	5.5	—	—	mA
$V_{CE(sat)}$ $I_F = 20mA, I_C = 1.8mA$	—	—	—	—	—	0.40	—	—	0.40	V
$V_{CE(sat)}$ $I_F = 30mA, I_C = 1.8mA$	—	—	0.40	—	—	—	—	—	—	V
t_{on} $V_{CC} = 5V, I_F = 30mA, R_L = 2.5K\Omega$	—	8	—	—	8	—	—	8	—	μs
t_{off} $V_{CC} = 5V, I_F = 30mA, R_L = 2.5K\Omega$	—	50	—	—	50	—	—	50	—	μs

Note 1: Stray irradiation can alter values of characteristics. Adequate shielding should be provided.

TYPICAL CHARACTERISTICS

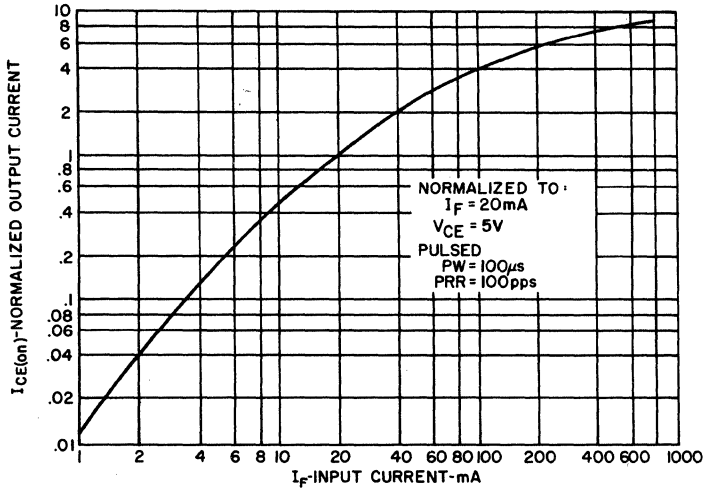

1. OUTPUT CURRENT VS. INPUT CURRENT

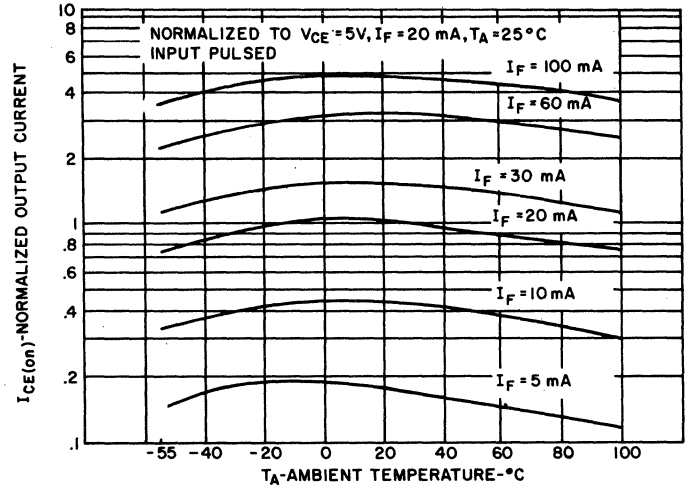

2. OUTPUT CURRENT VS. TEMPERATURE

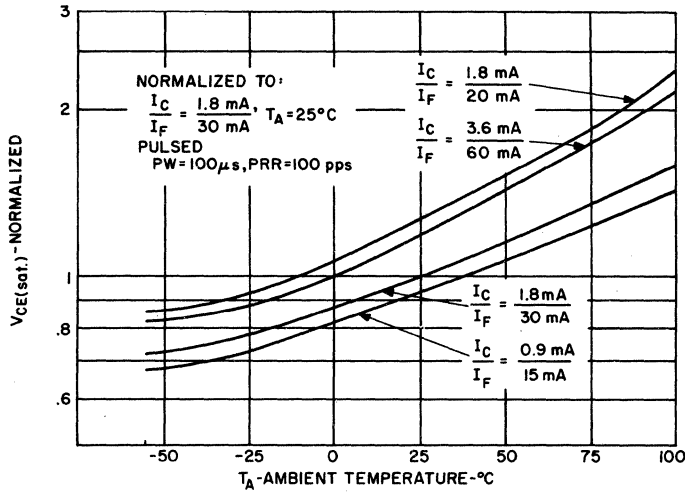

3. $V_{CE(sat)}$ VS. TEMPERATURE

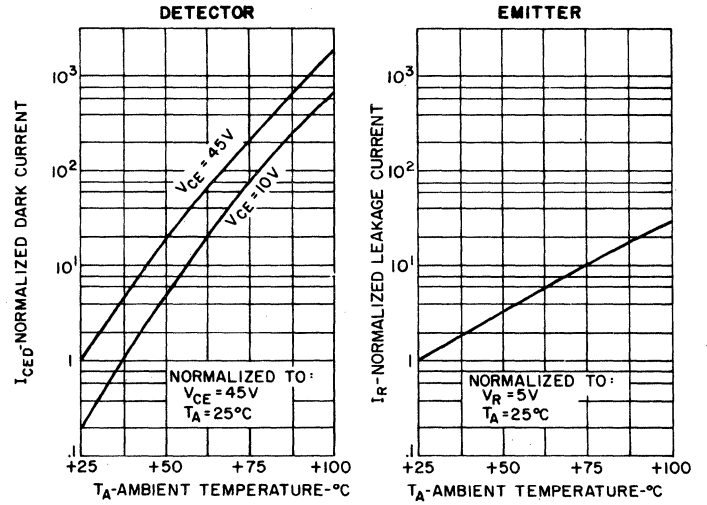

4. LEAKAGE CURRENTS VS. TEMPERATURE

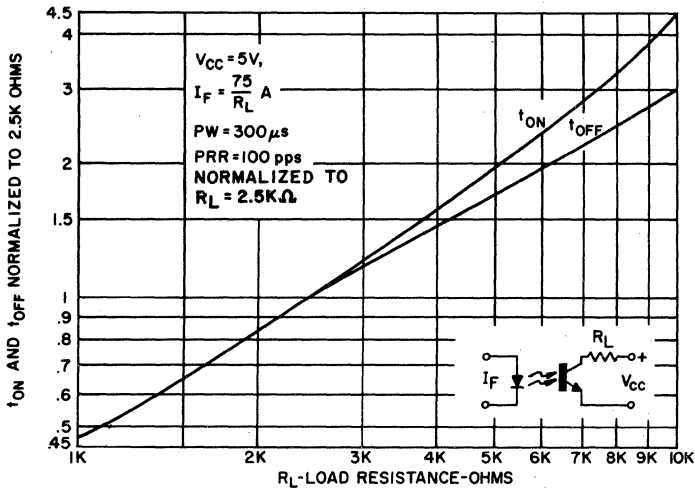

5. SWITCHING SPEED VS. R_L

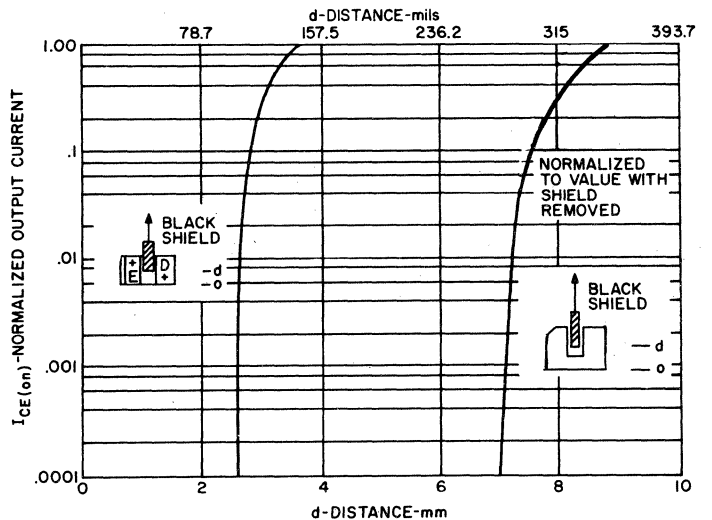

6. OUTPUT CURRENT VS. SHIELD DISTANCE



SOLID STATE OPTOELECTRONICS

1mm Aperture

Photon Coupled Interrupter Module H22B1, H22B2, H22B3

The General Electric H22B Interrupter Module is a gallium arsenide infrared emitting diode coupled to a silicon darlington connected phototransistor in a plastic housing. The packaging system is designed to optimize the mechanical resolution, coupling efficiency, ambient light rejection, cost, and reliability. The gap in the housing provides a means of interrupting the signal with an opaque material, switching the output from an "ON" into an "OFF" state.

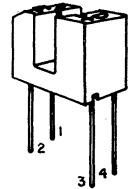
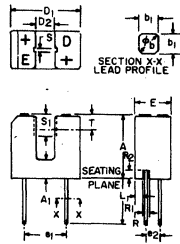

absolute maximum ratings: (25°C)

TOTAL DEVICE		
Storage Temperature	T_{STG}	-55°C to +100°C
Operating Temperature	T_J	-55°C to +100°C
Lead Soldering Temperature (5 seconds maximum)	T_L	260°C

INFRARED EMITTING DIODE			
Power Dissipation	P_E	*100	mW
Forward Current (Continuous)	I_F	60	mA
Forward Current (Peak) (Pulse Width $\leq 1\mu s$ PRR ≤ 300 pps)	I_F	3	A
Reverse Voltage	V_R	6	V

*Derate 1.33 mW/°C above 25°C ambient.

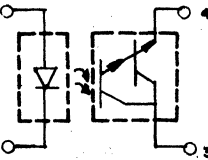

SYMBOL	MILLIMETERS		INCHES		NOTES
	MIN.	MAX.	MIN.	MAX.	
A	10.7	11.0	.422	.433	
A ₁	3.0	3.2	.119	.125	
ϕb	.600	.750	.024	.030	2
b ₁	.50 NOM.		.020 NOM.		2
D ₁	11.6	12.0	.457	.472	
D ₂	3.0	3.3	.119	.129	
e ₁	6.9	7.5	.272	.295	
e ₂	2.3	2.8	.091	.110	
E	6.15	6.35	.243	.249	
L	8.00		.315		
R	1.3 NOM.		.051 NOM.		
R ₁	1.3 NOM.		.051 NOM.		
R ₂	1.3 NOM.		.051 NOM.		
S	.85	1.0	.034	.039	
S ₁	3.45	3.75	.136	.147	
T	2.6 NOM.		.103 NOM.		3

NOTES:
 1. INCH DIMENSIONS ARE DERIVED FROM MILLIMETERS.
 2. FOUR LEADS, LEAD CROSS SECTION IS CONTROLLED BETWEEN 1.27 MM (.050") FROM SEATING PLANE AND THE END OF THE LEADS.
 3. THE SEATING AREA IS DEFINED BY THE "S" DIMENSION AND BY DIMENSION "T" ± 0.75 MM (.030 INCH).

DARLINGTON CONNECTED PHOTOTRANSISTOR			
Power Dissipation	P_D	**150	mW
Collector Current (Continuous)	I_C	100	mA
Collector-Emitter Voltage	V_{CEO}	30	V
Emitter-Collector Voltage	V_{ECO}	7	V

**Derate 2.0 mW/°C above 25°C ambient.

individual electrical characteristics:(25°C) (See Note 1)

EMITTER	MIN.	TYP.	MAX.	UNITS
Reverse Breakdown Voltage $V_{(BR)R}$ $I_R = 10\mu A$	6	—	—	V
Forward Voltage V_F $I_F = 60$ mA	—	—	1.7	V
Reverse Current I_R $V_R = 5$ V	—	—	100	nA
Capacitance C_i $V = 0, f = 1$ MHz	—	30	—	pF

DETECTOR	MIN.	TYP.	MAX.	UNITS
Breakdown Voltage $V_{(BR)CEO}$ $I_C = 1$ mA	30	—	—	V
Breakdown Voltage $V_{(BR)ECO}$ $I_E = 100\mu A$	7	—	—	V
Collector Dark Current I_{CEO} $V_{CE} = 25$ V	—	—	100	nA
Capacitance C_{ce} $V_{CE} = 5$ V, $f = 1$ MHz	—	5	8	pF

coupled electrical characteristics:(25°C) (See Note 1)

	H22B1			H22B2			H22B3			UNITS
	MIN.	TYP.	MAX.	MIN.	TYP.	MAX.	MIN.	TYP.	MAX.	
$I_{CE(on)}$ $I_F = 2$ mA, $V_{CE} = 1.5$ V	0.5	—	—	1.0	—	—	2.0	—	—	mA
$I_{CE(on)}$ $I_F = 5$ mA, $V_{CE} = 1.5$ V	2.5	—	—	5.0	—	—	10	—	—	mA
$I_{CE(on)}$ $I_F = 10$ mA, $V_{CE} = 1.5$ V	7.5	—	—	14	—	—	25	—	—	mA
$V_{CE(sat)}$ $I_F = 10$ mA, $I_C = 1.8$ mA	—	—	1.0	—	—	1.0	—	—	1.0	V
$V_{CE(sat)}$ $I_F = 60$ mA, $I_C = 50$ mA	—	—	—	—	—	1.5	—	—	1.5	V
t_{on} $V_{CC} = 5$ V, $I_F = 10$ mA, $R_L = 750\Omega$	—	45	—	—	45	—	—	45	—	μs
t_{on} $V_{CC} = 5$ V, $I_F = 60$ mA, $R_L = 75\Omega$	—	—	—	—	7	—	—	7	—	μs
t_{off} $V_{CC} = 5$ V, $I_F = 10$ mA, $R_L = 750\Omega$	—	250	—	—	250	—	—	250	—	μs
t_{off} $V_{CC} = 5$ V, $I_F = 60$ mA, $R_L = 75\Omega$	—	—	—	—	45	—	—	45	—	μs

Note 1: Stray irradiation can alter values of characteristics. Adequate shielding should be provided.

TYPICAL CHARACTERISTICS

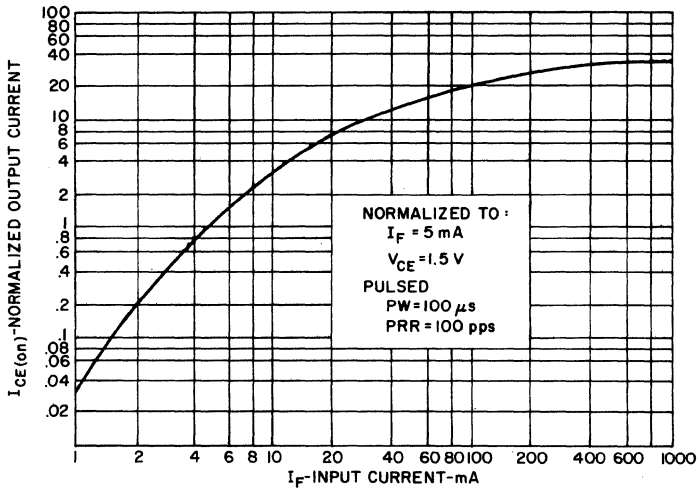

1. OUTPUT CURRENT VS. INPUT CURRENT

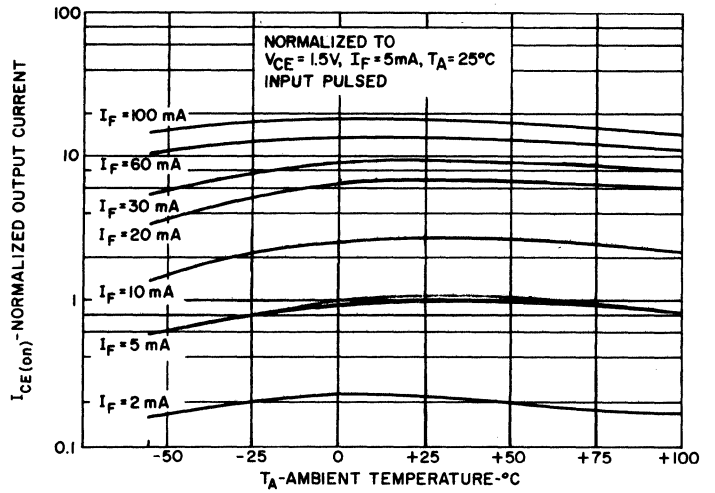

2. OUTPUT CURRENT VS. TEMPERATURE

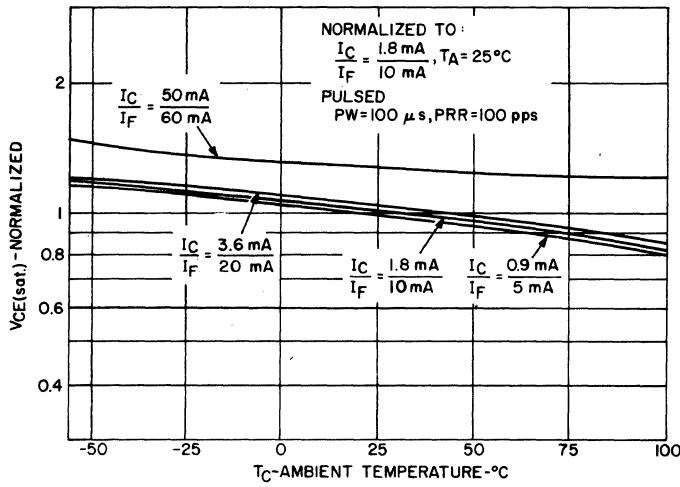

3. $V_{CE(sat)}$ VS. TEMPERATURE

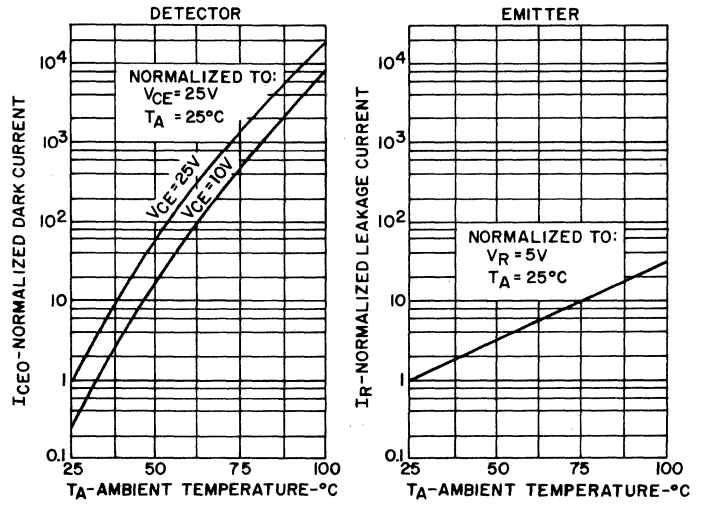

4. LEAKAGE CURRENTS VS. TEMPERATURE

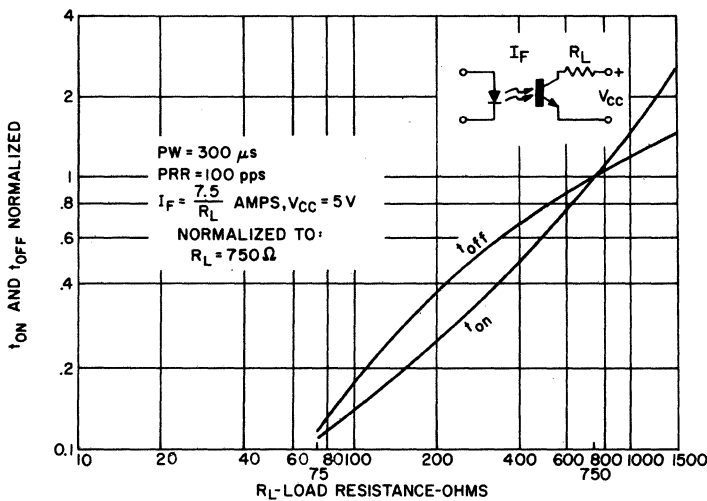

5. SWITCHING SPEED VS. R_L

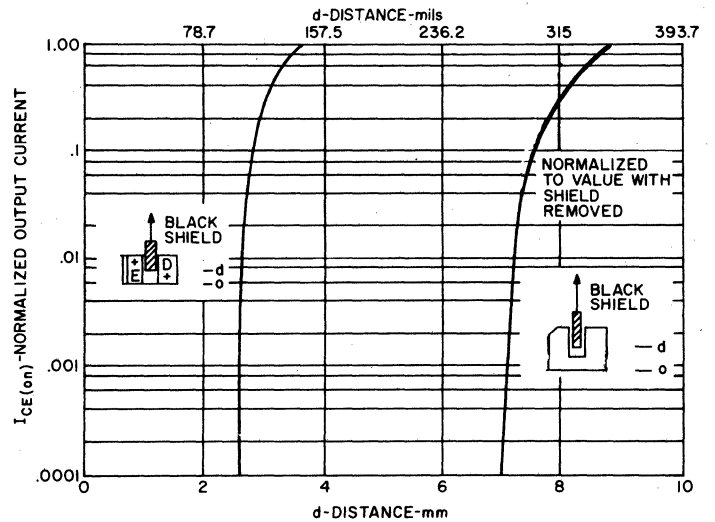

6. OUTPUT CURRENT VS. SHIELD DISTANCE



SOLID STATE

OPTO

ELECTRONICS

1mm Aperture

Photon Coupled Interrupter Module H22B4, H22B5, H22B6

The General Electric H22B Interrupter Module is a gallium arsenide infrared emitting diode coupled to a silicon darlington connected phototransistor in a plastic housing. The packaging system is designed to optimize the mechanical resolution, coupling efficiency, ambient light rejection, cost, and reliability. The gap in the housing provides a means of interrupting the signal with an opaque material, switching the output from an "ON" into an "OFF" state.

absolute maximum ratings: (25°C)

TOTAL DEVICE			
Storage Temperature	T _{STG}	-55°C to +100°C	
Operating Temperature	T _J	-55°C to +100°C	
Lead Soldering Temperature (5 seconds maximum)	T _L	260°C	

INFRARED EMITTING DIODE			
Power Dissipation	P _E	*100	mW
Forward Current (Continuous)	I _F	60	mA
Forward Current (Peak) (Pulse Width ≤ 1 μs PRR ≤ 300 pps)	I _F	3	A
Reverse Voltage	V _R	6	V

*Derate 1.33 mW/°C above 25°C ambient.

DARLINGTON CONNECTED PHOTOTRANSISTOR			
Power Dissipation	P _D	**150	mW
Collector Current (Continuous)	I _C	100	mA
Collector-Emitter Voltage	V _{CEO}	55	V
Emitter-Collector Voltage	V _{ECO}	7	V

**Derate 2.0 mW/°C above 25°C ambient.

individual electrical characteristics:(25°C) (See Note 1)

EMITTER	MIN.	TYP.	MAX.	UNITS
Reverse Breakdown Voltage V _{(BR)R} I _R = 10 μA	6	—	—	V
Forward Voltage V _F I _F = 60 mA	—	—	1.7	V
Reverse Current I _R V _R = 5V	—	—	100	nA
Capacitance C _i V = 0, f = 1MHz	—	30	—	pF

DETECTOR	MIN.	TYP.	MAX.	UNITS
Breakdown Voltage V _{(BR)CEO} I _C = 1 mA	55	—	—	V
Breakdown Voltage V _{(BR)ECO} I _E = 100 μA	7	—	—	V
Collector Dark Current I _{CEO} V _{CE} = 45V	—	—	100	nA
Capacitance C _{ce} V _{CE} = 5V, f = 1MHz	—	5	8	pF

coupled electrical characteristics:(25°C) (See Note 1)

	H22B4			H22B5			H22B6			UNITS
	MIN.	TYP.	MAX.	MIN.	TYP.	MAX.	MIN.	TYP.	MAX.	
I _{CE(on)} I _F = 2mA, V _{CE} = 1.5V	0.5	—	—	1.0	—	—	2.0	—	—	mA
I _{CE(on)} I _F = 5mA, V _{CE} = 1.5V	2.5	—	—	5.0	—	—	10	—	—	mA
I _{CE(on)} I _F = 10mA, V _{CE} = 1.5V	7.5	—	—	14	—	—	25	—	—	mA
V _{CE(sat)} I _F = 10mA, I _C = 1.8mA	—	—	1.0	—	—	1.0	—	—	1.0	V
V _{CE(sat)} I _F = 60mA, I _C = 50mA	—	—	—	—	—	1.5	—	—	1.5	V
t _{on} V _{CC} = 5V, I _F = 10mA, R _L = 750Ω	—	45	—	—	45	—	—	45	—	μs
V _{CC} = 5V, I _F = 60mA, R _L = 75Ω	—	—	—	—	7	—	—	7	—	μs
t _{off} V _{CC} = 5V, I _F = 10mA, R _L = 750Ω	—	250	—	—	250	—	—	250	—	μs
V _{CC} = 5V, I _F = 60mA, R _L = 75Ω	—	—	—	—	45	—	—	45	—	μs

Note 1: Stray irradiation can alter values of characteristics. Adequate shielding should be provided.

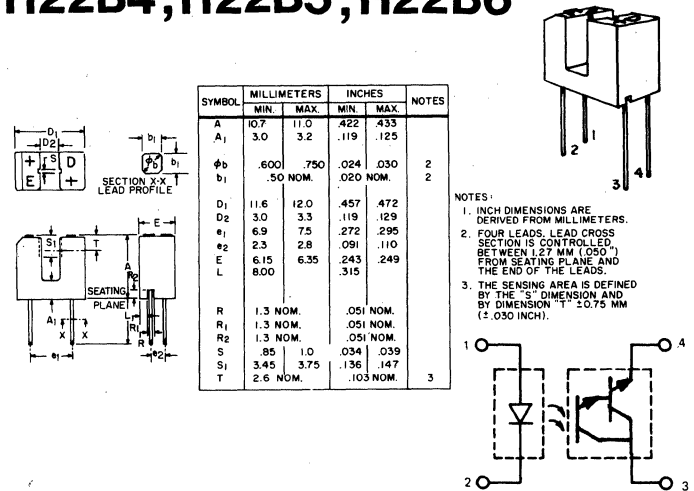

TYPICAL CHARACTERISTICS

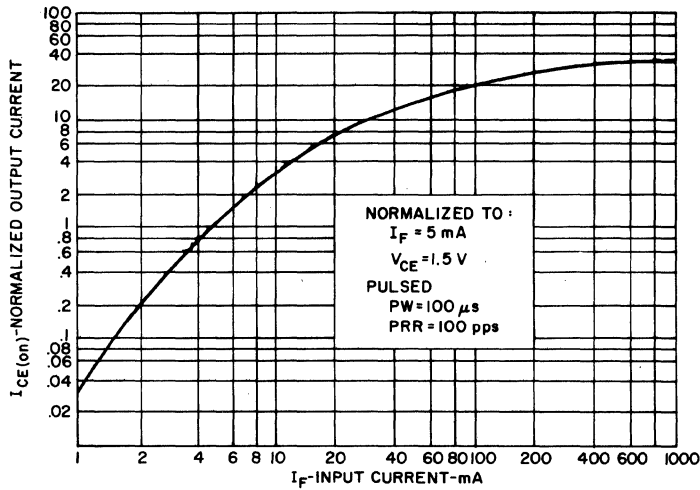

1. OUTPUT CURRENT VS. INPUT CURRENT

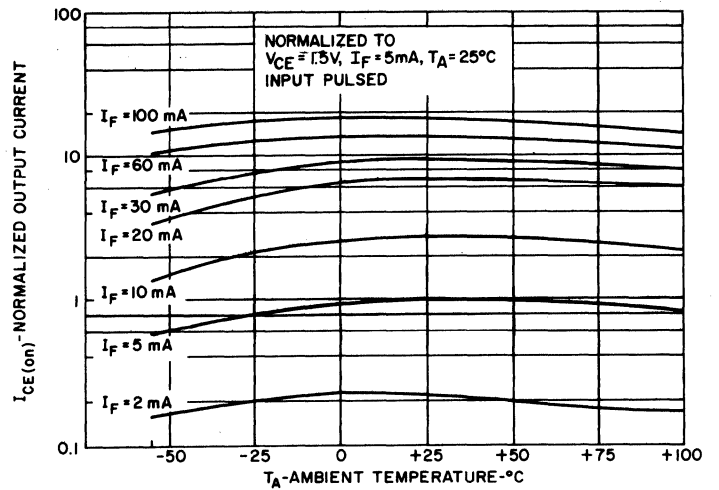

2. OUTPUT CURRENT VS. TEMPERATURE

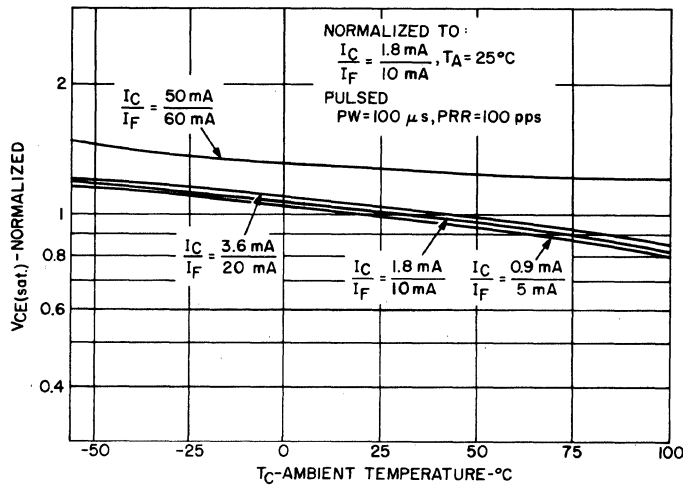

3. V_{CE(sat)} VS. TEMPERATURE

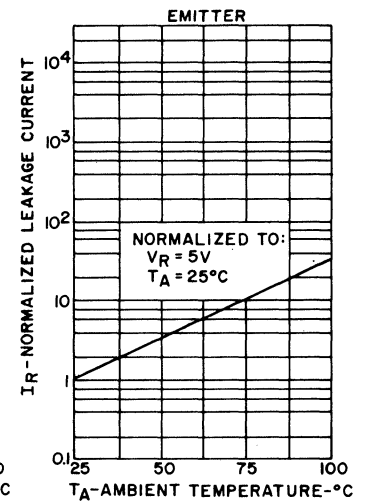
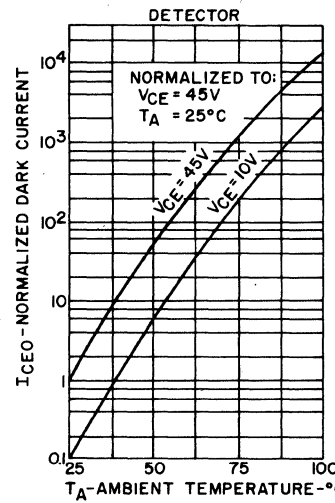

4. LEAKAGE CURRENTS VS. TEMPERATURE

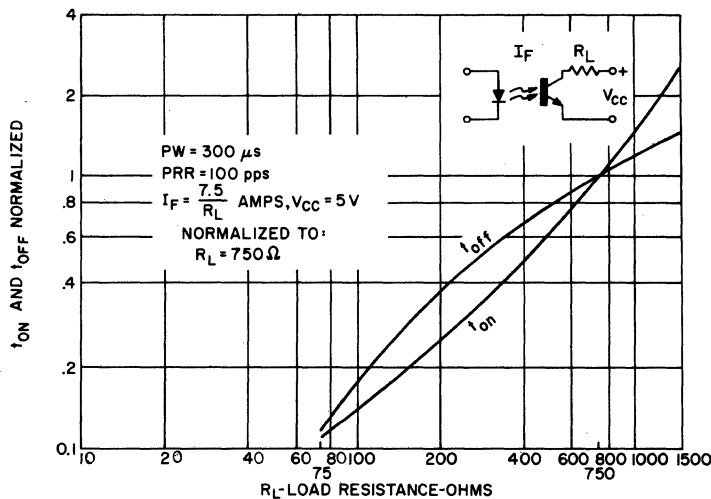

5. SWITCHING SPEED VS. R_L

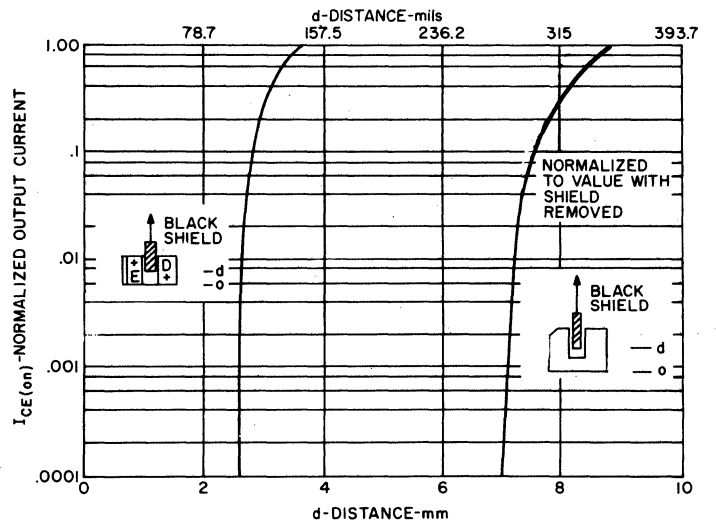

6. OUTPUT CURRENT VS. SHIELD DISTANCE



SOLID STATE

OPTO ELECTRONICS

1mm Aperture

Photon Coupled Interrupter Module H22L1, H22L2

The General Electric H22L series is a gallium arsenide, infrared emitting diode coupled to a high speed integrated circuit detector. The output incorporates a Schmitt Trigger which provides hysteresis for noise immunity and pulse shaping. The gap in the plastic housing provides a means of interrupting the signal with an opaque material, switching the output from an "ON" into an "OFF" state.

absolute maximum ratings: (25°C)

TOTAL DEVICE			
Storage Temperature	T_{STG}	-55°C to +85°C	
Operating Temperature	T_J	-55°C to +85°C	
Lead Soldering Temperature (5 seconds maximum)	T_L	260°C	

INFRARED EMITTING DIODE			
Power Dissipation	P_E	*100	mW
Forward Current (Continuous)	I_F	60	mA
Forward Current (Peak) (Pulse width $\leq 1 \mu s$ PRR ≤ 300 pps)	I_F	3	A
Reverse Voltage	V_R	6	V

*Derate 1.33 mW/°C above 25°C ambient.

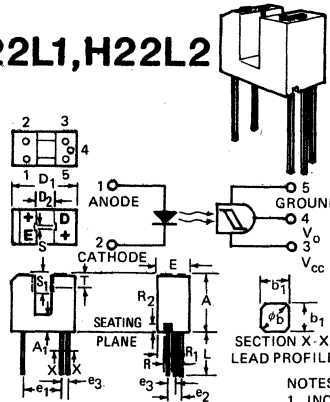

SYMBOL	MILLIMETERS		INCH		NOTES
	MIN.	MAX.	MIN.	MAX.	
A	10.7	11.0	.422	.433	
A ₁	3.0	3.2	.119	.125	
ϕb	.600	.750	.024	.030	2
b ₁	.50 NOM.		.020 NOM.		2
D ₁	11.6	12.0	.457	.472	
D ₂	3.0	—	.119	—	
e ₁	6.9	7.5	.272	.295	
e ₂	2.3	2.8	.091	.110	
e ₃	1.14	1.4	.045	.055	
E	6.15	6.35	.243	.249	
L	8.00	—	.315	—	
R	1.83 NOM.		.072 NOM.		
R ₁	1.3 NOM.		.051 NOM.		
R ₂	1.3 NOM.		.051 NOM.		
S	.85	1.0	.034	.039	
S ₁	3.94 NOM.		.155 NOM.		
T	2.6 NOM.		.103 NOM.		3

- NOTES:
1. INCH DIMENSIONS ARE DERIVED FROM MILLIMETERS.
 2. FOUR LEADS. LEAD CROSS SECTION IS CONTROLLED BETWEEN 1.27 MM (.050") FROM SEATING PLANE AND THE END OF THE LEADS.
 3. THE SENSING AREA IS DEFINED BY THE "S" DIMENSION AND BY DIMENSION "T" ± 0.75 MM (± 0.030 INCH).

PHOTO DETECTOR			
Power Dissipation	P_D	**150	mW
Output Current	I_4	50	mA
Allowed Range	V_{35}	0 to 16	V
Allowed Range	V_{45}	0 to 16	V

**Derate 2.0 mW/°C above 25°C ambient.

individual electrical characteristics: (0-70°C) (See Note 1)

EMITTER		MIN.	TYP.	MAX.	UNITS
Forward Voltage ($I_F = 20$ mA)	V_F	—	1.10	1.60	volts
Reverse Current ($V_R = 3$ V)	I_R	—	—	10	micro-ampere
Capacitance ($V = 0$, $f = 1$ MHz)	C_J	—	—	100	pico-farads

DETECTOR		MIN.	TYP.	MAX.	UNITS
Operating Voltage Range	V_C	4	—	15	volts
Supply Current ($I_F = 0$, $V_{CC} = 5$ V)	$I_{3(off)}$	—	1.0	5.0	milli-ampere
Output Current, High ($I_F = 0$, $V_{CC} = V_O = 15$ V)	I_{OH}	—	—	100	micro-ampere

coupled electrical characteristics (0-70°C) (See Note 1)

		MIN.	TYP.	MAX.	UNITS
Supply Current ($I_F = 20$ mA, $V_{CC} = 5$ V)	$I_{3(on)}$	—	1.6	5.0	milliampere
Output Voltage, Low ($R_L = 270 \Omega$, $V_{CC} = 5$ V, $I_F = 20$ mA)	V_{OL}	—	0.2	0.4	volts
Turn-On Threshold Current ($R_L = 270 \Omega$, $V_{CC} = 5$ V)	$I_{F(on)}$	H22L1	20	30	milliampere
		H22L2	10	15.0	milliampere
Turn-Off Threshold Current ($R_L = 270 \Omega$, $V_{CC} = 5$ V)	$I_{F(off)}$	H22L1	0.5	15	milliampere
		H22L2	0.5	8	milliampere
Hysteresis Ratio ($R_L = 270 \Omega$, $V_{CC} = 5$ V)	$I_{F(off)}/I_{F(on)}$	0.50	0.75	0.90	—
Switching Speeds: ($R_L = 270 \Omega$, $V_{CC} = 5$ V, $T_A = 25^\circ C$, $I_F = 20$ mA)					
Rise Time	t_r	—	0.1	—	$\mu sec.$
Fall Time	t_f	—	0.1	—	$\mu sec.$

Note 1: Stray irradiation can alter values of characteristics. Adequate shielding should be provided.

TYPICAL CHARACTERISTICS

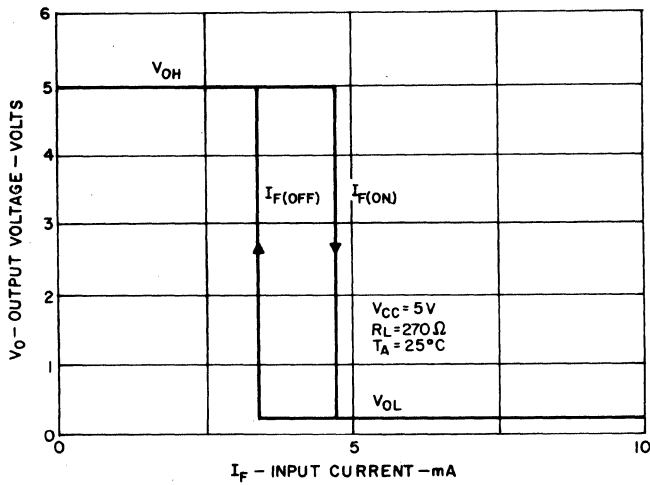

TRANSFER CHARACTERISTICS

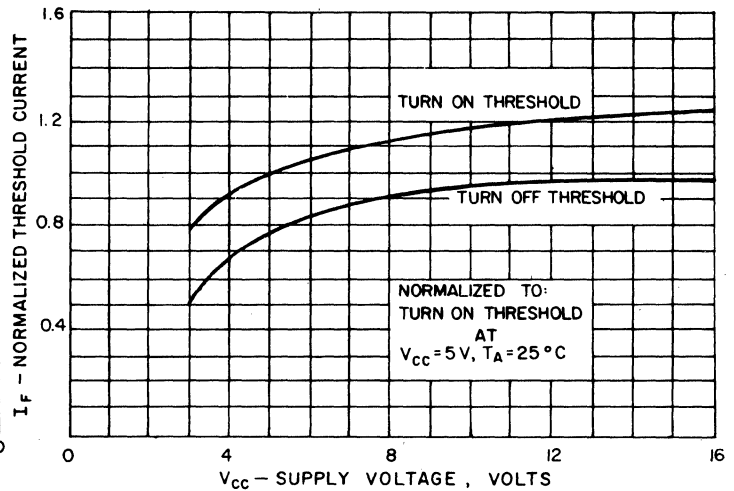

THRESHOLD CURRENT VS. SUPPLY VOLTAGE

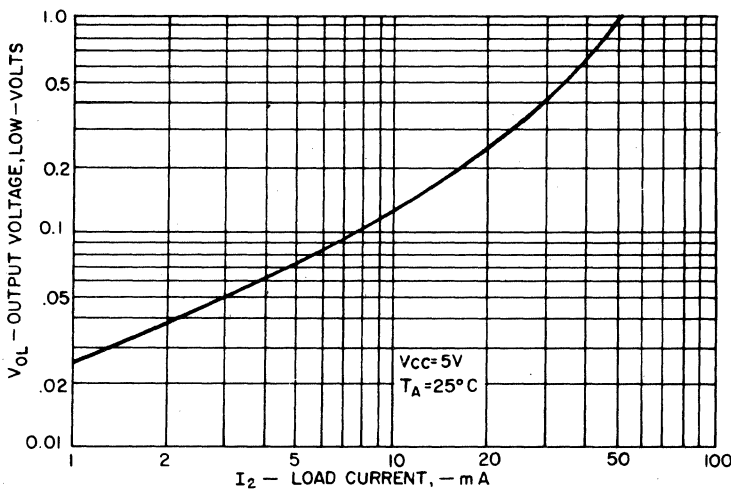

ON VOLTAGE VS. LOAD CURRENT

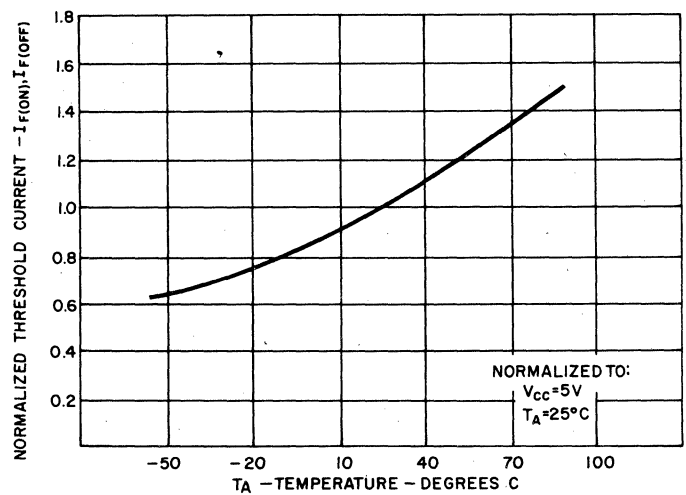

THRESHOLD CURRENTS VS. TEMPERATURE

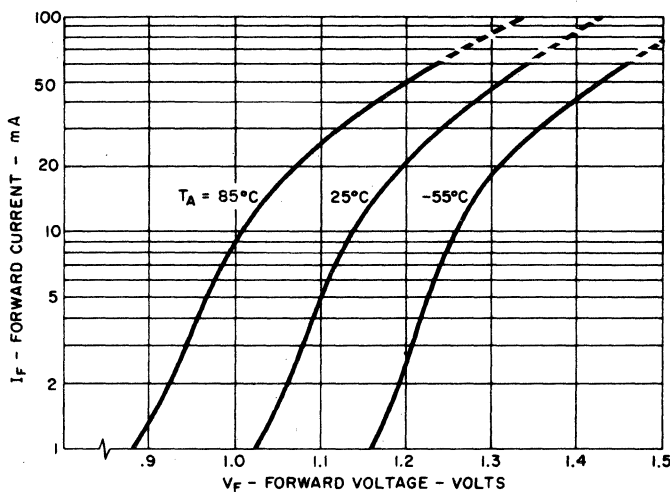

FORWARD VOLTAGE VS. FORWARD CURRENT

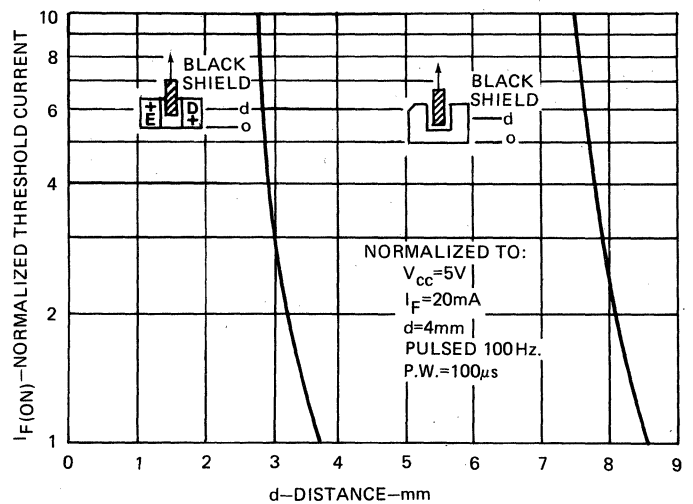

THRESHOLD CURRENT VS. SHIELD DISTANCE



SOLID STATE OPTOELECTRONICS

Matched Emitter-Detector pair H23A1-H23A2

The General Electric H23A1 is a matched emitter-detector pair which consists of a gallium arsenide, infrared emitting diode and a silicon phototransistor. The clear epoxy packaging system is designed to optimize the mechanical resolution, coupling efficiency, cost, and reliability. The devices are marked with a color dot for easy identification of the emitter and detector.

absolute maximum ratings: (25°C)

EMITTER-DETECTOR PAIR

Storage Temperature	T _{STG}	-55°C to +100°C
Operating Temperature	T _J	-55°C to +100°C
Lead Soldering Temperature (5 seconds maximum)	T _L	260°C

INFRARED EMITTING DIODE

Power Dissipation	P _E	*100	mW
Forward Current (Continuous)	I _F	60	mA
Forward Current (Peak) (Pulse Width ≤ 1μs PRR ≤ 300 pps)	I _F	3	A
Reverse Voltage	V _R	6	V

*Derate 1.33 mW/°C above 25°C ambient.

individual electrical characteristics (25°C) (See Note 1)

EMITTER	MIN.	TYP.	MAX.	UNITS
Reverse Breakdown Voltage V _{(BR)R} I _R = 10μA	6	—	—	V
Forward Voltage V _F I _F = 60 mA	—	—	1.7	V
Reverse Current I _R V _R = 5V	—	—	100	nA
Capacitance C _i V = 0, f = 1 MHz	—	30	—	pF

PHOTOTRANSISTOR

Power Dissipation	P _D	**150	mW
Collector Current (Continuous)	I _C	100	mA
Collector-Emitter Voltage	V _{CEO}	30	V
Emitter-Collector Voltage	V _{ECO}	6	V

**Derate 2.0 mW/°C above 25°C ambient.

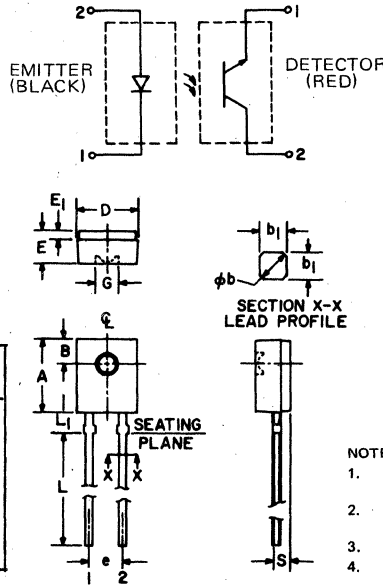

SYM	MILLI-METERS		INCHES		NOTES
	MIN	MAX	MIN	MAX	
A	6.59	5.80	.220	.228	
B	1.78	NOM.	.070	NOM.	2
φb	.80	.75	.024	.030	1
b ₁	.51	NOM.	.020	NOM.	1
D	4.45	4.70	.175	.185	
E	2.41	2.67	.095	.105	
E ₁	.58	.69	.023	.027	
e	2.41	2.67	.095	.105	3
G	1.98	NOM.	.078	NOM.	
L	12.7	—	.500	—	
L ₁	1.40	1.65	.055	.065	
S	.83	.94	.033	.037	3

NOTES:

- Two leads. Lead cross section dimensions uncontrolled within 1.27 MM (.050") of seating plane.
- Centerline of active element located within .25 MM (.010") of true position.
- As measured at the seating plane.
- Inch dimensions derived from millimeters.

coupled electrical characteristics (25°C) (See Note 1)

Note: Coupled electrical characteristics are measured at a separation distance of 4mm (.155 inches) with the lenses of the emitter and detector on a common axis within 0.1mm and parallel within 5°.

			MIN.	TYP.	MAX.	UNITS
I _{CE(on)}	I _F = 30mA, V _{CE} = 5V	H23A1:	1.5	—	—	mA
		H23A2:	1.0	—	—	mA
V _{CE(sat)}	I _F = 30mA, I _C = 1.8mA	H23A1:	—	—	0.40	V
	I _F = 30mA, I _C = .5mA	H23A2:	—	—	0.40	V
t _{on}	V _{CC} = 5V, I _F = 30mA, R _L = 2.5KΩ		—	8	—	μs
t _{off}	V _{CC} = 5V, I _F = 30mA, R _L = 2.5KΩ		—	50	—	μs

Note 1: Stray irradiation can alter values of characteristics. Adequate shielding should be provided.

TYPICAL CHARACTERISTICS

H23A1-H23A2

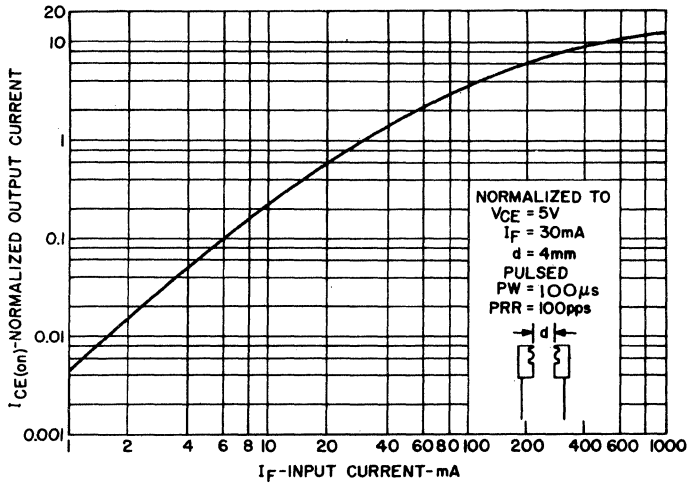

1. OUTPUT CURRENT VS. INPUT CURRENT

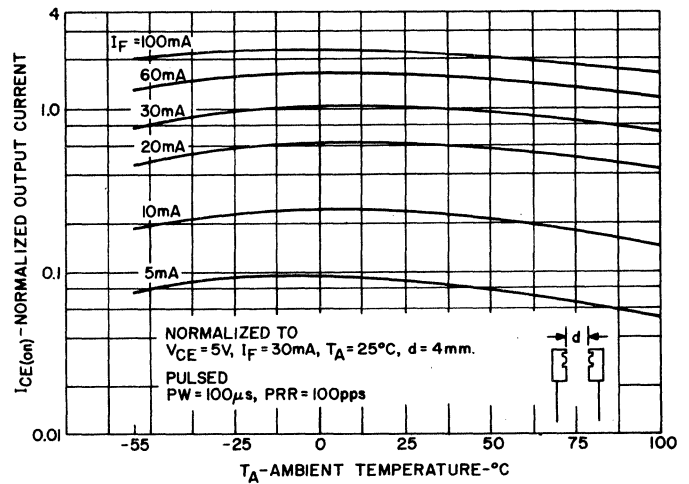

2. OUTPUT CURRENT VS. TEMPERATURE

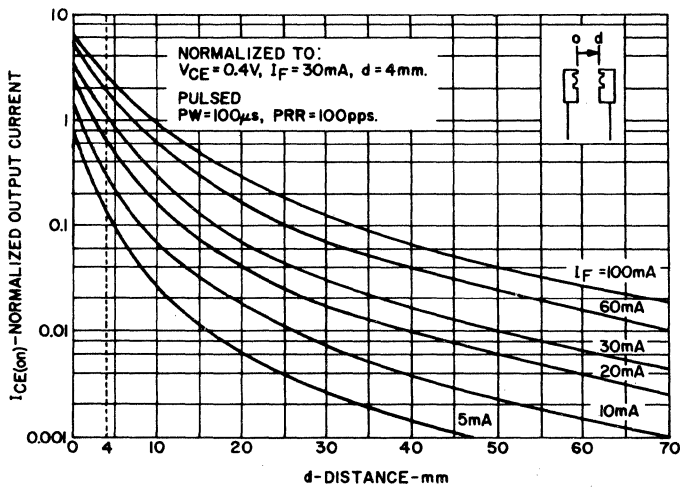

3. OUTPUT CURRENT VS. DISTANCE

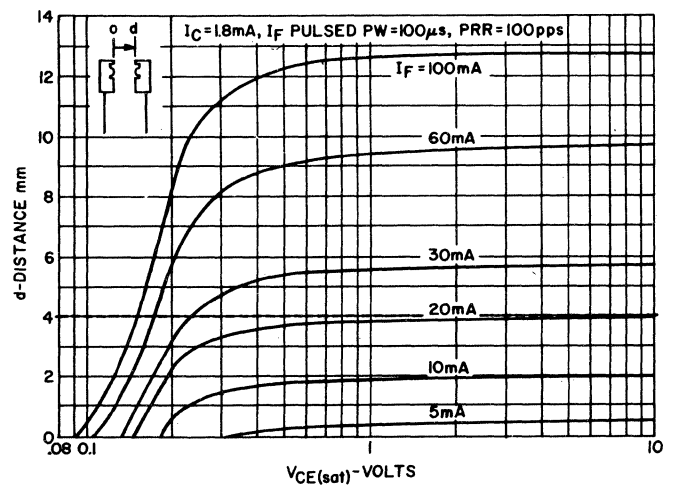

4. V_{CE(sat)} VS. DISTANCE

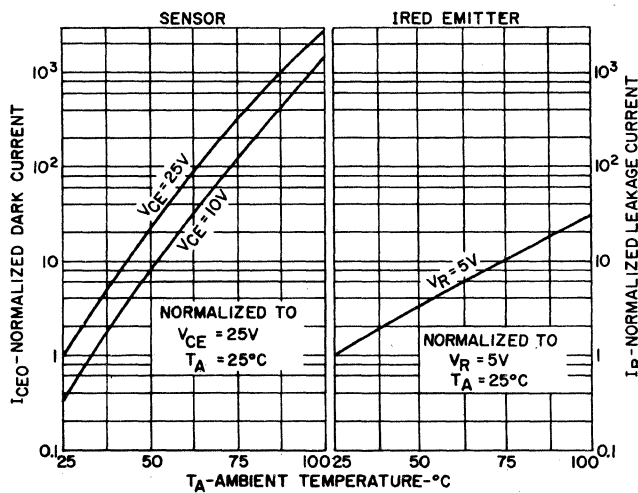

5. LEAKAGE CURRENTS VS. TEMPERATURE

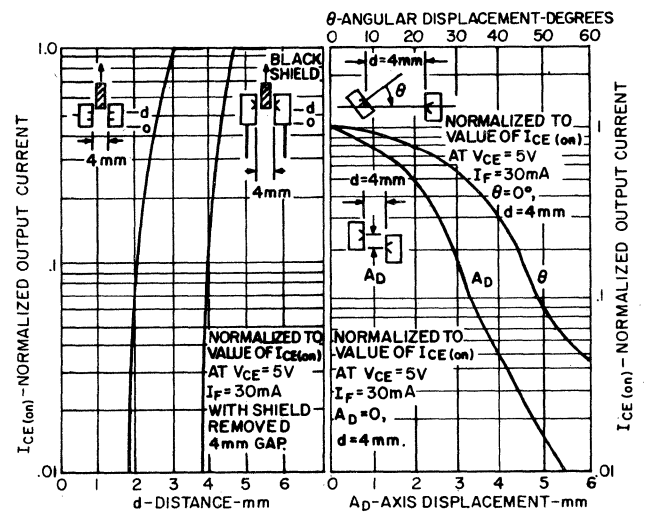

6A. OUTPUT CURRENT VS. SHIELD DISTANCE

6B. OUTPUT CURRENT VS. DISPLACEMENT (ANGULAR & AXIS)



SOLID STATE OPTO ELECTRONICS

Matched Emitter-Detector Pair H23B1

The General Electric H23B1 is a matched emitter-detector pair which consists of a gallium arsenide, infrared emitting diode and a silicon, darlington connected, phototransistor. The clear epoxy packaging system is designed to optimize the mechanical resolution, coupling efficiency, cost, and reliability. The devices are marked with a color dot for easy identification of the emitter and detector.

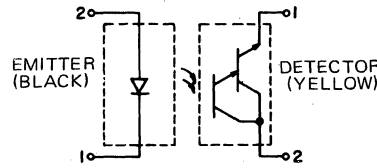

SYM	MILLI-METERS		INCHES		NOTES
	MIN	MAX	MIN	MAX	
A	5.59	5.80	.220	.228	
B	1.78	NOM.	.070	NOM.	2
φb	.60	.75	.024	.030	1
b1	.51	NOM.	.020	NOM.	1
D	4.45	4.70	.175	.185	
E	2.41	2.67	.095	.105	
E1	.58	.69	.023	.027	
e	2.41	2.67	.095	.105	3
G	1.98	NOM.	.078	NOM.	
L	12.7	—	.500	—	
L1	1.40	1.65	.055	.065	
S	.83	.94	.033	.037	3

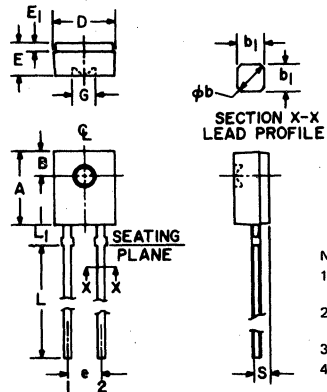

- NOTES:
- Two leads. Lead cross section dimensions uncontrolled within 1.27 MM (.050") of seating plane.
 - Centerline of active element located within .25 MM (.010") of true position.
 - As measured at the seating plane.
 - Inch dimensions derived from millimeters.

absolute maximum ratings: (25°C)

EMITTER - DETECTOR PAIR			
Storage Temperature	T _{STG}	-55°C to +100°C	
Operating Temperature	T _J	-55°C to +100°C	
Lead Soldering Temperature	T _L	260°C	
(5 seconds maximum)			

INFRARED EMITTING DIODE			
Power Dissipation	P _E	*100	mW
Forward Current (Continuous)	I _F	60	mA
Forward Current (Peak) (Pulse Width ≤ 1μs, PRR ≤ 300pps)	I _F	3	A
Reverse Voltage	V _R	6	V
*Derate 1.33 mW/°C above 25°C ambient.			

DARLINGTON CONNECTED PHOTOTRANSISTOR			
Power Dissipation	P _D	**150	mW
Collector Current (Continuous)	I _C	100	mA
Collector-Emitter Voltage	V _{CEO}	30	V
Emitter-Collector Voltage	V _{ECO}	7	V
**Derate 2.0 mW/°C above 25°C ambient.			

individual electrical characteristics (25°C) (See Note 1)

EMITTER	MIN.	TYP.	MAX.	UNITS
Reverse Breakdown Voltage V _{(BR)R} I _R = 10μA	6	—	—	V
Forward Voltage V _F I _F = 60 mA	—	—	1.7	V
Reverse Current I _R V _R = 5V	—	—	100	nA
Capacitance C _i V = 0, f = 1 MHz	—	30	—	pF

DETECTOR	MIN.	TYP.	MAX.	UNITS
Breakdown Voltage V _{(BR)CEO} I _C = 1 mA	30	—	—	V
Breakdown Voltage V _{(BR)ECO} I _E = 100 μA	7	—	—	V
Collector Dark Current I _{CEO} V _{CE} = 25 V	—	—	100	nA
Capacitance C _{ce} V _{CE} = 5V, f = 1 MHz	—	5	8	pF

coupled electrical characteristics (25°C) (See Note 1)

Note: Coupled electrical characteristics are measured at a separation distance of 4mm (.155 inches) with the lenses of the emitter and detector on a common axis within 0.1mm and parallel within 5°.

		MIN.	TYP.	MAX.	UNITS
I _{CE(on)}	I _F = 10mA, V _{CE} = 1.5V	7.5	—	—	mA
V _{CE(sat)}	I _F = 10mA, I _C = 1.8 mA	—	—	1.0	V
t _{on}	V _{CC} = 5V, I _F = 10mA, R _L = 750Ω	—	45	—	μs
t _{off}	V _{CC} = 5V, I _F = 10mA, R _L = 750Ω	—	250	—	μs

Note 1: Stray irradiation can alter values of characteristics. Adequate shielding should be provided.

TYPICAL CHARACTERISTICS

H23B1

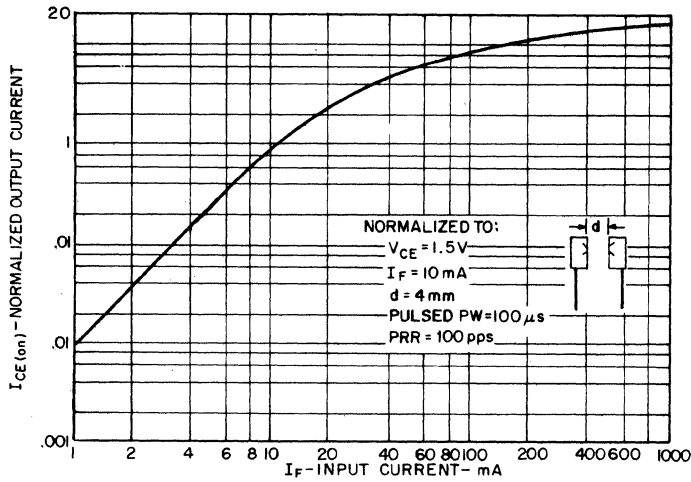

1. OUTPUT CURRENT VS. INPUT CURRENT

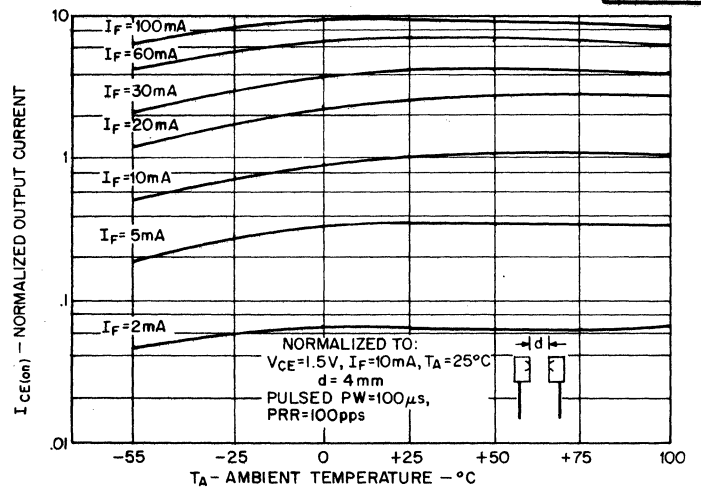

2. OUTPUT CURRENT VS. TEMPERATURE

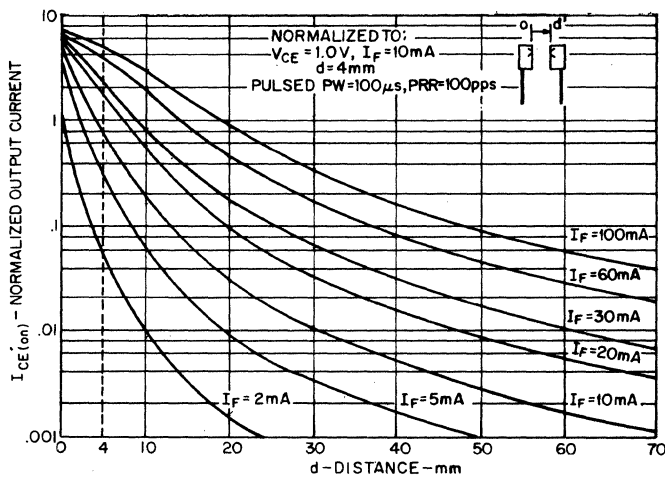

3. OUTPUT CURRENT VS. DISTANCE

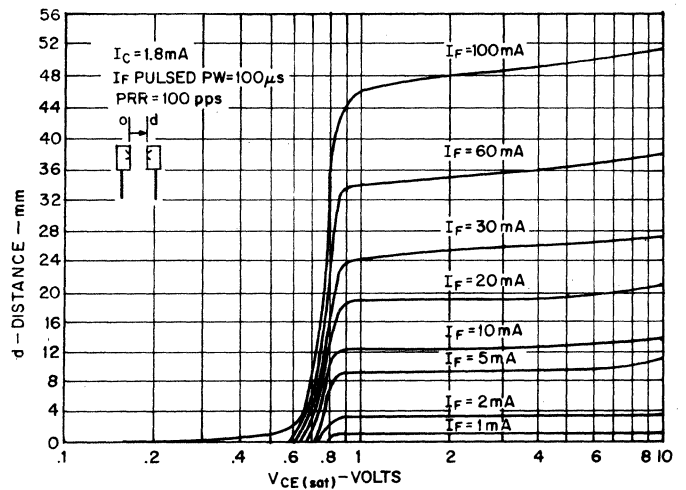

4. $V_{CE(sat)}$ VS. DISTANCE

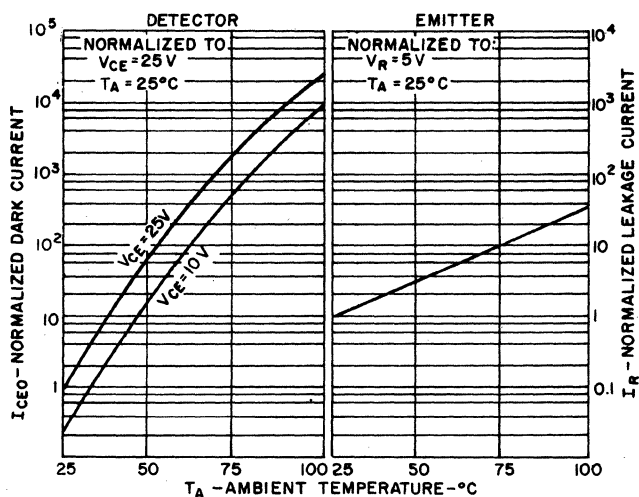

5. LEAKAGE CURRENTS VS. TEMPERATURE

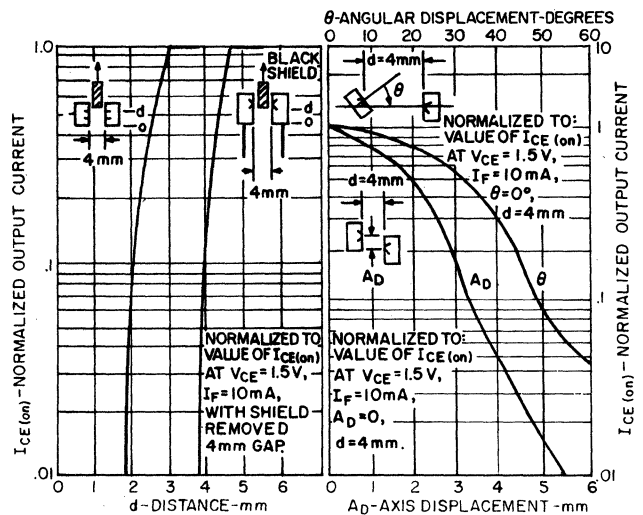

6A. OUTPUT CURRENT VS. SHIELD DISTANCE

6B. OUTPUT CURRENT VS. DISPLACEMENT (ANGULAR & AXIS)



SOLID STATE

OPTO ELECTRONICS

Matched Emitter-Detector Pair H23L1

The General Electric H23L1 is a matched emitter-detector pair which consists of a gallium arsenide, infrared emitting diode and a high speed integrated circuit detector. The output incorporates a Schmitt Trigger which provides hysteresis for noise immunity and pulse shaping. The detector circuit is optimized for simplicity of operation and utilizes an open collector output for maximum application flexibility. The clear epoxy packaging system is designed to optimize the mechanical resolution, coupling efficiency, cost, and reliability. The devices are marked with a color dot for easy identification of the emitter and detector.

absolute maximum ratings: (25°C)

EMITTER-DETECTOR PAIR		
Storage Temperature	T _{STG}	-55°C to +85°C
Operating Temperature	T _J	-55°C to +85°C
Lead Soldering Temperature	T _L	260°C
(5 seconds maximum)		
≥ 1/16" (1.6 mm) from Case		

INFRARED EMITTING DIODE		
Power Dissipation	P _E	*100 mW
Forward Current	I _F	60 mA
(Continuous)		
Forward Current (Peak)	I _F	3 A
(Pulse Width ≤ 1 μs PRR ≤ 300 pps)		
Reverse Voltage	V _R	6 V
*Derate 1.33 mW/°C above 25°C ambient.		

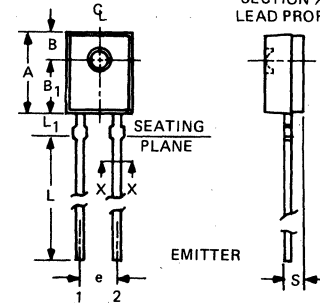
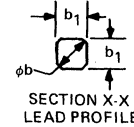
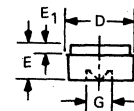
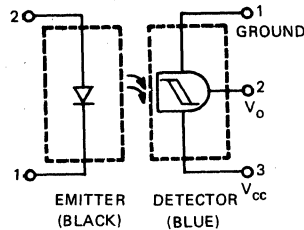

SYM.	MILLIMETERS		INCHES		NOTES
	MIN.	MAX.	MIN.	MAX.	
A	5.59	5.80	.220	.228	2
B	1.78	NOM.	.070	NOM.	
B1	3.68	3.94	.145	.155	1
phi b	.60	.75	.024	.030	
D	.51	NOM.	.020	NOM.	1
E	4.45	4.70	.175	.185	
E	2.41	2.67	.095	.105	3
E1	.58	.69	.023	.027	
e	2.41	2.67	.095	.105	3
e1	1.14	1.40	.045	.055	
G	1.98	NOM.	.078	NOM.	1
L	12.7	—	.500	—	
L1	1.40	1.65	.055	.065	1
R	1.27	NOM.	.050	NOM.	
S	.83	.94	.033	.037	3
T	—	1.65	—	.065	

NOTES:

- Two leads. Lead cross section dimensions uncontrolled within 1.27 MM (.050") of seating plane.
- Centerline of active element located within .25 MM (.010") of true position.
- As measured at the seating plane.
- Inch dimensions derived from millimeters.

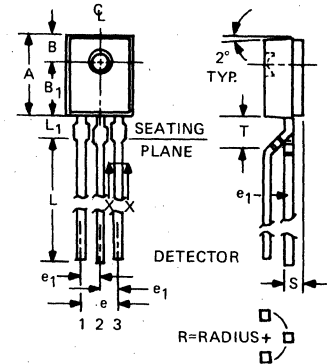

PHOTO DETECTOR		
Power Dissipation	P _D	**150 mW
Output Current	I ₂	50 mA
Allowed Range	V _{CC}	0 to 16 V
Allowed Range	V ₂₁	0 to 16 V
**Derate 2.0 mW/°C above 25°C ambient.		

individual electrical characteristics (0-70° C)

EMITTER		MIN.	TYP.	MAX.	UNITS
Forward Voltage $I_F = 20 \text{ mA}$	V_F	—	1.10	1.50	volts
Reverse Current ($V_R = 3\text{V}$)	I_R	—	—	10	micro-ampere
Capacitance ($V = 0, f = 1 \text{ MHz}$)	C_J	—	—	100	pico-farads

DETECTOR ($E_e = 0$)		MIN.	TYP.	MAX.	UNITS
Operating Voltage Range	V_{CC}	4	—	15	volts
Supply Current ($I_F = 0, V_{CC} = 5\text{V}$)	$I_{3(off)}$	—	1.0	5.0	milli-ampere
Output Current, High ($I_F = 0, V_{CC} = V_o = 15\text{V}$)	I_{OH}	—	—	100	micro-ampere

coupled electrical characteristics (0-70° C)

Note: Coupled electrical characteristics are measured at a separation distance of 4mm (.155 inches) with the lenses of the emitter and detector on a common axis within 0.1mm and parallel within 5°

		MIN.	TYP.	MAX.	UNITS
Supply Current ($I_F = 5 \text{ mA}, V_{CC} = 5\text{V}$)	$I_{3(on)}$	—	1.6	5.0	milliampere
Output Voltage, Low ($R_L = 270\Omega, V_{CC} = 5\text{V}$)	V_{OL}	—	0.2	0.4	volts
Turn-On Threshold Current ($R_L = 270\Omega, V_{CC} = 5\text{V}$)	$I_{F(on)}$	—	10.0	20.0	milliampere
Turn-Off Threshold Current ($R_L = 270\Omega, V_{CC} = 5\text{V}$)	$I_{F(off)}$	1.0	7.5	—	milliampere
Hysteresis, Ratio ($R_L = 270\Omega, V_{CC} = 5\text{V}$)	$I_{F(off)}/I_{F(on)}$	0.50	0.75	0.90	—
Switching Speeds: ($R_L = 270\Omega, V_{CC} = 5\text{V}, T_A = 25^\circ\text{C}$)					
Rise Time	t_r	—	0.1	—	$\mu\text{sec.}$
Fall Time	t_f	—	0.1	—	$\mu\text{sec.}$

TYPICAL CHARACTERISTICS

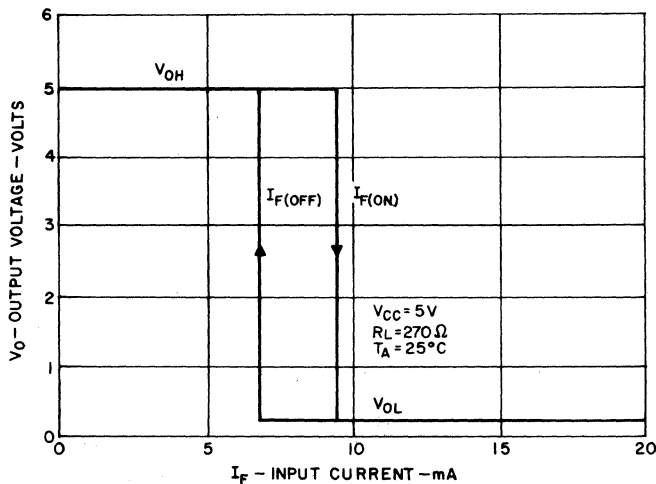

1. TRANSFER CHARACTERISTICS

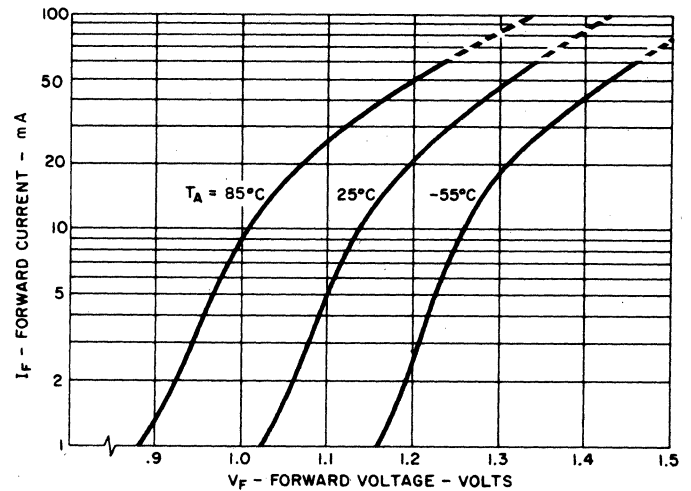

2. FORWARD VOLTAGE VS. FORWARD CURRENT

TYPICAL CHARACTERISTICS

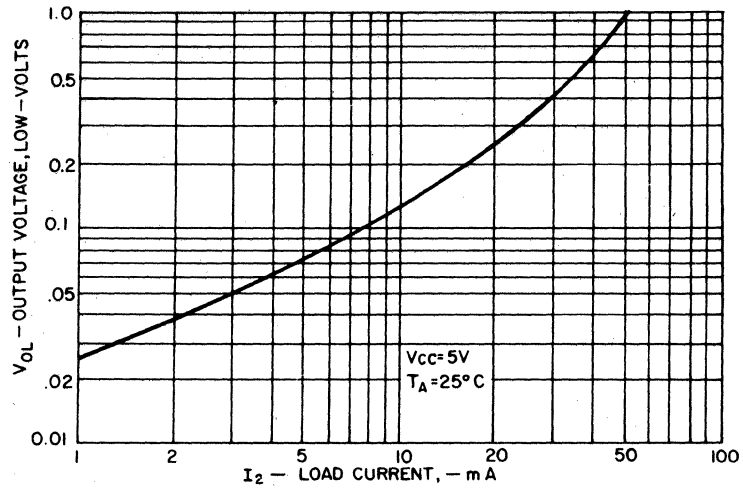

3. ON VOLTAGE VS. LOAD CURRENT

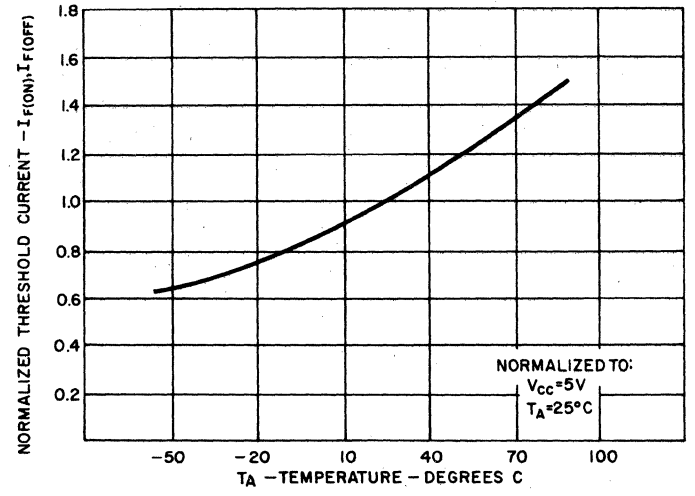

4. THRESHOLD CURRENTS VS. TEMPERATURE

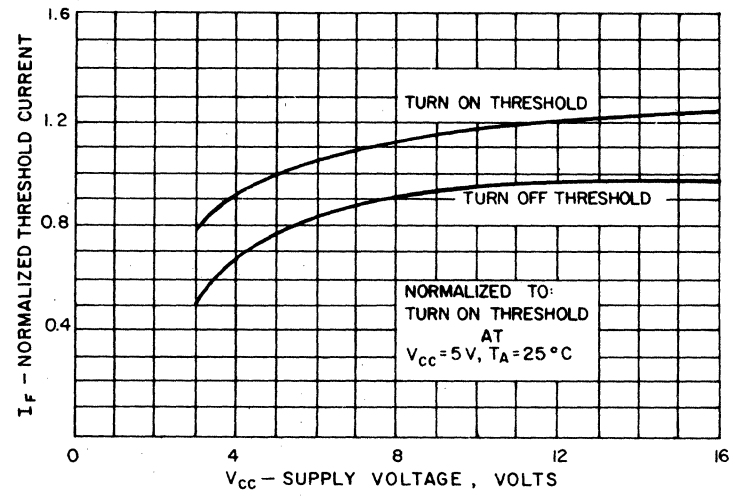

5. THRESHOLD CURRENT VS. SUPPLY VOLTAGE

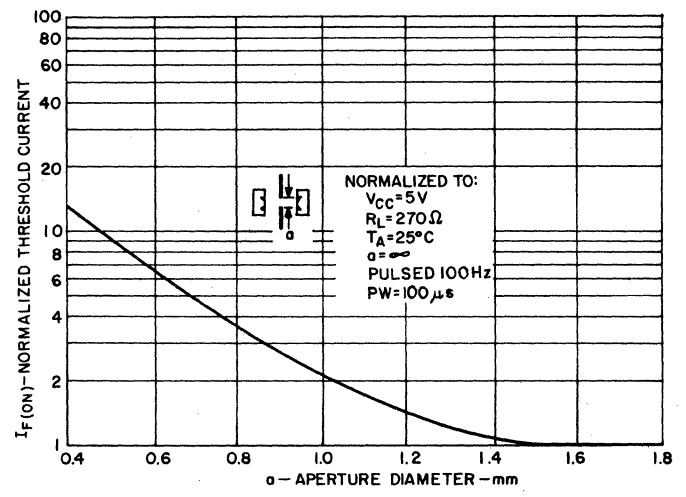

6. THRESHOLD CURRENT VS. APERTURE DIAMETER

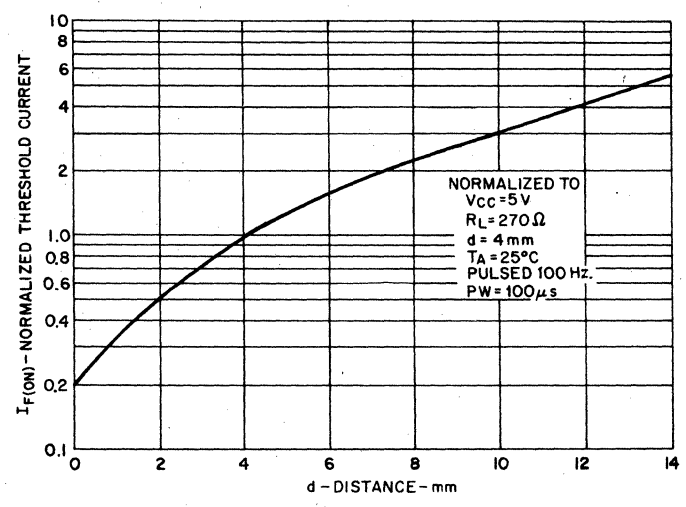

7. THRESHOLD CURRENT VS. DISTANCE

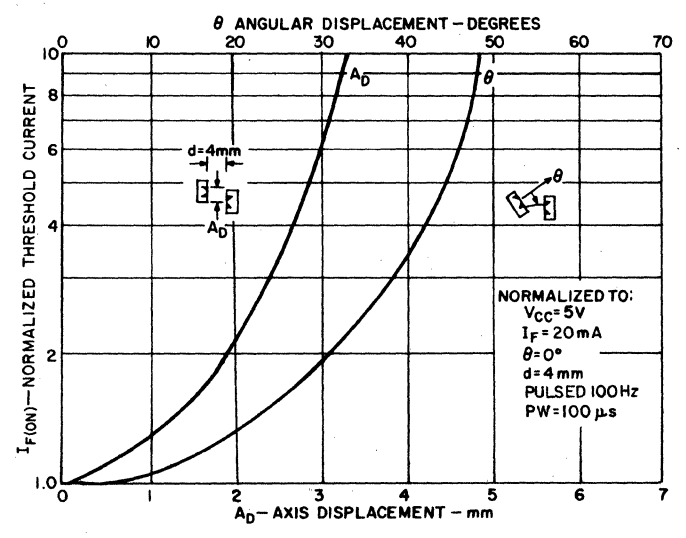

8. THRESHOLD CURRENT VS. DISPLACEMENT (ANGULAR AND AXIS)

TYPICAL CHARACTERISTICS

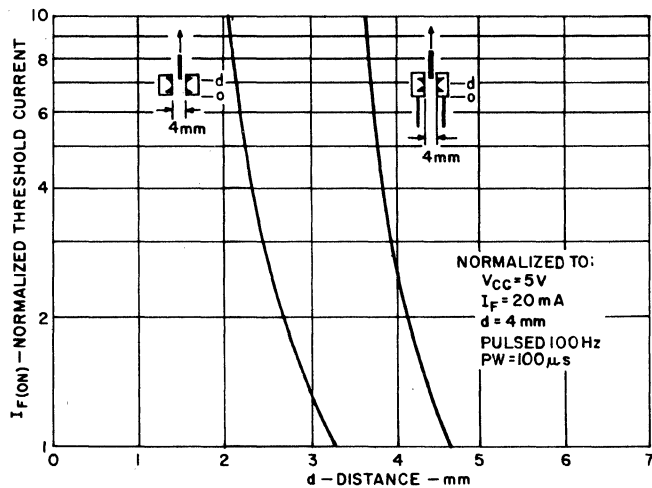

9. THRESHOLD CURRENT VS. SHIELD DISTANCE



SOLID STATE OPTOELECTRONICS

Photon Coupled Isolator H24A1-H24A2

Ga As Infrared Emitting Diodes & NPN Silicon Photo-Transistors

The General Electric H24A series consists of a gallium arsenide infrared emitting diode coupled with a silicon phototransistor.

The devices are housed in a low cost plastic package with lead spacing compatible with dual in-line package.

Covered under U.L. component recognition program, reference file E51868

absolute maximum ratings: (25°C)

TOTAL DEVICE			
Storage Temperature	T _{STG}	-55°C to +85°C	
Operating Temperature	T _J	-55°C to +85°C	
Lead Soldering Temperature	T _L	260°C	
(5 seconds maximum)			
Surge Isolation Voltage (Input to Output).			
		6000V _(peak)	4242V _(RMS)
Steady-State Isolation Voltage (Input to Output).			
		4500V _(peak)	3200V _(RMS)

SYMBOL	INCHES		MILLIMETERS		NOTES
	MIN.	MAX.	MIN.	MAX.	
A	—	.350	—	8.89	
φ _b	.024	.030	.600	.750	1
b ₁	.020	NOM.	.50	NOM.	1
D	—	.375	—	9.52	
e ₁	.285	.315	.724	8.00	
e ₂	.090	.110	2.29	2.79	
E	—	.250	—	6.35	
L	.300	—	7.62	—	1
R	.050	NOM.	1.27	NOM.	
S	.020	.030	.50	.76	
S ₁	.020	.030	.50	.76	

NOTE:
1. FOUR LEADS: LEAD DIMENSIONS CONTROLLED BETWEEN .050" (1.27 MM) FROM THE SEATING PLANE AND THE END OF THE LEADS.

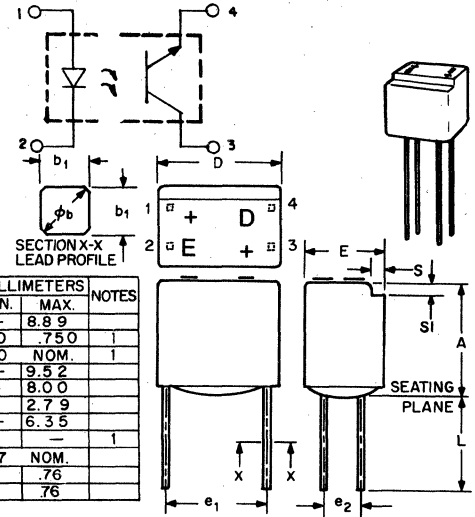

INFRARED EMITTING DIODE		(EMITTER)	
Power Dissipation	P _E	*100	mW
Forward Current	I _F	60	mA
(Continuous)			
Forward Current (Peak)	I _F	3	A
(Pulse Width ≤ 1 μs PRR ≤ 300 pps)			
Reverse Voltage	V _R	4	V

*Derate 1.67 mW/°C above 25°C ambient.

PHOTOTRANSISTOR		(DETECTOR)	
Power Dissipation	P _D	**150	mW
Collector Current	I _C	100	mA
(Continuous)			
Collector-Emitter Voltage	V _{CEO}	30	V
Emitter-Collector Voltage	V _{ECO}	6	V

**Derate 2.5 MW/°C above 25°C ambient.

individual electrical characteristics (25°C)

EMITTER	MIN.	TYP.	MAX.	UNITS
Reverse Breakdown Voltage V _{(BR)R} @ I _R = 10 μA	4	—	—	V
Forward Voltage V _F @ I _F = 60 mA	—	—	1.7	V
Reverse Current I _R @ V _R = 3V	—	—	1.0	μA
Capacitance C _i @ V = 0, f = 1 MHz	—	30	—	pF

DETECTOR	MIN.	TYP.	MAX.	UNITS
Breakdown Voltage V _{(BR)CEO} @ I _C = 1 mA, I _F = 0	30	—	—	V
Breakdown Voltage V _{(BR)ECO} @ I _E = 100 μA, I _F = 0	6	—	—	V
Collector Dark Current I _{CEO} @ V _{CE} = 10V, I _F = 0	—	5	100	nA
Capacitance C _{ce} @ V _{CE} = 5V, f = 1MHz	—	3.3	—	pF

coupled electrical characteristics (25°C)

		MIN.	TYP.	MAX.	UNITS	
CTR	— DC Current Transfer Ratio (I _F = 10mA, V _{CE} = 10V)	H24A1	100	—	—	%
		H24A2	20	—	—	%
V _{CE(sat)}	— Saturation Voltage — Collector to Emitter (I _F = 10mA, I _C = 0.5mA)	—	0.1	0.4	V	
R _{IO}	— Isolation Resistance (Input to Output Voltage = 500V _{DC}) †	100	—	—	GΩ	
C _{io}	— Input to Output Capacitance (Input to Output Voltage = 0, f = 1MHz) †	—	0.5	—	pF	
t _{on}	— Turn-On Time — (V _{CE} = 10V, I _C = 2mA, R _L = 100Ω)	—	9	—	μs	
t _{off}	— Turn-Off Time — (V _{CE} = 10V, I _C = 2mA, R _L = 100Ω)	—	4	—	μs	
t _{on}	— Turn-On Time — (V _{CC} = 5V, I _F = 10mA, R _L = 10KΩ)	—	6.5	—	μs	
t _{off}	— Turn-Off Time — (V _{CC} = 5V, I _F = 10mA, R _L = 10KΩ)	—	165	—	μs	

† Measured with input diode leads shorted together, and output detector leads shorted together.

TYPICAL CHARACTERISTICS

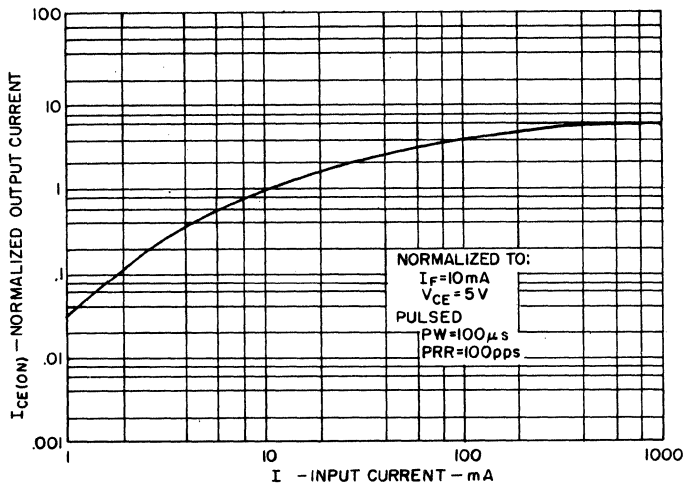

1. OUTPUT CURRENT VS. INPUT CURRENT

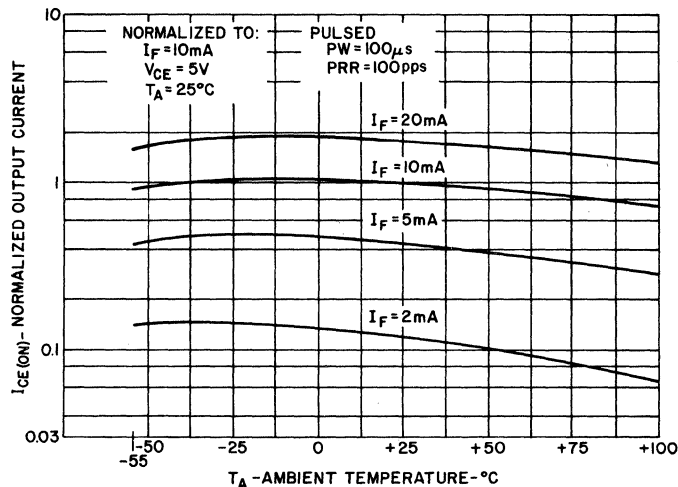

2. OUTPUT CURRENT VS. TEMPERATURE

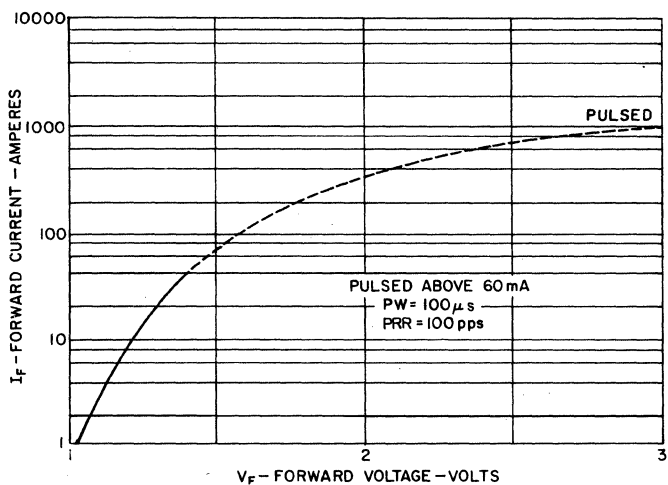

3. INPUT CHARACTERISTICS

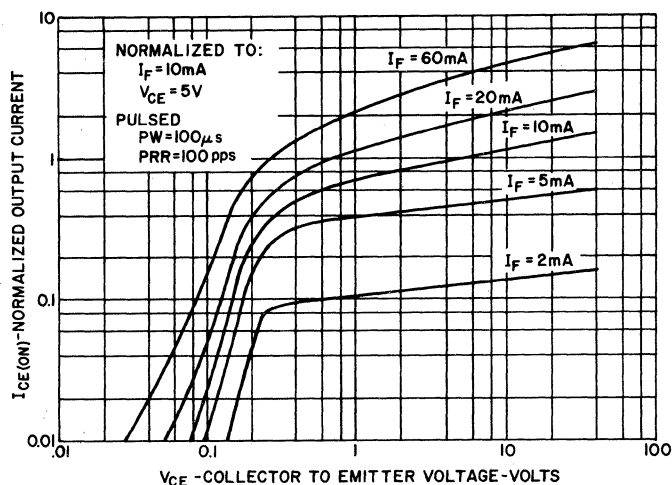

4. OUTPUT CHARACTERISTICS

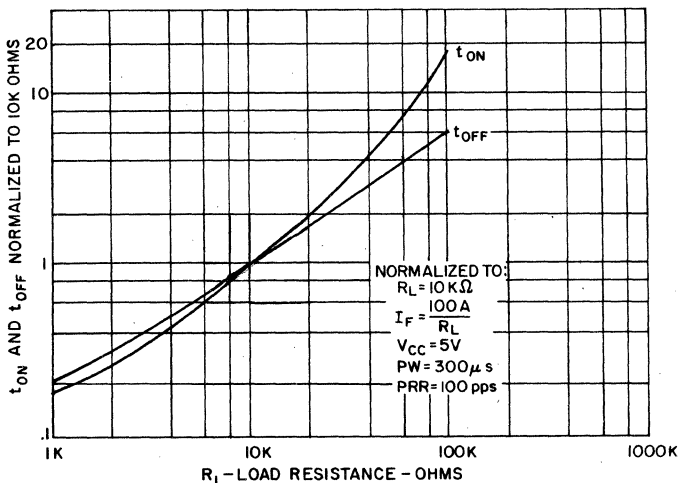

5. SWITCHING SPEED VS. R_L

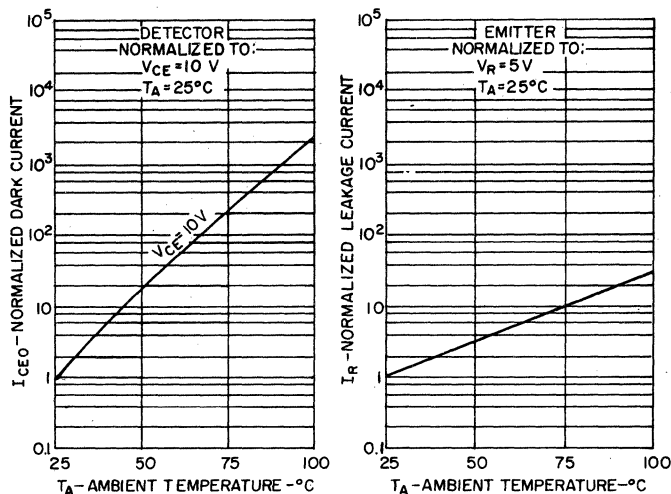

6. LEAKAGE CURRENTS VS. TEMPERATURE



SOLID STATE OPTOELECTRONICS

Photon Coupled Isolator H24B1-H24B2

Ga As Infrared Emitting Diode & NPN Silicon Photo-Darlington Amplifier

The General Electric H24B series consists of a gallium arsenide infrared emitting diode coupled with a silicon Darlington connected phototransistor. The devices are housed in a low cost plastic package with lead spacing compatible with dual in-line package.

Covered under U.L. component recognition program, reference file E51868

absolute maximum ratings: (25°C)

TOTAL DEVICE		
Storage Temperature	T _{STG}	-55°C to +85°C
Operating Temperature	T _J	-55°C to +85°C
Lead Soldering Temperature (5 seconds maximum)	T _L	260°C
Surge Isolation Voltage (Input to Output).		
6000V _(peak)		4242V _(RMS)
Steady-State Isolation Voltage (Input to Output).		
4500V _(peak)		3200V _(RMS)

SYMBOL	INCHES		MILLIMETERS		NOTES
	MIN.	MAX.	MIN.	MAX.	
Δ	—	.350	—	8.89	
φ _b	.024	.030	.600	.750	1
b ₁	.020	NOM.	.50	NOM.	1
D	—	.375	—	9.52	
e ₁	2.85	3.15	7.24	8.00	
e ₂	.090	.110	2.29	2.79	
E	—	.250	—	6.35	
L	.300	—	7.62	—	1
R	.050	NOM.	1.27	NOM.	
S	.020	.030	.50	.76	
S ₁	.020	.030	.50	.76	

NOTE:
1. FOUR LEADS: LEAD DIMENSIONS CONTROLLED BETWEEN .050" (1.27 MM) FROM THE SEATING PLANE AND THE END OF THE LEADS.

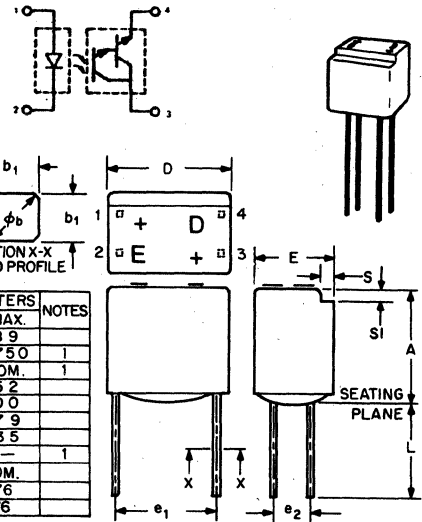

INFRARED EMITTING DIODE		(EMITTER)	
Power Dissipation	P _E	*100	mW
Forward Current (Continuous)	I _F	60	mA
Forward Current (Peak) (Pulse Width ≤ 1 μs PRR ≤ 300 pps)	I _F	3	A
Reverse Voltage	V _R	4	V

*Derate 1.67 mW/°C above 25°C ambient.

DARLINGTON CONNECTED PHOTOTRANSISTOR (DETECTOR)			
Power Dissipation	P _D	**150	mW
Collector Current (Continuous)	I _C	100	mA
Collector-Emitter Voltage	V _{CEO}	30	V
Emitter-Collector Voltage	V _{ECO}	7	V

**Derate 2.5 mW/°C above 25°C ambient.

individual electrical characteristics (25°C)

EMITTER	MIN.	TYP.	MAX.	UNITS
Reverse Breakdown Voltage V _{(BR)R} @ I _R = 10 μA	4	—	—	V
Forward Voltage V _F @ I _F = 60 mA	—	—	1.7	V
Reverse Current I _R @ V _R = 3V	—	—	1.0	μA
Capacitance C _i @ V = 0, f = 1 MHz	—	30	—	pF

DETECTOR	MIN.	TYP.	MAX.	UNITS
Breakdown Voltage V _{(BR)CEO} @ I _C = 1 mA, I _F = 0	30	—	—	V
Breakdown Voltage V _{(BR)ECO} @ I _E = 100 μA, I _F = 0	7	—	—	V
Collector Dark Current I _{CEO} @ V _{CE} = 10V, I _F = 0	—	5	100	nA
Capacitance C _{ce} @ V _{CE} = 5V, f = 1MHz	—	5	—	pF

coupled electrical characteristics (25°C)

		MIN.	TYP.	MAX.	UNITS
CTR — DC Current Transfer Ratio (I _F = 5mA, V _{CE} = 1.5V)	H24B1	1000	—	—	%
	H24B2	400	—	—	%
V _{CE(sat)} — Saturation Voltage — Collector to Emitter (I _F = 5mA, I _C = 2mA)		—	0.8	1.0	V
R _{IO} — Isolation Resistance (Input to Output Voltage = 500V _{DC}) †		100	—	—	GΩ
C _{io} — Input to Output Capacitance (Input to Output Voltage = 0, f = 1MHz) †		—	0.5	—	pF
t _{on} — Turn-On Time — (V _{CE} = 10V, I _C = 10mA, R _L = 100Ω)		—	105	—	μs
t _{off} — Turn-Off Time — (V _{CE} = 10V, I _C = 10mA, R _L = 100Ω)		—	60	—	μs
t _{on} — Turn-On Time — (V _{CC} = 5V, I _F = 10mA, R _L = 1.0KΩ)		—	10	—	μs
t _{off} — Turn-Off Time — (V _{CC} = 5V, I _F = 10mA, R _L = 1.0KΩ)		—	700	—	μs

† Measured with input diode leads shorted together, and output detector leads shorted together.

TYPICAL CHARACTERISTICS

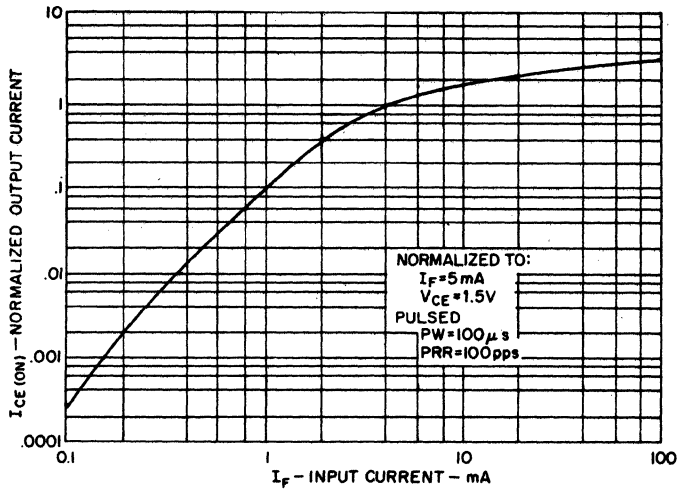

1. OUTPUT CURRENT VS. INPUT CURRENT

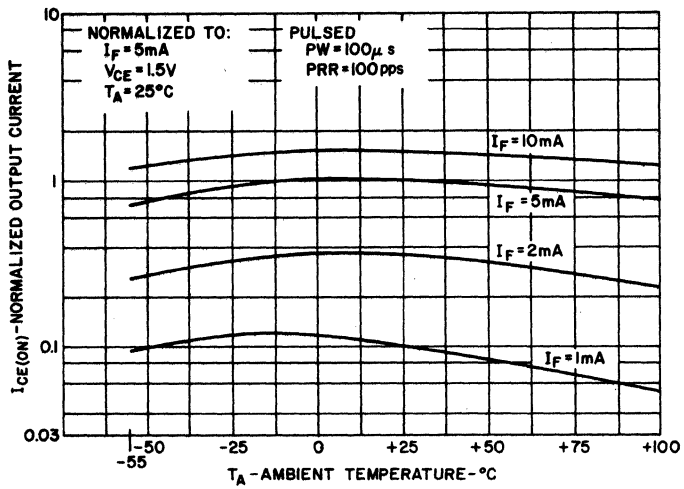

2. OUTPUT CURRENT VS. TEMPERATURE

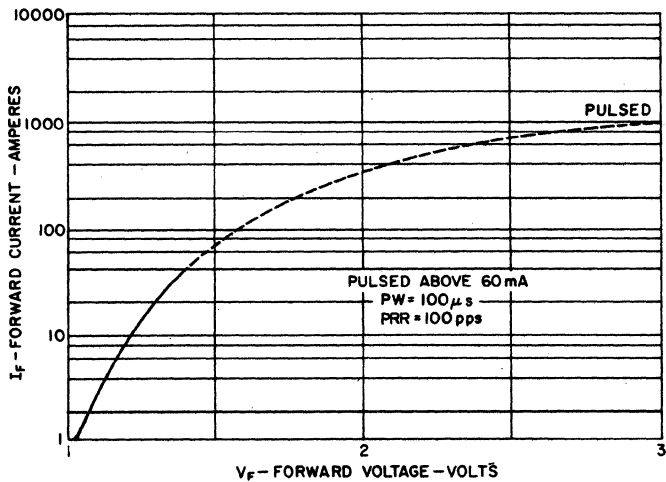

3. INPUT CHARACTERISTICS

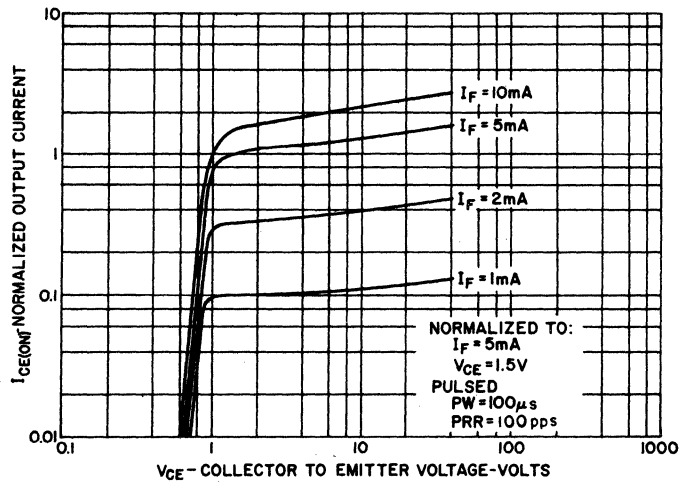

4. OUTPUT CHARACTERISTICS

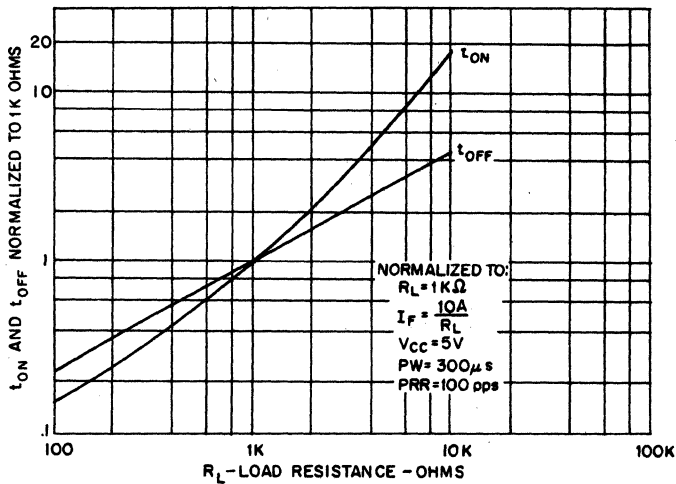

5. SWITCHING SPEED VS. R_L

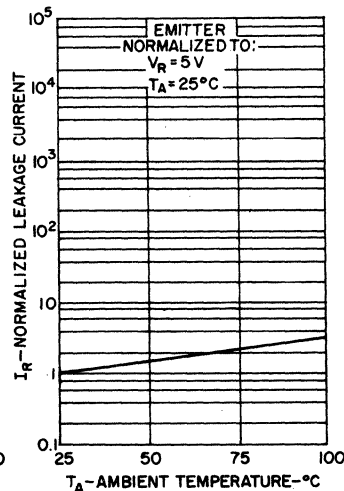
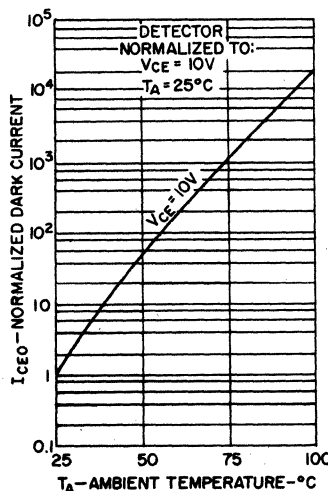

6. LEAKAGE CURRENTS VS. TEMPERATURE



SOLID STATE

OPTOELECTRONICS

Light Detector Planar Silicon Photo Transistor

NPN BPW36, BPW37

The General Electric BPW36 and BPW37 are highly sensitive NPN Planar Silicon Photo-transistors. They are housed in a TO-18 style hermetically sealed package with lens cap. These devices are ideal for use in optoelectronic sensing applications where both high sensitivity and fast switching speeds are important parameters. Generally only the collector and emitter leads are used; a base lead is provided, however, to control sensitivity and gain of the device.

absolute maximum ratings: (25°C unless otherwise specified)

Voltages — Dark Characteristics

Collector to Emitter Voltage	V_{CEO}	45	volts
Collector to Base Voltage	V_{CBO}	45	volts
Emitter to Base Voltage	V_{EBO}	5	volts

Currents

Light Current	I_L	50	mA
---------------	-------	----	----

Dissipations

Power Dissipation ($T_A = 25^\circ\text{C}$)*	P_T	300	mW
Power Dissipation ($T_C = 25^\circ\text{C}$ **)	P_T	600	mW

Temperatures

Junction Temperature	T_J	+150	$^\circ\text{C}$
Storage Temperature	T_{STG}	-65 to +150	$^\circ\text{C}$

*Derate 2.4 mW/ $^\circ\text{C}$ above 25 $^\circ\text{C}$ ambient

**Derate 4.8 mW/ $^\circ\text{C}$ above 25 $^\circ\text{C}$ case

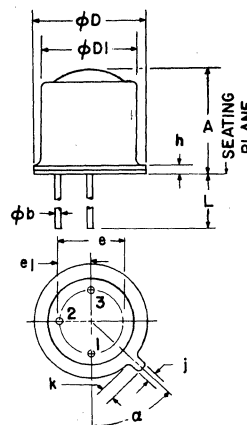
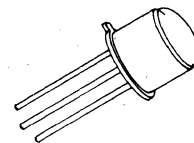

COLLECTOR CONNECTED TO CASE C (3)

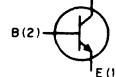

SYMBOL	INCHES		MILLIMETERS		NOTES
	MIN.	MAX.	MIN.	MAX.	
A	.225	.255	5.71	6.47	
ϕb	.016	.021	407	533	
ϕD	.209	.230	5.31	5.84	
ϕDI	.178	.195	4.52	4.96	
e	.100 NOM		2.54 NOM		2
e1	.050 NOM		1.27 NOM		2
h	—	.030	—	.76	
j	.036	.046	.92	1.16	
k	.028	.048	.71	1.22	1
L	.500	—	12.7	—	
a	45 $^\circ$	45 $^\circ$	45 $^\circ$	45 $^\circ$	3

NOTES:

1. Measured from maximum diameter of device.
2. Leads having maximum diameter .021" (.533mm) measured in gauging plane .054" +.001" - .000 (1.37 + .025 - .000mm) below the reference plane of the device shall be within .007" (.178mm) their true position relative to maximum width tab.
3. From centerline tab.

electrical characteristics: (25°C unless otherwise specified)

STATIC CHARACTERISTICS		BPW36		BPW37
		MIN.	MAX.	MIN.
Light Current ($V_{CE} = 5\text{V}$, $H^\dagger = 10\text{mW/cm}^2$)	I_L	6		3 mA
Dark Current ($V_{CE} = 10\text{V}$, $H = 0$)	I_D		100	nA
Emitter-Base Breakdown Voltage ($I_E = 100\mu\text{A}$, $I_C = 0$, $H = 0$)	$V_{(BR)EBO}$	5		5 V
Collector-Base Breakdown Voltage ($I_C = 100\mu\text{A}$, $I_E = 0$, $H = 0$)	$V_{(BR)CBO}$	45		45 V
Collector-Emitter Breakdown Voltage ($I_C = 10\text{mA}$, $H = 0$)	$V_{(BR)CEO}$	45		45 V
Saturation Voltage ($I_C = 10\text{mA}$, $I_B = 1\text{mA}$)	$V_{CE(SAT)}$		0.4	V
Turn-On Time ($V_{CE} = 10\text{V}$, $I_C = 2\text{mA}$, $R_L = 100\Omega$)	t_{on}		8	μsec
Turn-Off Time ($R_L = 100\Omega$)	t_{off}		7	μsec

$\dagger H$ = Radiation Flux Density. Radiation source is on unfiltered tungsten filament bulb at 2870 $^\circ\text{K}$ color temperature.
NOTE: A GaAs source of 3.0 mW/cm² is approximately equivalent to a tungsten source, at 2870 $^\circ\text{K}$, of 10 mW/cm².

TYPICAL ELECTRICAL CHARACTERISTICS

BPW36, BPW37

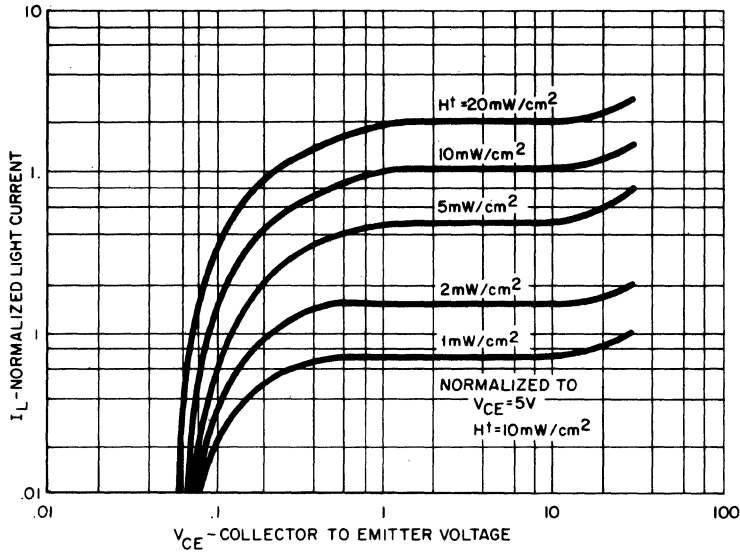

LIGHT CURRENT VS COLLECTOR TO EMITTER VOLTAGE

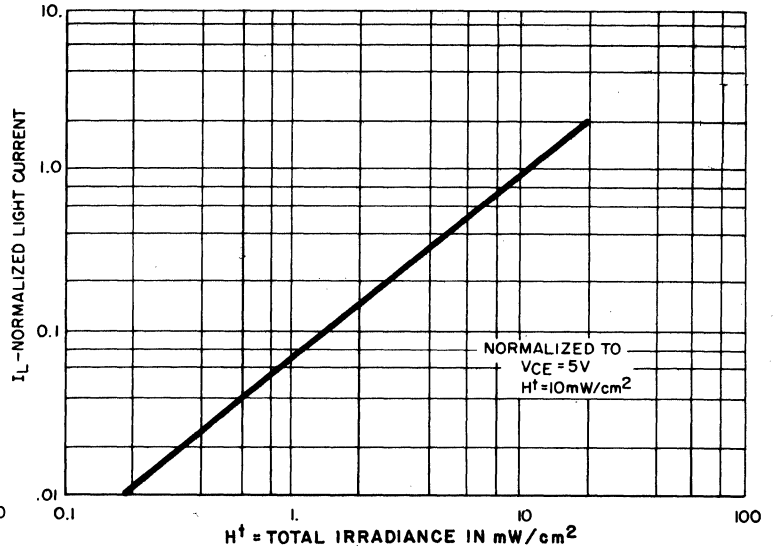

NORMALIZED LIGHT CURRENT VS RADIATION

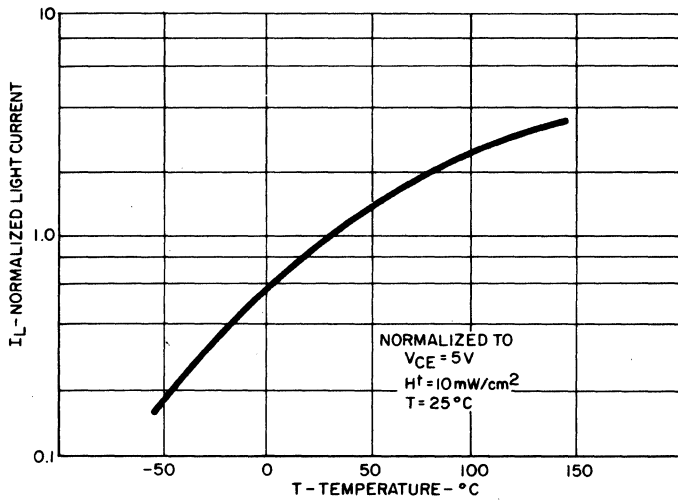

NORMALIZED LIGHT CURRENT VS TEMPERATURE

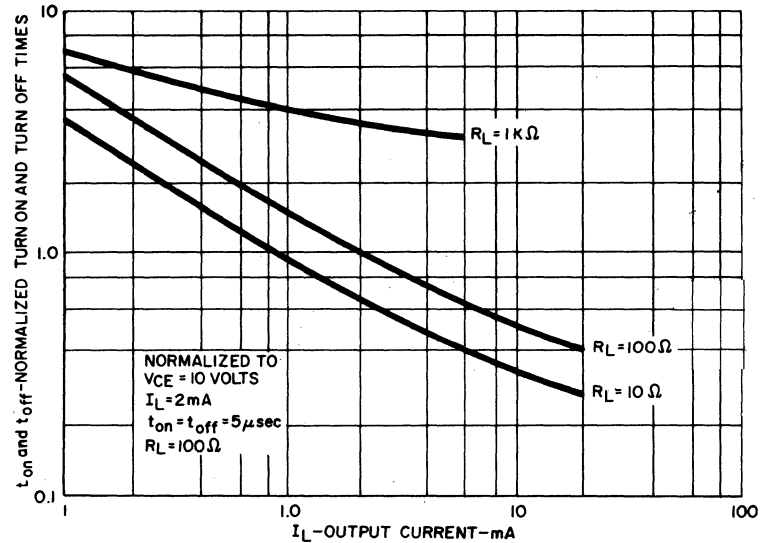

SWITCHING TIMES VS OUTPUT CURRENT

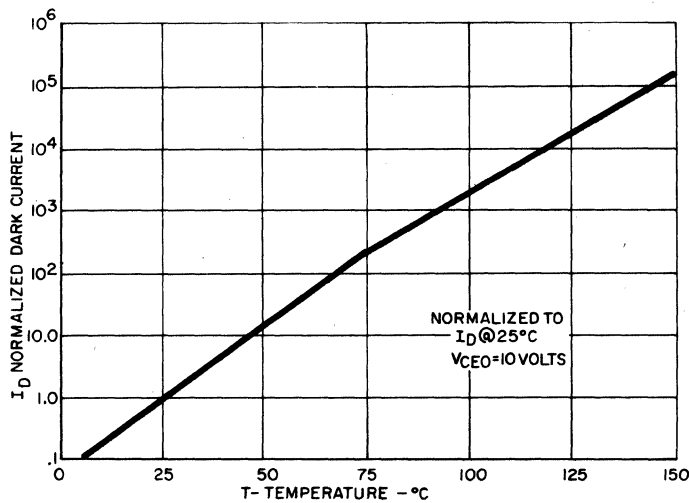

DARK CURRENT VS TEMPERATURE

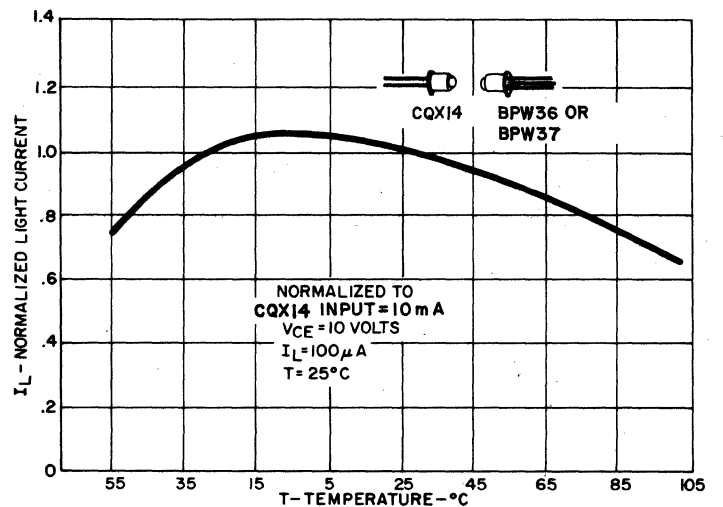

NORMALIZED LIGHT CURRENT VS TEMPERATURE
Both Emitter (CQX14) and Detector (BPW36 or BPW37) at Same Temperature



SOLID STATE

OPTO ELECTRONICS

Light Detector Planar Silicon Photo-Darlington Amplifier

NPN BPW38

The General Electric BPW38 is a supersensitive NPN Planar Silicon Photo-Darlington Amplifier. For many applications, only the collector and emitter leads are used; however, a base lead is provided to control sensitivity and the gain of the device. The BPW38 is a TO-18 Style hermetically sealed package with lens cap and is designed to be used in opto-electronic sensing applications requiring very high sensitivity.

absolute maximum ratings: (25°C unless otherwise specified)

VOLTAGES – DARK CHARACTERISTICS

Collector to Emitter Voltage	V_{CEO}	25	volts
Collector to Base Voltage	V_{CBO}	25	volts
Emitter to Base Voltage	V_{EBO}	12	volts

CURRENTS

Light Current	I_L	200	mA
---------------	-------	-----	----

DISSIPATIONS

Power Dissipation ($T_A = 25^\circ\text{C}$)*	P_T	300	mW
Power Dissipation ($T_C = 25^\circ\text{C}$ **)	P_T	600	mW

TEMPERATURES

Junction Temperature	T_J	150	°C
Storage Temperature	T_{STG}	-65 to 150	°C

*Derate 2.4 mW/°C above 25°C ambient.

**Derate 4.8 mW/°C above 25°C case.

electrical characteristics: (25°C unless otherwise specified)

STATIC CHARACTERISTICS

LIGHT CURRENT

$(V_{CE} = 5V, H^\dagger = 0.2 \text{ mW/cm}^2)$	I_L	3	—	mA
--	-------	---	---	----

DARK CURRENT

$(V_{CE} = 12V, I_B = 0)$	I_D	—	100	nA
---------------------------	-------	---	-----	----

EMITTER-BASE BREAKDOWN VOLTAGE

$(I_E = 100\mu\text{A})$	$V_{(BR)EBO}$	12	—	V
--------------------------	---------------	----	---	---

COLLECTOR-BASE BREAKDOWN VOLTAGE

$(I_C = 100\mu\text{A})$	$V_{(BR)CBO}$	25	—	V
--------------------------	---------------	----	---	---

COLLECTOR-EMITTER BREAKDOWN VOLTAGE

$(I_C = 10\text{mA})$	$V_{(BR)CEO}$	25	—	V
-----------------------	---------------	----	---	---

SWITCHING CHARACTERISTICS

(see Switching Circuit)

SWITCHING SPEEDS

$(V_{CC} = 10V, I_L = 10 \text{ mA}, R_L = 100\Omega)$

DELAY TIME	t_d	—	50	μsec
RISE TIME	t_r	—	300	μsec
STORAGE TIME	t_s	—	10	μsec
FALL TIME	t_f	—	250	μsec

$\dagger H$ = Radiation Flux Density. Radiation source is an unfiltered tungsten filament bulb at 2870°K color temperature.

NOTE: The 2870°K radiation is 25% effective on the photodarlington; i.e., a GaAs source of 0.05 mW/cm² is equivalent to this 0.2 mW/cm² tungsten source.

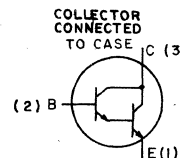
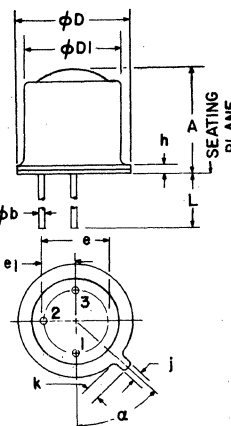
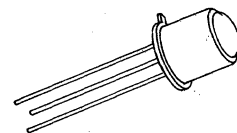

SYMBOL	INCHES		MILLIMETERS		NOTES
	MIN.	MAX.	MIN.	MAX.	
A	.225	.255	5.71	6.47	
ϕb	.016	.021	4.07	5.33	
ϕD	.209	.230	5.31	5.84	
ϕD_1	.178	.195	4.52	4.96	
e	.100 NOM		2.54 NOM		2
e_1	.050 NOM		1.27 NOM		2
h	—	.030	—	.76	
j	.036	.046	.92	1.16	
k	.028	.048	.71	1.22	1
L	.500	—	12.7	—	
α	45°	45°	45°	45°	3

- NOTES:
1. Measured from maximum diameter of device.
 2. Leads having maximum diameter .021" (.533 mm) measured in gauging plane .054" (+.001" - .000") (1.37 + .025 - .000 mm) below the reference plane of the device shall be within .007" (.178 mm) their true position relative to maximum width tab.
 3. From centerline tab.

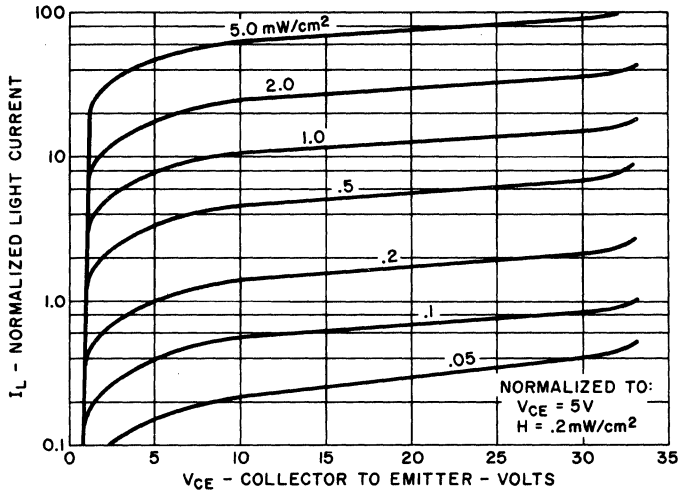

1. LIGHT CURRENT VS. COLLECTOR TO EMITTER VOLTAGE

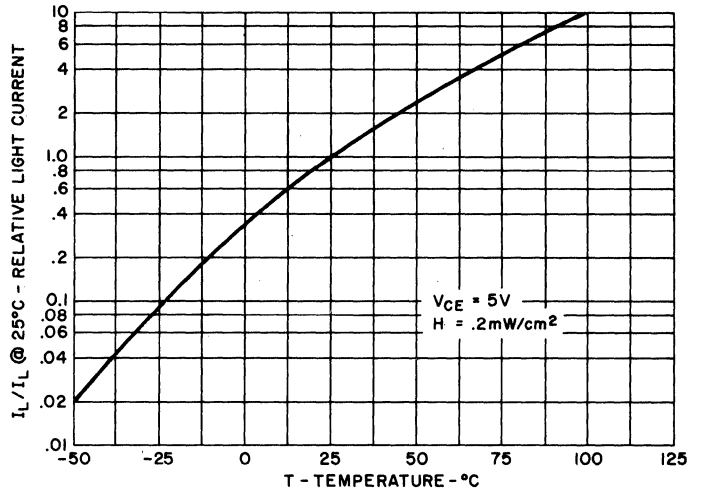

2. RELATIVE LIGHT CURRENT VS. AMBIENT TEMPERATURE

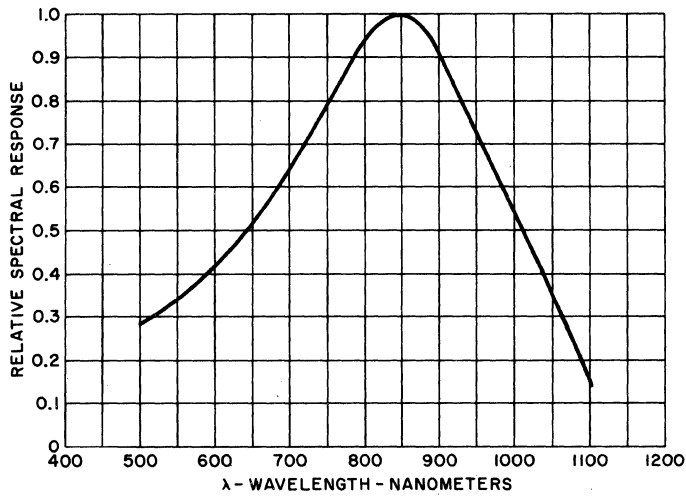

3. SPECTRAL RESPONSE CURVE

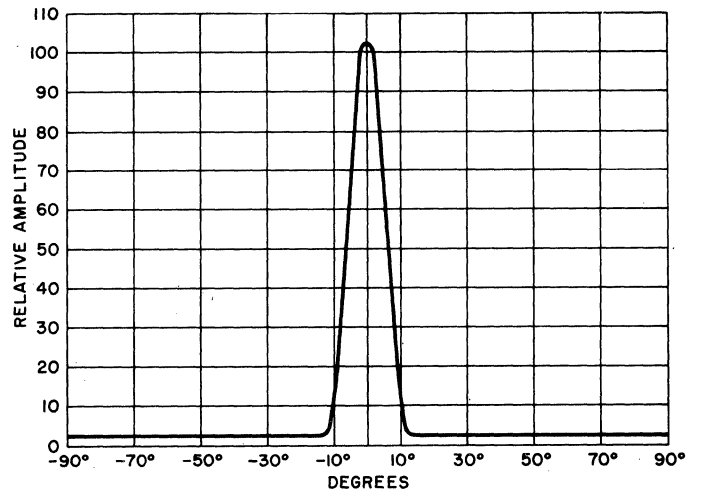

4. ANGULAR RESPONSE

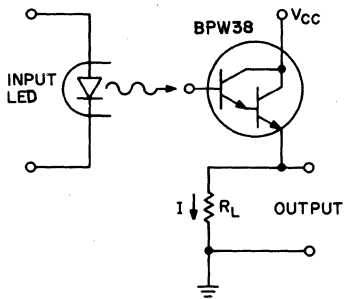

5. TEST CIRCUIT

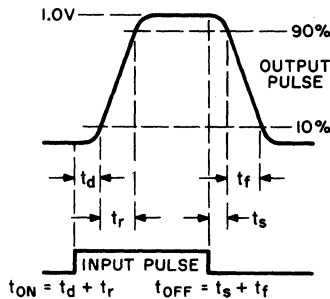

6. WAVE FORMS

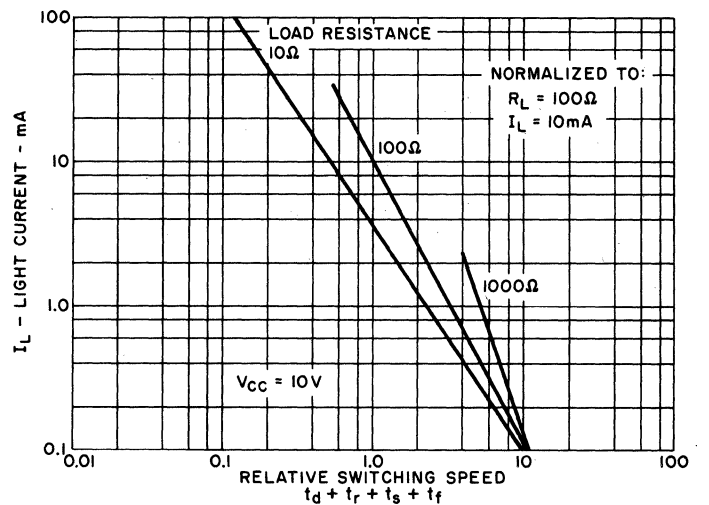

7. LIGHT CURRENT VS. RELATIVE SWITCHING SPEED



SOLID STATE OPTOELECTRONICS

Infrared Emitter

CQX14 - CQX15 - CQX16 - CQX17

Gallium Arsenide Infrared-Emitting Diode

The General Electric CQX14-CQX15-CQX16-CQX17 Series are gallium arsenide, light emitting diodes which emit non-coherent, infrared energy with a peak wave length of 940 nanometers. They are ideally suited for use with silicon detectors.

absolute maximum ratings: (25°C unless otherwise specified)

Voltage:

Reverse Voltage V_R 3 volts

Currents:

Forward Current Continuous I_F 100 mA

Forward Current (pw 1 μ s, 200 Hz) I_F 10 A

Dissipations:

Power Dissipation ($T_A = 25^\circ\text{C}$)* P_T 170 mW

Power Dissipation ($T_C = 25^\circ\text{C}$)** P_T 1.3 W

Temperatures:

Junction Temperature T_J -65°C to +150°C

Storage Temperature T_{stg} -65°C to +150°C

Lead Soldering Time 10 seconds at 260°C

*Derate 1.36 mW/°C above 25°C ambient.

**Derate 10.4 mW/°C above 25°C case.

CQX14, CQX16

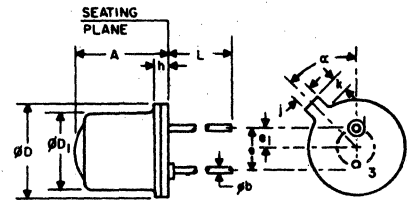

SYMBOL	INCHES		MILLIMETERS		NOTES
	MIN.	MAX.	MIN.	MAX.	
A		.255		6.47	
phi b	.016	.021	.407	.533	
phi D	.209	.230	5.31	5.84	
phi D1	.180	.187	4.57	4.77	
e	.100NOM.		2.54NOM.		2
e1	.050NOM.		1.27NOM.		2
h		.030		.76	
j	.031	.044	.79	1.11	
k	.036	.046	.92	1.16	1
L	1.00		25.4		
alpha	45°		45°		3

CQX15, CQX17

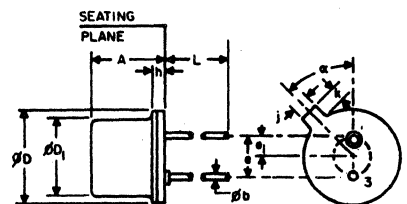

SYMBOL	INCHES		MILLIMETERS		NOTES
	MIN.	MAX.	MIN.	MAX.	
A		.155		3.93	
phi b	.016	.021	.407	.533	
phi D	.209	.230	5.31	5.84	
phi D1	.180	.187	4.57	4.77	
e	.100NOM.		2.54NOM.		2
e1	.050NOM.		1.27NOM.		2
h		.030		.76	
j	.031	.044	.79	1.11	
k	.036	.046	.92	1.16	1
L	1.00		25.4		
alpha	45°		45°		3

electrical characteristics: (25°C unless otherwise specified)

	MIN.	TYP.	MAX.	UNITS
Reverse Leakage Current ($V_R = 3V$)			10	μA
Forward Voltage ($I_F = 100mA$)		1.4	1.7	V

optical characteristics: (25°C unless otherwise specified)

Total Power Output (note 1)

($I_F = 100mA$)

CQX14-CQX15	P_O	5.4	mW
CQX16-CQX17		1.5	mW

Peak Emission Wavelength

($I_F = 100mA$) 940 nm

Spectral Shift with Temperature .28 nm/°C

Spectral Bandwidth 50% 60 nm

Rise Time 0-90% of Output 1.0 μ s

Fall Time 100-10% of Output 1.0 μ s

Note 1: Total power output, P_O , is the total power radiated by the device into a solid angle of 2π steradians.

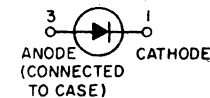

1. Measured from maximum diameter of device.
2. Leads having max. diameter .021" (.533mm) measured in gaging plane .054" + .001" - .000 (1.37 + 0.25 - 0.00mm) below the reference plane of the device shall be within .007" (.778mm) their true position relative to a maximum width tab.
3. From centerline tab.

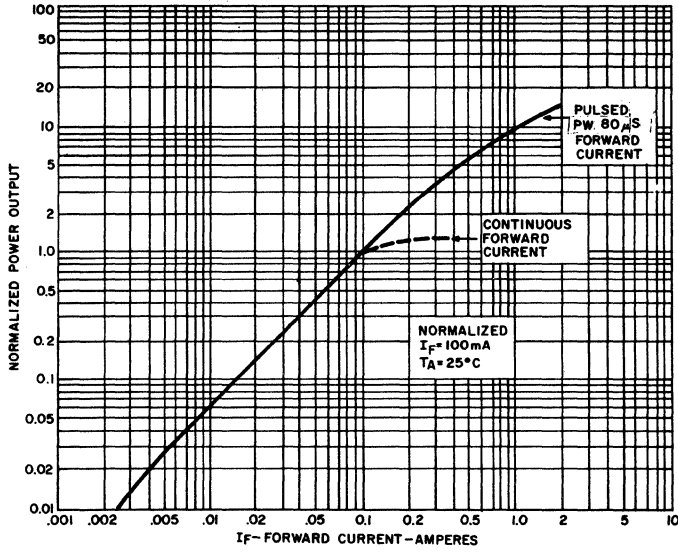

1. POWER OUTPUT VS. INPUT CURRENT

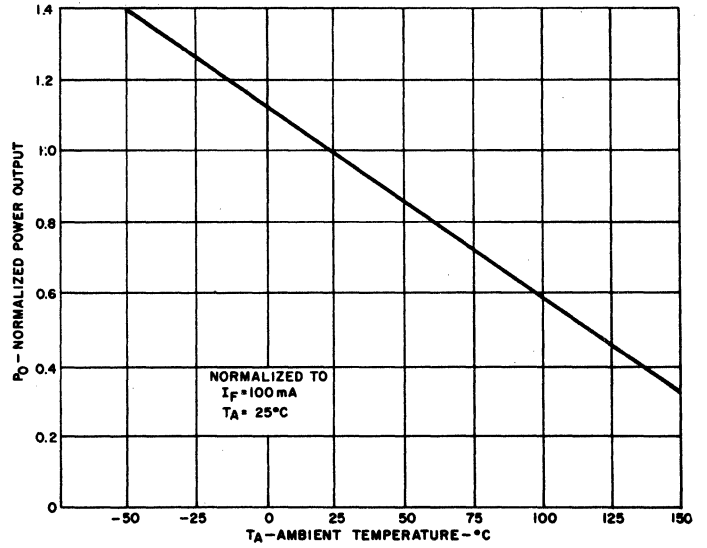

2. POWER OUTPUT VS. TEMPERATURE

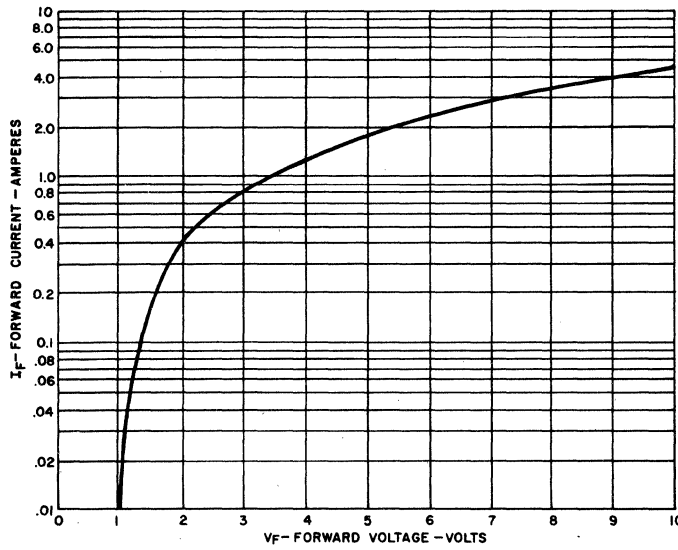

3. FORWARD VOLTAGE VS. FORWARD CURRENT

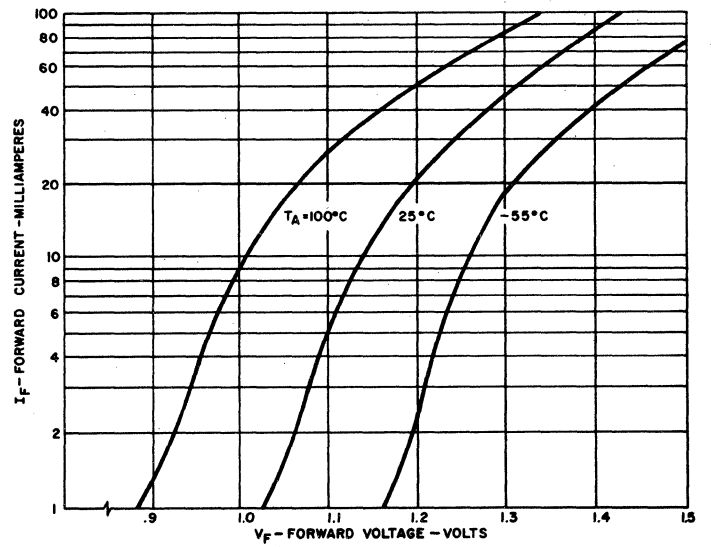

4. FORWARD VOLTAGE VS. FORWARD CURRENT

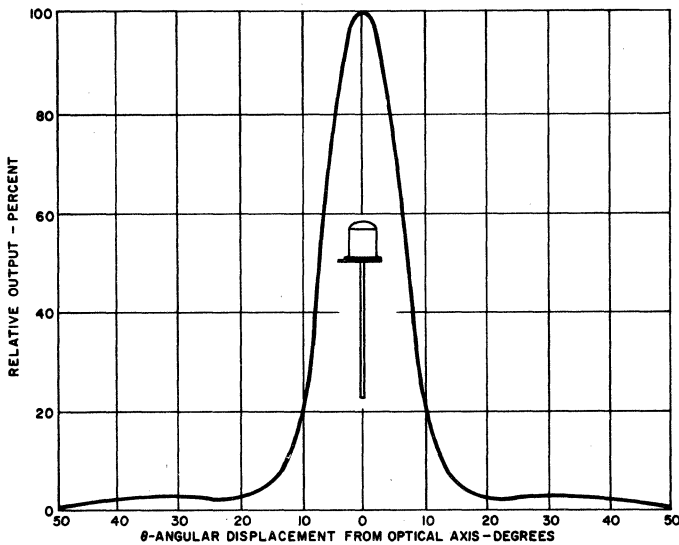

5. CQX14-CQX16
TYPICAL RADIATION PATTERN

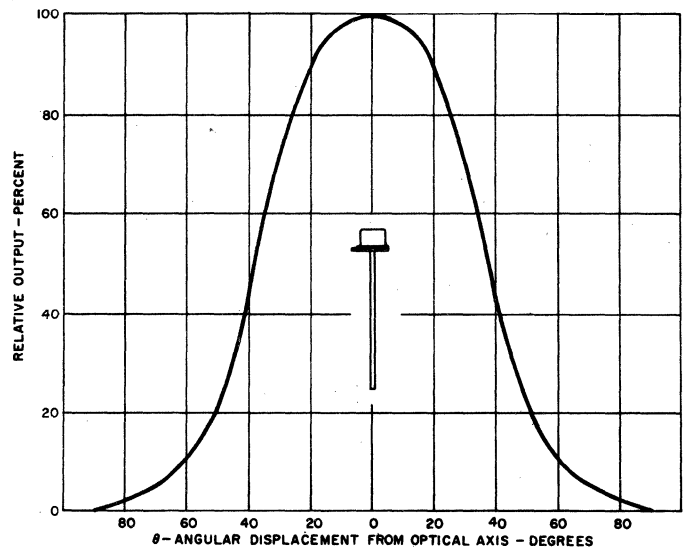

6. CQX15-CQX17
TYPICAL RADIATION PATTERN



SOLID STATE OPTOELECTRONICS

Photon Coupled Isolator CQY80

Ga As Infrared Emitting Diode & NPN Silicon Photo-Transistor

The General Electric CQY80 is a gallium arsenide, infrared emitting diode coupled with a silicon photo-transistor in a dual in-line package.

absolute maximum ratings: (25°C)

INFRARED EMITTING DIODE		
Power Dissipation	*100	milliwatts
Forward Current (Continuous)	60	milliamps
Forward Current (Peak) (Pulse width 1 μsec 300 P Ps)	3	ampere
Reverse Voltage	5	volts
*Derate 1.33mW/°C above 25°C ambient.		

PHOTO-TRANSISTOR		
Power Dissipation	**150	milliwatts
V _{CEO}	32	volts
V _{CBO}	70	volts
V _{ECO}	5	volts
Collector Current (Continuous)	100	milliamps
**Derate 2.0mW/°C above 25°C ambient.		

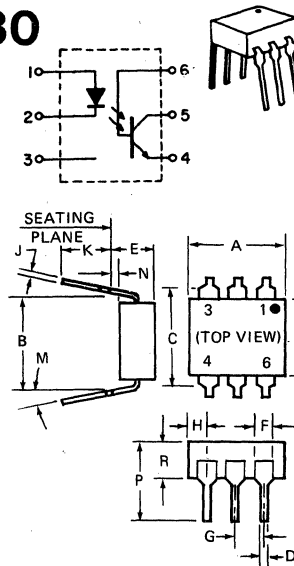

SYMBOL	MILLIMETERS		INCHES		NOTES
	MIN.	MAX.	MIN.	MAX.	
A	8.38	8.89	.330	.350	1
B	7.62 REF.		.300 REF.		
C	—	8.64	—	.340	2
D	.406	.508	.016	.020	
E	—	5.08	—	.200	3
F	1.01	1.78	.040	.070	
G	2.28	2.80	.090	.110	4
H	—	2.16	—	.085	
J	.203	.305	.008	.012	
K	2.54	—	.100	—	
M	—	15°	—	15°	
N	.381	—	.015	—	
P	—	9.53	—	.375	
R	2.92	3.43	.115	.135	
S	6.10	6.86	.240	.270	

- NOTES:
 1. INSTALLED POSITION LEAD CENTERS.
 2. OVERALL INSTALLED DIMENSION.
 3. THESE MEASUREMENTS ARE MADE FROM THE SEATING PLANE.
 4. FOUR PLACES.

TOTAL DEVICE
Storage Temperature -55°C to +150°C
Operating Temperature -55°C to +100°C
Lead Soldering Time (at 260°C) 10 seconds
Surge Isolation Voltage (Input to Output) 4000 V _{RMS}

individual electrical characteristics:(25°C)

INFRARED EMITTING DIODE	TYP.	MAX.	UNITS
Forward Voltage (I _F = 10 mA)	1.1	1.5	volts
Reverse Current (V _R = 3 V)	—	10	microamps
Capacitance (V = 0, f = 1 MHz)	50	—	picofarads

PHOTO-TRANSISTOR	MIN.	TYP.	MAX.	UNITS
Breakdown Voltage — V _{(BR)CEO} (I _C = 10 mA, I _F = 0)	32	—	—	volts
Breakdown Voltage — V _{(BR)CBO} (I _C = 100 μA, I _F = 0)	70	—	—	volts
Breakdown Voltage — V _{(BR)ECO} (I _E = 100 μA, I _F = 0)	5	—	—	volts
Collector Dark Current — I _{CEO} (V _{CE} = 10 V, I _F = 0)	—	5	100	nanoamps
Capacitance (V _{CE} = 10 V, f = 1 MHz)	—	2	—	picofarads

coupled electrical characteristics:(25°C)

	MIN.	TYP.	MAX.	UNITS
DC Current Transfer Ratio (I _F = 10 mA, V _{CE} = 5 V)	60	—	—	%
Saturation Voltage — Collector to Emitter (I _F = 10 mA, I _C = 0.5 mA)	—	0.1	0.4	volts
Isolation Resistance (Input to Output Voltage = 500 V _{DC})	100	—	—	gigaohms
Input to Output Capacitance (Input to Output Voltage = 0, f = 1 MHz)	—	—	2	picofarads
Switching Speeds: Rise/Fall Time (V _{CE} = 10 V, I _{CE} = 2 mA, R _L = 100Ω)	—	2	—	microseconds

TYPICAL CHARACTERISTICS

CQY80

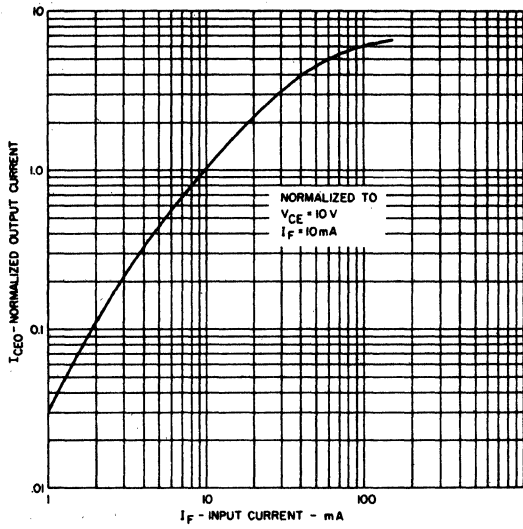

OUTPUT CURRENT VS. INPUT CURRENT

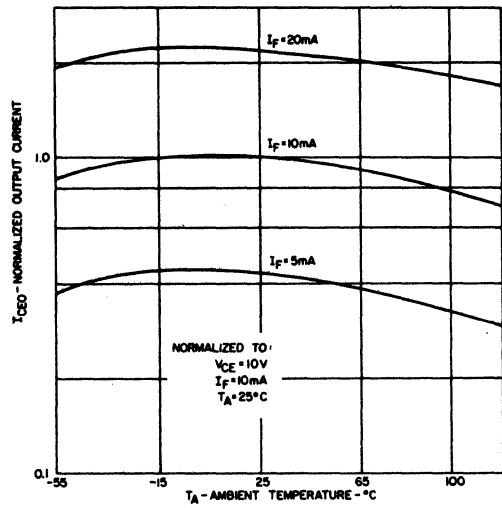

OUTPUT CURRENT VS. TEMPERATURE

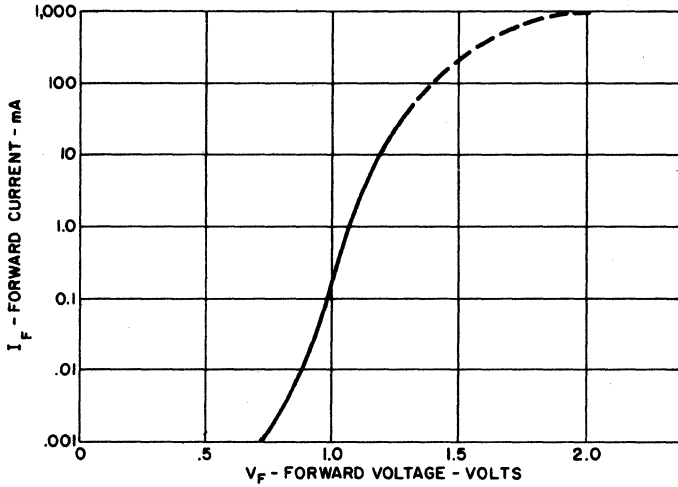

INPUT CHARACTERISTICS

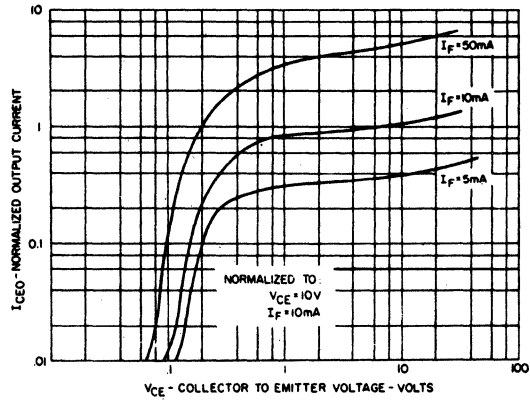

OUTPUT CHARACTERISTICS

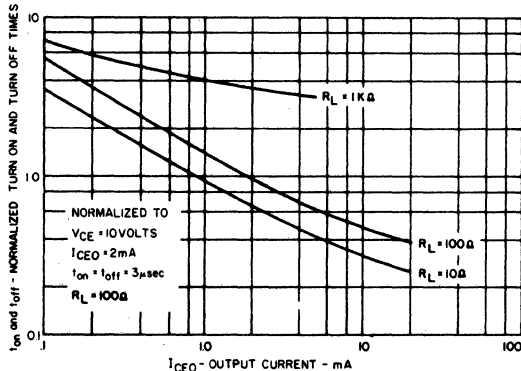

SWITCHING TIMES VS. OUTPUT CURRENT

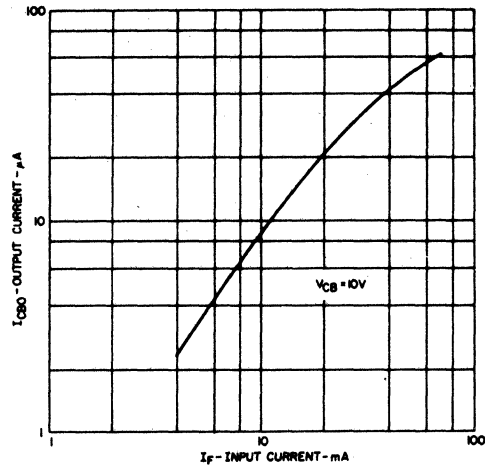

OUTPUT CURRENT (I_{CBO}) VS. INPUT CURRENT



SOLID STATE OPTOELECTRONICS

Photon Coupled Isolator CNY17

Ga As Infrared Emitting Diode & npn Silicon Photo - Transistor

The General Electric CNY17 consists of a gallium arsenide infrared emitting diode coupled with a silicon photo transistor in a dual in-line package.

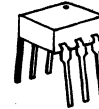

FEATURES:

- Fast switching speeds
 - High DC current transfer ratio
 - High isolation resistance
 - High isolation voltage
 - I/O compatible with integrated circuits
 - Covered under U.L. component recognition program, reference file E51868
- VDE approved to 0883/6.80 0110/11.72

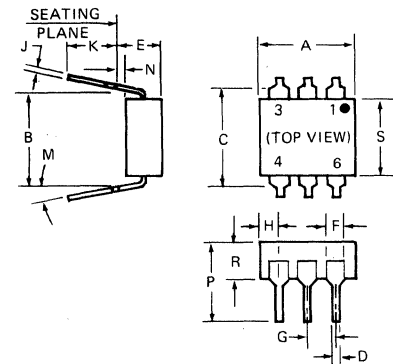

absolute maximum ratings: (25°C) (unless otherwise specified)

INFRARED EMITTING DIODE		
Power Dissipation - T_A	*100	milliwatts
Forward Current (Continuous)	60	milliamps
Forward Current (Peak) (Pulse width 1 μ s, 300 P Ps)	3	ampere
Reverse Voltage	3	volts
*Derate 1.33 mW/°C above 25°C		

PHOTO-TRANSISTOR		
Power Dissipation - T_A	**150	milliwatts
V_{CEO}	70	volts
V_{CBO}	70	volts
V_{ECO}	7	volts
Collector Current (Continuous)	150	milliamps
**Derate 2.0 mW/°C above 25°C		

SYMBOL	MILLIMETERS		INCHES		NOTES
	MIN.	MAX.	MIN.	MAX.	
A	8.38	8.89	.330	.350	1
B	7.62 REF.		.300 REF.		
C	—	8.64	—	.340	2
D	.406	.508	.016	.020	
E	—	5.08	—	.200	3
F	1.01	1.78	.040	.070	
G	2.28	2.80	.090	.110	4
H	—	2.16	—	.085	
J	.203	.305	.008	.012	4
K	2.54	—	.100	—	
M	—	15'	—	15'	4
N	.381	—	.015	—	
P	—	9.53	—	.375	4
R	2.92	3.43	.115	.135	
S	6.10	6.86	.240	.270	4

- NOTES:
 1. INSTALLED POSITION LEAD CENTERS.
 2. OVERALL INSTALLED DIMENSION.
 3. THESE MEASUREMENTS ARE MADE FROM THE SEATING PLANE.
 4. FOUR PLACES.

TOTAL DEVICE	
Storage Temperature	-55 to 150°C
Operating Temperature	-55 to 100°C
Lead Soldering Time (at 260°C)	10 seconds
Surge Isolation Voltage (Input to Output).	
5000V _(peak)	3000V _(RMS)
Steady-State Isolation Voltage (Input to Output).	
4000V _(peak)	2830V _(RMS)

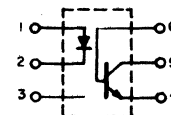

VDE Approved to 0883/6.80 0110b Certificate # 35025

individual electrical characteristics (25°C) (unless otherwise specified)

INFRARED EMITTING DIODE	MIN.	MAX.	UNITS
Forward Voltage – V_F ($I_F = 60\text{ mA}$)	.8	1.65	volts
Reverse Current – I_R ($V_R = 3\text{ V}$)	–	10	microamps
Capacitance – C_J ($V = 0, f = 1\text{ MHz}$)	–	100	picofarads

PHOTO-TRANSISTOR	MIN.	TYP.	MAX.	UNITS
Breakdown Voltage – $V_{(BR)CEO}$ ($I_C = 10\text{ mA}, I_F = 0$)	70	–	–	volts
Breakdown Voltage – $V_{(BR)CBO}$ ($I_C = 100\mu\text{ A}, I_F = 0$)	70	–	–	volts
Breakdown Voltage – $V_{(BR)ECO}$ ($I_F = 100\mu\text{ A}, I_F = 0$)	7	–	–	volts
Collector Dark Current – I_{CEO} ($V_{CE} = 10\text{ V}, I_F = 0$)	–	5	50	nanoamps
Capacitance – C_{CE} ($V_{CE} = 10\text{ V}, f = 1\text{ MHz}$)	–	2	–	picofarads
Current Transfer Ratio – h_{FE} ($V_{CE} = 5\text{ V}, I_C = 100\mu\text{ A}$)	100	–	–	

coupled electrical characteristics (25°C) (unless otherwise specified)

	MIN.	TYP.	MAX.	UNITS	
DC Current Transfer Ratio ($I_F = 10\text{ mA}, V_{CE} = 5\text{ V}$)	CNY17 I	40	–	80	%
	CNY17 II	63	–	125	%
	CNY17 III	100	–	200	%
	CNY17 IV	160	–	320	%
Saturation Voltage – Collector to Emitter ($I_F = 10\text{ mA}, I_C = 2.5\text{ mA}$)	–	–	0.3	volts	
Isolation Resistance ($V_{IO} = 500\text{ V}_{DC}$) (See Note 1)	100	–	–	gigaohms	
Input to Output Capacitance ($V_{IO} = 0, f = 1\text{ MHz}$) (See Note 1)	–	–	2	picofarads	
Turn-On Time – t_{on} ($V_{CC} = 10\text{ V}, I_C = 2\text{ mA}, R_L = 100\Omega$) (See Figure 1)	–	5	10	microseconds	
Turn-Off Time – t_{off} ($V_{CC} = 10\text{ V}, I_C = 2\text{ mA}, R_L = 100\Omega$) (See Figure 1)	–	5	10	microseconds	

Note 1: Tests of input to output isolation current resistance, and capacitance are performed with the input terminals (diode) shorted together and the output terminals (transistor) shorted together.

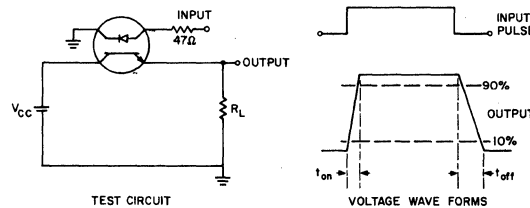

Adjust Amplitude of Input Pulse for Output (I_C) of 2 mA

FIGURE 1

TYPICAL CHARACTERISTICS

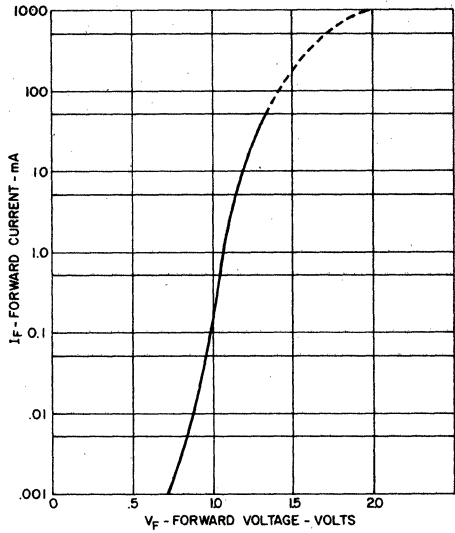

1. INPUT CHARACTERISTICS

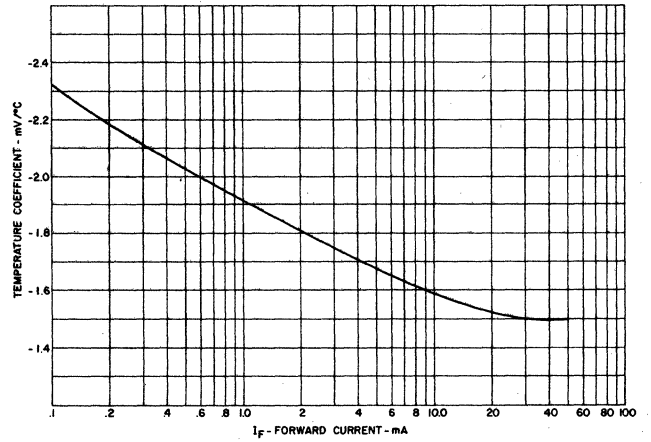

2. FORWARD VOLTAGE TEMPERATURE COEFFICIENT

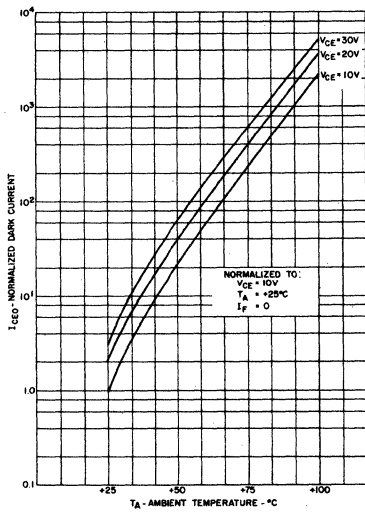

3. DARK I_{CEO} CURRENT VS TEMPERATURE

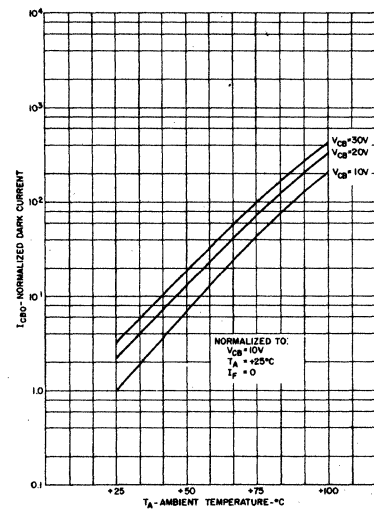

4. I_{CBO} VS TEMPERATURE

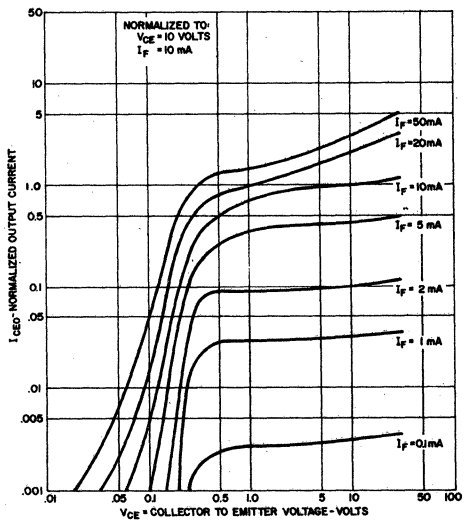

5. OUTPUT CHARACTERISTICS

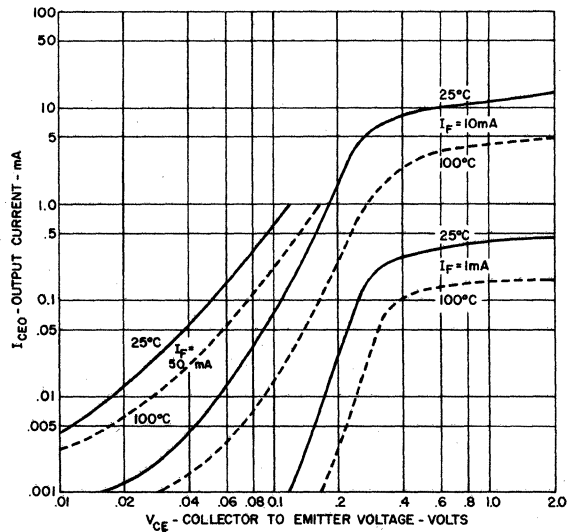

6. OUTPUT CHARACTERISTICS

TYPICAL CHARACTERISTICS

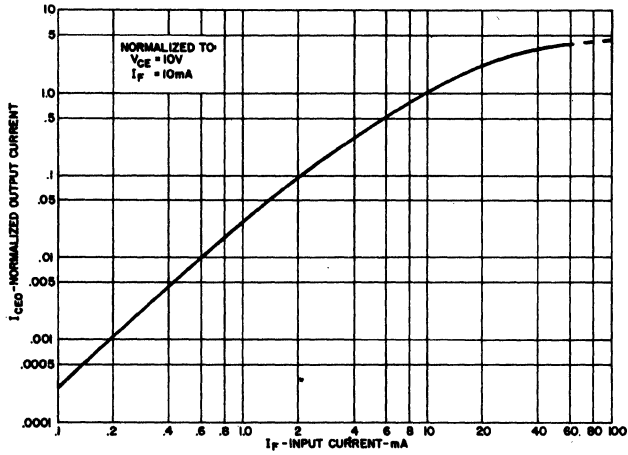

7. OUTPUT CURRENT VS INPUT CURRENT

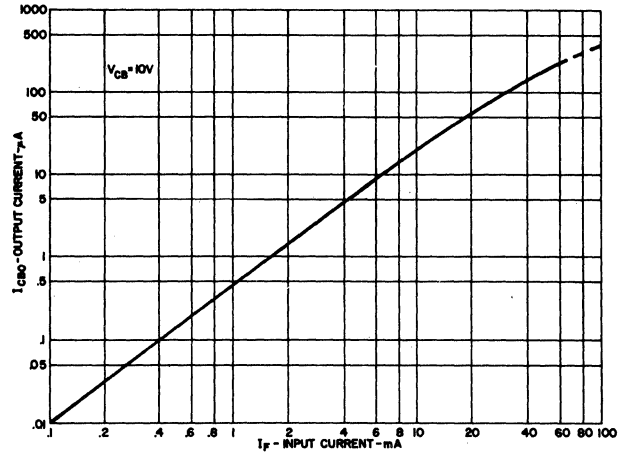

8. OUTPUT CURRENT - COLLECTOR TO BASE VS INPUT CURRENT

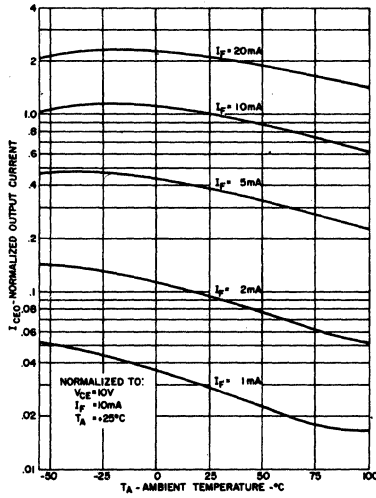

9. OUTPUT CURRENT VS TEMPERATURE

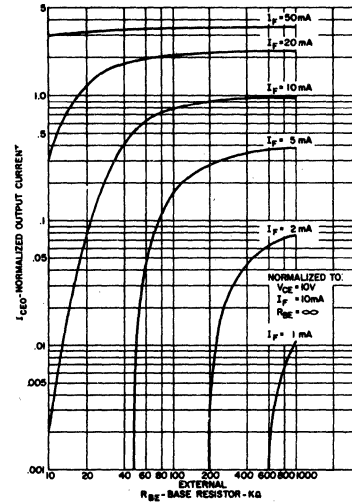

10. OUTPUT CURRENT VS BASE EMITTER RESISTANCE

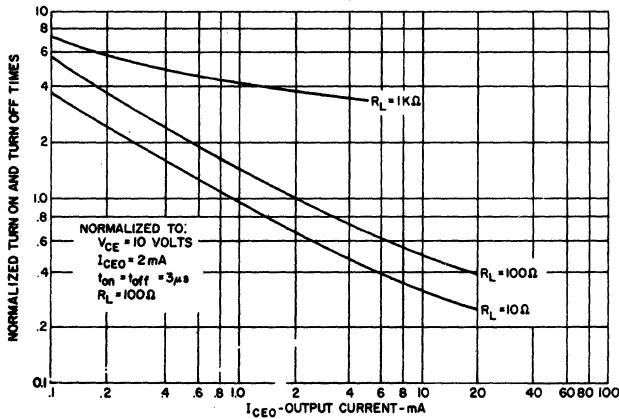

11. SWITCHING TIMES VS OUTPUT CURRENT

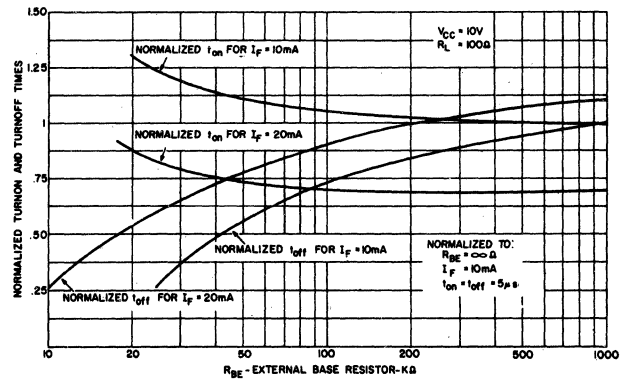

12. SWITCHING TIME VS R_{BE}



SOLID STATE OPTOELECTRONICS

Photon Coupled Interrupter Module CNY28

The General Electric CNY28 is a gallium arsenide infrared emitting diode coupled with a silicon photo-transistor in a plastic housing. The gap in the housing provides a means of interrupting the signal with tape, cards, shaft encoders, or other opaque material, switching the output transistor from an "ON" into an "OFF" state.

FEATURES:

- Low cost, plastic module
- Non-contact switching
- Fast switching speeds
- Solid state reliability
- I/O compatible with integrated circuits

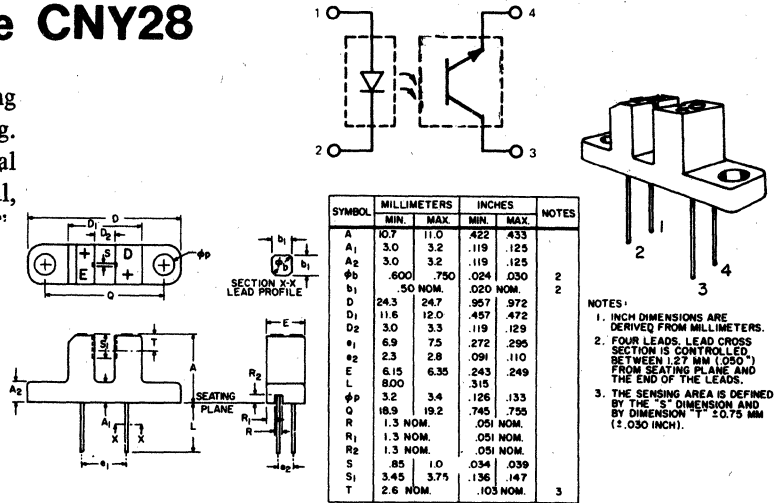

absolute maximum ratings: (25°C) (unless otherwise specified)

Storage and Operating Temperature -55° to 85°C. Lead Soldering Time (at 260°C) 10 seconds.

INFRARED EMITTING DIODE		
Power Dissipation	*100	milliwatts
Forward Current (Continuous)	60	milliamps
Forward Current (peak, 100μs, 1% duty cycle)	1	amp
Reverse Voltage	3	volts
*Derate 1.67mW/°C above 25°C ambient		

PHOTO-TRANSISTOR		
Power Dissipation	**150	milliwatts
Collector Current (Continuous)	100	milliamps
V _{CEO}	30	volts
V _{ECO}	5	volts
**Derate 2.5mW/°C above 25°C ambient		

individual electrical characteristics (25°C)

INFRARED EMITTING DIODE	TYP.	MAX.	UNITS	PHOTO-TRANSISTOR	MIN.	MAX.	UNITS
Forward Voltage (I _F = 10 mA)	1.2	1.7	volts	Breakdown Voltage V _{(BR)CEO} (I _C = 10 mA)	30	—	volts
Reverse Current (V _R = 2V)	—	10	μamps	Breakdown Voltage V _{(BR)ECO} (I _E = 100μA)	5	—	volts
Capacitance (V = 0, f = 1 Mhz)	150	—	pf	Collector Dark Current I _{CEO} (V _{CE} = 10V, I _F = 0, H=0)	—	100	nA

coupled electrical characteristics (25°C)

	MIN.	TYP.	MAX.	UNITS
Output Current (I _F = 20mA, V _{CE} = 10V)	200	400	—	μamps
Saturation Voltage (I _F = 20mA, I _C = 25μA)	—	0.2	0.4	volts
Switching Speeds (V _{CE} = 10V, I _C = 2mA, R _L = 100Ω)				
On Time (t _d + t _r)	—	5	—	μsec
Off Time (t _s + t _f)	—	5	—	μsec

TYPICAL CHARACTERISTICS

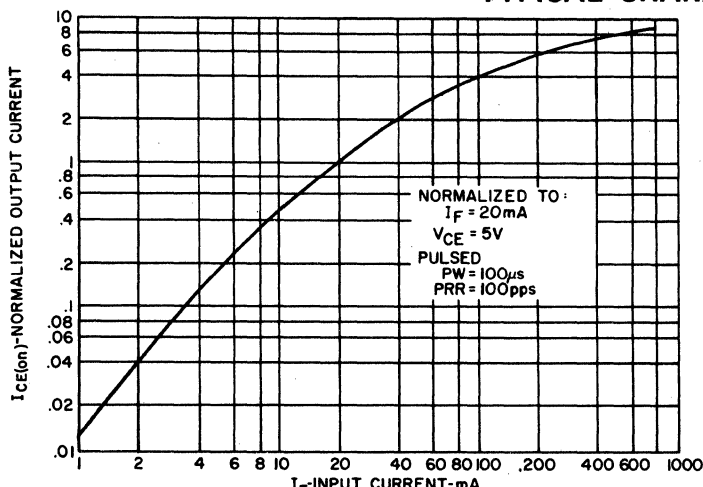

1. OUTPUT CURRENT VS. INPUT CURRENT

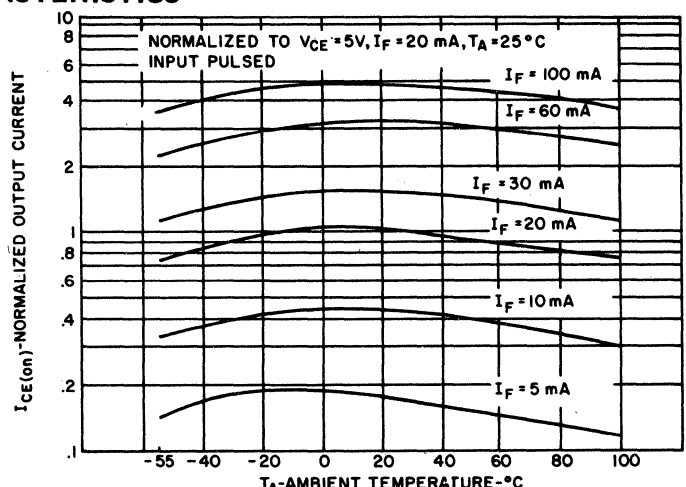

2. OUTPUT CURRENT VS. TEMPERATURE

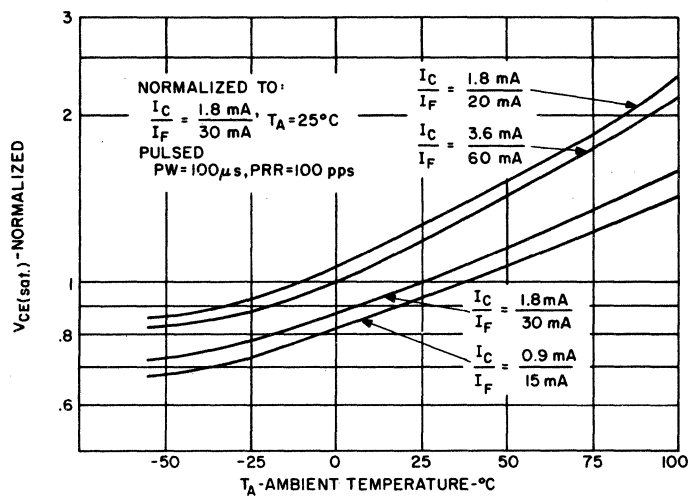

3. V_{CE(sat)} VS. TEMPERATURE

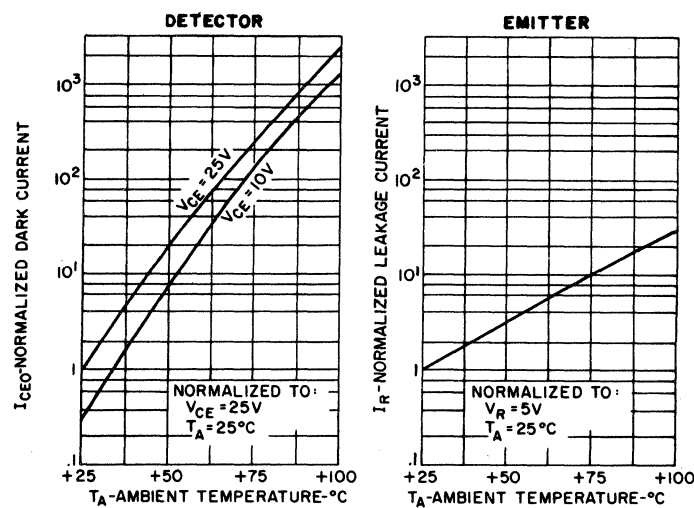

4. LEAKAGE CURRENTS VS. TEMPERATURE

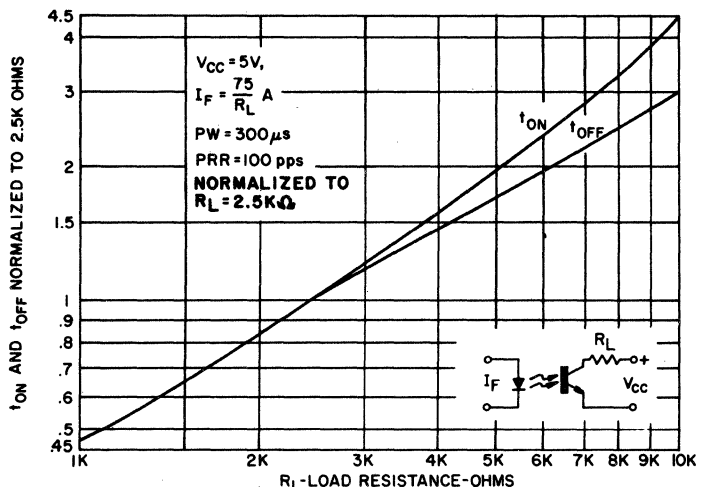

5. SWITCHING SPEED VS. R_L

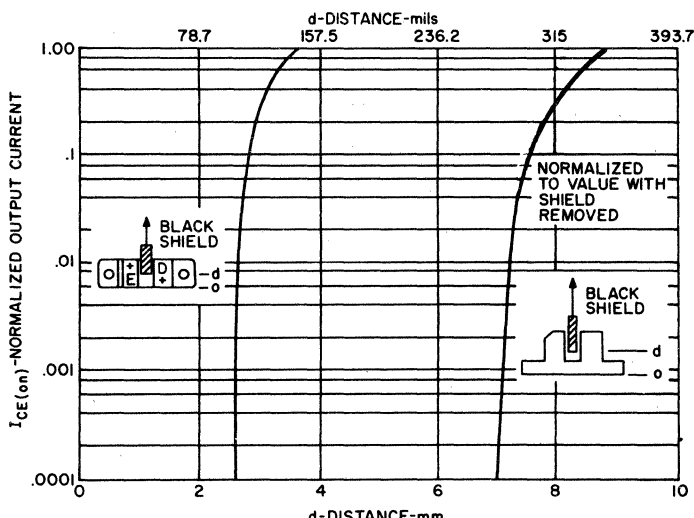

6. OUTPUT CURRENT VS. DISTANCE



SOLID STATE OPTOELECTRONICS

Photon Coupled Interrupter Module CNY29

The General Electric CNY29 is gallium arsenide infrared emitting diode coupled with a silicon photo-darlington in a plastic housing. The gap in the housing provides a means of interrupting the signal with tape, cards, shaft encoders, or other opaque material, switching the output transistor from an "ON" into an "OFF" state.

FEATURES:

- Low cost, plastic module
- Non-contact switching
- Solid-state reliability
- I/O compatible with integrated circuits

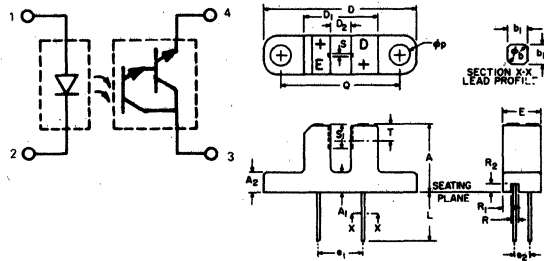

SYMBOL	MILLIMETERS		INCHES		NOTES
	MIN.	MAX.	MIN.	MAX.	
A	10.7	11.0	.422	.433	
A ₁	3.0	3.2	.119	.125	
A ₂	3.0	3.2	.119	.125	
Φb	.600	.750	.024	.030	2
b ₁	50 NOM.		.020 NOM.		2
D	24.3	24.7	.957	.972	
D ₁	11.6	12.0	.457	.472	
D ₂	3.0	3.3	.119	.129	
e ₁	6.9	7.5	.272	.296	
e ₂	2.5	2.8	.091	.110	
E	6.15	6.35	.243	.249	
L	8.00		.315		
ΦP	3.2	3.4	.126	.133	
Q	18.9	19.2	.745	.755	
R	1.3 NOM.		.051 NOM.		
R ₁	1.3 NOM.		.051 NOM.		
R ₂	1.3 NOM.		.051 NOM.		
S	.85	1.0	.034	.039	
S ₁	3.45	3.75	.136	.147	
T	2.6 NOM.		.103 NOM.		3

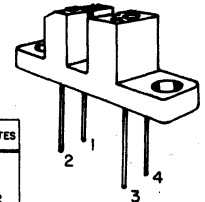

- NOTES:
1. INCH DIMENSIONS ARE DERIVED FROM MILLIMETERS.
 2. FOUR LEADS LEAD CROSS SECTION IS CONTROLLED BETWEEN 1.27 MM (.050") FROM SEATING PLANE AND THE END OF THE LEADS.
 3. THE SENSING AREA IS DEFINED BY THE "S" DIMENSION AND BY DIMENSION T = 0.75 MM (.030 INCH).

absolute maximum ratings: (25°C) (unless otherwise specified)

Storage and Operating Temperature -55° to 85°C. Lead Soldering Time (at 260°C) 10 seconds.

INFRARED EMITTING DIODE		
Power Dissipation	*100	milliwatts
Forward Current (Continuous)	60	milliamps
Forward Current (peak, 100 μs, 1% duty cycle)	1	amp
Reverse Voltage	3	volts
*Derate 1.67mW/°C above 25°C ambient		

PHOTO-DARLINGTON		
Power Dissipation	**150	milliwatts
Collector Current (Continuous)	100	milliamps
V _{CEO}	25	volts
V _{ECO}	7	volts
**Derate 2.5mW/°C above 25°C ambient		

individual electrical characteristics (25°C)

INFRARED EMITTING DIODE	TYP.	MAX.	UNITS
Forward Voltage (I _F = 10 mA)	1.2	1.7	volts
Reverse Current (V _R = 2V)	—	10	μamps
Capacitance (V = 0, f = 1 MHz)	150	—	pf

PHOTO-DARLINGTON	MIN.	MAX.	UNITS
Breakdown Voltage V _{(BR)CEO} (I _C = 10 mA)	25	—	volts
Breakdown Voltage V _{(BR)ECO} (I _E = 100 μa)	7	—	volts
Collector Dark Current I _{CEO} (V _{CE} = 10V, I _F = 0, H = 0)	—	100	nA

coupled electrical characteristics (25°C)

	MIN.	TYP.	MAX.	UNITS
Output Current (I _F = 20mA, V _{CE} = 5V)	2500	—	—	μamps
Saturation Voltage (I _F = 20mA, I _C = 0.5 mA)	—	—	1.2	volts
Switching Speeds (V _{CE} = 10V, I _C = 2 mA, R _L = 100Ω)				
On Time (t _d + t _r)	—	150	—	μsecs
Off Time (t _s + t _f)	—	150	—	μsecs

TYPICAL CHARACTERISTICS

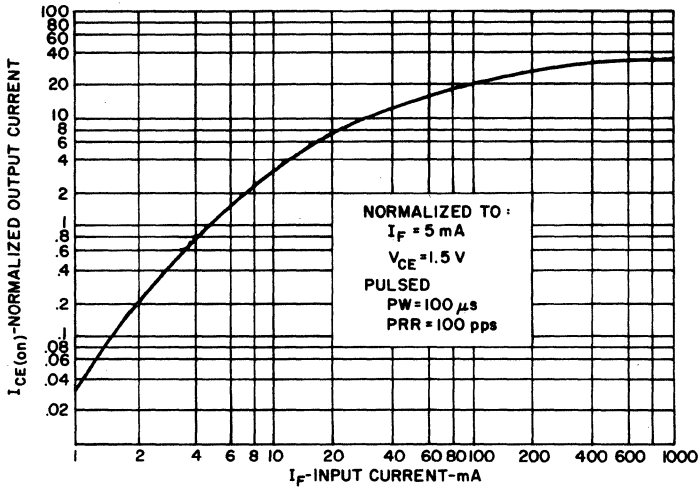

1. OUTPUT CURRENT VS. INPUT CURRENT

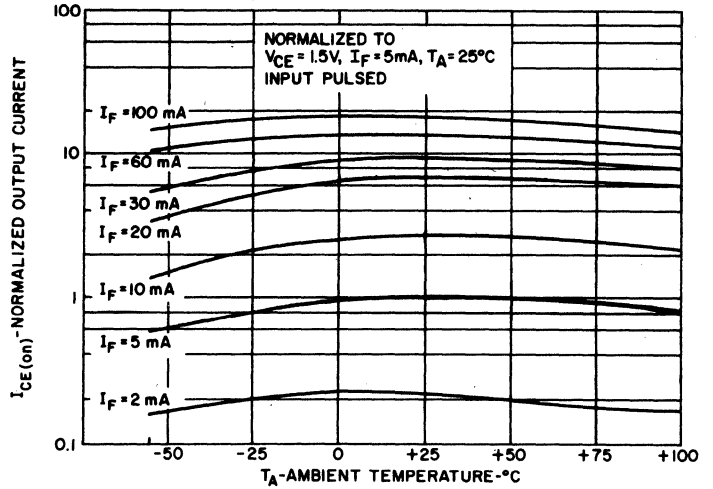

2. OUTPUT CURRENT VS. TEMPERATURE

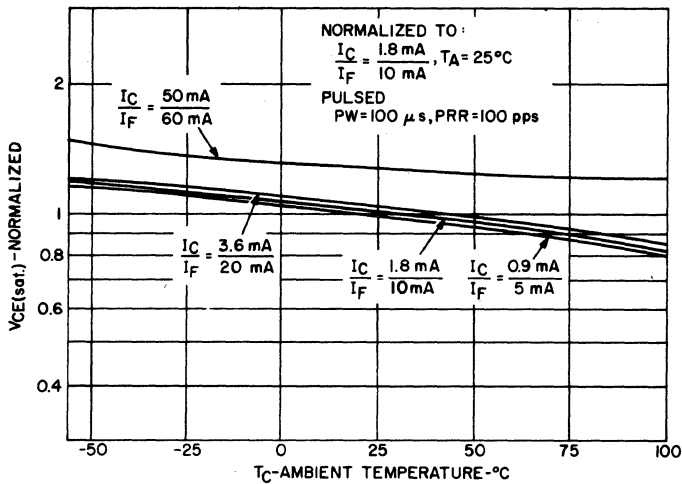

3. $V_{CE(sat)}$ VS. TEMPERATURE

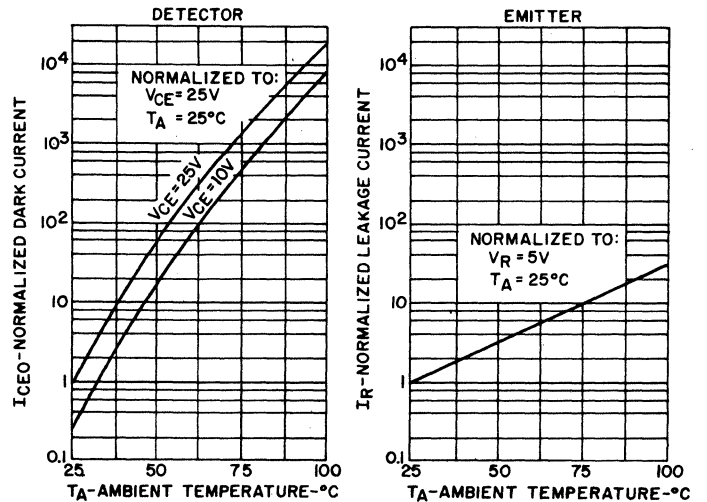

4. LEAKAGE CURRENTS VS. TEMPERATURE

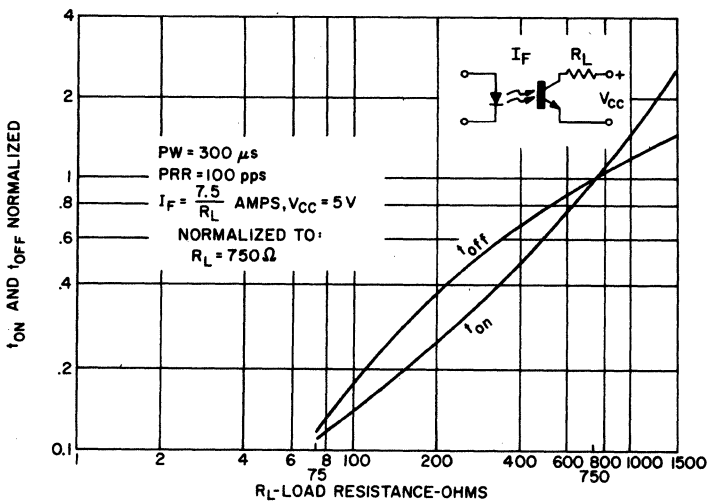

5. SWITCHING SPEED VS. R_L

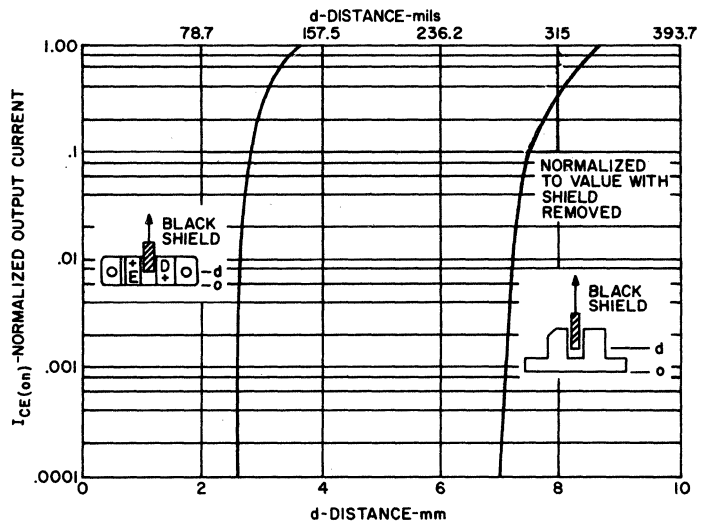

6. OUTPUT CURRENT VS. SHIELD DISTANCE



SOLID STATE OPTOELECTRONICS

Photon Coupled Isolator CNY30-CNY34

Ga As Infrared Emitting Diode & Light Activated SCR
 The General Electric CNY30 and CNY34 consist of a gallium arsenide, infrared emitting diode coupled with a light activated silicon controlled rectifier in a dual in-line package.
absolute maximum ratings: (25°C)

INFRARED EMITTING DIODE		
Power Dissipation (-55°C to 50°C)	*100	milliwatts
Forward Current (Continuous) (-55°C to 50°C)	60	milliamps
Forward Current (Peak) (-55°C to 50°C) (100 μs 1% duty cycle)	1	ampere
Reverse Voltage (-55°C to 50°C)	6	volts

*Derate 2.0mW/°C above 50°C.

PHOTO-SCR		
Off-State and Reverse Voltage (-55°C to 100°C)	CNY30 200 CNY34 400	volts
Peak Reverse Gate Voltage (-55°C to 50°C)	6	volts
Direct On-State Current (-55°C to 50°C)	300	milliamps
Surge (non-rep) On-State Current (-55°C to 50°C)	10	amps
Peak Gate Current (-55°C to 50°C)	10	milliamps
Output Power Dissipation (-55°C to 50°C)**	400	milliwatts

**Derate 8mW/°C above 50°C.

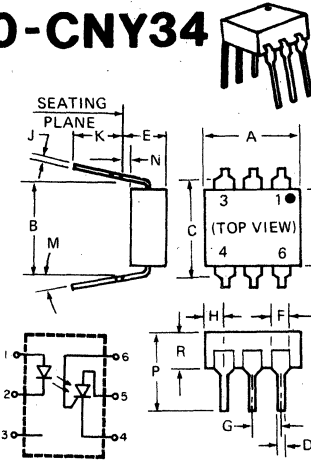

SYMBOL	MILLIMETERS		INCHES		NOTES
	MIN.	MAX.	MIN.	MAX.	
A	8.38	8.89	.330	.350	1
B	7.62 REF.		.300 REF.		
C	—	8.64	—	.340	2
D	.406	.508	.016	.020	
E	—	5.08	—	.200	3
F	1.01	1.78	.040	.070	
G	2.28	2.80	.090	.110	4
H	—	2.16	—	.085	
J	.203	.305	.008	.012	4
K	2.54	—	.100	—	
M	—	15°	—	15°	4
N	.381	—	.015	—	
P	—	9.53	—	.375	4
R	2.92	3.43	.115	.135	
S	6.10	6.86	.240	.270	4

NOTES:
 1. INSTALLED POSITION LEAD CENTERS.
 2. OVERALL INSTALLED DIMENSION.
 3. THESE MEASUREMENTS ARE MADE FROM THE SEATING PLANE. 4. FOUR PLACES.

TOTAL DEVICE	
Storage Temperature Range	-55°C to 150°C
Operating Temperature Range	-55°C to 100°C
Normal Temperature Range (No Derating)	-55°C to 80°C
Soldering Temperature (10 seconds)	260°C
Total Device Dissipation (-55°C to 50°C)	450 milliwatts
Linear Derating Factor (above 50°C)	9.0mW/°C
Surge Isolation Voltage (Input to Output)	2500V _(peak) 1770V _(RMS)
Steady-State Isolation Voltage (Input to Output)	1500V _(peak) 1060V _(RMS)

individual electrical characteristics (25°C) (unless otherwise specified)

INFRAREMITTINGDIODE	TYP.	MAX.	UNITS
Forward Voltage V _F (I _F = 10mA)	1.1	1.5	volts
Reverse Current I _R (V _R = 3V)	—	10	microamps
Capacitance (V = 0, f = 1 MHz)	50	—	picofarads

PHOTO-SCR	MIN.	MAX.	UNITS
Peak Off-State Voltage - V _{DM} (R _{GK} = 10KΩ, T _A = 100°C)	CNY30 200 CNY34 400	—	volts
Peak Reverse Voltage - V _{RM} (T _A = 100°C)	CNY30 200 CNY34 400	—	volts
On-State Voltage - V _T (I _T = 300mA)	—	1.3	volts
Off-State Current - I _D (V _D = 200V, T _A = 100°C, I _F = 0, R _{GK} = 10K)	CNY30 50 CNY34 150	—	microamps
Off-State Current - I _D (V _D = 400V, T _A = 100°C, I _F = 0, R _{GK} = 10K)	CNY30 50 CNY34 150	—	microamps
Reverse Current - I _R (V _R = 200V, T _A = 100°C, I _F = 0)	CNY30 50 CNY34 150	—	microamps
Reverse Current - I _R (V _R = 400V, T _A = 100°C, I _F = 0)	CNY30 50 CNY34 150	—	microamps

coupled electrical characteristics (25°C)

	MIN.	MAX.	UNITS
Input Current to Trigger	—	20	milliamps
Isolation Resistance	100	—	gigaohms
Turn-On Time - V _{AK} = 50V, I _F = 30mA, R _{GK} = 10KΩ, R _L = 200Ω	—	50	microseconds
Coupled dv/dt, Input to Output (See Figure 13)	500	—	volts microsec.
Input to Output Capacitance (V _{IO} = 0, f = 1 MHz)	—	2	picofarads

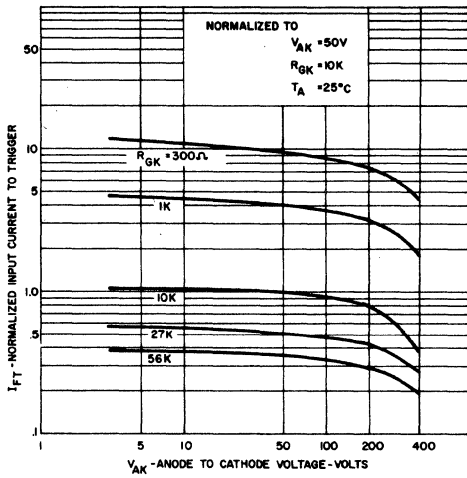

FIGURE 1. INPUT CURRENT TO TRIGGER VS. ANODE-CATHODE VOLTAGE

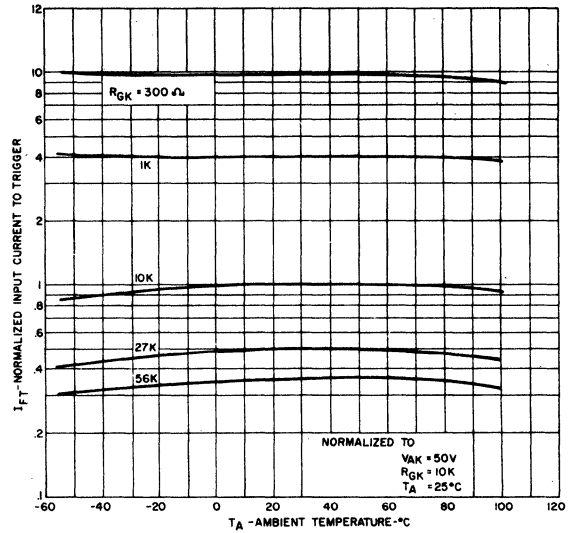

FIGURE 2. INPUT CURRENT TO TRIGGER VS. TEMPERATURE

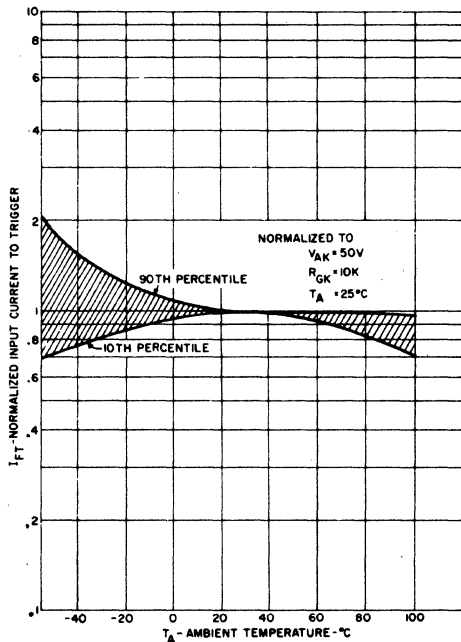

FIGURE 3. INPUT CURRENT TO TRIGGER DISTRIBUTION VS. TEMPERATURE

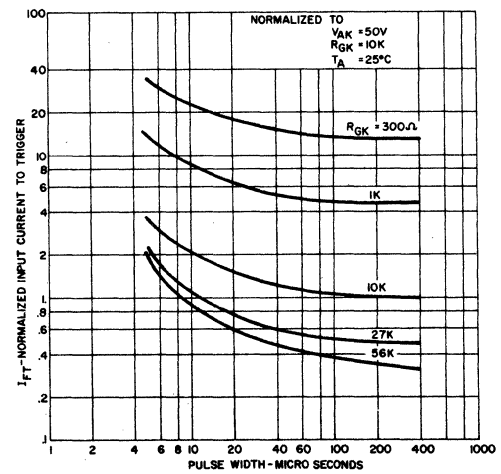

FIGURE 4. INPUT CURRENT TO TRIGGER VS. PULSE WIDTH

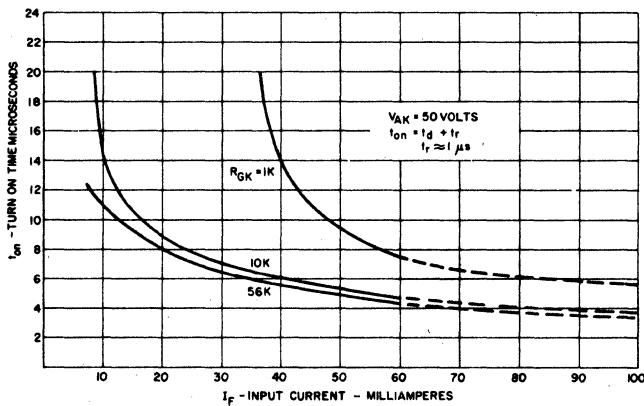

FIGURE 5. TURN-ON TIME VS. INPUT CURRENT

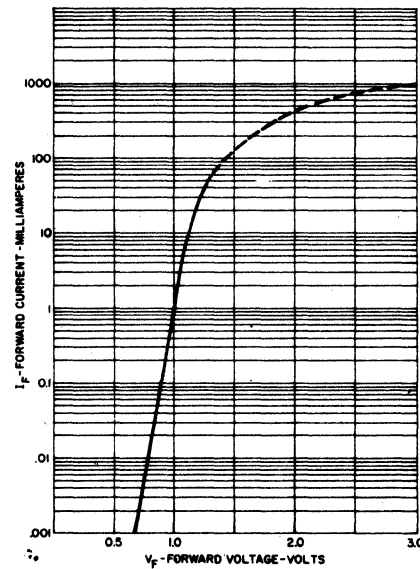

FIGURE 6. INPUT CHARACTERISTICS I_F VS. V_F

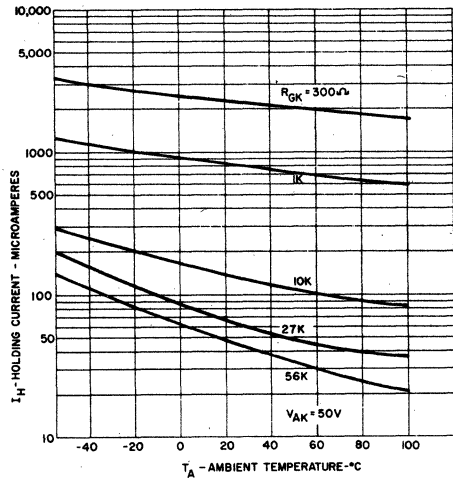

FIGURE 7. HOLDING CURRENT VS. TEMPERATURE

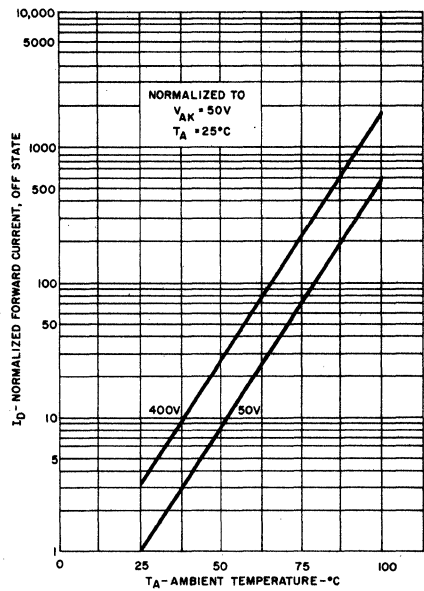

FIGURE 9. OFF-STATE FORWARD CURRENT VS. TEMPERATURE

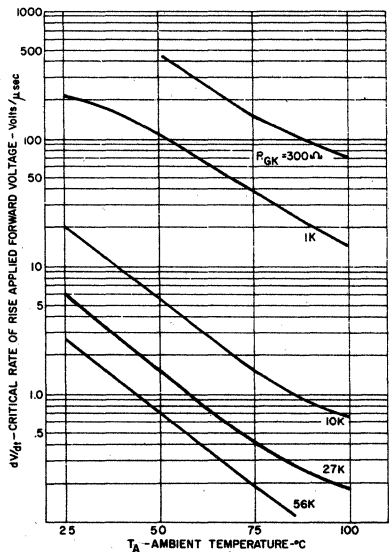

FIGURE 11. dv/dt VS. TEMPERATURE

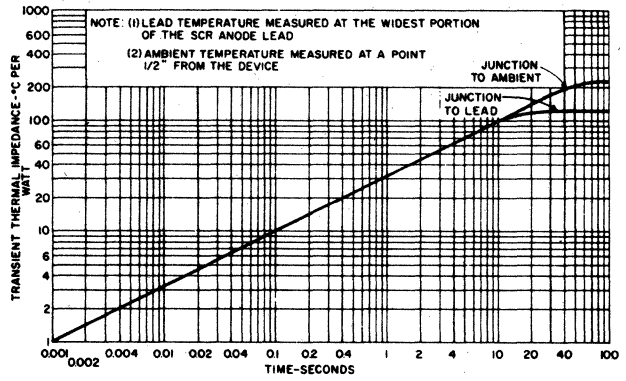

FIGURE 8. MAXIMUM TRANSIENT THERMAL IMPEDANCE

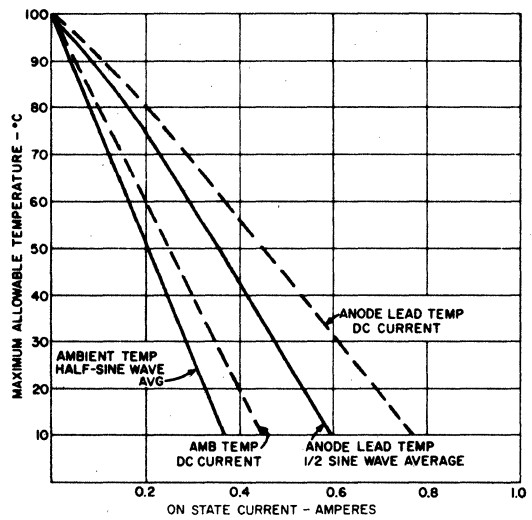

FIGURE 10. ON-STATE CURRENT VS. MAXIMUM ALLOWABLE TEMPERATURE

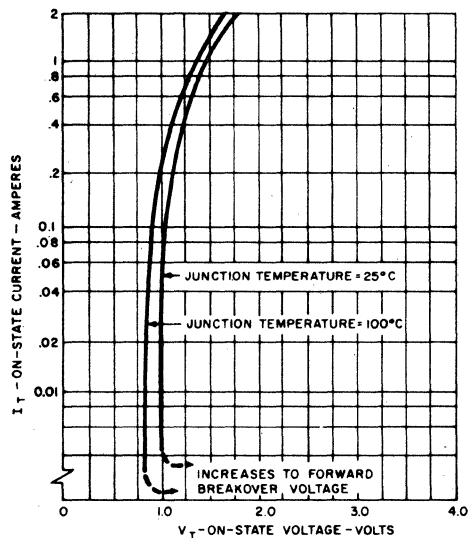
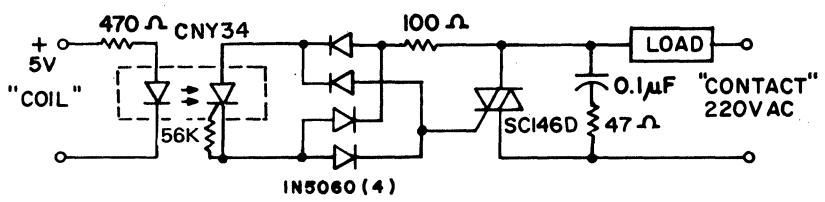

FIGURE 12. ON-STATE CHARACTERISTICS

TYPICAL APPLICATIONS

10A, T²L COMPATIBLE, SOLID STATE RELAY

Use of the CNY34 for high sensitivity, 2500V isolation capability, provides this highly reliable solid state relay design. This design is compatible with 74, 74S and 74H series T²L logic systems inputs and 220V AC loads up to 10A.



25W LOGIC INDICATOR LAMP DRIVER

The high surge capability and non-reactive input characteristics of the device allow it to directly couple, without buffers, T²L and DTL logic to indicator and alarm devices, without danger of introducing noise and logic glitches.

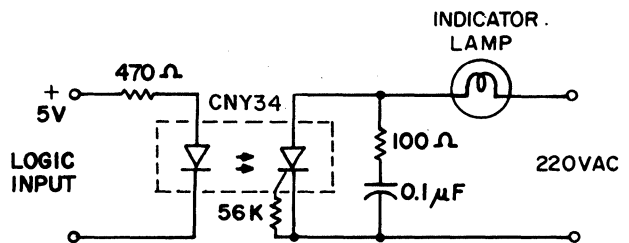

400V SYMMETRICAL TRANSISTOR COUPLER

Use of the high voltage PNP portion of the CNY34 provides a 400V transistor capable of conducting positive and negative signals with current transfer ratios of over 1%. This function is useful in remote instrumentation, high voltage power supplies and test equipment. Care should be taken not to exceed the CNY34 400 mW power dissipation rating when used at high voltages.

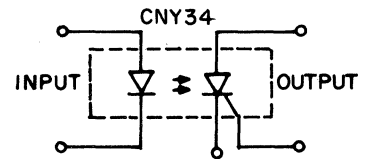
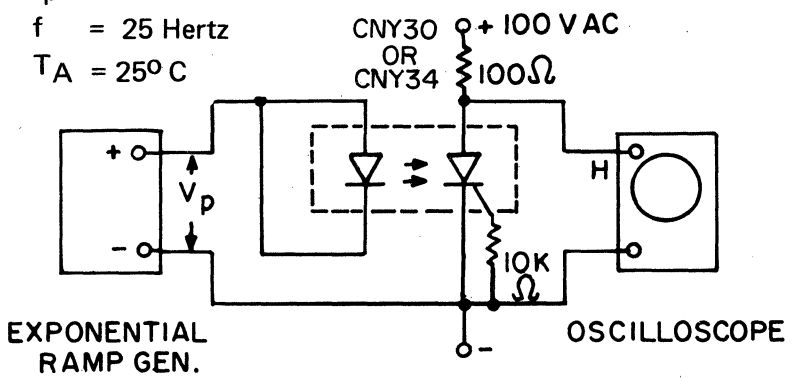
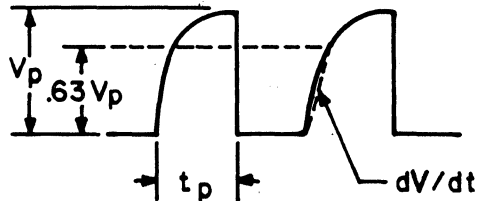

FIGURE 13
COUPLED dv/dt - TEST CIRCUIT

$V_p = 800$ Volts
 $t_p = .010$ Seconds
 $f = 25$ Hertz
 $T_A = 25^\circ$ C





SOLID STATE OPTOELECTRONICS

Photon Coupled Isolator CNY31

Ga As Infrared Emitting Diode & NPN Silicon Photo-Darlington Amplifier

The General Electric CNY31 is a gallium arsenide, infrared emitting diode coupled with silicon photo-darlington amplifier in a low cost plastic package with lead spacing, compatible to dual in-line package.

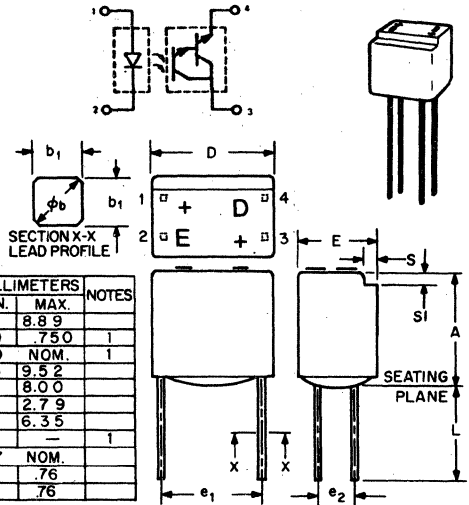

SYMBOL	INCHES		MILLIMETERS		NOTES
	MIN.	MAX.	MIN.	MAX.	
A	—	.350	—	8.89	
ϕ_b	.024	.030	.600	.750	1
b_1	.020	NOM.	.50	NOM.	1
D	—	.375	—	9.52	
e_1	.285	.315	.724	8.00	
e_2	.090	.110	2.29	2.79	
E	—	.250	—	6.35	
L	.300	—	.762	—	1
R	.050	NOM.	.127	NOM.	
S	.020	.030	.50	.76	
S_1	.020	.030	.50	.76	

NOTE:
1. FOUR LEADS; LEAD DIMENSIONS CONTROLLED BETWEEN .050" (1.27 MM) FROM THE SEATING PLANE AND THE END OF THE LEADS.

absolute maximum ratings: (25°C)

INFRARED EMITTING DIODE			
Power Dissipation	*100	milliwatts	
Forward Current (Continuous)	60	milliamps	
Forward Current (Peak)	3	ampere	
(Pulse width 1 μ sec 300 pps)			
Reverse Voltage	3	volts	
*Derate 1.67 mW/°C above 25°C ambient.			

PHOTO-DARLINGTON			
Power Dissipation	**150	milliwatts	
V_{CEO}	30	volts	
V_{ECO}	7	volts	
Collector Current (Continuous)	100	milliamps	
**Derate 2.5 mW/°C above 25°C ambient.			

TOTAL DEVICE	
Storage Temperature	-55 to 85°C
Operating Temperature	-55 to 85°C
Lead Soldering Time (at 260°C)	10 seconds
Surge Isolation Voltage (Input to Output).	
5650V _(peak)	4000V _(RMS)
Steady-State Isolation Voltage (Input to Output).	
3500V _(peak)	2500V _(RMS)

individual electrical characteristics (25°C)

INFRARED EMITTING DIODE	TYP.	MAX.	UNITS
Forward Voltage ($I_F = 10\text{mA}$)	1.1	1.7	volts
Reverse Current ($V_R = 3\text{V}$)	—	10	microamps
Capacitance ($V = 0, f = 1\text{MHz}$)	50	—	picofarads

PHOTO-DARLINGTON	MIN.	TYP.	MAX.	UNITS
Breakdown Voltage — $V_{(BR)CEO}$ ($I_C = 10\text{mA}, I_F = 0$)	30	—	—	volts
Breakdown Voltage — $V_{(BR)ECO}$ ($I_E = 100\mu\text{A}, I_F = 0$)	7	—	—	volts
Collector Dark Current — I_{CEO} ($V_{CE} = 10\text{V}, I_F = 0$)	—	5	100	nanoamps
Capacitance ($V_{CE} = 10\text{V}, f = 1\text{MHz}$)	—	6	—	picofarads

coupled electrical characteristics (25°C)

	MIN.	TYP.	MAX.	UNITS
DC Current Transfer Ratio ($I_F = 5\text{mA}, V_{CE} = 5\text{V}$)	400	—	—	%
Saturation Voltage — Collector to Emitter ($I_F = 5\text{mA}, I_C = 2\text{mA}$)	—	0.8	1.4	volts
Isolation Resistance (Input to Output Voltage = 500V _{DC})	100	—	—	gigaohms
Input to Output Capacitance (Input to Output Voltage = 0, $f = 1\text{MHz}$)	—	—	2	picofarads
Switching Speeds: Turn-On Time — ($V_{CE} = 10\text{V}, I_C = 10\text{mA}, R_L = 100\Omega$)	—	125	—	microseconds
Turn-Off Time — ($V_{CE} = 10\text{V}, I_C = 10\text{mA}, R_L = 100\Omega$)	—	100	—	microseconds

TYPICAL CHARACTERISTICS

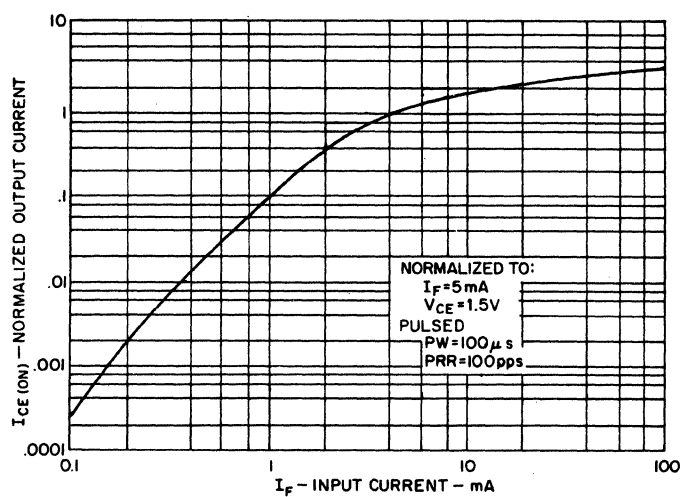

1. OUTPUT CURRENT VS. INPUT CURRENT

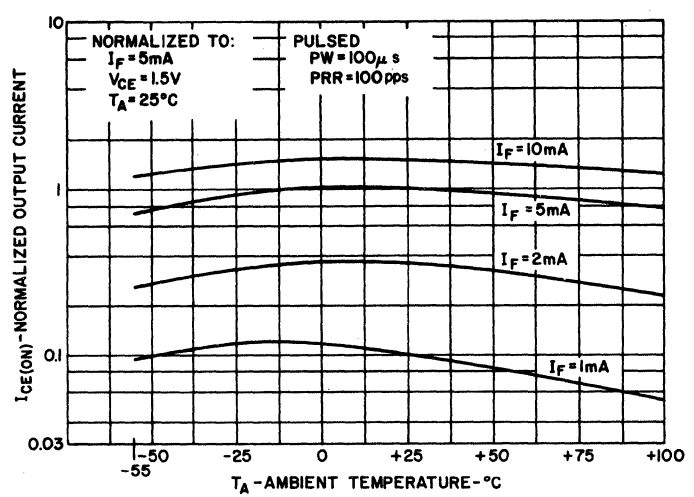

2. OUTPUT CURRENT VS. TEMPERATURE

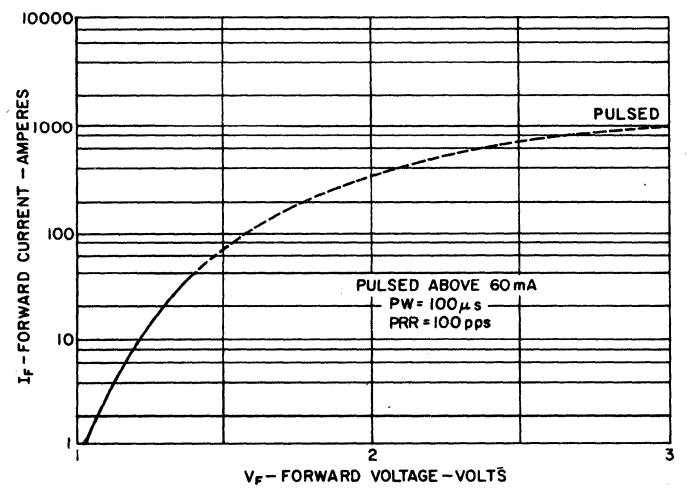

3. INPUT CHARACTERISTICS

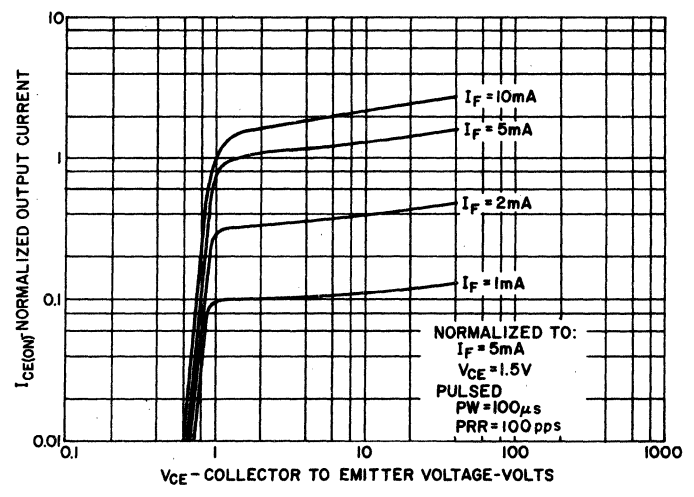

4. OUTPUT CHARACTERISTICS

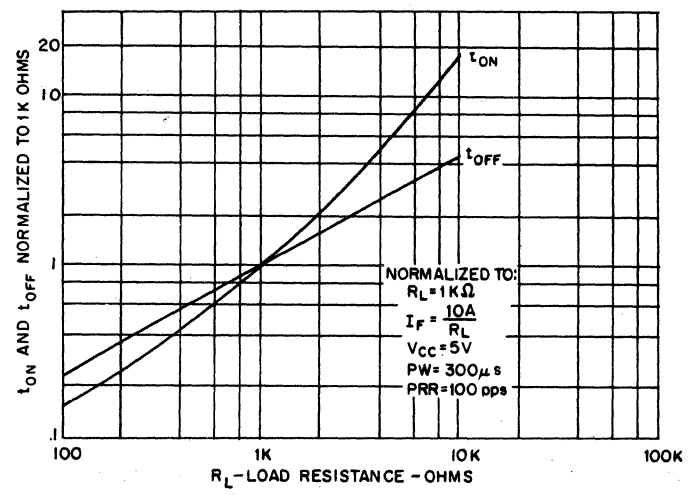

5. SWITCHING SPEED VS. RL

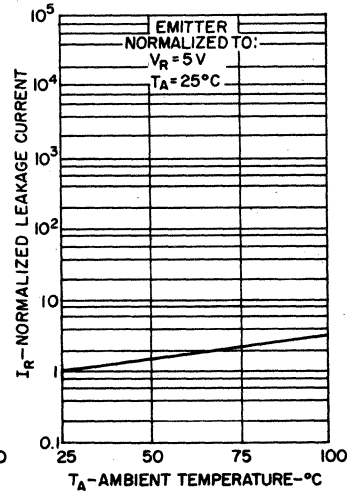
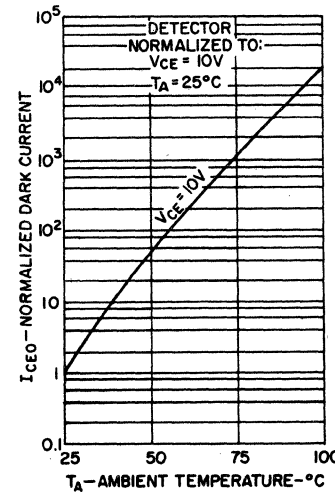

6. LEAKAGE CURRENTS VS. TEMPERATURE



SOLID STATE OPTOELECTRONICS

Photon Coupled Isolator CNY32

Ga As Infrared Emitting Diodes & NPN Silicon Photo-Transistors

The General Electric CNY32 is a gallium arsenide, infrared emitting diode coupled with a silicon photo transistor in a low cost plastic package with lead spacing, compatible to dual in-line package.

absolute maximum ratings: (25°C)

INFRARED EMITTING DIODE			
Power Dissipation	*100	milliwatts	
Forward Current (Continuous)	60	Milliamps	
Forward Current (Peak)	3	ampere	
	(Pulse width 1 μsec 300 pps)		
Reverse Voltage	3	volts	
*Derate 1.67 mW/° above 25°C ambient.			

PHOTO-TRANSISTOR			
Power Dissipation	**150	milliwatts	
V _{CEO}	30	volts	
V _{ECO}	5	volts	
Collector Current (Continuous)	100	milliamps	
**Derate 2.5 mW/°C above 25°C ambient.			

individual electrical characteristics (25°C)

INFRARED EMITTING DIODE	TYP.	MAX.	UNITS
Forward Voltage (I _F = 10mA)	1.1	1.7	volts
Reverse Current (V _R = 3V)	—	10	micoramps
Capacitance (V = 0, f = 1 MHz)	50	—	picofarads

PHOTO-TRANSISTOR	MIN.	TYP.	MAX.	UNITS
Breakdown Voltage — V _{(BR)CEO} (I _C = 10mA, I _F = 0)	30	—	—	volts
Breakdown Voltage — V _{(BR)ECO} (I _E = 100μA, I _F = 0)	5	—	—	volts
Collector Dark Current — I _{CEO} (V _{CE} = 10V, I _F = 0)	—	5	100	nanoamps
Capacitance (V _{CE} = 10V, f = 1 MHz)	—	3.5	—	picofarads

coupled electrical characteristics (25°C)

	MIN.	TYP.	MAX.	UNITS
DC Current Transfer Ratio (I _F = 10mA, V _{CE} = 10V)	20	—	—	%
Saturation Voltage — Collector to Emitter (I _F = 10mA, I _C = 0.5mA)	—	0.2	0.4	volts
Isolation Resistance (Input to Output Voltage = 500V _{DC})	100	—	—	gigohms
Input to Output Capacitance (Input to Output Voltage = 0, f = 1 MHz)	—	—	2	picofarads
Switching Speeds: Turn-On Time — (V _{CE} = 10V, I _{CE} = 2mA, R _L = 100Ω)	—	3	—	microseconds
Turn-Off Time — (V _{CE} = 10V, I _{CE} = 2mA, R _L = 100Ω)	—	3	—	microseconds

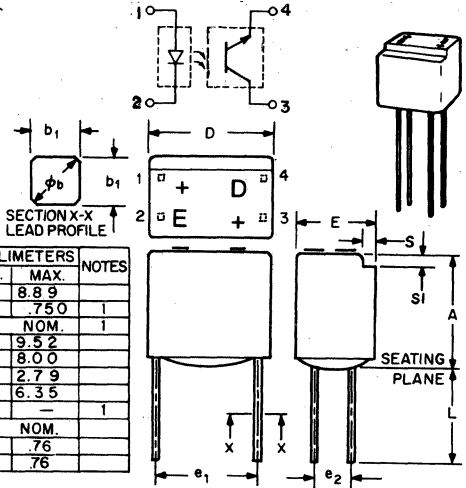

TOTAL DEVICE	
Storage Temperature	-55 to 85°C
Operating Temperature	-55 to 85°C
Lead Soldering Time (at 260°C)	10 seconds
Surge Isolation Voltage (Input to Output)	5650V _(peak) 4000V _(RMS)
Steady-State Isolation Voltage (Input to Output)	3500V _(peak) 2500V _(RMS)

TYPICAL CHARACTERISTICS

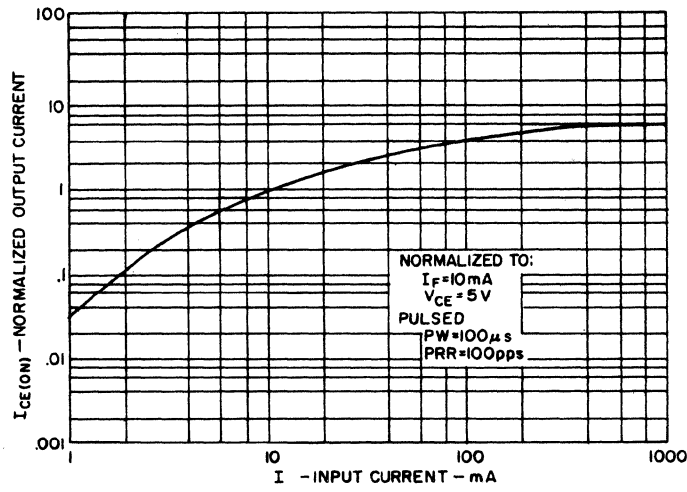

1. OUTPUT CURRENT VS. INPUT CURRENT

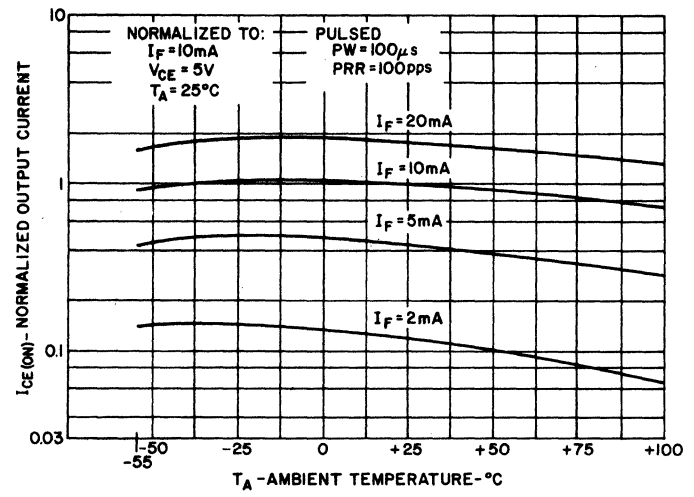

2. OUTPUT CURRENT VS. TEMPERATURE

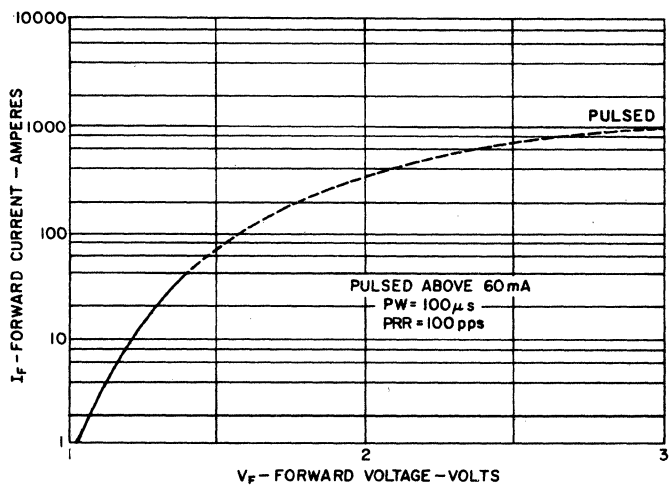

3. INPUT CHARACTERISTICS

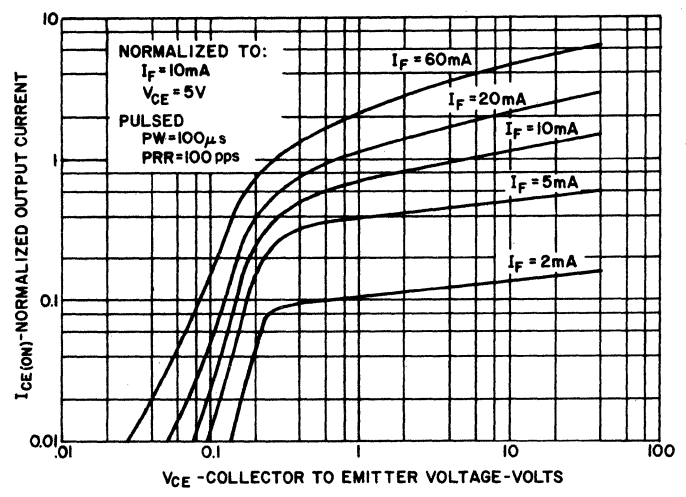

4. OUTPUT CHARACTERISTICS

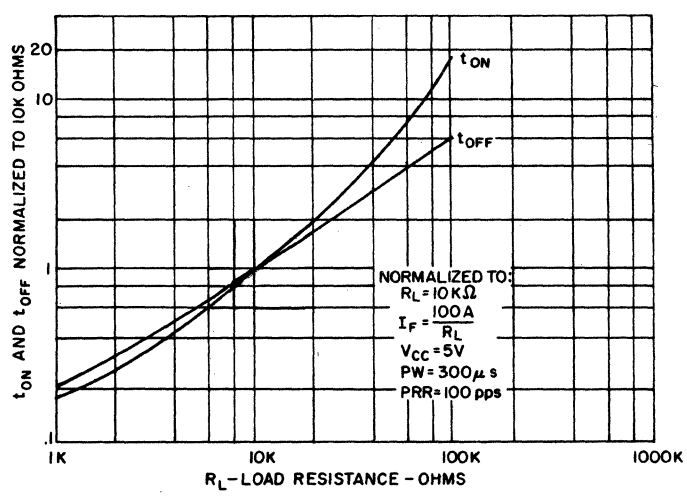

5. SWITCHING SPEED VS. R_L

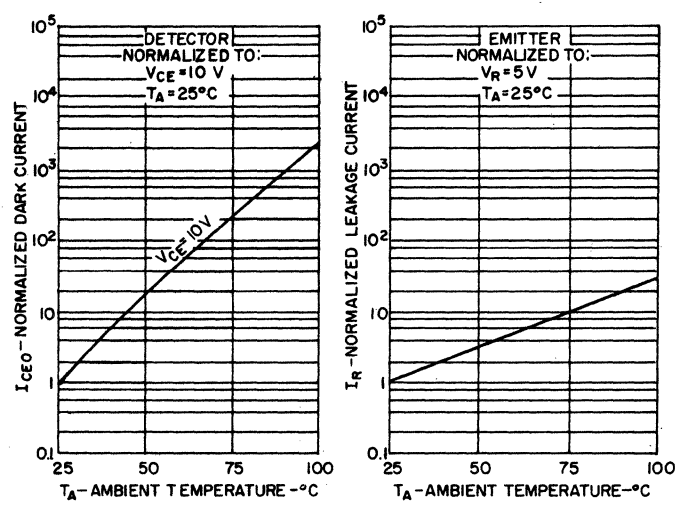

6. LEAKAGE CURRENTS VS. TEMPERATURE



SOLID STATE OPTOELECTRONICS

Photon Coupled Isolator CNY33

Ga As Infrared Emitting Diode & NPN Silicon High Voltage Photo-Transistor

The General Electric CNY33 is a gallium arsenide, infrared emitting diode coupled with silicon high voltage photo-transistors in a dual in-line package.

absolute maximum ratings: (25°C)

INFRARED EMITTING DIODE			
Power Dissipation	*100	milliwatts	
Forward Current (Continuous)	60	milliamps	
Forward Current (Peak) (Pulse width 1 μsec 300 pps)	3	ampere	
Reverse Voltage	6	volts	
*Derate 1.33mW/°C above 25°C ambient.			

PHOTO-TRANSISTOR			
Power Dissipation	**300	milliwatts	
V _{CEO}	300	volts	
V _{CBO}	300	volts	
V _{EBO}	7	volts	
Collector Current (Continuous)	100	milliamps	
**Derate 4.0mW/°C above 25°C ambient.			

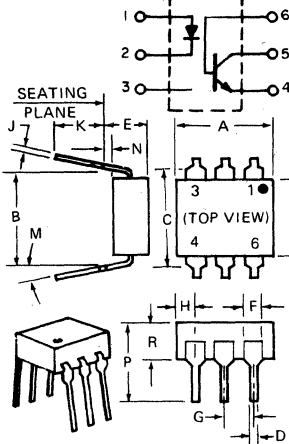

SYMBOL	MILLIMETERS		INCHES		NOTES
	MIN.	MAX.	MIN.	MAX.	
A	8.38	8.89	.330	.350	
B	7.62	REF.	.300	REF.	1
C	—	8.64	—	.340	2
D	.406	.508	.016	.020	
E	—	5.08	—	.200	3
F	1.01	1.78	.040	.070	
G	2.28	2.80	.090	.110	
H	—	2.16	—	.085	4
J	.203	.305	.008	.012	
K	2.54	—	.100	—	
M	—	15	—	15	
N	.381	—	.015	—	
P	—	9.53	—	.375	
R	2.92	3.43	.115	.135	
S	6.10	6.86	.240	.270	

- NOTES:
 1. INSTALLED POSITION LEAD CENTERS.
 2. OVERALL INSTALLED DIMENSION.
 3. THESE MEASUREMENTS ARE MADE FROM THE SEATING PLANE.
 4. FOUR PLACES.

TOTAL DEVICE.	
Storage Temperature	-55 to 150°C
Operating Temperature	-55 to 100°C
Lead Soldering Time (at 260°C)	10 seconds.
Surge Isolation Voltage (Input to Output).	
2500V _(peak)	1770V _(RMS)
Steady-State Isolation Voltage (Input to Output).	
1500V _(peak)	1060V _(RMS)

individual electrical characteristics (25°C)

INFRARED EMITTING DIODE	TYP.	MAX.	UNITS
Forward Voltage (I _F = 10mA)	1.1	1.5	volts
Reverse Current (V _R = 6V)	—	10	microamps
Capacitance (V = 0, f = 1 MHz)	50	—	picofarads

PHOTO-TRANSISTOR	MIN.	MAX.	UNITS
Breakdown Voltage – V _{(BR)CEO} (I _C = 1mA; I _F = 0)	300	—	volts
Breakdown Voltage – V _{(BR)CBO} (I _C = 100μA; I _F = 0)	300	—	volts
Breakdown Voltage – V _{(BR)EBO} (I _E = 100μA; I _F = 0)	7	—	volts
Collector Dark Current – I _{CEO} (V _{CE} = 200V; I _F = 0; T _A = 25°C)	—	100	nanoamps
(V _{CE} = 200V; I _F = 0; T _A = 100°C)	—	250	microamps

coupled electrical characteristics (25°C)

	MIN.	TYP.	MAX.	UNITS
DC Current Transfer Ratio (I _F = 10mA, V _{CE} = 10V)	20	—	—	%
Saturation Voltage – Collector to Emitter (I _F = 10mA, I _C = 0.5mA)	—	0.1	0.4	volts
Isolation Resistance (V _{IO} = 500V _{DC})	100	—	—	gigohms
Input to Output Capacitance (V _{IO} = 0, f = 1MHz)	—	—	2	picofarads
Switching Speeds: Turn-On Time – (V _{CE} = 10V, I _{CE} = 2mA, R _L = 100Ω)	—	5	—	microseconds
Turn-Off Time – (V _{CE} = 10V, I _{CE} = 2mA, R _L = 100Ω)	—	5	—	microseconds

VDE Approved to 0883/6.80 0110b Certificate # 35025

TYPICAL CHARACTERISTICS

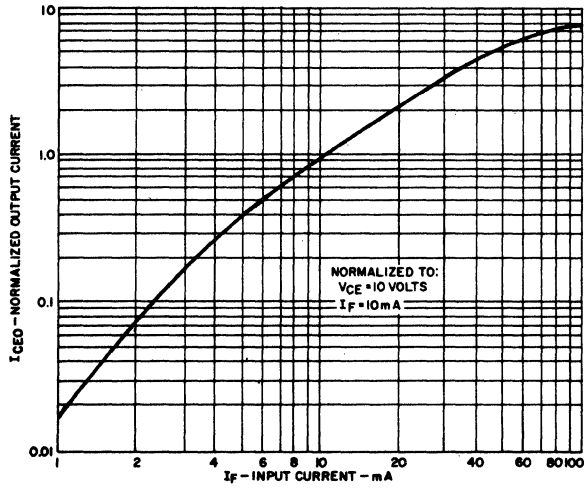

1. OUTPUT CURRENT VS INPUT CURRENT

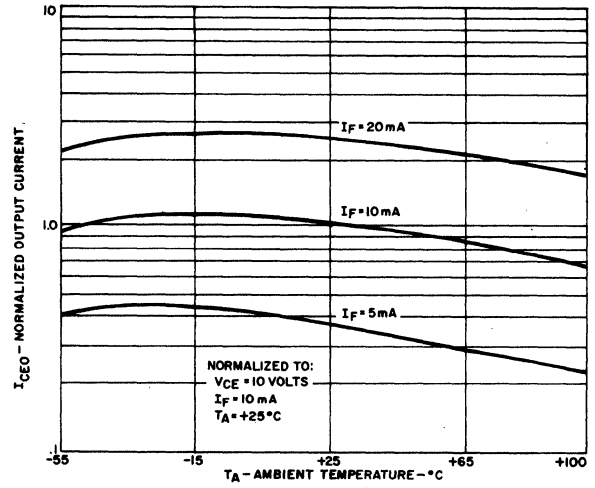

2. OUTPUT CURRENT VS. TEMPERATURE

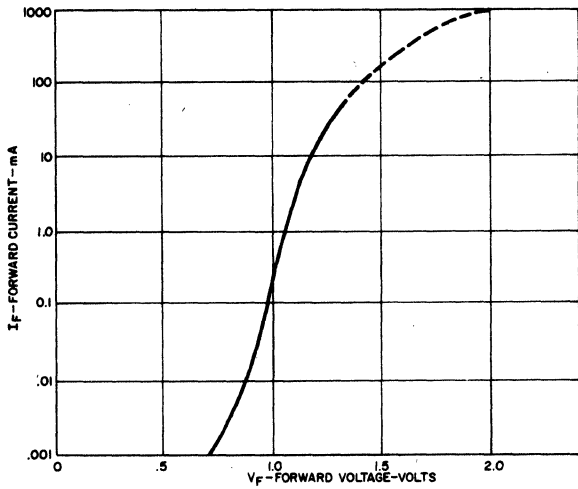

3. INPUT CHARACTERISTICS

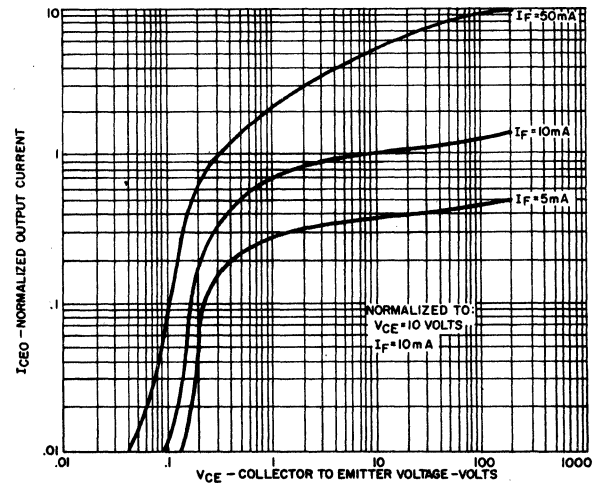

4. OUTPUT CHARACTERISTICS

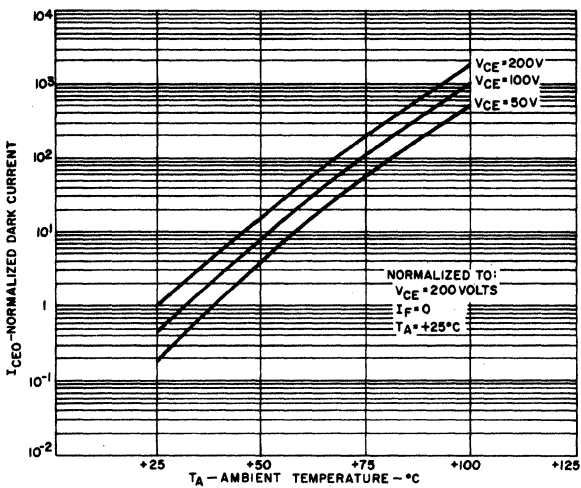

5. NORMALIZED DARK CURRENT VS. TEMPERATURE

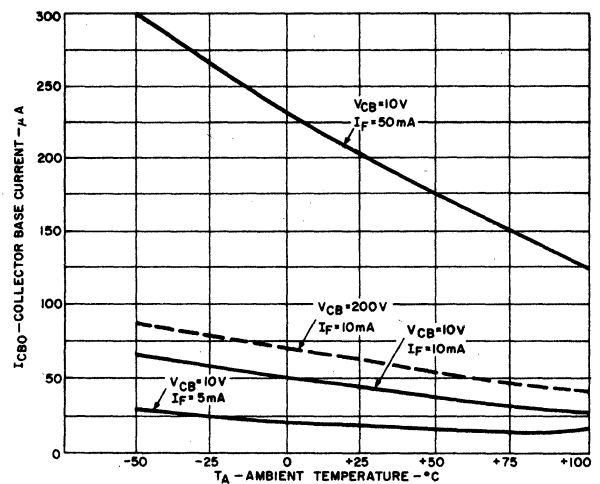

6. COLLECTOR BASE CURRENT VS. TEMPERATURE



SOLID STATE OPTOELECTRONICS

AC Input Photon Coupled Isolator CNY35

Ga As Infrared Emitting Diodes & NPN Silicon Photo-Transistor

The General Electric CNY35 consists of two gallium arsenide, infrared emitting diodes connected in inverse parallel and coupled with a silicon photo-transistor in a dual in-line package.

FEATURES:

- AC or polarity insensitive inputs
- Fast switching speeds
- Built-in reverse polarity input protection
- High isolation voltage
- High isolation resistance
- I/O compatible with integrated circuits

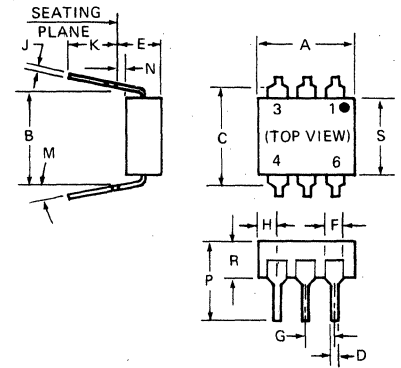
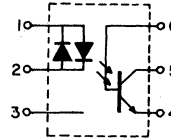
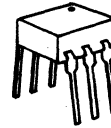

absolute maximum ratings: (25°C) (unless otherwise specified)

INFRARED EMITTING DIODE			
Power Dissipation – $T_A = 25^\circ\text{C}$	*100	milliwatts	
Power Dissipation – $T_A = 25^\circ\text{C}$ (T_C indicates collector lead temperature 1/32" from case)	*100	milliwatts	
Input Current (RMS)	60	milliamps	
Input Current (Peak) (Pulse width 1 μs , 300 pps)	± 1	ampere	
*Derate 1.33 mW/°C above 25°C			

PHOTO-TRANSISTOR			
Power Dissipation – $T_A = 25^\circ\text{C}$	**300	milliwatts	
Power Dissipation – $T_A = 25^\circ\text{C}$ (T_C indicates collector lead temperature 1/32" from case)	***500	milliwatts	
V_{CEO}	30	volts	
V_{CBO}	70	volts	
V_{EBO}	5	volts	
Collector Current Continuous)	100	milliamps	
**Derate 4.0 mW/°C above 25°C			
***Derate 6.7 mW/°C above 25°C			

SYMBOL	MILLIMETERS		INCHES		NOTES
	MIN.	MAX.	MIN.	MAX.	
A	8.38	8.89	.330	.350	1
B	7.62 REF.		.300 REF.		
C	—	8.64	—	.340	2
D	.406	.508	.016	.020	
E	—	5.08	—	.200	3
F	1.01	1.78	.040	.070	
G	2.28	2.80	.090	.110	4
H	—	2.16	—	.085	
J	.203	.305	.008	.012	
K	2.54	—	.100	—	
M	—	15°	—	15°	
N	.381	—	.015	—	
P	—	9.53	—	.375	
R	2.92	3.43	.115	.135	
S	6.10	6.86	.240	.270	

- NOTES:
1. INSTALLED POSITION LEAD CENTERS.
 2. OVERALL INSTALLED DIMENSION.
 3. THESE MEASUREMENTS ARE MADE FROM THE SEATING PLANE.
 4. FOUR PLACES.

TOTAL DEVICE
Storage Temperature -55 to 150°C
Operating Temperature -55 to 100°C
Lead Soldering Time (at 260°C) 10 seconds
Surge Isolation Voltage (Input to Output)
1500V _(peak) 1060V _(RMS)
Steady-State Isolation Voltage (Input to Output)
950V _(peak) 660V _(RMS)

individual electrical characteristics (25°C) (unless otherwise specified)

INFRARED EMITTING DIODE	MAX.	UNITS
Input Voltage – V_F ($I_F = \pm 10\text{mA}$)	1.8	volts
Capacitance ($V = 0, f = 1\text{ MHz}$)	100	picofarads

PHOTO-TRANSISTOR	MIN.	MAX.	UNITS
Breakdown Voltage – $V_{(BR)CEO}$ ($I_C = 10\text{mA}, I_F = 0$)	30	—	volts
Breakdown Voltage – $V_{(BR)CBO}$ ($I_C = 100\mu\text{A}, I_F = 0$)	70	—	volts
Breakdown Voltage – $V_{(BR)EBO}$ ($I_E = 100\mu\text{A}, I_F = 0$)	5	—	volts
Collector Dark Current – I_{CEO} ($V_{CE} = 10\text{V}, I_F = 0$)	—	200	nanoamps

coupled electrical characteristics (25°C) (unless otherwise specified)

	MIN.	MAX.	UNITS
Current Transfer Ratio ($V_{CE} = 10V, I_F = \pm 10mA$)	10	—	percent
Saturation Voltage – Collector to Emitter ($I_{CEO} = 0.5 mA, I_F = \pm 10mA$)	—	0.4	volts
Isolation Resistance $V_{IO} = 500V$ (note 1)	100	—	gigaohms

Note 1: Tests of input to output isolation current resistance, and capacitance are performed with the input terminals (diode) shorted together and the output terminals (transistor) shorted together.

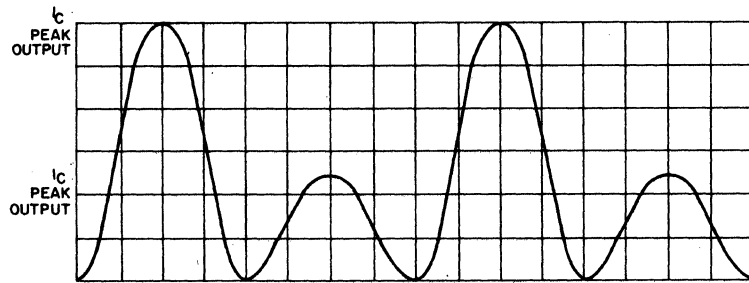

I_{CEO} OUTPUT WAVE FORM (SEE NOTE 2)
AT $V_{CE} = 5V$

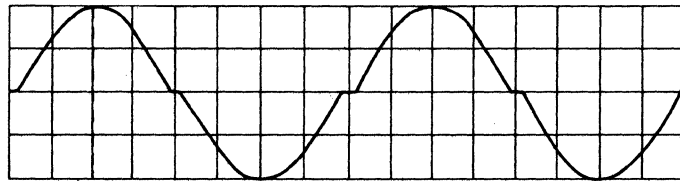

I_F INPUT WAVE FORM

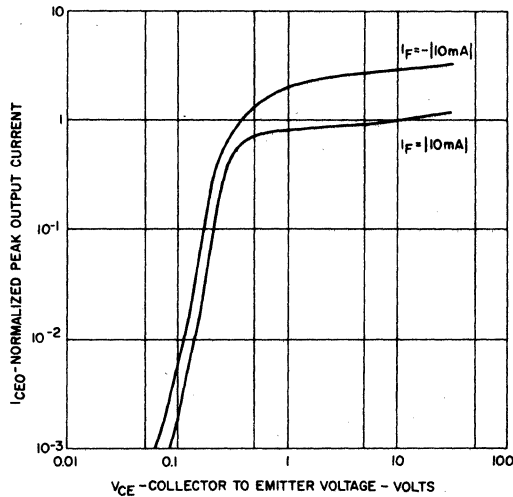

Note 2: These waveforms and curves are exaggerated in amplitude differences to indicate the outputs corresponding to the positive and negative input polarities will not be identical. Typical differences in amplitude is 10% to 20%.

TYPICAL CHARACTERISTICS

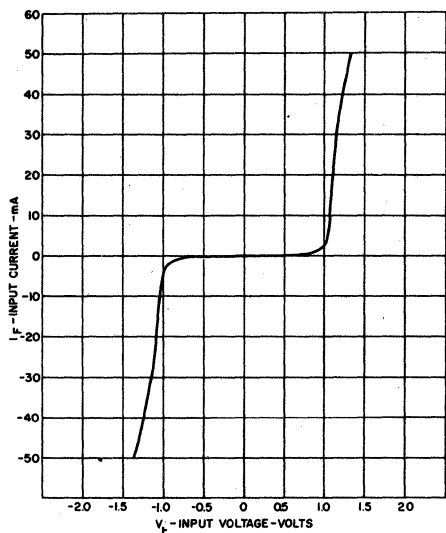

1. INPUT CHARACTERISTICS

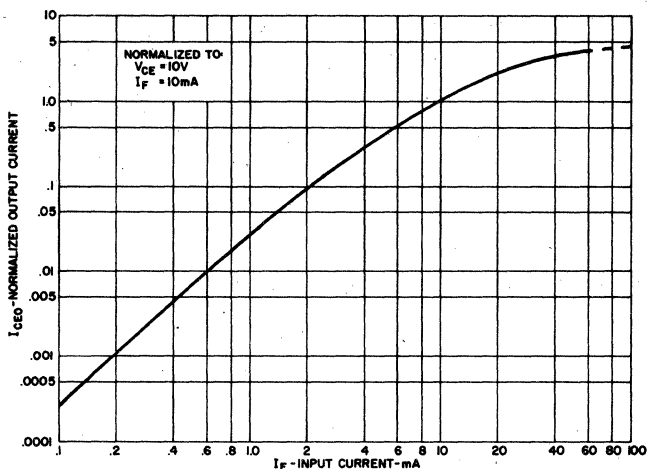

2. OUTPUT CURRENT VS INPUT CURRENT

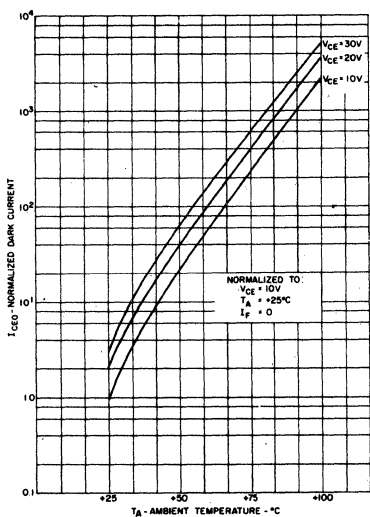

3. DARK I_{CEO} CURRENT VS TEMPERATURE

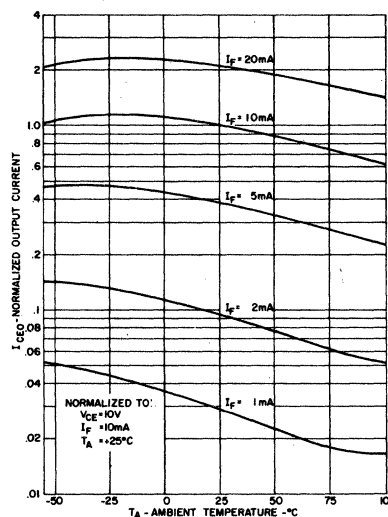

4. OUTPUT CURRENT VS TEMPERATURE

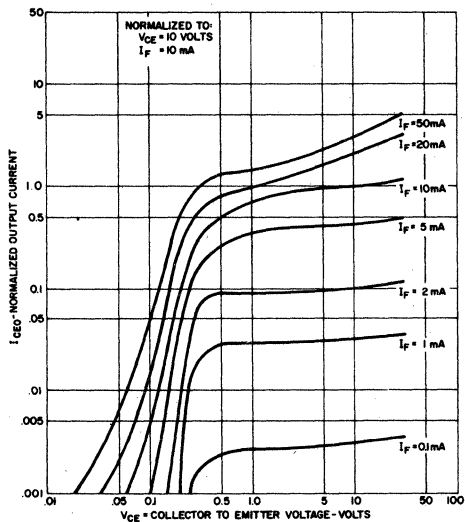

5. OUTPUT CHARACTERISTICS

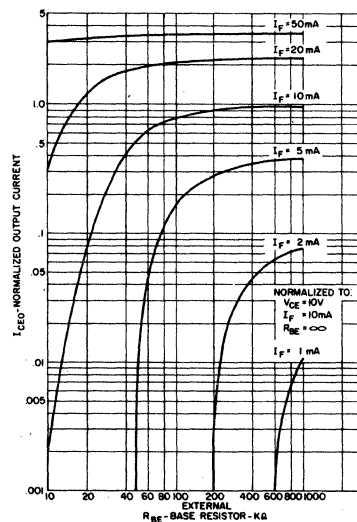

6. OUTPUT CURRENT VS BASE EMITTER RESISTANCE

LOAD MONITOR AND ALARM

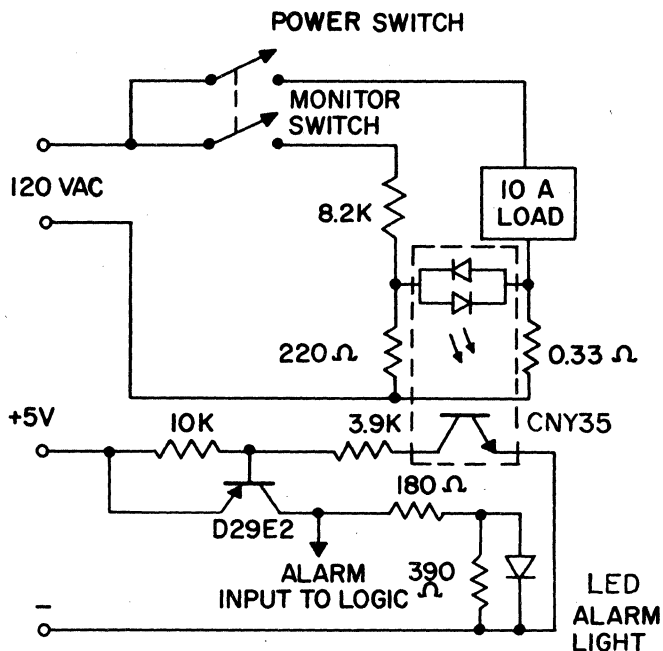

In many computer controlled systems where AC power is controlled, load dropout due to filament burnout, fusing, etc. or the opposite situation - load power when uncalled for due to switch failure can cause serious systems or safety problems. This circuit provides a simple AC power monitor which lights an alarm lamp and provides a "1" input to the computer control in either of these situations while maintaining complete electrical isolation between the logic and the power system.

Note that for other than resistive loads, phase angle correction of the monitoring voltage divider is required.

RING DETECTOR

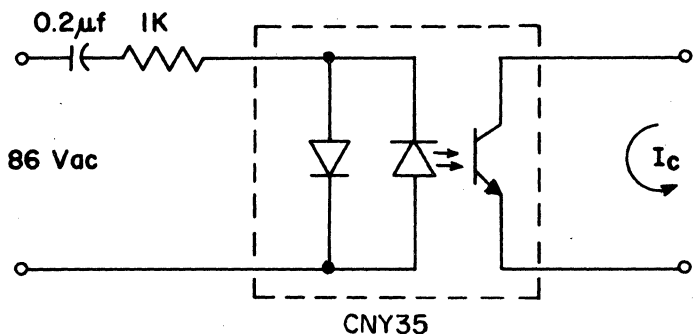

In many telecommunications applications it is desirable to detect the presence of a ring signal in a system without any direct electrical contact with the system. When the 86 Vac ring signal is applied, the output transistor of the CNY35 is turned on indicating the presence of a ring signal in the isolated telecommunications system.

UPS SOLID STATE TURN-ON SWITCH

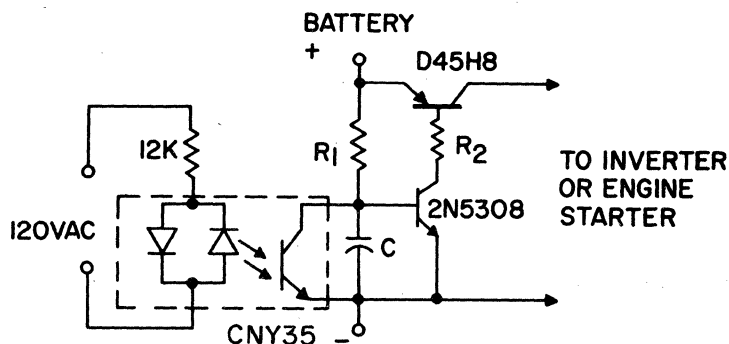

Interruption of the 120 VAC power line turns off the CNY35, allowing C to charge and turn on the 2N5308-D45H8 combination which activates the auxiliary power supply. This system features low standby drain, isolation to prevent ground loop problems and the capability of ignoring a fixed number of "dropped cycles" by choice of the value of C.



SOLID STATE OPTO ELECTRONICS

Photon Coupled Interrupter Module CNY36

The General Electric CNY36 is a gallium arsenide infrared emitting diode coupled with a silicon photo-transistor in a plastic housing. The gap in the housing provides a means of interrupting the signal with tape, cards, shaft encoders, or other opaque material, switching the output transistor from an "ON" into an "OFF" state.

FEATURES:

- Low cost, plastic module
- Non-contact switching
- Fast switching speeds
- Solid state reliability
- I/O compatible with integrated circuits

absolute maximum ratings: (25°C) (unless otherwise specified)

Storage and Operating Temperature -55° to 85°C. Lead Soldering Time (at 260°C) 10 seconds.

INFRARED EMITTING DIODE			
Power Dissipation	*100	milliwatts	
Forward Current (Continuous)	60	milliamps	
Forward Current (peak, 100μs, 1% duty cycle)	1	amp	
Reverse Voltage	3	volts	
*Derate 1.67mW/°C above 25°C ambient			

PHOTO-TRANSISTOR			
Power Dissipation	**150	milliwatts	
Collector Current (Continuous)	100	milliamps	
V _{CEO}	30	volts	
V _{ECO}	5	volts	
**Derate 2.5mW/°C above 25°C ambient			

individual electrical characteristics (25°C)

INFRARED EMITTING DIODE	TYP.	MAX.	UNITS	PHOTO-TRANSISTOR	MIN.	MAX.	UNITS
Forward Voltage (I _F = 10 mA)	1.2	1.7	volts	Breakdown Voltage V _{(BR)CEO} (I _C = 10 mA)	30	—	volts
Reverse Current (V _R = 2V)	—	10	μamps	Breakdown Voltage V _{(BR)ECO} (I _E = 100μA)	5	—	volts
Capacitance (V = 0, f = 1 Mhz)	150	—	pf	Collector Dark Current I _{CEO} (V _{CE} = 10V, I _F = 0, H=0)	—	100	nA

coupled electrical characteristics (25°C)

	MIN.	TYP.	MAX.	UNITS
Output Current (I _F = 20mA, V _{CE} = 10V)	200	400	—	μamps
Saturation Voltage (I _F = 20mA, I _C = 25μA)	—	0.2	0.4	volts
Switching Speeds (V _{CE} = 10V, I _C = 2mA, R _L = 100Ω)				
On Time (t _d + t _r)	—	5	—	μsec
Off Time (t _s + t _f)	—	5	—	μsec

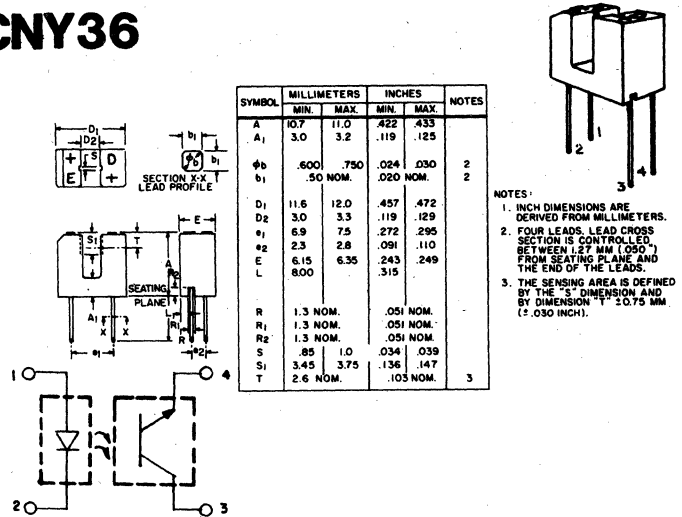

TYPICAL CHARACTERISTICS

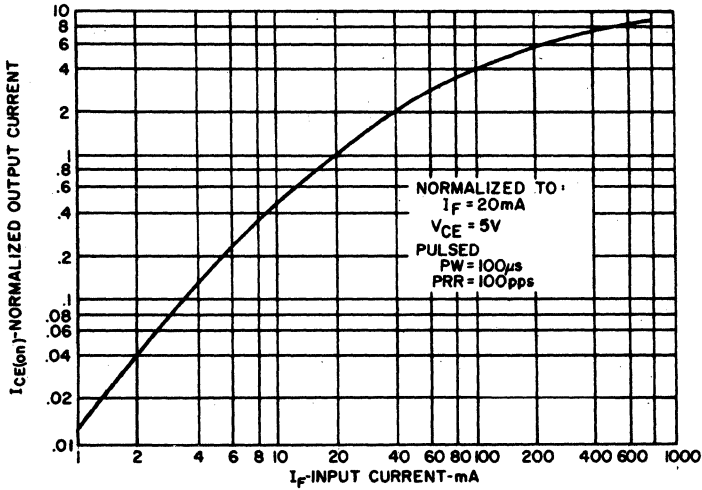

1. OUTPUT CURRENT VS. INPUT CURRENT

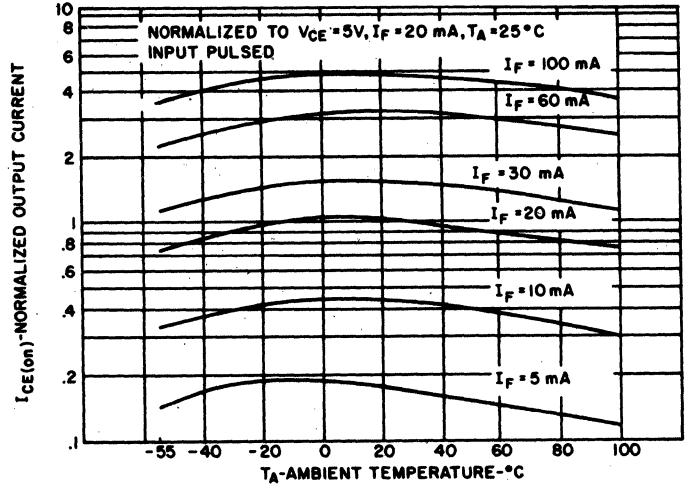

2. OUTPUT CURRENT VS. TEMPERATURE

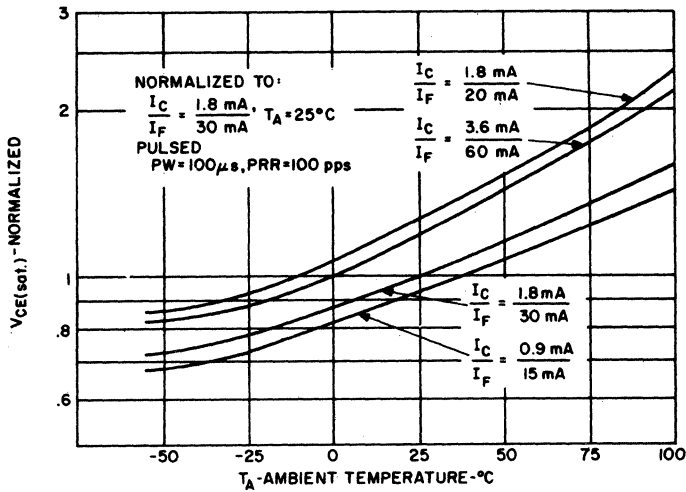

3. $V_{CE(sat)}$ VS. TEMPERATURE

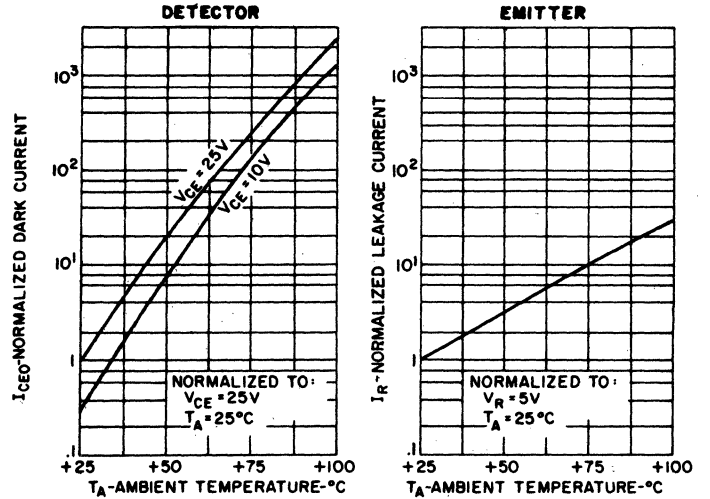

4. LEAKAGE CURRENTS VS. TEMPERATURE

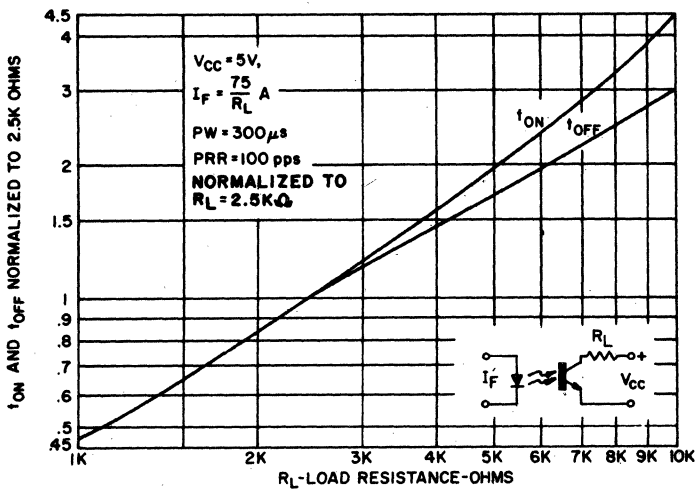

5. SWITCHING SPEED VS. R_L

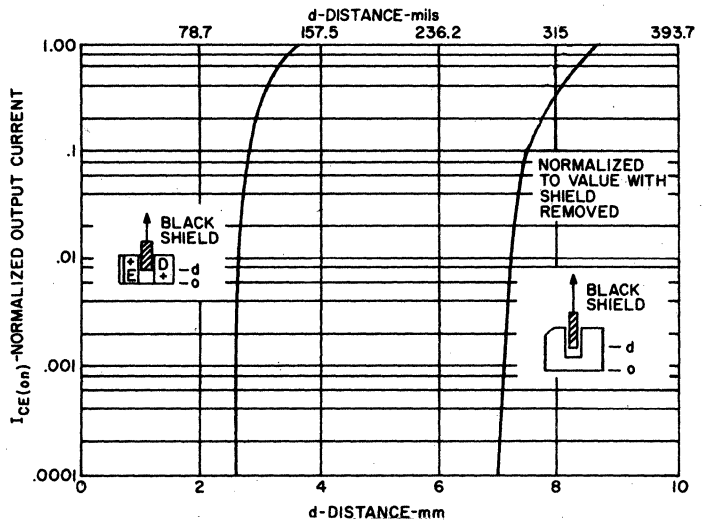

6. OUTPUT CURRENT VS. DISTANCE



SOLID STATE

OPTOELECTRONICS

Photon Coupled Isolator CNY47, CNY47A

Ga As Infrared Emitting Diode & NPN Silicon Photo-Transistor

The General Electric CNY47 and CNY47A are gallium arsenide infrared emitting diodes coupled with a silicon photo-transistor in a dual in-line package.

absolute maximum ratings: (25°C)

INFRARED EMITTING DIODE		
Power Dissipation	*100	milliwatts
Forward Current (Continuous)	30	milliamps
Forward Current (Peak) (Pulse width 1 μs 300 pps)	3	ampere
Reverse Voltage	3	volts
*Derate 1.33mW/°C above 25°C ambient		

PHOTO-TRANSISTOR		
Power Dissipation	**150	milliwatts
V _{CEO}	30	volts
V _{CBO}	50	volts
V _{EBO}	4	volts
Collector Current (Continuous)	30	milliamps
**Derate 2.0mW/°C above 25°C ambient		

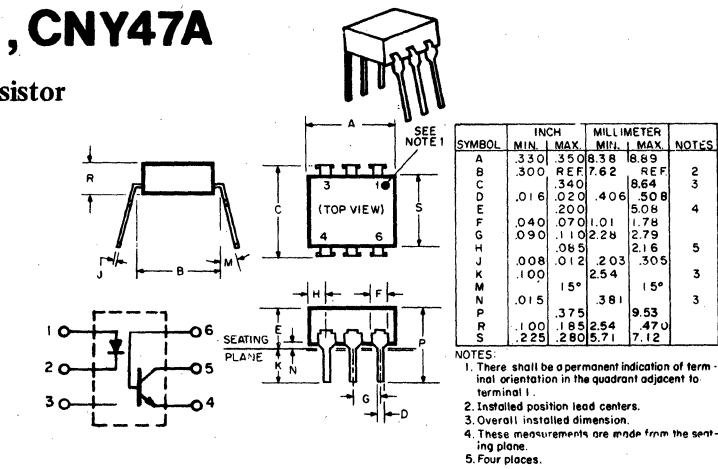

TOTAL DEVICE	
Storage Temperature	-55 to 150°C
Operating Temperature	-55 to 100°C
Lead Soldering Time (at 260°C)	10 seconds
Surge Isolation Voltage (Input to Output).	2828V _(peak) 2000V _(RMS)
Steady-State Isolation Voltage (Input to Output).	1695V _(peak) 1200V _(RMS)

individual electrical characteristics (25°C)

INFRARED EMITTING DIODE	TYP.	MAX.	UNITS
Forward Voltage (I _F = 10 mA)	1.1	1.5	volts
Reverse Current (V _R = 3 V)	—	100	microamps
Capacitance (V = 0, f = 1 MHz)	50	—	picofarads

PHOTO-TRANSISTOR	MIN.	TYP.	MAX.	UNITS
Breakdown Voltage—V _{(BR)CEO} (I _C = 10mA, I _F = 0)	30	—	—	volts
Breakdown Voltage—V _{(BR)CBO} (I _C = 100μA, I _F = 0)	50	—	—	volts
Breakdown Voltage—V _{(BR)EBO} (I _E = 100μA, I _F = 0)	4	—	—	volts
Collector Dark Current—I _{CEO} (V _{CE} = 10V, I _F = 0)	—	5	100	nanoamps
Collector Dark Current—I _{CBO} (V _{CB} = 10V, I _F = 0)	—	—	20	nanoamps
Capacitance (V _{CE} = 10V, F = 1 MHz)	—	2	—	picofarads

coupled electrical characteristics (25°C)

	MIN.	TYP.	MAX.	UNITS	
DC Current Transfer Ratio (I _F = 10mA, V _{CE} = .4V)	CNY47	20	—	60	%
	CNY47A	40	—	—	%
Saturation Voltage – Collector to Emitter (I _F = 10mA, I _C = 2mA)	CNY47	—	0.1	0.4	volts
	(I _F = 10mA, I _C = 4mA) CNY47A	—	—	0.4	volts
Isolation Resistance (V _{IO} = 500V _{DC})	100	—	—	gigaohms	
Input to Output Capacitance (V _{IO} = 0, f = 1 MHz)	—	—	2	picofarads	
Switching Speeds:					
Rise/Fall Time (V _{CE} = 10V, I _{CE} = 2mA, R _L = 100Ω)	—	2	—	microseconds	
Rise/Fall Time (V _{CB} = 10V, I _{CB} = 50μA, R _L = 100Ω)	—	300	—	nanoseconds	

VDE Approved to 0883/6.80 0110b Certificate # 35025

TYPICAL CHARACTERISTICS

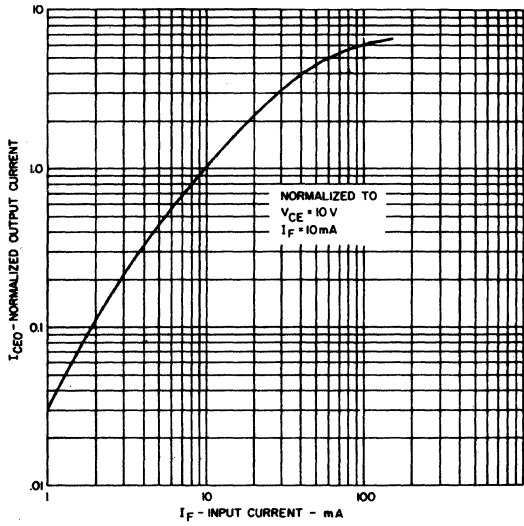

OUTPUT CURRENT VS INPUT CURRENT

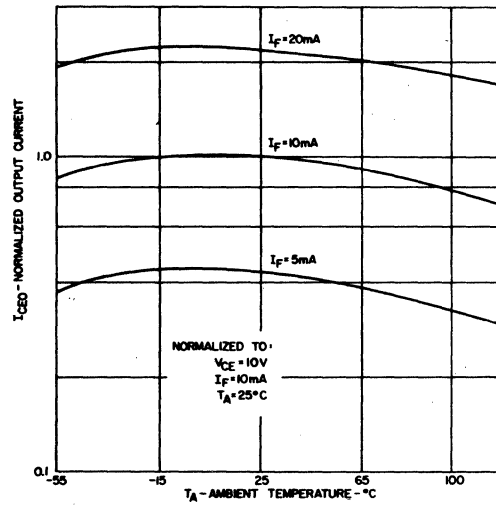

OUTPUT CURRENT VS TEMPERATURE

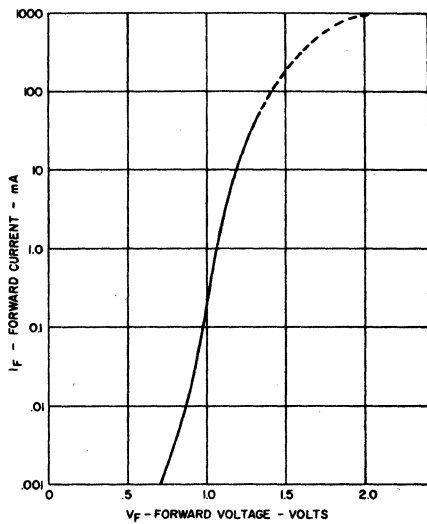

INPUT CHARACTERISTICS

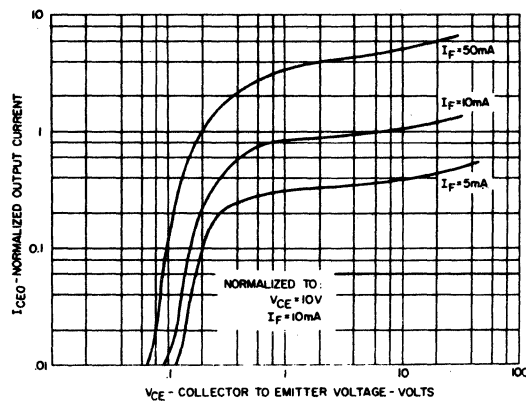

OUTPUT CHARACTERISTICS

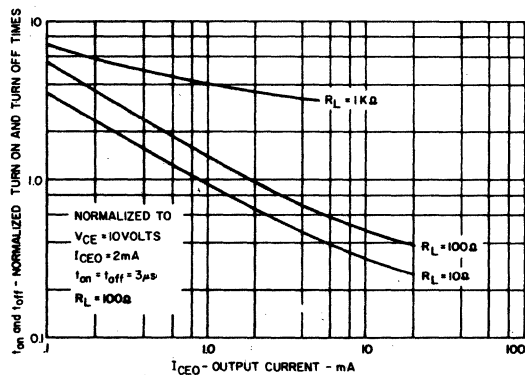

SWITCHING TIMES VS OUTPUT CURRENT

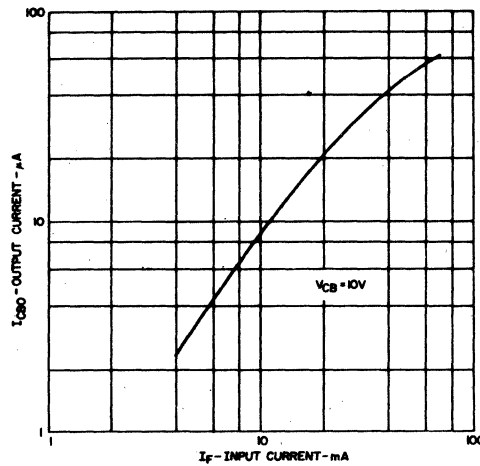

OUTPUT CURRENT (I_{CBO}) VS INPUT CURRENT



SOLID STATE

OPTOELECTRONICS

Photon Coupled Isolator CNY48

Ga As Infrared Emitting Diode & NPN Silicon Photo-Darlington Amplifier

The General Electric CNY48 consists of a gallium arsenide, infrared emitting diode coupled with a silicon photo-darlington amplifier in a dual in-line package.

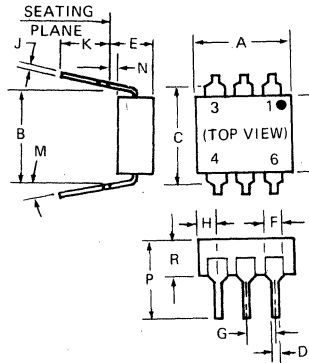
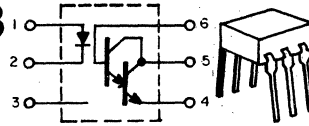

SYMBOL	MILLIMETERS		INCHES		NOTES
	MIN.	MAX.	MIN.	MAX.	
A	8.38	8.89	.330	.350	1
B	7.62 REF.		.300 REF.		
C	—	8.64	—	.340	2
D	.406	.508	.016	.020	
E	—	5.08	—	.200	3
F	1.01	1.78	.040	.070	
G	2.28	2.80	.090	.110	4
H	—	2.16	—	.085	
J	.203	.305	.008	.012	4
K	2.54	—	.100	—	
M	—	15°	—	15°	4
N	.381	—	.015	—	
P	—	9.53	—	.375	4
R	2.92	3.43	.115	.135	
S	6.10	6.86	.240	.270	4

- NOTES:
 1. INSTALLED POSITION LEAD CENTERS.
 2. OVERALL INSTALLED DIMENSION.
 3. THESE MEASUREMENTS ARE MADE FROM THE SEATING PLANE.
 4. FOUR PLACES.

absolute maximum ratings: (25°C)

INFRARED EMITTING DIODE			
Power Dissipation	*100	milliwatts	
Forward Current (Continuous)	60	milliamps	
Forward Current (Peak)	3	ampere	
(Pulse width 1 μs 300 pps)			
Reverse Voltage	3	volts	
*Derate 1.33mW/°C above 25°C ambient.			

PHOTO-DARLINGTON			
Power Dissipation	**150	milliwatts	
V _{CEO}	30	volts	
V _{CBO}	30	volts	
V _{EBO}	6	volts	
Collector Current (Continuous)	100	milliamps	
**Derate 2.0mW/°C above 25°C ambient.			

TOTAL DEVICE			
Storage Temperature	-65 to 150°C		
Operating Temperature	-55 to 100°C		
Lead Soldering Time (at 260°C)	10 seconds		
Surge Isolation Voltage (Input to Output).	2120 _(peak)	1500V _(RMS)	
Steady-State Isolation Voltage (Input to Output).	1270V _(peak)	900V _(RMS)	

individual electrical characteristics (25°C)

INFRARED EMITTING DIODE	TYP.	MAX.	UNITS
Forward Voltage (I _F = 10mA)	1.1	1.3	volts
Reverse Current (V _R = 3V)	—	10	microamps
Capacitance (V = 0, f = 1 MHz)	50	—	picofarads

PHOTO-DARLINGTON	MIN.	TYP.	MAX.	UNITS
Breakdown Voltage—V _{(BR)CEO} (I _C = 10mA, I _F = 0)	30	—	—	volts
Breakdown Voltage—V _{(BR)CBO} (I _C = 100μA, I _F = 0)	30	—	—	volts
Breakdown Voltage—V _{(BR)EBO} (I _F = 100μA, I _F = 0)	6	—	—	volts
Collector Dark Current—I _{CEO} (V _{CE} = 10V, I _F = 0)	—	5	100	nanoamps
Capacitance (V _{CE} = 10V, f = 1 MHz)	—	6	—	picofarads

coupled electrical characteristics (25°C)

	MIN.	TYP.	MAX.	UNITS
DC Current Transfer Ratio (I _F = 10mA, V _{CE} = 1V)	600	—	—	%
Saturation Voltage—Collector to Emitter (I _F = 1mA I _C = 2mA)	—	—	.8	volts
(I _F = 5mA I _C = 10mA)	—	—	.8	volts
(I _F = 10mA, I _C = 60mA)	—	—	1.0	volts
Isolation Resistance (V _{IO} = 500V _{DC})	100	—	—	gigaohms
Input to Output Capacitance (V _{IO} = 0, f = 1MHz)	—	—	2	picofarads
Switching Speeds: (V _{CE} = 10V, I _C = 10mA, R _L = 100Ω)				
On-Time	—	125	—	microseconds
Off-Time	—	100	—	microseconds

TYPICAL CHARACTERISTICS

CNY48

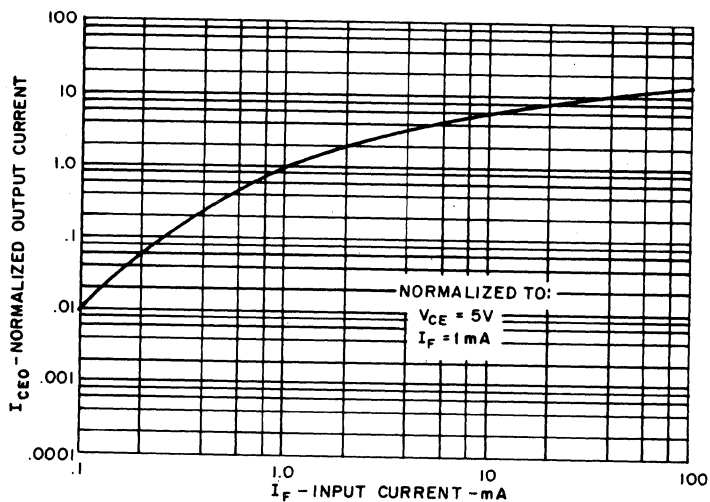

OUTPUT CURRENT VS INPUT CURRENT

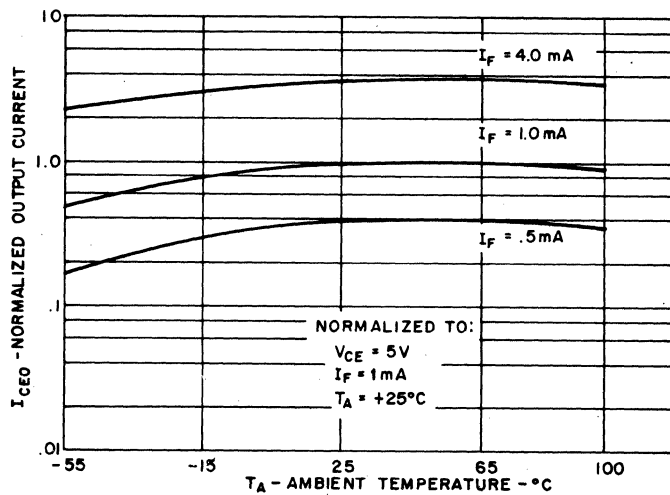

OUTPUT CURRENT VS TEMPERATURE

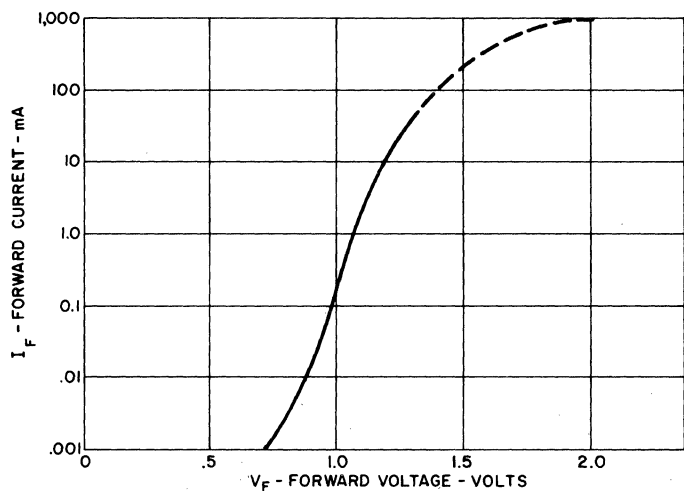

INPUT CHARACTERISTICS

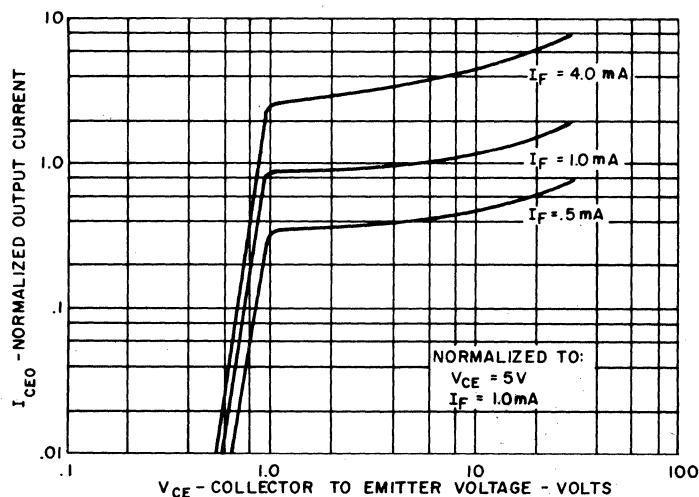

OUTPUT CHARACTERISTICS

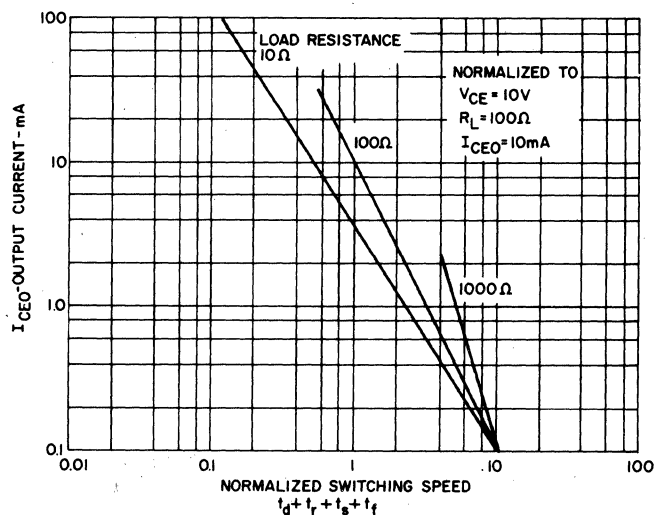

SWITCHING SPEED VS OUTPUT CURRENT

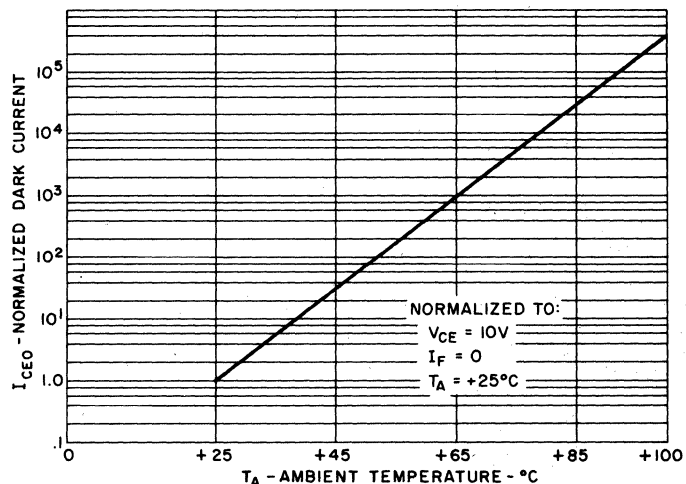

NORMALIZED DARK CURRENT VS TEMPERATURE



SOLID STATE OPTOELECTRONICS

Photon Coupled Isolator CNY51

Ga As Infrared Emitting Diode & NPN Silicon Photo-Transistor

The General Electric CNY51 consists of a gallium arsenide, infrared emitting diode coupled with a silicon photo-transistor in a dual in-line package.

FEATURES:

- High isolation voltage, 5000V minimum.
- General Electric unique patented glass isolation construction.
- High efficiency liquid epitaxial IRED.
- High humidity resistant silicone encapsulation.
- Fast switching speeds.

absolute maximum ratings: (25°C) (unless otherwise specified)

INFRARED EMITTING DIODE			
Power Dissipation - $T_A = 25^\circ\text{C}$	*100	milliwatts	
Forward Current (Continuous)	60	milliamps	
Forward Current (Peak)	3	amperes	
(Pulse width 1 μsec , 300 pps)			
Reverse Voltage	6	volts	
*Derate 1.33mW/°C above 25°C.			

PHOTO-TRANSISTOR			
Power Dissipation - $T_A = 25^\circ\text{C}$	**300	milliwatts	
V_{CE0}	70	volts	
V_{CBO}	70	volts	
V_{EBO}	7	volts	
Collector Current (Continuous)	100	milliamps	
**Derate 4.0mW/°C above 25°C.			

individual electrical characteristics (25°C) (unless otherwise specified)

INFRARED EMITTING DIODE	MIN.	MAX.	UNITS
Forward Voltage - V_F ($I_F = 60\text{mA}$)	—	1.65	volts
Forward Voltage - V_F ($I_F = 10\text{mA}$)	.8	1.5	volts
Forward Voltage - V_F ($I_F = 10\text{mA}$) $T_A = -55^\circ\text{C}$.9	1.7	volts
Forward Voltage - V_F ($I_F = 10\text{mA}$) $T_A = +100^\circ\text{C}$.7	1.4	volts
Reverse Current - I_R ($V_R = 6\text{V}$)	—	10	microamps
Capacitance - C_j ($V = 0, f = 1\text{MHz}$)	—	100	picofarads

PHOTO-TRANSISTOR	MIN.	TYP.	MAX.	UNITS
Breakdown Voltage - $V_{(BR)CE0}$ ($I_C = 10\text{mA}, I_F = 0$)	70	—	—	volts
Breakdown Voltage - $V_{(BR)CE0}$ ($I_C = 100\mu\text{A}, I_F = 0$)	70	—	—	volts
Breakdown Voltage - $V_{(BR)CE0}$ ($I_C = 100\mu\text{A}, I_F = 0$)	7	—	—	volts
Collector Dark Current - I_{CE0} ($V_{CE} = 10\text{V}, I_F = 0$)	—	5	50	nano-amps
Collector Dark Current - I_{CE0} ($V_{CE} = 10\text{V}, I_F = 0$) $T_A = 100^\circ\text{C}$	—	—	500	micro-amps
Capacitance - C_{CE} ($V_{CE} = 10\text{V}, f = 1\text{MHz}$)	—	2	—	pico farads

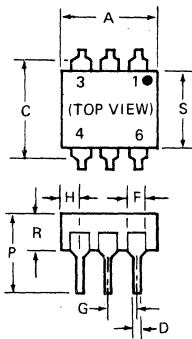
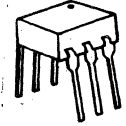
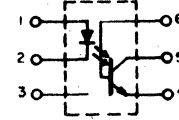

SYMBOL	MILLIMETERS		INCHES		NOTES
	MIN.	MAX.	MIN.	MAX.	
A	8.38	8.89	.330	.350	
B	7.62 REF.		.300 REF.		1
C	—	8.64	—	.340	2
D	.406	.508	.016	.020	
E	—	5.08	—	.200	3
F	1.01	1.78	.040	.070	
G	2.28	2.80	.090	.110	
H	—	2.16	—	.085	4
J	.203	.305	.008	.012	
K	2.54	—	.100	—	
M	—	15°	—	15°	
N	.381	—	.015	—	
P	—	9.53	—	.375	
R	2.92	3.43	.115	.135	
S	6.10	6.86	.240	.270	

- NOTES:
1. INSTALLED POSITION LEAD CENTERS.
 2. OVERALL INSTALLED DIMENSION.
 3. THESE MEASUREMENTS ARE MADE FROM THE SEATING PLANE.
 4. FOUR PLACES.

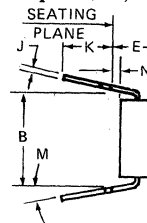

Creepage Distance 8.2mm min.
Air Gap 7.6mm min.

TOTAL DEVICE	
Storage Temperature	-55 to 150°C.
Operating Temperature	-55 to 100°C.
Lead Soldering Time (at 260°C)	10 seconds.
Surge Isolation Voltage (Input to Output). See Note 2.	5656V _(peak) 4000V _(RMS)
Steady-State Isolation Voltage (Input to Output). See Note 2.	5000V _(DC) 3000V _(RMS)

Covered under U.L. component recognition program, reference file E51868

VDE Approved to 0883/6.80 0110b Certificate #. 35025

coupled electrical characteristics (25 °C) (unless otherwise specified)

	MIN.	TYP.	MAX.	UNITS
DC Current Transfer Ratio ($I_F = 10\text{mA}$, $V_{CE} = 10\text{V}$)	100	—	—	%
Saturation Voltage — Collector to Emitter ($I_F = 20\text{mA}$, $I_C = 2\text{mA}$)	—	—	0.4	volts
Isolation Resistance (Input to Output Voltage = $500V_{DC}$. See Note 1)	100	—	—	gigaohms
Input to Output Capacitance (Input to Output Voltage = 0, $f = 1\text{MHz}$. See Note 1)	—	—	2.0	picofarads
Turn-On Time — t_{on} ($V_{CC} = 10\text{V}$, $I_C = 2\text{mA}$, $R_L = 100\Omega$). (See Figure 1)	—	5	10	microseconds
Turn-Off Time — t_{off} ($V_{CC} = 10\text{V}$, $I_C = 2\text{mA}$, $R_L = 100\Omega$). (See Figure 1)	—	5	10	microseconds

NOTE 1:

Tests of input to output isolation current resistance, and capacitance are performed with the input terminals (diode) shorted together and the output terminals (transistor) shorted together.

NOTE 2:

Surge Isolation Voltage

a. Definition:

This rating is used to protect against transient over-voltages generated from switching and lightning-induced surges. Devices shall be capable of withstanding this stress, a minimum of 100 times during its useful life. Ratings shall apply over entire device operating temperature range.

b. Specification Format:

Specification, in terms of peak and/or RMS, 60 Hz voltage, of specified duration (e.g., $5656V_{peak}/4000V_{RMS}$ for one minute).

c. Test Conditions:

Application of full rated 60 Hz sinusoidal voltage for one minute, with initial application restricted to zero voltage (i.e., zero phase), from a supply capable of sourcing 5mA at rated voltage.

Steady-State Isolation Voltage

a. Definition:

This rating is used to protect against a steady-state voltage which will appear across the device isolation from an electrical source during its useful life. Ratings shall apply over the entire device operating temperature range for a period of 10 minutes minimum.

b. Specification Format:

Specified in terms of D.C. and/or RMS 60 Hz sinusoidal waveform.

c. Test Conditions:

Application of the full rated 60 Hz sinusoidal voltage, with initial application restricted to zero voltage (i.e., zero phase), from a supply capable of sourcing 5mA at rated voltage, for the duration of the test.

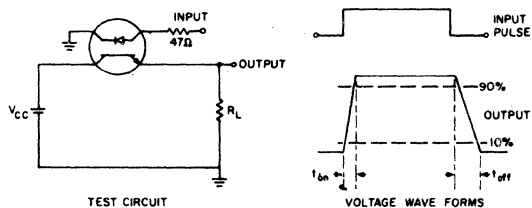
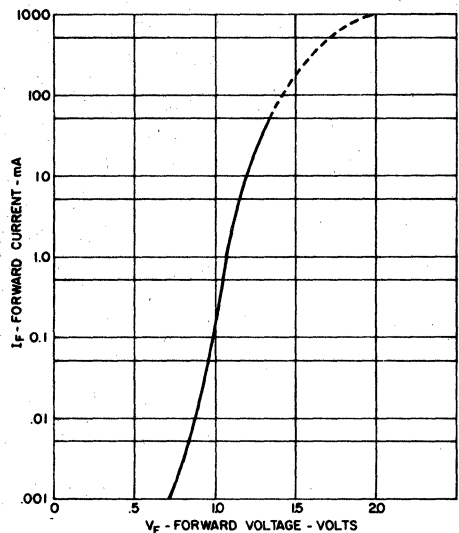
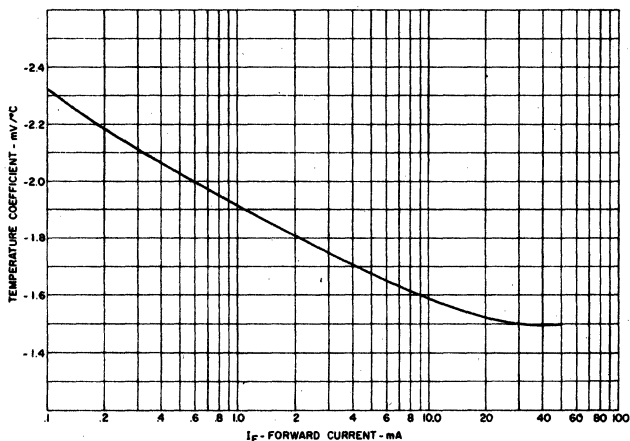

FIGURE 1: Adjust Amplitude of Input Pulse for Output (I_C) of 2mA



1. INPUT CHARACTERISTICS



2. FORWARD VOLTAGE TEMPERATURE COEFFICIENT

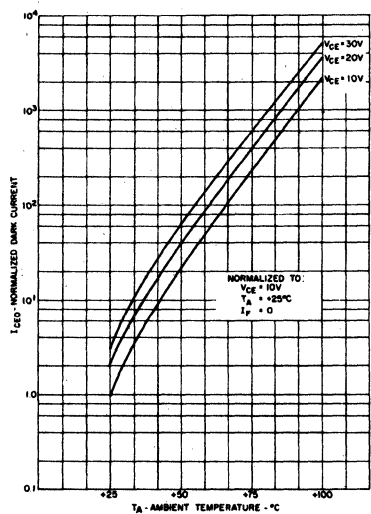

3. DARK I_{CEO} CURRENT VS TEMPERATURE

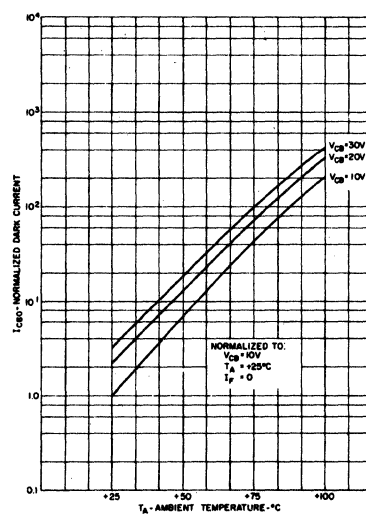

4. I_{CBO} VS TEMPERATURE

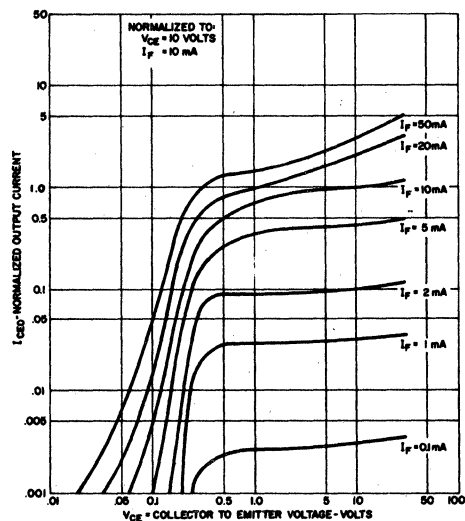

5. OUTPUT CHARACTERISTICS

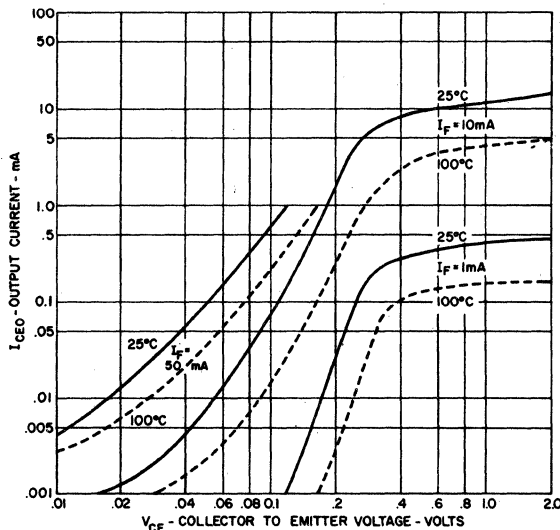

6. OUTPUT CHARACTERISTICS

TYPICAL CHARACTERISTICS

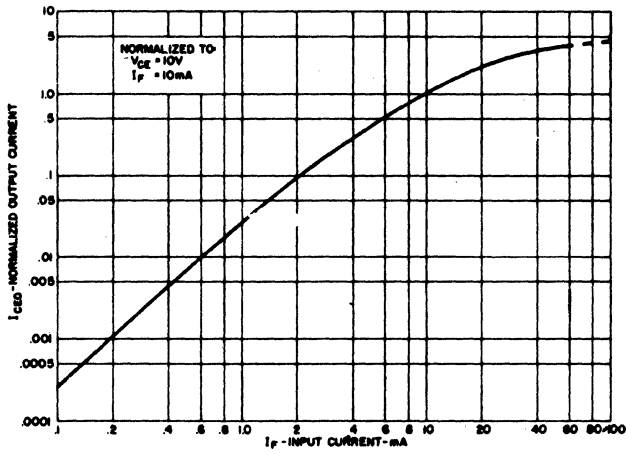

7. OUTPUT CURRENT VS. INPUT CURRENT

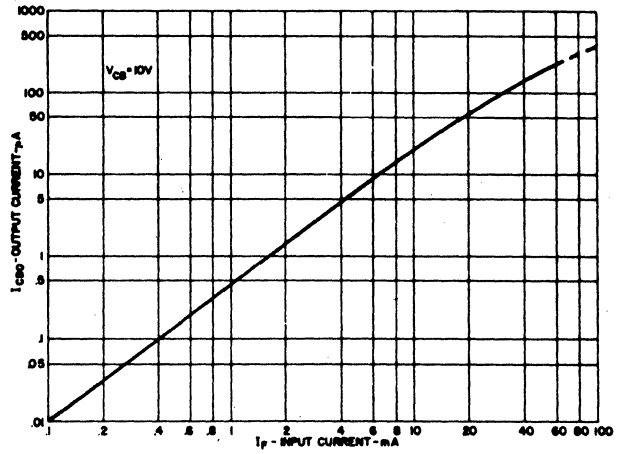

8. OUTPUT CURRENT - COLLECTOR-TO-BASE VS. INPUT CURRENT

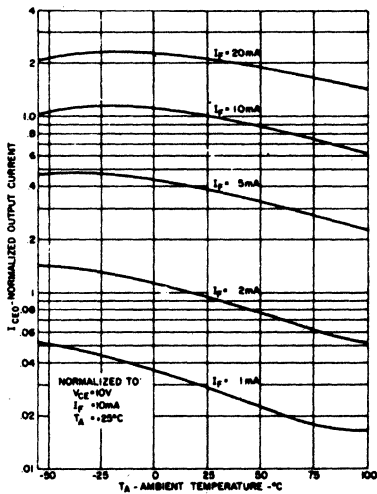

9. OUTPUT CURRENT VS. TEMPERATURE

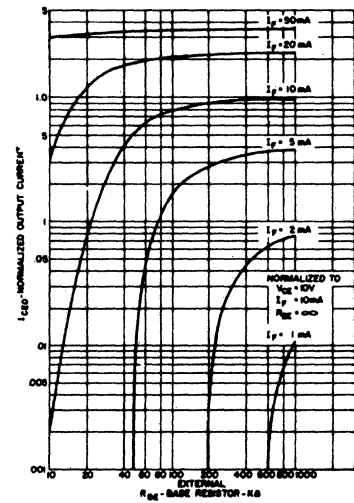

10. OUTPUT CURRENT VS. BASE EMITTER RESISTANCE

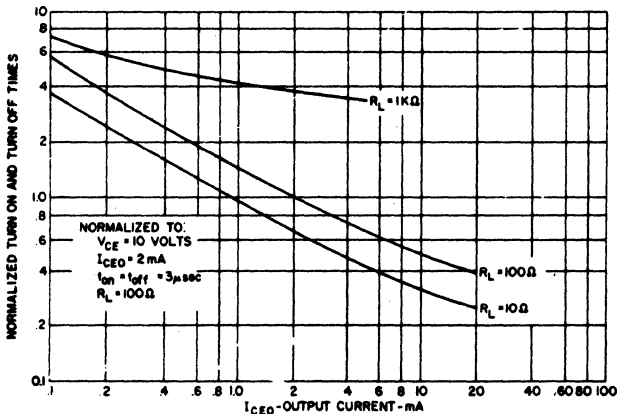

11. SWITCHING TIMES VS. OUTPUT CURRENT

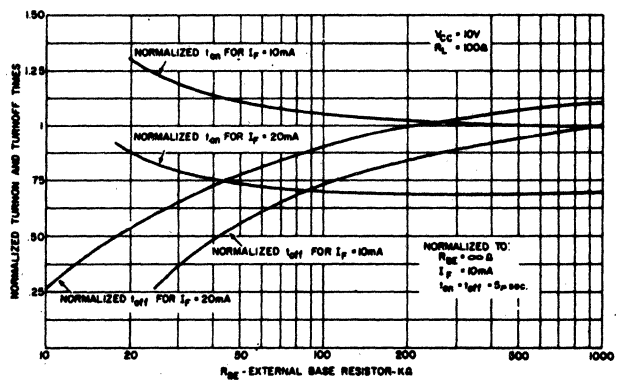

12. SWITCHING TIME VS. R_{BE}



SOLID STATE



ELECTRONICS

Photon Coupled Isolator GE3009-GE3012

Ga As Infrared Emitting Diode & Light Activated Triac Driver

The General Electric GE3009-GE3012 series consists of a gallium arsenide infrared emitting diode coupled with a light activated silicon bilateral switch, which functions like a triac, in a dual in-line package.

These devices are especially designed for triggering power triacs while maintaining dielectric isolation from the trigger control circuit.

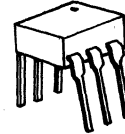

absolute maximum ratings: (25° C)

INFRARED EMITTING DIODE		
Power Dissipation	*100	milliwatts
Forward Current (Continuous)	50	milliamps
Forward Current (Peak) (Pulse width 1 μsec. 300 pps)	3	amperes
Reverse Voltage	3	volts

*Derate 1.33 mW/°C above 25°C ambient.

OUTPUT DRIVER		
Off-State Output Terminal Voltage	250	volts
On-State RMS Current (Full Cycle Sine Wave, 50 to 60 Hz)	100	milliamps
Peak Nonrepetitive Surge Current (PW = 10 ms, DC = 10%)	1.2	amperes
Total Power Dissipation @ T _A = 25°C	**300	milliwatts

**Derate 4.0 mW/°C above 25°C.

TOTAL DEVICE	
Storage Temperature	-55°C to +150°C
Operating Temperature	-40°C to +100°C
Lead Soldering Time (at 260°C)	10 seconds
Surge Isolation Voltage (Input to Output)	
5656 V _(peak)	4000 V _(RMS)
Steady-State Isolation Voltage (Input to Output)	
5300 V _(peak)	3750 V _(RMS)

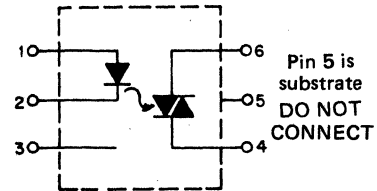
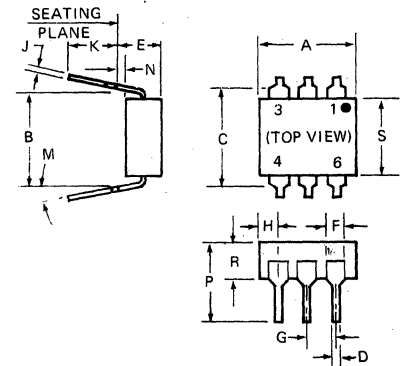

SYMBOL	MILLIMETERS		INCHES		NOTES
	MIN.	MAX.	MIN.	MAX.	
A	8.38	8.89	.330	.350	
B	7.62	REF.	.300	REF.	1
C	—	8.64	—	.340	2
D	.406	.508	.016	.020	
E	—	5.08	—	.200	3
F	1.01	1.78	.040	.070	
G	2.28	2.80	.090	.110	
H	—	2.16	—	.085	4
J	.203	.305	.008	.012	
K	2.54	—	.100	—	
M	—	15°	—	15°	
N	.381	—	.015	—	
P	—	9.53	—	.375	
R	2.92	3.43	.115	.135	
S	6.10	6.86	.240	.270	

- NOTES:
 1. INSTALLED POSITION LEAD CENTERS.
 2. OVERALL INSTALLED DIMENSION.
 3. THESE MEASUREMENTS ARE MADE FROM THE SEATING PLANE.
 4. FOUR PLACES.

Covered under U.L. component recognition program, reference file E51868

individual electric characteristics (25° C)

EMITTER	SYMBOL	TYP.	MAX.	UNITS
Forward Voltage ($I_F = 10 \text{ mA}$)	V_F	1.2	1.5	volts
Reverse Current ($V_R = 3\text{V}$)	I_R	—	100	microamps
Capacitance ($V = 0, f = 1 \text{ MHz}$)	C_j	50	—	picofarads

DETECTOR	See Note 1	SYMBOL	TYP.	MAX.	UNITS
Peak Off-State Current	$V_{DRM} = 250 \text{ V}$	I_{DRM}	—	100	nanoamps
Peak On-State Voltage	$I_{TM} = 100 \text{ mA}$	V_{TM}	2.5	3.0	volts
Critical Rate-of-Rise of Off-State Voltage	$V_{in} = 30 \text{ V}_{(RMS)}$ (See Figure 1)	dv/dt	10.0	—	volts/ $\mu\text{sec.}$
Critical Rate-of-Rise of Commutating Off-State Voltage	$I_{load} = 15 \text{ mA}$ $V_{in} = 30 \text{ V}_{(RMS)}$ (See Figure 1)	$dv/dt_{(C)}$	0.15	—	volts/ $\mu\text{sec.}$
Critical Rate-of-Rise of Off-State Voltage	$V_{in} = 140 \text{ V}_{(RMS)}$ JEDEC conditions	dv/dt	6.0	—	volts/ $\mu\text{sec.}$

coupled electrical characteristics (25° C)

		SYMBOL	TYP.	MAX.	UNITS
IRED Trigger Current, Current Required to Latch Output (Main Terminal Voltage = 3.0V, $R_L = 150 \Omega$)	GE3009	I_{FT}	—	30	milliamps
	GE3010	I_{FT}	—	15	milliamps
	GE3011	I_{FT}	—	10	milliamps
	GE3012	I_{FT}	—	5	milliamps
Holding Current, Either Direction		I_H	250	—	microamps

NOTE 1: Ratings apply for either polarity of Pin 6 — referenced to Pin 4.

Voltages must be applied within dv/dt rating.

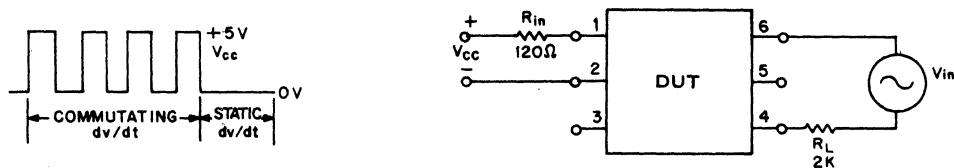

FIGURE 1. dv/dt — TEST CIRCUIT



SOLID STATE OPTOELECTRONICS

Photon Coupled Isolator GE3020-GE3023

Ga As Infrared Emitting Diode & Light Activated Triac Driver

The General Electric GE3020-GE3023 series consists of a gallium arsenide infrared emitting diode coupled with a light activated silicon bilateral switch, which functions like a triac, in a dual in-line package.

These devices are especially designed for triggering power triacs while maintaining dielectric isolation from the trigger control circuit.

absolute maximum ratings: (25°C)

INFRARED EMITTING DIODE		
Power Dissipation	*100	milliwatts
Forward Current (Continuous)	50	milliamps
Forward Current (Peak) (Pulse width 1 μsec. 300 pps)	3	amperes
Reverse Voltage	3	volts

*Derate 1.33 mW/°C above 25°C ambient.

OUTPUT DRIVER		
Off-State Output Terminal Voltage	400	volts
On-State RMS Current (Full Cycle Sine Wave, 50 to 60 Hz)	100	milliamps
Peak Nonrepetitive Surge Current (PW = 10 ms, DC = 10%)	1.2	amperes
Total Power Dissipation @ T _A = 25°C	**300	milliwatts

**Derate 4.0 mW/°C above 25°C.

TOTAL DEVICE	
Storage Temperature	-55°C to +150°C
Operating Temperature	-40°C to +100°C
Lead Soldering Time (at 260°C)	10 seconds
Surge Isolation Voltage (Input to Output)	5656 V _(peak) 4000 V _(RMS)
Steady-State Isolation Voltage (Input to Output)	5300 V _(peak) 3750 V _(RMS)

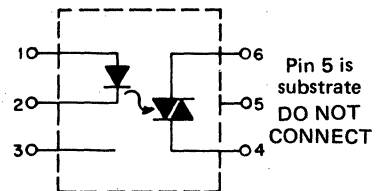
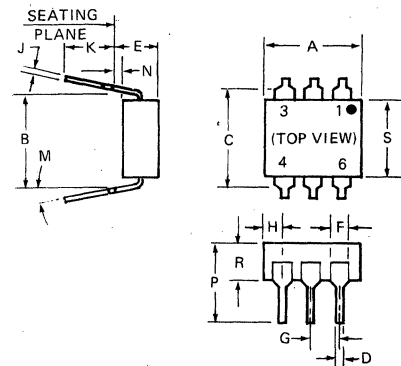
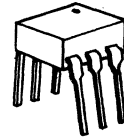

SYMBOL	MILLIMETERS		INCHES		NOTES
	MIN.	MAX.	MIN.	MAX.	
A	8.38	8.89	.330	.350	1
B	7.62 REF.		.300 REF.		
C	—	8.64	—	.340	2
D	.406	.508	.016	.020	
E	—	5.08	—	.200	3
F	1.01	1.78	.040	.070	
G	2.28	2.80	.090	.110	4
H	—	2.16	—	.085	
J	.203	.305	.008	.012	4
K	2.54	—	.100	—	
M	—	15°	—	15°	4
N	.381	—	.015	—	
P	—	9.53	—	.375	4
R	2.92	3.43	.115	.135	
S	6.10	6.86	.240	.270	4

- NOTES:
1. INSTALLED POSITION LEAD CENTERS.
 2. OVERALL INSTALLED DIMENSION.
 3. THESE MEASUREMENTS ARE MADE FROM THE SEATING PLANE.
 4. FOUR PLACES.

Covered under U.L. component recognition program, reference file E51868

individual electric characteristics (25° C)

EMITTER	SYMBOL	TYP.	MAX.	UNITS
Forward Voltage ($I_F = 10 \text{ mA}$)	V_F	1.2	1.5	volts
Reverse Current ($V_R = 3\text{V}$)	I_R	—	100	microamps
Capacitance ($V = 0, f = 1 \text{ MHz}$)	C_j	50	—	picofarads

DETECTOR	See Note 1	SYMBOL	TYP.	MAX.	UNITS
Peak Off-State Current	$V_{DRM} = 400 \text{ V}$	I_{DRM}	—	100	nanoamps
Peak On-State Voltage	$I_{TM} = 100 \text{ mA}$	V_{TM}	2.5	3.0	volts
Critical Rate-of-Rise of Off-State Voltage	$V_{in} = 30 \text{ V}_{(RMS)}$ (See Figure 1)	dv/dt	10.0	—	volts/ $\mu\text{sec.}$
Critical Rate-of-Rise of Commutating Off-State Voltage	$I_{load} = 15 \text{ mA}$ $V_{in} = 30 \text{ V}_{(RMS)}$ (See Figure 1)	$dv/dt_{(C)}$	0.15	—	volts/ $\mu\text{sec.}$
Critical Rate-of-Rise of Off-State Voltage	$V_{in} = 120 \text{ V}_{(RMS)}$ JEDEC conditions	dv/dt	6.0	—	volts/ $\mu\text{sec.}$

coupled electrical characteristics (25° C)

		SYMBOL	TYP.	MAX.	UNITS
IRED Trigger Current, Current Required to Latch Output (Main Terminal Voltage = 3.0V, $R_L = 150 \Omega$)	GE3020	I_{FT}	—	30	milliamps
	GE3021	I_{FT}	—	15	milliamps
	GE3022	I_{FT}	—	10	milliamps
	GE3023	I_{FT}	—	5	milliamps
Holding Current, Either Direction		I_H	250	—	microamps

NOTE 1: Ratings apply for either polarity of Pin 6 — referenced to Pin 4.

Voltages must be applied within dv/dt rating.

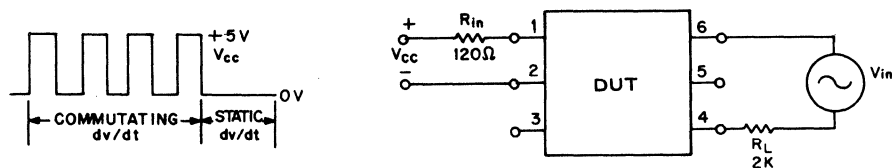

FIGURE 1. dv/dt — TEST CIRCUIT



SOLID STATE OPTOELECTRONICS

Photon Coupled Isolator GEPS2001

Ga As Infrared Emitting Diode & NPN Silicon Photo-Transistor

The General Electric GEPS2001 is a gallium arsenide, infrared emitting diode coupled with a silicon photo-transistor in a dual in-line package.

absolute maximum ratings: (25°C)

INFRARED EMITTING DIODE		
Power Dissipation	*100	milliwatts
Forward Current (Continuous)	60	milliamps
Forward Current (Peak)	3	ampere
(Pulse width 1μsec 300 P Ps)		
Reverse Voltage	5	volts
*Derate 1.33mW/°C above 25°C ambient.		

PHOTO-TRANSISTOR		
Power Dissipation	**150	milliwatts
V _{CEO}	30	volts
V _{CBO}	70	volts
V _{ECO}	7	volts
Collector Current (Continuous)	100	milliamps
**Derate 2.0mW/°C above 25°C ambient.		

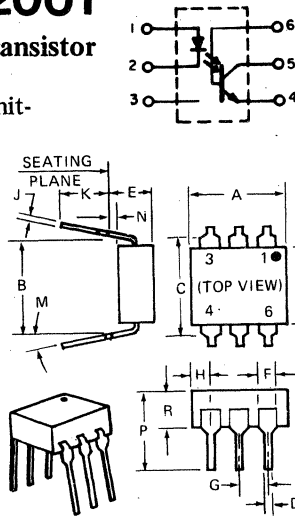

SYMBOL	MILLIMETERS		INCHES		NOTES
	MIN.	MAX.	MIN.	MAX.	
A	8.38	8.89	.330	.350	1
B	7.62 REF.		.300 REF.		
C	8.64		.340		2
D	.406	.508	.016	.020	
E	5.08		.200		3
F	1.01	1.78	.040	.070	
G	2.28	2.80	.090	.110	4
H	2.16		.085		
J	.203	.305	.008	.012	4
K	2.54	—	.100	—	
M	15°		15°		4
N	.381	—	.015	—	
P	9.53		.375		4
R	2.92	3.43	.115	.135	
S	6.10	6.86	.240	.270	4

- NOTES:
 1. INSTALLED POSITION LEAD CENTERS.
 2. OVERALL INSTALLED DIMENSION.
 3. THESE MEASUREMENTS ARE MADE FROM THE SEATING PLANE.
 4. FOUR PLACES.

TOTAL DEVICE	
Storage Temperature	-55 to 150°C
Operating Temperature	-55 to 100°C
Lead Soldering Time (at 260°C)	10 seconds
Surge Isolation Voltage (Input to Output).	2500 V _(peak) 1770 V _(RMS)

individual electrical characteristics (25°C)

INFRARED EMITTING DIODE	TYP.	MAX.	UNITS
Forward Voltage (I _F = 20mA)	1.1	1.4	volts
Reverse Current (V _R = 4V)	—	20	microamps
Capacitance (V = 0, f = 1MHz)	50	—	picofarads

PHOTO-TRANSISTOR	MIN.	TYP.	MAX.	UNITS
Breakdown Voltage - V _{(BR)CEO} (I _C = 10mA, I _F = 0)	30	—	—	volts
Breakdown Voltage - V _{(BR)CBO} (I _C = 100μA, I _F = 0)	70	—	—	volts
Breakdown Voltage - V _{(BR)ECO} (I _E = 100μA, I _F = 0)	7	—	—	volts
Collector Dark Current - I _{CEO} (V _{CE} = 10V, I _F = 0)	—	5	100	nanoamps
DC Current Gain h _{FE} (V _{CE} = 5V, I _C = 4mA)	—	400	—	

coupled electrical characteristics (25°C)

	MIN.	TYP.	MAX.	UNITS
DC Current Transfer Ratio (I _F = 20mA, V _{CE} = 5V)	30	—	—	%
Saturation Voltage - Collector to Emitter (I _F = 20mA, I _C = 2mA)	—	0.1	0.3	volts
Isolation Resistance (Input to Output Voltage = 1000V _{DC})	100	—	—	gigaohms
Input to Output Capacitance (Input to Output Voltage = 0, f = 1MHz)	—	0.8	2	picofarads
Switching Speeds: Rise/Fall Time (V _{CE} = 10V, I _{CE} = 2mA, R _L = 100Ω)	—	5	—	microseconds
Rise/Fall Time (V _{CB} = 10V, I _{CB} = 50μA, R _L = 100Ω)	—	300	—	nanoseconds

TYPICAL CHARACTERISTICS

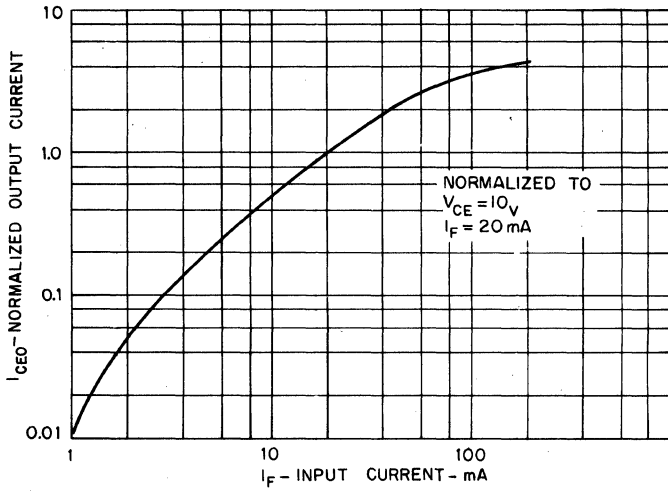

OUTPUT CURRENT VS. INPUT CURRENT

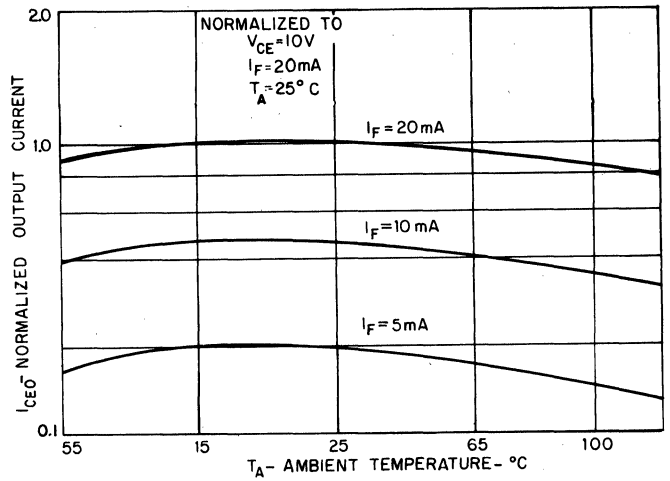

OUTPUT CURRENT VS. TEMPERATURE

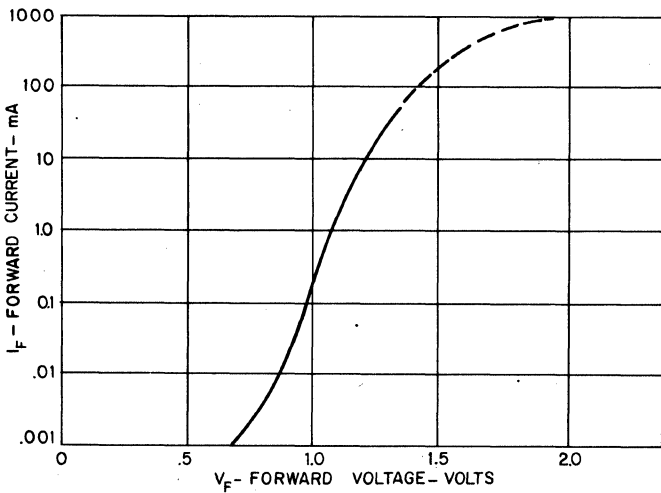

INPUT CHARACTERISTICS

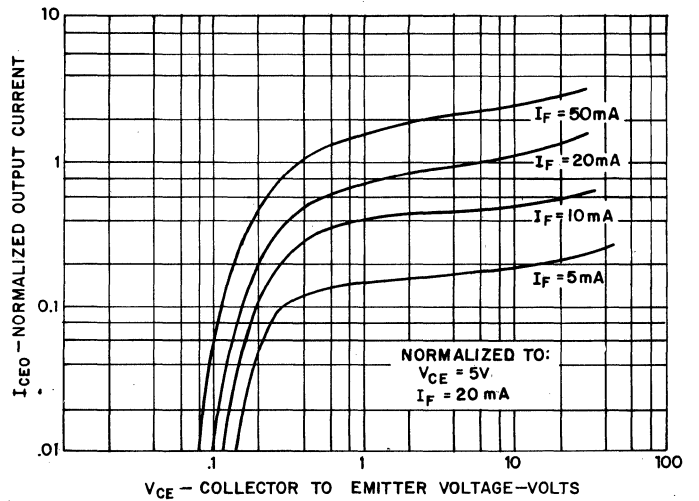

OUTPUT CHARACTERISTICS

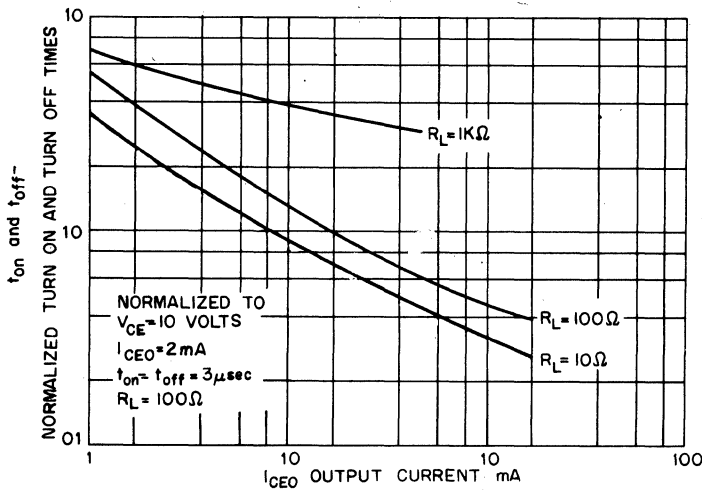

SWITCHING TIMES VS. OUTPUT CURRENT

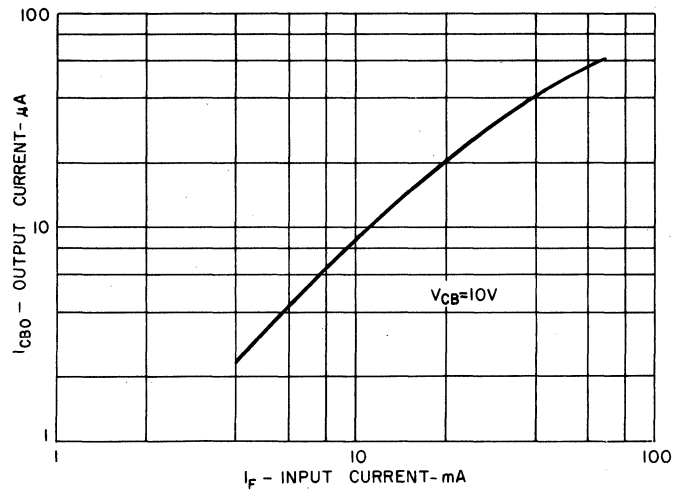

OUTPUT CURRENT (I_{CBO}) VS. INPUT CURRENT



SOLID STATE OPTOELECTRONICS

Photon Coupled Isolator GFH600

Ga As Solid State Lamp & NPN Silicon Photo-Transistor

The General Electric GFH600 consists of a gallium arsenide infrared emitting diode coupled with a silicon photo transistor in a dual in-line package.

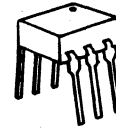

FEATURES:

- Fast switching speeds
- High DC current transfer ratio
- High isolation resistance
- High isolation voltage
- I/O compatible with integrated circuits

absolute maximum ratings: (25°C) (unless otherwise specified)

INFRARED EMITTING DIODE		
Power Dissipation - T_A	*100	milliwatts
Forward Current (Continuous)	60	milliamps
Forward Current (Peak) (Pulse width 1μs, 300 P Ps)	3	ampere
Reverse Voltage	6	volts

*Derate 1.33 mW/°C above 25°C

PHOTO-TRANSISTOR		
Power Dissipation - T_A	**150	milliwatts
V_{CE0}	70	volts
V_{CBO}	70	volts
V_{ECO}	7	volts
Collector Current (Continuous)	150	milliamps

**Derate 2.0 mW/°C above 25°C

TOTAL DEVICE	
Storage Temperature	-55 to 150°C
Operating Temperature	-55 to 100°C
Lead Soldering Time (at 260°C)	10 seconds
Surge Isolation Voltage (Input to Output)	
	4000V _(peak) 2800V _(RMS)

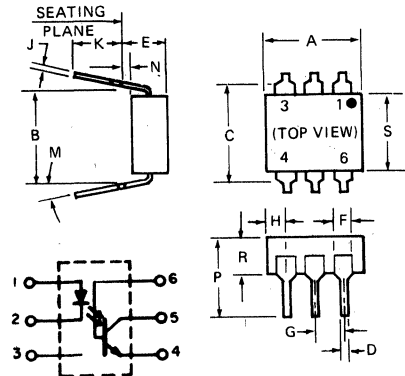

SYMBOL	MILLIMETERS		INCHES		NOTES
	MIN.	MAX.	MIN.	MAX.	
A	8.38	8.89	.330	.350	1
B	7.62 REF.		.300 REF.		
C	-	8.64	-	.340	2
D	.406	.508	.016	.020	
E	-	5.08	-	.200	3
F	1.01	1.78	.040	.070	
G	2.28	2.80	.090	.110	4
H	-	2.16	-	.085	
J	.203	.305	.008	.012	4
K	2.54	-	.100	-	
M	-	15	-	15	4
N	.381	-	.015	-	
P	-	9.53	-	.375	4
R	2.92	3.43	.115	.135	
S	6.10	6.86	.240	.270	4

- NOTES:
1. INSTALLED POSITION LEAD CENTERS.
 2. OVERALL INSTALLED DIMENSION.
 3. THESE MEASUREMENTS ARE MADE FROM THE SEATING PLANE.
 4. R PLACES.

individual electrical characteristics (25°C) (unless otherwise specified)

INFRARED EMITTING DIODE	MIN.	MAX.	UNITS	PHOTO-TRANSISTOR	MIN.	TYP.	MAX.	UNITS
Forward Voltage – V_F ($I_F = 60\text{ mA}$)		1.65	volts	Breakdown Voltage – $V_{(BR)CEO}$ ($I_C = 10\text{ mA}, I_F = 0$)	70	–	–	volts
Reverse Current – I_R ($V_R = 3\text{ V}$)	–	10	microamps	Breakdown Voltage – $V_{(BR)CBO}$ ($I_C = 100\mu\text{ A}, I_F = 0$)	70	–	–	volts
Capacitance – C_J ($V = 0, f = 1\text{ MHz}$)	–	100	picofarads	Breakdown Voltage – $V_{(BR)ECO}$ ($I_F = 100\mu\text{ A}, I_F = 0$)	7	–	–	volts
				Collector Dark Current – I_{CEO} ($V_{CE} = 10\text{ V}, I_F = 0$)	–	2	50	nanoamps
				Capacitance – C_{CE} ($V_{CE} = 10\text{ V}, f = 1\text{ MHz}$)	–	2	–	picofarads

coupled electrical characteristics (25°C) (unless otherwise specified)

	MIN.	TYP.	MAX.	UNITS
DC Current Transfer Ratio ($I_F = 10\text{ mA}, V_{CE} = 5\text{ V}$)				
GFH600 I	63	–	125	%
GFH600 II	100	–	200	%
GFH600 III	160	–	320	%
Saturation Voltage – Collector to Emitter ($I_F = 10\text{ mA}, I_C = 2.5\text{ mA}$)	–	–	0.3	volts
Isolation Resistance ($V_{IO} = 500\text{ V}_{DC}$) (See Note 1)	100	–	–	gigaohms
Input to Output Capacitance ($V_{IO} = 0, f = 1\text{ MHz}$) (See Note 1)	–	–	2	picofarads
Turn-On Time – t_{on} ($V_{CC} = 10\text{ V}, I_C = 2\text{ mA}, R_L = 100\Omega$) (See Figure 1)	–	5	10	microseconds
Turn-Off Time – t_{off} ($V_{CC} = 10\text{ V}, I_C = 2\text{ mA}, R_L = 100\Omega$) (See Figure 1)	–	5	10	microseconds

Note 1: Tests of input to output isolation current resistance, and capacitance are performed with the input terminals (diode) shorted together and the output terminals (transistor) shorted together.

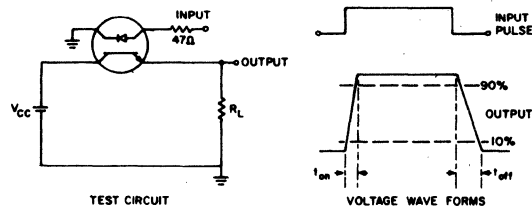

Adjust Amplitude of Input Pulse for Output (I_C) of 2 mA

FIGURE 1

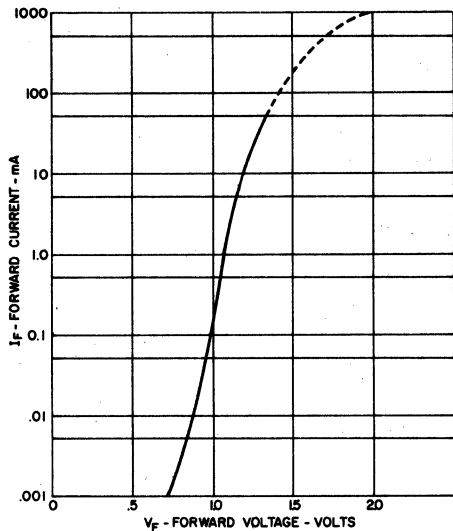

1. INPUT CHARACTERISTICS

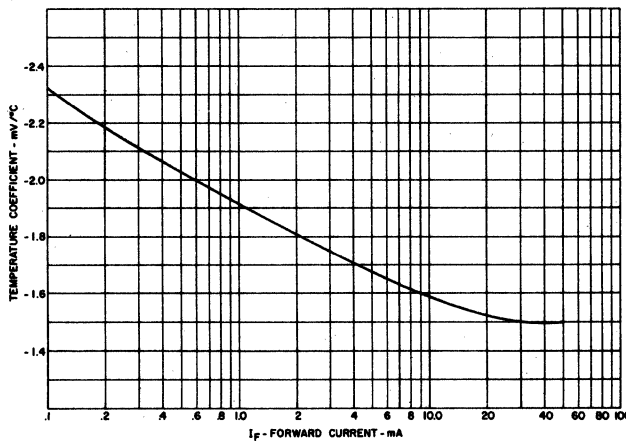

2. FORWARD CURRENT TEMPERATURE COEFFICIENT

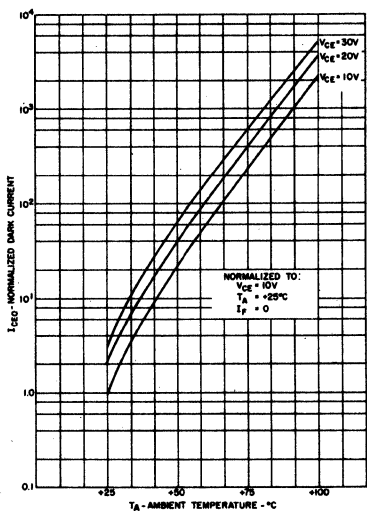

3. DARK I_{CEO} CURRENT VS TEMPERATURE

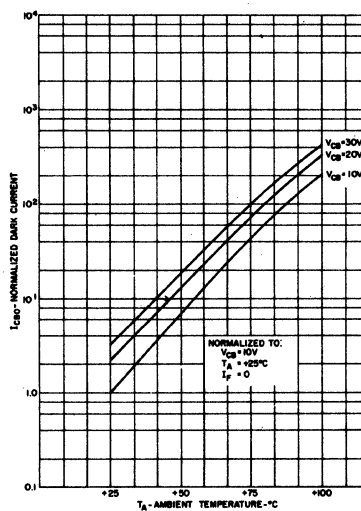

4. I_{CBO} VS TEMPERATURE

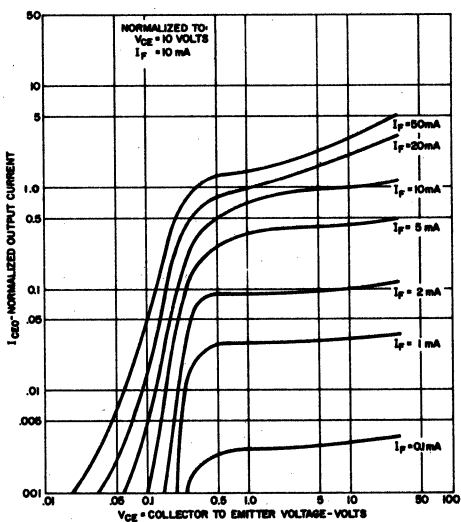

5. OUTPUT CHARACTERISTICS

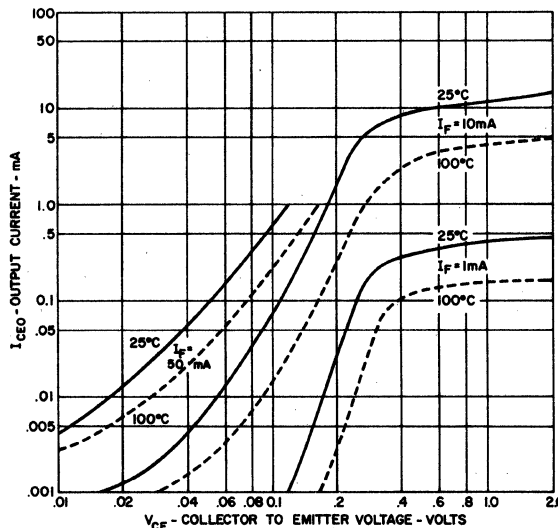

6. OUTPUT CHARACTERISTICS

TYPICAL CHARACTERISTICS

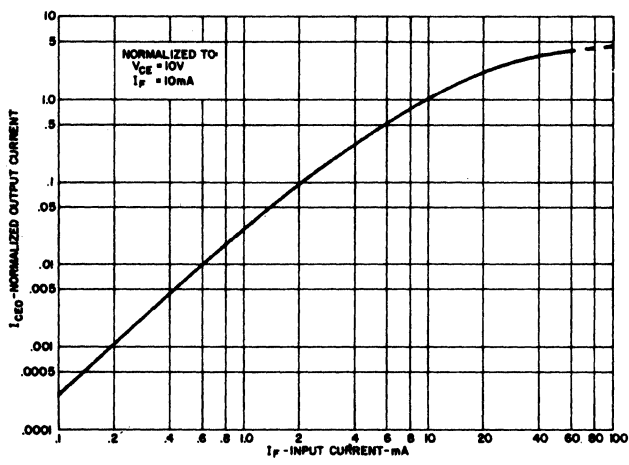

7. OUTPUT CURRENT VS INPUT CURRENT

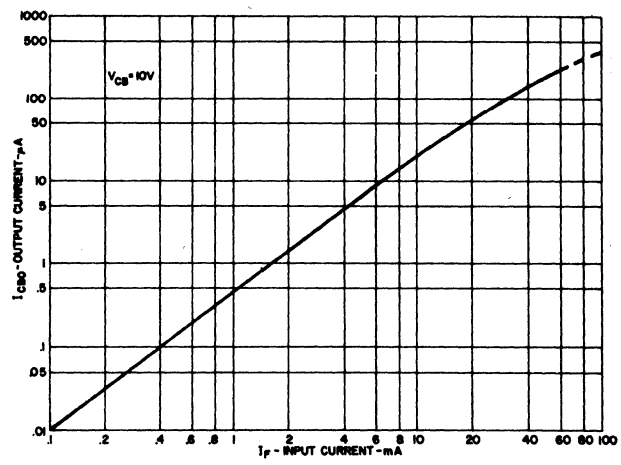

8. OUTPUT CURRENT - COLLECTOR TO BASE VS INPUT CURRENT

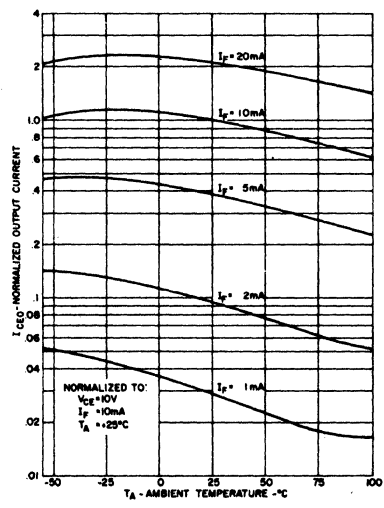

9. OUTPUT CURRENT VS TEMPERATURE

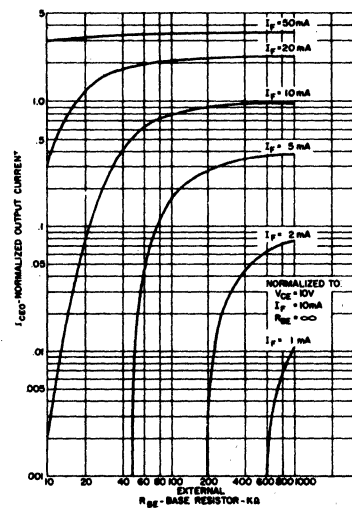

10. OUTPUT CURRENT VS BASE EMITTER RESISTANCE

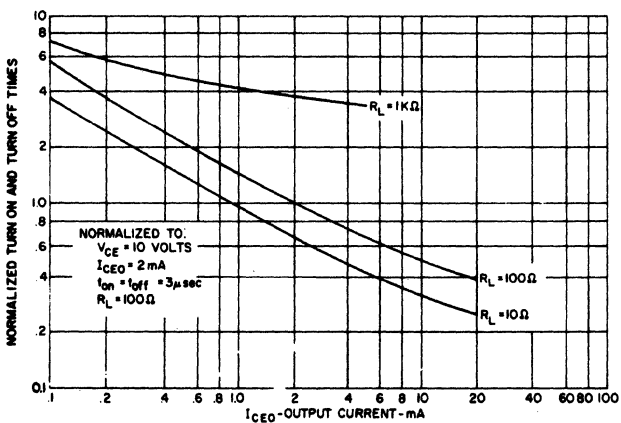

11. SWITCHING TIMES VS OUTPUT CURRENT

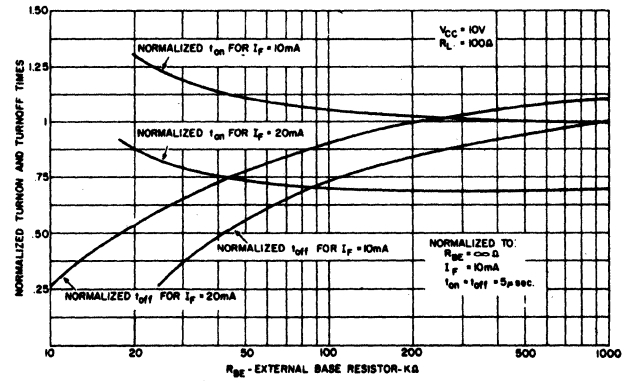

12. SWITCHING TIME VS R_{BE}



SOLID STATE OPTOELECTRONICS

Photon Coupled Isolator GFH601

Ga As Solid State Lamp & NPN Silicon Photo-Transistor

The General Electric GFH601 consists of a gallium arsenide infrared emitting diode coupled with a silicon photo transistor in a dual in-line package.

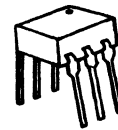

FEATURES:

- Fast switching speeds
- High DC current transfer ratio
- High isolation resistance
- High isolation voltage
- I/O compatible with integrated circuits

absolute maximum ratings: (25°C) (unless otherwise specified)

INFRARED EMITTING DIODE		
Power Dissipation – T _A	*100	milliwatts
Forward Current (Continuous)	60	milliamps
Forward Current (Peak) (Pulse width 1μs, 300 P Ps)	3	ampere
Reverse Voltage	6	volts
*Derate 1.33 mW/°C above 25°C		

PHOTO-TRANSISTOR		
Power Dissipation – T _A	**150	milliwatts
V _{CEO}	70	volts
V _{CB0}	70	volts
V _{ECO}	7	volts
Collector Current (Continuous)	150	milliamps
**Derate 2.0 mW/°C above 25°C		

TOTAL DEVICE	
Storage Temperature -55 to 150°C	
Operating Temperature -55 to 100°C	
Lead Soldering Time (at 260°C) 10 seconds	
Surge Isolation Voltage (Input to Output).	
5300V _(peak)	3750V _(RMS)

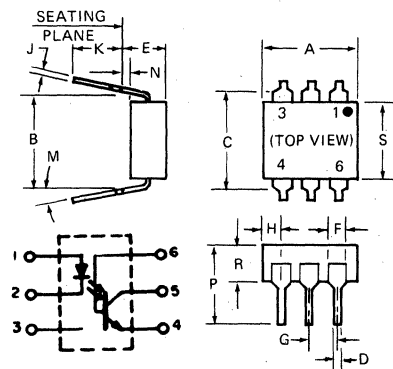

SYMBOL	MILLIMETERS		INCHES		NOTES
	MIN.	MAX.	MIN.	MAX.	
A	8.38	8.89	.330	.350	1
B	7.62 REF.	—	.300 REF.	—	
C	—	8.64	—	.340	2
D	.406	.508	.016	.020	
E	—	5.08	—	.200	3
F	1.01	1.78	.040	.070	
G	2.28	2.80	.090	.110	4
H	—	2.16	—	.085	
J	.203	.305	.008	.012	4
K	2.54	—	.100	—	
M	—	15°	—	15°	4
N	.381	—	.015	—	
P	—	9.53	—	.375	4
R	2.92	3.43	.115	.135	
S	6.10	6.86	.240	.270	4

- NOTES:
1. INSTALLED POSITION LEAD CENTERS.
 2. OVERALL INSTALLED DIMENSION.
 3. THESE MEASUREMENTS ARE MADE FROM THE SEATING PLANE.
 4. FOUR PLACES.



APPROVED TO:
 883 V_{DE} 0883/6.80
 V_{DE} 0110/11.72
 V_{DE} 0804/1.83
 V_{DE} 0806/8.81

CERTIFICATE #30415

Covered under U.L. component recognition program, reference file E51868

VDE Approved to 0883/6.80 0110b Certificate # 35025

individual electrical characteristics (25°C) (unless otherwise specified)

INFRARED EMITTING DIODE	MIN.	MAX.	UNITS	PHOTO-TRANSISTOR	MIN.	TYP.	MAX.	UNITS
Forward Voltage – V_F ($I_F = 60\text{ mA}$)		1.65	volts	Breakdown Voltage – $V_{(BR)CEO}$ ($I_C = 10\text{ mA}$, $I_F = 0$)	70	–	–	volts
Reverse Current – I_R ($V_R = 6\text{ V}$)	–	10	microamps	Breakdown Voltage – $V_{(BR)CBO}$ ($I_C = 100\mu\text{ A}$, $I_F = 0$)	70	–	–	volts
Capacitance – C_j ($V = 0, f = 1\text{ MHz}$)	–	100	picofarads	Breakdown Voltage – $V_{(BR)ECO}$ ($I_F = 100\mu\text{ A}$, $I_F = 0$)	7	–	–	volts
				Collector Dark Current – I_{CEO} ($V_{CE} = 10\text{ V}$, $I_F = 0$)	–	2	50	nanoamps
				Capacitance – C_{CE} ($V_{CE} = 10\text{ V}$, $f = 1\text{ MHz}$)	–	2	–	picofarads

coupled electrical characteristics (25°C) (unless otherwise specified)

		MIN.	TYP.	MAX.	UNITS
DC Current Transfer Ratio ($I_F = 10\text{ mA}$, $V_{CE} = 5\text{ V}$)	GFH601 I	40	–	80	%
	GFH601 II	63	–	125	%
	GFH601 III	100	–	200	%
	GFH601 IV	160	–	320	%
Saturation Voltage – Collector to Emitter ($I_F = 10\text{ mA}$, $I_C = 2.5\text{ mA}$)		–	–	0.4	volts
Isolation Resistance ($V_{IO} = 500\text{ V}_{DC}$) (See Note 1)		100	–	–	gigaohms
Input to Output Capacitance ($V_{IO} = 0, f = 1\text{ MHz}$) (See Note 1)		–	–	2	picofarads
Turn-On Time – t_{on} ($V_{CC} = 10\text{ V}$, $I_C = 2\text{ mA}$, $R_L = 100\Omega$) (See Figure 1)		–	5	10	microseconds
Turn-Off Time – t_{off} ($V_{CC} = 10\text{ V}$, $I_C = 2\text{ mA}$, $R_L = 100\Omega$) (See Figure 1)		–	5	10	microseconds

Note 1: Tests of input to output isolation current resistance, and capacitance are performed with the input terminals (diode) shorted together and the output terminals (transistor) shorted together.

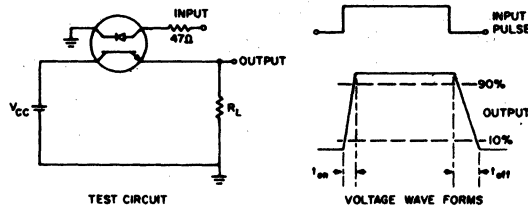

Adjust Amplitude of Input Pulse for Output (I_C) of 2 mA

FIGURE 1

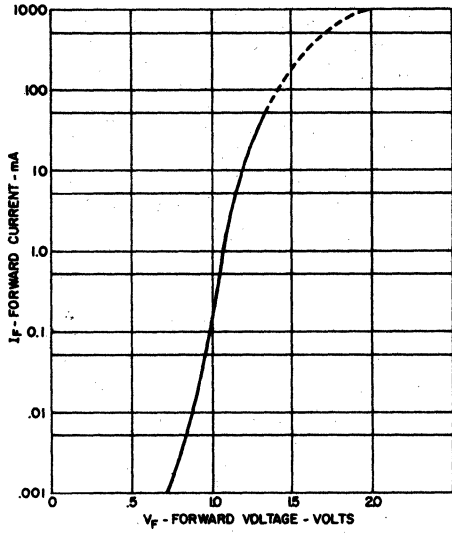

1. INPUT CHARACTERISTICS

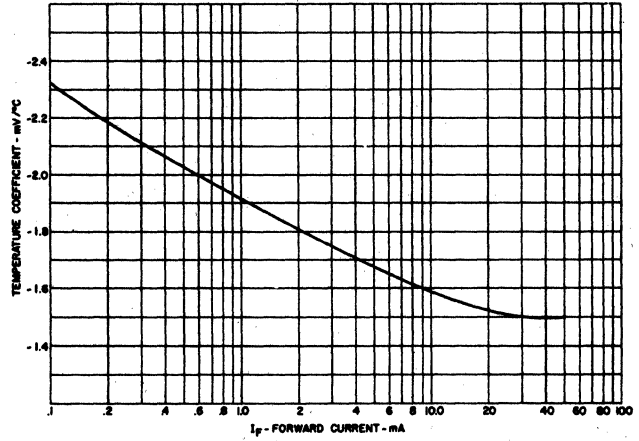

2. FORWARD VOLTAGE TEMPERATURE COEFFICIENT

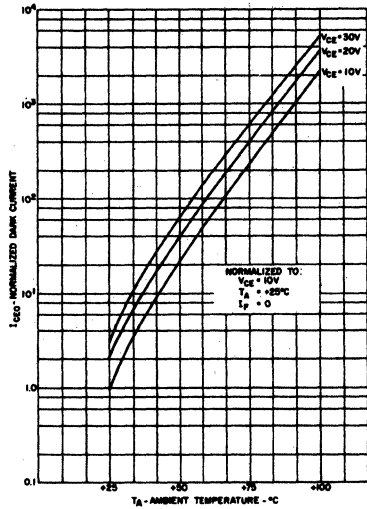

3. DARK I_{CEO} CURRENT VS TEMPERATURE

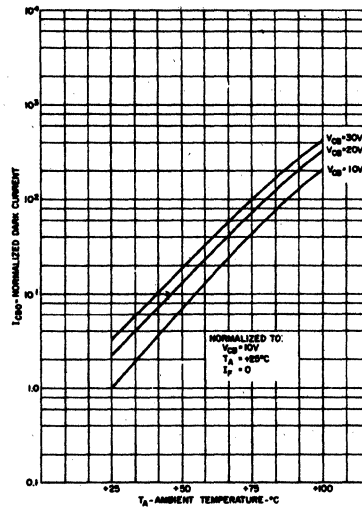

4. I_{CBO} VS TEMPERATURE

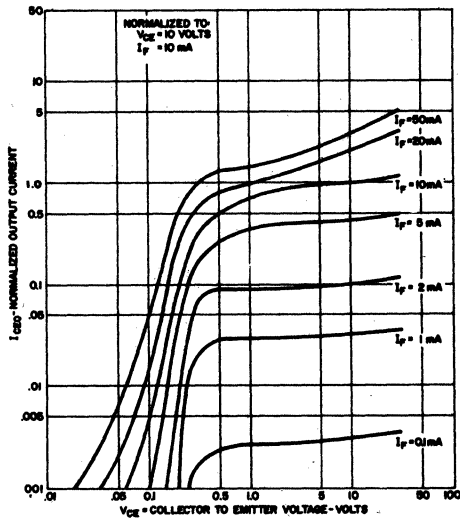

5. OUTPUT CHARACTERISTICS

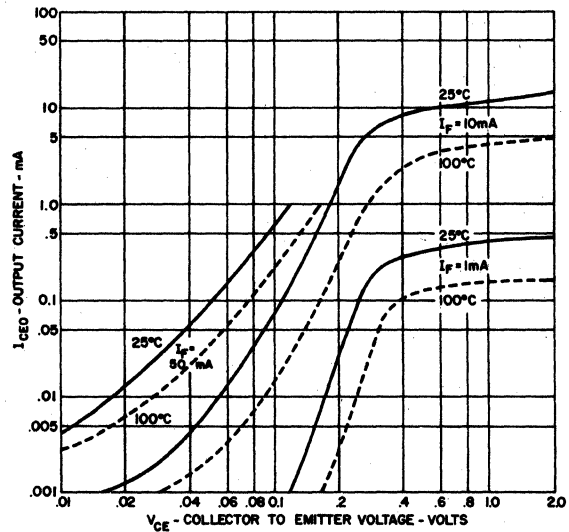

6. OUTPUT CHARACTERISTICS

TYPICAL CHARACTERISTICS

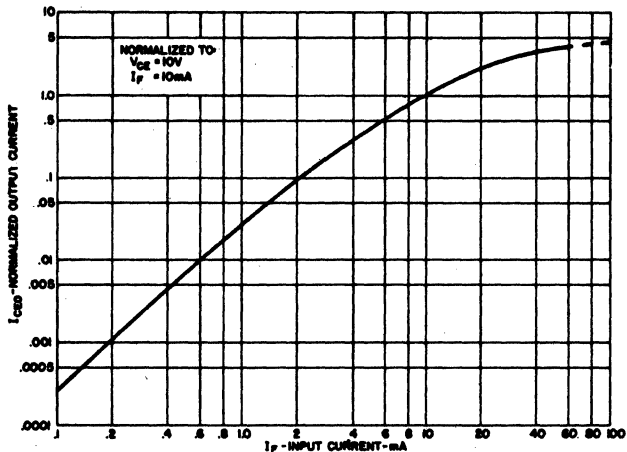

7. OUTPUT CURRENT VS INPUT CURRENT

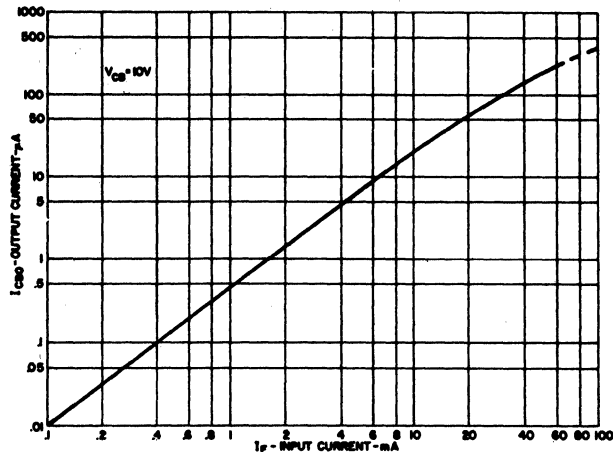

8. OUTPUT CURRENT - COLLECTOR TO BASE VS INPUT CURRENT

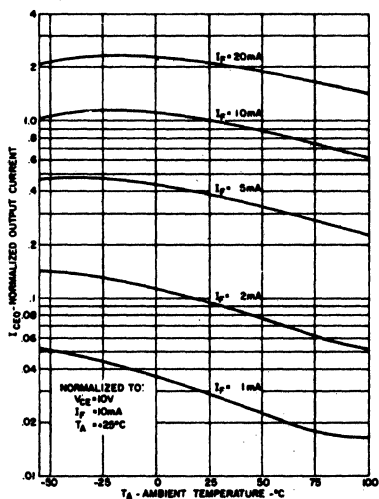

9. OUTPUT CURRENT VS TEMPERATURE

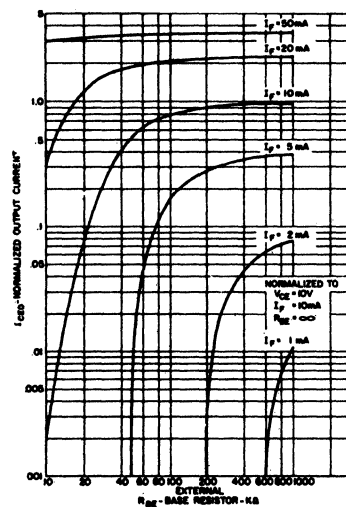

10. OUTPUT CURRENT VS BASE EMITTER RESISTANCE

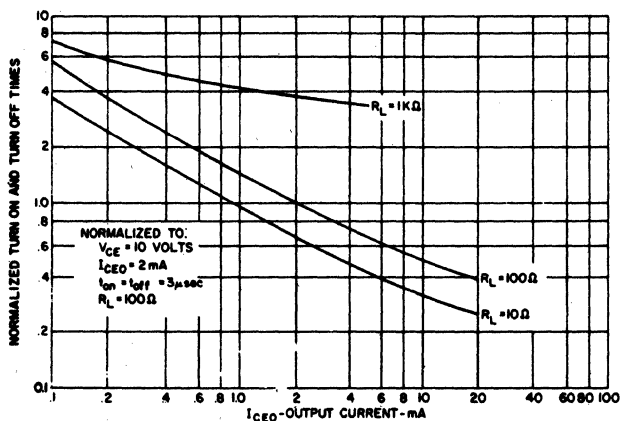

11. SWITCHING TIMES VS OUTPUT CURRENT

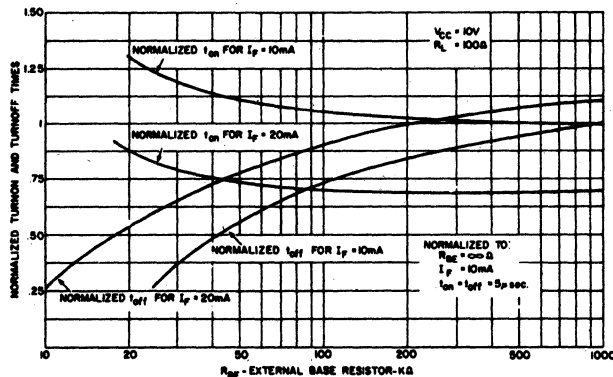

12. SWITCHING TIME VS R_{BE}

TYPICAL CHARACTERISTICS

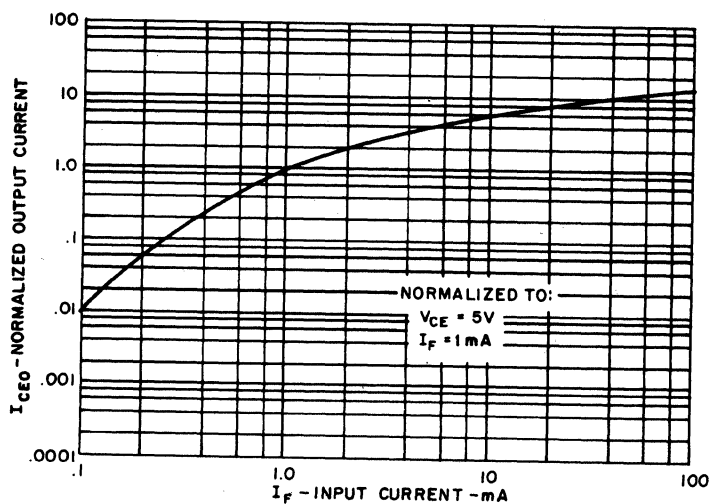

OUTPUT CURRENT VS INPUT CURRENT

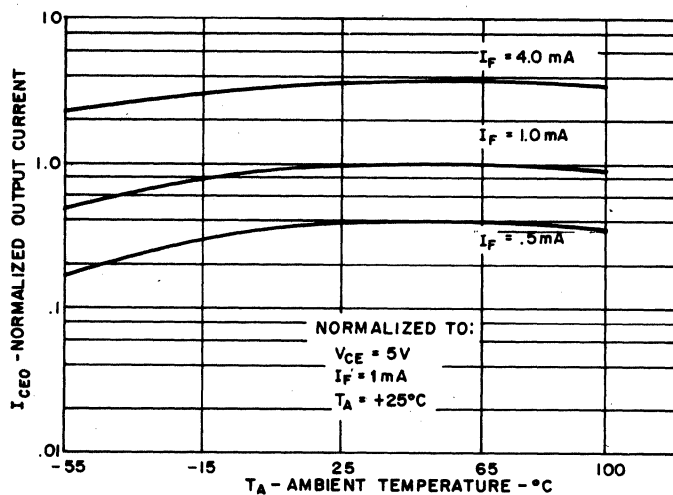

OUTPUT CURRENT VS TEMPERATURE

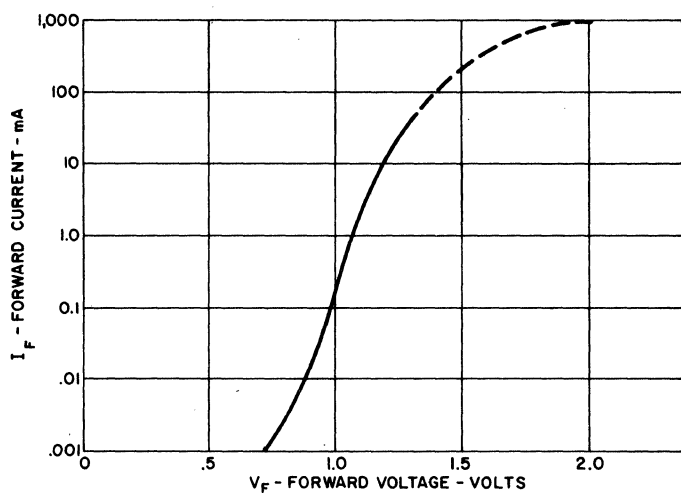

INPUT CHARACTERISTICS

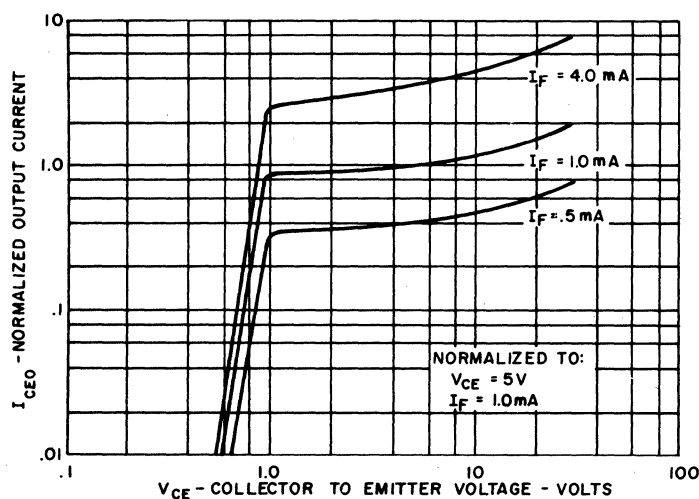

OUTPUT CHARACTERISTICS

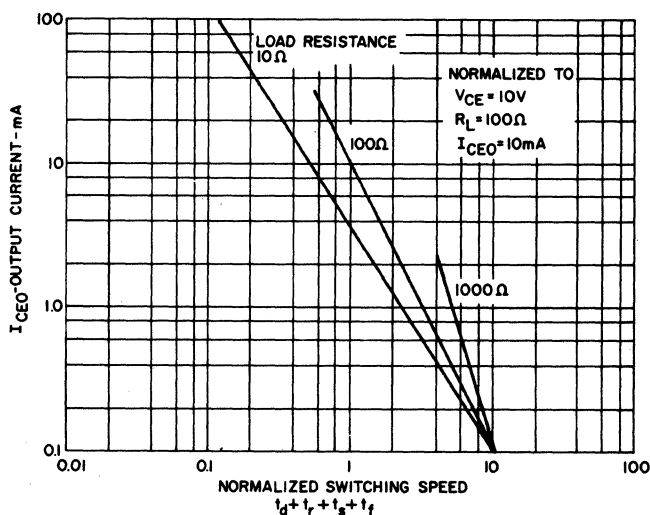

SWITCHING SPEED VS OUTPUT CURRENT

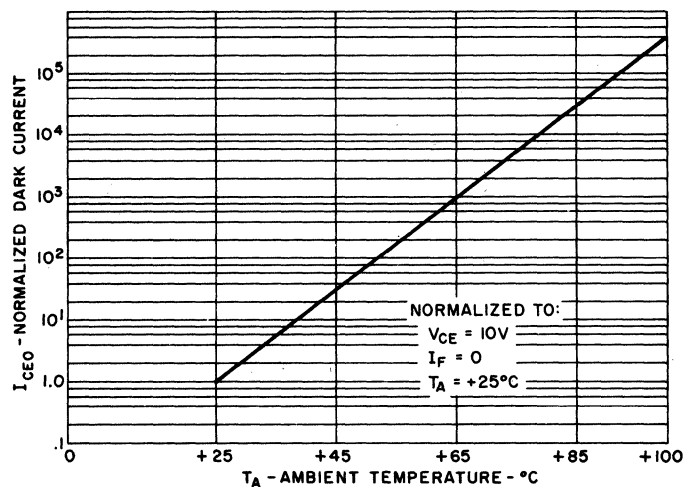

NORMALIZED DARK CURRENT VS TEMPERATURE



SOLID STATE OPTO ELECTRONICS

Photon Coupled Isolator MCS2, MCS2400

GaAs Infrared Emitting Diode & Light Activated SCR

The General Electric MCS2 and MCS2400 consist of a gallium arsenide, infrared emitting diode coupled with a light activated silicon controlled rectifier in a dual in-line package.

☑ Covered under U.L. component recognition program, reference file E51868

absolute maximum ratings

INFRARED EMITTING DIODE		
Power Dissipation	*100	milliwatts
Forward Current (Continuous)	60	milliamps
Forward Current (Peak) (100μsec 1% duty cycle)	1	ampere
Reverse Voltage	3	volts
*Derate 1.33mW/°C above 25°C ambient.		

PHOTO-SCR		
Off-State and Reverse Voltage	MCS2	200 volts
	MCS2400	400 volts
Peak Reverse Gate Voltage		6 volts
Direct On-State Current		300 milliamps
Surge (non-rep) On-State Current		10 amps
Peak Gate Current		10 milliamps
Output Power Dissipation	**400	milliwatts
**Derate 5.3mW/°C above 25°C ambient.		

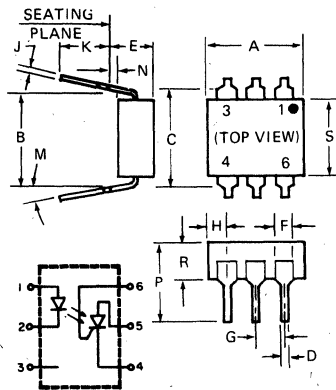

SYMBOL	MILLIMETERS		INCHES		NOTES
	MIN.	MAX.	MIN.	MAX.	
A	8.38	8.89	.330	.350	1
B	7.62 REF.		.300 REF.		
C	—	8.64	—	.340	2
D	.406	.508	.016	.020	
E	—	5.08	—	.200	3
F	1.01	1.78	.040	.070	
G	2.28	2.80	.090	.110	4
H	—	2.16	—	.085	
J	.203	.305	.008	.012	4
K	2.54	—	.100	—	
M	—	15	—	15	4
N	.381	—	.015	—	
P	—	9.53	—	.375	4
R	2.92	3.13	.115	.135	
S	6.10	8.86	.240	.270	

NOTES:
 1. INSTALLED POSITION LEAD CENTERS.
 2. OVERALL INSTALLED DIMENSION.
 3. THESE MEASUREMENTS ARE MADE FROM THE SEATING PLANE. 4. FOUR PLACES.

TOTAL DEVICE	
Storage Temperature Range	— 55°C to 150°C
Operating Temperature Range	— 55°C to 100°C
Soldering Temperature (1/16" from case, 10 seconds)	260°C
Total Device Dissipation	450 milliwatts
Linear Derating Factor (above 25°C)	6.0mW/°C
Surge Isolation Voltage (Input to Output)	3550 V _(peak) 2550V _(RMS)
Steady-State Isolation Voltage (Input to Output)	3150V _(peak) 2250V _(RMS)

individual electrical characteristics (25°C) (unless otherwise specified)

INFRARED EMITTING DIODE	TYP.	MAX.	UNITS
Forward Voltage V_F ($I_F = 20mA$)	1.1	1.5	V
Reverse Current I_R ($V_R = 3V$)	—	10	μA
Capacitance ($V = 0, f = 1MHz$)	50	—	pF

PHOTO-SCR	MIN.	MAX.	UNITS
Peak Off-State Voltage — V_{DM} $R_{GK} = 10K\Omega, T_A = 100^\circ C, I_D = 150\mu A$	MCS2	200	— V
	MCS2400	400	— V
Peak Reverse Voltage — V_{RM} ($T_A = 100^\circ C, I_R = 150\mu A$)	MCS2	200	— V
	MCS2400	400	— V
On-State Voltage — V_T ($I_T = 100mA$)		—	1.3 V
Off-State Current — I_D ($V_D = 200V, I_F = 0, R_{GK} = 27K$)	MCS2	—	2 μA
Off-State Current — I_D ($V_D = 400V, I_F = 0, R_{GK} = 27K$)	MCS2400	—	2 μA
Reverse Current — I_R ($V_R = 200V, I_F = 0$)	MCS2	—	2 μA
Reverse Current — I_R ($V_R = 400V, I_F = 0$)	MCS2400	—	2 μA
Holding Current — I_H ($V_{FX} = 50V, R_{GK} = 27K\Omega$)		10	500 μA

coupled electrical characteristics (25°C)

	MIN.	MAX.	UNITS
Input Current to Trigger			
Isolation Resistance (Input to Output)	$V_{AK} = 100V, R_{GK} = 27K\Omega$	I_{FT}	.5 milliamps
Turn-On Time — $V_{AK} = 50V, I_F = 30mA, R_{GK} = 10K\Omega, R_L = 200\Omega$	$V_{io} = 500V_{DC}$	r_{io}	100 gigaohms
Coupled dv/dt, Input to Output			— microseconds
Input to Output Capacitance (Input to Output Voltage = 0, f = 1MHz)			500 volts/microsec.
			— picofarads

☑ VDE Approved to 0883/6.80 0110b Certificate # 35025

TYPICAL CHARACTERISTICS

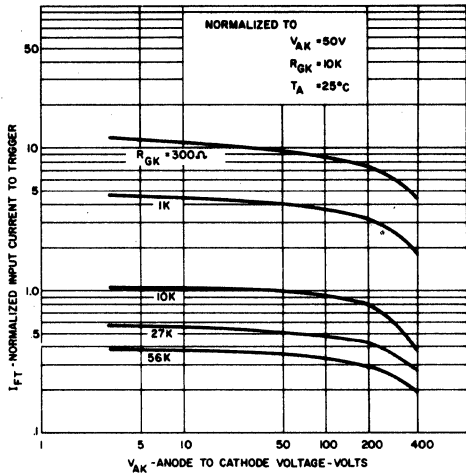

FIGURE 1. INPUT CURRENT TO TRIGGER VS. ANODE-CATHODE VOLTAGE

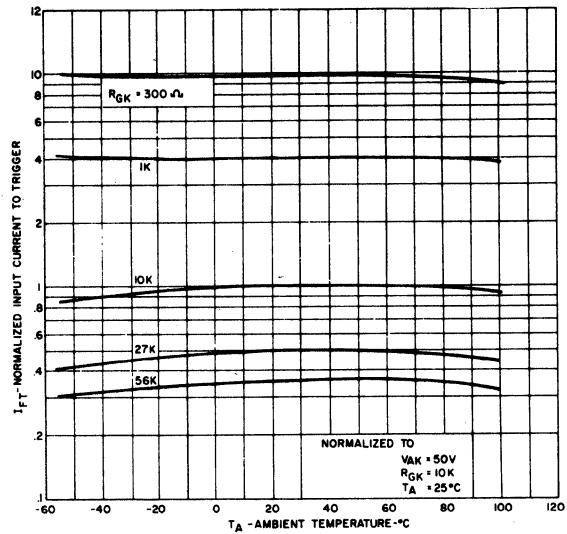

FIGURE 2. INPUT CURRENT TO TRIGGER VS. TEMPERATURE

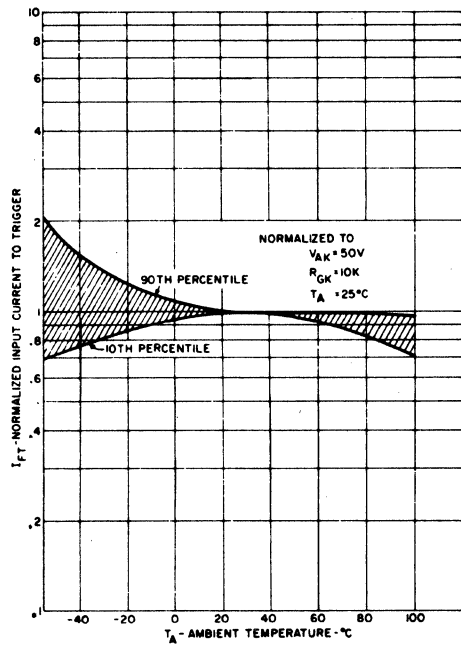

FIGURE 3. INPUT CURRENT TO TRIGGER DISTRIBUTION VS. TEMPERATURE

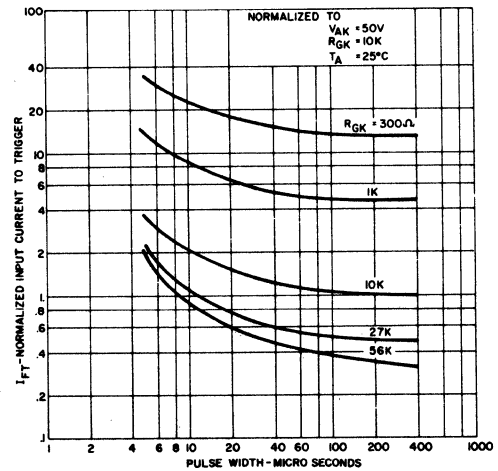

FIGURE 4. INPUT CURRENT TO TRIGGER VS. PULSE WIDTH

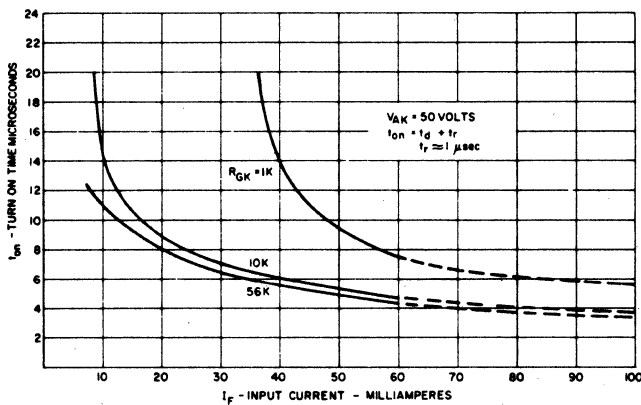

FIGURE 5. TURN-ON TIME VS. INPUT CURRENT

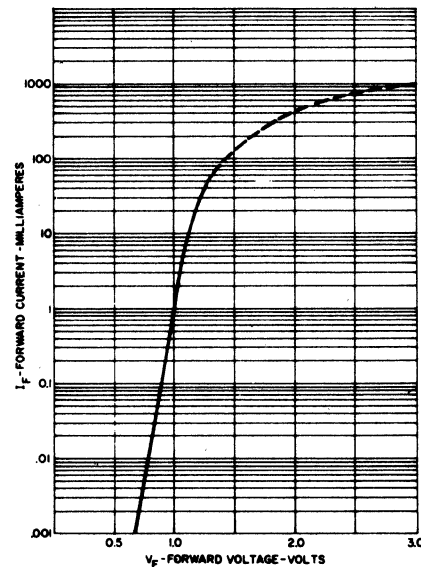

FIGURE 6. INPUT CHARACTERISTICS I_F VS. V_F



SOLID STATE OPTOELECTRONICS

Photon Coupled Isolator MCS21, MCS2401

GaAs Infrared Emitting Diode & Light Activated SCR

The General Electric MCS21 and MCS2401 consist of a gallium arsenide, infrared emitting diode coupled with a light activated silicon controlled rectifier in a dual in-line package.

Covered under U.L. component recognition program, reference file E51868

absolute maximum ratings

INFRARED EMITTING DIODE		
Power Dissipation	*100	milliwatts
Forward Current (Continuous)	60	milliamps
Forward Current (Peak) (100μsec 1% duty cycle)	1	ampere
Reverse Voltage	3	volts
*Derate 1.33mW/°C above 25°C ambient.		

PHOTO-SCR		
Off-State and Reverse Voltage	MCS21	200 volts
	MCS2401	400 volts
Peak Reverse Gate Voltage		6 volts
Direct On-State Current		300 milliamps
Surge (non-rep) On-State Current		10 amps
Peak Gate Current		10 milliamps
Output Power Dissipation	**400	milliwatts
**Derate 5.3mW/°C above 25°C ambient.		

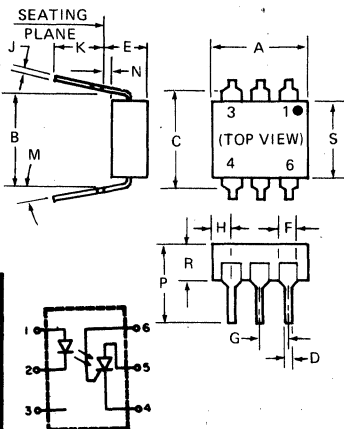

SYMBOL	MILLIMETERS		INCHES		NOTES
	MIN.	MAX.	MIN.	MAX.	
A	8.38	8.89	.330	.350	
B	7.62	REF.	.300	REF.	1
C	—	8.64	—	.340	2
D	.406	.508	.016	.020	
E	—	5.08	—	.200	3
F	1.01	1.78	.040	.070	
G	2.28	2.80	.090	.110	
H	—	2.16	—	.085	4
J	.203	.305	.008	.012	
K	2.54	—	.100	—	
M	—	15°	—	15°	
N	.381	—	.015	—	
P	—	9.53	—	.375	
R	2.92	3.43	.115	.135	
S	6.10	6.86	.240	.270	

NOTES:
 1. INSTALLED POSITION LEAD CENTERS.
 2. OVERALL INSTALLED DIMENSION.
 3. THESE MEASUREMENTS ARE MADE FROM THE SEATING PLANE. 4. FOUR PLACES.

TOTAL DEVICE	
Storage Temperature Range	— 55°C to 150°C
Operating Temperature Range	— 55°C to 100°C
Soldering Temperature (1/16" from case, 10 seconds)	260°C
Total Device Dissipation	450 milliwatts
Linear Derating Factor (above 25°C)	6.0mW/°C
Surge Isolation Voltage (Input to Output)	4000 V _(peak) 3000 V _(RMS)
Steady-State Isolation Voltage (Input to Output)	3500 V _(peak) 2500V _(RMS)

individual electrical characteristics (25°C) (unless otherwise specified)

INFRARED EMITTING DIODE	TYP.	MAX.	UNITS
Forward Voltage V_F ($I_F = 20mA$)	1.1	1.5	V
Reverse Current I_R ($V_R = 3V$)	—	10	μA
Capacitance ($V = 0, f = 1MHz$)	50	—	pF

PHOTO-SCR	MIN.	MAX.	UNITS
Peak Off-State Voltage — V_{DM} $R_{GK} = 10K\Omega, T_A = 100^\circ C, I_D = 150\mu A$	MCS21	200	V
	MCS2401	400	V
Peak Reverse Voltage — V_{RM} ($T_A = 100^\circ C, I_R = 150\mu A$)	MCS21	200	V
	MCS2401	400	V
On-State Voltage — V_T ($I_T = 100mA$)		1.3	V
Off-State Current — I_D ($V_D = 200V, I_F = 0, R_{GK} = 27K$)	MCS21	2	μA
Off-State Current — I_D ($V_D = 400V, I_F = 0, R_{GK} = 27K$)	MCS2401	2	μA
Reverse Current — I_R ($V_R = 200V, I_F = 0$)	MCS21	2	μA
Reverse Current — I_R ($V_R = 400V, I_F = 0$)	MCS2401	2	μA
Holding Current — I_H ($V_{FX} = 50V, R_{GK} = 27K\Omega$)		500	μA

coupled electrical characteristics (25°C)

	MIN.	MAX.	UNITS
Input Current to Trigger $V_{AK} = 50V, R_{GK} = 10K\Omega$		20	milliamps
		11	milliamps
Isolation Resistance (Input to Output) $V_{io} = 500V_{DC}$.5	—	gigaohms
Turn-On Time — $V_{AK} = 50V, I_F = 30mA, R_{GK} = 10K\Omega, R_L = 200\Omega$	100	—	microseconds
Coupled dv/dt, Input to Output	—	50	volts/microsec.
Input to Output Capacitance (Input to Output Voltage = 0, f = 1MHz)	500	—	picofarads
	—	2	picofarads

VDE Approved to 0883/6.80 0110b Certificate # 35025

TYPICAL CHARACTERISTICS

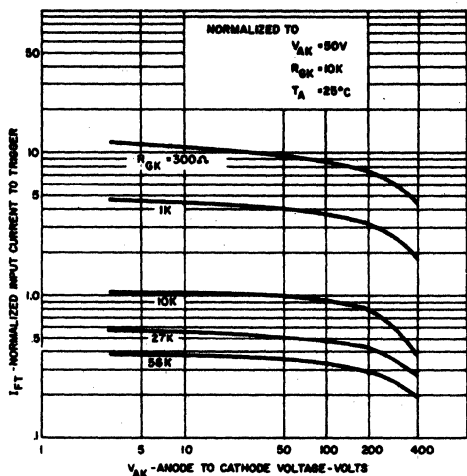

FIGURE 1. INPUT CURRENT TO TRIGGER VS. ANODE-CATHODE VOLTAGE

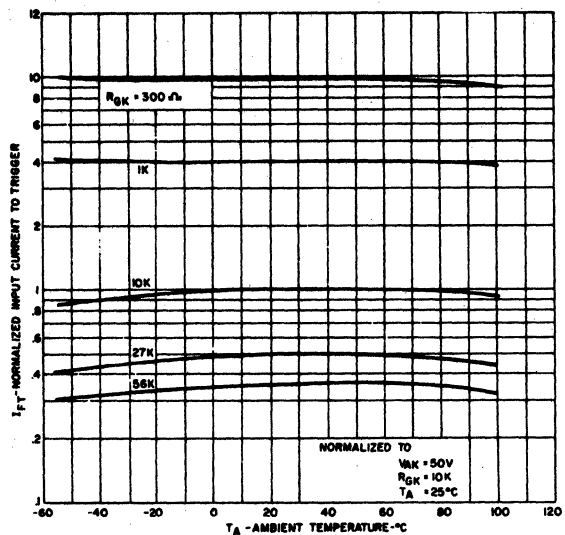

FIGURE 2. INPUT CURRENT TO TRIGGER VS. TEMPERATURE

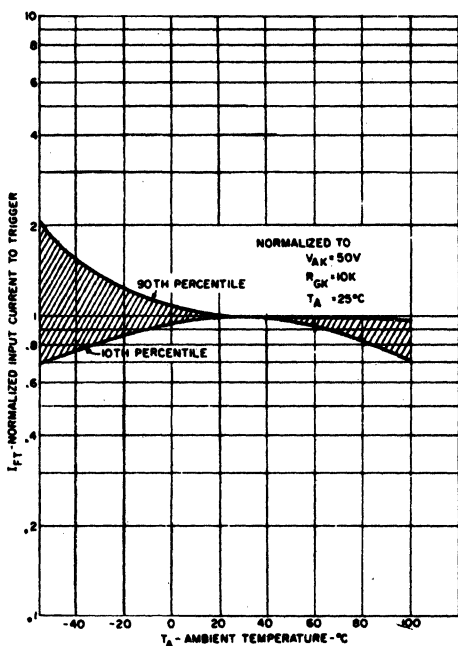

FIGURE 3. INPUT CURRENT TO TRIGGER DISTRIBUTION VS. TEMPERATURE

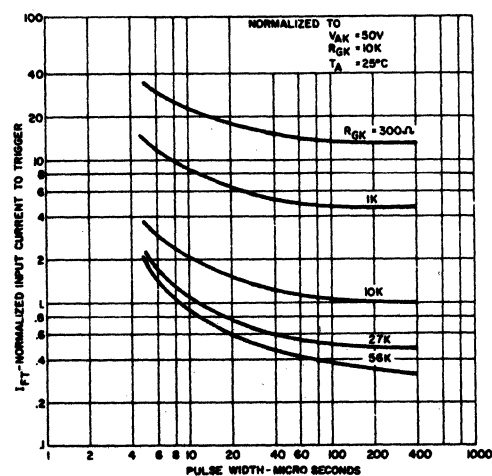

FIGURE 4. INPUT CURRENT TO TRIGGER VS. PULSE WIDTH

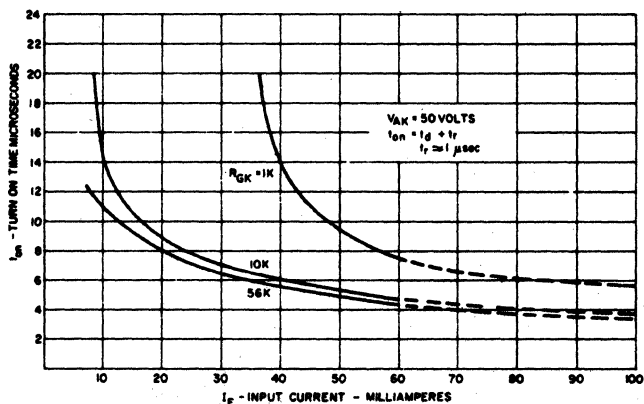

FIGURE 5. TURN-ON TIME VS. INPUT CURRENT

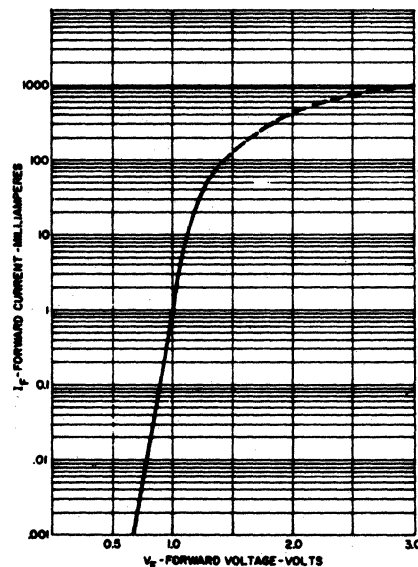
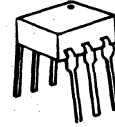

FIGURE 6. INPUT CHARACTERISTICS I_F VS. V_F



SOLID STATE OPTOELECTRONICS

Photon Coupled Isolator MCT2, MCT2E, MCT26



GaAs Infrared Emitting Diode & NPN Silicon Photo-Transistor

The General Electric MCT2, MCT2E and MCT26 are gallium arsenide, infrared emitting diodes coupled with a silicon photo-transistor in a dual in-line package.

☛ Covered under U.L. component recognition program, reference file E51868

absolute maximum ratings: (25°C)

INFRARED EMITTING DIODE		
Power Dissipation	*200	milliwatts
Forward Current (Continuous)	60	milliamps
Forward Current (Peak)	3	ampere
(Pulse width 1μsec 300 P Ps)		
Reverse Voltage	3	volts
*Derate 2.6mW/°C above 25°C ambient.		

PHOTO-TRANSISTOR		
Power Dissipation	**200	milliwatts
V _{CEO}	30	volts
V _{CBO}	70	volts
V _{ECO}	7	volts
Collector Current (Continuous)	100	milliamps
**Derate 2.6mW/°C above 25°C ambient.		

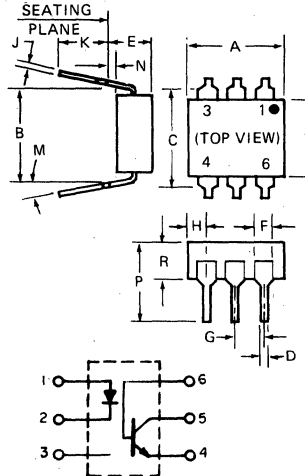

SYMBOL	MILLIMETERS		INCHES		NOTES
	MIN.	MAX.	MIN.	MAX.	
A	8.38	8.89	.330	.350	1
B	7.62	REF.	.300	REF.	
C	—	8.64	—	.340	2
D	.406	.508	.016	.020	
E	—	5.08	—	.200	3
F	1.01	1.78	.040	.070	
G	2.28	2.80	.090	.110	4
H	—	2.16	—	.085	
J	.203	.305	.008	.012	4
K	2.54	—	.100	—	
M	—	15.	—	15.	4
N	.381	—	.015	—	
P	—	9.53	—	.375	4
R	2.92	3.43	.115	.135	
S	6.10	6.86	.240	.270	4

- NOTES:
 1. INSTALLED POSITION LEAD CENTERS.
 2. OVERALL INSTALLED DIMENSION.
 3. THESE MEASUREMENTS ARE MADE FROM THE SEATING PLANE.
 4. FOUR PLACES.

TOTAL DEVICE	
Storage Temperature	-55 to 150°C
Operating Temperature	-55 to 100°C
Lead Soldering Time (at 260°C)	10 seconds
Surge Isolation Voltage (Input to Output)	
MCT2 — MCT26	1500V _(peak) 1060V _(RMS)
MCT2E	3500V _(peak) 2500V _(RMS)

individual electrical characteristics (25°C)

INFRARED EMITTING DIODE	TYP.	MAX.	UNITS
Forward Voltage (I _F = 10mA)	1.1	1.5	volts
Reverse Current (V _R = 3V)	—	10	microamps
Capacitance (V = 0, f = 1MHz)	50	—	picofarads

PHOTO-TRANSISTOR	MIN.	TYP.	MAX.	UNITS
Breakdown Voltage — V _{(BR)CEO} (I _C = 10mA, I _F = 0)	30	—	—	volts
Breakdown Voltage — V _{(BR)CBO} (I _C = 100μA, I _F = 0)	70	—	—	volts
Breakdown Voltage — V _{(BR)ECO} (I _E = 100μA, I _F = 0)	7	—	—	volts
Collector Dark Current — I _{CEO} (V _{CE} = 10V, I _F = 0)	—	5	50	nanoamps
Capacitance (V _{CE} = 10V, f = 1MHz)	—	2	—	picofarads

coupled electrical characteristics (25°C)

		MIN.	TYP.	MAX.	UNITS
DC Current Transfer Ratio (I _F = 10mA, V _{CE} = 10V)	MCT2 — MCT2E	20	—	—	%
	MCT26	6	—	—	%
Saturation Voltage — Collector to Emitter (I _F = 16mA, I _C = 2.0mA)	MCT2 — MCT2E	—	0.1	0.4	volts
Saturation Voltage — Collector to Emitter (I _F = 60mA, I _C = 1.6mA)	MCT26	—	—	0.5	volts
Isolation Resistance (Input to Output Voltage = 500V _{DC})		100	—	—	gigaohms
Input to Output Capacitance (Input to Output Voltage = 0, f = 1MHz)		—	—	2	picofarads
Switching Speeds: Rise/Fall Time (V _{CE} = 10V, I _{CE} = 2mA, R _L = 100Ω)		—	5	—	microseconds
Rise/Fall Time (V _{CB} = 10V, I _{CB} = 50μA, R _L = 100Ω)		—	3	—	microseconds

TYPICAL CHARACTERISTICS

MCT2, MCT2E, MCT26

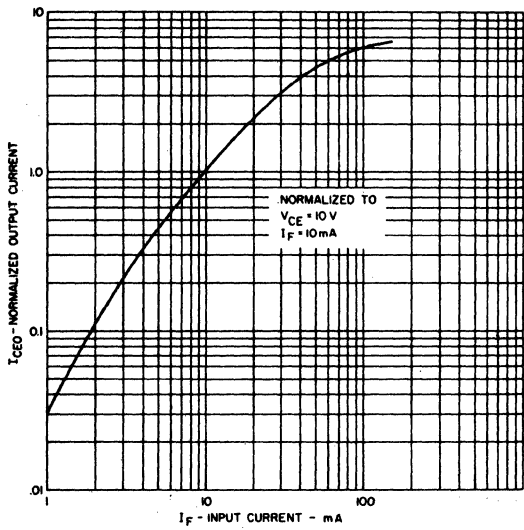

OUTPUT CURRENT VS INPUT CURRENT

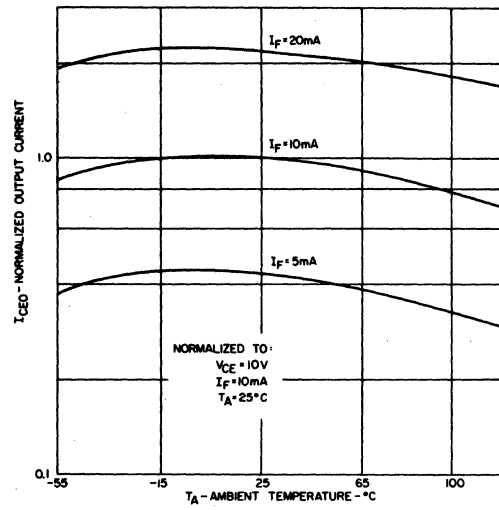

OUTPUT CURRENT VS TEMPERATURE

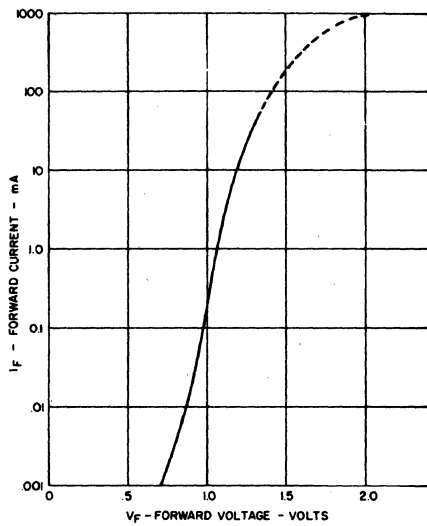

INPUT CHARACTERISTICS

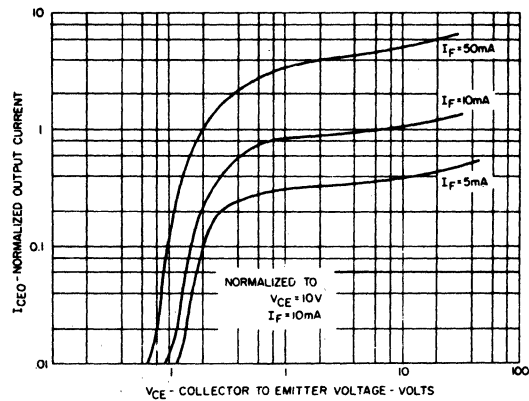

OUTPUT CHARACTERISTICS

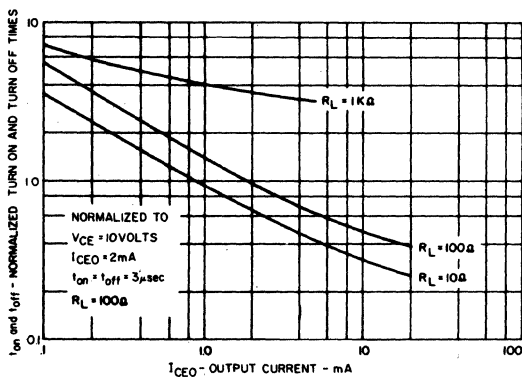

SWITCHING TIMES VS OUTPUT CURRENT

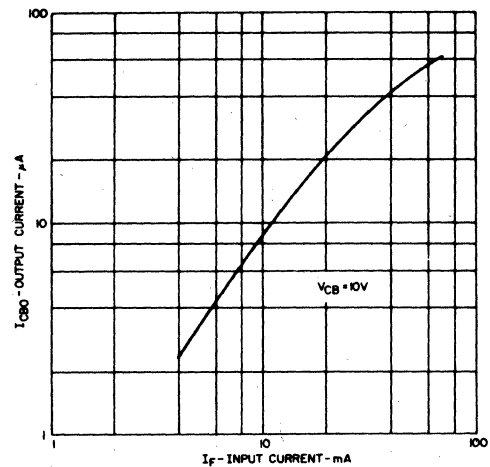

OUTPUT CURRENT (I_{CBO}) VS INPUT CURRENT



SOLID STATE OPTOELECTRONICS

Photon Coupled Isolator MCT210

GaAs Infrared Emitting Diode & NPN Silicon Photo-Transistor

The General Electric MCT210 is a gallium arsenide, infrared emitting diode coupled with a silicon photo-transistor in a dual in-line package.

Covered under U.L. component recognition program, reference file E51868

absolute maximum ratings: (25°C)

INFRARED EMITTING DIODE		
Power Dissipation	*200	milliwatts
Forward Current (Continuous)	60	milliamps
Forward Current (Peak) (Pulse width 1 μsec 300 P Ps)	3	ampere
Reverse Voltage	3	volts

*Derate 2.6mW/°C above 25°C ambient.

PHOTO-TRANSISTOR		
Power Dissipation	**200	milliwatts
V _{CEO}	30	volts
V _{CBO}	70	volts
V _{ECO}	7	volts
Collector Current (Continuous)	100	milliamps

**Derate 2.6mW/°C above 25°C ambient.

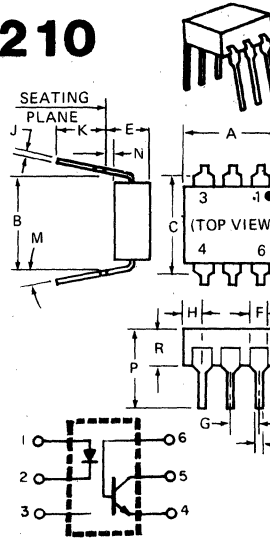

SYMBOL	MILLIMETERS		INCHES		NOTES
	MIN.	MAX.	MIN.	MAX.	
A	8.38	8.89	.330	.350	1
B	7.62 REF.		.300 REF.		
C	—	8.64	—	.340	2
D	.406	.508	.016	.020	
E	—	5.08	—	.200	3
F	1.01	1.78	.040	.070	
G	2.28	2.80	.090	.110	4
H	—	2.16	—	.085	
J	.203	.305	.008	.012	4
K	2.54	—	.100	—	
M	—	15°	—	15°	4
N	.381	—	.015	—	
P	—	9.53	—	.375	4
R	2.92	3.43	.115	.135	
S	6.10	6.86	.240	.270	4

- NOTES:
 1. INSTALLED POSITION LEAD CENTERS.
 2. OVERALL INSTALLED DIMENSION.
 3. THESE MEASUREMENTS ARE MADE FROM THE SEATING PLANE.
 4. FOUR PLACES.

TOTAL DEVICE	
Storage Temperature	-55 to 150°C
Operating Temperature	-55 to 100°C
Lead Soldering Time (at 260°C)	10 seconds
Surge Isolation Voltage (Input to Output).	
	2500V _(peak) 1500V _(RMS)
Steady-State Isolation Voltage (Input to Output).	
	2250V _(peak) 1250V _(RMS)

individual electrical characteristics (25°C)

INFRARED EMITTING DIODE	TYP.	MAX.	UNITS
Forward Voltage (I _F = 40mA)	1.1	1.5	volts
Reverse Current (V _R = 6V)	—	10	microamps
Capacitance (V = 0, f = 1 MHz)	50	—	picofarads

PHOTO-TRANSISTOR	MIN.	TYP.	MAX.	UNITS
Breakdown Voltage—V _{(BR)CEO} (I _C = 10mA, I _F = 0)	30	—	—	volts
Breakdown Voltage—V _{(BR)CBO} (I _C = 100μA, I _F = 0)	70	—	—	volts
Breakdown Voltage—V _{(BR)ECO} (I _E = 100μA, I _F = 0)	6	—	—	volts
Collector Dark Current—I _{CEO} (V _{CE} = 10V, I _F = 0)	—	5	50	nanoamps
Capacitance (V _{CE} = 10V, f = 1MHz)	—	2	—	picofarads

coupled electrical characteristics (25°C)

	MIN.	TYP.	MAX.	UNITS
DC Current Transfer Ratio (I _F = 3.2mA to 32mA, V _{CE} = 0.4V)	50	—	—	%
(I _F = 10mA, V _{CE} = 5V)	150	—	—	%
Saturation Voltage — Collector to Emitter (I _F = 32mA, I _C = 16mA)	—	0.1	0.4	volts
Isolation Resistance (Input to Output Voltage = 500V _{DC})	100	—	—	gigaohms
Input to Output Capacitance (Input to Output Voltage = 0, f = 1MHz)	—	—	2	picofarads
Switching Speeds: Rise/Fall Time (V _{CE} = 10V, I _{CE} = 2mA, R _L = 100Ω)	—	5	—	microseconds
Rise/Fall Time (V _{CB} = 10V, I _{CB} = 50μA, R _L = 100Ω)	—	300	—	nanoseconds

VDE Approved to 0883/6.80 0110b Certificate # 35025

TYPICAL CHARACTERISTICS

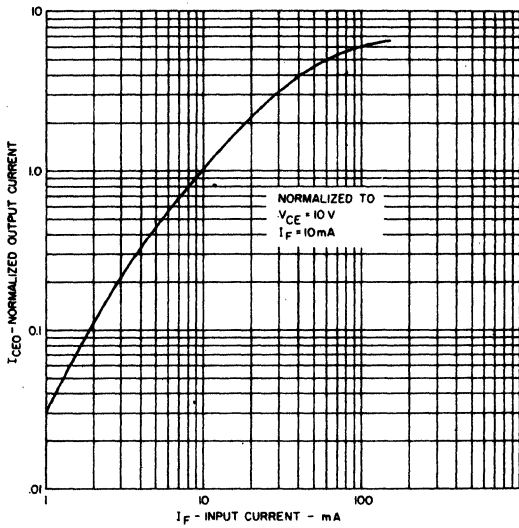

OUTPUT CURRENT VS INPUT CURRENT

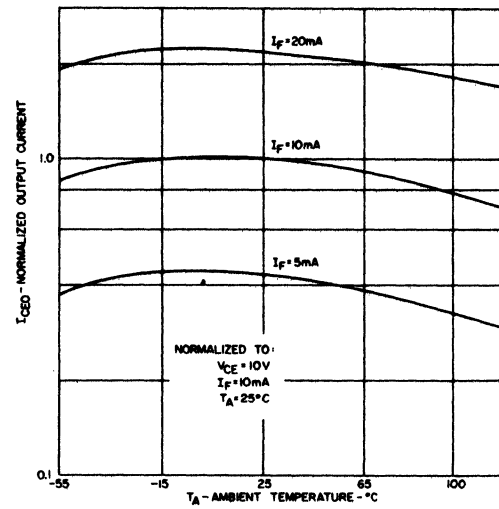

OUTPUT CURRENT VS TEMPERATURE

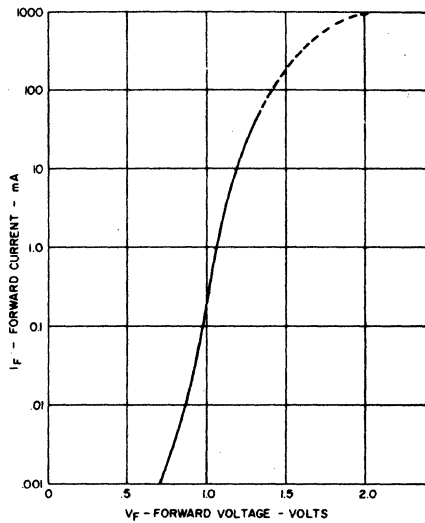

INPUT CHARACTERISTICS

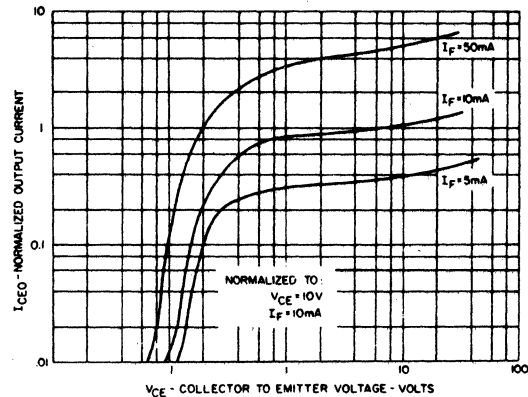

OUTPUT CHARACTERISTICS

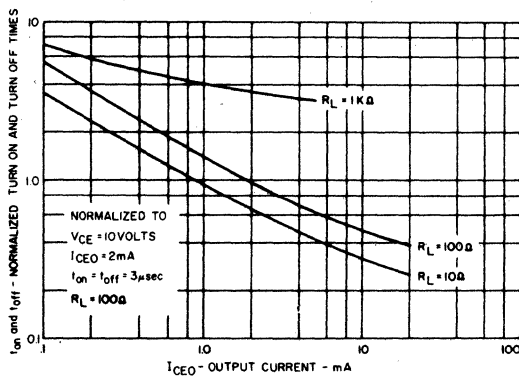

SWITCHING TIMES VS OUTPUT CURRENT

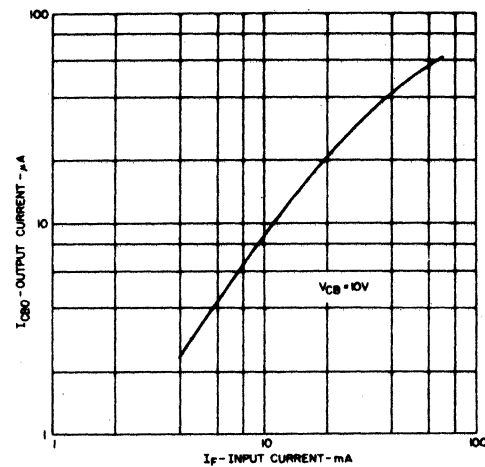

OUTPUT CURRENT (I_{CBO}) VS INPUT CURRENT

OPTOELECTRONICS CROSS REFERENCE

The suggested replacements represent what we believe to be equivalents for the products listed. GE assumes no responsibility and does not guarantee that the replacements are exact, but only the replacements

will meet the terms of its applicable published written product warranties. The pertinent GE product specification sheets should be used as the key tool for actual replacements.

COMPETITIVE TYPE NUMBER	NEAREST GENERAL ELECTRIC PART NUMBER	COMPETITIVE TYPE NUMBER	NEAREST GENERAL ELECTRIC PART NUMBER
1N6264	1N6264	CLI-230	H22B1
1N6265	1N6265	CLI-506	H11A3
1N6266	1N6266	CLI-506A	H11A3
4N25	4N25	CLI-506B	H11A3
4N25A	4N25A	CLI-510	4N37
4N26	4N26	CLI-511	4N37
4N27	4N27	CLI-800	H21A1
4N28	4N28	CLI-810	H21A1
4N29	4N29	CLI-811	H21A4
4N29A	4N29A	CLI-820	H21A2
4N30	4N30	CLI-821	H21A5
4N31	4N31	CLI-830	H21A3
4N32	4N32	CLI-831	H21A6
4N32A	4N32A	CLI-835	H21A1
4N33	4N33	CLI-836	H21A4
4N35	4N35	CLI-840	H21B1
4N36	4N36	CLI-841	H21B4
4N37	4N37	CLI-850	H21B2
4N38	4N38	CLI-851	H21B5
4N38A	4N38A	CLI-860	H21B3
4N39	4N39	CLI-861	H21B6
4N40	4N40	CLI-870	H21B1
BPW13A	L14C2	CLI-871	H21B4
BPW13B	L14C2	CLT2010	L14C2
BPW13C	L14C2	CLT2020	L14C1
BPW36	BPW36	CLT2130	L14G2
BPW37	BPW37	CLT2140	L14G2
BPW38	BPW38	CLT2150	L14G1
BPX-38-1	L14C1	CLT2160	L14G3
CL-100	LED56	CNY17I	CNY17I
CLI-2	H11A5	CNY17II	CNY17II
CLI-3	4N37	CNY17III	CNY17III
CLI-5	H11A3	CNY17IV	CNY17IV
CLI-6	H11A1	CNY28	CNY28
CLI-7	H11A3	CNY29	CNY29
CLI-8	H11A3	CNY30	CNY30
CLI-9	H11A3	CNY31	CNY31
CLI-10	H11B1	CNY32	CNY32
CLI-11	H11B1	CNY33	CNY33
CLI-12	H11B2	CNY34	CNY34
CLI-13	H11G3	CNY35	CNY35
CLI-14	H11G3	CNY36	CNY36
CLI-20	H11A2	CNY47	CNY47
CLI-210	H22A1	CNY47A	CNY47A
CLI-220	H22B1	CNY48	CNY48

<u>COMPETITIVE TYPE NUMBER</u>	<u>NEAREST GENERAL ELECTRIC PART NUMBER</u>
------------------------------------	---

CNY51	CNY51
CNY75A	GFH601II
CNY75B	GFH601III
CNY75C	GFH601IV
CQX14	CQX14
CQX15	CQX15
CQX16	CQX16
CQX17	CQX17
CQY80	CQY80
F5D1	F5D1
F5D2	F5D2
F5D3	F5D3
F5E1	F5E1
F5E2	F5E2
F5E3	F5E3
F5F1	F5F1
F5G1	F5G1
FCD810	H11A3
FCD810A	H11A5
FCD810B	H11A3
FCD810C	H11A520
FCD810D	H11A520
FCD820	H11A3
FCD820A	H11A2
FCD820B	H11A3
FCD820C	H11A520
FCD820D	H11A520
FCD825	H11A1
FCD825A	H11A1
FCD825B	H11A1
FCD825C	H11A550
FCD825D	H11A550
FCD830	H11A1
FCD830A	H11A2
FCD830B	H11A3
FCD830C	H11A520
FCD830D	H11A520
FCD831	H11A3
FCD831A	H11A3
FCD831B	H11A3
FCD831C	H11A520
FCD831D	H11A520
FCD836	H11A3
FCD836C	H11A520
FCD850	4N29
FCD860	H11B1
FCD865	H11B1
FPE500	LED56
FPE510	LED56F
FPE520	LED56
FPE530	LED56F

<u>COMPETITIVE TYPE NUMBER</u>	<u>NEAREST GENERAL ELECTRIC PART NUMBER</u>
------------------------------------	---

GE3009	GE3009
GE3010	GE3010
GE3011	GE3011
GE3012	GE3012
GE3020	GE3020
GE3021	GE3021
GE3022	GE3022
GE3023	GE3023
GFH600I	GFH600I
GFH600II	GFH600II
GFH600III	GFH600III
GFH601I	GFH601I
GFH601II	GFH601II
GFH601III	GFH601III
GFH601IV	GFH601IV
H11A1	H11A1
H11A2	H11A2
H11A3	H11A3
H11A4	H11A4
H11A5	H11A5
H11A10	H11A10
H11A520	H11A520
H11A550	H11A550
H11A5100	H11A5100
H11AA1	H11AA1
H11AA2	H11AA2
H11AA3	H11AA3
H11AA4	H11AA4
H11AG1	H11AG1
H11AG2	H11AG2
H11AG3	H11AG3
H11AV1	H11AV1
H11AV1A	H11AV1A
H11AV2	H11AV2
H11AV2A	H11AV2A
H11AV3	H11AV3
H11AV3A	H11AV3A
H11B1	H11B1
H11B2	H11B2
H11B3	H11B3
H11B255	H11B255
H11C1	H11C1
H11C2	H11C2
H11C3	H11C3
H11C4	H11C4
H11C5	H11C5
H11C6	H11C6
H11D1	H11D1
H11D2	H11D2
H11D3	H11D3
H11D4	H11D4
H11F1	H11F1

<u>COMPETITIVE TYPE NUMBER</u>	<u>NEAREST GENERAL ELECTRIC PART NUMBER</u>
H11F2	H11F2
H11F3	H11F3
H11G1	H11G1
H11G2	H11G2
H11G3	H11G3
H11G45	H11G45
H11G46	H11G46
H11J1	H11J1
H11J2	H11J2
H11J3	H11J3
H11J4	H11J4
H11J5	H11J5
H11L1	H11L1
H11L2	H11L2
H11L3	H11L3
H13A1	H21A1
H13A2	H21A1
H13B1	H21B1
H13B2	H21B1
H15A1	H24A2
H15A2	H24A2
H15B1	H24B2
H15B2	H24B2
H17A1	H23A1
H17B1	H23B1
H20A1	H22A1
H20A2	H22A1
H20B1	H22B1
H20B2	H22B1
H21A1	H21A1
H21A2	H21A2
H21A3	H21A3
H21A4	H21A4
H21A5	H21A5
H21A6	H21A6
H21B1	H21B1
H21B2	H21B2
H21B3	H21B3
H21B4	H21B4
H21B5	H21B5
H21B6	H21B6
H21L1	H21L1
H21L2	H21L2
H22A1	H22A1
H22A2	H22A2
H22A3	H22A3
H22A4	H22A4
H22A5	H22A5
H22A6	H22A6
H22B1	H22B1
H22B2	H22B2

<u>COMPETITIVE TYPE NUMBER</u>	<u>NEAREST GENERAL ELECTRIC PART NUMBER</u>
H22B3	H22B3
H22B4	H22B4
H22B5	H22B5
H22B6	H22B6
H22L1	H22L1
H22L2	H22L2
H23A1	H23A1
H23A2	H23A2
H23B1	H23B1
H23L1	H23L1
H24A1	H24A1
H24A2	H24A2
H24B1	H24B1
H24B2	H24B2
H74A1	H74A1
H74C1	H74C1
H74C2	H74C2
IL1	H11A3
IL5	H11A1
IL12	H11A5
IL15	H11A5
IL16	H11A5
IL74	H11A5
IL201	CNY17II
IL202	CNY17III
IL203	CNY17IV
IL250	H11AA3
ILA30	H11B3
ILA55	H11B255
ILCA2-30	H11B3
ILCA2-55	H11B255
L14C1	L14C1
L14C2	L14C2
L14F1	L14F1
L14F2	L14F2
L14G1	L14G1
L14G2	L14G2
L14G3	L14G3
L14N1	L14N1
L14N2	L14N2
L14P1	L14P1
L14P2	L14P2
L14Q1	L14Q1
L14R1	L14R1
LED55B	LED55B
LED55BF	LED55BF
LED55C	LED55C
LED55CF	LED55CF
LED56	LED56
LED56F	LED56F
MCA11G1	H11G1

COMPETITIVE TYPE NUMBER	NEAREST GENERAL ELECTRIC PART NUMBER
MCA11G2	H11G2
MCA8	H21B1
MCA81	H21B2
MCA230	MCA230
MCA231	MCA231
MCA255	MCA255
MCP3009	GE3009
MCP3010	GE3010
MCP3011	GE3011
MCP3020	GE3020
MCP3021	GE3021
MCP3022	GE3022
MCS2	MCS2
MCS21	MCS21
MCS2400	MCS2400
MCS2401	MCS2401
MCT2	MCT2
MCT2E	MCT2E
MCT8	H21A1
MCT26	MCT26
MCT81	H21A2
MCT210	MCT210
MCT271	CNY17I
MCT272	CNY17II
MCT273	CNY17III
MCT274	CNY17IV
MCT275	CNY17III
MCT277	H11A1
MFOD202F	GFOD1A1
MFOD302F	GFOD1B1
MFOE102F	GFOE1A1
MLED71	F5F1
MLED930	LED56
MOC1000	4N26
MOC1001	4N25
MOC1002	4N27
MOC1003	4N28
MOC1005	H11A520
MOC1006	H11A520
MOC119	H11B2
MOC1200	4N30
MOC3000	H11C6
MOC3001	H11C5
MOC3002	H11C3
MOC3003	H11C2
MOC3007	H11C3
MOC3009	GE3009
MOC3010	GE3010
MOC3011	GE3011
MOC3012	GE3012
MOC3020	GE3020

COMPETITIVE TYPE NUMBER	NEAREST GENERAL ELECTRIC PART NUMBER
MOC3021	GE3021
MOC3022	GE3022
MOC3023	GE3023
MOC5003	H11L2
MOC5004	H11L2
MOC5005	H11L2
MOC5006	H11L2
MOC5007	H11L1
MOC5008	H11L3
MOC5009	H11L2
MOC7811	H21A1
MOC7812	H21A2
MOC7813	H21A3
MOC7821	H22A1
MOC7822	H22A2
MOC7823	H22A3
MOC8020	H11G2
MOC8021	H11G2
MOC8030	H11G2
MOC8050	H11G2
MOC8100	H11AG3
MRD300	L14G1
MRD310	L14G2
MRD3050	L14G2
MRD3051	L14G2
MRD3052	L14G2
MRD3053	L14G2
MRD3054	L14G2
MRD3055	L14G2
MRD3056	L14G1
MRD360	L14F1
MRD370	L14F2
MRD701	L14Q1
MRD711	L14R1
MT1	L14C1
MT2	L14G1
OP130	LED56
OP130W	LED56F
OP131	LED55B
OP131W	LED55BF
OP132	LED55C
OP132W	LED55CF
OP133	LED55C
OP133W	LED55CF
OP135	LED55B
OP136	LED55B
OP136W	LED55BF
OP137	LED55C
OP137W	LED55CF
OP140	F5F1
OP140SL	F5F1
OP140SLD	F5F1

<u>COMPETITIVE TYPE NUMBER</u>	<u>NEAREST GENERAL ELECTRIC PART NUMBER</u>
OP230	F5D2
OP230W	F5E2
OP231	F5D2
OP231W	F5E2
OP232	F5D3
OP232W	F5E3
OP233	F5D1
OP233W	F5E1
OP240	F5G1
OP240SLA	F5G1
OP240SLB	F5G1
OP240SLC	F5G1
OP550	L14Q1
OP550SLA	L14Q1
OP550SLB	L14Q1
OP550SLC	L14Q1
OP550SLD	L14Q1
OP560	L14R1
OP800	L14G2
OP800W	L14C2
OP801	L14G2
OP801W	L14C1
OP802	L14C1
OP802W	L14G1
OP803	L14G3
OP804	L14P1
OP805	L14P1
OP811	L14G2
OP811W	L14C1
OP812	L14G1
OP813	L14G3
OP814	L14G3
OP830	L14F1
OP841	L14G2
OP841	L14C2
OP842	L14G1
OP842W	L14N1
OP843	L14G3
OP843W	L14N1
OP844	L14P1
OP844W	L14N1
OP845	L14P1
OP845W	L14N1
OPB120	H21A1
OPB242	H21A1
OPB243	H21B1
OPB800	H21A1
OPB800S	H21A1
OPB8003	H21B1
OPB804	H22A1
OPB806	H21A1
OPB813	H21A1
OPB814	H21A2

<u>COMPETITIVE TYPE NUMBER</u>	<u>NEAREST GENERAL ELECTRIC PART NUMBER</u>
OPB815	H21A2
OPB816	H21A1
OPB817	H21A2
OPI2100	MCT210
OPI2150	H11A4
OPI2151	H11A4
OPI2152	H11A2
OPI2153	H11A1
OPI2154	H11AG3
OPI2155	H11AG3
OPI2250	H11A3
OPI2251	H11A3
OPI2252	H11A3
OPI2253	H11A1
OPI2254	H11AG3
OPI2255	H11AG3
OPI2500	H11AA2
OPI3009	GE3009
OPI3010	GE3010
OPI3011	GE3011
OPI3012	GE3012
OPI3020	GE3020
OPI3021	GE3021
OPI3022	GE3022
OPI3023	GE3023
OPI3150	H11B2
OPI3151	H11B2
OPI3152	H11B3
OPI3153	H11B1
OPI3250	H11B1
OPI3251	H11B1
OPI3252	H11B1
OPI3253	H11B1
OPI4201	H11C1
OPI4202	H11C3
OPI4401	H11C4
OPI4402	H11C6
OPI5000	H11A520
OPI5010	H11A520
OPI6000	H11D1
OPI6100	H11D3
OPI7003	H24A2
OPI7010	H24A1
OPI7320	H24B2
OPI7340	H24B2
OPS690	H23A2
OPS691	H23A2
OPS692	H23A1
OPS693	H23A1
SCS11C1	H11C1
SCS11C3	H11C3
SCS11C4	H11C4

COMPETITIVE TYPE NUMBER	NEAREST GENERAL ELECTRIC PART NUMBER
SCS11C6	H11C6
SD3443-1	L14C1
SD5410-1	L14F1
SD5410-2	L14F1
SD5410-3	L14F1
SD5440-1	L14G2
SD5440-2	L14G2
SD5440-3	L14G2
SD5440-4	L14G1
SD5440-5	L14G1
SD5443-1	L14G2
SD5443-2	L14G3
SD5443-3	L14G3
SE3450-1	LED56F
SE3450-2	LED56F
SE3450-3	LED56F
SE3451-1	LED56F
SE3451-2	LED55BF
SE3451-3	LED55CF
SE3453-1	LED56F
SE3453-2	LED56F
SE3453-3	LED55BF
SE3453-4	LED55CF
SE3455-1	LED55BF
SE3455-2	LED55CF
SE5450-1	LED56
SE5450-2	LED56
SE5451-1	LED56
SE5451-2	LED55B
SE5451-3	LED55B
SE5453-1	LED56
SE5453-2	LED55B
SE5453-3	LED55B
SE5453-4	LED55B
SE5455-1	LED55B
SE5455-2	LED55C
SE5455-3	LED55C
SE5455-4	LED55C
SFH600-1	GFH600I
SFH600-2	GFH600II
SFH600-3	GFH600III
SFH601-1	GFH601I
SFH601-2	GFH601II
SFH601-3	GFH601III
SFH601-4	GFH601IV
SG1009	LED55B
SG1009A	LED55C
SPX2	H11A550
SPX2E	H11A550
SPX4	H11A550
SPX5	H11A550
SPX6	H11A5100

COMPETITIVE TYPE NUMBER	NEAREST GENERAL ELECTRIC PART NUMBER
SPX26	H11A520
SPX28	H11A520
SPX33	H11A520
SPX35	H11A5100
SPX36	H11A5100
SPX37	H11A5100
SPX53	H11A550
SPX103	4N35
SPX1872-1	H22A1
SPX1872-2	H22A1
SPX1872-3	H22B1
SPX1872-4	H22B1
SPX1873-1	H21A1
SPX1873-2	H21A1
SPX1873-3	H21B1
SPX1873-4	H21B1
SPX1876-1	H21A1
SPX1876-2	H21A1
SPX1876-3	H21B1
SPX2762-4	H22A2
SPX7271	CNY17I
SPX7272	CNY17II
SPX7273	CNY17III
SPX7910	H11L1
SPX7911	H11L3
TIL31A	LED55B
TIL31B	LED55B
TIL33A	LED55BF
TIL33B	LED55BF
TIL34A	LED56
TIL34B	LED56
TIL40	F5F1
TIL81	L14G1
TIL99	L14C2
TIL111	H11A4
TIL112	H11A5
TIL113	H11B2
TIL114	H11A3
TIL115	H11A3
TIL116	H11A3
TIL117	H11A1
TIL118	H11A5
TIL119	H11B2
TIL124	H11A520
TIL125	H11A520
TIL126	H11A520
TIL138	H21A1
TIL143	H21A1
TIL144	H21A1
TIL145	H21B1
TIL146	H21B1
TIL147	H22A3

**COMPETITIVE
TYPE NUMBER**

TIL148
TIL153
TIL154
TIL155
TIL156
TIL157
TIL411
TIL412
TIL903-1
TIL903-2

**NEAREST
GENERAL ELECTRIC
PART NUMBER**

H22A1
H11A520
H11A520
H11A550
H11G2
H11G2
L14Q1
L14R1
F5D2
F5D2

**COMPETITIVE
TYPE NUMBER**

TIL904-1
TIL904-2
XC88FA
XC88FB
XC88FC
XC88FD
XC88PA
XC88PB
XC88PC
XC88PD

**NEAREST
GENERAL ELECTRIC
PART NUMBER**

F5E2
F5E2
F5E2
F5E2
F5E3
F5E1
F5D2
F5D2
F5D3
F5D3
F5D1

index

A	
Absorption Coefficient, Light in Silicon	15
Accelerated Testing	77, 78
Acceleration Factors	77, 86, 88, 90, 157
AC Motor	111, 114
AC Relays	131, 139
AC Switch	55, 59, 61
AGC	120
Alignment	71, 121
Ambient Light	35, 37, 98, 106, 109, 112
Amplifier	51, 59, 63, 74, 115, 118, 120
Analog	58, 116, 129
Analog Information	116-121
Anode Supply Triggering	141
Answering Equipment	118
Antiparallel	47, 135, 139, 153
Antireflective Coating	76
Aperture	36, 37, 97
AQL	81
Area, Light Sensitive	30, 37
Attenuation	33, 69-73, 120
Avalanche Photodiode	16, 74
B	
Backlighting	37
Bandgap Energy	13-16
Base Resistor	20, 54, 55
Battery Operation	107, 108, 115, 148, 151
Battery Saver	148
Bias	13-21, 49, 52, 53, 55, 57-61, 64, 66, 75, 88-95, 98, 102
Bilateral Analog FET	51, 58, 102
Breakdown Protection	46, 61-63
Brightness Control	109, 110
Buffer	66, 122-124, 129, 132
Burn In	94
C	
Cabling	68
Capacitance	15, 17, 26, 43, 49, 52, 56-61, 64, 98, 100
Capacitor Discharge	49, 56, 58
Cascade Bias	38, 112
Channeling	47, 79
Chatter	133, 139
Checklist, Source/Detector	33
Click Suppression	124
CMOS	66, 123, 132
Coefficient of Expansion	76, 81
Coil	131, 148, 151
Communication Lines	43, 128
Communications	116, 124
Commutation	58, 61, 62, 129
Competitive	44, 46, 52, 81, 87, 90-95
Compression Amplifier	59, 120
Construction	22-26, 44, 62
Contacts	102, 133, 134
Conversion Efficiency	30
Cost	16, 23, 37, 38, 61, 71, 72, 75, 90, 93
Coupled dv/dt	56
Coupled Thermal Resistance	79
Coupling Efficiency	43
Critical Angle	69
CTR	25, 51, 53, 79, 81, 82, 101
Current Gain	33
Current Transfer Ratio	25
Curve Tracer	101
D	
Dark Current	18
Darlington	20, 79, 162

DC Linear Coupler	72
DC Motor	113, 148
DC Relay	146, 147
Defect Level	75
Degradation	83-87, 91-94
Degradation Slope	84, 86
Design Life	87, 89
Detectors	22, 36, 59, 61, 63, 69, 73, 74
Detectors, Light	15-22, 61-64
Dial Tap	124
Dielectric	25-27, 44-47
Dielectric Breakdown	46
Dielectric Stress	47
Diesel	151
Diffraction	37
Digital Information	121
Digital Line Receiver	128
Diode Laser	14
DIP	25, 26, 43, 44, 80, 81
Display Illumination	110
Drop Detector	112
Dual In-Line Package	25, 26, 43, 44
dv/dt	57, 61, 62, 102, 138, 150
Dynamic Response	52, 57, 136, 138
E	
Effective Irradiance	29, 31
Effectiveness	29, 33
Efficiency of IRED	32, 54
Electromechanical Relay	131
Electrostatic Shielding	43, 100
Emergency Light	108
EMI/REI Immunity	67, 131, 136, 153
Emitters	22, 29, 72, 77, 82
Epoxy Pellet Mount	92, 93
Expanded Base	22
Eye Hazard	104
F	
Fail Safe	103, 115
Failure Age	80
Failure Mode	46, 90-94
Failure Rate	75-81, 88-93
Fiber Bundles	72
Fiber End Polish	72
Fiber Optics	23, 33, 67-74, 116, 119, 136, 149
Fiber Optic Connectors	71
Fiber Optic Sensing	41, 42
Filters	99
Fixture	97
Flame Monitor	109
Flasher	108
Fluorescent Lamp	31
Forward Voltage	47
f/#	33
Frequency of LED Emission	13, 14
F5E	71, 73
G	
GaAlAs	14, 29, 32, 47, 50, 71
GaAs, GaAs (Si)	13, 16, 29, 31, 50, 72, 83, 86, 104
Gain — Photodarlington	19, 32, 33
Gain — Phototransistor	18, 32, 33
Gallium Arsenide	13, 104
Gate Bias	57
GE-MOV® II	46, 62
GFOD, E	23, 56, 72, 74, 78
Glass Dielectric	25, 28, 43, 44, 79
Glow Plug	151
Graded Index Core	68
Grey Code	38

index

H

H11A10 42, 127, 128
H11AA 47, 125, 127, 133
H11AG 48, 53
H11AV 28, 43, 100
H11BX522 125
H11C 56, 101, 134-146
H11G 55
H11L 48, 63, 102, 122, 126, 128, 151
H74A 122, 123
H74C 56, 122
Half Duplex Link 73, 119
Headlight Dimmer 105
Heater 153
Hermetic Package 24
 h_{FE} 16-18, 52, 93
High Frequency 116
High Voltage Switching 141-144, 147
High Voltage Trigger Values 143
HTRB 47, 79, 91, 93, 95
Humidity Life 76-78, 81, 88, 89, 91, 92
Hunting 113
Hysteresis 63, 133

I

I_{CEO} 18, 37, 53, 54, 98
 I_{FM} 82-87
 I_{FS} 82-87
 I_{FT} 56, 101
 I_H 56
IC Logic Bias 66
Indicator Lamp 128
Input Capacitance 49
Input Characteristics 47-49
Input Current 53, 54, 58
Integral Cycle Contact 136, 137
Integrated Circuits 61, 63, 66, 74, 120, 122
Interconnect 124
Interrupter 24, 42, 70, 78, 111
Inversion Layer 77
Inverter 149, 152
IRED 13, 14, 31-35, 38, 42, 44, 47-49, 51, 53-55
Irradiance 58, 61, 66, 72, 76-78, 82-88, 92-97, 120, 123
Isolation 25, 26, 32, 24, 69, 97
Isolation Capacitance 26, 43-47, 119, 120
Isolation Resistance 28, 43
Isolation Voltage 43
Isolation Voltage — Specification 25-29, 43-47
— Steady-State 45
— Surge 45
— Very High 45
Isolator 22
25-27, 128

J

Junction 13-19
Junction Temperature 56, 58, 75, 88-90

K

Key System 124

L

L14C 30, 105
L14G 55, 108-111, 115, 120
Lamps 29-31, 34, 98, 106
LASCR 23, 29
Laser 13, 14, 20, 72, 117
Latching Relay 139, 146, 147
Lead Bond Wire 17, 22, 46, 77, 92-94
Leakage Current 19, 34, 55, 59, 76, 93
LED 13, 14, 72
LED Wavelength 13, 14

Lens 22, 23, 72, 78, 108
Lenses 31, 35-37
Light 13, 15, 29, 31, 105-110
Light Detector 15-21, 30, 105-110
Light Output 13, 14, 31, 34
Linear Coupler 120, 121
Linearity 58, 59, 120, 121
Line Current Detector 125-127
Line Status 126
Liquid Epitaxial 13, 49, 72, 82, 117
Load Resistor 52, 55, 59, 60, 94, 98, 152
Logic Circuits 66, 122, 124, 131, 138, 140
Low Light Level 17, 105, 112
LSI 122, 123
LTPD 75

M

Machine Tool 43
Masking 36
Measurement 45, 46, 97-102
Mechanical 77, 83, 91-93
Miller Effect 51, 60
Model 83-90, 151
Modulation 72, 117, 120, 150
Moire Fringé 39
Monochromator 98
Motor Controls 111, 113-115, 137, 148, 149
MSI 122, 123
Multiplex Switch 129

N

N.C. Contacts 134, 137, 139, 147
Neon Lamp 13, 31, 108
Night Light 106-108
NMOS 66-124
N.O. Contacts 133-136, 138, 139, 147
Noise 34, 37, 120, 128, 136
Normalized Response 52-55, 57, 59
NRZ Data Rate 65, 122
Numerical Aperture 69

O

Object Detector 112-115
Offset Voltage 56, 58, 60, 129
Operating Life 76-80, 88, 91-95
Operational Amplifier 60, 120
Optical Cavity 16
Optical Measurements 30, 73, 97-99, 119
Optocoupler 25-27, 43-66
Optoisolator 25-27, 43-66
Output Characteristics 15, 21, 87, 49-66
Output Current 30, 53, 54, 59, 73

P

Packaging 22-26, 43, 44, 76, 77, 92
Paper Discriminator 112
Paper Tape Reader 112, 113
Peak Spectral Response 15, 29
Phase Control 109, 110, 114
Phone 124
Photocell 15, 97, 98
Photocurrent 17
Photodarlington 19, 53-56, 77, 80
Photodiode 15, 16, 29, 30, 34
Photographic Flash 105
PhotoSCR 20, 21, 56-58, 152
Photosensitivity 17, 34
Phototransistor 16-18, 51-53, 77
PIN Diode 74
PMOS 66, 124
PNP Action 51, 152
 P_o 32, 83-85, 117

index

Point Source	36, 98
Positioning	38-42, 97, 98
Power Dissipation	32, 55, 79, 88, 92, 117
PRM	117, 121, 153
Programmable Unijunction	58, 106, 110, 114-117
Proportional Control	120, 149
Pulsating DC	149-153
Pulse Width Modulation	34, 146
Pulsed Mode	149
Pulsed Operation	30, 32, 34, 87, 149
	68, 86, 87, 116, 149
Q	
Quality	75
R	
Radiant Intensity	97
Reflections	25, 37, 111
Reflector	23-26, 35, 42
Relay	131-148
Reliability	46, 60-62, 75-95, 103, 131
Reliability Enhancement	90
Reliability Prediction	76, 88, 89
Resolution	24, 36, 39
Response Time	15, 38, 49, 52, 64
Rework Rate	77
RFI	64, 67, 111, 131, 136, 153
R _{GK}	56, 57
Ring Detector	124, 125
Ring Extender	125
Rise Time	49, 65, 101, 129
Rotary Encoder	38
S	
Safety	103
Salt Atmosphere	78
Saturation Characteristics	56, 60
Scanning	41
Schmitt Trigger	48, 63, 111, 131
SCR	20, 51, 56, 80, 91, 133-135
	138, 141-145, 149, 152
Self Heating	59, 81, 104
Sensitivity	15-21, 33, 34, 37, 56
Signal to Noise Ratio	37, 116
Silicon	15, 30, 74
Slope	84-86
Snubber	43, 57, 61, 135, 138
Solid State Relay	131-147
Sources, Light	13, 29, 31
Spacial Distribution of Sources	29-37
Specification Selector	8-12
Spectral Effects	29, 31, 34, 70, 98
Speed	17, 34, 38, 60, 63, 72, 117
Steady-state Voltage	29-31
Step Index Core	68
Storage Life	76-81, 90, 92, 93, 95
Stored Charge	65, 117
Stress	76, 79, 83, 88-90
Sun	108
Surge Currents	107, 135, 137
Surge Voltage	45-47
Switching Speed	52, 101
— Bilateral Analog FET	60

— IRED	49, 117
— Photodarlington	56
— Phototransistor	17, 53
— Schmitt Trigger	65
Symmetrical Transistor	21, 51
Synchronous Rectification	38, 68
T	
t	83, 86, 91, 101
Tachometer	111, 114
Telecommunications	124
Temperature Acceleration	38, 84-86
Temperature Coefficient	37, 52, 54, 57, 63
Temperature Controller	153
Temperature Cycle	76-79, 81, 86, 88, 89, 91, 94
Thermal Fatigue	76
Thermal Resistance	58, 79
Thermopile	98
Three-phase Circuits	130, 144
Threshold Operation	48, 66, 125-128, 130
Time Delay	48, 107, 124-126
Toxic Hazard	104
Transceiver	34, 119
Transfer Characteristics	47-66, 101
Transimpedance	120
Translucence	112
Transmission	70-116
Transmissivity	33, 68
Transmitter	116-120
Triac	61, 107, 110, 114, 126, 135-139
Triac Driver	21, 61, 102, 138, 140
Triac Selector	107, 137
Triggering	56, 62, 101, 133, 138, 141
TTL	66, 122-124, 131
Tungsten Lamp	13, 29-31, 106, 137
Turn-off Time	57, 60, 65, 101
Turn-on Time	60, 65, 101
Two Transistor Model	22
U	
UCL	77-81
UL	103
Unijunction Transistor	38, 51, 58
V	
V _{BE}	18, 55, 106
VDE	26, 108
Virtual Initial	84
Voltage Capability	44
Voltage Gain	17, 51, 120
Voltage Waveform	64, 101
VOX	120
W	
Waveform	44, 64, 101
Welding	149
X	
Xenon Flash	31, 38, 105
Z	
Zener Diode	143-144
Zero Voltage Switching	57, 58, 130-137, 153

NOTES

NOTES



SEMICONDUCTORS
Optoelectronics • GE MOV II Varistors • Signal Transistors • Unijunctions
Rectifiers • SCRs • Tracs • Power Modules • Power Transistors • MOSFETs

**GENERAL ELECTRIC WORLDWIDE
ELECTRONIC COMPONENTS
SALES REPRESENTATIVES**

DOMESTIC

ALABAMA

CSR Electronics, Huntsville
(205) 533-2444

ARIZONA

Shefler-Kahn, Phoenix
(602) 257-9015

CALIFORNIA

Addem, San Diego
(619) 729-9216
Interstate Marketing, Woodland Hills
(213) 883-7606
Elrepc, Los Altos
(415) 962-0660

COLORADO

Thorson Rocky Mountain, Englewood
(303) 779-0666

CONNECTICUT

Advanced Component Sales, Meriden
(203) 238-6891

DISTRICT OF COLUMBIA

Robert Electronic Sales
(301) 982-1177

FLORIDA

EIR, Fern Park
(305) 830-9600
EIR, N. Lauderdale
(305) 975-8712

GEORGIA

CSR Electronics, Atlanta
(404) 396-3720

ILLINOIS

D. Dolin Sales, Chicago
(312) 286-6200

INDIANA

Giesting & Assoc., Fort Wayne
(219) 468-1912
Giesting & Assoc., Indianapolis
(313) 263-0005

IOWA

J.R. Sales, Cedar Rapids
(319) 393-2232

KANSAS

KEBCO, Kansas City
(913) 541-8431

MARYLAND

Robert Electronic Sales
(301) 995-1900

MASSACHUSETTS

Advanced Technology Sales, Burlington
(617) 272-0100

MICHIGAN

Giesting & Assoc., Novi
(313) 348-3811

Giesting & Assoc., Coloma
(616) 468-4200

MINNESOTA

PSI, Minneapolis
(612) 944-8545

MISSOURI

KEBCO, St. Louis
(314) 576-4111

NEW JERSEY

COMTEK, Mt. Laurel
(609) 235-8505

NEW MEXICO

Shefler-Kahn, Albuquerque
(505) 296-0749

NEW YORK

Ossmann Component Sales, Rochester
(716) 424-4460

Ossmann Component Sales, Syracuse
(315) 455-6611

S-J Assoc., Jamaica
(212) 291-3232

NORTH CAROLINA

CSR Electronics, Raleigh
(919) 878-9200

OHIO

Giesting & Assoc., Cincinnati
(513) 521-8800

Giesting & Assoc., Dayton
(513) 293-4044

Giesting & Assoc., Mentor
(216) 942-3407

OKLAHOMA

Bonser-Philhower Sales, Tulsa
(918) 496-3236

OREGON

LD Electronics, Beaverton
(503) 649-8556

PENNSYLVANIA

Giesting & Assoc., Pittsburgh
(412) 963-0727

TEXAS

Bonser-Philhower Sales, Richardson
(214) 234-8438

Bonser-Philhower Sales, Austin
(512) 458-3569

Bonser-Philhower Sales, Houston
(713) 495-3115

UTAH

Thorson Rocky Mountain, West Valley City
(801) 973-7969

WASHINGTON

LD Electronics, Snohomish
(206) 568-0511

LD Electronics, Spokane
(509) 922-4883

WISCONSIN

D. Dolin Sales, Milwaukee
(414) 482-1111

**SEMICONDUCTORS**Optoelectronics • GE MOV II Varistors • Signal Transistors • Unijunctions
Rectifiers • SCRs • Triacs • Power Modules • Power Transistors • MOSFETs**GENERAL ELECTRIC WORLDWIDE
ELECTRONIC COMPONENTS
SALES REPRESENTATIVES****INTERNATIONAL****ARGENTINA**

General Electric Argentina S.A.
Santo Domingo 3220
Buenos Aires, Argentina
Tel: (541) 28 1472

AUSTRALIA

Australian General Electric
Cnr. Lane Cove & Epping Rds.
North Ryde, P.O. Box 174
Willoughby NSW 2068, Australia
Tel: 02 888 8111

BELGIUM

General Electric Company
(USA)
Chaussee de la Hulpe 150
B-1170 Brussels
Tel: 660-20-10

BRAZIL

Applicacoes Electronicas .A.
Artimar Ltd.
Caixa Postal 5881
Sao Paulo
Tel: 231-0277

CANADA

Gidden-Morton Assoc., Inc.
7528 Bath Road
Mississauga, Ontario L4T 1L2
Tel: (416) 671-8111

CHILE

Electromat S.A. Fabrica
De Materiales Electricos
Casilla 2103
Santiago, Chile
(562) 53031

EGYPT

General Electric Int'l Opers.
1085 Corniche El Nil
Garden City
Cairo, Egvpt

UNITED KINGDOM

General Electric-Intersil
Balgrave House
Basing View
Basingstoke, Hampshire RG21 2YS
Tel: 256-57361

FRANCE

General Electric Company
6/8 Rue Du 4 Septembre
92130 Issy-Les-Moulineaux
Tel: 554-97-36

GERMANY

General Electric Germany
Postfach 2963
Praunheimer Landstrasse 50
6000 Frankfurt/Main,
Germany
Tel: 760-7333

GREECE

General Electric Trading Co.
P.O. Box 11549
Jumeirah
Dubai, U.A.E.
Tel: 237816

HONG KONG

General Electric Technical
Services Company, Inc., U.S.A.
3410 Connaught Centre
Hong Kong
Tel: 5-210-371

INDIA

IGE (India) Ltd.
Nirmal, 17th Floor
Nariman Point, Bombay 400 021
Tel: 233075

IGE (India) Ltd.

Archana Office Complex
Greater Kailashi 1
New Delhi 11048
Tel: 645230

INDONESIA

General Electric Company
18th Floor, Wisma, Kosgoro
J L M H
Thamrin No. 53
Jakarta, Indonesia
Tel: 321669

ITALY

CGE-General Electric
Electronic Components Operation
Via Carducci 17
20123 Milano Italy
Tel: 2/807186

JAPAN

General Electric Japan Ltd.
Kowa No. 35 Bldg., 4th Floor
1-14-14 Akasaka, Minato-Ku
Tokyo 107, Japan
Tel: 03-588-5171

KOREA

General Electric (USA)
Korea Co.
10th Fl, Hanmi Bldg.
1 Kongpyung-Dong,
Chongro-Ku
Seoul, Korea 110
CPO Box 871
Tel: 725-8651/6

MALAYSIA

General Electric Technical
Services Company, Inc.
Room 223, Kompleks
Antarabangsa
Jalan Sultan, Ismail
Kuala Lumpur, Malaysia
Tel: 03-482791

MEXICO

Provedora Electronica S.A.
Apdo. Postal 21-139
Mexico 21, D.F.
Tel: 5-54-8300

Raytel S.A.

Sullivan No. 47 Y 49
Mexico 4, D.F.
Tel: 5-46-0663

PHILIPPINES

General Electric
Philippines, Inc.
2291 Pasong Tamo Ext.
Makati Metro Manila
Philippines
Tel: 89-10-01

SINGAPORE

General Electric (USA)
Asia Co.
Suites 1303-1311 Tong Eng
Building
101 Cecil Street
Singapore 0106
Tel: 2216155

SPAIN

GETSCO Division
Internacional
Juan Bravo No. 3C
Madrid 6
Tel: 276-7062

TAIWAN

General Electric Technical
Services Company, Inc.
7th Floor
201, Tun-Hua North Road
Formosa Plastics Bldg.
Taipei, Taiwan
Tel: 713-1065

VENEZUELA

General Electric De
Venezuela S.A.
Sabana Grande
Caracas



Power Electronics Semiconductor Department
Auburn, New York 13021

