

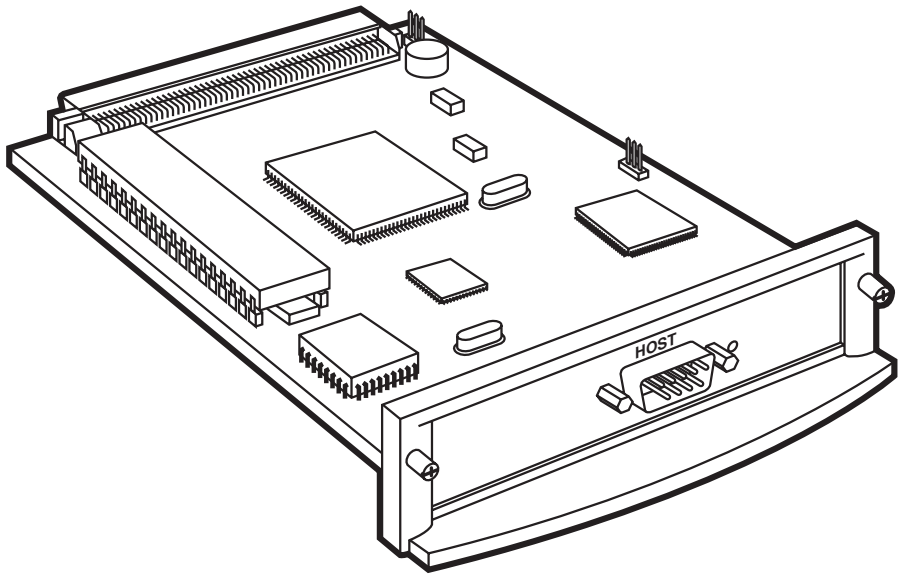

Laser Card for HP 4000 Twinax Printers

Laser Card for HP 4000 Coax Printers



CUSTOMER
SUPPORT
INFORMATION

Order toll-free in the U.S.: Call 877-877-BBOX (outside U.S. call 724-746-5500)
FREE technical support 24 hours a day, 7 days a week: Call 724-746-5500 or fax 724-746-0746
Mailing address: Black Box Corporation, 1000 Park Drive, Lawrence, PA 15055-1018
Web site: www.blackbox.com • E-mail: info@blackbox.com

**FEDERAL COMMUNICATIONS COMMISSION
AND
CANADIAN DEPARTMENT OF COMMUNICATIONS
RADIO FREQUENCY INTERFERENCE STATEMENTS**

This equipment generates, uses, and can radiate radio frequency energy and if not installed and used properly, that is, in strict accordance with the manufacturer's instructions, may cause interference to radio communication. It has been tested and found to comply with the limits for a Class A computing device in accordance with the specifications in Subpart B of Part 15 of FCC rules, which are designed to provide reasonable protection against such interference when the equipment is operated in a commercial environment. Operation of this equipment in a residential area is likely to cause interference, in which case the user at his own expense will be required to take whatever measures may be necessary to correct the interference.

Changes or modifications not expressly approved by the party responsible for compliance could void the user's authority to operate the equipment.

This digital apparatus does not exceed the Class A limits for radio noise emission from digital apparatus set out in the Radio Interference Regulation of the Canadian Department of Communications.

Le présent appareil numérique n'émet pas de bruits radioélectriques dépassant les limites applicables aux appareils numériques de la classe A prescrites dans le Règlement sur le brouillage radioélectrique publié par le ministère des Communications du Canada.

**NORMAS OFICIALES MEXICANAS (NOM)
ELECTRICAL SAFETY STATEMENT**

INSTRUCCIONES DE SEGURIDAD

1. Todas las instrucciones de seguridad y operación deberán ser leídas antes de que el aparato eléctrico sea operado.
2. Las instrucciones de seguridad y operación deberán ser guardadas para referencia futura.
3. Todas las advertencias en el aparato eléctrico y en sus instrucciones de operación deben ser respetadas.
4. Todas las instrucciones de operación y uso deben ser seguidas.
5. El aparato eléctrico no deberá ser usado cerca del agua—por ejemplo, cerca de la tina de baño, lavabo, sótano mojado o cerca de una alberca, etc..
6. El aparato eléctrico debe ser usado únicamente con carritos o pedestales que sean recomendados por el fabricante.
7. El aparato eléctrico debe ser montado a la pared o al techo sólo como sea recomendado por el fabricante.
8. Servicio—El usuario no debe intentar dar servicio al equipo eléctrico más allá a lo descrito en las instrucciones de operación. Todo otro servicio deberá ser referido a personal de servicio calificado.
9. El aparato eléctrico debe ser situado de tal manera que su posición no interfiera su uso. La colocación del aparato eléctrico sobre una cama, sofá, alfombra o superficie similar puede bloquea la ventilación, no se debe colocar en libreros o gabinetes que impidan el flujo de aire por los orificios de ventilación.
10. El equipo eléctrico deber ser situado fuera del alcance de fuentes de calor como radiadores, registros de calor, estufas u otros aparatos (incluyendo amplificadores) que producen calor.
11. El aparato eléctrico deberá ser conectado a una fuente de poder sólo del tipo descrito en el instructivo de operación, o como se indique en el aparato.

12. Precaución debe ser tomada de tal manera que la tierra física y la polarización del equipo no sea eliminada.
13. Los cables de la fuente de poder deben ser guiados de tal manera que no sean pisados ni pellizcados por objetos colocados sobre o contra ellos, poniendo particular atención a los contactos y receptáculos donde salen del aparato.
14. El equipo eléctrico debe ser limpiado únicamente de acuerdo a las recomendaciones del fabricante.
15. En caso de existir, una antena externa deberá ser localizada lejos de las líneas de energía.
16. El cable de corriente deberá ser desconectado del cuando el equipo no sea usado por un largo periodo de tiempo.
17. Cuidado debe ser tomado de tal manera que objetos líquidos no sean derramados sobre la cubierta u orificios de ventilación.
18. Servicio por personal calificado deberá ser provisto cuando:
 - A: El cable de poder o el contacto ha sido dañado; u
 - B: Objetos han caído o líquido ha sido derramado dentro del aparato; o
 - C: El aparato ha sido expuesto a la lluvia; o
 - D: El aparato parece no operar normalmente o muestra un cambio en su desempeño; o
 - E: El aparato ha sido tirado o su cubierta ha sido dañada.

TRADEMARKS

I-O[®] is a registered trademark and LaserCard[™], Duax[™], and Command Pass-Thru[™] are trademarks of I-O Corporation.

IBM[®] is a registered trademark of International Business Machines, Inc.

Centronics is a trademark of Centronics Computer Corporation.

HP, LaserJet, and Hewlett-Packard[®] are trademarks and registered trademarks of Hewlett-Packard .

PostScript[®] is a registered trademark of Adobe Systems Incorporated.

WordPerfect[®] is a registered trademark of WordPerfect Corporation.

Microsoft[®] is a registered trademark of Microsoft Corporation.

ny other trademarks mentioned in this manual are acknowledged to be the property of the trademark owners.

Contents

Chapter	Page
1. Specifications	8
2. Introduction	9
2.1 General	9
2.2 What the Package Includes	9
2.3 About This Manual	10
2.4 Static Caution	11
3. Quick-Start Guide	12
3.1 General	12
3.2 Installation	12
3.2.1 Print Coax Self-Test	13
3.2.2 Set Twinax Address	16
3.2.3 Print Twinax Self-Test	18
3.2.4 Coax and Twinax	19
4. Installation	21
4.1 Interface Self-Test	21
4.2 Connecting to the Host	29
4.3 Front-Panel Setup	29
4.4 Front-Panel Menus	30
5. Configuration—Twinax	32
5.1 Twinax Configuration	32
5.2 Twinax Host Download Commands	32
5.3 Host Download Command Overview	34
5.4 Configuration Options	35
5.5 Restoring the Factory Defaults	45
6. Operation—Twinax	47
6.1 Printer Sharing	47
6.2 Host Port Initialization	48
6.3 Host Printing	48
6.4 Font Change Commands	48
6.5 Formatting the Page	49
6.6 Paper Size	49
6.7 Printing on 11" x 17" and A3 Size Paper	50
6.8 Paper Input Bin Selections	51
6.9 Paper Output Bin Selection	52

Contents (continued)

Chapter	Page
6.10 Print Orientation	53
6.11 Changing Page-Rotation Settings	59
6.12 Envelope Printing	60
6.13 Document/Envelope Printing	60
6.14 Duplex Printing	62
6.15 Other Printer Commands	63
7. Advanced Features—Twinax	65
7.1 Command Pass-Thru™	65
7.2 User-Defined Strings	66
7.3 User-Defined Fonts	67
7.4 Color Printing	68
7.5 Printing Bar Codes	68
8. Troubleshooting—Twinax	69
8.1 Buffer Print (EBCDIC Hex)	69
8.2 ASCII Hex Dump	70
8.3 Self-Diagnostics	71
8.4 Problem- Resolution Guide	72
9. Configuration—Coax	78
9.1 Host Download Command Overview	79
9.2 Configuration Options	82
10. Operation—Coax	107
10.1 Printer Sharing	107
10.2 Coax Host Printing	108
10.3 Selecting Fonts	108
10.4 Computer Output Reduction (COR)	108
10.5 Automatic Print Orientation (APO)	109
10.6 Print Position and Page Length	111
11. Advanced Features—Coax	112
11.1 Command Pass-Thru™	112
11.2 Custom User Strings	113
11.3 SCS Mode Transparent Data	113

Contents

Chapter	Page
11.4 Other Printer Commands	114
11.5 Color Printing	114
11.6 Printing Bar Codes	114
12. Troubleshooting—Coax	115
12.1 Buffer Print (EBCDIC Hex)	115
12.2 ASCII Hex Dump	116
12.3 Problem-Resolution Guide	117
Appendix A: Font (FGID) Reference	120
Appendix B: Character Sets	130
Appendix C: Color Printing	133
Appendix D: Resident Scalable Font Numbers	134
Appendix E: Printing Bar Codes	136
Index	149

1. Specifications

System Requirements—PC124C: IBM AS/400 or System/3X Host, or 5X94 Controller; PC125C: IBM 30XX, 43XX, or 937X Host or 3174, 3274, and 3276 Controllers

Emulation—PC124C: IBM 3812-1 Printer Emulation; PC125C: IBM 3287, 3262, 3268, 3812-1, 4214, or 4224 (all non-IPDS) Printer Emulations

Number of Languages Supported—PC124C: 16; PC125C: 17

Interface—PC124C: Twinax; PC125C: Coax

Temperature—40 to 110°F (5 to 42°C)

Humidity—20 to 85%, noncondensing

Connectors—(1) DB9 male for connection to supplied coax or twinax interface cable

Power—Supplied by the printer

Size—0.8"H x 4.8"W x 6"D (2 x 12.2 x 15.2 cm)

Weight—0.3 lb. (0.1 kg)

2. Introduction

2.1 General

The Laser Card is an interface for internal installation in Hewlett-Packard printers with the new PCI-based EIO slot. Two models are available:

- Laser Card for HP 4000 Twinax (part number PC124C)
- Laser Card for HP 4000 Coax (part number PC125C)

With the Laser Card for HP 4000 Twinax installed, your printer will emulate an IBM 3812-1 (non-IPDS) printer when attached to an IBM AS/400, System/34, System/36, or System/38 host processor, or a 3287/3812-1 (non-IPDS) printer when attached to a 5X94 controller. With the Laser Card for HP Coax installed, your printer will emulate an IBM 3287, 3262, 3268, 3812-1, 4212, or 4224 (non-IPDS) printer when attached to an IBM 30XX, 43XX, or 937X host or 3174, 3274, or 3276 controller.

Printer auto-sharing in the HP LaserJet printer is accomplished using the printer's additional option slots or integrated parallel or serial ports. The HP printer will handle data from the parallel/serial ports as well as the internal option ports. This allows you to attach your printer to a personal computer (PC) or LAN, as well as the IBM host and automatically change between host and PC/LAN printing without changing cables or switches.

You can choose setup options to control the printer's output by using the printer's LCD display or making selections using host-download commands.

2.2 What the Package Includes

The following items are included in the package:

- Laser Card for HP 4000 Twinax (PC124C) or Laser Card for HP 4000 Coax (PC125C)
- Auto-terminating twinax V-cable (included with the PC124C) or 9-pin to coax adapter cable (included with the PC125C)
- Screwdriver
- This user manual

Inspect each item for shipping damage. If anything is missing or damaged, please contact Black Box immediately at 724-746-5500.

2.3 About This Manual

The following five sections contained in this user's guide will give you the information you need to get the most from your Laser Card.

- Chapter 1, Specifications.
- Chapter 2, Introduction, provides an overview of the Laser Card, including printer emulations, supported Hewlett-Packard printers, and the adapter cables required for either twinax or coax connectivity
- Chapter 3, Quick-Start Guide, gets your Laser Card up and running fast.
- Chapter 4, Installation, explains how to install the Laser Card in the HP 4000 LaserJet printer, perform a self-test, and how to connect to the twinax or coax host.
- Chapters 5 and 9, Configuration, explain the use of the printer's front-panel setup and twinax and coax configuration. Twinax configuration instructions begin on page 32; coax configuration instructions begin on page 78 of this manual.
- Chapters 6 and 10, Operation, provide a detailed overview of coax and twinax host printing, emulations, font change commands, user-defined command strings, and Command Pass-Thru™. Twinax operation instructions begin on page 47; coax operation instructions begin on page 107 of this manual.
- Chapters 7 and 11, Advanced Features, detail the advanced features of the Twinax and Coax models. Twinax instructions begin on page 65, while coax information starts on page 112.
- Chapters 8 and 12, Troubleshooting, provide a detailed troubleshooting guide. Twinax problem resolution instructions begin on page 69; coax problem resolution instructions begin on page 115 of this manual.
- Appendix A is a font reference.
- Appendix B lists twinax and coax character sets.
- Appendix C describes color printing for twinax and coax.
- Appendix D lists resident scalable font numbers for twinax.
- Appendix E describes printing bar codes for twinax and coax.

2.4 Static Caution

CAUTION

The Laser Card is static-sensitive, and can be damaged with static electricity. Take ESD (electrostatic discharge) precautions as you would with any static-sensitive device. These precautions include:

1. Be aware that some work surroundings, such as carpet, floor mats, dry air from winter heating, etc., can cause static buildup.
2. If available, wear a wrist strap or similar static-discharge device during installation. If not wearing a wrist strap, touch a grounded surface (such as an exposed twinax connector on a cable attached to the host) before handling the card.
3. Where available, stand on an anti-static mat or use an anti-static work surface when installing the card.
4. Do not touch components on the card. Handle the card by the edges only.

3. Quick-Start Guide

3.1 General

Follow these simple steps to have your Laser Card up and running in minutes.

Before you begin, locate these parts:

- Laser Card
- Twinax or Coax Adapter Cable
- Reversible-Blade Screwdriver

CAUTION

The Laser Card is static-sensitive. Make sure you do not damage the interface with static electricity. Where available, touch something metal first and stand on an anti-static work surface when installing the Card.

After you have successfully completed a printer self-test (check your printer's User's Guide), power OFF the printer, remove all cables, and then proceed with the following installation instructions.

3.2 Installation

1. To install the Laser Card:
 - a. Locate an available EIO slot. Using the screwdriver, remove the bracket covering it.
 - b. Insert the Laser Card and tighten the thumb screws.
 - c. Attach the twinax or coax adapter cable. Do NOT attach the host cable(s) to the adapter yet.
 - d. Re-attach the power cord and other printer cables.
 - e. Power ON the printer.
- f. For coax configuration, go to **Section 3.2.1**. For twinax configuration, go to **Section 3.2.2**.

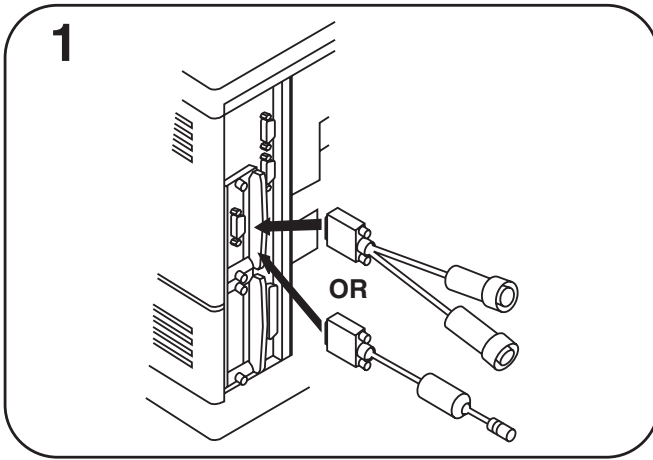

Figure 3-1. Installing the Card, Step 1.

3.2.1 PRINT COAX SELF-TEST

- 2. After the printer is ready, press Menu + until COAX CARD is displayed.

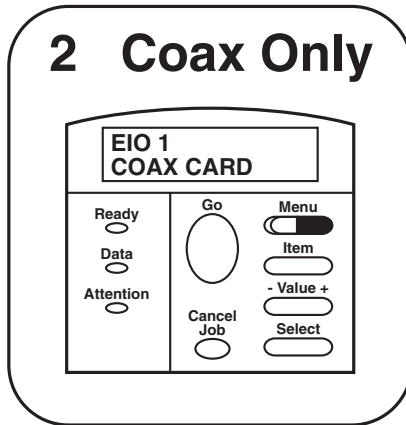

Figure 3-2. Coax Only, Step 2.

3. Press Item -.

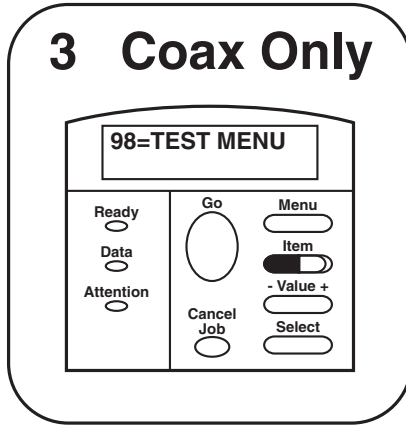

Figure 3-3. Coax Only, Step 3.

4. Press Value +.

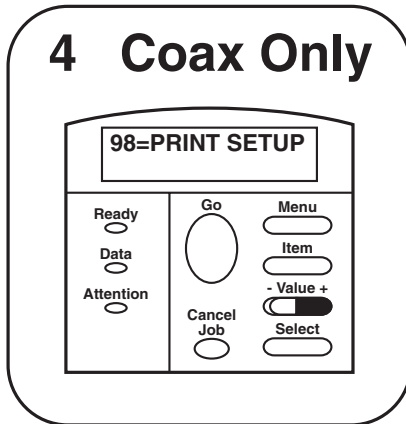

Figure 3-4. Coax Only, Step 4.

5. Press Select and then Go to print the interface self-test.

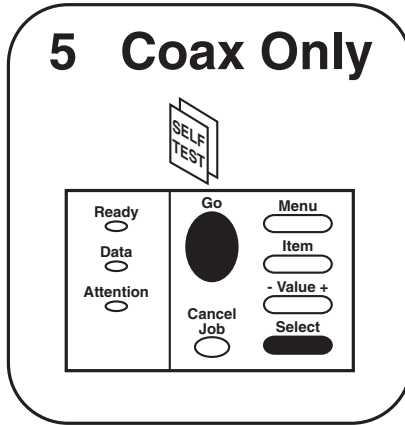

Figure 3-5. Coax Only, Step 5.

6. To complete the coax setup, proceed directly to Step 10. in Section 3.2.4.

3.2.2 SET TWINAX ADDRESS

2. After the printer is ready, press Menu+ until TWINAX CARD is displayed.

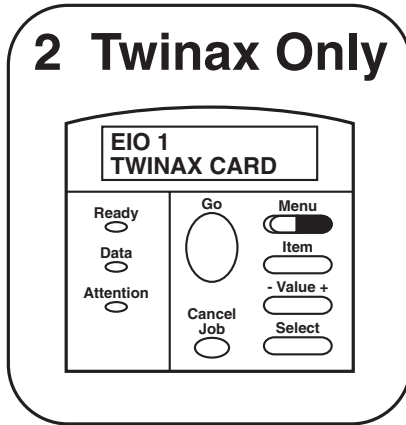

Figure 3-6. Twinax Only, Step 2.

3. Press Item +.

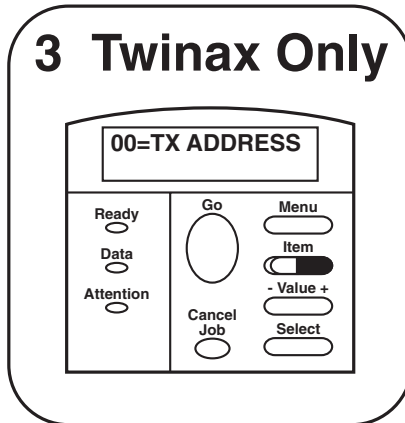

Figure 3-7. Twinax Only, Step 3.

4. Press Value ± to display the desired twinax address.

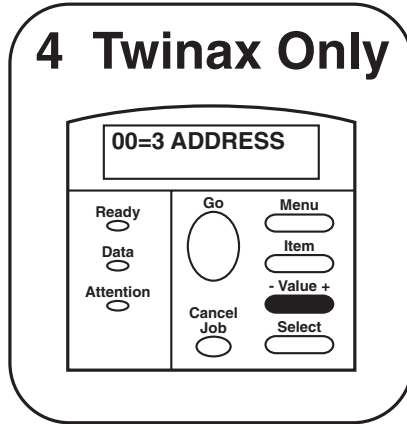

Figure 3-8. Twinax Only, Step 4.

5. Press Select and then Go to select the displayed twinax address.



Figure 3-9. Twinax Only, Step 5.

3.2.3 PRINT TWINAX SELF-TEST

6. After the printer is ready, press Menu+ until TWINAX CARD is displayed.



Figure 3-10. Twinax Only, Step 6.

7. Press Item -.

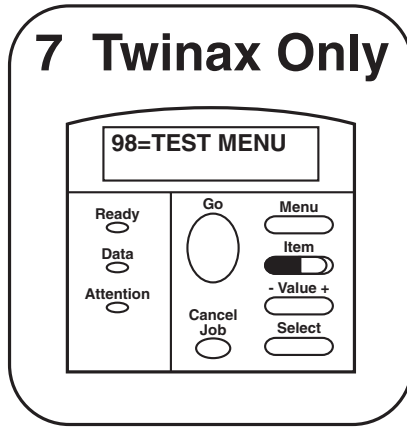

Figure 3-11. Twinax Only, Step 7.

8. Press Value +.

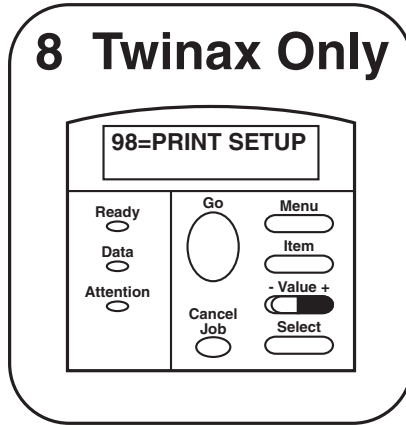

Figure 3-12. Twinax Only, Step 8.

9. Press Select and Go to print the interface self-test.

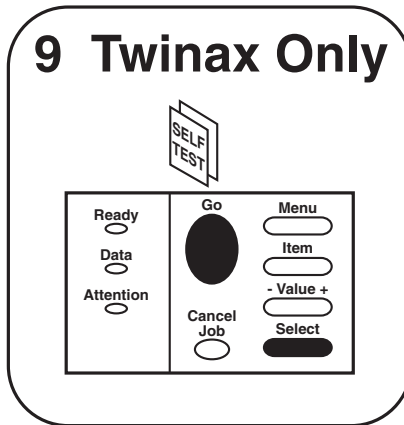

Figure 3-13. Twinax Only, Step 9.

3.2.4 COAX AND TWINAX

10. After the interface self-test pages print, review the configuration parameters and make changes as desired using the printer's operator panel or Host-Download Commands.

LASER CARDS FOR HP 4000 TWINAX AND COAX PRINTERS

11. Power OFF the printer and attach the host cable(s) to the twinax or coax adapter. Power ON the printer and send a print job from the host to verify proper installation and configuration.

4. Installation

To install the Laser Card, follow these simple steps. Consult the Quick Start Guide in **Chapter 3** for more information.

WARNING

The Laser Card is static sensitive. Follow the static sensitivity instructions in the front of this manual when handling the card.

1. Power ON the printer and perform a printer self-test as described in the printer's manual. Do not continue until the printer passes the self-test.
2. Power OFF the printer and remove all cables.
3. Locate an available EIO slot. Using the screwdriver, remove the bracket covering it.
4. Insert the Laser Card and tighten the thumb screws.
5. Attach the twinax or coax adapter cable. Do NOT attach the host cable(s) to the adapter yet.
6. Re-attach the power cord and other printer cables.

4.1 Interface Self-Test

Verify proper installation of the interface by performing an interface self-test. The self-test printout contains the current software version, memory condition (RAM and ROM) and the current setup selections for reference. Follow the steps below to print the self-test.

1. Make sure the proper (twinax or coax) 9-pin adapter cable is securely attached to the interface.
2. Power ON the printer and wait for it to go into "Ready" mode.
3. Press Menu repeatedly until TWINAX/COAX CARD is displayed.
4. Press Item - to display "98=TEST MENU"
5. Press Value - to display "98=PRINT SETUP".
6. Press Select. An asterisk will appear: "98=PRINT SETUP*".

7. Press Go. The interface will perform the self-test and print the self-test pages. Samples of the twinax and coax self-test pages are shown on the following pages. The numbers at the left margin correspond to the Host Download command numbers. Refer to the Configuration chapter for more information on these options.

If the interface self-test does not print, the interface failed the self-test. Contact Black Box Technical Support at 724-746-5500 for more information.

TWINAX EIO INTERFACE

Software Version 3.00

LASER CARDS FOR HP 4000 TWINAX AND COAX PRINTERS

Twinax Functional Level 2.10

Copyright 1997 SDE

RAM OK

ROM BAD

#00	-	Twinax Address	:	0	
#01	-	Alt. CPT Start Delimiters	:	2625	(&%)
#02	-	Alt. CPT End Delimiters	:	2625	(&%)
#03	-	Host Port Timeout	:	8	Seconds
#05	-	Host Language	:	01	USA/Canada
#07	-	Print Orientation	:	0	COR/Host override
allowed					
#08	-	Auto Print Orientation	:	1	On
#09	-	Paper Size	:	0	Host Selected
#10	-	True LPI	:	0	Compress LPI
#13	-	IBM Paper Drawer 1	:	1	PCL Tray Command
#14	-	IBM Paper Drawer 2	:	4	PCL Tray Command
#15	-	IBM Paper Drawer 3	:	5	PCL Tray Command
#16	-	Override Formatting Cmds	:	0	Normal
Oper					
#17	-	Character Set	:	1	Code Page 850
#18	-	Starting Vertical Position	:	0	
#19	-	Starting Horizontal Position	:	0	
#30	-	IBM Paper Drawer 4	:	1	PCL Tray Command
#31	-	IBM Paper Drawer 5	:	1	PCL Tray Command
#32	-	11 x 17/A3	:	0	Off
#33	-	Duplexing	:	0	Off
#42	-	Buffer Hex Dump	:	0	Off
#43	-	Ascii Hex Dump	:	0	Off
#11	-	Host Port Initialization:			
HP:					

#04 - User Defined Strings:

U0:

U1:

U2:

U3:

U4:

U5:

U6:

U7:

U8:

U9:

#21 User Defined Fonts

0:

1:

2:

3:

4:

5:

6:

7:

8:

9:

LASER CARDS FOR HP 4000 TWINAX AND COAX PRINTERS

IBM 3270 Printer Interface
 Software Functional 3.00
 Coax Functional Level 1.51
 Copyright 1997 SDE
 RAM OK
 ROM OK

#01	-	Buffer Size (Characters)	:	2 1920
#02	-	LPI	:	6
#03	-	CPI	:	Undefined
#04	-	Line Spacing	:	1 Single (6 or 8 LPI)
#05	-	Form Length (MPL)	:	66
#06	-	Maximum Print Position (MPP):		80
#07	-	Print Case	:	1 Dual
#08	-	LU1 Language	:	01 English (US)
#11	-	Paper Path	:	2 Primary
#12	-	FF Before Local Screen Copy:		0 No
#13	-	FF After Local Screen Copy:		0 No
#14	-	LU3 Print Image (NON-SCS Mode):		0 LU3 and Local Copy
Null Line suppress				
#15	-	CR at MPP + 1	:	0 Next Line
#16	-	NL at MPP + 1	:	0 Current Line + 2
#17	-	Valid FF Followed by Data:		0 2nd PP
#18	-	Valid FF at End of Buffer:		1 Line 1
#19	-	FF Valid Location	:	0 FF valid at 1st PP or MPP + 1
#20	-	Auto Function at End of Job:		0 NL
#25	-	IBM Motion Commands	:	0 Use FF
#26	-	Suppress Empty Forms	:	0 No
#27	-	Form Feed After TimeOut:		0 No
#30	-	Override Formatting Cmds:		0 Disabled
#31	-	Truncate/Wrap Select	:	0 Wrap text beyond MPP
#32	-	Paper Size	:	0 Letter (8.5 " x 11")
#34	-	Interv Required (IR) Timeout:		120 x 5 Seconds
#36	-	Suppress IBM Control Codes:		0 No control codes
suppressed				
#37	-	Vertical Channel Select (VCS):		1 3268/4224
#38	-	True LPI Spacing	:	0 Compressed (Normal)
#39	-	CPT End Delimiter(ASCII)	:	2625 (&%)
#40	-	CPT Start Delimiter(ASCII)	:	2625 (&%)
#41	-	ALT Command ID Char (ASCII)	:	5A (Z)

LASER CARDS FOR HP 4000 TWINAX AND COAX PRINTERS

#42 - Buffer Hex Dump : 0 Off
#43 - Ascii Hex Dump : 0 Off
#45 - SCS TRN Translate : 1 3287 emulation
emulation, SCS code 35
#51 - Host Port Timeout : 8 Seconds
#55 - Custom User Strings:
U0:
U1:
U2:
U3:
U4:
U5:

#57 - Host Port Init String:
HP:

#61 - Auto Print Orientation : 0 Active
#62 - Primary Tray Orientation : 0 COR
#63 - Alternate Tray Orientation: 0 COR
#64 - Manual Feed Orientation : 0 COR
#65 - Character Set Selection : 2 Code Page 850

LASER CARDS FOR HP 4000 TWINAX AND COAX PRINTERS

SCS (LU1) EBCDIC to ASCII Translate Table

EBCDIC	40	50	60	70	80	90	A0	B0	C0	D0	E0	F0	456789	ABCDEF
0	20	26	2D	D6	D2	B3	F3	5E	7B	7D	5C	30	&	-øØ°μ{ } \ 0
1	20	C5	2F	DC	61	6A	7E	BB	41	4A	20	31	é /	Éaj ~ £AJ1
2	C0	C1	A2	A4	62	6B	73	BC	42	4B	53	32	âêÄË	bks¥BK\$2
3	CC	CD	D8	A5	63	6C	74	F2	43	4C	54	33	äëÄË	clt · CLT3
4	C8	C9	A1	A3	64	6D	75	BE	44	4D	55	34	àèÄË	dmufDMU4
5	C4	D5	E0	E5	65	6E	76	BD	45	4E	56	35	áíÁí	env\$ENV5
6	E2	D1	E1	A6	66	6F	77	F4	46	4F	57	36	âîÁí	fow}FOW6
7	D4	DD	D0	A7	67	70	78	F7	47	50	58	37	âîÁí	gpx1/4GPX7
8	B5	D9	B4	E6	68	71	79	F8	48	51	59	38	çìÇì	hqy1/2HQY8
9	B7	DE	B6	A9	69	72	7A	F5	49	52	5A	39	ñBÑ`	irz3/4IRZ9
A	BF	21	7C	3A	FB	F9	B8	5B	2D	31	32	33	ç ! :	«ª ¡ [-123
B	2E	24	2C	23	FD	FA	B9	5D	C2	C3	DF	AE	.	,\$ #»°¿}ôùÖÜ
C	3C	2A	25	40	E4	D7	E3	B0	CE	CF	DA	DB	< * % @ ÷	∂ æ Ð - ö ü Ö Ü
D	28	29	5F	27	B2	20	B1	AB	CA	CB	E8	AD	() _ ' ,	Ý ° ò ù Ö Ü
E	2B	3B	3E	3D	F0	D3	F1	27	C6	C7	E7	ED	+ ; > =	p Æ þ ´ ó ú Ö Ü
F	7C	5E	3F	22	FE	BA	20	5F	EA	EF	E9	20	^ ? ±	€ _ ö ÿ Ö

DSC (LU3) DBC to ASCII Translate Table

DBC	00	10	20	30	40	50	60	70	80	90	A0	B0	0123456789	AB	
0	00	20	30	26	C8	CC	A1	D8	61	71	41	51	0&	àâÄÄ	aaqAQ
1	00	3D	31	2D	C9	CD	A3	A5	62	72	42	52	=1-	èëËË	brBR
2	00	27	32	2E	D9	DD	E6	A7	63	73	43	53	' 2 .	ïïlcsCS	
3	00	22	33	2C	CA	CE	E8	DA	64	74	44	54	" 3 ,	òòÖÖ	dtDT
4	00	2F	34	3A	CB	CF	AD	DB	65	75	45	55	/ 4 :	ùùÜÜ	euEU
5	00	5C	35	2B	E2	C0	E1	A2	66	76	46	56	∕5+	ââÄÄ	fvFV
6	00	7C	36	5E	EA	C1	E9	A4	67	77	47	57	∕6^	ðèÖË	gwGW
7	00	7C	37	B0	EF	D1	59	A6	68	78	48	58	∕7-	ÿíYí	hxHX
8	3E	3F	38	B3	C8	C2	41	DF	69	79	49	59	> ? 8	° à ò	À Ö ÿ ÿ
9	3C	21	39	00	C9	C3	45	AE	6A	7A	4A	5A	< 9	è ù	È Û jzJZ
A	5B	24	DE	5E	C5	C4	45	E0	6B	D7	4B	D3	∕\$B^	éáEÁ	kæKÆ
B	5D	BF	BD	7E	D9	C5	49	DC	6C	D6	4C	D2] ç \$	- í é	l l Ø L Ø
C	29	BB	23	AB	CA	D5	4F	E5	6D	D4	4D	D0) £ #	" ó í	ó í m M Á
D	28	BC	40	60	CB	C6	55	E7	6E	B5	4E	B4	(¥ @	' ú ó	U Ó ñ Ç Ñ Ç
E	7D	F2	25	A9	CF	C7	59	ED	6F	3B	4F	3B	} . %	ü ú	Y Ú ó ; O ;
F	7B	BA	5F	00	B5	B7	43	B6	70	2A	50	2A	{ € _	ç ñ Ç Ñ	p * P *

4.2 Connecting to the Host

Before connecting the Laser Card to a twinax host, you must set the device cable address properly. Please refer to **Section 4.3, Front-Panel Setup**, for instruction.

Take the following steps to connect the printer through the Laser Card to your IBM host system.

1. Power OFF the printer.
2. With adapter cable connected to the interface's 9-pin port, attach the host cable(s) to the adapter cable. The twinax V-connector automatically terminates when only one cable is attached and automatically cables through when two cables are attached.
3. After configuring the interface (see Sections 4.3 and **Chapters 5 and 9**), send a print job from the host to verify that it is printing correctly.

4.3 Front-Panel Setup

You can use the printer operator panel to change the various interface settings. Alternately, you can use host-download commands, a series of command strings that are embedded in the datastream sent from the IBM host to the interface. The active interface configuration is shown on the interface's self-test printout.

Follow the steps below to change interface configuration settings using the printer's operator panel:

1. Press Menu repeatedly until TWINAX/COAX CARD is displayed.
2. Press Item +/- to display the various I-O configuration parameters. They are listed below in the order that they appear on the printer's operator panel. Note that the number on the left margin corresponds to the Host Download number. Refer to the Configuration chapter for more information on these options.
3. When the desired configuration parameter is displayed, press Value +/- to scroll through the available command values.
4. To select a displayed value, press Select.
5. Then move on to the next configuration parameter by pressing Item +/- or return the printer to operating mode by pressing Go.

A complete description of the interface configuration options is found under **Section 5.2, Twinax Host Download Commands**, or **Section 9.1, Coax Host Download Command**.

4.4 Front-Panel Menus

The following pages show the organization of the menu system by listing the available selections and menus. The numbers in front of the configuration items refer to the corresponding Twinax or Coax Host Download Commands. Use these numbers to find a more detailed explanation of the configuration options in **Section 5.4** or **9.2**.

TWINAX CARD

- 00=TX ADDRESS
- 03=HOST TIMEOUT
- 05=HOST LANGUAGE
- 07=ORIENTATION
- 08=APO
- 09=PAPER SIZE
- 10=LPI SETTING
- 13=IBM DRAWER 1
- 14=IBM DRAWER 2
- 15=IBM DRAWER 3
- 16=OVERRIDE FP
- 17=CHARACTER SET
- 18=VERT. MARGIN
- 19=HORIZ. MARGIN
- 30=IBM DRAWER 4
- 31=IBM DRAWER 5
- 32=FORCE 11X17/A3
- 33=DUPLEXING
- 42=EBCDIC HEX
- 43=ASCII HEX DMP
- 98=TEST MENU
 - 98=PRINT SETUP
 - 98=FACTORY DEF
 - DIAGNOSTIC

COAX CARD

- 01=BUFFER SIZE
- 02=DEFAULT LPI
- 03=DEFAULT CPI
- 04=LINE SPACING
- 05=MPL (Max. Print Lines)
- 06=MPP (Max. Print Position)
- 07=PRINT CASE
- 08=LU1 LANGUAGE
- 11=PAPER PATH
- 12=LOCAL COPY (FF Before)
- 13=LOCAL COPY (FF After)
- 14=LU3 PRT IMAGE
- 15=CR at MPP+1
- 16=NL at MPP+1
- 17=DATA AFTER FF
- 18=FF AT EOB
- 19=FF VALID
- 20=EOJ FUNCTION
- 25=FF USAGE
- 26=EMPTY FORMS (Suppress)
- 27=AFTER TIMEOUT
- 30=FRMT OVERRIDE
- 31=TEXT AT MPP
- 32=PAPER SIZE
- 34=IR TIMEOUT
- 36=HOST CMDS
- 37=VCS (Vertical Channel Select)
- 38=TRUE LPI
- 42=EBCDIC HEX
- 43=ASCII HEX DMP
- 45=SCS TRN
- 51=HOST TIMEOUT
- 61=APO
- 62=PRIMARY TRAY (Orientation)
- 63=ALT. TRAY (Orientation)
- 64=MANUAL TRAY (Orientation)
- 65=CHARACTER SET
- 98=TEST MENU
 - 98=PRINT SETUP
 - 98=FACTORY DEF

5. Configuration—Twinax

5.1 Twinax Configuration

Before operating the interface card in twinax mode, the IBM host must be configured with a device address and device ID for the printer. See your system operator or system manuals for details. With the correct address selected, an AS/400 will automatically configure itself. If you are using a System 3X host, you must configure the host manually. The table below shows the recommended device IDs on the different host systems.

Table 5-1. Recommended Device IDs.

Host System	Emulation	Device ID
System/34	3812	5224 (2P) 5225 (2P) 5219 (3P)
System/36	3812	5219
System/38	3812	3812-1
AS/400	See note 2 below.	

1. Make sure the interface is properly connected to the twinax host and the correct device address is set.
2. Power on the printer. The AS/400 will auto-configure the printer address according to the interface settings.

5.2 Twinax Host Download Commands

Host download commands are used to configure your printer for entering custom printer commands such as printer-sharing timeout, character set, and page orientation. These commands can be sent to the interface/printer from the IBM host. They are placed in a host document or screen. The commands take effect when the print job or screen print is sent to the printer.

The command itself will not be printed if it was entered correctly, but the effect of the command should be evident (change in the print orientation, paper-size selection, and so on). If any part of the command is printed, the interface did not recognize the command because of a problem in the format. Check the syntax of the command and send the command again.

Host-download commands sent to the Laser Card take effect immediately and stay only in the interface's active memory. If you want the commands to be active when the printer is powered on, they must be stored permanently by the download command Z99.

The tables on the following pages provide a description of each command and how it is used.

Follow these steps to enter a host-download command.

1. Type the delimiter `&%` (or a custom delimiter as described in the table) in the document at the point you want the command to take effect.
2. Type an upper-case "Z".
3. Type the command number for the command you want to use, as shown in the table.
4. Type a comma.
5. Type the command. No spaces are allowed. A space or invalid character in a command causes the interface to ignore the command and resume printing from the point the error occurred.

For example, to change the timeout value from the default of 8 seconds to 20 seconds, enter:

```
&%Z03,20
```

5.3 Host Download Command Overview

Table 5-2 shows the host-download commands for the interface and corresponding command numbers in alphabetical order:

Table 5-2. Host Download Commands.

Host/PC Download Command	Command Number
11" x 17"/A3 Printing	32
Alternate CPT Start Delimiter	01
Alternate CPT End Delimiter	02
Automatic Print Orientation	08
Character Set	17
Duplex Printing	33
Front Panel Override	16
Horizontal Margin	19
Host Language	05
Host Port Timeout	03
Host Port Initialization	11
Paper Drawer 1	13
Paper Drawer 2	14
Paper Drawer 3	15
Paper Drawer 4	30
Paper Drawer 5	31
Paper Size	09
Print Orientation	07
Print Setup Parameters	98
Restore Factory Defaults	98
Save All Current Settings	99
True LPI	10
User Defined Font Strings	21
User Defined Strings	04
Vertical Margin	18

5.4 Configuration Options

Asterisks (*) identify factory-default settings. Invalid commands are ignored.

COMMAND 01: ALTERNATE CPT START DELIMITER

Creates an alternate Command Pass-Thru (CPT) start delimiter. This delimiter is also an alternate host-download delimiter. It may be one or two characters long. The first character may be any printable character other than “&.” Only one alternate CPT start delimiter is allowed. The default “&%” will always be recognized as CPT delimiter.

<u>Value</u>	<u>Description</u>
New characters	Alternate CPT start delimiter
Two spaces	Deletes alternate CPT start delimiter

Example: &%Z01,#* creates the alternate CPT start delimiter #*.

COMMAND 02: ALTERNATE CPT END DELIMITER

Creates an alternate CPT end delimiter as above. This delimiter cannot be used as an alternate host-download delimiter.

<u>VALUE</u>	<u>DESCRIPTION</u>
New characters	Alternate CPT end delimiter
Two spaces	Deletes the alternate delimiter

COMMAND 03: HOST PORT TIMEOUT

Selects a new timeout value for the interface to wait for data from the host before allowing the printer to honor PC print jobs. Each digit equals one second.

<u>VALUE</u>	<u>DESCRIPTION</u>
00 to 60	Sets new timeout value
*08	

Example: &%Z03,05 selects 5 seconds.

*Factory-default setting.

COMMAND 04: USER-DEFINED STRINGS

Creates up to ten user-defined strings to send to the printer later. Place the hex codes representing the desired printer command inside the parentheses (up to 25 hex pairs). Spaces between hex pairs are allowed to aid in readability. Consult the printer's user's guide for proper hex codes. The user-defined string is stored in the interface's memory under the selected value number (0 to 9). To activate the command, place a &%UX (where X is the value number) in the document.

<u>VALUE</u>	<u>DESCRIPTION</u>
0 to 9 (hex codes)	Assigns the hex command to a one digit delimiter (0-9).
0 to 9()	Deletes the specified user-defined string from memory.

Example: &%Z04,3(1B26643044) creates a user-defined string for a PCL printer to start underlining as command 3. The string is represented by the value 3. To use this function, place &%U3 in the document.

COMMAND 05: HOST LANGUAGE

Selects the host language to be used by the twinax host, when the command "Use Default Language" is received.

<u>VALUE</u>	<u>DESCRIPTION</u>
00	Multinational
*01	USA/Canada
02	Austria/Germany
03	Belgium
04	Brazil
05	Canada/French
06	Denmark/Norway
07	Finland/Sweden
08	France
09	Italy
10	Japan
11	Japan (U.S.)
12	Portugal
13	Spain
14	Spanish speaking
15	United Kingdom

Example: &%Z05,00 selects the multinational character set.

COMMAND 07: PRINT ORIENTATION

Determines the print orientation, if the print orientation is not already determined through the host or the interface's APO feature (Command 08).

<u>VALUE</u>	<u>DESCRIPTION</u>
*0 allowed	COR, but host override through Print Quality setting
1	Portrait
2	Landscape
3	COR

NOTE

Refer to page 54 for a detailed description of print orientation.

COMMAND 08: AUTOMATIC PRINT ORIENTATION

Selects or deselects Automatic Print Orientation (APO).

<u>VALUE</u>	<u>DESCRIPTION</u>
0	APO Off
*1	APO On

NOTE

Refer to page 54 for a detailed description of APO.

Example: &%Z08,1 turns the Automatic Print Orientation on.

COMMAND 09: PAPER SIZE

Selects paper-size setting.

<u>VALUE</u>	<u>DESCRIPTION</u>
*0	Paper size specified by host software
1	A4 size paper
2	Paper size selected through printer's front panel

Example: &%Z09,1 selects A4 size paper.

COMMAND 10: TRUE LPI

Selects compressed or true LPI (lines per inch) printing.

<u>VALUE</u>	<u>DESCRIPTION</u>
0	No, compressed LPI
1	Yes, true LPI
2	Xpoint Twinax Controller Compatibility

Example: &%Z10,1 selects true LPI.

NOTE

If you are using one of the popular Electronic Forms packages from companies like XPoint, Eclipse, Formula One, or others, use the true LPI selection. Use the last selection only if you want to run software that is set up for the XPoint Twinax Controller.

COMMAND 11: HOST PORT INITIALIZATION STRING

Enters a twinax-port initialization string (in hex code, up to 25 pairs) that is sent to the printer after the interface has reconfigured the printer for host printing. Consult the printer's user's guide for the available commands and proper hex values.

<u>VALUE</u>	<u>DESCRIPTION</u>
0 (hex codes)	Stores the hex command as a host-port initialization string

Example: &%Z11,0(1B266C3844) sets LPI to 8 LPI on a PCL Laser Printer.

COMMAND 13: PAPER DRAWER 1 COMMAND

Matches the host's Paper Drawer 1 command with a physical paper source from the printer. When the host sends a command to the printer to feed from paper drawer 1, the printer will feed from the paper source assigned to paper drawer 1. Consult the printer's user's guide for the available paper sources and respective numbers.

<u>VALUE</u>	<u>DESCRIPTION</u>
01 to 99	Paper sources available on the printer
*01	Default

Example: &%Z13,08 assigns the optional third 250 sheet feeder (Tray 4) to the host's paper drawer 1 command.

COMMAND 14: PAPER DRAWER 2 COMMAND

Matches the host's Paper Drawer 2 command with a physical paper source from the printer. When the host sends a command to the printer to feed from paper drawer 2, the printer will feed from the paper source assigned to paper drawer 2. Consult the printer's user's guide for the available paper sources and respective numbers.

<u>VALUE</u>	<u>DESCRIPTION</u>
01 to 99	Paper sources available on the printer
*04	Default

Example: &%Z14,08 assigns the optional third 250 sheet feeder (Tray 4) to the host's paper drawer 2 command.

COMMAND 15: PAPER DRAWER 3 COMMAND

Matches the host's Paper Drawer 3 command with a physical paper source from the printer. When the host sends a command to the printer to feed from paper drawer 3, the printer will feed from the paper source assigned to paper drawer 3. Consult the printer's user's guide for the available paper sources and respective numbers.

<u>VALUE</u>	<u>DESCRIPTION</u>
01 to 99	Paper sources available on the printer
*06	Default

Example: &%Z15,08 assigns the optional third 250 sheet feeder (Tray 4) to the host's paper drawer 3 command.

COMMAND 16: FRONT PANEL OVERRIDE

Allow operator settings on the printer's front panel to override format commands coming from the host.

<u>VALUE</u>	<u>DESCRIPTION</u>
*0	No, do not override IBM format commands
1	Yes, override all IBM format commands
2	Yes, override NLQ commands
3	Yes, override CPI commands

Example: &%Z16,1 enables the front panel to override all IBM format commands.

COMMAND 17: CHARACTER SET

Selects which character set will be used when both are available for the desired font. The character set selected is used as the underlying ASCII table for EBCDIC to ASCII translations. Consult the printer's user's guide to verify that the character set selected is also used by the printer and the selected font is supported.

<u>VALUE</u>	<u>DESCRIPTION</u>
0	Roman 8
*1	Code Page 850

Example: &%Z17,0 selects the Roman 8 character set.

COMMAND 18: VERTICAL MARGIN

Adjusts the upper left corner starting vertical position for printing on the page in 1/60 of an inch.

<u>VALUE</u>	<u>DESCRIPTION</u>
-128 to 127	Adjustment of vertical position in $\frac{1}{60}$ of an inch
*0	Default

Example: &%Z18,-20 moves printing on the page up $\frac{1}{3}$ inch or 2 lines at 6 LPI.

COMMAND 19: HORIZONTAL MARGIN

Adjusts the upper left corner starting horizontal position for printing on the page in $\frac{1}{60}$ of an inch.

<u>VALUE</u>	<u>DESCRIPTION</u>
-128 to 127	Adjustment of horizontal position in $\frac{1}{60}$ inch.
*0	Default

Example: &%Z19,12 moves printing on the page $\frac{1}{5}$ inch right or 2 characters at 10 CPI.

COMMAND 21: USER FONT STRINGS

Assigns a font ID to a font. The first number (0-9) is one of 10 available strings, the second number (0-65535) is the host font number. The characters shown in parentheses are sent to the printer when the host font number is received. Refer to the printer's user's guide or the documentation accompanying the font cartridge for a list of available fonts and their respective strings. Use the < character to indicate the ESCape character.

<u>VALUE</u>	<u>DESCRIPTION</u>
0-9,	One of ten available strings
0-65535	Host font number
(ASCII Char.)	Up to 25 ASCII characters representing the desired font.

Example: &%Z21,3,12345(<(12U<(s0p12h10v1s3b6T)

This selects the third font string to be font #12345 and selects for Lexmark Optra printer:

12U = code page 850

0p = fixed spacing

12h = 12 pitch

10v = 10 point

1s = italic

3b = bold

6T = letter gothic

COMMAND 30: PAPER DRAWER 4 COMMAND

Matches the host's Paper Drawer 4 command (print file) with a physical paper source from the printer. When the host sends a command to the printer to feed from paper drawer 4, the printer will feed from the paper sources currently assigned to this command. Consult the printer's user's guide for available paper sources and respective numbers.

<u>VALUE</u>	<u>DESCRIPTION</u>
01 to 99	Paper sources available on the printer.
*01	Default

Example: `&%Z30,08` assigns the optional third 250-sheet feeder (Tray 4) to the host's paper drawer 4 command.

COMMAND 31: PAPER DRAWER 5 COMMAND

Matches the host's Paper Drawer 5 command (print file) with a physical paper source from the printer. When the host sends a command to the printer to feed from paper drawer 5, the printer will feed from the paper sources currently assigned to this command. Consult the printer's user's guide for available paper sources and respective numbers.

<u>VALUE</u>	<u>DESCRIPTION</u>
01 to 99	Paper sources available on the printer
*01	Default

Example: `&%Z31,08` assigns the optional third 250-sheet feeder (Tray 4) to the host's paper drawer 5 command.

COMMAND 32: 11" x 17"/A3 PRINTING

Forces the printer to print on 11 x 17 inch or A3 size paper, even when the host sends requests for smaller paper sizes (letter, legal, A4, Executive). This only applies to printers capable of printing on 11 x 17 inch or A3 size paper.

<u>VALUE</u>	<u>DESCRIPTION</u>
*0	11 x 17/A3 selection is OFF
1	11 x 17/A3 selection is ON

NOTE

With the 11 x 17/A3 selection ON, the interface's APO feature (if turned ON) will automatically rotate all documents/reports with dimensions of 11 x 17 inches or smaller. To achieve COR in this case, the document/report has to be larger than 11 x 17 inches.

Example: &%Z32,1 forces printing on large paper. The interface will request the printer to load A3 size paper when the host requests A4 or A3, and 11 x 17 inch paper in all other cases.

COMMAND 33: DUPLEX PRINTING

Sets the interface to duplexing mode. This applies only when a printer with duplexing capability is attached.

<u>VALUE</u>	<u>DESCRIPTION</u>
*0	No
1	Yes
2	Tumble

Example: &%Z33,2 instructs the interface to duplex all host print jobs along the short edge of the paper.

COMMAND 42: START AND STOP EBCDIX HEX DUMP

After receiving a start command the interface, starting with the next buffer received, sends all host data directly to the printer as hexadecimal printing until the printer is powered off.

<u>VALUE</u>	<u>DESCRIPTION</u>
*0	No action taken
1	Start EBCDIC hex dump

NOTE

This command enables the user to print only the section of the document that is in question in buffer hex dump format.

Example: &%Z42,1 starts buffer hex dump printing.

COMMAND 43: START/STOP ASCII HEX DUMP

After receiving a start command, the interface, starting with the next buffer received, translates all host data into ASCII (from EBCDIC) and then causes the ASCII data to print in hexadecimal form. The ASCII hex dump is performed until the printer is powered off.

<u>VALUE</u>	<u>DESCRIPTION</u>
*0	No action taken
1	Start ASCII Hex Dump

Example: &%Z43,1 starts ASCII hex dump printing.

COMMAND 98: RESTORE DEFAULTS OR PRINT CONFIGURATION

Restores the factory default configuration selections, prints out a copy of the active configuration selections, or restores the permanent memory selections to the active setup status.

<u>VALUE</u>	<u>DESCRIPTION</u>
0	Restores the factory setup
1	Prints out the active setup selections
2	Restores the setup selections stored in the permanent memory to active status

NOTES

If a document is printed using temporary host download commands (commands not stored using the Z99,0 command), value 2 will restore the permanent memory selections.

Put a &%Z98,2 at the end of the document to restore the standard setup parameters for the next user of the printer.

The active setup and permanent memory setup selections are the same after a Command Z99,0 or a Command Z98,2 is sent to the printer.

Example: &%Z98,1 Prints out the active setup selections for review.

COMMAND 99: SAVE ALL CURRENT SETTINGS

Saves all current settings specified through Host/PC download commands or Setup Software into permanent memory.

<u>VALUE</u>	<u>DESCRIPTION</u>
0	Save all current settings

Example: &%Z99,0 saves all current settings to permanent memory.

5.5 Restoring the Factory Defaults

The factory default configuration can be restored to the non-volatile memory of the interface by either a host download command Z98.0 or by performing the following steps:

1. Press Menu repeatedly until TWINAX CARD is displayed.
2. Press Item - to display "98=TEST MENU."

LASER CARDS FOR HP 4000 TWINAX AND COAX PRINTERS

3. Press Value + twice to display “98=FACTORY DEF.”
4. Press Select and then Go to select and activate the setting.

6. Operation—Twinax

When the printer is turned on, the interface checks for a proper 9-pin host attachment cable to decide which mode of operation is desired. If a twinax or coax cable is not attached, the LaserCard will cause an error page to be printed. Power OFF the printer, attach the adapter, and then power ON the printer again.

6.1 Printer Sharing

The Laser Card allows your printer to automatically share printing from an attached PC (any parallel or serial source), an attached LAN (through an additional network card), and an IBM twinax host. The interface uses a timeout after each host print job before the interface allows the printer to honor PC/LAN jobs. Make sure the printer is loaded with paper and “READY” is displayed before printing.

When the printer receives PC/LAN (ASCII) data and the host attachment is not active, it honors the ASCII job. At the completion of the ASCII job, the printer has a timeout setting so it will wait and not accept data from another source.

NOTE

If the printer does not print host data for an extended time after an ASCII job, please check and possibly change the printer-sharing timeout in the printer.

If the PC print job is sent while a host job is printing, the printer responds as “busy” to the PC/LAN print request. The print job can be spooled through a spool program, sent to the printer when the host job is finished, or if the PC’s printer port is set for infinite retry through the DOS “Configure Printer” command (described in the DOS manual), the print job waits for the printer to be available to receive the data.

NOTE

If the interface’s timeout setting is too short (less than 4 seconds), it is possible the interface will interpret an interruption of a host print job as the end of the job and switch to PC/LAN printing.

6.2 Host Port Initialization

After shared printing, the Laser Card reconfigures the printer according to the active configuration settings. If you want to further modify the printer configuration (for example, select a different font for all host printing) take advantage of the host port initialization string. The Host Port Initialization String is not sent to the printer until after the interface has reconfigured the printer for host printing. The Initialization String is sent at the beginning of each printed page.

6.3 Host Printing

With the Laser Card installed, your printer emulates the IBM 3812-1. The IBM 3812-1 printer is a laser-type printer which provides font-changing capability, plus text rotation and compression features called Automatic Print Orientation (APO) and Computer Output Reduction (COR).

The Laser Card's emulation of the 3812 provides bolding, underlining, superscripts and subscripts by recognizing the host commands for these features in the document. A shadow print for bolding is performed automatically on fixed-pitch fonts. For proportionally spaced (typographic) fonts, the user must specify the font that is to be printed.

Like an IBM 5219 printer, the 3812 printer is configured with a default font ID on the host. Configure the most commonly used font as the system default, then change as necessary with a printer override or OCL command.

The table below shows which fonts can be used as system defaults for a System/36 or System/38 host.

6.4 Font Change Commands

You can place font change commands within the text of a word processing or data processing document to select a font other than the default font. The commands appear on the screen but do not print. The font change takes effect immediately and continues until the next font change. See the Font (FGID) Reference chart in Appendix A for a list of font IDs.

To change fonts, use the following format to type in a font change command.

`¬Q2304`

where ¬ is a "logical not" or alternately the caret "^" symbol, Q indicates a font change, and 2304 is the font ID.

To select a resident scalable font with a specific point size, use the following format:

¬F5687,14

where ¬ is a “logical not” or alternately the caret “^” symbol, F indicates a resident scalable font-change, 5687 is the font number, and 14 is the desired point size. The resident scalable font numbers are located in **Appendix D**.

All text following the command will be printed in the new font until you specify another font change command.

NOTE

The host may send the original font code to the printer at the beginning of each page. If this happens, you may need to put a font-change command at the beginning of each page of your document.

If the font-change command changes the pitch, the host may continue to format each line according to the original font ID pitch. For Text Management/38 and other word-processing programs, you may not be able to specify more than one font ID per line.

6.5 Formatting the Page

The printer prints up to 66 lines at 6.25 LPI (the line spacing is compressed slightly to fit). The System/36 only allows 65 lines per page. If you get one or two lines at the top of the next page, it's usually because you have formatted more lines per page than can be printed.

6.6 Paper Size

Configure the printer's setup to the paper size you use most. The MPP and font must match the paper size exactly to work correctly. The interface only recognizes these paper sizes:

Letter Paper 8.5 x 11 in. (215.9 x 279.4 mm)

A4 Paper 8.27 x 11.69 in. (210 x 297 mm)

Legal Paper 8.5 x 14 in. (215.9 x 355.6 mm)

Executive Paper 7.25 x 10.5 in. (184.2 x 266.7 mm)

11" x 17" Paper 11 x 17 in. (279.4 x 431.8 mm)

A3 Paper 11.69 x 16.54 in (296.9 x 420.1 mm)

If you choose any other paper dimensions in the word-processing program, the interface ignores it and uses the previous paper-size choice.

You can also choose a paper-size override through a host download command, or front panel selection as described in **Chapter 5, Configuration—Twinax**. The “Any Paper Size” selection uses the paper installed in the tray, regardless of size. The “A4 Size” selection uses A4 paper only.

With A4 paper size selected, 10 CPI fonts will print as 10.3 CPI. This allows 80 columns to be printed in portrait on A4 paper.

The following describes how to select legal-size paper in DisplayWrite/36 or AS/400 Office.

1. Choose legal-size paper on the host and send the print job.
2. The printer’s operator panel displays “Load Paper, Tray #, Legal.” Install the legal-size paper tray in the printer, and the printer will start printing.

The System/38 only sends margins and other format specifications to a printer when they are different from the previous document or when the printer has been turned off. To choose a different size paper, you must:

1. Select a paper size in the program.
2. Install the correct paper size in the printer.
3. Power off the printer for about five seconds, then power it back on again.
4. Release the job for printing at the printer’s controlling workstation.

The line format screens in DisplayWrite/36 (Command 20) also permit you to select “Justify,” which aligns the right margin. For best results in using justification, change the zone width to 1 (instead of 6). Right justification is only supported for fixed-pitch fonts.

6.7 Printing on 11" x 17" and A3 Size Paper

Some printers allow printing on 11" x 17" and A3 size paper. The Laser Card automatically recognizes these larger paper sizes. However, at times it might be advantageous to force the printer to print on 11 x 17 inch or A3 size paper, even

when the host sends requests for smaller paper sizes (letter, legal, A4, Executive). If this is desired, the interface's 11 x 17/A3 selection should be turned ON through Host Download command 32.

With this selection turned ON, the interface will request the printer to load A3 size paper when the host requests A4 or A3, and 11 x 17 inch paper in all other cases. In addition, the interface's APO feature (if turned ON) will automatically rotate all documents/reports with dimensions of 11 x 17 inches or smaller. To achieve COR in this case, the document/report has to be larger than 11 x 17 inches.

6.8 Paper Input Bin Selections

The IBM host give users the option to select different paper sources when printing. This can be done through the print file or through the Page Layout/Paper Options menu of OfficeVision/400 (see figures below). On the host, these paper sources are called Source Drawer (printer file) or Paper Drawer (Office Vision/400). On the printer, the actual paper sources are usually called trays. The interfaces will map the host's drawer values 1 through 5 to actual paper trays on the attached printer.

Users can easily change the default tray mapping through Host download commands 13, 14, 15, 30, 31. These commands can also be accessed through the printer's operator panel.

Command 13 will map the IBM drawer #1 to the paper tray of your choice. Paper trays are identified through a number. These tray numbers are printer-specific and are listed as PCL printer commands in your printer's user's guide.

For example, to change the mapping for the IBM paper drawer #1 from the default Tray 2 (the 250-sheet feeder just below the printer) to Tray 4 (the optional third 250-sheet feeder) of your HP LaserJet 4000, do the following:

1. Press Menu on the printer's operator panel to scroll to the TWINAX CARD.
2. Press Item + repeatedly until "13=IBM DRAWER 1" is displayed.
3. Press Value + repeatedly until "13=8 TRAY CMD" is displayed.
4. Press Select to select this setting. The display will show "13=8 TRAY CMD*".
5. Press GO to return the printer to operating mode.

LASER CARDS FOR HP 4000 TWINAX AND COAX PRINTERS

The next time you send a host print job that is to pull paper from the IBM drawer #1, the printer will actually feed paper from the optional third 250-sheet feeder.

The interface can be configured in a similar manner using host-download commands. To accomplish the remapping described above, simply send the command `&%Z13,08` to the interface.

Up to 5 different IBM drawers can be mapped to your printer's paper input trays. Review the following table for information on default settings and to determine which command to use to change the tray mapping.

IBM Drawer #	Card's default tray mapping	PCL Command*	I-O Command
1	1	ESC&11H	13
2	4	ESC&14H	14
3	5	ESC&15H	15
4	1	ESC&11H	30
5	1	ESC&11H	31

NOTE

Check your printer's user's guide to determine which PCL escape sequence corresponds to the desired input tray.

6.9 Paper Output Bin Selection

The Laser Card allows you to direct host print jobs to available output bins.

To send a host job to a particular output bin, insert an I-O output command on the first line (line 1, position 1) of the document/report. The output command consists of the "logical not" (`~`) or the "caret" (`^`) symbol followed by a capital letter "O" (for Output) and a two-digit number designating a destination bin. The two-digit number corresponds to the printer's PCL command for the particular output bin.

This command appears on the screen but will not print. The output command will take effect immediately and continues until the next output command is sent. Note that ^O00 causes the interface not to send any output instructions to the printer. All print jobs will be directed to the output bin set through the printer's operator panel.

The output commands are as follows:

6.10 Print Orientation

When operating the printer and printer interface in IBM 3812-1 emulation mode, the printer orientation of the host document or report is determined by a variety of factors. These factors are in order of their impact on the final print orientation:

1. Page Rotation specified in the print file of a data-processing document or in the document format menu of a word-processing document.
2. Automatic Print Orientation (APO) setting on the printer interface.
3. Print Orientation setting on printer interface.

As you read the following explanation, refer to Figure 6-1 for an illustration of the print-orientation logic.

1. PAGE ROTATION

Degrees of page rotation can be specified through the print file of a data processing document or in the document format menu of a word-processing document. See "Changing Page-Rotation Settings" in **Section 6.11** for a description on how to access the print file and the document format menu. The available settings are 0, 90, 180, 270 degrees and AUTO (AS/400 only). The print file also offers DEVD and COR (AS/400 only).

- a. With 0, 90, 180, and 270 degrees you can specify the desired rotation directly from the host.
- b. The COR setting will always print COR, unless the print quality (AS/400 and S/38) is set to NLQ or STD, or Text (S/36) is set to YES. If the page rotation is set to COR and print quality/text is one of the above mentioned settings, the print job will print in portrait in the requested font.
- c. With the DEVD and AUTO settings the host does not influence the print orientation. Rather, the print orientation is determined by the settings on the printer interface.

2. AUTOMATIC PRINT ORIENTATION

If no page rotation was specified on the host, the interface's Automatic Print Orientation (APO) feature is the first setting to determine the final print orientation. This feature automatically rotates print jobs with dimensions of 8.5 x 14 inches or smaller to portrait or landscape orientation.

- a. With the APO feature ON, the interface first checks the dimensions of the host print job. If the print job is larger than 8.5 x 14 inches, the interface cannot fit the print job on one page. In this case the orientation of the print job is determined by the print-orientation setting on the interface (Block 3 in **Figure 6-1**).
- b. If the dimensions of the print job are 8.5 x 14 inches or smaller, the interface compares the width to the height and automatically rotates the print job to portrait if the height is larger than the width or landscape if the width is larger than the height.

The dimensions of a word processing document are specified directly through the document format menu. The dimensions of a data-processing report are calculated in the following manner:

$$\text{Width} = \text{Page Width (in number of columns)} / \text{CPI}$$

$$\text{Length} = \text{Page Length (in number of lines)} / \text{LPI}$$

3. PRINT-ORIENTATION SETTINGS

The interface's print-orientation settings determine the orientation of the host document/report AFTER the host's page-rotation setting AND the interface's APO setting have been obeyed.

The available print-orientation settings are portrait, landscape, and two COR options. The COR feature rotates documents to landscape orientation and compresses the font as needed to fit the complete document on a standard 8.5" x 14" page. This allows the user to print a report initially designed to fit on 14 $\frac{1}{2}$ " x 11" green bar paper onto a standard letter or legal size page without redesigning the report.

When used together, the APO and COR features can be a powerful tool to print host jobs in portrait, landscape, or if required in landscape with reduced font (COR) without user intervention.

The first COR option is not a true IBM 3812 emulation. This COR setting was added to give the user a more straightforward way of obtaining COR. The COR

setting ignores print-quality settings and always prints COR (unless the host's page rotation or the interface's APO setting determine the print orientation).

The Laser Card also has a second COR option. This COR option is a true 3812-1 emulation. With certain page rotation settings on the host, the IBM 3812-1 printer allows the user to manipulate the final print orientation through the print quality setting. Note though, that this "override" only applies if the interface's print orientation is set to COR, host override allowed. The following tables show what page rotation settings can be manipulated through print quality settings and how the combination of page rotation and print quality affects the final print orientation.

LASER CARDS FOR HP 4000 TWINAX AND COAX PRINTERS

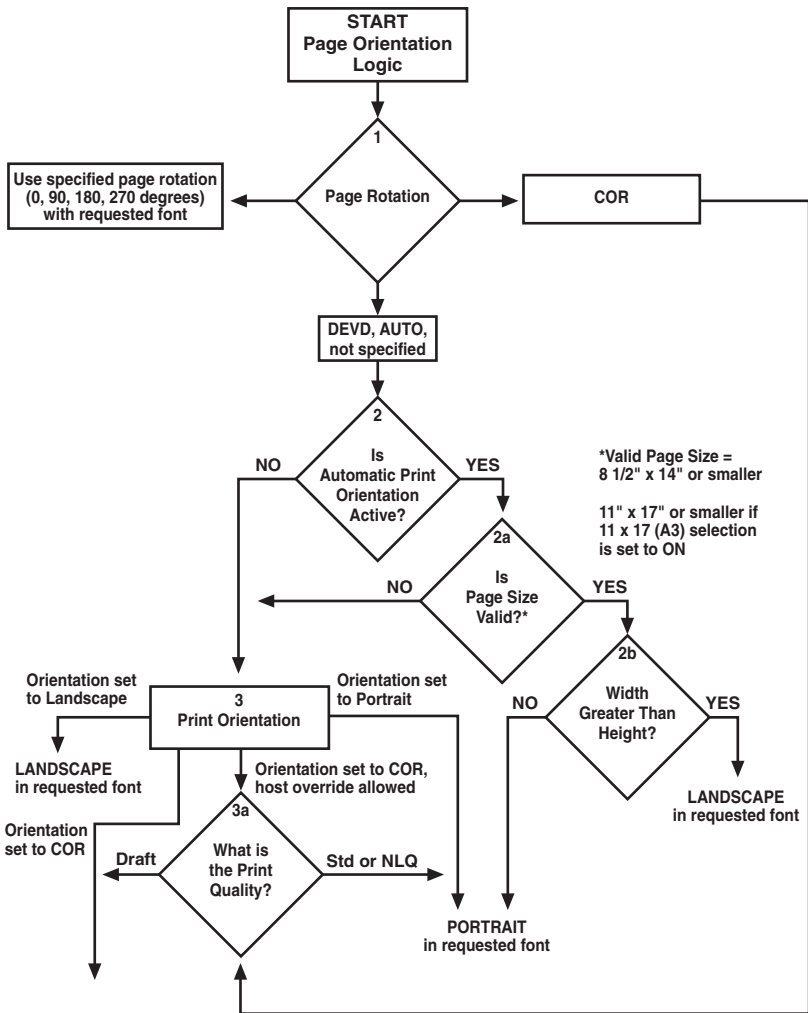

*Valid Page Size =
8 1/2" x 14" or smaller
11" x 17" or smaller if
11 x 17 (A3) selection
is set to ON

Computer Output Reduction (COR)
0.5" margins top and left
LANDSCAPE in reduced font:
10 pitch font to 13 pitch
12 pitch font to 15 pitch
15 pitch font to 20 pitch
Verticle spacing is:
6 LPI = 8.7
8 LPI = 11.6

Figure 6-1. Print-Orientation Logic.

LASER CARDS FOR HP 4000 TWINAX AND COAX PRINTERS

COR is defined as printing in landscape orientation, top and left margins set at 0.5", with CPI and LPI reduced according to the following tables:

Host System	Page Rotation Setting	Print Quality Setting
AS/400	*DEV D (print file)	*NLQ, *STD
AS/400	*AUTO (OfficeVision/400)	NLQ, Test
S/36	not specified	Text—Yes
S/38	not specified	*NLQ, *STD

Table 6-1 shows the print-orientation results desired and recommends a combination of settings required to obtain that result.

Host CPI	Reduced to:	
10	13.3	
12	15	
15	20	

Host LPI	Reduced to:	Maximum Rows (Lines)/Page
6	8.7	66
8	11.6	88

Table 6-1. Print Orientation Results.

Result	Host Setting	Printer Interface Setting for APO Print Orientation	
Data processing: Print reports with a width of 80 columns or less (at 10 CPI) in portrait AND print reports with a width of 132 (at 10 CPI) or 198 (at 15 CPI) columns in landscape with reduced font (COR)	Degree of Page Rotation...	ON	COR
Word processing: Print documents of up to 8.5 x 14 in portrait, 14 x 8.5 in landscape, and anything larger in landscape with reduced font (COR)	Rotate Paper...=1 (Automatic)		
Print all reports/documents in landscape with reduced font (COR)	Degree of Page Rotation...*AUTO; Rotate Paper...=1 (Automatic)	OFF	COR
Print all reports/documents in landscape with requested font	Degree of Page Rotation...*AUTO; Rotate Paper...=1 (Automatic)	OFF	Landscape
Print all reports/documents in portrait with requested font	Degree of Page	OFF	Portrait

6.11 Changing Page-Rotation Settings

Before changing page-rotation settings, first verify the current settings. In Office Vision/400 and DisplayWrite/36, page-rotation settings can be viewed and changed in the following manner:

1. Press F20 "Format options."
2. Press 1 "Document options" then ENTER.
3. Press 1 "Document format" then ENTER.
4. Press 4 "Page layout/paper options" then ENTER.
5. Press Page Down to scroll to the second screen.
6. Locate "Rotate Paper . . . option."
7. Move the cursor to the currently selected rotation setting and type in the desired selection.

To permanently change the page-rotation setting for a data-processing report, the print file must be changed. This should be done by an MIS staff member, since a changed print file most likely affects many printers. The page-rotation setting can be changed temporarily by overriding the print file. The print file must be changed or overridden before the host creates the print job. An overridden print file applies only to print jobs created on the host session that was active when the print file was overridden.

To view the current print-file settings, type CHGPRTF followed by a space and the name of the print file on the command line of the host. Press F4. Do not change any settings unless authorized by the IS director.

To change the print file:

1. Type CHGPRTF on the command line of the host, and press Enter.
2. Type in the name of the print file to be changed.
3. Press F10 to display additional parameters.
4. Press Page Down to scroll to the fourth screen.
5. Locate "Degree of page rotation . . ." option.

6. Move the cursor to the beginning of the dashed line and enter the desired selection.
7. Press ENTER to activate the selection and exit the print file menu.

To override the print file:

1. Type OVRPRTF on the command line of the host, and press Enter.
2. Type the name of the print file to be changed.
3. Press Page Down to scroll to the third screen.
4. Locate "Degree of page rotation . . ." option.
5. Move the cursor to the beginning of dashed line and enter the desired selection.
6. Press ENTER to activate the selection and exit the print file menu.

6.12 Envelope Printing

Use landscape orientation for envelope printing with the first line of the address on line 30 and a left margin of 55. A trial run with a blank sheet of paper helps in positioning the address. There are three ways to select envelopes:

1. Select "Manual Feed" in the word-processing program's paper-feed selections. The printer displays 3 on the operator panel. Place envelopes into the manual feed tray and press Start/Stop, then press Paper to select manual.
2. Place envelopes into the paper tray and move the tray stops to the proper position. Specify the bin number in the word processing program and the printer prints envelopes from the paper tray.
3. Select "Envelope Feed" in the word-processing program's paper feed selections, a paper width of 7.5" or 9.5" (or 220 mm), and paper length of 11.0". The printer automatically finds the envelope feeder (if installed) and prints from the feeder.

6.13 Document/Envelope Printing

You can print a letter and an envelope from DisplayWrite/36 or AS/400 Office in the same document by following this procedure:

1. Set the format for your letter. Enter your letter file. On the first typing line, press CMD20 for “Change Format.”
2. Select 1 for “Entire Document Options,” then another 1 for “Document Format.” Now select 3 for “Typestyle/Color.”
3. Select the font ID number for your letter, such as No. 11, 86, etc., then press <Enter>.
4. From the Document Format screen, select option 4 for “Page Layout/Paper Options.” Scroll to the second screen of these options and select a paper size of 8.5 (width) x 11 (length) inches and a paper source of 1. If the letter is more than one page, select a paper source of 1 for the following pages. Press <Enter> to return to the Document Format screen, then CMD12 to return to the Document Options screen.
5. You can now set up the alternate format for the envelope. Select 2 for “Alternate Format,” then 3 for “Typestyle/Color.” Select the font ID for the envelope, such as 5, and press <Enter> to return to the Alternate Format screen.
6. Select 4, “Page Layout/Paper Options.” Choose a first typing line of 1, then scroll down to the second screen of the options and choose a paper width of 7.5 (monarch size) or 9.5 (commercial, or #10 size) and a paper length of 4 inches. For a paper source, select 5 for “Envelope Feed.” Press <Enter> to return to the Alternate Format screen.
7. Select option 1 for “Margins and Tabs” and make the left margin 1. Press <Enter> and CMD3 until you are back in your document.
8. Type in the text. When you’re done, add in a “page end” by pressing <Alt><P>.
9. Now load in your alternate format for the envelope. To do this, press the CMD5 key, “Goto,” and type in rf for “Resetting Format.” Press <Enter>. Select option 4 on the Alternate Format screen, “Begin Alternate Format.” Press <Enter>.
10. The document will now be displayed with the alternate format. The cursor will be on the first typing line of 1 with a left margin of 1. Type in the envelope address, and send the file to print. The letter will print out first, followed by the envelope.

NOTE

The printer may eject a blank page when you change printing orientation. If the Buffer light and Ready light remain steady, press the Print/Check button on the printer's operator panel to eject the last page.

6.14 Duplex Printing

Some printer models can print both simplex (single sided) and duplex (double sided). They can print both long edge (landscape) and short edge (portrait) duplex printing.

The LaserCard allows access to the printer's duplexing capability in a variety of ways:

1. If you are running OS/400 V2R3 or later on the host, simply select duplex printing in the printer file. The menu option is called "Print on both sides . . ." and is found on the second to last menu screen. Available selections are *NO, *YES, and *TUMBLE.
2. Select duplex printing in the word processing program. In the OfficeVision/400 printer options menu, the printer option is called "Type of page printing . . ." and the available selections are: 1 = Single-sided; 2 = Double-sided; and 3 = Double-sided tumble.
3. Insert the I-O duplex printing command on the first line (line 1, position 1) of the document. The I-O duplex printing commands are:
 - D0 for simplex printing
 - D1 for duplex printing
 - D2 for duplex printing (tumble)
4. Set the interface to duplexing mode through the printer's front panel or Host Download command 33. The Host Download options are:
 - 0 = simplex
 - 1 = duplex
 - 2 = duplex (tumble)

Type `&%Z33,1` or `&%Z33,2` into the document or on the screen and print the document or the screen to set the interface to duplex printing. To return to simplex printing, type and print `&%Z33,0`.

For some duplex printing, if the last page is blank on the back side, the information for the last page may remain in the printer until the next printing job is received. If you want to print the last page, take the printer off-line by pressing the ONLINE button, then press the FORM FEED button to print the last page. Put the printer back on line by pressing the ONLINE button again.

6.15 Other Printer Commands

You can also enter commands into your document that allow you to control true LPI and response to host commands. These commands (shown in **Table 6-2**) are similar to font change commands.

The `-E` command allows you to send a PCL escape character to the printer to control the printing. For example, `-E(s3B` would begin bold printing (see your printer's manual for a list of the printer or escape commands).

The printer may compress line spacing to fit 66 lines onto the page. This may be undesirable, such as when using pre-printed forms that must align correctly. In these cases, the `-TY` command prevents the printer from compressing the line spacing.

Table 6-2. Other Printer Commands.

Command	Function
<code>-E</code>	Sends an ASCII ESC command to the printer
<code>-TY</code>	Enables true LPI printing
<code>-TN</code>	Disables true LPI printing
<code>-I</code>	Ignores all host formatting commands
<code>-S</code>	Stops ignoring host formatting commands

LASER CARDS FOR HP 4000 TWINAX AND COAX PRINTERS

Use the `-I` and `-S` commands to remove unwanted host commands from a print file. For example, when printing with forms-generating software, the files are recognized by the host as text files and formatted with unwanted carriage returns and line feeds. Placing the `-I` at the end of a line and `-S` at the front of the next line causes the interface to remove the host carriage-return and line-feed commands and send only the data to the printer.

7. Advanced Features — Twinax

There are several advanced features in the interface for accessing special functions of the attached printers, which are not normally available on the IBM 3812-1 printer:

- Command Pass-Thru™
- User-Defined Strings
- User-Defined Fonts
- Color Printing
- Bar Code Printing

Each of these features is described on the following pages.

7.1 Command Pass-Thru™

The Command Pass-Thru feature allows you to access all of the built-in features of your printer, even if these features aren't normally available through the host software. Command Pass-Thru lets you place printer-specific command sequences into the data sent to the printer. The interface recognizes these special sequences and "passes the command through" to the printer. The steps below describe how to use Command Pass-Thru.

1. Find the command for the print feature in the printer's manual.
2. Convert the printer command to hexadecimal.
3. Place the EBCDIC delimiter, as defined by a host-download command (refer to **Chapter 3, Configuration**) in the document at the point you want the feature to take effect. This signals the start of the print feature. Enter the beginning printer command, then enter the delimiter again. You may enter a space between hexadecimal code pairs to make the command easier to read, but do not put spaces between the delimiter and the hexadecimal characters.
4. Move the cursor to the point in the text that you want to end the print feature. Enter the delimiter, followed by the ending printer command, and then the delimiter again, into the document.

For example:

The command ESC&d0D begins underlining and ESC&d@ ends underlining. First convert the start command to the hexadecimal 1B 26 64 30 44 and the ending command to 1B 26 64 40. And, if the delimiter is the default &% (hex 50 6C), then enter the commands as follows:

This is an &%1B26643044&%underlined&%1B266440&% word. To print on the printer as:

This is an underlined word.

Only characters from 00 to FF are recognized (letters must be in upper case).

Errors in the Command Pass-Thru sequence will cause the I-O interface to ignore the command and printing will resume at the point the error occurred.

Although the command is displayed on the screen, the I-O printer interface treats it as a command and does not print it. If part of the sequence is printed, you have made an error in entering the codes; check your document and make sure you are using the correct format and EBCDIC hexadecimal characters.

Command Pass-Thru may change the horizontal spacing. (Since word-processing software sees printer commands as text, lines with commands in them may be shorter than other lines when you print the document.) Avoid sending codes that would move the print position during Command Pass-Thru. Since the I-O card does not process these commands, it cannot keep track of the print position changes; this may affect the position of following characters and page layout.

You can also send the I-O Command Pass-Thru strings to the printer by typing them on the host screen and pressing the screen print key.

Alternate Command Pass-Thru delimiters may be assigned by using the Z01 Command.

7.2 User-Defined Strings

To avoid keying in frequently used printer commands (which would appear in the document as hex values embedded in Command Pass-Thru delimiters), you should take advantage of the User-Defined Strings feature.

Using host-download command 04, assign the numbers 0 through 9 to frequently used printer command strings.

After a command string has been defined, activate it by typing the delimiter (&% or alternate CPT start delimiter) followed by the string number (U0 through U9) into the document or on the screen. When the document or screen is printed, the interface will recognize the &%U and send the command assigned to the string number to the printer.

For example, if command number U1 is assigned to a command string to turn on shadowed printing (hex codes 1B 28 73 31 32 38 53) for a PCL printer, then simply enter &%U1 in the document at the point where shadow printing is to begin.

Some commands, such as emphasized (bold) printing, may continue until another string is encountered that returns printing to normal, or, for some host systems, until the next page is sent to the printer.

The interface self-test prints out a list of command numbers and the command strings assigned to them.

7.3 User-Defined Fonts

The Laser Card supports a vast variety of fonts. For a list of the supported fonts refer to Appendices A and D. In addition, the User-Defined Fonts feature allows assignment of new or existing font IDs to different printer resident fonts or fonts from an optional font cartridge. Up to 10 new pairs of font IDs and fonts can be created.

The following example assumes the default font is specified as font 11. The font ID 11 represents the font Courier 10 CPI. If you want to change the default font but maintain the font ID 11, simply assign a new font to font ID 11 (for example, Courier bold 10 CPI). This is done by sending the host-download command &%Z21,0,11(<12U<(s0p10h12v0s3b4099T) to the printer. Font ID 11 has now been redefined as Courier bold 10 CPI. Consult the printer's user's guide for the information needed to write the string.

In the same manner, personalized font IDs can be assigned to printer-resident fonts or to fonts from an optional font SIMM. These fonts can then be called up by using the newly assigned font ID, the same way the standard printer-resident fonts are called up.

User defined fonts cannot be used with the -F font change commands.

7.4 Color Printing

For a complete description of Color support, refer to **Appendix C**.

7.5 Printing Bar Codes

For a complete description of internally generated bar codes, refer to **Appendix E**.

8. Troubleshooting—Twinax

This chapter provides instructions for performing diagnostic tests on the Laser Card. This chapter also contains a problem-resolution guide that describes common problems with the interface or the printer and their solutions. If you are unable to solve a problem by following the procedures outlined in this chapter, call Black Box Technical Support at 724-746-5500.

Before calling, verify that the Laser Card is installed correctly. Verify that the interface configuration settings are correct, perform the appropriate diagnostic tests outlined in this chapter, and have the following information ready:

- Printer and interface self-test printouts
- Model number and serial number of the interface
- Description of the problem
- Results of diagnostic tests
- Type of host system or controller

You may also need to print a “hex dump” or “buffer print” by enabling the Buffer Print option in the front-panel setup options. This causes all printing to be in hexadecimal code, just as it’s received from the host, to help in tracing problems.

If you need to ship the interface, use the original carton and packaging to prevent damage.

8.1 Buffer Print (EBCDIC Hex)

The interface can be set up to print the buffer in hexadecimal code. This can be useful for a technician to diagnose problems with the interface or the printer.

The EBCDIC hex data is printed on a grid corresponding to the data’s position in the buffer. If the hex data represents a printable character, that character is printed below the hex data in twinax.

You can start the buffer print from the printer’s operator panel as follows:

To start the EBCDIC hex dump through Host Download:

1. Verify that the interface is installed properly and the printer is in “READY” mode.
2. Type the Host Download command “&%Z42,1” on the screen.
3. Send the Host Download command to the printer (either press the Print Screen Button or print the document/file that contains the command).
4. Send the host data in question to the printer.
5. To stop the EBCDIC hex dump, power off the printer.

To start the EBCDIC hex dump through the printer’s operator panel:

1. Press Menu on the printer’s operator panel to scroll to the TWINAX CARD.
2. Press Item + repeatedly until “42=EBCDIC HEX” is displayed.
3. Press Value + to change the display to “42=HEX DMP Y”.
4. Press Select to select this setting. The display will show “42=HEX DMP Y*”.
5. Press Go to return the printer to operating mode.
6. To end the EBCDIC hex dump, power off the printer, or repeat steps 1 through 5, changing the display from “42=HEX DMP Y*” to “HEX DMP N*”.

8.2 ASCII Hex Dump

The interface can be set up to print the buffer in hexadecimal ASCII code. This differs from the EBCDIC hex dump in that the buffer is first translated into ASCII code before it is printed. This can be useful to diagnose problems with the interface or the printer.

To start the ASCII hex dump through Host Download:

1. Verify that the interface is installed properly and the printer is in “READY” mode.
2. Type the Host Download command “&%Z43,1 on the screen.
3. Send the Host Download command to the printer (either press the Print Screen Button or print the document/file that contains the command).
4. Send the host data in question to the printer.

5. To stop the ASCII hex dump, power off the printer.

To start the ASCII hex dump through the printer's operator panel:

1. Press Menu on the printer's operator panel to scroll to the TWINAX CARD.
 2. Press Item + repeatedly until "43=ASCII HEX DMP Y".
 3. Press Value + to change the display to "43=ASCII DMP Y*".
 4. Press Select to select this setting. The display will show "43=ASCII DMP Y*".
 5. Press Go to return the printer to operating mode.
6. To send the ASCII hex dump, power off the printer or repeat steps 1 through 5 changing the display from "43=ASCII DMP Y*" to "43=ASCII DMP N*".

The interface will start printing in buffer print after the selection is made active and the printer is again "Ready". As soon as the buffer print is selected, hexadecimal printing begins (there may be a delay while the printer finishes printing previously formatted data from the buffer).

8.3 Self-Diagnostics

The Laser Card has an additional twinax test to aid in the diagnosis of problems. You can set up the interface to perform a complete analysis of its functions. The interface transmits data to itself and then analyzes how that data is processed. If an error is detected, an error message is printed on the printer. Otherwise the interface prints the following message:

TEST SEQUENCE COMPLETE

The diagnostics repeat continuously. The Laser Card will fill up the entire test report page, which can take several minutes.

Power the printer OFF to end the testing.

Any error messages are printed between the "TEST SEQUENCE COMPLETE" messages.

NOTE

The twinax host must not be connected to the V-connector during this test.

Follow the steps below to perform the interface self-diagnostic:

1. Turn OFF the printer.
2. Disconnect the host cable(s) from the twinax V-adaptor. Remove all other cables from the printer.
3. Press Menu on the printer's operator panel to scroll to the TWINAX CARD.
4. Press Item - to display "TEST MENU".
5. Press Value + twice to change the display to "DIAGNOSTIC".
6. Press Select to select his setting. The display will show "DIAGNOSTIC*".
7. Press Go to start the diagnostic test. The interface will go into a continuous diagnostics cycle until you turn OFF the printer.

8.4 Problem-Resolution Guide

The following is a general guide to resolve common problems that may occur. Please refer to this guide before contacting Technical Support.

Table 8-1. Problem-Resolution Guide.

Problem or Message	Probable Cause	Action
"Printer not ready" message at host	Printer not in a ready status	Make sure printer is on line, has paper, etc.
Line sync LED is not on when connected to the host	Host is not configured for a printer at the address specified	Make sure the host is properly configured for the printer
	Configuration or address is incorrect	Make sure the host is configured for the 3812-1 (non-IPDS) printer at the proper address
	Host is not operating	Check host system

Table 8-1 (continued). Problem-Resolution Guide.

Problem or Message	Probable Cause	Action
	Damaged or improper cabling	Check host cabling for damage or improper connection
	Twinax cable improperly terminated	Make sure the prior device is not terminated (some PC emulation cards may terminate mid-line)
Line sync LED blinks on and off	Address conflict with another twinax device on this cable	Make sure no other device on this cable has the same address
	Damaged or improper host cables	Check twinax cabling for damage or improper connection
	Printer fault, such as paper out, paper jam, etc.	Make sure the printer has paper, is clear of jams, etc.
Printer loses host communication (drops off line)	Improper or damaged cabling	Check host cabling for improper connections or connections or damage
Right margin is cut off	Page width in word processing program is not wide enough	Change to a wider page
	Page width is too wide	Select a narrower page

Table 8-1 (continued). Problem-Resolution Guide.

Problem or Message	Probable Cause	Action
Extra blank sheets are ejected between sheets of printout	Form length not correct in software (maximum length is 66 lines)	Make sure your document length doesn't exceed the maximum number of lines
	Page orientation was changed	The printer may eject a blank page when the page orientation (portrait or landscape) is changed
Form length is incorrect	Form length incorrect in software	Change form length
	Incorrect configuration at the host	Make sure the host configuration matches the printer
Printer won't change fonts.	Incorrect typestyle number.	Make sure the font ID used is valid. Invalid font IDs are ignored by the printer
	Wrong optical fonts loaded.	Load the font that corresponds to the font ID
	Font SIMM damaged or not seated into the printer properly	If possible, try a known good SIMM to determine if SIMM is faulty. Make sure the SIMM is loaded properly
Printer does not print in landscape orientation	Did not select a rotation in the data-processing program	Select 90° or 270° orientation program

Table 8-1 (continued). Problem-Resolution Guide.

Problem or Message	Probable Cause	Action
	Did not select a rotation in the data-processing OCL statement	Add a 90° or 270° orientation instruction to the OCL statement
	APO feature is ON and size is 8½" x 14" or less, and width is less than height	Turn APO off or increase page size so it is larger than 8½" x 14", or change width and height so width is greater than height. Refer to the APO/COR section on page X for additional information.
	APO feature is OFF and is set to COR; COR host override allowed; or portrait	Set the Laser Card orientation to landscape
Printer does not print in requested font	Selected a rotation in the word-processing program	Deselect rotation setting in the word-processing program
	Selected a rotation in the data-processing OCL statement	Deselect rotation setting in the OCL statement
	APO feature is ON and page size is 8½" x 14" or less and width is greater than height	Turn APO off or increase page it is larger than 8½" x 14", or change width and height so width is less than height. Refer to Section 6.10 for more information.

Table 8-1 (continued). Problem-Resolution Guide.

Problem or Message	Probable Cause	Action
	APO feature is OFF and orientation is set to COR, is set to COR, COR, host override allowed, or landscape	Set Laser Card orientation to portrait
Printer does not print COR	APO feature is ON and page size is 8½" x 14" or less	Turn APO off or increase page size so it is larger than 8½" x 14"
	APO feature is OFF and orientation is set to portrait or landscape	Set orientation to COR
	APO feature is ON and orientation is set to portrait or landscape	Turn APO off or increase page size so it is larger than 8½" x 14"
	APO feature is OFF and set to portrait or landscape	Set orientation to COR
	APO feature is OFF and orientation is set to COR; COR, host override allowed	Set orientation to COR or change host settings (see the APO/COR section, Block 5 in Figure 6-1)
	AS/400 only: Rotation in data-processing printer file is set to *COR and other host print quality in printer file is *STD	Set orientation to COR or change host settings (see the APO/COR section, Block 5 in Figure 6-1)

Table 8–1 (continued). Problem Resolution Guide.

Problem or Message	Probable Cause	Action
Only part of the display-station setup screen appears on the display station	Cable to host is not disconnected	Make sure all devices on the twinax cable are powered off then disconnect the cable to the host
DisplayWrite/36 or Office Vision/400 document incorrectly	There might be a mistake in using DisplayWrite/36 or OfficeVision/400	Choose “yes” to printer error log on

9. Configuration—Coax

After installation and self-test, the Laser Card is ready to operate in most 3270 environments. The factory-default configuration settings will be satisfactory for many programs and applications. The interface also can be configured to meet the special needs of an application program using coax host-download commands (see below) or the printer's front-panel setup.

Coax Host-Download Commands

Host-download commands are placed in a host document or screen. The commands take effect when the print job is sent to the printer.

The command itself will not be printed if it was entered correctly, but the effect of the command should be evident (change in the line spacing, page length, and so on). If the command is printed, the interface did not recognize the command because of a problem in the format. Check the syntax of the command and send the command again.

If you wish to confirm the active setup configuration for the printer, you can print a listing page by selecting 98=Print Setup in the Coax card's TEST MENU through the printer's front panel, or by sending the Z98,1 command to the interface.

Host download commands sent through the printer's front panel to the interface take effect immediately and stay in the interface's memory until the printer is powered off. If you want the command to be permanent, send the Z99,0 command to the interface. This stores the selection in the printer's permanent memory so the commands are active each time the printer is powered on.

Host download commands use the following format:

```
&%Z[command number],[value and/or data][space or control character]
```

The "&%" is the delimiter that signals the interface that the information is a command. The uppercase "Z" is the default command ID character. You can select an alternate value for the command character using command 41. The space or control character signals the end of the command.

Multiple commands can be chained together by using a slash (/) or backslash (\) to separate the commands (no spaces are allowed). Each chained command string must be preceded by &% and terminated by one space or a control character (LF, NL, CR, or FF).

The terminating space or control character is not sent to the printer, but the host-download commands are sent to the printer and take effect immediately on the page where they are located.

For example, to set the characters per inch, line spacing, and form length (commands 3, 4 and 5) in one command string, place `&%Z3,15/Z4,2/Z5,70` followed by a space, in the document. This selects 15 CPI, double spacing, and 70 lines.

9.1 Host Download Command Overview

Table 9-1 lists the host download commands used to configure the interface to fit your application needs. These commands can be sent to the interface/printer from the 3270 host in a document or through a screen print.

A description of each command and how it is used is located directly after the table.

Table 9-1. Host-Download Commands.

Description	Command
Alternate Tray Options	63
Auto Print Orientation (APO)	61
Automatic Function at End of Job	20
Buffer Size	01
Character Set	65
Characters Per Inch	03
Coax Port Initialization String	57
Coax Port Timeout	51

Table 9-1 (continued). Host-Download Commands.

Description	Command
Command ID Character	41
CPT Beginning Delimiter Characters	40
CPT Ending Delimiter Characters	39
CR at MPP+1	15
Custom User Strings	55
FF After Time Elapse	27
FF Valid Location	19
Form Feed After Local Screen Copy	13
Form Feed Before Local Screen Print	12
Form Feed Usage	25
Form Length	05
Intervention Required (IR) Timeout	34
Line Spacing	04
Lines Per Inch	02

Table 9-1 (continued). Host-Download Commands.

Description	Command
LU1 Language	08
LU3 Print Image (Non-SCS Mode)	14
Manual Feed Tray Orientation	64
Maximum Print Position	06
NL at MPP+1	16
Override of Formatting Commands	30
Overwrite DSC (LU3) Translation Table	71
Overwrite EBCDIC (SCS/LUI) Translation Table	70
Paper Path	11
Paper Size	32
Primary Paper Tray Orientation	62
Print Case	07
Restore Defaults or Print Configuration	98
SCS TRN Translate	45
Start and Stop Buffer Hex Dump	42
Store Configuration in Permanent Memory	99
Suppress Empty Forms	26

Table 9-1 (continued). Host-Download Commands.

Description	Command
Suppress IBM Control Codes	36
True LPI Spacing	38
Truncate/Wrap Select	31
Valid FF at End of Print Buffer	18
Valid FF Followed by Data	17
Vertical Channel Select (VCS)	37

9.2 Configuration Options

In the command descriptions an asterisk (*) identifies the factory-default selection. Commands take effect immediately unless noted otherwise. Any errors cause the interface to ignore the command and continue printing. For a command to be permanently stored in permanent memory, the command Z99,0 must be used. RPQs are only active in LU3 (non-SCS) mode.

COMMAND 1: BUFFER SIZE

Selects logical default buffer size.

<u>VALUE</u>	<u>DESCRIPTION</u>
1	960 characters
*2	1920 characters
3	2560 characters
4	3440 characters
5	3564 characters

NOTES

This command, along with the Z99,0 command, changes the logical buffer size selection in the non-volatile memory of the interface. The logical buffer size is only reported to the host the next time the unit is powered up.

The physical buffer size is permanently set at 4K.

Example: &%Z1,3 sets logical buffer size to 2560 characters.

COMMAND 2: LINES PER INCH

Selects default LPI.

<u>VALUE</u>	<u>DESCRIPTION</u>
3	3 LPI
4	4 LPI
*6	6 LPI
8	8 LPI

NOTES

This default emulates the front-panel selection on an IBM printer.

The IBM host can control the LPI unless Command 36 is used to override the host LPI commands.

Example: &%Z2,8 sets the printer to 8 LPI default

COMMAND 3: CHARACTERS PER INCH

Selects default CPI

<u>VALUE</u>	<u>DESCRIPTION</u>
0	No default sent to printer
*10	10 CPI
12	12 CPI
15	15 CPI
16	16.7 CPI

*Factory-default setting.

NOTE

The IBM host can control CPI unless Command 36 is used to select override of host CPI commands.

Example: &%Z3,15 sets the printer to 15 CPI default

COMMAND 4: LINE SPACING

Selects default Line Spacing

<u>VALUE</u>	<u>DESCRIPTION</u>
*1	Single Space
2	Double Space

Example: &%Z4,2 Sets the printer to double-space default

COMMAND 5: FORM LENGTH

Selects default Form Length (MPL = Maximum Print Lines).

<u>VALUE</u>	<u>DESCRIPTION</u>
000	No form length control
001	Set form length in number of lines
to	
255	
*066	Factory Default

NOTE

The 000 value enables the front panel selection on the printer to control the form length when Command 25 is set to value 0.

Example: &%Z5,70 sets form length to 70 lines for A4 paper

COMMAND 6: MAXIMUM PRINT POSITION

Selects current and default Maximum Print Position, the maximum number of characters which can be printed on each line.

<u>VALUE</u>	<u>DESCRIPTION</u>
000	Infinite line length
001	Set MPP in number of characters
to	
255	
*80	Factory Default

NOTES

Normal values are 80, 132, or 198 characters. This default emulates the front-panel selection on an HP printer.

MPP and the current position will not be changed by changes in CPI.

The infinite line length will place no limits on the number of characters that can be sent to the printer on a single line.

Example: `&%Z6,63` sets MPP to 63 characters

COMMAND 7: PRINT CASE

Selects default print case.

<u>VALUE</u>	<u>DESCRIPTION</u>
0	Mono case
*1	Dual case

NOTE

This default only affects LU3 printing.

Example: `&%Z7,0` sets default to mono case

COMMAND 8: LUI LANGUAGE

Selects default LUI language.

VALUE DESCRIPTION

*01	English (U.S.) EBCDIC
03	Austrian/German
04	Belgian
05	Brazilian
06	Canadian (French)
07	Danish/Norwegian
08	Danish/Norwegian (alt.)
09	Finnish/Swedish
10	Finnish/Swedish (alt.)
11	French
12 (same as 11)	French (alt.)
13	Austrian/German (alt.)
14	International Set 5
15	Italian
16	Japanese (English)
19	Spanish
20	Spanish (alt.)
21	Spanish Speaking
22	English (U.K.)
23 (same as 07)	Norwegian

24 (same as 09)	Swedish
25 (same as 01)	EBCDIC (alt.)
26 (same as 08)	Norwegian (alt.)
27 (same as 10)	Swedish (alt.)
28	Portuguese
29 (same as 06)	Canadian (Bilingual)
30 (same as 11)	French AZERTY (105 character)
31 (same as 14)	Swiss German
32 (same as 14)	Swiss French

NOTE

This command, along with command Z99,0, changes the default LU1 language selection in the permanent memory of the interface. The command value should match the language number used in IBM CU configuration sequence number 121.

Example: &%Z8,04 sets LU1 language to Belgian

COMMAND 11: PAPER PATH

Selects default paper path for the Page Presentation Media (PPM) command.

<u>VALUE</u>	<u>DESCRIPTION</u>
0	Ignore the host PPM command and select the paper tray through the printer's front panel
*2	Cut-sheet feeding from primary bin is default
3	Cut-sheet feeding from alternate bin 1 is default
4	Envelope feeder default
5	Manual sheet-feed default
6	Manual envelope-feed default
9	Cut-sheet feeding from alternate bin 2 is default

*Factory-default setting.

NOTES

This command defines the default paper source for the Page Presentation Media (PPM) command in SCS mode. If the PPM command is received from the host, the interface always sends the paper source to the printer unless value 0 is selected.

If the printer does not have a secondary paper bin or an envelope feeder, it ignores the command, but it will be used for Commands 62-64 logic.

The printer ignores the command if it does not have a secondary paper bin or an envelope feeder.

A manual sheet feed command in the SCS PPM causes the printer to wait for the operator to insert paper in the manual feed tray. This command takes effect immediately if placed on the first position of the page (line 1, position 1); otherwise, it takes effect on the next page.

Example: `&%Z11,5` selects manual sheet feed as the default source of paper.

COMMAND 12: FORM FEED BEFORE LOCAL SCREEN PRINT

Specifies whether a form feed is performed before doing local screen print.

<u>VALUE</u>	<u>DESCRIPTION</u>
*0	No form feed before local screen dump
1	Form feed before local screen dump

NOTE

This command only affects the local screen copy function, not the host-initiated local copy printing, and functions only in LU3 (non-SCS) operations.

Example: `&%Z12,1` performs a FF before local screen dump

COMMAND 13: FORM FEED AFTER LOCAL SCREEN COPY

Specifies whether a form feed is performed after a local screen hard copy.

<u>VALUE</u>	<u>DESCRIPTION</u>
*0	No Form Feed after local screen dump
1	Form Feed performed after local screen dump

NOTES

To use this function, the RPQ should be:

IBM 3268 RPQ SC9508

IBM 3287 RPQ MC3750

IBM 4214 OPT 20=3

This command only affects the local screen copy, not the host-initiated local copy printing, and functions only in LU3 (non-SCS) operations.

Example: &%Z13,1 performs a FF after local screen dump

COMMAND 14: LU3 PRINT IMAGE (Non-SCS Mode)

Selects Null-Line Suppression or True Screen Image in LU3 printing mode.

<u>VALUE</u>	<u>DESCRIPTION</u>
*0	Null-line suppression in local copy and non-SCS print
1	Null-line suppression in non-SCS print and true screen image in local copy
2	True screen image in non-SCS print and null-line suppression in local copy
3	True screen image in non-SCS print and true screen image in local copy

NOTES

To use this function, the RPQ should be:

IBM 3268 RPQ SC9505

IBM 3287 RPQ SC3741

IBM 4214 OPT 18=2

Available only in LU3 (non-SCS) operations

0 and 1 are only functional from CUT terminals.

Example: &%Z14,3 prints true screen image in non-SCS print and local copy

COMMAND 15: CR at MPP + 1

Sets the printer in accordance with the RPQ installed in the control unit.

<u>VALUE</u>	<u>DESCRIPTION</u>
*0	First print position (PP) of next line
1	First PP of current line

NOTES

To use this function, the RPQ should be:

IBM 3268 RPQ SC9501

IBM 3287 RPQ S30219

IBM 4214 OPT 15=1

Available only in LU3 (non-SCS) operation

Example: &%Z15,1 prints first PP of current line as the next PP when a CR is received at MPP+1.

COMMAND 16: NL at MPP + 1

Sets the printer in accordance with the RPQ installed in the control unit.

<u>VALUE</u>	<u>DESCRIPTION</u>
*0	First PP of current line + 2 lines
1	First PP of next line

NOTES

To use this function, the RPQ should be:

IBM 3268 RPQ SC9502

IBM 3287 RPQ S30219

IBM 4214 OPT 15=1

Available only in LU3 (non-SCS) operation.

Example: &%Z16,1 performs first PP of next line as the next PP when an NL is received at MPP+1.

COMMAND 17: VALID FF FOLLOWED BY DATA

Sets the printer in accordance with the RPQ installed in the control unit.

<u>VALUE</u>	<u>DESCRIPTION</u>
*0	Second print position of first line on next form
1	First print position (PP) of first line on next form

NOTES

For the Value 1 selection, the RPQ would be:

IBM 3268 RPQ SC9503

IBM 3287 RPQ N/A

IBM 4214 OPT 16=2

Available only in LU3 (non-SCS) operation.

Example: &%Z17,1 performs first PP of first line on next form as the next PP when a valid FF is not positioned at the end of an IBM print buffer.

COMMAND 18: VALID FF AT END OF PRINT BUFFER

Sets the printer in accordance with the RPQ installed in the control unit.

<u>VALUE</u>	<u>DESCRIPTION</u>
0	First PP of second line on next form
*1	First PP of first line on next form

NOTES

To use this function, the RPQ should be:

IBM 3268 RPQ SC9504

IBM 3287 RPQ SC3749

IBM 4214 OPT 17=2

Available only in LU3 (non-SCS) operation.

Example: &%Z18,1 performs first PP of first line on next form as the next PP when a valid FF is received at the end of an IBM print buffer.

COMMAND 19: FF VALID LOCATION

Sets the printer in accordance with the RPQ installed in the control unit.

<u>VALUE</u>	<u>DESCRIPTION</u>
*0	FF is valid only at the first print position or at position MPP+1.
1	FF is valid anywhere it occurs.

NOTES

To use this function, the RPQ should be:
IBM 3268 RPQ SC9506
IBM 3287 RPQ SC3739
IBM 4214 OPT 19=1

Available only in LU3 (non-SCS) operation.

Example: &%Z19,1 makes FF valid anywhere it occurs

COMMAND 20: AUTOMATIC FUNCTION AT END OF JOB

Sets the printer in accordance with the RPQ installed in the control unit.

<u>VALUE</u>	<u>DESCRIPTION</u>
*0	NL is automatically executed after the buffer is completed (unless a FF, NL, or CR was last in the buffer).
1	FF is automatically executed after the print buffer is completed (unless a FF was last in the buffer).

NOTES

To use this function, the RPQ should be:
IBM 3268 RPQ SC9507
IBM 3287 RPQ SC3740
IBM 4214 OPT 20=2

Available only in LU3 (non-SCS) operation.

Do not press the form feed or line feed buttons on the front of the printer. This will cause the host and printer to lose synchronization of paper position. This command reduces the need to advance the paper.

Example: &%Z20,1 sets the printer to issue a FF automatically at the end of the print buffer.

COMMAND 25: FORM-FEED USAGE

Enables a Form Feed from the host system to be converted to the required number of line feeds (beneficial when forms length is controlled by the interface).

<u>VALUE</u>	<u>DESCRIPTION</u>
*0	Pass FF from host to the printer
1	Count the lines in Command 5 and send multiple line feeds to the printer in place of the host FF
2	Ignore all IBM Motion Commands

Example: &%Z25,1 sets the printer to count the lines specified in Command 5.

COMMAND 26: SUPPRESS EMPTY FORMS

Suppresses blank printout pages caused by form-feed commands that occur at the top of a form.

<u>VALUE</u>	<u>DESCRIPTION</u>
*0	No, do not suppress empty forms
1	Yes, suppress empty forms

NOTES

If selected, the interface ignores form-feed commands located at the top-of-form position.

This command affects printing in both DSC and SCS modes. This differs from the IBM 3287, which suppresses form feed only in DSC mode.

Example: &%Z26,1 sets the interface to suppress empty forms.

COMMAND 27: FF AFTER TIME ELAPSE

Sends a Form Feed if unprinted data remains in the print buffer for the coax-port timeout interval specified in Command 51.

<u>VALUE</u>	<u>DESCRIPTION</u>
*0	No extra FF is sent
1	Send FF after timeout value

NOTE

In most cases, the host application generates a termination FF and there is no need to change this command from the default.

Example: `&%Z27,1` sends a FF after time delay selected by command 51 (default = 5 sec.) when unprinted data remains in the print buffer.

COMMAND 30: OVERRIDE OF FORMATTING COMMANDS

Enables the printer's front-panel selections to control how a job is printed.

<u>VALUE</u>	<u>DESCRIPTION</u>
*0	Normal operation (disabled)
1	Formatting commands are not sent to the printer (enabled)

NOTES

When active, this command overrides the interface's default selections for CPI, LPI, font, orientation, bin selection, paper size, COR and line compression.

A reset command is sent to the printer before a coax print job in order to restore the printer's front panel default selections.

This command has no effect on the special features Command Pass-Thru, user strings, initialization strings and coax host RPQs.

Example: `&%Z30,1` sets override of formatting commands.

COMMAND 31: TRUNCATE/WRAP SELECT

Selects whether the interface truncates or wraps the text if the maximum print position is exceeded.

<u>VALUE</u>	<u>DESCRIPTION</u>
*0	Allow text to print on next line when maximum print position is exceeded
1	Truncate text beyond the maximum print position

Example: `&%Z31,1` causes text that exceeds the maximum print position to be truncated (not printed)

COMMAND 32: PAPER SIZE

Specifies the paper size used for printing.

<u>VALUE</u>	<u>DESCRIPTION</u>
*0	Selects 8 1/2" x 11" letter paper
1	Selects A4 (210mm x 297mm, 8.27" x 11.69") paper
2	Selects 8 1/2" x 14" legal paper
3	Selects 11 x 17 paper
4	Selects A3 paper (279.4 x 431.8 mm)
5	No paper size sent. Selected using the printer's front panel

Example: `&%Z32,1` selects A4 paper

COMMAND 34: INTERVENTION REQUIRED (IR) TIMEOUT

Sets the time interval before an intervention required signal is sent to the host after a printer error occurs. Note that the interface's setup switch #4 must be set to "0" (enabled).

<u>VALUE</u>	<u>DESCRIPTION</u>
000	Never send an IR
001 to 255	IR is sent (value *5) seconds after printer error occurs
*120	Default, send IR after ten minutes.

Example: `&%Z34,036` sets IR time interval to 3 minutes (=6 *5/60)

COMMAND 36: SUPPRESS IBM CONTROL CODES (Host Commands)

This function is used to select suppression of all or some IBM control codes sent from the host system.

<u>VALUE</u>	<u>DESCRIPTION</u>
--------------	--------------------

*0	Obeys all IBM control codes (Supp None)
1	Suppresses all IBM control codes (Supp All)
2	Suppresses LPI, CPI, MPP and MPL control codes (Supp CPI/LPI)
3	Suppresses CPI and MPP control codes (Supp CPI)
4	Suppresses LPI and MPL control codes (Supp LPI)
5	Suppresses print quality specified in the PPM command (Supp Quality)

NOTES

If this command is set to 1, documents need to be formatted by sending transparent control codes to the printer using Command Pass-Thru or SCS mode transparent data.

If value 2 is selected, the SCS pitch (CPI), line density (LPI), SHF (MPP), and SVF (MPL) commands will be suppressed (not sent to the printer).

Example: `&%Z36,2`: No LPI, CPI, MPP or MPL commands are sent to the printer. The document prints using the printer's defaults.

COMMAND 37: VERTICAL CHANNEL SELECT (VCS)

Specifies vertical channel select (VCS) emulation. Functions similarly to a vertical tab, except the 3287 does LF only.

<u>VALUE</u>	<u>DESCRIPTION</u>
0	3287 VCS emulation
*1	3268/4214/4224 VCS emulation

Example: `&%Z37,0` selects 3287 VCS emulation

COMMAND 38: TRUE LPI SPACING

Because laser printers have a non-printable border around the edge of single-sheet pages, 6 LPI and 8 LPI spacing is compressed slightly to enable 66 lines and 88 lines to be printed on 11-inch-long paper. This can occasionally cause a problem, especially when using preprinted forms that must align precisely. Command 38 enables a user to override the laser printer LPI compression.

<u>VALUE</u>	<u>DESCRIPTION</u>
0	Compress the vertical LPI spacing
*1	Print using true 6 and 8 LPI spacing

NOTE

If true LPI is selected, the user needs to adjust the document formats to allow for the reduced number of lines that can be printed per page, or the extra lines may print onto another sheet of paper.

Example: `&%Z38,1` specifies that vertical spacing prints using true 6 and 8 LPI.

COMMAND 39: CPT ENDING DELIMITER CHARACTERS

Specifies the two characters to be used for the ending delimiter characters or Command Pass-Thru.

<u>VALUE</u>	<u>DESCRIPTION</u>
XXYY	XX is the ASCII hexadecimal value of the first character and YY is the ASCII hexadecimal value of the second character.

NOTES

If an ending delimiter is not selected with this command, the delimited selected with Command 40 will be used as a default.

The default delimiter will no longer be active if the command is used to change it. If Command 39 and Command 40 are both entered, Command 39 must be sent after Command 40 to be active.

One delimiter character can be specified instead of two by entering the hex code for the character followed by two zeros (e.g., `&%Z39,2500` selects `&` as the delimiter).

A hex code that starts with 00 is invalid.

Example: `&%Z39,253F` specifies the `%?` characters as the alternate ending delimiter characters (the ASCII hex code for `%` is 25; the ASCII hex code for `?` is 3F).

COMMAND 40: CPT START DELIMITER CHARACTERS

Specifies the two characters to be used for the beginning delimiter characters for Command Pass-Thru.

<u>VALUE</u>	<u>DESCRIPTION</u>
XXYY	XX is the ASCII hexadecimal value of the first character and YY is the ASCII hexadecimal value of the second character.

NOTES

Host download commands use the CPT beginning delimiter characters as well. The new character(s) replace the &% in front of the Z.

If you do not select an ending delimiter with Command 39, the delimiter selected with this command will be used as the default ending delimiter.

The default beginning delimiter will no longer be active if you use this command to change it.

One delimiter character can be specified instead of two by entering the hex code for the character followed by two zeros (e.g., &%Z40,2500 selects & as the delimiter).

A hex code that starts with 00 is invalid.

Example: &%Z40,253F Specifies the %? characters as the beginning delimiter characters (the ASCII hex value of % is 25; the ASCII hex value of ? is 3F).

COMMAND 41: COMMAND ID CHARACTER

Specifies the character that is used for the command identifier that follows the delimiter characters.

<u>VALUE</u>	<u>DESCRIPTION</u>
00	Deletes the previously selected character
ZZ	ZZ is the ASCII hex value of the command ID character

NOTE

The character selected must be a hex value (L, P, or U).

Example: &%Z41,59 specifies "Y" as the command ID character

COMMAND 42: START AND STOP EBCDIC HEX DUMP

After receiving a start command, the coax interface, starting with the next buffer received, sends all host data directly to the printer as hexadecimal printing until the printer is powered off.

<u>VALUE</u>	<u>DESCRIPTION</u>
*0	No action taken
1	Start EBCDIC hex dump

NOTE

This command enables the user to print only the section of the document that is in question in buffer hex dump format. Hex printing starts with the buffer after the start command.

Examples: &%Z42,1 starts buffer hex dump printing

COMMAND 43: START/STOP ASCII HEX DUMP

After receiving a start command, the interface, starting with the next buffer received, translates all host data into ASCII (from EBCDIC) and then causes the ASCII data to print in hexadecimal form. The ASCII hex dump is performed until the printer is powered off.

<u>VALUE</u>	<u>DESCRIPTION</u>
*0	No action taken
1	Start ASCII Hex Dump

Example: &%Z43,1 starts ASCII hex dump printing.

COMMAND 45: SCS TRN TRANSLATE

Specifies how transparent data sent using SCS code 35 is handled.

<u>VALUE</u>	<u>DESCRIPTION</u>
0	Binary Transparent
*1	Emulate IBM 3287 Printer

NOTES

Value 1 causes valid graphic characters to be printed normally (i.e., converted from EBCDIC to ASCII), while control codes and invalid graphics are printed as hyphens, and normal page formatting is maintained.

Value 0 causes the 8-bit binary codes to be sent directly to the printer just as they are received from the host.

SCS code 36 functions the same as code 35.

Available in SCS (LU1) mode only.

Example: &%Z45,0: All SCS Code 35 data is sent to the printer as binary codes without translation.

COMMAND 51: HOST-PORT TIMEOUT

Selects the time interval that the interface waits for receipt of additional data from the coax host before automatically switching to check for data from the alternate (PC/LAN) host.

<u>VALUE</u>	<u>DESCRIPTION</u>
04	Time interval in number of seconds
to	
60	
*08	Factory default is 8 seconds

NOTES

The alternate (PC/LAN) host is responsible for sending any needed format commands required by the printer prior to sending printable data.

If your printer supports Intelligent Emulation Switching (IES), make sure the printer's IES timeout period is less than the command 50 timeout setting.

COMMAND 55: CUSTOM USER STRINGS

Allows the user to define up to six custom user strings, of up to 25 bytes each, which are stored in the memory of the interface and sent to the printer whenever the character delimiter, letter U, and number of the string appears in the text of the document (for example, &%U3).

<u>VALUE</u>	<u>DESCRIPTION</u>
0-5 (max. 25 bytes of ASCII hex code)	Defines the custom user string
0-5 ()	Deletes custom user string

NOTES

To aid in readability, a single space is allowed between hex bytes, but is not included in the string.

The strings could specify a special font-selection command or other custom command to be sent directly to the printer.

This command, if placed as the first printable data at the top of the page (position 1, line 1), will be sent to the printer prior to the data.

To change a custom user string, simply input the new custom user string values; the old string is automatically erased.

Example: `&%Z55,3(1B01)` defines the `&%U3` custom user string to send an "Escape and SOH" (1B and 01 hex) to the printer which is the double wide command).

COMMAND 57: HOST-PORT INITIALIZATION STRING

Allows the user to define an initialization string of up to 25 bytes, which is stored in the memory of the interface and is sent to initialize the printer for host printing after shared port printing has occurred. The interface also restores the host page format parameters after sending this string and prior to host printing. The initialization string is sent at the beginning of each page.

VALUE

DESCRIPTION

1(max. 25 bytes of ASCII hex code)

Defines the host port init string

1()

Deletes the host port init string

NOTES

To aid in readability, a single space is allowed between hex bytes but is not included in the string.

The coax-port initialization string is only sent to the printer when you turn the printer on and after printing by the shared parallel port has occurred.

Host SCS commands and download commands have priority over the initialization string instructions.

To change the initialization string, simply input the new command values. The old string is automatically erased. To delete the initialization string from the permanent memory, simply type the parentheses with nothing between them.

Example: &%Z57,1() deletes from permanent memory any hex string that had been previously defined for the coax-port initialization string

COMMAND 61: AUTOMATIC PRINT ORIENTATION (APO)

Laser printers have the ability to automatically control page orientation if the user decides to activate Auto Print Orientation (APO). Refer to the page-orientation logic chart in **Section 10.5**.

<u>VALUE</u>	<u>DESCRIPTION</u>
*0	APO is ACTIVE. The page dimensions of a document are checked to determine if the data should be printed in landscape because the width is greater than the length.
1	APO is NOT ACTIVE. Print orientation is controlled the orientation selections specified in Commands 62, 63, and 64.

NOTE

APO active is the recommended selection. A user can manipulate the page dimensions using SCS commands to control the orientation of the printing as long as the page size required is 8 1/2" x 11" or smaller.

Example: &%Z61,1 disables APO

COMMAND 62: PRIMARY PAPER TRAY ORIENTATION

The SCS (LU1) PPM command specifying the source for the paper can have a printing orientation assigned to the paper tray that is assigned. Refer to the page-orientation logic chart in **Section 10.5**. This command duplicates the IBM 3812 and 4028 printer's feature with the additional selection of option 3.

<u>VALUE</u>	<u>DESCRIPTION</u>
*0	Computer Output Reduction (COR) Mode is active when paper is specified to be selected from the primary tray
1	Prints PORTRAIT orientation using the active font when the primary tray is specified
2	Prints LANDSCAPE orientation using the active font when the primary tray is specified
3	User Defined mode. Documents are printed using the fonts and orientation that the user specifies with host-download font ID commands.

Example: `&%Z62,3` specifies that the document is printed as formatted when the primary paper tray is specified as the paper source.

COMMAND 63: ALTERNATE PAPER TRAY ORIENTATION

This command functions identically to Command 62 except it controls the orientation for printing that specifies the alternate tray for the paper source.

Even if the printer does not have an alternate paper tray, if the SCS (LU1) host specifies the alternate tray, the interface prints the document in accordance with the selection in Command 63.

Values are the same as in Command 62 except substitute “alternate tray” for “primary tray” in the descriptions.

NOTE

The value 3 is an excellent choice when COR is not required, since the user can choose the fonts and orientation by using host-download font ID commands.

Example: `&%Z63,2` specifies that landscape orientation will be used for all printing in which the SCS (LU1) PPM code specifies the alternate paper tray be used.

COMMAND 64: MANUAL FEED TRAY ORIENTATION

This command functions identically to Command 62 except it controls the orientation for printing when the PPM Command specifies the manual-feed tray for the paper source.

Values are the same as Command 62 except substitute “manual-feed tray” in place of “primary tray” in the descriptions.

NOTE

When you instruct the printer to print from the manual-feed tray, it will not print until paper is placed in the manual-feed slot. This allows you to insert special forms, letterhead, or colored paper into the manual-feed slot.

Example: `&%Z64,1` specifies that all printing using paper from the manual-feed slot be printed in portrait orientation

COMMAND 65: CHARACTER SET SELECTION

Enables the user to select the ASCII character set that is used in the conversion from EBCDIC (SCS/LU1) or DSC (LU3) to ASCII.

<u>VALUE</u>	<u>DESCRIPTION</u>
1	Roman 8 character set
*2	Code Page 850 character set

NOTES

The character set substitutions defined in Commands 70 and 71 must be adjusted if the ASCII character set is changed.

All previously defined substitutions are lost from NV memory when the character set selection is changed.

Refer to the character set summary tables at the end of the self test to confirm which ASCII character is printed for each of the 3270 hex codes. Both the EBCDIC and DSC tables are provided.

Example: `&%Z65,2` Selects the Code Page 850 character set

COMMAND 70: OVERWRITE EBCDIC (SCS/LU1) TRANSLATION TABLE

Custom substitutions defined by this command and stored in permanent memory are written into the EBCDIC (SCS/LU1) to ASCII translation table.

<u>VALUE</u>	<u>DESCRIPTION</u>
XX	The EBCDIC character to be changed (in hex)
YY	The substitute ASCII character for the EBCDIC character above

NOTES

Previously stored substitutions are automatically changed to the new selection when the same hex location is specified in the EBCDIC table.

Previously stored substitutions are canceled if an ASCII hex sequence of 00 is specified.

Command Z99,0 must be used to store the substitutions in permanent memory for them to be effective when the printer is next turned on.

The active EBCDIC (SCS/LU1) translation table prints out at the end of the interface self-test summary.

Example: &%Z70,7B,40/Z99,0 prints a 40 ASCII hex (a @ symbol) when the interface receives an EBCDIC 7B (a # symbol). The command is followed by a command Z99,0, which stores the active setup selections in permanent memory.

COMMAND 71: OVERWRITE DSC (LU3) TRANSLATION TABLE

Custom substitutions defined by this command, and stored in the permanent memory, are overwritten into the DSC (LU3) to ASCII translation table.

NOTES

This command functions similarly to Command 70 except the substitutions are applicable to the DSC (LU3) translation table. Refer to the Command 70 instructions.

The active DSC (LU3) translation table prints out at the end of the interface self-test summary.

COMMAND 98: RESTORE DEFAULTS OR PRINT CONFIGURATION

Restores the factory default configuration selections, prints out a copy of the active configuration selections, or restores the permanent memory selections to the active setup status.

<u>VALUE</u>	<u>DESCRIPTION</u>
0	Restores the factory setup
1	Prints out the active setup selections
2	Restores the setup selections stored in the permanent memory to active status

NOTES

If a document is printed using temporary host-download commands (commands not stored using the Z99,0 command), value 2 will restore the permanent memory selections.

Put a `&%Z98,2` at the end of the document to restore the standard setup parameters for the next user of the printer.

The active setup and permanent memory setup selections are the same after a Command Z99,0 or a Command Z98,2 is sent to the printer.

Example: `&%Z98,1` prints out the active setup selections for review.

COMMAND 99: STORE CONFIGURATION IN PERMANENT MEMORY

Send this command after all desired host-download configuration commands have been sent to the interface. It stores the active setup in the permanent memory of the interface so it will be in effect whenever the printer is powered on. Otherwise, active configuration commands are lost when the printer is turned off.

<u>VALUE</u>	<u>DESCRIPTION</u>
--------------	--------------------

0	To complete the command, the value 0 must be used
---	---

NOTE

Host-download selections followed by a Command Z99,0 will be stored in permanent memory and active when the printer is turned on. Only use Command Z99,0 when the host-download selection needs to be permanently stored in the memory of the interface.

Example: `&%Z99,0` stores the currently active setup selections in the permanent memory of the interface.

10. Operation — Coax

When the printer is turned on, the interface checks for a proper 9-pin host attachment cable to decide which mode of operation is desired. If a twinax or coax cable is not attached, the Laser Card will cause an error page to be printed. Power OFF the printer, attach the adapter, and then power ON the printer again.

10.1 Printer Sharing

The Laser Card allows your printer to automatically share printing from an attached PC (any parallel or serial source), an attached LAN (through an additional network card), and an IBM coax host. The interface uses a timeout after each host print job before the interface allows the printer to honor PC/LAN jobs. Make sure the printer is loaded with paper and “READY” is displayed before printing.

When the printer receives PC/LAN (ASCII) data and the host attachment is not active, it honors the ASCII job. At the completion of the ASCII job, the printer has a timeout setting so it will wait and not accept data from another source.

NOTE

If it seems that the printer is not printing host data for an extended time after an ASCII job, check, and possibly change, the printer-sharing timeout in the printer.

If the PC print job is sent while a host job is printing, the printer responds as “busy” to the PC/LAN print request. The print job can be spooled through a spool program, sent to the printer when the host job is finished, or if the PC’s printer port is set for infinite retry through the DOS “Configure Printer” command (described in the DOS manual), the print job waits for the printer to be available to receive the data.

NOTE

If the interface’s timeout setting is too short (less than 4 seconds), it is possible the interface will interpret an interruption of a host print job as the end of the job and switch to PC/LAN printing.

10.2 Coax Host Printing

With the Laser Card interface installed and a 9-pin to coax host adapter cable attached, your printer emulates a 3287, 3262, 3268, 3812-1, 4028, 4214, or 4224 (non-IPDS) printer on your 3270-type host system.

10.3 Selecting Fonts

You can select a printer resident font or a font from an optional font cartridge in the printer by entering a font change command in the document. The font-change commands take the following format:

`& %[P or L][font ID]`

The `& %` (or the alternate beginning delimiter selected with command 40) is the delimiter that signals the interface that the information following is a command. The letter P (portrait) or L (landscape) controls the orientation of the printing. The font ID number (5 digits) selects the font to be used for printing. Refer to **Appendix A** for a list of fonts and their font IDs.

For example:

`& %L00086` selects Prestige 12 CPI font in landscape orientation.

The font ID number must select a font available in the printer or in the installed cartridge. If the proper cartridge is not installed, or the font does not exist on the cartridge, then the printer will automatically select an alternate landscape font for printing. Multiple font changes can be made in a document as long as all fonts are in the same orientation. Changes in orientation (portrait or landscape) automatically eject the page. A font ID that changes the orientation from the previous page must be on the first line and first position of the page or a blank page will be ejected. A blank page at the beginning of a print job is often caused by a change in orientation.

10.4 Computer Output Reduction (COR)

Computer Output Reduction (COR) is an IBM printer feature that automatically rotates data-processing reports to landscape orientation and compresses the text to fit 198 columns x 66 lines on the page. COR is enabled by doing the following:

1. Select APO active with command 61 (value 0) or through the front panel.
2. Select COR for the paper source with commands 62-64 (value 0) or through the front panel.

When COR is enabled, the following format changes are automatically made to data-processing reports:

- The page is printed in landscape orientation.
- Vertical line height is 70% of that specified.
- A half-inch blank area is provided on the top and left edge of the paper.
- The selected pitch is changed: 10 pitch to 13.3 pitch; 12 pitch to 15 pitch; 15 pitch to 19 pitch.

A combination of control codes in the printer data stream and the settings in the configuration are used to determine page orientation when processing DSC, DSE, or LU1 (SCS) data streams.

Some applications will not allow the user to insert the data-stream commands required to select orientation and format. Where the insertion of the required data stream commands is not possible, the user can select the orientation and format desired by using the printer configuration settings. Use of the Write Control Character (WCC) in the DSC/DSE data streams for orientation and format selection is not recommended.

10.5 Automatic Print Orientation (APO)

When Automatic Print Orientation (APO) is activated (command 61, value 0) or through the front panel, the interface notes the format of the print image and calculates the required print dimensions. The illustration on the following page shows how the page size determines the orientation for coax COR.

If a calculated paper size is larger than 8 1/2" x 11", the paper-tray orientation selection (commands 62-64) determines the orientation.

In LU3 (DSC/DSE) mode, the values used in the calculations are specified by the interface's active configuration selections. In LU1 (SCS) mode, the values are specified in the data stream by the SCS controls. If a value has not been set in the SCS data stream, the interface's active configuration is used instead.

The APO feature also uses the calculated print width and length to determine the print orientation when the dimensions are less than 8 1/2" x 11". When the width is greater than the length and APO is active, the document prints in landscape, even if the font is specified as portrait.

LASER CARDS FOR HP 4000 TWINAX AND COAX PRINTERS

The steps below describe printing with the APO feature (refer to the illustration below).

1. If APO is not active (command 61, value 1; or front panel), the interface uses the paper source selections (commands 62-64, or front panel) to control orientation in the active font. If APO is active, the interface goes on to block 2.
2. The interface calculates the page size. If the page size is more than $8\frac{1}{2}$ " x 11" the interface uses the paper source selections to control the orientation in the active font. If the report is less than $8\frac{1}{2}$ " x 11", the interface goes on to block 3.
3. At block 3, the interface checks the length and width. If the report is longer than it is wide, it prints in portrait. If the report is wider than it is long, the report prints in landscape.

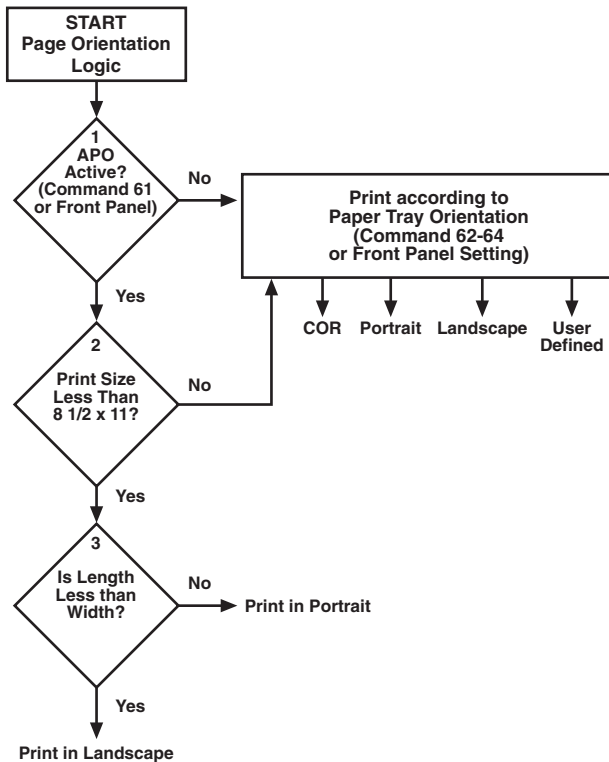

Figure 10-1. Page Orientation Logic.

10.6 Print Position and Page Length

Table 10-1 gives the PMPP (Physical Maximum Print Position) and PMPL (Physical Maximum Page Length) for letter, legal, and A4 size paper.

Table 10-1. Print Position and Page Length.

Paper Size	PMPP at				PMPL at		True 6 LPI	True 8 LPI
	10 CPI	12 CPI	15 CPI	17.1 CPI	6 LPI	8 LPI		
Letter								
Portrait	80	96	120	136	66	88	63	84
Landscape	105	126	157	178	50	87	48	84
COR136	154	201	201	66	89	—	—	
Legal								
Portrait	80	96	120	136	84	112	81	108
Landscape	135	162	202	230	50	67	48	64
A4								
Portrait	78	93	117	133	70	93	67	89
Landscape	112	134	167	191	49	66	47	62

11. Advanced Features—Coax

There are five advanced features in the Laser Card for accessing special functions of the printers, which are not normally available on the IBM 3287 or 4224 printers:

- Command Pass-Thru
- Custom User Strings
- SCS Mode Transparent Data
- Color Printing
- Bar Code Printing

11.1 Command Pass-Thru

The Command Pass-Thru feature allows access to all of the built-in features of your printer, even if these features aren't normally available through the host software. Command Pass-Thru lets you place printer-specific command sequences in the data sent to the printer. The interface recognizes these special sequences and "passes the command through" to the printer. The steps below describe how to use Command Pass-Thru.

1. Find the command for the print feature in the printer's user's guide.
2. Convert the printer command to hexadecimal.
3. Place the beginning delimiter `&%` (or the custom delimiter as defined with command 40) in the document at the point where you want the feature to take effect. This signals the start of the print feature. Enter the beginning printer command, then enter the ending delimiter `&%` (or the custom delimiter as defined with command 39). No spaces are allowed.
4. Move the cursor to the point in the text where you want to end the print feature. Enter the beginning delimiter followed by the ending printer command and then the ending delimiter into the document.

For example:

If ESC E begins bold printing and ESC F ends bold printing on your printer, first convert ESC E to the hexadecimal 1B45 (ESC = 1B and E=45) and ESC F to 1B46. Then enter the commands as follows:

This is a **word**.

to print on the printer as:

This is a **word**.

NOTES

Only numbers or the upper-case letters A through F are allowed.

Errors in the Command Pass-Thru sequence will cause the interface to ignore the command and resume printing at the point the error occurred.

Command Pass-Thru may change the horizontal spacing. (Since the word-processing software sees printer commands as text, lines with commands in them may be shorter than other lines then you print the document.)

1.2 Custom User Strings

Host download command 55 allows you to define up to six (0 through 5) custom user strings. A user string can be a font ID, a form feed, or another printer command that is frequently used. See Command 55 in **Section 9.2**.

After the custom user string is defined, the string is activated by placing the delimiter (& or the beginning delimiter defined with command 40), a capital letter U, and the number of the desired custom user string into the text of a document.

For example, use command 55 to define user string number 3 to send a form feed as follows (FF = 0C in hex):

```
&Z55,3(0C)
```

Then, to send a form feed at the end of a print job, enter the following at the end of the document:

```
&U3
```

Print the document, and the interface will send the 0C, or form-feed, command to the printer when it encounters the &U3 code.

11.3 SCS Mode Transparent Data

SCS transparent mode (SCS TRN code 35) provides a method for transparent data transmission when operating in LU1 mode. To use this method, you must be

connected to a system using SNA protocol and be operating as a Logical Unit Type 1.

An SCS TRN sequence begins with a one-byte binary count immediately following the TRN code. The count indicates the number of bytes, not including the count byte, of transparent data to follow. Up to 256 bytes of transparent data can be sent in each sequence.

SCS TRN data is user-defined and is not scanned for SCS control codes. However, to emulate the characteristics of the IBM 3287, non-printable characters (i.e., control characters) are converted to hyphens. Data is translated to ASCII with undefined characters printed as hyphens. The Laser Card offers a configurable option to emulate the IBM 3287 or to pass the data without translation. Refer to command 45, SCS TRN translate, on in **Section 9.2** for information.

11.4 Other Printer Commands

Commands can also be entered into the document to allow control of host formatting commands. These commands are:

- I Ignores all host formatting commands
- S Acknowledges all host formatting commands

Use the -I and -S commands to remove unwanted host commands from a print file. For example, placing a -I at the end of a line (before a carriage-return and line-feed command) and -S at the beginning of the next line, causes the interface to remove the host carriage-return and line-feed commands and send only the data to the printer.

11.5 Color Printing

For a complete description of color support, refer to **Appendix C**.

11.6 Printing Bar Codes

For a complete description of internally generated bar codes, refer to **Appendix E**.

11. Troubleshooting—Coax

This chapter provides instructions for performing diagnostic tests on the Laser Card. This chapter also contains a problem-resolution guide that describes common problems with the interface or the printer and their solutions. If you are unable to solve a problem by following the procedures outlined in this chapter, contact Black Box Technical Support at 724-746-5500.

Before calling, verify that the Laser Card is installed correctly and that the interface configuration settings are correct, perform the appropriate diagnostic tests outlined in this chapter, and have the following information ready:

- Printer and interface self-test printouts
- Model number and serial number of the interface
- Description of the problem
- Type of host system or controller

You may also need to print a “hex dump” or “buffer print” by enabling the Buffer Print option in the front-panel setup options. This causes all printing to be in hexadecimal code, just as it’s received from the host, to help in tracing problems.

If it becomes necessary to ship the interface, use the original carton and packaging to prevent damage.

12.1 Buffer Print (EBCDIC Hex)

The interface can be set up to print the buffer in hexadecimal code. This can be useful for a technician to diagnose problems with the interface or the printer.

The EBCDIC hex data is printed on a grid corresponding to the data’s position in the buffer. If the hex data represents a printable character, that character is printed below the hex data to the side in coax.

To start the EBCDIC hex dump through Host Download:

1. Verify that the interface is installed properly and the printer is in “READY” mode.
2. Type the host-download command “&%Z42,1” on the screen.

3. Send the Host Download command to the printer (either press the Print Screen Button or print the document that contains the command).
4. Send the host data in question to the printer.
5. To stop the EBCDIC hex dump, power off the printer.

To start the EBCDIC hex dump through the printer's operator panel:

1. Press Menu on the printer's operator panel to scroll to the COAX CARD.
2. Press Item + repeatedly until "42=EBCDIC HEX" is displayed.
3. Press Value + to change the display to "42=HEX DMP Y*".
4. Press Select to select this setting. The display will show "42=HEX DMP Y*".
5. Press Go to return the printer to operating mode.
6. To end the EBCDIC hex dump, power off the printer or repeat steps 1 through 5, changing the display from "42=HEX DMP Y*" to "42=HEX DMP N*".

12.2 ASCII Hex Dump

The interface can be set up to print the buffer in hexadecimal ASCII code. This differs from the EBCDIC hex dump in that the buffer is first translated into ASCII code before it is printed. This can be useful to diagnose problems with the interface or the printer.

To start the ASCII hex dump through Host Download:

1. Verify that the interface is installed properly and the printer is in "READ" mode.
2. Type the host-download command "&%Z43,1" on the screen.
3. Send the host-download command to the printer (either press the Print Screen Button or print the document that contains the command).
4. Send the host data in question to the printer.
5. To stop the ASCII hex dump, power off the printer.

To start the EBCDIC hex dump through the printer's operator panel:

1. Press Menu on the printer's operator panel to scroll to the COAX CARD.
2. Press Item + repeatedly until "43=ASCII HEX DMP" is displayed.
3. Press Value + to change the display to "43=ASCII DMP Y".
4. Press Select to select this setting. The display will show "43=ASCII DMP Y*".
5. Press Go to return the printer to operating mode.
6. To end the ASCII hex dump, power off the printer or repeat steps 1 through 5, changing the display from "43=ASCII DMP Y*" to "43=ASCII DMP N*".

The interface will start printing in buffer print after the selection is made active and the printer is again "Ready." As soon as the buffer print is selected, hexadecimal printing begins (there may be a delay while the printer finishes printing previously formatted data from the buffer).

12.3 Problem-Resolution Guide

The following is a general guide to resolve common problems that may occur. Please refer to this guide before contacting Technical Support.

Problem or Message	Probable Cause	Action
"Printer not ready" message at host	Printer not in a ready status	Make sure printer is on line, has paper, etc.
Line Sync LED is not on when connected to the host	Host is not operating	Check host system.
	Damaged or improper cabling	Check host cabling for damage or improper connection.
	Printer fault such as paper out, paper jam, etc.	Make sure the printer has paper, is clear of jams, etc.

LASER CARDS FOR HP 4000 TWINAX AND COAX PRINTERS

Problem or Message	Probable Cause	Action
Printer loses host communication (drops off line)	Improper or damaged cabling	Check host cabling for improper connections or damage.
Right margin is cut off	Wrong page width in word processing	Change to wider page; program is not set wide enough.
	Page width is too wide	Select a narrower page.
Extra blank sheets are ejected between sheets of printout	Form length not correct in software (maximum length is 66 lines)	Make sure your document length doesn't exceed the maximum number of lines.
	Page orientation was changed	The printer may eject a blank page when the page orientation (portrait or landscape) is changed.
Form length is incorrect	Form length incorrect in software	Change form length.
	Incorrect configuration at the host	Make sure the host configuration matches the printer's.

LASER CARDS FOR HP 4000 TWINAX AND COAX PRINTERS

Problem or Message	Probable Cause	Action
Printer won't change fonts	Incorrect typestyle number	Make sure the font ID used is valid. Invalid font IDs are ignored by the printer.
	Wrong optional fonts loaded	Load the font that corresponds to the font ID.
	Font SIMM damaged or not seated into the printer properly	If possible, try a known-good SIMM to determine if SIMM is faulty. Make sure the SIMM is loaded properly.
Printer does not print in specified orientation (host-download command or front panel setting)	APO is active (ON) and paper size is less than 8½" x 11"	Turn APO off.
CPT delimiter characters were accidentally set to 00XX	CPT delimiter characters starting with 00 are invalid	Restore factory defaults.

Appendix A: Font (FGID) Reference (Twinax and Coax)

Font (FGID) Reference

The following chart lists standard resident fonts of HP LaserJet printers and optional fonts available through various third parties, along with the font ID numbers used to select the fonts. These font selections are valid for both twinax and coax printing.

If you are using an IBM font card, a best fit will be required with one of the fonts listed below. For information on selecting fonts, refer to **Chapters 6 and 10** (Operation).

Typeface	Symbol	Orient	Pitch	Point	Typestyle No.
Line Printer	R-8/850	P/L	13.33	8.5	204
Line Printer	R-8/850	P/L	15	8.5	223
Line Printer	R-8/850	P/L	17.1	8.5	254
Line Printer	R-8/850	P/L	19	8.5	281
Courier	R-8/850	P/L	10	12	11
Courier Bold	R-8/850	P/L	10	12	46
Courier Italic	R-8/850	P/L	10	12	18
Courier	R-8/850	P/L	12	10	85
Courier Bold	R-8/850	P/L	12	10	88
Courier Italic	R-8/850	P/L	12	10	89
Letter Gothic	R-8/850	P/L	12	12	87
CG Times	R-8/850	P/L	Prop.	6	4605
	R-8/850	P/L	Prop.	8	4606
	R-8/850	P/L	Prop.	10	4607
	R-8/850	P/L	Prop.	12	4608
	R-8/850	P/L	Prop.	14	4609
	R-8/850	P/L	Prop.	18	4611
	R-8/850	P/L	Prop.	24	4614
	R-8/850	P/L	Prop.	30	4617
CG Times Bold	R-8/850	P/L	Prop.	6	4625
	R-8/850	P/L	Prop.	8	4626
	R-8/850	P/L	Prop.	10	4627

LASER CARDS FOR HP 4000 TWINAX AND COAX PRINTERS

Typeface	Symbol	Orient	Pitch	Point	Typestyle No.	
CG Times Italic	R-8/850	P/L	Prop.	12	4628	
	R-8/850	P/L	Prop.	14	4629	
	R-8/850	P/L	Prop.	18	4631	
	R-8/850	P/L	Prop.	24	4634	
	R-8/850	P/L	Prop.	30	4637	
	R-8/850	P/L	Prop.	6	4645	
	R-8/850	P/L	Prop.	8	4646	
	R-8/850	P/L	Prop.	10	4647	
	R-8/850	P/L	Prop.	12	4648	
	R-8/850	P/L	Prop.	14	4649	
	R-8/850	P/L	Prop.	18	4651	
	R-8/850	P/L	Prop.	24	4654	
CG Times Bold Italic	R-8/850	P/L	Prop.	30	4657	
	R-8/850	P/L	Prop.	6	4665	
	R-8/850	P/L	Prop.	8	4666	
	R-8/850	P/L	Prop.	10	4667	
	R-8/850	P/L	Prop.	12	4668	
	R-8/850	P/L	Prop.	14	4669	
	R-8/850	P/L	Prop.	18	4671	
	R-8/850	P/L	Prop.	24	4674	
	R-8/850	P/L	Prop.	30	4677	
	Univers Medium	R-8/850	P/L	Prop.	6	4805
		R-8/850	P/L	Prop.	8	4806
		R-8/850	P/L	Prop.	10	4807
R-8/850		P/L	Prop.	12	4808	
R-8/850		P/L	Prop.	14	4809	
R-8/850		P/L	Prop.	18	4811	
R-8/850		P/L	Prop.	24	4814	
R-8/850		P/L	Prop.	30	4817	
Univers Med Italic		R-8/850	P/L	Prop.	6	4825
		R-8/850	P/L	Prop.	8	4826
		R-8/850	P/L	Prop.	10	4827
		R-8/850	P/L	Prop.	12	4828
	R-8/850	P/L	Prop.	14	4829	
	R-8/850	P/L	Prop.	18	4831	
	R-8/850	P/L	Prop.	24	4834	

LASER CARDS FOR HP 4000 TWINAX AND COAX PRINTERS

Typeface	Symbol	Orient	Pitch	Point	Typestyle No.
	R-8/850	P/L	Prop.	30	4837
Univers Med	R-8/850	P/L	Prop.	6	4845
Cond.	R-8/850	P/L	Prop.	8	4846
	R-8/850	P/L	Prop.	10	4847
	R-8/850	P/L	Prop.	12	4848
	R-8/850	P/L	Prop.	14	4849
	R-8/850	P/L	Prop.	18	4851
	R-8/850	P/L	Prop.	24	4854
	R-8/850	P/L	Prop.	30	4857
Univers Med Cond.					
Italic	R-8/850	P/L	Prop.	6	4865
	R-8/850	P/L	Prop.	8	4866
	R-8/850	P/L	Prop.	10	4867
	R-8/850	P/L	Prop.	12	4868
	R-8/850	P/L	Prop.	14	4869
	R-8/850	P/L	Prop.	18	4871
	R-8/850	P/L	Prop.	24	4876
	R-8/850	P/L	Prop.	30	4877
Univers Bold	R-8/850	P/L	Prop.	6	4905
	R-8/850	P/L	Prop.	8	4906
	R-8/850	P/L	Prop.	10	4907
	R-8/850	P/L	Prop.	12	4908
	R-8/850	P/L	Prop.	14	4909
	R-8/850	P/L	Prop.	18	4911
	R-8/850	P/L	Prop.	24	4014
	R-8/850	P/L	Prop.	30	4917
Univers Bold	R-8/850	P/L	Prop.	6	4925
Italic	R-8/850	P/L	Prop.	8	4926
	R-8/850	P/L	Prop.	10	4927
	R-8/850	P/L	Prop.	12	4928
	R-8/850	P/L	Prop.	14	4929
	R-8/850	P/L	Prop.	18	4931
	R-8/850	P/L	Prop.	24	4934
	R-8/850	P/L	Prop.	30	4937
Univers Bold	R-8/850	P/L	Prop.	6	4945
Cond.	R-8/850	P/L	Prop.	8	4946

LASER CARDS FOR HP 4000 TWINAX AND COAX PRINTERS

Typeface	Symbol	Orient	Pitch	Point	Typestyle No.
	R-8/850	P/L	Prop.	10	4948
	R-8/850	P/L	Prop.	12	4949
	R-8/850	P/L	Prop.	18	4951
	R-8/850	P/L	Prop.	24	4954
	R-8/850	P/L	Prop.	30	4957
Univers Bold	R-8/850	P/L	Prop.	6	4965
Cond. Ital.	R-8/850	P/L	Prop.	8	4966
	R-8/850	P/L	Prop.	10	4967
	R-8/850	P/L	Prop.	12	4968
	R-8/850	P/L	Prop.	14	4969
	R-8/850	P/L	Prop.	18	4971
	R-8/850	P/L	Prop.	24	4974
	R-8/850	P/L	Prop.	30	4977
ITC Zapf	10L	P/L	Prop.	6	4985
Dingbats	10L	P/L	Prop.	8	4986
	10L	P/L	Prop.	10	4987
	R-8/850	P/L	Prop.	12	4988
	R-8/850	P/L	Prop.	14	4989
	R-8/850	P/L	Prop.	18	4991
	R-8/850	P/L	Prop.	24	4994
	R-8/850	P/L	Prop.	30	4997

Optional Fonts as originally found in ProCollection Cartridge

Line Printer	ASCII	P/L	17.1	8.5	253
Courier Bold	ASCII	P/L	10	12	45
Courier Italic	ASCII	P/L	10	12	17
Courier	ASCII	P/L	12	10	84
Courier Bold	ASCII	P/L	12	10	108
Courier Italic	ASCII	P/L	12	10	92
Courier	Legal	P	10	12	51
Courier Bold	Legal	P	10	12	52
Courier Italic	Legal	P	10	10	53
Courier	Legal	P	12	10	93
Courier Bold	Legal	P	12	10	94
Courier Italic	Legal	P	12	10	95

LASER CARDS FOR HP 4000 TWINAX AND COAX PRINTERS

Typeface	Symbol	Orient	Pitch	Point	Typestyle No.
Prestige Elite	ASCII	P/L	15	7	220
Prestige Elite	ASCII	P/L	12	10	83
Prestige Elite Bold	ASCII	P/L	12	10	113
Prestige Elite Italic	ASCII	P/L	12	10	114
Prestige Elite	Legal	P	15	7	219
Prestige Elite	Legal	P	12	10	97
Prestige Elite Bold	Legal	P	12	10	98
Prestige Elite Italic	Legal	P	12	10	99
Letter Gothic	ASCII	P/L	27	3.6	291
Letter Gothic	ASCII	P/L	19	6	281
Letter Gothic	ASCII	P/L	17.1	9.5	257
Letter Gothic	ASCII	P/L	12	12	66
Letter Gothic Bold	ASCII	P/L	12	12	69
Letter Gothic Italic	ASCII	P/L	12	12	68
Times Roman	ASCII	P	Prop.	8	163
Times Roman	ASCII	P	Prop.	10	164
Times Roman Bold	ASCII	P	Prop.	10	165
Times Roman Italic	ASCII	P	Prop.	10	166
Times Roman	ASCII	P	Prop.	12	167
Times Roman Bold	ASCII	P	Prop.	12	168
Times Roman Italic	ASCII	P	Prop.	12	169
Times Roman	Legal	P	Prop.	8	173
Times Roman	Legal	P	Prop.	10	174
Times Roman Bold	Legal	P	Prop.	10	175
Times Roman Italic	Legal	P	Prop.	10	176
Times Roman	Legal	P	Prop.	12	177
Times Roman Bold	Legal	P	Prop.	12	178
Times Roman Italic	Legal	P	Prop.	12	179
Helvetica	ASCII	P	Prop.	8	183
Helvetica	ASCII	P	Prop.	10	184
Helvetica Bold	ASCII	P	Prop.	10	185
Helvetica Italic	ASCII	P	Prop.	10	186
Helvetica	ASCII	P	Prop.	12	187
Helvetica Bold	ASCII	P	Prop.	12	188
Helvetica Italic	ASCII	P	Prop.	12	189

LASER CARDS FOR HP 4000 TWINAX AND COAX PRINTERS

Typeface	Symbol	Orient	Pitch	Point	Typestyle No.
Helvetica Bold	ASCII	P	Prop.	14	190
Helvetica Bold	Legal	P	Prop.	14	191

Optional Fonts as originally found in WordPerfect Cartridge

CG Times	DskTop	P	Prop.	6	4685
CG Times	DskTop	P	Prop.	8	4686
CG Times Bold	DskTop	P	Prop.	8	4706
CG Times Italic	DskTop	P	Prop.	8	4814
CG Times	DskTop	P	Prop.	10	4687
CG Times Bold	DskTop	P	Prop.	10	4707
CG Times Italic	DskTop	P	Prop.	10	4815
CG Times	DskTop	P	Prop.	12	4688
CG Times Bold	DskTop	P	Prop.	12	4708
CG Times Italic	DskTop	P	Prop.	12	4816
CG Times	DskTop	P	Prop.	14	4689
CG Times Bold	DskTop	P	Prop.	14	4709
CG Times Italic	DskTop	P	Prop.	14	4817
CG Times Bold	DskTop	P	Prop.	18	4711
CG Times Bold	DskTop	P	Prop.	24	4714
Univers	DskTop	P	Prop.	14	4789
Univers	DskTop	P	Prop.	18	4791
Univers	DskTop	P	Prop.	24	4794

Optional Fonts as originally found in Microsoft Cartridge

Helvetica	R-8	P	Prop.	8	34102
Helvetica	R-8	P	Prop.	10	34103
Helvetica Bold	R-8	P	Prop.	10	34123
Helvetica Italic	R-8	P	Prop.	10	34231
Helvetica	R-8	P	Prop.	12	34104
Helvetica Bold	R-8	P	Prop.	12	34124
Helvetica Italic	R-8	P	Prop.	12	34232
Helvetica Bold	R-8	P	Prop.	14	34125
TmsRmn	R-8	P	Prop.	8	5686
TmsRmn	R-8	P	Prop.	10	5687

LASER CARDS FOR HP 4000 TWINAX AND COAX PRINTERS

Typeface	Symbol	Orient	Pitch	Point	Typestyle No.
TmsRmn Bold	R-8	P	Prop.	10	5707
TmsRmn Italic	R-8	P	Prop.	10	5815
Times Roman	R-8	P	Prop.	12	5688
Times Roman Bold	R-8	P	Prop.	12	5708
Times Roman Italic	R-8	P	Prop.	12	5816
Times Roman Bold	R-8	P	Prop.	14	5709
Line Printer	R-8	P	Prop.	835	223

Optional Fonts as originally found in Polished Worksheet Cartridge

Prestige Elite	R-8/850	P/L	15	7	221
Prestige Elite	R-8/850	P/L	12	10	86
Prestige Elite Bold	R-8/850	P/L	12	10	111
Prestige Elite Italic	R-8/850	P/L	12	10	112
Prestige Elite	Legal	P/L	15	7	219
Prestige Elite	Legal	P/L	12	10	97
Prestige Elite Bold	Legal	P/L	12	10	98
Prestige Elite Italic	Legal	P/L	12	10	99
Letter Gothic	R-8/850	P/L	27	3.6	290
Letter Gothic	R-8/850	P/L	12	12	87
Letter Gothic Bold	R-8/850	P/L	12	12	110
Letter Gothic Italic	Legal	P/L	12	12	109
Letter Gothic	Legal	P/L	27	3.6	292
Letter Gothic	Legal	P/L	12	12	90
Letter Gothic Bold	Legal	P/L	12	12	107
Letter Gothic Italic	Legal	P/L	12	12	106
Presentation Bold	ASCII	P/L	8.1	16	434
Presentation Bold	Legal	P/L	8.1	16	431

Optional Fonts as originally found in Persuasive Presentations Cartridge

Letter Gothic	ASCII	P/L	10	14	39
Letter Gothic	Legal	P/L	10	14	38
Presentation Bold	ASCII	P/L	10	14	6
Presentation Bold	Legal	P/L	10	14	7

LASER CARDS FOR HP 4000 TWINAX AND COAX PRINTERS

Typeface	Symbol	Orient	Pitch	Point	Typestyle No.
Presentation Bold	ASCII	P/L	8.1	16	434
Presentation Bold	Legal	P/L	8.1	16	431
Presentation Bold	ASCII	P/L	6.5	18	435
Presentation Bold	Legal	P/L	6.5	18	432
Presentation Bold	ASCII	P/L	5.7	24	436
Presentation Bold	Legal	P/L	5.7	24	433
Helv Outline	ASCII	P/L	Prop.	24	34115
Helv Outline	Legal	P/L	Prop.	24	34116
Serifa	ASCII	P/L	Prop.	24	34215
Serifa	Legal	P/L	Prop.	24	34216
Line Draw	LinDrw	P/L	10	14	31
PC Line Bold	PCLin	P/L	10	14	32

Optional Fonts as originally found in Forms, Etc. Cartridge

Univers	R-8/850	P/L	Prop.	6	33101
Univers	R-8/850	P/L	Prop.	8	33102
Univers Bold	R-8/850	P/L	Prop.	8	33122
Univers Bold	R-8/850	P/L	Prop.	10	33123
Univers Bold	R-8/850	P/L	Prop.	12	33124

Optional Fonts as originally found in Forms, Etc. Cartridge

Univers Bold	R-8/850	P/L	Prop.	14	33125
Helv. Cond.	TXNum	P/L	Prop.	24	34128
Black Bold					
OCR-A	OCR-A	P	10	12	19
Tax Line Draw	Taxlin Drw	P/L	10	12	30

Optional Fonts as originally found in Bar Codes & More Cartridge

Letter Gothic	R-8	P/L	15	9.5	230
Letter Gothic	R-8	P/L	112	12	87
Letter Gothic	R-8	P/L	10	14	40
OCR-A	OCR-A	P	10	12	19

LASER CARDS FOR HP 4000 TWINAX AND COAX PRINTERS

Typeface	Symbol	Orient	Pitch	Point	Typestyle No.
OCR-B	OCR-B	P	10	12	3
Code 3 of 9	3 of 9	P	8.1	12	60
Code 3 of 9	3 of 9	P	4.6	12	240
EAN/UPC 10 Mil	UPC	P	Prop.	12	170
EAN/UPC 13 Mil Bold	UPC	P	Prop.	12	171
USPS	ZIP	P/L	Prop.	12	172
Line Draw	LinDrw	P/L	10	12	33

Optional Fonts as originally found in Text Equations Cartridge

Prestige Elite	R-8	P	15	7	221
Prestige Elite	R-8	P	17.1	7	256
Prestige Elite	R-8	P	12	10	86
Prestige Elite Bold	R-8	P	12	10	111
Prestige Elite Italic	R-8	P	12	10	112
CG Times	R-8	P	Prop.	8	157
CG Times	R-8	P	Prop.	10	158
CG Times Bold	R-8	P	Prop.	10	159
CG Times Italic	R-8	P	Prop.	10	155

Optional Fonts as originally found in Global Text Cartridge

CG Century Schlbk	R-8/850	P/L	Prop.	8	16950
CG Century Schlbk	R-8/850	P/L	Prop.	10	16951
CG Century Sclbk Bold	R-8	P/L	Prop.	10	16971
CG Century Sclbk Italic	R-8	P/L	Prop.	10	17079
CG Triumvirate	R-8	P/L	Prop.	10	33335
CG Triumvirate Bold	R-8	P/L	Prop.	14	33357

Optional Fonts as originally found in Pretty Faces Cartridge

Microstyle	ASCII	P	Prop.	18	5910
Microstyle Bold	ASCII	P	Prop.	36	5920
Hobo Medium	ASCII	P	Prop.	30	5930
Hobo Medium	ASCII	P	Prop.	14	5940
Thunderbird	ASCII	P	Prop.	54	5950

LASER CARDS FOR HP 4000 TWINAX AND COAX PRINTERS

Typeface	Symbol	Orient	Pitch	Point	Typestyle No.
Signet Roundhand	ASCII	P	Prop.	18	5960
Signet Roundhand	ASCII	P	Prop.	14	5970
ITC Dingbats	ITC	P	Prop.	36	5980
ITC Dingbats	ITC	P	Prop.	18	5990

Appendix B: Character Sets

The IBM 3812-1 printer emulation supports both the Roman 8 character set and Code Page 850. The selection between the two decides which is used when a font supports both. Refer to the printer user's guide for illustrations and information on character sets.

An EBCDIC to ASCII translation table is printed at the bottom of the interface self-test. The tables on the following pages illustrate how EBCDIC characters (from the twinax host) are converted to the ASCII characters in the Roman 8 and Code 850 character sets.

The first digit of the EBCDIC hex code is at the top of the table, and the second digit is on the left side. The corresponding ASCII hex code is where the two digits intersect. The character that corresponds to the ASCII hex code is in the chart to the right.

Roman-8 Symbol Set

	0	1	2	3	4	5	6	7	8	9	A	B	C	D	E	F	
0	NUL 0	DLE 16		0 48	@ 64	P 80	' 96	p 112			- 144	â 160	À 176	Á 192	À 208	À 224	À 240
1	SOH 1	DC1 17	! 33	1 49	A 65	Q 81	a 97	q 113			À 129	Ý 145	ê 161	î 177	Ã 193	þ 209	þ 225
2	STX 2	DC2 18	" 34	2 50	B 66	R 82	b 98	r 114			À 130	ý 146	ô 162	Ø 178	ã 194	.210	.226
3	ETX 3	DC3 19	# 35	3 51	C 67	S 83	c 99	s 115			È 131	° 147	û 163	Æ 179	D 195	μ 211	μ 227
4	EOT 4	DC4 20	\$ 36	4 52	D 68	T 84	d 100	t 116			È 132	Ç 148	á 164	å 180	ð 196	¶ 212	¶ 228
5	ENQ 5	NAK 21	% 37	5 53	E 69	U 85	e 101	u 117			È 133	ç 149	é 165	í 181	í 197	í 213	í 229
6	ACK 6	SYN 22	& 38	6 54	F 70	V 86	f 102	v 118			Î 134	Ñ 150	ó 166	ø 182	ì 198	— 214	— 230
7	BEL 7	ETB 23	' 39	7 55	G 71	W 87	g 103	w 119			Ï 135	ñ 151	ú 167	æ 183	Ó 199	1/4 215	1/4 231
8	BS 8	CAN 24	(40	8 56	H 72	X 88	h 104	x 120			Ï 136	ï 152	à 168	Ä 184	Ò 200	1/2 216	1/2 232
9	HT 9	EM 25) 41	9 57	I 73	Y 89	i 105	y 121			Ï 137	ÿ 153	è 169	ì 185	Û 201	ª 217	ª 233
A	LF 10	SUB 26	* 42	: 58	J 74	Z 90	j 106	z 122			Ï 138	€ 154	ò 170	Ö 186	õ 202	° 218	° 234
B	VT 11	ESC 27	+ 43	; 59	K 75	[91	k 107	{ 123			Ï 139	£ 155	ù 171	Ü 187	Š 203	« 219	« 235
C	FF 12	FS 28	, 44	< 60	L 76	\ 92	l 108	 124			Ï 140	¥ 156	ä 172	É 188	š 204	■ 220	■ 236
D	CR 13	GS 29	- 45	= 61	M 77] 93	m 109	} 125			Ï 141	§ 157	ë 173	ï 189	Ú 205	» 221	» 237
E	SO 14	RS 30	. 46	> 62	N 78	^ 94	n 110	~ 126			Ï 142	Œ 158	ö 174	ß 190	ÿ 206	± 222	± 238
F	SI 15	US 31	/ 47	? 63	O 79	_ 95	o 111	☒ 127			Ï 143	£ 159	ü 175	Û 191	Û 207	ÿ 223	ÿ 239

1st HEX Character

0 1

2nd
HEX
Character

	0	1	
0	NUL 0	DLE 16	<i>Decimal Equivalent</i>
1	SOH 1	DC1 17	
			DC1 HEX = 11 Decimal = 17

LASER CARDS FOR HP 4000 TWINAX AND COAX PRINTERS

Code Page 850 Symbol Set

	0	1	2	3	4	5	6	7	8	9	A	B	C	D	E	F
0	NUL	▶		0	@	P	`	p	Ç	É	á	⋮	Ł	ð	Ó	-
1	☺	◀	!	1	A	Q	a	q	ü	æ	í	☒	⊥	Ⓓ	β	±
2	☹	▯	"	2	B	R	b	r	é	Æ	ó	☒	⊥	Ê	Ô	=
3	♥	!!	#	3	C	S	c	s	â	ô	ú		†	Ë	3/4	
4	♦	¶	\$	4	D	T	d	t	ä	ö	ñ	†	-	È	õ	¶
5	♣	§	%	5	E	U	e	u	à	à	Ñ	Á	+	ı	Ö	§
6	♠	▯	&	6	F	V	f	v	â	û	ª	Â	ã	í	μ	÷
7	•	▯	'	7	G	W	g	w	ç	ù	º	À	Ã	î	þ	247
8	◻	↑	(8	H	X	h	x	ê	ÿ	¿	©	ℓ	ï	þ	º
9	◊	↓)	9	I	Y	i	y	ë	ÿ	®	≠	≠	⌋	Ú	”
A	◻	→	*	:	J	Z	j	z	è	Û	¬		≠	⌋	Û	•
B	♂	←	+	;	K	[k	{	ï	ø	1/2	☒	≠	☐	Ù	1
C	♀	-	,	<	L	\	l		î	£	1/4	☒	≠	☐	Ý	3
D	🎵	↔	-	=	M]	m	}	ì	Ø	i	©	=		Ý	2
E	🎵	▯	.	>	N	^	n	~	Ä	×	«	¥	≠	ì	-	■
F	☼	▯	/	?	O	_	o	◊	Å	f	»	⌋	€	☐	'	

1st HEX Character

0 1

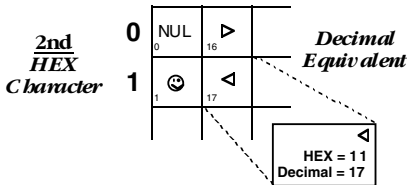

Appendix C: Color Printing

The Laser Card allows printing of color on printers that can print in color. Simply insert the color command in front of the text you want to print in color. Return to the “normal” black color by inserting -C00 or ^C00. The color commands are:

-C00 - Black	-C09 - Dark Blue
-C01 - Blue	-C10 - Orange
-C02 - Red	-C11 - Purple
-C03 - Magenta	-C12 - Dark Green
-C04 - Green	-C13 - Dark Turquoise
-C05 - Turquoise/Cyan	-C14 - Mustard
-C06 - Yellow	-C15 - Grey
-C07 - White	-C16 - Brown
-C08 - Black	

For example, to print the word “red” in the color red in the following sentence, type:

This prints -C02red-C00 in red.

Alternately, you can select a color through the Typestyle/color menu of Office Vision/400 (V3R1 or later). This menu is accessed by selecting F20 (Format Options), 1 (Document Options), 1 (Document Format), and finally 3 (Typestyle/color).

Appendix D: Resident Scalable Font Numbers

The following is a list of HP Resident Scalable fonts and font numbers for twinax printers. Fonts with ID numbers 410 through 490 are fixed pitch fonts. All others are proportional fonts.

Font	Font ID No.
Letter Gothic	410
Letter Gothic Bold	420
Letter Gothic Italic	430
Courier	460
Courier Bold	470
Courier Italic	480
Courier Bold Italic	490
Symbol	3400
Wingdings	3500
Dingbats	3600
CG Omega	4919
CG Omega Bold	4939
CG Omega Italic	5067
CG Times	5687
CG Times Bold	5707
CG Times Italic	5815
CG Times Bold Italic	5835
Arial	6199
Arial Bold	6219
Arial Italic	6327
Arial Bold Italic	6347
Garamond Antiqua	8503
Garamond Halbfett	8523
Garamond Kursiv	8631
Garamond Kursiv Halbfett	8651
Coronet	8759
Claredon Condensed	8779

LASER CARDS FOR HP 4000 TWINAX AND COAX PRINTERS

Font	Font ID No.
Marigold	8887
Albertus Medium	12855
Albertus Extra Bold	12875
Times New	16951
Times New Bold	12875
Times New Italic	17079
Times New Bold Italic	17099
Antique Olive	33335
Antique Olive Bold	33355
Antique Olive Italic	33463
Univers Medium Condensed	33591
Univers Bold Condensed	33601
Univers Medium Cond. Italic	33719
Univers Bold Cond. Italic	33729
Univers Medium	34103
Univers Bold	34123
Univers Medium Italic	34251
Univers Bold Italic	34251

3812 Font Numbers that use the CG Times Typeface

Sonoran-Serif	751
Sonoran-Serif	1051
Sonoran-Serif Bold	1053
Sonoran-Serif Italic	1056
Sonoran-Serif	1351
Sonoran-Serif Bold	1653
Sonoran-Serif Bold	2103

Appendix E: Printing Bar Codes

Using the bar-code feature, the following bar codes can be easily printed from the IBM host.

Type	Bar Code
1	Code 3 of 9
2	Code 128
3	Interleaved 2 of 5
4	POSTNET
5	UPC A
6	EAN 8
7	EAN 13

To print any of these bar codes, use the following format:

`¬B<type>,<height>,<width>,<hr>,<chkd>,<ast>,<data>¬B`

The bar code command string must contain all of these parameters, even if the parameter is irrelevant for the type of bar code being printed. For example, POSTNET comes in only one size, so any height or width specifications are ignored—but they must be present anyway.

`¬B`: Identifies the string as a bar-code command string. `¬B` must be placed at the beginning and at the end of the string.

`<type>`: Specifies the bar-code type according to the table shown above.

`<height>`: Specifies the height of the bar code. Height is expressed in multiples of 2.5 mm (approximately 1/10 inch). The height of the bar code can range from 1 (2.5 mm) to 9 (22.5 mm) inclusive.

Height values are ignored if a POSTNET bar code is being printed, since POSTNET uses one standard height. However, a valid value (1-9) must be entered for the height parameter to ensure that the bar code command string is complete.

`<width>`: Specifies the width of a bar code module. A module is defined as a specific combination of bars and spaces used to represent a human-readable character.

By changing the width parameter, you can determine the width of the module and the thickness of the bars and spaces.

Width parameters can range from 1 to 9.

To determine the total length of the bar code, simply multiply the module length (found in the table on the following page) with the number of bar-code characters.

NOTE

The table gives rounded values only.

Example: Using Code 3 of 9, you want to bar-code the word "PRINTERS." Assume the interface also generates a check digit and the start/stop characters. Setting the width parameter to 2 will yield a total bar-code length of approximately 4 cm or about 1.6 inches.

Number of characters: 11 (8 letters (PRINTERS) + 2 start/stop characters + 1 check digit)

Module width (from **Table E-1**) 3.6 mm (0.14 inches) Calculation: $11 \times 3.6 \text{ mm} = 39.6 \text{ mm} = 3.96 \text{ cm}$; or $11 \times .14 \text{ in} = 1.54 \text{ inches}$

Table E-1. Module Width in mm (inches)–PCL Laser.

Width	1	2	3	4	5	6	7	8	9
Code 3 of 9	2.6 (0.1)	3.6 (0.14)	4.5 (0.18)	5.5 (0.22)	6.5 (0.25)	7.5 (0.29)	8.4 (0.33)	9.4 (0.37)	10.4 (0.41)
Code 128	2.2 (0.09)	3.1 (0.12)	3.9 (0.15)	4.7 (0.19)	5.6 (0.22)	6.4 (0.25)	7.3 (0.29)	8.1 (0.32)	8.9 (0.35)
Interleaved 2 of 5	2.3 (0.09)	3.2 (0.12)	4 (0.16)	4.9 (0.19)	5.8 (0.23)	6.6 (0.26)	7.5 (0.30)	8.4 (0.33)	9.3 (0.36)
POSTNET	5.7 (0.23)								
EAN-13	1.5 (0.06)	2 (0.08)	2.5 (0.10)	3.1 (0.12)	3.6 (0.14)	4.2 (0.16)	4.7 (0.18)	5.2 (0.20)	5.8 (0.23)
EAN-8	1.7 (0.07)	2.3 (0.09)	2.9 (0.11)	3.6 (0.14)	4.2 (0.16)	4.8 (0.19)	5.4 (0.21)	6.1 (0.24)	6.7 (0.26)
UPC A	1.6 (0.06)	2.2 (0.08)	2.8 (0.11)	3.4 (0.13)	4 (0.16)	4.6 (0.18)	5.2 (0.20)	5.8 (0.23)	6.4 (0.25)

Width parameters are ignored when printing POSTNET bar codes, since POSTNET uses one standard width. However, a valid value (1-9) must be entered for the width parameter to ensure the bar code command string is complete.

<hr>: Identifies whether human-readables are printed or not. Human-readables are printed underneath the bar code. Valid values are:

0 = Do not print human-readables.

1 = Print human-readables.

<chkd>: Indicates whether the interface automatically calculates and causes a check digit to be printed. The following bar codes require a check digit, therefore, the interface automatically generates and adds a check digit to the bar-code data: Code 128, POSTNET, UPC A, EAN 8, EAN 13

If any of the bar codes listed above has been selected, the <chkd> selection is ignored by the interface. However, one of the following values must be entered to ensure that the bar-code command string is complete and valid. The options for the <chkd> parameter are:

0 = Do not calculate and add a check digit.

1 = Calculate and add a check digit to the bar code data.

<ast>: Specifies whether start/stop characters are automatically generated or manually added. This parameter only applies to bar-code type Code 3 of 9. For all other bar-code types, the start/stop characters are automatically generated by the interface and input for the <ast> parameter is ignored. However, one of the following values must be entered to ensure that the bar-code command string is complete and valid. The options for the <ast> parameter are:

0 = Do not automatically add start/stop characters.

1 = Automatically add start/stop characters.

NOTE

If value 0 is selected, you must manually enter start/stop characters (asterisks) together with the data. Failure to add the asterisks will cause an invalid bar code to be printed (i.e. a bar code without start/stop characters). If human-readables are being printed, the asterisks will also print as human-readables.

If value 1 is selected, you must not add asterisks as start/stop characters to the data. Adding asterisks will cause an invalid bar code to be printed (i.e. a bar code with a start/stop character pair in the beginning and a start/stop character pair in the end.)

<data>: The data to be printed as a bar code. Some bar codes require a certain number of characters. Others only allow alphanumeric or numeric characters. Before the interface processes the data string, it will check the complete data string and verify that it is valid. This is why the -B at the end is so important. If an invalid data string has been entered, the interface will print "Invalid Data" in the place of the bar code.

NOTES

1. Valid values must be entered for each of the parameters specified above, even if the parameter is irrelevant for the type of bar code being printed.

2. If an invalid parameter value (other than invalid data) has been entered, the interface will process the bar code command up to that point and then reject any information it receives after the incorrect value.

For example, a bar-code command string has been entered; however, an invalid <hr> value of 3 has been specified.

```
-B2,6,6,3,0,0,code128-B
```

The interface would cause all characters after the invalid value 3 to be printed:

```
,0,0,code128
```

This helps quickly identify where the mistake occurred.

3. Spaces in the bar code command string are invalid and will lead to the same result as mentioned in Step 2.

4. If invalid data (either too many characters or the wrong type of characters) is entered, the interface will print the error message: ** Invalid Data **

5. Allow for sufficient vertical spacing when printing text data beneath the bar code.

For example, when the bar code command sting is entered on line 1 of the document with a bar code height specified as 5 (approximately 1/2 inch or 3 lines at 6 LPI), and text is then entered on line 2, as follows,

```
-B5,7,1,0,0,0,1234567890-B
```

This data overrun by bar code

this will cause the bar code to overlap the text in the second line:



To avoid overlapping bar codes with text, always allow for sufficient vertical line spacing (for example, by adding line feeds) to accommodate the height of the bar code.

6. When text data is entered to the right of the bar-code command string, the printed text will appear immediately to the right of where the bar-code print ends.

Overview and Examples

The following examples give an overview of the supported bar code types. Note that the “maximum number of data characters” does not include start/stop characters and check digits.

Code 3 of 9

Maximum number of data characters:	30
Valid numeric characters:	0-9
Valid alphanumeric characters:	A-Z
Valid other characters:	space \$ % + - . / *

Example:

-B1,4,1,1,1,1,0123456789-B



0123456789

POSTNET

Maximum number of data characters:	30
Valid numeric characters:	0-9
Valid alphanumeric characters:	N/A
Valid other characters:	N/A

LASER CARDS FOR HP 4000 TWINAX AND COAX PRINTERS

Example:

-B4,1,1,1,1,0,0123456789-B

UPC A

Required number of data characters: 10

Valid numeric characters: 0-9

Valid alphanumeric characters: N/A

Valid other characters: N/A

Example:

-B5,5,1,1,1,0,0123456789-B



EAN 8

Required number of data characters: 7

Valid numeric characters: 0-9

Valid alphanumeric characters: N/A

Valid other characters: N/A

Example: -B6,3,1,1,1,0,1234567-B



EAN 13

- Required number of data characters: 12
- Valid numeric characters: 0-9
- Valid alphanumeric characters: N/A
- Valid other characters: N/A
- Example: -B7,3,1,1,1,0,012345678912-B



Interleaved 2 of 5

- Maximum number of data characters: 30
- Valid numeric characters: 0-9
- Valid alphanumeric characters: N/A
- Valid other characters: N/A
- Example:
-B3,3,1,1,1,0,0123456789-B



0123456789

NOTE

Since Interleaved 2 of 5 symbols are created from data-character pairs, the number to be encoded must have an even number of digits. If an odd number of data characters (including the optional check digit) is entered, the interface adds an “0” to the beginning of the bar code. If an even number of data characters (including the optional check digit) is entered, the interface prints the bar code exactly as it is input.

Code 128

Code 128 has three unique character subsets (code A, B, and C) shown in the table on the following pages. When entering data representing Code 128 bar code, follow these two steps:

1. Define which code set you want to use. For example, type “A” to represent code A; type “B” to represent Code B; and type “C” to represent code C.
2. If you are using code set B, enter the data characters directly. The ~ character and other special characters are represented by the Symbol Character Value found in the left column of the table on the following pages.

If you are using code set A or C, enter the Symbol Character Value found in the left column of the table. Each character is represented by two digits or a ~ followed by a digit. For example, to bar code the character “&” using Code Set A, type 06.

Maximum number of data characters: 30 (includes special characters)

Valid characters: Differs with selected code set; see table on following pages

Example: ~B2,3,2,1,1,0,BABCDEFHGHIJKLMNOPQRSTUVWXYZ~B



ABCDEFGHIJKLMNOPQRSTUVWXYZ

To show how multiple character sets are used, study the following data string. Height, width and other parameters were omitted in this example to focus your attention on the data string. Please note that this example is for illustration purposes only, and is not a recommended way of bar coding. The following data string is a fairly complex way of bar coding 10PrintBoxes10

~B2,...,A1716~6PrintBoxes~510~B

- A: selects code set A
- 17: selects the number 1 from code set A
- 16: selects the number 0 from code set A
- ~6: switches from code set A to code set B
- PrintBoxes: selects the characters PrintBoxes from code set B
- ~5: switches from code set B to code set C
- 10: selects the number 10 from code set C

Symbol Character Value	Code A	Data Character Code B	Code C
00	SP	SP	00
01	!	!	01
02	"	"	02
03	#	#	03
04	\$	\$	04
05	%	%	05
06	&	&	06
07	'	'	07
08	((08
09))	09

LASER CARDS FOR HP 4000 TWINAX AND COAX PRINTERS

Symbol Character Value	Code A	Data Character Code B	Code C
10	*	*	10
11	+	+	11
12	,	,	12
13	-	-	13
14	.	.	14
15	/	/	15
16	0	0	16
17	1	1	17
18	2	2	18
19	3	3	19
20	4	4	20
21	5	5	21
22	6	6	22
23	7	7	23
24	8	8	24
25	9	9	25
26	:	:	26
27	;	;	27
28	<	<	28
29	=	=	29
30	>	>	30
31	?	?	31
32	@	@	32
33	A	A	33
34	B	B	34
35	C	C	35
36	D	D	36
37	E	E	37
38	F	F	38
39	G	G	39
40	H	H	40
41	I	I	41
42	J	J	42
43	K	K	43

LASER CARDS FOR HP 4000 TWINAX AND COAX PRINTERS

Symbol Character Value	Code A	Data Character Code B	Code C
44	L	L	44
45	M	M	45
46	N	N	46
47	O	O	47
48	P	P	48
49	Q	Q	49
50	R	R	50
51	S	S	51
52	T	T	52
53	U	U	53
54	V	V	54
55	W	W	55
56	X	X	56
57	Y	Y	57
58	Z	Z	58
59	[[59
60	\	\	60
61]]	61
62	^	^	62
63	_	_	63
64	NUL	`	64
65	SOH	a	65
66	STX	b	66
67	ETX	c	67
68	EOT	d	8
69	ENQ	e	69
70	ACK	f	70
71	BEL	g	71
72	BS	h	72
73	HT	i	73
74	LF	j	74
75	VT	k	75
76	FF	l	76
77	CR	m	77

LASER CARDS FOR HP 4000 TWINAX AND COAX PRINTERS

Symbol Character Value	Code A	Data Character Code B	Code C
78	So	n	78
79	S	o	79
80	DLE	p	80
81	DC1	q	81
82	DC2	r	82
83	DC3	s	83
84	DC4	t	84
85	NAK	u	85
86	SYN	v	86
87	ETB	w	87
88	CAN	x	88
89	EM	y	89
90	SUB	z	90
91	ESC	{	91
92	FS		92
93	GS	}	93
~0	RS	~	94
~1	US	DEL	95
~2	FNC3	FNC3	96
~3	FNC2	FNC2	97
~4	SHIFT	SHIFT	98
~5	CODE C	CODE C	99
~6	CODE B	FNC4	CODE B
~7	FNC4	CODE A	CODE A
FNC1	FNC1	FNC1	

Index

9-pin adapter cable	21
9-pin to coax adapter cable	9
A	
Adapter cables	10
Auto-terminating twinax V-cable	9
Automatic Print Orientation (APO)	48, 53-54
B	
Buffer print	69
C	
Code 128	144
Code 3 of 9	141
Code Page 850	130
Color commands	133
Color printing	10, 133
Command Pass-Thru	65-66
Command strings	29, 67
Computer Output Reduction (COR)	48
D	
Device IDs	32
Diagnostic tests	69
Document Format	61
Document Options	61
E	
EAN 13	143
EAN 8	142
EIO slot	12, 21
Emphasized (bold) printing	67
F	
Factory-default settings	35
Font (FGID) Reference	120
Font change commands	48
Font IDs	67
Font reference	10

H	
Hewlett-Packard printers	10
Hex dump	69-71
Host Download	70
Host Port Initialization String	48
Host print job	52
Host printing	48
Host-download command	34, 66
HP Resident Scalable fonts	134
I	
IBM host	29, 32, 51
Interface self-test	22
Interface settings	29
Interleaved 2 of 5	143
L	
LCD display	9
P	
Page Rotation	53
Page-rotation settings	59
PCI-based EIO slot	9
Printer auto-sharing	9
Printer operator panel	29
Printer self-test	12, 21
Printing bar codes	10
Proportional fonts	134
R	
Roman 8 character set	130
S	
Scalable font numbers	10
Self-test	21-22
T	
Twinax and coax character sets	10
Twinax mode	32
Twinax V-connector	29
U	
UPC A	142



© Copyright 1998. Black Box Corporation. All rights reserved.

1000 Park Drive • Lawrence, PA 15055-1018 • 724-746-5500 • Fax 724-746-0746