

SIGNALLING NETWORK FUNCTIONS AND MESSAGES

CONTENTS

1. Introduction	1
1.1 General Characteristics of the Signalling Network Functions	1
1.2 Signalling Message Handling	1
1.3 Signalling Network Management	2
2. Signalling Message Handling	3
2.1 General	3
2.2 Routing Label	3
2.3 Message Routing Function	5
2.4 Message Discrimination and Distribution Functions	7
3. Signalling Network Management	7
3.1 General	7
3.2 Status of Signalling Links	8
3.3 Procedures Used in Connection with Link Status Changes.	10
3.4 Status of Signalling Routes.	12
3.5 Procedures Used in Connection with Route Status Changes.	12
3.6 Signalling Network Congestion	13
4. Signalling Traffic Management	15
4.1 General	15
4.2 Normal Routing Situation	16
4.3 Signalling Link Unavailability	16
4.4 Signalling Link Availability	17
4.5 Signalling Route Unavailability.	17
4.6 Signalling Route Availability.	17
4.7 Signalling Route Restriction	18
5. Changeover	18
5.1 General	18
5.2 Network Configurations for Changeover	18
5.3 Changeover Initiation and Actions	19
5.4 Buffer Updating Procedure	19
5.5 Retrieval and Diversion of Traffic	20
5.6 Emergency Changeover Procedures	20
5.7 Procedures in Abnormal Conditions	21
6. Changeback	22
6.1 General	22
6.2 Changeback Initiation and Actions	22
6.3 Sequence Control Procedure	23
6.4 Time-Controlled Diversion Procedure	24
6.5 Procedures in Abnormal Conditions	24
7. Forced Rerouting	25
7.1 General	25
7.2 Forced Rerouting Initiation and Actions	25
8. Controlled Rerouting	25
8.1 General	25
8.2 Controlled Rerouting Initiation and Actions	26
9. Management Inhibiting	26
9.1 General.	26

SIGNALLING NETWORK FUNCTIONS AND MESSAGES

9.2	Inhibiting Initiation and Actions.	27
9.3	Uninhibiting Initiation and Actions.	27
9.3A	Inhibit Test Procedure Actions.	29
9.3B	Procedures for Abnormal Conditions	29
10.	Signalling Traffic Flow Control	30
10.1	General.	30
10.2	Flow Control Indications.	30
11.	Signalling Link Management	31
11.1	General	31
11.2	Basic Signalling Link Management Procedures	32
11.3	Signalling Link Management Procedures Based on Automatic Allocation of Signalling Terminals.	34
11.4	Signalling Link Management Procedures Based on Automatic Allocation of Signalling Data Links and Signalling Terminals	38
11.5	Automatic Allocation of Signalling Terminals.	40
11.6	Automatic Allocation of Signalling Data Links	40
11.7	Different Signalling Link Management Procedures at the Two Ends of a Link Set.	42
12.	Signalling Route Management	42
12.1	General.	42
12.2	Transfer-Prohibited	43
12.3	Transfer-Allowed	44
12.4	Signalling-Route-Set-Test	45
12.5	Transfer-Restricted	46
12.6	Transfer-Controlled (International Network).	48
12.7	Transfer Controlled (U. S. Networks)	48
12.8	Transfer Controlled (National Option without Congestion Priorities).	49
12.9	Signalling-Route-Set-Congestion-Test	49
13.	Common Characteristics of Message Signal Unit Formats	50
13.1	General.	50
13.2	Service Information Octet.	50
13.3	Label.	52
14.	Format and Codes of Signalling Network Management Messages	52
14.1	General	52
14.2	Label	52
14.3	Heading Code (H0).	52
14.4	Changeover Message	53
14.5	Changeback Message	53
14.6	Emergency Changeover Message	54
14.7	Transfer-Prohibited Message	54
14.8	Transfer-Allowed Message	54
14.9	Transfer-Restricted Message	55
14.10	Signalling-Route-Set-Test Message	55
14.11	Management Inhibit Message	55
14.12	Signalling-Data-Link-Connection-Order Message	56
14.13	Signalling-Data-Link-Connection-Acknowledgement Message	56
14.14	Transfer-Controlled Message	57
14.15	Signalling-Route-Set-Congestion-Test Message	57
15.	State Transition Diagrams	60
15.1	General.	60

SIGNALLING NETWORK FUNCTIONS AND MESSAGES

15.2	Drafting Conventions	60
15.3	Signalling Message Handling.	60
15.4	Signalling Traffic Management.	60
15.5	Signalling Link Management.	61
15.6	Signalling Route Management.	61
15.7	Abbreviations and Timers Used in Figures 23/Q.704 to 46C/Q.704.	62

SIGNALLING NETWORK FUNCTIONS AND MESSAGES

LIST OF FIGURES

Figure 1/Q.704 - Signalling Network Functions	65
Figure 2/Q.704 - Message Routing, Discrimination and Distribution	65
Figure 3/Q.704 - International Routing Label Structure	66
Figure 3A/Q.704 - Routing Label Structure for U.S. Networks	66
Figure 3B/Q.704 - Signalling Point Code Structure	67
Figure 4/Q.704 - Example of Load Sharing Within a Link Set	67
Figure 5/Q.704 - Example of Load Sharing Between Link Sets	67
Figure 6/Q.704 (sheet 1 of 4) - Signalling Traffic Management Overview Diagram Signalling Link Availability	68
Figure 6/Q.704 (sheet 2 of 4) - Signalling Traffic Management Overview Diagram Signalling Link Availability	69
Figure 6/Q.704 (sheet 3 of 4) - Signalling Traffic Management Overview Diagram Signalling Route Availability Status	70
Figure 6/Q.704 (sheet 4 of 4) - Signalling Traffic Management Overview Diagram Signalling Traffic Reconfiguration and Flow Control	71
Figure 7/Q.704 - Signalling Link Management Overview Diagram	72
Figure 8/Q.704 - Signalling Route Management Overview Diagram	73
Figure 8A/Q.704 - Signalling Link Congestion Status= n (Congestion Onset)	74
Figure 8B/Q.704 - Signalling Link Congestion Status= n (Congestion Abatement)	74
Figure 8C/Q.704 - Signalling Link Discard Status= n	75
Figure 9/Q.704 - Example of Changeover to a Parallel Link	75
Figure 10/Q.704 - Example of Changeover to a Signalling Route Passing Through the Remote Signalling Point	75
Figure 11/Q.704 - Example of Changeover to a Signalling Route not Passing Through the Remote Signalling Point	76
Figure 12/Q.704 - Example of Time-Controlled Diversion Procedure	76
Figure 13/Q.704 - Service Information Octet	76
Figure 15/Q.704 - Changeover Message	77
Figure 16/Q.704 - Changeback Message	77
Figure 17/Q.704 - Emergency Changeover Message	77
Figure 18/Q.704 - Transfer-Prohibited/Transfer-Restricted Message	78

SIGNALLING NETWORK FUNCTIONS AND MESSAGES

Figure 19/Q.704 - Transfer Allowed Message	78
Figure 20/Q.704 - Signalling-Route-Set-Test Message	78
Figure 20A/Q.704 - Management Inhibit Message	79
Figure 21/Q.704 - Signalling-Data-Link-Connection-Order Message	79
Figure 22/Q.704 - Signalling-Data-Link-Connection-Acknowledgement Message	79
Figure 22A/Q.704 - Transfer-Controlled Message	80
Figure 22B/Q.704 - Signalling-Route-Set-Congestion-Test Message	80
Figure 23/Q.704 - Signalling Message Handling (SMH); Functional Block Interactions	81
Figure 24/Q.704 - Signalling Message Handling; Message Discrimination (HMDC)	82
Figure 25/Q.704 - Signalling Message Handling; Message Distribution (HMDT)	83
Figure 26/Q.704 (Sheet 1 of 2) - Signalling Message Handling; Message Routing (HMRT)	84
Figure 26/Q.704 (Sheet 2 of 2) - Signalling Message Handling; Message Routing (HMRT)	85
Figure 26A/Q.704 - Signalling Message Handling; Signalling Link Congestion (HMCG)	86
Figure 27/Q.704 (Sheet 1 of 2) - Signalling Traffic Management (STM): Functional Block Interactions	87
Figure 27/Q.704 (Sheet 2 of 2) - Signalling Traffic Management (STM): Functional Block Interactions	88
Figure 28/Q.704 (Sheet 1 of 8) - Signalling Traffic Management; Link Availability Control (TLAC)	89
Figure 28/Q.704 (Sheet 2 of 8) - Signalling Traffic Management; Link Availability Control (TLAC)	90
Figure 28/Q.704 (Sheet 3 of 8) - Signalling Traffic Management; Link Availability Control (TLAC)	91
Figure 28/Q.704 (Sheet 4 of 8) - Signalling Traffic Management; Link Availability Control (TLAC)	92
Figure 28/Q.704 (Sheet 5 of 8) - Signalling Traffic Management; Link Availability Control (TLAC)	93
Figure 28/Q.704 (Sheet 6 of 8) - Signalling Traffic Management; Link Availability Control (TLAC)	94
Figure 28/Q.704 (Sheet 7 of 8) - Signalling Traffic Management; Link Availability Control (TLAC)	95
Figure 28/Q.704 (Sheet 8 of 8) - Signalling Traffic Management; Link Availability Control (TLAC)	96

SIGNALLING NETWORK FUNCTIONS AND MESSAGES

Figure 29/Q.704 (Sheet 1 of 11) - Signalling Traffic Management; Signalling Routing Control (TSRC)	97
Figure 29/Q.704 (Sheet 2 of 11) - Signalling Traffic Management; Signalling Routing Control (TSRC)	98
Figure 29/Q.704 (Sheet 3 of 11) - Signalling Traffic Management; Signalling Routing Control (TSRC)	99
Figure 29/Q.704 (Sheet 4 of 11) - Signalling Traffic Management; Signalling Routing Control (TSRC)	100
Figure 29/Q.704 (Sheet 5 of 11) - Signalling Traffic Management; Signalling Routing Control (TSRC)	101
Figure 29/Q.704 (Sheet 6 of 11) - Signalling Traffic Management; Signalling Routing Control (TSRC)	102
Figure 29/Q.704 (Sheet 7 of 11) - Signalling Traffic Management; Signalling Routing Control (TSRC)	103
Figure 29/Q.704 (Sheet 8 of 11) - Signalling Traffic Management; Signalling Routing Control (TSRC)	104
Figure 29/Q.704 (Sheet 9 of 11) - Signalling Traffic Management; Signalling Routing Control (TSRC)	105
Figure 29/Q.704 (Sheet 10 of 11) - Signalling Traffic Management; Signalling Routing Control (TSRC)	106
Figure 29/Q.704 (Sheet 11 of 11) - Signalling Traffic Management; Signalling Routing Control (TSRC)	107
Figure 29A/Q.704 (sheet 1 of 3) - Signalling Traffic Management; Signalling Route Congestion Control (TRCC)	108
Figure 29A/Q.704 (sheet 2 of 3) - Signalling Traffic Management; Signalling Route Congestion Control (TRCC)	109
Figure 29A/Q.704 (sheet 3 of 3) - Signalling Traffic Management; Signalling Route Congestion Control (TRCC)	110
Figure 30/Q.704 (Sheet 1 of 3) - Signalling Traffic Management; Changeover Control (TCOC)	111
Figure 30/Q.704 (Sheet 2 of 3) - Signalling Traffic Management; Changeover Control (TCOC)	112
Figure 30/Q.704 (Sheet 3 of 3) - Signalling Traffic Management; Changeover Control (TCOC)	113
Figure 31/Q.704 - Signalling Traffic Management; Changeback Control (TCBC)	114
Figure 32/Q.704 - Signalling Traffic Management; Forced Rerouting Control (TFRC)	115
Figure 33/Q.704 - Signalling Traffic Management; Controlled Rerouting Control (TCRC)	116
Figure 34/Q.704 - Signalling Traffic Management; Signalling Traffic Flow Control (TSFC)	117

SIGNALLING NETWORK FUNCTIONS AND MESSAGES

Figure 35/Q.704 - Signalling Link Management (SLM); Functional Block Interactions	118
Figure 36/Q.704 - Signalling Link Management; Link Set Control (LLSC)	119
Figure 37/Q.704 (Sheet 1 of 3) - Signalling Link Management; Signalling Link Activity Control (LSAC)	120
Figure 37/Q.704 (Sheet 2 of 3) - Signalling Link Management; Signalling Link Activity Control (LSAC)	121
Figure 37/Q.704 (Sheet 3 of 3) - Signalling Link Management; Signalling Link Activity Control (LSAC)	122
Figure 38/Q.704 (Sheet 1 of 2) - Signalling Link Management; Signalling Link Activation (LSLA)	123
Figure 38/Q.704 (Sheet 2 of 2) - Signalling Link Management; Signalling Link Activation (LSLA)	124
Figure 39/Q.704 - Signalling Link Management; Signalling Link Restoration (LSLR)	125
Figure 40/Q.704 - Signalling Link Management; Signalling Link Deactivation (LSLD)	126
Figure 41/Q.704 - Signalling Link Management; Signalling Terminal Allocation (LSTA)	127
Figure 42/Q.704 (Sheet 1 of 2) - Signalling Link Management; Signalling Data Link Allocation (LSDA)	128
Figure 42/Q.704 (Sheet 2 of 2) - Signalling Link Management; Signalling Data Link Allocation (LSDA)	129
Figure 43/Q.704 (Sheet 1 of 2) - Signalling Route Management (SRM); Functional Block Interactions	130
Figure 43/Q.704 (Sheet 2 of 2) - Signalling Route Management (SRM); Functional Block Interactions	131
Figure 44/Q.704 (Sheet 1 of 2) - Signalling Route Management; Transfer Prohibited Control (RTPC)	132
Figure 44/Q.704 (Sheet 2 of 2) - Signalling Route Management; Transfer Prohibited Control (RTPC)	133
Figure 45/Q.704 (Sheet 1 of 2) - Signalling Route Management; Transfer-Allowed Control (RTAC)	134
Figure 45/Q.704 (Sheet 2 of 2) - Signalling Route Management; Transfer-Allowed Control (RTAC)	135
Figure 46/Q.704 (Sheet 1 of 3) - Signalling Route Management; Signalling Route Set Test Control (RSRT)	136
Figure 46/Q.704 (Sheet 2 of 3) - Signalling Route Management; Signalling Route Set Test Control (RSRT)	137
Figure 46/Q.704 (Sheet 3 of 3) - Signalling Route Management; Signalling Route Set Test Control (RSRT)	138

SIGNALLING NETWORK FUNCTIONS AND MESSAGES

Figure 46A/Q.704 - Signalling Route Management; Transfer Controlled Control (RTCC)	139
Figure 46B/Q.704 - Signalling Route Management; Signalling Route Set Congestion Test Control (RCAT)	140
Figure 46C/Q.704 - Signalling Route Management; Transfer Restricted Control (RTRC)	141

SIGNALLING NETWORK FUNCTIONS AND MESSAGES

LIST OF TABLES

Table 1 - Heading Code Allocation of Signalling Network Management Messages 58

SIGNALLING NETWORK FUNCTIONS AND MESSAGES

1. Introduction

1.1 General Characteristics of the Signalling Network Functions

1.1.1 Q.704 describes the functions and procedures for, and relating to, the transfer of messages between the signalling points, which are the nodes of the signalling network. Such functions and procedures are performed by the Message Transfer Part at level 3, and therefore they assume that the signalling points are connected by signalling links incorporating the functions described in Q.702 and Q.703. The signalling network functions must ensure a reliable transfer of the signalling messages, according to the requirements specified in Q.706, even in the case of the failure of signalling links and signalling transfer points; therefore, they include the appropriate functions and procedures necessary both to inform the remote parts of the signalling network of the consequences of a fault, and to appropriately reconfigure the routing of messages through the signalling network.

1.1.2 According to these principles, the signalling network functions can be divided into two basic categories, namely:

- (1) *Signalling message handling* and
- (2) *Signalling network management*.

The signalling message handling functions are briefly summarized in Section 1.2; the signalling network management functions in Section 1.3. The functional interrelations between these functions are indicated in Figure 1/Q.704.

1.1.2A The procedures specified herein are the set of procedures with national options to be used in U. S. networks. International procedures which will only be used for signalling on international routes are so indicated. *

1.2 Signalling Message Handling

1.2.1 The purpose of the signalling message handling functions is to ensure that the signalling messages originated by a particular User Part at a signalling point (originating point) are delivered to the same User Part at the destination point indicated by the sending User Part.

Depending on the particular circumstances, this delivery may be made through a signalling link directly interconnecting the originating and destination points, or via one or more intermediate signalling transfer points.

1.2.2 The signalling message handling functions are based on the label contained in the messages, which explicitly identifies the destination and originating points.

The label part used for signalling message handling by the Message Transfer Part is called the *routing label*; its characteristics are described in Section 2.

1.2.3 As illustrated in Figure 1/Q.704, the signalling message handling functions are divided into:

- (1) The *message routing* function, used at each signalling point to determine the outgoing signalling link on which a message has to be sent towards its destination point;
- (2) The *message discrimination* function, used at a signalling point to determine whether or not a received message is destined to the point itself. When the signalling point has the transfer capability and a message is not destined to it, that message has to be transferred to the message routing function;

* An * indicates a change from Recommendation Q.704 in Fascicle VI.7 of the CCITT Red Book [1]. *

SIGNALLING NETWORK FUNCTIONS AND MESSAGES

- (3) The *message distribution* function, used at each signalling point to deliver the received messages (destined to the point itself) to the appropriate User Part.

The characteristics of the message routing, discrimination and distribution functions are described in Section 2.

1.3 Signalling Network Management

1.3.1 The purpose of the signalling network management functions is to provide reconfiguration of the signalling network in the case of failures and to control the traffic in case of congestion. Such a reconfiguration is effected by use of appropriate procedures to change the routing of signalling traffic in order to bypass the faulty links or signalling points; this requires communication between signalling points (and, in particular, the signalling transfer points) concerning the occurrence of the failures. Moreover, in some circumstances it is necessary to activate and align new signalling links, in order to restore the required signalling traffic capacity between two signalling points. When the faulty link or signalling point is restored, the opposite actions and procedures take place, in order to reestablish the normal configuration of the signalling network.

1.3.2 As illustrated in Figure 1/Q.704, the signalling network management functions are divided into:

- (1) *Signalling traffic management,*
- (2) *Signalling link management,* and
- (3) *Signalling route management.*

These functions are used whenever an event (such as the failure or restoration of a signalling link) occurs in the signalling network; the list of the possible events and the general criteria used in relation to each signalling network management function are specified in Section 3.

1.3.3 Sections 4 to 10 specify the procedures pertaining to signalling traffic management. In particular, the rules to be followed for the modification of signalling routing appear in Section 4. The diversion of traffic according to these rules is made, depending on the particular circumstances, by means of one of the following procedures: *changeover*, *changeback*, *forced rerouting*, and *controlled rerouting*. They are specified in Sections 5 through 8, respectively. A signalling link may be made unavailable to User Part generated traffic by means of *management inhibiting* procedures described in Section 9. Moreover, in the case of congestion at signalling points, the signalling traffic management may need to slow down signalling traffic on certain routes by using the *signalling traffic flow control* procedure specified in Section 10.

1.3.4 ¹The different procedures pertaining to signalling link management are: *restoration*, *activation*, and *deactivation* of a signalling link; *link set activation*; and *automatic allocation* of signalling terminals and signalling data links. These procedures are specified in Section 11.

1.3.5 The different procedures pertaining to signalling route management are: the *transfer-prohibited*, *transfer-allowed*, *transfer-restricted*², *transfer-controlled*, *signalling-route-set-test*, and *signalling-route-set-congestion-test*² procedures specified in Section 12.

1.3.6 The format characteristics, common to all message signal units, which are relevant to the Message Transfer Part, level 3, are specified in Section 13.

1. Text from the CCITT Red Book Vol. VI referring to alternative (switchover) link management procedures has been deleted from this section. *

2. This is standard procedure for the U. S. networks. *

SIGNALLING NETWORK FUNCTIONS AND MESSAGES

1.3.7 Labeling, formatting, and coding of the signalling network management messages are specified in Section 14.

1.3.8 The description of signalling network functions in the form of state transition diagrams according to the CCITT Specification and Description Language (SDL) is given in Section 15.

2. Signalling Message Handling

2.1 General

2.1.1 Signalling message handling comprises message routing, discrimination and distribution functions which are performed at each signalling point in the signalling network.

Message routing is a function concerning the message to be sent, while message distribution and discrimination are functions concerning the received messages. The functional relations among message routing, distribution, and discrimination appear in Figure 2/Q.704. *

2.1.2 When a message comes from level 4 (or is originated at level 3, in the case of Message Transfer Part level 3 messages), the choice of the particular signalling link on which it has to be sent is made by the message routing function. When two or more links are used at the same time to carry traffic having a given destination, this traffic is distributed among them by the load sharing function, which is a part of the message routing function.

2.1.3 When a message comes from level 2, the discrimination function is activated, in order to determine whether it is destined to another signalling point. When the signalling point has the transfer capability and the received message is not destined to it, the message has to be transmitted on an outgoing link according to the routing function.

2.1.4 In the case that the message is destined to the receiving signalling point, the message distribution function is activated, in order to deliver it to the appropriate User Part (or to the local Message Transfer Part level 3 functions).

2.1.5 Message routing, discrimination and distribution are based on the part of the label called the routing label, on the service indicator and, in national networks, also on the network indicator. They can also be influenced by different factors, such as a request (automatic or manual) obtained from a management system.

2.1.6 The position and coding of the service indicator and of the network indicator are described in Section 13.2. The characteristics of the label of the messages pertaining to the various User Parts are described in the specification of each separate User Part and in Section 14 for the signalling network management messages. The label used for signalling network management messages is also used for testing and maintenance messages (see Q.707). Moreover, the general characteristics of the routing label are described in Section 2.2.

A description of the detailed characteristics of the message routing function, including load sharing, appears in Section 2.3; principles concerning the number of load-shared links appear in Q.705.

A description of the detailed characteristics of the message discrimination and distribution functions appears in Section 2.4.

2.2 Routing Label³

3. Text from the CCITT Red Book Vol. VI related to a modified label structure was deleted from this section. *

SIGNALLING NETWORK FUNCTIONS AND MESSAGES

2.2.1 The label contained in a signalling message, and used by the relevant User Part to identify the particular task to which the message refers (e.g., a telephone circuit), is also used by the Message Transfer Part to route the message towards its destination point.

The part of the message label that is used for routing is called the *routing label*, and it contains the information necessary to deliver the message to its destination point.

The U. S. national label contained in a signalling message only contains information necessary to deliver the message to its destination point. *

Normally, the routing label is common to all the services and applications in a given signalling network (national or international); however, if this is not the case, the particular routing label of a message is determined by means of the service indicator. *

The standard routing labels for use in U. S. networks are specified in the following. *

2.2.2 The standard international routing label has a length of 32 bits and is placed at the beginning of the Signalling Information Field. Its structure appears in Figure 3/Q.704.

2.2.2A The U. S. national routing label has a length of 56 bits and is placed at the beginning of the signalling information field. Its structure appears in Figure 3A/Q.704. *

2.2.3 The *Destination Point Code* (DPC) indicates the destination point of the message. The *Originating Point Code* (OPC) indicates the originating point of the message. In the international routing label the coding of these codes is pure binary. In the U. S. routing label each point code has the structure described in Section 2.2.3A. Within each field, the least significant bit occupies the first position and is transmitted first. *

A unique numbering scheme for the coding of the fields will be used for the signalling points of any network, irrespective of the User Parts connected to each signalling point. *

2.2.3A In the U. S. national routing label both the originating point code and the destination point code are constructed of fields as shown in Figure 3B/Q.704. *

2.2.3B In many cases the value in the network identifier field directly identifies the network to which a point code belongs; however, as specified in detail in Q.708, a number of values of that field have been reserved as escape codes so that more than 256 networks can be addressed. The appearance of one of these reserved values in the network identifier field of a point code indicates that the network cluster field should be used to identify the network to which the point code belongs. *

2.2.3C It is for further study whether any structure should be specified for the cluster and cluster member fields when the cluster field is used to identify a network. Otherwise, any network's use or recognition of subfields within the cluster or cluster member fields is solely at the option of that network. *

2.2.3D The cluster member code 00000000 is reserved for addressing signalling transfer points. *

2.2.4 The *Signalling Link Selection* (SLS) field is used, where appropriate, in performing load sharing, see Section 2.3. This field exists in all types of messages and always in the same position.

In the case of circuit related messages of the TUP for international signalling only, the field contains the least significant bits of the circuit identification code (or bearer identification code in the case of the Data User Part), and these bits are not repeated elsewhere. In the case of all other users, SLS is an independent field in accordance with the criteria stated in Section 2.2.5.

1. Red Book text from this section was deleted; it referred to the placement of the SLC in the SLS field. *

SIGNALLING NETWORK FUNCTIONS AND MESSAGES

2.2.5 From the rule stated in Section 2.2.4 above, it follows that the signalling link selection field of messages generated by any User Part will be used in the load sharing mechanism. As a consequence, in the case of User Parts which are not specified (e.g., transfer of charging information) but for which there is the requirement to maintain the order of transmission of the messages, the field should be coded with the same value for all messages belonging to the same transaction, sent in a given direction.

2.2.6 The above principles should also... (not applicable to U.S. networks) *

2.3 Message Routing Function

2.3.1 ⁵The message routing function determines the signalling link over which each outgoing message is sent. For most messages an outgoing link set (or combined link set: see Section 2.3.2) is determined on the basis of the destination point code in the message's routing label⁶, and a particular link within that link set is selected on the basis of the signalling link selection field. The load sharing of traffic over the links of a link set is described more fully in Section 2.3.2. Sometimes information beyond the routing label may be needed to route a message: *

- (1) Special link selection rules apply to some network management messages; see Section 2.3.4. *
- (2) The network indicator may have to be examined to determine what label structure is used in a message; see Section 2.4.3. *
- (3) The possibility of basing routing on the service indicator in addition to the routing label has been left open. For example, messages may be defined for signalling route test procedures (see Q.707) that require routing based on service indicator. The use of the service indicator for routing should be kept to a minimum in order to apply the same routing criteria to as many Users as possible. *

2.3.2 The purpose of load sharing is to distribute traffic evenly over the links of a link set (combined link set). Two basic cases of load sharing are defined, namely: *

- (1) Load sharing between links belonging to the same link set,
- (2) Load sharing between links not belonging to the same link set. A load sharing collection of one or more link sets is called a combined link set.

The capability to operate in load sharing according to both these cases is mandatory for any signalling point.

In case (1), the traffic flow carried by a link set is shared (on the basis of the signalling link selection field) between different signalling links belonging to the link set. An example of such a case is given by a link set directly interconnecting the originating and destination points in the associated mode of operation, such as represented in Figure 4/Q.704.

In case (2), traffic relating to a given destination is shared (on the basis of the signalling link selection field) between different signalling links not belonging to the same link set, such as represented in Figure 5/Q.704. The load sharing rule used for a particular signalling relation may or may not apply to all the signalling relations which use one of the signalling links involved (in the example, traffic destined to B is shared between signalling links DE and DF with a given signalling link selection field assignment, while that destined to C is sent only on link DF, due to the failure of link EC).

5. In this section Red Book text has been extensively revised for clarity *

6. The link set (combined link set) may be determined on the basis of the whole DPC or part of the DPC; see examples in Appendix of Q.705. *

SIGNALLING NETWORK FUNCTIONS AND MESSAGES

As a result of the message routing function, in normal conditions all the messages having the same routing label (e.g., call set-up messages related to a given circuit) are routed via the same signalling links and signalling transfer points.

Principles relating to the number of load-shared links and examples of the use of the SLS field in load sharing appear in Q.705. *

2.3.3 Routing information should be appropriately updated when some event happens in the signalling network, which is relevant to the concerned signalling point (e.g., failure of a signalling link or unavailability of a signalling route). The updating of the routing information is made according to the particular event (see Section 3) and to the signalling routing modification rules specified in Section 4.

2.3.4 Handling of Level 3 Messages⁵

2.3.4.1 Messages not related to a signalling link may be assigned any SLS code where load sharing of the message is necessary, or a default code such as 00000. They are handled in accordance with the normal routing function, using the SLS for load sharing. *

2.3.4.2 Some messages relating to a signalling link require special routing. For example, a signalling link test message (Q.707) must be routed over the link to which it refers, and a changeover message (Q.704) must not be routed over the link to which it refers. Precise descriptions of special routing requirements are included in the descriptions of the procedures that use messages that require special routing. See also Figure 26/Q.704. *

2.3.5 Handling of Messages under Signalling Link Congestion

2.3.5.1 ⁷In the international signalling network, congestion priorities of messages are only assigned and the decision to discard under congestion is only made within each User Part. Message discard will only occur in the MTP should there be an extreme resource limitation (for the MTP there is no congestion priority).

2.3.5.2 ⁶In U. S. signalling networks, each message is assigned by its generating User Part a congestion priority. This is used by the MTP to determine whether or not a message should be discarded under signalling link congestion. 4 levels of congestion priority levels are accommodated in the signalling network, with 0 being the lowest and 3 the highest. The highest priority is assigned to signalling network management messages. *

When a signalling link has been selected for transmitting a message, comparisons of the congestion priority of the message are made with the congestion status of the selected signalling link (see Section 3.6). If the congestion priority is not less than the signalling link congestion status, that message is transmitted using the selected signalling link.

Otherwise, a transfer-controlled message is sent in response as specified in Section 12.7. In this case, the disposition of the concerned message is determined according to the following criteria:

- (1) If the congestion priority of the message is greater than or equal to the signalling link discard status, the message is transmitted.
- (2) If the congestion priority of the message is less than the signalling link discard status, the message is discarded.

7. Some Red Book text dealing with multiple congestion priority levels has been moved from 2.3.5.1 to 2.3.5.2. *

SIGNALLING NETWORK FUNCTIONS AND MESSAGES

2.4 Message Discrimination and Distribution Functions

2.4.1 The routing criteria and load sharing method described in Section 2.3 imply that a signalling point sending messages pertaining to a given signalling transaction on a given link should be able to receive and process messages pertaining to that transaction, e.g., in response to the sent ones, coming from any (but only one) link.

The destination point code field of the received messages is examined by the discrimination function in order to determine whether or not they are destined to the receiving signalling point. When the receiving signalling point has the transfer capability and the message is not destined to it, that message has to be directed to the routing function, as described in the previous sections, in order to be sent on the appropriate outgoing link towards the message destination point.

When a signalling transfer point detects that a received message cannot be delivered to its destination point, it sends in response a transfer-prohibited message as specified in Section 12.2.

2.4.2 If the destination point code of the message identifies the receiving signalling point, the service indicator is examined by the message distribution function and the message is delivered to the corresponding User Part (or to the Message Transfer Part level 3).

2.4.3 In the case of a signalling point handling both international and national signalling traffic (e.g., an international gateway exchange), the network indicator is also examined, in order to determine the relevant numbering scheme (international or national) and possibly the label structure. Moreover, within a national network, the network indicator may be examined to discriminate between different label structures, or between different signalling point numbering if dependent on the network levels (see Section 13.2).

2.4.3A In the case of signalling network testing and maintenance messages there are two types of messages: *

- (1) Regular messages which use all the normal message handling procedures. *
- (2) Special messages which are denoted by service indicator value 0010 (see Section 13.2.1) and which use special message handling procedures which are invoked within message discrimination by inspection of the service indicator. In particular, messages with service indicator 0010 are discriminated and distributed by all signalling points, independent of the DPC in the routing label. *

3. Signalling Network Management

3.1 General

3.1.1 The signalling network management functions provide the actions and procedures required to maintain signalling service, and to restore normal signalling conditions in the event of disruption in the signalling links or at signalling points. The disruption may be in the form of complete loss of a signalling link or signalling point, or in reduced accessibility due to congestion. For example, in the case of a link failure, the traffic conveyed over the faulty link should be diverted to one or more alternative links. The link failure may also result in unavailable signalling routes and this, in turn, may cause diversion of traffic at other signalling points in the signalling network (i.e., signalling points to which no faulty links are connected).

3.1.2 The occurrence of, or recovery from, failures or congestion generally results in a change of the status of the affected signalling link(s) and route(s). A signalling link may be considered by level 3, either as "available" or "unavailable" to carry signalling traffic; in particular, an available signalling link becomes unavailable if it is recognized as "failed", "deactivated", "blocked"⁸ or "inhibited",

SIGNALLING NETWORK FUNCTIONS AND MESSAGES

and it becomes once again available if it is recognized as "restored", "activated", "unblocked" or "uninhibited", respectively. A signalling route may be considered by level 3 as "available", "restricted" or "unavailable", too. A signalling route set may be "congested" or "uncongested". The detailed criteria for the determination of the changes in the status of signalling links and routes are described in Sections 3.2 and 3.4 respectively.

3.1.3 Whenever a change in the status of a signalling link or route occurs, the three different signalling network management functions (i.e., signalling traffic management, link management and route management) are activated, when appropriate, as follows:

- (1) The signalling traffic management function is used to divert signalling traffic from a link or route to one or more different links or routes or to temporarily slow down signalling traffic in the case of congestion at a signalling point; it comprises the following procedures:
 - (1) Changeover (see Section 5)
 - (2) Changeback (see Section 6)
 - (3) Forced rerouting (see Section 7)
 - (4) Controlled rerouting (see Section 8)
 - (5) Management inhibiting (see Section 9)
 - (6) Signalling traffic flow control (see Section 10).
- (2) The signalling link management function is used to restore failed signalling links, to activate idle (not yet aligned) links and to deactivate aligned signalling links; it comprises the following procedures (see Section 11):
 - (1) Signalling link activation, restoration, and deactivation,
 - (2) Link set activation
 - (3) Automatic allocation of signalling terminals and signalling data links.
- (3) The signalling route management function is used to distribute information about the signalling network status, in order to block or unblock signalling routes; it comprises the following procedures:
 - (1) Transfer-restricted procedure (see Section 12.5)
 - (2) Transfer-prohibited procedure (see Section 12.2)
 - (3) Transfer-allowed procedure (see Section 12.3)
 - (4) Signalling-route-set-test procedure (see Section 12.4)
 - (5) Transfer-controlled procedure (see Section 12.6, 12.7 and 12.8)
 - (6) Signalling-route-set-congestion-test procedure (see Section 12.9).

3.1.4 An overview of the use of the procedures relating to the different management functions on occurrence of the link and route status changes is given in Sections 3.3 and 3.5. respectively.

3.2 Status of Signalling Links

3.2.1 A signalling link is always considered by level 3 in one of two possible major states: available and unavailable. Depending on the cause of unavailability, the unavailable state can be subdivided into seven possible cases as follows (see also Figure 6/Q.704):

- (1) Unavailable, failed or inactive
- (2) Unavailable, blocked
- (3) Unavailable, (failed or inactive) and blocked
- (4) Unavailable, inhibited

8. The "blocked" condition arises when the unavailability of a signalling link does not depend on a failure in the link itself, but on other causes, such as a "processor outage" condition in a signalling point.

SIGNALLING NETWORK FUNCTIONS AND MESSAGES

- (5) Unavailable, inhibited and (failed or inactive) *
- (6) Unavailable, inhibited and blocked *
- (7) Unavailable, (failed or inactive), blocked, and inhibited. *

The concerned link can be used to carry signalling traffic only if it is available. Eight possible events can change the status of a link: signalling link failure, restoration, deactivation, activation, blocking, unblocking, inhibiting, and uninhibiting: they are described in Sections 3.2.2 through 3.2.9. *

3.2.2 Signalling Link Failure. A signalling link (in-service or blocked, see Section 3.2.6) is recognized by level 3 as failed when:

- (1) A link failure indication is obtained from level 2. The indication may be caused by:
 - (1) Intolerably high signal unit error rate (see Q.703, Section 10),
 - (2) Excessive length of the realignment period (see Q.703, Sections 4.1 and 7),
 - (3) Excessive delay of acknowledgements (see Q.703, Sections 5.3 and 6.3),
 - (4) Excessive period of level 2 congestion (see Q.703 Section 9)
 - (5) Failure of signalling terminal equipment,
 - (6) Two out of three unreasonable backward sequence numbers or forward indicator bits (see Q.703, Sections 5.3 and 6.3),
 - (7) Reception of consecutive link status signal units indicating out-of-alignment, out-of-service, normal or emergency terminal status (see Q.703, Section 1.7).

The first two conditions are detected by the signal unit error rate monitor (see Q.703, Section 10).

- (2) A request (automatic or manual) is obtained from a management or maintenance system.

Moreover, a signalling link which is available (not blocked) is recognized by level 3 as failed when a changeover order is received.

3.2.3 Signalling Link Restoration. A signalling link previously failed is restored when both ends of the signalling link have successfully completed an initial alignment procedure (see Q.703, Section 7).

3.2.4 Signalling Link Deactivation. A signalling link (in-service, failed or blocked) is recognized by level 3 as deactivated (i.e., removed from operation) when:

- (1) A request is obtained from the signalling link management function (see Section 11);
- (2) A request (automatic or manual) is obtained from an external management or maintenance system.

3.2.5 Signalling Link Activation. A signalling link previously inactive is recognized by level 3 as activated when both ends of the signalling link have successfully completed an initial alignment procedure (see Q.703, Section 7).

3.2.6 Signalling Link Blocking. A signalling link (in service, failed or inactive) is recognized as blocked when:

- (1) An indication is obtained from the signalling terminal that a processor outage condition exists at the remote terminal (i.e., link status signal units with processor outage indication are received, see Q.703, Section 8);

9. Red Book text relating to the use of blocking by management systems has been deleted from this section. *

SIGNALLING NETWORK FUNCTIONS AND MESSAGES

- (2) A request... (Not applicable in U. S. Networks). *

Note: A link becomes unavailable when it is failed or deactivated or ((failed or deactivated) and blocked) (see Figure 6/Q.704).

3.2.7⁸ Signalling Link Unblocking. A signalling link previously blocked is unblocked when:

- (1) An indication is obtained from the signalling terminal that the processor outage condition has ceased at the remote terminal. (Applies in the case when the processor outage condition was initiated by the remote terminal.);
(2) A request... (Not applicable in U. S. Networks) *

Note: A link becomes available when it is restored, or activated, or unblocked, or ((restored or activated) and unblocked) (see Figure 6/Q.704).

3.2.8 Signalling Link Inhibiting. In U. S. networks the standard for management control of signalling links is the management inhibit procedure. A signalling link is recognized as inhibited when: *

- (1) An acknowledgement is received from a remote signalling point in response to an inhibit request sent to the remote end by the local signalling link management. Level 3 has marked the link locally inhibited.
(2) Upon receipt of a request from a remote signalling point to inhibit a link and successful determination that no destination will become inaccessible by inhibiting the link, the link has been marked remotely inhibited by Level 3. *

3.2.9 Signalling Link Uninhibiting. A signalling link previously inhibited is uninhibited when:

- (1) A request is received to uninhibit the link from a remote end or from a local routing function.
(2) An acknowledgement is received from a remote signalling point in response to an uninhibit request sent to the remote end by the local signalling link management.

3.3 Procedures Used in Connection with Link Status Changes.

In Section 3.3, the procedures relating to each signalling management function, which are applied in connection with link status changes, are listed. (See also Figures 6/Q.704, 7/Q.704 and 8/Q.704.) Typical examples of the application of the procedures to the particular network cases appear in Q.705.

3.3.1 Signalling Link Failed

3.3.1.1 Signalling traffic management: the changeover procedure (see Section 5) is applied, if required, to divert signalling traffic from the unavailable link to one or more alternative links with the objective of avoiding message loss, repetition or mis-sequencing; it includes determination of the alternative link or links where the affected traffic can be transferred, and procedures to retrieve messages sent over the failed link but not received by the far end.

3.3.1.2 Signalling link management: the procedures described in Section 11 are used to restore a signalling link and to make it available for signalling. Moreover, depending on the link set status, the procedures can also be used to activate another signalling link in the same link set to which the unavailable link belongs, and to make it available for signalling.

3.3.1.3 Signalling route management: in the case when the failure of a signalling link causes a signalling route set to become unavailable or restricted² the signalling transfer point which can no longer route the concerned signalling traffic applies the transfer-prohibited or transfer-restricted² procedures described in Section 12.

SIGNALLING NETWORK FUNCTIONS AND MESSAGES

3.3.2 Signalling Link Restored

3.3.2.1 Signalling traffic management: the changeback procedure (see Section 6) is applied, if required, to divert signalling traffic from one or more links to a link which has become available; it includes determination of the traffic to be diverted and procedures for maintaining the correct message sequence.

3.3.2.2 Signalling link management: the signalling link deactivation procedure (see Section 11) is used if, during the signalling link failure, another signalling link of the same link set was activated; it is used to assure that the link set status is returned to the same state as before the failure. This requires that the active link activated during the link failure be deactivated and considered no longer available for signalling.

3.3.2.3 Signalling route management: in the case when the restoration of a signalling link causes a signalling route set to become available, the signalling transfer point which can once again route the concerned signalling traffic applies the transfer-allowed or transfer-restricted² procedures described in Section 12 as appropriate. *

3.3.3 Signalling Link Deactivated

3.3.3.1 Signalling traffic management: as specified in Section 3.3.1.1.

Note: The signalling traffic has normally already been removed when signalling link deactivation is initiated.

3.3.3.2 Signalling link management: if the number of active signalling links in the link set to which the deactivated signalling link belongs has become less than the normal number of active signalling links in that link set, the procedures described in Section 11 may be used to activate another signalling link in the link set.

3.3.3.3 Signalling route management: as specified in Section 3.3.1.3.

3.3.4 Signalling Link Activated

3.3.4.1 Signalling traffic management: as specified in Section 3.3.2.1.

3.3.4.2 Signalling link management: if the number of active signalling links in the link set to which the activated signalling link belongs has become greater than the normal number of active signalling links in that link set, the procedures described in Section 11 may be used to deactivate another signalling link in the link set.

3.3.4.3 Signalling route management: as specified in Section 3.2.2.3.

3.3.5 Signalling Link Blocked

3.3.5.1 Signalling traffic management: will be the same as in Section 3.3.1.1.

3.3.5.2 ⁸Signalling route management: if the blocking of the link causes a signalling route set to become unavailable or restricted², the signalling transfer point which can no longer route the concerned signalling traffic applies the transfer-prohibited or transfer-restricted² procedures described in Section 12.

3.3.6 Signalling Link Unblocked

3.3.6.1 Signalling traffic management: the actions will be the same as in Section 3.3.2.1.

3.3.6.2 ⁸Signalling route management: if the link unblocked causes a signalling route set to become available the signalling transfer point which can once again route the signalling traffic in that route set applies the transfer-allowed or transfer-restricted² procedures described in Section 12, as appropriate. *

SIGNALLING NETWORK FUNCTIONS AND MESSAGES

3.3.7 Signalling Link Inhibited

3.3.7.1 Signalling traffic management: as specified in Section 3.3.1.1.

3.3.7.2 Signalling link management: as specified in Section 3.3.3.2.

3.3.8 Signalling Link Uninhibited

3.3.8.1 Signalling traffic management: as specified in Section 3.3.2.1.

3.3.8.2 Signalling link management: as specified in Section 3.3.4.2.

3.3.8.3 Signalling route management: if the link uninhibited causes a signalling route set to become available, the signalling transfer point which can once again route the signalling traffic in that route set applies the transfer-allowed or transfer-restricted² procedures described in Section 12, as appropriate. *

3.4 Status of Signalling Routes.

A signalling route can be in three states for signalling traffic having the concerned destination; these are available, restricted² and unavailable. A route may become available or unavailable because of changes in the availability of the local links in that route; however, the procedures already given in Section 3.3 handle such cases. Sections 3.4 and 3.5 deal with route status changes caused by receipt of signalling route management messages. *

3.4.1 Signalling Route Unavailability. A signalling route becomes unavailable when a transfer-prohibited message, indicating that signalling traffic towards a particular destination or cluster of destinations cannot be transferred via the signalling transfer point sending the concerned message, is received (see Section 12). *

3.4.2 Signalling Route Availability. A signalling route becomes available when a transfer-allowed message, indicating that signalling traffic towards a particular destination or cluster of destinations can be transferred via the signalling transfer point sending the concerned message, is received (see Section 12). *

3.4.3 Signalling Route Restricted². A signalling route becomes restricted when a transfer-restricted message, indicating that signalling traffic towards a particular destination or cluster of destinations is being transferred with some difficulty via the signalling transfer point sending the concerned message, is received (see Section 12). *

3.5 Procedures Used in Connection with Route Status Changes.

In Section 3.5, the procedures relating to each signalling management function which in general are applied in connection with route status changes caused by receipt of signalling route management messages are listed. (See also Figures 6/Q.704 and 8/Q.704.) Typical examples of the application of the procedures to particular network cases appear in Q.705. *

3.5.1 Signalling Route Unavailable

3.5.1.1 Signalling traffic management: the forced rerouting procedure (see Section 7) is applied; it is used to transfer signalling traffic to the concerned destination from the link set belonging to the unavailable route to an alternative link set which terminates in another signalling transfer point. It includes actions to determine the alternative route.

3.5.1.2 Signalling route management: because of the unavailability of the signalling route, the network is reconfigured; in the case that a signalling transfer point can no longer route the concerned signalling traffic, it applies the procedures described in Section 12.

3.5.2 Signalling Route Available

SIGNALLING NETWORK FUNCTIONS AND MESSAGES

3.5.2.1 Signalling traffic management: the controlled rerouting procedure (see Section 8) is applied; it is used to transfer signalling traffic to the newly available route. It includes the determination of which traffic should be diverted, and procedures for maintaining the correct message sequence. *

3.5.2.2 Signalling route management: because of the restored availability of the signalling route, the network is reconfigured; in the case that a signalling transfer point can once again route the concerned signalling traffic, it applies the procedures described in Section 12.

3.5.3 Signalling Route Restricted²

3.5.3.1 Signalling traffic management: the controlled rerouting procedures (see Section 8) is applied; it is used to transfer signalling traffic to the concerned destination from the link set belonging to the restricted route, to an alternative link set if one is available to give more, if possible, efficient routing. It includes actions to determine the alternative route.

3.5.3.2 Signalling route management: because of the restricted availability of the signalling route, the network routing is, if possible, reconfigured; procedures described in Section 12 are used to advise adjacent signalling points.

3.6 Signalling Network Congestion

3.6.1 General. In Section 3.6, criteria for the determination of signalling link congestion status and signalling route set congestion status are specified. The procedures relating to each signalling network management function, which in general are applied in connection with congestion status changes, are listed.

3.6.2 Congestion status of signalling links

3.6.2.1 When predetermined levels of MSU fill in the transmission or retransmission buffer are crossed, an indication is given to level 3 advising of congestion/congestion abatement. The location and setting of the congestion thresholds are considered to be implementation dependent.

Note: The criterion for setting the congestion thresholds is based on (1) the proportion of the total transmit and retransmit buffer capacity that is occupied and/or (2) the total number of messages in the transmit and retransmit buffers. (The buffer capacity below the threshold should be sufficient to overcome load peaks due to signalling network management functions and the remaining buffer capacity should allow User Parts time to react to congestion indications before message discard occurs.) The monitoring may be performed in different ways depending on the relative sizes of the transmit and retransmit buffers. In the case of a relatively small retransmit buffer, monitoring of the transmit buffer may be sufficient. In the case of a relatively large retransmit buffer, both the transmit buffer and retransmit buffer occupancies may need to be monitored.

- (1) In the international signalling network, one congestion onset and one congestion abatement threshold are provided. The congestion abatement threshold should be placed lower than the congestion onset threshold in order to provide hysteresis during the process of recovering from congestion.
- (2) In U. S. networks 3 separate thresholds are provided for detecting the onset of congestion. They are called congestion onset thresholds and are numbered 1, 2, and 3, respectively. 3 separate thresholds are provided for monitoring the abatement of congestion. They are called congestion abatement thresholds and are numbered 1, 2, and 3, respectively. *

Each congestion abatement threshold should be placed lower than the corresponding congestion onset threshold in order to provide hysteresis during the process of recovering from congestion.

Congestion abatement threshold n ($n=2$ or 3) should be placed higher than congestion onset threshold $n-1$ so as to allow for a precise determination of signalling link congestion status. *

SIGNALLING NETWORK FUNCTIONS AND MESSAGES

Congestion abatement threshold 1 should be placed higher than the normally engineered buffer occupancy of a signalling link.

Under normal operation, when the signalling link is uncongested, the signalling link congestion status is assigned the zero value.

At the onset of congestion, when the buffer occupancy is increasing, the signalling link congestion status is determined by the highest congestion onset threshold exceeded by the buffer occupancy. That is, if congestion onset threshold n ($n = 1, 2, \text{ or } 3$) is the highest congestion onset threshold exceeded by the current buffer occupancy, the current signalling link congestion status is assigned the value n (see Figure 8A/Q.704). *

At the abatement of congestion, when the buffer occupancy is decreasing, the signalling link congestion status is determined by the lowest congestion abatement threshold below which the buffer occupancy has dropped. That is, if congestion abatement threshold n ($n=1, 2, \text{ or } 3$) is the lowest congestion abatement threshold below which the current buffer occupancy has dropped, the current signalling link congestion status is assigned the value $n-1$ (see Figure 8B/Q.704). *

The use of the signalling link congestion status is specified in section 2.3.5.2.

3.6.2.2 In U. S. networks 3 separate thresholds are provided for determining whether, under congestion conditions a message should be discarded or transmitted using the signalling link. They are called congestion discard thresholds and are numbered 1, 2, and 3 respectively. *

Congestion discard threshold n ($n=1, 2, \text{ or } 3$) is placed higher than congestion onset threshold n in order to minimize message loss under congestion conditions. *

Congestion discard threshold n ($n = 1 \text{ or } 2$) should be placed at or lower than congestion onset threshold $n+1$ in order to make congestion control effective.

When the current buffer occupancy does not exceed congestion discard threshold 1, the current signalling link discard status is assigned the zero value.

When the current buffer occupancy exceeds congestion discard threshold n ($n = 1 \text{ or } 2$), but does not exceed congestion discard threshold $n+1$, the current signalling link discard status is assigned the value n (see Figure 8C/Q.704).

When the current buffer occupancy exceeds congestion discard threshold 3, the current signalling discard status is assigned the value 3.

The use of the signalling link discard status is specified in Section 2.3.5.2.

The provision of link discard thresholds is optional at signalling points at which all outgoing traffic is generated by local users and is subject to discard by signalling traffic flow control as specified in Section 10.2.4. *

3.6.2.3 In national signalling networks using... (This section has been deleted as it is not applicable to U. S. networks.) *

3.6.3 Procedures Used in Connection with Link Congestion Status Changes. In Section 3.6.3, the procedures relating to each signalling network management function, which in general are applied in connection with link congestion status changes, are listed.

Signalling route management: in the case when the congestion of a signalling link causes a signalling route set to become congested, the transfer-controlled procedure (see Section 12.6 and 12.7) is used, if required, to notify originating signalling points that they should reduce the concerned signalling traffic towards the affected destination.

3.6.4 Congestion Status of Signalling Route Sets. At each originating signalling point, there is associated with each signalling route set a congestion status, which indicates the degree of congestion in the signalling route set.

SIGNALLING NETWORK FUNCTIONS AND MESSAGES

- (1) In the international signalling network two states are provided, congested and uncongested.

If a link in a signalling route towards a given destination becomes congested, the congestion status of the signalling route set towards the affected destination is changed to congested.

When a transfer controlled message relating to a given destination is received, the congestion status of the signalling route set towards the affected destination is indicated to the level 4 User Parts in accordance with the transfer controlled procedure specified in section 12. The congestion status is not retained by level 3 at the receiving signalling point.

- (2) In U. S. signalling networks with multiple congestion levels² corresponding to the 4 levels of signalling link congestion, there are 4 values of signalling route set congestion status, with 0 being the lowest and 3 the highest.

Normally the congestion status of a signalling route set is assigned the zero value, indicating that the signalling route set is uncongested.

If a signalling link in the signalling route set to a given destination becomes congested, the congestion status of the signalling route set is assigned the value of the signalling link congestion status, if it is higher than the current signalling route set congestion status.

When a transfer-controlled message relating to a given destination is received, the congestion status of the signalling route set towards that destination is updated, in accordance with the transfer-controlled procedures as specified in Section 12.7.

The congestion status of the signalling route set towards that destination may be decremented in accordance with the signalling-route-set-congestion-test procedure as specified in Section 12.9.

- (3) In national signalling networks using...(This section has been deleted as not applicable to U. S. Networks.) *

3.6.5 Procedures Used in Connection with Route Set Congestion Status Changes. In Section 3.6.5 the procedures relating to each signalling network management function, which in general are applied in connection with route set congestion status changes, are listed.

3.6.5.1 Signalling traffic management: the signalling traffic flow control procedure (see Section 10) is applied, it is used to regulate the input of signalling traffic from User parts to the concerned signalling route set.

3.6.5.2 Signalling route management: as a national option, the signalling-route-set-congestion-test procedure (see Section 12.9) is applied; it is used to update the congestion status of the concerned signalling route set until the congestion status is reduced to the zero value.

4. Signalling Traffic Management

4.1 General

4.1.1 The signalling traffic management function is used, as indicated in Section 3, to divert signalling traffic from signalling links or routes, or to temporarily reduce it in quantity in the case of congestion.

4.1.2 The diversion of traffic in the cases of unavailability, availability or restriction² of signalling links and routes is typically made by means of the following basic procedures included in the signalling traffic management function:

- (1) Signalling link unavailability (failure, deactivation, blocking or inhibiting): the changeover procedure (see Section 5) is used to divert signalling traffic to one or more alternative links (if any);

SIGNALLING NETWORK FUNCTIONS AND MESSAGES

- (2) Signalling link availability (restoration, activation, unblocking or uninhibiting): the changeback procedure (see Section 6) is used to divert signalling traffic to the link made available;
- (3) Signalling route unavailability: the forced rerouting procedure (see Section 7) is used to divert signalling traffic to an alternative route (if any);
- (4) Signalling route availability: the controlled rerouting procedure (see Section 8) is used to divert signalling traffic to the route made available.
- (5) Signalling route restricted²: the controlled rerouting procedure (see Section 8) is used to divert signalling traffic to an alternative route (if any).

Each procedure includes different elements of procedure, the application of one or more of which depends on the particular circumstances, as indicated in the relevant sections. Moreover, these procedures include a modification of the signalling routing, which is made in a systematic way, as described in Sections 4.2 to 4.7.

4.1.3 The signalling traffic flow control procedures are used in the case of congestion in order to limit signalling traffic at its source. The procedures are specified in Section 10.

4.2 Normal Routing Situation

4.2.1 Signalling traffic to be sent to a particular signalling point in the network, is normally routed to one or more link sets. A load sharing collection of one or more link sets is called a combined link set. Within a link set (combined link set), a further routing may be performed in order to load share the traffic over the available signalling links (see Section 2). *

To cater for the situations when signalling links or routes become unavailable, alternative routing data are defined.

For each destination which may be reached from a signalling point, one or more alternative link sets (combined link sets) are allocated. An alternative combined link set may consist of one or more (or all) of the remaining available link sets which may carry signalling traffic towards the concerned destination. The possible link sets (combined link sets) appear in a certain priority order. The link set (combined link set) having the highest priority is used whenever it is available. It is defined as the normal link set (combined link set) for traffic to the concerned destination. The link set (combined link set) which is in use at a given time is called the current link set (combined link set). The current link set (combined link set) consists either of the normal link set (combined link set) or an alternative link set (combined link set). In case of load sharing between link sets, a normal link set (combined link set) exists for each portion of the divided signalling traffic. *

For each signalling link, the remaining signalling links in the link set (combined link set) are alternative links. The signalling links of a link set (combined link set) are arranged in a certain priority order. Under normal conditions, the signalling link (or links) having the highest priority is used to carry the signalling traffic.

These signalling links are defined as normal signalling links, and each portion of load shared traffic has its own normal signalling link. Signalling links other than normal may be active signalling links (but not carrying any signalling traffic at the time) or inactive signalling links, see Section 11.

4.2.2 Message routing (normal as well as alternative) is, in principle, independently defined at each signalling point. Thus, signalling traffic between two signalling points may be routed over different signalling links or paths in the two directions.

4.3 Signalling Link Unavailability

4.3.1 When a signalling link becomes unavailable (see Section 3.2), signalling traffic carried by the link is transferred to one or more alternative links by means of a changeover procedure. The alternative link or links are determined in accordance with the following criteria.

SIGNALLING NETWORK FUNCTIONS AND MESSAGES

4.3.2 In the case when there is one or more alternative signalling links available in the link set (combined link set) to which the unavailable link belongs, the signalling traffic is transferred within the link set (combined link set) to:

- (1) An active and unblocked signalling link, currently not carrying any traffic. If no such signalling link exists, the signalling traffic is transferred to
- (2) One or possibly more than one signalling link currently carrying traffic. The transferred traffic should be distributed so that the signalling links are loaded as evenly as possible.

4.3.3 In the case when there is no alternative signalling link within the link set (combined link set) to which the unavailable signalling link belongs, the signalling traffic is transferred to one or more alternative link sets (combined link sets) in accordance with the alternative routing defined for each destination. For a particular destination, the alternative link set (combined link set) is the link set (combined link set) in service having the highest priority.

Within a new link set, signalling traffic is distributed over the signalling links in accordance with the routing currently applicable for that link set; i.e., the transferred traffic is routed in the same way as the traffic already using the link set.

4.4 Signalling Link Availability

4.4.1 When a previously unavailable signalling link becomes available again (see Section 3.2), signalling traffic may be transferred to the available signalling link by means of the changeback procedure. The traffic to be transferred is determined in accordance with the following criteria.

4.4.2 In the case when the link set to which the available signalling link belongs already carries signalling traffic on other signalling links in the link set, the traffic to be transferred is the traffic for which the available signalling link is the normal one.

The traffic is transferred from one or more signalling links, depending on the criteria applied when the signalling link became unavailable (see Section 4.3.2).

4.4.3 In the case when the link set (combined link set) to which the available signalling links belongs does not carry any signalling traffic (i.e., a link set [combined link set] has become available), the traffic to be transferred is the traffic for which the available link set (combined link set) has higher priority than the link set (combined link set) currently used.

The traffic is transferred from one or more links sets (combined link set) and from one or more signalling links within each link set.

4.5 Signalling Route Unavailability.

When a signalling route becomes unavailable (see Section 3.4) signalling traffic carried by the unavailable route is transferred to an alternative route by means of forced rerouting procedure. The alternative route (i.e., the alternative link set or link sets) is determined in accordance with the alternative routing defined for the concerned destination (see Section 4.3.3).

4.6 Signalling Route Availability.

When a previously unavailable signalling route becomes available again (see Section 3.4) signalling traffic may be transferred to the available route by means of a controlled rerouting procedure. This is applicable in the case when the available route (link set) has higher priority than the route (link set) currently used for traffic to the concerned destination (see Section 4.4.3).

The transferred traffic is distributed over the links of the new link set in accordance with the routing currently applicable for that link set.

SIGNALLING NETWORK FUNCTIONS AND MESSAGES

4.7 Signalling Route Restriction².

When a signalling route becomes restricted (see Section 3.4), signalling traffic carried by the restricted route is, if possible, transferred to an alternative route by means of the controlled rerouting procedure, if an equal priority alternative is available and not restricted. The alternative route is determined in accordance with the alternate routing defined for the concerned destination (see Section 4.3.3).

5. Changeover

5.1 General

5.1.1 The objective of the changeover procedure is to ensure that signalling traffic carried by the unavailable signalling link is diverted to the alternative signalling link(s) as quickly as possible while avoiding message loss, duplication or mis-sequencing. For this purpose, in the normal case the changeover procedure includes buffer updating and retrieval, which are performed before reopening the alternative signalling link(s) to the diverted traffic. Buffer updating consists of identifying all those messages in the retransmission buffer of the unavailable signalling link which have not been received by the far end. This is done by means of a hand-shake procedure, based on changeover messages, performed between the two ends of the unavailable signalling link. Retrieval consists of transferring the concerned messages to the transmission buffer(s) of the alternative link(s).

5.1.2 Changeover includes the procedures to be used in the case of unavailability (due to failure, blocking or inhibiting) of a signalling link, in order to divert the traffic pertaining to that signalling link to one or more alternative signalling links.

These signalling links can be carrying their own signalling traffic, and this is not interrupted by the changeover procedure.

The different network configurations to which the changeover procedure may be applied are described in Section 5.2.

The criteria for initiation of changeover, as well as the basic actions to be performed, are described in Section 5.3.

Procedures necessary to cater for equipment failure or other abnormal conditions are also provided.

5.2 Network Configurations for Changeover

5.2.1 Signalling traffic diverted from an unavailable signalling link is routed by the concerned signalling point according to the rules specified in Section 4. In summary, two alternative situations may arise (either for the whole diverted traffic or for traffic relating to each particular destination):

- (1) Traffic is diverted to one or more signalling links of the same link set, or
- (2) Traffic is diverted to one or more different link sets.

5.2.2 As a result of these arrangements, and of the message routing function described in Section 2, three different relationships between the new signalling link and the unavailable one can be identified, for each particular traffic flow. These three basic cases may be summarized as follows:

- (1) The new signalling link is parallel to the unavailable one (see Figure 9/Q.704);
- (2) The new signalling link belongs to a signalling route other than that to which the unavailable signalling link belongs, but this signalling route still passes through the signalling point at the far end of the unavailable signalling link (see Figure 10/Q.704);
- (3) The new signalling link belongs to a signalling route other than that to which the unavailable signalling link belongs, and this signalling route does not pass through the signalling point

SIGNALLING NETWORK FUNCTIONS AND MESSAGES

acting as signalling transfer point, at the far end of the unavailable signalling link (see Figure 11/Q.704).

Only in the case of (3) does a possibility of message mis-sequencing exist; therefore, its use should take into account the overall service dependability requirements described in Q.706.

5.3 Changeover Initiation and Actions

5.3.1 Changeover is initiated at a signalling point when a signalling link is recognized as unavailable according to the criteria listed in Sections 3.2.2 and 3.2.6.

The following actions are then performed:

- (1) Transmission and acceptance of message signal units on the concerned signalling link is terminated;
- (2) Transmission of link status signal units or fill-in signal units, as described in Q.703, Sections 7 and 8 takes place;
- (3) The alternative signalling link(s) are determined according to the rules specified in Section 4;
- (4) A procedure to update the content of the retransmission buffer of the unavailable signalling link is performed as specified in Section 5.4 below;
- (5) Signalling traffic is diverted to the alternative signalling link(s) as specified in Section 5.5 below.

In addition, if traffic toward a given destination is diverted to an alternative signalling link terminating in a signalling transfer point not currently used to carry traffic toward that destination, a transfer-prohibited procedure is performed as specified in Section 12.2.

5.3.2 In the case when there is no traffic to transfer from the unavailable signalling link action, only item (2) of Section 5.3.1 is required.

5.3.3 If no alternative signalling link exists for signalling traffic towards one or more destinations, the concerned destination(s) are declared inaccessible, and the following actions apply:

- (1) The routing of the concerned signalling traffic is blocked and the concerned messages already stored in the transmission and retransmission buffers of the unavailable signalling link, as well as those received subsequently, are discarded¹⁰;
- (2) A command is sent to the user(s) (if any) in order to stop generating the concerned signalling traffic;
- (3) The transfer-prohibited procedure is performed as specified in Section 12.2;
- (4) The appropriate signalling link management procedures are performed as specified in Section 11.

5.3.4 In some cases of failures or in some network configurations, the normal buffer updating and retrieval procedures described in Sections 5.4 and 5.5 cannot be accomplished. In such cases, the emergency changeover procedures described in Section 5.6 apply.

Other procedures to cover possible abnormal cases appear in Section 5.7.

5.4 Buffer Updating Procedure

¹⁰ The adequacy of this procedure to meet the acceptable dependability objective in terms of loss of messages requires further study.

SIGNALLING NETWORK FUNCTIONS AND MESSAGES

5.4.1 When a decision to changeover is made, a changeover order is sent to the remote signalling point. In the case that the changeover was initiated by the reception of a changeover order (see Section 3.2.2), a changeover acknowledgement is sent instead.

A changeover order is always acknowledged by a changeover acknowledgement, even when changeover has already been initiated in accordance with another criterion.

No priority is given to the changeover order or changeover acknowledgement in relation to the normal traffic of the signalling link on which the message is sent.

5.4.2 The changeover order and changeover acknowledgement are signalling network management messages and contain the following information:

- (1) The label, indicating the destination and originating signalling points; *
- (2) The SLC, indicating the identity of the unavailable signalling link; *
- (3) The changeover-order (or changeover-acknowledgement) signal, and
- (4) The forward sequence number of the last message signal unit accepted from the unavailable signalling link.

Formats and codes of the changeover order and the changeover acknowledgement appear in Section 14.

5.4.3 Upon reception of a changeover order or changeover acknowledgement, the retransmission buffer of the unavailable signalling link is updated (except as noted in Section 5.6), according to the information contained in the message. The message signal units successive to that indicated by the message are those which have to be retransmitted on the alternative signalling link(s), according to the retrieval and diversion procedure.

5.5 Retrieval and Diversion of Traffic

When the procedure to update the retransmission buffer content is completed, the following actions are performed:

- (1) The routing of the signalling traffic to be diverted is changed;
- (2) The signal traffic already stored in the transmission buffers and retransmission buffer of the unavailable signalling link is sent directly towards the new signalling link(s), according to the modified routing.

The diverted signalling traffic will be sent towards the new signalling link(s) in such a way that the correct message sequences is maintained. The diverted traffic has no priority in relation to normal traffic already conveyed on the signalling link(s).

5.6 Emergency Changeover Procedures

5.6.1 Due to the failure in a signalling terminal, it may be impossible for the corresponding end of the faulty signalling link to determine the forward sequence number of the last message signal unit accepted over the unavailable link. In this case, the concerned end accomplishes, if possible, the buffer updating procedures described in Section 5.4, but it makes use of an emergency changeover order or an emergency changeover acknowledgement instead of the corresponding normal message; these emergency messages, the format of which appears in Section 14, do not contain the forward sequence number of the last accepted message signal unit. Furthermore, the signalling link is taken out of service, i.e., the concerned end initiates, if possible, the sending of *out-of-service* link status signal units on the unavailable link (see Q.703, Section 11).

When the other end of the unavailable signalling link receives the emergency changeover order or acknowledgement it accomplishes the changeover procedures described in Sections 5.4 and 5.5; the only difference being that it does not perform either buffer updating or retrieval. Instead, it directly starts sending the signalling traffic not yet transmitted on the unavailable link on the

SIGNALLING NETWORK FUNCTIONS AND MESSAGES

alternative signalling link(s).

The use of normal or emergency changeover messages depends on the local conditions of the sending signalling point only, in particular:

- (1) An emergency changeover order is acknowledged by a changeover acknowledgement if the local conditions are normal, and
- (2) A changeover order is acknowledged by an emergency changeover acknowledgement if there are local fault conditions.

5.6.2 It may happen that no signalling path exists between the two ends of the unavailable link, so that the exchange of changeover messages is impossible.

When the concerned signalling point decides to initiate changeover in such circumstances, after the expiry of a time $T1^{11}$, it starts signalling traffic not yet transmitted on the unavailable signalling link on the alternative link(s); the purpose of withholding traffic for the time $T1$ is to reduce the probability of message mis-sequencing.

An example of such a case appears in Q.705. *

In the abnormal case, when the concerned signalling point is not aware of the situation, it will start the normal changeover procedure and send a changeover order; in this case, it will receive no changeover message in response and the procedure will be completed as indicated in Section 5.7.2. Possible reception of a transfer-prohibited message (sent by an involved signalling transfer point on reception of the changeover order, see Section 12.2) will not affect changeover procedures.

5.6.3 Due to failures, it may be impossible for a signalling point to perform retrieval, even if it has received the retrieval information from the far end of the unavailable signalling link. In this case, it starts sending new traffic on reception of the changeover message (or on time-out expiry, see Sections 5.6.2 and 5.7.2); no further actions in addition to the other normal changeover procedures are performed.

5.7 Procedures in Abnormal Conditions

5.7.1 The procedures described in this section allow the completion of the changeover procedures in abnormal cases other than those described in Section 5.6.

5.7.2 If no changeover message in response to a changeover order is received within a time-out $T2^{10}$, new traffic is started on the alternative signalling link(s).

5.7.3 If a changeover order or acknowledgement containing an unreasonable value of the forward sequence number is received, no buffer updating or retrieval is performed, and new traffic is started on the alternative signalling link(s).

5.7.4 If a changeover acknowledgement is received without having previously sent a changeover order, no action is taken.

5.7.5 If a changeover order is received relating to a particular signalling link after the completion of changeover from that signalling link, an emergency changeover acknowledgment is sent in response, without any further action.

11. Recommended ranges for all timers are listed in 15.7

SIGNALLING NETWORK FUNCTIONS AND MESSAGES

6. Changeback

6.1 General

6.1.1 The objective of the changeback procedure is to ensure that signalling is diverted from the alternative signalling link(s) to the signalling link made available as quickly as possible, while avoiding message loss, duplication or mis-sequencing. For this purpose (in the normal case), changeback includes a procedure to control the message sequence.

6.1.2 Changeback includes the basic procedures to be used to perform the opposite action to changeover, i.e., to divert traffic from the alternative signalling link(s) to a signalling link which has become available (i.e., it was uninhibited, restored or unblocked). The characteristics of the alternative signalling link(s) from which changeback can be made are described in Section 5.2. In all the cases mentioned in Section 5.2, the alternative signalling links can be carrying their own signalling traffic, and this is not interrupted by the changeback procedures.

Procedures necessary to cater for particular network configuration or other abnormal conditions are also provided.

Note: The term "alternative signalling link(s)" refers to signalling link(s) terminating in the signalling point at which a changeback is initiated (see Section 4).

6.2 Changeback Initiation and Actions

6.2.1 Changeback is initiated at a signalling point when a signalling link is restored, or unblocked or uninhibited, and therefore it becomes once again available, according to the criteria listed in Sections 3.2.3, and 3.2.7, and 3.2.9. The following actions are then performed:

- (1) The alternative signalling link(s) are determined, to which traffic normally carried by the signalling link made available was previously diverted (e.g., on occurrence of a changeover);
- (2) Signalling traffic is diverted (if appropriate, according to the criteria specified in Section 4) to the concerned signalling link by means of the sequence control procedure specified in Section 6.3; traffic diversion can be performed at the discretion of the signalling point initiating changeback, as follows:

- (1) Individually for each traffic flow (i.e., on destination basis);
- (2) Individually for each alternative signalling link (i.e., for all the destinations previously diverted on that alternative signalling link);
- (3) At the same time for a number of, or for all, the alternative signalling links.

On occurrence of changeback, it may happen that traffic towards a given destination is no longer routed via a given adjacent signalling transfer point, towards which a transfer-prohibited procedure was previously performed on occurrence of changeover (see Section 5.3.1); in this case, a transfer-allowed procedure is performed, as specified in Section 12.3.

In addition, if traffic towards a given destination is diverted to an alternative signalling link terminating in a signalling transfer point not currently used to carry traffic toward that destination, a transfer-prohibited procedure is performed as specified in Section 12.2.

6.2.2 In the case when there is no traffic to transfer to the signalling link made available, none of the previous actions are performed.

6.2.3 In the case that the signalling link made available can be used to carry signalling traffic toward a destination which was previously declared inaccessible, the following actions apply:

- (1) The routing of the concerned signalling traffic is unblocked, and transmission of the concerned messages (if any) is immediately started on the link made available;

SIGNALLING NETWORK FUNCTIONS AND MESSAGES

- (2) A command is sent to the User Part(s) (if any) in order to restart generating the concerned signalling traffic;
- (3) The transfer-allowed procedure is performed, as specified in Section 12.3. However, in national networks when the recovered link is not on the normal route for this destination, the transfer-restricted procedure may be performed as specified in Section 12.5.

6.2.4 ¹²In the case that the signalling link made available is on the normal route for a destination which was previously declared restricted, the status of the destination is changed to accessible unless a transfer-prohibited or transfer-restricted message relating to the concerned destination has been received from the signalling point at the far end of the newly available link. *

6.2.5 If the signalling point at the far end of the link made available is currently inaccessible from the signalling point initiating changeback, the sequence control procedure specified in Section 6.3 (which requires communication between the two concerned signalling points) does not apply; instead, the time-controlled diversion specified in Section 6.4 is performed. This is performed also when the concerned signalling point is accessible, but there is no signalling route to it using the same outgoing signalling link(s) (or one of the same signalling links) from which traffic will be diverted. *

6.3 Sequence Control Procedure

6.3.1 When a decision is made at a given signalling point to divert a given traffic flow (towards one or more destinations) from an alternative signalling link to the signalling link made available, the following actions are performed, if possible (see Section 6.4). *

- (1) Transmission of the concerned traffic on the alternative signalling link is stopped; such traffic is stored in a *changeback buffer*;
- (2) A changeback declaration is sent to the remote signalling point of the signalling link made available via the concerned alternative signalling link; this message indicates that no more message signal units relating to the traffic being diverted to the link made available will be sent on the alternative signalling link.

6.3.2 The concerned signalling point will restart diverted traffic over the signalling link made available when it receives a changeback acknowledgement from the far signalling point of the link made available; this message indicates that all signal messages relating to the concerned traffic flow and routed to the remote signalling point via the alternative signalling link have been received. The remote signalling point will send the changeback acknowledgement to the signalling point initiating changeback in response to the changeback declaration; any available signalling route between the two signalling points can be used to carry the changeback acknowledgement.

6.3.3 The changeback declaration and changeback acknowledgement are signalling network management messages and contain:

- (1) The label, indicating the destination and originating signalling points; *
- (2) The SLC, indicating the identity of the signalling link to which traffic will be diverted; *
- (3) The changeback-declaration (or changeback-acknowledgement) signal; and
- (4) The changeback code.

Formats and codes of the changeback declaration and changeback acknowledgement appear in Section 14.

12. CCITT Red Book text specifying an immediate restart of traffic on the available link has been deleted from this Section.

SIGNALLING NETWORK FUNCTIONS AND MESSAGES

6.3.4 A particular configuration of the changeback code is autonomously assigned to the changeback declaration by the signalling point initiating changeback; the same configuration is included in the changeback acknowledgement by the acknowledging signalling point. This allows discrimination between different changeback declarations and acknowledgements when more than one sequence control procedures are initiated in parallel, as follows.

6.3.5 In the case that a signalling point intends to initiate changeback in parallel from more than one alternative signalling link, a sequence control procedure is accomplished for each involved signalling link, and a changeback declaration is sent on each of them; each changeback declaration is assigned a different configuration of the changeback code. Stopped traffic is stored in one or more changeback buffers (in the latter case, a changeback buffer is provided for each alternative signalling link). When the changeback acknowledgement relating to that alternative signalling link is received, traffic being diverted from a given alternative signalling link can be restarted on the signalling link made available, starting with the content of the changeback buffer; discrimination between the different changeback acknowledgements is made by the changeback code configuration, which is the same as that sent in the changeback declaration.

This procedure allows either reopening the recovered signalling link to traffic in a selective manner (provided that different changeback buffers are used) as soon as each changeback acknowledgement is received, or only when all the changeback acknowledgements have been received.

6.4 Time-Controlled Diversion Procedure

6.4.1 The time-controlled diversion procedure is used in the case when the remote signalling point is inaccessible at the signalling point initiating changeback, i.e., communication between the two ends of the signalling link made available is not possible via a signalling route other than that signalling link; the sending of changeback declaration is therefore impossible. An example of such a case appears in Figure 12/Q.704.

In this example, on failure of signalling link AB, traffic towards the destination was diverted to signalling link AC. When signalling link AB is made available, sending of changeback declaration from A to B is impossible, since no signalling link exists between C and B.

6.4.2 When changeback is initiated, a signalling point unable to send a changeback declaration stops traffic to be diverted from the alternative signalling link and stores it in a changeback buffer for a time T_3^{10} , after which it reopens traffic on the signalling link made available. The time delay minimizes the probability of out-of-sequence delivery to the destination point(s).

6.4.3 In the abnormal case, when the concerned signalling point is not aware of the situation, it will start a normal changeback procedure and send a changeback declaration; in this case, it will receive no changeback acknowledgement in response, and the procedure will be completed as indicated in Section 6.5.3. Reception of a transfer-prohibited message (sent by C, in the figure, on reception of the changeback declaration from A, see Section 12.2) will not affect the above procedures.

6.5 Procedures in Abnormal Conditions

6.5.1 If a changeback acknowledgement is received by a signalling point which has not previously sent a changeback declaration, no action is taken.

6.5.2 If a changeback declaration is received after the completion of the changeback procedure, a changeback acknowledgement is sent in response, without taking any further action. This corresponds to the normal action described in Section 6.3.2 above.

6.5.3 If no changeback acknowledgement is received in response to a changeback declaration within a time T_4^{10} , the changeback declaration is repeated and a new time-out, T_5^{10} , is started. If no changeback acknowledgement is received before the expiry of T_5 , the maintenance functions are alerted, and traffic on the link made available is started. The changeback code contained in the

SIGNALLING NETWORK FUNCTIONS AND MESSAGES

changeback acknowledgement message makes it possible to determine, in the case of parallel changebacks from more than one reserve path, which changeback declaration is unacknowledged and has therefore to be repeated.

7. Forced Rerouting

7.1 General

7.1.1 The objective of the forced rerouting procedure is to restore, as quickly as possible, the signalling capability between two signalling points towards a particular destination, in such a way as to minimize the consequences of a failure. However, since the unavailability of a signalling route is, in general, caused by the fact that the concerned destination has become inaccessible to a signalling transfer point, a probability of message loss exists (see Section 5.3.3). Therefore, the structure of the signalling network should be such as to reduce the probability of signalling route unavailability to limits compatible with the overall dependability requirements (see Q.706).

7.1.2 Forced rerouting is the basic procedure to be used in the case where a signalling route towards a given destination becomes unavailable (due to, for example, remote failures in the signalling network) to divert signalling traffic towards that destination to an alternative signalling route outgoing from the concerned signalling point. Signalling links pertaining to the alternative signalling route can be carrying their own signalling traffic (relating to different signalling routes), and this is not interrupted by the forced rerouting procedure.

7.2 Forced Rerouting Initiation and Actions

7.2.1 Forced rerouting is initiated at a signalling point when a transfer-prohibited message, indicating a signalling route unavailability is received.

The following actions are then performed:

- (1) Transmission of signalling traffic towards the concerned destination on the link set(s) pertaining to the unavailable route is immediately stopped; such traffic is stored in a *forced rerouting buffer*;
- (2) The alternative route is determined according to the rules specified in Section 4;
- (3) As soon as action (2) is completed, the concerned signalling traffic is restarted on a link set pertaining to the alternative route, starting with the content of the forced rerouting buffer;
- (4) If appropriate, a transfer-prohibited procedure is performed (see Section 12.2.2).

7.2.2 In the case when there is no signalling traffic to be diverted from the unavailable route, actions (2) and (4) only apply.

7.2.3 If no alternative route exists for signalling traffic towards the concerned destination, that destination is declared inaccessible, and the actions specified in Section 5.3.3 apply.

8. Controlled Rerouting

8.1 General

8.1.1 The objective of the controlled rerouting procedure is to restore the optimal signalling routing and to minimize mis-sequencing of messages. Therefore, controlled rerouting includes a time-controlled traffic diversion procedure, which is the same as that used in some cases of changeback (see Section 6.4).

8.1.2 Controlled rerouting is the basic procedure to be used in the following two cases:

SIGNALLING NETWORK FUNCTIONS AND MESSAGES

- (1) When a signalling route towards a given destination becomes available (due to, for example, recovery of previous remote failures in the signalling network), to divert back signalling traffic towards that destination from the alternative to the normal signalling route outgoing from the concerned signalling point.
- (2) When a transfer-restricted² message is received, after signalling traffic management has decided that alternative routing is appropriate (e.g., because it would be more efficient than routing via the link set over which the transfer-restricted message was received).

Signalling links pertaining to the alternative signalling route can be carrying their own signalling traffic (relating to different routes), and this is not interrupted by the controlled rerouting procedure.

8.2 Controlled Rerouting Initiation and Actions

8.2.1 Controlled rerouting is initiated at a signalling point when a transfer-allowed message, indicating that the signalling route has become available, is received; also when a transfer-restricted² message is received. The following actions are then performed:

- (1) Transmission of signalling traffic towards the concerned destination on the link set belonging to the alternative route or the route over which the transfer-restricted² message was received is stopped; such traffic is stored in a *controlled rerouting buffer*; a time-out, $T6^{10}$, is started;
- (2) A transfer-prohibited message is sent on the route made available (or the alternative route in the case of reception of a transfer-restricted² message, if the alternative route was not previously used), and a transfer-allowed message on the alternative one (or the restricted route in the case of the reception of transfer-restricted² message) (see Sections 12.2.2 and 12.3.2, respectively);
- (3) At the expiry of $T6$, the concerned signalling traffic is restarted on an outgoing link set pertaining to the signalling route made available, or the alternative route in the case of reception of the transfer-restricted² message, starting with the content of the controlled rerouting buffer; the aim of the time delay is to minimize the probability of out-of-sequence delivery to the destination point(s).

8.2.2 When there is no signalling traffic to be diverted to the route made available, the above actions are not performed, and the signalling point notes the availability of the route, which therefore may be used if necessary.

8.2.3 If the destination was inaccessible or restricted,² when the route is made available, then the destination is declared accessible and actions specified in Sections 6.2.3 and 6.2.4 apply (if appropriate).

9. Management Inhibiting

9.1 General.

Signalling link management inhibiting is requested by management when it becomes necessary, e.g., for maintenance or testing purposes, to make or keep a signalling link unavailable to user-generated signalling traffic. Management inhibiting is a signalling traffic management action, and does not cause any link status changes at Level 2. A signalling link is marked "inhibited" under the management inhibiting procedure. In particular, a signalling link that was active and in service prior to being inhibited will remain so, and will thus be able to transmit and receive maintenance and test messages.

Inhibiting of a signalling link may be requested by management functions at either end of the link. The request is granted, provided that the inhibiting action does not cause any previously accessible destinations to become inaccessible at either end of the signalling link. The request may also be refused under certain circumstances such as congestion.

SIGNALLING NETWORK FUNCTIONS AND MESSAGES

A signalling link normally remains inhibited until uninhibiting is invoked in the signalling point at which inhibiting was initiated. Uninhibiting is initiated either at the request of a management function or by routing functions at either end of the signalling link when it is found that a destination has become inaccessible for signalling traffic and the link sets associated with routes to that destination contain inhibited links. Unless unavailable for other reasons, uninhibiting causes the signalling link to enter the available state and changeback to be initiated.

Throughout the time that a signalling point has marked a signalling link locally inhibited it periodically transmits a local inhibit test message to the signalling point at the far end of the link marked inhibited. If the signalling point that receives a local inhibit test message considers the link referred to in the message to be remotely inhibited, it takes no further action. If it does not consider the link remotely inhibited, it requires forced uninhibiting of the link in order to align the inhibiting status at the two ends of the link. *

Throughout the time that a signalling point has marked a signalling link remotely inhibited, it periodically transmits a remote inhibit test message to the signalling point at the far end of the link marked inhibited. When a signalling point receives a remote inhibit test message, it checks if the concerned signalling link is marked locally inhibited. If the signalling link is marked locally inhibited, the receiving signalling point takes no further action. If the signalling link is not marked locally inhibited, the receiving signalling point initiates the uninhibiting procedure in order to align the inhibiting status at the two ends of the link. *

9.2 Inhibiting Initiation and Actions.

When at signalling point *X* a request is received from a management function to inhibit a signalling link to signalling point *Y*, the following actions take place:

- (1) A check is performed at signalling point *X* to determine whether, in the case of an available link, inhibiting will result in a destination becoming inaccessible, or in the case of an unavailable link, signalling point *Y* is inaccessible. If either is the case, management is informed that the inhibiting request is denied.
- (2) If inhibiting is permitted, signalling point *X* sends an inhibit message to signalling point *Y* indicating that it wishes to inhibit the signalling link identified in the message.
- (3) Signalling point *Y*, on receiving the inhibit message from *X*, checks whether, in the case of an available link, inhibiting will result in a destination becoming inaccessible; and, if so, an inhibit denied message is returned to signalling point *X*. The latter then informs the management function which requested inhibiting that the request cannot be granted.
- (4) If signalling point *Y* finds that inhibiting of the concerned link is permissible, it sends an inhibit acknowledgement to signalling point *X*, marks the link remotely inhibited, and starts inhibit test procedure timer T_{21}^{10} . *
- (5) On receiving an inhibit acknowledgement message, signalling point *X* marks the link locally inhibited, informs management that the link is inhibited, and starts inhibit test procedure timer T_{20}^{10} . *
- (6) For a currently available link, a transition to the processor outage state may be initiated at either end, changeover is invoked, and the link becomes unavailable. When changeover has been completed, the link is caused to return to the in-service state, so that, while inhibited, the link is unavailable for the transfer of user-generated traffic but still permits the exchange of test messages.
- (7) If, for any reason, the inhibit acknowledgement message is not received, a timer T_{14}^{10} expires and the procedure is restarted including inspection of the status of the destination of the inhibit message. If the destination is not available, management is informed.

9.3 Uninhibiting Initiation and Actions.

Signalling link uninhibiting is initiated at the signalling point which originally caused the link to be inhibited, upon receipt of an uninhibit or forced uninhibit request.

SIGNALLING NETWORK FUNCTIONS AND MESSAGES

In a given signalling point, an uninhibit request may be initiated for a locally inhibited link by the management or signalling routing control function, while a forced uninhibiting request may be initiated for a remotely inhibited link by the signalling routing control function only.

Signalling routing control will initiate signalling link uninhibiting if an inhibited link is found to be a member of a link set in a route to a destination which has become inaccessible.

9.3.1 Management Initiated Uninhibiting. Upon receipt of an uninhibiting request from the management function of signalling point *X* regarding an inhibited link to signalling point *Y*, the following actions take place:

- (1) A check is performed at signalling point *X* to determine whether an uninhibit message can be sent to signalling point *Y*, either over an available route, or, if all routes to signalling point *Y* are unavailable, over the concerned inhibited link. If all routes to signalling point *Y* are unavailable and the concerned inhibited link is marked failed or processor outage, management is informed that uninhibiting is not possible.
- (2) If uninhibiting is possible, signalling point *X* sends an uninhibit signalling link message to signalling point *Y* indicating that the link identified in the message should be uninhibited.
- (3) Upon receipt of the uninhibit signalling link message, signalling point *Y* returns an uninhibit acknowledgement message to signalling point *X* and cancels the remote inhibit indication. If no locally inhibited, failed or blocked condition exists on the link, it is put in the available state and changeback is initiated.
- (4) On receipt of the uninhibit acknowledgement message, signalling point *X* cancels the local inhibit indication, and informs management that the link has been uninhibited. If no remotely inhibited, failed or blocked condition exists on the link, it is put in the available state and changeback is initiated.
- (5) If, for any reason, the uninhibit acknowledgement message is not received, a timer $T12^{10}$ expires and the procedure is restarted including inspection of the status of the destination of the inhibit message. If the destination is not available, management is informed.

9.3.2 Signalling Routing Control Initiated Uninhibiting. Upon receipt of an uninhibit request from signalling routing control at signalling point *X* regarding an inhibited link to signalling point *Y*, the following actions take place:

- (1) A check is performed at signalling point *X* to determine whether an uninhibit message can be sent to signalling point *Y*, either over an available route, or, if all routes to signalling point *Y* are unavailable, over the concerned inhibited link. If all routes to signalling point *Y* are unavailable and the concerned inhibited link is marked failed or processor outage, signalling routing control is informed that uninhibiting is not possible. *
- (2) If uninhibiting is possible, a further check is performed by signalling point *X* to determine whether inhibiting initiated by *X* (local inhibiting) or inhibiting initiated by *Y* (remote inhibiting) is in effect. *
- (3) If local inhibiting is in effect, then the actions described in Section 9.3.1 (2), (3), (4) and (5) take place. *
- (4) If remote inhibiting is in effect, then the signalling point *X* requests forced uninhibiting of the signalling link by sending a forced uninhibit signalling link message to signalling point *Y*, which will then initiate uninhibiting in accordance with the description given in Section 9.3.1 (2), (3), (4) and (5). Also the forced uninhibit timer $T13^{10}$ is started. It is stopped when the uninhibit signalling link message is received. If the forced uninhibit timer expires before reception of the uninhibit signaling link message the forced uninhibiting procedure will be attempted again. *

SIGNALLING NETWORK FUNCTIONS AND MESSAGES

9.3A Inhibit Test Procedure Actions. *

When a signalling link becomes inhibited, either locally or remotely or both, the following test procedure actions take place, as appropriate: *

- (1) If timer T20 expires at signalling point *X* and the signalling link is locally inhibited at signalling point *X*, signalling point *X* transmits a local inhibit test message to the signalling point at the other end of the locally inhibited link and restarts timer T20. *
- (2) If timer T20 expires at signalling point *X* and the signalling link is no longer locally inhibited, no action is taken. *
- (3) If timer T21 expires at signalling point *X* and the signalling link is remotely inhibited at signalling point *X*, signalling point *X* transmits a remote inhibit test message to the signaling point at the other end of the remotely inhibited link and restarts timer T21. *
- (4) If timer T21 expires at signalling point *X* and the signalling link is no longer remotely inhibited, no action is taken. *
- (5) If signalling point *Y* receives a local inhibit test message from signalling point *X* and the concerned link is marked remotely inhibited, no action is taken. *
- (6) If signalling point *Y* receives a local inhibit test message from signalling point *X* and the concerned signalling link is not marked remotely inhibited, the forced uninhibiting procedure is invoked at signalling point *Y*, beginning with the transmission of a force uninhibit signalling link message to signalling point *X*. As a result of this procedure, the local inhibit indicator is cancelled at signalling point *X*. *
- (7) If signalling point *Y* receives a remote inhibit test message from signalling point *X* and the concerned link is marked locally inhibited, no action is taken. *
- (8) If signalling point *Y* receives a remote inhibit test message from signalling point *X* and the concerned signalling link is not marked locally inhibited, the uninhibiting procedure is invoked at signalling point *Y*, beginning with the transmission of a uninhibit signalling link message to signalling point *X*. As a result of this procedure, the remote inhibit indicator is cancelled at signalling point *X*. *

9.3B Procedures for Abnormal Conditions *

9.3B.1 An inhibit signalling link message concerning an inhibited signalling link is answered with an inhibit acknowledgement message without taking any further action. *

9.3B.2 An uninhibit signalling link message concerning an uninhibited link is answered with an uninhibit acknowledgement message without taking any further action. *

9.3B.3 A force uninhibit signalling link message concerning an uninhibited link is answered with an uninhibit signalling link message without taking any further action. *

9.3B.4 If an inhibit acknowledgement message is received and no inhibit signalling link message is outstanding for the concerned link, no action is taken. *

9.3B.5 If an uninhibit acknowledgement message is received and no uninhibit signalling link message is outstanding for the concerned link, no action is taken. *

9.3B.6 After a local processor recovery that involves loss of inhibit status information, the signalling point will mark all the links as uninhibited, and the traffic will be restarted. *

9.3B.7 The following rules apply when management or routing control requests uninhibiting of a signalling link for which an unacknowledged inhibit message is outstanding or when management requests the inhibiting of a signalling link for which an unacknowledged uninhibit message is outstanding. *

- (1) If a signalling point transmits an inhibit signalling link message concerning a particular signalling link, it will not transmit an uninhibit signalling link message concerning the same *

SIGNALLING NETWORK FUNCTIONS AND MESSAGES

signalling link until the inhibit signalling link message is acknowledged or the inhibit procedure is timed out. *

- (2) If a signalling point transmits an uninhibit signalling link message concerning a particular signalling link, it will not transmit an inhibit signalling link message concerning the same signalling link until the uninhibit signalling link message is acknowledged or the uninhibit procedure is timed out. *

9.3B.8 If traffic for Level 4 is received on an inhibited signalling link, the traffic will be discriminated and distributed. Reception of traffic on an inhibited signalling link is, however, considered an abnormal situation which occurs upon processor recovery. *

10. Signalling Traffic Flow Control

10.1 General.

The purpose of the signalling traffic flow control functions is to limit signalling traffic at its source in the case when the signalling network is not capable of transferring all signalling traffic offered by the User Parts because of network failures or overload situations.

Flow control actions may be taken as a consequence of a number of events; the following cases have been identified:

- (1) Failures in the signalling network (signalling links or signalling points) have resulted in route set unavailability. In this situation, flow control may provide a short term remedy until more appropriate actions can be taken;
- (2) Congestion of a signalling link or signalling point has resulted in a situation where reconfiguration is not appropriate;
- (3) Failure of a User Part has made it impossible for the User Part to handle all messages delivered by the Message Transfer Part.

When the normal transfer capability is restored, the flow control functions initiate resumption of the normal traffic flow.

10.2 Flow Control Indications.

The need for the following indications has been identified.

10.2.1 Signalling Route Set Unavailability. In the case when no signalling route is available for traffic towards a particular destination (see Sections 5.3.3 and 7.2.3), an indication is given from the Message Transfer Part to all User Parts, informing them that signalling messages destined to the particular signalling point cannot be transferred via the signalling network. Each User Part then takes appropriate actions in order to stop generation of signalling information destined for the inaccessible signalling point.

10.2.2 Signalling Route Set Availability. In the case when a signalling route becomes available for traffic to a previously inaccessible destination (see Sections 6.2.3 and 8.2.3), an indication is given from the Message Transfer Part to the User Parts, informing them that signalling messages destined to the particular Signalling Points can be transferred via the signalling network. Each User Part then takes appropriate actions in order to start generation of signalling information destined for the now accessible signalling point.

10.2.3 Signalling Route Set Congestion (International Signalling Network)

10.2.3.1 When the congestion status of a signalling route set changes to congested, the following actions will be taken:

- (1) When a message signal unit from a local User Part is received for a congested route set the following actions are performed:

SIGNALLING NETWORK FUNCTIONS AND MESSAGES

- (1) The MSU is passed to level 2 for transmission;
 - (2) A congestion indication primitive will be returned to each level 4 User Part, for the initial message and for every n messages ($n = 8$ provisional value) received for the congested destination. The congestion indication primitive contains as a parameter the DPC of the affected destination.
- (2) When a message signal unit is received at an STP for a congested route set, the following actions take place:
- (1) The MSU is passed to level 2 for transmission.
 - (2) A transfer-controlled message is sent to the originating point for the initial message for every n messages ($n = 8$ provisional value) received for the congested route set.

10.2.3.2 At the reception of a transfer controlled message the receiving signalling point informs each level 4 User Part of the affected destination by means of a congestion indication primitive specified in 10.2.3.1,(1).

10.2.3.3 When the status of a signalling route set changes to uncongested normal operation is resumed. Resumption of message transmission towards the concerned destination is the responsibility of the level 4 User Parts.

10.2.4 Signalling Route Set Congestion (National Option with Congestion Priorities).
In the case when the congestion status of a signalling route set changes as a result of either the receipt of a transfer-controlled message relating to a particular destination (see Section 12.7) or an indication of local signalling link congestion, or due to the signalling-route-set-congestion-test procedure (see section 12.9) an indication is given from the Message Transfer Part to the local level 4 informing them about the current congestion status of the signalling route set. Each user then takes appropriate actions in order to stop generation of signalling messages destined for the affected signalling point with congestion priorities lower than the specified congestion status. Message received from local level 4 with congestion priorities lower than the current signalling route set congestion status are discarded by the Message Transfer Part.

10.2.5 Signalling Route Set Congestion (National Option without Congestion Priorities). (This section has been deleted as it is not applicable to U. S. networks). *

11. Signalling Link Management

11.1 General

11.1.1 ¹The signalling link management function is used to control the locally connected signalling links. The function provides means for establishing and maintaining a certain predetermined capability of a link set. Thus, in the event of signalling link failures, the signalling link management function controls actions aimed at restoring the capability of the link set.

Three sets of signalling link management procedures are specified in the following sections. Each set corresponds to a certain level of automation as regards allocation and reconfiguration of signalling equipment. The basic set includes the minimum number of functions which must be provided for national or international application of the signalling system. *

The two alternative sets of signalling link management procedures are provided as options and include functions allowing for a more efficient use of signalling equipment in the case when signalling terminal devices have switched access to signalling data links.

11.1.2 A signalling link set consists of one or more signalling links having a certain order of priority as regards the signalling traffic conveyed by the link set (see Section 4). Each signalling link in operation is assigned a signalling data link and a signalling terminal at each end of the signalling data link.

SIGNALLING NETWORK FUNCTIONS AND MESSAGES

The signalling link identity is independent of the identities of the signalling data link and signalling terminals which it comprises. Thus, the identify referred to by the Signalling Link Code (SLC) included in some messages originated at Message Transfer Part level 3 is the signalling link identity, and not the signalling data link identity or the signalling terminal identity. *

Depending on the level of automation in an application of the signalling system, allocation of signalling data link and signalling terminals to a signalling link may be made manually or automatically.

In the first case, applicable for the basic signalling link management procedures, a signalling link includes predetermined signalling terminals and a predetermined signalling data link. To replace a signalling terminal or signalling data link, a manual intervention is required. The signalling data link to be included in a particular signalling link is determined by bilateral agreement (see also Q.702).

In the second case for a given signalling point, a signalling link includes any of the signalling terminals and any of the signalling data links applicable to a *link group*. As a result of, for example, signalling link failure, the signalling terminal and signalling data link included in a signalling link may be replaced automatically. The criteria and procedures for automatic allocation of signalling terminals and signalling data links are specified in Sections 11.5 and 11.6, respectively. The implementation of these functions requires that, for a given link group, any signalling terminal can be connected to any signalling data link.

Note: A link group is a group of identical signalling links directly connecting two signalling points. A link set may include one or more link groups.

11.1.3 When a link set is to be brought into service, actions are taken to establish a predetermined number of signalling links. This is made by connecting signalling terminals to signalling data links and for each signalling link performing an initial alignment procedure (see Q.703, Section 7.3). The process of making a signalling link ready to carry signalling traffic is defined as *signalling link activation*.

Activation of a signalling link may also be applicable, for example, when a link set is to be extended or when a persisting failure makes another signalling link in the link set unavailable for signalling traffic.

In the case of signalling link failure, actions should be taken to restore the faulty signalling link, i.e., to make it available for signalling again. The restoration process may include replacement of a faulty signalling data link or signalling terminal.

A link set or a single signalling link is taken out of service by means of a procedure defined as *signalling link deactivation*.

The procedures for activation, restoration and deactivation are initiated and performed in different ways depending on the level of automation applicable for a particular implementation of the signalling system. In the following, procedures are specified for the cases when:

- (1) No automatic functions are provided for allocation of signalling terminals and signalling data links (see Section 11.2);
- (2) An automatic function is provided for allocation of signalling terminals (see Section 11.3);
- (3) Automatic functions are provided for allocation of signalling terminals and signalling data links (see Section 11.4).

11.2 Basic Signalling Link Management Procedures

11.2.1 Signalling Link Activation

SIGNALLING NETWORK FUNCTIONS AND MESSAGES

11.2.1.1 In the absence of failures, a link set contains a certain predetermined number of active (i.e., aligned) signalling links. In addition, the link set may contain a number of inactive signalling links, that is, signalling links which have not been put into operation. Predetermined signalling terminals and a signalling data link are associated with each inactive signalling link.

The number of active and inactive signalling links in the absence of failures, and the priority order for the signalling links in a link set, should be identical at both ends of the link set.

Note: In the typical case, all signalling links in a link set are active in the absence of failures.

11.2.1.2 When a decision is taken to activate an inactive signalling link, initial alignment starts. If the initial alignment procedure is successful, the signalling link is active and the signalling link test is started. If the signalling link test is successful the link becomes ready to convey signalling traffic. In the case when initial alignment is not possible, as determined at Message Transfer Part level 2 (see Q.703 Section 7), new initial alignment procedures are started on the same signalling link, after a time $T17^{10}$ (delay to avoid the oscillation of initial alignment failure and link restart. The value of $T17$ should be greater than loop delay and less than the value of timer $T2$ (see Q.703 Section 7.3)). If the signalling link test fails, link restoration starts until the signalling link is activated or a manual intervention is made. If after a time $T19^{10}$ the signalling link has not been activated, then the procedure is stopped and a management function is notified. *

Note: In U. S. Networks the performance of a signalling link test as part of signalling link activation or restoration is optional. Even if a signalling point performs the test before starting traffic on the link, it must accept traffic from the link as soon as initial alignment is complete. The state transition diagrams for the signalling link management function do not include the signalling link test. *

11.2.2 Signalling Link Restoration. After a signalling link failure is detected, signalling link initial alignment will take place. In the case when the initial alignment procedure is successful, a signalling link test is started. If the signalling link test is successful, the signalling link is regarded as restored and thus available for signalling.

If initial alignment is not possible, as determined at Message Transfer Part Level 2 (see Q.703, Section 7), new initial alignment procedures may be started on the same signalling link after a time $T17$ until the signalling link is restored or a manual intervention is made; e.g., to replace the signalling data link or the signalling terminal. If after time $T19$ the signalling link has not activated, then the procedure is stopped and a management function is notified. *

If the signalling link test fails, the restoration procedure is repeated until the link is restored or a manual intervention is made.

Note: In U. S. Networks the performance of a signalling link test as part of signalling link activation or restoration is optional. Even if a signalling point performs the test before starting traffic on the link, it must accept traffic from the link as soon as initial alignment is complete. The state transition diagrams for the signalling link management function do not include the signalling link test. *

11.2.3 Signalling Link Deactivation. An active signalling link may be made inactive by means of a deactivation procedure, provided that no signalling traffic is carried on that signalling link. When a decision has been taken to deactivate a signalling link the signalling terminal of the signalling link is taken out of service. The deactivation procedure is given in Figure 40/Q.704. *

11.2.4 Link Set Activation. A signalling link set not having any signalling links in service is started by means of a link set activation procedure.

Two alternative link set activation procedures are defined:

SIGNALLING NETWORK FUNCTIONS AND MESSAGES

- (1) Link set normal activation,
- (2) Link set emergency restart.

11.2.4.1 Link Set Normal Activation. Link set normal activation is applicable when a link set is to be put into service for the first time (link set initial activation) or when a link set is to be restarted (link set normal restart); the latter is applicable for example in the case when:

- (1) All signalling links in a link set are faulty;
- (2) A processor restart in a signalling point makes it necessary to re-establish a link set;
- (3) A signalling point recognizes other irregularities concerning the interworking between the two signalling points.

provided that none of the above events create an emergency situation.

When link set normal activation is initiated, signalling link activation starts on as many signalling links as possible. (All signalling links in the link set are regarded as being inactive at the start of the procedure).

The signalling link activation procedures are performed on each signalling link in parallel as specified in Section 11.2.1. until the signalling links are made active.

Signalling traffic may, however, commence when one signalling link is successfully activated.

11.2.4.2 Link Set Emergency Restart. Link set emergency restart is applicable when an immediate reestablishment of the signalling capability of a link set is required (i.e., in a situation when the link set normal restart procedure is not fast enough.) The precise criteria for initiating link set emergency restart instead of normal restart may vary between different applications of the signalling system. Possible situations for emergency restart are, for example:

- (1) When signalling traffic that may be conveyed over the link set to be restarted is blocked,
- (2) When it is not possible to communicate with the signalling point at the remote end of the link set.

When link set emergency restart is initiated, signalling link activation starts on as many signalling links as possible, in accordance with the principles specified for normal link set activation. In this case, the signalling terminals will have emergency status (see Q.703 Section 7), resulting in the sending of status indications of type "E" when applicable. Furthermore, the signalling terminals employ the emergency proving procedure and short time-out values in order to accelerate the procedure.

When the emergency situation ceases, a transition from emergency to normal signalling terminal status takes place resulting in the employment of normal procedures and normal time-out values.

11.2.4.3 Time-out Values. The initial alignment procedure (see Q.703, Section 7.3) includes time-outs, the expiry of which indicates the failure of an activation or restoration attempt. The values of the time-outs are for further study.

11.3 Signalling Link Management Procedures Based on Automatic Allocation of Signalling Terminals.

11.3.1 Signalling Link Activation¹²

12. The procedures to be used on initialization of a new link set or re-initialization of a signalling point are for further study.

SIGNALLING NETWORK FUNCTIONS AND MESSAGES

11.3.1.1 In the absence of failures, a link set contains a certain predetermined number of active (i.e., aligned) signalling links. The link set may also contain a number of inactive signalling links.

An inactive signalling link is a signalling link not in operation. A predetermined signalling data link is associated with each inactive signalling link; however, signalling terminals may not yet be allocated.

The number of active and inactive signalling links in the absence of failures, and the priority order for signalling links in a link set, should be identical at both ends of the link set.

11.3.1.2 Whenever the number of active signalling links is below the value specified for the link set, actions to activate new inactive signalling links should be taken automatically. This is applicable, for example, when a link set is to be brought into service for the first time (see Section 11.3.4), or when a link failure occurs. In the latter case, activation starts when the restoration attempts on the faulty link are considered unsuccessful (see Section 11.3.2).

The signalling link(s) to activate is the inactive link(s) having the highest priority in the link set.

Generally, if it is not possible to activate a signalling link, an attempt to activate the next inactive signalling link (in priority order) is made. In the case when an activation attempt performed on the last signalling link in the link set is unsuccessful, the "next" signalling link is the first inactive signalling link in the link set (i.e., there is a cyclic assignment).

Activation of a signalling link may also be initiated manually.

Activation shall not be initiated automatically for a signalling link previously deactivated by means of a manual intervention.

11.3.1.3 When a decision is taken to activate a signalling link, the signalling terminal to be employed has to be allocated at each end.

The signalling terminal is allocated automatically by means of the function defined in Section 11.5.

In the case when the automatic allocation function cannot provide a signalling terminal, the activation attempt is aborted.

The predetermined signalling data link which may be utilized for other purposes, when not connected to a signalling terminal, must be removed from its alternative use (e.g., as a speech circuit) before signalling link activation can start.

11.3.1.4 The chosen signalling terminal is then connected to the signalling data link, and the initial alignment starts (see Q.703, Section 7).

If the initial alignment procedure is successful, the signalling link is active and a signalling link test is started. If the signalling link test is successful, the link is ready to convey signalling traffic.

If initial alignment is not possible, as determined at Message Transfer Part level 2 (see Q.703, Section 7), or the test fails, the activation is unsuccessful, and activation of the next inactive signalling link (if any) is initiated. Successive initial alignment attempts may, however, continue on the previous signalling link after a time T17 until it is restored, or its signalling terminal is disconnected (see Section 11.5). If after time T19 the signalling link has not been activated, then the procedure is stopped and a management function is notified.

Note: In U. S. Networks the performance of a signalling link test as part of signalling link activation or restoration is optional. Even if a signalling point performs the test before starting traffic on the link, it must accept traffic from the link as soon as initial alignment is complete. The state transition diagrams for the signalling link management function do not include the signalling link test.

SIGNALLING NETWORK FUNCTIONS AND MESSAGES

In view of the fact that if it is not possible to activate a signalling link an attempt is made to activate the next inactive signalling link in a link set, it may be that the two ends of a link set continuously attempt to activate different signalling links. By having different values of initial alignment time-out T2 at the two ends of the link set (see Section 11.3.4.3) it is ensured that eventually both ends of the link set will attempt to activate the same signalling link.

11.3.2 Signalling Link Restoration

11.3.2.1 After a signalling link failure is recognized, signalling link initial alignment will take place (see Q.703, Section 7). In the case when the initial alignment is successful; a signalling link test is started. If the signalling link test is successful the signalling link is regarded as restored, and thus available for signalling. If the initial alignment is unsuccessful, the signalling terminals and signalling link may be faulty and require replacement.

Note: In U. S. Networks the performance of a signalling link test as part of signalling link activation or restoration is optional. Even if a signalling point performs the test before starting traffic on the link, it must accept traffic from the link as soon as initial alignment is complete. The state transition diagrams for the signalling link management function do not include the signalling link test. *

11.3.2.2 The signalling terminal may be automatically replaced in accordance with the principles defined for automatic allocation of signalling terminals (see Section 11.5). After the new signalling terminal has been connected to the signalling data link, signalling link initial alignment starts. If successful, the signalling link is restored.

If initial alignment is not possible, or if no alternative signalling terminal is available for the faulty signalling link, activation of the next signalling link in the link set (if any) starts. In the case when it is not appropriate to replace the signalling terminal of the faulty signalling link (e.g., because it is assumed that the signalling data link is faulty), activation of the next inactive signalling link (if any) is also initiated. In both cases, successive initial alignment attempts may continue on the faulty signalling link after time T17 until a manual intervention is made, or the signalling terminal is disconnected (see Section 11.5). If after time T19 the signalling link has not been activated, then the procedure is stopped and a management function is notified. *

Notes: In the case when a signalling terminal cannot be replaced, activation of the next signalling link is only initiated if the link set includes an alternative link group having access to other signalling terminals than the signalling link for which restoration is not possible.

11.3.3 Signalling Link Deactivation. In the absence of failures, a link set contains a specified number of active (i.e., aligned) signalling links. Whenever that number is exceeded (e.g., as a result of signalling link restoration), the active signalling link having the lowest priority in the link set is to be made inactive automatically, provided that no signalling traffic is carried on that signalling link.

Deactivation of a particular signalling link may also be initiated manually; for example, in conjunction with manual maintenance activities.

When a decision has been taken to deactivate a signalling link, the signalling terminal and signalling data link may be disconnected.

After deactivation, the idle signalling terminal may become part of other signalling links (see Section 11.5).

11.3.4 Link Set Activation. A signalling link set not having any signalling links in service is started by means of a link set activation procedure. The objective of the procedure is to activate a specified number of signalling links for the link set. The activated signalling links should, if possible, be the signalling links having the highest priority in the link set. Two alternative link set activation procedures are defined:

SIGNALLING NETWORK FUNCTIONS AND MESSAGES

- (1) Link set normal activation,
- (2) Link set emergency restart.

11.3.4.1 Link Set Normal Activation. Link set normal activation is applicable when a link set is to be put into service for the first time (link set initial activation), or when a link set is to be restarted (link set normal restart); the latter is applicable, for example, in the case when:

- (1) All signalling links in a link set are faulty;
- (2) A processor restart in a signalling point makes it necessary to re-establish a link set;
- (3) A signalling point recognizes other irregularities concerning the interworking between the two signalling points; e.g., that a certain signalling data link is associated with different signalling links at the two ends of the link set;

provided that none of the above events create an emergency situation.

When link set normal activation is initiated, signalling link activation starts on as many signalling links as possible. (All signalling links in the link set are regarded as being inactive at the start of the procedure). If activation cannot take place on all signalling links in the link set (e.g., because a sufficient number of signalling terminals is not available), then the signalling links to activate are determined in accordance with the link priority order.

Note: All idle signalling terminals may not necessarily be made available for link set activation, thus making possible, for example, restoration of faulty signalling links in other links sets at the same time.

The signalling link activation procedures are performed as specified in section 11.3.1.

If the activation attempt for a signalling link is unsuccessful (i.e., initial alignment is not possible, activation of the next inactive signalling link, if any, in the priority order is initiated.¹³ According to the principles for automatic allocation of signalling terminals defined in Section 11.5, the signalling terminal connected to the unsuccessfully activated signalling link will typically be connected to the signalling data link of that signalling link for which the new activation attempt is to be made.

When a signalling link is successfully activated, signalling traffic may commence.

After the successful activation of one signalling link, the activation attempts on the remaining signalling links continue in accordance with the principles defined in Section 11.3.1, in such a way that the signalling links having the highest priorities are made active. This is done in order to obtain, if possible, the normal configuration within the link set. Signalling link activation continues until the predetermined number of active signalling links is obtained.

11.3.4.2 Link Set Emergency Restart. Link set emergency restart is applicable in the case when the link set normal restart procedure is not fast enough. Emergency restart is performed in the same way as link set normal activation except that, in the case of emergency restart, the emergency proving procedure and the short emergency time-out values (of Q.703 Section 7) are employed in order to accelerate the procedure (see further Section 11.2.4.2).

11.3.4.3 Time-Out Values. The values of the initial alignment time-outs T2 (see Q.703, Section 7) will be different at the two ends of the link set, if automatic allocation of signalling terminals or signalling data links is applied at both ends of a signalling link set. These values are for further study.

13. Inactive links exist in the case when the number of signalling terminals available is less than the number of signalling links defined for the link set

SIGNALLING NETWORK FUNCTIONS AND MESSAGES

11.4 Signalling Link Management Procedures Based on Automatic Allocation of Signalling Data Links and Signalling Terminals

11.4.1 Signalling Link Activation

11.4.1.1 In the absence of failures, a link set contains a certain predetermined number of active (i.e., aligned) signalling links. The link set may also contain a number of inactive signalling links.

An inactive signalling link is a signalling link currently not in operation. It is not associated with any signalling terminal or signalling data link (i.e., the signalling link is only identified by its position in the link set).

The number of active and inactive signalling links (in the absence of failures), and the priority order for the signalling links in a link set, should be identical at both ends of the link set.

11.4.1.2 Whenever the number of active signalling links is below the value specified for the link set, actions to activate new inactive signalling links should be taken automatically. This is, for example, applicable when a link set is to be brought into service for the first time (see Section 11.4.4), or when a link failure occurs. In the latter case, activation starts when the restoration attempts on the faulty link are considered unsuccessful (see Section 11.4.2).

The signalling link(s) to activate is the inactive link(s) having the highest priority in the link set.

If it is not possible to activate a signalling link, an attempt to activate the next inactive signalling link (in priority order) is made. In the case when an activation attempt performed on the last signalling link in the link set is unsuccessful, the "next" signalling link is the first inactive link in the link set (i.e., a cyclic assignment).

Note: Activation of the next signalling link is only initiated if the link set includes an alternative link group, having access to other signalling terminals and/or other signalling data links than the signalling link for which activation is not possible.

Activation of a particular signalling link may also be initiated upon receiving a request from the remote signalling point, or by a manual request.

Activation shall not be initiated automatically for a signalling link previously inactivated by means of a manual intervention.

11.4.1.3 When a decision is taken to activate a signalling link, the signalling terminals and signalling data link to be employed have to be allocated.

A signalling terminal is allocated automatically by means of the function defined in Section 11.5.

The signalling data link is allocated automatically by means of the function defined in Section 11.6. However, in conjunction with link set activation, the identity of the signalling data link to use may be predetermined (see further Section 11.4.4). A signalling data link which is not connected to a signalling terminal may be utilized for other purposes, e.g., as a speech circuit. When the data link is to be employed for signalling, it must be removed from its alternative use.

In the case when the automatic allocation functions cannot provide a signalling terminal or a signalling data link, the activation attempt is aborted.

11.4.1.4 When the signalling data link and signalling terminal to be used for a particular signalling link are determined, the signalling terminal is connected to the signalling data link and signalling link initial alignment starts (see Q.703, Section 7). If the initial alignment procedure is successful, the signalling link is active and a signalling link test is started. If the signalling link test is successful the link becomes ready to convey signalling traffic.

Note: In U. S. Networks the performance of a signalling link test as part of signalling link activation or restoration is optional. Even if a signalling point performs the test before

*
*

SIGNALLING NETWORK FUNCTIONS AND MESSAGES

starting traffic on the link, it must accept traffic from the link as soon as initial alignment is complete. The state transition diagrams for the signalling link management function do not include the signalling link test. *

If the initial alignment is not possible, as determined at Message Transfer Part level 2 (see Q.703, Section 7), alternative signalling data links are automatically connected to the signalling terminal, until an initial alignment procedure is successfully completed. In the case when the function for automatic allocation of signalling data links cannot provide an alternative signalling data link, the activation is regarded as unsuccessful, and activation of the next inactive signalling link (if any) is initiated (see, however, the Note to section 11.4.1.2 above). Successive initial alignment attempts may continue on the previous signalling link after a time T17 until it is activated, or its signalling terminal is disconnected (see Section 11.5).

11.4.2 Signalling Link Restoration

11.4.2.1 After a signalling link failure is recognized, signalling link initial alignment will take place (see Q.703, Section 7). In the case when the initial alignment is successful, a signalling link test is started. If the signalling link test is successful the link becomes restored, and thus available for signalling.

Note: In U. S. Networks the performance of a signalling link test as part of signalling link activation or restoration is optional. Even if a signalling point performs the test before starting traffic on the link, it must accept traffic from the link as soon as initial alignment is complete. The state transition diagrams for the signalling link management function do not include the signalling link test. *

If the initial alignment is unsuccessful, the signalling terminal and signalling data link may be faulty and require replacement.

11.4.2.2 The signalling data link may be automatically replaced by an alternative, in accordance with the principles defined in Section 11.6. After the new signalling data link has been connected to the signalling terminal signalling link, initial alignment starts. If successful, the signalling link is restored. If not, alternative data links are connected to the signalling terminal, until an initial alignment procedure is successfully completed.

If the automatic allocation function cannot provide a new signalling data link, activation of the next inactive signalling link (if any) is initiated (see, however, the Note to Section 11.4.1.2). Successive initial alignment attempts may, however, continue on the previous (faulty) signalling link after a time T17 until it is restored or its signalling terminal is disconnected.

11.4.2.3 The signalling terminal may be automatically replaced in accordance with the principles defined in Section 11.5. After the new signalling terminal has been connected to the signalling data link, signalling link initial alignment starts. If successful the signalling link is restored. If not, activation of the next signalling link in the link set (if any) starts (see, however, the Note to Section 11.4.1.2).

Successive initial alignment attempts may, however, continue on the previous (faulty) signalling link until it is restored or, for example, the signalling terminal or signalling data link is disconnected.

Note: Activation of the next signalling link in the link set should not be initiated as long as one of the activities described in Sections 11.4.2.2 and 11.4.2.3 above is taking place.

11.4.3 Signalling Link Deactivation. In the absence of failures, a link set contains a specified number of active (i.e., aligned) signalling links. Whenever that number is exceeded (e.g., as a result of signalling link restoration), the active signalling link having the lowest priority in the link set is to be made inactive automatically, provided that no signalling traffic is carried on that signalling link.

SIGNALLING NETWORK FUNCTIONS AND MESSAGES

Deactivation of a particular signalling link may also be initiated manually, e.g., in conjunction with manual maintenance activities.

When a decision has been taken to deactivate a signalling link, the signalling terminal and signalling data link may be disconnected. After deactivation, the idle signalling terminal and signalling data link may become parts of other signalling links (see Sections 11.5 and 11.6).

11.4.4 Link Set Activation. Link set activation is applicable in the case when a link set not having any signalling links in service is to be started for the first time or after a failure (see Section 11.3.4). The link set activation procedure is performed as specified in Section 11.3.4, also as regards the allocation of signalling data links; i.e., signalling data links are allocated in accordance with a predetermined list assigning a signalling data link to some or all of the signalling links in the link set. This is made in order to cater for the situation when it is not possible to communicate with the remote end of the link set (see Section 11.6). However, when a signalling link has become active, signalling data link allocation may again be performed automatically (i.e., activation of a signalling link takes place as specified in Section 11.4.1).

11.5 Automatic Allocation of Signalling Terminals.

In conjunction with the signalling link activation and restoration procedures specified in Sections 10.3 and 10.4, signalling terminals may be allocated automatically to a signalling link. A signalling terminal applicable to the link group is allocated in accordance with the following principles:

- (1) An idle signalling terminal (i.e., a signalling terminal not connected to a signalling data link) is chosen if possible,
- (2) If no idle signalling terminal is available, a signalling terminal is chosen which is connected to an unsuccessfully restored or activated signalling link.

Note: Activation and restoration is regarded as unsuccessful when it is not possible to complete the initial alignment procedure successfully (see Sections 11.3 and 11.4).

Measures should be employed to ensure that signalling terminals to be allocated to signalling links are able to function correctly (see Q.707).

A link set may be assigned a certain number of signalling terminals. A signalling terminal may be transferred from a signalling link in one link set to a signalling link in another link set [in accordance with (2) above] only when the remaining number of signalling terminals in the link set is not below the specified value.

Note: From a link set with a minimum number of signalling terminals, only one signalling terminal and signalling data link may be removed at a time (e.g., for testing, see Q.707).

11.6 Automatic Allocation of Signalling Data Links

11.6.1 In conjunction with the signalling link activation and restoration procedures specified in Section 11.4, signalling data links may be allocated automatically. Any signalling data link applicable to a link group may be chosen for a signalling link within that link group.

The signalling data links applicable to a link group are determined by bilateral agreement and may, for example, include all speech circuits between two exchanges. A signalling data link may also be established as a semipermanent connection via one or more intermediate exchanges.

When a potential signalling data link is not employed for signalling, it is normally used for other purposes (e.g., as a speech circuit).

The identity of the signalling data link to be used for a particular signalling link is determined at one of the two involved signalling points, and reported to the remote end by a signalling data link connection order message. The signalling point controlling the choice of signalling data link is the

SIGNALLING NETWORK FUNCTIONS AND MESSAGES

signalling point initiating the activation or restoration procedure or, in the case when both ends initiate the procedure at the same point in time, the signalling point having the highest signalling point code (included in the label of the message).

11.6.2 When a signalling data link has been chosen at a signalling point, the data link is made unavailable for other uses (e.g., as a speech circuit), and an order to connect the appointed signalling data link to a signalling terminal is sent to the signalling point at the remote end of the signalling link.

The signalling-data-link-connection-order contains:

- (1) The label, indicating the destination and originating signalling points; *
- (2) The SLC, indicating the identify of the signalling link being activated or restored; *
- (3) The signalling-data-link-connection-order;
- (4) The identity of the signalling data link.

Formats and codes for the signalling-data-link-connection-order message appear in Section 14.

11.6.3 Upon reception of the signalling-data-link-connection-order, the following applies:

- (1) In the case when the signalling link to which a received signalling-data-link-connection-order message refers is inactive, as seen from the receiving signalling point, the message is regarded as an order to activate the concerned signalling link, resulting in, for example, allocation of a signalling terminal. The signalling data link indicated in the signalling-data-link-connection-order is then connected to the associated signalling terminal, and signalling link initial alignment starts. An acknowledgement is sent to the remote signalling point.

In the case when it is not possible to connect the appointed signalling data link to a signalling terminal (e.g. because there is no working signalling terminal available), the acknowledgement contains an indication informing the remote signalling point whether or not an alternative signalling data link should be allocated to the concerned signalling link.

- (2) In the case when the signalling point receives a signalling data link connection order when waiting for an acknowledgement, the order is disregarded in the case when the signalling point code of the receiving signalling point is higher than the signalling point code of the remote signalling point. If the remote signalling point has the highest signalling point code, the message is acknowledged, and the signalling data link referred to in the received message is connected.
- (3) In the case when a signalling-data-link-connection-order is received in other situations (e.g., in the case of an error in procedure), no actions are taken.

The signalling-data-link-connection-acknowledgement contains the label, indicating the destination and originating signalling points, and the SLC, indicating the identity of the signalling link to activate or restore, and one of the following signals: *

- (1) Connection-successful signal, indicating that the signalling data link has been connected to a signalling terminal;
- (2) Connection-not-successful signal, indicating that it was not possible to connect the signalling data link to a signalling terminal, and that an alternative signalling data link should be allocated;
- (3) Connection-not-possible signal, indicating that it was not possible to connect the signalling data link to a signalling terminal, and that no alternative signalling data link should be allocated.

Formats and codes for the signalling-data-link-connection-acknowledgement message appear in Section 14.

SIGNALLING NETWORK FUNCTIONS AND MESSAGES

11.6.4 When the signalling point initiating the procedure receives a message indicating that signalling data link and signalling terminal have been connected at the remote end, the signalling data link is connected to the associated signalling terminal, and initial alignment starts (see Section 11.4).

In the case when the acknowledgement indicates that it was not possible to connect the signalling data link to a signalling terminal at the remote end, an alternative signalling data link is allocated, and a new signalling data link connection order is sent (as specified above). However, if the acknowledgement indicates that no alternative signalling data link should be allocated, the activation or restoration procedure is terminated for the concerned signalling link.

If no signalling-data-link-connection-acknowledgement or -order is received from the remote signalling point within a time-out $T7^{10}$, the signalling-data-link-connection-order is repeated.

11.6.5 When a signalling data link is disconnected in conjunction with a signalling link restoration or deactivation, the signalling data link is made idle (and available, e.g., as speech circuit).

11.7 Different Signalling Link Management Procedures at the Two Ends of a Link Set.

Normally both ends of a link set use the same signalling link management procedures.

However, if one end uses the basic signalling link management procedures, the other end may use the signalling link management procedures based on automatic allocation of signalling terminals. In that case a signalling link includes a predetermined signalling terminal at one end; a predetermined signalling data link; and at the other end, any of the signalling terminals applicable to the concerned link group.

In the case when one end of a link set uses the basic signalling link management procedures and the other end uses the signalling link management procedures based on automatic allocation of signalling terminals, the values of initial alignment time-out $T2$ do not have to be different at the two ends of the link set.

12. Signalling Route Management¹⁴

12.1 General.

The purpose of the signalling route management function is to ensure a reliable exchange of information between the signalling points about the availability of the signalling routes.

The unavailability, restriction² and availability of a signalling route is communicated by means of the transfer-prohibited, transfer-restricted², and transfer-allowed procedures, respectively, specified in Sections 12.2, 12.5 and 12.3.

Recovery of signalling route status information is made by means of the signalling-route-set-test procedure specified in Section 12.4.

In the international signalling network congestion of a route set is communicated by means of the TFC message specified in Section 12.6.

In U. S. networks, congestion of a signalling route set is communicated by means of the TFC as specified in Sections 12.7 and 12.8 and the signalling-route-set-congestion-test procedure specified in Section 12.9.

14. The possibility of referring to networks as well as individual destinations and clusters in signalling route management messages is for further study.

SIGNALLING NETWORK FUNCTIONS AND MESSAGES

12.2 Transfer-Prohibited

12.2.1 The transfer-prohibited procedure is performed at a signalling point acting as a signalling transfer point for messages relating to a given destination, when it has to notify one or more adjacent signalling points that they must no longer route the concerned messages via that signalling transfer point.

The transfer-prohibited procedure makes use of the transfer-prohibited message, which contains:

- (1) The label, indicating the destination and originating points;
- (2) The transfer-prohibited signal or the transfer-cluster-prohibited signal; and *
- (3) The destination, or cluster of destinations for which traffic transfer is no longer possible *

The format and codes of this message appear in Section 14.

The transfer-prohibited messages are always addressed to an adjacent signalling point. They may use any available signalling route that leads to that signalling point.

12.2.2 A transfer-prohibited message relating to a given destination *X* is sent from a signalling transfer point *Y* in the following cases unless, optionally, a transfer-cluster-prohibited message is sent instead according to the criteria in Section 12.2.2A:

- (1) When signalling transfer point *Y* starts to route (at changeover, changeback, forced or controlled rerouting) signalling traffic destined to signalling point *X* via signalling transfer point *Z* not currently used by signalling transfer point *Y* for this traffic. In this case, the transfer-prohibited message is sent to signalling transfer point *Z*.
- (2) When signalling transfer point *Y* recognizes that it is unable to transfer signalling traffic destined to signalling point *X* (see Sections 5.3.3 and 7.2.3) and signalling point *X* has been designated (by the administration of the network to which *Y* belongs) as one for which signalling transfer point *Y* should broadcast transfer-prohibited messages. In this case transfer-prohibited message is sent to all accessible adjacent signalling points (Broadcast method).
- (3) When a message destined to signalling point *X* is received at signalling transfer point *Y* and signalling transfer point *Y* is unable to transfer the message. In this case the transfer-prohibited message is sent to the accessible adjacent signalling point from which the concerned message was received (Response method).

As long as transfer-prohibited messages for any destination are being transmitted according to criteria (1) or (2) above, and also within T8¹⁰ after the last transfer-prohibited message was transmitted, no transfer-prohibited messages for that destination will be sent via the Response method (criterion 3) above.

Examples of the above situation appear in Q.705. *

12.2.2A ¹⁵ As a network option, a signalling transfer point *Y* that uses the same routing to transfer traffic to all destinations in a cluster *CX* may send transfer-cluster-prohibited messages relating to that cluster in the following cases: *

- (1) When signalling transfer point *Y* starts to route (at changeover, changeback, forced or controlled rerouting) signalling traffic destined to cluster *CX* via a signalling transfer point *Z* not currently used by signalling transfer point *Y* for this traffic. In this case, the transfer-cluster-prohibited message is sent to signalling transfer point *Z*. *

15. These procedures are subject to further study. *

SIGNALLING NETWORK FUNCTIONS AND MESSAGES

- (2) When signalling transfer point *Y* recognizes that it is unable to transfer traffic destined to a cluster *CX* (see Sections 5.3.3 and 7.2.3) and the concerned cluster has been designated (by the administration of the network to which *Y* belongs) as one for which signalling transfer point *Y* should broadcast transfer-prohibited messages. In this case a transfer-cluster-prohibited message is sent to all accessible adjacent signalling points (Broadcast method).
- (3) When signalling transfer point *Y* is unable to transfer messages to any signalling point within the cluster *CX* and a message destined to a signalling point within that cluster is received. In this case a transfer-cluster-prohibited message referring to the inaccessible cluster is sent to the adjacent signalling point from which the concerned message was received (Response method).

As long as transfer-cluster-prohibited messages for any cluster are being transmitted according to criteria (1) or (2) above, and also within $T8^{10}$ after the last such transfer-cluster-prohibited message was transmitted, no transfer-cluster-prohibited messages for that cluster will be sent by the Response method (criterion 3) above.

12.2.3 When a signalling point receives a transfer-prohibited message from a signalling transfer point *Y* it performs the actions specified in Section 7 (since reception of transfer-prohibited messages indicates the unavailability of the concerned signalling route, see Section 3.4.1). In other words, it may perform forced rerouting and, if appropriate, generate additional transfer-prohibited messages.

12.2.4 In some circumstances it may happen that a signalling point receives either a repeated transfer-prohibited message or a transfer-prohibited message relating to a non-existent route (i.e., there is no route from that signalling point to the concerned destination via signalling transfer point *Y*, according to signalling network configuration) or to a destination which is already inaccessible, due to previous failures; in this case no action is taken.

12.3 Transfer-Allowed

12.3.1 The transfer-allowed procedure is performed at a signalling point, acting as signalling transfer point for messages relating to a given destination or cluster of destinations, when it has to notify one or more adjacent signalling points that they may start to route to it, if appropriate, the concerned messages.

The transfer-allowed procedure makes use of the transfer-allowed message which contains:

- (1) The label, indicating the destination and originating points;
- (2) The transfer-allowed signal or the transfer-cluster-allowed signal; and
- (3) The destination or cluster of destinations for which transfer is now possible.

Formats and codes of this message appear in Section 14.

Transfer-allowed messages are always addressed to an adjacent signalling point. They may use any available signalling route that leads to that signalling point.

12.3.2 A transfer-allowed message relating to a given destination *X* is sent from signalling transfer point *Y* in the following cases:

- (1) When signalling transfer point *Y* stops routing (at changeback or controlled rerouting) signalling traffic destined to signalling point *X* via a signalling transfer point *Z* (to which the concerned traffic was previously diverted as a consequence of changeover or forced rerouting). In this case the transfer-allowed message is sent to signalling transfer point *Z*.
- (2) When signalling transfer point *Y* recognizes that it is again able to transfer via the normal route signalling traffic destined to signalling point *X* and only signalling point *X* in cluster *CX* (see Sections 6.2.3 and 8.2.3). In this case a transfer-allowed message is sent to all accessible adjacent signalling points (Broadcast method).

SIGNALLING NETWORK FUNCTIONS AND MESSAGES

Examples of the above situations appear in Q.705.

12.3.2A A transfer-cluster-allowed message relating to a given cluster of destinations *CX* is sent from a signalling transfer point *Y* in the following cases: *

- (1) When signalling transfer point *Y* stops routing (at changeback or controlled rerouting) traffic destined to the cluster via a signalling transfer point *Z*, (to which the concerned traffic was previously diverted as a consequence of changeover or forced rerouting). In this case the transfer-cluster-allowed message is sent to signalling transfer point *Z*. *
- (2) When signalling transfer point *Y* recognizes that it is again able to transfer, via the normal route, signalling traffic to more than one signalling point in cluster *CX*. In this case a transfer-cluster-allowed message is sent to all accessible adjacent signalling points (Broadcast method). *

12.3.3 When a signalling point receives a transfer-allowed or transfer-cluster-allowed message from signalling transfer point *Y*, it performs the actions specified in Section 8 (since reception of a transfer-allowed message indicates the availability of the concerned signalling route, see Section 3.4.2). In other words, it may perform controlled rerouting and, if appropriate, generate additional transfer-allowed messages.

12.3.4 In some circumstances it may happen that a signalling point receives either a repeated transfer-allowed message or a transfer-allowed message relating to a nonexistent signalling route (i.e., there is no route from that signalling point to the concerned destination via signalling transfer point *Y*, according to the signalling network configuration); in this case no action is taken.

12.4 Signalling-Route-Set-Test

12.4.1 The signalling-route-set-test procedure is used at a signalling point to test whether or not signalling traffic towards a certain destination may be routed via an adjacent signalling transfer point.

The procedure makes use of the signalling-route-set-test message, and the transfer-allowed, the transfer-prohibited, and the transfer-restricted² procedures.

The signalling-route-set-test message contains:

- (1) The label, indicating the destination and originating points;
- (2) The signalling-route-set-test signal;
- (3) The destination or, optionally, cluster of destinations, the accessibility of which is to be tested; and *
- (4) The current route status of the destination being tested.

Format and coding of this message appear in Section 14.

12.4.2 A signalling-route-set-test message is sent from a signalling point in the following cases:

- (1) When a transfer-prohibited or transfer-restricted² message is received from an adjacent signalling transfer point. In this case, a signalling-route-set-test message is sent to that signalling transfer point referring to the destination declared inaccessible or restricted by the transfer-prohibited or transfer-restricted² message, every T10¹⁰ until a transfer-allowed message, indicating that the destination has become accessible, is received. A signalling point should initiate signalling route set tests only for destinations that are in its routing tables. Otherwise, never-ending tests may be initiated for nonexistent destinations. *
- (2) When a previously unavailable link set, directly connecting the signalling point with a signalling transfer point, becomes available. In this case signalling-route-set-test messages sent to the signalling transfer point refer to all destinations which in the absence of failures are accessible via the signalling transfer point. Implementation of this item is a network *

SIGNALLING NETWORK FUNCTIONS AND MESSAGES

option. *

In case (1) above, the procedure is used in order to recover the signalling route availability information that may not have been received because of some signalling network failure.

In case (2) above, the positive, negative or restriction² response to the test messages (i.e. the reception of transfer-allowed transfer-prohibited or transfer-restricted² messages) are used to update route status in the signalling point.

In the case of a processor re-initialization, all destinations will be initialized as "accessible." The response mechanism in the transfer-prohibited procedure will correct the status of the destinations which are not "accessible."

12.4.2A ¹⁵As a network option, when a signalling point receives a transfer-cluster-prohibited or transfer-cluster-restricted message from an adjacent signalling transfer point, it may send a cluster signalling-route-set-test message referring to the cluster declared inaccessible or restricted to the adjacent signalling transfer point every T10 until a transfer-cluster-allowed message indicating that the cluster has become accessible is received. *

12.4.3 A signalling-route-set-test message is sent to the adjacent signalling transfer point as an ordinary signalling network management message.

12.4.4 At the reception of a signalling-route-set-test message, a signalling transfer point will compare the status of the destination in the received message with the actual status of the destination. If they are the same no further action is taken. If they are different, one of the following messages is sent in response, dictated by the actual status of the destination:

- (1) A transfer-allowed message, referring to the destination the accessibility of which is tested, if the signalling transfer point can reach the indicted destination via a signalling link not connected to the signalling point from which the signalling-route-set-test message was originated via normal routing;
- (2) A transfer-restricted² message where access to the destination is possible via an alternate to the normal routing which is less efficient, but still not via the signalling point from which the signalling route set test message was originated.
- (3) A transfer-prohibited message in the remaining cases (including the inaccessibility of that destination).

12.4.4A ¹⁵At the reception of a cluster signalling-route-set-test message, a signalling transfer point will compare the status of the cluster in the received message with the actual status of the cluster. If they are the same, no further action is taken. If they are different, one of the following messages is sent in response: *

- (1) A transfer-cluster-allowed message if any destination in the cluster is accessible via its normal routing and that normal routing is not via the signalling point that originated the test. *
- (2) A transfer-cluster-restricted message if a transfer-cluster-allowed message is not sent and any destination in the cluster is accessible through an alternate to its normal routing that does not involve the originating signalling point of the test. *
- (3) A transfer-cluster-prohibited message in the remaining cases. *

12.4.5 At the reception of the transfer-prohibited, transfer-allowed or transfer-restricted message, the signalling point will perform the procedures specified in Sections 12.2, 12.3, or 12.5 respectively.

12.5 Transfer-Restricted²

12.5.1 The transfer-restricted procedure is performed at a signalling point acting as a signalling transfer point for messages relating to a given destination or cluster of destinations, when it has to notify one or more adjacent signalling points that they should, if possible, no longer route the concerned messages via that signalling transfer point. *

SIGNALLING NETWORK FUNCTIONS AND MESSAGES

The transfer-restricted procedure makes use of the transfer-restricted message which contains:

- (1) The label, indicating the destination and originating points;
- (2) The transfer-restricted signal or transfer-cluster-restricted signal; and *
- (3) The destination or cluster of destinations for which traffic transfer is no longer desirable. *

Formats and codes of this message appear in Section 14.

Transfer-restricted messages are always addressed to an adjacent signalling point when the direct link set to that signalling point is available.

Note: Undesirable situations result in increased signalling delays, possibly overloading portions of the network. These inefficiencies could be avoided if the traffic can be appropriately diverted.

12.5.2 A transfer-restricted message relating to a given destination X is sent from a signalling transfer point Y in the following cases (all cases are related to the state of the normal, link set [combined link set] used by signalling point Y to route to destination X): *

- (1) When the normal link set experiences a long-term failure such as an equipment failure. In this case, a transfer-restricted message is sent to all directly accessible adjacent signalling points (Broadcast method). *

Note: Danger of congestion of the lower priority link set used as the alternate route or expiration of T11 characterizes long term failure. Of these two events, whichever arrives first causes invocation of the transfer-restricted procedure. *

- (2) When sufficient links in the normal link set have failed, causing a noticeable capacity reduction, with danger of congestion. In this case the transfer-restricted messages are sent by the response method, i.e., to those adjacent signalling points which are offering traffic to the concerned link set. The detailed criteria for sending transfer-restricted messages in this case are considered to be implementation dependent. The intent of the specification is that the transfer-restricted procedure be used to divert traffic away from the link set with reduced capacity before the crossing of congestion thresholds for the links remaining in service triggers blockage of traffic. *
- (3) When routing to a previously inaccessible destination X becomes possible, but only through a route other than the normal one. In this case a transfer-restricted message is sent to all directly accessible adjacent signalling points (Broadcast method). *
- (4) Optionally, when the processor at signalling transfer point Y is experiencing congestion such that the delivery of messages to destination X may suffer abnormal delay. In this case the transfer-restricted messages are sent by the response method. The criteria for determining congestion are considered to be implementation dependent. Further study is required to determine the criteria for invoking this procedure from a network view. *

12.5.2A When a signalling transfer point Y uses the same normal link set (combined link set) to route to all destinations within a given cluster CX , it may send transfer-cluster-restricted messages relating to that cluster in the following cases: *

- (1) When the normal link set (combined link set) used by signalling transfer point Y to route to cluster CX experiences a long term failure such as an equipment failure. *

Note: Danger of congestion of the lower priority link set used as the alternate route or expiration of T18 characterizes long term failure. Of these two events, whichever arrives first causes invocation of the transfer-cluster-restricted procedure. *

- (2) When routing to the previously inaccessible cluster CX becomes possible, but only through other than the normal link set (combined link set). *

SIGNALLING NETWORK FUNCTIONS AND MESSAGES

In both of the above cases a transfer-cluster-restricted message is sent to all directly accessible adjacent signalling points (Broadcast method). *

12.5.3 When a signalling point receives a transfer-restricted or transfer-cluster-restricted message from signalling transfer point *Y* and has an alternative equal priority link set available and not restricted to destination *X*, it performs the actions in Section 8.2. In other words, it performs controlled rerouting to maintain the sequence of messages while diverting them to the alternate link set. If it cannot perform alternate routing to destination *X* because no alternate link set is available, it may generate additional transfer-restricted or transfer-cluster-restricted messages. *

12.5.4 In some circumstances, it may happen that a signalling point receives either a repeated transfer-restricted message or a transfer-restricted message relating to a nonexistent route (i.e., there is no route from that signalling point to the concerned destination via signalling transfer point *Y*, according to signalling network configuration); in this case, no actions are taken.

12.5.5 When a transfer-restricted message is received updating a transfer-prohibited status, signalling traffic management decides if an alternative route is available or restricted; if it is not (i.e., no alternative route exists), the concerned traffic is restarted towards the signalling point from which the transfer-restricted message was received. Otherwise, no other actions are taken. *

12.5.5A ¹⁵The receipt of a transfer-cluster-restricted message relating to a cluster for which a transfer-cluster-prohibited message has previously been received for the same route causes signalling traffic management to determine if an alternative route is available or restricted; if it is not (i.e., no alternative route is usable), the concerned traffic is restarted towards the signalling point from which the transfer-cluster-restricted message was received. If no intervening transfer-cluster-prohibited message has been received, the receipt of a transfer-cluster-restricted message does not change the prohibited status of any individual signalling point for which a specific transfer-prohibited message has been received. Implementation of the procedures in 12.5.5A is a network option. *

12.6. Transfer-Controlled (International Network).

The only use made of the transfer-controlled procedure in the international signalling network is to convey the congestion indication from the signalling point where congestion was detected to the originating signalling point (see Section 10.2.3) in a transfer-controlled message.

The transfer-controlled message contains:

- (1) The label, indicating the destination and origination points;
- (2) The transfer-controlled signal;
- (3) The identity of the congested destination.

12.7. Transfer Controlled (U. S. Networks) *

12.7.1 The transfer-controlled procedure is performed at a signalling point acting as a signalling transfer point for messages relating to a given destination, when it has to notify one or more originating signalling points that they should no longer send to the concerned destination messages with a given message priority or lower.

The transfer-controlled procedure makes use of the transfer-controlled message which contains:

- (1) The label, indicating the destination and originating points,
- (2) The transfer-controlled signal,
- (3) The destination for which messages with a message priority lower than the specified congestion status should no longer be sent, and
- (4) The current congestion status encountered in routing a particular message towards the concerned destination.

SIGNALLING NETWORK FUNCTIONS AND MESSAGES

Format and coding of this message appear in Section 14.

12.7.2 A transfer-controlled message relating to a given destination X is sent from a signalling transfer point Y in response to a received message originating from signalling point Z destined to signalling point X when the message priority of the concerned message is less than the current congestion status of the signalling link selected to transmit the concerned message from Y to X .

In this case, the transfer-controlled message is sent to the originating signalling point Z with the congestion status field set to the current congestion status of the signalling link.

12.7.3 When the originating signalling point Z receives a transfer-controlled message relating to destination X and if the current congestion status of the signalling route set towards destination X is not greater than the congestion status in the transfer-controlled message, it assigns the congestion status of the signalling route set towards destination X with the value of the congestion status carried in the transfer-controlled message.

12.7.4 If within $T15^{10}$ after the receipt of the last transfer-controlled message relating to destination X , signalling point Z receives another transfer-controlled message relating to the same destination, the following action is taken. If the value of the congestion status carried in the new transfer-controlled message is not less than the current value of the congestion status of the signalling route set towards destination X , then the current value is updated by the new value.

12.7.5 If $T15$ expires after the last update of the congestion status of the signalling route set towards destination X by a transfer-controlled message relating to the same destination, the signalling-route-set-congestion-test procedure is invoked (see Section 12.9).

12.7.6 In some circumstances it may happen that a signalling point receives a transfer-controlled message relating to a destination which is already inaccessible due to previous failures; in this case the transfer-controlled message is ignored.

12.8. Transfer Controlled (National Option without Congestion Priorities).

Deleted.....not applicable to U. S. networks. *

12.9. Signalling-Route-Set-Congestion-Test

12.9.1 The signalling-route-set-congestion-test procedure is used at an originating signalling point to update the congestion status associated with a route set towards a certain destination. The purpose is to test whether or not signalling messages destined towards that destination with a given message priority or higher may be sent.

In the case of a processor restart, the congestion status of all signalling route sets will be initialized to the zero value. Response mechanism within the transfer-controlled procedure will correct signalling route sets whose congestion status does not have the zero value.

The procedure makes use of the signalling-route-set-congestion-test message, and the transfer-controlled procedure.

The signalling-route-set-congestion-test message contains:

- (1) The label, indicating the destination and originating points; and
- (2) The signalling-route-set-congestion-test signal.

Format and coding of this message appear in Section 14.

12.9.2 The signalling-route-set-congestion-test message differs from the other signalling network management messages in that it is not assigned the highest congestion priority. Instead, the congestion priority assigned to a signalling-route-set-congestion-test message to be sent to a given destination is equal to one less than the current congestion status associated with the signalling

SIGNALLING NETWORK FUNCTIONS AND MESSAGES

route set towards that destination.

12.9.3 If within $T16^{10}$ after sending a signalling-route-set-congestion-test message, a transfer-controlled message relating to the concerned destination is received, the signalling point assigns the congestion status of the signalling route set towards the concerned destination with the value of the congestion status carried in the transfer-controlled message. Following this, the procedures specified in Section 12.9.4 are performed.

If $T16$ expires after sending a signalling-route-set-congestion-test message without a transfer-controlled message relating to the concerned destination having been received, the signalling point changes the congestion status associated with the signalling route set towards the concerned destination to the next lower status.

12.9.4 Provided that the signalling route set toward destination X is not in the "unavailable" state, a signalling-route-set-congestion-test message is sent from an originating signalling point to destination X in the following cases:

- (1) When $T15$ expires after the last update of the congestion status of the signalling route set towards destination X by a transfer-controlled message relating to the same destination.
- (2) When $T16$ expires after sending a signalling-route-set-congestion-test message to destination X without a transfer-controlled message relating to the same destination having been received. After the congestion status has decremented by one, the test is repeated, unless the congestion status is zero.

12.9.5 At the reception of the signalling-route-set-congestion-test message, a signalling transfer point will route it as an ordinary message, i.e., according to the procedure specified in Section 2.3.5.

12.9.6 When a signalling-route-set-congestion-test message reaches its destination, it is discarded.

13. Common Characteristics of Message Signal Unit Formats

13.1. General.

The basic signal unit format which is common to all message signal units is described in Q.703, Section 2. From the point of view of the Message Transfer Part Level 3 functions, common characteristics of the message signal units are the presence of:

- (1) The service information octet,
- (2) The label, contained in the signalling information field and, in particular, the routing label.

13.2. Service Information Octet.

The Service Information Octet of the message signal units contains the service indicator and the subservice field. The structure of the service information octet is shown in Figure 13/Q.704.

13.2.1 Service Indicator. The service indicator is used by signalling handling functions to perform message distribution (see Section 2.4) and, in some special applications, to perform message routing (Section 2.3).

The service indicator codes are allocated as follows in U. S. networks:

*

SIGNALLING NETWORK FUNCTIONS AND MESSAGES

bits	D	C	B	A		
	0	0	0	0	Signalling network management messages	
	0	0	0	1	Signalling network testing and maintenance regular messages	
	0	0	1	0	Signalling network testing and maintenance special messages	*
	0	0	1	1	SCCP	
	0	1	0	0	Telephone User Part	
	0	1	0	1	iSDN User Part	
	0	1	1	0	Data User Part (call and circuit related messages)	
	0	1	1	1	Data User Part (facility registration & cancellation messages)	
	1	0	0	0	Spare	
	1	0	0	1	Spare	
	1	0	1	0	Spare	
	1	0	1	1	Spare	
	1	1	0	0	Spare	
	1	1	0	1	Reserved for individual network use (Used for ECIS6 in networks that support ECIS6)	* *
	1	1	1	0	Reserved for individual network use	*
	1	1	1	1	Spare	

The allocation of the service indicator codes for national signalling networks is a national matter. However, the above allocation of service indicator codes agrees with the allocation for international signalling given in the CCITT Red Book Recommendation Q.704 [1], except that codes 0010, 1101, and 1110 are spare in the Red Book. *

13.2.2 Subservice Field. The subservice field contains the network indicator (bits C and D) and two spare bits (bits A and B). The network indicator is used by signalling message handling functions (e.g., to determine the relevant version of a User Part); see Section 2.3 and 2.4.

If the network indicator is set to 00 or 01, the two spare bits coded 00, are available for possible future needs that may require a common solution for all international User Parts.

If the network indicator is set to 10 or 11 the two spare bits, are for national use. They may be used, for example, to indicate message priority, which is used in the optional flow control procedure in national applications.

The network indicator provides for discrimination between international and national messages. It can also be used, for example, for the discrimination between functionally two national signalling networks, each having different routing label structures and up to 16 User Parts defined by the 16 possible codes of the service indicator.

In the case of only one national signalling network the spare code of the network indicator reserved for national use can be used, for example, to define an additional 16 users (making a total of 32 User Parts) for that national signalling network.

The network indicator codes are allocated as follows:

bits	D	C	
	0	0	International message
	0	1	Spare (for international use only)
	1	0	National network
	1	1	Reserved for national use.

The international spare code (01) should not be used for implementing features which are to be provided both internationally and nationally.

In national applications, when the discrimination provided by the network indication between international and national messages is not used, i.e., in a closed national signalling network seen from the signalling point of view, the whole subservice field can be used independently for different

SIGNALLING NETWORK FUNCTIONS AND MESSAGES

User Parts.

In U. S. networks the message priority codes are allocated as follows:

bits	B	A	
	0	0	priority 0
	0	1	priority 1
	1	0	priority 2
	1	1	priority 3

Priority 3 is reserved for network management messages or other messages critical to the performance of the MTP.

13.3. Label.

The structure and content of the label is defined for each User Part, and is defined in the relevant specification. The common part of the label used for signalling message handling, the routing label, is specified in Section 2.2.

14. Format and Codes of Signalling Network Management Messages

14.1. General

14.1.1 The signalling network management messages are carried on the signalling channel in message signal units, the format of which is described in Section 13 and in Recommendation Q.703, Section 2. In particular, as indicated in Section 13.2, these messages are distinguished by the configuration of the Service Indicator (SI). The Network Indicator (NI) field of the messages is used according with the rules also indicated in Section 13.2.

14.1.2 The signalling information field consists of an integral number of octets, and contains the label, the heading code, and one or more signals and indications. The structure and function of the label, and of the heading code, are described in Sections 14.2 and 14.3, respectively; the detailed message formats are described in the following sections. For each message, the sequence of fields is shown in the corresponding figure, including fields that may or may not be present.

In the figures, the fields are shown starting from the right to the left (i.e., the first field to be transmitted is at the right). Within each field, the information is transmitted least significant bit first. Spare bits are coded 0 unless otherwise indicated.

14.1.2A The formats shown are those for signalling network management messages in U. S. networks. The formats for use in the international international signalling network are generally similar, but CCITT Recommendation Q.704 should be consulted for details [1].

14.2 Label¹⁶

For signalling network management messages, the label coincides with the routing label.

14.3 Heading Code (H0).

The heading code (H0) is the 4 bit field following the label, and identifies the message group.

The different heading codes are allocated as follows:

16. Text from CCITT Red Book referring to the use of the SLS field to carry the SLC was deleted from this section.

SIGNALLING NETWORK FUNCTIONS AND MESSAGES

0000	Spare
0001	Changeover and changeback messages
0010	Emergency changeover message
0011	Transfer-controlled and signalling-route-set-congestion-test messages
0100	Transfer-prohibited, -allowed, -restricted messages
0101	Signalling-route-set-test messages
0110	Management inhibiting messages
0111	Spare
1000	Signalling-data-link-connection messages

The remaining codings are spare.

The synopsis of signalling network management messages is given in Table 1.

14.4 Changeover Message

14.4.1 The format of the changeover message is shown in Figure 15/Q.704.

14.4.2 The changeover message is made up of the following fields:

- (1) Label (56 bits): see Section 14.2 *
- (2) Heading code H0 (4 bits): see Section 14.3
- (3) Heading code H1 (4 bits): see Section 14.4.3
- (4) SLC (4 bits) indicating the identity of the unavailable signalling link *
- (5) Forward sequence number of last accepted message signal unit (7 bits)
- (6) Spare (5 bits) coded 00000. *

14.4.3 The heading code H1 contains signal codes as follows:

bit	D	C	B	A	
	0	0	0	1	Changeover order signal
	0	0	1	0	Changeover acknowledgement signal

14.5 Changeback Message

14.5.1 The format of the changeback message is shown in Figure 16/Q.704.

14.5.2 The changeback message is made up of the following fields:

- (1) Label (56 bits): see Section 14.2 *
- (2) Heading code H0 (4 bits): see Section 14.3
- (3) Heading code H1 (4 bits): see Section 14.5.3
- (4) SLC (4 bits) indicating the identity of link to which traffic will be diverted *
- (5) Changeback code (8 bits): see Section 14.5.4
- (6) Spare (4 bits) coded 0000. *

14.5.3 The heading code H1 contains signal codes as follows:

bit	D	C	B	A	
	0	1	0	1	Changeback declaration signal
	0	1	1	0	Changeback acknowledgement signal

SIGNALLING NETWORK FUNCTIONS AND MESSAGES

14.5.4 The changeback code is an 8-bit code assigned by the signalling point which sends the message according to the criteria described in Section 6.

14.6 Emergency Changeover Message

14.6.1 The format of the emergency changeover message is shown in Figure 17/Q.704.

14.6.2 The emergency changeover message is made up of the following fields:

- (1) Label (56 bits): see Section 14.2 *
- (2) Heading code H0 (4 bits): see Section 14.3
- (3) Heading code H1 (4 bits): see Section 14.6.3
- (4) SLC (4 bits), indicating the identity of the unavailable signalling link *
- (5) Spare (4 bits) coded 0000. *

14.6.3 The heading code H1 contains signal codes as follows:

bit	D	C	B	A	
	0	0	0	1	Emergency changeover order signal
	0	0	1	0	Emergency changeover acknowledgement signal

14.7 Transfer-Prohibited Message

14.7.1 The format of the transfer-prohibited message is shown in Figure 18/Q.704.

14.7.2 The transfer-prohibited message is made up of the following fields:

- (1) Label (56 bits): see Section 14.2 *
- (2) Heading code H0 (4 bits): see Section 14.3
- (3) Heading coding H1 (4 bits): see Section 14.7.3
- (4) Destination (24 bits): see Section 14.7.4. *

14.7.3 The heading code H1 contains the signal codes as follows:

bit	D	C	B	A	
	0	0	0	1	Transfer-prohibited signal
	0	0	1	0	Transfer-cluster-prohibited signal

14.7.4 The destination field contains the identity of the signalling point to which the message refers for the transfer-prohibited message and the identity of the cluster for the transfer-cluster-prohibited message. *

14.8 Transfer-Allowed Message

14.8.1 The format of the transfer-allowed message is shown in Figure 19/Q.704.

14.8.2 The transfer-allowed message is made up of the following fields:

- (1) Label (56 bits): see Section 14.2 *
- (2) Heading code H0 (4 bits): see Section 14.3
- (3) Heading code H1 (4 bits): see Section 14.8.3
- (4) Destination (24 bits): see Section 14.8.3A. *

14.8.3 The heading code H1 contains signal codes as follows:

bit	D	C	B	A	
	0	1	0	1	Transfer-allowed signal
	0	1	1	0	Transfer-cluster-allowed signal

SIGNALLING NETWORK FUNCTIONS AND MESSAGES

14.8.3A The destination field contains the identity of the signalling point to which the message refers for the transfer allowed message and the identity of the cluster for the transfer-cluster-allowed message. *

14.9 Transfer-Restricted Message²

14.9.1 The format of the transfer-restricted is shown in Figure 18/Q.704.

14.9.2 The transfer-restricted message is made up of the following fields:

- (1) Label (56 bits): see Section 14.2 *
- (2) Heading code H0 (4 bits): see Section 14.3 *
- (3) Heading code H1 (4 bits): see Section 14.9.3 *
- (4) Destination (24 bits): see Section 14.9.4. *

14.9.3 The heading code H1 contains signal codes as follows:

bit	D	C	B	A	
	0	0	1	1	Transfer-restricted
	0	1	0	0	Transfer-cluster-restricted *

14.9.4 The destination field contains the identity of the signalling point to which the message refers for the transfer-restricted message and the identity of the cluster for the transfer-cluster-restricted message. *

14.10 Signalling-Route-Set-Test Message

14.10.1 The format of the signalling-route-set-test message is shown in Figure 20/Q.704.

14.10.2 This message is made up of the following fields:

- (1) Label (56 bits): see Section 14.2 *
- (2) Heading code H0 (4 bits): see Section 14.3 *
- (3) Heading code H1 (4 bits): see Section 14.10.3 *
- (4) Destination (24 bits): see Section 14.7.3 *

14.10.3 The heading H1 codes are allocated as follows:

bit	D	C	B	A	
	0	0	0	1	Signalling-route-set-test signal for prohibited destination
	0	0	1	0	Signalling-route-set-test signal for restricted destination ²
	0	0	1	1	Signalling-route-set-test signal for prohibited cluster *
	0	1	0	0	Signalling-route-set-test signal for restricted cluster ² *

14.11 Management Inhibit Message

14.11.1 The format of the management inhibit message is shown in Figure 20A/Q.704.

14.11.2 The management inhibit message is made up of the following fields:

- (1) Label (56 bits): see Section 14.2 *
- (2) Heading code H0 (4 bits): see Section 14.3 *

SIGNALLING NETWORK FUNCTIONS AND MESSAGES

- (3) Heading code H1 (4 bits): see Section 14.11.3
- (4) SLC (4 bits) indicating the identity of the signalling link to be inhibited *
- (5) Spare (4 bits): Coded 0 0 0 0. *

14.11.3 The heading code H1 contains signal codes as follows:

bit	D	C	B	A	
0	0	0	0	1	Link inhibit signal
0	0	0	1	0	Link uninhibit signal
0	0	0	1	1	Link inhibit acknowledgement signal
0	1	0	0	0	Link uninhibit acknowledgement signal
0	1	0	1	1	Link inhibit denied signal
0	1	1	0	0	Link force uninhibit signal
0	1	1	1	1	Link local inhibit test signal *
1	0	0	0	0	Link remote inhibit test signal *

14.12 Signalling-Data-Link-Connection-Order Message

14.12.1 The format of the signalling-data-link-connection-order message is shown in Figure 21/Q.704.

14.12.2 The signalling-data-link-connection-order message is made up of the following fields:

- (1) Label (56 bits): see Section 14.2 *
- (2) Heading code H0 (4 bits): see Section 14.3
- (3) Heading code H1 (4 bits): see Section 14.12.3
- (4) SLC (4 bits), indicating the identity of the signalling link being activated or restored *
- (5) Signalling data link identity (14 bits): see Section 14.12.4 *
- (6) Spare (6 bits) coded 000000. *

14.12.3 The heading code H1 contains one signal code as follows:

bit	D	C	B	A	
0	0	0	0	1	Signalling-data-link-connection-order signal

14.12.4 The signalling data link identity field contains the Circuit Identification Code (CIC), or the Bearer Identification Code (BIC) in case of a 56 kbit/s channel used to carry submultiplexed data streams, of the transmission link corresponding to the signalling data link.

14.13 Signalling-Data-Link-Connection-Acknowledgement Message

14.13.1 The format of the signalling-data-link-connection-acknowledgement message is shown in Figure 22/Q.704.

14.13.2 The signalling-data-link-connection-acknowledgement message is made up of the following fields:

- (1) Label (56 bits): see Section 14.2 *
- (2) Heading code H0 (4 bits): see Section 14.3
- (3) Heading code H1 (4 bits): see Section 14.13.3
- (4) SLC (4 bits), indicating the identity of the signalling link being activated or restored. *
- (5) Spare (4 bits), coded 0000.

14.13.3 The heading code H1 contains signalling codes as follows:

SIGNALLING NETWORK FUNCTIONS AND MESSAGES

bit	D	C	B	A	
	0	0	1	0	Connection-successful signal
	0	0	1	1	Connection-not-successful signal
	0	1	0	0	Connection-not-possible signal

14.14 Transfer-Controlled Message

14.14.1 The format of the TFC message is shown in Figure 22A/Q.704.

14.14.2 The transfer-controlled message is made up of the following fields:

- (1) Label (56 bits): see Section 14.2 *
- (2) Heading Code H0 (4 bits): see Section 14.3 *
- (3) Heading Code H1 (4 bits): see Section 14.14.3 *
- (4) Destination (24 bits): see Section 14.14.4 *
- (5) Status (2 bits): see Section 14.14.5 *
- (6) Spare (6 bit): justifies to integral number of octets *

14.14.3 The heading code H1 contains one signal code as follows:

bit	D	C	B	A	
	0	0	1	0	Transfer-controlled signal

14.14.4 The destination field carries the address of the destination to which the message refers.

14.14.5 The status field in the transfer-controlled message is used to carry the congestion status associated with the destination.

14.15 Signalling-Route-Set-Congestion-Test Message²

14.15.1 The format of the signalling-route-set-congestion-test message is shown in Figure 22B/Q.704.

14.15.2 The signalling-route-set-congestion-test message is made up of the following fields:

- (1) Label (56 bits): see Section 14.2 *
- (2) Heading code H0 (4 bits): see Section 14.3
- (3) Heading code H1 (4 bits): see Section 14.15.3

14.15.3 The heading code H1 contains one signal code as follows:

bit	D	C	B	A	
	0	0	0	1	Signalling-route-set-congestion-test signal

SIGNALLING NETWORK FUNCTIONS AND MESSAGES

Message Group	H1	0000	0001	0010	0011	0100	0101	0110	0111	1000	1001	1010	1011	1100	1101	1110	1111	
	H0																	
	0000																	
CHM	0001	COO	COA					CBD	CBA									
ECM	0010	ECO	ECA															
FCM	0011	RCT	TFC															
TFM	0100	TFP	TCP	TFR	TGR	TFA	TCA											
RSM	0101	RSP	RSR	RCP	RCR													
MIM	0110	LIN	LUN	LIA	LUA	LID	LFU	LLI	LRI									
	0111																	
DLM	1000	DLC	CSS	CNS	CNP													
	1001																	
	1010																	
	1011																	
	1100																	
	1101																	
	1110																	
	1111																	

TABLE 1/Q.704 - Heading code allocation of signalling network management messages

SIGNALLING NETWORK FUNCTIONS AND MESSAGES

CBA - Changeback-acknowledgement signal
CBD - Changeback-declaration signal
CHM - Changeover and changeback messages
CNP - Connection-not-possible signal
CNS - Connection-not-successful signal
COA - Changeover-acknowledgement signal
COO - Changeover-order signal
CSS - Connection-successful signal
DLC - Signalling-data-link-connection-order signal
DLM - Signalling-data-link-connection-order message
ECA - Emergency-changeover-acknowledgement signal
ECM - Emergency-changeover message
ECO - Emergency-changeover-order signal
FCM - Signalling-traffic-flow control messages
LFU - Link forced uninhibit message
LIA - Link inhibit acknowledgement message
LID - Link inhibit denied message
LIN - Link inhibit message
LUA - Link uninhibit acknowledgement
LUN - Link uninhibit message
MIM - Management inhibiting messages
RCP - Signaling-route-set-test cluster-prohibited signal
RCR - Signalling-route-set-test cluster-restricted signal
RCT - Signalling-route-set-congestion-test signal
RSM - Signalling-route-set-test message
RSP - Signalling-route-set-test prohibited signal
RSR - Signalling-route-set-test restricted signal
TCA - Transfer-cluster-allowed signal
TCP - Transfer-cluster-prohibited signal
TCR - Transfer-cluster-restricted signal
TFA - Transfer-allowed signal
TFC - Transfer-controlled signal
TFM - Transfer-prohibited, transfer-allowed, transfer-restricted messages
TFP - Transfer-prohibited signal
TFR - Transfer-restricted signal

SIGNALLING NETWORK FUNCTIONS AND MESSAGES

15. State Transition Diagrams

15.1 General. For each major function, a figure illustrates a subdivision into functional specification blocks, showing their functional interactions as well as the interactions with the other major functions. In each case, this is followed by figures showing state transition diagrams for each of the functional specification blocks.

The detailed functional breakdown shown in the following diagrams is intended to illustrate a reference model, and to assist interpretation of the text in the earlier sections. The state transition diagrams are intended to show precisely the behavior of the signalling system under normal and abnormal conditions as viewed from a remote location. It must be emphasized that the functional partitioning shown in the following diagrams is used to facilitate understanding of the system behavior, and is not intended to specify the functional partitioning to be adopted in a practical implementation of the signaling system.

15.2 Drafting Conventions

15.2.1 Each major function is designated by its acronym (e.g., SMH = signalling message handling).

15.2.2 Each functional block is designated by an acronym which identifies it, and also identifies the major function to which it belongs (e.g., HMRT = signalling message handling-message routing; TLAC = signalling traffic management-link availability control).

15.2.3 External input and outputs are used for interactions between different functional blocks. Included within each input and output symbol in the state transition diagrams are acronyms which identify the functions which are the source and destination of the message, e.g.:

L2 → L3 indicates that the message is sent between functional levels:

from: functional level 2,
to: functional level 3.

RTPC → TSRC indicates that the message is sent within a functional level (3 in this case):

from: signalling route management - transfer prohibited control,
to: signalling traffic management - signalling routing control.

15.2.4 Internal inputs and outputs are only used to indicate control of time-outs.

15.2.5 Notation for national options (deleted...not used in this specification). *

15.3 Signalling Message Handling. Figure 23/Q.704 shows a subdivision of the Signalling Message Handling (SMH) function into smaller functional specification blocks, and also shows the functional interactions between them. Each of these functional specification blocks is described in detail in a state transition diagram as follows:

- (1) Message discrimination (HMDC) is shown in Figure 24/Q.704;
- (2) Message distribution (HMDD) is shown in Figure 25/Q.704;
- (3) Message routing (HMRT) is shown in Figure 26/Q.704.
- (4) Handling of messages under signalling link congestion (HMCG) is shown in Figure 26A/Q.704.

15.4 Signalling Traffic Management. Figure 27/Q.704 shows a subdivision of the Signalling Traffic Management (STM) function into smaller functional specification blocks, and also shows functional interactions between them. Each of these functional specification blocks is

SIGNALLING NETWORK FUNCTIONS AND MESSAGES

described in detail in a state transition diagram as follows:

- (1) Link availability control (TLAC) is shown in Figure 28/Q.704;
- (2) Signalling routing control (TSRC) is shown in Figure 29/Q.704;
- (3) Changeover control (TCOC) is shown in Figure 30/Q.704;
- (4) Changeback control (TCBC) is shown in Figure 31/Q.704;
- (5) Forced rerouting control (TFRC) is shown in Figure 32/Q.704;
- (6) Controlled rerouting control (TCRC) is shown in Figure 33/Q.704;
- (7) Signalling traffic flow control (TSFC) is shown in Figure 34/Q.704;
- (8) Signalling route set congestion control (TRCC) is shown in Figure 29A/Q.704.

15.5 Signalling Link Management. Figure 35/Q.704 shows a subdivision of the Signalling Link Management Function (SLM) into smaller functional specification blocks, and also shows functional interactions between them. Each of these functional specification blocks is described in detail in a state transition diagram as follows:

- (1) Link set control (LLSC) is shown in Figure 36/Q.704;
- (2) Signalling link activity control (LSAC) is shown in Figure 37/Q.704;
- (3) Signalling link activation (LSLA) is shown in Figure 38/Q.704;
- (4) Signalling link restoration (LSLR) is shown in Figure 39/Q.704;
- (5) Signalling link deactivation (LSLD) is shown in Figure 40/Q.704;
- (6) Signalling terminal allocation (LSTA) is shown in Figure 41/Q.704;
- (7) Signalling data link allocation (LSDA) is shown in Figure 42/Q.704.

15.6 Signalling Route Management. Figure 43/Q.704 shows a subdivision of the Signalling Route Management (SRM) function into smaller functional specification blocks, and also shows functional interactions between them. Each of these functional specification blocks is described in detail in a state transition diagram as follows:

- (1) Transfer-prohibited control (RTPC) is shown in Figure 44/Q.704;
- (2) Transfer-allowed control (RTAC) is shown in Figure 45/Q.704;
- (3) Transfer-restricted control (RTRC) is shown in Figure 46C/Q.704;
- (4) Transfer-controlled control (RTCC) is shown in Figure 46A/Q.704;
- (5) Signalling-route-set-test control (RSRT) is shown in Figure 46/Q.704;
- (6) Signalling-route-set-congestion-test control (RCAT) is shown in Figure 46B/Q.704.

SIGNALLING NETWORK FUNCTIONS AND MESSAGES

15.7 Abbreviations and Timers Used in Figures 23/Q.704 to 46C/Q.704.

BSNT	Backward sequence number of next signal unit to be transmitted
DPC	Destination Point Code
FSNC	Forward sequence number of last message signal unit accepted by remote level 2
HMCG	Signalling link congestion
HMDC	Message discrimination
HMDT	Message distribution
HMRT	Message routing
L1	Level 1
L2	Level 2
L3	Level 3
L4	Level 4
LLSC	Link set control
LSAC	Signalling link activity control
LSDA	Signalling data link allocation
LSLA	Signalling link activation
LSLD	Signalling link deactivation
LSLR	Signalling link restoration
LSTA	Signalling terminal allocation
MGMT	Management system
RCAT	Signalling-route-set-congestion-test control
RSRT	Signalling-route-set-test-control
RTAC	Transfer-allowed control
RTCC	Transfer-controlled control
RTPC	Transfer-prohibited control
RTRC	Transfer-restricted control
SLM	Signalling link management
SLS	Signalling link selection
SMH	Signalling message handling
SRM	Signalling route management
SLTC	Signalling link test control
STM	Signalling traffic management
TCBC	Changeback control
TCOC	Changeover control
TCRC	Controlled rerouting control
TFRC	Forced rerouting control
TLAC	Link availability control
TRCC	Signalling route congestion control
TSFC	Signalling traffic flow control
TSRC	Signalling routing control

SIGNALLING NETWORK FUNCTIONS AND MESSAGES

Timers		Recommended Range ¹⁸ (seconds)	
T1	Delay to avoid message mis-sequencing on changeover	0.5 (0.8) to 1.2	
T2	Waiting for changeover acknowledgement	0.7 (1.4) to 2.0	
T3	Time controlled diversion — delay to avoid mis-sequencing on changeback	0.5 (0.8) to 1.2	
T4	Waiting for changeback acknowledgement (first attempt)	0.5 (0.8) to 1.2	
T5	Waiting for changeback acknowledgement (second attempt)	0.5 (0.8) to 1.2	
T6	Delay to avoid message mis-sequencing on controlled rerouting	0.5 (0.8) to 1.2	
T7	Waiting for signalling data link connection acknowledgement	1 to 2	
T8	Transfer-prohibited inhibited timer (transient solution)	0.8 to 1.2	
T9		not used	
T10	Waiting to repeat signalling-route-set-test message	30 to 60	
T11	Transfer-restricted timer.	30 to 90	
T12	Waiting for uninhibit acknowledgement	0.8 to 1.5	
T13	Waiting for force uninhibit	0.8 to 1.5	
T14	Waiting for inhibition acknowledgement	2 to 3	
T15	Waiting for repeat signalling route set congestion test	2 to 3	
T16	Waiting for route set congestion status update	1.4 to 2.0	
T17	Delay to avoid oscillation of initial alignment failure and link restart	0.8 to 1.5	
T18	Transfer-cluster-restricted timer	30 to 90	*
T19	Failed link craft referral timer	480 to 600	*
T20	Waiting to repeat local inhibit test	90 to 120	*
T21	Waiting to repeat remote inhibit test	90 to 120	*

¹⁸ The values in parentheses are the lower bounds to be used for long propagation delay signalling routes, e.g., routes using satellite sections.

SIGNALLING NETWORK FUNCTIONS AND MESSAGES

REFERENCES

- [1] CCITT Recommendation Q.704 "Signalling Network Functions and Messages," *CCITT Red Book*, Vol. VI, Fascicle VI.7, Geneva, Switzerland: International Telecommunication Union, 1985.

SIGNALLING NETWORK FUNCTIONS AND MESSAGES

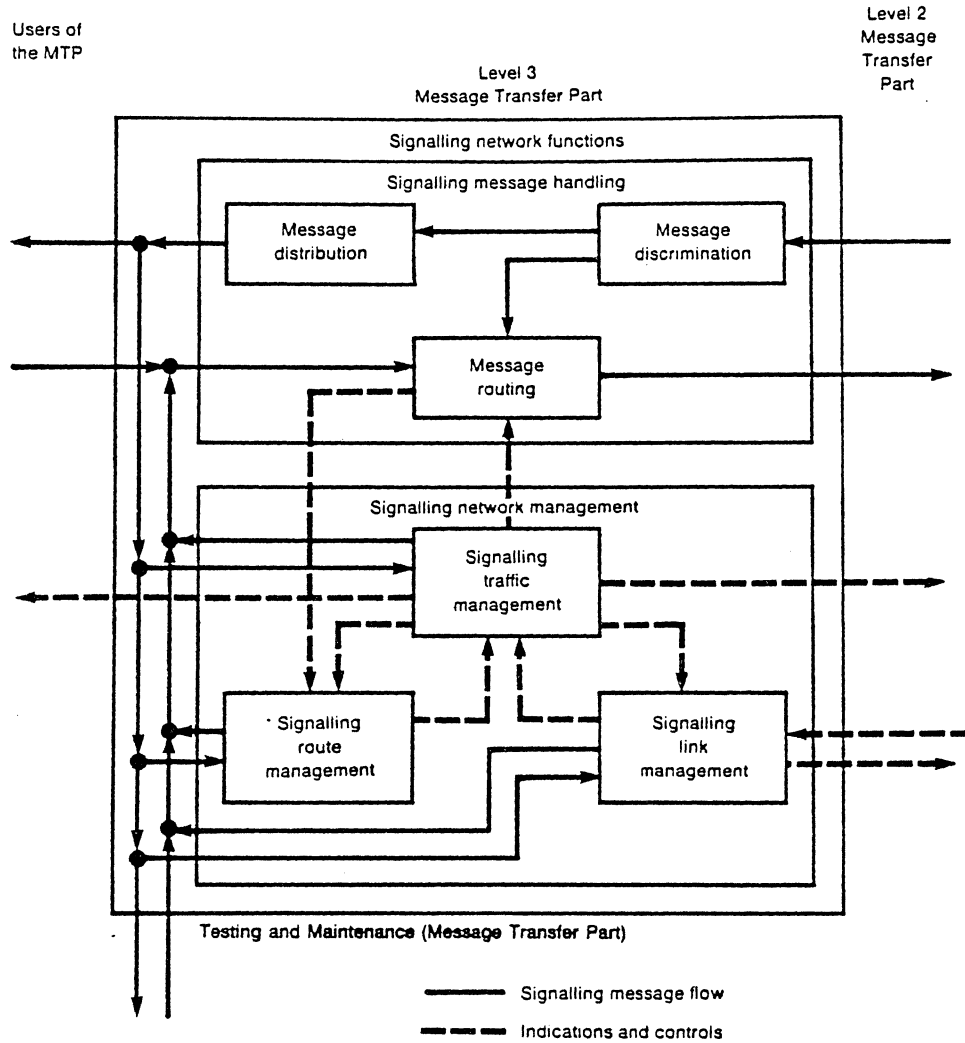

Figure 1/Q.704 - Signalling Network Functions

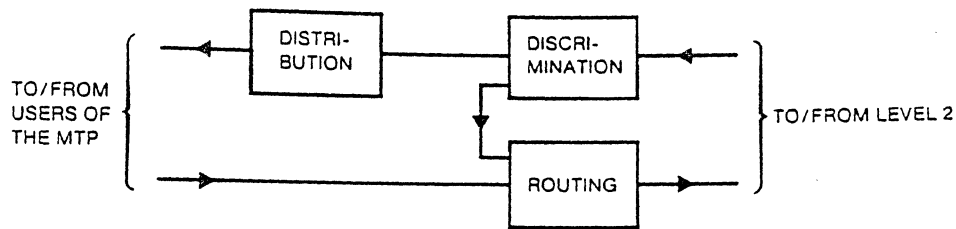

Figure 2/Q.704 - Message Routing, Discrimination and Distribution

SIGNALLING NETWORK FUNCTIONS AND MESSAGES

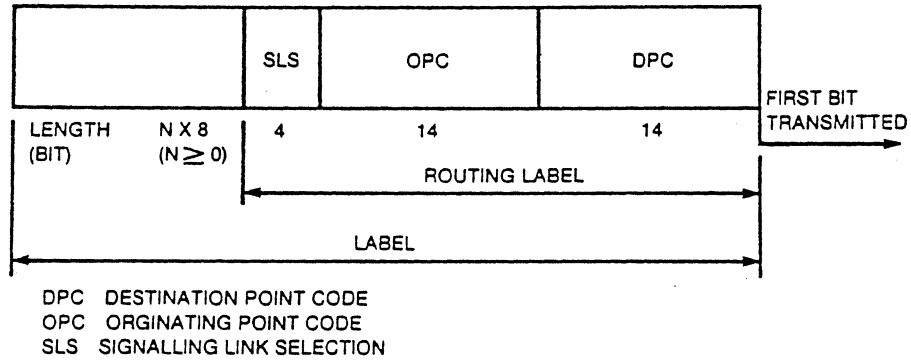

Figure 3/Q.704 - International Routing Label Structure

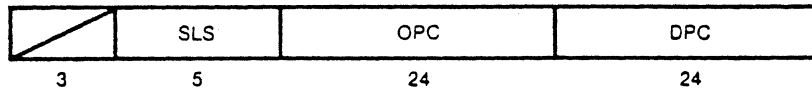
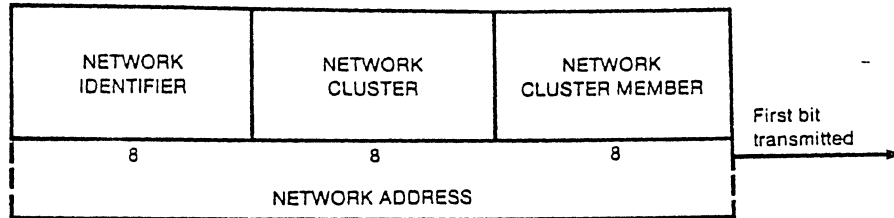

Figure 3A/Q.704 - Routing Label Structure for U.S. Networks

*
*
*
*
*
*
*
*
*
*

SIGNALLING NETWORK FUNCTIONS AND MESSAGES



*
*
*
*
*
*
*
*
*
*

Figure 3B/Q.704 - Signalling Point Code Structure

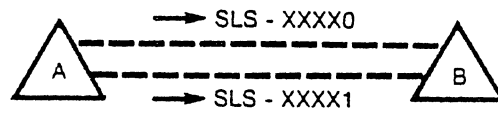

Figure 4/Q.704 - Example of Load Sharing Within a Link Set

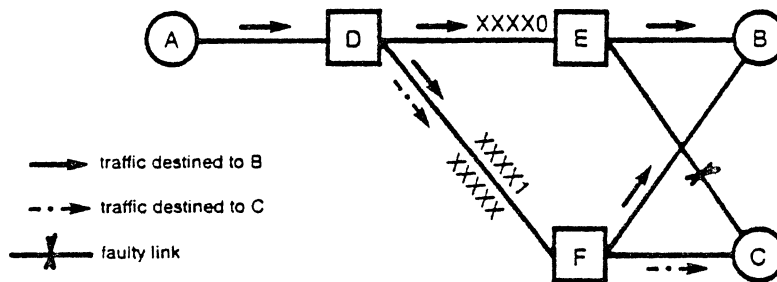

Figure 5/Q.704 - Example of Load Sharing Between Link Sets

SIGNALLING NETWORK FUNCTIONS AND MESSAGES

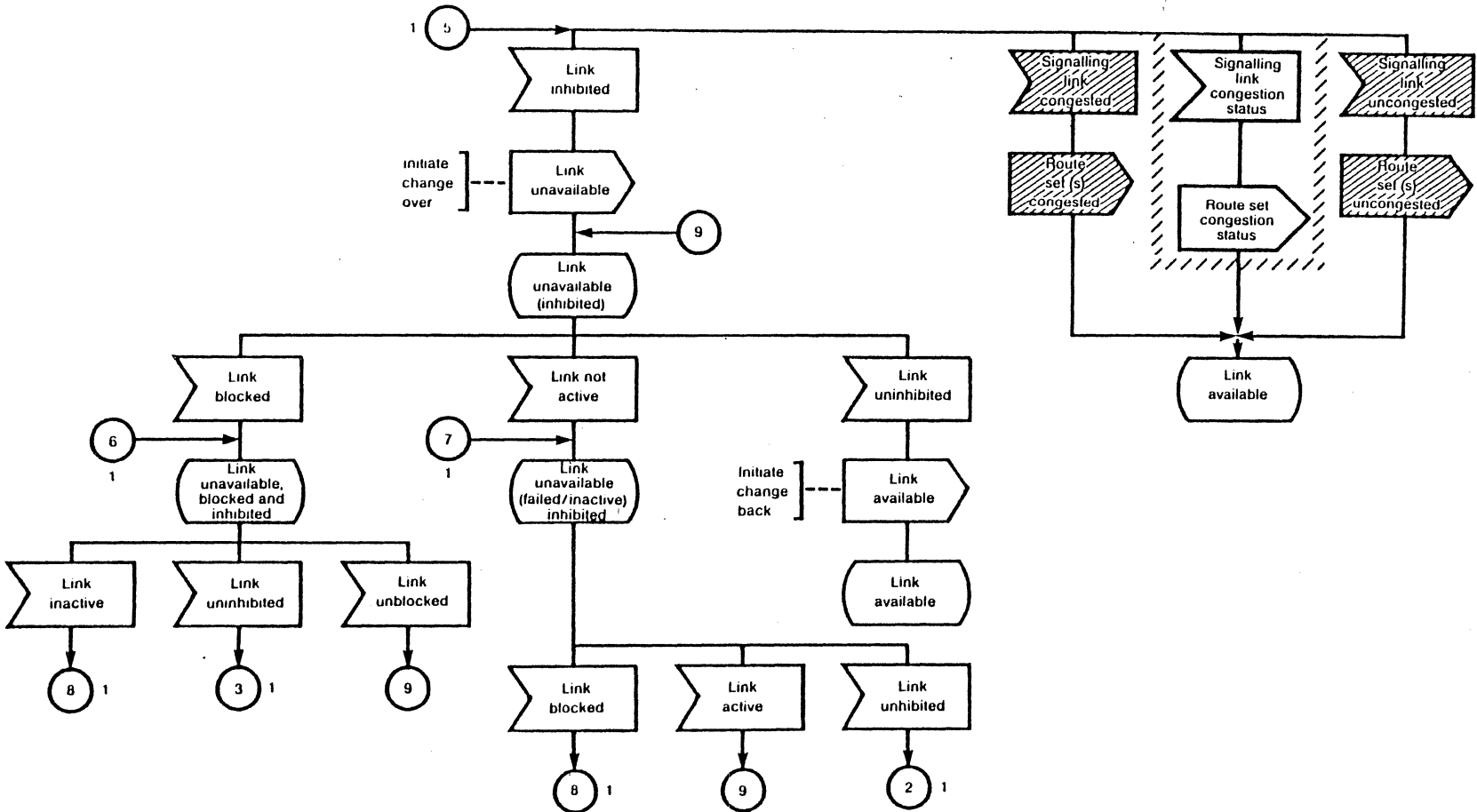

Figure 6/Q.704 -
 Signalling traffic management overview diagram:
 signalling link availability (sheet 1 of 4)

-03-

SIGNALLING NETWORK FUNCTIONS AND MESSAGES

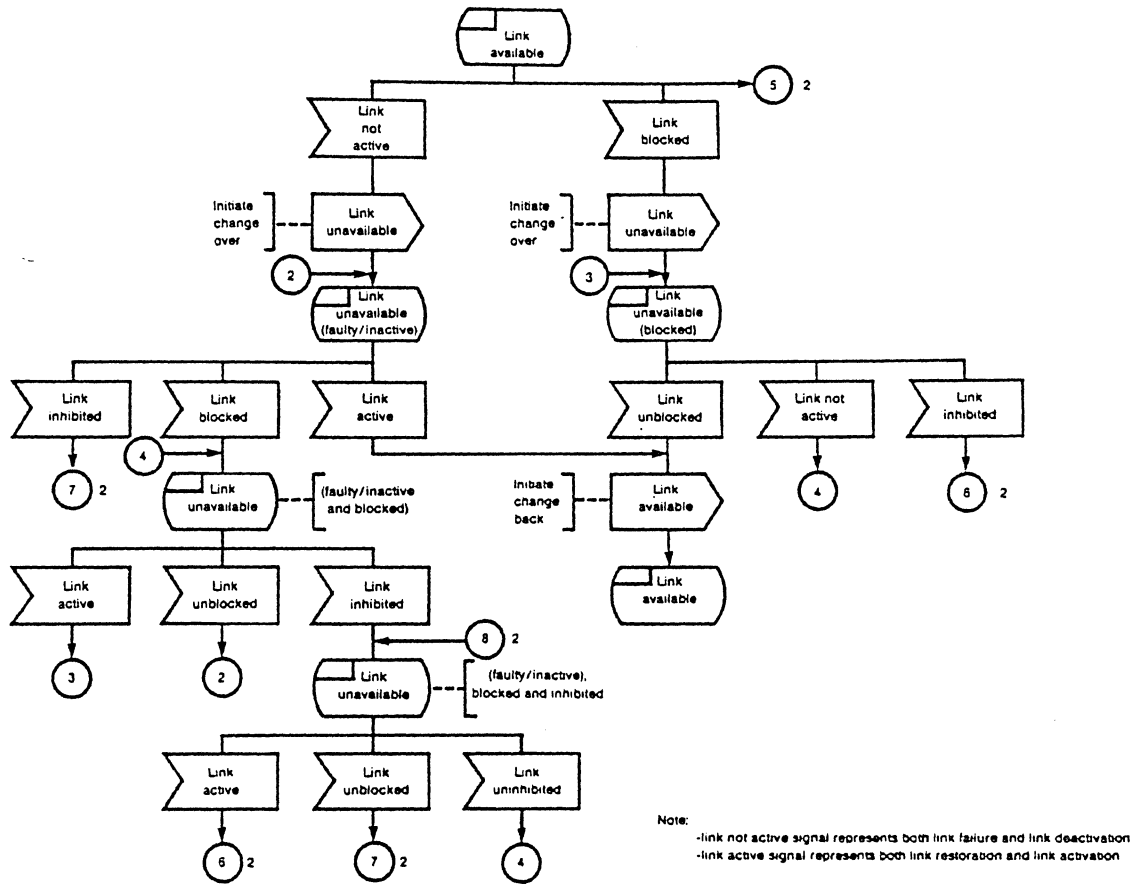

Figure 6/Q.704 (sheet 2 of 4) - Signalling Traffic Management Overview Diagram Signalling Link Availability

SIGNALLING NETWORK FUNCTIONS AND MESSAGES

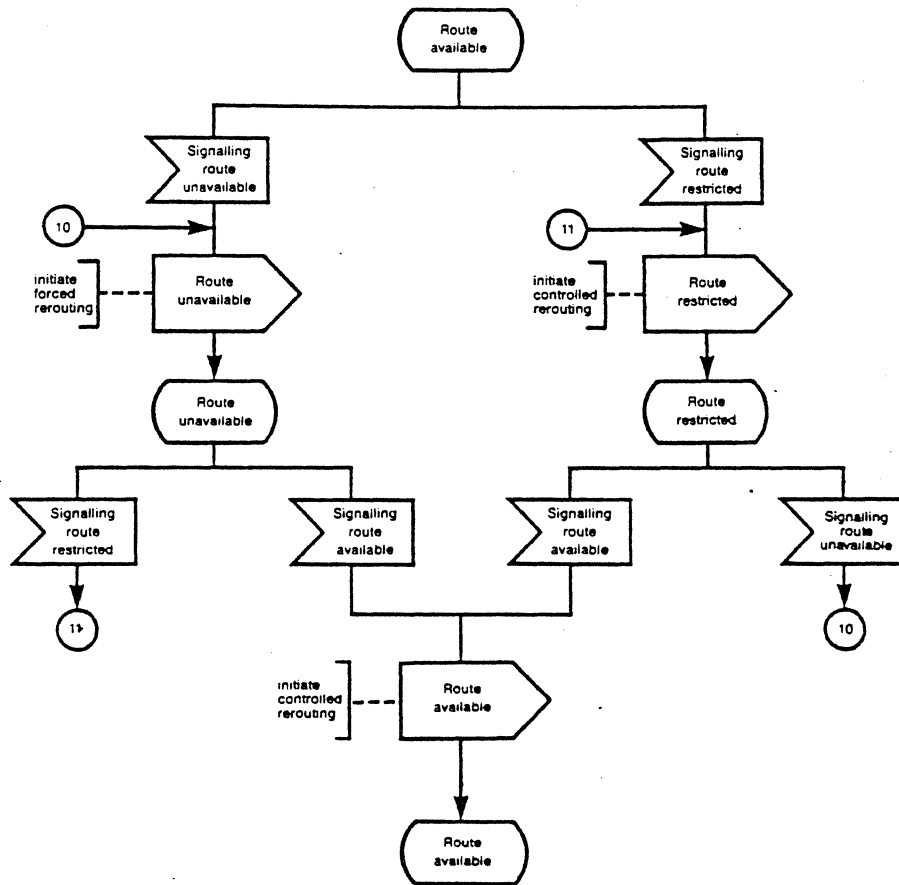

Figure 6/Q.704 (sheet 3 of 4) - Signalling Traffic Management Overview Diagram Signalling Route Availability Status

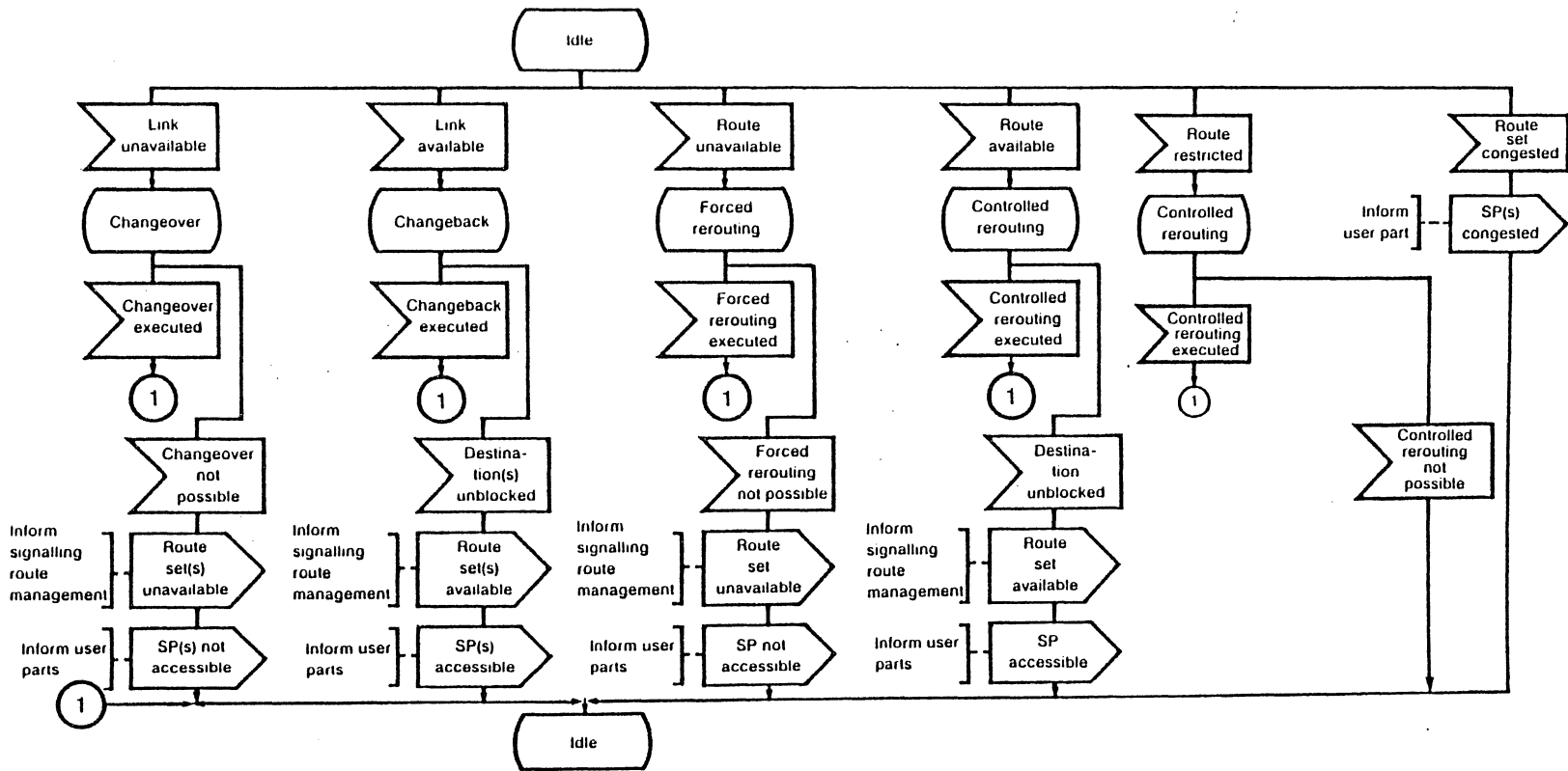

Figure 6/Q.704 -
 Signalling traffic management overview diagram:
 signalling link availability (sheet 4 of 4)

SIGNALLING NETWORK FUNCTIONS AND MESSAGES

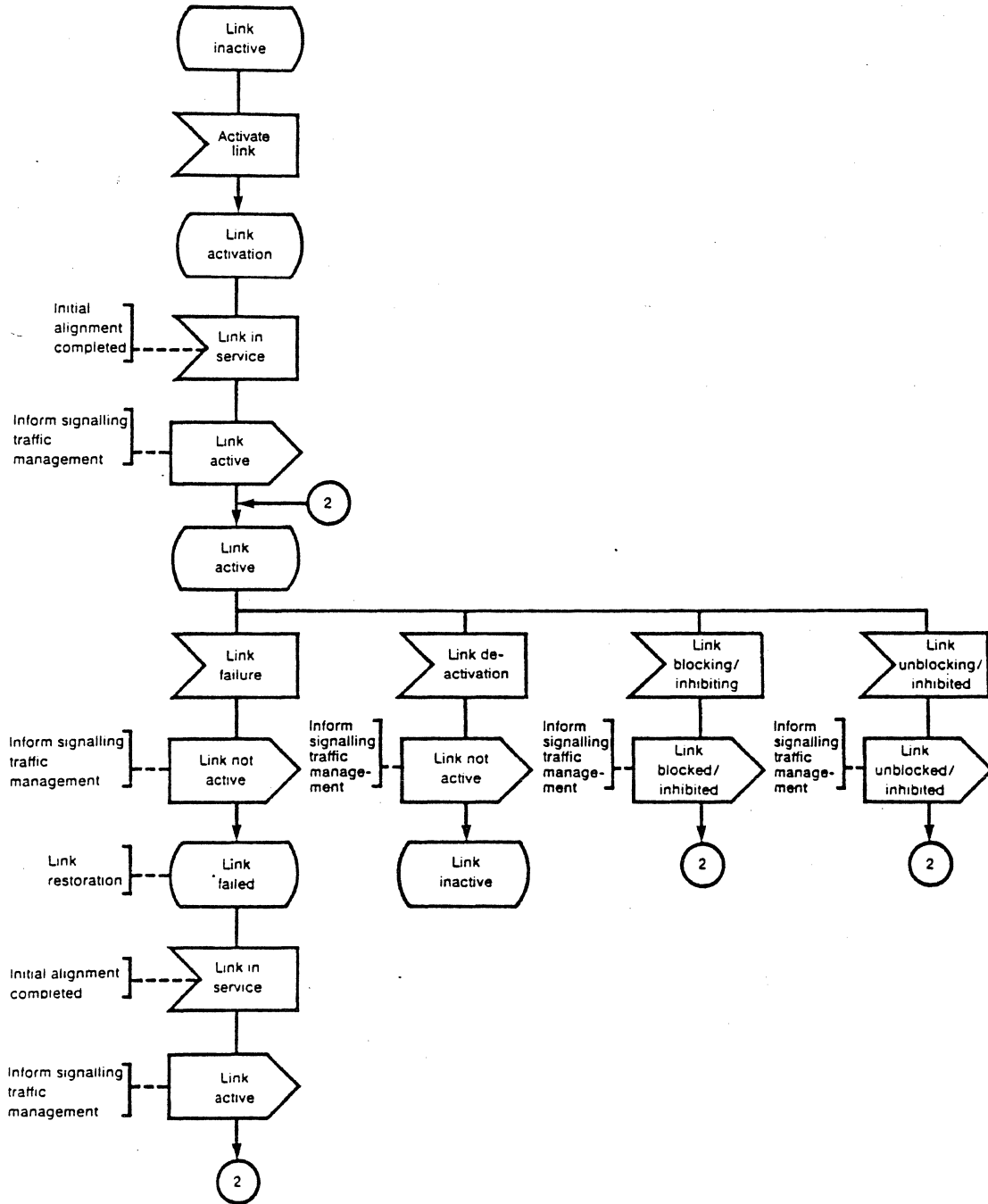

Figure 7/Q.704 - Signalling Link Management Overview Diagram

SIGNALLING NETWORK FUNCTIONS AND MESSAGES

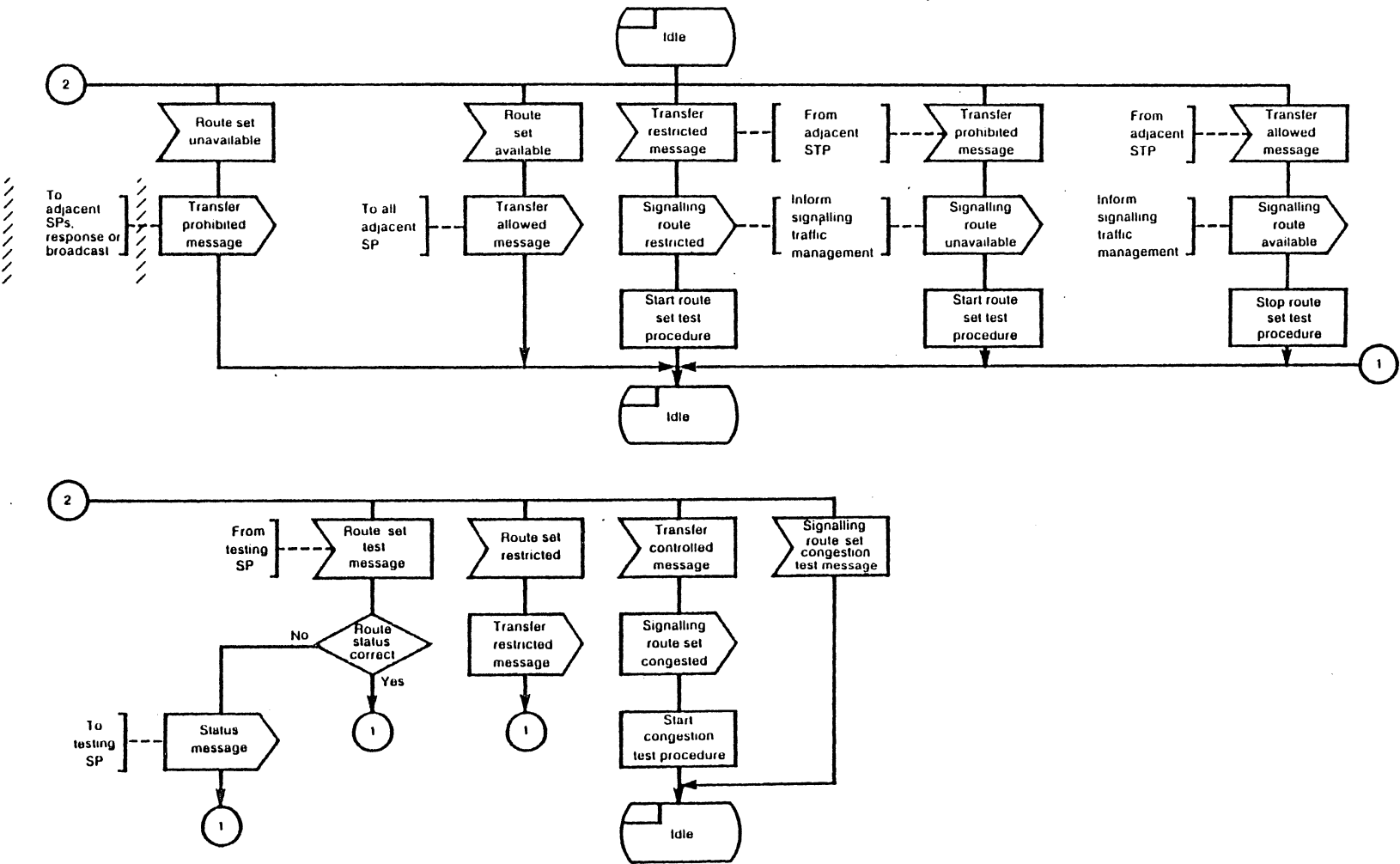

Figure 8/Q.704 - Signalling route management overview diagram

SIGNALLING NETWORK FUNCTIONS AND MESSAGES

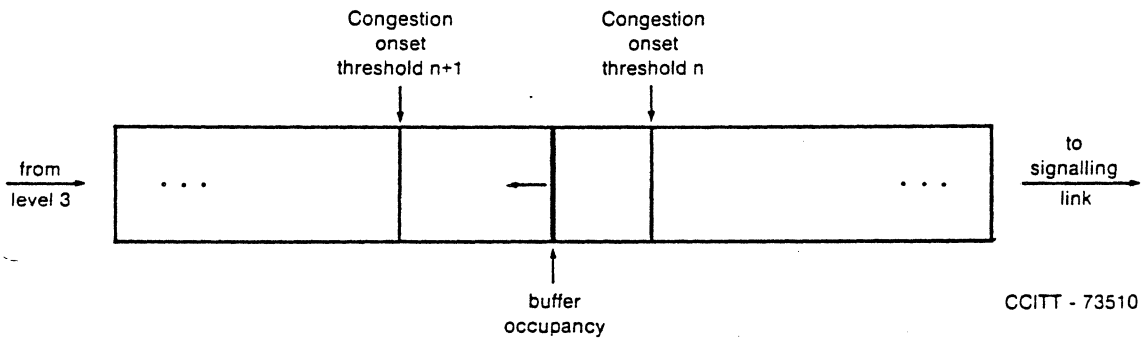

Figure 8A/Q.704 - Signalling Link Congestion Status= n (Congestion Onset)

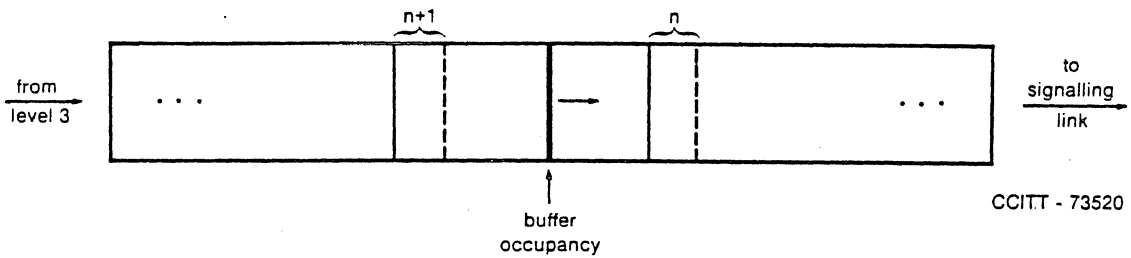

Figure 8B/Q.704 - Signalling Link Congestion Status= n (Congestion Abatement)

SIGNALLING NETWORK FUNCTIONS AND MESSAGES

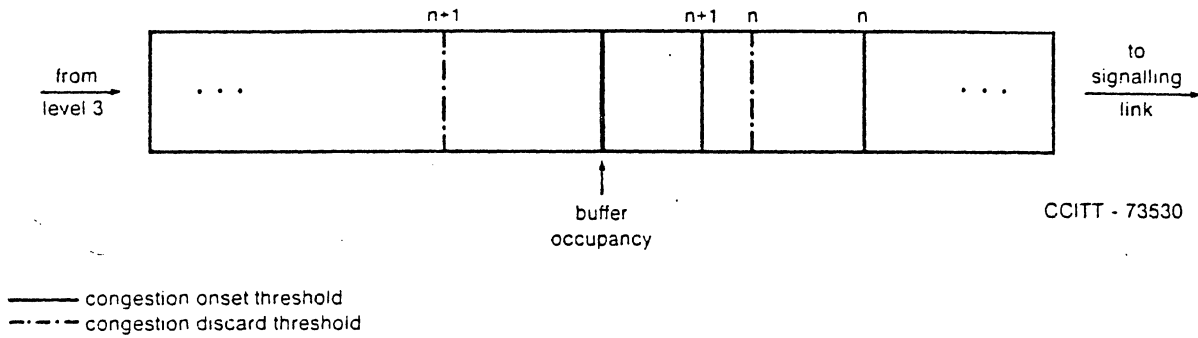

Figure 8C/Q.704 - Signalling Link Discard Status= n

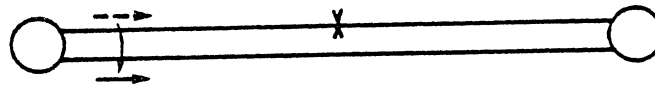

Figure 9/Q.704 - Example of Changeover to a Parallel Link

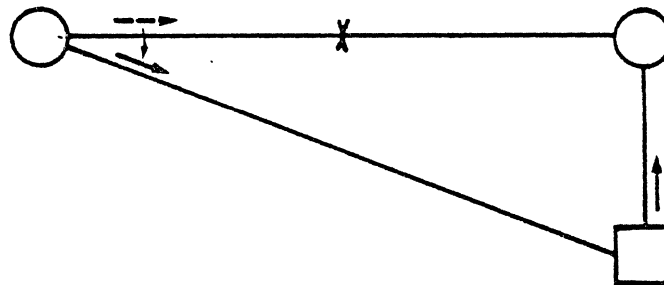

Figure 10/Q.704 - Example of Changeover to a Signalling Route Passing Through the Remote Signalling Point

SIGNALLING NETWORK FUNCTIONS AND MESSAGES

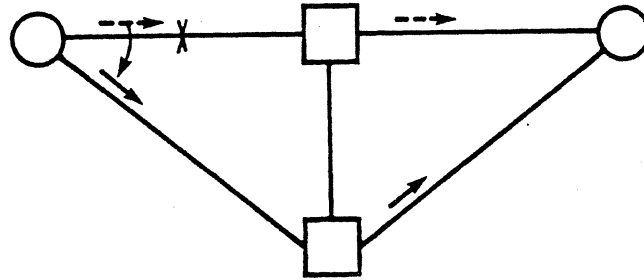

Figure 11/Q.704 - Example of Changeover to a Signalling Route not Passing Through the Remote Signalling Point

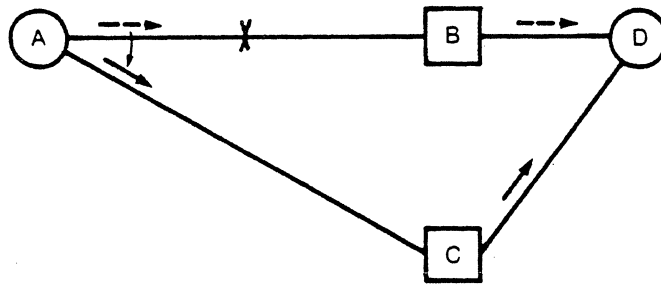

Figure 12/Q.704 - Example of Time-Controlled Diversion Procedure

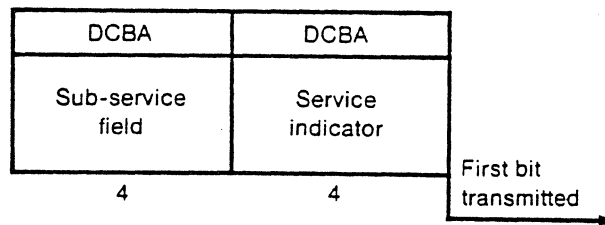

Figure 13/Q.704 - Service Information Octet

SIGNALLING NETWORK FUNCTIONS AND MESSAGES

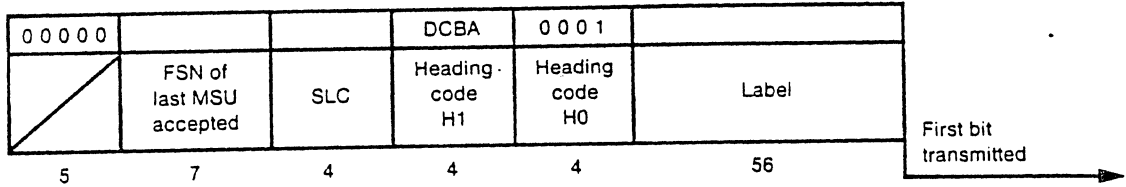

Figure 15/Q.704 - Changeover Message

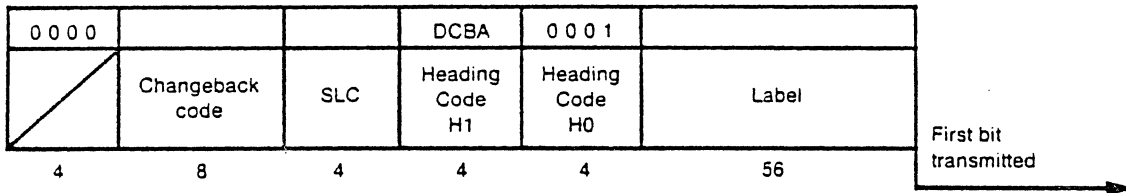

Figure 16/Q.704 - Changeback Message

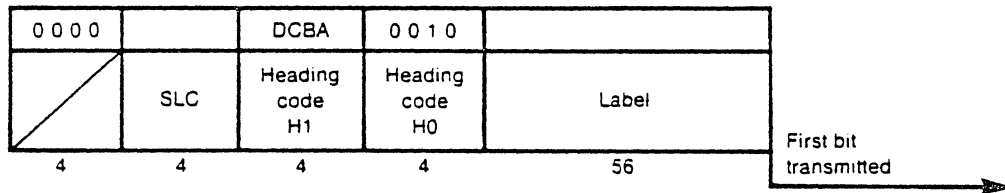

Figure 17/Q.704 - Emergency Changeover Message

SIGNALLING NETWORK FUNCTIONS AND MESSAGES

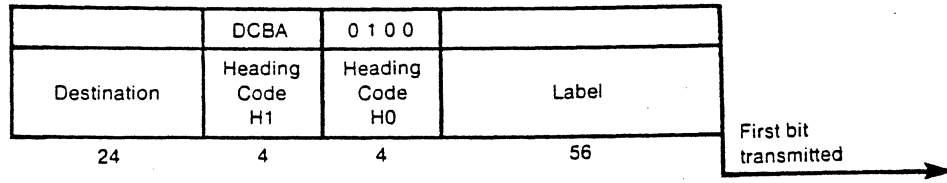

Figure 18/Q.704 - Transfer-Prohibited/Transfer-Restricted Message

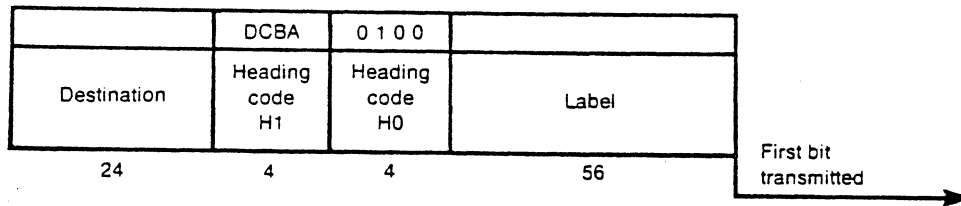

Figure 19/Q.704 - Transfer Allowed Message

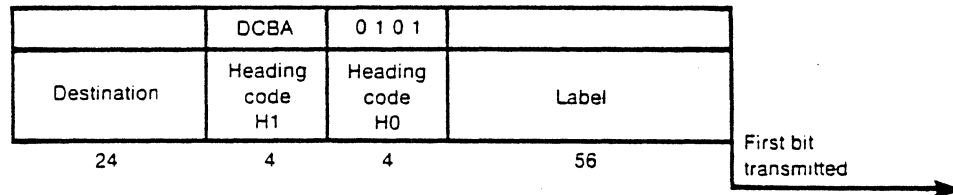

Figure 20/Q.704 - Signalling-Route-Set-Test Message

SIGNALLING NETWORK FUNCTIONS AND MESSAGES

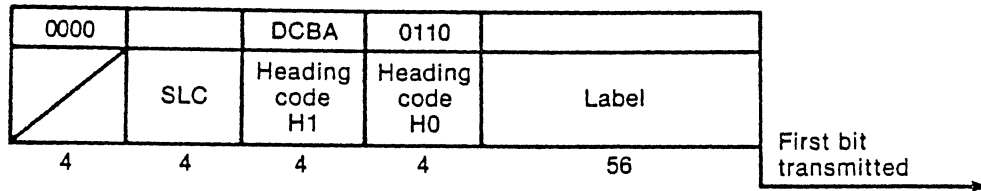

Figure 20A/Q.704 - Management Inhibit Message

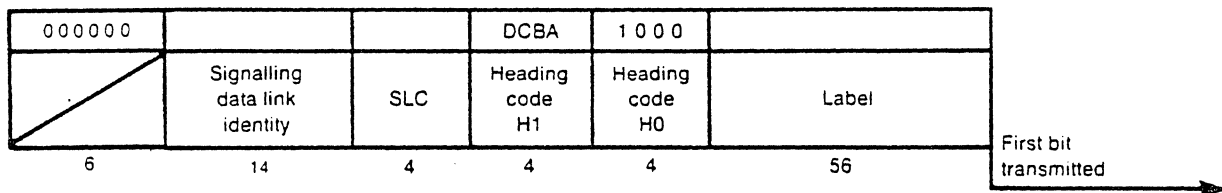

Figure 21/Q.704 - Signalling-Data-Link-Connection-Order Message

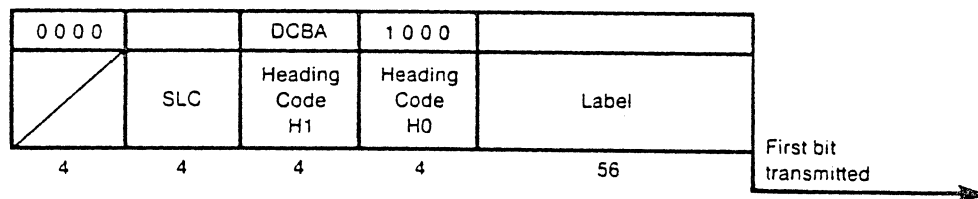

Figure 22/Q.704 - Signalling-Data-Link-Connection-Acknowledgement Message

SIGNALLING NETWORK FUNCTIONS AND MESSAGES

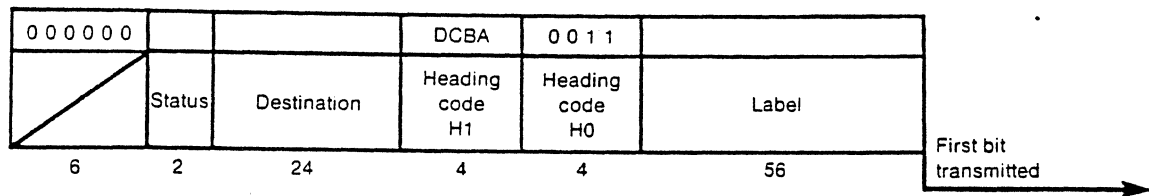

Figure 22A/Q.704 - Transfer-Controlled Message

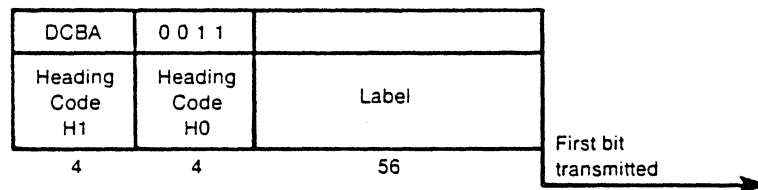
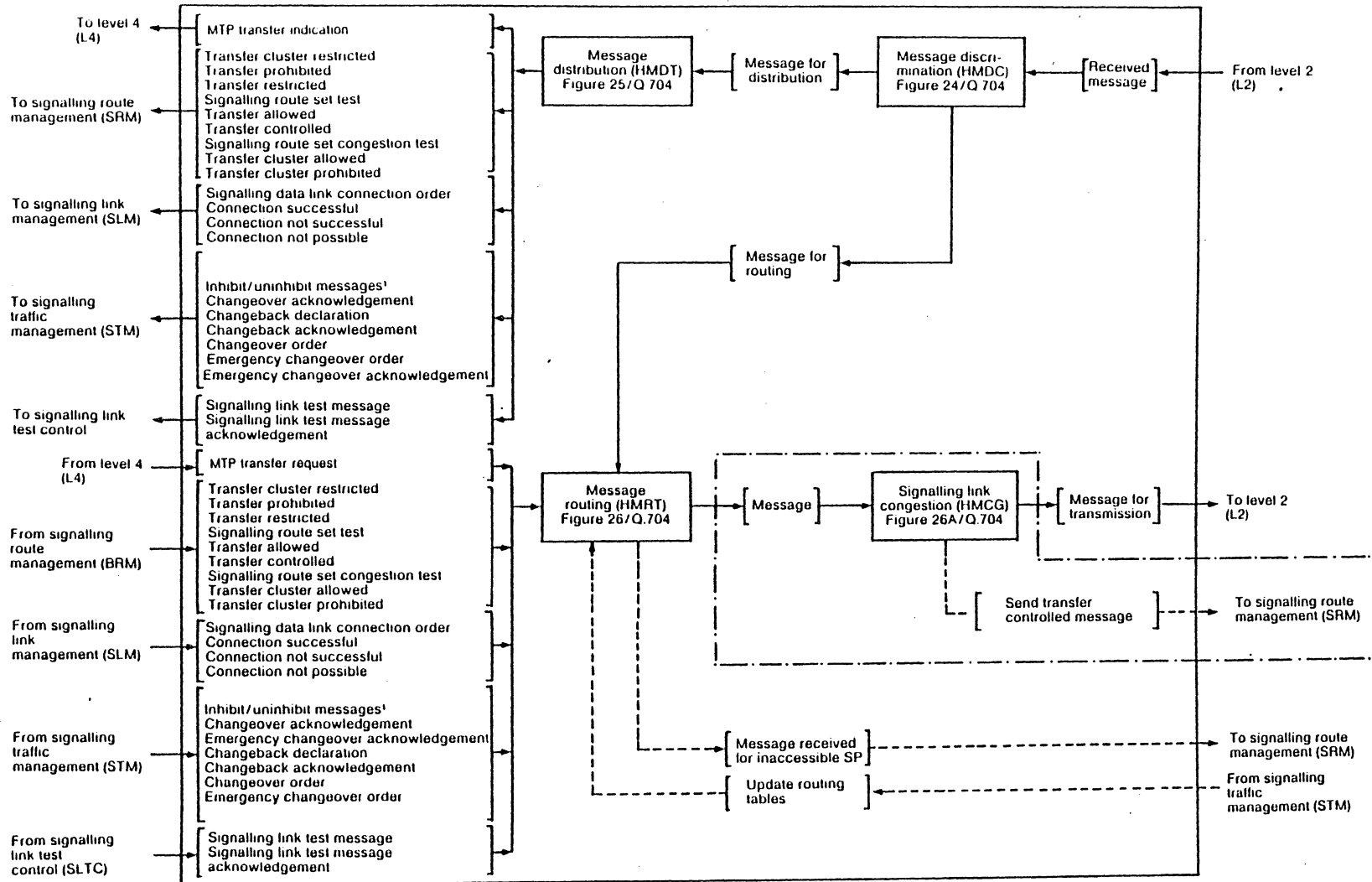

Figure 22B/Q.704 - Signalling-Route-Set-Congestion-Test Message

SIGNALLING NETWORK FUNCTIONS AND MESSAGES



1. This includes:

- inhibit signalling link message
- uninhibit signalling link message
- inhibit acknowledgement
- uninhibit acknowledgement
- inhibit denied
- force uninhibit
- local inhibit test
- remote inhibit test

Figure 23/Q.704 - Level 3 signalling message handling (SMH): functional block interactions

SIGNALLING NETWORK FUNCTIONS AND MESSAGES

Q.704

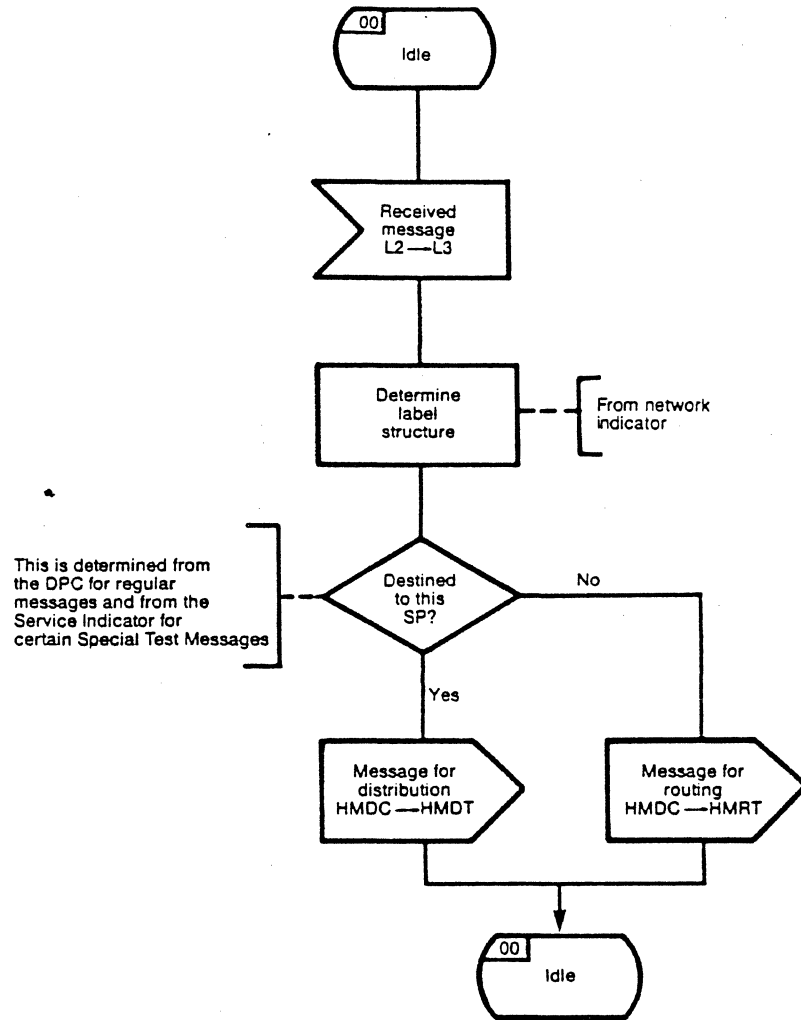

Figure 24/Q.704 - Signalling Message Handling; Message Discrimination (HMDC)

SIGNALLING NETWORK FUNCTIONS AND MESSAGES

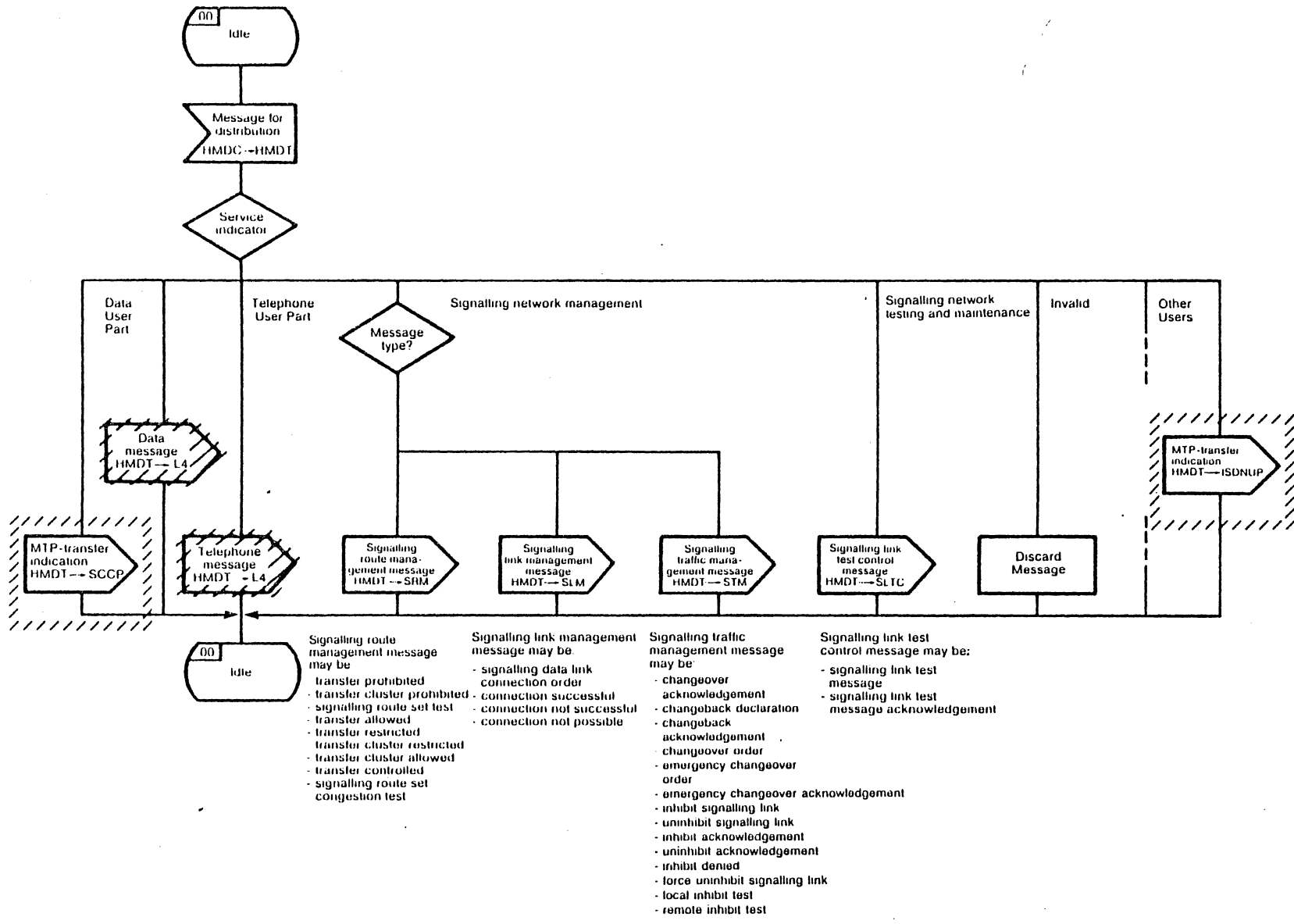

Figure 25/Q.704 - Signalling message handling: message distribution (HMDT)

SIGNALLING NETWORK FUNCTIONS AND MESSAGES

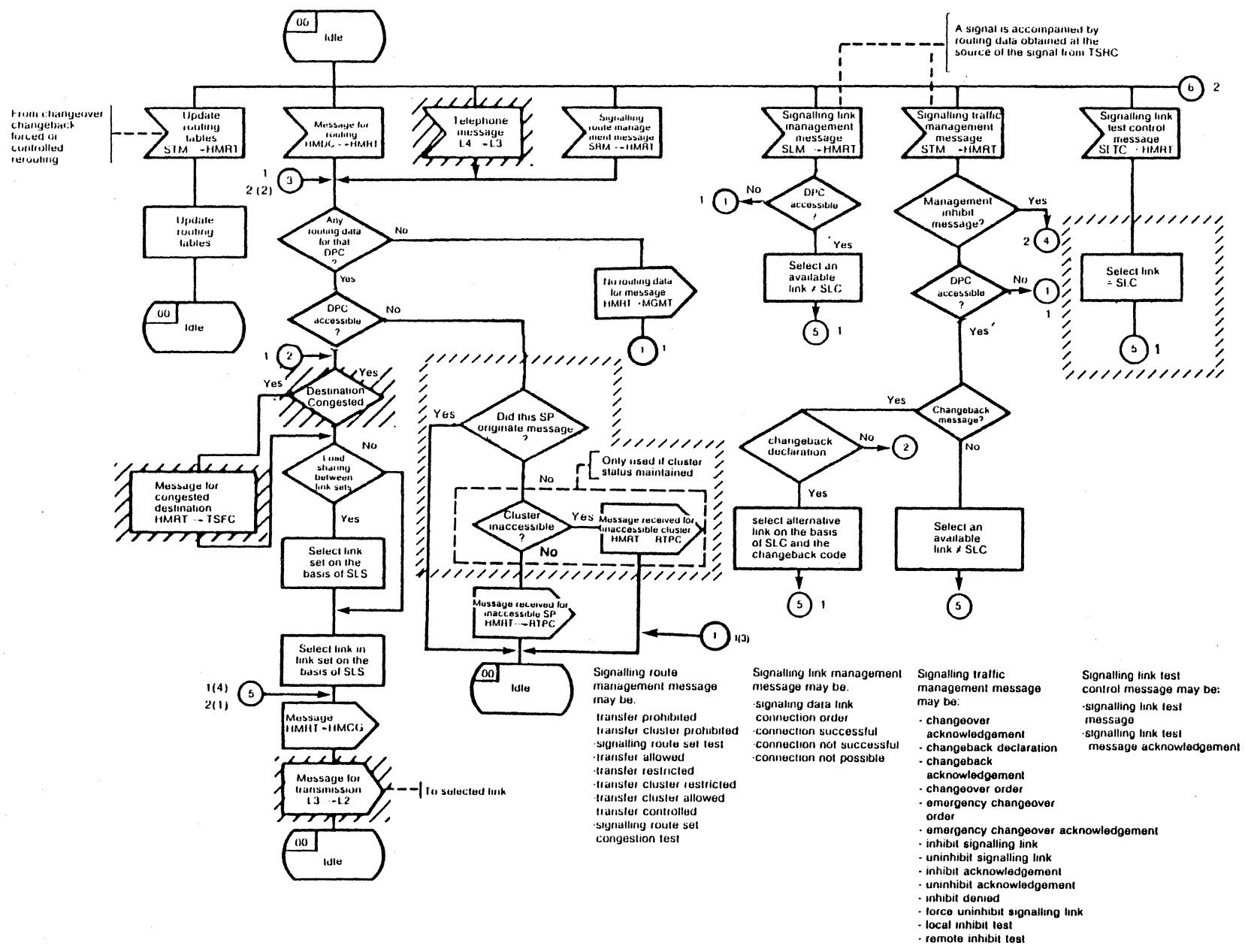

Figure 26/Q.704 - Signalling message handling: message routing, HMRT (sheet 1 of 2)

SIGNALLING NETWORK FUNCTIONS AND MESSAGES

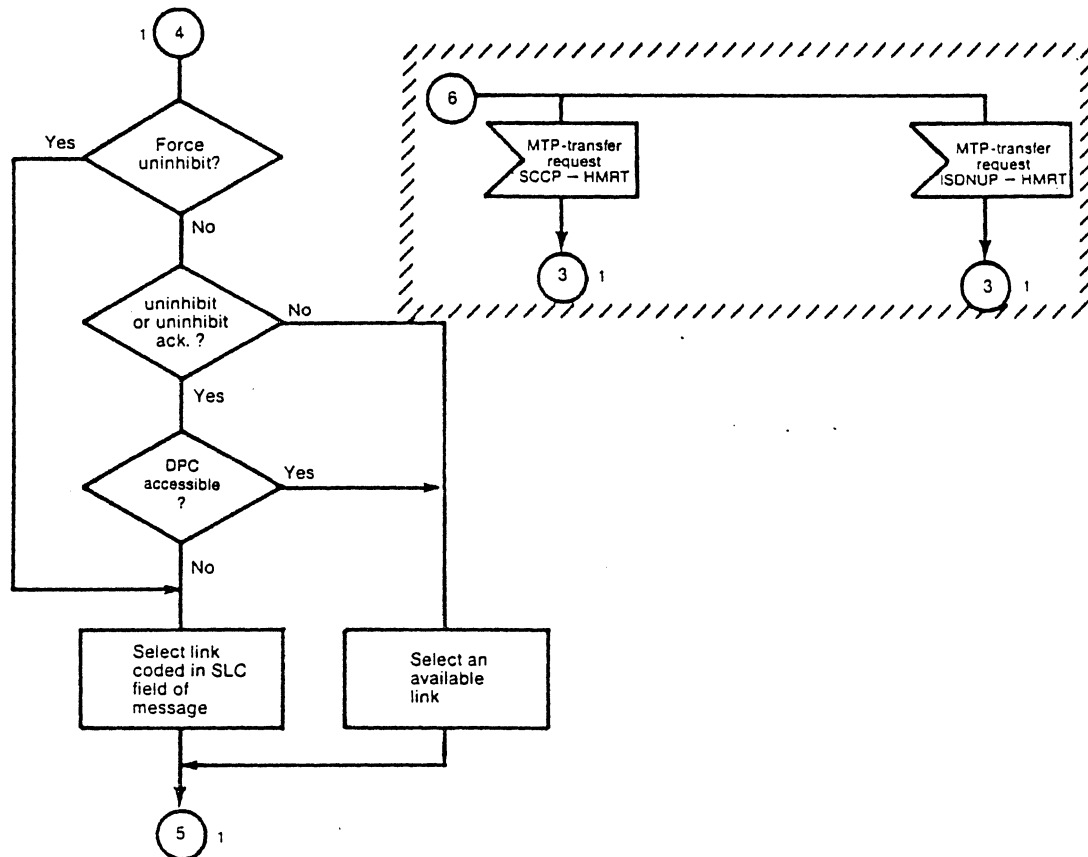

Figure 28/Q.704 (Sheet 2 of 2) - Signalling Message Handling; Message Routing (HMRT)

SIGNALLING NETWORK FUNCTIONS AND MESSAGES

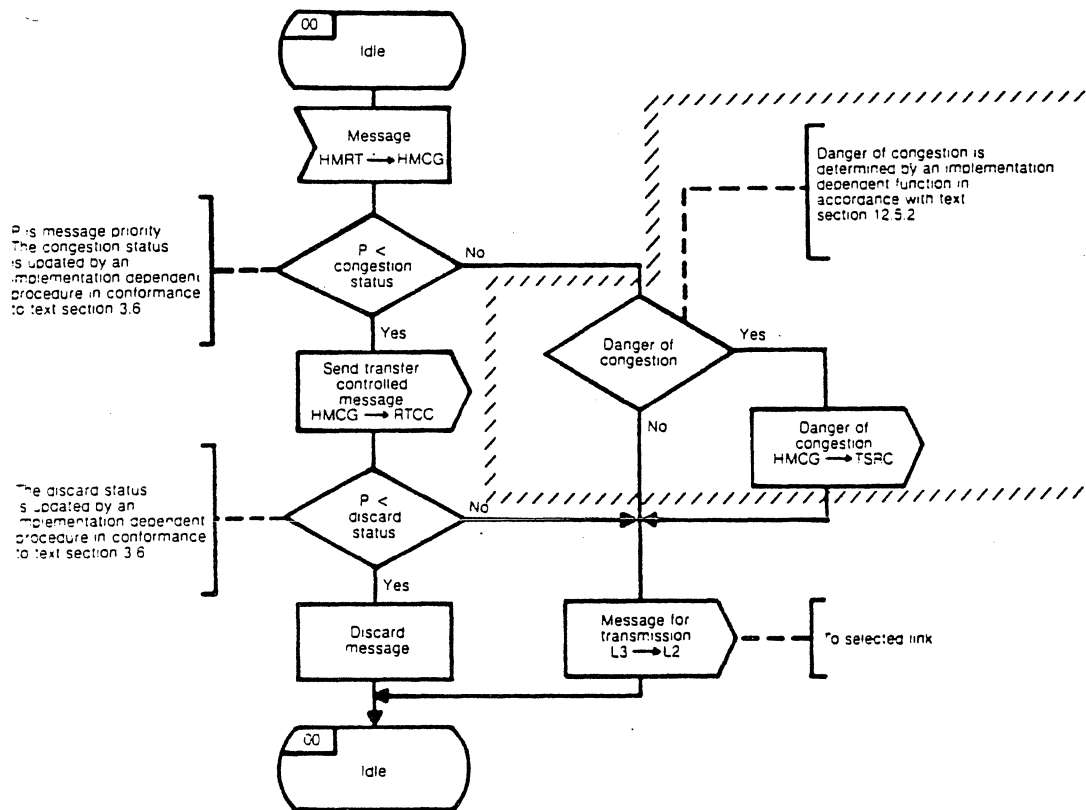
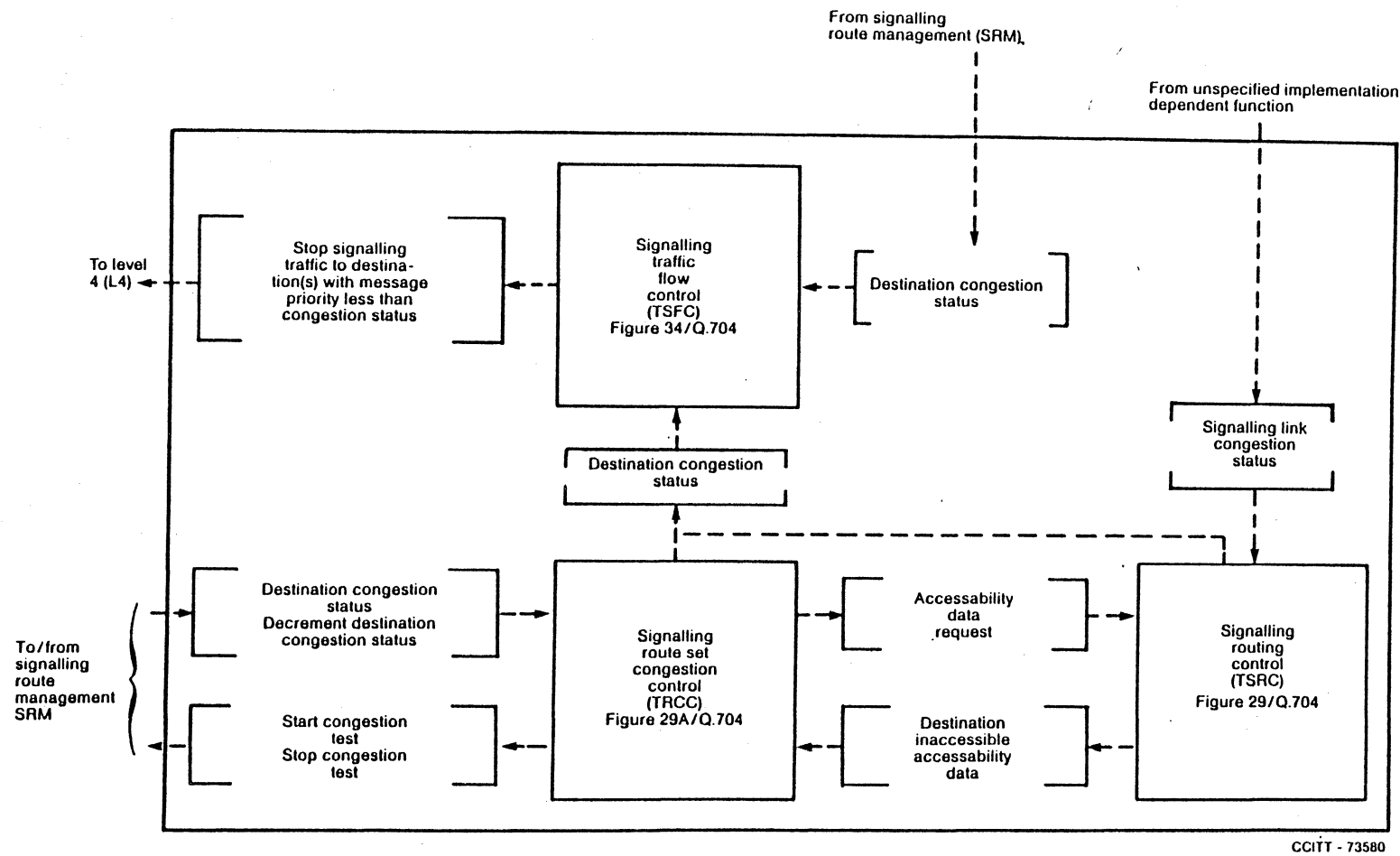

Figure 28A/Q.704 - Signalling Message Handling; Signalling Link Congestion (HMCG)



CCITT - 73580

Figure 27/Q.704 - Level 3 -
 Signalling traffic management (STM):
 functional block interactions (sheet 2 of 2)

SIGNALLING NETWORK FUNCTIONS AND MESSAGES

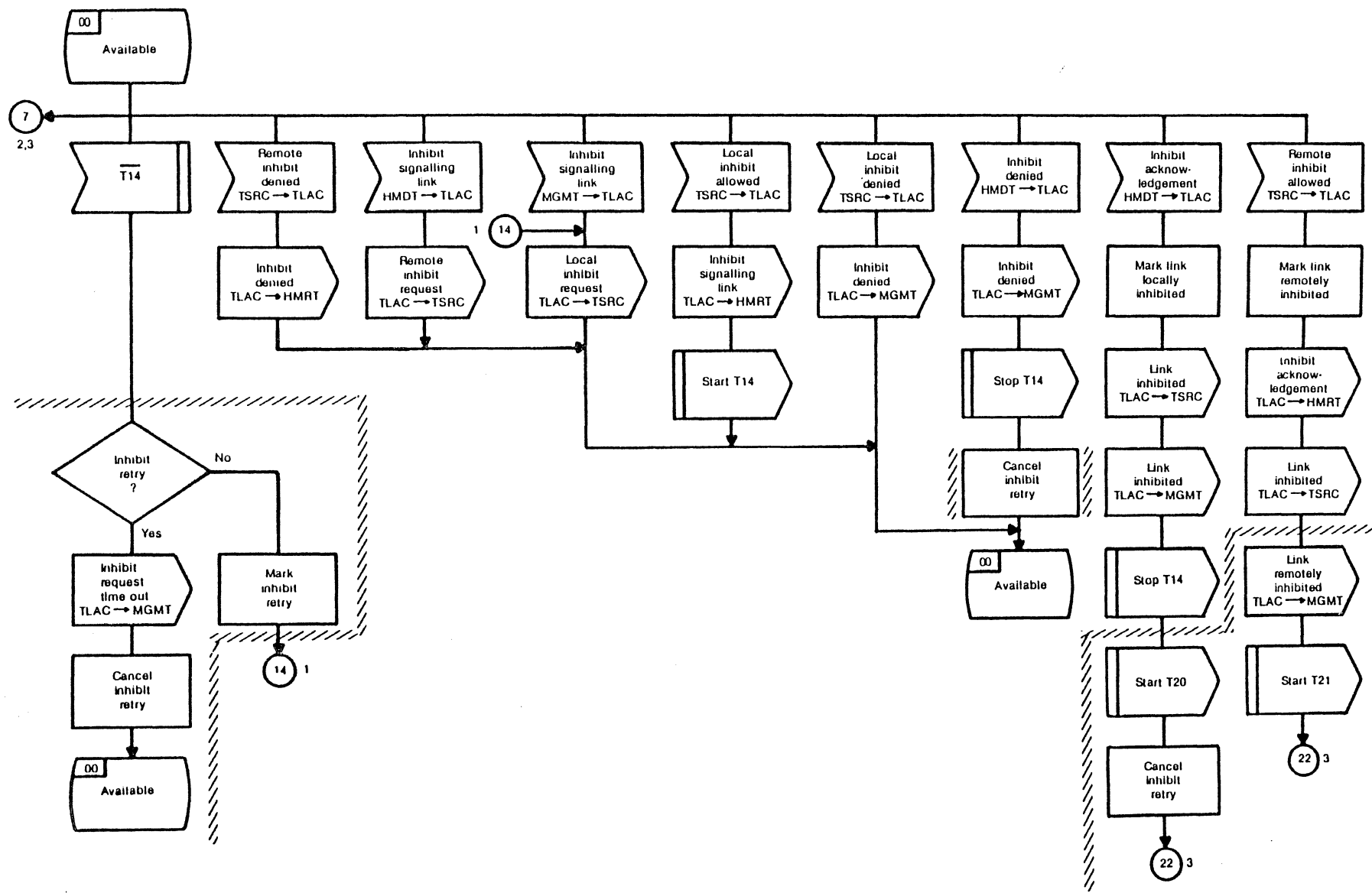

Figure 28/Q.704 Signalling traffic management: link availability control, TLAC (sheet 1 of 8)

-S01

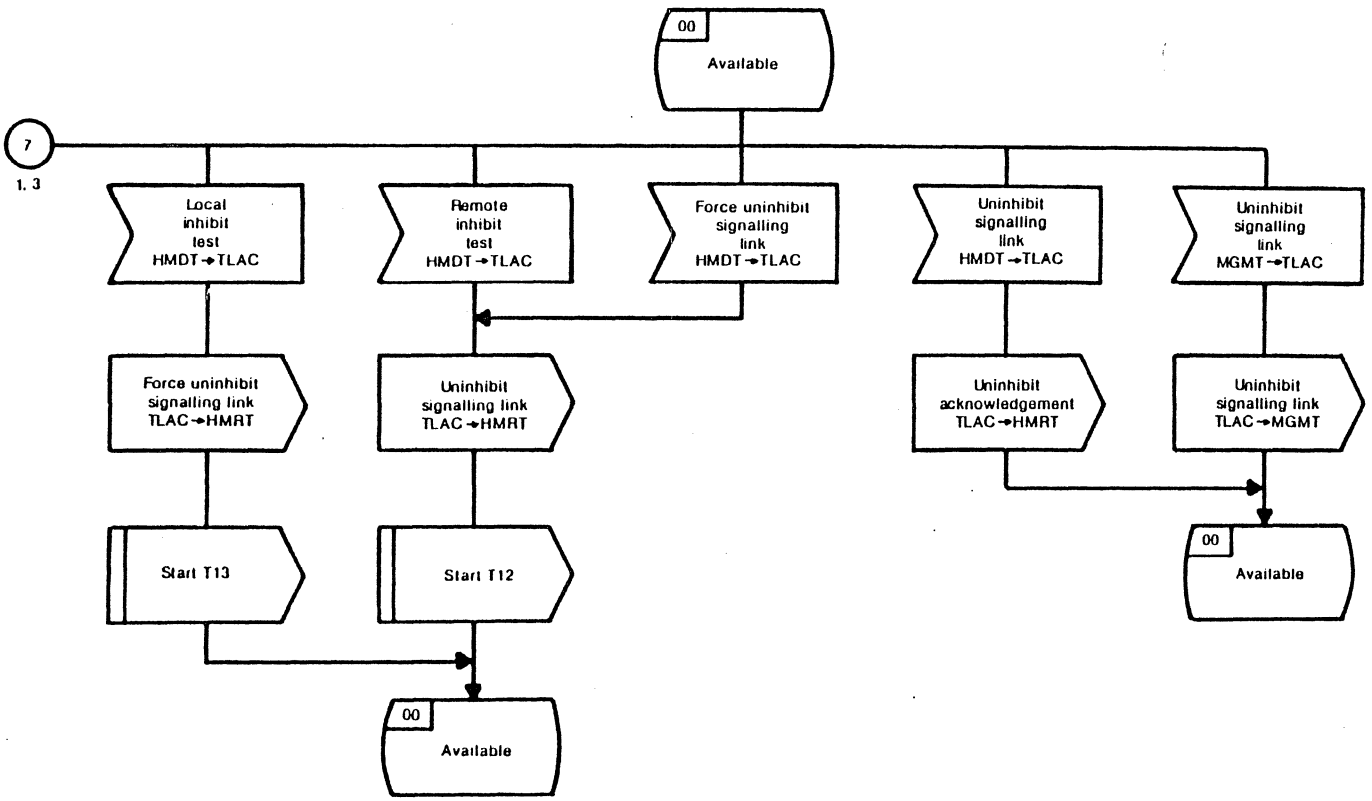

Figure 28/Q.704 Signalling traffic management: link availability control, TLAC (sheet 2 of 8)

SIGNALLING NETWORK FUNCTIONS AND MESSAGES

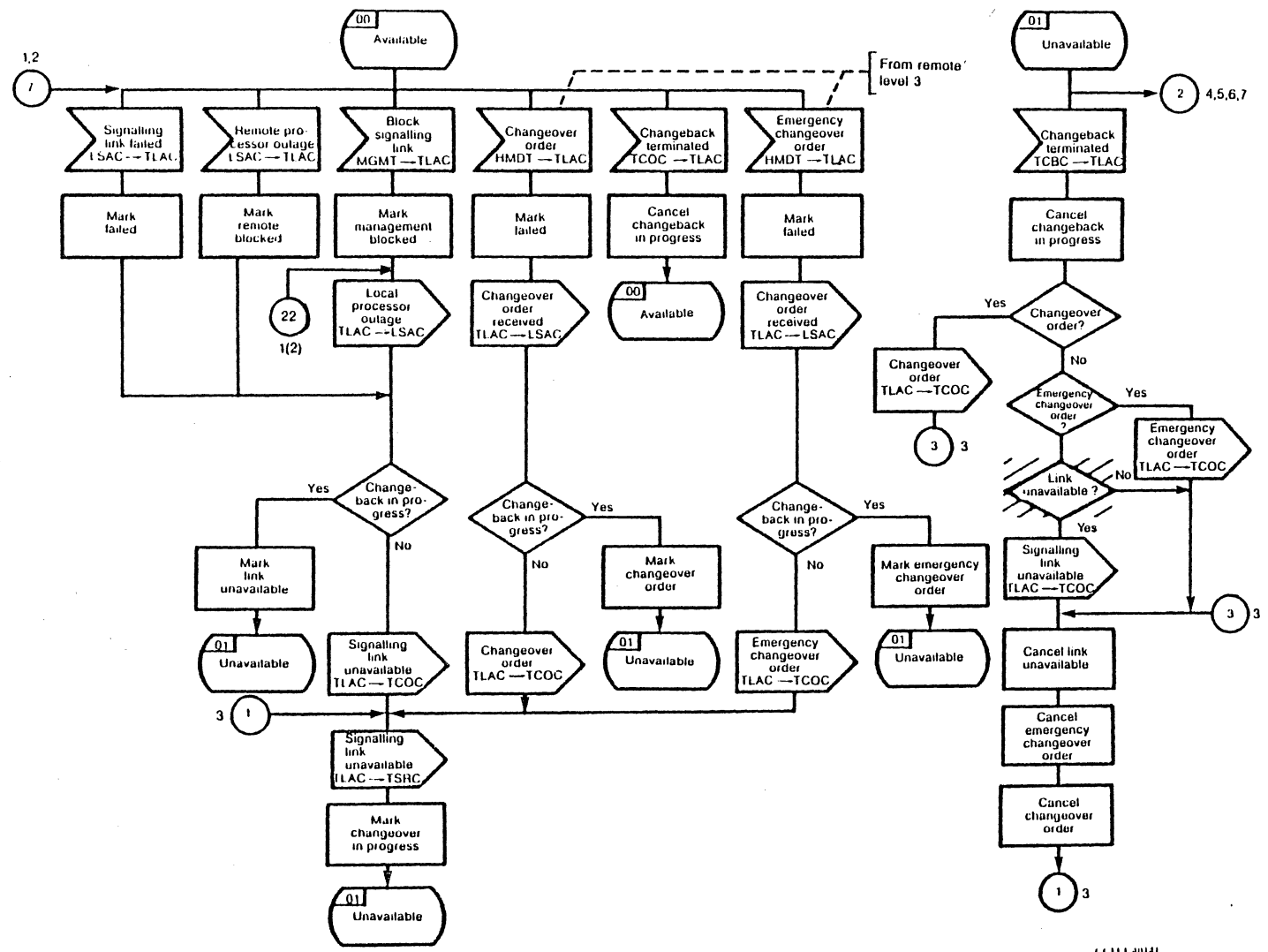
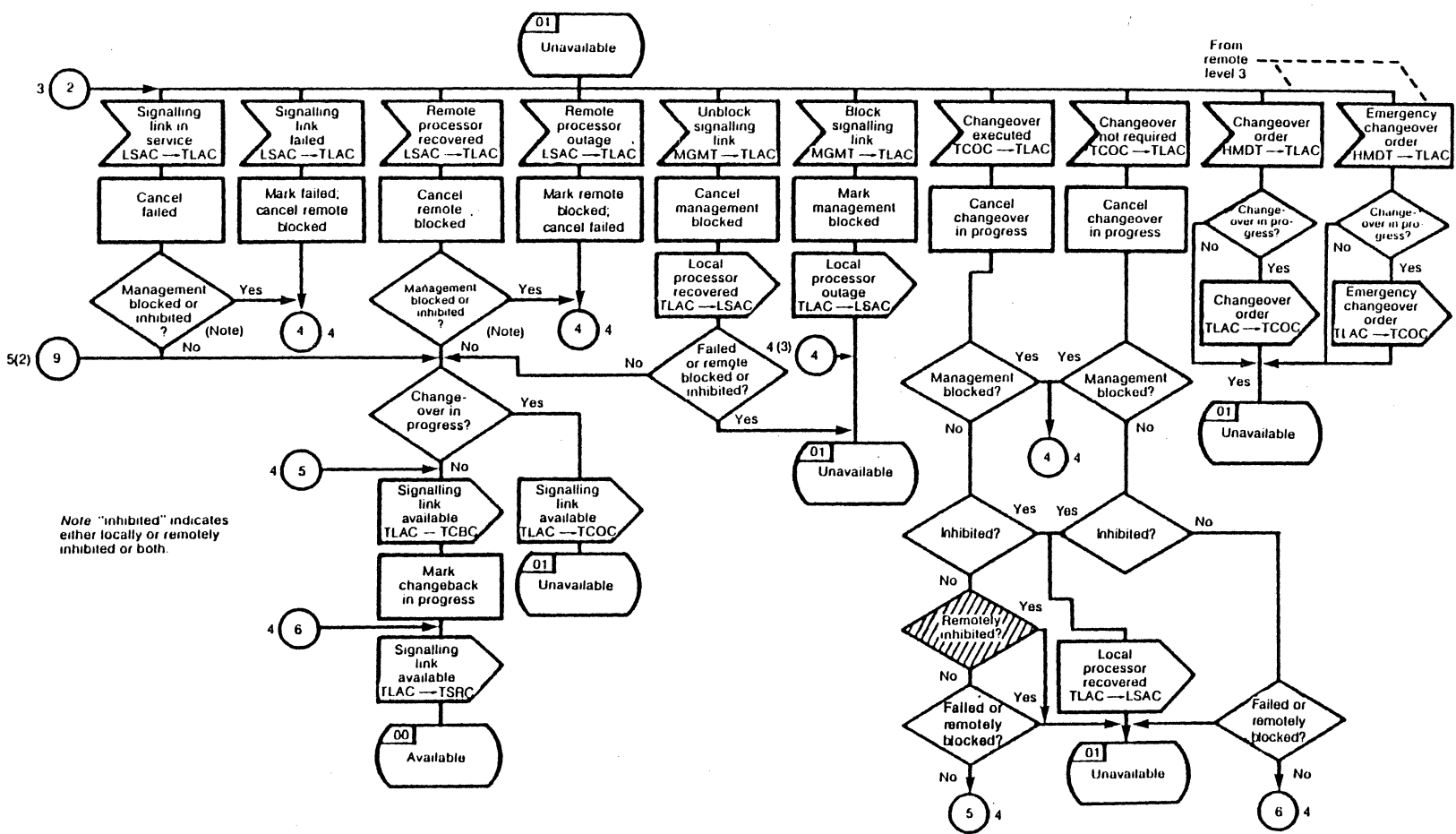

Figure 28/Q.704 Signalling traffic management: link availability control, TLAC (sheet 3 of 8)

SIGNALLING NETWORK FUNCTIONS AND MESSAGES



Note "inhibited" indicates either locally or remotely inhibited or both.

Figure 28/Q.704 Signalling traffic management: link availability control, TLAC (sheet 4 of 8)

SIGNALLING NETWORK FUNCTIONS AND MESSAGES

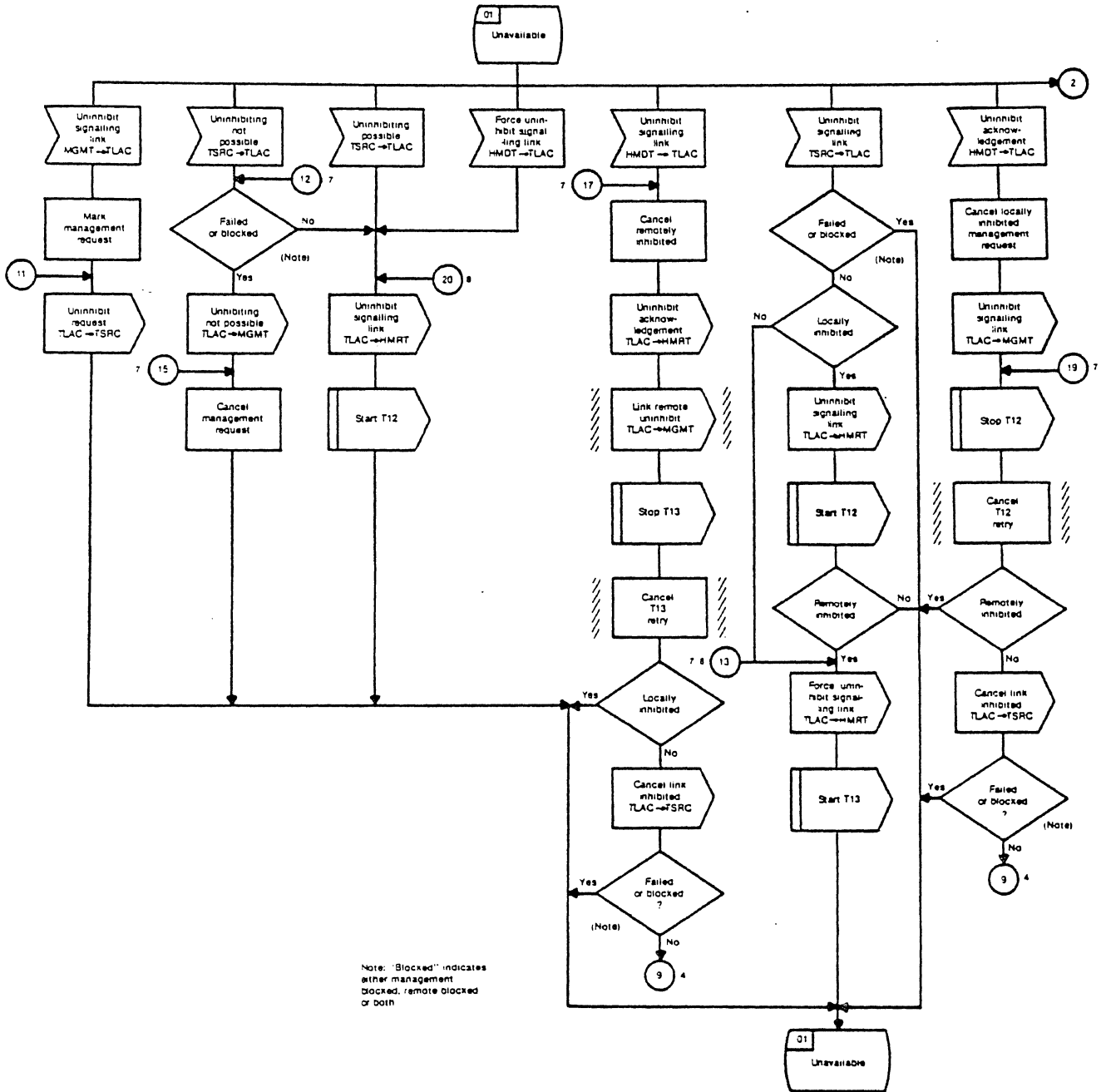

Figure 28/Q.704 (Sheet 5 of 8) - Signalling Traffic Management: Link Availability Control (TLAC)

SIGNALLING NETWORK FUNCTIONS AND MESSAGES

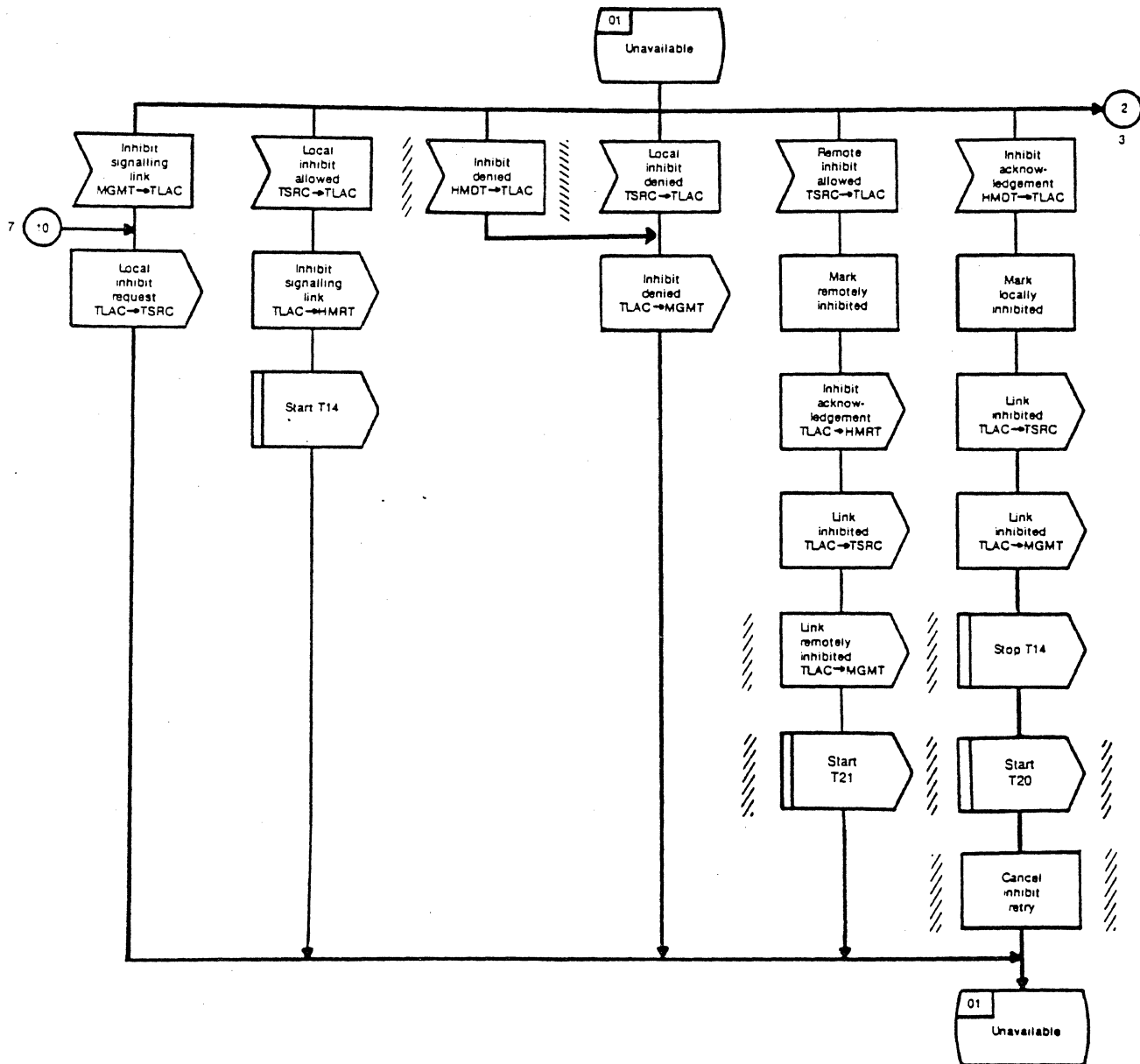

Figure 28/Q.704 (Sheet 6 of 8) - Signalling Traffic Management; Link Availability Control (TLAC)

SIGNALLING NETWORK FUNCTIONS AND MESSAGES

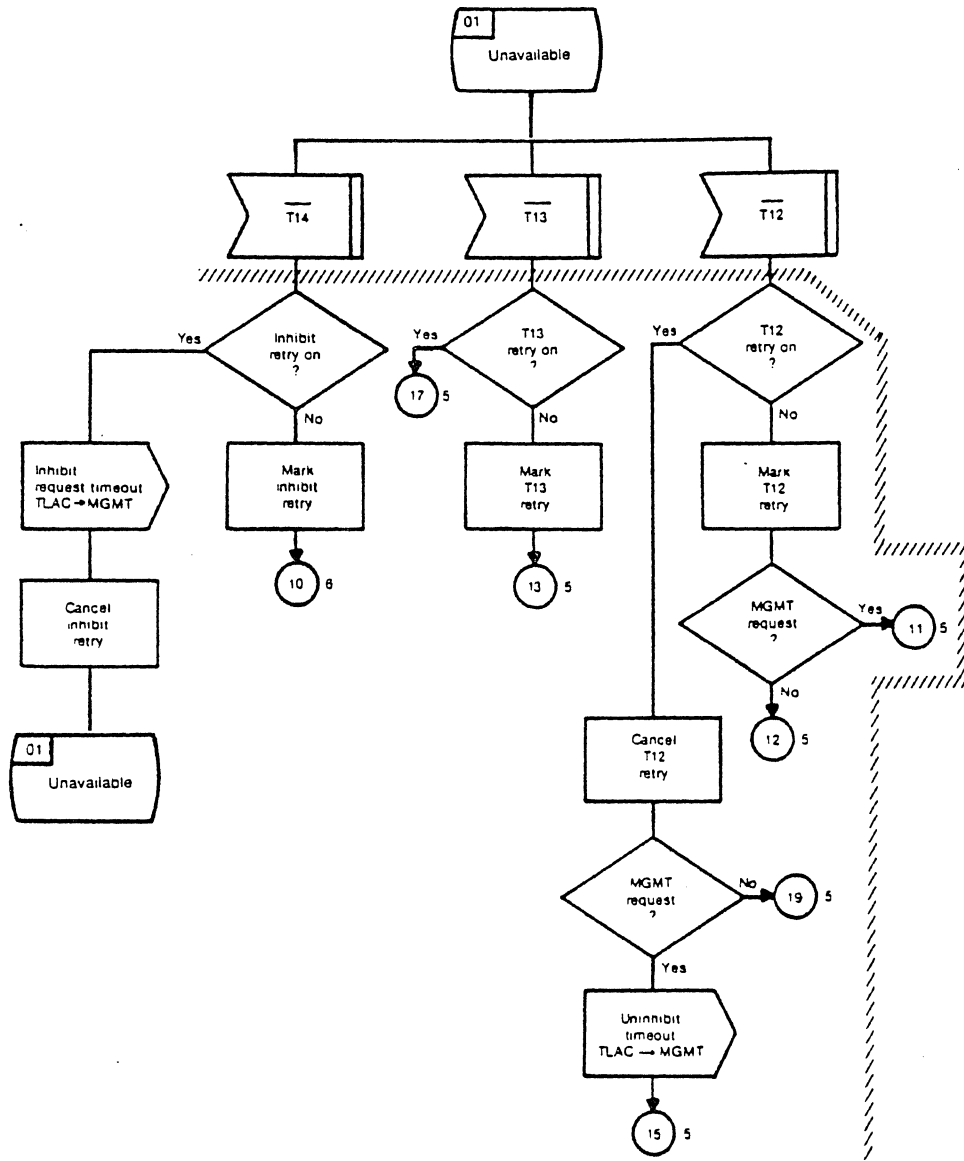

Figure 28/Q.704 (Sheet 7 of 8) - Signalling Traffic Management; Link Availability Control (TLAC)

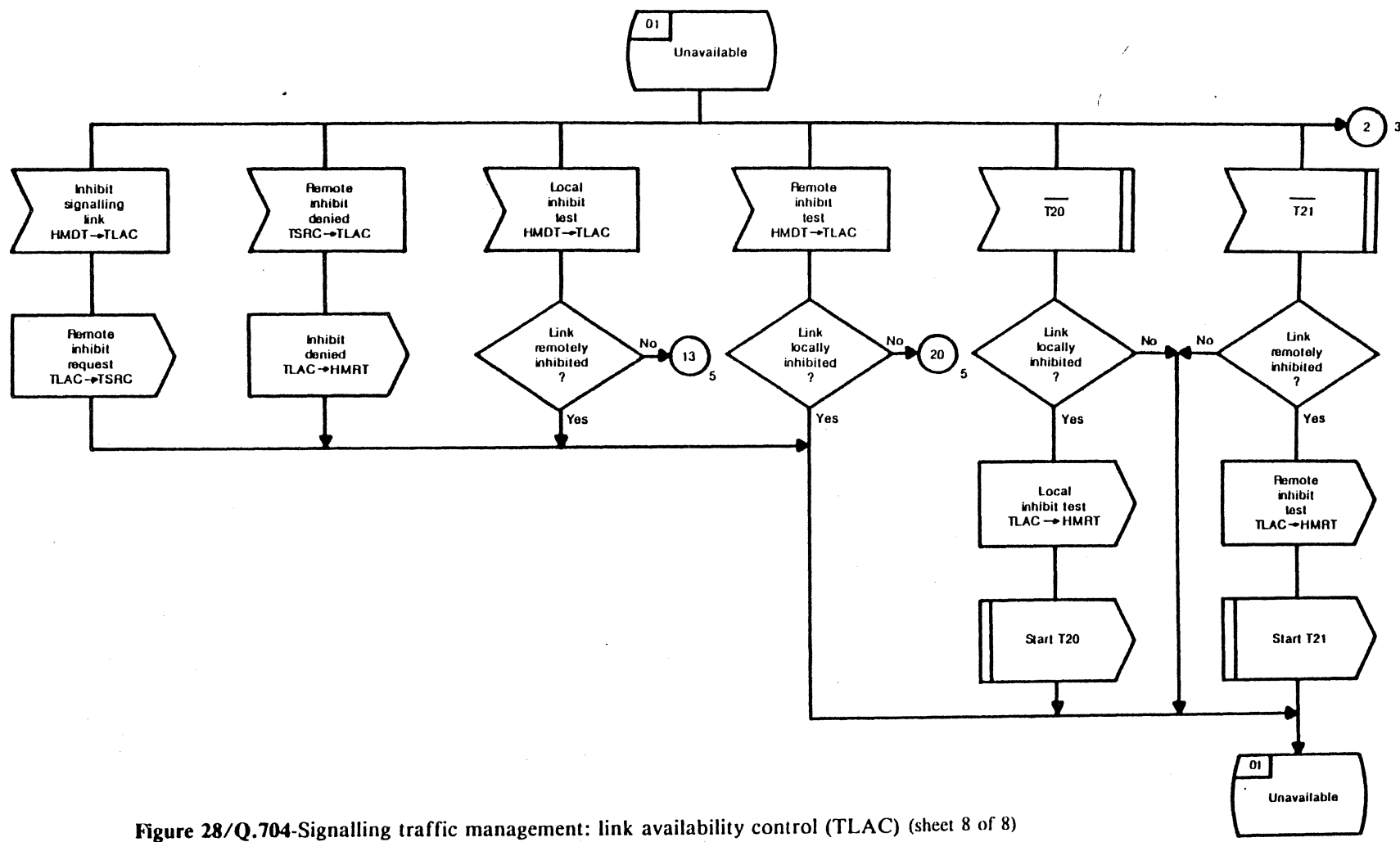

Figure 28/Q.704-Signalling traffic management: link availability control (TLAC) (sheet 8 of 8)

SIGNALLING NETWORK FUNCTIONS AND MESSAGES

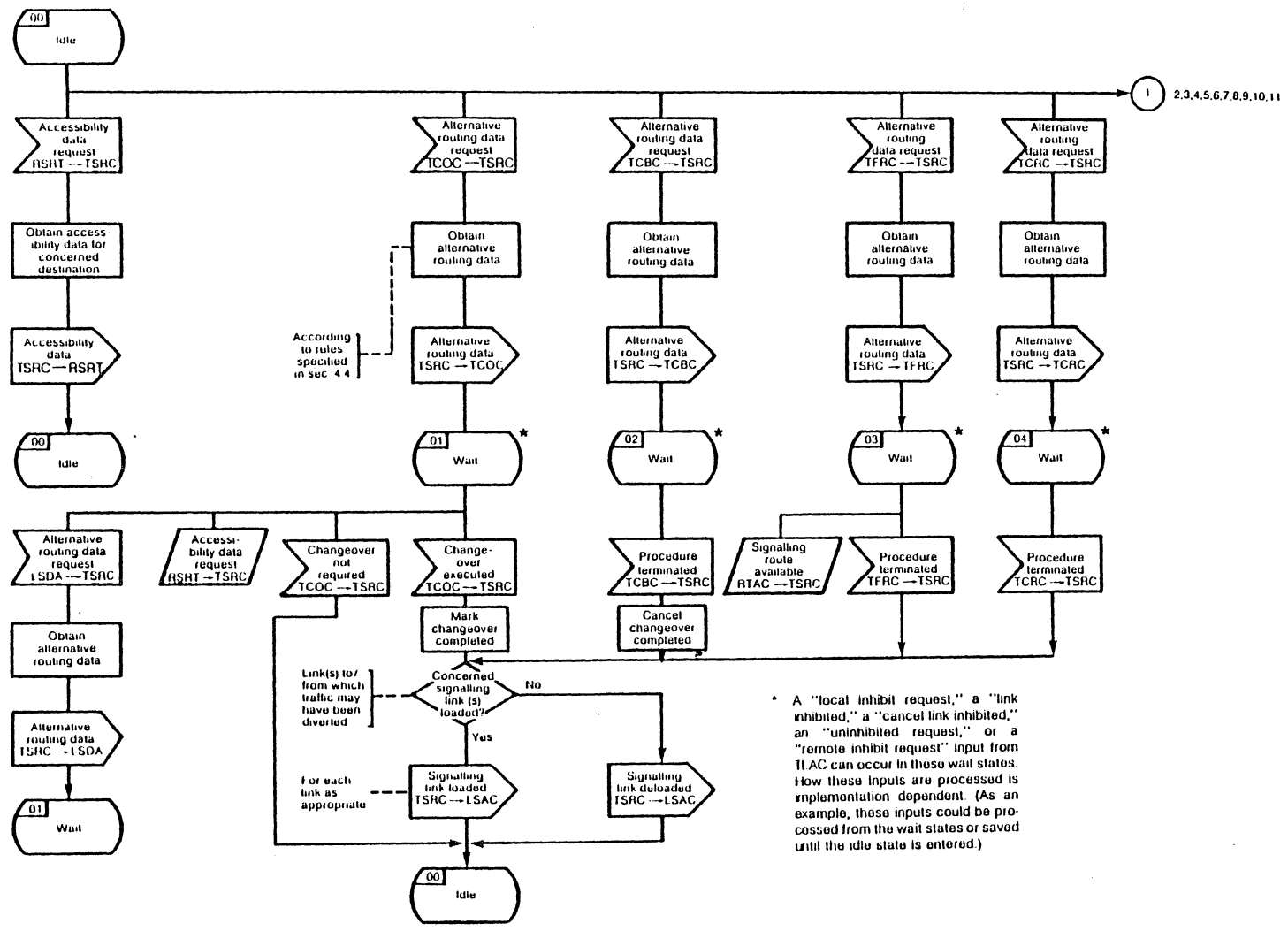

Figure 29/Q.704 Signalling traffic management: signalling routing control, TSRC (sheet 1 of 11)

SIGNALLING NETWORK FUNCTIONS AND MESSAGES

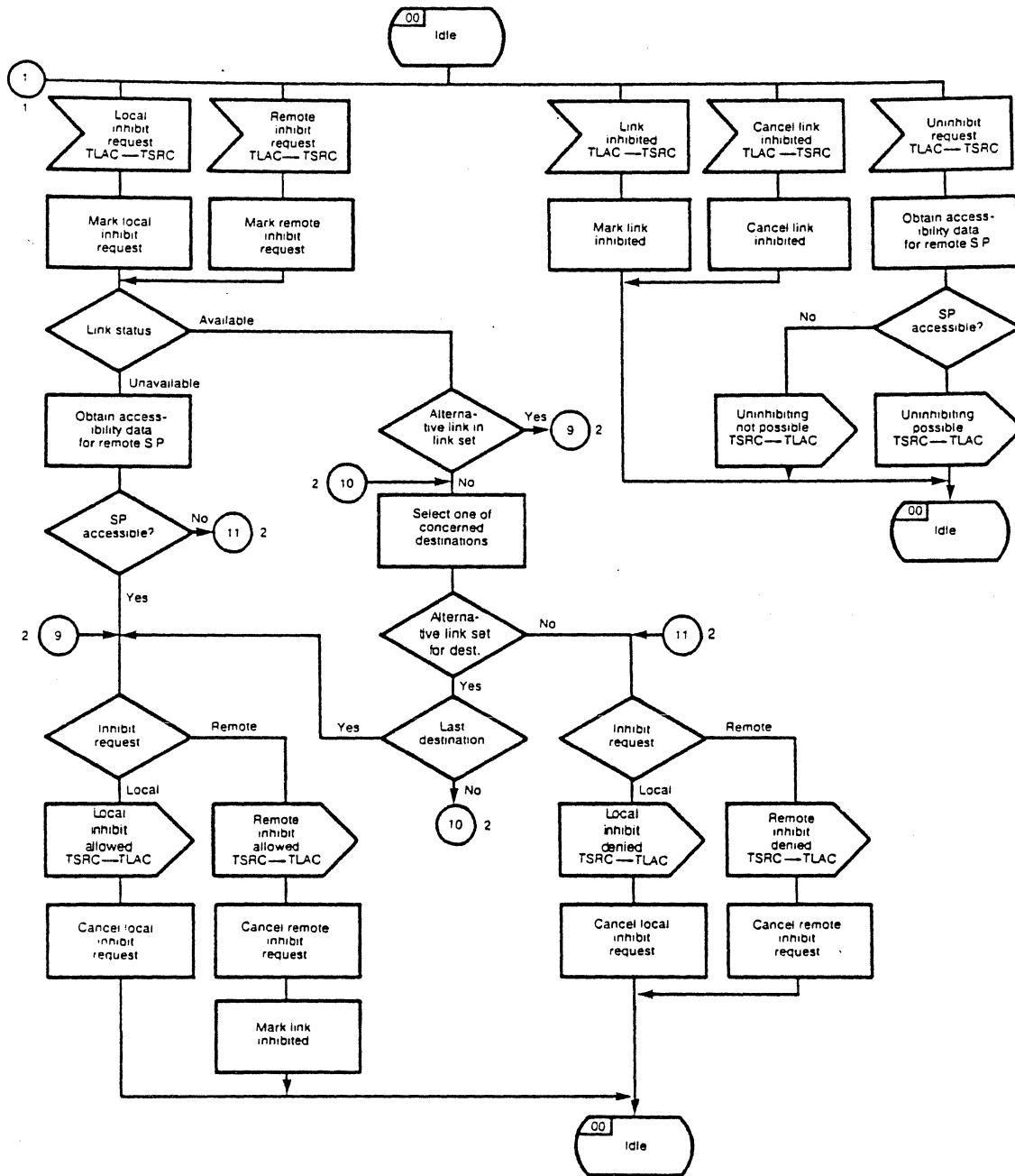

Figure 29/Q.704 (Sheet 2 of 11) - Signalling Traffic Management; Signalling Routing Control (TSRC)

SIGNALLING NETWORK FUNCTIONS AND MESSAGES

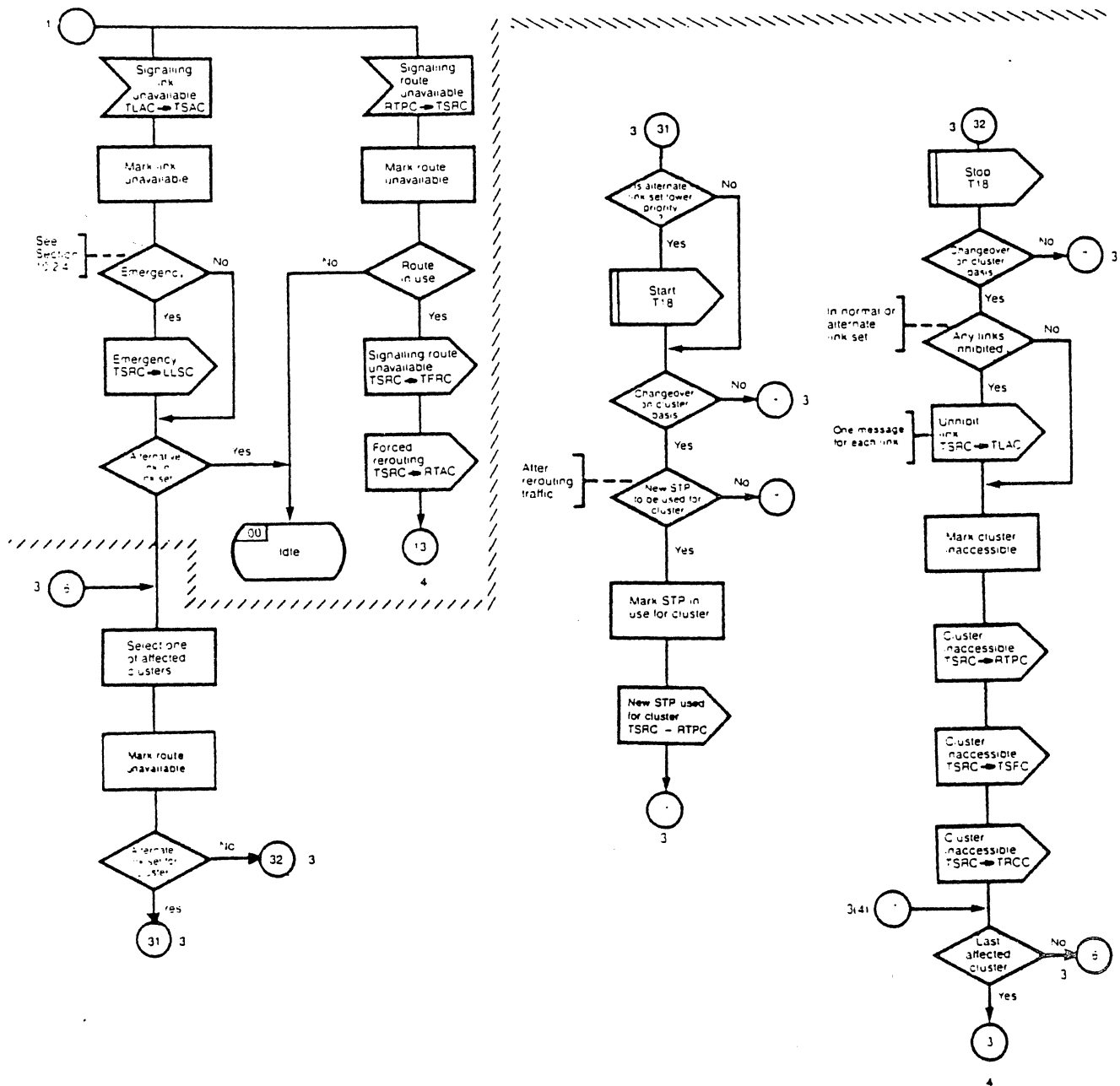

Figure 29/Q.704 (Sheet 3 of 11) - Signalling Traffic Management: Signalling Routing Control (TSRC)

SIGNALLING NETWORK FUNCTIONS AND MESSAGES

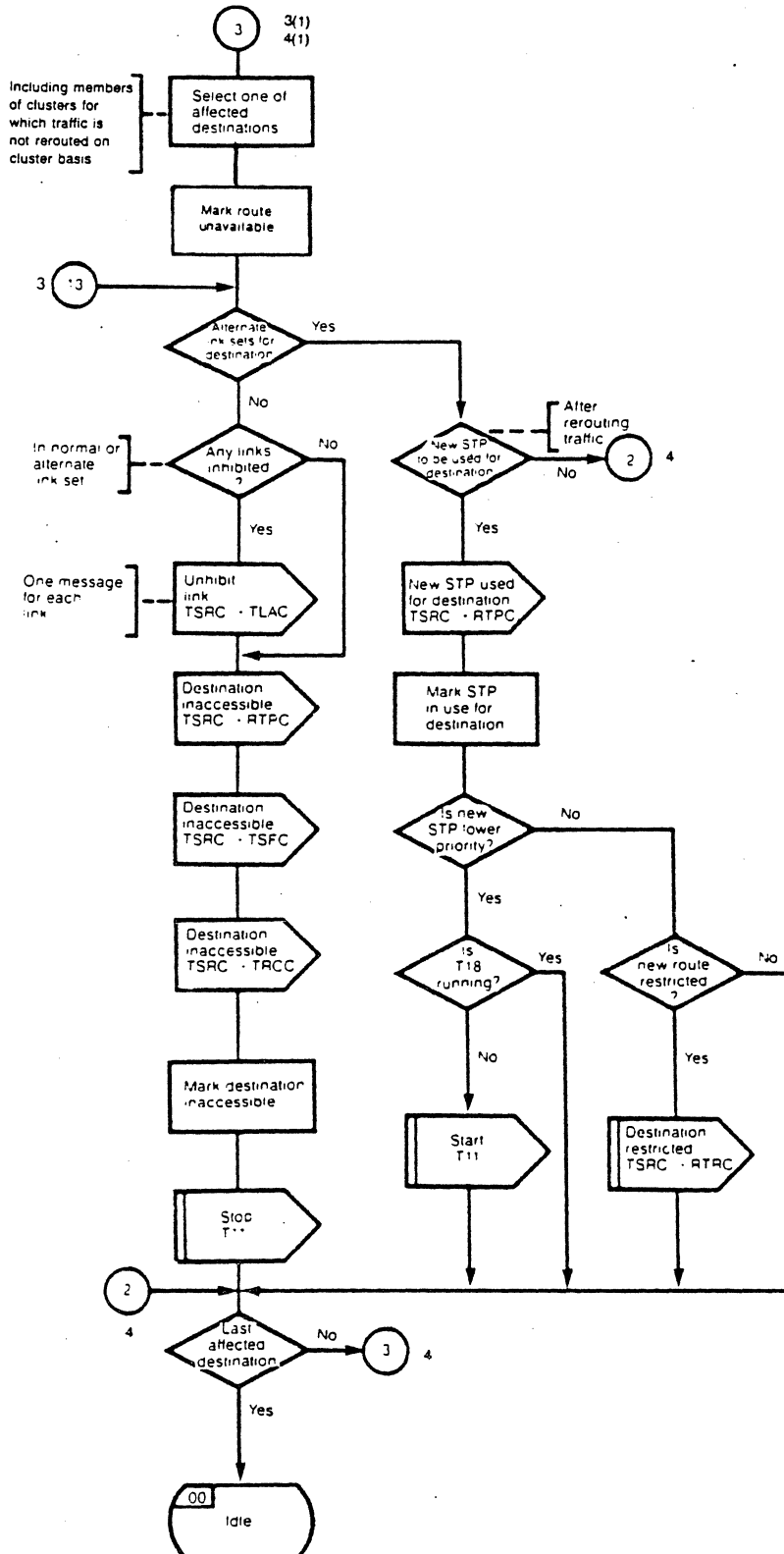

Figure 29/Q.704 (Sheet 4 of 11) - Signalling Traffic Management; Signalling Routing Control (TSRC)

SIGNALLING NETWORK FUNCTIONS AND MESSAGES

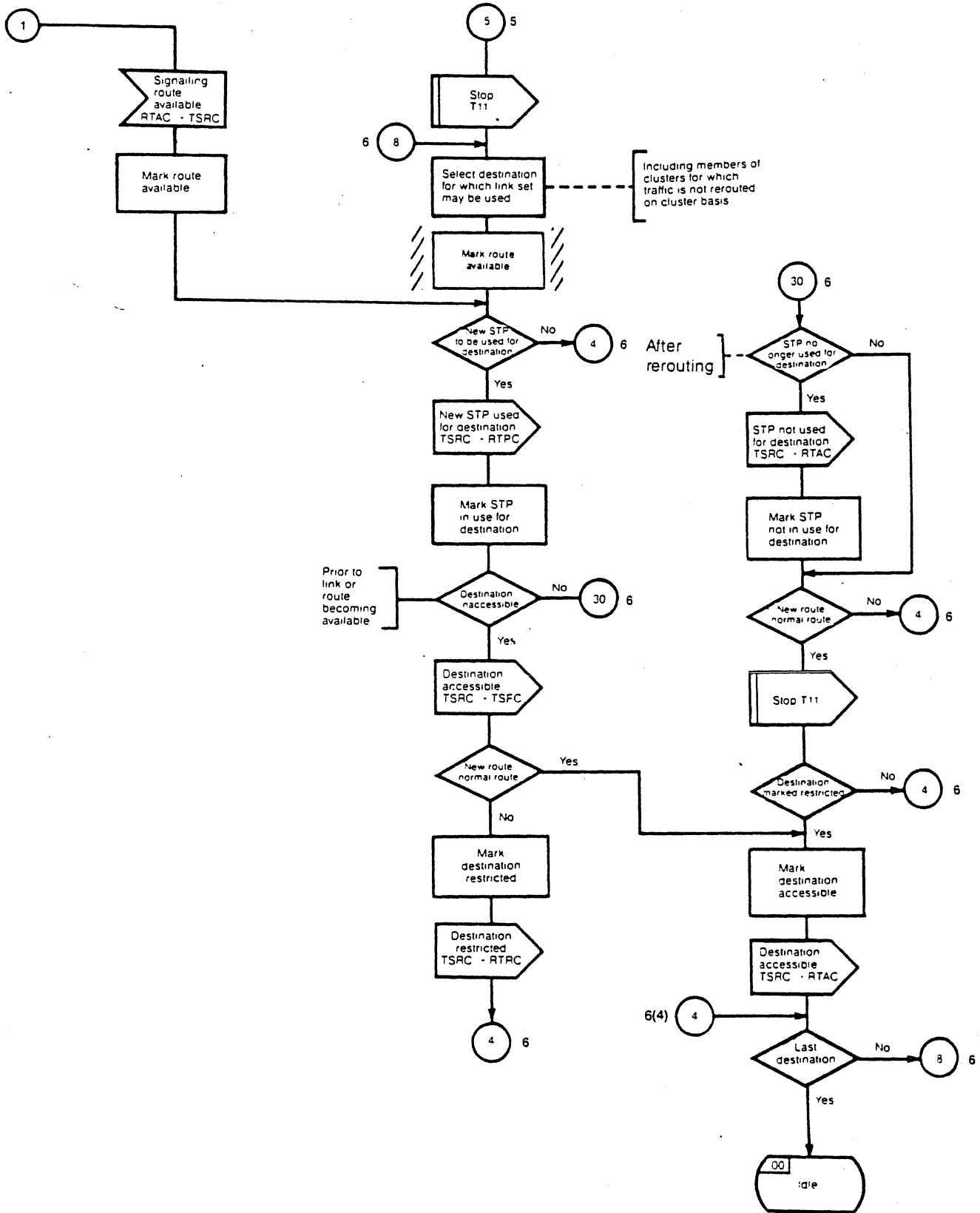

Figure 29/Q.704 Signalling traffic management: Signalling routing control, TSRC (sheet 6 of 11)

SIGNALLING NETWORK FUNCTIONS AND MESSAGES

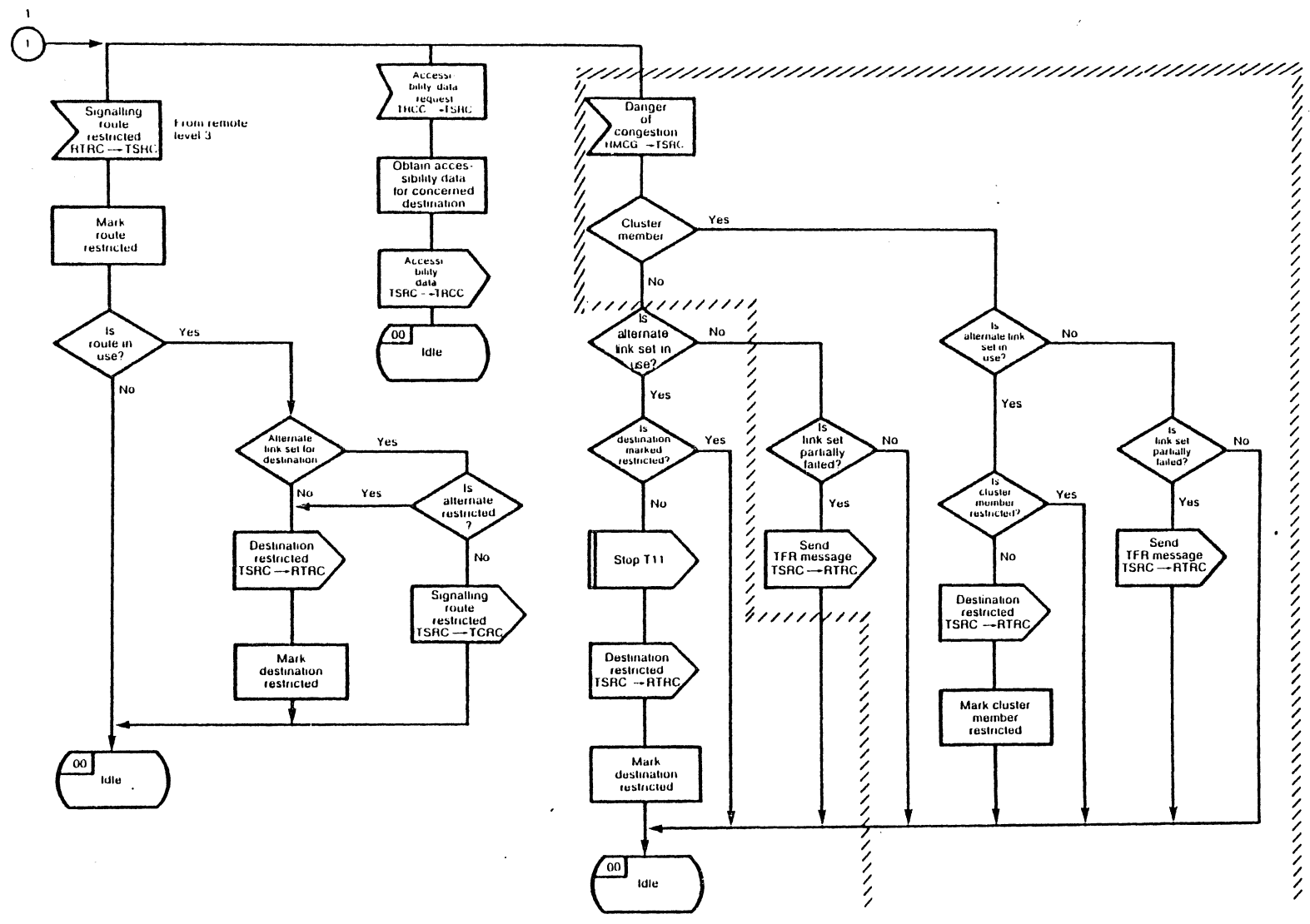

Figure 29/Q.704 Signalling traffic management: signalling routing control, TSRC (sheet 7 of 11)

SIGNALLING NETWORK FUNCTIONS AND MESSAGES

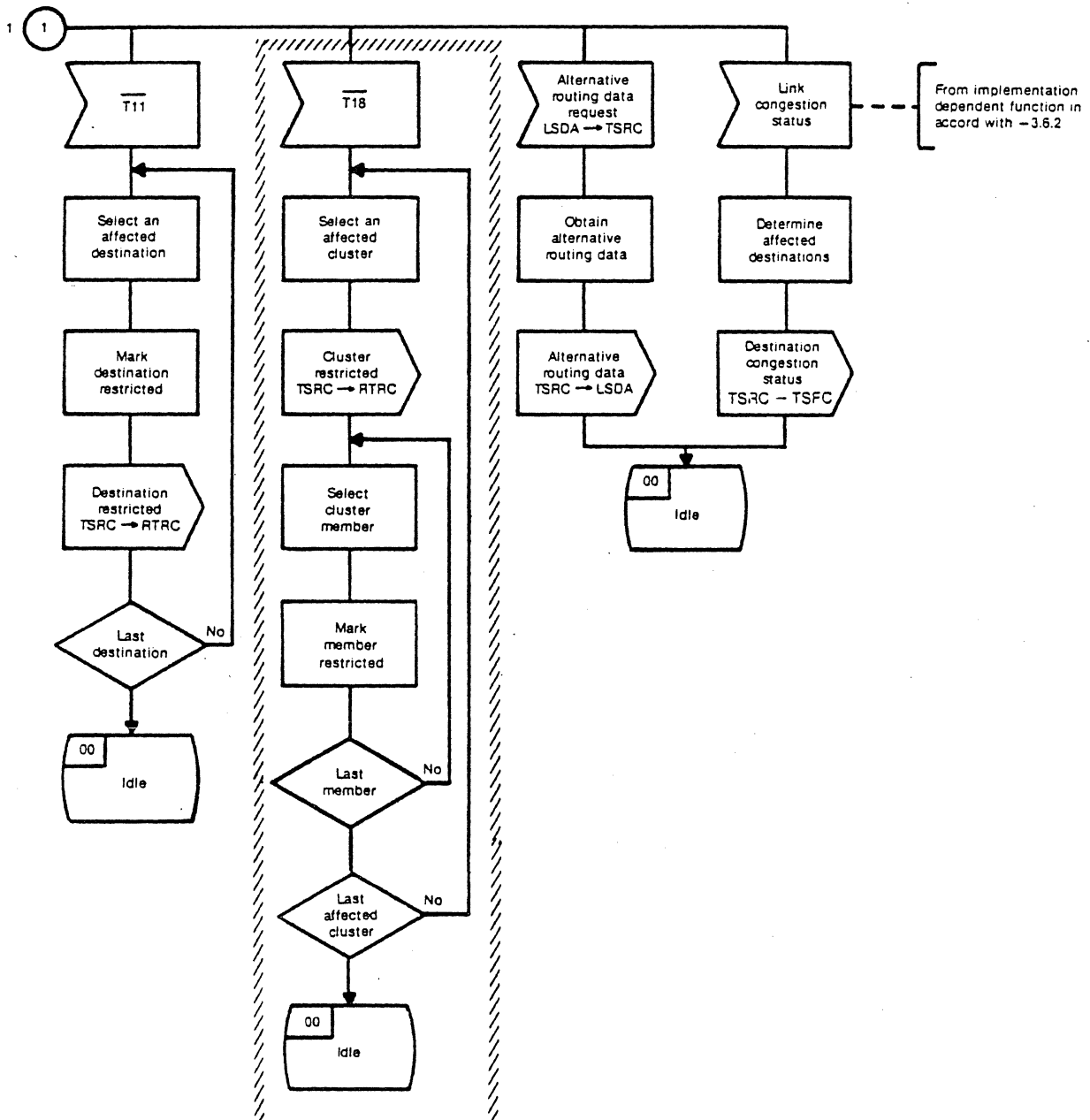
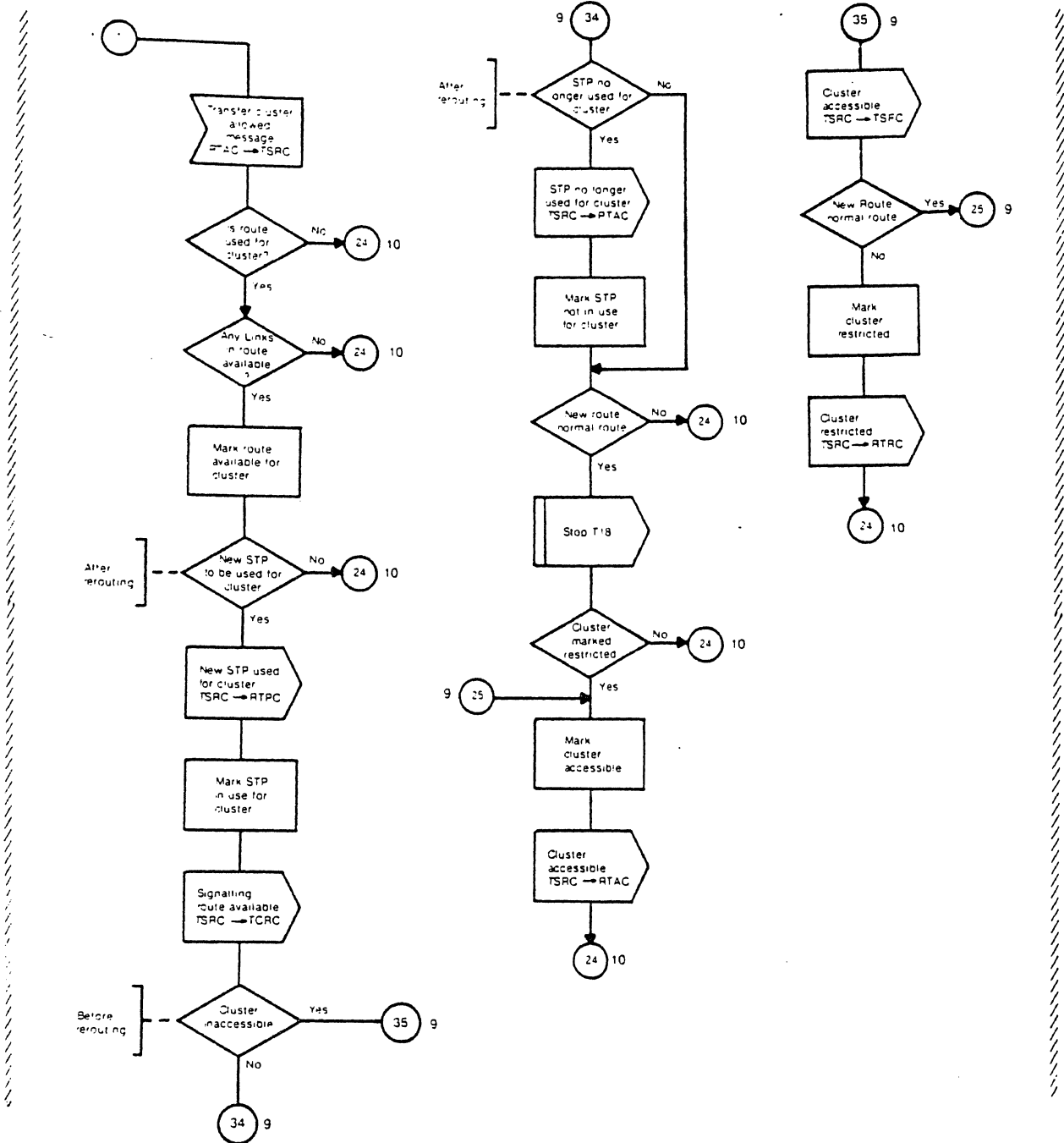

Figure 29/Q.704 (Sheet 8 of 11) - Signalling Traffic Management; Signalling Routing Control (TSRC)

SIGNALLING NETWORK FUNCTIONS AND MESSAGES



NOTE For simplicity, rerouting of traffic on a cluster basis is assumed. The current network configuration may require that some cluster members be specially routed.

Figure 29/Q.704 (Sheet 9 of 11) - Signalling Traffic Management; Signalling Routing Control (TSRC)

SIGNALLING NETWORK FUNCTIONS AND MESSAGES

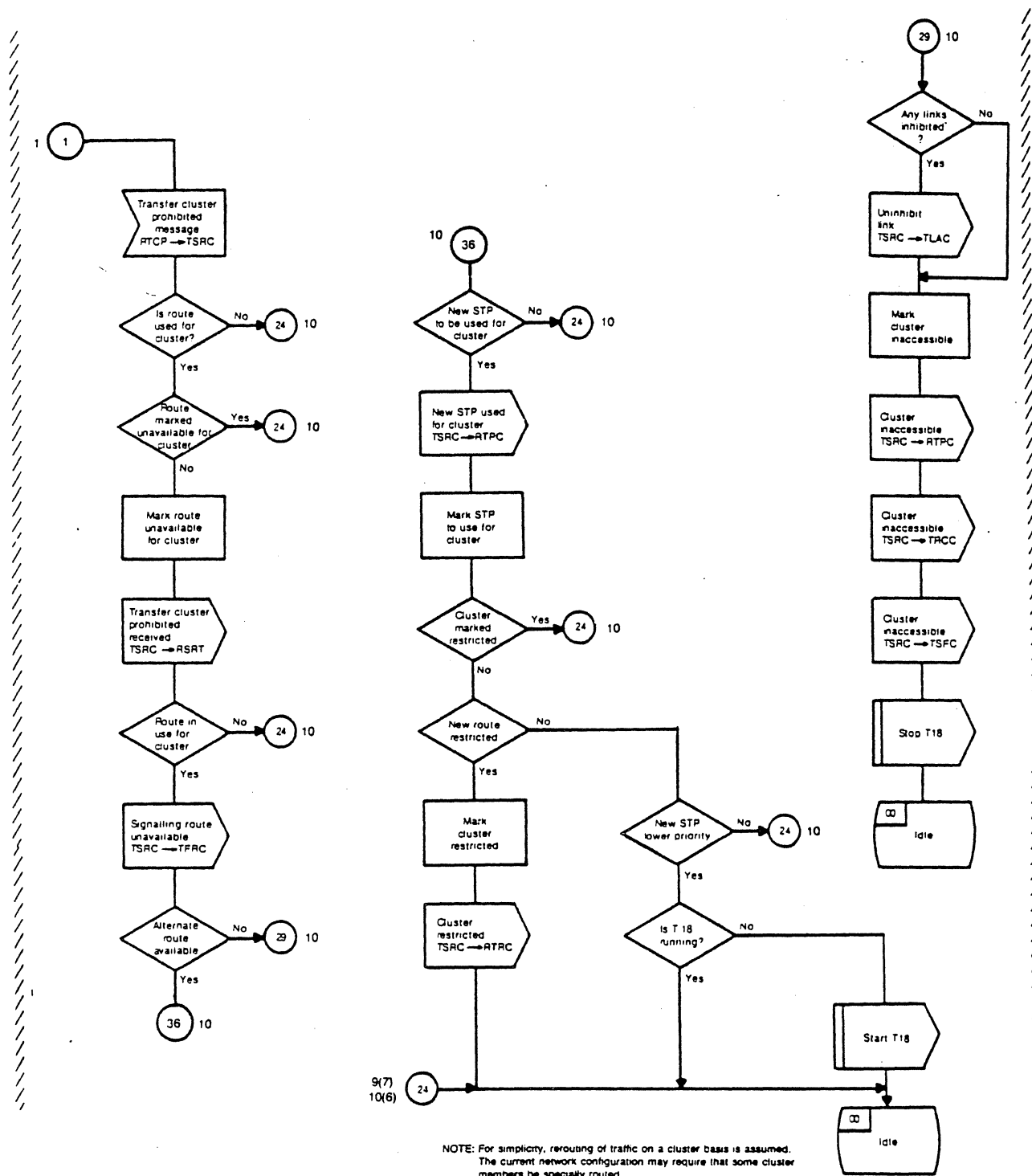

Figure 29/Q.704 (Sheet 10 of 11) - Signalling Traffic Management; Signalling Routing Control (TSRC)

SIGNALLING NETWORK FUNCTIONS AND MESSAGES

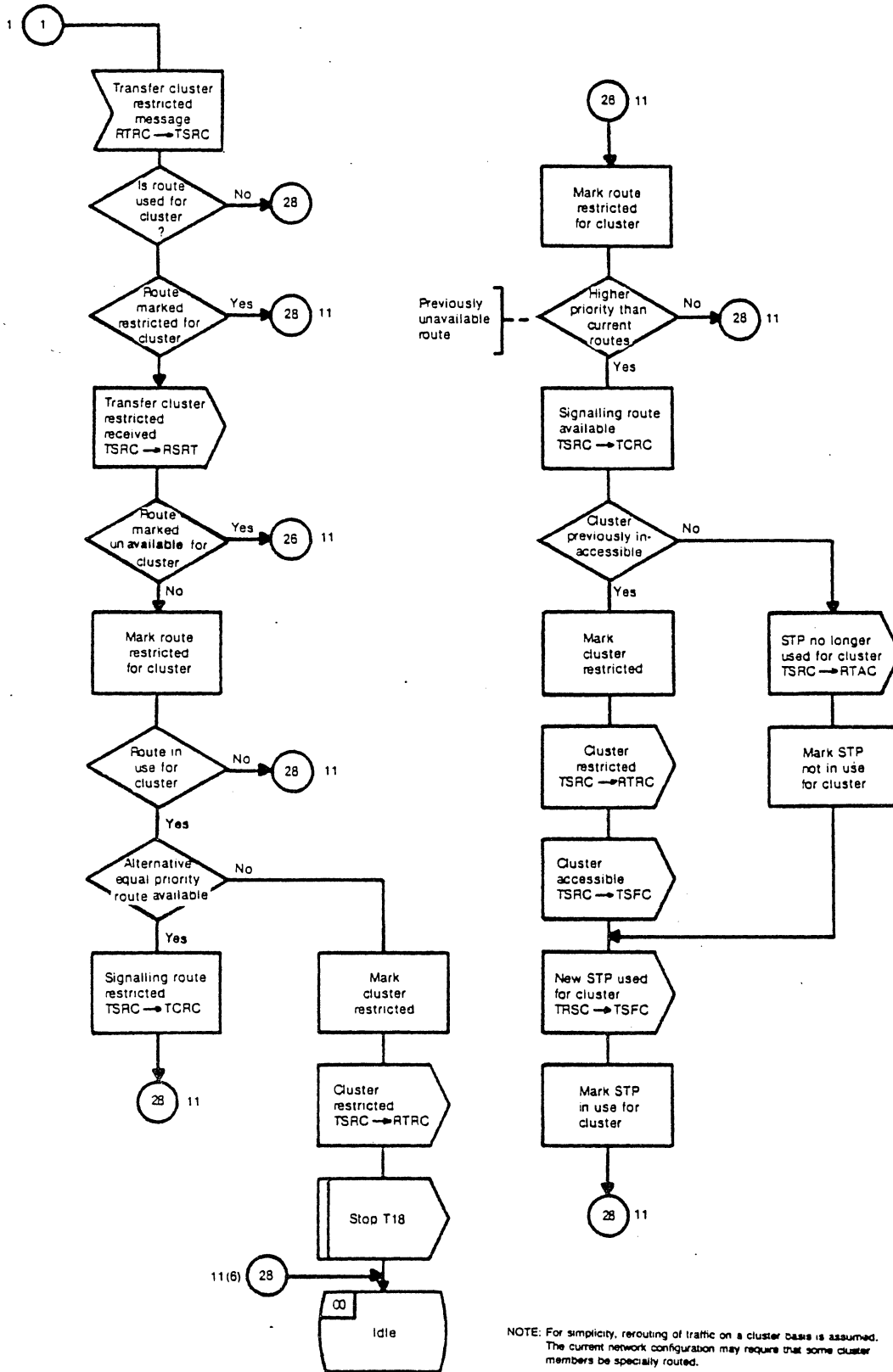

Figure 29/Q.704 Signalling traffic management: signalling routing control, TSRC (sheet 11 of 11)

SIGNALLING NETWORK FUNCTIONS AND MESSAGES

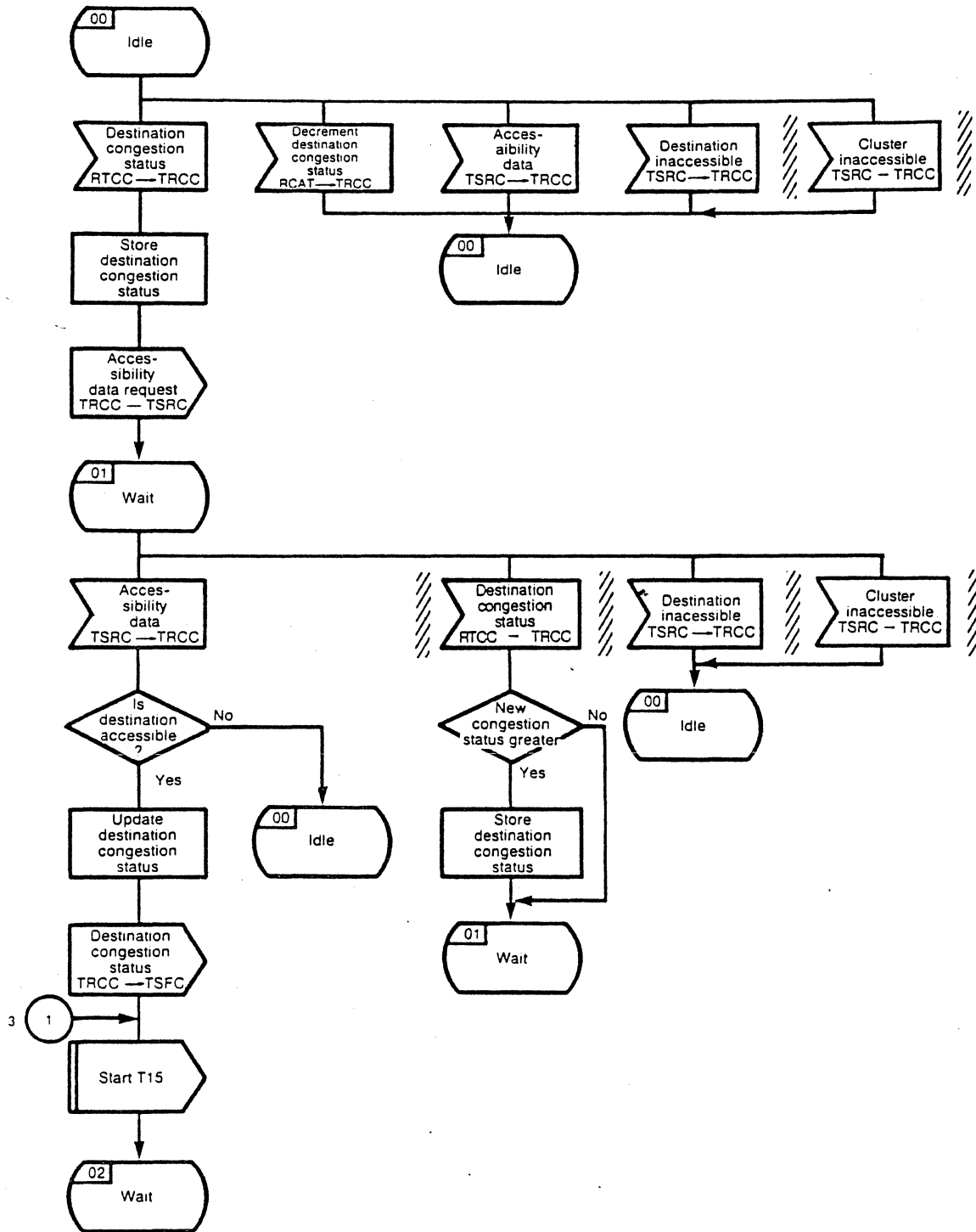

Figure 29A/Q.704 (sheet 1 of 3) - Signalling Traffic Management; Signalling Route Congestion Control (TRCC)

SIGNALLING NETWORK FUNCTIONS AND MESSAGES

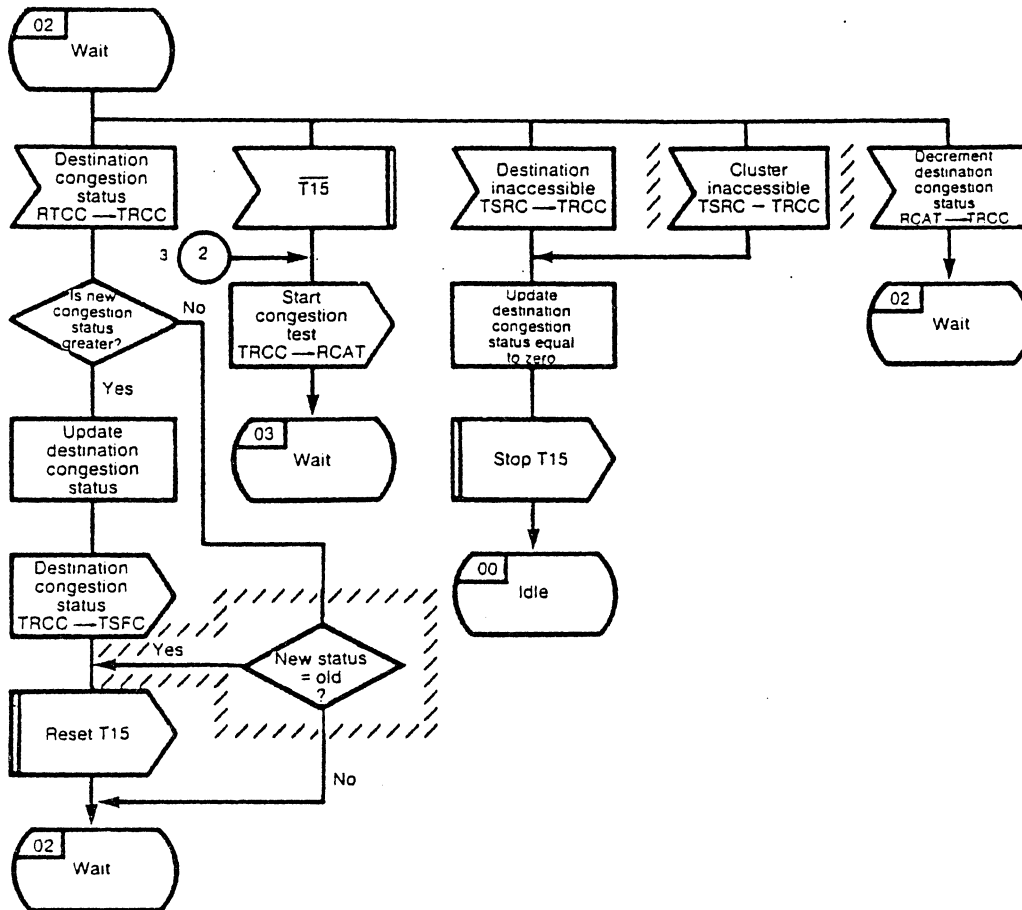

Figure 29A/Q.704 (sheet 2 of 3) - Signalling Traffic Management; Signalling Route Congestion Control (TRCC)

SIGNALLING NETWORK FUNCTIONS AND MESSAGES

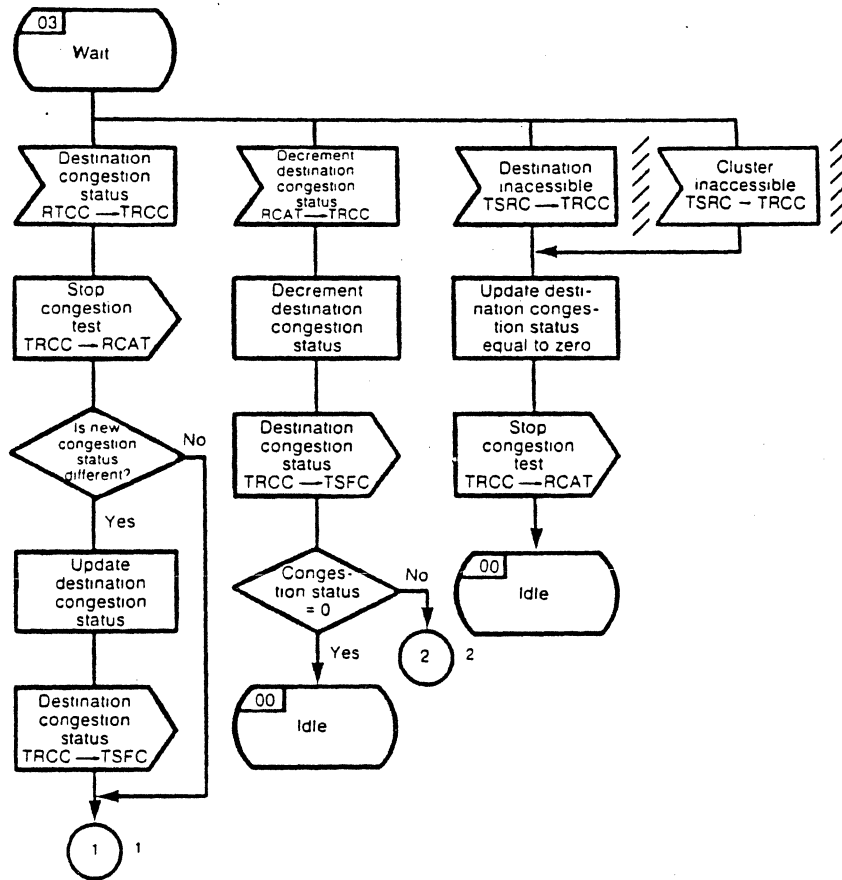

Figure 29A/Q.704 (sheet 3 of 3) - Signalling Traffic Management; Signalling Route Congestion Control (TRCC)

SIGNALLING NETWORK FUNCTIONS AND MESSAGES

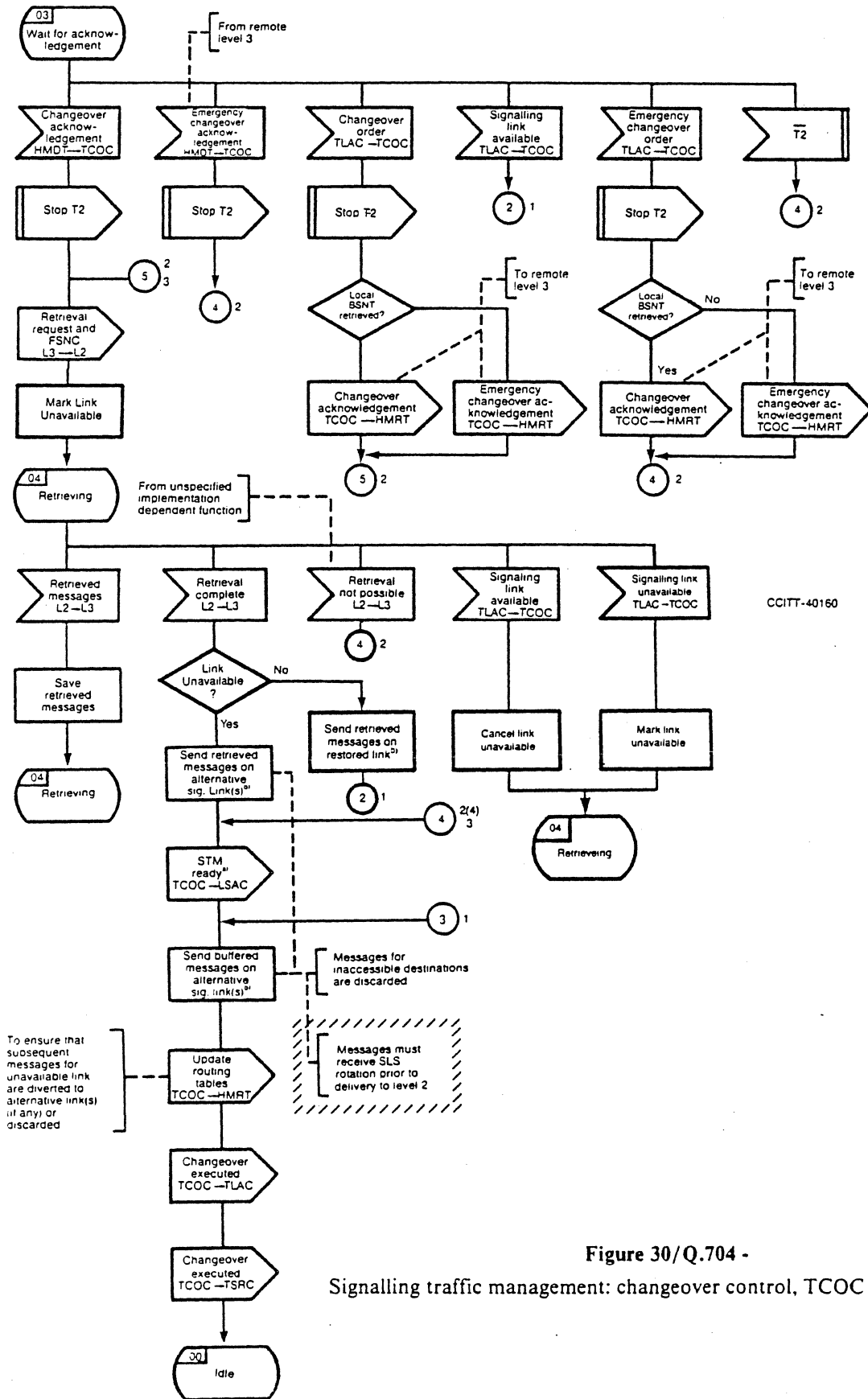

Figure 30/Q.704 -
 Signalling traffic management: changeover control, TCOC (sheet 2 of 3)

SIGNALLING NETWORK FUNCTIONS AND MESSAGES

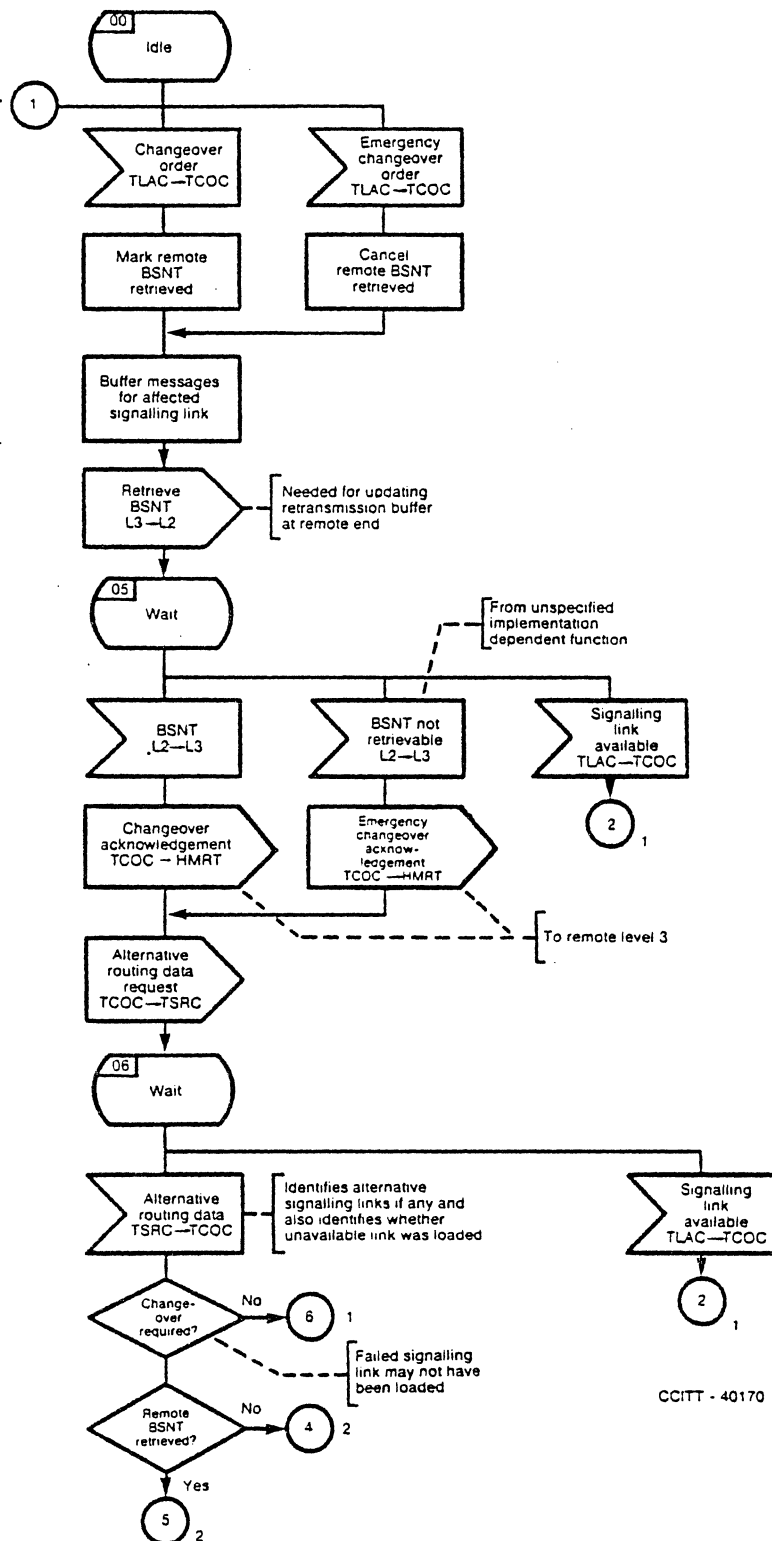

Figure 30/Q.704 (Sheet 3 of 3) - Signalling Traffic Management; Changeover Control (TCOC)

SIGNALLING NETWORK FUNCTIONS AND MESSAGES

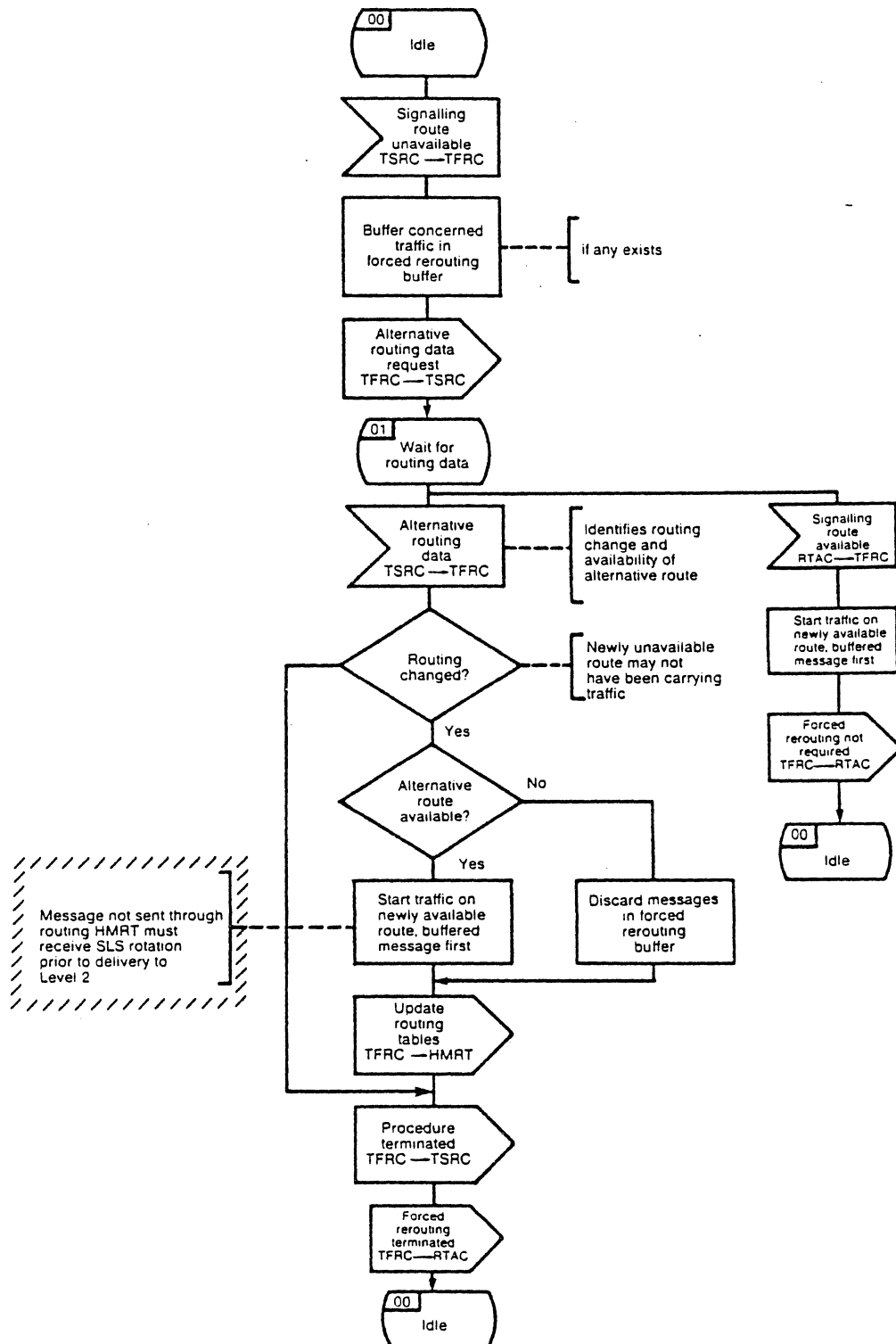
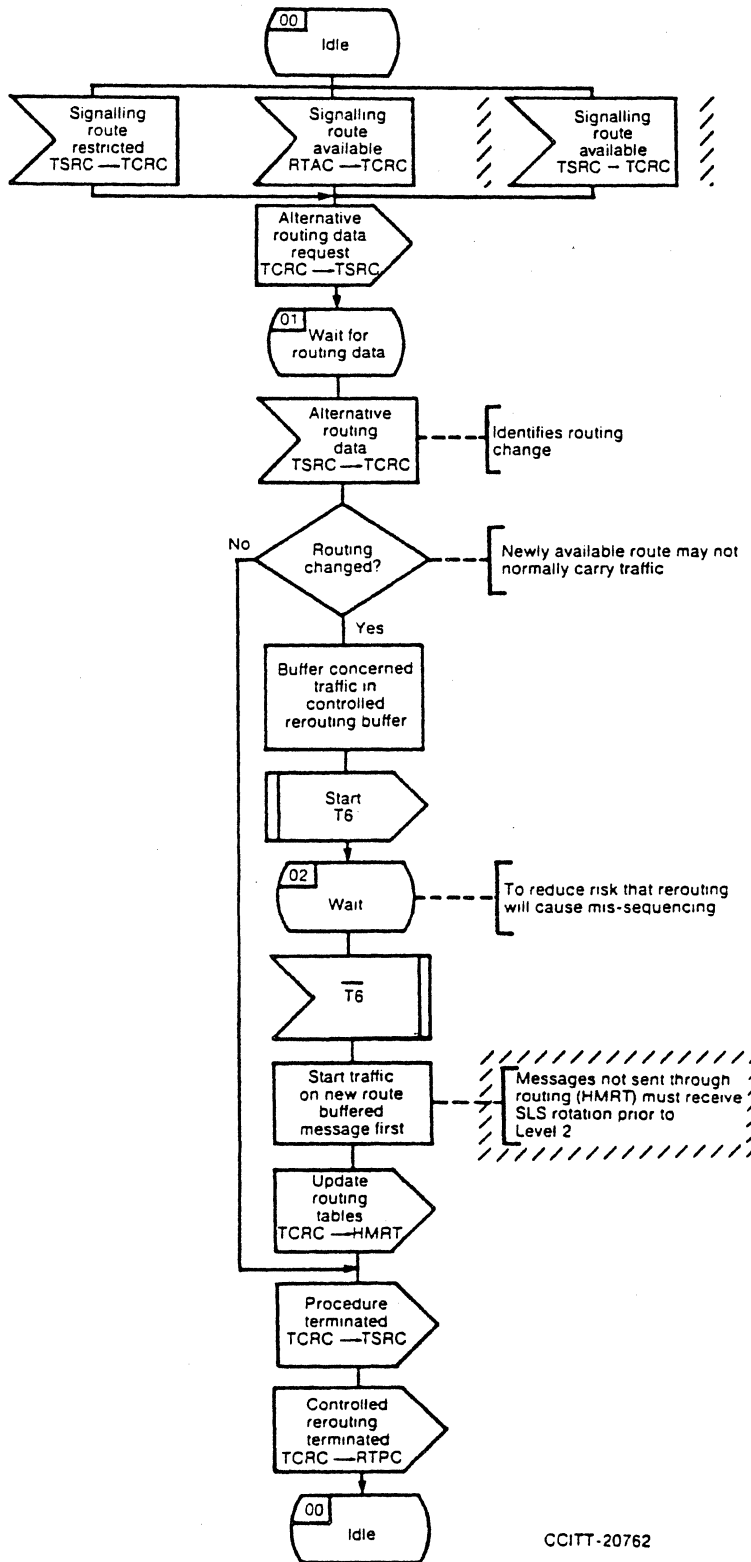

Figure 32/Q.704 - Signalling Traffic Management; Forced Rerouting Control (TFRC)

SIGNALLING NETWORK FUNCTIONS AND MESSAGES



CCITT-20762

Figure 33/Q.704 - Signalling Traffic Management; Controlled Rerouting Control (TCRC)

SIGNALLING NETWORK FUNCTIONS AND MESSAGES

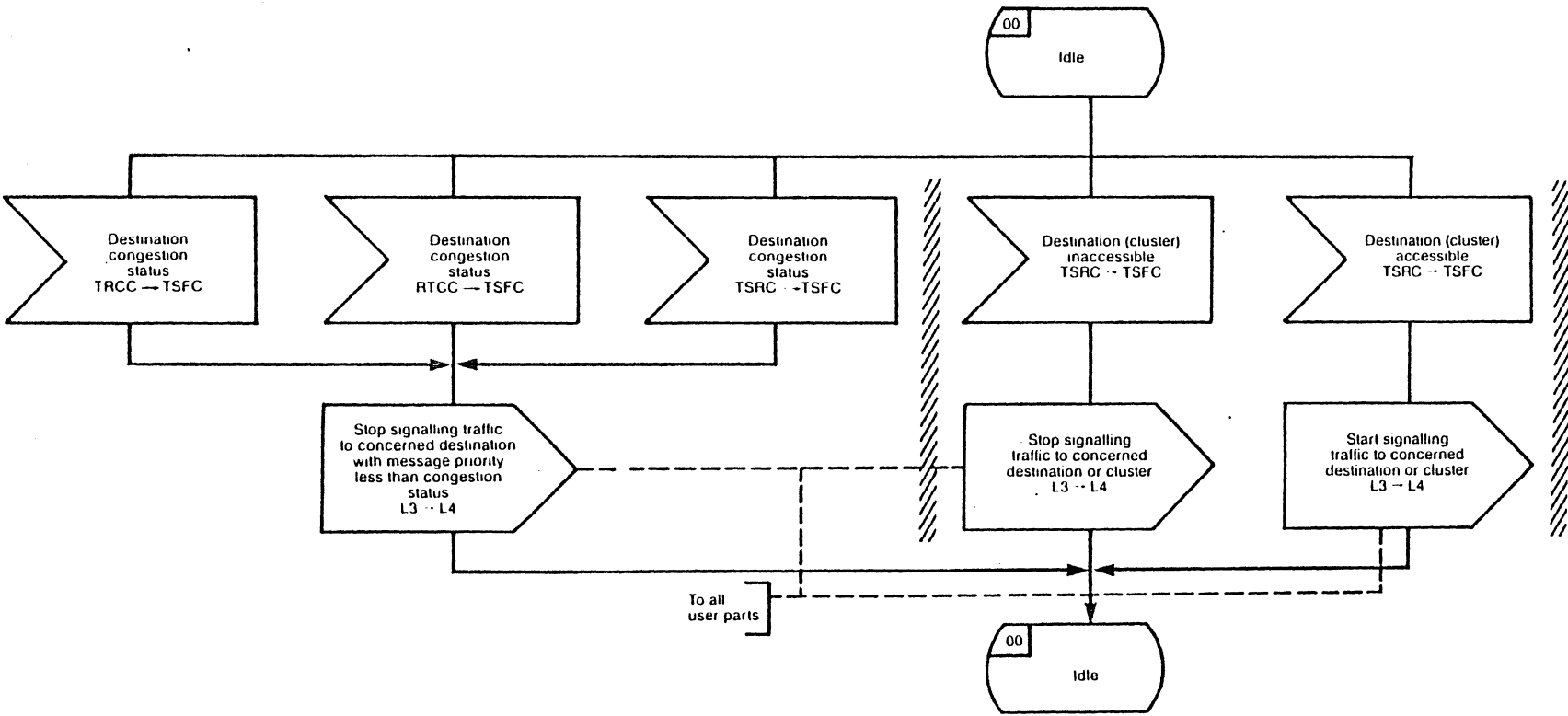
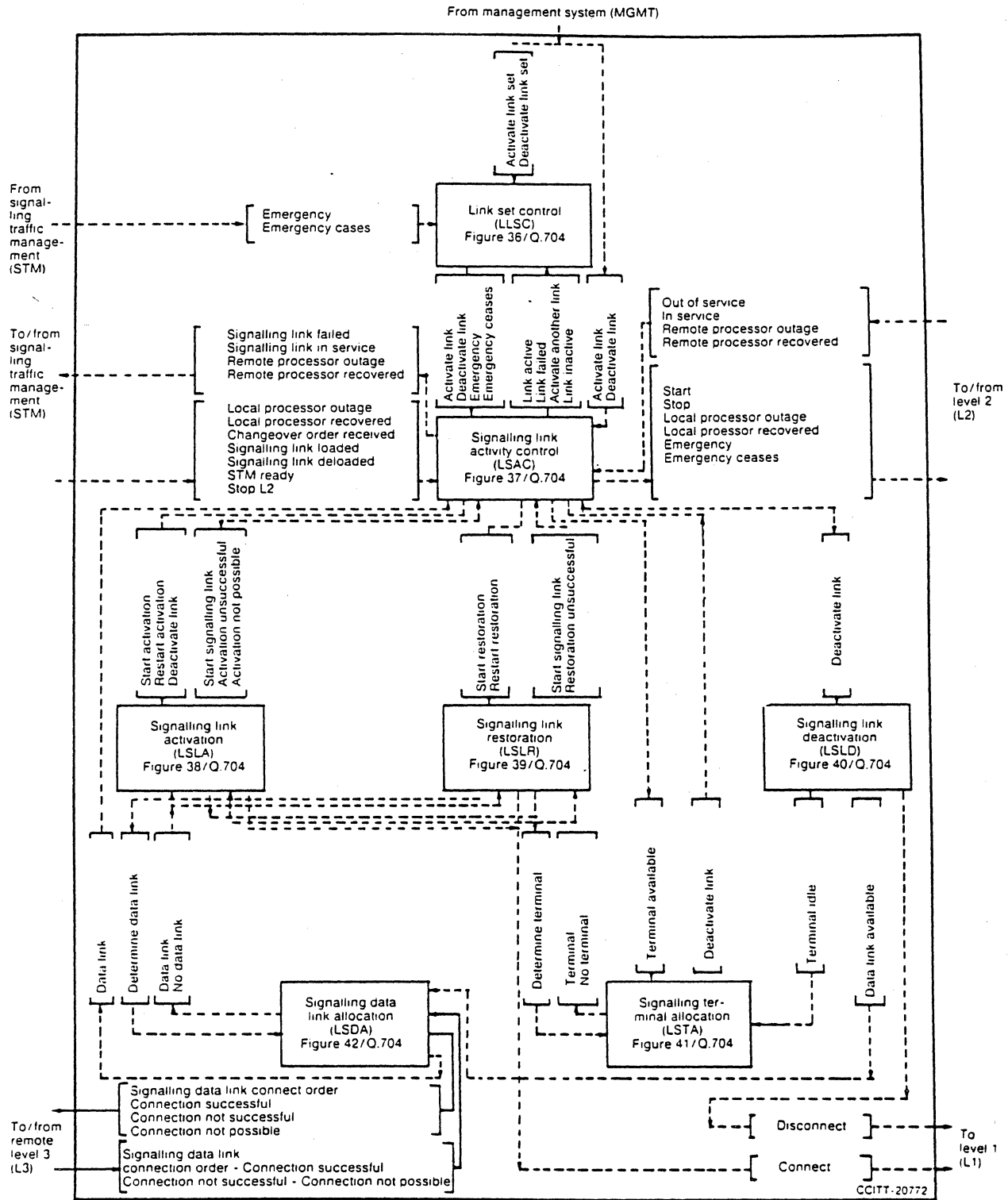

Figure 34/Q.704 - Signalling traffic management: signalling traffic flow control (TSFC)

SIGNALLING NETWORK FUNCTIONS AND MESSAGES



Note - Abbreviated message names have been used in this diagram (i.e. origin - destination codes are omitted).

Figure 35/Q.704 - Signalling Link Management (SLM); Functional Block Interactions

SIGNALLING NETWORK FUNCTIONS AND MESSAGES

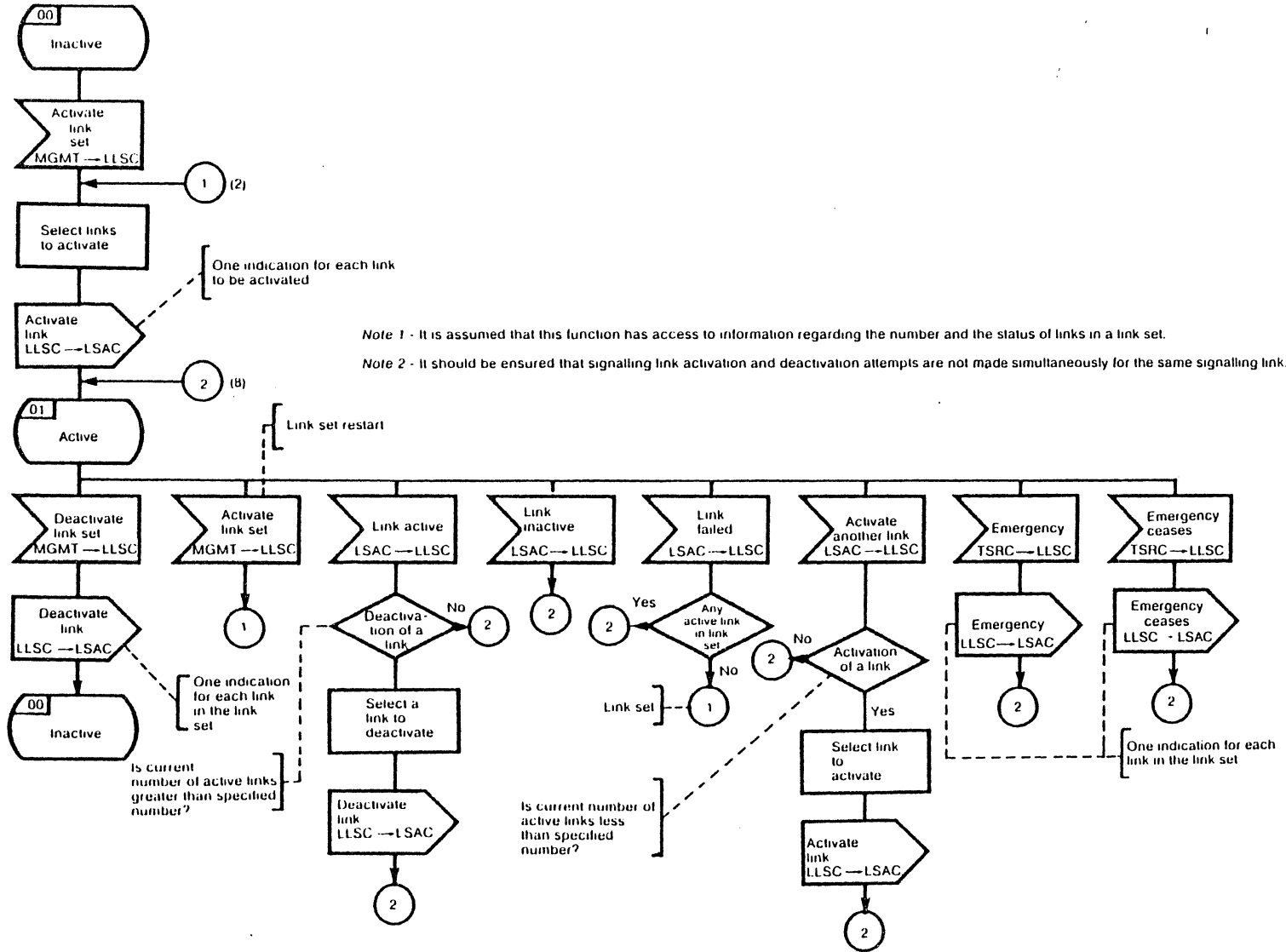

Figure 36/Q.704 - Signalling link management: link set control (LLSC)

SIGNALLING NETWORK FUNCTIONS AND MESSAGES

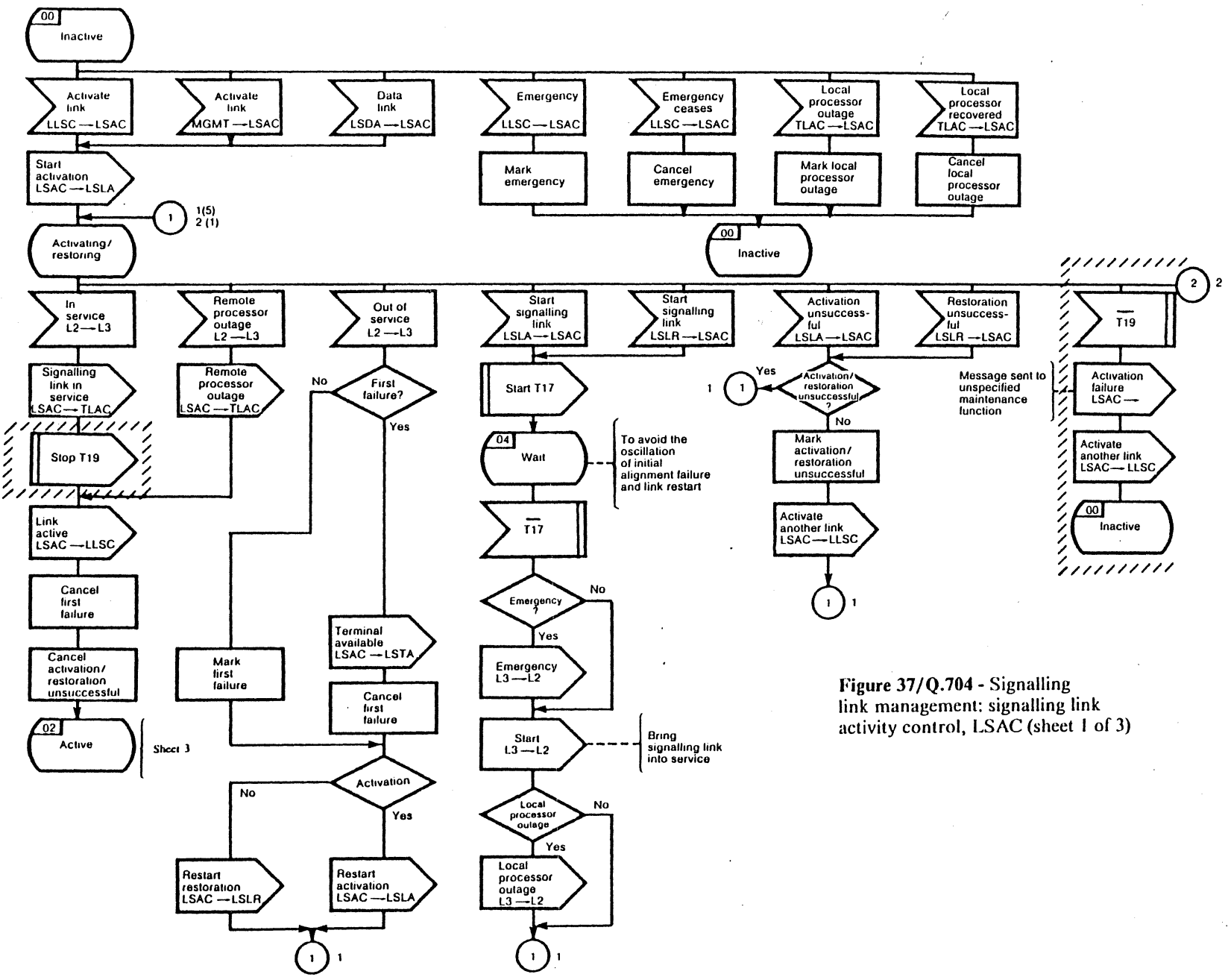

Figure 37/Q.704 - Signalling link management: signalling link activity control, LSAC (sheet 1 of 3)

-1-20-

Sheet 3

SIGNALLING NETWORK FUNCTIONS AND MESSAGES

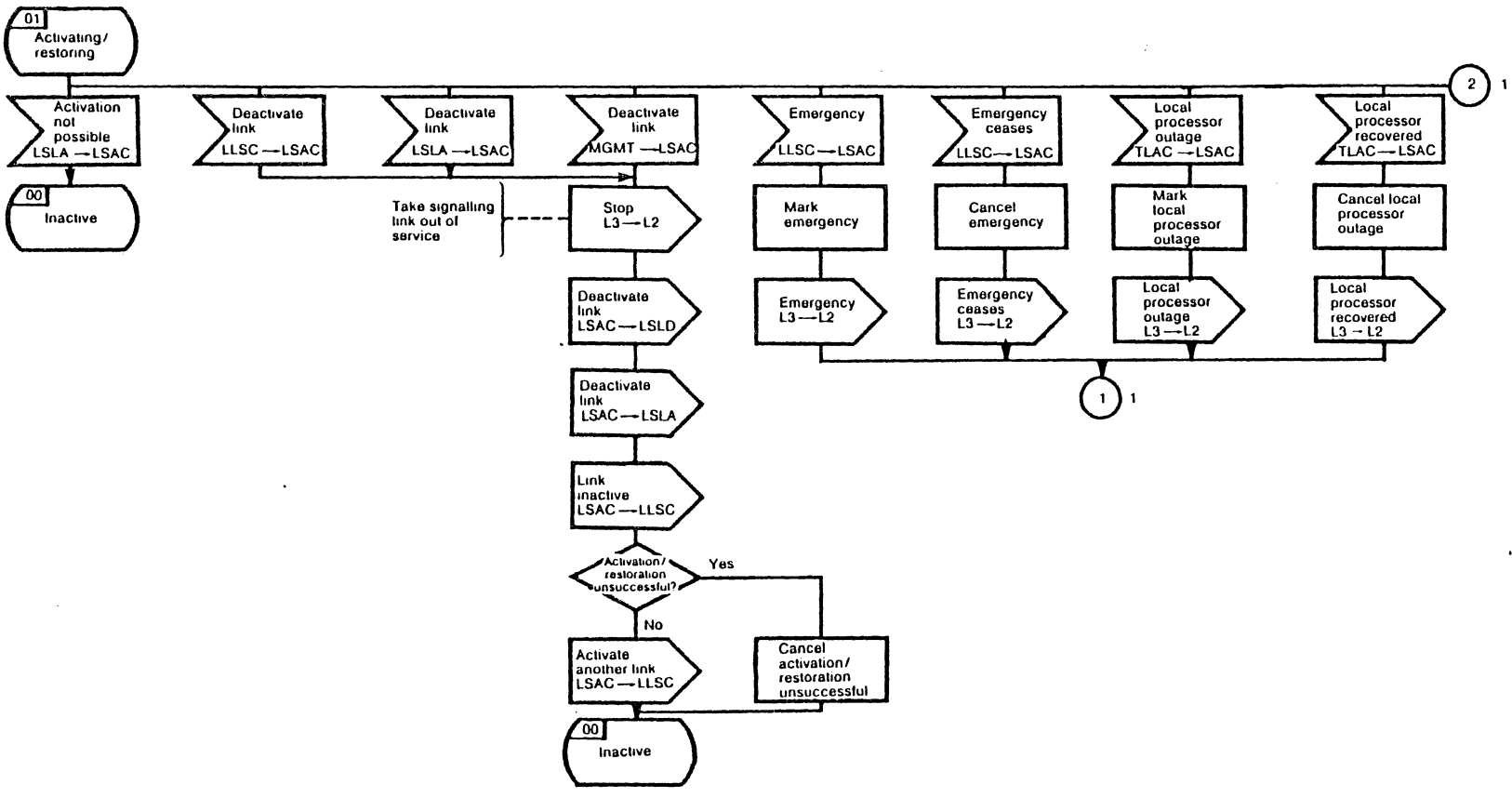

Figure 37/Q.704 - Signalling link management: signalling link activity control, LSAC (sheet 2 of 3)

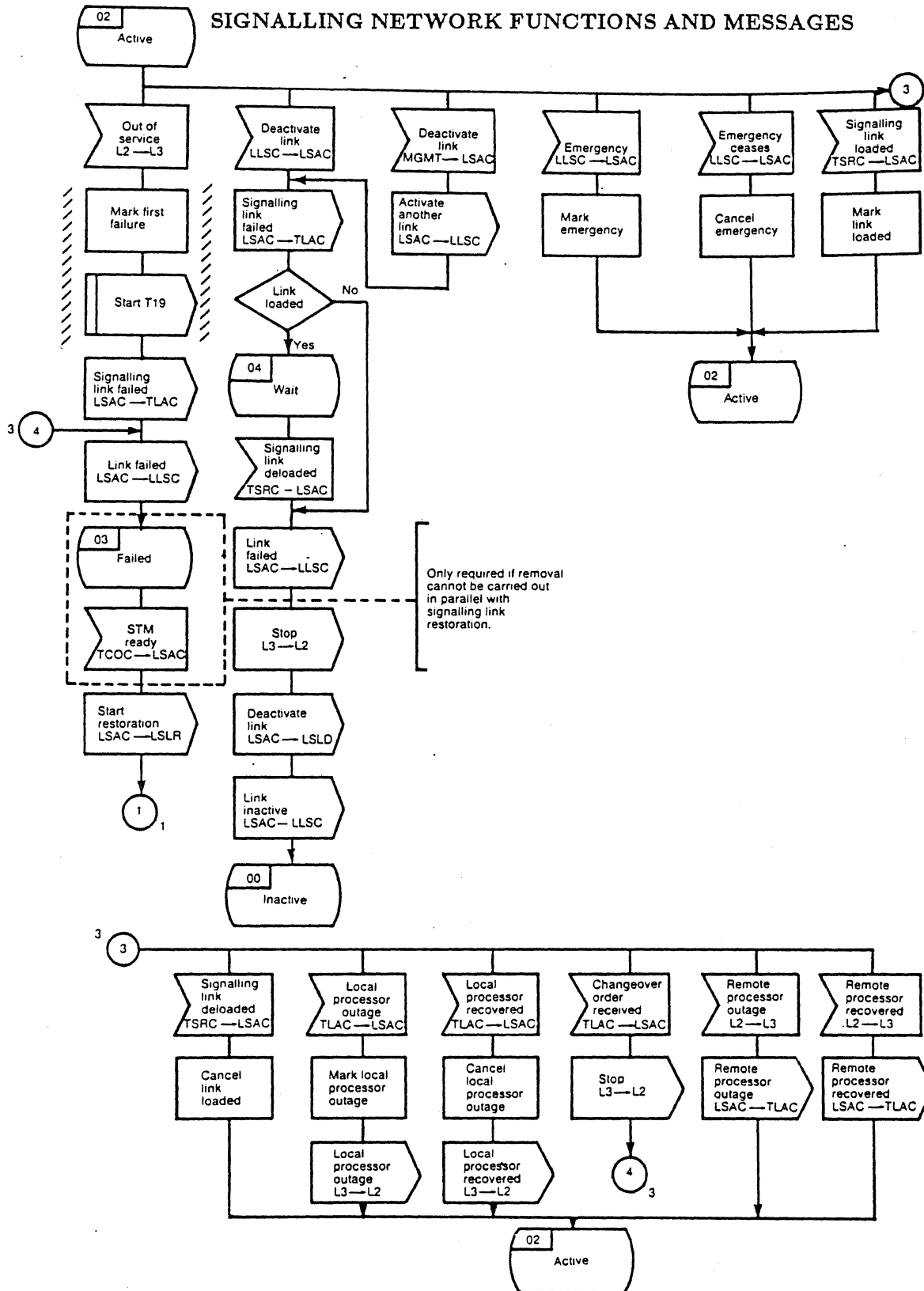

Figure 37/Q.704 (Sheet 3 of 3) - Signalling Link Management; Signalling Link Activity Control (LSAC)

SIGNALLING NETWORK FUNCTIONS AND MESSAGES

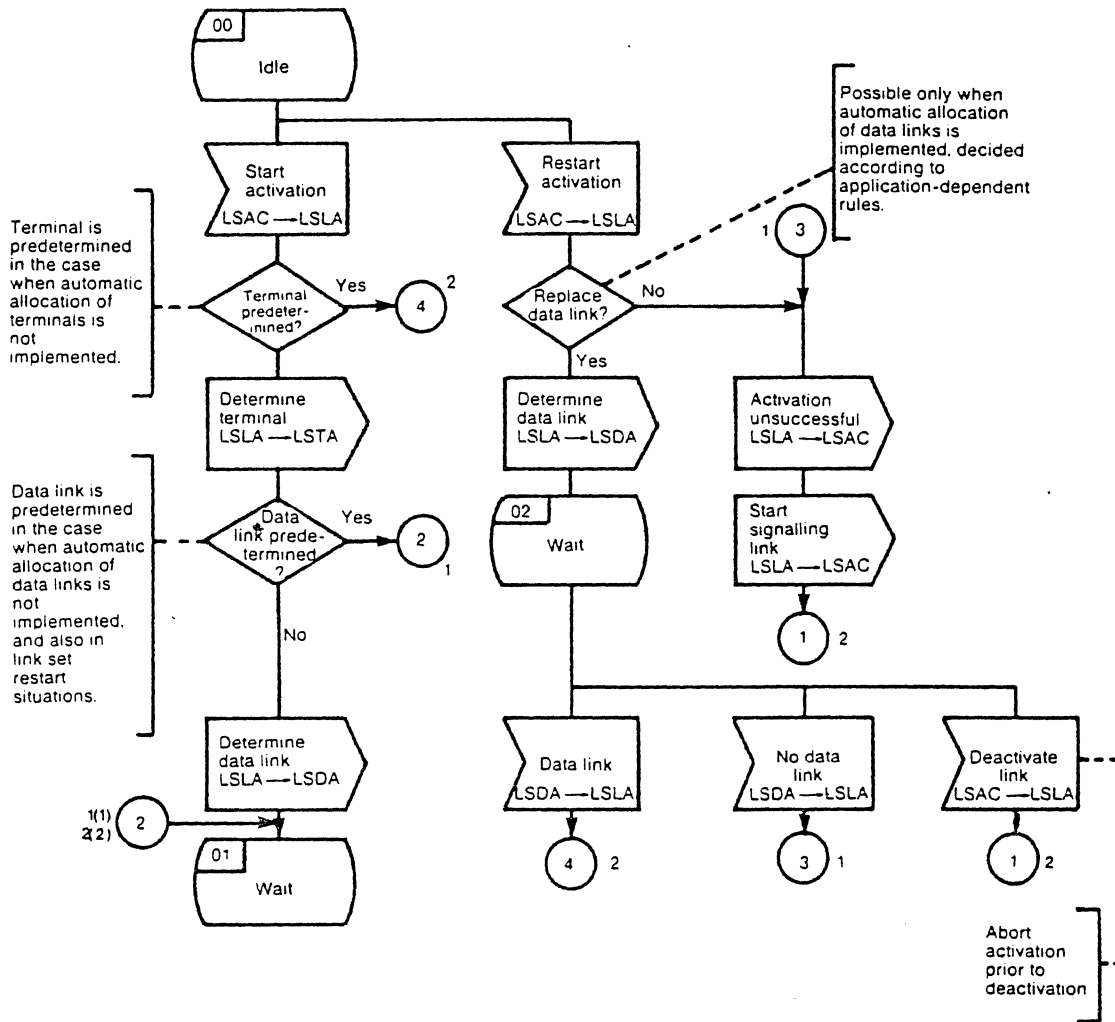

Figure 38/Q.704 (Sheet 1 of 2) - Signalling Link Management; Signalling Link Activation (LSLA)

SIGNALLING NETWORK FUNCTIONS AND MESSAGES

Q.704

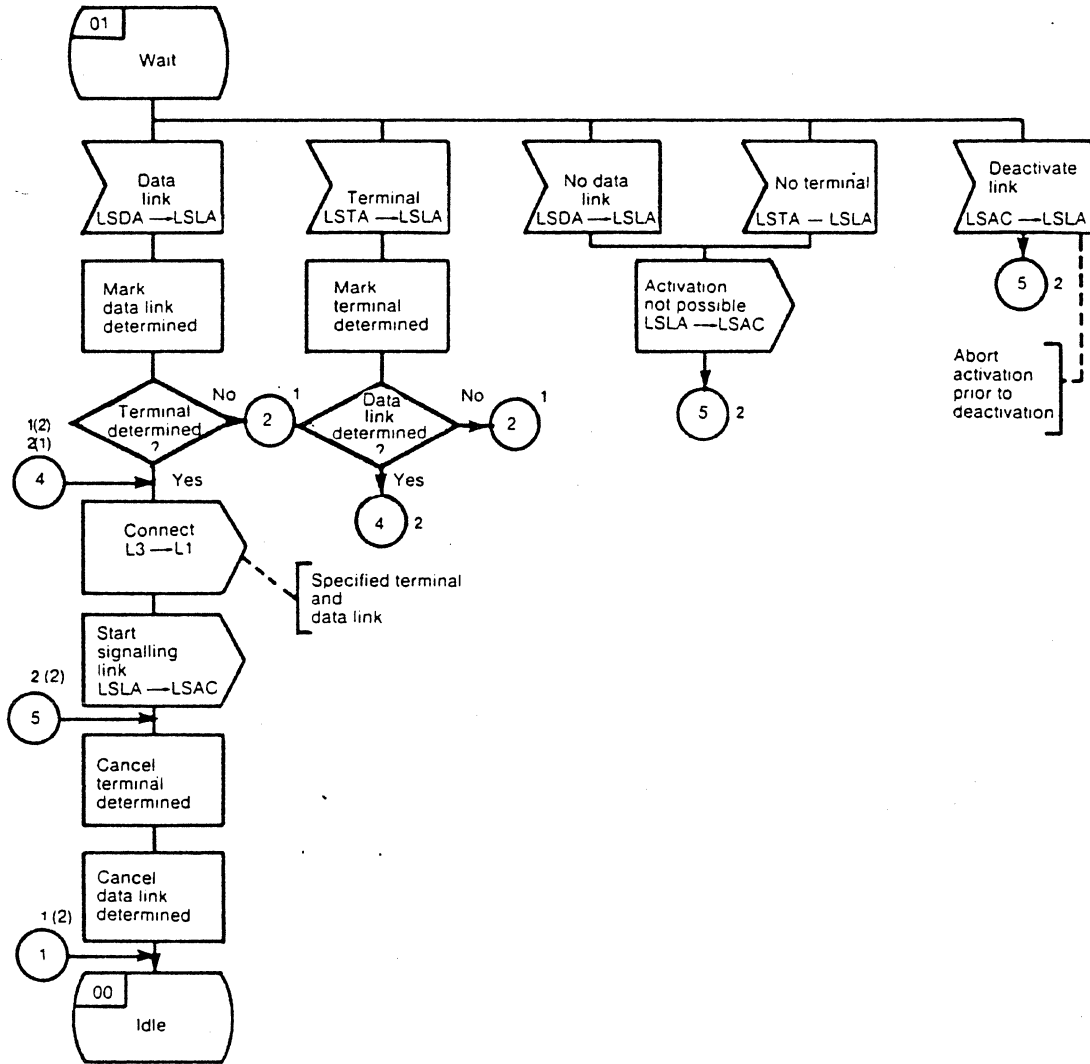

Figure 38/Q.704 (Sheet 2 of 2) - Signalling Link Management; Signalling Link Activation (LSLA)

SIGNALLING NETWORK FUNCTIONS AND MESSAGES

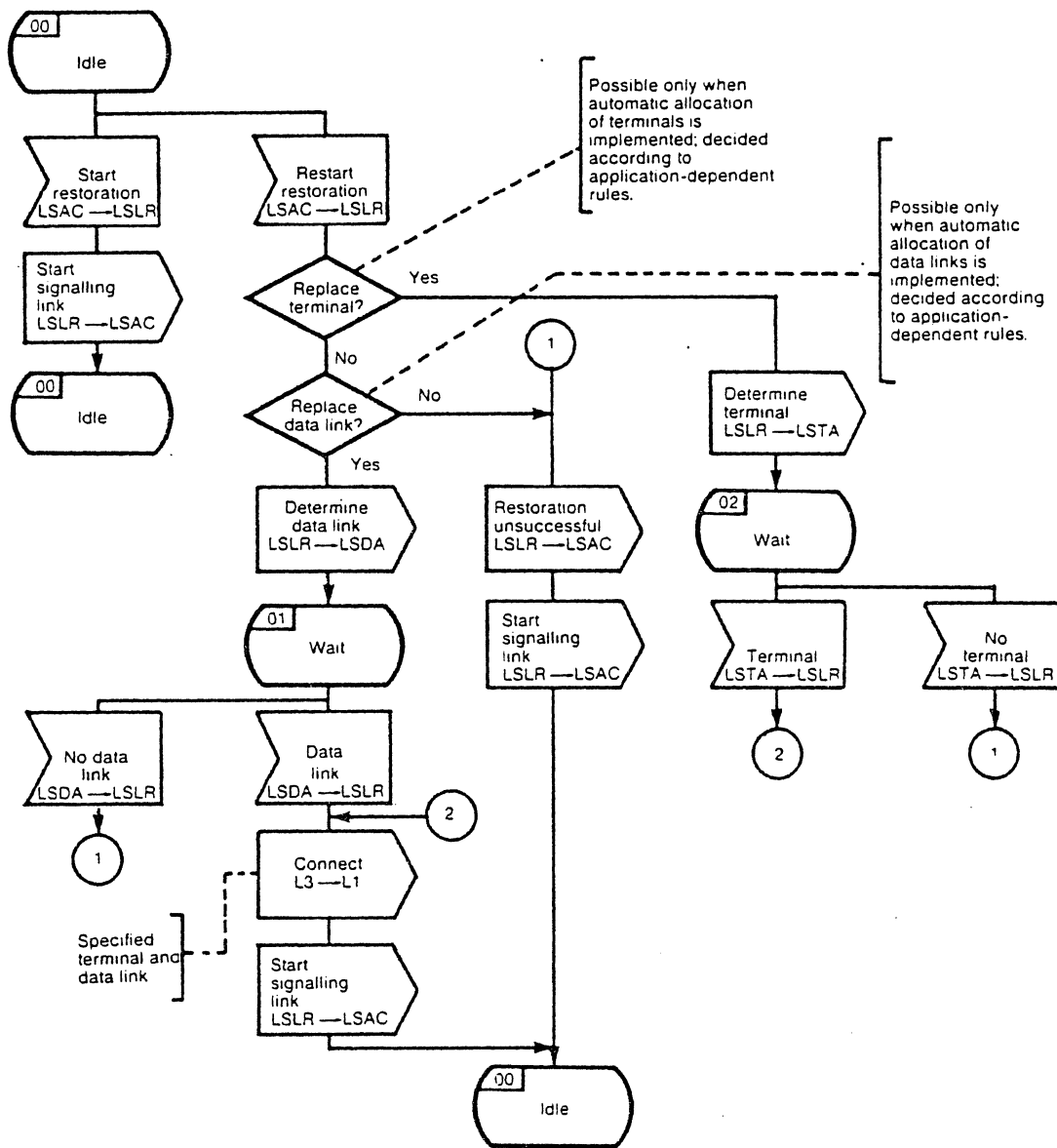

Figure 39/Q.704 - Signalling Link Management; Signalling Link Restoration (LSLR)

SIGNALLING NETWORK FUNCTIONS AND MESSAGES

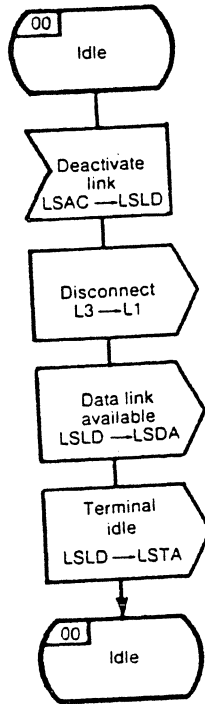

Figure 40/Q.704 - Signalling Link Management; Signalling Link Deactivation (LSLD)

SIGNALLING NETWORK FUNCTIONS AND MESSAGES

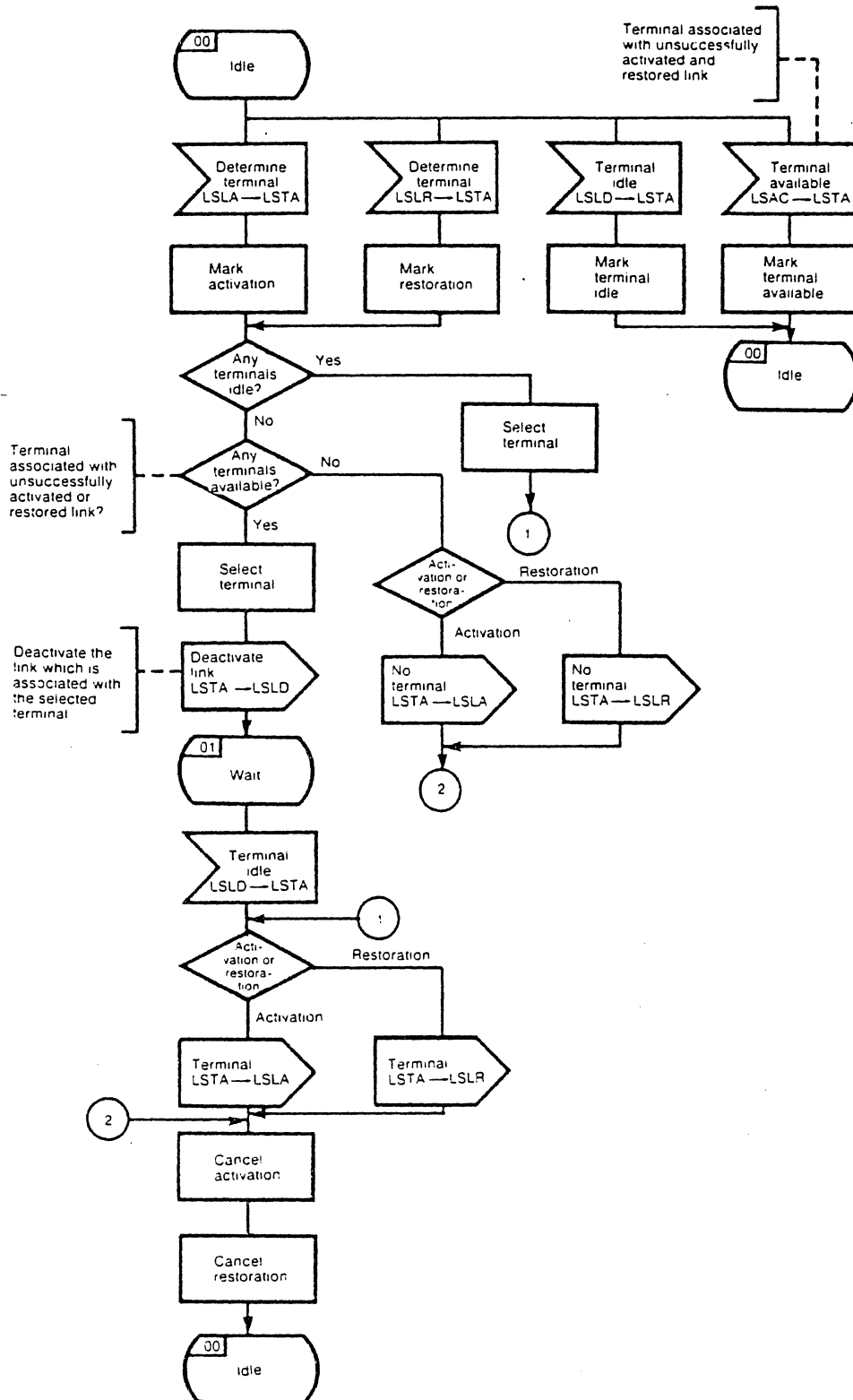

Figure 41/Q.704 - Signalling Link Management; Signalling Terminal Allocation (LSTA)

SIGNALLING NETWORK FUNCTIONS AND MESSAGES

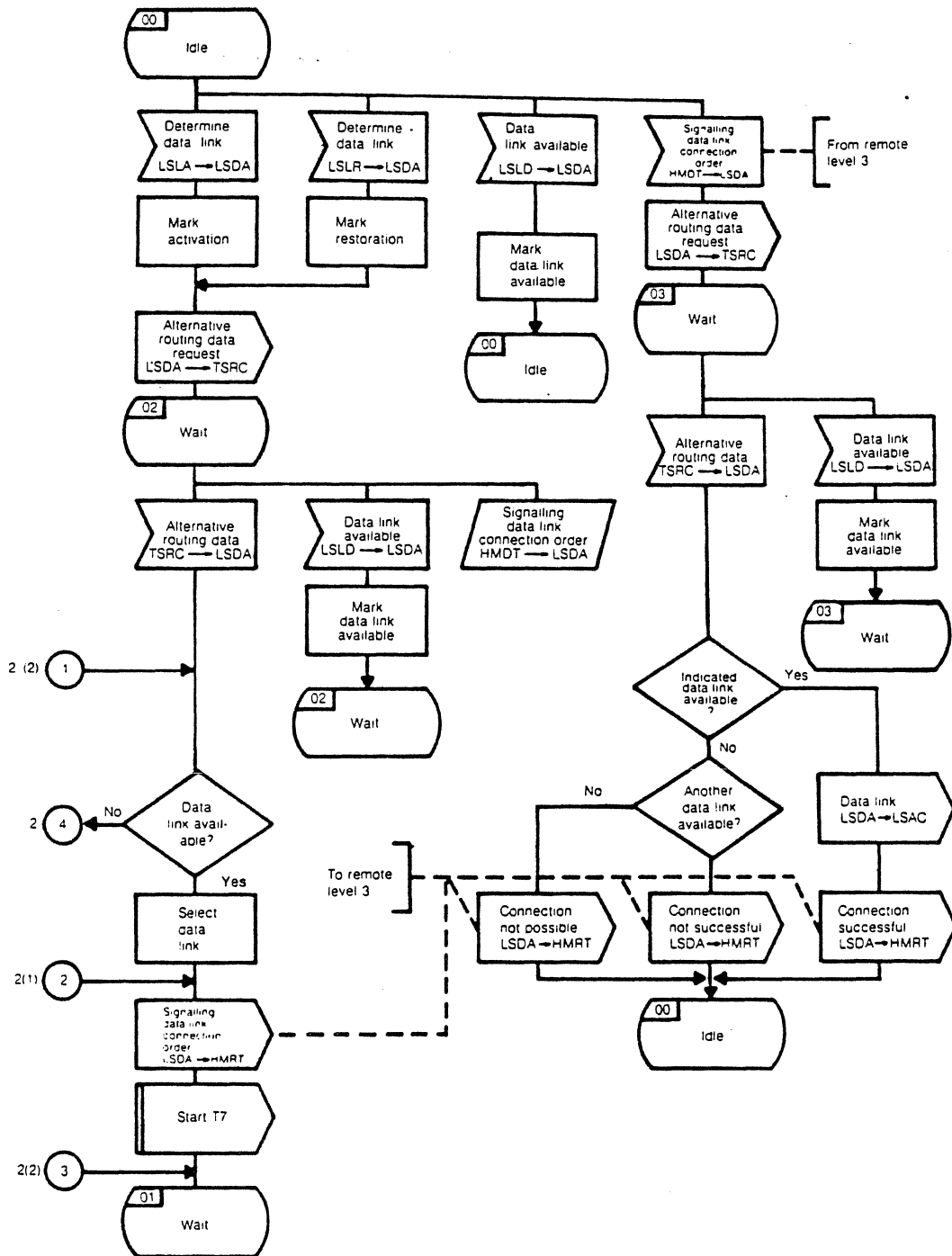

Figure 42/Q.704 (Sheet 1 of 2) - Signalling Link Management; Signalling Data Link Allocation (LSDA)

SIGNALLING NETWORK FUNCTIONS AND MESSAGES

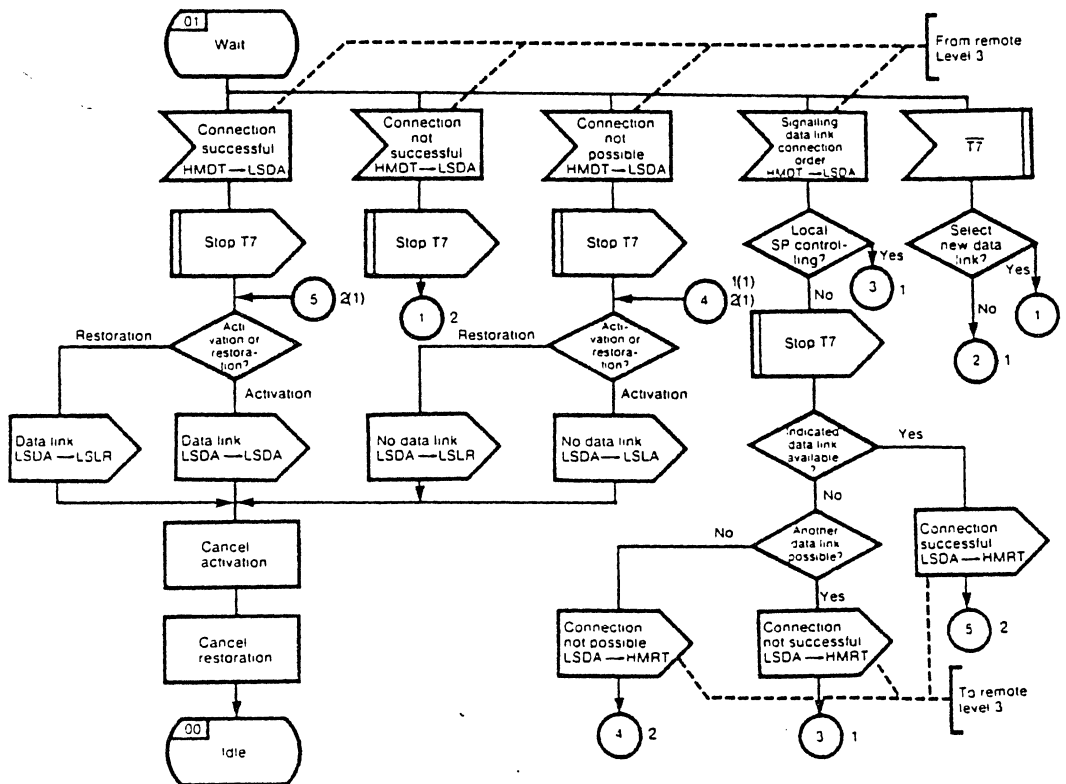
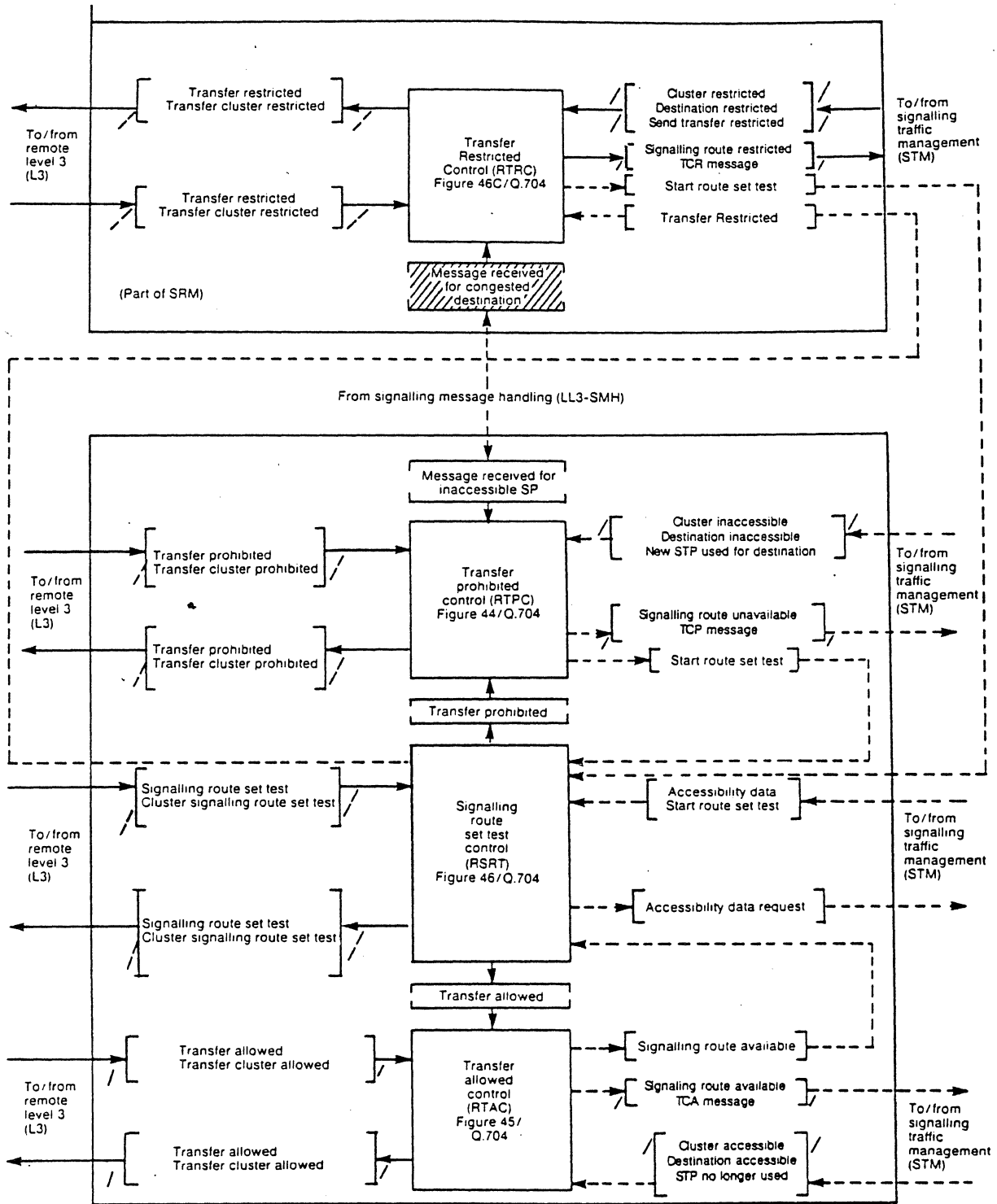

Figure 42/Q.704 (Sheet 2 of 2) - Signalling Link Management; Signalling Data Link Allocation (LSDA)

SIGNALLING NETWORK FUNCTIONS AND MESSAGES



Note - Abbreviated message names have been used in this diagram (i.e. origin - destination codes have been omitted).

Figure 43/Q.704 (Sheet 1 of 2) - Signalling Route Management (SRM); Functional Block Interactions

SIGNALLING NETWORK FUNCTIONS AND MESSAGES

+ functions modified in the case of multiple congestion levels

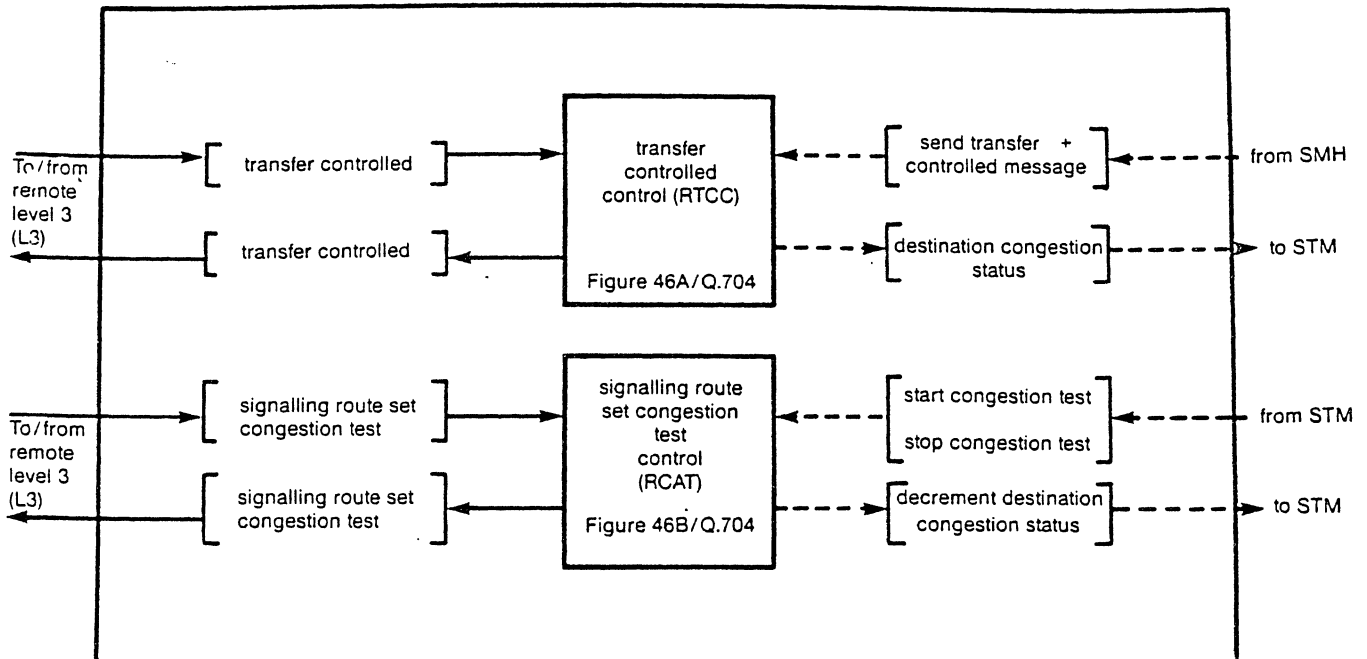

Figure 43/Q.704 (Sheet 2 of 2) - Signalling Route Management (SRM); Functional Block Interactions

SIGNALLING NETWORK FUNCTIONS AND MESSAGES

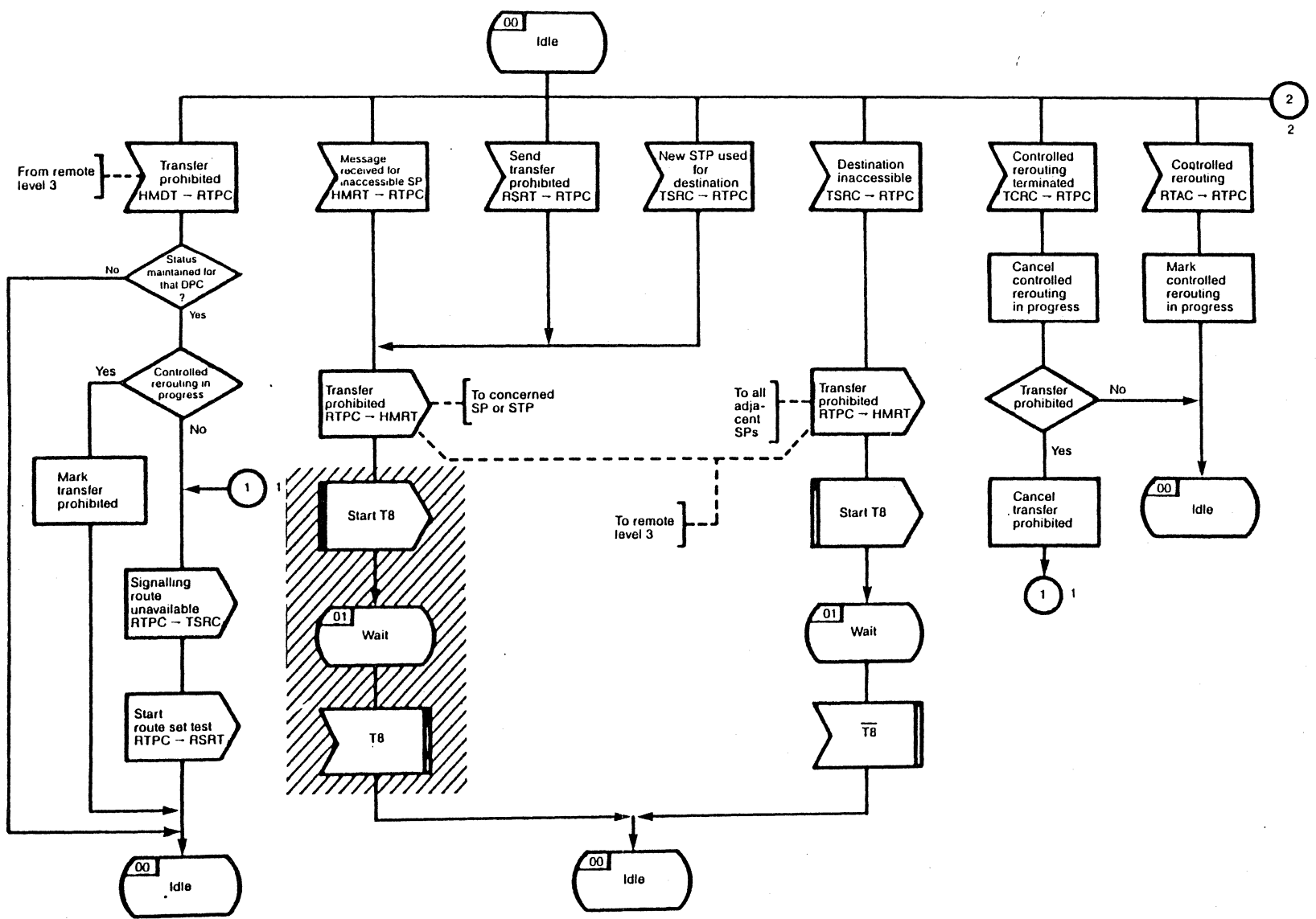

Figure 44/Q.704 -
 Signalling route management; transfer prohibited control, RTPC (sheet 1 of 2)

SIGNALLING NETWORK FUNCTIONS AND MESSAGES

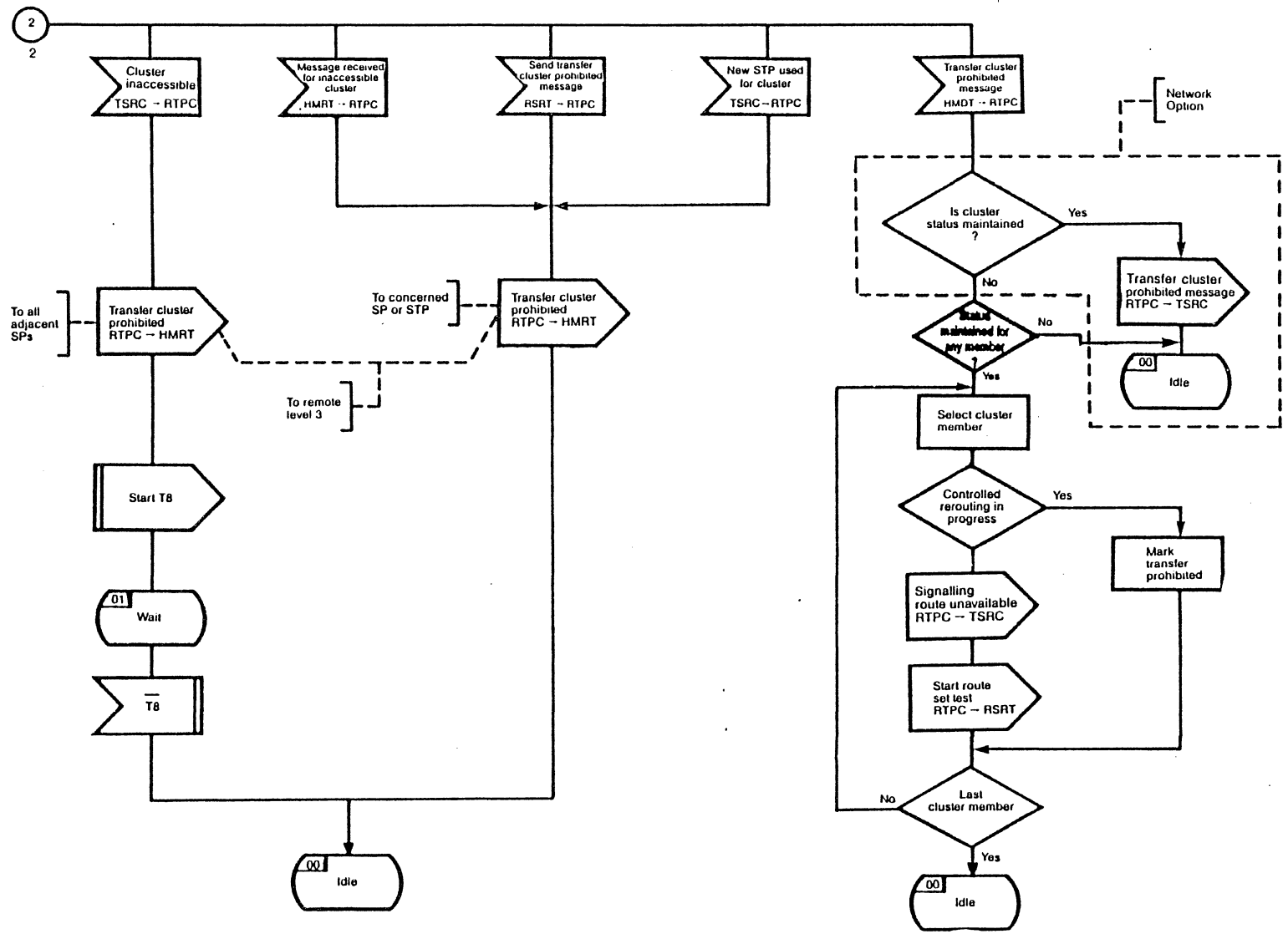

Figure 44/Q.704 - Signalling route management: transfer prohibited control, RTPC (sheet 2 of 2)

SIGNALLING NETWORK FUNCTIONS AND MESSAGES

Q.704

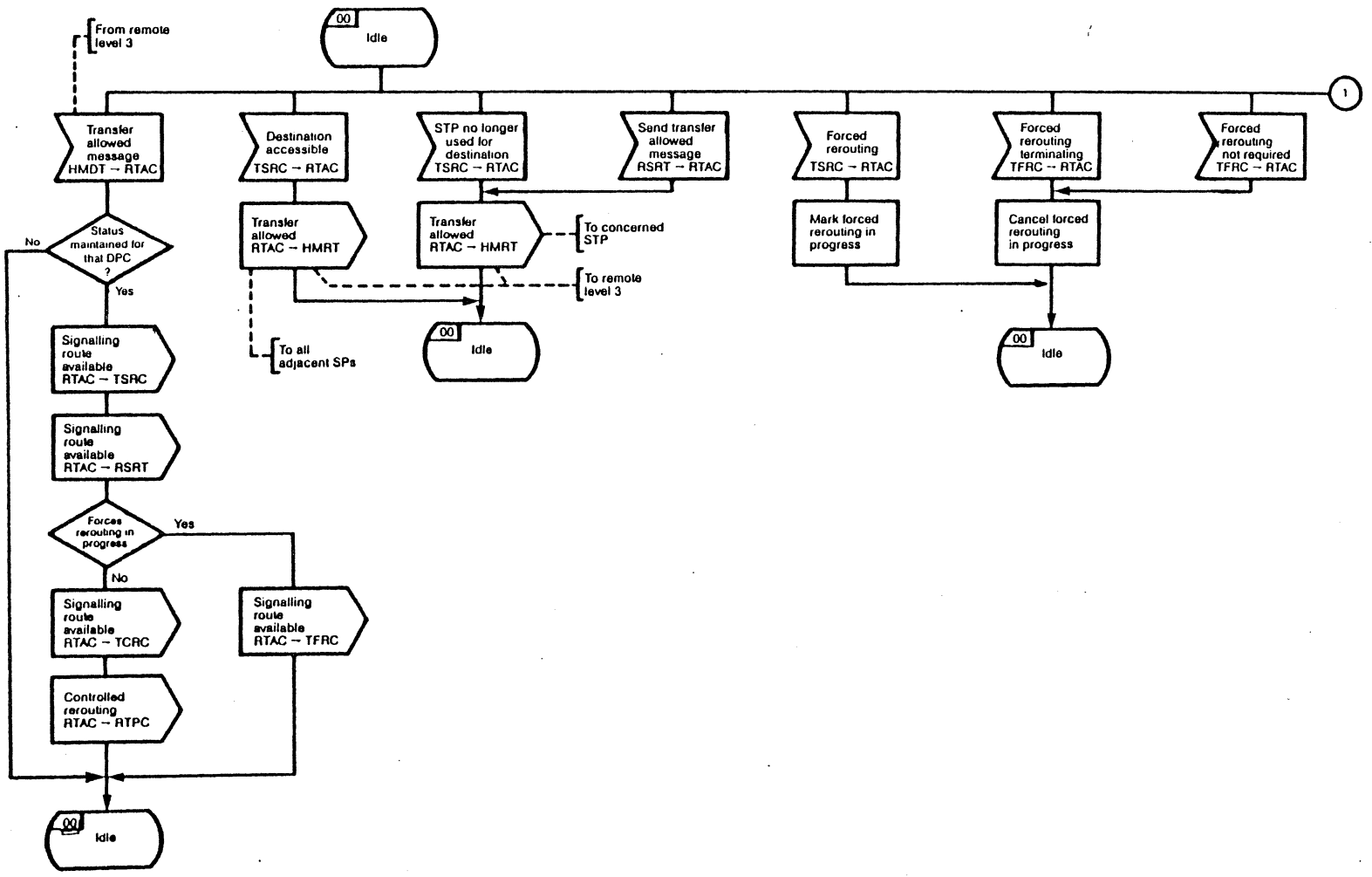

Figure 45/Q.704 Signalling route management; transfer allowed control, RTAC (sheet 1 of 2)

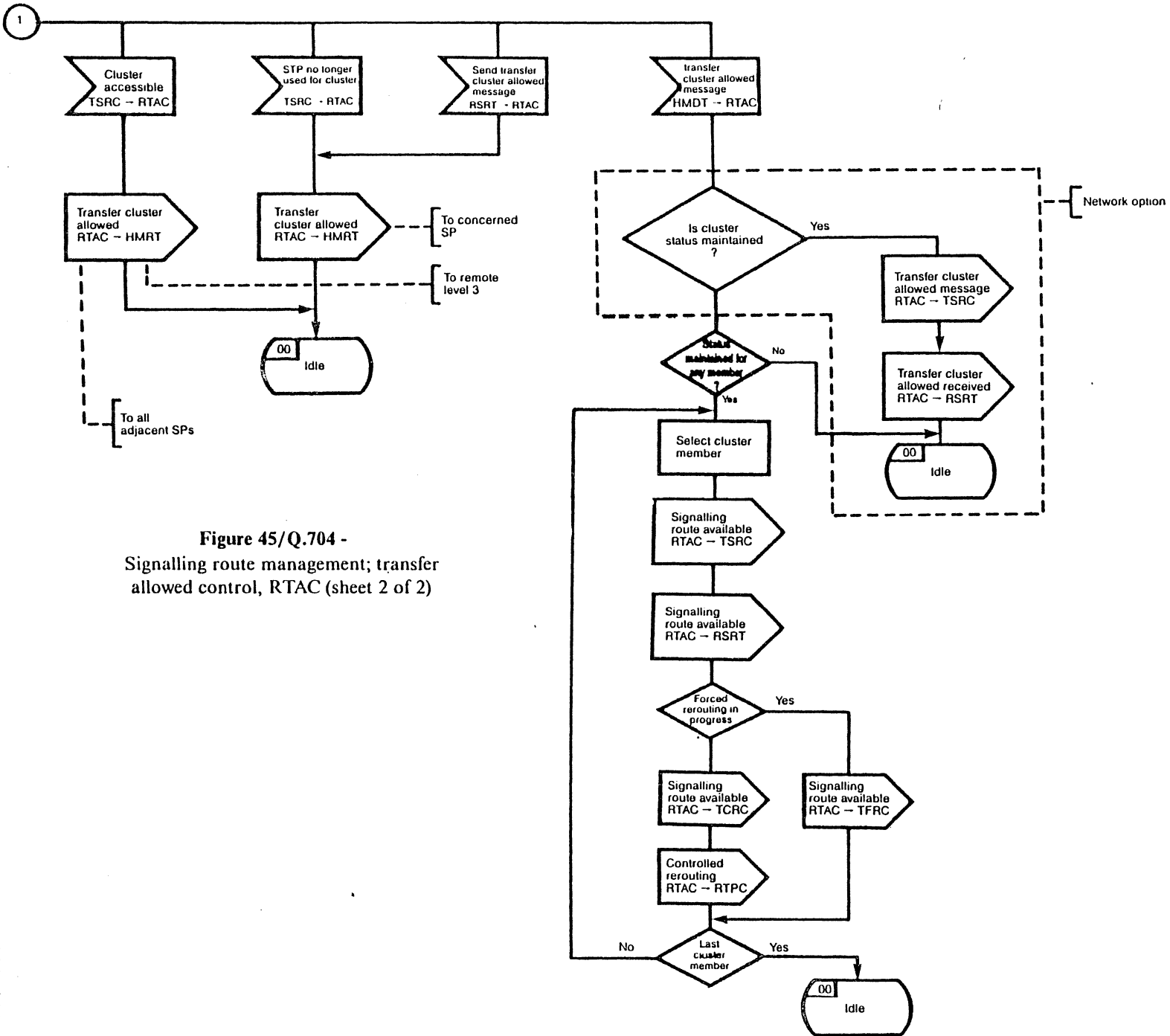

Figure 45/Q.704 -
 Signalling route management; transfer
 allowed control, RTAC (sheet 2 of 2)

SIGNALLING NETWORK FUNCTIONS AND MESSAGES

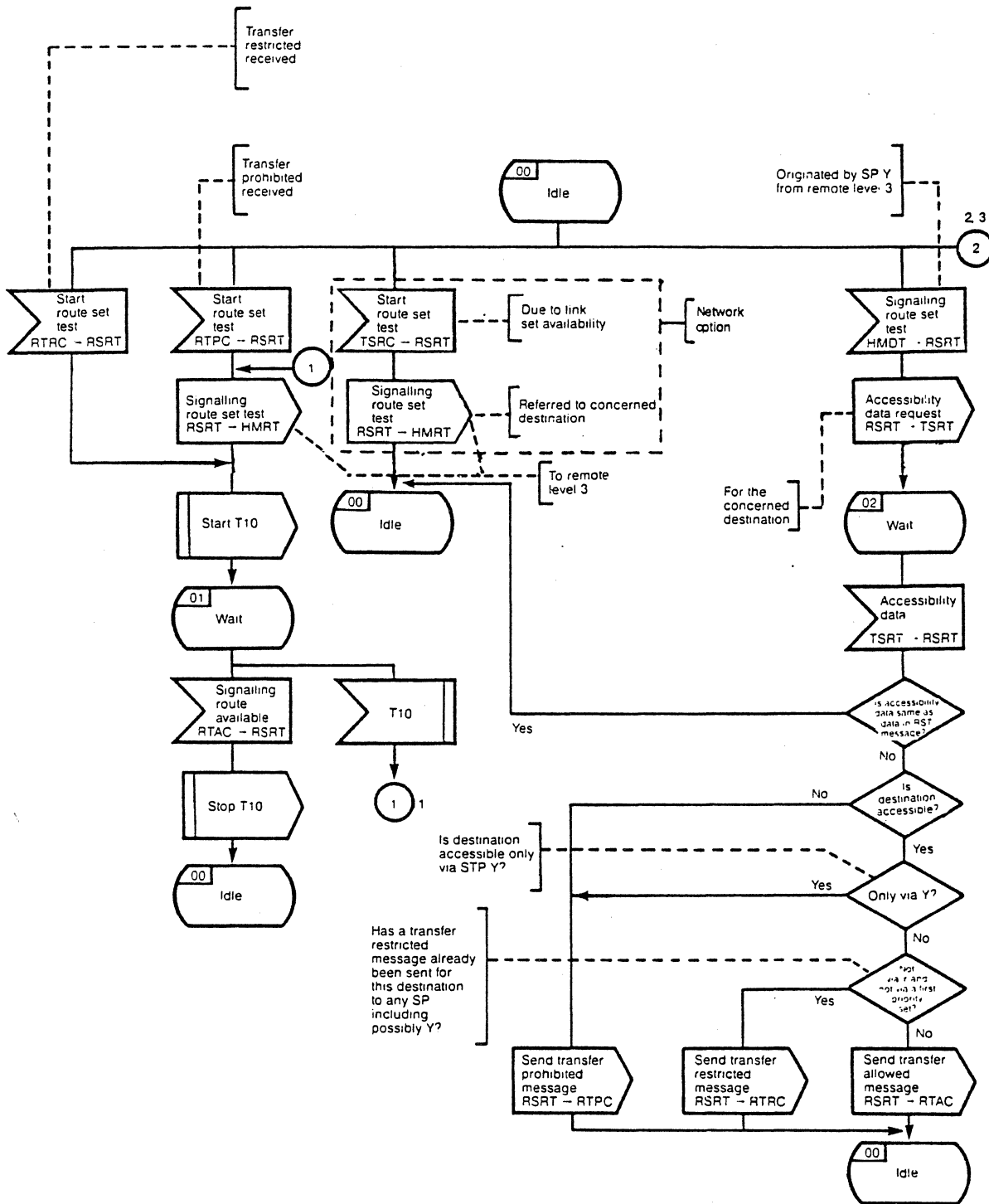

Figure 46/Q.704 (Sheet 1 of 3) - Signalling Route Management; Signalling Route Set Test Control (RSRT)

SIGNALLING NETWORK FUNCTIONS AND MESSAGES

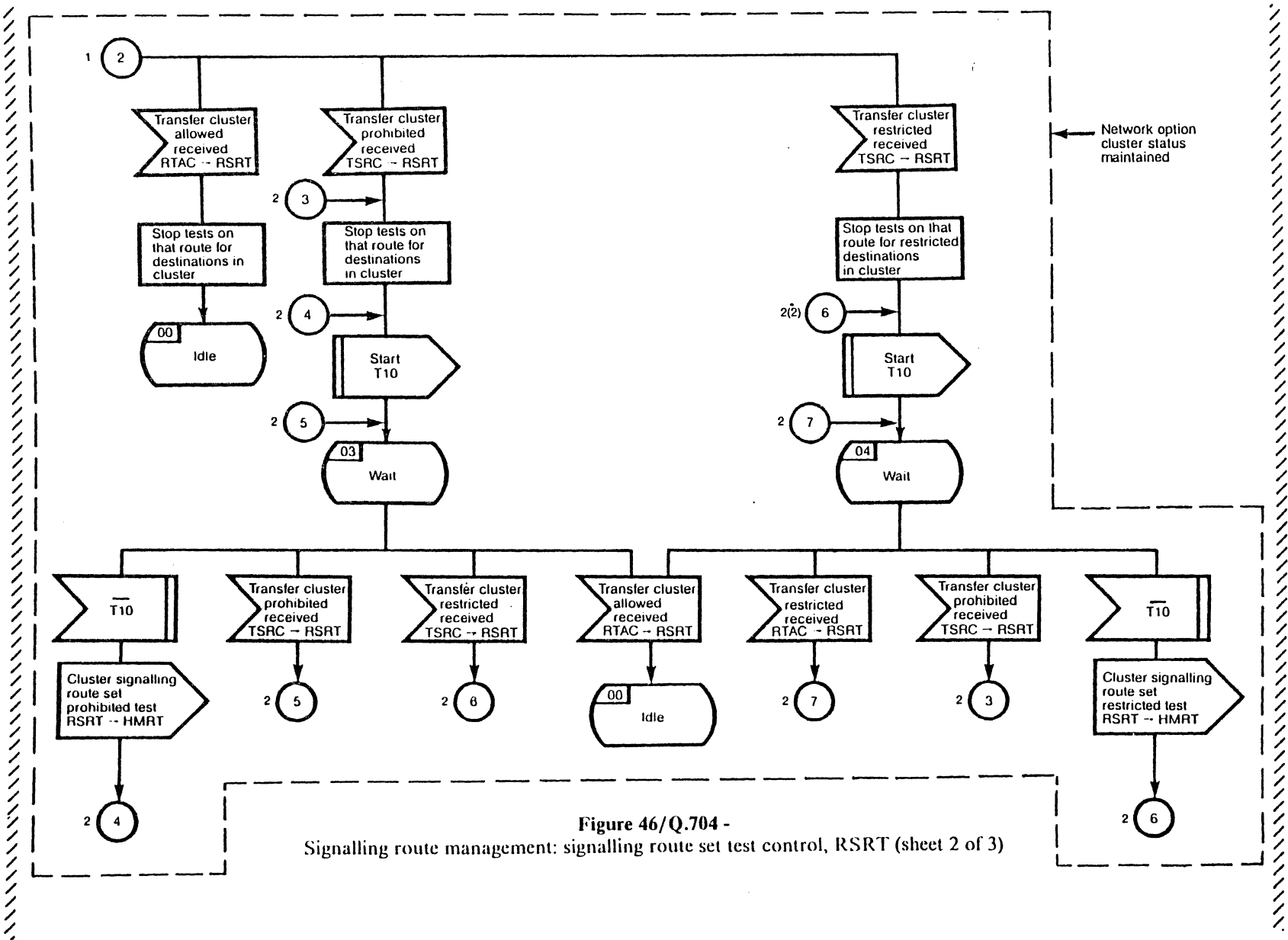

Figure 46/Q.704 -
 Signalling route management: signalling route set test control, RSRT (sheet 2 of 3)

1327

SIGNALLING NETWORK FUNCTIONS AND MESSAGES

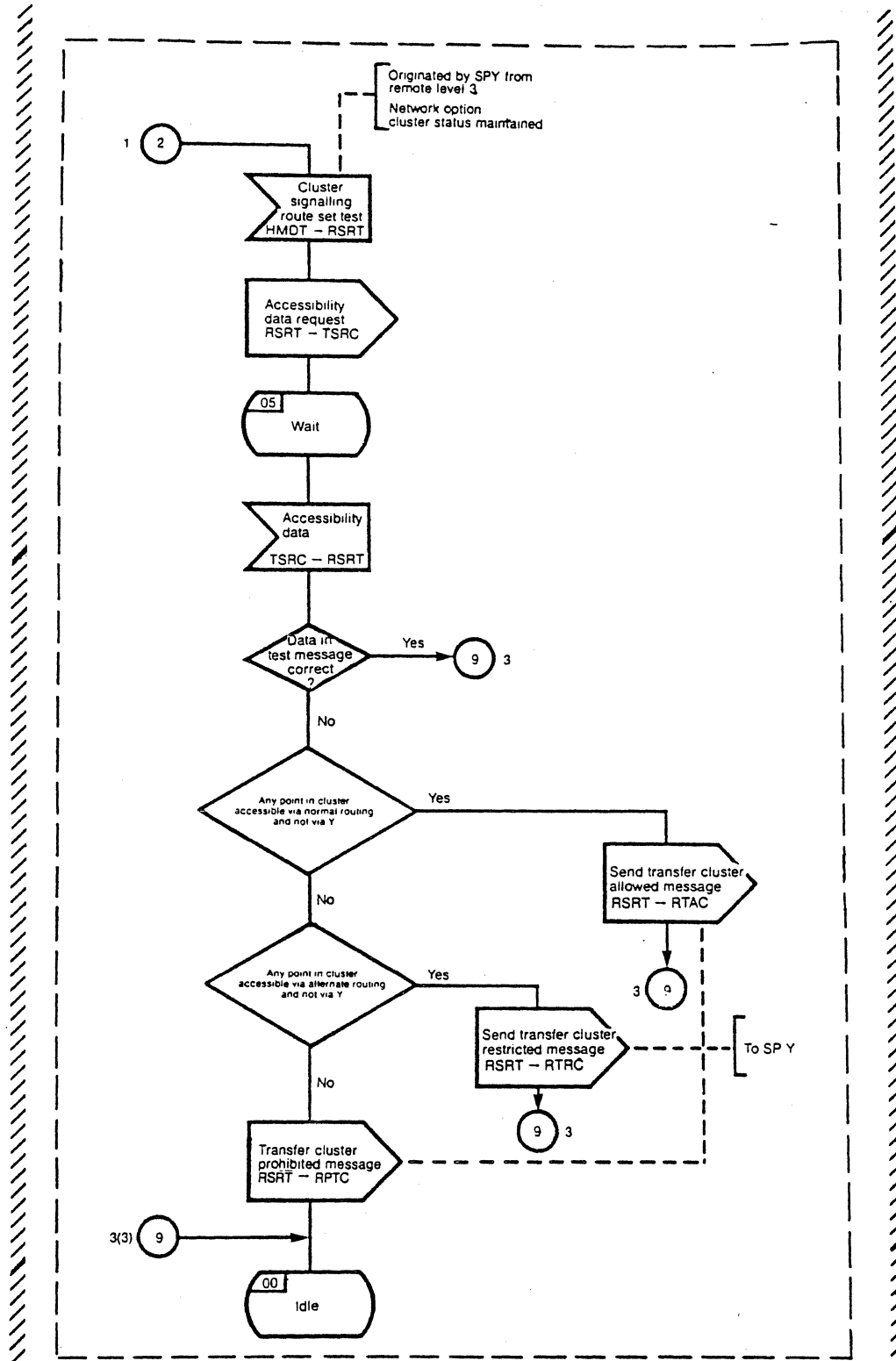
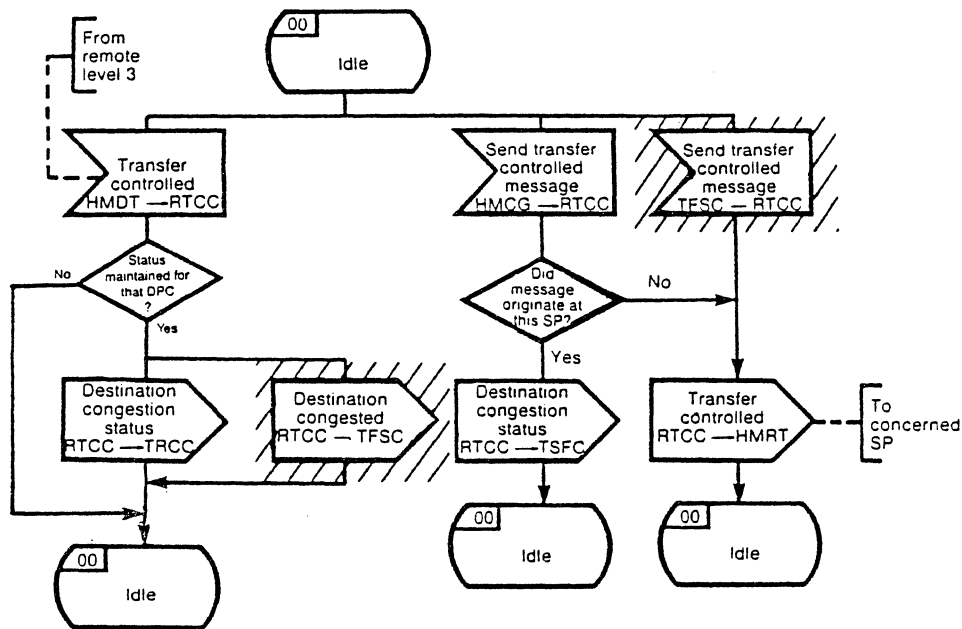

Figure 46/Q.704 (Sheet 3 of 3) - Signalling Route Management; Signalling Route Set Test Control (RSRT)

SIGNALLING NETWORK FUNCTIONS AND MESSAGES



+ functions modified in the case of multiple congestion levels

Figure 46A/Q.704 - Signalling Route Management; Transfer Controlled Control (RTCC)

SIGNALLING NETWORK FUNCTIONS AND MESSAGES

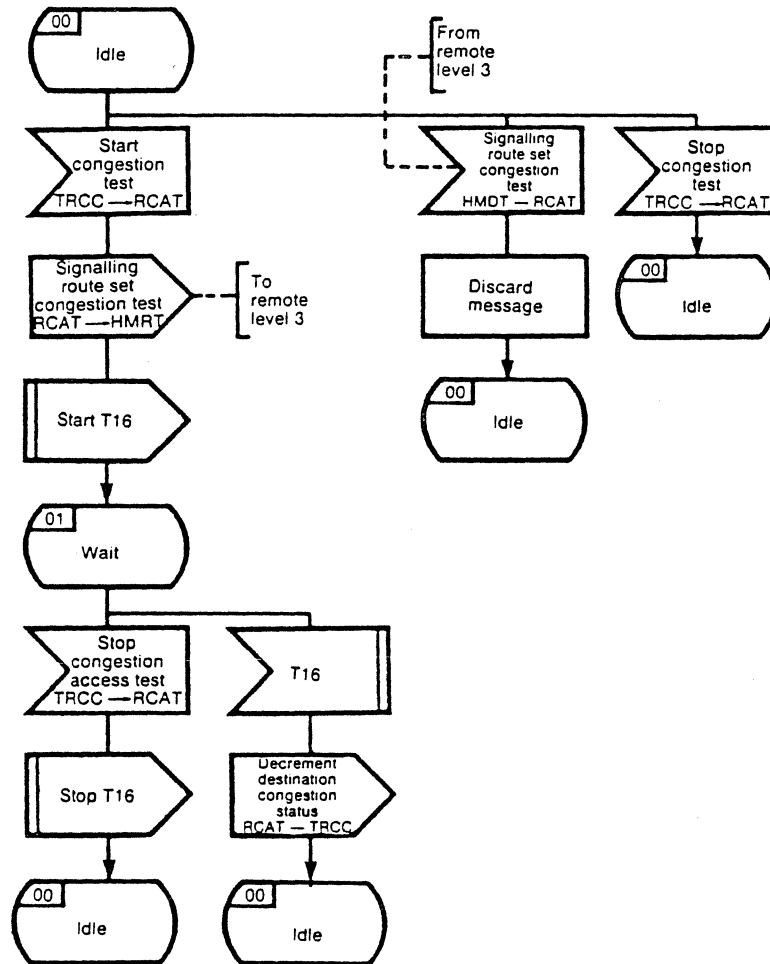

Figure 46B/Q.704 - Signalling Route Management; Signalling Route Set Congestion Test Control (RCAT)

SIGNALLING NETWORK FUNCTIONS AND MESSAGES

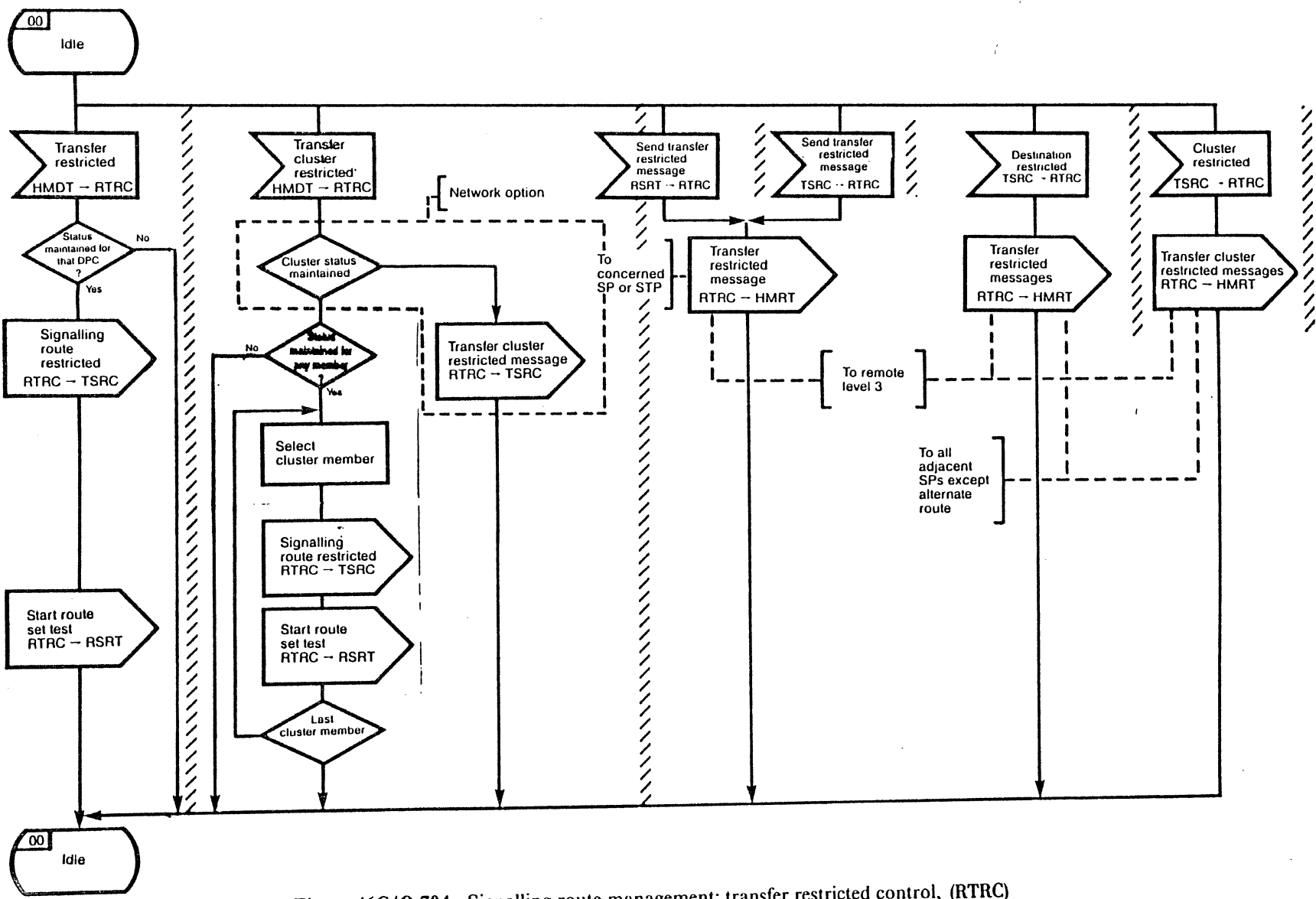

Figure 46C/Q.704 - Signalling route management: transfer restricted control, (RTRC)