

D2

Peripheral Conversion Language

Technical Manual



701 South Aviation Boulevard
El Segundo, California 90245
213 679-4511

XEROX

Xerox BPM/BTM/UTS

Sigma 5-9 Computers

Peripheral Conversion Language Technical Manual

FIRST EDITION

90 19 32A

August 1972

Price: \$3.75

NOTICE

This publication documents the Peripheral Conversion Language (PCL) processor that operates under the G00 version of BPM/BTM and the C01 version of UTS.

RELATED PUBLICATIONS

<u>Title</u>	<u>Publication No.</u>
Xerox Sigma 5 Computer/Reference Manual	90 09 59
Xerox Sigma 6 Computer/Reference Manual	90 17 13
Xerox Sigma 7 Computer/Reference Manual	90 09 50
Xerox Sigma 8 Computer/Reference Manual	90 17 49
Xerox Sigma 9 Computer/Reference Manual	90 17 33
Xerox Universal Time-Sharing System (UTS)/TS Reference Manual	90 09 07
Xerox Universal Time-Sharing System (UTS)/TS User's Guide	90 16 92
Xerox Universal Time-Sharing System (UTS)/SM Reference Manual	90 16 74
Xerox Universal Time-Sharing System (UTS)/OPS Reference Manual	90 16 75
Xerox Universal Time-Sharing System (UTS)/BP Reference Manual	90 17 64
Xerox Batch Time-Sharing Monitor (BTM)/TS Reference Manual	90 15 77
Xerox Batch Time-Sharing Monitor (BTM)/TS User's Guide	90 16 79
Xerox Batch Processing Monitor (BPM)/BP, RT Reference Manual	90 09 54
Xerox Batch Processing Monitor (BPM) and Batch Time-Sharing Monitor (BTM)/SM Reference Manual	90 17 41
Xerox Batch Processing Monitor (BPM) and Batch Time-Sharing Monitor (BTM)/OPS Reference Manual	90 11 98
Xerox Batch Processing Monitor (BPM)/System Technical Manual	90 15 28
Xerox BPM/BTM/UTS/Overlay Loader Technical Manual	90 18 03
Xerox Batch Time-Sharing Monitor (BTM)/Delta Subsystem Technical Manual	90 18 79
Xerox BPM/BTM/UTS/System Generation Technical Manual	90 18 77
Xerox Batch Time-Sharing Monitor (BTM)/Edit Subsystem Technical Manual	90 19 11

Manual Content Codes: BP – batch processing, LN – language, OPS – operations, RBP – remote batch processing, RT – real-time, SM – system management, TS – time-sharing, UT – utilities.

The specifications of the software system described in this publication are subject to change without notice. The availability or performance of some features may depend on a specific configuration of equipment such as additional tape units or larger memory. Customers should consult their Xerox sales representative for details.

CONTENTS

PCL - Executive Routine _____	1	Error Subroutines _____	64
Command Processing Subroutines _____	16	ERROR - Report Errors _____	64
COPYTO - COPY Command _____	16	PRTErr - Print Error Messages _____	67
COPYALL - COPYALL or COPYSTD Command _____	19	COMBINE - Check for Errors in Parameter Combinations _____	69
LIST - LIST Command _____	24	Conversion Subroutines _____	72
DELETE - DELETE Command _____	29	DEVTRAN - Translate Device Label to Device Code _____	72
DELETEAL - DELETEAL Command _____	31	INTARG - Convert Integer to Binary _____	74
REW - REWIND or REMOVE Command _____	34	STORVLP - Store Variable Length Parameters _____	76
TABS - TABS Command _____	37	GETARG - Extract Argument from Command _____	78
WEOF - WEOF (Write End-of-File) Command _____	39	FILTRAN - Translate File ID _____	80
SPE - SPE (Space to the End on Labeled Tape) Command _____	40	FIXARG - Table Search _____	81
SPF - SPF (Space File on Free Form Tape) Command _____	42	TEXTARG - Check Argument Length _____	83
REVIEW - REVIEW Command _____	44	Utility Routines _____	84
Command Scan Subroutines _____	46	BCD2BIN _____	84
COPYTRAN - COPY Command Translator _____	46	BIN2BCD _____	85
Input/Output Subroutines _____	51	HEX2BCD _____	86
BLDCB - Build Input or Output DCB and Open the File _____	51	CALL1 _____	87
RDWRT - Read Input from M:EI and Write Output to M:EO _____	55	CLOSEI _____	88
HEXDUMP - Hexadecimal Dump Conversion _____	62	CLOSEO _____	89
		CLRARG _____	90
		GETPAGE _____	91
		RELPAGES _____	92
		MBS _____	93
		REVARG _____	94
		PRTNOF _____	95
		UNPRINT _____	96

ID

PCL - Executive Routine of PCL Processor

PURPOSE

PCL provides for processing of user commands which direct information movement between input and output devices. The Executive Routine is the main driving routine for the PCL subsystem.

OVERVIEW

PCL reads each user command, identifies the command action verb, and transfers control to the appropriate subroutine for each legal action verb. Control is always returned to PCL after each command is processed by its subroutine.

USAGE

The PCL subsystem is called on-line from TEL with one of the following two commands:

!PCL (RET)
or
!COPY... (RET)

If a PCL command is used, PCL reads commands through the M:SI DCB until an END command is read which causes a return of control to TEL. PCL exits to TEL immediately after processing a TEL COPY command. PCL may also be called in batch mode by a !PCL control card.

INPUT

External data references:

- J:JIT - used for on-line/batch testing.
- J:CCBUF - TEL command is moved from this buffer to internal buffer CMDBUF.
- M:EI - file name is extracted if break occurs while processing a COPYALL or DELETEALL command.
- M:UC - DCB used for printing on-line messages.
- M:LL - DCB used for printing batch command. Closed before exit from PCL.
- M:LO - if assignment differs from that for M:LL, the batch command is also printed through this DCB. Closed before exit from PCL.
- M:DO - closed before exit from PCL.
- M:SI - DCB used for reading on-line and batch commands.

Internal data references:

ARGBUFF - argument buffer
TERM - terminator of current argument
D2 - register 13 - maximum error severity

PCL control commands via M:SI.

OUTPUT

R0 - initialized to zero.
R7 - set to address of data base page obtained by a Get Page CAL.
D1 - register 12 - current action code
CMDBUF - control command buffer
CMBX - CMDBUF index
MAXCMBX - maximum CMDBUF index
BUFSIZE - I/O buffer size
ERCMBUF - buffer for command line error pointer
BREAK - break flag. Initialized to 0 before each command.
ERRFLAG - table of keys to ERRMSG file
IOERR - I/O error flag. Initialized to 0 before each command.
PREVACT - previous action code
FPARAM - receiving buffer for file name copied from M:EI DCB
SFACCT - standard file account flag. Initialized to 0 before each command.
COPYSTDF - COPYSTD flag. Initialized to 0 before each command. Set to 1 if COPYSTD command.
COPYSK - COPYALL select flag which is initialized to 0.
FROMFILE - base address of 'from' value of a range specification. Initialized to 0 before each command.
RDTBL - address of table used when read accounts are specified. Initialized to 0 before each command.
TOFILE - base address of 'to' value of a range specification. Initialized to 0 before each command.
WRTBL - address of table used when write accounts are specified. Initialized to 0 before each command.
COPYPHY - PHY option flag which is initialized to 0.

INTERACTION

Modules used for command processing:

- COPYALL - COPYALL or COPYSTD command
- COPYTO - COPY command
- PCLLIST - DELETE, DELETEALL, REW, REMOVE, SPE, SPF, WEOF, and LIST commands
- PCL - TABS or REVIEW command

Other modules used:

- PRERR - print error messages.
- ERROR - report errors.
- GETARG - get command verb.
- UTILITY - print file name (UNPRINT).

Monitor services used (handwritten CALs and FPTs):

- M:GP - get page from data base.
- M:PC - set prompt character to <.
- M:INT - set break control.
- M:WRITE - write output through M:UC (on-line) or through M:LL and M:LO (batch).
- M:READ - read user command through M:SI.
- M:DEVICE - skip to top of form, compare M:SI and M:UC (on-line only), or compare M:LO and M:LL (batch only).
- M:CLOSE - close M:LO, M:LL, and M:DO DCBs.
- M:TRTN - return from break routine.

Monitor services used (procedures):

- M:EXIT - normal exit to TEL.
- M:ERR - exit if error return from M:GP.

DATA BASES

The following data base is established and initialized by PCL. Most routines in the PCL subsystem access this data base.

- RSTACK - doubleword stack pointer into the 511-word data buffer.
 - +2 - heading flag
 - SYNFLAG - if zero, no synonym encountered by COPYALL. If nonzero, synonym encountered.
 - BUFSIZE - byte size of dynamic buffer (IOBUF) used by routine RDWRT.
 - ERCMDBUF - thirty-five-word buffer used to contain pointer to scan position if error is encountered.
 - ARGBUFF - eight-word buffer containing the current argument in TEXTC format. Set by GETARG scan routine.
 - ARGTBL - thirty-six-word table of values and codes whose layout is described by the following six symbols.
- DEVICE device ID code set by DEVTRAN (first word of ARGTBL)
- +1 number of reel numbers if tape device set by DEVTRAN.
 - +2 CMBX value of first reel number set by DEVTRAN
- FILE file type indicator:
- 1 - name
 - 2 - name and account
 - 3 - name, account, and password
 - 6 - account only
- (fourth word of ARGTBL).
- +1 CMBX value of file name set by FILTRAN. Set to point to account if above indicator is 6.
- CODE data conversion types set by COPYTRAN (sixth word of ARGTBL).
- MODE BCD/BIN mode set by COPYTRAN (seventh word of ARGTBL).
- +1 7T/9T mode set by COPYTRAN.
 - +2 byte 0 - RD/WR mode
 - byte 1 - K mode
 - byte 2 - TX mode
 - byte 3 - PK/UPK mode

- +3 byte 0 - SSP/DSP/VFC mode
- byte 1 - NC/CR mode
- byte 2 - FA/NFA mode
- byte 3 - DEOD mode

SEQUENCE card sequencing type code (eleventh word of ARGTBL).

- +1 four-character EBCDIC identification
- +2 starting sequence value
- +3 incremental value
- +4 maximum sequence value

SELECT number of record selection specifications (sixteenth word of ARGTBL).

- +1 low value of first record selection
- +2 high value of first record selection
- ⋮
- +19 } pairs of low and high values of sub-
- +20 } sequent record selections

- CMBX - current byte index into CMDBUF
- CMDBUF - thirty-five-word command buffer for all PCL commands
- DCBADD - current DCB address set by BLDCB routine
- DVLARG - thirty-six-word table of device arguments set by COPYTRAN routine. Same layout as ARGTBL.
- ERRFLAG - number of error messages to print which is set by ERROR routine.
- +1 - nine-word table of EDIT-type keys into the ERRMSG file. Set by ERROR routine.
- INSWT - flag indicating if M:EO is closed (0 = open, 1 = closed).
- IOERR - contents of SR3 returned by the file management system on an error or abnormal condition.
- MAXCMBX - maximum value of CMBX for the current command
- NCHAR - number of characters in the argument in ARGBUFF
- NPAGE - number of pages of core required by BUFSIZE
- PREVACT - previous action verb code set by subroutine TRANSACT.
- RDFPT - six-word area reserved for FPT set up for Read CALs by RDWRT routine.
- TERM - current termination character set by GETARG routine.
- TOARG - fifteen-word buffer to save TO arguments (DEVICE through SEQUENCE+4).
- TOSWT - flag indicating if output device has been defined (0 = not defined, 1 = defined).

WRTFPT	-	eight-word area reserved for FPT set up for write CALs by RDWRT routine.
TOVER	-	action code for TO or OVER
PRNTBUF	-	twenty-four-word print buffer used by HEXDUMP routine.
RECNUM	-	current record number set by RDWRT routine
SAVCMBX	-	backup pointer in CMDBUF set by FIXARG routine
IOBUF	-	I/O buffer origin
FPARAM	-	FPARAM buffer used by BLDCB routine for OPEN CAL
OPNFPT	-	FPT buffer used by BLDCB routine for OPEN CAL
PRTBUF	-	error message buffer used by PRterr routine. Also used output buffer by LIST routine.
BREAK	-	BREAK key flag (0 = no break, nonzero = break).
STACK	-	buffer used as register save area and break control buffer.
ATTRB	-	attribute flag used by LIST routine.
# DELIM	-	index into delimiter table in GETARG (normally 0)
RDACCT	-	table of read accounts set up by LIST routine (same location as SELECT).
WRTACCT	-	table of write accounts set up by LIST routine (same location as PRNTBUF).
CARDSEQ	-	two-word sequence information if CS option is used.
KEY	-	edit key which is set if LN option is used.
TABSET	-	a five-word table containing the settings specified on a PCL TABS command and the address of the TABS table.
RSSAVE	-	save word for the number of record selections.
SYNONYM	-	SYNON flag used in listing attributes.
SFCNT	-	count of files copied on a COPYSTD command.
CIBUSED	-	number of bits used in record being converted from compressed to symbolic.
CIBLEFT	-	number of bits left in record being converted from compressed to symbolic.
CIBTOTAL	-	total number of bits to be processed in an input compressed record.
CIWORD	-	address of current compressed word being converted to symbolic.
RECSIZE	-	true size of input record
CISEQ	-	sequence number used for checking sequencing of compressed input.
COBUSED	-	number of bits used in record being compressed.
COBLEFT	-	number of bits left in record being compressed.
COWORD	-	address of current compressed word in output buffer
COPYSTDF	-	COPYSTD flag
LINENO	-	location equal to three words less than IOBUF. Contains reconstructed edit key when K option is used.
STRDFPT	-	area reserved for standard file read FPT.
SFACCT	-	standard file account flag
SEQNUM	-	location equal to two words less than LINENO. Contains record sequence number which prints when K option is used.
SCRATCH	-	contains serial number of scratch tape or 0.

- SFTEMP - contains name of the temporary standard file (for COPYSTD) if one was created.
- SFDEV - a two-word area containing the input and output device codes for a COPYSTD command.
- DELETEF - flag set nonzero if REVIEW command used on-line.
- FROMFILE - an eight-word buffer containing the 'from' field on a REVIEW, COPYALL or DELETEALL command. First word set to 1 if field is null.
- TOFILE - an eight-word buffer containing the 'to' field on a REVIEW, COPYALL or DELETEALL command. First word set to 1 if field is null.
- RDTBL - two-word table containing count of read accounts (on COPY or COPYALL) and CMBX value of first account.
- WRTBL - two-word table containing count of write accounts (on COPY or COPYALL) and CMBX value of first account.
- DATETBL - eight-word table of date attributes from VLP
- COPYSK - COPYALL select flag. Set negative if range given on DELETEALL.
- EATTRB - extended attribute flag (EA option)
- SFARG - save area for standard file argument table.
- LISTCMBX - save word for current scan pointer for LIST command with multiple fids.
- LISTTERM - save word for current delimiter for LIST command with multiple fids.
- FROMCMBX - pointer to end of 'from' field of range specification
- COPYPHY - PHY (physical order on tape) option flag
- GRANCNT - granule count when listing attributes of a directory.
- TLABEL - sixty-four-word tape label buffer.

SUBROUTINES

- ACTION ACTION is called by the PCL Executive Routine to control the command processing. Previously, only the first three characters of the command were identified. ACTION scans further to distinguish DELETE from DELETEALL and COPY from COPYALL and COPYSTD. Upon entry, D1 (register 12) contains the code for the action verb. ACTION selects the appropriate command processing routine based upon the action code in D1 and the additional scan mentioned above. Before and after calling the LIST processor, a top-of-page Device CAL is issued if M:LO is assigned to the line printer.

TRANSACT TRANSACT saves the previous action verb code from D1 in PREVACT. This is necessary in order that the COPYTO routine can perform a TO/OVER test. GETARG is called to place the action verb in ARGBUFF and FIXARG is called to check for a legal action verb. Only the first three characters of an action verb are checked; this is sufficient to identify the action verb. An ON action verb is set to the same code as a TO. Blank termination of the action verb is always legal. A test is made for each action verb that should not be terminated by a blank. If none of these, an action verb code of zero is set to indicate an error to the calling routine.

All other subroutines used by PCL are described in the subsections which follow. These are listed in the Table of Contents.

ERRORS

'UNDEFINED COMMAND ACTION VERB'

Issued if error return from subroutine TRANSACT.

DESCRIPTION

PCL first obtains the data base page with a GET PAGE CAL. The page is then zeroed. BUFSIZE is initialized at half a page (4*256 words). The upper half of the data base page is the origin of the input/output buffer. RSTACK is initialized as a doubleword stack pointer, pointing to the 511-word stack buffer, STACK.

In on-line mode, BREAK control and the prompt character are set by monitor CALs. The contents of J:CCBUF is copied into CMDBUF. MAXCMBX is set up according to the character count of the command in J:CCBUF. CMBX is initialized at the first character position of CMDBUF and ERCMDBUF is blanked. TRANSACT is called to identify the command action verb. Otherwise, control goes to ACTION to process the TEL COPY command and control returns to TEL.

When called as a processor, PCL identifies itself with the 'PCL version HERE' message, if in on-line mode, and reads the first command directly into CMDBUF. In on-line mode, the assignment of M:SI is compared to that for M:UC. If they differ, the command, preceded by a prompt character, is printed through M:UC. MAXCMBX, CMBX, and ERCMDBUF are initialized as above. In addition, ERRFLAG and IOERR are zeroed. TRANSACT is called to identify the action verb. At ACTION, the proper subroutine is called to process the command. Upon return from command processing, a check is made to determine if the BREAK key was hit. If the BREAK key was hit and the last command was a COPYALL, COPYSTD, or DELETEALL, the

name of the last file completely copied or deleted is printed. If during the processing of the command no errors were detected, control goes back to read the next command. If D2 is greater than one, an error was detected and the subroutine, PRterr, is called to print the error message. After returning from PRterr, control goes back to read the next command. The END command is processed by writing the message

'PCL PROCESSING TERMINATED'

(batch only), and returning control to TEL.

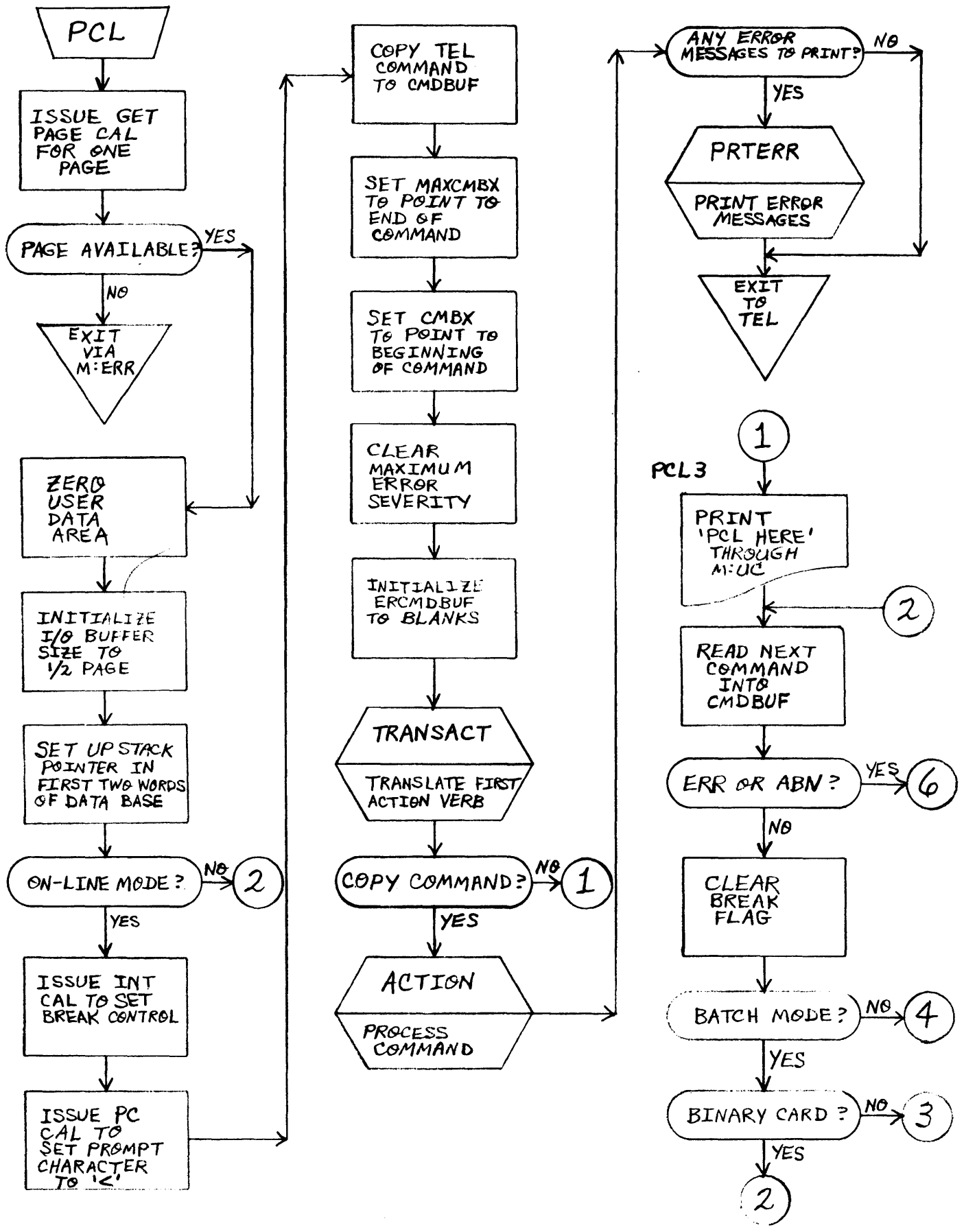

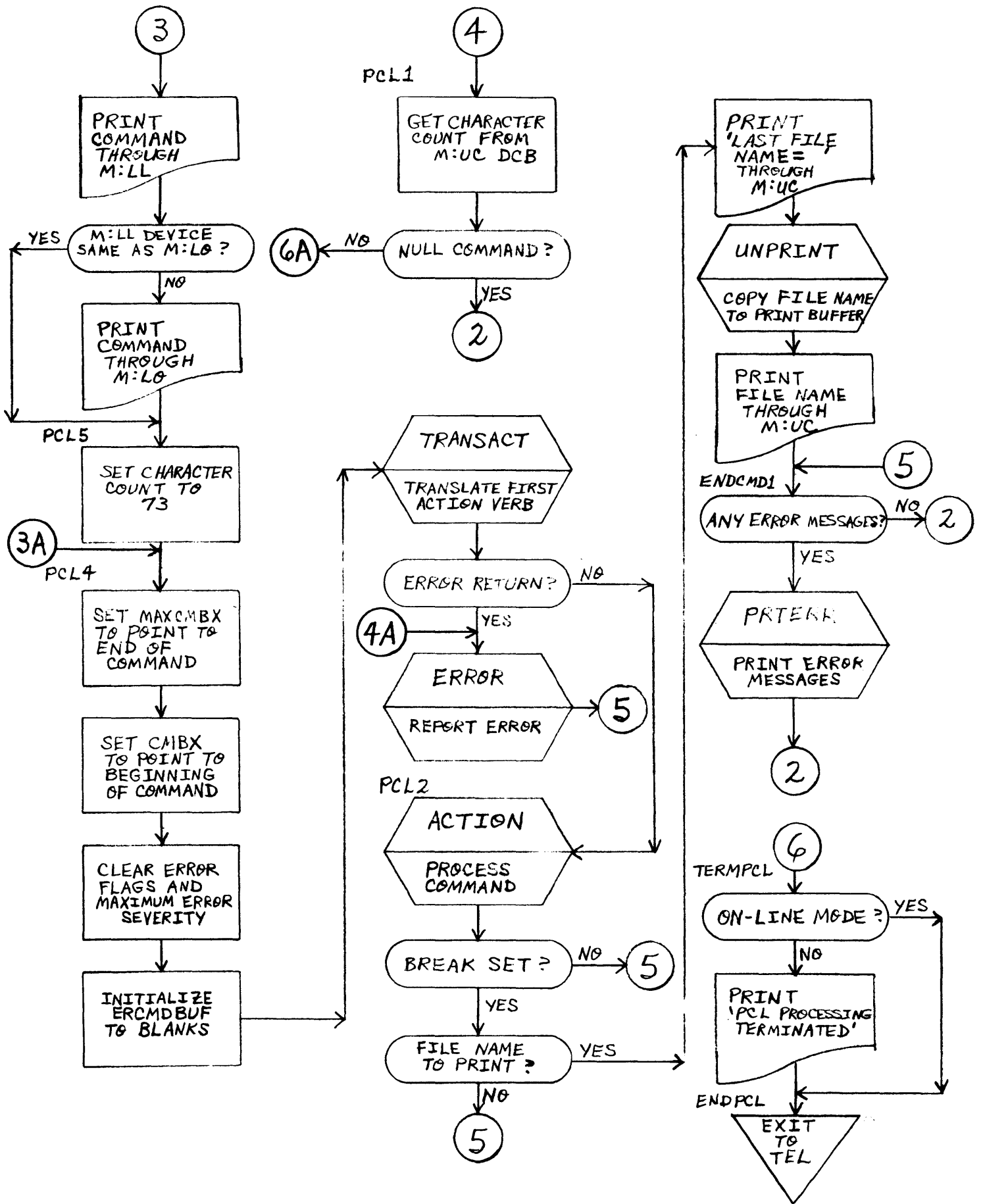

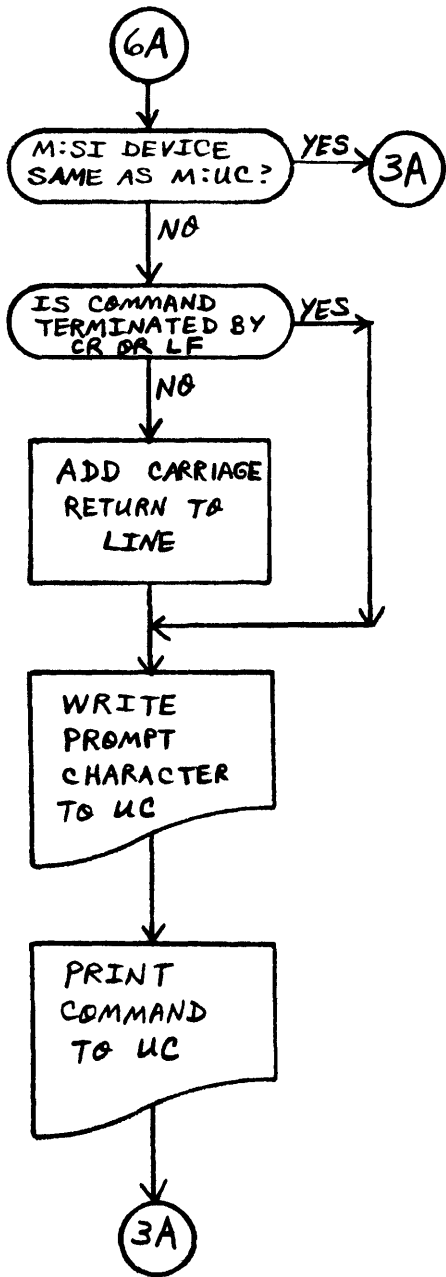

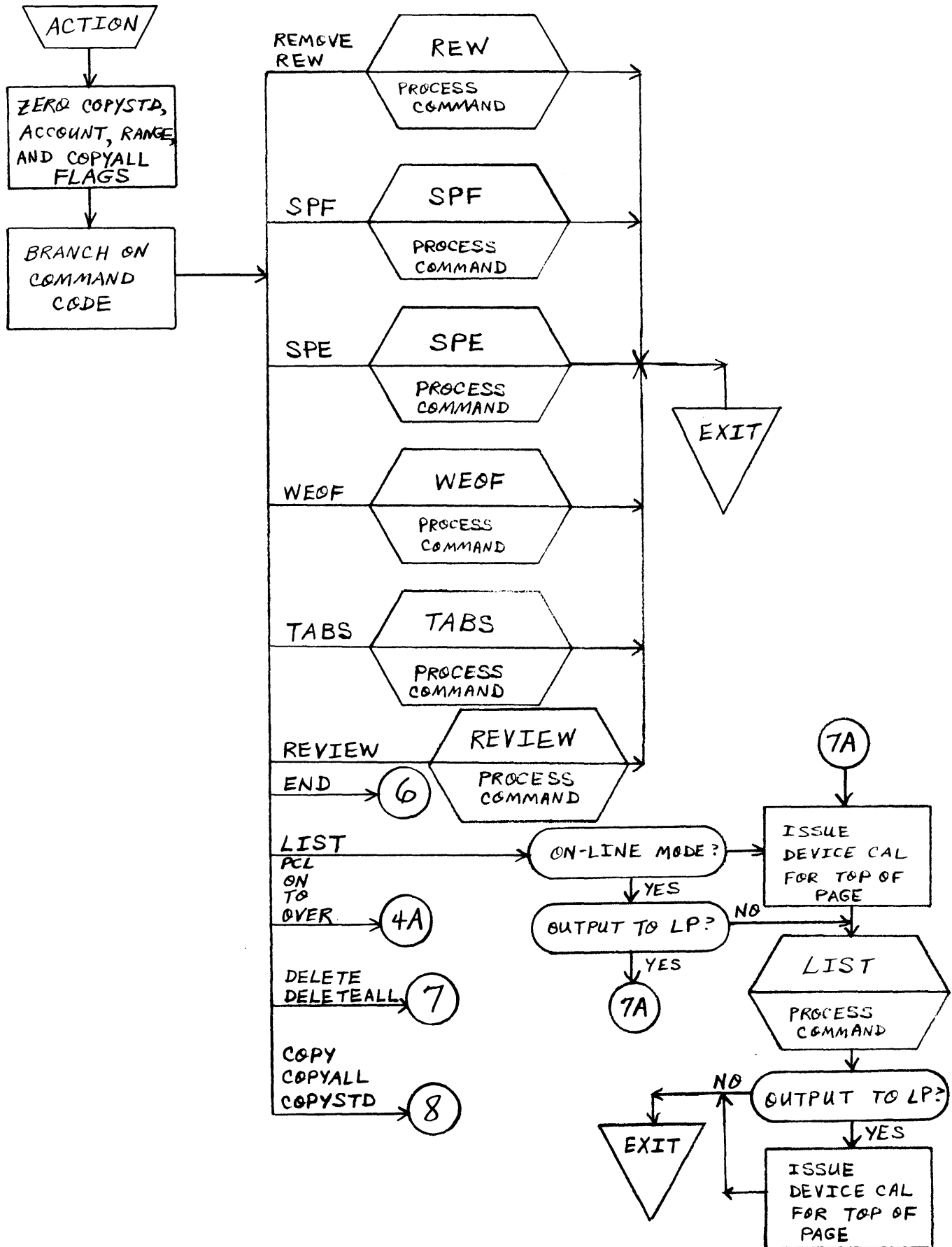

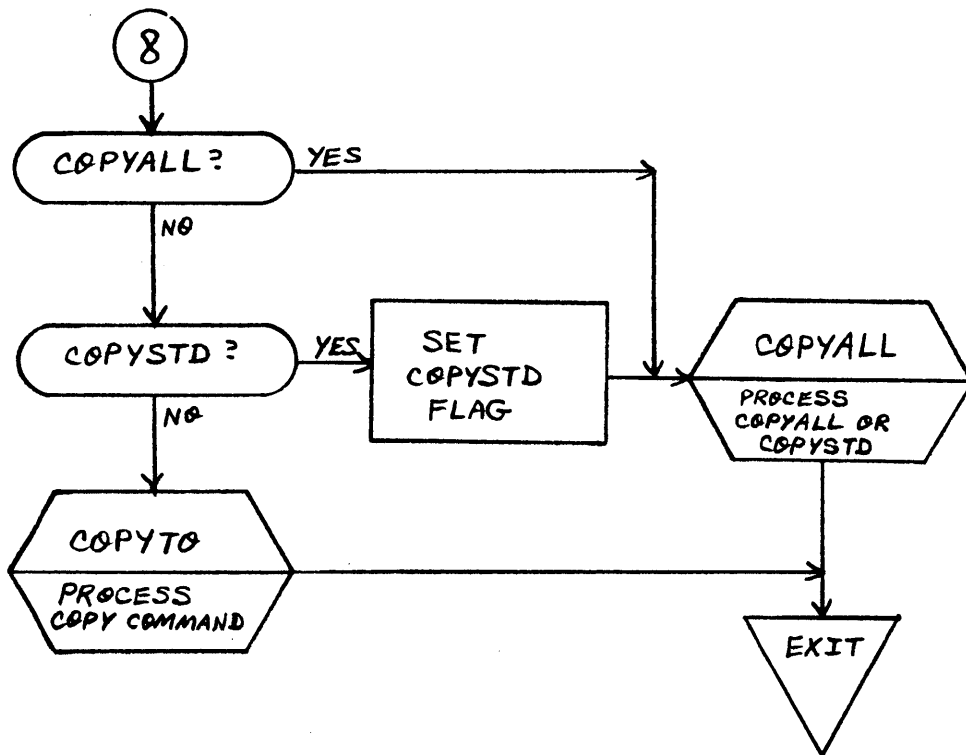
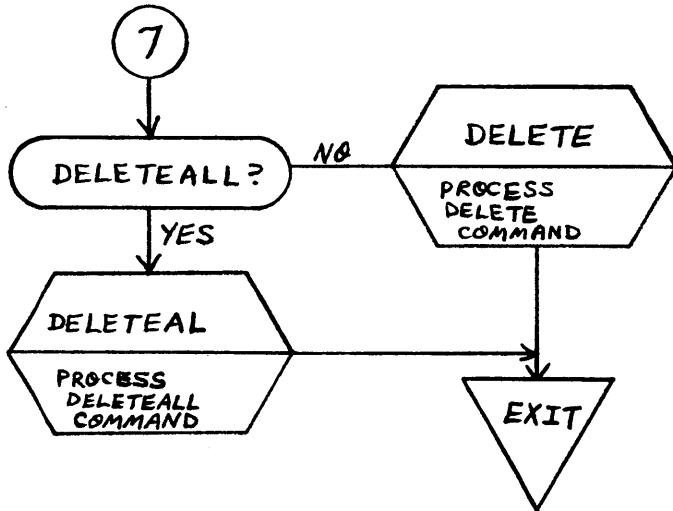

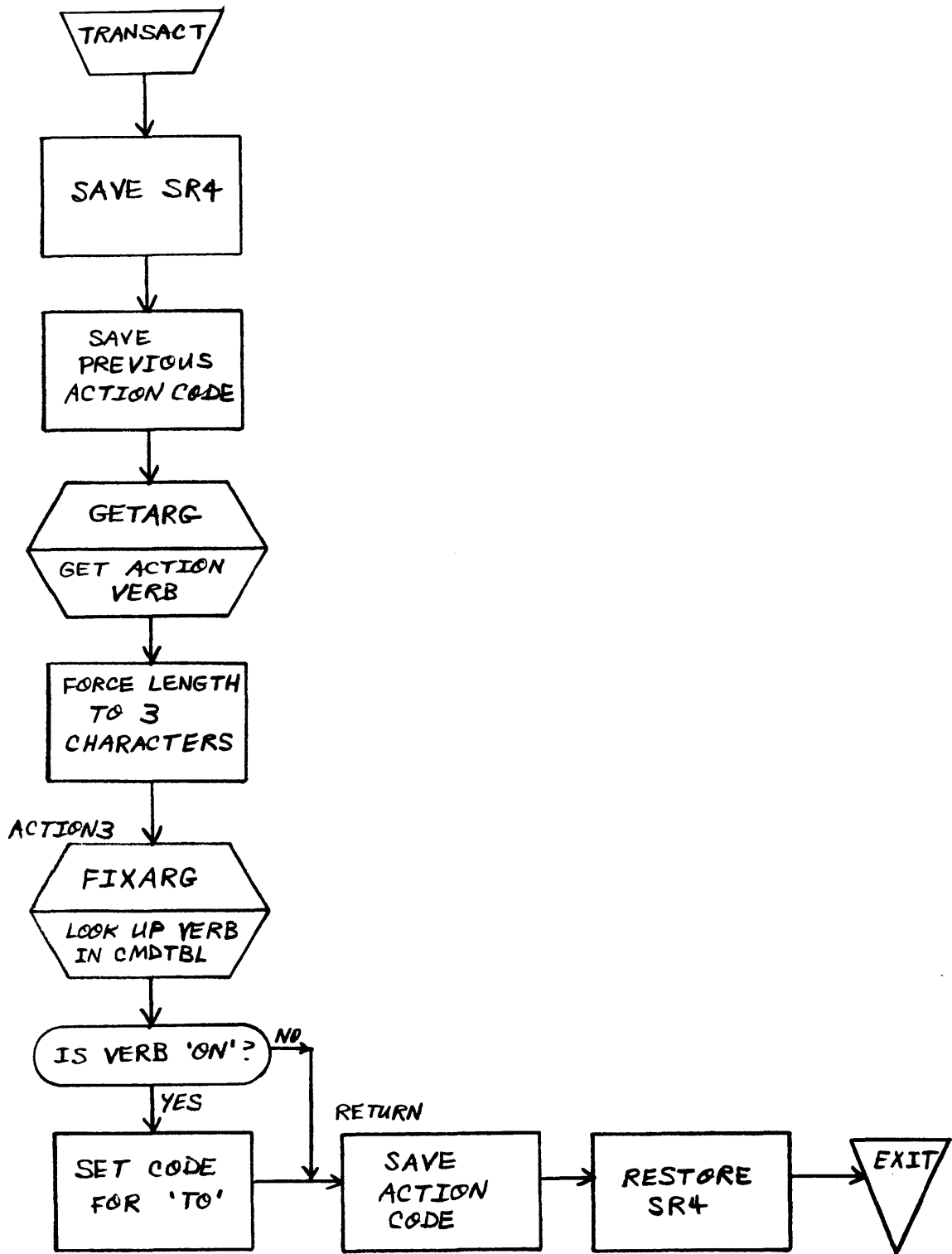

ID

COPYTO - COPY Command Processor

PURPOSE

To perform a syntax analysis of the COPY command. COPYTO calls the RDWRT routine to perform the file copy. For copying files in a standard file, entry is made at COPYSF from COPYALL.

USAGE

Calling sequence:

BAL, SR4 COPYTO
or
BAL, SR4 COPYSF

Input and output registers:

D1 (reg. 12) - command action code
D2 (reg. 13) - maximum error severity

INPUT

PREVACT	-	previous action verb code set by TRANSACT subroutine
TERM	-	current termination character set by GETARG routine
BREAK	-	break key flag
FILE	-	file ID indicator
TOARG	-	table of output arguments
*FPTPROMT	-	FPT for M:PC CAL to set '<' prompt.
M:EI	-	DCB used for input.
M:UC	-	DCB used for writing on-line messages.
PRNTBUF	-	address of buffer containing standard file record
COPYSTDF	-	COPYSTD flag
J:JIT	-	tested for on-line/batch mode.

*UTS only

OUTPUT

- CMBX - current byte index into CMDBUF (or PRNTBUF for standard files)
- INSWT - set to zero if M:EO is open, otherwise, set to one.
- TOSWT - set to zero if output is defined, otherwise, set to one.
- TOVER - COPY TO/OVER flag
- MAXCMBX - set to the 80th character of PRNTBUF as a scan limit.
- IOERR - set to 0 if I/O error 3 or X'14' occurs on opening a file named in a standard file.
- SFCNT - count of standard files which is incremented by one for each file copy.
- DEVICE - set to code for ME if output not defined. Set to code for DC if device label used as file name in standard file input.

INTERACTION

Modules used:

- BLDCB - build input (M:EI) or output (M:EO) DCB.
- UTILITY - close M:EI (CLOSEI), close M:EO (CLOSEO), clear argument table (CLRARG), release excess I/O buffer space (RELPAGES), or save output arguments (REVARG).
- FILTRAN - translate file identifier (COPYSTD only).
- COPYTRAN - scan input or output arguments on COPY command.
- PCL - translate second action verb (TRANSACTION).
- ERROR - report error condition.
- RDWRT - copy file.

Monitor services used (handwritten CALs and FPTs):

- *M:PC - set prompt character to '.' or '<'. .
- *Adjust DCB - remove password from M:EI DCB.
- *M:WRITE - write '..COPYING' to UC.

ERRORS

- 'EH?' Input or output argument field is not terminated by a blank or carriage return.
- ' "TO" OR "OVER" NOT SPECIFIED'
Self-explanatory.
- 'NO DEFINED OUTPUT DEVICE'
Output arguments are not defined for the COPY command (batch only).

*UTS only

DESCRIPTION

The COPY command is completely scanned and checked for syntax errors before any I/O takes place. If no errors are encountered, a second scan takes place, and the input device specifications are copied to the output device specification in order of appearance on the command.

The CMBX value of the first input specification is saved in SR2. COPYTRAN is then called to translate the first device and file, if present. Each subsequent input device/file is translated by COPYTRAN. The scan is terminated if an error of severity level 3 is detected by COPYTRAN. If no output specification is on the COPY command, control goes to address TO1 where translation for I/O takes place. If an output specification is present (i. e., TO or OVER action verb present on the command), the output device is translated by COPYTRAN which checks for errors. The CMBX value of the output device is saved in SR1.

The COPY-TO COPY-OVER determination is made by adding the two command action verb values. COPY-TO is equal to 3, COPY-OVER is equal to 14. The value is placed in TOVER and is used by BLDCB to ensure that in the case of COPYTO the output file does not exist.

If present, the output specification is translated by COPYTRAN. The defined output specification flag, TOSWT, is set and the M:EO DCB closed flag, INSWT, is set. The TO arguments are then placed in the TOARG table by subroutine REVARG (in module UTILITY). The first input specification is then translated by COPYTRAN, the returned CMBX value and the next argument level flag must be saved in SR2 and R5, respectively, in order to translate subsequent input device/file specification by COPYTRAN.

A severity level of three prevents further processing of the copy.

When the input device is a file type, the M:EI DCB is opened with the FPARAM option set. If a new output device is specified, the parameters for its specification are put into ARG TBL, and BLDCB is called to open the new output DCB. REVARG is then called to put the output arguments into TOARG and the input arguments into ARG TBL. If input is from the terminal, an M:PC CAL is issued to change the prompt character to a period. Subroutine RDWRT is called to execute the read-write CALs to accomplish the copy. Upon return from RDWRT, the prompt character is restored to a '<' if input was from the terminal. The input DCB is closed by subroutine CLOSEI (in module UTILITY). A check is made to determine if additional device/files are to be copied. If so, each device/file is translated by COPYTRAN and RDWRT is called to perform the copy. When the copy is complete, all excess buffer space is released back to the monitor. Control is then returned to the executive routine PCL.

A special entry is made to COPYSF from the COPYALL routine to perform a standard file copy. The scan portion of COPYTO is skipped; only the portion which performs the I/O is used. If any files named within the standard file are nonexistent or are passworded, this condition is reported by the message

'CANNOT FIND OR ACCESS FILE xxx'

and processing of the standard file continues.

ID

COPYALL - COPYALL or COPYSTD Command Processor

PURPOSE

To scan the COPYALL or COPYSTD command for correct syntax. If the command is COPYALL, all files or a specified subset of the files on RAD (in user's account or another account), on labeled tape, or on disk pack are copied to the specified output device. If the command is COPYSTD, the file itself and all files named within the file will be copied from RAD, labeled tape, or disk pack to the specified output device.

USAGE

Calling sequence:

BAL, SR4 COPYALL

Input and output registers:

D1 (reg. 12) - code for command action verb
D2 (reg. 13) - maximum error severity

INPUT

BREAK	-	If on, BREAK key has been depressed. Immediate exit is made to the executive.
IOBUF	-	address of I/O buffer used in performing reads and writes for copying files.
M:EI	-	input DCB constructed by BLDCB routine.
J:JIT	-	used for on-line/batch mode testing.
M:LO	-	DCB used for printing batch messages.
M:UC	-	DCB used for printing on-line messages.
TLBLSIZE	-	size, in bytes, of tape label buffer
ARGTBL	-	argument table for current device specification
F:STD	-	DCB used for reading standard file.
PRNTBUF	-	buffer used for reading standard file input.
ARGBUFF	-	buffer containing current argument.
FROMFILE	-	buffer containing 'from' value of range specification.
M:EO	-	element output DCB
NCHAR	-	number of characters in current argument
TOFILE	-	buffer containing 'to' value of range specification.

OUTPUT

CMBX	-	index into command buffer CMDBUF or into standard file buffer PRNTBUF
SYNFLAG	-	flag indicating if synonym names are present.
TLABEL	-	set to size of tape label buffer if input is from labeled tape; otherwise, set to zero.
TOSWT	-	set to zero to indicate no previous output specification.
COPYSTDF	-	flag which is set nonzero to indicate COPYSTD command was input. Value is normally positive but is set negative to indicate to routine BLDCB that F:STD is to be opened.
DEVICE	-	set to three to indicate standard file is to be copied to or read from RAD.
INSWT	-	set to one to indicate to routine COPYTO that a new output file is required.
SFARG	-	save area for the argument table containing codes required for reading the standard file.
SFCNT	-	count of files copied for a COPYSTD command, including the standard file itself.
STRDFPT	-	FPT for reading standard file.
TOARG	-	location of output device code. Reset to value saved in SFDEV+1.
COPYSK	-	select flag which is initialized to X'40' for copying all files.
FILE+1	-	set to BA(SFTEMP) if temporary standard file is created.
FPARAM	-	buffer for formatting NAME = xx if output is to a list device.
GRANCNT	-	temporary storage for code for 7T mode on input
MODE+1	-	word in argument table which is set to code for 7T mode.
SAVCMBX	-	backup pointer which is set to CMBX value when DC is optional.
SFDEV	-	two-word area set to the device codes on a COPYSTD command.
SFTEMP	-	set to temporary file name formatted from job ID.
TERM	-	set to terminator of command verb.

INTERACTION

Modules used:

BLDCB	-	build input or output DCB and open the file.
UTILITY	-	zero ARG_TBL (CLRARG), close M:EI (CLOSEI), close M:EO (CLOSEO), release excess I/O buffer space (RELPAGES), print summary message (PRTNOF), move file name to buffer (UNPRINT), or save input or output arguments (REVARG).
DEVTRAN	-	translate device label to device code.
ERROR	-	report error condition.
RDWRT	-	copy file.

PCL	-	translate second action verb (TRANSACTION) or process range specification (REVIEW).
COPYTO	-	entered at COPYSF to copy standard file.
COPYTRAN	-	translate file ID on COPYSTD command, or scan read and write accounts (RWACCT).
COMBINE	-	check for valid option combinations.
GETARG	-	get next argument from command.
PCLLIST	-	test if file is in range (TESTFNC).

Monitor services used (handwritten CALs and FPTs):

M:OPEN	-	open next file in user's or specified account.
M:WRITE	-	print 'CAN NOT ACCESS FILE xxx' through M:UC (on-line) or through M:LO (batch).
M:SETDCB	-	set error and abnormal addresses in M:EI DCB.
M:READ	-	read standard file.
M:CLOSE	-	close standard file.

ERRORS

'INVALID DEVICE TYPE FOR THIS COMMAND'

A device label other than DC, DP, or LT was specified as an input device.

'REEL NUMBER SPECIFICATION NOT VALID FOR THIS DEVICE'

A reel number was specified with the DC option.

'EH?'

The input specification is not delimited by a blank. Also issued if 'TO' is not specified on the command.

'IMPROPER TERMINATION OF THE COMMAND'

Self-explanatory. Processing continues.

'CAN NOT ACCESS FILE xxx'

Printed if a file cannot be accessed due to a password restriction (COPYALL only). Processing continues.

'CAN NOT FIND OR ACCESS FILE xxx'

Printed if a file named in a standard file is nonexistent or has restricted access. Processing continues.

'INVALID OPTION FOR COPYALL'

Self-explanatory.

DESCRIPTION

The COPYALL or COPYSTD command is completely scanned and checked for syntax errors before any I/O is performed. If no errors are encountered, a second scan takes place, and if the command is COPYALL, the files are copied from the specified input device to the specified output device.

The CMBX value of the input specification is saved in SR2. If the command is COPYSTD, COPYTRAN is called to translate the input field. For a COPYALL command, CLRARG is called to zero the argument table and DEVTRAN is called to translate the input device. If a range specification is present, subroutine REVIEW is called to process it. If options are present on input, control goes to COPYSEL to process the options. If the "end of command" does not follow the input field, TRANSACT is called to scan the next field which must be 'TO'. The output specification is scanned by first saving the CMBX value in SR1, then calling CLRARG to zero the argument table. DEVTRAN is called to translate the output device. If output options are present, they must be RD, WR, or 7T. If the RD or WR option is used, subroutine RWACCT is called to process the specified accounts with each option. The command is not honored if an error of severity level 2 or 3 is detected.

The copying of files actually begins at program label FROM1. CMBX is set to the value saved in SR2. Control goes to COPYSTD for executing a COPYSTD command. The argument table is zeroed by CLARG, the device code 'DC' is indicated to be optional, and DEVTRAN is called to translate the input device specification. The file count in SR2 is initialized to zero, and BLDCB is called to build the M:EI DCB with the open next and FPARAM options. The input arguments are moved from ARG_TBL to TOARG by the REVARG routine. If the output field is not null, it is processed by setting CMBX to the value in SR1, calling CLRARG to zero the argument table, and then calling DEVTRAN to translate the output device specification. If a file range was specified, subroutine TESTFNC is called to test if the current open file is within range, and, if not, it is skipped. A further test is made to determine if files are being selected by organization type (SEQ, KEY, or RAN option) and, if so, to test if this file qualifies for selection. If the file is wanted, BLDCB is called to build the M:EO DCB with the open next and FPARAM options. The input options are restored by calling REVARG to exchange ARG_TBL and TOARG. RDWRT is called to perform the file copy. The M:EI and M:EO DCBs are closed by calling CLOSEI and CLOSEO, respectively, and the file count in SR2 is incremented by one. If errors have occurred, or if the BREAK key has been depressed, an immediate exit is made at this point.

If input is from labeled tape, the size of the tape label buffer is computed and set in TLABEL. The routine continues to loop by issuing an open next CAL for the input file, testing if the file is wanted, calling BLDCB to create the output DCB, and calling RDWRT to copy the file.

The error severity level and break action are tested after each file copy.

If a synonym abnormal return occurs (code 08), SYNFLAG is set to indicate presence of synonym names. At end of directory (code 02), this flag is tested, and if synonyms are present, the synonym files are placed on the output device. Return is then made to the PCL executive.

If a file cannot be opened due to password restriction, the message

'CAN NOT ACCESS FILE XXX'

is printed and the routine continues by attempting to open the next file.

The COPYSTD routine is entered after the syntax scan of a COPYSTD command is complete. COPYTRAN is called to translate the input field and BLDCB is called to open the standard file. This file will be copied to the output device unless the form

'COPYSTD X TO DC'

is used, where X is in the user's account. If the copy is LT to LT, the file is copied a second time to RAD as a temporary file. The standard file is then closed and re-opened through the F:STD DCB, thus freeing M:EI and M:EO for the individual file copies. The standard file is read, and each record is treated by the COPYTO routine as if it were the input field of a COPY command and this routine will perform the I/O. A count of files copied is kept in SFCNT, and processing continues until end-of-file occurs in reading the standard file.

Before returning to the PCL executive, subroutine PRTNOF (in module UTILITY) is called to print the message

'..NNNN FILES COPIED'.

ID

LIST - LIST Command Processor

PURPOSE

To scan the LIST command for correct syntax and to list the names of files on RAD, disk pack, or tape as specified by the command. If attributes are requested for single files or a file directory, the organization, record count, size in granules, and modification date for each file are listed. Date attributes are also listed if the EA option is used. This routine is also entered to process a REVIEW command. A tape may be identified by the 'LIST FT#sn' command.

USAGE

Calling sequence:

BAL, SR4 LIST

Input and output registers:

D2 (reg. 13) - maximum error severity

INPUT

ARGBUFF	-	argument buffer
CMBX	-	index into command buffer
FPARAM	-	location of VLP list
J:JIT	-	used for testing if on-line or batch mode.
M:EI	-	element input DCB
M:LO	-	DCB used for all output for LIST command.
M:UC	-	terminal I/O DCB
NCHAR	-	number of characters in current argument
TERM	-	current termination character set by GETARG routine
COPYPHY	-	flag set if PHY option was used.
FROMFILE	-	buffer containing 'from' field of range specification.

OUTPUT

ATTRB	-	attribute flag (-1 = directory, 0 = none, 1 = fid)
BREAK	-	set to zero before exiting if it has been set nonzero due to break action.
IOERR	-	I/O error flag which is zeroed to suppress an error message for an access problem (abnormal X'14').

- MODE+1 - word in MODE table which is set to 3 for 7T option or 4 for 9T option.
- PRTBUF - print buffer used for LIST command output
- RDACCT - table of read accounts extracted from the VLP list and headed by a count
- SAVCMBX - save word for CMBX.
- DELETF - flag set if on-line REVIEW.
- EATTRB - flag set if EA option is present.
- GRANCNT - count of granules when listing attributes of a directory
- LISTCMBX - save word for scan pointer.
- LISTTERM - save word for terminator of last fid.
- WRTACCT - table of write accounts extracted from the VLP list and headed by a count.
- COBUSED - save word for error severity.
- IOBUF - buffer used for listing synonym files and read and write accounts.
- OPNFPT - FPT for opening files on labeled tape for 'LIST FT#sn' command. The serial number and account are obtained from the tape and entered into the FPT.
- SYNFLAG - save word for the month when formatting date attributes.
- SYNONYM - set to save address for synonym file name.
- TOFILE - buffer containing 'to' field of range specification. Bit 0 of first word is set when end of range is reached.
- DEVICE - device ID code which is initialized to 3 to indicate RAD file.

INTERACTION

Modules used:

- BLDCB - build M:EI DCB and open first file.
- DEVTRAN - translate device label.
- ERROR - report error condition.
- FILTRAN - translate file identifier
- GETARG - get next argument
- UTILITY - convert binary to BCD (BIN2BCD), convert BCD to binary (BCD2BIN), enter file name in buffer (UNPRINT), close M:EI (CLOSEI), zero argument table (CLRARG), or print number of files listed (PRTNOF).

Monitor services used (handwritten CALs and FPTs):

- M:SETDCB - set error and abnormal addresses in M:EI and M:EO DCBs.
- M:WRITE - write all LIST command output through M:LO. Also used to write messages through M:UC (on-line) or through M:LO (batch).
- M:PRECORD - used to determine the number of records in a file. Also used to backspace over tape header records.
- M:OPEN - open next file in specified account. Testfile bit is set if listing a directory (UTS only).
- M:REW - rewind tape.
- M:PFIL - space forward over tape header file.
- M:READ - read label and account records from tape. Also used to read reply to file name on REVIEW command (UTS only).
- M:CLOSE - used to remove tape read as free-form tape before reading it as labeled tape. Also used to delete file on REVIEW command (UTS only).
- *Adjust DCB CAL used to remove password from M:EI DCB.

SUBROUTINES

- TESTFN - This subroutine is entered for a REVIEW, DELETEALL or COPYALL command to test if the file name in the M:EI DCB is within the specified range. If the file is within range, or if a range was not specified, a return is made to c(SR4) + 1. The 'not in range' exit is to c(SR4).

ERRORS

- 'INVALID DEVICE TYPE FOR THIS COMMAND'
A device label other than DC, DP, FT, or LT was specified.
- 'REEL NUMBER SPECIFICATION NOT VALID FOR THIS DEVICE'
A reel number was specified with the DC option.
- 'IMPROPER TERMINATION OF THE COMMAND'
Self-explanatory. Processing continues.
- 'MODE SPECIFICATION NOT VALID FOR THIS DEVICE'
An option was specified other than A, EA, 7T, or 9T. Also issued if 7T or 9T is specified for RAD or disk pack.
- 'EH?'
A syntax error has occurred within the command.

*UTS only

DESCRIPTION

The LIST routine is assembled as part of the module PCLLIST. LIST begins by calling CLRARG to zero ARGTL. The attribute flags, ATTRB and EATTRB, and the file count in SR2 are zeroed. Since the device label DC is optional, the device code, DEVICE, is initialized to 3 to indicate DC. If no arguments are present in the LIST command, a transfer is made to simply list the names of files in the user's directory. If options are present, these must be either A, EA, 7T, or 9T, and if the device is DC or DP only A or EA is allowed. If the option A is present, the attribute flag is set to -1 to indicate that attributes for all files in the directory are to be listed.

DEVTRAN is called to translate the device label unless it is obvious from the syntax that DC is implied. If DEVTRAN cannot identify the field as a device label, it is assumed that the command has the form:

'LIST fid [, fid...]'.

In this case, the routine functions as if a '/' terminator followed the device specification and each field thereafter is treated as a file identifier. FILTRAN is called to translate the file specification, and the attribute flag is set to 1 to indicate that attributes of specified files are to be listed.

The M:EI DCB is built by the BLDCB routine. R1 is set to convey to BLDCB if an open next is to be done ($\text{ATTRB} \leq 0$), and if the FPARAM option is wanted ($\text{ATTRB} \neq 0$). BLDCB opens the first, or only, file. R1 is also set to indicate if the Testfile CAL is to be used (for LIST DC or REVIEW). If no attributes are wanted, the LIST routine continues by copying the file name from the M:EI DCB to the buffer PRTBUF and listing the name through the M:LO DCB. CLOSEI is called to close the file. The file count is incremented and an Open CAL is issued to open the next file. LIST continues to loop by listing the file name, closing the file, incrementing the file count, and opening the next file until an abnormal code 2 is returned indicating end of the file directory. A summary message is then printed stating the number of files listed and exit is made to the caller.

If the attribute flag is nonzero, this means that attributes of the file are wanted. An attribute heading is printed only once for the command. The file name is extracted from the M:EI DCB. The organization code is obtained from the M:EI DCB. The number of granules, read accounts, write accounts, modification date, and synonym are obtained from the VLP list. The number of records in the file is determined by issuing one or more Precord CALs with a record count of 32767 in order to force an abnormal return. All of these attributes except synonyms and accounts are entered in buffer PRTBUF and printed through the M:LO DCB. If a synonym or read or write accounts (other than defaults) were present, these are listed on separate lines. If the EA option was specified, the creation date, access date, backup date, and expiration date are listed if they are present in the VLP list. The file is then closed by calling CLOSEI and the file count is incremented. If single fids were specified, and another field is present, FILTRAN will be called to translate the file identifier. BLDCB will be entered again and the process above repeated until end of command. If an entire directory is specified (option A),

an Open CAL is issued to open the next file and the processing above is repeated until an abnormal code 2, signaling end of directory, is returned from the Open CAL. A summary message is then printed stating the number of files listed and exit is made to the caller.

If, when opening a file for which attributes are to be listed, an abnormal code X'14' is returned, the message

'RESTRICTED ACCESS'

or

'FILE BUSY'

is appended to the file name and no attributes are printed. After closing each file, BREAK is tested to determine if break action has occurred. If so, BREAK is zeroed, a summary message is printed stating the number of files listed, and an exit is made.

The LIST routine is also entered from the REVIEW routine to perform the REVIEW command. A flag, DELETEF, is set to indicate on-line REVIEW. The batch REVIEW command functions identically to LIST. The file name and attributes are obtained by issuing a Testfile CAL with NXTF set. Subroutine TESTFN is called to test if the file is in range. If not, the file is skipped and a Testfile issued for the next file. If the file is in range, the file name is printed and, if an abnormal X'14' did not occur, a Read CAL is issued for the user's response. If a 'D' is typed, the file is opened and closed with the release option. If any other response is received, the file is not deleted. If an abnormal X'14' occurs, an appropriate message is printed and solicitation of the user's response is bypassed. Break action terminates the command as for LIST.

ID

DELETE - DELETE Command Processor

PURPOSE

To scan the DELETE command for correct syntax and to release the specified RAD files.

USAGE

Calling sequence:

BAL, SR4 DELETE

Input and output registers:

D2 (reg. 13) - maximum error severity

INPUT

TERM - current termination character set by GETARG routine.
M:EI - element input DCB.

OUTPUT

DEVICE - set to 3 to indicate RAD file.
BREAK - if nonzero due to break action, set to 0 and an exit is made.

INTERACTION

Modules used:

UTILITY - zero table ARG_TBL (CLRARG), or print summary message (PRTNOF).
FILTRAN - process file specification.
ERROR - report error condition.
BLDCB - build M:EI DCB and open file.

Monitor services used (handwritten CALs and FPTs):

M:CLOSE - release the file.
Adjust DCB CAL - remove password from M:EI DCB (UTS only).

ERRORS

'IMPROPER TERMINATION OF THE COMMAND'

Self-explanatory.

DESCRIPTION

The DELETE routine is assembled as part of the module PCLLIST. DELETE begins by calling CLRARG to zero ARGTL. FILTRAN is called to translate the file specification. A severity 3 error encountered by FILTRAN causes an immediate exit from DELETE. Any terminating character other than 'end of command' or comma causes an error message to be issued. The M:EI DCB is built for each file specified and the file is opened by the BLDCB routine. A Close CAL, with the release option specified, is issued to delete each file. The password is removed from the DCB after every delete (UTS only).

The DELETE routine is repeated for each file specified on the command. Errors encountered in opening files are reported by BLDCB. When a terminator other than a comma is encountered, the message

'..NNNN FILES DELETED'

is printed.

The BREAK flag is tested after deleting a file and, if on, it is zeroed and the summary message is printed.

If an attempt is made to delete a random file which another user has open, the message

'CAN NOT ACCESS FILE XXX'

is printed.

ID

DELETEAL - DELETEALL Command Processor

PURPOSE

To release all or a portion of the RAD files in the user's account.

USAGE

Calling sequence:

BAL, SR4 DELETEAL

INPUT

TERM	-	current termination character set by GETARG routine.
CMDBUF	-	command buffer used for testing if confirmation was received.
J:JIT	-	used for on-line/batch mode testing.
*FPTPROMT	-	FPT for M:PC CAL to set '<' prompt.
*M:UC	-	DCB used for reading on-line confirmation.
*FPTCONSL	-	FPT for Read CAL to read on-line confirmation.
M:EI	-	element input DCB
M:LO	-	DCB used for printing messages.
BREAK	-	break flag which is tested after each file is deleted.
DELETEF	-	if nonzero, the section of code at ALL2 was entered while processing an on-line REVIEW command.
FROMFILE	-	if nonzero, a range specification was present.
TOFILE	-	if negative, the end of a range specification has been encountered.
CMBX	-	index into command buffer

OUTPUT

DEVICE	-	set to 3 to indicate RAD file.
FPARAM	-	receiving buffer for file name copied from M:EI DCB.
COPYSK	-	set to -1 if range specification present.
IOERR	-	set to 0 if error occurs when opening random file again.

*UTS only

INTERACTION

Modules used:

UTILITY	-	zero table ARG_TBL (CLRARG) close random file or file not in range (CLOSEI), enter file name in buffer (UNPRINT), or print summary message (PRTNOF).
BLDCB	-	build M:EI DCB and open first file.
ERROR	-	report error condition.
PCL	-	process range specification (REVIEW).
PCLLIST	-	test if file is in range (TESTFNC).

Monitor services used (handwritten CALs and FPTs):

M:WRITE	-	solicit confirmation (UTS on-line), or write 'CAN NOT ACCESS FILE' through M:LO.
M:SETDCB	-	set error and abnormal addresses M:EI DCB.
M:CLOSE	-	release a file.
M:OPEN	-	open next file or open random file again.
M:READ	-	read confirmation (UTS on-line only).
M:PC	-	set prompt character to '.' and reset to '<' (UTS only).

ERRORS

'IMPROPER TERMINATION OF THE COMMAND'
Self-explanatory. Processing continues.

'CAN NOT ACCESS FILE XXX'
File cannot be opened due to password requirement, Also printed if random file cannot be deleted because it is open by another user. Processing continues.

DESCRIPTION

The DELETEAL routine is assembled as part of the module PCLLIST. A confirmation message is solicited, if in on-line mode, and a test made to determine if a confirmation was received. If the user has not typed 'YESS', an immediate exit is made from DELETEAL. Otherwise, processing continues by calling CLRARG to zero table ARG_TBL.

If the terminating character is other than 'end of command', it is assumed that a range specification is present and the REVIEW routine is called to process the range. The BLDCB routine is then called to build the FPT for M:EI and to open the first file. If a range specification is present, TESTFNC is called to determine if the file is within range. If the file is not within range, CLOSEI is called to close and save the file. Otherwise, the file is released via a close CAL. If no more files are wanted for a range specification, an immediate exit is made. Otherwise, an Open CAL is issued to open the next file. The routine loops by testing for file in range, either closing with a save or a release option,

incrementing a file count, and opening the next file until an abnormal code is returned. If the abnormal code is 2, signaling end of the file directory, subroutine PRTNOF is called to print a summary message and an exit is made. If the file cannot be accessed due to a password requirement, a message to this effect is issued and processing resumes by attempting to open the next file. If an abnormal code of 8 is returned, it is a synonym and the file is skipped and processing continues. Other codes cause an I/O error message to be reported and an exit made. After releasing each file, BREAK is tested to determine if the BREAK key has been depressed. If BREAK is nonzero, an immediate exit is made.

If a random file in the user's account is currently open by another user, the file is not deleted and the message

'CAN NOT ACCESS FILE XXX'

is printed.

ID

REW - REWIND or REMOVE Command Processor

PURPOSE

To scan the REWIND or REMOVE command for correct syntax. The specified tape is rewound and, if the command is REMOVE, a dismount message is transmitted to the operator's console. The REMOVE command may also be used to remove a disk pack (UTS only).

USAGE

Calling sequence:

BAL, SR4 REW

Input registers:

D1 (reg. 12) - command action code

Output registers:

D2 (reg. 13) - maximum error severity

INPUT

TERM	-	current termination character set by GETARG routine.
CMDBUF	-	address of command buffer
ARGBUF	-	set to current argument by GETARG routine.
M:EI	-	element input DCB

OUTPUT

DEVICE	-	set to 11 to indicate MT operational label. Set to 6 to indicate free-form tape if 7T option is used.
DEVICE +1	-	set to one to indicate only one reel number permitted.
DEVICE +2	-	set to CMBX value of reel number.
# DELIM	-	set to 6 to enable '#' as a delimiter. Reset to zero before exiting.
CMBX	-	set to beginning of command buffer.
MODE +1	-	set to 3 if 7T option is present.

INTERACTION

Modules used:

DEVTRAN	-	translate device label.
UTILITY	-	zero table (CLRARG) or close M:EI (CLOSEI).
GETARG	-	extract reel number or option from command.
TEXTARG	-	check reel number.
PCL	-	rescan command (TRANSACTION).
ERROR	-	report error condition.
BLDCB	-	build M:EI DCB and open file. If REM command is for a disk pack, an open next is done (UTS only).

Monitor services used (handwritten CALs and FPTs):

M:REW	-	used to rewind tape if REWIND command was input.
M:CLOSE	-	used with REM option specified to rewind and remove tape or to remove disk pack (UTS only) if REMOVE command was input.
M:OPEN	-	do open next if REM command is for disk pack (UTS only).

ERRORS

'ONE REEL NUMBER MUST BE SPECIFIED ON THIS COMMAND'

The user has specified more than one reel number.

'UNABLE TO DISMOUNT'

A file cannot be opened on the disk pack specified on the REM command.

'MORE THAN FOUR CHARACTERS IN A REEL NUMBER SPECIFICATION'

Self-explanatory. Reported by TEXTARG routine.

'EH?'

A syntax error prevents execution of the command.

DESCRIPTION

The REW routine is assembled as a part of the module PCLLIST. REW begins by enabling the '#' as a delimiter and rescanning the command verb. This is necessary in case a blank does not terminate the command verb. TRANSACT (in module PCL) is called to scan the command verb. DEVICE is set to a device code of 11 to indicate MT operational label. If the terminator is a '#', this indicates that a reel number follows, and DEVICE+2 is set to the current command buffer index. If the terminator is not a '#', the next argument must be LT#sn, FT#sn, DP#sn (allowed only in UTS on REM), (7T), or end of command. If the 7T option is present, MODE+1 is set to 3 to indicate 7-track tape and DEVICE is set to 6 to indicate free-form tape. If the LT device label is used, DEVICE is set to 11 to indicate MT. If the device label is not DP, BLDCB is called to build the M:EI DCB and open the device. If the device label is DP, BLDCB is called to try to open the first file on the disk pack by doing an open next. A loop containing an open next CAL is executed as many times as required to open a file. If a REW command was input, a Rewind CAL is issued, CLOSEI is called to close M:EI, and an exit made. If a REM command was input, a Close CAL with the REM option specified is issued, causing a dismount message to be transmitted to the operator's console (for tape only), and an exit made. The '#' delimiter is always disabled before exiting.

ID

TABS - TABS Command Processor

PURPOSE

To record the values specified on a TABS command to be referenced whenever a TX (tab expansion) option is used on a COPY command.

USAGE

Calling sequence:

BAL, SR4 TABS

Input register:

D1 (reg. 12) - command action code

Output register:

D2 (reg. 13) - maximum error severity

INPUT

TERM - current termination character

OUTPUT

TABSET - a five-word table containing, in the first four words, the specified values on the TABS command. The fifth word contains the address of TABSET or the address of the tab settings in M:UC (UTS only) if there is no PCL TABS command.

INTERACTION

Modules used:

GETARG - get next tab value.
INTARG - convert value to binary and test if value is in range.
ERROR - report error condition.

ERRORS

'EH?'

Terminator of field is neither a comma nor end-of-command.
The scan is terminated; however, all tab values scanned
will be honored.

'INVALID TAB SPECIFICATION'

Tab value is nonnumeric or is not between 0 and 255.

DESCRIPTION

The tab settings in table TABSET are initialized to 0. GETARG is called to get each value, INTARG is called to convert the value to binary and, if the value is legal, it is stored in the next available byte in table TABSET. Processing continues as long as comma terminators are present and no more than 16 values are present. The address of table TABSET is entered in the fifth word of the table.

The TABS routine is assembled as part of module PCL.

ID

WEOF - WEOF Command Processor

PURPOSE

To write an end-of-file on the current output device and to close the output file.

USAGE

Calling sequence:

BAL, SR4 WEOF

INPUT

TERM - current termination character set by GETARG routine.

INTERACTION

Modules used:

ERROR - report error condition.
UTILITY - close M:EO (CLOSEO).

Monitor services used (handwritten CALs and FPTs):

M:WEOF - write end-of-file on current output device.

ERRORS

'IMPROPER TERMINATION OF THE COMMAND'
Self-explanatory. Processing continues.

DESCRIPTION

The WEOF routine is assembled as part of the module PCLLIST. WEOF begins by testing the termination character. Any terminating character other than "end-of-command" causes an error message to be reported; however, processing continues. If an output device is not defined, an exit is made. Otherwise, an end-of-file is written on the current output device, CLOSEO is called to close M:EO, and an exit is made.

ID

SPE - SPE Command Processor

PURPOSE

To scan the SPE command for valid arguments and to position the specified labeled tape past the last file.

USAGE

Calling sequence:

BAL, SR4 SPE

Output registers:

D2 (reg. 13) - maximum error severity

INPUT

TERM	-	terminator of current argument
DEVICE	-	device ID code set by DEVTRAN
DEVICE +1	-	set by DEVTRAN to number of reel numbers specified.
FILE	-	set by DEVTRAN to 6, if account is specified.
M:EI	-	element input DCB
ARGBUFF	-	set by GETARG to current argument.

OUTPUT

MODE +1	-	set to 3, if 7T option present.
---------	---	---------------------------------

INTERACTION

Modules used:

UTILITY	-	zero table ARGTB (CLRARG) or close each file through M:EI (CLOSEI).
DEVTRAN	-	translate device label to device code.
ERROR	-	report error condition.
BLDCB	-	build M:EI DCB and open first file.
GETARG	-	get option, if present.

Monitor services used (handwritten CALs and FPTs):

M:OPEN - open next file through M:EI.

ERRORS

'INVALID DEVICE TYPE FOR THIS COMMAND'
A device label other than LT was specified.

'ONE REEL NUMBER MUST BE SPECIFIED ON THIS COMMAND'
The user has specified more than one reel number.

'ACCOUNT SPECIFICATION NOT VALID ON "SPE" COMMAND'
Self-explanatory.

'IMPROPER TERMINATION OF THE COMMAND'
Self-explanatory.

DESCRIPTION

The SPE routine is assembled as part of the module PCLLIST. SPE begins by calling CLRARG to zero table ARG TBL. DEVTRAN is called to translate the device label to a device code. A device label other than LT results in an error message being reported and an exit made. A test is made to determine if DEVTRAN encountered more than one reel number; if so, an error message is reported and an exit made. If DEVTRAN encountered an account specification, an error is reported and an exit made. If the 7T option was used, MODE+1 is set to 3 to indicate 7-track tape. The BLDCB routine is next entered to build the M:EI DCB and to open the first file on the tape. The routine loops by closing the current file and opening the next file until an abnormal code of 2 is returned, indicating end of all files, after which an exit is made. Any other error or abnormal code results in an I/O error being reported and an exit made.

ID

SPF - SPF Command Processor

PURPOSE

To scan the SPF command for valid arguments and to position the designated free-form tape according to the direction indicated and number of files specified.

USAGE

Calling sequence:

BAL, SR4 SPF

Output registers:

D2 (reg. 13) - maximum error severity

INPUT

DEVICE	-	device ID code set by DEVTRAN
DEVICE +1	-	set by DEVTRAN to number of reel numbers specified.
NCHAR	-	set by GETARG to number of characters in argument.
ARGBUFF	-	set by GETARG to current argument.

OUTPUT

WRTFPT	-	two-word buffer set to FPT used by PFIL CAL.
MODE +1	-	set to 3 if 7T option is used.

INTERACTION

Modules used:

UTILITY	-	zero table ARG_TBL (CLRARG), convert number of files to binary (BCD2BIN), or close input file (CLOSEI).
DEVTRAN	-	translate device label to device code.
ERROR	-	report error condition.
BLDCB	-	build M:EI DCB and open file.
GETARG	-	extract option, direction indicator, and number of files.

Monitor services used (handwritten CALs and FPTs):

M:PFIL - position tape forward or backward one file.

ERRORS

'INVALID DEVICE TYPE FOR THIS COMMAND'

A device label other than FT was specified.

'ONE REEL NUMBER MUST BE SPECIFIED ON THIS COMMAND'

The user has specified more than one reel number.

'OVERFLOW ON NUMBER OF FILES ON SPF COMMAND'

Overflow occurred during conversion to binary.

'INVALID DIRECTION INDICATOR ON SPF COMMAND'

A character other than '+' or '-' has been used as a direction indicator.

'IMPROPER TERMINATION OF THE COMMAND'

Self-explanatory. Processing continues.

'EH?'

A syntax error prevents execution of the command.

DESCRIPTION

The SPF routine is assembled as part of the module PCLLIST. SPF begins by calling CLRARG to zero table ARGTL. DEVTRAN is called to translate the device label to a device code. A device label other than FT results in an error message being reported and an exit made. A test is made to determine if DEVTRAN encountered more than one reel number; if so, an error message is reported and an exit made. If the 7T option was used, MODE +1 is set to 3 to indicate 7-track tape. The BLDCB routine is next entered to build the M:EI DCB and to open the file. The FPT for the PFIL is moved to WRTFPT in the data base. The direction indicator and number of files are extracted by GETARG. The number of files are converted to binary by BCD2BIN and, if a direction indicator is present, it is tested for validity. If the direction indicator is '-', a bit is set in the FPT at WRTFPT to indicate backward direction. A PFIL CAL is issued to position the tape one file in the desired direction. Additional PFILs are issued until the tape has been moved the specified number of files. CLOSEI is then called to close M:EI and the routine exits to the caller.

ID

REVIEW - REVIEW Command Processor and range specification scan routine

PURPOSE

To process the REVIEW command by scanning an optional range specification and calling the LIST routine to execute the command. Also entered for scanning the range specification on a COPYALL or DELETEALL command.

USAGE

Calling sequence:

BAL, SR4 REVIEW

INPUT

ARGBUFF - buffer containing current argument
CMBX - index into command buffer CMDBUF
COPYPHY - flag indicating if PHY option was used on a COPYALL.
COPYSK - flag indicating type of command:
 0 = REVIEW
 < 0 = DELETEALL
 > 0 = COPYALL
NCHAR - number of characters in current argument
TERM - terminator of current argument

OUTPUT

FROMCMBX - set to CMBX value of end of the 'from' field.
FROMFILE - eight-word buffer containing the 'from' field.
 If field is null, first word of buffer is set to 1.
TOFILE - eight-word buffer containing the 'to' field.
 If field is null, first word of buffer is set to 1.

INTERACTION

Modules used:

BLDCB - get 'from' or 'to' field (ADDFILEN).
ERROR - report error condition.
PCLLIST - execute REVIEW command (LIST).

No monitor services used.

ERRORS

'EH?'

Syntax error prevents execution of a DELETEALL command.

'IMPROPER TERMINATION OF THE COMMAND'

Self-explanatory

'INVALID FILE RANGE SPECIFICATION'

The 'to' field is alphanumerically less than the 'from' field.
Command is not executed.

DESCRIPTION

REVIEW is assembled as part of the module PCL. Entry is made for the REVIEW command or for a range specification on a COPYALL or DELETEALL command. FROMFILE and TOFILE are eight-word buffers which are set to the 'from' and 'to' fields, in TEXTC format, respectively. The first word of each buffer is initialized to a 1 in case either field (or possibly both fields for a REVIEW) is null. ADDFILEN (in module BLDCB) is called to extract each field, which may be an alphanumeric string, a character string within quotes, or a hexadecimal string. The 'to' field must be alphanumerically equal to or greater than the 'from' field unless the PHY option is present. If the command is REVIEW, the LIST routine (in module PCLLIST) is called to execute the command. For other commands, control simply returns to the caller after a syntax analysis and extraction of the fields of the range specification.

ID

COPYTRAN - COPY Command Translator

PURPOSE

To translate all arguments specified in either the input or the output field of a COPY command. The results of the translation are entered in the argument table, ARG_TBL. COPYTRAN is also called to translate the input field of a COPYSTD command.

USAGE

Calling sequence:

BAL, SR4 COPYTRAN

Input register:

R1 - argument level (1 = device, 2 = file).

Output register:

R1 - next argument level (0 = none, 1 = device, 2 = file).

INPUT

ARGBUFF	-	argument buffer
ARGBUF4	-	byte equivalent of ARGBUFF
NCHAR	-	number of characters in current argument
TERM	-	terminator of current argument
FILE	-	file ID indicator
COPYSTDF	-	flag which is nonzero if command is COPYSTD.
J:JIT	-	used for on-line/batch mode testing.
M:UC	-	terminal I/O DCB.
SFARG	-	table containing standard file arguments.
RDTBL	-	table containing read account information.
SFDEV	-	a two-word table containing input and output device codes for COPYSTD.
WRTBL	-	table containing write account information.

OUTPUT

ARGTBL	-	location of argument table
CMBX	-	command buffer index. Reset to value on entry if device code not present (default = DC).
CODE	-	word of ARGTBL which is set to data format code ID if a code was specified.
DEVICE	-	device code ID. Set to 3 (for DC) if no device code present.
DVLARG	-	thirty-six word table for saving device level arguments in ARGTBL.
CARDSEQ	-	two-word card sequence value which is initialized to character zeroes.
TABSET+5	-	set to M:UC+15 if TX option is used on-line without a PCL TABS command.
MODE	-	a four-word table in ARGTBL in which IDs for mode specification are entered.
SAVCMBX	-	set to value of CMBX on entry.
SELECT	-	a 21-word table in ARGTBL of record selection values, headed by a selection count.
SEQUENCE	-	a five-word table in ARGTBL in which sequencing information is placed if a record sequence specification is used in a command.

INTERACTION

Modules used:

UTILITY	-	convert selection integer to binary (BCD2BIN), zero argument table (CLRARG).
COMBINE	-	edit parameter combinations.
DEVTRAN	-	translate device label.
ERROR	-	report error condition.
FILTRAN	-	translate file specification.
FIXARG	-	table search for specified options.
GETARG	-	get next argument from the command buffer.
INTARG	-	convert and edit N or K value on CS or LN option.
TEXTARG	-	edit read or write account specification.

No monitor services required.

SUBROUTINES

RWACCT - This subroutine is entered whenever an RD or WR option is encountered on a COPY or COPYALL command. The first byte of MODE+2 in ARG TBL is set to a 22 to indicate to the COMBINE subroutine that accounts are present. On entry, register 2 contains a 1 if the option is RD and a 2 if the option is WR. Table RDTBL or WRTBL is set to the number of accounts specified on the option and the CMBX value of the first account. If more than eight accounts are specified, only the first eight are used.

ERRORS

'EH?'

Input or output field of COPY is not terminated by a blank or end-of-command. Also given if syntax is invalid on an account specification. Processing is terminated.

'NULL ARGUMENT (TWO DELIMITERS IN A ROW)'

In scanning the options on a COPY command, two delimiters were used as consecutive characters. Processing continues.

'ILLEGAL FILE NAME SPECIFICATION'

A file name is not present with a DC device code. Processing is terminated.

'TX OPTION USED WITHOUT TABS COMMAND'

If in batch mode, a PCL TABS command was not previously used. If on-line, neither a PCL nor a TEL TABS command was used. Processing continues with single blanks replacing tab characters on output.

'INVALID OPTION FOR COPYSTD'

The only option allowed for COPYSTD is '7T'.

'MORE THAN TEN RS FIELDS FOR AN INPUT DEVICE'

The number of record select pairs is limited to ten. Editing continues.

'OVERFLOW ON A RS VALUE'

The conversion of a record selection value caused overflow. Editing continues.

'CS ID-FIELD GREATER THAN FOUR CHARACTERS'

The sequence identification is limited to four characters. Field is truncated to four characters and processing continues.

'ERROR ON N OR K VALUE OF CS OPTION'

Either the N or K value of a CS or LN option is out of range.
Processing continues.

'IMPROPER TERMINATION WITHIN RS, LN, OR CS OPTION'

Self-explanatory. Processing is terminated.

')) MUST TERMINATE RS, LN, OR CS OPTION'

Self-explanatory. Processing is terminated.

'SPECIAL ARGUMENTS MUST HAVE) AS TERMINATION CHARACTER'

Special arguments must be terminated by comma or right parenthesis.
Processing is terminated.

'MORE THAN EIGHT READ OR WRITE ACCOUNTS'

Self-explanatory. Processing continues with excessive accounts
ignored.

DESCRIPTION

COPYTRAN begins its translation of arguments by testing the argument level input in R1. If entered at the device level, CLRARG is called to zero the argument table and DEVTRAN is called to translate the device. If a file named in a standard file is being copied, and a device code is not present, the device arguments in ARG_TBL are set from those in SFARG. If no special arguments or file follows, a test is made for proper field termination, COMBINE is called to edit parameter combinations, and control is returned to the caller. If special arguments are present at the device level, table searches to identify each argument are performed by calling FIXARG for the mode table, the data code table, and the sequence table until a match is found. If a match is not found, the argument is then tested if it is RD or WR. If so, subroutine RWACCT is entered to scan the accounts. If the argument cannot be identified, it is assumed to be a record selection. As many as ten record selection pairs are allowed, and the count of pairs is maintained in SELECT in the user's data area, while the selection values are entered in a 20-word table beginning at SELECT+1. Codes and sequencing information are added, as appropriate, to table ARG_TBL.

If a file follows a device specification, the device level arguments are saved in table DVLARG, the argument level is set to a file, and FILTRAN is called to translate the file specification. Special arguments at the file level are processed in the same manner as at the device level, and will cause information to be added to table ARG_TBL.

If the argument level is set to indicate a file on entry to COPYTRAN, the device arguments in table DVLARG are restored to table ARGTL, and processing continues by calling FILTRAN, as described above.

Exit is made from COPYTRAN if the terminator is a semi-colon (indicating new device follows), a comma after a file specification (indicating another file follows), a blank, an end-of-command, or an invalid terminator. R1 is set to indicate the argument level (device or file) before exiting. If the device code is DC and a file identifier is not present, this error is reported before exiting.

ID

BLDCB - Build Input or Output DCB

PURPOSE

BLDCB constructs an Open FPT for either the M:EI or the M:EO DCB, based upon input flags, and issues an Open CAL for the DCB.

USAGE

Calling sequence:

BAL, SR4 BLDCB

Input registers:

- R1 - bit 12 - Testfile open, if set (UTS only).
- bit 28 - INOUT mode, if set.
- bit 29 - NXTF option, if set.
- bit 30 - FPARAM option, if set.
- bit 31 - I/O switch (0 = input, 1 = output)

Output registers:

- SR3 - set to error or abnormal codes if failure on Open for DCB.
- D2 (reg. 13) - set to 3 to indicate maximum severity if 'TO' was used with an existing file (on-line only).

INPUT

- DEVICE - device ID code
- IOBUF - beginning address of I/O buffer
- J:JIT - used for on-line/batch testing.
- M:UC - terminal I/O DCB
- NCHAR - number of characters in current argument
- TOVER - TO-OVER flag
- FPARAM - address of VLP list
- TLBLSIZE - size of tape label buffer
- COPYSTDF - flag which is nonzero if command is COPYSTD.
- SEQUENCE - tested for LN or NLN options.
- TOARG - contains input arguments which are tested when entered in output mode.
- SFTEMP - tested to determine if temporary standard file is to be opened.

FROMFILE	-	buffer containing 'from' field of range specification in TEXTC format.
PRNTBUF	-	buffer containing record of a standard file.
RDTBL	-	two-word table containing the number of read accounts specified and the CMBX value of the first account.
COPYPHY	-	flag set if PHY option was used on a COPYALL.
FROMCMBX	-	contains CMBX value of end of the 'from' field of a range specification.
WRTBL	-	two-word table containing the number of write accounts specified and the CMBX value of the first account.

OUTPUT

ARGBUFF	-	set to serial number of scratch tape before calling STORVLP.
ARGTBL	-	argument table into which default values are entered if needed.
CMBX	-	command buffer index which is set from saved values in ARGTBL when scanning reel numbers or file parameters.
CODE	-	if 0, set to code for EBCDIC or, if PR or PP device, set to code for ASCII.
DCBADD	-	set to current DCB address (M:EI, F:STD, or M:EO).
M:EI	-	element input DCB
M:EO	-	element output DCB
MODE	-	set to default mode codes, if codes were not specified.
TLABEL	-	tape label buffer, the first byte of which contains the length of the buffer.
OPNFPT	-	Open FPT in data base
FILE	-	set to 1 to indicate file name only when entered in output mode for a file in a standard file.
LINENO	-	save word for argument pointer when scanning a file ID.
SFACCT	-	set to CMBX value of account specification on a COPYSTD command.
#DELIM	-	set to index of desired delimiter table in GETARG.
SCRATCH	-	set to the serial number of a scratch tape.

INTERACTION

Modules used:

UTILITY	-	used to issue various M:DEVICE CALs (CALL1). If input and output file names are identical, used to close the M:EI DCB (CLOSEI). Used to enter file name in print buffer (UNPRINT). Used also to close the M:EO DCB after opening to test if file exists (CLOSEO).
GETARG	-	used to extract reel numbers or file arguments from command.
STORVLP	-	used to store reel numbers or file arguments in VLP.
ERROR	-	report error condition.

Monitor services used (handwritten CALs and FPTs):

M:WRITE	-	write message through M:UC DCB.
M:OPEN	-	open M:EI or M:EO DCB.

ERRORS

'ON FILE "xxx" ILLEGAL'
'ON' or 'TO' was used with an existing file (on-line mode).

I/O errors are reported by calling the ERROR routine and are printed later by the PRERR routine.

DESCRIPTION

BLDCB is called by any routine that must construct a DCB for execution of a PCL command. Table DEFAULT is searched to determine if default values apply to the current device. If so, each default value is entered in the appropriate entry of table ARG_TBL, if this entry is zero. The Open FPT is initialized by moving a skeletal form into the user's data area. If reel numbers are present, these are added to the Open FPT as variable length parameters by routine STORVLP. If a file specification or account number is present, these arguments are also added to the Open FPT by routine STORVLP. The appropriate operational label assignment and, if required, the file or label existence flag are entered in the Open FPT.

If BLDCB is entered in input mode, the address of M:EI is normally entered in the Open FPT and Testfile (UTS only), FPARAM, NXTF, and INOUT options are added to the FPT if requested on entry. However, if the COPYSTDF flag is set negative, this indicates that F:STD is to be opened for input.

If BLDCB is entered in output mode, the address of M:EO is entered in the Open FPT, CALL1 is called to issue an M:DEVICE CAL to turn off VFC. The max key length and the organization code are copied to the Open FPT from the M:EI DCB. The access code in the FPT is set to direct. If the FPARAM bit is set on entry, the variable length parameters are copied from FPARAM to the Open FPT. If the user is in on-line mode, a test is made to determine if he is trying to copy 'TO' an existing file. If so, an error message is sent to his terminal and exit is made to the caller. The function code in the FPT is set for 'OUT', unless synonyms are being added as part of a COPYALL, in which case the function is set for 'INOUT'.

If the next file option is set and a 'from' field was present on a range specification, the 'from' field is entered into the Open FPT by calling STORVLP. An Open is performed without the NXTF flag set. In this case, an error return on opening the file will be treated as an error only if copying a synonym or if the PHY option was used. For other conditions, control goes to INXTF2 to issue an Open Next CAL.

If BLDCB is entered in output mode and the input file is random, a test is made to determine if output is to labeled tape. If so, the output organization is set to consecutive and the RLIM value from the M:EI DCB and a code word are entered into the tape label buffer.

If BLDCB is entered in output mode and the output destination is RAD or disk pack with input from labeled tape, the tape label is checked for the random file code word. If the codes match, the RSTORE entry in the output Open FPT is set from the RLIM value saved in the tape label and the output organization is set to random.

The DCB is next opened, and in case of an error or abnormal return, the codes in SR3 are saved and control is returned to the caller. CALL1 is called to issue an M:DEVICE CAL to set the proper bits for BCD/BIN, PK/UPK, or H conversion in the DCB. If SSP, DSP, or VFC has been specified, CALL1 is called again to add the proper code to the DCB via an M:DEVICE CAL. Control is then returned to the caller.

ID

RDWRT - Read M:EI/Write M:EO

PURPOSE

This routine issues the Read and Write CALs that perform a file copy. All of the multiple reel logic is contained in this routine.

USAGE

Calling sequence:

BAL, SR4 RDWRT

INPUT

DEVICE	-	input device code
J:JIT	-	used for testing if on-line or batch mode.
M:EI	-	element input DCB
M:EO	-	element output DCB
M:LO	-	DCB for writing batch messages
M:UC	-	DCB for writing on-line messages
TOARG	-	table of output arguments
IOERR	-	contains returned SR3 after an I/O error occurs.
MODE	-	input mode table which is tested for DEOD option
CODE	-	word in input argument table containing data format code.
TABSET	-	table of tab values
COPYSK	-	tested to determine if COPYALL command.
COPYSTDF	-	tested to determine if COPYSTD command.

OUTPUT

BUFSIZE	-	byte size of dynamic I/O buffer
IOBUF	-	origin of I/O buffer
RDFPT	-	FPT for Read CAL
RECNUM	-	current record number
SELECT	-	count of record select options
TOSWT	-	switch which is zeroed before exiting if an error or abnormal return (other than end-of-reel) occurs on output.
WRTFPT	-	FPT for Write CAL
ATTRB	-	temporary save word used by subroutine COMPRESS

CARDSEQ	-	a doubleword area which is set to the BCD sequence value if the CS option was used.
CIBLEFT	-	set to number of bits left in current compressed word when converting compressed to symbolic.
BREAK	-	break flag which, if set, is reset to zero if command is COPY.
GRANCNT	-	flag set if COPY command is aborted.
CIBTOTAL	-	set to number of bits in input compressed record.
CIBUSED	-	set to number of bits used in current compressed word when converting compressed to symbolic.
CISEQ	-	current sequence value used for testing sequencing on compressed input
CIWORD	-	pointer to current compressed word in input buffer
COBLEFT	-	set to number of bits left in current compressed word when converting symbolic to compressed.
COBUSED	-	set to number of bits used in output compressed word when converting from symbolic to compressed.
COWORD	-	pointer to current compressed word in output buffer
KEY	-	set to next write key when LN option has been used.
LINENO	-	a three-word area immediately preceding the output buffer which is set to the Edit line number if the K option was used.
PRTBUF	-	buffer used for output record whenever C option is used on either input or output.
RECSIZE	-	actual record size of symbolic input or output record when converting to or from compressed.
RSSAVE	-	save word for number of record selections.
SEQNUM	-	a two-word area immediately preceding LINENO which is set to the record sequence number if the K option was used.

INTERACTION

Modules used:

UTILITY	-	convert sequence number of EDIT key to BCD (BIN2BCD) or get additional buffer pages (GET PAGE).
ERROR	-	report error.
HEXDUMP	-	convert input record into hexadecimal dump format and write it.

Monitor services used (handwritten CALs and FPTs):

M:SETDCB	-	set error and abnormal addresses in M:EI and M:EO DCBs.
M:READ	-	read an input record, or read reply after break during COPY command.
M:WRITE	-	write an output record, write '--EOD--ENCOUNTERED', or write 'ENTER X TO ABORT COMMAND'.

- M:CVOL - advance to next input tape reel or close current output volume.
- M:WEOF - write end-of-file mark.
- M:PRECORD - backspace one record.
- M:PFIL - position file to BOF.
- M:DEVICE (SIZE) - set binary mode in M:EO DCB.
- M:CLOSE - release partial RAD file if error occurs.
- M:PC - change prompt character.

SUBROUTINES

- NCCHK - Test for NC option. If the NC option was not used, a return is made to (SR4) +1. Otherwise, the last byte of the record is examined and if it is a carriage return or a line feed, a return is made to (SR4). If the test for carriage return fails, a return is made to (SR4) +1.
- READCOMP - Read compressed input. The compressed input record is read and checked for validity. Control words are initialized for converting compressed to symbolic.
- DECOMPR - Construct a symbolic record from compressed input. The compressed input is converted to symbolic and, if necessary, an additional compressed record is read to produce a symbolic output record.
- COMPRESS - Produce a compressed output record from symbolic input. The input symbolic record is converted to compressed. When the output buffer is full, the record is written and the remainder of the input record is compressed and entered into the buffer as the first part of the next record.
- WRITECO - Write a compressed record. The correct byte count is entered into the write FPT. The sequence field of the records is incremented by 1. A checksum is computed and entered into the control word. If sequence or line number options were specified, these are processed next. The record is then written.
- SETEOD - Set record size to true byte count. The record size of a symbolic record is reduced by the number of trailing blanks. The true size is saved in RECSIZE and is also returned in R3.
- LINENUM - Construct a write key. A write key is constructed from the current line number. This number is derived from the values specified with an LN option. The output argument table is always updated to contain the next key value. The current value is stored in KEY.

- TABEXP - Perform tab expansion. If the TX option was used, this routine is entered for each output record to expand any embedded tab characters.
- One of the following methods of expansion is used:
1. If a PCL TABS command was input, the values on this command are used.
 2. If a PCL TABS command was not input, but tab values are present in the M:UC DCB, these values are used in the expansion. This applies to on-line only.
 3. If no tab values have been specified, single blanks are substituted for tab values.
 4. If insufficient tab values were specified, single blanks are substituted for the remaining tab characters in the record.
- SEQOUT - Construct sequence information. This routine constructs a doubleword BCD sequence value from the ID and current sequence number contained in the output argument table. If overflow occurs, the sequencing reverts to 0. The information is stored in CARDSEQ.
- SEQOUTB - Sequence binary output. The sequence information in CARDSEQ is converted from an eight-byte BCD value to a twelve-byte binary equivalent. The converted value is entered into the last three words of the output buffer.
- ULBLCHK - Test for trailer label. This routine is entered for a X'1C' abnormal (EOV) or an end-of-file. If the input and output devices are both labeled tape, a test is made to determine if a trailer label is present. If so, a CVOL or CLOSE CAL is issued for M:EO to transfer the trailer label to the output tape.
- BRCHK - Test Break flag. If the Break flag is set and the command is a COPY, the message 'ENTER X TO ABORT COMMAND' is issued. If the user's reply is 'X', the copy is aborted. Any other reply causes the copy to be continued.

ERRORS

'RECORD SIZE EXCEEDS AVAILABLE MEMORY'

Required buffer space for reading input records is not available. File copy is terminated.

'INPUT RECORD SIZE LARGER THAN 32767 BYTES'

The number of bytes in an input record from unlabeled tape or paper tape exceeds $2^{15}-1$. File copy is terminated.

'RECORD SELECTION SPECIFICATION NOT VALID FOR THIS DEVICE'

Record selections are specified out of sequence for card reader input. File copy is terminated.

'RS SPECIFICATION BEYOND END OF FILE'

The range of records selected is not within the file.

'ERROR IN COMPRESSED INPUT'

Either the record length, ID, checksum, or sequencing of compressed input is in error. The copy is terminated.

'C OPTION IS INVALID ON BOTH INPUT AND OUTPUT'

Self-explanatory. The copy is not performed.

'RECORD SELECTION INVALID WITH C OPTION'

The C option is not allowed on either input or output if record selection is specified. The copy is not performed.

'OVERFLOW ON EDIT LINE NUMBER'

The key value computed, when copying with LN option, exceeds 9999. File copy is terminated.

The occurrence of an I/O error will cause SR3 to be saved and the error to be reported later by the PRTErr routine.

DESCRIPTION

RDWRT is called for each file that is copied. The Read FPT is moved to RDFPT in the user's data base and the current buffer size is entered in the FPT. The Write FPT is moved to WRTFPT. The buffer address is entered in the Read and Write FPTs.

If a random file is being copied, and the buffer size is less than a page, GETPAGE is called to get an additional page. The buffer size is set to one page and the key address is removed from the Write FPT. If the LN option was used, the address of KEY is entered in the Write FPT.

If the C option was used on either input or output, control goes to RDWRTCO to perform the I/O and the conversion. Otherwise, SETDCB CALs are issued to set error and abnormal addresses in M:EI and M:EO

The record selection table index is initialized to point to the first selection pair. The record number count is zeroed, the EOF indicator zeroed, and a Read CAL issued. After a normal return from a Read CAL, the record count is incremented by one and a test made to determine if record selection is to be done. If so, the current record number is compared against the values to which the selection table index points. If less than the X value, the next record is read from the file. If greater than the Y value, the count of record select options is decremented by one and the next selection pair in the table is used for comparison. If the current record is within range, the routine continues by preparing to output the record.

If the current record number is greater than the X value of the next selection pair, this indicates that selections are out of sequence and a PFIL CAL is issued to position to the beginning of the file. In this case, the record count is zeroed and the file is read again.

If the current record is to be output, its size is obtained and placed in the Write FPT. If the NC option was specified, the last byte of a non-null record is tested to see if it is a carriage return. If so, the record size in the Write FPT is decreased by one to strip the carriage return from the record.

If the TX option was used, TABEXP is called to expand tab characters. If a sequence option was specified, this option is processed next.

If the output is to be in hexadecimal dump format, the subroutine HEXDUMP is called to convert and write the output record. Control then goes to read the next record.

If the K option was used, and the input file has a three-byte key and output is to the terminal or line printer, the key is converted to an Edit line number and printed as the first part of each record.

The Write CAL is then issued. At this point, subroutine BRCHK is called to test the BREAK flag. If no abnormal or error conditions have occurred, control goes back to the Read CAL and this loop continues until an error or abnormal condition occurs.

READ ABNORMAL:

A check is made for EOD (5) or EOF (6). If so, the END OF FILE indicator (R6) is incremented by one and is checked for a value of 2.

If a double END OF FILE has occurred, subroutine ULBLCHK is called to test if a trailer label is present. Control is returned to the calling subroutine (i.e., copying is terminated with a double END OF FILE). When the END OF FILE indicator is one, a WRITE END OF FILE CAL is issued to the output (M:EO) DCB. Control goes back to the Read CAL if an abnormal code 5 (EOD) occurred. However, if an abnormal code 6 (EOF) occurred, an exit is made from RDWRT.

A check is made for lost data (7). If so, the GETPAGE subroutine is called to obtain additional buffer pages. If no pages are available, subroutine ERROR is called to report the error and control returns to the calling subroutine. When the page is available, a check is made to insure that the buffer size to read a record from a DEVICE is not greater than 15 bits. The new record size is entered in the READ FPT and BUFSIZE. The input file is backspaced one record to re-read the same record.

A check is made for END OF REEL (X'1C'). If so, subroutine ULBLCHK is called to test if a trailer label is present. A CLOSE VOLUME CAL is issued to switch to the next reel.

If none of the above READ ABNORMAL conditions have occurred, an I/O error is reported to subroutine ERROR and control returns to the calling subroutine.

READ ERROR:

A check is made for last reel (X'56'). If so, control returns to write the last record. If a X'42' is returned, and the input file is random, this signals the end of input and an exit is made from RDWRT. Otherwise, an I/O error is reported to subroutine ERROR and control returns to the calling subroutine.

WRITE ABNORMAL:

A check is made for END OF REEL (X'1C'). If so, two END OF FILES are written to clean up a free form tape and a CLOSE VOLUME CAL is issued to switch to the next reel. Otherwise, control goes to WRITE ERROR.

WRITE ERROR:

The output DCB M:EO is closed and TOSWT is reset to indicate no defined output specification. The Write Error is reported to subroutine ERROR and control is returned to the calling subroutine.

ID

HEXDUMP - Hexadecimal Dump Routine

PURPOSE

Converts an input data record into a hexadecimal dump format and writes it. This routine is called from the RDWRT routine if the X format conversion has been specified.

USAGE

Calling sequence:

BAL, SR4 HEXDUMP

INPUT

IOBUF	-	I/O buffer origin if input is not compressed.
M:EI	-	element input DCB
M:EO	-	element output DCB
RECNUM	-	current record number
WRTFPT	-	FPT for Write CAL
CODE	-	input data code
PRTBUF	-	input buffer if input is compressed.
TOARG	-	output device code
CCTAB	-	table used for testing if character is unprintable.

OUTPUT

PRNTBUF	-	line buffer
BREAK	-	set to zero and an immediate exit made if Break key was depressed.
SFDEF	-	current word pointer in input buffer

INTERACTION

Modules used:

UTILITY	-	convert binary to BCD (BIN2BCD), put file name or key in buffer (UNPRINT), or convert hexadecimal to BCD (HEX2BCD).
---------	---	---

Monitor services used (handwritten CALs and FPTs):

M:DEVICE	-	used to reset VFC or to position to top of page.
M:WRITE	-	used to print all messages and converted lines through M:EO.

DESCRIPTION

The VFC bit in the output DCB (M:EO) is reset because the output of HEXDUMP does not contain a VFC byte at the start of each record. A Top-of-Page CAL is executed before the first record is printed if output is to the line printer.

The record size must be rounded to word resolution to print any partial word at the end of the record. If the input record is from a device type, there is no file name or key name to print so the record number is printed. When the input record is from a file and output is to the line printer, the file name is printed before the first record only. When the input file is keyed, the key name is printed, otherwise, the record number is printed. When the keyed record size is zero, a message is printed and control is returned to RDWRT.

The number of words per line is set according to where the output is going. Output to the line printer is set at eight words per line; output to a terminal is set at four words per line.

The first line is converted to EBCDIC by subroutine HEX2BCD word-by-word and placed in PRNTBUF byte-by-byte. After each word is converted, a check is made to determine if the end of the input buffer has been reached. If so, and if output is to the terminal, the line is printed. If output is to the printer, the input characters are moved to the output buffer with unprintable characters replaced by a period. Each subsequent line is then checked against the previous line to check for duplication of lines. Duplicate lines are not printed unless it is the last line of the record. When a duplicate line is found, the asterisk flag is set, and when a subsequent line is printed, an asterisk is printed along with the address to indicate that one or more lines have been skipped.

Before the last line of a record is printed, a check is made to determine if the last word of the record is only a partial word. If so, only the high order bytes contained in the input record are printed.

After the last line is printed, control is returned to the subroutine RDWRT.

The BREAK flag is tested after each line is printed and, if set, it is zeroed and exit is made to subroutine RDWRT.

ID

ERROR - Error Reporting Routine

PURPOSE

To report an error for subsequent printing by PRTER. This is done by entering a '\$' pointer into the error flag buffer and, if UTS, entering into a table the key needed to read the desired message from the system error message file (ERRMSG.:SYS). In BPM, the table entry is an index into an internal error message table.

USAGE

Calling sequence:

BAL, SR4 ERROR

Input registers:

- R1 - contains the error code from which the key is to be built. If zero, the error code is contained in SR3.
- SR3 - I/O error code (as returned on an error or abnormal I/O operation) if R1 contains zero.

Output registers:

- D2 - maximum error severity encountered (1 = warning, 2 = terminate execution, 3 = terminate Edit and execution).

INPUT

- CMBXDIFF - offset from CMBX to get desired location for entering '\$' in flag buffer.
- CMBX - current byte index into CMDBUF
- J:JIT - tested for on-line/batch mode.
- TERM - current termination character.

OUTPUT

- ERRFLAG - table of ERRMSG file keys into which a key is entered for the error to be reported (UTS only). In BPM, the table entry is the error code itself. The first word of the table is incremented to reflect the number of table entries present.

IOERR - contents of SR3 returned by the File Management system,
if R1 is zero on entry.

ERRORS

The following messages are contained in the ERRMSG.:SYS file (UTS only). The number of the message (contained in R1 on entry) is used to construct the key. In BPM, these messages constitute a table contained in module PRTERR.

1. ARGUMENT GREATER THAN 31 CHARACTERS
2. ILLEGAL DEVICE CODE
3. MORE THAN FOUR CHARACTERS IN A REEL NUMBER SPECIFICATION
4. ILLEGAL FILE NAME SPECIFICATION
5. ILLEGAL ACCOUNT NUMBER SPECIFICATION
6. ILLEGAL PASSWORD SPECIFICATION
7. TOO MANY FIELDS IN A FILE IDENTIFICATION SPECIFICATION
8. INVALID FILE RANGE SPECIFICATION
9. MORE THAN TEN RS FIELDS FOR AN INPUT DEVICE
10. OVERFLOW ON A RS VALUE
11. ERROR ON Y VALUE OF RS OPTION
12. CS ID-FIELD GREATER THAN FOUR CHARACTERS
13. ERROR ON N OR K VALUE OF CS OPTION
14. IMPROPER TERMINATION WITHIN RS, LN, OR CS OPTION
15.)) MUST TERMINATE RS, LN, OR CS OPTION
16. SPECIAL ARGUMENTS MUST HAVE) AS TERMINATION CHARACTER
17. EH?
18. UNDEFINED COMMAND ACTION VERB
19. ILLEGAL INPUT DEVICE
20. NO DEFINED OUTPUT DEVICE
21. ILLEGAL OUTPUT DEVICE
22. REEL NUMBER SPECIFICATION NOT VALID FOR THIS DEVICE
23. FILE SPECIFICATION NOT VALID FOR THIS DEVICE
24. DATA CODE SPECIFICATION NOT VALID FOR THIS DEVICE
25. MODE SPECIFICATION NOT VALID FOR THIS DEVICE
26. SEQUENCE SPECIFICATION NOT VALID FOR THIS DEVICE
27. RECORD SELECTION SPECIFICATION NOT VALID FOR THIS DEVICE
28. PK/BIN/7T COMBINATION NOT VALID
29. NULL ARGUMENT (TWO DELIMITERS IN A ROW)
30. IMPROPER TERMINATION OF THE COMMAND
31. ONE REEL NUMBER MUST BE SPECIFIED ON THIS COMMAND
32. 'TO' OR 'OVER' NOT SPECIFIED
33. RECORD SIZE EXCEEDS AVAILABLE MEMORY
34. INVALID DEVICE TYPE FOR THIS COMMAND
35. MORE THAN THREE REEL NUMBERS SPECIFIED

- 36. OVERFLOW ON NUMBER OF FILES ON 'SPF' COMMAND
- 37. INVALID DIRECTION INDICATOR ON 'SPF' COMMAND
- 38. INPUT RECORD SIZE LARGER THAN 32767 BYTES
- 39. INVALID OPTION FOR COPYALL
- 40. ACCOUNT SPECIFICATION NOT VALID ON 'SPE' COMMAND
- 41. RS SPECIFICATION BEYOND END OF FILE
- 42. ERROR IN COMPRESSED INPUT
- 43. C OPTION INVALID ON BOTH INPUT AND OUTPUT
- 44. RECORD SELECTION INVALID WITH C OPTION
- 45. INVALID TAB SPECIFICATION
- 46. OVERFLOW ON EDIT LINE NUMBER
- 47. ZERO INCREMENT ON CS OR LN OPTION
- 48. TX OPTION USED WITHOUT TABS COMMAND
- 49. INVALID OPTION FOR COPYSTD
- 50. MORE THAN EIGHT READ OR WRITE ACCOUNTS
- 51. MORE THAN 16 TAB VALUES
- *52. UNABLE TO DISMOUNT

DESCRIPTION

On entry, register D2 is updated to the highest severity level encountered on the command. The byte table SEVERE contains the severity level for each error code. If an I/O error is being reported ($R1 = 0$), SR3 is stored in IOERR. A '\$' is entered as a scan pointer in the error flag buffer. If the error has already been reported, an immediate exit is made. Many commands are scanned twice - once for syntax analysis and once for execution, so it is possible to detect severity one errors a second time.

If an I/O error is being reported, an exit is now made. If a PCL error is being reported ($R1 \neq 0$), a key is formed by multiplying the error code by 100 and adding a constant that forms an EDIT-type file key (UTS only). In BPM, the error code itself is used. The value is stored in table ERRFLAG. The first word of ERRFLAG contains the number of entries in the table and the subsequent words contain the entries. There is one entry per word and a maximum of nine entries. These entries are used by PRTERR to read file ERRMSG.:SYS (or to look up in internal table for BPM) to obtain the text of each error message. Control is always returned to the caller.

*UTS only

ID

PRTERR - Print Error Messages

PURPOSE

To print the error messages corresponding to the error codes processed by the ERROR routine. PRTERR is called after processing is completed, or has been terminated, for each command. It is called if the maximum error severity level exceeds one.

USAGE

Calling sequence:

BAL, SR4 PRTERR

Input register:

D2 (reg. 13) - contains maximum error severity.

INPUT

CMDBUF	-	command buffer
ERCMBUF	-	flag buffer containing a '\$' pointer for each error
ERRFLAG	-	a table set up by the ERROR routine which contains, in the first word, a count of errors reported, followed by the ERRMSG file keys for the errors.
J:JIT	-	tested for on-line or batch mode.
M:DO	-	diagnostic output DCB
M:EI	-	element input DCB
M:LL	-	command output DCB (batch only)
M:UC	-	terminal I/O DCB
COPYSTDF	-	COPYSTD flag

OUTPUT

IOERR	-	on entry, contains codes returned in SR3 if an I/O error was encountered. It is changed to contain the ERRMSG file key (or the error code itself) formed from these codes.
PRTBUF	-	the buffer used for reading and writing error messages.

INTERACTION

Modules used:

UTILITY - convert binary to BCD (BIN2BCD), convert hexadecimal to BCD (HEX2BCD), or close M:EI DCB (CLOSEI).

Monitor services used (handwritten CALs and FPTs):

M:DEVICE - used to compare M:LL and M:DO assignments.
M:OPEN - used to open ERRMSG file (UTS only).
M:READ - used to read messages from ERRMSG through M:EI DCB (UTS only).
M:WRITE - used to write messages and flags through M:UC, if on-line, or M:DO, if batch mode.
M:SETDCB - used to set error and abnormal in the M:EI DCB.

DESCRIPTION

The PCL command is printed again through the M:DO DCB if this DCB has a different assignment from M:LL and if the user is in batch mode. In UTS, the M:EI DCB is opened to the ERRMSG file. The significant portion of the error flag buffer (containing '\$' pointers) is printed. A Read CAL is issued for the ERRMSG file for each key contained in the ERRFLAG table. If a Read is not successful, the message

'PCL ERROR CODE NN'

is printed and the routine continues to issue additional Read CALs if other PCL errors were reported. Each successful Read is followed by printing the error message which was read. When all PCL error messages for the reported errors have been printed, a test is made to determine if an I/O error was reported. If not, the M:EI DCB is closed and control is returned to the caller. If an I/O error was reported, a key is formatted from the error code and subcode which were returned in SR3, and a Read CAL is issued for this keyed record in the ERRMSG file. If the Read is unsuccessful, the M:EI DCB is closed and the message

'*****I/O ERROR NN-S'

is printed. Control then returns to the caller. If the Read is successful, the I/O error message which was read is printed, the M:EI DCB is closed, and control returns to the caller.

In BPM, the PCL error messages are obtained from an internal table. I/O error messages are formatted by PCL from the error codes returned from File Management.

All output is directed through the M:UC DCB, if on-line, or through the M:DO DCB, if batch mode.

ID

COMBINE - Check for Errors in Parameter Combinations

PURPOSE

To examine all options specified on a COPY command and check for valid combinations.

USAGE

Calling sequence:

BAL, SR4 COMBINE

Input register:

D1 (reg. 12) - current action verb code

INPUT

CODE	-	a word in ARG_TBL containing the ID for a data format code
DEVICE	-	contains device ID code.
FILE	-	a two-word table containing a file ID indicator and the command buffer index of the file name.
MODE	-	a four-word table containing IDs for specified modes.
SELECT	-	contains the number of record selection specifications.
SEQUENCE	-	contains record sequencing ID code.

OUTPUT

PRTBUF	-	used as temporary storage for mode.
--------	---	-------------------------------------

INTERACTION

Modules used:

ERROR	-	report error condition.
-------	---	-------------------------

No monitor services used.

SUBROUTINES

TESTARG - The TESTARG subroutine is entered many times in order to test various parameter combinations. A table EDITBL is referenced to test for legal combinations. This table also contains the error codes to be reported for invalid combinations. Input requirements are as follows:

- R1 - contains address of argument.
- R2 - contains index into EDITBL.
- R6 - device code, if input; device code +6, if output.

An immediate exit is made if the value of the argument is zero.

ERRORS

'ILLEGAL OUTPUT DEVICE'

CR or PR was specified as an output device.

'ILLEGAL INPUT DEVICE'

LP, CP, or PP was specified as an input device.

'REEL NUMBER SPECIFICATION NOT VALID FOR THIS DEVICE'

A reel number was specified with a device other than LT, DP, or FT.

'FILE SPECIFICATION NOT VALID FOR THIS DEVICE'

A file was specified with a device other than DC, DP, or LT.

'DATA CODE SPECIFICATION NOT VALID FOR THIS DEVICE'

A data code or data format specification has been used incorrectly.

'MODE SPECIFICATION NOT VALID FOR THIS DEVICE'

A mode specification has been used incorrectly.

'SEQUENCE SPECIFICATION NOT VALID FOR THIS DEVICE'

CS, NCS, LN, or NLN option has been used incorrectly.

'RECORD SELECTION SPECIFICATION NOT VALID FOR THIS DEVICE'

Record selection was specified for an output device.

'PK/BIN/7T COMBINATION NOT VALID'

The options BIN and 7T were not specified when PK was specified.

'ZERO INCREMENT ON CS OR LN OPTION'

Self-explanatory.

DESCRIPTION

COMBINE examines the contents of ARG_TBL to determine if any of the options specified on a COPY command are invalid for the device. On entry, a test is made to determine if the field being processed is the input or output field. If output, the device code is incremented by six to obtain a correct index value into a bit string used in editing combinations. If an input device label has been used for output or an output device label has been used for input, the error is reported and an immediate exit is made. Otherwise, calls are made to TESTARG to edit the device/file combination, the device/data code combination, the device/mode combination, the device/sequence combination, and the device/record selection combination. An additional test is made to see that, if PK is specified, BIN and 7T are also specified. Any errors detected in editing combinations are reported by calling the ERROR routine, and COMBINE continues by editing any remaining combinations.

ID

DEVTRAN - Translate Device Specification

PURPOSE

To translate a device specification of a PCL command.

USAGE

Calling sequence:

BAL, SR4 DEVTRAN

INPUT

CMBX	-	command buffer index of device specification
TERM	-	terminator of current argument
COPYSTDF	-	COPYSTD flag
ARGBUFF	-	buffer containing current argument

OUTPUT

DEVICE	-	three-word table set to the device ID code, the number of reel numbers for the device, and the CMBX value of the first reel number.
FILE	-	set to 6 if account number follows a device code.
FILE+1	-	set to CMBX value of account number if FILE is set.
#DELIM	-	set to 6 to enable '#' as a delimiter when scanning reel numbers. Reset to zero when through scanning reel numbers.

INTERACTION

Modules used:

ERROR	-	report error condition.
FIXARG	-	look up device label in table DEVTBL
GETARG	-	extract argument from device specification.
TEXTARG	-	edit reel number or account specification.

No monitor services used.

ERRORS

'MORE THAN THREE REEL NUMBERS SPECIFIED' Self-explanatory.

DESCRIPTION

On entry, the '#' is enabled as a delimiter by setting #DELIM to 6. The device code is scanned in the command by calling GETARG. The EBCDIC device code is looked up in the DEVTBL table by calling subroutine FIXARG. If a match is not found and the command is other than COPY or LIST, an error is reported by FIXARG. Otherwise, the numeric device code is stored in DEVICE. When the device is terminated with a # character, that indicates that a tape reel number follows. The CMBX value of the first tape reel number is saved in DEVICE+2. Each reel number is scanned by GETARG and the number of characters in each reel number is checked by the subroutine TEXTARG. Each reel number must have between one and four characters. A maximum of three reel numbers is allowed for a free form tape or labeled tape specification. The number of reels specified is saved in DEVICE+1.

When a terminator is not a # character, the '#' delimiter mode is disabled by setting #DELIM to zero. If a '.account' specification follows a device code, FILE is set to 6 to indicate a ccount only. The CMBX value of the account is stored in FILE+1. GETARG is called to scan the account field and TEXTARG is called to check the field for correct length. Exit is then made to the caller.

ID

INTARG - Convert and Check Integer Argument

PURPOSE

To convert an integer argument to binary. The converted integer is compared with value limits supplied by the caller.

USAGE

Calling sequence:

BAL, SR4 INTARG

Input registers:

R1 - minimum integer value
R2 - maximum integer value

Output registers:

R1 - integer in binary
R2 - type of return (0 = normal, 1 = invalid, 2 = range error)

INPUT

ARGBUF4+1 - address of first byte of integer
NCHAR - number of characters in integer

INTERACTION

Modules used:

UTILITY - convert BCD to binary (BCD2BIN).

No monitor services used.

DESCRIPTION

The argument at address ARGBUF4+1 is converted to a binary value by the subroutine BCD2BIN. If BCD2BIN returns with an error flag, R2 is set to 1 and control is returned to the caller. If a normal return is made from BCD2BIN, a range check is made against the values input in R1 and R2. If the integer is within range, a normal exit is made with R2 set to zero. If the integer is not within range, an exit is made with R2 set to 2.

ID

STORVLP - Store Variable Length Parameters

PURPOSE

To store a variable length parameter in the OPEN FPT. This parameter may be name, account, password, INSN, OUTSN, read account, or write account.

USAGE

Calling sequence:

BAL, SR4 STORVLP

Input registers:

R1 - VLP code (1 = name, 2 = account, 3 = password, 4 = INSN,
5 = OUTSN, 6 = read account, 7 = write account)

INPUT

ARGBUF4 - byte location of argument buffer
NCHAR - number of characters in argument

OUTPUT

OPNFPT - location of the OPEN FPT for the current file. STORVLP
enters the existence flag for the argument.
VLPOPEN - location of the VLP list of the OPEN FPT. If argument is a
password, a live password entry is made.

INTERACTION

Modules used:

UTILITY - move byte string (MBS).

No monitor services used.

DESCRIPTION

STORVLP is entered with R1 containing a code indicating the type of parameter in the argument buffer. If the parameter is a password, the length of the account entry in the VLP is changed from five words to two words to make a live password entry. R1 is used as an index into table VLPLINK which contains codes for building a VLP entry for each parameter. The parameter existence flag is set in the OPEN FPT. The length of the parameter is extracted from table VLPLINK. This length is zero if the parameter is a file name and the actual length is obtained from NCHAR. Subroutine MBS is called to move the parameter from ARGBUFF to the VLP list. The word length of the parameter is calculated and entered in the VLP control word. Control is then returned to the caller.

ID

GETARG - Get Argument From Command Buffer

PURPOSE

To extract the next argument from the command buffer and place it in TEXTC format in the argument buffer.

USAGE

Calling sequence:

BAL, SR4 GETARG

INPUT

MAXCMBX - pointer to end of command in the command buffer.
#DELIM - used to select desired delimiter table. The value is an index into table DELIMIT and may be set to one of the following:

- 0 - normal scan mode
- 6 - include '#' as a delimiter
- 12 - file ID mode
- 17 - character string mode
- 22 - hexadecimal string mode

OUTPUT

ARGBUFF - set to contain current argument string in TEXTC format.
CMBX - command buffer index which is updated to point beyond delimiter of current argument
NCHAR - set to number of characters in the argument.
TERM - set to delimiter of argument.

INTERACTION

Modules used:

ERROR - report error condition.

No monitor services used.

ERRORS

'ARGUMENT GREATER THAN 31 CHARACTERS' Self-explanatory.

DESCRIPTION

ARGBUFF is blanked. The leading blank flag and trailing blank flag are reset. The current CMBX value is placed in a register. The MAXCMBX value is always checked before each character is scanned to determine when the End-of-Command is reached. When the End-of-Command is encountered, the termination code of X'15' is set as the field terminator.

Each character is tested for blank or tab (X'05'). If a tab, the value is changed to a blank for further testing. When the character is a blank and is a leading blank, it is ignored and the next character is checked.

When the first nonblank character is encountered, it is checked to determine if it is a terminator. If so, return is made to the calling subroutine.

When the character is text, a check is made to determine if this is the end of a trailing blank string. If so, a blank terminator is set and the CMBX value is reduced by one to point to the first character of the new field.

When the text character is part of the current field a check is made to determine that the field does not exceed 31 characters. The character is placed in ARGBUFF and the Leading Blank Flag is set to reflect the end of the leading blank string.

When the first trailing blank is encountered, the Leading Blank Flag is reset and the Trailing Blank Flag is set. The Leading Blank Flag is reset to cause a shorter blank skipping loop and plays no other part in the scan logic.

The delimiter table is selected by the contents of #DELIM. If this value is 12, it indicates a file ID is being scanned and the argument is examined to determine if it is a character (leading quote) or hexadecimal (leading X') string. Hexadecimal strings are moved without change to the argument buffer; character strings have their outside quotes removed and any double quotes within reduced to a single quote.

At the RETURN address, TERM is set with the termination character. CMBX is set with the byte index of the next field. The character count of the current field is placed in byte zero of ARGBUFF to make it TEXTC format. The character count is also placed in NCHAR. Control is then returned to the caller.

ID

FILTRAN - File ID Translator

PURPOSE

To translate the name, account, and password fields of a file ID in a command.

USAGE

Calling sequence :

BAL, SR4 FILTRAN

INPUT

CMBX	-	command buffer index of file ID
TERM	-	delimiter of current argument

OUTPUT

FILE	-	set to number of parameters in the file ID.
FILE+1	-	set to the CMBX value of the file name.
#DELIM	-	set to 12 on entry. Set to zero before exiting.

INTERACTION

Modules used:

ERROR	-	report error condition.
GETARG	-	get next argument.
TEXTARG	-	check argument length.

No monitor services used.

ERRORS

'TOO MANY FIELDS IN A FILE IDENTIFICATION SPECIFICATION'
More than three fields were specified in a file ID.

DESCRIPTION

The CMBX value of the file name is saved in register R6. R5 is set to the code for file name (1). GETARG is called to scan the file name. If a '.' terminator is found, an account name follows. R5 is incremented by one. If a password is present, R5 is incremented to three.

The number of characters in each field is checked by subroutine TEXTARG. The two-word table FILE is set to the count of the number of fields (contained in R5) and the CMBX value of the file name field. Control then returns to the calling subroutine.

ID

FIXARG - Table Search Routine

PURPOSE

To look up an argument in a table and return with the index of the argument as an ID.

USAGE

Calling sequence:

BAL, SR4 FIXARG

Input registers:

R1 - 0-7 error code desired
15-31 table address

Output registers:

R1 - table index of argument

INPUT

ARGBUFF - location of argument to be looked up
SAVCMBX - CMBX value if called when device label is optional; otherwise, zero.

OUTPUT

CMBX - set to saved value in SAVCMBX if this value is nonzero and argument is not in table.
TERM - set to '/' if CMBX is set as described above.

INTERACTION

Modules used:

ERROR - report error condition.

No monitor services used.

ERRORS

An error message is produced if a match is not found in the table. The text of the message is dependent on the error code supplied in R1 on entry to FIXARG.

DESCRIPTION

The table pointed to by R1 is searched for the argument contained in ARGBUFF. If a match is found, control is returned to the caller with the table index of the argument in R1. If a match is not found, a test is made to determine if FIXARG was entered to look up a device label and the label is optional. If so, the CMBX pointer is restored to point to the beginning of the argument. The syntax 'DC/' is simulated by setting TERM to '/' and the code in R1 to 3. This action permits the calling routine to look at the argument again as a file name. If a match is not found, and the test described above fails, the ERROR subroutine is called to report the error based on the error code supplied in R1. R1 is set to zero before returning to indicate a match was not found.

TEXTARG - Check Argument Length

PURPOSE

To check the length of the argument in ARGBUFF to determine if it falls within the limits supplied by the caller.

USAGE

Calling sequence:

BAL, SR4 TEXTARG

Input register:

R1 - byte 0 - error code desired
byte 1 - unused
byte 2 - minimum number of characters allowed
byte 3 - maximum number of characters allowed

INPUT

NCHAR - number of characters in argument

INTERACTION

Modules used:

ERROR - report error condition.

No monitor services used.

ERRORS

An error message is produced if the length of the argument does not fall within the limits supplied by the caller. The text of the message is dependent on the code supplied in R1 on entry to TEXTARG.

DESCRIPTION

The value in NCHAR is checked against the limits in R1. If the number of characters in the current argument is within limits, control returns to the caller. If the number of characters in the current argument is out of range, subroutine ERROR is called with the error code contained in R1. Control is then returned to the caller.

ID

BCD2BIN - Decimal-to-Binary Conversion Routine

PURPOSE

To convert a string of EBCDIC decimal characters to a binary value.

USAGE

Calling sequence:

BAL, SR4 BCD2BIN

Input registers:

- R1 - byte index of argument into Data Base page
- R2 - number of characters in argument

Output registers:

- R1 - byte index of terminating character
- R2 - number of unconverted characters in argument
- R3 - converted binary value
- R4 - type of return (0 = normal, 1 = nonnumeric character in string, 2 = overflow.

DESCRIPTION

Each EBCDIC character is obtained from the argument and, if numeric, the low-order four bits is extracted. The accumulator (initially 0) is multiplied by ten and the new digit is added to the accumulator. Control is returned to the caller when a nonnumeric character is encountered, overflow occurs, or the end of the argument string is reached.

ID

BIN2BCD - Binary-to-Decimal Conversion Routine

PURPOSE

To convert a binary value to an eight-character EBCDIC decimal integer with leading blanks.

USAGE

Calling sequence:

BAL, SR4 BIN2BCD

Input registers:

R1 - binary integer to be converted

Output registers:

R1 - binary integer/100,000,000
R2, R3 - decimal integer (right-justified with leading blanks)
R4 - number of nonblank characters in result

DESCRIPTION

The binary value is divided by ten and a X'F0' added to the remainder. The resulting byte is placed in the proper position of R2, R3. This process continues until a quotient of zero results from the division by ten.

ID

HEX2BCD - Hexadecimal-to EBCDIC Conversion Routine

PURPOSE

To convert a word in hexadecimal to a two-word BCD equivalent.

USAGE

Calling sequence:

BAL, SR4 HEX2BCD

Input registers:

R1 - hexadecimal word to convert

Output registers:

R1 - input hexadecimal word

R2, R3 - BCD equivalent of hexadecimal word

DESCRIPTION

Each four-bit hexadecimal digit has the proper constants added to it to convert it to EBCDIC. The resultant byte is stored into the correct position of R2, R3. R1 is left intact by the routine.

ID

CALL1 - CAL1, 1 Routine

PURPOSE

To issue a CAL1, 1 based on information supplied in registers.

USAGE

Calling sequence:

BAL, SR4 CALL1

Input registers:

R1	-	FPT code right-justified
R2-Rn	-	FPT

INPUT

DCBADD - contains address of DCB.

INTERACTION

A CAL1, 1 is issued.

DESCRIPTION

The function code is shifted left 24-bit positions and the address of the DCB is OR'ed into the register. A CAL1, 1 is issued using registers R1-Rn as the FPT.

ID

CLOSEI - Close M:EI DCB

PURPOSE

To close the M:EI DCB if it is open.

USAGE

Calling sequence:

BAL, SR4 CLOSEI

INTERACTION

Monitor services used (handwritten CALs and FPTs):

M:CLOSE - used to close the M:EI DCB.

DESCRIPTION

A test is made to determine if the M:EI DCB is closed and, if so, control is returned to the caller. If M:EI is open, a CAL1, 1 is issued to close the DCB and control is returned to the caller.

ID

CLOSEO - Close M:EO DCB

PURPOSE

To close the M:EO DCB if it is open.

USAGE

Calling sequence:

BAL, SR4 CLOSEO

INTERACTION

Monitor services used (handwritten CALs and FPTs):

M:CLOSE	-	used to close and save file assigned to M:EO.
M:WEOF	-	used to write end-of-file on free form tape.
M:PRECORD	-	used to position free form tape before second end-of-file mark.

DESCRIPTION

If the M:EO DCB is closed, control is returned to the caller. When the M:EO DCB is not opened to a free form tape, the DCB is closed and saved by issuing a CAL1, 1.

In order to set up a free form tape so that additional files may be added with only one file mark between files, CLOSEO writes a file mark on the free form tape and positions back over the file mark. The tape is now positioned to add additional files with only one file mark between files. When the CAL1, 1 for the CLOSE is issued, no tape operation results because that last operation through the DCB was not a write. Therefore, the tape is left with two consecutive file marks if no additional files are added. This is the correct end-of-tape indicator.

ID

CLRARG - Zero Table ARG_TBL

PURPOSE

To zero the argument table ARG_TBL.

USAGE

Calling sequence:

BAL, SR4 CLRARG

INPUT

ARG_TBL - location in data base of argument table

DESCRIPTION

CLRARG is called before a new device specification is processed. All of the arguments set up to describe the previous device specification are cleared by zeroing table ARG_TBL.

ID

GETPAGE - Get Additional Pages

PURPOSE

To get additional pages of memory for the RDWRT copy buffer. This routine is used only in UTS.

USAGE

Calling sequence:

BAL, SR4 GETPAGE

OUTPUT

NPAGE - incremented by number of pages obtained.

INTERACTION

Monitor services used (handwritten CALs and FPTs):

M:GP - issued to get desired number of pages.

DESCRIPTION

The number of pages in NPAGE (initially 0) is incremented by one, this value is multiplied by 16 and a CAL1, 1 issued to get the computer number of pages. NPAGE is incremented by the contents of SR1 which is the actual number of pages obtained.

ID

REL PAGES - Release Excess I/O Buffer Pages

PURPOSE

To release additional I/O buffer pages which were obtained by GETPAGE. This routine is used only in UTS.

USAGE

Calling sequence:

BAL, SR4 REL PAGES

OUTPUT

NPAGE - set to zero.
BUFSIZE - set to 3072 (size of initial I/O buffer.)

INTERACTION

Monitor service calls (handwritten CALs and FPTs):

M:FP - issued to release pages.

DESCRIPTION

An immediate exit is made if there are no pages to release. Otherwise, the FPT code for M:FP is OR'ed into the register containing the page count. A CAL 1, 8 addressing this register as the FPT is issued. NPAGE is set to zero to indicate no excess buffer space. BUFSIZE is set to 3072, which is the initial buffer size.

ID

MBS - Move Byte String

PURPOSE

To move a byte string of any length.

USAGE

Calling sequence:

BAL, SR4 MBS

Input registers:

R1	-	number of bytes to be moved.
R2	-	source byte index into data base
R3	-	destination byte index into data base

DESCRIPTION

The number of bytes in R1 is moved from the source byte address to the destination byte address. It is assumed that these addresses are indexes into the data base page. The Move Byte String instruction is not used in order to have BTM Sigma 5/7 compatibility.

ID

REVARG - Exchange the First 15 Words of ARGBUF and TOARG

PURPOSE

To bring up the input or output arguments for access by exchanging the first 15 words of ARGBUF and TOARG.

USAGE

Calling sequence:

BAL, SR4 REVARG

OUTPUT

ARGBUF	-	set to first 15 words of TOARG.
TOARG	-	set to first 15 words of ARGBUF.

DESCRIPTION

The first 15 words of ARG TBL are exchanged with the 15-word TOARG table.

ID

PRTNOF - Print Total File Count Plus Supplied Text String

PURPOSE

To convert and print a file count supplied in SR2 followed by a four-word text string supplied by the caller.

USAGE

Calling sequence:

BAL, SR4 PRTNOF

Input registers:

R5 - contains pointer to a four-word message which has a X'15' as the last character.
SR2 - file count in binary

Output registers:

Same as input.

INPUT

J:JIT - used for on-line/batch mode testing.
M:UC - terminal I/O DCB
M:LO - used to output message if batch mode.

OUTPUT

PRTBUF - buffer used for formatting message to print.

INTERACTION

Modules used:

UTILITY - convert binary to BCD (BIN2BCD).

Monitor services used (handwritten CALs and FPTs):

M:WRITE - write message through M:UC (on-line) or M:LO (batch mode).

DESCRIPTION

A message of the format '..NNNN message' is constructed in the print buffer PRTBUF. BIN2BCD is called to convert the file count in SR2 to BCD. The count and the caller-supplied message are entered in the print buffer and a Write CAL issued to print the message. Exit is then made to the caller.

ID

UNPRINT - Test for Unprintable Characters and Enter Argument in Buffer

PURPOSE

To test an argument for unprintable characters and, if found, enter argument in the buffer as a hexadecimal string instead of a character string.

USAGE

Calling sequence:

BAL, SR4 UNPRINT

Input registers:

R1 - pointer to argument in TEXTC format
D3 - buffer pointer.

Output registers:

R2 - number of characters moved to buffer
D3 - buffer pointer (same as input)

INPUT

CCTAB - table used for testing if a character is unprintable.

DESCRIPTION

An argument is moved byte-by-byte to the buffer. If an unprintable character is found, the routing starts over and moves the argument again but converts it to a hexadecimal character string of the form X'-----'.

STAPLE

STAPLE

FOLD

FIRST CLASS
PERMIT NO. 229
EL SEGUNDO, CALIF.

BUSINESS REPLY MAIL
NO POSTAGE STAMP NECESSARY IF MAILED IN THE UNITED STATES

POSTAGE WILL BE PAID BY

Xerox Data Systems

701 South Aviation Boulevard
El Segundo, California 90245

ATTN: PROGRAMMING PUBLICATIONS

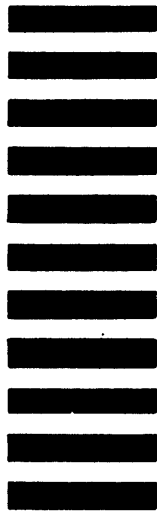

CUT ALONG LINE

FOLD